

THE NEW! **Amateur**
73[®] Radio Today

MAY 2001
ISSUE #486
USA \$3.95
CANADA \$4.95

A New Shape on the Horizon

PAGE 23



El Supremo & Founder
Wayne Green W2NSD/1

Associate Publisher
F. I. Marion

Executive Editor
Jack Burnett

Managing Editor
Joyce Sawtelle

Technical Editor
Larry Antonuk WB9RRT

Contributing Culprits
Mike Bryce WB8VGE
Jim Gray II
Jack Heller KB7NO
Chuck Houghton WB6IGP
Andy MacAllister W5ACM
Joe Moell K0OV
Steve Nowak KE8YN/0
Dr. Rick Olsen N6NR

Advertising Sales
Evelyn Garrison WS7A
21704 S.E. 35th St.
Issaquah WA 98029
425-557-9611
Fax: 425-557-9612

Circulation
Frances Hyvarinen

Data Entry & Other Stuff
Norman Marion

Business Office
Editorial - Advertising - Circulation
Feedback - Product Reviews
73 Amateur Radio Today Magazine
70 Hancock Rd.
Peterborough NH 03458-1107
603-924-0058
Fax: 603-924-8613

Reprints: \$3 per article
Back issues: \$5 each

Printed in the USA

Manuscripts: Contributions for possible publication are most welcome. We'll do the best we can to return anything you request, but we assume no responsibility for loss or damage. Payment for submitted articles will be made after publication. Please submit both a disk and a hard copy of your article [IBM (ok) or Mac (preferred) formats], carefully checked drawings and schematics, and the clearest, best focused and lighted photos you can manage. "How to write for 73" guidelines are available on request. US citizens, please include your Social Security number with submitted manuscripts so we can submit it to you know who.

THE NEW! 73 Amateur Radio Today

TABLE OF CONTENTS

FEATURES

- 10 **Modular Remote Coax Switch — KB1HQ**
Build this handy device to save time, money, and XYL yelling.
- 16 **"How High's the Water, Mama?" — KC7IZH**
The story of a packet public service project flooded with success.
- 32 **Bookbind THIS! — Conclusion — W6WTU**
Get organized, and save money, too.
- 40 **Preventive Brain Surgery for Icom Xcvrs — KI4RK**
Trying to resurrect a comatose Icom transceiver can be bad news. Here's how to prevent the dreadful fate in the first place.

DEPARTMENTS

- 49 Ad Index
64 Barter 'n' Buy
50 Calendar Events
54 The Digital Port — KB7NO
52 Hamsats — W5ACM
36 Homing In — K0OV
4 Never Say Die — W2NSD/1
48 New Products
47 On the Go — KE8YN/0
60 Propagation — Gray
1 QRX
63 Radio Bookshop

REVIEWS

- 23 **Kenwood's Hot New TS-2000 — N6NR**
Could YOU handle all these features?
- 44 **Air Hamtronics — N6NR**
If you're a pilot, this aviation receiver should be in your flight plan.

E-Mail
design73@aol.com

Web Page
www.waynegreen.com

QRX . . .

In Case You've Forgotten

Here is the Amateur Radio Code, as found in the 1955 ARRL Handbook:

1. The Amateur is Gentlemanly. ... He never knowingly uses the air for his own amusement in such a way as to lessen the pleasure of others. He abides by the pledges given by the ARRL in his behalf to the public and the Government.
2. The Amateur is Loyal. ... He owes his amateur radio to the American Radio Relay League, and he offers it his unwavering loyalty.
3. The Amateur is Progressive. ... He keeps his

station abreast of science. It is built well and efficiently. His operating practice is clean and regular.

4. The Amateur is Friendly. ... Slow and patient sending when requested, friendly advice and counsel to the beginner, kindly assistance and cooperation for the broadcast listener; these are the marks of the amateur spirit.

5. The Amateur is Balanced. ... Radio is his hobby. He never allows it to interfere with any of the duties he owes to his home, his job, his school, or his community.

Continued on page 6

73 Amateur Radio Today (ISSN 1052-2522) is published monthly by 73 Magazine, 70 Hancock Rd., Peterborough NH 03458-1107. The entire contents ©2001 by 73 Magazine. No part of this publication may be reproduced without written permission of the publisher, which is not all that difficult to get. The subscription rate is: one year \$24.97, two years \$44.97; Canada: one year \$34.21, two years \$57.75, including postage and 7% GST. Foreign postage: \$19 surface, \$42 airmail additional per year, payable in US funds on a US bank. Second class postage is paid at Peterborough, NH, and at additional mailing offices. Canadian second class mail registration #178101. Canadian GST registration #125393314. Microfilm edition: University Microfilm, Ann Arbor MI 48106. POSTMASTER: Send address changes to 73 Amateur Radio Today, 70 Hancock Rd., Peterborough NH 03458-1107. 73 Amateur Radio Today is owned by Shabromat Way Ltd. of Hancock NH.



...POWER ON WITH ASTRON

SWITCHING POWER SUPPLIES...



MODEL SS-10TK



MODEL SS-12IF



MODEL SS-18



MODEL SS-25M



MODEL SRM-30

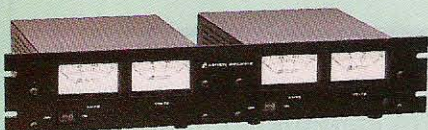

MODEL SRM-30M-2



MODEL SS-12SM/GTX



MODEL SS-10EFJ-98

SPECIAL FEATURES:

- HIGH EFFICIENCY SWITCHING TECHNOLOGY SPECIFICALLY FILTERED FOR USE WITH COMMUNICATIONS EQUIPMENT, FOR ALL FREQUENCIES INCLUDING HF
- HEAVY DUTY DESIGN
- LOW PROFILE, LIGHT WEIGHT PACKAGE
- EMI FILTER
- MEETS FCC CLASS B

PROTECTION FEATURES:

- CURRENT LIMITING
- OVERVOLTAGE PROTECTION
- FUSE PROTECTION.
- OVER TEMPERATURE SHUTDOWN

SPECIFICATIONS:

INPUT VOLTAGE: 115 VAC 50/60HZ
OR 220 VAC 50/60HZ
SWITCH SELECTABLE
OUTPUT VOLTAGE: 13.8VDC

AVAILABLE WITH THE FOLLOWING APPROVALS: UL, CUL, CE, TUV.

DESKTOP SWITCHING POWER SUPPLIES

MODEL	CONT. (Amps)	ICS	SIZE (inches)	Wt.(lbs.)
SS-10	7	10	1 1/2 x 6 x 9	3.2
SS-12	10	12	1 1/2 x 6 x 9	3.4
SS-18	15	18	1 1/2 x 6 x 9	3.6
SS-25	20	25	2 1/4 x 7 x 9 1/2	4.2
SS-30	25	30	3 1/4 x 7 x 9 1/2	5.0

DESKTOP SWITCHING POWER SUPPLIES WITH VOLT AND AMP METERS

MODEL	CONT. (Amps)	ICS	SIZE (inches)	Wt.(lbs.)
SS-25M*	20	25	2 1/4 x 7 x 9 1/2	4.2
SS-30M*	25	30	3 1/4 x 7 x 9 1/2	5.0

RACKMOUNT SWITCHING POWER SUPPLIES

MODEL	CONT. (Amps)	ICS	SIZE (inches)	Wt.(lbs.)
SRM-25	20	25	3 1/2 x 19 x 9 1/2	6.5
SRM-30	25	30	3 1/2 x 19 x 9 1/2	7.0

WITH SEPARATE VOLT & AMP METERS

MODEL	CONT. (Amps)	ICS	SIZE (inches)	Wt.(lbs.)
SRM-25M	20	25	3 1/2 x 19 x 9 1/2	6.5
SRM-30M	25	30	3 1/2 x 19 x 9 1/2	7.0

2 ea SWITCHING POWER SUPPLIES ON ONE RACK PANEL

MODEL	CONT. (Amps)	ICS	SIZE (inches)	Wt.(lbs.)
SRM-25-2	20	25	3 1/2 x 19 x 9 1/2	10.5
SRM-30-2	25	30	3 1/2 x 19 x 9 1/2	11.0

WITH SEPARATE VOLT & AMP METERS

MODEL	CONT. (Amps)	ICS	SIZE (inches)	Wt.(lbs.)
SRM-25M-2	20	25	3 1/2 x 19 x 9 1/2	10.5
SRM-30M-2	25	30	3 1/2 x 19 x 9 1/2	11.0

CUSTOM POWER SUPPLIES FOR RADIOS BELOW

EF JOHNSON AVENGER GX-MC41
EF JOHNSON AVENGER GX-MC42
EF JOHNSON GT-ML81
EF JOHNSON GT-ML83
EF JOHNSON 9800 SERIES
GE MARC SERIES
GE MONOGRAM SERIES & MAXON SM-4000 SERIES
ICOM IC-F11020 & IC-F2020
KENWOOD TK760, 762, 840, 860, 940, 941
KENWOOD TK760H, 762H
MOTOROLA LOW POWER SM50, SM120, & GTX
MOTOROLA HIGH POWER SM50, SM120, & GTX
MOTOROLA RADIUS & GM 300
MOTOROLA RADIUS & GM 300
MOTOROLA RADIUS & GM 300
UNIDEN SMH1525, SMU4525
VERTEX — FTL-1011, FT-1011, FT-2011, FT-7011

NEW SWITCHING MODELS

SS-10GX, SS-12GX
SS-18GX
SS-12EFJ
SS-18EFJ
SS-10-EFJ-98, SS-12-EFJ-98, SS-18-EFJ-98
SS-12MC
SS-10MG, SS-12MG
SS-101F, SS-121F
SS-10TK
SS-12TK OR SS-18TK
SS-10SM/GTX
SS-10SM/GTX, SS-12SM/GTX, SS-18SM/GTX
SS-10RA
SS-12RA
SS-18RA
SS-10SMU, SS-12SMU, SS-18SMU
SS-10V, SS-12V, SS-18V

RAMSEY

Spring 2001 Catalog is now available. Over 100 new products! *Get yours today!*

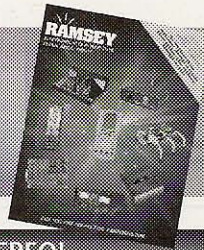

COMMERCIAL 35W FM TRANSMITTER

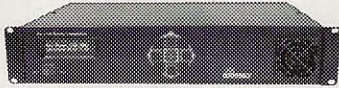

Clean and powerful, plus an on board computer that's your "virtual" station engineer! We can now supply turn-key packages for your community or LPFM station.

Call or visit our broadcast web site, www.highpowerfm.com, for more details.
PX1 \$1,795.00

BROADCAST YOUR MP3 AND .WAV FILES

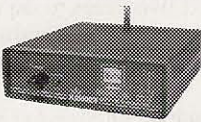

Our FM broadcaster designed specifically for PC sound-cast. Broadcast MP3s, internet radio and more to any FM radio in your house or yard. You can't buy an assembled broadcaster this powerful or clean. Kit includes case and power supply.

MP3FM \$99.95

FM100 SYNTHESIZED FM STEREO RADIO STATION

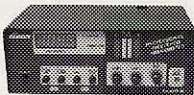

- Synthesized 88 to 108 MHz for no frequency drift!
- Built in mixer - 2 line inputs and one microphone input!
- Strappable for higher power output
- Low pass filter for great audio

Our FM100 is used all over the world by serious hobbyists as well as churches, drive in theaters, and schools. The kit includes metal case, whip antenna and built-in 110 volt AC power supply.

FM100 Super-Pro FM Stereo Radio Station Kit \$249.95
FM100WT 1 Watt, Wired Export Version \$399.95

FM STEREO RADIO TRANSMITTER



Great entry level FM broadcast kit. Thousands in use. Handy for sending music through house and yard, ideal for school projects too - you'll be amazed at the exceptional audio quality! Runs on 9V battery or 5 to 15 VDC. Add matching case and whip antenna set for great pro look.

FM10A Tunable FM Stereo Transmitter Kit \$34.95
CFM Matching Case and Antenna Set \$14.95
FMAC 12V DC Wall Plug Adapter \$9.95

CARPET ROVER II ROBOT KIT

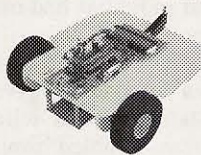

This advanced kit is an 8 x 8" differentially steered base that is excellent for carpet or tiled floor experimentation. It uses the Next Step microcontroller, a BASIC Stamp 2 controller that can use the BS2 or BS2-E (sold separately). A host PC is required to download programs to the robot. This complete kit includes the Rover, programming cable, IR proximity detector, bumper switch kit, and line follower kit.

RK3000 Carpet Rover II Complete Kit \$185.00

COMBUSTIBLE GAS DETECTOR KIT

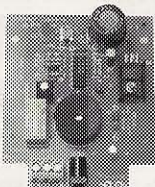

Build this kit and detect combustible gases and vapors including natural gas, gasoline, propane, and dozens more. Model GLD1000 is a local alarm only, GLD1010 includes a relay to control external alarms.

GLD1000 \$29.95
GLD1010 \$39.95

BUILD YOUR OWN STEREO!

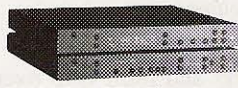

We've got the kit! Our K4500 is a synthesized FM stereo tuner, the K4100 is a matching pre-amp. Both are fully digitally controlled with an optional IR remote control (kit also). Add our

K4020 2 x 155W Class A power amplifier kit to complete your drop-dead stereo. We also have tube amplifier kits. Visit us on the web, or request our new catalog for more information.

K4500 Synthesized FM Stereo Tuner Kit \$399.99
K4100 Digital Preamp Kit \$399.99
K4101 IR Remote Control Kit \$69.95
K4020 Solid State 310W Power Amp Kit \$499.99

ELECTRONIC PROTOTYPING SOFTWARE...

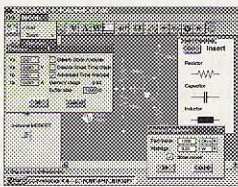

Priced for the hobbyist!

You can create and test AC and DC circuits minutes after installing this package on your PC. Start from scratch, or from the included library of pre-designed circuits. Drag and drop placement from a complete list of active and passive components. Test using a complete list of virtual instruments, Oscilloscope, voltmeter, ohmmeter, ammeter, and watt meter.

PLAB4 \$49.95

RAMSEY NOW CARRIES BASIC STAMPS

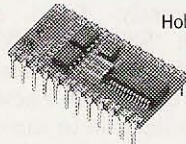

Hobbyists and educators have embraced the Basic Stamp family of microcontrollers thanks to their power, ease of programming and simple interface. Ramsey now offers popular BS boards, kits, and trainers. If you've been wanting to learn microcontrollers, or build them into a project, now's the time!

BS1IC Basic Stamp I Module \$34.00
BS2IC Basic Stamp II Module \$49.00
27205 Basic Stamp 1 Starter Kit \$109.00
28150 Board of Education Full Kit \$109.00

MINI-KITS

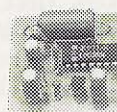

These are easy to build kits that can be used either stand alone or as building blocks for more complex projects.

BN9 Super Snoop 2W Audio Amp \$8.95
MB1 Mad Blaster 15W Warble Alarm \$4.95
TS1 Touch Switch \$6.95
SA7 RF Broadband Preamp +20 dB \$14.95
TT7 Touch Tone Decoder \$29.95

RF WIRELESS LINK MODULES

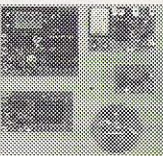

- SAW Resonators for high stability - NO Drift!
- Powerful +10 dbm output
- Range up to 600'
- 433 MHz license-free band
- Sensitive superhet receiver with RF LNA
- Stable over full 3-12 VDC range
- Optional on-board 12 bit encoder/decoder using Holtek HT12 series chips

RXD433 433 MHz Receiver/Decoder Mod., Assembled \$26.95
TXE433 433 MHz Transmitter/Encoder Mod., Assembled \$24.95
RX433 433 MHz Data Receiver Mod., Assembled \$21.95
TX433 433 MHz Data Transmitter Mod., Assembled \$19.95

VISA

Ramsey Electronics • 793 Canning Parkway • Victor, NY 14564

Order Toll Free: 800-446-2295 • Technical Info or Order Status: 716-924-4560

See our catalog online: www.ramseykits.com



NEVER SAY DIE

Wayne Green W2NSD/1

w2nsd@aol.com
www.waynegreen.com

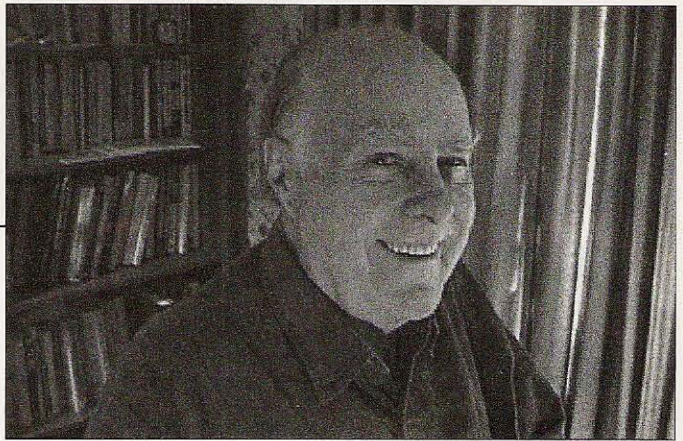

Die De Die

When I got interested in electronics, the first thing I did was join my high school radio club (W2ANU). When I got interested in photography, I joined the school camera club. When I got interested in books, I joined the book club. And my interest in Gilbert and Sullivan got me to join the Savoyards club, where we put on *The Mikado* in front of an audience of over 5,000 students. I played the part of Koko, the Lord High Executioner. In *The Pirates of Penzance*, I played Major-General Stanley.

I don't think my joining a club is out of the ordinary. My point is that when kids get interested in electronics or radio today there should be a welcoming club available. The best place is in high schools, but lacking that, the nearby radio clubs should be doing everything in their power to get kids to come to the meetings.

The next step is to make sure that the youngsters have a good time and learn things. Club meetings should be both fun and educational.

On the fun side, I was disappointed when I offered to get on the telephone and give talks to ham clubs anywhere in the country — and not one club took me up on it.

Clubs are extremely important in keeping our hobby going. If my high school hadn't had a ham club, I might well have just continued to build hi-fi gear and other gadgets.

It was my interest in ham radio that got me to go to an engineering university and, in my junior year, be elected president of the ham club (W2SZ). I took a club with 15

members and built it to over 400 within a year.

If your club puts up meeting notices on all nearby school bulletin boards, on the boards of local markets, the Radio Shack, in the local papers, on local radio stations, and so on, people will start coming to see what it's all about.

Then, if your club meetings are boffo, they'll be back.

What helps make meetings fun? First, and foremost, get newcomers to talk about themselves.

How about a short report from a DXer on what he's worked recently. Ditto a member on SSTV, RTTY, packet, on the ham satellites, and so on. Anyone with a new rig should bring it in to show and tell. Keep the talks short — maybe five minutes each.

Put an amplifier on the telephone and have a talk by an expert in the ham industry. You won't have any problem getting good speakers. Heck, I can go on for hours about the adventures amateur radio has provided me. I can talk about the day Khrushchev saved amateur radio (I was there). And about the greatest disaster in the history of the hobby.

For those interested, you might have a Q&A session on the license tests to help people learn some electricity fundamentals.

ITU 2003?

The next World Radiocommunications Conference (WRC) is scheduled for the summer of 2003. So what does that mean to you? Well, it means that this is going to be the time when a lot of the radio spectrum is going to get new

users — very possibly some of ours. Having been one of the U.S. delegates to a past WRC, where we came th-a-a-t close to losing much of our HF bands, I have some perspective on how these conferences work.

The International Telecommunications Union (ITU) conferences work on the basis of one country, one vote, so Chad has as much say in how our ham bands will end up as the U.S., Japan, or the U.K.

Well, at least we'll have the U.S. delegation fighting for us, right?

Most of the U.S. delegation is there representing the needs of their industries, not amateur radio. At the conference where I was a delegate, I heard unanimous support for maintaining the current ham band allocations from the other U.S. delegates. That was very reassuring — except, when I took them out individually to lunch or dinner, they all confided that their instructions were to support amateur radio, but if their service were to be in danger of losing any frequencies, they were to do everything in their power to see that the loss was shifted to the nearest ham band, thus preserving their frequencies.

That only makes sense, since we're a service which has almost zero clout. Money talks and poverty walks.

With 150 countries expected to attend, and about 100 of them from third world countries, all in desperate need of more spectrum space, and few with any interest in amateur radio, the cards are stacked against us.

Hopeless? Not if we use the next two years to do more than twiddle our thumbs and hope we don't get hurt too badly.

So, what can you do? What can any one person do? Plenty. And I don't mean getting on the air and kvetching about it.

There's this national American organization, one of whose responsibilities is to protect our frequencies. Well, what better time to see some protective plans going into action?

Here's what I'd do if I were the League General Manager. I'd put together some teams of ham ambassadors to visit the heads of these third world countries — the ones who will be swinging the votes at the coming WRC — and explain the benefits of amateur radio to their country. All we have to do is point to Jordan and the enormous impact amateur radio has had on that country.

In 1970 I heard that King Hussein had been given a ham station by his wife for Christmas. I cabled him, asking if he needed any help in learning the ropes with it. He cabled back to come on over. I did, and spent two fantastic weeks in his summer palace operating with him. He had a ball!

I explained the benefits to Jordan if he'd get his youngsters interested in the hobby — how in the U.S. 80% of the new hams were teenagers and that 80% of them went on, as a result, to high-tech careers. He gathered his government

Continued on page 8

Big Savings on Radio Scanners

Uniden® NEW!



Bearcat® 780XLT Trunk Tracker III

Mfg. suggested list price \$529.95

Less - \$190 Instant Rebate / Special \$339.95

500 Channels • 10 banks • CTCSS/DCS • S Meter

Size: 7 5/8" Wide x 6 1/4" Deep x 2 1/8" High

Frequency Coverage: 25,000-512,000 MHz., 806,000-

823,9875MHz., 849,0125-868,9875 MHz., 894,0125-1300,000 MHz.

The Bearcat 780XLT has 500 channels and the widest frequency coverage of any Bearcat scanner ever. Packed with features such as Trunktracker III to cover EDACS, Motorola and EF Johnson systems, control channel only mode to allow you to automatically trunk certain systems by simply programming the control channel, S.A.M.E. weather alert, full-frequency display & backlight controls, built-in CTCSS/DCS to assign analog and digital subaudible tone codes to a specific frequency in memory, PC Control with RS232 port, Beep Alert, Record function, VFO control, menu-driven design, total channel control and much more. Our CEI package deal includes telescopic antenna, AC adapter, cigarette lighter cord, DC cord, mobile mounting bracket with screws, owner's manual, trunking frequency guide and one-year limited Uniden factory warranty. For maximum scanning enjoyment, order magnetic mount antenna part number ANTMBC for \$29.95; The BC780XLT comes with AC adapter, telescopic antenna, owner's manual and one year limited Uniden warranty. Not compatible with AGEIS, ASTRO or ESAS systems. For fastest delivery, order on-line at www.usascan.com.

Bearcat® 895XLT Trunk Tracker

Mfg. suggested list price \$499.95

Less - \$320 Instant Rebate / Special \$179.95

300 Channels • 10 banks • Built-in CTCSS • S Meter

Size: 10 1/2" Wide x 7 1/2" Deep x 3 3/8" High

Frequency Coverage: 29,000-54,000 MHz., 108,000-174

MHz., 216,000-512,000 MHz., 806,000-823,995 MHz., 849,0125-

868,995 MHz., 894,0125-956,000 MHz.

The Bearcat 895XLT is superb for intercepting trunked communications transmissions with features like TurboScan™ to search VHF channels at 100 steps per second. This base and mobile scanner is also ideal for intelligence professionals because it has a Signal Strength Meter, RS232C Port to allow computer-control of your scanner via optional hardware and 30 trunking channel indicator annunciators to show you real-time trunking activity for an entire trunking system. Other features include Auto Store - Automatically stores all active frequencies within the specified bank(s). Auto Recording - Lets you record channel activity from the scanner onto a tape recorder. CTCSS Tone Board (Continuous Tone Control Squelch System) allows the squelch to be broken during scanning only when a correct CTCSS tone is received. For maximum scanning enjoyment, order the following optional accessories: PS001 Cigarette lighter power cord for temporary operation from your vehicle's cigarette lighter \$14.95; PS002 DC power cord - enables permanent operation from your vehicle's fuse box \$14.95; MB001 Mobile mounting bracket \$14.95; EX711 External speaker with mounting bracket & 10 feet of cable with plug attached \$19.95. The BC895XLT comes with AC adapter, telescopic antenna, owner's manual and one year limited Uniden warranty. Not compatible with AGEIS, ASTRO, EDACS, ESAS or LTR systems.



SCANNERS

Bearcat® 245XLT Trunk Tracker II

Mfg. suggested list price \$429.95/CEI price \$189.95

300 Channels • 10 banks • Trunk Scan and Scan Lists

Trunk Lockout • Trunk Delay • Cloning Capability

10 Priority Channels • Programmed Service Search

Size: 2 1/2" Wide x 1 3/4" Deep x 6" High

Frequency Coverage:

29,000-54,000 MHz., 108-174 MHz., 406-512 MHz., 806-823,995

MHz., 849,0125-868,995 MHz., 894,0125-956,000 MHz.

Our Bearcat TrunkTracker BC245XLT is the world's first scanner designed to track Motorola Type I, Type II, Hybrid, SMARTNET, PRIVACY PLUS and EDACS® analog trunking systems on any band. Now, follow UHF High Band, UHF 800/900 MHz trunked public safety and public service systems just as if conventional two-way communications were used. Our scanner offers many new benefits such as Multi-Track - Track more than one trunking system at a time and scan conventional and trunked systems at the same time. 300 Channels - Program one frequency into each channel. 12 Bands, 10 Banks - Includes 12 bands, with Aircraft and 800 MHz. 10 banks with 30 channels each are useful for storing similar frequencies to maintain faster scanning cycles or for storing all the frequencies of a trunked system. Smart Scanner - Automatically program your BC245XLT with all the frequencies and trunking talk groups for your local area by accessing the Bearcat national database with your PC. If you do not have a PC simply use an external modem. Turbo Search - Increases the search speed to 300 steps per second when monitoring frequency bands with 5 KHz. steps. 10 Priority Channels - You can assign one priority channel in each bank. Assigning a priority channel allows you to keep track of activity on your most important channels while monitoring other channels for transmissions. Preprogrammed Service (SVC) Search - Allows you to toggle through preprogrammed police, fire/emergency, railroad, aircraft, marine, and weather frequencies. Unique Data Skip - Allows your scanner to skip unwanted data transmissions and reduces unwanted birdies. Memory Backup - If the battery completely discharges or if power is disconnected, the frequencies programmed in your scanner are retained in memory. Manual Channel Access - Go directly to any channel. LCD Back Light - An LCD light remains on for 15 seconds when the back light key is pressed. Autolight - Automatically turns the backlight on when your scanner stops on a transmission. Battery Save - In manual mode, the BC245XLT automatically reduces its power requirements to extend the battery's charge. Attenuator - Reduces the signal strength to help prevent signal overload. The BC245XLT also works as a conventional scanner. Now it's easy to continuously monitor many radio conversations even though the message is switching frequencies. The BC245XLT comes with AC adapter, one rechargeable long life ni-cad battery pack, belt clip, flexible rubber antenna, earphone, RS232C cable, Trunk Tracker frequency guide, owner's manual and one year limited Uniden warranty. Not compatible with AGEIS, ASTRO, ESAS or LTR systems. Hear more action on your radio scanner today. Order on-line at www.usascan.com for quick delivery.



with AC adapter, one rechargeable long life ni-cad battery pack, belt clip, flexible rubber antenna, earphone, RS232C cable, Trunk Tracker frequency guide, owner's manual and one year limited Uniden warranty. Not compatible with AGEIS, ASTRO, ESAS or LTR systems. Hear more action on your radio scanner today. Order on-line at www.usascan.com for quick delivery.

More Radio Products

Save even more on radio scanners when purchased directly from CEI. Your CEI price after instant rebate is listed below:

Bearcat 895XLT 300 ch. Trunktracker I base/mobile scanner.....	\$179.95
Bearcat 780XLT 500 ch. Trunktracker III base/mobile.....	\$339.95
Bearcat 278CLT 100 ch. AM/FM/SAME WX alert scanner.....	\$159.95
Bearcat 245XLT 300 ch. Trunktracker II handheld scanner.....	\$189.95
Bearcat 248CLT 50 ch. base AM/FM/weather alert scanner.....	\$89.95
Bearcat Sportcast 200 alpha handheld sports scanner.....	\$169.95
Bearcat Sportcast 180B handheld sports scanner.....	\$149.95
Bearcat 80XLT 50 channel handheld scanner.....	\$99.95
Bearcat 60XLT 30 channel handheld scanner.....	\$74.95
Bearcat BC177 information mobile scanner.....	\$139.95
AOR AR8200 Mark II Wide Band handheld scanner.....	\$539.95
AOR AI16BQ Wide Band scanner with quick charger.....	\$209.95
ICOM ICR8500 wideband communications receiver.....	\$1,469.95
ICOM PCR1000 computer communications receiver.....	\$379.95
ICOM R10 handheld wideband communications receiver.....	\$279.95
Uniden WX100 Weather Alert with S.A.M.E. feature.....	\$49.95

AOR

AOR® AR8200 Mark IIB Radio Scanner

AOR8200 Mark IIB-A wideband handheld scanner/SPECIAL \$539.95

1,000 Channels • 20 banks • 50 Select Scan Channels

PASS channels: 50 per search bank + 50 for VFO search

Frequency step programmable in multiples of 50 Hz.

Size: 2 1/2" Wide x 1 3/8" Deep x 6 1/8" High

Frequency Coverage:

500 KHz to 823,995 MHz., 849,0125-868,995 MHz., 894,0125-2,040,000 MHz.

(Full coverage receivers available for export and FCC approved users.)

The AOR AR8200 Mark IIB is the ideal handheld radio scanner for communications professionals. It features all mode receive:

WFM, NFM, SFM (Super Narrow FM), WAM, AM, NAM (wide, standard, narrow AM), USB, LSB & CW. Super narrow FM plus Wide and Narrow AM in addition to the standard modes. The AR8200 also has a versatile multi-function band scope with save trace facility, twin frequency readout with bar signal meter, battery save feature with battery low legend, separate controls for volume and squelch, arrow four way side rocker with separate main tuning dial, configurable keypad beep/illumination and LCD contrast, write protect and keypad lock, programmable scan and search including LINK, FREE, DELAY, AUDIO, LEVEL, MODE, computer socket fitted for control, clone and record, Flash-ROM no battery required memory, true carrier re-insertion in SSB modes, RF preselection of mid VHF bands, Detachable MW bar aerial. Tuning steps are programmable in multiples of 50 Hz in all modes. 8.33 KHz airband step correctly supported. Step-adjust, frequency offset, AFC, Noise limited & attenuator, Wide and Narrow AM in addition to the standard modes. For maximum scanning pleasure, you can add one of the following optional slot cards to this scanner: CT8200 CTCSS squelch & search decoder \$89.95; EM8200 External 4,000 channel backup memory, 160 search banks. \$69.95; RU8200 about 20 seconds chip based recording and playback \$69.95; TE8200 256 step tone eliminator \$59.95. In addition, two leads are available for use with the option socket. C8200 PC control lead with CD Rom programming software \$109.95; CR8200 tape recording lead \$59.95. Includes 4 1,000 mAh AA ni-cad batteries, charger, cigar lead, whip aerial, MW bar antenna, belt hook, strap and one year limited AOR warranty. Enter your order now at <http://www.usascan.com>.



Buy with Confidence

Order on-line and get big savings

For over 32 years, millions of communications specialists and enthusiasts worldwide have trusted Communications Electronics for their mission critical communications needs. It's easy to order. For fastest delivery, order on-line at www.usascan.com. Mail orders to: Communications Electronics Inc., P.O. Box 1045, Ann Arbor, Michigan 48106 USA. Add \$20.00 per radio transceiver for UPS ground shipping, handling and insurance to the continental USA. Add \$13.00 shipping for all accessories and publications. For Canada, Puerto Rico, Hawaii, Alaska, Guam, P.O. Box or APO/FPO delivery, shipping charges are two times continental US rates. Michigan residents add sales tax. No COD's. Your satisfaction is guaranteed or return item in unused condition in original packaging within 61 days for refund, less shipping, handling and insurance charges. 10% surcharge for net 10 billing to qualified accounts. All sales are subject to availability, acceptance and verification. Prices, terms and specifications are subject to change without notice. We welcome your Discover, Visa, American Express, MasterCard, IMPAC or Eurocard. Call anytime 1-800-USA-SCAN or 800-872-7226 to order toll-free. Call 734-996-8888 if outside Canada or the USA. FAX anytime, dial 734-663-8888. Dealer and international inquiries invited. Order your radio scanners from Communications Electronics Inc. today at www.usascan.com.

For credit card orders call 1-800-USA-SCAN

e-mail: cei@usascan.com

www.usascan.com

PO Box 1045, Ann Arbor, Michigan 48106-1045 USA

For information call 734-996-8888 or FAX 734-663-8888

Price schedule effective March 2, 2001 AD #03020173 © 2001 Communications Electronics Inc.

**COMMUNICATIONS
ELECTRONICS INC.**
Emergency Operations Center

Visit WWW.USASCAN.COM • 1-800-USA-SCAN

continued from page 1

6. The Amateur is Patriotic. ... His knowledge and his station are always ready for the service of his country and his community.

Seen in the Modulator, newsletter of The Fort Myers ARC, Inc., Nov. '99.

Hamvention Awards Announced

The names of ham radio's Emmy and Oscar winners for 2001 are out. This, as the Dayton Amateur Radio Association tells the world the names of this year's Technical Achievement, Specific Achievement, and Radio Amateur of the Year award winners:

George Jacobs lives in Silver Spring, Maryland. His callsign is W3ASK, and the Dayton Amateur Radio Association has chosen him as its 2001 Radio Amateur of the Year.

"I do not want to get emotional over it," said Jacobs, "but it really gratifies me that somebody thought of rewarding me. I don't really feel that what I have contributed to Amateur Radio is as much as I have gotten out of Amateur Radio."

If the name George Jacobs sounds familiar, it should. For the past 50 years — yes — we said fifty years — Jacobs has been bringing propagation forecasting to the world of amateur radio in the pages of *CQ Magazine*. He has also been

a contributing editor for *World Radio TV Handbook* for 39 years and has authored hundreds of technical articles which have appeared in print worldwide.

"The truth of the matter is that it ought to be the other way around," W3ASK continued. "I ought to be giving the award to amateur radio for all it has done for me in my personal life and professional life."

There is a lot more to W3ASK than just letting hams and SWLs know where to hunt for DX. In the world of broadcasting, Jacobs is considered to be the engineer's engineer and the consultant's consultant. He is the man whom planners go to when trying to solve the most difficult or impossible RF problems. As such, his contributions to communications technology have furthered the state of the art for over half a century.

George Jacobs is in good company with this year's Dayton Special Achievement Award winner. Actually, it's another resident of Silver Spring, Maryland: Frank Bauer KA3HDO.

And who is Frank Bauer, you ask? Well, if you have ever talked to an astronaut on board the Space Shuttle or International Space Station, you have been a part of the world of KA3HDO. Bauer's countless hours of behind-the-scenes work with SAREX — the Space Amateur Radio Experiment — and ARISS — Amateur Radio International Space Station — operations have made these very high profile activities worldwide successes. But in accepting the award, Bauer

says that he is only a small part of a worldwide group of volunteers who are dedicated to keeping ham radio in space:

"As I said, I am very humbled to get this award, and I would like to, in particular from my perspective, thank all of the hundreds of volunteers around the world who have made this [ham radio in space] program possible. They put in thousands of hours because they believe in what we are doing in space; they believe in our youth and they believe in Amateur Radio."

As AMSAT's Vice President for Human Space Flight, Frank Bauer organized the teams that provide the links to schools so that children can talk with astronauts as they orbit the earth. He also developed band plans for spectrum utilization for amateur radio space operations. As an executive, in charge of the Guidance and Control section at NASA's Goddard Space Flight Center, he continues a leadership role as a technical liaison between the Amateur Service and National Aeronautics and Space Administration.

The third big winner at Dayton, the United Kingdom's Peter Martinez G3PLX, has been chosen to receive this year's Technical Excellence Award for his development of a new low bandwidth digital mode called PSK 31 that has taken ham radio by storm.

These days you cannot tune any band without hearing some reference to PSK 31. What makes this mode so unique is its simplicity, its ease of operation, its conservation of spectrum, and its overall reliability. Non-existent just 3 or 4 years ago, PSK 31's unique design has helped revitalize interest in high frequency digital operations.

According to the folks in Dayton, George Jacobs W3ASK, Frank Bauer KA3HDO, and Peter Martinez G3PLX, represent the very best of amateur radio as practiced in the year 2001.

Thanks to Roy Neal K6DUE, via Newline, Bill Pasternak WA6ITF, editor.

Time for a New Hamsat?

AMSAT North America says that it's time to plan for a new generation of ham radio satellites. Operating the next generation of ham radio satellites should be a lot easier. AMSAT NA has announced ambitious plans for a new satellite to be placed into a geostationary transfer orbit at some unspecified future date.

Unlike most of today's ham radio satellites, which move rapidly from horizon to horizon, the new bird will fly a huge ellipse, peaking at about 23,000 miles out in space, then dipping down to a few hundred miles at perigee. Tracking will be easy. The satellite should be in range of ground stations for many hours at a time and it will seem to move very slowly in the heavens.

When you go on the air with the proposed new satellite, you will find transponders for 2 meters,

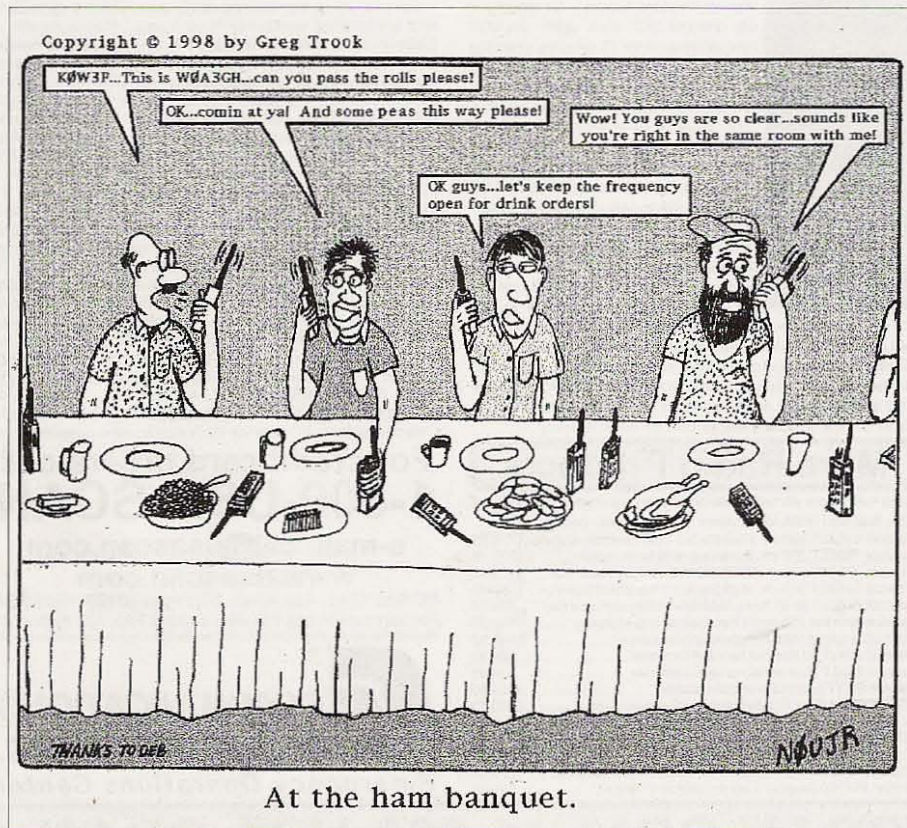

At the ham banquet.

Continued on page 39

hy-gain. HF BEAMS...

... are stronger, lighter, have less wind surface and last years longer. Why? Hy-Gain uses durable **tooled** components -- massive boom-to-mast bracket, heavy gauge element-to-boom clamps, thick-wall swaged tubing -- virtually no failures!

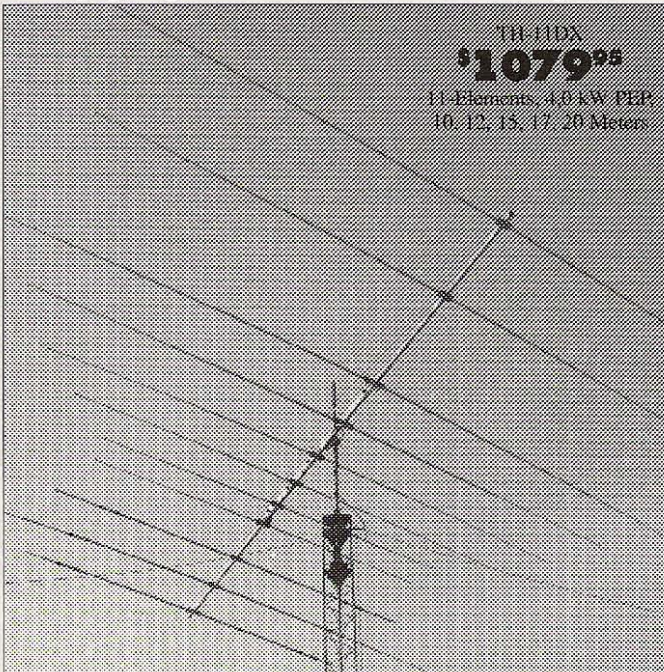

TH-11DX, \$1079.95. 11-element, 4.0 kW PEP, 10,12,15,17,20M

The choice of top DXers. With 11-elements, excellent gain and 5-bands, the super rugged TH-11DX is the "Big Daddy" of all HF beams! Handles 2000 Watts continuous, 4000 Watts PEP. Every part is selected for durability and ruggedness for years of trouble-free service.

Features a low loss log-periodic driven array on all bands with monoband reflectors, BN-4000 high power balun, corrosion resistant wire boom support, hot dipped galvanized and stainless steel parts. Stainless steel hardware and clamps are used on all electrical connections.

TH-7DX, \$819.95. 7-element, 1.5 kW PEP, 10,15,20 Meters

7-Elements gives you the highest average gain of any Hy-Gain tri-bander! Dual driven for broadband operation without compromising gain. SWR less than 2:1 on all bands. Uniquely combining monoband

and trapped parasitic elements give you an excellent F/B ratio. Includes Hy-Gain's diecast aluminum, rugged boom-to-mast clamp, heavy gauge element-to-boom brackets, BN-86 balun. For high power, upgrade to BN-4000.

TH-5MK2, \$699.95. 5-element, 1.5 kW PEP, 10,15,20 Meters

The broadband five element TH5-MK2 gives you outstanding gain.

Separate air dielectric Hy-Q traps let you adjust for maxi-

mum F/B ratio on each band.

Also standard is Hy-Gain's exclusive BetaMATCH™, stainless steel hardware and compression clamps and BN-86 balun.

TH-3MK4, \$439.95. 3-element, 1.5 kW PEP, 10,15,20 Meters

The super popular TH-3MK4 gives you the most gain for your money in a full-power, full-size durable Hy-Gain tri-bander!

You get an impressive average gain and a whopping average front-to-back ratio. Handles a full 1500 Watts PEP. 95 MPH wind survival.

Fits on average size lot with

room to spare -- turning radius is just 15.3 feet. Four piece boom is ideal for DXpeditions. Rotates with CD-45II or HAM-IV rotator.

Features Hy-Gain BetaMatch™ for DC ground, full power Hy-Q™ traps, rugged boom-to-mast bracket and mounts on standard 2" O.D. mast. Stainless steel hardware. BN-86 balun recommended.

TH-2MK3, \$339.95. 2-element, 1.5 kW PEP, 10,15,20 Meters

The 2-element TH-2MK3 is Hy-Gain's most economical full power (1.5kW PEP) full size tri-bander.

For just \$339.95 you can greatly increase your effective radiated power and hear far better!

Ruggedly constructed, top-performing, compact 6 foot boom, tight 14.3 foot turning radius. Installs almost anywhere. Rotate with CD-45II or HAM-IV. BN-86 balun recommended.

EXP-14, \$549.95. 4-element, 1.5 kW PEP, 10,15,20 Meters

Revolutionary 4-element compact tri-bander lets you add 40 or 30 Meters! Has 14 foot boom and tight 17.25 feet turning radius. Fits on roof tri-pod, mast or medium duty tower.

Hy-Gain's patented broadbanding Para Sleeve gives you

less than 2:1 VSWR. 1.5kW PEP.

BetaMATCH™ provides DC ground to eliminate static. Includes BN-86 balun. Easily assembled.

Truly competitive against giant tri-banders at half the cost!

QK-710, \$169.95. 30/40 Meter option kit for EXP-14.

Compact 3-element 10, 15, 20 Meter Tri-Bander

For limited space ... Installs anywhere ... 14.75 ft turning radius ... weighs 21 lbs ... Rotate with CD-45II, HAM-IV

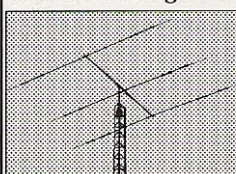

Fits on light tower, suitable guyed TV pole, roof tri-pod

TH-3JRS, \$329.95. Hy-Gain's most popular 3-element 10, 15, 20 Meter tri-bander fits on most lots! Same top performance as the full power TH3MK4 in a compact 600 watt PEP design.

Excellent gain and F/B ratio let you compete with the "big guns".

Tooled manufacturing gives you Hy-Gain durability with 80 MPH wind survival.

Model No.	No. of elements	avg Gain dBd	avg F/B dB	MaxPwr watts PEP	Bands Covered	Wind sq.ft. area	Wind (mph) Survival	Boom (feet)	Longest Elem. (ft)	Turning radius(ft)	Weight (lbs.)	Mast dia O.D.(in.)	Recom. Rotator	Retail Price
TH-11DX	11	For Gain and F/B ratio--See...		4000	10,12,15,17,20	12.5	100	24	37	22	88	1.9-2.5	T2X	\$1079.95
TH-7DX	7	For Gain and F/B ratio--See...		1500	10, 15, 20	9.4	100	24	31	20	75	1.5-2.5	HAM-IV	\$819.95
TH-5MK2	5	www.hy-gain.com		1500	10, 15, 20	7.4	100	19	31.5	18.42	57	1.5-2.5	HAM-IV	\$699.95
TH-3MK4	3	Hy-Gain catalog		1500	10, 15, 20	4.6	95	14	27.42	15.33	35	1.9-2.5	CD-45II	\$439.95
TH-3JRS	3	Call toll-free		600	10, 15, 20	3.35	80	12	27.25	14.75	21	1.25-2.0	CD-45II	\$329.95
TH-2MK3	2	800-973-6572		1500	10, 15, 20	3.25	80	6	27.3	14.25	20	1.9-2.5	CD-45II	\$339.95
EXP-14	4	800-973-6572		1500	10,15,20 30/40	7.5	100	14-	31.5	17.25	45	1.9-2.5	HAM IV	\$549.95

Tooled Manufacturing ... Highest Quality Materials

1. Hy-Gain's famous super strong tooled die cast Boom-to-Mast Clamp



2. Tooled Boom-to-Element Clamp



3. Thick-wall swaged aluminum tubing



Tooled manufacturing is the difference between Hy-Gain antennas and the others -- they just don't have it (it's expensive!).

Die-cast aluminum boom-to-mast bracket and element-to-boom compression clamps are made with specially tooled machinery.

Hy-Gain antennas feature tooled swaged tubing that is easily and securely clamped in place. All tubing is deburred and cleaned for smooth and easy assembly.

Durable precision injection molded parts. Hy-Gain antennas are stronger, lighter, have less wind surface area, better wind survival, need no adjustments, look professional and last years longer.

Free Hy-Gain Catalog and Nearest Dealer ... 800-973-6572 Call your dealer for your best price!

hy-gain.

Antennas, Rotators & Towers
308 Industrial Park Road, Starkville, MS 39759 USA
Toll-free Customer Sales Hotline: 800-973-6572
• TECH: 662-323-9538 • FAX: 662-323-6551
<http://www.hy-gain.com>

Prices and specifications subject to change without notice or obligation. © Hy-Gain®, 2001.

leaders around a big table and had me explain the plan to them and, as a result, ham clubs were set up in youth clubs and schools in every city in Jordan. Three years later I went from one end of the country to the other, meeting over 400 newly licensed hams.

The children of Bedouin sheep herders loved the potential for joining the 20th century and building high-tech skills.

In a more recent visit, Prince Raad JY2RZ organized a special meeting of the Jordanian hams and introduced me as the man who had had more of an influence on Jordan than anyone other than the king.

Surely the League can organize and fund some ham ambassador teams to get out there and sell the product to third world countries. These countries need hams. They need 'em badly. And I'll bet that the League could get some of their member clubs to partner with a third world country to help get ham gear for their school clubs.

The American hams, if asked, could come up with tons of no-longer-used ham gear. When I asked for ham equipment to be sent to Jordan, I received hundreds of donations of gear, all in good operating condition, which I forwarded to the Jordanian Embassy in Washington for shipment to Jordan.

The leaders of every country in the world know that technology is the name of the game. Hopping around, banging drums, doesn't cut it in today's world. With communications and travel getting ever cheaper, even the thirdest of the third world leaders has to come to grips with the Internet and satellites. And that means they need technicians and engineers — which is what ham radio can supply.

But, unless someone gets out there with the message, there's no way the leaders would know about this. If we can get ham radio going in the third world countries we'll

have enough clout at WRC to stop the big-buck corporate delegates from fleecing us.

If the League does nothing, be prepared to get sheared again. Say baa.

Money Talks

Just as you are continuing to re-elect your senators and congressmen ensures that they are going to keep digging deeper into your paycheck before you even see it, your continued blind support of the ARRL, no matter what they do or don't do, absolutely guarantees that nothing is going to change. The only voice you have is your membership money. That's your only vote.

The only bright spots on the ham horizon in the last few years were when the FCC finally trashed the League's beloved code barrier to the higher class licenses, and their opening of a no-code Tech license, also vigorously fought by the ARRL. Both brought us brief spurts of new hams. But, in the long run, we either have to promote and advertise the hobby or it is going to slowly blow away. I've been like a broken record about the need for the League to mount a national promotional campaign. Nothing's happened. We members dutifully send in our yearly dues and the Newington Country Club ends up with a lot of it.

Has your club ever demanded a visit from your director? Have you then asked him what the League's plans are to revive our dying hobby? Have you ever threatened him with not renewing your membership if he doesn't get some action?

We should be seeing articles in the national magazines touting our hobby. We should be seeing TV coverage. We should be hearing about it on talk radio. Far's I know, the only hint the public has had about ham radio has been when Art Bell and I have talked about it on his program.

There are thousands of talk radio shows, and they're a great way to get the word around. I love to get on and

talk about the fantastic adventures amateur radio has brought me. The hobby has been a key element in my whole life.

It doesn't cost much to mount a very effective publicity campaign. All it takes is some know-how, persistence, and a couple people to make it happen. Heck, I've been doing a good business selling a \$40 video I made on how any company can easily generate an extra million dollars in sales just by effectively using promotion. And I go through the process, step by step.

This is something any company or organization can do, and few (if any) are. When I was publishing the first and third largest magazines in the country, I was dealing with the largest ad agencies in the country. Not one of them had a clue as to how to use promotion effectively. Why? That's simple, they get their money from commissions on ads they make and place, not on the sales their campaigns generate. The more free ads they get for a company, the less money the agency makes. Money talks.

If You Can't Talk

Has your ham club ever made the slightest effort to get local publicity? Long ago I recommended that every ham club have a promotional officer whose job was to get notices of club meetings into the local newspapers, on the radio and TV stations, and even onto local store and school bulletin boards.

If you have someone in the club who has the ability to talk — which may be difficult to find, I suspect, gauging from what I hear on the air — get the members to start a campaign to get your talker interviews on radio and TV talk shows. If you have no volunteers, then line me up as a guest. I love talking on these shows, and have no problem with there being millions of listeners. And the listeners love hearing me talk.

The Art Bell show newsletter says tapes of my shows are their best sellers.

Mad Cow Madness

The scare over bovine spongiform encephalopathy (BSE), the Mad Cow Disease, has scared Big Mac attacks out of millions of Americans. Well, that can be a super plus for their health, but, as usual, it's a crock.

Yes, there's a lot of BSE in England; no, it's not likely to be spread to the U.S.

The real cause of BSE has been obscured by the furor over the bonemeal being fed to cattle being cited. However, Cambridge University specialist David Brown's experiments have shown clearly that the real culprit has been the use of phosmet, an organophosphate insecticide used in the British warble-fly campaigns.

Naturally, with millions at stake, the insecticide manufacturers ganged up to discredit the research.

In humans, BSE is called Creutzfeld-Jakob Disease. The clusters of CJD downwind of a British phosmet production plant are hard for scientists to ignore.

Another researcher in the field is scientist and organic farmer Mark Purdey. Purdey, who has been refused any research funding by the British government, has had his house burned down, his lawyer driven off the road and killed, and the veterinarian working with him killed in a car crash — locally reported as "Mystery Vet Death Riddle." Another researcher, Dr. Bruton, a CJD specialist, had just written a paper on the subject when he was killed in a car crash before it could be published.

Will this news make headlines and a TV exposé show, or be plowed under by the affected industries?

Anyone interested can read the whole disgusting story in the March issue of Acres USA.

Now, you can go back to McDonald's or Wendy's and continue killing yourself, only more slowly. Do you want fries with that? Fried in hydrogenated canola oil (rapeseed oil)?

Continued on page 61

LOW NOISE PREAMPS

LNY-() ECONOMY PREAMP ONLY \$29/w&t

- Miniature MOSFET Preamp.
- Low noise figure.
- Available for various bands from 28 to 450 MHz.



LNK-() PREAMP

ONLY \$59/w&t

Low noise LNY-type preamp in alum case w/ BNC jacks.

LNP-() PRESELECTOR ONLY \$39/w&t

- Eliminate intermod!
- Sharp 3-section filter
- Low noise preamp
- Available for bands from 137 to 170 MHz.



HIGH QUALITY VHF & UHF EXCITER & RECEIVER MODULES

FM EXCITERS:

Rated for continuous duty, 2W continuous duty output.

T301 Synthesized VHF

Exciter: for various bands 139-174MHz, 216-226 MHz. Dip switch freq. setting.

- Kit (ham bands only) (TCXO option \$40)..... \$109
- Wired/tested, incl TCXO..... \$189

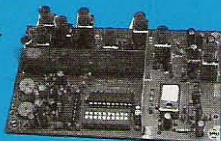

T304 Synthesized UHF Exciter:

for various bands 400-470 MHz.

- Kit (440-450 ham band only) incl TCXO \$149
- Wired/tested..... \$189

CRYSTAL CONTROLLED:

- TA51: for 6M, 2M, 220 MHz kit \$99, w/t \$169
- TA451: for 420-475 MHz. kit \$99, w/t \$169
- TA901: for 902-928 MHz, (0.5W out)..... w/t \$169

VHF & UHF POWER AMPLIFIERS:

Output levels from 10W to 100W..... Starting at \$99

FM RECEIVERS:

Very sensitive - 0.2µV.

Superb selectivity, >100 dB down at ±12 kHz, best available anywhere, flutter-proof squelch.

R301 Synthesized VHF

Receiver: various bands 139-174MHz, 216-226 MHz.

- Kit (ham bands only) (TCXO option \$40) only \$139
- Wired/tested (incl TCXO) \$209

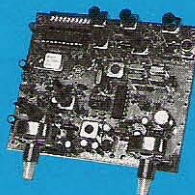

R304 Synthesized UHF Receiver:

various bands 400-470MHz.

- Kit (440-450 ham band only) (incl TCXO) \$179
- Wired/tested \$209

CRYSTAL CONTROLLED:

- R100 for 46-54, 72-76, 140-175, or 216-225 MHz. kit \$129, w/t \$189
- R144 Like R100, for 2M, with helical resonator in front end kit \$159, w/t \$219
- R451 for 420-475 MHz. kit \$129, w/t \$189
- R901 for 902-928MHz kit \$159, w/t \$219

CTCSS TONE ENCODER/DECODER

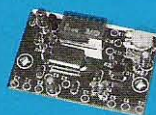

Access all your favorite closed repeaters!

- Encodes all standard subaudible tones with crystal accuracy and convenient DIP switch selection.
- Decoder can be used to mute receive audio and is optimized for installation in repeaters to provide closed access. High pass filter gets rid of annoying rcvr buzz.
- TD-5 CTCSS Encoder/Decoder Kit \$39
- TD-5 CTCSS Encoder/Decoder Wired/tested \$59

TRANSMITTING & RECEIVING CONVERTERS

No need to spend thousands on new transceivers for each band!

- Convert vhf and uhf signals to & from 10M.
- Even if you don't have a 10M rig, you can pick up very good used xmtrs & rcvrs for next to nothing.
- Receiving converters (shown above) available for various segments of 6M, 2M, 220, and 432 MHz.
- Rcvg Conv Kits from \$49, wired/tested units only \$99.



- Transmitting converters for 2M, 432 MHz.
- Kits only \$89 vhf or \$99 uhf.
- Power amplifiers up to 50W.

Get more features for your dollar with our REP-200 REPEATER

A microprocessor-controlled repeater with full autopatch and many versatile dtmf remote control features at less than you might pay for a bare bones repeater or controller alone!

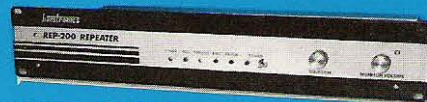

- kit still only \$1095
- factory assembled still only \$1295

50-54, 143-174, 213-233, 420-475 MHz.
(FCC type accepted for commercial service in 150 & 450 MHz bands.)

Digital Voice Recorder Option. Allows message up to 20 sec. to be remotely recorded off the air. Play back at user request by DTMF command, or as a periodic voice id, or both. Great for making club announcements! only \$100

REP-200C Economy Repeater. Real-voice ID, no dtmf or autopatch. Kit only \$795, w&t \$1195

REP-200N Repeater. Without controller so you can use your own. Kit only \$695, w&t \$995

You'll KICK Yourself If You Build a Repeater

Without Checking Out Our Website First!

Hamtronics has the most complete line of modules for making repeaters. In addition to exciters, pa's, and receivers, we offer the following controllers.

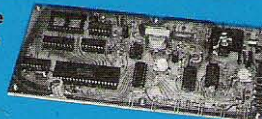

COR-3. Inexpensive, flexible COR module with timers, courtesy beep, audio mixer. only \$49/kit, \$79 w/t

CWID-2. Eeprom-controlled ID'er. only \$54/kit, \$79 w/t

DVR-1. Record your own voice up to 20 sec. for voice id or playing club announcements. \$59/kit, \$99 w/t

COR-4. Complete COR and CWID all on one board. ID in eeprom. Low power CMOS only \$99/kit, \$149 w/t

COR-6. COR with real-voice id. Low power CMOS, non-volatile memory. kit only \$99, w/t only \$149

COR-5. µP controller with autopatch, reverse ap. phone remote control, lots of DTMF control functions, all on one board, as used in REP-200 Repeater. \$379 w/t

AP-3. Repeater autopatch, reverse autopatch, phone line remote control. Use with TD-2. kit \$89

TD-2. Four-digit DTMF decoder/controller. Five latching on-off functions, toll call restrictor. kit \$79, w/t \$129

TD-4. DTMF controller as above except one on-off function and no toll call restrictor. w/t \$89

HANDY FREQUENCY COUNTERS

Pocket sized, but lab quality! 3GHz bandwidth, 1ppm accuracy, very affordable. NiCd battery, ac adapter/charger, rugged black anodized aluminum case. Telescoping whip antenna and great sensitivity allow measurements even from a distance.

Three models with prices from \$99 to \$219. All go up to 3 GHz. Some go as low as 10 Hz with noise filters and other advanced features.

See our website for details.



Hamtronics, Inc.

65 Moul Rd; Hilton NY 14468-9535

Ph: 716-392-9430; Email: sales@hamtronics.com

See special offers and view or download complete catalog on our web site

hamtronics.com

R121 AVIATION RECEIVER



- Exciting new AM receiver for the 118-137 MHz aircraft band.
- Ideal for monitoring at airports.
- Allows pilot control of runway lighting.
- ELT monitor to detect and locate downed aircraft.

- Dip switch frequency selection.
- Superior sensitivity and selectivity.

R121 Receiver module wired/tested \$209

R121 Receiver in cabinet (see website)..... \$299

WEATHER FAX RECEIVER

Join the fun. Get striking images directly from the weather satellites!

A very sensitive wideband fm receiver optimized for NOAA APT & Russian Meteor weather fax on the 137MHz band.

Covers all 5 satellite channels. Scanner circuit & recorder control allow you to automatically capture signals as satellites pass overhead, even while away from home.

- R139 Receiver Kit less case \$159
- R139 Receiver Kit with case and ac power adapter \$189
- R139 Receiver w/t in case with ac power adapter... \$239
- Internal PC demodulator board & imaging software. \$289
- Turnstile Antenna \$135



WEATHER ALERT RECEIVER



A sensitive and selective professional grade receiver to monitor critical NOAA weather broadcasts. Good reception even at distances of 70 miles or more with suitable antenna. No comparison with ordinary consumer radios!

Automatic mode provides storm watch, alerting you by unmuting receiver and providing an output to trip remote equipment when an alert tone is broadcast. Crystal controlled for accuracy; all 7 channels (162.40 to 162.55).

- RWX Rcvr kit, PCB only \$79
- RWX Rcvr kit with cabinet, speaker, & AC adapter \$99
- RWX Rcvr wired/tested in cabinet with speaker & adapter \$139

WWV RECEIVER

Get time & frequency checks without buying multiband hf rcvr. Hear solar activity reports affecting radio propagation.

Very sensitive and selective crystal controlled superhet, dedicated to listening to WWV on 10 MHz. Performance rivals the most expensive rcvrs.

- RWWV Rcvr kit, PCB only \$59
- RWWV Rcvr kit with cabt, spkr, & 12Vdc adapter \$89
- RWWV Rcvr w/t in cabt with spkr & adapter \$129



Modular Remote Coax Switch

Build this handy device to save time, money, and XYL yelling.

Have you looked at the price of coax cable these days? Do you have more than one antenna system to feed? Then you just might be interested in this HF remote coax switching system to save time, money, and the XYL screaming about the holes in the wall.

As we know very well, the homes we purchase these days are larger than they were years back. This translates to longer distances between the antenna system and the radio shack. There are two problems that arise from this situation. The first is RF power loss on the coax cable and the cost per foot. Generally speaking, you can ignore the loss along a 200-ft. cable at frequencies below 15 MHz, but there is still the cost-per-foot challenge. If you like to use frequencies from 15 MHz to 30 MHz, then you will have to pay attention to cable losses and the number of one-half wavelengths of distance you have to transverse. This equates to dollars

for the premium cable for runs beyond 100 feet. The losses are just too great to ignore. There are plenty of articles and published data for you to understand what this all is about. The bottom line here is that for over 200 ft. at 28 MHz, you will need a 1 kW linear amplifier just to make up for those line losses.

The average cost for general purpose cables like RG-213, RG-8, etc., is about 45 cents per foot, plus the cost of reliable connectors. This is at least \$100 per cable run. If you have monoband antennas for 10, 15, and 20 meters, you need at least three runs of coax. If you like to work 160 through 40 meters, then there are three more

runs which may run 300 or 400 feet. A guy would have to consider purchasing stock in the coax cable company to be able to purchase this quantity of the stuff!

Anyway, the remote coax cable switch looks pretty good at this point to most people. The cable switch is typical of the switches offered by a couple of companies, including the now-gone Heathkit Company. Most of the models available are 1 of 4 or 1 of 6 types. They use very large open-air 20 amp relays and the type of components used in the 1950s. The price of these commercial switches usually exceeds \$125 — not to mention the extra multiconductor cable they need to supply relay switching



Photo A. Control and low pass filter.

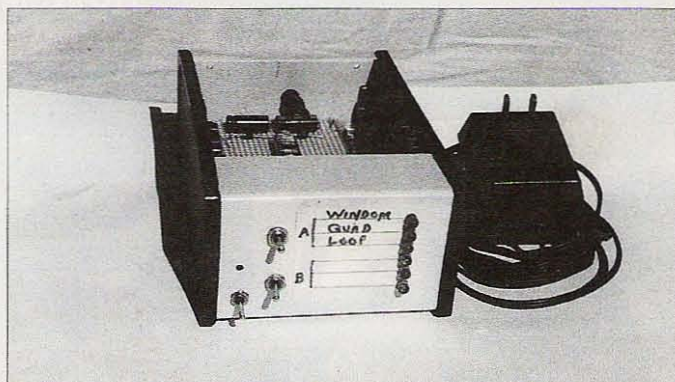

Photo B. Control internals.

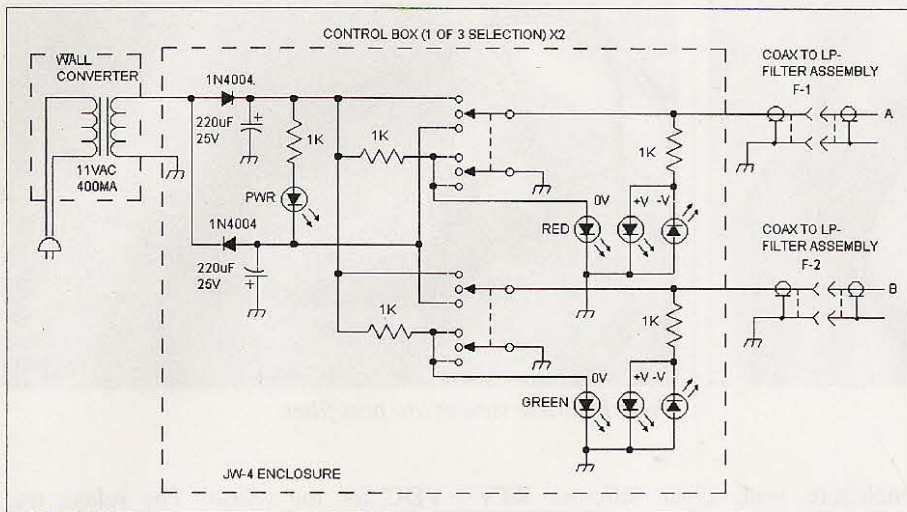

Fig. 1. Control box.

voltages. This article presents a much less expensive do-it-yourself alternative.

My main objective here is to have folks purchase the components from the five sources listed and do a real home-made quality project. When friends come around to see the shack, it is always a source of pride to announce that you built it yourself! It gets the ham out of the appliance operator category. It just plain makes you feel good! I have a complete list of component parts numbers and sources (prices included), which I will be happy to make available to those who provide me with a large SASE.

Qty.	Description
2	Chassis "F" connectors
1	Ten-Tec JW-4 enclosure
1	6-in. x 8-in. (0.1) perfboard, RS #276-1396)
1	11 VAC 400 mA AC wall converter (Hosfelt #56-786)
2	1N4004 rectifier diodes
2	220 μ F 25 V electrolytic caps
5	1k 1/4 W carbon film resistors
3	5 mm diffused LEDs, red
3	5 mm diffused LEDs, green
1	Red fault LED (power)
2	DPDT (3-pos.) sub-mini toggle switches (Jameco #138907)
1	Rubber grommet (RS #64-302)
COST = approx. \$20	

Table 1. Fig. 1 parts list.

The design of the switch(es) is to provide a 1 of 3 selection on two coax

runs. The control is a small, good-looking enclosure designed to occupy a minimum of space on your operating tabletop. The heavy coax cable runs coming from your equipment go to the floor where the low pass filter (LPF) assembly will lie or be physically mounted. This keeps the strain of the heavy cables, four of them, from hauling the control enclosure from your operating table. There are only two 5-ft. runs of very flexible RG-8X running between the tabletop control and the low pass filter enclosures. This cable provides the control voltages which are injected on to the coax cable runs. The low pass filter(s) keep(s) any 1 kW level RF currents from entering the control box. These low pass filters block RF from about 1.8 MHz through

Amplifiers, ATU Down Converters & Hard to Find Parts

LINEAR AMPLIFIERS

HF Amplifiers
PC board and complete parts list for HF amplifiers described in the Motorola Application Notes and Engineering Bulletins:

AN779H (20W)	AN 758 (300W)
AN779L (20W)	AR313 (300W)
AN 762 (140W)	EB27A (300W)
EB63 (140W)	EB104 (600W)
AR305 (300W)	AR347 (1000W)

2 Meter Amplifiers (144-148 MHz)
(Kit or Wired and Tested)

35W - Model 335A,	\$79.95/\$109.95
75W - Model 875A,	\$119.95/\$159.95

HARD TO FIND PARTS

- RF Power Transistors
- Broadband HF Transformers
- Chip Caps - Kemet/ATC
- Metalclad Mica Caps - Unelco/Semco
- ARCO/SPRAGUE Trimmer Capacitors

We can get you virtually any RF transistor!
Call us for "strange" hard to find parts!

DIGITAL FREQUENCY READOUT
For older analog transceivers
TK-1 (Wired and Tested) \$149.95

For detailed information and prices, call or write for our free catalog!

CCI Communication Concepts Inc.

508 Millstone Drive • Beavercreek, Ohio 45434-5840
e-mail: cci.dayton@pobox.com
www.communication-concepts.com

ADDITIONAL ITEMS

Heat Sink Material
Model 99 Heat Sink (6.5" x 12" x 1.6"), \$24
CHS-8 Copper Spreader (8" x 6" x 3/8"), \$24
Low Pass Filters (up to 300W) for harmonics \$12.95
Specify 10M, 15M, 20M, 40M, 80M or 160M
HF Splitters and Combiners up to 2KW

ATU Down Converters

(Kit or Wired and Tested)

Model ATV-3 (420-450) (GaAs-FET)	\$49.95/\$69.95
Model ATV-4 (902-926) (GaAs-FET)	\$59.95/\$79.95

Ham Mall

The world's largest internet store dedicated to Ham Radio!

www.HamMall.com

This is the internet store that has it all! Open 7 days per week - 24 hours per day. Browse through our catalog viewing pictures, descriptions, accessories, and our low prices. If you are looking for a hard to find item, Email us at Bill@HamMall.com, and we will try to locate it for you.

Check out all we offer!

Call Wall QSL Manager Listing News, Announcements and Specials
Ham-to-Ham Discussion Groups Ham Shack Photos

Visa/MasterCard accepted on line. Free shipping in continental US on all orders over \$100.

When in Seattle visit us at:
Radio Depot, Suite 176, 5963 Corson Ave., So. Seattle, WA 98108
Phone (206) 763-2936 Fax (206) 763-4172

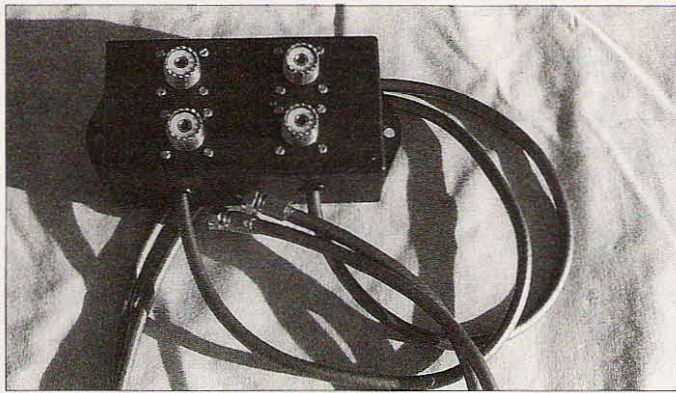

Photo C. Low pass filter assembly.

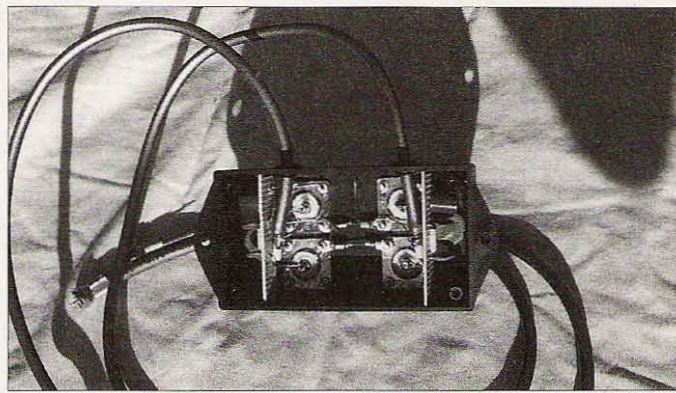

Photo D. Inside view of low pass filter.

50 MHz, yet allow injection of the 12 VDC relay voltage. The two large coax cable runs then leave the low pass filter enclosure to exit the radio shack and go out to the various antenna systems. There are two gray PVC NEC-approved enclosures which will contain the relays and associated components. These switches can be mounted at a central location at the base of the antenna site. If, for example, a three-band quad or a Christmas tree yagi system is in place, then it could be mounted close to the driven elements so that a minimum coax run would be needed from the switch to the driven elements.

So, the complete system is composed of one control box, one double LPF enclosure, and two remote switching boxes. We will take a look at them one at a time and provide an explanation and some information on construction. The assembly is point-to-point solder connections and wirewrap techniques. All of the components are mounted on a perforated board or mounted to the

enclosure with clear silicone RTV caulk. The caulk is available from building supply sources at about \$4 per tube. Most of the tube will not be used, but will be available for other projects used in your home.

The cost of the complete system is about \$75 in components and enclosures, as detailed in this article. About \$25 could be saved if junk box and less attractive enclosures are used. I wanted sealed good-looking enclosures for my project, so that is why I used a Ten-Tec JW-4 desktop enclosure, Pan-Tec ABS low pass filter enclosure, and \$6-each gray PVC NEC-approved outdoors enclosures.

The control box is a Ten-Tec JW-4 enclosure. It provides plenty of room for the hardware and small perfboard used to provide the switching voltages. The power to the box is provided by an inexpensive 11 volt AC wall converter transformer. This item is less than \$1.50 and is UL/CSA listed. It is the simplest way to get 120 VAC power to the box to provide the plus/minus 12

VDC for the relays. The relays use about 25 mA and are very state-of-the-art devices. Only two are energized at a time, so the current draw is very small. The wall converter is rated at 150 mA.

The components are mounted and connected as per the schematic in Fig. 1. Component placement is not critical. AWG-30 wirewrap wire was used for all hookup in this enclosure. Upon completion of the wiring, a quick test should be conducted to ensure proper operation. With the power on, check to see if the bank "A" red LEDs operate properly. When the selection switch is up, the first LED should light; center position, the second LED; and down position, the third LED. Do the same for bank "B." If all is well, then hook up a DC volt meter to bank "A" output (F-1) and move the selection switch again. Up position (1) gives you a plus 12 VDC out, the middle position (2) has 0 V, and the down position gives you a minus 12 VDC out. If everything checks out, move on to bank "B" output (F-2) and verify it.

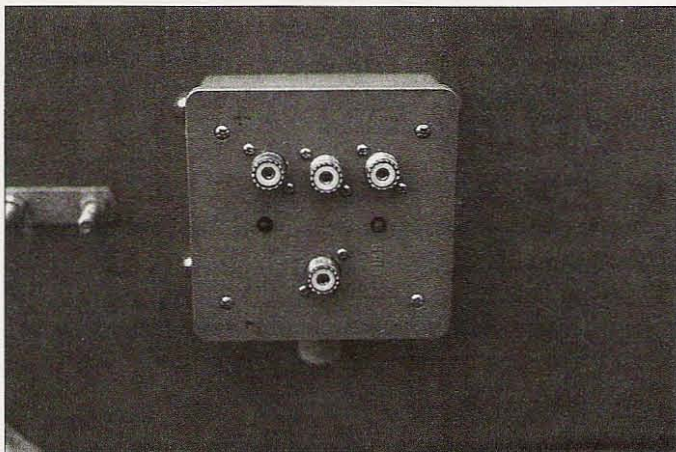

Photo E. Remote switch box.

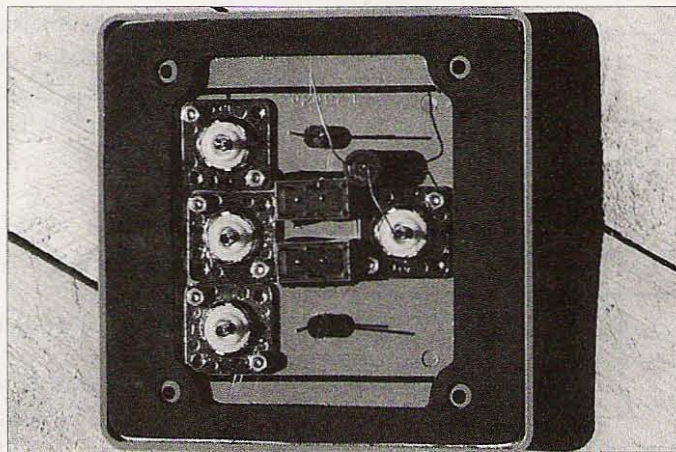

Photo F. Back of switch box.

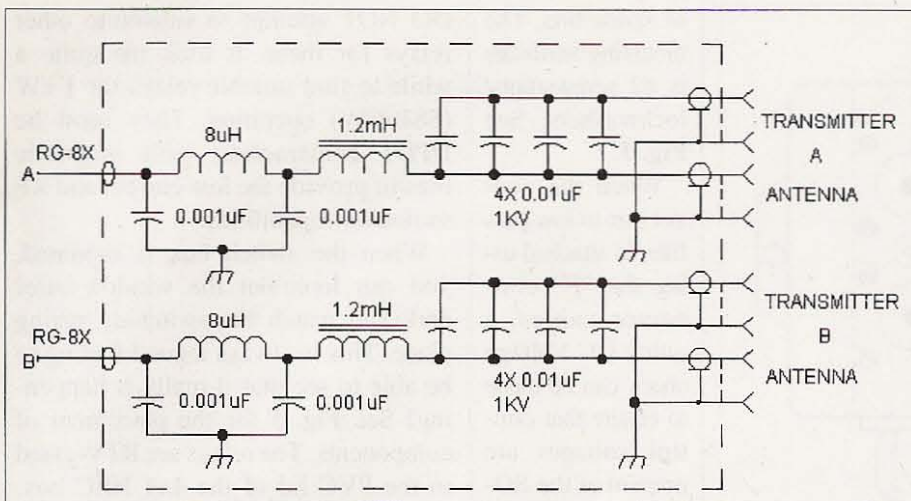

Fig. 2. The complete low pass filter schematic.

Now that you have a working control box which is the source of your power to operate the relays, we can move on to the low pass filters assembly. The enclosure selected can be purchased from your local Radio Shack store for about \$4. It is made of ABS black plastic and has an aluminum cover held on by sheet metal screws. The box is attractive because it has side mounting ears and internal perfboard slots, to hold the perfboard assembly in place without adhesive or hardware. The component placement on the two small perfboards is not critical; however, I did try to make the large RFC lead close to the SO-239 coax connector for soldering. Refer to

Fig. 4 for recommended placements. The complete schematic is shown in Fig. 2. Notice that four .01 μF 1 kV capacitors are used to make up the 0.4 μF 1 kV RF bypass capacitor. This capacitor blocks the DC relay voltage from entering any of the equipment, yet allows the 1 kW RF to bypass on to the coax and antenna system. The enclosure

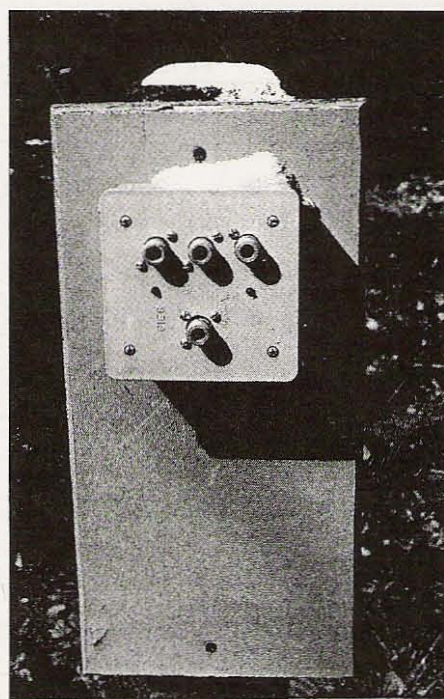

Photo G. Remote switch with "N" connectors.

requires four 5/8-inch-diameter holes to be drilled for the SO-239s. I used a

Qty.	Description
1	Pantec FLX-T4624 box (RS #RSU1165810)
2	2.3-in. x 4.4-in. perfboard
4	0.001 μF 50 V ceramic caps
4	SO-239 coax connectors
2	1.2 mH 250 mA RF chokes (Mouser #43LH212)
2	8.2 μH RF chokes (Mouser #43LQ826)
2	Rubber grommets (RS #64-302)
10 ft.	RG-8X coax (flexible)
16	#2 nuts/screws/lockwashers
8	0.01 μF 1 kV ceramic cap (Jameco #97375)

COST = approx. \$10

Table 2. Fig. 2 parts list.



World's best ham weather station*



Actual size: 6 1/4" x 2 1/4" x 1 1/4"

The ULTIMETER® 2000 tracks more than 100 values so you can monitor and record weather extremes in your area.

Instant access to: • current values • today's highs and lows • long term highs and lows • time/date for all highs/lows • rain totals† for today, yesterday, and long term • alarms, and much more. Easy to install.

• Connect data output directly to TNC for APRS weather station.

Features superbly accurate: • barometric pressure • 3-hr. pressure change • indoor/outdoor humidity† • dew point† • wind speed/direction • indoor and outdoor temperature • wind chill temperature • rainfall†. Only \$379 plus shipping (†Optional sensors add'l.) Other ULTIMETER models starting at \$189. *Even *WeatherWatch* magazine concludes "the best we have seen."

The Weather Picture®

An eyepopping add-on to your ULTIMETER

The most popular accessory for our precision weather systems, The Weather Picture® continuously displays all the vital weather data you've pre-selected from your ULTIMETER® Weather Station. Big red numerals are easy to read from across the room, day or night. Available in two sizes, in brushed aluminum, traditional oak, or solid teak.

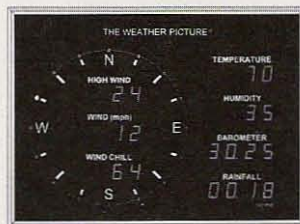

Size shown: 15 1/4" x 11 1/4"

Call TOLL-FREE: 1-866-364-7338 FAX 407-892-8552

PEET BROS. COMPANY, Inc. 31 E. 17th Street, St. Cloud FL 34769

Our 26th Year

© 2001 Peet Bros. Co.

Visit our Home Page to see and actually try our Weather Stations:

www.peetbros.com

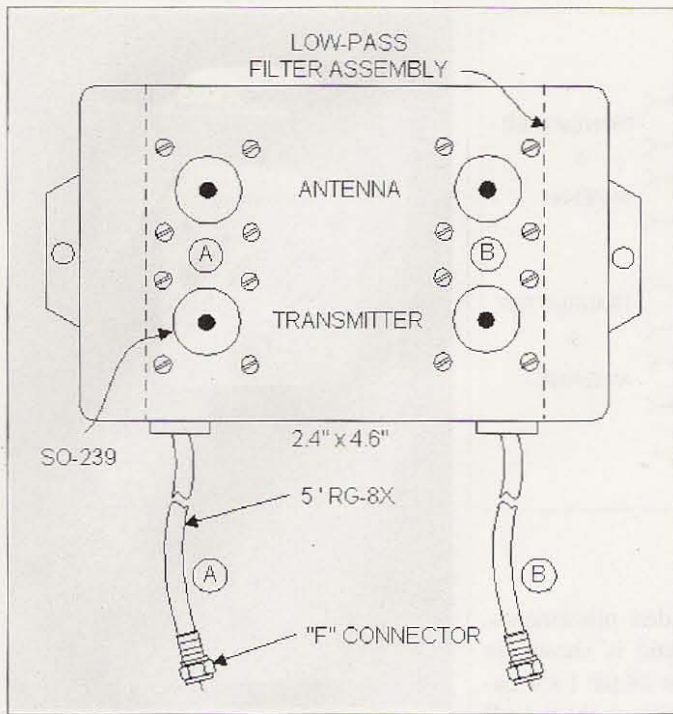

Fig. 3. Low pass filter(s).

Forstner drill bit for this task, which made a perfectly clean hole. This would not be the case if using metal twist drill

for xcvr connections and two upper SO-239s are for the antenna system coaxes.

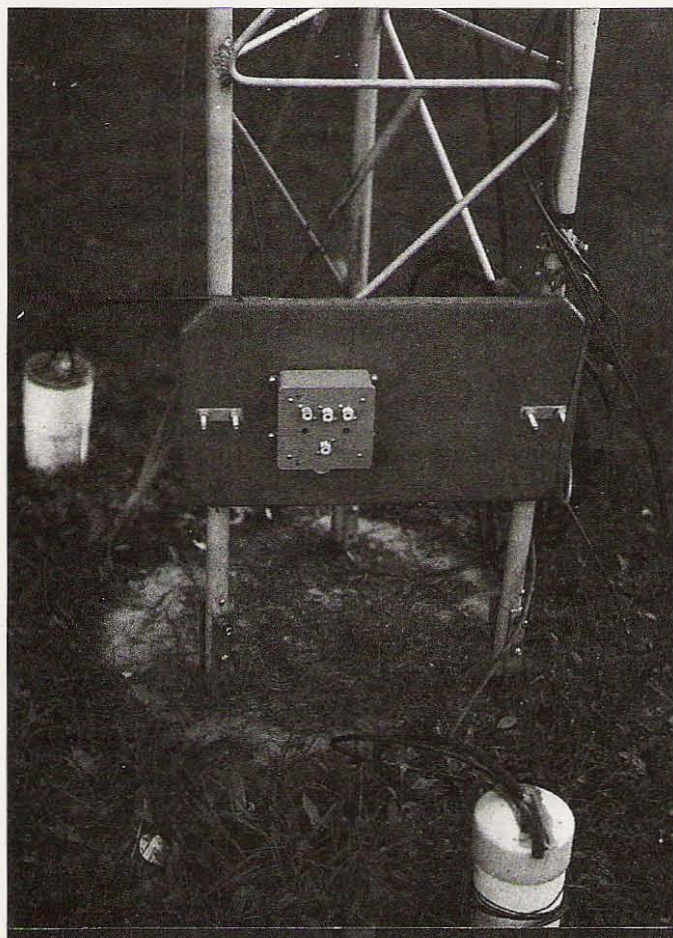

Photo H. Tower mounting

or spade bits. The mounting hardware is #2 screws/nuts/lockwashers. See Fig. 3.

When the control box to low pass filter is attached using the "F" connector cables, a quick DC Voltage check can be made to ensure that control voltages are present at the SO-239 coax connectors that go to the two antenna systems. When verified, you can move on to the remote switch boxes. In my version the two lower SO-239s are

DO NOT attempt to substitute other relays for these. It took me quite a while to find suitable relays for 1 kW (SSB/CW) operation. They must be DPDT construction with magnetic bias to provide the low current and RF switching capabilities.

When the switch box is mounted, you can look out the window after dark and watch the switching taking place. This is always a good feeling to be able to see that it really is happening! See Fig. 5 for the placement of components. The relays are RTV-glued to the PVC lid of the 4x4 NEC box. The box is mounted but has no components inside. All components are mounted on the lid so as to provide easy access for repair on an inside workbench if ever necessary. I just don't like that outside work in the snow and cold! Use AWG-14 wire for all RF interconnects. The switching circuit can be wired with AWG-24 or other light gauges. The gas discharge device is optional; however, it is nice to know that a 600 V/2 nS gas device is there to prevent static charge buildup on the antenna from creeping down the cable to this switch unit. It is well worth its \$1.25 price tag!

Now, for a little background on the antenna switch box circuit. See Fig. 5. Note that two 5mm LEDs are used to ensure that only the proper polarity will operate the intended relay. The relays are polarized and nitrogen-filled 5 amp DC types, which can handle RF quite well.

Remember, there is no DC continuity between the SO-239s and the input SO-239, because there is a .04 μF 1 kV blocking capacitor in place. Testing amounts to checking LED indications. If it is felt to be necessary, jumper around the blocking capacitor and do your DC voltage tests at the appropriate SO-239s. The final test is to hook up a dummy load and check with RF looking at the SWR of the coax cable system.

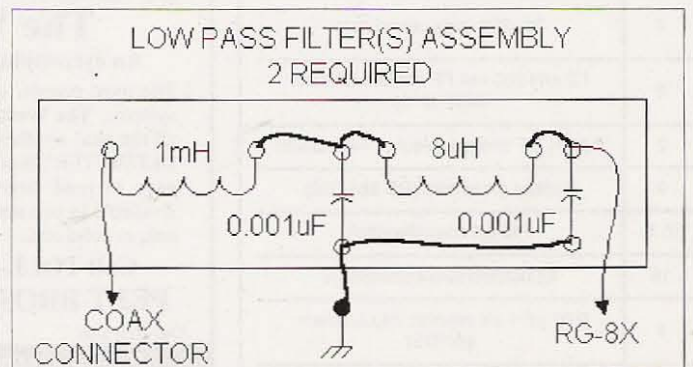

Fig. 4. Low pass filter(s) assembly. Note: Box has slots to hold perfboard.

PVC COVER, PARTS PLACEMENT, AND INTERCONNECTS

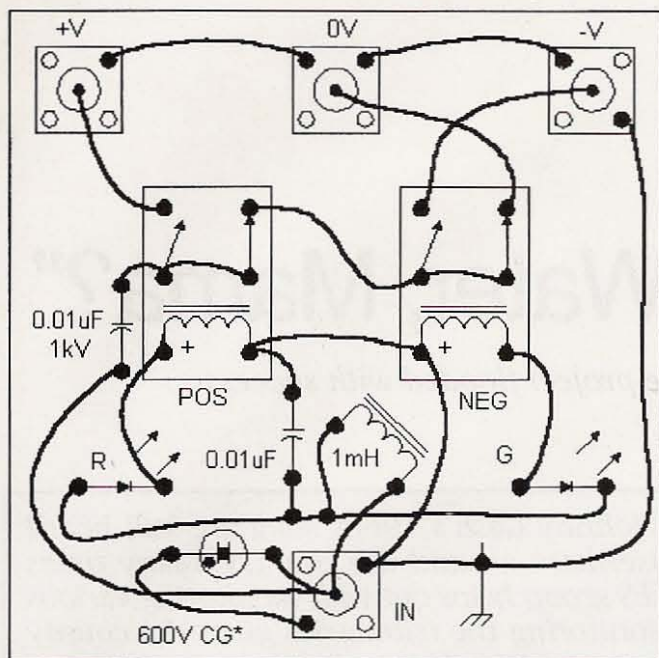

Fig. 5. Remote coax switch(es). Note: Do not substitute relay types. Aeromat DSPIM-12 V only!

In summation, I can highly recommend this unit. It will provide quite a

an old wine bottle cork to plug it up. Venting did not seem to be necessary.

savings on coax, or entice you to purchase some of that expensive premium cable. I use a special semi-hard RG-6 equivalent which runs 500+ ft. to a 1000 ft. loop antenna system, without any noticeable losses, even at 28 MHz. This is a special Teflon-type cable, but it would not make a difference at the 15-MHz-and-below design criteria. Another item to be noted is that the gray PVC enclosures have a one-half-inch opening at the bottom of the enclosure. I used

Qty.	Description
4	SO-239 coax connectors (Hosfelt)
1*	600 V gas device (Mouser CG-600)
4	0.01 µF 1 kV ceramic caps (Jameco # 97375)
1	0.01 µF 50 V ceramic cap (Jameco #15229)
1	1.2 mH 250 mA RF choke (Mouser #43LH212)
2	Aeromat DSPIM 12 V relays 5 amp (Digi-Key #255-1047)
1	Red LED, 5 mm
1	Green LED, 5 mm
1	4-in. x 4-in. PVC enclosure (Carlton #E9802CN)
1	4-in. x 4-in. PVC blank lid (Carlton #E9802CN)
*Optional	
Note: Do NOT substitute relay types — Aeromat DSPIM 12 V only!	
COST = approx. \$21 each	

Table 3. Fig. 5 parts list.

Continued on page 58

“How High’s the Water, Mama?”

The story of a packet public service project flooded with success.

These words from country-and-western singer Johnny Cash’s 1960s song are still heard here in the state of Washington, as they are elsewhere around the country. Many times during flood season, the Clark County ARES/RACES group helps out with monitoring various stream levels in the county’s key tributaries. Monitoring the tributaries gives the county emergency planners up-to-the-minute data to make key decisions on manpower and materials during emergency periods of extreme rain or melt-off, and resultant flooding.

Normally, this requires several dedicated volunteers in “round the clock” shifts trudging out in the rain every 15 minutes to manually read stream gauges. In the fall of 1998, Zeph McNaughton N7WAP and his wife, Jan KB7OKG, worked with the county to identify all the locations that would need to be monitored; they developed a handbook showing which locations had stick gauges, where to park for observation, what equipment to bring, and what to expect at each location. **Photo A** shows a typical installation site.

Zeph brought the problem to the local packet group, which led to a brainstorming session about how to reduce the amount of manpower required for this operation. Miles Bond AB7ZX, as the new head of the packet group, coordinated efforts and provided encouragement, cajoling, coffee, and cookies, as required. It was felt this would be an ideal opportunity to demonstrate the

benefits of Unmanned Radio Telemetry. In developing the criteria for a stream-level monitoring device, it was decided that a semi-permanent unit was needed that could be placed in service for an extended period of time. Recommendations from the county (and past experience) indicated that they would want to know levels of streams in approximately a ten-foot range, in increments of 0.1-foot. It was also felt that some method of monitoring battery voltage would be advantageous. Of course, cost was also to be a major factor in all choices.

At first, the county had indicated that it would install wells that were connected by culvert at the bottom of the stream bed. In practice, we eventually ended up with a “bulb housing” for our measuring device.

The packet group met, and the process was broken down into its individual components, according to expertise. **Fig. 1** shows a block diagram of our solution.

Digital telemetry

The Kantronics KPC-3 Plus Packet Terminal Node Controller (TNC) was the obvious choice for transmitting

water level and battery voltage via packet radio. John Fletcher KB7FND was by far the most experienced of the group in sending telemetry data streams (channels) via radio using the standard Kantronics KPC-3 Plus™ TNC. Most of the TNC discussion revolves around this newer version of the venerable KPC-3 Plus TNC. This

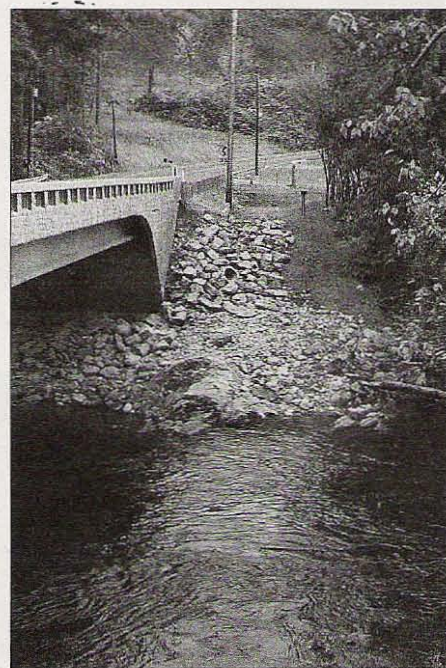

Photo A. Installation site.

This article originally appeared in the January 2000 issue of *Rocking Chair*, newsletter of the Clark County (WA) Amateur Radio Club, Bob Goodale K7YFJ, editor.

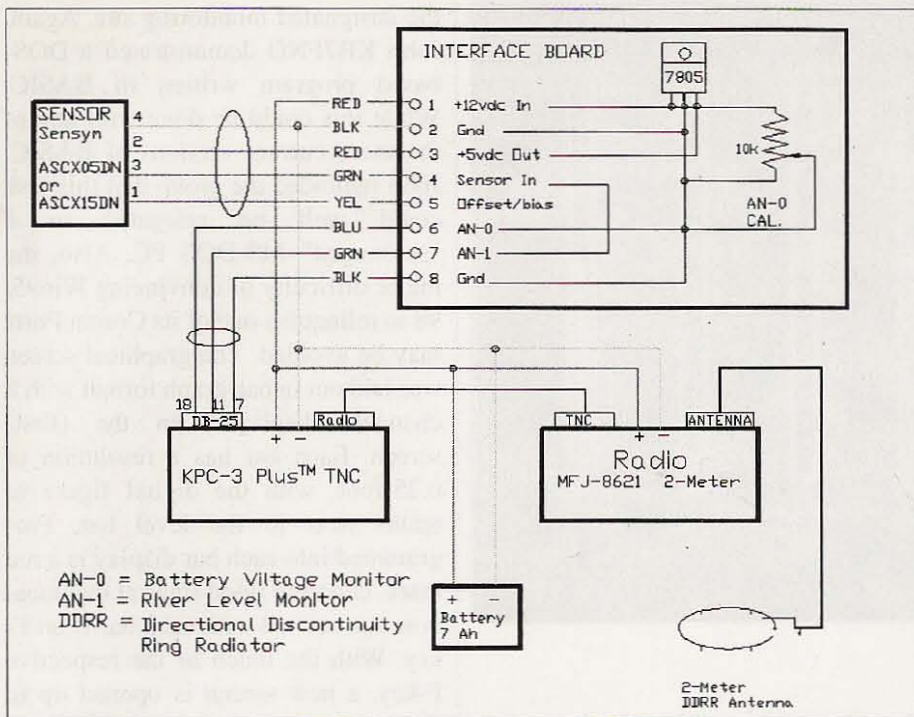

Fig. 1. Block diagram of river gauge station.

would enable each of the sensors to be relatively low-power by using the digipeater feature of the KPC-3 Plus to pass the data as packet messages in relay fashion until it reached the proper monitoring station. John emphasized that the signal from the sensor to the KPC-3 Plus unit needed to be in the 0.0 to 5.0 VDC range. This turned out to be the limiting design criterion, meaning that every design decision of the metering device would be based upon this factor. Since there are two analog input channels available on the KPC-3 Plus, we would be able to monitor stream levels and battery voltage concurrently.

The KPC-3 Plus has two channels available, labeled AN0 and AN1. It accepts the analog input of 0-5 VDC and converts it to a decimal count in the range of 000 through 255. This equates to 0.0196 VDC per count.

John outlined many of the features of the KPC-3 Plus that would be used to our advantage in this experiment. As these units will be powered by gel-cell battery (with a minimum of 72 hours' battery life as the goal), power consumption and its conservation will be refined to the limits — even the status LEDs may be turned off for low power consumption.

The more predominant feature will be the remote programmability of the unit. This will enable the group to change the "sampling rate" from, say, 15 minute intervals to shorter intervals, such as every 5 minutes. Since all the parameters stay in memory due to the internal lithium battery, this will enable the initial programming to be accomplished "in house" and not out in the field.

John displayed a standard DB-25 jumper connection box that will enable the analog signals to be introduced to the units in a reasonable fashion. An interface box will also be needed to hold a small PC board that will house the 5 VDC regulator (7805) that supplies power to the sensor and the small 10k potentiometer that will be used to drop the voltage of the battery *proportionally* down to the 0-5 VDC range required by the KPC-3 Plus. This normally requires the resistance to be in the neighborhood of 3.33k, which provides 0-15 volt range (read as 0-5 V by the TNC). At this point, we must remember that as a rule of thumb, 9.6 volts is the "deep cycle discharge point" of a normal gel-cell; any lower, and the battery may be damaged. The display software was programmed to

Continued on page 18

ALL ELECTRONICS CORPORATION

Ultrabright Red LED

5 mm diameter T 1 3/4 LED.
3000 MCD ultrabright.
Water-clear in off-state.
Operates at 20 mA.

CAT # LED-50

2 for \$1.00

11+ 25¢ each
1000+ 15¢ each

Miniature DC Motor

Mabuchi # FF-N20PN
Miniature 1.5 to 3 Volt DC motor.
Ideal for models and radio control applications where small size is important.
No load rating: 15,800 RPM @ 2.4 V, 96 mA.
Length (excluding shaft), 0.654" long x 0.47" x 0.39". 0.039" (1mm) dia. x 0.13" long shaft.
Solder-loop terminals. Large quantity available.

CAT# DCM-166

2 for \$1.50

150 for 60¢ ea.
600 for 50¢ ea.
1500 pieces 35¢ ea.

Solar Panel

Output: approx.
3 Volts @ 40 mA.
2.40" square x 0.13" thick epoxy-encapsulated silicon photovoltaic panel removed from solar lighting system. Solid, almost unbreakable module with easy-to-solder spots on backside. Ideal for solar-powered battery chargers and other projects.

CAT # SPL-60

\$3.50 each

Nickel-Metal Hydride 4.8V 850 mAh Battery Pack

Philips # 25733.
New, rechargeable pack manufactured for cell-phones. Contains four 1.2 Volt, 850 mAh cells. Each cell is 1.8" x 0.65" x 0.3".
With little effort you can remove the cells from the enclosed battery pack and reconfigure them to suit your needs.

CAT# NMH-53

\$2.00 each

10 for \$17.50

ORDER TOLL FREE
1-800-826-5432
SHOP OUR ONLINE STORE
www.allelectronics.com
CHARGE ORDERS to Visa, Mastercard, American Express or Discover

TERMS: NO MINIMUM ORDER. Shipping and handling for the 48 continental U.S.A. \$5.00 per order. All orders including AK, HI, PR or Canada must pay full shipping. All orders delivered in CALIFORNIA must include local state sales tax. Quantities Limited. NO COD. Prices subject to change without notice.

CALL, WRITE FAX or E-MAIL for our FREE 96 Page CATALOG Outside the U.S.A. send \$3.00 postage.

MAIL ORDERS TO:
ALL ELECTRONICS CORPORATION
P.O. Box 567
Van Nuys, CA 91408
FAX (818)781-2653
e-mail allcorp@allcorp.com

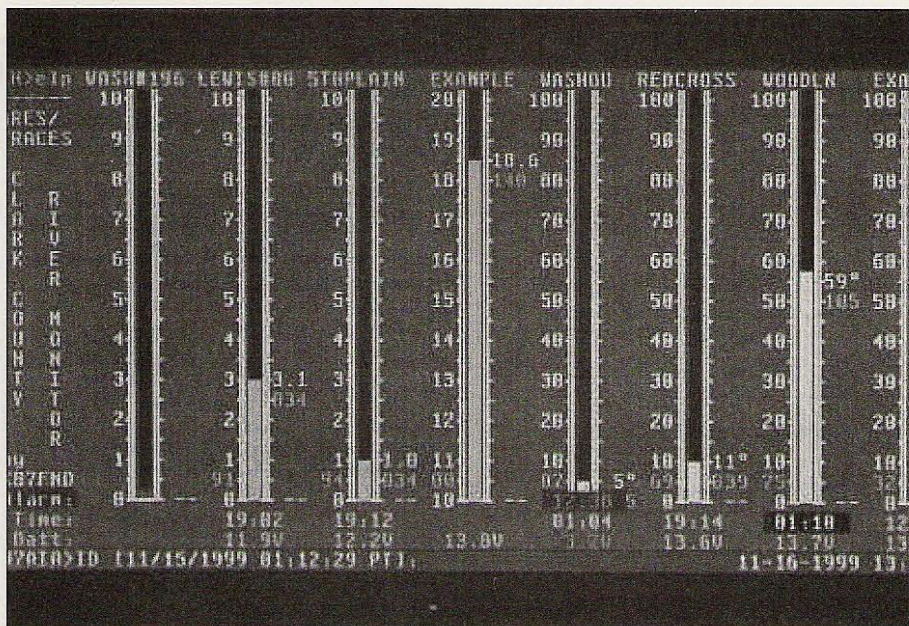

Photo B. Screen monitor.

alarm at 11.0 volts to trigger attention to that particular unit.

Transceiver

While a plain beacon-type transmitter would work in this application, it was felt that a transceiver would be advantageous, as this would afford the group the ability to remotely program the TNCs — especially the sampling rate. An MFJ-8621 2-meter 5-watt radio, crystallized on the club's packet frequency, would give us the ability of digipeating the data across the ARES packet network. It is also understood that the internal clock will enable the TNCs to be programmed so as not to double on transmissions with another sensor.

Packet telemetry

The KPC-3 Plus has two analog input ports that are connected to its processor's analog-to-digital (A/D) converter. Each analog quantity (0 to +5 VDC) is digitized into an 8-bit binary number, which in turn is converted by the TNC's software to a decimal number in the range of 000 to 255. The decimal number for each of the two analog inputs is then inserted into a special telemetry beacon and transmitted at a user-defined interval (10 seconds to 42.5 minutes). This transmitted beacon can be digipeated

by other packet stations in the region, allowing the use of a low power transmitter at the measurement site. A number of local ARES/RACES members have set up their home packet stations to perform this digipeating function to provide coverage throughout the county. The beacon will be in the following format:

```
KC7IZH-12>BEACON, RELAY,
WIDE* [11/08/1999 22:05:32 PT]:
T#320,235,047,043,056,125,00011001
```

In this example, the first analog quantity is decimal 235 and the second is decimal 047, representing analog voltage inputs to the TNC of 4.0678 volts and 0.9216 volts respectively. Each decimal count represents 0.0196078 volts (5.0 volts divided by 255 count). The "T#320" is the telemetry beacon cycle number. Each time the telemetry beacon is transmitted, this count is incremented. The count starts out at 000 when the TNC is powered up. When the count reaches 999, it rolls over to 000. By keeping track of this number, the display software can determine if a beacon was missed. The display software also uses this number to eliminate multiple beacons received from more than one digipeating station.

Then the data from each sensor will be collated in a tabular format and converted to depth by the software at

the designated monitoring site. Again, John KB7FND demonstrated a DOS-based program written in BASIC. While this could be done with any of the more current versions of BASIC, John reminded the group that this task could well be relegated to a "scrounged" MS-DOS PC. Also, the major difficulty of convincing Win95/98 to relinquish one of its Comm Ports may be avoided. The graphical screen was laid out in bar-graph format with 8 channels displayed on the (first) screen. Each bar has a resolution of 0.25-foot, with the digital figure in tenths next to the level bar. Programmed into each bar display is a red mark, denoting flood stage at that location. Associated with each bar is an F-key. With the touch of the respective F-key, a new screen is opened up to display that particular sensor's history over the past 24 hours in a line-graph display. The bar colors were green on a blue background. It was suggested that the planned user-preset alarm level should turn the bar red to alert attention to the alarm condition. **Photo B** shows the software display.

Another feature in our beta software is the ability to monitor temperature in the same format as levels. This demonstrates not only the flexibility of the setup, but other possibilities available as well.

It was felt that only the raw data need be logged to disk for later trending analysis.

At the bottom of each bar is the last reporting time with the corresponding battery voltage. This would allow the monitoring (duty station) to alert a particular team of a low battery in need of a change-out. Programming will change the numerical value to red should the voltage drop below 11.0 VDC.

Additionally, the software will be monitoring the time and cycle stamp of each transmission. With this, we can disregard any duplicates as a result of digipeating. We will be able to monitor "lost" readings of a nonreporting station if the cycle numbers aren't numerically continuous.

Display stations (using a PC and appropriate software) can be set up anywhere in the county to monitor the

water level and battery voltage of each measuring site. The software program can display up to eight sites in "gauge" form, or the operator can select a graph form that plots the previous 24 hours of collected data for a selected site. Alarm points can be set for each site to sound an audible alarm when the water level or rate of rise reaches a critical value. Another alarm sounds when the battery voltage drops below 11.0 volts. Each display station needs only a receiver on the packet frequency (a scanner will do) and any TAPR-2-style TNC to receive and display the transmitted beacons. The following parameters need to be set in the receive TNC in order to output the above format.

DAYTIME (date/time in the format of YYMMDDHHMM[ss]; seconds optional)

HEADERLN ON
MON ON
MSTAMP ON

An additional feature of the KPC-3 Plus series of TNCs is the ability of the packet SYSOP to change the TNC's parameters remotely. The telemetry beacon interval is one of the parameters that can be changed. This allows the SYSOP to remotely change the interval at a particular site as stream conditions change. The longer the interval, of course, the longer the battery life at the measurement site. Tests have shown that a 7 Ampere-hour (Ah) battery can power a site (5-watt transmitter) for five days at a beacon interval of 30 minutes before reaching a battery voltage of 11.0 volts. This is well above the deep discharge point. Additional battery capacity can be added to extend the reporting life of a station.

At the transmitting station, the following KPC-3 Plus parameters must be set:

MYCALL (station call)

MYREMOTE (remote call)

TELEMETRY 180 (1800 sec) (beacon interval of 30 min., for example)

RTEXT (remote password text - see manual)

UNPROTO (set the digipeat path[s] here)

LED FLASHLIGHTS (and more!)



Colors: white, blue, red, and green

D & L Antenna Supply Co.

Secure Ordering On Line at

www.wavehunter.com

1-800-965-8880

Great Christmas Gift! (\$4.95 and Up)

- Lasts 4 times longer than regular flashlights
- Lifetime warranty including LED lights
- Shockproof
- Features 4 high intensity LED lights
- Powered by 3 AA alkaline batteries

See our new
8 LED flashlight
at our Dayton Hamvention
Booth #324!

- DIP switch programmable
- Miniature in size
- 37 EIA tones, 27 non-standard tones from 33.0 to 254.1 Hz included
- Reverse Burst built-in
- Easy 3 wire hookup

SS-64 CTCSS Encoder
.66" x 1.08" x .21"

SS-64 DIP Switch Programmable CTCSS Encoder \$28.95



- Fully enclosed CTCSS encoder
- All 32 EIA tones from 67.0 to 203.5 Hz included
- Perfect for mobile / base applications

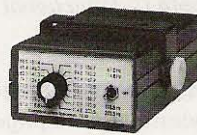

TE-32
5.25" x 3.3" x 1.7"

TE-32 Multi-Tone CTCSS Encoder \$49.95

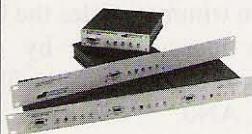

TP-3200 Shared Repeater Tone Panel

- 51 CTCSS Tones
- 106 DCS Codes
- Supports 157 Repeater Subscribers
- On-Line Computer Help
- Repeater CW ID
- Air Time Loading & Analysis Graphs
- Signalling Formats: CTCSS, DCS & DTMF

TP-3200D Table Top Version

\$269.95 each

TP-3200RM-A Single Rack Mount version

\$279.95 each

*TP-3200RM-B Triple Rack Mount version

\$279.95 each

*Holds up to three TP-3200s

Call or write to receive our full Product Catalog or visit our Web site for complete information at:
<http://www.com-spec.com>



ID-8 Automatic Morse Code Identifier
1.85" x 1.12" x .35"

ID-8 Automatic Morse Station Identifier \$69.95



COMMUNICATIONS SPECIALISTS, INC.
426 WEST TAFT AVENUE • ORANGE, CA 92865-4296
(714) 998-3021 • FAX (714) 974-3420
Entire U.S.A. • (800) 854-0547 • FAX (800) 850-0547
<http://www.com-spec.com>

HANG YOUR NEXT WIRE ANTENNA THE EZ HANG WAY

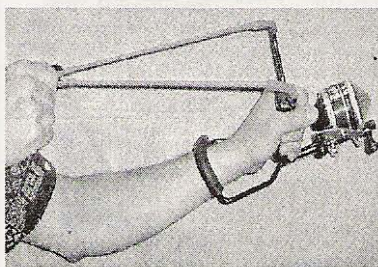

Everything you need; the original **EZ Hang**,
the **EZ Winder** intermediate line dispenser
and five extra weights:

\$62.95 + \$7.95 (US) S&H

EZ Hang, Code 7, 8645 Tower Dr, Laurel, MD 20723

540-286-0176

www.ezhang.com

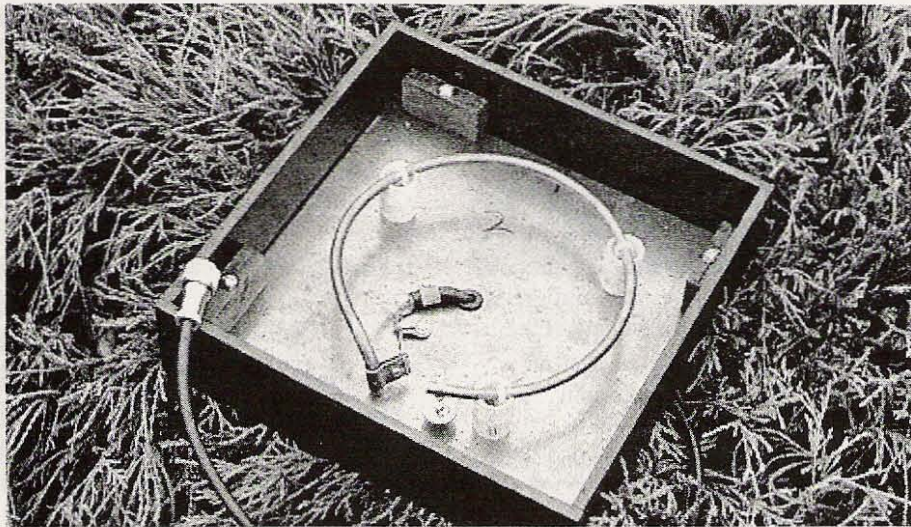

Photo C. Directional Discontinuity Ring Radiator antenna.

"How High's the Water Mama?"
continued from page 18

Interface board

An interface board makes up the final part of the station package. As shown in Fig. 1, the 12 volt battery output is dropped and regulated to

+5 volts for the input to the pressure sensor. Output from the sensor is connected to the TNC analog input AN1.

A 10 k-ohm trimmer scales the battery voltage measurement by one third, making it suitable for the TNC analog input, AN0.

Antennas

The packet group felt that a simple antenna would be needed that would be tamperproof and withstand the rigors of northwest weather. One suggestion was that some sort of antenna (dipole or fractal) would be fashioned and "potted" in an epoxy resin for protection against the elements and curious fingers. Another idea would be to trace/etch some sort of folded dipole or yagi onto a blank sheet of PC board. It was felt different antennas would be needed for each of the varied installations.

Initially, our test sensor will use a cheap mag-mount antenna mounted to the metal cover of the standpipe. Another option used was a low profile "Directional Discontinuity Ring Radiator" (DDRR) antenna (see *The ARRL Antenna Book*) shown in Photo C. This particular antenna was used to showcase some of the more imaginative designs available today. A 2-meter version of this low-profile antenna was

 <p>TRANS-MITTING TUBE Eimac #3CX10000A7 power output tube used in radio transmitters, RF heating equipment, sputtering and diffusion equipment. 20A001 \$1495.00</p>	<p>NEW CATALOG! 108 pages of bargains that you can download from our web site, or send US\$3.00 (\$4.50 foreign) for a printed copy.</p>	 <p>TV IF MODULE Zenith part 9-1320 has AGC and video pots and audio, AFC and osc coils. 99V012 \$6.95</p>
<p>Computer Beige DESK WART Input: 115 VAC. Output: +5 VDC @ 3.0 A, +12 VDC @ 2.0 A, -12 VDC @ 0.35 A. With pinout docs. 98E015 \$7.95</p>	<p>TVRO PARTS BOARD These are motherboards from block-conversion-type satellite TV receivers. The tuners and PROMs have been removed, but there are hundreds of useful RF and digital parts left, including the 70MHz IF strip. 94V005 \$7.95</p>	 <p>HELPING HANDS MAGNIFIER Heavy cast iron base. 2X 2.2" magnifying glass. Locks at any angle. 93U002 \$5.95</p>
<p>2x40 CHARACTER LCD DISPLAY Has 14-pin interface with documentation to help you interface to your microcontroller projects. 94L005 \$14.95</p>	<p>Check the list of vacuum tubes on our website!</p>	 <p>NEC PASSIVE SPEAKERS Excellent sound quality. Will handle up to 30 Watts. Woofer, midrange and tweeter in case. 20V004 \$8.95/pair</p>
<p>FERRITE ROD 1KHz-1MHz frequency range. Material 33. 5.875"L x 0.5"D. Docs included. 98P005 \$4.95</p>	<p>ALLTRONICS Download Our Catalog: http://www.alltronics.com Open 9-6 M-F and 10-3 Sat. Visa, M/C and AmEx accepted. 2300-D Zanker Road - San Jose, CA 95131-1114 Voice (408-943-9773 - Fax (408) 943-9776</p>	

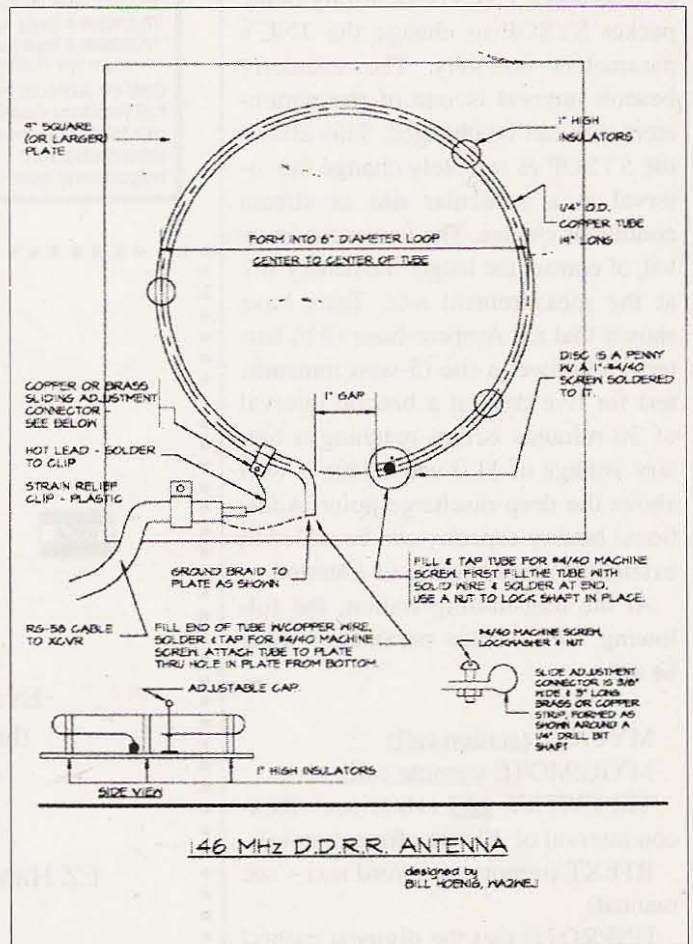

Fig. 2. 146 MHz D.D.R.R. Antenna.

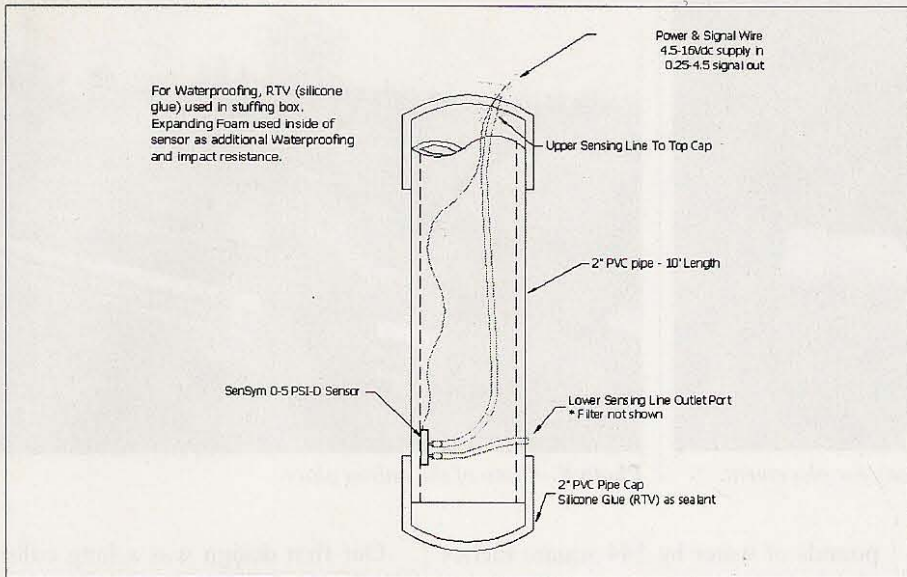

Fig. 3. Sensor capsule. For waterproofing, RTV (silicone glue) was used in stuffing the box. Expanding foam was used inside the sensor for additional waterproofing and impact resistance.

mounted on top of the metal enclosure that houses the electronics; it was covered with a plastic radome. Construction details for the antenna are shown in Fig. 2.

Mechanical sensor

Many designs were discussed, such as floats, potentiometers, pulleys, and magnetic relays. I was familiar with this field, and offered to do a bit of research into any other options. Using either relays or magnetic reed switches would require the use of some sort of float assembly. This type of sensor, while being accurate, is prone to clogging and binding when placed out in the "field" among the elements (Murphy's corollary). With the advent of solid state pressure transmitting devices, this offered another avenue for investigation.

Buying something ready-made off the shelf was entirely out of the question, as costs quoted were in the four figure range! However, further investigation led to the discovery of the SENSYM company and their family of inexpensive pressure transducers. More important to our purposes was their differential pressure transducer in the 0 to 5 PSI range. The sensor measures the difference between the pressure at the two tubing connections. These sensors will run on DC voltage

from 4.5 to 16 volts and their output signal is linear between 0.25 and 4.5 volts, exactly what we needed. These are available from Digi-Key at \$48 singly or \$35 in batches of ten.

If you are wondering why I am discussing a pressure transducer to measure depth of water, a short discussion in fluid mechanics is needed to clarify the problem:

Pressure at depth is related to the vertical height of the fluid above the measuring point and its specific gravity. In fluid dynamics, this is referred to as "head." Pressure is linear and directly proportional to depth or head. Mathematically this is expressed as SPECIFIC WEIGHT x HEIGHT. Head pressure is not related to the amount of water in containment, only to the depth of liquid in that container.

Try to visualize a one square inch column of water one foot high. If you could magically turn this column to Jell-o and stand it upright on a scale, it would weigh .433 pounds. Remember that our column is only ONE SQUARE INCH, so we have .433 pounds per square inch. We can verify this by converting the weight of one cubic foot of fresh water (62.4 pounds) to that weight per square inch at its

www.amcominc.com

Toll Free Orders: 1-888-803-5823

Am-Com, Inc. ClearSpeech® Speaker

5.5" X 4.3" X 2.5"



\$149⁹⁵

plus S&H
(Reg. Price \$179.95)

This easy-to-use DSP speaker activates automatically and filters 95% background noise, static and other interference.

- Improves clarity & intelligibility
- Improves signal to noise ratio
- Continuous, adaptive removal of background noise
- Engineered for use with amateur radios
- Listen with less fatigue & greater concentration
- Speaker output jack

Am-Com, Inc. ClearSpeech® Base

You asked for it. The unique digital noise canceling technology of the popular ClearSpeech® Speaker, but without the internal speaker. Removes up to 95% of noise from received audio.



3"X1"X5.5"

\$149⁹⁵

plus S&H
(Reg. Price \$179.95)

Use in-line with your favorite base station or mobile speaker.

Your One Source Amateur Radio Dealer.

Best Icom Radio Prices

Guaranteed.

Email: amcom@digisys.net

Mail Orders To: Am-Com, Inc., 100 Bierney Rd., Suite C, Lakeside, Montana 59922



Photo D. Here is the sensor capsule, all ready for placement.



Photo E. Photo of the unit in place.

bottom. Since there are 144 square inches in a square foot, dividing 62.4

Qty.	Part	Source	Cost
1	Sensym 0-5 PSID gauge	Digi-Key	\$48.00 + s/h
1	10-inch length 2-inch PVC sched 40	Hardware store	.75
2	2-inch PVC cap	Hardware store	.89
1	Roll 1/4-in. x 100 ft. drip sys. tubing	Hardware store	5.99
1	Roll 1/2-in. x 100 ft. drip sys. tubing	Hardware store	12.00
1	Pkg 1/4-in. barb connectors	Hardware store	4.49
1	Silt stopper — "aquarium stone"	Aquarium or pet store	1.00
1	3-leg voltage regulator (7805)	Hardware store	3.00
1	25-turn trimpot	Electronics store	3.00
	Acrylic for antenna cover	Hardware store	12.00
1	Roll copper tubing for DDR	Hardware store	12.00
12	1/4-in. tubing clamps	Hardware store	3.00
6	Padlocks	Hardware store	35.00
1	7 Ah gel-cell battery	Your choice	23.00
Misc.: plugs, wire, connectors, assorted screws, RTV, PVC cement, acrylic glue, expanding foam			
1	Model 8621 Data Radio	MFJ	125.00
1	KPC-3 Plus TNC	Kantronics	130.00

Table 1. Parts list.

pounds of water by 144 square inches yields .433 pounds per square inch. So, to apply this to our purpose, we merely generate a table of HEIGHT OF FRESH WATER VS. PRESSURE and we can use this table to calibrate our measurements. Thus, 0-5 PSI should give us the range of 10 feet we desire (10 feet of Fresh Water = 4.33 PSI). We will use a DIFFERENTIAL pressure gauge so that we can SUBTRACT the weight of the AIR on top of the water (14.7 PSI). This will eliminate any error that would otherwise be introduced related to changes in barometric pressure.

We will need a waterproof, semi-rigid enclosure that is easily and cheaply constructed. PVC pipe with the proper I.D. dimensions (2") was found to be the best choice. Also, it was felt prudent to fabricate some sort of silt/debris guard to protect the 1/4" tube lower sensing line. A simple porous stone air bubbler from the pet store aquarium department was chosen as offering good surface area with the possibility of some "self-cleaning" characteristics. Ideally, a larger diameter pipe could be attached over the lower sensing end with horizontal "slits" cut at intervals to reduce debris and maintain good water flow. We also thought of reducing the upper portion of the sensor to 1", but felt that the added rigidity of the 2" PVC afforded the cheapest and easiest structural stiffness. A porous stone filter will also be added to the upper or atmospheric sensor to repel any debris or homeless insects.

Our first design was a long column of 2" PVC pipe to be lashed or strapped to the bridge column. Unfortunately, when the prospective bridge sites were initially surveyed, they were free span bridges with no upright column supports rising from the water. So, back to the drawing board, and it was decided to reduce the design to a waterproof "capsule" to protect the sensor. The final design is shown in Fig. 3 and Photo D.

This left only the 1/4" tubing and the four conductor wires exiting the sensor "capsule" to be led through a 1/2" drip irrigation tubing in a shallow trench up to the radio/TNC box. Remember, one of the lengths of tubing must be in the atmosphere at all times. The "capsule" was anchored with a duckbill anchor, which works similarly to how a lag bolt or screw works. This will ensure that our sensor won't be floating away anytime soon.

The county did the trenching, installation, and backfill of the sensors. They also provided the radio box enclosures fabricated from steel. Miles AB7ZX supervised the radio/TNC installations, with John KB7FND doing the on-site wiring and fine tuning. A few minor troubleshooting problems were ironed out within the first week of "shakedown" operation. The radio required fine-tuning for maximum signal sensitivity with minimum power consumption. Photo E shows the final installation.

The ultimate goal of this project is to be able to correlate stream height

Continued on page 58

Kenwood's Hot New TS-2000

Could YOU handle all these features?

I recall several years ago when I made a prediction that the Trio Corporation would eventually consider the Kenwood Communications amateur product line a rounding error in the grander scheme of things, and we would have one less manufacturer of ham gear to draw from. MAN, was I ever wrong! Not only has Kenwood not disappeared, but they are extending the state-of-the-art of amateur radio products in an aggressive way. The new TS-2000 is vivid proof of that.

I will confess to you that I was a bit excited when I heard about this product. When Dave N7KZN called me to let me know that the first TS-2000 to hit the state of Washington was on his counter at Radio Depot in Seattle, I made the 25-mile trip from my QTH in less than 30 minutes. After a brief period of manhandling the controls, I decided to give it a new home.

Having said that, however, I want to assure you that what follows is a purely objective review of this new offering from the good folks at Kenwood.

General overview

From a functional standpoint, the TS-2000 is two transceivers in one box. It is an HF transceiver that incorporates many of the features of the TS-570 and the TS-870 (while adding a few of its own), as well as a variation of the multifaceted TM-D700A. Its delineation is not quite that simplistic, however. The TS-2000 is a complex matrix of transceiver components that allows it to operate as two independent radios in one box. It can allow the user to operate on HF and either VHF or UHF simultaneously, which is

something that recent offerings in the arena of 160m to 70cm all-mode radios cannot currently do. It also has the capability of operating as a full-duplex VHF and UHF transceiver for the purpose of working the OSCARs, or similar applications. What is truly unique is the on-board packet TNC that was borrowed from the TH-D7G, which has the ability to transfer data over the air at selectable rates of 1200 and 9600 bps. **Tables 1 through 4** show the general specifications of the TS-2000.

Physical characteristics

Kenwood has listed a number of

distinctive features in their promotional literature. However, it is my opinion that they have overlooked an important feature that definitely adds value from a consumer perspective: ruggedness. The box that houses the electronics is an aluminum casting. The fasteners are of a good quality, and the machine work is very high-caliber. When viewed in comparison to some radios that come in a thin-walled, spot-welded enclosure, the TS-2000 has extraordinary structural integrity.

The front panel is a stylistic ergonomic design. I found that everything was easily accessed, and functionally



Photo A. This is the front view of the stylishly new Kenwood TS-2000 — a true work of art. (Photo compliments of Kenwood)

Receiver		TS-2000 TS-B2000	TS-2000X
Sensitivity	SSB/ CW/ FSK (S/N 10 dB)	0.5 ~ 1.705 MHz: 4 µV or less 1.705 ~ 24.5 MHz: 0.2 µV or less 24.5 ~ 30.0 MHz: 0.13 µV or less 50.0 ~ 54.0 MHz: 0.13 µV or less 144 ~ 146 MHz: 0.11 µV or less (All E-types) 144 ~ 148 MHz: 0.16 µV or less (K-type) 430 ~ 440 MHz: 0.11 µV or less (All E-types) 430 ~ 450 MHz: 0.11 µV or less (K-type) 1240 ~ 1300 MHz: 0.11 µV or less (All types)	
	AM (S/N 10 dB)	0.5 ~ 1.705 MHz: 31.6 µV or less 1.705 ~ 24.5 MHz: 2.0 µV or less 24.5 ~ 30.0 MHz: 1.3 µV or less 50.0 ~ 54.0 MHz: 1.3 µV or less 144 ~ 146 MHz: 1.0 µV or less (All E-types) 144 ~ 148 MHz: 1.4 µV or less (K-type) 430 ~ 440 MHz: 1.0 µV or less (All E-types) 430 ~ 450 MHz: 1.0 µV or less (K-type) 1240 ~ 1300 MHz: 1.0 µV or less (All types)	
	FM (12 dB SINAD)	28.0 ~ 30.0 MHz: 0.22 µV or less 50.0 ~ 54.0 MHz: 0.22 µV or less 144 ~ 146 MHz: 0.18 µV or less (All E-types) 144 ~ 148 MHz: 0.25 µV or less (K-type) 430 ~ 440 MHz: 0.18 µV or less (All E-types) 430 ~ 450 MHz: 0.18 µV or less (K-type) 1240 ~ 1300 MHz: 0.18 µV or less (All types)	
	AM (S/N 10 dB)	Sub	144 ~ 146 MHz: 1.55 µV or less (All E-types) 144 ~ 148 MHz: 2.25 µV or less (K-type) 430 ~ 440 MHz: 1.55 µV or less (All E-types) 438 ~ 450 MHz: 1.55 µV or less (K-type)
	FM (12 dB SINAD)		144 ~ 146 MHz: 0.28 µV or less (All E-types) 144 ~ 148 MHz: 0.40 µV or less (K-type) 430 ~ 440 MHz: 0.28 µV or less (All E-types) 438 ~ 450 MHz: 0.28 µV or less (K-type)
Selectivity	SSB (Low-cut: 300 Hz/ Hi-cut: 2600 Hz)	Main	-6 dB: 2.2 kHz, -60 dB: 4.4 kHz
	AM (Low-cut: 100 Hz/ Hi-cut: 3000 Hz)		-6 dB: 6.0 kHz, -50 dB: 12.0 kHz
	FM		-6 dB: 12.0 kHz, -50 dB: 25.0 kHz
	AM	Sub	-6 dB: 12.0 kHz, -50 dB: 25.0 kHz
	FM		-6 dB: 12.0 kHz, -50 dB: 25.0 kHz
Image rejection	Main transceiver	70 dB or more	
	Sub-receiver	60 dB or more	
1st IF rejection	Main transceiver	70 dB or more	
	Sub-receiver	60 dB or more	
Notch filter attenuation (at 1 kHz)		30 dB or more	
Beat cancel attenuation (at 1 kHz)		40 dB or more	
RIT shift frequency range		±20.0 kHz	

Table 1. Receiver performance specifications. Source: Kenwood Service Manual.

Receiver		TS-2000 TS-B2000	TS-2000X
Circuit type	Main transceiver	SSB/ CW/ AM/ FSK: Quadruple conv. superheterodyne FM: Triple conversion superheterodyne	
	Sub-receiver	FM/ AM: Double conversion superheterodyne	
Frequency range	Main transceiver	0.03 ~ 60.0 MHz (All types) 142 ~ 152 MHz (K-type) 144 ~ 146 MHz (All E-types) 420 ~ 450 MHz (K-type) 430 ~ 440 MHz (All E-types) 1240 ~ 1300 MHz (w/ UT-20)	0.03 ~ 60.0 MHz 142 ~ 152 MHz 420 ~ 450 MHz 1240 ~ 1300 MHz
	Sub-receiver	118 ~ 174 MHz (K-type) 144 ~ 146 MHz (All E-types) 220 ~ 512 MHz (K-type) 430 ~ 440 MHz (All E-types)	118 ~ 174 MHz 220 ~ 512 MHz
Intermediate Frequency (IF)	Main transceiver	1st IF: 0.03 ~ 60 MHz: 69.085 MHz or 75.925 MHz 118 ~ 512 MHz: 41.895 MHz 1240 ~ 1300 MHz: 135.495 MHz 2nd IF: 10.695 MHz 3rd IF: 455 kHz 4th IF: 12.0 kHz	
	Sub-receiver	1st IF: 58.525 MHz 2nd IF: 455 kHz	

Table 2. Receiver operational specifications. Source: Kenwood Service Manual.

well organized. I appreciated the fact that the buttons were not too small for me to control, and that the markings were easy for me to read. Of course, the most important feature of any HF radio is how good the tuning knob feels. This one has all the feel of something superbly machined. There is no wobble that I could detect, and the motion is smooth and easy. The tuning rate is front panel menu controllable at rates of 500 and 1000 Hz-per-revolution. This tuning rate may be reduced by a factor of 10 by depressing the FINE button on the front panel. Did I mention that the tuning knob has a nice feel to it?

The rear panel is also well designed. There is a minimum of clutter. The RF connectors are placed in such a manner as to minimize coax runs from their respective circuit boards. There are two selectable HF ports, as well as a handy RCA jack input for the ham who has a beverage or two that he or she would like to employ. The really nice thing is that the RCA jack is menu-selectable. There is no need to pull the cover off and manipulate a tiny microswitch.

There is a nice feature brought forward from (if I remember correctly) the TS-570. There are two separate CW interface ports. One is the standard stereo jack for the keyer paddles. The other is a direct keying jack that functions in parallel with the keyer. This is really nice when using your favorite contest logging software. You can operate the keying function of the logging software and the internal paddle simultaneously. And I might as well mention it now: There is also a menu item that allows the keyer to override the direct keying port if the operator so desires.

Circuitry overview

As I stated earlier, the TS-2000 operates by the carefully planned manipulation of a matrix of common circuitry, as well as a cadre of dedicated components. For example, the receiver front ends and transmitter power amplifiers operate as common assets for the two receivers. There are, in essence, two independent receivers. One is referred

Transmitter			TS-2000 TS-B2000	TS-2000X
Output power	SSB/ CW/ FSK/ FM	Max.	100 W (160 m ~ 2 m band)/ 50 W (70 cm band)/ 10 W (23 cm band)	
		Min.	5 W (160 m ~ 2 m band)/ 5 W (70 cm band)/ 1 W (23 cm band)	
	AM	Max.	25 W (160 m ~ 2 m band)/ 12.5 W (70 cm band)/ 2.5 W (23 cm band)	
		Min.	5 W (160 m ~ 2 m band)/ 5 W (70 cm band)/ 1 W (23 cm band)	
Modulation	SSB		Balanced	
	FM		Reactance	
	AM		Low level	
Spurious emissions	160 m ~ 10 m band		-50 dB or less	
	6 m ~ 70 cm band		-60 dB or less	
	23 cm band		-50 dB or less	
Carrier suppression (SSB)			50 dB or more	
Unwanted sideband suppression (modulation frequency 1.0 kHz)			50 dB or more	
Maximum frequency deviation (FM)	Wide		±5 kHz or less	
	Narrow		±2.5 kHz or less	
XIT shift frequency range			±20.0 kHz	
Microphone impedance			600 Ω	

Table 3. Transmitter performance specifications. Source: Kenwood Service Manual.

to as the MAIN receiver, and the other the SUB receiver. The MAIN receiver's frequency is displayed in the prominent central position above the main tuning knob, while the SUB receiver is displayed in a half-sized font to the right. There is an exception to this, of course, as in the case of satellite operation, where the A and B bands may be switched back and forth, and when the MAIN unit is operating in SPLIT mode. It should be noted that even when something other than the

SUB receiver's frequency is being displayed in the right window, it continues to operate normally. This is to say that the SUB function is not suspended when the MAIN section is operating SPLIT.

The audio detection of the various operating modes (other than FM in the SUB receiver) is accomplished in the final IF using DSP. The ability to set the center frequency and width of the IF DSP filter on the fly means that there are no expensive crystal or mechanical

Transmitter			TS-2000 TS-B2000	TS-2000X
Frequency range	160 m band		1.8 ~ 2.0 MHz (K-type) 1.81 ~ 2.0 MHz (E-type) 1.83 ~ 1.85 MHz (E2-type)	1.8 ~ 2.0 MHz
	80 m band		3.5 ~ 4.0 MHz (K-type) 3.5 ~ 3.8 MHz (All E-types)	3.5 ~ 4.0 MHz
	40 m band		7.0 ~ 7.3 MHz (K-type) 7.0 ~ 7.1 MHz (All E-types)	7.0 ~ 7.3 MHz
	30 m band		10.1 ~ 10.15 MHz	
	20 m band		14.0 ~ 14.35 MHz	
	17 m band		18.068 ~ 18.168 MHz	
	15 m band		21.0 ~ 21.45 MHz	
	12 m band		24.89 ~ 24.99 MHz	
	10 m band		28.0 ~ 29.7 MHz	
	6 m band		50.0 ~ 54.0 MHz (K-type) 50.0 ~ 52.0 MHz (E-type) 50.0 ~ 50.2 MHz (E2-type)	50.0 ~ 54.0 MHz
	2 m band		144 ~ 148 MHz (K-type) 144 ~ 146 MHz (All E-types)	144 ~ 148 MHz
	70 cm band		430 ~ 450 MHz (K-type) 430 ~ 440 MHz (All E-types)	430 ~ 450 MHz
	23 cm band		1240 ~ 1300 MHz (w/ UT-20)	1240 ~ 1300 MHz

Table 4. Transmitter operational specifications. Source: Kenwood Service Manual.



The impressive **IC-756 Pro** covers HF plus 6 meters. The high resolution 5 inch TFT color display provides more operating information than ever, including a spectrum scope. The 32 bit floating point DSP provides crisp, clear reception with 41 built-in filters. The "Pro" is the choice for serious DXers and contesters.

IC-746 ✓ 160 to 2 Meters!



The **IC-746** covers 160-10 meters plus 6 and 2 meters with 100 watts on all bands. Call or visit our website for further details and pricing on this and other ICOM radios.

universal radio inc.
Universal Radio
 6830 Americana Pkwy.
 Reynoldsburg, OH 43068
 ♦ Orders: 800 431-3939
 ♦ Info: 614 866-4267
www.universal-radio.com

AEA
RF and Audio Equipment

CableMate®

Time Domain Reflectometer (TDR)

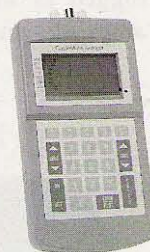

Specifically Designed for the RF Service Technician.

Reduced Price!
 now only **\$399.95**

Detect and Locate Faults (Real Time) in cables ranging from 16 to 2,000 feet.

Come take a look
 at our updated website

www.aea-wireless.com

AEA RF and Audio Equipment

1487 Poinsettia Suite #127 Vista, CA 92083
 P: (800) 258-7805
 P: (760) 798-9687
 F: (760) 798-9689
 e-mail: aea@aea-wireless.com

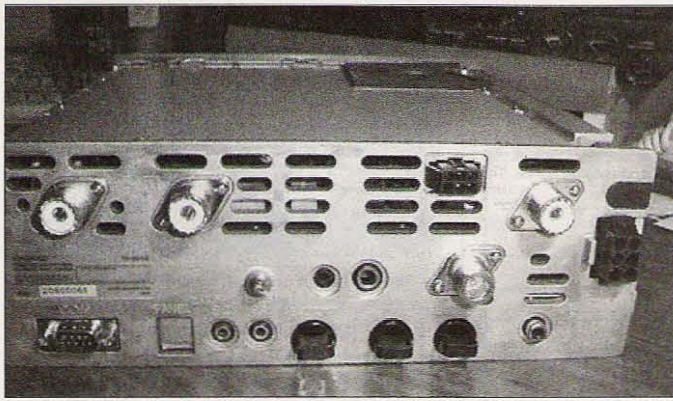

Photo B. The rear view shows the very solid nature of the chassis, and the position of the various interfaces. Note that the UHF antenna connector is type-N. The antenna connector for the 1296 module is a pigtail (not installed on this radio) that protrudes from the black cover in the upper right-hand corner. (This and remaining photos by Rick Olsen)

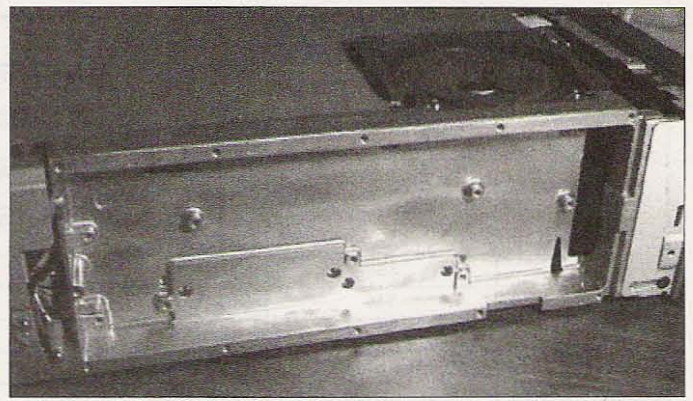

Photo C. This is the enclosure for the 1296 module. Note that there is a conductive cover over the upper portion of the chassis, which houses the transmitter power amplifiers and the antenna tuner. On the lower right you can see that the front panel is hinged to allow direct access to the control board and display components.

filters to purchase. However, since both receivers cannot use DSP detection simultaneously, the SUB receiver only operates on FM and AM. There are a number of audio DSP algorithms available to the MAIN receiver (which will be discussed in a bit). DSP is used in the transmit path as well. This allows the user to program special RX and TX audio characteristics from the main menu. The frequency response of the RX and TX may be tailored to the specific tastes of the operator, or, if you are a kind-hearted soul, to the tastes of the listener at the other end.

There are three RF power amplifiers (four with the 1296 module installed). All three amplifiers run class AB, allowing linear operation on SSB and AM. They are quite rugged as well. The 2m and HF/6m amps shown in

Fig. 1 are on the large board on the underside of the radio, and both are capable of 100 watts. The 440 amp is on its own board, and puts out 50 watts. Here is a case where the aluminum casting design comes in quite handy. It functions well as a heatsink, and is cooled by a very quiet fan that is controlled by temperature sensors.

I almost forgot to mention the superb automatic tuner that is included with the TS-2000. This is one of the better ones that I have used so far. While most of the automated tuners intended to drive coaxial antenna circuits are limited to around a 3:1 VSWR, this one is not. It has successfully tuned circuits with an indicated VSWR greater than 6:1. It has its limitations, though, and it will tell you up front. The limit appears to be in the 6:1

range, and will refuse to tune above that. It will also send you a polite "SWR" in Morse code to let you know that the tuning limit has been exceeded (a warning to you "slow-coders" out there — it's faster than 5 wpm). I was very pleasantly surprised at the speed and range of this tuner.

Back to DSP

Part of the genius of this radio is the way in which it does signal processing. In this radio there is not one, but two independent DSP chips (see **Photo J**). They both run at a clock speed of 100 MHz, and actually communicate with each other when performing their individual tasks.

I have already mentioned that the operator may select preset frequency contouring for receive and transmit

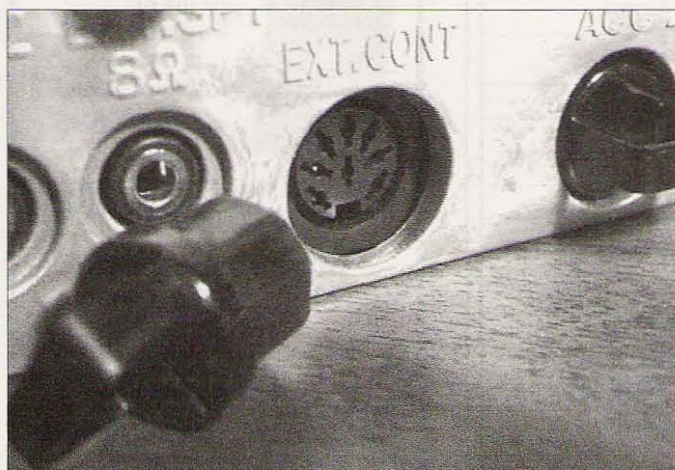

Photo D. The accessory ports have dust covers to protect them when not in use.



Photo E. The com port, which doubles as the rig control and TNC interface, is a DB-9. The "panel" port to the right is the interface for the RC-2000 remote head.

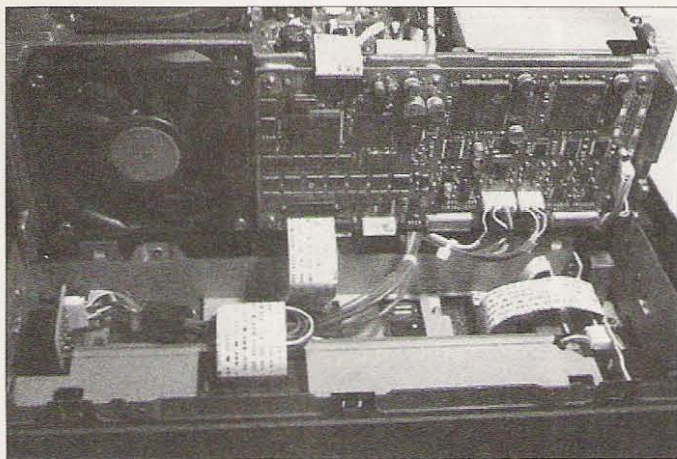

Photo F. This is the front view with the display tilted down to provide access to the display boards, and to the control board that houses the TNC and DSP components. I was quite surprised at how quiet the fan is, especially considering its size.

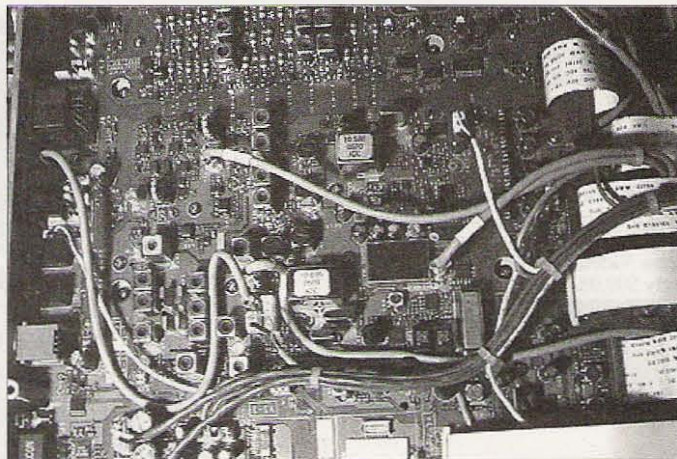

Photo H. This is the main TX/RX unit circuit board. This is where all the "sharing" occurs. Note that there are numerous coax and ribbon cable interfaces to the smaller ancillary TX/RX units not shown here.

audio from the menu. What I did not mention is that the soon-to-be-released ARCP2000 radio control software will provide the ability to personalize one of those menu items. I hope to have a separate feature on that software in the near future. (I wrote this review during and after the big earthquake here in Seattle, so I didn't get a chance to review the software.)

As for the IF filters, there are default settings that come up when a given mode is selected for the first time. You may then select the center and width of

the filter for that mode according to your own tastes, and the radio will remember that setting from then on. You don't need to re-enter these settings every time you turn the radio on. For your convenience, the center frequency and filter width are set using two vernier knobs in the lower left-hand corner of the front panel. The front panel shows both analog and alphanumeric displays of the filter settings.

Another aspect of the power of this formidable DSP engine is the ability to reduce broadband noise and coherent interference. The MAIN receiver enjoys two types of noise reduction filters. The first, called NR1, is a linear adaptive filter that is similar to that found in many modern transceivers. What is noteworthy is that the threshold of NR1 mode is front panel selectable, or may be left in the AUTO mode. I have played with this a bunch, and found that leaving it in the AUTO mode works fine for me, especially when working SSB and FM. I should mention that the SUB receiver can employ this filter as well, but only this one. The others are not available

The second mode is NR2, which is a correlation algorithm that has a variable duration of 2 to 20 msec. This is an excellent filter for CW use, but takes a little time to get used to. I have found that a setting of 8 msec is ideal for the type of CW operating that I enjoy, which ranges in speeds from about 18 to 30 wpm. It also took me a little

time to get used to the mechanical artifact sound of the background noise. It sounds more like a babbling brook than the soft hiss of a Collins 73S3. Not to worry, though. It will sound normal to you in no time.

The TS-2000 has three, count them, THREE digital mechanisms for getting rid of those pesky 40m AM carriers and careless tuner-uppers. The first is an automatic notch filter with a variable threshold that can be controlled from the front panel. This is useful if there is some distortion or other modulation characteristics present on the unwanted carrier. There is also a beat-canceller, which leaves the IF passband alone, and removes the note from the audio. It is an adaptive filter that can handle more than one beat note, and will automatically shift frequency in synch with those tones that drift about.

If you're like me and have been frustrated by the efficiency of these types of unwanted tone removers, especially when they work so well at also canceling the station you want to listen to on CW, then fret no more. The TS-2000 also has a MANUAL beat canceler. This is great! I finally have the ability to notch out that nudnik who likes to tune up on me when I am in QSO on CW. What a blessing, and it works very well. And what's better is that it doesn't introduce a lot of distortion to the passband like the analog notch filters do.

There are some additional features associated with the DSP engine in this

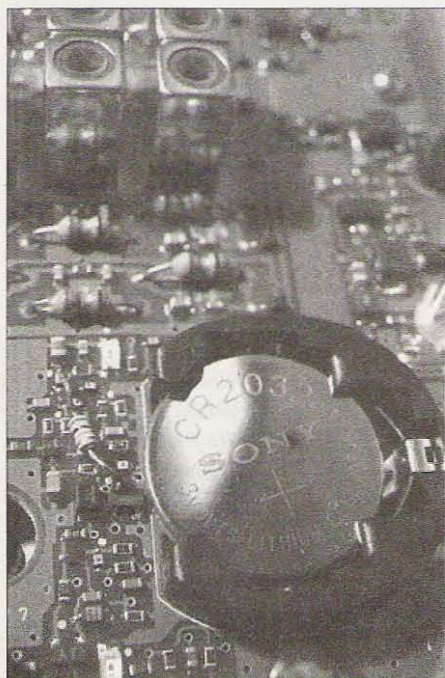

Photo G. The circuit boards consist of primarily surface-mount components, with a smattering of larger discrete devices.

Pay TV and Satellite Descrambling
New Volume 12 New

Pay TV and Satellite Descrambling VOL-
UME 12 has latest cable and satellite fixes
including new EK-1, bullet blockers, etc.
\$18.95. Complete Pay TV And Satellite
Descrambling Series CD-ROM, Vol. 1-12
\$59.95. Scrambling News Online includes pi-
racy \$59.95/yr. Hacking Digital Satellite Sys-
tems Video IV \$29.95. Everything listed here
only \$99.95. Free catalog.

Scrambling News
915 N.W. 1st Ave., #2902
Miami, FL 33136
Voice/FAX 305-372-9427
www.scramblingnews.com

Repeaters

6 & 2 m & 440 On your frequency

\$399.95 & \$499.95

Repeater Controllers

RC-1000V \$259.95 / RC-100 \$129.95

Micro Computer Concepts

8849 Gum Tree Ave

New Port Richey, FL 34653

727-376-6575 10 AM-10 PM

e-mail n9ee@akos.net

http://mcc.stormfan.com

Ad Sales
call
Evelyn Garrison
425-557-9611

HamCall™ CD-ROM
U.S. & International - Over 1.63 million listings



We make a new HamCall every
month! Clearly, the most
current and complete
CD-ROM available.

Latest Features

- Choose font and color of data display.
- Displays flag and map for each country.
- Shows CQ, ITU zone, and continent.
- History list shows each call sign entered.
- Print labels in a variety of formats.
- View & search interests of 39,000 hams.
- Search for club, military, vanity, silent keys,
name, address, and more.

Over 1,631,000 U.S. and International listings, 128,000
e-mail addresses, 4,000 photos and QSL cards, 37,000
vanity calls, and 20,000 references to QSL managers.

Shows path distance & bearing.
Precise latitude/longitude for over 90% of addresses.
HamCall is \$50.00, included is 6 months free access to
our HamCall Internet Service - request when ordering.

HamCall Mousepad, with morse code reference,
7.5" x 8", blue with yellow letters. \$5.00+ \$3 shipping.
\$5.00 shipping (\$8 Intl) per order. Your satisfaction guaranteed!

BUCKMASTER
6196 Jefferson Highway • Mineral, VA 23117 USA
e-mail: info@buck.com
540:894-5777 • 800:282-5628 • 540:894-9141 (fax)

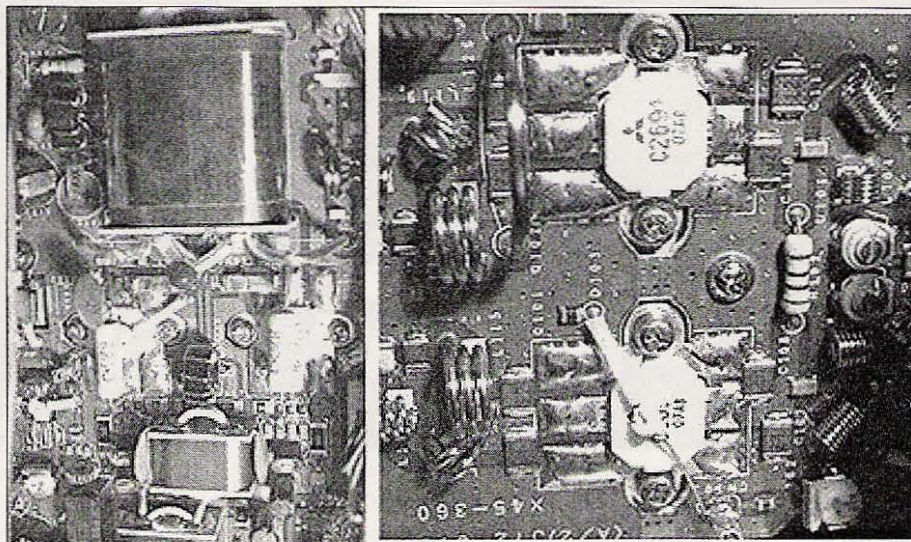

Photo 1. The RF power amplifiers are very rugged, and represent the latest in device technology. The 100W HF amp is on the left. The 100W VHF amplifier is on the right. The 50W UHF amplifier is on a separate board not shown here. I might add that the HF amp stands as a testament to the design of my late friend Helge Granberg, K7ES/OH2ZE. The design that he pioneered in the early '70s is still with us today. The good stuff always stands the test of time.

radio, like the vernier control of the AGC, that you can discover on your own.

Additional features

This radio is so feature-rich that if I were to describe all of them, this article

would cease to be an operator's review, and become a rewrite of the operator's manual. But there are a few that should be mentioned, the first of which is the memory and configuration management capability of the TS-2000. There are 300 memory channels available,

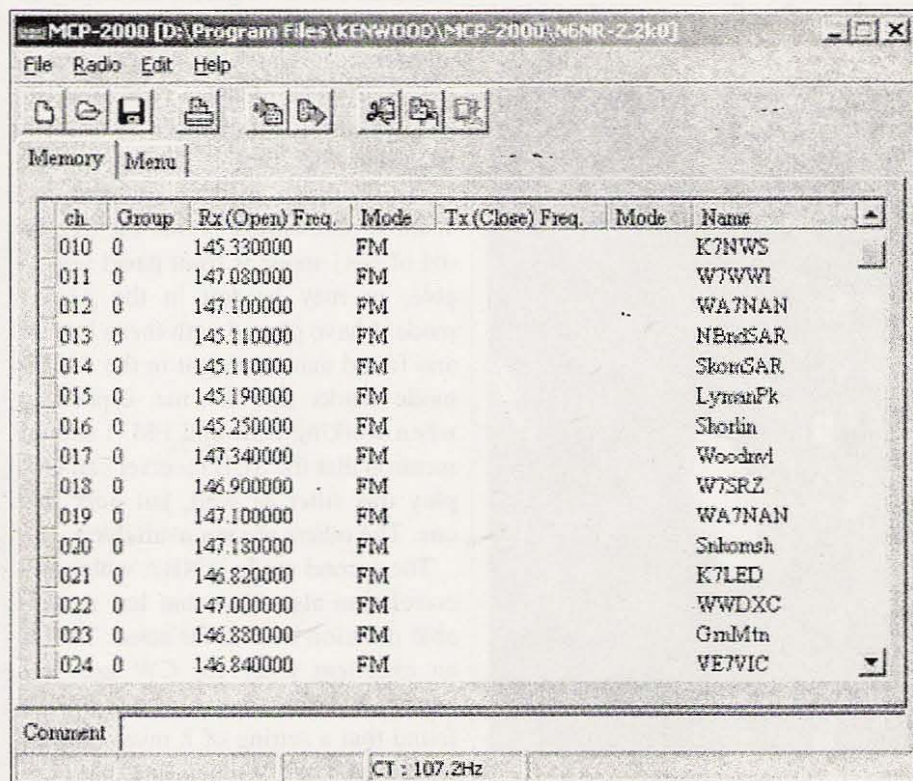

Fig. 1. This is the memory control panel for the MCP2000 software provided for free by Kenwood.

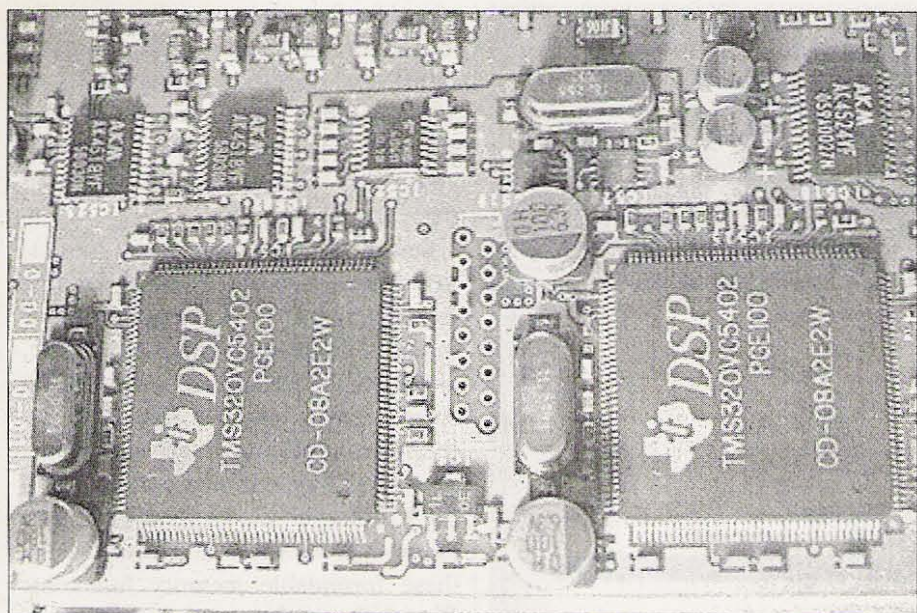

Photo J. Not one, but two TMS320s serve as the core of the DSP functions inherent within the TS-2000. One processes the IF and functions as a variable bandpass filter and demodulator, while the other does the audio processing (noise reduction, etc.). This DSP engine also allows for linear control of the AGC time constant.

which are easily programmable from the front panel. Let me tell you that this is a real blessing. These channels may also be programmed with an alphanumeric name tag (also from the front panel) that facilitates easy recall of just why-in-the-heck I saved each

frequency and mode. These memory channels may also be grouped and scanned in 10 subgroups. This is quite handy for segregating the frequent- from little-used channels in the scanning process.

If you are in a hurry, and don't want to fiddle with programming a specific

Memory Channel

Memory Channel Number

<p>Frequency</p> <p>Rx Frequency <input type="text" value="147.080000"/> MHz</p> <p>Mode <input type="text" value="FM"/></p> <p>Step <input type="text" value="5kHz"/></p> <p>Offset <input type="text" value="600"/> kHz</p> <p><input type="radio"/> Split</p> <p><input type="radio"/> Simplex <input type="checkbox"/> Reverse</p> <p><input checked="" type="radio"/> Plus Shift</p> <p><input type="radio"/> Minus Shift</p>	<p>Tone/CTCSS/DCS</p> <p><input checked="" type="checkbox"/> Tone <input type="checkbox"/> CTCSS <input type="checkbox"/> DCS</p> <p>Tone Frequency <input type="text" value="103.5Hz"/></p> <p>CTCSS Frequency <input type="text" value="107.2Hz"/></p> <p>DCS Code <input type="text" value="023"/></p> <p>Option</p> <p>Memory Group <input type="text" value="0"/></p> <p>Memory Name <input type="text" value="W7WWI"/></p> <p><input type="checkbox"/> Lock Out</p>
---	---

Fig. 2. This shows the detailed control panel that may be used to program each memory channel. This detail may be copied from channel to channel using the main memory control panel, and then modified here. This prevents the need to re-program every detail when perhaps only the memory name and frequency are different.

LOW PROFILE HF ANTENNAS
THAT REALLY WORK!
"Work the World Without Working Up the Neighborhood"

ISOTRON
BILAL COMPANY
Call for a **FREE** Catalog:
719/687-0650
137 Manchester Dr.
Florissant, CO 80816
www.rayfield.net/isotron

208-852-0830
<http://rossdist.com>

Over 9050 HAM Items in Stock!

ICOM
Special
Under \$460.00 **IC-2800H**

RDC Check Out Our Specials! We're On The Web.
ROSS DISTRIBUTING COMPANY All Prices Cash
78 S. State Street, Preston, ID 83263 FOB Preston
Hours Tue.-Fri. 9-12 2-5:30 • 9-12 2-30-3:30 Mon. Closed Sat & Sun

SAVE 47%!

on 12 months of **73**

Only \$24.97

Call 800-274-7373

GORDON WEST
HAM TEST PREP TAPES
BOOKS SOFTWARE VIDEOS

Prepare for your ham test with "Gordo" WB6NOA as your personal instructor.

- **THE NEW THEORY** on audio cassettes
No-Code Technician (4 tapes)\$19.95
General Class (4 tapes)\$19.95
Amateur Extra Class (4 tapes)\$19.95
- **THE CODE** on audio cassettes
Learning CW (0-7wpm 6 tapes)\$29.95
Speed Builder (5-16wpm 6 tapes) ..\$29.95
Speed Builder (10-28wpm 6 tapes) ..\$29.95
- **NEW STUDY MANUALS** by "Gordo"
No-Code Technician (**Element 2**) ..\$11.95
General Class (**Element 3**)\$12.95
Extra Class (**Element 4**)\$14.95
- **PC SOFTWARE** with study manuals
No Code Technician (**Element 2**) ...\$34.95
Tech/Tech+/Gen. (+ Code, Windows)\$49.95
General Class (**3+Code, Windows**). \$34.95
Extra Class (**4 + Code, Windows**).. \$34.95
Ham Operator (**Tech.-Extra + Code**) \$59.95
Morse Software Only\$12.95
- **VIDEO** VHS with study manual
No-Code Tech Video Course.....\$31.95

Add \$5.00 shipping 1st item, .50 each additional
Priority Mail 2-3 day service available
VISA, Mastercard, Discover, & AMEX Accepted

W5YI Group
P.O. Box 565101 • Dallas TX 75356
1-800-669-9594
www.w5yi.org

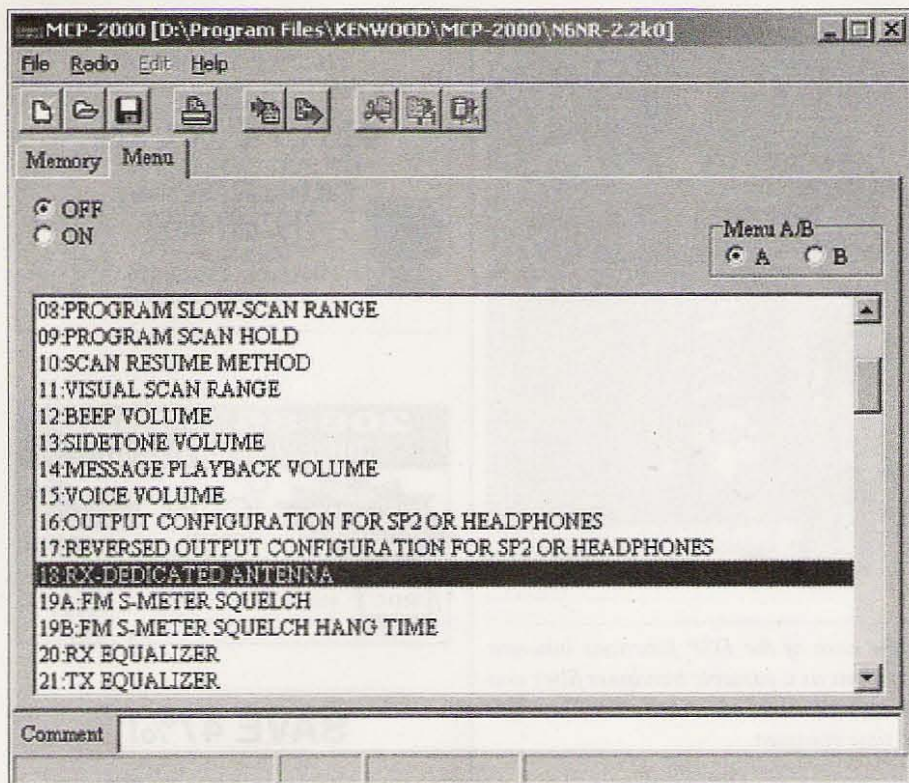

Fig. 3. This is the menu for the memory control. Each menu item is programmable from this panel. Note that it also allows for the programming of the settings for each of the two primary menu configurations that can be set for a specific operating mode or location.

channel, there is also the QUICK MEMORY function that may be used in the VFO mode, and provides convenient storage of 10 channels for quick retrieval. It has been very handy for me in contests, and in pileup management. It stores things like frequency, RIT settings, operating mode

(CW, USB, etc.), and interference rejection modes.

There are also two generic memories for storing the basic configuration of the radio. If you operate the radio as both a mobile and base station, the entire configuration of the radio (all of the menu-controllable items) may be

stored for those two operating environments. Another use would be simply to differentiate between primarily CW or SSB operation, or between contesting and rag-chewing. You get to choose, and it's all commanded by a couple of front panel keystrokes.

One of the things that I feel is commendable concerning Kenwood is that fact that they DON'T charge their customers for memory control software, and make it available in downloadable form on the Internet. If you go to the [http://www.kenwood.net] web page, you can download a program called MCP2000 that allows for simple programming, storage, and retrieval of these formidable memory functions.

Figs. 1, 2, and 3 are screen captures of MCP2000. **Fig. 2** shows an expanded control panel that allows detailed programming of each memory channel shown in **Fig. 1**. **Fig. 3** shows how each menu memory setting may be programmed without having to go to a separate panel for providing the programming detail. This software is a must. I highly recommend it, and it's FREE.

Packet terminal node controller

One area where Kenwood has been out front in the development of technology for us radio amateurs is in the inclusion of packet terminal node controllers (TNCs) in their transceivers. They started with a handheld (TH-D7G), and quickly included their flagship dual-band mobile (TM-D700A). They have closed the product line loop with the TS-2000. The TS-2000 service manual states that the TNC is the same one developed for the TH-D7 by Tasco. It appears to me, at least, that this is the same product that has gone into the TH-D7 and TM-D700, and the Alinco DR135TP. Only minor variations in the command set for the TNC in each radio exist. Kenwood's statement about the derivation of the TS-2000's TNC appears to be right on the mark. Although there is no obvious way to connect a GPS receiver to the TS-2000, the GPS commands found in the TH-D7 instruction set can be observed when sending the DISP command to the TNC in the TS-2000. I am

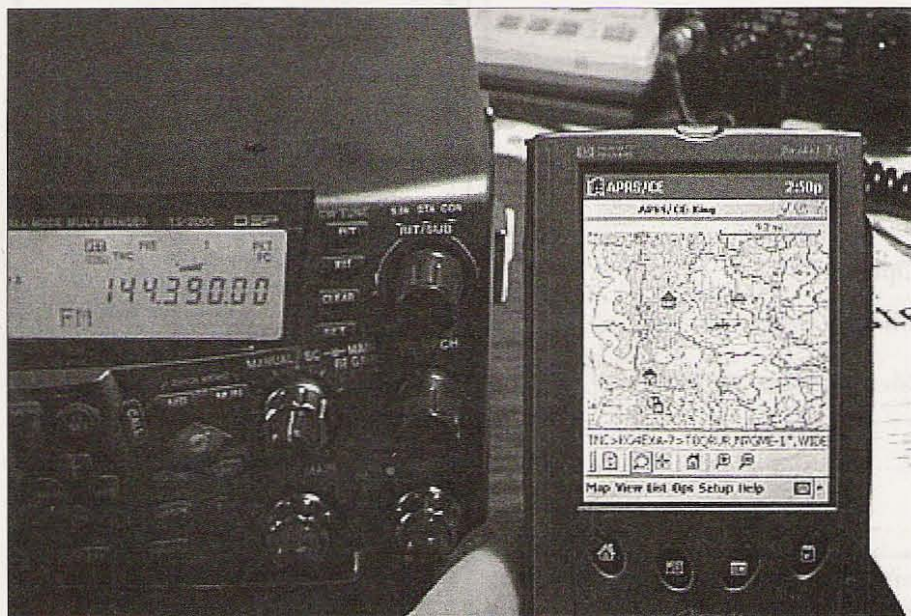

Photo K. This is a snapshot of Rob Wittner's APRS/CE program running on my Jornada 548 in conjunction with the PACKET mode on the SUB portion of my TS-2000.

hoping that a future "blue-wire" mod will come forth from either Kenwood or the general amateur community that will allow GPS interface via one of the unused ACC ports (hint, hint).

The TNC itself is a modest performer, and has been well chronicled in other reviews that feature the radios mentioned above that also have it on board. Interface between the TNC and a PC or laptop is accomplished via a DB-9 serial port on the back of the radio. No high-priced level converters are required. In the case of the TS-2000, the TNC's function is enhanced by its ability to access the DSP chipset to provide some prefiltering when operating AFSK at 1200 bps. At 9600 bps, the TNC has a direct analog route to the outside world via the FM modulator and discriminator. KISS mode for TCP/IP is included, and I can vouch for the fact that it seems to work quite well at both baud rates. I had an opportunity to test it on the local TCP/IP network that is run by Puget Sound's WetNet Experimenters Group.

Although the APRS functionality found in the TM-D700 is not included in the TS-2000, there is yet one very unique and useful internal function that it can perform. It is called the Packet Cluster Tune (PCT) function. This is really slick, and it works like this. The user sets the SUB RX to the local DX packet cluster frequency, sets the SUB RX as the data band, and turns on the PCT function. When a packet cluster DX spot announcement is received, the frequency, callsign and other related data appear in the SUB window. The information is also automatically written to the QUICK MEMO pad for later retrieval.

The PCT function may be configured by front panel menu commands to do the following. First, it will provide an announcement to the operator in the form of a beep, a CW recital of the callsign, or (if you have the optional VS-3 voice synthesizer unit installed) a voice announcement of the same. That's not all. You can also set this function to automatically set the radio to the frequency from the DX spot that is displayed in the SUB window. If that sounds like a potential inconvenience,

the radio may also be configured to only change frequency when commanded to do so by depressing the SET button. I showed that function to some of the members of the Redmond Top Key Contest Club, and they got a big kick out of it. I have to admit that I have used that function quite a few times myself. It really helps to keep the traffic density down on the packet cluster channels, as this is a passive feature (meaning it doesn't require any transmitting). With the dual radio personality of the TS-2000, the monitoring of the packet cluster channel is uninterrupted while carrying on a QSO on HF.

Wrap-up

There is much more that I could write about the features and performance of this radio. I intend to write a separate review on the anticipated ARCP2000 remote control software that is soon to be released with their introduction of the "box" version of the radio. You heard me right. By the time you read this, Kenwood will have released the TS-B2000, which is a blank-faced version of the TS-2000 that may be controlled by the ARCP2000 software on a PC or laptop, and via the RC-2000 remote control head (borrowed from the TM-D700). In that review, I will also talk a bit about the following features:

- Sky Command II
- Crossband repeat
- Remote control
- Microphone control
- Direct FSK operation
- Satellite operation
- User-defined digital filtering of RX and TX audio

Until then, I encourage you to have a close look at this fine radio for yourself. My neighbor did, and went in and bought one for himself, and he is very critical of radios — their performance and features, that is. That in and of itself is a testimony to the impact that this rig can have on hams who come in contact with it.

The bottom line is that Kenwood has not just produced an excellent radio. What they have done is to further the state-of-the-art in affordable amateur

equipment. And I will stand by my assertion that this radio provides a very high level of features and performance for its price, which, by the way, is currently about \$2,270 over the counter. When I first heard about its impending introduction, I was certain that the price would easily exceed three kilobucks. Having said that, I believe that the price including the optional accessories such as the VS-3 voice synthesizer, the DRU-3A digital recording unit, the RC-2000 remote kit, and the soon-to-be-released UT-20 1296 module, will drive the total cost over that mark. However, these are optional items that can be purchased later based on a value-added decision that concerns your own operating needs and desires. The radio as it stands today is quite impressive.

Congratulations and many thanks to Kenwood for maintaining their vision, engineering and manufacturing skills, as well as the financial commitment required to continue to provide innovative products to the amateur radio marketplace. 73

Back Issues

of
73 Magazine

Only \$5.00 Each!

Call 800-274-7373 - -

The New Pools!

Examination Test
Questions & Answers

*The exact questions, multiple choices
and answers for the Technician Class,
General Class, and Extra Class
operator's license.*



Only
\$9.95
Plus \$3.50 S&H

Omega Sales

P.O. Box 376
Jaffrey, NH 03452
800-467-7237



Bookbind THIS! — Conclusion

Get organized, and save money, too.

This is the third and final part of this series. The previous two described the tools, materials, and fixtures required for the processes involved. The objective behind the process is to save valuable technical information that has been placed into your hands. Most all of the technical knowledge shared with us is in the form of a schematic diagram, which, if saved, will continue to share the knowledge forever.

The final stage of the process involves rasping the stem of the “new” volume in preparation for the stem to be glued. After being glued, the new volume is then ready for a cover that will be marked to identify the new volume. The end result will be the recovery of shelf space while saving valuable information in an organized manner.

Prep stage

After clamping the stack tightly, the

paper stem will be cut using a rasp, and if tight enough the paper will cut like soft wood (see **Photo A**). For binding purposes, it is desirable to create a straight/square-cut stem. The rasp is best held with both hands and drawn at a 45-degree angle downward across the stem. Rasping continues until about 1/8-inch of the stem remains exposed beyond the blocks — or until the shortest page is exposed. Upon inspection, if it appears that the lower pages have folded away from the rasp rather than be cut, the rasp cutting

direction can be reversed such that the rasp is drawn upward while you take note to make sure the lower pages are being trimmed to match the others.

One of the objectives of rasping the stem is to reduce the wider pages to be equal to the narrowest ones. But there is no guarantee that all of the pages will be exposed to the stem backing after the rasping appears to be complete. In an attempt to pick up all of the pages and to mechanically strengthen the stem region of the “new” volume, kite string is tied into the stem. Three

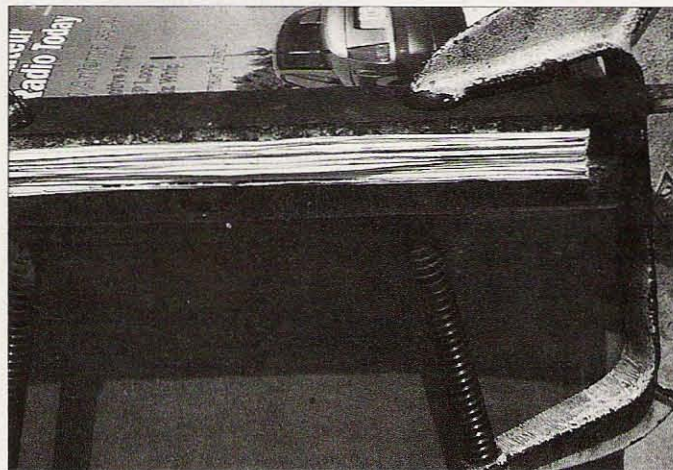

Photo A. Annual volume stacked in the clamping fixture. Note the ragged stem prior to being trimmed with the rasp.

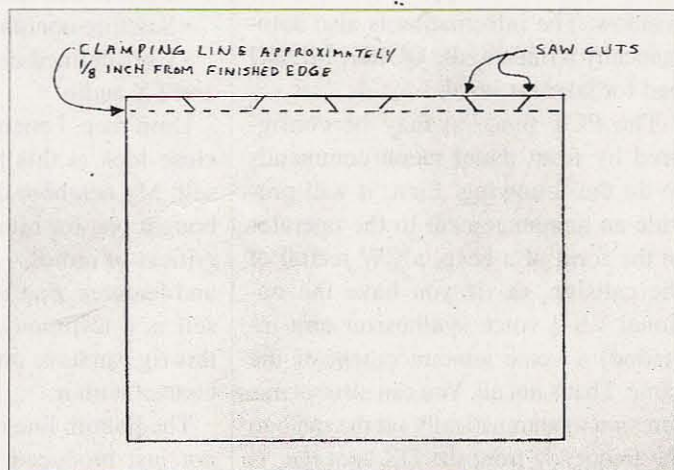

Fig. 1. Saw cuts for kite string. Cuts made at approximately 30–40 degrees.

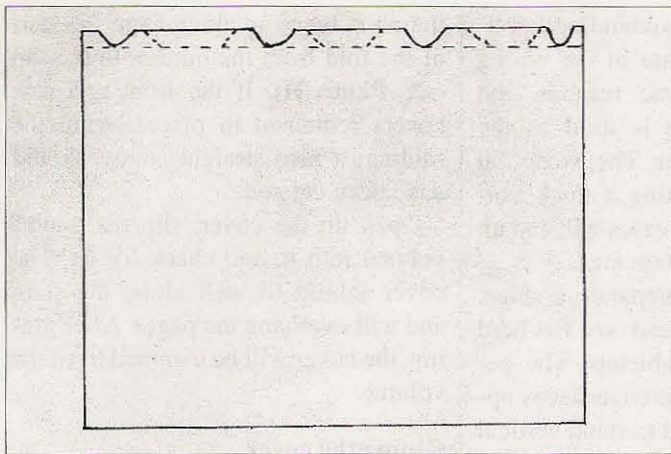

Fig. 2. Deep file cuts/notches used to expose the narrowest pages for gluing.

pairs of saw cuts are made into the stem area as shown in **Fig. 1**. The specific angle of the cut is not at all critical, but it must be at a slight angle sufficient to keep the string in place until glue is applied.

A loose page found in a newly bound volume is very frustrating, so an additional precautionary step is taken in the process. The precaution step taken is shown in **Fig. 2**, where the sharp teeth on the edge of the rasp, and/or the rounded side of the rasp, are used to cut some deep “V” or “U” shape cuts in the stem. The cuts are as deep as the clamping fixture will allow (about 1/8-inch), and are made sufficiently wide to allow glue to reach deeply into the stem area and hopefully capture ALL of the pages (see **Photo B**).

Once all of the rasping and cutting

has been completed, the stem should be vacuumed well to remove as much paper dust as possible. I’ve found that a shop-vac with a narrow pickup nozzle works best.

When everything is clear of dust, kite string is placed into the saw cuts (see **Photo C**). I’ve found that looping the string twice around and through the cuts is sufficient. The string is looped through each pair of angular cuts and pulled fairly snug. In most cases, three sets of string cuts are ample to maintain the strength of the stem for normal usage.

The ends of the string are tied only tight enough to keep the string from falling out of the saw cuts. Once applied, the glue will hold the string in place. The ends of the string beyond the knot may be left fairly long to be glued against the back of the stem, providing extra strength.

The last step before removing the volume from the clamps is to apply glue to the stem area (see **Photo D**). I’ve found that an acid brush works well because it has a stiff hair bristle. Glue is worked into the saw cut in an attempt to coat the string that is buried in the cut. Glue is then spread along the stem and into the “V” or “U” cuts and scrubbed into the paper. How much glue should be applied? The amount isn’t too critical at this stage, but it should touch each page and not be so heavy that it runs off onto the fixture. The book volume is a little difficult to remove from the clamping block if the glue has gotten between the paper and the block. A sharp knife or razor blade may be used to cut the glue, should it be necessary. Just lift

Continued on page 34

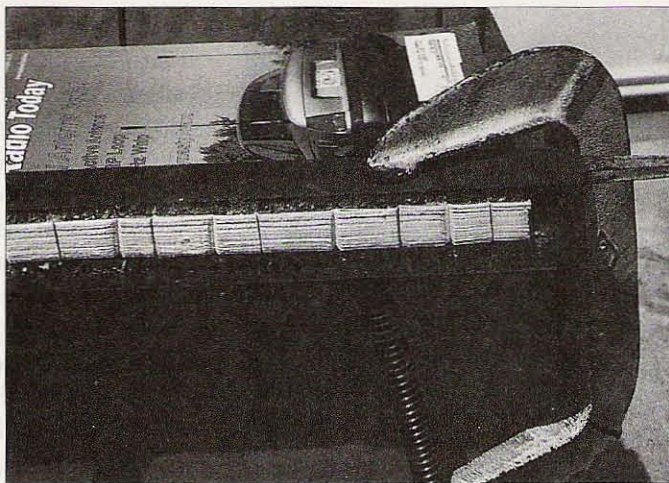

Photo B. Stem after being rasped, sawed, and notched.

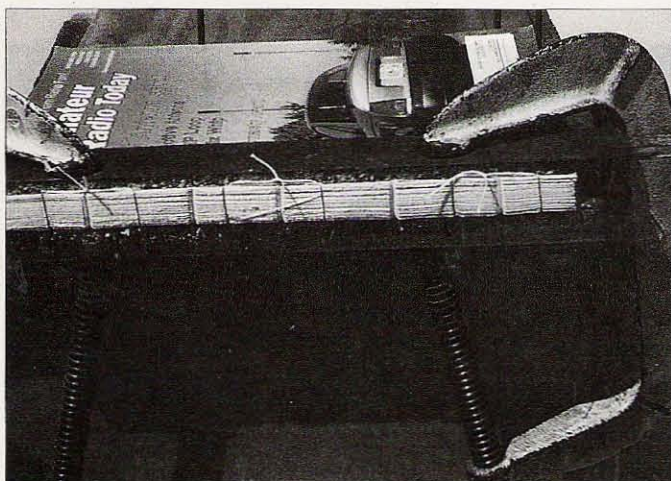

Photo C. Kite string tied through sawed slots. Loose string ends left to be glued against the stem.



Photo D. Glued stem.

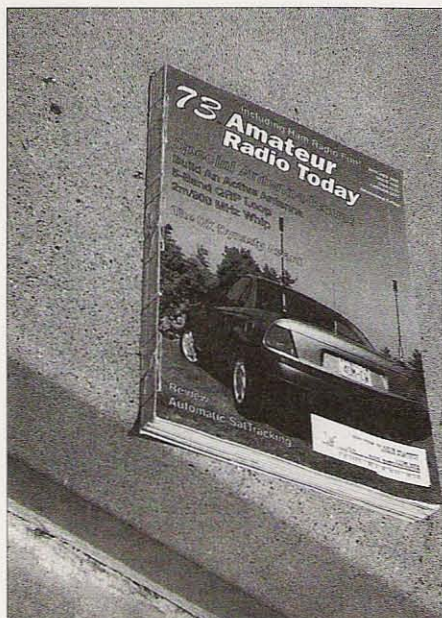

Photo E. Completed/glued stem. Volume is ready for the cover.

Bookbind THIS! — Conclusion

continued from page 33

the book, exposing the glue strip, and cut it with a blade.

More glue will be added later on so that only enough need be applied at this stage to maintain the integrity of the stack/volume. **Photo E** shows the bound and glued volume now ready for a cover.

Preparing the cover

A manila folder is the easiest material to use as a cover. Most manila folders have been pre-creased several times adjacent to the fold so that they can be sized to fit the needs of the user.

Unfortunately, for bookbinding applications, the creases are in the wrong position. For cosmetic reasons, the multiple-creased side is used as the back of the new cover. The exception is when accommodating a thick volume — some of the creases will end up appearing along the stem area.

During the cover preparation stage, the cover must be placed on a flat hard surface such as a tabletop. The selected front side of the cover faces upward and is then lifted to stand vertical with respect to the back. Now in an open position, the new volume is placed on the cover back while you press the stem against the vertical cover. Using a pencil, a short line is drawn on the inside of the front cover at the height of the volume (see **Photo F**). The volume is then removed and placed aside momentarily.

With the cover opened up flat, use a thumbnail or other tool to create a short crease along the pencil line at the edge of the cover. The short crease will be used to start a new fold in the cover to accommodate the height of the volume. Place a thumbnail at the edge of the cover, on the short crease, and begin folding the cover down against the thumb and table (see **Photo G**). When a distinct crease has been started, the top and bottom cover edges are aligned to one another and held tightly with hand pressure.

At this point, a new crease/fold can be started at the folder's edge by holding pressure against the two cover sides so that they won't slip or twist. A

thumb is then run along from the start of the fold from the bottom to the top (see **Photo H**). If the front and rear covers remained in place during the folding, a nice straight crease should have been created.

Open up the cover, slip the "new" volume into it, and check for fit. The cover should fit well along the stem and will overhang the pages. After gluing, the cover will be trimmed to fit the volume.

Gluing the cover

Before gluing the cover, arrangements must be made for clamping the cover to the volume. Several techniques may be utilized for this purpose. I've found that standing the volume on its stem works well. Small "C"-clamps are used to hold the ends of the cover to the volume. Heavy weights are also pressed against the sides of the volume (see **Photo I**) both to hold the cover tightly against the volume and to support the volume in a vertical position while the glue dries.

Several volumes may be clamped simultaneously if the clamps are large enough, or enough weights are available.

Padding compound dries rather quickly, but it should be allowed to cure for five or more hours before the volume is opened. White glue dries more slowly and should be allowed to set for 24 hours or more.

An ample amount of glue is applied to the stem of the new volume with

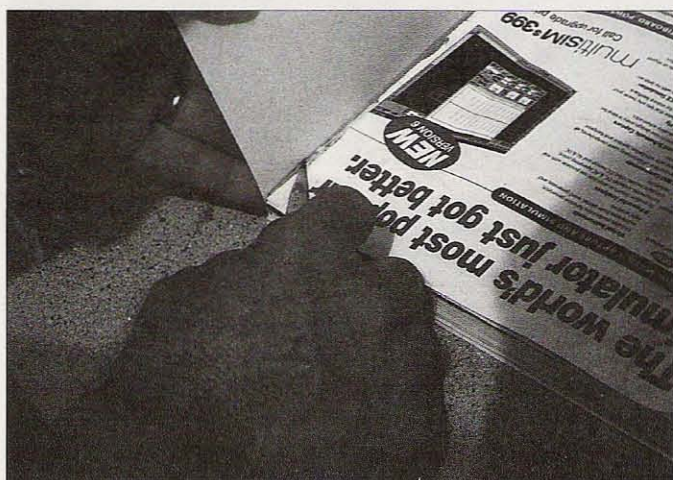

Photo F. Pencil is used to mark the volume height inside of the cover.

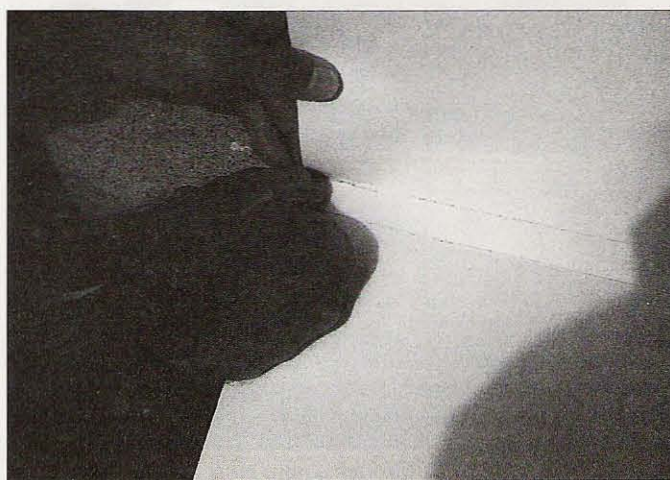

Photo G. Creasing the cover over the thumbnail at the pencil mark.

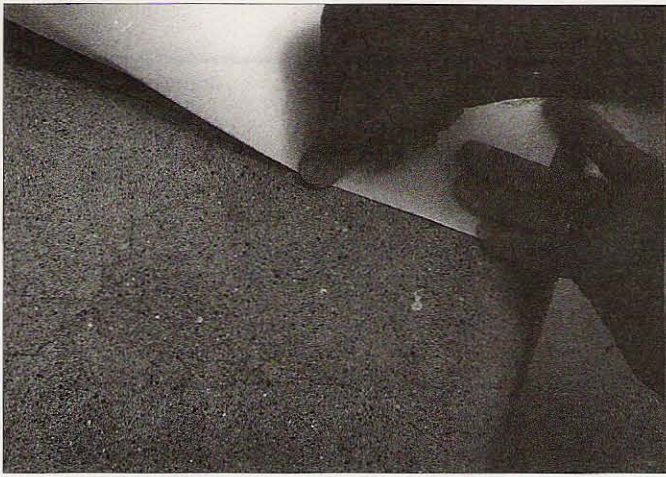

Photo H. Cover folded over at the crease — crease being extended across the cover.

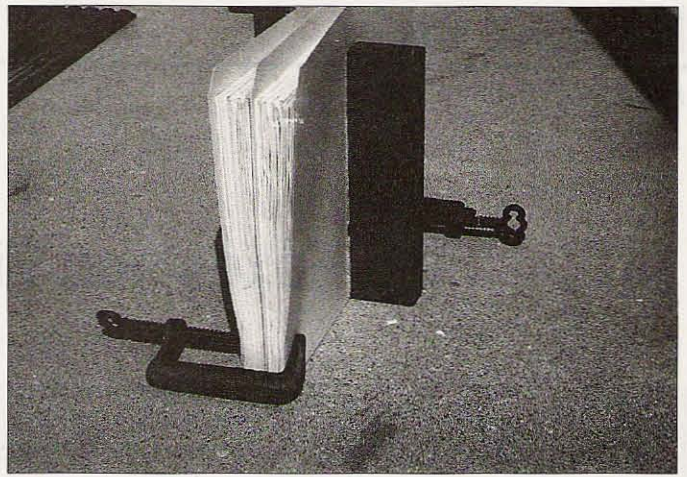

Photo I. Freshly glued volumes standing on their stem while the glue dries. Clamps/weights are used to hold the volumes in a vertical position.

care to fill all of the spots possibly missed during the binding process. A thin line of glue, about 1/8-inch wide, is run down both the front and rear edges of the volume adjacent to the stem. Glue in this area will tie down the string loops and provide additional support for the new cover near the stem.

Immediately after the glue is applied, the volume is carefully fitted into the new cover. It is important to NOT get any glue onto the cover in areas where it shouldn't be. If glue does get on areas where it doesn't belong, a water-dampened cloth can be used to remove the extraneous glue. Slipping a small piece of waxed paper between the cover and volume will prevent the residual glue spot from binding them together.

With the glued volume and cover in place, the volume should be "seated" to the cover by holding it between the

hands and then allowing it to drop an inch or two onto the stem. The volume must be supported during the drop to prevent it from falling over during the impact. Once seated, the volume can be placed between weights to hold it in a vertical position. **Photo J** shows how the excess cover material is removed. Scissors are held against the volume using the volume as a cutting guide.

Marking the cover

Marking on the cover is done with a fine-tip Sharpie™ pen or equivalent. Marking is done on the cover, stem, and bottom of the volume (see **Photo K**).

On the cover, the first row of title characters should be at a position approximately three fifths of the way up from the bottom of the volume, placing it at a desirable viewing perspective. A second row, if used, is placed below the first to suit the user's perspective.

The volume year is centered and placed about an inch or so below the title characters. When there are missing issues to the volume, I've found that adding a note below the date indicating either those issues contained or those missing helps later on during a reference search.

Marking the stem and bottom should also be done as well. Title marking should begin near the top of the stem and extend down as far as necessary. The volume date is placed a short distance up from the bottom of the stem.

To facilitate identifying the volume when it is in a stack of other volumes, marking the bottom edge is very desirable. An abbreviated title and date is usually all that's required.

Opening the new volume

Care must be taken when opening

Continued on page 58

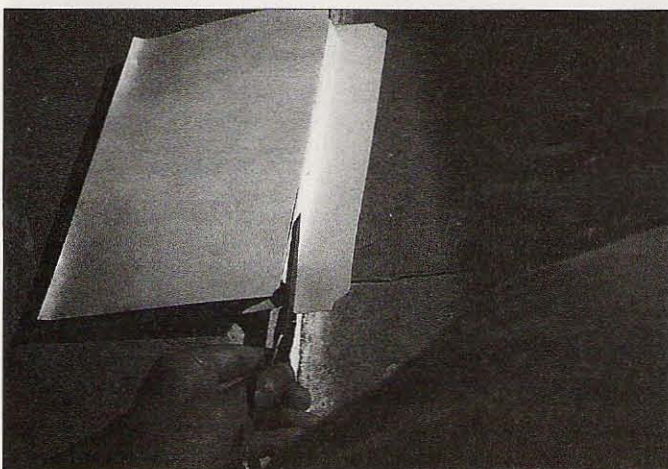

Photo J. Glued cover being trimmed flush with the volume edge.

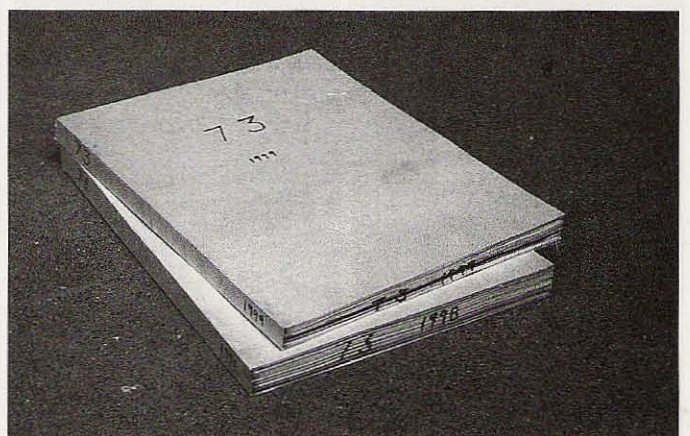

Photo K. Marking/identification placed on the cover, stem, and bottom of the volume.

Find Foxes and Fight RFI with RDF

Will it be the best-attended transmitter hunt ever held in the Americas? The 2001 USA ARDF Championships are capturing the attention of on-foot foxhunters (also called foxtailers, radio-orienteers, and ARDFers) across the country and around the world.

These historic championships will take place July 31 through August 4 in Albuquerque, NM. They are open to all ARDF enthusiasts, including visitors from any member country of the International Amateur Radio Union (IARU).

As I write, E-mail has just arrived from Han ZhaoFang BG1HZF, leader of the Chinese Radiosports Association, announcing CRSA's intent to send a team to our championships. So if you didn't have the opportunity to join Team USA in its competition

against the Chinese and other countries in Nanjing last fall, you have a second chance this summer, much closer to home. Australians have registered, and registrations from European countries are expected shortly.

Members of the Albuquerque Amateur Radio Club are working hard to put on a first-class ARDF event. Headquarters will be on the campus of the University of New Mexico. That's where dorm rooms and cafeterias will house and feed the participants, and training sessions will take place. The

formal competitions, one each on two meters and eighty meters, will be at nearby well-mapped sites in the beautiful Sandia Mountains.

The USA ARDF Championships are for anyone, with or without a ham license, at any ARDF skill level, beginner to expert. Competitors will be divided into appropriate age and gender divisions. To learn more, visit the special Web site [<http://groups.yahoo.com/group/abqardf/files/web/index.html>] or contact Albuquerque Amateur

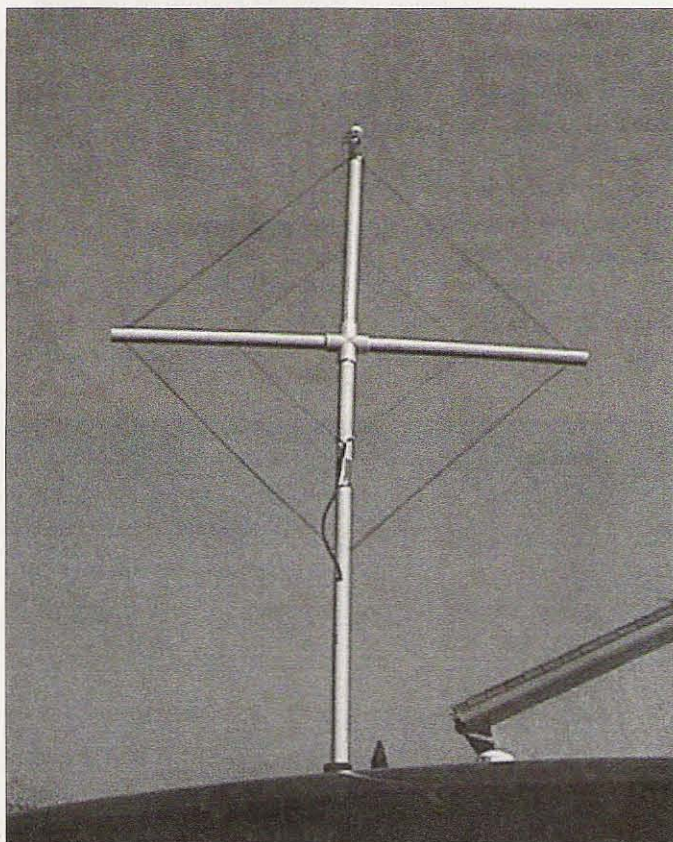

Photo A. Not fancy, but functional, this simple loop on a PVC pipe frame will ferret out interference sources on 75/80 meters.

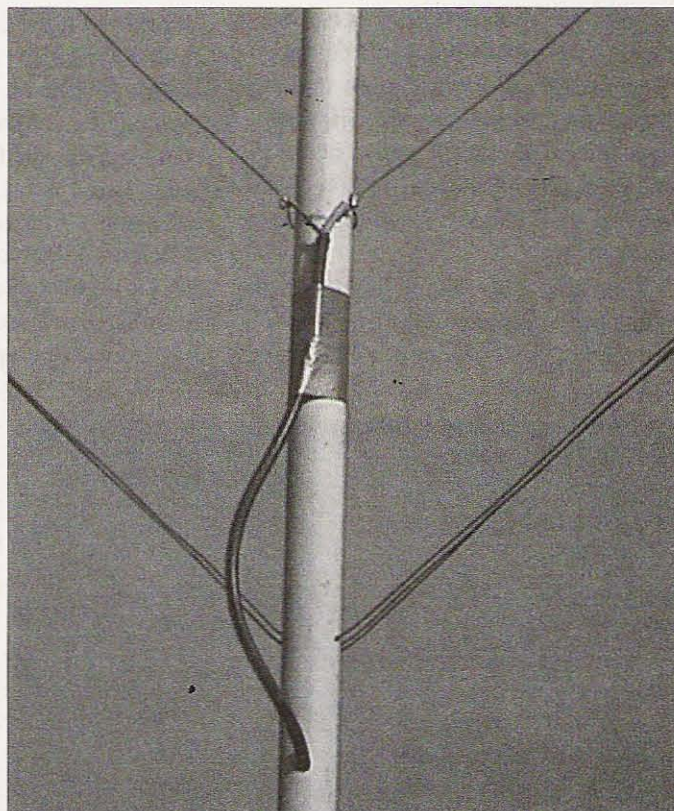

Photo B. Coax is dressed away from main loop L1 and connects only to inner loop L2. Note the individual frame holes for each wire of the main loop.

Radio Club, P.O. Box 11853, Albuquerque NM 87192.

Tracking RFI on 80 meters

Every ham should understand basic Radio Direction Finding (RDF) equipment and techniques. Even if you don't enjoy competitive mobile transmitter hunting or radio-orienting, you will probably need to go DFing at some point. It's very likely that your target will be some sort of non-ham RF interference (RFI).

Over the years, I have searched for dozens of noise sources, from aquarium heaters to gas oven thermostats. One of my most interesting (and frustrating) RFI adventures took place in Stanton, California. By reading about it, you will get a good idea of how RFI detective work is done. You'll also learn some of the technical and nontechnical roadblocks you may face in your own RFI sleuthing.

The story is true, but I'll leave out actual names, calls, and addresses. The victim (we'll call him W6XYZ) loved rag-chewing and daily nets on 75 meters. One day, a strange signal began to crowd him out. It was a very unstable carrier, moving up and down the band and occasionally disappearing.

Most of the time, the signal was 20 dB over S9 and right on top of his favorite net frequency near 3900 kHz. By the time I got involved, W6XYZ's block had been checked out by the power and cable TV companies, who could not find the source in their lines.

The first rule of RFI-busting is to search on the highest practical frequency. At 80 and 40 meters, long power lines and other objects re-radiate signals and distort RDF measurements. Null-type RDF antennas are the norm. At VHF, gain antennas are practical and long radiators are less common.

I set up a general coverage receiver and a calibrated RF attenuator in W6XYZ's shack and tuned from 150 kHz up, making a chart of all RFI carriers by frequency and relative amplitude. There were a lot of them, but they all sounded different. The strongest (20 dB above the 3900 kHz spur) was at 3400 kHz.

Harmonics at varying levels (11 to 33 dB down) were present every 3400 kHz all the way up to 30 MHz, the top of the receiver range. I figured that the 15th harmonic at 51.05 MHz should be strong enough to detect. If so, my six meter T-hunt "Shrunken Quad" (see "Homing In" for January 1990) could DF the source.

A few days later, April WA6OPS and I were back with the van set up for six meter

hunting. The 51 MHz harmonic dropped off rapidly as we drove away from W6XYZ's home. All the bearings pointed right back to his house. Using a Yaesu FT-690R and its whip, we sniffed around the house and found the source of the 51 MHz harmonic. It was the solar heating control unit in W6XYZ's own closet!

Gleefully, we turned off the controller and ran to the shack to check the HF bands. Sure enough, the noise at 3400 and its harmonics had stopped. In fact, the spectrum was very quiet — all except the signal at 3900 kHz. It was as strong as ever. Rats!

Building a loop

So the direction finding had to be done on 75 meters. There was no time or motivation to do anything fancy. All we needed was an indication of which way to go. A loop antenna was the clear choice. It only took a couple of hours to build. All the parts were in my garage.

The main loop (L1) is three turns of 18 AWG solid enameled wire, resonated with a 100 picofarad air variable capacitor (C1). Signal snagged by this outer loop couples to the coax via single-turn inner loop L2. Inductive coupling works much better than direct coax connection to L1, which would upset balance and cause poor nulls.

Photo A shows the completed antenna on the T-hunt van. The frame is Class 125 (thin wall) PVC pipe, 3/4-inch trade size. That matches with my standard mast system for hunting on other bands. Note that the coax bows slightly so it does not touch the bottom of L1 (**Photo B**).

To build this antenna, cut the top and side PVC frame members and assemble them into a slip-type PVC cross fitting. Bond them with PVC pipe glue. Use a 5/64-inch drill bit to make individual holes through the mast and crosspieces for the three large loop wires. Space the turns of the large loop about 3/16 of an inch apart. Holes for the large loop wires are 16 inches from the center of the cross, and holes for the inner pickup loop are 8 inches out.

Tuning the antenna is easy — just connect it to the receiver and peak the background noise on the hunt frequency by adjusting C1 with an insulated tool (**Photo C**). Keep yourself and other objects clear of the loop during tuning.

Check out your loop on a local (ground-wave) signal before going RFI-hunting. The pattern of small (less than 0.08 wavelength) loops like this has two broad peaks (in the

Continued on page 38

EVERY ISSUE OF
73 Amateur
Radio Today
on Microfiche!

The entire run of **73** from October 1960 through last year is now available. Over 800 fiche!

You can have access to the treasures of **73** without several hundred pounds of bulky back issues. Our 24x fiche have 98 pages each and will fit in a card file on your desk.

We offer a battery operated hand held viewer for \$150, and a desk model for \$260. Libraries have these readers.

The collection of microfiche, is available as an entire set, (no partial sets) for \$325, plus \$10 shipping (USA). Annual updates available for \$10, plus \$3 shipping/handling. Satisfaction guaranteed or money back!



BUCKMASTER



6196 Jefferson Highway
Mineral, Virginia 23117 USA
540:894-5777 • 800:282-5628
Fax 540:894-9141
e-mail: info@buck.com

WANTED

Fun, easy to build projects
for publication in **73**.

For more info, write to:

Joyce Sawtelle,
73 Amateur Radio Today,
70 Hancock Road
Peterborough NH 03458.

The Gordon West Study Guides

Examination Test
Questions & Answers
for General Class and Extra Class
with explanations of the answers



General Class
\$12.95
Plus \$3.50 S&H



Extra Class
\$14.95
Plus \$3.50 S&H

Omega Sales

P.O. Box 376
Jaffrey, NH 03452
800-467-7237



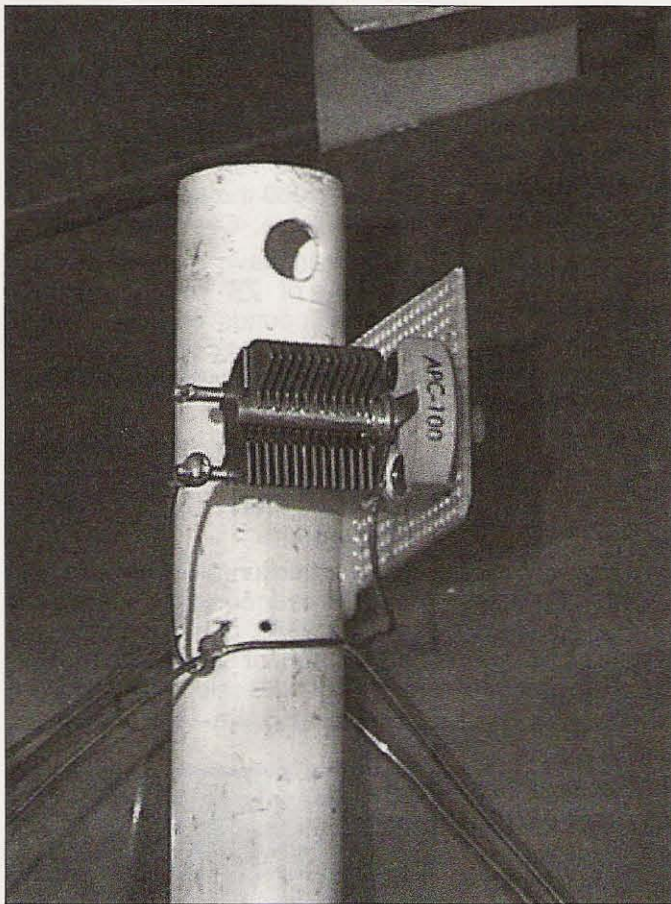

Photo C. Air variable capacitor C1 is mounted on a small bracket at the top. It is in series with the main loop, L1.

HOMING IN

continued from page 37

plane of the loop) and two sharp nulls (looking through the loop). The nulls are easiest to use and most accurate for RDF.

The ambiguous nulls 180 degrees apart

whip is on the left rear bumper, it will give a slight amount of enhancement to signals coming from the right front.

Be sure to remove your 75-meter whip from the car while DFing with the loop. The proximity of a resonant whip causes inaccurate loop nulls. Similarly, avoid taking bearings when directly under power lines, etc.

If you expect to hunt very strong signals and your receiver does not have a wide range RF gain control, connect an RF attenuator between antenna and receiver. Do not transmit into the loop or attenuator. Unplug the mike and key to prevent accidents.

The loop will not give good nulls close-in if a long power line or the wiring of a house

radiates the RFI. For example, let's say you are 200 feet away from the center of a radiating overhead power line 400 feet long. The difference in azimuth from the left end to the right end of the line is 90 degrees.

When you attempt to null the left end, the right end lies in the peak of the loop response. No matter which way you turn the loop in this case, there will be some signal to "fill" the null in the pattern. So when you get too close to get good nulls, switch from the loop to a whip and move around, looking for highest S-meter readings.

Sources for C1

Surplus Sales of Nebraska
1502 Jones St.
Omaha NE 68102
(402) 346-4750
[www.surplussales.com]
Part number: (CTA)APC-100

Ocean State Electronics
P.O. Box 1458
Westerly RI 02891
(401) 596-3080
[www.oselectronics.com]
Part number: APC-100

Closing in

A few days later, we went off to Stanton to snop around with the loop. RDF bearings and S-meter readings showed the hottest area to be about two blocks away from W6XYZ in a cul-de-sac. The curbside signal was strongest in front of House A, and almost as strong in front of House B. Both were fed from one overhead power line in the rear.

House A's owner was not at home, so we rang the bell at House B. When I explained the problem, the family was very receptive and let me probe the back yard with a Sony ICF-7600 portable shortwave set. The power drop to the house and the breaker box were radiating plenty of 75-meter RF.

We found no obvious "hot spots" inside or outside. I asked if I could turn off the House B main breaker for a minute. They consented, I flipped the breaker, and the noise continued in the portable receiver.

By now, the owner of House A was home, but he was not interested in W6XYZ's plight. "Hams cause all the TV interference problems," he said, "so I don't care if I cause a problem for a ham."

I told him I just wanted to check the

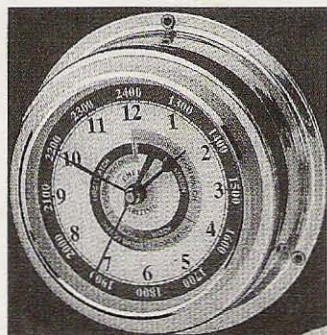

Chelsea Clock

Clockmakers since 1897
The choice of The Coast
Guard Foundation.

Quartz Clock
4" Dial

Beautifully hand-polished.
Stamped brass case and
bezel.
Curved glass crystal.
Wall or bulkhead mounting.
Made so well they last from
generation to generation!
Order this month and save
\$20!

Your price \$75

Omega Sales
P.O. Box 376

Jaffrey NH 03452
1-800-467-7237

incoming power line in his back yard. "Come back with the Edison Company," he replied, and asked us to leave.

When I told W6XYZ about our experience, he began to despair. He said that he was thinking of selling his house and taking a long trip in his RV. I wasn't ready to give up yet.

To be absolutely sure that House A was the culprit, I did a "porch light survey," reading the signal strength of the 3900 kHz radiation from the front porch light wiring of every house in the neighborhood on the Sony receiver. Sure enough, the light at House A radiated 20 dB more signal than any other.

I tried one more time at the door of House A, this time with W6XYZ along. Despite our best efforts at diplomacy, the owner would not let us into his house or yard, nor would he turn off any breakers for tests.

FCC gets involved

I gathered all the RDF and porch light data. Then I put together copies of my maps of the neighborhood, showing how House A was clearly the RFI source. I wrote a cover letter to the Engineer-in-Charge of the Los Angeles area FCC office, detailing the problem. I pointed out that the 3900 kHz radiation from House A was so great as to be a violation of FCC Part 15, that the owner was uncooperative, and that FCC intervention was needed.

Less than two weeks after sending the letter and data, FCC sent a letter by certified mail to the owner of House A, telling him that he was in violation of Part 15 and had fifteen days to correct the problem. Apparently that really lit his fuse. I heard that he promptly drove to the FCC office and railed against W6XYZ and me. Fortunately, the FCC stood firm.

From that point on, my information is second-hand. I was no longer needed, so I stepped aside. I heard that circuit breaker checks showed the QRM definitely came from House A, and that a bad power line ground and loose cable TV hardware were found and fixed. But the 3900 kHz radiation continued.

Two months later, I heard that an FCC engineer had located the RFI source in the house, and ordered it to be repaired. But by that time, W6XYZ had sold his house and was moving out.

Apparently the malfunctioning device never got fixed. I drove down W6XYZ's old street two years later and heard an unstable carrier on 3900 kHz. If you like 75 meters and are thinking of buying a home in Stanton, contact me first. 75

QRX

continued from page 6

70 centimeters, and 1.2, 2.4, and 5.4 GHz. The actual uplink and downlink frequencies will be determined at a later date.

But that's not all. Unlike the ailing AO-40, this will be a relatively small bird. Thanks to advances in technology, the next generation of ham radio satellites will have a maximum mass of only about 100 kilograms and a power consumption of about 100 watts. Stabilization will be provided by spinning the spacecraft.

This satellite would have a new control system or Internal Housekeeping Unit. In fact it will be a universal design for use in future AMSAT satellites. The reason for a new controller is simple. While the existing design has proven to be very stable, it uses parts that are getting harder and harder to find. AMSAT NA says that the new unit will use more readily available components.

The AMSAT North America Board of Directors made these far-ranging decisions when they met in Orlando, Florida, on February 24th and 25th. At the same time, the AMSAT NA leaders approved the design, construction, and demonstration of a new mode using digital modulation techniques. The AMSAT directors say that this holds the potential of improving communications under very poor conditions or, alternatively, permitting the use of lower power and/or simple antennas with future ham radio birds.

The AMSAT North America Board of Directors did not specify a name for this next generation of ham radio satellite, but it's unofficially known simply as JJ.

And as to why the next satellite won't be left permanently in geostationary orbit? Ham satellites are always international projects requiring the cooperation of hams in AMSAT groups around the world. Even if a place could be found in the equatorial geostationary satellite parking belt, leaving an amateur radio satellite in one place forever would not be fair to those in other nations with hams who contributed to its development and launch.

Thanks to Roy Neal K6DUE, to AMSAT NA, and to VE3FRH, all via Newsline, Bill Pasternak WA6ITF, editor.

Take My License — Please!

In what has to be one of the most bizarre enforcement incidents to date, a ham not under investigation has told the FCC he has canceled his own ham radio license.

The now-former ham who took this action is Stephen H. Anderson, the ex-AA8DP of Somerset, Kentucky. Back on January 24th, FCC chief rules enforcer Riley Hollingsworth sent a note off to Anderson asking that he either confirm or deny that he was in control when Technician class licensee Charles Puckett KF4ZMG operated, transmitting on 3.860 MHz — a frequency not authorized under Puckett's Technician-class

license. Puckett had earlier told the FCC that Anderson was in control at the times the transmissions had been made.

Nothing out of the ordinary, you say? Well, we will let Riley Hollingsworth tell you what happened next: "The license of Stephen H. Anderson AA8DP, of Somerset, Kentucky, was canceled by the Wireless Bureau after Anderson sent the license into the Enforcement Bureau and informed us that the United States government was a foreign corporation — and that's certainly news to me. He informed us that he did not recognize its jurisdiction and he didn't recognize the jurisdiction of the FCC."

Anderson's letter also told the FCC that he does not reside in any territory or possession of the federal government of the United States of America. As such, says Anderson, he is not "subject to any regulation by this fictitious entity."

The regulatory agency was very understanding. It did not question Anderson's motives or reasons for sending in this letter. It simply canceled his license, and Anderson is no longer a radio amateur in the eyes of the FCC.

Thanks to the FCC, and Bill Burnett KT4SB, via Newsline, Bill Pasternak WA6ITF, editor.

Microsoft vs. GM

Word has it that at a computer expo one time, Bill Gates reportedly compared the computer industry with the auto industry and stated: "If GM had kept up with technology like the computer industry has, we would all be driving \$25 cars that got 1,000 miles to the gallon."

In response to Bill's comments, General Motors allegedly issued a press release stating:

"If GM had developed technology like Microsoft, we would all be driving cars with the following characteristics:

1. For no reason whatsoever, your car would crash twice a day.

2. Every time they repainted the lines on the road, you would have to buy a new car.

3. Occasionally your car would die on the freeway for no reason, and you would just accept this, restart, and drive on.

4. Occasionally, executing a maneuver such as a left turn would cause your car to shut down, and refuse to restart, in which case you would have to reinstall the engine.

5. Only one person at a time could use the car, unless you bought "Car95/98" or "CarNT," but then you would have to buy more seats.

6. Macintosh would make a car that was powered by the sun, reliable, five times as fast, and twice as easy to drive, but would run on only 5% of the roads.

7. Your oil, water temperature, and alternator warning lights would be replaced by a single "general car fault" warning light.

8. New seats would force everyone to have the same size butt.

9. The airbag system would say "Are you sure?" before going off.

Continued on page 61

Preventive Brain Surgery for Icom Xcvrs

Trying to resurrect a comatose Icom transceiver can be bad news. Here's how to prevent the dreadful fate in the first place.

In the November 2000 issue of 73, I read with great interest the Hamsats column by Andrew MacAllister W5ACM. The column was titled "If Your Xcvr Goes Brain-Dead."

Normally, since I'm not into ham satellite work, I generally only skim over this column. However, I thought it was an unusual title for the column, and it caught my attention. In addition, I recalled working on a fellow ham's Icom 730 some time ago that had suffered the same fate as the one mentioned in the column.

This past summer, my ham shack and home suffered a powerful lightning strike that took out most of my radios. After the insurance claim was settled, I opted to sell my radios as is. Next, at

the Winchester Virginia hamfest, I ran across two mint-condition radios to replace my HF and VHF station. I picked up the Icom 271A and Icom 751. About a month later, I ran across the matching Icom 471A on e-Bay and was the successful bidder. Now I'm the proud owner of three of these venerable Icom rigs, which also have the potential to suffer from this electronic form of Alzheimer's disease.

Since all three radios were working fine, I didn't really see the need to invest in about \$200 worth of EPROM

for the three rigs. I also was concerned that since the radios were about 10-12 years old, and had the original Icom batteries, that I was awaiting the inevitable if something was not done.

A search of the Internet uncovered some old E-mail postings on a few ham Web sites concerning the problem. I found one that appeared to address the prevention of the failed memory problem, and discussed how to change the battery on the RAM board. The instructions, however, contained no illustrations, and were not



Photo A. Here is a view of my power supply hook-up.

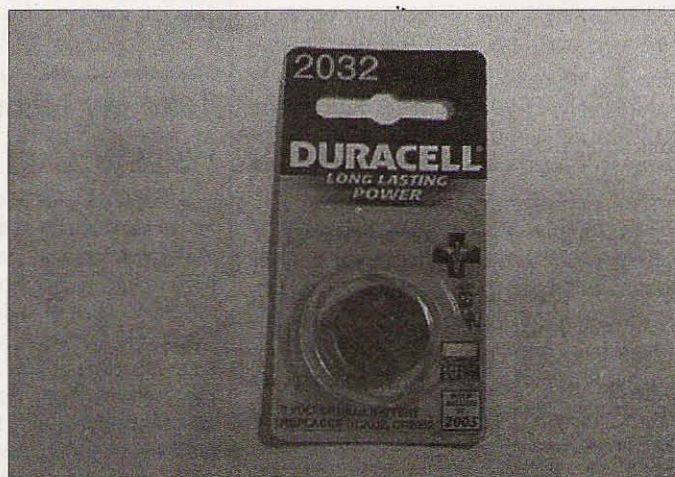

Photo B. Lithium coin cells such as this CR2032 are available from most any retail store such as Wal-Mart or Radio Shack.

the clearest and easiest to read. After pondering through them several times, and looking over my Icom 271A, I decided to try the procedure.

Here below are the results of my battery replacement, and a modified procedure, complete with illustrations of what to do. This procedure was used on my Icom IC-271A, IC-471A, and IC-751. It should work on most any Icom rig made in the 1980s and 1990s that uses a similar RAM board. These include all of the IC-x71 series, and some other radios as well, like the IC-751/751A.

What you'll need

First, let me say that this procedure will not help you if your battery has gone dead. You'll need to follow one of the suggested routes in the November 2000 Hamsats column. Also, beware that if you are not careful, you could wipe out your RAM backup if you fail to follow the procedure correctly or if a slip-up occurs, such as shorting out the battery or power supply terminals. Hence, caveat emptor, and proceed at your own risk.

To start with, you'll need the following items: a regulated five-volt power source, with leads to connect to the RAM board. Test leads to connect to the RAM board, once it's removed. I recommend something that will stay firmly connected, such as EZ-Hooks-type grabber leads, since these will be much less prone to coming loose. If they come loose while the battery is being removed, then the RAM will be wiped out, and you'll have a brain-dead radio. **Photo A** shows a picture of my power supply hookup.

You'll also need a small soldering iron, a few short lengths of red and black hookup wire, and a lithium coin cell, CR2032, available from most any retail store such as Wal-Mart or Radio Shack (see **Photo B**). Note the date code. In this case, the battery has a guaranteed shelf life until March 2005. In all likelihood, the battery will last 10 years, but to be safe, I'll plan on replacing mine every five years.

To make future battery change out a snap, you'll need a battery holder. A suitable holder is available from many

mail order sources, as well as at Radio Shack, catalog number 270-430, lithium battery holder. This is an off-the-shelf stock item that has solder tabs for PC board mounting. By going ahead and installing this now, when 2005 rolls around, all that will be needed is to power up the radio, and change out the battery while the rig is turned on. This will greatly simplify future battery replacements. Hence, if

you follow this procedure, the bulk of the work required has to be performed only once!

Doing the upgrade

First, take your rig where you'll have space to work on it. I suggest laying it on a soft cloth or piece of carpet while you work on it, so as not to scratch the case. In the x71 series, first

"CQ? CQ?" Is everyone out there?"

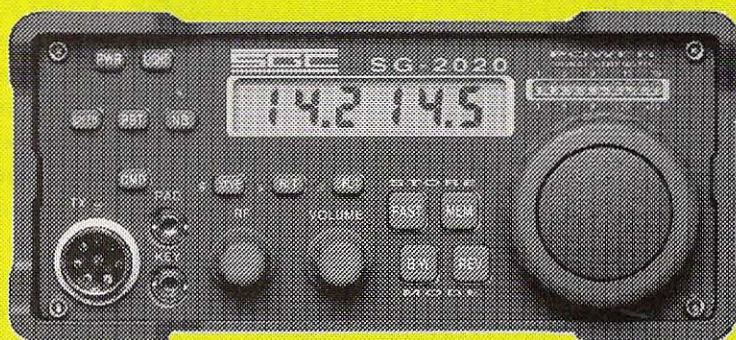

The SG-2020

All the ham frequencies and much more...

The leader in portable HF-SSB operation. The SG-2020 puts out **maximum power** even under mismatched loads and varying SWR conditions. The **high-visibility** LCD display and crystal clear receiver sensitivity make the SG-2020 perfect for any type of application - **fixed, mobile, portable or aviation**. Built to military specifications and weighing **only 4½ pounds (2 kg)**, the SG-2020 can be placed in a location where space is precious and **minimal current consumption** is needed. Legendary SGC **quality and reliability** at an incredibly low price.

Full HF Range ~ RX/TX ~ 1.8 to 30 MHz ~ 20 Watts ~ 12.6 VDC

1-800-259-7331

Get **FREE QSL CARDS** at
www.sgcworld.com

"No Compromise Communications"

SGC



13737 SE 26th St., Bellevue, WA 98005 USA
Phone (425) 746-6310 Fax (425) 746-6384
E-mail: sgc@sgcworld.com

We'll see you in Dayton ☞ Booths #623, 624, 630, 631

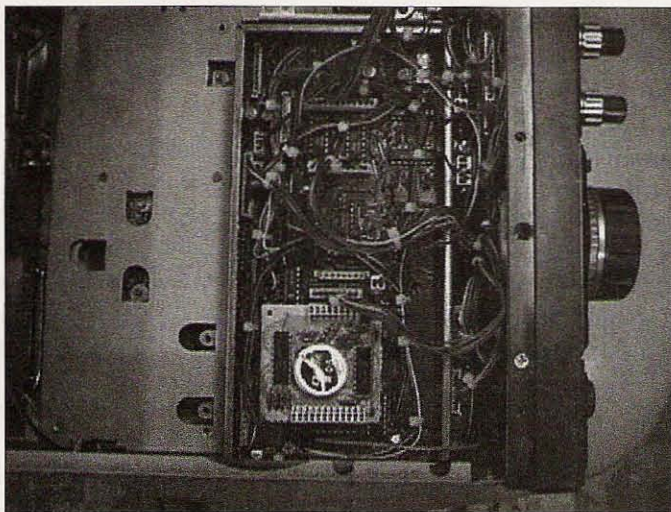

Photo C. This is the smaller PC board with the quarter-sized battery near the bottom of the photo.

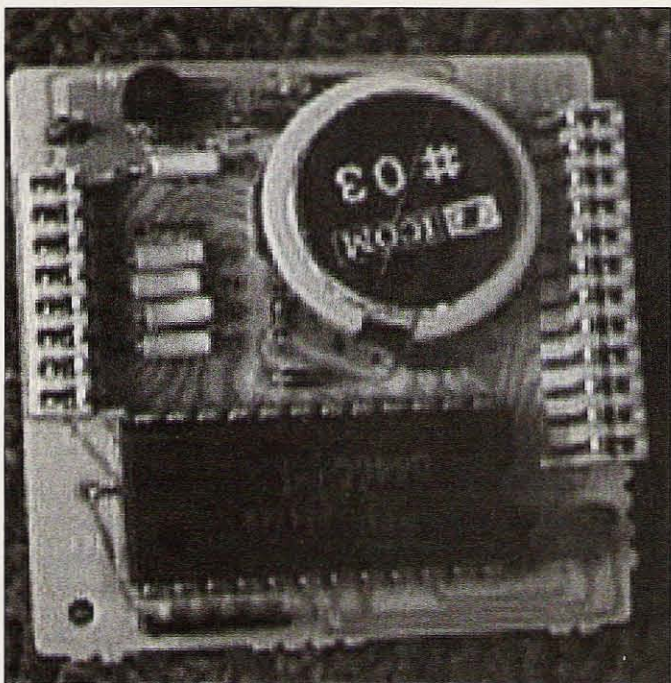

Photo D. The board after it is removed.

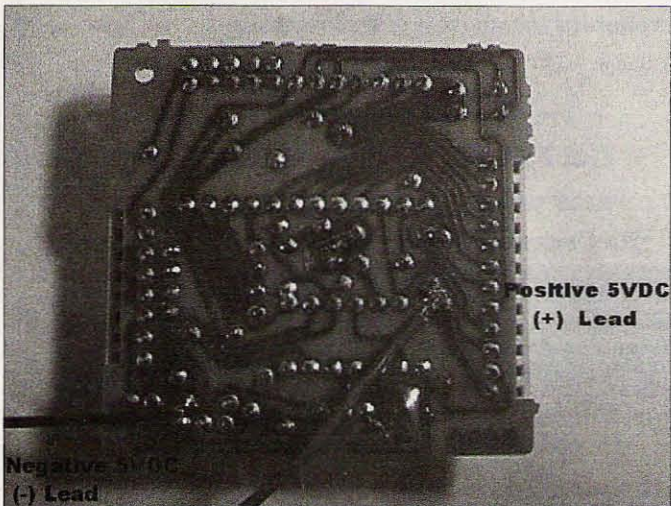

Photo E. Attach the temporary 5VDC power leads as shown.

you must remove the top cover on the rig, via several Phillips-head screws. The bottom cover is partially recessed into the top cover — hence the need to remove both top and bottom cover to get to the RAM board, which is located in the bottom of the rig.

Turn the rig upside down, and remove the bottom cover. You'll need to locate a small PC board mounted on top of a larger board. This small board has a battery attached to it. See **Photo C**. Here, you see the smaller PC board with the quarter-size battery near the bottom of the photo.

The whole board will need to be removed to get at the battery. To do this, carefully pull up on the board to remove it. It is held in place by two rows of push-on contact pins, and will pull off. Note that the two rows of contact pins are different lengths, which ensures that the board can only be installed one way. **Photo D** shows the board after it is removed.

Now, we will need to tack-solder some wires onto the board, to provide 5 VDC to keep the RAM backed up while we remove and replace the battery. Orient the RAM board as shown in **Photo E**, which shows where to solder these temporary 5 VDC power leads. The +5 VDC lead is the lead shown attached on the right side of the photo, and is just to the left of the longer contact socket.

The negative lead connects to the bottom left corner of the board, just to the right of the smaller contact socket. Now, connect the 5 VDC power source to the temporary leads we just installed. Observe proper polarity. Again, let me stress the need to be sure your power supply leads are firmly connected to these two temporary leads. You'll have to rotate the board and flip it over a few times in the next steps, and you don't want to lose your power connection!

Now, you'll need to grab a soldering iron and some desoldering braid. Locate the tabs holding the lithium battery to the board, and unsolder these tabs. Before removing the old battery, note which solder tab is positive and which one is negative. Remove the battery. In its place, insert the lithium coin cell holder, being sure to reconnect the new battery holder in the proper polarity (positive lead of the holder to the hole on the PC board where the battery positive was connected). Do the same for the negative lead. With the Radio Shack holder, it will be necessary to remove one of the extra solder tabs from the holder. The holder has three tabs, and only two are used (one negative and one positive).

Solder the holder in place. Insert the new CR2032 lithium coin cell in the battery holder. Install the battery with the polarity as indicated on the holder. See **Photo F**. Now, flip the board back over. Take a DVM, and measure the battery voltage at the PC board where the new holder was just installed. It should be around 3 VDC. Again, observe that the battery is connected to the PC board with proper polarity.

If you did not read 3 VDC, check to be sure your new battery is good, that your battery is installed correctly, and that there are no cold solder joints.

Assuming all is well with the DVM voltage check, we can now remove the power supply. Cut off the supply,

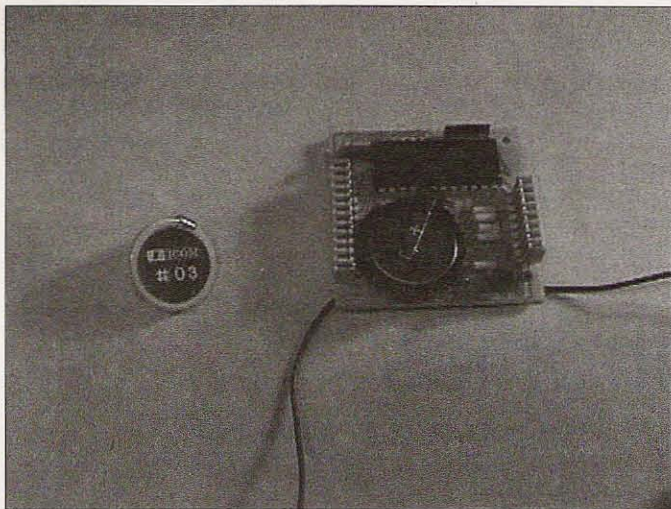

Photo F. Insert the new CR2032 lithium coin cell in the battery holder. Install the battery with the polarity as indicated on the holder.

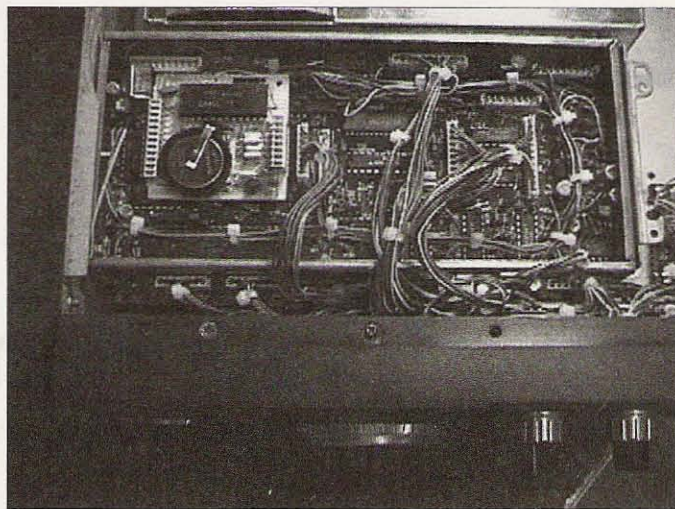

Photo G. Here is the newly installed board. Turn the radio on and test it before replacing the covers.

remove the test leads, and then unsolder the temporary leads installed on the RAM board.

Finishing up

We're almost finished. Reinstall the board back into the radio. Be careful not to pinch any wires under the RAM

board when you reinstall it. The first time I did, I pinched one of the wires on the main board below, and it caused my S meter to stay pegged. Removing and reseating the board while pushing the wire on the main board out of the way cured that.

At this point, I'd suggest turning your radio on, and testing it before

replacing the covers, just in case. All functions should work normally, and any memory channels that were saved before beginning should still work. **Photo G** shows the newly installed board. Reinstall the covers, and your rig should be ready to go.

Continued on page 59

ELMERS • VE's • INSTRUCTORS • CLUB GREETERS

Become A

HAM AMBASSADOR

The ham industry wants to support your efforts for ham radio growth with free instructor materials.



- Wall Maps • Log Books • Band Plan Charts
- Frequency Charts • Grid Square Guides
- Discounts on Licensing Materials
- Equipment Discount Program
- Gift Certificates

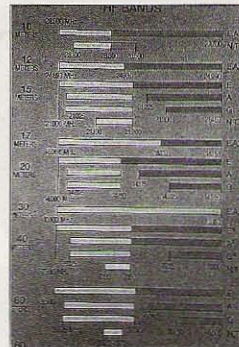

To request a detailed Ham Ambassador Introductory package, write to:

Gordon West c/o 73 Magazine 70 Hancock Rd.,
Peterborough, NH 03458. E-mail design73@aol.com

Air Hamtronics

If you're a pilot, this aviation receiver should be in your flight plan.

It is remarkable to see the number of radio amateurs who also possess a pilot's license of one type or another. Man or woman, it doesn't matter. The internal makeup of someone who enjoys sitting for hours in front of dials, gauges, meters, etc., while carrying on a conversation logically progresses to those who like to do the very same thing while hurtling themselves through the air. If you buy that, then it should be no surprise that we at 73 would like to review an aviation-related product for you which comes from our good friend Jerry Vogt at Hamtronics, Inc.

Jerry and his team have recently developed a product that dovetails the interests of the experimenter and the pilot that exist in so many of us. Their new product is the R121. An air-band receiver it is, but that's where the similarity ends between this product and something you might find dangling from someone's belt, or hidden somewhere in a flight bag. This is a rugged, dependable device that is intended to serve a couple of very important functional

applications. The benefits from this little box do not stop there, however. You need only exercise your imagination, especially when confronted by the cost of just about everything associated with aviation (let's not go there, OK?), to understand how important the relatively low price tag on this rig is, too.

The point that I seem to be circling to land upon is that Jerry and company have brought to market a robust receiver that fits nicely into the hands

and budgets of rural airport operators, search and rescue (SAR) aircraft owners, and just about anyone else that has a desire to tinker with and dream about what they would like to do with their experimental aircraft.

Functional specifications

I have left you hanging long enough. It's time to talk about what this thing is, and what it does. The R121 is a mature, low-tech (and that's good, by the

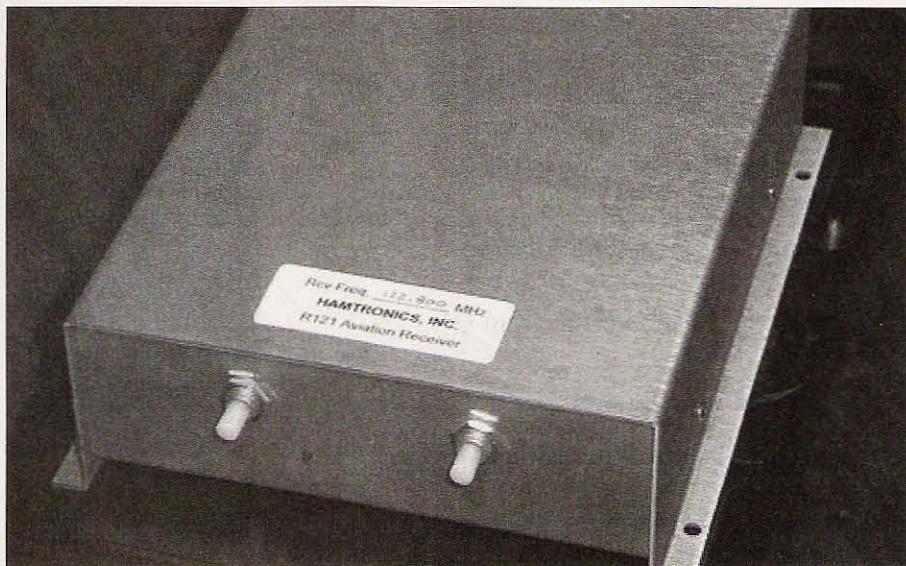

Photo A. This is the front view of Hamtronics' new R121 programmable air-band receiver

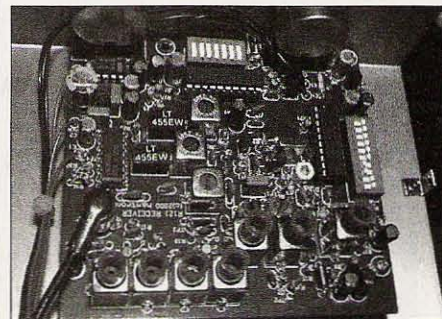

Photo B. R121 receiver board is a simple single-sided board circuit that appears to be G-10. It measures 4 x 3.8 x 1.5 inches, with the volume and squelch controls protruding forward. All components and test points are easily identifiable, with the exception of the MC145190F synthesizer chip, which is mounted on the foil side as it is a surface-mount device.

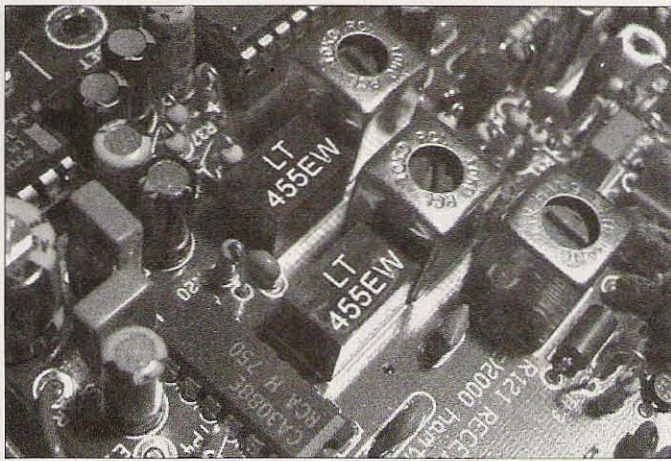

Photo C. Here is a close-up shot of the 455 kHz IF and detector. Even an over-50 Norwegian with "short-arms disease" like me can actually REPAIR something on this scale. Way cool!!

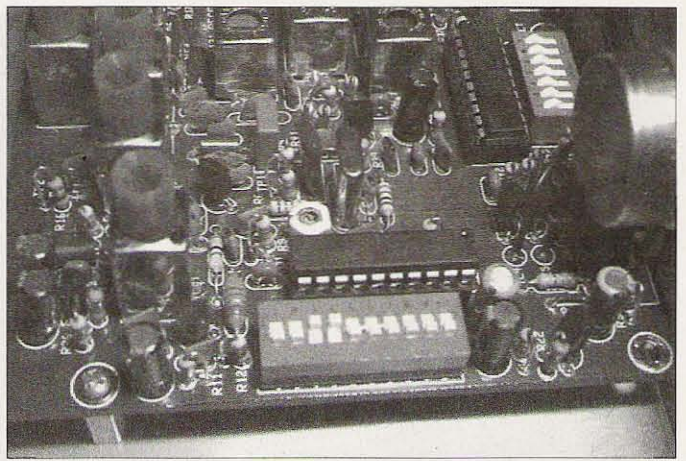

Photo D. Here is a close-up of the synthesizer programming switch. The function switch is in the upper right-hand corner of the photo.

way), double-conversion receiver that is programmable from 118 to 137 MHz. The receiver consumes between 75 and 200 mA (full audio output) at 13.6 VDC. Its baseline frequency stability is +/- 2 ppm all the way from -30 to +50 degrees C. It employs a standard CA3088 amplifier/AM detector, and will provide 2 watts of audio to an 8-ohm speaker, while providing a 10 dB signal-to-noise ratio at 0.2 microvolts. Trust me, I tested it. The one I evaluated was closer to 0.18 microvolts at 121.775 MHz (some of you CAP types should recognize that frequency). The R121 also employs a pair of inexpensive, easy-to-obtain 3SK122 dual-gate MOSFETs in the front end and mixer. One very nice thing is the adjacent channel selectivity of 80 dB. This is very important if you are going to use any receiver around an airport.

The R121 will also provide the user with a relative signal strength indication by driving 1 mA full-scale meter. The synthesizer is DIP-switch programmable in 25 kHz steps. A simple MC68HC705J1A microprocessor interprets the switch settings for the synthesizer. You can tell that Jerry didn't design this receiver for the average scanner listener, as you actually have to do some math to program the receive frequency. This is not rocket science (I hate that term), and Jerry provides the owner with a very simple technique in his well-written manual for setting the R121 on the desired channel. If you have access to the

Internet, you can go to the Hamtronics, Inc., Web page to obtain switch settings for every frequency that the R121 will tune to (the URL is at the end of this article).

Functions and applications

I mentioned earlier that Jerry and his team developed this receiver around two main applications. These are, but are certainly not limited to, airport runway lighting control, and emergency locator transmitter (ELT) detection and tracking. Actually, there are two other modes available: a simple monitor mode, and a test mode. All of these are DIP-switch-settable. A second 705J1A μ P chip controls the timing functions, and drives the three open-collector outputs (2N3904) that are provided for the alarm and control features. The S-meter output is an unbuffered output that comes directly from the detector chip.

Pilot control of runway lighting (PCL) mode

For many years now, airport operators have sought to conserve energy by not leaving the runway lights up at full strength, especially during low-use, or non-tower-controlled periods. What a pilot may do is key his or her transmitter on the common traffic advisory frequency (CTAF) either three, five, or seven times within a five-second period to get low, medium, or full intensity runway lights functioning on the

airport without ground intervention. Nope, nobody has to go out and light the smudge pots anymore, when you want to come in for a night landing. All you need now is an R121 driving the lighting controls at your airport. The three open-collector outputs may be used to drive a variable intensity lighting relay system at your home airport, or even at Boeing Field for that matter.

ELT detection and tracking mode

This mode is near and dear to my heart. I own a PA28-140B with a 160 HP Penn Yan conversion that I use for flying SAR missions for the State of Washington, and for the CAP (I'm also my squadron's communications officer). ELT search missions happen a lot around here, and I am sure that they do where you are as well. In the CAP corporate aircraft here in Washington Wing we leave a receiver on 121.5 all the time the avionics master switch is on. I am not so blessed with the appropriate hardware in my Cherokee, but I intend to remedy that situation. The R121 is an excellent candidate for that.

The fact is that the R121 may be used in a fixed base operator's (FBO) location to see if any of the ramp angels or hanger queens are chirping away on 121.5 after good hard student landing. It may also be used in a ground team search vehicle equipped

Continued on page 46

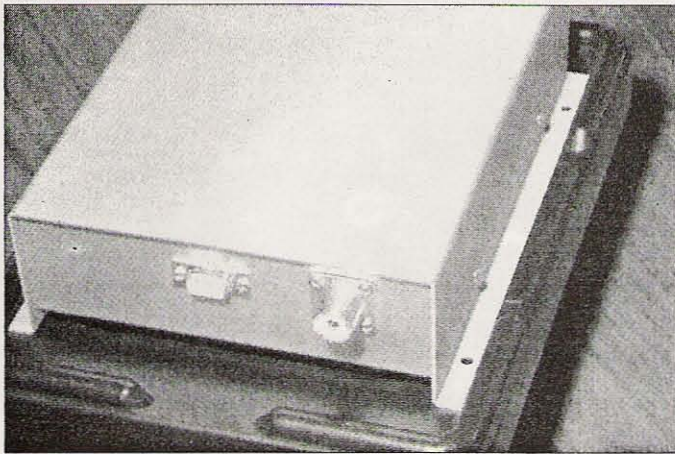

Photo E. The rear panel provides an SO-239 connector for RF, and a DB9 connector for power, audio, and control outputs.

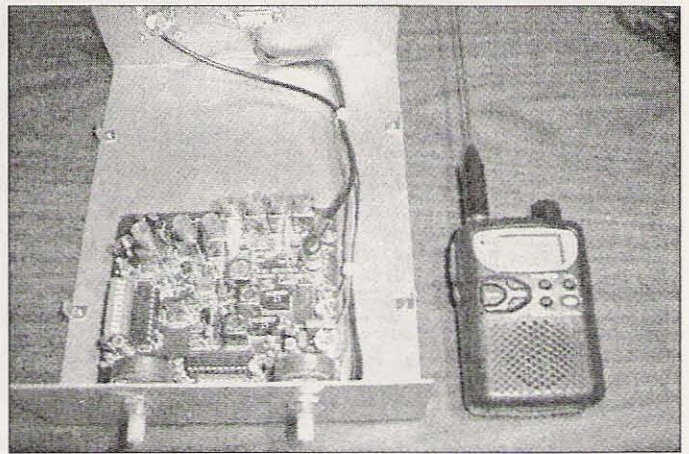

Photo F. Here is an idea of the size of the R121. On the right is my tiny little ICQ7A.

Air Hamtronics

continued from page 45

with DF equipment, or as a dedicated DF receiver in an aircraft.

A GREAT gift idea for yourself, your ham friend(s), or your child's school library

is a subscription to 73 Magazine ... only \$24.97!
Call 800-274-7373 or write to 70 Route 202 North,
Peterborough NH 03458

TRANSMITTER LOCATION

New fixed site direction finders provide 2 degree accuracy, and include software for triangulation from a central control site. Mobile versions also available covering 50MHz to 1 GHz

Doppler Systems Inc.

PO Box 2780 Carefree, AZ 85377
Tel: (480) 488-9755 Fax: (480) 488-1295
www.dopsys.com

European Marketing Director Denis Egan
PO Box 2, Seaton, Devon EX12 2YS England
Tel & Fax: 44 1297 62 56 90



In the ELT mode, the receiver can be set up to monitor 121.5, and can also provide a delayed alarm that is programmable in 5-minute increments up to 75 minutes. This is to prevent an accidental alarm trip during the FAA-allowed ELT test period of each hour. The alarm feature is facilitated by the μ P and open-collector circuits, and is programmed by the mode switch.

The R121 then becomes a piece of mission-critical

hardware for SAR work. The possible applications don't end there, however. Like I said before, just use your imagination.

Wrap-up

I really like this receiver. It is a very simple, mature design that is both rugged and easy to work on. It can be easily 337'd into my Cherokee as a dedicated ELT receiver, conveniently placed out of sight, and away from passengers, hardware, or rigging.

The R121 is currently available from Hamtronics in two ways. Their current pricing indicates that it may be obtained wired and tested in a circuit-board-only configuration for \$209, or may be purchased in a very solid anodized aluminum case for \$299.

For more information, I suggest you contact the manufacturer directly. Their address is Hamtronics, Inc., 65 Moul Road, Hilton NY 14468-9535. Their phone number is (716) 392-9430. If you have access to the Internet, their URL is [http://www.hamtronics.com]. You can communicate with Jerry directly at [jv@hamtronics.com].

Now, let's see if Jerry forgets to ask me to send this little box back. I might be tempted to stick it under the back seat tray in my little "Volkswagen-with-wings."

73

Say You Saw it In 73!

Just What Does “Amateur” Mean?

One of the things I like most about amateur radio is the fact that it really and truly is an amateur activity. Professionals get paid for performing a particular function. We amateurs, on the other hand, are specifically prohibited from accepting compensation for providing radio services in the amateur bands. This, by definition, is what makes us amateurs.

Being amateurs does not mean that what we do has no value, and in many cases we provide significant value to our neighbors and community. Many amateur radio public service liaisons calculate what our services would cost if someone provided it on a fee-for-service basis. For example, if amateurs weren't available, what would it cost to provide fully trained and equipped communicators? The local government could be charged thousands of dollars for the communications support. As amateurs we provide the service for free.

Sometimes it's the word "amateur" that gets in the way. It sounds like a second-class citizen. We have an expectation that a professional who makes his livelihood from his activity naturally takes pride in how he performs. An "amateur" might not be expected to perform to the same high standard. In practice, however, amateurs provide some of the highest-quality service on the airwaves; but that word creates certain images.

The big difference is that as amateurs we engage in amateur radio for a different reason than our professional counterparts. We do not engage in communications for money. We don't get involved because we have to. We develop our skills, pass our license exams, and acquire a selection of equipment because we enjoy it. Nothing more, nothing less. Amateur radio is a labor of love. We are after the enjoyment, fulfillment, and just plain fun that the hobby provides. I enjoy my job, but if I found I had a winning lottery ticket, I'm not sure I would wish to continue to work. On the other hand, I have no doubt that I would continue to enjoy ham radio. In fact, I can only imagine the ham radio toys that I would buy if I in fact won the lottery!

I think this is why there are so many aspects to the hobby. There is virtually

something for everyone. Of course, there would have to be in order to keep so many people interested. We come from all walks of life, all career paths, all education levels, and all parts of the world. Each of us, out of love for the hobby, finds a niche that pleases us, keeps us interested, and provides a little break at the end of the day or on the weekend.

What we do may not make sense to others, and sometimes may not make sense even to us. We do certain things because we can — not because we must. To many people (both amateur and non-amateur) communicating by Morse code is a quaint but obsolete curiosity. To some hams, it is the ONLY way they truly enjoy the hobby. There is no reason to work CW except for pure love of the mode. I know CW can get through when other modes fail. I know that a QRP rig works best with CW. But let's face it — you gotta love it or you'll choose another mode.

Some hams love to design and build equipment, even though excellent factory-assembled equipment is readily available. The off-the-shelf equipment may have significantly better features, but it is the pure enjoyment of building that drives some of us. Then there are those of us who prefer the challenge of making global contacts by various inefficient and unreliable methods. Why would a rational human being bother with a contact via meteor scatter or earth-moon-earth bounce when the telephone and Internet access are within reach. Why? Because it's fun. Like hunters used to say, "The thrill of the hunt is in the chase, not the kill."

Every once in a while, when the hobby becomes a little too routine, it's good to stop and remind yourself that this is a hobby and we do enjoy it. I enjoy it more than any other hobby I've attempted, but still

find it important to stop and smell the roses (or maybe I should say the rosin flux).

What aspects of ham radio hit your ON button? What makes you glad to be an amateur? What do you do for the pure love of the hobby? Is there something that excites you, or has it become just a habit? Is mobile operations what you participate in the most? If so, what is it about the mobile operations that you particularly enjoy? Is it the ability to chat with the same group on a regular basis? Maybe it's just some way to pass the time on the way to and from work. How about the chance to speak with hams around the world while on a trip? On the other hand, it might just be that mobile operations characterize your only available time to spend with the hobby.

As you know, I enjoy public service and disaster communications. Given that my career is in health care, there seems to be a natural fit. Because of my interest in these areas, the reliance on mobile and portable operations is a natural progression, since both are critical in the effective management of an emergency situation. On the other hand, for the few days each year that I'm involved in public service communications, there are hundreds when the hobby is there just for the fun of it.

I'm suggesting that each of us take a few minutes to look at the hobby with a fresh perspective and think about some aspect of it that might be fun. I mean *real* fun, and preferably something that we've never tried. It could be a new mode or a different band. If you're not a contester, then maybe try a contest. How long has it been since you participated in Field Day? If it's been a few years, then maybe that's a possibility. Choose something just because it sounds fun. When you do, give it a try and drop me a note as to how it went!

NEW PRODUCTS



AOR AR8600 Wide-Range Receiver

"The AR8600 reflects a blend of advanced technology, innovative thinking, and some proven techniques in giving the operator a world of listening choices and options," said Taka Nakayama, vice president for AOR USA. "The AR8600 is so advanced, its design has been awarded U.S. patent 6,002,924. It can accommodate optional cards that allow the user to add extended features, and it can accept Collins mechanical filters for amazing selectivity."

The AR8600 has a Temperature-Compensated Crystal Oscillator (TCXO) as an extremely stable frequency reference. It can hold up to 1,000 memories (20 banks x 50 channels/bank) and can search those memories for signals at a rate up to 37 channels per second. In addition, there are 40 different search banks. Tuning range is 520 kHz—2.040 GHz. By law, cellular frequencies are blocked, but an unblocked version of the AR8600 is available to qualified agencies.

Receive modes include wide FM, narrow FM, super-narrow FM, wide AM, narrow AM, upper sideband, lower sideband, and continuous wave. Received signals are processed through a newly designed front end. There are three operating modes: VFO (featuring two independent VFOs), Memory, and Search.

Innovative features include an area for up to three optional slot cards that perform various functions, including: CTCSS,

Tone Eliminator, Voice Inversion, Digital Recording, and External Memory. In addition, optional Collins mechanical filters can be added for precise selectivity.

In the wide FM mode, the AR8600 can use its 10.7 MHz IF output in conjunction with the SDU5500 Spectrum Display Unit. The AR8600 can also display spectrum activity on its front-panel display.

Computer management of the AR8600 is done through a rear-panel RS-232C port, and free software for controlling the unit is available from the AOR Web site, [<http://www.aorusa.com>]. Each memory can store frequency and an array of special choices, including alphanumeric channel labeling.

Front panel controls include power switch, a multifunction keypad for direct frequency entry and secondary functions. Additional controls include volume, squelch, operating modes (VFO, Memory, or Search), keyboard lock, and an "arrow matrix" to aid in menu choices. There is also a front panel connection for headphones.

The AR8600 comes with a movable front support and a BNC antenna port with telescoping antenna, and operates on 12 volts DC from a power cube or station power supply.

"The AR8600 is a strong advancement in receiver technology," said Mr. Nakayama. "We believe there will be a strong demand for it by commercial and institutional operators as well as those listening enthusiasts who demand the best."

For further information, contact AOR U.S.A., Inc., 20655 S. Western Ave., Suite 112, Torrance, CA 90501; tel.: (310) 787-8615; fax: (310) 787-8619.

Buckmaster's HamCall CD-ROM

This disk gives you over 1,635,000 US and international callsigns. Features include ability to view and search interest profiles for over 35,000 hams; search for club, military, RACES, vanity, and silent keys; access over 122,000 E-mail addresses; get latitude and longitude for over 90% of all addresses, with precision down to a few hundred feet; see flag and map for each country; see ITU zone and continent; print labels for QSLs; interface with most popular logging programs; edit entry information; and much more. \$50, plus \$5 s/h USA, \$8 s/h international. Update service and on-line advanced search services also available for additional fee.

For further information, contact Buckmaster Publishing, 6196 Jefferson Highway, Mineral VA 23117; tel. (800) 282-5628; E-mail: info@buck.com

News from Kenwood

- Kenwood has published a new video for club (only) presentations about its new multiband/multimode TS-2000 transceiver. The video describes this latest state of the art equipment that allows operation in many different configurations, including mobile, personal computer, and spinning the traditional VFO. The short video is a great addition to any club meeting. You can request one on a club letterhead including UPS address from Kenwood Amateur Group Video Offer, 3975 Johns Creek Ct. #300, Suwanee GA 30024 or by faxing (678) 474-4730. For US ham clubs only, please.

- Kenwood has announced that it has contracted with INSINC, Interactive Netcasting Systems, Inc., to broadcast live events during the Dayton Hamvention (May 18–20) using the power of the Internet. For the first time, hams around the globe can attend activities at Dayton and hear interviews with the real movers and shakers of amateur radio. Watch [www.kenwood.net] for more details.

Hamcalc Version 50 Released

V. 50 of Hamcalc has now been released. Details on this disk can be found in our February "New Products" column.

For a free Hamcalc CD-ROM, please send US \$7.00 in check or money order (no stamps or IRCs, please), to cover cost of materials and airmail to anywhere in the world, to George Murphy VE3ERP, 77 McKenzie St., Orillia ON L3V 6A6, Canada. E-mail: [ve3erp@encode.com].

**Your new product announcement could be here.
Call Joyce Sawtelle at 800-274-7373.**

ADVERTISERS' INDEX

R.S.#	page	R.S.#	page	R.S.#	page	R.S.#	page
• AEA	25	10 Communications		• Kenwood		• Radio Book Shop	29
• Alinco	CV2	Specialists, Inc.	19	Communications	CV4	• Radio Book Shop	31
• All Electronics Corp.	17	• Creative Services	86	MFJ Enterprises	7	• Radio Book Shop	37
• Alltronics	20	Software, Inc.	59	MFJ Enterprises	55	• Radio Book Shop	46
• Am-Com, Inc.	21	• D & L Antenna Supply Co.	19	• Michigan Radio	49	• Radio Book Shop	51
16 Astron Corporation	2	• Dayton Hamvention	15	160 Micro Compute Concepts	28	• Radio Book Shop	63
42 Bilal Company	29	13 Doppler Systems	46	193 Morse Tutor Gold	57	• Ramsey Electronics	3
168 Buckmaster Publishing	28	• E-Z Hang	19	• Omega Sales	31	• Ross Distributing	29
56 Buckmaster Publishing	37	193 GGTE	57	• Omega Sales	37	• Scrambling News	28
99 Communication		• Ham Ambassadors	43	• Omega Sales	38	• SGC	41
Concepts, Inc.	11	• Ham Mall	11	• Peet Bros.	13	• Universal Radio	25
• Communications		• Hamtronics, Inc.	9	• Radcomm Radio	57	• W5YI Group	29
Electronics, Inc.	5	42 Isotron	29	• Radio Book Shop	28	• Yaesu	CV3

When you buy products from these advertisers, please tell them that you saw their ads in 73.
 Subscribe to 73 right now...call 800-274-7373 (9-5 Monday-Friday EST).



WE SHIP WORLDWIDE

Michigan Radio
SALES SERVICE

Local & Tech 1-810-771-4711, Service 1-810-771-4712, Fax Service 1-810-771-6546

OPEN
TUES, WED, THUR 10-6
FRI 11-8
SAT 10-3
CLOSED SUN & MON



Terms do not include shipping. Price and availability subject to change without notice. Most orders shipped same day. COD's welcome (\$5.50 & shipping).

26014 Groesbeck, Warren, MI 48089
1-800-TRU-HAMM (orders only)
 (800-878-4266)

Now on the World Wide Web <http://michiganradio.com> E-mail mirad@mich.com



KENWOOD



ICOM



YAESU

Convert Excess Equipment to CASH • We buy good, clean, used equipment • Estate Sales

CALENDAR EVENTS

Listings are free of charge as space permits. Please send us your Calendar Event two months in advance of the issue you want it to appear in. For example, if you want it to appear in the August issue, we should receive it by June 5. Provide a clear, concise summary of the essential details about your Calendar Event.

MAY 5

CADILLAC, MI The Wexauke ARC will hold their 39th Annual Amateur Radio and Computer Swap Meet on Saturday, May 5th, from 8 a.m.–12 p.m. at the Cadillac Junior High School in Cadillac MI. Talk-in on 146.980/K8CAD rptr. Free parking. Admission is \$5, tables \$8 per 8 ft. table. VE exams at 10:30 a.m., by pre-registration only; contact *Alton NU8L* (231) 862-3774 or E-mail [amccconnell3@hotmail.com]. For more info please write to *The Wexauke ARC, P.O. Box 163, Cadillac MI 49601*.

CEDARBURG, WI The Ozaukee Radio Club will sponsor its 23rd Annual Cedarburg Swapfest, 8 a.m.–1 p.m. at the Circle-B Recreation Center, Hwy. 60 and County I (located 20 miles north of Milwaukee, west of Grafton). Admission is \$4, both in advance and at the door. 4 ft. tables are \$5 each (limited power available on request). Seller's setup 6:30 a.m. VE exams start at 9 a.m. Talk-in on 146.37/.97 and 146.52. For tickets, table reservations, maps, or additional info, send an SASE to *Gene Szudrowitz KB9VJP, ORC Swapfest Chairman, W55 N865 Cedar Ridge Dr., Cedarburg WI 53012. Tel. (262) 377-6792; or Skip Douglas at (262) 284-3271*.

MAY 5-6

ABILENE, TX The Key City ARC will sponsor the ARRL West Texas Section Convention and 16th annual Hamfest at the Abilene Civic Center from 8 a.m.–5 p.m. Saturday, and from 9 a.m.–2 p.m. Sunday. Free parking. VE exams. Wheelchair access. Limited RV parking for a nominal fee. Tables \$7 each. Pre-registration \$7 (must be received by April 30th), \$8 at the door. Talk-in on 146.160/.760. For reservations and info contact *Peg Richard KA4UPA, 1442 Lakeside Dr., Abilene TX 79602. Tel. (915) 672-8889; E-mail [ka4upa@arrl.net]*.

MAY 12

RENO, NV The Reno Area Metro Simplex ARC will sponsor the Reno Spring Ham Swap at Television Station KNPB, 1670 N. Virginia St. (on the campus of the Univ. of Nevada, Reno). From I-80, take the Virginia St. exit and head north one mile. Free admission to all. Vendors, bring your own tables. Large indoor/outdoor swap. Plenty of parking. Tours will be given of the High Definition TV Station. For VE

exams, contact *Don Freeman W7FD, (775) 851-1176; or [dfree1@worldnet.att.net]*. Talk-in on 147.060(+123). For more info contact *Glen Haggard KK7IH, (775) 673-6401; [kk7ih@nvrams.org]*.

MAY 27

WEST FRIENDSHIP, MD The Maryland FM Assn., Inc., will host its Memorial Day Hamfest, Sunday, May 27th, at the Howard County Fair Grounds, Rt. #144, West Friendship MD, 8 a.m.–2:30 p.m. The premises MUST be cleared by 5 p.m. Talk-in on WA3DZD/R rptr., 146.16/.76, 223.16/224.76, and 449.0/444.0. Plenty of food and drink will be supplied by the West Friendship 4-H. No private sale of food or drink permitted. Donation \$5. Tailgaters \$5 per space. Inside table rentals \$20 in advance, \$25 at the hamfest. Only paid reservations are valid. No pay, no reservation. For info and reservations, contact *Craig Rockenbauch WA3TID, 429 Severnside Dr., Severna Park MD 21146. Tel. (410) 987-6042*. Make checks payable to MFMA, Inc. All proceeds will be used for amateur radio related purposes. Commercial vendors must have proper tax/license certificates available. All items offered for sale must be amateur radio-related.

JUNE 2

SPRINGFIELD, IL The Sangamon Valley Radio Club Hamfest will be held at the Illinois State Fairgrounds Cooperative Extension Building in Springfield, rain or shine. From I-55 take Sangamon Ave. west to the Illinois State Fairgrounds. Stay on Sangamon Ave. past the main gate. Go to the next gate (Gate 11). Enter Gate 11 and drive straight back to the Cooperative Extension Building. Talk-in on 146.685 MHz(-.600). Tickets \$5 each, or 3 for \$10. No additional charge to set up in the 100,000 sq. foot covered flea market area. Limited indoor tables may be available. Contact *Ed Gaffney KA9ETP, 13977 Frazee Rd., Box 14A, Divernon IL 62530; tel. (217) 628-3697; or E-mail [egaffney@family-net.net]*. For more info about the Sangamon Valley RC, this hamfest, or obtaining an amateur radio license, please visit [WWW.W9DUA.NET]. This hamfest is co-sponsored by Shooting Stars 4-H. Food service provided by Shooting Stars 4-H.

JUNE 3

CHELSEA, MI The 23rd Annual Chelsea Swap, Ham and Antique Radio Swap, will be held on June 3rd in Chelsea MI, at the Chelsea Fairgrounds, on Old US 12 at M-52 in Chelsea. Gates open at 6 a.m. for sellers; 8 a.m. for the public. Donation is \$4 in advance, \$5 at the door, under 12 free. Plenty of parking; easy access from I-94. Talk-in on 145.450(-), WD8IEL Chelsea rptr. Trunk sales \$5 a space. Table space, \$10 per 8-ft. table. Handicap access. For reservations and more info, E-mail [WD8IEL@hotmail.com]; or contact *Bill Altenberndt WB8HSN, 19501 Bush Rd., Chelsea MI 48118*. Sponsored by the Chelsea ARC, Inc.

MANASSAS, VA Virginia's Ole Fashioned Manassas Hamfest, amateur radio, computer and electronics show, will be presented by the Ole Virginia Hams ARC, Inc., at Prince William County Fairgrounds, 1/2 mile south of Manassas, on Rte. 234. Talk-in on 146.97(-), 224.660(-), and 442.200(+). General admission is \$5 per person at the gate. No advance sale. Gates open at 7 a.m. Free parking. Indoor exhibitor space with 8-ft tables, \$30 each with chairs and electricity. Tailgating \$5 per space (plus admission), gates open at 6 a.m. Setups 2 p.m.–10 p.m. Saturday, June 2nd. Ample room for everyone. For VE exams, contact *Ruth KU4WH, tel. (703) 331-1234; or E-mail [Friszy2@aol.com]*. Features: ARRL Roanoke Div. officers and 4th Call Area QSL Bureau reps will be present; DXCC QSL card checking; Virginia QSO Party Awards Ceremony. Food vendors must have prior written approval from the Hamfest Chairman. For dealer info, contact *Jack N4YIC, tel. (703) 335-9139; fax (703) 330-7987; E-mail [N4YIC@arrl.net] or [patrjack@erols.com]*. For general info, contact *Mary Lu KB4EFP, tel. (703) 369-2877, E-mail [mblasd1638@aol.com]*.

JUNE 10

BETHPAGE, NY The LIMARC Spring 2001 Electronics Hamfair and Flea Market will be held at Briarcliffe College, 1055 Stewart Ave., Bethpage NY, beginning at 8:30 a.m. Gates open at 7 a.m. for vendors. General admission is \$6, children 12 and under accompanied by a paying parent, and non-ham sweethearts will be admitted free. For more info, visit the LIMARC Web site at [http://www.limarc.org],

or call the 24-hour info line at (516) 520-9311. Talk-in on the 146.850 rpt. PL 136.5. E-mail [hamfest@limarc.org].

WHEATON, IL The Six Meter Club of Chicago, Inc., will hold its 44th Annual Hamfest, a ham radio and electronic flea market which also features antique and vintage radios. The event will take place Sunday, June 10th, at DuPage County Fairgrounds, 2015 Manchester Rd. (north of Roosevelt Rd. (Rte. 38), east of County Farm Rd.). This hamfest will be held rain or shine. ARRL and dealer displays. Free parking, no extra charge for space in outdoor flea market. Limited overnight RV parking with electrical hookup — \$10 each by advance registration, required by May 25th. Advance tickets \$5 each, \$6 at the gate. Advance tickets available from *Joseph Gutwein WA9RIJ, 7109 Blackburn Ave., Downers Grove IL 60516*, or any club member. For info call the 24-hour InfoLine at (708) 442-4961. General parking at the West Gate; sellers ONLY at the East Gate. Handicap parking, use East Gate. Gates open at 7 a.m., buildings open to the public at 8 a.m. Talk-in on K9ONA 146.52 or K9ONA/R 146.37/.97 (107.2). Commercial tables 8 ft. w/ 110V in main bldg., air cond., \$12 before April 30th, \$15 after. Indoor flea market tables, 8 ft., no electric, \$10 before April 30th, \$12 after. ARRL VE exams 9 a.m.–11 a.m.; call the InfoLine to pre-register for testing. Make check payable to *Six Meter Club of Chicago*, and send with SASE to *Six Meter Club of Chicago, 7109 Blackburn Ave., Downers Grove IL 60516*, no later than May 25th. Absolutely no alcoholic beverages permitted. All sellers are responsible for cleanup of their spaces. No sales of food or beverages permitted.

JUNE 16

DUNELLEN, NJ W2QW, The Raritan Valley Radio Club of Martinsville NJ, will hold a Hamfest at Columbia Park, near the intersection of Routes 529 and 28, 7 a.m.–2 p.m., June 16th. Sellers set up at 6 a.m. Admission: Buyers \$5, sellers \$10 (\$5 each additional space). Talk-in on 146.625(r), 447.250(r), 447.250(r) tone 141.3, and 146.520 simplex. Contact *Doug Benner W2NJH, (732) 469-9009, [WB2NJH@AOL.COM]*; or *Fred Werner KB2HZO, (732) 968-7789, before 8 p.m.*

JULY 4

BRESSLER, PA The Harrisburg Radio Amateur Club, W3UU, will hold its Firecracker Hamfest in celebration of its 29th year, at Emerick Cibort Park, Bressler PA. Set up on July 3rd from 6 p.m.–9 p.m., or July 4th at 6 a.m. The park opens to the general public at 8 a.m. July 4th. 80 covered tables, all with electricity, only \$12 each, prepaid by June 1st. All tables paid for after July 1st will be \$15 each, prepaid on a first come first served basis. 48 hour cancellation notice required for

refunds. Contact *Pete deVolpi K3PD, 408 Hillside Ave., New Cumberland PA 17070. Weekday phone (717) 705-1370, weekends and evenings 6–9 p.m. (717) 938-8249. E-mail [w3uu@aol.com]. See the Web site at [http://members.aol.com/w3uu/].*

SPECIAL EVENTS, ETC.

CIS DIPLOMA The Radio Amateur's Diploma of the Commonwealth of Independent States, is established by International Radioamateur's Club "Funkner DX Family," to promote a greater amateur radio interest in republics of the Commonwealth of Independent States. The diploma is available to licensed amateurs and to shortwave listeners, and given for working and/or hearing 12 amateur radio stations in all of the 12 countries of CIS: 4K — Azerbaijan; 4L — Georgia; EK — Armenia; ER — Moldova; EU — Belarus; EX — Kyrgyzstan; EY — Tajikistan; EZ — Turkmenistan; R — Russia; UK — Uzbekistan; UN — Kazakhstan; and UR — Ukraine. All contacts must have been made by any mode on any bands, according to the license of the competitor, since January 1st, 1993. QSL cards are not required. The application for obtaining the diploma is verified by the statements of the log. The manager of the diploma reserves the right to test the validity of any reported QSO. The cost of the diploma for the radio amateurs of the Russian Federation is an equivalent 2 US at the rate of the Central Bank of Russian Federation at the date of the application; for radio amateurs from other republics of CIS, equivalent of 3 US; for the radio amateurs of other countries, 6 US. The payment in IRC on a relationship of 1 US = 2 IRC is possible. An equivalent are the rubles of the Russian Federation. The application for the diploma, together with the payment, should be sent to *Funkner DX Family, P.O. Box 50, Moscow 109439 Russia*. Any problems concerning the diploma can be decided on the air through operators of the Club Station RZ3DZZ, or via E-mail to [fdxf@aha.ru]. Check out the Web site at [http://www.funccap.narod.ru/index.html].

MAY 4–6

AQUINAH, MA The Fall River ARC will operate W1ACT/P from the Gay Head Lighthouse, May 4, 18:00 UTC–May 6, 19:00 UTC. IOTA NA046. QSL via *Roland Daignault, Jr., N1JOY, 19 Davis Rd., Westport MA 02790, SASE only*. Frequencies: 14.260, 21.260, 28.460, 50.130.

MAY 5–6

CONNECTICUT QSO PARTY The Candlewood ARA will sponsor the Connecticut QSO Party 2000Z May 5th–2000Z May 6th, with a rest period 0400Z–1200Z. Modes: Phone, RTTY and CW. Work stations once per band and mode, mobiles as they cross county lines. No repeater QSOs. Single operator, fixed/mobile, Novice, QRP(5W), Multi-single

Multi-multi classes plus Connecticut club competition. Connecticut stations may contact other Connecticut stations for QSO/multiplier credit. Connecticut stations exchange report and county; others exchange report and state/province/DXCC country. Non-CT stations work CT stations only. Frequencies: CW — 40 kHz up from lower band edges; Novices 25 kHz up from low end. Phone — 1.860, 3.915, 7.280, 14.280, 21.380, and 28.380. VHF — 50.150, 144.200, and 146.580. RTTY/PSK31/Digital — normal RTTY bands. All bands (HF, VHF, UHF) except WARC bands count. Score one point per phone QSO and two points per CW or RTTY/Digital QSO. QSOs with club station W1QI, and ARRL HQ station W1AW count 5 points. Connecticut stations multiply QSO points by states/provinces/Connecticut counties worked (DX only one multiplier); others multiply by Connecticut counties worked (work CT stations only). Plaques and certificates (100 point minimum). Special certificate for working all 8 Connecticut counties. Send entry and SASE for results by June 6th to *CARA, P.O. Box 441, Danbury CT 06813-3441 USA*.

MAY 16–26

ONTARIO, CA A "Run for The Wall" event volunteer will operate N7LFLK 1600Z May 16th–0700Z May 26th, mobile across the heartland of the USA during the 13th annual pilgrimage to Washington DC. Phone 14.265, 21.365, and 28.465. For a certificate, send QSL to *RFTW (Mike Paxton) P.O. Box 2625, Gearhart OR 97138-2625 USA*. This event is to help create a groundswell of support for all American prisoners of war and missing in action (from all wars). This event brings together fellow veterans to promote physical and emotional healing from the results of being injured by war and its consequences. All military veterans who were radio operators, are urged to operate N7LFLK, giving their old military call signs, their duties, and locations they operated from. This mobile special event will close at the National Vietnam Memorial (The Wall) in Washington DC on May 26th. For further info contact *N7LFLK, Mike Paxton, at (503) 738-7853, or visit [www.rftw.org]*. 73

Subscriptions

to
73 Magazine

Only \$24.97 — 1 year
\$44.97 — 2 years
\$65.00 — 3 years*

*best buy (54% off cover price!)

Call 800-274-7373

AO-40 at Home

The proliferation of commercial S-band downconverters, originally for multichannel cableless pay TV, that have been successfully pressed into service for AO-40 (AMSAT-OSCAR-40) Mode "S" reception has been fast and exciting.

While most of these units can be used "as is," they typically convert the 13-cm signals from AO-40 on 2401.323 MHz to non-ham frequencies in the vicinity of 122 MHz. This is usually outside the optimum range of the converters, thus providing low gain and poor noise factors.

The most common commercial unit that has been used successfully is the Drake 2880. Hundreds, if not thousands of these devices have been plucked from the shelves of surplus distributors here and in Japan. With a relatively simple modification, 2400 MHz can be converted to 144 MHz by simply changing the main oscillator crystal. The 2880 then becomes a great asset for terrestrial and S-band hamsat reception. Other changes to move the IF (Intermediate Frequency) filter center down to the two-meter ham band, and tune the input filter with very slight lengthening of three internal striplines to favor 2400 MHz, provide useful gain and noise figure enhancements.

For the price of a new crystal (\$12 to \$14), and the surplus downconverter (\$25-\$45), the result is a cost-effective station addition

that can hear the beacons from AO-40, AO-16 (AMSAT-OSCAR-16), and UO-11 (UoSAT-OSCAR-11). As mentioned in the March "Hamsats" column, a good place to start for S-band converter and antenna information is Jerry K5OE's Web page [<http://members.aol.com/k5oe/drake.htm>].

Antennas that will do well in conjunction with these downconverters are easy to get. Due to the wide range of channels in use for various MDS (Multipoint Distribution Service) TV setups, most antennas will work from 2100 to above 2600 MHz. They range in price from \$40 to \$75, depending on source, type, and quantity purchased.

I recently did some simple qualitative tests in the back yard using three Drake 2880s and a Swedish-made Parabolic AB [<http://www.parabolic.se>] "AMSAT Mode S Converter." The commercially-built amateur-radio converter (\$220 shipped via air) became my comparison standard. It is advertised as a weather-proof downconverter with an input range of 2400 to 2404 MHz, output from 144 to 148 MHz, a maximum noise figure of 1.0 dB, a gain figure of

30 dB, and power supply requirement of 11.5 to 15.5 VDC at 300 mA. DC power is sent back through the coax to the antenna-mounted converter. The unit comes with mounting brackets, but the bias tee is sold separately. Most hams make their own or find one for a MDS converter that can supply the right voltage and current.

After completing the easier modifications to the three Drakes, two were mounted to large (higher-gain) MDS antennas in the back yard. The Swedish Parabolic converter was connected to a smaller antenna with about half the surface area of the others. All three antennas were bolted to a single cross boom above a tripod. A small 2400.600 MHz signal source that had been used for S-band receiver experiments during the early days of AMSAT-OSCAR-13 was activated in the house. About an hour prior to a good UO-11 pass (2401.500 MHz carrier), the Drakes were calibrated to match the frequency conversion specifications of the Swedish unit. While the Drakes exhibited a lot more frequency drift on power-up than was hoped, they at least seemed to be working.



Photo A. Comparing Drake 2880s, a Parabolic AB "AMSAT Mode S Converter," and three antennas in the back yard.



Photo B. Close-up view of the Parabolic downconverter on the small center antenna.

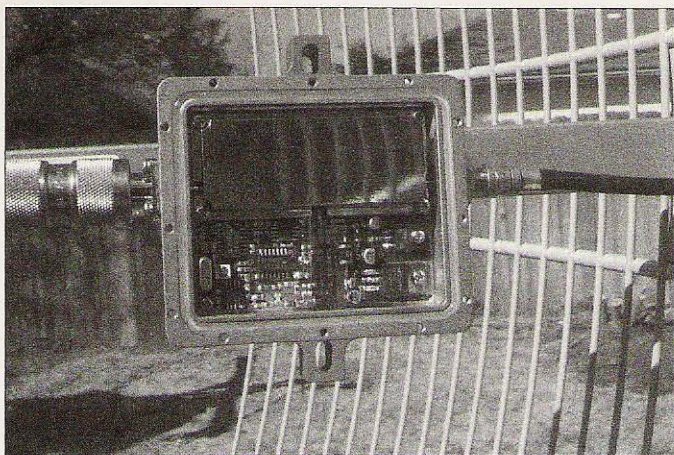

Photo C. Close-up of an open Drake 2880 ready for tuning. The crystal and tuning capacitor are in the lower left.



Photo D. The AMSAT-NA Board of Directors met in Orlando, Florida, in February to define new projects and direction.

When it was time for UO-11 to arrive at the horizon, there were a few surprises. First, the downconverters were all working, but — second — it was extremely difficult to keep up with the Doppler shift during the course of the pass (about 100 kHz in 10 minutes), and the antenna pointing efforts due to the relatively narrow beamwidth of the antennas, the relative speed of the satellite across the sky, and the lack of rotators in this simple test setup.

A single VHF receiver was used with all of the downconverters via a coax switch. The S-meter readings were slightly lower on the Drakes compared to the Swedish Parabolic unit. Since the Parabolic used an antenna with at least 3 dB less gain, the Drakes were calculated to be at least 4 to 5 dB less sensitive. This deficiency was notable, but not a problem when the strong signal from AO-40's S-band beacon was later monitored.

February 2001 AMSAT board meeting

On the morning of Saturday, February 24,

2001, an AMSAT-NA Board of Directors meeting was convened in Orlando, Florida. The purpose was to begin the process of defining projects and direction for the future. Attendees included Jan King W3GEY, Harwood "Shep" Shepherd AA7MH, Dick Daniels W4PUJ, Dick Jansson WD4FAB, Keith Baker KB1SF, Lyle Johnson KK7P, Barry Baines WD4ASW, Bruce Paige KK5DO, Bill Tynan W3XO, Tom Clark W3IWI, Lou McFadin W5DID, Ray Soifer W2RS, Robin Haighton VE3FRH, B'dale Garbee KBØG, Phil Karn KA9Q, and your reporter.

The first order of business was a presentation by Keith Baker on the findings of the AMSAT-NA Strategic Planning Committee at their recent meeting in Washington, DC.

During the weekend of February 17, 2001, the AMSAT-NA Strategic Planning Committee met to formalize their findings over the previous two years. The vision of the committee encompasses the premise that AMSAT is a vibrant, solid organization providing continuous worldwide amateur-radio satellite service. The four goals defined by the group were:

1. AMSAT-NA will develop utilities and related equipment for continuous amateur radio communications.
2. AMSAT-NA will provide opportunities for members to participate and contribute on many levels.
3. AMSAT-NA will be the primary resource for amateur satellite information, training, and education.
4. AMSAT-NA will acquire sufficient resources to support the organization's vision.

Following the presentation and ensuing discussion about the strategic planning efforts, the activity continued with three project summaries promoting options for the next AMSAT-NA satellite. The choices go beyond digital versus analog. There are orbital options, launch opportunities, power systems, and frequency considerations.

Longtime AMSAT supporter and previous member of the AMSAT Board of Directors Phil Karn KA9Q discussed his ideas for a digital communications system that could be used in a number of environments.

Continued on page 59



Photo E. Jan King W3GEY and Phil Karn KA9Q compare notes at the AMSAT-NA BoD meeting.



Photo F. Bill Tynan W3XO, Barry Baines WD4ASW, Lou McFadin W5DID, and Robin Haighton VE3FRH during a visit to the AMSAT-NA lab in Orlando, Florida.

MFJ TUNERS

MFJ-989C Legal Limit Antenna Tuner

MFJ uses super heavy duty components to make the world's finest legal limit tuner

MFJ uses super heavy duty components -- roller inductor, variable capacitors, antenna switch and balun -- to build the world's most popular high power antenna tuner.

The rugged world famous MFJ-989C handles 3 KW PEP SSB amplifier input power (1500 Watts PEP SSB output power). Covers 1.8 to 30 MHz, including MARS and WARC bands.

MFJ's AirCore™ roller inductor, new gear-driven turns counter and weighted spinner knob gives you exact inductance control for absolute minimum SWR.

You can match dipoles, verticals, inverted vees, random wires, beams, mobile whips,

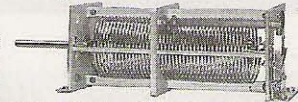
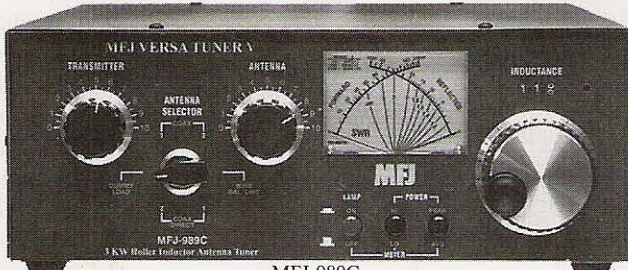

MFJ AirCore™ Roller Inductor gives high-Q, low loss, high efficiency and high power handling.

MFJ's exclusive Self-Resonance Killer™ keeps damaging self-resonances away from your operating frequency.

Large, self-cleaning wiping contact gives good low-resistance connection. Solid 1/4 inch brass shaft, self-align bearings give smooth non-binding rotation.

MFJ No Matter What™ Warranty MFJ will repair or replace your MFJ-989C (at our option) no matter what for one year.

shortwave -- nearly any antenna. Use coax, random wire or balanced lines.

You get everything you've ever wanted in a high power, full featured antenna tuner -- widest matching range, lighted Cross-

MFJ-989C
\$359⁹⁵

Needle SWR/Wattmeter, massive transmitting variable capacitors, ceramic antenna switch, built-in dummy load, TrueCurrent™ Balun, scratch-proof Lexan front panel -- all in a sleek compact cabinet (10 1/2"Wx4 1/2"Hx15D in).

More hams use MFJ tuners than all other tuners in the world!

MFJ-986 Two knob Differential-T™

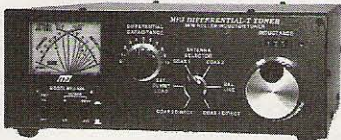

Two knob tuning (differential capacitor and AirCore™ roller inductor) makes tuning foolproof and easier than ever. Gives minimum SWR at only one setting. Handles 3 KW PEP SSB amplifier input power (1.5 KW output). Gear-driven turns counter, lighted peak/average Cross-Needle SWR/Wattmeter, antenna switch, balun. 1.8 to 30 MHz. 10 1/2"Wx4 1/2"Hx15 in.

MFJ-962D compact Tuner for Amps

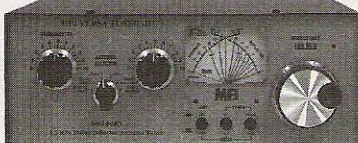

A few more dollars steps you up to a KW tuner for an amp later. Handles 1.5 KW PEP SSB amplifier input power (800W output). Ideal for Ameritron's AL-811H! AirCore™ roller inductor, gear-driven turns counter, pk/avg lighted Cross-Needle SWR/Wattmeter, antenna switch, balun, Lexan front. 1.8-30MHz. 10 1/2"Wx4 1/2"Hx10 1/2 in.

MFJ-969 300W Roller Inductor Tuner

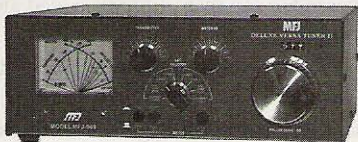

Superb AirCore™ Roller Inductor tuning. Covers 6 Meters thru 160 Meters! 300 Watts PEP SSB. Active true peak reading lighted Cross-Needle SWR Wattmeter, QRM-Free PreTune™, antenna switch, dummy load, 4:1 balun, Lexan front panel. 3 1/2"Hx10 1/2"Wx9 1/2"D inches.

MFJ-986
\$329⁹⁵

MFJ-962D
\$269⁹⁵

MFJ-969
\$199⁹⁵

MFJ-949E deluxe 300 Watt Tuner

More hams use MFJ-949s than any other antenna tuner in the world! Handles

300 Watts. Full 1.8 to 30 MHz coverage, 48 position Precision48™ inductor, 1000 Volt tuning capacitors, full size peak/average lighted Cross-Needle SWR/Wattmeter, 8 position antenna switch, dummy load, QRM-Free PreTune™, scratch proof Lexan front panel. 3 1/2"Hx10 1/2"Wx7D inches. MFJ-948, \$129.95. Economy version of MFJ-949E, less dummy load, Lexan front panel.

MFJ-941E super value Tuner

The most for your money!

Handles 300 Watts PEP, covers 1.8-30 MHz, lighted Cross-Needle SWR/Wattmeter, 8 position antenna switch, 4:1 balun, 1000 volt capacitors, Lexan front panel. Sleek 10 1/2"Wx2 1/2"Hx7D in.

MFJ-945E HF+6 Meter mobile Tuner

Extends your mobile antenna bandwidth so you don't have to stop, go outside and adjust your antenna. Tiny 8x2x6 in. Lighted Cross-Needle SWR/Wattmeter. Lamp and bypass switches. Covers 1.8-30 MHz and 6 Meters. 300 Watts PEP. MFJ-20, \$4.95, mobile mount.

MFJ-971 portable/QRP Tuner

Tunes coax, balanced lines, random wire 1.8-30 MHz. Cross-Needle Meter. SWR, 30/300 or 6 Watt QRP ranges. Matches popular MFJ transceivers. Tiny 6x6 1/2"x2 1/2 inches.

MFJ-901B smallest Versa Tuner

MFJ's smallest (5x2x6 in.) and most affordable wide range 200 Watt PEP Versa tuner. Covers 1.8 to 30 MHz. Great for matching solid state rigs to linear amps.



MFJ-949E
\$149⁹⁵



MFJ-941E
\$129⁹⁵



MFJ-945E
\$119⁹⁵



MFJ-971
\$99⁹⁵



MFJ-901B
\$79⁹⁵

MFJ-16010 random wire Tuner

Operate all bands anywhere with MFJ's reversible L-network. Turns random wire into powerful transmitting antenna. 1.8-30 MHz. 200 Watts PEP. Tiny 2x3x4 in.

MFJ-906/903 6 Meter Tuners

MFJ-906 has lighted Cross-Needle SWR/Wattmeter, bypass switch. Handles 100 W FM, 200W SSB. MFJ-903, \$49.95, Like MFJ-906, less SWR/Wattmeter, bypass switch.

MFJ-921/924 VHF/UHF Tuners

MFJ-921 covers 2 Meters/220 MHz. MFJ-924 covers 440 MHz. SWR/Wattmeter. 8x2 1/2"x3 inches. Simple 2-knob tuning for mobile or base.

MFJ-922 144/440 MHz Tuner

Ultra tiny 4x2 1/2"x1 1/4 inch tuner covers VHF 136-175 MHz and UHF 420-460 MHz. SWR/Wattmeter reads 60/150 Watts.

MFJ-931 artificial RF Ground

Creates artificial RF ground. Also electrically places a far away RF ground directly at your rig by tuning out reactance of connecting wire. Eliminates RF hot spots, RF feedback, TVI/RFI, weak signals caused by poor RF grounding. MFJ-934, \$169.95, Artificial ground/300 Watt Tuner/Cross-Needle SWR/Wattmeter.

Free MFJ Catalog
and Nearest Dealer . . . 800-647-1800

<http://www.mfjenterprises.com>

1 Year No Matter What™ warranty 30 day money back guarantee (less s/h) on orders from MFJ
MFJ ENTERPRISES, INC.
Box 494, Miss. State, MS 39762
(662) 323-5869; 8-4:30 CST. Mon.-Fri.
FAX: (662) 323-6551; Add s/h
Tech Help: (662) 323-0549
Prices and specifications subject to change. (c) 2000 MFJ Enterprises, Inc.

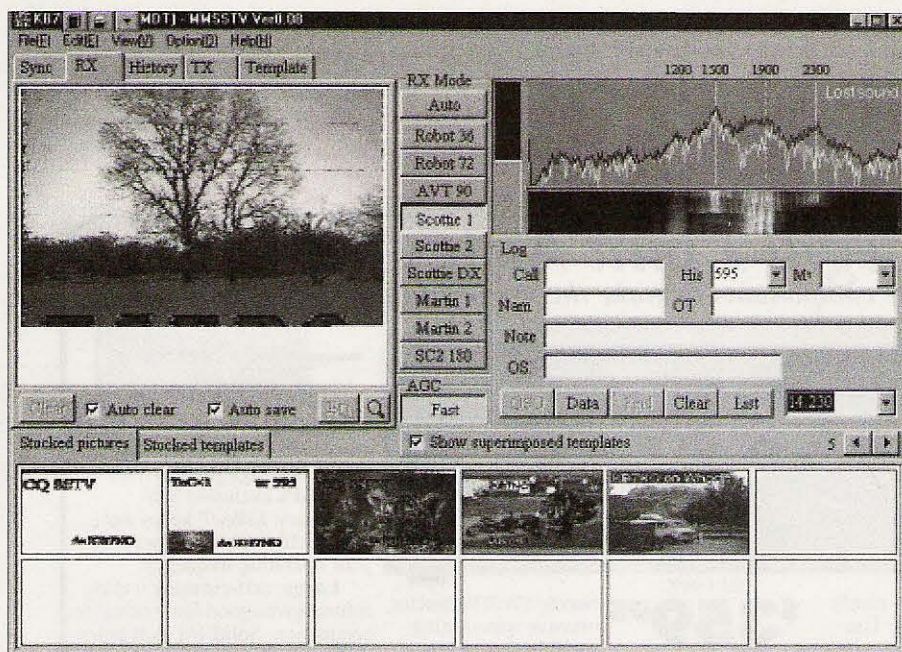

Fig. 2. Screenshot 2. This is the new MMSSTV program by Makoto Mori JE3HHT. I took this shot of a received image before it was finished so that you could see the DSP filter in action on the spectral display. The display will show much wider bandwidth when the QSO returns to SSB vocal reception according to the filter setting in your rig. This version .08 is the first that provided for JPEG format. The thumbnails at the bottom of the panel can be clicked on and dragged to the transmit pane and vice versa. This helps at this time to facilitate file handling (see text). In the thumbnail to the right, you will see the image pasted from the SSTV-PAL program (see text for procedure). There is also a History file of received images which you can access by clicking the History tab above the main image panel. When in this mode, you will have a set of arrows at the bottom of that pane so you can click back through any or all of the previously received images. The History subdirectory is found in the MMSSTV directory, so it is possible to manipulate these files however you please. This program was popular within just a few days after the first beta release, and is surely going to help focus new attention on another great ham mode.

really didn't want to load up my drive with a lot of .bmp (bitmap) files, so the additional format was welcome.

The next area to address was the still limited ability of the program to add little extras to the images such as callsigns or text messages. Perhaps these features were somewhere waiting in the wings but the Help File was hiding them. Further, my graphics software package ran into a snag right away when I went to insert a caption in one of my first images.

This was no fault of the graphics program, but did put a crimp in progress. This next magic piece of software came to the rescue and handled the minor edits with ease. I like things that work.

More freeware to the rescue. A short time ago, I became aware of a program that is designed to take care of this problem, and it does it very well. It is SSTV-PAL, written by Erik VK7AAB and available for download at the URL listed in The Chart. And, while you are there, you will see also listed his PSK-PAL, which I haven't had

much of a chance to use as yet. Perhaps, next month.

At the time of this writing, SSTV-PAL is highly effective in adding effects and "ham-preferred" changes to images on the fly for the other popular SSTV software such as ChromaPIX. I will assume that by the time you read this, SSTV-PAL will be much more cooperative with MMSSTV users. [See sidebar. — ed.]

I found the only thing necessary to get these two programs to work together was to study the file structure in MMSSTV. That is, if you will look in your MMSSTV directory, there is a "stock" file setup as soon as you install the program. It will have a few templates available that you can open in SSTV-PAL by clicking the "Load pic" button, manipulating the windows file directory that appears to the right of the button to the "stock" subdirectory, and selecting the file you wish to edit. A double click should bring it in.

Then you will want to learn all the magic available, or at least a portion of the magic,

do the necessary edits, and, when you are finished, save it back to the file directory where you keep your images for MMSSTV.

For editing, you will find a lot of help from the balloons that pop up when your cursor points to a button. The "tool tips ON" option makes sure this happens. You will also find a lot of info in the Help File. I found the Help button would not address this file, so, while the program was running, I double clicked on the Help File in the subdirectory and it came up nicely in Windows Help format. The author feels that once you are used to using the program, you won't need this excess baggage anyway, so he purposely did not integrate it.

Saving requires a study in file manipulation. This is easier than it looks, but there is not, at this writing, a built-in push-button to accomplish this automatically. MMSSTV is new and SSTV-PAL has those automatic set-ups for programs like ChromaPIX, W9SSSTV, JVcomm, and several other popular programs.

At this time it was necessary to devise a simple work-around to move the finished work where I wanted it. If you will look in the upper left corner of the SSTV-PAL panel, you will see a "Copy" button. That, you will find, will copy the image in the large editing pane to the Windows clipboard. That is the handy, yet invisible, feature in Windows 95™ that allows us to use the copy and paste commands.

I think there is a little more visibility of this file in the newer versions of Windows. I do have a computer with Windows 98™ and I need to study that system a bit more. Even the simple transition to Win98 caused me a few anxious moments as I lost my self-defined logic path to the files. Back to the story.

Then go to the MMSSTV panel, which you should have running in the background, and click on the transmit tab, and, just for good measure, also click on the transmit image pane. Then hit Control V (to paste) and your edited image from SSTV-PAL will magically appear. From there, you click and drag it down to the row of thumbnails at the bottom of the MMSSTV panel. If you check the "stock" subdirectory before and after this cart-and-pony performance, you will be pleased to see that you have added an image to the list.

From there you can manipulate the file however you wish. There is room in the MMSSTV stock image thumbnail display for over 200 images for instant recall, so you can edit your favorites and have them at the ready when you are on the air.

It took a little cut-and-try to discover this method of file transfer, but you can always

say you saw it here first. And ... hopefully ... very soon, the SSTV-PAL will have an automated setup for the MMSSTV. Until then, this is one way to get the job done.

Now you are ready to start having fun with the pictures over the air. This MMSSTV is evolving so quickly, it seems phenomenal. In the process of daily living, I have missed the last two updates, but I will tell the great things I have noticed to this point in time.

There are numerous modes you can use when operating SSTV. Commonly, state-side, we use what is referred to as Scottie 1. Just by listening, most of us have no clue what is coming at us, so the MMSSTV, since it is written to be used anywhere in the world and commonly used modes vary from country to country, will automatically determine the received mode and make the necessary switch for you.

For example, I was monitoring received signals one of the first evenings I had the program installed and it was fascinating to watch three images follow one another in three different modes and watch the mode buttons light up during the automatic switching process in the order that was necessary.

This automation isn't supposed to be entirely dependable under marginal conditions, but I saw an European image with a considerable amount of noise lines, and it worked just like it was supposed to for that one. It is always good practice to announce the mode you are going to transmit in, by voice, before sending your image, and you can see the reason why when poor conditions prevail.

Instant Update

Just one day after this article was in the mail to 73, I received the update that makes it a one-button image transfer from SSTV-PAL to MMSSTV. The work-around described in the article will work in the event you have technical difficulties. Erik made the fix with the following file: [SstvPalUpdate23FEB20001.zip], which you can download from his site. [Yes, that's an extra zero in 2001. — ed.]

Unzip this or perhaps by the time you read this a later update, and place the file in your SSTV-PAL directory. You will then have the option (a button will display in the upper left corner) to "send to MMSSTV" as soon as you follow the directions so that SSTV-PAL can find MMSSTV. Both programs must be running for the Send function to work.

Enjoy!

MMSSTV also has its own minilog and it works very well. Simple entry and save. And the important feature to me is that it will export in ADIF format so that I can import it into the logging program. It is necessary to have all the communications programs have their activities coordinated in one piece of software, so this was a nice feature to find.

Just a little afterthought: When you are downloading these programs, download all the Help File type information you can find. At this time, the SSTV-PAL has a very nice Help File but does not seem to address it from the Help button. But if you go directly to the file and double click on it, the windows format Help feature will run, and there is good information for you to use.

MMSSTV has a lot of information ready for download, but it is too early for a Help File to come forth. One of the bits of information you will find is that the author recommends a fairly fast processor and plenty of RAM. I am using 120 MHz CPU with 32 Mb RAM, and when I get these programs running along with the other "necessities," the machine tends to slow down and issue various warnings, but it keeps on plugging. And the operation has been a success despite what is termed "limited resources" by the programming crowd.

A few little tidbits. You will notice there has been a transition of the eGroup's reflectors to the Yahoo site. There are the same discussion groups as well as a file section. I have not included any advisory for download from Yahoo. I went there and had to

sign up before gaining access to the purported Files section and never found the digital files for downloading. I heard other such complaints. It is complex and requires a certain amount of luck.

The bad part is that the spam to my mailbox increased exponentially all of a sudden and I am getting all these ridiculous sales pitches that I cannot put a stop to. The "Remove" addresses do not exist when you send Remove mail to them. The damage is done, but I am finding download sites to list in The Chart that are elsewhere, so perhaps you may be spared the spam. This problem will hopefully abate soon as the Groups move

WANT TO LEARN CODE?

Morse Tutor Gold from G.G.T.E. is the answer for beginners and experts alike.

*Get the software the ARRL sells and uses to create practice and test tapes; and **Morse Tutor Gold** is approved for VE exams at all levels.

*Since 1987, GGTE has guided nearly 25,000 hams and prospective hams around the world through proven structured lessons and a variety of character, word and conversational drills. Straight forward menus make the process simple and fun.

*This program features easy and speedy self-installation; random character drills with the characters you select; and you can create your own drills or import text files. You can type what you hear or copy by hand and see the results one line at a time. Pick the Farnsworth or the standard method; select the tone frequency most comfortable for you or select your code speed in tenths of a word per minute. For all DOS computers. You are always in command.

Certified by



Morse Tutor Gold uses your internal speaker or sound board. And, if you use a sound board Morse Tutor Gold supports volume control.

Sound Blaster and the Sound Blaster Compatibility Logo are trademarks of Creative Technology Ltd.



Available thru dealers: the ARRL, or send \$29.95 + \$5.00 S&H (CA residents add \$2.62 tax) to: GGTE, 23801 Cassandra Bay, Dana Point, CA 92529

USA's #1 Independent ALINCO Dealer!

4 years in a row



DR-135TP

2 Meter Mobile

Internal TNC for Packet & APRS®



DR-605T

2M/440 MHz Mobile/Base

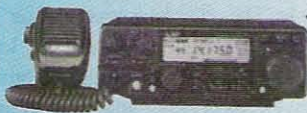

DX-70TH Compact,
100W, HF



DR-610T

2M/440MHz Mobile/Base

Call For Alinco Specials



DJ-196T

2 Meter Handheld
CTCSS en/decode
and DCS



DJ-V5TH
V/UHF, FM
Handheld



3300 82nd St. #E, Lubbock, TX 79423

1-800-588-2426

806-792-3669 FAX 806-785-3699

www.rad-comm.com



Source for:	Web address (URL):
Mix W Soundcard program for PSK31, RTTY, new modes, MTTY, FSK31, more	http://tav.kiev.ua/~nick/my_ham_soft.htm http://users.nais.com/~jaffejim/mixwpage.htm
MMHam site — MMTTY — MMSSTV	www.geocities.com/mmhamssoft/
VK7AAB — SSTV-PAL — PSK-PAL	http://users.origin.net.au/~crac/
TrueTTY — Sound card RTTY w/ PSK31	www.dxsoft.com/mitrtty.htm
Pasokon SSTV programs & hardware	www.ultranet.com/~sstv/lite.html
PSK31 — Free — and much PSK info	http://aintel.bi.ehu.es/psk31.html
Interface for digital - rigs to computers	www.westmountainradio.com/RIGblaster.htm
Soundcard interface info — includes Alinco	www.packetradio.com/psk31.htm
Interface info for DIY digital hams	www.qsl.net/wm2u/interface.html
WinWarbler info and free download	www.qsl.net/winwarbler/
MFSK-related tech info — how it works	www.qsl.net/z11bpu/
Throb — New — lots of info	www.lsear.freereserve.co.uk/ www.btinternet.com/~g3vfp/
Download Logger, also Zakanaka	www.geocities.com/kc4elo/
PSKGNR — Front end for PSK31	www.al-williams.com/wd5gnr/pskgnr.htm
Digipan — PSK31 — easy to use — new v. 1.6	http://members.home.com/heller/digipan/
TAPR — Lots of info	www.tapr.org
TNC to radio wiring help	http://freeweb.pdq.net/medcalf/ztx/
ChromaPIX and ChromaSound DSP software	www.siliconpixels.com
Timewave DSP & AEA (prev.) products	www.timewave.com
Auto tuner and other kits	www.ldgelectronics.com
XPWare — TNC software with sample DL	www.goodnet.com/~gjohnson/
RCKRtty Windows program with free DL	http://www.rckrtty.de/
HF serial modem plans & RTTY & Pactor	http://home.att.net/~k7sz/
SV2AGW free Win95 programs	www.raag.org/index1.htm
Source for BayPac BP-2M & APRS	www.tigertronics.com/
Int'l Visual Communication Assn. — nonprofit org. dedicated to SSTV	www.mindspring.com/~sstv/
Hellschreiber & MT63 & MFSK16 (Stream)	http://iz28bly.sysonline.it
HamScope — multimode w/ MFSK16	http://users.mesatop.com/~ghansen/
YPLog shareware log — rig control — free demo	www.nucleus.com/~field/

Table 1. The Infamous Chart ... updated monthly.

to another site. I will watch and see. I may be forced to change my E-mail address that I have had for many years due to the annoying spam that has no end in sight.

I understand from other hams that there are filters available when you use the Microsoft mail software to eliminate some of the spam, but then you find the really clever programmers who have no life and write viruses which attack the Microsoft mail program directly and leave some of these others alone. Choices to make.

QRP PSK is going to be around a long time. There are hams running low power to avoid RFI and there are others who have found there are very few big guns to cause

them QRM. Additionally, there are those QRP purists whom I have to admire.

I have had the pleasure of working a number of QRP stations, and the other day, a simple lesson was taught. The other ham was running 10 watts to my 50 and he was on the east coast, let's say 2,000 miles away. The path was marginal with fair copy. He suggested going to QPSK and reducing power. Soon we were both running 5 watts with decent antennas and perfect copy for the rest of a pleasant rag chew session.

A lesson well learned. If QRP operators can coordinate their efforts, the print on the monitor can be a lot more enjoyable. Just a little thought to pass around. Could make life easier and hamming more productive.

That's about it for this month. If you have questions or comments about this column, E-mail me [jheller@sierra.net]. I will gladly share what I know or find a resource for you. For now, 73, Jack KB7NO. 73

Modular Remote Coax Switch

continued from page 15

I would be happy to answer any reasonable question you might have, if an SASE is enclosed.

We now have excellent-looking FR4 silk-screened and drilled PC boards, five of them in a set, for \$23.00 plus \$1.50 S/H per set for those who prefer to build the units in this manner. Order from FAR Circuits, 18 N 640 Field Court, Dundee IL 60118. For additional ordering information, check the FAR Circuits Web site at [www.cl.ais.net/farcir/]. 73, Carl Markle K8IHQ. 73

"How High's the Water, Mama?"

continued from page 22

trends with rainfall amounts within a known flood area during heavy rainfall. The beauty of using packet radio for this is the "real time" information provided. The raw data may be imported into a spreadsheet to historically correlate this and other outside data.

I wish to stress that *teamwork* was the key to the successful implementation of this project, as was the generous assistance of the parties involved in my preparation of this article.

Bookbind THIS! — Conclusion

continued from page 35

the new volume for the first time to prevent damage to the bound stem and cover. The procedure that I've found suitable is as follows:

- Place the volume on a table so that it is flat.
- Using a thumbnail, run a crease along the cover adjacent to and parallel with the stem at about 1/8 inch from the stem.
- Open the cover carefully and allow it to fold along the crease.

• To prevent damage to the bound stem, the volume should not be opened up to a completely "flat" position.

Although the number of steps in the process appear to be many, they are provided for clarity. The actual steps involved are simple and easily performed with minimum tools and material.

Now that the bookbinding process is complete, sit back and think about the amount of technical information that has been saved for future use. In addition, think about all of the valuable shelf space that has been retained. If in doubt about the space savings achieved, implement the process and gauge the results. You will be pleasantly surprised!

73

Preventive Brain Surgery for Icom Xcvrs

continued from page 43

Now and in the future

Performing this procedure has put my mind at ease. Now I'm not worried about my rig going blank at some future date. To remind me that the battery was changed, and so I'll know when it will need a fresh one, on the rear of the rig I placed a small sticker with the date the lithium cell was changed, and when a new one is due in five years. Plus, in five years, it will be a snap to change the new battery.

All I'll have to do is remove the covers, power the Icom up, and remove and replace the CR2032 lithium battery. No soldering will be needed! This modification should add several more years of life to your radios, and you'll have the satisfaction of being able to keep them running indefinitely!

73

HAMSATS

continued from page 53

Using TDMA (Time Division Multiple Access) encoding, simple design parameters, limited bandwidth, and low power in the satellite hardware, Phil's concept would provide a 21st-century microsats-style hamsat. Several channels of data, digital communications, and digital voice would be simultaneously supported. His proposal

goes one step further to include inexpensive ground system gear, to be developed parallel to the satellite hardware portion of the project.

Previous AMSAT Vice President of Engineering Dick Jansson WD4FAB has defined his version of the next Phase 3 (high orbit and long life) satellite. In an effort to adhere to the KISS principle to "keep it simple," Dick's satellite would have features similar to AMSAT-OSCAR-40's, but would not have any internal rocket motors, would be spin-stabilized, cost much less than AO-40, use frequencies between 70 and 13 cm, fit on an Ariane 5 ASAP (Ariane Structure for Auxiliary Payloads) ring for a flight to GTO (Geostationary Transfer Orbit), and require only two to three years to complete. It's still an ambitious project, but would incorporate a lot of technologies that have been used before.

Lyle Johnson KK7P was actively involved with AO-40 digital systems and projects at TAPR (Tucson Amateur Packet Radio). Lyle's satellite proposal had many similar characteristics with that of WD4FAB, but differed on the antenna configuration and basic spaceframe shape. While WD4FAB's system called for patch antennas on the surface facing the earth and short whip antennas on the back side for perigee (lowest part of the orbit) operation, KK7P's configuration calls for collinear antennas extending from the top and bottom of a spinning satellite that would be positioned so the plane of the antennas would be perpendicular to the earth when at apogee (highest point of the orbit).

Due to the nature of the GTO provided by an Ariane 5 (about 650 km perigee, 40,000 km apogee, and 7-degree inclination to the equator), satellite configuration is an issue. WD4FAB's design favors a shape that looks like a suitcase with tapered ends. All sides are covered with solar cells, with the exception of the side with the patch antennas that faces the earth. KK7P's design is a more cylindrical shape, with solar cells around the sides.

Lyle KK7P also proposed a new version of the IHU (Internal Housekeeping Unit) computer that has been used on previous Phase 3 satellites. His rendition would use only a few integrated circuits to achieve the same capability that has required much larger circuit boards in the past. It would also run on about a tenth of a watt.

During the second day of the Board of Directors meeting, AMSAT President Robin Haighton VE3FRH provided a synopsis of the proposals along with brief comments on the state of the organization. AMSAT-NA is currently in excellent shape. Although it is true that the Phase 3D (AO-40) project has caused significant financial stress, the organizational enthusiasm is high and there are some fine new projects on the horizon.

The Board views the GTO as the best orbit for the next large AMSAT satellite, and LEO (Low Earth Orbit) as the perfect testing ground for new digital technologies, like those proposed by KA9Q. A study was requested to pick the best points of the two

Continued on page 61

PSK-31, RTTY, CW, PACTOR, AMTOR and Logging! Creative Services Software has Windows software for hams!

The advertisement displays several software boxes for 'Creative Services Software' including 'DIGITAL VOICE', 'DIGITAL DATA', 'DIGITAL FAX', and 'DIGITAL LOG'. To the right is a screenshot of a logging software interface with a table of log entries.

Date	Time	Call Sign	Mode	Power	Rate	Country	ISL	Comments
230200	19:32	NHNSMM	USB	10	59	United States	N	K
190200	20:06	WZ1AQT	USB	20	59	United States	V	N
190200	18:44	K8JLD	USB	20	59	United States	V	N
190200	15:43	AA3ID	USB	15	59	United States	V	N
180200	13:52	K2QLG	USB	20	59	United States	N	N
180200	03:39	W1LY	USB	20	59	United States	N	N
170200	06:27	K5AGI	USB	10	59	United States	V	N
170200	06:17	K6FARNT	USB	10	59	United States	V	N
160200	22:47	W4UCI	USB	20	59	United States	N	N
150200	22:54	K6FARNT	USB	20	59	United States	V	N

Purchase from your favorite dealer or directly from CSS at 256-381-6100

<http://www.cssincorp.com>

More Good than Bad

Atmospheric noise will severely limit activity on the upper bands, and daytime ionization will substantially weaken the lower ones as May progresses and summer arrives.

Because of these seasonal influences, the bulk of your foreign contacts are likely to be in the 17- to 30-meter range, but unusually erratic solar behavior could cause conditions on all bands to range from very good (VG) to very poor (VP) this month.

The best period, as shown on the calendar, is likely to last from the 2nd through 8th and should provide the most favorable DX conditions that we've seen in quite awhile. There are several other promising periods of shorter duration to watch for, and on average we should experience more good days than bad.

I've pegged the 9th through the 16th as being very unfavorable, but hang in there because conditions are likely to fluctuate widely throughout the period. I'm forecasting the sun to be particularly restless around the 11th, so expect a geomagnetic storm to develop by the 13th if a large flare or CME is launched in our direction.

Band-by-band summary

10 and 12 meters

Daytime absorption will increase, causing seasonally weak signals as summer approaches. Follow the sun as usual and work to the east in the morning and west during the afternoon. Look for a mid-afternoon peak on 15 meters, especially to the southern hemisphere. Short-skip will be between 1,000 and 2,000 miles.

15 and 17 meters

These bands will also weaken with the approach of summer, but should hold up fairly well throughout May. Signals will typically peak toward the east in the mid-morning hours. Latin America and South America will be best on either side of local noon and into

May 2001						
SUN	MON	TUE	WED	THU	FRI	SAT
		1 F	2 F-G	3 G	4 F-G	5 G
6 G	7 VG	8 VG	9 F-P	10 F-P	11 F-P	12 P
13 VP	14 P	15 P	16 F	17 F-G	18 F-G	19 G
20 F-P	21 F	22 F-G	23 G	24 G	25 F-P	26 F
27 F-G	28 G	29 G	30 G	31 F-G		

EASTERN UNITED STATES TO:												
GMT	00	02	04	06	08	10	12	14	16	18	20	22
Central America	15-20	(15) 30	20 (40)	(20-40)	x	(20)	20	(20)	(15)	(15)	15 (20)	(10) 17
South America	15 (20)	(15) 20	20 (40)	(20-40)	(20)	x	(15)	(15)	x	(10)	(10-20)	(10) 20
Western Europe	20	20	(20-40)	(40)	x	(20)	x	x	x	x	(20)	20
South Africa	x	(40)	x	(20)	x	x	x	x	(15)	(15)	x	x
Eastern Europe	20	20 (40)	(20)	x	x	x	(20)	x	x	(15)	(15)	(20)
Middle East	20	20 (40)	(20)	x	x	x	x	x	x	x	(20)	(15)
India/Pakistan	(15-20)	(20)	x	x	(20)	x	x	x	x	x	x	x
Far East/Japan	(15)	x	x	x	x	x	(20)	(15-20)	(15)	x	x	(15)
South East Asia	(15-20)	x	x	(20)	x	x	(20)	x	x	(15)	x	x
Australia	(15)	(15)	x	x	(20-30)	(20-30)	(20)	(20)	x	x	x	x
Alaska	(15-20)	(15-20)	(15-20)	20	20 (40)	(20-40)	(20)	(20)	x	x	(15)	(15-20)
Hawaii	(15-20)	(15-20)	(15-20)	20	20 (40)	(20-40)	(20)	(20)	x	x	x	(15)
Western USA	(10) 30	(10) 30	(10) 40	(15) 40	(20) 40	(20-40)	(15) 20	(10) 20	(10-20)	(10-20)	(10) 20	(10) 20

CENTRAL UNITED STATES TO:												
Central America	South America	Western Europe	South Africa	Eastern Europe	Middle East	India/Pakistan	Far East/Japan	South East Asia	Australia	Alaska	Hawaii	Western USA
(10) 20	(15) 30	20 (40)	(20-40)	(20)	(20)	(15) 20	(15-20)	(10-20)	(10-20)	(10) 17		
10 (20)	(10) 20	(15) 30	(15) 30	(20-40)	(20)	(20)	(15)	(15)	(10)	(10-15)	(10-20)	
(15) 20	20	(20-40)	(20-40)	x	(20)	(20)	x	x	x	x	(15-20)	
x	x	(40)	(20-40)	(20)	x	x	x	(10-15)	(10-20)	(20)	x	
(20)	(20)	(20)	(20)	x	x	(20)	(20)	x	(15)	(15-20)	(15-20)	
(15-20)	(20)	(20)	(20)	x	x	x	x	x	x	(20)	(20)	
(15-20)	(15-20)	(20)	x	x	x	(20)	x	x	x	x	x	x
x	(15)	(15)	x	x	(20-40)	(20)	20	(20)	x	x	x	x
(15)	(15)	(15-20)	(20)	x	x	(20)	(20)	(15-20)	(15)	(15)	x	
(15)	(15)	(15)	(20)	20 (40)	(20-40)	(20-40)	20	(20)	x	(15)	x	
(10) 30	(10) 30	(10) 40	(15) 40	(20) 40	(20) 40	(20-40)	(15) 40	(10) 30	(10-20)	(10-20)	(10) 20	(10) 20
(15-20)	15 (20)	(15-20)	20	20	(20)	(20)	(20)	x	x	x	(15)	

WESTERN UNITED STATES TO:												
Central America	South America	Western Europe	South Africa	Eastern Europe	Middle East	India/Pakistan	Far East/Japan	South East Asia	Australia	Alaska	Hawaii	Western USA
(10) 17	(15) 20	(15) 20	20	(20)	(20)	(20)	(20)	(20)	(10-20)	(10-15)	(15-20)	
(10-20)	(10) 17	15-20	(15) 20	(20)	(20)	(20)	(15)	(15)	x	(15)	(10-15)	
(15-20)	(20)	20	(20)	x	x	x	(20)	(15)	(15)	(20)	(15-20)	
x	x	x	(20)	(20)	x	x	(20)	(20)	(15)	x	x	
(15-20)	(20)	(20)	(20)	x	x	x	(20)	x	x	x	(15-20)	
(20)	(15-20)	(15-20)	(20)	x	x	x	x	x	x	x	(20)	
x	x	(15)	x	x	x	x	(20)	x	(15)	x	x	
(15)	(15)	(20)	(20)	(20)	(20-40)	(20-40)	(20)	(20)	(15-20)	x	(15)	
x	x	(15)	(15)	x	(20)	(20)	(20)	(15-20)	(15-20)	(15)	x	
(10-15)	(10-15)	15	(15-20)	20	20	20	(20)	20	(20)	x	(15)	
(10) 40	(10) 40	(10) 40	(15) 40	(20) 40	(20) 40	(20-40)	20-40	(15) 40	(10) 40	(10) 40	(10) 40	
(10-15)	(10-20)	(10-20)	(15-20)	20	20	(20-40)	20 (40)	(20-40)	x	x	(10-15)	
(10) 30	(10) 30	(10) 40	(15) 40	(20) 40	(20) 40	(20-40)	(15-20)	(10) 20	(10-20)	(10-20)	(10) 20	

Table 1. Band, time, country chart. Plain numerals indicate bands which should be workable on Fair to Good (F-G) and Good (G) days. Numbers in parentheses indicate bands usually workable on Good (G) days only. Dual numbers indicate that the intervening bands should also be usable. When one number appears in parentheses, that end of the range will probably be open on Good (G) days only.

the early evening. Work westward from late afternoon through mid-evening and pay particular attention to long paths across the equator, especially on 17 meters. Short-skip will average between 1,000 miles and 2,000 miles.

20 meters

Around-the-clock communications will be possible to most areas of the world when HF conditions are good. The strongest peaks will occur right after sunrise and just before sunset, but late afternoon peaks often occur as well, especially to the southeast. In the evening, try working over the pole as well as toward the western and southern Pacific. Short-skip will be between 500 and 2,000 miles during the day and from 1,000 to 2,000 miles at night.

30 and 40 meters

These bands could be your best choices from sunset until sunrise on good (G) days, but increasing thunderstorm activity will often limit opportunities. Atmospheric noise is typically higher on paths across the tropics but the best openings are still most likely to be found in the southern hemisphere. Don't overlook daytime openings, but skip will be limited to about 750 miles. At night, expect skip to vary from 500 to over 2,000 miles.

80 and 160 meters

High static and weak signals will prevail but a few openings will still be available between sunset to sunrise on the good (G) days shown on the calendar. Peaks will usually occur near midnight and again in the pre-dawn hours, but won't happen regularly. Expect short-skip to vary from 1,000 to 2,000 miles. 73

HAMSATS

continued from page 59

GTO designs proposed by WD4FAB and KK7P. Funding was allocated for the new IHU design by KK7P, which would be useful for multiple platforms.

Additionally, the Board voted to begin work on KA9Q's multichannel, amateur-radio version of a TDMA satellite and the necessary ground systems, which would be out to potential users even at the Beta-test (pre-launch) stage. The final satellite hardware could possibly be used on the space station, a GTO satellite, or be attached to almost any other primary satellite as a passenger.

In addition to these efforts directly from AMSAT-NA, there are other groups working with support or input from AMSAT-NA on shorter-term satellite programs. Will the next hamsats be from university programs, ham clubs, or small, dedicated hamsat groups? Watch for new, exciting projects, and even new hardware in space before the end of the year! 73

QRX

continued from page 39

10. Occasionally, for no reason whatsoever, your car would lock you out and refuse to let you in until you simultaneously lift the door handle, turn the key, and grab hold of the radio antenna.

11. GM would require all car buyers to also purchase a deluxe set of Rand McNally (now a GM subsidiary) road maps, even though they neither need them nor want them. Attempting to delete this option would immediately cause the car's performance to diminish by 50% or more. Moreover, GM would become a target for investigation by the Justice Department.

12. Every time GM introduced a new model, car buyers would have to learn how to drive all over again, because none of the controls would operate in the same manner as the old car."

Thanks to Skip, newsletter of the Fresno Area Amateur Radio Club, Inc., Dec. '99.

Crunch This!

Wired News reports that Seti@Home — a project that many hams are deeply involved in — has clocked half-a-million years in computer time searching for ET on home personal computers.

The Seti@Home project harnesses the spare computing cycles of millions of individually owned personal computers worldwide to search for tell-tale signs of intelligent life in radio signals beamed from outer space.

For the uninitiated, SETI stands for Search for ExtraTerrestrial Intelligence.

Thanks to Newline, Bill Pasternak WA6ITF, editor.

Football Freaks ... er, Freqs

According to Fred Maia's *W5YI Report*, one of the most concentrated RF environments on any given NFL Sunday can be a National Football League stadium. It appears as if everyone from coaches to players to officials to television crews is using wireless devices.

Now, so as to keep the various users of RF gear from bothering one another, the NFL is providing official frequency coordinators at each stadium during the regular season. (And you thought it was hard getting a channel pair for your new repeater!) Cont.

No word yet on whether the new XFL, following their coin-toss suite of a football scramble, will force spectrum suitors to wrestle for HTs at midfield in order to get first choice of frequency.

Thanks to W5YI, via Newline, Bill Pasternak WA6ITF, editor. 73

NEVER SAY DIE

continued from page 8

Those Root Canals

One of my readers sent along a paper on a new approach to dealing with root canal teeth.

The problem with the normal approach to teeth with root canals is that the millions of tiny tubules that make up our teeth tend to harbor microbes in that warm, wet medium, once the root is dead. These are a source of infection which can seriously affect the immune system and your body.

It's been discovered that when the dead tooth is packed with calcium oxide that this seals off these tubules, preventing microbes from setting up base there. One commercial product is Biocalex.

That beats the heck out of just having to extract the tooth.

Big & Bigger

Considering the way we're being bamboozled at every turn, I'd almost welcome the 97% reduction of the world's population being predicted by several prophets with good past records. It would not only destroy our grossly bloated government, it would break up the conglomerates which have used a weak point in the capitalist system to grow so big that they're able to do just about anything they want.

Big? Three companies, ConAgra, Excel, and IBP supply 81% of our meat! ADM and Cargill have the grain market almost totally tied up. Tyson and Pilgrim's Pride control the poultry market.

Cows and steers these days aren't out grazing in the fields; they're in huge barns being stuffed with grain, water, growth hormones, and antibiotics to fight the sicknesses the growth hormones cause.

Grass? Sunlight? Exercise? You aren't going to have healthy cattle without these. And we don't. But we do get rather tasteless fat-hormone-antibiotic-laden steaks and Big Macs.

Killing off 97% of humanity is a lousy way to get rid of the establishment, and there's no probability that we'll have learned anything from our mistakes, so

Continued on page 62

NEUER SAY DIE

continued from page 61

the new establishment could well be even worse. Look at the mess Russia is in as a result of the collapse of Communism.

Slavery Alive and Well

Not here anymore, technically, but it's sure alive and doing a brisk business in Africa. In Mauritania, our State Department estimates there are 90,000 blacks living as the property of Berbers. In Sudan, black women and children go for \$90.

In Sudan, the Muslim government militias raid the southern black Christian tribes, killing the men and bringing the women and children north to the slave auctions. Yep, this is going on right now, in 2001.

There's no secret about all this, except for our almost totally silent media. And our black "leaders." Jesse Jackson has remained silent.

Lives Barely Lived

Just as the things that poison our bodies taste so-o-o go-o-o-d, or feel so good, we're spiritually poisoned by activities that feel so-o-o go-o-o-d. Like entertainment, TV, the movies, gambling, most talk radio.

So we get up every morning, go to work all day at some job, go home, have dinner, and watch TV. Have we used the day to learn anything? Not if we can help it. Have we done anything creative? Have we done anything that will help the world progress a little? Har-de-har.

When our lifestyle makes us sick, we go to the doctor. We vote every couple years or so for whoever has the best TV commercials. Or we don't bother.

Have we tried to be really good at anything? Even our jobs? How many books have you read that might help you to do your job better? Read any magazines on the subject? Gone to any lectures, conferences, or workshops?

That's someone else up there on the stage performing. Someone else on TV. Someone else visiting the Pyramids and the Taj Mahal. Someone else up there in a hot air balloon. Someone else on a DXpedition to Navassa Island. Someone else's name on that magazine article or the cover of a book.

Jets have made this huge world easier to see. Libraries and book stores have made learning about anything easier.

God put you here to learn and contribute, not to take a free ride.

Say amen.

Remediation

At California state universities with large black enrollments, close to 90% of the freshmen require remedial classes, mostly in math and English. But, has there been a whimper from the politicians about the fraudulent high school diplomas that have caused this waste of money and time? Last year, the state universities kicked out 6% of the freshmen for failing to master basic math and English skills, even after a year of remedial classes.

I remember when we had a black blues group from Missouri here to record in my studio. When Sherry and I took them out to dinner, we found they were unable to read the restaurant menu. We had to read it to them.

Virtually every black and civil-rights leader is in bed with the National Education Association (NEA), which vigorously fights any effort to improve the system.

Our Founders

Our government today would stun the founders of our country. As James Madison wrote in *The Federalist Papers* (which best explain the intent of the Constitution), except in time of war, the federal government should do 5% and the states 95% of the governing. Today it's more like the other way around.

We were supposed to have a confederation of states,

with a minimal federal government to deal with foreign affairs and provide a military for our protection.

Today, between Congress making a mess of everything it does, and a proliferation of federal bureaus, all issuing rules which have the force of laws, we've allowed a monster to gradually be created.

This whole system is so incalculated now that it isn't going to be easy to turn around. Sure, we grouse about the feds taking 60% of our hard-earned money. And we feel totally helpless to do anything about it.

And that's what Congress wants you feel. But, dammit, we are not helpless. We're still allowed a couple minutes every two years to have our say. Our direct say. Alas, virtually all of us throw away those minutes by re-electing the crooks who are stealing and wasting our money.

Is there any way you can (a) make sure that you vote, and (b) never, ever re-elect anyone? Never! Start with the primaries to flush that corrupt Washington toilet. After a couple of elections with no incumbents being re-elected, the crooks...oops, I mean politicians, are going to find it virtually impossible to get all those generous donations from businesses needing influence. This will force thousands of lobbyists to look for more honest work. Like drug smuggling.

That'll be a good start.

Grumble.

We started this nonsense back in 1913, when the federal income tax was established. At that time, only the richest 2% of the people had to pay anything, and the maximum levy was 7%. Now look at the humongous battles over lowering taxes even a smidgen.

Am I exaggerating about Congress making a mess of everything it does? Here's what a recent Cato Institute letter cited:

- Politicians have so mis-managed the Social Security system that it now has a \$10 trillion unfunded liability.

- The 40,000-page income tax code now takes a higher

percentage of GDP than at any peacetime period in American history.

- Both houses of Congress voted to make it a crime to mention the name of a candidate for federal office in an advertisement within 60 days of an election (only a filibuster kept it from becoming law).

- OSHA made plans to send federal bureaucrats into our homes to check on the "ergonomics" of home office furniture.

- The White House has been giving taxpayer dollars to television networks for inserting messages supporting the War on Drugs into their programs.

- Bypassing Congress, the administration at last count had an astonishing 4,538 business regulations in the process of being implemented by fiat through federal agencies before year-end.

Taxing the Rich

The Democrats' cry that a tax cut is going to favor the rich gets what little is left of my goat. That's pure pandering to the ignorant. They know full well that every time there's a tax cut, the people who are paying the highest taxes are going to benefit more than the people who aren't.

So what?

The rich aren't doing like Scrooge McDuck and wallowing in vaults of money. That would be really stupid, which most rich people aren't, and usually has some connection with their being rich. They know that unless their money is invested in something, that inflation is going to cost them a bundle.

Sure, Bill Gates built a \$300 million home, and plans to make it even bigger. But all that money went to hundreds of companies and through them to thousands of workers.

The rest of Bill's billions are invested in Microsoft, and the stock market. When the rich put their money into the stock market, that provides money for the companies

Continued on page 64

Here are some of my books which can change your life (if you'll let 'em). If the idea of being healthy, wealthy and wise interests you, start reading. Yes, you can be all that, but only when you know the secrets which I've spent a lifetime uncovering.

.....Wayne

The Bioelectrifier Handbook: This explains how to build or buy (\$155) a little electrical gadget that can help clean the blood of any virus, microbe, parasite, fungus or yeast. The process was discovered by scientists at the Albert Einstein College of Medicine, quickly patented, and hushed up. It's curing AIDS, hepatitis C, and a bunch of other serious illnesses. The circuit can be built for under \$20 from the instructions in the book. \$10 (#01)

The Secret Guide to Wisdom: This is a review of around a hundred books that will help you change your life. No, I don't sell these books. They're on a wide range of subjects and will help to make you a very interesting person. Wait'll you see some of the gems you've missed reading. \$5 (#02)

The Secret Guide to Wealth: Just as with health, you'll find that you have been brainwashed by "the system" into a pattern of life that will keep you from ever making much money and having the freedom to travel and do what you want. I explain how anyone can get a dream job with no college, no résumé, and even without any experience. I explain how you can get someone to happily pay you to learn what you need to know to start your own business. \$5 (#03)

The Secret Guide to Health: Yes, there really is a secret to regaining your health and adding 30 to 60 years of healthy living to your life. The answer is simple, but it means making some difficult lifestyle changes. Will you be skiing the slopes of Aspen with me when you're 90 or doddering around a nursing home? Or pushing up daisies? No, I'm not selling any health products. \$5 (#04)

My WWII Submarine Adventures: Yes, I spent from 1943-1945 on a submarine, right in the middle of the war with Japan. We almost got sunk several times, and twice I was in the right place at the right time to save the boat. What's it really like to be depth charged? And what's the daily life aboard a submarine like? How about the Amelia Earhart inside story? If you're near Mobile, please visit the Drum. \$5 (#10)

Wayne's Caribbean Adventures: My super budget travel stories - where I visit the hams and scuba dive most of the islands of the Caribbean. You'll love the special Liat fare which let me visit 11 countries in 21 days, diving all but one of the islands, Guadeloupe, where the hams kept me too busy with parties. \$5 (#12)

Cold Fusion Overview: This is both a brief history of cold fusion, which I predict will be one of the largest industries in the world in the 21st century,

plus a simple explanation of how and why it works. This new field is going to generate a whole new bunch of billionaires, just as the personal computer industry did. \$5 (#20)

Cold Fusion Journal: They laughed when I predicted the PC industry growth in 1975. PCs are now the third largest industry in the world. The cold fusion ground floor is still wide open, but then that might mean giving up watching ball games. Sample: \$10 (#22).

Julian Schwinger: A Nobel laureate's talk about cold fusion—confirming its validity. \$2 (#24)

Improving State Government: Here are 24 ways that state governments can cut expenses enormously, while providing far better service. I explain how any government bureau or department can be gotten to cut its expenses by at least 50% in three years and do it cooperatively and enthusiastically. I explain how, by applying a new technology, the state can make it possible to provide all needed services without having to levy any taxes at all! Read the book, run for your legislature, and let's get busy making this country work like its founders wanted it to. Don't leave this for "someone else" to do. \$5 (#30)

Mankind's Extinction Predictions: If any one of the experts who have written books predicting a soon-to-come catastrophe which will virtually wipe most of us out are right, we're in trouble. In this book I explain about the various disaster scenarios, like Nostradamus, who says the poles will soon shift (as they have several times in the past), wiping out 97% of mankind. Okay, so he's made a long string of past lucky guesses. The worst part of these predictions is the accuracy record of some of the experts. Will it be a pole shift, a new ice age, a massive solar flare, a comet or asteroid, a bioterrorist attack? I'm getting ready, how about you? \$5 (#31)

Moonoggle: After reading René's book, *NASA Mooned America*, I read everything I could find on our Moon landings. I watched the videos, looked carefully at the photos, read the astronaut's biographies, and talked with some of my readers who worked for NASA. This book cites 25 good reasons I believe the whole Apollo program had to have been faked. \$5 (#32)

Classical Music Guide: A list of 100 CDs which will provide you with an outstanding collection of the finest classical music ever written. This is what you need to help you reduce stress. Classical music also raises youngster's IQs, helps plants grow faster, and will make you healthier. Just wait'll you hear some of Gotschalk's fabulous music! \$5 (#33)

The Radar Coverup: Is police radar dangerous? Ross Adey K6UI, a world authority, confirms the dangers of radio and magnetic fields. \$3 (#34)

Three Gatto Talks: A prize-winning teacher explains what's wrong with American schools and why our kids are not being educated. Why are Swedish youngsters, who start school at 7

years of age, leaving our kids in the dust? Our kids are intentionally being dumbed down by our school system—the least effective and most expensive in the world. \$5 (#35)

Aspartame: a.k.a. NutraSweet, the stuff in diet drinks, etc., can cause all kinds of serious health problems. Multiple sclerosis, for one. Read all about it, two pamphlets for a buck. (#38)

One Hour CW: Using this sneaky booklet even you can learn the Morse Code in one hour and pass that dumb 5wpm HF entry test. \$5 (#40)

Code Tape (T5): This tape will teach you the letters, numbers and punctuation you need to know if you are going on to learn the code at 13 or 20 wpm. \$5 (#41)

Code Tape (T13): Once you know the code for the letters (#41) you can go immediately to copying 13 wpm (using my system). This should only take a couple of days. \$5 (#42)

Code Tape (T20): Or, you can start right out at 20 wpm and master it in a weekend. \$5 (#43)

\$1 Million Sales Video: The secret of how you can generate an extra million dollars in sales just by using PR. This will be one of the best investments you or your business will ever make. \$40 (#52)

Reprints of My Editorials from 73. Very few things in this world are as we've been taught, and as they appear. I blow the whistle on the scams around us, such as the health care, our school system, our money, the drug war, a college education, sugar, the food giants, our unhealthy food, fluorides, EMFs, NutraSweet, etc.

1996 Editorials: 120 pages, 100 choice editorials. \$10 (#72)

1997 Editorials: 148 fun-packed pages. 216 editorials. \$10 (#74)

1998 Editorials: 168 pages that'll give you lots of controversial things to talk about on the air. \$10 (#75)

1999 Editorials: 132 pages of ideas, book reviews, health, education, and anything else I think you ought to know about. \$10 (#76)

2000 Editorials: 76 pages (thinner magazine as a result of our slowly-dying hobby). \$5 (#77)

Silver Wire: With two 5-in. pieces of heavy pure silver wire + three 9V batteries you can make a thousand dollars

worth of silver colloid. What do you do with it? It does what the antibiotics do, but germs can't adapt to it. Use it to get rid of germs on food, for skin fungus, warts, and even to drink. Read some books on the uses of silver colloid, it's like magic. \$15 (#80)

Colloid Reprint. April 97 article on a silver colloid maker, history, and how to use the stuff. \$5 (#98).

Colloid Kit. Three 9V battery clips, 2 alligator clips & instructions. \$5 (#99).

Wayne's Bell Saver Kit. The cable and instructions enabling you to inexpensively tape Art Bell W6OBB's nightly 5-hr radio talk show. \$5 (#83)

NH Reform Party Keynote Speech. It wow'd 'em when I laid out plans for NH in 2020, with much better, yet lower cost schools, zero state taxes, far better health care, a more responsive state government, etc. \$1 (#85)

Stuff I didn't write, but you need:

NASA Mooned America: René makes an air-tight case that NASA faked the Moon landings. This book will convince even you. \$30 (#90)

Last Skeptic of Science: This is René's book where he debunks a bunch of accepted scientific beliefs—such as the ice ages, the Earth being a magnet, the Moon causing the tides, and etc. \$30 (#91)

Dark Moon: 568 pages of carefully researched proof that the Apollo Moon landings were a hoax—a capping blow for René's skeptics. \$35 (#92)

Travel Diaries: You can travel amazingly inexpensively—once you know the ropes. Enjoy Sherry and my budget visits to Europe, Russia, and a bunch of other interesting places. How about a first class flight to Munich, a rented Audi, driving to visit Vienna, Krakow in Poland (and the famous salt mines), Prague, back to Munich, and the first class flight home for two, all for under \$1,000. Yes, when you know how you can travel inexpensively, and still stay in first class hotels. \$5 (11)

73 Writer's Guide: It's easy, fun, can pad your résumé, and impress the hell out of your friends. \$0 (78)

Radio Bookshop

Box 416, Hancock NH 03449

Name _____ Call _____

Address _____

City-State-Zip _____

Use the numbers in the brackets or copy page and mark the books you want. Add \$3 s/h per total order in US (\$5 priority mail), \$6Can, \$10 foreign. _____

Order total: US\$ _____ Phone (for CC orders) _____

MC/Visa for orders over \$10. # _____ Expire _____

www.waynegr.com • phone orders: 603-525-4747 • fax: 603-588-3205 • w2nsd@aol.com

Yes! Put me down for a year of 73 for only \$25 (a steal). Canada US\$32. Foreign US\$44 by sea.

I'd like to get more romance into my dreary life so send me your How-To-Dance Videos catalog.

I need some industrial strength stress reduction so send me your Adventures In Music CD catalog

Allow 4 weeks for delivery except foreign, though we try to get most orders shipped in a day or two.

Your e-mail address: _____

Barter 'n' Buy

Turn your old ham and computer gear into cash now. Sure, you can wait for a hamfest to try and dump it, but you know you'll get a far more realistic price if you have it out where 100,000 active ham potential buyers can see it, rather than the few hundred local hams who come by a flea market table. Check your attic, garage, cellar and closet shelves and get cash for your ham and computer gear before it's too old to sell. You know you're not going to use it again, so why leave it for your widow to throw out? That stuff isn't getting any younger!

The 73 Flea Market, Barter 'n' Buy, costs you peanuts (almost)—comes to 35 cents a word for individual (noncommercial!) ads and \$1.00 a word for commercial ads. Don't plan on telling a long story. Use abbreviations, cram it in. But be honest. There are plenty of hams who love to fix things, so if it doesn't work, say so.

Make your list, count the words, including your call, address and phone number. Include a check or your credit card number and expiration. If you're placing a commercial ad, include an additional phone number, separate from your ad.

This is a monthly magazine, not a daily newspaper, so figure a couple months before the action starts; then be prepared. If you get too many calls, you priced it low. If you don't get many calls, too high.

So get busy. Blow the dust off, check everything out, make sure it still works right and maybe you can help make a ham newcomer or retired old timer happy with that rig you're not using now. Or you might get busy on your computer and put together a list of small gear/parts to send to those interested?

Send your ads and payment to: 73 Magazine, Barter 'n' Buy, 70 Hancock Rd., Peterborough NH 03458 and get set for the phone calls. The deadline for the July 2001 classified ad section is May 10, 2001.

President Clinton probably doesn't have a copy of *Tormet's Electronics Bench Reference* but you should. Check it out at [www.ohio.net/~rtormet/index.htm]
—over 100 pages of circuits, tables, RF design information, sources, etc. BNB530

TELEGRAPH COLLECTOR'S PRICE GUIDE: 250 pictures/prices. \$12 postpaid. **ARTIFAX BOOKS**, Box 88, Maynard MA 01754. Telegraph Museum: [<http://w1tp.com>]. BNB113

Great New Reference Manual with over 100 pgs of P/S, transistor, radio, op-amp, antenna designs, coil winding tables, etc. See details at [www.ohio.net/~rtormet/index.htm] or send check or M.O. for \$19.95 + \$2.00 P&H to RMT Engineering, 6863 Buffham Rd., Seville OH 44273. BNB202

RF TRANSISTORS TUBES 2SC2879, 2SC1971, 2SC1972, MRF247, MRF455, MB8719, 2SC1307, 2SC2029, MRF454, 2SC3133, 4CX250B, 12DQ6, 6KG6A, etc. **WESTGATE**, 1-800- 213-4563. BNB6000

QSL CARDS. Basic Styles; Black and White and Color Picture Cards; Custom Printed. Send 2 stamps for samples and literature. RAUM'S, 8617 Orchard Rd., Coopersburg PA 18036. Phone or FAX (215) 679-7238. BNB519

Cash for Collins: Buy any Collins Equipment. **Leo KJ6HI**. Tel./FAX (310) 670-6969. [radioleo@earthlink.net]. BNB425

Browse our web site and check out the "Monthly Special." TDL Technology, Inc. www.zianet.com/tdl. BNB500

MAHLON LOOMIS, INVENTOR OF RADIO, by Thomas Appleby (copyright 1967). Second printing available from **JOHAN K.V. SVANHOLM N3RF**, SVANHOLM RESEARCH LABORATORIES, P.O. Box 81, Washington DC 20044. Please send \$25.00 donation with \$5.00 for S&H. BNB420

Ham Radio Repair, Quality workmanship. All Brands, Fast Service. **Affordable Electronics**, 7110 E. Thomas Rd., Scottsdale, AZ 85251. Call 480-970-0963, or E-mail HAM_SERVICE@AOL.COM. BNB427

METHOD TO LEARN MORSE CODE FAST AND WITHOUT HANGUPS **Johan N3RF**. Send \$1.00 & SASE. SVANHOLM RESEARCH LABORATORIES, P.O. Box 81, Washington DC 20044 USA. BNB421

SATELLITE TV — Large selection of items at reasonable prices. We specialize in Big Dish TVRO C & Ku Band equipment. Check us out at www.daveswebshop.com. BNB646

HEATHKIT COMPANY is selling photocopies of most Heathkit manuals. Only authorized source for copyright manuals. **Phone:** (616) 925- 5899, 8-4 ET. BNB964

"MORSE CODE DECIPHERED" Simple, elegant, inexpensive, comprehensive, logical, easy! E-mail [judlind@earthlink.net]. BNB428

Electricity, Magnetism, Gravity, The Big Bang. New explanation of basic forces of nature in this 91-page book covering early scientific theories and exploring latest controversial conclusions on their relationship to a unified field theory. To order, send check or money order for \$16.95 to: American Science Innovations, PO Box 155, Clarington OH 43915. Web site for other products [http://www.asi_2000.com]. BNB100

COLLOIDAL SILVER GENERATOR! Why buy a "box of batteries" for hundreds of dollars? Current regulated, AC powered, fully assembled with #12 AWG silver electrodes, \$74.50. Same, but DC powered, \$54.50. Add \$2.50 shipping. **Thomas Miller**, 216 East 10th St., Ashland, OH 44805. Web address www.bioelectrifier.com. BNB342

COLD FUSION! - FUEL CELL! - ELECTRIC BI-CYCLE! Each educational kit: (Basic - \$99.95, Deluxe - \$199.95, Information - \$9.95.) CATALOG - \$5.00. **ELECTRIC AUTOMOBILE BOOK** - \$19.95. **KAYLOR-KIT**, POB 1550ST, Boulder Creek CA 95006-1550. (831) 338-2300. BNB128

ANTENNA SCIENCE: Why do antennas radiate electromagnetic waves? Learn for yourself from this enlightening paper by **MAX RESEARCH**. Gain an understanding of the radiation mechanism of antennas! Written in a clear style for radio hobbyists, inquisitive amateurs and experimenters. \$4.95 ... ppd. Order from **MAX RESEARCH**, P.O.

Box 1306, East Northport, NY 11731. BNB426

ROHN TOWERS HUGE DISCOUNTS CHECK PRICES AT HILLRADIO.NET BNB600

K8CX HAM GALLERY <http://hamgallery.com> BNB620

Wanted: Manual or copy for 14AVQ/WBS Hy-gain antenna. Bob, 35 Clarence St., Belleville, MI 48111. K8HHP@Yahoo.Com. BNB635

New miniature oscillator modules are now available ... all under \$20 ... plus our great reference book is still for sale. Write to **RMT Engineering**, 6863 Buffham Road, Seville, OH 44273 or see our Web site at www.ohio.net/~rtormet/index.htm. BNB640

TELEGRAPH KEYS AT DAYTON HAMFEST: 500+ Civil War - Present. Bring Yours! History, Information, Appraisals, Pretzels! Buying, Trading, Selling. **SPACE 2555**. <http://w1tp.com> BNB645

NEVER SAY DIE

continued from page 62

they invest in to expand their businesses, and that means more jobs, either directly, or through their buying goods and services from smaller contractors.

Every dollar the rich get from a tax break ends up going into expanding the economy. And that explains why every tax reduction in history has resulted in a stronger economy.

When the government takes money from us in taxes some of it comes back to us in more jobs, but much of these jobs do not contribute to the economy. Like the so-called War on Drugs, which is costing billions. Like the billions in pork, the thousands of government bureaus.