

73 Amateur Radio Today

SEPTEMBER 1995
ISSUE #420
USA \$3.95
CANADA \$4.95
A WGI Publication
International Edition

35th Anniversary Issue

ANTENNAS!

Loop Antenna · Discone Antenna
J-Type Vertical Antenna · Bridge Checkers
Longwave Plus DX · Tuners

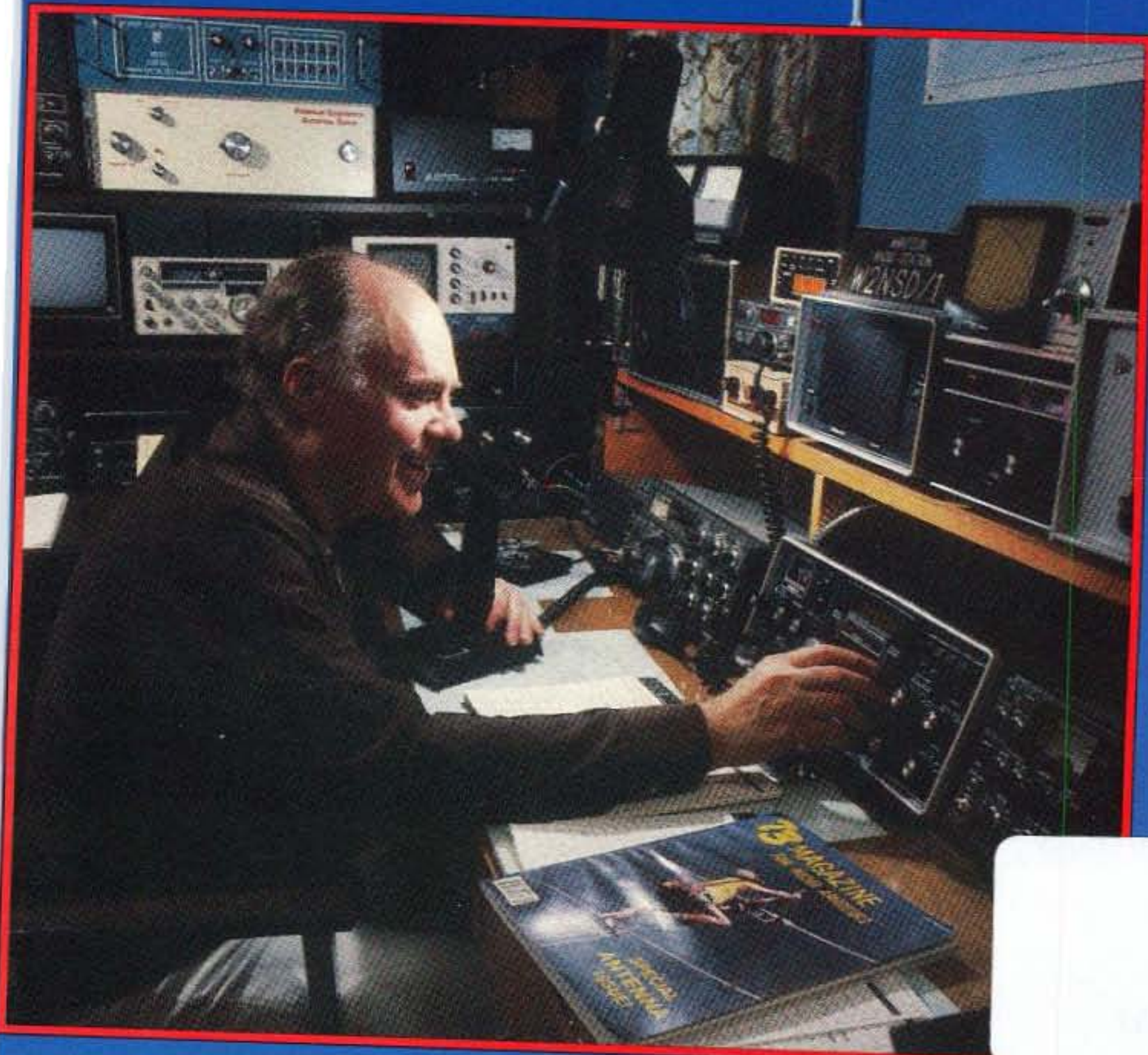

73 REVIEWS
Sony ICF-SW100S
Pocket SW
Transceiver
Icom IC-738
HF Transceiver

Expand Your Horizons to 6 Meters!



IC-736: 6 Meters and HF!

- HF and 6 Meters!
- 100 W Output for Both HF and 50 MHz
- Internal AC Power Supply
- Automatic Antenna Tuner (Covers 6 M to 160 M)
- Dual Antenna System
- 100% Full Duty Cycle
- Newly Developed DDS Circuit for 1 Hz Fine Tuning Resolution
- Quick Split Function (with pre-programmable offset)
- MOS-FET "Class A" Audio
- Multi-Function Meter (4-in-1)
- Double Cooling Fan
- Selectable Filters
- 10 dB Pre-amp, 20 dB Attenuator
- Built-in Electronic Keyer
- RIT, Δ Tx, Δ Rx
- 10 Key Pad
- VOX
- RF Gain
- 101 Memory Channels
- Passband Tuning
- AF-type Speech Compressor
- CW Full Break-In
- Notch Filter
- Noise Blanker
- Large Display

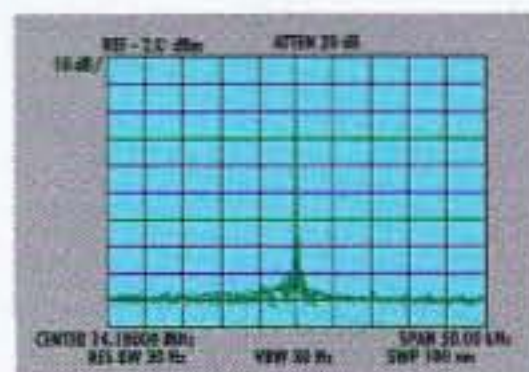

Transmitter C/N Ratio

Now you can work all of the HF bands AND have access to one of the most exciting amateur bands - 6 M! The IC-736 is an all band, all mode transceiver with a general coverage receiver. Only an antenna, coaxial cable and AC outlet are necessary to get up-and-running with this rig. Cutting edge features and "plug 'n play" operation make the IC-736 a "complete station in a box!"

The IC-736's compact and cleverly designed **Automatic Antenna Tuner** has preset memories for each 100 kHz step, thereby providing very high speed tuning. Tunes all ham bands plus 6 M!

Equipped with **2 Antenna Connectors**, the IC-736 includes an **Automatic Antenna Selector**. In each band, the band memory memorizes the selected antenna so you don't need to change an antenna manually each time you change the operating band.

The IC-736 employs power **MOS-FET's** in the driver and final amplifier stages, providing a clean, 100 W of output power over all of the ham bands as well as the 50 MHz band.

An **Aluminum Die-Cast Frame** and **2 Large Cooling Fans** help stabilize the

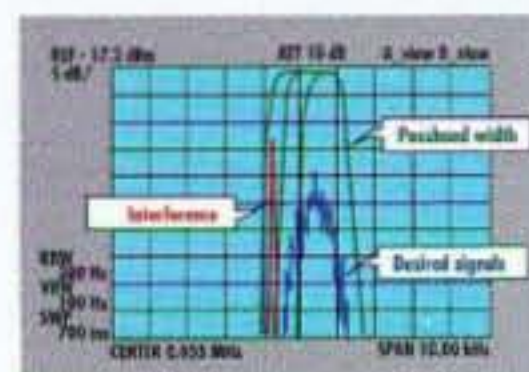

PBT Characteristics

IC-736's PA circuit to obtain 100% full duty cycle operation. Performance you can count on under the most demanding of conditions.

CW fans will love the IC-736. The **Full Break-In Function** (QSK) allows you to receive signals between transmitted keying pulses (semi break-in is also available). **Separately Designed CW Key Jacks** allow you to connect both a memory keyer and a paddle - great for contest operation!

The **Double Band Stacking Register** memorizes 2 frequencies along with modes in each band so it can be used like 2 VFO's in one band.

Up to 10 **Electronic "Memo Pads"** are available. This is especially useful during contests or while DX hunting. When catching a station you would like to temporarily store, simply push the memo pad-write button. The frequency and mode is automatically stored in a memo pad so you can continue band searching.

For interference rejection, the IC-736 has **Passband Tuning** and a **Notch Filter**. During crowded band conditions, these two functions can be used in combination, providing an extremely effective method of reducing most types of interference.

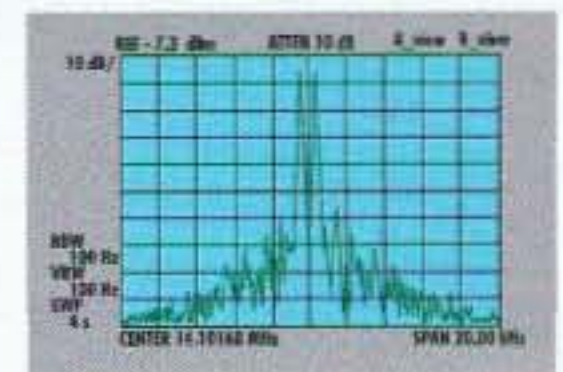

3rd IMD Characteristics

The **RIT** and **Δ Tx** functions independently change the receive or transmit frequencies, respectively. Great for split frequency operation or for compensating for the frequency drift of another station.

The IC-736's offset frequency for **Quick Split** Function can be pre-programmed. A **Split Lock** function prevents you from mistakenly changing the receive frequency while changing the transmit frequency.

A newly designed **DDS** (Direct Digital Synthesizer) provides frequency resolution to an exacting 1 Hz. Rotate the main dial and experience the comfortable analog feeling of fine tuning. One complete dial rotation is equal to 200 Hz.

Call (206) 450-6088 for **FREE Literature!**

View a video demonstration of this product



at your participating ICOM dealer today!

ICOM America, Inc. Corporate Headquarters
2380-116th Ave. N.E., Bellevue, WA 98004

© 1994 ICOM America, Inc. The ICOM logo is a registered trademark of ICOM, Inc. All stated specifications are subject to change without notice or obligation. All ICOM radios significantly exceed FCC regulations limiting spurious emissions. 736794Y

Experience the Quality

ICOM

PEAK PERFORMANCE

LOW POWER

The KPC-3 offers more performance than any other TNC in its price range. No wonder it's the #1-selling TNC on the market today. And now, the KPC-3 can connect to GPS receivers with an NMEA-0183 interface. And it's the only TNC with enhanced GPS operations, including multiple string parsing; storage of outgoing data in tracking buffers; time-

slotted broadcasting based on the GPS clock (so multiple stations can report without collision); and remote access to reconfigure the GPS unit. Like all Kantronics

TNCs, the KPC-3

is thoroughly contemporary; it can run on a 9-volt battery, and it's portable. It also provides more than 20K of personal mailbox space that inexpensively expands to 100K.

Get your own KPC-3 today.
It's just the lift you've been needing.

Kantronics

For more information, contact your authorized Kantronics dealer or Kantronics at
1202 E. 23rd St., Lawrence, KS 66046-5006
913-842-7745 FAX 913-842-2031.

ENJOY THE RUN



Kantronics KPC-3

HI-PERFORMANCE

The new Hi-Performance line is a hi-professional range of mobile antennas for the discriminating Radio Amateur. Best material quality, hi-tech design and maximum performance; this the result of years of experience and technological research by Sirio. Hi-Performance line, second to none !!

We are looking for distributors in the U.S.A. please, contact us !

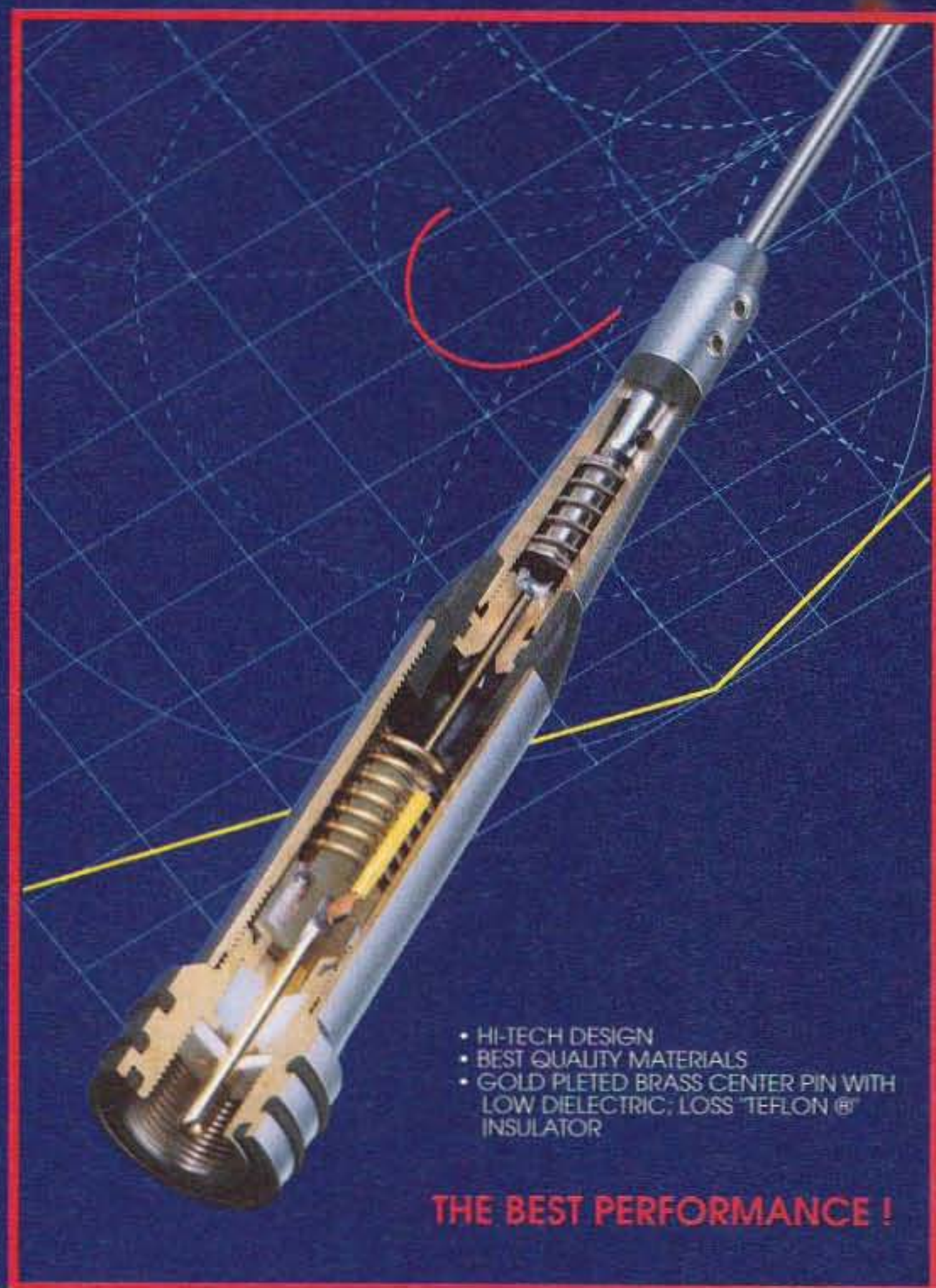

- HI-TECH DESIGN
- BEST QUALITY MATERIALS
- GOLD PLETED BRASS CENTER PIN WITH LOW DIELECTRIC; LOSS "TEFLON"® INSULATOR

THE BEST PERFORMANCE !

See us at the 15th Hong Kong Electronics Fair (October 11/14th).



HP 2070



HP 2070 H

SIRIO
antenne

Strada dei Colli Sud, 1/Q - 46049 VOLTA MANTOVANA - MN - ITALY
Tel. (39) 376/801515 - Fax (39) 376/801254

THE TEAM

PUBLISHER
Wayne Green W2NSD/1

SENIOR/TECHNICAL EDITOR
Wayne Green W2NSD/1

MANAGING EDITOR
David Witham

EDITORS
Joyce Sawtelle
Victor Lapuszynski

CONTRIBUTING EDITORS
Bill Brown WB8ELK
Mike Bryce WB8VGE
Joseph E. Carr K4IPV
Michael Geier KB1UM
Jim Gray W1XU/7
Chuck Houghton WB6IGP
Dr. Marc Leavey WA3AJR
Andy MacAllister WA5ZIB
Joe Moell K0OV
Carole Perry WB2MGP
Jeffrey Sloman N1EWO

ADVERTISING SALES MANAGER
Gerry Foss
1-603-924-0058
1-800-274-7373
FAX: 1-603-924-9327

TECHNICAL DRAWINGS
Mike Nugent WB8GLQ
Writers

**GRAPHICS MANAGER/
PAGINATION**
Linda Drew

DESIGN/PRODUCTION
Joan Ahern

GRAPHIC SERVICES
FilmWorks, Inc.
Antrim NH

CIRCULATION
To subscribe: 1-800-677-8838

WAYNE GREEN, INC.

Editorial Offices
70 Route 202N
Peterborough NH 03458
1-603-924-0058;
FAX: 1-603-924-9327

Subscription Services
1-800-677-8838
Foreign Subscribers
1-609-461-8432

Reprints: \$3.00 per article.
Back issues: \$4.00 each.

Write to *73 Amateur Radio Today*,
Reprints, 70 Route 202N,
Peterborough, NH 03458.

Printed in the U.S.A. by
Quad Graphics,
Thomaston, Georgia.

73 Amateur Radio Today

September 1995
Issue #420

TABLE OF CONTENTS

FEATURES

- 10 Simple J-Type 10m Vertical**
For more versatile DXing.....W6IOJ
- 14 Tuner Helper**
An easier (and safer) way to tune your antenna while
driving.....K3PUR
- 20 Just Another Loop Antenna**
Or is it?WB2EGQ
- 32 A Discone Antenna for 10 Meters**
It looks like a bird cage, but works like a yagi.W1ZB/6
- 34 Check Your SWR Bridge**
Think you have a good bridge? Find out for sure.K1WVX
- 38 Longwave-Plus DX Techniques**
Exploring the undervalued lower frequencies.G2BZQ

DEPARTMENTS

- 62 Above and Beyond
73 Ad Index
54 Ask Kaboom
58 ATV
80 Barter 'n' Buy
68 Carr's Corner
17 Feedback Index
56 Hams with Class
64 Hamsats
59 Homing In
6 Letters
4 Never Say Die
79 New Products
81 Propagation
72 QRP
8 QRX
70 RTTY Loop
78 Special Events
86 Uncle Wayne's
Bookshelf

REVIEWS

- 42 The Icom IC-738
HF Transceiver**
A sturdy and popular
rig.....WB2WIK/6
- 50 Sony ICF-
SW100S Pocket
Shortwave
Receiver**
A ham station in your
pocket.....KB1UM

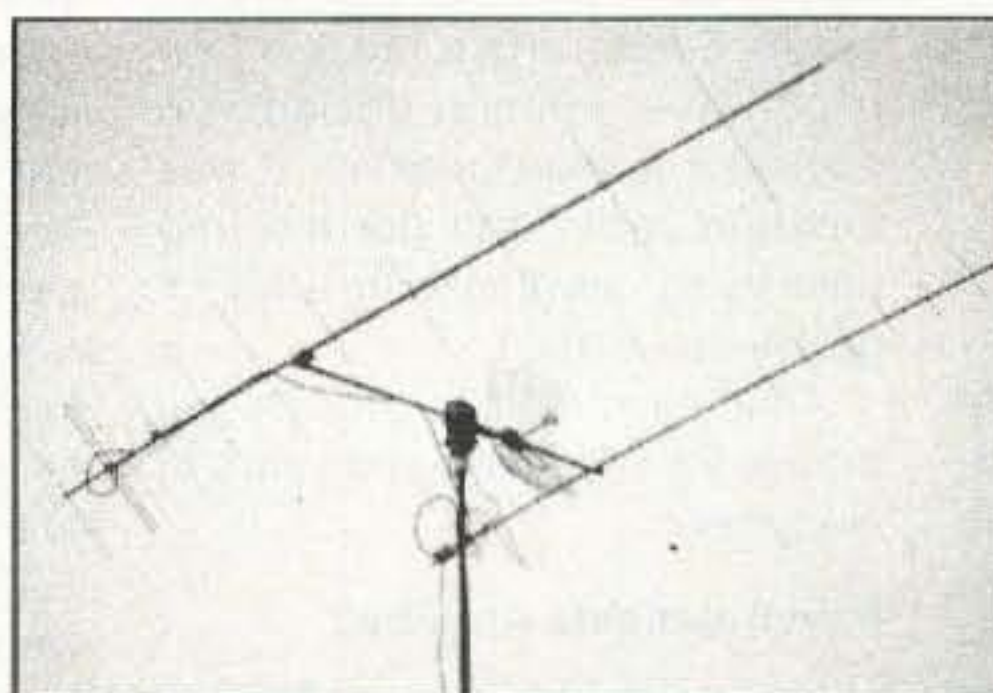

Two large KLM crossed Yagis and a Bob Myers "S" dish for Field Day satellite work.
See Hamsats on page 64.

FEEDBACK... FEEDBACK!

It's like being there—right here in our offices! How? Just take advantage of our FEEDBACK list on page 17. You'll notice a feedback number at the beginning of each article and column. We'd like you to rate what you read so that we can print what types of things you like best.

On the cover: That's vintage Wayne in the hamshack. Sure been at it awhile, spreadin' ideas all over the air. And behind him is a pair of Cushcraft Model A3S antennas that can help do the spreadin'.

FB

Editorial Offices
70 Route 202N
Peterborough NH 03458
phone: 603-924-0058

Advertising Offices
70 Route 202N
Peterborough NH 03458
phone: 800-274-7373

Circulation Offices
70 Route 202N
Peterborough NH 03458
phone: 603-924-0058

Manuscripts Contributions in the form of manuscripts with drawings and/or photographs are welcome and will be considered for possible publication. We can assume no responsibility for loss or damage to any material. Please enclose a stamped, self-addressed envelope with each submission. Payment for the use of any unsolicited material will be made upon publication. Please submit all material on disk as an IBM-compatible ASCII file. All contributions should be directed to the 73 editorial offices. "How to Write for 73" guidelines are available upon request. US citizens must include their Social Security number with submitted manuscripts.

73 Amateur Radio Today (ISSN 1052-2522) is published monthly by Wayne Green Inc., 70 Route 202 North, Peterborough NH 03458. Entire contents ©1995 by Wayne Green Inc. No part of this publication may be reproduced without written permission of the publisher. For Subscription Services, write to *73 Amateur Radio Today*, P.O. Box 7693, Riverton NJ 08077-7693, or call 1-800-289-0388. The subscription rate is: one year \$24.97, two years \$39.97; Canada: \$34.21 for one year, \$57.75 for two years, including postage and 7% GST. Foreign postage: \$19.00 surface or \$42.00 airmail additional per year. All foreign orders must be accompanied by payment in US funds. Second class postage paid at Peterborough, NH, and at additional mailing offices. Canadian second class mail registration #178101. Canadian GST registration #125393314. Microfilm Edition—University Microfilm, Ann Arbor MI 48106. POSTMASTER: Send address changes to *73 Amateur Radio Today*, P.O. Box 7693, Riverton NJ 08077-7693.

Contract: You have now been legally obliged, by the mere act of reading this, henceforth to act with all the duties and responsibilities befitting the status of a human being. You must now behave with dignity and kindness toward all beings, honoring the ancient and educating the young. And if you're obnoxious on the air, my cousin "Big" Bruno's gonna find you with his Doppler.—Vic

NEVER SAY DIE

Wayne Green W2NSD/1



Ooops!

In my July editorial I mentioned the Virginia Beach Hamfest as being in July. Wrongo! It's September 23-24 and, if you are within any kind of driving distance, I expect to see you there. No excuses. Yes, of course, I'll be talking. And talking. Well, I kept 'em entertained for a couple of hours at the recent Edmonton hamfest. More like three, I guess. Nobody left and everyone was laughing. I'll be at the Queen Mary hamfest over Labor Day, but I haven't been asked to speak (yet). I'll try to bring some tapes to tide the deprived over if the ARRL can't find any time for me on their program. I'll have some of my books there to autograph, too.

Good Grief, 35 Years!

When I started publishing 73 with the October 1960 issue, I was too busy living in the present to even imagine that 35 years later I might still be at it. It was something which I felt was needed at the time; something I enjoyed doing. So I sold everything I could and scraped just enough money together to print the first issue. That's the sort of a gamble only a naive entrepreneur would make.

At 38, it never occurred to me that I'd still be publishing the magazine when I was 73. But then, who really plans their future out for years? I took opportunities as they presented themselves, with little thought to the long run, other than investing in building as many skills as I could and reading endlessly.

The big landmarks in my life were my interest in amateur radio, which began in earnest in 1938; my four years in the navy during WWII and the superb electronics education I was provided; my interest in Dianetics in 1950,

which was a major turning point for me; my first entrepreneurial adventure: manufacturing loudspeakers; my entry into ham publishing, starting 73 in 1960, FM and repeaters in 1969, and microcomputers in 1975; the sale of my microcomputer empire and entry into the music business in 1983; my involvement with the New Hampshire Economic Development Commission in 1991; and my venture into cold fusion in 1994.

It was amateur radio that got me to go to Rensselaer Polytechnic Institute, and then into the navy as an electronics technician. This led to me working for Airborne Instruments, doing R&D for the Air Force, where I took a new microwave antenna design and applied it to loudspeakers. It was amateur radio that got me into publishing, starting with a RTTY newsletter in 1951.

Amateur radio has brought me thousands of friends and years of enjoyment.

Psychokinesis Anyone?

You no doubt missed the article in the April *Wired* on the Princeton Engineering Anomalies Research (PEAR) laboratory, where they have confirmed the ability of minds to influence matter. It turns out that about two-thirds of the people tested were able to influence random events. Of course, there were a few people who are completely off the charts. Endless tests have shown that it doesn't make any difference where the people are being tested. The effect works just as well in the same room as halfway around the world or out in space.

I remember a video of a psychic changing the surface tension of a jar of water from hundreds of miles away. This was shown at the ISSSEEM (subtle energies) conference in Monterey in 1993. I

hope to have more to report on this year's conference in Boulder (which by now you've missed, despite my entreaties to attend). The same psychic was able to disturb a cloud chamber from afar.

But then, if you've been getting the books I've recommended, you know about the incredible ability of your cells to keep in touch with each other, no matter how separated they are from you.

Now, to put this in ham terms, please don't tell me you have nothing more to talk about on the air than your rig and antenna. Or the weather. There's a whole world out there that we're just beginning to explore. We don't know how the mind works. We need to know more about death . . . and never mind what your religion has taught you. When millions of people over thousands of years have a near-death experience and then come back to report similar experiences, it's almost enough to make a person think.

I talked with a chap in Florida who claims he can teach people to move matter with their minds. He says he can spin a whole room full of pizza pans from anywhere he is, and has done it under the most carefully checked scientific circumstances.

One of the problems with exploring the mind and consciousness is the number of people taking advantage of the vacuum of information in this field. They're out there waiting to take advantage of the gullible at every turn. But if you throw the baby out with the bathwater, you're just refusing to explore uncharted territory . . . if you don't mind my metaphors.

One only has to look at the endless examples of scientific resistance to evidence to begin to question our authorities. I've written about stomach ulcers, in which the medical establishment

refused for years to even look at the evidence that they might be connected to a microbe: *Helicobacter pylori*.

The more you read about carefully researched near-death experiences (NDEs), angels, contactees, UFOs, reincarnation, and so on, the more you realize that thousands to millions of people have for some reason been having similar experiences all over the world. What do you know of the research of Sir Crookall, Wilhelm Reich, Royal Rife, Gaston Naessens, and other unsung pioneers?

Homeopathic medicine was a big and successful healing art here in the 19th century. My great grandfather was the town doctor for Littleton (NH) and was still being talked about appreciatively by the townspeople when I was a kid, 30 years after his death. He was a homeopath. Now, if you've been keeping up, you know that allopathic doctors mounted a battle against the homeopaths in the 1920s and put them out of business in America by taking over all of the American teaching hospitals. However, homeopathy still lives in England, where recent double-blind research has shown that the basic theory does work, though there is no scientifically accepted explanation for how.

The more I read, the more convinced I am that millions of people are suffering and dying needlessly, all as a result of the AMA-FDA and the supporting insurance companies refusing to look into even the strongest of research data on alternatives to the use of drugs and surgery as a solution to our sickness problems.

Oh yes, lest I forget. If you have some unfortunately overweight people in your ham club, you could help add quite a few years to their lives by getting them a subscription to 73 and let me keep after them to give up their beer and doughnut diets and shift more to fruits and veggies. No, I'm not a vegetarian or anything. But it doesn't take a rocket scientist to figure out that your body has to keep rebuilding itself from the food you eat, so it's going to last a lot longer if you provide what it needs. Coffee and danish are new additions to our diets. The human body developed over the millennia to work on meat, vegetables, and fruit, not Dunkin Doughnuts, beer, Big Macs, and fries.

Continued on page 74



JST-245

160-10 Meters PLUS 6 Meter Transceiver



Fifteen reasons why your next HF transceiver should be a JST-245...

- 1** All-Mode Operation (SSB,CW,AM,AFSK,FM) on all HF amateur bands and 6 meters. JST-145, same as JST-245 but without 6 meters and built-in antenna tuner.
★ JST-145 COMING SOON ★
- 2** MOSFET POWER AMPLIFIER • Final PA utilizes RF MOSFETs to achieve low distortion and high durability. Rated output is 10 to 150 watts on all bands including 6 meters.
- 3** AUTOMATIC ANTENNA TUNER • Auto tuner included as standard equipment. Tuner settings are automatically stored in memory for fast QSY.
- 4** MULTIPLE ANTENNA SELECTION • Three antenna connections are user selectable from front panel. Antenna selection can be stored in memory.
- 5** GENERAL COVERAGE RECEIVER • 100 kHz-30 MHz, plus 48-54 MHz receiver. Electronically tuned front-end filtering, quad-FET mixer and quadruple conversion system (triple conversion for FM) results in excellent dynamic range (>100dB) and 3rd order ICP of +20dBm.
- 6** IF BANDWIDTH FLEXIBILITY • Standard 2.4 kHz filter can be narrowed continuously to 800 Hz with variable Bandwidth Control (BWC). Narrow SSB and CW filters for 2nd and 3rd IF optional.
- 7** QRM SUPPRESSION • Other interference rejection features include Passband Shift (PBS), dual noise blanker, 3-step RF attenuation, IF notch filter, selectable AGC and all-mode squelch.
- 8** NOTCH TRACKING • Once tuned, the IF notch filter will track the offending heterodyne (± 10 KHz) if the VFO frequency is changed.
- 9** DDS PHASE LOCK LOOP SYSTEM • A single-crystal Direct Digital Synthesis system is utilized for very low phase noise.
- 10** CW FEATURES • Full break-in operation, variable CW pitch. built in electronic keyer up to 60 wpm.
- 11** DUAL VFOs • Two separate VFOs for split-frequency operation. Memory registers store most recent VFO frequency, mode, bandwidth and other important parameters for each band.
- 12** 200 MEMORIES • Memory capacity of 200 channels, each of which store frequency, mode, AGC and bandwidth.
- 13** COMPUTER INTERFACE • Built-in RS-232C interface for advanced computer applications.
- 14** ERGONOMIC LAYOUT • Front panel features easy to read color LCD display and thoughtful placement of controls for ease of operation.
- 15** HEAVY-DUTY POWER SUPPLY • Built-in switching power supply with "silent" cooling system designed for continuous transmission at maximum output.



Japan Radio Co., Ltd.

430 Park Ave., 2nd Floor New York, NY 10022 Phone: (212) 355-1180 Fax: (212) 319-5227

CIRCLE 159 ON READER SERVICE CARD

From the Ham Shack

Joseph Falcone, Att'y (no call given) I have been reading your 73 editorials for some time now. At first I thought you were simply "off-the-wall" and interested solely in eliminating amateur radio Morse Code exam requirements so you could sell more magazines and other stuff to more licensees.

But, after reading your editorials, I realized that you are in fact a visionary who is quite upset that people in America, including amateur radio operators, appear to be content to sit on their butts and let the world pass them by. You consistently point out that commercially connected computers can pass information millions of times faster than some amateur radio modes, and you urge the amateur radio operators to forget about long boring 75 meter phone QSOs and allegedly "meaningless" CW QSOs. But, Wayne, you are missing the point. Amateur radio is not going to compete with the Internet or cellular phones in efficient ways to communicate. Those modes of communication have passed by amateur radio in pure efficiency and capital investment. What amateur radio has that the commercial communication operations will never have is: (1) amateur radio operators who volunteer to be mobilized in an emergency to provide true "emergency" communications; and (2) the ability to provide education and training to America's population about basic electronics.

By keeping CW in use, amateur radio provides a means by which its participants can build and use very basic equipment to communicate. Let's face it, the average person will not be able to design and build a new, improved 486 computer chip, with its three million transistors. But, the average person can build a small QRP transmitter and learn how transistors and other basic components work.

Back in the 50s you and amateur radio were in the forefront of technology. Today, that just is not so, and will likely never happen again. Smell the roses, Wayne! Our store-bought equipment is so complicated today that we are

lucky if we can figure out how to use it, much less understand how it really works. Forget about actually building a TNC or 2 meter HT. That simply does not happen any more, and will never again.

If we want to keep amateur radio valuable to this country, and not just a cheap way to get around using cellular phones and long-distance telephone lines, we must promote the use of CW in amateur radio to insure that the hobby is not simply a group of people who like to chat on the two meter repeater systems that Uncle Wayne invented 20 years ago. Are the two meter repeater operators any more productive than the windbags on 75 meters you so disdain?

All the "hot" technology is in the UHF/VHF area. The UHF and VHF amateur radio bands are "code free." All the "scientists" that you and others say want to rush into amateur radio, but are prevented because of a 5- or 13-wpm Morse Code requirement, can easily obtain a no-code license and can experiment to their hearts' content on the higher bands. Just allow the old HF bands to be the training ground for people who want to know why electronic things work, rather than what the buttons do.

When I look at the main Japanese ham magazine, running 500-600 pages every month, packed with innovative and some highly advanced construction projects, I see what American hams used to be able to do—and you claim they will never again. But then the Japanese have not been saddled with the code requirement for decades. Joe, I have never had any quarrel with the code as a way to have fun, only with using it as a way to freeze out new hams, which it has done and is still doing very effectively. Maybe you haven't noticed that over 50% of the American hams today are Novices or Techs. For some weird reason you seem to believe that the only way you can get hams to use CW is to force them by law to learn the code. How typical of a lawyer! I have a

news flash for you, Joe, the need for ham emergency communications is dwindling. Our ability to provide basic electronic training has been almost totally destroyed by the ARRL memorization system for passing license tests. So I'm sitting up here in the beautiful mountains of New Hampshire smelling something, but it isn't roses, as more and more Americans become lawyers instead of engineers. Have I really missed the point? . . . Wayne

Cecil Moore KG7BK I've just got to take issue with your June review of the SGC-230 automatic antenna tuner for mobile operation. You say it doesn't work well in the trunk. Well, then don't install it in the trunk. You say it doesn't work well with coax. Well, then don't use coax. Implying that it's not a good automatic tuner for mobile use is just not true. It sure outperforms my old system on the higher bands. Since it's weather-proof, it is logical to install it on a grounded rod mounted to the bumper. Mine is a 5/8" piece of threaded rod bolted to the trailer hitch hole. A standard antenna mount is located at the top of the grounded rod. My antenna is a 13-foot whip fed by 2 inches of wire from the SGC-230. There is no coax involved. The whip is a resonant quarter-wave on 17m and does an excellent job on 20m. It outperforms my old tuner on 15m, 12m, and 10m because of the gain associated with an antenna longer than a quarter-wave. The 13' whip and the SGC-230 is only one S-unit down from a resonant Bugcatcher on 40m. I hope SGC doesn't lose any sales because of your disinformation. It is an ideal solution for 10m-20m automatic tuning mobile operation.

John Slivka WA2X I want you to know that I really appreciate your column every month in 73, and I view your position as really the chief spokesperson for amateur radio. Keep the great ideas flowing! I've wanted to write to you for a long time because I'm concerned about the future of ham radio and the spirit of camaraderie and good will which have always been associated with it. We need to keep fostering friendly on-the-air contacts. I recommend that we make sure to say something positive during each QSO. This will have a rip-

ple effect, helping to make hamming more fun for everyone. It might even lead to your running for president of the ARRL, making it possible to break up the old-timers now running our national organization. Keep up the good work. Your magazine is an inspiration to me.

The ARRL presidency is for someone who has a need to feel important. It's a figurehead job I haven't time for, but thanks for the kind words and the thought. I really like your idea of being positive on the air. But then ham camaraderie still lives in many parts of our country where hams gather to help a fellow ham put up his tower. I just wish I'd get more good pictures of things like that . . . Wayne

Richard Mollentine WA0KKC Wayne, there seems to be a "new breed of hams." They argue, cuss (those four-letter words) on the ham bands and are determined to start an argument over anything, not an adult discussion. Surely ham radio wasn't planned and licensed for that kind of stuff.

Unfortunately, the FCC has not included a sanity section in the license tests, so we have our crazies. I'm open to any creative suggestions from readers on how we should handle nasty hams, and I've run into my share of them. This seems to increasingly be a challenge for us. And the solution is up to us, not the FCC. Are we "self-policing," as we keep bragging? Well, that's up to you. In coming up with creative approaches to things like this, keep in mind that the angry person is expressing a deeply felt inferiority and is overcompensating by putting people down as a way to build himself up. Let's not set out to really get even with these sickos . . . like sending perfumed letters to him at home thanking him for making your visit to his town so memorable and signing it with a woman's name. That might require some explaining to his long-suffering wife. Tsk. If you have a phone ROM, you could send letters to his neighbors asking them to tell him to cut out the nastiness over the air. Now, put on what's left of your thinking cap after the mice and moths have had at it all these years, and let's see what you can come up with . . . Wayne 73

LOW NOISE RECEIVER PREAMPS

LNG-(*)

still only \$59
wired & tested



FEATURES:

- Very low noise: 0.7dB nf vhf, 0.8dB uhf
- High gain: 13-20dB (depends on freq)
- Wide dynamic range - resist overload
- Stable: dual-gate GAS FET

*Specify tuning range: 26-30, 46-56, 137-139, 139-152, 152-172, 210-230, 400-470, 800-960 MHz.



LNW-(*) MINIATURE PREAMP

still only \$29 kit, \$44 wired & tested

- Low-cost MOSFET preamp.
- Small size. Only 5/8"W x 1-5/8"L x 3/4"H.
- Nf 1.2dB vhf, 1.5dB uhf.
- Solder terminals for coax & pwr connect.

*Specify tuning range: 25-35, 35-55, 55-90, 90-120, 120-150, 150-200, 200-270, 400-500 MHz.

LNS-(*)

IN-LINE PREAMP



ONLY \$89 kit, \$119 wired & tested

- Automatically switches out of line during transmit.
- GaAs FET Preamp with features similar to LNG series.
- Use with base or mobile transceivers up to 25W.

*Tuning range: 120-175, 200-240, or 400-500.

HELICAL RESONATORS

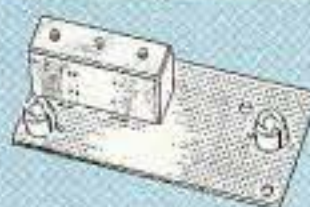

Helical resonator filters may reduce your intermod & cross-band interference.

MODEL HRF-(*), \$59 vhf, \$99 uhf.

*Specify tuning range: 136-140, 142-150, 150-162, 162-174, 213-233, 420-470.

RECEIVING CONVERTERS

Low noise converters to receive vhf & uhf bands on a 10M receiver.



- Input ranges avail: 50-52, 136-138, 144-146, 145-147, 146-148, 220-222, 222-224 MHz, 432-434, 435-437, 435.5-437.5, and 439.25 (atv conv. to chan 3).
- Kit less case \$49, kit w/case & BNC jacks \$79, w&t in case \$99.

TRANSMITTING CONVERTERS

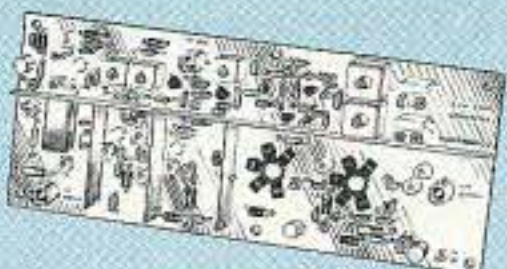

XV2 for vhf and XV4 for uhf. Models to convert 10M ssb, cw, fm, etc. to 2M, 432, 435, and atv. 1W output. Kit only \$89 (vhf), \$99 (uhf). PA's up to 45W available.

RÉPEATER CONTROLLERS

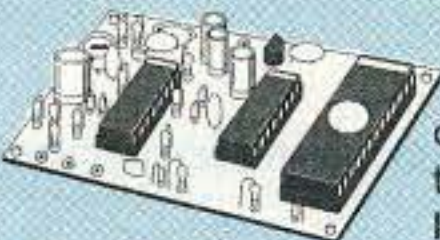

NEW CWID-2. Eprom-controlled, miniature, easy to build, low power CMOS.

(specify call) only \$54 kit, \$79 w/t

COR-6. COR & Real Voice ID

on one board. Digital ic records up to 20 seconds of your voice. Can record multiple id messages. Tail and time-out timers, courtesy beep, solid-state relay to key transmitter.

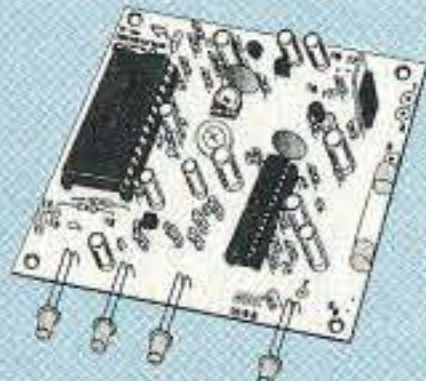

..... kit \$99, w&t \$149

COR-3. COR, timers, court.beep kit \$49

CWID. Diode programmable kit \$59

COR-4. Complete COR and CWID all on one board. CMOS logic for low power consumption. EPROM programmed; (specify call) kit \$99, w&t \$149

ACCESSORIES

DVR-1 DIGITAL VOICE RECORDER. Records up to 20 sec. of your voice with built-in mic. or external mic. Terrific as voice ID'er for repeaters or fox hunt xmtr, contest caller, radio notepad, etc. Extensive manual tells how to use multiple messages adapt to many applications. kit \$59, w&t \$99



TD-4 SELECTIVE CALLING Module. Versatile dtmf controller with 1 latching output. Mutes speaker until someone calls by sending your 4-digit tt code. Or use it with a long tt zero digit to alert anyone in club. Also may be used to control autopatch or other single device. kit \$49, w&t \$79

TD-3 CTCSS (SUBAUDIBLE TONE) DECODER/ ENCODER kit \$29, w/t \$59

AUTOPATCHES

AP-3 REPEATER AUTOPATCH. Reverse patch and phone line remote control. kit \$89, wired & tested \$139

AP-2 SIMPLEX AUTOPATCH Timing Board. Use with above for simplex operation using a transceiver. kit \$39

TD-2 DTMF DECODER/CONTROLLER. 16 digits, jumper-programmable, toll-call restrictor. Can turn 5 functions on/off. kit \$79, wired & tested \$129

DATA MODEMS

MO-202 FSK DATA MODULATOR & DE-202 DEMODULATOR. Run up to 1200 baud digital signals through any fm transmitter & receiver. kits \$49, w&t \$79

9600 BAUD DIGITAL RF LINKS. Call for info on low-cost packet networking system: MO-96 Modem and special versions of our 144, 220, or 450 MHz fm xmtrs and rcvrs. Use directly with most TNC's. Fast, diode-switched PA's output 15 or 50W.

WWW RECEIVER

Get time and freq checks without buying expensive hf rcvr. Very sensitive and selective xtal controlled superhet, dedicated to listening to WWW on 10.000 MHz. only \$59 kit, \$99 w/t



You get more features for your dollar with our

REP-200 REPEATER

A fully microprocessor-controlled repeater with autopatch and many versatile dtmf control features at less than you might pay for a bare-bones repeater or controller alone!

Kit still only \$1095
w&t still only \$1295

- Available for the 50-54, 143-174, 213-233, 420-475, 902-928 MHz bands.
- FCC type accepted for commercial service in 150 & 450 bands. (Request catalog for details.)



REP-200T Voice Message Repeater. As above, except includes Digital Voice Recorder. Allows message up to 20 sec. to be remotely recorded off the air. Play back at user request by DTMF command, or as a periodical voice id, or both. Great for making club announcements! adds only \$100!

REP-200C Economy Repeater. Uses COR-6 Controller (no DTMF control or autopatch). Features real-voice ID. Kit only \$795, w&t \$1195

REP-200N Repeater. Want to use your own controller? No problem! We'll make you a repeater with rf modules only. Kit only \$695, w&t \$995

XMTRS & RCVRs FOR REPEATERS, AUDIO & DIGITAL LINKS, TELEMETRY, ETC.

Also available in rf-tight enclosures, and with data modems.

FM EXCITERS: 2W continuous duty. FCC type accepted for com'l bands.

- TA51: 50-54, 143-174, or 213-233MHz.
- TA451: 420-475 MHz. *New low price!*

Either model: kit \$99, w/t \$169.

• TA901: 902-928 MHz, (0.5W out); *New low price!* w/t \$199.

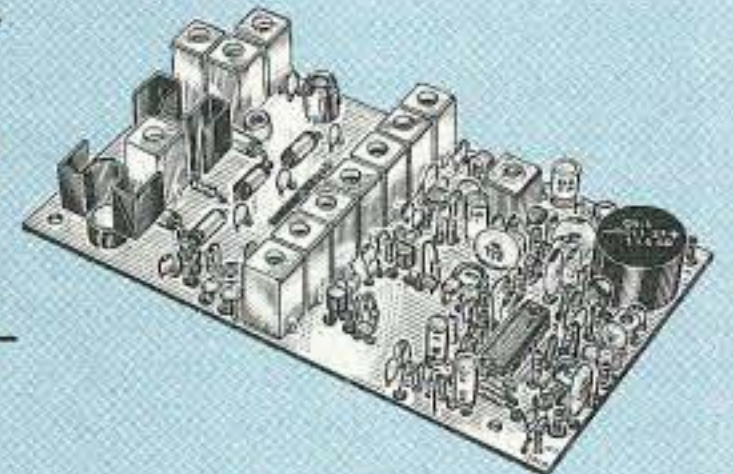

VHF & UHF AMPLIFIERS.

For fm, ssb, atv. Output levels from 10W to 100W. Models starting at \$99.

FM RECEIVERS:

NEW R100 FM RECEIVERS for 46-54, 72-76, 140-175, or 216-225 MHz. Very sensitive - 0.15uV, exceptional selectivity - both crystal & ceramic if filters for >100dB at ±12kHz (best available anywhere), flutter-proof squelch. *New low price!* kit \$129, w/t \$189.

• R451 FM RCVR, for 420-475 MHz. Similar to above. *New low price!* kit \$129, w/t \$189.

• R901 FM RCVR, for 902-928MHz. Triple-conversion. *New low price!* \$159, w/t \$219.

NEW R150 MONITOR RCVR for 143-164 or 216-225 MHz. 4-channels. Great for monitoring repeaters, amateur calling frequencies, packet radio, commercial two-way radio, police/fire frequencies, or weather forecasts. Good starter kit, easy to assemble and align kit only \$99, w/t \$189.

• R120 AIRCRAFT RCVR for 110-136 MHz kit only \$99, w/t \$219.

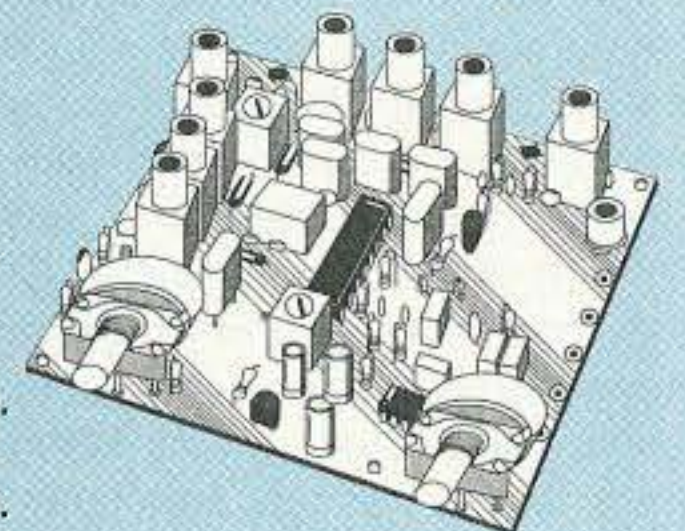

WEATHER SATELLITE RECEIVER

NEW Our R138 Is The Most Affordable WeFax Receiver!

We used our 30+ years of experience in designing high-quality vhf receivers to bring you this enhanced version of our long-popular WeFax Receiver, a very sensitive wideband fm receiver especially for amateur reception of NOAA and Meteosat weather facsimile images on the 137 MHz band. Use with demodulators and software from MultiFax, S.S.C., A&A Eng., and others. Features 0.2uV sensitivity, wideband filters for low distortion, and four crystal controlled channels at a fraction of the cost and complexity of synthesized units. Optional Scan Adapter allows you to automatically search for and record signals as satellites pass overhead while you are away from the shack.

- R138 Receiver \$129 kit, \$189 w/t
- AS138 Scan Adapter \$39 kit, \$69 w/t
- Channel Crystals \$12 ea
- ARRL Weather Satellite Handbook \$20

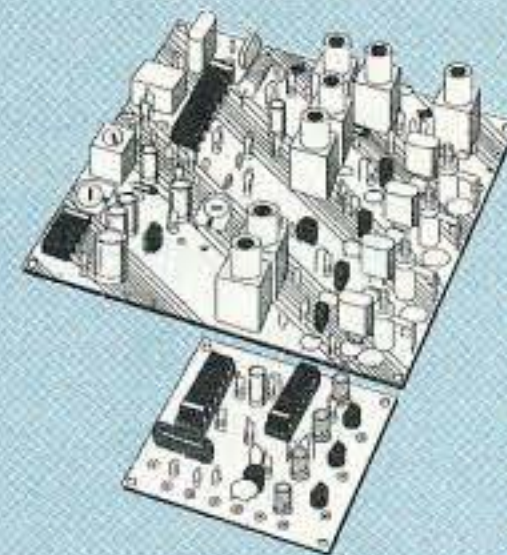

- Buy at low, factory-direct net prices and save!
- For complete info, call or write for free catalog. (Send \$2 for overseas air mail.)
- Order by mail, fax, or phone (9-12 AM, 1-5 PM eastern time).
- Min. \$5 S&H charge for first pound plus add'l weight & insurance.
- Use VISA, Mastercard, Discover, check, or UPS C.O.D.

Our 33rd Year!
hamtronics, inc.
65-D Moul Rd; Hilton NY 14468-9535
Phone 716-392-9430 (fax 9420)

TNX

Wayne Green and all the staff of *73 Amateur Radio Today* want to extend our deepest gratitude to all our writers, advertisers, past and present employees, and, most especially, you, our readers. It's been a great 35 years! May we all be together for 35 more.

An International Adventure

This piece from Rajiv Dewan AA2UI, I recently installed an HF rig in my car and rediscovered the joys of HF mobiling. It was a rainy day when I left for work around 8 am on Tuesday last. I backed out of the garage, stopped and installed the three-foot whip on the Hamstick. The antenna with the whip is too tall for the garage. Serious QRM greeted me as I settled in the car seat and turned on the radio. My mobile rig is a Kenwood TS-50s that is mounted in the passenger seat well of a Saturn sedan. It is mounted to the side of the gear shift console so the radio faces up and is easily seen. The controls are within easy reach. Its power cord goes directly to the battery, with both leads fused. The antenna is a 30m Hamstick mounted to the tow hitch at the back of the car. I am most pleased about my keying arrangement. The paddles are tiny brass ones, called Einbau Wabblers, which are imported from Germany by Electro Switch of Atlanta. The paddles are mounted on a small die-cast aluminum box containing the CMOS Super II memory, keyer, and keyer batteries. The whole keyer and paddle assembly is mounted on a 'C' shaped leg clamp from a WWII J45 key used by aviators. I attach the clamp to my leg just above the knee so that the paddles are near where my right hand rests near the gear shift lever. The setup makes it quite easy to send without ever having to look at the paddles and keyer assembly. It is just as effortless as holding down the PTT switch of a microphone.

Back to the rainy day. I was on a street about half a mile from a highway entrance ramp when I caught the fragment of a QSO: "JOE QTH CHIBA." The QTH sounded exotic and the signal had a watery, over-the-pole flutter DX quality to it. It was JA1LZR in QSO with a W1. When Joe finished his QSO I quickly reached down and sent AA2UI/M twice. A roar of W1 and W4 calls greeted me as soon as I stopped transmitting. I was not the only one calling him. Much to my surprise, I broke through the pileup. It must be the 5 dB/M advantage. I was merging with the traffic on the highway as Joe came back to me. I needed to shift from fourth to the fifth gear before I got back to Joe or I would not be able to hear him amid the engine scream. Fortunately, the pileup wasn't impatient and no one took advantage of the slight delay. I merged into the center lane and started my QSO. Joe's signal was quite strong and so I assumed that I would be getting in quite well into Chiba, which is on Tokyo Bay, just east of Tokyo. Joe came back

with a strong signal that provided clean copy despite the QRM. He was putting 400 watts into an inverted vee and it was enough to communicate despite my compromise mobile antenna made of spirals of wire wound on a fiberglass rod and a steel whip. Joe's signal began to fade as I went down the exit ramp and was almost lost as I turned on to the surface street. I thanked Joe for the QSO and signed. Little did Joe know that I was thanking him not just for the QSO, but also for starting my day off with a bang—a DX QSO. It sure beat listening to traffic complaints on the local 2m machine! Reprinted from the *North Shore Radio Club Transmitter*.

French Fry Fox Hunting?

I've been goofy about fox hunting, whether hunter or huntee, since before they invented sunspots. I was once in a club that ran a fox hunt every Sunday, rain or shine, on 10 meters. They started with transmitters hidden in bushes, but soon progressed to the ridiculous. Like "mag mounting" a transmitter to the side of a bus. The guy who did that was forbidden from ever again hiding the transmitter. Another member got his muscle-bound, six-foot two, brother to park in a car with the transmitter and snarl at anyone who approached.

One incident sticks in my mind as sneaky even by that club's standards. A technically adept brother built a transmitter only an inch or two on a side—the first transistorized transmitter I'd seen that would fit inside a bag of french fries. He concealed the antenna by threading it through a long fry that stuck out of the package. He selected me to talk into the transmitter, so I enlisted an actor friend to provide me with a disguise. After an hour of preparation, I took a seat in a local fast-food emporium.

Soon the hunters appeared outside. They circled the restaurant for some time, aiming their directional loops this way and that. Finally one of them got up the nerve to bring his equipment inside. Instantly, the manager rushed out and asked if they were a bomb squad. After convincing him they were only deranged hams, they searched the dining area. They were on their way back outside when they passed near me—just as little girl at the next table shouted, "Daddy, why is that man talking to his french fries?"

TNX to Jim Reed KD3S via *Maryland Radio Center*, *Indiana County ARA's The Sine of the Times*, and the *ARNS Bulletin*.

Astronomer Joins Alien Search

The director of the Ohio State University Radio Observatory has been appointed a technical advisor to The SETI League, Inc., in the Search for Extra-Terrestrial Intelligence. Ohio State professor Dr. Robert S. Dixon's considerable expertise will help the organization to privatize research once conducted by NASA.

The Ohio State radiotelescope, affectionately

known as Big Ear, was home to a mysterious microwave signal detected on August 15, 1977. Known thereafter as the "Wow!" signal (after a single word scribbled in the margin of the computer printout by researcher Jerry Ehman), it exhibited all of the expected characteristics of a coherent signal of intelligent extraterrestrial origin. Scientists consider the "Wow!" signal to be the best evidence to date of the existence of other technologically advanced civilizations in the cosmos. Although it has stood up to eighteen years of scrutiny, it has never reappeared. Dixon and his SETI League colleagues hope to detect additional "Wow!"-type signals.

SETI seeks to determine through scientific measurements whether humankind is alone in the universe. Congress terminated all of NASA's SETI funding in late 1993. Experimenters interested in participating in a privatized search, or citizens wishing to help support it, should contact The SETI League, Inc., membership hotline at 1(800) TAU-SETI. The SETI League, Inc., is a membership-supported, non-profit educational and scientific corporation dedicated to the electromagnetic Search for Extra-Terrestrial Intelligence.

ARRL President Resigns

George Wilson W4OYI, 63, who was incapacitated by a stroke last February and is still in the hospital recuperating, resigned in July as the ARRL president. Filling his place until the end of his term in January is Rodney Stafford KB6ZV of San Jose. Rod is now a Santa Clara County municipal judge, after lawyering for 18 years.



The Certificate of Proclamation by the mayor of Englewood, NJ.

Englewood Proclamation

The mayor of Englewood, New Jersey, has issued an Englewood Amateur Radio Association Week proclamation for the 34th consecutive year to celebrate the club's outstanding Field Day activity, where they've won first place in their transmitter category for 30 of the last 32 years.

DIAMOND'S STATE OF THE ART VHF / UHF MOBILE ANTENNAS—MAXIMUM PERFORMANCE WITHOUT COMPROMISE !!

DIAMOND
ANTENNA

SG
series

CR
series

NR
series

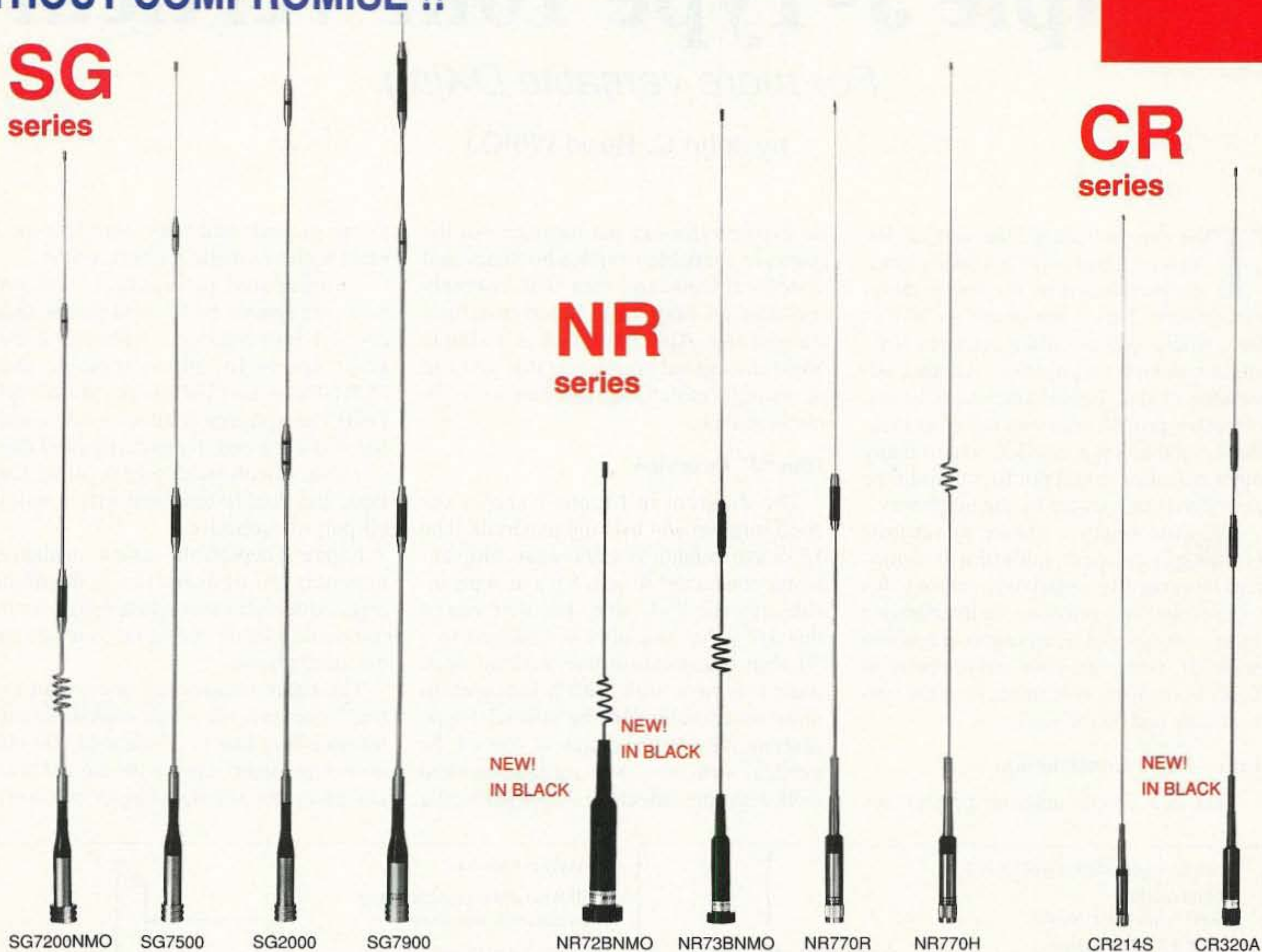

SG7200NMO

SG7500

SG2000

SG7900

NR72BNMO

NR73BNMO

NR770R

NR770H

CR214S

CR320A

NEW!
IN BLACK

NEW!
IN BLACK

NEW!
IN BLACK

MODEL	BAND	GAIN(dBd)	POWER (w)	MOUNT	HT (IN)	ELEMENT PHASING
R-72BNMO	2m/70cm	2.15	100	NMO	13.8	1/4 λ, 1/2 λ
R-73BNMO	2m/70cm	2.15/5.3	100	NMO	33.5	1/2 λ, 2-5/8 λ
R-770SA	2m/70cm	2.15/2.15	100	UHF	16.9	1/4 λ, 1/2 λ
R-770HA	2m/70cm	3.0/5.5	200	UHF	40.2	1/2 λ, 2-5/8 λ
R-770HNMO	2m/70cm	3.0/5.5	200	NMO	38.2	1/2 λ, 2-5/8 λ
R-770RA	2m/70cm	3.0/5.5	200	UHF	38.6	1/2 λ, 2-5/8 λ
R-790A	2m/70cm	4.5/7.2	120	UHF	57.5	6/8 λ, 3-5/8 λ
G-7000	2m/70cm	2.15/3.8	100	UHF	18.5	1/4 λ, 6/8 λ
G-7200NMO	2m/70cm	3.2/5.7	150	NMO	36.6	1/2 λ, 2-5/8 λ
G-7500A	2m/70cm	3.5/6.0	150	UHF	40.6	1/2 λ, 2-5/8 λ

MODEL	BAND	GAIN(dBd)	POWER (w)	MOUNT	HT (IN)	ELEMENT PHASING
SG-7900	2m/70cm	5.0/7.6	150	UHF	62.2	7/8 λ, 3-5/8 λ
SG-2000	2m	5.2	150	UHF	62.6	7/8 λ
NR-140A	1-1/4m	3.8	100	UHF	36.2	5/8 λ
NR-124	23cm	8.4	100	N	25	4-5/8 λ
CR-214S	2m/1-1/4m	2.15/3.4	120	UHF	37	1/2 λ, 5/8 λ
CR-224A	2m/1-1/4m	5.0/6.0	150	UHF	68.5	7/8 λ, 2-5/8 λ
CR-320A	2m/1-1/4m/70cm	2.15/3.8/5.5	200/200/100	UHF	37.4	1/4 λ, 1/2 λ, 2-5/8 λ
NR-2000NA	2m/70cm/23cm	3.15/6.3/9.7	100	N	39	1/2 λ, 2-5/8 λ, 5-5/8 λ

SPECIAL FEATURES

Factory pre-tuned /no adjustment
 Highest Performance antennas
 SG&NR series do not need grounding
 NMO and UHF (PO) base styles
 New black color models available
 Fold-over feature on most models



FOLD-OVER

PATENTED ONE-TOUCH FOLD-OVER FEATURE



RF PARTS

SAN MARCOS, CALIF.
 (619) 744-0900

Simple J-Type 10m Vertical

For more versatile DXing.

by John C. Reed W6IOJ

The main advantage the vertical HF antenna has over its horizontal counterparts is its low-angle radiation pattern. This is important on 10 meters, where success often requires low-angle radiation propagation. Another advantage of the vertical antenna is its unobtrusive profile. You can use it in locations, such as on a city lot, where many other antennas would not fit, or would be considered an eyesore by the neighbors.

The main negative feature of verticals is that ground path radiation is dominantly vertically polarized, making this type of antenna sensitive to interference from such sources as automotive ignition noise. If, however, your environment is fairly noise-free, as is mine, then the vertical may just be for you!

Entry-Level Construction

This is a simple antenna project any

do-it-yourselfer can put together. All the parts are available from Radio Shack and your local hardware store. The assembly includes an easy-build balun-matching transformer. Also described is a simple SWR directional coupler so that you can accurately match the antenna to a 50-ohm feedline.

10m "J" Overview

The diagram in Figure 1 shows the configuration and lists the materials. The 1/2-wave radiator is a 1/4-wave whip antenna connected to a 1/4-wave wire inside a plastic PVC pipe. The wire end of this 1/2-wave assembly is matched to a 50-ohm transmission line with an open wire 1/4-wave stub with a balanced to unbalanced balun. In the normal J-type antenna the 1/4-wave stub is part of the vertical structure. My antenna worked well with the stub close to perpendicular

to the ground; you may want to experiment with this angle for best results.

As indicated in Figure 1, the stub wires are spaced 1 1/2" with plastic spacers at 1-foot intervals. Although I used glass epoxy for the spacers (etched PCB), Plexiglas (TM) works just as well. Drill the spacers with wire clearance holes at each end, temporarily hold them in position with small pieces of masking tape, and then fasten them with a spot of all-purpose adhesive.

Figure 2 depicts the simple method of mounting the whip antenna in the plastic pipe. Although I used glass epoxy for the indicated plastic washers, you can use any hard plastic.

The balun transformer detailed in Figure 3 converts the single-ended, 50-ohm transmission line to a balanced 200-ohm output for interfacing with the 1/4-wave antenna stub. The transformer consists of

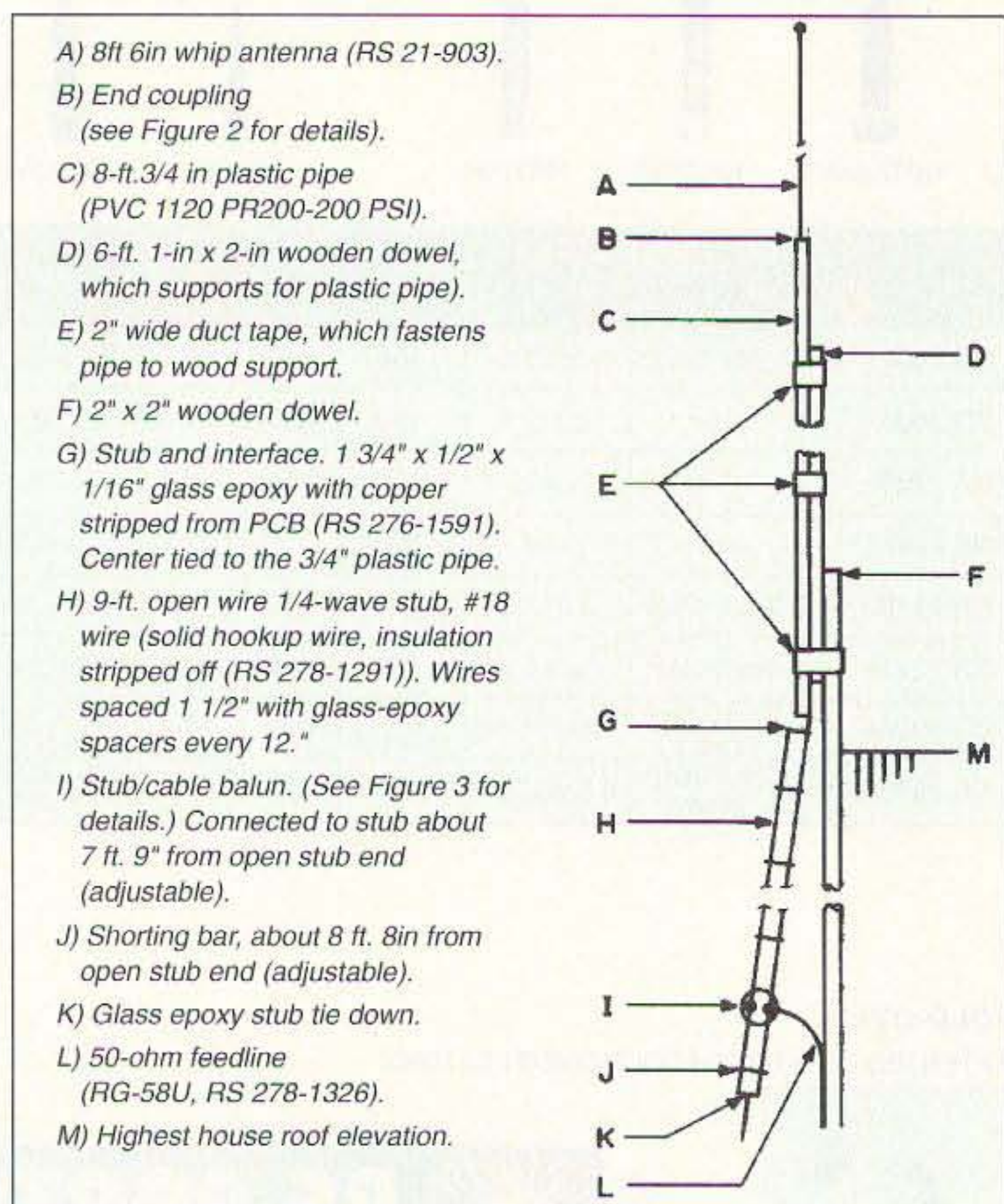

Figure 1. Antenna Schematic.

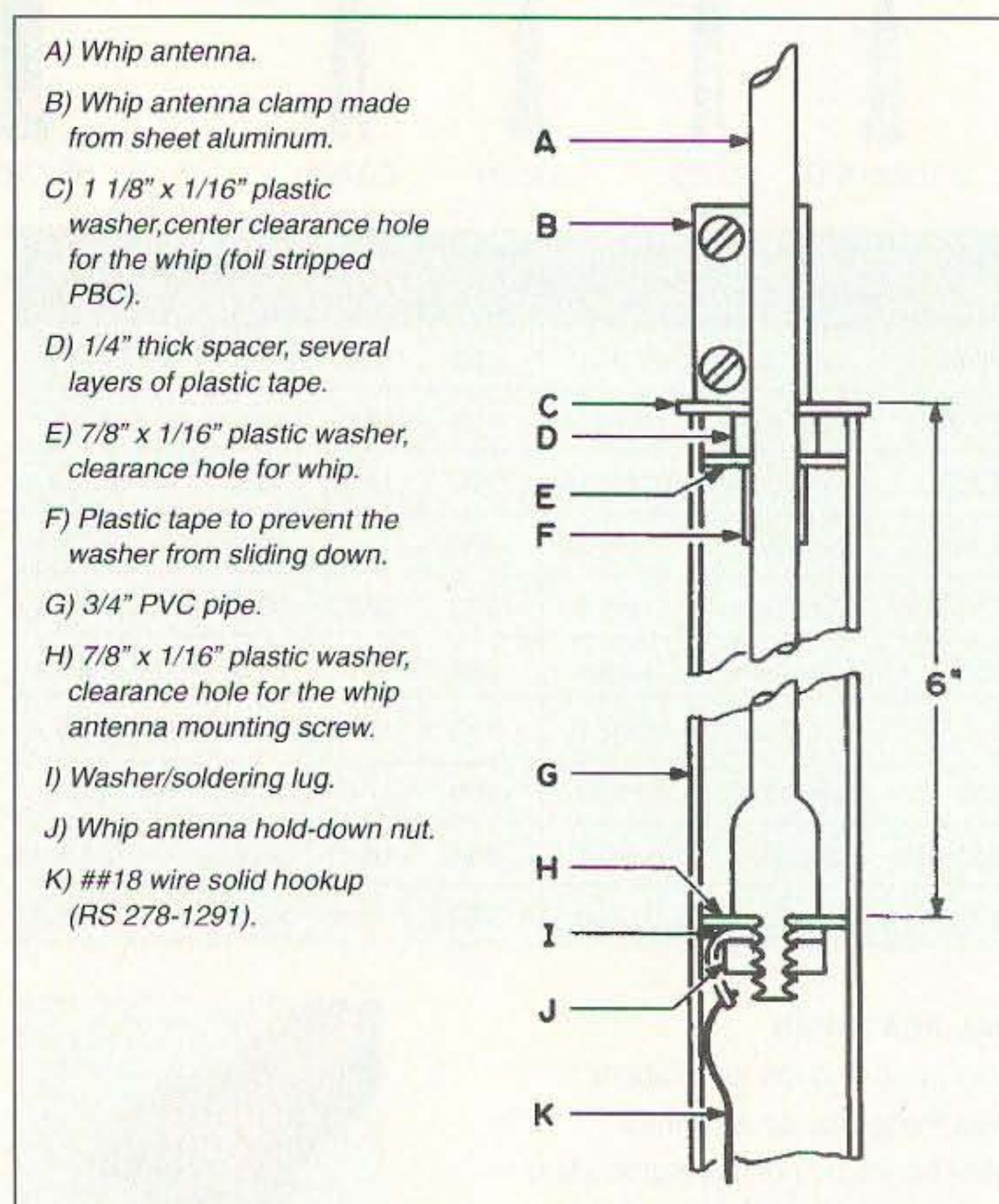

Figure 2. Whip antenna-PVC pipe interface detail.

MFJ HF/VHF SWR Analyzer™

... Read your antenna SWR from 1.8 to 170 MHz... built-in 10 digit LCD frequency counter... RF Resistance Meter™... smooth vernier tuning...

MFJ-259 handheld **Universal SWR Analyzer™** lets you read your antenna SWR from 1.8 to 170 MHz quickly and easily without any other equipment!

MFJ's exclusive **RF Resistance Meter™** lets you measure RF resistance up to 500 ohms at minimum SWR. Has built-in 10 digit LCD frequency

counter and smooth vernier tuning. You get **four** instruments in one... 10-digit frequency counter... RF signal generator... **SWR Analyzer™**... **RF Resistance Meter™**

Measure antenna resonant frequencies and 2:1 SWR bandwidths. Adjust mobile antennas, antenna tuners and matching networks in seconds.

Measure RF resistance, inductance, capacitance, resonant frequency of tuned circuits, transmission line velocity factor /impedance/ loss. Test RF chokes, baluns.

MFJ-209, \$109.95, same as MFJ-259 less frequency counter and **RF Resistance Meter™**

See free MFJ catalog for complete line of MFJ SWR Analyzers™.



MFJ-949E 300 W Tuner



World's most popular antenna tuner covers 1.8-30 MHz, has lighted *peak* average Cross-Needle SWR/wattmeter, 4:1 balun for balanced lines and *full size* 300 watt dummy load.

Versatile 8 position antenna switch lets you *pre-tune* MFJ-949E into dummy load to minimize QRM.

Custom inductor switch was carefully engineered to withstand extreme voltages and currents.

Cabinet is chemically etched to MFJ's bond tough *baked-on* paint.

VHF/HF Packet TNCs

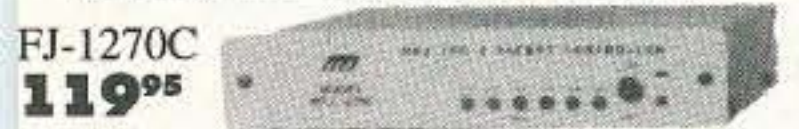

MFJ-1270C super TAPR TNC alone has a world wide reputation as the most reliable packet TNC in the world -- many work 24 hours a day for years without a single failure!

Fully TAPR TNC-2 compatible, VHF and HF operation, *free* AC power supply, new *enchanced* mailbox expandable to 512K with auto/reverse mail forwarding, WeFAX mode lets you print weather maps, optional plug-in 2400/9600 baud modems, TSS interface, *now* GPS compatible.

MFJ TNC/Mic Switch



Switch between your TNC or microphone by pushing a button!

Just plug pre-wired cables into our rig's mic connector and TNC.

Plug-in jumpers let you use nearly any rig with 8 pin mic connector. **MFJ-1272B/MFJ/TAPR TNC2** clones; **MFJ-1272BX/PK-232**; **MFJ-1272BYV/KAM VHF/KPC3**; **MFJ-1272BYH/KAM HF Port**; **MFJ-1272BZ/PK-88**, \$39.95 each. *or 8 pin RJ45 modular phone jack replace B with M in model number above.*

Regenerative RCVR Kit



Build this regenerative shortwave receiver kit and listen to shortwave signals from all over the world with just a 10 foot wire antenna.

Has RF stage, vernier reduction drive, smooth regeneration, five bands.

MFJ-1278B Multi-Mode Data Controller

Use this **MFJ-1278B**, your transceiver and computer to transmit and receive digital communications! You'll discover a whole new world of ham radio and communicate in ways you never knew existed on our ham bands.

The *world class* MFJ-1278B Multi-Mode and MultiCom™ software is packed with features *no other* multi-mode gives you.

You get *10 digital modes*... Packet, AMTOR, PACTOR (at no extra cost), RTTY, ASCII, Navtex, Color SSTV, 16 Gray Level FAX, CW and Memory Keyer plus an *enchanced* 32K Mailbox.

You'll have fun joining worldwide *packet* networks and exchanging *color SSTV* pictures with your buddies around the world. You'll marvel at *full color FAX* news photos as they come to life on your screen. You'll see weather changes on highly detailed *weather maps* in all 16 gray levels. You'll eavesdrop on late breaking news as it happens on RTTY. You'll enjoy error free HF QSOs on PACTOR and AMTOR and receiving packet mail in an *enchanced* 32K mailbox. Want to copy some CW? Just watch your screen.

MFJ-1289, \$59.95, MultiCom™ software and cables.



MFJ halfwave vertical Antenna

6 bands: 40, 20, 15, 10, 6, 2 Meters... No radials or ground needed!

Operate 6 bands -- 40, 20, 15, 10, 6 and 2 Meters --with this MFJ-1796 ground independent halfwave vertical antenna! No radials or ground ever needed!

It's only 12 feet high and has a *tiny* 24 inch footprint! You can mount it anywhere from ground level to the top of a tower -- on apartments, condos, small lots, even on motorhomes. Perfect for vacations, field day, DX-pedition, camping.

Frequency selection is fully automatic -- all you do is transmit. Its *low angle of radiation* really reaches out and brings in DX. Omni-directional. 1500 watts PEP.

Efficient *end loading*, no lossy traps. *Entire length* is always radiating. *Full size* halfwave on 2 and 6 Meters. High power *air-wound* choke balun eliminates feedline radiation. Adjusting one band has minimum effect on other bands. Add \$20 s/h.

Easy to assemble -- you'll have it on the air in an afternoon.

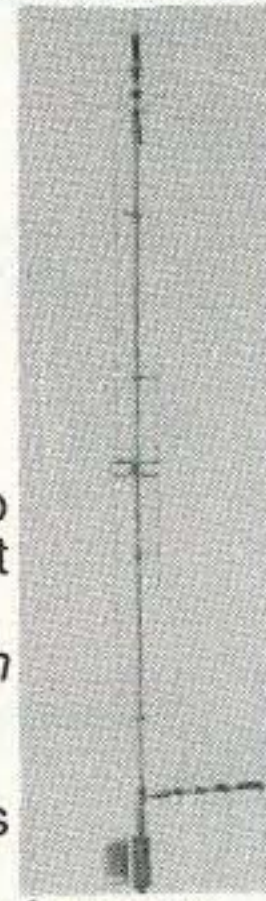

MFJ's world famous 3 KW Versa Tuner V

Here's why the MFJ-989C is the finest 3 KW antenna tuner money can buy...

Two massive 250 pf transmitting variable capacitors can handle *amps* of RF current and 6000 RF volts. Logging scales.

Precision ball bearing roller inductor, three digit turns counter and spinner knob give you exact inductance control for minimum SWR.

Lighted *peak/average* Cross-Needle SWR/Wattmeter has 200/2000 watt ranges. Super heavy duty *current* balun has two giant 2 1/2 inch powder iron toroid cores wound with *Teflon®* wire.

Six position *ceramic* antenna switch has extra large contacts. Flip stand, dummy load, one year *unconditional* guarantee, aluminum cabinet, tough *baked-on* paint, locking compound on nuts/bolts, handles 3 KW PEP, 10 1/8x4 1/2x15 in. Meter lamp needs 12 volts. Add \$13 s/h.



MFJ No Matter What™ Guarantee

MFJ's famous one year *No Matter What™* unconditional guarantee means we will repair or replace (at our option) your MFJ product sold in this ad *no matter what* for a full year.

Super Hi-Q Loop Antenna

MFJ-1786 \$299.95

Tiny 36 inch diameter high efficiency loop antenna covers 10-30 MHz *continuously* with low SWR. Handles 150 watts.

Ideal for home installations where space is limited-- apartments, condos, small lots. Take on trips.

All welded construction.

Remote control has *Automatic Band Selection™*, Cross-Needle SWR/Wattmeter. No control cable needed. Use batteries or 110 VAC. Add \$20 s/h.

No ground or tuner needed.

MFJ-1782, \$269.95, like MFJ-1786 but remote control has only slow/fast tune buttons.



Dual Band Mobile Ant.

Mobile Antenna for 144/440 MHz

MFJ dual band magnet mount mobile antenna for 144/440 MHz

has 19 inch stainless steel radiator, low SWR. For mobile rigs with SO-239 UHF connector *and* handie-talkies with *included* BNC adapter.

5/8 Wave Mobile Ant.

Maximum Gain™ 5/8 Wave 2 Meter magnet mount mobile antenna

has stainless steel radiator, 12 ft coax, low SWR. For mobile rigs with SO-239 UHF connector *and* handie-talkies with *included* BNC adapter.

5/8 Wave Ground Plane

\$19.95 gets you a 2 Meter 5/8 wave ground plane *home station* antenna!

You get the highest gain of any single element antenna, shunt fed matching, ceramic insulators.

MFJ-1752, \$19.95, for 220 MHz.

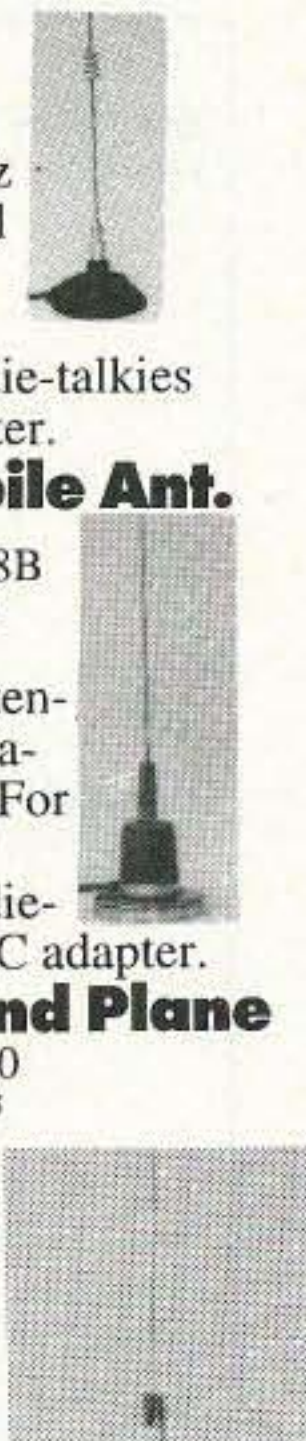

Free MFJ Catalog

Write or call... 800-647-1800

Nearest Dealer/Orders: 800-647-1800 Technical Help: 800-647-TECH (8324)

• 1 year unconditional guarantee • 30 day money back guarantee (less s/h) on orders from MFJ • Free catalog

MFJ MFJ ENTERPRISES, INC. Box 494, Miss. State, MS 39762 (601) 323-5869; 8-4:30 CST, Mon-Fri. FAX: (601)323-6551; Add \$6 s/h

MFJ... making quality affordable

Prices and Specifications subject to change © 1995 MFJ Enterprises, Inc.

a bi-filar six-turn coil wound on a 1-1/16" diameter form (3/4" PVC). The wire used is #18 solid hook-up wire (RS 278-1291).

The J Measures Up

Line type performance results from the distributed capacitance between the two wires, making a relatively wide bandpass transformer. Performance was measured using a 50-ohm source together with a 200-ohm resistive load. Although the results indicated the response is less than -0.5 dB at 14 MHz, it falls off much faster at the high frequencies. At 146 MHz, it's about -20 dB (an advantage when working RS-11).

To measure insertion loss, I connected two transformers in series (50-200-200-50-ohm), and measured the response with and without the transformers. The difference was about 0.1 dB. This is trivial when considering radiation loss, but there is still significant thermal (heating) losses while running high power. In the final antenna configuration, with 100 watts into the antenna, element heating is just barely apparent to the touch.

You can double the wattage capability by simply paralleling two transformers.

Correction Factors for Selected Diodes

Vp In	Vp Out	Factor
5.0	4.88	1.02
4.0	3.90	1.03
3.0	2.87	1.04
2.0	1.89	1.06
1.0	0.92	1.09
0.8	0.72	1.11
0.6	0.52	1.15
0.5	0.43	1.16
0.4	0.33	1.21
0.3	0.24	1.25
0.2	0.15	1.33
0.1	0.06	1.67
0.05	0.02	2.5

My tests of this configuration show near identical results at 28 MHz, but the frequency response becomes sharper—about -1 dB—at 14 MHz. When fabricating the transformer, you must hold the wires close together to achieve the desired distributed capacitance between wires. Do this by making the form length the same as the bi-filar coil width, and strapping the two together.

For the strapping I used two pieces of masking tape about 1/4" wide. I wrapped them through the form

center and around the wire, then coated the masking tape with an all-purpose adhesive (RS 642307). In forming the coil, first wind the wire on a mandrel smaller than the actual form to make certain the wire has a snug fit when placed on the final form.

Directional Coupler

This antenna, which is essentially an end-fed wire dipole, has a significant Q (about 13). Since the 10m band is so wide (28–29.7 MHz), a high-Q antenna there will give high SWR values at the band edges, so it's important to accurately trim the 1/4-wave stub length (shorting bar position), and adjust the balun connecting position for minimum SWR. You can do this easily by using a simple home-made directional coupler.

The directional coupler detailed in Figure 4 uses glue-down 1/8" wide PCB

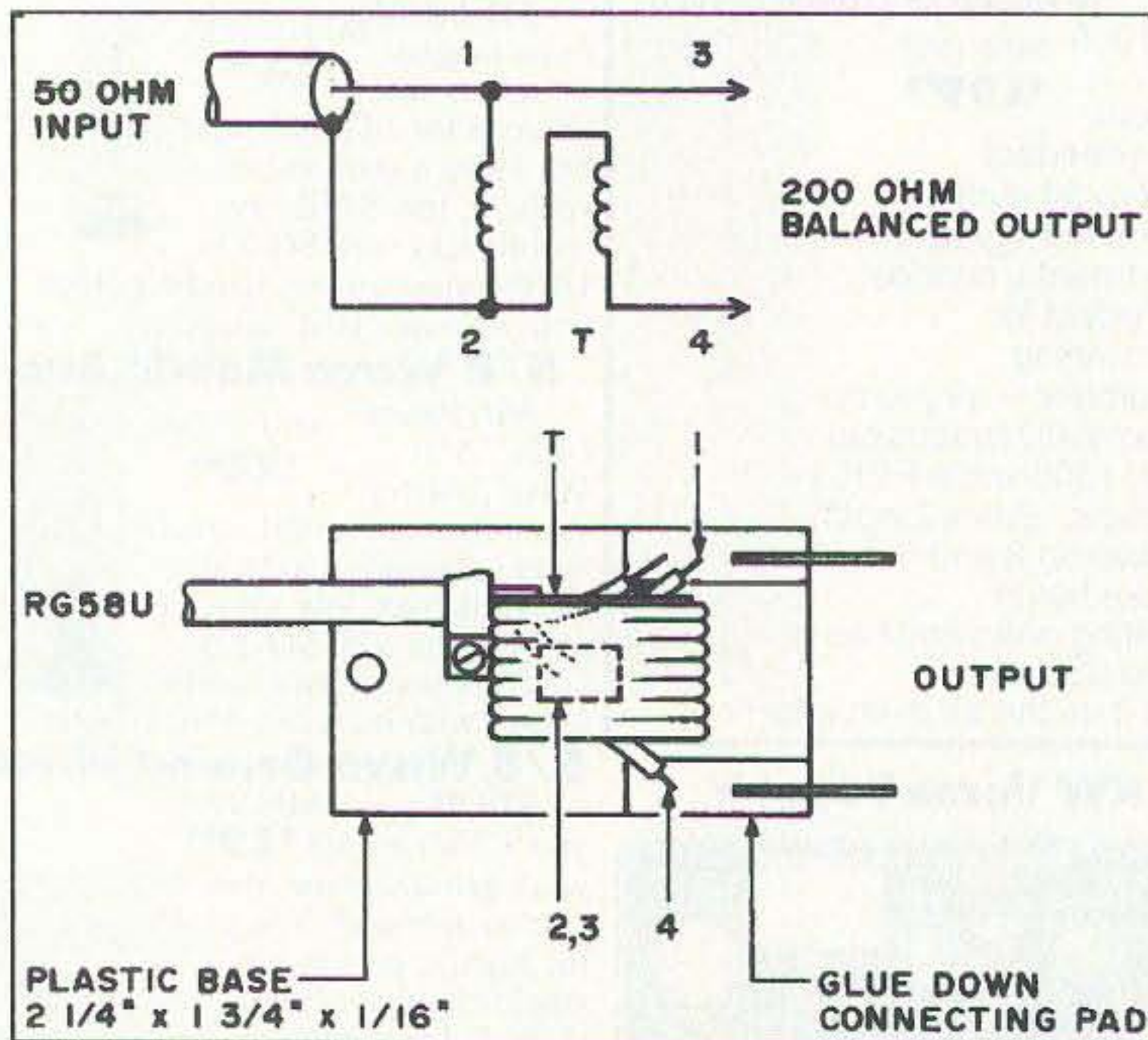

Figure 3. Balun construction details. (The numbers 1–4 and T in the schematic correspond to those in the lower diagram, which shows the balun's physical layout.)

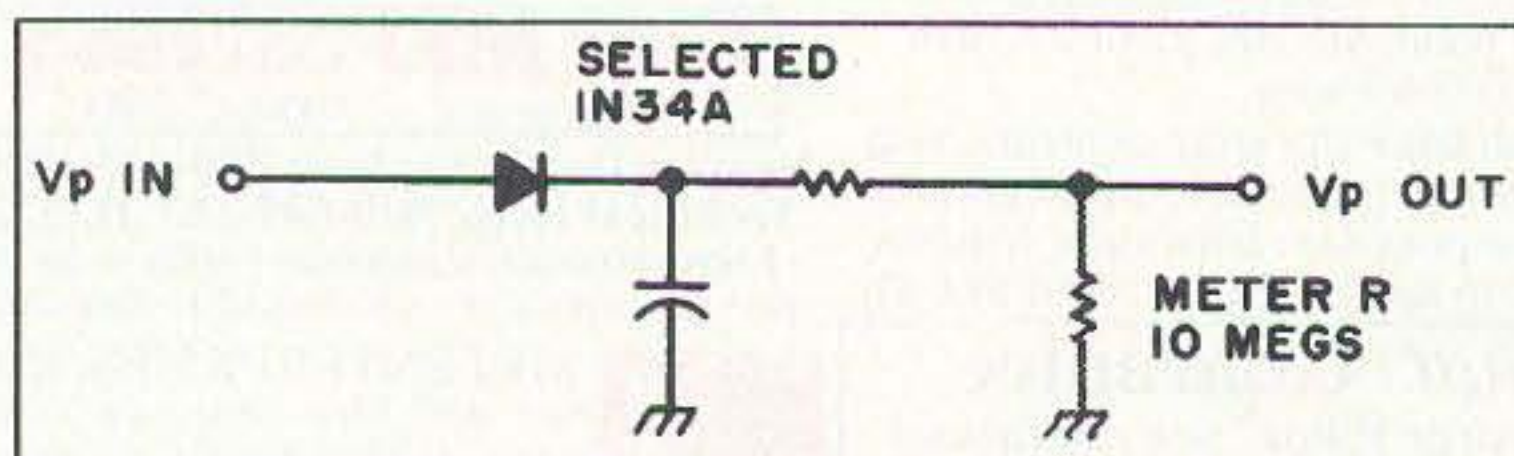
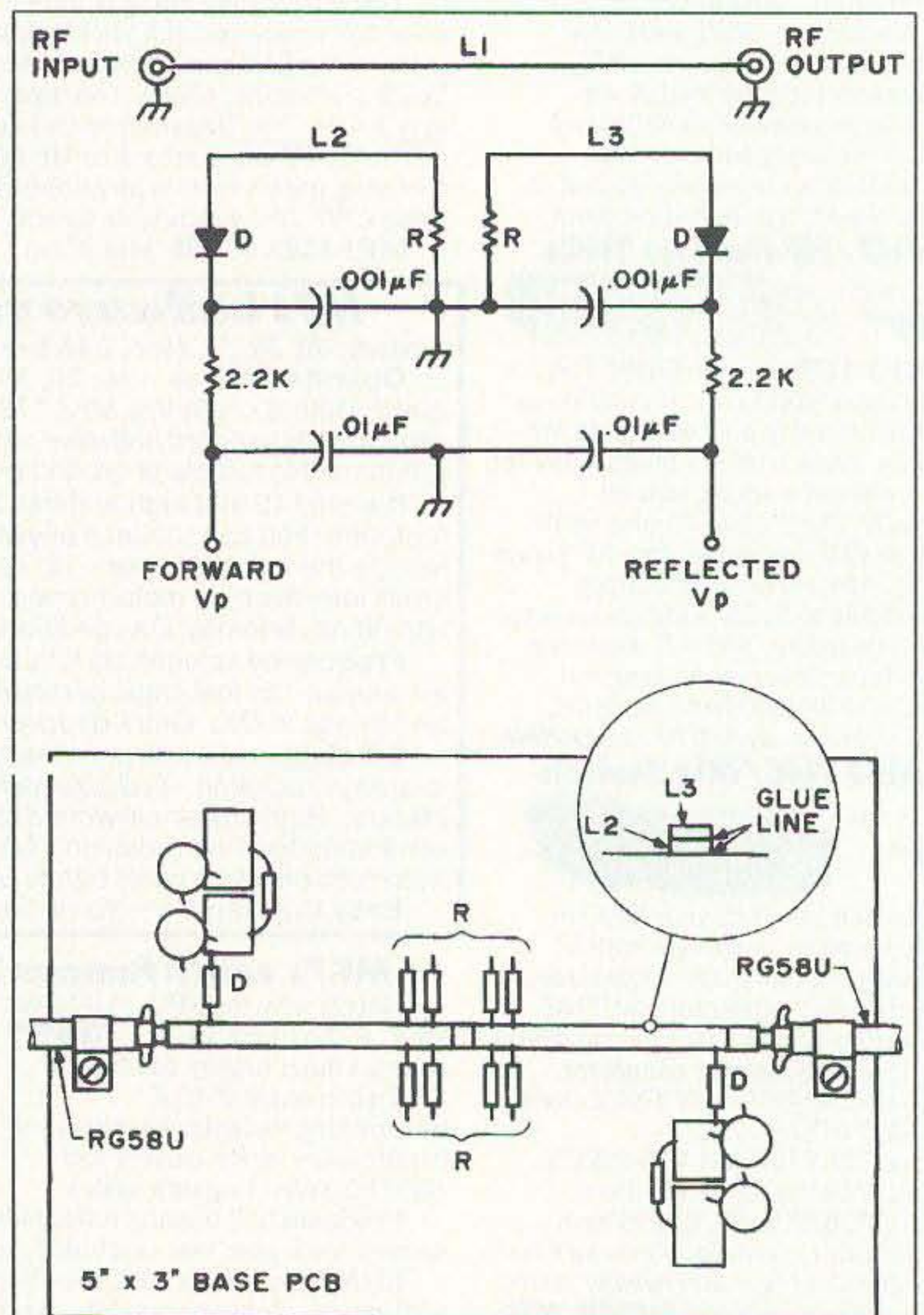

Figure 5. Correction factors for selected diodes, which are those having a reverse resistance of greater than 5 megohms.



D) 1N34A, selected for greater than 5-megohm reverse resistance (RS 276-1123).
 L1) 3 1/2" x 1/8" x 1/16" glass epoxy PCB, either single- or double-sided copper (RS 276-1591). Glue to base PCB with adhesive (RS 64-2307).
 L2) 1-1/4" x 1/8" x 1/16" glass epoxy PCB, either single- or double-sided copper. Glue to top of L1.
 L3) Same as L2; leave about 1/32" spacing between ends of L2 and L3.
 R) Select for minimum reflected power. About 36 ohms (100-100-150-1k in parallel).

Figure 4. Directional coupler.

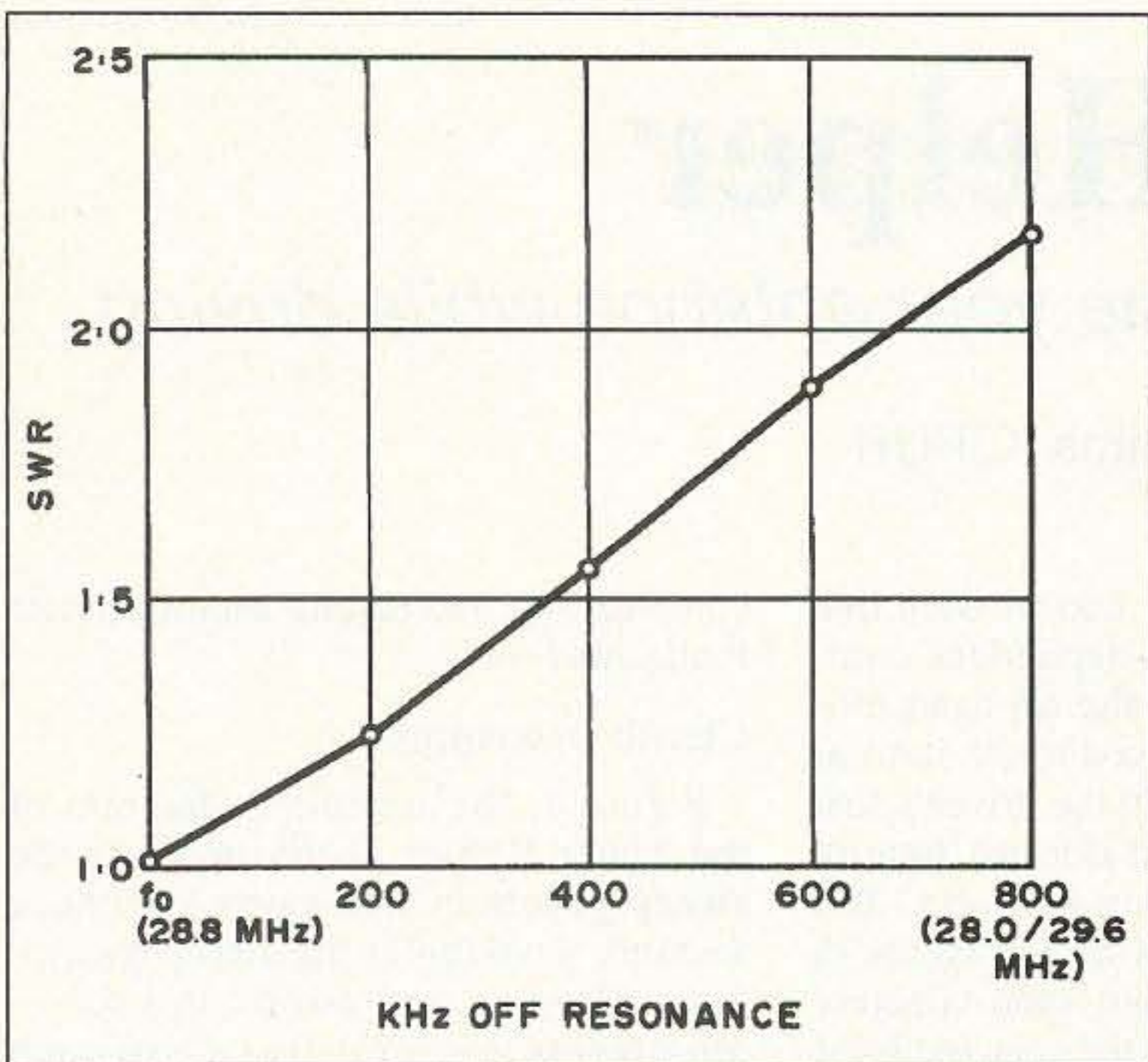

Figure 6. Measured standing wave ratio.

strips. Directional current is detected with short strips glued to the top of a transmission stripline. Resistor terminations on these coupled strips cancel the effective coupled output in one direction. These terminations are trimmed for minimum SWR indication with 20-watt or more input into the directional coupler and loaded with a 50-ohm dummy load. My dummy is 20 1k 1/2-watt resistors in parallel, immersed in a pint of cooking oil.

The termination resistor is actually four 1/4-watt resistors in parallel, which lets you select various resistor values to establish minimum reflection indication. My assembly uses 100-100-150-1k-ohm resistors. This value will be different for different assemblies, depending upon the PC thickness and dielectric constant. When aligned, and with 20-watt input, the coupler output should read about 2 Vp in the forward direction and less than 0.1 Vp in the reflected direction ($SWR = \frac{V(fwd) + V(ref)}{V(fwd) - V(ref)}$). 1N34A diodes with a reverse resistance of 5 megohm or greater give reliable Vp readings up to less than 0.1. Correction factors for the low voltage readings are indicated in Figure 5. (Since sensitivity is directly

proportional to frequency, this directional coupler works well in the VHF/UHF frequency range.)

Alignment is simple when using the directional coupler. Simply slide the shorting bar and the balun connecting position for minimum reflected Vp. The adjustments are rather critical, but it is not too hard to obtain an SWR of less than 1:1. The final measurement results are shown in Figure 6.

Cover More Angles

I compared the vertical antenna performance with that of my horizontal antenna using a coax relay to switch quickly between the two. My horizontal antenna is a center-fed long wire with dominant nodes in specific directions (66 feet long).

The antennas complemented each other very well. As mentioned above, the vertical tended to perform better on low-angle skip; the horizontal on high-angle skip. It was also handy to be able to switch between the two to find a better S/N ratio, depending on whether vertically or horizontally polarized ambient noise dominated.

For little money and a few hours of home-brewing, I improved my DXing considerably!



OWN THE WORLD'S BEST FOUR-WHEEL-DRIVE BASE STATION

Add a QMS Antenna Tuner System to your SSB.

\$895.00

The QMS is an SGC Smartuner[®] automatic antenna coupler, an SG-303 extended full-range antenna, and the special exterior—waterproof—mounting package, all in one.

The QMS is that large box strapped to the side. We admit, at first glance it looks a little unusual.

But once you use it, you'll find an almost unbelievable jump in reception and transmitting range (3-20 db). The QMS makes a typical HF-SSB perform like it's never performed before. Match it with a cutting edge SGC HF-SSB and it will blast holes through major mountain ranges and probably some laws of physics. Power and focus are everything in HF-SSB ham rigs. Buy this and own the best base station on—or off—the road.



Mounting the tuner and antenna on the outside reduces engine noise and eliminates power-draining antenna wire runs between the antenna and tuner.

QMS. It's the look of focused power.

LEARN TO LOVE THE LOOK

SMARTUNER[®]
INSIDE

SGC

NO COMPROMISE
COMMUNICATIONS



1-800-259-7331

The SGC Building P.O. Box 3526 Bellevue, WA 98009 USA (206) 746-6310 Fax: (206) 746-6384

J-Pole in your Pocket?

Tough dual-band antenna for the travelin' man or the condo dweller. Hang-anywhere style and extra range can save life in an emergency.

James H. Gray W1XU

During my years of traveling around the eastern United States on business or vacation, I often wished I had a small, inexpensive and easy-to-use antenna to match my little handheld 2 meter radio. Occasionally I had an HF rig in the car, but more often it was the little 2 meter radio which was useful and fun. On long road trips it alleviated boredom, kept me awake and almost always assisted me to find a motel, restaurant, or other ham's QTH. On such trips the mobile antenna was fine until I needed more range from the motel.

When I traveled by plane, the rig was the handheld with no amplifier. It had only a small telescoping whip that I could extend to about 19 inches. If I happened to be close enough to a repeater in a large city, that was fine and I managed to "work" the locals in spite of low power and a minimal antenna.

But there were occasions when there was no local repeater, or when I was inside a steel-and-concrete building. At such times I wasn't able to make any contacts at all and had to resort to dull tedious television programs before going to bed.

If you face similar problems when traveling light and by air, you know how it feels to be alone among the many.

The Pico Solution

Today, the travelin' man has a ready solution to the problem: a neat antenna produced by

Antennas West and called the "Pico-J." It meets all the requirements set forth in the first sentence. Pico means "small," as in "picofarad," and "J" stands for "J-pole," the well-known low-angle, omnidirectional vertically polarized antenna—just what's needed for 2 meters.

Antennas West's Pico-J offers some features not found in the usual J-pole. For example, the feedpoint is already found and matched for you, and the antenna is small and light—so much so that it can be rolled up and slipped into a small eye-glasses case. It looks like a sleek black ribbon 55 inches long. A six-foot small-diameter coax feedline comes off the bottom. Its gold-pin BNC attaches directly to your radio.

A small loop at the top may be slipped over a curtain rod or a nail or

any other suitable projection. But, if by chance you don't happen to find a suitable support, Antennas West thoughtfully provides a small suction cup with an embedded hook that can be slapped up on a window or any smooth surface, and presto!—you're on the air!

Pico-J is completely weather-sealed and could be hung outdoors if you wish. Otherwise, you can hang it in a closet or a doorway; in fact, anywhere that is convenient and where your signal won't be blocked. The extra reach provided by this beauty could save life in an emergency, and is always useful when just plain chatting with the locals.

Your Pico-J stretches range, improves reception, reaches far-away repeaters, and saves your battery pack.

The measured VSWR is less than 2:1 between 142 and 150 MHz—ideal for CAP, MARS, and other services near the 2 meter band—and is a very beautiful 1:1 at 146 MHz. Not bad, eh?

Best of all, considering the benefits, is the price: \$19.95 for the 2 meter model, \$26 for the 2m/70cm dual bander, both complete with the soft vinyl case to store your Pico-J when it's not in use.

On a recent trip I tucked Pico-J into my briefcase, right next to the handheld. No, I didn't even use the "duckie" or the telescoping whip because I had all I needed in this one neat antenna. Maybe you'll find the same.

—condensed from *RadioFun*



**PASS THIS TEST!
WIN \$5**

Clip this ad and circle the TigerTail™. Send it with your order to get \$5 off any purchase.

Can You Find the Tiger's Tail?



If your eyes are sharp you can spot the **TigerTail™** in the photo above. It's not attached to something that bites; instead it puts extra growl into the signal from the HT it's attached to.

TigerTail™ improves SWR, lowers radiation angle, and extends range.

You can use low power and save your battery pack, but still have a big signal.

Better than an amplifier, it improves reception too. **TigerTail™** does all this by simply slipping under your flex antenna and just hanging down—without sticking up or out or getting in the way.

No Antennas Allowed?

Who will see Pico-J hanging in your closet or on the balcony? But your signal will be heard. Pico-J's half wave radiator is sleek and unobtrusive. His thin flexible feedline is barely noticeable. When his work is done Pico-J rolls up and slides into his pouch like the Genie slipping back into the bottle.

Carry Pico-J on hikes or trips as you would carry a pair of glasses. Keep him in your emergency jumpkit. When you need gain and low angle omnidirectional coverage pull out Pico-J and be full quieting when it counts.

New Pico-J's for 1995

PJ Packet \$22—Maximum efficiency on 2m packet frequencies.
PJ 220 \$19.95—Go everywhere gain for the "private" band.
Pilot's Pico-J \$39—Aviation band range booster for pilots on the go.

Yes, I want to increase range and save my batteries!

Send my Pico-J. 2m or 220=\$19.95, Packet=\$22, Dual=\$26, Pilot=\$39.

Send my TigerTail. (1 for \$7.95, 2 for \$15, 3 for \$21. Specify band)

Send a combo (PJ + TT). (Just add \$5 to your Pico-J order) All prices ppd.

Yes, I circled the TigerTail! Knock \$5 off my order.

Name _____

Call _____

Phone _____

Street _____

Unit _____

City _____

State _____

Zip _____

Antennas West
Box 50062-S Provo UT 84605

InfoPak \$1

Order Hotline

800 926 7373

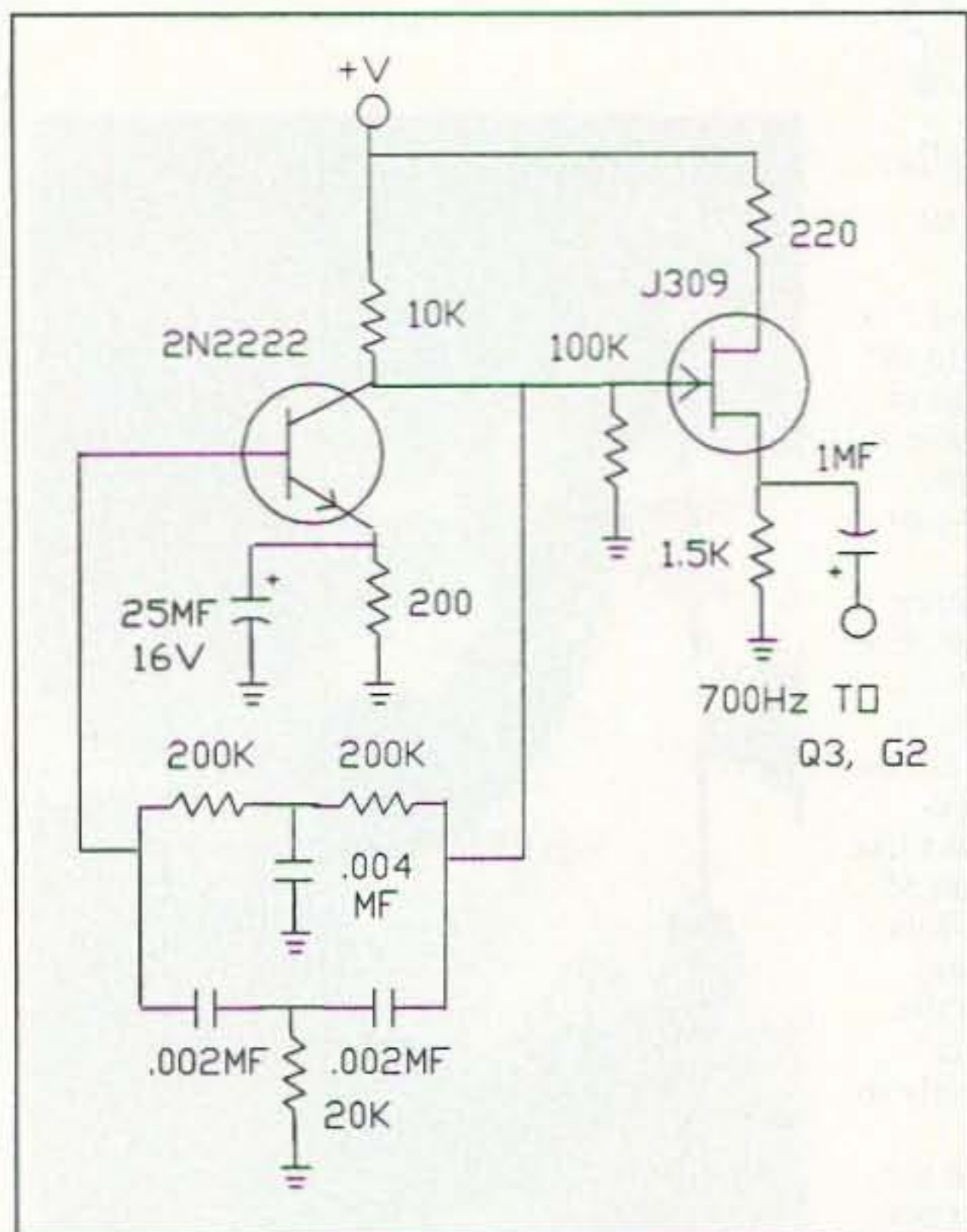

Figure 2. Tone oscillator.

forwards the voltage level of C1 to U1c. Configured as a comparator, U1c output pin 8 goes low when pin 9 rises above 9 volts. This switching action applies a trigger pulse via capacitor C2 to activate the monostable multivibrator U2. The resulting high pulse from pin 3 of U2 provides a discharge path for capacitor C1 through turned-on transistor Q2. A continuous sweep ramp with reset is produced at pin 7 of U1b at a rate determined by R1C1 (approximately 75 Hz).

The swept oscillator section consists of a dual-gate MOSFET transistor in a Colpitts configuration, followed by a buffer amplifier that provides the RF from the selected frequency range to an output amplifier and short antenna. As the output sawtooth waveform from U2, pin 7, is applied to the varactor, the capacitance of the tank circuit decreases from approximately 62 pF at the low end of the ramp to a very low value at the maximum sweep level of about 9.2 volts. The on-off switching action of the sweep waveform modulates the generated RF to produce an obnoxious buzz, which is easy to discern from other low-level signals at the selected receiver frequency when adjusting the tuner or antenna.

Those hams more interested in being able to tune manually to a specific frequency instead of sweeping a band, especially for fixed station operation, may replace the sweep generator section, C3, C4, and the varactor/biasing circuitry. A

50 pF variable capacitor across the tank circuit will allow tuning across each band. Depending on your circuit layout, the 68 pF capacitor may have to be decreased to obtain the necessary tuning range. To maintain the tone capability in the manual tuning version, you may add the twin-T oscillator shown in Figure 2. It provides a 700 Hz audio signal to gate 2 of Q3 for mixing with the generated RF.

Since the human ear can supposedly detect a change in audio level only greater than 3 dB, and a moving vehicle is not akin to an anechoic chamber, I added an additional level indicator, remotely mounted on the dashboard (no looking down at the S-meter). As shown in Figure 3, an LED bar graph and driver are connected to the receiver audio output to provide a visual, as well as audible, indication of received signal level. Since it's mounted in a small enclosure and attached to the dashboard with double-sided or hook-and-eye tape, it's easy to tune the rig without having to look down at the S-meter for the final couple of dBs.

Construction

The Tuner Helper is easily built using a pre-drilled, general-purpose circuit board with solder pads, such as the Radio Shack number 276-158. A suggested layout is shown in Figure 4. To make it more convenient for both construction and testing, the bandswitch S1 was

mounted to the circuit board using a small angle bracket made from scrap aluminum. Final installation of S1 should be delayed until the five coils are successfully wound and tested. The five toroid coils are then mounted vertically and secured by silicon cement, directly behind the bandswitch. After the space required for the toroids has been defined, construct the circuit. Begin with the varactor and other components of the tank circuit, and then progress to the oscillator, buffer, and amplifier. Test this part of the circuit with each individual coil by connecting a 10k-ohm, or greater, variable resistor across a voltage source of approximately 10 volts, with the wiper temporarily attached to the sweep end of the varactor biasing resistor. By monitoring the output frequency on a frequency counter or receiver, while adjusting the biasing voltage from about 1.2 to 9.2 volts, you can check each coil for minimum frequency range. Capacitor C3 is set to bring the lowest frequency as close to 3.5 MHz as possible, with the high end reaching 6 MHz on the low band. After the swept oscillator section is completed and tested, you can construct the sweep generator. Test points for voltages and waveforms are noted in the schematic diagram.

There is plenty of room on the circuit board for layout. The size of the board makes it compatible with many small enclosures, such as the Radio Shack number 270-253, or smaller versions available from Ocean State Electronics—(800) 866-6626 (order line), or (401) 596-3080 (information). The antenna consists of a 6-inch piece of #12 or #14 solid wire soldered into an RCA male plug, with a short piece of insula-

Continued on page 18

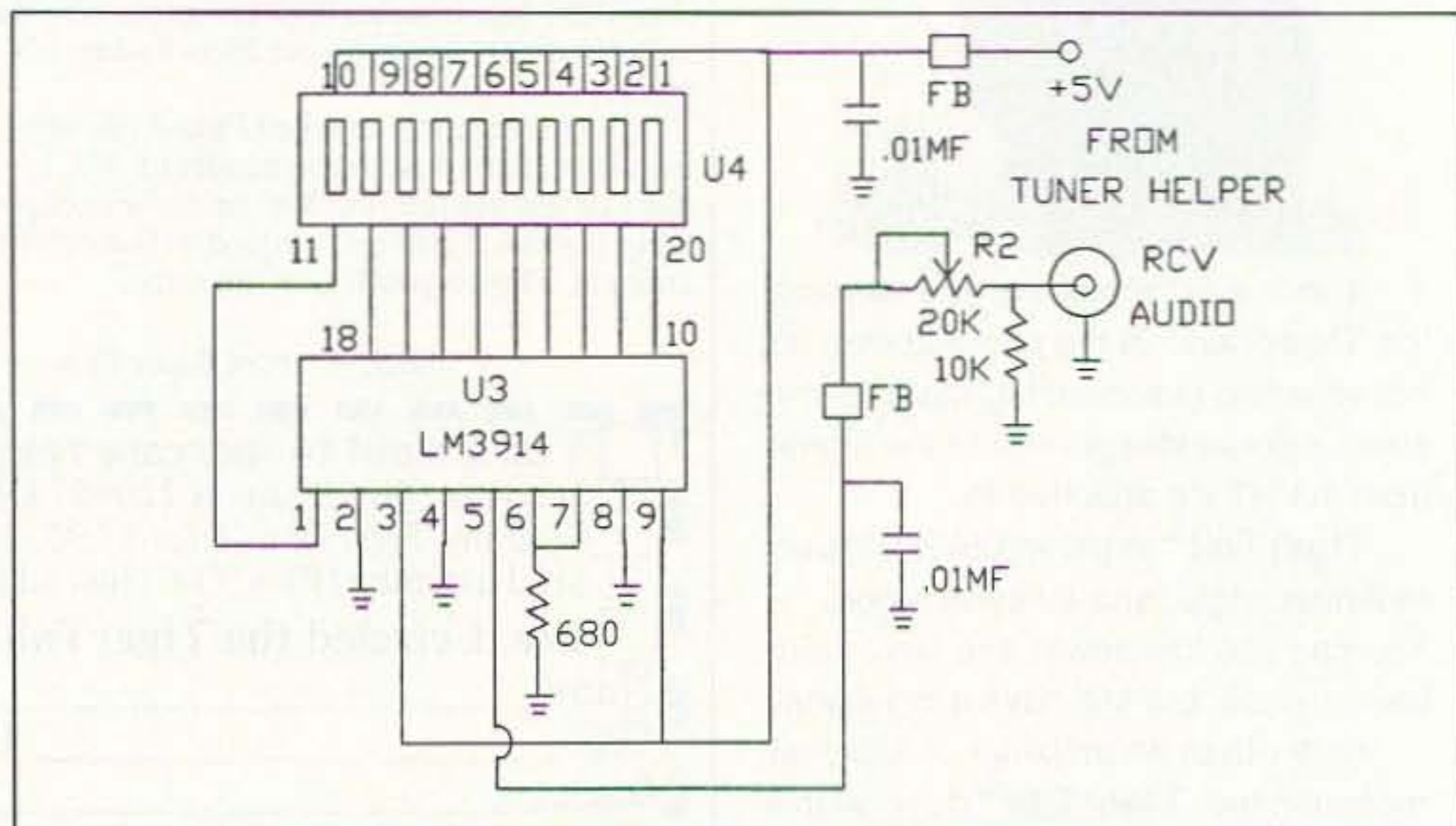

Figure 3. Bar graph schematic.

FEEDBACK

In our continuing effort to present the best in amateur radio features and columns, we recognize the need to go directly to the source—you, the reader. Articles and columns are assigned feedback numbers, which appear on each article/column and are also listed here. Please rate each feature or column as "Great," "OK," or "No Way." Mail your responses to: 73 Magazine Feedback, 70 Route 202N, Peterborough, New Hampshire 03458.

- 1 Never Say Die
- 2 Letters
- 3 QRX
- 4 Simple J-Type 10m Vertical
- 5 Tuner Helper
- 6 Just Another Loop Antenna
- 7 A Discone Antenna for 10 Meters
- 8 Check Your SWR Bridge
- 9 Longwave-Plus DX Techniques
- 10 Review: Icom IC-738 HF Transceiver
- 11 Review: Sony ICF-SW100S Pocket Shortwave Receiver
- 12 Ask Kaboom
- 13 Hams with Class
- 14 ATV
- 15 Homing In
- 16 Above and Beyond
- 17 Hamsats
- 18 Carr's Corner
- 19 RTTY
- 20 QRP
- 21 Special Events
- 22 New Products
- 23 Barter 'n' Buy
- 24 Propagation

OVER A MILLION CALL SIGNS
"ONLINE" U.S. INTERNATIONAL CALL DIRECTORY
 Hamcall online service gives you access to over a million hams via your computer & modem. Updated each month! **Only \$29.95** per year. Unlimited use - 24 hours a day - you pay for the phone call.
 800:282-5628 540:894-5777 FAX 540:894-9141
BUCKMASTER
 Route 4, Box 1630 - Mineral, Virginia 23117
 Internet: info@buck.com

CIRCLE 7 ON READER SERVICE CARD

UHF VIDEO TRANSMITTER

Miniature 200 Mw p.e.p. Video Transmitter Built tough. Housed in a black anodized milled aluminum case with stainless steel SMA antenna connectors & screws.

Available either at 434 mhz or 423.25 mhz Using SAW Resonator technology



\$279 plus s/h \$5
 Check, Money Order, Visa or Mastercard
 CA Res. add 8.25% tax

TECHNICAL

Modulation Type: AM
 Voltage: 12 vdc - 100 ma
 RF Output: 200 mw PEP
 Frequencies: 434 Mhz, 423.25 Mhz
 Specify when ordering
 Dimensions: 17/8" L x 1-3/8" W x 5/8" H
 47mm L x 34.5mm W x 15mm H

A.I.G., INC.
 P.O. Box 642057
 Los Angeles, CA
 90064-2057
 TEL: 310 821-6770
 FAX: 310 821-6690

Field Strength Meters

Commercial, Industrial, OEM, EMI Test, RF Labs, R&D, Medical & Scientific

Features:

- DC to 12 GHz
- External Antenna Option
- Great Sensitivity
- Low Battery Indicator
- Calibration Curves
- Ultra Low Current Drain

Model "A" shown



\$229.00 OUR BEST MODEL

DIGI-FIELD Field Strength Meters

More Than twice the Bandwidth at 1/2 the price!

To order call - (800) FIELD 58 (343-5358)

I.C. Engineering

16350 Ventura Blvd., Suite 125, Encino, CA 91436

818-345-1692

818-345-0517 Fax

CIRCLE 293 ON READER SERVICE CARD

HUGE 100 PAGE CATALOG

- Communications Receivers
- Portable Receivers
- Scanners
- Amateur HF Transceivers
- VHF/UHF Transceivers
- HT's and Mobiles
- Amateur and SWL Antennas
- Accessories and Parts
- RTTY and FAX Equipment
- Books and Manuals

This catalog includes prices!

Send \$1 to



Universal Radio
 6830 Americana Pkwy. 73
 Reynoldsburg, OH 43068
 Tel. 614 866-4267

CENTAUR ELECTRONICS **NEW!** Station Tuning Instrument
 SPECIALIZING IN CUSTOM ELECTRONIC PRODUCTS

- **CRICKET PULSER:** User Controlled, Variable Duty Cycle Station Tuning Instrument. Positive and Negative Keying Circuit. Compatibility: 200 V max, 750 MA max. Adjustable duty cycle: 0.5% to 95% 9 volt battery operation. BNC output custom cable supplied. Dual controls-Pulse and Key Down.
- **1:1 Dipoles and YAGI mounts:** Very broadband - .5 to 50 MHz - 3 kW SSB, stainless hardware, Teflon SD 239A connectors.
- **4:1 High Performance Ladder Line and YAGI Baluns:** 0.5 to 50 MHz, 3 kW SSB.
- **"Big Bertha" Series** - 10 KW AEGIS class coaxial choke baluns. "N" Conn. High Power apps.

ANTENNA SYSTEMS (includes Balun, Wire, Insulators, Wire Terminations)

- **1:1 Dipole Balun:** 160 or 80/40 or 30/17/12 or 20/15/10 (m) - \$95⁰⁰
- **Coaxial Center Supports:** high power applications, stainless hardware, SD-239A Teflon connectors, custom connectors available - \$19⁰⁰

Systems with Coaxial Center Support: 160 or 80/40 or 30/17/12 or 20/15/10 (m) - \$49⁰⁰

HIGH QUALITY WIRE PRODUCTS (Competitive Prices, Call for Quote)

- MHC-17 coax, ratings to 10 kW • Pre-fab wire/connector combinations • General and specialty coax • Ladder line • special orders • Heavy duty rotor cable, (B conductor).

Custom Built High Power Antenna Switching Systems - call for quote

CENTAUR ELECTRONICS
 3720 S. PARK AVE., #604
 TUCSON, AZ 85713
 (520) 622-6672 • FAX (520) 622-1341

Do You Know...

Striking News
 From PolyPhaser

NASA Records Color Storm Flashes In Space

In This Issue...

- ▶ PolyPhaser's Versus 1/4 Wave Stub
- ▶ Lightning Protection Facts and Fallacies
- ▶ Bulletin Board Updates

- ▶ what effect soil pH may have on grounding?
- ▶ entrance panels are a last defense against lightning?
- ▶ the facts & fallacies of oscilloscope sampling rates?

FREE - join the more than 30,000 readers and learn from **The Leader in Lightning & Grounding Solutions**

PolyPhaser CORPORATION

(702) 782-2511

FAX: (702) 782-4476

BBS: (702) 782-6728

2225 Park Place • P.O. Box 9000
 Minden, NV 89423-9000

CIRCLE 49 ON READER SERVICE CARD

tion covering the portion where the ground connector of the plug is clamped over the wire. A right-angle bend is then made to the wire at the rear of the connector, after attaching the cover.

I enclosed the bar graph circuitry in a small plastic box that previously held parts. Make an opening for the bar graph display in the middle of the front of the box using a Dremel tool and file. You can then make connection to the Tuner Helper with two-conductor shielded cable, which enters the bar graph box through a rubber grommet on the side so that the cable runs down along the dashboard when the display is mounted vertically. A cable clamp on the circuit board ensures that the cable connections do not twist loose. A Radio Shack board number 276-150 is used for the bar graph circuit construction. Cut the board in half along the outer solder pad number 12, producing two almost square boards. Then these two boards are again cut in the opposite dimension, above the two common solder pad lines, to pro-

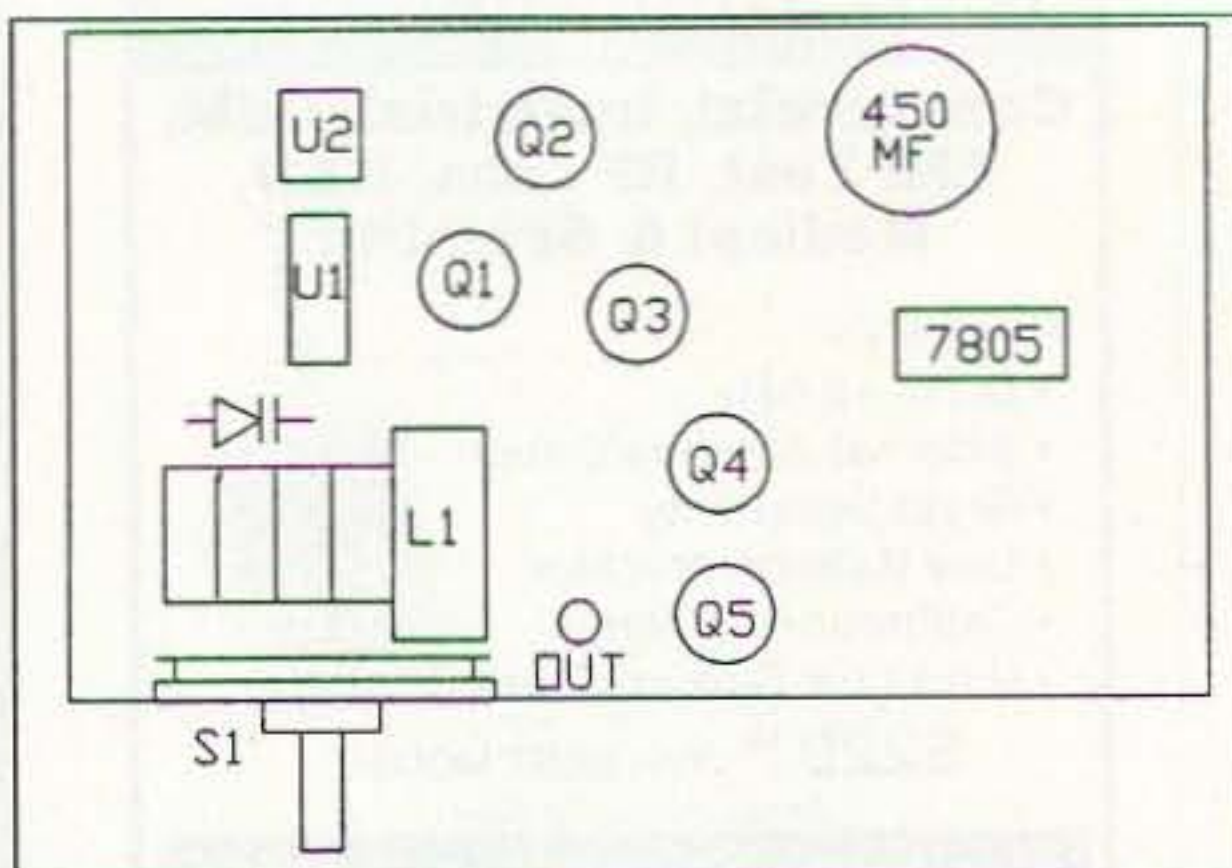

Figure 4. Suggested layout.

vide two smaller boards where each chip could be mounted. Solder the bar graph IC to the configuration pads on one board, allowing space on either end for screw holes to be made to attach it, via spacers, to the enclosure through the previously made cutout. Also solder the driver IC to the other board and make connections to the bar graph board, which is placed at a right angle to the driver board, via parallel bus wire. Care must be taken to insure that the two ICs are mounted in a configuration that al-

lows the outputs of one to be parallel to the other's inputs. The remaining connections are then made and the driver board attached to the bottom of the plastic enclosure with double-sided foam strips. Since the enclosure is so small and the display board is attached to the top via screws, no additional attachment is necessary for the bottom board.

Although the audio attenuation resistors are shown on the bar graph schematic, they may be mounted on the main Tuner Helper board, if desired, to save space on the driver board. The trimpot is set by determining which band produces the lowest audio in the installed configuration, and then adjusting the trimmer for about half-scale display on the bar graph. If the strongest band still lights all of the LEDs, then the trimmer can be reset for lower drive level. As shown in the main schematic, the bar graph display is active whether the Tuner Helper is in use or not. If you would rather not have the display react to the receiver audio when not required for tuning, then place the

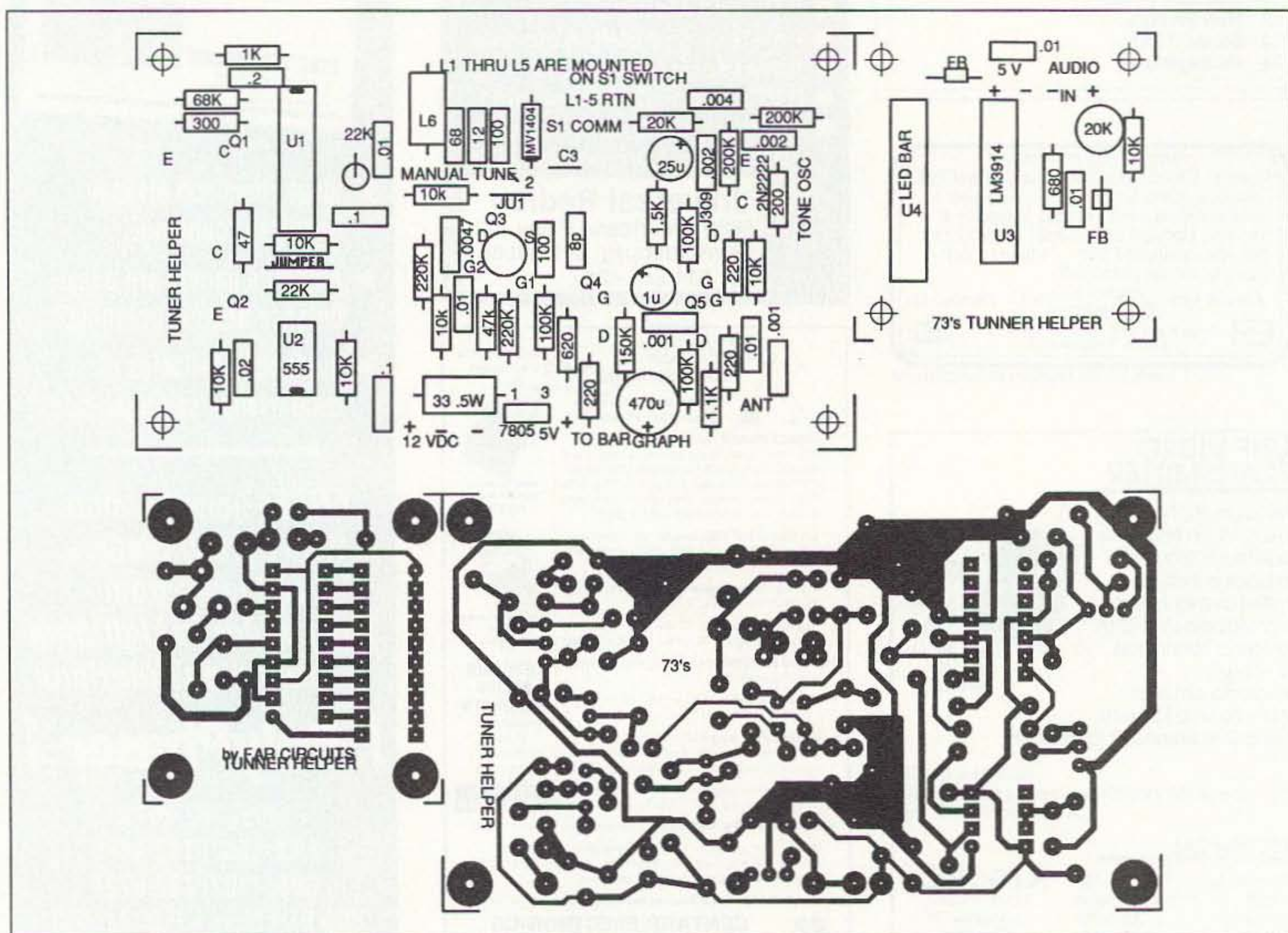

Figure 5. Printed circuit board layout. Pre-made boards are available for \$6.00 cash plus \$1.50 S&H per order from FAR Circuits, 18N640 Field Ct., Dundee, IL 60118.

voltage supply line to the 5-V regulator dropping resistor on the output side of power switch S2.

Although the Tuner Helper originated to meet a specific need, it has also found use as a signal generator on the test bench for filter design, receiver alignment, and antenna testing.

References

Veronese, Fabio, "Build A 'Gate-Dip' Meter," Popular Electronics, November 1994.
Rakes, Charles D., "Circuit Circus," Popular Electronics, November 1994.

Parts List

Qty.	Part	Value
1	Resistor	300
1	Resistor	1k
1	Resistor	68k
1	Resistor	47
2	Resistor	22k
1	Resistor	33, 0.5 W
6	Resistor	10k
1	Resistor	47k
1	Resistor	220k
1	Resistor	270
1	Resistor	150k
2	Resistor	100k
1	Resistor	620
2	Resistor	220
1	Resistor	1.1k
1	Resistor	680
1	Trimpot	20k
1	Variable cap	20 pF
1	Mylar cap	0.2 μF
1	Mylar cap	0.1 μF
1	Mylar cap	0.02 μF
1	Silver mica cap	100 pF
1	Ceramic cap	8 pF
1	Ceramic cap	12 pF
1	Ceramic cap	68 pF
1	Ceramic cap	0.0047 μF
1	Ceramic cap	0.1 μF
5	Ceramic cap	0.01 μF
1	Ceramic cap	100 pF
2	Ceramic cap	0.001 μF
1	Electrolytic cap	470 μF, 25 V
2	Ferrite bead	
1	Varicap	MV1404
1	PNP transistor	MPS2907
1	NPN transistor	2N2222
1	Dual-gate MOSFET	40673
2	NFET	J309
1	5V regulator	7805
1	LED driver	LM3914
1	Bar graph display	Radio Shack 276-081
1	J1	P605C jack, T607C plug (Ocean State Electronics)
1	J2	3/8" stereo plug/jack
1	J3	RCA plug/jack
1	Power connector	Radio Shack 274-222
1	S1	Radio Shack 275-1386
1	S2	Radio Shack 275-624
1	Choke	100 μH

Coil Data

L1	3.5-6 MHz	25 μH	T80-6	65T	#28 wire
L2	6-10 MHz	0 μH	T37-6	47T	#30 wire
L3	10-15 MHz	3.6 μH	T37-6	27T	#28 wire
L4	15-22 MHz	1.6 μH	T37-6	18T	#28 wire
L5	22-30 MHz	0.92 μH	T37-6	13T	#28 wire

C. W. WOLFE COMMUNICATIONS

BUY · SELL · TRADE
All Brands of 2 Way Radios
and Equipment

1113 Central, Billings, MT 59102
406-252-9220 Fax: 406-252-9617
Call or write for current flyer

Field Day G5RV QuicKits™

created by Antennas West Box 50062-S, Provo, UT 84605

<ul style="list-style-type: none"> Fast & Easy To Build Fail-Safe visual instructions No measuring or cutting Everything included Finish antennas in minutes 	<ul style="list-style-type: none"> Double Size G5RV \$59.95 204 ft. 160-10 Dipole Full Size G5RV \$39.95 102 ft. 80-10 Dipole Half Size G5RV \$29.95 51 ft. 40-10 dipole Quarter Size G5RV \$25.95 26 ft. 20-10 Dipole
<ul style="list-style-type: none"> Presoldered Silver Fittings Kinkproof QuietFlex wire Fully insulated, wx sealed, no-corrode, low noise design Tune All Bands Incl WARC 	<ul style="list-style-type: none"> ReadyMade 102 ft. G5RV \$59.00 ReadyMade 51 ft. G5RV/2 \$49.00 2007 Dacron 250# line \$11.95

West Plans, Patterns, Data? Order TechNote #124-D \$6.95 ppd USA Order Hot-Line: Add \$5 P&H 1-801-373-8425

CIRCLE 296 ON READER SERVICE CARD

BackPack Solar?

10 watt DesertStorm panel is size of open 73 magazine, weighs 1lb, and delivers 600mA for 12v charging or direct operation. Tough, Solid, with no glass to break. So rugged Uncle Sam used this for spotter communications and portable repeaters in Desert Storm. Ready to use. \$169. Add \$5 S&H. Info \$1.



AntennasWest
Box 50062 Provo UT 84605

Order HotLine
801 373 8425

CIRCLE 340 ON READER SERVICE CARD

HI-PERFORMANCE DIPOLES

Antennas that work! Custom assembled to your center freq. ea. band - advise ft. of center and each end - hang as inverted "V" - horizontal, vert. dipole, sloping dipole - commercial quality - stainless hardware - legal power - no-trip, high-efficiency design. Personal check, MO or C.O.D. (\$2.00)

MPD-5'	80, 40, 20, 15, 10M Max-Performance Dipole 87' or 78' long	\$110.00
MPD-2'	80, 40M Max-Performance Dipole 85' long	\$65.00
MPD-3712	30, 17, 12M Max-Performance Dipole, 31' long	\$72.00
HPD-3'	160, 80, 40M Max-Performance Dipole, select 113' or 125'	\$83.00
SSD-6	160, 80, 40, 20, 15, 10M Space-Saver Dipole 71' long	\$146.00
SSD-5'	80, 40, 20, 15, 10M 42' long	\$110.00

*Tunes 9 Bands with Wide-Matching-Range Tuner S&H per Antenna \$6.00

\$5.2 SASE for catalog of 30 dipoles, slopers, & unique antennas

W9INN ANTENNAS

Box 393 Mt. Prospect IL 60056 708-394-3414

CIRCLE 38 ON READER SERVICE CARD

24 HOUR SHIPPING

ELENCO • HITACHI • B&K PRODUCTS

TO ORDER
CALL TOLL FREE
1-800-292-7711
1-800-445-3201 (Can.)

AFFORDABLE - HIGH QUALITY
2 YEAR WARRANTY

ELENCO OSCILLOSCOPES

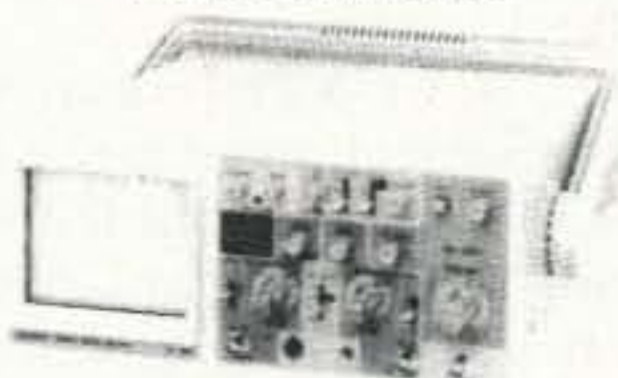

STANDARD SERIES
S-1235 25MHZ \$325 S-1340 40MHZ \$495
S-1365 60MHZ \$849

- Features:
- High Luminance 6" CRT
 - 1mV Sensitivity
 - X-Y Operation
 - Voltage, Time, & Frequency differences displayed on CRT thru the use of cursors (S-1365 only)
 - Plus much, much more

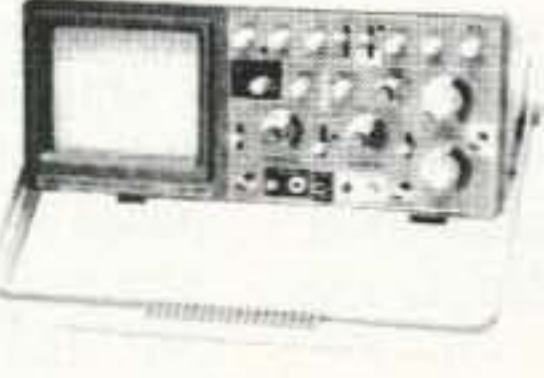

DELUX SERIES
S-1330 25MHZ \$449 S-1345 40MHZ \$575
S-1360 60MHZ \$775

- Features:
- Delayed Sweep
 - Automatic Beam Finder
 - Z Axis Modulation
 - Built-in Component Test
 - Plus all the features of the "affordable" series

Hitachi Compact Series Scopes

V-212 - 20MHz Dual Trace	\$449
V-525 - 50MHz, Cursors	\$1,069
V-523 - 50MHz, Delayed Sweep	\$995
V-522 - 50MHz, DC Offset	\$975
V-422 - 40MHz, DC Offset	\$849
V-222 - 20MHz, DC Offset	\$695
V-660 - 60MHz, Dual Trace	\$1,375
V-665A - 60MHz, DT, w/cursor	\$1,449
V-1060 - 100MHz, Dual Trace	\$1,549
V-1065A - 100MHz, DT, w/cursor	\$1,695
V-1085 - 100MHz, QT, w/cursor	\$2,125

B&K OSCILLOSCOPES

2120 - 20MHz Dual Trace	\$389
2125 - 20MHz Delayed Sweep	\$539
1541B - 40MHz Dual Trace	\$749
2160 - 60MHz Dual Trace, Delayed Sweep, Dual Time Base	\$949
2190 - 100MHz Three Trace Dual Time Base, Delayed Sweep	\$1,379
2522A - 20MHz / 20MS/s Storage	\$869

Digital Multimeter EDM-83B
\$175.00
Almost every feature available. Bargain of the decade.

Elenco LCR + DMM LCM-1950
\$79
12 Functions Freq to 4MHz Inductance Capacitance

Digital Capacitance Meter CM-1555
\$49.95
Measures capacitors from .1pf to 20,000pf • 3-1/2 Digit LCD readout with unit indicator

Digital LCR Meter LCR-680
\$79.95
3-1/2 Digit LCD Display • Inductance 1μH to 200H • Resistance .1Ω to 20MΩ • Capacitance .1pf to 200μF

Function Generator GF-8026
\$239
Int/Ext Operation Sine, Square, Triangle, Pulse Ramp, 2 to 2MHz, Freq Ctr

3-3/4 Digit Multimeter BK-390
\$139.00
0.1% DCV acy • Analog bar graph • Auto/manual ranging • 4,000 count LCD display • Capacitance meas. • Temperature probe

Digital Multimeter Kit with Training Course
By Elenco M-2665K \$49.95
Full function 34 Ranges • Extra large display • Ideal school project M-2661 (Assembled) \$55.00

Frequency Counter F-1225
\$225.00
8 Digit LED display • Wide measuring range • High sensitivity • Data hold function • Input impedance 1MΩ or 50Ω • 10:1 input attenuation function

FLUKE MULTIMETERS (All Models Available Call)

Scopemeters	70 Series
Model 93 \$1,225.00	Model 7011 \$69.95
Model 95 \$1,549.00	Model 7711 \$149.00
Model 97 \$1,795.00	Model 7911 \$175.00
10 Series	80 Series
Model 10 \$62.95	Model 87 \$289.00
Model 12 \$84.95	

FM Receiver Kit & Training Course
\$44.95 AR2N6 kit
Ideal training aid for beginners. Makes it fun and easy to learn about amateur radio.
Covers both 2 meter (144-148MHz) and 6 meter (50-54MHz) FM.
Dual conversion superheterodyne

Butane Soldering Iron
ISOTIP #7980 \$24.95
Two tools in one! Perfect, portable tool for hobbyists and technicians.

Combination Emf/Microwave Tester EM 204
\$89.95
Affordable electromagnetic (Emf) and microwave tests made easy!

Telephone Kit PT-223K
\$14.95
Available Assembled PT-223 \$15.95

Function Generator Blox #9600
By Elenco \$29.95
Kit \$26.95
Sine, Triangle, Square wave

Learn to Build and Program Computers with this Kit
MM-8000 By Elenco \$129.00
From scratch you build a complete system. Our Micro-Master trainer teaches you to write into RAMs, ROMs and run a 8085 microprocessor, which uses similar machine language as IBM PC.

Electronic Tool Kit TK-1000
\$39.95
A professional organizer tool kit at affordable prices. Includes 25 high quality tools in a high impact carrying case which includes a pocket for meter.

Digital/Analog Trainer Complete Mini-Lab For Building, Testing, Prototyping Analog and Digital Circuits
XK-550 \$169.95
Kit XK-550-K \$139.95
Elenco's trainer is designed for school projects with 5 built-in power supplies. Includes a function generator with continuously variable sine, triangular square wave forms. All power supplies are regulated and protected against shorts. The case can include a full line of tools and meter of your choice.

Transistor Radio Kits with Training Course
AM/FM Radio Model AM-FM-106 \$29.95
AM Radio Kit Model AM-550 \$19.95

Telephone Line Analyzer
Kit TT-400K \$19.95
Assembled TT-400 \$26.95

WE WILL NOT BE UNDERSOLD
UPS SHIPPING - 48 STATES 5%, OTHERS CALL
IL RES add 7.75% TAX
PROBES INCL ALL SCOPES & METERS

C&S SALES INC.
1245 ROSEWOOD, DEERFIELD, IL 60015
FAX: 708-520-0065 • (708) 541-9710

15 DAY MONEY BACK GUARANTEE
FULL FACTORY WARRANTY
WRITE FOR FREE CATALOG

CIRCLE 184 ON READER SERVICE CARD

Just Another Loop Antenna

Or Is It?

by John Sehring WB2EGQ

Just when you start to feel comfortable with an old, familiar antenna which you think you know all about, along comes a new twist. No, this is not just another antenna article. Question: *Would you like to get some directionality on 75 meters (and 160 capability, too) from a familiar antenna, without moving parts or phased arrays?* Then read on!

I've always liked loop antennas. When they're one wavelength or more in length, they can show a bit of gain over a dipole. They are broadbanded, are tolerant of their surroundings, and seem quieter for reception.

About 10 years ago, when I lived in New Jersey, up went about 275 feet of 14-gauge stranded insulated wire in the shape of an inverted delta loop. Its length was calculated from the formula for the driven element of a square (quad) loop: $L = 1005/F$, where L is the length in feet and F is the frequency, in my case 3.8 MHz. I added about 25 feet of wire "just in case."

The loop was in the shape of an isosceles triangle with the horizontal portion on top, about 45 feet high, and tied between two trees. It looked like an upside-down "delta" and lay wholly in the vertical plane. The plane of the wire ran in the northeast-southwest direction. The bottom end was almost at ground level and came right into the basement shack; so there was practically no feedline, just six feet of extra wires at the ends.

The resonant frequency of the loop turned out to be 3.8 MHz; therefore, the extra 25 feet of wire was necessary. Because my impedance bridge showed the loop's input impedance to be about 165 ohms resistive at resonance, I made up a 4:1 voltage-type balun¹. The balun transforms the impedance of the antenna downward toward 50 ohms.

It also matches the unbalanced coaxial feed to the balanced load of the antenna.

The wire's insulation, while not necessary, does serve three purposes: 1) it keeps RF off of tree branches; 2) due to a velocity factor of about 0.98, it reduces a bit the necessary size of the antenna; and 3) it prevents wire corrosion, which can increase the wire's resistance (especially to RF), thus reducing antenna efficiency².

On the air, the loop performed well both transmitting and receiving. Compared to a 130-foot-long, end-fed wire that ran from ground level upward at a 30° angle, it seemed quieter with respect to local QRN and QRM, such as power line noise. During the day, signals from further away were now readable, thanks to reduced noise levels—a definite improvement as the SNR was better.

Surprise!

I discovered an unsuspected facet of the antenna quite by accident. The feed points of the loop were temporarily connected to the balun with alligator clips. One day as I listened to a QSO on 75m, one of the clips popped off. This left only one of the two feed wires of the loop connected and the other dangling.

When that happened, the signal to which I was listening dropped considerably in signal strength but the noise lev-

el stayed about the same, indicating that the antenna was still "hearing." Reversing the connections by hooking up the other feed wire of the loop (leaving the first one unconnected) made the signal stronger! Further checking revealed definite directional properties of the loop when it was fed this way. The nulls were quite narrow and deep, and sometimes useful in reducing QRM and QRN. The directionality seemed evident in both azimuth and elevation.

In spite of the interesting directional properties of the loop when fed this way (end-fed with an L-network against ground, like the high impedance end of a long wire), the balanced feed produced stronger signals on both transmit and receive for the kind of casual operation (out to 1,000 miles) that I usually do on 75m. So I left the end-fed arrangement for receive-only use, where signal-to-QRM and/or signal-to-QRN ratio, not just signal strength alone, are important for hearing a desired signal.

DX

Then, during the cooler months came some excellent DX propagation conditions on 75m. Surprisingly, the end-fed configuration was often superior to the balanced feed. It usually elevated DX signals from the northeast direction (for example, Europe from New Jersey) by a few dB or so and, at the same time, suppressed stateside signals and QRN significantly. Curiously, these effects occurred most often when feeding the wire end toward the northeast; here was that directionality again.

Evidently, the end-fed loop had a high elevation angle null in its pattern, tilted away from the end that was being fed. Local signals and noise were suppressed as their high angle of arrival put them right into the null.

What I had found here was an

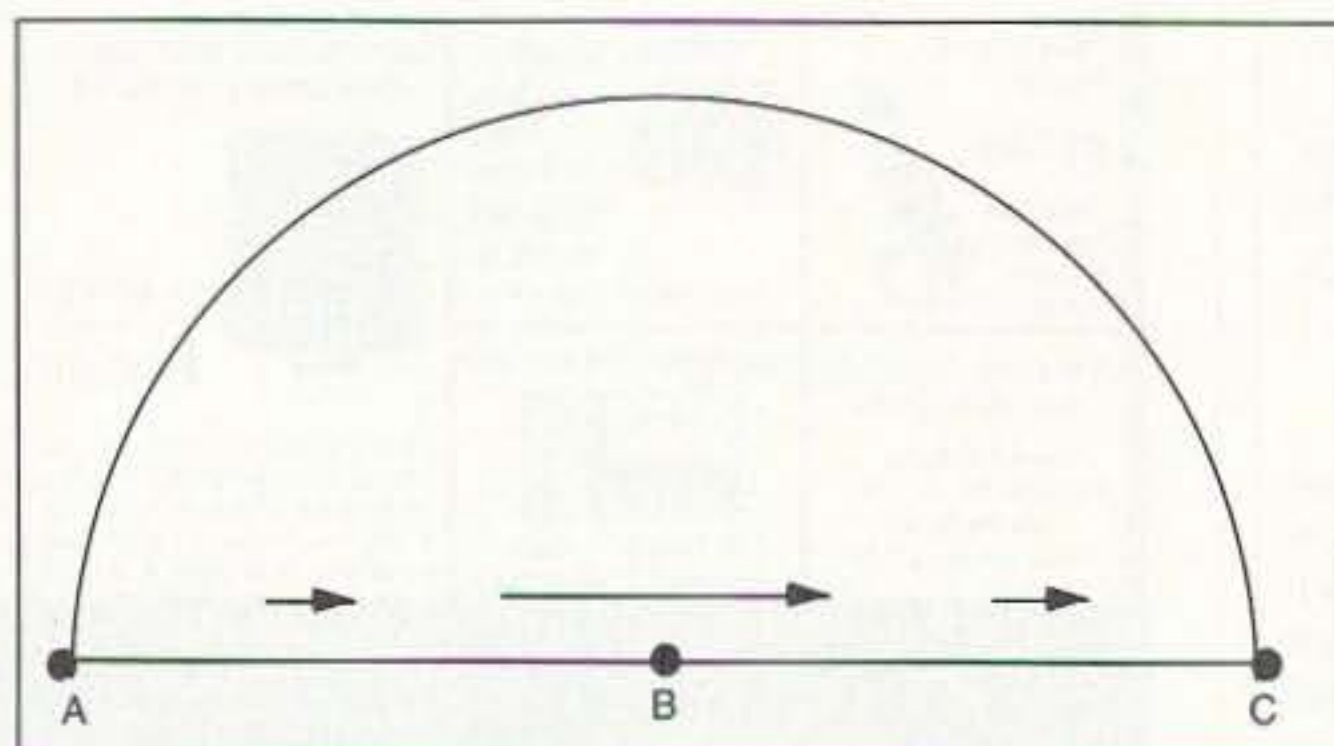

Figure 1. Current distribution of a half-wavelength dipole.

ASTRON POWER SUPPLIES

• HEAVY DUTY • HIGH QUALITY • RUGGED • RELIABLE •



MODEL VS-50M

SPECIAL FEATURES

- SOLID STATE ELECTRONICALLY REGULATED
- FOLD-BACK CURRENT LIMITING Protects Power Supply from excessive current & continuous shorted output
- CROWBAR OVER VOLTAGE PROTECTION on all Models except RS-3A, RS-4A, RS-5A, RS-4L, RS-5L
- MAINTAIN REGULATION & LOW RIPPLE at low line input Voltage
- HEAVY DUTY HEAT SINK • CHASSIS MOUNT FUSE
- THREE CONDUCTOR POWER CORD except for RS-3A
- ONE YEAR WARRANTY • MADE IN U.S.A.

PERFORMANCE SPECIFICATIONS

- INPUT VOLTAGE: 105-125 VAC
- OUTPUT VOLTAGE: 13.8 VDC ± 0.05 volts (Internally Adjustable: 11-15 VDC)
- RIPPLE Less than 5mv peak to peak (full load & low line)
- All units available in 220 VAC input voltage (except for SL-11A)

SL SERIES



• LOW PROFILE POWER SUPPLY

MODEL	Colors		Continuous Duty (Amps)	ICS* (Amps)	Size (IN) H x W x D	Shipping Wt. (lbs.)
	Gray	Black				
SL-11A	•	•	7	11	2 5/8 x 7 5/8 x 9 3/4	12
SL-11R	•	•	7	11	2 5/8 x 7 x 9 3/4	12
SL-11S	•	•	7	11	2 5/8 x 7 5/8 x 9 3/4	12
SL-11R-RA		•	7	11	4 3/4 x 7 x 9 3/4	13

RS-L SERIES



• POWER SUPPLIES WITH BUILT IN CIGARETTE LIGHTER RECEPTACLE

MODEL	Continuous Duty (Amps)	ICS* (Amps)	Size (IN) H x W x D	Shipping Wt. (lbs.)
RS-4L	3	4	3 1/2 x 6 1/8 x 7 1/4	6
RS-5L	4	5	3 1/2 x 6 1/8 x 7 1/4	7

RM SERIES



MODEL RM-35M

• 19" RACK MOUNT POWER SUPPLIES

MODEL	Continuous Duty (Amps)	ICS* (Amps)	Size (IN) H x W x D	Shipping Wt. (lbs.)
RM-12A	9	12	5 1/4 x 19 x 8 1/4	16
RM-35A	25	35	5 1/4 x 19 x 12 1/2	38
RM-50A	37	50	5 1/4 x 19 x 12 1/2	50
RM-60A	50	55	7 x 19 x 12 1/2	60
• Separate Volt and Amp Meters				
RM-12M	9	12	5 1/4 x 19 x 8 1/4	16
RM-35M	25	35	5 1/4 x 19 x 12 1/2	38
RM-50M	37	50	5 1/4 x 19 x 12 1/2	50
RM-60M	50	55	7 x 19 x 12 1/2	60

RS-A SERIES



MODEL RS-7A

MODEL	Colors		Continuous Duty (Amps)	ICS* (Amps)	Size (IN) H x W x D	Shipping Wt. (lbs.)
	Gray	Black				
RS-3A		•	2.5	3	3 x 4 1/4 x 5 3/4	4
RS-4A	•	•	3	4	3 3/4 x 6 1/2 x 9	5
RS-5A		•	4	5	3 1/2 x 6 1/8 x 7 1/4	7
RS-7A	•	•	5	7	3 3/4 x 6 1/2 x 9	9
RS-7B	•	•	5	7	4 x 7 1/2 x 10 3/4	10
RS-10A	•	•	7.5	10	4 x 7 1/2 x 10 3/4	11
RS-12A	•	•	9	12	4 1/2 x 8 x 9	13
RS-12B	•	•	9	12	4 x 7 1/2 x 10 3/4	13
RS-20A	•	•	16	20	5 x 9 x 10 1/2	18
RS-35A	•	•	25	35	5 x 11 x 11	27
RS-50A	•	•	37	50	6 x 13 3/4 x 11	46
RS-70A	•	•	57	70	6 x 13 3/4 x 12 1/2	48

RS-M SERIES



MODEL RS-35M

MODEL	Continuous Duty (Amps)	ICS* (Amps)	Size (IN) H x W x D	Shipping Wt. (lbs.)
• Switchable volt and Amp meter RS-12M	9	12	4 1/2 x 8 x 9	13
• Separate volt and Amp meters RS-20M	16	20	5 x 9 x 10 1/2	18
RS-35M	25	35	5 x 11 x 11	27
RS-50M	37	50	6 x 13 3/4 x 11	46
RS-70M	57	70	6 x 13 3/4 x 12 1/2	48

VS-M AND VRM-M SERIES



MODEL VS-35M

• Separate Volt and Amp Meters • Output Voltage adjustable from 2-15 volts • Current limit adjustable from 1.5 amps to Full Load

MODEL	Continuous Duty (Amps)			ICS* (Amps) @13.8V	Size (IN) H x W x D	Shipping Wt. (lbs.)
	@13.8VDC	@10VDC	@5VDC			
VS-12M	9	5	2	12	4 1/2 x 8 x 9	13
VS-20M	16	9	4	20	5 x 9 x 10 1/2	20
VS-35M	25	15	7	35	5 x 11 x 11	29
VS-50M	37	22	10	50	6 x 13 3/4 x 11	46
• Variable rack mount power supplies						
VRM-35M	25	15	7	35	5 1/4 x 19 x 12 1/2	38
VRM-50M	37	22	10	50	5 1/4 x 19 x 12 1/2	50

RS-S SERIES



MODEL RS-12S

• Built in speaker

MODEL	Colors		Continuous Duty (Amps)	ICS* Amps	Size (IN) H x W x D	Shipping Wt. (lbs.)
	Gray	Black				
RS-7S	•	•	5	7	4 x 7 1/2 x 10 3/4	10
RS-10S	•	•	7.5	10	4 x 7 1/2 x 10 3/4	12
RS-12S	•	•	9	12	4 1/2 x 8 x 9	13
RS-20S	•	•	16	20	5 x 9 x 10 1/2	18
SL-11S	•	•	7	11	2 3/4 x 7 5/8 x 9 3/4	12

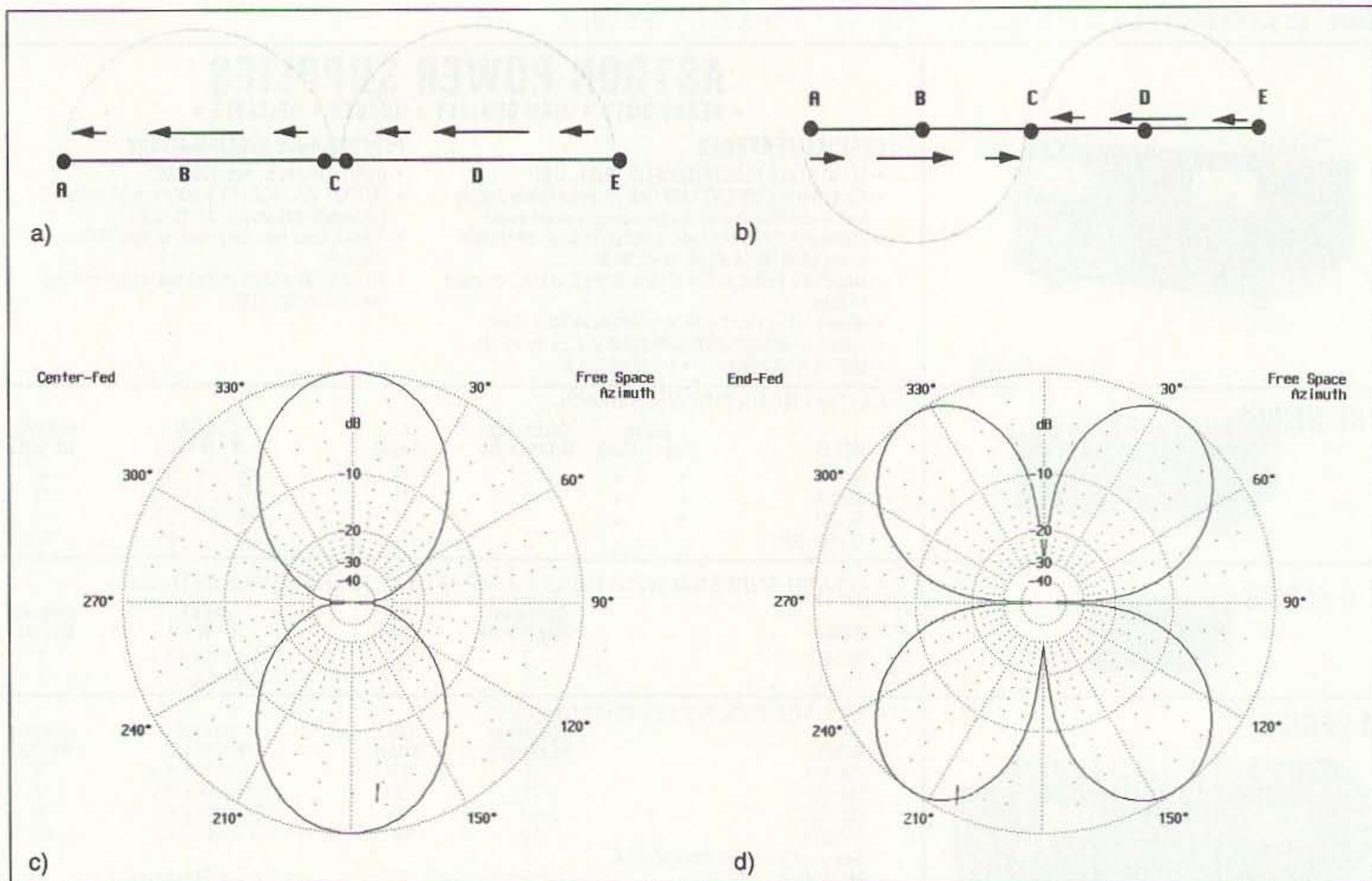

Figure 2. A) current distribution of an end fed full-wavelength antenna; B) current distribution of a full-wavelength center-fed antenna; C) radiation pattern for a center-fed one-wavelength antenna; D) radiation pattern for an end-fed one-wavelength antenna.

antenna of flexibility, capable of strong high-elevation angle performance for stateside contacts (when balanced-fed) and, at the flip of a switch, improved performance for DX with a low-angle lobe and simultaneous high-angle rejection (when end-fed). An added bonus was the 180° switchable endfire directivity.

No, it cannot compete with a dipole at 150 feet, or phased vertical or parasitic arrays, but the improvement over a typical low dipole or inverted-vee is obvious, and the complexity and cost is minimal.

Some Detective Work

The loop's unusual properties when end-fed caught my interest. To see what was happening, I compared the antenna's current distribution in free space with both balanced- and end-feed, so I could estimate what kind of radiation patterns they would produce. Yes, there are computer programs that analyze antennas, but they are most efficiently used when you have at least a qualitative understanding of how an antenna works. I'll touch on this again.

Half-Wavelength Wire

Figure 1 shows the current distribution of a half-wavelength dipole that is sinusoidal. The dotted lines show the amount of current in various parts of the antenna. The arrows show both the direction of current flow and, by their length, the amount of current flow where they are drawn, like a vector.

The relative amount of current at a point on an antenna can tell us the impedance there. Since impedance equals voltage divided by current ($Z = E/I$), high current indicates a low feed-point impedance and, conversely, low current indicates a high impedance.

The amount of current in a dipole is highest at its center (point B), giving a low impedance there. We know this to be true, as its impedance when center-fed is usually about 50 to 70 ohms.

At each end of the dipole we have current minimums. It has to be this way because it's the end of the antenna and so current cannot flow to anywhere. The impedance there, at points A and C, is therefore high.

To avoid upsetting the symmetric current distribution of a dipole when center feeding it, we need to use a balanced

feed (a coaxial feedline would need a balun). A balanced feedline presents equal but opposite polarity (plus and minus) voltages, so its presence in the center of a dipole would not disturb current distribution there.

Full-Wavelength Wire

Now we'll extend our wire to one full wavelength and draw the current flow again (see Figure 2). If we feed it at the center (point C), we get the current distribution shown in Figure 2A. There are now two current maximums, at points B and D. Current in both halves is forced to run in the same direction (they are in phase) by the feedline. Current is at a minimum in the center and at both ends (points C, A, and E, respectively).

But if we feed this antenna at an end instead of the center, the current distribution will be quite different, as seen in Figure 2B. There are once again two current maximums. But current in the two halves now runs in opposite directions (they are anti-phase). It could be fed at either end, point A or E, which are, once again, high impedance points.

Since it is current flow (its strength and direction) that generates a radiation pattern from an antenna, we expect

WE SHIP WORLDWIDE

Barry Electronics Corp.

WORLD WIDE AMATEUR RADIO SINCE 1950

Your one source for all Radio Equipment!

For the best buys in town call:
212-925-7000
Los Precios Mas Bajos en Nueva York
WE SHIP WORLDWIDE!
Export orders expedited.

KITTY SAYS: WE ARE OPEN 7 DAYS A WEEK

Sat. 10-5 Sun 11-4 M-F 9-6 Come to Barry's for the best buys in town



Wherever I go, I take my radio.
Specialist in **RADIOS**;
Business marine aviation,
ham radios and scanners.



MOTOROLA

SP10, SP50, P110, GP3000, M120,
GM300, GR300 repeaters.
Domestic, exports and gov't. orders.

Yaesu Vertex Portables
FTH-2070 dual band
VHF/UHF 5 watts VX500,
FTH 2008/7008/VTR
VR-2500, 5000 repeater.



CONTACT US FOR THE LATEST IN
BUSINESS AND HAM RADIOS,
SHORTWAVE RECEIVERS & SCANNERS.
MOTOROLA, YAESU, ICOM, KENWOOD, ALINCO,
STANDARD, MAXON, RELM, JRC, KING, SONY,
GRUNDIG
BRAND NEW Long Range Repeater service for business

"YAESU Ham & Vertex Business Radios" FT-530,
FT-51R, FT8500, FT-11, FT-2500, FT-890, FRG-100B, FT-1000D, FT-530, FT-
5200, FT411E, FT-840, FT-900AT, FRG-100B, FT-23R, FL-7000 Linear. New
VXR-5000 synthesized repeater 25 watts, VHF or UHF. NEW MARINE VXM-100.

ICOM

**HAM, MARINE, BUSINESS
AND AVIATION RADIOS.**
281-H, 481-H, 2340-H,
2700-H, IC-D100, GP-22A
New F30LT/F40LT, H16,
U16, V100, and repeaters.
SHORTWAVE RECEIVERS
R-1, R-100, R-7000,
R-9000, R-71, GP-22A.

KENWOOD



ANTENNAS
A-S, AES, Cushcraft, Hy-Gain,
Hustler, KLM, METZ, Urban,
MODUBLOX, TONNA, Butternut,
Multi-Band

"TS-50S", TS450S/AT, R-5000, TS-850S,
TM 241/AJ441A, TR-751A, Kenwood Service
Repair, TS140S, TS690S, RZ-1, TS-790A,
TS950SD, TH-78A, TH28/48A, TM-941A,
TM-741A, TM-732A, TM-641A, TM-742A.

MARINE RADIOS

ICOM M7, M11, M56, M700TY, M800,
AVIATION PORTABLE ICOM A22,
MOTOROLA, TRITON MARINE, KING KX99.

SCANNERS

AOR:
900, 1000,
1500, 2500,
2800, 3000A
ICOM:
R-1, R100,
R71A, R72A,
R7000,
R7100,
R9000
Bearcat

ICOM HANDHELDS

F30LT, -40 LT, W31A, Z1A, V68,
W21AT, 2GXAT, T21A, T22A,
2GXAT, 4GXAT, V21AT, X21AT.



ICOM Repeater
VHF or UHF
Synthesized



LANDMOBILE HT'S

ICOM: U16, H16, V100, U400
MAXON, MOTOROLA,
YAESU: FTH 2008/7008
UNIDEN, REGENCY, KING,
MARINE ICOM: M7, M56, M700
AVIATION ICOM: A22, A200



TH-79A Kenwood
FT-51R Yaesu

SATELLITE TELEPHONES

Ultimate, transportable telephone
communications terminal. Make
and receive phone calls, fax, telex,
data, anywhere in the world where
there are no phone lines. Small,
compact with 1.2 meter dish. Fits
in suitcase. Also, larger units for
marine & building mounts
Write or call.

Save money on batteries.
Ask for Special Prices.

Barry's supplies all
MFJ products
Call us direct.

Surveillance Devices
Available

Linear Amplifier

Ameritron, Icom, Kenwood, Yaesu

ZIA

IC-H16/U16

IC2IA

MOTOROLA RADIUS
COMMERCIAL RADIOS

Wide selection of SW &
Amateur Publications

Antenna Tuners:

MFJ, AEA AT-300,
ICOM, KENWOOD,
YAESU, VERTEX

**COMMERCIAL
& HAM
REPEATERS
STOCKED.
WRITE FOR
QUOTES**

Kantronics
KAM PLUS, KPC 2/3/4,
KPC2400, SUPER FAX II,
KPC IV, Data Engine, D4-
10, etc.

**SHORTWAVE RECEIVERS
STOCKED**

Shortwave Receivers

• SONY • GRUNDIG • JRC
• YAESU • ICOM

Call 2212-925-7000

Satellite telephone in suitcase for
worldwide use. CALL

CB Radios Stocked

148 GTL, Warington, Ranger 2950-70,
Wilson 1000, 10/11 Meter Antennas,
Antron, Shakespeare, etc.
Astatic power mics, Power & ECHO mikes
Silver Eagle w/beep, etc.

Computer Interfaces

Stocked: MFJ-1270B,
MFJ-1274, MFJ-1224, AEA
PK-88, MFJ-1278T, PK-900,
PK-232 MBX W/FAX, DRSI
PRODUCTS DSP 2232

Domestic & Special
Prices for Export

GP300, GM300, P110, FP50, etc.

**MOTOROLA AUTHORIZED DEALER
KACHINA COMMUNICATIONS DEALER**

**AUTHORIZED
DEALER**

SONY

Shortwave Radios Stocked
DIGITAL FREQUENCY COUNTERS

OPTOELECTRONICS model 1300 H/A, 0-1300MHz
2300, 2210 H, 0-2200 MHz, 2600H, UTC-3000, 2810

Long-range Wireless
telephone for overseas. CALL

**BENCHER PADDLES
BALUNS, LOW PASS FILTERS
IN STOCK**

MIRAGE/RFC Amplifiers
ASTRON POWER SUPPLIES
Belden Wire & Cable, Int'l Wire
OPTOELECTRONICS STOCKED

**Radios for Business,
Government
Stocked & Serviced
Call or FAX for Great Prices!**

Telephone Autopatch

Patches telephone calls from your radio to phone line,
Great for making and receiving phone calls where there are
no phone lines. Simple to use. Write or fax for inquires.

Shortwave Radios

**JRC, ICOM,
KENWOOD, YAESU,
SONY and GRUNDIG**

**Amplifiers, HF/VHF/UHF
AMERITRON, etc.**

Hy-Gain Towers
will be shipped
direct to you
FREE of
shipping cost.

ANTENNAS:
AEA, AlphaDelta,
ANLI, Antenna
Specialist, Barker &
Williamson,
Comet, Cushcraft,
Diamond, GAP,
Hy-Gain, Hustler,
Larsen, Etc.



EIMAC
3-500Z
572B, 6JS6C
12BY7A &
6146B



GARMIN GPS RECEIVERS

BARRY ELECTRONICS CORP., 540 BROADWAY, NY, NY 10012 (Five blocks N. of Canal St., between Spring & Prince St.) **FAX 212-925-7001 Phone 212-925-7000**

New York City's

LARGEST STOCKING TWO WAY RADIO DEALER
COMPLETE REPAIR LAB ON PREMISES

"Aqui Se Habla Espanol"

BARRY INTERNATIONAL

FAX 212-925-7001 Phone 212-925-7000

For Orders Call 1-800-990-2929

Monday-Friday 9 AM to 6 PM

Saturday 10-5PM/Sunday 11-5PM

Subways: #6 Spring St. stop, N. or R. train to Prince St. stop
F train to Houston St. stop.

Bus: Broadway bus to Prince St. stop, Path train to 9th St./6th Ave.

**COMMERCIAL RADIOS
STOCKED: ICOM, Motoro-
la, MAXON, Standard,
Yaesu. We serve municipa-
lities, businesses, Civil
Defense, etc. Portables,
mobiles, bases, re-
peaters...**

We stock: AEA, Alinco, Ameco, Ameritron, Antenna Specialist, ARRL,
Astatic, Astron, B&K, Belden, Bencher, Bird, Butternut, CES, Cushcraft,
Codan, Daiwa, Eimac, Henry Heil, Hustler, Hy-Gain, Icom, KLM,
Kantronics, Kenwood, Larsen, Maxon, MFJ, Mirage, Motorola, Nye,
Palomar, RF Products, Shure, Standard, TUBES & Tube Cartons,
Uniden, Yaesu, Vibroflex, Duplexers, Repeaters, Scanners, Radio

**WE NOW STOCK COMMERCIAL COMMUNICATIONS SYSTEMS
DEALER INQUIRIES INVITED PHONE IN ORDER & BE REIMBURSED
COMMERCIAL RADIOS STOCKED & SERVICE ON PREMISES.
EXPORT orders shipped immediately. CALL**

SALES FINAL

Technical help offered upon purchase

FAX: 212-925-7001

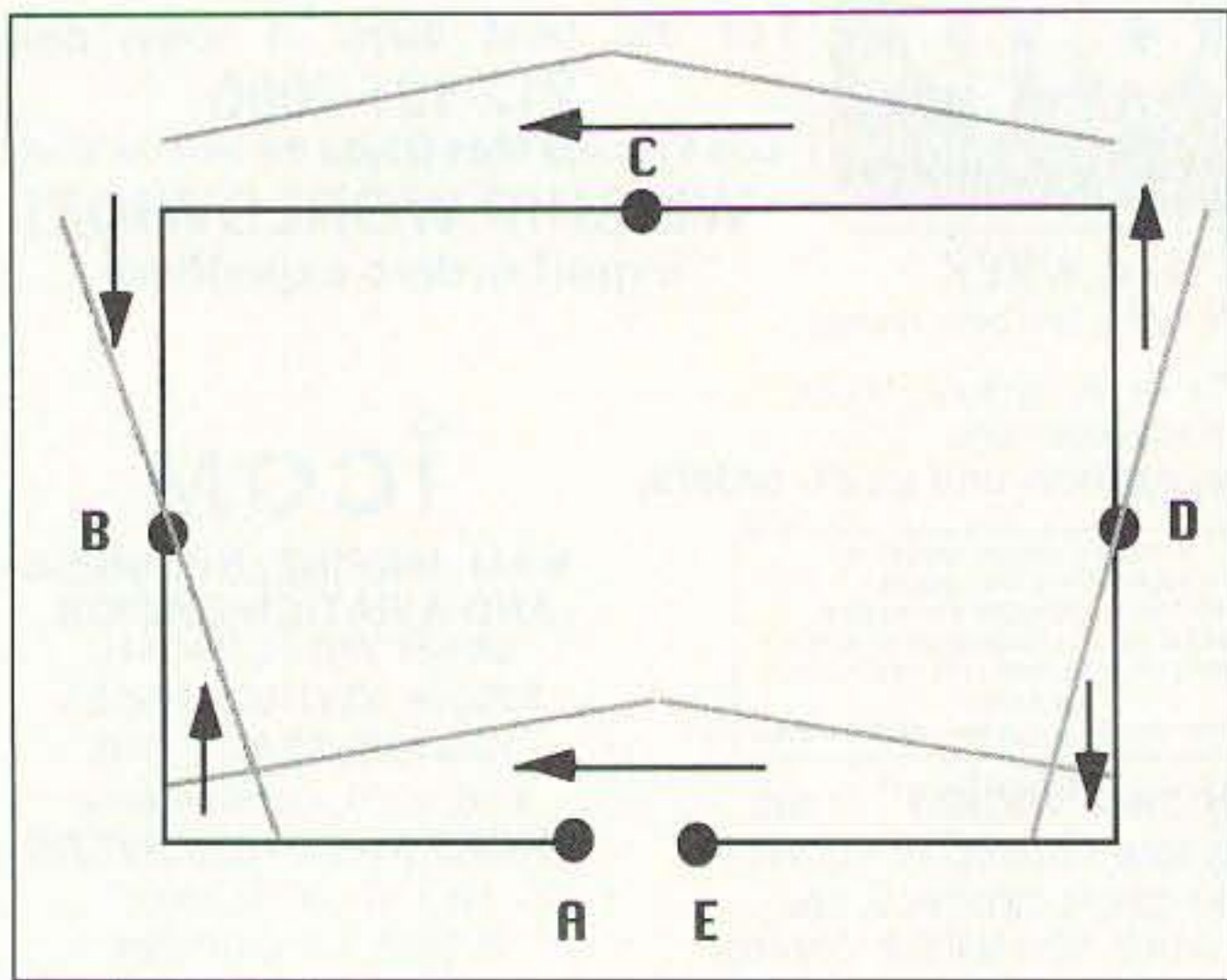

Figure 3. Current distribution of a quad loop.

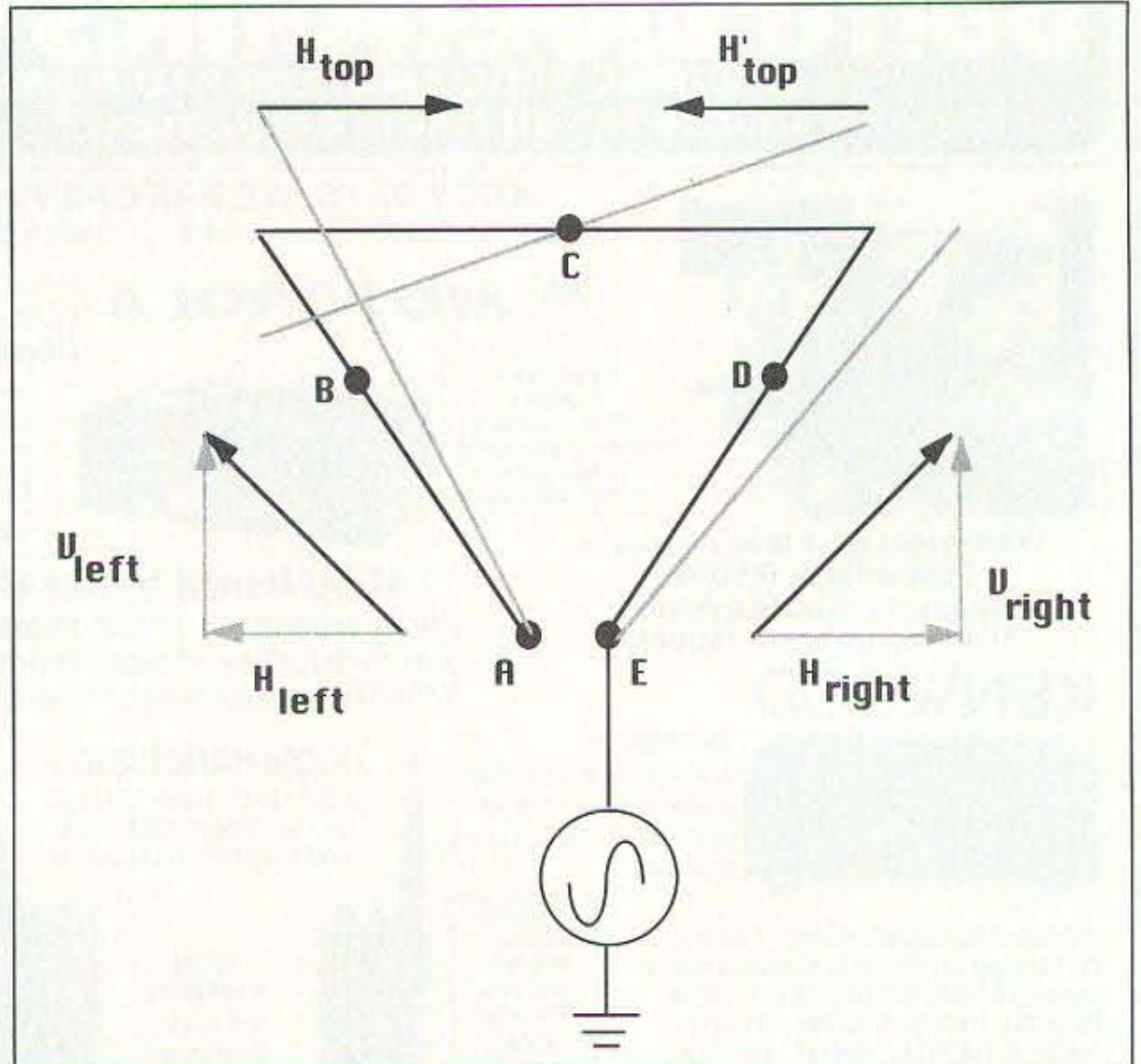

Figure 5. Current distribution of an end-fed full-wavelength loop.

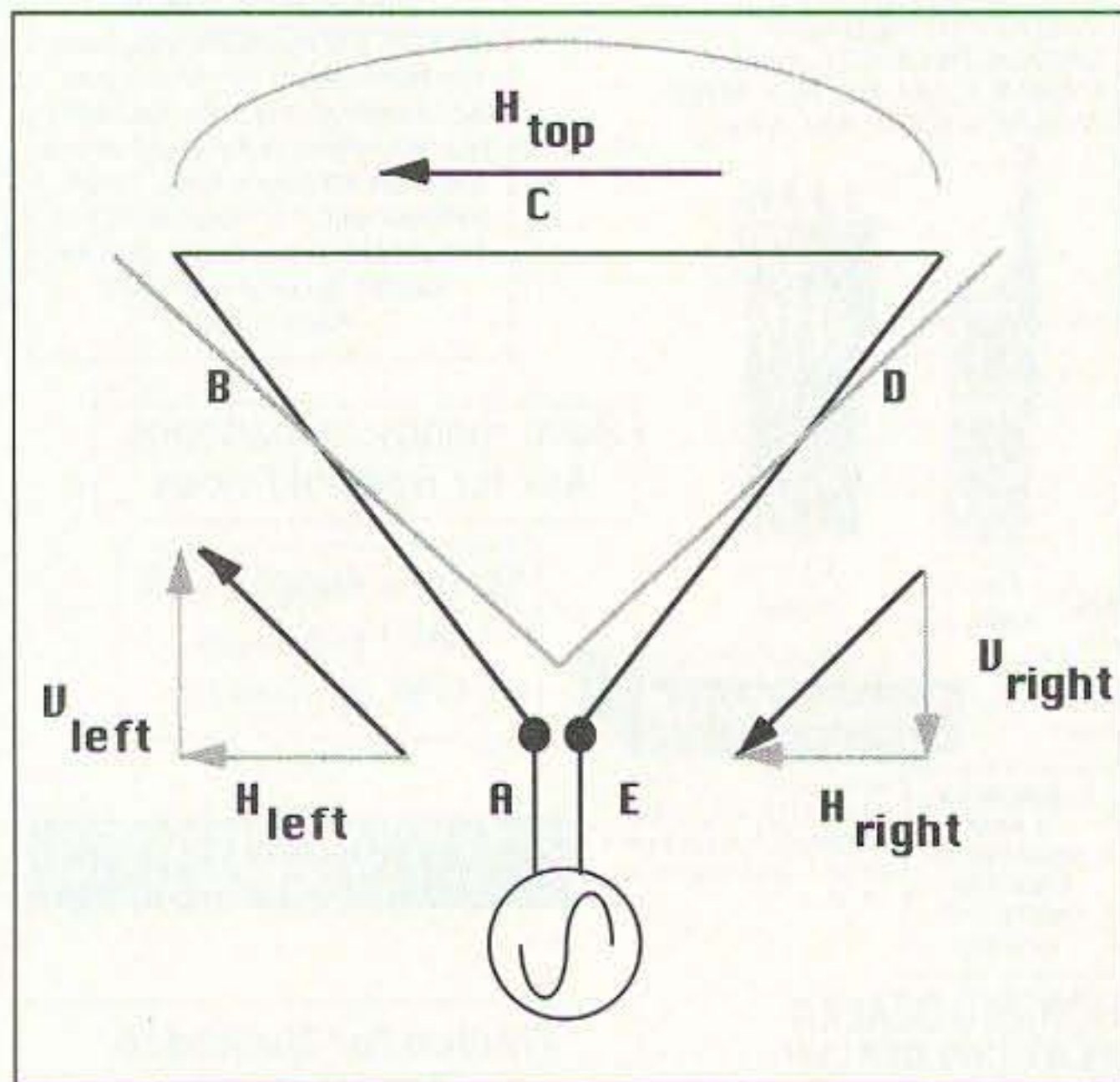

Figure 4. Current distribution of an inverted delta loop, balanced fed.

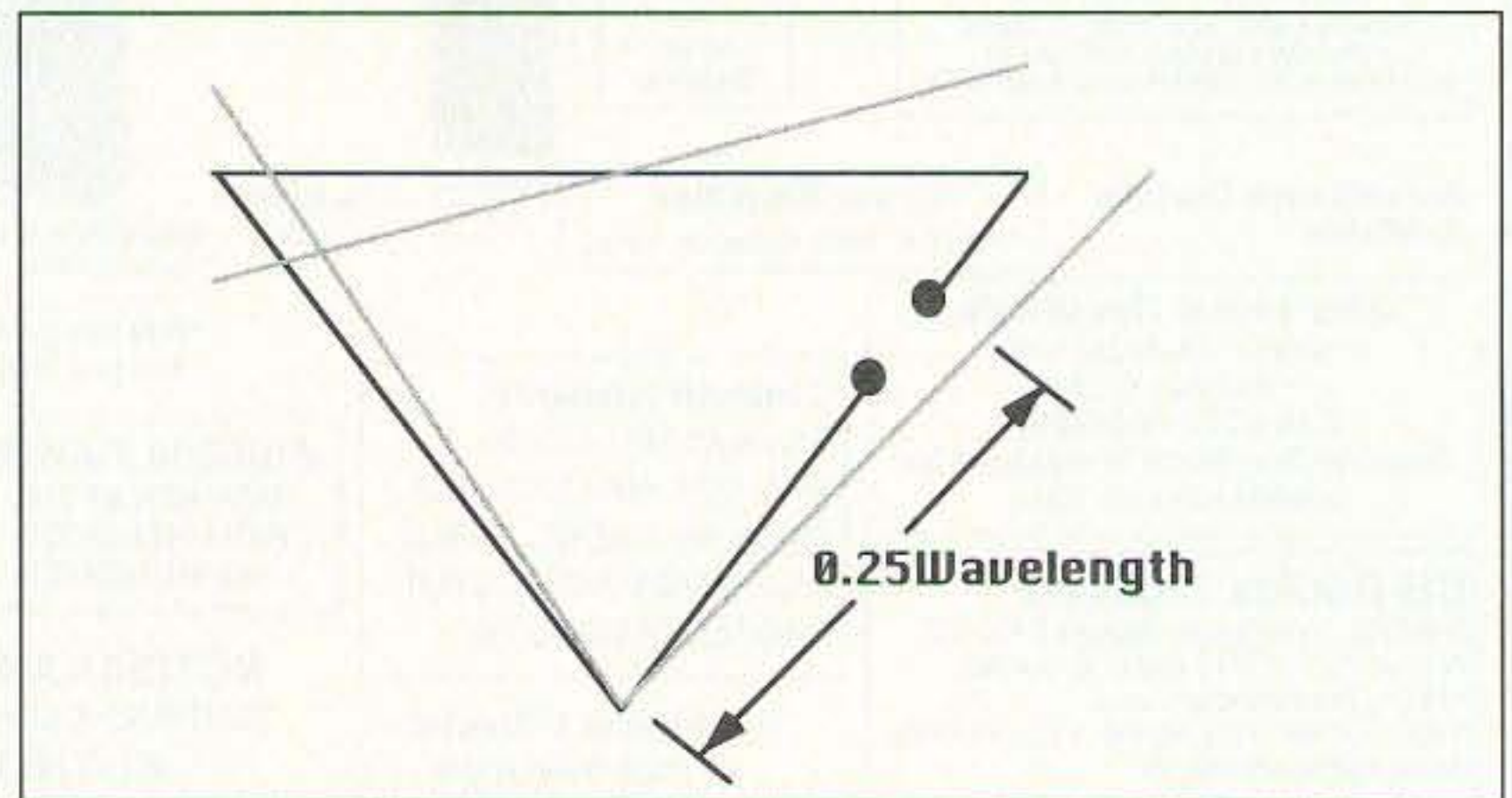

Figure 6. Current distribution of an inverted delta loop, side-fed.

(correctly so) that the directivity will be different when it is fed in these two different ways.

Looking at the end-fed antenna plot from a direction perpendicular to the wire's axis, radiation from the two equal but opposing currents cancels. On the other hand, the center-fed antenna's in-phase currents add up to produce maximum radiation in this same direction. Figures 2C and 2D show this (the plots are for free space patterns; the wire axis runs side to side in both plots).

So, by simply moving the feed point, we can get very different radiation patterns from the same piece of wire.

Balanced-Fed Loop

Let's now draw the current distribution for a balanced-fed inverted delta loop by starting with a quad (square) loop. You can think of a quad loop as two half-wavelength dipoles stacked a

quarter wavelength apart, with their ends bent up (and down) to touch each other. See Figure 3.

We know from our experience that the quad loop has a low input impedance, so current must be at a maximum at the center feed point, point A-E (and also at point C opposite the feed point). The quad's upper and lower halves' current distribution does in fact correspond to a pair of dipoles. Compare the current distribution of the top and bottom halves of the quad with the dipole shown in Figure 1: They are the same.

We can now reshape the quad loop, along with its current distribution, into an inverted delta loop shape, shown in Figure 4. To see what's happening, we break the side leg currents into their horizontal and vertical components, H and V. These are shown as Hleft and Vleft for the *horizontal* and *vertical*

components on the left leg of the loop, and as Hright and Vright for those on the right leg. The current in the top section, Htop, flows strictly in the horizontal direction (to the left).

The horizontal side currents Hleft and Hright both run in the same direction as the horizontal current Htop in the top portion of the antenna (to the left), so all three add up. Hence we have horizontally polarized broadside radiation from this antenna.

We see that Vleft and Vright go in opposite directions (up and down, respectively). Therefore, these vertical current components cancel each other in a direction broadside to the loop—that is, in and out of the plane of the page—and there is no broadside vertically polarized radiation. (Due to the side leg spacing, there will be some vertically polarized radiation in the endfire directions.)

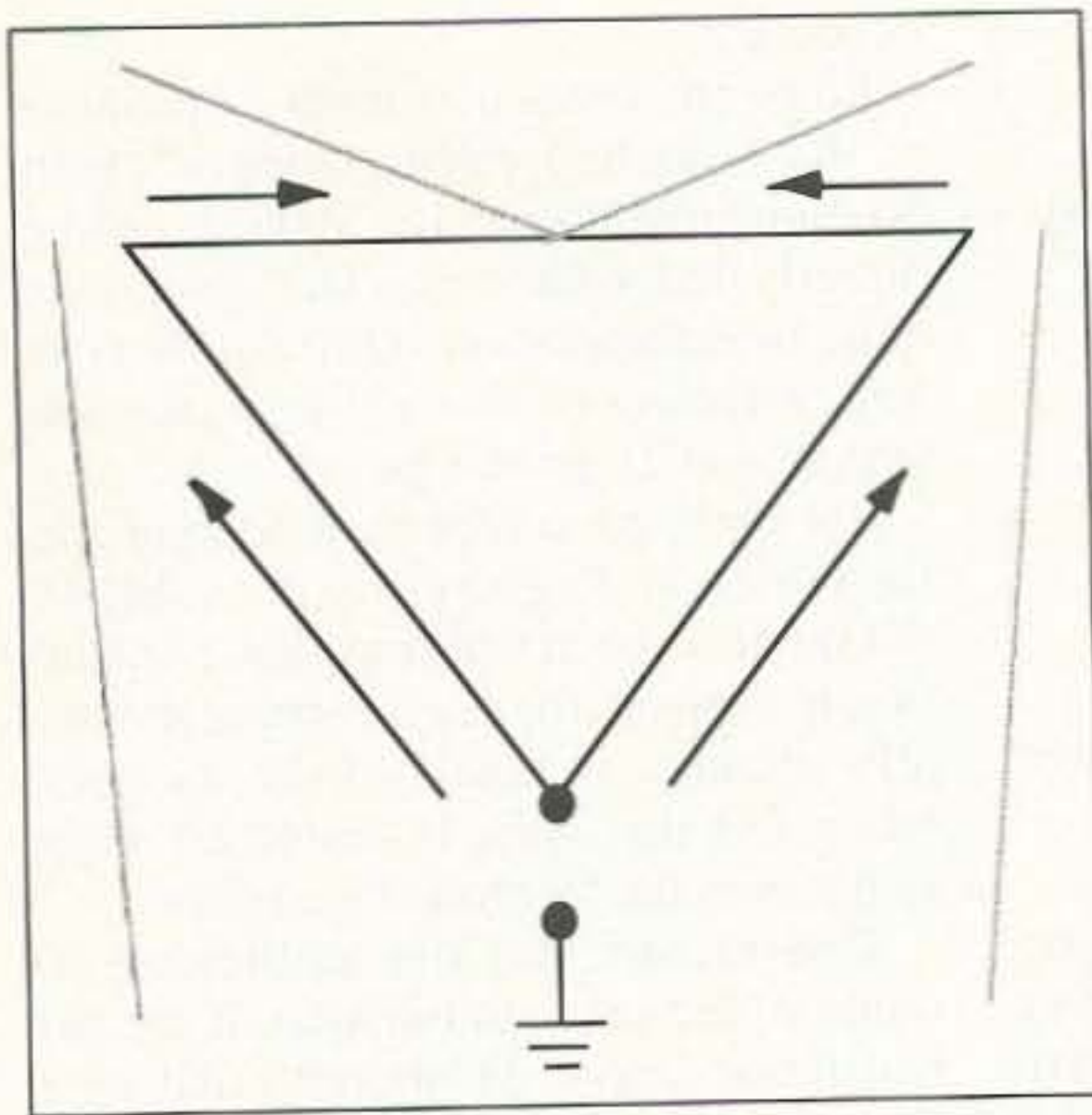

Figure 7. Current distribution of an inverted delta loop, $F = 1.9 \text{ MHz}$, fed as a vertical element.

End-Fed Loop

Now what about feeding only one of the wires, leaving the other unconnected? Let's fold the one-wavelength, end-fed wire of Figure 2B into an inverted delta shape along with its current distribution (see Figure 5).

We now have high impedance at our feed point as the current maximums have moved to points B and D of Figure 5. This altered current distribution in the loop changes its pattern, just as we saw with the straight wires in Figures 2C and 2D.

In this case, there are two horizontal currents (H_{top} and H'_{top}) in the top portion that are equal in strength but run in opposite directions and so cancel. The side leg currents, broken again into horizontal and vertical components, show that H_{left} and H_{right} also run in opposite directions and they too cancel. The result is no horizontally polarized radiation.

But the vertical components V_{left} and V_{right} now run in the same direction (up) and so aid each other. Thus, we have vertically polarized broadside radiation from the antenna when it is fed this way.

And depending on the spacing of, and relative phasing of current in, the two side legs, we also have the potential for endfire vertically polarized radiation. But we haven't yet explained the two different endfire directivities noted on the air.

Endfire Directivity

The end-fed loop currents in the side legs should be in phase with each other since the distance from the feed point to the end of the antenna is exactly one

wavelength; 360° of phase shift brings you around to 0° , in phase again. If this were actually so, the end-fed loop would have exactly the same pattern in both endfire directions.

But this is not so. We have observed endfire pattern changes when switching feeds from one end to the other. This could occur only if there were an extra amount of phase shift in the currents as they moved along the wire. What can the source of this phase shift be?

Traveling Waves

It is caused by "traveling waves" on the antenna. Non-center-fed antennas display a traveling wave effect. This shows up as an increasing phase shift in the current as we move away from the feed point. It is mostly the result of RF energy being radiated from the antenna. The effect of the traveling wave is to skew the pattern of an antenna, pulling it in the direction of the wire axis away from the end feed point^{3, 4, 5}.

In the case of our end-fed loop (which, you recall, is a bent, end-fed antenna), it makes the pattern nonsymmetric in the two endfire directions. This shows up as different low-angle gain and a high-elevation angle null that is tilted away from the end being fed.

Side Feed

Another possible feed arrangement for the inverted delta loop is to break it at an upper corner to feed. This is reported to be a good configuration for DX with a strong, low-elevation angle, a vertically polarized lobe, and only a weak high-angle lobe⁶.

A further refinement is to feed it below the upper corner, on one side leg, at a distance of a quarter wavelength up from the wire axis at the bottom (see Figure 6)⁷. This side feed location forces the currents in the two bottom legs to reverse direction exactly at the bottom junction and exactly in the middle of the top section, when the loop is operated at resonance.

This gives perfect current symmetry: The vertical components add up and the horizontal components cancel, to the greatest possible extent. This maximizes the strength of the low-elevation angle lobe, while producing the deepest high-angle null.

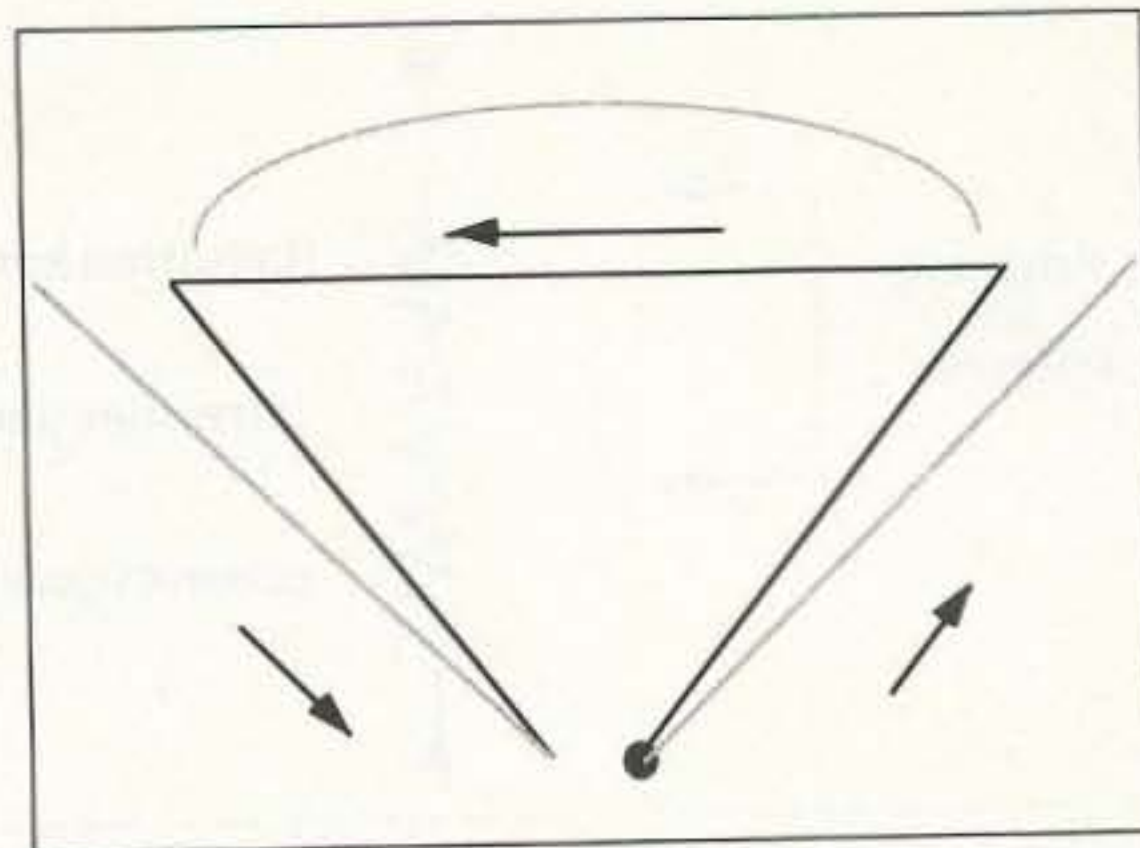

Figure 8. Current distribution of an inverted delta loop, $F = 1.8 \text{ MHz}$, end-fed.

Surprise Number Two

Drawing the currents of the side-fed loop shown in Figure 6 reveals a startling fact: The current distribution is exactly the same as for our end-fed loop! Compare it with Figure 5.

I had long wanted to try the side feed arrangement, but was daunted by the fact that this configuration would not be optimum for non-DX contacts and that the upper corners of my loop were located in high trees. So there would be no easy, quick way of changing the feed point from bottom to side, and vice versa, to switch modes. End feeding the loop solved these problems and gave switchable endfire directivity, too.

You Mean There's More?

Yes, 160m can also be had with this piece of wire. Here's how: If you could grab the middle of the top of the loop and stretch it all the way up, you'd have a quarter-wavelength long, 160m vertical antenna consisting of two parallel wires connected at the top.

So I thought to feed the wire as a "squashed" or wide cage quarter-wavelength long vertical antenna. I did this by tying both bottom ends together and feeding them against ground. The input impedance was about 50 ohms.

Once more we can plot the currents (see Figure 7), remembering that on 160m the wavelength is twice as long as on 80m. Based on an analysis of the current as before, the horizontal components of the current in the sides and top run in opposite directions and so cancel. This leaves only the vertical components of current in the sides running in the same direction (up) and so add together, and we have vertically polarized radiation.

Another ham suggested that I ground one end of the loop and feed the other against ground. This turns it into a conical, vertical, folded unipole (half of a

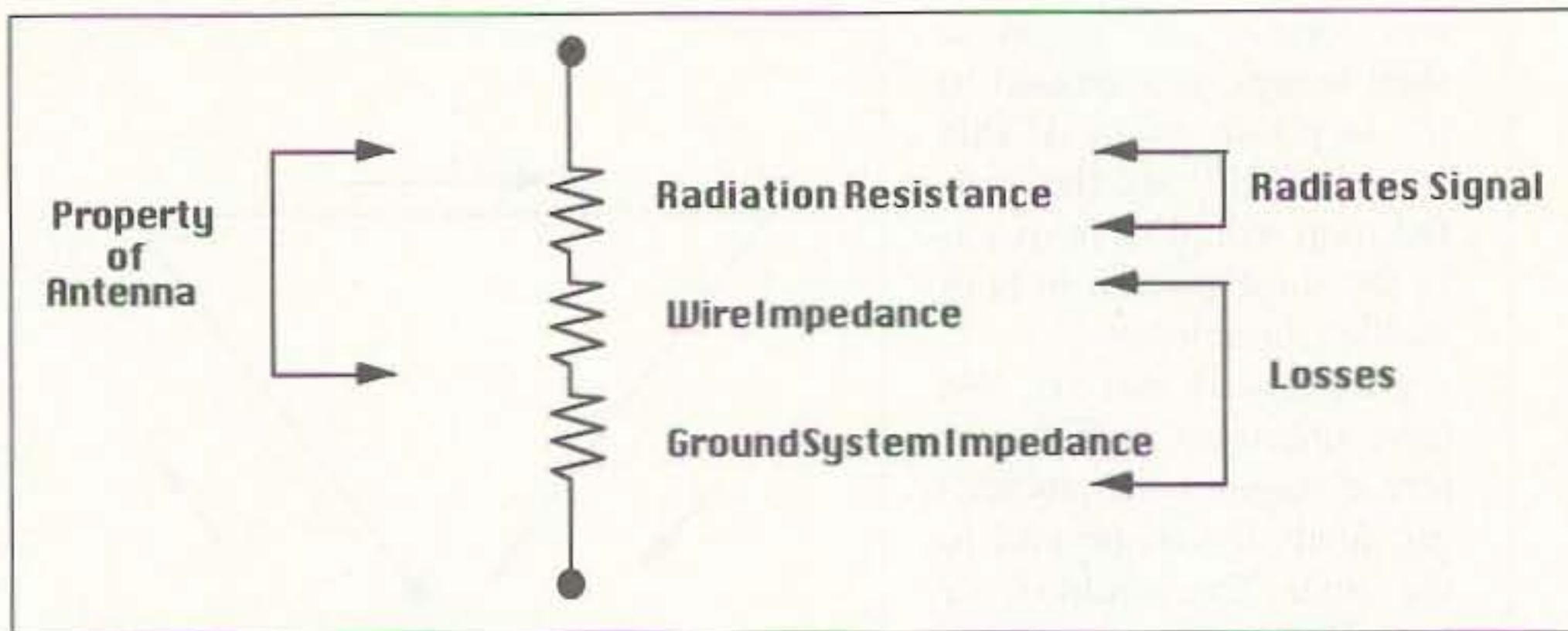

Figure 9. Equivalent circuit of a vertical antenna and ground system.

folded dipole). The feed point impedance is about 75 ohms, which still allows direct coax feed. This configuration works about as well as the squashed vertical feed arrangement above but is sometimes noisier on receive.

Don't kid yourself about improved efficiency here, though. It's just the input impedance of the antenna that's been stepped up by the folded dipole action. Series losses due to ground resistance are still there to the same extent⁸.

Let's give that end-fed trick a try on 160 too, again using the L-network and fed against ground. We could be surprised some more; it sometimes worked better than the squashed vertical configuration and occasionally displayed some mild directivity when I swapped feed ends. Looking at the currents (Figure 8) shows that it's a mostly straight-up, horizontally polarized broadside radiator with vertically polarized endfire radiation. This should give a decent combined polarization, omnidirectional pattern.

Ground System

In general, you need a good ground system to get the most out of antennas that produce vertically polarized radiation, as our end-fed and squashed vertical fed loop does.

With a base-fed quarter-wavelength vertical antenna, current flow is maximum at its bottom end, right next to the ground. The amount of ground current that is caused to flow depends on the amount of antenna current flow closest to the ground.

As a result, a large amount of current will flow in the nearby ground around the base of a quarter-wavelength antenna. This leads to highest I^2R_{GROUND} losses as the ground currents fight their way, in a radial pattern, back to the base of the antenna through lossy soil, heating up the dirt.

For this kind of antenna to work most efficiently, the ground system must in-

tercept as much of the surrounding ground current as possible and convey it, with the least amount of loss, back to the base of the antenna.

As the ground resistance appears in series with the impedance of the antenna, power applied to the antenna will divide between them depending on the relative impedances. The ground system is therefore very important for good performance in this situation. A good radial or counterpoise (elevated radial) system, plumbing connections, ground rods, and so forth are needed to get the most performance from such antennas.

This shows why we need to think of the combination of antenna and its ground as a system.

160m Ground

On 160m, we're running the squashed vertically fed loop just like a quarter-wavelength vertical antenna (maximum current at the bottom end of the antenna), and so a good ground system is

necessary.

Since the measured input impedance of our squashed vertical loop is about 50 ohms resistive at 1.9 MHz, it can be directly fed with coax. The antenna is quite broadband on 160m due to 1) its large effective diameter (like a cage antenna), and 2) ground losses.

But both my computer modeling and the *Antenna Engineering Handbook*⁹ tell me that the actual impedance (radiation resistance, the useful part that actually radiates a signal) of the antenna, when fed this way, is about 20 ohms rather than the 50 ohms I measured.

This means that the additional 30 ohms is due to a combination of ground resistance (about 28 ohms¹⁰) and wire impedance (about 2 ohms; this is not DC resistance but the RF impedance of the wire that is higher due to the skin effect—see Reference 1) that show up in series with the radiation resistance of the antenna. Figure 9 shows the equivalent circuit of the system.

This causes inefficiency, about 8 dB worth, which means I'm throwing about 60% of the power away with my particular ground system! A better ground system would reduce this loss and thereby increase antenna efficiency.

Your tip-off here to better performance is that the antenna's measured input impedance will drop toward, but won't quite ever reach, about 20 ohms as the ground system is improved.

75m Ground

When our loop is end-fed on 75m, its current maximums (points B and D in

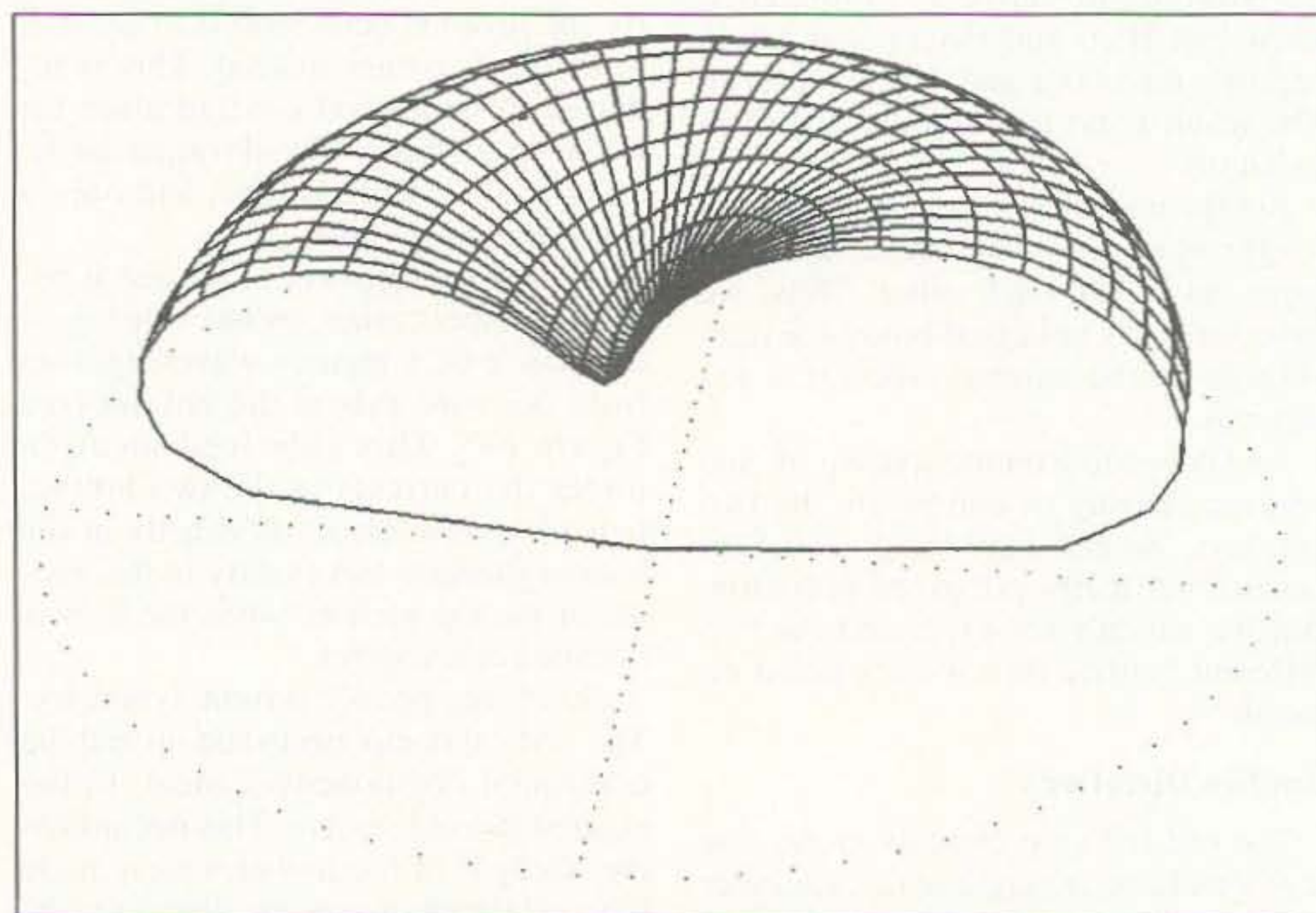
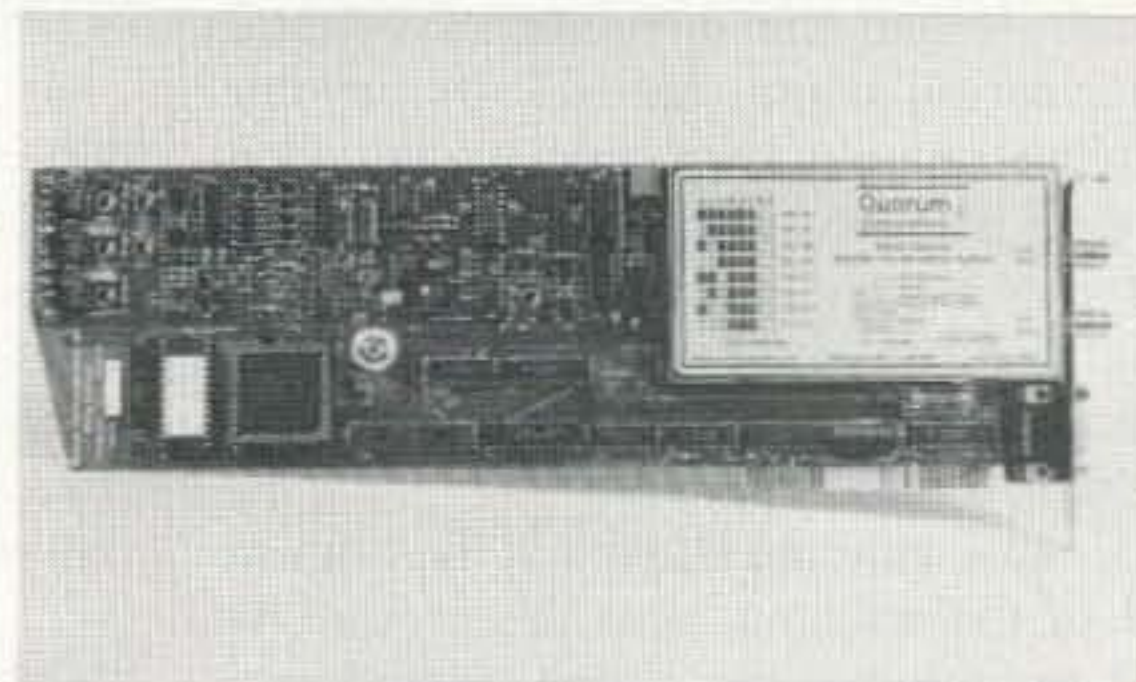
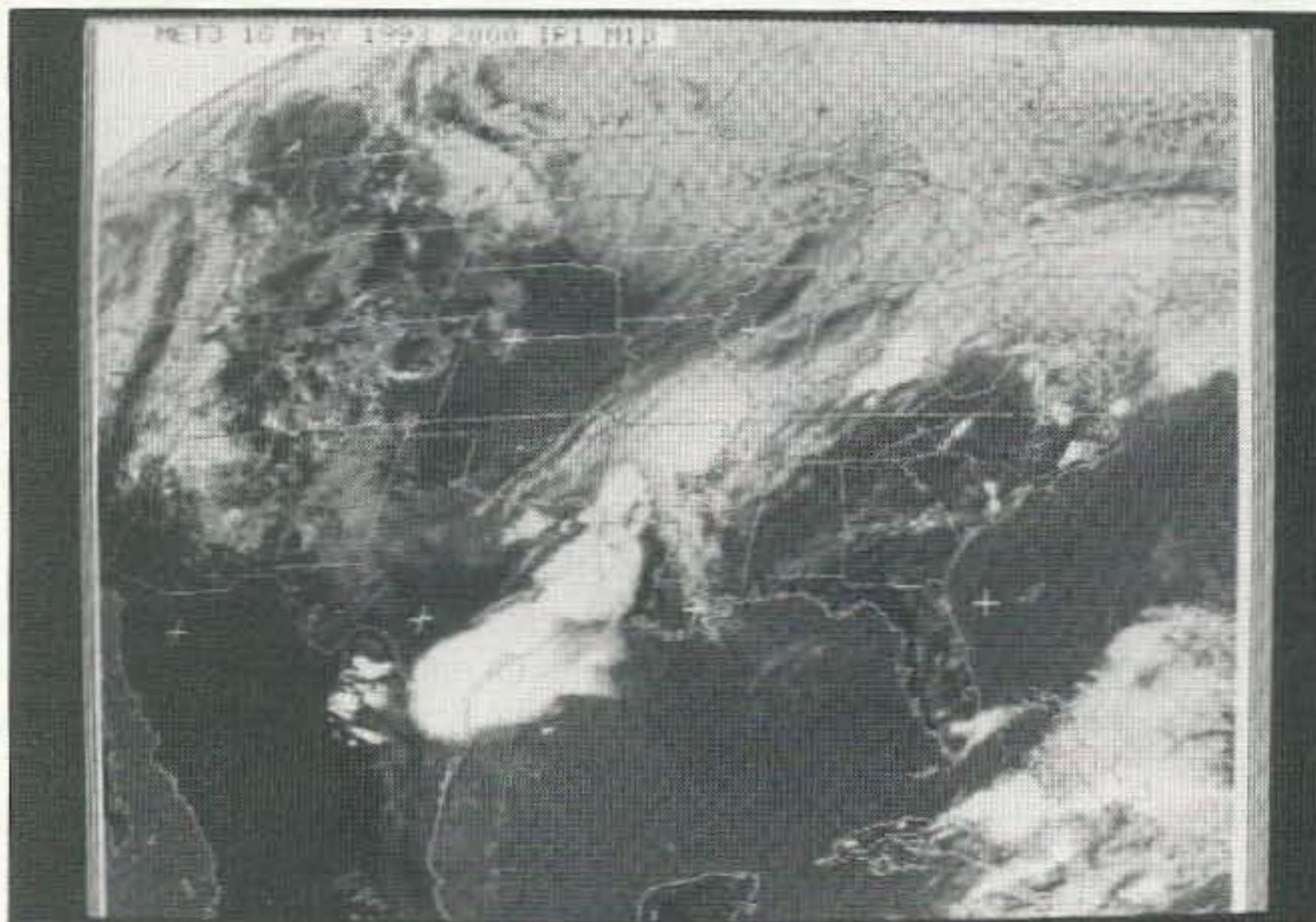

Figure 10. The 3-D plot of the end-fed loop (75 meters), showing the high-angle null in the pattern which is tilted away from the end being fed, and the low-angle lobe all around.

Explore The World of Quorum Wefax



Wefax Explorer

Integrated Wefax / APT Receiver and Scan Converter with Qfax software.

\$695.00 complete
shipping and taxes not included

The Best Price / Performance. Period!

Construct a Wefax / APT reception system from individual component receivers, scan converters and image processing software and you'll spend more money for fewer features, poorer performance, no automation and a jungle of wires. With the Wefax Explorer, simply connect an antenna and a few mouse clicks later you're receiving the highest quality images possible. The Explorer is backed by a 1 year limited warranty and the extensive experience of the leading Wefax hardware manufacturer. Quorum equipment is used by virtually all wefax suppliers in worldwide amateur, commercial and military systems.



QFAX Features

- GOES / Meteosat Wefax Reception
- NOAA / Meteor APT Reception
- HF Nafax Reception
- Dual RF ports for geosync and polar reception under software control
- Integrated preamp and down converter power inserters
- 50 user definable configurations
- Software controlled receiver with 2 UHF, 10 VHF memories and scan
- On board audio amplifier and speaker with software controlled volume, squelch and mute
- Automatic Unattended Animation works continuously
- 8 bit data for up to 256 gray levels
- View at up to 1280 x 1024 256 color
- Use TIFF, GIF or PCX file formats and convert to BMP, JPEG, EPS and binary
- Contrast, Brightness, 3D effect, Sharpen, Smooth, Noise, Histograms and other image processing

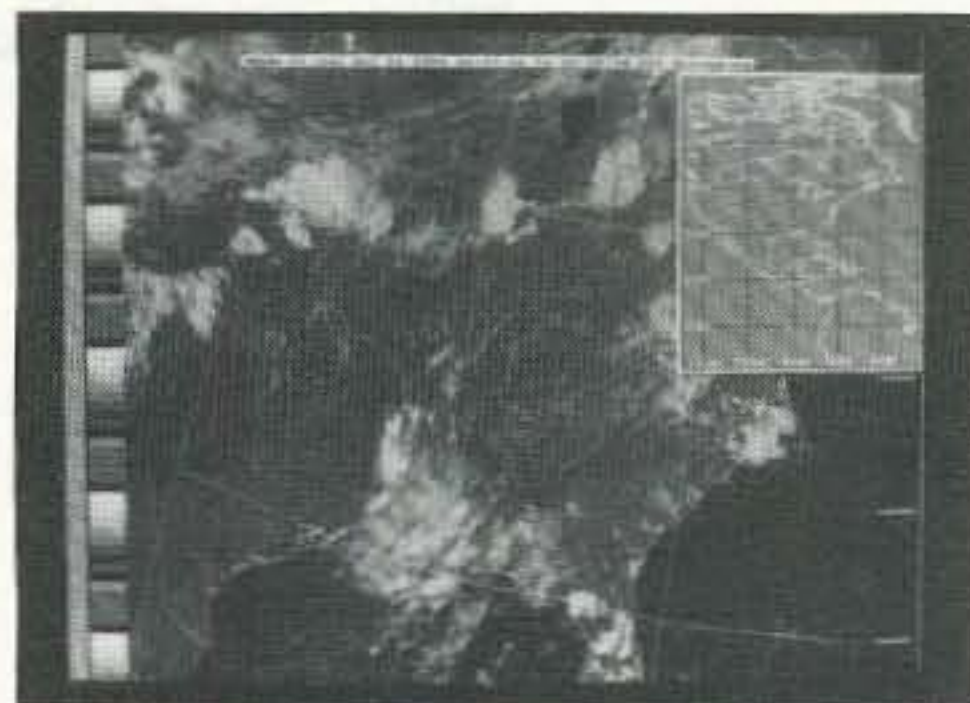
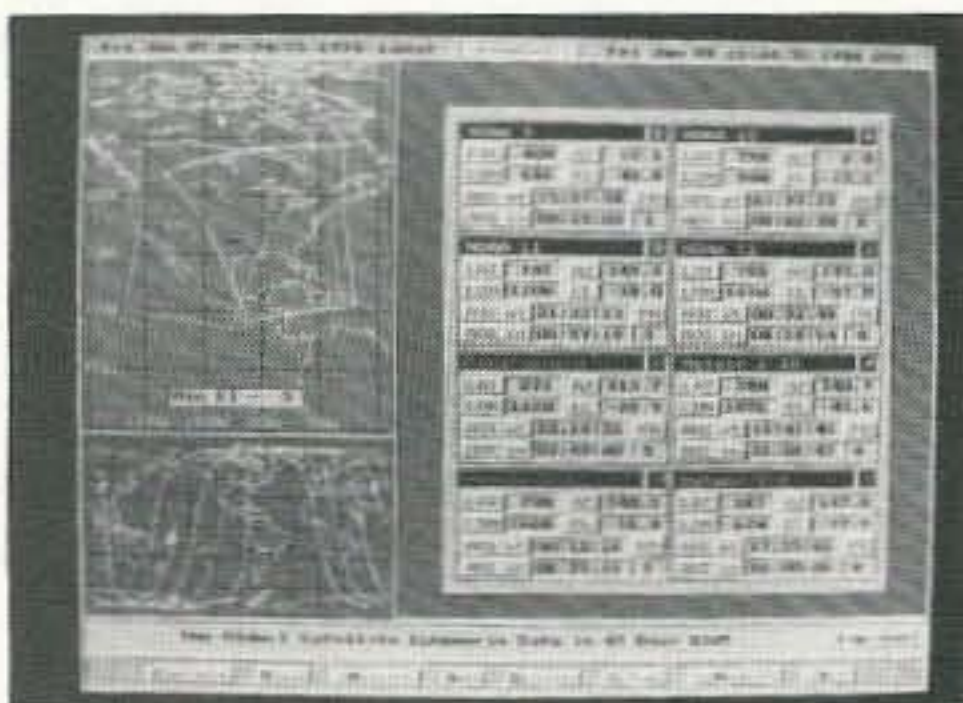

- Integrated Satellite visibility prediction with automatic capture for up to 8 satellites simultaneously
- Automatic time and ephemeris stamping for navigation
- 2 7 day programmable schedulers
- Automatic digital gain lock in ALL modes, PLL clocking
- Ephemeris based NOAA APT navigation with geo-political and Lat-Lon overlays
- NOAA Tools show satellite path, Lat-Lon of cursor, distance and bearing to reference point
- Automatic Temperature Calibration
- Color Palettes and NOAA curves

Quorum Communications, Inc. FAX (214) 915-0270
8304 Esters Blvd. - Suite 850 - Irving, Texas 75063 (214) 915-0256 BBS (214) 915-0346

Figure 5) are raised up off the ground, to a height approaching a quarter wavelength. Recall that it produces vertical polarization when end-fed. Its current distribution is like a half-wavelength vertical antenna, with the current maximum now raised up a quarter wavelength in the air. Rotate the dipole of Figure 1 by 90° and put one end touching the ground to see this.

Because antenna current at the bottom end of the antenna, near the ground, is now minimum, less (lossy) ground current is induced. Also, the feed point impedance is now higher so that relatively less voltage gets developed across the ground system impedance, as in Figure 9. This means that ground system requirements are less stringent for our end-fed loop on 75m than they are on 160 m¹¹.

Because those parts of the antenna radiating the most (the current maximums) are now raised off the ground, the end-fed loop on 75m shares some of the other advantages of a half-wavelength vertical antenna: 1) A slight lowering the elevation angle of radiation; and 2) Better clearance of nearby obstacles. Overall, there is a reduction of

ground, environment, and feed losses, relative to a base-fed quarter-wavelength vertical.

My loop worked satisfactorily with four insulated-wire, quarter-wavelength radials that just lie on the ground. Two radials are cut for 75m and two for 160m. They lie in the plane of (directly beneath) the antenna in both directions. This arrangement of radials gives me maximum measured RF ground current.

Broadcast Band

Since the upper edge of the standard AM broadcast band lies just below 160m, I thought to try the antenna and its feed variations there. I noted different reception effects when changing among the feed types, down to about 1100 kHz though they are strongest toward 1600 kHz.

For example, feeding the antenna as a squashed vertical brought one vertically-polarized 50 kW BC station on 1560 kHz located within ground-wave range well up in signal strength. Switching to end feed suppresses it so greatly (20 to 30 dB) that co-channel skywave-propagated stations never before heard become audible.

On one occasion, switching among balanced, end, and squashed vertical feed allowed three different co-channel stations to be logged. This is an admittedly rare occurrence but illustrates how useful selectable directivity and polarization can be.

SWLing

As the loop shows numerous HF resonances, it's not surprising that it's useful all the way up to the top of the HF spectrum and beyond. Once again, the various feed arrangements are useful in optimizing HF reception. As before, some feeds optimize SNR and some optimize signal strength; they are not always the same!

Since the antenna is so broad and flexible, I believe that construction of the largest loop within the limits of available real estate and supports, regardless of its size (and therefore resonant frequency), would provide an excellent SWL antenna. The L-network could probably be dispensed with for reception, but you'd definitely want to be able to switch easily among various feed arrangements.

Other Bands

The loop also works fine on 40, 20, 15, and 10 meters using the various feed and matching arrangements. I haven't tried it on 30, 17, or 12 meters yet but I'd expect good results there too.

Other Loop Shapes

I think it's worth trying these various feed arrangements with any other loop shape (quad, delta, circular, and so forth) as well, no matter what their height above ground, or length and type of feedline, or whether they are oriented in the vertical or horizontal plane, or anywhere between.

Computer Modeling

After using the antenna for several years, I was able to model it using the MININEC antenna analysis program. MININEC has certain limitations when modeling antennas with horizontal wires, or horizontally flowing currents, less than 0.2 wavelengths off the ground: For example, gain predictions will be too high, but pattern shapes will be reasonably correct¹².

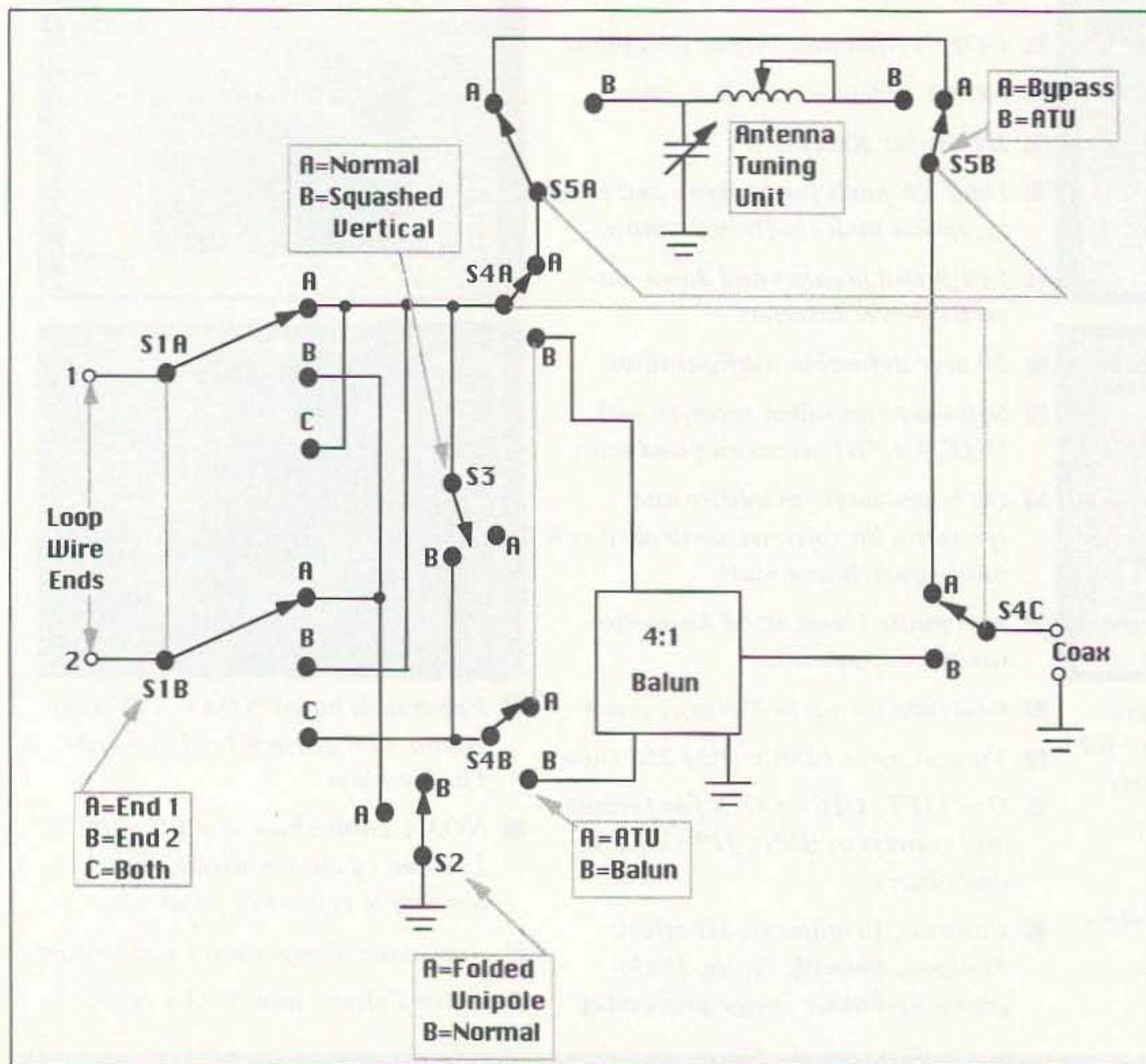

Figure 11. Loop switching and feeding arrangement for convenient selection of all the different feed arrangements described.

COMET

MODERN, MULTI-BAND ANTENNA SYSTEMS

MOBILE ANTENNA PRODUCTS



Modern, high-performance stations use COMET Antennas, Duplexers, Triplexers and Accessories! COMET products are designed to provide an exceptional level of signal quality and coverage area. Whether operating mobile or from your base station, COMET products make you sound good. No other product line has the selection, convenience, quality and performance!

DUAL-BAND MOBILE ANTENNAS

FL-67S Dual-Band 146/446MHz w/Fold-Over, No Ground Plane Required
Gain & Wave: 146MHz 4.5dBi 1/2 wave, 446MHz 7.2dBi 1/2 wave x 3
VSWR: 1.5:1 or less
Max Power: 150 watts
Length: 4' 11"
Connector: Gold Plated PL-259

FL-62S Dual-Band 146/446MHz w/Fold-Over, No Ground Plane Required
Gain & Wave: 146MHz 3.5dBi 1/2 wave, 446MHz 6.0dBi 1/2 wave x 2
VSWR: 1.5:1 or less
Max Power: 150 watts
Length: 3' 5"
Connector: Gold Plated PL-259

NEW! **SB-7/SB-7NMO** Dual-Band 146/446MHz w/Fold-Over, No Ground Plane Required
Gain & Wave: 146MHz 4.5dBi 1/2 wave center-loaded, 446MHz 7.2dBi 1/2 wave x 3
VSWR: 1.5:1 or less
Max Power: 70W FM
Length: 4' 7"
Connector: PL-259 or NMO style

NEW! **SB-5/SB-5NMO** Dual-Band 146/446MHz w/Fold-Over, No Ground Plane Required
Gain & Wave: 146MHz 3.0dBi 1/2 wave, 446MHz 5.5dBi 1/2 wave x 2
VSWR: 1.5:1 or less
Max Power: 120W FM
Length: 38"
Connector: PL-259 or NMO style

NEW! **SB-2/SB-2NMO** Dual-Band 146/446MHz
Gain & Wave: 146MHz 2.15dBi 1/4 wave, 446MHz 3.8dBi 1/2 wave
VSWR: 1.5:1 or less
Max Power: 60W FM
Length: 18"
Connector: PL-259 or NMO style

B-10/B-10NMO Dual-Band 146/446MHz, Cellular Look-a-like
Gain & Wave: 146MHz 0dBi 1/4 wave, 446MHz 2.15dBi 1/2 wave
VSWR: 1.5:1 or less
Max Power: 50W FM
Length: 12"
Connector: PL-259 or NMO style

B-20/B-20NMO Dual-Band 146/446MHz, Cellular Appearance, No Ground Plane Required
Gain & Wave: 146MHz 2.15dBi 1/2 wave, 446MHz 5.0dBi 1/2 wave x 2
VSWR: 1.5:1 or less
Max Power: 50 watts
Length: 30"
Connector: PL-259 or NMO style

NEW! **SB-25/SB-25NMO** Mono-Band 146MHz w/Fold-Over, No Ground Plane Required
Gain & Wave: 146MHz 4.1dBi 1/2 wave center loaded
VSWR: 1.5:1 or less
Max Power: 100W FM
Length: 4' 9"
Connector: PL-259 or NMO style

COMET products are available from most major dealers. For customer service, or a complete catalog, please call us at 800/962-2611. We're confident COMET products and accessories will enable you to enjoy Amateur Radio to its fullest!

NEW! **COMET PRODUCTS**
 1275 North Grove Street
 Anaheim, CA 92806
 (714) 630-4541
 FAX (714) 630-7024

MINI SPEAKER/MIC



HM-P2K/F
 Mini spkr/mic featuring full TX/RX quality!
 Light weight, extremely small: 1"x2" with collar pocket clip.
 HM-P2K: Kenwood Version
 HM-P2F: Icom/Yaesu Standard/Ainco/etc.

TRI-BAND MOBILE ANTENNAS

CX-224/224NMO Tri-Band 146/220/446MHz, w/Fold-Over, No Ground Plane Required
Gain & Wave: 146MHz 2.15dBi 1/2 wave, 220MHz 3.6dBi 1/2 wave, 446MHz 6.0dBi 1/2 wave x 2
VSWR: 1.5:1 or less
Max Power: 100 watts
Length: 3'
Connector: PL-259 or NMO style

FJ-15S Tri-Band 52/146/446MHz w/Fold-Over
Gain & Wave: 52MHz 2.15dBi 1/4 wave, 146MHz 4.5dBi 1/2 wave, 446MHz 7.2dBi 1/2 wave x 3
VSWR: 1.5:1 or less
Max Power: 120 W FM
Length: 4' 10"
Connector: PL-259

HF MOBILE AND HT ANTENNAS



HA-4S Quad-Band HF 40/* (20)/15/12/10 Meters w/Fold-Over
Wave: 1/4 wave
VSWR: 2:1 or less
Weight: 1 lb. 14 oz.
Length: 4' 4"
Max Power: 120W SSB (200W SSB 28MHz)
Connector: PL-259

*L-14HS Optional 20 Meter Coil

SH-55 Super Flexible 146/446MHz HT Antenna
Gain & Wave: 146MHz 1.5dBi 1/4 wave, 446MHz 3.2dBi 1/2 wave x 2
Max Power: 10 watts
Length: 15.5"
Connector: BNC

NEW! **CH-722SA** High Gain HT Antenna
Gain & Wave: 146MHz 3.0dBi 1/2 wave, 446MHz 5.5dBi 1/2 wave x 2
Max Power: 50 watts
Length: 35", 2 sections, 18" each
Connector: BNC

CH-32 Miracle Baby 146/446MHz HT Antenna
Gain & Wave: 0dB 1/4 wave
Max Power: 10 watts
Length: 1.75"
Connector: BNC

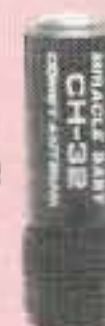

DUPLEXERS AND MOBILE MOUNTS



CF-4106K, I, J, 146/446MHz
Band Pass, Ins Loss, Max Pwr. 1.3-150MHz, 0.1dB, 800w PEP
 400-540MHz, 0.2dB, 500w PEP
Isolation: 60dB
CONNECTORS:
 4160K 4160I 4160J
 Output: SO-239 SO-239 SO-239
 Low In: PL-259 PL-259 SO-239
 High In: PL-259 N-Male SO-239



RS-21
 Trunk, hatchback, rear door (van, blazer, etc.) mount. Adjustable to virtually ANY angle. Rubber-coated base protects vehicle paint.



NEW! **RS-820**
 Heavy-Duty, Low Profile Trunk Lip or Hatch Back Mount. Rubber-coated base protects vehicle paint.



WS-1M
 Multi-Adjustable Window Clip Mount. 11.5 feet of high quality coax. Gold-plated UHF Conns. for Antennas up to 40" in height.

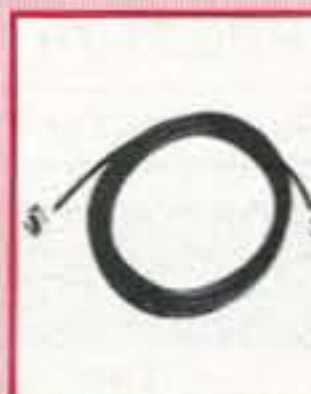

3D4M Standard Cable Assembly
 13.5 feet of low loss coax. Gold plated UHF (PL-259/SO-239) connectors.
3D5M Standard Cable Assembly
 Same as 3D4M, but 17 feet of coax



CK-5M Deluxe Cable Assembly
 13 feet double shielded very low loss coax + 12' RG-188 teflon coax. Gold plated UHF (PL-259/SO-239) connectors.
CK-5M5 Deluxe Cable Assembly
 Same as CK-5M, but 17 feet of coax

The analysis clearly revealed what I had noticed on the air when end feeding the antenna on 75m. The 3-D plot shown in Figure 10 shows the high-angle null in the pattern that is tilted away from the end being fed, and the low-angle lobe all around.

Summary

This article has described four different ways of feeding an inverted delta loop antenna: 1) balanced feed at bottom; 2) end-fed at bottom (one wire fed and the other wire left floating); interchanging the fed end swaps the endfire directional patterns; 3) one wire-fed and the other wire-grounded, a folded unipole; 4) both bottom end wires tied together, fed against ground, as a squashed vertical.

Figure 11 shows a switching arrangement for convenient selection of all the different feed arrangements. This could also be done with patch cords and alligator clips.

I would enjoy hearing about your experiences with this kind of antenna (Box 373, Baker, MT 59313). Please include an SASE if you'd like a reply.

Epilogue

Since moving to Montana, I have put the antenna up again. Unfortunately, I have just one row of relatively short trees to use for supports, so the loop now lies in a plane tilted about 20° from horizontal. The top of the loop still runs horizontally for about 95 feet, but is only 30 feet high.

The side legs are quite unequal in length. One leg is partly draped over the

roof. The lower end of the loop (the feed point) slopes downward. The feed point is about 10 feet above ground. The feedline consists of a parallel run of extra wire that runs into the shack (again in the basement!).

In spite of these handicaps, the loop still shows some directivity effects and can be used in all the ways previously described. When end-fed on 75m, it does not have the low-elevation angle capability of the original arrangement, though. When balanced-fed, it's more of a "cloud warmer" but is still quite satisfactory. It seems to have better performance on 40m than before.

On 160, it's now electrically too long for resonance at 1.9 MHz, so I use a three-gang AM broadcast receiver-type variable capacitor in series with it to tune out the inductive reactance. When fed against a decent ground, its input impedance approaches 50 ohms resistive.

It works surprisingly well on 160 meters for such a low antenna; its top is only about 0.12 wavelength off the ground on 160m. However, soil conductivity is quite high here due to a large amount of dissolved alkaline minerals. This would enhance the performance of the antenna considerably.

References

1. The ARRL Handbook, *American Radio Relay League*, 1983, p. 19.7. Plans for a balun can be found in almost any amateur radio handbook. Orr, W. I.
2. Radio Handbook (21st Ed.), *Editors and Engineers Div. of Howard W. Sams*, Indianapolis, 1978, p. 3.18. As frequency is raised, more and more of the current is

forced to flow in the outer layers of a conductor toward its surface. This means that corrosion of antenna wires or elements, which occurs on the surface, can have a stronger effect on antenna losses because more of the RF current flows there. Insulated or coated, wire and elements can prevent corrosion.

3. Rautio, J.C., "The Effect of Real Ground on Antennas—Part 5," *QST*, November 1984, Figures 4H-4L, 5.
4. The ARRL Antenna Book, *American Radio Relay League*, 1974, p. 58, Figures 2-70.
5. Balanis, C.A., *Antenna Theory*, Harper-Row, New York, 1982, pp. 372-374. Additional traveling wave effects are caused by wire impedance and ground effects.
6. Mayhead, L. V., "Loop Aerials Close to the Ground," *Radio Communications*, May 1974, Figures 9, 15. Gives experimental results from measuring scale-model, variously shaped and fed, one-wavelength loops over a metallic ground.
7. Devoldere, J., *Low-Band DXing*, ARRL, 1987, p. II-49, Figure 2.55(C). I adapted his feed idea for a delta loop for use with an inverted delta loop.
8. Devoldere, p. II-25, par. 2.4.4.
9. Jasik, H., ed., *Antenna Engineering Handbook (1st edition)*, McGraw-Hill, New York, 1961, Figures 3-13.
10. Devoldere, op. cit., p. II-24, Table 12, "Equivalent Series Resistance of Radial Systems in Ohms." See entry for two quarter-wavelength radials.
11. Belrose, J. S., "160-meter Antennas," *Technical Correspondence*, *QST*, July 1991, p. 49-50.
12. Lewallen, R., "MININEC: The Other Edge of The Sword," *QST*, February 1991, pp. 18-22. There is also a well-known frequency offset error in this program for which I have accounted in my analysis. This article gives a good overview of the program.

SMART BATTERY CONTROLLERS FOR LEAD-ACID OR GELL-CELLS

6 TO 28V, 110/220 VAC, 50/60 HZ
CONTINUOUS CHARGE, UC3906 I.C.,
PTC FUSE, SWITCHABLE CURRENT,
REVERSE BATTERY PROTECTION,
TRICKLE START, DBL. SIDED PCB,
SCREW TERMINALS, & MANUAL.

PURCHASE BASIC UNIT OR COMPLETE KIT W/ METER, LO-VOLT
OPTION TRANSFORMER, & ENCLOSURE

COMPLETE KIT: BC-CONTL-06 FOR 6 V, 1 AMP MAX. \$126.95
BC-CONTL-12 12 OR 14 V, 1 AMP MAX. \$126.95
BC-CONTL-28 24 OR 28 V, 1/2 AMP MAX. \$139.95

BASIC CONTROLLER: 6 TO 14V, 1 AMP MAX. \$ 54.95
24 TO 28V 1/2 AMP. \$ 64.95

OPTIONS: TRANSFORMER KIT \$ 18.95
AUTO LOW VOLT DISCONNECT W/ ALARM OUTPUT \$ 18.00

SOLAR CONTROLLER: DUAL LEVEL VOLT CONTROL
SC-CONTL-00 (W/ LO-VOLT & ENCLOSURE) \$109.95
SC-BASIC-00 BASIC SOLAR CONTROLLER \$ 54.95
BC-04 COMPLETE 5 AMP CONTROLLER \$199.95

CURTIS KEYSER KIT

INCLUDES AUDIO AMPLIFIER, IAMBIC KEYING, ADJUSTABLE
SPEED CONTROL \$ 39.95; SPEED METER \$ 10.00
POSINEG KEYING, TONE-WEIGHT CONTROL \$ 10.00

ANTENNAS

MARCONI: 80 M - \$37.95; 160 M - \$ 44.95
J-POLES: (2M, 6M, 220, 440 M-HZ) \$ 10.95 - \$ 42.95
USA SHIP COST \$3.00 1ST \$100 + \$1.00/EA. ADD'L \$100

1-800-JADE PRO (523-3778) FAX: 603-329-4499
VISA, MASTERCARD, CHECK OR M.O. PRICES & SPEC SUBJECT TO CHANGE
JADE PRODUCTS, INC. E. HAMPSTEAD NH 03826-0368

Available PLASTIC COAX-SEAL
"The Original Connector Sealant!"

SEALS COAX FITTINGS FROM MOISTURE AND CORROSION!

The Only Material That Will Adhere to Polyvinyl or Vinyl Outer Coax Jackets!

- Forms around and seals odd-shaped fittings.
- Non-contaminating and non-conductive.
- Wide ambient temperature range (-30° F to +180° F).
- Stays flexible for years insuring moisture-proof connections.
- Reusable—quick disconnection and resealing with same material.
- A must for satellite TV—microwave work.
- Hundreds of uses.
- Moistureproofs all connections.

EVERY LNB AND COAXIAL CONNECTOR NEEDS COAX-SEAL

Trial packet for 4 connectors - \$1.00 ppd.

UNIVERSAL ELECTRONICS, INC.
4555 Groves Road, Suite 12 Columbus, OH 43232
Phone (614) 866-4605 • FAX (614) 866-1201

CIRCLE 32 ON READER SERVICE CARD

Subscribe to 73
by calling
(800)
677-8838.

VHF REPEATER

Make high quality VHF repeaters from Motorola MICOR mobiles.

- 45 Watt Mobile - DUO\$99
- Conversion Information.....\$12

CALL FOR MORE INFORMATION
(Information without radio purchase \$40)

Versatel Communications
Orders 1-800-456-5548 For info. 307-266-1700
P.O. Box 4012 • Casper, Wyoming 82604

CIRCLE 259 ON READER SERVICE CARD

THE ULTIMATE NOISE/INTERFERENCE REDUCTION AND FILTER UNIT

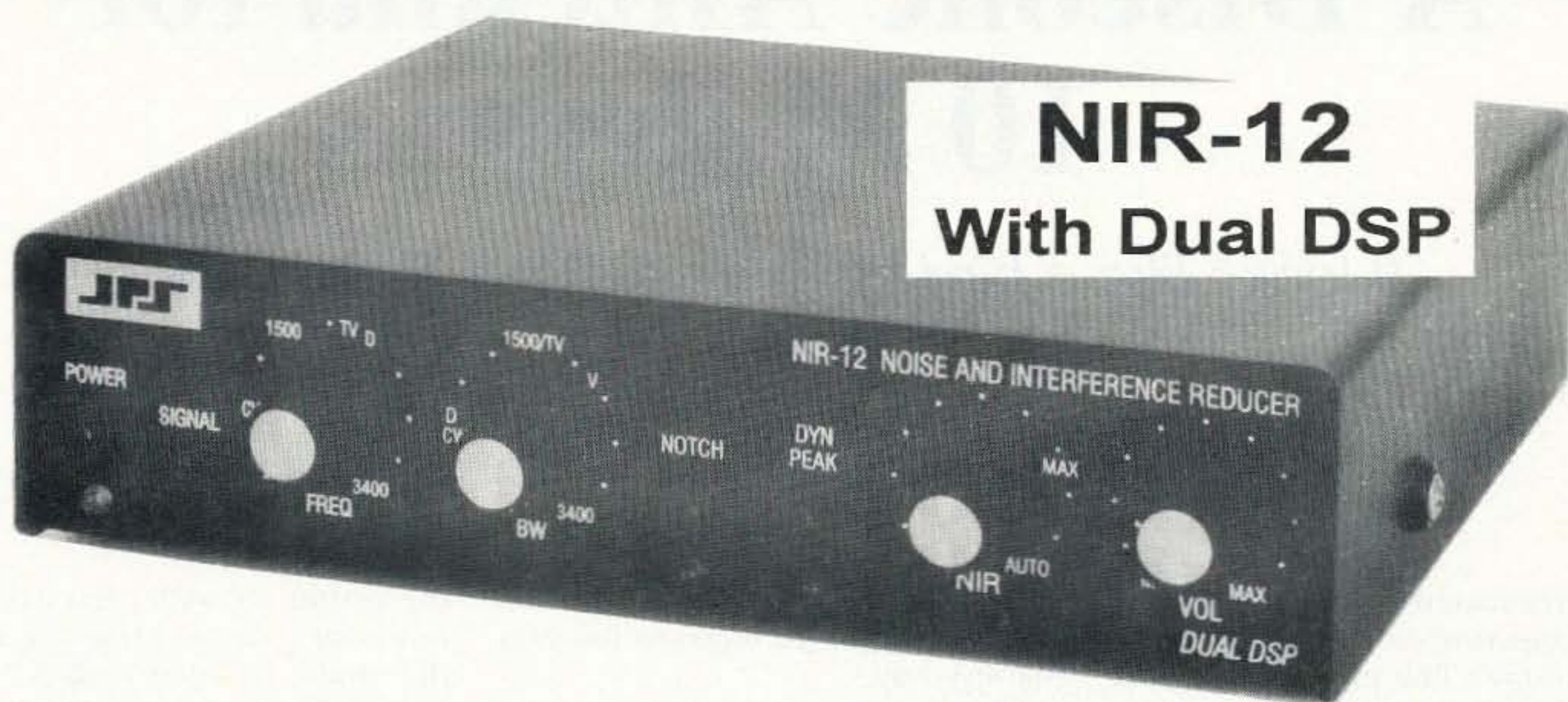

At long last, the most advanced noise reduction/filter unit is now available from JPS. DUAL DSP chips are used in the NIR-12 to provide simultaneous bandwidth filter, noise reduction (2 types) and tone removal. Both Spectral Subtraction (NIR[®]) and Dynamic Peaking noise reduction methods are included to provide reduction of IMPULSE noises as well as atmospheric white noise. An AUTOMATIC NIR[®] mode is included to set the noise reduction at the optimum point, based upon the measured Signal-To-Noise ratio of the received signal. A spectral notch filter provides cancellation of multiple heterodynes from tune-ups, adjacent channel carriers, CW, RTTY, or similar signals without interfering with voice signals. The notch filter operates in 5 milliseconds or less. The super-selective FIR filters are continuously variable in both bandwidth and center frequency. Bandwidth is adjustable between 50 Hz and 3200 Hz. The user-friendly front panel gets you operating on the air in the shortest possible time. An internal access to the dual DSPs is provided via RS-232 for experimenters.

Other fine JPS Amateur Radio products include: NIR-10 Noise & Interference Reducer; NRF-7 General Purpose Noise Reducer & Filter Unit; NTR-1 Wideband Noise and Tone Remover; SSTV-1 DSP Filter for SSTV; NF-60 DSP Spectral Notch Filter. 115VAC/12VDC adapter available

If you want the best, get JPS.

 **JPS Communications, Inc.**

"First and Finest in DSP Noise Reduction"

Features

- Superior Audio Noise Reduction
 - Atmospheric White Noise
 - Automobile Ignition Noise
 - Power Line Noise
 - Static
 - Computer/TV Interference
 - Digs Out Weak Difficult-to-read Signals
 - Greatly Reduces Listener Fatigue
- Both Spectral Subtraction and Dynamic Peaking Noise Reduction
- Manual and AUTOMATIC NIR[®] Noise Reduction Control
- Operates on Audio From Any Radio
- Dual DSP Accessible Via RS-232
- All Modes Usable Simultaneously
- Notch Filter Removes All Tones from Voice and Operates in <5 msec
- Super FIR Filters provide:
 - Fully Adjustable Bandwidth, Center Frequency
 - "Real Time" Operation
 - Very Steep Skirt Selectivity
 - Greater than 60dB Ultimate Rejection
 - Linear Phase; Minimum Passband Ripple
 - Usable as Bandpass, Highpass or Lowpass

TOLL FREE ORDER LINE: 800-533-3819

We accept MC, VISA, Money Order, or Check (\$US)
P.O. Box 97757, Raleigh, NC 27624
FAX: (919)790-1456 Technical Info: (919)790-1048
CompuServe: 71673.1254 Internet: jps@nando.net

Contact us for a dealer near you.

A Discone Antenna for 10 Meters

It looks like a bird cage, but works like a yagi.

by O.B. Boddie W1ZB/6

A truncated cone antenna is a superior radiator, equaled by none. The cone antenna is used extensively on VHF and UHF, and the Skelton cone is a version of it for HF.

The discone antenna described in this article resembles the old cage antenna of the spark days. My XYL says it looks like a bird cage. But, looks can be deceiving. This small antenna was tested extensively, with a

6-dB gain three-element yagi as a standard. It proved equal to the yagi in every way.

This discone antenna has a gain of 6 dB across the entire 10 meter band. How does it do this? It has an infinite number of half waves in parallel for a radiation pattern. It always has the right angle of radiation because of the rotating field pattern.

You can build it as a single cone 5 feet high to sit on the roof, giving you a 3-dB gain in all directions at a low angle. This is fine for apartment dwellers and works well from the inside of the apartment because of the multi-angle radiation pattern. It is easy to construct and the cost is so low that anyone can afford to build it. Or, you can construct two cones separately and hang them both from

the ceiling or under the eaves on a house or garage. Mine are hung in the shape of an inverted "V" and favor signals broadside. Mounted vertically, it radiates in all directions with a 3-dB gain when using only a 5-foot antenna.

The low angle of radiation makes this cone an excellent DX antenna. It even picked up a few new countries I could not raise on the yagi! For 20 me-

ters, double all measurements and you can have a 6-dB gain antenna on 14 MHz.

If you are using a single cone antenna, no tuner is necessary. On the discone antenna, however, an antenna tuner may be necessary for a perfect match.

Construction Details

These details are for a single cone. Make two of them for a discone.

"This is fine for apartment dwellers and works well from the inside of the apartment because of the multi-angle radiation pattern."

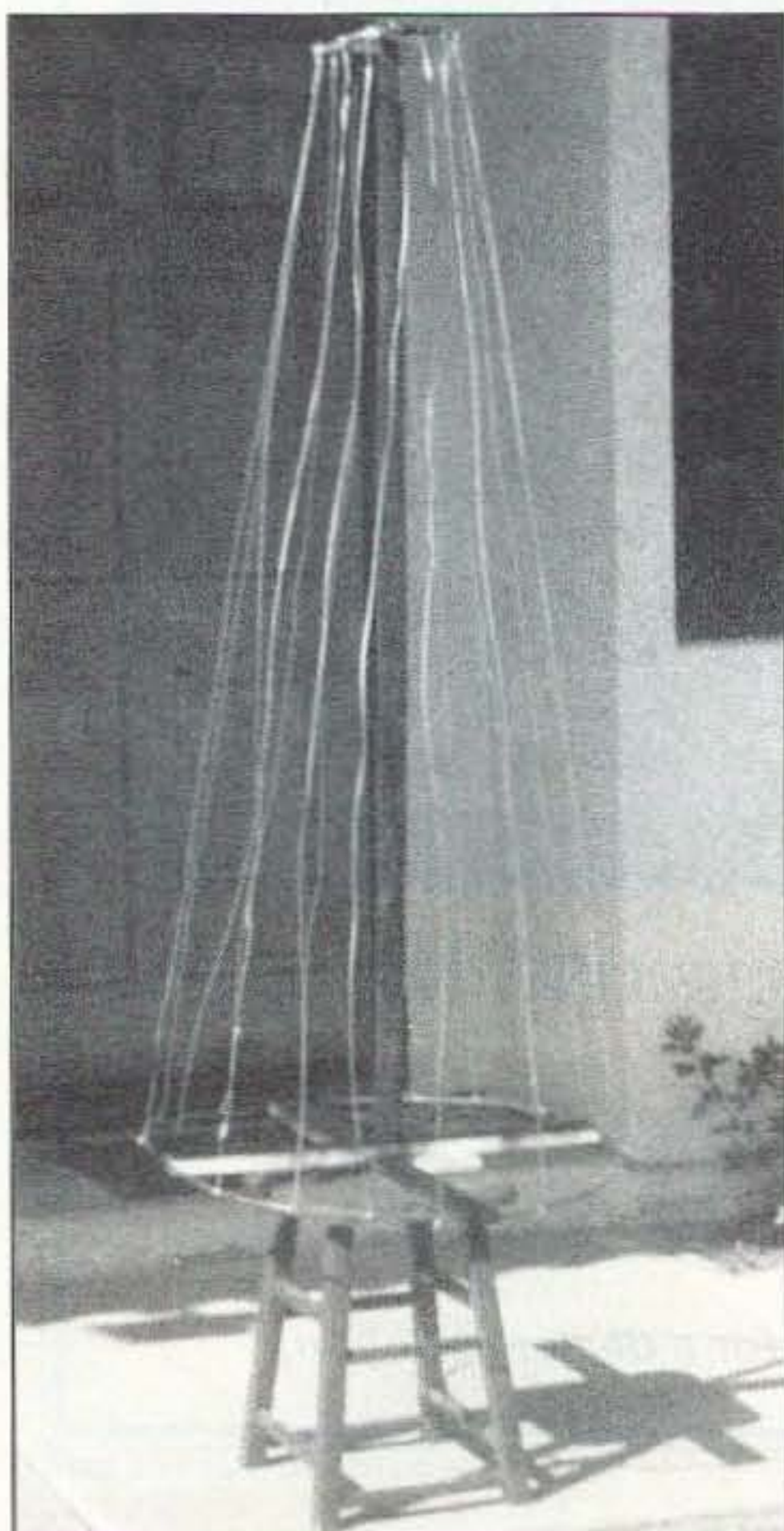

Photo A. Finished discone antenna.

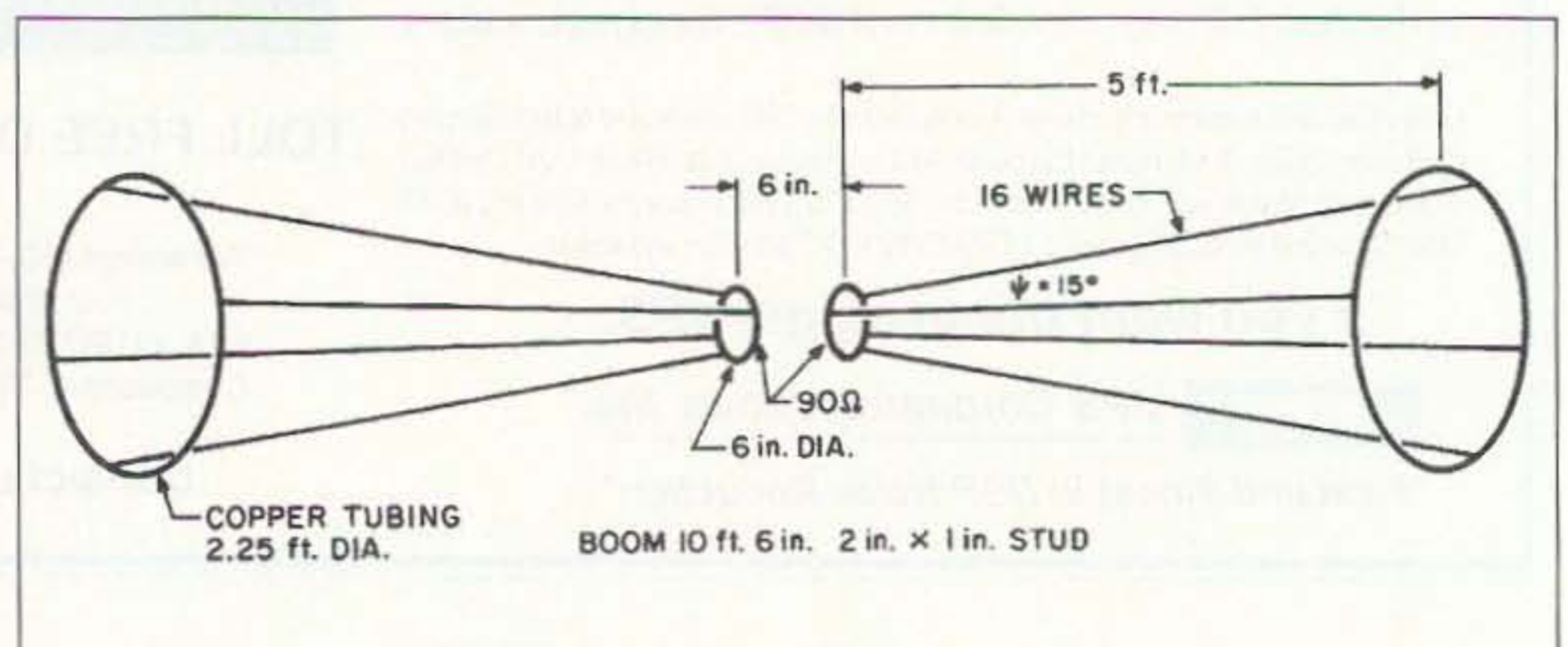

Figure 1. Discone for 10 meters.

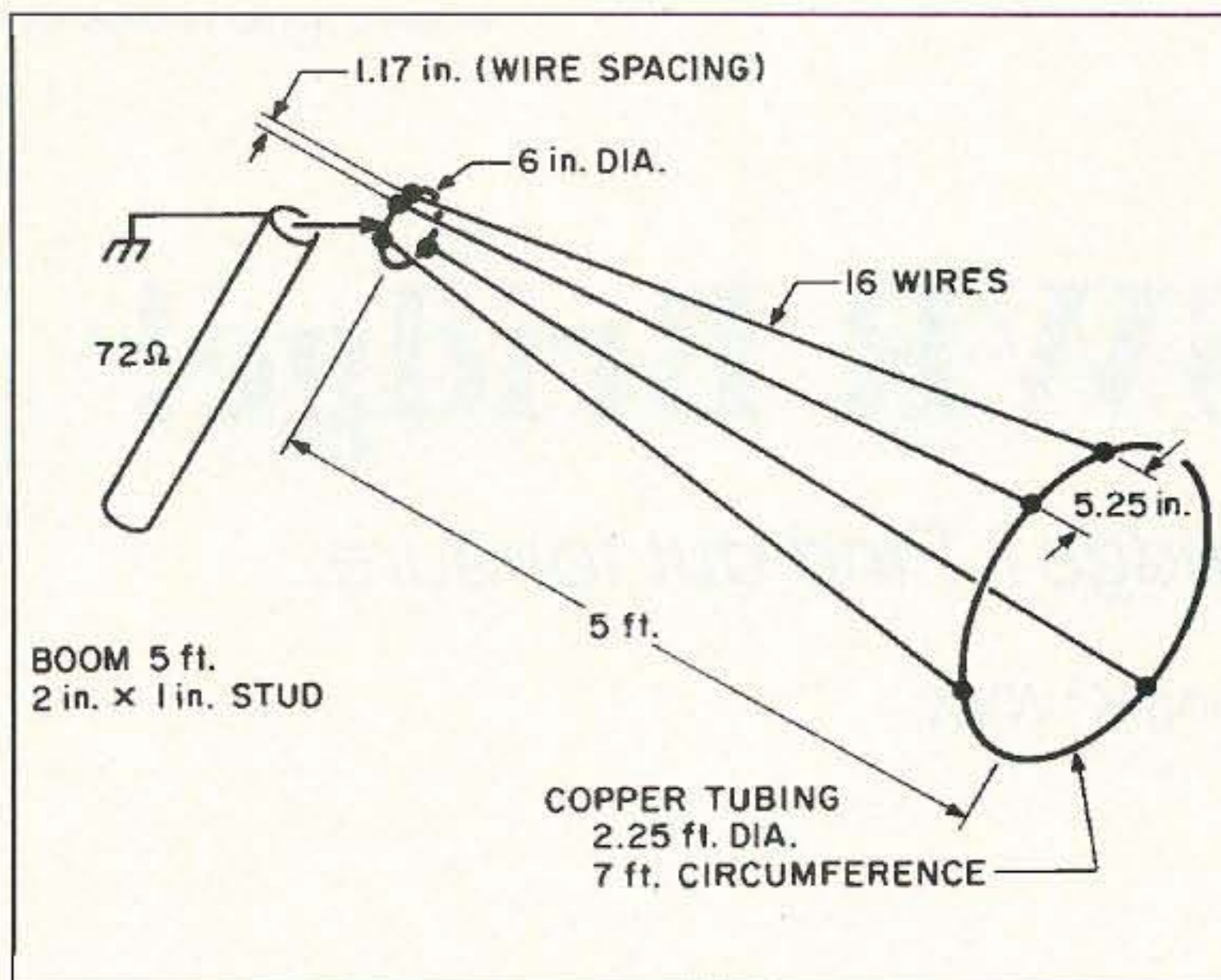

Figure 2. A 10 meter conical.

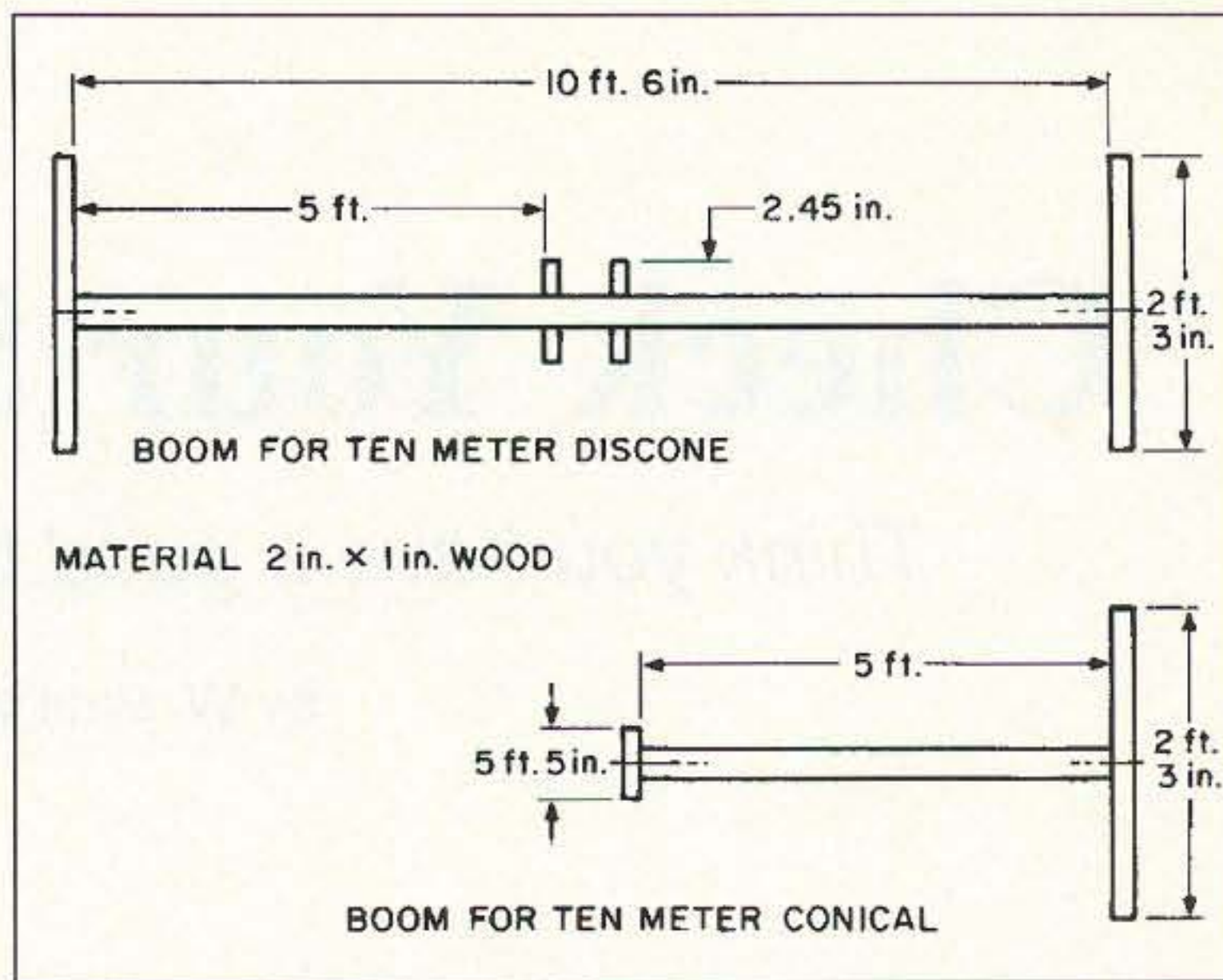

Figure 3. Boom for conicals.

First, make the booms, following the details in Figure 1. Next, cut a 7.20-foot piece of copper tubing. Flatten one inch on the ends with a hammer. Bend it in a circle. Drill through the flattened ends with a #18 drill clearance for an 8-32 machine screw.

Cut off a 20-inch piece of copper tubing. Flatten 1 inch on the ends with a hammer. Bend this piece of tubing in a 6-inch circle. Drill through the flattened ends with a #18 drill clearance for an 8-32 machine screw.

Bolt together the two copper tubing circles with 8-32 machine screws.

It is easy to construct and the cost is so low that anyone can afford to build it.

Insert the tubing circles onto the boom for fit. Shave down the wood for fit. Flatten the copper tubing where it goes over the 2-inch by 1-inch ends of wood.

On both the large and small loops, drill two holes through the copper at the flat

portion to clear 5/8-inch by 8-inch wood screws. Remove the copper tubing loops and drill 1/16-inch holes, evenly spaced, in 16 places on each copper tubing loop.

Assemble boom and copper tubing loops together. Tighten the wood screws to hold the assembly together. String 16 wires as per Figure 4 after scraping enamel off the ends of wire for good contact.

Parts List (for one cone; double for disccone)

- 10 feet of 1/4 inch copper tubing
 - 100 feet of #18 copper wire enamel covered
 - 32 each 3/8 inch #6 pan head sheet metal screws
 - 2 each 1 1/2 inch #8 flat head Phillips brass wood screws
 - 2 each 8-32 1/4 inch-long machine screws and nuts
 - 1 five-foot 2 inch x 1 inch wood stud for boom
 - 1 two-foot-3-inch 2 inch x 1 inch wood for end piece
 - 1 six-inch 2 inch x 1 inch wood for end piece
- Note. For the disccone, two cones make the boom 10 ft. 6 inches long.

Construction

1. Make booms as per drawing.
2. Cut off a 7-foot 3-inch piece of copper tubing. Flatten 1 inch on ends with hammer. Bend it in a circle.
3. Drill through flattened ends with a #18 drill clearance for an 8-32 machine screw.
4. Cut off a 20-inch piece of copper tubing. Flatten 1 inch on ends with hammer. Bend it in a 6-inch circle.
5. Drill through flattened ends with a #18 drill clearance for an 8-32 machine screw.
6. Bolt together copper tubing circles with 8-32 machine screws.
7. Insert copper tubing circles on to the boom for fit. Shave down wood for fit. flatten copper tubing where it goes over 2 inch x 1 inch ends of wood.
8. Drill two holes through copper at flat portion to clear 1 1/2 inch x 8 wood screws.
9. Do this for large and small loops of copper tubing.
10. Remove copper tubing loops and drill 1/16 inch holes in 16 places on each copper tubing boom evenly spaced.
11. Assemble boom and copper tubing loops together. Screw down wood screws to hold assembly together.
12. String 16 wires as per drawing after scraping enamel off the ends of wires for good contact.

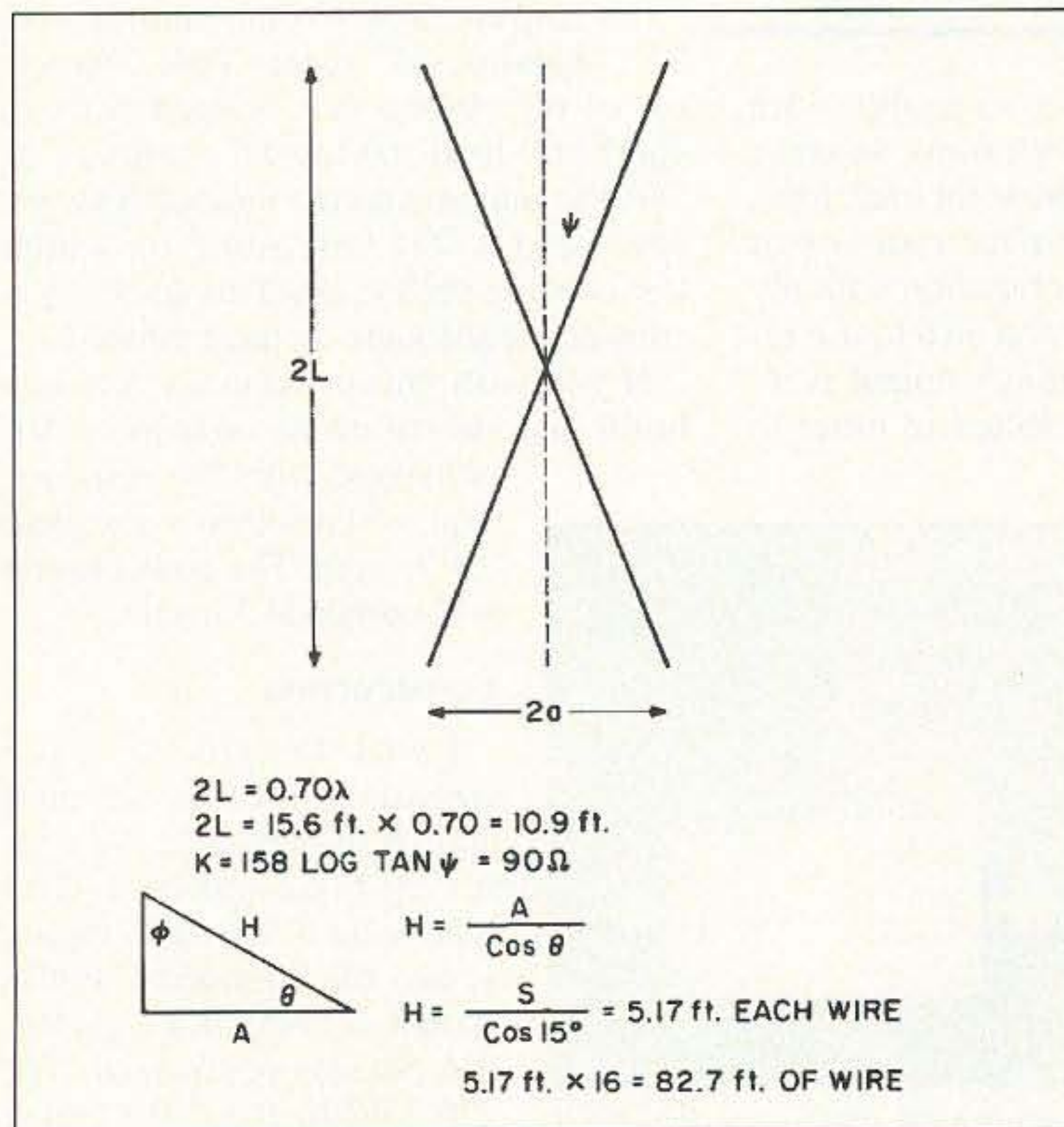

Figure 4. Conical math.

Check Your SWR Bridge!

Think you have a good bridge? Find out for sure.

by W. Paul Wing K1WVX

You should check your SWR (Standing Wave Ratio) bridge, rather than assume that you have a good one. Good-quality SWR bridges that have been left in the line have usually been overranged a number of times. Many inexpensive bridges have poor accuracy. Most SWR bridge construction articles only provide instructions for checking at an SWR of 1:1. This one-point check, which is made by using a standard 50-ohm dummy load, is inadequate.

I will describe how to use resistances in conjunction with your 50-ohm dummy load to check your bridge at several test points.

Resistances to Use

The easiest way to check your bridge at an additional point is to borrow a friend's 50-ohm dummy load and connect it in parallel with your own. You can make this connection with a coaxial tee and a short length of coaxial cable, as shown in Photo A. The resulting 25-ohm dummy load will produce an SWR of 2:1. The reason for this is that the SWR is equal to the ratio between the line impedance and the load resistance, which is $50/25 = 2.0$. When necessary, this ratio is inverted in order always to produce a ratio greater than 1. This subject is more fully covered in *The ARRL Antenna Book*. If you cannot borrow a second dummy load, you can easily make one for use at reduced power. The construction of the unit will be covered in a subsequent paragraph.

Also, if you make a 25-ohm dummy load having two con-

nectors, it can be used in series with your 50-ohm load to produce an SWR of 1.5:1, and it can be used in parallel to produce an SWR of 3.0:1. If both "add-on" dummy loads are provided, SWR values of 1.5, 2.0, and 3.0 can be checked, in addition to the usual 1.0 SWR check.

Reduced Power Dummy Load

The main difficulty with building dummy loads is that noninductive resis-

"The main difficulty with building dummy loads is that noninductive resistors are not generally available with power ratings above two watts."

tors are not generally available with power ratings above two watts. In order to avoid using 50 of these for each load, I chose to use a smaller number of 2-watt resistors in combination with my 50-ohm dummy load, and also to use reduced power. A transmitter output power of 35 watts was selected in order to

substantially reduce the number of resistors required. Almost all solid state and tube-type transmitters can be reduced to the 35-watt output level by using the front panel controls. Remember that this is approximately equal to 70 watts of input power. Some SWR bridges are not sensitive enough to get readings on 75 and 80 meters with reduced power. In this case, the testing is limited to 10 through 40 meters.

Accuracy

Two-watt resistors with tolerances of 2%, 5%, and 10% are usually available in radio parts stores. I used 2% resistors because they are not very expensive, and improve the overall accuracy. My conventional 50-ohm dummy load measures 47 ohms. This is an error of 6%. When this is used with an "add-on" load having an accuracy of 2%, the maximum errors range between 3.4% and 4.7%, depending on which test is being performed. This accuracy is considered adequate by most amateurs.

If you wish greater accuracy, you can build and substitute an additional 50-ohm load with 2% resistors. This will result in a complete 2% system. The power rating will remain at 35 watts.

Construction

I will describe first the construction of the 25-ohm unit. It uses twelve 300-ohm resistors in parallel. The schematic is shown in Figure 1, and the completed unit is shown in Photo B. I used Radio Shack perfboard No. 276-1396A. It is 1/16" thick and has holes spaced 0.10" x

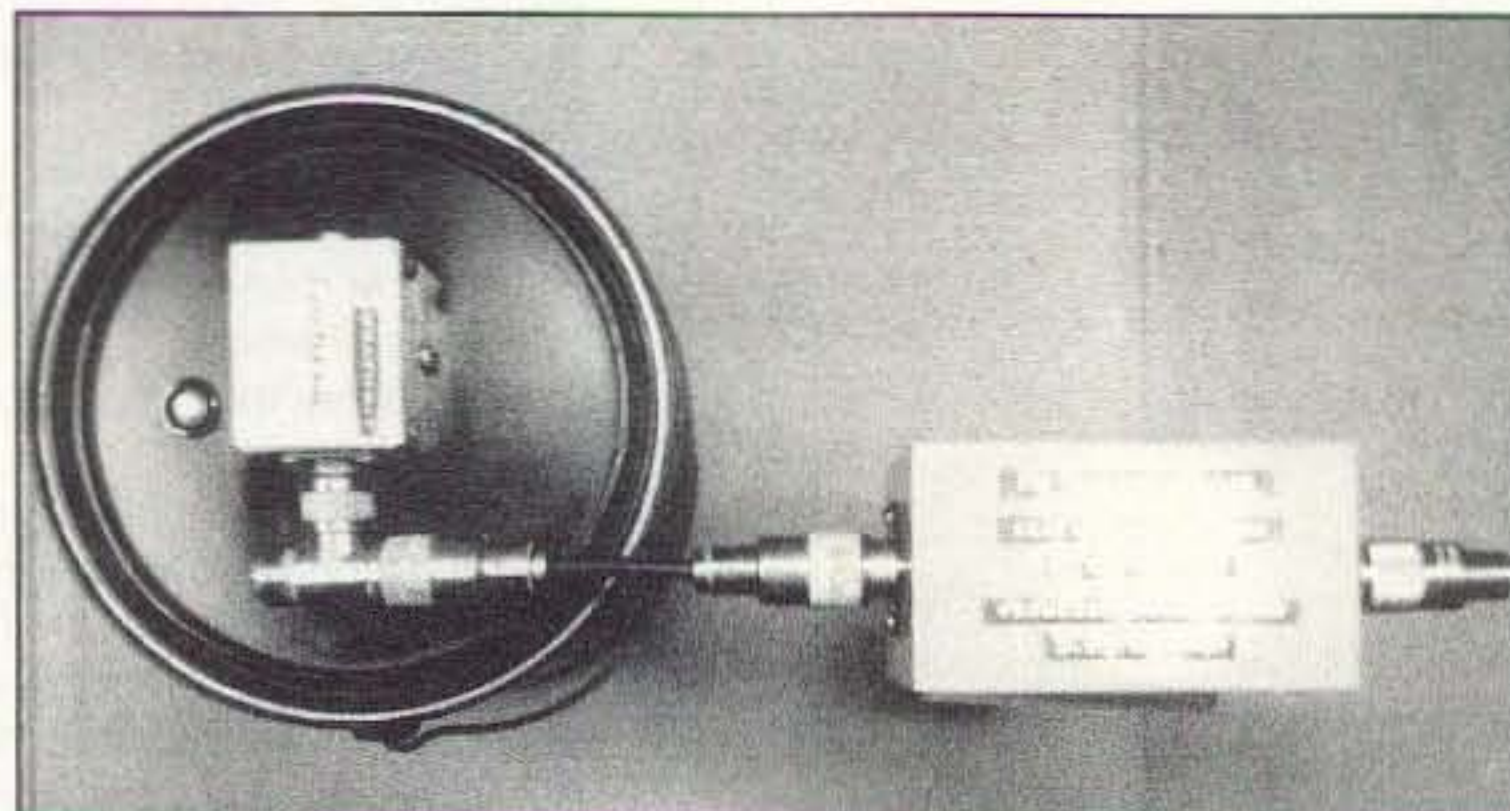

Photo A. A conventional 50-ohm dummy load, connected in parallel with an "add-on" load. The feedline is connected at the coaxial tee.

0.10" apart. Cut a piece of this perfboard 1-7/8" x 3-1/16" so that it has 18 holes along the short side and 30 holes along the long side. Drill two 1/8" diameter mounting holes at diagonally opposite corners, as shown in Photo B. These holes are located 7/32" from both edges of the board. Also cut five pieces of perfboard 1/2" x 2-5/16" long. These will be used as spacers during soldering. Bend both leads of the twelve resistors 90 degrees so that they will fit through holes in the perfboard that are 0.90" apart. Stack three spacers on the board and hold them in place with masking tape. Install six resistors on top of the spacers with their leads going through holes in the board. The resistors are spaced 0.40" from each other. Hold the resistors in place with masking tape.

Cut two pieces of No. 14 AWG copper wire 4" long. Solder one of these wires to the six resistor leads, as shown in Photo B. The wire is positioned 1/8" above the board by using the two remaining spacers. Turn the board around and repeat this process to solder the other #14 wire.

Stack the two spacers on top of the lower row of resistors and fasten with tape. Install the six top row resistors and solder their leads to both wires. Cut the lead lengths of the two end resistors to measure 9/16" below the board. Bend these four leads through holes 0.3" toward the centerline of the board so as to secure the resistor assembly to the board. Cut off the leads of the other 10 resistors flush with the bottom of the board. Remove all spacers and masking tape.

The enclosure is a Bud-Minibox No. CU-2103-B, which measures 2-1/4" x 2-1/4" x 4". Cut the center holes for the two SO-239 coaxial connectors at the center of each end of the box. Drill

SWR Bridge	Test Freq. (MHz)	Actual SWR			
		1.0	1.5	2.0	3.0
Bridge A	28.4	1.05	1.4	1.8	2.6
	7.25	1.05	1.05	2.2	3.2
Bridge B	28.4	1.3	1.3	2.4	3.1
	7.25	1.15	1.1	2.0	3.1
Bridge C	28.4	1.1	1.4	2.7	Approx. 4.0
	7.25	1.05	1.1	2.2	Approx. 4.0

Table 1. Test results for the three inexpensive SWR bridges.

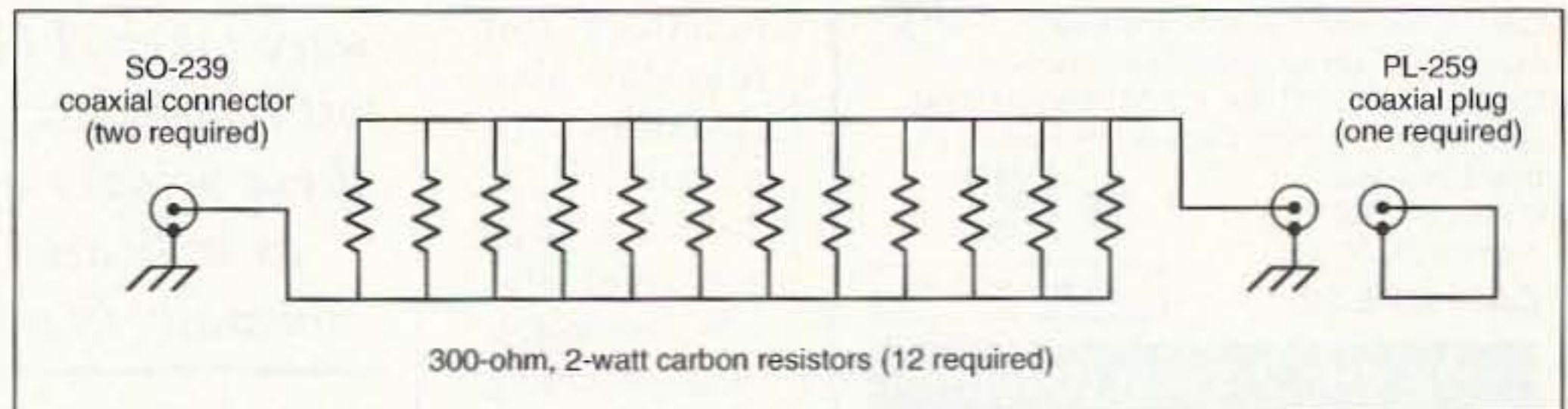

Figure 1. Schematic for the 25-ohm "add-on" load and grounding

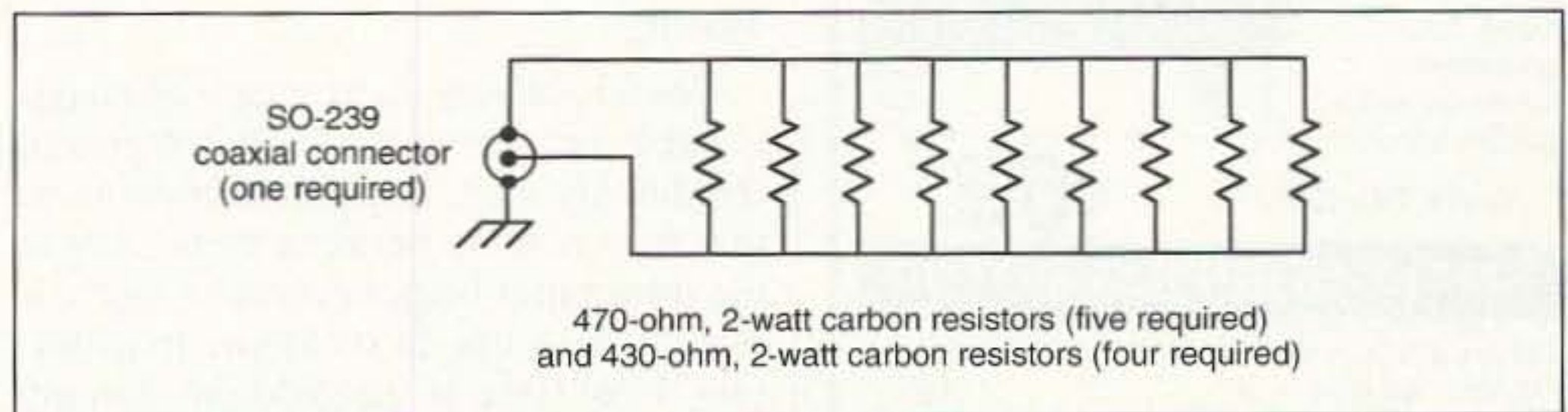

Figure 2. Schematic for the 50-ohm "add-on" load.

two screw holes for fastening each connector on the same horizontal centerline. Remove enough paint where the connectors mount to be sure of good electrical contact. Drill eight 3/16" diameter holes in the enclosure to provide ventilation. The two mounting brackets for the board are made from No. 5 solder lugs. Use a piece of #14 copper wire to solder each pair of lugs together as, shown in Photo B. Bend the brackets 90°, as shown. Attach the connectors and brackets with 4-40 x

1/4" long screws and nuts.

Bend the two #14 leads and trim their ends, as shown in Photo B. Bend the mounting brackets to keep them away from the resistor leads. Attach the board with 4-40 x 1/4" long screws and nuts. Solder the #14 wires to the coaxial connectors, and then install the enclosure cover. Check the resistance between the connector center conductors to be sure that the resistance is close to 25 ohms. Also check the resistance between the connector shells to be

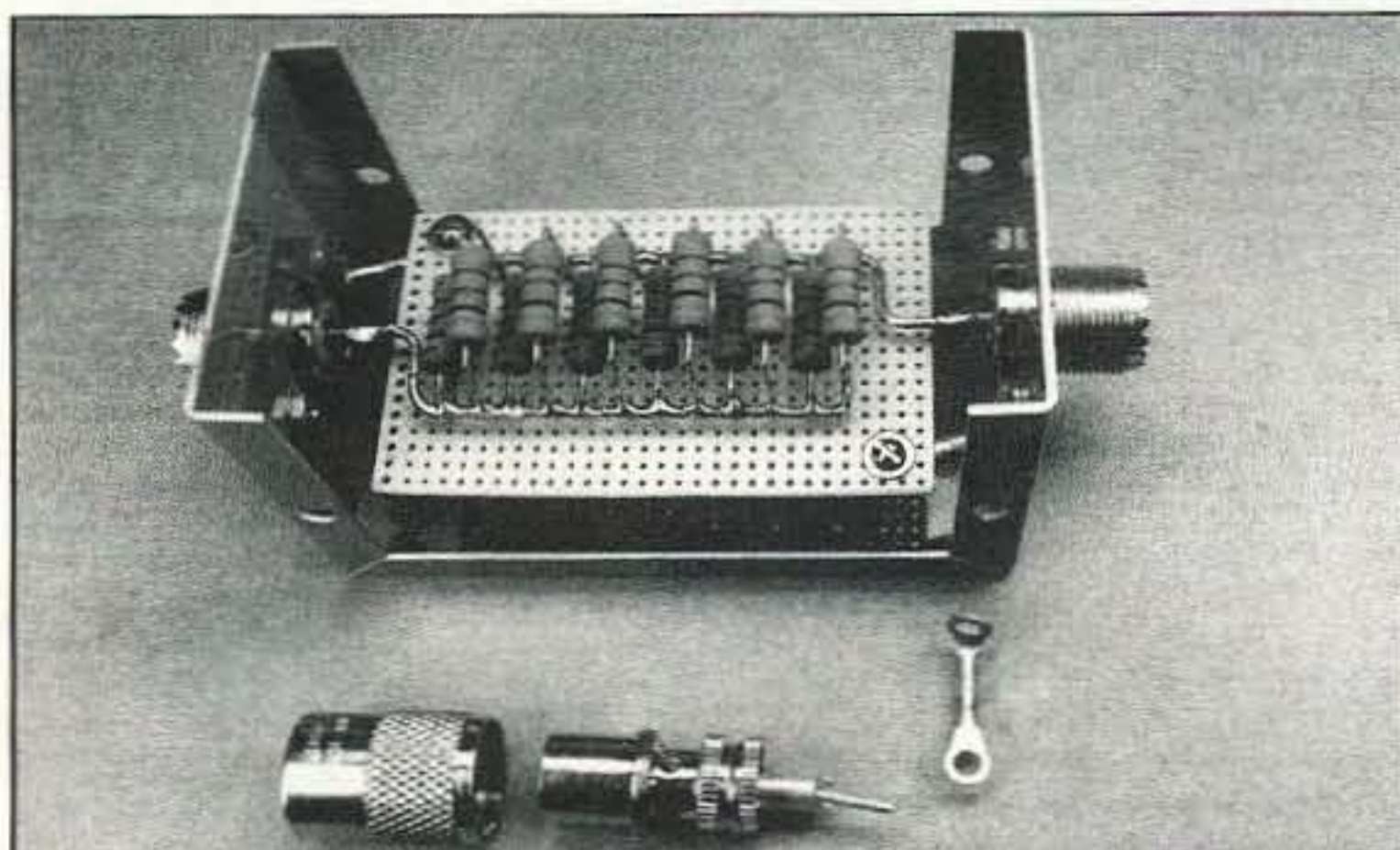

Photo B. The 25-ohm dummy load is shown with its cover removed. The grounding plug and one perfboard mounting bracket are shown in the foreground.

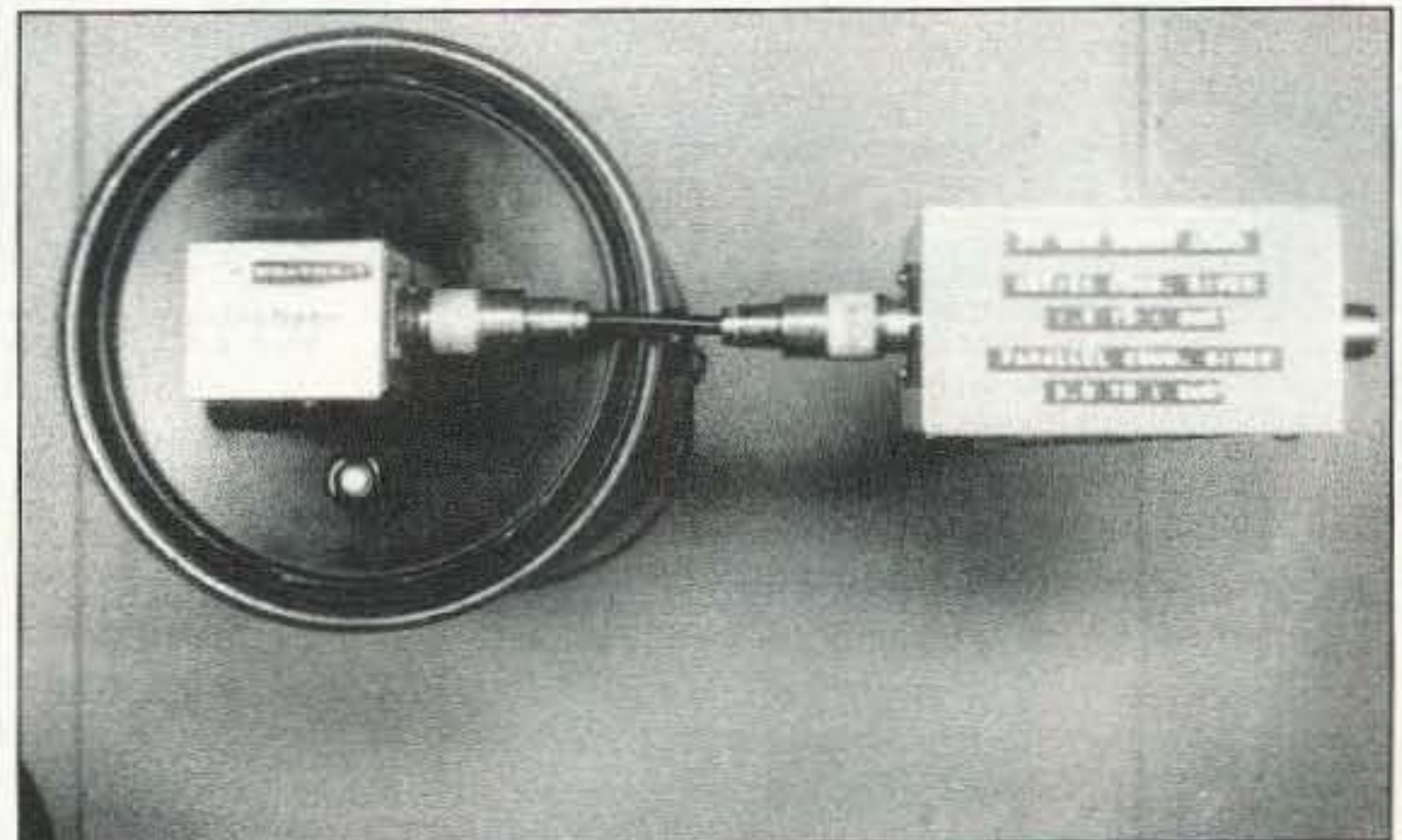

Photo C. A conventional 50-ohm dummy load, connected in series with an "add-on" load.

ALL ELECTRONICS

FAST SERVICE • DISCOUNT PRICES

Visit Our **INTERNET** Site
<http://www.allcorp.com/allcorp/>

S.P.D.T. MOMENTARY PUSH BUTTON

SPECIAL PRICE!

Alcoswitch # MPS103D-R
S.P.D.T. miniature pushbutton switch.
Push-on / Push-off, snap-action switch.
Unthreaded, 0.24" dia. X 0.33" long bushing.
Green 0.4" dia. cap. Right-angle pins for PC
board mounting.
Contacts rated
3 amps @ 115 Vac.



\$1.00
each

CAT# MPB-22

25 for \$22.50

12 Vdc 2.3 A/h (Used) GELL CELL BATTERY

7" X 2.37" X 1.35"
Used, but
guaranteed
functional sealed
gel cell batteries.



CAT# GC-123U

\$6.00
each

SMALL STEPPING MOTOR

Airpax # NB82115-M3
12 Vdc, 65 ohm
stepper motor with
6 leads. 15 degree
step angle. 1" diameter x 0.5"
high. Mounting flange with holes on 1.25"
centers. 0.08" (2mm) dia. X 0.2" long shaft.
0.27" diameter pulley is press-it onto shaft.
Great for robotics
and experimentation.



\$1.50
each

CAT# SMT-13

10 for \$12.50

9' DUAL AUDIO CABLE

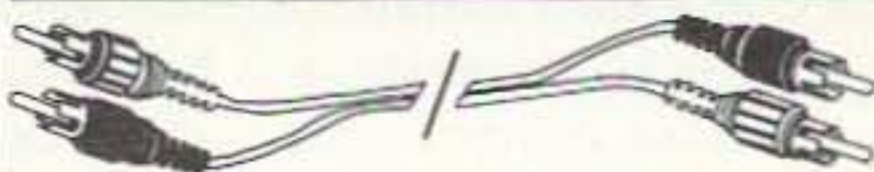

9' shielded dual audio cable with color coded
(red and yellow) RCA style pin
plugs either end. Black cable.

\$1.00
each

CAT# DCB-108

10 for \$8.50 • 100 for \$75.00
1000 for \$500.00

**LARGE
QUANTITY
AVAILABLE!**

ORDER TOLL FREE

1-800-826-5432

CHARGE ORDERS to Visa, Mastercard or Discover

TERMS: NO MINIMUM ORDER. Shipping and handling for the
48 continental U.S.A. \$5.00 per order. All others including AK,
HI, PR or Canada must pay full shipping. All orders delivered in
CALIFORNIA must include local state sales tax. Quantities
Limited. NO COD. Prices subject to
change without notice.

CALL, WRITE,
FAX or E-MAIL
for a FREE
64 Page
CATALOG
Outside the U.S.A.
send \$2.00 postage.

MAIL ORDERS TO:
ALL ELECTRONICS
CORPORATION
P.O. Box 567
Van Nuys, CA 91408
FAX (818)781-2653

E-mail allcorp@allcorp.com

CIRCLE 194 ON READER SERVICE CARD

sure that it is close to zero.

The grounding plug is made by soldering a short piece of #14 wire between the center conductor and shell of a PL-259 coaxial plug. This is shown in Photo B before it was soldered and trimmed. Check the resistance between the center conductor and shell to be sure that it is close to zero. The schematic for the 50-ohm dummy load is shown in

Figure 2. It has five 470-ohm resistors and four 430-ohm resistors in parallel. It does not have a second SO-239 connector, or a grounding plug. Otherwise, its construction is the same as the 25-ohm unit.

Testing

Use a relatively short length of coaxial cable between your SWR bridge and the dummy load. Bypass all other items that may now be between them. Adjust the transmitter output power to approximately 35 watts. Discontinue transmitting. Install one of the "add-on" dummy loads and proceed with testing. Photo A shows the parallel connection, and Photo C shows the series connection. Don't forget to use the grounding plug with the parallel connection. It can be at-

tached to either end of the 25-ohm dummy load.

Test Results

The test results for three inexpensive SWR bridges are shown in Table 1. The accuracy of these bridges was not as good as had been expected. Whenever poor accuracy was evident, the test set-up was checked to be sure that the resistance was the correct value, and that a good ground connection existed. The SWR meters were also checked to be sure that they zeroed properly, and that they did

"Since many precautions were taken, I believe that the test results are valid, and that these bridges would perform as indicated when used normally in a ham station."

not have broken jewels. Since many precautions were taken, I believe that the test results are valid, and that these bridges would perform as indicated when used normally in a ham station.

Conclusion

Conclusion

The test results show that many inexpensive SWR bridges have poor accuracy. You should check your bridge rather than assume that it is accurate.

You can check one additional point by simply borrowing another dummy load, build either one or two "add-on" loads or a complete 2% system. The choice is yours.

**When you contact our advertisers, be sure to
tell them you saw their ad in 73.**

MAKE CIRCUIT BOARDS THE NEW, EASY WAY



WITH TEC-200 FILM

JUST 3 EASY STEPS:

- Copy circuit pattern on TEC-200 film using any plain paper copier
- Iron film on to copper clad board
- Peel off film and etch

convenient 8 1/2 x 11 size
With Complete Instructions
SATISFACTION GUARANTEED

5 Sheets for **\$4.95** 10 Sheets only **\$6.95**
add \$2.00 postage

The MEADOWLAKE Corp.

Dept. G • PO Box 1555 • Oneco, FL 34264

Quality Microwave TV Systems
**WIRELESS CABLE - ITFS - MMDS
ATV - INTERNATIONAL - S-BAND**
Amplifiers • Antennas • Books • Components
Filters • Systems • Video Products
• RF Frequency 1990 - 2700 MHz
• Cable Ready - VHF - UHF Outputs
• SASE For "FREE" Catalog or Send \$1
PHILLIPS-TECH ELECTRONICS
PO Box 8533 • Scottsdale, AZ 85252
CHALLENGER SYSTEM
33-Channel 52dB+ Gain
Complete Grid \$265
Five Year Warranty
FREE SHIPPING Visa • M/C • Amx • Disc • COD's • Qty Pricing

CIRCLE 249 ON READER SERVICE CARD

RDC **ROSS DISTRIBUTING COMPANY**
SPECIAL
KENWOOD TS-50S
Under **\$1100.00**
More savings on Kenwood, Yaesu, Icom, AEA, Astron, Cushcraft, Alinco, TimeWave Technology, Kantronics, MFJ, Telex Hy-gain, Diamond, Comet, Genesys, Maitoi, Daiwa, Larsen, Amertron, Hustler, Van Gorden Engineering, Heil Sound, JSC Cable, M Squard, Watkins Johnson, ARRL Books, Etc.
Over 9039 Ham Items in Stock. All Prices Cash FOB Preston
Phone For More Specials
78 S. State Street, Preston, ID 83263 (208) 852-0830
Closed Sunday

CIRCLE 254 ON READER SERVICE CARD

YOU ASKED FOR IT WE'VE GOT IT

SPECTRUM ANALYZER SCOPE ADAPTER



1 MHz TO 500MHz
SPECTRUM
ANALYZER



AS SEEN ON YOUR SCOPE

100% FACTORY ASSEMBLED **NOT A KIT** MADE IN THE USA

MUST FOR EVERY SHOP:

The SA500ADP Spectrum Analyzer Scope Adapter works with any Scope. Just one connection to the Vertical & Trigger Inputs and any scope becomes a full function spectrum Analyzer. Tune H.T.'s Filters, mixers. Check all RF based Systems. The SA500ADP Scope Adapter will compliment

any Ham Shack, Radio Service Shop or EMI Test Lab.. **MADE IN THE USA** Not a kit. If you have been waiting for a low cost High performance Spectrum Analyzer at an affordable price, take Advantage of our special introductory offer. Add a 500MHz Tracking/Noise Generator for only \$100 and save a total of \$200.

SA500ADP ONLY **\$399.00**

Add Tracking Gen. **\$100.00**

Introductory offer only

\$499.00

SAVE OVER \$200 Reg. price \$699

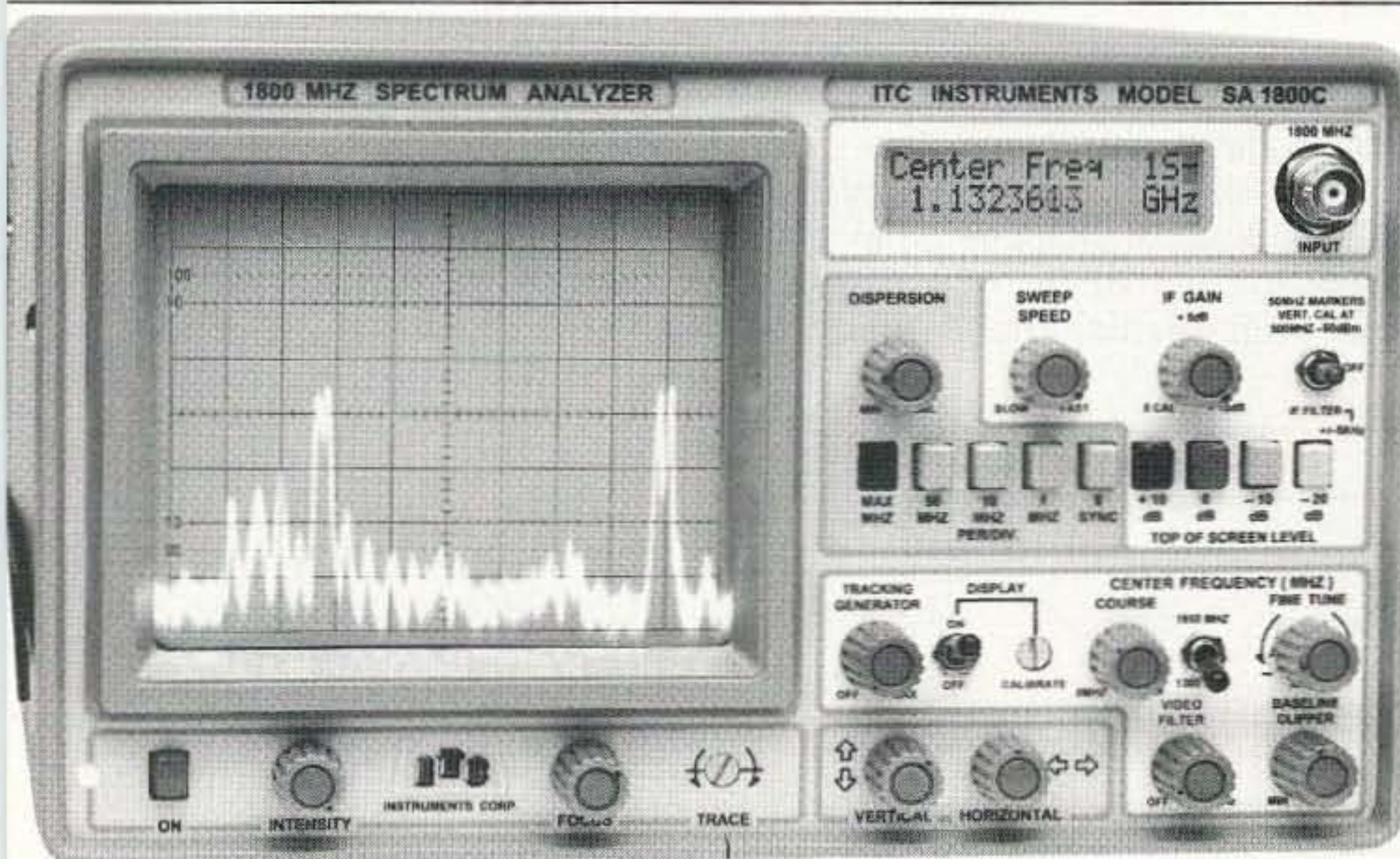

SETTING THE STANDARD

SA500A, SA1300B, SA1800C

SPECTRUM ANALYZERS

STARTING AT \$995.00

MADE IN THE USA

6" x 12" x 16" (H x W x D) (only 16 LB)

SA1800C Shown \$2395.00

Model SA1300B **1-1300 MHz In One Sweep \$1995.00** Options 1,3,5,6

SPECTRUM DISPLAY MONITOR \$995.00

The SA500A easily attaches to any receiver IF output jack. Providing a panoramic signal display of your scanner or communication receiver. The SA500A is a Full Function Spectrum Analyzer with +/- 5KHz Narrow Band Filter, Center Freq. Display, 50 MHz Marker. SA500A The first affordable **Professional Spectrum Monitor/Analyzer** for all serious Ham Radio and Radio Monitoring Operators. With Opt. 1,3,5,6

TWO FULL FUNCTION ANALYZERS

Quality & Performance with 80dB on Screen, -100 dBm Sensitivity, Center Freq. Display, +/- 5KHz Narrow Band Filter 50 MHz Marker. **DISPERSION ZOOM**, Baseline Clipper, Adjustable Sweep Speed, Video Filter, and 40dB Input Attenuation. SA1300B 1-1300MHz

SA1800C 1-1300 & 850-1850MHz **\$2395** With Opt. 1,3,5,6

ADVANTAGE INSTRUMENTS CORP. MC-VISA - DISCOVER call 800-566-1818

3579 Hwy. 50 East Carson City, Nevada 89701 702-885-0234 FAX 702-885-7600

PRICES & SPECIFICATIONS SUBJECT TO CHANGE WITHOUT NOTICE OR OBLIGATION. F.O.B. CARSON CITY NV. NV. RESIDENTS ADD SALES TAX.

CIRCLE 149 ON READER SERVICE CARD

Longwave-Plus DX Techniques

Exploring the undervalued lower frequencies.

by Richard Q. Marris G2BZQ

The LF spectrum below 500 kHz is where wireless communications originated, but for many years has remained neglected by the enthusiast in favor of HF, VHF, and UHF. With the advent of so much commercial equipment for these bands, many enthusiastic experimenters have been taking a growing interest in the lower frequencies (LF, VLF, ELF) where there is a mass of interesting activity. For example, take a look at the longwave band (148.5 kHz to 283.5 kHz or 2020 to 1058 meters). For convenience, add the no man's land between the MW and LW bands (525 to 283 kHz) and, for the purpose of this article, we will call the total the longwave-plus band, which then covers 148.5 kHz (2020 meters to 525 kHz).

In Europe, N. Africa, the Middle East, and right into Asian Russia, there are AM broadcast stations. Worldwide there are numerous aeronautical/marine beacons and stations, information stations, CW traffic stations, and so forth. In North America, there is the 160–190 kHz amateur band. In the UK, there are moves to introduce an amateur band somewhere in the LF/VLF ranges.

My renewed interest in the lower frequencies commenced in the 1970s while G2BZQ/WØ in Minnesota. Having an all-band German marine portable receiver, I kept a check on the longwave band. I heard many nonbroadcast stations and beacons, which in England would often be obliterated by high-power AM broadcast stations located eastwards in Russia and south through Europe into North

Africa and Turkey. Every European country appears to pump out longwave AM broadcasts right around the clock.

I was staying in Connecticut when Hurricane Bella roared northwards from Atlantic City, crossed the end of Long Island, and came across the Connecticut coast during the late evening. Hurricanes very seldom occur in England and are very tiny compared with the American variety. The Holiday Inn room was on the top floor (!), and a pitch was found, down below, at the end of the bar, where the progress of Bella could be seen on a nearby TV screen. A sporadic listening watch, with headphones, was kept on the marine portable, and I noticed that the longwave band was being seriously affected. When the "eye" of Bella was overhead, the BBC on 198 kHz suddenly appeared with rapidly increasing signal strength until it peaked at full volume. It equally rapidly disappeared as the eye moved on. Why? No answer has been offered. The antenna

was a long, fat, built-in ferrite rod/coil.

Since that time, some 20 years ago, I have monitored from 150 kHz to around 525 kHz. Back in Minnesota, I made a 40" x 40" multiturn box loop and kept a sporadic watch during the long winter nights. AM BC stations were occasionally heard from Europe, plus a mass of the usual beacons and other stations throughout North America. The band abounds with activity, and what you receive depends on where you are located, the prevailing conditions, and the time of day and time of year.

To get the best from this longwave-plus band you will do best with a directional antenna and a receiver with AM, CW, USB, LSB, optional AVC, and noise limiter facilities.

The Antenna

The type of antenna used depends on the space available, but must be directional. Three simple types are described below. All are simple, easy to construct

and comparatively low cost. In all cases the actual antenna is described, and the method of mounting is left to the individual. The golden rule is to use non-metallic materials for rod/coil supports and in enclosing the variable capacitor. Also, ideally, the tuning capacitor should be mounted below the antenna with its metal body clear of the wire turns.

The "Simplex" Longwave-Plus Antenna

The frequency range of this antenna is 140 kHz to 450 kHz. Its heart is a MW/LW ferrite rod antenna as used in transistor radios, and can be purchased

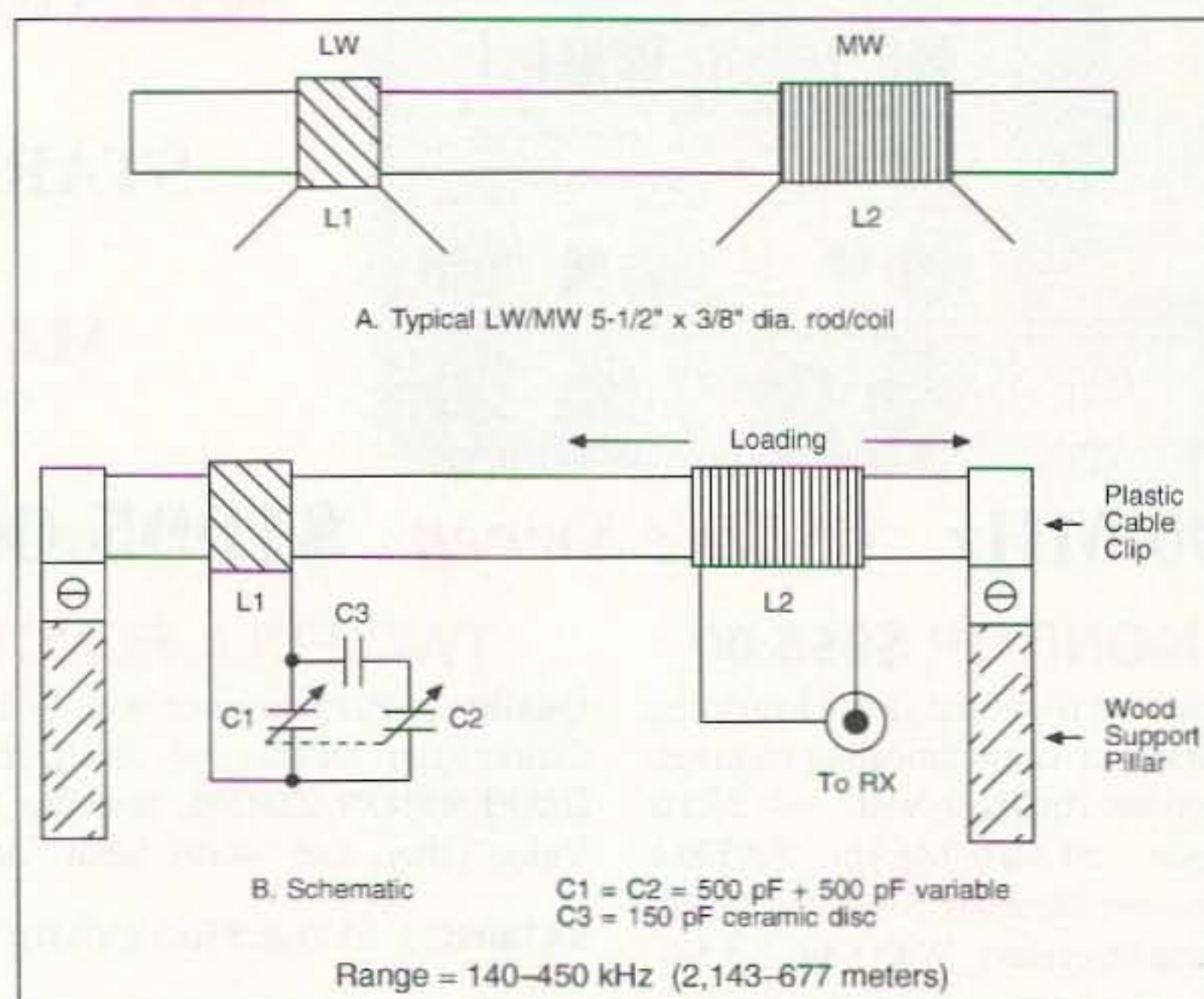

Figure 1. Typical LW/MW 5 1/2" x 3/8 dia. rod/coil.

from suppliers, or salvaged from an old transistor radio. The rod used was 5 1/2" long by 3/8" dia. (see Figure 1A), with LW (L1) and MW (L2) windings. The typical inductances were LW = 4.7 mH and MW = 370 μ H. As these coils are moved towards the rod center, the inductance goes up; and when removed to the rod ends the inductance goes down. This feature is used to establish the required antenna frequency range.

The schematic (Figure 1B) shows the LW/MW rod/coil arrangement. The LW winding (L1) is moved towards the end, and the MW winding (L2) is now used for antenna coupling, to the receiver, by moving it along the rod for best coupling/matching—it can then be held in position with a spot of hot candle wax.

L1 is resonated with a 2 gang x 500 pF variable capacitor C1/C2 wired in parallel with C3 (150 pF) in series with C2. On the prototype the frequency range was 140 kHz to 450 kHz, which can be adjusted, to personal requirements, by altering the value of C3, e.g. a salvaged coil may well be a different length and diameter from the one used. The rod/coil can be plastic cable clipped to two 3/8" x 3/8" vertical hardwood, or plastic, pillars, as shown, fastened to a baseplate, with C1/C2 underneath the rod/coil.

The "Simplex" antenna will prove very effective with any receiver.

The "Super-Ferriter" Antenna

This personal favorite is a convenient small DX antenna with a frequency range of 140–520 kHz. The schematic (Figure 2) shows a high grade 7 1/2"-long x 1/2" diameter type 61 material Amidon rod. Alternatively an 8"-long 61 material rod can be fabricated from

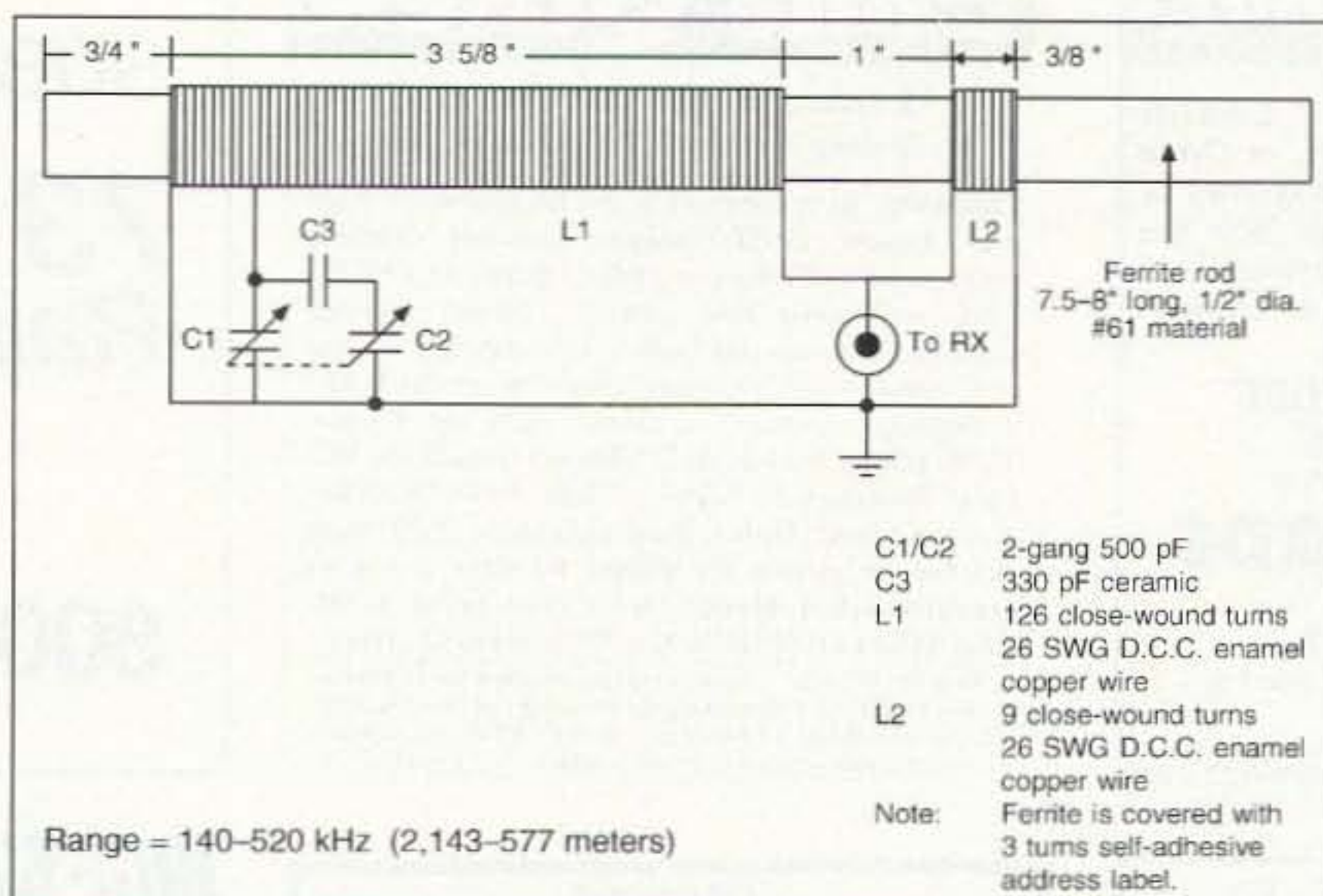

Figure 2. "The Super Ferriter"

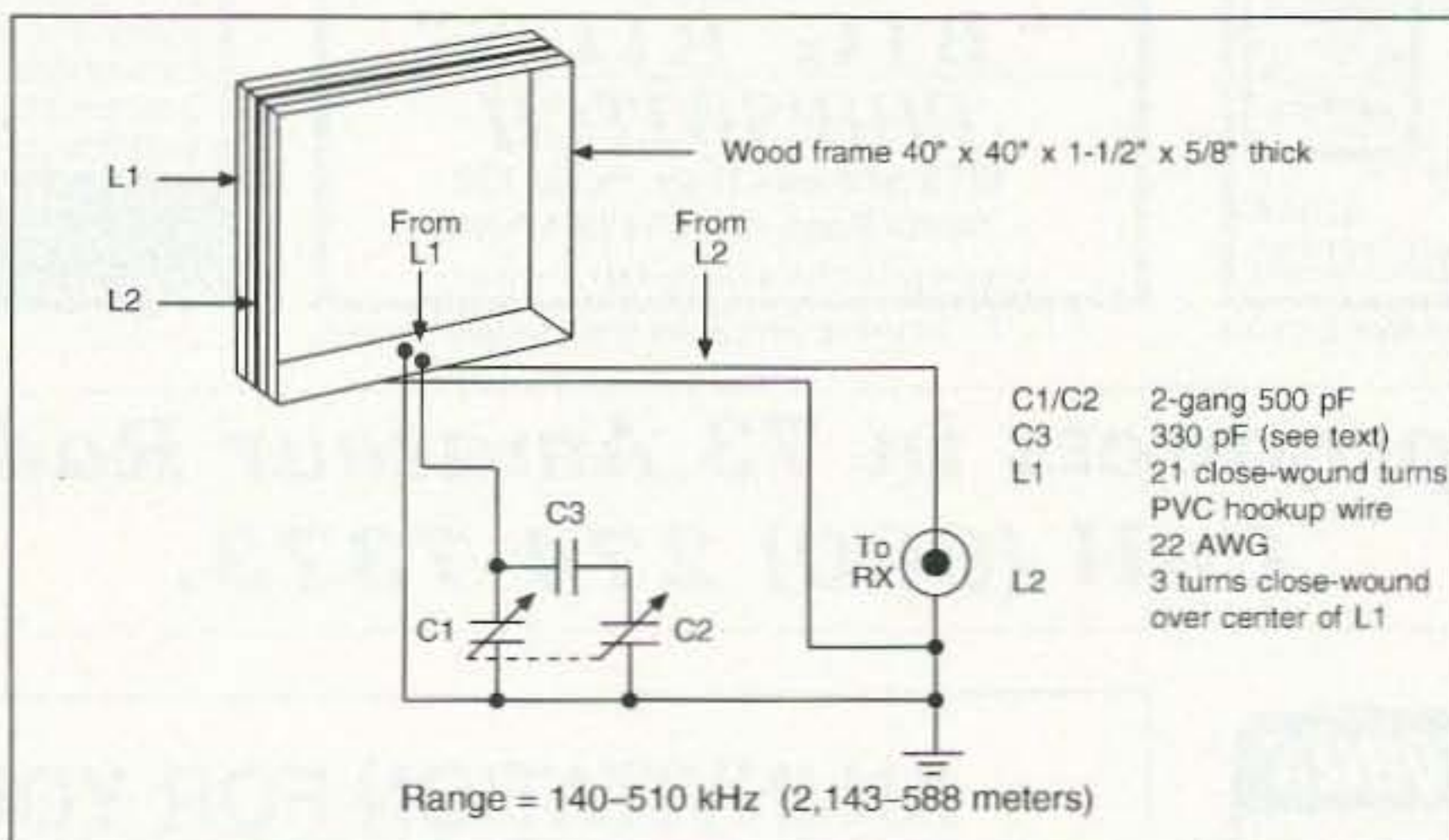

Figure 3. "The Box Loop"

Parts Lists

The "Simplex"

- C1/C2 2 gang x 500 pF variable capacitor.
- L1/L2 Transistor radio type ferrite rod (MW/LW) antenna, 5 1/2" x 3/8" diameter on prototype from Maplin Electronics type LB12N or similar. Or MW/LW rod/coil salvaged from old MW/LW radio. (Maplin Electronics address: P.O. Box 3, Rayleigh, Essex SS6 8LR England.)
- C3 150 pF ceramic (see text).

The "Super-Ferriter"

- C1/C2 2 gang x 500 pF variable capacitor.
- C3 330 pF ceramic.
- L1/L2 #26 SWG DCC enamel copper wire—2 ounce reel.
- Ferrite rod 7 1/2" long x 1/2" diameter type R61—050-750 OR 8" x 1/2" diameter rod fabricated from two R61—050—400 4" rods glued end to end (see text). (Amidon Associates Inc., 2216 East Gladwick Street, Dominguez Hills CA 90220. USA).

The "Box Loop"

- C1/C2 2 gang x 500 pF variable capacitors.
- C3 330 pF ceramic.
- Wire PVC covered Hook-Up wire (22 AWG).

two 4" x 1/2" diameter rods stuck end-to-end with Superglue or quick setting epoxy adhesive. The rod is first covered with three layers of self-adhesive white address labels.

Two windings are shown (L1 & L2). L1 is series tuned with a combination of C1 C2 C3. L2 is the impedance matching/coupling coil giving 50 ohms matching to the receiver input. The coil wind-

ings use 26 SWG DCC Enamel Copper Wire (DCC = double cotton covered). The cotton covering effectively spaces the wire turns. The tuning and coupling circuit used give maximum RF signal output voltage to the receiver, and the "Super Ferriter" produces results normally associated with a much larger wire antenna, but with a much lower noise level—QRN & QRM.

The "Box Loop"

This Loop (Figure 3) requires a lot more domestic space than the "Super-Ferriter." The frequency range is 140 kHz to 510 kHz.

A simple wood frame is made of four lengths of 40" long x 1 1/2" wide x 5/8" thick seasoned timber. The whole is glued together as shown. Strengthening blocks can be glued inside each corner.

The main winding (L1) is 21 close-wound turns of PVC covered hook-up wire (22 AWG) around the outside of the frame. Two layers of masking tape should be wound over the center of L1. The coupling winding L2 consists of three turns of PVC covered wire close-wound over the center of L1, over the masking tape turns. L1 is tuned with C1 in parallel with C3 in series with C2. The ends of the coupling winding L2 are taken to a coaxial socket.

Operation

The above three antennas should be connected to the receiver antenna input, with a length of coaxial feed-line, which should be as short as possible. The antennas should be kept clear of the electric supply wiring and metal objects. All are directional, and should be rotated towards the received station for maximum signal and interference elimination. A simple turntable is an advantage to assist with loop rotation.

MORSE CODE MUSIC!

SENSATIONAL NEW WAY TO LEARN CODE—Do Aerobics, Sing, Jog, or Drive while learning code! A fun & easy way to learn or retain Morse Code skills. Now the secret is yours with this amazing synchronized breakthrough! Great fun tape for all licenses and classrooms! Order:

"THE RHYTHM OF THE CODE"
Version 2 cassette today!

Send \$9.95 and include \$2.00 S/H to:

KAWA RECORDS

P.O. Box 319-ST
Weymouth, MA 02188

Check or money order only. We ship all orders within 5 days.
MA residents add 5% sales tax.

CIRCLE 2 ON READER SERVICE CARD

Code Quick

"Receiving my Extra satisfied one of my lifelong dreams!" BT Oklahoma City

Thousands have used our scientific approach to get their tickets, FAST. Imagine yourself enjoying every aspect of amateur radio! Surprise EVERYONE with your new power! Smash through stubborn plateaus like butter. Your amazing course now contains SIX cassettes, visual image cards and a technique jammed manual. Just \$42.95 plus \$5.95 p/h. to WARRL, 38221 Desert Greens Dr. W. - Palm Desert, CA, 92260 or info 1-800-782-4869. You can't lose! Follow the simple steps. YOU must succeed or return kit within 90 days for a no questions asked refund! Order yours today. V/MC ASK FOR CODE QUICK #107 (CA add \$3.22Tax)

"Dear Dr. Wheeler, "To my surprise, within 8 hours I could copy 10 WPM! I jumped on the air using your system and after another 8 hours I found myself at 17 WPM. No plateaus! I would highly recommend your product..." ET Parker CO

SUBSCRIBE TO

73 Amateur Radio Today

Call

800-274-7373

ULTIMATE MODIFICATION BIBLE VOL. IV NEW AND MORE COMPLETE!!!

OVER 800 MIKE WIRING CODES FOR CB AND HAM RADIOS.
OVER 400 CB POWER/MODULATION BOOST INSTRUCTIONS.
OVER 200 MOD. FOR CB PLL'S.
OVER 175 MOD. FOR HAM RADIOS.
OVER 50 COMPLETE SYNTHESIZED CRYSTAL CHARTS WITH INSTRUCTIONS.
OVER 25 SCANNER MOD. AND TEN METER RADIO MOD.
OVER 20 PRECALCULATED MOD. CRYSTAL CHARTS.
LINER SCHEMATIC'S AND ANT./COAX db GAIN/LOSS CHARTS.



KDC SOUND Orders Only: 1-800-256-9895 \$29.95
17294 FM 3083 Conroe, TX 77302 All Other Calls: 409-231-3753 MONEY ORDER, COO MC/DISC/MISA OR CK

CIRCLE 151 ON READER SERVICE CARD

GIVE YOUR HR-2510 HR-2600

the same features as the
"BIG RIGS"

CHIPSWITCH

4773 Sonoma Hwy. Suite 132
Santa Rosa, CA 95409-4269

Write or call (707) 539-0512 for FREE information

CIRCLE 265 ON READER SERVICE CARD

CB-TO-10 METERS

We specialize in CB radio modification plans and hardware. Frequency and FM conversion kits, repair books, plans, high-performance accessories. Thousands of satisfied customers since 1976! Catalog \$3.

CBC INTERNATIONAL

LOU FRANKLIN/K6NH Owner

P.O. BOX 31500X, PHOENIX, AZ 85046

**Sell your products in 73 Amateur Radio Today.
Call (800) 274-7373.**

MOUNTS & ACCESSORIES

TPM-6
6" Pedestal Mount. Adjustable with thumb screws. Triple black finish.

\$19⁹⁵



Extensions... Recommended for use with the TPM6.

T2EXT (2") \$2.95
T4EXT (4") \$4.95
T6EXT (6") \$6.95

\$19⁹⁵

THTC

Universal Cradle for HT, Cellular Phone, or Scanner. Attaches to the AMPS plate of the TPM6 or similar mounts. Securely holds portables from 1.375" to 2.875" wide.



TRANSEL
TECHNOLOGIES
MADE IN USA

123 EAST SOUTH STREET
HARVEYSBURG, OHIO 45032
(800) 829-8321 FAX: (513) 897-0738

Add \$5.00 S&H on All Orders!



CIRCLE 11 ON READER SERVICE CARD

AN INVITATION FOR YOU TO JOIN THE GREEN TEAM

73, Radio Fun, and "Cold Fusion" magazines are actively recruiting more members for the lean, mean, Wayne Green team here in Peterborough. Translation: Wayne's hiring experienced and/or trainee employees.

Wayne needs an assistant technical editor now. Non-smoking ham with technical, editing and/or writing abilities would be near perfect because setting up and maintaining W2NSD's ham shack and reviewing equipment and manuscripts are some of the main responsibilities. The final focus will be a metamorphosis to Editor-in-Chief desk. Translation: Wayne wants someone capable (technically literate) to manage the magazines so W2NSD can go on more DXpeditions.

Other career opportunities abound for **MAC literate people** who know how to use Microsoft Word, Quark Xpress and/or Adobe Photoshop, **create technical drawings, edit manuscripts, etc.** There's a need for **circulation management and advertising sales people** too. Translation: **Help wanted.**

What skills do you have to offer? If you are a non-smoker and in the southern NH area, please contact Frances Hyvarian at 603-924-0058 or FAX 603-924-8613 for an interview or send detailed résumé which includes your work experiences, future ambitions, and phone number to Green Team, 73 Magazine, 70 Rte. 202 N, Peterborough, NH 03458.

SAM Amateur Radio Callsign Database

Find Hams quickly and easily by Callsign or by Name. Search for a specified City, State, or Zip Code. Print with standard or customized output. Ideal for mailing lists, QSL's etc. **NEW FOR '94**, search filters that allow you to specify FIRST NAME, LICENSE CLASS, AGE, ADDRESS, or CALL SUFFIX, AREA, OR PREFIX.

SAM Option files include County Cross Reference, License Expiration Date, Full Date of Birth, Previous Calls and Date First Licensed.

Requires IBM Compatible PC, 17.5 MB of hard drive space, and high-density floppy drive.

NOW AVAILABLE ON CD-ROM

Disk Version \$39.95 CD-ROM \$39.95
SAM OPTIONS \$7.50 each
Shipping and Handling \$5.00

RT SYSTEMS, INC

8207 STEPHANIE DRIVE, HUNTSVILLE, AL 35802
1-800-723-6922 or 1-205-882-9292
Visa, MasterCard or Discover

The World of Ham Radio Callsign Sept 95 Database

You can have the latest US and Alien callsigns available. 20,000+ software files for amateur radio. AmCall auto-logging station log book included with every CD. Over 1,350 Radio Mods. The latest space photos. The newest releases of amateur software. 1,100 images of lost & missing children. Thousands of SWL frequencies. Published every JAN/MAY/SEP Special rates for clubs. FTP, BBS, & PBBS sysops. DOS & Windows compatible. Can you afford to be without the biggest & best CD for amateur radio? Subscribe and get 3 issues for \$99 US. \$109 Foreign Single issues \$39 plus shipping. USA \$3. Overnight USA \$11. Foreign Air Mail \$5. AmSoft, PO Box 666, New Cumberland, PA 17070-0666 USA. FAX 717-938-6767 Internet: amsoft@epix.net

AmSoft 717-938-8249

CIRCLE 113 ON READER SERVICE CARD



\$39
CD-ROM



DIGITAL FIELD STRENGTH METER
FS 73
"SIGNAL CUBE"[®]
High Performance, Precision Instrument
measures in relative and
absolute units

- Relative measurements from 60 Hz to the GHz range and absolute measurements from 1 MHz to 100 MHz. (Broad band with no tuning adjustment).
- Adjustable length dipole antenna sets required sensitivity (At high gain settings, ambient R.F. fields from local sources will indicate on the display).
- Dipole antenna eliminates need for a counterpoise. (A single antenna type field strength meter utilizes the person holding the unit as the counterpoise).
- Consistent and repeatable readings can be obtained with the Nye Engineering unit since it is not necessary for the observer to hold or be in close proximity to the meter.
- A heavy duty cast aluminum, gasketed cubical enclosure is used. It does not easily tip over.
- The "SIGNAL CUBE"[®] is factory calibrated to a standard for both absolute and relative measurements.

NYE ENGINEERING CO. INC.

4020 Galt Ocean Drive Suite #606
Ft. Lauderdale, FL 33308

Made in USA



Phone: 305-566-3997
Fax: 305-537-3534

\$169
plus \$5.00 shipping

CIRCLE 290 ON READER SERVICE CARD

FREE
SAMPLE
COPY!

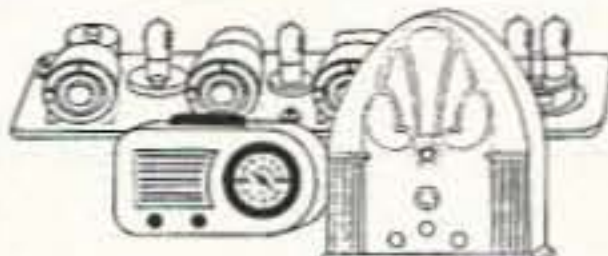

ANTIQUE RADIO CLASSIFIED

Antique Radio's Largest-Circulation
Monthly Magazine

Articles - Classifieds - Ads for Parts & Services
Also: Early TV, Ham Equip., Books,
Telegraph, 40's & 50's Radios & more...
Free 20-word ad each month. Don't miss out!

1-Year: \$34.95 (\$51.95 by 1st Class)
6-Month Trial - \$17.95. Foreign - Write.

A.R.C., P.O. Box 802-E10, Carlisle, MA 01741

Or Call: (508) 371-0512

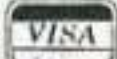

QUICK, EASY, & COMPACT

Flash cards *NOVICE thru EXTRA* theory Key words underlined. Over 4000 sets in use! For beginner, OMs, XYLS & kids.

NOVICE	\$11.95
TECHNICIAN	\$10.95
GENERAL	\$9.95
ADVANCED	\$15.95
EXTRAS	\$14.95
Shipping	1-\$3.00
2 or more	-\$4.00
CLUB DISCOUNTS	

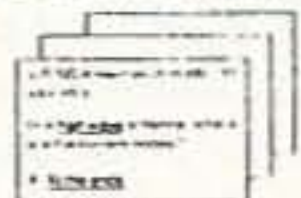

Order Today!
from

VIS STUDY CARDS

P.O. BOX 17377
HATTIESBURG, MS 39404



CIRCLE 104 ON READER SERVICE CARD

CornerBeam?

SWR < 1.2:1 across the band
Gain of a 15 ft Yagi
No dimension over 7 ft
40 dB Front-to Back Ratio
60° Half-power Beamwidth
Mounts directly to mast
Vertical or Horizontal Polarization
2meters \$145, 220 MHz \$145, 70 cm \$115, Dual 146/440 \$165
Weights only 10 lbs. Add \$11 Shipping & Handling. Info \$1.



AntennasWest
Box 50062 Provo UT 84605

Order HotLine
801 373 8425

CIRCLE 380 ON READER SERVICE CARD

40th

OUR YEAR!

**IT MAY BE YOUR HOBBY,
BUT IT'S OUR BUSINESS!**

- WT 51 ----- \$1,050
- LM 354HD ----- \$1,900
- LM470 ----- \$3,658

Designed to UBC 1991 - 70mph

CALL OR WRITE
FOR A FREE
CATALOGUE!

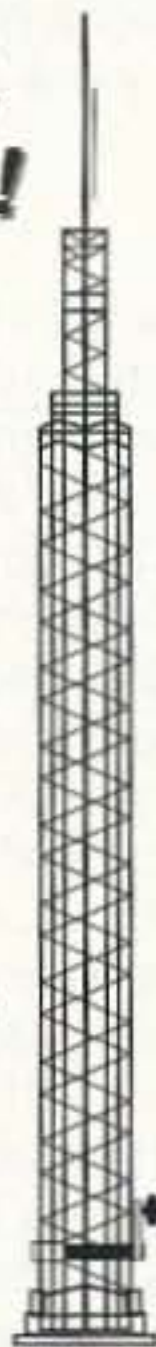

Iri-Ex[®]
TOWER CORPORATION

7182 Rasmussen Ave. • Visalia, CA 93291

Where engineering and quality come first!

TO ORDER CALL
800-328-2393

TECH SUPPORT
209-651-7859

FAX
209-651-5157

CIRCLE 22 ON READER SERVICE CARD

TRANSMITTER LOCATION

Direction Finding System
Tracks Down

- Stuck Microphones
- Cable TV Leaks
- Jammed Repeaters & Cell Sites

Models available with
computer interface,
synthesized speech,
for fixed or mobile
use, covering 50 MHz
to 1 GHz. Call or fax
for details



DOPPLER SYSTEMS, INC.
P.O. Box 2780
Carefree, Arizona 85377
Tel: (602) 488-9755
Fax: (602) 488-1295

The Icom IC-738 HF Transceiver

A sturdy and popular rig.

I'm lucky enough to be frequently offered new equipment for review, and my luck was running well in early April when 73 arranged to have a new IC-738 delivered to me for this purpose.

The IC-738 has been on the market long enough that it's already popular, as is its more pricey sibling, the IC-736. There are only two differences between these units: The IC-736 offers 6 meter (as well as HF band) coverage and has a built-in AC power supply, while the IC-738 lacks 6 meter coverage and requires an external source of 13.8 VDC

power. The two rigs share a common owner's manual and most other features. Because the IC-738 lacks an internal power supply, it weighs less (19 lbs) than the IC-736 (23.1 lbs) and may be easier to handle for field operations. As far as I can tell, the IC-736 has no provision for external DC power at all, making it a base station rig in every sense.

Despite the 738's lighter weight and potential battery-power operation, it, too, is really a base station radio because it is not small. Measuring 13" x 4.4" x 11.2" (H x W x D), the IC-738 has the look and feel of a real radio. Most of its controls are large and spaced far enough apart for even clumsy fingers, and its display is large enough to be viewed from across a large room. The Icom's 59 panel-mounted controls are easy to use, with the possible exceptions of the RF-gain and power output controls.

The IC-738 comes well-packed and includes most items needed to get on the air quickly, save for power supply and antenna. Its instruction manual is reasonably complete and well written. The transmitter output power is rated at 100 watts SSB, CW, and FM, without any note regarding possible derating requirements for high-duty-cycle operation (like FM or RTTY). I don't know whether Icom would consider it safe to operate at 100-W output continuously or not. Also, the specifications discuss only SSB, CW, FM, and AM, and don't mention the digital modes except



Photo A. The IC-738 has a clean, uncluttered front panel that's user-friendly with a huge main display.

for brief connection instructions on page 16 of the manual, which state, "The transceiver does not have an FSK mode for RTTY, AMTOR, packet, etc.; however, you can operate these using AFSK in the SSB or FM mode." I'm neither a Digital Demon nor a Binary Bimbo, but even so, I'd expect more discussion of such a popular subject.

Strengths

A point in its favor, though, is that the IC-738 passed my "Can I use this radio without opening the manual?" test with flying colors. I had the rig out of the box and on the air and completed my first 50 or so contacts, without ever glancing at the manual. And that's good. This is important because, in an emergency, there may be no time to indoctrinate operators; they need to sit in front of the radio and use it immediately. The more intuitive the rig is to operate without instructions, the better its design, as far as I'm concerned. On a scale of 1 to 10, I'd give the IC-738 a "9" for intuitive use. I'd have given it a "10," except its built-in, two-port antenna switch (front-panel controllable) kept switching to the unused port as I switched bands, making me scratch my head about why signals seemed so weak on bands where I knew they should be strong! (The IC-738 remembers which antenna position was last used on each band, and reverts to it. As it comes from the factory, who knows how it will be set up? You can

override this feature, but it is not intuitive and probably requires an instruction reference.)

The first thing I noticed about the IC-738 was how uncluttered its display is. On power-up, the display panel indicates VFO frequency, mode, tuner status, VFO selection (A or B), and channel number for memory operation. That's it! I like the tidy display, and only wish it omitted the channel number unless memory operation is actually in use. It would then display only what the operator absolutely has to know. The frequency indicator numerals are large

(1/2" high) and very easy to read, being dark gray segments against a bright orange background. The display is readable even operating outdoors on a sunny day.

The second thing I noticed is how quiet the receiver is. Unless the PREAMP is activated, the noise level on every band tends to indicate about "S0" (no reading) and the ambient hiss between signals is very slight. This tempts one to turn the volume up very high, to hear *something*. Then, when you tune across a signal, the sound jumps out at you from the rig's top-mounted speaker. The background noise is so low that you wonder if the receiver has the sensitivity we've come to expect from modern equipment. It does. The IC-738 tests as sensitive as any receiver I've come across. The small amount of hiss is due to advancements in synthesizer, IF, and audio stage design. The rig is deceiving. It doesn't *sound* sensitive until you need it to be, and then it's right in there with the best of them.

Weaknesses

Within a few QSOs made, I was able to find a few shortcomings with the Icom—not in performance, but in creature comforts. For example, the analog meter indicates only one of three possible data on transmit: either power output (watts scale), SWR (1 to infinity, with SWR = 3 at center scale), or ALC activity (thick "normal" range). However, there is no

way to tell which scale is active. There is no three-position panel-mounted switch to which to refer. The meter is switched by a single push-button, which toggles the meter mode between the three possibilities.

Another example is the power level control, which, like the receiver RF-gain control, is a small knobless shaft protruding through the front panel to the lower left of the main VFO tuning knob. While I don't find myself adjusting RF gain much, I do frequently like to change transmitter output power. This is a control that gets a real workout in my station, as I've never been an "AKTR" (All Knobs To Right) operator. If I work some-

body very strong, I tend almost automatically to reduce my power. If the station worked is very weak, I almost automatically turn it back up. Rapid-fire contesting notwithstanding, I adjust this control a lot, and know many others who do, too. The IC-738's control for this function is too small to be easily and repeatedly adjusted.

One other thing that struck me as inconvenient is the placement of the VOX controls, which are on the rear panel. It is inconvenient to have to reach around behind the rig to make adjustments. In many shacks, it might take quite a bit of effort, and maybe a flashlight, to do so! VOX controls, especially the DELAY control, need to be more accessible.

My last gripe is that the IC-738 lacks transmitter mike gain. The factory-supplied, hand-held mike is quite good and sounds fine on the air, but has rather low output level and requires the 738's gain control to be run literally all the way up to make the ALC work properly.

The only other complaints I might have is that the CW sidetone level adjustment is internal and requires removing the covers. The rig has any CW offset you might want by using the Δ Tx control (similar to a receive RIT, but works the transmitter offset), but the sidetone pitch always remains the same. As a true CW operator, I like being able to adjust everything I can when using this mode.

Okay, enough gripes. Other than these small issues, the IC-738 works really great!

Strengths again!

If you're already familiar with modern HF gear, you won't need any training in how to use the Icom. If this is your first modern HF transceiver, read the manual and try out each function one at a time. I like that the 738 has two key input jacks, one of them three-circuit for connection of a paddle to use the rig's (standard) internal electronic keyer, and a separate two-circuit jack for use with a straight key, "bug," external keyer, or computer control. I also like the rig's use of a common RCA "phono" jack for connecting the key line to an external linear amplifier. (Note: This jack is labeled SEND, which is a bit mislead-

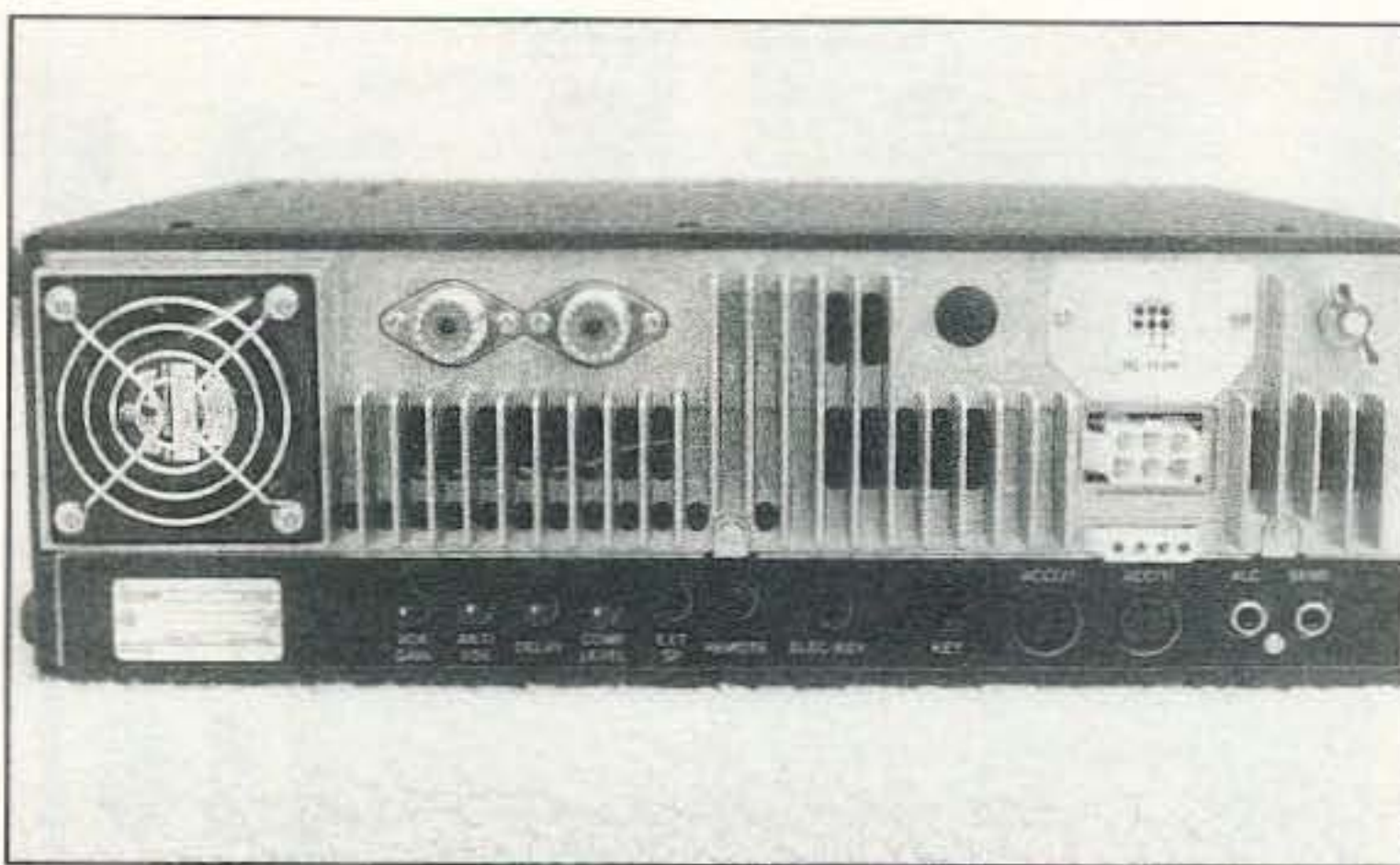

Photo B. Rear View of the IC-738. The two side-by-side SO-239 coaxial receptacles are for two antenna connections. The cooling fan to the left side of the photo is one of two cooling fans used to keep the unit loafing along even at continuous duty at full power.

ing. It is connected in common with pins on ACC[1] and ACC[2], the two accessory DIN-jacks, and is a dual-function I/O port. If grounded, as with a footswitch, the rig will transmit. If connected to the key jack of most amplifiers, it will ground on transmit and cause the amplifier to key.) I happen to like RCA phono plugs and jacks, mostly because they've been around for generations, are likely to be in nearly everyone's junk box, and can be picked up inexpensively at a local Radio Shack in a pinch. DINs are fine, but are also the kind of thing you might forget to bring to a DXpedition; DINs are also difficult to assemble in the field.

Operating

My first 30 or 40 QSOs with the new IC-738 were on CW, my favorite mode. (I can hear the boos and hisses, but to each his own.) The rig had no trouble producing more than 100-W output on every band. The semi-QSK worked great and so did the full-QSK (break-in) mode, up to at least 45 wpm.

On SSB, the stock microphone lacks punch unless the mike gain is turned fully clockwise. I'll guess that Icom might have a fix for that by now. I did try using one of my favorite desk mikes, an old American-made Shure 444 (big and clunky, but they usually sound good), and it produced far more punch than the stock hand-held mike and reports received were excellent. With the 444, I was able to turn the mike gain down about halfway and still have sufficient audio to get an ALC indication. The IC-738 has a built-in speech processor whose function is labeled COMP (compression) on the front panel. Its adjustment is also labeled COMP and is located on the rear apron of the radio, next to the VOX controls. The compressor worked pretty well, although stations contacted advised my audio sounded more natural with it off. This is a pretty subjective issue, and I'm used to getting mixed reports about speech processors and compressors. Despite most stations' reports telling me I sounded better with it off, the compressor did its job of increasing PEP output power as indicated on my Autek WM-1 PEP computing wattmeter.

This is all one can ask for from a simple speech compressor circuit.

The rig's IF bandwidth, stated as 2.1 kHz (-6 dB), is very adequate for SSB work, but might be too wide for crowded CW operation. I liked the way the receiver sounded with the factory-equipped filter on SSB. It was tight enough to prevent much adjacent-channel interference, but wide enough to allow excellent fidelity of received signals. I thought it was just about the proper balance, and the receiver is one of the best I've ever listened to. Although I have four modern HF rigs, my standards of comparison for HF receiver performance are older equipment that in many ways outperform the latest gear. I use a 1978-vintage Drake

TR-7 (transceiver) and a 1958-vintage Collins 75A4 (receiver). Believe it or not, these old-timers offer better performance under some conditions than anything built since. If a modern synthesized transceiver can hold its own against these two radios, I'm usually astounded. The IC-738 comes very close.

The IC-738 is one of the few modern HF rigs I've used having a receiver that I like listening to on SSB. I did not have at my disposal the optional narrow CW filters on the review model, so I can't comment on them. But the standard SSB filter works very well, and the optional filters are plug-in, not solder-in (although installation does require removing the radio's covers).

The 738's standard, built-in ATU (automatic antenna tuning unit) is fast and smooth as silk. I was extremely impressed with it. The ATU is activated and then implemented with a single push-button control (TUNER). A fast push activates it, and a longer push engages the tuner, which makes the transmitter operate at reduced power until the tuner finds a nearly perfect match point. I could not find any point in any band where I could not achieve a nearly perfect match with the antennas I normally use. I could even get my 6 meter vertical to load up on 80 meters, as well as achieving success with my 160 meter dipole on every single band, including 10 meters.

As an experiment, I tried loading up a 12" long Radio Shack clip lead (#20-gauge wire with an alligator clip on each end) on 20 meters. I clipped the far end of the lead to a paper poster hanging on the wall (a contest award, actually!) and the rig found a match within a few seconds. I answered a strong W5 in Arkansas, and completed a contact with the clip-lead antenna. I should note that my shack is at ground level, enclosed within the house and having no windows to the outside. This is not a very objective test, and I have no way to measure the impedance of the clip lead on 14 MHz, but it goes a long way in demonstrating the effectiveness of this tuner.

The ATU obviously has memories, and seems to know how to retune itself (once set

points have been established by prior use) as the receiver is being tuned across each band. The problem is that I don't know how many tuner memories it actually has, because the manual does not address this point. The ATU also retunes itself to the presets as one tunes around on the receiver, which makes transmitting at full power on nearly any frequency as easy as pressing the PTT button or key; but the manual does not discuss this point, either. This is a shortcoming of the manual: The rig has features that work very well but aren't even mentioned!

The receiver's PREAMP works well to boost receiver sensitivity on the higher bands like 10 meters, but serves no useful purpose on the noise-laden lower bands. (This is typical of many modern HF rigs. Nobody needs a preamplifier when using any reasonable transmitting antenna to receive below 10 MHz.) The IC-738 also has an ATTenuator, which reduces signals reaching the front end and might be useful when receiving on or near the frequency of extremely strong signals.

The IC-738 contains the normal complement of features and functions found in HF base station transceivers of the nineties. I've already mentioned most of the important ones, but a tour of the rig's panel controls would be incomplete without mentioning these as well.

The AGC switch is a push-button that toggles between FAST and SLOW. Although it lacks an OFF or MEDIUM mode, I found it satisfactory for most operations. The AGC performance is good. Concentric to the volume control (labeled AF) is a squelch control (SQL) that functions on all modes but is normally used only for FM work in the 29.6 MHz range. The rig has a pulse-type noise blanker activated by a push of the NB switch. It works as well as most I've used, and does a fine job of reducing ignition noise.

The built-in electronic keyer for CW work has a speed control (KEY SPEED) concentric to the mike gain (MIC) control and adjusts smoothly from 7 wpm to 41 wpm. The keyer works fine, but I usually use an external memory keyer for contest work. Still, an internal keyer is handy in a pinch or for portable work. The previously mentioned antenna switch is an internal relay that is activated by a press on the ANT button, above which are mounted two LED indicators to indicate the antenna ("1" or "2") selected. The ANTenna selection data is normally automatically stored in band memory, but may be overridden at any time by a push of the ANT button.

The RF PWR control adjusts the rig's output power from less than 5 W to full output (100 W, except on AM, where the max is about 40 W). It works well and adjusts output smoothly, but I wish it had a larger knob to make for easier frequent use. Just below the

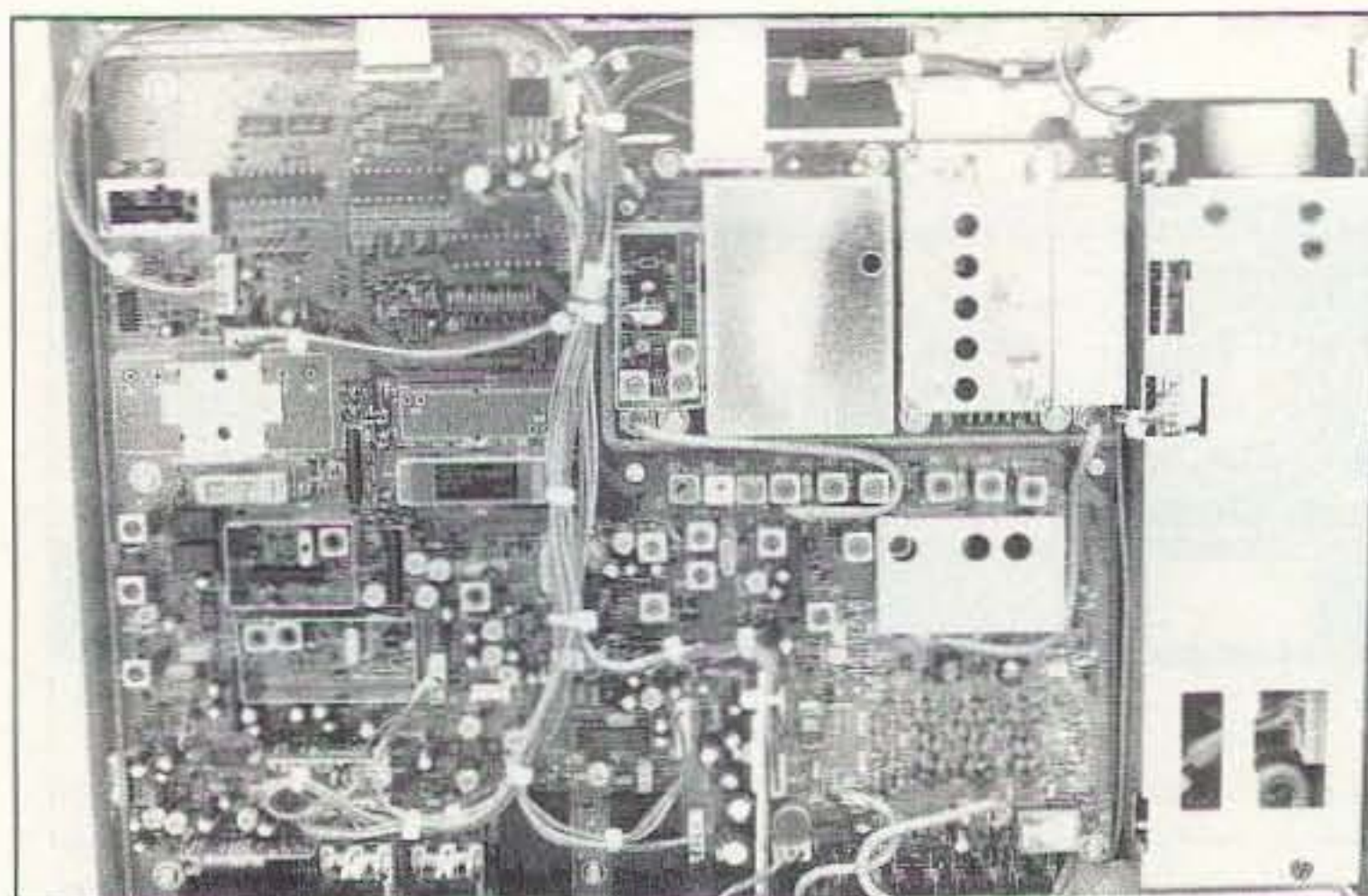

Photo C. Inside the IC-738, bottom view. The rig has a clean layout and appears easy to service. To the right, in the shielded compartment, is the ATU (automatic antenna tuning unit).

main VFO tuning knob is a tuning brake adjustment screw, turned by a small Phillips-type screwdriver, to vary tuning dial tension. I found the factory setting just about perfect, but you can adjust this to your heart's content, from quite loose (allowing a spin across the band) to fairly tight (won't jar the knob even if the rig is bumped hard).

The main VFO tuning knob operates smoothly and has a weighted feel. Large enough to provide a comfortable grip, it also has a large circular finger-hole depression for rapid motion using a single finger. I liked it a lot. This is one of those features that many hams overlook, but can make a real difference in operating, especially for long periods (like contesting). I wish every rig out there had a tuning knob like this one. Just above the tuning knob is an electronic dial lock switch (LOCK), which prohibits the VFO from changing frequency. I never actually use this function, although most modern rigs offer it.

The IC-738 offers 101 channel memories and six pages of the owner's manual are devoted to describing its operations. The memories will store frequency, offset, mode, antenna selection, and so forth. The memories can be of great assistance in a variety of ways, but I use them mostly for rapid band and mode changes, or to store repeater frequencies in the 10 meter FM subband. A very handy feature is the IC-738's scratchpad memories. These are five additional memories (extendible to 10 if desired) which do not occupy space in the normal 101 memory register, and can be instantly stored and recalled with a single push of the MP-W (Memo Pad-Write) or MP-R (Memo Pad-Read) button. If you want to store the frequency to which you're tuned, and then tune somewhere else, just punch the MP-W button and spin the knob. A single push of the MP-R button instantly recalls where you were before you tuned around. These memories stack up, and the factory default allows stacking five of them; if you add a sixth, the oldest one stored will drop out of the memory, and you'll be able to recall the latest five. This feature is very handy when DXing or contesting, and easier to use than the other 101 memories,

which require more thinking and keystrokes.

Like any good, modern rig, the IC-738 has a frequency/band keypad, a set of 12 push-button switches that can be used to change bands instantly, or access specific operating frequencies without the need for spinning the VFO knob. Eleven of these buttons are labeled with band designators and/or the numbers "1" through "0," plus a decimal point. If you're on 80 meters and want to switch to 10 meters instantly, just push the "28" button, and you're there, right on the last 10 meter frequency used. If you want to dial up a specific frequency without turning the VFO knob, that's easy, too. For 14.225 MHz, you'd press

FREQ INP (frequency input), followed by 1-4.-2-2-5, followed by ENT (enter).

Another way to tune around besides using the VFO knob is to use the UP and DOWN buttons, located below the keypad just discussed. If you press and hold either button, the rig will electronically tune up or down the band in programmed steps from 1 kHz to 1 MHz. Having this function on the front panel is almost superfluous, however. The function may be duplicated with the UP and DOWN buttons atop the handheld microphone (and also found on most desk mikes). That can be handy.

Operating "split" with the 738 is as easy as with most modern rigs, and involves using the SPLIT button in combination with the A/B (VFO "A" or "B" select) button. If you wish to check your transmit frequency instantly when operating split, a push of the XFC (Transmit Frequency Check) button will toggle the VFO from the receive VFO to the transmit VFO. If you press XFC and hold it down, the VFO knob may be tuned to change your transmitter frequency to anything desired, without changing your receiver frequency. When you release the button, your transmitter frequency will be whatever was last tuned. Very handy for working split-frequency pileups.

A Quick Tuning switch (TS, for Tuning Speed) allows changing the VFO tuning speed from normal (1 Hz or 10 Hz, user-selectable) to fast (1 kHz) for rapid band excursions. When the normal (slow) tuning mode is selected to allow 1 Hz tuning, a third numeric indicator to the right of the frequency decimal point illuminates; otherwise, when the normal tuning mode is 10 Hz, this digit is blanked and not part of the frequency display. Not a bad idea. Using the 1 Hz tuning mode can be painfully slow and is rarely necessary (can you really hear a 1 Hz change?), although it might be nice when using a sharp CW filter and the NOTCH function.

The mode selector buttons are easy to use and large enough to operate quickly. Located just to the left of the main VFO tuning knob, the mode switches are labeled SSB (toggles between LSB/USB); CW/N (toggles between CW wide and CW narrow if the optional nar-

row filter is installed); AM; and FM/TONE (toggles between FM and FM+CTCSS tone [encode] if the optional UT-30 tone encoder is installed).

The IC-738, like most recent Icom products for HF, has both RIT and XIT functions. RIT, Receive Incremental Tuning, is featured under various names on all HF transceivers made in the past two decades or so. XIT allows similar adjustment of the transmitting frequency, independent of the receiving frequency. Using either one or the two together, you can work split up to about 20-kHz separation, without needing to use the SPLIT function. The RIT and XIT functions are individually addressable but share a common tuning knob labeled RIT/ΔTX.

The rig also has two interference-fighting tools: PBT (PassBand Tuning) and NOTCH filtering. The PBT control has a center off detent, while the NOTCH control has its own separate on/off switch. I found the passband tuning PBT function extremely helpful under a variety of situations, but the NOTCH not particularly useful. Notch filters are mostly intended for reducing the intensity of an interfering single-frequency carrier, and don't help much in reducing interference from a nearby SSB station. Used in combination with some patience and skill, the PBT and NOTCH can complement each other to further reduce some types of interference. But I think the PBT will be of greatest help for most users, and the one in the IC-738 is good.

The unit has the usual scanning features that may be used to frequency-scan between memories or preset band limits. The scan modes are "programmed scan," "memory scan," and "select memory scan," and are described in two pages of clear instructions within the manual.

Technically speaking

The IC-738 uses a triple-conversion receiver with "up conversion" as has become the norm. Its receive first IF is at 69 MHz, second IF at 9 MHz, and third at 455 kHz, allowing the use of conventional bandpass filters. Following the signal path from the antenna jack, received signals are first routed through the antenna switching relay, then through the T/R relay, a low-pass filter, and the receive attenuator switch before they reach either a low-pass filter for reception up to 1.6 MHz, or a set of diode-switched bandpass filters for coverage of 1.6 through 30 MHz. Seven such bandpass filters are employed, each covering an octave or less.

The filtered signals are routed to the receive preamplifier switch, where, if the preamp is engaged, they are amplified by a pair of 2SK2218 JFETs in parallel. Signals are low-pass filtered once again before reaching the first RF mixer, a pair of balanced 2SK2171 JFETs, then are bandpass filtered at the first IF of 69.0115 MHz before being amplified by the first IF amplifier, a 3SK121 dual-gate MOSFET. Received signals are

then bandpass filtered once more at 69.0115 MHz before being mixed down to the 9.0115-MHz second IF in a diode balanced mixer, type ND487CIT. LO injection to both mixers is provided by the PLL unit. The first mixer injection provided by the PLL tunes from 69.0415 through 99.11499 MHz, thus allowing continuous receive coverage of nearly the entire 30-MHz spectrum. This output range is achieved by four VCOs having outputs 69.0115 MHz above the received tuning range. (For example, VCO1 produces 69.0145 through 76.0114 MHz; VCO2 produces 76.0115 through 84.0114 MHz, and so forth). The second mixer injection at 60.000 MHz is provided by a frequency-doubled 30-MHz crystal oscillator, also located in the PLL unit.

The 9.0115-MHz second IF is filtered using another 2-pole bandpass monolithic device, after which the noise blanker gate is located. The noise blanker gate is a set of four MA77 diodes driven by a gate control circuit located on the output of the noise blanker loop. The noise input to the blanker is sampled at the 9.0115-MHz IF and is amplified and detected in a noise blanker AGC loop of its own prior to driving the gate control circuit. After the diode gate, the 9-MHz IF signals are amplified once more and then bandpass filtered by one of two 9-MHz crystal filter units. (The 2.1-kHz unit is standard, but an optional narrow CW filter may be installed at this point as well. AM or FM signals continue through the

BATTERIES

BUY DIRECT FROM US, THE MANUFACTURER!



YAESU

FNB-2	10.8v @	600 MAH
FNB-4	12v @	750 MAH
FNB-4A	12v @	1000 MAH
* FNB-10(S)	7.2v @	1200 MAH
FNB-12(S)	12v @	600 MAH
FNB-17	7.2v @	600 MAH
FNB-25	7.2v @	600 MAH
FNB-26	7.2v @	1200 MAH
**FNB-26(S)	7.2v @	1500 MAH
FNB-27	12v @	600 MAH
**FNB-27(S)	12v @	800 MAH
***1/4" longer than FNB-27		
FNB-31	4.8v @	600 MAH
FNB-33(S)	4.8v @	1500 MAH
FNB-35(S)	7.2v @	600 MAH
* FNB-35(S)(S)	7.2v @	1500 MAH
FNB-38	9.6v @	600 MAH
*1 1/3" longer than FNB-38 case		

BATTERY ELIMINATORS AVAILABLE

SPECIAL

FOR THE
MONTH OF SEPTEMBER

10% OFF

ON ALL

ALINCO

Replacement Batteries

LOOK FOR OCTOBER'S
SPECIAL OF THE MONTH

MONTHLY DISCOUNTS
APPLICABLE TO END-USERS ONLY

Powerpac+®

6 V for Camcorders & 12 V for 2-way



Prices and specifications subject to change without notice.

W & W ASSOCIATES

800 South Broadway, Hicksville, NY 11801

WORLD WIDE DISTRIBUTORSHIPS AVAILABLE. PLEASE INQUIRE

In U.S.A. and Canada Call Toll Free:(800) 221-0732 • In NY State Call:(516) 942-0011 • Fax:(516) 942-1944

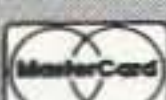

NYS residents add 8 1/2%
sales tax. Add \$4.00 for
postage and handling

MADE IN
THE U.S.A.
SEND FOR
FREE CATALOG
AND PRICE LIST

CIRCLE 191 ON READER SERVICE CARD

diode filter switch without filtering and go on to the third mixer, whose description follows.)

The third mixer is an integrated circuit type uPC1037HA having LO injection at about 9.4665 MHz, generated by the crystal oscillator with some frequency shift afforded by the PBT control. This mixer's output at 455 kHz is filtered by one of four diode-switched ceramic filters, three of which are standard (SSB/CW, AM, and FM) and one of which is optional (CW narrow). The 455-kHz final IF signals are postamplified by a 3SK131 DG MOSFET and then directed to either of two additional IF amplifiers (2SK882 JFETs) before reaching the appropriate detector stage for the mode selected.

The detectors used are a uPC1037HA integrated mixer/product detector for SSB and CW; a set of diodes (HSM88AS) for AM; or a MC3357DR integrated FM subsystem that acts as an IF amplifier/limiter and discriminator. Injection to the product detector is provided by a mixer (another uPC1037HA) used to provide the difference frequency of the 9.4665-MHz crystal oscillator previously discussed and a 9.0130-MHz "BFO" crystal oscillator. This difference frequency, minus the 455-kHz IF, provides an audio frequency output from the product detector. This AF output goes through the NOTCH switch and filter before being amplified by a set of cascaded 2SC4081 bipolar audio amplifiers, whose output is level adjusted by the front-panel AF (volume) control before driving another

2SC4081 and the final audio amplifier, a uPC1241H integrated audio amplifier rated at 2.6 W output.

AGC control is provided by an AGC detector driven by the last IF amplifier (455 kHz), then amplified by a 2SC4081 to control the IF amplifiers used at 69 MHz, 9 MHz, and 455 kHz. It is thus an IF-derived control loop that simultaneously adjusts the gain of all the IF amplifying stages in the receiver and is quite effective.

The circuitry is modern and well thought-out to provide a minimum of spurious or image signals. Most of the same circuitry is also used in the transmit signal path, as is typical of modern PLL-tuned transceivers. The primary differences are described below.

On transmit, the output of the 69.0115-MHz bandpass filter (already discussed in the receiver section) drives a 2SK882 JFET IF amplifier (which also provides "S" meter data to a meter amplifier) and then a balanced mixer using a pair of 3SK131 dual-gate MOSFETs, whose output is high-pass filtered to drive a 2SC4673 bipolar RF amplifier. Injection to this mixer is provided at 69.0415 to 99.11499 MHz by the PLL Unit and comes from the same set of four VCOs discussed earlier for receive injection tuning of the first RF mixer.

The output of the 2SC4673 RF amplifier is low-pass filtered and then attenuated to provide a fixed terminating load for this filter before being delivered to the PA Unit. The PA

Unit contains a pre-driver (2SC1971 bipolar, operating common emitter with emitter peaking), driver (push-pull 2SC3133 bipolars, grounded emitter with adjustable base bias), and power amplifier. The final power amplifier (PA) uses a pair of push-pull 2SC2904s, grounded emitter with base bias regulation provided by a 2SD1406 series regulator.

Also located in the PA Unit is the fan control circuit, which appears to be driven by a thermostat and uses a 2SB909M bipolar fan driver. There is no discussion of how this circuit operates, and because I am unfamiliar with some of the parts used, I can't say much about it. But it does work, and the fan in my unit came on within a few minutes of transmitting at full power and kept the unit quite cool to the touch. There are actually two fans used in the IC-738 and they appear to operate in parallel.

The output of the PA is routed to the Filter Unit, a set of relay-switched (12 relays used) low-pass filters using dual pi-sections to cover each band segment (except for the 10/14-MHz LPF, which uses three pi-sections). The SWR-detector circuit, which drives the panel meter to indicate forward output power and SWR, and also provides reflected power data for the control loop that reduces the transmitter's drive in the event of a significant mismatch (as well as data for the ATU control loop), is also located in the Filter Unit, as is the two-position ("1" or "2") antenna switching relay, RL16.

Get A New Image



PC HF Fax Plus \$129

PC HF Fax Plus is a simple, yet comprehensive HF system that receives Fax, RTTY, CW, and AMTOR on an IBM PC or compatible. It includes an FSK demodulator, advanced signal processing software, tutorial audio cassette, and complete reference manual. Just plug the demodulator into a serial port, install the software and get text and vivid images on your PC.

PC SSTV \$149.95

PC Slow Scan Television is a complete system for sending and receiving full color amateur SSTV. The package includes an SSTV FSK modem, SSTV software, image capture utilities and reference manual. All popular formats are supported including Robot, Scottie, Martin and AVT. The system requires a 286, 386 or faster PC with VGA or super VGA display.



Have It All For Only \$199.95

For a limited time we are offering both software packages with a single FSK modem for under \$200. This combination offer will let you send and receive the popular HF image and text transmission modes.

Call or write for our free catalog. Visa and Mastercard welcomed.

Software Systems Consulting
615 S. El Camino Real, San Clemente, CA 92672
Tel. (714) 498-5784 Fax. (714) 498-0568

CIRCLE 250 ON READER SERVICE CARD

- Packet Radio - Portable & Affordable!



Model BP-1
Packet Modem
Made in U.S.A.

- ★ Simple Installation
- ★ No External Power
- ★ Smart Dog™ Timer
- ★ Perfect For Portable
- ★ Assembled & Tested
- ★ VHF, UHF, HF (10M)

Whether you're an experienced packeteer or a newcomer wanting to explore packet for the first time, this is what you've been waiting for! Thanks to a breakthrough in digital signal processing, we have developed a tiny, full-featured, packet modem at an unprecedented low price. The BayPac Model BP-1 transforms your PC-compatible computer into a powerful Packet TNC, capable of supporting sophisticated features like digipeating, file transfers, and remote terminal access. NOW is the time for YOU to join the **PACKET REVOLUTION!**

Just...
\$49.95
+Shipping

Tigertronics
Incorporated

400 Daily Lane
P.O. Box 5210
Grants Pass, OR
97527

1-800-8BAYPAC

VISA 1-800-822-9722
(503) 474-6700

CIRCLE 269 ON READER SERVICE CARD

SIRIO *HI* PERFORMANCE Antennas

Sirio has designed the new **HI PERFORMANCE** line for the discriminating Radio Amateur. These antennas are the very best available in terms of material quality, hi-tech design and maximum performance. The result of years of experience and technological research by **Sirio**! All models are fabricated with the very best materials available to guarantee maximum strength and best performance. Year after year. **Sirio** whips are very flexible and incorporate a custom inclination system that allows them to be tilted to 90° without the use of keys or special tools.

An innovative approach has been taken in the construction of the base impedance matching transformers. This new process results in very high and previously unattainable unit to unit precision. Particular attention has also been paid to the UHF male antenna mounting connector which uses a gold-plated center pin, "TEFLON®" insulation and a rubber weather seal for hi-performance and protection from the elements. All **Sirio HP** Antennas are factory adjusted and no additional tuning is normally required.

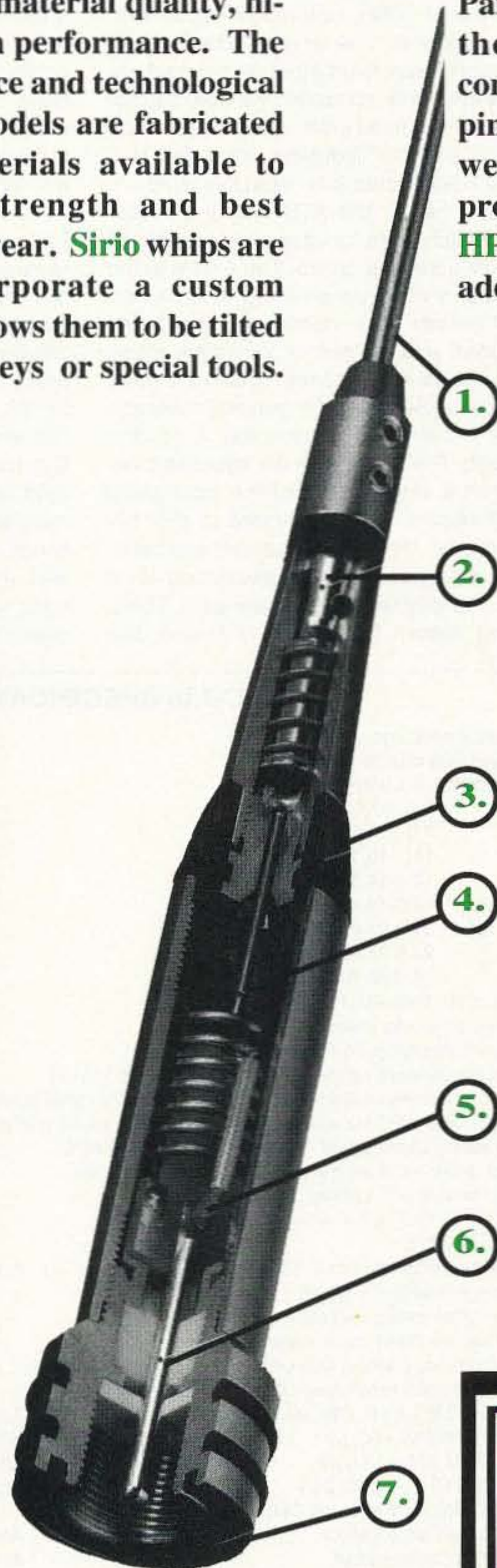
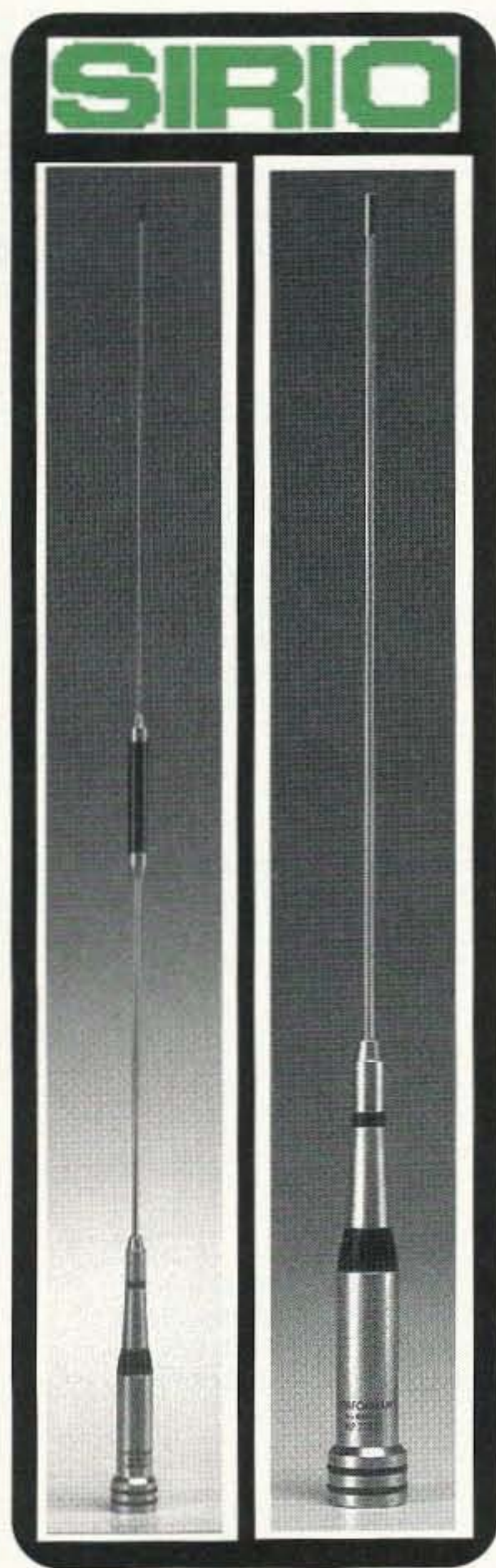

1. Hi Quality 17/7PH stainless steel whip.
2. Tiltable section with rubber gasket and stainless steel retention spring
3. Dielectric low-loss "ZYTEL" insulator with brass insert soldered at the coil
4. High "Q" air wound coil for low dielectric loss
5. High voltage ceramic capacitor for a perfect impedance matching
6. Gold plated brass center pin with low dielectric loss "TEFLON" insulator
7. Silicone rubber gasket and O-Ring for a perfect waterproofing

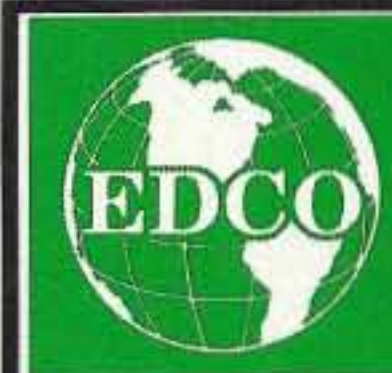

Electronic Distributors
325 Mill St.
Vienna, Va. 22180
PH 703-938-8105

Exclusive Distributors for North & So. America

TOUCH TONE DECODERS

Speaker muting
Repeater control, etc.
Decodes 16 digits
Detects 4 digit sequence
Crystal referenced
12V D.C. @ 20ma

TD-16

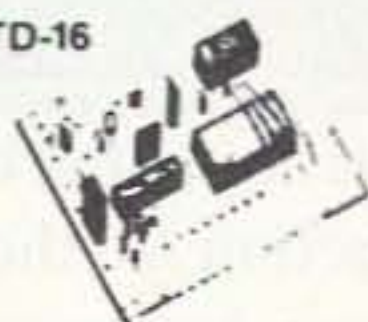

KIT: \$49.95*
WIRED & TESTED: \$59.95*

TD-16A

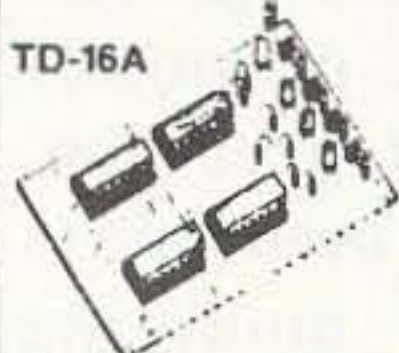

Adds 4 latched outputs to TD16
Directly drives 4 relays
Separate on & off codes
KIT: \$19.95*
WIRED & TESTED: \$29.95*

Detects any one of 16 digits
Compact 1 1/2" x 3/4" x 3/16"
Fits inside HTs, etc.
5 to 12V. DC @ 10ma
Generates alert signal or
switches external device
when tone is detected

TD-1M



WIRED & TESTED: \$34.95*

TD-16BP

Connects to TD-16 to create a basic repeater
(non-simplex) auto patch:
WIRED & TESTED: \$59.95*

Norcon Engineering

P.O. BOX 4042, WILMINGTON, NC 28406
910-791-7600



NC residents add 6% sales tax
*Add \$2.50 S & H per order



SPY ON THE EARTH

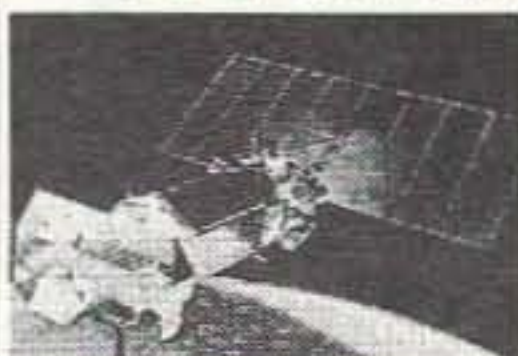

See live on
your PC
what
satellites in
orbit see

Capture live breathtaking images of the Earth for fun or profit with our SpySat software and hardware package that does it all. Track, capture, display, zoom and analyze images directly from 6 or more environmental satellites. Complete Earth station package includes antenna, LNA, satellite receiver, demodulator, A-D converter and software, all for only \$399 plus \$25 shipping. For FREE information log-on to our bulletin board anytime at: (718) 740-3911. For information by mail send \$5 (includes demo disk).

VANGUARD Electronic Labs
Dept. A, 196-23 Jamaica Ave.
Hollis, NY 11423 Tel.718-468-2720



Handheld Repeater Controller

Spectrum Electronic Products introduces the world's first handheld repeater controller. No larger than most handheld radios, the HRC-10 converts a single or dual-band radio into a full featured simplex or duplex repeater system. Key features of the HRC-10 include voice IDer, DTMF control and programming, hang and time-out timers, Digital Voice Operated Squelch (DVOS™), telemetry tones, and private voice mail slot. **\$299**
Phone 800-566-2788
FAX 408-438-6027

The ATU is located on its own board called the Tune Unit. It uses 12 relays to switch combinations of "T"-networks to achieve the best possible match to a wide range of antenna impedances. While Icom's published specifications claim a tuning range of 16.7 to 150 Ohms (thus, it should match any antenna having a VSWR = 3 or less), I found in actual use the tuner was better than this and successfully matched a clip lead on 20 meters. (This was discussed earlier.) I also used the ATU to match rain downspouts, window screens and other ridiculous loads with amazing success. The relay-switched matching network uses fixed input and output capacitors and tuner-controlled variable capacitors across the fixed units, along with combinations of shunt "T" inductors. It's a slick system that works better than most I've used.

In most cases, the ATU can find a successful match point for reasonable antennas within just a second or two. The ATU is in the RF path only when transmitting, which is normal. (It cannot work without a signal being transmitted, and we cannot transmit a signal outside the amateur bands. Thus, the tuner would be useless for the general-coverage receiver without having some way to adjust it manually.) The tuner may be bypassed entirely with a single touch of the front-panel TUNER button. When operated in the "bypass" mode, the display screen indicates THRU. When the tuner is searching for a match, the display screen flashes a TUNE warning. When the match is found, the

TUNE indicator stops flashing but remains illuminated.

Conclusions

I like the IC-738. It works very well and is easy to use. It meets its specifications with considerable margin, especially with regard to receiver performance, transmitter output power, and ATU matching range. If this were a perfect world, I'd get Icom to move the VOX controls to the front panel, make the RF power output level adjustment a larger knob, add a three-position rotary switch for meter function control on transmit, add a more readily accessible CW sidetone adjustment, and include sidetone pitch as well as volume, add more mike gain, and improve the owner's manual to more fully discuss some features and functions that are not well addressed.

As someone who has done a lot of technical writing, I'm more critical than most regarding operating manuals. And as someone who has done an awful lot of operating of amateur equipment over the past 30 years, I'm probably also more critical than most regarding control placement. After all this time, I know what I like, and no rig I've ever seen offers everything in one box. But Icom's on the right track. When all is said and done, on-the-air performance is more important than slick manuals and lots of knobs. And the IC-738 performs exceptionally well. It's a pleasure to use under most conditions, and I'll give it a thumbs up as a wise choice for a broad spectrum of users.

IC-738 SPECIFICATIONS

Frequency coverage:

Receiver: 500 kHz-29.995 MHz

Transmitter: 1.8-1.9999 MHz

3.5-4.0000 MHz

7.0-7.3000 MHz

10.1-10.150 MHz

14.0-14.350 MHz

18.0-18.168 MHz

21.0-21.450 MHz

24.8-24.990 MHz

28.0-29.700 MHz

Actual: 30 kHz-29.999 MHz

Actual: as published

3.4-4.099 MHz

6.9-7.499 MHz

9.9-10.499 MHz

13.9-14.499 MHz

17.9-18.499 MHz

20.9-21.499 MHz

24.4-25.099 MHz

28.0-29.999 MHz

Modes: SSB, CW, AM, FM

Number of memory channels: 101

Antenna impedance: 50 Ohms nominal

Usable temperature range: -10° to +60° C (14° to 140° F)

Frequency stability: <200 Hz from 1 min. to 60 mins. after power is applied. After that, <30 Hz/hour at 25° C (77° F), and <350 Hz with temperature fluctuations from 0° to 50° C (32° to 122° F).

Power supply requirement: 13.8 VDC ± 15% @ 20 ADC

Current drain: 1.6 A receive (2.1 A at full audio output)

20.0 A transmit at full power

Dimensions: 13.0" x 4.4" x 11.2" (H x W x D)

Weight: 19.0 lbs.

Transmitter output power: 5-100 W

Actual: 2-120 W

Spurious emissions: <-50 dB

Carrier suppression: >40 dB

Unwanted sideband suppression: >50 dB

Microphone impedance: 600 Ohms

Receiver sensitivity (preamp ON):

1.8-29.995 MHz SSB, CW: <0.15 µV

Actual: <0.12 µV (10 dB S+N/N)

28-29.7 MHz FM: <0.5 µV

Actual: <0.35 µV (12 dB SINAD)

0.5-1.8 MHz AM: <13.0 µV

Actual: <9 µV (10 dB S/N)

1.8-29.995 MHz AM: <2.0 µV

Actual: <1.5 µV (10 dB S/N)

Squelch sensitivity (preamp ON):

SSB: <5.6 µV at threshold

Actual: not measured

FM: <0.3 µV at threshold

Actual: as published

Spurious and image: >70 dB

Actual: >80 dB worse case

Audio output power: >2.6 W @ 10% distortion, 8-Ohm load

RIT/XIT range: ± 9.999 kHz

Actual: as published

CIRCLE 69 ON READER SERVICE CARD

CAT-300 Repeater Controller

Attention Repeater Owners

Finally a repeater controller with a TI voice synthesizer and full feature autopatch incredibly priced at \$299.00.

Features Include:

- ✓ Voice Synthesizer
- ✓ (412) Word Vocabulary
- ✓ Twelve Voice Messages
- ✓ Two Voice Identifiers
- ✓ CW Identifier
- ✓ Full Feature Autopatch
- ✓ User Speed Dials
- ✓ Emergency Speed Dials
- ✓ Reverse Autopatch
- ✓ DTMF Key Pad Test
- ✓ DTMF Repeater Access
- ✓ DTMF Repeater Muting
- ✓ (56) Control Functions
- ✓ Remote Control Switches
- ✓ Hardware Logic Inputs
- ✓ DVR Controller Ready *
- ✓ Female Voice & Sound Effects
- ✓ Programmable Courtesy Tones
- ✓ Programmable Codes and Timers

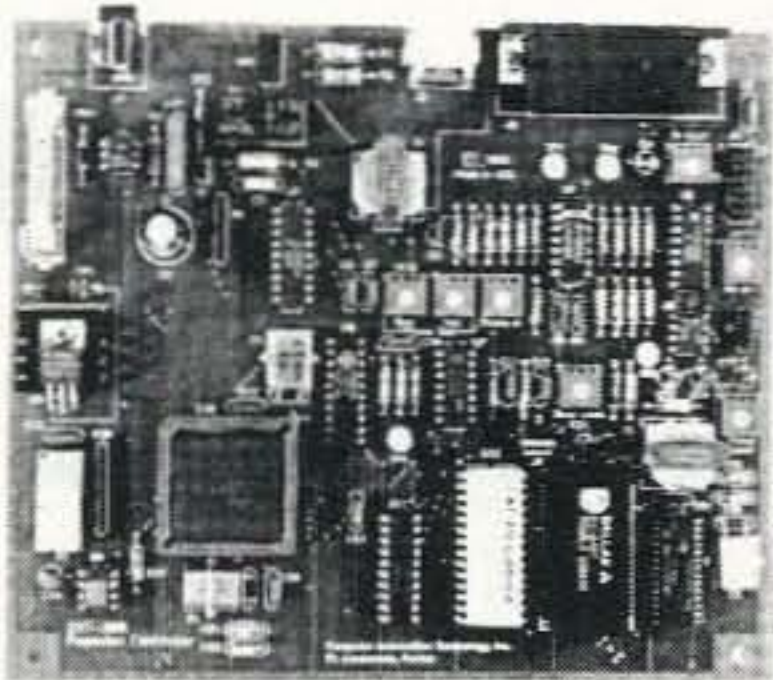

* (Requires MF-1000 Serial Interface Card \$59.00)

Write or Call for a brochure describing the CAT-300 Controller, including schematic, voice word list, and control functions.

CAT-300 Controller Board \$299.00 Wired and Tested

Computer Automation Technology, Inc.

4631 N.W. 31st Avenue, Suite 142, Fort Lauderdale, Florida 33309
(305) 978-6171

CIRCLE 268 ON READER SERVICE CARD

NEW Kenwood TM-741 A or TM-742 A UPGRADES NEW The RC-740X Band Unit Expansion Box

The RC-740X has been designed to accommodate those Hams who require more capacity for their dollar. With it, you may install up to four additional units. This allows you the option of having all



six bands, either mobile or at your base station. No longer must you decide which upgrade band units you will do without. Purchase any or all four of them. The RC-740X has been designed with the Ham in mind, allowing you to install it without modification to your Kenwood radio. Simply follow the clear instructional guide and you will be up and ready for that elusive QSO.

Size: 4" (H) x 6" (W) x 5.75 (D)

Power: 13.8 VDC / 100 ma minimum

Capacity: Four Kenwood band units:
28 MHz, 50 MHz, 220 MHz, 1200 MHz

Empty Weight: 2 lbs.

Remote Mount Compatible

Compatibility: Kenwood • 741 A

• 742 A • 641 A • 642 A • 942 A

\$399⁰⁰

Plus tax & shipping

CALL (800) 560-7234

R•C•S•I

Radio Control Systems, Inc.

8125-G Ronson Road, San Diego, CA 92111

Tech Support (619) 560-7008;

10am-4:30pm PST

VISA, MasterCard,

UPS COD



Serving the LORD
Since 1987

\$49.95!

THE POWER STATION

The POWER STATION is a 12V x 7 AmpHr gel-cell battery complete with voltmeter, wall charger and a cord for charging via automobiles. It will power most HT's at 5 Watts for 2-4 weeks (depending upon how long-winded you are). Also VHF, UHF, QRP, or HF mobiles such as the KENWOOD TS-50 (at 50W). There are no hidden costs, all you need is your mobile, HT power cord or cigarette lighter adapter.

The POWER STATION provides 12V from a cigarette plug and has two recessed terminals for hardwiring. A mini-phone jack with regulated 3V, 6V, or 9V output can be used separately for CD players, Walkmans, etc. THE POWER STATION can be charged in an automobile in only 3 hours, or in the home in 8 hours. The charger will automatically shut off when the battery is completely charged, so you can charge it even when it has only been slightly discharged, (unlike Ni-Cads that have memory). Our charging circuit uses voltage sensing circuitry, other brands are timed chargers which always charge the battery a full cycle, this damages their battery and shortens its' life if it only needs a partial charge. The POWER STATION has a voltmeter that shows the exact state of charge of the battery, not worthless idiot lights that tell you "YOUR BATTERY IS NOW DEAD." The voltmeter can even be used to measure voltages of other sources.



SEE
REVIEWS
NOV. '94 CQ
MAY '94 73

To order, send check or money order for \$49.95 + \$8.50 for shipping, along with your shipping address and telephone number to:

Guaranteed
Best
Prices

Joe Brancato

THE HAM CONTACT

P.O. Box 3624, Dept. 73
Long Beach, CA 90803.

CA Residents Add 8 1/4% Sales Tax. Alaska, Hawaii, and Candian Residents, please send U.S. Money Order & \$17.10 Shipping.

If you wish more information please send a SASE to the above Address. For COD orders, call (910) 433-5860, outside of CA Orders only call (800) 933-HAM4 and leave a message. Dealer Inquires Invited.

CIRCLE 384 ON READER SERVICE CARD

by Michael Geier KBIUM

Sony ICF-SW100S Pocket Shortwave Receiver

A Ham Station in your pocket?

Well, not quite—it doesn't transmit. Still, Sony's new ICF-SW100S pocket shortwave receiver is quite a little handful, offering advanced features never before available in such a tiny radio, including some that make the new set of interest to ham operators.

What You Get

The receiver measures 4 3/8" x 2 7/8" x 15/16", and is designed in a clamshell style, like a baby laptop computer. It looks very snazzy, and the control buttons and display are protected when you close it up. The set fits in the palm of your hand and, at 7.8 ounces (including batteries!), weighs next to nothing. It runs on two AA cells for a long time (the manual says 18 hours) or forever from the provided AC adapter.

On the lower half of the clamshell are the buttons, which include power, a numeric keypad for frequency entry, up/down tuning, timer settings and more. On the upper half are the very large display and the speaker, along with a lamp button. On the sides are jacks for the included external active antenna, stereo earphones, line out for a tape recorder, and DC power input. There's also a local/DX sensitivity switch, tone switch, and a master power switch that prevents accidental turn-ons. On the back is a good-sized telescoping whip antenna.

Along with the radio, you get an AC adapter. Curiously, the set is shipped to other countries with a self-adjusting, multivoltage adapter that can be used anywhere in the world. The U.S. version, though, operates only on 120 VAC, even though Americans are the most traveled people in the world. Go figure.

The rig comes with a nice, leather case that screws onto the back of the radio. The case opens up and lets you use the radio without removing it. Also included are a pair of earbud-type headphones, a shortwave frequency guide, and an operating manual. Finally, you get the active antenna. Unlike its predecessor, the SW-1, the SW100S gets its power from the radio, and does not require its



Photo A. The Sony ICF-SW100S Pocket Shortwave Receiver.

own batteries, making it nice and light.

What It Does

So what can something this small do? Plenty! This diminutive receiver has digitally synthesized frequency coverage from 150 kHz to 29,999 MHz, plus the FM broadcast band, with FM stereo through headphones. The receiver is dual-conversion, with up-conversion on the shortwave bands for good image rejection. It has 50 memories organized into 10 pages of five memories each, and each memory can store a 6-character alphanumeric label, along with the frequency and other parameters. What other parameters? How about selectable sideband, with true SSB reception? This is not the usual "AM receiver with a BFO" style of consumer shortwave radio. This unit not only lets you pick the sideband but also has synchronous detection for AM, a valuable feature previously found only on much larger receivers.

In the AM mode, the set tunes in either 1-kHz or 5-kHz steps, using the inner and outer tuning buttons (there is no tuning knob). When you hold one of the inner buttons down, the set moves up or down so smoothly it almost seems like analog tuning; you don't hear any "tick tick tick" noise or muting as the synthesizer steps. If you press one of the out-

er buttons, you get 5-kHz steps. On my old SW-1, I used to like to hold the tuning button, which had only 5-kHz steps, and scan the radio manually, stopping whenever I heard something interesting go by. I liked that better than the automatic scan, which muted the set between stations. Nearly all shortwave broadcast stations are spaced at 5-kHz intervals, so it was very convenient. On the SW-100, though, holding down a 5-kHz button causes the radio to go into scan mode. Even if you keep holding it, the set stops on each active frequency, and you must let go of the button and press it again to keep it going. I prefer the old way, employing a separate scan button. Still, you can hold down the 1-kHz buttons and get the same effect, only more slowly.

In SSB mode, the inner buttons tune in 100-Hz steps, which is a little coarse by ham standards, but still gets you close enough to your desired frequency to enjoy SSB and CW without too much difficulty. The outer buttons change to 1-kHz steps, but they still have the same problem: They make the set scan if you hold them. This makes tuning in SSB awkward, because the inner buttons' 100-Hz steps are too small to get you where you're going fast enough, and the outer ones force a scan unless you press and release them over and over. I find the easiest way to get around a ham band is to go to AM mode, tune for signals with the inner buttons at 1-kHz steps, and then go to USB or LSB and fine-tune in 100-Hz steps with the same buttons.

Memories

At first, I thought that 50 memories on a pocket shortwave receiver would be overkill. How wrong I was! With the ability to store 6-character alphanumeric labels, and the organization of 10 banks of five memories each, it is very tempting to want to put all the frequencies for a particular broadcaster in one bank. Such neat organization makes it easy to find your station on any of its frequencies, but it limits you to 10 broadcasters. Oh well, complaining about having "only" 50 memories is like complaining about great pizza: You love

100KHZ TO 2060MHZ

Trident TR2400 Scanning Receiver

100KHz to 2060MHz with AM/FM/WFM/BFO/SSB 1KHz steps. Features 1000 memory channels, lockout on search and scan, backlighted LCD display, Attenuator, Delay, Hold, Bank lockout, VFO tuning, Signal strength meter in display. Programmable search/scan delay times. One Year Warranty., Cellular Locked out.. Size: 7.5H x 3 3/4W x 2 1/4D. Wt 14oz. Ground shipping: \$6.95. Air Freight: \$9.95. Call or Fax your order Toll Free, 24 hours a day.



\$499.00



Call 1-800-445-7717

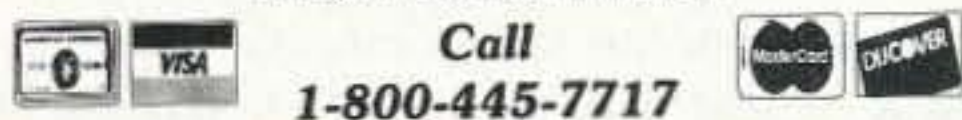

10707 E. 106th Street Fishers, IN 46038
317-842-7115 Fax 1-800-448-1084

CIRCLE 164 ON READER SERVICE CARD

CABLE X-PERTS, INC.

COAX (LOW LOSS GROUP)	100FT/UP500FT
"FLEXIBLE" 9913 FOIL +95% BRAID 2.7 dB @ 400 MHz	58FT .56FT
9913 EQUAL FOIL +95% BRAID 2.7 dB @ 400 MHz	42FT .40FT
9914 EQUAL "FOAM" FOIL +95% BRAID 3.5 dB @ 400 MHz	40FT .38FT
LMR 400 DBL SHLD IIIA JACKET 2.7 dB @ 450MHz	62FT .80FT
LMR 400 UltraFlex DBL SHLD "TPE" JACKET 3.1dB @ 450 MHz	75FT .72FT
LMR 600 DBL SHLD IIIA JACKET 1.72dB @ 450MHz	1.47FT 1.45FT
LMR 900 DBL SHLD IIIA JACKET 1.10dB @ 450MHz	4.05FT 4.00FT
LMR 1200 DBL SHLD IIIA JACKET 0.864dB @ 450MHz	4.55FT 4.54FT

COAX (HF GROUP)	
RG 213/U MIL-SPEC DIRECT BURIAL JACKET 1.8dB @ 50MHz	36FT 34FT
RG8/U FOAM 95% BRD UV RESISTANT JACKET 1.2dB @ 50MHz	32FT 30FT
RG MINI 8X95% BRD BLK, SILVER, or CLEAR UV RES JKT	15FT 13FT
RG214/U (2) SILVER BRAID SHIELDS MIL-SPEC	1.30FT 1.20FT
RG393/U DBL SILVER SHLD "TEFLON" 25,000 W, 10MHz	4.00FT 3.75FT
RG142/U DEL SILVER SHLD "TEFLON"	1.10FT 1.00FT
RG58/U 95% BRAID	15FT 13FT
RG58/U 95% TC BRAID	17FT 15FT
450 OHM LADDER LINE	12FT 10FT
440 OHM LADDER LINE 16GA STRANDED	18FT 16FT

COAX W/SILVER TEFLON PL259's EA END	
100FT RG213/U MIL-SPEC DIRECT BURIAL JKT 1.5dB @ 50MHz	\$45.00/EA
50FT RG213/U MIL-SPEC DIRECT BURIAL JKT 1.5dB @ 50MHz	\$25.00/EA
100FT RG8/U FOAM 95% BRD UV RESISTANT JKT 1.2dB @ 50MHz	\$40.00/EA
50FT RG8/U FOAM 95% BRD UV RESISTANT JKT 1.2dB @ 50MHz	\$22.50/EA

ROTOR CABLE	100FT/UP500FT
5971 8/COND (2/18 6/22) for runs up to: 125ft BLK UV RES JKT	22FT 20FT
4090 8/COND (2/16 6/20) for runs up to: 200ft BLK UV RES JKT	36FT 36FT
1418 8/COND (2/14 6/18) for runs up to: 300ft BLK UV RES JKT	50FT 48FT
18GA TINNED COPPER 4/C GRAY PVC JACKET	20FT 18FT
18GA TINNED COPPER 5/C GRAY PVC JACKET	22FT 20FT
18GA TINNED COPPER 7/C GRAY PVC JACKET	28FT 24FT

ANTENNA WIRE	
14GA 168 STR "SUPERFLEX" UNINSULATED	12FT 10FT
14GA 7/22 "HARD DRAWN" BC UNINSULATED	10FT .08FT
14GA SOLID "COPPERWELD" UNINSULATED	09FT 07FT
14GA SOLID "BARE COPPER" UNINSULATED	09FT 07FT
12GA 19/25 "BARE COPPER" UNINSULATED	13FT .11FT
16GA 28/30 "BARE COPPER" PVC INSULATED	09FT 07FT
14GA 41/30 "BARE COPPER" PVC INSULATED	11FT .09FT
12GA 65/30 "BARE COPPER" PVC INSULATED	17FT .15FT
DACRON ROPE DBL BRD 3/16 770# TEST	12FT 10FT

AUTOMOTIVE "ZIP" CORD	
10GA 2/C "FLEXIBLE" OIL&GAS RESISTANT RED/BLK "ZIP"	40FT 38FT
12GA 2/C "FLEXIBLE" OIL&GAS RESISTANT RED/BLK "ZIP"	30FT 28FT
18GA, 16GA & 14GA Stocked Too	

BALUNS	PRICE
W2AU 1:1 OR 4:1 1.8-40 MHZ TRANSFORMER TYPE	\$21.00/EA
W2DU 1:1 1.8-30 MHZ CURRT TYPE DIPOLE OR BEAM	\$23.00/EA
W2DU 1:1 1.8-30MHz "IN LINE" CURRENT BALUN	\$26.00/EA
LADDER-LOC	\$11.95/EA

GROUNDING BRAID	
1" TINNED COPPER BRAI	25FT \$22.00 50FT \$44.00 100FT \$85.00 LONGER
1/2" TINNED COPPER BRAID	25FT \$12.50 50FT \$25.00 100FT \$48.00 LENGTHS TOO

CONNECTORS	
PL 259 SILVER/TEFLON/GOLD TIP	10PKS \$11.00 25 PKS \$25.00
"N" CONNECTOR SILVER/GOLD TIP	10PKS \$32.50 25 PKS \$75.00

We install our connectors PL259 & "N" Connectors Price: \$5.00/per termination (+ connector cost)

MORE ITEMS STOCKED CABLE & WIRE CUT TO YOUR SPECIFIC LENGTH!
ORDERS ONLY: 800-828-3340
TECH INFO: 708-506-1886 FAX: 708-506-1970
113 McHenry Rd., Suite 240, Buffalo Grove, IL 60089-1797

For Complete Literature Mail SASE

ELECTROMAGNETIC FIELD METER

Reduce exposure to potentially harmful electromagnetic fields. AlphaLab's handheld TriField™ Meter measures AC electric fields, AC magnetic fields and radio/microwave power density. Find ground faults, AC current wires or measure high-field generators with the *Magnetic* setting (.2 - 100 milligauss, 60 Hz); identify poorly grounded or shielded equipment, high VDT or fluorescent light fields, distinguish hot vs. ground wires with *Electric* setting (.5 - 100 kV/m, 60 Hz); measure antenna radiation patterns, leaky microwave ovens, etc. on *RF/microwave* setting (50 MHz to 3 GHz, .01 to 1 mW/cm²).

Electric and magnetic settings are omnidirectional, measuring full magnitude of fields without the need to reorient the meter. Price of \$145 includes delivery and one-year warranty.

AlphaLab, 1280 South 300 West, Salt Lake City, UT 84101. Call 800-769-3754 OR 801-487-9492 for speedier service or free literature on electromagnetic radiation health risks.



Mini Project Boxes	W x D x H (in)	PRICE \$
MPB-1	1.5 x 1.5 x 1.5	1.50
MPB-2	2.0 x 2.0 x 2.0	2.00
MPB-3	2.5 x 2.5 x 2.5	2.50
MPB-4	3.0 x 3.0 x 3.0	3.00
MPB-5	3.5 x 3.5 x 3.5	3.50
MPB-6	4.0 x 4.0 x 4.0	4.00
MPB-7	4.5 x 4.5 x 4.5	4.50
MPB-8	5.0 x 5.0 x 5.0	5.00
MPB-9	5.5 x 5.5 x 5.5	5.50
MPB-10	6.0 x 6.0 x 6.0	6.00
MPB-11	6.5 x 6.5 x 6.5	6.50
MPB-12	7.0 x 7.0 x 7.0	7.00
MPB-13	7.5 x 7.5 x 7.5	7.50
MPB-14	8.0 x 8.0 x 8.0	8.00
MPB-15	8.5 x 8.5 x 8.5	8.50
MPB-16	9.0 x 9.0 x 9.0	9.00
MPB-17	9.5 x 9.5 x 9.5	9.50
MPB-18	10.0 x 10.0 x 10.0	10.00
MPB-19	10.5 x 10.5 x 10.5	10.50
MPB-20	11.0 x 11.0 x 11.0	11.00
MPB-21	11.5 x 11.5 x 11.5	11.50
MPB-22	12.0 x 12.0 x 12.0	12.00
MPB-23	12.5 x 12.5 x 12.5	12.50
MPB-24	13.0 x 13.0 x 13.0	13.00

GREAT LITTLE BOXES FOR LOW COST CONSTRUCTION DESIGNED TO GET THE JOB DONE WITHOUT THE FRILLS!
0.040" BARE ALUMINUM PANELS
NEW
FOR INFO ON OTHER ENCLOSURES REQUEST FREE CONSTRUCTOR'S CATALOG
MENTION AD AND TAKE 5% OFF FIRST ORDER!
ORDER TODAY! (\$30.00 MINIMUM ORDER)
ALL PRICES INCLUDE WORLDWIDE SHIPPING!
A IS USA, CANADA & MEXICO, B IS REST OF WORLD
ORDER (800) 634-3457 FAX (800) 551-2749
(702) 565-3400 FAX (702) 565-4828
SESCOM, INC. 2100 WARD DR., HENDERSON, NV 89015
SESCOM, INC. is not responsible for inadvertent typographical errors and prices and specifications are subject to change without notice.

CIRCLE 167 ON READER SERVICE CARD

From Micro Computer Concepts

RC-1000 REPEATER CONTROLLER

- Autopatch • Reverse Autopatch
- User Programmable CW ID, Control & User Codes & Timeouts

Manual with schematics • 90-Day Warranty
Wired & Tested w/ manual **\$239.95**

Micro Computer Concepts
8849 Gum Tree Ave.
New Port Richey, FL 34653
813-376-6575

CIRCLE 160 ON READER SERVICE CARD

ONV SAFETY BELT CO.
P.O. Box 404 • Ramsey, NJ 07446
800-345-5634
Phone & FAX 201-327-2462

ONV Safety Belt With Seat Harness

\$89.95

OSHA We Ship Worldwide Order Desk Open 7 Days/Week

ONV Tool Pouch **\$15.95**

Add \$4.00 For Handling VISA M/C CHECK

ONV Belt W/O Seat Harness **\$74.95**

CIRCLE 102 ON READER SERVICE CARD

PERSONAL COMPUTER REPEATER CONTROLLER

PCRC™

Speaks for Itself

- ✓ Full Duplex Autopatch
- ✓ 911 Emergency Access
- ✓ Reverse Autopatch
- ✓ Voice Mail
- ✓ Voice/Tone/DTMF Paging
- ✓ Links
- ✓ Hardware Logic I/O
- ✓ Morse Code Practice
- ✓ Toll Restriction
- ✓ Voice ID's
- ✓ Scheduler
- ✓ BSR X10
- ✓ Remote Control
- ✓ Remote Base

PCRC/2 Combines the power of your XT/AT platform with a high quality play and record voice digitizer creating the ultimate repeater controller. **from \$695**

516-563-4715
Fax: 563-4716 BBS: 286-1518

CIRCLE 198 ON READER SERVICE CARD

it, but you can't get enough, no matter how much they give you!

Entering the memories and their names is as easy as could be, given that there's no typewriter-style keyboard. As a bonus, if you want to move the contents from one memory to another, all you have to do is recall it, go to the other memory, and press "enter."

Clocks

As in ham radio, world time is important for shortwave listening. This radio has a versatile world clock with times for major world cities, along with their offsets from UTC. You can easily step through them to find your home QTH, or to know what time it is in Bangkok. Even better, you can rename any one of them you want, so you can change your own time zone to your city's name. Or you can replace it with your own name to prevent any confusion about who owns the radio!

Receiver Performance

With the internal whip antenna, sensitivity is pretty good, but not as hot as on some small shortwaves I've seen. Plug in the active antenna, though, and it's another story. Now the rig will hear just about anything out there. AM-mode selectivity is excellent; if you're more than 1 kHz off, you can tell. At 5 kHz off, you really can't stand it. The filtering is quite sharp for such a tiny set. Frequency accuracy is excellent; the synthesizer seems to be within about 100 Hz, which is much better than any consumer shortwave I've seen before, and approaches the accuracy of many ham rigs.

Lock On!

Synchronous detection is to AM listening what the local carrier is to SSB. In sync detection, a local oscillator is phase-locked to the incoming carrier, replacing it in the detector. Why do that? Long-distance AM signals are subject to a peculiar kind of fading distortion, caused by the fact that fading is somewhat frequency selective. The effect is that the two sidebands and the carrier do not necessarily fade together. When the carrier gets weak relative to the sidebands, the signal starts to look something like SSB, which causes a distorted mess in an AM detector. So, why not simply add in your own carrier? That'll work fine, as long as it doesn't beat against the real one. And that's why sync detectors are synced!

The Sony sync detector lets you select the sideband to which you choose to listen. It's most useful when there's an adjacent station on one side of the desired signal, but not the other (a common condition on the shortwave bands). The effect is startling. In AM, the unwanted station causes a heterodyne, or perhaps some splatter, making listening unpleasant. You press the "sync" button and the set goes to SYNC USB, syncing to the incoming station in about 1 second. If the offending signal is below your tuned station, it

simply disappears! If it's above, you just press the sync button again and switch to SYNC LSB, reversing the situation.

Making a good sync detector is not as easy as it might seem. It must lock onto a wildly varying carrier, and it must stay locked through deep fades, or it'll growl as it heterodynes with the real carrier. Sony is famous for its sync detectors, but this one falls a little short of the ideal. It does a great job of removing signals on one side of the one you want, which makes it worth having, but it is less than effective against fading distortion; I couldn't tell much difference with it on or off when the signal faded significantly. And, mine tended to unlock on rapidly fading signals. Oddly, it did it on signal peaks; it held well on fades. Still, even though it isn't the greatest sync detector I've ever heard, it sure beats not having one.

SSB

As I mentioned, this radio gives you true SSB, not just a BFO. It lets you select between USB and LSB. There's very little bleedthrough from the opposite sideband, keeping QRM to a minimum. Unfortunately, the set is quite microphonic in the SSB

"Still, the Sony does let you listen to the ham bands on a rig that fits in your pocket, with room to spare for a candy bar, and perhaps it is asking too much to expect it to perform like a tabletop rig."

mode. Walking with it, bumping or jarring it, or even just pressing the buttons causes a warbly effect. Thinking that my first unit was defective, I returned it and got another one. When it behaved the same way, I contacted Sony. They were very helpful, but their final comment was that "that's just the way it is, due to the radio's size." I suspect the PLL's loop constants are too fast, causing bounce and overshoot when vibration of the coils and crystals causes a slight frequency bobble. That may help the synthesizer lock on frequency faster as you tune, but it makes for instability on SSB. After a second or so of undisturbed operation, it settles down somewhat, but it never completely clears up. Both CW and voice signals always sound a bit warbly. Can you enjoy SSB on this thing? Yes, but forget trying to decode RTTY or SSTV from it, and don't expect full-sized HF rig performance. For that matter, the receiver shows in other ways that it isn't a full-blown ham rig. Signals outside the passband cause significant AGC pumping, especially on 75 meters, and the overall selectivity on SSB isn't what you'd get from a full-sized SSB filter. Of course, that filter would probably be about the same size as Sony's entire receiver!

By the way, although the memories do store the mode, such as LSB or SYNC USB, they don't store fractional frequencies. Let's say you select 3910 LSB and then tune to 3910.6 to receive a station clearly. Now, you store all that in a memory. When you recall it, you'll be tuned to 3910, not 3910.6. It's a little inconvenient, but doesn't seriously detract from the usefulness of the rig.

The Sound

The overall audio quality isn't bad for something this size, but it's not as good as on my SW-1. The tiny, 1 5/8" speaker does a remarkable job, but there's not much audio output power, even into headphones. At more than moderate levels, voice peaks clip and distort. Compounding that situation is the overly fast AGC, which overshoots, exacerbating the fading of signals. My Sony liaison acknowledged the fast AGC, stating that the company feels it helps in some listening situations. As any ham will tell you, though, a slow AGC is nicer for most conditions. I have a very inexpensive, analog pocket shortwave that sounds significantly better than the SW-100S on rapidly fading signals, thanks to its much slower AGC that doesn't allow the receiver sensitivity to get out of phase with the fading rate. On SSB, the fast AGC makes the beginning of each word clip and pump as the '100 clamps down, having opened up too much since the last word. Still, the Sony does let you listen to the ham bands on a rig that fits in your pocket, with room to spare for a candy bar, and perhaps it is asking too much to expect it to perform like a tabletop rig.

What I Liked

The ICF-SW100S is a slick little radio with tons of features. It's easy to use, and it runs for a long time on the batteries. The memory data is nonvolatile, so you don't have to worry about keeping fresh batteries installed, as you do on the SW-1.

What I Didn't Like

The sync detector doesn't disable when you're tuning, causing all kinds of unpleasant noises unless you turn it off each time you search for new stations. It would have been easy to have it disable itself until you let go of the tuning buttons, or until the scanner found a signal.

The AGC speed and the warbly SSB were my biggest complaints. I suspect the AGC is also the cause of the sync detector's unlocking on signal peaks. If they'd slow it down and put in a little more audio oomph, this thing would be darned near ideal.

Conclusion

If you want to listen to everything under 30 MHz on a radio you can take anywhere, this is a great way to do it! The ICF-SW100S is the most advanced pocket shortwave on the market, giving you the world in the palm of your hand. There's nothing else like it. 73

WANT TO LEARN CODE?

Morse Tutor Gold from G.G.T.E. is the answer for beginners and experts alike.

*Get the software the ARRL sells and uses to create practice and test tapes; and Morse Tutor Gold is approved for VE exams at all levels.

*Since 1987, GGTE has guided nearly 20,000 hams and prospective hams around the world through proven structured lessons and a variety of character, word and conversation drills. Straight forward menus make the process simple and fun.

*This program features easy and speedy self installation; random character drills with the characters you select; and you can create your own drills or import text files. You can type what you hear or copy by hand and see the results one line at a time. Pick the Farnsworth or the standard method; select the tone frequency most comfortable for you or select your code speed in tenths of a word per minute. For all DOS computers. You are always in command.

Certified



by Morse Tutor Gold uses your internal speaker or sound board. And, if you use a sound board Morse Tutor Gold supports volume control.

Sound Blaster and the Sound Blaster Compatibility Logo are trademarks of Creative Technology Ltd.

Available thru dealers, the ARRL, or send \$29.95 + \$4 S&H (CA residents add \$2.32 tax) to: GGTE, P.O. Box 3405, Dept. MS, Newport Beach, CA 92659 Specify 5 1/4 or 3 1/2 inch disk.

CIRCLE 193 ON READER SERVICE CARD

Slow Scan TV

doesn't have to be expensive anymore!



Every day more hams are enhancing their communication by using images. Join the fun and see what you've been missing.

Quality Color SSTV is easy and affordable with Pasokon TV. \$239.95

Requires IBM PC-compatible, 386 or better CPU, 1 Megabyte of memory, color VGA display, MS-DOS. Shipping: \$5 to U.S.A. and Canada, \$15 for others. Write or call for complete details.

Absolute Value Systems
115 Stedman St. # 7
Chelmsford, MA 01824-1823
(508) 256 6907
e-mail: johnl@world.std.com

CIRCLE 351 ON READER SERVICE CARD

hambrew

FOR AMATEUR RADIO DESIGNERS AND BUILDERS

• HF • QRP • UHF • VHF • RCVRs
• XMTRS • QRO • ANTS. • PROJECTS

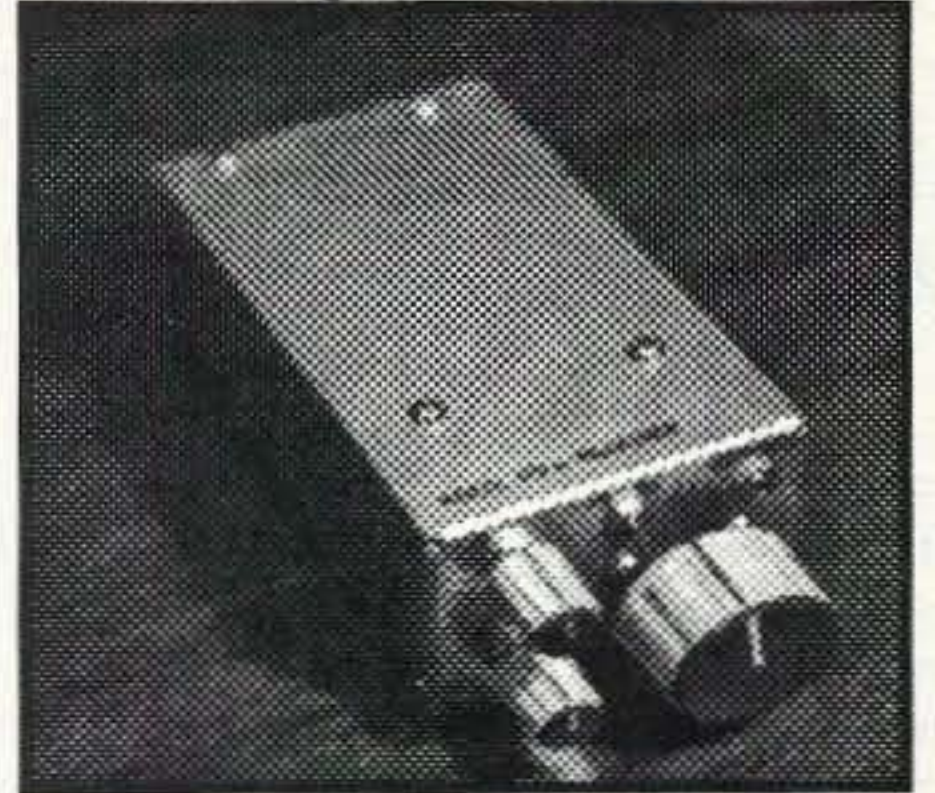

BUILD IT-THEN OPERATE IT!

NEW LOW PRICE!

Quarterly \$10/yr.

• HAMBREW Contests
• From Kits To RF Design • New Products
• Free Classified Ads To Subscribers
• Design Awards For Amateur Builders

\$15/yr. (Canada, Mexico) • \$21/yr. (Intr.)
PO Box 260083 • Lakewood, CO 80226
VISA • MC only: 1-303-989-5642

CIRCLE 286 ON READER SERVICE CARD

TNT Today's No-Tune Multiband Antenna

No pruning. No tuning. No knobs to twist. TNT is No-Tune on 80 cw, 40, 20, 17, 12, 10. TNT/2 is No-tune on 40, 20, 10. Work other bands w/ tuner. DX & Gain rise w/ frequency. Ready to Use. Includes isolation balun & 99 ft RG8x. The modern coax-fed version of the classic off-center fed window. Technote 126-\$6.95 ppd. **AntennasWest** Box 50062S, Provo, UT 84605

No tuning. Kink-Proof Wx-Sealed Low Noise. No traps or Resistors Insulated to 3000 V Rated 500 Watts.

TNT Window 135 ft. long P&H \$89.95 +\$8
TNT/2 Window 67 ft. long P&H \$79.95 +\$7

Order Hotline 800-926-7373

CIRCLE 135 ON READER SERVICE CARD

Six Shooters?

Indoor / Outdoor 6 meter Antennas
• Affordable • Effective • Unobtrusive • Efficient • Fully Assembled • Easy to Use • Weather Sealed • Insulated to 3KV • Direct 50 OHM Feed

Maxi J Hang from limb or pole or drop out window for low angle omnidirectional coverage. Fine tune to any band segment.
UniLoop Low noise reception with moderate gain and directionality. Great in-doors, super high and outdoors. Wide band-width.
HalfSquare Sharp directionality and low angle radiation for best DX. Hang indoors on walls, outdoors from caves or between trees.

All install fast anywhere roll up to stow in a pocket. Great for biking, hiking, & covert use. Your Choice \$35 Any \$99 +\$4 Three S&H

Antennas West Box 50062 Provo UT 84605
Order Hotline 800-926-7373

CIRCLE 359 ON READER SERVICE CARD

3 PORT REPEATER AND LINK CONTROLLER

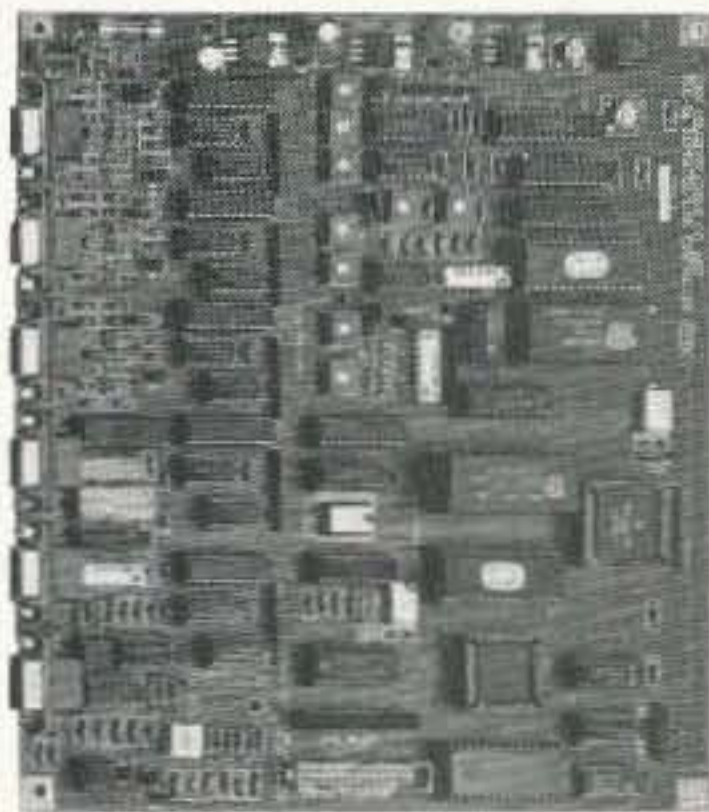

FEATURES:

- 3-full duplex radio ports
- 1-receive only control port
- Optional Autopatch available -200 number autodialer
- 100 Voice/CW messages -DVR option available
- DTMF control from any port
- 30 user command macros
- 20 Event scheduler
- Time of Day Clock
- 300-9600 baud serial port
- 4-Voltage/Temperature inputs
- Icom/Kenwood remote base
- 4-Layer board construction
- Priced for any groups budget

RLC-2a REPEATER CONTROLLER

Benefits:

With DTMF and serial programming features, your controller is more secure from unwanted access. Use only 1 controller at your site to control up to 3 separate repeaters/links with their own personalities and features intact. Make emergency autopatch calls with the telephone option. Only the RLC-2a can make these features available at such a low price.

ONLY \$649.95



Link Communications, Inc.

115 2nd Ave. N.E., Sidney, MT 59270

Call for information about our complete line of controllers
(406) 482-7515 (Voice) (800) 610-4085 (Orders) (406) 482-7547 (Fax)
E-Mail address linkcomm@netins.net

CIRCLE 47 ON READER SERVICE CARD

REPEATER CONTROLLER With AUTOPATCH \$139.95

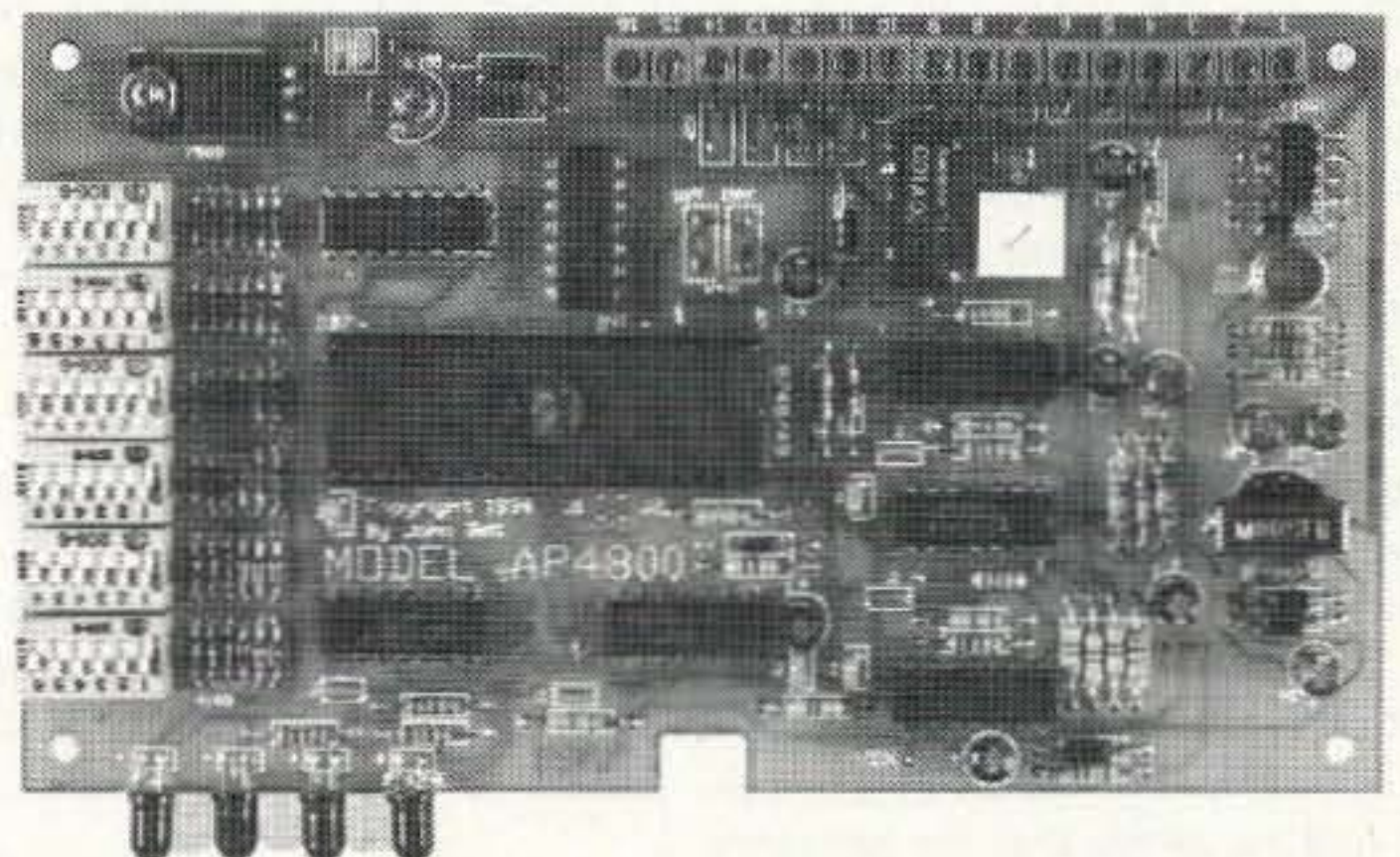

DTMF Controlled Autopatch and 4 control outputs. Switch selectable CWID. VOX or COR receiver control. Assembled tested board. LED's for Power, TX, RX, Phone. Intel 8748 microcontroller. Board size 3.8 x 6.3 inches. You add receiver, transmitter, power supply (12v), phone line, and antenna system. Circuit board is top quality, double sided, plated through holes, solder mask on both sides and parts legend. Shipping \$4 for UPS GROUND or \$6 for UPS BLUE, COD add \$4. For more information call or write to:



John Bell (702) 267-2704

1381 Saratoga St. Minden, NV 89423

CIRCLE 27 ON READER SERVICE CARD

ASK KABOOM

Number 12 on your Feedback card

Your Tech Answer Man

Michael J. Geier KB1UM
c/o 73 Magazine
70 Route 202 North
Peterborough NH 03458

More Measuring Up

As hams, we're used to throwing terms like "frequency," "spectrum," "harmonics," "resonance," and "intermod" around on a daily basis. We know that when we press the PTT button on our radios, we're sending out electromagnetic waves at a specific frequency, with some sidebands around it that relate to our modulation. We also know we could be putting out some energy on other frequencies in the form of harmonics or (gasp!) spurs, especially if we're unlucky and have some kind of technical problem with our radios or antennas. But what does all that really mean? What, exactly, is a frequency and how does it relate to this invisible quantity called the spectrum? With such questions in mind, let's take ourselves out of the time domain and enter the odd universe of spectral thinking.

In any circuit, a voltage or current can have only one value at a time. That much seems intuitive; how can any point on a circuit have different simultaneous values? Yet, it is possible for it to *seem* as if there are multiple events happening at the same time, thanks to time-division multiplexing, which is a fancy way of saying that you can have very rapid changes that seem simultaneous to the relatively slow human nervous system.

A good analogy is music: Its sound pressure waveforms are just like voltage levels in a circuit. It makes sense that the pressure of the air arriving at your eardrums can only have one value at one time. (Of course, in the case of heavy metal music that value may be close to infinity!) After all, how can air be moving forward and backward at the same time? Yet, you can hear many instruments playing together, and it's not hard to separate them all out in your head; certainly, you can tell the difference between the drums and the guitar, or between the oboe and the trumpet. The reason is the same: Things

happen fast enough for you to integrate the information over time and filter it all out, even though it arrives mixed together into one composite waveform.

Master of Your Domain

This brings up the concepts of time domain and frequency domain. Our normal way of viewing things is in the time domain. All that means is that events, such as rising and falling voltages or changing air pressures, change over time. Think of a sine wave. Imagine yourself looking through a slit in a piece of paper as a graph of the wave on another piece of paper underneath it goes by as while being pulled left to right. You see a rising and falling spot that represents the voltage as it changes over time, and that's time-domain thinking. By the way, that's how an analog-to-digital device, like the one used to encode music on a CD, works: It samples the music waveform over and over, very fast, capturing a "snapshot" of the waveform's voltage value at the instant of sampling and storing the value as a binary number. Later on, the numbers are converted back into voltages and assembled, step by step, into a very good facsimile of the original waveform. Yup, digital conversion and reconstruction are time-domain processes.

Enter Another Dimension

The frequency domain, though, is a whole other ball of wax. The easiest way to think of it is this: The frequency domain is where events that change over time are

considered constant entities unto themselves, with their rate of change being their defining factor, rather than the changes themselves indicating movement! So, the sine wave is considered to be one constant thing, rather than a series of moving voltages. That makes for a different kind of graph, with up and down representing the amplitude of the sine wave taken over a period equal to at least one cycle (rather than instantaneously), and other waves of higher and lower frequencies represented to the right and left.

3-D

Notice I called the time domain a "when" and a frequency domain a "where." To think spectrally, you have to imagine in three dimensions if you want to see everything. Imagine you're looking down from above on a bunch of waves lined up *next* to each other. The time domain of this 3-D graph is from back to front; that is, the waves would be coming straight at you if you were looking at the graph as you would in the time domain. Looking exactly straight down from above, you can't really see the up and down movement of the time domain of these waves very easily. (If you angle yourself slightly, then you can see them a little better.) To your left are waves of lower frequency, with their longer time periods stretching from the back toward the front. To your right are the higher frequencies, with shorter periods. If you're having trouble seeing this in your head, get a piece of paper and try to draw a frequency-domain graph. Of course, without the third dimension of up and down, you'll have to fake the waves' amplitudes. Still, you can get a good idea of what it will all look like. See Figure 1.

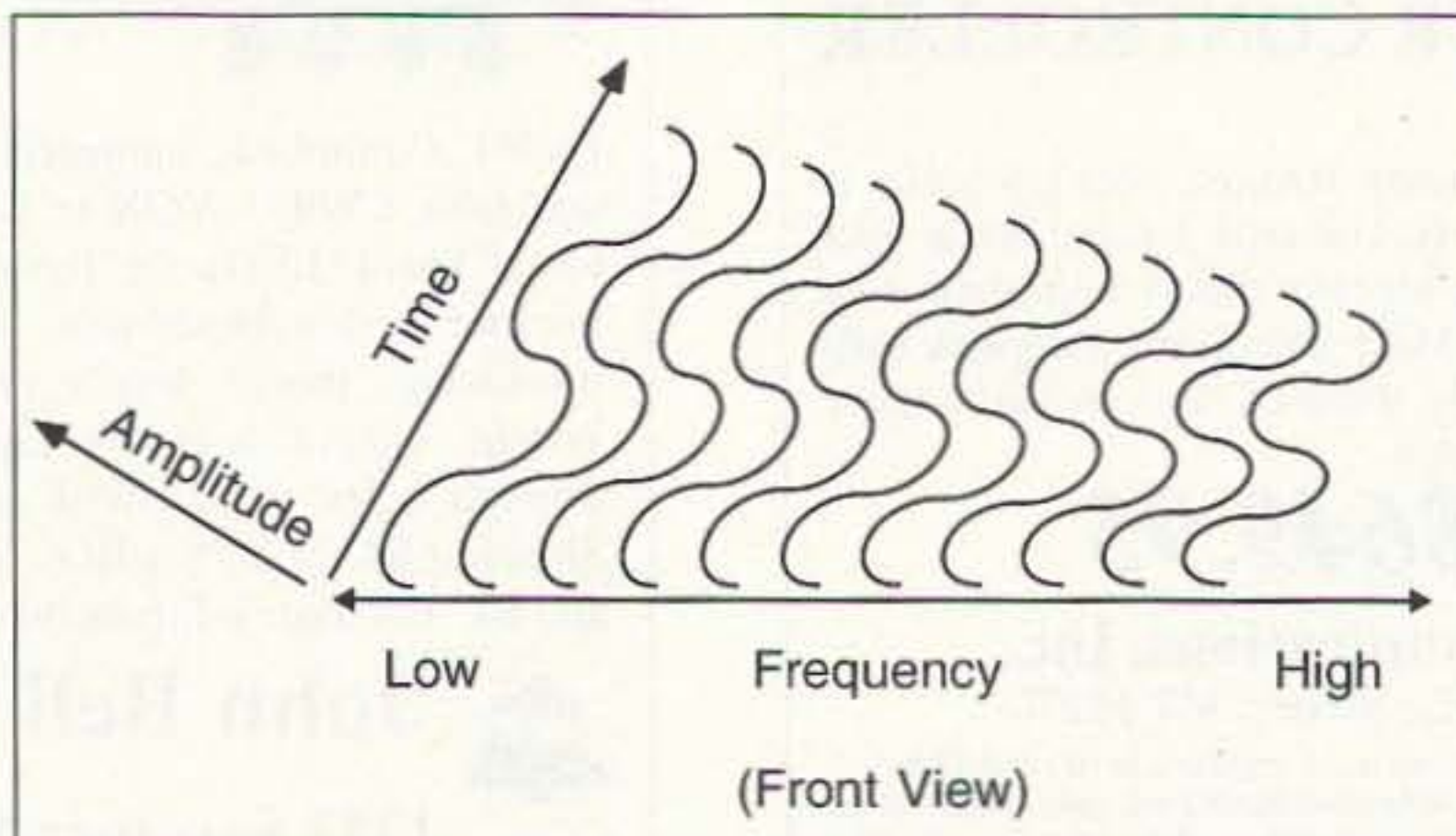

Figure 1. A frequency-domain graph.

What Are Little Signals Made Of?

We all know that signals are composed of rising and falling voltages that force corresponding currents through the resistances of circuits, be they ICs or electromagnetic field-space interfaces (now there's a fancy way to talk about a dipole, huh?). Spectrally, though, what you have are little bunches of frequency units. When you transmit a pure carrier, with no modulation, you get just one wave on the spectrum chart, with nothing to the left or right of it. When you modulate that wave, though, you start spreading out in the spectrum, thanks to the mixing of the modulation with the carrier and its effect of momentarily altering the carrier from a pure, steady sine wave. On SSB, the modulation adds and/or subtracts from the carrier frequency, depending on which sideband you use. On AM, you get mirror-image sidebands on both sides of the carrier frequency. On FM, it's quite a bit more complicated. Still, there are sidebands above and below the carrier frequency; their relationship to the modulation is not as obvious.

Harmonics

Why do a violin and a clarinet playing the same note sound so different? Their unique sonic signatures result from their waveforms, which are vastly different because of the physical structures of the instruments and their different methods of tone production.

A mathematician named Fourier created what he called "transforms" to describe the makeup of various waveforms in terms of their harmonic content. He proved that any waveform could be broken down into its fundamental frequency and its harmonic frequencies. Here's the kicker: Deconstructed in this way, *all* waveforms can be shown to be made of sine waves! Yup, even square and triangle waves. If you filter out all the frequencies above the fundamental frequency of any wave, you'll get a sine wave. It really works, both on a theoretical basis and in the real, physical world. The logical conclusion here is that sine waves themselves have no harmonics. That turns out to be true. In fact, they are the only waves having all their energy on only one frequency.

Does that mean the other

frequencies present are randomly scattered all over the spectrum? No! There's an orderly structure here, which makes sense when you consider that whatever non-sine-wave elements in a wave create, the harmonics have to recur in each cycle of the wave. That suggests the frequencies of these harmonics are multiples of the fundamental, or lowest, frequency. And that's exactly what happens.

Square waves, for instance, have only odd harmonics, meaning there's energy at three, five, and seven times the fundamental frequency, but none at two, four, and six. Triangle waves, on the other hand, have energy at *all* harmonics. So, just how far do these harmonics go? In general, most harmonics decrease in amplitude inversely to their number. So, the third harmonic of a square wave will be at 1/3 the strength, the fifth at 1/5, and so on. Of course, it's possible to have other ratios, but the resulting composite wave will then have a different shape. In the real world, the harmonics don't go on forever; all circuits have upper frequency limits. That's why

square waves don't have infinitely fast rise and fall times; the lack of infinite harmonics keeps the rise and fall times finite, and the more harmonics you lop off, the slower those times get. Lop 'em all off and you're left with . . . yup, a sine wave.

Spurs

You've probably heard of this kind of emission, especially with VHF and UHF repeater installations. Spurs are considered non-harmonic energy. This suggests that their cause does not repeat with every cycle of the wave, and that's true. Spurs can be caused by oddities of circuit design or proximity to other signals resulting in mixing products that are not locked to the period of the wave. So, they can be harder to pinpoint, because you can't go looking at some convenient multiple of your carrier frequency. How do you find spurs, or for that matter, harmonics?

Magic Window

Whether or not you've used one, you're undoubtedly familiar with the oscilloscope, which is an electronic graphing machine that

presents a picture of voltage over time. Does that help us here? To some degree, it can. If you see an obviously distorted waveform (in other words, anything but a sine wave), you know there is energy on some other frequency. But where? On that question, the good ol' scope fails us. We need something stronger.

It's called a spectrum analyzer. It looks much like an oscilloscope, but it presents a frequency-domain picture instead of a time-domain one, letting us see exactly where the energy lands in the spectrum. Before, though, I said that you needed a three-dimensional graph to do that. Have they invented 3-D image tubes or what?

That would be nice! So far, though, we're still stuck in the 2-D imaging world, for the most part. So, spectrum analyzers squash the time axis flat, showing you only amplitude versus frequency. You can't see the waveforms at all, but you really don't need to. All you need to know are their amplitudes and where they fall on the frequency axis. So, how do you make a measurement device actually

work in the frequency domain?

Fake It

You don't! Frequency, being a combination of time and amplitude, doesn't really exist in the direct sense. Even frequency-sensitive, resonant filters really function because of the *time* it takes for the electrical energy to get from one end of the filter to the other and back again. So, to fake a frequency display, we have to go back to the time domain.

A spectrum analyzer is nothing more than an oscilloscope with a narrow bandpass filter that sweeps up the frequency spectrum in step with the beam moving horizontally across the face of the tube. The vertical movement of the beam is made to represent the amplitudes of incoming signals as their component frequencies, a la Fourier, are consecutively passed by the input. You see what appears to be a simultaneous spectrum plot, but it's really a rapidly swept, time-domain fake. You've been had, but in a very useful way.

Next time, we'll look some more at this topic. Until then, 73 de KB1UM. 73



\$79.95!

THE MINI STATION

The MINI STATION is a very compact and portable 2 Amp-Hour gel cell battery that will power your HT via your cigarette power cord at 5 Watts for days on end. It can even power a mobile rig for a few days or so (depending on how long winded you are). It's great for those situations when you need more talk power and longer battery life. The MINI STATION is also a fantastic power source for cellular phones, laptop computers, or anything that plugs into a car's cigarette lighter. We even used a customer's one million candle-power Q-BEAM spot light as a demo at the '95 Dayton Hamfest.

The MINI STATION is a very similar to a QUANTUM battery, except theirs costs about \$200.00 with its special adapters. The MINI STATION utilizes your HT's cigarette power cord. In addition to a wall charger, it comes complete with a handy carrying pouch that has a removable shoulder strap. The pouch also has a belt strap that buckles, so you don't need to unfasten your belt to wear it.

The MINI STATION also has 2 LED's for indicating when the battery is switched on, running low on power, or has finished charging. Since the MINI STATION is a gel cell, it does not suffer from memory effect, so you don't need to wait until the battery is dead before you charge it. That means you can use it all week and then charge it, or use it everyday and charge it everyday so that it's always fully charged. It can be charged thousands of times with the supplied charger, for years of enjoyment. It automatically stops charging when its voltage sensing circuitry detects it is fully charged. Other brands have timed charging circuits (or no charging shutoff at all) which can damage their battery or not fully charge it!

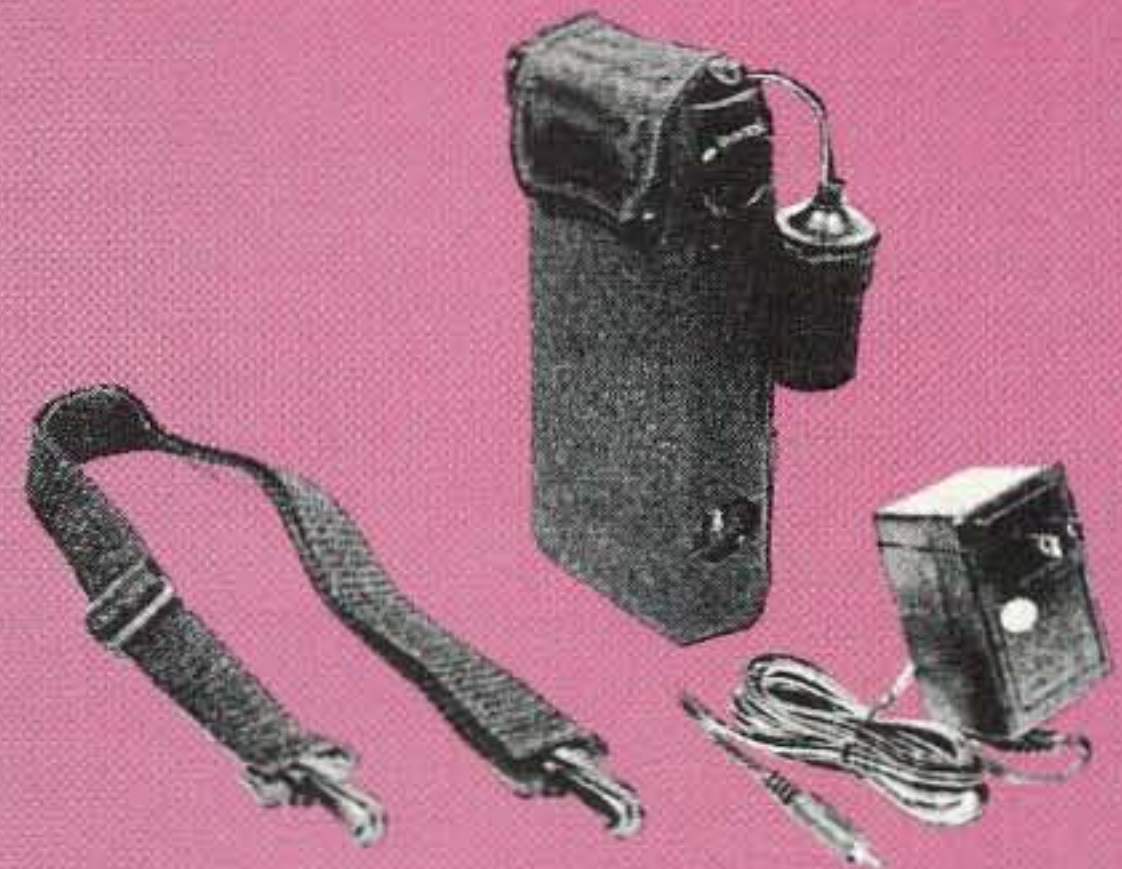

The MINI STATION weighs less than 2 pounds and is approximately 1" x 3" x 6".

Guaranteed Best Prices

Serving the LORD Since 1987



To order, send check or money order for \$79.95 + \$6.50 to:

THE HAM CONTACT
P.O. Box 3624, Dept. MS
Long Beach, CA 90803
for information call (310) 433-5860
COD Orders call (800) 933-HAM4
(800) 933-4264

HAMS WITH CLASS

Number 13 on your Feedback card

Carole Perry WB2MGP
Media Mentors Inc.
P.O. Box 131646
Staten Island NY 10313-0006

Please Touch the Exhibits

With the new fall term almost upon us, many of us who teach will be racking our brains trying to come up with new and exciting ideas for field trips. It isn't always easy coming up with an appropriate place for my 6th-, 7th-, and 8th-grade ham radio classes to visit. Fortunately, our school is located in Staten Island, New York, which is only 20 minutes away from Manhattan. New York City, of course, has much to offer in the way of museums and other interesting facilities. The problem has always been to find a highly motivating facility that would be appropriate for the inquisitive minds of preteens. At this age, the youngsters want to get involved with things that pique their interest. This is also an age group that is not known for its long attention span.

The Liberty Science Center in Jersey City, New Jersey, is the latest answer to a science teacher's prayer. This \$67 million facility is one of the nation's newest hands-on centers. It is located in Liberty State Park, just minutes from the Statue of Liberty, Ellis Island, and downtown Manhattan. The 170,000-square foot facility features two signature design elements: The Kodak OMNI Theater's geodesic globe housing the world's largest OMNIMAX Theater; and the 170-foot observation tower.

The original plans for the science center came about out of concern for the dwindling scientific literacy among many inner-city students. In 1981, the business community, members of the Research and Development Council, and many prominent, concerned citizens of the state began assembling the plans for an institution that would aid in the development of future generations of science-literate young people.

The Liberty Science Center contains over 60,000 square feet of exhibition space on four floors, with more than 250 innovative

and engaging "hands-on" exhibits, allowing visitors of all ages to experience firsthand the excitement of science and the satisfaction of individual discovery. All the electronics that control the various exhibits are encased in clear plastic for the children to examine. Even the escalator and the computer controls are covered with clear plexiglass.

There is a Health floor that includes a sensory deprivation tunnel and an ambulance for kids to walk through and examine. Many different kinds of body simulation displays are featured requiring interactive participation. The Environment floor is also fascinating. It contains a one-of-a-kind, 60-foot interactive theater showing environmentally related films where the children make choices that control the final outcome of the action.

Of greatest interest to me and the children with me was the Invention floor. One section of the floor has a separate workshop area, in which dozens of youngsters were seated working diligently on various individual projects. Several parents were involved with their kids building small motors and generators. There were also four Liberty Science Center employees who were highly visible, moving around the



Photo B. See sound waves interact with foam pellets to create standing waves in the Resonance Tube at Liberty Science Center.

workshop area and offering assistance when needed. In addition to the shelves filled with circuit boards from stereo systems, television sets, and radios, the work area has many reference books and is well stocked with all kinds of tools for kids to use.

The students and I were especially impressed with the "swap" center. Youngsters can bring in old electronic components and swap them for other items they may need. First the child is asked

to explain the item in detail. The LSC personnel then assign a points value to the presentation, which can be used to obtain other electronic items in the showcase. This is truly a wonderful child-oriented facility.

In several designated areas on this floor live demonstrations were going on. We got to see an exciting demonstration on virtual reality the day we were there. Various computers were invitingly set up so that not a single one was vacant. I enjoyed the fact that every time a lecturer asked if there were any questions, one of my kids would inevitably ask if they planned to install an amateur radio station at the center. One of the administrators responded that they were reviewing plans for a radio station.

Professional scientists make themselves available for mentoring of students who are doing research projects at the center. Private contributions and donations from more than 100 U.S. corporations help to support the Liberty Science Center.

For any teacher who is in the tri-state area, a visit to this most unique learning center is a must. If you are a ham radio operator, be sure to leave your suggestion about the value of having a ham radio station at the location. For more information call (201) 200-1000.



Photo A. Liberty Science Center is conveniently located on the Hudson River, just across from the World Trade Center.

**EVERY ISSUE OF
73 Amateur Radio Today
on Microfiche!**

The entire run of 73 from October 1960 through last year is available.

You can have access to the treasures of 73 without several hundred pounds of bulky back issues. Our 24x microfiche have 98 pages each and will fit in a card file on your desk.

We offer a battery operated hand held viewer for \$75, and a desk model for \$260. Libraries have these readers.

The collection of over 600 microfiche, is available as an entire set, (no partial sets) for \$285 plus \$5 shipping (USA). Annual updates available for \$10.

Satisfaction guaranteed or money back!

BUCKMASTER

Route 4, Box 1630

Mineral, Virginia 23117

540:894-5777-800:282-5628

Internet: info@buck.com

Fax 540:894-9141

VISA

MasterCard

CIRCLE 168 ON READER SERVICE CARD

**Be an FCC
LICENSED
ELECTRONIC TECHNICIAN!**



Earn up to
\$60 an hour
and more!

Learn at home in spare time.
No previous experience needed!

No costly school. No commuting to class. The Original Home-Study course prepares you for the "FCC Commercial Radio-telephone License." This valuable license is your professional "ticket" to thousands of exciting jobs in Communications, Radio-TV, Microwave, Maritime, Radar, Avionics and more...even start your own business! You don't need a college degree to qualify, but you do need an FCC License.

No Need to Quit Your Job or Go To School
This proven course is easy, fast and low cost! **GUARANTEED PASS**—You get your FCC License or money refunded. **Send for FREE facts now. MAIL COUPON TODAY!**
Or, Call 1-800-932-4268 Ext. 73

COMMAND PRODUCTIONS

FCC LICENSE TRAINING, Dept. 73
P.O. Box 2824, San Francisco, CA 94126
Please rush FREE details immediately!

NAME _____
ADDRESS _____
CITY _____ STATE _____ ZIP _____

**BAMCOM
COMMUNICATIONS**



YAESU

AEA

ICOM



MFJ

pro-am



800-283-8696

504-277-6815

P.O. BOX 557 ARABI, LOUISIANA 70032

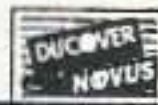

MON.-THUR. 9-6 CTZ

POCKET-SIZE... TOTALLY DIGITAL...
MICROPROCESSOR INSIDE

RF ANALYST™



**FREQUENCY
DIGITAL SWR
IMPEDANCE
RF L/C METER** **NEW!**

Model RF-1 \$129.95 (+ \$6 S/H)

SWR: Find your exact antenna resonance and SWR curve (1.2-35 MHz). See how much to shorten, lengthen, or adjust it so it works! Adjust AT THE ANTENNA, or adjust your tuner, without transmitting! This works like similar products. But there's more:
IMPEDANCE: RF resistance. Tells much more than just SWR. Check yagi, quad impedance, baluns, trap frequencies, coax, 75 and 300 ohm lines. See affect of adding more vertical radials. Cut precise 1/2 or 1/4 wave feedlines or stubs. Instructions show how to do this, and much more! 0 to 2000 ohms.
RF L/C: Other L/C meters measure at 1 kHz, but L & C can be greatly different at RF! Now you can see true RF values!

L from .04 uH (about the inductance of 1" of wire) to 300 uH (ten times a 160M coil.) C from 1 to 9999 pF. Easily build matching networks. An antenna builders dream!
TOTALLY MODERN: A/D converters. Crystal-based four-digit frequency accuracy (1kHz below 10 MHz.) Much more accurate than even the narrowest antenna. Smooth bandsread. Push two buttons and cycle between modes twice/sec., e.g. SWR and FREQ, to see both together. Also a low-distortion sinewave generator. LARGE 1/2" LCD display loves sunlight. Tiny 4.5 x 2.5 x 1.5 in. ABS cabinet. Only 7 oz. with standard 9V battery (not supplied). Another Autek classic!

DELUXE SWR & WATTMETER



**COMPUTING SWR
NO ADJUSTMENTS!
REMOTE RF HEAD
PEP & AVERAGE
2KW OR QRP**

Model WM-1 \$119.95 (+ \$6 S/H)

We designed the WM1 with features most have left out. Like magic, it automatically computes SWR. SWR doesn't change with power. No more nomographs, adjusting or squinting at crossed needles. Welcome to the 90's, goodbye to the old ways! It even reads SWR in PEP when talking on SSB!
The Remote Head keeps the coax up to 4 feet from the meter, avoids "meter pull-off." The WM1 uses large 2 1/4" meters and a heavy case, designed to last for decades.

(Also see the excellent review in Nov. 1989 QST.)
Specs. are a conservative 5% FS, 1-30 MHz, but it also works accurately to 1 watt or less. 2000, 200, and 20 watt power scales, with a 5 watt center scale on the lowest range for QRP. Uses 8-18 VDC or 115 VAC. No extras to buy. 6 1/2" x 3 1/4" x 3"D. Attractive light-dark grey styling.
WHY PUT UP WITH AN INFERIOR METER?
Call or write today!

THE AUTEK "QRM ELIMINATOR"



**FOR SSB/CW/AM
& DIGITAL MODES**

Model QF1-A \$89.95 (+ \$6 S/H)

Auxiliary Notch rejects
80 to 11,000 Hz! Covers signals
other notches can't touch.

Four main filter
modes for any QRM
situation.

Continuously variable
main selectivity
(to an incredible 20 Hz!)

Continuously variable
main frequency.
(250 to 2500 Hz)

Thousands of QF1-A owners have discovered the easy way to improve their radios' selectivity—no matter how expensive it is. Don't confuse it with simple audio filters on transceivers, which aren't very effective. Or with other simple add-on peak/notch filters. The QF1-A is INFINITELY VARIABLE. You vary selectivity 100:1 and frequency over the entire communications range. Reject up to two whistles with two notches.

SSB hiss and splatter with LP, and low frequencies with HP. Imagine what the NARROWEST CW FILTER MADE (20 Hz.) will do to QRM! Skirts exceeded 80 dB. 1 watt spkr. amp. 115 VAC. 6 1/2" x 2 1/2" x 4 1/2" D. Light-dark grey styling.
Best of all, it hooks up in minutes to ANY xcvr./rcvr. Just plug into your phone jack, and connect a speaker or phones to the output. Then enjoy the difference. If it can't pull him out, nothing can!

Autek Research

P.O. Box 8772 • Madeira Beach, FL 33738
813-886-9515 ext. 73



We sell only factory direct. No dealer markup in our price. Order with check, MO, MC, VISA. Add \$6 S/H in 48 states. Add tax in FL. Add \$9 to Canada, HI, AK. Add \$25 each elsewhere (shipped air elsewhere). Speedy insured shipment.

Ham Television

Bill Brown WB8ELK
c/o 73 Magazine
70 Route 202 North
Peterborough NH 03458

Record-Setting Band Opening

A couple of months ago I wrote about a fantastic DX opening that occurred in the Midwest last Christmas. It turns out that during that opening, a contact was made that surpassed the overland DX record mentioned in that column. The following is an account of the band opening as observed by Wilbur Wollerman K8AEH.

P5 FOG

On the day following Christmas, Wilbur K8AEH arose early for a snack and some coffee. Contemplating whether to sleep in some more, he noticed the thick layer of fog outside. After years of chasing ATV DX on 70cm, he knew that this kind of thick fog usually meant excellent tropo conditions.

Sure enough, he saw that stations from Dayton, Cincinnati, and Indiana were already working into Michigan, Illinois, and Wisconsin. Throughout the day, P1 signals came up to P3 and soon P5 pictures were seen from stations several hundred miles away as the fog really started rolling in. Around 11 pm it was ATV bedlam on 439.25 MHz. No matter where the antenna was pointed, pictures could be seen. Snow-free images were rolling in from Pittsburgh and Wheeling to the east and

from Missouri, Arkansas, Illinois, and Wisconsin to the west. There were so many stations on the air that you just couldn't work them all.

Wilbur took pictures of many of the DX contacts. Unfortunately he ran out of film in the wee hours of the morning, just as the band seemed to be peaking out! Now where do you get a roll of film at 3 am? The correct answer is *not* to wake up the XYL and ask to borrow her camera. After she rocketed off of the bed, hitting her head in the process, Wilbur very nearly ended up with her camera permanently embedded in his head!

It turned out to be worth risking his life, since he got some excellent photos of the peak of the band opening.

Record DX

Wilbur's longest contact was with Elmo Knoch K5YWL in Harrison, Arkansas. The signal strength was between P4 to P5 over an incredible 628-mile path.

Wilbur's station consisted of an 88-element J-Beam at 70 feet, a two-stage GaAsFET amplifier and a 1-kilowatt (dual 4CX250Bs) amplifier with its own video and audio modulator that was driven by a 2C39 exciter.

Elmo K5YWL was using a quad array of FO-22 antennas at 76 feet and a 100-watt Mirage amplifier. *Thanks to Wilbur Wollerman K8AEH for the above information.*



Photo A. Actual reception of Elmo K5YWL's ATV signal from Harrison, Arkansas, as seen by Wilbur K8AEH in Reynoldsburg, Ohio. Photo by K8AEH.



Photo B. Wilbur K8AEH makes the record-breaking ATV contact from his ham shack during the Christmas band opening. Photo by K8AEH.

DX Observed from K8AEH

WJ9Z	St. Francis, WI	WB0ZJP	O'Fallon, MO
K9SM	Hillsboro, IL	N8TSM	Lansing, MI
N9AB	NW Chicago, IL	KA8VSV	Detroit, MI
W9MZH	Fort Wayne, IN	KA3FZF	Monroeville, PA
AA9IG	Peoria, IL	N8AW	Jackson, MI
KA9TGX	Lafayette, IN	W8AHY	Lansing, MI
N9LBN	Milwaukee, WI	W9LPR	Milwaukee, WI
W9NTP	Waldron, IN	WD9ASI	Chicago, IL
K5YWL	Harrison, AR	N8TBM	Lansing, MI
KA9VXS	Lafayette, IN	WA4GSS	Ashland, KY
K3IBD	Pittsburgh, PA	KA8VZV	Wheeling, WV



REYNOLDSBURG, OHIO
1672 Rosehill Rd. 43068

K8AEH
-AAF8AEH-

Radio K5YWL Confirming QSO of 12-26-94 at PM E.S.T.
 U-439.25 Mc. GW Sigs RST P4 Ant: J-BEAM 70' TOWER
 Xmit: 4CX250B 1 KW Recv: 2 STAGE GAS FET PREAMP
 Remarks: TNX FER FAST SCAN FROM ARKANSAS
 Pse QSL Txn 73. Wilbur L. Wollerman
 W8WRN PRINT **TNX ELMO**

Figure 1. QSL cards confirming the record overland DX contact of 628 miles between Arkansas and Ohio.

Radio Direction Finding

Joe Moell P.E. K00V
P.O. Box 2508
Fullerton, CA 92633

The T Is on! Let's Find It!

If you drive the freeways and surface streets of southern California, you're sure to see some cars, vans, and jeeps zipping along with unusual antennas on top, turning erratically back and forth. You may have encountered a group of them parked on a hilltop (see Photo A) and noticed blinking display boxes on the dashboards.

Two meter operators here are used to hearing strange beep-beep signals on 146.565 MHz simplex, and sometimes through repeaters, too. They have CW or voice identifiers giving "T numbers." On some weekends, half a dozen are on the air at a time!

As you have probably guessed, the hams with the weird mobile antennas are trying to find the sources of the weird signals. They call it "T-hunting" because they are looking for hidden Ts (transmitters). The sport is growing and spreading to large cities and small towns across the country. In some places it's traditionally called "foxhunting" and the hidden station is called the "fox." The technical name for the process is radio direction finding (RDF).

T-Hunting Basics

The idea is simple: One or two hams take a transmitter, antenna, and some sort of distinctive audio source to a carefully chosen spot, and then make continuous or intermittent transmissions. Usually the T remains stationary throughout the event, though mobile "bunnies" are allowed once in a while. The hunters, as individuals or in teams, do their best to home in on the hidden station with their mobile and portable RDF gear. Sometimes there are multiple foxes to be found in sequence. Prizes for the winners are rare; usually there is only fleeting fame, glory, and the opportunity to be hider for the next hunt.

Every team competes independently. Neither clues nor outside assistance are allowed. While the majority of southern California T-hunts are on two meter FM simplex, a few beginner-level hunts are on repeater inputs. That makes it easy for everyone to tell when the T is on the air.

Southern California is the undisputed T-hunting capital of the USA. There are over 20 competitive hunts each month. The majority start in Los Angeles and Orange counties. Monthly hunts are also available in Riverside, San Diego, and Santa Barbara counties. The latest T-hunt calendar, published by Cathy Livoni KD6CYG, shows hunts scheduled for every day of the week except Tuesday. (Hmmm . . .)

Each monthly hunt has its own set of rules. Some are very strict, defining the number of Ts, length of transmissions, antenna polarization, boundaries, proximity to roads, time limits, and so forth. On the other hand, a few merely demand that a T be copyable at the start point or through a repeater. Just about anything else goes on these "no complaints" hunts.

Hunts are scored by one of two methods: first finder wins or low mileage wins. A few groups like timed hunts because they simulate the urgency of hunting for repeater jammers or QRM. But the vast majority prefer mileage hunts because they are more like a rally than a road race. On a mileage hunt, there is plenty of time to plot bearings carefully and plan strategy (see Photo B).

Odometer-calibration differences are easily resolved because hunters obtain an odometer correction factor in advance of the hunt by driving a standard course.

The boundaries of the three monthly two meter Saturday night hunts are all different, encompassing areas ranging from 78 to 2,320 square miles. The hidden T could be 50 miles away on the Pathfinder hunt, which has the largest of the three boundaries. This hunt typically lasts from three to eight hours.

The varied terrain of southern California adds excitement and variety to T-hunting. Most hunt boundaries include flatlands of urban Los Angeles and Orange County, plus the Chino and Puente Hills, some of which are over 1,000 feet high. Other hunts include even higher mountains. With careful planning (and a little luck), the signal's characteristics will entice hunters to approach the T from the most difficult direction, with impassable roads or other obstructions, even though the T is easily reached by other routes. Sometimes the hider camouflages the setup so well that the hunters don't discover the transmitter unless they literally trip over it.

The most challenging of all are the All-Day Hunts. But that's a misnomer—a better name would be All-Weekend Hunts. They start at 10 am on the fourth and fifth Saturdays of each month. There are five types of All-Day Hunts. Rules for four of them allow the transmitter to be anywhere in the continental USA.

Hiding spots for All-Day Hunts have ranged from the banks of the Salton Sea, 228 feet below sea level, to the top of an 8,350-foot mountain peak. The distance record is currently held by Jim

Forsyth AF6O and Eric Nansen N6YKE, who hid four transmitters in four states on one hunt. The farthest was in Utah, 344 miles from the Rancho Palos Verdes starting point. To provide an audible but deceptive two meter signal back to Palos Verdes, All Day Huntmasters often invent very unusual transmitting setups. For example, Jim Ford N6JF and Gordon Nichols K6KYW have used a 35-element yagi antenna with a 100-foot-long boom!

Why Big Beams?

More often than not, Los Angeles area T-hunts involve weak signals. You may have solid copy on the T from the hilltop starting point, only to have it become faint or disappear as you drive down the hill. If you start out in the wrong direction, you might not hear it again! Even if you go the right way, you could travel for many miles before acquiring the signal. For this reason, experienced southern California hunters maximize their receiving sensitivity. They prefer high gain antennas such as quads and yagis for getting their bearings.

Three- to six-element cubical quads are the most popular T-hunting beams. Usually they have a boom of wood or PVC pipe. Elements are made of thin wire (AWG 20 or 22) strung on Fiberglas spreaders in "diamond" form. Some hunters, myself included, prefer to use PVC element spreaders and heavy (AWG 10 or 12) wire formed into square elements. This design is more resistant to the dreaded "quad eating willow." When mashed by low-hanging tree branches, it is easily reshaped and returned to service, whereas thin-wire models tend to suffer wire breakage.

Yagis are a close second to cubical quads in popularity. Commercial models work fine, provided that they have a well-matched feedline, rugged construction, and good mechanical balance. Occasionally you will see some other kind of directional antenna such as a circular-element quad, a "ZL special" phased array, or a delta quad, affectionately known as a "turkey rack."

Rules usually allow transmitting any wave polarization. It is important for hunters to attempt to determine the hider's polariza-



Photo A. At sunset on a summer Saturday, southern California T-hunters gather on a hilltop to have their odometers read before the hidden transmitter comes on the air. Most have yagis or quads on rotatable masts extending through their vehicle roofs.



Photo B. Low-mileage-wins T-hunting encourages careful driving and meticulous plotting of bearings. John Roberts WA6LAB is getting ready to start on the Southern California Six Meter Club's monthly hunt on 50.3 MHz simplex.



Photo C. With a little thought, you can come up with a simple no-holes way to mount a rotating beam through the passenger window of almost any car. Put some sort of thrust bearing in the armrest at mast bottom for easy turning at highway speeds. Mount the beam so that a twist of the boom changes polarization.

tion and match it for receiving. A team using the wrong polarization is at an extreme disadvantage, because direct signal pickup is reduced and signal reflections (multipath) from buildings and terrain features are enhanced. Depending on circumstances, such a team may do nothing but chase reflected signals for the duration of the hunt!

Most hunters install some sort of slip joint at the beam's boom-to-mast junction. They rotate the boom to match the signal polarization at the start of the hunt,

and sometimes along the way. A few builders add strings and pulleys and are able to conveniently adjust polarization from inside the car.

Doppler RDF sets have not caught on among southern California T-hunters due to their lower sensitivity, compared to beam set-ups. Vertically polarized doppler antennas are at a competitive disadvantage when the hider transmits horizontal polarization. Around here, dopplers are better suited for hunting repeater jammers, who usually use high-power and vertically polarized antennas.

For the same sensitivity and polarization reasons, switched dual-antenna RDF sets sold by companies such as BMG Engineering, Ramsey Electronics, and Radio Engineers are seldom used for mobile T-hunts in southern California. However, some teams employ them at the end

of the hunt, when signals are strong, for searching out the T on foot.

Jump Right In

Isn't it great that the RDF method most suited for T-hunting on two meters is also the simplest and cheapest? This means it's easy to join in your club's T-chasing antics without a lot of work and expense. Just mount a beam antenna to your vehicle and off you go!

As a beginner, you'll do fine by lashing up a simple passenger-side, through-the-window mount that secures the mast bottom in the armrest and holds the mast center in place next to the top of the window frame (see Photo C). Why the right side? Because your state's vehicle code probably has a provision that outlaws left-side overhang. Nothing must protrude beyond the line of the fenders on the driver's side, but a few inches of overhang are permitted on the passenger side. Check to be sure.

The ideal place for a mobile RDF beam is above the center of the roof. Thus both driver and passenger can rotate it, the effect of the car's body on directional pattern is minimized, and you can use a bigger beam without worrying about overhang. If you have a

sunroof, you can probably figure out a quick weatherproof holder for the mast. Some hunters have developed suction-cup mounts with belt or rod-and-crank links to go atop a vehicle (see Photo D).

The bold way, of course, is to drill a 2-inch diameter hole through the roof. Most serious hunters in southern California have overcome the objections of family members and gotten out the hole saw, as you can see from Photo A. No matter how you mount the mast, be sure to include some sort of indicator to show mast position. Straight ahead is zero degrees, dead right is 90 degrees, and so forth.

Getting a beam bearing is easy and intuitive. As you rotate your antenna, watch your receiver S meter for maximum signal indication. Carefully rotate back and forth to determine the exact peak. If the signal is too weak to view on the meter, open the receiver squelch and use your ear to detect the direction corresponding to greatest "quieting" of the noise. When you get so close that the S meter goes off scale, add RF attenuation in the feedline as necessary. Most hunters use simple resistive RF attenuators, home-built or bought for a few dollars at a ham radio swap meet.

T-hunters agree that you can't have too many maps. Start collecting them now; you will need them. Mount a map of the entire hunt area on a board with clear covering so you can plot and erase bearings. A good car compass is a big help in taking mobile bearings relative to true north. You can mount the compass at a slight angle on the dashboard to offset the magnetic declination (the difference between magnetic north and true north in your location). Carefully follow the compass calibration procedure to compensate for the effect of the vehicle body.

To get a true bearing (a bearing relative to true north), add the true vehicle heading to the mast indication. If the sum is greater than 360 degrees, subtract 360. For example, if you are heading down a westbound street (270 degrees) and the beam pointer reads 130 degrees, the true bearing is 40 degrees.

A few hams prefer to T-hunt alone, but most say it's much more fun to team up. The driver concentrates on handling the vehicle, while the DFER turns the beam and calculates bearings.



Photo D. James Swenson KC6YSV figured out a clever way to mount his yagi atop the car roof without drilling a big hole. Handles at each end of the PVC pipe framework allow both driver and passenger to rotate the yagi.

The DFER also handles maps and plotting (navigating), unless there is a third team member for that task.

You Gotta Sniff, Too

On most hunts, you won't be able to drive all the way until you can touch the hidden T. It may be up a tree in a park, buried on a hillside, or under groceries in a shopping cart. Searching out a T on foot is called "sniffing." Special sniffing gear is great if you have it, but you can usually find the T with just a handi-talkie and simple accessories.

The simplest way to get a bearing in the field is the "body fade." Hold your HT tight against your chest and spin around slowly, looking for the direction at which your body blocks the signal most effectively. At this point, the signal is coming from behind you. When you are so close that you can't find the signal minimum, remove the HT's antenna and try again. For even more signal reduction, use a cardboard tube about 3 feet long and 4 inches in diameter, covered with aluminum foil (leave both ends open). The more you lower the HT into the

tube, the more signals are progressively attenuated.

It's not practical to use a directional antenna and ordinary resistive attenuator with a hand-held for sniffing at close range. Strong signals will penetrate the case of the HT and make it impossible to get bearings. In a pinch, you can reduce signal level by tuning the receiver 5 or 10 KHz off frequency. If you have a dual-band hand-held, you get will the equivalent of 40 to 60 dB attenuation by tuning it to the third harmonic of the hunt frequency. A small UHF yagi or quad will give sharp bearings on the hidden T's third harmonic when you are within a few dozen feet.

More Toys

As you gain experience and skill, you will want to add additional gadgets to increase hunting enjoyment (and win more hunts). Early on, you'll see the need for a large easy-to-read external S meter (mechanical or LED bargraph) on the dash. Another favorite add-on is an audio S meter, so you can keep eyes on the road and yet hear signal level fluctuations.

To increase sensitivity to hear those really weak Ts, build or buy a low-noise RF preamplifier, add a noise meter to measure the FM quieting of the signal, or a beat-frequency oscillator and single-sideband detector. For occasions when strong signals penetrate your mobile receiver's case, build an internal gain reduction system. All these projects are fully described in the 323-page book *Transmitter Hunting—Radio Direction Finding Simplified*, available from Uncle Wayne's Bookshelf.

As in any other specialty of ham radio, the more T-hunting gear you have, the more you want. But don't be intimidated by all the gizmos you see in the big vans and little jeeps of the long-time RDFers. A beam, attenuator, and good receiver is all it takes to find most Ts, and it is not unusual for a beginner to beat the "big guns." Go on a hunt and see for yourself. Bring the family; it's a great "togetherness" activity. If there are none in your area, get together with the leaders of your club and schedule one. Be prepared for some pleasant surprises. When you set out on a hunt,

you never know where you'll end up, and you never know what you'll find.

Get The List

If you think it's hard to find information on T-hunting, you haven't been reading *73 Amateur Radio Today*. There has been far more on the subject here than in any other ham magazine. When answering reader inquiries, I frequently can't remember which of the 80 Homing In installments to date cover a particular RDF topic, so I put together an index of titles and subjects.

If you would like a copy of the Homing In Index, send me a self-addressed stamped envelope. My address is at the beginning of this article. If you have the capability, request the index by E-mail and I'll send it in a return message. My Internet address is HomingIn@aol.com and my CompuServe ID is 75236,2165.

While you're at it, tell me about T-hunting activities in your home town. Your photos are welcome, too. Future columns will cover unusual T-hunting customs across the country and around the world; so let's hear about yours.

AMATEUR TELEVISION

GET THE ATV BUG



≥10 Watt pep
Transceiver
Only \$499
 Made in USA
 Value + Quality
 from over 30years
 in ATV...W6ORG

Snow free line of sight DX is 90 miles - assuming 14 dBd antennas at both ends. 10 Watts in this one box may be all you need for local simplex or repeater ATV. Use any home TV camera or camcorder by plugging the composite video and audio into the front phono jacks. Add 70cm antenna, coax, 13.8 Vdc @ 3 Amps, TV set and you're on the air - it's that easy!

TC70-10 has adjustable RF out (1 to 10w p.e.p.) and sync stretcher to properly match RF Concepts 4-110 or Mirage D1010N-ATV amps for 100 Watts p.e.p. Specify 439.25, 434.0, 427.25 or 426.25 MHz, 2nd xtal add \$20. Hot GaAsfet downconverter varicap tunes whole 420-450 MHz band to your TV ch3. 7.5x7.5x2.7" aluminum box.

Transmitters sold only to licensed amateurs, for legal purposes, verified in the latest Callbook or send copy of new license.

Hams, call for our complete 10 pg. ATV catalog
Everything you need for 400, 900 or 1200 MHz ATV.

(818) 447-4565 M-Th 8am-5:30pm pst Visa, MC, UPS COD

P.C. ELECTRONICS

2522 Paxson Lane Arcadia CA 91007

Tom (W6ORG)
 Maryann (WB6YSS)

MCM Electronics®

One Catalog Says It All



MCM is the complete source for all of your electronic parts needs. Our 332 page catalog has over 21,000 items including semiconductors, tools, test equipment, power supplies, computer components, connectors, cable and two-way equipment too!

The MCM line of 2M/70CM radios, antennas and accessories are purchased directly from the best manufacturers in the world, offering the utmost in performance at prices near half the competition.

Discover what you should be paying for power supplies, mobile and base antennas, duplexers and other accessories. Get your free catalog today!

Call **1-800-543-4330**
 Or mail the inquiry card bound in this section.



MCM ELECTRONICS®
 850 CONGRESS PARK DR.
 CENTERVILLE, OH 45459-4072
 A PREMIER Company

Get fast delivery from our distribution facilities near Reno, NV and Dayton, OH!

CODE: 73M02

ABOVE & BEYOND

VHF and Above Operation

C. L. Houghton WB6IGP
San Diego Microwave Group
6345 Badger Lake Ave
San Diego CA 92119

The Surplus Cellular Telephone —900-MHz Component Parts

Well, last month we covered HP power meters and the selection process for surplus power heads. I hope you now have all the information needed to test and evaluate used surplus power meter heads and avoid purchasing defective ones. I have been using the resistance check method described last month and it has worked out very well as a field evaluation test. I want you to benefit from my experiences also and so avoid the purchase of a defective unit as they can be quite costly even as a bargain. A bad or unbalanced power meter head is not a bargain if it will not function. I just don't want to see anybody purchase a bad or defective product if they can help it. After all, the dollar we spend is usually from a tight budget.

So many people have asked me how our group keeps coming up with new material all the time. Others have looked but have not had as much success as we have enjoyed. I have heard this scenario many times. The area you look in might not be as fertile for electronic scrap as the San Diego area is. Even with the large manufacturing base here in electronics, we still put forth an effort to locate used and surplus material from sources that are new and interesting.

I guess it's a little like fishing. My son is so good at fishing that he goes just for the sport of catch and release. He will tell you what type of fish he has on his line when he has 50 feet or so of line still to reel in. At that point the fish is not struggling with the line, just being tempted by the bait. He can hand the line to me and describe what to notice and I feel a dead line, and will bet on it (the first couple of times). Handing the rod back to my son, he will reel in the fish he described and collect from the old man.

Locating surplus material is similar. Kind of like putting a blood hound on the trail, but not knowing just what might turn up. In many cases it's like drilling for oil—another dry well. But a good part of the time pay dirt is struck. It's just good perseverance and sticking to the trail of good, usable items that make the chase worthwhile. You don't have to reveal how many dry wells you had to dig; you can only talk about the ones that struck pay

dirt. People will think of you as a keen hunter.

Here's some real pay dirt, another surplus material idea that can pay off in short order. I am talking about the *cellular telephones* that are becoming available for almost nothing. At least that's what is happening here in San Diego. It seems that the cellular telephone companies here are offering new miniature cell phones for as little as *one percent* of full price. There is a hook: You guarantee to purchase cell phone activation and keep it active for one year of service. To make it more lucrative, you get credit for 10 minutes of air time for each month's usage. As long as you don't engage in long-winded conversations, the cost of these small new phones is such a deal that they are being snapped up faster than peanuts at a ball park. You ask what does that mean to me, the radio amateur. It means that the older briefcase-type telephones that weighed in at five pounds are being scrapped at unprecedented rates in preference to the newer, very small lightweight purse or pocket-type replacement phones.

Inside the newer type of phone you can see a very miniaturized, highly integrated circuit, almost unrecognizable as a RF transceiver for UHF operation. The newer phones are almost not worth retrieving components for amateur uses. Yet this prospect is not bleak, for the larger units are very unpopular and unwanted by the cellular companies. To the radio amateur, these larger units are just what the doctor ordered.

The larger units were constructed with discrete components and larger modules to construct the cell phone's circuitry. This large weight and older technology (discrete construction) makes a unit from which we can salvage por-

tions of circuitry that can be used on the 902-MHz band. Now I haven't tried all the possible ideas but want to mention a few before all of these older, large phones disappear from the market.

The unit that started this train of thought was a mobile permanent trunk type of cell phone that I picked up for \$1. It was missing all the interconnecting cables but the basic phone unit was intact. Upon removing the unit's case, I noticed immediately the very large PC board controller for the phone's operation. It was a circuit board about 8" X 10" long. It was stuffed with chips and other components that seemed to be very complex, but not of any great interest for our use. Apparently this unit took care of the housekeeping of the cell phone's operation and had nothing to do with the RF end other than being the processor for synthesizer control.

The other side of this cell phone was more interesting from a pure RF operation standpoint. This side contained four modules, a diplexer antenna module, a transmitter power amp module, a receiver module, and a synthesizer module. See Photo A for a graphic depiction of the circuitry involved in this part of the circuit. Because the circuitry is large, it invites our consideration for salvage operations. Taking a close look at Photo A, you can see some of the larger components, including two VCOs for 800 and 900 MHz. Also included are the standard chip set rather than miniature surface mount chips. These larger components make it very easy to recover and reuse whole circuits or individual parts. This goes for the processor on the other side of the board. I don't believe modification is in order for the processor, but component part salvage is.

For the RF side of the board, a prime PC board for intact removal is the receiver circuitry itself. Looking at the PC board with the cover plates removed, you can readily identify the RF amp, mixer, and LO inputs. I haven't tried to trace the power pins back, but with all the electrolytics and full-size standard

ICs, it should be easy to back trace DC power leads. I have found many such PC boards that have lent themselves to reverse engineering for developing partial schematics of the particular PC board circuit you wish to utilize.

It's a good electronics game to sharpen your skill level on component and circuit identification. This type of operation lets those who try, to make something inexpensive into a very usable device. Sort of making a sow's ear into the proverbial silk purse. Even if the project does not realize all your ambitious plans, remember: It was obtained for very little and the most you can lose is effort. Along the way, however, you have gained quite a lot of solid technical updating by the reverse engineering process and delving into technical pubs for IC pinouts, trying to make use of the PC board you selected.

In my case, I removed the main PC board and tossed it into the component salvage pile for plain old PC boards; nothing special about this board but some parts at a later date. I removed the four RF modules and tried to make some sense out of two of the boards. First, just what does it take to make the synthesizer run and is it convertible? Or better, are there some VCO components to use in construction of another, simpler synthesizer. This is the approach I took for a 902-MHz converter to be constructed out of this heap of parts.

In regards to the receiver PC board, much of the circuitry was quite standard in design, with a basic receiver block diagram layout adapted to the PC board. This unit I removed gingerly as I believed I could make use of this unit with a minimum of conversion modifications. One great feature of this receiver unit is that the receiver subdeck is totally enclosed in its own shielded compartment. This will make its use in the 902 MHz receiver quite neat in appearance. The shielded enclosure will allow modifications to the original PC board to be covered by the shield plates, thereby retaining the shield function.

Figuring the synthesizer input and IF frequencies used should be of little difficulty, as they can be bypassed while the unit is function tested on the work bench. In place of the synthesizer, a bench signal generator will supply the local oscillator frequency during testing. A 2 meter HT will serve as the new IF for both up and down conversion. Power connections and control of the receiver now only need to be reverse engineered. While the receiver is in a mock test jig, all sorts of modifications as needed can be attached or removed from the original circuitry to bring the receiver back to life.

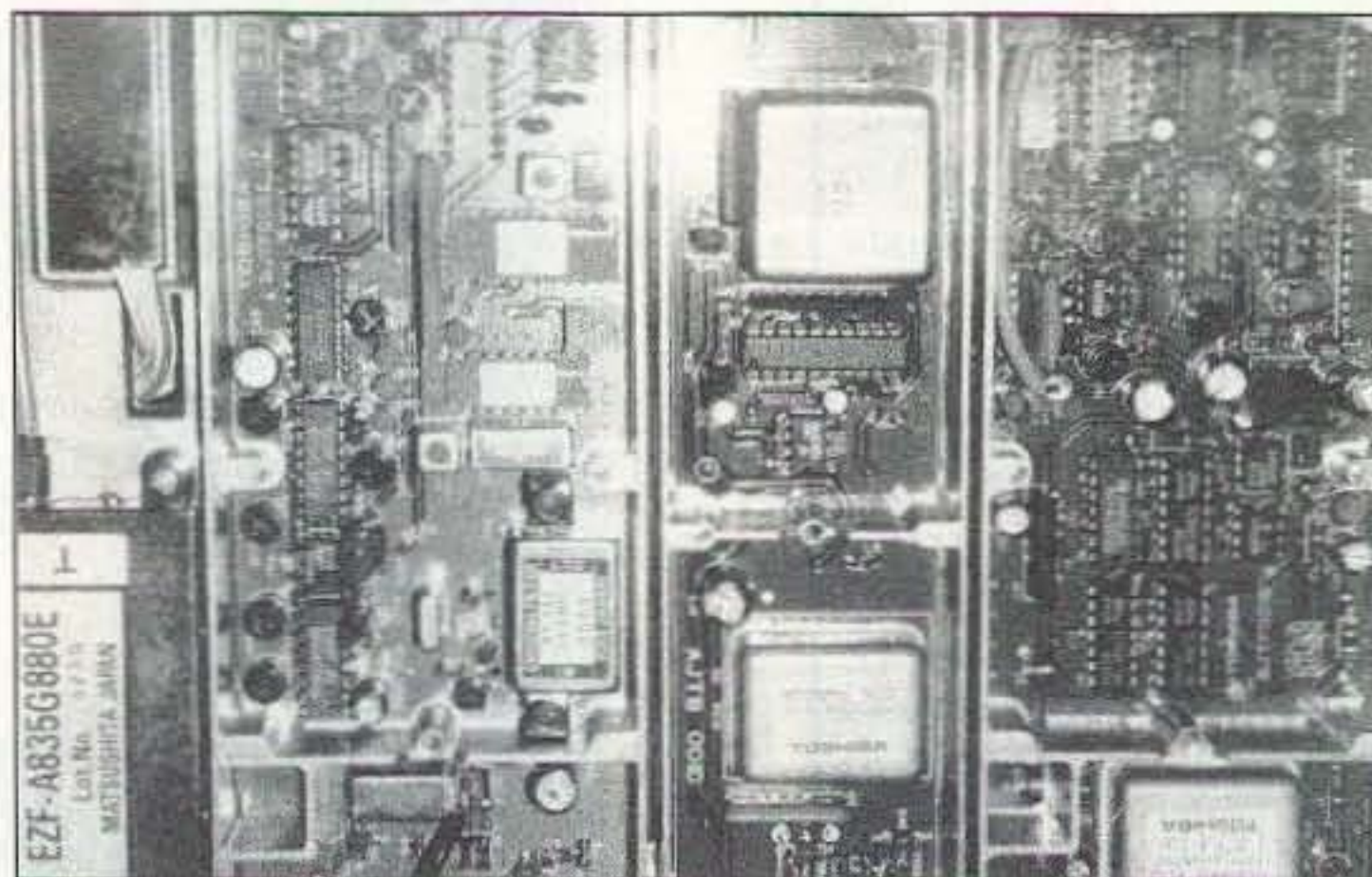

Photo A. Large-scale circuitry (relatively speaking) invites consideration for salvage.

Inasmuch as we are starting this project on a radio that has no accompanying information or schematics, this conversion will have to be an individualized task. It's not a difficult one, but rather fun-filled at reusing the quality circuitry for another amateur band, especially as these units can be obtained for little or nothing. That is what makes the appeal universal. Diligent calling around in your own part of the country will obtain you some of these larger junk cell phones. Even if you have to pay for the unit, it can't be very much. As I stated before, these larger units are a drug on the market and are not wanted.

Check out your local cellular telephone companies and retail suppliers of cell phones. Talk to the technical people, if possible. An especially important note: Make sure the cellular people know that you do not intend to use the equipment for commercial purposes, that it will not be "resurrected" on the cell network. This remark is usually enough to divert some material from the scrap heap into your modification workbench. In this light, be prepared to pick up a partially wrecked phone or one that has been disabled. Even the transmitter circuit of these phones includes a module that is capable of output powers of from 1-3 watts. This varies from model to model, but it still is a source of good components.

I studied the unit that I picked up for quite some time and determined that the units for my conversion will be the synthesizer and the receiver front end. I plan to save the other components for a later project or stocking the junk box. Don't be hasty in disposing of the remaining dregs from the cell phone; they could be put to use in other projects.

The synthesizer circuitry appears to be quite straightforward in design. My unit used a 900-MHz voltage controlled oscillator under the control of an MC-145146 synthesizer chip. Also on this same subchassis was a temperature-compensated crystal oscillator (TCXO) at 12.45 MHz. I have yet to test this module fully but, looking at the synthesizer chip, I can see that its programming lines are coupled off the board for control to the processor side of the original cell phone. My hope is that the synthesizer chip can be controlled by a dip-switch type of programming on the input synthesizer control lines. If this proves to be true after the power lines are determined for this board, it will be up and running on clip leads on the bench.

Well, I don't mean to say that clip leads will be used for everything. A point to remember when making a mock-up connection on the test bench is that lead length

can be a factor in the test configuration. For DC power connections, clip leads can most certainly be used and work well. Where long leads or connections must be dressed properly or kept to a minimum is in the RF output (coaxial), and in the programming lines. If the oscillator and the RF divide by circuitry prior to coupling to the lower frequency synthesizer chip, these leads must be very short and properly dressed to maintain circuit operation.

Any attempt to use clip leads on the prescaler leads to the divide would result in a nonfunctioning circuit. What can you do? Take a look at how the circuit was originally tied together and try and maintain similar connections between the portions of the circuitry; learn by making it just like the original circuit. Anything resembling the original circuit should function reasonably well in a mock-up test configuration.

I designed a similar synthesizer many years ago, using components from a CATV control box. I used the Plessey divide-by-256 and a voltage-controlled oscillator that was regulated by a Motorola MC-145106 synthesizer chip. I intended to have a dip switch control the pull up leads on the synthesizer chip and put forth a schematic on that. The same circuit was used with the CATV tuner just a few months ago.

Back to the synthesizer chip in the cell phone: Mine was a Motorola MC-145146 (I looked up the device) and is processor controlled. That eliminates any concept of adapting a dip switch to lock the device to a usable LO frequency. I am looking at the possibility of pulling the original chip and replacing it dead-bug-style with the experimenter's special, the old MC-145106, a manual dip switch programmable synthesizer. What makes this chip suitable is the pin dip switch programming capabilities, and that I have a small quantity of them on hand.

The receiver front end I removed looked quite easy to convert to a simple down converter for 10.7 MHz, the IF frequency. The rest of the circuitry should just be removed, unless you want to trace it out for the possibility of reusing more of the circuitry. I took the easy way out by coupling the existing 10.7-MHz IF chain to an external circuit. You can put the remainder of the circuitry in the parts bin. Hey, when you pick up an old cell phone for less than a couple of bucks, there will be lots of extra parts for the junk box. In any case, there are still quite a few high-speed CMOS chips that can be smoked off with a heat gun. Hope you have fun ripping and tearing apart circuitry from your cell phone, your new source of parts for the 900-MHz band via surplus.

Mail Box

Pierre Binggeli HB9IAM of Geneva, Switzerland, is quite interested in the 1-watt power amplifier that is converted from 14 GHz to our 10-GHz band. He plans to use it for ATV at 10400 MHz. Pierre requests information on the conversion and modification details on retuning to 10 GHz. He is also looking for information on Frequency West or similar MS-740V microwave sources with modulation input.

Well, Pierre, I am sending you the conversion information and schematic details on the 1-watt poser amp. Also, I will include some schematic info on Frequency West "brick"-type frequency sources that I happen to have. I plan to cover the conversion of the 1-watt amplifier and other component parts (especially the synthesizer) in another column. There has been quite a lot of input since the last presentation, so the new information should receive the widest dissemination.

John Zima WA2OSA writes, "I have read your column in *73 Amateur Radio Today* magazine and am quite impressed with the way you make the 'art' of UHF and microwave simple to the layman. I have attempted some of your conversions with some actual success. The one I liked best was the

conversion of a TVRO LNA feedhorn into a wideband amplifier. That was a painless conversion. Do you have any plans to convert a similar unit to a GOES weather converter?"

Well, John, I haven't had a plan to include such a unit, but I do see the need and will try to convert a similar TVRO LNA, or more properly a LNB/LNC, to a 1691 converter. The LNA was just a preamp while the LNB is a complete preamp mixer oscillator and IF amplifier. I will try to work out some of the details for this column next month on this conversion. I have a few ideas that look like a natural. Be on the lookout for suitable LNB TVRO converters to adapt to this mode of operation. The innards of the LNB should provide all the circuitry necessary for the 1691 converter, except for the local oscillator. More next month. Other projects include developing a very miniature 10-GHz transceiver converted from some of the newest microwave surplus just becoming available. Still working out the details and conversion information and will fill you in when it becomes complete.

As always I will be glad to answer questions on this and other similar amateur-related topics. Please send a SASE for prompt reply. 73 Chuck WB6IGP. 73

AMATEUR TELEVISION

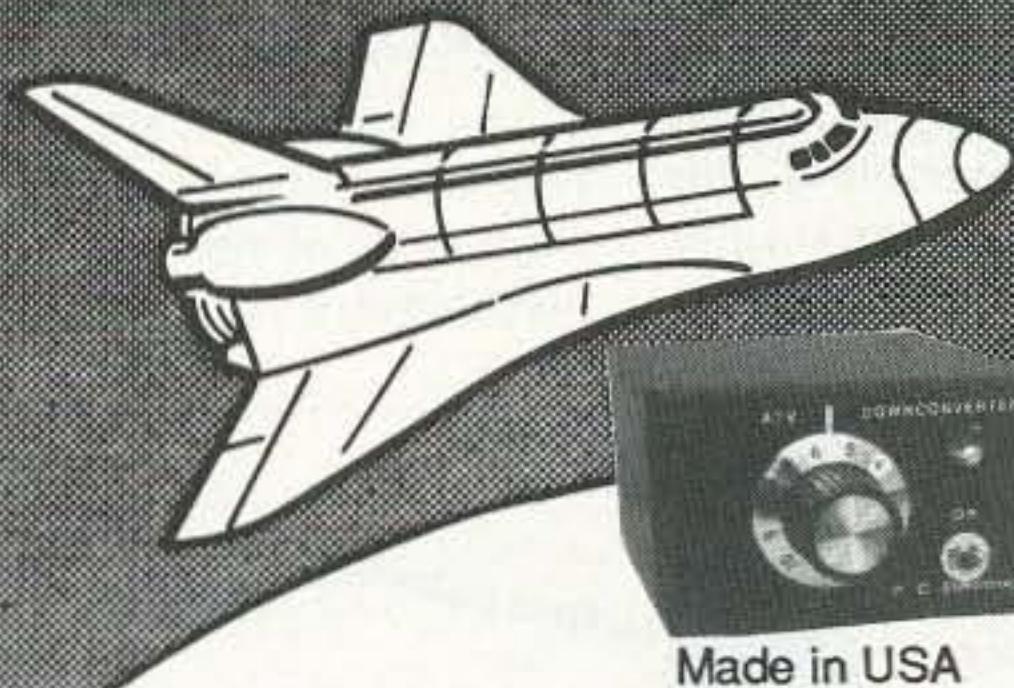

Made in USA

**TVC-4G
only \$89**

SEE THE SPACE SHUTTLE VIDEO

Many ATV repeaters and individuals are retransmitting Space Shuttle Video & Audio from their TVRO's tuned to Spacenet 2 transponder 9 or weather radar during significant storms, as well as home camcorder video. If it's being done in your area on 420 - check page 538 in the 95-96 ARRL Repeater Directory or call us, ATV repeaters are springing up all over - all you need is one of the TVC-4G ATV 420-450 MHz downconverters, add any TV set to ch 2, 3 or 4 and a 70 CM antenna (you can use your 435 Oscar antenna). We also have ATV downconverters, antennas, transmitters and amplifiers for the 400, 900 and 1200 MHz bands. In fact we are your one stop for all your ATV needs and info. We ship most items within 24 hours after you call. **Hams, call for our complete 10 page ATV catalogue.**

(818) 447-4565 M-Th 8am-5:30pm
P.C. ELECTRONICS
2522 Paxson Ln, Arcadia CA 91007

Visa, MC, UPS COD
Tom (W6ORG)
Maryann (WB6YSS)

Amateur Radio Via Satellites

Andy MacAllister WA5ZIB
14714 Knights Way Drive
Houston, TX 77083

Field Day Via Satellite

It was great. Activity was up on all the satellites this year. During June's Field Day weekend, the transponders were packed on the analog hamsats and the queues were full on the digital birds. The American Radio Relay League (ARRL) rules were the same as always, but modifications to the Radio Amateur Satellite Corporation (AMSAT) rules provided the impetus for many to pay attention to anything in the sky that might provide a few more points.

The ARRL rules are simple with regard to satellite activity and have not changed for many years. One satellite contact is worth 100 bonus points. Satellite contacts are viewed as a "band" like 80 or 40 meters for normal scoring. If a station worked K7TR using CW on AMSAT-OSCAR-13 Mode "S" (70 cm up and 13 cm down), a subsequent CW contact via RS-12 (15 meters up and 10 meters down) would be a "dupe." However, the rules do not reflect the reality of today's hamsats. Unlike the 80 meter band, the satellite world is constantly changing with new orbiting systems using HF frequencies up through the microwaves.

The AMSAT rules are quite different. Each satellite is considered a "band." During this year's Field Day, seven satellites were available for analog modes, and several more for digital communications. Special rules for the digital pacsats provided extra points for uploaded and downloaded Field Day greeting messages. Due to the nature of the broadcast-style packet protocol of the digital pacsats, it was possible to score points just by monitoring the downlink

and collecting messages requested by other users without ever transmitting.

No limit was placed on the number of stations in use at any one Field Day location. Some groups like K7TR set up three satellite positions. One was specifically for RS-12 work while

"The ARRL rules are simple with regard to satellite activity and have not changed for many years."

the other two covered the digital satellites and the high, elliptical-orbit hamsats like AMSAT-OSCAR-10 and A-O-13. For participants it provided an opportunity to focus on specific satellites. For observers it provided examples of different satellite-station configurations for unique modes. A station for mode K usually consists of dipoles for antennas and HF rigs. A mode S installation may use a parabolic dish to receive, a helix for transmitting, and a mix of converters in conjunction with VHF and UHF radios.

The N5EM Experiment

The Houston AMSAT group has made satellite activity the primary focus of their Field Day operation every year. If the HF posi-

tion interferes with hamsat chasing, the HF is either shut down or moved to another band. This year was no exception, but Ed N5EM offered a new twist. He suggested doing a QRP Field Day, satellite rigs included.

The original plan was to build a large array of satellite antennas. This would give back some of the gain lost by the move from 100-watt amplifiers to attenuated, 5-watt transmitters. The antenna project wasn't ready in time for Field Day, but a pair of the large

KLM antennas was made available at the last minute. Some participants felt that the task of running QRP with a normal antenna system was impossible during Field Day. Some amplifiers were brought along as back up.

Setup started late due to delays of the ferry boat from Galveston, Texas, across to Bolivar peninsula and Fort Travis Seashore Park. N5EM finally made it on the air 45 minutes after the start of the event. A-O-10 provided some difficult contacts, but the 5-watt signal was being heard.

It was soon discovered that stations that sounded too loud on the satellites were probably not hearing very well. Portable operation with noisy generators and

many nearby transmitters make weak-signal satellite work difficult. Weaker stations away from the center of the transponders were better candidates for possible contacts.

Operation through A-O-13 turned out to be the best. The satellite was visible to most U.S. hams in the early hours of Sunday. Signals were good and stations were plentiful. Mode S was lightly populated, but three stations successfully copied the low-power signals from N5EM uplinked on 436 MHz and downlinked on 2400 MHz. A small Bob Myers Communications dish fit nicely in the KLM array, and worked quite well in conjunction with a German downconverter from TGN Nachrichtentechnik GmbH.

For the 9600-baud digital satellites, the low-power operation became a problem. During normal daily activity it is often difficult to get in the queue for file downloading. The 5 watts on the 2 meter uplinks for UoSAT-OSCAR-22, KitsatOSCAR-23 and -25, rarely got through during the crowded event. Many Field Day files were still downloaded with only a few successful requests for new file starts and hole fills. Uploading a complete greeting message was worse. Only one greeting file was sent and logged into the directory of a digital satellite. Yet at five points each the pursuit of downloaded and uploaded Field Day files was still worth the effort under the AMSAT rules.

The Dark Side

While many have argued for a change to the ARRL Field Day rules to acknowledge the changes in the satellite world, there is still a problem. Increased activity on the birds can be damaging to the satellites. The heavy load of continuous use can put a strain on the batteries, and as the available transponder output power is shared among the users, individual signals get weak. Some users then increase uplink power levels to get better returns, thus knocking out the QRP stations and making the transponder load-

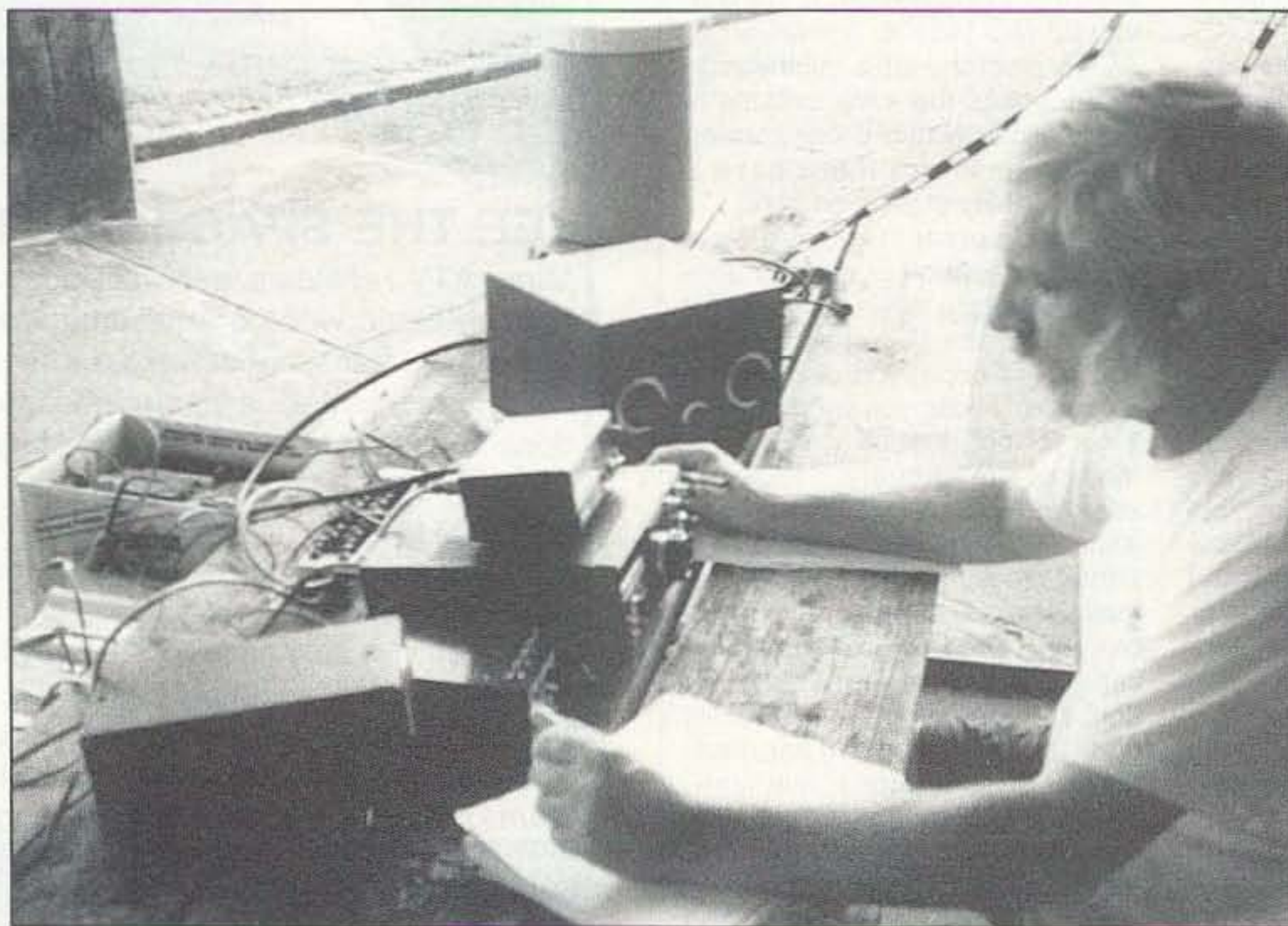

Photo A. Ed N5EM working the low-power HF Field Day station.

5 BOOKS FOR ONLY \$4.95

WHEN YOU JOIN THE **Electronics Book Club®**

VALUES TO \$126.75

The leading source of information for electronics hobbyists for over 30 years!



070824X \$24.95



0339635 \$24.95 Hardcover

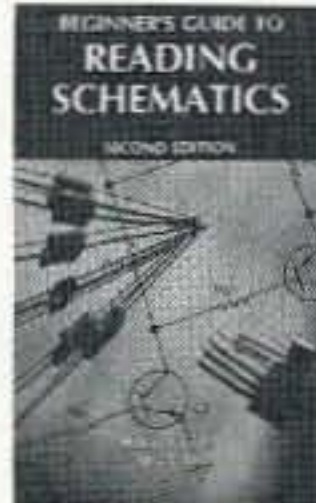

3632P \$10.95

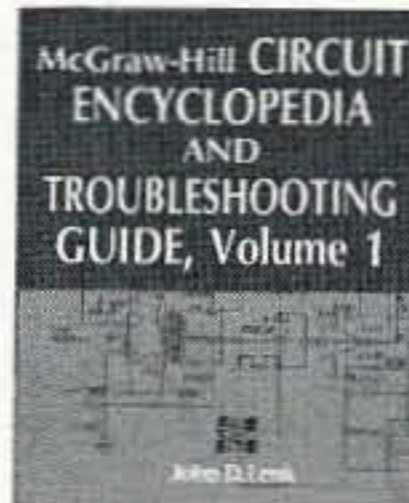

0376034-XX \$59.50 Counts as 2/Hardcover



3362P \$14.95

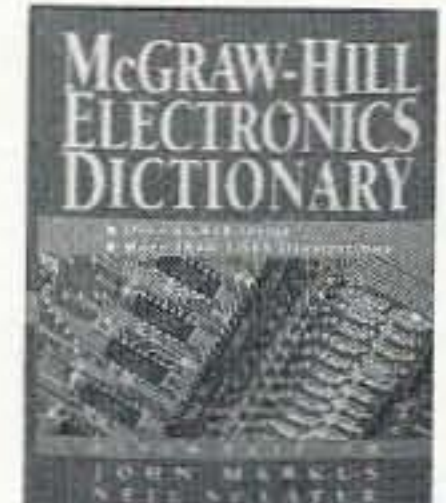

0404348-XX \$49.50 Counts as 2/Hardcover

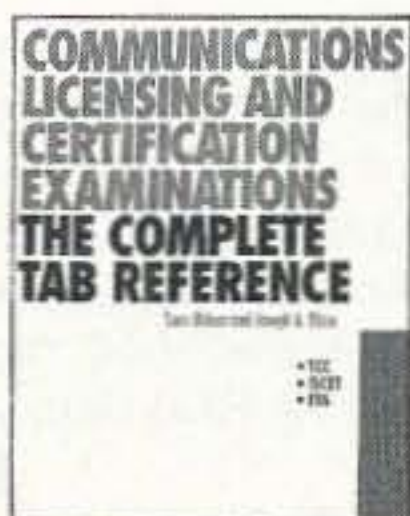

0708223-XX \$44.95 Counts as 2/Hardcover

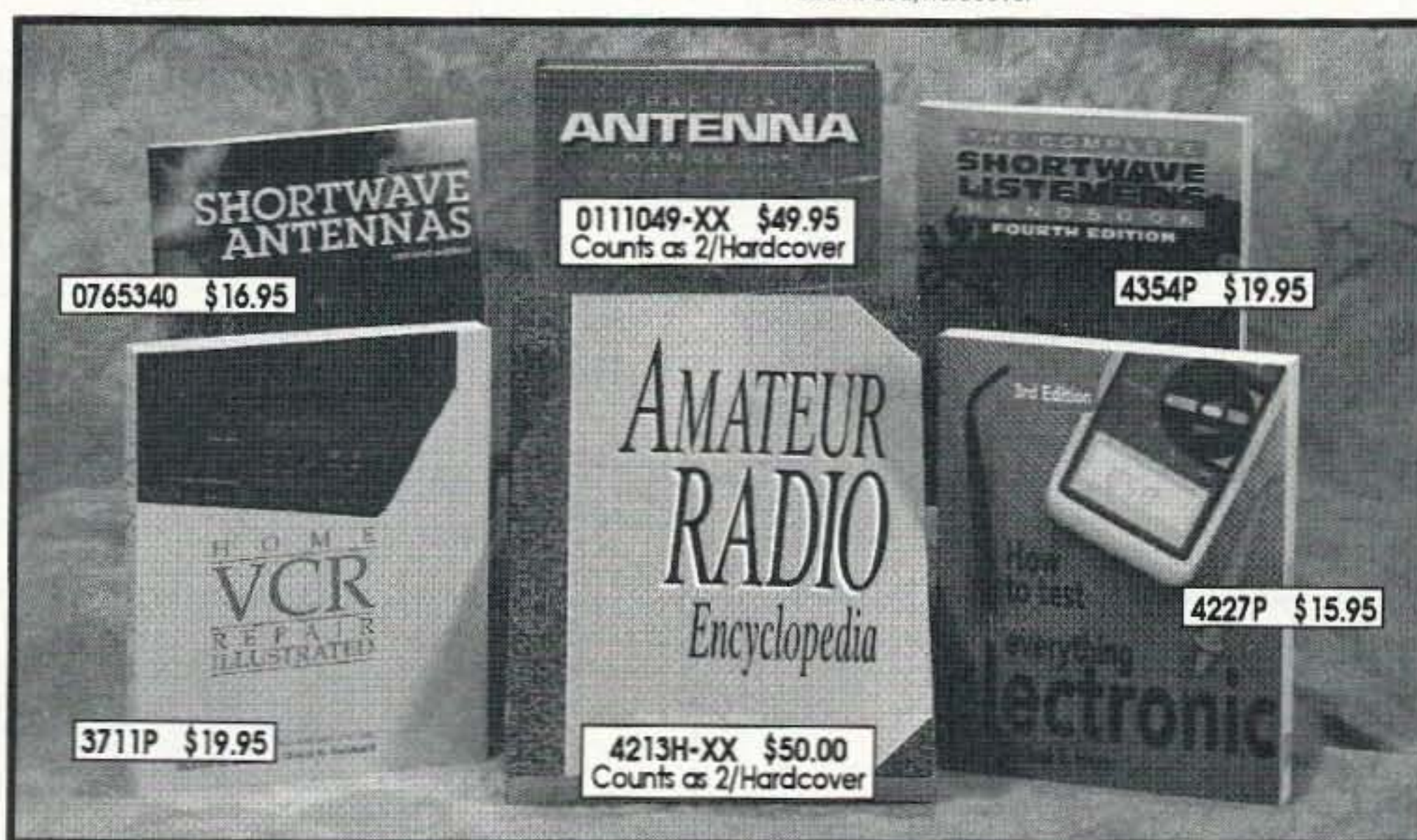

0765340 \$16.95

0111049-XX \$49.95 Counts as 2/Hardcover

4354P \$19.95

4227P \$15.95

3711P \$19.95

4213H-XX \$50.00 Counts as 2/Hardcover



0380899-XX \$60.00 Counts as 2/Hardcover

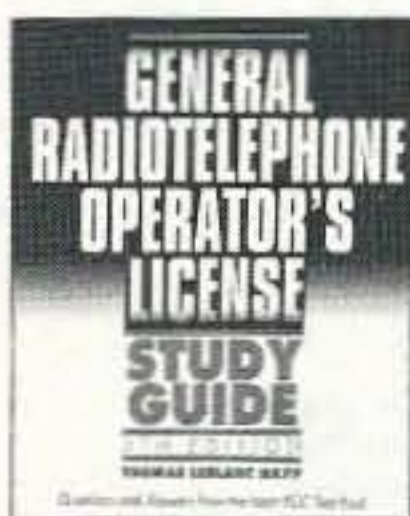

0369364 \$29.95 Hardcover

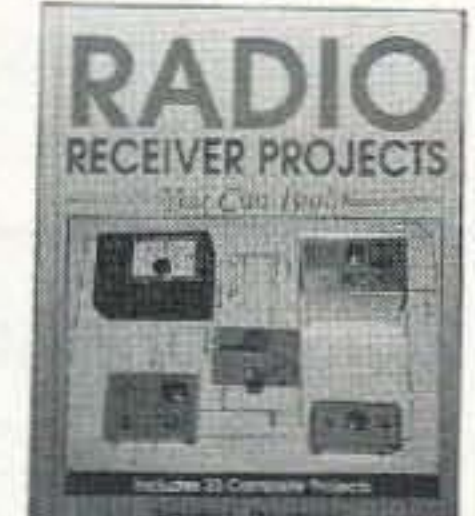

4256P \$18.95



4231H \$19.95 Hardcover

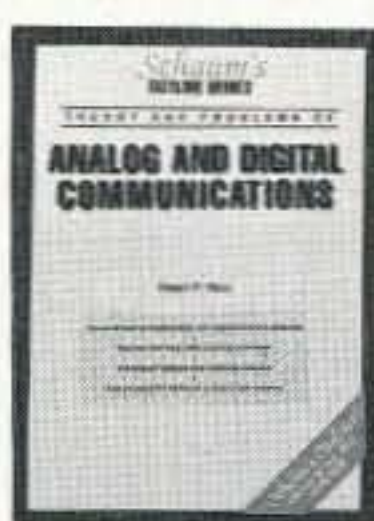

0306362 \$13.95



4359P \$21.95



3258P \$19.95



0487375 \$24.95



032381X-XXX \$119.50 Counts as 3/Hardcover

As a member of the ELECTRONICS BOOK CLUB...

you'll enjoy receiving Club bulletins every 3-4 weeks containing exciting offers on the latest books in the field at savings of up to 50% off the regular publishers' prices. If you want the Main Selection, do nothing and it will be shipped automatically. If you want another book, or no book at all, simply return the reply form to us by the date specified. You'll have at least 10 days to decide. If you ever receive a book you don't want due to late delivery of the bulletin, you can return it at our expense. Your only obligation is to purchase 3 more books during the next 12 months, after which you may cancel your membership at any time. And you'll be eligible for FREE BOOKS through our Bonus Book Program.

PHONE: 1-614-759-3666
(8:30 a.m. to 5:00 p.m. EST Monday-Friday)

FAX: 1-614-759-3749
(24 hours a day, 7 days a week)

Electronics Book Club®

A Division of McGraw-Hill, Inc., P.O. Box 549, Blacklick, OH 43004-9918

YES! Please send me the books listed below, billing me just \$4.95 plus shipping/handling & tax. Enroll me as a member of the **Electronics Book Club** according to the terms outlined in this ad. If not satisfied, I may return the books within 10 days without obligation and have my membership cancelled.

--	--	--	--

If you select a book that counts as 2 choices, write the book number in one box and XX in the next.
If you select a book that counts as 3, write the book number in one box and XXX in the next two boxes.

Name _____

Address/Apt. # _____

City/State _____

Zip _____ Phone _____

Valid for new members only, subject to acceptance by EBC. Canada must remit in U.S. funds drawn on U.S. banks. Applicants outside the U.S. and Canada will receive special ordering instructions. Publishers' prices shown. A shipping/handling charge & sales tax will be added to all orders. STAR995

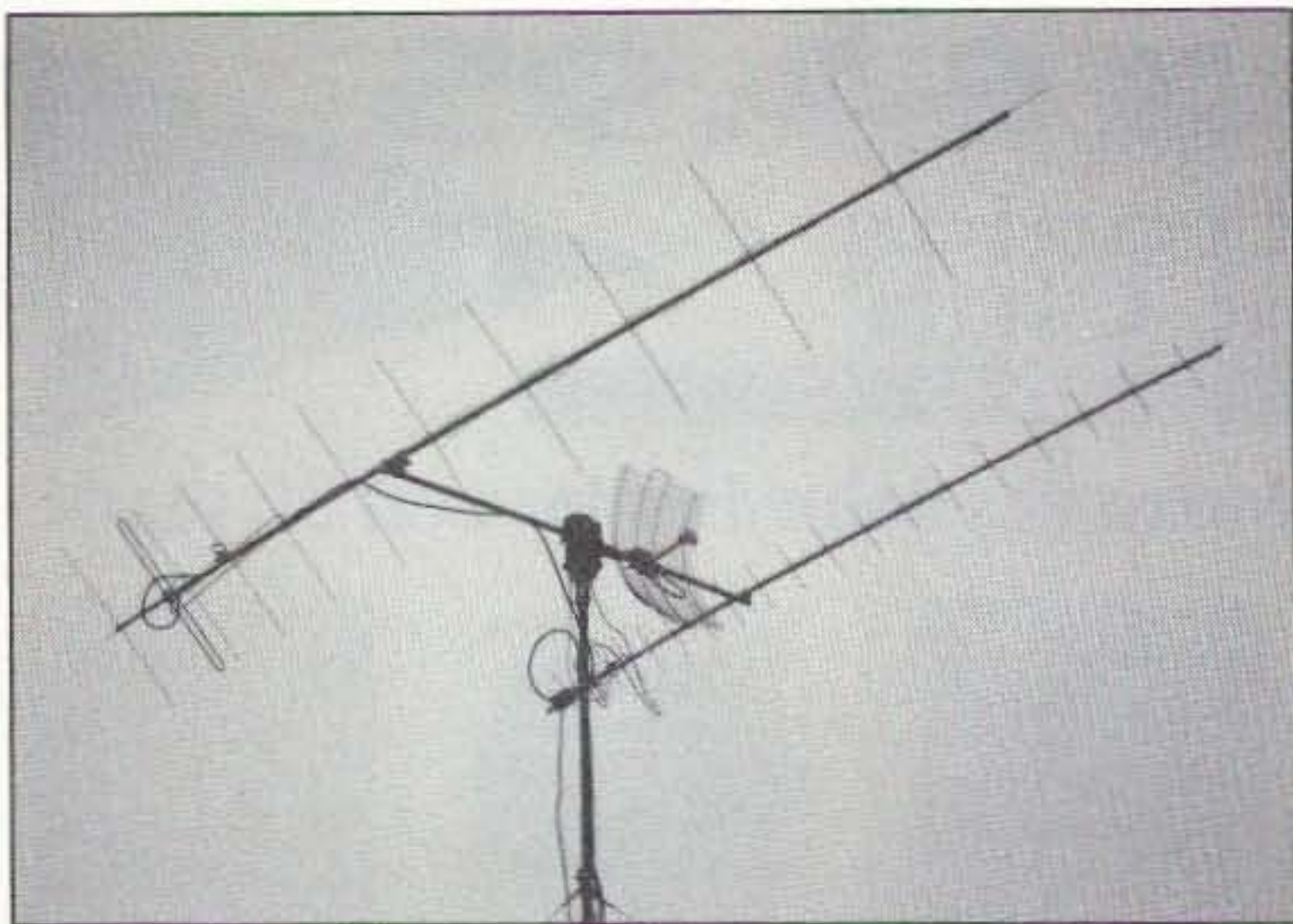

Photo B. Two large KLM crossed Yagis and a Bob Myers Mode "S" dish for Field Day satellite work.



Photo C. The hamsat station at N5EM was ready for everything from Mode "K" through Mode "S," including 9600-baud digital activity.

ing even heavier. On the low-orbit RS satellites, crowding became so fierce this year that contacts were impossible for some. AM-SAT rule changes next year are likely to promote QRP, but a wait-and-see attitude might be best for any ARRL modifications.

Future Field Days

Even if the high-orbit Phase 3-D satellite is launched prior to Field Day next year, it will probably not be available for contest activity. A long check-out period will be necessary, and the changes to get to the final orbit may take as

long as a year after initial orbital insertion. But when the new satellite is usable for contest events, it will be fantastic. The N5EM QRP station of 1995 will be more than enough to keep up with the rest of the field. Signal levels will be at least 10 dB better on all bands.

Mode S will be a common mode rather than the exotic experiment it is today, and the experimenters will be checking out their 10- and 24-GHz systems. Camera tripods with little dishes and short Yagis may be the rule for Field Days yet to come. 77

Don't miss all the fun! Subscribe to *Radio Fun* today by calling (800) 274-7373.

ID-8 Automatic Morse Station Identifier

Compatible with Commercial, Public Safety, and Amateur Radio applications. Uses include Repeater Identifiers, Base Station Identifiers, Beacons, CW Memory Keyers, etc. Great for F.C.C. ID Compliance.

- Miniature in size, 1.85"x 1.12"x 0.35".
- Totally RF immune.
- All connections made with microminiature plug and socket with color coded wires attached.
- CMOS microprocessor for low voltage, low current operation: 6 to 20 VDC unregulated at 6ma.
- Low distortion, low impedance, adjustable sinewave output: 0 to 4 volts peak to peak.
- Crystal controlled for high accuracy.
- Transmitter PTT output (to key transmitter while ID is being sent), is an open collector transistor that will handle 80 VDC at 300ma.
- Field programmable with SUPPLIED keyboard.
- Confirmation tone to indicate accepted parameter, plus tones to indicate programming error.
- All programming is stored in a non-volatile EEPROM which may be altered at any time.
- Message length over 200 characters long.
- Trigger ID with active high or low.
- Inhibit ID with active high or low. Will hold off ID until channel is clear of traffic.
- Generates repeater courtesy tone at end of user transmission if enabled.
- Double sided tape and mounting hardware supplied for quick mounting.
- Operating temperature range, -30 degrees C to +65 degrees C.
- Full one year warranty when returned to the factory for repair.
- Immediate one day delivery.

Programmable Features

- Eight programmable, selectable, messages.
- CW speed from 1 to 99 WPM.
- ID interval timer from 1-99 minutes.
- ID hold off timer from 0-99 seconds.
- CW tone frequency from 100 hz to 3000 hz.
- Front porch delay interval from 0 to 9.9 seconds.
- CW or MCW operation.

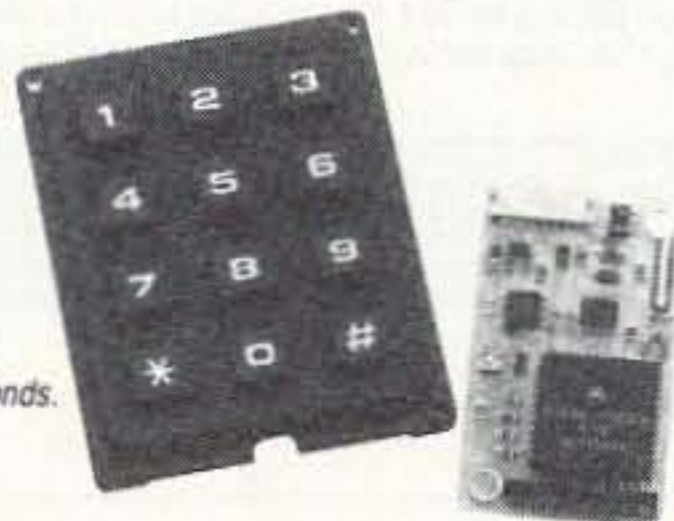

\$89.95 each
programming keyboard included

COMMUNICATIONS SPECIALISTS, INC.
426 WEST TAFT AVENUE • ORANGE, CA 92665-4296
(714) 998-3021 • FAX (714) 974-3420
Entire U.S.A. (800) 854-0547 • FAX (800) 850-0547

CIRCLE 10 ON READER SERVICE CARD

Join the **FUN** on the
SATELLITES
YES! Anyone with a Technician Class
license or higher can work
the

Coming SOON
Phase 3D

More Modes
More Bands
Even MORE FUN



via the
OSCARs

Learn how: Join AMSAT today!
Until September 30: New members & renewals receive, FREE:

- ORBITs - Satellite tracking software by W0SL
- OR
- Up/Down - Software listing all the amateur satellites with their modes and frequencies by KF0JT

Dues: \$30 U.S. \$36 Canada/Mexico, \$45 elsewhere VISA/MC accepted

Write or call: [®]



AMSAT

PO Box 27 Washington, DC 20044
Phone: 301-589-6062

CIRCLE 110 ON READER SERVICE CARD

ORDER NOW 1-800 4 HOBBY KITS

- 2 Meters
- 223 MHz
- 440 MHz
- 6 Meters

FANTASTIC FM TRANSCEIVERS

Ramsey breaks the price barrier on FM rigs! The FX is ideal for shack, portable or mobile. The wide frequency coverage and programmable repeater splits makes the FX the perfect rig for Amateur, CAP or MARS applications. Packeteers really appreciate the dedicated packet port, "TRUE-FM" signal and almost instant T/R switching. High speed packet? ...No problem. Twelve diode programmed channels, 5W RF output, sensitive dual conversion receiver and proven EASY assembly. Why pay more for a used foreign rig when you can have one AMERICAN MADE (by you) for less. Comes complete less case and speaker mike. Order our matching case and knob set for that pro look.

FX-50 kit (6 Meters).....	\$149.95	FX-146 kit (2 Meters).....	\$149.95
FX-223 kit (1 1/4 Meters).....	\$149.95	FX-440 kit (3/4 Meters).....	\$169.95
CFX matching case set.....	\$29.95	FXM-1, ICOM/Yaesu style speaker mike	\$29.95

2 MTR & 220 BOOSTER AMPS

Here's a great booster for any 2 meter or 220 MHz hand-held unit. These power boosters deliver over 30 watts of output, allowing you to hit the repeater's full quieting while the low noise preamp remarkably improves reception. Ramsey Electronics has sold thousands of 2 meter amp kits, but now we offer completely wired and tested 2 meter, as well as 220 MHz units. Both have all the features of the high-priced boosters at a fraction of the cost.

PA-10 2 MTR POWER BOOSTER (10 X power gain) Fully wired & tested	\$99.95
PA-20 220 MHz POWER BOOSTER (8 X power gain) Fully wired & tested.....	\$99.95

SX-20 20 METER SSB/CW TRANSCEIVER

Finally, a handy go anywhere rig that puts the fun back into ham radio. How about the DDS synthesizer that tunes in 10 Hz steps with exceptionally low noise for weak signal reception. Or, how about the built-in lambic CW keyer that has a digital readout of your CW speed. Perky 10 watt RF output (that's only 11/2S units below a 100 watt rig!) can be tuned down for true QRP operation. Included with the SX-20 is the hand mike with handy UP/DOWN buttons for remote tuning of the rig while driving — or biking — or boating. Available in both fully assembled and fun to build kit form, you'll find that the SX-20 will become your favorite rig.



SX-20 20 meter SSB/CW Transceiver, fully wired, 1 yr. warranty	\$429.95
SX-20 20 meter SSB/CW Transceiver Kit Form.....	\$349.95
Optional CW Audio Filter SXCWN WT.....	\$49.95
Kit	\$39.95

Miniature SPEAKER-MIKE



Fits Icom, Yaesu, Alinco, Ramsey and Radio Shack rigs! Looking for a handy little speaker-mike to compliment your FX transceiver or other ICOM style handie-talkie?

The Ramsey SM-1 speaker-mike is a beauty. It's only 1 1/2" wide by 2 1/2 inches high and has a handy clip on the back so you can easily clip it to your lapel or shirt. Its small internal speaker isn't going to break any eardrums but is very clear and has plenty of pop to be heard when worn. There's even a jack on the mike so when you plug it in, you still have the use of the speaker jack from your radio. Fits all Radio Shack, ICOM, Yaesu, Alinco and Ramsey rigs.

SM-7 Mini-Speaker mike, Fully assembled.....	\$24.95
-------------------------------------------------	---------

SHORTWAVE RECEIVER

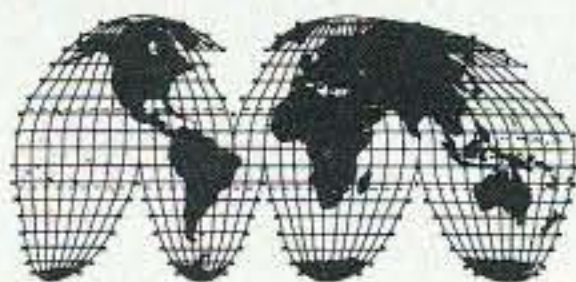

Fantastic receiver that captures the world with just a 12" antenna! Can receive any 2 MHz portion from 4-11 MHz. True superhet, has smooth varactor tuning. AGC, RF gain control, plenty of speaker volume and runs on a 9V battery. Fascinating Scout, school or club project, provides hours of fun for even the most serious DXer. For the car, consider our shortwave converter. Two switchable bands (in 3-22 MHz range), each 1 MHz wide—tunable on your car radio dial. Add some interest to your drive home!

Shortwave receiver kit, SR1.....	\$29.95
Shortwave converter kit, SC1.....	\$27.95
Matching case set for SR1, CSR ..	\$14.95
Matching case set for SCI, CSC ..	\$14.95

CW KEYER

Send perfect CW. Microprocessor keyer features 4 programmable memories of up to 26 words each, lambic keying, dot-dash memory, variable speed from 3-60 WPM, adjustable sidetone, keying to any rig and fully RFI proof. EAROM memory keeps messages up to 100 years - you'll go silent before the key! Includes built-in touch paddles or use your own. Easy assembly and matching case set available for a nice station look.

CW-700 Micro keyer kit.....	\$69.95	MK Matching case set.....	\$14.95
CW-700WT Assembled CW-700and case	\$119.95		

ACTIVE ANTENNA

Cramped for space? Get longwire performance with this desktop antenna. Properly designed unit has dual HF and VHF circuitry and built-in whip antenna, as well as external jack. RF gain control and 9V operation makes unit ideal for SWLs, traveling hams or scanner buffs who need hotter reception. The matching case and knob set gives the unit a hundred dollar look!

AA-7Kit.....	\$28.95	Matching case & knobset, CAA ..	\$14.95
--------------	---------	---------------------------------	---------

AIRCRAFT RECEIVER



Hear exciting aircraft communications—pick up planes up to 100 miles away! Receives 110-136 MHz AM air band, smooth varactor tuning superhet

with AGC, ceramic filter, adjustable squelch, excellent sensitivity and lots of speaker volume. Runs on 9V battery. Great for air shows or just hanging around the airport! New 30-page manual details pilot talk, too. Add case set for "pro" look.

AR-1 kit	\$29.95
Matching case set, CAR	\$14.95

2M POWER AMP

Easy to build power amp has 8 times power gain, 1W in, 8W out, 2W in, 16W out, 5W is for 40W out. Same amp as featured in many ham magazine articles. Complete with all parts, less case and T-R relay.

PA-1, 40W pwr amp kit.....	\$34.95
TR-1, RF sensed T-R relay kit.....	\$14.95

MINI KITS

Ramsey carries a complete line of low cost, easy to build, easy to use functional kits that can be used alone or as building blocks in larger more complex designs. Mini-kits include audio amps, tone decoders, VOX switches, timers, audio alarms, noise-makers and even shocking kits! Call for our free catalogue!

QRP AMPLIFIER

For a slick little QRP boost, use one of the 20 Watt amplifiers. Needs only 1/2-2 watts of drive for full output, linear for SSB, AM or CW operation, power MOSFETs for high efficiency and multistage low pass filter for a clean signal. Built-in T/R relay for automatic switching, runs on 12-15 VDC at 2-4 amps. Add our matching case set for a complete station look.

Your choice of bands.....	\$49.95
Specify band: (QAMP-20, 30, 40, 80)	
CQAMP Matching case set.....	\$14.95

2WAY RADIO SERVICE MONITOR



COM-3, the world's most popular low-cost service monitor. For shops big or small, the COM-3 delivers advanced capabilities for a fantastic price—and our

new lease program allows you to own a COM-3 for less than \$3.00 a day. Features • Direct entry keyboard with programmable memory • Audio & transmitter frequency counter • LED bar graph frequency/error deviation display • 0.1-10.000 μ V output levels • High receive sensitivity, less than 5 μ V • 100 kHz to 999.9995 MHz • Continuous frequency coverage • Transmit protection, up to 100 watts • CTS tone encoder • 1 KHz and external modulation. COM-3 2 Way Radio Service Monitor

\$2995.00

FOXHUNT HEADQUARTERS



Locate hidden or unknown transmitters fast. The Foxhound direction finder connects to the antenna and speaker jack on any radio receiver, AM or FM from 1 MHz to 1 GHz. The antenna (a pair of dipole telescopic whips) is rotated until the Null meter shows a minimum. A pair of LEDs indicate to turn Left or Right. The Foxhound is ideal to use with a walkie-talkie, if you wish to transmit, go ahead, a built-in T/R switch senses any transmitted RF and switches itself out of circuit while you talk. It doesn't get any easier than this! We provide all parts except for a few feet of 1/2 inch PVC pipe available at any hardware store for a dollar or two. Add our matching case set for a complete finished unit. Be the one with the answers, win those transmitter hunts and track down those jammers, you'll do it all with your Foxhound.

Add some fun to your club events by having a transmitter hunt! Foxhunting is a craze sweeping the nation, but many clubs are missing out on the action because they lack the expertise or time to develop their own foxhunt transmitter. We set one of our most devious and sneaky engineers to the task of designing an easy to build and use, yet highly capable Foxhound transmitter. A snazzy microprocessor controller has both preset and programmable transmission characteristics allowing you to easily set the difficulty level from "beginner" to "know-it-all"! The SlyFox, FHT-1, is crystal controlled in the 2 meter band (crystal for 146.52 included) with a power output of 5 watts that is adjustable by the controller. The transmitter is programmed to ID in CW or add our voice option if you really want to aggravate the troops - "Ha ha, you can't find me!" Join the fun, get rid of those stuffy old meetings and picnics, have a foxhunt!

DF-1 Foxhound direction finder kit	\$59.95	CDF Matching case set for DF-1	\$14.95
FHT-1 SlyFox Foxhound transmitter kit	\$129.95	FHID-1 Voice ID option	\$29.95
CFHT Heavy duty metal matching case set for FH T-1	\$29.95		

PACKET RADIO

Two new versions are available for the Commodore 64 (P-64A) or the IBM-PC (P-IBM). Easy assembly NO TUNING! Includes FREE disk software, PC Board and Full Documentation. Kit form.

P-64A.....	\$59.95	P-IBM	\$59.95	CASE CPK.....	\$14.95
------------	---------	-------------	---------	---------------	---------

STEREO FM TRANSMITTER

Run your own Stereo FM radio station! Transmits a stable signal in the 88-108 MHz FM broadcast band up to 1 mile. Detailed manual provides helpful info on FCC regs, antenna ideas and range to expect. Latest design features adjustable line level inputs, pre-emphasis and crystal controlled subcarrier. Connects to any CD or tape player, mike mixer or radio. Includes free tuning tool too! For a pro look add our matching case set with on-board whip antenna

FM-10A Stereo transmitter kit ..	\$34.95
CFM Case, whip ant set.....	\$14.95

SPEECH SCRAMBLER

Descramble most scramble systems heard on your scanner radio or set up your own scrambled communication system over the phone or radio. Latest 3rd generation IC is used for fantastic audio quality - equivalent to over 30 op-amps and mixers! Crystal controlled for crystal clear sound with a built-in 2 watt audio amp for direct radio hook-up. For scramble systems, each user has a unit for full duplex operation. Communicate in privacy with the SS-70. Add our case set for a fine professional finish.

SS-70 Scrambler /descramblerkit	\$39.95
CSSD matching case set.....	\$14.95
SS-70WT Assembled	
SS-70 and case set	\$79.95

MICRO-MIKE

World's smallest FM wireless mike. Smaller than a sugar cube - including battery and mike. Two sets of SMT parts supplied in case you are clumsy! Terrific audio pick-up (pin drop at 5 ft) and transmit range of 300 ft. We include the battery (watch style), electret mike and even a tuning tool! Be a James Bond and learn SMT too!

FM-5 Micro mike kit.....	\$19.95
--------------------------	---------

CRYSTAL RADIO

Relive the radio past with a crystal set like your grandfather built. Uses genuine Galena crystal and catwhisker. Several different types of radios are built, including standard AM broadcast, shortwave and even WW II foxhole style. To compare modern semiconductor detectors, we include a diode for comparison. No soldering required and we even give antenna ideas. Radio for free, get it now before Clinton taxes it!

CS-1 Crystal set kit	\$19.95
----------------------------	---------

DR. NI-CAD CONDITIONER/FAST CHARGER

Quit spending big bucks for replacement battery packs, rejuvenate and condition your batteries for peak capacity. Advanced circuitry has optimized discharge before charge to eliminate memory effect and to condition batteries that have been poorly cared for in the past. Quick charge rapidly brings battery to full charge in less than an hour-just 15 minutes for some types! And "top-off" charge mode squeezes every last bit of energy into each cell for the absolute most capacity. Switch-mode regulator controls constant current charge while being monitored by a negative delta-V system that cuts off the fast charge at the exact point of full charge-batteries are charged, not cooked! Charges NiCads or NiMH packs from 2 to 10 cells (easily expanded) and current capacities up to 10 Amp-hours. Runs on 12 to 15 VDC. Quit cooking your batteries, buying new packs, waiting hours for recharge, get a Dr. Ni-Cad today! Available in money saving kit form or wired and tested with case at a special price. Kit builders: add our matching case set for a snazzy finish.

DN-1 Dr. Ni-Cad conditioner/fast charger kit	\$49.95
CDN Matching case set.....	\$14.95
DN-1WT Fully assembled Dr. Ni-Cad with case.....	\$89.95

ORDERS CALL 1-800-4 HOBBY KITS (446-2295) ORDERS ONLY TECH/ORDER/INFO (716)924-4560 FAX (716)924-4555

TERMS: Satisfaction guaranteed. Examine for 10 days. If not pleased return in original form for refund. Add \$4.95 for shipping, handling and insurance. For foreign orders add 20% for surface mail. COD (U.S. only) add \$5.00. Orders under \$20 add \$3.00 NY residents add 7% sales tax. 90-day parts warranty on kit parts. 1-year parts & labor warranty on wired units.



RAMSEY ELECTRONICS, INC 793 CANNING PARKWAY VICTOR NY 14564

CIRCLE 34 ON READER SERVICE CARD

Joseph J. Carr K4IPV
P.O. Box 1099
Falls Church VA 22041

A Kit-Built Low-Frequency (0-2 MHz) Sweep Generator

In a past column we looked at the Boyd Electronics (1998 Southgate Way, Grants Pass, OR 97526; 1-503-476-9583) RSG-30 high-frequency sweep generator. A sweep generator is a signal source that will sweep over a range of frequencies, rather than sit at just one frequency. It is used to test any resonant or passband circuit (indeed, any frequency-selective circuit) by displaying its bandpass characteristics on an oscilloscope.

The Boyd unit previously tested was available in kit form or ready-built, and tuned in the range 2 to 30 MHz. At the time, I wondered why there wasn't a low-frequency model. The reason is that many IF filters and other resonant or bandpass circuits operate in that area. The Boyd Electronics Model RSG-2 answers that need: It tunes from 0 to 2,000 kHz (0-2 MHz).

Boyd supplied me with a copy of their kit-built generator. Although the signal generator is also available ready-built at a somewhat higher price, I make it my policy to do the kit form in order to judge its complexity for readers. The Boyd RSG-2 (and RSG-30) can be easily constructed by anyone with ordinary electronic workbench skills—even be-

ginners, if they follow instructions.

Figure 1 shows the "macro" block diagram for the Boyd RSG-2. It consists of two printed circuit boards. The mixer board contains a double-balanced mixer, a fixed-crystal oscillator, and a voltage-controlled oscillator (which supplies the sweeping action). The sweep board generates a sawtooth waveform and a synchronization pulse to trigger the external oscilloscope.

The sweep board also contains three controls: FREQ, SWEEP, and WIDTH. The FREQ control sets the center frequency of the sweep (or the exact frequency in the CW mode); the SWEEP control is a three-position switch that selects the CW, VIDEO, or SYMMETRICAL output modes (described below).

Figure 2 shows the internal block diagram in somewhat more detailed form. The crystal oscillator/mixer board contains five main elements: voltage-controlled oscillator, crystal oscillator, double balanced transconductance cell mixer, a low-pass filter, and an output buffer amplifier. The voltage-controlled oscillator (VCO) is a transistor variable frequency LC tuned oscillator in which the part of the capacitance that sets the frequency is set by an MV-1662 variable capacitance ("varactor") diode. Changing the voltage applied to the VCO IN point causes the frequency to change. If a sawtooth waveform is applied to VCO IN, then the frequency will sweep from a low frequency linearly up

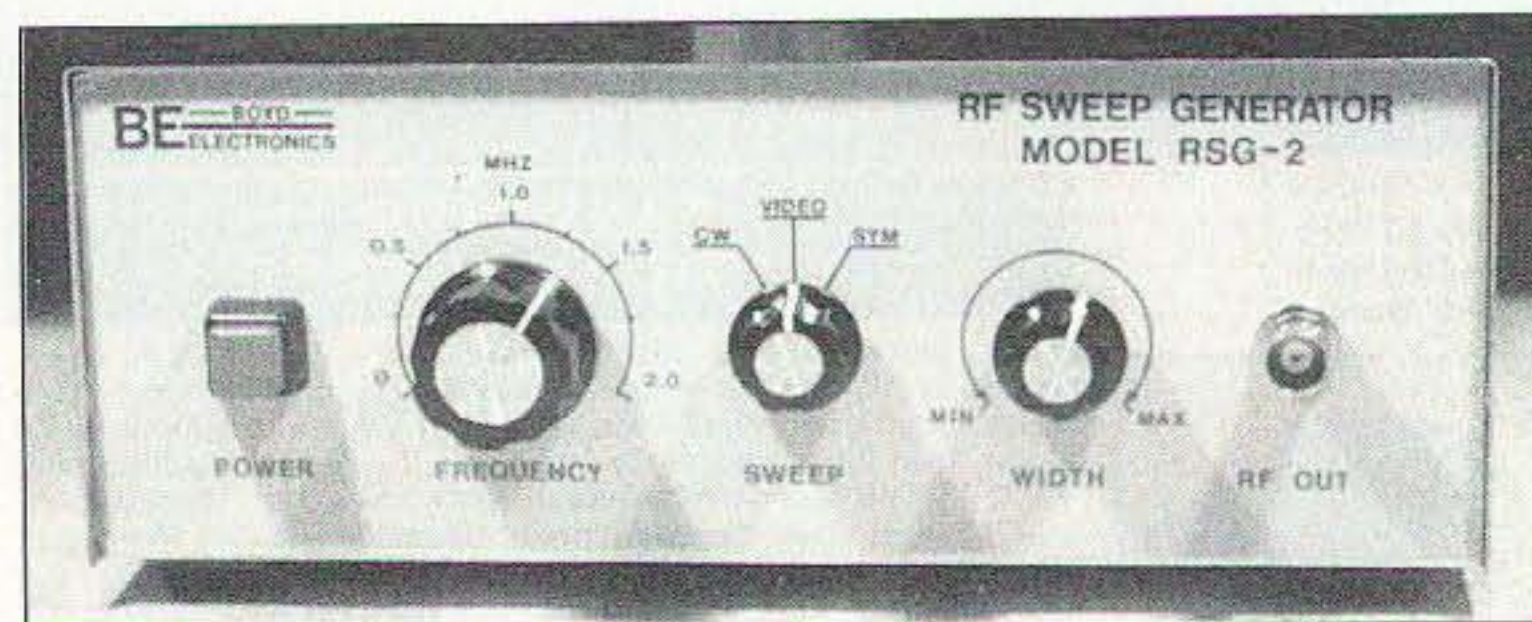

Photo A. RSG-2 as-built.

to a high frequency, and then snap back to the low-frequency end.

The crystal oscillator and mixer are provided from an NE-602 integrated circuit. The crystal oscillator is a 5-MHz oscillator that uses the NE-602 internal oscillator stage. The output of the VCO is applied to the RF input of the NE-602. The output of the NE-602 is passed through a low-pass filter that removes any signal above 2,000 kHz, and then the signal is passed to a buffer amplifier before it goes to the output.

RSG-2 Operating Modes

The RSG-2 sweep generator has three different output modes: Continuous Wave (CW), Video, and SYM (SYM). The continuous wave output is the same as any other RF signal generator. It produces a fixed amplitude RF signal that can be tuned over the range 0-2,000 kHz by turning the FREQUENCY knob.

The VIDEO mode sweeps from the lowest frequency to the highest frequency (0-2,000 kHz). The FREQUENCY control has no effect in this mode, and the WIDTH control only affects the highest frequencies.

The SYM mode allows the sweep to center around the frequency set by the FREQUENCY

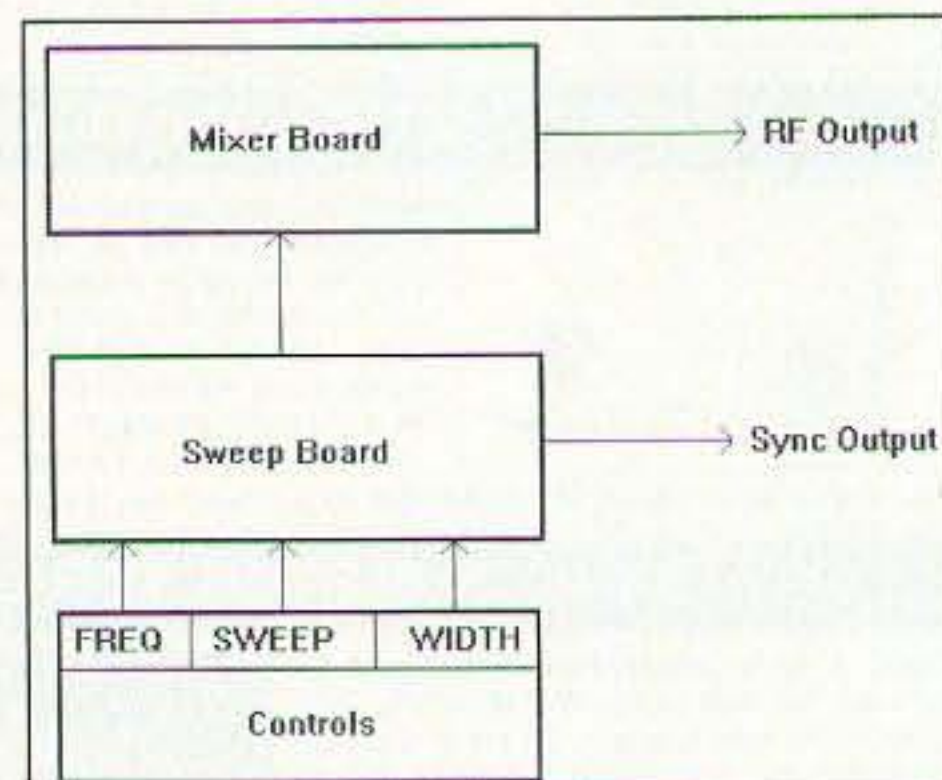

Fig. 1. Internal block diagram of the RSG-2.

control. The WIDTH control varies the sweep magnitude about the frequency set by the FREQUENCY control. The sweep width in this mode can be set from 5 kHz to some higher bandwidth. It is the SYM mode normally used to check filters, IF amplifiers, and the like.

Construction

Like its earlier cousin the Boyd RSG-30, the RSG-2 is built inside of a Radio Shack 270-274 cabinet. Boyd offers versions of the kit with and without the cabinet so that people who want to use their own favorite cabinet are accommodated. Photo A shows the RSG-2 unit that I built, while Photo B illustrates the internal works of the project. Note that the interconnecting wires between the printed circuit boards, and between the boards and the front and rear panel components, are

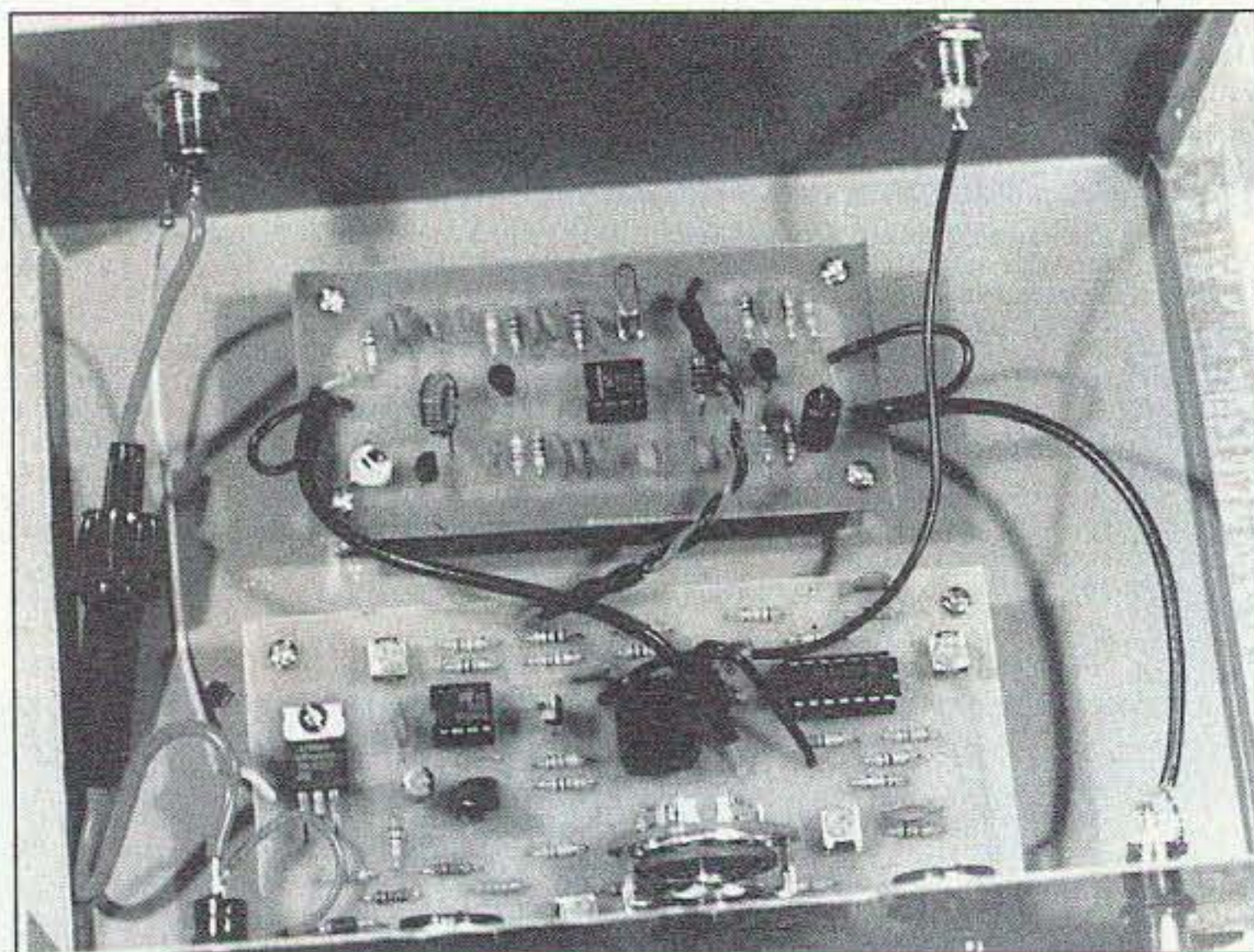

Photo B. Internal view of the RSG-2.

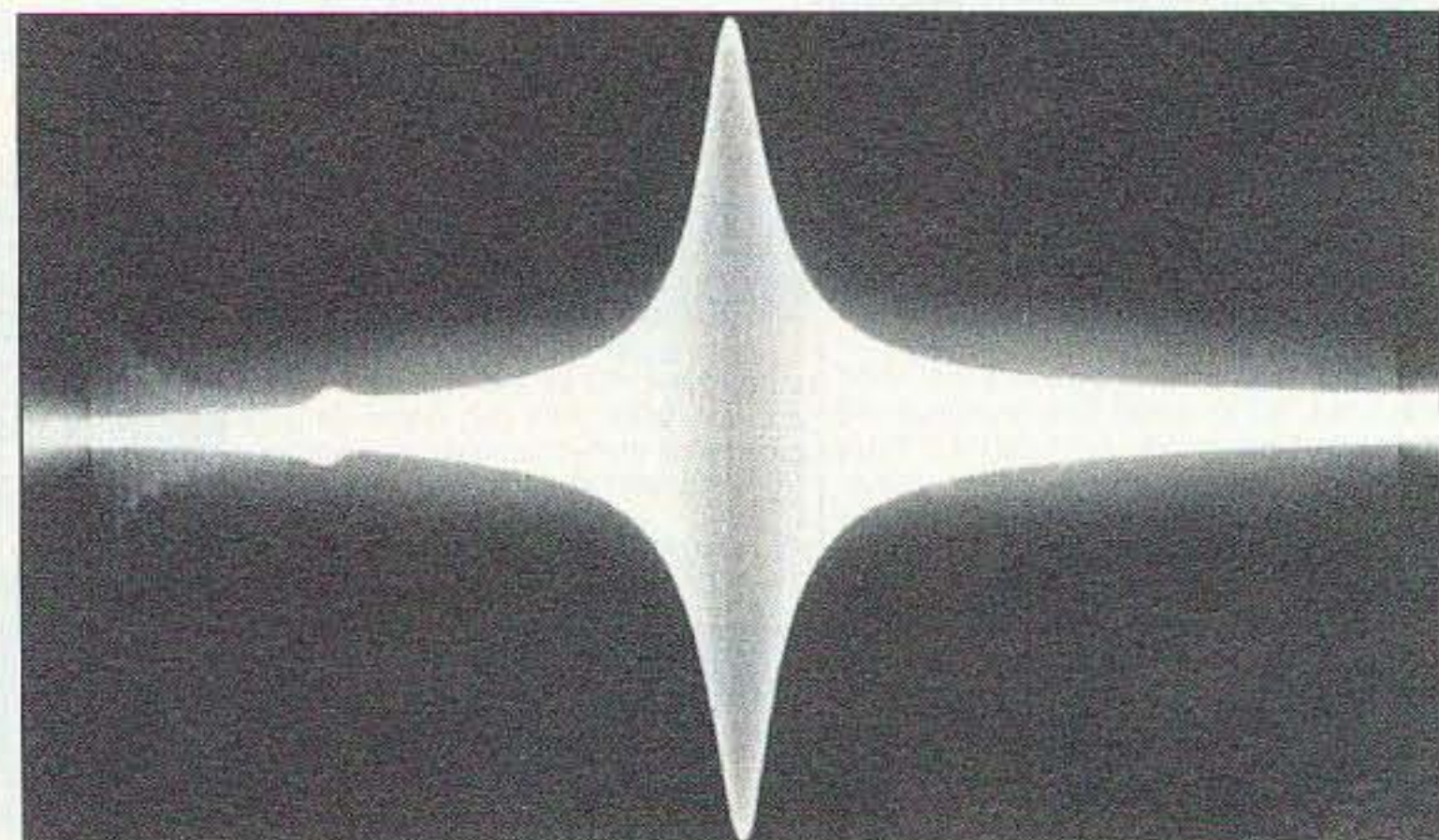

Photo C. Output waveform of the RSG-2 when passed through a 455-kHz IF transformer.

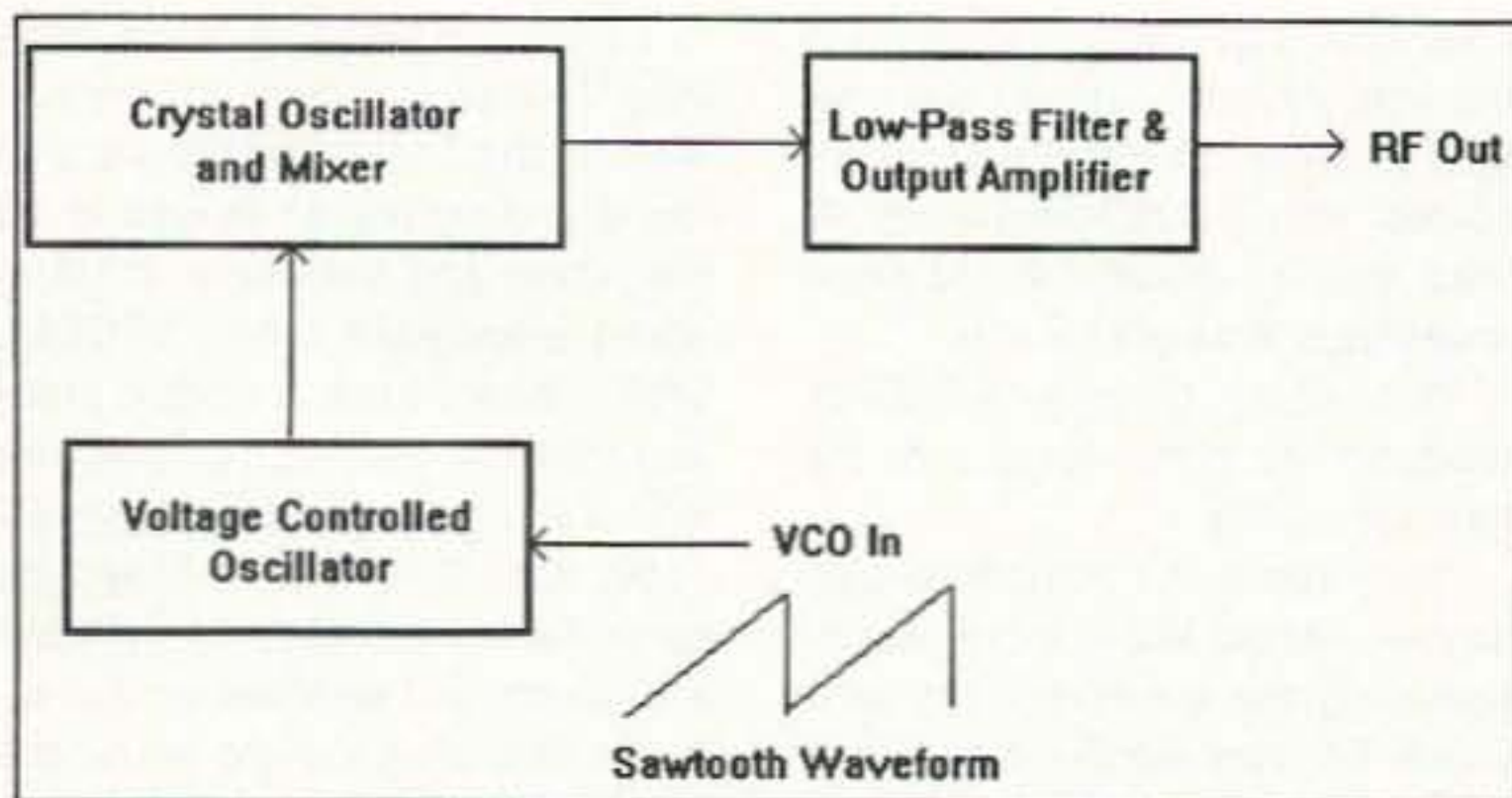

Fig. 2. A more detailed block diagram.

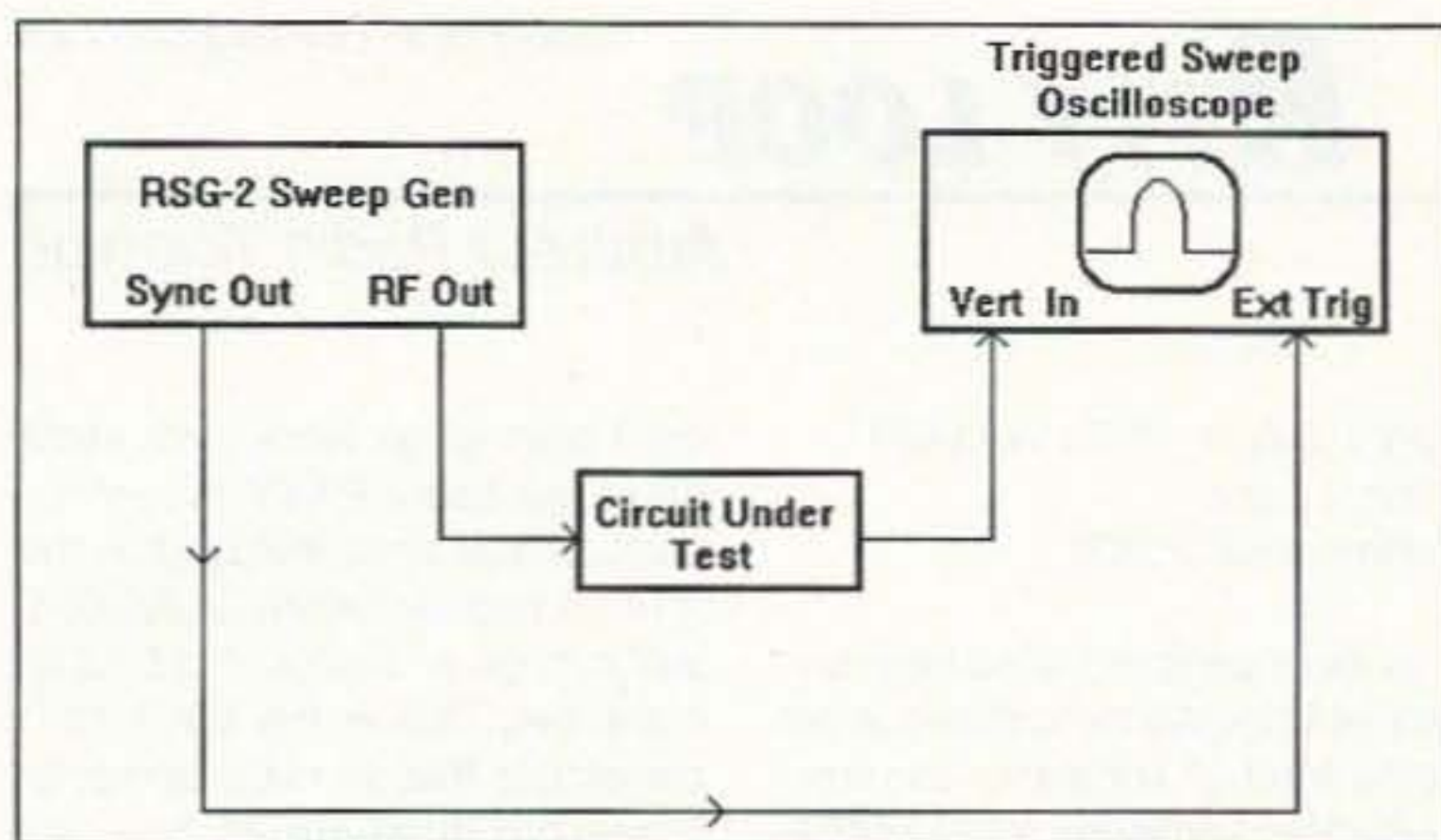

Fig. 3. External connection configuration for the RSG-2.

precut by Boyd, and so are very easily installed, even by novice builders.

Photo C shows the output waveform (this one taken using a 455-kHz IF transformer as the circuit under test). Note that it has both positive and negative peaks. In practice, the baseline would be placed at the bottom edge of the oscilloscope, so only the positive peak shows.

Connection to Circuits

Figure 3 shows the connection of the RSG-2 sweep signal generator into a usable configuration. The display unit is a triggered

sweep oscilloscope. Given the low frequencies involved, nearly any old clunker of an oscilloscope will work quite well, and possesses little or no advantage over the modern 50- or 100-MHz bandwidth models currently on the market. A coaxial cable from a BNC connector on the rear panel of the RSG-2 connects the SYNC OUT to the external trigger (EXT TRIG) input of the oscilloscope. When a pulse is received at the EXT TRIG input, the 'scope will initiate a single sweep of the horizontal time base. Because repetitive pulses are sent from the RSG-2, the sweep is continuous.

The RF OUT of the RSG-2 is connected to the input of whatever circuit or device is being tested, while the output of the circuit being tested is connected to the vertical input of the oscilloscope.

My conclusion about the RSG-2 is the same as that regarding the RSG-30 reviewed earlier in this column: It's a darn good, handy thing to have in any electronics workshop, especially a ham radio workshop where RF circuits are being tested or developed. Normally, sweep generators are beyond the means of most amateurs, but the RSG-2

and RSG-30 make them available to nearly everyone. Write to them at the address at the beginning of this column for further information about their products.

Antlers for Windows Software

If you own a Windows computer, then you might want to use the Antlers for Windows 2.00 software for calculating antenna lengths. It is available from me for \$30 (P.O. Box 1099, Falls Church, VA, 22041). Comments, questions, and requests for future topics can also be directed at me at that address.

PCB / Schematic CAD - from \$195

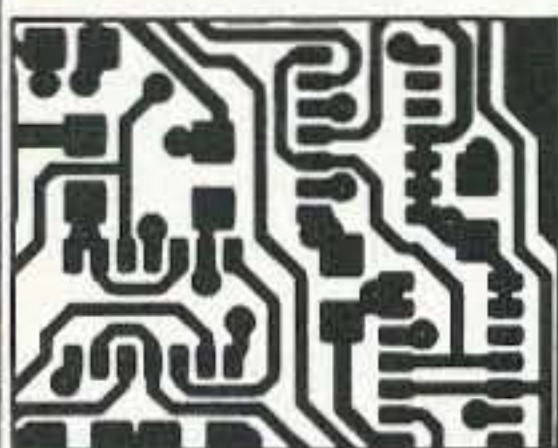

EASY-PC - For single sided and multilayer boards to 17"x17". Phenomenally fast and easy to use. Over 18,000 copies in use worldwide. **EASY-PC Professional** for boards up to 32" x 32" at .001" resolution, 16 layers. Schematic capture and netlist extraction - integrates seamlessly with PULSAR and ANALYSER III. Runs on PC/XT/AT/286/386/486 with EGA or VGA displays.

Logic Simulation - from \$195

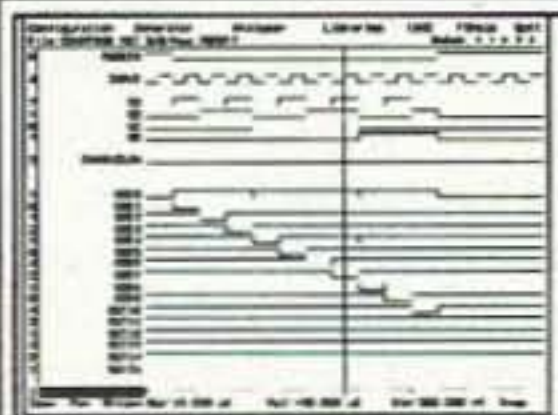

PULSAR and **PULSAR Professional** - Full featured digital logic simulators. Allow you to test your designs quickly and inexpensively without the need for sophisticated test equipment. **PULSAR** can detect the equivalent of a picosecond glitch occurring once a week! Runs on PC/XT/AT/286/386/486 with EGA or VGA displays.

Analogue Simulation - from \$195

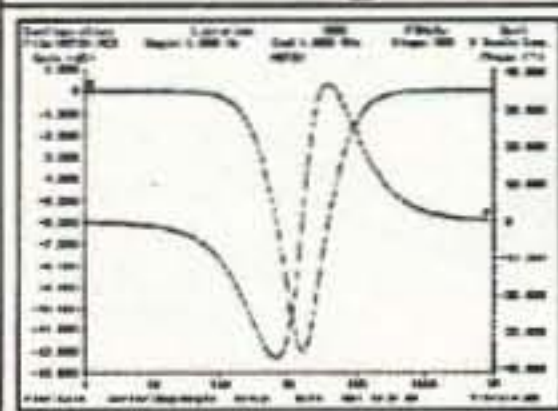

ANALYSER III and **ANALYSER III Pro**. Powerful linear circuit simulators have full graphical output, handle R's, L's, C's, Bipolar Transistors, FET's, Op-Amp's, Tapped Transformers and Transmission Lines etc. Plots Input and Output Impedances, Gain, Phase and Group Delay. Covers 0.001 Hz to >10GHz. Runs on PC/XT/AT/286/386/486 with EGA or VGA displays.

For information write, fax or call:

Number One Systems

REF: 73, 1795 Granger Ave., Los Altos, CA94024

(415) 968 9306

VISA and MasterCard welcome.

CIRCLE 1 ON READER SERVICE CARD

Motron 310 Garfield St Suite 4
PO Box 2748
ELECTRONICS Eugene, Oregon 97402

Only
\$99.00

The NEW AUTO-Kall® AK-16

DTMF Controller Board features 16 relay driver outputs and DTMF to X10 control capability!

- >CW ID
- >0-12 digit security code
- >User programable using your DTMF keypad!
- >ASCII Serial Output of incoming DTMF
- >Watch-dog timer reset
- >Relay driver outputs may be mated with our **RB-8/1** or **RB-16/1** relay boards
- >Several modes of operation allow combinations of real-time control, on/off/momentary output control, and CW response tones
- >Small size, only 2.75 X 3.25 inches
- >12VDC @ 25ma

Visa, MASTERCARD, AMERICAN EXPRESS, DISCOVER CARD
COD ON CASH OR MONEY ORDER basis only
S/H: \$6 USA; \$10 CANADA; \$15 FOREIGN. COD: \$5
Price and Specifications are subject to change without notice

Orders: (800) 338-9058
Info: (503) 687-2118 Fax: (503) 687-2492
Catalogs are also available via the Internet
motron.info@emerald.com

CIRCLE 248 ON READER SERVICE CARD

RTTY LOOP

Number 19 on your Feedback card

Amateur Radio Teletype

Marc I. Leavey, M.D., WA3AJR
6 Jenny Lane
Baltimore MD 21200

In most parts of the country, unless your local school district is on some kind of trimester system, September brings the return of children to school. With that joyous event always seems to come the need to respond to your questions. So, let me roll up to the keyboard, and see what's in the IN box.

Terry Perrault, R.N., WA6MVV, of Retsil, Washington, writes: "I am a retired male nurse and have been interested in RTTY since the early years, (originally) with Model 15s and 32s. I finally broke down and got into computers. Guess I am a holdout, because I still like ARC-5 gear. Anyway, I don't know what to get.

"Sure would like a hint. Don't have much money, but maybe you could give me some hints on some older but usable gear, and a source for same. Of course, in the 'old days' you built a T.U. using a 5763. Can't do that any more, I guess! I would just love to get on HF RTTY. It's been a lifelong dream, and I don't want my dream to go away."

Well, Terry, as I have stated here, before, about any transmitter and receiver that is good enough for sideband operation is good enough for HF RTTY. That means that if you have a station, use it. If not, ask around at the local ham club, radio supply store, or even Radio Shack to see if someone has an old transmitter and/or receiver to sell.

Presuming you get that far without a problem, the computer will be your next hurdle. Here, again, you

don't have to go fancy. Just about all of the basic RTTY programs, such as the ones included in the RTTY Loop Software Collection, will run on a simple 8086/8088 computer. This is the basic "XT" compatible that so many computer users are dumping as they upgrade to newer and faster machines. If you ask around, you may be able to get such a machine for a song, or maybe a song and dance. Even if you went out and bought a new machine, for RTTY it does not have to be the most expensive number cruncher in the store.

All that is left is interfacing the two together, and here you have two choices. You could use a hardware interface box, such as the Kantronics KAM, AEA PK-232, or other such controller, to handle both transmitting and receiving with a minimum of software requirements. These boxes are, in essence, RTTY modems, which can run with simple communications programs on the computer or dedicated RTTY controller programs which exploit all the bells and whistles of the hardware. Alternatively, you can use a strictly software solution, where your computer does all the hard work of converting digital pulses to tones and back, using only a simple one or two chip interface to actually bridge the hardware together. One of these solutions is the popular Baycom program, which is in the Collection as well. Drop me a self-addressed, stamped envelope, or E-mail a request, for the latest listing of programs in the RTTY Loop Software Collection.

At any rate, with some frugal shopping, and especially if you have a few good friends, it

shouldn't cost you much at all in the way of hard cash to get onto RTTY. Now, as to the time involved, that's a different story. At least you're retired! Let me know how things work out for you.

Yuan-Ying Chang, KE6LTH, dropped me a message over the Internet saying:

"Hi! I am a 73 magazine subscriber. I would like to thank you for providing the schematic for BAYCOM. It's very helpful for a lot of RTTY operators. I tried to build the board a few years ago, but could not find any source for the IC 3105. By the way, because I couldn't find the TCM3105, I used the AMD7910 as a replacement. It works fine, except that it needs external DC power."

I appreciate the remarks, Yuan-Ying, especially with regard to the chip substitution. I have looked around a bit in the catalogs at WA3AJR, and don't readily see the TCM3105, either. Any readers with sources are invited to put their two cents into the pot.

Hopefully, the material presented last month on using a sound card on RTTY will speak to questions received this month from Steve Carlisle VE7AHL, who expresses interest in any material in that regard; and from Phil Reid WB7OZE, who notes that the SoundBlaster sells for less than \$100 in the Pacific Northwest and it has the hardware onboard, including DSP, to do the job.

As detailed last month, about all of the material I have located is for the Cardinal flavor of sound boards. For some reason, the SoundBlaster brand is not well represented here. One presumes, as detailed last month, that the programming is more straightforward on the other boards. This is not to say that it cannot, or has not, been done with the SoundBlaster, I just have not seen any of the results. Will keep at least one eye open for this one, though.

James Thomas drops a note from Taiwan, in which he says: "I was in the local bookstore and found a story written by you in 73 magazine and you were chatting about a program called XPCOM. Well, I think I have a related problem that I hope you can help me with. I just got my hands on an IC-7100, IC-R72, and CT-17 interface controller from Icom and I can't find a program in Taiwan or on the Internet that will allow me to use the Icom CT-17 to control my two Icom radios via the computer. Do you have any leads on where on the Internet I could find a program that can use the CT-17 to control the radios?"

Well, James, I looked around, and about all I found was a file detailing modifications to and features of the Icom IC-7100 receiver. You might try looking at ftp://ftp.qrz.com/mods for some of these modification files.

That URL, by the way, is the file server of the QRZ Home Page, which can be found on the world wide web at http://www.qrz.com. This is a very useful little page on the Web which, among other things, supports a rather nice set of programs, including a call book lookup. If you access your own call book entry, you can even put in an E-mail address, to facilitate users finding you. Since spots of interest on the net are rapidly becoming one of the more common requests received here, I will try to tell you about one with each new edition of RTTY Loop.

Meanwhile, I look forward to your comments and questions, as usual, by any of the common means. Feel free to drop me a line at the above address, or via E-mail on CompuServe (75036,2501), Delphi (MarcWA3AJR), America Online (MarcWA3AJR), or on the Internet (MarcWA3AJR@aol.com). Who knows, maybe a RTTY Loop Home Page will be on the Internet in the future, as well!

CABLE T.V. CONVERTERS

Jerrold™, Oak, Scientific Atlantic, Zenith, & many others. "New" MTS stereo add-on: mute & volume. Ideal for 400 & 450 owners.

1-800 - 826-7623

B & B INC.

4030 Beau-D-Rue Dr.
Eagan, MN 55122



CIRCLE 21 ON READER SERVICE CARD

Silent Solar Power



The \$349.00 Bullet-Tested QRV Solar Power Supply keeps your repeater on the air 'round the clock or powers your 100w HF station 60 hrs a month. Control circuit speeds charge, protects gel cells & sealed batteries. Fully assembled, QRV, portable. Easily expanded.

Add \$10 S&H Info \$1
AntennasWest
(801)373-8425 Box 50062 Provo UT 84605

CIRCLE 336 ON READER SERVICE CARD

THE ISOTRON
COMPACT ANTENNAS FROM 160-10 METERS

NO TUNERS
NO RADIALS
NO RESISTORS
NO COMPROMISE

SIX EXCELLENT REVIEWS JUST
DON'T HAPPEN BY CHANCE
CALL US FOR A FREE CATALOG.

*See review in Oct. 73, 1984 *Sept. 73, 1985 March 73, 1986
CQ, Dec. 1988 Mar. W.R. 91 NOV. 73, 1994

BILAL COMPANY
137 Manchester Drive
Florissant, Colorado 80816
(719) 687-0650



CIRCLE 42 ON READER SERVICE CARD

HAM RADIO & MORE

National Talk Radio Show With Len Winkler, KB7LPW

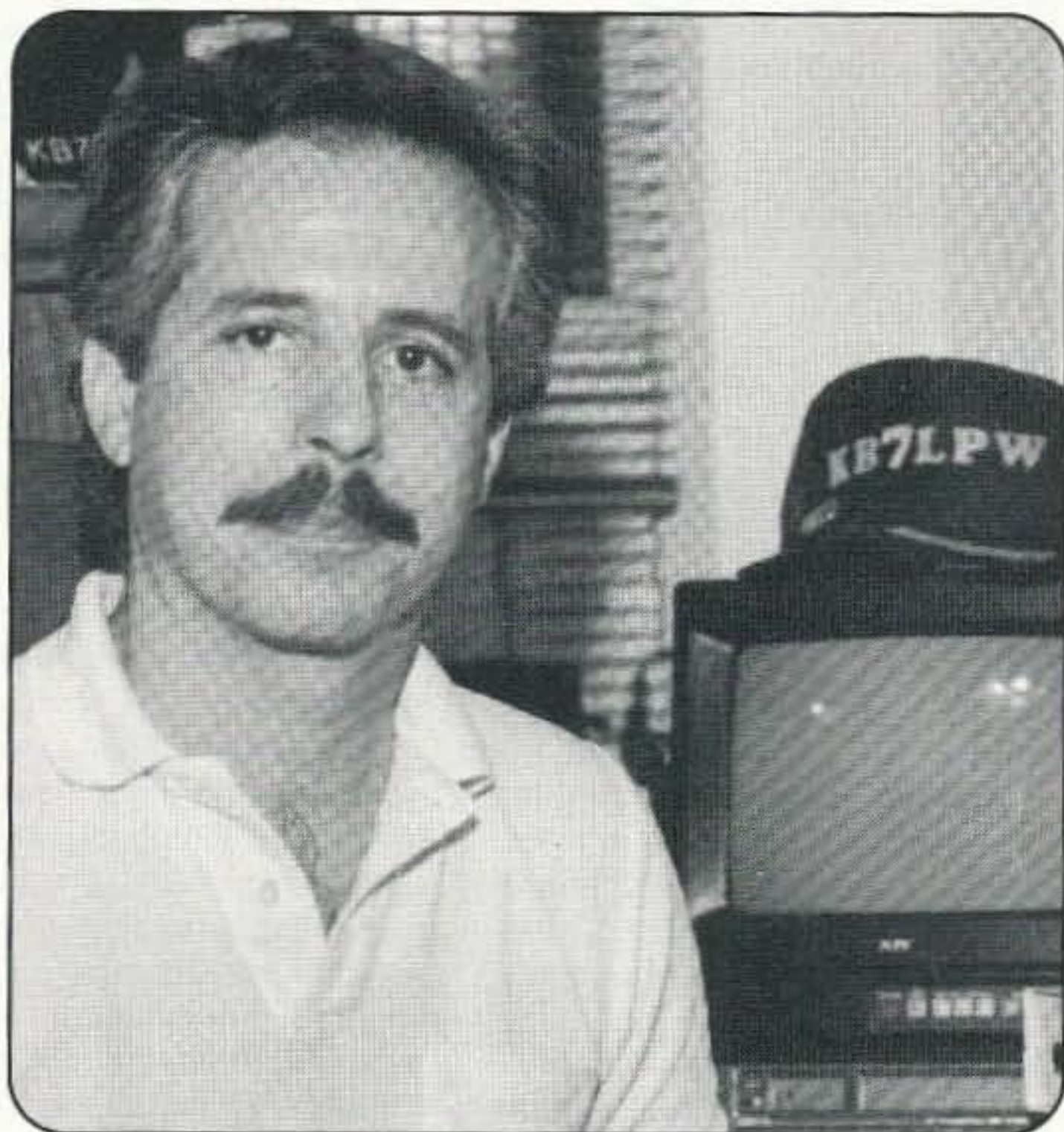

**America's Only
Ham Radio
Show On The
Broadcast
Bands!**

**Sundays
6:00 pm EST**

Weekly Co-Hosts, John Moore, NJ7E and Ned Stearns, AA7A Weekly DX Update With Lee Finkel, KY7M
Tune in each week for national ham radio news, FCC news, weekly guests from the amateur radio community, ham trivia contests, prizes, listener call-in and more!
Sponsored in part by *73 Amateur Radio Today*.

Ham Radio & More Affiliates

AR: KNWA 1600	BELLEVILLE	WTTL 1310	MADISONVILLE	NM: KICA 980	CLOVIS
KELD 1400	ELDORADO	KEEL 710	SHREVEPORT 50,000 WATTS!!	OH: WIOI 1010	CHARLESTON/HUNTINGTON/NEW BOSTON
AZ: KFNN 1510	PHOENIX	MA: WNBH 1340	NEW BEDFORD/PROVIDENCE	OK: KTMC 1400	MCALESTER
KVRD 1600	PRESCOTT	MI: WMKT 1270	BOSTON CABLE CHANNEL 38B	KADS 1240	OKLAHOMA CITY
KVNA 600	FLAGSTAFF	WABJ 1490	TRAVERSE CITY/CADILLAC	OR: KBNP 1410	PORTLAND
CA: KNSN 1290	CHICO/REDDING	MO: WBGZ 1570	ST. LOUIS	PA: WJMW 550	SCRANTON/WILKES-BARRE
CT: WATR 1320	HARTFORD	KSLQ 1350	WASHINGTON	SC: WPCC 1410	CLINTON
FL: WFFG 1300	MIAMI/KEYS	KNWA 1600	SPRINGFIELD	WJMX 970	MYRTLE BEACH/FLORENCE
WIPC 1280	TAMPA/ST. PETERSBURG	KSWM 940	AURORA	WDAR 1350	DARLINGTON
GA: WGIG 1440	BRUNSWICK	MS: WSUH 1420	MEMPHIS, TN/OXFORD, MS	TN: WRWB 740	KNOXVILLE
IL: WKTA 1330	CHICAGO	MT: KDRG 1400	BUTTE/DEER/LODGE	TX: KIVY 1290	CROCKETT/PADDINGTON
WBGZ 1570	ALTON	NC: WSKY 1230	GREENVILLE/SPARTENBURG.	UT: K26EM	CHANNEL 26 TV EMERY
WTIM 1410	TAYLORVILLE/SPRINGFIELD	WEEB 990	FAYETTEVILLE	VT: WSYB 1380	RUTLAND
WKEI 1450	KEWANEE	WCRY 1460	RALEIGH	WI: WHBY 1150	GREEN BAY/APPELTON
IN: WPDJ 1300	HUNTINGTON	WHKY 1290	HICKORY	WV: WWRN 620	BLUEFIELD/BECKLEY
IO: WKEI 1450	DAVENPORT	NE: KICS 1550	LINCOLN/HASTINGS	WNMR103.9FM	WHEELING/NEW MARTINS
IO: WKEI 1550	WICHITA/WINFIELD				
KY: WMTA 1380	CENTRAL CITY				

Ham Radio & More is also available on Satellite!
Spacenet 3, Transponder 9, 6.8 Audio for Home Dish (Analog).
Find out what radio station airs "Ham Radio & More" in your local area by calling the originating station, KFNN, at 602-241-1510.
For sponsorship information contact Ron Cohen at 602-241-0482

Now
Heard On WWCR
Shortwave 7.435 MHZ
Call For
Show Times

Michael Bryce WB8VGE
2225 Mayflower NW
Massillon OH 44646

A QRP Receiver That's Easy, Simple, and Effective

I wanted to use this month to finish up some of the smaller projects for the NN1G Small Wonder Labs transceiver. But, alas, time did not permit me to get all the circuits tested. So look for those projects in the coming months.

Instead, let us look at a simple receiver for the QRP'er. Just about anyone can sit down with solder iron in hand and build a QRP transmitter. Whipping up a receiver that works is an entirely different subject. Well, there is now some good news from the folks at Ten-Tec. The Model 1056 is a direct conversion receiver you can assemble on any ham band from 160 meters to 10 meters. Best of all, all the frequency-dependent components have been included. Just pick your band and stuff the PC board with the correct capacitors and inductor.

A Closer Look

The Model 1056 is based on a simple but effective design. It also sports several novel features not normally found in simple direct conversion receivers. I'll explain these later on, but for now let's look at the audio stage of the receiver.

In a direct conversion receiver, almost all of the gain is derived by the audio stage, and the Model 1056 is no exception. However, in this case, the audio stages are fine-tuned. They produce enough gain to allow the receiver to hear weak signals, but without the distortion and microphonics that plague most direct conversion designs.

If you're accustomed to the lackluster audio from most homebrew receivers, you're in for quite a surprise. Instead of the usual QRP rig audio amplifier chip, the LM386, Ten-Tec designed the Model 1056 around a hybrid audio amplifier. The BAH packs a lot of power in a single in-line package. Ten-Tec has a history for excellent audio designs in their transceivers. No doubt, the audio amplifier stage is an off-shoot from one of their many

Low Power Operation

transceivers. The Model 1056 is one of the few direct conversion receivers that can drive an external speaker with room-filling audio.

It has a PC board-mounted jack so that you can use a set of "walkthing" headphones. You can also hardwire a speaker or audio jack if you desire. The end result is the same: The Model 1056 sounds good.

Another feature you won't find in most direct conversion designs is an audio bandpass control. The bandpass is an active audio filter ahead of the audio power amplifier stage. It gives the user a small degree of control over the bandwidth of the receiver. This control works in the AUDIO section of the receiver and does not affect any of the RF stages. It seems most effective while tuning in a SSB QSO. The bandpass is not a sharp audio filter for CW. It does improve CW reception, but don't think of it as a QRM cure.

But, there are still more features found in the 1056's audio stage. You can easily inject a low-level sidetone directly into the audio stage. This is great if you're thinking about using the Model 1056 as a beginning for a single-band transceiver.

Along with sidetone injection, you can also mute the audio stage. Again, this is a slick feature for those wishing to roll their own transceiver.

The RF Side

Here the Model 1056 is rather generic. An NE602 is used as a mixer and VFO. Incoming signals are mixed inside the NE602 and then routed to the audio stages. This is classic direct conversion design.

The VFO is varactor tuned with a PC board-mounted pot. In my review unit, I had coverage from 7.000 all the way up to 7.300 MHz. The tuning is very fast. But wait! To make tuning usable, a technique from way back when is used. It's called a bandspread control. In this case, it makes tuning the band enjoyable. As the Model 1056 is designed to be played with, I would start changing values in the circuit to improve the tuning range. A 10-turn pot could easily be installed to really

smooth out the bandspread.

The band on which you operate the Model 1056 will determine the components used in the VFO circuitry. There are no coils to wind. I found setting the VFO to the desired frequency easy to do with a frequency counter. Ten-Tec makes this easy to accomplish because they have included the necessary components to pick off some of the VFO's output. It's a nice touch to include in the design!

The front end includes a tuned input circuit for the band being used. A brute-force RF-gain control provides some means of controlling front-end overload.

Building the Model 1056

All components for the PC board are supplied from Ten-Tec. This includes all the components used for all the bands on which the Model 1056 will operate. You end up with a lot of extra parts and pieces when you're done! Add 'em to your junk box, or change bands when you get tired of the one you're on.

Everything mounts on one single-sided PC board. This includes the speaker jack, RF gain, main tuning, bandspread, bandpass, and volume control. The PC board has a top silk screen, but the foil side is not plated or reflow solder plated. All the PC board-mounted components fit the board, including the disc capacitors.

Assembly starts with the audio sections. You assemble the audio power amplifier and bandpass section. Then apply power to the receiver and do some simple checks. If this stage is working, you then proceed to the RF section.

The assembly manual that Ten-Tec provides gives you plenty of information on how to put the kit together. It's not overly detailed, but does use the "install part and check off" procedure. Such things as the polarity of electrolytic capacitors are clearly explained. Ditto for diodes and the ICs. It's about as clear as you can make it.

Adjustments and Alignments

Since a direct conversion receiver lacks an IF stage, the only adjustment you have to do on the Model 1056 is to set the VFO to the proper operating frequency. The best method is to use a frequency counter. If you lack one, you can press a general coverage receiver into use. Listen for the

VFO and adjust it to the operating frequency desired.

With the VFO set, and providing the band you selected is open, you'll hear stations. I always choose the 40 meter band, as there is something on it 24 hours a day.

Operating Notes on the Model 1056

With such a simple circuit, it's amazing what it can hear. If I could hear it on my Argosy, the Model 1056 was able to detect it as well.

As I mentioned earlier, there's plenty of audio. This is one direct conversion receiver in which you won't have to run the audio gain all the way into its stops just to hear some band noise. The bandpass control works as it should and does help with some stations. I get the most use out of this control when listening to SSB.

The tuning and bandspread controls work together. You will do most of your tuning around the bands with the bandspread control, leaving the main tuning in one spot.

I did notice some AM bleed-through on 40 meters at night. I suspect two causes: I was using a multiband vertical antenna; and I did not reduce the RF gain. After playing with the rig for awhile, you can adjust the RF gain and audio gain controls to almost eliminate AM bleed-through. Using a single-band antenna would be a major factor in preventing out-of-band AM signals from reaching the Model 1056.

Of course I tested the rig with it just laying out on the desk. It held its own in terms of frequency stability. However, to really make it stable, it needs to be mounted in a secure enclosure. This is a *must* if you plan to use the Model 1056 on any band above 30 meters. The reason is simple. A direct conversion receiver as simple as this runs the VFO at the operating frequency. At 10 meters, the on-board VFO will be running at 28 MHz! So consider investing in a solid, all-metal box.

The Model 1056 is a great little receiver. You can't beat it for the money. It does what it says it will do and more, and would also be a great club project. The circuit provides enough features to let you listen to the world, without killing your budget. No matter if you're a seasoned QRP builder or a newcomer to the hobby, the Model 1056 will not disappoint you. 73

ADVERTISERS

R.S.#	page	R.S.#	page	R.S.#	page	R.S.#	page
351 Absolute Value Systems	53	• Command Productions	57	234 Lentini Communications	73	• SAMS	41
164 Ace Communications of Indianapolis	51	156 Compute Corporation	80	47 Link-Com	53	36 Scrambling News	80
• Advanced Info Group, Inc.	17	99 Communication Concepts	77	• Maggiore Electronics Lab	77	167 Sescom, Inc.	51
149 Advantage Instruments Corp	37	• Communications Data Corp	82	• MCM Electronics	61	188 SGC Inc.	13
194 All Electronics Corporation	36	10 Communications Specialists, Inc.	66*	• Meadowlake Corp	36	92 Shack Attack	85
• Alphalab	51	276 Computer Aided Technology	77	• Memphis Amateur Elect.	76	• Sirio Antenne	2
110 AMSAT	66	268 Computer Automation Technology	49	86 MFJ Enterprises	11	• Smiley Antenna Co. Inc.	75
113 Amsoft	41	15 Comtelco Industries, Inc.	76	160 Micro Computer Concepts	51	250 Software Systems	46
57 Antennas West	15	• Cubex Company	85	345 Microtek	76	51 Spectrum Communications	84
296 Antennas West	19	• Doppler Systems	41	193 Morse Tutor Gold	53	69 Spectrum Electronics	48
340 Antennas West	19	• Down East Microwave	80	248 Motron Electronics	69	384 The Ham Contact	49
380 Antennas West	41	114 E. H. Yost	76	64 Mouser Electronics	76	384 The Ham Contact	55
135 Antennas West	53	• Electronics Book Club	65	114 Mr. Nicad	76	269 Tigertronics	46
359 Antennas West	53	• Electronics Distributors	47	54 NCG/Comet	29	• T.J. Antenna Company	85
336 Antennas West	70	169 G & G Electronics	85	• Norcon Engineering	48	11 Transel Technologies	40
324 Antennas West	83	193 GGTE	53	1 Number One Systems Ltd.	69	22 Tri-Ex	41
• Antique Radio Classified	41	286 Hambrew Magazine	53	290 Nye Engineering	41	• Uncle Wayne's Bookshelf	86,87
16 Astron Corporation	21	• Ham Radio & More	71	102 ONV Safety Belt	51	32 Universal Electronics, Inc.	30
• Autek Research	57	• Hamtronics, Inc.	7	• P.C. Electronics	61*	• Universal Radio	17*
• Bamcom Communications	57	293 IC Engineering	17	• P.C. Electronics	63*	• Vanguard Labs	48
41 Barry Electronics Corporation	23	179 ICOM America, Inc.	CV2*	68 Periphex	83	259 Versatel Communications	30
21 B & B, Inc.	70	42 Isotron	70	198 Personal Computer Repeater Controller	51	278 Virginia Beach Hamfest	75
42 Bilal Company	70	55 J-Com	85	249 Phillips Industries, Inc.	36	104 Vis Study Guides, Inc.	41
168 Buckmaster Publishing	57*	• Jade Products	30	49 Polyphaser	17	191 W & W Associates	45
56 Buckmaster Publishing	80*	159 Japan Radio	5	257 Quorum Communications	27	38 W9INN Antennas	19
7 Buckmaster Publishing	17	26 J.M.S.	83	110 Radio Amateur Satellite	66	• Wheeler Applied Research	40
• Butternut Electronics	82	285 JPS Communications	31	153 Radio City	88	• Wolfe Communications	19
222 Byers Chassis Kits	80	27 John Bell	53	• Radio Control Systems	49	• Yaesu Electronics Corporation	CV3
184 C & S Sales, Inc.	19	• Kantronics, Inc.	1	58 Radio Engineers	83		
• CABLE X-PERTS, INC.	51	2 Kawa Productions	40	34 Ramsey Electronics	67*		
• CBC International	40	151 KDC Sound	40	• RF Parts Co.	9		
• Centaur Electronics	17	• Kenwood USA Corporation	CV4	254 Ross Distributing	36		
265 Chipswitch	40			• RT Systems	41		

* Advertisers who have contributed to the National Advisory Committee (NIAC).

TOLL FREE **1-800-666-0908** PRICING AND ORDERS ONLY

KENWOOD

TH-79AD & TH-79ADH Hi-Power Model
Dual Band HT
\$4.99 Glove Leather Case

TH-22AT
TH-28A
2m Handheld

TM-733A
Dual Band Mobile

TM-241A 50W, 2m Mobile

TM-742A/642A
Dual Band Mobile with Optional 3rd Band Module
6M/10M/220MHz/440MHz/1.2GHz

TS-850S/AT
TS-450SAT
All-Band HF Transceiver

TS-50S HF
TS-60S 6 Meter

CALL FOR LATEST SPECIALS & COUPONS
ALL KENWOOD RADIOS & ACCESSORIES AT DISCOUNT PRICES

YAESU

FT-900AT
NEW HF MOBILE with Removable Front Panel & Built-in Antenna Tuner

FT-8500
DUAL BAND MOBILE Complete Control with FS-10 Mic, Remote LCD Display... Much More!

FT-51R
FT-51RH High Power Model
New Dual Band HT with Windows

FT-2500
2M Mobile, 50 Watt, Heavy Duty, Large LCD Display

FT-5100
Dual Band Mobile 50W VHF, 35W UHF

FT-530
Dual Band HT SPECIAL PRICING!

FT-840
All Band HF Transceivers At A Great Low Price!

FT-1000D/FT990

CALL FOR LATEST SPECIALS & COUPONS
ALL YAESU RADIOS & ACCESSORIES AT DISCOUNT PRICES

STANDARD

C508A
World's Smallest Dual Band HT

C5718DA
DUAL BAND MOBILE Complete Control Mic

C568A
Dual Band HT SPECIAL PRICING!

C558A
C228A
C528A

C188A
C288A

C158A
Call for Special Savings

CALL FOR LATEST SPECIALS & COUPONS
ALL STANDARD RADIOS & ACCESSORIES AT DISCOUNT PRICES

NEW EQUIPMENT PRICING AND ORDERS 1-800-666-0908 • OUT OF STATE TECHNICAL, USED GEAR, INFO 203-666-6227 • 24HR FAX 203-667-3561

Hours:
M-F 10-6,
SAT. 10-4



LENTINI COMMUNICATIONS INC.

21 GARFIELD STREET, NEWINGTON, CT 06111



C.O.D.s OK Same Day Shipping

CIRCLE 234 ON READER SERVICE CARD

Never Say Die

Continued from page 4

Say, if you find out about anything in the health field you think I'd be interested in, send me a clipping or the name of a book you recommend I read. And I'll be reviewing some great books I've read recently for you.

Having been fat, I know all about the problem. I had a 44 waist for years. It's been 36 for the last 20 years, ever since I decided once and for all to take off the crummy fat and stay normal. I'm living proof that it can be done, so I'm not asking anyone to do something I haven't done. Another *been there, done that*. And, yes, I exercise every day, no matter where I am. There I was at 6 am jogging along the streets of Hong Kong, Beijing, Taipei, Osaka, Tokyo, Seoul, Kuching, Bangkok, Kota Kinabalu, Macao, Manila, Monaco, Paris, London, Mbabane, Maseru, Nairobi, Amman, Bahrain, and New Hampshire. The next "world" may be a great place and all that, but I intend to stick around here as long as I can . . . and do my best to keep you here with me. We can get together for a rag chew in heaven, where time runs on a different clock, and I'm not trying to get so much done in what little time I have left.

Meanwhile, there's a lot you can learn, and endless opportunities to explore and pioneer new ideas and technologies. Remember, most of the really important break-throughs in science have been made by amateurs. Or did you miss the great article in issue #1 of 73 by John Campbell W2ZGU, back in October 1960?

Good grief, I've been at this for 35 years!

Special ARRL Discounts?

A letter from Ivan N4EYQ really surprised me. He explained that as a handicapped ham he was getting a special \$6-a-year membership and subscription from the League. Wow! I think that's very humanitarian of them to offer such a bargain, though it could turn out to be illegal if challenged.

Does anyone know what limitations the ARRL has put on this special rate? To what handicaps do they apply? Ivan is legally blind (20/200 or worse), but it seems to me this subscription rate would probably apply to hearing-impaired hams, too. We've had some mover-and-shaker hearing-impaired hams. Bob Weibrecht W6NRM comes to mind. He and I made the first coast-to-coast 80m RTTY contact one night awhile back. We also worked on 11m, back before our lack of use of the band prompted the FCC to turn it into a CB band. Well, I warned everyone at the time in my editorials, but I just got called a doom and gloomer. I got

the same from the old-timers when I warned that we could lose part of 220 if we didn't use it. I've still got some "220—use it or lose it" buttons I was distributing at the time.

We've had some wonderful contributions to the hobby by blind hams. I'll never forget Stan W2ER, who built and serviced all his own equipment. Or Bob Gunderson W2JIO, who published the Braille Technical Press for years.

But how about hams on welfare or unemployment compensation (job-challenged)? How about the substance-abuse disadvantaged (drug addicts)? How about our poor old seniors trying desperately to get along on their social security pittance (age-challenged)? Or is it social insecurity these days? How about our disabled military veterans? How about all of our physically challenged hams?

For that matter, how about poor old Uncle Wayne? No, I'm not blind, but I am disadvantaged and multi-challenged. I'm struggling to get along on my social security and a veteran's disability pension. I'm too old and decrepit for anyone to consider hiring me any more. Shouldn't I qualify?

Repent! The End of the World Is Near!

Fasten your seat belt. This is going to be a direct attack on contests. Yes, I recognize that I'm getting into a theological discussion. I suspect that the prefix "theo" means "il" or "non," because as soon as religion gets involved, logic has little more to do with things. Or reason.

Okay, now let's make at least an attempt to put on your thinking cap. Now, doing your very best to think, what is by far the biggest contest in amateur radio? I remember one ham (the last I heard he's in prison) who bragged that he was making over \$50,000 a year in completely untaxed income just by cheating at this contest. I checked on this myself in several countries and I don't think he was exaggerating.

What one contest has forced more hams off the air than all the rest of 'em combined? What contest has generated more anger and resentment with US hams by foreign hams than all the others combined? Either you know the answer or you need to get your thinking cap refurbished.

One more chance: what contest requires the greatest investment in ham equipment just to participate?

Of course I'm talking about the ARRL's DXCC contest and their accursed Honor Roll listings.

Whenever I visit a relatively rare country, I find the local hams furious over what this has done to them. Every time they get on the air they are besieged for 15-second contacts and

a QSL. Now you may think it's fun to sit and fill out thousands of QSLs every month, particularly if you have to look up each contact in your log to check it. That's when you find that a surprising percentage of US hams have no idea of what GMT is, and many have apparently even lost track of the date.

Only by calling stations who have called CQ, and by giving their own call a minimum of times, can they manage to make any real contacts. As soon as the word gets around the 2m DX-chasing nets, they are bludgeoned into contest-type operation or, as is more usual, forced off the air.

When I'm going to be visiting a rare country, I ask a local ham if I can use his station and promise to take care of the QSLs I generate. They know that this will tend to ease the pressures for him in the long run, so I've never had anyone refuse. It really isn't fun for a DX ham to be stuck with endless contest-type contacts. It's difficult enough in many of these countries to get a ticket, and then getting the rig is even harder. And after all that, the hams won't let you have a decent conversation because they "need a new country for DXCC."

When I first went to Jordan, my main aim was to work as many DX-ers as I could so that His Majesty would have a little less pressure to just give signal reports and send a QSL card. I spent a couple weeks working the pileups from his Summer Palace, just outside of Amman. I worked thousands upon thousands.

I've done the same thing from dozens of other rare spots. Well, it was fun for me, but if I were living there, I know it would get old. For that matter, I guess it's gotten old for me. My last real DXpedition was several years ago to St. Pierre. More recently, when I visited 11 Caribbean islands, I didn't bother to take a rig or arrange to borrow one. I did get on the air from a few islands, but only for a few contacts. Mostly around the Caribbean.

Basis And Purpose

So, if we're not going to be needed for emergency communications, and hams no longer are of the slightest interest to the military in case of war, what might be our new reason for having the use of billions of dollars of spectrum? Yes, it's a wonderful way for retired old white men to spend the time during which they aren't playing golf. But is that of more value to the country than leasing our ham spectrum to commercial companies and using the revenue to retire the national debt?

I'm proposing as a new basis for the hobby a goal of using it as a way to make high-tech careers more interesting for our youngsters. It sure

worked in Jordan, where I was able to introduce that concept. It could work here, if we could get the ARRL to make some desperately needed changes to make hamming more attractive to kids. Yes, it's that code thing. But it's also our need for promotion, publicity, and even some advertising. Most kids have never even heard of amateur radio. Is it something like CB? Yeah, kid, now get away and stop bothering me.

We know that the vitality of America lies in the education and skills of our workforce. We know that an ability to cope with and use technology has a high priority. So here we are, with the worst and most expensive school system in the world, and with less than 10% of our high school graduates even able to cope with an engineering college. I've done my homework on all this in my work on the RPI Council and the New Hampshire Economic Development Commission, so I'm not exaggerating.

I keep preaching the need to get our schools to institute an eight-year course in electronics, communications, and computers, in grades 5-12. And as part of that we would encourage the kids to get into hamming so they'd be learning because it's fun, not because it's another class in school where all they have to do is pass the final test and move on, forgetting at least 90% of what they learned.

We need five million hams instead of 500,000. How about 50 million? You say that might tend to crowd our bands? Let me remind you that at present we're actually using less than 3% of our assigned spectrum. With ten times as many hams we might expand that to 30% usage. But we might also encourage the development of more spectrum-efficient modes. We know we could get a hundred times as much information exchanged in the same bandwidth with already developed data-compacting techniques.

Bringing in kids could save our bacon. Up until 1963, when the ARRL bombed the hobby and the industry with their infamous and deceptively-named "Incentive Licensing," 80% of all new hams were youngsters. The ARRL directors, led by multi-millionaire Mort Kahn W2KR, put an end to that, as well as the US dominance of the ham manufacturing industry.

Repent! The end is near!

Another Ooops, But Not Mine

The Navy has been busy assuring home owners near their Extra Low Frequency (ELF) stations in Upper Michigan and Cape Cod that these radio waves won't have any effect on them. Thus a new report from the Michigan Technological University may send Navy officials scurrying to

handle damage control.

It seems that these "harmless" radio waves that are used to communicate with submarines are causing up to 50% faster growth of several kinds of trees in the vicinity. Particularly affected were aspen, red maple, and red pine. Now, if radio waves can do that to trees, what may they be doing to the cells of people in the vicinity? We don't know how our cells know where they fit into the body's architecture, but each cell seems to have a blueprint for the whole body and know when to be replaced and by what. We know from the work of Ross Adey K6UI that radio frequency fields can screw up this system, causing serious problems.

I know that if the Navy wanted to put one of the ELF installations anywhere near my home, I'd fight it in every way I could and then, if I lost the battle, I'd move the heck out of there. There are enough outside influences knocking down my immune system without adding one more. And I say that as a veteran submarine electronics technician and thus well aware of the need for submarine communications . . . and of the difficulties involved in getting through to submerged subs.

Whadaya read?

If you count up the total paid cir-

ulation of all three ham magazines, and even if you don't figure any overlap of readers at all, less than half of all licensed amateurs are bothering to read any ham magazines!

Now, is this because over half of us have no real interest in the hobby, or is it that perhaps the ham magazines are unappealing? And that might even include 73, since over 500,000 licensed hams are not reading it.

I suppose that to the essentially brain-dead who are merely logging call letters, handles, and signal reports, who have no interest in any information about other ham activities, are satisfied with their rig, and couldn't care less about any new equipment coming out, there's no need to read a ham rag. Ditto those who are spending their remaining days on one or two local repeaters. The whole idea of getting on packet or making satellite contacts is so far beyond their conception that magazine space devoted to these activities is irritating.

The next time you're on the air, start asking the chaps you contact which of the ham magazines they read. Ask them which they enjoy the most; which they've found helps them learn more about technology; which has inspired them to try some new ham activity. Please keep track

and send me a copy of what you've discovered. I want to know what I'm up against. Or whether I should just give up trying to get hams enthused about our hobby and go on a long vacation and DXpedition.

Beyond that I'd appreciate it if you'd take a good critical look at 73 and let me know how it shapes up for you on the above questions. We do have far more reviews of new products than the other ham rags, but maybe you haven't noticed. It's fun to get something new now and then, and our readership surveys always show a top interest in reviews. We tend to steer away from heavy contest coverage, even though I used to enjoy them. CQ is so totally devoted to contests that I leave that niche to them.

How does 73 rate in comparison with the others? Going by my mail, it seems that it rates highest with most readers. But then, if I'm going to attract more readers I've got to know where 73 really stands.

The magazine was doing very well when I was forced to sell it to IDG a few years ago. When I sold all of my computer magazines, I had to sell the buildings that went along with them, plus all of my publishing equipment. That left me with no way to produce 73. Oh, they said that they wouldn't make any changes and

that they wanted me to continue my editorials. But as soon as the ink dried on the agreement, I was out. They didn't even tell me about it; I had to find out by reading the local paper. It took me almost a year to build a new publishing business so I could start *Digital Audio*. Meanwhile, 73 just about fell apart under the new management. It lost half its circulation and half its advertising, and was heading for the pits when I finally got it back.

By then I was deeply into the music business, publishing *CD Review*, *Music Retailing*, and *IMPS Journal*. Plus I had a couple record companies, a recording studio, and a few other ancillary businesses. That kept me from really concentrating on rebuilding 73's circulation. Now that I've sold most of my music publications and businesses, I'd like to get 73 back to being the biggest of the ham rags. And that means getting more readers. More readers will attract more advertising, and for every page of ads we can run an extra page of articles for you.

So see what you can do to find out why about 90% of the hams are not reading 73, and let me know. What do I have to do, start a national ham organization and run 20 pages or so of club news every month? I'd rather get hams doing more things,

THE SMILEY ANTENNA CO.
THE HAND TUNED PERFORMANCE SYSTEM
FEATURING PORTABLE RADIO SIMULATION TUNING
TO GIVE YOU A 3 TO 9 DB GAIN



Electrical

Maximum Power..... 50 Watts
Frequency Range..... 118-932 MHz.
Impedence..... Matched to the Portable
Specialized Tuning Available.

Mechanical

Coating Material..... A. Dipped in Synthetic Rubber to Seal and Webb Coil, Preventing Distortion
B. 1. PVC Covering
2. Mil-Spec MPQ-2000, A Solvent and Acid Resistant Covering.

Radiating Element..... A. Helical Wound Hardened Steel Wire, Copper Plated for Lower Resistance and Higher Velocity
B. .125 dia High Carbon Steel, Bias Wound Flexible Shaft Core-Plated

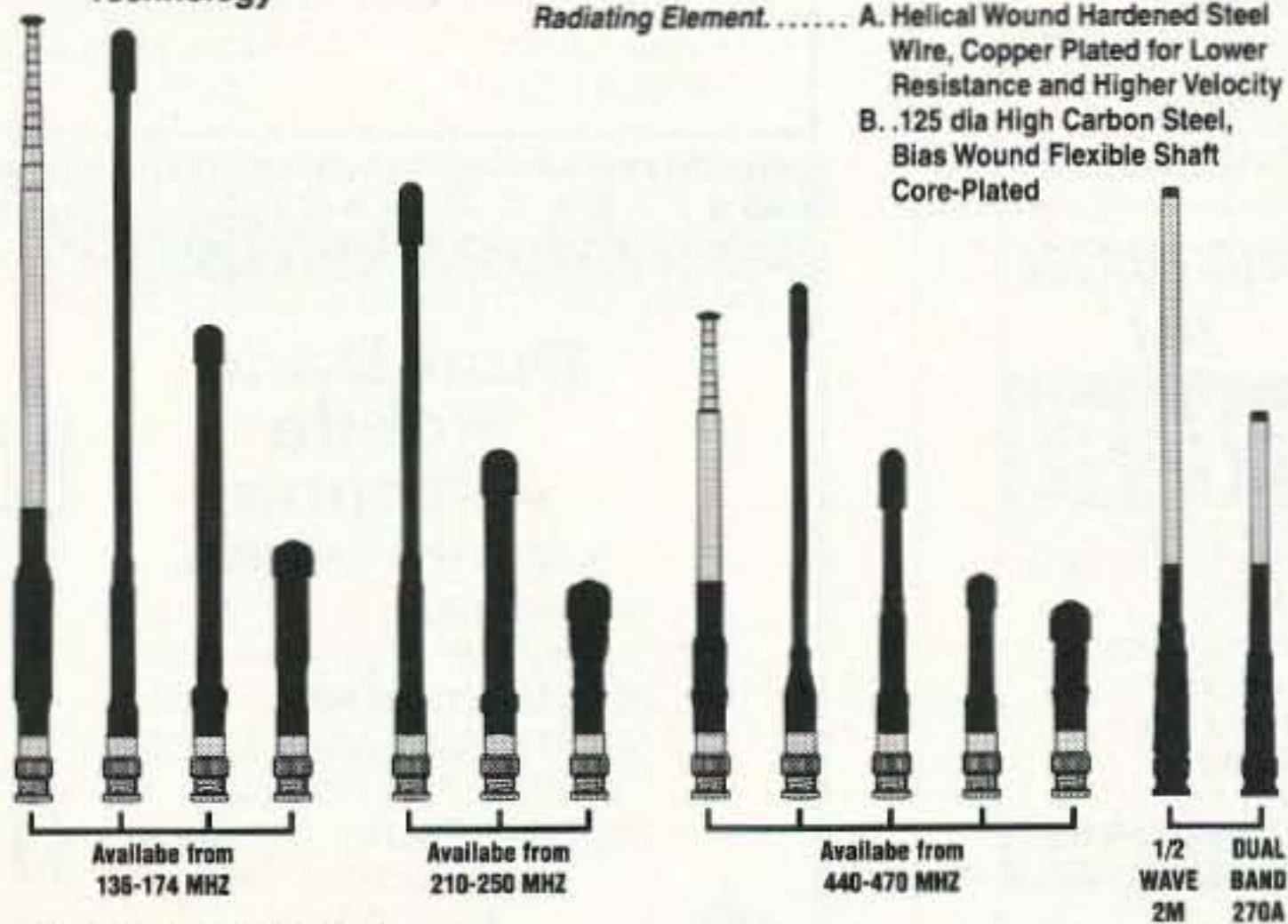

FOR DEALER LOCATION CALL (619) 579-8916
SMILEY ANTENNA CO., INC. 408 LA CRESTA HEIGHTS ROAD EL CAJON, CA 92021

20th Annual Virginia Beach HamFest & Computer Fair™

ARRL Virginia State Convention
Sept. 23 & 24, 1995

- Major Commercial Exhibitors, Dealers & Organizations
- Amateur Exams & Upgrades
- DX and Technical Forums
- Computer Hardware, Software and Accessories
- Plenty of FREE PARKING
- Held at the Va. Beach Pavilion
- Talk-In on 146.97 MHZ
- Speakers: Wayne Green & Gordon West
- Saturday night banquet



Admission Tickets \$6.00
Tickets Good Both Days!

HamFest Information Line
1-804-HAMFEST

Tickets & General Info:

Manny Steiner, K4DOR
3512 Olympia Lane
Virginia Beach, VA 23452

Exhibitor and Dealer Info:

Lewis Steingold, W4BLO
1008 Crabbers Cove Lane
Virginia Beach, VA 23452

Send SASE - Checks Payable to TRCI, Inc.

and maybe even thinking now and then. It's kinda fun.

What You Can Do!

I've probably been boring you with my constantly urging you to get kids involved with amateur radio. Presumably you agree with me that unless we make some headway with attracting kids, we could easily lose everything. The old basis and purpose for our government-supported hobby have been mostly blown away by changes in technology. Well, we don't want to be in the same position with amateur radio as workers are who have not developed new skills to cope with technological changes. Hey, I've been doing the same job for years and now I've been fired!

So yes, there is something that you can do that will help. As I've mentioned, when I give talks on entrepreneurialism at schools and colleges, I always ask for a show of hands of those who know about amateur radio. I see very few hands. With no organization to get us PR, the result is very few newspaper or magazine articles, and almost nothing on broadcast radio or TV. The ARRL apparently doesn't want to spend any of those millions they've socked away to hire a PR person to help promote the hobby. The directors seem to feel that our bands are

already too crowded, so who needs more hams?

One simple way to help kids know more about hamming is to make sure that their school libraries have subscriptions to *Radio Fun* and *73*. For \$30 you can endow your local school library with a year's subscription to both publications. And how about your local public library, too? Libraries are underfunded, so they need help with magazine subscriptions. Make out a check to *73* magazine or provide your credit card number and the address of the school libraries you wish to endow with subscriptions. We'll start the subscriptions and send a letter informing the principal of the school of your gift, suggesting it be posted so the students will be aware that the magazines are now available in their library. Even if your subscription only gets one youngster into amateur radio, it'll be a wonderful bargain for you.

Paying The Freight

So here we are, having fun making our ham contacts—around town via our repeaters, around the country, and around the world. We're having a ball with packet, RTTY, slow-scan, ATV, ham satellites, and so on. Of course, unlike some other countries, we don't have to pay anything for the use of our ham bands. I guess we fig-

ure that as Americans we have some sort of birthright to them. And we also believe we have the right for our government to pick up the tab for what it costs to keep our fun going. And that they should also act as policeman, judge, and jury when we have any problems.

You know, when I got into hamming, back almost 60 years ago, we were paying our way with services to our country. Our country got a huge payback when WWII came along, and never mind any benefits we'd provided in emergencies. We had about 50,000 licensed hams at that time and our average age was in the high 20s. Eighty percent of the hams joined the armed forces and we contributed very significantly to the war effort. I was there. I joined the Navy and went to their electronics schools to learn about the Navy radio, sonar, and radar equipment. Their schools were superb. Most of my instructors were hams, as were many of my classmates, and we Radio Technicians (RT-3/c) had no problem in learning how every circuit of the Navy receivers, transmitters, sonar, radar, and test equipment worked. Thus we were able to quickly fix anything we might run into.

Of course in the 1930s we hams had to build and service our own rigs. We bought our receivers, but we had

to fix them ourselves. Now most of us buy everything and send it back to the factory when it breaks. How many hams do you know who can help you fix your synthesized transceiver if it conks out?

Amateur radio, as you know, has changed. Few hams build anything but kits now. Almost none of us are able to fix a broken rig. Where in the 1930s hams were years ahead of the military in equipment design, today we are hopelessly out of touch with the state of the communications art.

When I went to work for GE during the summer of 1941, testing their BC-191 and BC-375 transmitters, I couldn't believe how seriously outdated the design was. When I checked, I found the design had last been modified in 1935.

While it seems unlikely that we'll ever have to gear up for another major war, we hams would have almost nothing to offer if one occurred. Our value to the military is obviously no longer a valid reason for our government to spend millions of dollars maintaining our hobby. Nor is our vaunted ability to copy the code.

I'm old enough so I can remember when we used to be in the forefront of radio technology. We pioneered FM, NFM, SSB, SSTV, and so on. Well, those laurels withered away years ago. Now I see hams pushing

53,226

ELECTRONIC COMPONENTS

Whether you order 1 part or all 53,226...MOUSER stocks and...ships same day!!

CALL...(800) 992-9943



for your FREE CATALOG

958 North Main St.
Mansfield, TX 76063

MOUSER®

ELECTRONICS

Sales & Stocking Locations Nationwide

CIRCLE 64 ON READER SERVICE CARD

ATTENTION RAMSEY FX OWNERS



Want to expand the features of your FX kit? The RC series of controllers from MICROTEK will do just that. With features such as:

- 7 seg LED display
- 12 button keypad
- Set rpt offsets with push of a button
- 20 channel memory
- Fast scanning (100ms/channel) of all frequencies in memory
- Call or write for more details

RC2 for the FX146 •RC6 for the FX50
•RC220 and RC440 coming soon

And only \$110+\$4 shipping and handling.
Va. residents don't forget to add 4.5% sales tax.

MICROTEK
RR 3 Box 4361•Bumpass, Va. 23024
540-872-7020

CIRCLE 345 ON READER SERVICE CARD

Mr. NiCd

YOUR SOURCE FOR

BATTERIES!

- AMATEUR RADIO BATTERY PACKS
- REPLACEMENT RECHARGEABLE INSERTS
- LAPTOP COMPUTER BATTERIES
- DISTRIBUTOR OF SANYO NI-CD CELLS
- CAMCORDER BATTERY PACKS
- CELLULAR PHONE BATTERY PACKS
- SEALED LEAD-ACID BATTERIES
- O.E.M. & CUSTOM ASSEMBLY PACKS

Call or write for our free catalog!

E.H. Yost & Company
7344 Tetiva Rd. - Sauk City, WI 53595
Phone (608) 831-3443 / Fax (608) 831-1082
DEALER INQUIRIES INVITED

CIRCLE 114 ON READER SERVICE CARD

For the Brands you know
AT PRICES YOU CAN LIVE WITH

TOLL FREE **1-800-238-6168**
FAX 901-682-7165



IN TENNESSEE CALL 901-683-9125

WE TRADE FOR GOOD USED GEAR

MEMPHIS AMATEUR ELECTRONICS, INC.
1465 Wells Station Road, Memphis, TN 38108
• VISA • COD OPEN 9-5, MON./FRI.
• MASTERCARD SAT., 9-12

COMTELCO INDUSTRIES

Dual Band Mobile Antenna

140 MHz, 440 MHz

MAGNET MOUNT \$21.95
150 watt 12ft. RG58 + connector

PERMANENT MOUNT \$23.50
with NMO/TAD mount 17ft RG58
BNC or PL259 connector

DBD2 DUPLEXER \$49.00
UHF connectors 8" leads
Add 3.50 S&H

1-800-634-4622
COMTELCO INDUSTRIES, INC.
501 Mitchell Rd., Glendale Hts., IL 60139



CIRCLE 15 ON READER SERVICE CARD

to keep the code test as a barrier to new hams, knowing that the code hasn't been of any real use to the military for almost 50 years. And one look at the technical articles in the ham magazines today would show any engineer that we are years behind today's technology. Is there a term for reverse pioneering?

With Congress looking for every possible area to cut government expenses, what would you say to a congressional committee in support of the FCC's expenses for maintaining our billions of dollars of ham spectrum, the costs of licensing, and monitoring? Would you say, "Look what we did for you 50 years ago"? And if their support staff has done their homework for them, they might point out that ham radio today is little more than a sort of retired white men's federal welfare program.

What do you propose we do about this?

Can RF Cure Cancer?

More of Wayne's baloney? Or could it be true? You're going to want to get a copy of an amazing book on the life of Royal Rife and read about a chap who invented a superpowerful microscope back in the 1920s, one that enabled him to see microbes and viruses smaller than any other microscopes could let people see, yet do it

At least you can read ---- **THE RIFE REPORT**

THE CANCER CURE THAT WORKED!

FIFTY YEARS OF SUPPRESSION

Written by
BARRY LYNES

Special section on the AIDS connection

without killing them.

Electron microscopes provide similar magnifications, but they can only let us view dead material. Rife was able to see filterable microbes and viruses as they lived and multiplied. He discovered while watching them that one particular radio frequency could resonate and blow each type apart. With this tool he was able to build radio generators which were curing cancer and many other illnesses back in the 1930s.

So what happened to this amazing discovery? It was another victim of the American Medical Association's control of the industry, and its power

with the FDA. The story is that the head of the AMA demanded part of the action. When Rife refused, the FDA moved in and destroyed Rife's generators and even his microscopes!

You'll want to read about all this in *The Cancer Cure That Worked!* by Barry Lynes. It's available from Marcus Books, Box 327, Queensville, Ontario, Canada L0G 1R0. If there is enough interest, I'll see if we can stock it in Uncle Wayne's Bookshelf. If there isn't enough interest, that'll be proof to me that your curiosity has truly been killed by our school system.

As you read this 168-page paperback, you'll find that Rife discovered that microbes don't cause illness; they're the result of it. Oh well, our so-called health care system is always treating the symptoms and not the causes of illness, so what's new? And now we're seeing a renewed attack on alternative approaches to health by the FDA in cities all around the country. Please save us from our government bureaucrats.

Of course you can wait until some dread illness strikes you or your family and then wonder if your doctor knows what he is doing as he puts you through chemotherapy or bypass surgery. You aren't going to like the answer if you read much about the alternatives. Could tuning your rig

to one specific frequency blast out cancer cells? Or can AIDS be cured by putting a small voltage across your ankles?

I hope you read enough to know the sorry recent history of stomach ulcers and the fight of one doctor to get the medical industry to recognize that they're caused by a microbe (*H. pylori*). The AMA and the FDA fought him viciously for years. Now they sheepishly admit that, by golly, he was right. The New Yorker had a fine article on this, as they have on several other health matters.

If you've read about anyone else pursuing the Rife approach to getting rid of microbes and viruses, please clue me in.

Cover Photos

We need a good cover photo every month; so keep your eyes peeled for interesting ham subjects. Kids, unusual antennas, action, club activities, unbelievable ham shacks. The 73 cover requires a vertical format, with some uncluttered space on the left to list features, so keep your camera turned sideways. You'll get pretty good shots with 35mm if you use a tripod, but a larger negative is preferred. Your pictures should be very sharp. We pay \$100 or so and you get the by-line. Now let's see what you can do. **73**

Pocket Morse Code Trainer

Learn Code Faster & Easier
Better than code tapes
Take it anywhere to practice
Ideal for beginners to advance



Features: **Only \$29.00**

- Code rates from 3 to 31 wpm
- Plays standard or Farnsworth.
- Dimensions 1" x 3.8" x 2.4"
- Runs 40 hr on one 9v battery

3 Modes of Operation

1. Continuous fresh random code. (selectable letter groups, ie A-Z, 0-9, and more)
2. Random code practice test. (Check your accuracy against the answer key)
3. Interactive training mode

Deluxe Pocket Morse Code Trainer

6 Modes of Operation \$49.00

The deluxe unit has 3 additional modes

4. Continuous newly generated QSO. (New QSO are generated everytime)
5. Practice code exams just like the real code test. (incl. answer key to check accuracy)
6. Continuous random words

Computer Aided Technology Visa&MC, Add \$5 S&H
10132 Monroe Dr., Dallas, Tx 75229 PH 214-350-0888

CIRCLE 276 ON READER SERVICE CARD

MAGGIORE ELECTRONIC LAB.

Hi Pro Repeater

Maggiore Electronic Lab.

Model R1

INTRODUCES THE NEW Hi Pro "R1" REPEATER
HERE IS A COMPLETE LOW COST VHF REPEATER, LESS CONTROLLER, PRICE \$589.00
A 35 WATT VHF REPEATER WITH VOICE, AUTO PATCH, AUTO DIALERS ETC. \$1145.00
THIS IS NOT A KIT BUT A COMPLETE REPEATER WITH A 2 YEAR WARRANTY
AVAILABLE IN BOTH VHF OR UHF. FOR MORE INFORMATION CALL OR WRITE,
MAGGIORE ELECTRONIC LAB., 600 WESTTOWN ROAD, WEST CHESTER, PA., 19382, Ph: 610-436-6051 Fax: 610-436-6268

Amplifiers, ATV Down Converters & Hard to Find Parts

LINEAR AMPLIFIERS

HF Amplifiers

PC board and complete parts list for HF amplifiers described in the Motorola Application Notes and Engineering

Bulletins:

AN779H (20W)
AN779L (20W)
AN 762 (140W)
EB63 (140W)
AR305 (300W)
AN 758 (300W)
AR313 (300W)
EB27A (300W)
EB104 (600W)
AR347 (1000W)

2 Meter Amplifiers (144-148 MHz)

(Kit or Wired and Tested)
35W - Model 335A, \$79.95/\$109.95
75W - Model 875A, \$119.95/\$159.95

440-450 MHz Amplifiers

(SSB-FM-ATV)
100W - Model KEB 67, \$159.95



ATV Down Converters

(Kit or Wired and Tested)

Model ATV-3 (420-450)
(Ga AS - FET)
\$49.95/\$69.95
Model ATV-4 (902-926)
(GaAS - FET)
\$59.95/\$79.95

HARD TO FIND PARTS

- RF Power Transistors
- Broadband HF Transformers
- Chip Caps - Kemet/ATC
- Metalclad Mica Caps - Unelco/Semco
- ARCO/SPRAGUE Trimmer Capacitors

We can get you virtually any RF transistor!
Call us for "strange" hard to find parts!

DIGITAL FREQUENCY READOUT
For older analog transceivers
TK-1 (Wired and Tested)\$149.95

For detailed information and prices, call or write for a our free catalog!

ADDITIONAL ITEMS

Heat Sink Material
Model 99 Heat Sink (6.5" x 12" x 1.6"), \$24.00
CHS-8 Copper Spreader (8" x 6" x 3/8"), \$24.00
Low Pass Filters (up to 300W) for harmonics
Specify 10M, 15M, 20M, 40M, 80M or 160M
HF Splitters and Combiners up to 2KW

Add \$4.50 for shipping and handling

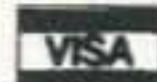

CCI Communication Concepts Inc.

508 Millstone Drive • Beaver Creek, Ohio 45434-5840
Phone:(513) 426-8600 • FAX (513) 429-3811

CIRCLE 99 ON READER SERVICE CARD

SPECIAL EVENTS

Number 21 on your Feedback card

Ham Doings Around the World

SEP 16

GLORIETA, NM The Northern NM ARC will sponsor their annual Hamfest 8:30 AM-3 PM at the Glorieta Conference Center, Patio Building, 16 mi SE of Santa Fe on I-25, exit 299. VE Exams at 10 AM. Talk-in on 146.52. Contact *Helenrose Burke W5IXS, Box 73 HCR, Ojo Sarco NM 87521. Tel. (505) 689-2367.* For hotel/motel room, contact *Glorieta Conference Center, P.O. Box 8, Glorieta NM 87585; Tel. (505) 757-6161.*

GRAND RAPIDS, MI The Grand Rapids ARA will hold its ARRL approved "Super Swap 95" at Unity Christian H.S., 3487 Oak St., Hudsonville MI. Setup at 6 AM; doors open at 8 AM. For ticket info and table reservations, contact *Jeff Belknap N8RWS, 454 Harp St. SE, Kentwood MI 49548, or call (616) 531-7899.*

PHOENIX, AZ Sixteen local amateur radio clubs of Phoenix will sponsor the 3rd annual Family Amateur Radio Event, 9 AM-2 PM at Rawhide Rodeo Pavilion, 23000 N. Scottsdale Rd. (north of Scottsdale). The Entrance is on Williams Rd. Swap Meet. ATV. Packet. Exhibits. Lots of great non-ham activities. Talk-in on 146.76. For info, contact *Len Winkler KB7LPW, (602) 861-0303.* For advance tickets, spaces, write to *FARE, P.O. Box 9219, Phoenix AZ 85068.* Please enclose SASE.

RANDOLPH, VT The Central Vermont ARC's 7th annual Fall Foliage Hamfest/Computer Fair will be held at the Judd Gym., Vermont Tech. College, 9 AM-3 PM. VE Exams at 12:30. Forums. Flea Market. Talk-in on 147.09/.69 and 146.625/.025. Contact *Barry Driscoll N1NPU, RR 1 Box 3165, Barre VT 05641; (802) 479-1408; or Tom Girardi WA1YNU, P.O. Box 261, Waterbury VT 05676; (802) 244-7836.*

SANTA ROSA, CA Sonoma County Radio Amateurs annual Flea Market/Auction will be held at Holy Ghost Hall, 7960 Mill Station Rd., Sebastopol CA. For info/pre-reg., send SASE to *Rick Reiner, 2120 Slater St., Santa Rosa CA 95404. Tel. (707) 575-4455 (exams).*

SEP 16-17

PEORIA, IL The Peoria Area ARC will present "Peoria Superfest '95" at Exposition Gardens. VE Exams on Sun. Contact *Ron Morgan KB9NW, Chairman, Peoria Superfest '95, c/o The Peoria Area ARC, Box 3508, Peoria IL 61612-3508.* Or dial the (309) 685-6698 answering service.

SEP 17

ADRIAN, MI The Adrian MI AARC Hamfest/Computer Show will be held at Lenawee County Fairground, 8 AM-2 PM. Talk-in on 145.37(-). VE Exams, walk-ins accepted. Contact *Greg KZ8X, 4281 Mohawk Trail, Adrian MI 49221. Tel. (517) 263-1153.*

MT. CLEMENS, MI L'Anse Creuse ARC will hold its 23rd annual Swap & Shop, 8 AM-2 PM, at L'Anse Creuse H.S. in Mt. Clemens. VE Exams at 11 AM. Contact *Don Olszewski WA8IZV at*

(810) 294-1567; Prodigy ID#SSTG41a. For info, send SASE to *Mark Castiglione N8REZ, 26279 Fairwood, Chesterfield MI 48051-3031. Tel. (810) 949-2508.* Talk-in on 147.08(+) or 146.52 simplex.

NEWTOWN, CT The Western CT Hamfest will be held at the Edmond Town Hall, RT 6, 9 AM-2 PM. Setup at 7 AM. Exit 10 on I-84. Talk-in on 147.12/.72. Flea Market. New equip. dealers. Computers. Tailgating. Contact *Ken Weith KD1DD, P.O. Box 3441, Danbury CT 06813-3441. Tel. (203) 743-9181.*

PITTSFIELD, MA A Hamfest, sponsored by the Northern Berkshire ARC, will be located at Teconic H.S. on Valentine Rd., 8 AM-2 PM. Setup at 7 AM. Talk-in on 146.91. VE Exams at 9:30 AM. Walk-ins accepted. Flea Market. Contact *Chuck Lowery N2IZ, (413) 447-8377.*

SEP 23

NEWPORT, NH CVFMA "For Sale and Trade Social" will be held at Sugar River SB Community Room, Main St., 35 mi north of Keene NH; RTE 10 and RTE 10 south I-89 exit 13 or RTE 11 west from I-89 exit 12. Setup 12:30 PM. Public 1 PM-4 PM. This event will be held after a test session. Talk-in on 146.760. Contact *Conrad Ekstrom WB1GXM, P.O. Box 1076, Claremont NH 03743. Tel. (603) 543-1389.*

SEP 23-24

VIRGINIA BEACH, VA The Virginia Beach Hamfest and ARRL Virginia State Convention will be held at Virginia Beach Pavilion. Commercial Booths: *Lewis Steingold W4BLO, 1008 Crabbers Cove Ln., Virginia Beach VA 23452; (804) HAM-FEST. Tickets and Tables: Manny Steiner K4DOR, 3512 Olympia Ln., Virginia Beach VA 23452; (804) HAM-FEST.*

SEP 24

COTTLEVILLE, MS The St. Peters ARC Swapfest will be held 7 AM-1 PM at St. Charles County Comm. College Campus, 4601 Mid Rivers Mall Dr., Cottleville MS. VE Exams. Talk-in on 145.41 and 444.275 MHz. Contact *Jay Underdown W00GS, 58 Judy Dr., St. Charles MO 63301. Tel. (314) 723-4200.*

FRAMINGHAM, MA The Framingham ARA will hold its Fall Flea Market and Exams at Framingham H.S., A St. Doors open 9 AM to early bird buyers; 10 AM to all buyers. Setup is 8 AM. Table Reservations: *Lew Nyman K1AZE, (508) 879-7456.* Send check payable to *FARA, P.O. Box 3005, Framingham MA 01701.* To register for Exams, send check for \$5.90, payable to *ARRL/VEC, to Dick Marshall WA1KUG, 37 Lyman Rd., Framingham MA 01701.* Walk-ins not accepted after 10 AM. Talk-in on 147.15/R.

YONKERS, NY Metro 70cm Network will host a Giant Electronic Flea Market, 9 AM-3 PM at Lincoln H.S., Kneeland Ave. VE Exams. To reg., call *Otto Supliski WB2SLQ, (914) 969-1053.* Talk-in on 440.425 PL 156.7; 223.760 PL 67.0;

Listings are free of charge as space permits. Please send us your Special Event two months in advance of the issue you want it to appear in. For example, if you want it to appear in the April issue, we should receive it by January 31. Provide a clear, concise summary of the essential details about your Special Event.

146.910 Hz; or 443.350 PL 156.7. Mail paid reservations to *Metro 70CM Network, 53 Hayward St., Yonkers NY 10704.*

SEP 30

ELMIRA, NY The Elmira ARA will present the 20th annual Internat'l Hamfest at the Chemung County Fairgrounds, 6 AM-5 PM. Flea Market. New Equip. Dealer Displays. Advance tickets: *Dave Lewis, RD1 Box 191, Van Etten NY 14889. Tel. (607) 589-4523.*

OCT 1

LIMA, OH The NW Ohio ARC will hold a Hamfest at Allen County Fairgrounds, State RTE 309. Opens at 8 AM. VE Exams, all classes, with complete FCC Form 610 and a check for \$5.90, made payable to *ARRL/VEC.* Send to *Jon Solomon W8TY, 1370 Stevick Rd., Lima OH 45807.*

QUEENS, NY The Hall of Science ARC Hamfest will be held 9 AM-3 PM, at the NY Hall of Science, 47-01 111 St. Ham Radio/Computer Flea Market. Tune-up Clinic. ARRL info. For more details, call (nights only), *Arnie Schiffman WB2YXB, (718) 343-0172; or Charlie Becker WA2JUU, (516) 694-3955.* Talk-in on 444.200 WB2ZZO/R and 146.52 simplex.

OCT 7

BELTON, TX "Ham Expo '95" will be sponsored by the Temple ARC, starting at 7 AM at Bell County Expo Center at 1 PM. VE Exams. Transmitter Hunt. Talk-in on 146.82. Contact *Temple ARC, 2014 S. 53rd, Temple TX 76504.* Call Mile WA5EQQ, (817) 773-3590; e-mail: 72437.424@compuserve.com or laird@vvm.com.

OCT 8

DURHAM, CT The 1995 Nutmeg Hamfest/Computer Show will be held at the Fairgrounds in Durham CT, 9 AM-3 PM. Setup Sat., Oct. 7th, at 4 PM. VE Exams; contact *Joel Curneal N1JEO, (203) 235-6932.* Sponsors: *Meriden ARC; Middlesex ARS; and Shoreline ARC.* For Hamfest info, call *Bill Wawzeniak W1KKF, (203) 269-8252* eves. General info on packet *KA1NRG.CT.USA.NA.* Vendors contact *Dan Murphy KA1SZP, 162 Tri-Mountain Rd., Durham CT 06422; (203) 349-1304* eves.

SPECIAL EVENT STATIONS

SEP 9-10

ASHEVILLE, NC The Western Carolina ARS, and its club station W4MOE, will hold its annual Special Events Operation from Mt. Pisgah and Blue Ridge Parkway, 1600Z Sat.-1600Z Sun. The event commemorates the 100th Anniversary of the opening of the Biltmore Estate by George Vanderbilt, which included the Mt. Pisgah and Pisgah Nat'l. Forest area. Operations will be on HF, VHF and UHF, with modes including SSB, CW and Packet. For QSL and a special commemorative certificate, send your QSL card and a large manila SASE with two units of postage, to *W4MOE, c/o WCARS, P.O. Box 1488, Asheville NC 28801.* For info, contact

Dan Henderson WA4QQN, Operating Event Coordinator, WCARS, P.O. Box 188, Skyland NC 28776. Tel. (704) 669-4450.

SEP 11-16

ATLANTIC CITY, NJ Southern Counties ARA will operate K2BR from the Miss America Pageant on Absecon Island (IOTA: NA 111). Freq.: Phone - 25 kHz inside lower General class band-edge; CW - 65 kHz inside lower General class bandedge; Novice 28.100 - 28.500 kHz. QSL with #10 SASE via *SCARA, P.O. Box 121, Linwood NJ 08221.* A certificate commemorating the 25th Anniversary of the Station and the 75th Anniversary of the Miss America Pageant will be sent with the Miss America QSL card. Operations will start at 10 AM EST, Sep. 11th.

SEP 17

NEWTOWN, CT The Candlewood ARA will operate W1QI 1300 UTC-1700 UTC to commemorate its 55th year of affiliation with the ARRL. Operations will be on or near 7.280 and 14.280. For a certificate, send QSL and a 9" x 12" SASE to *CARA, P.O. Box 3441, Danbury CT 06813-3441.*

SEP 23

GILFORD, NH The Nashua Area RC will conduct a demonstration of amateur radio at "New Hampshire Jamboree '95" at the Gunstock ski area. Station *WB1FFZ* will be on the air from 1200 UTC-2100 UTC. Freq.: Phone - 3.940, 7.090, 14.290, 18.140, 21.360, 28.350, 24.960, 28.350, and 28.990; CW - 3.590, 7.030, 14.070, 18.080, 21.140, 24.910, 28.190; Packet - 145.09. QSL, with an SASE, via *WB1FFZ.*

SEP 23-24

RALEIGH, NC *WB4ZTF* will operate 1300Z-2400Z, both days, to commemorate the Sons of Confederate Veterans presentation of "Echoes of Dixie," the reenactment of the War Between the States (Battle of Wyse Fork NC). Operation will be on 10 and 20 meters CW around 28.350 and 14.050 MHz. Listen for CQ CSA. For a certificate, send QSL and a 9" x 12" SASE to *Stanley M. Grady WB4ZTF, 2512 Win Rd., Garner NC 27529.*

VIRGINIA BEACH, VA The Virginia DX Century Club will operate *KE4ZYX* from 1400Z-1800Z both days, to commemorate the 20th Anniversary of the Virginia Beach Hamfest. Operation will take place at the hamfest site, on phone and CW, in the General class subbands of at least 20 and 40 meters. For a certificate, send QSL and a 9" x 12" SASE to *N4AIG, 528 Water Oak Rd., Virginia Beach VA 23452.*

OCT 7

PISCATAWAY, NJ The Piscataway ARC will operate *AA2KS* 1300Z-2100Z to commemorate Marconi's first wireless transmission from the Twin Lights at the Navesink Highlands in NJ. Operation will be in the lower portion of the General 80, 40, and 20 meter phone bands. For a certificate, send QSL and a SASE to *PARC, P.O. Box 1233, Piscataway NJ 08854.*

NEW PRODUCTS

Number 22 on your Feedback card

Compiled by Victor Lapuszynski

Par Electronics

Par Electronics has introduced filters to help resolve the increasing problem of intermod interference and desense on 2 meters. Previously, expensive and bulky bandpass filters were used, or else smaller ones that needed to be switched out during transmit because of insertion loss. The VHF DN152 solves the problem by notching out the offenders—paging services located in the 152–153 MHz range. Insertion loss is close to zero, VSWR is less than 1.2:1, and the filter allows for reception of the 120–175 MHz spectrum for those radios so equipped. A smaller model (VHF DN152HT) at lower power has male and female BNC connectors to connect directly to an HT. The VHF DN152Q, which measures 2" x 4" x 3.5", is de-

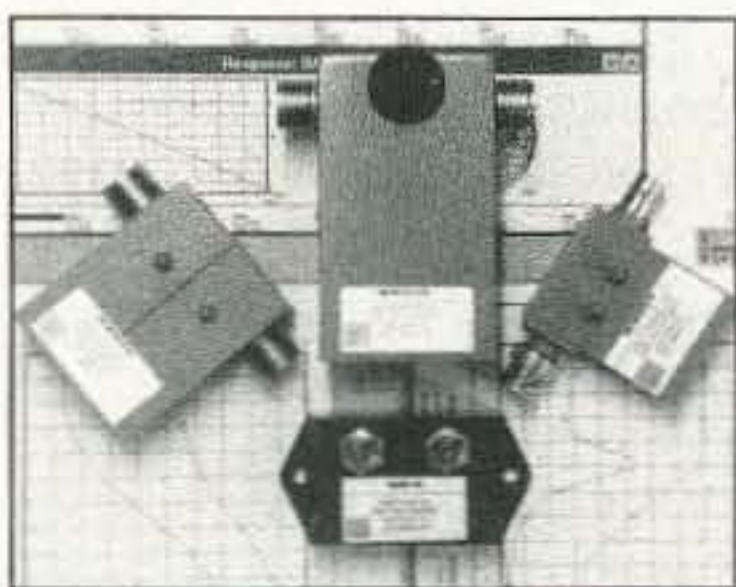

signed for packet and mode B satellite users. This filter permits notching an offending frequency as close as 700 kHz to the desired passband.

Each of the amateur models has a counterpart for VHF scanner enthusiasts. For more information, contact: *Par Electronics, 6869 Bayshore Dr., Lantana, FL 33462; (407) 586-8278, fax: (407) 582-1234.* Or circle Reader Service No. 201.

Fieldpiece

The LT6 is a low-cost DMM that works with all of Fieldpiece's accessories. Service technicians want a multimeter that's inexpensive and has ranges and functions that they can use, without a



clamp, a dual-temperature converter, a microamp head, or a relative humidity head. Furthermore, for low ranges (200 mVAC/mVDC), the LT6 can display an accuracy 10 times that of most other DMMs.

lot of unneeded functions that just get in the way. For \$39.00, this unique meter measures volts (AC/DC), ohms, and amps (AC/DC), indicates continuity by beep, and tests power semiconductors for catastrophic failure. Yet it can further attach accessories such as a 300 A current

Fieldpiece offers products that are small, easy to use, and versatile. For further information, contact: *Fieldpiece Instruments, Inc., 231 E. Imperial Highway, Suite 250, Fullerton, CA 92635; (714) 992-1239, fax: (714) 992-6541.* Or circle Reader Service No. 202.

RF Applications

The P-1500 Digital RF Power/VSWR Indicator is the newest addition to the company's family of digital RF power measurement equipment. The P-1500 features a four-digit numeric and a bargraph-style display. Forward power, VSWR, reflected power, and true power can be displayed. Using a built-in sensor, the P-1500 automatically selects from three ranges (0–120 W, 0–750 W, and 0–1,500 W), so there are no range switches. Frequency coverage is 1.8 to 30 MHz. The P-1500 continuously monitors VSWR, and there are indicators to signal VSWR over 3.0 and less than 1.5 (even



when VSWR is not selected on the display). The P-1500 operates on 12 VDC and measures 4" wide by 3.5" high by 4" deep. The P-1500 lists for \$219.95. *RF Applications, Inc., 9310 Little Mountain Road, Kirtland Hills, OH 44060.* Or circle Reader Service No. 205.

Active Antenna Scrapbook

So what's an "active antenna?" It's one using a preamplifier, generally to make up for a shorter antenna than would work best. But it also helps cut down your noise. Read all about it in a 29-page, self-published booklet by Ken Cornell W2IMB. It has antennas, and circuits for a bunch of easily made preamplifiers. Ken may even get you interested in checking out the very low frequencies using some of his active an-

tennas and regenerative detectors. The book is \$10 postpaid from *Ken Cornell, 225 Baltimore Ave., Point Pleasant Beach NJ 08742 (908-899-1664).* Tell him Wayne sent you.



On the other hand, maybe you aren't curious about stuff like this, in which case find a 5-by 10-cm board about a meter long and start hitting yourself on the head until you wake up. Or circle Reader Service No. 204.

Cushcraft Corporation

Cushcraft has announced the ASL-2010 SkyLog Log Periodic Antenna for hams who would like to have a single antenna covering 13.5 through 32 MHz. Because it uses a single feedline, with included balun, there's no need to switch antennas when changing bands. The antenna is not power limited and can operate easily and continuously at full legal limit. Without any kind of traps, the wind load is reduced significantly (10.1 sq. ft.). Boom is 18'; gain, 6.4 dB; and it has eight elements, the longest of which is 38'. Boom, elements, brackets, and mounting

plates are aluminum; U-bolts and worm clamps are stainless steel.

List price is \$800. For more information, contact: *Cushcraft Corporation, P.O. Box 4680, Manchester, NH 03108; (603) 627-7877, fax: (603) 627-1764, E-mail: sales@cushcraft.com.* Or circle Reader Service No. 203.



Shack Attack

Here's a great way to keep your HTs from getting knocked around. The Handie Station, from Shack Attack, provides a safe way to store your HTs and keeps the antennas handy. The Handie Station is made from alder wood (a medium-dark wood) and has a drop-in slot that is custom cut to your HT specs, with additional drop-ins to hold antennas. The top edges of the Station and drop-ins are routed, so your HT is easy to put in and take out. The bottom of the HT drop-in slot is lined with rubber to cushion your radio, and rubber grips are fastened on the base to prevent slipping. Each Handie Station is personalized with your callsign mounted on the front in large 2" laser-cut letters made from 1/8"-thick birch. Each unit is sealed with two coats of clear polyurethane gloss for a beautiful natural appearance.



There are two models to choose from, each having a small footprint that is easily accommodated by any ham's shack. The dimensions of the one-radio model, "Single Handie Station," are 6" x

3-1/2" x 2", and it holds four antennas. Those of the two-radio model, "Dual Handie Station," are 11-1/2" x 3-1/2" x 2", and it stores up to six antennas.

The Single Handie Station is available from Shack Attack for \$12.95; the Dual Handie Station is \$15.95. Shipping and handling is \$3.50 for each item ordered. Be sure to include the dimensions or footprint and make/model of your HT. Quantity discounts and club fund-raiser programs are available. Call toll-free (800) 573-7388. E-mail: kb7vrd@aol.com. *Shack Attack, 1394 N 770 W, Dept. 73, Orem, UT 84057-5903.* Or circle Reader Service No. 206.

BARTER 'N' BUY

Number 20 on your Feedback card

Turn your old ham and computer gear into cash now. Sure, you can wait for a hamfest to try and dump it, but you know you'll get a far more realistic price if you have it out where 100,000 active ham potential buyers can see it than the few hundred local hams who come by a flea market table. Check your attic, garage, cellar and closet shelves and get cash for your ham and computer gear before it's too old to sell. You know you're not going to use it again, so why leave it for your widow to throw out? That stuff isn't getting any younger!

The 73 Flea Market, Barter 'n' Buy, costs you peanuts (almost)—comes to 35 cents a word for individual (noncommercial) ads and \$1.00 a word for commercial ads. Don't plan on telling a long story. Use abbreviations, cram it in. But be honest. There are plenty of hams who love to fix things, so if it doesn't work, say so.

Make your list, count the words, including your call, address and phone number. Include a check or your credit card number and expiration. If you're placing a commercial ad, include an additional phone number, separate from your ad.

This is a monthly magazine, not a daily newspaper, so figure a couple months before the action starts; then be prepared. If you get too many calls, you priced it low. If you don't get many calls, too high.

So get busy. Blow the dust off, check everything out, make sure it still works right and maybe you can help make a ham newcomer or retired old-timer happy with that rig you're not using now. Or you might get busy on your computer and put together a list of small gear/parts to send to those interested?

Send your ads and payment to the Barter 'n' Buy, 73 Magazine, 70 Rte. 202N, Peterborough NH 03458, and get set for the phone calls.

The deadline for the November 1995 classified ad section is September 11, 1995.

ALL ABOUT CRYSTAL SETS. Theory and construction of crystal set radios. \$9.95 each, ppd USA. Send to: **ALLABOUT BOOKS**, Dept. S, P.O. Box 22366, San Diego CA 92192. BNB200

SUPERFAST MORSE CODE SUPEREASY Subliminal cassette \$12. LEARN MORSE CODE IN 1 HOUR. Amazing supereasy technique \$12, both \$20. Moneyback guarantee. **Free catalog: SASE** Bahr-T1, 150 Greenfield, Bloomingdale, IL 60108 BNB221

WANTED Western electric amplifiers, tubes, speakers & parts. **Free Quote!** 1-800-251-5454. BNB268

COMMODORE 64 REPAIR. Fast turn around. **SOUTHERN TECHNOLOGIES AMATEUR RADIO**, 10715 SW 190th Street #9, Miami FL 33157. (305)238-3327. BNB295

KENWOOD AUTHORIZED REPAIR. Also ICOM, Yaesu. **GROTON ELECTRONICS**, Box 379, Groton MA 01450. (508)448-3322. BNB310

NOW ON 40 METERS! NEW, KNOB-TUNED w/DIGITAL DISPLAY, SYNTHESIZED qrp transceiver. Complete kit only \$199.95. S&H \$7.50 (continental US). **GUARANTEED TO WORK.** For info send SASE: Call/write to order: **S & S ENGINEERING**, 14102 Brown Road, Smithsburg MD 21783; (301)416-0661. BNB334

RCI-2950/2970: New modification manual including Power increase. Clarifier modification. Modulation increase. Operating hints, and more. Parts included. Only \$20.00 ppd in U.S. (Missouri residents add \$1.15 tax). **SCOTT**, P.O. Box 510408, St., Louis MO 63151-0408. (314)846-0252. Money Orders or C.O.D. BNB340

73 MAGAZINES From first issue (Oct.1960 thru Dec.1987) \$175.00. BNB349

Continued on page 82

DOWN EAST MICROWAVE INC. TRANSVERTERS!

- 50 MHz - GaAs FET, High level mixer, 20W, Assem. PCB, Kit.....\$295
- 144 MHz - GaAs FET, High level mixer, 25W, Kit.....\$295, Assem.\$395
- 222 MHz - GaAs FET, High level mixer, 30W, Kit.....\$295, Assem.\$395
- 432/440 MHz - GaAs FET, High level mixer, Dual osc., 30W, Assem.\$425
- 903 MHz<1.0dB NF, 10W,Assem...\$395
- 1296 MHz<1.0dB NF, 3W, Kit\$295
- 2304-3456 MHz - 1.0dB NF, 2 Watts, Assem. only\$450

Options available for all of the above
Write or call for Catalog.
Product descriptions available.

DOWN EAST MICROWAVE INC.

954 Rt. 519
Frenchtown, NJ 08825
TEL. 908-996-3584
FAX 908-996-3702

Say You Saw It In
73 Amateur Radio Today

PAY TV AND SATELLITE DESCRAMBLING
All New Info VOLUME 6 All New Info
Volume 6 —
Our entire collection of all current cable satellite and wireless turn-ons
• Pay TV Volumes 1-5 Satellite and DBS Handbook (includes Hacker info)
• Wireless Cable Hacking • Hacker Video
• Complete Wizard (VCil+) • Cellular Phone Hacking
\$15.95 each or 3/\$34.95 or 5/\$52.95.
Newsletter \$29.95/12 issues. Catalog\$1. All our info \$129.95 (includes sub)
SCRAMBLING NEWS
3494 Delaware Ave., Buffalo, NY 14217-1230
Voice/FAX 716.874.2088 BBS 716.871.1915
CIRCLE 36 ON READER SERVICE CARD

HamCall™ CD-ROM
US & International Callsign Lookup
Over 1,185,000 listings and 113 Countries
Now includes new FCC data format containing:
U.S. clubs, military stations, reciprocal calls, 687,000 U.S. amateurs, and 392,000 International calls.
ICALL DOS & windows programs look up name, address, expiration date, birth date, license class, county, lat/long, area code, time zone, grid square, previous call and class, latest FCC transaction.
Retrieve by any data element including county on PC; call sign on MAC. Hundreds of new shareware programs are on this disc. For a larger software collection see ad below.
• No hard disk required • Print Labels • Export to hard/disk or floppy • TSR runs from text window, now displays county
• Updated every April & Oct • Standing orders accepted • Dealer discount on 25 or more • Latest public domain PC software. Price remains \$50.00 plus shipping; \$5.00 U.S., \$10.00 International.
Newly Updated CD-ROM
Electronics Software Compendium™
The Electronics Software Compendium is a collection of shareware programs and data files that pertain to electronics, broadcasting, amateur radio and SWL activity.
Over 25,000 files in total. The disc is updated and issued annually in April. Over 300 megabytes of PC and 50 MB for MAC. Send for your new edition today! The price is still only \$25.00 plus shipping; \$5.00 U.S., \$10.00 International.
BUCKMASTER
Route 4, Box 1630 - Mineral, VA 23117
540.894-5777 • 800.282-5628
540.894-9141(Fax)
Internet: info@buck.com
Try our call sign server www.buck.com
CIRCLE 56 ON READER SERVICE CARD

All Aluminium
Chassis Kits Rack Shelves
Cabinet Kits Rack Equipment
Assembled Cabinets Antenna Grounding Kits
Slope Box Kits Tower Mounted Box Kits
UHF & VHF Antenna Dipole Hangers
Power Divider Kits Other Enclosures
Small sheets Aluminum and Brass
UHF / VHF Antenna Parts
Byers Chassis Kits
Charles Byers K3IWK
5120 Harmony Grove Road • Dover, PA 17315
Phone 717 - 292-4901
Between 6PM and 9:30PM EST. Eves.
CIRCLE 222 ON READER SERVICE CARD

C.P.I.
Dealers for Kenwood, Yaesu, Icom, Cushcraft, AEA, Kantronics, Bencher, Diamond, Astron, MFJ, Hustler, Ameritron, Larsen, ARRL, and more...
Service is also available.
Get your best price then call us LAST!!
(801) 567-9494 - (800) 942-8873
7946 South State Street
Midvale, UT 84047
CIRCLE 156 ON READER SERVICE CARD

PROPAGATION

Number 24 on your Feedback card

Dennis S. Kopecky WJ2R

Dennis S. Kopecky WJ2R
P.O. Box 875
Rahway, NJ 07065

Amateur Persistence

The first rule of DXing (and all of amateur radio, too) is: Listen, listen, listen.

The next most important rule is: Be there to practice Rule No. 1!

Okay, so we all admit conditions could be better. But along with filling in for your column's conductor once in a while as he takes a much needed vacation, it also gives me great pleasure to do Rule No. 1 as often as time permits. And as many of you as possible should be out there to do Rule 1, as often as your time permits.

Consider the major contest weekends: Even if conditions are not like what we saw in 1989 through 1991 or 1992, we still see phenomenal scores. But why? Because the bands are heavily populated with a large part of the amateur community out there, participating for whatever reason they wish, the chances of making that needed contact are bettered. My point is that even when conditions are not supposed to be good, it may still be possible to work the DX that you might have missed if you hadn't tried. If enough stations worldwide would take this "let's-try-and-see" attitude, conditions might not really be so bad after all. I know that even with these "poor" and "fair" levels in W1XU's forecasts, in the weeks preceding this column I was adding a country or two a week, beyond DXCC!

September promises to be a month of contrasts in the propagation scene. We can expect some fireworks in the early and middle parts of the month, but too much atmospheric noise will make DXing a hobby for the patient and persevering. It may be possible to work some DX in the higher bands during the last third of the month. As always, look for conditions to match what is predicted, one or two days before or after the specified date, and also don't forget your 18-minutes-after schedule with WWV, to get an indication of the current conditions.

10 and 12 Meters

Not expected to be very good, but still should be monitored for trans-equatorial/tropical paths during the daylight hours.

15 and 17 Meters

Similar in overall outlook as 10 and 12 meters, but with better chances to work DX because of the outright popularity of these bands throughout our worldwide community.

20 Meters

This is your workhorse band for worldwide DX during the daylight hours this month, with occasional openings beyond local time sunset, moving from east to west, and long skip north and south.

40 Meters

DX on this band should be available from just before sunset until just after sunrise, which also

means broadcast station interference in the phone portion of the band. Concentrate on the days marked fair or even poor, as conditions on the higher bands (which should still be checked) may make them unusable.

80 and 160 Meters

Expect some fairly good DX and short-skip openings during the hours of darkness, which, as we enter the change of seasons, will be lengthening the time we

will be able to pursue our pastime!

VLF (160-190 kcs)

Anyone with interesting happenings in this portion of the spectrum are invited to contact either Jim or me. We'd like to receive data regarding conditions over a period of time—that is, fair, improving, to very good over a period of days, and vice versa—with signal levels, distances worked, time of day, and so forth (the usual stuff! TNX).

73

EASTERN UNITED STATES TO:

GMT:	00	02	04	06	08	10	12	14	16	18	20	22
ALASKA							20	20				
ARGENTINA								15	15	15	15	15
AUSTRALIA						40	20	20			15	15
CANAL ZONE	20	40	40	40	40		20	15	15	15	15	20
ENGLAND	40	40	40				20	20	20	20		
HAWAII		20			40	40	20	20				15
INDIA							20	20				
JAPAN							20	20				
MEXICO		40	40	40	40		20	15	15	15	15	
PHILIPPINES							20	20				
PUERTO RICO		40	40	40	40		20	15	15	15	15	
SOUTH AFRICA									15	15	15	
U.S.S.R.							20	20				
WEST COAST			80	80	40	40	40	20	20	20		

CENTRAL UNITED STATES TO:

ALASKA	20	20						15				
ARGENTINA										15	15	15
AUSTRALIA	15	20				40	20	20				15
CANAL ZONE	20	20	40	40	40	40			15	15	15	20
ENGLAND		40	40					20	20	20	20	
HAWAII	15	20	20	20	40	40	40					15
INDIA								20	20			
JAPAN								20	20			
MEXICO	20	20	40	40	40	40			15	15	15	20
PHILIPPINES								20	20			
PUERTO RICO	20	20	40	40	40	40			15	15	15	20
SOUTH AFRICA										15	15	20
U.S.S.R.								20	20			

WESTERN UNITED STATES TO:

ALASKA	20	20	20		40	40	40	40				15	
ARGENTINA	15	20		40	40	40						15	15
AUSTRALIA		15	20	20			40	40					
CANAL ZONE			20	20	20	20	20	20					15
ENGLAND										20	20		
HAWAII	15	20	20	40	40	40	40						15
INDIA		20	20										
JAPAN	20	20	20			40	40	40				20	20
MEXICO			20	20	20	20	20						15
PHILIPPINES	15						40		20				
PUERTO RICO			20	20	20	20	20	20					15
SOUTH AFRICA											15	15	
U.S.S.R.									20				
EAST COAST		80	80	40	40	40	40	20	20	20			

1Check next higher band

*Bp-Meters possible on good days only

September should bring some very disturbed conditions blended with excellent fall propagation on the HF bands. Expect an unsettled geomagnetic field on the 1st and 2nd, and an active field from the 5th or 6th through the 10th. We may see the return of significant sunspot activity—and possibly a flare! Earthquakes and volcanic eruptions possible around the 2nd and 11th.

G = Good, F = Fair, P = Poor, * = Disturbed magnetic field coupled with some unusual geophysical conditions (50-75% probability).

SEPTEMBER 1995

SUN	MON	TUE	WED	THU	FRI	SAT
					1 F	2 P
3 P	4 F	5 G	6 G	7 F	8 F	9 G-F
10 F	11 F-G	12 F	13 F	14 P	15 P	16 P
17 F	18 G	19 G	20 G	21 VG	22 G	23 VG
24 G	25 F	26 G	27 G	28 F	29 F-G	30 G

ComDa
RADIO

1-800-382-2562

SALES ONLY



Communications
Data
Corporation

MC • VISA • DISCOVER • C.O.D. Same Day Shipping

YAESU

FT-51R

- 2mtr/440Handheld
- 120 Memories
- DTMF/CTCSS
- Extended RCV
- Remote Control
- Mic available
- Very small



-STOCK-

ICOM

IC-W21AT

- 70 Memories
- DTMF/CTCSS
- VHF/UHF
- Extended RCV
- Multi-Power
- Versatile
- Reliable



-STOCK-

ALINCO

DR-600T

- Dual Band
- 28 Memories
- DTMF/CTCSS
- Detachable Panel



-STOCK-

YAESU

FT-900AT

- Remote Front Panel Design
- All Mode with Tuner
- General Coverage
- State-of-the-art



-STOCK-

ICOM

IC-736

- Deluxe HF XCVR w/6 Mtr
- All Mode with Tuner
- General Coverage
- Top Quality



-STOCK-

STANDARD

C5718DA

- Remote Mike
- 2 Meter/440 FM Xcvr
- Extended RCV
- Packet Plug



-STOCK-

Stocking Dealer For:

- | | | | | |
|-------------------|--------------|-------------|----------------|------------|
| AEA | BENCHER | DAIWA | MFJ | STANDARD |
| ARRL Publications | BENDIX KING | HUSTLER | MIRAGE/KLM | TIMEWAVE |
| ALINCO | CELLWAVE | ICOM | RADIO CALLBOOK | VAN GORDEN |
| AMERITRON | COMETAntenna | ICOM MARINE | RF CONCEPTS | VIBROPLEX |
| ASTRON | CUSHCRAFT | KANTRONICS | SMILEY | YAESU |

CALL FOR CATALOG!

1051 MAIN STREET
ST. JOSEPH, MICHIGAN 49085

Mon.-Fri. 9-6 E.T Sat 9-1 (616) 982-0404

HR2510, RCI2950, CONNEX 3300, COBRA 148, GALAXY SATURN, plus many more kits to increase your modulation, \$19.95. (800)536-0109. BNB350

2m INTERMODFILTER direct from Invenor. Original only in Die-cast alu box. 3-stage HELICAL filter. Auto R/T switching. \$US 79 Mail shipping paid WW,V,MC,AMEX. M.A.S. ENTERPRISES 104 King S. St. JACOBS on NOB 2N0 519-664-2896 Fax 519-664-3082 BNB360

WANTED: Squires-Sanders SS1BS, SS1RS, SS1R, SS1V WEBER, 4845 West 107 Street, OAK Lawn Illinois,60453-5252 BNB381

IT'S BACK! The return of the HW-8 Handbook! Second printing. Modifications for the Heath QRP rigs. First class mail \$11. DX add \$4 for air mail shipping. Mike Bryce, WB8VGE, 2225 Mayflower NW, Massillon OH 44647. BNB404

ASTRON power supply, brand-new w/warranty, RS20M \$95, RS35M \$139, RS50M \$199. Call for other models. 818-286-0118. BNB411

CALL SIGN BADGES plaques & trophies, general engraving S.A.S.E. for price list PETE'S ENGRAVING 722 S. 138 E. Ave. Tulsa OK 74108,(800)899-9674 Ext.2835 Fax/voice BNB417

MAHLON LOOMIS, INVENTOR OF RADIO; by Thomas Appleby, (Copyright 1967). Second printing available from JOHAN K.V. SVANHOLM, N3RF, SVANHOLM RESEARCH LABORATORIES, P.O.Box 81, Washington DC 20044. Please send \$25.00 donation with \$5.00 for S&H BNB420

Butternut Antennas New in box. 1 hf2v \$140 , 1 hf5b \$200. Also 1 prop-pitch rotator \$200 (210)435-6190 BNB435

QRZ! Callsign Database on CD-ROM \$21.95!!! Over 750,000 callsigns, thousands of ham programs, mods, etc. Runs on OS/2, WINDOWS, DOS, and UNIX.To order call 1-800-260-8860, 1-909-517-1100, or fax (24 hrs) 1-909-517-1105. Rom-Dezvous Multimedia, 3811 Schaefer Ave. Suite 1, Chino, CA. 91710. S&H \$5.95. Visa, MC, Disc, Amex, personal checks. BNB440

HAMS—NEED COMPUTER RIBBONS? Lowest prices. Color or black. State your needs. Free info. HARCLY(I), P.O.Box830A, Coquille, OR 97423 BNB457

Secret Powers? Prove to yourself the impossible is real! Amazing and Wonderful Mind Machines You Can Build. Order Today! \$17 post paid. Hither & Yon P.O.Box 215 Chula Vista, CA. 91912 BNB465

CANADIAN QSL's \$1.00 Brings samples. VE7FI 18610-62nd Avenue, Surrey, B.C., V3S 7P1 BNB475

WHY RISK FAILURES With Aerial Supports? Dacron rope, high UV resistant, non-stretch Military Type black DOUBLE (unlike our competitors' single) braided. 1-800-328-4773. BNB557

A NO-RADIAL VERTICAL THAT COVERS 80 OR 75 METERS?

THERE'S ONE NOW!

No, we won't insult your intelligence by telling you that it's a "halfwave" or that ANY vertical will operate more efficiently without a good radial system than with one; it certainly won't! If you want expensive fairy tales talk to our competitors! If, however, you've no room for even the smallest radial system just install the most efficient multiband vertical in the business, the HF9V-X, over our counterpoise kit. You'll not only save a tidy sum but you'll work DX that the shorter and more lossy no-radial "halfwaves" can't touch because both the HF6V-X and HF9V-X use longer active element lengths for higher radiation resistance and greater efficiency on more bands than any of the so-called halfwaves. Ask for our free brochure for complete specs on all Butternut models and receive technical note DLS-1 "Dirty Little Secrets from the Antenna Designer's Notebook") that shows you how to calculate the probable efficiency of any vertical antenna using the manufacturer's own specs so you won't have to learn the truth the hard way!

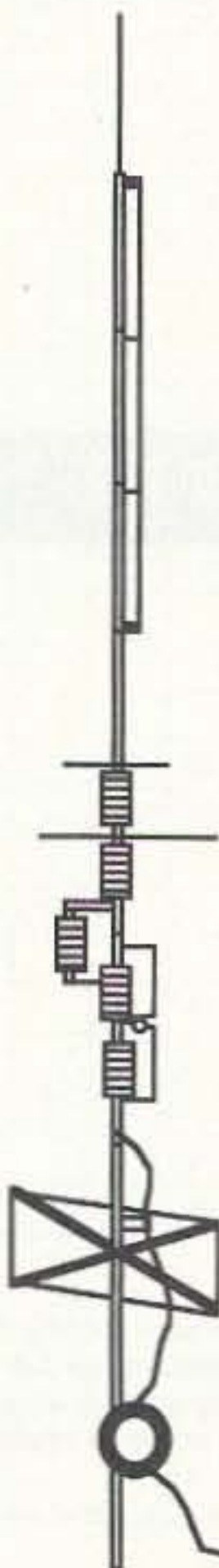

Model HF9V-X (shown to the left) for 80/75, 40, 30, 20, 17, 15, 12, 10 and 6 meters.



Model CPX counterpoise kit for Butternut models HF9V-X, HF6V, and HF6V-X; substitutes for ground or elevated radials. Self-supporting tubing bolts onto base of antenna. Mast not provided.

BUTTERNUT ANTENNAS from BENCHER INC.

831 N. Central Av. • Wood Dale, Il 60191 • 708-238-1183

SATELLITE EQUIPMENT Best \$\$\$ USA.
(800) 851-6534. BNB640

For Sale Computer 286AT, 60MB, 3.1 MS-DOS. Printer, Software, Modem (212-942-6963). BNB695

Surplus electronic test equipment for sale at deep discounts. Write, phone, or fax to request the current list. **Jim Stevenson**, 3401 Sunny Slope Rd, Bridgewater, NJ 08807
Phone: (908)722-6157 Fax: (908)722-6391
BNB705

ELECTRON TUBES: All types and sizes. Transmitting, receiving, microwave . . . Large inventory = same day shipping. **DAILY ELECTRONICS**, 10914 NE 39th ST. Suite B-6, Vancouver, WA 98682. (800)346-6667 or (360)896-8856. BNB719

Ham & Two-Way Radio Repair Prompt service, competitive prices, **Centurion Communications**, 892 N. Delsea Dr., Vineland NJ 08360 (609)794-8000 Fax (609)794-8989
BNB750

HAM RADIO REPAIR—Prompt service. **ROBERT HALL ELECTRONICS**, 1660 McKee Rd., Suite A, San Jose CA 95116. (408)729-8200. BNB751

WANTED: HAM EQUIPMENT AND RELATED ITEMS. Donate your excess gear, new-old-in-any-condition to the Radio Club of Junior High School 22, the nation's only full-time, nonprofit organization working to get ham radio into schools around the country as a teaching tool using our EDUCOM—Education Thru Communication—program. Send your radio to school. Your donated material will be picked up ANYWHERE or shipping arranged, and this means a tax deduction to the full extent of the law for you as we are an IRS 501(c)(3) charity in our 15th year of service. It is always easier to donate and usually more financially rewarding, BUT MOST IMPORTANT your gift will mean a whole new world of educational opportunity for children nationwide. Radios you can write off, kids you can't. Make 1995 the year to help a child and yourself. Write, phone or FAX the WB2JKJ "22 Crew" today: The RC of JHS 22, P.O. Box 1052, New York NY 10002. 24 hours call (516)674-4072 or FAX (516)674-9600. Join us on the **WB2JKJ CLASSROOM NET**, 7.238 MHz 1200-1330 UTC daily and 21.395 MHz from 1400 to 2000 UTC. Meet us at Beachfest 95 on November 11 in Myrtle Beach SC sponsored by the Grand Strand ARC. BNB762

SERIOUS ABOUT SOLAR POWER? The PVSP starter kit comes with a 32 watt Solarex VLX panel and a ten amp Sunlogic charge controller. Special introductory price \$275 plus \$7 shipping. **SUNLIGHT ENERGY SYSTEMS**, 2225 Mayflower NW, Massillon OH 44647. BNB774

Amateur Radio T-Shirts & Sweat Shirts. Electronics Books. Send for catalog Paul Washa 4916 Three Points Blvd. Mound, MN. 55364-1245 BNB805

Hot Summer Savings!



Order direct from our factory or from one of our dealers near you!

Offer Good July 1, 1995 until Sept. 30, 1995 on the following batteries:

BP-3	Icom 8.4v 350ma	\$32.99
BP-83S	Icom 7.2v 800ma	\$34.99
PB-13S	Kenwood 7.2v 1200ma	\$39.99
CNB-153	Standard 7.2v 1100ma	\$44.95
FNB-14	Yaesu 7.2v 1100ma	\$39.99

PLEASE CALL FOR DETAILS ON OUR COMPLETE LINE OF REPLACEMENT BATTERIES

Order Toll Free (800) 634-8132

Dealer inquiries welcome!

PERIPHEx inc.

the only thing low about our charge is the cost...

We also supply: Camcorder Batteries, Cordless Phone Batteries, NiCad Cells, Accessories, Custom Battery Packs, Lithium Cells

Periphex, Inc. 300 Centre Street • Holbrook, MA 02343 • (617) 767-5516 • FAX (617) 767-4599

CIRCLE 68 ON READER SERVICE CARD

Walking-Stick Beam?

Hold it in your hand—it's a walking stick made of aluminum with rubber ends. But inside are all the elements of a 4 element yagi that goes together in 2 minutes. Ready for the T-Hunt. Ready to get your signal out of a hole into the repeater. No little bits to drop and get lost. Everything fits clean and tight and tough. 2meters \$79. 70 cm \$49. Weighs only 1 lb. Add \$6 Shipping & Handling. Info \$1.

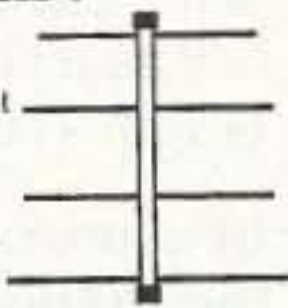

AntennasWest
Box 50062-S Provo UT 84605

Order HotLine
801 373 8425

CIRCLE 324 ON READER SERVICE CARD

DIRECTION FINDERS

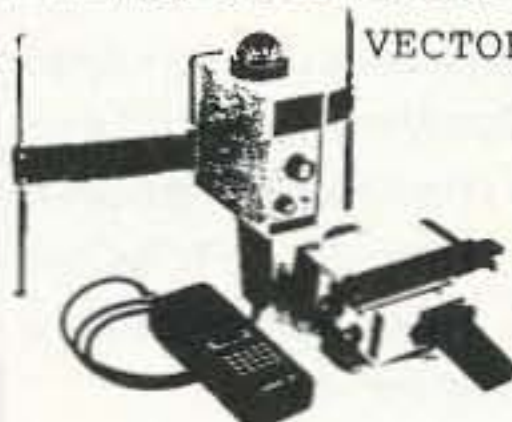

VECTOR-FINDER

HAND-HELD
PHASE SENSE
ANTENNAS FOR
VHF DIRECTION
FINDING. USES
ANY FM RCVR.
ARMS FOLD FOR
STORAGE.

TYPE VF-142 144-220 MHZ \$139.95
TYPE VF-142Q LEFT-RIGHT LEDS &
AUDIO, 144-220 MHZ \$239.95
TYPE VF-142QM SAME AS Q MODEL
EXCEPT FREQ. 144-500 MHZ \$289.95
TYPE VF-121Q SAME AS VF-142Q
PLUS 121.5 MHZ ELT FREQ \$379.95
CALL ABOUT HP DF, ADD \$4.50 S/H
ATTENUATORS CA ADD TAX

RADIO ENGINEERS

7969 ENGINEER RD, #102
SAN DIEGO, CA 92111

619-565-1319 FAX 619-571-5909

CIRCLE 58 ON READER SERVICE CARD

IS YOUR SHACK GROUNDED?

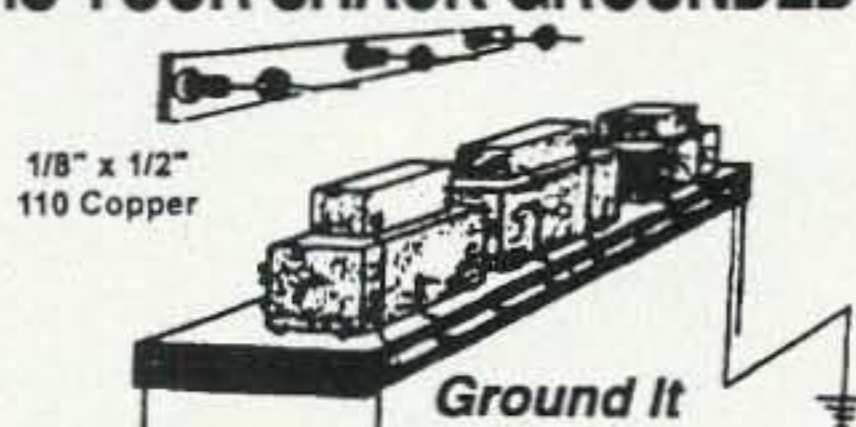

Helps Protect Expensive Equipment and Reduces QRN.

Solid Copper Buss Stainless Steel Hardware Grounding Stud Every 6 Inches

Ground all of your equipment chasis's to a single earth ground in one easy installation.

2 ft. \$11.95 3 ft. \$16.95 4 ft. \$21.95

\$5.00 S&H + \$2.00 each add'l per buss

Custom Lengths Available

Mail check/money order

Flexible Rope Wire Straps w/Term.
Ends All Solid Copper \$2.00 Per Ft.
S & H free w/buss order, \$3.00 without

Money Back Guarantee if not Satisfied

J.M.S.

J. Martin Systems

35 Hilltop Ave. Dept. 7 • Stamford, CT 06907

CIRCLE 26 ON THE READER SERVICE CARD

For High Performance in Repeater Technology, Go with the Leader—

SPECTRUM



S-7R Basic Repeater



- "Stand Alone" or use with your controller

Inquire About Our New Low Cost S-7R Repeaters

- 10-40 Watt Units
- 2M, 222, 440 MHz
- Super Sensitive/Selective Receivers
- Unusually Good Repeat Audio
- Proven Performance throughout the World!

For that new Machine—Spectrum makes 2 lines of Repeaters—the Deluxe SCR1400 and the new basic low cost S-7R line.

The S-7R Repeaters maintain the quality of design, components and construction which have made Spectrum gear famous throughout the world for years.

However, all of the "bells & whistles" have been eliminated—at a large cost savings to you! The S-7R is a real "work-horse" basic machine designed for those who want excellent, super-reliable performance—but no frills! For use as a complete "stand-alone" unit, or with a controller.

Of course, if you do want a Full Featured/Super Deluxe Repeater with Full panel metering and controls, and a complete list of 'built-in' options, then you want our SCR1400—the new successor to the "Industry Standard" SCR1000/4000.

Available with Autopatch/Reverse Patch/Landline Control; TouchTone Control of various repeater functions; 'PL'; "Emergency Pwr./ID; High/Low TX Power; Tone & Timer Units; Sharp RX Filters; Power Amps, etc.

■ Complete Line of VHF/UHF Rcvr. & Xmtr. Link Boards & Assemblies also available. Plus ID, COR, DTMF Control Bds., Antennas, Duplexers, Cabinets, etc. Inquire.



10-150 Watts

SCR1400 REPEATER W/150 WT. 2M Amp & 30A POWER SUPPLY.
(All items available separately)



Shown in optional cabinet.

Call or write today for details and prices! Get your order in A.S.A.P. Sold Factory Direct or through Export Sales Reps. only.

R-390A SALES & SERVICE. Info SASE: MILTRONIX, P.O. Box 80041, Toledo OH 43608. BNB813a

R-390 Power Input Cables \$25 Shipped. (419)255-6220 BNB813b

Morse Code Computer Interfaces \$49.95, CW Filters \$39.95. Free IBM Shareware and Ham Catalog. Dynamic Eletronics, Box 896, Hartselle, AL 35640, (205)773-2758 Fax 773-7295 BNB815

FCC COMMERCIAL LICENSE PREPARATION RADIOTELEPHONE-RADIOTELEGRAPH GMDSS. Latest home study fast easy audio video. Q & A pool disks. FREE details WPT PUBLICATIONS (800)800-7588. BNB840

Sencore Stereo Generator Sencore CB Analyzer Photofacts for car radios, tapedecks and CB radios. Call John (516)321-4402 BNB845

Hi, my name is Steve Tyllisz, N9ODW, I'm 18 and will be attending Purdue, majoring in Electrical Engineering in the fall. I have been an amateur operator for the past four years and I have come up with a few nifty ideas for the hamshack that you can put together very easily and inexpensively. I am trying to sell sets of my ideas in the form of complete plans including pictures and diagrams in the hope to raise some money for college. These plans include: a side arm for your tower, 3/4" hardline connectors, 12 volt power strip, and a repeater interface that allows you to hook two radios together to make a repeater. The price for these is \$4.00 for all four. Please send orders to Steve Tyllisz, 117 Stimpson Ct., Michigan City, IN 46360 Thanks and 73's! BNB850

ELECTRONICS GRAB BAG! 500 pieces of new components: inductors, capacitors, diodes, resistors. \$5.00 postpaid. ALLTRONICS, 2300 Zanker Rd., San Jose CA 95131. BNB855

WANTED: BUY AND SELL All types of Electron Tubes. Call (612)429-9397, Fax (612)429-0292. C & N ELECTRONICS, Harold Bramstedt, 6104 Egg Lake Road, Hugo MN 55038. BNB915

COMMODORE 64 HAM PROGRAMS-8 disk sides over 200 Ham programs \$16.95. 32¢ cent stamp gets unusual software catalog of Utilities, Game and British Disks. HOME-SPUN SOFTWARE, Box 1064-BB, Estero, FL. 33928 BNB917

Capacitor Close-out Retiring HamFest Scene. Must Sell thousands of brand new capacitors. Electrolytic, Disc, Tantalum. All must go! Free Listing. Send SASE to: James Grogan, Box 20809, Raleigh NC 27619. BNB945

RF TRANSISTORS, Japanese transistors and tubes need dealers, repair shops, kit makers, etc. for 2SC1969, 2SC2312, MB8719, MRF455, MRF454, 2SC2879 and more. WESTGATE (800)213-4563. BNB950



SPECTRUM COMMUNICATIONS CORP.

1055 W. Germantown Pk, S4 • Norristown, PA • (610) 631-1710 • FAX: (610) 631-5017

CIRCLE 51 ON READER SERVICE CARD

FREE HAM GOSPEL TRACTS. SASE. N3FTT, 5133 Gramercy, Clifton Heights PA 19018. BNB960

HEATH COMPANY is selling photocopies of most Heathkit manuals. Only authorized source for copyright manuals. **Phone(616)925-5899, 8-4 ET. BNB964**

PRINTED CIRCUIT BOARDS for projects in 73, *Ham Radio*, *QST*, ARRL Handbook. List SASE. **FAR CIRCUITS, 18N640 Field Ct., Dundee IL 60118. BNB966**

AZDEN SERVICE by former factory technician. **SOUTHERN TECHNOLOGIES AMATEUR RADIO INC., 10715 SW 190 St. #9, Miami FL 33157. (305) 238-3327. BNB979**

ROTOR PARTS ROTOR SERVICE, ROTOR accessories: Brak-D-Lays, Quik-Connects, Pre-Set mods. NEW models for sale. Free catalog. C.A.T.S., 7368 State Road 105, Pemberville OH 43450. BNB996

SECRET CB BOOKS 1-29 \$10 ea., SAMS books \$15 ea. Tune up masters books 1-6 \$20 ea., Uniden export service manual \$10, RCI 2950/2970 service manual \$10. Call for free catalog of other goodies. 1-800-536-0109. BNB999

Wanted for Museum: Apple-1 and other pre-1980 microcomputers. Also early microcomputer journals, newsletters and advertising literature. KK4WW, 703-231-6478/763-2321. BNB1001

CODE 5 News and Petition information. SASE to KB7PNQ, 503 Dubois Atreet, Cheney, WA 99004. BNB1012

AMATEUR RADIO REPAIR, most makes and models, discount labor rates until June 1995. WESTERN AMATEUR RADIO REPAIR CO., John Rupe, Box 697, North Cove, WA 98547; (360) 267-4011. Thanks, AB7DR. BNB1015

"CHOICE OF THE DX KINGS"



2 ELEMENT— 3 BAND KIT SPECIAL ONLY \$289.95

FOB BREA CA. (boom & wire not included)

NEW FROM CUBEX . . .
The World's First FIVE BAND (20- 17- 15- 12- 10-M) Beam Antenna with SEPARATE FULL WAVE Driven and Parasitic Elements on EACH BAND!
A full size 2 Element Quad only requires a 10' turning radius
Write for Details.

MK II - 3 BAND COMPLETE "PRE-TUNED" QUAD ONLY \$349.95

CUBEX also provides a complete line of Quad Antenna Parts, including Cast Aluminum Spiders - Fiberglass Spreader Arms - Matching Transformers - Antenna Switches - etc.....
WRITE OR CALL FOR COMPLETE DETAILS

CUBEX COMPANY
2761 Saturn St. Unit E, Brea, CA 92621
714-577-9009, 714-577-9124 fax
YOU CAN'T SAY "QUAD" BETTER THAN "CUBEX"

Display Your Ham License in Style
New! Callsign License Plaque

- Meet FCC Station Requirements Sec 97.3
- Handsome dark wood accents your shack
- Your call sign displayed in large 2" letters
- Great gift idea! Will ship direct
- Satisfaction Guaranteed!

Only \$19.95 - \$3.50 s/h
Call or Write Today!

"My plaque is the centerpiece of my shack."
- K06KU

Shack Attack 1394 N 770 W, Dent, UT 84057, 801 225-3340
800 573-7388 Internet: kb7vrd@aol.com

CIRCLE 92 ON READER SERVICE CARD

T.J. Antenna Company
Antennas for Hams by Hams
Presents the all Band Motorized Remote tuned Mobile Antenna...
The BROADBANDER BB3.

Specifications :

Freq. Range.....1.8 to 54 Mhz
Power Handling.....1500 Watts SSB
Material.....Copper on Copper
Coil-Q @ 3.8Mhz.....256
Coil TPI.....8
Coil Travel.....19"
Coil Travel Time.....< 60 sec.
Coil Contacts.....Beryllium/Copper
Impedance.....6.33 ohms @ 3.8Mhz
Motor.....20 in/oz @ 430 RPM
Weight.....9.5 lbs
Length.....136 inches
Diameter.....2 inches

Call T.J. Antenna Company on our 800 line to find out why we can beat the competition! Find out why we can money back guarantee The STRONGEST MOBILE SIGNAL.

BROADBANDER BB3.....\$265.00
160 METER COIL.....24.95
REMOTE CONTROL UNIT.....34.95

Unconditional 30 day money back guarantee and 1 year on parts and materials. We accept Mastercard, VISA, COD, and Checks.

T.J. Antenna Company
1055 North 1st Place 3E
Hermiston, Or. 97838
1-800-443-0966 • 503-567-7885
Tom/KA7W John/KG7GD
Prices and Specifications subject to change without notice.

COMMODORE® USERS

ART-1 ART-1: A complete interface system for send and receive on CW, RTTY (Baudot & ASCII) and AMTOR, for use with the Commodore 64/128 computer. Operating program on disk included. ~~\$199.00~~ **NOW \$169.95**

AIR-1 AIR-1: A complete interface system for send and receive on CW, RTTY (Baudot & ASCII) and AMTOR, for use with Commodore VIC-20. Operating program in ROM. **\$99.95**

SWL SWL: A receive only cartridge for CW, RTTY (Baudot & ASCII) for use with Commodore 64/128 Operating program in ROM. ~~\$89.95~~ **NOW \$49.95**

AIRDISK AIRDISK: An AIR-1 type operating program for use with your interface hardware. Both VIC-20 and C64/128 programs on one disk. **\$39.95**
AIR-ROM: Cartridge version for C64/128 only. **\$59.95**

MORSE COACH MORSE COACH: A complete teaching and testing program for learning the Morse code in a cartridge. For C64 or C128 — **\$49.95**
VEC SPECIAL — **\$39.95**

G AND G ELECTRONICS OF MARYLAND
8524 DAKOTA DRIVE • GAITHERSBURG, MD 20877
(301) 258-7373

CIRCLE 169 ON READER SERVICE

DSP II Filter



What is DSP? DSP allows the "construction" of various filters of great complexity by using computer code. This allows us to have easy access to a variety of filters, each perfectly optimized for whatever mode we are operating. The DSP II has been designed to operate in 10 different modes. Four filters are optimized for reducing interference to SSB phone signals from CW, heterodynes and random noise interference. Four more filters operate as "brick-wall" CW bandpass filters. The remaining two filters are designed for reliable recovery of RTTY and HF packet radio information signals. A single front panel switch selects any of these filters. Easy hookup to rigs speaker jack.

The W9GR DSP II is the most popular DSP on the market — Thousands in use worldwide!

W9GR DSP Filter\$299.95
12V DC Power Supply\$11.95

Personal Autopatch



Make and receive phone calls from your mobile rig or handie-talkie with your own personal autopatch. Connection is easy — just hook-up to the mike and speaker jacks on your base station rig and plug into the phone line! Complete control is assured through touch-tone access codes that you set and change at will. Long distance toll access is controlled by special code that you set, preventing fraudulent usage. All programmable codes and set-ups are stored in special non-volatile memory immune to power failures. Repeater owners use the SDP-600 as well for reliable and solid repeater autopatches. Power required is 12 volts DC at 100 MA. Experience the freedom of owning your own autopatch, on your own frequency, to use when and as you wish. The SDP-600 is made in the USA and carries a one year warranty.

SDP-600 Personal Autopatch, fully wired.....\$249.95
SDPA 12 volt powersupply unit.....\$11.95

j-Com Transceiver Control Computer Interface



\$54.95

The j-Com Transceiver Control Computer Interface is functionally identical to the **Kenwood IF-232C, Icom CT-17, Yaesu FIF-232C, Ten-Tec 305 and Heath** computer interfaces. It will work with all radios and rig control software which use these interfaces.

- No external power supply is necessary. The j-Com TC interfaces require very little power for operation. This power is obtained directly from the computer COMM port.
- All electronics are enclosed in the shielded DB-25 connector hood. RFI susceptibility and radiation is reduced.
- Fully assembled and tested.
- Fully Hardware and Software Compatible. Works with all rig controlled software — Free shareware disk included!

RAMSEY ELECTRONICS, INC
793 CANNING PARKWAY VICTOR NY 14564

AMERICAN EXPRESS VISA
MasterCard Discover

ORDERS CALL 1-800-446-2295
ORDERS ONLY

TECH/ORDER/INFO (716)924-4560 FAX (716)924-4555

TERMS: Satisfaction guaranteed. Examine for 10 days. If not pleased return in original form for refund. Add \$4.95 for shipping, handling and insurance. For foreign orders add 20% for surface mail. COD (U.S. only) add \$5.00. Orders under \$20 add \$3.00 NY residents add 7% sales tax. 90-day parts warranty on kit parts. 1-year parts & labor warranty on wired units.

j-COM • 793 CANNING PKWY • VICTOR, NY 14564

CIRCLE 55 ON READER SERVICE CARD

Uncle Wayne's Bookshelf

REFERENCE

RS-1 The Amateur Radio Mail Order Catalog and Resource Directory, 4th Edition is the most comprehensive source book for electronic parts, software, and equipment targeted at the radio amateur or serious electronic hobbyist anywhere! Plus a wealth of "value-added" reference material all in 262 pages. 4th Edition clearance at only **\$8.95**. (was \$16.00)

TAB2701 Transmitter Hunting by Joseph Moell and Thomas Curlee Radio direction finding simplified. **\$19.95**

UE202 RTTY Today by Dave Ingram Modern guide to amateur radioteletype. **\$8.95**

TP002 The World Ham Net Directory by Mike Witkowski New—2nd edition. Introduces the special interest ham radio networks and shows you when and where you can tune them in. **\$9.50**

WGP87158 1995 North American Callbook The 1995 North American Callbook lists the calls, names, and address information for 500,000+ licensed radio amateurs in all countries of North America. **\$35.00**

MMH24 Radio Handbook, 23rd Ed. by William L. Orr W6SAI 840 pages of everything you wanted to know about radio communication. **\$39.95**

WGP1234 1995 International Callbook The new 1995 International Callbook lists 500,000+ licensed radio amateurs in the countries outside North America. It covers South America, Europe, Africa, Asia, and the Pacific area (exclusive of Hawaii and the U.S. possessions). **\$35.00**

AR4092 Your RTTY/AMTOR Companion invites you to explore the world of HF digital

communications. If you've never operated RTTY or AMTOR before, this book is written especially for you! You won't find complicated technical jargon here. Just information you can use right away. You'll discover how to... Assemble your own RTTY/AMTOR station... Use RTTY and AMTOR to talk to amateurs throughout the world... Compete in RTTY/AMTOR contests... Hunt for digital DX. **\$8.00**

AR3754 Radio Frequency Interference—How to find it and fix it. Interference problems are challenging, but curable. With the techniques in this book, you can help restore electronic peace in your neighborhood. **\$15.00**

DOV41 Basic Electronics Prepared by the Bureau of Naval Personnel Covers the important aspects of applied electronics and electronics communications. **\$12.95**

DOV76 Second Level Basic Electronics Prepared by the Bureau of Naval Personnel Sequel to Basic Electronics, thorough treatment of the more advanced levels of applied electronics. **\$9.95**

20N096 How To Read Schematics (4th Ed.) by Donald E. Herrington Written for the beginner in electronics, but it also contains information valuable to the hobbyist and engineering technician. **\$19.95**

WLSWOC Radio Operator's World Atlas by Walt Stinson, W0CP This is a compact (5x7), detailed, and comprehensive world atlas designed to be a constant desk top companion for radio operators. **\$17.95**

GEI3579 Final Quantum Revelations Dr. Kiril Chukanov uses not only science but revelation to answer difficult and profound questions about physical reality and cosmic destiny. **\$34.95**

TEC7787 Exploring the Physics of the Unknown Universe by Milo Wolff Packed with intriguing discussions like, What is the origin of the laws of physics? and What is the nature of space? A simple and readable book on how mathematics describes the physical universe and what paradoxes and enigmas remain for an enterprising mind to solve, with speculations on the nature of subatomic particles as standing interference patterns of spherical waves. **\$39.00**

TAB37109 Secrets of RF Circuit Design by Joseph J. Carr Written in clear non-technical language, covers everything from antennas to transistors. **\$21.95**

TAB11065-1 Mastering Radio Frequency Circuits by Joe Carr, 411 p. If you're interested in learning about radio components and circuits, this book is great! Plus there are a ton of simple circuits you can build. It explains

WAYNE'S PICKS

WG2 The Million Dollar Video Explains how just about any company can increase sales by over a million dollars through the sneaky (aka intelligent) use of promotion. Explains in detail how you can get tons of free advertising. Uncle Wayne shows you how to beat the system. **\$39.95**

"SEEK YOU" by The Ham Band—The titles include "Always on the air", "On the Monday Evening Grayline", "Radio Widow", "The Trip to Dayton", "The Contest" and seven more. Ham radio CD includes experiences that radio hams go through. This is an extremely entertaining CD and will strike a chord with any radio ham. SWL or XYL—an ideal present! **SYCD \$15 SYTAPE \$10.**

IB8657 Dumbing Us Down: The Hidden Curriculum Of Compulsory Schooling. by John Gatto If you enjoyed "Declare War", you'll enjoy this also. A Wayne Green recommended reading. **\$9.95.**

WG1H LEARN THE CODE There are two ways to learn the code. (1) the easy way, (2) everyone else's way. Your choice. There are two speeds of code you need to know — one (5 wpm) you can learn in less than an hour, the other (20 wpm) takes longer, but nowhere near as long as you probably think. Sure, you can also learn it at 13 wpm, if you want, but that just wastes your time.

Learning to copy code is just like learning to type or play the piano, if you have to stop and think, you can't do it. It has to be made automatic, so if you go the usual code training route of starting slow and speeding up you are screwing up. That brings you to that dreaded plateau at about 10 wpm, where you've reached the brain's clock speed. Then you have to start all over from scratch and do it the way you should have in the first place. With Uncle Wayne's tape you start right out at 20 wpm and train your hand to write what your ears hear.

Uncle Wayne gives you a choice on the 5

how circuits work, about test equipment, receivers, the works. This will take a lot of the mystery out of how radios work... the easy way. This will be one of your better \$20 ham investments. **\$20.00**

DP919 73 Magazine Index 1960-1990 A complete index to every article published in 73 Magazine through 1990. IBM software **\$20.00**



wpm code test. You can either buy the El Zippo one hour method of passing the test, which is enormously over-priced at \$5 (order 73-EZ), or you can buy two tapes... one, The Genesis, takes about an hour to teach you the code characters (\$5.95 — 73T05) and the other, The Stickler (\$5.95 — 73T06) gives you an hour of fiendishly difficult practice at 6 wpm. Then there's the 13 wpm Back Breaker (\$5.95 — 73T13), in case you for some masochistic reason want to bother learning the code at 13 per. And the ever popular Courageous 20 wpm tape (\$5.95 — 73T20). If you find you've become a code fanatic, there's the 25 wpm Mind Boggler (\$5.95 — 73T25) which will serve you right.

Until wiser herds... er, heads... are able to dump the code requirement from the ham exams, the El Zippo and Courageous are the least frustrating route to ham nirvana. And by the way, anyone can learn the code if they go about it Uncle Wayne's way.

NEW BOOKS

AR4920 Introduction to Radio Frequency Design In this practical book, the author emphasizes use of models and their application to both linear and nonlinear circuits, reviews traditional material stressing the viewpoints taken by the RF designer and illustrates subject material by numerical examples. Includes 3 1/2 inch disk for IBM PC or compatibles. **\$30.00**

R&D57450 Raptures of the Deep by Fred Jueneman What we understand in science today, and the challenges facing scientists in just about every field. An incredible job of research on how and why scientists believe what they do about our world and how it works. **\$29.95**

SHORTWAVE

NBPAW94P 1995 Passport to World Band Radio by International Broadcasting Services, Ltd You'll get the latest station and time grids. **\$19.95**

07R25 The RTTY Listener by Fred Osterman New and expanded. This specialized book compiles issues 1 through 25 of the *RTTY Listener Newsletter*. Contains up-to-date, hard-to-find information on advanced RTTY and FAX monitoring techniques and frequencies. **\$19.95**

09S42 The Scanner Listener's Handbook by Edward Soome N2BFF Get the most out of your scanner radio. **\$14.95**

CRBSM1 Scanner Modification Handbook, Vol. 1 by Bill Creek provides straightforward step-by-step instructions for expanding the operating capabilities of VHF scanners. **\$17.95**

CRBSM2 Scanner Modification Handbook Vol. 2 by Bill Creek Here it is—a companion to Vol. 1. In fact, Vol. 2 has a section that provides improved approaches and updated techniques for the mods in Vol. 1. There's 18 new exciting modifications for popular scanners. **\$17.95**

TAB 339643 Tuning In To RF Scanning From Police to Satellite Bands. Bob Kay, 150p

1994, Tab Books. This is a wonderful book for the VHF-UHF scanner listener. It explains about the various radio bands, antennas, the laws, and lists frequencies for every imaginable service... including the Secret Service, FBI, military, IRS, prisons, Fish & Wildlife, McDonald's order windows, nuclear search teams, railroads, Russian satellites, Treasury Dept., wireless microphones for concerts, and so on. **\$14.95.**

07A66 Aeronautical Communications Handbook by Robert E. Evans Exhaustive, scholarly treatment of shortwave aeronautical listening. **\$19.95**

AR4025 Beyond Line of Sight. Shows how hams pushed forward the discovery of the propagation modes that make VHF DX possible: tropo, sporadic-E, aurora and auroral-E, meteor scatter, F-Layer propagation, transequatorial propagation and earth-moon-earth. **\$12.00**

TAB 447748 The Shortwave Listener's Q&A Book—Everything you need to know to enjoy Shortwave Listening. Choosing receivers, accessories, antennas, frequencies, and getting QSLs. SWL is an exciting hobby... that's what got me interested in hamming... Wayne. **\$12.95**

SOFTWARE

GGTE Morse Tutor From beginner to Extra Class. Code from 1 to over 100 words per minute. Standard or Farnsworth mode. Create your own drills. Exams conform to FCC requirements. 5 1/4" floppy for IBM PC, XT, AT, PS/2 or compatibles.

GG52/5 Morse Tutor 5.25" Disk **\$19.50**
GG31/2 Morse Tutor 3.5" Disk **\$19.50**
GGADV5 Gold Edition 5.25" Disk **\$29.95**
GGADV3 Gold Edition 3.5" Disk **\$29.95**

W5GWHO Ham Operator Education Package Software. Novice—Extra for PC's, contains both 3 1/2" and 5 1/4" disks. **\$39.95**

W5GWNSW No-Code Ham Radio Software Package for PC's, contains both 3 1/2" and 5 1/4" disks. **\$29.95**

LANZE Code Programs—(Available on 5 1/4" * disk.) Inexpensive complete study guide code programs for both the C64/128 Commodores and the IBM compati-

bles. Programs include updated FCC questions, formulas, schematic symbols, diagrams, and simulated (VE) sample test.

	IBM Part#	Commodore Part#	Price
Novice	LZIBM01	LZCOM01	\$14.95
Tech	LZIBM02	N/A	\$14.95
General	LZIBM03		\$14.95
Advance	LZIBM04	N/A	\$19.95
Extra	LZIBM05	LZCOM05	\$19.95

* Add \$2.00 for 3 1/2" Disk

VIS Study Cards Compact, up-to-date Flash Cards with Key Words, Underlined, Quiz on back. Formulas worked out. Schematics at your fingertips. Used SUCCESSFULLY by ages 6 to 81!

NOVICE	VIS01	\$11.95
TECH	VIS02	10.95
GENERAL	VIS03	9.95
ADVANCED	VIS04	15.95
EXTRA	VIS05	14.45

LAST CHANCE ITEMS

ONLY A FEW LEFT

SAM22488 IC User's Casebook A "must" for any hobbyist's workshop, covers ideal operation amplifiers, inverting and noninverting followers, linear amplifiers, active filters, digital circuits and waveform generators and timers. **\$12.95**

SAM48441 178 IC Designs & Applications A comprehensive collection of linear developments for electronic design and basic applications. **\$12.95**

ARRL BOOKS

AR1995 **ARRL 1995 Handbook (71st Ed.)** Features: added DSP, improved treatment of Pi and Pi-L, all new all-digital logic, plus lots more. \$30.00

AR1086-4 **ARRL Operating Manual (4th Ed.)** Information on how to make the best use of your station, including: interfacing home computers, OSCAR, VHF-UHF. \$18.00

AR3657 **QRP Notebook** by Dave DeMaw W1FB Presents construction projects for the QRP operator. \$10.00

AR3207 **W1FB's Design Notebook** by Dave DeMaw W1FB Filled with simple practical projects that can be built using readily available components and common hand tools. \$10.00

AR0402 **Solid State Design** Good, basic information, circuit designs and applications; descriptions of receivers, transmitters, power supplies, and test equipment. \$15.00

AR4173 **Now You're Talking! All You Need To Get Your First Ham Radio License (2nd Edition)** A complete study guide for the Technician and Novice written exam. Practical information every beginner needs is written clearly and simply and in small doses. \$19.00

AR4971 **ARRL Repeater Directory 1995-1996** 19,000+ listings with digipeaters, bandplans, CTCSS (PL/TM) tone chart, frequency coordinators, ARRL special service clubs, and beacon listings from 14 MHz to 24 GHz. \$7.00

AR3398 **The DXCC Companion** by Jim Kearman

KRIS Spells out in simple, straightforward terms what you need to be a successful DXer. \$8.00

AR1250 **Log Book—Spiral** \$3.50

AR3177 **The ARRL Spread Spectrum Source Book.** From a deceptively simple beginning, a group of experimenters set out to develop first theoretical and later practical systems for spread spectrum communications. This book consists of articles, papers and government reports that document the process whereby amateur spread spectrum progressed from the drawing board to the airwaves. \$20.00

AR2960 **Transmission Line Transformers (2nd Ed.)** by Dr. Jerry Sevick W2FMI Practical designs and specific information on construction techniques and sources of material. \$20.00

AR3851 **Hints and Kinks** Ideas for setting up your gear for comfortable, efficient operation. \$10.00

ARRL License Manuals Complete FCC question pools with answers.

AR4181 **Technician Class** \$ 6.00
AR4688 **General Class** \$12.00
AR3274 **Advanced Class** \$ 8.00
AR3282 **Extra Class** \$ 8.00

AR3185 **The Satellite Experimenter's Handbook, (2nd Ed.)** by Martin Davidoff K2UBC Expanded and revised. Focusing on satellites built by and for the international radio amateur community. \$20.00

AR2030 **Your Gateway to Packet Radio (2nd Ed.)** Tells everything you need to know about this popular new mode. \$12.00

ANTENNAS

AR4114 **Low Profile Amateur Radio** For the Ham who lives where antennas are frowned upon. From hiding your antenna to operating with low power. This book tells you how to get on the air using these techniques, and others, without calling attention to yourself. \$8.00

UE220 **The Easy Wire Antenna Handbook** by Dave Ingram K4TJW. All of the needed dimensions for a full range of easy to build and erect "sky wires." \$9.95

WGP87034 **All About Cubical Quad Antennas** by William Orr and Stuart Cowan "The Classic" on Quad design, theory, construction, operation. New feed and matching systems. New data. \$11.95

TAB 3270P **Practical Antenna Handbook—Second Edition, 1994,** Joseph Carr, Tab Books. This 560-page book is a real treasure. Starts with the fundamentals of antenna and feedline theory, explains about propagation of all kinds, and then provides a ton of easy antenna construction projects. Covers antennas and feeders for all bands. The explanations are simple and well illustrated, with some math, where it's unavoidable, but it won't bog you down. It even has the ZL-Special antenna, which I've used on 20m with some spectacular DX-ing success. A low angle of radiation and made it so I could always work the rare stuff first... Wayne. \$26.95.

AR4734 **ARRL Antenna Book** The new 16th Edition represents the best and most highly regarded information on antenna fundamentals, transmission lines, design, and construction of wire antennas. \$30.00

AR0194 **Antenna Compendium Vol. 1** Materials on verticals, quads, loops, yagis, reduced size antennas, baluns, Smith Charts, antenna polarization. \$10.00

AR2545 **Antenna Compendium Vol. 2** Covers verticals, yagis, quads, multiband and broadband systems, antenna selection. \$12.00

AR2626 **Companion Software for Antenna Compendium Vol. 2** 5 1/4" MS-DOS floppy. \$10.00

AR4017 **Antenna Compendium Vol. 3** More verticals, yagis, quads, plus loops, arrays, mobile, direction finding, controlled currents, computerized.

installation, overloads, plus 40 new articles for beginner's to advanced. \$14.00

AR4661 **Antennas and Techniques for Low-Band DXing** can be your ticket to low-band success. Drawing on the experiences of successful DXers and the author's own considerable experience, John Devoldere, ON4UN, shares the tips and techniques that can make the difference between a station that takes part in a contest and one that wins it! \$20.00

AR3819 **Physical Design of Yagi Antennas** by David B. Leeson W6QHS provides the tools here to design and build robust Yagi antennas, using sound mechanical engineering principles. You need no longer fear the consequences of wind or ice storms on your antennas. With this information, you can build or "beef up" existing Yagis. \$20.00

AR2618 **W1FB's Antenna Notebook** by Dave DeMaw W1FB Get the best performance out of unobtrusive wire antennas and verticals. Build tuners and SWR bridges. \$10.00

WGP87107 **All About Vertical Antennas** by William Orr Comprehensive coverage of amateur communications. \$11.95

WGP87042 **Beam Antenna Handbook** by William Orr and Stuart Cowan Everything you need to know about beam design, construction, and operation. \$11.95

WGP87077 **Simple, Low-Cost Wire Antennas For Radio Amateurs** by William Orr and Stuart Cowan All New! Low-cost, multi-band antennas; inexpensive beams, "Invisible" antennas for hams in "tough" locations! New data. \$11.95

AR2200 **Antenna Impedance Matching** by Wilfred N. Caron Most comprehensive book written on using Smith Charts in solving impedance matching problems. \$20.00

AR0410 **Yagi Antenna Design** A Ham Radio series polished and expanded by Dr. Lawson. \$15.00

AR2995 **Reflections** will help dispel the half-truths and outright myths that many believe are true about transmission lines, standing waves, antenna matching reflected power and antenna tuners. \$20.00

AR3118 **Reflections—Software for IBM 5-1/4"** \$10.00

packet newcomer. \$8.00

AR3878 **Your VHF Companion** Explore the fascinating activities on the VHF bands, FM and repeaters, packet, CW & SSB, Satellites, ATV, transmitter hunting and more. \$8.00

03R02 **RTTY Today** by Dave Ingram K4TJW Most comprehensive RTTY guide ever published. \$8.50

UHF/VHF/PACKET

ARTSCI **U.S. Repeater Mapbook** by Robert Martin The Guide for traveling radio amateurs. \$9.95

TP001 **The Basic Guide to VHF/UHF Ham Radio** by Edward M. Noll Provides a first rate introduction to the 2.6 and 1.25 meter bands as well as 23, 33, and 70cm. \$6.95

AR3959 **Your Packet Companion** Perfect for the

BOOKS FOR BEGINNERS

TAB4354 **The Beginner's Handbook of Amateur Radio, Third Edition** by Clay Laster W5ZPV. 395 pages. Wonderful book for newcomers. It is basic and well illustrated. Even if you have all the other ham handbooks, you'll still find this one useful. \$22.00

W5GWNV **No-Code Video, Manual, Part 97 Rules** Learn how to be a ham radio operator. \$29.95

W5GWNC **Technician Class License Manual: New No-Code** by Gordon West This book

covers everything you need to become a Technician Class Ham. Every question and answer on the examinations is found in this one book. FCC Form 610 application. \$9.95

XTAL-1 **The Crystal Set Handbook** by Phil Anderson W0XI. Want to give a kid an exciting present? Or maybe yourself? Crystal sets are alive and fun. Here's a whole book packed with crystal set circuits that anyone can build. Now start saving those oatmeal boxes, okay? 133 pages \$10.95

AR4645 **Satellite Anthology** The latest information on OSCARs 9 through 13 as well as the RS satellites, the use of digital modes, tracking antennas, RUDAK, microcomputer, and more! \$10.00

AR4483 **Weather Satellite Handbook (4th Ed.)** by Dr. Ralph Taggart W8DQT Expanded and revised to reflect today's weather-fax satellite technology. \$20.00

AR4653 **Companion Software for Weather Satellite Handbook** 5 1/4" MS-DOS Floppy. \$10.00

AR2083 **Complete DX'er (2nd Ed.)** by Bob Locker W9K1 Learn how to hunt DX and obtain hard-to-get QSL cards. \$12.00

AR3762 **Your QRP Operating Companion** No special rigs or expensive equipment to enjoy the excitement and challenge of low-power operating. \$6.00

AR3169 **QRP Classics** Compilation of ARRL publications on building receivers, transmitters, transceivers, accessories. \$12.00

AR4270 **FCC Rule Book** A must for every active radio amateur. \$9.00

AR0356 **Morse Code: The Essential Language** by L. Peter Carron, Jr. W3DKV Expanded and revised in its 2nd edition. How to handle distress calls heard not only on the hambands but on maritime and aircraft frequencies. \$6.00

AR3983 **Understanding Basic Electronics** An ARRL book. 314 big pages. This explains everything very simply: the math, DC, AC, transistors, even tubes (wow!). Dirt cheap at \$17. Isn't it about time you understood the fundamentals? \$17.00

WAYNE WRITES

WG1 **We The People Declare War On Our Lousy Government—360p** soft cover. This is Wayne's report explaining what the major problems are facing both New Hampshire and the country, and proposing simple, inexpensive solutions: a simple way to have government departments happily cut their expenses by 50% within three years; how to cut the cost of incarcerating prisoners by over 90%; how to end welfare; how to reduce the deficit; how to cut medical costs and improve health care; how to cut school costs and improve schools. An absolute steal at \$13.

WG4 **20/20 Foresight—20p** 16p updates on the **Declare War** book—320p. Further proposals for solving critical American problems, such as a new approach to financing small businesses, how to finance Russia and other countries and make a profit doing it, the real dope on bioelectromagnetics, a new kind of polytechnical university, a new electronics technology, why Africa is in such a mess, why Perot bombed, how to have tuition-free universities, a plan for making Congress turn honest, etc. Plenty more. Ridiculously priced at \$10.

WG5 **Submarine Life in WWII—60p.** Wayne's story of his adventures on the USS Drum SS-228 on five war patrols in the Pacific in 1943-45. What's it really like on a submarine when you're being depth charged? And what's the day-to-day life on a submarine like? Did you see the movie *Das Boot*? Exciting stuff and only \$7.50.

WG6 **Uncle Wayne's Caribbean Adventures—96p.** Wayne's adventures scuba diving all around the Caribbean, visiting ham operators, and sightseeing. If you're interested in how to travel economically, you'll get some great ideas from this. He starts out with his "Diving, the Wimp Sport." You'll love the visits to 11 islands in 21 days trip. A measly \$7.50.

WG7 **Uncle Wayne's Travels—52p.** Wayne travels to Russia, London, Aspen, St. Pierre, Munich, Vienna, Krakow, and Prague without it costing nearly as much as you might think. Cheap for you too, at \$5.00.

WG9 **Wayne Talks: 'Dayton' 1995-90** minute tape—What he would have said if he'd been asked to speak. \$5.00

CODE TAPES

73T05 **"Genesis" \$5.95 5 wpm**—This beginning tape, takes you through the 26 letters, 10 numbers, and necessary punctuation, complete with practice every step of the way.

73T06 **"The Stickler" \$5.95 6+ wpm**—This is the practice tape for those who survived the 5 wpm tape, and it's also the tape for the Novice and Technician licenses. It is comprised of one solid hour of code. Characters are set at 13 wpm and spaced at 5 wpm.

73T13 **"Back Breaker" \$5.95 13+ wpm**—Code groups again, at a brisk 13+ wpm so you'll be really

at ease when you sit down in front of a steely-eyed volunteer examiner who starts sending you plain language code at only 13 per.

73T20 **"Courageous" \$5.95 20+ wpm** Congratulations! Okay, the challenge of code is what's gotten you this far, so don't quit now. Go for the extra class license. We send the code faster than 20 per.

73T25 **"The Mind Boggler" \$5.95 25+ wpm** Fiendishly generated by kindly old Uncle Wayne for hams with a strong need for self punishment. Once you've conquered 25 per let Unk know if you need a 50 wpm tape.

Uncle Wayne's Bookshelf Order Form

You may order by mail, telephone, or fax. All payments are to be in US funds. Allow 4 weeks for delivery. (Prices subject to change without notice if suppliers increase prices.)

Item	Title	Qty.	Price	Total

Shipping: All US orders add \$5.00 shipping—shipped UPS. (Please provide street address.)
Make checks payable to "Uncle Wayne's Bookshelf."

SHIPPING TOTAL

Foreign Orders: Choose one: surface shipping air shipping.
(Surface delivery may take 2 to 3 months.)

Note: The actual foreign shipping costs will be additional to regular shipping and handling fees.

Name _____

Street _____

City _____ State _____ Zip _____

TOTAL \$ _____ Check/Money Order

AE MC VISA \$10 minimum for credit card orders

Card # _____ Expiration Date _____

Signature _____ Phone # _____

Telephone: (603) 924-4117 (800) 234-8458 FAX: (603) 924-8613 UW 09/95

Mail: Uncle Wayne's Bookshelf, 70 Route 202N, Peterborough, NH 03458

YES! Send me 12 issues of 73 at the low rate of \$19.97. (Save 43% of cover price.)
Canada add \$7 plus \$1.40 GST. Foreign add \$9 surface; \$42.00 airmail.

YES! Send me 12 issues of *Radio Fun* at the low rate of \$12.97. (Save 20% of cover price.)
Canada add \$7 plus \$.70 GST. Foreign add \$12 surface; \$36.00 airmail.



\$595*
For 2 Day Delivery

*Up to 12 lbs. in Continental USA



1-800-426-2891

FAX (612) 786-6513

Internet

<http://www.radiocty@skypoint.com>

Celebrating our 13th Year

Phone Hours
M-F 9am-7:30pm
Sat. 10am-5pm

Call For Catalog
Ask For Ext. 22

Send SASE for Floppy Version

ALINGO ELECTRONICS INC.

ICOM

YAESU

ALL MODE ALL FUN

DX-70

160 meters through 6 meters with a removable face plate make this mobile ready for your vacation fun NOW! Dual VFO's, 100 memories, wide band receive provide long lasting performance.

PRICE WATCH

IC-2340H

SAVE 150 MORE

This new 2 meter/440 MHz dual band features separate tuning, volume & squelch controls for each band, 100 memories, and high power output.

PRICE WATCH

IC-706*

There's new meaning to all band all mode in radio with this new mobile. Features include receive 30 KHz-200MHz, removable/removable front panel, compact size with 100 watts on HF & 6 meter & 10 watts on 2-WDVI!

PRICE WATCH

FT-650

The FT-650 offers self contained high performance in a 100 watt 24 MHz through 50 MHz transceiver.

The FT-900 provides full features & a small foot print. 100 watts, 100 mem's & more.

FT-900**

SAVE 150 MORE

PRICE WATCH

FT-290R/II

Portable or mobile, this 2 meter all-mode transceiver delivers fun and function. The 25 watt linear amplifier clips on in place of an optional battery case to extend your operating horizon.

- FT-690 6m Txcr
- FT-790 70 cm Txcr

PRICE WATCH

FT-736R

Satellite and all-mode 2m/70cm work gets exciting with this full-feature transceiver. Linked tuning, 12 unlinked memories, 100 memories, and 2 optional modules offers band extensions for 6m, 220MHz, or 1.2 GHz operation.

PRICE WATCH

DJ-G5T

Here's a dual band H.T. to the Max. Channel scope, 160 mem's, DTMF, RF att. V/V-U/U, TOT, APO & 20 more features add up to fun & function. More channel scope, 120 mem's, LITZ alert & multi color display panel to create user friendly fun.

NEW DJ-G5T

NEW DUAL BAND

DR-610

PRICE WATCH

IC-2000H

SAVE 10 MORE

Say good-bye to intermod & hi to 60 memories, 50 watts CTCSS encode, alpha numeric display & more. This unit offers great features & fun as a bonus.

with coupon \$309⁹⁵

PRICE WATCH

IC-820H

This new satellite dual band all mode base is designed to provide critical performance with Icom technology. Competitively priced. Features include data port, 50 memories, TXCO, noise blanker, DDS, compact size and much much more.

PRICE WATCH

FT-8500

Control in the palm of your hand with "Spectra analyzer, menu programming, removable front panel, CTCSS encode, & much more.

This packet ready machine sports 100 mem's, lit keypad, dual watch, crossband RPT & more.

SAVE 130 MORE

FT-5100

PRICE WATCH

FT-2500M

This 2 meter with advance track tuning, time out timer, A.P.O., 9600 bps option, 31 memories, new "omni-glow" LCD display and more!

This compact, full-featured mobile comes with 49 memories, 10 DTMF autodial memories, A.R.S., CTCSS encode, digital squelch and lighted keypad are standard features.

SAVE 130 MORE

FT-2200H

SAVE 30 MORE

PRICE WATCH

FT-51R/31

This new H.T. is the world's smallest dual bander. FET output, back lit keypad, V-V, U-U and U-V operating modes. Spectrascope™, CTCSS encode, DTMF paging, HT features 120 memories, cloning, and much more.

This 2 mtr HT features a new alpha-numeric display, super small profile, new square "D" battery design, lit keypad, AM air craft receive, DSQ & CTCSS encode.

SAVE 130 MORE

FT-11R/31

PRICE WATCH

KENWOOD

Be Ready For Sporadic E

Coupons Expire 9-30-95

TM-733A

New features set the pace in this new dual band mobile, 6 program mode memories, 72 memories, AIP, dual in band RX, CTCSS enc., DTSS enc. & more provide a performance edge enhanced by the removable front panel.

PRICE WATCH

TS-690S

A radio that can star in virtually any role with it's 100w transmission capabilities on nine amateur bands plus 50 watts output on 6 meters. Compact, lightweight construction makes this HF transceiver particularly suited for DX-ing.

PRICE WATCH

TS-50S

SAVE 150 MORE

Enjoy high performance communications plus go-anywhere convenience with the world's smallest 100w mobile HF transceiver. All modes and all bands complete this package. Limited supplies.

with coupon \$999⁹⁵

PRICE WATCH

TS-60S

Here's the twin to the TS-50. Engineered for 90 watts of fun on 6 meters. Features include 100 memories, compact size, DDS, L.C.D. panel and more.

PRICE WATCH

TM-255A

This new all mode mobile will provide new fun for Satellite, Packet and DXing. Features include a 9600/1200 baud data port, 40 watts, DDS circuitry, CTCSS encode and much much more.

- TM-455A 70cm

PRICE WATCH

TH-79AD

This slim line dual bander sports a dot-matrix LCD (for a perfect Alpha numeric display), 82 memories, non-volatile memory with ID, DTSS, DTMF & CTCSS V/V & U/U receive & "FET" power make this a winner.

- TH-79ADH

SAVE 130 MORE

with coupon \$425⁸⁰

PRICE WATCH

TM-742A

New VHF/UHF tri-bander with third band optional includes many enhancements such as, direct frequency entry, CTCSS encode, DTMF remote control and much, much more. Also available in a tri-band model TM-942A.

PRICE WATCH

TS-850

SAVE 100 MORE

Kenwood's technology endows the TS-850S/AT with specs that place it at the top of amateur radio equipment. Automatic antenna tuner, 100 memories, three scan modes, DDS, digital PLL system plus more.

PRICE WATCH

TS-450S

SAVE 150 MORE

A compact, lightweight radio with 100w transmission capabilities on all nine amateur bands. Rugged reliability is matched with leading-edge electronics, automatic antenna tuner, AIP system, and DDS for fine tuning.

PRICE WATCH

TM-241A

SAVE 130 MORE

This 2 meter FM mobile comes complete with extra-large display, DTMF microphone, wide band receive and illuminated switches.

with coupon \$299⁹⁵

PRICE WATCH

TM-251A

This new 2 meter transceiver provides dual band receive and gives you a data port that's 9600 baud ready. CTCSS encode, 41 memories are expandable, cross band repeat, time out timer, DTSS and much more.

- TM-451A 70cm Tx, 2m Rx

PRICE WATCH

TH-22AT

Small just got smaller. In a category all its own, this new FM transceiver features long battery life, DTMF keypad, user-friendly menu system, scan functions, 41 memories, CTCSS encode, DTSS, and much more.

SAVE 20 MORE

with coupon \$234³⁰

PRICE WATCH

Authorized Factory Warranty Center

We offer factory authorized warranty service for Icom, Kenwood and Yaesu. We service all makes and models. Our customers may send any product requiring service to us, and we will handle it for them. This is a one-stop service that keeps our customers having more fun than hassle in this hobby. If you need a custom cable for packet and don't have time to make it, let us do it for you. C.A.P. & M.A.R.S. mods are also available at reasonable rates to authorized hams only.

2663 County Road I, Mounds View, MN 55112

Metro: (612)786-4475 • Nat'l Watts: 1-800-426-2891 • FAX: (612)786-6513

Store Hours: M-F, 10:00 am-7:30 pm, Sat.: 10:00 am-5:00 pm

Phone Hours: M-F, 9:00 am-7:30 pm, Sat.: 10:00 am-5:00 pm

Not Responsible For Typographical Errors

CALL FOR CATALOG
Ask For Ext. 22

Expires
September
1995



Prices Subject To Change Without Notice

CIRCLE 153 ON READER SERVICE CARD

Advanced Track Tuning, Mil Spec, true FM. All in one radio!

Outside, you can easily see why the FT-2500M stands up to the shock and vibration like no other. We engineered the first mobile radio to meet the rigid standards set by the U.S. Military back in the '80s, and that same critical design is in the FT-2500M. From the simplified front panel, rubber coated knobs, durable pebbled finish coating, and huge Omni-Glow™ display to the one-piece die-cast chassis, the FT-2500M can take whatever you throw at it!

Inside, the electrical circuitry meets standards so uncompromising the FT-2500M can respond like no other radio. Built-in 3-Stage Advance Track Tuning (ATT), automatically retunes from 140 to 174 MHz permitting consistent receiver sensitivity across the entire band.

But there's more. Like alpha-numeric display capability! Lets you program a frequency or a 4-character name on any of the 31 memories. With three selectable power output levels and up to 50 watt power output, the FT-2500M extra large heat sink means forced air cooling is not necessary. And, as a bonus, Yaesu's

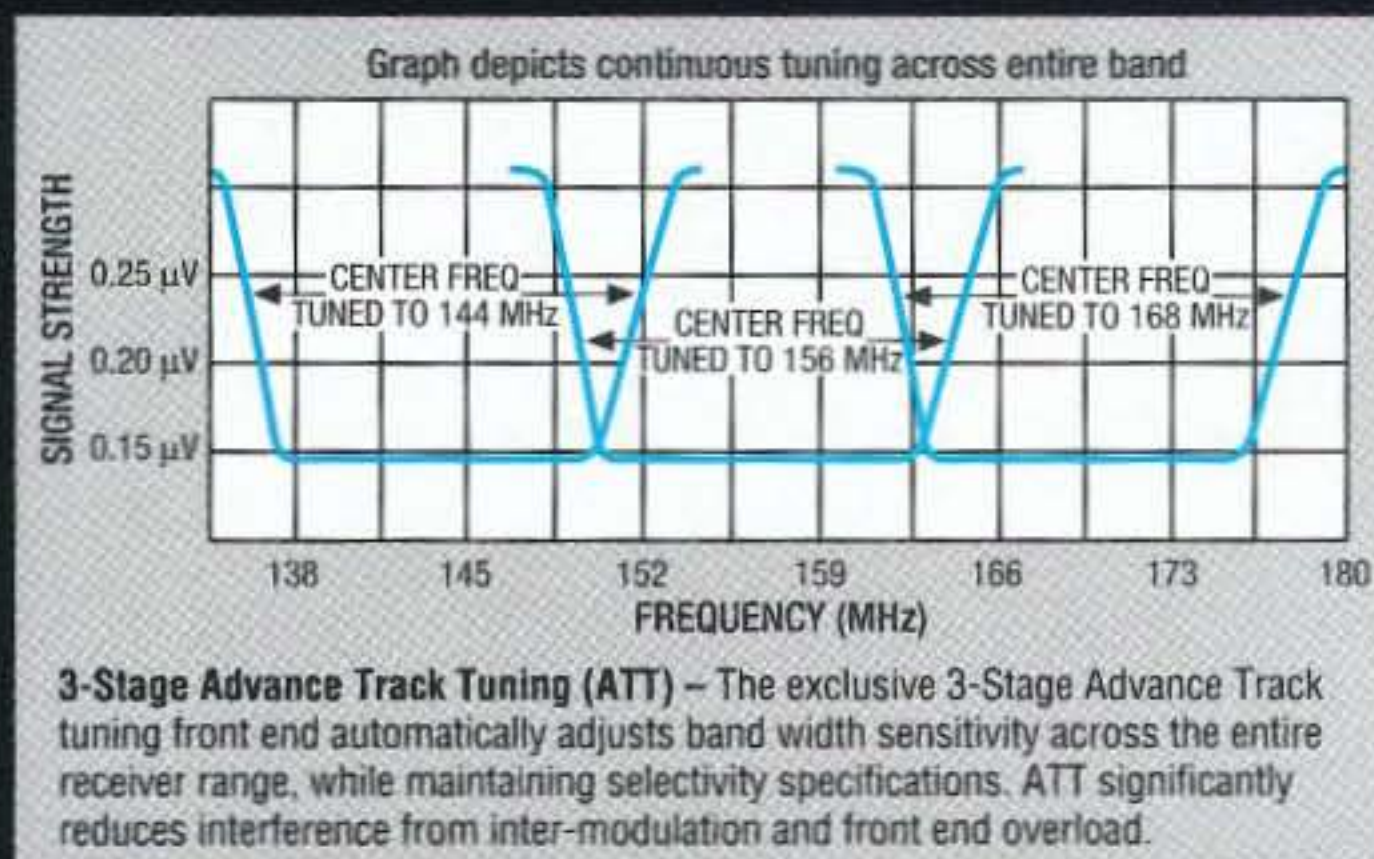

exclusive backlit DTMF mic comes with every FT-2500M. Experts say the FT-2500M is the only commercial-grade amateur radio available. So, for tough manufacturing standards, inside and out, with true FM clarity, and outstanding performance, the FT-2500M is your mobile.

YAESU
Performance without compromise.™

"Just look inside. Military spec really means something to Yaesu!"

"A QST review says 'the FT-2500M exhibited superior 10 MHz offset IMD dynamic range of 103 db!'"



"This Advanced Track Tuning practically eliminates intermod!"

"Yaesu did it again."

FT-2200/7200

Just 5.5"W x 1.6"H x 6.5"D, the FT-2200/7200 radios are designed to fit into today's more compact cars with ease.

SPECIFICATIONS • Frequency Coverage: FT-2200 RX: 110-180 MHz, TX: 144-148 MHz. FT-7200 RX/TX: 430-450 MHz. • Wide Receiver Coverage: 110-180 MHz • AM "Aircraft" Receive: 110-139 MHz • Built-in DTMF Paging/Coded Squelch • Selectable Channel Only Display • 10 Memory DTMF Auto Dialer • Backlit DTMF Mic • Power Output 50/20/5 Watts (FT-7200 35/15/5 Watts) • 50 Memory Channels • Remote Operation w/ Optional MW-2 • CTCSS Encode Built-in • Optional Digital Voice Storage System. Accessories: See your authorized Yaesu dealer.



Specifications

- **Frequency Coverage:**
FT-2500M
RX: 140-174 MHz
TX: 144-148 MHz
FT-7400H
RX/TX: 430-450 MHz
- Rugged Military Spec Design
- Advanced Track Tuning (ATT)
- Selectable Alpha-Numeric Display
- Omni-Glow™ Display, largest available
- **Power Output:**
FT-2500M 50/20/5 Watts
FT-7400H 35/15/5 Watts
- Flip Up Front Control Panel hides seldom used buttons
- Backlit DTMF Mic
- 31 Memory Channels
- CTCSS Encode Built-in
- Automatic Power Off (APO)*
- Time-Out Timer (TOT)*
- Manual* or Automatic Backlighting Adjustment
- **Accessories:**
FP-800 20 Amp HD Power Supply w/ Front Mounted Speaker
FRC-6 DTMF Paging Unit
FTS-17A CTCSS Decode Unit
SP-4 External Mobile Speaker w/ Audio Filters

*FT-2500M



Low Drain, No Pain!

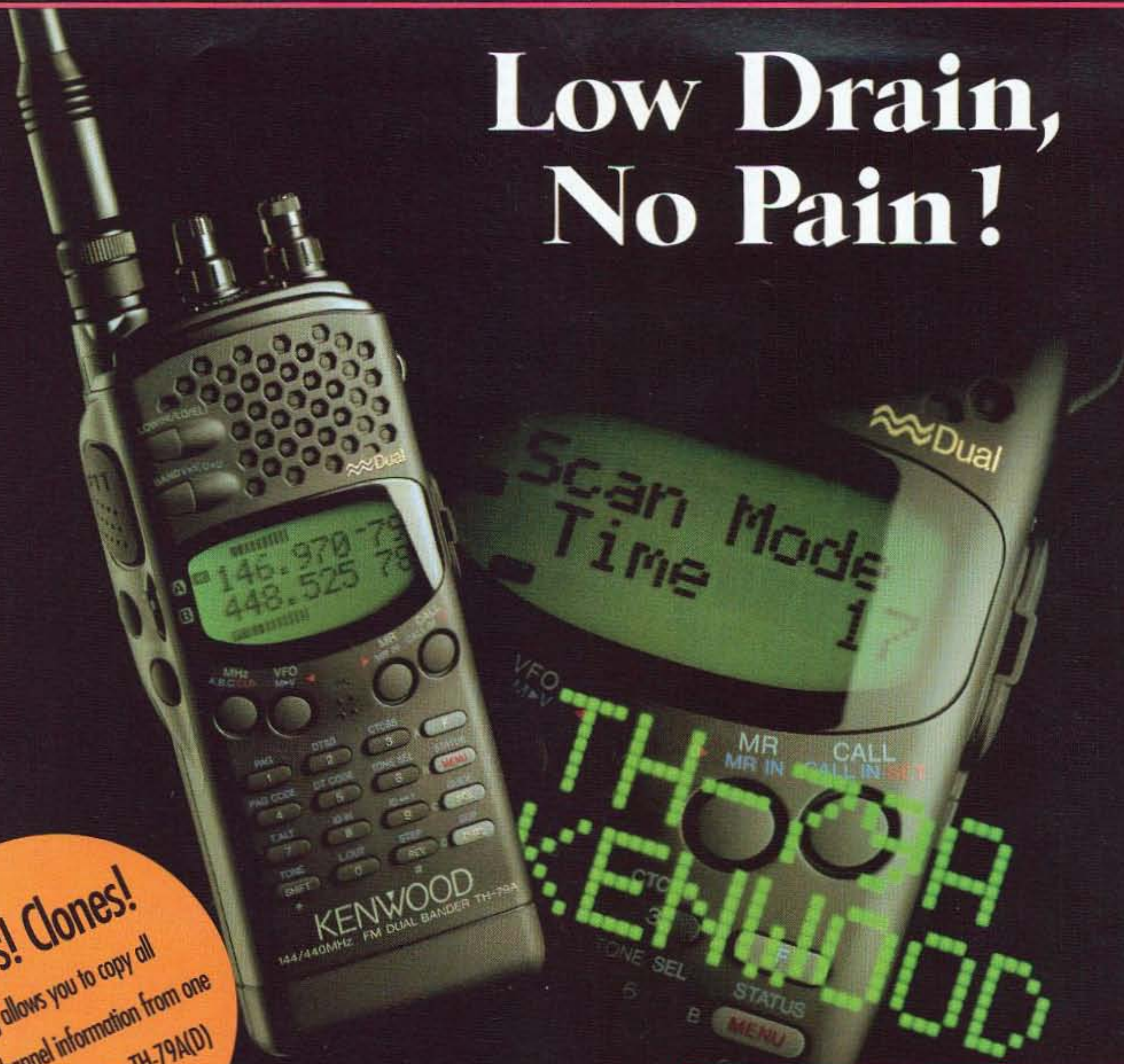

Clones! Clones!

Cloning allows you to copy all memory channel information from one TH-79A(D) to another TH-79A(D)

TH-79A (Deluxe) FM DUAL BANDER

Information at your fingertips. Everything you need to know about operating the new TH-79A(D) FM dual-bander (144MHz/440MHz) can be viewed in its unique dot-matrix LCD with alphanumeric display. No need for the manual. In addition to this innovative guide function, the TH-79A(D) sports a user-friendly menu system, providing easy access to the many powerful features of this slim-line handheld transceiver. Such as 82 non-volatile memory channels with ID, DTSS and page functions, and a DTMF memory function for autodial operation. Full-crossband duplex operation is available, as is the ability to receive two frequencies on the same band (VHF+VHF or UHF+UHF) simultaneously. And thanks to the FET power module, long hours of operation are possible on one charge. With the TH-79A(D), transceiver technology enters the 21st century.

Features

NEW 5-WATT
VERSION NOW AVAILABLE

- 2.7 approx. output (144MHz), 2W approx. output (440MHz) from MOS FET power module and supplied 6V battery; 5W approx. output using optional PB-34
- Dot-matrix LCD with menu/guide system
- 82 non-volatile memory channels with ID
- DTMF keypad with memory function
- DTSS (Dual-Tone Squelch System) with page
- Built-in CTCSS tone encoder/decoder
- Automatic band change
- Power-on call sign display
- Auto repeater offset (VHF)
- Wide-range flexible antenna
- Input overvoltage warning
- 3-position output power control
- Auto power-off and battery save function
- Time-out timer
- Memory channel lock-out (scan mode)
- Cross-band repeater function
- Page answer-back function
- Channel display function
- Wideband receiver coverage, including AM receive on the aircraft band*
- Clone function
- Modifiable for MARS/CAP use**

*Specifications guaranteed for Amateur bands only.

**Permits required. Specifications guaranteed for Amateur bands only.

KENWOOD COMMUNICATIONS CORPORATION

AMATEUR RADIO PRODUCTS GROUP
P.O. Box 22745, 2201 E. Dominguez St., Long Beach, California 90801-5745
Customer support/Brochures (310) 639-5300
Repair Locations/Parts (800) KENWOOD Bulletin Board Service (BBS) (310) 761-8284

KENWOOD ELECTRONICS CANADA INC.

6070 Kestrel Road, Mississauga, Ontario, Canada L5T 1S8

KENWOOD