

October 1980 \$2.95

73 MAGAZINE

FOR RADIO AMATEURS



Happy 20th Anniversary!

**INSIDE:
Our Gift to You!**

Twenty Years of 73

**Escape from
Mt. St. Helens!**

**Blind Sprinter
Runs by Radio**



Henry



...STILL THE TOP FAMILY IN LINEAR AMPLIFIERS

IT'S A FACT... HENRY RADIO STILL PRODUCES THE BROADEST LINE OF SUPERIOR QUALITY AMPLIFIERS IN THE WORLD. WHETHER FOR AMATEUR RADIO, COMMERCIAL OR MILITARY USE, WE OFFER A CHOICE OF FIELD PROVEN STATE-OF-THE-ART UNITS TO FIT THE REQUIREMENTS AND BUDGETS OF THE MOST DISCRIMINATING USER.



In a class by itself
2K-4A

If you want to move up to the very best, this is it. The 2K-4A offers engineering, construction and features second to none. Loads along at full legal power for as long as you wish. \$1195.

The 1KD-5 ...the newest member of the famous Henry Radio family of fine amplifiers. And we're still convinced that it's the world's finest linear in its class. The 1KD-5 was designed for the amateur who wants the quality and dependability of the 2KD-5 and 2K-4, who may prefer the smaller size, lighter weight and lower price and who will settle for a little less power. But make no mistake, the 1KD-5 is no slouch. Its 1200 watt PEP input (700 watt PEP nominal output) along with its superb operating characteristics will still punch out clean powerful signals...signals you'll be proud of. Compare its specifications, its features and its fine components and we're sure you will agree that the 1KD-5 is a superb value at only \$695.

The 2KD-5 We have been suggesting that you look inside any amplifier before you buy it. We hope that you will. If you "lift the lid" on a 2KD-5 you will see only the highest quality, heavy duty components and careful workmanship...attributes that promise a long life of continuous operation in any mode at full legal power. The 2KD-5 is a 2000 watt PEP input (1200 watt PEP nominal output) RF linear amplifier, covering the 80, 40, 20, and 15 meter amateur bands. It operates with two Eimac 3-500Z glass envelope triodes and a Pi-L plate circuit with a rotary silver plated tank coil. Price \$945.

And don't forget the rest of the Henry family of amateur amplifiers...the Tempo 2002 high power VHF amplifier and the broad line of top quality solid state amplifiers. Henry Radio also offers the 3K-A and 4K-Ultra superb high power H.F. amplifiers and a broad line of commercial FCC type accepted amplifiers for two way FM communications covering the range to 500 MHz.

NEW TOLL FREE ORDER NUMBER: (800) 421-6631
For all states except California.
Calif. residents please call collect on our regular numbers.



11240 W. Olympic Blvd., Los Angeles, Calif. 90064 213/477-6701
931 N. Euclid, Anaheim, Calif. 92801 714/772-9200
Butler, Missouri 64730 816/679-3127

Prices subject to change without notice.

Henry Radio

Rack Attack from DenTron

Components are the latest in communication systems adapting to your stations' needs. The DTR-3KA and DTR-1200L are equipped with heavy-duty handles for easy rack mounting and rack brackets that can be easily removed. The DTR-1200L linear amplifier provides 1200 watts SSB and 1000 watts CW input continuous duty. It features large 3 1/2" shadow box, back lit meters for easy reading, and tuned input for compatibility with solid state or tube transceivers. The DTR-3KA antenna tuner handles a full 3KW PEP. It features a built in 2KW dry dummy load with thermostatically controlled forced air cooling, a remote sensor box to insure meter accuracy and 50 OHM impedance. Component racks available at your DenTron Dealer.

DTR-1200L Linear Amplifier

Frequency Ranges:

80 Meter Band	3.45 - 4.6 MHz
40 Meter Band	6.00 - 9.0 MHz
20 Meter Band	10.00 - 16.00 MHz
15 Meter Band	20.95 - 23.50 MHz
10 Meter Band	Export Model

Modes:

USB, LSB, CW, RTTY, SSTV

Power Input:

1200W - SSB, 1000W - CW

Power Requirements:

234/117 VAC 50/60 Hz

RF Drive Power:

150 Watts maximum and 65 watts minimum for 1 KW DC input.

DC Plate voltage:

Idle + 2300V approximate

Duty Cycle:

100% SSB, CW, RTTY, SSTV

Input Impedance:

50 Ohms nominal

Input VSWR:

1.5 to 1 average

Output Impedance:

50 Ohms nominal

Antenna load VSWR:

2 to 1 maximum

ALC:

negative going, adjustable from front panel

Spurious Emissions:

IMD - greater than 30 db down

Harmonics - greater than 40 db down

Switchable 12VDC accessory output voltage

Multimeter:

Plate Voltage	0 - 3000VDC
Plate Current	0 - 500ma
Relative Output	Adjustable

Front Panel Plate Voltage Switching

FCC Type Accepted

Size:

5 1/4" H x 17" W x 13" D (19" W with rack brackets)

Weight:

46 pounds

DTR-3KA Antenna Tuner

Frequency Coverage: 1.8 - 30 MHz continuous

Built in 2 KW PEP Dummy Load - Forced Air Cooled

Input Impedance: 50 ohms (Resistive) to transmitter

Antenna Inputs

Coax 1, 2 & 3 - unbalanced—may range from a few ohms to a high impedance

Long wire - low to high impedance

Balanced line - 75-660 ohms

Power Capability: 3000 watts P.E.P.

Wattmeter: 200 watts forward

2000 watts forward

200 watts reflected

Accuracy: ± 5%

Remote sensor box

3 1/2" backlit meters

Dummy Load: with manual or automatic forced air cooling.

Integral 3KW Balun

CIRCLE 8 ON READER SERVICE CARD



DenTron
Radio Co., Inc.
1605 Commerce Drive
Stow, Ohio 44224
(216) 688-4973

INFO

Manuscripts

Contributions in the form of manuscripts with drawings and/or photographs are welcome and will be considered for possible publication. We can assume no responsibility for loss or damage to any material. Please enclose a stamped, self-addressed envelope with each submission. Payment for the use of any unsolicited material will be made upon acceptance. All contributions should be directed to the 73 editorial offices. "How to Write for 73" guidelines are available upon request.

Editorial Offices:

Pine Street
Peterborough NH 03458
Phone: 603-924-3873, 924-3874

Advertising Offices:

Elm Street
Peterborough NH 03458
Phone: 603-924-7138

Circulation Offices:

Elm Street
Peterborough NH 03458
Phone: 603-924-7296

Subscription Rates

In the United States and Possessions:
One Year (12 Issues) \$25.00
Two Years (24 Issues) \$38.00
Three Years (36 Issues) \$53.00

Elsewhere:

Canada—\$27.00/1 year only, U.S. funds. Foreign surface mail—\$35.00/1 year only, U.S. funds. Foreign air mail—\$62.00/1 year only, U.S. funds.

To subscribe, renew or change an address:

Write to 73 Magazine, Subscription Department, PO Box 931, Farmingdale NY 11737. For renewals and changes of address, include the address label from your most recent issue of 73. For gift subscriptions, include your name and address as well as those of gift recipients. Postmaster: Send form #3579 to 73 Magazine, Subscription Services, P.O. Box 931, Farmingdale, NY 11737.

Subscription problem or question:

Write to 73 Magazine, Subscription Department, PO Box 931, Farmingdale NY 11737. Please include an address label.

73 Magazine (ISSN 0098-9010) is published monthly by 73, Inc., 80 Pine Street, Peterborough NH 03458. Second class postage paid at Peterborough NH 03458 and at additional mailing offices. Copyright (c) 1980 by 73, Inc. All rights reserved. No part of this publication may be reprinted or otherwise reproduced without written permission from the publisher. Microfilm Edition—University Microfilm, Ann Arbor MI 48106.

A NOTE

Some years ago, in my pre-Green past, I was employed in a moving and storage warehouse. The owner was something else. If we were booked to capacity, he would book more storage. If we were overbooked, he would book still more. "No" was not in his vocabulary. "But Sir, we have 200,000 pounds more than we can handle right now! How can we take in another 50,000 tonight? Where can we put it?" "I don't care where you put it! Put it somewhere, put it *anywhere*, because we've got another 100,000 coming in tomorrow!"

Now, this man was definitely snapped out. Even though I thought he was highly successful, I *knew* he was crazy and figured he had to be at the top of the entrepreneurial heap. Then I met Wayne Green.

It is not easy working for Wayne. Being subject to a hard taskmaster is difficult enough, but having to deal with one who never sleeps falls under the cruel and unusual clause. He works at least 100 hours a week—at *least*. He produces more editorial material per month (55 magazine pages in July, in four different publications) than possibly any other editor/publisher in the world. He travels, makes guest appearances, gives speeches. He turns out correspondence by the bushel. He reads scores of other publications every month. He monitors the day-to-day operations of a multi-division corporation. And he expects everybody else to keep up with him. Right.

He has his faults. If his pen is mightier than his sword, his tongue is—more often than not—sharper than his pen. "I don't want to *hear* about problems—I want *SOLUTIONS!*" He will listen attentively to a well-reasoned proposal, but don't try to snow him with meaningless drivel. Don't interrupt him when he's typing. Repeat—Don't interrupt him while he's typing! Don't use the color brown. Don't be late for the staff meeting, and did you bring the chart I asked you for? Why is that halftone muddy? Why are there so many quotation marks here? We need to hire ten more people by next Tuesday. Here's an idea for a new magazine—I want the finished product in my hands in a month. Think, think, think. Push, push, push. Never Say Die.

For Wayne Green, no possibility is too remote to be investigated, no idea too wild to be pursued. We of his staff would just like to say thank you to Wayne for the twenty years of NSDing it took to get 73 to this point at which we can all take part in this 20th Anniversary celebration. We know that you're highly successful, but there are those of us who are beginning to think that maybe you might *not* be crazy. So thank you, happy 20th, and, yes, we know that you'd rather have an ad in this space.

J.B.

Escape from Mt. St. Helens!

..... W7WFO 34

Sheila Ran!

— a sightless sprinter's triumph is one of ham radio's finest hours..... WB0IFF 38

The First Man in Space Was a Ham

— UA1LO remembered..... W1QMS 42

NASA Satellites You Can Use

— with permission, of course..... K4OVK 50

Undertones

— a fractional frequency oscillator..... W4FEC 56

A Computer-Controlled Talking Repeater

 — part I: Introduction..... WA6AXX 124

Murphy's Own OSCAR Tracker

 — simple pointer for satellite antennas..... K8BG 132

Counting with Class

— build this 500-MHz LSI frequency counter..... WB4EKB 134

A Transistor for True Believers

— tubes forever? Not with FETs!..... WB7CMZ 142

Stay Cool with TM

— use thermostat modulation to lower your heating costs..... WB2EQG 144

One Man's Magazine: Twenty Years of 73

..... N1AUI 146

How To Be An Amateur

..... W2ZGU 156

73 MAGAZINE

oct. 80



Escape! — 34



Run, Sheila! — 38

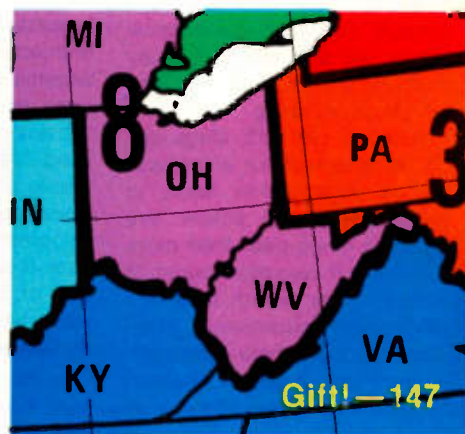

Gift! — 147

The Arcane Art of ATV

— the transverter approach to fast-scan television..... WB8DQT 60

How to Make a Good Scanner Better

— a bevy of useful mods..... WA4PYQ 68

Win Friends for Your Club

— PR is the name of the game..... WASTUM 76

Field Strength for Free

— a home-brew conversion..... Staff 82

The QRM Killer

— antenna alternative for 40..... W9HBF 88

PC Boards— A Photographic Method

— it's easy when you take it step by step..... WB5HGR 104

Free CMOS Timers

— build one-shots from spare inverters..... WD5DDR 113

Late Check-Ins Come Now

 — zero-beat on this computerized NCS system..... N8AD 120

Some Guys Make It

— and then there's us..... K2ORS 168

The 40-Meter Band Blaster

— this antenna works, but why?..... W9HBF 179

Gilding the Lily

— FT-101 mod for crazed purists..... WB4HLZ 188

Mike Mods for the KDK-2016A

— improved scanning..... WB9WNU 190

Clock Blocks

— a compendium of TTL and CMOS oscillators..... K4IPV 192

Build a Better Battery Tester

— test 'em under load..... Staff 196

Getting the SB-220 to Idle

— a final-saving mod for Heath's popular linear..... W9RY 197

Egad! An Easy-to-Build Synthesizer!

..... N4CEY 210

A Note— 4, Never Say Die— 6, Looking West— 12, DX— 14, Contests— 16, RTTY Loop— 18, Awards— 20, Leaky Lines— 23, Letters— 24, OSCAR Orbits— 26, Fun!— 28, New Products— 30, Our Gift to You!— 147, Ham Help— 23, 224, 227, 230, 241, Review— 226, Social Events— 228, FCC— 234, Dealer Directory— 273

Cover: Tedd Cluff, special photography. Diana Shonk, art. Eastern Rainbow (Derry NH), special color.

W2NSD/1 NEVER SAY DIE

editorial by Wayne Green



STATUS REPORT

On the event of our twentieth anniversary, and particularly for you readers who have hung in there for much of that time, I thought you might like to know where we are with our many projects at this time...and where we're aiming.

Starting with *73 Magazine*, the backbone of our whole publishing organization, we're in reasonably good shape. We have for years published more articles and even more pages of articles every month than any other ham magazine...often more than all others combined. A recent count put us at about two and a half times as many articles as *QST*.

In case you haven't taken the time to count, *73* also has more pages of paid advertising than any other ham magazine. Our survey earlier this year shows why: *73* readers number slightly over 150,000 and are spending an average of \$9,500,000 a month on ham gear and accessories. Obviously the ads and articles in *73* are influencing this flow of sales.

With nearly \$10 million a month changing hands, it is no wonder that *73* has so many advertisers. This benefits you in several ways...first by making the magazine larger and even more packed with articles. Then it keeps the flow of money going into our industry and thus promotes the development of products to make hamming more fun. It also encourages amateurs to work on new inventions which we will eventually see as articles in *73* and then as commercial products. Everyone gains and amateur radio pays for its space in the spectrum by

helping the development and pioneering of new equipment and techniques for everyone.

We really can't forget that it was via amateur radio that FM repeaters became a worldwide phenomenon...that sideband became a practical communications medium...that slow scan television was developed and used. The list is a long and honorable one. But without magazines such as *73*, these developments would not be practical. It takes the cross-fertilization of ideas and the work of many people to make each of these ideas come to fruit.

In the 1980s we'll be pushing hard for amateur radio to pioneer many more breakthroughs in communications. Such ideas as automatic identification, microcomputer-oriented communications, wide-band techniques, synchronous detection of DSB signals, use of commercial satellites for ham communications, new ideas in slow scan which would make it useful to virtually every ham, panoramic reception, a new design technique for transceivers, packet communications with look-up dictionaries on a chip, etc. You, the readers, will be inventing these communications systems and we'll be publishing them and helping you start successful companies using these new ideas.

Another very serious need is for a massive attack on the lack of ham growth. To me this means that every ham club in the country must organize to get new licensees into their classes, preferably from the high schools. Not only do we need more amateurs, and need them desperately, but the country needs the

technicians and engineers which will result from this program. If we are ever going to get technical leadership of the world back from Japan, we have to out-ham them...and they are about 800% ahead of us on the basis of active hams per capita.

Part of our attack will have to be centered on Washington, with pressures on both the FCC and Congress. We need to get deregulation going again and assert control over our hobby. We have shown that we can do it and we should be allowed to expand this function. It will only be through such deregulation that we will be able to do the experimenting, inventing, and pioneering which must be done during the next few years. The insistence of the FCC that hams only use modes of communications which are over 20 years old (so that their ancient monitoring stations can copy all signals) has put a heavy chill on amateur inventiveness and must be ended.

Another part of our attack should be on a national basis, where we must do everything possible to get our activities into the media...with coverage of important amateur services being reported on television, in newspapers, and via articles in the national magazines. The more we make amateur radio known for its benefits to the country, the easier it will be to recruit new hams into our classes and the easier it will be to get needed legislation through Congress or the FCC.

Then there is the need for promoting amateur radio on a worldwide basis. I've been asking for a \$1,000 donation for my hamfest talks toward a fund to work on

this situation for the last year and have, surprisingly enough, been able to get this. Recently, the Richland, Washington, hamfest sent a check which has gone into this world development fund. During 1981 I'll be available on a similar basis to help hamfests draw larger crowds (I hope).

The basic plan is to try to get amateur radio into as many of the lesser developed countries (LDC) as possible, using the scheme which worked so well in Jordan. His Majesty, King Hussein, has agreed to help with this project, so with some funding, I should be able to get into gear in time to perhaps help us at the next ITU conference. The African countries are becoming more and more aware of their need for communications and the importance of developing native technicians and engineers, so our sales pitch will be simpler than it might have been a few years ago.

In all, the most exciting years of amateur radio are ahead of us.

COMPUTERS

Well, so much for the hamming end of things. The largest part of our publishing activity today is involved with microcomputers...and this appears to offer us the greatest possibilities or growth.

In 1975, shortly after the invention of the microcomputer, our group of *73* staffers started up *Byte* magazine. Indeed, I don't think there was a person on the *73* staff who was not involved in getting *Byte* going. It was a lot of work and utterly devastating to us when *Byte* suddenly moved out one night. The litigation on that situation will be long and expensive, with several millions of dollars involved, I expect.

Still, the *73* crew has survived even tougher blows in the past, such as an attempt by a previous business manager to put the magazine under so he could start his own magazine. That almost did it to us, but everyone worked around the clock for months and we pulled out of it. Then there was an IRS blitz, from the same source, and that was about as traumatic as anything in my life. By the time the *Byte* thing happened, we could survive just about anything.

It took a year before we were on our feet enough to launch a

Small wonder.



Processor, N/W switch, IF shift, DFC option

TS-130S/V

An incredibly compact, full-featured, all solid-state HF SSB/CW transceiver for both mobile and fixed operation. It covers 3.5 to 29.7 MHz (including the three new Amateur bands!) and is loaded with optimum operating features such as digital display, IF shift, speech processor, narrow/wide filter selection (on both SSB and CW), and optional DFC-230 digital frequency controller. The TS-130S runs high power and the TS-130V is a low-power version for QRP applications.

TS-130 SERIES FEATURES:

- **80-10 meters, including three new bands**
Covers all Amateur bands from 3.5 to 29.7 MHz, including the new 10, 18, and 24-MHz bands. Receives WWV on 10 MHz. VFO covers more than 50 kHz above and below each 500-kHz band.
- **Two power versions . . . easy operation**
TS-130S runs 200 W PEP/160 W DC input on 80-15 meters and 160 W PEP/140 W DC on 12 and 10 meters. TS-130V runs 25 W PEP/20 W DC input on all bands. Solid-state, wideband final amplifier eliminates transmitter tuning, and receiver wide-band RF amplifiers eliminate preselector peaking.
- **Built-in speech processor**
Increases audio punch and average SSB output power, while suppressing sideband splatter.

• CW narrow/wide selection

"N-W" switch allows selection of wide and narrow bandwidths. Wide CW and SSB bandwidths are the same. Optional YK-88C (500 Hz) or YK-88CN (270 Hz) filter may be installed for narrow CW.

• SSB narrow selection

"N-W" switch allows selection of narrow SSB bandwidth to eliminate QRM, when optional YK-88SN (1.8 kHz) filter is installed. (CW filter may still be selected in CW mode.)

• Sideband mode selected automatically

LSB is selected on 40 meters and below, and USB on 30 meters and above. SSB REVERSE position is provided on the MODE switch.

• Built-in digital display

Six-digit green fluorescent tube display indicates actual operating frequency to 100 Hz. Also indicates external VFO or fixed-channel frequency. RIT shift, and CW transmit/receive shifts. Also analog subdial for backup frequency indication.

• IF shift

Allows IF passband to be moved away from interfering signals and sideband splatter.

• Single-conversion PLL system

Improves stability as well as transmit and receive spurious characteristics.

• Built-in RF attenuator

For optimum rejection of intermodulation distortion.

• Built-in VOX

For convenient SSB operation, as well as semi-break-in CW with sidetone.

• Effective noise blanker

Eliminates pulse-type interference such as ignition noise.

• Built-in 25-kHz marker

Accurate frequency reference for calibration.

• Compact and lightweight

Measures only 3-3/4 inches high, 9-1/2 inches wide, and 11-9/16 inches deep, and weighs only 12.3 pounds. It is styled to enhance the appearance of any fixed or mobile station.



Optional DFC-230 Digital Frequency Controller

Allows frequency control in 20-Hz steps with UP/DOWN microphone (supplied with DFC-230). Includes four memories (handy for split-frequency operation) and digital display. Covers 100 kHz above and below each 500-kHz band. Very compact.

Ask your Authorized Kenwood Dealer about the compact, full-featured, all solid-state TS-130 Series.

NOTE: Price, specifications subject to change without notice and obligation.

MATCHING ACCESSORIES FOR FIXED-STATION OPERATION:

- PS-30 base-station power supply (remotely switchable on and off with TS-130S power switch).
- SP-120 external speaker
- VFO-120 remote VFO
- MC-50 50kΩ/500Ω desk microphone
- Other accessories not shown:
- YK-88C (500 Hz) and YK-88CN (270 Hz) CW filters
- YK-88SN (1.8 kHz) narrow SSB filter
- AT-130 compact antenna tuner (80-10 m, including 3 new bands)
- MB-100 mobile mounting bracket
- MC-30S and MC-35S noise cancelling hand microphones
- PC-1 phone patch
- TL-922A linear amplifier
- HS-5 and HS-4 headphones
- HC-10 world digital clock
- PS-20 base-station power supply for TS-130V



- SP-40 compact mobile speaker
- VFO-230 digital VFO with five memories

STAFF

PUBLISHER/EDITOR
Wayne Green W2NSD/1

ASSISTANT PUBLISHER/EDITOR
Jeff DeTray WB8BH

ASSOCIATE PUBLISHER
Edward Ferman WA1UFY

MANAGING EDITOR
John Burnett

ASST. MANAGING EDITOR
Susan Philbrick

EDITORIAL ASSISTANTS
Nancy Noyd
Richard Phenix

CONTRIBUTING EDITOR
Chris Brown N1AUI

ADMINISTRATIVE ASSISTANTS
Suzy Clyne
Pat Graham

ASSOCIATES
Robert Baker WB2GFE
Jim Cain K1TN
Bill Gosney WB7BFB
Sanger Green
Dave Ingram K4TWJ
Larry Kahaner WB2NEL
Joe Kasser G3CZC
Dr. Marc Leavey WA3AJR
Dave Mann K2AGZ
Bill Pasternak WA6ITF
John Schultz W4FA
Peter Stark K2OAW

DIRECTOR OF MANUFACTURING
Noel Self

ASST. DIRECTOR OF MANUFACTURING
Dion Owens

ART DIRECTOR
Diana Shonk

PRODUCTION DEPARTMENT

ART STAFF
Steve Baldwin
Tedd Cluff
Linda Drew
Robert Drew
Bruce Hedlin
Kenneth Jackson
Ross Kenyon
Michael Murphy
Robert Sawyer
Patrice Scribner
Susan Symonds
John White

PHOTOGRAPHY
William Heydolph
Terrie Anderson

TYPESETTING
Barbara Latti
Sara Bedell
Linda Locke

EXECUTIVE VICE PRESIDENT
Sherry Smythe

CORPORATE CONTROLLER
Alan Thulander

EXECUTIVE ASSISTANT
Leatrice O'Neil

ACCOUNTING MANAGER
Knud Keller

CIRCULATION MANAGER
Debra Boudrieau

CIRCULATION
Doris Day
Pauline Johnstone

BULK SALES MANAGER
Ginnie Boudrieau

ADVERTISING
603-924-7138
Jim Gray W1XU, Mgr.
Nancy Ciampa, Asst. Mgr.

second microcomputer magazine, *Kilobaud*. It started off much faster than *Byte*, but playing catch-up is more difficult than covering new ground, so *Byte* is still ahead in circulation. By the end of 1979, *Kilobaud Microcomputing* had passed 73 in advertising pages and was neck and neck and circulation!

In January, 1980, we started a new magazine, *80 Microcomputing*, devoted just to the TRS-80 computer, its accessories and software. This turned out to be one of the most successful new technical magazines in history, passing a hundred pages of paid advertising within nine months of starting publication. The circulation started at 50,000 for the first issue and is expected to pass 100,000 by the end of this year. This magazine is having a significant effect upon the sales of the Radio Shack computer systems and may be the one factor which will help them stay ahead of the coming Japanese invasion of microcomputers.

The microcomputer field, which started in 1975 with sales of about \$5 million (mostly by one firm: Mits), has grown at a rate of over 300% per year on the average, with no hint of any slowdown, even in response to the recent recession. Every person in the field can find five jobs or more since there is a desperate need for trained people. Virtually every hobbyist of the early years is now working happily in the industry... or has his own firm.

Perceiving the eventual need for massive amounts of software to support the growth of the industry, I started a small group working on evaluating programs submitted by independent authors for mass publication and distribution in the computer stores. This was started in 1978, down in the old potato cellar at 73 in our 250-year-old building on Pine Street. That function has grown to fill most of what used to be a Peterborough motel, a 26-room and restaurant complex. The lab, one of the largest microcomputer labs in the world, is being geared to handle the needs of two local colleges and the high school as well as the work required by Instant Software. Almost a thousand programs are currently either in production or nearly ready for release.

The software programs are supportive of the TRS-80 and a half dozen other popular microcomputer systems. They are being produced in three European languages and several more are scheduled before the end of the year. A production plant is being organized for opening in Ireland to supply the European, African, and Middle East markets.

Plans are also well along for massive support of new microcomputer systems through conversion of existing successful programs for use on the new systems. These are popular with programmers because one order for a single program can provide a royalty on the order of \$25,000.

Instant Software is the largest of the microcomputer software publishers... and we hope to keep it that way. The biggest problem we face is in getting qualified people to help us grow... and in getting office and production space in the Peterborough area. The 40-room house on Pine Street is full. The Instant Software building is full... now where?

There is no way to really know how big the software market will be for microcomputers, but estimates by firms in the business of making educated guesses about the future of industries put it at \$10 billion within ten years. I think they are low. With microcomputers on every desk in every office, plus in offices at home, on every desk in schools... and again at home for home study, plus home computers, we're looking at an incredible computer market. Every one of those computers is going to need programs... and a lot of them. These programs will sell or rent for a few dollars up to as high as thousands of dollars per program.

In order to support this growing field, we are planning on starting a business-oriented computer magazine and another in the educational field.

OTHER STUFF

In addition to my few personal interests, such as hamming, fooling around with computers, gourmet cooking, skin diving, skiing, hi-fi, etc., I read about 200 magazines a month to keep up with my state of two arts as well as the state of the world. There are also demands on my time for writing the editorials for four magazines, answering a few

hundred letters a month, and keeping up with a couple hundred developing situations, lawsuits and the like.

Some of my time is taken in traveling to visit computer shows and manufacturers, doing consultation, attending an occasional hamfest or club talk, and setting up representatives for Instant Software in as many countries as possible. Add to that some work for the local Chamber of Commerce, where I am the vice president, my membership in the National Industry Advisory Committee for the FCC (NIAC), a few local Mensa meetings, membership in MITA (computer industry group) and ARMA (amateur industry), an occasional newsletter for the USS *Drum* reunions (I served on the submarine during WWII), and there is little time to waste.

My need to watch the television I want on my own terms got me involved with video recorders... and that has escalated to video recording. I have in mind making some video shows for ham clubs and computer clubs. If that turns out to be of interest, I'll expand on that. Our camera systems are working well and I'm awaiting a new staffer or two to get this plan into motion. This may be a way to make my travelog of color slides available to many ham clubs, since there are just so many hours in the day for me to work. Videotapes might be the answer.

MY AIM

If I can survive the amount of work needed, I'm aiming for doing all in my power to see that we have one million hams in our country by 1985. I think we need them if we are going to have the technical and pioneering developments we need. We are also going to need them if we ever intend to get the ball back from Japan on technical products design and manufacturing. I'm talking about consumer products such as television sets, video recorders, calculators, integrated circuits, computer developments, ham rigs, etc.

In addition to that, I hope to quickly get the microcomputing industry together to set a standard for electronic mail. This could solve much of the US mail problem for us... and also cut down on the cost and time wasted on phone calls. I assume

Continued on page 244



*Simply...
the Best*

ICOM AMERICA, INCORPORATED
2112 116th Avenue N.E., Bellevue WA 98004, (206) 454-8155
3331 Towerwood Dr., Suite 307, Dallas, TX 75234, (214) 620-2780

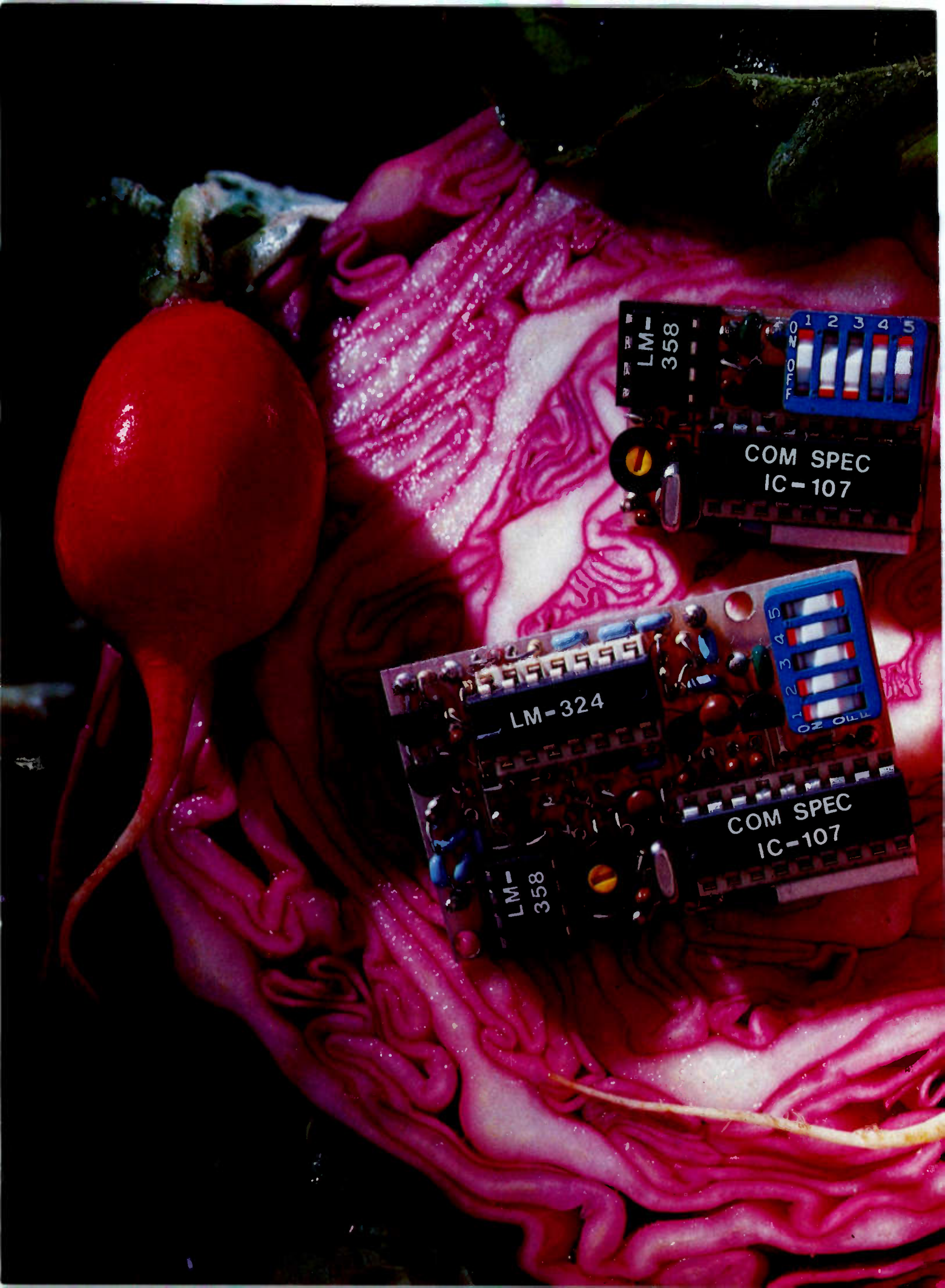

LM-358

1 2 3 4 5
OZ OLL

COM SPEC
IC-107

LM-324

1 2 3 4 5
OZ OLL

COM SPEC
IC-107

LM-358



A fresh idea!

Our new crop of tone equipment is the freshest thing growing in the encoder/decoder field today. All tones are instantly programmable by setting a dip switch; no counter is required. Frequency accuracy is an astonishing $\pm .1$ Hz over all temperature extremes. Multiple tone frequency operation is a snap since the dip switch may be removed. Our SS-32 encode only model is programmed for all 32 CTCSS tones or all test tones, touch-tones and burst-tones. And, of course, there's no need to mention our 1 day delivery and 1 year warranty.



TS-32 Encoder-Decoder

- Size: 1.25" x 2.0" x .40"
- High-pass tone filter included that may be muted
- Meets all new RS-220-A specifications
- Available in all 32 EIA standard CTCSS tones

SS-32 Encoder

- Size: .9" x 1.3" x .40"
- Available with either Group A or Group B tones

Frequencies Available:

Group A			
67.0 XZ	91.5 ZZ	118.8 2B	156.7 5A
71.9 XA	94.8 ZA	123.0 3Z	162.2 5B
74.4 WA	97.4 ZB	127.3 3A	167.9 6Z
77.0 XB	100.0 1Z	131.8 3B	173.8 6A
79.7 SP	103.5 1A	136.5 4Z	179.9 6B
82.5 YZ	107.2 1B	141.3 4A	186.2 7Z
85.4 YA	110.9 2Z	146.2 4B	192.8 7A
88.5 YB	114.8 2A	151.4 5Z	203.5 M1

- Frequency accuracy, $\pm .1$ Hz maximum -40°C to $+85^{\circ}\text{C}$
- Frequencies to 250 Hz available on special order
- Continuous tone

Group B			
TEST-TONES:	TOUCH-TONES:	BURST-TONES:	
600	697 1209	1600 1850	2150 2400
1000	770 1336	1650 1900	2200 2450
1500	852 1477	1700 1950	2250 2500
2175	941 1633	1750 2000	2300 2550
2805		1800 2100	2350

- Frequency accuracy, ± 1 Hz maximum -40°C to $+85^{\circ}\text{C}$
- Tone length approximately 300 ms. May be lengthened, shortened or eliminated by changing value of resistor

Wired and tested: TS-32 \$59.95, SS-32 \$29.95



COMMUNICATIONS SPECIALISTS

426 West Taft Avenue, Orange, California 92667
(800) 854-0547 / California: (714) 998-3021



LOOKING WEST

Bill Pasternak WA6ITF
24854-C Newhall Ave.
Newhall CA 91321

Have you ever started reading a book and found that you couldn't put it down? That's just what happened to me last night. The book I have just finished is titled *The Magic of Ham Radio*, written by a 60-year veteran of amateur radio named Jerrold Swank W8HXR.

The Magic of Ham Radio is more than just a look into the past. It's a detailed trip through time narrated by someone who has lived the story. It's something you feel rather than just read. It has a rare something that makes you a part of the book—you are not just an outsider looking in on someone else, reading someone else's story. The book is you, me, and everyone else who has ever had any contact with the amateur service. Simply, the book is a true joy, and one that can be understood by anyone—a ham or someone who dwells outside our special world. The book is priced at \$4.95 and in my opinion is worth every penny. It's published by 73 and available through direct mail order from 73, Inc.

FIELD DAY AND THE MEDIA DEPARTMENT

For some reason, the media has discovered Amateur Radio Field Day. I have heard such reports on my own radios and have watched news coverage on my very own Sony TV! For instance, radio station KMPC here in Los Angeles has a new weekend format titled "Weekend L.A." Part of the program revolves around live on-the-spot coverage of events taking place in this town. On Field Day weekend, KMPC sent one of its radio-equipped News Cruisers, a reporter, and a field producer to various Field Day sites to interview the amateurs participating in the event.

Under the watchful eye of producer Kevin Gershan, the reports were interesting, informative, and portrayed the amateur service in a very positive light. Never once was amateur radio

confused with CB, even though neither the producer nor air talent was an amateur operator. Obviously they had done their preparatory work well.

The same held true of TV news coverage here in Los Angeles. For instance, Metro-media TV channel 11 had an excellent news feature about Field Day which was recorded at a site in Griffith Park. Here again there was no confusion between amateur radio and CB. The report headlined the emergency communications capability of amateur radio. Others have told me that similar stories were aired by other stations on their news programs. This news coverage was not limited to the Los Angeles area. Norm Brooks K6FO, one of the staff writers for *Worldradio*, telephoned to tell me of his personal experience with the media in regard to Field Day.

Norm's name and call were part of a wire service story about Field Day activities in the Sacramento area. Apparently a network producer for RKO General in New York City read the wire copy and attempted to contact Norm. He was at his club's Field Day site at the time. After receiving the message, he returned the producer's call via a local 2-meter autopatch system right from his club's Field Day location. He was able to give a rather graphic demonstration of exactly how amateur radio functioned, in that the interview was done via the autopatch! Later in the day, it was part of their network news feed and thereby attained national status.

According to Norm, this producer had also done her homework in regard to the differences between the amateur and Citizens Band services. Never once was there any mixup between the two on the part of the interviewer. There are similar stories from amateurs in other parts of the country who were contacted by the local electronic media with the result being some very positive publicity for our service. It didn't take a disaster to bring them to us, as is usually the case. In my mind, this signals a very positive step forward in

gaining recognition for our hobby. I doubt if you will ever see a prime-time network special dealing with amateur radio, but then again who knows what some exec might have in mind. Nevertheless, Field Day 1980 was probably the best publicized outing of its type in the history of amateur radio. And . . . Field Day 1981 is only a year away.

SIX METERS CONTINUED

Last month we began to discuss six meters, the deregulation that occurred during the summer, and a possible way in which the band might be developed. Since as this month's column is being written, last month's has not yet reached print, I cannot tell you of any feedback on what I put forth last month. Confusing? Remember, there is a 60-day time lag from when I write until the time you read.

To continue, one question most often asked of me is why the six-meter band is deserted. In many areas, this has been blamed on TVI to television channel 2. In other places, the story is that everyone else is operating on two-meter FM. Both are quite valid reasons, but six meters is to me a very important band regardless of the problems and/or excuses. There is no real excuse for leaving this vital parcel of amateur spectrum unattended. I can give you one very good reason that more of you should consider getting on 6 meters. One of these days it might well get discovered by the 11-meter crowd and be populated by them either legally (as was the case with the establishment of 11 meters) or illegally (as is the case with 10½ meters)!

Not long ago, the FCC acted to deny any further expansion of 11-meter spectrum to CB. Many CB organizations had hoped for the creation of either a new pseudo-amateur-type service or some form of SSB-only CB expansion. The lobbying for this was extensive, and everyone thought it would be a rubber stamp deal. In fact, the decision to deny was a shock to most 10½-meter SSB enthusiasts. (For our purposes, 10½-meters is defined as 27.410 through 27.540 MHz.) The proposal before the FCC was to create 25 new SSB-only channels and permit limited vfo operation as well

as skip contacts with other United States and Canadian stations. Also, the five-minute rule on contacts would have been abolished. Though it had the backing of both the Private Radio Bureau and the Office of Chief Scientist, the proposal ran into heavy opposition from the Field Office Bureau.

Field Office Bureau Chief Jim McKinney argued that this approach would not solve the problems of the 11-meter band, and would in effect be rewarding the current illegal inhabitants of 10½ meters with new spectrum. McKinney noted that his monitoring stations had recorded conversations between illegal 10½-meter operators in which it was stated that said operators would "move away from any new expansion so as to maintain their clear channels." Later reports I heard from various sources told of plans by these operators to "take 10 meters" if necessary. Had this occurred, it would have meant an all-out war between the illegals and the amateur radio community.

What does all this have to do with 6 meters, you ask? Simply this. Unlike 10 meters, which is fairly well inhabited by licensed amateurs, these days the six-meter band has an estimated 3000 to 4000 users on various modes scattered nationwide. If 50,000 illegals decided to take the band, how hard to you think it would be for them to accomplish this? "Wait," you say. "These guys are only interested in working skip, and there is little of that on 6 meters." True, many are into pseudo-amateur DXing, but thousands of others are rag-chewers, not unlike you who operate on 2, 220, and 450. All they want is a nice clear parcel of spectrum where they can chew the fat across town without any interference. Is not 6 meters the ideal band to simply take? Could we really protect it from such an invasion? I think not. TVI won't stop them. Many of the 10½-meter illegals operate with very high power levels and already cause severe TVI and RFI problems in their neighborhoods and care little about it. If they're breaking the law anyhow, what's TVI to them?

How then can six meters be protected from such a potential threat? There is only one an-

Continued on page 240

Move over imports, here's the new TEN-TEC

DELTA

the notable change in hf transceivers



All new, all **nine** hf bands and only \$849!

DELTA — the symbol of change—the name of a great new TEN-TEC transceiver. A transceiver for changing times, with new features, performance, styling, size and value.

TOTAL SOLID-STATE. By the world's most experienced manufacturer of hf solid-state amateur radio equipment.

ALL 9 HF BANDS. First new transceiver since WARC. 160-10 Meters including the three new hf bands (10, 18 & 24.5 MHz). Ready to go except for plug-in crystals for 18 and 24.5 MHz segments (available when bands open for use).

SUPER RECEIVER. New, low noise double-conversion design, with 0.3 μ V sensitivity for 10 dB S+N/N.

HIGH DYNAMIC RANGE. 85 dB minimum to reduce overload possibility. Built-in, switchable, 20 dB attenuator for extreme situations.

SUPER SELECTIVITY. 8-pole monolithic SSB filter with 2.4 kHz bandwidth, 2.5 shape factor at 6/60 dB points. And optional 200 Hz and 500 Hz 6-pole crystal ladder filters. Eight pole and 6-pole filters cascade for 14 poles of near ultimate skirt selectivity. Plus 4 stages of active audio filtering. To sharpen that i-f response curve to just 150 Hz bandwidth. 4-position selectivity switch.

BUILT-IN NOTCH FILTER. Standard equipment. Variable, 200 Hz to 3.5 kHz, with notch depth down to -50 dB. Wipes out interfering carriers or CW.

OFFSET TUNING. Moves receiver frequency up to ± 1 kHz to tune receiver separately from transmitter.

"HANG" AGC. For smoother, clearer, receiver operation.

OPTIONAL NOISE BLANKER. For that noisy location, mobile or fixed.

WWV RECEPTION. Ready at 10 MHz.

"S"/SWR METER. To read received signal

strength and transmitted standing wave ratio. Electronically switched.

SEPARATE RECEIVER ANTENNA JACK. For use with separate receiving antenna, linear amplifier with full break-in (QSK) or transverters.

FRONT PANEL HEADPHONE AND MICROPHONE JACKS. Convenient.

DIGITAL READOUT. Six 0.3" red LEDs.

BROADBAND DESIGN. For easy operation. Instant band change—no tuneup of receiver or final amplifier. From the pioneer, TEN-TEC.

SUPER TRANSMITTER. Solid-state all the way. Stable, reliable, easy to use.

200 WATTS INPUT. On all bands including 10 meters (with 50 ohm load). High SWR does not automatically limit you to a few watts output. Proven, conservatively rated final amplifier with solid-state devices warranted fully for the first year, and pro-rata for five more years.

100% DUTY CYCLE. All modes, with confidence. 20 minutes max. key-down time. Brought to you by the leader in solid-state finals, TEN-TEC.

QSK — INSTANT BREAK-IN. Full and fast, to make CW a real conversation.

BUILT-IN VOX AND PTT. Smooth, set-and-forget VOX action plus PTT control. VOX is separate from keying circuits.

ADJUSTABLE THRESHOLD ALC & DRIVE. From low level to full output with ALC control. Maximum power without distortion. LED indicator.

ADJUSTABLE SIDETONE. Both volume and pitch, for pleasant monitoring of CW.

SUPER STABILITY. Permeability tuned VFO with less than 15 Hz change per F° change over 40° range after 30 min. warmup—and

less than 10 Hz change for 20 Volt AC line change with TEN-TEC power supply.

VERNIER TUNING. 18 kHz per revolution, typical.

SUPER AUDIO. A TEN-TEC trademark. Low IM and HD distortion (less than 2%). Built-in speaker.

SUPER STYLING. The '80s look with neat, functional layout. "Panelized" grouping of controls nicely human engineered for logical use. New, smaller size that goes anywhere, fixed or mobile (4 $\frac{3}{4}$ "h x 11 $\frac{3}{8}$ "w x 15"d). Warm, dark front panel. Easy-to-read contrasting nomenclature. Black "clam-shell" aluminum case. Tilt bail.

MODULAR/MASS-TERMINATION CONSTRUCTION. Individual circuit boards with plug-in harnesses for easy removal if necessary. Boards are available.

FULL ACCESSORY LINE. All the options: Model 282 200 Hz CW filter \$50; Model 285 500 Hz CW Filter \$45; Model 280 Power Supply \$149; Model 645 Dual Paddle Keyer \$85; Model 670 Single Paddle Keyer \$34.50; Model 247 Antenna Tuner \$69; Model 234/214 Speech Processor & Condenser Microphone \$163; Model 215 PC Ceramic Microphone \$34.50. Model 283 Remote VFO, Model 287 Mobile Mount, and Model 289 Noise Blanker available soon.

Experience The Notable Change In HF Transceivers, Experience DELTA. See your TEN-TEC dealer or write for full details.

TEN-TEC
SEVIERVILLE, TENNESSEE 37862
EXPORT 5715 LINCOLN AVE. CHICAGO, ILL. 60646

DX



Jim Cain K1TN
306 Vernon Avenue
Vernon CT 06066

Dateline: Mid-October, 1974. Seems like only yesterday, as Frederick Lewis Allen would have said. A phone call came in about 2200 UTC from one of the locals who got home from work earlier than we did. "Jim, 15 is wide open to Japan! I can't believe it!" "Skew path over Australia?" we asked. "Nope, direct, just like the real thing, and they're about S7-good, steady signals." It was tough putting in that last half hour at the salt mine, and we pushed the Porsche's pedal to the floor to get home. The 15-meter antenna hadn't been pointed toward Japan for anything other than trying to find our local noisy power

pole in at least two years.

Sure enough, we ended up sitting at the radio for a couple of hours, happily exchanging reports with the JA stations, many of them low-power novice operators who had never worked anything in the States east of Seattle; they did their best to pronounce "Connecticut" for the first time and it was easy to sense the thrill in their voices. The openings continued for several evenings, only to Japan and immediately surrounding areas, though. We worked about 500 JA stations in a few weekday evening operating stints, and got about 495 QSL cards through the QSL bureau for the effort. Dinner went uneaten, chores were undone, and sleeping was curtailed during this period, which W1HDQ would later call an unprecedented rise in the solar flux and sunspot activity during a sunspot minimum.

What most of us would call it is a miracle. In the autumn of 1974, conditions had deteriorated for a couple of years, since about 1971, and things were going to get a lot worse before they started getting any better. Ten

meters was basically useless, 15 was a joke most of the time, and 20 was no great shakes. Long path? Forgotten. Japan coming in over Europe? Don't be silly. Many of us just kept up a 20-meter beam and concentrated on 40, 80, and 160 for the duration of the vacation the sun had taken from spotting. This writer had over 200 DXCC countries confirmed on 80 meters, with 40-15 long finished for 5-Band DXCC, but 10 looked hopeless. We had rushed home a couple of times that summer to catch multiple-hop Sporadic E openings (or whatever they were) into Europe, attempting to work a hundred on 28 MHz, but the openings were always extremely sharp geographically and never extended into the USSR and seldom into eastern Europe in general. Those, friends, are stinko conditions.

Just five years after the propagation pits of 1974 came the winter of '79-'80, the best in twenty years. Japan was worked from Connecticut on six meters, and hundreds got Alaska and Hawaii on 50 MHz to finish up Worked All States. Ten meters opened to places like 4S7 Sri Lanka at midnight, and Californians worked long path into Africa on 10. Fifteen meters was open many days 'round the clock, with all continents S9 simultaneously. Twenty, of

course, was unbelievable, and with 15 and 10 taking some of the load, 20 was often pleasantly uncrowded.

What will this coming operating season be like? The forecasters tell us that the peak of sunspots was reached sometime last winter...this time may not see the phenomenal 6-meter propagation, and 10 might be just a hair less terrific, but still this winter will be the best for at least another six or seven years, and no serious radio operator should miss it. While sunspot lulls do encourage low band DXing and push us into often-ignored frequency territory, the minimum years are really pretty dismal, and, lest we forget, they will return. So enjoy October, 1980, because the radio won't be this good again soon.

The premier operating event of October (of the whole year, for that matter) is the CQ Worldwide Contest phone weekend (CW is in November). Don't miss it. Activities like the CQ WW generate the worldwide participation which enables us to discover band openings on paths which are normally unrecognized for mere lack of signals...like the old "does a tree falling make any noise if there's no one to hear it?" question. This contest in 1979 produced such feats as several stations who worked all 40 CQ zones over the weekend, 150 different DXCC countries, etc. K1RM set a new USA record on 15 meters, an all-time mark for a USA single operator on any band, and although it might seem that Vince could rest on his laurels for a while, his record could be broken this year, given a DXer at the right station. Maybe K1RM will break his own record, which now stands at 1768 contacts, 38 zones, and 129 countries.

DXCC NEWS

What is a *deleted country*? In DXCC terms, it is one which has ceased to count for the award; the last page of the ARRL's DXCC Countries List (CD-216) lists almost fifty such deleted countries. To make the Honor Roll, one must have worked, confirmed, and received DXCC credit for all but nine (or fewer) of the active countries on the list. That's why when the Honor Roll listing is published in QST,



Alvaro Fernandez K operated special callsign 6D2AF during the ARRL 1980 Contest; QSL Apartado A-23, Ciudad Obregon, Sonora Mexico.

Continued on page 220

A LIFETIME GUARANTEE AND 11 OTHER REASONS TO BUY AN "OPTOELECTRONICS" FREQUENCY COUNTER

- 1. SENSITIVITY:** Superb amplifier circuitry with performance that can't be matched at twice the price. Average sensitivity of better than 15 mV from 10 Hz to 500 MHz on every model and better than 30 mV from 500 MHz to 1.1 GHz on the Series 8010A and 8013.
- 2. RESOLUTION:** 0.1 Hz to 12 MHz, 1 Hz to 50 MHz, 10 Hz over 50 MHz.
- 3. ALL METAL CASES:** Not only are the heavy gauge aluminum cases rugged and attractive, they provide the RF shielding and minimize RFI so necessary in many user environments.
- 4. EXTERNAL CLOCK INPUT/OUTPUT:** Standard on the 8010/8013 series and optional on the 7010 series is a buffered 10 MHz clock time base input/output port on the rear panel. Numerous uses include phase comparison of counter time base with WWVB (U.S. National Bureau of Standards). Standardize calibration of all counters at a facility with a common 10 MHz external clock signal, calibrate scopes and other test equipment with the output from precision time base in counter, etc., etc.
- 5. ACCURACY:** A choice of precision to ultra precision time base oscillators. Our ± 1 PPM TCXO (temperature compensated xtal oscillator) and ± 0.1 PPM TCXO are sealed units tested over 20-40°C. They contain voltage regulation circuitry for immunity to power variations in main instrument power supply, a 10 turn (50 PPM) calibration adjustment for easy, accurate setability and a heavily buffered output prevents circuit loads from affecting oscillator. Available in the 8010 and 8013 series is our new ultra precision micro power proportional oven oscillator. With $\pm .05$ PPM typical stability over 10-45°C, this new time base incorporates all of the advantages of our TCXO's and virtually none of the disadvantages of the traditional ovenized oscillator: Requires less than 4 minutes warm-up time, small physical size and has a peak current drain of less than 100 ma.
- 6. RAPID DISPLAY UPDATE:** Internal housekeeping functions require only .2 seconds between any gate or sample time

period. At a 1 second gate time the counter will display a new count every 1.2 seconds, on a 10 second gate time a new count is displayed every 10.2 seconds. (10.2 seconds is the maximum time required between display updates for any resolution on any model listed).

- 7. PORTABILITY:** All models are delivered with a 115 VAC adapter, a 12 VDC cord with plug and may be equipped with an optional ni-cad rechargeable battery pack installed within its case. The optional Ni-Cad pack may be recharged with 12 VDC or the AC adapter provided.
- 8. COMPACT SIZES:** State-of-the-Art circuitry and external AC adapters allowed design of compact easy to use and transport instruments.
Series 8010/8013: 3" H x 7-1/2" W x 6-1/2" D
Series 7010: 1-3/4" H x 4-1/4" W x 5-1/4" D
- 9. MADE IN U.S.A.:** All models are designed and manufactured at our modern 13,000 square foot facility at Ft. Lauderdale, Florida.
- 10. CERTIFIED CALIBRATION:** All models meet FCC specs for frequency measurement and provided with each model is a certificate of NBS traceable calibration.
- 11. LIFE TIME GUARANTEE:** Using the latest State-of-the-Art LSI circuitry, parts count is kept to a minimum and internal case temperature is only a few degrees above ambient resulting in long component life and reliable operation. (No custom IC's are used.) To demonstrate our confidence in these designs, all parts (excluding batteries) and service labor are 100% guaranteed for life to the original purchaser. (Transportation expense not covered).
- 12. PRICE:** Whether you choose a series 7010 600 MHz counter or a series 8013 1.3 GHz instrument it will compete at twice its price for comparable quality and performance.

MODEL 8010A/8013 1.1 GHz/1.3 GHz

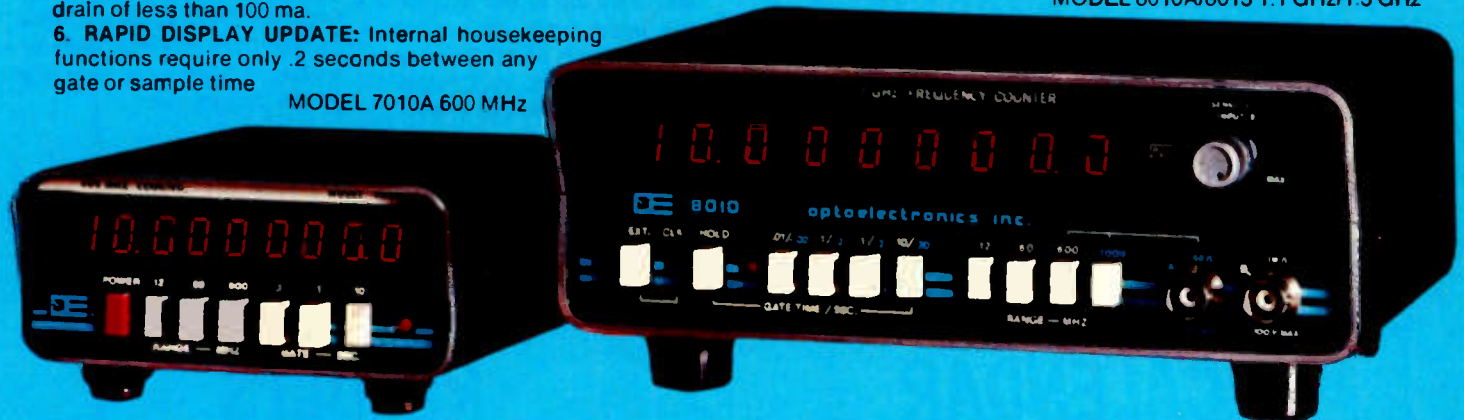

MODEL 7010A 600 MHz

MODEL	RANGE (From 10 Hz)	10 MHz TIME BASE			AVG. SENSITIVITY		GATE TIMES	RESOLUTION			EXT. CLOCK INPUT/OUTPUT	SENSITIVITY CONTROL	NI-CAD BATTERY PACK
		STABILITY	AGING	DESIGN	10 Hz to 500 MHz	500 MHz to 1.1 GHz		12 MHz	60 MHz	Max. Freq.			
7010A	600 MHz	± 1 PPM	<1 PPM/YR	TCXO*	15 mV	N/A	(3) .1, 1, 10 sec.	1 Hz	1 Hz	10 Hz (600 MHz)	YES OPTIONAL	NO	YES OPTIONAL
7010 1A		± 0.1 PPM											
8010A	1.1 GHz	± 1 PPM	<1 PPM/YR	TCXO*	15 mV	30 mV	(4) .01, .1, 1, 10 sec.	1 Hz	1 Hz	10 Hz (1.1 GHz)	YES STANDARD	YES	YES OPTIONAL
8010 1A		± 0.1 PPM											
8010.05A		$\pm .05$ PPM											
8013.1	1.3 GHz	$\pm .1$ M	<1 PPM/YR	TCXO*	15 mV	30 mV	(4) .01, .1, 1, 10 sec.	1 Hz	1 Hz	10 Hz (1.3 GHz)	YES STANDARD	YES	YES OPTIONAL
8013.05		$\pm .05$ PPM											

TCXO = Temperature Compensated Xtal Oscillator

**OCCO = Proportional Oven Controlled Xtal Oscillator

SERIES 7010A

#7010A	600 MHz Counter - 1 PPM TCXO	\$199.95
#7010 1A	600 MHz Counter - 0.1 PPM TCXO	\$249.95
OPTIONS		
#70-M	Handle/Tilt Bail (not shown)	\$2.95
#Ni-Cad-701	Ni-Cad Battery Pack & Charging Circuitry Installed Inside Unit	\$19.95
#EC-70	External Clock Input/Output	\$35.00
#CC-70	Carry Case - Padded Black Vinyl	\$9.95

SERIES 8010A/8013

#8010A	1.1 GHz Counter - 1 PPM TCXO	\$399.00
#8010.1A	1.1 GHz Counter - 0.1 PPM TCXO	\$450.00
#8010.05A	1.3 GHz Counter - .05 PPM Oven	\$499.00
#8013.1	1.3 GHz Counter - 0.1 PPM TCXO	\$550.00
#8013.05	1.3 GHz Counter - .05 PPM Oven	\$599.00

OPTIONS

#Ni-Cad-801	Ni-Cad Battery Pack & Charging Circuitry Installed Inside Unit	\$49.95
#CC-80	Carry Case - Padded Black Vinyl	\$ 9.95

ACCESSORIES

#TA-10W	Telescope antenna with right angle BNC	\$ 9.95
#P-100	Probe, 50 Ohm, 1X	\$13.95
#P-101	Probe, Lo-Pass Audio Usage	\$16.95
#P-102	Probe, Hi-Z General Purpose	\$16.95
#LFM-1110	Low Frequency Multiplier X 10, X 100, X 1000 For High Resolution of Audio Freq.	\$119.95



Optoelectronics inc

5821 N.E. 14th Avenue, Fort Lauderdale, Florida 33334

1-800-327-5912

FROM FLORIDA (305) 771-2051/2

TERMS: Orders to U.S. and Canada, add 5% for shipping, handling and insurance to a maximum of \$10.00. All other orders add 15% C.O.D. collection fee \$2.00. Florida orders add 4% state tax. Personal checks must clear before goods are shipped.

CONTESTS



Robert Baker WB2GFE
15 Windsor Dr.
Atco NJ 08004

CALIFORNIA QSO PARTY

Starts: 1800 GMT October 4
Ends: 2359 GMT October 5

The contest is sponsored by the Northern California Contest Club, with strong efforts being made to have all 58 counties in California on for the contest duration.

Single-operator stations may operate only 24 hours of the contest period; off times must be clearly marked in the log. Multi-operator stations may operate the full 30 hours. Stations may be worked only once per mode per band. All contacts must be simplex. California stations that change counties are considered to be new stations and may be contacted again for points credit.

EXCHANGE:

CA stations send QSO number and county. Others send QSO number and state, province, or ARRL country.

FREQUENCIES:

Novice—3725, 7125, 21125, 28125. CW—1805, 3560, 7060, 14060, 21060, 28060. SSB—1815, 3895, 7230, 14280, 21355, 28560.

SCORING:

Each completed phone contact is worth 2 QSO points. Each completed CW contact is worth 3 QSO points. For multiplier, CA stations use the number of states, VO/VE 1-7, and VY1/VE8 for possible of 58. Others use the number of CA counties worked for a possible total of 58. The final score is the number of QSO points multiplied by the number of multipliers.

AWARDS:

Certificates for highest-scoring station in each CA county, each state/province, and each country. Trophies to the highest-scoring out-of-state single op, highest-scoring CA single op, and highest-scoring DXpedition to a CA county.

ENTRIES:

All logs and summary sheets must be postmarked by November 1st and addressed to: NCCC, c/o Dennis Egan N6QW, 811 Byerley Avenue, San Jose CA 95125. Please include an SASE with your entry.

AWARDS:

Attractive certificates will be awarded to each country (each call area in USA, USSR, and Japan) for the top scorer using all bands. Other certificates may be awarded (2nd and 3rd depending on activity and conditions prevailing).

VK/ZL/OCEANIA DX CONTEST Phone

Starts: 1000 GMT October 4

Ends: 1000 GMT October 5
CW

Starts 1000 GMT October 11

Ends 1000 GMT October 12

Sponsored by the New Zealand Association of Radio Transmitters, Inc.

EXCHANGE:

Send 5 or 6 digits made up from the RS(T) report plus a three-digit QSO number starting with 001.

SCORING:

Oceania stations (other than VK/ZL) score 2 points for each QSO on a specific band with the rest of the world. For the rest of the world (other than VK/ZL), score 2 points per QSO on a specific band with VK/ZL and 1 point for each QSO on a specific band with Oceania stations other than VK/ZL. The final score is the total QSO points (from all bands used) multiplied by the sum of VK/ZL call areas worked on all bands.

ENTRIES:

Logs must show information in this order: date/time in GMT, callsign of station contacted, band, serial number sent, and serial number received. Underline each new VK/ZL call area contacted and make a separate log for each band used. Include a summary sheet to show: callsign, name and address (please use block letters!), details of equipment used, and, for each band, QSO points for that band and total VK/ZL call areas worked on that band. Include a signed declaration that all rules and regulations have been observed.

All logs should be posted to reach: NZART Contest Manager, ZL2GX, 152 Lytton Road, Gisborne, New Zealand before January 31st. Any logs, even for a small number of contacts, are greatly appreciated!

SWL SECTION:

A VK or a ZL station only must be heard in a QSO and the fol-

Continued on page 222

CALENDAR

Oct 4-5	California QSO Party
Oct 4-5	VK/ZL/Oceania DX Contest—Phone
Oct 11-12	ARRL CD Party
Oct 11-12	Montana QSO Party
Oct 18-19	ARRL Simulated Emergency Test
Oct 18-19	VK/ZL/Oceania DX Contest-CW
Oct 18-19	Scouting Jamboree
Oct 18-20	QRP October QSO Party
Oct 25-26	CQ Worldwide DX Contest—Phone
Nov 1-2	ARRL Sweepstakes—CW
Nov 8-9	European DX Contest—RTTY
Nov 8-9	IPA Contest
Nov 9	International OK DX Contest
Nov 15	DARC Corona 10-Meter RTTY Contest
Nov 15-16	ARRL Sweepstakes—Phone
Nov 29-30	CQ Worldwide DX Contest—CW
Dec 6-7	ARRL 160-Meter Contest
Dec 13-14	ARRL 10-Meter Contest
Jan 10-11	Hunting Lions in the Air
Jan 18	FRACAP Worldwide Contest
Mar 7-8	1981 SSTV Contest

RESULTS

RESULTS OF THE 2ND DARC CORONA 10-METER RTTY CONTEST FROM 10 MAY 1980

Call	Score	QSO	Countries	Prefix
<i>Class A</i>				
1. 9G1JX	2703	51	17	36
2. YT2D	1225	35	09	26
3. G3UUP	980	28	11	24
4. I5CBF	930	30	10	21
5. EA3BLQ	780	26	09	21
6. EA3BQQ	744	24	10	21
7. HB9LP	713	23	11	20
8. I2WEG	504	21	08	16
9. G3VXN	437	19	07	16
10. G3HJC	336	16	07	14
<i>Class B</i>				
1. H. BALLEMBERGER	368	16	10	13
2. K. WUESTNER	260	13	09	11
3. W. LUDWIG	66	06	05	06

TRAC



Features:

- State-of-the-Art CMOS Circuitry
- Choice of Message Storage
 - A. Six 30 character messages
 - B. Twelve 25 character messages
 - C. 27 combinations of message programming
- Records at any speed—plays at any speed
- Memory operating LED
- Use for daily OSO or contests

PLUS:

- Self-completing dots and dashes
- Both dot and dash memory
- Lambic Keying with any squeeze paddle
- 5.50 wpm
- Speed, volume, tone, tune and weight controls
- Sidetone and speaker
- Low current drain CMOS battery operation—portable
- Rear panel jack for auxiliary power
- Deluxe quarter inch jacks for keying and output
- Keys grid block and solid rigs
- **WIRED AND TESTED FULLY GUARANTEED—LESS BATTERY**

"BRAND NEW"
**CHAMPION MESSAGE
 MEMORY KEYSER**
 Model TE-292
\$125.95

DELUXE MESSAGE MEMORY KEYSER



\$89.95

Model TE-284

Features:

- State-of-the-Art CMOS Circuitry
- Three choices of Message Storage
 - A. Two 50 character each message storage
 - B. Four 25 character each message storage
 - C. One 30 character and two 25 character message storage
- Records at any speed plays at any speed
- Memory operating LED
- Use for daily OSO or contests

PLUS:

- Self-completing dots and dashes
- Both dot and dash memory
- Lambic Keying with any squeeze paddle
- 5.50 wpm
- Speed, volume, tone, tune and weight controls
- Sidetone and speaker
- Low current drain CMOS battery operation portable
- Deluxe quarter inch jacks for keying and output
- Keys grid block and solid state rigs
- **WIRED AND TESTED FULLY GUARANTEED—LESS BATTERY**



Model # TE201

\$69.95

Features:

- Advanced CMOS message memory
- Two (50 char each) message storage
- Repeat function
- Records at any speed—plays back at any speed
- Longer message capacity
 Example: send CQ CQ CQ Dx de WB2YJM WB2YJM R—then play second message on contact—de WB2YJM QSL NY NY 579 579 Paul Paul R.
- Use for daily OSOs or contests

**MESSAGE
 MEMORY
 KEYSER**

✓ 76

MODEL TE144—Deluxe CMOS Electronic Keyer

\$59.95

MODEL TE133—same as TE144 with wgt. and tone control internal, less semi-auto keying.

\$49.95

MODEL TE122—same as TE133 less wgt., tune, solid state keying

\$36.50

AT YOUR DEALER OR SEND CHECK OR MONEY ORDER.

(plus \$2.00 s/h NY res. add tax)

TRAC ELECTRONICS, INC
 1108 RAND BLDG.
 BUFFALO NY 14203

Touch-Tone Decoders



**TWELVE
 DIGIT
 DECODER**
\$155.00

- Decodes digits 1, 2, 3, 4, 5, 6, 7, 8, 9, 0, * and #.
- Twelve 5-volt output lines.
- Isolated 5000 ohm input.
- Operates from any DC voltage + 12 to + 30 volts.
- Output drives TTL logic or relays.



Model T2 \$59.95

- Decodes one Touch-Tone digit.
- Available for digits 1, 2, 3, 4, 5, 6, 7, 8, 9, 0, *, and #. Also for digits A, B, C, D.
- Relay output SPST 1/2 amp.
- Operates on any DC voltage + 12 to + 30 volts.



Model AR-3 \$59.95

- Sequence decoder.
- Connects to 12-digit decoder.
- Three digits must appear in correct order and timing to close output relay.
- For foolproof secure signalling.

Send for free brochure. ORDER TO-DAY. Add \$3 shipping/handling. Add sales tax in California.

Palomar Engineers

Box 455, Escondido, CA. 92025 • Phone: [714] 747-3343

RTTY LOOP

Marc I. Leavey, M.D. WA3AJR
4006 Winlee Road
Randallstown MD 21133

Okay, now, how many of you out there have heard of iRL? Come on, raise your hands. That's one, two, three... hmmm, not too many. I guess this goes along with what one of the guys from the company told me. You see, they have a new RTTY demodulator, the FSK 1000, and, in his words, "While we haven't expected the FSK 1000 to stun the free world and enrich us overnight, we still can't quite see why people would want to spend almost two hundred bucks more for something else." Well, after looking at the FSK 1000, I don't know what the problem is either.

Over the past few months, we have covered many demodulator designs and considered what makes a good demodulator. A common design point of many of these was the inclusion of a limiter stage in the front end. What the limiter does is boost the signal input to a clipped or limited level so that—in theory—all signals present are processed to the same amplitude. In practice, however, this only works for signals that are in the clear or reasonably noise-free. The ability to work without a limiter, in true limiterless (often called AM) mode, is a distinct advantage on our often crowded ham bands.

Unfortunately, most of the demodulators marketed to the RTTY amateur have not featured true limiterless operation. While a front-panel switch may be marked "LIMITER ON/OFF" or "AM/FM", there is usually no way to vary the input level to best take advantage of what signal there is. Further, selective fading without adequate logic to allow instantaneous reception on mark or space can be equally disastrous. The FSK 1000 changes all that.

A front-panel input level control and an LED which lights upon clipping, thus exceeding the linear range, make limiterless operation of the FSK 1000 easy. By adjusting the input so that the LED is just extin-

guished, maximum capability is ensured. By increasing the input level, any degree of clipping from controlled to hard limiting may be achieved. Clearly, all signals are not alike. Now there is no reason that the demodulator needs to stay the same, either.

Another bugaboo of demodulator design has been the filters. Through the years, filters have ranged, as we have seen, from TV-width coils to toroids to coil-less active filters. The problem has always been to maintain adequate selectivity, gain, and bandwidth at reasonable cost vs. performance trade-off. Well, iRL has come through, again, by using modern, sixth-order active filters in the FSK 1000. This permits selectable bandwidth and tunable peaks to cover any shift from 50 to 1000 Hz, with switch selection of 850 Hz, 425 Hz, and 170 Hz. The shift change is accomplished by tuning a multiple bandpass filter of constant bandwidth, rather than using audio frequency mixers in a heterodyning process. Thus, audio image problems, birdies, and spurious frequencies are minimized.

Now, as if the guts were not impressive enough, the boys at iRL have also worked hard to provide a heck of a box. The circuit board is a hefty 3/32-inch glass epoxy number, and the pots and other components are name brands. Full-sized, standard connectors are used on the rear skirt; no scrounging for mox plugs here. The whole thing is enclosed in an anodized aluminum box that unscrews for service but looks like it will support a TD on top of it. (I said "looks like it will"—I have not done it!)

There are even a bunch of options, as if the basic unit weren't enough. You can get a video board mounted inside and make a full terminal. ASCII-to-Baudot conversions go with that one. Some of the standard features are even more impressive, however. A RS-232 keyboard can be hooked into the back to key the loop, and RS-232 outputs are available also. That means the thing will work with our computer terminal, without a 60-mA

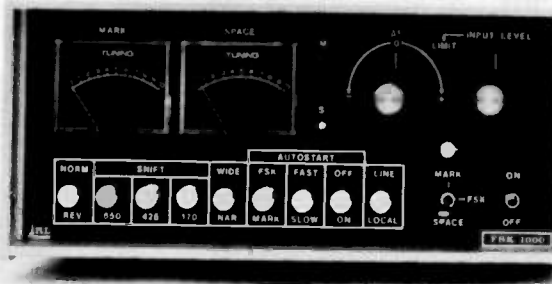

The FSK 1000 from iRL.

loop at all. There is a keyboard-activated switch (hitting any key turns on your transmitter) and a CW ID key jack. Tuning meters, scope outputs... I even think it makes a pretty good cup of coffee.

There are a few gripes, however. First off, look at the picture. I seriously considered having a contest to see how many of you could tell which push-button on the front panel was pushed. You see, even in real life, it is hard as the devil to tell what shift you are on, whether autostart is on or off, or whatever. Some form of indicator, LED, or whatever, or changing to toggle switches is needed to clear up that front panel. Speaking of clarity, about midway between the delta-tune and input knobs is a small knob labeled "THRESHOLD." This knob was added to late production runs, and allows you to adjust the autostart threshold (that is, the level at which the autostart will start) from the front panel. Fine, but there is no calibration, scale, or logging on the knob. No way to know where it is set nor return it to a previous setting. Bad news, fellas. And one last note: the autostart. When I first started playing with this thing, about a minute or two into the session, the front lights died and the printer went off. Now, if just the printer and loop had gone off, I would have known the autostart disengaged. But killing the front-panel lights made me think I'd blown a fuse. Only a fortuitous signal brought life to the machine and saved the day. Really, now, why not leave the lights alone? Other-

wise, when killing equipment at the end of the day, there is no quick way to know the thing is on.

All in all, however, I have to commend the folks at iRL. They have turned out a solid demodulator that well should stun the free world. The FSK 1000 currently sells for \$449.00, and you can see their ads here in 73 or write to iRL, 700 Taylor Road, Columbus, Ohio 43230.

I received a letter recently from Tom Waarvik of Indianapolis, Indiana, who related that he was a beginner, with a Teletype Model KSR-35 and a modem, and that he wanted to be able to receive Morse, Baudot, and ASCII on that setup. He notes that much of the commercial gear is over his budget, and he is looking for cheap ways of code conversion. Well, Tom, this is where the computer in the shack comes in handy. There are reams of published programs for receiving any or all of these modes with just about any of the popular computer chips. You might check back issues of 73 and *Microcomputing* magazines. In September and December, 1979, I listed many of these articles in this column. See if you can scrounge a copy in your area, or check with 73's back issue department. Which computer? Well, I am partial to the 6800 and have written some fairly sophisticated programs to work RTTY on one. But whichever you can get within your budget, 6800, 8080, Z-80, Apple, Pet, or TRS-80, they can be made to work on RTTY and Morse. That is probably the best way to go.

WHEN OUR CUSTOMERS TALK... WE LISTEN.



John Fail, KL7GRF/6
Long Beach, CA



Vernelle "Red" Irwin, K9KUW
Kenney, IL

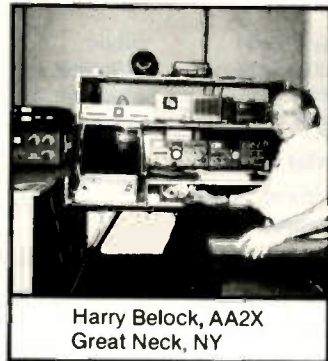

Harry Belock, AA2X
Great Neck, NY

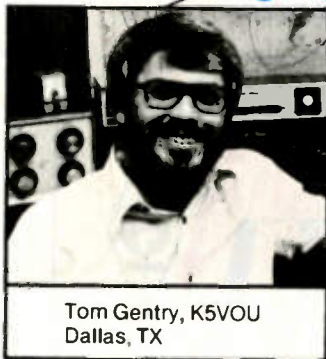
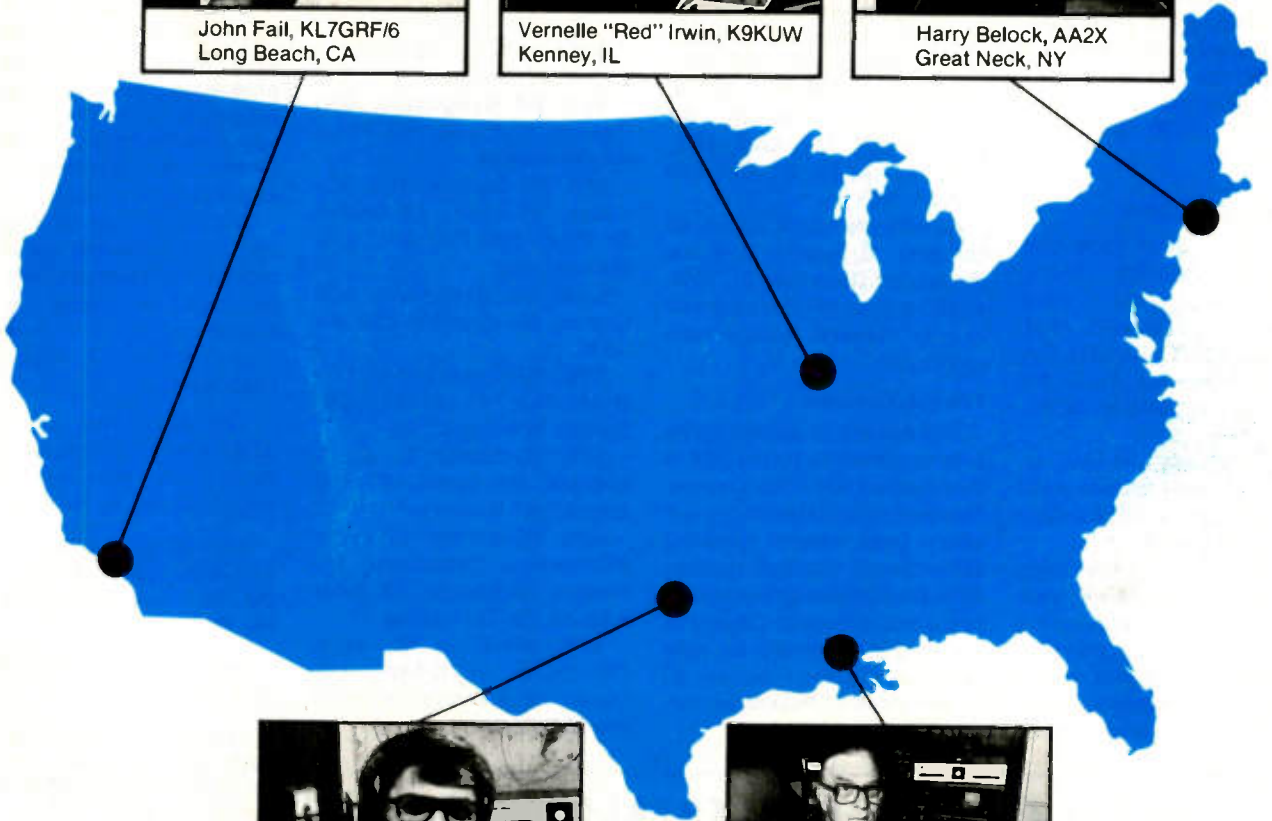

Tom Gentry, K5VOU
Dallas, TX

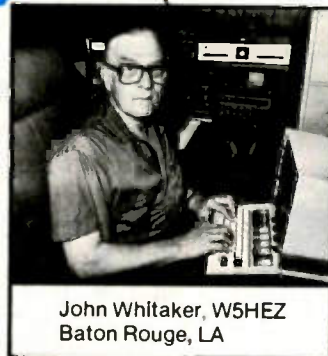

John Whitaker, W5HEZ
Baton Rouge, LA

And we respond with unexcelled RTTY equipment.

One reason RTTY equipment designed by HAL is always state-of-the-art quality is our open channel of communications with customers.

We *want* to hear the "What if's . . ." and "How about's . . ." that come from active and dedicated RTTY operators. Our engineers have combined

customer ideas with their own to create the most advanced equipment features and capabilities in the industry.

It adds up to greater enjoyment of RTTY operation and a dependability factor backed with a full one-year warranty.

Write or give us a call. We'll be glad to send you our new RTTY catalog.



HAL COMMUNICATIONS CORP.
Box 365
Urbana, Illinois 61801
217-367-7373

✓ 345

For our European Customers Contact:
Richter & Co., D3000 Hannover 1
Transradio SA, 6816 Bissone/Lugano

STOP RF SPILLOVER!

You may be losing up to half the available output from your vertical gain antenna because of RF spillover. The amazing AEA Isopole with unique decoupling design, virtually eliminates RF spillover and can help you multiply your power in all directions on the horizon relative to an ideal half-wave dipole, or end-fed non-decoupled "gain" antennas.



CALL TODAY
BRITT'S

2-way Radio Service
2508 North Atlanta Road
Belmont Hills Center
Smyrna, Georgia 30080
Phone (404) 432-8006

AEA Brings you the
Breakthrough!

FAST SCAN ATV

WHY GET ON FAST SCAN ATV?

- You can send broadcast quality video of home movies, video tapes, computer games, etc, at a cost that is less than slowscan.
- Really improves public service communications for parades, RACES, CAP searches, weather watch, etc.
- DX is about the same as 2 meter simplex — 15 to 100 miles.



ALL IN ONE BOX

TC-1 Transmitter/Conv
Plug in camera, ant, mic and you are on the air \$399 ppd



HITACHI HV-62 TV CAMERA
High performance closed circuit camera just right for atv. with lens \$239 ppd

PUT YOUR OWN SYSTEM TOGETHER



TVC-1B CONVERTER tunes 420 mhz down to ch 2 or 3 . . \$49.50 ppd
TXA5 EXCITER \$69 ppd
PA5 10 WATT LINEAR . . \$79 ppd
FMA5 Audio Subcarrier . \$24.50 ppd

SEND FOR OUR CATALOG, WE HAVE IT ALL

Modules for the builder, complete units for the operator, antennas, color cameras, repeaters, preamps, linears, video ider and clock, and more. 19 years in ATV.

Call 213-447-4565 5-6 pm ur time

57



Maryann
WB6YSS

P.C. ELECTRONICS

2522 PAXSON
ARCADIA, CA 91006

Tom
W6ORG



NEW FROM ALLIANCE!



HD-73 HEAVY-DUTY ROTATOR

with exclusive Dual-Speed Control!

For antennas up to 10.7 sq. ft. of wind load area. Mast support bracket design permits easy centering and offers a positive drive no-slip option. Automatic brake action cushions stops to reduce inertia stresses. Unique control unit features DUAL-SPEED rotation with one five-position switch. SPECIFICATIONS: Max. wind load bending moment—10,000 in.-lbs. (side-thrust overturning); Starting torque — 400 in.-lbs.; Hardened steel drive gears; Bearings —100- $\frac{3}{8}$ " diameter (hardened); Meter — D'Arsonval, taut band (back-lighted). There's much, much more — so get the whole story!

Mail this coupon for complete details!

YES! Send me complete details on the new HD-73!
 Give me the name of my nearest dealer!

NAME _____

ADDRESS _____

CITY _____

STATE _____

ZIP _____



The **ALLIANCE** Manufacturing Co., Inc., Alliance, Ohio 44601
A NORTH AMERICAN PHILIPS COMPANY

Maker of the famous Antenna Rotator . . . Alliance Tenna-Rotor® . . . "TV's Better Color Getter!"

© 1978 The Alliance Mfg. Co., Inc.

THE GIANT **AZDEN** COMPANY

REVOLUTIONIZES THE STATE OF THE ART

AWE AND AZDEN INTRODUCE THE BRILLIANT NEW **PCS-2000**

**MICROCOMPUTER
CONTROLLED**

**SUPERIOR COMMERCIAL GRADE
2 METER FM TRANSCEIVER**

NOT \$550.00

FALL
SALE

\$259⁰⁰

REG. \$369.00

NOT \$550.00

FALL
SALE

\$259⁰⁰

REG. \$369.00



COMPARE THESE FEATURES WITH ANY UNIT AT ANY PRICE



- **FREQUENCY RANGE:** Receive and transmit: 144.00 to 147.995 MHz, 5Khz steps + MARS-CAP CAPABILITY BUILT IN (142-149.995 MHz).
- **ALL SOLID STATE-CMOS PL DIGITAL SYNTHESIZED.**
- **SIZE: UNBELIEVABLE! ONLY 6 3/4" x 2 3/8" x 9 3/4". COMPARE!**
- **MICROCOMPUTER CONTROLLED:** All scanning and frequency-control functions are performed by microcomputer.
- **DETACHABLE HEAD:** The control head may be separated from the radio for use in limited spaces and for security purposes.
- **SIX-CHANNEL MEMORY:** Each memory is re-programmable. Memory is retained even when the unit is turned off.
- **MEMORY SCAN:** The six channels may be scanned in either the "busy" or "vacant" modes for quick, easy location of an occupied or unoccupied frequency. **AUTO RESUME. COMPARE!**
- **FULL-BAND SCAN:** All channels may be scanned in either "busy" or "vacant" mode. This is especially useful for locating repeater frequencies in an unfamiliar area. **AUTO RESUME. COMPARE!**
- **INSTANT MEMORY-1 RECALL:** By pressing a button on the microphone or front panel, memory channel 1 may be recalled for immediate use.
- **MIC-CONTROLLED VOLUME AND SQUELCH:** Volume and squelch can be adjusted from the microphone for convenience in mobile operation.
- **ADDITIONAL OFFSETS:** Provides three additional offset values: +0.4 MHz, +1 MHz and +1.6 MHz. Other offsets may also be obtained.
- **25 WATTS OUTPUT:** Also 5 watts low power for short-distance communication.
- **DIGITAL S/R/F METER:** LEDs indicate signal strength and power output. No more mechanical meter movements to fall apart!
- **LARGE 1/2-INCH LED DISPLAY:** Easy-to-read frequency display minimizes "eyes-off-the-road" time.
- **PUSHBUTTON FREQUENCY CONTROL FROM MIC OR FRONT PANEL:** Any frequency may be selected by pressing a microphone or front-panel switch.
- **SUPERIOR RECEIVER SENSITIVITY:** 0.28 uV for 20-dB quieting. The squelch sensitivity is superb requiring less than 0.1 uV to open. The receiver radio circuits are designed and built to exacting specifications, resulting in unsurpassed received-signal intelligibility.
- **TRUE FM, NOT PHASE MODULATION:** Transmitted audio quality is optimized by the same high standard of design and construction as is found in the receiver. The microphone amplifier and compression circuits offer intelligibility second to none.
- **OTHER FEATURES:** Dynamic Microphone, built in speaker, mobile mounting bracket, external remote speaker jack (head and radio) and much, much more. All cords, plugs, fuses, microphone hanger, etc. included. Weight: 6 lbs.
- **ACCESSORIES:** 15' REMOTE CABLE.....\$29.95. CS-6R A/C POWER SUPPLY.....\$49.95. TOUCHTONE MIC. KIT.....\$39.95. EXTERNAL SPEAKER.....\$18.00.

AMATEUR-WHOLESALE ELECTRONICS ORDER NOW TOLL FREE

8817 S.W. 129th Terrace, Miami, Florida 33176
Telephone (305) 233-3631 • Telex: 80-3356
HOURS: 8-6, Mon. - Thur.

1-800-327-3102

U.S. DISTRIBUTOR
DEALER INQUIRIES INVITED

CREDIT CARD HOLDERS MAY USE OUR TOLL FREE ORDERING NUMBER.

LEAKY LINES

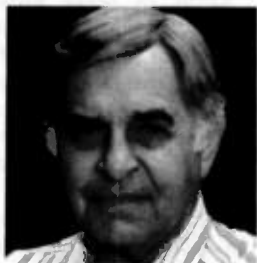

Dave Mann K2AGZ
3 Daniel Lane
Kinnelon NJ 07405

When I was teaching school, back a few years ago, I was serving in a rather prestigious private school in New York which operated on a trimester basis. During the periods between the trimester divisions, the faculty offered what were known as "mini-courses." These abbreviated sessions, embracing a broad variety of subject matter which was generally unrelated to the general courses of study, were highly popular with our students.

Although I was head of the music department of the high school division of the school and might have been expected to present some musical material such as jazz, folk singing, Calypso, or the like, I did not. Because of my ties with amateur radio, I chose instead to present a condensed ham radio course for the ten-day period, leading to the Novice license. My plan was to get as many students licensed as would be required to get a viable ham radio club going... club station and all.

I had no fears concerning the aptitude of the students; our kids were all thoroughly capable in their scholastic abilities... excellent in math and science... and the only question in my mind was their talent for CW. I needn't have worried. In all the time I held such courses, not one student ever failed to negotiate the code element.

A typical experience: Out of about a dozen boys and girls, nine or ten would succeed in passing the Novice exam. And of those who did, at least fifty percent would upgrade to General, and about ten percent of each original mini-course group would acquire the Amateur Ex-

tra ticket in due course, and sometimes surprisingly soon afterward.

As you can understand, my experience with teen-aged kids has been a very rewarding one. But a veritable ocean of negative stuff has been written and spoken about today's young people. Much of it, of course, has been prompted by genuine fears and concerns on the part of the adult population, which has been constantly barraged with TV news stories about juvenile crime in the larger cities. Not that such reports are untrue. But we tend to grow myopic when we are exposed consistently to just one side of a given question. Much of the adult mistrust and apprehensiveness is undeserved. The kids represent what is both good and bad in our society, just as adults do.

Some of our kids came from pretty bad environments; we had a very liberal scholarship program and drew about one-third of our students from inner-city slum areas. Although some of them were never able to overcome their hostilities in order to capitalize on the opportunity to succeed, most fared better. These were among the best kids in the school. Perhaps this was because they realized that unless they tried their best, they would be unlikely to have the opportunity ever again.

I won't pretend that ham radio is the only avenue through which to lead kids into productivity as responsible contributors to society. Nor will I claim that it is the best avenue. But I know that it is an effective one.

We amateurs frequently devote effort toward the recruitment of youth through well-established organizations such as the Boy Scouts, Girl Scouts, Campfire Girls, De Molay, the Shrine, various fraternal and social groups, and the like. This is good, of course, and should be continued, by all means. But I would like to urge hams to investigate the possibility of reaching out into the less-advantaged, easily-ignored sections of the society. The work that can be

done is enormously needed, to be sure. And its potential benefit to amateur radio is incalculable.

While we hams are fond of saying that our hobby cuts across all sorts of socio-economic lines, that the amateur radio fraternity is not divided by differences but united by common interests and purposes, this is really a vague generalization and oversimplification. The fact is that although we don't discuss them openly as a general rule, there do happen to be wide disparities, especially economically, and some of us are far more capable of footing the bills which are involved in ham radio. What I am leading up to is that I think that we should have many more club stations in this country than we have. If we did, it is likely that we would have a much greater number of hams, for many young persons who are intimidated at the realization that rigs cost a great deal of money would then seek recruitment into our ranks.

I think that most of us agree that we should seek an increase in our ham population; there are very few who mistakenly advocate a closed group under the illogical theory that this would tend to make us an aristocratic minority... better than others. But if we were to confine our efforts to proselytize among the well-to-do exclusively, we would probably be eliminating many of those who, potentially, might make some of the greatest contributions to the hobby.

At this point in time, when the twin monsters of inflation and unemployment have impoverished many families and when this phenomenon cannot help but affect the growth of ham

radio, we should be assisting in the development of as many ham club stations as possible.

I personally know persons who could not possibly use all the gear they possess if they lived to be a thousand! The stuff just sits there, unused and forgotten, to be brought out, perhaps, once in a while during some flea market. It is rarely sold, but if it is, it brings in a few paltry bucks.

Let me remind you that the tax laws permit us to make gifts and to declare them as such and take credits based upon their value. There must be enough gear gathering dust and cobwebs to equip tens of thousands of club stations. Why couldn't we organize a campaign among ourselves to try to put such equipment to use so that the club station idea might be stimulated into healthy growth?

The kid who at some future time may sit at an operating table with a headset and a telegraph key, working DX, handling traffic, or rag chewing, won't be hanging around a poolroom, vandalizing someone's house, spraying painted graffiti on subway cars, heisting pocketbooks from old ladies, or shooting dope into his veins!

The Amateur Service has always contributed to the society; our record of public service is our proudest achievement. We can add greatly to that record by making the growth of club stations an urgent priority. And in so doing we will be making a meaningful contribution toward the future of our hobby.

How better could we give back a small portion of all that it has given us?

HAM HELP

Can anyone help me obtain information on the WWII British aircraft receiver type R-1147A. This receiver was possibly used in the Spitfire or other fighter aircraft of this period. Any bit of info you might have would be of value. Schematics and manuals are needed as well (copies would be great). Thanks.

Steven Johnson WD8DAS
823 Irvington NE
Massillon OH 44646

I need a schematic and/or operating manual for a Panoramic Ultrasonic Spectrum Analyzer model SB-7A & PS-8 Power Supply. I also need the same for a TN-337/UPM-72 Frequency Converter (1120-3200 MHz in, 30 MHz out). I will pay for copying or I'll do the copying and return the manuals. Thanks.

Gary McConville WB4SQQ
4144 Rebel Trails Drive
Douglasville GA 30135

LETTERS

HISTORY LESSON

I'm not much given to writing to "ye Ed" except to that of the *SMPTE Journal* for which, in my ancient age, I still review technical papers.

However, the thing that set me off was the letter about "Operation 'Peckerwatch'" in the August issue. Speaking for myself, I'm for it. Oh, I'm aware of the ramifications...heck, I spent all of my adult life in communications, the last 27 years as chief engineer of a large TV station. Perhaps the great FCC would eventually get around to twisting the arms of the toothless tiger at State to apply pressure via the World Court at the Hague. By the way, did you not notice that while the WARC was in session, the woodpecker was quiet?

Obviously the ARRL is, as an organization, doing "sweet damn all" about the situation. *QST* should be full of continued exhortations urging the membership to inundate Senators and Congressmen with complaints. What do we have? A totally Casper Milquetoast-ish attitude. When I wrote to Baldwin saying that I had done just that, I heard from one of his minions (apparently he can't be bothered to answer himself... a cardinal requirement for any executive). The reply wanted to know what success I had had!

Re the ARRL: I have no desire to see its destruction, but some major changes have been hanging fire for decades. For the record, I go back to 1930 when I became W3CMY. Came World War Two and other than very, very, brief spurts as W8ENC and W4GPN, I dropped out... as chief engineer of a TV station which designed and built much of its equipment running into several hundreds of units, I had more than enough electronics to keep me busy. But, coming back as KB4GF two years ago, I found that although amateur radio had advanced tremendously, all that I had to do was to scratch the name of "Warner" and substitute "Baldwin." I found the same autocratic attitude which

is a autocratic as can be.

I strongly object to the method of electing (?) officers, especially "el presidente"; more on the incumbent later. There was a similar problem with IEEE where the "establishment," the "club," would select a candidate, period. Only this year have we finally gotten a non-establishment person elected to the office. It is about time that something similar occur in the ARRL.

All of which brings me to "el presidente" en situ. This man, as reported in *High Fidelity*, attended an FCC hearing on the subject of RFI. In respect to radio interference to hi-fi gear, he pulled a small capacitor out of a pocket, waved it in the air, and said that this was the solution to all such problems. This character, mind you, is listed in my IEEE directory as an engineer!

Then there is the matter of intellectual integrity, especially as it concerns DXCC. I'm one of the originals and I wouldn't touch the current version with a barge pole. Once upon a time a country was a country. But now apparently any old rock in the ocean will do even if it is totally under water at high tide. Some of the places which have been granted "country" status are incredible. I wonder who are the characters who constitute the DXCC committee and what their qualifications may be as geographers and/or demographers, if any. Apparently their sole interest is a slavering after a continually rising country count. I'm reminded of what I consider a real dandy... Desecheo. I sailed the Mona passage as a very young "Sparks" (only spark and arc in that day). I know the story behind *that*, but having sailed in that area, it seems like a very bad joke.

Autocrat though he may have been, I know that TOM/HPM would have taken the dimmest of views of this. *He* was a man of integrity.

I enjoyed W6CK's article and the "Kilroy" story brought back many memories... New York to Matadi via Norwegian freighter, Leopoldville to Cairo via Qantas

Short Brothers flying boat mostly over the desert, Mid East, North Africa, 50 kW transmitter installations, Southern Italy, Rome where I ran Italy's equivalent of RCA's Rocky Point cum AT&T's Lawrenceville plants, Brenner Pass, and no one wanted to accept my orders whereat I said to hell with it, I was going home.

Ah, well, them was the days!

Keep it up. You've got a pretty good rag there, though many of your ideas I find somewhat incomprehensible. But then, variety is the spice of...? I may even re-subscribe.

Hugo A. Bondy KB4GF
Decatur GA

I've read all of Hiram Percy Maxim's books and I'm sorry that he stepped off the world while I was only 14 and just barely getting interested in electricity and radio. I'm sure we would have been great friends...and I know what he would have thought of those who followed him in the ARRL. But that is the same problem every benevolent dictator has...unbenevolent dictators who follow, most of whom get into control by ruthless power plays.—Wayne.

DOUBLE-DECKER

Don Wagner's interesting article on combining Velcro® with a hump floor mount ("The Soft Mount," August, '80) prompts me to describe a variation that I've been using successfully to hold multiple VHF-UHF rigs.

My 1978 Olds Cutlass, like most recent mid-size cars, has inadequate room to mount both a 2-meter KDK and a 220 Midland under the dash without getting in the way of the accelerator and brake pedals.

Looking at the boxes, I discovered that the Midland had air vents on the bottom and sides while the KDK was vented only on the sides. This meant that the 2-meter rig could sit on top of the 220 rig without blocking any of the vents.

The first step was to purchase a metal CB mount with an adjustable tilting top which screws directly to the transmission hump. Once the hump mount was in position, the 220 mounting bracket was permanently attached using bolts, lock washers, and wing nuts. A 1½" strip of black Velcro was glued

along each side of the top of the 220 Midland. Since some air circulation was desirable between the top of the 220 and the bottom of the 2 meter rigs, I glued the remaining Velcro to 1½" x ¾" strips of scrap plywood which were, in turn, glued along each side of the bottom of the KDK. The 2-meter rig was placed on top of the 220 and that radio was attached to its mounting bracket which was permanently affixed to the hump mount.

Presto. Both radios were securely in position at a convenient angle and adequate air circulation was ensured. A touch-tone pad mounted in a chassis box was then Velcroed to the top of the 2-meter transceiver. Since the 2-meter mounting bracket was not used, convenient pre-tapped holes on each side of the KDK were available and mobile microphone brackets were attached using the proper size screws and lock washers. Audio was brought out to surplus Motorola speakers mounted on the rear package shelf of the Olds.

As a result, both radios, touchtone pad, and mikes were conveniently located and the entire assembly can be removed for security or maintenance by merely unsnapping the 220 mounting bracket.

Jon J. Gallo KB6WT
Los Angeles CA

Good, and thanks for telling us about your setup. Also, thanks to you and your wife for dinner back during the NCC show... it was good to get together with you and Joe Merdler for a rag chew.—Wayne.

NO PHONEY

This afternoon, I attempted to check into a certain east coast net in the General portion of the 40-meter band. This net is an informal one, with a fairly large group of amateurs checking in each day.

When the net control station said "This is K2--- for ECA---; are there any check-ins with or without traffic?", I replied by stating my callsign, AF2M. The K2 net control seemed to have a great deal of difficulty with the callsign; he kept on calling me A2FM. I patiently gave him my callsign again, using phonetics

Continued on page 238



NEWS

BULLETIN

LOOK WHAT WE'VE GOT
IN STORE FOR YOU!!

TRADE-INS?
You BET we trade
on both new and
used equipment.



DRAKE TR-7



ICOM IC-720

SELECTION

SERVICE

and

SATISFACTION!

YAESU FT-707



KENWOOD TS-830S

DEAR OM:

There are TWO IMPORTANT FACTORS in any purchase of ham radio equipment - - - the PRODUCT and the DEALER.

Accordingly, we stock over 50-lines of QUALITY/BRAND-NAME merchandise offering YOU a "SELECTION" of HF and VHF equipment, antennas, operating aids and accessories that is "one of the best" in the Midwest.

But, it's not so much WHAT we sell, rather HOW we sell it that's worth your most serious consideration BEFORE YOU BUY.

When it comes to FAST DELIVERY, HONEST DEALING and PROMPT, RELIABLE "SERVICE" back-up . . . we don't just "advertise it" . . . WE GIVE IT!

Our friendly staff is more than READY, WILLING and ABLE to answer your questions, listen to your complaints and solve your problems. We WANT to "HELP YOU" enjoy your hobby and we take great pride in doing the job RIGHT.

Above all else, your full and COMPLETE "SATISFACTION" is our most important asset and we'll go a long-long way to PLEASE YOU — even if it takes a certain "EXTRA" amount of time and energy on our part.

YOU and your CONFIDENCE in us are well worth any and every EFFORT we can muster. And, we will be here to serve you in this fashion for many years to come.

73's STAN BURGHARDT WØIT BILL BURGHARDT WBØNBO JIM SMITH WBØMJY



"AMERICA'S MOST RELIABLE AMATEUR RADIO DEALER"

STORE HOURS: 9:00 A.M. thru
5:00 P.M. (CST) Mon. thru Fri.
Open Saturdays from
9:00 A.M. to 1:00 P.M. (CST)

PHONE:
605/886-7314

208 East Kemp Avenue ✓ 306
P.O. Box 73
Watertown, South Dakota 57201

Write today for our latest Bulletin/Used Equipment List.

OSCAR ORBITS

Courtesy of AMSAT

The OSCAR satellites are subject to atmospheric drag, of course, and the present period of intense solar activity has accentuated the problem. During this period, our sun has been expelling huge numbers of charged particles, some of which find their way into the Earth's upper atmosphere, increasing the density (and thus the drag) there. It is through this region that the OSCARs must pass. OSCAR 8, in a lower orbit than OSCAR 7, is the more seriously affected of the two.

If the drag factor is not considered when OSCAR calculations are performed, long-range orbital projections will be in error. For example, by the end of 1979, OSCAR 8 was more than 20 minutes ahead of some published schedules. The nature of orbital mechanics is such that extra drag on a satellite causes it to move into a lower orbit, resulting in a shorter orbital period. Thus, the satellite arrives above a given Earthbound location earlier than predicted.

Using data supplied to us by Dr. Thomas A. Clark W3IWI of AMSAT, the equatorial crossing tables shown here were generated with the aid of a TRS-80™ microcomputer. The tables take into account the effects of atmospheric drag and should be in error by a few seconds at most.

The listed data tells you the time and place that OSCAR 7 and OSCAR 8 cross the equator in an ascending orbit for the first time each day. To calculate successive OSCAR 7 orbits, make a list of the first orbit number and the next twelve orbits for that day. List the time of the first orbit. Each successive orbit is 115 minutes later (two hours less five minutes). The chart gives the longitude of the day's first ascending (northbound) equatorial crossing. Add 29° for each succeeding orbit. When OSCAR is ascending on the other side of the world from you, it will descend over you. To find the

equatorial descending longitude, subtract 166° from the ascending longitude. To find the time OSCAR 7 passes the North Pole, add 29 minutes to the time it passes the equator. You should be able to hear OSCAR 7 when it is within 45 degrees of you. The easiest way to determine if OSCAR is above the horizon (and thus within range) at your location is to take a globe and draw a circle with a radius of 2450 miles (4000 kilometers) from your QTH. If OSCAR passes above that circle, you should be able to hear it. If it passes right overhead, you should hear it for about 24 minutes total. OSCAR 7 will pass an imaginary line drawn from San Francisco to Norfolk about 12 minutes after passing the equator. Add about a minute for each 200 miles that you live north of this line. If OSCAR passes 15° east or west of you, add another minute; at 30°, three minutes; at 45°, ten minutes. Mode A: 145.85-95 MHz uplink, 29.4-29.5 MHz downlink, beacon at 29.502 MHz. Mode B: 432.125-175 MHz uplink, 145.975-925 MHz downlink, beacon at 145.972 MHz.

At press time, OSCAR 7 was scheduled to be in Mode A on odd numbered days of the year and in Mode B on even numbered days. Monday is QRP day on OSCAR 7, while Wednesdays are set aside for experiments and are not available for use.

OSCAR 8 calculations are similar to those for OSCAR 7, with some important exceptions. Instead of making 13 orbits each day, OSCAR 8 makes 14 orbits during each 24-hour period. The orbital period of OSCAR 8 is therefore somewhat shorter: 103 minutes.

To calculate successive OSCAR 8 orbits, make a list of the first orbit number (from the OSCAR 8 chart) and the next thirteen orbits for that day. List the time of the first orbit. Each successive orbit is then 103 minutes later. The chart gives the longitude of the day's first ascending equatorial crossing. Add 26° for each succeeding orbit. To find the time OSCAR 8 passes the North Pole, add 26 minutes to the time it crosses the equator. OSCAR 8 will cross the imaginary San Francisco-to-Norfolk line about 11 minutes after crossing the equator. Mode A: 145.85-95 MHz uplink, 29.4-29.50 MHz downlink, beacon at 29.400 MHz. Mode J: 145.90-146.00 MHz uplink, 435.20-435.10 MHz downlink, beacon on 435.090 MHz.

OSCAR 8 is in Mode A on Mondays and Thursdays, Mode J on Saturdays and Sundays, and both modes simultaneously on Tuesdays and Fridays. As with OSCAR 7, Wednesdays are reserved for experiments.

OSCAR 7 ORBITAL INFORMATION FOR OCTOBER

ORBIT #	DATE	TIME (GMT)	EQ. CROSSING (DEGREES WEST)
26889	1	0943:19	84.4
26902	2	0137:33	98.0
26914	3	0936:52	82.9
26927	4	0131:06	96.5
26939	5	0938:24	81.3
26952	6	0124:39	94.9
26964	7	0923:57	79.8
26977	8	0118:12	93.3
26989	9	0917:30	78.2
27002	10	0111:45	91.8
27014	11	0911:03	76.6
27027	12	0105:18	90.2
27039	13	0904:36	75.1
27052	14	0900:50	88.6
27065	15	0101:05	102.2
27077	16	0902:23	87.1
27089	17	0146:38	100.7
27102	18	0904:56	85.5
27115	19	0140:11	99.1
27127	20	0909:29	83.9
27140	21	0133:43	97.5
27152	22	0903:01	82.4
27165	23	0127:16	96.0
27177	24	0926:34	88.8
27190	25	0120:49	94.4
27202	26	0920:07	79.3
27215	27	0114:21	92.8
27227	28	0913:40	77.7
27240	29	0107:54	91.3
27252	30	0907:12	76.1
27265	31	0101:27	89.7

OSCAR 8 ORBITAL INFORMATION FOR OCTOBER

ORBIT #	DATE	TIME (GMT)	EQ. CROSSING (DEGREES WEST)
13118	1	0931:28	62.5
13132	2	0936:16	63.8
13146	3	0941:04	65.8
13160	4	0945:53	66.2
13174	5	0950:39	67.4
13188	6	0955:27	68.7
13202	7	0100:15	69.9
13216	8	0105:03	71.1
13230	9	0109:51	72.3
13244	10	0114:38	73.6
13258	11	0119:26	74.8
13272	12	0124:14	76.0
13286	13	0129:01	77.2
13300	14	0133:49	78.4
13314	15	0138:36	79.7
13327	16	0900:12	55.1
13341	17	0904:59	56.3
13355	18	0909:47	57.5
13369	19	0914:34	58.8
13383	20	0919:21	60.0
13397	21	0924:09	61.2
13411	22	0928:56	62.4
13425	23	0933:43	63.7
13439	24	0938:30	64.9
13453	25	0943:18	66.1
13467	26	0948:05	67.3
13481	27	0952:52	68.5
13495	28	0957:39	69.8
13509	29	0102:26	71.0
13523	30	0107:13	72.2
13537	31	0112:00	73.4

OSCAR 7 ORBITAL INFORMATION FOR NOVEMBER

ORBIT #	DATE	TIME (GMT)	EQ. CROSSING (DEGREES WEST)
27277	1	0900:45	74.6
27290	2	0904:59	88.1
27303	3	0149:14	101.7
27315	4	0948:32	86.6
27328	5	0142:47	100.2
27340	6	0942:05	85.0
27353	7	0136:19	98.6
27365	8	0935:37	83.5
27378	9	0129:52	97.0
27390	10	0929:10	81.9
27403	11	0123:25	95.5
27415	12	0922:43	88.3
27428	13	0116:57	93.9
27440	14	0916:15	78.8
27453	15	0110:30	92.3
27465	16	0909:48	77.2
27478	17	0104:02	90.8
27490	18	0903:20	75.6
27503	19	0902:35	89.2
27516	20	0101:49	102.8
27528	21	0901:07	87.6
27541	22	0145:22	101.2
27553	23	0944:40	86.1
27566	24	0138:54	99.7
27578	25	0938:12	84.5
27591	26	0132:27	98.1
27603	27	0931:45	83.0
27616	28	0125:59	96.5
27628	29	0925:17	81.4
27641	30	0119:32	95.0

OSCAR 8 ORBITAL INFORMATION FOR NOVEMBER

ORBIT #	DATE	TIME (GMT)	EQ. CROSSING (DEGREES WEST)
13551	1	0116:47	74.7
13565	2	0121:34	75.9
13579	3	0126:20	77.1
13593	4	0131:07	78.3
13607	5	0135:54	79.5
13621	6	0140:41	80.8
13634	7	0902:15	56.2
13648	8	0907:02	57.4
13662	9	0911:49	58.6
13676	10	0916:35	59.8
13690	11	0921:22	61.1
13704	12	0926:08	62.3
13718	13	0930:55	63.5
13732	14	0935:41	64.7
13746	15	0940:28	65.9
13760	16	0945:14	67.2
13774	17	0950:00	68.4
13788	18	0954:47	69.6
13802	19	0959:33	70.8
13816	20	0104:19	72.0
13830	21	0109:05	73.3
13844	22	0113:51	74.5
13858	23	0118:38	75.7
13872	24	0123:24	76.9
13886	25	0128:10	78.1
13900	26	0132:56	79.4
13914	27	0137:42	80.6
13928	28	0142:28	81.8
13941	29	0904:02	57.2
13955	30	0908:47	58.4



10% DISCOUNT Off List

64K 1 Drive \$3499.00

No Taxes on Out of State Shipments

Immediate Shipment From Stock

AUTHORIZED
TRS-80® DEALER A301

COMPUTER SPECIALISTS

- Popular 16K Level II System with Keypad \$ 670.00
- 26-1145 RS-232 Board 84.00
- 26-1140 "O" K Interface 249.00
- 26-1160 Mini Disk 424.00
- 26-1171 Telephone Modem 169.00
- Fast 100 CPS Centronics 730 Printer 675.00
- Text Quality Centronics 737 Printer 850.00

1-800-841-0860 Toll Free Order Entry
MICRO MANAGEMENT SYSTEMS, INC. ✓313

DOWNTOWN PLAZA SHOPPING CENTER
115 C SECOND AVE. S.W.
CAIRO, GEORGIA 31728
GA. PHONE NO. (912) 377-7120



15% DISCOUNT Off List

4K Level II \$552.00

Full Factory Warranty on All Items Sold

Largest Inventory in S.E. U.S.A.

Antenna Tuner

MEMORY KEYER BREAK- THROUGH!

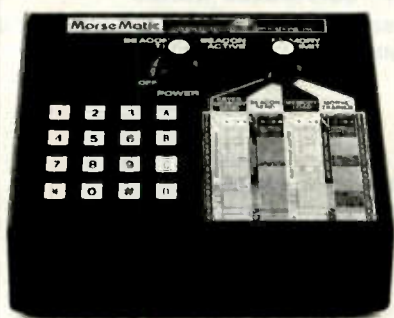

The remarkable AEA Morse-matic memory keyer has 35 fantastic features including two AEA designed microcomputers, up to 2,000 character memory, automatic serial number, beacon mode, and automatic morse trainer mode. The AEA Morsematic is already the undisputed leader in high quality multi-feature Morse Keyers.

CALL TODAY
Call 505-623-7388

**Pecos Valley
Amateur Radio
Supply**

112 West 1st
Roswell, New Mexico 88201

AEA Brings you the
Breakthrough!



New low profile design.

Here is the famous Palomar Engineers high power tuner in a new compact size. Only 5½" x 14" x 14" yet it has all the features, works from 160 through 10 meters, and works with coax, single wire and balanced lines. And it lets you tune up without going on the air!

WE INVESTIGATED

All tuners lose some rf power. We checked several popular tuners to see where the losses are. Mostly they are in the inductance coil and the balun core.

So we switched from #12 wire for the main inductor to ¼" copper tubing. It can carry ten times the rf current. And we've moved the balun from the output, where it almost never sees its design impedance, to the input where it always does. Thus more power to your antenna.

IMPOSSIBLE FEAT

The biggest problem with tuners is getting them tuned up. With three knobs to tune on your transceiver and three on the tuner and ten seconds to do it (see the warning in your transceiver manual) that's 1½ seconds per knob.

We have a better way; a built-in 50-ohm noise bridge that lets you set the tuner controls without transmitting. And a switch that lets you tune your transmitter into a dummy load. So you can do the whole tuneup without going on the air. Saves that final; cuts QRM.

BROCHURE AVAILABLE NOW

For further details on this exciting new high-power low-loss, easy-to-use tuner send for our new brochure. Or visit your Palomar Engineers dealer.

Model PT-3000, \$349.50. To order send \$10.00 shipping/handling. California residents add sales tax.



Palomar Engineers

Box 455, Escondido, CA. 92025 • Phone: [714] 747-3343

FUN!

John Edwards WB2IBE
78-56 86th Street
Glendale NY 11385

Tests have always played an important role in Amateur Radio. From pre-amateur status until we reach the exalted goal of an Extra-class license, much of our time is spent poring through license manuals and study guides as we scale our way up the ham radio licensing ladder. Yet, no matter how important the FCC's tests may be, let's be honest! From Novice through Extra, they're all about as dull as the finish on an eight-year-old car. You know, pages full of schematics and math problems—not to mention those dreary legal questions—all designed to make us competent radio operators.

Well, since the FCC isn't about to make their theory exams any more fun, and since study guides must accurately reflect the test's subject matter, it looks like studying is going to remain the grim pastime it has always been.

Still, there's no law that says learning has to be painful. Why not add a little fun to all that tedium? That's the goal here. What follows is a test created to teach about amateur radio in a *fun* sort of way. By fun, we mean we've selected interesting questions, devised word games, and transformed some raw radio data into a more digestible form.

Now, if you pass our little exam, you're not going to get a higher-grade license; you won't even receive an award. What you may obtain, however, is a little extra knowledge about our hobby, which may someday help you get that desired ticket or award. And if we accomplish that, while having a little fun in the process, that's just about a perfect combination.

So, sharpen your pencils, prepare your scrap paper (be sure to sign it and return it to the lady at the desk at the end of the test), and let's begin. Answers appear on page 225.

ELEMENT 1—CROSSWORD PUZZLE (Illustration 1)

- | Across | Down |
|-----------------------------------|------------------------------------|
| 1 W1AW | 1 1,000,000 Hertz |
| 4 Soviet satellite (abbr.) | 2 Amplitude modulation (abbr.) |
| 6 YL gender (abbr.) | 3 Highest DX place (abbr.) |
| 7 420 MHz (abbr.) | 5 The "S" in RST (abbr.) |
| 9 Above UHF (abbr.) | 8 What we operate on |
| 10 A transceiver | 9 Simulated Emergency Test (abbr.) |
| 11 Norwegian prefix | 14 What many dials do |
| 12 Morse "from" | 16 Ribbon at QSO's end |
| 13 Tube condition | 18 Irish prefix |
| 15 To cease operation | 23 Intermediate frequency |
| 17 Austrian prefix | 25 Radio frequency (abbr.) |
| 18 Liberian prefix | 26 Faroe Isl. |
| 19 Wireless | 28 Polish prefix |
| 20 Element (abbr.) | |
| 21 Antenna tuner | |
| 22 Contester's aim | |
| 24 _____ beat | |
| 27 In the Commission's possession | |
| 29 Guianian prefix | |

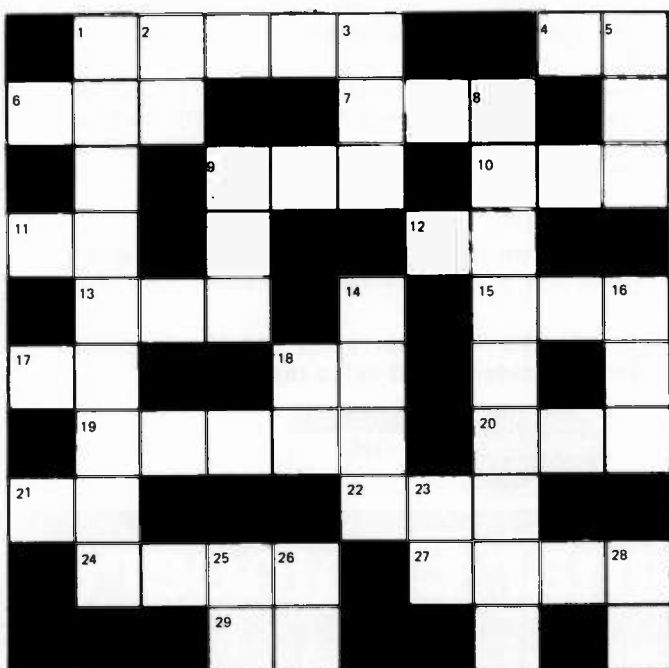

Illustration 1.

ELEMENT 2—SCRAMBLED WORDS

Instructions: Here are some familiar radio terms rendered unfamiliar by jumbling the letters. Your job—unscramble 'em.

- | | | | |
|---------|-------|--------|------|
| EMRAAUT | GYIA | YRTT | UEBT |
| XCDC | XCAO | DLI | LICO |
| NENTNAA | SVTS | LOPEID | VTI |
| SBS | YKEER | CSPEO | OXV |
| DEDIO | RACOS | DLRESO | VMTV |

ELEMENT 3—MULTIPLE CHOICE

Instructions: Same as the FCC's.

- 1) In addition to being the father of Amateur Radio, Hiram Percy Maxim was the father of a famous piece of weaponry. It was . . .
- 1) the cannon.
 - 2) the gun silencer.
 - 3) the "fireless" rifle.
 - 4) the revolver.
- 2) Your transmitter is set to 7.070 MHz. Can you plunk your CW signal right on top of a broadcast station using that same frequency, even though you'll obviously interfere with him?
- 1) No, a ham station may not interfere with any other station.
 - 2) Yes, because 40 meters is shared on an equal basis between hams and broadcasters.
 - 3) Yes, since a broadcast station on this frequency would be "out of band."
 - 4) Yes, but only if you run under 250 Watts.
- 3) One night, while on the 15-meter Novice band, you hear N1XXX transmitting RTTY. Is it within the law to send F1 on a Novice band?
- 1) No, only CW is permitted on Novice bands, regardless of license class.
 - 2) Yes, with an appropriate license, a ham may operate RTTY on any CW band between 80-10 meters.
 - 3) No, RTTY may only be transmitted between .070-.100 of any band.
 - 4) Yes, RTTY is permissible in any portion of any band.
- 4) What musical instrument did Sir Charles Wheatstone (inventor of the "Wheatstone Bridge") perfect? This is not a joke.
- 1) The harmonica.
 - 2) The Wheatophone.
 - 3) The piano.
 - 4) The saxophone.

Continued on page 225

INTIMIDATED BY MORSE CODE?



THE NEW AEA MODEL MT-1 COMPUTERIZED MORSE TRAINER MAKES MORSE CODE EASY AND FUN TO LEARN.

KT-1 Computerized Keyer With All Features of Above Trainer is Also Available in Same Package

- Automatic Speed Increase, User May Program: Starting Speed, Ending Speed, Practice Duration; 5 Letter code Groups or Random Space; Common or All Characters.
- Precise Speed Control 1 to 99 WPM (Tailor to Your Exact Requirements).
- 24,000 Character Answer Book Available For 10 Starting Positions.
- Random Mode For Practice (No Answers).

CALL TODAY

ROSS DISTRIBUTING COMPANY

Closed Monday at 2:00 p.m., 78 SOUTH STATE STREET, PRESTON, IDAHO 83263, TELEPHONE: (208) 852-0830

AEA Brings you the Breakthrough!



Germantown Amateur Supply, Inc.

MEMPHIS, TENNESSEE

NO MONKEY BUSINESS!

- (A) Complete Service Facilities
- (B) Good Deals on most Brands
- (C) Shipping within 24 Hours
- (D) All inquiries handled by Active Hams with over 20 years experience in ham radio

CALL TOLL FREE

1-800-238-6168

IN TENNESSEE, CALL 901-452-4276

MONDAY - SATURDAY 8:30-5:30

FOR YOUR SPECIAL.

Write: 3202 Summer Ave., Memphis, Tennessee 38112

Shortwave Listener?

SEND FOR FREE CATALOG!

Scanner Buff?

Increase Your Listening Power!

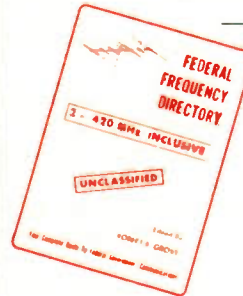

FEDERAL FREQUENCY DIRECTORY

\$14.95
(Plus \$2.00 del.chg.)

OVER 100,000 UNCLASSIFIED FREQUENCIES, AGENCIES, AND LOCATIONS OF US FEDERAL GOVERNMENT COMMUNICATIONS STATIONS, 2-420 MHz. MILITARY, JUSTICE, TREASURY, AIRCRAFT TOWERS, NASA, DOZENS MORE!



SOUNDS OF SHORTWAVE

\$5.95
(Plus .50 del.chg.)

A 60-MINUTE CASSETTE IDENTIFIES THOSE STRANGE SOUNDS: TELEMETRY, MULTIPLEX JAMMING, SPY TRANSMISSIONS, SWEEPERS, TELETYPE, MANY MORE. EXPLAINS IN EASY-TO-LISTEN TERMS: HOW TO BUY A RECEIVER, PLANNING THE PROPER ANTENNA, COPING WITH INTERFERENCE, WHEN AND HOW TO LISTEN, CHOOSING ACCESSORIES.

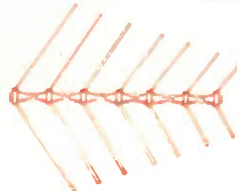

SCANNER BEAM

\$39.95
(Plus \$2.00 del.chg.)

FINALLY, A DIRECTIONAL ANTENNA MADE ESPECIALLY FOR SCANNERS. PICK UP THOSE WEAK, DISTANT STATIONS WITH EASE. OPTIMIZED FOR 108 - 174 AND 406 - 512 MHz AIRCRAFT, LAND MOBILE, AND AMATEUR SERVICES. ALSO RECEIVES 30 - 50 MHz (non-directional). MATCHING TRANSFORMER AND MOUNTING HARDWARE INCLUDED.

SEARCHING FOR THE SOUNDS OF TOMORROW
GROVE ENTERPRISES

ROUTE 1 BOX 156 K BRASSTOWN, NC 28902

• DEALER INQUIRY INVITED • 352

NEW PRODUCTS

ATV DOWNCONVERTER

P. C. Electronics has introduced a new fast-scan ATV downconverter which tunes the entire 420-to-450-MHz band down to your TV's channel 2, 3, or 45-MHz i-f with full bandwidth for color and computer video.

The standard model TVC-4 contains a new microstrip converter with a low-noise MRF901 preamp stage, 12 V dc power supply, BNC antenna input connector, and type F output connector to the TV set. The low-noise figure preamp stage enables seeing sync bars down to as low as .3 microvolts. An ultra-low-noise NE64535 preamp stage is also available as an option to get you down to .2 microvolts in the TVC-4L.

The TVC-4 downconverter comes in an attractive Ten-Tec JW-5 enclosure measuring approximately 5" x 5" x 2 1/4". Ten-Tec has also specially coated the Cyclac wood grain side panels with a conductive coating for excellent shielding.

For further information, contact *P. C. Electronics*, 2522 S. Paxson Lane, Arcadia CA 91006;

(213)-447-4565. Reader Service number 480.

HEATHKIT ALLBAND VERTICAL ANTENNA OFFERS MAXIMUM PERFORMANCE IN LIMITED SPACE

Heath Company has added a new five-band vertical HF antenna to its amateur radio line. The HDP-1473 is a vertically-polarized, omnidirectional antenna designed to give complete CW and SSB coverage of the 80- through 10-meter amateur bands.

The antenna employs specially-designed high-Q traps to optimize operating bandwidth, and the swr is 1.5:1 or less at resonance on each band. The HDP-1473 may be used with any transmitter or transceiver employing nominal 50-Ohm input. A built-in coax connector takes the PL-259 on the operator's feedline. Measuring 28 feet, four inches, the HDP-1473 is designed to accept maximum legal power.

For more information on the HDP-1473, contact *Heath Company*, Dept. 350-310, Benton Har-

bor MI 49022. Reader Service number 479.

THE AZDEN PCS-2800 10-METER FM TRANSCEIVER

Last summer, Japan Piezo Company came out with their first product aimed at the US amateur, the Azden PCS-2000 2-meter FM radio. Now they are marketing a 10-meter FM transceiver using the same micro-computer design. If you have been holding back on 10-meter FM because you don't want to convert a CB radio or design your own unit, cheer up! The PCS-2800 is specifically designed for this group of amateurs. It should help popularize this interesting band just as recent commercially-made equipment has revolutionized 160 meters.

For those not familiar with 10-meter FM, the band is structured as follows. The national simplex frequency is 29.60 MHz. There is also a simplex channel at 29.50 MHz that is helping to thin out the congestion at 29.60. There are four repeater channels: 29.52/.62, .54/.64, .56/.66, and .58/.68. (The input frequencies are 100 kHz below the output frequencies.) Thus there are six channels at present, with 29.60 MHz functioning as a "priority" channel. The PCS-2800 scans these six channels for

either a busy or vacant spot.

The transmitter has two selectable levels of output power: 1 Watt and 10 Watts. The FM deviation is ± 5 kHz, the same as on 2 meters. The receiver is designed for FM only, although it covers the entire band plus a bit extra (28.00 MHz to 29.99 MHz). Tuning Increments are 10 kHz.

Keyboard

The 12-button keyboard on the PCS-2800 performs all frequency control and scanning operations. In this respect, it resembles its 2-meter brother. But there are a few differences.

Four keys, 100K UP, 100K DOWN, 10K UP, and 10K DOWN, advance the frequency by the indicated amounts within either of two ranges, 28.00-28.99 MHz or 29.00-29.99 MHz. The MHz range is chosen by the MHz UP key.

By holding down the 10K UP or 10K DOWN key, the MHz range can be "swept" in an upward or downward direction at a rapid rate. This gives the feeling of vfo tuning. As the desired frequency is approached, the key is released and then actuated once or twice as necessary to get the radio on frequency.

Either MHz range can be scanned in 10-kHz steps by pressing the AUTO SCAN key. The SCAN MODE switch, in the upper right-hand corner of the front panel, selects "busy," "vacant," or "free" scan. In free scan, the range is scanned continuously regardless of channel status. A quick check for band openings might be one use for this scanning mode; signals will briefly open the squelch and cause a burst of noise.

There are six programmable memory channels. Channel 1 is immediately accessible by pressing the M1 CALL key. This key may be found in two places: on the keyboard and on the microphone. The national simplex frequency, 29.60 MHz, might be a good choice for memory channel 1.

Memory programming, recall, and scanning are carried out by means of the four keys M ADRS, M SCAN, M CALL, AND M WRITE. The memory is reprogrammable at will, and is backed up by three small cells so that memory will not be lost when the unit is off or in storage.

Other Controls

The SCAN MODE switch has a second function: simplex/off-



P.C. Electronics' TVC-4 ATV downconverter.

FULL BANDWIDTH FIREWORKS,

144-148 MHz

KLM'S DUAL-DRIVEN ELEMENTS DO IT AGAIN:

SUPER-GAIN ACROSS THE WHOLE BAND for FM, SSB, DX, TROPO, EME, etc.

15.5 dBd

- No tuning or matching
- 1KW balun supplied
- Less weight and windload
- Strong 1 1/2" boom/ no truss needed

VSWR CURVE

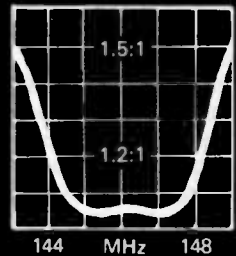

KLM's 144-148-13LB

WORLDS ONLY WHOLE BAND/ALL MODE SUPER-GAIN ANTENNA

KLM P. O. Box 816, Morgan Hill, CA 95037

Solid-State H.F. Kilowatt Amplifier

NO TUNING !

"FCC TYPE ACCEPTED"

All new, all nine hf bands



160 thru 10* meters including the new 10, 18 and 24 MHz bands.

MODEL: A1000 115/230VAC, 50-100W Input \$1395.00

*MODEL: A1000X 115/230VAC, 15-35W Input \$1395.00



*Export Model



Use your Master Charge or BankAmericard/VISA when you order.

✓63



DEALER INQUIRIES INVITED
RF POWER LABS, INC.

21820 87th S.E., Maltby Industrial Village,
Woodinville, WA 98072, (206) 481-8833
Telex No. 32-1042

set selection. When this switch is set to the left of center, the transmitting frequency is 100 kHz lower than the receiving frequency, facilitating repeater operation. When the SCAN MODE switch is to the right of center, the radio operates simplex. The three scan modes (free, busy, and vacant) are provided on either side of center; there are thus six switch positions.

High power (10 Watts output) or low power (1 Watt output) may be selected by means of a lock button. Another lock button transfers volume and squelch control from the front panel to the microphone.

The PCM-2000 microphone is the same microphone that is used with the Azden 2-meter radio. Volume, squelch, and memory channel 1 recall can be controlled from the microphone; the 10K UP and 10K DOWN buttons are also duplicated there. This makes operating "on the road" convenient and enjoyable.

Remote Head

The PCS-2800, like its 2-meter brother, can be pulled apart into two pieces. The microcomputer is housed in the smaller, front-panel piece, which is called the "head." The transmitting and receiving rf circuits are in the rear section. If there isn't enough room in your car to conveniently

install the entire unit, the head can be mounted under the dash and the rear section placed under a seat or in the trunk. Azden manufactures a heavy-duty, 15-foot interconnecting cable (optional) for remote-head operation.

Operation

The 10-meter FM band is quite a bit different from either 10-meter CW/SSB or 2-meter FM. The 28-MHz band is of course subject to worldwide ionospheric propagation, especially at the present sunspot maximum. Any time you have ionospheric propagation, you'll encounter fading. Fading affects FM in an interesting and peculiar manner. This is especially true for selective fading. CW and SSB have relatively narrow bandwidths and are not affected much by this type of fading, but FM has a deviation of ± 5 kHz, and the modulation itself is accomplished by frequency variations. Selective fading will sometimes produce a whining or buzzing sound on FM signals. Nevertheless, it is not uncommon to hear full-quieting signals from thousands of miles away.

FM has some definite advantages over other modes. Most important is its relative immunity to noise, both man-made and atmospheric. FM communica-

tion may be possible in a noisy location where SSB or even CW would be unreadable at the same frequency and power level. Also, FM is less likely to be demodulated by home stereo hi-fi equipment. This could be important to some hams whose neighbors are less than totally rational and compassionate!

With the PCS-2800 connected to a whip about 8 feet long (I didn't even measure it) fed with 100 feet of RG-58/U, I was able to make contacts from as far away as Vermont. I didn't try hard to work any DX, but stations were heard from all four corners of the continental United States within a 1-hour period. All this took place on the national simplex frequency, 29.60 MHz.

Conclusion

The Azden PCS-2800 comes with power cord (+12 V dc) and fuse, microphone, and mobile mounting hardware. An optional 15-foot connecting cable is available for remote-head operation. A base-loaded mobile antenna with "mag" mount is also available; it comes with 10 feet of RG-58/U and connector, ready to use. A 12-volt dc power supply is also available.

The PCS-2800 and accessories are distributed by *Amateur Wholesale Electronics, 8817 SW 129 Terrace, Miami FL 33176; (305)-233-3631*. Reader Service number 482.

Stan Gibilisco W1GV
Cocoa Beach FL

NEW DVOM FROM HICKOK

New from the Hickok Electrical Instrument Company is the latest in their LX series of hand-held DVOMs. The new LX 304 features an easy-to-read, 1/2-inch-high, 3 1/2-digit LCD display; automatic polarity, zero, and overrange indication; 1/2-year battery life in typical use; simplified one-hand operation; and ultra-rugged construction with excellent overload characteristics for long-term reliability.

Other features include an automatic decimal point, a built-in low battery indicator, diode and transistor testing capability, and 0.5% accuracy on V dc ranges.

Engineered and manufactured in the US, Hickok LX series multimeters are self-contained, with test leads that store in the removable, protective thermoplastic cover. They will with-

stand a four-foot drop without loss of accuracy.

For further information, contact *The Hickok Electrical Instrument Company, 10514 Dupont Avenue, Cleveland OH 44108; (216)-541-8060*. Reader Service number 476.

RADIO SHACK'S SAFE HOUSE RF FIELD DISTURBANCE ALARM

Computers are penetrating every part of our modern lives, so it should come as no surprise that Radio Shack now offers a computerized motion-detector security system. Now you can protect your home or business with an rf field as well as with optional window and door switches.

Radio Shack's Safe House should not be confused with lower-priced ultrasonic systems. The Safe House uses a low-level microwave signal at approximately 10 GHz. When the microwave field is disturbed, the transmitter source is affected and triggers the alarm. The motion-sensing unit is combined with a single-chip computer which provides the necessary delays and a sophisticated on-off switching scheme.

The Safe House is simple to use. For basic protection, set it in a location where its field will create space traps in and around doorways. When triggered, the unit will drive a speaker with a piercing siren-like sound. Once the speaker is in place, all that is needed is a 110 V ac outlet into which to plug the system.

A potentiometer allows the user to tailor the field size to a particular location. If the level is too high, the unit might be triggered by false reflections. Arming and clearing the unit is accomplished by punching a four-digit code on the front panel. No keys or hidden switches are needed. There are approximately 25 seconds during which the alarm will not be activated. This delay gives you time to enter or leave the room after the alarm has been armed without activating the siren.

For use in a recreational vehicle or boat, the Safe House can be hooked directly to a 12-volt battery. A built-in gel cell battery will automatically be switched in to power the unit for up to four hours if the conventional source fails.

Continued on page 242



Hickok's new LX 304 DVOM.

IC-720

The New Standard in Ham Radio

You're looking at the next generation in ham radio design. The ICOM IC-720 has standard features offered elsewhere as options... or not offered at all:

Transmit on all 9 HF bands...

Receive from 1 to 30 MHz...

with just a push of a button.

Dual built-in VFO's.

Automatic sideband selection (reversible). All solid state. Fully synthesized. Etc., etc., etc., etc.

There isn't enough room to list all of the specifications and features of this exceptional radio. So, please visit an authorized ICOM dealer or write to the address below for additional information.



2112 116th Avenue NE, Bellevue WA 98004
3331 Towerwood Drive, Suite 307, Dallas TX 75234

Escape from Mt. St. Helens!

Marianna S. Kearney W7WFO
3401 N.E. Corbin Road
Vancouver WA 98665

“Mt. St. Helens has erupted!” Dorman W7ZDR excitedly reported as we listened intently for news from home at the shack of Ralph ZL2PI

in New Zealand. (It was March 28th there, but the 27th back home in Vancouver, Washington.) The first intimation of this sensational event had reached us on ten meters at the station of Dennis ZL2AQA, over which we learned that earthquakes had been shaking the mountain since March 20th. The volcano had been dormant for 123

years.

Ten days after our return from New Zealand, we left our home (forty-five miles southwest of the mountain) for the foothills of 9671' Mt. St. Helens, a major Cascade peak, as volcano watchers. At that time, geologists were apprehensive of a bulge of rock and ice on the northwest side which was then growing at the

alarming rate of five feet a day. We had volunteered for a one-week mission with the Washington State Department of Emergency Services and had been signed up for public service by Al K7KNZ. From the 4240' high point of a logging road, we would observe the high slopes and report steam vents, mud slides, and avalanches, with special attention to the South Fork of the Toutle River Canyon, critical because of flood potential. We'd be perched just outside the red (restricted access) zone and eight miles due west of the summit.

Arriving at the end of the pavement in the fog on May 13th, we threaded our way up a maze of roads using the directions that Chuck N7ALB, a volcanology student and former observer, had given us. After locating the best view spot, we were soon in business, running one Watt of power with an Icom 210 (borrowed from our club, W7AIA). Working under RACES, we reported to Reade N7AGG, Washington State RACES Officer in Olympia.

With nearly zero visibility, the first few days allowed us only fleeting glimpses of the snow-

Photograph copyright 1980 by Ty Kearney and Alan Kearney



Mt. St. Helens at 8:32 am May 18th. View is looking east with the summit 8 miles distant. The South Fork of the Toutle River is at left. Our escape road went 1 1/2 miles toward the mountain on the right before we were able to turn south.

crowned summit, making us feel uneasy with no knowledge of the volcano's activity. On one of those foggy days, Ty W7WFP climbed on a stump with his hand-held Icom 215 and called Russ K7SUX, RACES Radio Officer for Clark County. (He was checking our low-power half-Watt communications of a stand-by rig.) Meanwhile, I walked among the logging slash admiring the fragile avalanche lilies blooming in the harsh winds and sleet and snow that occasionally whitened the log jumbles and low fir trees.

On Friday, May 16th, Channel Six TV parked their van next to ours, doing a story on loggers in the Toutle. That afternoon we watched large helicopters urgently ferrying equipment from various camps in the doomed South Fork of the Toutle River Canyon.

Saturday, May 17th, dawned in a blaze of scarlet, burning away the last shred of fog and providing excellent visibility. The once dazzling white mountain had been dulled by purple-grey ash flows, giving it a surprisingly barren appearance. On the northwest side, the bulge appeared menacingly as a large warp on the left skyline. Otherwise the peak retained its nearly symmetrical shape. It was easy to retrace my old climbing route of many years ago with everything so seemingly quiet and bright and every feature showing on the west face.

That day the seismic report came in late but seemed routine. Originating from the University of Washington, it had been relayed daily by Dorothy WB7OBB in Seattle. (Only harmonic tremors over 4 were reported, which was usually about ten a day.) For awhile, a helicopter carrying geologists perched on the crater rim itself. Al

K7KNZ called asking about avalanches in the Toutle, but all we saw were a few bright steam plumes high up.

By late afternoon, another volcano-watcher, Gerald (Jerry) Martin W6TQF, drove his motorhome to a location near Coldwater Peak, seven miles north-northwest of the mountain and ten and one-half miles north-northeast of us. That evening Bob K7UPT and friends came up with supplies, staying for a potluck dinner. (Bob had checked out the 5700 Road along the South Fork of the Toutle River as a possible escape route for us.) It was a perfect evening and we laughed at Bob's shoveling up a load of ash-covered snow to take home. Later, over two meters, we had a limited chance to get acquainted with Jerry before the fateful day arrived. The day closed with the peak looming high into a star-sprinkled sky, apparently at peace.

A light overcast replaced the flawless skies of Saturday, but the dawn was colorful with Mt. Rainier in full view. Jerry's cheery "Good morning!" had greeted us this calm Sunday, May 18th. It was peaceful and windless with the temperature at 47 degrees F. Jerry and Ty discussed two steam vents high up on the north-northwest skyline just under the crater rim. Two of the plumes were white and had been seen Saturday, but a new one appeared tan or dust-covered and drifted across the Wishbone Glacier. From his viewpoint, Jerry could pinpoint its location. He was just commenting on this when Ty felt the earthquake that unbalanced the delicate equilibrium in the area of the bulge. Jerry felt it also. Outside our van I was sitting in a folding chair sketching the mountain; I did not feel



Ty W7WFP and Marianna W7WFO with their Dodge "Van Go."

it. (Later reports confirmed the quake at magnitude 5.0, the strongest since the mountain came alive on March 27th.)

Less than one minute after the jolt, the volcano sent up its first black clouds. It was 8:32 am. I stood up watching the black billows boil up out of the summit and the north side simultaneously, thinking, "What an interesting show!" Scarcely had the thought surfaced when the entire summit area was enveloped in rolling, velvet-black billows that growled like muffled thunder, expanding at an incredible rate. One fantastic cloud exploded huge rocks and ice. Ty saw a part of the Goat Rocks formation slide away, the toe of a mammoth landslide. We imagined Jerry, terrified, witnessing the entire north side of the mountain sliding toward him. With the black explosion cloud racing northward in a horizontal blast at 120 miles per hour, Jerry had only minutes for his last transmission: "I've got to try to back out of here!"

Ty ran for his camera and took seven pictures as the blast rolled out toward Mt. Rainier. He noted that the enormous black cascade, indescribably complex and banded with steam, was

fanning out toward the South Fork of the Toutle, the last protection for our exposed ridge. "Let's get out of here!" Ty yelled as I walked toward our car, stunned.

Jumping in the van, we sped eastward down the road (toward the mountain) for one and one-half miles before turning south. "Which way are you going?" Bob K7UPT's voice pierced the static, and I screamed, "South!" I also remember shouting, "The cloud is going toward Coldwater Peak and Jerry!"

Our fourteen-mile ride down over the rough forest roads seemed as unreal as a nightmare. I found myself on my knees clutching the radio, being showered by falling objects from an open cupboard. Out our van windows, the death cloud virtually filled the visible sky in its immensity. It was dirty grey and suffocating as a tomb with darker columns slowly rising to a billowing mushroom top.

It was almost beyond conception—an unimaginable evil abstracting bizarre patterns of twisting, undulating smoke and hot gases ascending to the roof of hell. In a race against time, our frail vehicle paralleled that horrendous cloud, flashing with bolt lightning and only one mile away. It

dwarfed everything by its magnitude; the spindly alder trees loomed like matchsticks that swayed slightly before the churning terrible greyness. Against the deep gloom, the pale sickening grey of the cauliflower column of the main eruption writhed upwards, carrying its load of ash and pumice and superheated poisonous gases. For a short while a blue car hurtled down behind us, as terrified as we were, and then it turned off.

The last thing I remember before we reached the relative safety of Lake Merrill (below the exposed ridge) was a swelling deep grey cloud dramatically rimmed in sunlit silver and edging the sky's soft blueness. At last we dared to stop. We breathed silent prayers of thanks. We switched the 210 to high power and picked up Marv

W7RPT in Vancouver, who relayed to Olympia that we were OK and returning home. We could now see the cloud's edge, steam-whitened and rising fountainlike above us to a scalloped saucer-shaped disk, swirling with graceful effects.

At the junction of the forest road with the highway, we passed a roadblock and then bordered Yale Lake where people were driving toward the mountain to sightsee. Soon we were in green country and on paved roads again. Never have green and growing things looked so beautiful! Though churchbells were ringing in a country chapel, people were outside watching the towering inferno of a volcano that had unleashed an explosion as powerful as the hydrogen bomb.¹ Into the hazy blue sky the decapitated

mountain² was pouring multiple columns of ash and steam twelve miles high and eventually around the world. (No eruptions of Mt. St. Helens had been this big for nearly 3000 years.)

We turned away from the black horror of a sunny Sunday in May and drove home, experiencing a strong sense of unreality. We knew that people like Jerry Martin W6TQF, Reid Blackburn KA7AMF, and Dave Johnston³ had died in the terrible blast of our once serene Mount St. Helens. We had been allowed to live.⁴ We felt humble. ■

Author's Notes

1. The blast, fanning out twelve to fifteen miles in a northwest, north, and northeast direction, devastated 156 square miles, felled trees like matchsticks, and rained ash to a depth of four feet in the area where Jerry Mar-

tin, Reid Blackburn, and Dave Johnston were working. It destroyed 2 billion board feet of timber and left a "moonscape" of unrecognizable land forms around the Spirit Lake area.

2. The explosion lowered the mountain by 1300 feet. It opened a new huge crater on the north side measuring about 2½ miles long by 1½ miles wide.

3. Reid Blackburn KA7AMF, a newspaper photographer, was doing voluntary work for USGS and National Geographic. He was in the same general area as Dave Johnston, working for USGS, and Jerry. Though Jerry Martin is presumed dead, he is listed among the missing. He spent about a month on volcano watch at a different location before coming to the viewing spot near Coldwater Peak.

4. Though the devastation stopped at the South Fork of the Toutle Canyon uncomfortably close (within a mile) to our location, it did not reach our camp, except for some light ash. One gas can we'd left in our hurry was picked up later that day and said to be very warm.

new—useful—clear—colorful—complete

Chart of UNITED STATES AMATEUR RADIO PRIVILEGES

by class of license, emission type, and frequency from 160 thru 2 meters, including provision for the new 30, 17, and 12 meter bands. This 22 x 28 in. twelve-color chart is the first of its kind to be both informative and decorative. Enhance your shack.

Regular price \$3.00. SPECIAL INTRODUCTORY PRICE GOOD THROUGH OCTOBER: \$2.50. Includes postage and handling.

Larry Dennison—KB6KG
5002 Marion Avenue ✓365
Torrance, California 90505

name _____

address _____

city _____

state _____ zip _____





JAN CRYSTALS KEEP YOU ON THE AIR

- CB
- CB standard
- 2 meter
- Scanners
- Amateur Bands
- General Communication
- Industry
- Marine VHF
- Micro processor crystals

Send 10 for our latest catalog. Write or phone for more details.

Jan Crystals ✓39
2400 Crystal Drive
Ft. Myers, Florida 33907
all phones (813) 936-2397

easy to charge



Organize your shack with a CLUTTERFREE MODULAR CONSOLE \$179.95

- Large, 42" H x 57" W x 29"D
- Strong groove-construction
- Mar-resistant wood grain finish
- Options, drawers & face plate
- For ham or home computer
- Visa and Master Charge

CLUTTERFREE MODULAR CONSOLES ✓89

P.O. Box 5103 Tacoma, WA 98405
(206) 572-8570 9 a.m.—5 p.m.
(206) 759-1611 Evenings

Signalcrafters Presents The Most Advanced Automatic Computing Power Meters In Amateur Radio!



MODELS 31 and 32*

Our portable Models 31 and 32 feature the same state-of-the-art technology that is incorporated in their Big Brother, the Model 30. Never again will you have to bother with SWR "calibrate" controls and switches! Signalcrafters' custom integrated circuit makes power and SWR measurement a "handsoff" operation by automatically computing SWR. The result is unparalleled accuracy and ease of operation.

FEATURES:

- **CUSTOM IC**—Computes SWR from the level sensed on the transmission line independent of the power level. This analog computer operates over a range of only one watt to the full scale of the meter with unequaled accuracy.
- **RUGGED TAUT-BAND METERS**—Provide accuracy and readability that must be seen to be appreciated.
- **HEAVY DUTY CABINETS**—Handsome heavy duty metal cabinets complement virtually every transceiver on the market today.
- **TWO MODES—PEAK OR AVERAGE**—The amateur may choose between either peak or average power readings.
- **POWER REQUIREMENTS**—Due to the advanced low current design, battery life is truly outstanding, making this meter a natural for portable or field day operation. Uses standard 9 volt battery or 120V AC with optional AC adaptor.
- **ATTRACTIVE AFFORDABLE PRICING**
 *Model 31A (0 to 200w)
 31B (0 to 20w)
 only \$149.00
 Model 32A (0 to 200w, 0 to 2000w)
 32B (0 to 20w,
 0 to 200w)
 ✓66 only \$169.00

SIGNALCRAFTERS, INC.®
 5460 BUENA VISTA DRIVE
 SHAWNEE MISSION, KANSAS 66205
 913/262-6565; TELEX 42-4171

All Signalcrafters products are designed, engineered, and produced in the U.S.A. Prices include shipping to all U.S.A. VISA and Master Charge accepted. Kansas Residents please add 3% percent.

STOP RF SPILL- OVER!

You may be losing up to half the available output from your vertical gain antenna because of RF spillover. The amazing AEA Isopole with unique decoupling design, virtually eliminates RF spillover and can help you multiply your power in all directions on the horizon relative to an ideal half-wave dipole, or end-fed non-decoupled "gain" antennas.

CALL TODAY
**Portland
 Radio
 Supply
 Co.**

1234 S.W. Stark
 Portland, Oregon
 97205
 503-228-8647

AEA
 Brings you the
 Breakthrough!



TRIONYX^{IND}

2 METER TELESCOPING ANTENNA with BNC

- USE ON ANY 2 METER HAND-HELD RADIO WITH A BNC CONNECTOR SUCH AS:
 KENWOOD
 WILSON
 YEASU
 MANY OTHERS
- 3dB GAIN OR BETTER OVER ANY RUBBER DUCKIE
- 19½" EXTENDED —
 3¼" CLOSED



\$895

PLUS \$1.50 POSTAGE

Indiana residents add 4% sales tax

TRIONYX INDUSTRIES ✓327
 6219 COFFMAN ROAD
 INDIANAPOLIS, IND. 46268
 317-291-7280

MASTER CHARGE/VISA — ACCEPTED

DEALER PRICING UPON REQUEST
 WE CAN PUT ANY TYPE OF
 CONNECTOR ON THE ANTENNA
 WRITE FOR PRICE AND AVAILABILITY.

Sheila Ran!

— a sightless sprinter's triumph
is one of ham radio's finest hours

Got to run faster... faster, Sheila thought to herself as she ran down the track... where is that 50-meter mark? "50 now," she heard and put on some extra effort. "75 looks good!" was the

next she heard; then, "Left, keep going, looks real good —THERE'S THE END! You did real good!"

At that moment, Sheila's friend Jennie grabbed her, and she knew for sure the race was over. Now came



Photo A. Sheila during a practice session.



Photo B. Ed Mulvin WB0IFF and Sheila, with the Motorola MT 500 transceiver.

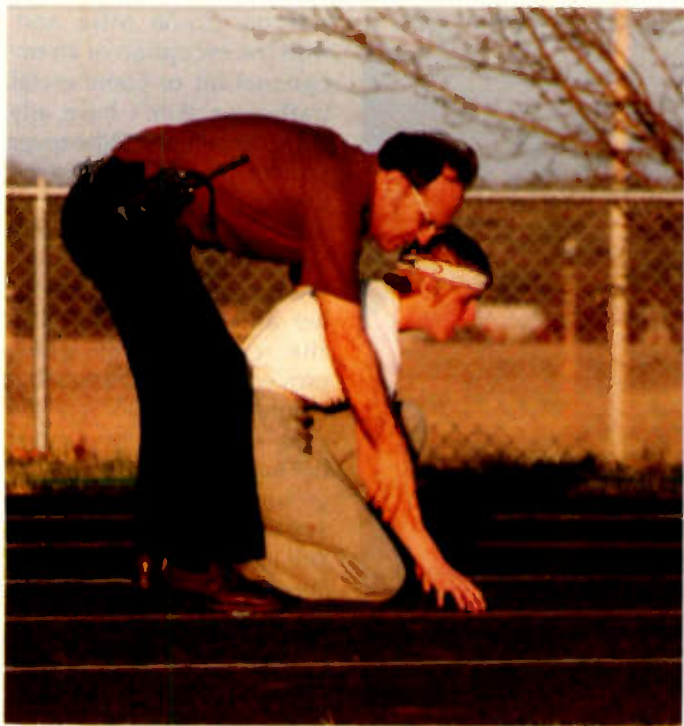

Photo C. WB0IFF positions Sheila's hands so that she can "see" the lane markers.

that wait for the official time and placement.

From the starting position, I carefully put the Motorola transceiver into the belt holster and ran toward the track officials to find out quickly where Sheila placed. This was one of many trips I had made over the last four years. This also was the last year that I would be doing this because Sheila was now a senior in high school and would be finished with high-school track. My special logbook soon would record the last of some 220 hours of training and track meets with Sheila.

The preceding scenario represents the culmination of a four-year experiment in human engineering utilizing the facilities of amateur radio. You may have read my earlier 73 article, "Run, Sheila, Run!" (December, 1977). At that time, I described an innovative use of ham radio which could enable a young girl who is totally blind (she wears glass eyes for cosmetic purposes) to compete in high-

school track. Originally, with the assistance of Ron Kinton WB0MBZ, a retired, tired, 6-meter model airplane radio-control receiver was modified and equipped to receive an AM signal. I dragged along an old Gonset 6-meter transceiver—and a car battery for power—to every practice and track meet and was able to direct Sheila down the track with an amazing amount of success. Sheila was an excellent and willing candidate for this type of experiment. She ran in the cold, the heat, the rain, the snow—in anything—with never a complaint.

After the first track season was completed, Ron Kinton and I put a smaller transmitter together. It, too, was basically a Heathkit radio-control transmitter strip with an AM audio input added, along with a rechargeable nicad battery pack. Life became easier for me after that.

Sheila and I trained intermittently that summer. When track season started in March, 1978, there was



Photo D. Sheila talks with the ABC news crew, May 15, 1979.

too much snow on the track and we were forced to run in the halls at her school. That was a really hairy experience because the halls at Dowling High School are sort of short for a blind kid, and there was a post in the middle of the end of one hall! All of these things really scared me, but Sheila trusted and ran! The other runners (sighted) could run around the corners and up and down the stairs, but this was a little too much for Sheila.

Whenever we could get outdoors, we would, but the temperatures were frequently below freezing with lots of wind. We ran on the road in front of her house, and if I could guide her around the curve, we could get a good 100 meters. Sometimes she would get into a snow bank, but that didn't hurt. We also would go over to a large parking lot at the church across the street. It was quite mind-boggling to see this young girl race across the lot in her sweat suit, the hood up over her head with the draw strings

pulled so tight that her eyes were completely covered! Sometimes I would let Sheila get into the snow banks, as she couldn't get hurt. I would be rewarded with a round of snowballs—she had good aim! Finally, the snow melted and we could work out on the track. Life got easier for both of us.

During track meets the first two years, Sheila would run her heat by herself with no one else running on the track with her. April 8, 1978, was a cold, drizzly day and a track meet was scheduled. This was the first anniversary of the very first time Sheila had ever tried the radio, and *this was the first track meet she would win!* Her time for 100 yards (it was changed to meters the next year) was 13.4 seconds. You must remember that Sheila had a distinct advantage: the cold drizzle got into the eyes of the other girls and slowed them down, but it didn't affect Sheila.

Later on during this season, we discovered that



Photo E. The ABC "That's Incredible" crew prepares Sheila's segment of the May 12, 1980 show.

heavy crosswinds would affect her course. This could be dangerous because now the track officials were wanting her to run with other competitors on the track. We were able to get them to allow us to have the lanes vacant on either side of her and this was some comfort, but the first track meet with other competitors on the track brought a lot of stress. This was only the second time she had run this way, the first time being on the day before in practice.

At this meet, Sheila came out of the starting blocks on a diagonal! I lost my cool and shouted too loud into the mike, overmodulating the transmitter and distorting the signal in her receiver; Sheila kept running. When she came to the grass at the left side of the track she turned and ran until she hit the grass on the right side, then turned again, got to the end of the track, and finished a respectable third. She was disqualified, and the officials asked the other girls if they wanted to run the meet over. They de-

clined, with one of them asking, "What good would it do? I couldn't get near her anyhow!"

It's a good thing Sheila couldn't see during that particular run, as I'm sure she would have been scared pea green. I was! She missed kids, hurdles, and track officials. Later, I learned to keep cool and control my voice, and this served me very well when one time she was within two inches of a curb and I was able to get her away from it very slowly and avert possible injury.

The third year (1979) we really had a lot of problems. It was practice in the afternoons and sit up every evening repairing the receiver—it was aging and had lost its sensitivity. Components were deteriorating rapidly. I made a trip to Ron's, and the decision was to work the receiver over completely and put an AM receiver chip into it. This meant more stripping of the existing components and changing the battery voltage to 9 volts. This worked for a few weeks, but the

main problem was in the first mixer stage and the coils were not available.

We were at the early start of the official practice season. Along with the miserable cold and snow, the radio wasn't working the way we needed it to work. The original design required a long trailing antenna in free space. We stuffed a pair of three-foot pieces of wires down her shirt—one in front and one in back. Being in such close proximity to her body affected the receiver very adversely. This, coupled with the age of the receiver and the reduced power of the transmitter, made for some overwhelming problems. Ron was on the verge of stripping out an old Motorola pager and putting it on two meters FM, but during a quick conversation with Dick Bugler of the Des Moines Motorola sales office, I told him of our dilemma. Dick was able to loan me the necessary commercial gear to keep Sheila running for the rest of the 1979 track season.

The commercial gear

was on 155.58 MHz and, with the exception of an occasional bit of commercial traffic, we didn't have any QRM problems. Whenever something did come through we just waited. Fortunately, there wasn't any interference during a meet. We had ear molds made for her and these, along with the commercial gear, proved to be an unbeatable combination! This was the year she would be first in her heat and her time would go from 14.06 to 13.8 for the 100-meter dash. This was still junior varsity track, and she turned in some very good performances. She still had not gained the ability to remain completely in her lane, but there were no serious problems.

The local news media gave us excellent coverage. The local ABC affiliate, WOI, Channel 5, televised a meet which interested the network enough to send a news crew out from Chicago on May 15, 1979. This appeared on ABC news May 17 and was picked up by David Hartman on "Good Morning, America" the next morning.

Now things were happening fast and furious because after "Good Morning, America," Motorola had taken a very active interest in Sheila. Motorola sent a film crew and a public relations man to make some film of our project. They became very excited and decided to take Sheila and her family to Fort Lauderdale, Florida, where they presented her with a pair of the newest MT 500 handie-talkies along with a Page-boy II receiver. Wow, did we have the gear! (The gear was placed in the amateur band for us and we operated on 147.99 MHz.) Sheila received a letter in track for her efforts that year, and that, along with all the coverage we received and the support of Motorola, really



Photo F. Ron Kinton WB0MBZ works on the module.

made all the efforts worthwhile.

The fourth and final year (1980) started just like the rest except that we didn't have the extreme cold. A lack of snow cover made the practice sessions go very well, and we had a radio that worked! Sheila had to run varsity, however, and this put a lot of pressure on her. The first meet gave her a time not as good as the previous year, but she was still very competitive and her course down the track was as good as anyone's. I was elated—she had never run so true as now.

Then the weather turned cold, the pressure became almost unbearable, and her ability to hold a true course deteriorated. There was still nothing seriously wrong, however, and she kept on running. I was able to interest the television program "That's Incredible," and they arrived in Des Moines for a video taping

session with us. This added to the pressures that were building up, and Sheila turned in the worst time she had yet had for the season. She finished last. The cameraman did worse—he lost the finish of the race. What luck! When Sheila realized where she finished and realized that this was the next to the last meet she could run (the next meet would be a qualifying heat for another meet), she decided to quit.

Sheila may have stopped running now, but she proved that the blind can be very serious competitors. She is the only person that we know of who has ever tried to run this way. The ability of a human being to make such a complete transition to hearing from sight while actively competing has been proved by Sheila Holzworth in Des Moines, Iowa! It all was made possible by the privileges we have with amateur radio. ■

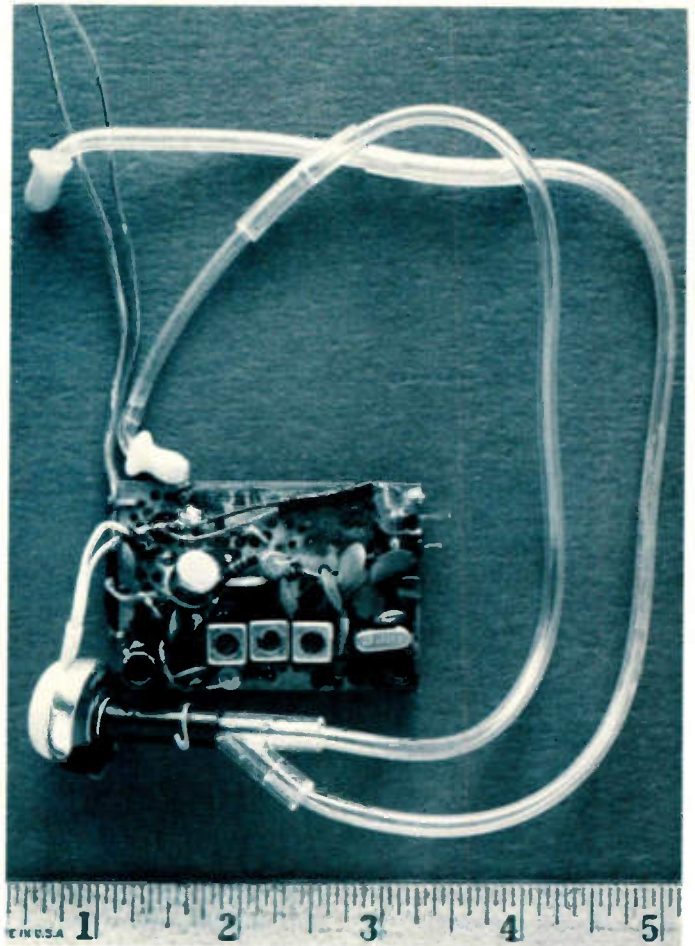

Photo G. The original module.

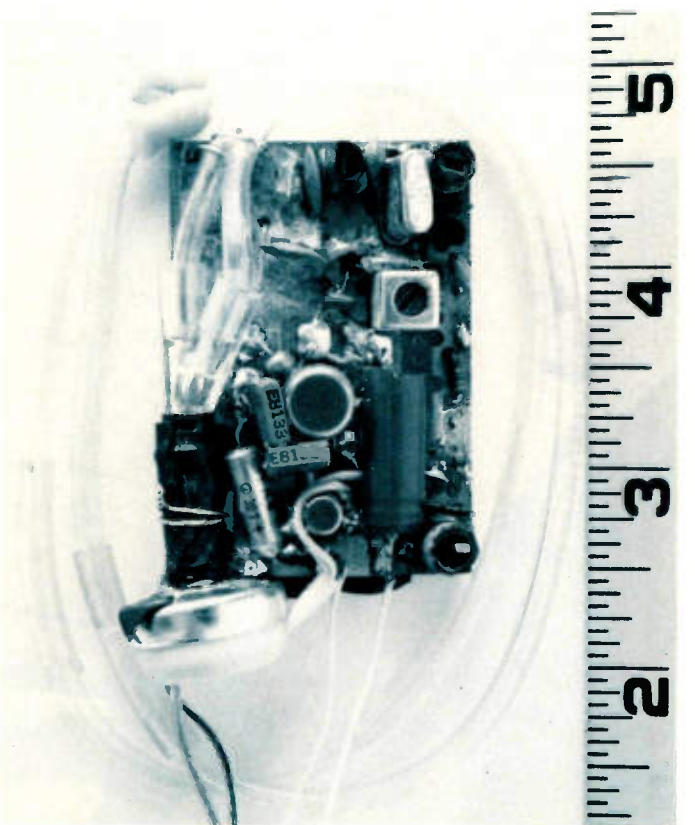

Photo H. The module after Ron worked it over.

The First Man in Space Was a Ham

— UA1LO remembered

Back on February 13, 1962, I happened to be in the right place at the right time and had a chance meeting with a very distinguished radio amateur, UA1LO, Yuri A. Gagarin, the first cosmonaut to orbit the Earth—a trip of 1 hour

and 48 minutes. Although I had never worked him, I followed space research and travel closely as Sputnik went up and successive manned flights took their turn—theirs and ours.

There have been many articles and much specula-

tion about an amateur in space or in government—will he use 2 meters?—and so forth. I saved such articles and even have a front cover of 73—"A Ham in the White House—K7UGA"!

I spent a few months in Italy, and a cable directed me to Athens to demonstrate a police X-band radar to the Greek Ministry of Transport, Physical Society, and all the high brass of the constabulary. As I landed in Athens, I saw a red carpet and a rose-covered open Cadillac at the terminal building which seemingly was lined with all the police of the city.

"This is nice," I said to my distributor. "This is for me?"

"Well, no," he said. "You can walk on the carpet, but the car is for Yuri Gagarin, the Russian cosmonaut. Look, here comes his plane now."

We cleared the suitcase radar through customs and headed for the city. Major Yuri Gagarin, 28, was the Air Force hero being wel-

comed by the City of Athens. I had a selling job to do and demonstrated the radar successfully that afternoon.

That evening, UA1LO was being feted at a banquet in his honor. Anyone and everyone in physics, astronomy, and electronics was there, and I was at a side table as a guest of the chief of police. There were speeches in Greek and Russian, toasts, and hurrahs.

The next day I had the day off and went to the Acropolis to see the Parthenon. I had two color-loaded cameras, 120 format and 35mm, plus the old 8mm movie format with color film. I stood on top of the hill—and then the open Cadillac came up to the threshold of the Acropolis and Yuri Gagarin and entourage made the climb to the top.

I had a good vantage point and used all three cameras. Yuri was given an olive branch and stood by the Parthenon. I took a



Yuri Gagarin UA1LO.

EXTRA

Hamfest News

EXTRA

Special Edition For Those Seeking a Good Time

October 4 & 5, 1980

THOUSANDS in PRIZES Biggest Show in the East

The Great Boxboro Convention Returns!!

Remember the fantastic Boxboro hamfest back in 1978? Well here we go again with improvements galore to make the show even better! Located in the "country" on Route 495 at Route 111 the New England ARRL Convention for 1980 features free shuttle bus service to and from a giant new free parking area — no more parking worries!!

Prizes Awarded Both Days of Show

Through the generous cooperation of the manufacturers and exhibitors lucky conventioners will be taking home transceivers, antennas, microphones, amplifiers . . . the list goes on endlessly. The event is a non-profit affair and surplus funds go directly into the prize fund.

See Every Possible Make of Ham Gear

Virtually everybody who is anybody will be at the show. Equipment on display should include Kenwood, Icom, HyGain, Hustler, Dentron, Microwave Modules, Kantronics, Yaesu, Cushcraft, Robot, HAL, Ten-Tec, Tri-Ex, ETO, Vomax, Heath, TPL, DSI, Ramsey, Optoelectronics, Larsen, Telex, Wilson, Azden, Collins/Rockwell, etc. etc. Manufacturers and distributors will be there in force.

Big Events All Weekend

Two meter fox hunts, YL programs, seminars on all aspects of ham radio including microprocessors, RTTY, SSTV and DX, a Wouff Hong ceremony, Saturday night banquet show and dance, plus prizes awarded all weekend.

There will be a home brew equipment exhibit and contest, FCC exams, QSL and CW contests, an antique wireless exhibit and special YL programs.



FLEA MARKET

New England's only Flea Market

UNDER A GIANT 80' TENT

**Come rain or shine!
First come — best spaces.**

Flea Market Sellers' Permits
\$5 per 6'x2½' space
(per day)
includes a table.

TELL YOUR FRIENDS!

Early Bird Tickets Available by Mail Only!

Registration is \$4 early bird, \$5 at the door. Banquet and show tickets, \$12 each. Order tickets from George Stewart, W1ZQQ, 17 Barnes Avenue, East Boston, Mass. 02128. Include SASE! Hotel reservations must be made directly with the Sheraton Boxboro Hotel, Boxboro, Mass. 01719; \$42 single, \$46 double. Hotel will NOT ACCEPT phone reservations!

SAVE OSCAR 9-B Matching Fund!

Add 50¢ to your ticket order and we will match it with another 50¢.

MEMORY KEYS BREAKTHROUGH!



The remarkable AEA Morsematic memory keyer has 35 fantastic features including two AEA designed microcomputers, up to 2,000 character memory, automatic serial number, beacon mode, and automatic morse trainer mode.

ORDER NOW TOLL FREE 800-527-3418

AGL Electronics

13929 N. Central Expressway,
Suite 419, Dallas, Texas 75243, (214) 699-1081

AEA Brings you the Breakthrough!

prize picture and then went up to shake his hand. I wore my W1QMS lapel pin and he spied it and said, "Ya, UA1LO. I am UA1LO active on CW. You, too?"

I said, "Mostly 10-meter AM phone."

Newsreels ground away—the Greeks led him away to the Museum. I had the privilege of translating between him and an English reporter who asked if Yuri saw the Parthenon from orbit. He said, "Nyet—too small,"—but said that he saw the zigzag Great Wall of China as a distinguished Earth landmark! (His highest point above Earth was 203 miles, and his average speed was 17,000 mph.)

That ended a very brief encounter with UA1LO. If I had not worn my lapel pin, this never could have happened.

The Greek newspapers put Yuri on page 1 for several days, and my radar

work was on page 8. Such is life!

My photos were slightly over-exposed, but useful. While at an exposition in Moscow in 1974, to demonstrate photo-interpretation gear, I hung an 8×10 enlargement of Yuri on the wall of the booth. Russians from every walk of life looked at the picture in awe, and the women, with deep reverence, said a little prayer.

The head of the USSR space program came by, followed by Premier Kosygin, and I requested that the picture be presented to Yuri's widow.

One never knows who the fellow next to you might be.

Yuri Gagarin, regretfully, became an untimely silent key a few years later. He was killed in an airplane crash, and the amateur radio fraternity prematurely lost UA1LO. ■

From: **DIGITREX**
ELECTRONICS COMPANY

PA-19 Wideband Preamplifier

- 2 to 200 MHz Bandwidth (-3dB Points)
- 19dB Gain!
- 50 Ohms Input & Output Impedance
- Tiny PC Board Size (7/8" x 1-5/8")
- Absolutely No Tuning Required
- Extremely Stable
- Draws only 20mA @ 12VDC
- Great Way to Increase Sensitivity of Receivers, Counter, etc.
- Fully Assembled and Tested
- Instructions Provided, Full Warranty



only
\$8.95

+ .50 Shipping/Handling

PS-600 600 MHz Prescaler

- Provides ÷10 and ÷100 TTL Level Output
- 75 MV RMS Input Sensitivity
- Built in 5 Volt Regulator Allows Use at 8-12 VDC @ 90-110 MA.
- Tiny PC Board Size (1-1/4" x 1-3/8")
- Fully Assembled and Tested
- Instructions Provided, Full Warranty



only
\$28.95
ppd

New PS-1250 1.25 GHz Prescaler
complete **\$79.95** ppd

COD Orders Accepted
4412 Fernlee

Royal Oak, Michigan 48073
Phone 313-651-9247

THE Famous CLEGG TWINs

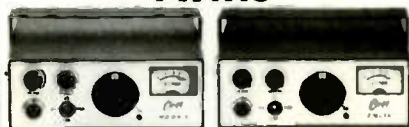

MARK-3 144-148 MHz 15 Watts \$205
FM-76 220-225 MHz 10 Watts \$195

For 2 meters & 220 mhz

12 channel operation at unbelievable price—plus the performance & reliability you have learned to expect from Clegg.

Special quantity pricing is available on both models. Get your group together & call 1-800-233-0250 for a quote on your requirements.

*MARK-3 can be supplied with special modification for CAP or MARS!

Call or write today for descriptive brochure.

Clegg

Communications Corp.

1911 Old Homestead Lane
Greenfield Industrial Park East
Lancaster, PA 17601
(717) 299-7221

✓ 13

GIGA Hz Preamp!!

Ultra-wideband
1 MHz
to 1000 MHz

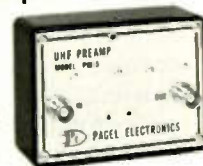

The PM-5 preamp module covers the entire range from 1 MHz to 1 GHz (1000 MHz). Perfect for the new GHz counters and higher UHF bands, the tremendous bandwidth of this preamp makes it so versatile you will soon depend on it whenever added gain is needed for RF measurements. Also for scopes, mV power meters, detectors, etc. Gain is 30 dB from 1 MHz to 500 MHz decreasing to 15 dB at 1 GHz. Maximum output is 1 volt p into 50 ohms. It is designed to work in either 50 or 75 ohm systems. The preamp is ready to use with the power adapter provided or any 7.5 to 15 volt DC supply at 50 mA. It can be "built-in" or mounted on your equipment if desired. Made with fine quality plated-thru boards, strip-line design using microwave transistors. BNC connectors.
Model PM-5 UHF Preamp (w/power adapter).....\$59.95

SENSITIZE YOUR COUNTER

It's Ten Times Better
with a
COUNTER PREAMP



Wide band preamps with 20 to 30 dB gain. Improves performance of low price counters considerably. Probe reads oscillators without loading. Generators can be set to lower output avoiding frequent shifts. Also for scopes, meters, etc. Valuable troubleshooting aid. Powered by 3 pencils. BNC connectors. HI Z Input. Output is 200 to 400 mv rms into 50 ohms.

Model VP-2, VHF Counter Preamp.
100 KHz to 200 MHz.....\$39.95
Model UP-3; UHF Counter Preamp.
1 MHz to 500 MHz.....\$54.95

Order from PAGEL ELECTRONICS, 6742-C Tampa Ave., Reseda, CA 91335. Send check or MO for ppd. shipment via UPS when avail. Or call 213-342-2714 for COD. Foreign add 10% for airmail & handling. Calif. res. add 6% sales tax. One year warranty, money back guarantee.

✓ 348

PAGEL ELECTRONICS

WILSON SYSTEMS INC.

SYSTEM 33

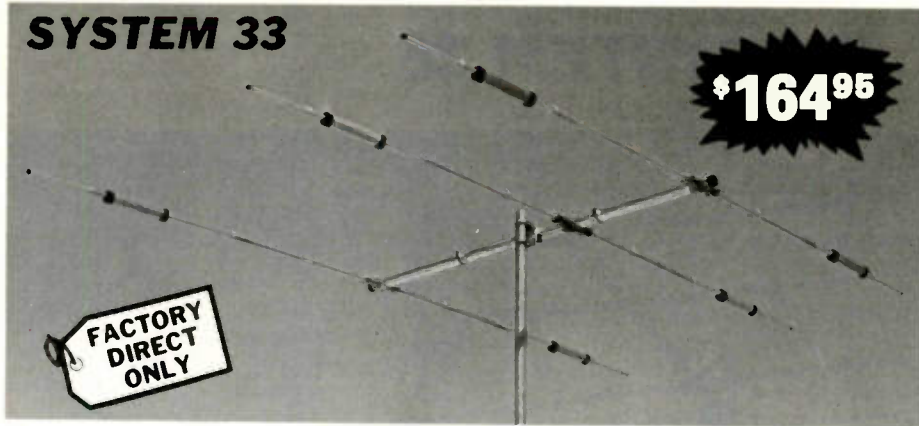

Capable of handling the Legal Limit, the **SYSTEM 33** is the finest compact tri-bander available to the amateur.

Designed and produced by one of the world's largest antenna manufacturers, the traditional quality of workmanship and materials excels with the **SYSTEM 33**.

The boom-to-element mount consists of two 1/8" thick formed aluminum plates that will provide more clamping and holding strength to prevent element misalignment.

Superior clamping power is obtained with the use of a rugged 1/4" thick aluminum plate for boom to mast mounting.

The use of large diameter High-Q Traps in the **SYSTEM 33** makes it a high performing tri-bander and at a very economical price.

A complete step-by-step illustrated instruction manual guides you to easy assembly and the lightweight antenna makes installation of the **SYSTEM 33** quick and simple.

SPECIFICATIONS

Band MHz. 14-21-28
 Max. power input . . . Legal limit
 Gain (dbd) 8
 VSWR at resonance. 1.3:1
 Impedance 50 ohms
 F/B ratio. up to 20

Boom (O.D. x length) 2" x 14'4"
 No. elements 3
 Longest element 27'4"
 Turning radius 15'9"
 Max. mast diameter . . . 2" O.D.
 Surface area 5.7 sq. ft.

Wind load @ 80 mph . . 114 lbs
 Assembled Wt. 37 lbs
 Shipping Wt. 42 lbs
 Direct 52 ohm feed
 no balun required
 Max wind survival . . . 100 mph

ACTUAL SWR CURVES

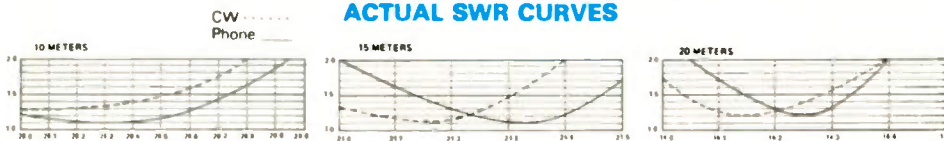

COMPARE THE SY33 WITH OTHERS...

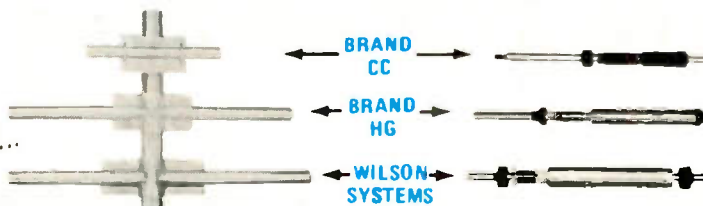

Compare the size and strength of the boom to element clamps. See who offers the largest and heaviest duty. Which would you prefer?

Wilson Systems traps offer a larger diameter trap coil and a larger outside housing, giving excellent Q and power capabilities.

ADD 40 METERS TO YOUR TRI-BAND WITH THE 33-6 MK

— IN STOCK —

\$64.95

Now you can have the capabilities of 40-meter operation on the **SYSTEM 36** and **SYSTEM 33**. Using the same type high quality traps, the 40-meter addition will offer 150 KHZ of bandwidth. The 33-6 MK will fit your present SY36, SY33, or SY3 and use the same single feed line.

The 33-6 MK adds approximately 15' to the driven element of your tri-bander, increasing the tuning radius by 5 to 6 feet. This addition will offer a rotatable dipole at the same height of your beam.

WSD WILSON SYSTEMS, INC.

4286 S. Polaris Ave. Las Vegas, Nevada 89103

Prices and specifications subject to change without notice.

ORDER FACTORY DIRECT
 1-800-634-6898

\$64.95

WV-1A

4 BAND TRAP VERTICAL (10 - 40 METERS)

No bandswitching necessary with this vertical. An excellent low cost DX antenna with an electrical quarter wavelength on each band and low angle radiation. Advanced design provides low SWR and exceptionally flat response across the full width of each band.

Featured is the Wilson large diameter High-Q traps which will maintain resonant points with varying temperatures and humidity.

Easily assembled, the WV-1A is supplied with a base mount bracket to attach to vent pipe or to a mast driven in the ground.

NOTE: Radials are required for peak operation or above ground mounting. (See GR-1 below)

SPECIFICATIONS

- 19' total height
- Self supporting — no guys required
- Weight — 14 lbs.
- Input impedance: 50 Ω
- Powerhandling capability: Legal Limit
- Two High-Q traps with large diameter coils
- Low angle radiation
- Omnidirectional performance
- Taper swaged aluminum tubing
- Automatic bandswitching
- Mast bracket furnished
- SWR: 1.1:1 or less on all bands

GR-1

GROUND RADIAL KIT

\$14.95

The GR-1 is the complete ground radial kit for the WV 1A. It consists of 150' of 7/14 aluminum wire, heavy duty egg insulators and instructions. The GR-1 will increase the efficiency of the WV-1 by providing the correct counterpoise.

WILSON SYSTEMS, INC.

the SYSTEM 36

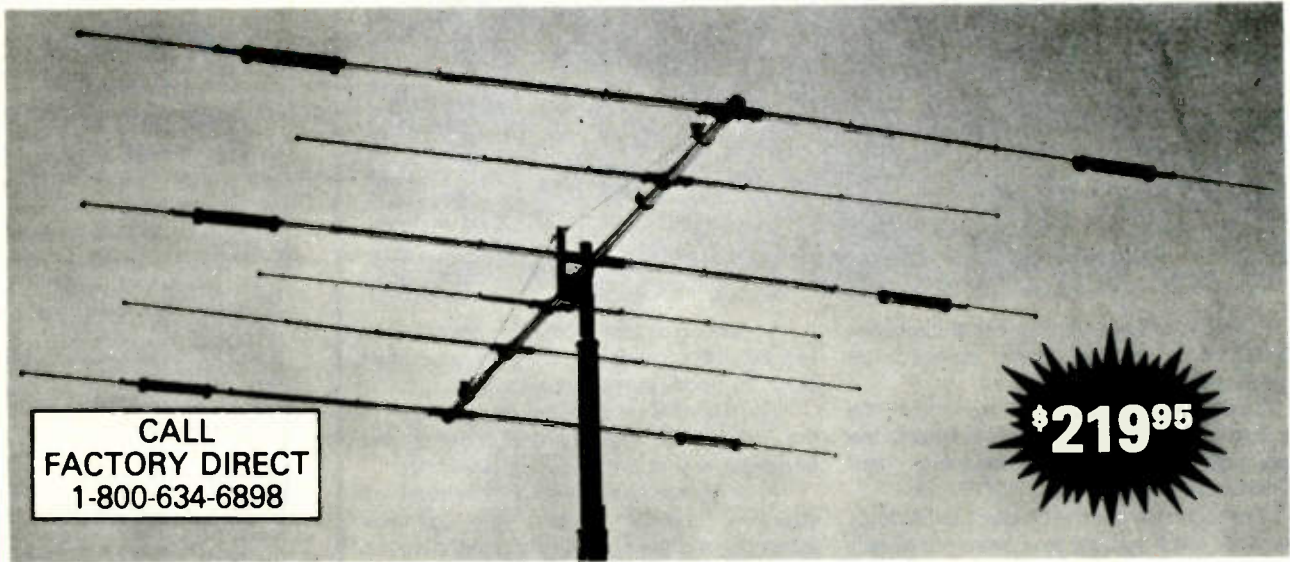

**CALL
FACTORY DIRECT
1-800-634-6898**

\$219⁹⁵

A trap loaded antenna that performs like a mono-bander! That's the characteristic of this six element three band beam. Through the use of wide spacing and interlacing of elements, the following is possible: three active elements on 20, three active elements on 15, and four active elements on 10 meters. No need to run separate coax feed lines for each band, as the bandswitching is automatically made via the High-Q Wilson traps. Designed to handle the maximum legal power, the traps are capped at each end to provide a weather-proof seal against rain and dust. The special High-Q traps are the strongest available in the industry today.

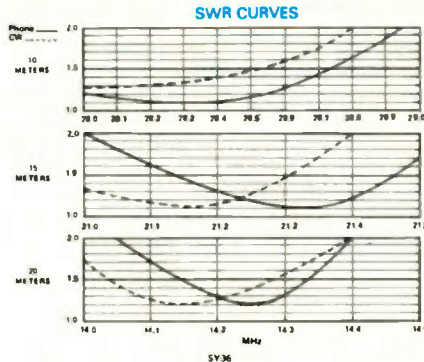

SPECIFICATIONS

- Band MHz 14-21-28
- Maximum power input Legal Limit
- Gain (dbd) 9 db
- VSWR @ resonance 1.3:1
- Impedance 50 ohm
- F/B Ratio 20 db or Better
- Boom (O.D. x Length) 2" x 24' 2 1/2"
- No. of Elements 6
- Longest Element 28' 2 1/2"
- Turning Radius 18' 6"
- Maximum Mast Diameter 2"
- Surface Area 8.6 sq. ft.
- Matching Method Beta
- Wind Loading @ 80 mph 215 lbs.
- Maximum Wind Survival 100 mph
- Feed Method Balun (Supplied)
- Assembled Weight (approx.) 53 lbs.
- Shipping Weight (approx.) 62 lbs.

Compare the SY-36 with others . . .

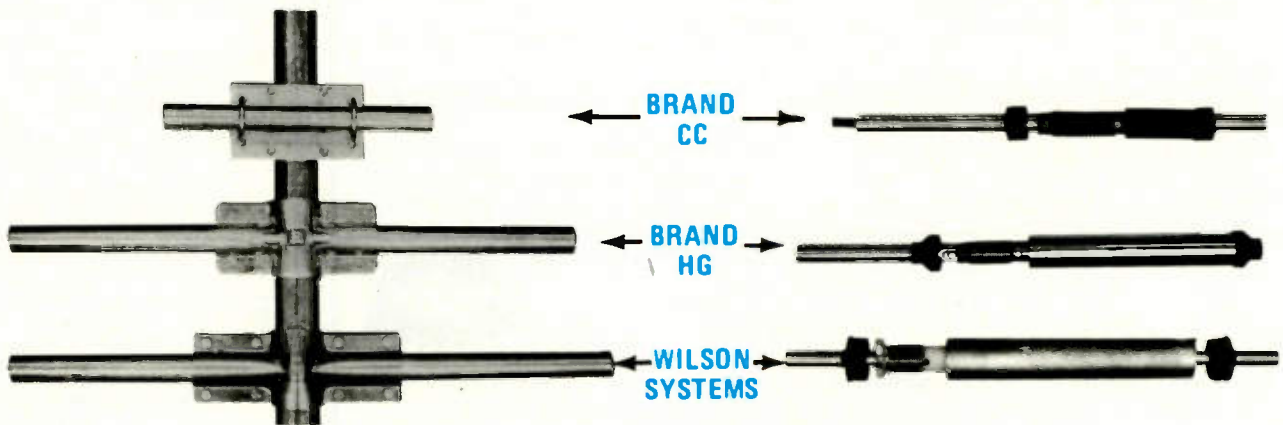

Compare the size and strength of the boom to element clamps. See who offers the largest and heaviest duty. Which would you prefer?

Wilson Systems traps offer a larger diameter trap coil and a larger outside housing, giving excellent Q and power capabilities.

**CALL
FACTORY DIRECT
1-800-634-6898**



4286 S. Polaris Ave., Las Vegas, Nevada 89103

Prices and specifications subject to change without notice.

WILSON SYSTEMS, INC. PRESENTS

THE SYSTEM 40 TRIBANDER

3 MONOBAND ANTENNAS IN ONE — EACH WITH FULL MONOBAND PERFORMANCE

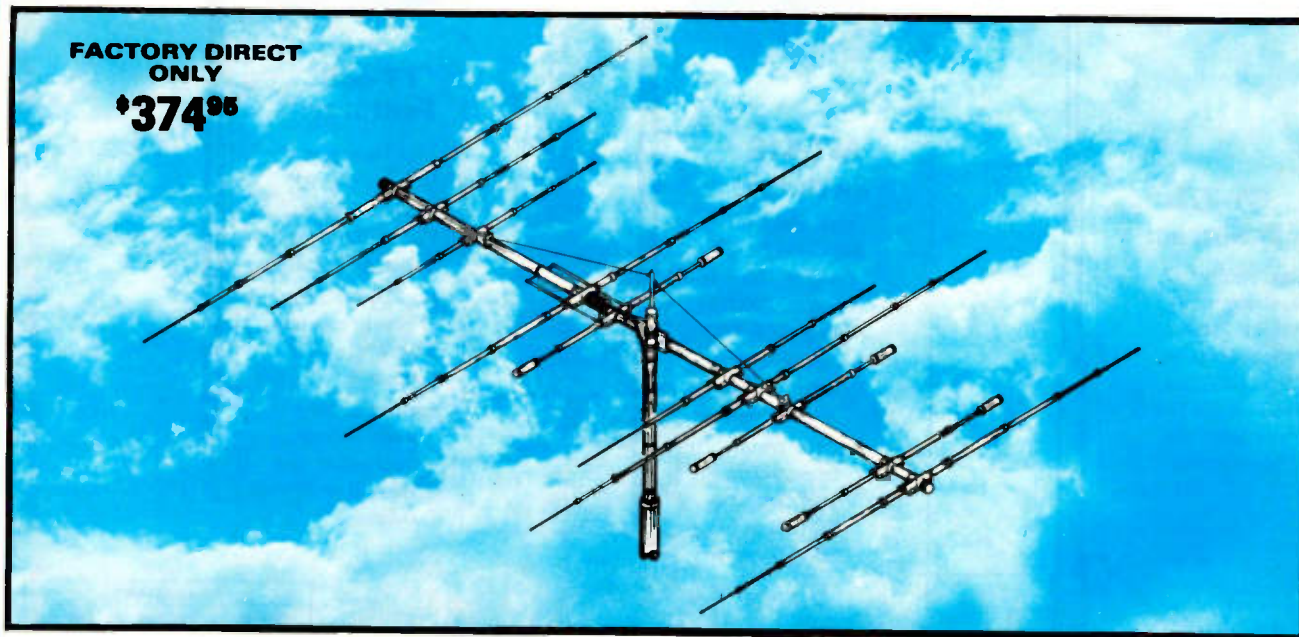

A NEW CONCEPT IN ANTENNA DESIGN USING A 26 FT. BOOM

- FOR THE SERIOUS DXer WHO WANTS MONOBANDERS ON 10-15-20
- FOUR FULL SIZE 20 MTR ELEMENTS WITH 10 dbd GAIN & 25 db F/B
- FOUR WIDE SPACED 15 MTR ELEMENTS WITH 10 dbd GAIN & 20 db F/B
- FIVE WIDE SPACED 10 MTR ELEMENTS WITH 11.5 dbd GAIN & 20 db F/B
- ONLY ONE FEED LINE REQUIRED
- HEAVY DUTY BALUN INCLUDED
- DESIGNED WITH NO INTERACTIONS BETWEEN ELEMENTS
- ALL DRIVEN ELEMENTS AND DIRECTOR ELEMENTS ARE INSULATED FROM BOOM
- SAME QUALITY HARDWARE AS USED IN ALL WILSON ANTENNAS

— SPECIFICATIONS —

Max. Pwr. Input	Legal Limit	Longest Element	36'
VSWR @ Res.	1.2:1	Turning Radius	22' 6"
Impedance	50 ohm	Boom	26'
Feed Method	Coax Balun Supplied	Surface Area	12.1 sq. ft.
Matching Method	Modified Beta	Wind Loading @ 80 mph	309 lbs.
F/B Ratio	See Above	Assem. Weight	75 lbs.
Gain	See Above	Shipping Weight	99 lbs.

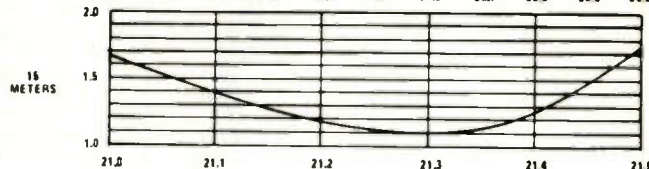
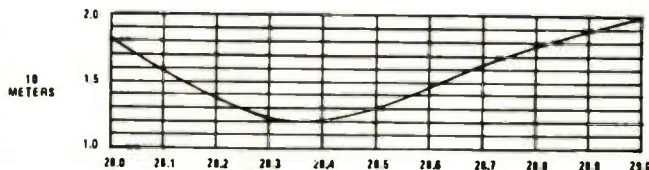
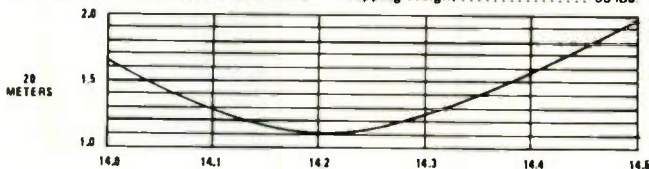

**AVAILABLE ONLY
FACTORY DIRECT
CALL**

1-800-634-6898 TOLL FREE

**W S I WILSON
SYSTEMS, INC.**

4286 S. Polaris Ave., Las Vegas, Nevada 89103

PRICES AND SPECIFICATIONS SUBJECT TO CHANGE WITHOUT NOTICE.

WILSON SYSTEMS TOWERS

— FACTORY DIRECT —

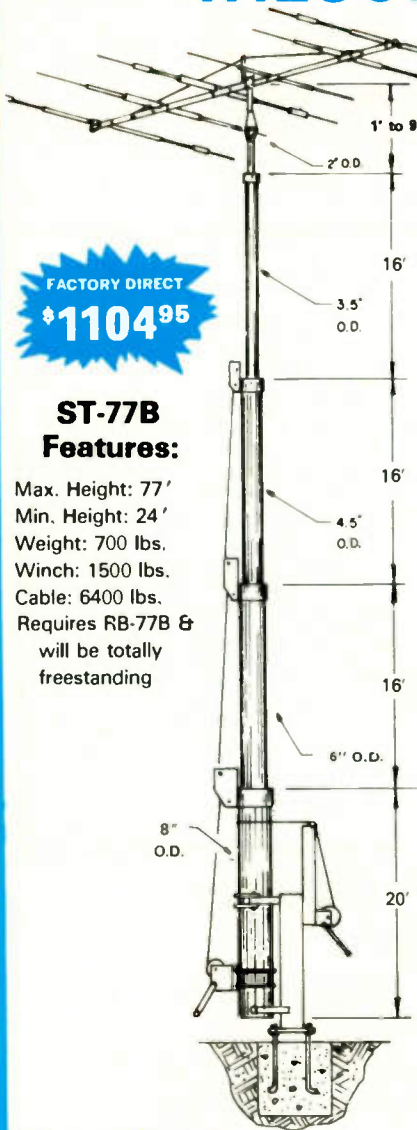

FACTORY DIRECT
\$1104⁹⁵

ST-77B Features:

Max. Height: 77'
Min. Height: 24'
Weight: 700 lbs.
Winch: 1500 lbs.
Cable: 6400 lbs.
Requires RB-77B & will be totally freestanding

FACTORY DIRECT
\$619⁹⁵

MT-61B Features:

Max. Height: 61'
Min. Height: 23'
Weight: 450 lbs.
Winch: 1200 lbs.
Cable: 4200 lbs.
No Guys required when mounting against house.
For completely freestanding installation, use RB-61B or FB-61B below.



FACTORY DIRECT
\$399⁹⁵

TT-45B Features:

Max Height: 45'
Min. Height: 22'
Weight: 1200 lbs.
Winch: 1200 lbs.
Cable: 4200 lbs.
No Guys required when mounting against eve of house.
For completely freestanding installation, use RB-45B or FB-45B below.

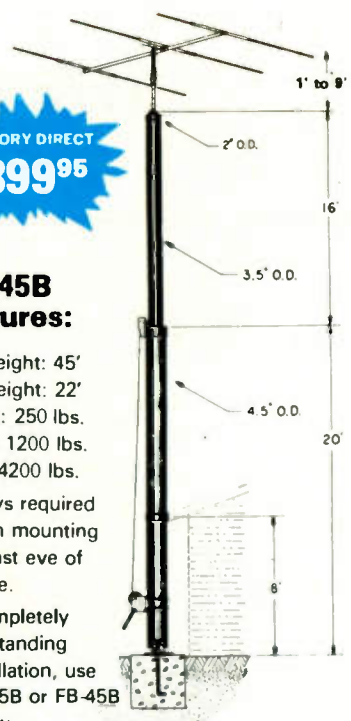

NEW! Wilson Electric Winch

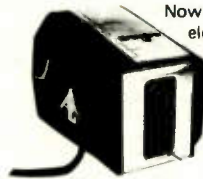

Now you can raise and lower your Wilson Tower electrically. The electric winch will replace the hand operated winch. Available for use on the TT-45, MT-61 and ST-77 towers.

EW-45 (TT-45)
EW-61 (MT-61)
EW-77 (ST-77)

\$249⁹⁵

BASE CHART		
TOWER	WIDTH	DEPTH
TT-45B	12" x 12"	30"
FB-45B	30" x 30"	4 1/2'
RB-45B	30" x 30"	4 1/2'
MT-61B	18" x 18"	4'
FB-61B	3' x 3'	5 1/2'
RB-61B	3' x 3'	5 1/2'
ST-77B	See Below	
RB-77B	3 1/2' x 3 1/2'	6'

Tower	WIND LOADING Height	Sq. Ft.	Square Footage Based on 50 MPH Wind
ST-77B	69	18	
	77	10	
MT-61B	53	18	
	61	12	
TT-45B	37	18	
	45	12	

Wilson Systems uses a high strength carbon steel tube manufactured especially for Wilson Systems. It is 25% stronger than conventional pipe or tubing. The tubing size used is: 2" & 3 1/2"-.095; 4 1/2" & 6"-.125; 8"-.134. All tubing is hot dip galvanized. Top section is 2" O.D. for proper rotor and antenna mounting.

The TT-45B and MT-61B come complete with house bracket and hinged base plate for against-house mounting. For totally freestanding installation, use either of the tilt-over bases shown below.

The ST-77B cannot be mounted against the house and must be used with the rotating tilt-over base RB-77B shown below.

TILT-OVER BASES FOR TOWERS

FIXED BASE

The FB Series was designed to provide an economical method of moving the tower away from the house. It will support the tower in a completely free-standing vertical position, while also having the capabilities of tilting the tower over to provide an easy access to the antenna. The rotor mounts at the top of the tower in the conventional manner, and will not rotate the complete tower.

FB-45B .. 112 lbs... *189⁹⁵
FB-61B .. 169 lbs... *269⁹⁵

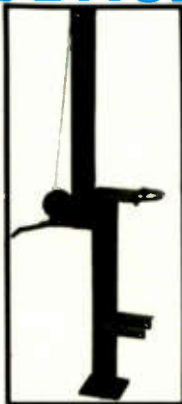

ROTATING BASE

The RB Series was designed for the Amateur who wants the added convenience of being able to work on the rotor from the ground position. This series of bases will give that ease plus rotate the complete tower and antenna system by the use of a heavy duty thrust bearing at the base of the tower mounting position, while still being able to tilt the tower over when desiring to make changes on the antenna system.

RB-45B .. 144 lbs... *269⁹⁵
RB-61B .. 229 lbs... *344⁹⁵
RB-77B .. 300 lbs... *514⁹⁵

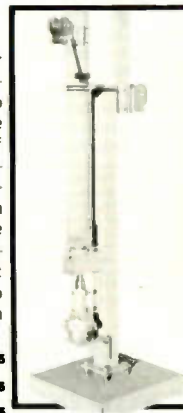

Tilting the tower over is a one-man task with the Wilson bases. (Shown above is the RB-61B. Rotor is not included.)

ORDER FACTORY DIRECT
1-800-634-6898

Prices Effective 10-1-80 to 10-31-80

W S I WILSON SYSTEMS, INC.

4286 S. Polaris Ave. Las Vegas, Nevada 89103

WILSON SYSTEMS, INC.

WILSON GUYED TOWERS

GT-46 234⁹⁵

46' GUYED TOWER

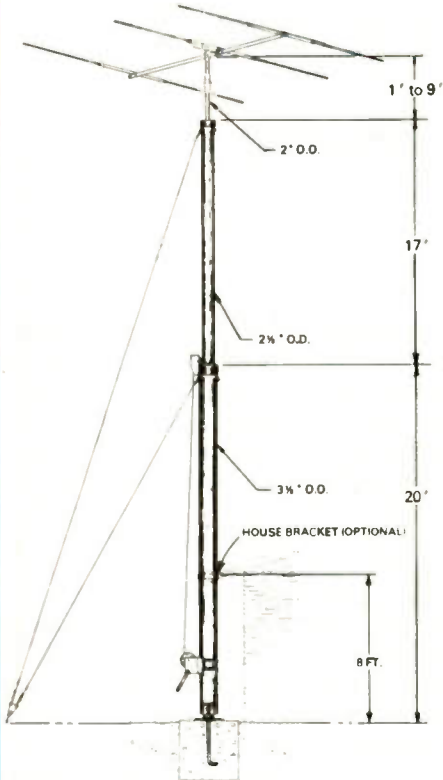

WIND LOADING			
Tower	Height	Sq. Ft.	Square Footage Based on 50 MPH Wind
GT-46	46	6	
	41	8	
	36	10	
TT-27	27	6	
	22	8	
	18	10	

(When Properly Guyed)

TT-27 159⁹⁵

27' GUYED TOWER

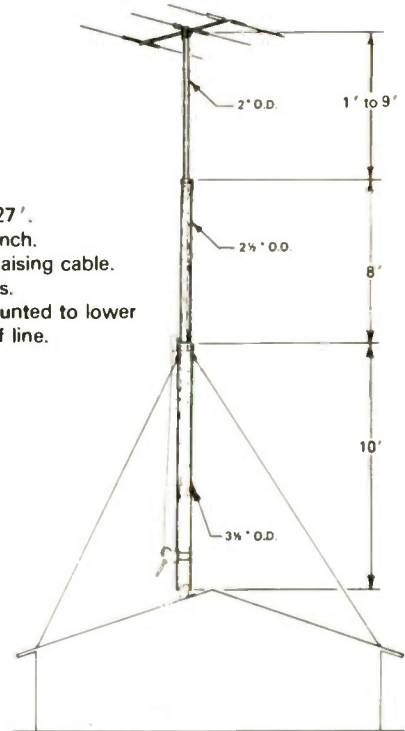

TT-27 FEATURES:

- Maximum height, 27'.
- 800 lb. capacity winch.
- 2,000 lb. capacity raising cable.
- Total weight, 84 lbs.
- Can be ground mounted to lower antenna below roof line.

GT-46 FEATURES:

- Maximum height, 46'.
- 800 lb. capacity winch.
- 2,000 lb. capacity raising cable.
- Only one cubic ft. of cement required.
- Total weight, 117 lbs.

GENERAL FEATURES

All towers use high strength heavy galvanized steel tubing that conforms to ASTM specifications for years of maintenance free service. The large diameters provide unexcelled strength. All welding is performed with state-of-the-art equipment. Top sections are 2" O.D. for proper antenna/rotor mounting. A 9' push-up mast is included in the top section of each tower. Hinge-over base plates are standard with each tower. The high loads of today's antennas make Wilson crank-ups a logical choice.

WILSON SYSTEMS, INC. — 4286 S. Polaris
Las Vegas, NV 89103 — (702) 739-7401

FACTORY DIRECT ORDER BLANK

Toll-Free Order Number

1-800-634-6898

Qty.	Model	Description	Shipping	Price	Qty.	Model	Description	Shipping	Price
	SY40	10 Ele. Tribander for 10, 15, 20 Mtrs.	UPS	374.95		GT-46	46' Guyed Tower	TRUCK	234.95
	SY36	6 Ele. Tribander for 10, 15, 20 Mtrs.	UPS	219.95		TT-27	27' Guyed Tower	TRUCK	159.95
	SY33	3 Ele. Tribander for 10, 15, 20 Mtrs.	UPS	164.95		TT-45B	Freestanding 45' Tubular Tower	TRUCK	399.95
	33-6 MK	40 Mtr. Mod Kit for SY33 & SY36	UPS	64.95		RB-45B	Rotating Base for TT-45B w/tilt over feature	TRUCK	259.95
	WV-1A	Trap Vertical for 10, 15, 20, 40 Mtrs.	UPS	64.95		FB-45B	Fixed Base for TT-45B w/tilt over feature	TRUCK	189.95
	GR-1	Ground Radials for WV-1A	UPS	14.95		MT-61B	Freestanding 61' Tubular Tower	TRUCK	619.95
	M-420A	4 Elements on 20 Mtrs.	UPS	174.95		RB-61B	Rotating Base for MT-61B w/tilt over feature	TRUCK	344.95
	M-515A	5 Elements on 15 Mtrs.	UPS	139.95		FB-61B	Fixed Base for MT-61B w/tilt over feature	TRUCK	269.95
	M-415A	4 Elements on 15 Mtrs.	UPS	99.95		ST-77B	Freestanding 77' Tubular Tower	TRUCK	1104.95
	M410A	4 Elements on 10 Mtrs.	UPS	74.95		RB-77B	Rotating Base for ST-77B w/tilt over feature	TRUCK	514.95
		ACCESSORIES				GK-46	Guying Kit for GT-46	UPS-TRK	74.95
	T ² X	Tail Twister Rotor	UPS	274.95		GK-45B	Guying Kit for TT-45B	UPS-TRK	69.95
	HD-73	Alliance Heavy Duty Rotor	UPS	109.95		GK-61B	Guying Kit for MT-61B	UPS-TRK	79.95
	RC-8C	B/C Rotor Cable	UPS	.12/ft.		GK-77B	Guying Kit for ST-77B	UPS-TRK	99.95
	RG-8U	RG-8U Foam-Ultra Flexible Coaxial Cable. 38 strand center conductor, 11 gauge	UPS	.21/ft.		WTB-1	Thrust Bearing for Top of Rotating Towers	UPS-TRK	59.95
	EW-45	Wilson Electric Winch for TT-45B	UPS	249.95					
	EW-61	Wilson Electric Winch for MT-61	UPS	249.95					
	EW-77	Wilson Electric Winch for ST-77	UPS	249.95					

NOTE:

On Coaxial and Rotor Cable, minimum order is 100' and 50' multiples.
Prices and specifications subject to change without notice.
Ninety (90) Day Limited Warranty—Shipping Not Included in Above

Prices Effective Oct. 1-31, 1980 Nevada Residents add Sales Tax
Ship C.O.D. Check enclosed Charge to VISA MasterCharge

Card No. _____ Expires _____
Bank No. _____ Signature _____
Name _____ Phone _____
Street _____
City _____ State _____ Zip _____

Prices and specifications subject to change without notice.

NASA Satellites You Can Use

— with permission, of course

Illustrations courtesy of NASA

The older of a certain pair of aging satellites celebrated its thirteenth anniversary last December.* The original communications experiments for the

*ATS-1 was launched on December 7, 1966. ATS-3 was launched on November 5, 1967. ATS-2 and 4 failed to achieve orbit. ATS-5 lost sync and is presently uncontrollable at 70° west longitude. ATS-6 was removed from orbit in August, 1979, after five years in service.

two have long since been concluded. NASA experts have given up predicting the date of their demise.

They are the Applications Technology Satellites, ATS-1 and ATS-3, and they are up and running every day providing dependable communications to remote areas of the world and to ships on the high seas.

The amateur radio fraternity should be particularly interested in these satellites

for a number of reasons. The most attractive is their operating frequency. Both employ the same 100-kHz-wide transponder frequency plan with the center uplink at 149.22 MHz and the downlink center at 135.6 MHz, tantalizingly close to the two-meter band. The fact is that ham gear is used presently by some ATS ground stations with satisfactory results.

Another fascinating as-

pect of the ATS spacecraft is that they reside in geosynchronous orbit at 149 degrees west and 105 degrees west longitude, respectively. As is the case with all geosynchronous satellites, they revolve around the Earth's axis over the same equatorial subpoint once a day at an altitude of 22,282 miles (that's roughly 5½ times the Earth's radius). Both satellites have flies in their orbital ointments, however, and I'll get back to this later.

The National Aeronautics and Space Administration (NASA) has proven technical feasibility with regards to the use of VHF transponders aboard geosynchronous satellites, and experiments along these lines are no longer conducted or entertained. However, proposed projects concerning imaginative communications applications are constantly being reviewed by the ATS experiments managers at NASA Headquarters in Washington. If a project shows merit, a time slot, usually an hour a day, is provided to the user for the experiment to be conducted. For example, certain hospital emergency rooms and ambulances in Mississippi and Alabama have recently been outfitted

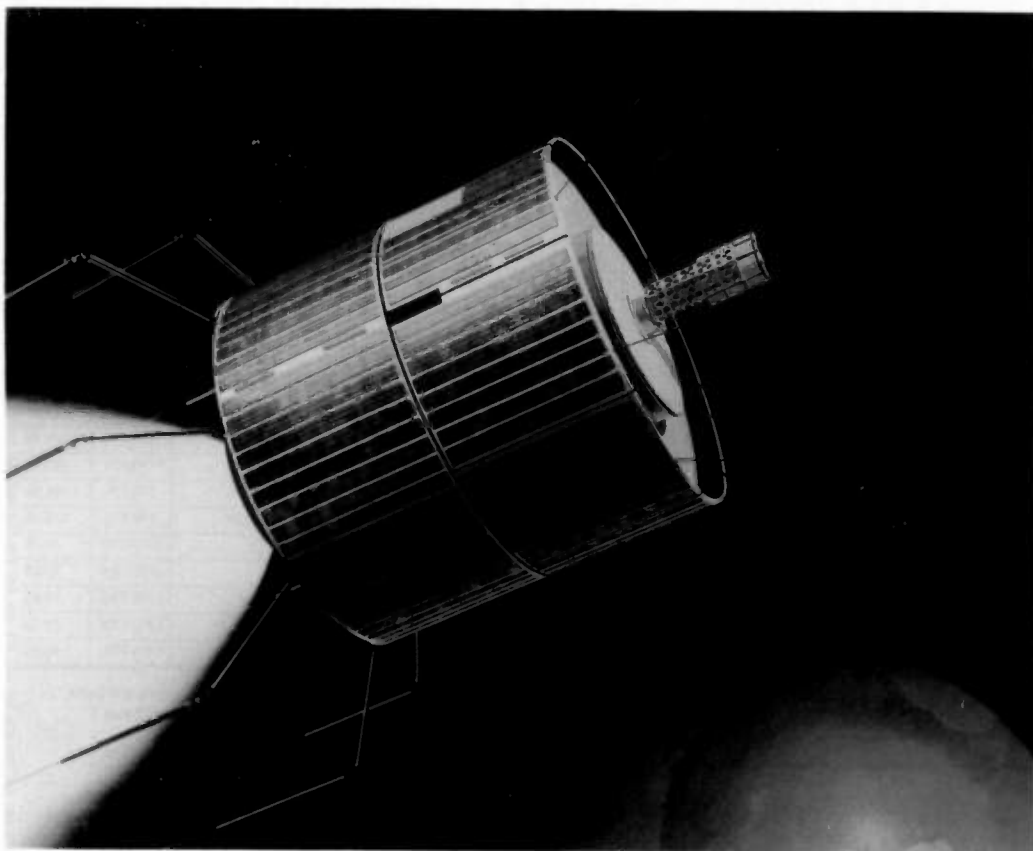

with ATS equipment after it was suggested that satellite communications be used when conventional terrestrial links fail.

The transponder occupancy rates during satellite daytime hours are presently approaching 100 percent. The day usually begins for ATS-3 when personnel at Palmer and Siple stations in the Antarctic talk with their respective university sponsors in the United States. Promptly at 1300 UTC, research vessels from both the Atlantic and Pacific begin communicating with their bases, passing such traffic as position reports, equipment requests, and project status.

Occasionally, RTTY and FAX are used on the network. Tests of all sorts are conducted throughout the day from points as remote as rescue sites in Panama to NASA stations in Hawaii. The research vessels return for an hour slot at 1600 UTC, and, usually, after a final Palmer and Siple station schedule, the quiet hours on ATS-3 begin. ATS-3 is not silent because its batteries need charging. ATS-3 stands mute because nobody wants to conduct experiments at night.

To the radio amateur, this is downright ludicrous. For a period of over fourteen hours a day, this spacecraft sits perched high above the United States (and the entire Western Hemisphere, for that matter) anxiously awaiting the proper stimulus to carry out its mission. If you or your group can devise a nighttime program acceptable to NASA, you can provide the stimulus needed to awaken a sleeping giant.

Meanwhile, ATS-1 hangs conveniently over the equator at a point serving the continental United States, Alaska, Australia, and, of course, everything in between. (See Fig. 1.) Its primary use is as a govern-

mental, medical, and educational party line for the Pacific region. Late night and early morning hours (satellite sun time) find ATS-1 dormant. Once again, this down time offers tremendous opportunity for those of you with a unique communications idea.

NASA has arbitrarily designated five channels within the 100-kHz transponders, listed in Table 1. These channel assignments are intended to be used by radio equipment with 5-kHz peak deviation frequency modulation. Sound familiar?

ATS-1 users normally operate on channel three, while ATS-3 users operate on channels two and four. There is a good reason for this procedure. Due to certain antenna side-lobe characteristics, ground-station uplinks occasionally access both satellites at once.

You may have noted that the downlink transponders fall within the VHF aircraft band. One of the first experiments NASA conducted was communications tests with aircraft in flight. Depending upon your location, you may be plagued by AM interference from high-flying aircraft. For example, the Washington DC area is within range of such interference on channel three (135.6 MHz) when aircraft work the Cleveland Air Traffic Control Center.

Other types of interference are emitted from the spacecraft themselves. The US Air Force operates security police networks in the uplink passband and this traffic can be received on the corresponding downlink frequencies. A Canadian paging service, CHC-343, is a regular on 135.640 MHz.

Although it is unlikely, NASA has the ability to select other orbital sub-points for ATS-1. Gas thrusters enable it to be

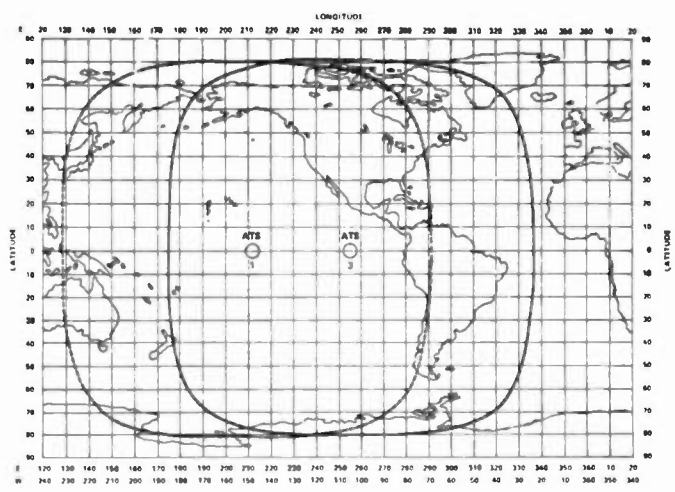

Fig. 1. Earth coverage of ATS-1 (at 149° west longitude) and ATS-3 (at 105° west longitude).

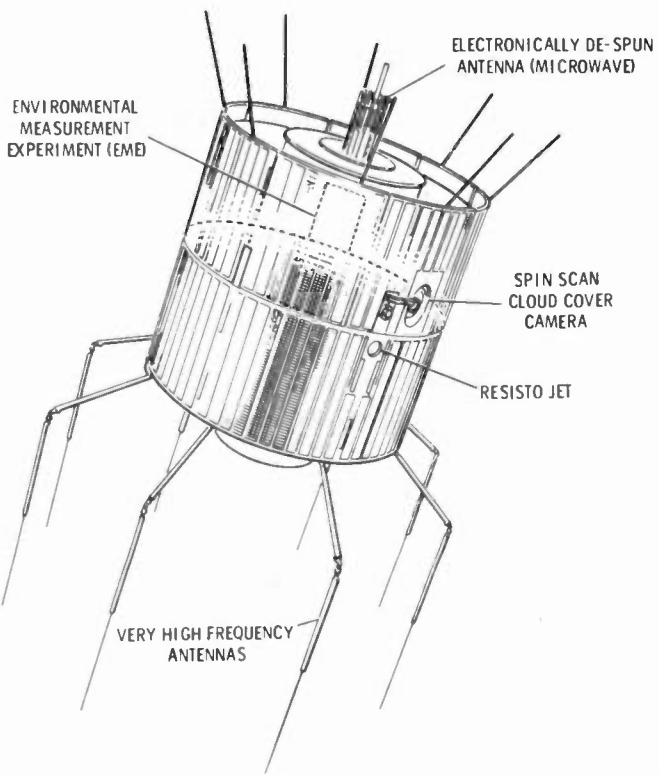

Fig. 2. ATS exterior experiments.

driven anywhere along the geosynchronous highway. The fuel supply aboard ATS-3, however, was exhausted shortly after it was parked at its eternal resting place of 105 degrees west. Gravitational imperfections and oblateness of the Earth have created this spacecraft graveyard. (Another one is located at about 79 degrees east.) Once their fuel supplies are depleted, all geosynchronous satellites swing over one of these two stable

Channel Number	Uplink Frequency	Downlink Frequency
1	149.175	135.555
2	149.195	135.575
3	149.220	135.600
4	149.245	135.625
5	149.265	135.645

Table 1. Transponder channels.

points like a pendulum. ATS-1 has a tendency to slip eastward, requiring a velocity change of 155 feet per second per year to keep it at 149° west.

Antenna azimuth for ATS-3 from Washington DC:

X = 27.8 degrees

Y = 38.5 degrees

$$\text{Azimuth} = \tan^{-1} \frac{\tan X}{\sin Y}$$

Substituting:

$$\begin{aligned} \text{Azimuth} &= \tan^{-1} \frac{\tan 27.8}{\sin 38.5} \\ &= \tan^{-1} \frac{.527}{.623} \\ &= \tan^{-1} .846 \\ &= 40.23 \text{ degrees} \end{aligned}$$

Since Washington is east of the spacecraft, we add the result to 180°. Therefore, the azimuth is 220.23 degrees.

Antenna elevation for ATS-3 from Washington DC:

$$\text{Elevation} = \tan^{-1} \frac{\cos X \cos Y - .151}{\sqrt{1 - (\cos X \cos Y)^2}}$$

Substituting:

$$\begin{aligned} \text{Elevation} &= \tan^{-1} \frac{\cos 27.8 \cos 38.5 - .151}{\sqrt{1 - (\cos 27.8 \cos 38.5)^2}} \\ &= \tan^{-1} \frac{.692 - .151}{\sqrt{1 - .479}} \\ &= \tan^{-1} \frac{.541}{.722} \\ &= \tan^{-1} .749 \\ &= 36.8 \text{ degrees} \end{aligned}$$

Geosynchronous satellite range in miles may be found by the formula:

$$\text{Range} = 26210 \sqrt{1.023 - .302 (\cos X \cos Y)}$$

Once more, from Washington, the range in miles to ATS-3 can be computed as follows:

$$\begin{aligned} \text{Range} &= 26210 \sqrt{1.023 - .302 (\cos 27.8 \cos 38.5)} \\ &= 26210 \sqrt{1.023 - .302 (.692)} \\ &= 26210 (.902) \\ &= 23641 \text{ miles} \end{aligned}$$

In order for their axis synchronizations to be maintained—that is, the spacecraft's angle in relation to Earth—the satellites are spin-stabilized. The spin rate is about 96 rpm and provides a noticeable amplitude-modulated pulsation, particularly from weak signals.

As I mentioned earlier, there are anomalies in both ATS orbits. ATS-1 is presently experiencing a north-south inclination of about 10 degrees, while ATS-3 suffers from a similar inclination of 8.5 degrees. These disorders are uncontrollable from Earth and will

continue to increase at a rate of .86 degrees per year. Beamwidths of most ground station antennas are in the range of 30-40 degrees, so the necessity for tracking does not yet exist. Siple station (64° south latitude) now must meet ATS-3 orbital schedules since the spacecraft is over the horizon during its north inclination.

Let's now address ourselves to an ATS receiving system. For one reason or another, NASA has excluded channels one and five from operation, so we are concerned only with three receiving frequencies:

135.575 MHz, 135.600 MHz, and 135.625 MHz. Some ground stations own mammoth General Dynamics diversity-telemetry receivers, but for most of us this kind of equipment comes straight from fantasyland and is certainly not necessary. The University of Miami purchased some inexpensive crystal-controlled VHF scanners a while back, and they continue to perform satisfactorily.

AM aircraft receivers will not work. (The spin-stabilized carriers are sometimes recognizable on these receivers.) Old tunable VHF monitor receivers will not work very well due in part to their poor sensitivity and unnecessarily wide i-f bandwidth. Surplus General Electric and Motorola receiver strips are great and fill the bill perfectly. Since I already owned a Bearcat 210 synthesized scanner (which does not tune to 135 MHz), I decided to go the converter route. My converter is designed so that its i-f is exactly 100 MHz below the input frequency, allowing me, for example, to punch up 35.6 MHz to receive channel three.

With regard to antennas, a simple 88-inch loop fed with 75-Ohm coax will work adequately. But remember, there's a 168-dB path loss between the satellite and your station, so you should give your receiver all the help it can get. If your coax run is long, an inexpensive rf preamplifier will help tremendously. (The serious listener should purchase a preamp anyway. Janel Labs has them in stock for \$21.95. Ask for Model 137PB.)

My antenna, which is best described as a four-element quagi, cost \$4.80 and consists of three pieces of wood and some aluminum clothesline. This antenna is linearly polar-

ized and is mounted at my QTH in the horizontal plane. The antennas on the ATS satellites likewise are linearly polarized, but this arrangement is of little consequence. Radio signals in the VHF range are severely affected by a phenomenon known as Faraday Rotation, causing ultimate receive polarizations to be unpredictable. It is rare that I encounter no signal at all, and then this situation lasts only a minute or so. Most ATS ground stations transmit and receive on circularly-polarized antennas, of both the helix- and cross-yagi variety. Although this solves the Faraday Rotation problem, an immediate loss of 3 dB is realized over an antenna in the same plane.

Your next objective is to point the antenna in the right direction. You should be able to use the guess method if your antenna is a loop or small yagi. However, here are the geosynchronous aiming formulas for those of you with super arrays—as well as for the mildly curious.

Where X = the difference between satellite longitude and site longitude in degrees, and Y = the site latitude in degrees:

$$\begin{aligned} \text{Azimuth} &= \tan^{-1} (\tan X / \sin Y), \text{ and—} \\ \text{Elevation} &= \tan^{-1} \frac{\cos X \cos Y - .151}{\sqrt{1 - (\cos X \cos Y)^2}} \end{aligned}$$

Note: If you are in the Northern Hemisphere and west of the spacecraft, subtract your answer from 180°. If you are east of the spacecraft, add your answer to 180°.

For examples, see the box.

If you are in Washington, or about 23,641 miles from ATS-3, and are communicating with a friend whose station is likewise that distance from the spacecraft, you can expect a signal delay of approximately one fourth of a second: $2 \times 23,641 = 47,282$

path miles; divided by 186,000 miles per second, it means a .2542-second path time.

ATS ground station transmitters vary in power from 50-500 Watts depending upon communications reliability, geographical location, antenna gain, and other considerations. The Antarctic stations operate with 500-Watt transmitters, while many research vessels do well with 80 Watts into an eight-turn helix.

Once the satellite transponders have been saturated, additional uplink power is wasted. The entire downlink transponder power aboard each spacecraft is about 40 Watts. Satellite output power is a function of the input. ATS-3 is designed so that two or more uplink signals will produce the corresponding output ratios. For example, if uplink signal A on channel two is twice as strong as

uplink signal B on channel four, the downlink power will exhibit this same two-to-one power ratio. ATS-1 compresses the weaker signals and the downlink is not a linear function of the uplink.

It is time now for you to formulate an operational plan. Your first step is to obtain the "ATS VHF Experiments' Guide." This can be procured by writing: ATS Experiments Manager, Office of Applications, Code ECS, NASA, Washington DC 20546.

Finally, ATS usage proposals must be well thought out, thoroughly described, and unique in approach. If your proposal is rejected and you still believe you've come up with a great idea, contact your Congressman—he may have a sympathetic ear and place a call to NASA on your behalf. In any event, good luck! ■

INTIMIDATED BY MORSE CODE?



THE NEW AEA MODEL MT-1 COMPUTERIZED MORSE TRAINER MAKES MORSE CODE EASY AND FUN TO LEARN.

KT-1 Computerized Keyer With All Features of Above Trainer is Also Available in Same Package

- Automatic Speed Increase, User May Program: Starting Speed, Ending Speed, Practice Duration; 5 Letter code Groups or Random Space; Common or All Characters.
- Precise Speed Control 1 to 99 WPM (Tailor to Your Exact Requirements).
- 24,000 Character Answer Book Available For 10 Starting Positions.
- Random Mode For Practice (No Answers).

CALL TODAY

BEN FRANKLIN ELECTRONICS

115½ N. MAIN • HILLSBORO, KS 67063 • 316-947-2269

AEA Brings you the Breakthrough!



SIMPLY THE BEST! FOX TANGO FILTERS YAESU-KENWOOD-DRAKE-COLLINS-HEATH

Whether your SSB rig is old or new, there is no easier or essentially less expensive way to significantly upgrade its performance than by improving its IF passband filtering.

FOX-TANGO filters are made of specially-treated high-Q quartz crystals, affording excellent shape factors and ultimate rejection exceeding 80 dB. They are custom made for drop-in installation; matching perfectly, both physically and electronically. Our Diode Switching Boards make possible (now or in the future) the addition of a variety of switch-selectable filters affording superior variable bandwidth without the need to buy an expensive new model. If you want the best for less, you'll buy FOX-TANGO. Just tell us the bandwidth(s) desired for your make and model.

*DIODE SWITCHING BOARDS available to permit 1, 2 or more filters than those for which manufacturer provides room. SPECIFY make and model.

Single-filter type: \$12 Airmail postpaid worldwide.

Dual-filter type: \$21 Airmail postpaid worldwide.

Florida residents add 4% (sales tax) (FOREIGN ADD \$5 per filter)

Dealer Inquiries Welcomed

Visa/MC welcomed. Money back if not satisfied.

BROCHURE ON REQUEST

8-POLE FILTER BANDWIDTHS IN STOCK

CRYSTAL FILTER	CW (Hz)						SSB-AM (kHz)				
	125	250	400	500	600	800	1.8	2.1	2.4	6.0	8.0
YAESU	\$55 EACH										
*FT-101/F/FR-101		✓		✓	✓		✓	✓	✓	✓	✓
*FT-301/FT-7B/620		✓		✓			✓		✓	✓	
*FT-901/101ZD/107		✓		✓			✓		✓	✓	
FT-401/560/570		✓		✓			✓	✓			
FT-200/TEMPO 1							✓	✓		✓	
KENWOOD	\$55 EACH										
*TS-520/R-599		✓	✓				✓	✓		✓	• 2nd IF \$125
*TS-820/R-820		✓	✓				✓	✓		✓	for R-820 only
HEATH	\$55 EACH										
ALL HF		✓	✓				✓	✓		✓	
DRAKE	FOR PRICES SEE NOTES										
R-4C	GUF-1 Broad 1st IF Superior Shape Factor/Ult Rej \$65 ✓ ✓ GUF-2 Narrow 1st IF ✓ ✓ + pcb w sw relays \$90 2nd IF ✓ ✓ Plug in type ✓ \$55 GUD Product Detector pcb w relay double balanced type \$30										
COLLINS:	SPECIAL \$125 EACH										
75S-3B/C		✓									EQUALS DR EXCELS \$400 COLLINS UNIT

FOX-TANGO CORP. Box 15944c, West Palm Beach, FL 33406

SCR1000 VHF—SCR4000 UHF

**For Your New Repeater or Link System,
Or, to Replace
Your Old "Klunker"**

*Go First
Class!*

Go With Spec Comm!

2 Mtr.

220 MHz

450 MHz

- 30W Output.
- Low Noise/Wide Dynamic Range Front End for Excellent Sensitivity & IM Rejection.
- Sensitivity: 0.3uV Typ.
- 12 Pole IF Filter, & 8 Pole Front End Filter.
- Full Metering, Lighted Status Indicators/Control Push-buttons, Btry. Power Input, AC Pwr. Supply, CW IDer, etc. etc.

If you plan to install a new Repeater or VHF/UHF Link System (with or w/o Autopatch), you'll find that you can't find better quality, more reliable equipment, with all of the features and options you want at anywhere near our prices—! you can find it all!

For many years now, we have specialized specifically in the field of VHF/UHF Repeaters, Links, Transceivers and all of the accessories to make up a complete system. We now have hundreds of repeater and link systems operating successfully all over the world!

When you buy Spec Comm gear, you get the benefit of a lot of these years of experience—you get the best! And, years from now, you'll still be glad you went with Spec Comm!

Shown in Optional Cabinet

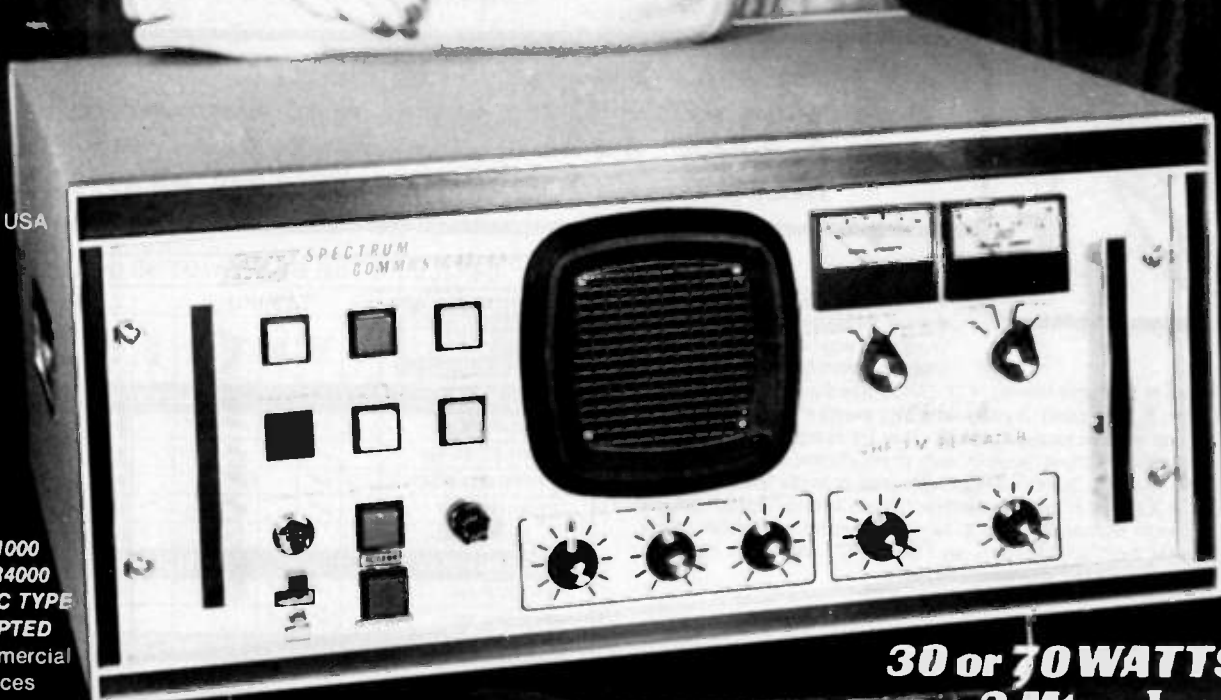

Made in USA

**SCR1000
& SCR4000
ARE FCC TYPE
ACCEPTED
for Commercial
Services**

**30 or 70 WATTS
on 2 Mtrs.!**

Available just the way you want it—with Full Autopatch/Reverse Patch/Land-Line Control Touch Tone Control of various repeater functions "PL"; "Emergency Pwr. I.D."; various Tone & Time Units, etc. PLUS—the finest Duplexers, Cabinets, Antennas, Cables, etc. Our Repeaters are sold factory direct only, or through Foreign Sales Reps. Get your order in A.S.A.F.!

Commercial Business Radio Dealer Inquiries Invited

180 Day Warranty

Call or write today and get the details!



SPECTRUM

Export Orders — Contact our International Dept.

1055 W. Germantown Pk., Dept. S10

new

COMMERCIAL MOBILE & BASE TRANSCEIVERS

Spec Comm "Professional Communications Line"

136-174 MHz

220-240 MHz (Commercial Export and Amateur)

• Very attractive woodgrain housing

Features

- 6 channels.
- 0.35 uV Rcvr.
- 8 Pole Crystal Fitr.
- Beautiful Audio—RX + TX.
- Provision for CTCSS.
- Very Reasonable Price!

PCL250 30 Wt. Mobile Unit

• "Super Rugged" Housing

Solid 1/8" Thk. Aircraft Aluminum!



- Built-in AC Power Supply
- Front Panel Status Indicator Lights
- Optional Rcvr. Scanning Function Available

PCL300 30 Wt. Base Station

► FCC TYPE ACCEPTED—PARTS 21, 81, 90 ◀

SPEC COMM REPEATER BOARDS & SUB-ASSEMBLIES

These are Professional "Commercial Grade" Units—Designed for Extreme Environments (-30 to +60° C).

All equipment assembled & tested. For 2M, 220 MHz & New 450 MHz!

SCR450 BOARD

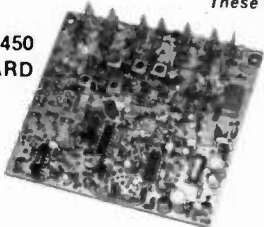

SCR100 VHF Receiver Board

- Wide dynamic range! Reduces overload, 'de-sense', and IM.
- Sens. 0.3 uV/12dB SINAD typ.
- Sel. 6dB @ ± 6.5 KHz, -110dB @ ± 30KHz. (8 Pole Crystal Fitr.)
- 'S Meter' Output.
- Exc. audio quality! Fast squelch! w/0.0005% Crystal.

SCR100 Receiver Assembly

- SCR100 mounted in shielded housing
- Same as used on SCR1000
- Completely asmbld. w/F.T. caps, SO239 conn., AF GAIN POT, etc.

SCR450 UHF Receiver Bd. or Assy.

- Similar to SCR100, except with 12 Pole IF Fitr. & 8 Resonator Front End Fitr.!
- Discriminator & Deviation Mtr. Outputs
- **Totally New Advanced Design!**

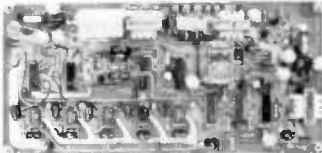

SCAP Autopatch Board

- Provides all basic autopatch functions
- 3 Digit Access; 1 Aux. On/Off function; Audio AGC; Built-in Timers; etc.
- 0/1 Inhibit bd. also available.
- Write/call for details and a data sheet.

RPCM Board

- Used w/SCAP board to provide "Reverse Patch" and Land-Line Control of Repeater
- Includes land line "answering" circuitry



FL-6

FL-6 Rcvr. Front-End Preselector

- 6 Hi Q Resonators with Lo-Noise Transistor Amp (2M or 220 MHz).
- Provides tremendous rejection of "out-of-band" signals **w/out the usual loss!** Can often be used instead of large, expensive cavity filters.
- Extremely helpful at sites with many nearby VHF transmitters to "filter-out" these 'out-of-band' signals.
- Voltage Gain: apx. 10 dB.
- Selectivity: -20 dB @ ±2.0 MHz; -60 dB @ ±6 MHz (typ.)

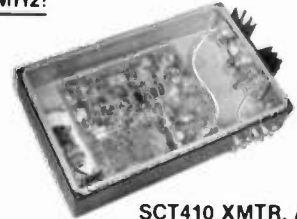

SCT410 XMTR. ASSY.

SCT110 VHF Xmtr/Exciter Board

- 7 or 10 Wts Output 100% Duty Cycle!
- Infinite VSWR proof
- True FM for exc. audio quality
- New Design—specifically for continuous rpt service
- Very low in "white noise"
- Spurious -70 dB. Harmonics -60 dB
- With .0005% xtal
- **BA-10 30 Wt. Amp board & Heat Sink, 3 sec. L.P Filter & rel. pwr. sensor.**

SCT110 Transmitter Assembly

- SCT110 mounted in shielded housing
- Same as used on SCR1000
- Completely asmbld. w/F.T. caps, SO239 conn.
- 7, 10 or 30 Wt. unit.

SCT410 UHF Transmitter Bd. or Assy.

- Similar to SCT110 8-10 Wts
- Avail. w/ or w/o OS-18 Super High Stability Crystal Osc./Oven.
- **BA-40 30W. min. UHF Amp. Bd. & Heat Sink.**

ID1000 Automatic Base Station CW Identifier



- For Repeaters, Base Xmters., etc.
- Fully Automatic ID timing & xmt. keying.
- Convenient Front Panel Controls. Many Deluxe Features!
- AC or DC powered
- Easy to install! 19" Rack Mount
- Reasonable Price! Ask for Data Sheet

new

CTC100 COR/Timer/Control Board

- Complete COR circuitry
- Carrier 'Hang' & T.O. Timers
- Remote xmt. Inhibit/Reset control
- Provision for panel control switches & lamps
- 100% Solid State CMOS logic
- Many other features

ID250 CW ID & Audio Mixer Board

- Adjustable ID tone, speed, level, timing cycle.
- 4 Input AF Mixer & Local Mic amp.
- COR input & xmt. hold circuits.
- CMOS logic; PROM memory—250 bits/channel.
- Up to 4 different ID channels!
- Many other features Factory Programmed

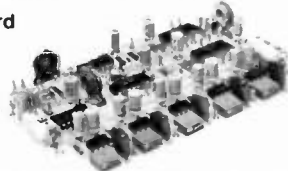

TTC100 Touchtone

Control Board

- 3 digit ON, 3 digit OFF control of a single repeater function. Or, (optional) 2 functions (2 digits ON/OFF each).
- Can be used to pull in a relay, trigger logic, etc.
- Typically used for Rptr ON/OFF, HI/LO Pwr., P.L. ON/OFF, Patch Inhibit/Reset, etc.
- Stable, anti-falsing design 5s Limit on access
- For Add'l Function(s)—Add a "Partial TTC" Board.

COMMUNICATIONS CORP.

Send for Data Sheets!

✓68

Norristown, PA 19401 • (215) 631-1710

Undertones

— a fractional frequency oscillator

Last time I wrote a ham magazine article, Wayne Green and company misspelled my name (April, 1957, CQ) so I've been hesitant about trying again. Oh well, after 22 years he deserves another chance.

Now, all of you have heard of crystal oscillators. Almost all of you have heard of overtone oscillators, where the circuit oscillates on an approximate whole integer, odd harmonic of the crystal fundamental frequency. But how many have heard of the "Undertone Oscillator"? (My name; gotta call it something!) This one oscil-

lates on some fraction of the crystal fundamental such as $\frac{1}{2}$, $\frac{1}{3}$, $\frac{1}{4}$... $\frac{1}{100}$, etc. Well, read on, my friend, it is very simple.

This circuit is a by-product of work on a crystal-controlled vfo with a 1000-kHz range. (Works very well, thank you.) Fig. 1 shows the very simple circuit. U1c is an optional buffer to isolate the oscillator from load capacitances. U1 is any TTL NAND gate, 7400, etc. If the NAND gate has more than two inputs, e.g., a 7410, tie all unused inputs to +5 V dc. 74Sxx ICs have been tried but aren't quite as stable and

draw too much current. 74LSxx ICs might work well. CMOS NAND gates, e.g., 4011, might work OK at lower frequencies. The circuit has been tested from fundamental oscillations through $\frac{1}{350}$ th of fundamental. Almost any crystal will work except some very low frequency rocks such as a 200-kHz one that I tried.

The oscillation frequency is set by C1 and R1/R2. C3 is optional for trimming the oscillator to an exact frequency. C2 is optional for help in locking the frequency to a function of the crystal frequency. R1/R2 and R3 bias U1a into its linear region. The output is a TTL-compatible square wave. Larger division factors (lower frequencies) are limited because it is too difficult to select the desired division factor. $\frac{1}{100}$ is about the maximum I have found practical.

R1 gives a wide range, as Table 1 shows. Different undertones can be selected by small R1 changes, so a 10-turn trimmer pot helps in picking the desired one. At

small division factors (higher frequencies), R1 adjustment is not so critical, so R1/R2 and C1 can be fixed components selected experimentally. Also, at small division factors, better operation is obtained with C1 selected so that R1 is near the higher end of its range (1000 Ohms) for the desired frequency. At higher frequencies, the load capacitance affects the setup of the circuit. Therefore, it is better to have the circuit connected to the next stage or load when adjusting. If the 7400 IC is used and the other two gates are uncommitted, one of them used as a buffer (unused input to +5 V dc) eliminates this problem.

The table shows some ranges for different values of C1 obtained from a 11,000-MHz crystal. A frequency counter or a general coverage receiver are helpful for establishing the oscillation frequency. The circuit will oscillate even without a crystal. Between selected division factors, it oscillates on random, unstable frequencies.

A strange thing is that some division factors lock in better than others. For instance, with a given crystal and C1 value, $\frac{1}{15}$, $\frac{1}{16}$, $\frac{1}{17}$ and $\frac{1}{18}$ might lock in

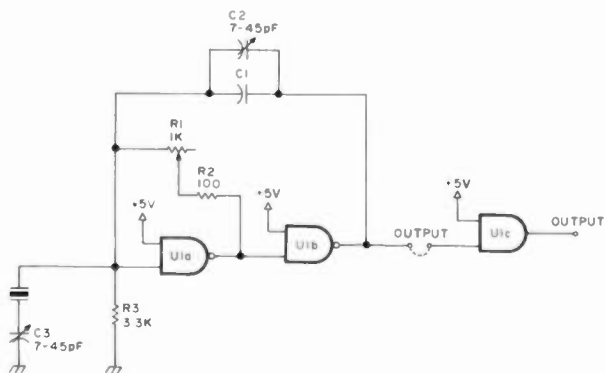

Fig. 1.

C ₁	150pF	300pF	560pF	1120pF	002μF	0047μF	0067μF	01μF
DIVISION FACTORS	-1 - -3	-2 - -6	-3 - -13	-5 - -26	-8 - -40	-18 - -94	-23 - -132	-55 - -350

Table 1.

STOP RF SPILL-OVER!

You may be losing up to half the available output from your vertical gain antenna because of RF spillover. The amazing AEA Isopole with unique decoupling design, virtually eliminates RF spillover and can help you multiply your power in all directions on the horizon relative to an ideal half-wave dipole, or end-fed non-decoupled "gain" antennas.



CALL TODAY
**JR
Amateur
Radio**

1185 Scottsville Road
Rochester,
N.Y. 14624
716-235-7540

AEA
Brings you the
Breakthrough!

Directional RF Wattmeter

Dielectric wattmeters are your best choice for making accurate RF measurements. These rugged, dependable wattmeters can discriminate between forward and reflected power in all types of 50 ohm coaxial transmission lines and RG type cables.

In addition, they:

- Measure from 100mW to 5kW
- Have $\pm 5\%$ full scale accuracy
- Measure from 2MHz to 1GHz
- Have an easy-to-read 4½" mirrored meter scale
- Feature a taut-band meter movement for longer life
- RF Elements available for all measurements

The 1000-A from Dielectric — you can't buy an easier reading, more accurate RF wattmeter.

A complete line of RF loads are also available.



RAYMOND, MAINE 04071 ✓ 17
TEL. 207/655-4555 • 800/341-9678

HI-Q BALUN

- For dipoles, yagis, inverted vees & doublets
- Replaces center insulator
- Puts power in antenna
- Broadbanded 3-40 MHz
- Small, lightweight and weatherproof
- 1:1 Impedance ratio
- For full legal power and more
- Helps eliminate TVI
- With SO 239 connector



\$10.95

HI-Q ANTENNA CENTER INSULATOR



Small, rugged, lightweight, weatherproof. Replaces center insulator. Handles full legal power and more.

\$5.95 With SO 239 connector

HI-Q ANTENNA END INSULATORS



Rugged, lightweight, injection molded of top quality material with high dielectric qualities and excellent weatherability. End insulators are constructed in a spiral winding fashion to permit winding of loading coils or partial winding for tuned traps.

- May be used for Guy wire strain insulators
- End or center insulators for antennas

\$4.95 • Construction of antenna loading coils or multiband traps

DIPOLES

MODEL	BANDS	LENGTH	PRICE WITH HI-Q BALUN	WITH HI-Q CENTER INSULATOR
Dipoles				
D 80	80-75	130	\$28.95	\$24.95
D 40	40-15	66	29.95	21.95
D 20	20	33	24.95	20.95
D 15	15	22	23.95	19.95
D 10	10	16	22.95	18.95
Shortened dipoles				
SD 80	80-75	90	31.95	27.95
SD 40	40	45	28.95	24.95
Parallel dipoles				
PD 8010	80-40-20-10-15	130	39.95	35.95
PD 4010	40-20-10-15	66	43.95	29.95
PD 8040	80-40-15	130	35.95	31.95
PD 4020	40-20-15	66	29.95	25.95

Dipole shorteners - only, same as included in SD models

S 80 80-75 \$11.95 pr

S 40 40 \$10.95 pr

All antennas are complete with HI-Q Balun or HI-Q Antenna Center Insulator. No. 14 antenna wire contacts insulators (HI-Q) nylon antenna support ropes (SD) models only (SO) rated for full legal power. Antennas may be used as an inverted V and may also be used by NARS or SWL.

Antenna accessories - available with antenna ropes.

Nylon guy rope - 450# test 100'-4' \$3.49

Cylindrical (bugbars) Type antenna insulators 70 pr

SO 239 coax connectors 55

All prices are postpaid USA 48

Available at your favorite dealer or direct from:

Van Gorden Engineering ✓ 373

BOX 21205, S. EUCLID, OHIO 44121

Dealer Inquiries Invited

MEMORY KEYS BREAKTHROUGH!

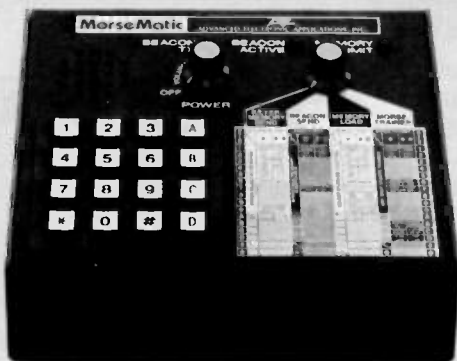

The remarkable AEA Morsematic memory keyer has 35 fantastic features including two AEA designed microcomputers, up to 2,000 character memory, automatic serial number, beacon mode, and automatic morse trainer mode.

CALL TODAY

La Rue Electronics

1112 GRANDVIEW STREET
SCRANTON, PA. 18509 - Ph. (717) 343-2124

AEA Brings you the
Breakthrough!

nically. Then 1/19 might not lock, but 1/20, 1/21, etc., might lock well. Some factors lock with poor stability. If the factor you want doesn't lock well, try a slightly different value of C1. Division factors greater than about 1/30 become fairly critical to set and aren't very practical. One-half through 1/10 are easy, and very stable operation can be obtained. After a division factor has been selected, remove the power, wait a few seconds, then turn it back on. Readjust R1 until it always starts oscillation on the desired frequency. This is more critical at larger division factors (lower frequencies). There is a little drift in the first 30 seconds the oscillator is on. (This is minimal at small division factors such as 1/10.)

What can this circuit be used for? Use your imagination. Let's say you want a 1000-kHz reference, and in

your junk box is an old 40-meter, 7-MHz rock. Set up the circuit with C1 at 1000 pF and set R1 for divide-by-7, and presto, there is a 1000-kHz crystal oscillator. The 11-MHz crystal is set up to divide by 110 (C1 at 6700 pF) and makes a nice 100-kHz reference rich in harmonics.

I would be interested to hear of applications that others might find for this circuit, and of any new developments in the circuit. Also, if anyone knows where this type of oscillator is covered in any literature, I would appreciate hearing about it.

A note: Be careful; sometimes the circuit can be made to lock on unusual division factors such as 1/3.5! Operation in this case is unreliable. Although it will work, this is not a particularly good circuit for fundamental frequency oscillation. ■

H.F. Transceiver Bonanza

YAESU FT-101 ZD

(With New WARC Bands)

List Price
\$942.00

\$769⁰⁰

(Add \$15.00 Shipping & Handling
U. S. A. Continental 48 States)



Supply Limited

* 160-80-40-30*-20-17*-15-12*-10 meter coverage. (*Proposed WARC Bands).

* Built-in A.C. Power Supply.

* Digital plus Analog Freq. Display

* 180 Watts D.C. Input

* Variable Receive I.F. Bandwidth.

* 6146B Final Amp. Tubes.

* Built-in VOX, NB & R.F. Speech Processor.

Optional Accessories: 600 Hz CW Filter - \$40.00, 350 Hz. CW Filter - \$45.00,
Cooling Fan - \$20.00, FV-10Z Remote VFO - \$157.00

Call toll-free

1-800-325-3636

HAM RADIO CENTER 30
8340-42 Olive Blvd. P.O. Box 28271 St. Louis, MO 63132

Call toll-free

1-800-325-3636

“HARD”

COPY



.....on inexpensive paper too. Our latest addition, the MICROLOG companion printer for the ATR-6800, plugs in directly for easy 'hard copy' of your QSO's, messages, programs, etc. When the tape interface isn't enough, our printer is ready on keyboard command. Complete system for CW/RTTY: ATR-6800, video and printer \$2,445, without printer \$1995, printer alone \$495. We're always up to something new here at MICROLOG CORPORATION, 4 Professional Drive, Suite 119, Gaithersburg, Maryland 20760. Telephone (301) 948-5307.

MICROLOG

Innovators in Digital Communications

✓ 51

The Arcane Art of ATV

— the transverter approach
to fast-scan television

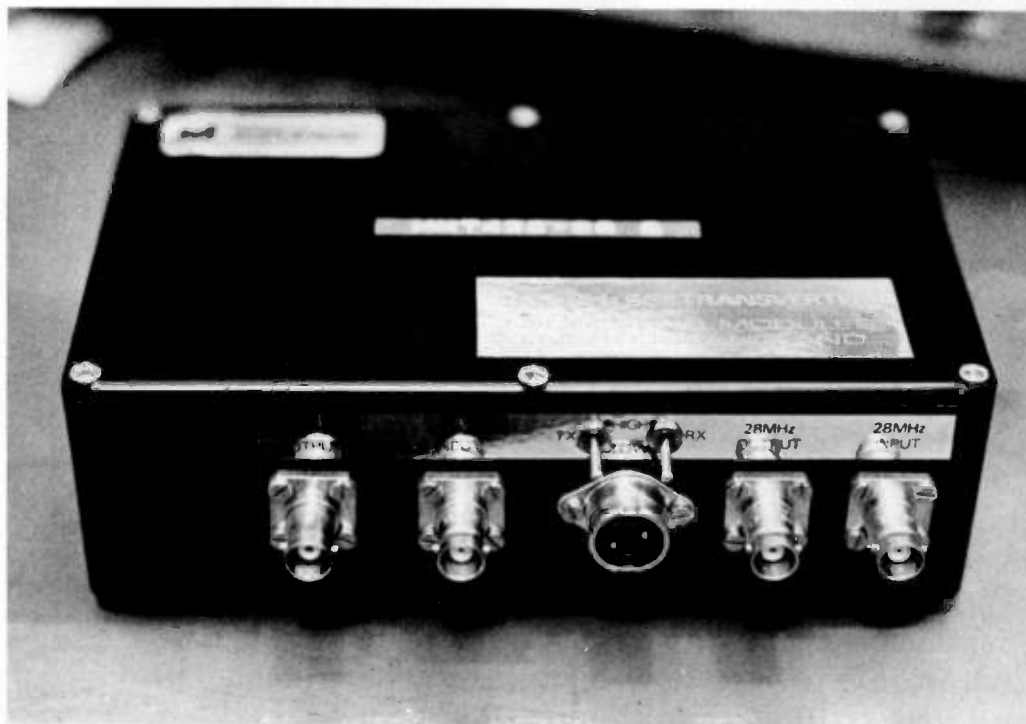

Photo A. The standard MMT 432/28 transverter, manufactured by Microwave Modules of Great Britain. All inputs and outputs are available along one side of the rugged cast-aluminum enclosure. The 432-MHz output is on the left, followed by the 432 input port. This is normally not connected, but you can jumper the receive-converter input to the connector when using an external linear. The DIN power and control socket is in the middle, followed by the receive-converter output with the transmitting-converter input on the far right. This particular unit is a dual-LO unit with control switches for the two crystals above the DIN socket. The dual-LO units are useful in working repeaters and can be used to make an ATV or all-mode repeater, as noted in the text.

Dr. Ralph E. Taggart WB8DQT
602 S. Jefferson
Mason MI 48854

Back in the "good old days" of amateur television (ATV), in the 50s and 60s, one constructed a 420 transmitter, modulator, and converter, teamed the latter up with the station communications receiver, and fired up on the air. Today, almost no one uses that approach for 432 work. The ready availability of highly effective HF side-band transceivers has resulted in a wholesale switch to transverters for point-to-point and satellite communications. Quite remarkably, considering the state of the art in compact solid-state transverters for 432, little attention has been paid to the use of transverters for ATV operations. The only exception I know of was an old *QST* article (Campbell, 1962) that described a tube-type transmitting converter for ATV. This novel approach

involved amplifying the video-modulated rf output from a standard TV camera and heterodyning the signal up to the 420-450-MHz band. It was a very interesting concept, although somewhat cumbersome to implement with the state of the art at that time.

One of the most popular transverters for 432 MHz now in use is the MMT 432/28, manufactured by Microwave Modules of Great Britain. This company is well known for its quality line of VHF and UHF equipment. One of the major US outlets for the line is Spectrum International of Concord, Massachusetts. John Beanland of SI has always been very cooperative when it comes to making interesting modifications of Microwave Modules gear for specialized applications, and the two of us spent considerable time working up a modification of their standard 432 converter for use on ATV.

In the course of one of our many phone conversations on that subject, we got on to the notion of using the MMT 432/28 in ATV service. Unable to resist the urge to tinker with a new idea, I had John make me up a modified version of the transverter. The modifications included realignment of the LO system to provide for converter output on channel 3 with channel 3 rf drive to actuate the transmitting converter. John delivered the unit at the Dayton Hamvention two years ago, and I put it through its paces as soon as I got it home.

With an internal jumper in the driver input circuit, the transverter will develop its rated 10 Watts peak output with only 5 mW of drive, and I thought it might be possible to drive it with the rf output of a standard camera, à la Campell. The receive section worked just

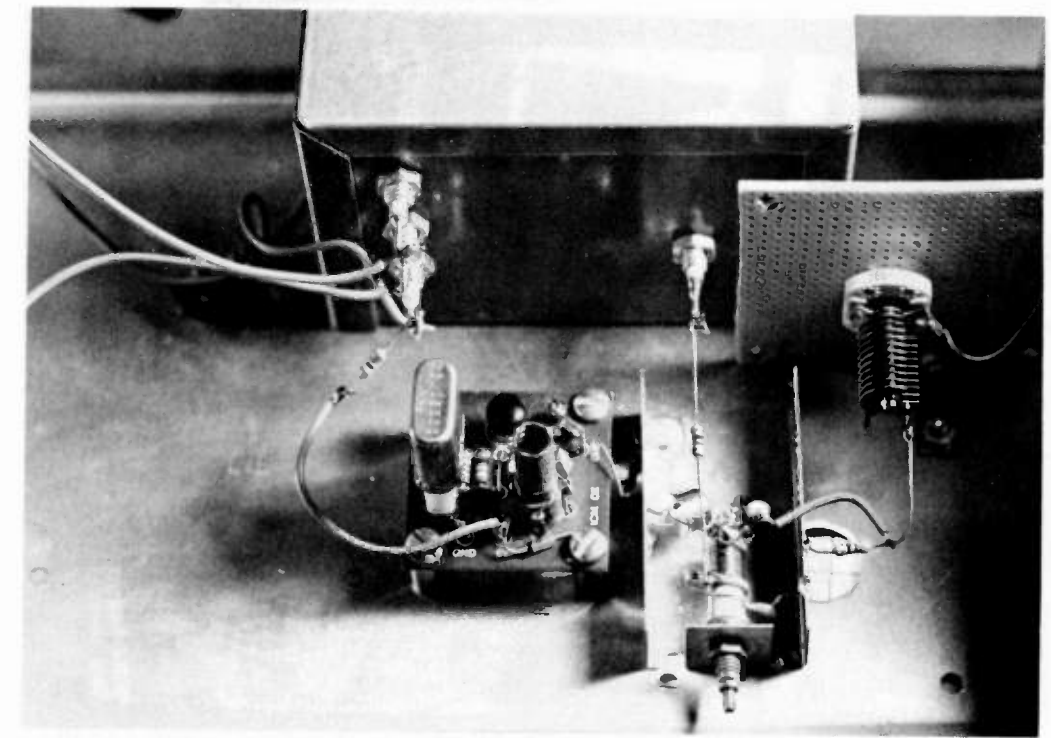

Photo B. Rock-crusher driver for channel 3. The power capabilities and complexity of the driver are clearly evident! The little OX oscillator board, complete with EX crystal, is in the center. The final output stage is in a small brass channel assembly to provide shielding. I don't know if the shielding is required, but I used it anyway. The half-box contains the final output transistor coil and collector bypass cap. The output-coupling capacitor comes out to the right and taps into the 47-Ohm load resistor with the ground side of the resistor soldered to the brass wall. The variable-output drive capacitor should be mounted so as to insulate the shaft from ground. The modulator is in the small box to the rear. This shielding and the feedthrough caps were a holdover from using the modulator with the 432 transmitter strip and power module. In this application, you could simply wire it on perfboard.

as expected and the transmitter strip would develop full output with a few milliwatts of drive, but the direct approach to transverting did not work out since no available camera had sufficient rf output to more than tickle the transmitting converter. The project was temporarily shelved due to time pressures and the unit was loaned out to a series of new ATV operators in our area for use as a receiving converter.

Eventually, however, I got around to thinking about upgrading the ATV station, only to come face-to-face with the ravages of inflation. It was then that memories of the \$\$ I had spent on the transverter surfaced, and I suddenly developed the time to reexamine the basic concept!

The transverter was snatched back from the last borrower and was put to work in an amazingly short time. The project went so easily and worked so well that I think the transverter idea deserves careful consideration by anyone planning to set up an ATV station.

System Components

Only four black boxes are required for a basic 10-Watt ATV station. The first and most important box is the transverter itself. Photo A shows one variation of a standard MMT 432/28 transverter. Modified versions for ATV are available from Spectrum International for \$259.00. You need to provide two items of information when ordering. The first is your local ATV frequency. In the

Lansing, Michigan, area, we use 437.25 MHz. 439.25 MHz is perhaps the most widely used frequency nationwide, but you should check for the standards in use in your area. If your area has a repeater, check the information at the end of this article.

The second item is the VHF channel you want as your i-f output—either channel 2 or 3 is suggested, depending upon your local VHF TV-channel allocations. We use channel 2, which is vacant in central Michigan, but my original transverter was set up for channel 3 because we planned to try the unit out in Dayton and that was the clear channel in that area. We do get a moderately strong broadcast signal on channel 3 in our area which creates some weak signal

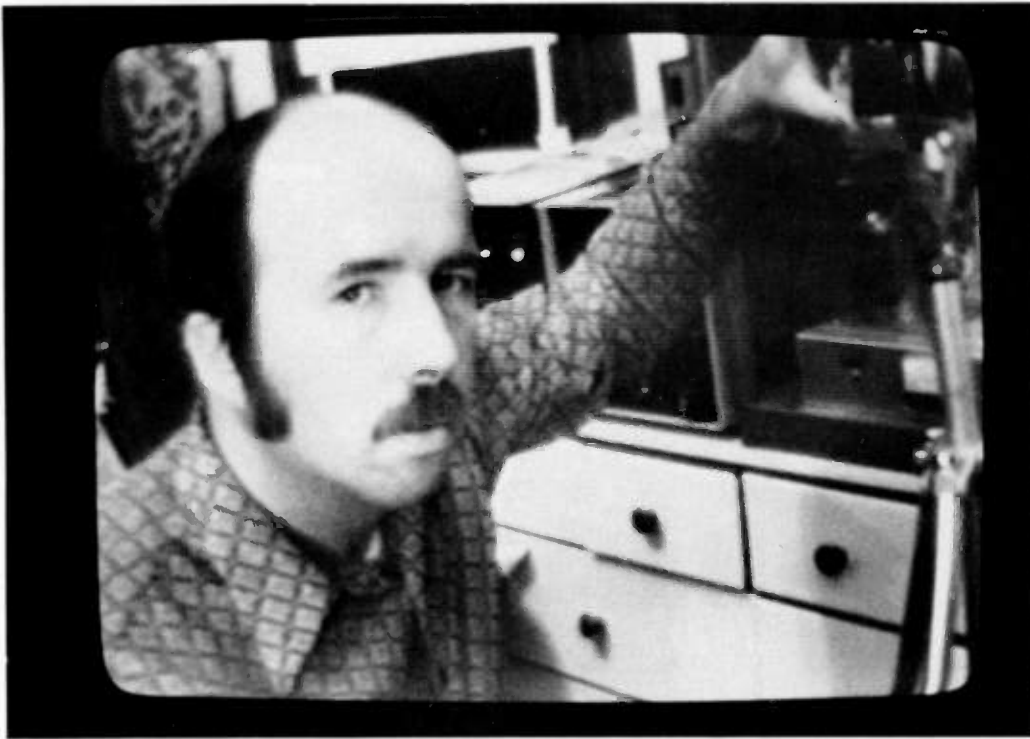

Photo C. The author, delivering a penetrating stare to the Lansing ATV crowd while snapping his own picture. The camera was photographing the 437.25-MHz output signal on the station TV while running about 60 Watts peak output. The system delivers a perfectly stable signal with gray scale and resolution capabilities limited only by your TV camera and lighting. A Sanyo CCTV camera is used at my station along with bounce lighting. If you have a color camera, the modulator and driver will handle the signal with no problem.

problems, so choose a vacant channel for your i-f.

You also will need a TV set. Almost any set of modern vintage will do, although a transformer-

operated set is preferred due to the ease of converting such a set to serve double duty as a video monitor. You also will need a TV camera. New cameras of

quite good quality can be obtained for as little as \$250, and at larger hamfests such as Dayton, you can do even better. Used cameras usually can be obtained for \$50-\$100, but these may need a new vidicon.

Finally, you will require a source of video-modulated rf on channel 2 or 3. This is the only construction part of the project and presents no problem, as we shall see. The transverter draws 2.1 Amps peak, so an inexpensive 2.5-Amp, 12-14-V supply (see your local Radio Shack) will handle the power-supply needs.

The system has a number of advantages that place it a cut above your usual ATV system:

1. Since the transverter incorporates a state-of-the-art, crystal-controlled converter, you really can't do any better, and no add-on preamps are required. The fine-tuning range of the TV will handle a several-MHz

spread between stations, so mixing 437.25 and 439.25 operations is no problem (we do it all the time).

2. Drive requirements are limited to an extremely low-powered VHF unit which is easy and inexpensive to build and easy to modulate.

3. Transmitter modulation adjustment is easily made while watching the VHF signal on the TV set.

4. On-the-air monitoring is quite simple and effective since while you transmit, you are watching the low-powered VHF driver, which will not overload the set regardless of your power output on UHF.

Construction

As noted earlier, the only part of the system you have to build is the milliwatt VHF driver. Fig. 1 shows a circuit diagram for this unit. The heart of the driver is one of the little OX oscillator kits from International Crystal. This oscillator, teamed up with an inexpensive EX crystal for channel 2 (55.25 MHz) or channel 3 (61.25 MHz), provides our basic frequency reference. Actually, the OX oscillator has more than enough output to drive the transverter to full output, and the first evening's operation involved video modulation of the OX oscillator. Although the resulting signal was as good as many you see on ATV, you really can't get the best possible video signal with this approach. Instead, a simple final amplifier stage was added. You don't really need the power—we will throw most of it away—but video modulation of the final will produce all the video quality your camera is capable of delivering.

The 2N2219 transistor specified was used because I had it on hand for use in switching applications. It works very well at this frequency. You may be tempt-

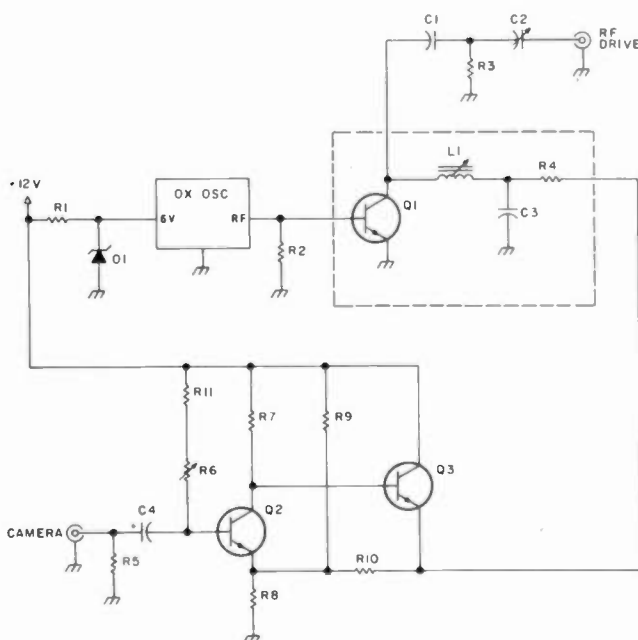

Fig. 1. Schematic diagram of the VHF TV driver circuit. See Table 1 for component values.

ed to try a hotter transistor (such as the 2N3866), but if you do you may have oscillation problems. At 5/\$1.00 from James, the 2N2219 does just fine!

The output transistor and coil were isolated in a small half-box of brass to provide shielding. A small hole in one wall passes the base lead which was insulated with a small piece of spaghetti stripped from hookup wire. The base resistor is grounded to the outside wall, and a short wire connects to the rf output of the OX oscillator. Since the final has far more output than needed (it draws 200 mW, as shown), the output is capacitively coupled to a 47-Ohm load resistor. The top of the resistor is connected to the driver output via a variable capacitor which serves as a drive level control.

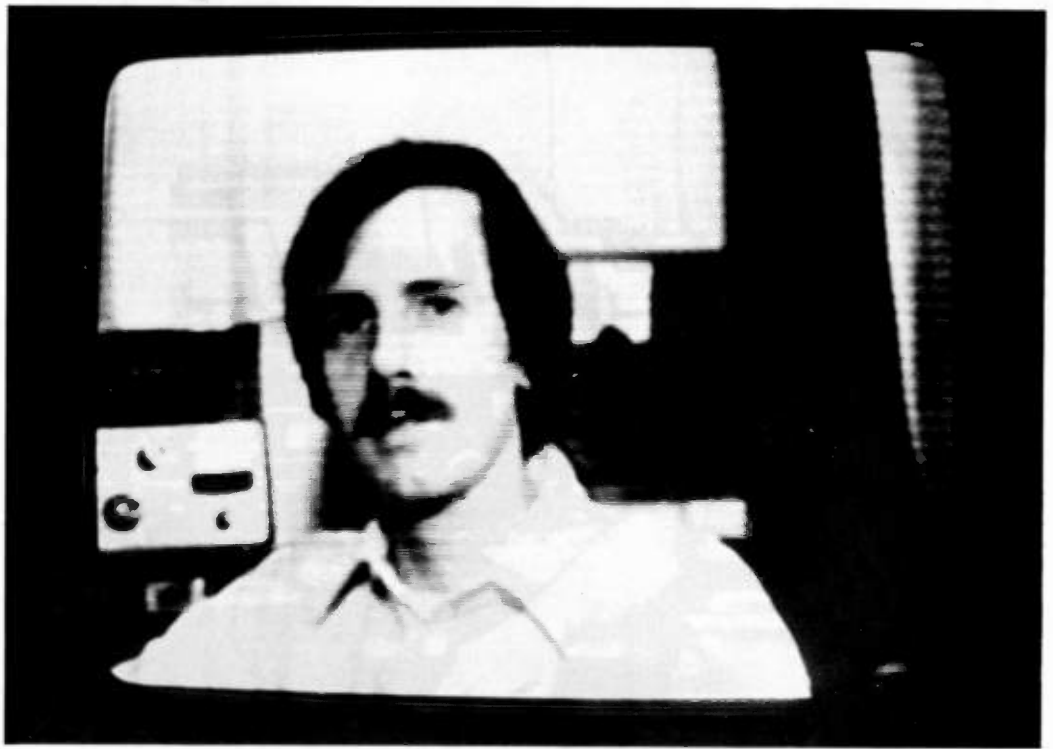

Photo D. Mike WB8JXF, one of the original "dynamic duo" in Lansing ATV. The path is about 8 miles, and he was loafing his amplifier along at about 100 Watts peak output when the picture was taken.

The modulator is a circuit designed by WB8JXF. The only modification involves an adaptation for use with ac-coupled cameras—far more common than the more expensive dc-coupled cameras with which the original circuit was used. Modulator layout is non-critical. The shielded enclosure and feedthrough capacitors shown in Photo B were a holdover from earlier use of the modulator with various 432 transmitter strips, and such elaborate packaging is not required here.

Tune-up is quite simple, but a few regulatory cautions are in order. The essential point is that we are not authorized to broadcast TV signals on channel 2 or 3, even if the channel is not in use locally. The little driver doesn't put out much rf compared to the transmitter strip, but if you connect it to a wire or antenna, it will radiate and that could be an invitation to trouble. If the unit is built in a shielded box and coax

is used to make the interconnections, you will be hard pressed to pick up the VHF signal on the TV in the shack and you will not be radiating the signal.

A grid-dip meter makes for easy tune-up, although it is not essential. If one is available, switch the dipper to the wavemeter mode (assuming the proper coil is in place) and couple the coil to the OX oscillator coil. Tuning around the proper frequency should show an rf peak. Tune to the peak and you will be on frequency regardless of the usually poor calibration of most dippers (the one I used turned out to be off by 10 MHz). Now switch to the dip mode and couple to the final output coil. With the lead from the modulator disconnected, tune the coil for a dip. At this point you can connect the modulator lead and you should be on frequency. If you switch the dipper to the wavemeter mode, you should see a very substantial rf peak from the final.

If no dipper is available, you can proceed as follows. Temporarily remove the connection between the fixed output capacitor and the 47-Ohm load resistor. Solder the free lead of the capacitor to the base of a #49 lamp and ground the shell. Disconnect the modulator lead and connect the 100-Ohm resistor to 12 V dc and tune the output coil for maximum brilliance on the lamp. Reconnect the capacitor to the load resistor and connect the 100-Ohm resistor back to the modulator output.

Use a piece of coax to connect the output of the driver to the input of your TV and tune the latter to the i-f channel. Set the drive capacitor to minimum (plates completely unmeshed) and turn the driver on. The TV screen should go blank with a strong signal. Connect a properly-adjusted camera to the video input and run the camera input pot through its range. At one extreme, white areas will begin to

smear, eventually spreading to cover and obscure any video display. This is called "whiting out." At the other end of the range, the contrast will increase and you will begin to lose sync. The proper setting is

- R1—100 Ohms
- R2—1000 Ohms
- R3—47 Ohms
- R4—100 Ohms
- R5—100 Ohms
- R6—10k linear-taper, panel-mounting pot
- R7—47 Ohms, 2 Watts
- R8—10 Ohms, 2 Watts
- R9—560 Ohms
- R10—100 Ohms
- R11—2200 Ohms
- C1—.001-uF ceramic disc
- C2—5-30-pF variable (DRIVE)—value not critical
- C3—.001-uF ceramic disc
- C4—100-uF, 16-V aluminum electrolytic
- D1—9-V, 1-Watt zener
- Q1—2N2219
- Q2—1306 (CB driver)
- Q3—1307 (CB final)
- L1—15 turns of #28 enamel on a 1/4 inch slug-tuned form

Table 1. Component values for Fig. 1. All resistors are 1/4 Watt unless otherwise noted.



Photo E. Jeff WB8RJY, about 5 miles from my QTH. Jeff is running the VHF Engineering 1-Watt exciter, Motorola power module, and a 2C39 cavity final with about 20 Watts average output when the picture was taken. He is not nearly as gnome-like as he looks—really, he is suffering from the very common “wattmeter syndrome”! The 1-Watt modulated exciter is driving the power module beyond its quasi-linear input range, resulting in some sync instability and excessive contrast. A little more padding between the exciter and the module, and he now runs the same output power with no problems. You can run into similar problems, as noted in the text, if you overdrive the transverter. TV is not a mode that makes the best of any amplifier, and you will always have to trade off some power to get video quality.

achieved by starting at the white-out end of the range and advancing the control until any evidence of whitening is absent from bright

areas of the picture. Camera adjustments can be touched up at this point if desired. What you should see on the screen is a faith-

ful reproduction of the camera output.

System Interconnections

We are ready now to tie

the system together and put it on the air. Fig. 2 shows the system interconnections for a basic 10-Watt peak output station using the barefoot transverter, while Fig. 3 shows how to handle an external power amplifier. Let's look briefly at each option.

10 Watts. If we are using just the transverter, we need make no provisions for T-R switching of that unit. The MMT 432/28 incorporates PIN diode switching, activated by an rf-sensing circuit at the driver input. Thus, our manual T-R switch need only key the driver in transmit. The tune-up with this version is most easily accomplished with a power output indicator such as a Bird meter or the new Heathkit 1-GHz inline wattmeter.

Start with the drive capacitor at minimum and key the driver. Slowly advance the drive control to the point where power output no longer increases. Note the peak output reading and back off the drive until you hit about 2/3 of the previous peak reading. If the drive control is set too low, you will not only hurt picture quality, but also you will not be getting all of the power the transverter can deliver. If the drive is set too high, you will begin to get picture pulling and other signs of sync instability.

You can check the drive setting on the air by having the other station look at the stability of your picture. This is best adjusted with a signal level that just introduces some snow into the picture. You can swing either the transmitting or receiving antenna (or both) to cut the signal level down for this test. If the picture is unstable (pulling, “hooking” at the top of the picture, rolling, etc.), back off the drive until the pic-

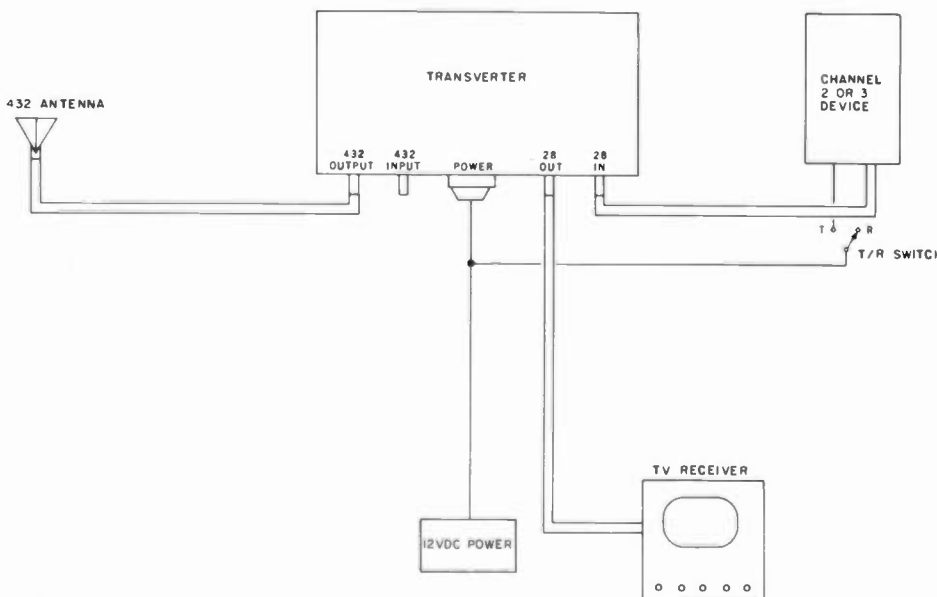

Fig. 2. System interconnections for using the transverter barefoot, providing a basic 10-Watt peak output ATV station.

ture stabilizes. If the display is solid, you can try advancing the drive slightly until instability is noted. You then can back it off slightly.

All tests on the air should be conducted with a station which will provide an honest video report. Some fellows are so enthused by seeing a TV signal they will give rave reviews even if they have to roll their eyes to keep up with the picture. Avoid such a station! You are now in business at the 10-Watt level. Note that in transmit you will get a nice clear picture on your i-f channel—very nice for use as a viewfinder!

High Power. At 10 Watts peak output, the MMT 432/28 transverter will drive a variety of linear amplifiers to quite respectable power outputs. A number of different amplifiers are in use with our ATV group. WB8JXF and I run 4CX250s in VHF Handbook cavities. With a 2-kV plate supply, the transverter will drive such an amplifier to close to 500 Watts peak input—provided you supply plenty of air! My own cavity is run with only 800 V on the plate and loaf along at about 160 Watts peak input.

Several other stations are using 2C39 cavities from commercial FM equipment (Motorola and GE), running them in AB1 with excellent results. In grounded grid service, these amplifiers will supply 25-30 Watts of average power output when operated off an old transceiver power supply. The K2RIW and some of the newer 432 power amplifiers should do equally well. One approach which has not been used in our area involves using one of the linearized solid-state power amplifiers. The cost of such amplifiers and their high current supplies makes a tube-type power amplifier far more appealing. Dollar



Photo F. Jim WB8YSC, running about 10 Watts average power output using a 2C39 cavity final. Most of our ATV group (six operators as of the last net) are located east and south of Lansing, but Jim is in Grand Ledge, Michigan, off to the west of Lansing. This is about a 10-mile path to my QTH, and despite the fact that both of our antennas are just mounted at rooftop height, the use of sensitive crystal-controlled converters at the receiving end provides a perfectly usable picture. Jim does his share with careful transmitter setup and good lighting—both factors which make a big difference over an extended path.

for dollar, you probably can do far better with a tube-type circuit.

Fig. 3 can be used as a

guide in hooking up such an amplifier. Several differences from the low-power system exist that are

worth comment. First, you will have to provide a separate receive input for the transverter. The BNC

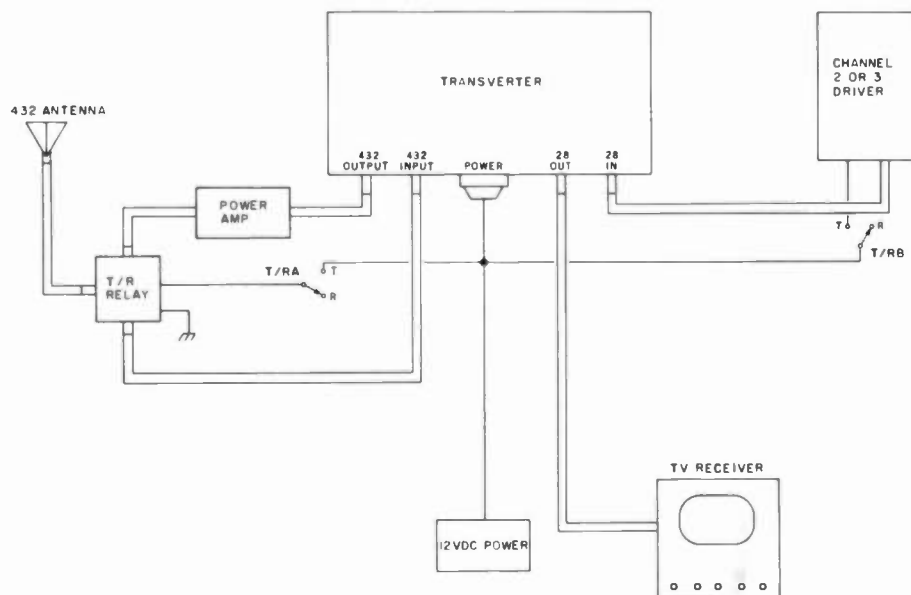

Fig. 3. System interconnections when using the transverter with an external power amplifier. In addition to the amplifier, you will need an antenna change-over relay and an additional set of contacts on the T-R switch to control the relay. You also will have to connect the receive-converter input to the 432 input jack as noted in the text and your transverter manual. Depending upon your amplifier and power supply, you can run 500 Watts or more peak input with such a system.

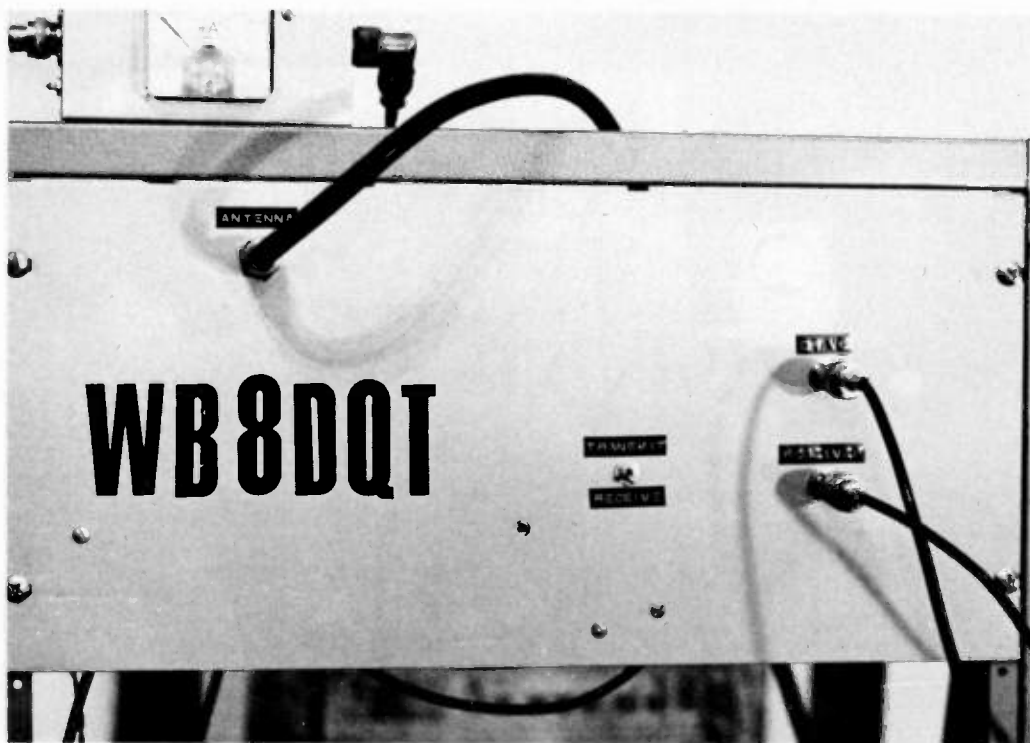

Photo G. Rack-mount installation of the transverter at my station. An old rack panel from another project was salvaged to house the transverter installation. The transverter mounts behind the panel, as does the shielded driver unit. In the 10-Watt mode, only three interface cables are required—the antenna transmission line (above the call letters), the camera output, and the receiver output to the TV—the latter two coming in on the right end of the panel. The power output meter can be seen on top of the desk-top rack. The 4CX250 linear sits on the base of the rack with extension cables running down the back to the amplifier inputs and output. The vacant center area in the rack is now occupied by the voice transmitter which uses the old 1-Watt exciter and the 10-Watt power module. This way, nothing was wasted and I ended up with a high-quality sound system.

connector for this purpose is mounted on the unit and you should follow the instructions in your manual for making the one new connection required. Second, although the transverter does not require a relay for switching, the external amplifier does mean that we will need an antenna change-over relay. A check with a local two-way service shop handling Motorola or GE mobile equipment will reveal a variety of 12-V dc relays designed for UHF service that can be purchased for moderate cost.

A DPDT T-R switch will be needed, with one set of contacts actuating the driver and another switching the antenna relay. It has been our experience that the linear can be left drawing resting plate current during receive with no

problems, so bias or other switching is rarely required. If you do want to cut the amplifier off during receive, it is easier to switch the relatively low voltage of the bias supply rather than trying to switch the HV line.

Setup follows the pattern outlined for the 10-Watt power level. Your limiting factor will be the drive level to the transverter and usually not the drive from the transverter to the external amplifier. If the 10-Watt transverter can overdrive the linear, you probably are using an amplifier that is hardly worth hanging onto the system. If you are going to fuss with an amplifier, it should be one that will deliver useful power gain.

Sound

Sound transmission, in the early stages of system

development, is probably best handled on 2-meter FM. Most people have or can get 2-meter FM gear, and, in theory at least, the sound commentary should attract some additional converts. Sound transmission up on 420 usually is handled in one of three ways. One method, used in some areas, is to FM the video carrier. With this system, the various stations use an auxiliary UHF-FM receiver tuned to the carrier frequency. Although the FM modulation has no real effect on the TV transmission, this system has disadvantages. First, you must provide the separate sound receiver. Second, unless the TV signal is quite strong, it is difficult to limit out the AM-TV modulation, resulting in considerable sync buzz on the signal.

The second approach is

to use a 4.5-MHz FM sub-carrier system. With this technique, you FM modulate a 4.5-MHz oscillator and then mix this signal with the camera video prior to feeding it to the video modulator. The FM signal then appears on the transmitted signal, 4.5 MHz above and below the video carrier. The FM signal above the carrier frequency then provides audio through the TV set.

This system has the advantage of simplicity, and only one antenna is required. Your amplifiers, however, must be wide enough to pass both the video and audio subcarrier. This is no problem with the transverter and you may wish to give it a try. This approach is used on a number of commercially-made ATV rigs, two of which are in use in our area. In our experience, this approach provides marginal results. Neither of the two stations routinely uses its 4.5-MHz sound system, because each of them has excessive sync buzz coupled with relatively low audio level. Since each operator has gear from a different manufacturer, one does tend to wonder about the effectiveness of the system.

The latest trend in our area is to crystal up an FM strip 4.5 MHz above the video carrier and operate that as a separate sound system. Results with this approach are excellent, providing full quieting in the TV sound system and very good audio levels. Ideally, you would use a transmitter power level and sound transmitter antenna gain that would provide an erp for the sound that would run about 1/5 of that which you attain on the video transmission.

In practice, many operators locally will get by with 10-30 Watts of sound output into an omnidirectional antenna system.

Commercial surplus strips, the VHF Engineering transmitter strip and Motorola power module, or one of the newer 440-FM transceivers now on the market, will all do for sound transmission. While this approach is more complex than the subcarrier system, the results are well worth it.

Results

The transverter approach has proved to be completely trouble-free in day-to-day operations and produces a signal whose quality is limited only by the camera or other video source used. Photo C shows a sample of the 437.25-MHz output of my system when an inexpensive Sanyo CCTV camera is used. Photos D, E, and F show typical results on received signals. My only reservation is that it took me so long to get around to trying the system out!

Future Developments

Other VHF Drivers. Several other options exist for the VHF driver stage for those interested in experimenting. If your camera has modulated rf output, you may want to experiment with transverting that signal. The rf output level of cameras and other video sources is limited by FCC regulations and is far too low to drive the system directly. About 30-40 dB gain would probably be needed with most rf sources. Since you are starting at a reasonable signal level, an amplifier designed like a multi-stage, 6-meter front end would probably do the job and you wouldn't have to worry about noise figure. One approach that I am working on currently involves the little rf interface module kit marketed by Radio Shack. This module will provide both video and sound output on channel 3 or 4, and if the quality proves acceptable, it is a real possibility.

The unit puts out about 1.75 mV across 75 Ohms, so a multi-stage amplifier will be required to develop sufficient drive as noted above.

If you really want to go first class, consider the use of one of the VHF modulator circuits that cable TV companies use to put a signal on your local CATV system. Such units should be able to drive the transverter directly, and they have capability for high quality video and sound. They are expensive if purchased new, but that should not deter the true amateur scrounger!

Repeaters. Linear transverters like the MMT 432/28 have several applications in the repeater area. The Microwave Modules unit is available in a dual-LO version for the OSCAR operators who also want standard SSB capabilities on 432. If your area has an ATV repeater, the output is probably on 439.25 or thereabouts with an input down near 427. In such a case, you could order the dual-frequency transverter with one LO hard-wired to provide transmitter output at the repeater input.

Such a dual-LO unit also can be used directly as a repeater in several modes. One that I am looking at seriously is really quite simple in concept. One LO chain would operate the receiver at the low end input frequency. The second would run the transmitter at the output frequency. The converter output would loop out at channel 2 or 3, be amplified, and then be fed back to the driver input. The normal rf-sensing circuit would be disabled and a TV would be hung on the converter output for control. A 15-kHz PLL tone decoder connected to the sync detector of the TV would trigger the manual T-R pin of the MMT 432/28 transverter. With this

INTIMIDATED BY MORSE CODE?



THE NEW AEA MODEL MT-1 COMPUTERIZED MORSE TRAINER MAKES MORSE CODE EASY AND FUN TO LEARN.

KT-1 Computerized Keyer With All Features of Above Trainer is Also Available in Same Package

- Automatic Speed Increase, User May Program: Starting Speed, Ending Speed, Practice Duration; 5 Letter code Groups or Random Space; Common or All Characters.
- Precise Speed Control 1 to 99 WPM (Tailor to Your Exact Requirements).
- 24,000 Character Answer Book Available For 10 Starting Positions.
- Random Mode For Practice (No Answers).

CALL TODAY

CW Electronic Sales Co.

800 Lincoln Street, Denver, Colorado, 303-832-1111

AEA Brings you the Breakthrough!

system, any TV signal at the input frequency would be retransmitted at the output, but non-TV signals would not be repeated. Of course, this function could be bypassed if you want a multi-function repeater.

The advantage of such a transverter-repeater is that it would operate with any mode—CW, SSB, AM, TV, you name it! Hang an amplifier in the system and your repeater can operate at any desired transmitting level. ATV growth in the Lansing, Michigan, area has now reached the point where it becomes tedious to swing the antenna around to the different stations, leaving some stations looking at a snowy picture while you work the fellow across town. A central repeater, with all antennas in the area pointed at it, is beginning to look appealing!

Summary

Well, there is little more

to be said. It's simple, clean, and works extremely well. The method is extremely versatile, leaving lots of room for experimentation and development. If you would like to try something like this, contact John at Spectrum International. Unlike dealers who sell black boxes made in Japan, John just loves to work with someone with a new application or idea! As for you fellows in northern Ohio, Indiana, and Illinois, the central Michigan ATV net meets on Monday evenings. Swing the antennas north for a change, and if the band is in decent shape, we would love to work you! ■

Author's Note:

The modified transverters are available from Spectrum International, PO Box 1084, Concord MA 01742; telephone: (617)-263-2145. Contact them regarding options and current pricing. International Crystal, the source for the OX oscillator boards and EX crystals, is at 10 N. Lee St., Oklahoma City OK.

How to Make a Good Scanner Better

— a bevy of useful mods

All programmable scanners are not the same. At this writing, Radio Shack

(PRO 2001, 2008), Electra (Bearcat 160, 210, 211, 220, 250, and 300), and Regency

(Touch, K100, K500, Digital Flight Scan, and M100) are the only direct-frequency-

entry scanners on the market. The Regency receivers are shown in Photos A through D. Early contenders like those from Tenelec and JIL (SX-100) have gone by the wayside.

Among those in the present field of scanners, the Regency series is well suited for field modifications. Why modify a good scanner? Because there are certain flexibilities which are desirable but have not yet been incorporated into the programmables. Extended frequency range is one; selectable AM detection is another. With programmability extendable down below 30 MHz, AM detection would be an asset. In this article, we shall examine both modifications.

Which Regency to convert? Naturally, the more recent scanners are an im-



Photo A. The K100 is an improved version of the original Touch.

DOUBLE YOUR PLEASURE



Versatility Plus . . . Work Both 2 and 3/4 Meters With Yaesu's New FT-720R

The FT-720R series is a compact VHF/UHF mobile transceiver that harnesses the incredible power of the microprocessor to bring you top-operating flexibility. Start with the FT-720R Control Head, then add either the 10 watt FT-720RU 440 MHz or 25 watt FT-720RVH 2 meter RF Deck. You can clamp the Control and RF Deck together or use an optional remote cable to hide the RF Deck. The best news is still to come! By using the optional S-72 Switching Box and two remote cables, you can use a single Control Head for operation with both the 440 MHz and 2 meter decks, giving you a high-performance two band FM station for your car or home. Compare the features below, then ask your dealer for a demonstration of the fabulous FT-720R series. . . another winner from the performance leader . . . Yaesu.

- Four simplex/repeater memory channels, plus receive-only memory channel.
- Scanning controls or microphone with search for busy or clear channel.
- Optional 32 tone CTCSS module for accessing private repeaters.
- Colorful, easy-to-read LED power output/S meter.
- Built-in 1800 Hz tone generator.
- Priority channel with search-back feature.
- Pause feature that holds, then restarts scan, on busy or clear channels.
- Digital display of last four digits of operating frequency.
- Single Control Head may be used for operation on both 440 MHz and 2 meters via optional switching box and remote cables.
- Extremely compact size, light weight.

FT-720RVH	Specifications	FT-720RU
144.00-147.99 MHz	Frequency Coverage	440.00-449.975 MHz
10 kHz	Synthesizer Steps	25 kHz
25 watts	Power Output	10 watts
.32 uV for 20 dB quieting	Sensitivity	0.5 uV for 20 dB quieting
±6 kHz (-6dB)	Selectivity	±12 kHz (-6dB)
±12 kHz (-60 dB)		±24 kHz (-60 dB)

Price And Specifications Subject To
Change Without Notice Or Obligation

YAESU
The radio.



480

YAESU ELECTRONICS CORP. 6661 Westfield Way, Paramount, CA 90723 ● (213) 883-4007
YAESU ELECTRONICS Eastern Service Co., 8812 Princeton-Glendale Rd., Cincinnati, OH 45246

provement over the original Touch (ACT-T-16K), but many of those originals are still in the field.

The Touch

The ACT-T-16K was Regency's entry into the direct-entry programmable field; as a first-generation scanner, there were many shortcomings which were corrected in subsequent models. For those owners of the original Touch, we offer the following modification notes.

As factory issued, the Touch may be programmed out-of-range by sequentially pressing MA, 9, and CL before entering the desired frequency. The algorithm ranges which may be displayed are: 10.00-71.255, 110.74-192.655, and 311.00-515.5875 MHz. Unfortunately, the receiver rf tracking will not accommodate this great a range, even with retuning.

Without realignment, most ACT-T-16Ks can receive the following frequency excursions when given the out-of-band command (individual units will vary slightly): 21.4-57.5, 142.825-178.9, and 406.95-515.425 MHz. But by some judicious realignment, the tuning flexibility of the Touch can be programmed to receive far more useful ranges: 15.375-49.785 MHz (adding shortwave, WWV, CB, and 10 meters), 136.74-171.17 MHz (adding weather satellites and military base communications), and 388.8375-492.1 MHz (adding some military aeronautical, plus the UHF government band).

While it would be delightful if we could control each of the three ranges separately, unfortunately we can't. All ranges are set by a master voltage-controlled oscillator. Let's compromise on an optimum frequency range which allows the flexibility of the scanner to cover those frequencies which are



Photo B. The K500 is loaded with microprocessor-controlled features.

most active: 18-53, 141-174, and 401-501 MHz. Not all Touches will wind up with these identical ranges, but most should come close. You will need standard alignment tools and a signal generator for these adjustments.

Part A: Vco Board Frequency Range Set

- Check receiver on all functions for normal operation.
- Remove antenna.
- Remove 4 screws from bottom of cabinet; slide chassis out.
- Remove 6 hex-head screws from top lid of vco compartment; remove screw from top of shield. Carefully pry up top lid and remove.
- Locate R407 (56k) from Fig. 1. Solder a 120k resistor across it.
- Turn radio on.
- Check regulated B+ at standoff terminal adjacent to voltage regulator IC501. Adjust R534 if necessary to read between 9.50 and 9.55 volts dc.
- Locate coil L401 (yellow) as shown in Fig. 1. Carefully screw slug outward until it is flush with coil form. Advance squelch knob fully

clockwise; volume should be at one-third.

● Press in sequence: MA, 9, CL.

● Enter 141 MHz into channel 1. Press MA.

● Screw L401 slug slowly in until squelch breaks (background noise will be heard). This setting will adjust band-edge limits on all three ranges.

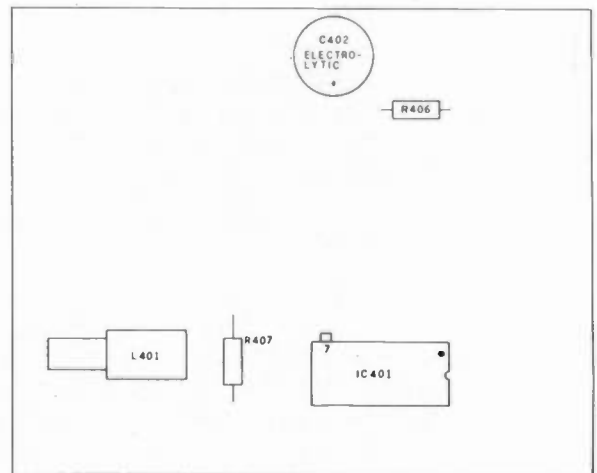

Fig. 1. The vco board, showing parts locations.

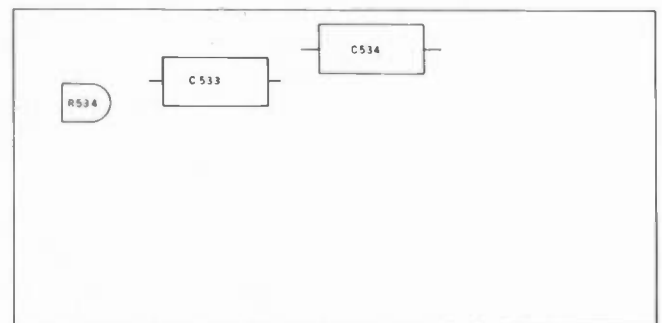

Fig. 2. Trimpot R534 is on the mixer board and adjusted in Touch conversion.



**AUTOMATIC SWR & PEAK READING
HF POWER METER
MODEL APM-1H \$99.95**
Frequency Coverage: 1.8 – 60 MHz
Input Impedance: 50 – 52 ohms
Power Range: 0 – 200, 1000, 2000W
SWR Range: 1:1 – 10:1
Power Modes: Average & PEP
Accuracy: ±10%
Power Requirements: 117 VAC 60 Hz



**SWR & POWER METER FOR HF/VHF
MODEL PM-3HV \$54.95**
Frequency Coverage: 3 – 150 MHz
Input Impedance: 50 – 52 ohms
Power Range: 0 – 20, 200, 1000W
SWR Range: 1:1 – 5:1
Accuracy: ±10%
Power Requirements: 12 VDC
Illuminated meters for mobile operator



**SWR & POWER METER FOR HF/VHF
MODEL PM-4HV \$44.95**
Frequency Coverage: 3 – 150 MHz
Input Impedance: 50 – 52 ohms
Power Range: 0 – 20, 200, 1000W
SWR Range: 1:1 – 3:1
Accuracy: ±10%
Power Requirements: None
Velcro for mobile mounting



**AUTOMATIC SWR & PEAK READING
VHF POWER METER
MODEL APM-1V \$99.95**
Frequency Coverage: 50 – 150 MHz
Input Impedance: 50 – 52 ohms
Power Range: 0 – 20, 200W
SWR Range: 1:1 – 10:1
Power Modes: Average & PEP
Accuracy: ±10%
Power Requirements: 117 VAC 60 Hz



**MIKE COMPRESSOR WITH LINEAR
AMPLIFIER
MODEL MCLA-1 \$89.95**
Compressor Section
Frequency Range: 100 – 10000 Hz
Distortion: Within 0.4%
Linear Amplifier Section
Frequency Range: 300 – 10000 Hz
Gain: 25 dB (12V)
Power Requirements: 9 VDC



**FLAT RESPONSE SWR & POWER METER
FOR HF
MODEL PM-2H \$89.95**
Frequency Coverage: 1.8 – 60 MHz
Input Impedance: 50 – 52 ohms
Power Range: 0 – 200, 1000, 2000W
SWR Range: 1:1 – 3:1
Accuracy: ±10%
Power Requirements: None

Best Amateur Radio Accessories

AKIGAWA



**ACTIVE AUDIO FILTER
MODEL AAF-1 \$89.95**
Filters: Band Pass+Notch
Center Frequency
Shift Width: 200 – 2500 Hz
Input Impedance: 8 – 600 ohms
Output Impedance: 8 ohms
Output Power: 1W max.
Power Requirements: 9 VDC 150 mA



**FLAT RESPONSE SWR & POWER METER
FOR VHF
MODEL PM-2V \$89.95**
Frequency Coverage: 50 – 150 MHz
Input Impedance: 50 – 52 ohms
Power Range: 0 – 20, 200W
SWR Range: 1:1 – 3:1
Accuracy: ±10%
Power Requirements: None



**SWR & POWER METER FOR MOBILE
MODEL PM-5H (HF) \$49.95
MODEL PM-5V (VHF) \$49.05**
Frequency Coverage: 1.8 – 30 MHz (PM-5H)
50 – 150 MHz (PM-5V)
Input Impedance: 50 – 52 ohms
Power Range: 0 – 20, 200 W ±10%
Power Requirements: 12V DC
Complete with directional coupler unit



**PRESELECTOR
MODEL PR-1 \$109.95**
Frequency Coverage: 3 – 30 MHz
Gain: 20 dB at 7 MHz,
Variable
RF Attenuation: –20 dB & –10 dB
Input/Output
Impedance: 50 – 75 ohms
Relay Power
Capability: 200W CW
Power Requirements: 117 VAC 60 Hz

(Prices are suggested list and are subject to change without notice.)



Photo C. The Digital Flight Scan is a programmable 108-to-136-MHz AM scanner for aircraft buffs.

- Replace cover on vco compartment. Do not replace screws until you are certain that the desired frequency ranges are covered by the new vco setting. (Also see part F.)

Part B: Low-Band Rf and I-f Alignment

- Enter 41.1 MHz into channel 1. Press MA.
- Set signal generator exactly on 41.1 MHz so heard

weakly by scanner.

- Adjust L303 and L302 for best quieting. The locations of these coils are shown in Fig. 3.
- Enter weather channel (or other local steady signal) and adjust L314 (discriminator) for greatest audio output.

Part C: High Vco Buffer (UHF Tracking)

- Turn receiver off.
- Locate L311; solder 3.9-pF capacitor (NPO or silver mica) from bottom terminal to adjacent ground foil.
- Turn receiver back on.
- Enter 406.1 MHz into channel 1; enter 470.1 MHz into channel 2.
- Carefully connect a dc voltmeter between emitter of Q307 and ground foil. Attachment to emitter lead may be made at adjacent resistor R343 lead closest to back of radio.
- Press channel 1 and channel 2 alternately, adjusting L311 for equal readings (approximately 3.8 volts).

Part D: VHF High-Band Rf Alignment

- Enter 157.1 MHz into

channel 1; enter 139.1 MHz into channel 2; enter 174.0 MHz into channel 3.

- Press channel 1 and MA.
- Adjust rf signal generator accurately to be received weakly on 157.1 MHz.
- Adjust L305, L306, and L307 for best quieting.

Part E: UHF Rf Alignment

- Enter 445.1 MHz into channel 1; press MA.
- Set signal generator for weak signal to be heard on 445.1 MHz (channel 1).
- Peak trimmers C325, C328, and C338 for best quieting.

These steps will complete the rf and i-f alignment procedures for the ACT-T-16K.

Early models of the Touch had a characteristic search whine which was quite distracting; some reduction may be experienced by the following addition of a resistor. Try it in place before soldering permanently. If it helps, fine; if not, forget it.

Part F: Search Whine Reduction

- Remove vco compartment lid.
- Locate resistor R406 (6.8k next to large electrolytic).
- Solder a 470-Ohm resistor to lead closest to electrolytic capacitor; wrap the other resistor under loosened mounting screw and tighten. Replace vco cover.
- Check operation on search to see whether whine interference has been reduced. If not, remove 470-Ohm resistor and disregard Part F modification.

Part G: AM Detection for CB and Shortwave

Notes: Audio recovery will be ragged and of a low volume, but more readable than with straight FM detection. We are reducing the signal level below hard limiting, thus permitting some amplitude modulation to sneak through to the

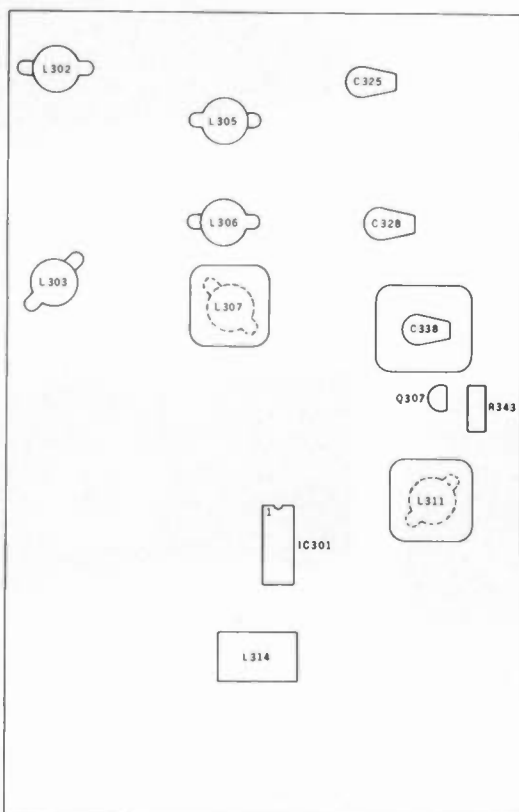
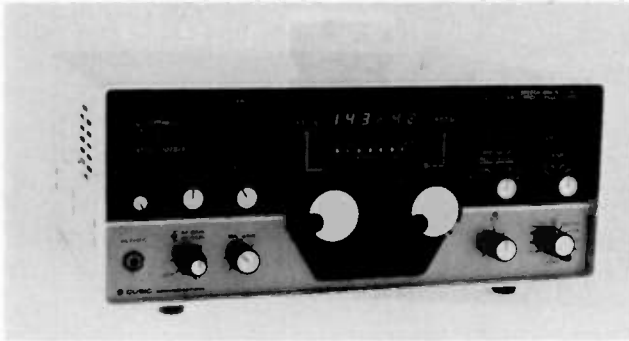

Fig. 3. Locations of rf and i-f components for Touch alignment procedures.

ASTRO-LOGICAL

From Swan to Cubic

102BXA — \$1195.00



Dual PTO's, 235 Watts PEP & CW on all Frequencies, IF Passband Tuning, with LED Position Indicators and Full Break-In

150A — \$925.00

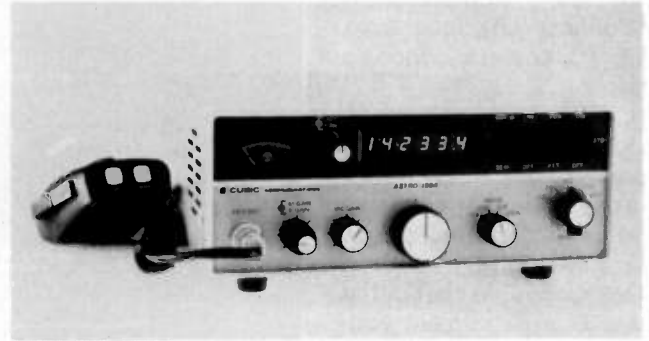

HF SSB Transceiver Featuring "VRS™" a Knob with a New Twist, and Over 100,000 Fully Microprocessor-Controlled Frequencies on Present or Envisioned "Ham" Bands.

Please note that CUBIC COMMUNICATIONS, INC. is screened on the front panel. The Swan "bug" is on the meter face.

Cubic Corporation is a multi-million, diversified, 29-year old American Stock Exchange listed company, with Divisions and Subsidiaries world-wide. We feel the Amateur should know the strength and longevity of the company he is dealing with to know that when he needs service the company will still be around! The combined technical skills and resources now available are light years away from the "old Swan." We intend to slowly let the Swan name disappear from the scene.

From glowing user reports being received daily, there is no question that the PERFORMANCE of the new ASTRO LINE FROM Cubic Communications, Inc. is superb!

Now is the time to sell AMERICAN PRODUCTS TO AMERICAN HAMS and keep our dwindling supply of dollars AT HOME if our children and grandchildren are to inherit the proud and free AMERICA we have enjoyed and fought for.

All prices remain the same. The ASTRO-102BXA, however, will be supplied LESS THE OLD MARGINAL CWN CRYSTAL FILTER. A superior CWN 400 Hz 6 pole filter to operate with the Passband tuning is available as an option and is priced at \$82.50 list.

ACCESSORIES AVAILABLE
SEND FOR COMPLETE BROCHURE
CALL FOR QUOTES

MADISON

Electronics Supply, Inc.

1508 McKinney • Houston, Texas 77002 • 713/658-0268

detector. Be sure receiver is switched off before beginning this modification! Part C is not recommended unless AM detection is of paramount importance. I assume no responsibility for damage resulting from this modification!

- Mount an SPST switch conveniently for use.
- Connect one lead from the switch to chassis ground.
- Connect other switch lead through a 10-Ohm resistor to pin 9 of IC301. Make certain that you have correctly identified pin 9. Measure voltage with a VOM to double-check that there is no significant voltage present which could damage the IC by grounding the pin. Be extremely careful while soldering; the IC paths are very close together, and the IC is easily destroyed by accidental voltages on the wrong pins. I know from sad experience!

The K100

The K100 offers considerable improvement over the earlier Touch. Most of the shortcomings of its predecessor have been corrected, and the general alignment recommendations listed below apply equally well to its bigger brother, the K500. No tests were performed on the new M100, but it may be assumed that the procedure would be similar. To program the K100 beyond its advertised frequency ranges, press the decimal key before entering the desired frequency. Algorithm ranges displayed are approximately 10.19-92.10, 131.1-213.015, and 372.737-576.875 MHz. By careful realignment, the following ranges were actually receivable in our test unit (vco slug inserted): 15.2-53.8, 136.1-174.7, and 387.0-502.5 MHz; (vco slug removed): 20.65-66.14, 141.56-187.0, and 403.2-539.6 MHz. The



Photo D. The M100, newest in the Regency line, features straightforward, compact design.

vco coil is located under the top shielded compartment, toward the front of the cabinet.

After setting the vco slug so that the squelch breaks at the desired upper and lower limits on each band, proceed with the rf alignment.

Rf Alignment

- Monitoring a weak signal from a signal generator set to approximately 45 MHz, peak the two coils located under the fuse for best quieting (maximum signal strength).
- Monitor a signal near 165 MHz and peak the three coils in a line located near the antenna jack. Peak adjacent trimpot near 150 MHz. Alternatively, the trimpot may be peaked near 147 MHz for best 2-meter reception. (Note: High-band tracking is only about 6 MHz wide, factory set for 155-163 MHz, approximately.)
- Locate the two trimmer capacitors adjacent to the open 1-turn coils. These are the UHF trimmers. Tune in a weak signal near either 470 or 492 MHz (whichever is more active in your loca-

tion). Peak the two trimmer capacitors for best quieting. Locate the shielded trimmer capacitor and peak it for best signal near the *minimum* capacitance setting. Peak the adjacent trimpot near 420 MHz. The alignment steps should be repeated until no improvement is noted.

AM Detection for the K100

Again, as pointed out with the Touch AM modification, this feature is only moderately successful, but if selectable AM is vital, it will work in a pinch.

Connect an SPST switch in series with any convenient capacitance of from .01 to 1 microfarad between pins 3 and 5 of IC301, the i-f chip. When the switch is closed, AM will be detected.

The K500

As received from the factory, one sample K500 showed the following algorithm readouts: 19.600-60.555, 135.100-176.055, and 371.6875-576.475 MHz. The actual extended ranges which would break squelch as factory adjusted were: 19.600-57.0, 137.60-176.055,

and 388.1875-513.025 MHz. These ranges may be improved by the same type of alignment procedure as outlined for the K100.

Conclusion

It must be pointed out that these are experimental modifications only and worked with the particular samples of Regency scanners available at the time the improvements were attempted. I can assume no responsibility for the projects of readers nor for damage which may result to circuitry!

It would be a good idea to obtain a factory service manual to verify the procedures outlined above, and for ideas regarding additional modifications later.

The experimental procedures suggested in this article will allow a listener slightly more reception flexibility than originally possible with the factory issued scanners. If any readers come up with additional field modifications (such as an S-meter circuit operated from the audio squelch bus), I would like to hear about them! ■

CALL TOLL FREE
1-800-228-4097

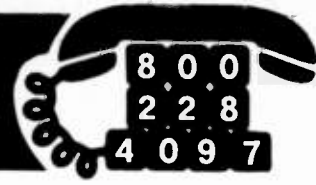

Another Great Buy!

- FEATURES**
 No Crystals to buy
 Lo Band 32-50 MHZ
 Ham Band 146-148 MHZ
 High Band 148-174 MHZ
 UHF Band 450-470 MHZ
 "T" Band 470-512 MHZ
 Auto Search
 Delay Scan
 Automatic Lock Out
 AC/DC Operation
 Simple Programming
 Scan Rate 20 ch./sec.
 Ext. Antenna Jack
 Ext. Speaker Jack
 Big 3" Front Mounted Speaker
 UL Listed / FCC Certified

Bearcat® 210
 PROGRAMMABLE SCANNER

**LIMITED SPECIAL
 ONLY
 \$199.95**



PANASONIC RF-2900

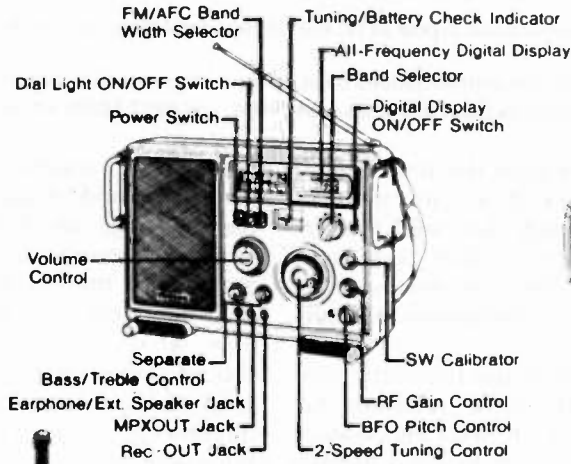

**Suggested List \$329.95
 SPECIAL \$219.95**



PANASONIC RF-4900
 General Coverage Receiver
 List \$549.95
 Ours \$399.95



NEW SHURE 444D
 Dual Impedance
 Normal/Vox Slide Switch
 Adjustable Height
 Mfg. List \$90.00
SAVE AT ONLY \$49.95

KENWOOD TR-7800
 2 Mtr. Transceiver
 CALL for Discount Price



KENWOOD TR-2400
 2 Mtr. Hand Held
 144-148 MHZ
 List \$395.00
 CALL FOR PRICE

Call for LOWEST PRICES on Antennas and Towers

New QTH

We Export

✓ 15 PRICES SUBJECT TO CHANGE AND AVAILABILITY

Communications Center

1840 "O" STREET LINCOLN, NEBRASKA 68508
 In Nebraska Call 402/476-7331



Win Friends for Your Club

— PR is the name of the game

Editor's note: If you plan to write a news item or story for 73, do as we do and not as this article says! Ask us for a copy of our one page "How To Write for 73."

While we have edited this article according to our rules of style, the author's recommendations on style are not changed to conform with ours since he writes about styles for most newspapers and radio and TV news desks. Follow his advice and you can't go far wrong.

A two-year public relations plan of a South Texas amateur radio club led to a free place for club meetings and a tower built by college welding students without charge from material donated by an oil field supply company.

The tower was erected with manpower and equipment loaned by a television cable company and the US Navy. Its site was provided by Bee County College.

The Beeville Amateur Radio Club (BARC) pays no electric utility bill or rental at its repeater location.

BARC members have been featured in more than 20 newspaper stories, were cited in a popular column distributed to more than 30 newspapers, and have appeared on three talk-show telecasts on a Corpus Christi television station. They also were subjects of a TV news film feature during a field day, and different television studio photos appeared in the December, 1979, issues of 73 and QST.

BARCers have been

heard over 10 AM and FM commercial radio stations, have given public demonstrations, and have shown amateur radio films to Rotary and Lions Clubs. This summer they staged their fourth amateur radio class in cooperation with the college and have had public service spots run on radio and television—all without charge. In a city of less than 15,000, they have seen the area's ham population grow to more than 30.

Other clubs likewise can provide needed exposure for amateur radio through a carefully executed public information program which reaps rewards.

BARC's success has been simple: It has applied basic journalistic rules to public information news releases to provide quality news and features about ham radio to electronic and print media. This, coupled with a club aimed toward community service, has led to high visibility of amateur radio with subsequent rewards.

Articles in ham publica-

tions over the past several years have accurately stressed the need for enhanced public relations, but few provide step-by-step prescriptions for success.

Since the foundation for solid public relations begins with news and feature stories ("releases") of high quality which will be accepted by any newsroom or city desk with little or no editing, this article will:

- help your club understand the word "news" and give pointers to help clubs recognize what is a genuine news story and what is feature material;
- provide a few rules of accepted journalistic style;
- show examples of acceptable and incorrect styles; and
- pave a path through the process of writing and preparing the story.

News Is Like Bananas

News is as perishable as bananas. Today's White House statement will be tomorrow's bird-cage bottom. Feature stories, on the

other hand, usually have "shelf life" and fit Sunday's feature page or September's supplement. Your first move, and that of fellow club members, is to recognize what is news. You should understand how to tailor that news to the requirements of the publications you send it to.

A club publicity officer should be chosen. He should develop the ability to prepare material harmonious in style with the *Associated Press Stylebook*,¹ considered by most journalists to be the bible of the newspaper profession.

Your local newspaper is the best teaching tool at hand. It can be an excellent "journalism professor," especially if it is a major daily. Grab a copy of it and examine page one. (Using the paper serving your immediate area is important because what is news in "Midtown" is not necessarily news in Manhattan.) With that front page, analyze the stories. Tear them apart and scrutinize individual ingre-

dients. Components will include newness, immediacy, prominence, proximity, suspense, consequence, emotions, and/or oddity.

Get a copy of any Sunday newspaper and examine the features section. You will find stories about hobbies, unusual and unique interests, and personalities. Others may be yarns that include everything from fire prevention to hurricane protection and diet.

Pick a few of the "straight" or "hard" news stories from page one and clip them. Select a feature or two from the Sunday paper, and save both types of stories as patterns for yours.

Recognize that what you do at the club meeting Saturday can be news. Play it all the way with an advance "what's gonna happen Saturday" story and a follow-up "what did happen" piece. An advance story explaining that the local repeater bunch, for instance, will install autopatch rather than have a formal meeting is marketable "hard" news and feature material. That club members, for example, are building the autopatch in Joe's garage employing 30 key-thumpers from all walks of life could give the story the "feature" or "human interest" angle needed to unload your yarn at the city desk.

Nobody but a ham gives a hoot in hell about ICs, capacitors, and other miscellanea of the autopatch, but readers do need to know what a repeater means to them and how the autopatch serves in emergencies. They will be amazed that a walkie-talkie can call a telephone 15 miles away when their \$350 CB won't reach a "good buddy" down at the pool hall.

This gathering in Joe's garage may also be worth a

high quality photograph—in black and white, precisely focused, accurately exposed, well-planned, artistically composed, and expertly printed. A picture of the whole mob, beer cans and all, staring at a nervously-held Instamatic is not news. A penetrating closeup of a 13-year-old ham feeding solder to the gun tip mastered by the retired physician can be featured on the front page.

Good news or feature photography tells much of the story without words, although news and feature shots are supported by written captions under them, called "cutlines." The best photojournalism, however, could stand alone.

In addition to ensuring that the photograph is technically tops, remember that newspapers have limited space. Their incomes are from advertising and every word or picture is "worked around" the dollar, which is valuable space. A group picture of the beer-belly bunch consumes at least three columns of costly space to get every grinning, yawning, shut-eyed mug. The suggested "tight" closeup, preferably shot vertically, ideally will be a two-column shot, but might even fit in one. Sure, it would be great to have three or four columns, but one top-grade photo will find its way to publication when a dozen "handshaking, certificate-passing" shots won't stand a chance.

A wide angle 24mm or 28mm lens on a 35mm single-lens reflex and a perspective approach can help. Outstanding examples of ageless photojournalism of the highest quality can be seen in any old copy of *Life*. Good photographers crawl in holes, bear blizzards, scale towers, and wallow in leech-infested swamps, if necessary, for that different, unusual angle. Look for the view that snatches

STOP RF SPILLOVER!

You may be losing up to half the available output from your vertical gain antenna because of RF spillover. The amazing AEA Isopole with unique decoupling design, virtually eliminates RF spillover and can help you multiply your power in all directions on the horizon relative to an ideal half-wave dipole, or end-fed non-decoupled "gain" antennas.

CALL TODAY
**SLEP ELECTRONICS
COMPANY**

704-524-7519
P.O. Box 100,
Highway 441, Dept. 10
Otto, North Carolina 28763

**AEA Brings you the
Breakthrough!**



reader attention. Don't underestimate the impact of a fine photo to "sell" your story.

Thirty bucks or so out of the club treasury for a professional photographer is worthwhile if your group can't tap a member or friend with a high-quality camera and a trained eye. Newspaper photogs don't earn much money, and most will freelance. Not only will you get a quality shot from them, but newspapers like to run their own stuff.

Snappy 8 × 10 glossy prints are preferred by most papers, and that size grabs the green-eyeshade gang's attention much quicker than your local drugstore snapshot that looks as though it were developed along with your teenager's socks in Monday's laundry.

A photo isn't always called for, and there are many other opportunities for news or feature releases

even if your club isn't meeting in Joe's garage. Story suggestions include the following:

- Advance story on election of officers; post-meeting story on who was elected.

- Advance stories on all club meetings—where they will be held, when, and why.

- Advance stories on all fund-raising activities and what the income will be used for; follow-up on how much was raised and how it will be used.

- Features or "brites" on unusual contacts: A chat with VR6TC, citing his relationship to the *HMS Bounty*, ties in history and adds color to your hobby. A conversation with any "rare" or famous station is good for at least a few lines (and maybe a photo) in Sunday's paper.

- Every field day should be covered photographically and in writing. This calls for

an advance piece and after-the-fact article.

● A transmitter hunt should be shark bait to the TV crews—fine feature material on film and for the newspaper.

● Swapfests will bring in droves of camera crews if details of the event are given advance notice through releases.

● Any public service activity or adventure should be given top publicity.

● How the club is prepared for emergencies is both "hard" news and feature material.

● Personalities of club members, age differences, and husband and wife teams are usually good human interest material. Don't overlook the possibility that a prominent banker, politician, police chief, or preacher may be in your midst. A feature highlighting "prominence" will "sell."

● The fact that you sold a piece to 73 is worth a photo for most hometown papers. For the photo, stick the magazine way out in front—at arm's length—and the photographer, using an ultrawide lens, will make the magazine look six feet long and your grin three feet across.

● Ham radio lends itself to public demonstrations at fairs, school career days, and conventions. Give it everything—pictures, stories, and mailed invitations.

● Handicapped persons often overcome significant odds to get on the air. If they are willing, a yarn about their FCC test preparation and subsequent operation is photo and feature meat.

● RACES, MARS, or other such operations warrant stories and photos. While "Midtown" is sweating in a 100-degree heat wave, tantalize the TV crew through an icy chat with the Navy's "Operation Deep Freeze"

hams.

● Don't ever skip the "kid-die angle." Newspapers love shots and stories with curtain climbers, whether it's the elementary school science demonstration or 6-year-old Tammy getting her ticket.

● Have you built any unusual gear, like a device to help the sightless ham tune his rig? Maybe you've built a radio-controlled combination bird-feeder, dog-walker, and canopy. Anything unusual will stimulate the city editor to peer seriously over his half-frame specs.

● If you've scheduled a talk for a civic club, give the news media advance notice. TV crews or a newspaper reporter might even show up and cover the story for you.

● Plenty of publicity can be generated for and as a result of ham radio classes. This is one of your better opportunities for spreading the word. Interested? Call the community education department at your nearby educational institution. They'll likely help you get the thing kicked off and give support with lesson plans, equipment, classroom space, and publicity.

Recognize Elements of News

Let's inspect the autopatch project in Joe's garage and see how this is news and feature material.

Immediacy or "nowness" is present in that a ham radio meeting Saturday is focused on building and installing a new device, called an autopatch, which can benefit the community. Because homeowners can relate to disasters such as earthquakes, floods, hurricanes, or tornadoes, this brings the value of emergency repeater power and autopatch "home." That's the proximity of the news—how it affects readers.

The element of "oddity"

or the unusual quality of your information is exemplified by the youngster and the senior citizen bound in friendship through a common thread—their hobby.

Additional elements may combine to form the basics of your release. Perhaps the club president is mayor, city manager, police chief, bank president, or brain surgeon. The fact that it's the mayor who is calling Moscow makes news. That's "prominence."

"Consequence," sometimes allied with "proximity," is readers seeing results of reliable repeater operation during a disaster. Examples should be cited to drive home that point in your autopatch feature.

If you've ever climbed a tower, there also can be "suspense" for the news. It takes imagination, but a tower-climber's tale could be done suspensefully. If your club joins a search effort or pitches in during a rescue, there's clearly the element of suspense, and also emotion, to amplify in your story.

Use Accepted Style

This aspect of producing your news release is vital to success. Editors have neither the time nor the patience to rewrite your submission. If it isn't up to acceptable standards, it probably will wind up in the circular file (or even worse, may be assigned to the library reporter, Miss Elmira Furd, who will get all the facts screwed around, calling your club the local CB REACT team transmitting VHF's around impressionable children).

After you've grasped the basics of news elements, it's time to organize that news in an acceptable journalistic format, in step with the *Stylebook*.

There are three pieces of gear any successful news-writer should have: a good

dictionary, a clean-printing typewriter, and a stylebook. Although stylebooks are necessary for serious writers, the club publicity officer—if he is slightly sharper than a wet Kleenex—can put that "old professor," the newspaper, to work for the same effect.

Unlike writing for English grades when in high school or college, newswriting requires that you write for others. Gobbledygook and ham radio jargon are synonymous to the average reader. He doesn't give a diddly-damn about QRZs, QRXs, beams, baluns, and bands. What he is concerned about is himself, his health, his well-being, and the happiness of his family and friends. He can comprehend the importance of emergency power making communication possible in the aftermath of Camille, Carla, Beulah, Dandy-Don, or whatever the last big storm was called.

When a repeater is compared in operation with that of police radio, the reader understands how important that tool is to his family during trouble. Because it operates at VHF frequencies, narrowband FM, into a Ringo Ranger at 500 feet using Phelps-Dodge duplexers feeding one and seven-eighths-inch Heliac, concerns him no more than the emotional impact of the price fluctuation of cotton on sharecroppers in southern Alabama during Christmas, 1891.

With a newspaper as a guide, examine those stories on the front page—car wrecks, city council meetings, international news, and political news. Interwoven throughout each are answers to the inescapable five "Ws" and the "H."

Who? What? Where? When? Why? and How?

Those must be answered fast in a "straight" news story. It's called the "in-

verted pyramid," and it means "Hit 'em with the big facts first and follow down the story, bang, bang, bang, in a descending order of importance."

Put yourself in the reader's place and sift through your notes for what will be most important to *him*. That goes in your first or "lead" paragraph. It's not like writing a novel. It's not like writing for *73*, and it sure as hell isn't *Penthouse*. An acceptable six paragraphs for a "straight" or "hard" news approach to the weekend autopatch story follow:

Members of the Midtown Amateur Radio Club Saturday will install a communication device which can save lives if another hurricane strikes.

John J. Jones, city police chief and amateur radio operator, explained that his club "will build a gizmo called an autopatch that will allow hams in an emergency to call any telephone from walkie-talkies."

"The beautiful thing about it," Jones added, "is that the whole repeater and autopatch system is totally independent of electrical power from the utility company and can operate at least three days on storage batteries."

Jones explained: "The autopatch hooks the repeater automatically to telephone lines, but telephone lines are not needed for basic repeater operation. It's an added extra. We can call telephones or other hams on radios with the system."

Midtown's police chief also pointed out that the "repeater system is a relay trans-

Bill W. Smith
Public Information Officer
Midtown Amateur Radio Club
P.O. Box 9282
Midtown, TX 70260

(EVENT IS SATURDAY, MAY 10, 1980)

(FOR IMMEDIATE RELEASE)

Members of the Midtown Amateur Radio Club will elect officers Saturday and afterward will tour computer facilities of a company with world-wide operations.

John J. Jones, club president, stressed: "All members should attend. We will serve coffee and doughnuts and following our election, we will drive to Media, Inc., for a demonstration of their Hewlett-Packard 3000 computer."

Media, Inc., an industrial microfilming organization, maintains its computer at 30 East Harbor St.

Jones, city police chief and a ham radio operator, said the club's 60-member organization operates two different radio repeater stations in Midtown, giving hams communication coverage throughout the county.

Jones explained that repeaters, which are relay devices, extend range of low-powered mobile and walkie-talkie radios "making amateur radio operators tremendously valuable to Midtown during an emergency."

The local group meets the second Saturday every month beginning at 10 a.m. in the police commissioner's conference room at City Hall, 3322 Washington St.

Club meetings are open to the public, Jones said.

###

5/5/80

(FOR FURTHER INFORMATION: CALL BILL SMITH AT 664-2981)

A press release prepared like this will likely see print. Every club working for enhanced public relations can ensure that amateur radio frequencies remain dedicated to public service and not commercial interests.

mitter and receiver that extends the range of small hand-held or mobile radios."

Jones said hams will be the only Midtowners with the capability to either call telephones from walkie-talkies or talk to highway patrol headquarters if power fails.

The typical story would

continue, building on a few more details, explaining that the equipment was built by club members, their possible affiliation with RACES, and other details of interest to readers. The final paragraph might list club officers and tell where and when the organization meets and whether or not the public is welcome.

That "straight" news be-

ginning would be the "before the fact" story submitted to electronic and print media. If no reporters or camera crews show up at Joe's garage, then the publicity officer's next move is to prepare a feature story about the event. An example of the first few paragraphs of such a feature follow:

A 13-year-old from Crockett Junior High

School and retired surgeon Dr. Nicholas Barnhardt joined forces Saturday in a neighbor's garage where their 60-year age difference dissolved in a plan to save lives.

Barnhardt's "scalpel" was a soldering iron and his "assistant," Jody Merriman, put wrinkles in his freckled seventh-grade face as he helped the doctor design and build an "autopatch."

This "patch" won't splint a bone or suture a cut, but it will help heal broken lines of commercial communication during hurricane season.

Barnhardt, who retired from surgical practice last year, and Merriman, son of Mr. and Mrs. Frank J. Merriman, 620 Los Altos, share a common bond—a tie they have with a king, a senator, a Florida blonde, a Texas farmer, and nearly a million others worldwide.

Now that you have had a dose of precisely what makes hard news and how features differ in approach, let's examine some rules:

- Avoid personal pronouns. I, me, my, your, and our are not used at all in newswriting and seldom in feature stories except in direct quotes. [And, also, except in 73! — Ed.]

- Omit needless words. Keep sentences and paragraphs short. Write simply, clearly, concisely.

- Avoid ham radio jargon. If it must be used, explain it in simple terms.

- Avoid unnecessary capitals. Capitalize titles before names. Lowercase titles are used alone or when set off from a name by commas. Examples:

John J. Jones, presi-

dent of the Midtown Amateur Radio Club, said, "Jody's assistance was invaluable in the system's design."

Midtown Police Chief John Jones today explained the benefits of amateur radio.

Midtown's police chief said today, "Ham radio classes start Monday at 7 p.m. at the college."

The words "ham radio" and "amateur radio" are lowercase except when preceded by a proper club name or used in FCC terminology: "Hams operate under rules and regulations of the FCC's Amateur Radio Service."

- President Carter "stated." Nearly everybody else "said," "explained," "pointed out," "asked," "added," "complained," "stressed," or "emphasized." Use them naturally. "Said the senator" is *Time Magazine's* own style and it isn't seen in most newspapers. Rather, use: "Jones said," "Jones emphasized," "Jones stressed," "he said," "the chief explained."

- Avoid use of "Mr." before names. John J. Jones, not Mr. John J. Jones. It is, however, correct to write: Mr. and Mrs. John Jones or John and Evelyn Jones. If both husband and wife are later cited, he becomes "Jones" and she is either Mrs. Jones or Ms. Jones, if she prefers. Tantalizing teenager Tammy Jones becomes Miss Jones or Ms. Jones, and brat Jimmy is just another "Jones."

- Avoid use of first names after initial introduction. John J. Jones becomes "Jones," not "John."

- MDs, DOs, ODs, DVMS, PhDs, EdDs, DDs, DDSs, and other doctorally-titled men and women are granted that title only once in a news story. Use it with their names only in first

reference. They then become "Jones" or "Smith" like everyone else. They may be called "the physician," "the surgeon," "the dentist," "the optometrist," or, in limited cases, "the doctor," but not "Dr. Jones" after first use and never "Doctor Jones."

- Do not use qualifiers unless directly quoted. Qualifiers include very, pretty, good, bad, best, worst, finest, sharpest, rather, sort of, kind of. Certain usages in features are excepted, but avoid them for news.

- Do not editorialize! Opinion is left to the editorial page. Opinion in news should be only in the form of a direct quotation. Don't even *think* about using opinion when writing a news story. Anything even vaguely approaching the writer's opinion must be fully substantiated by quotations taken from the subject. Following are some opinions that give editors ulcers:

Ham radio is the only way to fly.

Ham radio is a fun hobby.

Ham radio is a blast. A good time was had by all.

A cordial invitation is extended.

Come one, come all. We all had a ball.

It is the best group of guys and gals in town. Try it; you'll like it.

However, it would be acceptable to quote someone on such opinion. Examples:

In comparing CB to ham radio, Jones said: "It's like trying to compare a kite to a Boeing 747. The jet will get you there, but the kite only flops in the breeze. Ham radio is the only way to fly."

Jones, inviting the public to the next meeting, said, "We have a ball. Come one, come all, and

meet the best group of guys and gals in town."

- Use of numbers: Spell out numbers under 10 except when used with dates, times, addresses, or telephone numbers. Numbers over nine are written in figures except at the beginning of a sentence. Consult your stylebook for further exceptions.

- Use of dates: Abbreviate Jan., Feb., Aug., Sept., Oct., Nov., and Dec. when used as dates. Spell them out when used as words. If the event occurs within the week, use day of the week and *not* the month. Don't abbreviate days of the week. If the event is more than seven days distant, use the date but not the year. Examples: "Nov. 8 is the deadline for application," "Midtown hams will stage their annual talent show in November," "The club meets Saturday."

- Avoid clichés.

- Leave ornamental decoration and glitter on the Christmas tree. Remember, your writing is not to impress anyone with verbosity or intellect, but to promote amateur radio. Mushy writing isn't good news.

- Memorize news deadlines at your newspaper and radio and television stations and observe them. If you expect a camera crew from the television station, they must have plenty of advance notice through your release. Call them a few hours before the event as a *gentle* reminder, but in no case should you lead them to believe that you expect or demand their appearance. Don't think your feature on Joe's garage dropped off at the newspaper's city desk late Saturday afternoon will make the Sunday feature page. It won't. Whatever media deadlines are, respect them as you would a wet bobcat found in your VW glovebox.

● NEVER tell a television news director, reporter, or newspaper editor how to run his business. Never. Don't tell the editor where or when you believe the story should appear. Leave your item, thank him, and get out of the way. Never walk in complaining "Why didn't my piece about plate dissipation on 811s get in Sunday?" However, when a story is run—and it won't be about 811s—call the editor or news director with sincere thanks.

● To stretch truth with news media personnel will end up stretching the club's collective neck. If any club members are yearning for lobotomies by running about the countryside shooting up garbage cans, wagging shotguns, slashing tires, planting jamming devices, and sending psychotic notes of threats to other repeater groups, help investigative reporters and

law-enforcement officials uncover the slime. That earns respect and flushes sewage. If the club is ever guilty of a cover-up or information manipulation, move. Tomorrow. To Adak.

● Do establish friendly relations with CB radio clubs and try not to blast them in your stories. The comparison of a Boeing 747 and the kite that I made earlier is a bit harsh for public consumption. Explain clearly the differences in the two modes of communication and downplay negative aspects. Work with the REACT team and you will gain new hams. Invite them to your meetings and show, through example, "how to fly."

● Do include radio news directors in your distribution of releases. Electronic media writing styles are slightly different, but they will use your release to prepare their copy.

● Meet management at the local radio and television stations and make plans for public service spots. What hams do for public service is gravy for those responsible for meeting the federal requirements that stations provide a certain amount of public service programming. Tag the photographer for some brilliant slides. With management, explain the relationship of your hobby to their mission of public service. That means free publicity for ham radio classes and other benefits. (The ARRL has available without charge some 16mm color film spots, in sound, and taped radio announcements.)

After understanding the basic rules, plop down at your typewriter and hack away. A final draft of your release should be double-spaced, grammatically precise, error-free, and immaculately typed. See the

box for an example.

If all this seems like too much trouble, think about that free space at 500 feet on your local TV station tower, and maybe some free "slave" labor headed by the station engineer to rig it. Or, maybe your club needs a rent-free place for meetings or help with electric bills for the repeater and club station. Perhaps your organization would benefit by county- or city-paid telephone bills, or first choice in sifting through surplus at the next sale.

Or, of course, you can forget about it all and let 10m, 15m, 20m, 40m, 75m, 160m, or 220 go to commercial interests.

Don't say it'll never happen. Eleven meters once was a ham hangout. Remember? ■

Reference

1. *The Associated Press Stylebook* (New York: The Associated Press, 1977).



FAST DELIVERY
1-800-325-3609
 MO. RESIDENTS CALL (314) 961-9990

We have it!
 And we'll get it to you fast.

To our extensive list of major brands; we proudly announce the addition of:

- Bearcat scanners
- Regency scanners
- Vibroplex

One call will let you know why we're "The Direct Connection" for delivery too.

MIDCOM ELECTRONICS, INC.

2506 S. BRENTWOOD BOULEVARD
 ST. LOUIS, MISSOURI 63144
 Hours: 9-7 Mon.-Fri. 9-5 Sat.

VISA
 master charge
 CODE OF ETHICS

Field Strength for Free

— a home-brew conversion

Probably many amateurs have old VOMs that have outlived their usefulness or have been replaced by better test equipment. In our case, a ten-year-old Japanese VOM was starting to develop all sorts of problems—a switch that was activated when the pin tip from a test lead was inserted in the Ohms jack made erratic contact, resulting in false resistance

readings, jacks on various other functions were worn out, and two current ranges were burned out. The VOM had a good meter movement and case, however, so rather than simply discard it, we turned it into a very handy and sensitive field-strength meter.

Undoubtedly, the same can be done with many other VOMs at minimum or no cost using junk-box

parts. One can end up with quite an attractive looking instrument, as good as the one shown in the photograph of the front of the converted VOM.

In the case of this VOM, there was a series of pin jacks running vertically on both sides and along the bottom of the space below the meter. These were covered up with a piece of Lexan (the black, wrinkle-finish material seen in the photograph) and the pin jack holes used with 6-32 hardware to hold the material in place. Of course, any sort of attractive plastic or metal can be used as a covering plate. The miniature on/off switch for the amplifier circuit incorporated in the field-strength meter is shown in the center of the plate. You can also

just discern (on the right side) the knob for a sensitivity control.

The instrument's meter originally had the usual VOM scales. However, the scales were on a plate which could be unscrewed and turned around to reveal a black surface. This surface was painted gray and the numbers shown were placed on it using a rub-on lettering/numbering transfer sheet. The method of dressing up an old VOM will vary with the instrument involved, but with a bit of imagination one usually can find a method that will result in a new-looking instrument rather than one which is a reminder of a discarded VOM.

The VOM had a 250- μ A movement, so it was al-

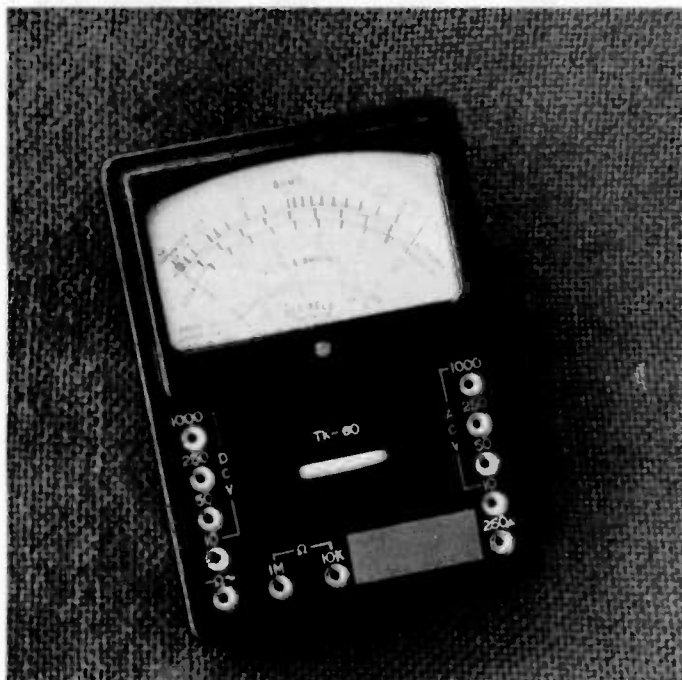

Photo A. The front of the VOM as it originally appeared. It still looks good, but electrically it was falling apart.

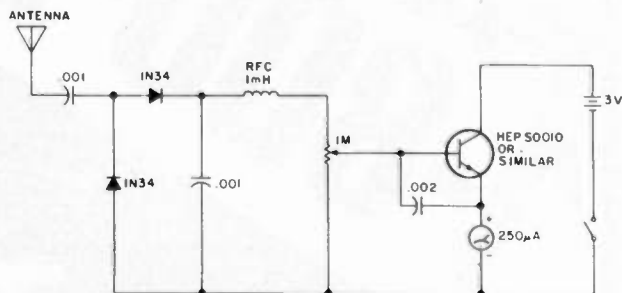
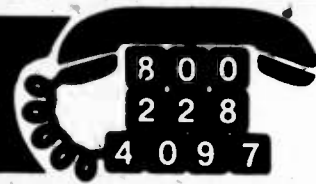

Fig. 1. Broadband voltage-doubler/rectifier and dc amplifier used in the converted VOM.

CALL TOLL FREE
1-800-228-4097



Win the contest with an Alpha!!



ALPHA 76A

Two 8874 Tubes
 1.5 KVA Heavy Duty Transformer
 2.5 K.W. PEP, 1 K.W. CCS Average
 Efficiency better than 60%



ALPHA 374

With "No Tune Up" convenience
 Instantaneous band switching
 2+K.W. PEP
 Two 8874 Tubes
 1000 watt DC "No Time Limit" Power Supply



ALPHA 78

The new Alpha 78 combines the best features of all previous ALPHA'S: More quiet brut power than the original Alpha 77--- A new "no tune up" system even better than the 374A --- and the same superb QSK system used in the Alpha 77DX.

Call for discount prices.

ANTENNAS

CUSHCRAFT

ATB-34	4-Element Triband Beam	\$ 219.95
ATV-4	40-10 mtr Trap Vertical	84.95
ATV-5	80-10 mtr Trap Vertical	89.95
ARX-2	2 mtr "Ringo Ranger"	32.95
A-3219	19-Element 2-mtr "Boomer"	74.95
A-214B	14-Element 2-mtr "Boomer"	56.95
A-214FB	14-Element 2-mtr FM "Boomer"	56.95
A-228FB	28-Element 2-mtr FM Power Pack	179.95
A-147-11	11-Element 2-mtr FM Beam	32.95
A-147-22	22-Element 2-mtr FM Power Pack	95.95
ARX-450	450 MHz "Ringo Ranger"	32.95
A-144-10T	10-Element 2-mtr "Oscar" ant.	39.95
A-144-20T	20-Element 2-mtr "Oscar" ant.	56.95
A-432-20T	20-Element 432 MHz "Oscar" ant.	49.95

LOWEST PRICES IN THE COUNTRY ON ANTENNAS
 HY-GAIN - CUSHCRAFT - MOSLEY - HUSTLER

HY-GAIN

		Regular	Special
TH3DX	Super Thunderbird	\$329.95	\$239.95
TH3BK3	3 el. 10-15-20M beam	222.95	188.95
TH3JR	3 el. 10-15-20M beam	180.95	129.95
Hy-Quad	2 el. 10-15-20M Quad	274.95	208.95
206BA	5 el. "Long John" 20M beam	329.95	239.95
155BA	5 el. "Long John" 15M beam	199.95	149.95
105BA	5 el. "Long John" 10M beam	129.95	99.95
204BA	4 el. 20M beam	249.95	188.95
204BK5	5 el. conversion kit	99.95	79.95
163BA	3 el. 15M beam	89.95	79.95
103BA	3 el. 10M beam	74.95	59.95
402BA	2 el. 40M beam	239.95	189.95
BN-86	Beam for beam antennas	15.95	15.95
TH2MK3	2 el. 10-15-20M beam	149.95	119.95
18HT	Hy-Tower 80-10M vertical	\$359.95	\$289.95
18AVT/WB	80-10M Trap vertical	105.95	84.95
14AV/WB	40-10M Trap vertical	69.95	57.00
12AVD	20-10M Trap Vertical	42.95	34.95
14RMQ	Roof Mounting Kit (verticals)	33.95	29.95
580Q	80-10M Trap doublet	108.95	89.95
280Q	80-40M Trap doublet	59.95	49.95
648	6 el. 8M beam	119.95	99.95
203	3 el. 2M beam	15.95	
206	5 el. 2M beam	21.95	
208	8 el. 2M beam	29.95	
213	14 el. 2M beam	34.95	
LA-1	Deluxe lightning arrester	59.95	49.95
TH5DX	5 el. 10-15-20 M Beam	269.95	199.95

We Export

PRICES SUBJECT TO CHANGE AND AVAILABILITY ✓14

Communications Center

1840 "O" STREET LINCOLN, NEBRASKA 68508
 In Nebraska Call 402/476-7331



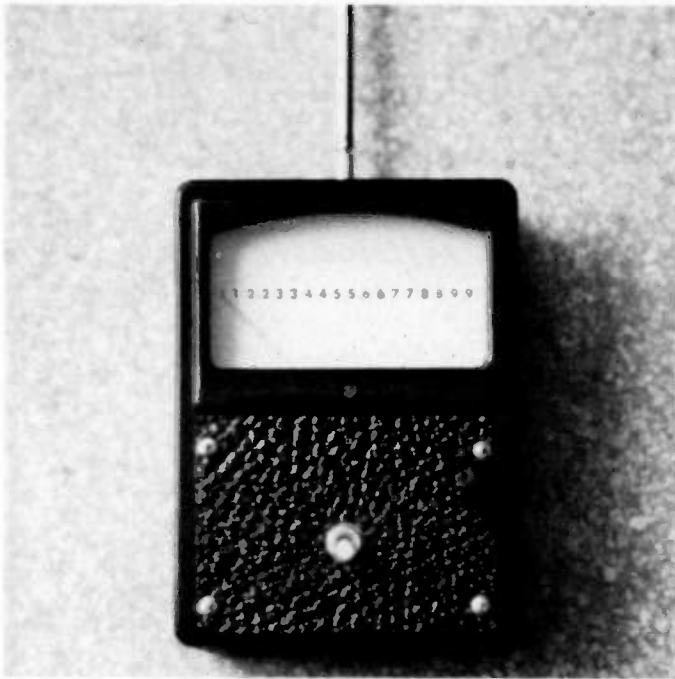

Photo B. Front of the converted VOM.

ready reasonably sensitive. However, it was decided to add the simple dc amplifier stage shown in Fig. 1 to increase the sensitivity. In this circuit, the diodes are arranged in a voltage-doubling circuit to develop a dc voltage to drive the amplifier stage. The meter is placed in the emitter lead, so even if the battery is open the meter will still function as a simple, non-amplified field-strength meter. Using a small telescoping antenna, the meter would easily indicate rf from low-powered transmitters up to 144 MHz.

One may prefer other dc amplifier circuits, depending on the sensitivity of the meter in a VOM and perhaps the battery voltage in a VOM (since the battery-mounting clips can be retained for use). Fig. 2 shows two very useful circuits. The FET circuit requires a 9-volt battery, but is quite good when a meter movement with only modest sensitivity is available. It will convert a 0-1-mA movement into the equivalent of a 0-2- μ A movement. The 1k-Ohm "zero set" potentiometer need be only a trim type mounted internal-

ly since it will not require frequent adjustment.

The bipolar transistor circuit has the advantage that only a single 1.5-volt battery is necessary for operation. Again, the "zero set" control need be only an internally-mounted trim potentiometer.

The sensitivity of any field-strength meter can be still further greatly increased if a simple parallel resonant circuit is placed at its input. A suitable circuit for the HF bands also is shown in Fig. 2.

The photograph of the field-strength meter removed from its case shows the internal wiring. The batteries mount in their original clips, and the amplifier components mount on a small piece of perfboard. The on/off switch is seen to the right of the board and a miniature potentiometer for a sensitivity control is seen to the left of the board. The board is held in place simply by the stiff wiring to the switch and potentiometer. The telescoping antenna, which is a simple portable radio replacement type, is mounted in the top of the case using shoulder washers for insula-

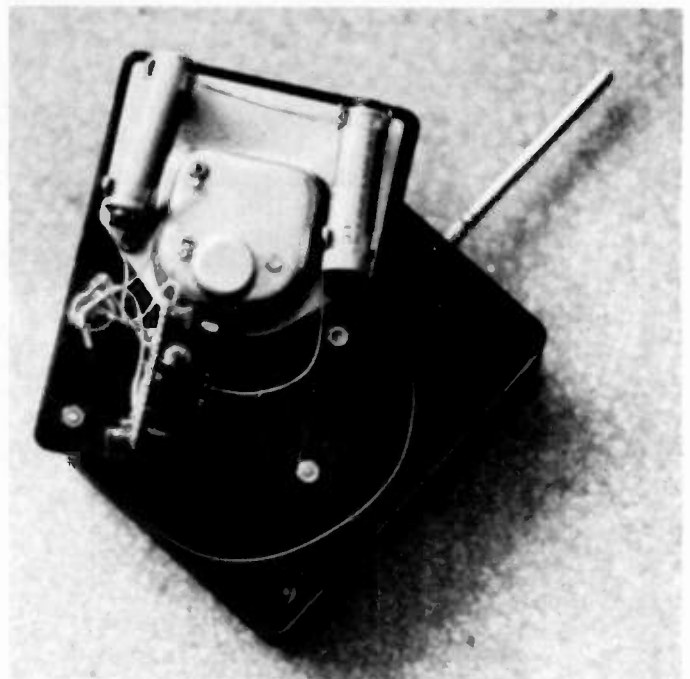

Photo C. The VOM removed from its case, showing the placement of the dc amplifier. The battery holders are the original ones.

tion. However, one could just as well mount a binding post in the case and use a short wire antenna.

This article has presented just one realization of an idea. Many more will prob-

ably occur to the reader. So, don't throw away those old VOMs. Convert them and have a field-strength meter as good as or better than any of the commercial units in the \$15 range. ■

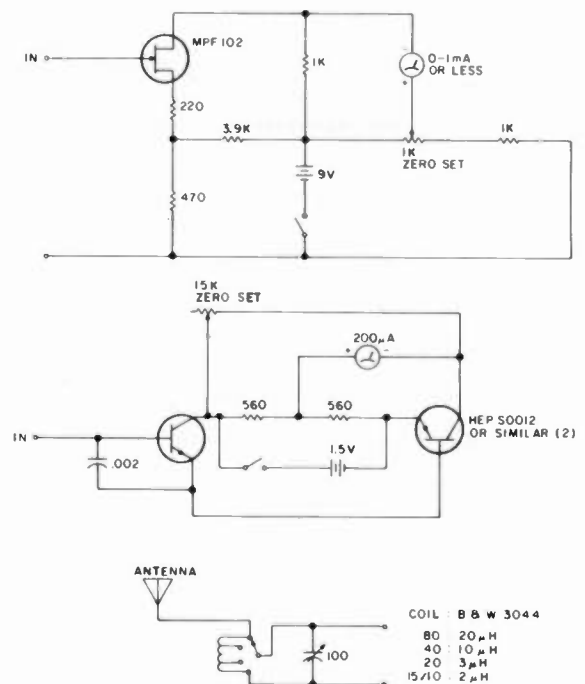
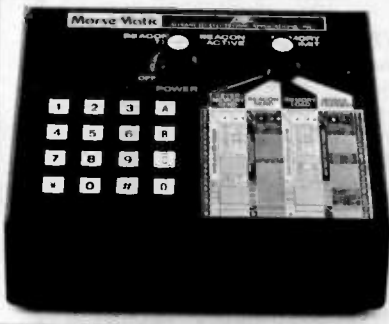

Fig. 2. Two other useful dc amplifier circuits which could be used following the 1-meg potentiometer shown in Fig. 1. Also shown is a simple tuned circuit for the HF bands which would further increase the sensitivity of the field-strength meter.

MEMORY KEYER BREAK- THROUGH!



The remarkable AEA Morsematic memory keyer has 35 fantastic features including two AEA designed microcomputers, up to 2,000 character memory, automatic serial number, beacon mode, and automatic morse trainer mode. The AEA Morsematic is already the undisputed leader in high quality multi-feature Morse Keyers.

CALL TOLL FREE
1-800-426-7741



6115-15th Ave. N.W.
Seattle, WA 98107, 784-7337
WASHINGTON RESIDENTS
CALL 1-800-562-6818

AEA Brings you the
Breakthrough!

MIRAGE MIRAGE MIRAGE

COMMUNICATIONS EQUIPMENT, INC.

5 YEAR WARRANTY

Parts and Labor
1 yr. on RF Power Transistors

Peak Reading
Watt/SWR Meters



MPI — HF
1.8 to 30 mhz
25, 200, 2000
watts ± 5%
\$119.95

MP2 — VHF
50 to 200 mhz
50, 500, 1500
watts ± 5%
\$119.95

ALL MODE
2 METER AMPLIFIERS
WITH BUILT IN
RECEIVE PREAMP

Dual Purpose: Hts or Transceivers.

B108	B1016	B3016	RC-1
10 w. in — 80 w. out 2 w. in — 36 w. out FM, SSB, CW 13.6 VDC 10 - 12 Amps	10 w. in — 160 w. out 2 w. in — 95 w. out FM, SSB, CW 13.6 VDC 20 - 25 Amps	30 w. in — 160 w. out FM, SSB, CW 13.6 VDC 17 - 22 Amps	Remote Control 18 foot cord
\$179.95	\$279.95	\$239.95	\$24.95

✓364

Available at leading amateur dealers worldwide.

MIRAGE COMMUNICATIONS P.O. BOX 1393 GILROY, CA 95020 (408) 847-1857

Poly Paks[®] INC. Quality Electronics For Less!

NEW! PET 73 KEY COMPUTER KEYBOARDS

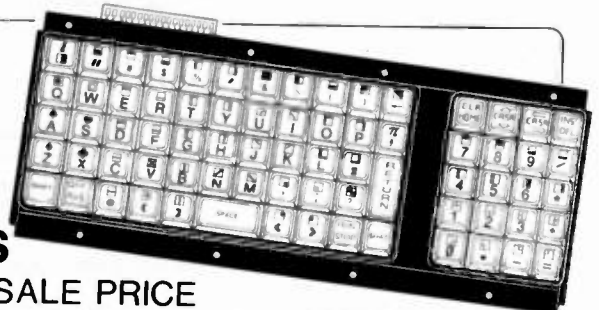

Cat. No. 92CU6671
REG. \$39.95
SALE PRICE
\$29.95

- **SAVE OVER 25%!**
- **QUANTITIES ARE LIMITED!**
- **100% MONEY BACK GUARANTEE!**

ASCII-Compatible Original Factory Keyboards!
Suitable For Add-On OR Direct Replacement!
Includes: 53-Key Alphanumeric, & 20-Key Hex

Complete 73-key PET keyboards include all Alphabetical, Numeric, Graphics, Game and Command legends commensurate with the PET 8K microcomputer. 64 ASCII characters are available without shift and all 64 graphic & reverse field characters are accessible from keyboard (with shift). Keys are color-coded for quick reference, and are precision mounted in a compact 9-1/2" x 3-7/8" high-impact plastic frame. Terminates in standard 18-contact single-sided edge connection. Plugs directly into PET systems, and can be soldered to for interface with other makes. Adds a versatile, professional touch to any microcomputer system.

Send For Our FREE Catalog Today!

Featuring sensational savings on Computer Peripherals, Speakers, Transformers, Solar Products, Fans, Stereo Equipment, Relays, and a wide variety of other diverse electronic components. Take advantage of our 25 years as America's foremost supplier of discount electronics.

For Faster Service
Order By Phone
1-617-245-3828



COMPLETE COUPON AND MAIL TO
Poly Paks
P.O. BOX 942, 73 10 SOUTH LYNNFIELD, MA. 01940
Send me _____ keyboards @ \$29.95 ea.
Plus \$5 each for Postage & Handling ✓58

NAME _____
ADDRESS _____
CITY _____
STATE _____

Enclosed is CHECK, MONEY ORDER

Charge my MASTERCARD VISA

ACCT. # _____ EXP. DATE _____

Send me your FREE catalog

TET[®]

ANTENNA SYSTEMS

1-800-654-3231

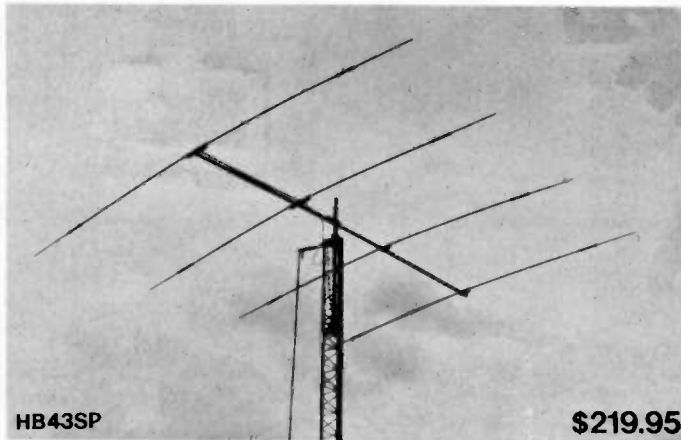

HB43SP

\$219.95

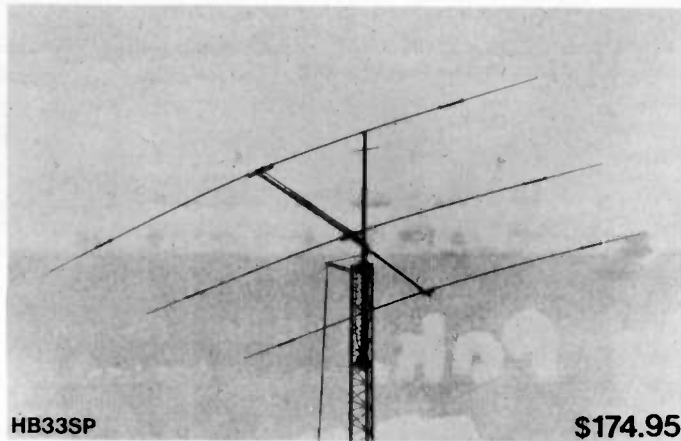

HB33SP

\$174.95

TET, THE LEADER IN WIDEBAND ANTENNA DESIGN, introduces another new triband antenna to provide unmatched wideband performance on the 10, 15 and 20 meter amateur bands. This radical departure from conventional triband antenna design employs TWO DRIVEN ELEMENTS with a rigid phasing line to couple power from the radiator element to the reflector. Phase relationships have been carefully engineered to provide extremely high gain figures without neglecting the need for high front to back ratio. The two element drive system is coupled to one parasitic director on the model HB33SP; two parasitic directors on a longer boom with the model HB43SP.

FULL BAND COVERAGE is possible without the need for antenna tuners or separate CW and phone antenna adjustments. The 1.5:1 VSWR bandwidth covers the entire 20 and 15 meter amateur bands, with a little extra for MARS operation. On 10 meters, coverage is in excess of 1 MHz.

QUALITY CONSTRUCTION and repeatable performance permit TET to deliver an antenna package without need for any tuning adjustments. All tubing is cut and pre-drilled to precision tolerances. The phasing harness and feed assembly for the two driven elements are pre-assembled to insure ease of construction and reliable performance.

MOVE UP with the performance oriented leader in antenna technology. Order your new high performance wideband triband antenna system from TET today.

MODEL	BANDS	ELE- MENTS	ELE- MENTS PER BAND	MAX PWR	VSWR	IMPEDANCE	MAX ELEMENT LGTH	BOOM LGTH	TURN- ING RADIUS	WIND SURFACE AREA	WIND LOAD @80 mph	BOOM DIA- METER	MAST SIZE	WT
HB43SP	14/21/28	4	4	2KW	BELOW 1.5	50 Ohm	27'	19' 8"	16' 9"	6.62 sq.ft.	131.3 lb.	2"	1 1/2'-2"	38 lb.
HB33SP	14/21/28	3	3	2KW	BELOW 1.5	50 Ohm	27'	13' 2"	15'	4.73 sq.ft.	102 lb.	1 9/16"	1 1/2'-2"	27 lb.

Call Factory for ANTENNA GAIN dBd and FRONT TO BACK RATIO.

TET FACTORY DIRECT PRICE

HB43SP \$219.95

HB33SP \$174.95

CALL TOLL FREE 1-800-654-3231



TET U.S.A., INC.

✓73



425 HIGHLAND PARKWAY, NORMAN, OKLAHOMA 73069 TEL: 405-360-6410

INTIMIDATED BY MORSE CODE?

THE NEW AEA MODEL MT-1
COMPUTERIZED MORSE
TRAINER MAKES MORSE CODE
EASY AND FUN TO LEARN.



- Automatic Speed Increase, User May Program: Starting Speed, Ending Speed, Practice Duration; 5 Letter code Groups or Random Space; Common or All Characters.
- Precise Speed Control 1 to 99 WPM (Tailor to Your Exact Requirements).
- 24,000 Character Answer Book Available For 10 Starting Positions.
- Random Mode For Practice (No Answers).

KT-1 Computerized Keyer With All Features of Above Trainer is Also Available in Same Package

Germantown

Amateur Supply Inc.

CALL TOLL FREE 1-800-238-6168
In Tennessee Call: 901-452-4276
MON.-SAT. 8:30-5:30, Write: 3202
Summer Ave., Memphis, TN 38112

AEA Brings you the
Breakthrough!

DUPLXERS

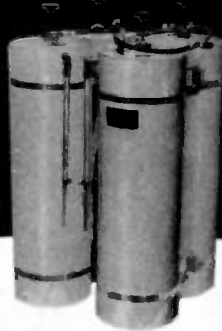

US PATENT
4080601

✓ 79

OUR NEW BANDPASS-
REJECT DUPLXERS WITH
OUR EXCLUSIVE

BpBr CIRCUIT*

... provides superior performance, especially at close frequency spacing.

Models available for all Ham bands. Special price for Amateur Repeater Clubs

CALL OR WRITE FOR DETAILS:

WACOM PRODUCTS, INC.



P. O. Box 7127
Waco, Texas 76710
817/848-4435

GREAT NEWS



CLEGG AB-144

For owners of Multi-Mode 2 Meter Transceivers!

Your present rig becomes a superb VLF/LF/MF/HF receiver tuning continuously from 100 KHz to 30 MHz.

ORDER YOURS TODAY VIA

1-(800)-233-0250

or write for DATA SHEET.

ONLY \$129.95 including UPS

Full refund (less shipping costs) within 10 days if not delighted.

Clegg

✓ 13
Communications Corp.

1911 Old Homestead Lane
Greenfield Industrial Park East
Lancaster, PA 17601
(717) 299-7221

Attention radio amateurs!

FCC-
APPROVED
8-LEVEL ASCII
TELEPRINTER
SALE!

Model 33ASR SF
Good Working Condition

~~\$550~~

Now

\$400!

plus tax and shipping.

Code: ASCII

Speed: 10 cps, 100 baud.

Interface: 20/60 mA,
EIA optional.

From RCA Service Company.
Nationwide Service Available.

RCA

✓ 347

Write:

J.M. Hennelly

RCA Service Company

Bldg. 204-2, Route #38

Cherry Hill, New Jersey 08358

Or call:

800-257-7784 (except New Jersey)

800-232-6973 (New Jersey only)

The QRM Killer

— antenna alternative for 40

Like many people, I have a special problem. While I dearly love amateur radio, my actual operating time is quite limited. Having a busy young family with varied interests, I find that it is usually quite late in the evening by the time things settle down. My job demands that I rise no later than 6:00 am during the workweek, so any hamming I do usually occurs somewhere between 9:30 and 11:00 pm. (I should add that this is further complicated by the fact that I have come to enjoy 40-meter phone operation. Have you ever tried to work the General portion of 40 phone late in the evening?)

The following is a list of common problems I'm sure that many of you can identify with:

- Only 75 kHz is available (7.225-7.300 MHz) in the General portion of the 40-meter band, and it appears that the entire ham population in America wants to operate there in the late evening.
- Foreign broadcast stations mysteriously appear (seemingly out of nowhere) all evening long, usually right after I think I've found a spot clear enough to get a CQ through. These stations also have the temerity to use AM, which is all but uncopyable on most SSB transceivers—so I often

don't even know who they are. Generally, however, they tend to wait until I have engaged some unfortunate in a QSO before they fire up on frequency.

- High ambient rf noise level seems to intensify as the evening proceeds. For example, it might be an S6 level at the start and then various QRM levels may combine to bring this to an S9 within a few hours or so. I should add that I am basically vertically polarized, so this may act to compound the problem somewhat.

- QRM is compounded by those who can't hear me (or anyone else) on the frequency because they, too, have trouble hearing much of anything in the evening.

- I've tried more power, such as provided by a linear, and it solves nothing. The problem is in reception.

- I haven't the desire or space to erect wire beams that are switchable in all directions. Besides, I would never be able to get them high enough to realize their full potential. (Even a fraction of a wavelength at 40 meters is big!)

A few points may be worth mentioning here

because they are probably not unique to my situation: First, the high QRM level is hard to combat—period. Second, the Q5 QSO problem cannot be solved with a linear. Third, and most important, it is necessary to appreciate the fact that the yagi beam (or something comparable) will not solve the problem either. Why? Well, on 40 meters in the evening, we are not exactly facing a traditional type of problem. As a result, simplistic solutions won't work. To illustrate:

- A few weeks ago, using split-frequency operation, I worked two Italian stations in succession on 40-meter phone. One gave me an S9, the other an S7. I copied both Q5 because they were in the clear. The message was gratifying for someone like me who normally has trouble holding a Q5 QSO with either American coast. QRM is clearly the problem. I certainly don't need more power or a beam in order to be heard or to hear anyone else, if I have a clear frequency.

- If I switch from a vertical to a horizontal antenna on receive, sometimes a complete transformation results

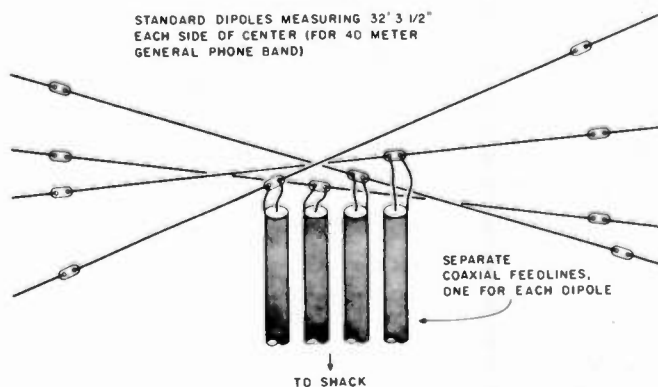

Fig. 1. The basic principle for the QRM Killer evolved from this simple matrixing of crossed dipoles.

—depending upon where the station is that I'm listening to. He could go from Q2-3 to Q5 because of an improved signal-to-noise ratio.

Short Antennas

Much has been written lately about short antennas for the low bands. However, you must build entirely new antennas and the tuning can be difficult. Top hats are also most peculiar-looking. I cannot, somehow, picture my XYL seated under a top-hat umbrella (as depicted in a recent article on short antennas). In addition, I am convinced that I need antenna help primarily for receive.

Why go through an elaborate antenna investment just to solve what is basically a receive problem? What can short antennas accomplish on receive? Well, judging by the latest Sony and Panasonic double- and triple-conversion, battery-powered, allband portable receivers—plenty. (I copied the Italian station mentioned earlier on a Sony that my XYL got me for Christmas. But get this: I received them on the Sony's built-in one-foot telescoping antenna while underground in my basement ham shack. Their signals were every bit as good as they were on my transceiver, which was hooked to a outdoor ham-band antenna.)

Clearly, receivers (including transceivers) have more gain than they need on the low frequencies, so antenna gain itself is not necessary. This is not the case on VHF or on 10 meters, where beams do perform a needed service.

What this does tell us, however, is that short antennas—perhaps those that can be rotated—could be a practical consideration on 40 meters. You might not want to transmit on them, but they certainly might im-

prove the receive situation in the evening.

Here are a few practical considerations:

- While helically-wound elements can "shorten" antenna size on 40, they may not be necessary if we're not planning to load up with rf.

- Element spacing, necessary to achieve directivity and front-to-back ratio, cannot be shortened. So, what good are one-foot elements if we must space them 15 feet apart?

- If a short vertical antenna is constructed, what's the advantage? We still have a vertical, with no directivity, no front-to-back ratio, and no signal-to-noise improvement—probably a degradation.

But, what about a short dipole? The more I thought about this, the more possibilities came to mind.

The Progression

Like tens of thousands of amateurs today, I use a multi-band commercial vertical. Mine is a roof-mounted Hy-Gain 14AVQ-WB which has the minimum number of radials required (2 for each band) per the manufacturer's recommendations. Operationally, it actually performs as a ground plane when elevated in this manner.

On 40 meters, the radiating element is about one-eighth of a wavelength; the radials, however, are a full quarter of a wavelength.

I have experienced exceptionally good luck with this very simple antenna system. After much study, I feel there are two reasons for this:

- 1) The antenna height is almost exactly one quarter of a wavelength on 40 meters.

- 2) All radials are elevated above the roof.

With these points in mind, let's go back and see if such a system can solve our basic problem.

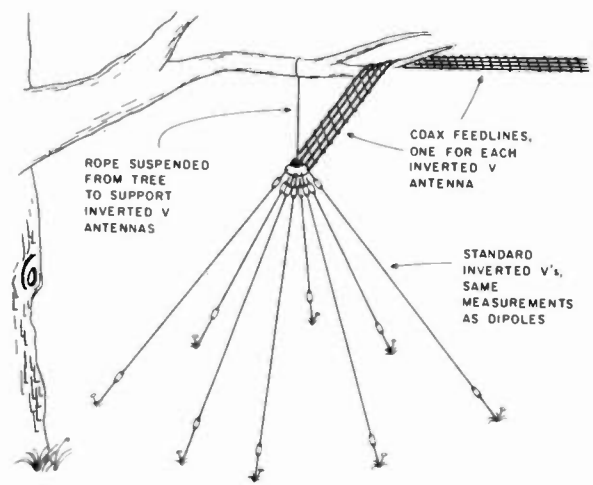

Fig. 2. More appropriate for most hams—at least those who use 40 meters—might be this crossed system of inverted vees. (Notice how this resembles most rooftop vertical radial systems.)

If a dipole, even a short receive dipole (as contrasted with the vertical), could possibly solve the 40-meter QRM problem, a switchable dipole array might also afford the directivity necessary to null out unwanted signals (see Fig. 1).

This idea has its drawbacks, however. First, it would mean that I must install another antenna system in the trees. Second, it would take up a lot of space, especially if I were to go full size with the elements, although that might not be necessary.

A variation of this, though, would be the same principle used in an inverted-vee fashion (see Fig. 2). This might be somewhat easier to erect, but could run the risk—depending upon apex angles—of functioning as a vertically-polarized array. Either system holds potential, especially in short-element configurations.

What about interaction between the dipoles? What would happen if we could select one dipole and ground all unused dipoles? This concept of grounding unused elements is an interesting one and, as far as I know, has not yet been fully explored. It holds some fas-

inating potential in the areas of pattern changes, broadbanding effects, and general quieting.

Take another look at Fig. 2. What does it resemble? Right—the radial system of a roof-mounted vertical.

Notice how easily we have progressed to the central idea: Why not work up a system that will selectively activate a portion of a radial system, converting it to dipole operation while leaving the remaining radials functioning as is, and feed this dipole through a separate coaxial line for receive? It wouldn't have to work exactly like that, but the central idea seems to be well worth exploring.

Results

Let me digress a moment and summarize what has happened since this idea first struck. At first I looked far and wide to find someone who had tried it, to no avail. Second, I reviewed every antenna article I could find published over the last 20 years and could find nothing on this approach. So, I resigned myself to having to actually construct something and give it a try.

I have conducted a series of tests on the air, and the results are extremely en-

couraging and worth reporting. In my ham shack I now have a remote-control unit which will select any given radial on the roof, remove it from the antenna circuit, convert it to a dipole, and allow me to use it as a receive antenna. Here's a summary of how it operates:

- Surprisingly, I find I can load the selected radial/dipole on transmit as well. Only one radial/dipole presents an SWR change from the basic 1:1 of the vertical, and that one only presents 1.24:1.
- The basic unit does solve the receive problem that has plagued me for years now. I can pull any signal out of the noise/QRM by "rotating" the system until I hit the optimum antenna.
- No receive preamplifier

is necessary, even though several radials are cut for other frequencies.

- So far, I have not lost one QSO! I can copy everything!
- Noise level is reduced considerably. For example, if one examines the ratio of noise level to overall signal strength when comparing the old vertical with the new system, the results are shown in Table 1.
- It is possible to null foreign broadcast QRM. In all cases, I've been able to lift the desired station above the foreign broadcast QRM level.
- In 40% of the cases, my own signal report goes up one to two S-units when I transmit over the radial/dipole, in contrast to the vertical. This difference diminishes with distance, of

course, as the vertical continues to excel over DX hauls.

- If I call CQ and several stations reply, I now find myself eager and able to select the weakest signal respondent for the QSO. I'm finding a whole new world of DX and QRP people out there who were probably there all along—but I simply couldn't hear them.

Now, I don't want to mislead anyone into thinking that this system eliminates all 40-meter evening-hour difficulties. It does not. It does, however, solve more problems in this area than anything else I've ever seen.

So far, everyone I've spoken with has requested (over the air) a detailed explanation of the system and how it works. I've found that this is not the best way to disseminate the information. It takes too much time and reaches too few people. This article will, hopefully, inform a large enough audience and spark other experiments in this direction. Most conversations, once I've explained the system, usually end with the other station saying, "How simple. I wonder why no one has done it before?" I have the same question myself!

Other Benefits

Aside from performance,

there are several other benefits to be derived from this configuration:

- 1) No "new" antenna(s) must be constructed.
- 2) The switching unit is not ugly and, thus, no new neighborhood eyesore is created.
- 3) It is incredibly easy to construct.
- 4) It can be expanded easily, so that additional radials/dipoles can be added if desired.
- 5) It is quite inexpensive to put together as all parts are readily available from either a junk box, hamfest flea markets, ham parts dealers, or your local Radio Shack or Olson Radio outlet.
- 6) It will work almost as well on other bands as on 40 meters.

I honestly feel you'll enjoy building something that, until now, has not been done and is not yet commercially available. This means you'll be able to configure the design for your own particular requirements and be able to completely baffle others who will be wondering how you are suddenly able to do so much better.

How It Works

While this may not be the most effective example of the principle, the unit I constructed functions quite simply.

Each radial on the vertical is disconnected from the antenna, and an insulator is inserted as close to the original tie point as possible.

Next, a short jumper wire is affixed to the radial, which then is connected to a relay at the antenna. The relay, unless activated, grounds the radial back to the antenna. In this fashion, the vertical performs as usual unless a relay is turned on.

Two radials, opposite each other, tie to a single

Call	Vertical Q factor	Percent of noise	New Q factor	New Percent of noise
WB8CHJ	Q4	60%	Q5	20%
KA3AVP	Q4	50%	Q5	15%
K2ZTL	Q3	70%	Q5	20%
K3VK	Q2-3	60-75%	Q5	25%
W9UPV	Q4-5	40-50%	Q5	10%
K9HWØ	Q1	98%	Q5	20%

Table 1.

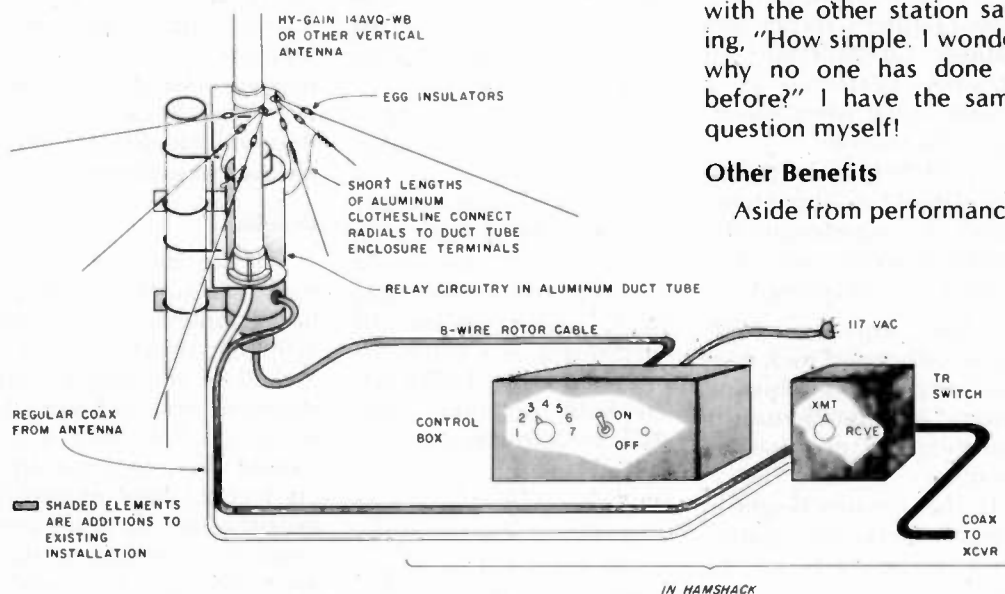

Fig. 3. Overall view (not drawn to scale) of the QRM Killer system, composed of the existing rooftop vertical, the adapter box attached to the antenna, a new feedline and length of rotor cable, and the control box at the ham shack. In operation, the radials/dipoles are steered remotely from the shack. Relays in the adapter unit on the roof select any given radial pair, disconnect them from the overall antenna, and re-configure them into an active-dipole antenna.

THE BEST



TS-520SE



FT-101ZD



TR-7800

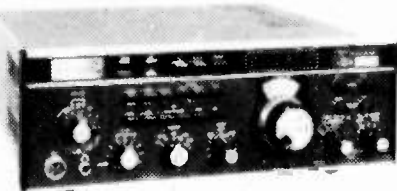

TR-7



IC-251A

TOP OF THE LINE. NUMBER ONE!

IF YOU'RE THE TYPE OF PERSON THAT WILL SETTLE FOR NOTHING LESS, WE'VE GOT WHAT YOU'RE LOOKING FOR — TOP OF THE LINE FROM THE TOP LINES. WE OFFER MORE THAN JUST THE RIGS — SUPER SERVICE AFTER THE SALE. CALL US SOON FOR A QUOTE ON YOUR NEXT RIG.

ORDER TOLL FREE!

800-845-6183



G.I.S.M.O. ✓²⁷
2305 CHERRY ROAD
ROCK HILL, S.C. 29730

Service Department
Call 803-366-7158

relay (I used a 3PDT type). When the relay is turned on, both radials are removed from the vertical antenna ground circuit and connected, instead, to a separate (new) coaxial line feeding down to the shack. One of the two radials is connected through the relay to the shield of the coax, the opposite radial to the center conductor. The effect realized is a sloping dipole, with the angle depending solely on your own particular rooftop.

I find that fascinating effects can be realized by the interaction which results from the fact that the existing design leaves all deactivated radials still functioning as radials. Similarly, by selectively removing the activated radial pair from the system when using the vertical in its normal state, interesting things happen to the otherwise normal omnidirectional vertical pattern. It is entirely possible, I'm finding, to actually improve transmit effectiveness by eliminating a particular radial pair, depending on where the other station is located.

How does this thing work? I'm not completely sure myself. From an equipment standpoint, my system uses a standard 8-wire rotor cable to interconnect the antenna-mounted relay bank with the remote-control switcher in the basement ham shack. There, a single-pole rotary switch fires a transformer-reduced (to 6 V ac) current to the desired rooftop relay. When the transformer unit is switched off, the entire system shuts down and the vertical system operates as usual.

Construction: The Enclosure

While I can now think of a multitude of other and perhaps better ways to operate this system, let me first discuss exactly what I constructed. If you wish to

follow the approach I used, at least you can be assured that it won't cost you very much for parts. (Later, we'll discuss practical variations, including one that I have added to my own unit.)

I suggest that the first item you obtain should be the enclosure. (I failed to do this myself and ended up doing some rewiring that otherwise would not have been necessary.)

For the primary rooftop enclosure, I wanted some-

thing that could be readily mounted at the antenna itself and as close to the radials as possible in order to eliminate long leads that might otherwise alter resonant frequencies. I wanted it to be made of aluminum, easily weatherproofed, easy to get inside of if necessary, and capable of circuit expansion later, if so desired.

My only other consideration was that it should be vertical, to complement the

existing 14 AVQ-WB antenna from a visual standpoint. The perfect solution for this was found just around the corner at the neighborhood hardware store—heat ducting.

What I obtained was just the ticket and ended up only costing about two dollars:

- 1) A standard 6" diameter aluminum duct tube, about two feet long.
- 2) A reducing vent cap to fit the top of the tube,

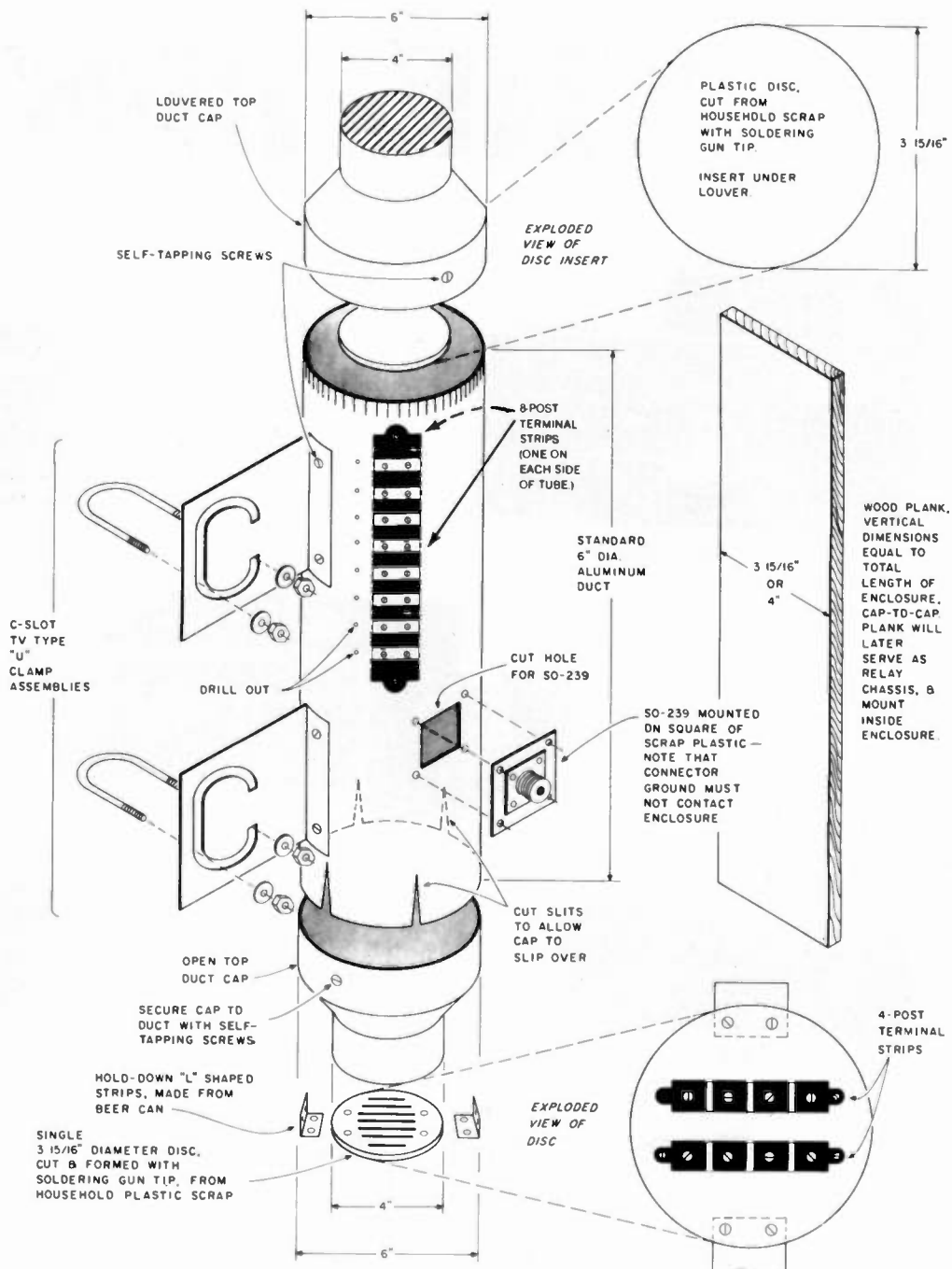

Fig. 4. Detail of the rooftop enclosure, fashioned from standard small-diameter aluminum duct work, available at any hardware store.

Good-bye RFI

With the compact ATR-6800, you can forget about RFI . . . Add silent RTTY/CW/SSTV capability to your station with equipment that's designed to be ham gear! Unlike plastic-cased home computers, your ATR-6800 will sit right next to your kilowatt and ignore it! (And your receiver won't know it's there either!) By combining everything in one rugged aluminum enclosure, we have eliminated another source of RFI — all those boxes and assorted cables. The ATR-6800 is really complete; the AFSK-terminal unit, keying circuits, video drive, computer . . . everything's inside for direct connection and control of your transceiver. To get the full story, write for our ten page brochure or pick one up at your local dealer. Microlog Corporation, 4 Professional Drive, Suite 119, Gaithersburg, MD 20760. Telephone (301) 948-5307.



MICROLOG ✓ 51

Innovators in Digital Communications

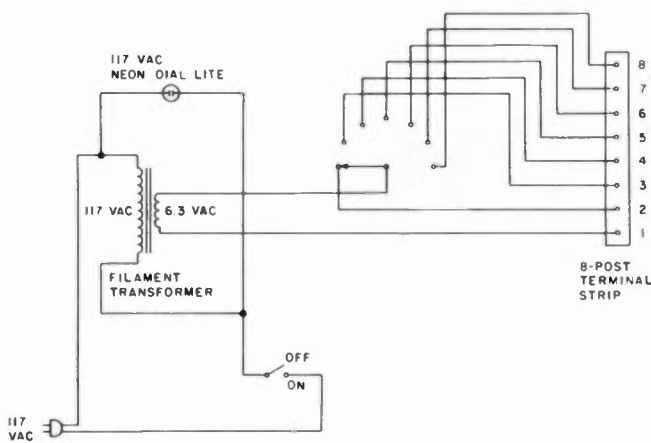

Fig. 5. Schematic of the control box used to activate and steer the system.

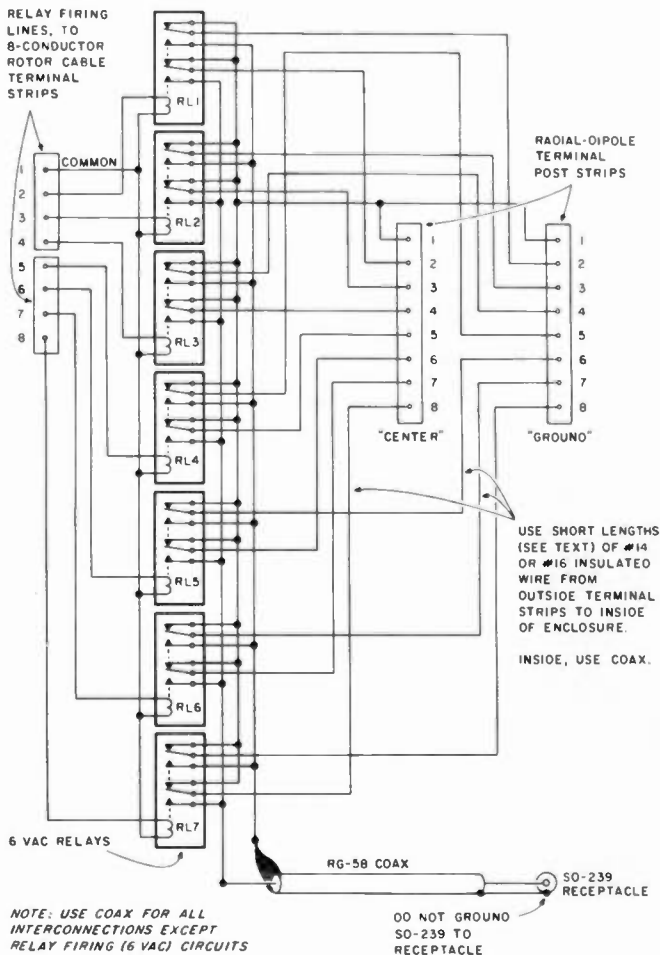

Fig. 6. Schematic of the relay-switching circuit, heart of the QRM Killer. This circuit is mounted on a wood strip and inserted into the duct-tube enclosure at the antenna.

which looks like a round, 4" louvered lid. This vent cap slips over the 6" diameter tube with a 1/2" to 2" lip.

3) An open-ended reducing cap, much like the louvered one, which also can be made to fit over the duct tube. (See Fig. 4 for more

detail on this enclosure.)

As with any piece of ducting, one end is ridged to be able to slip into another identically-diametered piece of duct work. To cap off both ends as I did, however, you'll need to slot the bottom end

of the duct with a pair of metal cutters in order to permit the open-ended cap to slip over the end.

The temporarily-mounted caps should then be drilled through to permit two self-tapping screws on either side of each cap to serve as fasteners.

Next, find some plastic scrap around the house. I used a split clear-plastic shoebox.

With a heated soldering-gun element, "cut" two disks to fit inside the 4" diameter caps. The top disk is simple. The bottom disk should be formed the same, except that it should have two rectangular holes to allow for installation of two screw-type outboard terminal strips used later to connect to the rotor cable. I bought 4-post terminal strips at the local Radio Shack. Drill holes to install the terminal strips in the bottom disk, affixing them with small nuts and bolts.

To connect the radials to the system, you'll find it useful to use two 8-terminal strips mounted vertically near the top or upper center of the enclosure on opposite sides of the duct tube. These should be positioned at right angles, away from the U-clamp assemblies. More on this shortly.

Drill a hole through the enclosure duct next to each terminal-strip connection, for a total of 8 holes per strip. You'll ultimately feed insulated wires through these holes which will terminate at the RG-58/U coax used to connect to internal relays.

At this point, the enclosure is almost complete, save for the coax connector and a means of mounting.

First, drill out a hole in the tube's lower section and install an SO-239 connector.

The mounting method really had me perplexed until I stumbled onto the solution while at Radio Shack.

They make an unusual U-bolt hardware assembly that is circularly slotted. This means that the U-bolts, which come with the assembly, can be turned in one direction for clamping even though the duct tube runs in another. Perfect! (See Fig. 4 again for some idea of what these things look like.)

Gads! I almost forgot to tell you how I affixed the bottom plastic (with terminal strips) to the end cap! Get out the tin snips and prepare to operate on a beer can. Cut yourself a 1" x 3" strip for each side of the disk. Connect them by bolt and nut to the disk and use self-tapping screws to connect them to the aluminum cap.

It is also important that the enclosure be conductive, for two reasons:

1) Primary electrical ground to the vertical antenna will be accomplished through the U-clamp to the grounded vertical masting below the radiating element of the 14AVQ-WB.

2) The entire enclosure functions as a very effective shield for the circuitry inside, enabling radial resonance to be maintained on the antenna itself. This shielding enclosure also helps to minimize stray-lead pickup of signals.

All I know is that it works well the way it is, although the more ingenious among you may easily devise another means of electrically grounding and shielding in a simpler way.

The Control Box

This part is so simple that I will go over it rather quickly. I happened to have an available panel box that I'd used before for a different antenna-switching system.

The key elements are:
 ● A 6.3-volt filament transformer (chosen because I didn't want to ever run the risk of electrocuting myself).

- A piece of 117-V ac line cord.

- A single-pole rotary switch with at least 8 available positions.

If you wish to add a few refinements (as I did), you'll need a miniature 117-V ac toggle switch and a panel-mounted neon lamp.

The circuit that I used for the control box is shown in Fig. 5. I also installed an 8-post terminal strip on the rear of my control box for easy interconnection to the rotor cable. For the common lead, I used the black rotor wire.

Relay Switching Circuit

For my own system, this was the really fun part. I enjoyed wiring and testing the relay system which does the actual conversion of radials into operating dipoles. Here's what I used:

- 1) Seven 6-volt ac 3PDT enclosed relays. You actually need only two of the three operating circuits, but these relays came cheap for me.

- 2) Two more 4-post terminal strips.

- 3) Two more beer cans (to make clamps to hold the relays in place).

- 4) Some RG-58/U coax.

- 5) Some hookup wire.

- 6) A plank of wood, as long as the enclosure, yet narrow enough to fit snugly inside the 4" diameter enclosure caps. This wood becomes your chassis.

You could probably eliminate the beer cans if you obtain relays which could be fastened down or socketed. Mine could not be, so I had to empty the beer cans and fabricate some hold-down strips from them.

For the circuit, refer to Fig. 6. This is much simpler than the original version, which was designed before I realized the advantage of using the conducting enclosure—which eliminated a lot of ground wiring.

However simple, it works very well. For clarity, the schematic (Fig. 6) shows the radials as dipoles. In reality, though, remember that they are opposite radial pairs—the same ones now on the vertical.

The only change you must make later is to install egg insulators at the antenna to force the radials to go through your relay-switching circuit in order to function normally.

If you are a typical BTV or 14AVQ owner, you've noted by this time that I've several more relays going here than you have radial pairs (four are normal, one each for 10, 15, 20, and 40 meters). This allows for further expansion of the rooftop system, which we will discuss later. However, you could simply use four relays and do just fine.

There is nothing particularly tricky about this circuit, except its objective—which you may want to change somewhat to suit your own needs. Personally, my desire is to have all radials functioning as radials at all times, except when I select a pair by activating the corresponding relay.

In the circuit shown, the selected pair of radials is removed from the antenna circuit completely and connected in dipole fashion to a second feedline going down to the ham shack. This "receive" dipole can then be switched into the primary transceiver antenna feed whenever desired. Another option, of course, would be to use the transceiver relay to automatically kick in an antenna changeover relay on receive that would be connected to the new relay system. However, at the moment, I enjoy the manual select operation because it permits me instant comparison with the vertical system.

In wiring the relay circuits, I found myself mak-

ing errors. Initially, I used insulated wire throughout. However, because I had to rewire anyway (because of the errors), it seemed like a good time to switch over to RG-58 coax for all the active rf circuits. In retrospect, it is probably a good idea to do this at the outset to minimize the length of "free" wire, carrying either primary or ground-circuit rf. If I hadn't done this, I probably would have had to shorten the antenna radials to return them all to resonance.

Mechanically, I mounted each relay about one relay-length from each other on the long strip of wood mentioned earlier. This was more than ample, and there was plenty of room both in-between and alongside to run the wires and coax (see Fig. 7).

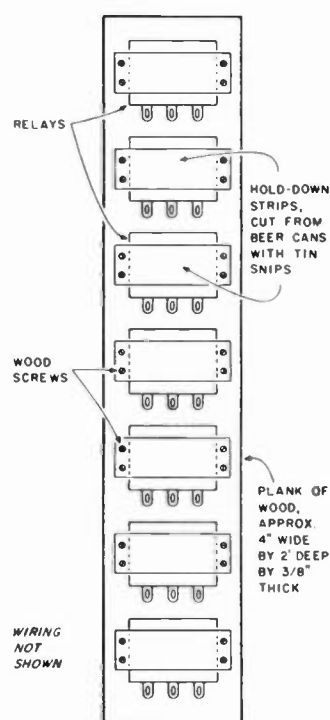

Fig. 7. General mechanical layout of the relay-switching circuit.

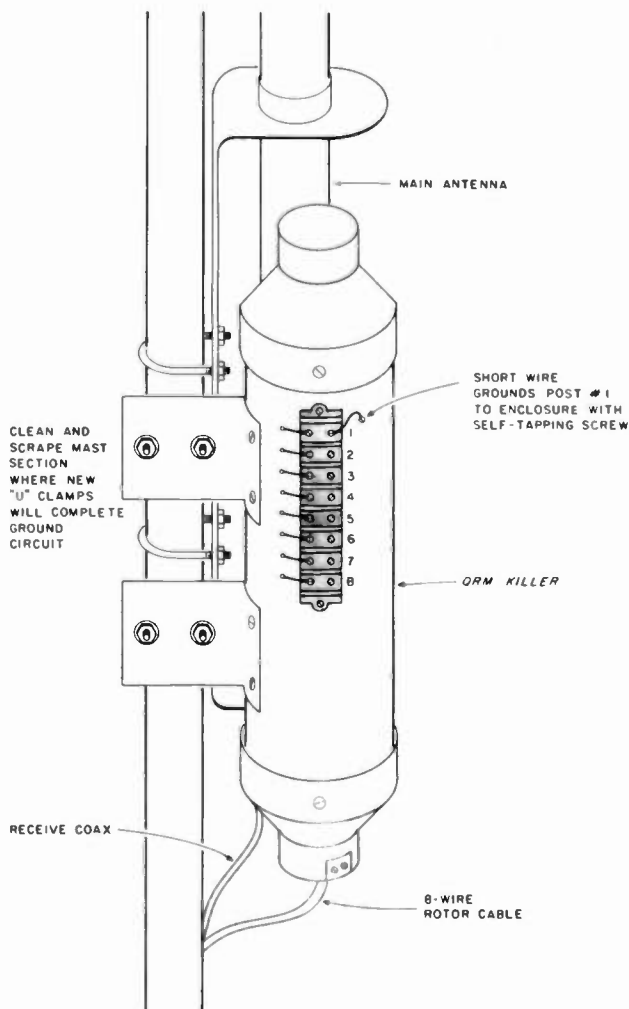

Fig. 8. Pictorial shows how the enclosure is mounted to the rooftop antenna, after assembly is complete and tested.

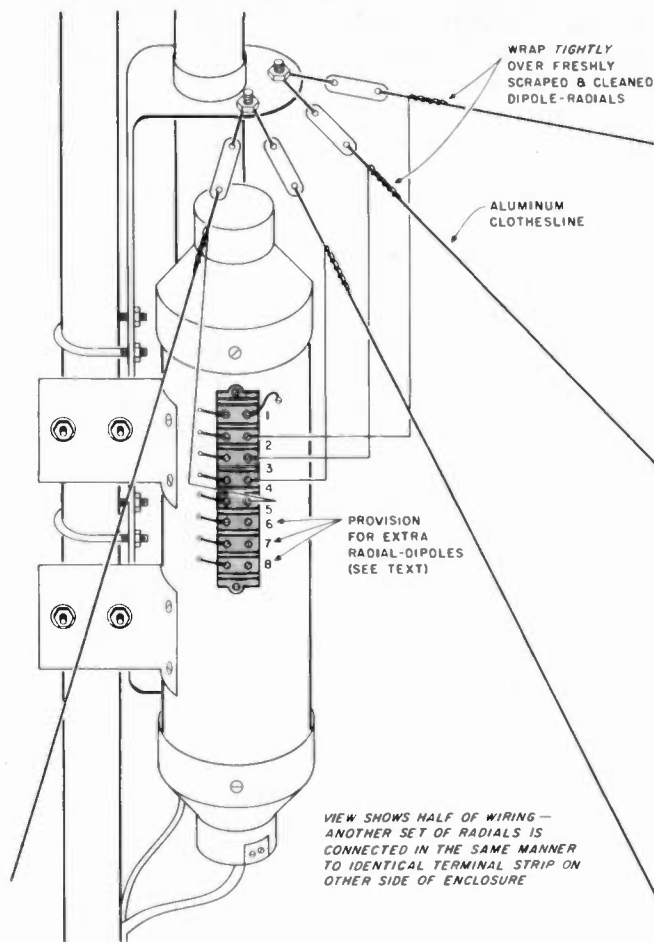

Fig. 9. This view shows how the radials are connected to the enclosure unit. A simulated wire-wrap technique using short lengths of aluminum clothesline does quite well.

Mounting the Relay Assembly in the Enclosure

Before attempting to put the relay assembly and the rooftop enclosure together, you'll want to do a few more things to the enclosure. Specifically, add the interconnecting wiring as follows (see Fig. 8):

1) Cut 14 lengths of stranded insulated wire, each about a foot long. This can be #14, #16, or whatever. Strip the ends and pass them through all the 8-post terminal holes on the side of the enclosure except the top two—terminal one at the top of each strip.

2) Make certain there is some play between the diameter of the holes you drilled and the size of the wire; too tight a condition might lead to an inadvertent stripping of the insulation and a shorting-out of

the leads to the enclosure ground.

3) Next cut two short pieces, strip the ends, and terminate each of these to the top screw-down terminal posts. Remember that there are two 8-post terminal strips on each side of the enclosure. To summarize:

Terminal one gets the short lead. Drill a hole through the enclosure near terminal post one on each strip, insert a self-tapping screw, and terminate the other end of the short terminal #1 lead to ground in this manner.

Terminate terminals 2 through 8 on each strip to the long 1' wires.

The total of 14 wires now passing through to the inside of the enclosure will later be terminated to coax

from the relay circuits.

4) Next, take the long coax feedline that goes into the relay circuit (the receive line) and connect it to the SO-239 receptacle connection points on the inside of the enclosure. Allow enough feedline so that you'll be able to slip in the entire relay strip later. There will be ample room inside the enclosure to house any extra coax length that may be necessary here.

Now the relay firing wires must be connected to the terminal strips on the underside cap of the enclosure. Again, leave ample room for maneuvering later on. These should, of course, be connected in sequence to correspond with the control-box switching system.

You are now ready to insert the relay strip and its associated wiring into the enclosure. You'll want to slip it through from the bottom.

Once this has been accomplished, pull all the coax ends from the relays through the top of the enclosure. Do the same with the insulated terminal-strip wires. Match them carefully, strip the coax, and connect them, using as short a length of the insulated wire as you can and still be able to move the relay strip in and out of the enclosure.

For simplicity's sake, I use one of the outside vertical 8-post terminal strips as "center" and the other as "ground" and I mark them that way on the outside of the enclosure. This greatly eases coax wiring at this stage.

Each terminal-strip-wire number (corresponding to a given post point) is either soldered to a coax center or to a coax-shield ground. In this manner, for example, the "center" terminal strip post-2 wire goes to relay one's coax center conductor. The shield from that relay goes to the "ground" terminal strip post-2 wire.

This sequence is repeated until all posts are so terminated.

At this point, before everything is permanently capped off and bolted shut, it is a good idea to check performance. If you have done everything correctly, you should be able to interconnect the control box to the enclosure assembly, connect a piece of interconnecting coax from the SO-239 connector to your transceiver, and give it a whirl on receive.

All this can be done in the shack. To check out the switching, listen for a sequential relay clacking as you rotate the control-box switch through its various positions. So far so good?

Next, connect a couple of wires to the antenna lead coming from your rooftop antenna. Connect the ground side to the "ground" terminal strip, terminal 2, and the center conductor to the "center" terminal strip, terminal 2. Activate the control box and switch to the first relay. At this point it should be quite obvious to your receiver that this thing is working. In this position, you should have normal reception, with next to nothing on all the other positions.

Repeat this test on terminals 3 through 8 until you are satisfied that each works as it should. You may hear some signals very weakly on the posts not connected to your antenna, but most of this pickup comes from exposed wiring. This will all but disappear after you connect the assembly to your antenna.

If everything is okay, you have a little more work to do at this point:

1) Position the relay strip inside the enclosure, center it vertically, and stuff all the wiring inside.

2) Now, insert the plastic disk into the top ventilating cap (to keep the rain out), center the wood strip, and

Even WEAK SIGNALS print clearly with a HAL Demodulator.

ST-6000 Demodulator \$659.00



ST-5000 Demodulator \$239.00



Pulling in weak or distorted signals with a HAL Demodulator is no problem. Even if the band is crowded.

With high-gain, wide-bandwidth limiters and extremely linear active detector circuits, both the ST-6000 and ST-5000 Demodulators convert RTTY tones into strong, readable signals that display bright and clear.

Tones necessary for transmitting RTTY are conveniently generated and receive filters and transmit tones are accurately set and matched to assure on-the-money transceive operation.

Both the ST-6000 & ST-5000 offer these features:

Internal Loop Supply • Internal AFSK Generator with CW ID Tone • Internal Tuning Indicator • Autostart Motor Control • Line/Local Loop Control • TTY Machine Compatibility • RS-232 type DATA Interface • "High" or "Low" Tones • 120/240, 50/60 Hz Power • Normal/Reverse Switch • 170 and 850 Shift • Active Discriminator • Metal Cabinets for RF Shielding.

Special Features of the ST-6000:

Mark-Hold • Antispace • Automatic Threshold Control (ATC) • Decision Threshold Hysteresis (DTH) • Keyboard Operated Switch (KOS) • MIL-188 and CMOS Data Interface • Oscilloscope Tuning Indicator • Crystal Controlled AFSK Tones • Active Input Bandpass Filter • Pre-Limiter AGC • Three Shifts (170 - 425 - 850)

Write or give us a call. We'll be glad to send you our new RTTY catalog.



HAL COMMUNICATIONS CORP.
Box 365
Urbana, Illinois 61801
217-367-7373

For our European customers, contact: Richter & Co. D3000 Hannover 1 • I.E.C. Interelco, 6816 Bissone/Lugano • Radio Shack Ltd., London NW6 3AY • Erik Torpdahl Telecom, DK 3660 Stenlose Denmark

slide the cap over the relay wood strip and then on down over the duct work. Now, using self-tapping screws, secure the top cap to the main enclosure.

3) Follow pretty much the same procedure for the bottom cap assembly. Make certain the wood inserts into the smaller diameter of the cap.

4) Once the bottom cap is secured, drill and use woodscrews through the sides of the enclosure into the edges of the wood at one or two places. This will relieve the duty of the caps (which should be for positioning and centering only) and give more support to the wooden relay strip.

When you are all through, the entire unit should be able to be jarred without rattling. As a safety precaution at this point, repeat the testing procedure conducted earlier, running the circuit through posts 2 through 8 to verify that everything is still okay.

Rooftop Installation

Before the unit is installed, you'll want to electrically disconnect all the radials from the antenna itself.

Depending on how many radials you're using, you'll need a number of egg insulators. Cut the radials a few inches out from where they are terminated to the antenna. You'll need this extra lead length (I left 6-8 inches) to secure the egg insulator at the antenna. Do this all around the antenna.

If your radials also serve as guys, you'll want to reconnect the radial ends to the insulators as you go—to prevent your antenna from crashing down on the rooftop. In some cases, you may have to readjust the end lengths so that they will free enough extra radial lead at the insulator to wrap around sufficiently to ensure a secure termination (see Fig. 9).

Important: If you have followed these instructions fairly well, the radial lengths, even though they are now shortened a mite because of the new insulators, will still resonate well at the operating frequencies for which they are intended after installation is complete. This is because of the internal wiring from the two 8-post terminal strips to the coax. The rest of the needed length will be accomplished later.

Once the radials have been insulated off and re-secured, it is time to mount the unit. As indicated earlier, it mounts vertically, but note that the U-clamp assembly mount causes a mechanical standoff condition to exist, so that the duct tube parallels the antenna mast about two inches away.

The two U-clamps are all that is required to connect the unit to the antenna mast. Position the unit as high as possible under the antenna, so that the terminal strips will be immediately underneath the radials. This will allow your connections to the radials to be reasonably short.

Now, for connection of the radials to the unit. I found that aluminum clothesline is perfect for this job (see Fig. 9). I removed the screw from post 2 of the terminal strip, bent the end of a short length of clothesline around it, and then screwed it back down into the terminal post.

The free end of the clothesline is now *tightly* wrapped around a *cleaned* section of radial. If you use a couple of pairs of pliers when doing this, you'll have a neat, wire-wrap effect. Now find the opposite radial and connect that to terminal post 2 of the opposite terminal strip. Do this in rotation all the way around the antenna until all radials are connected.

Once this is done, your

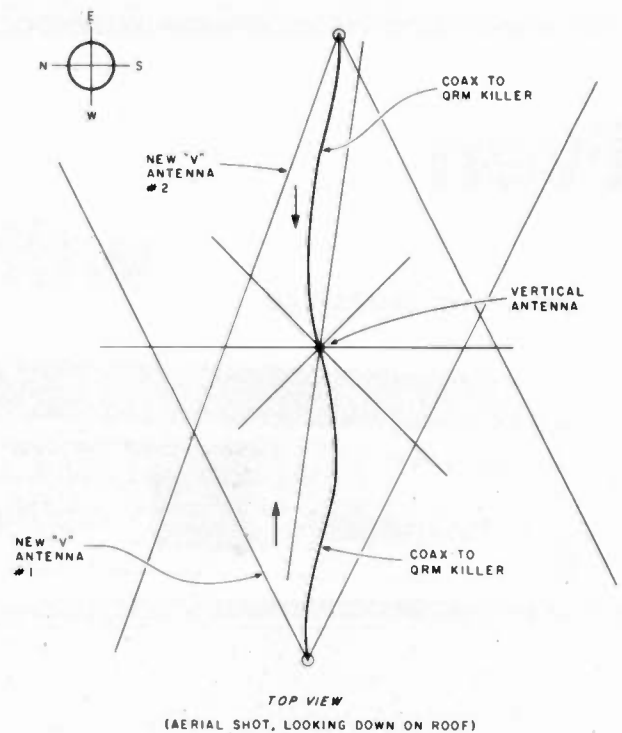

Fig. 10. This view shows the rooftop system with two vees added by the author. While these are east and west of each other at my QTH, the vee configuration not only fits the roof but also concentrates the beam in the desired direction.

installation is complete. All you need do now is install a length of RG-58/U (or RG-8/U, or whatever) to the SO-239 on the enclosure and wire up your rotor cable correctly to the bottom of the unit. You may want to tape these connections or otherwise seal them from the weather.

Return now to the shack and give her a try! Your swr should be the same as it was originally, before the new system was installed.

Modifications

As was noted, I provided for more relays than I had original radials.

How I took advantage of this is shown in Fig. 10. I set up two new vee antennas on the roof, each firing in an opposite direction, although both are basically capturing east-west signals because of the layout of my particular roof.

For these vees to be optimum, they need to be elevated from the roof somewhat. TV-type standoff insulators are ideal for this

purpose.

To feed these vees, I use RG-58/U and terminate it to the unit at the 8-post terminal strips.

Other modifications are possible which might markedly improve the ease with which this system operates. One would be a system which would use the transceiver relay to automatically trigger a T-R relay. Another possibility would be to add a circuit at both the box and the relay strip to switch in the primary coax at the antenna, thus eliminating all need for a separate receive feedline to the ham shack. I would guess that many of you may elect to go this route. If you would like to do this, simply wire up one of the relays provided to permit this to happen and see that it remains activated no matter which of the other relays is selected for receive.

Another modification that some may wish to experiment with would be to change the basic wiring

SOMETHING DIFFERENT

The FT-107 Series with "DMS"*

"It's A Cut Above The Rest"

* **OPTIONAL DIGITAL MEMORY SHIFT ("DMS")**
12 discrete memories. Stores individual frequencies or use as 12 full coverage VFOs (500 kHz each)

- Solid State
- 240 watts DC SSB/CW
- 160-10 meters, WWV (2 auxiliary band positions are available for future expansion)
- RF Speech Processor
- SSB, CW, AM, FSK
- Built-in SWR Meter
- Excellent Dynamic Range
- Audio Peak/Notch Filter
- Variable Bandwidth
- Full Line of Accessories



The FT-107 has been created as a result of a blending of technologies — computer, solid state and RF design. By careful utilization of these disciplines and the experience gained from our FT-301 series, YAESU has achieved an HF transceiver which offers unique features (e. g. "Digital Memory Shift"), efficient operation and a level of performance that has been previously unattainable.

(Receiver Section) FT-107 TRANSCEIVER SPECIFICATIONS (Transmitter Section)

Sensitivity: 0.25 μ V for 10dB S/N, CW/SSB, FSK
1.0 μ V for 10dB S/N, AM

Image Rejection: 60dB except 10 meters (50dB)

IF Rejection: 70dB

Selectivity: SSB 2.4 kHz at -6dB, 4.0 kHz at -60dB.
*CW 0.6 kHz at -6dB, 1.2 kHz at -60dB.
*AM 6 kHz at -6dB, 12 kHz at -60dB
Variable IF Bandwidth

20dB RF Attenuator

Peak/Notch Audio Filter

Audio Output: 3 watts (4-16 ohms)

Accessories: FV-107 VFO (standard not synthesized)
FTV-107 VHF (UHF Transverter)
FC-107 Antenna Tuner
SP-107 Matching Speaker
FP-107 AC Power Supply

*CW/AM Filters Optional

Power Input: 240W DC (SSB/CW) 80W DC (AM/FSK)

Opposite Sideband Suppression: Better than 50dB

Spurious Radiation: -50dB.

Transmitter Bandwidth 350-2700 hz (-6dB)

Transmitter: 3rd IMD -31dB neg feedback 6dB

Transmitter Stability: 300 hz after 10 min. warmup
less than 100 hz after 30 min.

Antenna Input Impedance: 50 ohms

Microphone Impedance: 500 ohms

Power Required: 13.5V DC at 20 amps
** 100/110/117/200/220/234V AC at 650 VA
**FP-107 or FP-107E Optional

YAESU ⁸³ 

The radio. 1179RR

Price And Specifications Subject To
Change Without Notice Or Obligation

YAESU ELECTRONICS CORP., 6851 Waltham Way, Paramount, CA 90723 • (213) 633-4007
YAESU ELECTRONICS Eastern Service Ctr., 9812 Princeton-Glendale Rd., Cincinnati, OH 45246

some system for measuring results. Well, I'm still in the process of doing that with this array:

● First, I check for improved receive Q-factor. My system (shown in Table 1) is a simple listing of existing Q-factor and existing noise level expressed as a percentage. I "rotate" my system, find the optimum position, and record the findings. Once a pattern has been established, you should be able to find the "right" radial/dipole fast.

● Next, I check the antenna pattern. This is a bit more difficult because there are several patterns to deal with here. However, a simple method is to begin with the "nulling" out of identified foreign broadcast signals.

As for me, I'm still working on the pattern situation and don't know if I'll ever really get it all figured out. The most intriguing situation, at least to me, is the primary-antenna pattern change which sometimes occurs as a particular radial/dipole is removed from the circuit. Often, it produces startling results to just listen on the main vertical antenna and then rotate through the radials/dipoles.

Conclusions

While this design undoubtedly will be refined and improved upon by many over the years ahead, I have formed a few preliminary conclusions based on my own results to date:

1) It works better on 40 meters than on just about any other band. On 20, it is gangbusters on receive, but does not perform as well on transmit as would a rotatable yagi or quad.

2) It proves (through active use of radial elements not cut for 40) that short antennas are very effective on receive, with nothing needed (as far as loading coils, etc.) to make them work well.

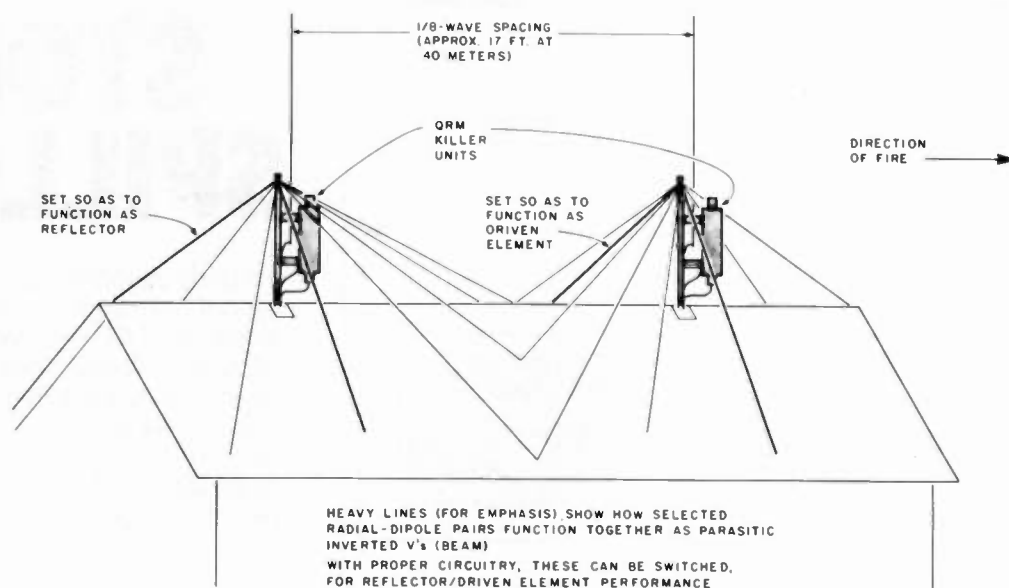

Fig. 13. Layout of a double QRM Killer array, showing how parasitic coupling could be achieved, if desired, for added 2-element directivity. See text for details.

3) The system should work well for anyone now using a roof-mounted vertical (ground-plane) antenna.

4) Signal-to-noise ratio is dramatically improved, particularly if the noise is QRM-generated.

5) A degree of directivity is achieved, directivity which can be beamed in a particular direction by rotating the system remotely.

One Final Thought

Though I have not yet tried this, it seems entirely possible that parasitic element performance—and, hence, even greater directivity—could readily be obtained by adding another vertical array.

I plan to do this in the near future. What I will install is another Hy-Gain 14AVQ essentially for phasing purposes.

However, for simplicity's sake, one could forego phasing and simply place the two arrays about 15 feet apart for 40 meters (if this is the desired band for this effort).

A second array could be wired into the same control box so that, as radial/dipole "A" is activated from antenna #1, the same thing happens at antenna #2.

That is, the corresponding radial/dipole "A" on antenna #2 is also activated by removing it from antenna ground and putting it into a parasitic relationship with that on antenna #1. The next logical step would be to work up a system for lengthening either of the two radials/dipoles on command from the ham shack. Doing so would enable you to realize pattern reversibility, as one radial/dipole functions as the driven element while the other functions as a reflector. This would make for a most interesting study. And the very least that could happen (which would be nothing) would still leave you with an omnidirectional overall system gain of 3 dB, as the two verticals are driven together (less fading would be noticeable, also).

If one were to add phasing to the system, spacing at 40 meters should probably be about 17 feet between the two antennas (1/8 wavelength) (Fig. 13). If you went out to the full 40-meter 1/4-wave spacing (34 feet), you might be too far out to realize any desired parasitic interaction. However, with a correct phasing system and corresponding delay-line switch box at the

ham shack, you should be able to pick up 10 dB or so when flipping between end-fire and broadside positions. Then, when firing up the paralleled systems discussed in this article, considerable additional directivity and front-to-back ratio might be achieved through the reversal of the driven element and reflector and relay-controlled "rotation" of the radial/dipole element. (This assumes that the phasing system would also be flipped into the activated radial/dipole circuit as well.)

If everything worked out, you could easily end up with the same effect (and maybe better) that you would realize with a full-size rotatable 2-element 40-meter beam. Plus, you'd have the advantage of being able to switch polarization to take advantage of DX.

Well, regardless of what you end up doing with this thing, I'll continue tinkering and will report results of other designs as they evolve. Meantime, if you are troubled with 40-meter QRM and are thinking of giving it all up for 2 meters, do give this system a try. You'll be pleasantly surprised. ■

NEW!!

ATTENTION MOBILE HAMS

**15 METER MOBILE TRANSCEIVER
CW & USB**

NCG 15SB



THE QRP RIG WITH THE **BIG RIG SOUND** ACTIVE NOISE BLANKER—RF GAIN—CW SWITCH—SQUELCH—MIC GAIN—DIGITAL FREQUENCY DISPLAY—HI/LO POWER SWITCH—13.8 VDC 5A POSITIVE OR NEGATIVE GROUND.

See your dealer for a demonstration.

DEALER INQUIRY INVITED

NCG Co.

NEW 438 to 450 MHz
PLL mobile
Memory-Scan

✓ 318

1275 N. GROVE ST.
ANAHEIM, CALIF. 92806 (714) 630-4541

STOP RF SPILLOVER!

You may be losing up to half the available output from your vertical gain antenna because of RF spillover. The amazing AEA Isopole with unique decoupling design, virtually eliminates RF spillover and can help you multiply your power in all directions on the horizon relative to an ideal half-wave dipole, or end-fed non-decoupled "gain" antennas.

CALL TODAY

KENNEDY ASSOCIATES

2618 RIGSBY AVE.
SAN ANTONIO, TX 78222
(512) 333-6110

AEA Brings you the Breakthrough!



The antenna with a big difference... the five band trap vertical Hustler 5-BTV™

The 5-BTV is made heavier for better performance and quality. Heavier traps assure accurate and permanent trap resonance. Solid one-inch fiberglass trap forms give optimum electrical and mechanical stability.

One setting provides total band coverage from 40 through 10 meters. SWR is 1.6 or better at the band edges.

The 5-BTV is top loaded at 80 meters (tuneable to 75 meters). This means greater bandwidth and lower angle of radiation.

Easy to assemble and install, the 5-BTV features 1 1/4" high strength aluminum construction. And an extra-heavy bracket with low loss-high strength insulators. Feed with any length 50 ohm coax.

For the big difference in performance, it's the Hustler 5-BTV antenna.

Clearly the choice of those who know quality.

HUSTLER INC. ✓ 305

3275 North B. Ave. • Kissimmee, Florida 32741

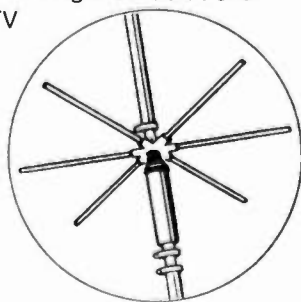

HUSTLER

DEALERS

Amateur Radio Center
1117-19 West 36th St.
Baltimore, MD 21211
301-889-5214

Coles Communication Center
3907 Fredricksburg Rd.
San Antonio, TX 78201
512-734-4613

Hamtronics
4003 Brownsville Rd.
Trevose, PA 19047
215-347-1400

Power Communications Corp.
6012 North 27th Ave.
Phoenix, AZ 85017
602-242-8990

RSE Ham Shack
1207 W. 14 Mile Rd.
Clawson, MI 48017
313-435-5660

Tedco, Inc.
437 South Babcock St.
Melbourne, FL 32901
305-727-2311

**YOU ARE LOOKING AT
EVERYTHING
THAT IS NOT ON SALE
THIS MONTH
AT HAM RADIO CENTER**

**FOR BEST PRICE – FAST DELIVERY
CALL TOLL - FREE**

1-800-325-3636

HAM RADIO CENTER ✓32
8340-42 Olive Blvd. • P.O. Box 28271 • St. Louis, MO 63132



PC Boards— A Photographic Method —it's easy when you take it step by step

Modern electronic equipment, be it digital or analog, is dependent upon printed circuitry for cost effectiveness, reproducibility, and ease of assembly. The home-brew enthusiast will sooner or later consider acquiring the equipment, materials, and skills to produce his or her own boards. If you've never tried it, be prepared for a pleasant surprise. Very little investment of time or money is required for quality results.

There are two general methods of PC board construction. Both result in a hard, acid-resistant coating on copper-clad board made from any one of several

materials. This coating duplicates the conductor pattern and solder pad layout for the actual components. Therefore, when immersed in an acid bath, the copper is removed where not protected by this coating. Following acid etching, only the desired copper pattern remains on the board. Holes are then drilled for the component leads, and away you go.

The two methods differ only in the manner in which this acid-resistant coating is put on the board. Let's compare them.

Direct-Resist Versus Photographic Methods

In the so-called direct-

resist method often used by beginners and old hands alike, the coating pattern is hand-drawn directly on the copper surface. First, a pencil drawing is made of the layout so that any mistakes hopefully will be made there and easily corrected. Next, either before or after drilling the component holes, the layout is drawn on the board. This usually is done with black lacquer dispensed by a felt-tip pen and/or a small brush.

This procedure works and works well. It does, however, suffer from several drawbacks:

- The method is inefficient when more than one copy of the board is to be made.
- Altering the layout once it is drawn on the board is difficult and messy.
- Tracing from published layouts can still result in errors since a direct overlay cannot be used.
- The finished product may unavoidably turn out sloppy looking. This impedes troubleshooting if

nothing else.

- Intricate patterns with close-spaced conductors and components are difficult to implement.

Photographic procedures cure all the above-mentioned ills. And you may be surprised at the low cost and skill level required to get started in this method.

The Five Steps of Photo PC Board Construction

Photographic methods break down into five steps:

- Design the component and conductor path layout in pencil if a published pattern is not available.
- Reproduce this layout as "positive artwork."
- Photographically reverse the positive to make a negative.
- Expose a sensitized copper-clad board, using the negative as an exposure mask. Then develop the sensitized surface.
- Etch the developed board in an acid bath, then drill the lead holes.

Description	Source
a) Thin lead drawing pencil (Pentel or equivalent)	Office Supply
b) Plastic circle template	Office Supply
c) Two 30° x 60° plastic triangles	Office Supply
d) Plastic engineer's scale	Office Supply
e) 10-by-10-to-the-inch grid paper	Office Supply
f) Drafting or masking tape	Office Supply
g) Drawing board (optional)	Office Supply
h) T-square (optional)	Office Supply

Table 1. Equipment and materials for original layout.

The first and last steps are essentially the same as in the direct-resist method. In between will be the crux of our interest. Here is a discussion of these steps and the materials and equipment—mostly home brew—required to perform them. Stay with me; it really is simple.

Preparing the Layout

Unless a published board pattern is available for your project, one will have to be designed. A list of equipment and materials for this purpose is given in Table 1. The utility of most items listed should be self-evident, but a few comments are in order.

The 10-by-10-to-the-inch grid paper is an especially good choice for the drawing. Many component leads, those of integrated circuits in particular, are on .1-inch centers or multiples thereof. So, this paper lets you dispense with a lot of actual measurements.

Also, while a plain wooden pencil is fine for your drawing if kept sharp, the Pentel™ thin lead drawing pencil is a pleasure to use. It dispenses .5-mm lead, allowing very neat and precise drawings to be made.

To begin your layout, it is helpful to have the pinout description for all ICs and transistors ready at hand. Any non-standard-sized other components such as electrolytic capacitors should also be available. Then the proper lead spacing and so forth can be allowed for.

To proceed, define the overall board dimensions. If possible, make these such that you don't waste a lot of an available piece of board material. Define tentative board edges on the grid paper. They can be enlarged or cut down later if necessary. Then study the schematic and form a general layout plan in your

mind's eye. Having done this, draw the component pad locations on your layout and begin adding the interconnecting conductor paths. The whole process is a little like working a puzzle, and there is nothing wrong with several false starts. It's really a matter of using your own ingenuity, but here are some useful hints that come to mind:

1. Board appearance and troubleshooting are enhanced if component packages and conductor paths are placed parallel to the board edges insofar as possible.

2. Choose a standard lead spacing for similar components. For example, I use ½ inch for ½-Watt resistors. Stick to this spacing except in special cases and board appearance will be better.

3. Don't be afraid to use jumpers—several, if necessary. On the other hand, don't give up too easily in your puzzle-working efforts. Take note of the fact that a component such as a resistor or capacitor which will be in series with a line apparently needing a jumper can itself be the jumper.

4. Remember that in some cases the pin connections on digital ICs and multiple-unit op amps, as shown in published schematics, are not always the only way to implement the circuit. For example, a 16-pin hex inverter IC contains six identical and independent units. It may be helpful to juggle which inverter is going to serve which input to simplify your layout.

5. Take special care when looking up the pinouts for ICs to note whether you are looking at a diagram from the bottom or top of the IC. What is needed, of course, is the bottom view, since you are drawing the foil side of the board.

6. If your layout begins to

Description	Source
a) Technical drafting pen (Rapido-graph or equivalent)	Office Supply
b) Ink for pen (Pelikan™ #17 black, or Leroy™ Lettering Ink #58-0005 or equivalent)	Office Supply
c) Small plastic French curve	Office Supply
d) Sharp knife (X-acto or equivalent)	Office Supply
e) Transparent plastic sheets (mylar or equivalent)	Office Supply
f) Assortment of conductor path tape of various widths	Kepro or Bishop Graphics
g) Assortment of adhesive-backed component pad patterns	Kepro or Bishop Graphics

Table 2. Equipment and materials for positive artwork.

get really complicated, requiring many jumpers, consider the use of a double-sided board. Although plated-through holes usually found on commercial products are next to impossible to implement at home, you can use eyelets instead. Sometimes most of the problem may be solved by just moving one set of conductors (such as the address bus on a computer board) to the second side of the board. If only a few connections must be made to the bus, you can jump from one side to the other with wire through holes.

These little hints could go on forever. The best thing to do is dive in and design a few boards yourself. Most of the knacks to it will become evident quickly.

Finish your layout and check it carefully against the schematic. If satisfied, you can go on to make the positive artwork.

Making the Positive Artwork

Having made a pencil layout that satisfies the circuit schematic, it must be duplicated in a form suitable for photographic reversal. The base material for this drawing must be a clear or very translucent material such as mylar™.

The layout is drawn using a good dense ink, precut opaque black pad patterns and tape, or a combination of the two. For a complete list of drawing equipment

and other materials required, refer to Table 2.

The Rapidograph™ pen listed is a must unless you think all your patterns can be reproduced using only the stick-on transfers. Invariably, however, there will be a few strange shapes which will require the pen. With it, precise inked lines and circles can be drawn. As a further benefit, you will save a good bit of money by using the pen instead of the stick-ons for all but the most exacting work. In any case, just any drafting ink won't do. It must be very dense to block light during the reversal exposure process to be described. The two inks listed in Table 2 are satisfactory.

The stick-on patterns, on the other hand, are a pleasure to use and are a must for integrated circuit patterns, card edge connectors, and the like where precise dimensions are required. Also, the use of tape for conductor paths is actually quicker than drawing with the pen once you get the hang of it. What I do is place the end of the tape at one end of a conductor run, lay it out, then at the other end press down with the X-acto® knife blade while simultaneously pulling up on the rest of the roll. This cuts the tape off cleanly and quickly. You may come up with a better technique yourself.

To proceed, lay the transparent base over your pencil layout or published

TOP AND BOTTOM ARE PLATE GLASS - 12" x 13"

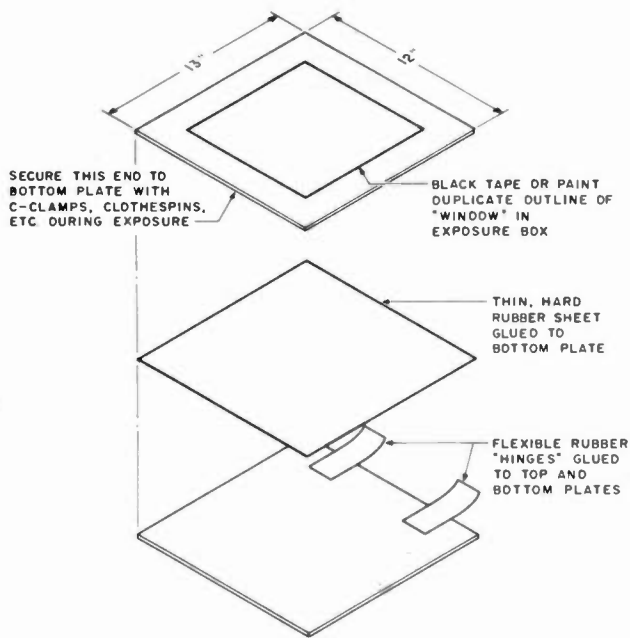

Fig. 1. The print frame sandwiches the positive tightly against the negative film to make a sharp, clear, and accurate exposure.

pattern and square up the edges of the sheets. Then place the pads for the individual component leads, ICs, etc., where required. Follow this with the interconnecting conductor paths.

After the layout has been duplicated as positive art-

work, be sure to delineate the corners of the board with registration marks. This will aid in positioning the positive on your negative film and, ultimately, the negative on the board, prior to exposure. Corner registration is particularly critical on double-

Description	Source
a) Print frame (see text)	Home brew
b) Exposure box (see text)	Home brew
c) Safelight with Kodak #1A filter (or home-brew light; see text)	Photo Store
d) Three plastic developing trays	Photo Store
e) 1-liter plastic darkroom graduate or other measuring cup	Photo Store
f) Three 1-pint plastic bottles with caps	Photo Store
g) Plastic funnel	Photo Store
h) Plastic stirring rod	Photo Store
i) Darkroom thermometer	Photo Store
j) Sheet film (see Table 4)	Photo Store
k) Developer and fixer (see Table 4)	Photo Store
l) Acetic acid stop bath	Photo Store

Table 3. Equipment and materials for making negatives.

Film	Developer	Fixer
Polychrome Accu-Rep™ Line Ortho Film: .004" polyester base	Polychrome A & B Liquid	Polychrome Liquid & Hardener
Kodak Kodalith Ortho Type 3: No. 2556 .004" Estar™ base	Kodak Kodalith A & B Powders	Kodak

Table 4. Films and developing chemicals.

sided boards where holes and solder pads must be in alignment from side to side.

Preparing the Negative

This step, the photographic reversal of the positive artwork to yield a negative, involves procedures which may be foreign to many electronics hobbyists. They were to me since I had never dabbled in photography past the instant camera stage. Don't be put off, though; the procedures and equipment are really simple and inexpensive.

The actual methods involved belong more to the realm of graphic arts than anything else. The film used is known as lithographic film and is of a high contrast nature (either completely black or clear image).

Production involves exposing a negative film which is in intimate contact with the positive to the proper amount of light for an appropriate period of time. The amount of light and time required are inversely proportional to one another, as you may surmise.

With the litho film recommended here, an ordinary 7½-Watt incandescent light bulb in an appropriate enclosure, coupled with exposure times on the order of one-half to one second, will do the trick. Before proceeding, let's discuss the simple, mostly home-brew, equipment required to implement the exposure.

The Print Frame

This item, used not only for exposing the negative but also for board exposure, can be as simple as two pieces of plate glass. However, you will probably be ahead if you build up something like the one shown in Fig. 1. The hinged construction keeps everything together and is easy to

use. The only real purpose for this gadget is to sandwich the positive artwork tightly against the negative film during exposure. This results in a reversal pattern that is sharp, clear, and of the same dimensions as the positive. You may want to get the two sheets of glass to start with and use them later to build the frame. Use clamps of some sort in the interim to secure the pieces together.

The Exposure Box

For reproducible exposure intensity and time, something like the box shown in Fig. 2 should be built. It is not much more than a box with a window of sandblasted glass in the top and a light bulb inside. The sandblasted (or ground) glass is used to diffuse light from the bulb for a more even exposure. The momentary contact switch in series with the 110-volt line gives enough control over timing.

A closed box arrangement is used instead of an open frame construction to allow a heavy towel to be laid over the top, thus sealing in most of the light during exposure. This allows making several "shots" in the darkroom without having to worry about exposing other film which may be lying about or being developed at the same time.

This piece of equipment and the print frame mentioned above constitute our "camera." Not very fancy, maybe, but it works like a charm.

A Safelight

Unless you want to do all your work in complete darkness (a pain), you will need a safelight. This can be purchased, with a Kodak™ No. 1A red filter, or you can make one yourself. To do this, all you need is a 7½- to 15-Watt red light bulb available at any department or drug store.

Conley Radio ✓ 367

CONLEY RADIO SUPPLY OFFERS YOU
SENSATIONAL PRICES WITH EXCEPTIONAL
SERVICE. THE NUMBER ONE OUTLET IN THE
NORTHWEST Red Hot Prices From Conley Radio



TS-120S \$699.95



IC-251A LIST PRICE \$699.00
CASH PRICE \$599.00

ORDER YOUR NEW...
KENWOOD TR-2400

2 METER PROGRAMMABLE
H.T. WITH NICADS, CHARGER
AND RUBBER ANTENNA

\$395.00

*TS-180/W DFC.
\$1149.95

*Special sale, limited offer.
call for quote

Other Kenwood gear we stock...

Model	List Price
TS-180S/DFC	\$1149.95
TS-520 SE	\$629.95
TS-120S	\$699.95
PS-30	\$139.00
R-1000	\$495.00
TR-2400	\$395.00
TR-7800	\$399.95
TR-9000	\$499.95
TL-922A	\$1199.00
TS-820 TRANSCEIVER	869.00
R-1000 RECEIVER	495.00
TR-8300 450 Mhz.	369.00
R-820 RECEIVER	1099.00
TS-600 6 M. TRANS	799.00
SM-220 MON SCOPE	349.00
BS-5 PAN ADAPTER	75.00
BS-8 PAN ADAPTER	75.00
DG-5 DIG DISPLAY	199.00

CALL FOR OUR
LOW QUOTE

*We will meet or
beat any reasonable offer

**OVER 50 MAJOR LINES OF
EQUIPMENT AND
AMATEUR ACCESSORIES**

No Sales Tax in Montana.

Write or Call for Catalog

ALL ITEMS F.O.B. BILLINGS, MONTANA
CERTIFIED CHECK, M.O. OR SHIPPED COD UPS.

**NO SALES TAX
CALL TODAY
406-259-9554**

318 N. 16th Street Billings, Mt 59101



IC-255A
* LIST PRICE \$389.00

Other ICOM gear we handle.

Model	List Price	Cash Price
IC-255	\$389.00	\$329.00
IC-211	\$870.00	\$659.00
IC-701/S	\$1375.00	\$1195.00
IC-551	\$449.00	\$399.00
IC-551D	\$849.00	\$769.00
IC-260A	\$489.00	\$439.00
IC-251A	\$699.00	\$599.00
IC-2AT	\$249.50	---
IC-2A	\$229.50	---
IC-2A	\$199.50	---

With Alkaline Batteries
The FT-707
has the new WARC bands



List Price \$810.00
Cash Price \$729.00

Other Yaesu gear we carry

MODEL	LIST PRICE	CASH PRICE
FT-101ZD	\$942.00	\$849.95
FT-901 DM	\$1535.00	\$1379.00
FT-107	\$1045.00	\$939.00
FP-107E	\$145.00	---
FP-107	\$139.00	---
DMS-107	\$125.00	---
FT-707	\$810.00	729.00
FV-707 DM	\$279.00	\$249.00
FP-707	\$162.00	\$145.00
FV-101Z	\$175.00	\$157.50
FT-207	\$399.00	\$375.00
FRG-7	\$370.00	\$329.00

MEMORY KEYER BREAK- THROUGH!



The remarkable AEA Morse-matic memory keyer has 35 fantastic features including two AEA designed microcomputers, up to 2,000 character memory, automatic serial number, beacon mode, and automatic morse trainer mode. The AEA Morsematic is already the undisputed leader in high quality multi-feature Morse Keyers.

ORDER NOW TOLL FREE
800-523-8998

HAMTRONICS

A Division of TREVOSE
ELECTRONICS, INC
4033 Brownsville Road
TREVOSE, PA. 19047

Telephone: (215) 357-1400

AEA Brings you the
Breakthrough!

Then buy a small can of red spray enamel paint. Spray the bulb with this enamel to cover up the inevitable pinholes in the bulb's red ceramic coating. A safe-light made in this manner will work fine. Just don't hold the film up to the bulb for any length of time. Keep the light about three feet or more away from any undeveloped film.

Films and Chemicals

Other than the miscellaneous items listed in Table 3 and the equipment described above, you will, of course, need some film and developing chemicals. Two suitable types and their associated chemicals are listed in Table 4. There are others, but these should be easy to find. Films for this purpose are known as "graphic arts" film with the Kodalith™ being among the better known.

Be sure, whatever film you use, that it has a so-called "stable base." Usually this material will be polyester, and it simply means that it won't shrink. Size changes would, of course, be a no-no for our purposes. The film comes in quantities of 25 to 50 sheets per box and in sizes from about 4" X 5" on up. It is very economical, with a box of 50 sheets running about \$10.00.

With respect to the chemicals, I have used one brand of chemical with another of film quite successfully. However, you would probably be ahead to get matching products to start with to cut down on at least one variable.

Mix up about one pint each of developer, stop bath, and fixer which can be stored in the plastic bottles mentioned in Table 3. The Kodak chemicals come in powdered form. There is an "A" part and a "B" part for the developer and just one powder for the fixer. These are mixed with ordinary tap

water in the proportions given on the package. About the only critical thing here is that for easy mixing, the water must be in the temperature range given on the package (about 80° to 90° F). The powder must go completely into solution to avoid spots on the negative, so mix everything well.

The Polychrome™ materials come in liquid form and are therefore somewhat easier to use. The stop bath is nothing more than an acetic acid solution that is sold for use with almost all films.

Film Exposure and Developing

Next get yourself situated in a completely dark room. The film to be used is not terribly sensitive, but it will be ruined if any white light actually falls upon the surface with any intensity to speak of.

Don't be too fanatical about absolute darkness, but if you consistently get negatives with poor contrast, light leakage is almost certainly the culprit. At any rate, a bathroom, preferably one with no windows which must be blocked off, is your best choice since the film must be washed in running water after development.

The developer, stop bath, and fixer should fill their respective trays 1/2 inch deep. Set up your safelight, print frame, and exposure box. Then, with some sheets of film and a positive available, you are ready to go.

I suggest that you make up a small positive with some tape lines, an IC package pattern or two, and some individual component pads for testing purposes. Make some lines and pads with ink as well as with tape and stick-ons to see if you are using dense enough

ink in the technical pen. Then, with everything set up, turn off the room lights and turn the safelight on. In a few moments you'll get used to the red light and will be able to work quite well under these conditions.

Open the film package and lay out one sheet. After replacing the rest of the film in its light-tight plastic bag, reseal it with electrical tape and put it back in the box. Next, cut the sheet of film into several pieces about the same size as your "test positive."

Now note, by gently stroking the film, that one side is very slick and the other has a matte texture, or rougher feel. The matte side is the emulsion side. Place a piece of film in your print frame emulsion side up. Next, place the positive, with the artwork side down, on top of the film. The positive artwork will be

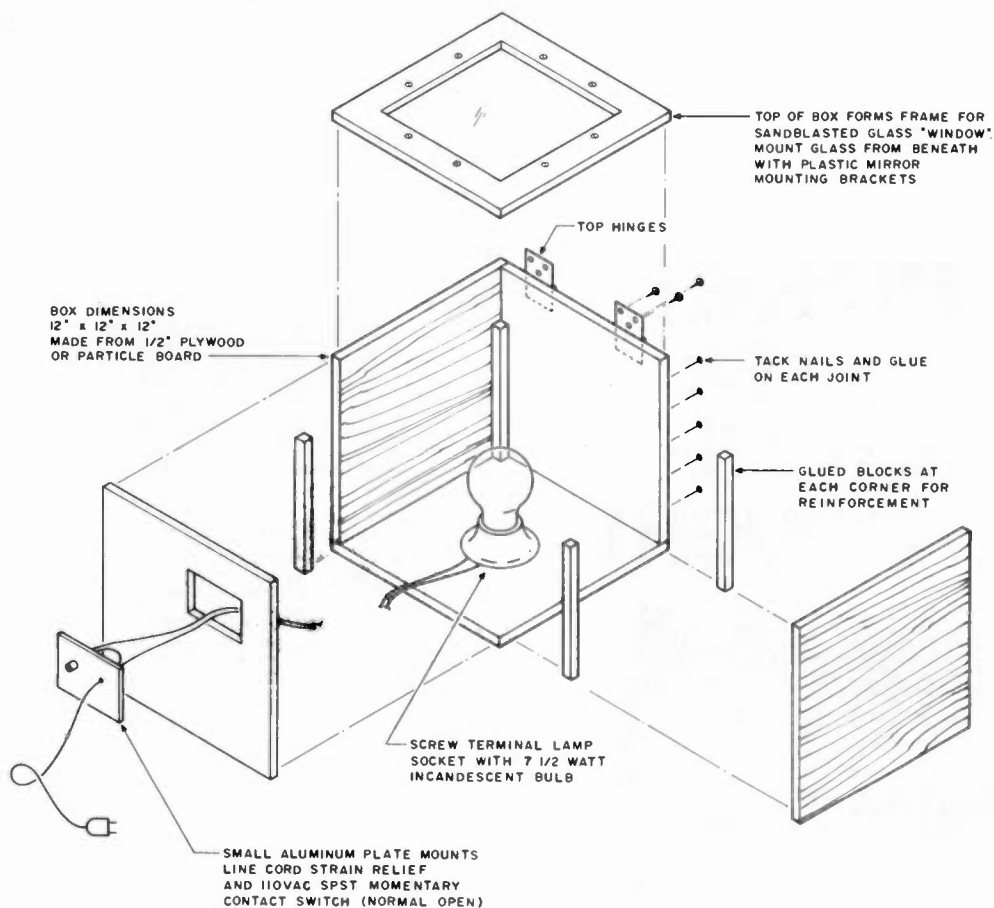

Fig. 2. The exposure box, which gives control over the amount of exposure light, is the "camera" for making a PC board negative from the positive artwork.

INTIMIDATED BY MORSE CODE?



THE NEW AEA MODEL MT-1 COMPUTERIZED MORSE TRAINER MAKES MORSE CODE EASY AND FUN TO LEARN.

KT-1 Computerized Keyer With All Features of Above Trainer is Also Available in Same Package

- Automatic Speed Increase, User May Program: Starting Speed, Ending Speed, Practice Duration; 5 Letter code Groups or Random Space; Common or All Characters.
- Precise Speed Control 1 to 99 WPM (Tailor to Your Exact Requirements).
- 24,000 Character Answer Book Available For 10 Starting Positions.
- Random Mode For Practice (No Answers).

CALL TODAY

G & K Amateur Supply

2920 East 9th Street, Des Moines, Iowa 50316, 515-262-1745

AEA Brings you the Breakthrough!

MOVING?

Let us know 8 weeks in advance so that you won't miss a single issue of 73 Magazine.

Attach old label where indicated and print new address in space provided. Also include your mailing label whenever you write concerning your subscription. It helps us serve you promptly. Write to:

73 magazine

Subscription Department
P.O. Box 931
Farmingdale NY 11737

- | | |
|---|---|
| <input type="checkbox"/> Address change only | <input type="checkbox"/> Payment enclosed |
| <input type="checkbox"/> Extend subscription | |
| <input type="checkbox"/> Enter new subscription | <input type="checkbox"/> Bill me later |
| <input type="checkbox"/> 1 year \$25.00 | |

If you have no label handy, print OLD address here.

Name _____ Call _____

Address _____

City _____ State _____ Zip _____

print NEW address here:

Name _____ Call _____

Address _____

City _____ State _____ Zip _____

301B55

AFFIX LABEL

October Specials

11C05 1GHz, pre. Special \$59.95



ATF 417 pre-amp net Special \$19.95

MRF 901 UHF transistors, 1 GHz Special \$ 3.95

COMPLETE KITS: CONSISTING OF EVERY ESSENTIAL PART NEEDED TO MAKE YOUR COUNTER COMPLETE. **HAL-600A** 7-DIGIT COUNTER WITH FREQUENCY RANGE OF ZERO TO 600 MHz. FEATURES TWO INPUTS: ONE FOR LOW FREQUENCY AND ONE FOR HIGH FREQUENCY. AUTOMATIC ZERO SUPPRESSION. TIME BASE IS 1.0 SEC OR .1 SEC GATE WITH OPTIONAL 10 SEC GATE AVAILABLE. ACCURACY ± .001%. UTILIZES 10-MHz CRYSTAL 5 PPM.

COMPLETE KIT..... \$129

HAL-300A 7-DIGIT COUNTER WITH FREQUENCY RANGE OF ZERO TO 300 MHz. FEATURES TWO INPUTS: ONE FOR LOW FREQUENCY AND ONE FOR HIGH FREQUENCY. AUTOMATIC ZERO SUPPRESSION. TIME BASE IS 1.0 SEC OR .1 SEC GATE WITH OPTIONAL 10 SEC GATE AVAILABLE. ACCURACY ± .001%. UTILIZES 10-MHz CRYSTAL 5 PPM.

COMPLETE KIT..... \$109

HAL-50A 8-DIGIT COUNTER WITH FREQUENCY RANGE OF ZERO TO 50 MHz OR BETTER. AUTOMATIC DECIMAL POINT. ZERO SUPPRESSION UPON DEMAND. FEATURES TWO INPUTS: ONE FOR LOW FREQUENCY INPUT AND ONE ON PANEL FOR USE WITH ANY INTERNALLY MOUNTED HALTRONIX PRE-SCALER FOR WHICH PROVISIONS HAVE ALREADY BEEN MADE. 1.0 SEC AND .1 SEC TIME GATES. ACCURACY ± .001%. UTILIZES 10-MHz CRYSTAL 5 PPM.

COMPLETE KIT..... \$109

PRE-SCALER KITS

HAL 300 PRE..... \$14.95
(Pre-drilled G10 board and all components)

HAL 300 A/PRE..... \$24.95
(Same as above with preamp)

HAL 600 PRE..... \$29.95
(Pre-drilled G10 board and all components)

HAL 600 A/PRE..... \$39.95
(Same as above but with preamp)

TOUCH TONE DECODER KIT

HIGHLY STABLE DECODER KIT. COMES WITH 2 SIDED, PLATED THRU AND SOLDER FLOWED G-10 PC BOARD, 7.567's, 2 7402, AND ALL ELECTRONIC COMPONENTS. BOARD MEASURES 3 1/4" x 5 1/2" INCHES. HAS 12 LINES OUT. ONLY \$39.95

DELUXE 12-BUTTON TOUCHTONE ENCODER KIT utilizing the new ICM 7206 chip. Provides both VISUAL AND AUDIO indications! Comes with its own two-tone anodized aluminum cabinet. Measures only 2 3/4" x 3 3/4". Complete with Touch-Tone pad, board, crystal, chip and all necessary components to finish the kit.

PRICED AT..... \$29.95

For those who wish to mount the encoder in a hand-held unit, the PC board measures only 9 1/16" x 1 3/4". This partial kit with PC board, crystal, chip and components.

PRICED AT..... \$14.95

ACCUKEYER—MEMORY OPTION KIT THIS ACCUKEYER MEMORY KIT PROVIDES A SIMPLE, LOW COST METHOD OF ADDING MEMORY CAPABILITY TO THE WB4VVF ACCUKEYER, WHILE DESIGNED FOR DIRECT ATTACHMENT TO THE ABOVE ACCUKEYER, IT CAN ALSO BE ATTACHED TO ANY STANDARD ACCUKEYER BOARD WITH LITTLE DIFFICULTY. \$16.95

ACCUKEYER (KIT) THIS ACCUKEYER IS A REVISED VERSION OF THE VERY POPULAR WB4VVF ACCUKEYER ORIGINALLY DESCRIBED BY JAMES GARRETT, IN QST MAGAZINE AND THE 1975 RADIO AMATEURS HANDBOOK. \$16.95

ACCUKEYER—MEMORY OPTION KIT—TOGETHER ONLY \$32.00

6-DIGIT CLOCK • 12/24 HOUR

COMPLETE KIT CONSISTING OF 2 PC G10 PRE-DRILLED PC BOARDS, 1 CLOCK CHIP, 6 FND 359 READOUTS, 13 TRANSISTORS, 3 CAPS, 9 RESISTORS, 5 DIODES, 3 PUSH-BUTTON SWITCHES, POWER TRANSFORMER AND INSTRUCTIONS. DON'T BE FOOLED BY PARTIAL KITS WHERE YOU HAVE TO BUY EVERYTHING EXTRA.

PRICED AT..... \$12.95

CLOCK CASE Available and will fit any one of the above clocks. Regular Price ... \$6.50 But Only \$4.50 when bought with clock

SIX-DIGIT ALARM CLOCK KIT for home, camper, RV, or field-day use. Operates on 12-volt AC or DC, and has its own 60-Hz time base on the board. Complete with all electronic components and two-piece, pre-drilled PC boards. Board size 4" x 3". Complete with speaker and switches. If operated on DC, there is nothing more to buy.

PRICED AT..... \$16.95
Twelve-volt AC line cord for those who wish to operate the clock from 110-volt AC. \$2.95

SHIPPING INFORMATION

ORDERS OVER \$20.00 WILL BE SHIPPED POSTPAID EXCEPT ON ITEMS WHERE ADDITIONAL CHARGES ARE REQUESTED. ON ORDERS LESS THAN \$20.00 PLEASE INCLUDE ADDITIONAL \$1.50 FOR HANDLING AND MAILING CHARGES. SEND SASE FOR FREE FLYER



"HAL" HAROLD C. NOWLAND
WB2ZXH

HAL-TRONIX  ³¹

P. O. BOX 1101
SOUTHGATE, MICH. 48195
PHONE (313) 285-1782

Description	Source
a) Print frame (same as for negative)	Home brew
b) No. 2 Photoflood bulb	Photo Store
c) Metal developing tray (cake pan, etc.)	Dept. Store
d) Blank PC boards sensitized with Kodak KPR-4	Kepro
e) Kepro Type KD Developer	Kepro

Table 5. Equipment and materials for board exposure and developing.

reversed from the pattern actually required as you look at it in this attitude. Clamp the print frame pieces securely to force the positive and film tightly together.

Next, place the print frame over the "window" in your exposure box with the positive side down. Now the positive artwork will be between the film and the light source. Either cover the extra pieces of film you cut out earlier or place a heavy towel or equivalent over the whole exposure box-print frame assembly and you're ready to take the picture. Press the button on the exposure box and hold it down for one second. Remove the film from the frame and clip one corner off to indicate your first exposure. Cover the film up and reload the frame with another piece. Expose it as above except make the exposure time 1/2 second this time.

Remove your second exposure from the frame and clip two corners off to mark it; then cover it up. Make a final exposure with the button pressed and released about as fast as you can. Clip three corners off this piece and then develop all three exposures together as follows:

1. Place the film, emulsion side down, in the developer for a second or two. Next, turn it over and agitate for about ten seconds. Push the film to the bottom of the tray and leave it for 2 1/2 minutes. (Handle the film by the edges at all times.)

2. Remove the film from

the developer, allowing excess liquid to drain off in the tray, then transfer the film to the stop bath. Agitate it in the bath for about 30 seconds.

3. Remove the film from the stop bath, draining the excess, and place it in the fixer tray. Leave it in the fixer for about three minutes, agitating periodically.

4. Remove the film from the fixer and place it under running water for 20 to 30 minutes. Ordinary room lights may be turned on after removal from the fixer.

5. Dry the film with a squeegee and hang it up with film clips or clothespins to dry completely.

You should actually see the pattern image on film shortly after beginning Step No. 1. It will appear white on a dark background. After a few seconds of agitation in the fixer, however, it should seem to disappear. Holding it up to the safelight will reveal that the white areas have actually turned clear on a black background.

The shortest exposure probably will turn out to be the best of the three. Examine them all carefully, though, as you should be able to see some effects of exposure time.

After thorough drying, the negative is complete and may be used to expose PC boards to produce the pattern as many times as is desired.

Board Exposure and Developing

This final step, the equipment and materials for

which are listed in Table 5, is the simplest of all. However, since the board material, unlike our litho film, is expensive, you should take a little extra care to avoid ruining a board. About the biggest danger is that you may inadvertently expose the photosensitized surface to too much light before the negative is in place. Fortunately, they are sensitive to ultraviolet light; subdued ambient light will not ruin them. The Kepro instructions call for a 15- or 25-Watt incandescent (not fluorescent) bulb at least seven feet away and shaded from your work area when setting up the board for exposure. They also say the red safelight is satisfactory, but I've not tried this.

To continue, you would do well to take one 4" X 6" board from the light-tight package and, under proper lighting conditions, as above, cut it into pieces which will fit your previously-obtained test negative. Place a piece of sensitized board in your print frame with the copper side up. For this and all subsequent operations, handle the board only by its edges.

Next, position the negative on top of the PC board with the pattern showing as you want the board to look (i.e., make sure it isn't reversed). Take some pains to align the negative correctly, using your registration marks. Press the board and negative firmly together by clamping the print frame closed.

Expose the board using a #2 photoflood bulb about 12 inches away from the print frame for about five to six minutes. The exposure time here is not critical. Next, put the board copper side up in a metal tray with about 1/2 inch of developer. Leave it in the developer for three minutes, with periodic agitation.

Remove the board from

the developing solution and rinse it well under running water for a minute or two. A sink spray attachment works well for this. Note that after being in the developer for the prescribed time, the board is no longer light sensitive. After rinsing, hold the board at an angle to the room lighting and your pattern should be visible as a texture difference on the board surface.

The final step is to let the board dry overnight or in a warm (150°) oven for about five minutes. As mentioned before, avoid touching the copper surface at any time. Prior to drying, the resist pattern is soft and can be damaged. Also, the other areas of the board will not respond as well to the acid bath during etching if oils from your fingers are on it.

Board Etching

After the drying step, you may proceed to etch the board as you would with the direct-resist method. Place it in a plastic tray with about 1/2 inch of the ferric chloride etchant solution. Agitate the tray during etching to speed up the process. Also, if you can raise the temperature of the bath to about 100° F, the time required will be reduced. Depending upon the amount of agitation, temperature, and how fresh the etchant is, the etching process should take roughly 30 minutes to one hour.

After all unwanted copper has been etched away, remove the board from the tray and rinse it well under running water for two or three minutes to stop the chemical reaction. Then, using fine steel wool, remove the resist from the copper pattern. Now drill your lead holes and the job is done.

Troubleshooting

As mentioned several

MODEL TR70A

ATV RECEIVING CONVERTER, 420-450 MHz



- TUNABLE—vernier tuned, 420 to 450 MHz
- HIGH PERFORMANCE—low noise RF preamp., mosfet mixer, mosfet IF amp. [Ch2 or 3 out]
- SELF-CONTAINED—including power supply
- 1 YEAR WARRANTY
- PRICE: \$ 88.00 [includes shipping. Add \$ 1.15 for COD shipment]

To order, or receive detailed information, write us or call us at 1-812-336-4775

APTRON LABORATORIES
 PO BOX 373, BLOOMINGTON, INDIANA, 47402

STOP RF SPILLOVER!

You may be losing up to half the available output from your vertical gain antenna because of RF spillover. The amazing AEA Isopole with unique decoupling design, virtually eliminates RF spillover and can help you multiply your power in all directions on the horizon relative to an ideal half-wave dipole, or end-fed non-decoupled "gain" antennas.

ORDER NOW TOLL FREE

1-800-845-6183

G.I.S.M.O.

In S.C. call: 1-366-7157
 2305 Cherry Road,
 Rock Hill, S.C. 29730
 (Exit 66-B off I-77)

AEA Brings you the Breakthrough!

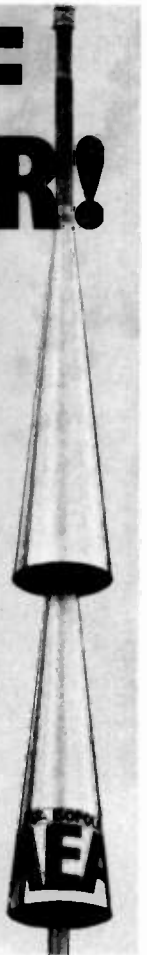

New 2 Meter Avanti Mobile Antenna

Mounts on glass — no holes!

- Receives and transmits through glass.
- Superior performance equivalent to 5/8 wave.
- Superior radiation full Omni-Directional.

It's easy to install — No holes to drill, no magnet to scratch the paint, no clamps. Uses an especially developed epoxy adhesive that secures antenna to window like a 1/4" bolt. The capacity coupling box is simply attached with a special adhesive tape to inside of window. Worried about crimping or corroding coaxial cables? It's all inside and out of sight.

Models also available for 220 MHz and 450 MHz.

AH 151.3G SPECIFICATIONS	
Gain	Equivalent to 5/8 wave
2 meter V.S.W.R. Band Width	Better than 1.5:1
Maximum power	150 watts
Nominal Impedance	50 Ohms
Chrome plated castling. Stainless Steel hardware. Swivel whip holder	
Height	33"
Performance and Mechanical Patents Pending	

Buy one from your nearest AVANTI dealer. If your dealer does not have one in stock, have him call the following toll free number and we will ship him one within 24 hours:

(800) 323-9429

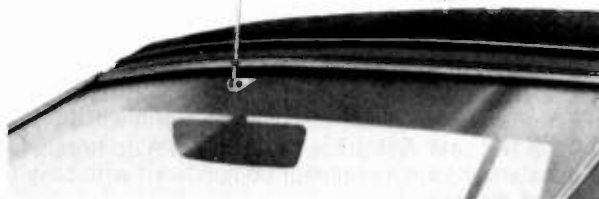
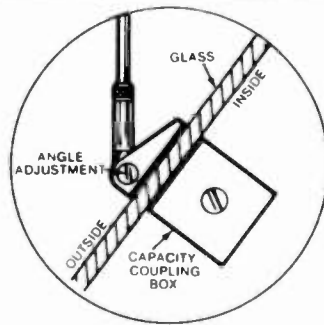

See Avanti's other new amateur mobile and base antennas. Write for new catalog today.
 Send 50¢ for handling and postage.



Avanti Research and Development, Inc.,
 340 Stewart Ave., Addison, IL 60101
 In Canada: Lenbrook Ind., Scarborough, Ontario M1H 1H5

MEMORY KEYS BREAKTHROUGH!



The remarkable AEA Morsematic memory keyer has 35 fantastic features including two AEA designed microcomputers, up to 2,000 character memory, automatic serial number, beacon mode, and automatic morse trainer mode.

CALL TODAY (406) 259-9554

Conley Radio Supply

318 N. 16th St., Billings, Montana 59101

AEA Brings you the Breakthrough!

times previously, this whole process is very simple. However, below are listed some possible glitches and their solutions.

● *Problem:* Poor negative contrast.

Likely Causes: Exposure time too short for the given light intensity; developing chemicals are old or improperly mixed.

● *Problem:* Good contrast but pattern edges fuzzy, and/or line widths and pads are smaller than on the positive.

Likely Causes: Exposure time too long for the given light intensity; positive and negative not clamped tightly enough together. (A similar problem might occur when exposing the board.)

● *Problem:* Board takes excessively long to etch.

Likely Causes: Insufficient agitation; temperature way too low; etching solution is old and loaded with copper

from previous use.

● *Problem:* Small patches on the board take excessively long to etch.

Likely Causes: Oil from fingers or other foreign material on the board surface.

The above are the most likely possible difficulties you may encounter. In all honesty, though, you probably won't have any trouble at all. If you do, an SASE to me with a description of your problem will fetch a prompt reply. ■

Supplier Addresses

Kepron Circuit Systems, Inc., 630 Axminster Drive, Fenton MO 63026; (800)-325-3878 outside Missouri, (314)-343-1630 in state. Kepron will sell direct to user.

Bishop Graphics, Inc., 5388 Sterling Center Drive, Box 5007, Westlake Village CA 91359; (213)-991-2600. Bishop Graphics has begun selling mainly through distributors, but write and ask for their catalog No. 106.

RAPID MOBILE CHARGER

The DEB-TED Rapid Mobile Charger is a constant voltage charger that will charge your batteries off a 12 Volt source in 4-6 hours. You may use the charger at all times, this includes transmit and receive periods. It is equipped with a cigarette lighter plug on the input side and the appropriate charging plug on the output side. Models available now for the Kenwood TR2400, Yaesu 207R, Tempo S1, S2, S5 and the Wilson Mark II and IV. Other models available also please call or write for info. \$34.95.



COMING SOON THE NEW AC VERSION

VEHICLE INTRUSION ALARM

An easy to assemble and install kit that offers options not normally found in other alarm systems. Hidden switch mounts under the dash. Kit has provisions for sensors and remote control switch. Programmable time delays for exit, entry and alarm periods. Basic hook-up utilizes dome light circuit activating when doors are opened. The alarm will drive a siren or pulse horn at a 1HZ rate. Not prone to false alarm do to reliable CMOS circuitry. No external switch required! Complete kit with easy to follow instructions and diagrams. \$12.95
Wired and Tested \$19.95

"SEE THE WORKS" CLOCK

OUR EASIEST CLOCK TO ASSEMBLE!

6 Digits 12 or 24 Hour Format Clock rests between two pieces of clear plexiglas A GREAT CONVERSATION PIECE! Kit is complete including top quality PC board, all componets, pre-cut and drilled plexiglas and all hardware \$29.95
Wired and Tested \$39.95

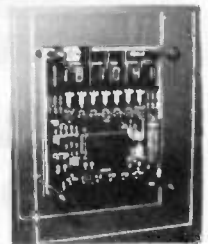

SPECIAL



SPECIAL

MODEL 5314 CLOCK KIT 12 or 24 hour format 6 large "5 Digits. Kit is complete with all parts, pc board and custom designed cabinet. (Specify Whit or Black) \$29.95



DEBCO ELECTRONICS
P.O. BOX 9169
CINCINNATI, OHIO 45209

330

Phone: (513) 731-7220

- Add 5% Shipping for U.S. & Canada
- All foreign orders add 10%
- COD orders add \$1.25
- Master Charge and Visa Welcome
- Orders under \$20.00 add \$1.00 handling
- Ohio residents add 4 1/2% Tax

CALL OR WRITE FOR CATALOG

Free CMOS Timers

— build one-shots from spare inverters

Most articles published in ham magazines use the 555 IC for timing (one-shot) purposes. An alternative, for most purposes, which uses less

power and can be operated directly from a 12-volt power source, is the 74C14 inverter. Fig. 1 shows the schematic of the 74C14 hex inverter from which (see

Fig. 2) you can obtain three or more one-shots.

The 74C14 is a Schmitt trigger-type inverter, and the one-shot makes use of the Schmitt trigger action. A Schmitt trigger is a very stable, noise immune, gate circuit. The output changes state rapidly at a very select area of the input voltage shift—usually well within a range of 8 volts.

Because of the tolerances built into the 74C14's triggering voltage range, a stable time period is obtained. By using the input (G1) gate to discharge C1, then the charging time of C1 through R1 provides a time period for the output of G2. This simplest of circuits is, of course, a resettable one-shot, but proper latching-gate circuits can be added on the G1 side to provide a not-resettable function.

The stability of this type of one-shot is dependent upon the quality of capacitor and voltage-source stability, but for most ham radio purposes normal ceramic and tantalum capacitors provide sufficient stability.

Most less complex devices (ten or so ICs) usually

end up with extra, unused inverter stages, hence the "for free" one-shot. The diode is a general-purpose switching type (1N914, 1N4148 variety) and the only critical factor is that your capacitor *not* be of high leakage (the currents involved in CMOS dictate this consideration).

I have used this type of one-shot in several projects with perfect results, including stability requirements of less than 5%.

Another advantage of this use of the CMOS one-shot circuit is that for long duration timings the size of the capacitor is drastically smaller. For extremely long timing periods, a resistor must be added in series with the diode going to the output of G1 to counter the leakage of larger value capacitors; 2k or 3k Ohms is correct.

Some approximate values of C are given in Table 1 for various timing durations.

As always when working with CMOS, remember to be alert for sources of static charge; keep yourself, your tools, and your work area at ground potential. ■

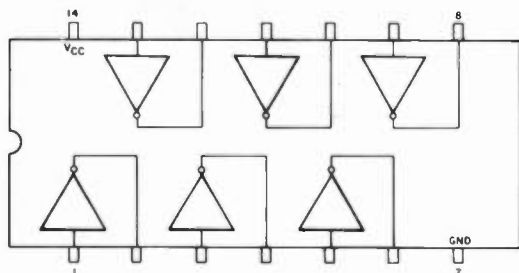

Fig. 1. The 74C14 integrated circuit.

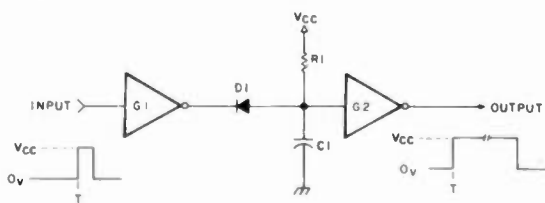

Fig. 2. The 74C14 used as a one-shot.

Time (Seconds)	R1 (Megohms)	C1 (Microfarads)	D1
0.1	1.0	0.1	1N4148
1.0	1.0	1.0	1N4148
10.0	5.0	2.0	1N4148
100.0	5.0	10.0	1N4148
0.2	1.0	0.2	1N4148
2.0	2.0	1.0	1N4148
20.0	10.0	2.0	1N4148
200.0	3.3	25.0	1N4148

Table 1. Approximate values for timings.

Introducing

The ICM TV-4300

SATELLITE RECEIVER

**HIGH PERFORMANCE
LOW PRICE**



International's TV-4300 is a high performance satellite receiver that tunes all channels within the 3.7 — 4.2 GHz band. Standard dual audio output provided at 6.2 and 6.8 MHz. Others available.

The TV-4300 is a fully packaged and assembled receiver complete with a built-in LNA power supply, built-in AFC, tuner, control circuitry and power cable. All output levels compatible with video monitor and VTR input. Easy to use! Simple tuning!

\$995.00

Select These Options

Remote tuning control \$99.50

Six frequency, crystal control, audio with stereo output. (Factory installed 6.2 and 6.8 MHz crystals supplied) \$89.50

Other audio frequency crystals \$9.50 ea.

Model TV-4300A . . . supplied with remote control and six frequency, crystal control, audio with stereo output \$1,149.00



Write for information.



✓36

INTERNATIONAL CRYSTAL MANUFACTURING CO., INC.
10 N. Lee, Oklahoma City, Oklahoma 73102. 405-236-3741

INTIMIDATED BY MORSE CODE?

THE NEW AEA MODEL MT-1
COMPUTERIZED MORSE
TRAINER MAKES MORSE CODE
EASY AND FUN TO LEARN.



- Automatic Speed Increase, User May Program: Starting Speed, Ending Speed, Practice Duration; 5 Letter code Groups or Random Space; Common or All Characters.
- Precise Speed Control 1 to 99 WPM (Tailor to Your Exact Requirements).
- 24,000 Character Answer Book Available For 10 Starting Positions.
- Random Mode For Practice (No Answers).

KT-1 Computerized Keyer With All Features of Above Trainer is Also Available in Same Package

**RUSH
ELECTRONICS, INC.**

call toll free 1-800-251-0264
Regular inquiries and Tenn.
residents call: 1-615-764-0831
1315 Bluff City Hwy., Bristol, TN. 37620

AEA Brings you the
Breakthrough!

**Louis N. Anciaux WB6NMT
researched, engineered, tested
and produced the NMT-11
Yagi-Uda antenna for his own
moonbounce operation.**

**NOW YOU CAN OWN THIS SAME
ANTENNA AT M&M'S SPECIAL
INTRODUCTORY PRICE OF \$69.95.**

This high quality 2 meter antenna is up to four feet shorter, and lighter than other antennas, yet its performance is one of the best you'll ever hear. When used in a quad array for moonbounce work, signal levels produced are definitely at the top of the class.

The NMT-11 has the usual top quality construction and components found in all Lunar products, yet it's priced no higher than ordinary mass produced antennas.

You've got to try this new NMT-11 Yagi-Uda with your station to appreciate its outstanding performance, and we make it easy for you.

**DEFECTIVE
PART REPLACEMENT
WITHIN 90 DAYS
OF PURCHASE**

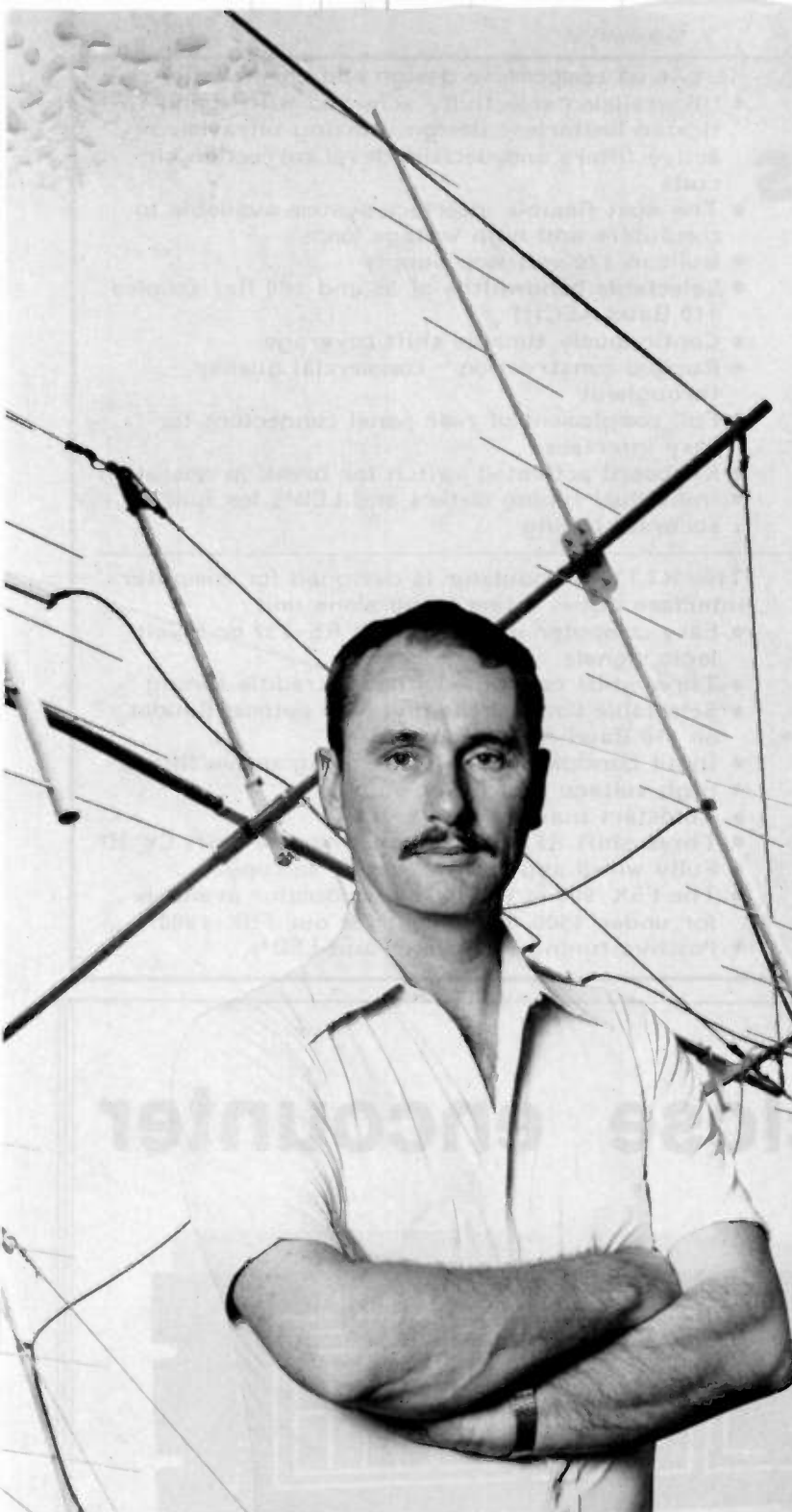

144 MHz Models

NMT-11 \$69.95
TRY A PAIR @ \$64.95 EACH
A QUAD OF 4 @ \$59.95 EACH

220 MHz Models

SINGLE \$64.95
 PAIR \$59.95
 FOUR \$54.95

Specify sub-band model (144 or 147; 220 or 223) and connector type (Type N or S0-239).
 Power dividers also available. Shipping charges additional.

**MANUFACTURED BY LUNAR ELECTRONICS
 AND AVAILABLE EXCLUSIVELY FROM**

M&M RF DISTRIBUTORS
 2785 KURTZ STREET, STE. 4 • SAN DIEGO, CA 92110 • (714) 299-9741
 P.O. BOX 82183 • SAN DIEGO, CA 92138

**USE YOUR VISA
 OR MASTERCARD!**

ORDER TODAY!

**CALL
 (714) 299-9741**

RTTY Demodulators

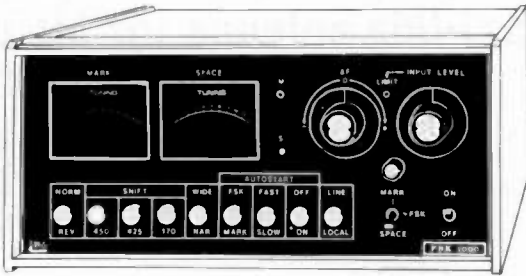

\$449.00 Ham net

FSK-1000 T.M.

- Here is no compromise design and construction:
- Unparalleled selectivity achieved with sophisticated limiterless design utilizing ultrasharp active filters and decision level correction circuits
 - The most flexible interface system available to computers and high voltage loops
 - Built in 170 volt loop supply
 - Selectable bandwidths of 55 and 100 Hz. (copies 110 Baud ASCII)
 - Continuously tunable shift coverage
 - Rugged construction - commercial quality throughout
 - Full complement of rear panel connectors for easy interface
 - Keyboard activated switch for break in operation
 - Individual tuning meters and LED's for quick, accurate tuning



\$197.00 until Nov. 1, \$229.00 after

FSK-500 T.M.

This RTTY demodulator is designed for computer interface but is a fine stand alone unit:

- Easy computer interface with RS-232 or 5 volt logic signals
- Three shift coverage without straddle tuning
- Selectable bandwidths give you optimal Baudot or 110 Baud ASCII copy
- Input bandpass preselector using active filters
- High voltage loop keyer output
- Autostart built in
- Three shift AFSK keyer plus narrow shift CW ID
- Fully wired and tested: ready to copy!
- The FSK-500 is the best demodulator available for under \$500.00 (Except for our FSK-1000!)
- Positive tuning with meter and LED's

IRL

Order direct on Visa or MC

700 Taylor Road
Columbus, Ohio 43230

T.M. Call (614) 864-2464

close encounter

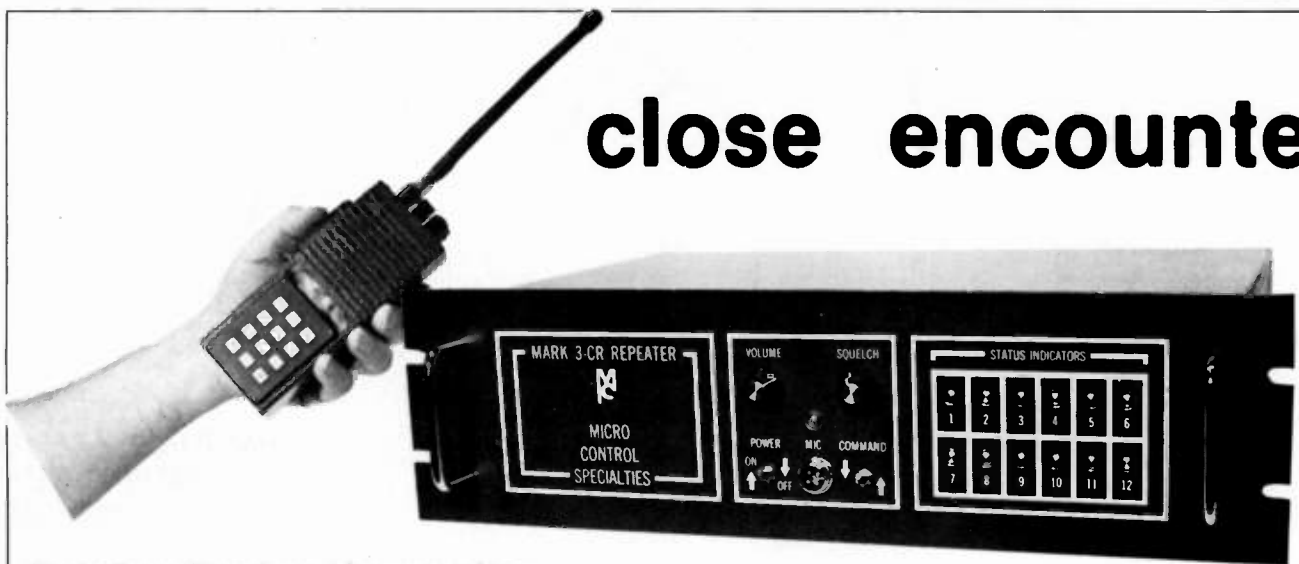

Dateline Dayton Hamvention . . .

To demonstrate the selectivity of our Mark 3CR repeater we keyed a transmitter 15 KHz off frequency and set it directly against the receiver input. Our Mark 3CR didn't even notice the close encounter.

Sure the Mark 3CR can withstand severe interference.. it uses both crystal filtering and double conversion. And that's just the beginning. Its performance continues with a transmitter that meets commercial specs plus a microprocessor controller that gives you 39 functions and 13 Morse messages. For peak performance have your own close encounter with a Mark 3CR / Repeater or Mark 3C Controller.



call or write for specifications ✓49

MICRO CONTROL SPECIALTIES
23 Elm Park, Groveland, Ma. 01834
(617) 372-3442



SSTV'ers will get first look at Voyager I Saturn Encounter.

Thanks to the JPL Amateur Radio Club, hams with Slow Scan Television equipment will be able to receive and view the pictures of Saturn to be transmitted from Voyager I next month (November) as the spacecraft passes the ringed planet. The club will maintain a regular operating schedule (see below) during Voyager I's pass-by of Saturn so that you will be able to receive and view these memorable pictures within

seconds of their arrival on earth. JPL scientists advise us that Saturn's rings will appear with much greater clarity than ever before, so it should be a fascinating show.

If you missed out on Voyager I's Jupiter Encounter last year, we highly recommend you add a Robot Model 400 scan converter to your station soon to enjoy next month's historical Saturn Encounter. Not only will the Robot enable you to

view these pictures on a monitor or your home TV set, but you can record them on an audio tape recorder for future playback.

Exciting things are happening on SSTV. Be a part of it; add a Robot Model 400 to your station today.

Write for your Free SSTV Fact Pack and the name of your nearest dealer today! November will be here soon!

JPL'S AMATEUR RADIO CLUB'S VOYAGER I/SATURN ENCOUNTER OPERATING PERIOD

Call Sign: W6VIO
(Voyager in Outer Space)
SSTV Freq: 14235, 21340,
or 28680 kHz. (± 5 kHz)

Dates: Nov. 1 - Nov. 16, 1980
Times: Daily
1930 to 2130 GMT
0030 to 0430 GMT

Additional activity is planned for weekends. Listen to announcements on above frequencies for additional times and frequencies.

Closest encounter: Nov. 12

ROBOT

ROBOT RESEARCH, INC.
7591 Convoy Court
San Diego, CA 92111
(714) 279-9430

STOP RF SPILLOVER!

You may be losing up to half the available output from your vertical gain antenna because of RF spillover. The amazing AEA Isopole with unique decoupling design, virtually eliminates RF spillover and can help you multiply your power in all directions on the horizon relative to an ideal half-wave dipole, or end-fed non-decoupled "gain" antennas.

Henry Radio

**New Toll Free Order Number:
(800) 421-6631**

11240 W. Olympic Blvd., Los Angeles, Calif. 90064
213/477-6701
931 N. Euclid, Anaheim, Calif. 92801
714/772-9200

**AEA Brings you the
Breakthrough!**



Dear Subscriber

73 Magazine does not keep the subscription records on the premises, therefore, calling the Peterborough offices doesn't solve your subscription problem.

To quickly solve your problem please send your most recent address label and a description of the problem to:

73 Magazine
Subscription Department
PO Box 931
Farmingdale, NY 11737

Please allow the subscription department at least two weeks for an answer or a solution to your problem.

Thank you and enjoy your subscription.

Sincerely,

Debra L. Boudricau
Circulation Manager

CAN 20% BE WRONG?

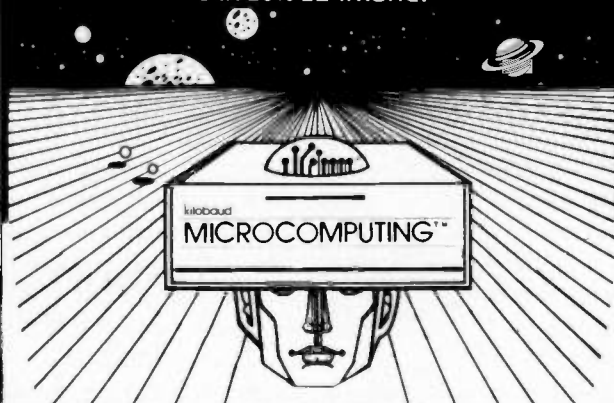

A recent survey showed that 20% of the 73 subscribers also read Kilobaud MICROCOMPUTING magazine . . . and enjoy it. This is the best way to learn and keep up with the rapidly developing world of microcomputers. There's nothing to be afraid of, you just have to read an interesting magazine and you'll learn. Try a subscription to Kilobaud MICROCOMPUTING and see for yourself.

- New subscription Renewal 12 Issues for \$25.00
 Payment enclosed \$ _____ 24 issues for \$38.00
 VISA MC AE Bill me 36 issues for \$53.00

Card # _____ Interbank # _____

Signature _____ Exp. date _____

Name _____

Address _____

City _____ State _____ Zip _____

—for even faster ordering service call toll free (800) 258-5473

Canadian: \$27, one year only, U.S. funds. Other foreign:
\$35, one year only, U.S. funds. Please allow 6-8 weeks for delivery. 308B6

MICROCOMPUTING • POB 997 • Farmingdale NY 11737

TRS 80* OWNERS ARISE!

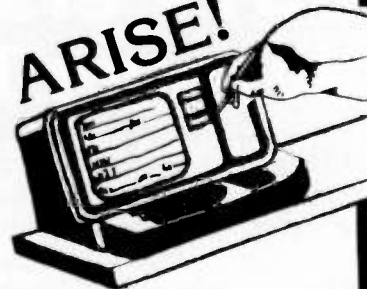

Arise and subscribe to 80 MICROCOMPUTING, the newest and fastest growing microcomputer magazine. This is full of news about programs, accessories and theory on the world's largest selling computer, the TRS-80*. Definitely beginner level and includes lots of program listings. Find out what all the fuss is about.

- New subscription Renewal 12 issues for \$18
 Payment enclosed \$ _____ 24 issues for \$30
 VISA MC AE Bill me 36 issues for \$45

Card # _____

Interbank # _____ Exp. date _____

Signature _____

Name _____

Address _____

City _____ State _____ Zip _____

80 microcomputing

• P.O.B. 981 • Farmingdale N.Y. 11737

*TRS-80 is a trademark of Tandy Corporation.

Please allow 6 to 8 weeks for delivery
Canadian: 1 yr. only/\$20 in U.S. Funds
Foreign: 1 yr. only/\$28 in U.S. Funds

308B6

Buy Direct from the Tri-Ex[®] Factory

**Factory Direct Prices
Save You 25%!**

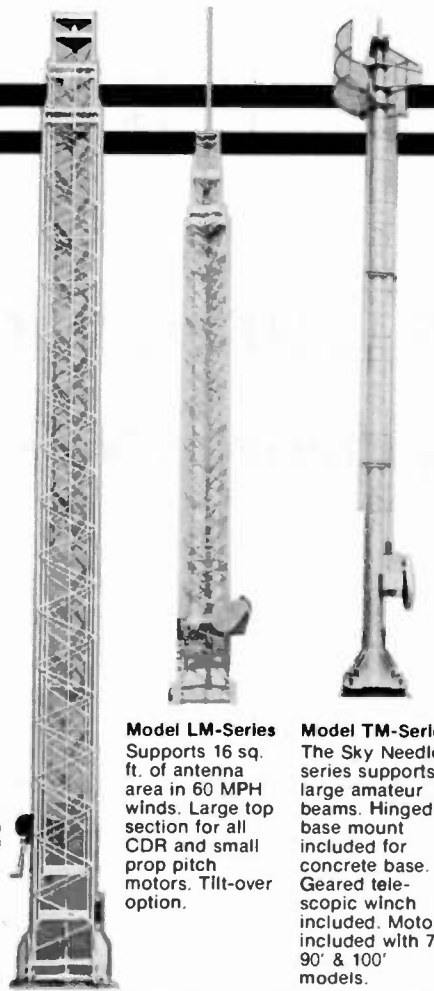

Model W-Series
Supports 9 sq. ft. of antenna area in 50 MPH winds. CDR rotator mounting plate in top section. Rigid base mount included.

Model LM-Series
Supports 16 sq. ft. of antenna area in 60 MPH winds. Large top section for all CDR and small prop pitch motors. Tilt-over option.

Model TM-Series
The Sky Needle series supports large amateur beams. Hinged base mount included for concrete base. Geared telescopic winch included. Motor included with 70', 90' & 100' models.

Come to Tri-Ex for innovative tower design and engineering! Our towers are famous all over the world for their strength, stress and wind resistance. Now you can buy a superior Tri-Ex tower at **FACTORY SAVINGS!**

Choose your metal. Towers can be fabricated in steel to ASTM Specifications with hot-dipped galvanized finish (done after construction so that inside surfaces are zinc-coated, too). Or in Triexium[™], our lightweight, corrosion resisting, high-strength light alloy.

Tri-Ex HAM towers are available self-supporting or guyed; take your choice. The W series of crank-up towers, the LM series of crank-up/tilt-over towers and the TM sky needles are self-supporting.

Use your charge power to buy your tower. Tri-Ex honors Visa and Master Charge credit cards. **If you have questions about tower accessories or which size tower is right for your antenna, call Bill Salerno, his technical sales know-how is ready to serve you.**



Tri-Ex[®]
TOWER CORPORATION
7182 Rasmussen Ave., Visalia, CA 93277

*Call me!
73 Bill Salerno*



W2ONV

**TOLL FREE
800-526-5277**
in New Jersey
201-279-7528
CALL NOW



or
USE THIS HANDY ORDER FORM

Mail to Tri-Ex Tower Corp.
7182 Rasmussen Avenue, Visalia, CA 93277

Name

Street

City State Zip

Check Enclosed Visa  M/C 

Card # Expires

Bank # Signature

Model Number	Nested Height	Extended Height	Wind Load or 50 MPH Antenna Load	Factory Direct Price
ED 40*	13' 0"	40'	6.0 Sq. Ft. †	\$ 492.00
MW 35**	20' 5"	35'	9.5 Sq. Ft. ‡	435.00
MW 50**	20' 10"	50'	8.6 Sq. Ft. ‡	668.00
MW 65**	21' 3"	65'	5.0 Sq. Ft. ‡	913.00
W 36**	20' 6"	36'	9.0 Sq. Ft.	546.00
W 51**	21' 0"	51'	9.0 Sq. Ft.	844.00
WT 51**	21' 0"	51'	9.0 Sq. Ft.	923.00
W 67**	22' 0"	67'	9.0 Sq. Ft.	1,816.00
LM 237**	20' 6"	37'	16.0 Sq. Ft.	1,064.00
LM 354**	21' 0"	54'	16.0 Sq. Ft.	1,537.00
LM 470**	23' 6"	70'	16.0 Sq. Ft.	2,826.00
LM 470D** Motorized	23' 6"	70'	16.0 Sq. Ft.	3,221.00
TM 490** Sky Needle	28' 0"	90'	37.8 Sq. Ft.	10,560.00

*Triexium[™]
**Also available in Triexium. Please consult factory for prices.
†When properly guyed 2 positions.
‡Roof bracket or guyed at 1st level.

NOTE: All products FOB Visalia, CA. Prices and specifications subject to change without notice. Ninety day limited warranty. California residents add sales tax.

Late Check-Ins Come Now

— zero-beat on this computerized NCS system

```
L=END LIST      R=LIST ENTRIES  T=LIST TRAFFIC  C=LOOK FOR CALL
F=FIND CITY     E=EDIT          X=DELETE CHECK-IN
-----
THIS IS A SCRATCH PAD FOR CHECK-INS
? _
```

Fig. 1. Program initializes to this display.

```
L=END LIST      R=LIST ENTRIES  T=LIST TRAFFIC  C=LOOK FOR CALL
F=FIND CITY     E=EDIT          X=DELETE CHECK-IN
-----
THIS IS A SCRATCH PAD FOR CHECK-INS
? N8AD
? KB8AM
? UCS
? WB4VI
? L_
```

Fig. 2. Full and partial callsigns entered during check-in.

```
N8AD
WHAT IS THE CORRECT CALL SIGN?
WHAT IS THE NAME? LEN
WHAT IS THE QTH? ELYRIA
WHAT IS THE TRAFFIC (NONE-PRESS ENTER)? OBERLIN
NOT AVAILABLE YET
(PRESS ENTER)? _
```

Fig. 3. After last check-in, additional information is entered for each station.

```
KB8AM
WHAT IS THE CORRECT CALL SIGN? KB8AM
WHAT IS THE NAME? BILL
WHAT IS THE QTH? OBERLIN
KB8AM CALL N8AD LEN HE IS LOOKING FOR YOUR CITY
WHAT IS THE TRAFFIC (NONE-PRESS ENTER)? DETROIT
NOT AVAILABLE YET
(PRESS ENTER)? _
```

Fig. 4. When KB8AM's QTH was entered, the program immediately announced that N8AD was looking for that city (Oberlin).

During my years as an amateur radio operator, I have served as a net control station for a few different nets. One of the requirements of a good net control station is the ability to keep track of all the stations that have checked in and to know where they are located and if they have any traffic. I used to use quite a bit of paper to do this, and my penmanship during busy sessions was more of a hindrance than an aid in operating. Since the TRS-80 Level II has such good string-handling ability, I decided it was time to do away with all my chicken scratching.

"Net Control" has been used at my station for about a year now, and it sure makes for a much smoother operation.

Normally, in net operations, the net control operator asks for people to check in with him by giving their callsigns. After he has gathered a certain number

of check-ins, he goes back and systematically "runs" each station through the net.

Basically, what the program does is ask for a list of new check-ins. When net control asks for check-ins, there usually is mass confusion and not all of the callsigns are intelligible. It is up to the control station to get enough of each call to separate them one from another. So, for the program, it is necessary only that a portion of each call is entered. (It is desirable to have the complete callsign go in, but it is not necessary.)

When everyone has checked in, or when the service control station determines that he's had enough, he halts any further entries. The program's list is halted by typing the letter L on the line after the last callsign. This tells the computer to start doing its thing.

```

# CALL      NAME      QTH      TRAFFIC
-----
1  NBAD     LEN      ELYRIA
2  KB8AM   BILL     OBERLIN  DETROIT
3  WA3UCS  STEVE    ERIE      W9ILU
4  WB4VIK  JOHN     GUSTON

```

END OF LIST SO FAR ? _

Fig. 5. The R command lists all check-ins.

Since a new check-in list has been set up, the program will now go to the top of the list and take each station separately, just as the net control normally would. On most nets, the NCS would ask for the operator's name, his location, and for any traffic he may have. The program starts out by asking for the correct callsign, since the NCS may have gotten only part of it the first time. If the NCS was quick and got the call right the first time, he merely hits ENTER and the call will be retained.

When the right call is entered, the system asks for the name of the check-in. Some nets do not want this, but it's my opinion that it adds a more personal touch. If no name is given, simply press ENTER and an N/A is substituted.

The program next asks, "WHAT IS THE QTH?" This is entered. I use an abbreviation for almost every city to save time and memory. (Being an air traffic controller, and since almost every city has an airport, I use a prescribed three-letter airport identifier. For example, St. Louis = STL, Chicago = ORD, Cleveland = CLE, etc.) Watch out if you do this, however: If an abbreviation is used for a city or for traffic, it must be used throughout the entire session.

After the QTH, the computer asks if there is any traffic. If there is none, simply press ENTER. If traffic is listed, enter it—either the callsign of the station needed or the location sought, and ENTER.

The computer now will store all of the information

and repeat the above steps for each check-in left on the list. When it comes to the last entry (the one before the L), it will "run" him and return to the command mode; the TV will display "THIS IS A SCRATCH PAD FOR CHECK-INS." (See Fig. 1.)

There are seven commands available to the user:

```

L=LIST END
R=LIST ENTRIES
T=LIST TRAFFIC
C=LOOK FOR CALL
F=FIND CITY
E=EDIT
X=DELETE CHECK-IN

```

Their functions are more or less self-explanatory. L stops the check-in scratch pad and sends the program to gather all the info about each station.

Once the first check-ins are entered, the other six commands are useful. If R is typed in, the program will give you a list of all the stations entered so far (#, call, name, QTH, traffic). Ten stations will be displayed at a time until all have been read out.

Command T lists all the traffic that is being looked for and the stations that have that traffic.

If you have a long list of checked-in stations and don't want to read through the whole mess with the R command to see if a particular station is on the net, use the C command. Type C and ENTER; the computer asks "WHAT CALL SIGN ARE YOU LOOKING FOR?" and you answer, then press ENTER. If the station has been entered previously, the program will come back with his (or her) name, call, QTH, and the number assigned on

```

.....
THIS IS A LIST OF ALL THE TRAFFIC WE ARE LOOKING FOR
.....
DETROIT ----- BY KB8AM      W9ILU ----- BY WA3UCS

```

(PRESS ENTER TO CONTINUE)? _

Fig. 6. The T command lists unresolved traffic.

```

WHAT CALL SIGN ARE YOU LOOKING FOR? NBAD
LEN NBAD IN ELYRIA CHECKED IN # 1

```

(PRESS ENTER TO CONTINUE)? _

Fig. 7. The C command looks for a particular callsign. F does the same for cities.

```

NBAD      LEN      ELYRIA
WHAT DO YOU WANT TO CHANGE :
1  CALL
2  NAME
3  QTH
4  TRAFFIC
5  NOTHING
-----
? _

```

Fig. 8. The E command allows you to edit an entry.

the list, or it will tell you that he hasn't checked in yet by the fact that he's not listed.

The F command works the same as the C command except that it looks for cities instead of callsigns.

The E command was programmed probably because I am a lousy typist. It allows the user to edit any previous check-in already on the list. When the computer is in the command mode ("THIS IS A SCRATCH PAD FOR CHECK-INS"), type E and press ENTER. The program then asks "WHAT NUMBER DO YOU WANT TO EDIT?" The number can be found using the R command as described above. If you want to edit the last station on the list, just hit ENTER.

The computer now will respond as shown in Fig. 8, and you reply with the appropriate number. The computer then asks for the correct information, which you enter.

Command X drops a check-in from the list. Type X in the command mode and press ENTER. The computer then asks "WHAT NUMBER DO YOU WANT TO DELETE?" (which can be found with the R command). Enter the number

for the station leaving and hit ENTER. The station will be removed and everyone after him will be moved up one to fill his slot.

There is one more command that is transparent to the operator: the D command (DROP). In the command mode, typing D and ENTER will get the prompt "WHAT CALL SIGN DO YOU WANT TO DROP?" If you answer with a call on the list, the program will place an asterisk at the end of the call string and also at the end of the QTH string. It also deletes any traffic the station had listed. The addition of the asterisk makes string comparison impossible for the other functions (unless you add the asterisk to the call or QTH when you use the other commands).

This command could be used when a station hooks up and moves off the net frequency or says he is checking out but will be back in a few minutes.

The description of the program so far makes it seem like a TV typewriter program for storing a list of all the stations that have checked in. It is much more than that, however, and here is where it shines.

When someone checks in, a data base is set up with call, name, QTH, and

```

10 REM INITIALIZE
20 CLEAR1500 : DIM CS(100),NS(100),QS(100),TS(100)
100 REM MAIN PGM
105 X=1:Z=1
110 CLS:PRINT"END LIST","R=LIST ENTRIES","T=LIST TRAFFIC","C=LOOK FOR
CALL","F=FIND CITY","E=EDIT","X=DELETE CHECK-IN":PRINT STRINGS(63,"-
"):PRINT" THIS IS A SCRATCH PAD FOR CHECK-INS"
130 INPUT CS(X)
135 IF CS(X)="" THEN GOTO130
137 IF CS(X)="X" THEN GOTO1500
140 IF CS(X)="L" THEN GOTO 200
150 IF CS(X)="R" THEN GOTO300
160 IF CS(X)="T" THEN GOTO400
170 IF CS(X)="F" THEN GOTO500
180 IF CS(X)="C" THEN GOTO600
190 IF CS(X)="D" THEN GOTO700
195 IF CS(X)="E" THEN GOTO900
197 Y=X : X=X+1
198 GOTO130
200 CLS:FOR X=ZTOY
210 PRINT#200, CS(X)
215 IF CS(X)="L" THEN GOTO 110
220 PRINT:INPUT"WHAT IS THE CORRECT CALL SIGN";CS(X)
225 GOSUB 1100
230 PRINT:INPUT"WHAT IS THE NAME";NS(X)
235 IF NS(X)="" THEN NS(X)="N/A"
240 PRINT:INPUT"WHAT IS THE QTH";QS(X)
242 IF QS(X)="" THEN QS(X)="N/A"
245 GOSUB 1200
250 PRINT:INPUT"WHAT IS THE TRAFFIC (NONE-PRESS ENTER)";TS(X)
252 IF TS(X)="" THEN GOTO 260
255 GOSUB 1000
260 CLS:NEXT X
270 Z=X : GOTO110
300 CLS:PRINT" "; "CALL", "NAME", "QTH", "TRAFFIC" :PRINTSTRINGS(63,"-")
FOR X=1TOY
310 PRINTX," ";CS(X),NS(X),QS(X),TS(X)
320 W=W+1 : IF W=10 THEN PRINT:INPUT"(PRESS ENTER TO CONTINUE)";GS:W=0
CLS : PRINT" "; "CALL", "NAME", "QTH", "TRAFFIC" : PRINT STRINGS(63,"-")
330 NEXT X
335 PRINT:INPUT" END OF LIST SO FAR ";GS
340 W=0:GOTO110
400 CLS:PRINT" THIS IS A LIST OF ALL THE TRAFFIC WE ARE LOOKING FOR":PR
INTSTRINGS(63,"*")
410 FOR X=1TOY
415 IF TS(X)="" THEN NEXT X ELSE PRINT TS(X);" ----- BY ";CS(X), : N
EXT X
440 PRINT:PRINT:INPUT" (PRESS ENTER TO CONTINUE)";GS : GOTO 110
500 CLS :PRINT:PRINT:INPUT"WHAT CITY ARE YOU LOOKING FOR";FS
510 FOR X=1TOY : IF FS=CS(X) THEN PRINT NS(X);" ";CS(X);" IN ";QS(X);" C
HECKED IN #";X : Q=1
520 NEXT X
525 IF Q=0 THEN PRINT FS;" IS NOT AVAILABLE YET"
530 PRINT:PRINT:INPUT" (PRESS ENTER TO CONTINUE)";GS
540 Q=0:GOTO 110
600 CLS : PRINT:PRINT:INPUT" WHAT CALL SIGN ARE YOU LOOKING FOR";F
S
610 FOR X=1TOY : IF FS=CS(X) THEN PRINT NS(X);" ";CS(X);" IN ";QS(X);"
CHECKED IN #";X : Q=1
615 NEXT X
620 IF Q=0 THEN PRINT FS;" IS NOT AVAILABLE YET"
630 PRINT:PRINT:INPUT" (PRESS ENTER TO CONTINUE)";GS
640 Q=0:GOTO110
700 CLS
710 PRINT:INPUT" WHAT CALL SIGN DO YOU WANT TO DROP ";FS
720 FOR X=1TOY : IF FS=CS(X) THEN CS(X)=CS(X)+ "*" :QS(X)=QS(X)+ "*" :TS(X)
=" "
730 NEXT X
740 GOTO 110
900 CLS : N=Y :INPUT"WHAT NUMBER DO YOU WANT TO EDIT";N
910 CLS:PRINT:PRINT CS(N),NS(N),QS(N),TS(N)
920 H=5:PRINT:INPUT" WHAT DO YOU WANT TO CHANGE :
1 CALL
2 NAME
3 QTH
4 TRAFFIC
5 NOTHING
-----
";H
930 IF H=1 THEN INPUT" WHAT IS THE CORRECT CALL SIGN";HS : CS(N)=HS
940 IF H=2 THEN INPUT" WHAT IS THE CORRECT NAME";NS : NS(N)=HS
950 IF H=3 THEN INPUT" WHAT IS THE CORRECT QTH";QS : QS(N)=HS
960 IF H=4 THEN INPUT" WHAT IS THE CORRECT TRAFFIC";KS : TS(N)=KS :TS(X)
=TS(N) : CS(X)=CS(N) : GOSUB 1000 :TS(N)=TS(X) : TS(X)=""
990 GOTO 110
1000 FOR C=1TOY-1 : IF TS(X)=CS(C) THEN PRINT CS(X);"---"; NS(C);" ";CS(C)
C) : IN ";QS(C);" CHECKED IN # ";C : Q=1
1004 NEXT C
1005 IF Q=1 THEN TS(X)="" :GOTO1015
1015 FOR C=1TOY-1:IF TS(X)="" THEN GOTO1016 ELSE IF TS(X)=QS(C) THEN PRI
NT CS(X);"---";NS(C);" ";CS(C);" IN ";QS(C);" CHECKED IN # ";C: R=1
1016 NEXT C:IF R=1 THEN TS(X)="" :GOTO1030
1020 IF Q=0 AND R=0 THEN PRINT" NOT AVAILABLE YET" : INPUT"(PRESS ENT
ER)";GS: RETURN
1030 Q=0:R=0 : INPUT" (PRESS ENTER TO CONTINUE)";GS : RETURN
1100 FOR C=1TOY-1 :IF TS(C)=CS(X) THEN PRINT CS(X);" CALL "; CS(C);" ";
NS(C);" HE IS LOOKING FOR YOU" : Q=1
1105 IF Q=1 THEN TS(C)="" : Q=0
1110 NEXT C
1140 Q=0:RETURN
1200 FOR C=1TOY-1 : IF TS(C)=QS(X) THEN PRINT CS(X);" CALL ";CS(C);" ";
NS(C);" HE IS LOOKING FOR YOUR CITY" : Q=1
1205 IF Q=1 THEN TS(C)="" : Q=0
1210 NEXT C
1240 Q=0 : RETURN
1500 CLS:INPUT"WHAT NUMBER DO YOU WANT TO DELETE";D
1510 FOR K=DTOX:CS(K)=CS(K+1):NS(K)=NS(K+1):QS(K)=QS(K+1):TS(K)=TS(K+1):
NEXT K : X=X-1:Y=Y-1:Z=Z-1: GOTO110

```

DONE

Program listing.

traffic. As each element is entered for the station—for example, his correct callsign—the program scans everyone else's traffic to see if that call is be-

ing looked for. If it is, the program automatically lets the NCS know. The same is true for the check-in's QTH; as soon as his location is entered, it is com-

pared to the list to see if anyone can use it. If so, the program tells you who is calling, and his name. If matches are found, the program reworks the data base and deletes the traffic from the appropriate station(s), keeping everything up to date.

If the check-in has traffic, upon entering it, the previous stations are scanned, and if someone has what he's looking for, the computer lets you know and updates the data base.

From my experience, this system sure beats looking through five pages of log trying to see if you can match up one station with another.

It is my impression that non-programmer types like myself who submit programs for publication are apologetic for their technique. I am not. There is no structure and I do not imply that good technique has been used. Undoubtedly, memory was wasted and speed could be improved, but the algorithm works and, as far as I have seen, no bugs are prevalent. Please change things around if you are inclined to do so.

Program Modifications and Explanations

I do not have a TRS-80 computer. I use a homebrew Z-80 system with 7K of static RAM. My system is configured the same as Radio Shack's, and, to the operator, there is no difference between the two except for all the flashing LEDs and a slightly larger size.

If you are using a Level II with 16K of memory, you should change line 20. It is not necessary that the change be made, but since I run only 7K of RAM, I have to limit my string space. Line 20 dimensions how many stations can be

put into the program and clears string space.

Line 920 probably needs explanation (see program listing). What you see is what actually is entered, but after each line of printing, press the DOWN ARROW key; don't enter a bunch of spaces. Everything else should be pretty straightforward.

Final Notes

Sometimes the obvious is not so obvious! When the program is first run and a list of check-ins is entered into the system, another list can be added whenever the command mode appears. The new list is added to the existing list(s) and, in actual operation, I have gotten up to about 75 stations in the program at one time. Execution time with this number is fast enough for smooth operating, but, of course, is not instantaneous.

My system topped out at around 80 stations listed, but only because there is not enough string space available with the CLEAR 1500 statement in program line 20. 16K systems should have no problem handling the full 100 stations, if CLEAR 1500 is changed to a value of, say, 2500.

There are no error-handling routines, so if you feel you will exceed the 100-station limit or the string space that's set aside, use the X command to remove all the stations that are no longer around. If the above are exceeded, the program will BOMB and you will lose all the information that has been entered. Error-trapping in the main program would have been nice, but I didn't have the memory to sacrifice. If you feel you are close to string-space limits, BREAK the program and print the string space available, (PRINT FRE(A\$), then type CONT. ■

MAKE MONEY... SELL 73 MAGAZINE

Selling 73 Magazine, the ham radio magazine that offers quality and quantity, brings the ham into your store. Once through the door you can sell him anything.

Plus... you make a profit selling "73". Newsstand price is \$2.95 and you pay only \$1.97 an issue (that's the standard dealer discount of 33 $\frac{1}{3}$ %). You make 98¢ on each issue sold.

Our dealers are telling us that "73" outsells them all... so call today and join the dealers who make money with 73 Magazine.

For information on selling 73 Magazine call 603-924-7296 and speak with Ginnie Boudrieau, our Bulk Sales Manager. Or write to her at:

73 MAGAZINE
80 PINE STREET
PETERBOROUGH NH 03458



Attention TRS-80* owners:

Computerize your log book with QSL Manager

How many times have you looked at your log book and wondered if you remembered to send a QSL to that operator you worked last week? Or perhaps you sent a QSL, but you can't remember getting one in return. The QSL Manager program will help you set up a computerized log book that will give you fast, efficient access to your records.

The program will allow you to make complete log entries which include: date, time, call sign, name, band, both the sent and received signal reports, the mode, whether a QSL was sent or received, and any remarks you want to add. Up to 1400 entries can be recorded on diskettes (depending on how many disk drives you have).

You won't have to fumble with index cards or papers when you're in the middle of a contact. The QSL Manager program has a built-in search function that will locate and present the information on any call sign in your records. You can even list all the QSO's for a particular date, time, band worked, mode, or a specific signal report. The program will even give you a list of all entries where a QSL was sent but none was received in return.

The QSL Manager program has built-in editing features that let you always keep your log book up-to-date. Of course, there's also a command that lets you output your log entries to a printer for hard copy.

In that next QSO, knock their socks off with your infallible memory. Just don't tell them you use the QSL Manager program.

This package requires the following minimum system:

1. A TRS-80 Level II with 16K RAM.
2. An Expansion Interface with 16K RAM (or more).
3. One or more disk drives.
4. Any compatible Disk Operating System.
5. A printer (optional).

Pkg. 0151RD (disk-based version) \$19.95.

TO ORDER: Look for this program at the dealer nearest you. If your store doesn't stock Instant Software send your order with payment to: Instant Software Inc., Dept. 8/73, Peterborough, N.H. 03458 (Add \$1.00 for handling) or call toll-free: 1-800-258-5473 (VISA, Master Charge and American Express accepted).

Instant Software™

Peterborough, New Hampshire 03458

A Computer-Controlled Talking Repeater

— part I: Introduction

One of the most natural combinations of microcomputer technology and amateur radio is in repeater control. Using the real strengths of the computer to build in features not feasible without it is the challenge. But selecting the features that are truly useful for the average user is also part of the challenge.

Ideally, the repeater

should be clean, pleasant to listen to, and be responsive to simple commands of its users. The fact that the repeater is controlled by a computer should be transparent to its users; once the project is complete it's the features, not the computer, that are important.

This article describes a control system built for a small, closed 220-MHz re-

peater in northern California. The work was shared by Bruce Martin WA6EQS. The features incorporated include all those on our original "wish list"—everything within reason that we felt would be useful on the machine. The controller has been in operation, performing as intended, since June, 1979.

This isn't intended to be a

construction article, but hopefully it will present ideas helpful to anyone considering a similar project for repeater control or for other dedicated microcomputer applications.

Repeater Features

A key to an interactive, well human-engineered repeater is the use of speech synthesis. With a voice, commands can be echoed and information can be provided on almost a conversational basis. The voice should sound natural and be intelligible. Speech-synthesizer boards from Telesensory Systems¹ were used, which provide the voice. They're easy to control and are highly intelligible.

With the widespread use of low-power handie-talkies, it's often useful to check how well you're getting into the machine. Often, when inside a building it's helpful to find a "hot spot." By simply pressing touchtoneTM keys, the repeater reads back an S-meter reading. Similarly, frequency error can be measured and read back to check on frequency drift or to net a new crystal onto channel.

The autopatch operation

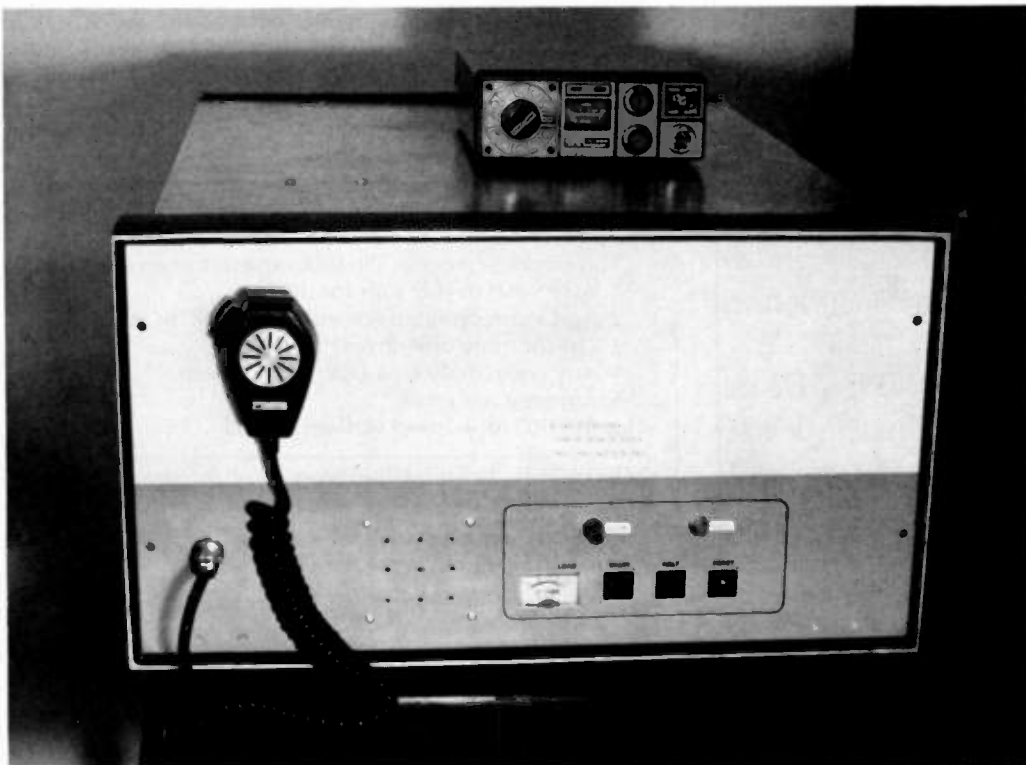

Photo A. Repeater is self-contained inside a 19"-wide cabinet, with the exception of IC-22S two-meter remote base and audio tape cartridge machine (not shown).

is simplified and refined to allow easy access and, at the same time, to protect the repeater owner against unauthorized and long distance calls. The phone number entered is read back to the user, allowing him to cancel the request if he entered it wrong. The repeater actually does the dialing, virtually eliminating wrong numbers. Before dialing, the repeater checks the phone number prefix against a table of local dialing prefixes to determine if it's a toll charge. Toll calls can be made, but require more user interaction. This makes the user aware that the call will be billed, and prevents abuse by unauthorized users.

Aside from standard phone-patch operation, a versatile autodialer is available for frequently called numbers. Storage of phone numbers is in CMOS RAM, with independent battery backup, allowing users to enter any local phone number into any of sixty autodialer locations as well as to change or move them at any time. The numbers are loaded over the air using touchtone commands. The autodialer greatly improves the safety of patch operations when the user is driving. Autodialer location and phone number readback ensure dialing the correct number.

Single-digit access to the telephone operator simplifies emergency communications. A simple touchtone sequence accesses the "time lady," so there's no need to build a time-of-day clock into the repeater (got away easy on that one).

The reverse autopatch has been taken a step further, allowing a directed ringback. When someone wants to contact a user of the repeater, a phone call to the repeater and entry of the correct command causes the machine to say

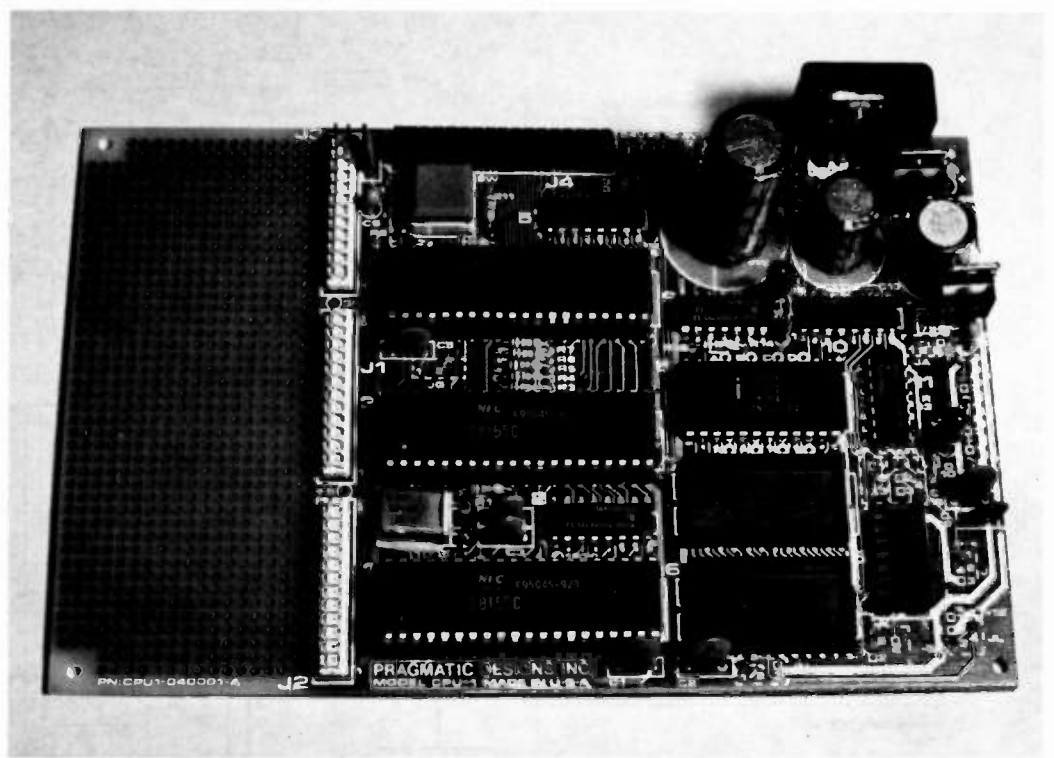

Photo B. Pragmatic Designs CPU-1A microcomputer for dedicated applications. I/O interfaces through 26-pin Great Jumper™ cables (A P Products). Breadboard area allows customizing to fit the application.

the call of the individual, then "ring" until picked up or until a one-minute timer times out.

The repeater can be tied to two meters as a remote base. The two-meter equipment is an Icom IC-22S and is programmed by the user to any frequency between 145.8 and 148 MHz, for simplex or plus or minus 600-kHz transmitter offset. The repeater reads back the frequency and offset when changed. The remote base transmitter is enabled independently, allowing monitoring only and talking over the two-meter signals. The remote base allows flexible emergency communications should the need arise.

Since the control over the air is by touchtone commands, a touchtone pad test feature allows checking pads by reading back any sequence of keys sent.

The repeater operates with a long hang time, with a beeper to indicate the end of a transmission and timer

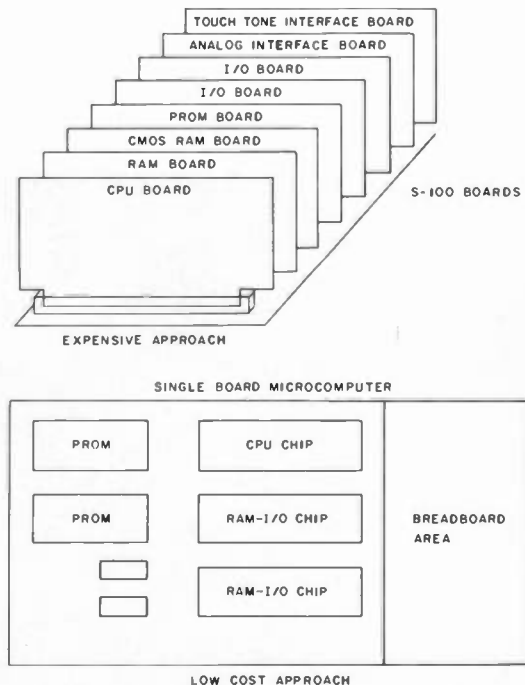

Fig. 1. Expensive approach vs low-cost approach to dedicated application microcomputer.

reset. An audio-delay line is used to allow muting of the received signal squelch tail, as well as to mute touchtone command signals. The absence of the double kerchunk heard on most repeaters makes the

machine far more pleasant to listen to.

The speech synthesizer allows voice rather than CW IDs. Exor, the little man with the voice, tries hard to avoid interrupting a conversation and will never talk

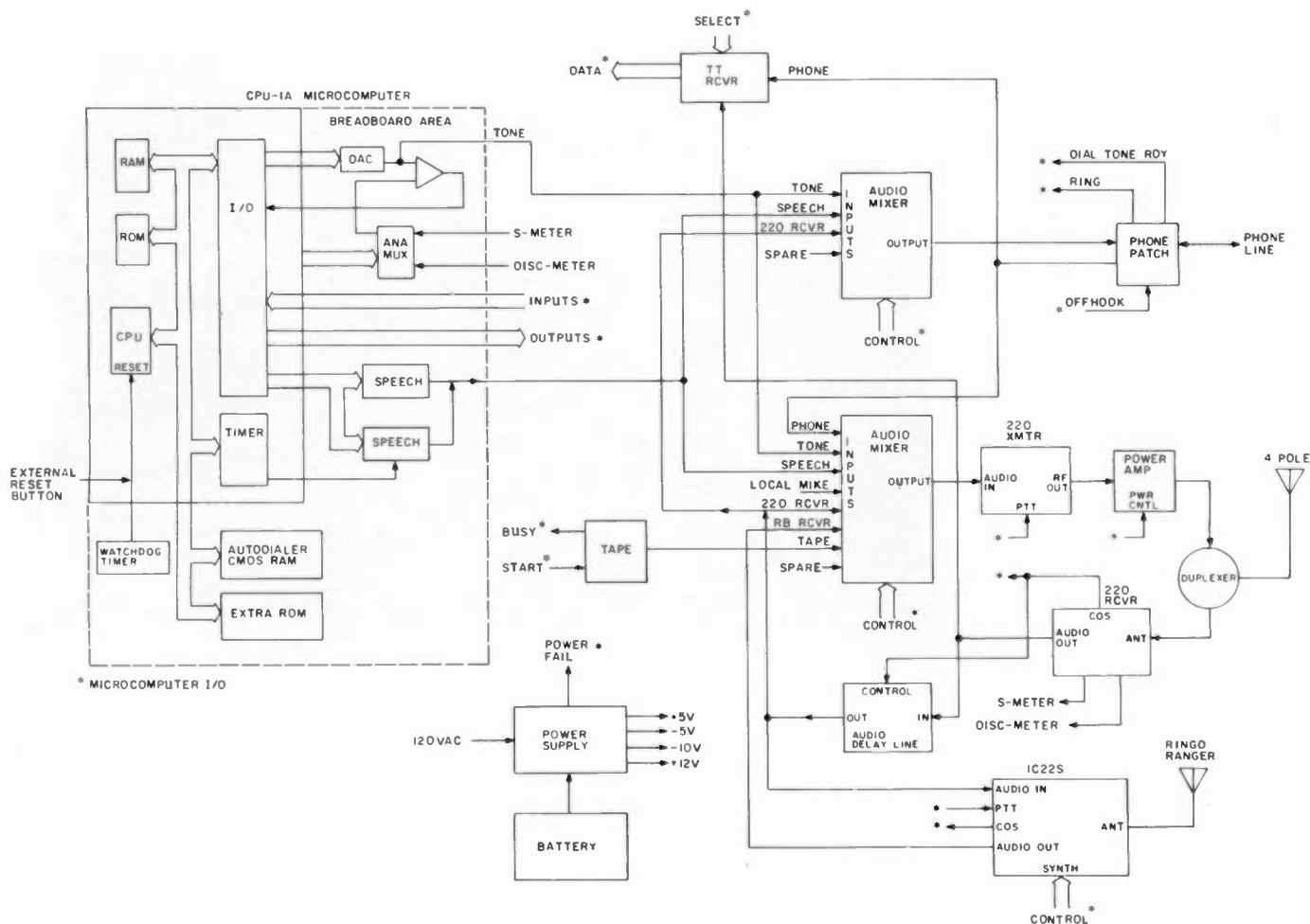

Fig. 2. Repeater hardware block diagram. Microcomputer provides all timing and control.



Photo C. Repeater control board. Main board mounts on the cabinet's "front door." Clockwise from upper right are CPU-1A microcomputer, audio delay line, audio mixers, phone patch, and dc-dc converter.

over anyone. Since an ID is required at least every ten minutes, starting at six minutes in the repeater looks for a hang-timer timeout to work in its ID. By nine minutes in, it will try to ID at the end of a user's transmission and, if all else fails, Exor will get out his key and ID in Morse code over a conversation at ten minutes in. If someone starts to transmit while he's speaking, he'll stop and wait for another opportunity so as not to be rude.

An audio tape cartridge machine contains another voice ID—this one by Nancy. She is touchtone commandable and also comes up every thirty minutes on the hour and half hour for a time-reminding ID. If a QSO is in progress when she's scheduled to speak, she waits until the end (hang-timer timeout). As a result, she never inter-

rupts but often gets in the last word of a QSO.

Design Approach

Several approaches can be taken in selecting the computer used in a repeater controller. A number of commercially available boards—CPU, RAM, ROM, I/O, and other special function boards—could be assembled to form the computer. For example, an S-100 motherboard plus off-the-shelf S-100 cards would do the job nicely, but would cost well over \$1000! A more cost-effective approach (and the one used in this project) is to use a single-board microcomputer specifically intended for dedicated applications. The computer is treated as a programmable logic block in the system. The board selected includes enough breadboard area right on the board for customizing and interfacing to the rest of the repeater and costs only \$160 as a kit. Aside from the low cost of this approach, reliability is enhanced because of the very many fewer components and interconnections of a single board computer.

The 8085A CPU was selected based on programming experience and development capability. The 8085A is also ideal in that it can be configured for a very low parts count but complete computer, with all the software power of the original 8080. It also has a versatile interrupt structure built in, high speed, and single +5-volt supply.

The Pragmatic Designs² CPU-1 Single-Board Microcomputer uses the 8085A and its LSI companion, 8155, which provides 256 bytes of RAM, 22 I/O lines, and a programmable counter/timer. The CPU-1A uses two 8155s and was selected for this project. Up to 4K of EPROM can be accommodated directly on the CPU-1. Customizing and in-

terfacing can be placed neatly in CPU-1's breadboard area.

A fundamental design decision made at the beginning of the project (one made in any microcomputer project) was determining which functions would be implemented in hardware and which in software. In general, this decision is based on minimizing overall cost, which primarily includes development cost and manufacturing cost. Since software is largely a one-time development cost while hardware costs are attached to each unit produced, the decision depends on how many units are to be produced. If many are to be built, a software-intensive design is preferred because the development cost is spread out over the large number of units, while manufacturing cost is minimized because of the reduced amount of hardware.

In this project, where only one repeater controller is to be built, implementing in

MEMORY KEYS BREAKTHROUGH!



The remarkable AEA Morsematic memory keyer has 35 fantastic features including two AEA designed microcomputers, up to 2,000 character memory, automatic serial number, beacon mode, and automatic morse trainer mode.

CALL TODAY

KRYDER ELECTRONICS

5826 Northwest 50th, MacArthur Square Shopping Center
Okla. City, Okla. 73122 (405) 789-1951

AEA Brings you the Breakthrough!



Photo D. Development system consisting of IMSAI 8080, dual floppies, keyboard, and 9" CRT. ROM-simulator boards connect to small dedicated application microcomputers for in-circuit emulation-type software debug.

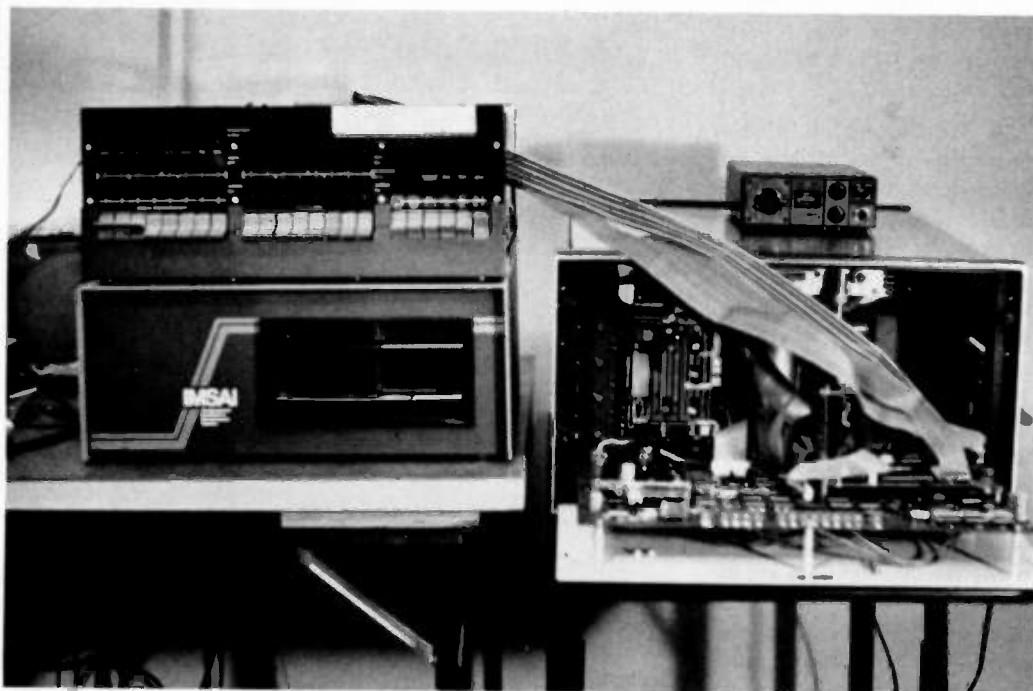

Photo E. Repeater in final checkout. Program runs out of ROM simulator in IMSAI to allow rapid program changes.

software only those functions difficult to implement in hardware would be reasonable. But since the goal of a hobby project is not to minimize cost but to learn, I bit the bullet and made the design heavily software-intensive. A general-purpose, real-time software nucleus was developed which has been applied to other projects since starting the repeater design. The control system illustrates the capability of a minimum-configuration microcomputer. Reliability and power consumption are improved in the system as a result of the minimum-hardware approach.

Hardware

The repeater hardware will be discussed in detail in

parts II and III of this article, but an overview can be provided by the block diagram in Fig. 2. The rf portion of the machine consists of a split-apart Midland 13-509, with a preamp and 50-Watt power amplifier. A duplexer allows use of one antenna for both transmitting and receiving.

The microcomputer provides all timing and control required by the repeater. The CPU-1A contains the CPU, RAM, ROM and I/O for the microcomputer. Mounted in the breadboard area of the CPU-1A is a digital-to-analog converter (D/A) for tone generation. A software-controlled analog-to-digital (A/D) converter is formed with the D/A plus the comparator and analog multiplexer. The Telesen-

sory speech synthesizer boards and a small CMOS RAM board with battery backup plug into connectors mounted on the CPU-1A. A watchdog timer generates a reset pulse if a software bug or noise glitch causes the computer to crash and be unable to service the timer.

The touchtone receiver connects to the 220 receiver and to the phone line. Audio mixers under computer control connect the proper audio sources to the 220 transmitter and to the phone line. The audio-delay line circuitry allows muting of squelch tails and touchtone signals before they reach the transmitter audio input.

The two-meter IC-225 synthesizer is programmed by ten output bits from the microcomputer, with simplex or plus or minus 600-kHz transmitter offset.

The power supply contains a dc-dc converter for the negative supply so that only +12 volts is required for repeater operation, simplifying battery backup. If ac power fails, the microcomputer reduces the power level of the transmitter

and shortens the repeater hang time to conserve power.

Software

Writing a large program to control a system in real time is quite a bit different than writing small applications programs which run on a general-purpose microcomputer. There are lots of books that describe assembly language instruction sets in detail and guide the newcomer through examples of writing small programs. Real-time control programming, however, where the computer is apparently performing many control tasks simultaneously, is an area that hasn't been widely written about. We're pretty much on our own.

There exists from Intel a Real-Time Multi-Tasking Executive (RMX/80™) which provides the software nucleus for a system such as the repeater controller. Since it costs \$2100 and requires use of their \$15k development equipment and their \$500 single-board computer, I chose not to use it.

The key to approaching the software development in a project such as this is to find or design a simple, general-purpose nucleus with enough capability to handle the specific job. The nucleus will be described in detail in part II of this article, but Fig. 3 illustrates its fundamental organization.

An Initialization module sets up the hardware and program variables on power-up or reset.

The Foreground module manages "foreground tasks," which include activities such as speech synthesizer control, tone generation, and command sequence detection.

The Background module is an interrupt routine executed every 5 ms. It monitors receiver squelches, phone ring, and other status

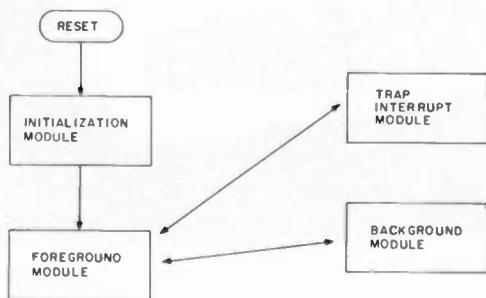

Fig. 3. Software nucleus block diagram.

signals. It decides transmitter off/on and phone off/on hook. The Background module also performs periodic A/D conversions and stores the results in memory.

An important element in the Background module is a general-purpose timer structure. Any number of independent timers may be implemented, with limitations based only on total execution time relative to the interrupt period. Each timer has a unique routine associated with it which is executed on timeout of that particular timer. The repeater controller uses 19 timers, for such functions as beep timer, hang timer, phone-patch timeout, phone-answer delay timer, etc.

Finally, a separate Trap Interrupt module loads touchtone commands into a RAM buffer when received, to be evaluated later by the sequence detector in the Foreground module.

While developed specifically for the repeater-control software, the nucleus is general purpose and can easily be adapted to many similar real-time control applications.

Development Equipment

The development approach used in this project was ROM simulation—the program ROM of the repeater's computer during development was actually RAM inside an IMSAI S-100 computer. Three Pragmatic Designs DBM-1, 2K-byte ROM simulator boards were used.

The ultimate approach to microcomputer development is CPU in-circuit emulation. The CPU in the microcomputer under development (target) is replaced by a cable which goes to the development system computer. The development system can then emulate the target com-

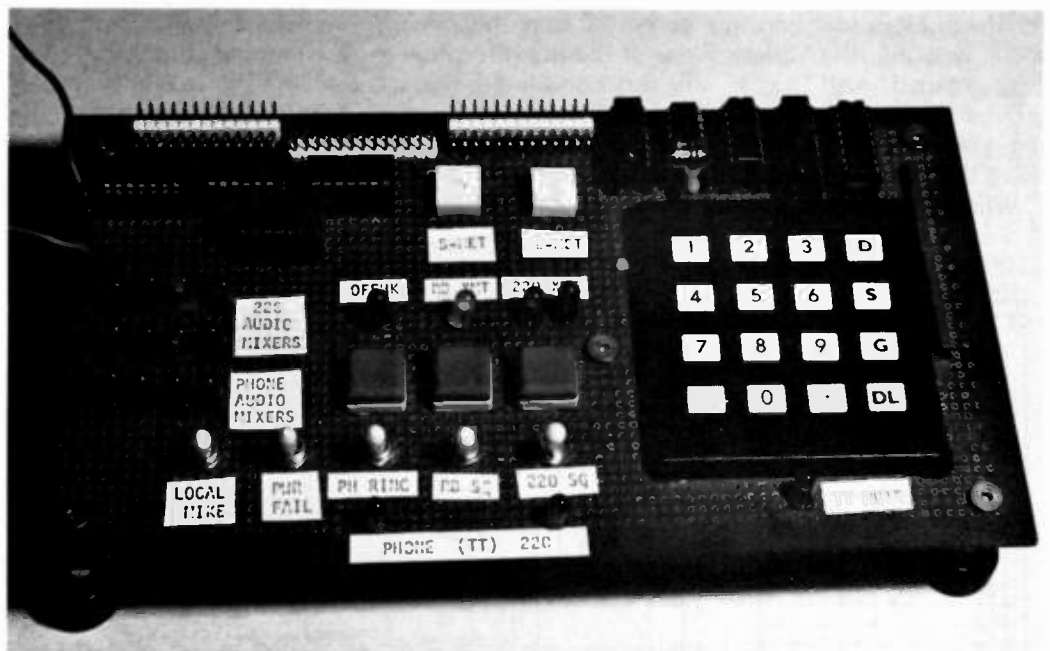

Photo F. Repeater simulator used during software development before checkout was possible on actual repeater.

puter's CPU and any combination of RAM, ROM, and I/O. The cable is the link between the powerful diagnostic capability of the development system and the realities of the target computer hardware.

Development systems with full in-circuit emulation capability, such as the Intel MDS or Tektronix 8002, cost \$15-20k, putting them beyond the reach of many potential users. Emulation of just the program ROM rather than the CPU is an effective alternative approach to developing and debugging small- to medium-sized programs which run in target hardware. The link from a low cost S-100 computer can be through the target computer's ROM sockets. A ROM simulator looks like RAM to the development computer, and like ROM to the target. The target program can be loaded and modified from the console of the S-100 development computer but can run in the target computer, allowing rapid program changes as bugs are found and corrected.

The development equipment used in this project consisted of an IMSAI 8080

with 28K of RAM, a pair of Persci full-sized floppy disk drives, and three Pragmatic Designs DBM-1, ROM simulator boards to simulate up to 6K of program memory in the repeater's computer.

One of the most critical requirements for effective use of any development hardware is good quality, reliable system software—disk-operating system, assembler, and debugger. Such software exists for 8080/Z80-based systems from Digital Research. The CP/M™ disk-operating system manages access to information stored on disk and includes file-handling utilities, a text editor, an 8080 assembler, and a debugger program. Also available from Digital Research³ is MAC™, a nicer assembler with macro-capability, and SID™, a debugger program which allows symbolic as well as absolute references.

This software must be the greatest bargain in the world of microcomputers today. Comparable software packages from Intel for their development systems can cost several thousand dollars, while CP/M—in many ways better than

other industrially-available system software—costs about \$100!

Since the software development was spread out over several months and the repeater was not available until final checkout, the bulk of the software was checked out on a repeater simulator—LEDs and switches simulating the repeater's functions (Fig. 4). A simple circuit with keypad simulated the Mostek MK5102 touchtone receiver. An audio amplifier and speaker were used to listen to the speech synthesizer and tone generator during development.

The microcomputer hardware was designed and built in parallel with the software development. The hardware was tested first using simple routines run with the ROM simulator before attempting to bring up the repeater software.

When the hardware was known to be working, the basic software foreground/background nucleus was brought up. Just a switch simulating receiver squelch and an LED indicating transmitter status were used to test a simple COR and timer function. Af-

ter the nucleus was known to be working, the various foreground and background routines were written and tested to implement the features desired.

When the software was

complete and the remainder of the interface circuitry was completed, the system was ready to be integrated into the repeater. The machine was brought down off the hill and the

mechanical work was done to mount the new hardware. The repeater simulator was unplugged from the computer, the control board was plugged in, and presto!—within a couple of

hours the repeater was back on the air. The machine stayed at the low level site for two weeks to complete mechanical work, do some rf work, make minor software changes, and let the system burn in.

Next Time

Part II of this article will describe details of the microcomputer hardware and the software nucleus. Part III will discuss hardware and software interfacing of peripheral circuits including the speech synthesizer, remote base, audio delay line, and other sections that may be of particular interest. ■

References

1. Telesensory Systems, Inc., 3408 Hillview Avenue, PO Box 10099, Palo Alto CA 94304.
2. Pragmatic Designs, Inc., 950 Benicia Ave., Sunnyvale CA 94086.
3. Digital Research, Box 579, Pacific Grove CA 93950.

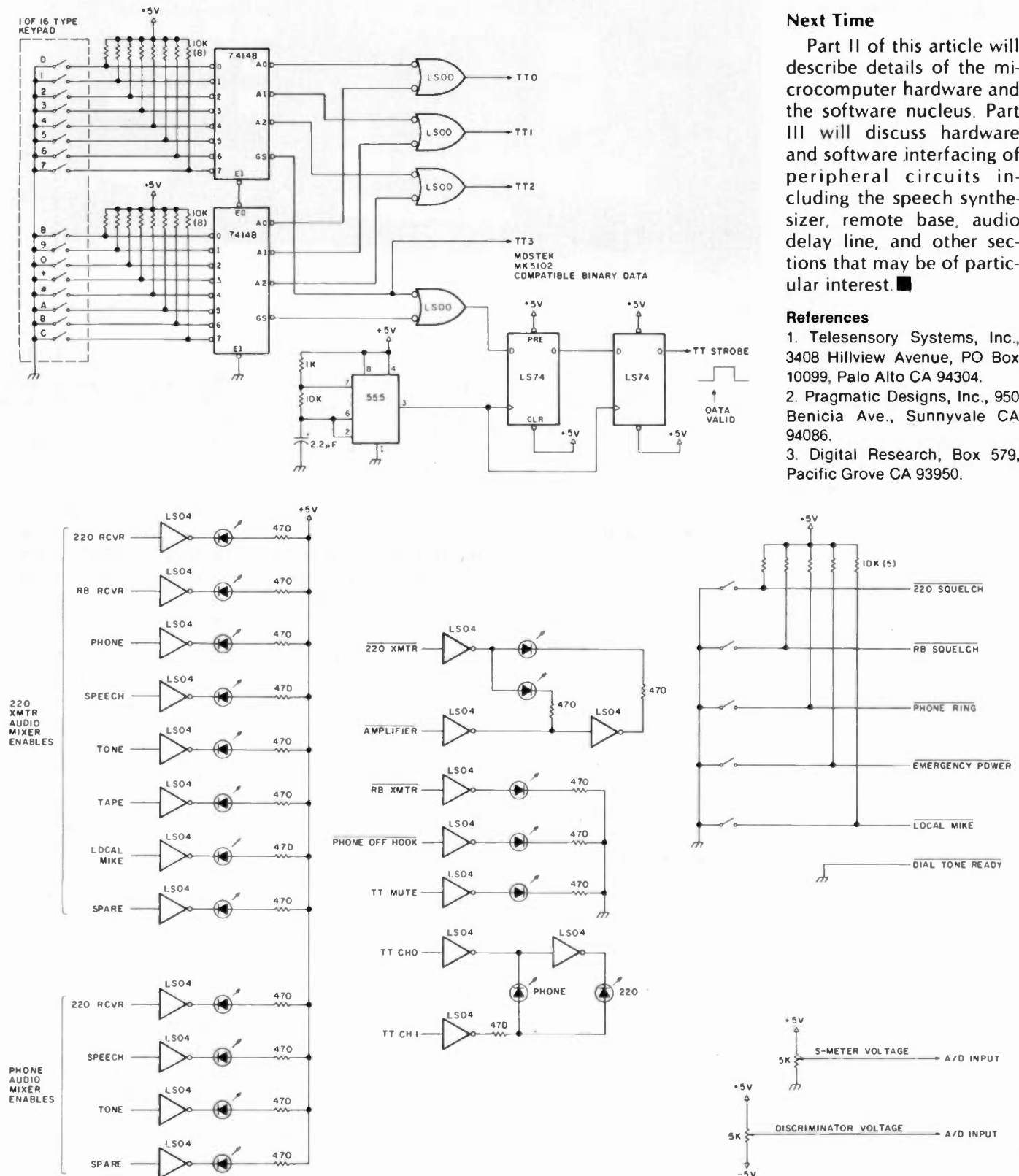
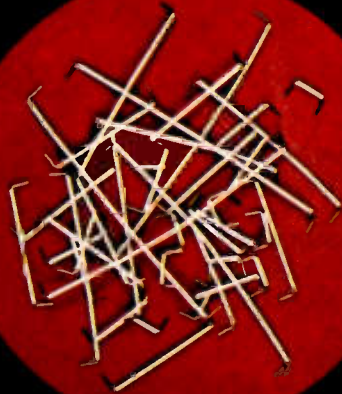
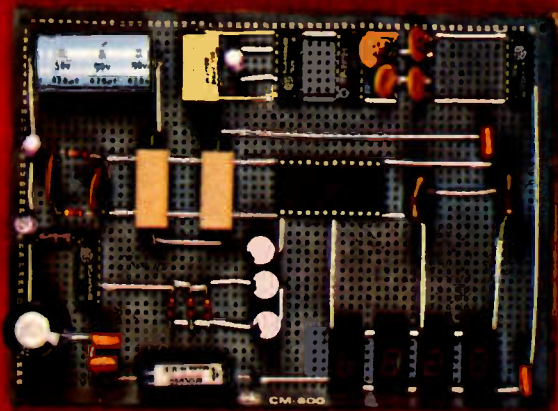
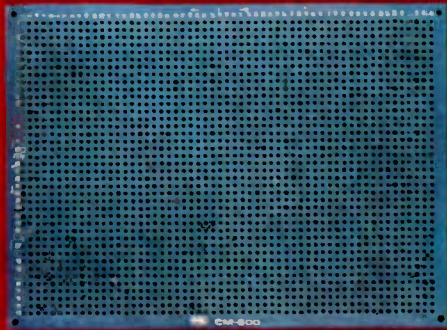

Fig. 4. Repeater simulator. Switches and LEDs simulate the repeater's status inputs and control outputs during software development. Keypad plus logic simulates Mostek MK5102 touchtone receiver.



CM-600 Circuit Mount



CM-600 \$6.95*
RW-50 \$2.98*

NEW CM-600 SOLDERLESS PROTOTYPE BOARD

CM-600 is a unique system for solderless construction of circuit prototypes, useful to both engineers and hobbyists. The CM-600 is a neoprene board 4½" (114mm) x 6" (152mm) with 2280 holes on .100" (2.54mm) centers. Standard components including DIP's are mounted by simply inserting leads into the holes in the long life neoprene material. Interconnections are easily made using 20 or 22 AWG (0,8 or 0,65mm) wire jumpers. Positive contact is assured by the elasticity of the hole, which compresses the leads together. To remove components or leads, simply pull out. This facilitates easy circuit changes making it ideal for breadboarding experimental circuits. CM-600 also features numbered rows and columns for easy reference.

Accessory Kit RW-50 contains 50 pcs of AWG 20 (0,8mm) insulated jumper wires of assorted lengths from ½" (13mm) to 4" (100mm). Both ends are stripped and bent 90° for easy insertion. In stock directly from

OK Machine & Tool Corporation ✓ 54

3455 Conner St., Bronx, N.Y. 10475 U.S.A.

Tel. (212) 994-6600 Telex 125091

* Minimum billings \$25.00, add shipping charge \$2.00
New York State residents add applicable tax

Murphy's Own OSCAR Tracker

— simple pointer for satellite antennas

I had decided to embark on the video RTTY route by way of the Radio Shack TRS-80 and the Macrotronics M-80 ham interface. Since N6EE has done all of the work on the M-80, there was little involved in getting the system going on teletype. However, I had chosen that system over a dedicated RTTY video system because of my interest in OSCAR. Once I

had a program to obtain antenna bearings for satellite passes, it seemed a logical step to let the computer control the antenna directly.

As I considered the problem, I realized that there could be many possible approaches from the trivial to the elegant. Recalling that one computer corollary of Murphy's Law states that the likelihood of a program

working is inversely proportional to its complexity, I decided on a trivial approach. The M-80 hardware has both solid-state and relay- (or optoisolator) controlled switches which respond to commands from the computer. For example, the BASIC statement `X=INP(3)` will cause the normally-closed relay contacts to open, while `X=INP(4)` will close them again. It seemed then that once antenna bearings were known, a simple timing routine to turn the antenna rotor on and off through the M-80 board would suffice.

To do that, I needed to know a bit about the timing features of the computer. I decided to use the engineering (try and try again) rather than the scientific (figure it out) approach to this problem. Program 1 is a short program that will cause the computer to function as a clock. Statement 1 allows entrance of current (or just future) time in hours and minutes. The input statement then holds execution until ENTER is

hit. `PRINT CHR$(23)` sets up a 32-character line instead of the usual 64-character line. Statement 2 prints the time in hours, minutes, and seconds in the center of the screen. The loop does the timing (that is the reason for the program, after all) while the following statements take care of adding minutes after 60 seconds and adding hours after 60 minutes. If you run this program on your machine, you will be able to see how many executions of the FOR-NEXT loop equal one second. I found that 551 came quite close. The longer you let the program run, the more accurate will be the estimate.

With that done, the rest of the task is really easy. Program 2 shows the routine for controlling the antenna—it is not a complete program in itself. My satellite-tracking program calculates antenna bearings (azimuth and elevation—though I currently control only azimuth) for each minute of a satellite pass. These are stored as

```
1 INPUT "ENTER TIME IN HRS, MINS";H,M:INPUT"HIT
'ENTER' TO START CLOCK";Z:CLS:PRINT CHR$(23)
2 PRINT@534,H;" ":"M":" :S
3 FOR I=1 TO 551:NEXT
4 S=S+1:IF S<60 THEN 2 ELSE S=0:M=M+1:IF M=60
THEN M=0:H=H+1
5 IF H=24 THEN H=0
6 GOTO 2
```

Program 1. Trivial clock.

```
600 IF D(INT(I9/2))<360 AND D(INT(I9/2))>180 THEN FOR
I=1 TO I9:IF D(I)<90 THEN D(I)=360:NEXT ELSE NEXT
605 I9=I9-1:FOR I=1 TO I9:D(I)=ABS(D(I)-D(I+1))/6:NEXT:
X=INP(4):PRINT "SET ANTENNA TO PROPER INITIAL
HEADING AND SET TRACKING SWITCH":INPUT"HIT 'ENTER'
TO START TRACKING";X$
610 FOR I=1 TO I9:FOR J=1 TO 15000:NEXT
615 X=INP(3):FOR J=1 TO 500*D(I):NEXT:X=INP(4)
620 FOR J=500*D(I) TO 15000:NEXT:NEXT:GOTO 555
```

Program 2. OSCAR tracking routine. Note: I9 is a variable set in the body of the program. It equals the total number of minutes that the satellite is available for communication.

NEW & DIFFERENT

FROM BARKER & WILLIAMSON, INC.

Barker & Williamson, Model 370-15, Broad Band Dipole Antenna with balun. Rugged construction for long life.

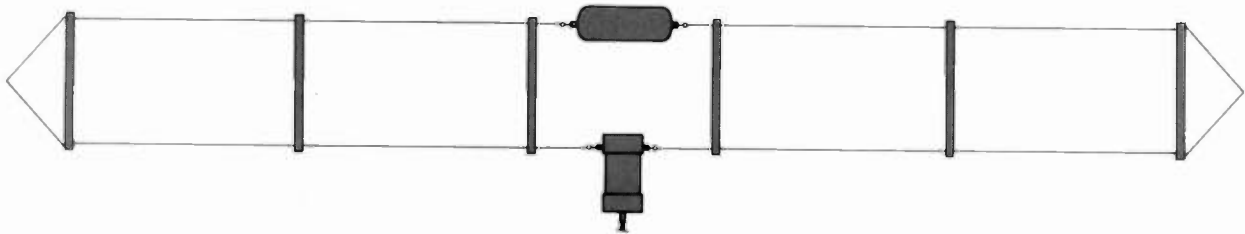

Covers 3.5–30 MHz including the new 12, 17 and 30 meter bands. Only 90 feet long! Can be used as a sloping or flat top antenna.

Supplied completely assembled with high tensile strength steel copper clad wire, 50 ft. RG coax cable and PL259 connector.

Will handle 2.5 KW–5 KW PEP

See your Dealer or Write:

✓ 11



Barker & Williamson, Inc., 10 Canal Street, Bristol, Pa. 19007

D(I) during the computation process. The program allows the user to see these on the screen or to obtain a printout. After all values are obtained, the machine asks, "Do you want antenna control?" If you indicate "yes," then the program branches to line 600, which is where Program 2 begins.

This routine is relatively straightforward. After some housekeeping which I will explain in a moment, the program begins keeping time. It is started by the user hitting ENTER. It then delays 30 seconds, rotates the antenna for a sufficiently long time to get to the bearing for minute 2, it delays for the balance of minute 1, then delays another half minute before rotating to the bearing for minute 3.

Here are the details. Since the bearings may begin just east of north then continue to the west, as

with a morning pass, I decided to let the antenna sit at north and then track west, which is what I generally do when controlling manually. Therefore, line 600 asks if the middle of the pass has bearings to the west of the QTH (between 280 and 360 degrees). If so, any bearings which are less than 90 are converted to 360. This means that several bearings will be 360, then bearings will decrease in value toward 180.

Line 605 changes the D(I) to values which will be usable in the timing routine. They are changed in the following manner. D(I) now equals the original D(1) minus D(2) divided by six. Actually, the absolute value of the difference is used. The difference is the difference in degrees between the antenna bearing at minute 1 and that at minute 2. The division by six

is done since my rotor moves at 6 degrees per second. Thus, D(I) is now the number of seconds that the rotor must be turned on to move from bearing 1 to bearing 2, etc.

Line 610 starts the timing process after ENTER has been hit. The I loop is used once for each minute of tracking. The first J loop—for 1 to 15000—provides a 30-second delay. Then, in line 615, the X=INP(3) statement turns on the rotor, J loop keeps it on for D(I) seconds, and X=INP(4) turns it off. Line 620 then continues to delay for 30 – D(I) seconds, then the process begins again. Line 555 is in the body of the main program and asks the user if computations are required for the next orbit.

I should make one comment about the hardware. I am using the 5-volt supply and normally-open relay contacts to control a sec-

ond relay which I have placed in the housing of my rotor control. That relay, in turn, controls the rotor. An SPDT switch determines whether closure of the relay will cause clockwise or counterclockwise rotation. So, at the start of a pass, I place the antenna in the correct initial position and set the switch according to which way I want the antenna to move. At the proper time, I hit ENTER, and then tracking will be done automatically during the pass.

There are certainly more elegant ways to perform this task, but I doubt if there is a much simpler way. Even with the two programs shown here, though, you can make some nice refinements. For example, you can use the clock in program 1 to display time until the pass is to begin, then automatically trigger line 610 and begin tracking. ■



Counting with Class

— build this 500-MHz LSI frequency counter

Kerry Erendson WB4EKB
352 Tequesta Drive
Tequesta FL 33458

After deciding that I could no longer do without a frequency counter,

I began to look through my back issues of 73 for ideas. It seems that the accepted way to build a counter is by stacking together as many counter-latch-display driver sets as you want digits. Looking at the ads for today's commercially-built counters, it's ob-

vious from size alone that this approach has become outdated. The way to go is LSI (large-scale integration).

The choice of ICs that are available is very broad. There are quite a few companies putting a lot of great circuits on LSI. After reviewing many data sheets, I

decided that LSI Computer Systems LS7031 had everything I wanted. It's billed as a "6-decade MOS up counter with 8-decade latch and multiplexer."

What this means in an 8-digit counter is that it replaces six of the eight decade counters, all eight latches, and requires only one external decoder driver for the display. This is a savings of 21 standard TTL ICs. Other considerations which made it ideal were: TTL compatible I/O, single 5-V supply operation, and external decade-counter inputs for the first two digits. Due to the provision for external TTL decade counters, 1-Hz resolution can be obtained since it is not limited by the relatively slow MOS circuitry. The pinout given in the data sheet is included.

Operation

An 8-digit counter which I designed around the

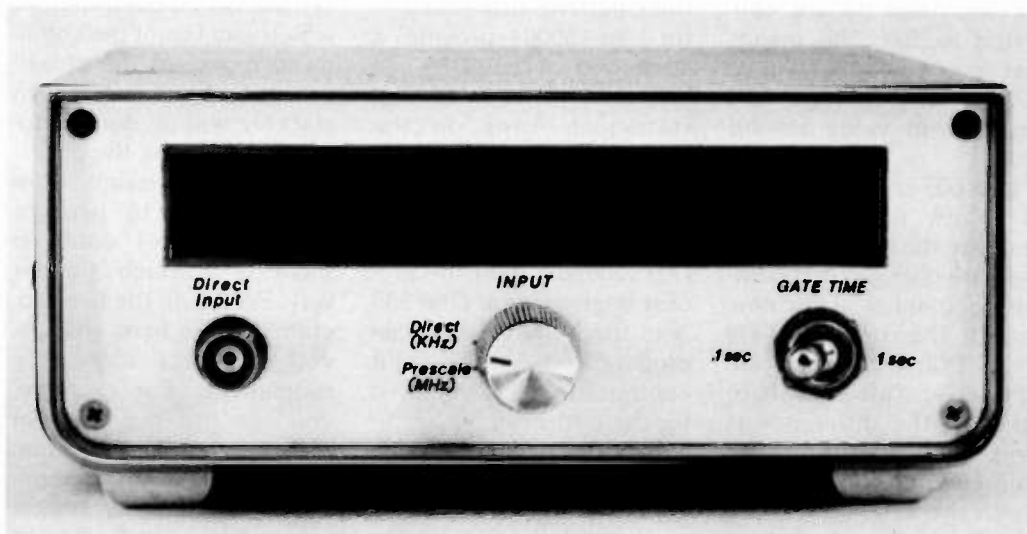

Photo A. Front panel.

Have you ever wondered why the best ham bargains are advertised in 73?

You'll find a wider selection of ham bargains . . . and lower prices in 73, because 73's readers buy far more than readers of other ham magazines.



Wayne Green

THE LEADING EDGE

That shouldn't come as a surprise to you . . . For twenty years we've been publishing more construction projects and articles than any other ham magazine, so it is natural for the active hams to read 73 . . . and buy from the ads.

The readers of 73 catch the leading edge, through side-band in the early 60's, then solid state in the mid-60's, FM and repeaters in the early 70's . . . SSTV, ATV, RTTY and all other special modes have received more coverage in 73 than all other ham magazines combined.

NEXT YEAR WE'LL BE PUSHING . . .

In the next year or so, we'll be pushing for amateur experimentation and pioneering with new modes of communications, via computer, automatic identification, satellite, wideband techniques, synchronous detectors, time slicing. Never before was a point in time so exciting to contemplate, and with 73 you can keep up with the new ideas and changes.

We'll also be pushing for increased pressure on the FCC for better and more responsive rules, for a return to a national growth and for amateur radio development in as many of the emerging nations as possible.

ALL OF THIS IS MADE POSSIBLE BY YOU

All of this is made possible by you reading 73 and getting your friends and club members to subscribe to 73. I admit

that we're not really pushing the radio relay of messages, since that is more geared to the 1920's than the 1980's and is more likely than other activities to cause troubles with foreign governments nervous about potential lost telephone revenues. We're looking toward the 1990's, with over one million hams in our country using state of the art communications techniques to keep in touch with hams worldwide.

I will appreciate your help in getting word of 73 out to more prospective subscribers. You might even express your friendship at Christmas with gift subscriptions to 73 . . . 2300 pages of a real ham encyclopedia during the last twelve months. That's about two and a half times as many articles and pages of articles as the next largest ham magazine!

YEAR 2000?

What will amateur radio be like in the year 2000? We can't really even imagine, except that we know it will be different from 1980 . . . probably as different as amateur radio is today from what it was in 1960, when FM and repeaters were all but unknown, and AM was still going strong on our phone bands. A frequency synthesizer required over a hundred tubes and radioteletype circuits were larger than the printers. You can be sure that 73 will be in the vanguard of the developments to come . . . reporting on them and giving you the information so you can participate.

Bill me for one year of 73 at \$20.00 New Subscription Renewal

Name _____

Address _____

City _____ State _____ Zip _____

Canadian \$22.00/1 year only, US funds Foreign \$30.00/1 year only, US funds

Please allow 4-6 weeks for delivery.

73 Magazine • PO Box 931 • Farmingdale NY 11737

30AT6

**73 Magazine's
20th Anniversary.....**

**73 Magazine's
20th Anniversary.....**

**73 Magazine's
20th Anniversary.....**

**73 Magazine's
20th Anniversary.....**

**APPLE Owners
send & receive
CW/RTTY**



FEATURES

- Send & Receive MORSE BAUDOT ASCII
- Connects to APPLE game I/O port
- Split Screen - edit while receiving
- Uses builtin PLL or external TU

- Includes hardware, cassettes & manual
 - Word Oriented Editor
 - Instant Break operation — preserve type-ahead buffer
 - Eight message memories — 255 char. ea
 - Auto transmitter control — PTT
 - Diddle, Replay, Cassette Save, CW ID (RTTY only)
 - Random Practice, Beacon, change spacing (Morse only)
 - CA650 In cabinet as illustrated \$259
 - TA650 FSD-1 active filter HTTY demodulator, XTL 1 xtal controlled AFSK and AC power supply installed in CA650 (assembled/tested) \$499
 - A6500 adds disk-based RTTY to CA650/ TA650 \$50
- Write or call for complete catalog

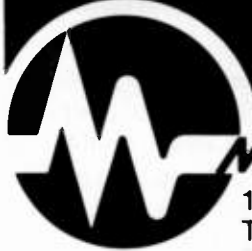

MACROTRONICS, inc. ®

1125 N. Golden State Blvd. / Suite G
Turlock, CA 95380 (S)
(209) 667-2888 / 634-8888



*We are experiencing telephone difficulties,
please keep trying.*

California residents add 6% tax

INTIMIDATED BY MORSE CODE?

**THE NEW AEA MODEL MT-1
COMPUTERIZED MORSE
TRAINER MAKES MORSE CODE
EASY AND FUN TO LEARN.**



- Automatic Speed Increase, User May Program: Starting Speed, Ending Speed, Practice Duration; 5 Letter code Groups or Random Space; Common or All Characters.
- Precise Speed Control 1 to 99 WPM (Tailor to Your Exact Requirements).
- 24,000 Character Answer Book Available For 10 Starting Positions.
- Random Mode For Practice (No Answers).

KT-1 Computerized Keyer With All Features of Above Trainer is Also Available in Same Package

THE COMM CENTER INC.

Laurel Plaza Route 198
Laurel, Md. 20810, MD: 301-792-0600
OPEN TUES. THRU SAT.
CALL TOLL FREE 1-800-638-4486

AEA Brings you the
Breakthrough!

The UDT 170



The SMART TU for RTTY & MORSE

The UDT 170 Universal Data Transceiver will instantly convert any ASCII or Baudot teletype or video terminal into a multiple baud rate data transceiver for ASCII, Baudot or Morse operation. It features ...

- 170/850 HZ Shift
- Dual 6 pole active filters for weak signal operation
- ASCII/Baudot Regeneration with multiple baud rates
- CW Auto Ident (optional)
- 1-150 WPM Morse with Auto-track
- Computes & Displays WPM copy rate & Buffer Status
- Selectable line length from 40 to 80 characters
- Metal Enclosure 12"x7 1/4"x3 1/2"

For more information write or phone

Price, Complete and Assembled **\$549**

XITEX CORP. ®

9861 Chartwell Drive
Dallas, Texas 75243
(214) 349-2490



Price subject to change without notice

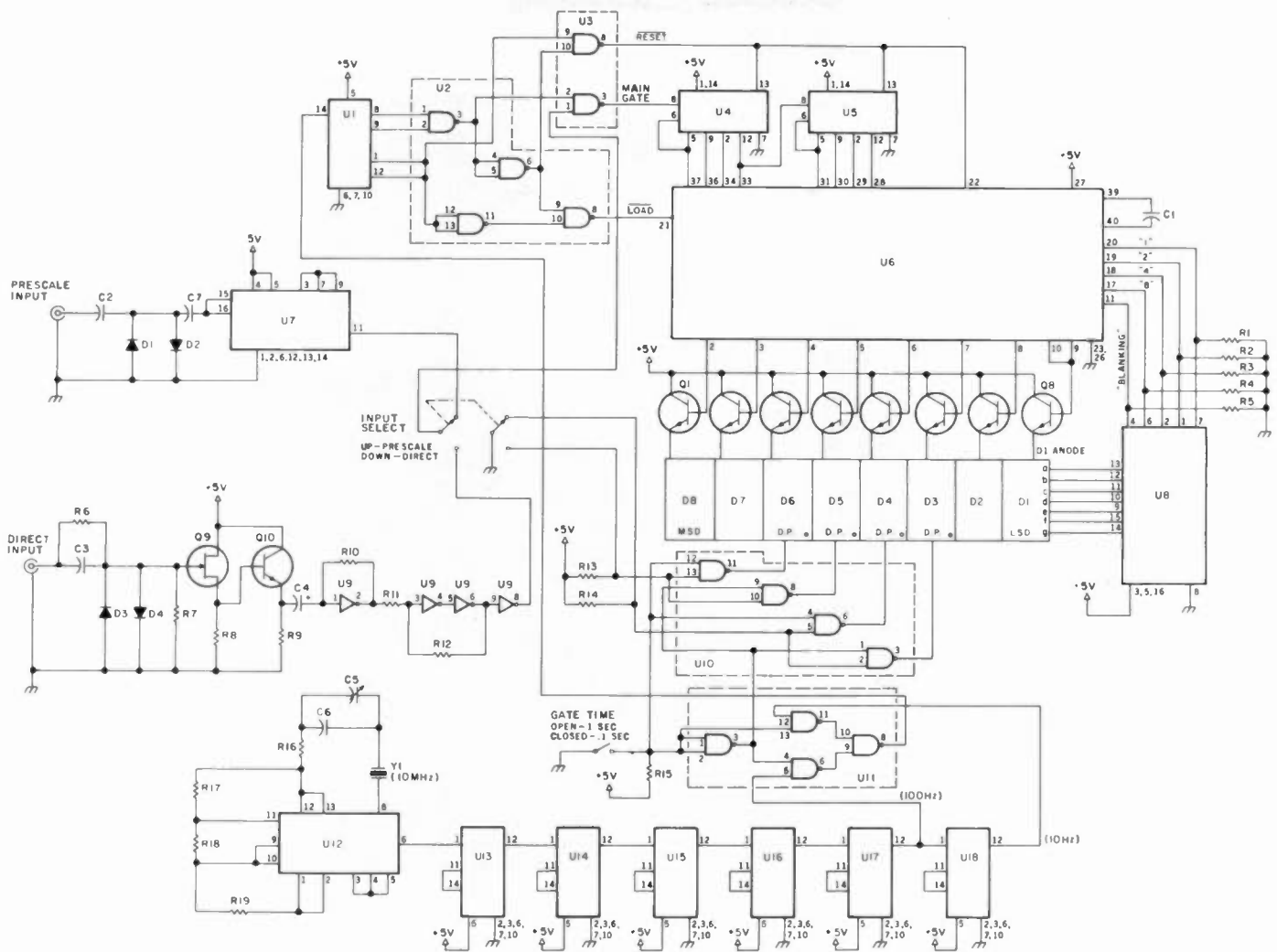

Fig. 1. Schematic. For U2, U3, U9, U10, U11, and U12, Vcc = pin 14 and ground = pin 7. Note: Two gates in U3 and two inverters in U9 are not used; ground all unused inputs.

LS7031 is described below. It has 1-Hz resolution on direct or 10-Hz resolution on prescale using 1-second gate time, or 10-Hz resolution on direct and 100-Hz resolution on prescale using .1-second gating. The direct input is good to at least 50 MHz, and the prescaled input should exceed 500 MHz. The counter has leading 0 blanking, and, if turned on with no input signal, will just display a 0 at the least significant digit position along with the decimal point to remind you what range you are on. In the direct mode, the decimal point is placed to read in kHz; in the prescale mode, the display is in MHz.

Circuitry

As can be seen in the

block diagram, the LS7031 greatly simplifies the circuitry. The prescaler is an 11C90 ECL IC which divides the input signal by 10 and outputs in TTL. The direct input preamp was taken from "The Latest in

Counters" by WA1UFE, in the December, 1976, issue of 73.

The input-select switch chooses the source. This signal is gated by U3 during the 0 to 9 counts of U1. At count 10, the Load input to

U6 goes low, latching in each digit's value and displaying it, and at count 11, the Reset line goes low, resetting to 0 all the counters, both internal and external. Then it begins to tabulate a new value during the

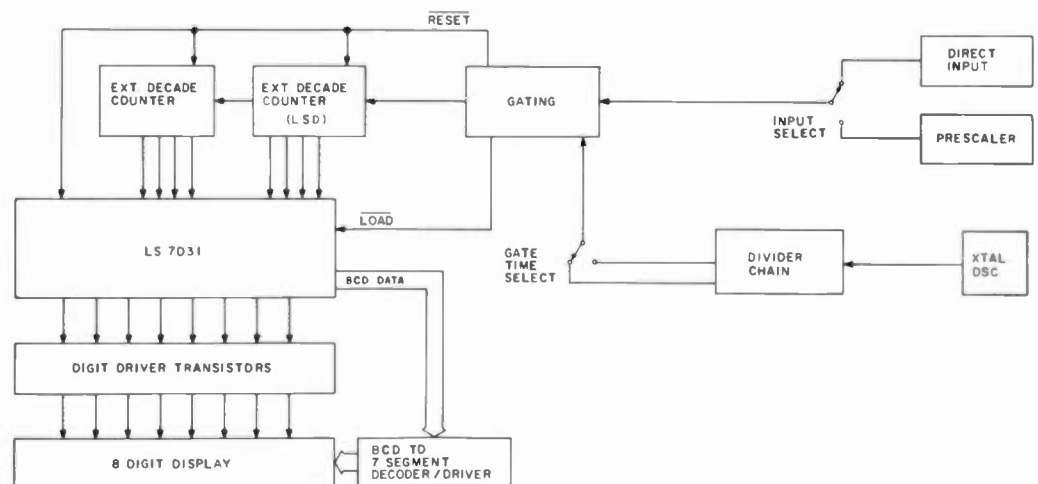

Fig. 2. Block diagram of LSI-based counter.

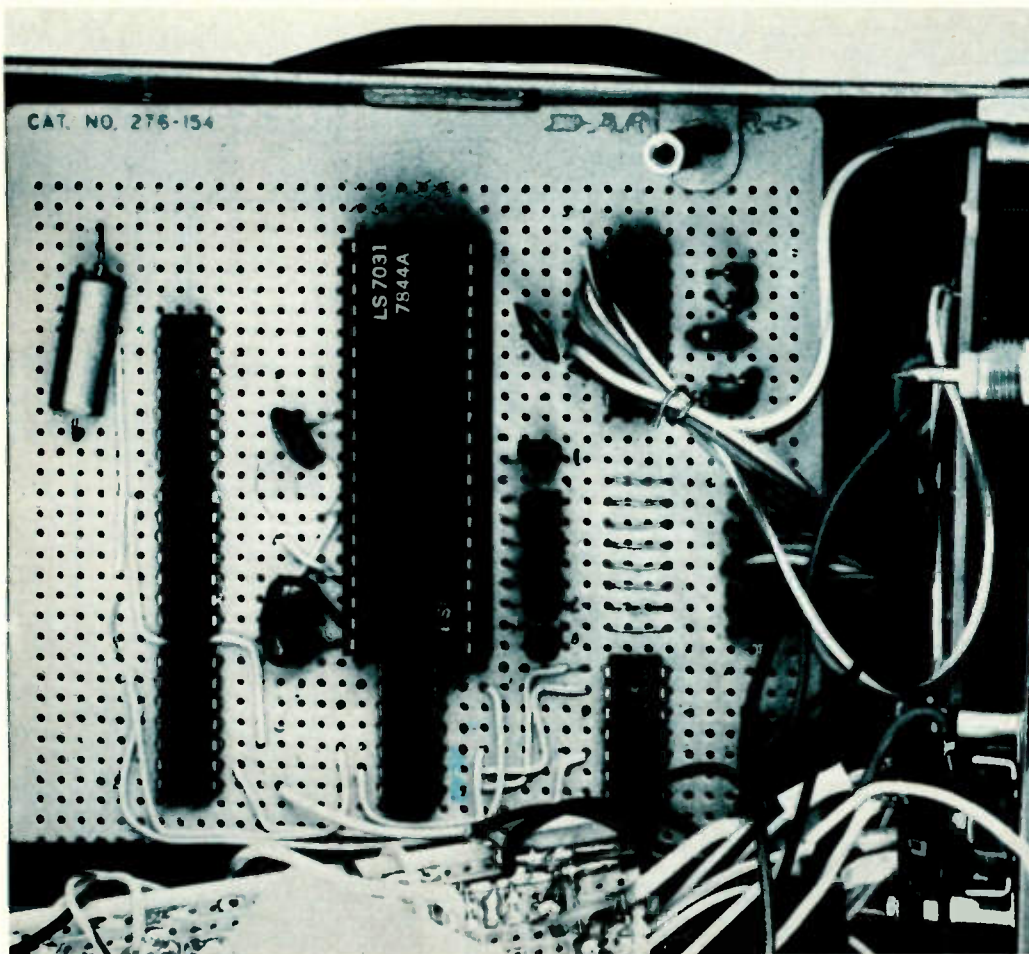

Photo B. Count/gate/display board, showing placement of parts—especially the digit-driver transistors.

0 to 9 count of U1, but the display keeps the old value until a new one is available, making a nice, steady display.

The crystal oscillator and

divider chain provide 100 Hz or 10 Hz to U1 for .1- or 1-second gating, respectively. U10 places the decimal point in the proper place depending upon the gate

time and input chosen. All of the cathodes for each segment should be wired together from display to display, except for the decimal point cathodes which go to U10 for D3 through D6. U8 takes the BCD data from U6 and drives these segment buses. C1 on U6 provides the display multiplexing rate.

Construction

I assembled the counter on two Radio Shack multi-purpose edge card boards. One board was used for the oscillator-divider chain, prescaler, and direct input preamp, and another was used for all the other components. For the latter, the board style with two voltage source buses etched on it was used. This made connection to U6 easier and provided a neat layout for the display driver tran-

Parts List

ICs	
U1	7492
U2	7400
U3	74LS00
U4,U5	74196
U6	LS7031
U7	11C90
U8	7447
U9	74LS04
U10,U11	7400
U12	74LS00
U13-U18	7490
LM309K	

Transistors	
Q1-Q8	2N3704
Q9	MPF102
Q10	2N708

Diodes	
D1-D4	1N914
D5-D8	1N4001

Resistors (all 1/4 Watt)	
R1-R4	1k
R5	560
R6	100k
R7	1 meg
R8	4.7k
R9	220
R10	560
R11	470
R12	15k
R13-R15	1k
R16	220
R17	1.8k
R18	220
R19	560

Capacitors	
C1	500 pF
C2, C7	.01 uF
C3	68 pF SM
C4	47 uF, 10 V
C5	20 pF trimmer cap
C6	15 pF
Pwr. Sup.	2500 uF, 15 V 1 uF, 6 V tantalum

Displays	
D1-D8	FND-507 or any other common-anode display

Misc.	
Y1	10-MHz crystal
	Gate time switch, SPST
	Input select switch, DPDT
	On/Off switch, SPST
	BNC or SO-239 connectors for inputs
	40-pin DIP socket

sistors, where the bases went to the U6 lands, the collectors soldered directly to the 5-V bus, and the emitters spanned across to their own land for easy connection of wires to the display.

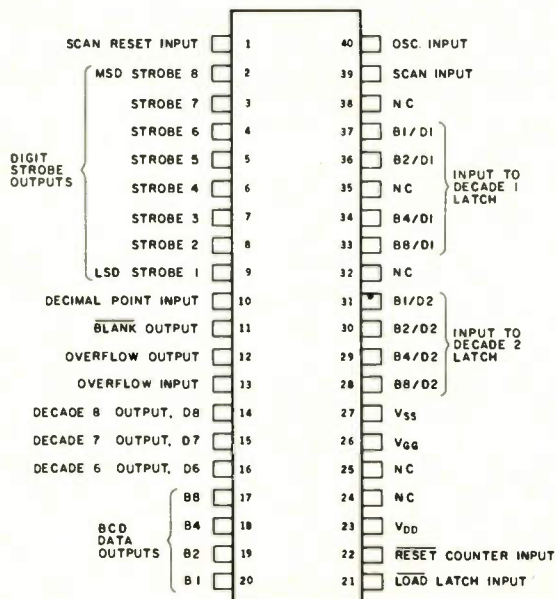

Fig. 3. Top view, pinout for LS7031.

A 40-pin socket must be used for the LS7031, and be careful not to touch the pins when you insert the chip, as MOS is static-sensitive.

If you use FND-507 1/2" displays, there's an excellent mounting technique I thought of which you may wish to use. Since these displays have their pins in a horizontal DIP configuration, they can be mounted as if they were ICs. Both CSC and Radio Shack offer an experimenter's PC board which is etched to match a protoboard-type breadboard socket. It just so happens that eight FND-507s fit perfectly on one of these boards.

Before installing them, use bare wires as jumpers on the component side of the board, and wire together all the segments (all "a" segments together, all "b", etc.). There are ten

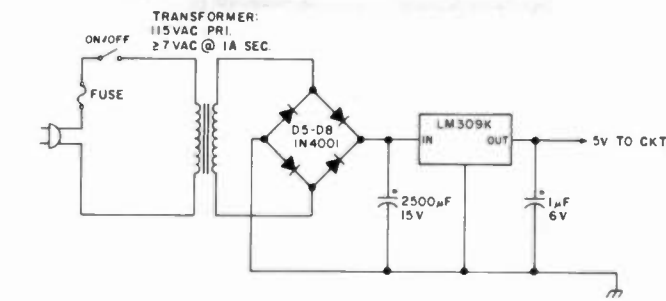

Fig. 4. Power supply for frequency counter.

holes in each column; subtracting two for the display, that leaves room for the seven horizontal bus lines to be run on the component side. Two of these will be under the display, so wire them first. Now solder on the displays, and you have an instant display multiplexing board. One final construction note: Make sure that you use a 560-Ohm resistor for R5.

Parts

All of the parts except the 11C90 prescaler and the

LS7031 are extremely common and inexpensive. The LS7031 can be bought from the manufacturer: LSI Computer Systems, Inc., 1235 Walt Whitman Road, Melville NY 11746. The 11C90 can be ordered from a number of 73 advertisers.

Conclusion

I used an old cabinet from a Lafayette low-band police monitor and even used the SO-239 connector on the back and some of the switches. The opening for the dial accommodated

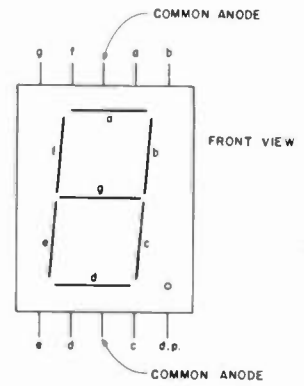

Fig. 5. Pinout for FND-507 or -510 common-anode display.

the display perfectly.

This is a good project to customize with, as no placement or other problems are important. I happened across a crystal oven for mine, but accuracy without it is completely acceptable (depending, of course, on the crystal used). It's fun to use LSI, and the fewer parts, the less room for error. ■



Handful of POWER

Give your low-power 2-meter rig real punch by delivering a potent 25 watt signal with only two watts of drive (also available set up for 200 milliwatts drive). Compact and convenient to mount, VoCom's Model 2C025 is ideal for car, boat or anywhere you've got a 12 VDC source. At only \$84.95 (\$99.95 for 200 mW drive), it's the perfect companion for your Drake, Encomm, Henry, Icom, Kenwood, Motorola, Standard, Wilson, Yaesu or other 2-meter FM portable!

Available now from your local amateur radio dealer or order direct:

- 2 or 2 watt nominal drive (specify)
- 2 watt model delivers 15-20 watts with only one watt of drive
- 10 MHz bandwidth for CAP or MARS
- Harmonic and spurious down more than 70 dB
- 200 mW drive model permits operating Icom IC-2A or Yaesu FT-207R on their battery-saving low-power mode
- Only \$84.95 (\$99.95 for 200 mW drive)

Ask about our 50 and 100 watt amplifiers for use with low-power hand-held radios!

✓ 90

VoCom Box 219, Prospect Heights, IL 60070
PRODUCTS CORPORATION (312) 870-8060

STOP RF SPILLOVER!

You may be losing up to half the available output from your vertical gain antenna because of RF spillover. The amazing AEA Isopole with unique decoupling design, virtually eliminates RF spillover and can help you multiply your power in all directions on the horizon relative to an ideal half-wave dipole, or end-fed non-decoupled "gain" antennas.

CALL TODAY HOUSE OF ELECTRONICS

1021 Broadway, P.O. BOX 28
SEASIDE, OR 97138
(503) 738-9694

AEA Brings you the
Breakthrough!

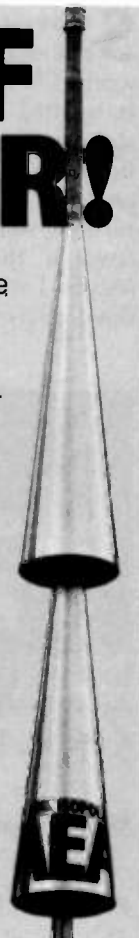

A Transistor for True Believers

— tubes forever? Not with FETs!

Some time back, I decided to build the world's finest ham receiver. It would be my home-station receiver, so I would not have to compromise on *anything*. It would not matter if it weighed a ton and used a thousand Watts. Maybe I would even bolt it down to a concrete founda-

tion block and wire it right into the fuse box.

W7KJM came into my shack and stood warming his hands by the fire. The snow melted off his overcoat and dribbled on the floor. "What for are you testing all those tubes?" he asked.

"I need to have spares for

anything I design into this. Can't get tubes hardly anywhere no more, Ed."

And I told him my plans.

"So go solid state, already," he advised.

"Solid state is for *appliance* operators. They see it in the catalog. They send in a thousand bucks. They plug in their grey boxes and don't even know how to replace a fuse. I am a *real* ham, now. First I bought junk and repaired it. Then I bought surplus and converted it. Next I bought kits and built them. Now I am going to do what I should have been doing all along. I will design my own and build it out of my junk box."

"Well, Glenn, with a half-acre junk box you ought to have plenty of material."

Ed was right. I must have had ten tons of electronic surplus, all Army green and Navy grey.

"But I must say," he continued, "you would be much happier with solid

state. You could design your own and..."

"Transistors don't make sense. Only a graduate engineer with a million-dollar lab and a billion-dollar computer could ever figure out a single circuit. You lay a soldering iron to one of those tin bugs and you fry it before the solder melts. You scuff your foot on the carpet and you curdle its innards with static electricity. You hit one with a strong signal and its thermals all run away. If you abuse a tube, you may weaken it, but one volt too much on a transistor and it's lost and gone forever. Only transistor equipment I have is my signal tracer, and I'm ashamed of having been weak enough to get the stupid little thing. Maybe I can change the battery in it, but darned if I have any idea how it works. Probably Black Magic, anyway."

Ed listened to my ranting

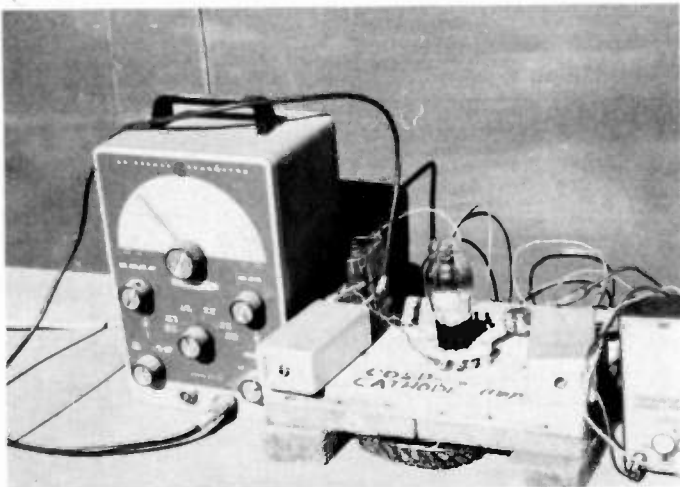

Photo A. The experimental cold-cathode tube being tested as an i-f amp.

until it changed tone and wound down, like a Victrola that needs cranking.

"Glenn, what you say is true about some types, but..."

"And furthermore, if the Lord had meant us to use the nasty little things, He would have had Thomas A. Edison discover geraniums instead of emission!"

"That's germanium, Glenn."

"Oh."

"And some types of transistors behave a lot like tubes."

"Sure they do! You drop them and they fall."

Ed left. He came back much later that day. He handed me a nice big vacuum tube. It had a high-wall octal base. I couldn't see inside much because the glass was silvered and blackened 'most everywhere. The only marking was on a stick-on label, in felt-tip pen: 40673.

"Glenn, here's a peace offering. Since you're set on building your new receiver with tubes, you might just as well use the latest. This one is an experimental cold-cathode, low-voltage tube."

"Now you're talking, Ed."

"What do you want to use it for?"

"Will it make an i-f amp?"

"I guess. Here're the parameters."

"Hmmm... Hey! Which pins are the filaments?"

"Ain't no filaments. I told you, it's cold-cathode emission. Whole new concept."

"How much voltage on the plate?"

"Oh, five, ten, fifteen, whatever's handy."

"And on the screen grid?"

"That's just a second control grid, Glenn."

"How 'bout that! We can run the signal into one and the automatic gain control into the other. Ed, how much do these babies cost? Ten bucks?"

"Lot less than that. About

a buck."

"You gotta be stealing 'em! Let's see... say it draws twenty mils average and the cathode bias resistor wants to drop two volts... E equals IR , so then R equals E over I and two over two hundredths is a hundred Ohms for the bias resistor. See what I mean? Anybody can dope out a tube circuit. Only those pointy-headed dudes at Em-Eye-Tee could get a transistor circuit to work."

"Yeah."

"Tenth-mike ought to bypass the cathode resistor about right for this frequency. Now for an RC network to keep the agc from acting instantaneously. What's that formula for time constants?"

"Time equals R times C ?"

"I think so. Is that with Ohms and farads? Megohms and microfarads?"

"Either way."

"O.K. Say we want a hundredth of a second agc time, and we got a hundredth of a microfarad capacitor, then we use a megohm. Simple."

"Glenn, I left something on the stove. You have this all under control. I'll see you tomorrow after I get the mail. By the way, why did you start with an i-f amp?"

"Have to start somewhere. And the i-f is where all the selectivity and gain come from. It's the real guts of a receiver, no?"

After Ed left, I drew the circuit in Fig. 2 and commenced to breadboard it. It went together in a few minutes on a little slab of pine. I hooked up a signal generator and a signal tracer to it and a pair of lantern batteries. It worked the first time around. I sat gazing at it, wondering about this new, low-voltage, cold-cathode emission technology. Imagine! A tube that needs no warm-up time, no filament wiring, and only a few volts to run

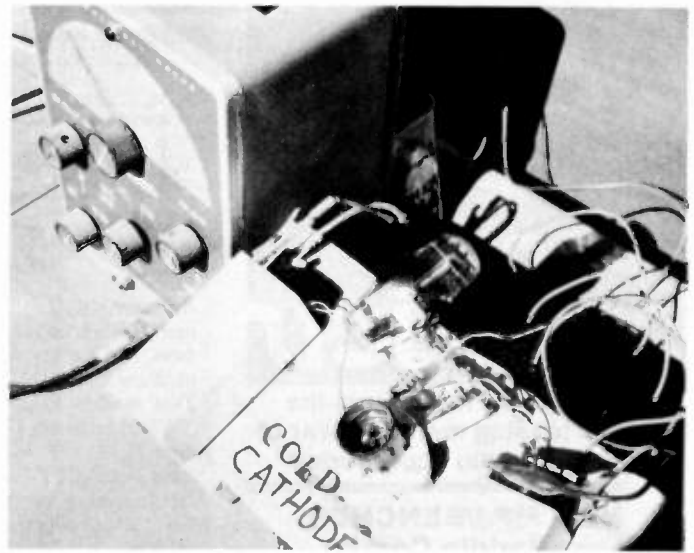

Photo B. Busted-off short and still going!

it. This would sweep the world as soon as it got into production. I would have Ed get me a couple dozen of these experimental 40673s and build the entire receiver with them. I vowed right then and there I would write the whole thing up for *73 Magazine* so that everyone could get in on this marvel.

The next day, Ed came in again. I had the circuit still on the breadboard, still working, and still hooked up to the signal generator and the signal tracer.

"Looks good. Here, let me screw this tube in tighter," he offered. Before I could stop him, he twisted the glass bulb of my 40673. I heard a sickening snap. The entire beautiful envelope came out of the base in his hand!

"Ed! You broke it! You know tubes don't screw into their sockets! You did that on purpose! Why..."

Then I noticed my signal tracer was still tracing

signal. I noticed that Ed was grinning from ear to ear. I looked at my breadboard amplifier. There, inside the "empty" bakelite tube base was a little-bitty metal cylinder with a rim around the base and four wires running into the tube pins. A transistor!

"Welcome to the twentieth century, Glenn," laughed Ed. That 40673 is a modern dual-gate, insulated, diode-protected field-effect transistor—a ninety-seven cent MOSFET. You pointy-headed genius, you designed the circuit for it without any roomful of computers!"

"Oh," I said. ■

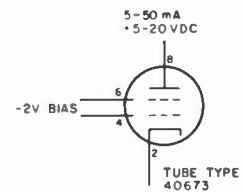

Fig. 1. The experimental cold-cathode, low-voltage tube.

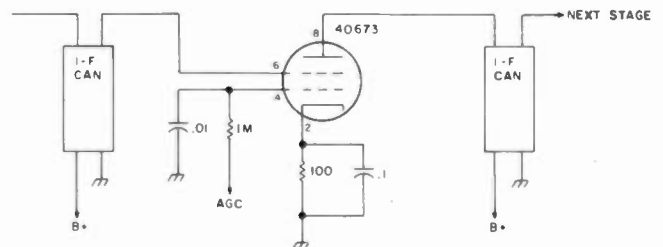

Fig. 2.

MFJ

NEW PRODUCTS

exciting new ideas from the world's leading manufacturer of amateur radio accessories

NEW MFJ/BENCHER Keyer-Paddle Combo — "The Pacesetter"



MFJ-422
Combo
\$99⁹⁵ (+\$4)

MFJ-422X Keyer only
\$69⁹⁵ (+\$4)

The best of all CW worlds — a deluxe MFJ keyer in a compact configuration that fits right on the BENCHER iambic paddle! And you can buy the combination or just the keyer to fit on your BENCHER.

New MFJ keyer — small in size, big in features. Curtis 8044 IC, adjustable weight and tone, front panel volume and speed controls (8-50 wpm), built-in dot-dash memories, speaker, sidetone, and push-button selection of semi-automatic/tune or automatic modes.

Ultra-reliable solid-state keying: grid-block, cathode and solid-state transmitters (-300 V, 10 mA max; +300 V, 100 mA max). Fully shielded. Uses 9 V battery or optional AC adapter (\$7.95 +\$2)

Beautiful functional engineering. The keyer mounts on the paddle base to form a small (4 1/4" W x 2 3/8" H x 5 1/2" L) attractive combination that's a pleasure to look at and use. The BENCHER paddle is a best seller. Fully adjustable; gold-plated silver contacts; lucite paddles; chrome plated brass; heavy steel base with non-skid feet.

NEW MFJ Shortwave Accessories



MFJ-1040
\$99⁹⁵ (+\$4)

MFJ-1020
\$79⁹⁵ (+\$4)



MFJ-1040 Receiver Preselector
Boosts weak signals, rejects out of band signals, reduces images. Covers 1.8-54 MHz with up to 20 dB gain from low noise MOSFET circuitry. Works with 2 antennas and 2 receivers (even XCVRS to 350W input).

Built-in 20 dB attenuator prevents receiver overload. Also includes auto-bypass, delay control, PTT jack. Operates on 9 V battery,

NEW MFJ 4 & 8-Band Mobile Shortwave Converters



MFJ-304 \$59⁹⁵ (+\$4)



MFJ-308 \$79⁹⁵ (+\$4)

Another MFJ "first," these low cost mobile SWL converters provide new excitement and variety for your driving/listening pleasure.

Two models to choose from. The 4-band "World Explorer I" (MFJ-304) offers complete 19, 25, 31 and 49 meter coverage (the most popular HF bands due to their distance capabilities at various times of the day and year). Hear countries from Europe, Africa, Middle East, Asia, the Islands, North and South America. The 8-band "World Explorer II" (MFJ-308 adds 13, 16, 41, and 60 meter bands) for even greater listening variety.

Compact and sensitive. The 4-band model

measures just 5 1/4" W x 1 1/4" H x 4" D to fit anywhere in your vehicle (the 8-band version is just 1" wider and 1" deeper). Two dual-gate MOSFETS give these converters excellent sensitivity and selectivity when combined with your automotive receiver.

Easy to use, easy to install. Push a converter button to choose the band, tune in stations with your regular car radio. To install, just plug the car antenna into the converter and insert the converter cable into your car radio antenna jack; connect the power lead to 12 VDC.

Listen to the world on the road. Get the new MFJ mobile SWL converters — "World Explorers I & II."

NEW MFJ Active CW/SSB/Notch Filters



MFJ-722
\$69⁹⁵ (+\$4)

MFJ-723
\$49⁹⁵ (+\$4)

is optimized for reduced sideband splatter and less QRM (375 Hz highpass cutoff plus selectable lowpass cutoffs at 2.5, 2.0, and 1.5 kHz, 36 dB/octave rolloff). Size: 5x2x6".

New model MFJ-723 is similar to the 722 but is for CW only, has a 60 dB notch tunable from 300-1200 Hz, and measures 2x4x6". Other models: MFJ-721, \$59.95, like 722 but less notch; MFJ-720, \$39.95, like 723 but less notch.

Versatile, all models plug into the phone jack, provide 2 watts for speaker or can be used with headphones. All require 9-18 VDC, 300 mA max (or 110 VAC with optional AC adapter at \$7.95 +\$2).

Enjoy pleasant listening and improved readability with one of these new MFJ filters.

Two new super-selective filters. The new MFJ-722 "Optimizer" offers razor sharp, no-ring CW filtering with switch-selectable bandwidths (80, 110, 150, 180 Hz centered on 750 Hz), steep-skirted SSB filtering, and a 300-3000 Hz tunable 70 dB notch filter.

The 8-pole (4-stage) active IC filter gives CW performance no tunable filter can match. (80 Hz bandwidth gives -60 dB response one octave from center and up to 15 dB noise reduction). The 8-pole SSB audio bandwidth

NEW MFJ "Dry" 300W & 1KW Dummy Loads

MFJ-262
\$49⁹⁵ (+\$4)



MFJ-260
\$26⁹⁵ (+\$4)

Air Cooled, non-inductive 50-ohm resistors in perforated metal housings with SO-239

connectors; both rated to full load for 30 seconds; de-rating curves to 5 minutes included. Just right for tests and fast tune up. **Low VSWR.** 300W: 1.1:1 max to 30 MHz, 1.5:1 max. 30-160 MHz. 1 kW: 1.5:1 max to 30 MHz. MFJ-260 (300W) is just 2 1/2 x 2 1/2 x 7"; MFJ-262 (1kW) is 3 x 3 x 13".

TO ORDER PRODUCTS, CALL TOLL FREE



800-647-1800

VISA

For tech. info., order or repair status, or calls outside continental U.S. and inside Miss., call 601-323-5869.

- All MFJ products unconditionally guaranteed for one year (except as noted)
- Products ordered from MFJ are returnable within 30 days for full refund (less shipping)
- Add shipping & handling charges in amounts shown in parentheses

Write for FREE catalog, over 60 products

MFJ ENTERPRISES INCORPORATED

Box 494; Mississippi State, MS 39762

MFJ 941C Versa Tuner II



MFJ-941C
\$84⁹⁵
 (+\$4)

Fastest selling MFJ tuner . . . because it has the most wanted features at the best price.

SWR + dual range wattmeter (300 & 30 watts full scale, forward and reflected power). *Sensitive meter* measures SWR down to 5 watts output.

More flexible antenna switch selects 2 coax lines, direct or through tuner, random wire/balanced line, or tuner bypass for dummy load.

12 position efficient airwound inductor for lower losses, more watts out.

Built-in 4:1 balun for balanced lines. 1000v capacitor spacing.

Matches everything from 160-10 meters: dipoles, inverted vees, random wires, verticals, mobile whips, beams, balanced and coax lines.

Easy to use, anywhere. Measures 8x2x6". has SO-239 connectors, 5-way binding posts, finished in eggshell white with walnut-grained sides.

MFJ-945, \$74.95, like model 941C but less ant. switch. Optional mobile bracket for either model is \$3.

MFJ 484 "Grandmaster" Memory Keyer

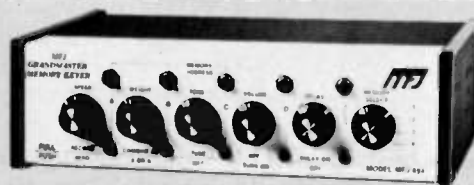

MFJ-484
\$139⁹⁵
 (+\$4)

Up to twelve 25 character messages plus 100, 75, 50 or 25 ch. messages (+096 bits). **Repeat any message continuously or with pauses** of up to 2 min. LEDs show use.

Record, playback, or change messages instantly at touch of a button. Memories are resettable with button or touch of the paddle.

Built-in memory saver — 9 V battery takes over when power is lost.

Iambic operation with squeeze key. Dot-dash insertion. Optional BENCHER paddle \$42.95 + \$4.

Dot-Dash memories, self-completing, jam-proof spacing, instant start.

Panel controls: Speed (8-50wpm)/Record; Weight/Memories Combined; Tone/Tune; Delay (0-2 min.)/Repeat; rotary Vol/On-Off; Memory Select; Message Buttons select desired 25 ch. messages; Memory Reset button.

Ultra reliable solid state keying: grid block, cathode, solid state transmitters (-300 V, 10 mA max; +300 V, 100 mA max). Operates 12-15 VDC or 110 VAC with optional adapter, \$7.95 + \$2. Size 8x2x6". **MFJ-482, \$99.95,** four 25 or 50 + two 25 ch. messages; **MFJ-481, \$89.95,** two 50 ch. messages. **Get the best seller keyers-MFJ "Grandmasters"**

MFJ 410 "Professor Morse" Code Generator/Keyer



MFJ-410 Now Only **\$129⁹⁵**
 (+\$4)

NEW LOW PRICE Save \$20

Use it to learn, use it to operate. It sends *unlimited random code* in random groups for practice; *never repeats* sequences. And when you're on the air, it's a *full feature keyer*.

Vary speed from 5-50 wpm; meter readout.

Vary spacing; give fast sound to low speed. **Alpha or alphanumeric** with punctuation.

Built-in speaker and phone jack; tone and vol. Ideal for classroom or private use.

Full feature keyer includes vol., speed, tone and weight controls, tune switch, dot-dash memories, keys grid block, cathode, solid-state rigs. Optional BENCHER paddle \$42.95 + \$4. Operates on 9-18 VDC, two 9 V batteries or 110 VAC with optional adapter \$7.95 + \$2. Size 7x2x6". **Get "Professor Morse"** — you'll never outgrow it.

MFJ Dual Tunable SSB/CW Filter "Signal Enhancer"

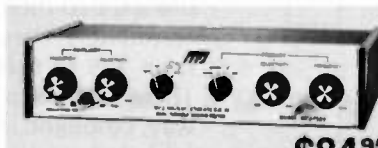

MFJ-752B **\$84⁹⁵**
 (+\$4)

Dual filters give unmatched performance.

The primary filter lets you *peak, notch, low pass or high pass* with extra steep skirts.

Auxiliary filter; 70 dB notch, 40 Hz peak.

Both filters tune from 300 to 3000 Hz with variable *bandwidth from 40 Hz to nearly flat*.

Constant output as bandwidth is varied; linear frequency control.

Switchable noise limiter for impulse noise.

Simulated stereo sound for CW lets ears and mind reject QRM.

Inputs for 2 rigs, switch selectable. Plugs into phone jack. Two watts for speaker. OFF bypasses filter. 9-18 VDC, 300 mA or 110 VAC with optional adapter \$7.95 + \$2. 10x2x6". **MFJ 751, \$59.95,** similar, primary filter only, less high pass & noise limiter.



favorite products from the world's leading manufacturer of amateur radio accessories

GMT Clock/ID Timer



MFJ-101
\$29⁹⁵
 (+\$4)

24 hour, solid-state, blue 0.6" digits. ID timer sounds every 9 min (also a snooze alarm), regular alarm for skeds or to awaken, power-out/alarm-on indicators, ready to use on 110VAC, 50-60Hz. 6x2x3".

KW Dummy Load With Oil



MFJ-250
\$29⁹⁵
 (+\$4)

Rated at 1 kW CW or 2 kW PEP for 10 min., half that for 20 min., cont. at 200 W CW, 400 W PEP, non-inductive 50 ohm resistor, quality transformer oil (no PCB), VSWR under 1.2:1 to 30 MHz, 1.5:1, 30-300 MHz, 2:1, 300-400 MHz. Coax conn., vent cap., 7 1/2" h x 6 3/8" diam.

300 Watt Antenna Tuner



MFJ-949B
\$129⁹⁵
 (+\$4)

Does it all! Built-in dummy load, SWR, forward and reflected power meter, antenna switch, balun, matches everything from 1.8-30 MHz (coax, random wires, balanced lines), coax conn., binding post, 10x3x7".

TO ORDER PRODUCTS, CALL TOLL FREE



800-647-1800



For tech. info., order or repair status, or calls outside continental U.S. and inside Miss., call 601-323-5869.

- All MFJ products unconditionally guaranteed for one year (except as noted)
- Products ordered from MFJ are returnable within 30 days for full refund (less shipping)
- Add shipping & handling charges in amounts shown in parentheses

Write for **FREE** catalog, over 60 products

MFJ ENTERPRISES INCORPORATED

Box 494; Mississippi State, MS 39762

Stay Cool with TM

— use thermostat modulation to lower your heating costs

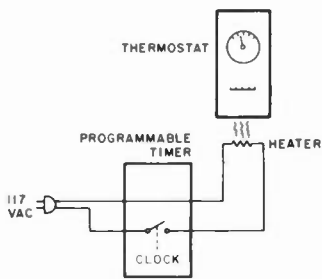

Fig. 1.

Perhaps hams are more sensitive than most people to the value of energy since they depend on electricity to run all of their equipment. So, the energy crunch found me looking for ways to conserve energy inexpensively, with a minimum loss of comfort and convenience. If the thought of painlessly saving from 5 to 20% on

your home heating costs by using a simple-to-make device appeals to you, then read on. No, this is not a ham radio project, but it is right down our alley, being electrical in nature.

thus accomplishing our setback. The heat source could consist of a small resistor controlled by an inexpensive programmable timer. See Fig. 1 for the basic circuit.

Numerous studies have shown that setting your thermostat back to a lower temperature at night and when no one is at home can provide significant savings in heating costs. The convenient way to accomplish this setback is, of course, to use a timed thermostat. Unfortunately, they are priced from \$35 to \$100 or more! There just has to be a better way, I thought; let's put that fabled ham ingenuity to work!

The actual system as it shaped up in my mind had the following features:

- Adjustable temperature setback.
- Nighttime setback cycle.
- Daytime setback cycle.
- Weekend cycle to disable the daytime setback and delay the morning heat-up cycle.

After a while, a very simple idea occurred to me: Why not just install a small source of heat right under the existing thermostat? When activated, the extra heat would fool the thermostat into thinking that the surrounding environment was warmer than it really was. The thermostat would then regulate at a lower room temperature,

It was easier to do than you'd think, and Fig. 2 shows the final circuit. Using the resistance values shown, you should get at least 12° of setback: A thermostat set for 67° would regulate at 55° when the heater (R1) was on. A smaller value of resistance will allow even more setback by running hotter. Remember the formula $P = V^2/R$: A resistor's heat output will increase as its resistance is decreased. Here, $P = (6.3)^2/30 = 1.3$ Watts.

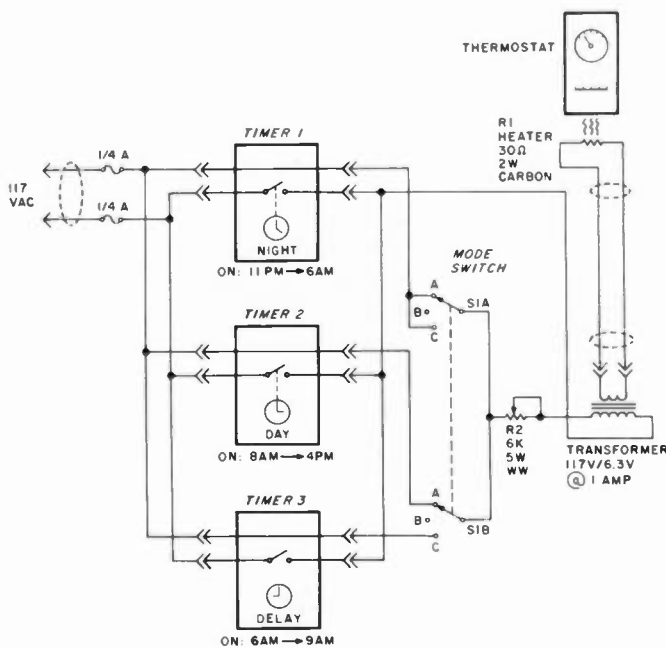

Fig. 2.

Two fuses are included for safety's sake, and the 6.3-volt transformer keeps high voltage away from the thermostat. Resistor R2 allows you to reduce the amount of setback temperature, if desired. Mode switch S1 is a DPDT toggle type with a center-off position. Mode A gives both day and night setback cycles, Mode B shuts off all setback cycles, and Mode C eliminates the daytime setback and delays the morning heat-up cycle for weekend use. If you don't want the latter delay, just eliminate Timer 3; if you don't need the daytime setback at all, just leave out Timer 2.

I constructed my system on a piece of 12" x 6" x 1/2" wood; the layout is entirely non-critical, but do follow safe wiring practices here! Each of the plug-in timers is mounted on a flat-surface, 3-way electrical outlet.

You'll have to watch the polarity of your wiring carefully, as the timers use SPST (not DPST) switches inside. As a result, only one side of the line is isolated.

When setting up your controls, remember to allow enough time for your particular heating system to respond to heat-up commands. Hang a small thermometer near, but not on, your thermostat to see how much setback you're getting, since the thermostat's own indicator will not show the actual temperature.

It works like a charm, to the point where I forget that it's even running, and it's much more flexible (and cheaper) than the store-bought kinds. Maybe the XYL will let me use some of the heating-bill savings for—well, I can think of several things! Build one yourself, and I'll bet you can think of a use for your savings, too! ■

MEMORY KEYS BREAKTHROUGH!

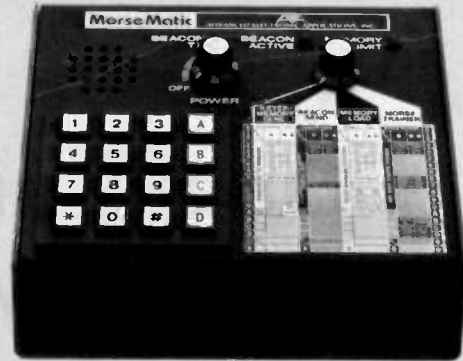

The remarkable AEA Morsematic memory keyer has 35 fantastic features including two AEA designed microcomputers, up to 2,000 character memory, automatic serial number, beacon mode, and automatic morse trainer mode.

Call toll-free 1-800-325-3636

HAM RADIO CENTER

8340-42 Olive Blvd., P.O. Box 28271
St. Louis, MO 63132

AEA Brings you the
Breakthrough!

MEMPHIS HAMFEST

THE LAST BIG ONE OF THE SEASON

Memphis Loves Hams... Find out for yourself when you come to the **MEMPHIS HAMFEST**, Saturday & Sunday, October 11 & 12, at the Mid-South Fairgrounds Youth Building—34,000 square feet of comfortable space.

You'll think you're in Ham Heaven when you see the **GIGANTIC FLEA MARKET**. Buy, sell or trade—there will be plenty of bargains, all under one roof. (Spaces are \$5.00 per day, tables furnished).

Another big feature of this year's event will be the **FCC EXAMS**. So hit the books now and come prepared*.

It's all indoors—come rain or shine—**Exhibits, New Equipment Dealers, Seminars, Hourly Awards.**

Plus ladies activities and the traditional southern hospitality party Saturday night.

To make your visit a pleasure, there will be special **motel accommodations** at the Holiday Inn near Overton Square as well as **On-Site Trailer Hook-Ups**.

Admission is only \$3.00 for adults, children 14 and younger **FREE**. Exhibitor booths are still available.

For detailed brochure with map, program guide, and motel reservation form, write to **MEMPHIS HAMFEST**, P.O. Box 3845, Memphis, TN 38103.



**MEMPHIS
HAMFEST**



*All applicants for the FCC Exams must appear by 8:00 AM Saturday with a copy of current license, on the campus of CBC College across from the Fairgrounds.

One Man's Magazine: Twenty Years of 73

The author, first licensed in 1962 as KN1UOJ, is a member of the 73 staff.

This month marks an important anniversary for one of amateur radio's best-known (and occasionally best-loved) publications. Twenty years usually means an engraved watch and a thank you, or a platinum memento. In the magazine business, twenty years is a milestone and a definitive statement of success. Many magazines never grow that old. *73 Magazine* is twenty years old this month.

In the summer of 1960, Wayne Green W2NSD sold almost everything he owned, rented a tiny office above a candy store in the Flatbush section of Brooklyn, and began his magazine publishing career by launching a monthly for amateur radio operators. Two publications, *QST* and *CQ*, already served this narrow field, but Green sensed the need for another viewpoint, another voice, in the ham community. Today, Wayne Green, Inc., produces three monthly magazines, two industry newsletters, and many technical and reference books. *73 Magazine* remains the backbone of the corporation and, in many ways, the source of its identity.

From the beginning, a sense of whimsy has pervaded the pages of *73*. Early issues were 73 pages in length (a printer's nightmare) and cost "a cheap" 37 cents each (two for 73 cents). Times and prices have changed, but *73 Magazine* has always retained a sense of humor, a unique achievement for a periodical in a highly technical field.

73 Magazine was intended to be a journal of contemporary construction projects for hams with a yen for home brew and, through the years, the magazine has fulfilled this intention. One thing not foreseen by Green in those early days was the role *73* would play as the "loyal opposition" in relation to the American Radio Relay League, the FCC, and other establishment organizations. This role resulted directly from publisher Green's individualist inclinations with regard to the ham-radio hobby. His outspoken editorials and the vitriolic letters to the editor that appeared every month served as a forum in which issues of the day could be discussed, often more openly and honestly than they were on the ham bands.

By 1962, *73 Magazine*

was 96 pages long, and, despite the publisher's claims to the contrary, financially solvent. Manufacturers were quick to sense a winner, and all the major names of the era advertised with *73*. Clegg, National, Hallicrafters, Polycomm, Hammarlund, and Drake were regulars.

The sixties were a time of turmoil in both the microcosm of American life called amateur radio and in the larger landscape of America itself. As the country became increasingly involved in the war in Southeast Asia, amateur radio had its own polarizing issue, called incentive licensing.

This restructuring of the ham licensing procedure divided the amateur community along well-defined lines. Those in favor found a willing leader in the ARRL. Those against rallied behind *73 Magazine* and the organization it sponsored, called the IoAR (Institute of Amateur Radio). The IoAR was created as an alternative to the ARRL, and disillusioned hams opposed to incentive licensing were encouraged to join.

The core of the issue was the disenfranchisement of those who were then General and Advanced operators. As the docket was written,

these operators would, over a period of time, lose many of their choice phone and CW privileges on the popular HF bands. Since no grandfather clause was included in the docket, the incentive licensing proposal was a threat to many active hams. It was the FCC's hope that eventually most hams would feel compelled to upgrade their licenses by taking more comprehensive technical exams, thereby increasing the overall technical expertise of the ham community.

In the meantime, other new developments confounded many veteran operators. A strange and more efficient mode of communication called single sideband was making inroads in what traditionally had been AM sections of the 80-, 40-, and 20-meter phone bands. Impossible to tune with many AM receivers, this new mode was a source of frustration for many hams. In addition, American electronic technology was becoming transistorized. Advances wrought by solid-state physics left many hams confused and alienated. No longer able to feel comfortable with obsolete, tube-type rigs, hams in the early sixties had to choose between reeducation or retreat. *73 Magazine* actively

Fold
Out

Our Gift to You!



Cartoonist Bandel Linn K4PP, creator of our very first cover, has entered his third decade with 73.

pushed for the switch to SSB and transistors by running a large number of construction articles for hams who were starting from square one.

During this period, 73's editorial pages were filled with the incentive licensing debate, but its publisher's differences with the ARRL and FCC lay deeper. He was diametrically opposed to both these organizations on a philosophical level. Green distrusted bureaucracies, and he perceived the leadership of both these organizations as inept, if not downright corrupt. His mood reflected that of much of the country in the anti-establishment atmosphere of the mid-sixties.

In the April, 1963, issue of 73, he unmercifully spoofed the League's publication, *QST*. His *QST*-like cover and inside layout closely resembled the League's official journal, and the entire issue was "Devoted Wholeheartedly To Amateur Radio." The issue has become a collector's item. The April fool tradition was continued for several years and included put-ons of *Playboy* (April, 1964) and *MAD Magazine* (April, 1965). Even Little Anny Hammy and Ham vs. Ham comic strips were included in these issues.

In 1962, 73 *Magazine* left Brooklyn for Peterborough, "New Ham Shire." Editorials of the time extolled the virtues of clean air, country living, and spartan life styles. 73's content continued to reflect the changing trends in amateur radio and, as ATV, activity on 432 and 1296 MHz, OSCAR 6, and VHF FM developed, along with freedom rides and zip codes, 73 kept up a constant stream of "how to" articles.

New repeaters were appearing daily all over the country but no standards were in effect regarding their design, frequency allo-

cations, or input/output spacing. 73's self-imposed mission during this period was to pull all repeater groups together in an effort to work out universally-acceptable standards. This grand design soon put 73 *Magazine* and Wayne Green in conflict with the federal government.

The FCC was struggling to control the explosion in popularity of CB radio. Its Personal Radio Division had as its head, in the person of Prose Walker, a hard-line doctrinaire in favor of heavy regulation. Standards were proposed by Walker's division which made it impossible for repeater groups to get new machines on the air without considerable expense and paper work. The net result was that repeater development came to a halt.

At this point, 73 *Magazine* decided to take on the federal government. In a hard-hitting series of editorials, publisher Green debunked the commission's position on repeaters and cast doubt on the competency of Prose Walker. Hams nationwide rallied behind 73, and eventually the demands for a new hearing on the repeater issue became loud enough to be heard in Washington. A hearing was held in 1974, and much of the architecture of today's repeater system was determined at that time.

In April of 1967, Jim Fisk was named managing editor. Jim stayed with 73 for less than a year, and then left to start his own amateur publication. The rift between Green and Fisk was never closed after Jim's departure in 1967, and a cross-town rivalry soon developed between 73 and the new magazine in the field, *Ham Radio*.

Fisk was one of many notables to grace the 73 masthead over the years. Others included Ken Ses-

sions, Don Miller, Bill Hoisington, Peter Stark, and Gus Browning.

As the Vietnam war escalated in the late sixties, and college campuses plunged into chaos over the bombing of Cambodia, 73 *Magazine* remained preoccupied with the problems of amateur radio. The October, 1969, editorial however, offered Wayne Green's solution to the problems in Southeast Asia. His prescription for peace in that troubled land was founded on a faith in the ability of grass-roots capitalism to pacify the multitudes. Thailand today seems a case in point.

While men walked on the moon in 1969, ham operators headed for 2 meters in increasing numbers. The popularity of VHF FM was growing and the proliferation of repeaters on six and two was facilitating that growth. 73 ran scores of articles on FM conversions and repeater construction, while the editorial pages hammered away at the problems of repeater use.

During these years, publisher Green was possessed by wanderlust. His frequent European forays to pick up Porsche sports cars, ski the Alps, explore the night life of West Berlin, or meet foreign hams, were well documented in the pages of 73 and form an ongoing travelog of \$5-a-day adventures. Green also made trips to Jordan during the early 70s, helped to write that country's amateur regulations, and eventually installed a 2-meter repeater in Amman for use by Jordan's King Hussein and the growing number of young hams in that country. A DXpedition to Navassa Island in the Caribbean occupied the summer of 1972 — and provided Green some calm before a gathering storm.

Early in 1973, the IRS wanted to talk to the pub-

lisher about tax deductions he had claimed during the previous years. Month after month, the editorial pages of 73 *Magazine* told about the plight of citizen Green vs. Big Government. Was he really victimized by the IRS because of the pressure 73 *Magazine* had applied to the FCC over the repeater issue? Or was he merely another businessman with a fool for an accountant? The details were murky, but the resulting tax-evasion case was well covered in 73 and competing amateur publications.

73 *Magazine* continued to grow with the hobby. Its coverage of satellite operations grew in relation to its page count (now close to 200) and the entire July, 1975, issue was devoted to OSCAR. Slow-scan TV also was becoming popular and received lots of attention in 73. The magazine ran a slow-scan contest and devoted an issue to this new ham activity, also.

Computers became a force in ham radio in the seventies, and 73's pioneering efforts to disseminate information about this esoteric subject shifted into high gear. The I/O (input/output) section of 73, devoted exclusively to the technology of bits and bytes, was rapidly becoming so large that it was a magazine in its own right. In 1975, therefore, *Byte Magazine* was spun off from 73 to service the computer-hungry public.

In January, 1976, 73 *Magazine* reluctantly abandoned its six-by-nine format. *QST* and *CQ* already had announced that a change to a larger format was coming, but 73 was the first to implement it.

The days of skeleton crews peopled by jacks-of-all-trades were over. No more communal living and working in a rambling New Hampshire farmhouse, raising horses and vegetables in

off hours, or DXing from the mountaintop QTH. The magazine had become a demanding taskmaster that ate up time and energy voraciously.

Controversy was still a friend, though. A series of articles in 1975, entitled "Inside Ma Bell," resulted in a lawsuit of large proportions. Mrs. Bell, never to be accused of having a sense of humor, took offense at the publication of its toll-call billing secrets for all the world to read. Later, an ersatz 5" x 7" \$100 bill printed as part of a subscription promotion also provoked the ire of the establishment. Warned by the Treasury Department not to circulate any of the monster bogus bills, *73 Magazine* once again found itself in the role of the *enfant terrible* of the ham publishing industry.

In August of 1979, the magazine ran an article on

MDS (Multipoint Distribution System) TV equipment. For detailing construction specifics of antennas and downconverters for this metropolitan pay-TV system, *73 Magazine* again was taken to task. A lawsuit involving everyone but the cleaning lady is in litigation at present, this time brought by the MDS industry.

As one looks back over the past twenty years, the role that *73 Magazine* has played as loyal opposition, technical innovator, hell-raiser, and self-consciously fallible friend of ham radio is easy to see.

In essence, the magazine has always been the man: Wayne Green. From the earliest beginnings in Flatbush, the magazine and the man have been inseparable. *73's* style, tone, editorial viewpoint, and appearance have reflected its publisher's personality. Green's dislike of

excessive white space on magazine pages (born of Yankee frugality) and his adversary position in relation to the ARRL (a mistruster of bureaucracies) are reflected in the look and feel of *73*. More than any other publication in the field, *73 Magazine* represents one man's vision of the world and of the ham radio hobby, what they are, and what they should be.

Over the past twenty years, many adjectives have been used to describe Green and his magazine: zany, annoying, insightful, foolish, rabble-rousing, visionary, short-sighted. At one time or another, all have been applicable. Through it all, a sense of humor and self-deprecation has prevailed in *73*, and that is the attraction the magazine holds for many of its readers.

Whether railing against the League's position on in-

centive licensing in 1963 or detailing specifics of the Multipoint Distribution System in 1979, *73 Magazine* has always been lively and ready to poke fun at the sacred cows of amateur radio and the electronics industry. This seems extraordinary for a magazine devoted to technology, but it is quite understandable as a print extension of one man's personality.

What the next twenty years hold in store for us as ham operators and citizens is subject to conjecture: satellite communications systems, computerized station operation, energy shortages, war in the Middle East.

As history unfolds, it should be hoped that publications willing to take stands, air issues, and operate close to the edge continue to exist. A hobby and a democracy need that kind of journalism to thrive. ■

PUNCH THROUGH **BOOST YOUR VOICE POWER!**
WITH THE **STRONGEST, CLEARST SIGNAL POSSIBLE!**
NEW from **SOUNDPOWER**



INSTANT BY-PASS SWITCH

SP 100 SPEECH PROCESSOR

Uses new technique in speech processing. Multiplies effective voice power over 10 times. Features easy installation. Switch for normal or processor operation. Adjustments for gain and output level. One year manufacturer warranty. Patent Pending

UP TO 10X TIMES MORE EFFECTIVE!
THAN OTHER SPEECH PROCESSORS

NEW HI-POWER MODEL SP-100 79⁹⁵
complete with MIC and POWER CONNECTORS
PS9 Optional AC Power Supply **5.95**
Add 3.00 Shipping & Handling

ORDER DIRECT FROM

SOUNDPOWER

17 CLINTON PARK DRIVE
BERGENFIELD, N. J. 07621

Radio World

CENTRAL NEW YORK'S MOST COMPLETE HAM DEALER



Featuring Kenwood, Yaesu, Icom, Drake, Ten-Tec, Swan, Dentron, Alpha, Robot, MFJ, Tempo, Astron, KLM, Hy Gain, Mosley, Larsen, Cushcraft, Hustler, Mini Products, Bird, Mirage, Vibroplex, Bencher, Info-Tech, Universal Towers, Callbook, ARRL, Astatic, Shure. We service everything we sell!

Write or call for quote. **You Won't Be Disappointed.**

We are just a few minutes off the NYS Thruway (I-90) Exit 32

OUT OF STATE CALL TOLL FREE 800-448-9338

ONEIDA COUNTY AIRPORT TERMINAL BUILDING
ORISKANY, NEW YORK 13424
N.Y. Res. Call (315) 337-0203

Warren - K2JXN
Bob - WA2MSH

Microcraft's New RTTY READER



Decodes RTTY signals directly from your receiver's loudspeaker. * Ideal for SWLs, novices & seasoned amateurs. * Completely solid state and self-contained. Compact size fits almost anywhere. No CRT or demodulator required. . . . Nothing extra to buy! * Built-in active mark & space filters with tuning LEDs for 170, 425 & 850 Hz FSK. * Copies 60, 67, 75, & 100 WPM Baudot & 100 WPM ASCII. * NOW you can tune in RTTY signals from amateurs, news sources & weather bulletins. The RTTY READER converts RTTY signals into alphanumeric symbols on an eight-character moving LED readout. Write for details or order factory direct.

RTTY READER KIT, model RRK \$189.95
RTTY READER wired and tested, model RRF \$269.95

Send check or money order. Use your VISA or MasterCard. Add \$5.00 shipping and handling for continental U.S. Wisconsin residents add 4% Wisconsin State Sales Tax.

Microcraft Corporation Telephone: (414) 241-8144
Post Office Box 513G, Thiensville, Wisconsin 53092

Twenty Years of 73

October

1960



.....de W2NSD

Please understand that this is Volume 1, Number 1 of 73. It is NOT perfect—is isn't even anywhere as good as I'd like it to be. But, all things considered, a major miracle has been worked and this issue IS in print.

Feedback

We both have a vested interest in 73 being as interesting as possible. You can help me keep my finger on your pulse by sending a postcard every month listing the articles in the order of your interest. I will publish results of this monthly survey as an encouragement to the authors. The top author each month will get, in addition to the compliment, a check from us for 50% of his original payment. Thus your vote each month will serve to help me in the selection of future articles and will encourage good writers both with plaudits and some extra cash!

Writing For 73

ONE of the first moves in planning the publication of 73 was to get in touch with past authors of ham articles and explain to them that there was a new magazine coming and that it needed articles. To encourage them we established the firm policy of paying for all articles immediately upon acceptance. This encouraged quite a few, as you can see in this issue, and as you will see in the subsequent issues.

There must be a lot more of you with interesting ideas to communicate. Naturally we prefer technical and construction articles, but if it is interesting and hammy we'll probably shell out. One author has hustled us for over \$1000 so far and shows no sign of drying up yet.

Suggested Procedure

If you're in doubt about whether we'll buy or not just send in an outline and, if possible, some pictures. We'll probably OK it. Try to get the best pictures you can and type it up double spaced (use a dictionary).

Laboratories Needed

Readers and manufacturers both expect us to run the same old tests on new equipment and write up pleasant little blurbs which carefully sidestep the obvious shortcomings of the gear and repeat almost verbatim the specifications published in the ads. I have tried running honest reports on equipment in the past only to meet mountains of emotion from the manufacturers and their advertising agencies and

apathy from the readers. This was not the correct approach.

After much stewing over this problem I think I have an answer that will satisfy one . . . even me. Unfortunately, even twenty-four year collection of radio around the shack I don't have the equipment to do the job of testing that I have in mind. And any of you chaps with an inclination to do something helpful for us all suitably equipped? You'd need a pretty good 'scope, dummy loads for various power levels, an rf voltmeter, an ac ammeter, a KW Variac for line voltage tests, an audio oscillator, frequency meter, antenna tuner, etc. This would enable you to run fairly good checks on a transmitter. The receiver tester would have to have different gear.

What I want is a thorough technical listing of the facts about the equipment. For a transmitter we want to know the list price, weight, size, tubes used, bands covered, ac power on standby, ac power under full load, heating under full load, input to final, output power, efficiency, frequency stability during transmit, drift during standby, antenna switching provisions, compatibility with other commercial gear, how well fused, how well the operator is protected from electrocution, ease of servicing, TVI, ease of tuning, ease of band-changing, calibration of VFO (if any), resetability of VFO, backlash of VFO dial, spotting switch, high voltage on standby, high voltage under full load, interlocked, overload relay or protection, 108 volt test, 132 volt line test, audio response, shipping weight, connecting wires supplied, driving power required (amplifiers) on various bands, etc.

Then comes the objective on-the-air activity with the rig for a couple of weeks to get the feel of it. By this time the writer should be able to turn out quite a piece, listing the statistics and pointing up the more positive aspects of the equipment in a general commentary.

We need the same treatment for receivers and other ham items. Anybody interested? The pay is miserable. All those who do not volunteer take one step backwards.

Our Advertisers

It takes a lot of personal interest in the hobby for an advertiser to run an ad in a brand new ham magazine. He has to put aside questions about what this will cost him in dollars per thousand readers and how much duplication he is getting of readership in other ham magazines. He already has his budget allocated for a long time ahead and this means an extra unexpected expense which may well bring little return.

Since it is advertising revenues that make it possible for magazines to be published we all owe a lot of gratitude to the handful of

(Continued on page 25)

Twenty Years of 73

73 THANKS CUSHCRAFT—
ADVERTISER IN 1960,
ADVERTISER IN 1980!

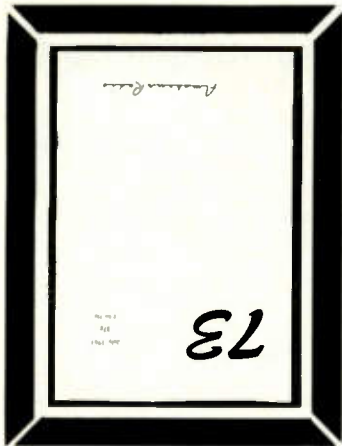

1961

August

... de W2NSD

(never say die)

Back at first I was running hamfest and convention announcements. Several postcards have mentioned that they are not particularly anxious to have space taken up with local announcements in a national magazine. I'm in agreement with this notion since we're trying to make sure that everything in the magazine will be of the widest interest. For that matter, though you may be looking particularly for VHF articles, you will find that just about everything we publish will be good reading. Some of the best articles may be hidden with unlikely titles too. Heh! If you disagree about our leaving out announcements all you have to do is pound the table a little and we'll start an (ugh) Announcement Column.

Cover

The July cover brought interesting reactions. Several readers wrote in to mention that, though their cover was OK, they found the rest of the magazine to be printed upside down. Subway and bus readers startled their fellow travelers. There were a few fellows who called up to find out if we knew the cover was upside down. These chaps should know all the trouble we went to, to make sure that it got printed that way. This included verbal and written instructions to the entire work force of our printer's New York office where the magazine is set in type as well as the entire force in Norwalk, Connecticut where it is printed. We really expected that someone wouldn't get the word somewhere along the line and would "fix" the mistake.

Our printers are getting used to us now. They no longer shudder at our printing a 73 page magazine, no doubt the only magazine in history to do so. They are getting used to our surplus ads with the five point mice type, though they fight every one we bring in and charge until our heads spin for them.

We have made great strides on the delivery of magazines to our office. We almost fainted the first month when the truck drove up with 10,000 copies on a huge skid. The office was on the second floor and Virginia and I had to hand carry 2500 pounds of magazines upstairs. The next month we got them to mail

a lot of them directly from the plant and deliver the rest in cartons. Virginia has gotten very good at hefting those 65 pound cartons up the stairs now . . . somehow I always seem to be away when the truck comes. They increased the cartons to 85 pounds last month. Virginia almost broke her back. I complained. The following note came from the printer. "Your latest epistle decrying the weight of our cartons has caused me deep chagrin, pain and a wart on my left index finger. It has never been the policy of Ye Olde O'Briene Presse to cast a Dresden-like beautiful orchidous creature like Virginia in the role of a Russian weight lifter. The dastardly culprit who sponsored this hernia-inviting operation right now is on his way to the salt mines, minus both thumbs. Rest assured most kind sir that our cartons in the future will be of a gossamer quality and of a weight that can be handled by the midget masquerading as a little girl in the Castro Convertible Ads. Regards, Charles Joseph Hauser III* (*The first two were executed for mopery.)"

Answered Plea

The small call for help last month was answered. Volunteers arrived from all over. One of the long distance helpers was Hall Bond K5ZSB of Dallas, a pilot for Braniff Airways, who dropped in and lent a hand for a few hours of stencil sorting. All this extra help has enabled us to get out a lot more mail recently and we've sent out the first mailing to advertisers announcing the First Annual Almanac, Yearbook and Buyers Guide which we plan to publish this fall.

One thing that has bugged me for years is the problem of finding out about a product when I want to know about it. Someone will mention over the air that he has one of the new Super-Bandbangers and that he thinks it is great. I immediately plunge into the ham magazines looking for more info. Well, it seems I've heard about it a bit late and they are now advertising the newer Rx-7388. After much searching through back issues I finally find some ads for the Bandbanger, but they sure don't tell very much. Being persistent, I

Ringo Ranger II: We've made the best better.

The new Cushcraft Ringo Ranger II incorporates Cushcraft's latest design features for increased performance and greater operating pleasure. Ringo Ranger II is the most recent design from Cushcraft's engineering team. The wisdom of Cushcraft's founder Les Cushman, W1BX (50 years of licensed ham radio and antenna designing) plus the effort of Dave Olean, K1WHS, world renowned active VHF/UHF enthusiast (first 2 meter EME WAC) and creator of many recent Cushcraft antennas have led to this superior design.

The new Cushcraft Ringo Ranger II is the longest lasting best performing 2 meter FM base station antenna. Check these features.

Ringo Ranger II incorporates proven features with new insulating materials and 5/8 wavelength decoupling section for increased gain and feedline isolation.

Covers entire band yet can be optimized for your location and favorite operating frequency.

Made from 6063-T832 corrosion resistant seamless aluminum tubing. Does not have the seaming producing "stovepipe" seams. Longer life because insulators are not degraded by short exposures to sunlight. Clean profile for best appearance and least wind loading.

Strong enough to endure wind and ice storms. Built-in lightning arrester to reduce static noise and lightning hazard. Conveniently mounted and it fits nicely on towers with other antennas.

ANTENNAS			
ARX-2B	144-174 MHz	\$49.95	
ARX-220B	220-225 MHz	49.95	
ARX-450B	435-470 MHz	49.95	

Ringo Ranger II Conversion kit includes decoupling section with mounting ring, hardware, RG-8/U cable, vinyl connector boots plus a built-in lightning arrester. An easy upgrade for your Ringo Ranger.

CONVERSION KITS		
ARB-2K	\$19.95	
ARB-220K	19.95	
ARB-450K	19.95	

Available through dealers worldwide.



The Antenna Company
48 Perimeter Road, P.O. Box 468C
Manchester, NH 03108

41

Twenty Years of 73



1962

August

de W2NSD/1

never say die

The moving of offices that was casually referred to in the last editorial turned out, when reduced to practice, to be quite a process. It is a big deal for an ordinary family to move across town. Your imagination would be staggered at the amount of ham gear that I have gathered down through the years. I was staggered when I looked it over. And all this had to be packed up and moved 250 miles!

One of the commercial movers came out to give me an estimate. He blanched. I had expanded to fill three and half garages, all of a seven room apartment and a good deal of a full sized house. He calculated \$2000 if we did all the packing, but I got the idea that this might turn out to be low once they found out how solidly packed those garages were and how heavy radio equipment is. I started calling rental truck companies.

U-Haul seemed to have one of the best prices so I rented one of their 16-foot vans and started loading. It held a lot more than I thought it would. Even with Virginia, me, our subscription man and two local hams pitching the stuff in, it still took a full day to fill it up. Perhaps we were a little too enthusiastic in the loading for when we stepped back to survey the results we noticed that the truck springs were bent backwards and the six tires almost flat from the weight. It was obvious that the truck could never make it.

It did come close though. It got to within one half mile of the house in Peterborough before one of the tires exploded. Luckily the tire vaporized right in front of the local Gulf station, winning them the job of trying to locate a jack strong enough to allow repairs. It was a warm day and the first jack sank into



New Headquarters Building

Twenty Years of 73

May

1963

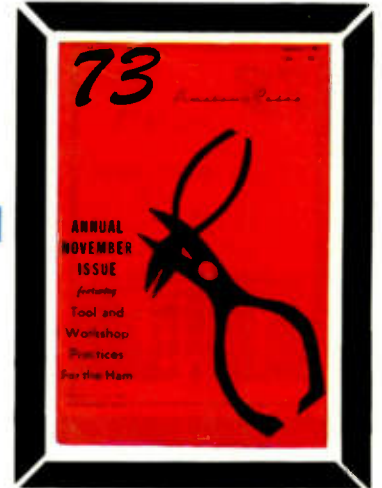

de W2NSD

Never say die

Notice to ARRL Members

It is now obvious that QST is going to keep heating the drums for their building fund until you all pay up. If you'd send in the money then QST could get back to their detailed operating news reports. After all, Egypt has its pyramids and China has its wall, so why shouldn't we have our ARRL Skyscraper? Get with it fellows: you joined the ARRL, now support it in its time of crisis. Of course this won't stop you from needling them a bit by marking your check out to the ARRL BUILDING FUND (73 WING). Send it to ARRL, West Hartford 7, Conn. Save just a little in case we get too jealous of the new building and have to have a shanty fund for 73 (we'd never be able to get enough for a building).

73 Parts Kits

My introduction of parts kits for our simpler construction projects back in March brought on mixed reactions. The readers wrote in complimenting us on the move. Some even went so far as to order kits, though not many. Remembering how long it took the Bookshop to build up steady orders I was encouraged that even twenty kits should be ordered the first month.

CQ, in an attempt to hurt us with the parts distributors, where my latest figures show we are outselling CQ by better than two to one, sent out a letter viewing the 73 kits with great alarm and worrying that we might shortly put parts distributors out of business. Though their intent was unfriendly, the result was very helpful for CQ's hysteria made many parts distributors aware of our kits and they were thus more disposed to go along with us on handling the parts kits through their companies.

It was obvious from the first we would not be able to finance more than a short test of the kit idea. You see, keeping our subscription rates and advertising rates very low keep us from making any money, so if something costs more than a few hundred dollars we have to forget it. The kit program won't make any money for anyone for a long time and I doubt if I could have convinced many parts distributors (or *any*) to participate without CQ's attack.

Now that we are getting better organized with the kits we will be looking into our back issues for good kit projects and will try to work up a good comprehensive kit list for you to select from.

April Cover

Old timers probably got a kick out of our April Fool cover last month. I am happy to report that the IIQ gang seemed to enjoy it... see, they're not as stuffy as you thought. I did consider doing a parody of CQ, but couldn't think of anything funnier than they have now so turned my attention to QST.

Small Issue

We had planned upon running 128 pages again this month, but several factors interfered. For one thing the cost of running the 128 pages last month was considerably higher than had been estimated. Then I was laid low by a cold at advertiser harassment time and didn't get quite as many ads this month as I could have. And finally, Virginia, who does most of the work around here, had to take a couple of days off to have a baby. Next month we're going to have a really big issue, so wait it out. (It's a girl.)

(moron 4)

Twenty Years of 73

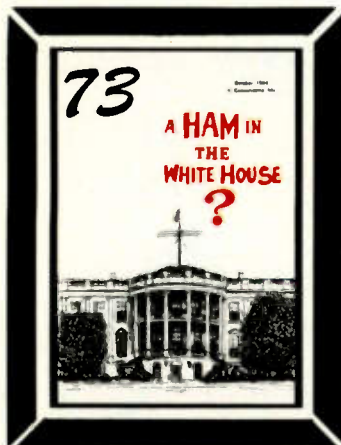

1964

January

INCENTIVE LICENSING

I am upset. I am upset over the idea of incentive licensing. I know, as I watch the government going into more and more businesses and controlling more and more things tighter and tighter, that I am opposing a relentless force. I still feel like speaking out when someone wants to get something done and their first turn is to the government. What has happened to free enterprise?

The case in point is the ARRL's petitioning of the FCC to force the amateur to study more radio theory in order to hold on to his present privileges. If the ARRL feels that the amateurs should spend more time learning theory why didn't they at least make even a slight attempt to talk the amateurs into this idea and lead them in that direction? Why, without even a try at getting hams to learn, did they turn immediately to the government and petition them to force everyone to do what the ARRL wanted?

Is government force the only "incentive" that will work? Shades of Russia.

If I am wrong and it actually is impossible to get amateurs to voluntarily improve themselves, then I can see some application for incentive licensing. This does not mean that I am not upset over the ARRL proposals. I am very upset over them.

The ARRL says we are going to pot. This is unarguable because there is no possible way to prove a case pro and con. I don't believe we are going to pot. I am distressed and disappointed to see the ARRL and fellows like Bill Orr tearing down our wonderful hobby.

I am upset over the way that the ARRL went about putting in its petition to the FCC. Now that it is in we can see that there never was any intention at any time of asking the membership what they thought. Apparently

even the Directors were hoodwinked to a degree too, though this is their own fault for leaving decisions of this magnitude to the League Officials. One Director wrote to me in confidence that *he* was opposed to incentive licensing. Rather than go into detail over this aspect of the petition I recommend that you read the two rebuttals to RM-499 that I've included in this issue. They are both different enough to warrant publication and both make many good points.

I am upset over the actual proposals made by the ARRL. Why was their schedule of taking away phone bands from the great mass of licensees planned to present the worst possible picture of occupancy of our most precious bands just before Geneva Conference time? Why did they decide to have General and Conditional licensees re-examined and yet exclude the Advanced Class licensees? Why did they decide to take away privileges from the great proportion of amateurs rather than offering them additional privileges? Why did they make no provision whatever for incentive for the CW operator? Why was absolutely no announcement of their actual plan made until after it had been submitted to the FCC?

I am upset over the rumors that have been circulating about RM-499. I have had several reports that a major League Official has actually named an FCC official as acting advisor to the ARRL in rigging RM-499. I do not believe that an FCC official would be guilty of such collusion and I think it poor ethics on the part of the ARRL to try to convince amateurs through a stratagem of this nature that there is no use in fighting the proposal since it is actually FCC sponsored and therefore will obviously go through. This is a terrible thing to say for it could easily wreck the career of the FCC official involved. I have not the slightest indication from any source (and I have a lot of sources) that the FCC was in any way a party to this proposal or that they look upon it with even the slightest degree of favor. In view of the reported ARRL allegations many of us are watching the FCC procedure with more than the usual interest to see if RM-499 gets any more preferential treatment than, say, RM-399.

de
W2NSD/1

never say die

2

73 MAGAZINE

Twenty Years of 73

April

1965



de W2NSD/1

never say die

OK fellows, I've got you right where I want you. While I've been pot slotting away at the ARRL from up here in the wilds of New Hampshire from my lofty perch on 73 Mountain, my cohorts have been busy making arrangements for me to step in and take over the League and run amateur radio as my own personal empire.

My man on the ARRL Executive Committee has thrown dust in the other eyes . . . a simple matter, really . . . and that detested Article 12 of the ARRL Articles of Association has been thrown out the window. I thought we might have a battle getting it dumped, but there was nothing to it. I sat up here telling them how awful it would be to have Dannals on the Board of Directors and they went ahead and moved heaven and earth and got him on.

Article 12? Oh, that was that old hangover from the early days of ham radio when everyone worried that someone would use the League for commercial purposes.

Article 12 states: "No person shall be eligible for the office of Director, Vice-Director or President who is commercially engaged in the manufacture, sale or rental of radio apparatus capable of being used in radio communication or commercially engaged in the publication of radio literature intended in whole or in part for consumption by radio amateurs."

So I had to wait until they threw that one out before I could announce for Director, and scheme my way, with some inside help, onto the Executive Committee. He, he.

Article 12 stood in the way of Dannals being accepted, so Article 12 got the axe instead of Dannals. Now, as seems absolutely certain, if the Board of Directors seats Dannals as the Hudson Division Director at the May Board meeting, the rule will have been completely bypassed. Dannals, you see, works for Sperry Gyroscope at Lake Success, New York. According to the Electronic Engineer's Master, Sperry makes the following radio apparatus capable of being used in radio communication: Aircraft

communications systems, airport traffic control systems, microwave communications systems, telemetering systems, microwave transmitters, radar transmitters, telemetry transmitters, VLF, UHF and VHF transmitters, beacon, command, direction finding, interrogation loran, microwave and UHF/VHF receivers. Obviously Dannals is intimately engaged in the specific activity that is prohibited by Article 12. OK, so the Directors have a choice of throwing out either Dannals or Article 12. How about that Vice-Director, Stan Zak K2SJO? Well, Stan works for Madam Bell, that ubiquitous gal who is even more involved in manufacturing, sale and rental of radio communications equipment than Sperry. With over 7% of the Hudson Division members of the League dropping out last year, perhaps they don't need any representation anyway.

K6BX Really Does It

For some months now I have been devoting quite a few spare moments to a compilation of facts which are under the working title of the "ARRL Black Paper." This accumulation of data, letters, bulletins, statements, etc., all document in considerable detail events which the League headquarters is trying desperately to keep secret. Few amateurs realize the extent that the ARRL is ruled by commercial interests, for instance.

So along comes a twenty-two page exposé of ARRL management from Clif Evans K6BX that makes my effort look puny. Clif, in his usually pungent style, quotes at length from confidential letters written by directors to other directors and assistant directors, exposing plots and events that would be considered completely unbelievable if they were not thoroughly documented. This is an incredible tale of corruption and callous disregard for the ARRL membership that will shake the League to its core.

Frankly, I would like to print some of the material here so you could see the fantastic extent that things have gone, but Clif has the

Continued on p. 86.

How To Be An Amateur

The Good Amateur—that is, the amateur who is useful in causing progress in the field he's in—has certain basic characteristics that are the same, no matter what that field may be. He may be an amateur in radio, electronics, chemistry, painting, or anything else; to be useful he must have a certain basic code—the Code of the Amateur.

A Good Amateur is . . .

1. Ignorant.
2. Egocentric.
3. Impractical.
4. Disrespectful of authority.
5. Materialistic, or pragmatic—not idealistic/theoretical.
6. Inconsistent.
7. Illogical.
8. Discontented.
9. Aggressive.
10. Unfair.

Every one of those characteristics, you no doubt noticed, is generally considered antisocial. The Good Amateur is antisocial; he's egocentric, and enjoys his own company, his own work, more than the best chitchat of the cocktail-party group that is, of course, the highest ideal of the extrovert-social type. The Amateur is antisocial in

that he *likes*—actually *enjoys!*—thinking! He actually prefers using his brains to flapping his jaw; he normally thinks *before* opening his mouth. This is, of course, antisocial, because it imposes the necessity of thinking on those around him—which naturally makes them very uncomfortable. They're not used to it.

The Amateur is Ignorant; this is necessary, because he wants to learn—and you can't learn something you already know. The thing that makes an amateur's ignorance so useful, however, is that you can't learn if you already *think* you know, either. The old line about "It ain't so." The Amateur is Ignorant and escapes that trouble. Throughout history, amateurs have been lousing things up for professionals by doing what everyone who knew anything about the business knew was impossible. . . until the amateur, who didn't know any better, did it.

Like Mad Anthony Wayne during the Revolution—the amateur soldier. He attacked a perfectly impregnable British position. Anyone with military knowledge knew it was impregnable because there were sheer, 300-foot cliffs protecting it on three sides, making attack from those

directions impossible. Mad Anthony, not knowing any better, led his men up the Pallisades at night and cleaned out the British.

The Amateur has to be Egocentric. That is, nobody's going to pay him for all the hard work he does, so he'd better enjoy what he's doing because it pleases *him*. All his work will, 99.99% of the time, yield nothing but discarded materials and passed time. In the course of ten years, an Amateur may spend \$10,000 on his hobby and wind up with \$2 worth of junk and nothing else. . . except the self-satisfying fun he had doing it.

That, by the way, is one of the ways in which the Amateur is Impractical and Unfair. Amateurs happily tackle a research project that has one chance in 10,000 of succeeding, and spend ten years and \$10,000 on it. Obviously, this is economically unsound; no professional research organization would consider so risky a venture; it would be economic suicide. For one thing, the Amateur in question may be a \$100,000-a-year executive in a major corporation; he's worth that to his company because of the extremely high level of judgment he has. That high ability to judge, to select

between alternatives, is being applied in his hobby—the \$10,000 worth of material he invests in his hobby is nothing compared to the \$1,000,000 worth of highly trained judgment he's also investing!

But the Amateur can, of course, charge off all those expenses, all the investment of time, effort, energy, and money to "Entertainment." It's a heads-I-win-tails-you-lose setup; if his research does not yield the desired result—it still yields ten years of fine entertainment.

This is very unfair competition from the viewpoint of the professional, who has to charge all the time, effort, and money invested to "expenses"—he can't call it "entertainment." The Amateur's research project, in other words, can never wind up bankrupt—in the red—a net loss. The fun of doing it, not the result, is the main product; any workable result is, then, pure gravy—a bonus over and above the call of entertainment.

Time and time again in the history of Science, the great breakthroughs have been made by amateurs; the great breakthroughs always will, for all time to come, be made by amateurs. The reason's simple: A true Amateur can tackle a

problem with no reasonable hope of success and not suffer any loss. No professional can do so.

The essence of a breakthrough discovery, however, is that *it could not have been predicted* on the basis of previously known facts. Pasteur, a chemist, not a biologist or doctor, achieved the great breakthrough in medical-biological science—the discovery of germ disease. It could not have been predicted beforehand. No one could have, a year previously, reasoned that investigation of microscopic life-forms would be the way to solve the problem of disease.

Put it this way: Today, in the race for space, we need something a darned sight better than rockets. Rockets can never be developed to an economically practical method of commercial use of space; chemical-fueled rockets must consume tons of starting fuel for every pound of payload put into space. Nuclear or photon rockets can never be used to take off from Earth—the exhaust from such a rocket motor necessarily has an appalling energy intensity. It would slag down half a county behind it as it thrust itself up into space.

We *must* develop either an antigravity device, or a true space-drive—some kind of a device that can sink its claws into the structure of empty space and climb like a squirrel going up a tree.

No professional will ever achieve such a breakthrough invention; if Dr. Quiddius Q. Quidnunk of the Research & Development division of the Brontosauric Manufacturing Company does turn up as the discoverer—you can bet he did it as a hobby-amateur project, not in his official capacity as an R & D man for Brontosauric.

The reason's easy to see. Given: We want an anti-

gravity device. It's worth \$500,000,000 to the company that gets it. With a prize that size dangling, surely it pays to do research on it!

It would indeed... if someone could suggest someplace to start!

In 1935, Dr. Robert A. Millikan, one of the world's top atomic physicists, said it would be "250 years, at least" before we could release atomic energy. He was wrong by 243 years. What he meant was that as of 1935, no one had the slightest idea where to start looking for the answer! In 1940, they did know where to start; uranium-235 was the starting point. It took only two years to get an engineering device, once that was known.

The Amateur, because it's "entertainment," can start looking for the place-to-start; he doesn't have to wait for it to be discovered before launching his research.

The great Bell Laboratories had, of course, been looking for some way of amplifying electrical signals for years before that kid, Lee De Forest, came up with the triode vacuum tube. The transcontinental telephone line was impossible until an amplifier was invented. Bell needed one, knew they needed one, and couldn't imagine where to start looking for one, of course.

There's a lot of government-sponsored research being done today; Commissions, Authorities, Departments, and Divisions of the government set up boards, committees, and Agencies to assign research projects.

Let's imagine that government-sponsored research had been common throughout the history of the United States, and consider the probability that a government agency would have made the actually-correct assignment. The boards

"ONV SAFETY BELT" A "MUST" FOR SAFETY!

'73 Bill Salerno



W2ONV
President

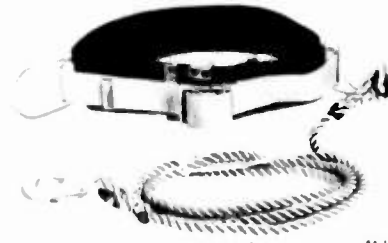

NOW AVAILABLE
ONV TOOL POUCH
DESIGNED FOR ONV SAFETY BELT
\$9.95 EACH
Shipping & Handling Prepaid

At last!! — a safety belt designed to meet the safety needs of radio amateurs, radio stations, TV stations, boat owners, painters, construction workers, maintenance people — anyone with the need to climb — now at an affordable price.

Our "ONV Safety Belt" is fitted with two drop forged steel "D" rings. Onto one is spliced a 3 foot length of 1/2" diameter nylon rope fitted with a drop forged steel snap hook. The 3" wide nylon body comfort pad is secured to 1 1/2" wide, 9500 lb test nylon webbing, which is resin or latex treated for abrasion resistance. The belt is adjustable up to size 46" waist.

Only \$38.95 plus \$3.00 for postage and handling. NJ residents add 5% sales tax.



✓37

UPI Communication Systems, Inc.

Mail To: P.O. Box 902 • Saddle Brook, N.J. 07662
N.J. (201) 279-7528 • (800) 526-5277
(Office) 481 Getty Ave. • Paterson, N.J. 07503
Cable: Unipage Telex: 642597

must, of course, act logically, with careful consideration of the opinions of the authorities in the field. Project assignments must be allotted fairly, logically, on the basis of the best available theoretical knowledge.

Would they, then, have assigned:

1) Development of a rapid, long-distance communication technique to a second-rank portrait painter by the name of Sam Morse?

2) Development of a technique for voice communication to an obscure teacher of the deaf in the Boston area, Alex Bell?

3) Development of a heavier-than-air flying machine to a two-man bicycle shop in Ohio?

Other projects would not have been assigned at all, by a committee which, not being amateur, was logical, had respect for authorities in the field, and acted on theoretical grounds. They

would never, for instance, have assigned the project of developing an electric lighting system to anybody; it was proven mathematically by top physicists of the time that such things could never be practical.

The reason is one any radio ham can understand: It was "known" that the maximum energy transfer in an electrical circuit was achieved when the resistance of the generator equaled the resistance of the load. Therefore, in an electric lighting system, one-half of the energy would be dissipated in the generator and only half would be available for lighting. This made the maximum possible efficiency 50% — but worse, it meant that for any sizable electric system a tremendous amount of heat would be generated in the dynamo. Large machines would be impossible because they

would simply melt themselves into scrap.

It's most certainly true that if modern generators weren't 99% efficient, they would melt themselves into scrap. It's hard enough to get rid of 1% of ten megawatts, or 100 kilowatts of heat; if the Learned Authorities had been properly respected by Edison, he'd have recognized the futility of inventing incandescent lights.

The Amateur can, of course, expect all kinds of trouble when he *does* achieve something. The Learned Authorities assure him he's a crackpot; not infrequently the said Learned Authorities have the police arrest him to protect the public from his phoney racket. Alexander Graham Bell was arrested for trying to sell stock in his telephone company, I understand. Louis Pasteur threw his future into jeopardy when he first used his anti-rabies treatment on some Russians who had been bitten by rabid wolves. No MD would give them the treatment; Pasteur was not an MD and risked trial for murder if one of his patients died. (Things are different now; under modern laws, Pasteur would have been jailed for curing the dying patients. Now it's illegal to try to cure someone, successfully or not, unless you're a licensed MD.)

It's interesting to realize that three of the most famous criminals in history were, technically, amateurs. Jesus, Galileo, and George Washington were all, technically, criminals and amateurs. (Jesus defied the theocratic laws of the Jewish government; Galileo taught, without being properly accredited by the orthodoxy of his time, and Washington was, of course, defying the British Crown, as an amateur statesman-general. Meanwhile, Ben Franklin, amateur diplo-

mat, was doing a bang-up job in France, to England's most acute annoyance.)

A considerable amount of Aggressive determination is, therefore, a *sine qua non* requirement for the Good Amateur. He can expect a battle when he does achieve his goal.

Obviously, he's achieved it illogically. If it could be achieved logically, from the accepted facts, professionals would have beaten him to it. The criminal-amateur must have achieved the goal by some illogical, unfair step. ("Unfair," when looked at closely, means "You did it by a method I didn't consider proper!") Obviously, if the professional had considered the method proper and had tried it, he'd have beaten the amateur to the punch.)

Go back and check over the ten points that make for the Good Amateur, and you'll see why they are necessary. If he weren't Discontented, of course, he wouldn't be trying to do something that "can't be done," or trying to do better a thing that can be done.

But the Good Amateur must be practical in one respect; he must not seek to compete with the professional on any fair, even-stein basis. He must always seek some underhanded, unfair trick. The amateur must not waste his time-effort-money on trying to do what the professional lab can do a thousand times better, faster, and easier. Don't build your own voltmeter... unless you want to learn, by actual building, what a voltmeter really is. Then, of course, you're really building your own knowledge-understanding, not a voltmeter.

You simply can't wind as perfect a moving coil, or make as precise and perfectly aligned bearings as a huge production machine-complex can; it's inefficient to try. Don't try to make

your own transistors. Don't try to solve any problem that the professional research labs are working on *in the way the pro labs are trying*.

The pro labs are now, just as an example, trying to find a better method of long-distance communication. They've sent up that Echo satellite reflector; they've investigated troposphere scatter, they've explored single sideband, pulse-code modulation, pulse-time modulation, a thousand variations. Don't compete; you'd be "fighting fair," and would be sure to lose.

Be Unfair; try finding out how telepathy works. Solve that one, and you'll junk all the multi-megabuck projects the pros have invested in. No pro researcher can tackle the problem because, of course, it's one of those things that you can't tell where to start working.

Legend has it that Alexander cracked the Gordian Knot problem by slashing through the Knot with his sword. Now there's an interesting thing about this; any amateur knows that it's a damn sight easier to untangle a snarl of wire that has only two ends than one that's been cut in two and has about 50 ends. With the two-ended knot you can, at least, start *here*, and know that, by simply keeping at it, you'll necessarily come out *there*.

Any pro lab can beat you six ways from zero on that sort of problem; they've got electronic computers, large staffs, and megabucks to grind away at the starting end, and follow it through.

The one that stops the pros, though, is the Gordian Knot after Alexander slashed through. It's got 100 ends, none of which can lead to "the" end.

The real fundamental-research scientist is a Good Amateur; that's why government research programs

simply can't do a decent job of supporting true basic research. To be truly basic research, the project must not know where it's going to wind up, it must not know how it's going to get there, and must not be logically deductible from known factors.

The tunnel diode was the result of a Good-Amateur-type experiment; the result obtained not only could not have been predicted by previous knowledge—previous knowledge specifically predicted that it couldn't happen! Since it is theoretically impossible for electrons to travel at the speed of light, it could be shown that, theoretically, no electronic mechanism can have signal-transit times as short as light speed would make possible.

Happily thumbing its miniscule nose at theory, the tunnel diode is an electronic device with signal-transit velocity equal to light speed.

It also violates all proper transistor solid-state semiconductor theoretical approaches. To be any good, a solid-state semiconductor must have very, very, VERY little impurity—"doping"—in it. The tunnel diode results from doping the germanium or silicon like crazy. Do the wrong thing—that's what works!

In the early days, the hams got shortwave radio going by doing wrong things like taking the carefully manufactured tubes right out of their carefully cemented-on bases, and soldering the leads directly into their circuits.

The real motto of the amateur must be, "Never give a pro an even break! Be unfair!"

To be a Good Amateur, don't compete with the pros—do what no pro would ever think of doing. And be Egocentric—whatever project you pick, pick it because you like it, not be-

cause somebody says it is your duty. That way, you're playing the heads-I-win-tails-you-lose game; no matter whether your project succeeds or not, you'll have had a hell of a lot of fun! Tackle the absolutely impractical projects—the ones where you'll have no pro competition. And always disregard Authorities; of course they're sure it's impossible. If they weren't, they'd have gone after it themselves. A thing can be economically impossible for professional research—and be completely practical for the happy little amateur. Lord knows climbing Mt. Everest is economically impossible in any profit-and-loss sense. What possible financial profit can be made up there?

And the amateur doesn't have to explain why his gadget works; to hell with theory! Be pragmatic; simply use it. Show that it works, and let the red-hot theoreticians worry about why if they want to.

Also, be ready and willing to be completely Inconsistent at any moment. If, one day, while working on a new idea for a two-meter half-kilowatt rig that you've told everybody is going to be a two-meter transmitter, said unit should suddenly start rising off the bench and floating up toward the ceiling—be inconsistent! Say, "I'm building an anti-gravity machine," and if somebody protests that you said it was a radio transmitter—why, point out that it obviously is an anti-gravity machine, so, obviously, that's what you were actually building. That's common sense, isn't it? Why should you care that it consumes a full gallon, and peeps out with only 2 Watts on 2? It floats, doesn't it?

Always be willing to change your project if something better slugs you along the way. Like George Baekland; he was trying to

synthesize some complex organic chemical when his chemicals in the apparatus clabbered, turned into goo, and finally set into a solid mess. Efforts to clean his apparatus of the stuff proved totally futile; he couldn't dissolve the mess in anything he could find; it just sat there sneering at all his high-power solvents.

Of course, other chemists had had similar sad accidents, and had had to throw away not only their chemicals, but their apparatus as well. Baekland was by no means the first to wind up with a mess that nothing known to chemistry would remove.

Baekland was simply the first to be a Good Amateur about it; he was Inconsistent. "I," he decided, "am not synthesizing 1, 2-alpha, betaomicron after all. I'm synthesizing something as useful as the fabled Universal Solvent—the Universal Insoluble! Since I can't get rid of the damn stuff... there must be somebody that wants a material that stubborn, so I'll sell it." With that inconsistency of approach, things were easy. It was a snap to remove the apparatus from the mass of bakelite—the glass would break, or dissolve in hydrofluoric acid.

Remember, too, that Bell was working to invent the "musical telegraph"—what we now know as carrier-frequency telegraphy—when he got the wrong result. He was a Good Amateur, and immediately decided he was inventing a telephone instead of a musical telegraph.

There are lots of patents to be gained by seeing how bad a job you can do. The body-capacitance burglar-alarm, for instance, is the worst possible approach to a stable vfo, exaggerated and patented. Almost anything that is extremely one thing or another has some useful application. Vide

INTIMIDATED BY MORSE CODE?



THE NEW AEA MODEL MT-1 COMPUTERIZED MORSE TRAINER MAKES MORSE CODE EASY AND FUN TO LEARN.

KT-1 Computerized Keyer With All Features of Above Trainer Is Also Available in Same Package

- Automatic Speed Increase, User May Program: Starting Speed, Ending Speed, Practice Duration; 5 Letter code Groups or Random Space; Common or All Characters.
- Precise Speed Control 1 to 99 WPM (Tailor to Your Exact Requirements).
- 24,000 Character Answer Book Available For 10 Starting Positions.
- Random Mode For Practice (No Answers).

CALL TODAY

UNIVERSAL AMATEUR RADIO, INC.

1280 AIDA DRIVE, COLUMBUS (REYNOLDSBURG) OH
43068, 614-866-4267

AEA Brings you the Breakthrough!

Bakelite.

Transistors tend to be very temperature-sensitive; they make wonderful high-sensitivity thermometers because of that. The RC oscillators such as the multi-vibrator are horribly unstable... which makes them wonderfully useful as frequency multipliers and/or dividers. Being inherently unstable, they'll happily lock in with the frequency of any nearby oscillator.

Each of the characteristics I've listed as necessary to the Good Amateur is considered anti-social. Each of them is... in the wrong place, or wrong degree. But be inconsistent about that, too; in the right place, and right degree, each of them is tremendously useful.

I do not, for instance, recommend Disrespect of Authorities when they say "The human organism does not normally operate well

after being connected to a 2000-volt power supply."

It is also necessary to respect authorities in another sense; they should be respected just as you should respect rattlesnakes, mules' heels, and dynamite. They frequently have power, and should be treated accordingly.

The crackpot is the bird who not only fails to respect authority, but also fails to respect good judgment.

The Good Amateur, of course, fulfills the only useable definition of a Genius: "A Genius is a crackpot who makes money at it."

Naturally... because "makes money at it" is simply another way of saying "has an idea which is economically sound and workable."

Remember that almost any crackpot can get a patent; it takes a Genius to get one and sell it! ■

Twenty Years of 73

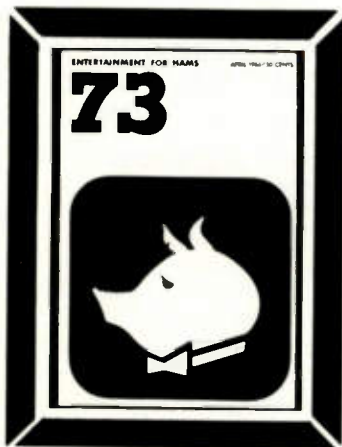

1966

October

de
W2NSD/1

never say die

de W2NSD/5ZA

This is being written while on "safari" in the remote wilds of northern Kenya. I put safari in quotes because the 1966 concept of a safari over here is probably quite different from anything you have in mind. It certainly is different from the stories I have read and movies I have seen down through the years of safaris. Perhaps I should disclaim here: readers who want only ham info in their ham magazine should turn to the next article because there is absolutely nothing of amateur radio to follow. Readers who have mistaken 73 for *Holiday* or *Venture* may be interested in the adventures of a newcomer to Africa.

The trip over here from Boston was supposed to take just one day. Jim Cotten W5PYI



Wayne with guides and waterbuck.

and Larry Frank WA6TCI arrived on Monday night and I picked them up in Boston and drove them up to the 73 headquarters for a day of getting acquainted. Larry had been with me in 1963 on the 73 tour of Europe. On Tuesday we finished our packing and had a long QSO with Robby 5Z4ERR in Nairobi. Robby answered a lot of our questions for us. When we finished our QSO with Robby we were called by 9Q5HF in Linga in the Congo. We are planning on visiting Ed after our safari and visit to Kenya. Ed assured us that we could visit the Congo in perfect safety. That was comforting.

Jim Fisk WA6BSO/1, who is minding the button factory while I'm away, drove us all down to the airport Tuesday evening. We had gone to lengths to make sure our baggage was within the weight limit of 44 pounds each, providing they didn't weigh us with our hand luggage. Our flight was by Alitalia to Rome and then, with about a two hour delay, Alitalia on to Nairobi. With everything connecting right we should leave Tuesday evening and arrive in Nairobi the following evening. It took us three days to get to Nairobi.

The flight started off an hour late, making us a little nervous about that connection in Rome. They had oversold the tourist compartment and the three of us had to suffer through the ten course dinner and champagne of the first class section. The seats were much larger and roomier too, but not really comfortable enough to promote much sleep. We arrived the next morning in Rome rather pooped. OK, where do we find the Nairobi plane? The Alitalia people looked nervously at each other. Where is it? Well, you see, we er . . . ah . . . had to cancel that flight. Today is Wednesday and we think we will have another flight on Saturday. Certainly by next Tuesday. In the meanwhile you will be the guests of Alitalia. You will stay at a nice hotel with rooms and meals paid.

How about alternate ways of getting to Nairobi? No, very sorry, but we have checked that and all flights are fully booked. You'd best wait for our Saturday flight. Most of the people caught in this situation just gave up and went to the hotel. Not us. Jim grabbed an airline manual and started looking up possible ways of getting from Rome to Nairobi . . . via anywhere. Of the many possibilities the best seemed via Tel Aviv or via Athens. We tried for reservations on these two paths and both came through for us. We flipped a coin and it was Athens. That would get us into Nairobi by Friday noon.

(Continued on page 96)

Twenty Years of 73

March

1967

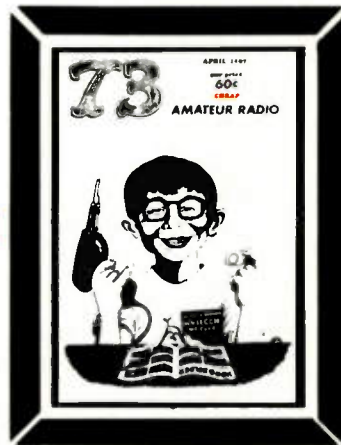

de
W2NSD/1

never say die

I see that ARRL is still leaving no stone unturned to try and kill off the Institute of Amateur Radio. They've done their usual thorough job of making sure that the League is the only national amateur organization. Not that the Institute is dead, by any means, it's just a definite unsuccess.

The responsibility for the failure of the Institute to succeed is largely mine. I know when I started it that it would be fought by every means possible by the ARRL and I was sure that CQ would be as truthful as usual in reporting about it. But I am an incurable idealist and somehow convinced myself that enough amateurs would be interested in helping to keep amateur radio going to overcome the barrage of lies and distortions.

Let me go back and explain. As one of the three officially recognized amateur radio delegates to the 1959 ITU conference I had an opportunity to see at first hand the workings of that organization. I was incredulous that amateur radio went into that conference almost totally unprepared. I felt that we had been deceived and completely failed by the ARRL. I watched the two League representatives living it up in millionaire style . . . they managed to spend over \$15,000 of the ARRL funds in just a few weeks. The complete failure of the League to get support for amateur radio, even within the U.S. delegation, was incredible. I talked with the other members of our delegation to find out what had gone wrong and what could be done to see that this didn't happen again.

I'm afraid that they all thought I was very naive . . . and I guess I was. *I had not recognized just how important Washington was until then.* This is where everything comes to a head . . . this is where it happens. Each of these gentlemen explained patiently to me that amateur radio was at the very bottom of their list as far as priority in frequency allocations was concerned and that it would remain that way as long as

we did not pressure where it counts: Congress.

They pointed out that every other user of radio frequencies maintains a presence in Washington to look after their interests. They wondered if I thought that all this money would be spent on lobbies if they weren't well worth the investment? Then they brought up the fact that every other major hobby group looks after the interests of their field by having a voice in Washington. I certainly can't argue the effectiveness of their field by having a voice in Washington. I certainly can't argue the effectiveness of the American Rifle Association, the Aircraft Owners and Pilots Association, and many others.

Amateur radio, they laughed, has no voice in Washington. But what about the League counsel in Washington? No, son, this gentleman can only represent the ARRL in dealings before the FCC and cannot, by law, approach any Senators or Congressmen in behalf of the League. No, if the League were to lobby for amateur radio in any way they would have to give up their tax-free setup and operate as a regular business. The law just does not permit tax-free organizations to try to influence legislation.

If a voice in Washington is of such great importance, why is it, I asked, that the ARRL doesn't give up its tax-free situation and do the job that will protect our future? They are the obvious ones to be lobbying for amateur radio. The answer was dollars, of course. Loss of the tax-free government subsidy of the League might cost them well over \$100,000 a year, forcing them to either increase the subscription rates to QST or else cut down on the number of high salaries being paid. Neither course is desirable so we have no lobbying permitted by the League.

By 1963, 73 had reached a size where I thought we might be able to get something started to fill in this lobby gap in amateur radio. Time seemed to be growing short too, for in 1959 the USSR came to our rescue and put off the changes in our frequencies until the next ITU conference and this seemed to be headed for us in the late 1960's, leaving not much time for building up support both within the U.S. and internationally. The Institute of Amateur Radio was formed with the major job of lobbying for our hobby in Washington.

It was never the purpose of the Institute to compete with the ARRL as an alternate organization for amateurs to join. The In-

(Continued on page 114)

Twenty Years of 73



1968

February



de
W2NSD

HERE'S WHAT HAPPENED

Subscribers during September and October ran into unreasonable delays on our part. We are trying to make sure that everyone gets every issue they bargained for, but the letters are still coming in from all over the world. While the immediate explanation is programming difficulties with a new computer, the long range explanation is more complicated.

It has been quite a while since I have written about how things are going with 73. A letter from Richard, WB2UMH, asks what happened to some of the old 73 services such as the Radio Bookshop, 6-UP, ATV Experimenter, and the Parts Kits. He also wants to know what has happened to the old aggressiveness of 73.

Perhaps I can put this in perspective if I go back to the beginning.

Ham radio grabbed me during my freshman year in high school, back in 1936. The great bulk of my 35c a day lunch money went into radio parts during high school. I built up a storm and had a wonderful time with my own receivers, transmitters and transceivers. The code bugged me, though, and it took several nerve wrenching visits to the FCC before I managed to steady my hand down enough to pass the code test. The only reason I passed, I think, is because I merely went along with a friend who was taking the test and then, at the last minute I decided to give it a try . . . it didn't cost anything in those days. It was

easy when I wasn't worried about passing and soon I had W2NSD.

A year later came the war. I joined the Navy in '42 and went through what I consider one of the world's greatest electronic schools at Treasure Island. I had joined the Navy with the understanding that when I graduated from school I would go to work for the Naval Research Laboratory in Bethesda, but I changed my mind and volunteered for submarines. During 1943-44-45 I was in the thick of the Pacific war as an Electronic Technician 1/c. Then I was "retired" to New London where I taught school until the end of the war.

After finishing college in 1948 I tried my hand at being a broadcast engineer-announcer at a few stations around the country. Then I got into television, putting WPIX on the air as an engineer and later KBTB in Dallas as a producer-director. It was in 1948 that I got interested in ham-RTTY. I was very interested. When I got a job in 1951 with WXEL-TV in Cleveland as a director I immediately latched onto their mimeo machine and started publishing an RTTY bulletin. By the next year I was writing an RTTY column for CQ.

Television was fast turning to formulas so I decided to get out of that business. Those of you who have read, "Only You, Dick Daring" will understand what is wrong with that industry. I went into hi-fi manu-

FREE!
RADIO AMATEURS
WORLD ATLAS
 with purchase of famous
CALLBOOK
MAP LIBRARY!

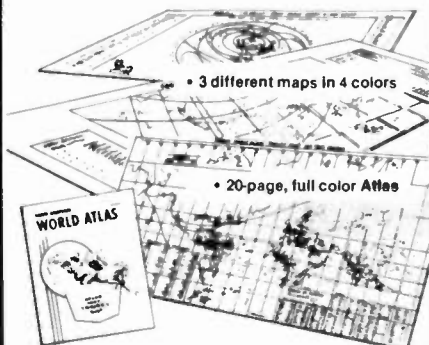

Here's an offer you can't refuse! You receive three, information-packed, Amateur Callbook maps, folded, plus the World Atlas for only \$3.75 plus \$1.50 shipping and handling. If purchased separately, total value of map/atlas offer would be \$6.25, plus shipping. You save \$2.50 and get these invaluable radio amateur aids!

- 1. Prefix Map of the World, folded.**
World-wide prefixes. Shows 40-zone map on one side, 90-zone map on the other. Size 40" x 28"
- 2. Map of North America, folded.**
Includes Central America and Caribbean to the Equator. Shows call areas, zone boundaries, prefixes, etc. Size 30" x 25"
- 3. Great Circle Chart of World, folded**
Centered on 40°N, 100° W Shows cities, latitude, longitude, great circle bearings and more! Size 30" x 25"

Plus special FREE bonus!
 The Callbook's own **Radio Amateur World Atlas**, **FREE** with the purchase of the 3 maps. Contains eleven full color maps of the world, looking at things from the radio amateurs point of view.

Callbook Map Library	\$3.75
Shipping	\$1.50
Total	\$5.25

Special Limited Offer!
Amateur Radio Emblem Patch
 only \$2.50 prepaid



Pegasus on blue field, red lettering. 3" wide x 3" high. Great on jackets and caps. Sorry, no call letters.

ORDER TODAY!

Order from your favorite electronics dealer or direct from the publisher. All direct orders add \$1.50 for shipping. Illinois residents add 5% Sales Tax.

RADIO AMATEUR
callbook INC.
 Dept. B
 925 Sherwood Drive
 Lake Bluff, Ill 60044

73 THANKS
 RADIO AMATEUR CALLBOOK
 AND BARRY ELECTRONICS—
 ADVERTISERS IN 1960,
 ADVERTISERS IN 1980!

BARRY ELECTRONICS...

New York's largest and best-stocked dealer.

Call the store with more!

COLLINS
 KWM 380... taking orders
DENTRON
 Clipperton L... call
DRAKE
 TR-7/DR-7 transceiver
 R-7 Receiver... call



Yaesu FT-901D

DSI
 Frequency counters... in stock
ENCOMM
 HT-1200... we have them

ICOM
 IC2AT hand-held with pad... in stock
KEYS
 Ham Key... in stock
 NYE... in stock



Cubic Astro 150A

MFJ
 Complete line... ask
J.W. MILLER
 Daiwa CN-720 watt-meter/bridge
 Daiwa CS-401 RF coaxial switch



Icom IC-2A

MIRAGE-KLM-TEMPO
 two-meter amplifiers... in stock
ROBOT
 800 and 400... in stock
ROTORS
 Ham IV... special. Call



Yaesu CP-2500RK

SWAN
 Astro 150A... Barry has 'em
TEMPO
 S1, 2, 5... In stock



Yaesu FT-101ZD

TRIONYX
 TR-1000 frequency counters \$159.95
YAESU
 FT-101ZD
 FT-107M
 FT-207R
 FT-227RB
 FT-707
 CPU-2500RK
 All in stock... Call

Ask about our amateur radio licensing classes. **NOVICE** through **EXTRA!**

BARRY specializes in business band equipment.

BARRY specializes in world wide export, licensing, packing and shipping.

BARRY stocks most major brands... call or write.

¡ AQUÍ SE HABLA ESPAÑOL **!**

BARRY ELECTRONICS

512 Broadway, New York, N.Y. 10012

Telephone (212) 925-7000

Twenty Years of 73

1969

October

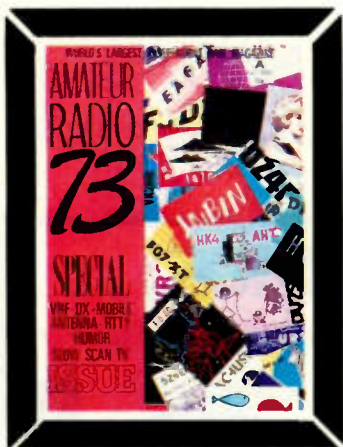

...de W2NSD/1

Wayne Green

Gravity Waves

My thanks to old friend Neil W2OLU for sending in a clipping from the New York Times announcing that Professor Weber of the University of Maryland has detected gravitation waves. The existence of gravitational radiation is predicted by Einstein's General Theory of Relativity and Professor Weber believes that he has experimentally verified Einstein's prediction.

A century ago Maxwell predicted from mathematical calculations that there were other types of electro-magnetic radiation than light rays. In 1888 Hertz confirmed Maxwell's predictions and opened the radio spectrum.

As I mentioned a few months ago, here is a field that is wide open for the amateur. There are no professionals in the field yet. What, all of us want to know, is the velocity of propagation of a gravity wave? Speed of light? Instantaneous? If it is faster than it would make a wonderful communication medium for interstellar contacts . . . and might explain how those pesky UFO's are able to get here from planetary systems so far away that reputable scientists say that they cannot exist just because there is no possible way for them to come that distance.

If you have any info to pass along on gravity generators or detectors, let's pass it along through 73.

Vietnam Solution?

The educated opinion seems to be that President Nixon has been hoping that he could use the same route for settling the war that Eisenhower used for closing out the Korean conflict. That meant working through Moscow, who, because of the Chinese difficulties, were supposed to be anxious to accommodate the U.S.

This approach doesn't seem to have worked out in practice at all, a situation

which leaves us still boiling in our own kettle of soup. Unilateral disengagement means, essentially, the slaughter of most of South Vietnam, the historic consequence of losing a war in Asia. This, in turn, can hardly help the non-communist forces in Laos, Thailand, Cambodia, Malaysia, Burma and India. Any promises we have made in the past of help will hardly be honored after the disaster in Vietnam, and they know this.

Obviously, getting out of Vietnam unilaterally is a very bad solution to our problems. Should we then turn around and escalate again? We have seen that the communists are able to match every escalation. They have no intention whatever of losing the war. They have been at it for many years there and are not about to drop it now.

This is a subject that can better be argued in a book-length form than a brief editorial comment such as this, however I would like to make an abbreviated suggestion for a new course of action that might possibly prove more rewarding. I wrote about this a couple years ago upon my return from Asia, but not much came of it. The ideas still seem quite valid . . . perhaps even more valid than ever, since more options have been tried in the meanwhile without noticeable success.

Basically, I propose that the Pentagon and the State Departments do not have a corner on the U.S. brain market. Experience has rather indicated negatively in this respect. Possibly then, we could do better than depend upon them for our total effort in Vietnam, directing the fighting and peace talks, which about sums up our activities there.

Just suppose that we decided to fight a much more basic fight, using our biggest weapon? The bomb? No, not at all. The battle between communism and capitalism is

Twenty Years of 73

June

1970



NEVER SAY OIE

...de W2NSD/I

EDITORIAL BY WAYNE GREEN

A Visit to Jordan

With nothing more to go on than a note in Gus' DX bulletin to the effect that King Hussein of Jordan had been heard on the bands fighting off tremendous piles of QRM, I sent a cable to him asking if he could use some help for a few days to beat down the multitudes. With Radio Today just being started and the tight U.S. economy making its pinch felt all too clearly on 73, I wasn't really too enthusiastic about my proposal.

On the other hand, the insurmountable problems at 73 have continued without any real letup for a long time, with me there or away, so perhaps a few days off wouldn't be too serious. And uppermost in my mind was the opportunity to possibly make a good friend for amateur radio, one who could have a strong long-range impact on the hobby. If amateur radio could be developed in the Arab countries this would not only benefit them tremendously by encouraging the growth of engineers and technicians, but would help amateur radio by giving it a few more votes at the ITU conferences in the future.

Much to my surprise an answering cable arrived from His Majesty asking me to come. Within a few days I was off to Jordan and whatever lay ahead. Where would the station be? At an army base? Perhaps in the palace? Would I be able to operate much? Would I get to do more than just meet His Majesty? Those of you who have been reading my editorials know that all sorts of ingenious plans for solving the mid-East crisis started coming to my mind.

When I checked in at the airport in Boston they suggested that I hand carry all films with me since all checked baggage is x-rayed at London before going on to the mid-East. This called for a complete repacking of my bags in the black of the parking lot, and I ended up by carrying on two bulky bags full of cameras and film.

Lin didn't think I should go in my dungarees, so I hope the IRS will agree that the business suit I bought for the trip was a necessary business expense. You don't need business suits very much in New Hampshire.

The plane left Boston in the evening and arrived in London the next morning. As usual on these trips I managed zero sleep. They had some fool movie that I had seen so I saved the \$3 for

the earphones, but still couldn't keep my eyes off it.

After a couple of hours wait at London in the passenger lounge I was off again to Beirut. I'd written Bob ODSBZ there, hoping he would have time for dinner between my planes. Late that afternoon I arrived at Beirut, but no Bob. I found out later that he was out of the country on business. I put away a great Arabian meal at the airport restaurant and continued on to Amman on a Royal Jordanian Airline plane, landing there about 9:30, wide awake on my second wind, beyond being tired.

There was a big commotion outside of the plane, with newsreel photographers and all... the man beside me said, "Look out there and see our King." Sure enough! I could end that there, leaving you with the notion that he had come to see me, but actually he was greeting his sister. I was met by a man from the palace who expedited my passport and bags through, told the King that I had arrived, and drove me in a beautiful Mercedes to the Jordan Intercontinental Hotel where I was to be the guest of His Majesty!

I slept.

The Hotel Jordan, as it is called, is an American style hotel... showers, wall-to-wall carpeting, the whole bit. It has a serviceable coffee shop and a first rate restaurant on the roof. The "maids" are men, but they know all the ropes such as opening your door at 6 a.m. to see if the room is occupied. Just like America. They try the door again at 7 to make sure they were right at 6.

The next morning a phone call explained that a Mrs. Salti would be picking me up shortly. Mrs. Salti turned out to be the private secretary to His Majesty and a very nice looking English girl. She explained that there was some sort of big do on shortly if I would like to come... I grabbed my camera case and we were Mercedes'd to the gigantic sports arena... Jammed with people. We sat up in the grandstand, not far from the King's box and awaited developments.

The "do" consisted of a couple hours of speeches, His Majesty presenting flags to a number of artillery groups, inspection, parades, and some really beautiful precision marching by both military and bagpipe bands. There were some-

Twenty Years of 73

1971

December



Meaningful Contacts

EDITORIAL BY WAYNE GREEN

One of the more consistent complaints lodged against our hobby is that so little of our incredible communications capability is used for the exchange of more than superficial information.

Unfortunately the complaint is an all too legitimate one. Considering the reasons why this is so, I wonder if anything can really be done to reverse this pattern? Perhaps a look at some of the more basic reasons will help bring the problems into focus and give us some insight into solutions. Maybe not.

While the resultant lack of any real communication is the common result, there are several causes for this and each has to be considered separately. The chap on the two meter FM repeater has his trade-offs which limit the use he can make of that facility. The DX operator has his problems, some the same, others quite different. The Novice has his miseries, and so it goes.

Perhaps if we start with the more narrowly limiting factors and close in on the generally inhibiting situations we can best outline the whole problem. For instance, the operator working through an FM repeater has a whole bunch of cards stacked against him when it comes to opening up an interesting and meaningful conversation with someone else.

First of all, one or the other is probably driving a car. This means that a good portion of his attention is on the car driving and his radio contact has to take second place in his mind. If there is a second person in the car, this further divides his attention, and you will notice that little of what you say to this chap seems to have gotten across at all. You will be right.

Operating through a repeater could possibly work out well if two ops were putting good signals into the repeater, both had nothing whatever to do except pay attention to the other, both knew that there would be no interruptions, and both had lots of time and knew that they both had the time.

But it doesn't work this way at all. Few repeater users do not have the psychological feeling that they should get off the pot as soon as possible to make way for someone else. One, the

other, or both are preoccupied with something else. The signals often fade in and out, losing part of the conversation. One is wideband - the other narrow - and one therefore finds it difficult to understand the other, even when the signal is strong. And so it goes.

Add to this the fundamental difficulty of communicating with a person you don't know, whom you can't see, about whom you know little, if anything, a person you can't even hear except when you stand by for him, cutting off those conversation reinforcing grunts and uh-huhs which help keep two people talking with each other. The restriction of having to talk with no reinforcement, covering everything the other chap has said (as nearly as you can remember) and then originating new things to talk about is a very severe one. It is no wonder that such a large percentage of the radio amateurs stick pretty much to short recitations of their equipment and the weather.

The amateur radio type of contact is quite abnormal and has no counterpart in our learning process, so most of us are unprepared to tackle the difficulties it poses. Even on the telephone you can hear the reinforcing noises of agreement and be stopped when the other person has something to add or disagree about. Way back in the long-dead past of amateur radio this type of communication did develop for a while. Oldtimers will remember with great warmth the duplex contacts on 160 meters where it was possible to just leave your rig turned on and tune in to your contact on the other end of the band. Just like the telephone.

When sideband started and VOX became the way to go, this system looked as if it would partially bring back the old arrangement. But the clank of the relays was too much for most operators and, after uh-huhs between sentences to keep that con-labbed VOX from tripping, they went back en masse to push-to-talk.

While a few of the DX brethren do indulge in interesting contacts, most of the exchanges are of little more value to anyone than the hasty hello over the local two meter repeater. The pressures of other stations trying to work your rare one, fading, other

contacts on frequency, and such jazz make long contacts rare. Even if you have the ability and experience to manage an interesting contact you would be hard put to bring it off.

I would dearly love to talk with YA1GNT for an hour, yet I have one devil of a time carrying on an hour contact with Chicago a good deal of the time. Oh, I can make it now and then, but I have to lose a lot of sleep waiting for the right conditions.

Are there any answers to the problem? Are there any changes that might be made so more of us could indulge in meaningful conversations via our incredible amateur radio bands? I think so.

There are no simple answers to such a complex set of problems, obviously. But we can all help out if we are first of all aware of what we are missing and make a determined effort to move in the direction of better use of our bands.

On the FM repeaters I would suggest that repeater owners seriously consider the installation of a second or third repeater. While the spectrum between 146-147 MHz is about full in many areas, there is still little going on in the 145-146 and the 147-148 bands. The emerging 220 units will make that band an invaluable addition to the two meter repeater setup. With enough repeaters we can afford the luxury of long-winded contacts. With both 146 and 220 repeaters we might even develop a duplex system of operating. The use of two- or three-minute timers on repeaters will aid the mobile operator in getting a word in when two long-winded ops are talking. Timers like that will also shorten some of the endless and pointless pontifications which drive ops off the air for weeks at a time when they get snagged.

I'd be very interested in what you, the reader, thinks might improve our ability to use amateur radio for true communication. Should phone patches be eliminated except for serious emergencies? Should nets be curtailed or encouraged? Should DX for QSL card purposes be channeled to a small set of frequencies? What can we do? Here we are, able to talk anywhere in the world, and what do we do?

When you consider that we have virtually the ONLY system for people-to-people contact around the world, perhaps you can appreciate the importance of our really making something of it. Tourists rarely get to meet the people in a country they are visiting. They meet the tour guides, hotel clerks, and taxi drivers, and that is about it. No wonder so many Europeans have incredibly distorted ideas of Americans... they know us from our movies and television ex-

Twenty Years of 73

November

1972



THE NEW REGULATIONS WAYNE'S VIEW

The heavy hand of an insensitive government has just dealt a cruel blow to the most exciting and fun aspect of amateur radio in many, many years. FM will never be the same.

It is sad to listen to the voices on the bands agreeing that, yes, the new rules do seem rather restrictive, but we can live with them. Sure, we can live with them. Man has shown himself to be eminently adaptable — able to live under almost any conditions, from Russian prison camps to the Inquisition.

But now, just as amateur radio has at last been staggering back from the blow of "incentive licensing," one of the last things we really need is to have a hysterectomy in the FM department.

THE GOOD PART

Many years late, the Commission has finally opened the 147 MHz segment of the two meter band to Techs. This move appears to have been purposely held up to try and sweeten the bitter pill of repeater restriction. It is the only major benefit from this otherwise negative and crushing report and order.

The other dim ray of light in the order was the relaxing of logging rules for repeaters. Much of the charm of this change was taken out by a re-affirmation of the need for detailed logging by everyone but repeaters. The Commission cannot, I believe, produce any substantial arguments to support the continuing of such logging. It is a hold over from the earliest days of radio and serves little purpose today.

THE BAD PART

The licensing of repeaters is now set up so that it is a great big deal just to apply for the license — and expensive. You have to have topographical maps to work out the average terrain — antenna radiation pattern charts, vertical and horizontal — diagrams of the entire repeater and control system (which has to be approved before each and every change) — provision for monitoring input and outputs of the repeater — a license for each and every control point — a license for the link — and a license for the repeater.

At \$9 per license, this can mount up rapidly.

Another disaster is the matter of monitoring. The new regulations are quite explicit in demanding continuous monitoring of the repeater input and output frequencies. This means that all but a few repeaters will have to be shut down when the control operators are asleep — when they are at work — on vacation — at the movies — playing cards — at a party — or (hopefully) with the wife. There doesn't seem to be any logical reason for this rule other than harassment and hamstringing of amateur repeater service since it is not difficult to provide safeguards which will shut down a repeater in the event of malfunction or funny business.

Let's take that to an extreme. Let's suppose that a berserk amateur has taken over the input of the repeater and is yelling porno and mayhem through the air — and he carries on for 24 hours straight before collapsing. A few of us with the patience to stick it out will have had something to talk about for years to come — the rest of us will have to use another repeater for a day. One or two sensitive souls may suffer a mental hernia from hearing such terrible things — providing they haven't ever been in a locker room or in the armed forces — or in college or high school during their lives. The rest of us will come out of it unscathed.

Direction finding gear being as it is, I doubt it will take very long to find the idiot. A recent case in New York hardly took any time at all before the repeater group was able to pinpoint the dingy who broke in on a repeater with hair-curling filth. Getting the FCC to do something about it was something else again, they seemed more entertained than alarmed.

The removal of the 220-222 MHz segment from repeater use blows the national agreed-upon plan for that band to bits. Pity, for the amateurs have displayed admirable cooperation in working out their own rules and allocations, complete with unofficial governing committees to keep everything in order. The FCC obviously was not impressed. The only logical reason

that comes to mind for the strapping repeaters out of the lower two meter band is to make room for the new citizens band which the Electronics Industry Association is pushing for the Japanese.

The removal of repeaters from the 440-442 MHz segment of the band is another kick in the head. In the degree of organization that some amateur groups have shown in the development of this band, it is difficult to understand this move. It serves little purpose and will be tremendously expensive to us.

Section 97.111c prohibits the crossbanding of repeaters. How come? There has been so little of this done that there is no way for it to have yet caused any problems. The two repeaters that I have used that had crossband facilities (W1ALE in Concord NH and W1KGO in Peterborough NH) never had any problems worthy of mention. Indeed, both provided a good deal of fun for those involved and made it possible for the six meter FMers to have a little window to talk with the two meter boys — and vice versa.

It is not practical to set up mobile FM gear for 52 MHz, 146 MHz, 220 MHz and 440 MHz all in one car. It is just too much. Too much investment — too much space — too much antennas — and too much to operate while driving. So what are we to do, have four different groups of amateurs using repeaters, with few ever able to talk with any of the other groups? Crossband repeaters with suitable controls are important, not only for fun, but particularly in times of emergency when it can be critical to be able to reach everyone.

Since repeaters are, under these new regulations, only permitted to operate in bands where all licenses above Novice are legal, there is no question of any operator being repeatered out of his class of license.

I believe most amateurs will join me in thanking the Commission for finally opening up 147 MHz for Techs — for relaxing logging for repeaters — for permitting mobile control points for repeaters and remote base stations.

As for the rest of the regulations, they appear to be gratuitous harassment of the amateur service. They do not seem necessary. They are in some cases extremely harmful to the spirit of amateur radio. Little good can come from them.

ARTICLES NEEDED

While we do try and cover all bases in 73, the readership seems to prefer construction projects — particularly those using the newer ICs and transistors, so if you are building gear along

Some Guys Make It — and then there's us

You know, when you really step off a cliff, you know you've done it. It's just like looking out from the observation tower at the Empire State Building, and suddenly you're in mid-air and you know that there's no going back. I mean, it's a great flight while it lasts.

It's maddening. You notice that up and down the street the guys in the big Cadillacs never get tickets? Have you ever seen a ticket on a fat Mercedes? Let me tell you, I used to come back with my motor scooter decorated like a Christmas tree. You know, all those little green tags hanging like tinsel all over it. And in front of me would be a tagless Cadillac, and behind me a tagless Mercedes. Both parked there since last Easter. My scooter... I'd slow down, and the fuzz would be running alongside me, tying 'em on.

Well, that goes in all directions. There are guys

who always get it you-know-where, and there are guys who don't. It's just that way. Now I don't know how it's set. I don't know whether it's predestination. I don't know whether it's preordained, but some guys from the very minute they're born—and they can be born in a rotten neighborhood—but from the very minute they're born, they are preordained or something to Make It. And there are other guys who are born to be Sunk. I mean just born to it. Your ship is leaking. From the very minute you start to walk. Your shoes squeak. And you're phonying it up, and hoking it up from the time you're six. Other guys *win* the sack races. You know, legitimately. They can run faster.

Well, let me tell you what happened one time. I'm on the air, you see. I'm a ham, and this is when I began to discover this principle. I'm a kid, and I got this paper route—rout. It was both a route and a rout. It's terrible to have to admit

that even when I was a paperboy, I was a paperboy for a paper that was about to go out of business.

Every week you'd come around and you'd try to collect, and they'd tell you they want to drop the subscription, it's a rotten paper. It's awful. I had a paper called the *Herald-Examiner*. Did you ever hear of it, the *Chicago Herald-Examiner*? And you know, it was such a bad paper that they didn't even read it in my house, and we had a free subscription.

I used to go running around the neighborhood at four o'clock in the morning, delivering this rotten paper. It was a losing battle. And on Saturdays, every morning, I would go up and I'd knock on every third door, trying to collect the dough, and they'd say:

"Here's forty cents for last week. Please don't deliver the paper any more."

Well, then I'd have to go back and tell George The Paper Man that they quit

down there, on Cleveland Street, those people down there, and he'd say:

"Ah, they're rotten people."

George was fighting a losing battle too, because he had the *Herald-Examiner* franchise in the neighborhood and he was going down with the ship. And all these poor little kids who were 12 years old and who were getting knobby knees from running around with this paper, they were going down, too. Whereas right across the street from us there were a bunch of wise-guy kids who had the *Tribune*. And this big fat guy who had the franchise for the *Trib*. And they all got fat. All those kids are Republicans today. And Cub fans. All of the rest of us kids that had the *Herald-Examiner*, look at us. Ha! Democrats, following the White Sox till the day we die.

So anyway, I'm a kid and I get my ticket, and I figure I'm licensed, like all the rest of the guys. Except, of

course, the Cadillac has the same kind of license on it that you've got, you know. It's the same piece of metal on the back, but Boy, what a difference.

So I get my ticket. I'm really gonna swing. I'm on 40 CW for about six to eight months, when I get on 'phone. Now I'll tell you what I was doing as far as 'phone is concerned. I figure I'm gonna try and make it in the big leagues. And I have a single 2A5. Final driven by a 56 tri-tet oscillator. Do you know anything about the 2A5? Well, it was a pentode, a power pentode. Receiving type. I got ahold of this 2A5, and I was using a Majestic B Eliminator, which I had found in the basement of somebody's house, to power this thing. And it put out 135 volts. I can tell you exactly what was running, it was 135 volts on the plate at 10 mils. So you can figure out what my input was. Into an RCA mismatched receiving doublet SWL antenna. A special design they had to mismatch on everything. Didn't match anything. I could have done better with the bedsprings.

And so I've got this thing tuned up, and I'm running a cool 135 volts at 10 mils on the plate. I built a modulator. Oh, when I think of it... how sad.

The modulator was another 2A5, and I am grid-modulating the final. Well, you can realize the kind of output I have. I'm probably running about 7/10ths of a Watt, and you will never guess what band I'm running it on. I'm on 160 meters. Where a low-power guy was running 200 Watts and the high-power guys ran all the way up to, well, I would say WNBC standards.

I had this poor little receiver. I don't know whether you ever heard 160 meters when it really was wild. You know what you

could do on 160? You could tune into the band, and when you hit the band it was one heterodyne from one end to the other. One solid heterodyne, without a break. And the heterodyne was of such magnitude that your S-meter was on the pin all the way across the band. It never fell off.

So one night I'm on there. I throw my 7/10ths of a Watt right into the middle of it all. I have a very vocal special sound, the bored sound of a high-power man, calling CQ. Nonchalantly:

"Hello CQ, CQ, 160. Hello CQ, hello CQ, hello CQ." Then there's a little silence while I'm tuning. Sound of arc being drawn by pencil from final plate.

"Hello. One Two Three... hello. Hello CQ, hello CQ, hello CQ."

Where you really sound like a big leaguer is when you turn the radio in the next room all the way up, so you sound like you've got so much power and so much gain, so much preamp gain that you can't cut down the background noise in your house. It sounds real great.

I've got the the cans on. I'm wearing cans monitoring myself on my receiver. I am the only guy who can hear me, the only guy who could hear my signal.

"Hello CQ, hello CQ, hello CQ, hello CQ."

It's 9 o'clock at night, and everybody in the country is on. Believe me, that band was so insane and my rig so weak that with my signal on and my receiver on, I could hear the heterodynes through my carrier. If you know what I mean.

"Hello CQ, hello CQ, hello CQ, hello CQ 160, hello CQ."

I am calling CQ from 9 o'clock at night till 4 o'clock the next morning. All I am raising is our light bill. That's all that's happening. So the next night I

come on again. I get on the air again, and it's great, you know, just to throw on all the switches. The one thing I had that was heartwarming was that my BH tube was leaky. I had a gassy BH. Did you ever hear of the BH cold-cathode rectifier? Well, it was leaky. It was gassy. It made a beautiful blue light like an 866 when I talked. Made me feel like I had real power.

"Hello CQ, hello CQ, hello CQ, hello CQ, hello CQ." And I'd see that blue light flickering. It was just great.

"Hello CQ, hello CQ, hello CQ, hello CQ."

Well, this goes on for one solid week. They can't even hear me in the next room. I haven't raised even a BCL.

"Hello CQ, hello CQ, hello CQ."

Finally Friday night comes along. Friday night comes along. And my friend Chuck, down the street, is W9AHS. He has not worked anybody on 20 since the preceding spring, when he worked a guy who was mobile and who drove right past his house. So the two of us are in the same leaky rowboat.

Chuck comes home from school, and he says:

"You're on 160, huh? How're you doing?"

And I say:

"Ah, pretty good, Chuck. How are you doing on 20?"

Twenty is a real big league band. He says:

"Oh, not bad. Not bad."

We both made Class A, you see, but I didn't have the guts to go on 20 yet, because the band scared me.

Chuck says:

"What do you say we work a little crossband tonight?"

Chuck lived 10 blocks away from me. So I say:

"Okay, Chuck."

So Chuck has got his receiver tuned to 160 and I'm listening on 20 and sure enough, between all the

heterodynes I hear Chuck come in:

"Hello, hello W9QWN, hello W9QWN, W9QWN. W9AHS calling W9QWN."

So I throw on my transmitter. I'm on 160:

"Hello W9AHS, W9AHS."

And Chuck comes back to me! Fantastic! He could hear me. Right in between all the heterodynes he says he could hear this little squeak, this little thing. He says:

"You're coming in. You're about an S-2. About an S-2. Readability is very low. About an R-3, I'd say, about every 3rd or 4th syllable."

So, without thinking about it, we slip into crossband work, into duplex. And I leave my transmitter on, Chuck leaves his on, and I'm talking to Chuck. We worked crossband, duplex, for not more than 30 seconds.

Illegal.

And I'm talking to Chuck, Chuck's talking to me, back and forth. It was great. Finally:

"73, Chuck."

"Okay, Dad."

"Hello CQ, hello CQ, hello CQ, 160 phone—hello CQ, hello CQ."

Six or eight weeks go by. When suddenly, in the mail, would you believe it? I get a card from the FCC. They got a listening station in San Diego. And they have ticketed me for crossband illegal operation. I am coming in there 599 XXXX. A ton of bricks! On 160!

Well, I figured, you know, there's some guys get ticketed and then there's others that don't. About that time I realized that there are born losers and there are born winners.

Oh well, it doesn't matter. It only gets worse. But the thing you got to keep saying to yourself is that it gets worse for everybody, simultaneously, all of the time. Maybe. ■

Twenty Years of 73

1973

July



...de W2NSD/I

EDITORIAL BY WAYNE GREEN

WALKER SPEAKS

The guest speaker at the Rochester Hamfest this year was A. Prose Walker, the chief of the citizens and amateur division of the FCC. Walker spoke before a full house at the hamfest banquet.

Walker had quite a lot to say to the crowded room full of amateurs. He explained that in his view amateur radio was no longer justifying itself — that appliance operators seemed to be in the overwhelming majority and that amateurs no longer were making significant contributions technically and that in the eyes of the Commission there was some question about the value of the amateur service.

He read off parts of the FCC rules pertaining to the reasons for amateur radio existing and indicated that in his opinion — and probably also in the opinion of the FCC commissioners — amateurs were not shaping up and we'd better do something about it.

Walker went on to extol the merits of the citizens band — and to point out the extreme difficulties they have to work under with only 22 channels for over 800,000 licensees and some 4,000,000 base and mobile stations licensed. A tear dropped down each amateur cheek — partly for the poor CBers and partly for Walker and his concern.

Walker pointed out that these chaps have over one billion dollars invested in their equipment.

How I would love to get Mr. Walker on a platform in a debate. I am sure that many amateurs sat there and listened with increasing fury to find that the top man in the Commission is so opinionated — and so terribly wrong! This is the man who has the ear of the seven Commissioners! Apparently this is the ONLY man who has their ear, for when you write to any of the Commissioners your answer comes back from Walker.

If Walker had not been too busy to attend the talk I gave earlier in the day he would have gotten some data which would have shot holes in his pet theory that amateurs are no longer making contributions technically. I cited chapter and verse on amateur development in the development of CW, of sideband, RTTY, and even FM! The involvement is deeper than

most amateurs are aware — and obviously more than the Commission is aware.

Since this was a banquet speech, no one could jump up and point out the obvious fallacies in what Walker was saying. As one fellow said after the banquet, sure there are lots of CBers crammed onto 22 channels — but this is not the same as one million hams on 22 channels on 75 meters, as suggested by Walker. When you consider that a five watt CB rig normally has a range of just a few miles, under the best of circumstances, you see that there are several thousand separate cities and towns where CB can communicate. If you figure a 20-mile range for a CB rig you end up with about 15,000 such communities around the country. Let's say that we only consider 3000 of those — 22 channels per area — and 100 users per channel (a repeater with only 100 users is occupied only a few hours a day on the average and the range is ten times that of a clear CB channel) — you find that you can handle 6.6 million CBers... without any need for serious interference. Of course high power, beams, excessive use, and such would eat into that number — and it has — It has.

The one billion dollar investment story seems to be Walker's answer to suggestions about eliminating 27 MHz CB. May I remind Walker that there is good and adequate precedent to make a small change in this band which could cure the problem — and not interfere with the billion investment. Remember that not long ago amateurs were forced to either upgrade their licenses or else move out of the bands they had been using — and I don't recall any concern over the amateur investment involved. General licensees were forced out of the choicest parts of the phone bands, right across the board.

Suppose the Commission decided to change 27 MHz back into an amateur band — perhaps a Novice Class band with the simple Novice technical and code exam? Upgrade or get out would be the message — just as the Commission told the amateurs. No loss in investment — even a seven year old child can get a Novice license. The one billion dollars is protected.

The manufacturers could be gotten behind this scheme by getting the power limit raised to one kilowatt — VFO operation anywhere within the band — etc. They could quickly sell another billion dollars worth of hardware.

To those few readers who tend to take all of my suggestions seriously, may I point out that sometimes I am just being sarcastic. In this case I hope that you realize the above suggestion was not seriously tendered. I don't think the FCC has the guts to make any change in 27 MHz. That's a rough bunch down there on eleven and they can set up a squawk in Washington and via the EIA lobby that the Commission will avoid at all costs. The FCC doesn't like congressmen calling up with complaints.



Now, about those appliance operators. Immediately after the Walker speech, the Rochester club gave out awards to a number of amateurs who had performed outstanding service during the recent floods — including a plaque to one of the top amateurs. Sure, we talk a lot on the air — but when we're needed we are there. A show of hands was asked for — how many here have two meter FM mobile? Over half of those present raised a hand. How many have been involved in a serious emergency in which amateur radio has helped — almost the same number of hands. A lot of us may buy rigs and spend a good part of our declining years putting out hot air on the ham bands — but most of us are right in there when we are needed — and by virtue of the equipment we use for gassing we can do a bang up job when the chips are down. My hand unit has only saved a life once — but how many times is enough? Even if nine out of ten hams are never needed — It still is enough.

About that building — while not many of us build our transmitters — there are more counters and synthesizers being built in hamshacks today than transmitters in the 30's. There are more builders today — not only in number, but in percentage, if you count the innovative builders and discount the kit assemblers (which is about what building was like in the 30's — and I was there).

Continued on page 16

Twenty Years of 73

1974

March

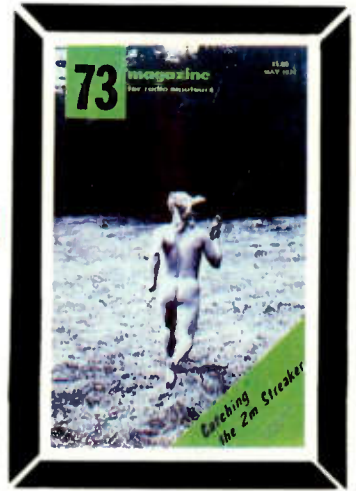

EDITORIAL BY WAYNE GREEN

FCC HEARS AMATEUR PLEA!

The reaction of amateurs and repeater groups to the new rules for repeaters released in 1972 under the heading of Docket 18803 was so vigorous that it eventually resulted in a precedent shattering hearing before the full Commission!

When Docket 18803 was originally proposed in 1970 the amateur reaction was immediate and vigorous. The then Chief of the Amateur Division decided that the proposals were unworkable and that a completely new docket would have to be devised, one which would be more in line with the FM scene as it was at that time. The proposal for repeater rules had been kicking around for years and was hopelessly out of date in 1970.

The old Chief of the Amateur Division retired and was replaced by Walker and most repeater groups expected the new shuffle to materialize on the proposed rules. Consternation was the order of the day when Docket 18803 suddenly was enacted. The repeater groups could hardly believe what they saw, the rules were so incredible and so unrealistic, "Assinine," was the comment of ARRL spokesman McCoy, the League's FM "expert."

The first reaction was a flood of petitions and letters, all asking for mercy. The second blow was when the Commission announced that every petition, without exception, had been summarily denied. It was reliably reported that this was done by the Commission at the request of Walker to try and save him the embarrassment of admitting that his work on the rules had been faulty.

Walker went even further at Rochester where he told the amateurs there in a speech that any further petitions for Docket 18803 rule changes would be thrown out since that matter had already been completely considered. What could amateurs do next?

The alarm of the repeater groups turned out to be valid. Amateurs have always prided themselves on their ability to be self-policing and on being the best behaved service under the FCC. Suddenly several responsible groups of amateurs decided that the

rules were so unfair and inequitable that they would ignore those which were most odious and which were senseless to them.

The FCC bogged down almost totally under the burden of repeater applications so that extension after extension had to be granted to the impractical deadlines set in the docket. The new rules were so complicated and demanding that, even with all the guidance 73 and OST could provide, over 90% of the applications were rejected. With rule and application interpretations changing every few days, and with the embarrassment of this debacle becoming more apparent daily, less and less information became available from the Commission to the magazines.

CONGRESS ALERTED TAPES AVAILABLE

With all approaches to the FCC seemingly closed down, amateurs turned to Congress for help. Dozens of amateurs sent in for copies of the 73 letter to Congress which explained about the value of amateur radio, what repeaters are, and the difficulty with the repeater regulations. These were sent, together with covering letters, to their Congressmen and Senators. The Commission, being sensitive to such pressures, responded favorably.

A special hearing was set up for January 14th for the Commissioners to be presented with a report on the repeater regulations and the reasons why they are restrictive and should be changed. A synopsis of the material to be covered during the hearing was prepared by Wayne Green and sent, along with copies of over 3000 signatures requesting a reopening of Docket 18803, to the Commissioners.

The hearing before the Commissioners on the need for changing the repeater regulations is a first. Never before has an amateur radio group been able to appeal to the Commission en banc for changes in the rules. Of course, never before has there been such a unanimity of purpose among amateurs that rules need changing.

Representatives of repeater councils of California, Colorado, Wyoming,

Michigan, Georgia, West Virginia, Greater New York, Missouri, Eastern New York and England attended and testimony was made of the hearing and available from 73 Magazine, Peterborough NH 03458 on a minute cassette for \$5. The tape out quite well. It makes for listening. The 90-minutes is long for a single club meeting, but it might be split in half for two meetings. It's a little long for a few of the repeater timers, but that is surmountable.

The Commissioners not only were interested in the proceeding, but responded with good questions and indicated a sympathetic attitude. They asked that the hearing be followed up with new petitions for rule changes. This was the result that everyone had hoped for.

FREEDOM WAS THE GIST

The main thrust of the testimony before the Commission was that amateurs should be free to invent, to experiment, and to be self-regulating. The example of the repeater councils was given to demonstrate that amateurs are able to set up their own sub-bands and even coordinate frequencies for channelized operation.

Good cases were made for relaxing the monitoring restrictions, the sub-band frequency restrictions, the cross-banding restrictions, linking of repeater restrictions, ten meter repeater restrictions, and such. None of these restrictions are needed and all tend to inhibit amateur ingenuity.

If any serious results had resulted from the freedom that repeater groups had before Docket 18803, then some of the new rules might make more sense, but the fact was that difficulties were individual and isolated, being by far the exception to the normal. A sense of perspective seemed to be missing. Just because one New York repeater had a C8er raising hell with it for a few days and a Chicago repeater had a musician giving the boys music until he was routed out is hardly enough reason for making over a thousand repeaters monitor 24 hours a day to prevent a repetition of these outrages.

One result of over-reacting like that will be that amateurs will shut the FCC off from communication and not let them know about little problems in fear of future over-reaction. It is possible that a Midcars complaint to the FCC about interference to their net by unidentified stations could trigger off a rule that every transmitter in the amateur service be equipped with a builtin automatic identifier, like a repeater, thus killing the flea with a sledgehammer.

Twenty Years of 73

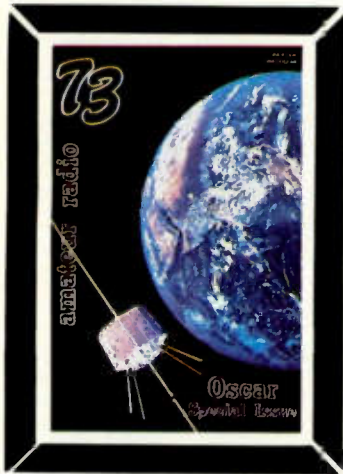

1975

August



EDITOR/PUBLISHER
Wayne Green W2NSD/1

BUSINESS MANAGER
Virginia Londner Green

EDITORS
Eric K. Albrecht K8BFH/1
Alex Barvicks WB4RVH
John Burnett

EDITORIAL ASSISTANT
Susan G. Phitrick

PRODUCTION MANAGER
Lynn Panciera-Fraser

ART DEPARTMENT
Bob Drew
Nancy Estle
Neal Kandel
Peri Mahoney
Bob Sawyer

PRINTER
Biff Mahoney

PHOTOGRAPHY
Bill Heydolph

TYPESETTING
Barbara Latti

ADVERTISING
Bill Edwards WB6BD/1
Nancy Cluff

COMPTROLLER
Knud E. M. Keller KV4GG/1

MARKETING
David H. Lodge

CIRCULATION
Barbara Block
Susan Chandler
Dorothy Gibson
Judy Havey
Cheryl Hurd
Pearl Lahey
Marge McCarthy

INVENTORY CONTROL
Marshall Raymond

PLANT MAINTENANCE
Bill Barry
Elaine Mercier

ASSOCIATES
Robert Baker WA1SCX
Schley Cox WB9LHO
Tom DiBisce WB8KZD
Terry Fox WB4JFI
W. Sanger Green
Dave Ingram K4TWI
Joe Kasser G3ZCZ
Bill Pasternak WA6ITF
John Schultz W2EZY
Waller Scott K8DIZ
Peter A. Stark K2OAW
Bill Turner WA0ABI

DRAFTING
Bill Morello
Lynn Maio
T. M. Graham Jr. W8FKW



EDITORIAL BY WAYNE GREEN

BYTE MAGAZINE

The response to computer-type articles in 73 has been so enthusiastic that we here in Peterborough got carried away. I found myself enormously interested in the rapidly evolving microcomputer field and started subscribing to many of the small newsletters in the field. The more I read the more enthusiastic I got... and on May 25th we made a deal with the publisher of a small (400 circulation) computer hobby magazine to take over as editor of a new publication which would start in August... BYTE.

We figured we could print the first issues on our own small offset presses as the magazine gathered steam. We might run 5000 copies of a 24 page magazine for starters. Within a couple of days, with the telephone ringing constantly, we knew we had underestimated the thing... it would take a 10,000 run of 48 pages to meet the interest. A week later we were up to 96 pages and a 35,000 press run, far beyond our small print shop facilities.

How come all the enthusiasm? Well, it appears that just about everyone who is in any way involved with computers has a very deep need to have one for himself. You can get a nice little computer working for under \$500 and use it for a wide range of applications. You can hook in cassette recorders, television typewriters, and teletypewriters. All kinds of goodies are available surplus. The applications are myriad... some are using their systems to aim antennas for Oscar or

moonbounce, some for keeping track of their music or book libraries, some to index ham articles, some to automatically print weather satellite pictures, some to automate RTTY stations, some to run their home security systems, and almost all to play a wide range of games.

Calls come in daily with more uses... one chap has a program to look for key words in any text and set your printer going when matter comes up of interest. Suppose you tune in the RTTY broadcasts of the Congressional Record every day and scan it for the words "amateur radio." Others are working out ways to make use of the one minute phone rates for a maximum exchange of information, computer to computer. Remember that there is no charge if your computer is called and tells the calling computer that it has nothing for it... or if the exchange is under a second or two. Many of the commercial computer systems use this aspect of the phone system... polling dozens or even hundreds of computers through the night and only interconnecting (with a phone charge) where there is traffic to be passed.

Most of the top writers in the field have leaped to help get BYTE going in good style and articles are pouring in... lots of information on the presently available microcomputers such as the Altair 8800, the Scelbi 88, RGS 008A, etc. BYTE will cover interconnecting to these units, peripherals, interfaces, the circuits and construction plans for building your own CPUs, news of all user clubs, news of programs available and how to get them, news of all specialized publications, explanations of all computer terms and how the various computer programming systems work.

In no time at all you'll be throwing around computer buzz words such as loader, compiler, assembler, basic, Dibal, Cobol, machine language, byte, bit, word, flag, and so forth.

Computers will be adding a whole new dimension to amateur radio... you wait and see. Right now you have the choice of getting in at the

BIG REWARD

The big companies in amateur radio today were, for the most part, started by one or two amateurs... and many grew very rapidly as a result of the low ad rates in 73 and the wide circulation among active (buying) hams. We'll give you 10% of the first ad run by a new company if you let us know about them and they advertise first in 73. Do yourself and the new firm a big favor - drop a note to 73 Advertising, Peterborough NH 03458.

STEP UP TO TELREX

Professionally Engineered Antenna Systems

"MONARCH" 10, 15, 20 Meter "Tri-Band"
Model TB5EM/4KWP

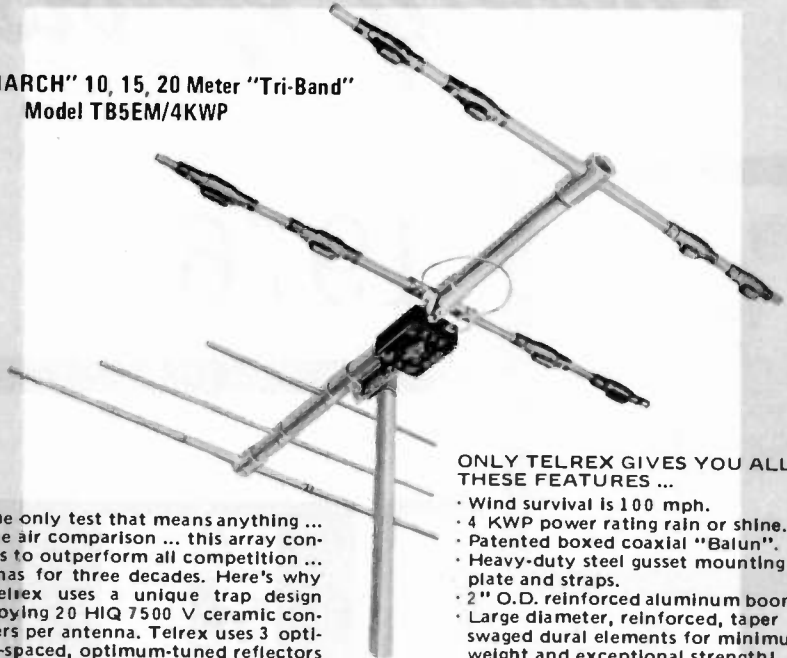

ONLY TELREX GIVES YOU ALL THESE FEATURES ...

- Wind survival is 100 mph.
- 4 KWP power rating rain or shine.
- Patented boxed coaxial "Balun".
- Heavy-duty steel gusset mounting plate and straps.
- 2" O.D. reinforced aluminum boom.
- Large diameter, reinforced, taper swaged dural elements for minimum weight and exceptional strength!
- Stainless steel electrical hardware.
- Phone and CW capability all bands!

By the only test that means anything ... on the air comparison ... this array continues to outperform all competition ... and has for three decades. Here's why ... Telrex uses a unique trap design employing 20 HIQ 7500 V ceramic condensers per antenna. Telrex uses 3 optimum-spaced, optimum-tuned reflectors to provide maximum gain and true F/B Tri-Band performance.

A Telrex "Balun" fed "Inverted-Vee" kit is the ideal hi-performance inexpensive and practical to install low-frequency mono or multiple band, 52 ohm antenna system.



Better than optimum full sized Dipole performance in an antenna which can be set up within the hour, needing a minimal support structure. (existing tower, house tree etc.) The "Inverted-Vee" produces a low-angle "Balanced" Omni-Directional pattern, which increases the signal to noise, and signal to interference ratios. Complete simplified instructions are provided.

NO TUNERS NEEDED!

MIVD/2 frequencies \$75.95 Post Paid (U.S.)

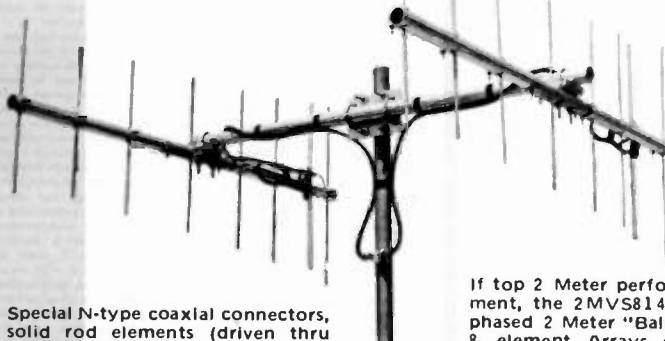

If top 2 Meter performance is your requirement, the 2MVS814 kit consisting of 2 ea. phased 2 Meter "Balun" fed precision tuned 8 element Arrays outperform even quad stacked antennas of other makes.

Special N-type coaxial connectors, solid rod elements (driven thru the boom), tinned connecting lugs, and s/s electrical hardware provide you with peace of mind for many years!

For technical data and prices on the complete Telrex line, write for Catalog PL-8

Communication Antennas Since 1921
✓ 328

telrex LABORATORIES

P.O. Box 879 - Asbury Park, N.J. 07712 Phone 201-775-7252

T
L
I

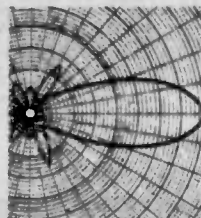

73 THANKS
TELREX

AND CLEGG—

ADVERTISERS IN 1960,

ADVERTISERS IN 1980!

THE FAMOUS CLEGG TWINs



MARK-3

FM-76

144-148 MHz' 15 Watts 220-225 MHz 10 Watts
\$205 \$195

FOR 2 meters & 220 MHz

12 channel operation at unbelievable price—plus the performance & reliability you have learned to expect from Clegg.

Special quantity pricing is available on both models. Get your group together & call 1-800-233-0250 for a quote on your requirements.

*MARK-3 can be supplied with special modification for CAP or MARS!

Call or write today for descriptive brochure.

Clegg Communications Corp.

1911 Old Homestead Lane
Greenfield Industrial Park East
Lancaster, PA 17601
(717) 299-7221 ✓ 13

Twenty Years of 73

1976

July



73 staff

EDITOR/PUBLISHER
Wayne Green W2NSD/P

GENERAL MANAGER
Bill Mahoney

MANAGING EDITOR
John C. Burnett

ASSISTANT EDITOR
Susan G. Philbrick

HO EDITOR
John Craig

ASSOCIATE EDITOR
Fred R. Goodwin W4TWS

PRODUCTION MANAGER
Lynn Parker a Fraser

ART DEPARTMENT
Nancy Eddy
Robin MacFar
Virginia Mammon
Michael Murphy
Bob Sawyer

PRINTING
Brent Leaver
Michael Potter

PHOTOGRAPHY
Bill Heydolph

TYPESETTING
Barbara J. Latti

ADVERTISING
Bill Edwards W6BBD/J
Nancy Civil W6TFS/H

COMP/ROLLER
Knut E. M. Kevin KV4GJ/T

CIRCULATION
Barbara Block
Susan Chandler
Carol Daniels
Fran Dillon
Dorothy Gibson
Florence Goldman
Pearl Lohrey
Maeg Nielsen
Theresa Toubant
Judy Wastman

MARKETING
Sherry Smythe

INVENTORY CONTROL
Kim Johnson
Margaret Raymond

PLANT MAINTENANCE
Bill Barry
Lorraine Pickering

ASSOCIATES
Robert Baker W4TSC/P
E. R. Barnett W6B/JK
Schey Gay W6B/HO
Tom DiBene W6BK/ZD
Terry Fox W6AJ/J
W. Sanger Green
Dave Ingam W4TBJ
Joe Kiser G3ICE
Bill Pasternak W6A/TF
John Schultz W2EY/W3E2
Walter Scott W6B/JZ
Peter A. Stark K2QAW
Bill Turner W6ABA/I

COMPUTER ENGINEERING
James Muthman

DRAFTING
Bill Muzzano
Lynn Mabo
T. M. Graham Jr. W6FEW



EDITORIAL BY WAYNE GREEN

THE GOOD THE BAD THE UGLY

What with the Fourth of July, the bicentennial and other red, white and blue stimuli, I'm given to paying some attention to the number of bi-centennial callings I'm not hearing on the bands. Tsk.

Yes, I know all about the bad aspects of our country... the incredibly awful conditions, seemingly without solution, in parts of New York City... the IRS... the prison system (if the word "system" is adequate)... the inability of our schools to teach... there are many outrages and frustrations and, unless you have a way to put things into perspective, they can bring you down. Our news media are certainly no help, with their dwelling on death and destruction to cater to our morbid fascination with these things.

For all the problems we have in this country, where else would you rather live? If you are very much traveled you have reached the same conclusion I have... for all its problems, the U.S. is by far the best. I think I liked it a bit better when I was young and when we had only about half as many people... and cities were about one fourth their present size... and hot dogs were a nickel. The dreams of youth.

But a country is not its geography... it is its people and we have great people. Yes, I know, we have some rotten people, too... I moved to New Hampshire from New York City, didn't I? We have a sprinkling of sour people around us... even on our ham bands... but we try to avoid them as much as we can. The general impression you get in listening to the amateur bands is one of friendliness and good cheer... heck, we even hear that attitude on CB these days, just to show how things can change.

My message is this. Resist the outrages and back the good things. Use your bicentennial calling proudly... we have a great country and we can make it a lot better if we join those working towards improving it and resist those trying to tear it down.

When you see the courts refusing to acknowledge the Constitution, raise hell. When Ma Bell grinds some poor bastard into the dust just because he can't afford to fight... raise hell. We can cure many of the outrages we now accept with a shrug... and thank heavens they happened to someone

else and not us... If we stop looking around for someone else to stand up and say NO! If something needs stopping, get busy and see what you can do about it... get some friends to help... write letters to the news papers, television stations... picket... arrange a media event... write your congressman... raise hell and put a brick under it. Be a trouble maker and be damned proud of it.

Our country was not started by sheep... those men were trouble makers... and look what they've done! Note that they were constructive troublemakers, not fanatics... we don't have to tear things down to make them better... we have to build and improve them. Bombing Ma Bell won't make for better or cheaper service... letters to Congress about Bell outrages will... etc.

A lot of people put me down because I speak out... I'm called a radical... but I often wonder how far to the right people must be who see me as radical! I'm accused of tilting at windmills... and I smile at that because it does prove that I am at least trying to get something positive done while my critics are doing nothing but being destructive.

When people get power they have a strong tendency to abuse that power... and that holds for big business, for government officials and for labor leaders. I feel that the strength of our country lies in our ability to fight against powerful people bent on doing bad things. The most serious weakness we have is the ability of many (if not most) people to put up with these bad things and not raise hell about them.

The number of bad things happening is almost overwhelming at times. It would be most discouraging if we could not compare our situation with other countries... where we find that most have it a lot worse. Since our news media tend to stress disasters, we are not much in the habit of thinking in terms of the good things which are going on... pity, for though these things are not "news," they more than overshadow the miseries.

In amateur radio we have some bad guys and a whole lot of good guys. The good guys are organizing and running traffic nets, eyebank nets, emergency nets, DXpeditions, repeaters, club, which are teaching new hams our hobby, hamfests and they are experimenting with new techniques of RTTY, slow scan television, moonbounce, Oscar operating,

computers, new antennas... etc. The bad guys are trying to louse up nets, spoil contacts with interference, make DX pileups a mess, organize repeater wars, keep AM alive on 75, jam RTTY or SSTV transmissions, etc.

You know what I do when I hear some ass proving he is one on the air? I go ahead and tell him what I think of him and the lousy things he is doing. Oh, this makes me some enemies, no doubt about that... but they are enemies I am proud of and point to with pride. I don't think you'll hear many bad guys claiming friendship with Wayne Green... nor many good guys giving me the bad mouth. I would not want as friends those enemies of whom I am aware.

So much for the soapbox this July... now, about those bi-centennial callings. I want to hear all you good guys out there using them... proud of the best aspects of our country and the things we have accomplished. Let's look on those callings as advertisements for the United States... and as promises to do everything we can to make it better... to put ourselves on the line to fight as best we can the bad things... the arrogance of big business... of government. When something is wrong let's stamp our foot and try our very best to make it right. It is not easy to stick up for your rights... particularly when everyone else is shuffling around uneasily, trying to figure out how to avoid trouble.

Troublemakers started our country... and they will keep it strong. It is sometimes absolutely amazing what one troublemaker can do. One lone troublemaker managed to get parking meters outlawed for an entire state! Most of the time the entrenched power of government officials is tough to fight, but each has his weak points and you can find them. They either are appointed or elected, and this means you may be able to get in your licks at re-appointment time or reelection time... if all else fails.

The Watergate mess has weakened the power grip of many government agencies on us... the FBI, CIA, DIA, IRS, and such... but they will build it up again unless we keep the pressures on them. They got much of their power in order to help them fight organized crime. Instead, they leveled the power at the less-powerful us, the unorganized citizens... and left the powerful organized crime

Continued on page 6

Twenty Years of 73

1978

August



EDITOR/PUBLISHER
Wayne Green W2NSD/1

EXECUTIVE VICE PRESIDENT
Sherry Smythe

ASSISTANT PUBLISHER
Jeffrey D. DeTray WB8BTH/1

ADMINISTRATIVE ASSISTANT
Dorothy Gibson

ASSISTANT BUSINESS MANAGER
Robert R. LaPointe

MANAGING EDITOR
John C. Burnell

ASSISTANT MANAGING EDITOR
Susan G. Philbrick

NEWS EDITOR
Gene Smarte WB6TOW/1

BOOK PUBLICATIONS
Christopher E. Smith

PRODUCTION MANAGER
Lynn Patricia-Fraser

ART DEPARTMENT
Craig Brown
Gayle Cabana
Bob Drew
Bruce Hadin
Carl Jackson
James Lamothe
Don Owens
Noel R. Sall WB1ARP
Robin M. Sloan

PRINTING
Gary Stembach
Andy Comeau
Dan Morgan

PHOTOGRAPHY
Bill Haysoph
Tedd Cluff

TYPESETTING
Barbara J. Lattil
Jennifer Johnson
Mary Kinzel
Marie Walt

BOOKKEEPER
Knud E. M. Keller KV4GG/1

CIRCULATION
Barbara Block
Laura Sarmice

DATA ENTRY
Judy Brumaghim
Linda Cate
Mary Kinzel

DIRECTOR OF MARKETING
Daniel D. Savage

BULK SALES MANAGER
Judy Waterman

SHIPPING
Theresa Toussaint
Sue Chandler
Ethan Perry
Bill Barry

RECEPTIONIST
Don Jarvis

ASSOCIATES
Robert Baker WB2GFE
E. H. Barnett WB8IX
Schley Cox WB9LHO
Tom DiBiase WB8KZD
Terry Fox WB4LFI
W. Sanger Green
Oave Ingram K4TJN
Larry Kahner WB2NEJ
Joe Kasser G3ZCZ
Bill Kesterak WB8TF
John Schultz W4FA
Walter Scott K6DIZ
Peter Stark K2QAW
Bill Turner W4AB1

COMPUTER PROGRAMMING
Richard J. Dykema
Ron Cooke
Steven B. Lionel

CUSTOMER SERVICE
Florence Goldman
Joyce Tarr

ADVERTISING
Aline Coudu
Marcia Stone
William G. York
Nancy Clampa

W2NSD/1 NEVER SAY DIE

editorial by Wayne Green



ARMA GETS MOVING

One of the main features of the Atlanta Hamfestival this year was a meeting of the Amateur Radio Manufacturer's Association (ARMA). The main subject of the meeting was a report of the results of my visit a few days earlier to the ITU in Geneva. I went there to find out what the feeling was of the amateurs at the ITU as far as prospects for the continuation of the amateur radio allocations which might result from WARC next year.

U.S. amateurs seem to be optimistic, mostly as the result of the report of the actions of the WARC preliminary conference within our own country. The news that the U.S. position asks for several new ham bands in the shortwave bands is encouraging, until you have some input as to the actual chances of such a theory coming off.

My report to ARMA was that I was unable to find any cause for optimism at Geneva. The recent actions of the ITU have been to express the solidity of the Black Block, a 44-vote African steamroller which has so far wiped out all the amateur satellite frequency allocations above 450 MHz (a loss of 237,249 MHz in the amateur allocation) and made hash of the marine band allocation, defying all technical and scientific advice in the process.

In general, the African feeling is this: 10 percent of the people of the world grabbed 90 percent of the frequencies at the 1947 WARC, they prevented any changes being made at the next WARC in 1959, they prevented any WARC at all in 1969, and now, in 1979, the chickens all come home to roost and the

Africans are set to really get even.

Amateur radio is of incredible value to these countries—we know that, but they don't. They think of ham radio as a white man's hobby, and they have some pretty negative feelings about the whole matter. My proposal for ARMA is to organize a drive to fund a mission to go to some of these black countries to see if it might be possible to get them to give the Jordan scheme a try. In 1970, despite a very brisk civil war in Jordan, ham club stations were set up in every youth club in the country and classes were run to teach amateur radio theory and code. Within three years, they had active ham stations going everywhere and over 500 licensed amateurs. Within just three years, Jordan went from having no technicians to having a large number, enough so that they could consider setting up an electronics manufacturing facility.

Also heard was a testimony from Noel Eaton, the president of IARU, the ARRL's international arm. Noel was asked to explain what the ARRL and their IARU had done to prevent a situation such as had taken place in 1971 when we lost the satellite microwave ham bands. He said that IARU had worked only in those countries where they had member societies, a fact which was dismaying since there are no amateur societies possible in countries where amateur radio is virtually undeveloped, and these are the countries with the votes which we need so badly next year at Geneva. ARMA will be asking everyone—manufacturers, dealers, and individual

hams—to contribute to a fund to send a mission to some of these Black Block countries and make the effort to try and get them interested for their own benefit in developing amateur radio and in supporting it next year at Geneva. The amount of money needed is insignificant really, \$10 to \$20 per week for a period of three months for every firm in the field, plus donations from amateurs who care enough to try to preserve amateur radio. By mid-July, it should have been apparent if amateurs and the ham industries are supporting this emergency plan. There is very little time left to try to influence the WARC decision, so if we are unable to get this going immediately, it'll be too late.

BRAVO FOR FRED

Fred Goldstein, who was one of our editors a couple years back, has some good ideas for those of you with pioneering blood still left unclotted. His article two years ago, "AM Is Not Dead, It Never Existed At All," upset a lot of old-timers. His current article may just do the same to sidewinders. Is it really possible that double sideband may be more band conservative than single sideband? How can a 6 kHz wide signal conserve more band than a 2.7 kHz signal?

Fred doesn't go into this aspect of the situation, but G.E. brought it up back in the '50s when they were trying to get DSB accepted by the military over SSB. Frankly, as I've written several times down through the years, I think G.E. may have had the better system and that Collins outfoxed them politically when they laid Collins

73 Magazine is published monthly by 73, Inc., Peterborough NH 03458. Subscription rates in the U.S. and Canada are \$15 for one year, \$26 for two years, and \$36 for three years. Outside the U.S. and Canada, write for rates. Second class postage paid at Peterborough NH 03458 and at additional mailing offices. Publication No. 700420. Phone: 603-924-3873. Entire contents copyright 1978 by 73, Inc. INCLUDE OLD ADDRESS AND ZIP CODE WITH ADDRESS CHANGE NOTIFICATION. Microfilm edition—University Microfilms, Ann Arbor MI 48106.

SLEP mail-order specials

AIA INC.	
MW-3 MORSE MATIC WITH FREE AC-1 POWER SUPPLY	199.95
ISO POLE 144 VHF BASE STATION ANTENNA	49.95
ISO POLE 220 VHF BASE STATION ANTENNA	49.95
COI ROTORS	
AR-22XL (13 SQ FT)	49.00
HAM-415 (5 SQ FT)	159.00
TAIL TWISTER (30 SQ FT)	229.00
S1467-10 HEAVY DUTY LOWER MAST SECTION FOR HAM 4 TAIL TWISTER	
8 CONDUCTOR ROTOR CABLE, PER FT	20

ORABE	
TR-7DR-7 DIGITAL TRANSCEIVER	\$1,385.00
PS-7 POWER SUPPLY TR-7DR-7 DELUXE	269.00
PS-7S POWER SUPPLY TR-7DR-7	179.00
SP-7S SPEECH PROCESSOR TR-7DR-7	148.00
SL-300 SL-500 SL-1800 SL-4000, FL-6000 FILTERS TR-7DR-7 or R-7 (ea.)	49.00
FA-2 FAN, TR-7	29.00
RV-7 REMOTE VFO	175.00
MS-7 SPEAKER	39.00
7077 DESK MIKE W/PLUG TR-7	46.00
AUC-7 RANGE PROGRAM BOARD TR-7	42.00
NB-7 NOISE BLANKER TR-7	62.00
MN-7 ANTENNA TUNER 250W, 160-10M	159.00
MN-2700 ANTENNA TUNER 2K W 160-10M	269.00
C5-7 REMOTE CONTROLLED ANTENNA SWITCH	158.00
WA-7 WATT METER 2K W 1.8-30 MHz	89.00
B-1000 BALUN 4:1 MIN-7, MAX-2700	79.00
DL-100 DRY DUMMY LOAD 100W	26.95
DL-1000 DRY DUMMY LOAD 1KW	53.00
L-7 AMPLIFIER WITH PIS AND TUBES	1,175.00
TV-3300 LP LOW PASS FILTER 1KW	26.00
R-7DR-7 RECEIVER, DIGITAL, 0-30 MHz	1,295.00
R-7TR-7 CABLE INTERFACE KIT	29.50
AK-75 MULTI BAND DIPOLE ANTENNA 160-10M	29.95
FL-250 FL-500, FL-1500, FL-6000 FILTERS FOR R-4C RECEIVER (ea.)	49.00

HINCO	
A10-4 BEAM 10 METER HEL	58.00
A6-1 BEAM 6 METER SEL	42.00
A6-2 BEAM DUAL 6/2 METER	66.00
A2-10 BEAM 2 METER 10EL	39.00
A1-14 BEAM 220 MHz 10EL	29.00

MUSTLER	
48TV VERTICAL 40-10 MTR	85.00
58TV VERTICAL 80-10 MTR	109.00
BBLM-144A 58W MOBILE MAGNETIC MOUNT 143.49 MHz 17 FT COAX	37.50
BM-1 BUMPER MOUNT, W/STAINLESS STEEL STRAP	17.00
CG-144 TWO-METER COLINEAR WITHOUT MOUNT	26.00
CGT-144 TWO-METER COLINEAR WITH TRUNK LIP MOUNT	39.00
CG-144 TWO-METER BASE STATION COLINEAR 7DB	109.00

KCOM	
251A TRANSCEIVER 2M AC/12V MULTI-MODE 10W	625.00
551 TRANSCEIVER 6M AC/12V MULTI-MODE 10W	390.00
551D TRANSCEIVER 6M 80W, 12V W/EX 10T, 10B	585.00
720 HF TRANSCEIVER, GENERAL COVERAGE WITH PIS	1,168.00
255A 2M FM 25W TRANSCEIVER 12V	345.00
260A 2M FM 55B 10W 12V	429.00
PS-20 PIS 20 AMP 551D	170.00
EX100B FM OPTION 551, 551D	100.00
EX100V VFO OPTION 551	49.00
EX100B BAND PASS TUNING OPTION 551	98.00
NM-6 TOUCH TONE MIKE, 251A, 255A, 260A	19.00
SM-2 DESK MIKE 251, 701	32.50
IC-2A H.T. WITH NICADS, CHARGER, ANT	270.00
IC-2A H.T. WITH TOUCH-TONE, NICADS ETC	235.00

MIRAGE	
B108 2 METER AMPLIFIER FM55B 10 IN 80 WATTS OUT	164.00
B1016 2 METER AMPLIFIER FM55B 10 IN 160 WATTS OUT	258.00
RC-1 REMOTE CONTROL W/IFT CABLE FOR B108, B1016	24.95
MP-1 HF PEAK READING WATTMETER 1.8 THRU 30 MHz, SWR, POWER RANGES 25, 200, 2000 WATTS	109.95
MP-2 VHF PEAK READING WATTMETER 50 THRU 200 MHz, SWR, POWER RANGES 50/500/1500 WATTS	109.99

MINI PRODUCTS	
HQ-1 MINIQUAD BEAM ANTENNA	139.00

NYE-VIKING	
MB101 ANTENNA TUNER WITH BALUN	298.00
046-001 AUTOMATIC PHONE PATCH W/LOUD SPEAKER	42.00
114-33001 MASTER KEY, HEAVY DUTY BASE WITH NAVY KNOB, 3 FT TWO CONDUCTOR CABLE AND 3/4" PLUG, THE FINEST STRAIGHT KEY	23.50
55K-1CIP DUAL PADDLE SQUEEZE KEY CHROME PLATED	37.95

SWAN	
100Mx TRANSCEIVER 12V	585.00
ASTRO 150 TRANSCEIVER 12V	795.00
ASTRO 102BX TRANSCEIVER 12V	995.00
PSU-5A POWER SUPPLY 13.8VDC, 20 AMP FOR 100Mx OR ASTRO 150	158.00
PSU-6 POWER SUPPLY 13.8VDC, 20 AMP FOR ASTRO 102BX	168.00
1500Z LINEAR AMPLIFIER	545.00

SHURE	
444D NEW MODEL BASE STATION MICROPHONE, DUAL IMPEDANCE PTT AND VFO SWITCH	48.00
404C MOBILE MICROPHONE HI-Z	34.00

TEMPO	
S-11 H.T. WITH TOUCH-TONE 2M	258.00
S-21 H.T. WITH TOUCH-TONE 15W 2M	359.00
S-21 H.T. WITH TOUCH-TONE 220 MHz	359.00
15CC CARRY CASE ALL MODELS	16.00
15-HA MEDICAL ANTENNA 2M	9.00
15-HAZ MEDICAL ANTENNA 220 MHz	9.00
HENRY 1KDS LINEAR AMPLIFIER	675.00
HENRY 2KDS LINEAR AMPLIFIER	925.00

TEN-TEC	
515 ARGONAUT, SW 55BCW TRANSCEIVER \$	379.00
546 OMNI-DIGITAL, SERIES C NEW MODEL	1,045.00
570 CENTURY 21, 70W CW TRANSCEIVER	310.00
580 DELTA, 9 BAND NEW MODEL	745.00
444 HERCULES, 1KW LINEAR AMPLIFIER W/PIS	1,395.00
270 POWER SUPPLY ARGONAUT	32.00
255 POWER SUPPLY, DELUXE, ALL-TRANSCEIVERS	
280 POWER SUPPLY, ALL TRANSCEIVERS	149.00
208 NOTCHW/ FILTER S15	135.00
214 ELECTRE I MIKE FOR 234	37.00
215 PC MIKE WITH PLUG, COIL/DCORD	34.50
217 500 HZ FILTER 545/546	32.00
218 1.8 KHZ FILTER 545/546	49.00
219 250 HZ FILTER 545/546	45.00
234 SPEECH PROCESSOR	112.00
243 REMOTE VFO 545/546	159.00
247 ANTENNA TUNER	63.00
248 NOISE BLANKER 545/546	44.00
249 NOISE BLANKER 540/544	28.00
276 CRYSTAL CALIBRATOR, 570	26.00
277 ANTENNA TUNER/SWR BRIDGE	80.00
282 250 HZ FILTER 580	45.00
283 REMOTE VFO 580	159.00
285 500 HZ FILTER 580	42.00
289 NOISE BLANKER 580	37.00
645 ULTRAMATIC KEYS ALL MODELS	80.00
670 REVER CENTURY 21	32.00

CONGRATULATIONS TO "73 MAGAZINE"
... WE HAVE BEEN ADVERTISING WITH YOU FOR 20 YEARS!

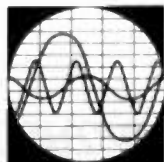

SLEP ELECTRONICS COMPANY
P.O. Box 100, Highway 441,
Dept 73
OTTO, NORTH CAROLINA
28763

✓ 366

ORDER BY MAIL OR PHONE BILL SLEP, (704) 524-7519. WE PAY SHIPPING TO 50 STATES, APO, FPO — MASTER CHARGE, VISA OR CHECKS ACCEPTED. SAVE MONEY BY ORDERING TODAY AT THESE LOW DISCOUNT PRICES.

73 THANKS
SLEP ELECTRONICS COMPANY
AND FAIR RADIO SALES—
ADVERTISERS IN 1960,
ADVERTISERS IN 1980!

G133 HF RECEIVER

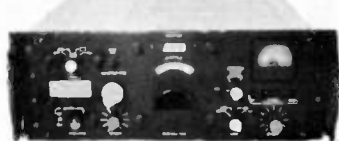

0.2 to 30 Mhz SSB, AM, CW in thirty continuously tuneable bands. Set is Collins 51S1 repackaged by LTV-Temco for military with added AM BFO, extra filtering, and jack for 14-600 Khz tuner. 50 ohm input impedance; 600 or 4 ohm audio output. 16 tubes. Requires 115/230 VAC 50-400 Hz; 24 VDC for AM BFO. 6 1/4 x 18 1/4 x 13"; 40 lbs. sh. More info upon request. Used, repairable: **\$695**. Checked: **\$850**. Collins 51S1 manual, **\$15** when purchased with G133.

STACO 4 AMP POWER SUPPLIES

Solid state, new. #FPS-4, filtered 12 VDC: 5x3x5 1/2", 5 lbs. sh. **\$12.95 2/\$22**. #RPS-4, filtered, regulated 13.8 VDC, 5x3x6 3/4", 6 lbs. sh. **\$18.95 2/\$35**.



Prices F.O.B. Lima, O. • VISA, MASTERCARD Accepted. Allow for Shipping • Send for New FREE CATALOG! Address Dept. 73 • Phone: 419/227-6573

FAIR RADIO SALES 22
1016 E. EUREKA • Box 1105 • LIMA, OHIO • 45802

Twenty Years of 73

1979

March

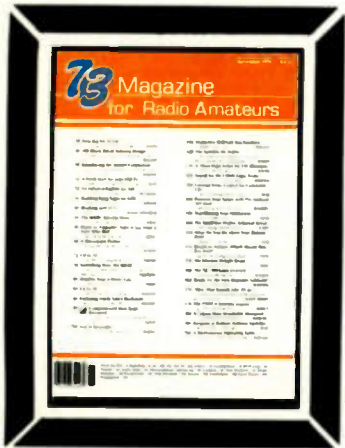

EDITOR/PUBLISHER
Wayne Green W2NSD/1

EXECUTIVE VICE PRESIDENT
Sherry Smythe

ASSISTANT PUBLISHER
Jeffrey D. DeTray WB6TH/1

ADMINISTRATIVE ASSISTANT
Dorothy Gibson

MANAGING EDITOR
John C. Burnett

ASSISTANT MANAGING EDITOR
Susan G. Philbrick

NEWS EDITOR
Gene Smarte WB6TOV/1

EDITORIAL ASSISTANTS
Lizabeth Backmore
Cynthia Smith
Richard Pennie

BOOK PUBLICATIONS
William Q. Hoyle
Jim Perry

PRODUCTION MANAGER
Lynn Finckler/Fran

ART DEPARTMENT
Craig Brown
Claire Gattana
Bob Drew
Bruce Hedlin
Dion Owens
Noel R. Seil WB1ARP
Robin M. Sloan

PRINTING
Gary Sienbach

PHOTOGRAPHY
Bill Heydolph
Ted Cluff

TYPESETTING
Barbara J. Latti
Mary Ritzer
Holly J. Walsh
Sara Beisel

BOOKKEEPER
Knut E. M. Røtler KV4GG/1

CIRCULATION
Barbara Block
Laurie Barnicle

DATA ENTRY
Mary Kinzel
Denise Lorange

DIRECTOR OF MARKETING
Robert R. LaPointe

BULK SALES MANAGER
Judy Waterman

SHIPPING
Ethan Perry
Bill Barry
Michelle Walsh

RECEPTIONIST
Maureen Smith

ASSOCIATES
Robert Baker WB2GFE
E. M. Barnett WB9JX
Schley Cox WB9HO
Tom DiBaise WB9KZD
Terry Fox WB4JFI
W. Sanger Green
Dave Ingram K4TWJ
Larry Kanner WB2NEL
Joe Kasser G3ZCZ
Bill Pasternak WA5ITF
John Schult WA5FA
Walter Scott K6DKZ
Peter Stern K2DAW
Chuck Stuart N9KCC
Bill Turner WA8ABI

COMPUTER PROGRAMMING
Richard J. Dykema

CUSTOMER SERVICE
Florence Goldman
Joyce Farr
Ellen Blanchard

ADVERTISING
Aime Coult
Bill York
Nancy Clamps
Rita Howard
Lori Mugford
Gayle Halbig

W2NSD/1 NEVER SAY DIE

editorial by Wayne Green



WHAT WENT WRONG AT THE ARRL?

Yes, I can hear the sighs of resignation from ARRL devotees won't Wayne ever stop attacking the ARRL? ... and why is Wayne trying to kill off the only national organization representing amateur radio? What utter nonsense!

The ARRL could and should be an organization which is run for the benefit of radio amateurs everywhere, and one to which all of us should be able to point with pride. The fact is that it is a sorry mismanaged shambles. It is managing to lose money despite the highest membership in history, and despite the most advertising in history in its magazine. To be able to come up with a disastrous deficit in the face of such monumental prosperity indicates either extremely bad management or else a very heavy hand in the till. We're talking about millions of dollars.

If the board of directors had any real power to manage the League, one could lay the blame for the problems at their door. One or two fast meetings a year which are almost totally controlled by the headquarters "Mafia" hardly constitute much power to control. I don't think we can really blame the directors, other than to perhaps let them know that we think they should have recognized the problems and gotten together to really do something about them, even if it meant the immediate firing of Baldwin and his cohorts.

THE REAL PROBLEM

The seeds of the disaster presently befalling the League go back many years. The odd situation is that it is the success of the League in drawing in newcomers that has led to

things coming apart.

Sometime in the early days of the League, it was decided that everything possible should be done to prevent any other organization ever getting a chance to get started. This would perpetuate a competition-free situation and allow the ARRL to be a dictator in the field. In order to get anything serious going in opposition to the League it was believed that another group would have to have a publication to use as a medium for communication with its members and for drawing in new members, much as QST has been used by the League all these years. To discourage this possibility, the advertising rates of QST were set at such a low rate that it was thought no sane persons would try to buck the establishment (ARRL) by competing with them.

Not too long ago, I sat down with a list of the advertising rates of all of the magazines in the country (SRDS) and compared their advertising rates with those of QST. I found that few of them had ad rates less than three times those of QST for the same approximate number of readers, and most were four or more times the QST rates.

If this is true, how is it possible? And how come there are some competing ham magazines ... one of which obviously is doing rather well? The key to the legerdemain by which the ARRL was able to keep their ad rates so low was in their special second-class postage rates as a nonprofit organization. These rates are a tiny fraction of the rates paid by any regular magazine publisher. This means a saving of thousands of dollars a month, paid for by the U.S. government instead of QST, and sub-

stituted for the income which would normally be expected from advertising.

But, then, how can 73 compete against the low advertising rates and succeed in spite of the ARRL scheme? The secret to this, as anyone who has visited the 73 HQ can attest, is in efficient management. 73 is run from an extremely low-cost part of the country, from a very low-cost building, without the fantastic executive salaries of the ARRL, and almost all functions of the publication except printing are done in house.

No one knows for sure how much the head men at ARRL HQ make except the directors. You won't find it in the annual reports, nor will you even find any listed expenses which will give you a true hint of the salaries. I've been told that some go as high as \$100,000 per year, but I doubt if they really are much over \$75,000. At one time, the two top people at the League were making more than the entire staff of 73.

THE CURE

A few years ago, before I got so involved with computers, the smartest thing the ARRL directors could have done would have been to make a deal whereby 73 and QST would amalgamate and I would manage the League. I guarantee you the organization would be in the black, our future would have been a lot more secure at WARC, we would have a lot more satellites up and running, and we would still have most of our ham satellite frequencies. The League needs a strong entrepreneurial type of person, not obfuscating bureaucrats who have come up through the ranks by never offending anyone.

Continued on page 170

73 Magazine (ISSN 0098-9010) is published monthly by 73, Inc., Peterborough NH 03458. Subscription rates in the U.S. and Canada are \$16 for one year, and \$45 for three years. Outside the U.S. and Canada, write for rates. Second class postage paid at Peterborough NH 03458 and at additional mailing offices. Publication No. 709420. Phone: 603/924-3673. Microfilm edition—University Microfilms, Ann Arbor MI 48106. Entire contents copyright 1979 by 73, Inc. INCLUDE OLD ADDRESS AND ZIP CODE WITH ADDRESS CHANGE NOTIFICATION and send to 73, Inc., Peterborough NH 03458.

The 40-Meter Band Blaster

— this antenna works, but why?

I don't own an isotropic dipole. In fact, I don't even own a conventional reference dipole.

So purists can just flip these pages and go on to something a bit more com-

prehensible.

But I can tell you that the antenna about to be described develops more real gain than anything I've ever used on the HF ham bands—and that covers a

lot of years, a lot of antennas, and a lot of hamming.

Here's what gain this antenna is providing, as best as I can do (no isotropics here):

- Gain over 4-element wire beam—5 dB.
- Gain over 2 dipoles, driven together—6 dB.
- Gain over double-extended zepp—6 dB.
- Gain over a pair of phased verticals—12 dB.
- Gain over roof-mounted ground plane—15 dB.

Admittedly, not all the above antennas are installed under optimum conditions. However, these gain differences are quite accurate at this QTH. If these figures interest you, read on.

Actually, I've been somewhat reluctant to write this article. First, it has been rather fun having nearly the strongest signal on the

40-meter General phone band all to myself! Second, I don't really understand much about why this antenna develops so much gain! (Theoretically, it shouldn't produce more than 3-4 dB.)

Yet people keep calling and writing me for details on this antenna. One night, I got a call out of the blue at 1:00 am from a chap 100 miles away who simply couldn't contain himself any longer and had to have the lowdown. However, after the number of requests for data on this antenna topped 100 (out of 300 QSOs), I decided that the best thing to do would be to write a report.

I had hoped to be able to explain this thing a bit better than I am prepared to do right now. But suffice it to say that this antenna has been in nearly constant operation every night I can

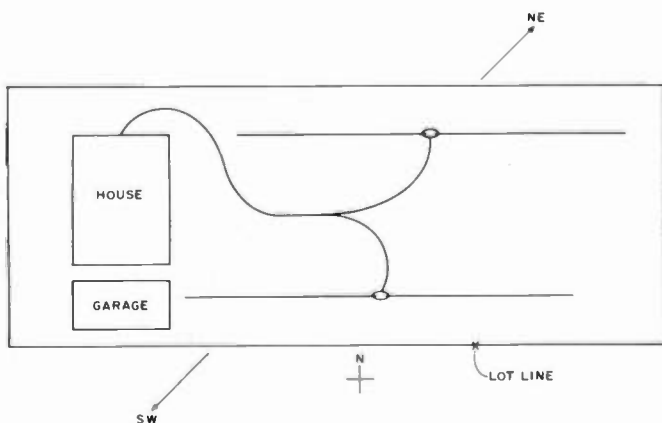

Fig. 1. Bird's-eye view of the original antenna system, set up as a dual-dipole for 75 meters. The offset between the two dipole centers was designed to reorient the firing pattern of the array so that contacts with St. Louis (southwest) could be maintained reliably. This antenna was the origin of the 40-meter array described in this article.

manage on 40-meter phone for the last month, and it is producing outstanding results.

How It Happened

Three years ago, I constructed a matched pair of 75-meter dipoles, driven from a common feedline, in order to be able to talk regularly to my father, WØPRQ, in the St. Louis, Missouri, area. For a number of reasons, we never made much use of this array, and my activity gravitated toward 40 meters. We found that we could get through okay up there most of the time. Then about a month ago, it occurred to me that rather than have that thing sit there dormant, why not cut it down for 40 meters and see what would happen?

I should mention that the antenna was originally set up in an offset condition so as to "beam" whatever rf was possible to the St. Louis area. This offset was required because it was necessary to direct the rf southwest, although my lot runs east and west, and supporting tree branches were available in just so many locations, so the offset was almost a necessity just to be able to mechanically hold up the array. Refer to Fig. 1 to understand this setup.

This system, on 75 meters, did work as planned and satisfactory performance was enjoyed on that band. (This was somewhat surprising, as the antenna was only about 15 feet above the ground, although I've been told by antenna buffs that because the two antennas are operated together, height is not as important as it normally is. I don't fully understand this phenomenon, but it has proved true, as you will see shortly.) The spacing between these two dipoles was as close to the lot line

edges as I could get—probably about 65 feet center-to-center between the dipoles.

The 40-Meter Conversion

It was a relatively simple procedure to cut the 75-meter dipole system down to 40 meters. It took all of a few moments to do. Immediately after returning to the ham shack, however, it was apparent that something very important had happened.

Signals across 40 meters were considerably stronger than before. At the time, I'd been using a roof-mounted ground plane. Signals on receive were over two S-units stronger! My first contacts were amazing. People said I was extremely strong and immediately wanted to know what I was running. I was getting reports of 20-30 dB over S9, something quite unusual for me.

Getting It Higher

Within a couple of days I was thinking that if this thing was working so well at 15 feet, imagine what it would do if higher in the air. So I spent one entire Saturday out in the backyard raising the antenna.

Due to trees, which I must use as supports, raising the antenna considerably altered the spacing between the elements and dipole centers. Once this was completed, the antenna took on the rather unusual shape it is now in, although the offset between dipole centers remained. In all, it was brought up to the point where one dipole was over 25 feet and the other 30, at the centers. The elements stretched downward somewhat, not enough perhaps to qualify as inverted Vs, but enough so that they were no longer straight dipoles. The spacing between the dipole centers

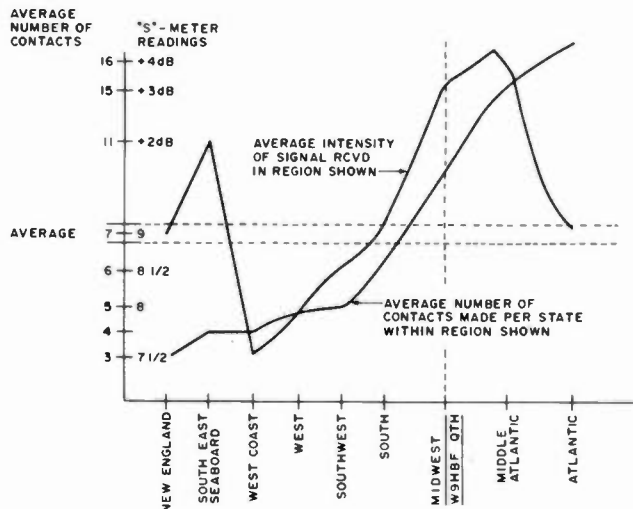

Fig. 2. This chart combines the signal report analysis and the number of contacts made per state. (Base is 285 contacts with stations running barefoot into dipoles or inverted Vs: 41 states, 9 regions.)

closed in considerably to the point where it now stands, at about 38 feet.

Well, as indicated earlier, results after all this work were relatively disappointing. No perceptible increase in gain was achieved by raising the height of the array. However, interestingly enough, no corresponding decrease in gain was noted either, which says something for the workability of the array regardless of the actual center-to-center spacing between the driven dipoles.

On-the-Air Results

Thus resigned to the fact that height increases would not really improve things much further, I decided just to operate this thing a while and see what kind of consistent results it would provide. After all, the 2-S-unit gain was indeed startling and needed to be checked out further.

Well, what I have done in my operating since that day has been startling for sure. While you may be skeptical of what you are about to read, I invite anyone who finds this incredible to stop by this QTH and see for himself—or, better yet, look for me on 40 phone. (You'll find me there in the

evenings between 7250 and 7300 kHz.) Just listen for a while. You'll be as amazed as I am.

First, this antenna produces a pileup. And I mean a major pileup. All it takes is one CQ and then I simply have to sit back and wait it out. Due to the inevitable QRM that results on a frequency when normal QSOs are taking place, I have elected to follow this procedure when operating with this antenna:

- Call only one CQ for the entire evening. (It is all that is required to start up the action.)

- Pick out one caller from the pileup to respond to, but before doing so, announce that there are a number of stations calling, so QSOs will be short so as to be able to talk with as many as possible of those who have been kind enough to call.

- Then I announce the call letters of the station I wish to respond to, again repeating that this will have to be short, as others are standing by.

- Then we have a short QSO, after which I announce that W9HBF is QRZ on the frequency and standing by.

Then the pileup starts all

SCANNERS:

KENWOOD TR7400A, TR7600, & TR7625,
TEMPO (COMMUNICATORS), KDK 2015R, KDK 2016A,
ICOM IC22S, MIDLAND 13-510, 13-513,
CLEGG FM-28, COMTRONIX, YAESU FT227R

- AED continues to expand its line of quality scanners.
- All of AED's scanners are custom designed to install completely inside of their respective rigs.
- Installation is simple. Unlike other competitive products all AED scanners are designed so that it is totally unnecessary to cut any wires inside your rig during installation.
- All P.C.B.s are silk-screened and tin plated for easier and more effective soldering.
- The kit comes complete with all parts and a detailed instruction manual including schematics.
- In the scanner OFF mode the rig operates normally. In the scanner ON mode the scanner locks on an occupied frequency, pauses for a preset time (about 5 sec.) and then resumes scanning (except 22S).
- The frequency being scanned is displayed on the digital readout (except 22S and Tempo).
- This gives you the ability to eavesdrop all over the band without lifting a finger. When you hear something interesting, you flip the switch to the LOCK mode and the rig is ready to transmit.

KIT PRICE 39.95
PREASSEMBLED, REG. ... 59.95
SPECIAL, NOW 49.95

10 METER FM —THE NEW FRONTIER

The AED FM ADAPTER is now available

- The AED adapter converts existing HF transceivers to transmit on 10 meter FM.
- To use the adapter you are required to have an HF SSB transceiver and a 2M FM transceiver or receiver.
- The AED kit consists of 2 P.C. boards. Both boards are designed to fit entirely inside your HF rig. (Each board measures 1" X 2")
- One board serves as the modulator which FM's your existing HF transceiver's VFO.
- The second board is a receiver adapter which converts your HF transceiver's IF to a 2M frequency. This will allow you to receive noise free 10M FM on your 2M transceiver.
- This modification can be disabled with the on-off switch supplied with the kit.
- The kit comes complete with all parts and a detailed instruction manual (copied not included).

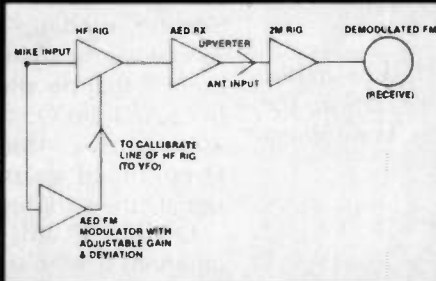

KIT PRICE 39.95
PREASSEMBLED, REG. ... 59.95
SPECIAL, NOW 49.95

AED ELECTRONICS ✓ 3 INCLUDE \$1.50 FOR
750 LUCERNE RD., SUITE 120 DEPT. A POSTAGE AND HANDLING PER ITEM
MONTREAL, QUEBEC, CANADA H3R 2H6
TEL. 514-737-7293

Compact, economical,
& easy **RTTY**



We speak your language

\$169.95 buys the most economical terminal unit available today – not the cheapest, but the best for the price. The TU-170 is a single unit that connects your rig, printer, and computer at an economical price. That's a language anyone can understand.

Flesher Corporation ✓ 23
P.O. Box 976 Topeka, KS 66601 913•234•0198
Distributors In Canada and Australia

ROM-116 THE COMPLETE AMATEUR RTTY OPERATING SYSTEM

TRS-80/RTTY*

THE CROWNING TOUCH

CROWN
MicroProducts

P. O. Box 892
Marysville, Washington 98270

206-659-4279 ✓ 16

*a trademark of Tandy Corporation

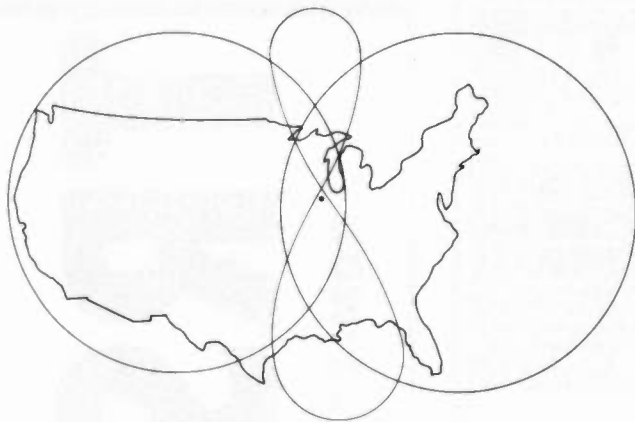

Fig. 3. Basic pattern developed from all QSOs made. While the pattern shows clear east/west orientation, the antenna is physically located running in the same direction, suggesting end-fire performance.



Fig. 4. A close-up look within the basic pattern (Fig. 3) showing the shape and path of most extraordinary results.

over again.

This has the decided advantage of clearing the frequency coast-to-coast because it doesn't take long for people to realize that I am serious about responding to everyone who calls, and they realize they will not have long to wait.

Can you imagine how much fun 40-meter General phone nighttime hamming can be under this kind of clear-frequency condition? Well, it is downright nifty. For example, it is entirely possible to pick out stations which would not ordinarily be heard because of QRM. Seldom does an evening go by when I'm not hearing from a remote Canadian way up there many hundreds of miles distant, from the Canal Zone or other Central American region, or from Bermuda (VP9). But the most fun is simply see-

ing how many people are hearing me and can be worked stateside. A typical evening will produce dozens of contacts from all over the US. And they all tell me about the same thing.

What People Say About the Signal

The plaudits this antenna produces in QSOs are fascinating:

- "You're absolutely the strongest signal I've heard on the band this evening."
- "I've been listening to you for the last hour and just had to give you a call to tell you how well I'm copying you here."
- "You are without a doubt the strongest signal we've ever heard from the Chicago area."
- "You are literally the strongest signal ever copied on this receiver. The

S-meter is running between 35 and 40 dB over 9; previously, it's never gone higher than 20 over."

● "What are you running for an antenna? You are plowing in here way above the foreign broadcast QRM, strong and steady. Hardly any QSB at all."

The average S-meter reading I get is 20 dB over S9. While I fully realize that S-meter readings can be somewhat meaningless, the point is that people call me because I am Q5 copy and way above the signal strength of most other signals they are hearing.

Often, I will switch antennas over to see the differences on transmit. The three I usually switch between are (a) this array, (b) the double-extended zepp, and (c) the roof-mounted ground plane. In all cases, the reports I get directly corroborate the gain findings cited earlier in this article: 15 dB over the ground plane and 6 dB over the zepp. In some cases, I get a 10-dB gain reading over the zepp, but that is probably due to the rather directive characteristics of that antenna. Which brings up an interesting point: What about the pattern this array generates?

Pattern Observations

This thing at first appearance seems to generate a somewhat omnidirectional pattern. In no way does it produce the northeast/southwest major lobes that it did when functioning originally as a 75-meter array.

So uncharacteristic is this antenna's performance that I thought an interesting way to track its lobes would be simply to make log notations of signal strength from stations contacted and see what this produced. I recorded the signal strengths of stations worked and then tabulated them. For charting pur-

poses, I drew up a scale running from 1 through 19. Each point represented a signal strength reading recorded in the log. Number 1 represented S6, 2 was S6½, 3 was S7, and so on up to 19 which was 22 dB over S9.

On the other axis of the chart were states organized into nine regions: New England, Atlantic, Southeastern seaboard coastal, South, Mid-Atlantic, Midwest, Southwest, West, and West Coast. (See Fig. 2.)

Only contacts made at the same time of the evening were charted. Also, only those identifying station line-up and antenna were recorded, and only those using barefoot rigs and either an inverted V or conventional dipole were included in the charting effort. Charting was done on 285 contacts in 41 states, an average of 7 contacts per state. As shown in Fig. 2, most contacts were in the Atlantic region, and the fewest were in New England.

Evaluation of Signal Reports

A much more telling finding can be deduced from an examination of the signal reports. These were done state-by-state within regions, averaged, and then shown as a state average. They then were averaged for the region as a whole. The results are shown in Fig. 2.

These are stingy receive-only readings. The signal reports I was getting were generally 10-25 dB stronger than those given. This is probably due to Kenwood sticking with a 50 microvolts = S9 spec on the original TS-520. But in any case, this data shows a clear pattern of maximum operation, and it definitely is not to the west.

Fig. 2 shows that the peculiar lobes producing the most gain vs frequency-

ASTRON POWER SUPPLIES

• HEAVY DUTY • HIGH QUALITY • RUGGED • RELIABLE •

SPECIAL FEATURES

- SOLID STATE ELECTRONICALLY REGULATED
- FOLD-BACK CURRENT LIMITING Protects Power Supply from excessive current & continuous shorted output.
- CROWBAR OVER VOLTAGE PROTECTION on Models RS-7A, RS-12A, RS-20A, RS-35A, RS-20M & RS-35M
- MAINTAIN REGULATION & LOW RIPPLE at low line input Voltage.
- HEAVY DUTY HEAT SINK • CHASSIS MOUNT FUSE
- THREE CONDUCTOR POWER CORD
- ONE YEAR WARRANTY • MADE IN U.S.A.
- VOLT & AMP METER ON MODELS RS-20M & RS-35M



ASTRON 20 AMP REGULATED POWER SUPPLY Model RS-20M

16 Amps continuous
20 Amps ICS*
5" (H) x 9" (W) x 10.5" (D)
Shipping Weight 20 lbs.
Price \$117.95

PERFORMANCE SPECIFICATIONS

- INPUT VOLTAGE: 105 - 125 VAC
- OUTPUT VOLTAGE: 13.8 VDC ±0.05 volts (Internally Adjustable: 11-15 VDC)
- RIPPLE: Less than 5mv peak to peak (full load & low line)
- REGULATION: ±0.5 volts no load to full load & low line to high line

Other popular POWER SUPPLIES also available: (Same features and specifications as above)

Model	Continuous Duty (amps)	ICS* (amps)	Size (in.) H X W X D	Shipping Wt. (lbs.)	Price
RS-35M	25	35	5 X 11 X 11	29	\$167.95
RS-35A	25	35	5 X 11 X 11	29	\$149.95
RS-20A	16	20	5 X 9 X 10½	20	\$99.95
RS-12A	9	12	4½ X 8 X 9	13	\$74.95
RS-7A	5	7	3¼ X 6½ X 9	8	\$54.95
RS-4A	3	4	3¼ X 6½ X 9	5	\$39.95

*ICS — Intermittent Communication Service (50% Duty Cycle)
If not available at your local dealer, please contact us directly.

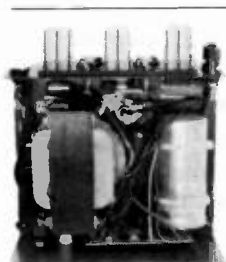

Inside View — RS-12A

ASTRON CORPORATION

1971 South Ritchey Street
Santa Ana, CA 92705
(714) 835-0682

✓358

AEA MorseMatic

in stock now at **AES**



The MorseMatic - one of the finest Morse keyers ever built. It features something for everyone whether a beginner, CW enthusiast, contestor or serious VHF DX'er. Functions as a memory keyer, Morse trainer, beacon, or automatic serial number sequencer. Operates with all popular paddles. Keys grid block, cathode or transistor circuits. Operates off of external 9 to 16 volts DC.

- MM-1 MorseMatic Programmable keyer \$199.95
- ME-1 2000 char. memory expansion - MM-1 59.95
- AC-1 600 ma. AC adaptor for MM-1 & ME-1 14.95
- MK-1 non-message 2.99 WPM keyer 79.95
- AC-2 350ma. AC adaptor for MM-1 & MK-1 9.95

other popular AEA products:

- AD-1, AD-1/UV-3, AD-1/ICOM Auto dialer .. \$129.95
- Magicom RF speech processor for T-4XC 52.50
- Magicom RF speech proc. for TS-520/S, TR-7 42.50
- Magicom RF speech proc. module - TS-820/S 27.50
- ISOPOLE 144 2 meter base station antenna 49.95
- ISOPOLE 220 220 Mhz base station antenna 44.95

Call TOLL FREE
1-800-558-0411



AMATEUR ELECTRONIC SUPPLY®

4828 W. Fond du Lac Avenue
Milwaukee, Wisconsin 53216
Phone: (414) 442-4200

Wisconsin WATS: 1-800-242-5195
Nationwide WATS: 1-800-558-0411

IMPORTANT! The following Branch and Associate Stores are set-up for WALK-IN or TELEPHONE business only. They do not have facilities to respond to written inquiries, etc. Please direct all mail to the Milwaukee address shown above.

BRANCH STORES

WICKLIFFE, OH 44092; 28940 Euclid Avenue
Phone: (216) 585-7388

Ohio in-state WATS: 1-800-362-0290

ORLANDO, FL 32803; 621 Commonwealth Ave.
Phone: (305) 894-3238

Florida in-state WATS: 1-800-432-9424

LAS VEGAS, NV 89106; 1072 Rancho Road
Phone: (702) 647-3114

Outside Nevada WATS: 1-800-634-6227

AES STORE HOURS: (except Las Vegas)
Mon, Tues, Wed & Thurs 9-5:30; Fri 9-8; Sat 9-3

ASSOCIATE STORE
ERICKSON COMMUNICATIONS, INC.
CHICAGO, IL 60630 5456 N. Milwaukee Ave.
Phone: (312) 631-5181
Outside Illinois WATS: 1-800-621-5802

For your TRS-80
send & receive
CW/RTTY

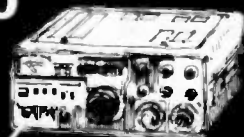

FEATURES

- Auto Send & Receive RTTY & CW
 - Connects to TRS-80 User Port & Key / head phone jacks
 - 10 message memories 255 char. ea.
 - Uses builtin PLL or external TU
 - Includes hardware, cassette & manual
 - Morse tutorial-10 lessons-corrects mistakes simplest, fastest way to learn the code
 - Morse practice-random 5 letter words
 - Auto numbering contest keyer
 - Interactive graphics custom PIX
 - Autotransmitter control PTT
 - Requires Level II Basic & 16K RAM
 - M80 Software, PC Board, Manual \$149
 - CM80 As above in Cabinet \$279
 - TM80 As above plus demodulator & AFSK \$499
 - M800 Adds advanced RTTY to M80 / CM80 / TM80 \$99
- PET, APPLE, SORCERER versions available
Write or call for complete catalog



MACROTRONICS, inc.®

1125 N. Golden State Blvd. / Suite G
Turlock, CA 95380 (S)
(209) 667-2888 / 634-8888

California residents add 6% tax

We are experiencing telephone difficulties, please keep trying.



✓44

of-contact are three: New England, Southeastern seaboard, and Atlantic. The other regions track pretty much as they should, considering that close-by regions would naturally see higher signal reports and more QSOs than distant ones.

Look at Fig. 3. This shows the basic pattern as developed from QSOs made. Its shape is just the opposite of what one would expect from a dipole array mechanically positioned east and west (where one would expect it to fire north/south). Instead, it appears to be operating as an end-fire array.

A Close-up Look at Beam Shape

Fig. 4, however, is more telling. This is a look within the basic Fig. 3 pattern that shows where the most extraordinary performance is going, based on the signal report analysis made earlier, transposed to a map of the US.

This much more approximates what one would expect from a yagi beam of several elements. It is quite sharp in pattern, and extraordinary indeed for an array of this design. However, it also explains somewhat why this array out-performed by an S-unit a 4-element wire beam facing east that it was tested against. Apparently, this antenna simply develops more front-to-back, somehow.

Fig. 5 shows lobes configured into three classifications: (a) below average, (b) average, and (c) above average. This grouping was made possible by a recalculation of the S-meter data. A tabulation showed that the average for all stations worked was S9. Those below S9 are shown as below average; those above, as above average.

Remember that the gain developed is rather sensa-

tional from coast to coast, from reports I get here. So the totality of the overall omnidirectionality of the system must be kept in mind.

Fig. 6 is a final mapping which shows that signals are stronger in the southeast than they are along the way there. This is undoubtedly due to nighttime skip conditions that prevail late in the evening. It substantiates that this skip (or whatever) is happening in one direction only, so it would lead one to believe that the earlier patterns are somewhat accurate overall.

Why the Beam Effect?

The offset positioning of the dipoles in this array is probably the reason for this unusual patterning. While the offset shift worked admirably while the antenna was configured originally for 75 meters, the ratio of the dimension of the offset, physically, to the wavelength at 40 meters is significant. Hence, the offset produced the desired result on 75, yet a somewhat unpredictable one on 40.

Physical Characteristics

A basic appeal of this antenna centers on its ease of assembly. For many people who do not have a lot of real estate to erect wire beams, this should be ideal.

Here are a few of the features:

- No baluns required.
- Height is not a major factor.
- Cost is nil: All you need are insulators, stranded copper dipole wire, and coax. (I use RG-58 because of its lightweight characteristics.)
- Spacing between dipoles appears not to be critical.
- The antenna is pretty much invisible once erected and in position.
- Directionality apparently can be controlled by the degree of offset shift used.

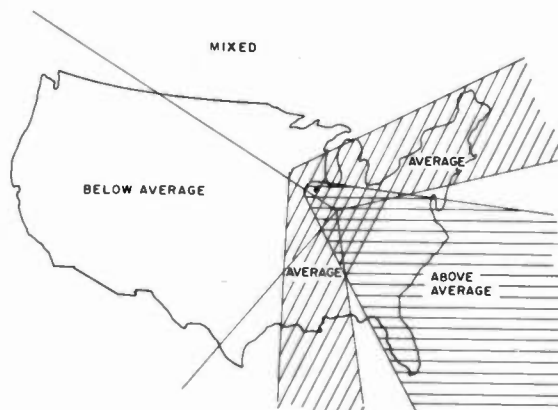

Fig. 5. An accurate visual projection of experiences at W9HBF, based on received (and contacted) station signals. Average is S9.

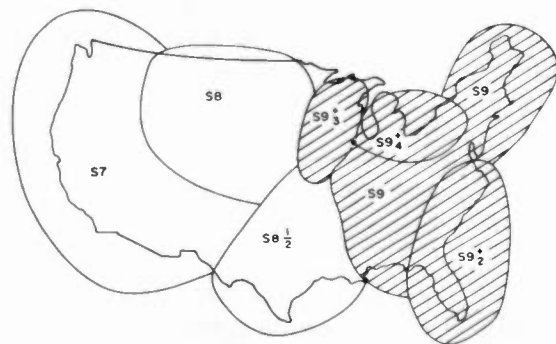

Fig. 6. Clustering of S-meter reports, based on received signal analysis over 41 states. Reports given to me were generally much higher. (These reports were accumulated on a rather stingy S-meter.)

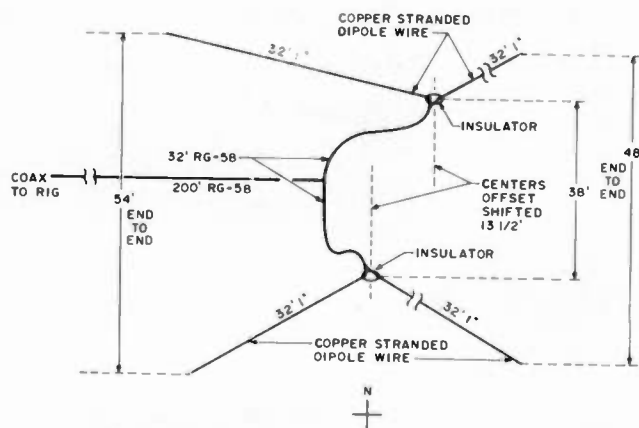

Fig. 7. Completed antenna design as installed at W9HBF. Dimensions shown as far as spacing is concerned do not seem to be critical.

There is no major part of the live element section of this array that is not touching leaves or branches. However, this one seems to have properties quite similar to a quad or closed loop in this respect: Trees and nearby structures do not appear to hamper or severely alter the perfor-

mance of the array. My backyard is full of trees, most of which, one would think, are positioned all wrong. But they do the job for me, and they help to disguise the wires.

Construction

Fig. 7 shows the completed antenna design, as

CB TO 10 METER

10 METER CONVERSION KITS
FOR CB RADIOS AM-FM & SSB

- Kits for over 300 Models of CB Radios
- Low Cost from \$10.00
Easy to Install with All Instructions
Tune-Up Procedure Alignment
- KITS FOR MOST POPULAR UNITS
Over 5,000 Satisfied Customers
- Write or Call Today for Our Free
1980 Catalogue

AMERICAN CRYSTAL SUPPLY COMPANY

PO Box 638
W Yarmouth, MA 02673
(617) 771-4634 ✓7

AUXILIARY POWER for Emergency or Portable Operation

Generac

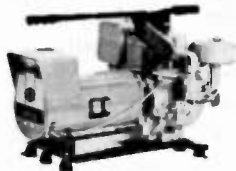

Light wt. Portable Alternator. Stand-by power for Ham Equipment, household needs during power outages or operation in remote areas. Operates lighting, refrigerators, heating systems or other appliances including freq. sensitive loads such as TV sets, induction motors and fluorescent lights. Solid-state voltage regulation 25% surge capacity. B&S engine. Alternator draws just enough engine output to meet load resulting in up to 25% fuel savings. Low interference. Advanced design. Drip-proof construction protects windings from rain and dirt assuring long life. One-year warranty by manufacturer.

Models available with 1350 to 7000 watt ratings.

Write for our quote and additional information.

Mastercharge or VISA accepted

OUTDOOR OUTFITTERS ✓325

705 Elm St. • Waukesha, WI 53187
Ph 1-414-542-7772 • Ken, N9KS—Mgr



2300 MHZ
DOWN CONVERTER

Finally a proven design with a small size. PC board mounts on back of coffee can. PC board contains a Rt amp Mixer, Lo, and an If amp.

Kit supplied with a 5 page brochure, PC board, Diodes, Chip Caps, Transistors, and all parts to complete a working board.

\$35.00

Money Order, Cod, or Check
mail or Phone ✓351

UNIVERSAL COMMUNICATIONS

1825 JOCYLE: ARLINGTON, TEX. 76010
817-265-0391

... at last ...
your shack organized!

A beautiful piece of furniture — your XYL will love it!

\$16450 S-F RADIO DESK

Deluxe - Ready to Assemble

Designed with angled rear shelf for your viewing comfort and ease of operation.

FINISHES: Walnut or Teak Stain.
Floor Space: 39" Wide by 30" Deep

Radio equipment
not included

Also Available ...
Floor Space: 51" Wide by 30" Deep
\$192.50

\$9

Additional Information on Request.
Checks, Money Orders, BankAmericard
and Master Charge Accepted.

F.O.B. Culver City. (In Calif. Add 6% Sales Tax.)
— DEALER INQUIRIES INVITED —

S-f Amateur Radio Services ✓65
4384 KEystone AVENUE • CULVER CITY, CALIF. 90230 — PHONE (213) 837-4870

Now — the
industry's
first truly

super keyboard

INFO-TECH M-300C TRI-MODE KEYBOARD

A microprocessor controlled keyboard
that generates: Morse, RTTY, & ASCII.



Morse Features:

- 4 to 125 W.P.M. in 1 W.P.M. increments.
- 9 adjustable weight levels
- relay keying
- sidetone with tone and level adjustments
- special keys: AS, BK, BT, AR, SK, CQ, DE

RTTY Features:

- 4 speeds
- 2 shifts (170 & 850 hz)
- built in AFSK
- built in CWID
- built in RY generation

ASCII Features:

- 110 & 300 Baud
- 2 shifts (170 & 850 hz)

Other Features:

- Built in quick brown for generator on all modes
- Automatic CR/LF
- 700 Character Running Buffer
- 10 recallable, user programmable message memories of 120 characters each

- CQ & DE special keys on all modes
- Keyboard control of all functions
- 4 row keyboard eliminates figures/letters shifting on RTTY
- Many more features.

Best of all, \$450.00
still only
F.O.B. Factory

Order direct or from these dealers:

A-1 Technik
Blomberg 3
D-5882 Meinerzhagen 2
West Germany

Cohoon Amateur Supply
307 McLean Avenue
Hopkinsville, Kentucky 42240
(502) 886-4534

Coimay Products
14903 Beachview Ave.
White Rock, B.C. Canada V4B1N8
(604) 536-3058

Dialta Amateur Radio Supply
212 48th Street
Rapid City, South Dakota 57701
(605) 343-6127

Germantown Amateur Supply
3202 Summer Avenue
Memphis, Tennessee 38112
1-800-238-6168

Gilfer Associates, Inc.
52 Park Avenue
Park Ridge, New Jersey 07656
(201) 391-7887

Global Communications
606 Cocoa Isles Blvd
Cocoa Beach, Florida 32931
(305) 783-3624

Ham Radio Center
8342 Olive Blvd.
St. Louis, Missouri 63132
1-800-325-3636

Marcucci SPA
Via F.lli Bronzetti
37 20129
Milan, Italy

N & G Distributing
7285 NW 12th Street
Miami, Florida 33126
(305) 592-9685, 763-8170

Radio World
Terminal Building
Oneida County Airport
Oriskany, New York 13424
(315) 337-2622

Ray's Amateur Radio
1590 U.S. Highway 19 South
Clearwater, Florida 33516
(813) 535-1416

Universal Amateur Radio
1280 Arda Drive
Reynoldsburg, Ohio 43068
(614) 866-4267

INFO-TECH ELECTRONIC EQUIPMENT

Manufactured by:

DIGITAL ELECTRONIC SYSTEMS, INC. ✓35

1633 Wisteria Court • Englewood, Florida 33533 • 813-474-9518

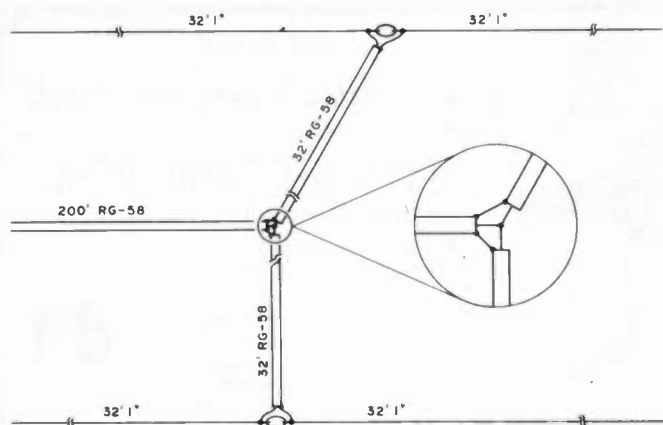

Fig. 8. Close-up of coaxial "T" interconnections. Actual coax length from this point to the dipoles is 32 feet each way. This section is elevated to a height mid-point between the heights of the two dipole centers.

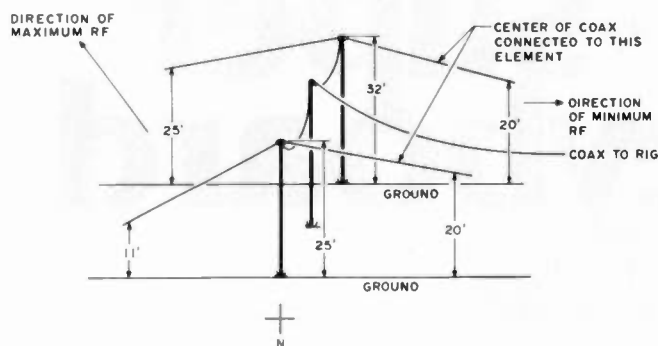

Fig. 9. W9HBF installation, looking south. (In reality, trees, not poles, are used as supports.) Note that maximum rf direction is almost opposite to that of the live dipole elements.

viewed from the top looking down toward the ground. Equal 32-foot lengths of RG-58 are used between the two dipole-type elements. This length was chosen not scientifically, but simply because it was the length required to reach between the two antennas when they were originally spaced when the array was cut for 75 meters. But many experts tell me that this coax spacing may have a great deal to do with why this antenna performs so well. I leave it up to you to decide what will work best overall.

The 13½-foot offset dipole centers also may help to explain a great number of things about this antenna, but I'm not sure just what at this point. I rather suspect that you could experiment with this

shift considerably with interesting results.

Overall, 200 feet of RG-58 runs back to the operating position from the antenna. I often drive this with 2 kW in, and have yet to have a problem. The majority of the coax feeds back to the house at the elevated point where the two coax dipole break off—so it is also possible that the effect of the coax adds something to the antenna itself. The coax runs through high tree branches much as the elements do.

Fig. 8 shows how the coaxial "T" is interconnected. I simply used black plastic electrical tape; the connections at W9HBF are not even soldered together—just twisted. You may want to experiment by reversing the center con-

ductor feeds to the dipole elements, just to see the effect it might have on your pattern. I use a string to hoist up the "T" point into a tree so that the coax doesn't droop down into a play area where the youngsters often congregate.

Fig. 9 shows the installation from the north, looking south. (Poles, not trees, are shown here to simplify the diagram.) Note that the area of maximum radiation (gain) is quite opposite to where the center conductors of the coax feed. I have no way to explain this phenomenon.

Cutting/Pruning

I had to do no cutting/pruning whatever. The original 40-meter cut, to 7.250 MHz, is the only cut made, and that was by way of standard dipole formulae.

At W9HBF, due to extensive antenna experimentation conducted with wire arrays, all feedlines go into a switchbox and then into a DenTron Monitor Tuner. As a result, I've not had to be concerned over vswr problems, nor have I ever had any with this antenna.

I can report, however, that this antenna matches very closely to the settings used for the double-extended zepp. In fact, there is only 1.3:1 difference between the two. (In other words, if the transmatch is set for the zepp, which uses a balanced 300-Ohm line, switching in the unbalanced coax feed of the array through the DenTron "coax"/"balanced" panel switch produces only a 1.3:1 swr on the array. As a result, only a very minor adjustment is required to bring the array to a perfect 1:1.) This is quite advantageous, since it simplifies the problem of getting quick comparative antenna checks over the air.

TVI is one final aspect of this antenna that is worth mentioning. No TVI can be noted at all. This is not the case with the double-extended zepp or the roof-mounted ground plane.

This Array on Other Bands

Results on other bands are interesting. However, my comparison standard is a vertical Hy-Gain 14AVQ only. However, here's what I get:

- 20 meters: The vertical is better, by 6 dB.
- 15 meters: The array is better, by 12 dB.
- 10 meters: The array is better, by 24 dB.

Needless to say, this array sees a lot of 10-meter use at W9HBF. Contacts into Europe and Asia are especially good, and my signal frequently beats out all the boys with big beams, as the DX station invariably comes back to me first. Further, DX station contacts tend to be solid and reliable (no QSB), so half-hour-long rag chews on 10 meters with Europe are not uncommon.

Since my vertical does not function below 40 meters, I cannot use it as a comparison standard for 75 meters. But the double-extended zepp does work well there. A comparison here shows that the zepp has it over this array by 18 dB. This is probably because the zepp approximates a dipole at 75 meters. However, the array does function on 75, which surprised me.

Overall, though, the array seems to shine best on 10, 15, and 40. But because of the lack of effective gain-antenna competition at 7 MHz, it stands out more on this band than perhaps anywhere else.

I hope that others may experience equally satisfying results and that they will report refinements that further improve effectiveness. ■

avanti® antennas

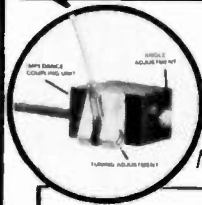

2 Meters ✓ 301

144-174 MHz

Model AH 151.3G

FEATURES:

- HALF WAVE SELF-RESONANT DESIGN that does not require a ground image plane to achieve low S.W.R. and low take-off angle as do standard 1/4 wave or 5/8 wavelength antennas. It improves omni-directional radiation pattern with lower take-off angle.
- Low profile appearance.
- Removable whip for car wash
- Can also be used on:
 - Commercial frequencies
 - Marine FM Band
- Mounted high on vehicle for best range



Amateur equipment accessories & antennas.
CODX USA. Export Anywhere.
Amateur & commercial repair service.

2317 Vance Jackson Rd. San Antonio, TX 78213
(800)531-5405 (512)734-7793 in Texas



THE NEW AEA MORSEMATIC!™ 37 FANTASTIC FEATURES!

The amazing AEA MorseMatic. Whether you are a contester, serious VHF DXer, learning code for the first time, studying for a marine radio operator's ticket, or simply a CW enthusiast, you can now own the finest electronic Morse keyer ever built and program it to your specific needs. Count these features!

1. Two custom designed microcomputer chips. 2. Two wpm to 99 wpm in one wpm increments. 3. Selectable dot and/or dash memory.

4. MorseMatic is a memory keyer. 5. 500 Morse character memory (optional to 2,000 characters) 6. Unique "Soft-Partitioning"™ to eliminate wasted memory space. 7. Use entire memory for one message or divide memory in up to ten messages. 8. Message loading begins with first character sent. 9. Easy to load memory. Choice of automatic mode for perfect format or real-time mode for individualizing messages. 10. Special editing mode for memory load correction. 11. Load memory in automatic keyer mode or semi-automatic "bug" mode (garbage in/perfection out). 12. Low power memory hold. 13. Memory limit indicator lights when 20 characters are left in memory. Monitor tone changes when memory overflows.

14. MorseMatic is a Morse trainer. 15. Computer generated Morse trainer. Incorporates ten repeatable (answers available) and one random starting position. 16. Programmable speed-up of code rate from beginning to end of practice session. 17. Select "slow code" or "fast (Farnsworth) code" method. 18. Select five character code groups or random group lengths. 19. Selectable, unselectable, uncommon characters for advanced radio operator training. 20. Use trainer mode to key transmitter for on-air practice.

21. MorseMatic is a beacon. 22. Unique beacon mode for beacons; moon-bounce, scatter or tropospheric DX scheduling. 23. Computers set message code speed to fit programmed transmitting window.

24. MorseMatic has serial number. 25. Automatic serial number sequencing for sweepstakes and other contests. 01 - 9999 (even beacon mode). 26. Serial number placement at any point within message. 27. Serial number repetition within same message. 28. Easy serial number repeat in next message.

29. Operates with all popular paddles- 30. Easy to learn and use keypad control for all features. 31. Plug in IC's. 32. Independently selectable dot and/or dash weighting. 33. Can be used to key transmitter for tuning. 34. Transmitter keying output for grid block, cathode or transistor circuits. 35. Operates off 8 to 16 volts DC. 36. Fully tested and 96 hour burn-in. 37. Introductory price only \$199.95.

The MorseMatic is also available strictly as a non-memory keyer for only \$79.95 (introductory price). For your free MorseMatic booklet explaining these and more features, or for information about ordering a MorseMatic, write or call Advanced Electronic Applications, Inc., P.O. Box 2160, Lynnwood, WA 98036. Phone 206/775-7373. (Dealer inquiries invited.)



AEA

Brings you the breakthroughs!

REPEATER

TAIL CHOPPER



SQUELCH TAIL ELIMINATOR

Better than 6db Sinad Sens.
Wide temperature range.
Tone enable-disable.

TC-2000 Regency U10R	MODELS
TC-2100 Universal	FROM
TC-2200 PC Mt.	\$54.95

Easy installation for most repeaters

TAIL CHOPPER



CIRCUIT ELECTRONICS, INC.
621 Bishop, Salina, KS 67401

24 HOUR ORDER LINE
CALL TOLL FREE ✓ 368
1-800-448-5523 or
Hear TAIL CHOPPER in Action
Call 913-827-4521

Gilding the Lily

— FT-101 mod for crazed purists

John E. Carter WB4HLZ
2622 Rolling View Drive
Smyrna GA 30080

While visiting K4QC, the subject of improvements to his rig came up (doesn't it always?). Jim wanted to be able to switch sidebands on his FT-101 without retuning the vfo. While he hunted up the schematic, WD4JOH (his XYL, Ruth) provided coffee

and cake—food for thought, as great decisions were about to be made.

On close examination, the schematic yielded its secret—the varicap diode in the vfo, used for the clarifier, could be used to shift the vfo frequency when

changing sidebands. (I know you use the other sideband only when checking someone's signal for suppression of that sideband, but remember the title of this article.) By shifting the frequency of the vfo up about 3 kHz when switching to LSB, the carrier frequency would be unchanged and retuning of the vfo would not be required. Raising the frequency of the vfo could be done easily by increasing the bias voltage on the varicap, which would decrease its capacitance and thereby raise the frequency.

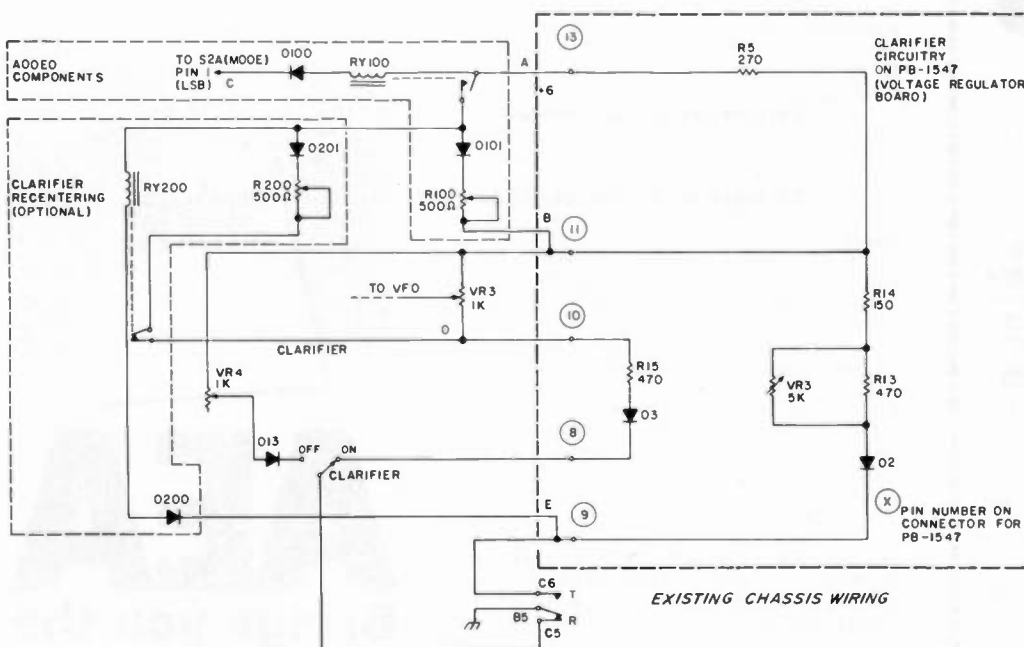

Fig. 1. FT-101 modifications.

A quick trip to Radio Shack netted the required parts: a small six-volt relay, a 500-Ohm pot, and a couple of diodes. Assembling the parts (see schematic, Fig. 1) and gluing the perf-board to the top of the vfo housing is the easy part. Now get another cup of coffee and start counting pins on the PC board connectors and switches in the FT-101. Pull the plug before you

open the covers!

The rest of the modification reads like an assembly manual, but maybe you won't go to sleep. Most of the wiring is done to the connector for PB-1547, the voltage regulator board, as this is where most of the clarifier circuitry is located. All the wiring is add-in; no removals. (It's easier this way and I'm basically lazy.) The pins on the connector start numbering with 1 at the rear of the transceiver and count up toward the front.

Point A on the schematic goes to pin 13 of the PB-1547 connector (red/white wire). Point B goes to pin 11 (yellow wire), and point C goes to pin 1 of the MODE switch (wafer closest to front panel, grey/white wire). If you remove the speaker mounting plate, the wire to the MODE switch can be threaded

through the existing clips.

Adjustment is simple. Just turn the calibrator on and tune for zero beat in the USB position (clarifier off), then switch to LSB and adjust R100 for zero beat. That's it. Well, almost. This modification causes the clarifier control zero point to be offset about 90 degrees when on LSB with the clarifier on. If you don't use the clarifier or if the offset doesn't bother you, the rest of this article is just nice to know. If you want to re-center the clarifier tuning, read on.

Another addition (still the easy way) will re-center the clarifier control on LSB. The 200-series parts are used to change the vfo offset in receive with the clarifier on and then change it back when the T-R relay is operated. (This probably could be done with solid-state switches if you want

to try it.)

The perfboard will have to be expanded to hold the additional parts, and the wiring goes as follows: point D to pin 10 of the PB-1547 connector (blue wire) and point E to pin 9 (you should be able to find this one).

Adjustment of this part of the circuit is easy also: MODE to LSB, clarifier off, tune in the calibrator for zero beat. Turn the clarifier on and set its tuning control to 0 offset (center of range). Adjust R200 for zero beat, and you are finished. Be sure to plug the rig back in before attempting to make any adjustments. (You did unplug it before you started, didn't you?)

If you have read this far, you deserve an explanation of how it works. R5 is part of a three-legged voltage divider, the legs being: (1)

VR3, R15, D3 (receive frequency with clarifier on); (2) VR4, D13 (receive frequency with clarifier off); and (3) R14, R13, VR3, D2 (transmit frequency). By shunting R5 with R100, the voltage at the junction of R5, R14, VR3, and VR4 is increased in the LSB mode. This increases the voltage applied to the varicap in both transmit and receive, providing the desired vfo frequency change. R200 is shunted across the combination of R5, R100, and VR3 during receive to re-center the clarifier tuning range.

No, I don't know if it will work on your transceiver if it's other than the FT-101. Yes, I will answer your questions (if I can), but remember that I don't have a diagram of your transceiver and I can't even guess at connection points without one. And, please, send an SASE. ■

ANTENNA SYSTEMS/TOWER HARDWARE

HY-GAIN ANTENNAS

TH5DX	New 5-El. Triband Beam	\$209
TH6DXX	6-El. Triband Beam	\$229
TH3MK3	3-El. Triband Beam	\$179
TH3JR	3-El. Triband Beam	\$129
TH2MK3	2-El. Triband Beam	\$109
HYQUAD	2-El. Triband Quad	\$209
402BA	2-El. 40-mtr Beam	\$175
205BA	5-El. 20-mtr "Long John"	\$229
155BA	5-El. 15-mtr "Long John"	\$145
105BA	5-El. 10-mtr "Long John"	\$94
204BA	4-El. 20-mtr Beam	\$175
203BA	3-El. 20-mtr Beam	\$99
153BA	3-El. 15-mtr Beam	\$64
103BA	3-El. 10-mtr Beam	\$54
D81015A	3-El. 10/15 mtr Beam	\$129
64B	4-El. 6-mtr Beam	\$42
66B	6-El. 6-mtr Beam	\$89
18HT	Hy-Tower 80-10 mtr Vert.	\$279
18AVT/WB	80-10 mtr Trap Vert.	\$85
214	14-El. 2-mtr Beam	\$29
28DQ	80/40 mtr. Trap Dipole	\$49
58Q	80-10 mtr. Trap Dipole	\$89
BN86	80-10 mtr. KW Balun	\$14

OTHER HY-GAIN MODELS IN STOCK - CALL!

HUSTLER

48TV	40-10 mtr Vert.	\$ 79
58TV	80-10 mtr Vert.	\$ 99
HF Mobile Resonators Standard (400W)	Super (2KW)	
10 & 15-mtrs		\$15
20 mtrs		\$18
40 mtrs		\$21
75 mtrs		\$32

Bumper mounts, springs, folding masts, Supergain 2-mtr Mobile Colinear Antennas in Stock - Call!

MINI PRODUCTS

HQ-1	Miniquad	\$139
------	----------	-------

ROTORS & CABLES

Hy-Gain HDR-300 (25 sq. ft.)	\$399
Alliance HD-73 (10.7 sq. ft.)	\$ 99
Alliance U-100 (Elevation Rotor)	\$ 39
CDE CD-45-2 (9 sq. ft.)	\$ 99
CDE HAM 4 (15 sq. ft.)	\$159
CDE TAILTWISTER (30 sq. ft.)	\$229
8 Conductor Rotor Cable	\$0.18/ft.
Heavy Duty 8 Conductor Rotor Cable	\$0.36/ft.

CUSHCRAFT ANTENNAS

A3	New 3-El. Tribander	\$175
ATB34	4-El. Tribander	\$219
ATV3	20-10 mtr. Vert.	\$ 39
ATV4	40-10 mtr. Vert.	\$ 85
ATV5	80-10 mtr. Vert.	\$ 90
20-3CD	3-El. 20 mtr "Skywalker"	\$165
20-4CD	4-El. 20 mtr "Skywalker"	\$239
15-3CD	3-El. 15 mtr "Skywalker"	\$ 82
15-4CD	4-El. 15 mtr "Skywalker"	\$ 98
10-3CD	3-El. 10 mtr "Skywalker"	\$ 59
10-4CD	4-El. 10 mtr "Skywalker"	\$ 75
A50-5	5-El. 6 mtr Beam	\$ 59
617-6B	6-El. 6 mtr "Boomer"	\$169
32-19	19-El. 2 mtr "Boomer"	\$ 75
214B	14-El. 2 mtr "Boomer"	\$ 59
214FB	14-El. 2 mtr FM "Boomer"	\$ 59
228FB	28-El. 2 mtr FM "Power Pack"	\$188
220B	17-El. 220 MHz "Boomer"	\$ 69
A147-11	11-El. 2 mtr Beam	\$ 34
A147-22	22-El. 2 mtr "Power Pack"	\$ 98
ARX 2	2 mtr "Ringo Ranger"	\$ 34
ARX 450	450 MHz "Ringo Ranger"	\$ 30
A147-20T	2 mtr Vert. & Horiz. Beam	\$ 59
A144-10T	10-El. 2 mtr "Oscar" Ant.	\$ 37
A144-20T	20-El. 2 mtr "Oscar" Ant.	\$ 53
A435-24T	New 24-El. "Oscar" Ant.	\$ 49
AT-4B	New 145/435 MHz "Oscar" Ant.	\$ 99
A14T-MB	Dual "Oscar" Ant mounting boom	\$ 20

KLM

KT34A	4-El. Triband Beam	\$319
KT34XA	New 6-El Triband Beam	\$479
7.2-1	40-mtr Rotatable Dipole	\$139
144-14813L B	13-El. 2 mtr Long Boomer	\$ 79
432-161B	Bumper 16-El. 432 MHz Long Boomer	\$ 69
144-150-16C	16-El. 2 mtr "Oscar" Ant.	\$ 89
420-450-18C	18-El. 435 MHz "Oscar" ant	\$ 49

Power Dividers, Circularity Switchers, and other popular KLM Antennas in stock - Call!

TEXAS TOWERS

A DIVISION OF TEXAS COMMUNICATIONS PRODUCTS

Serving you from our New Location!

1108 Summit Ave., Suite 4

Piano, Texas 75074

Mon.-Fri. 9 a.m. - 6 p.m. Sat. 9 a.m. - 1 p.m.

TELEPHONE: (214) 423-2376

PRICES SUBJECT TO CHANGE WITHOUT NOTICE

ROHN TOWERS

20G \$29.50	25G \$38.50	45G \$83.60
HDBX 40	Free-standing 40' (18 sq. ft.)	\$249
HDBX 48	Free-standing 48' (18 sq. ft.)	\$305
HDX-56	Free-standing 56' (10 sq. ft.)	\$335
FK2548	48' 25G Foldover Tower	\$659
FK2558	58' 25G Foldover Tower	\$739
FK2568	68' 25G Foldover Tower	\$799
FK4548	48' 45G Foldover Tower	\$929
FK4558	58' 45G Foldover Tower	\$1029
FK4568	68' 45G Foldover Tower	\$1119

(Freight paid on all foldover towers. Prices 10% higher west of Rocky Mountain states.)

ALL ROHN ACCESSORIES IN STOCK-CALL!

GALVANIZED STEEL

TOWER HARDWARE

3/16" EHS Guywire	\$11/100 ft. \$99/1000 ft.
1/4" EHS Guywire	\$14/100 ft. \$129/1000 ft.
5/32" 7 x 7 Aircraft Cable	\$10/100
3/16 CCM cable clamps (3/16" or 5/32" cable)	\$0.30
1/4 CCM cable clamps (1/2" cable)	\$0.40
1/4 TH Thimble (fits all sizes)	\$0.25
3/8 EE (3/8" Eye & eye turnbuckle)	\$5.50
3/8 EJ (3/8" Eye & jaw turnbuckle)	\$6.00
1/2 EE (1/2" Eye & eye turnbuckle)	\$8.50
1/2 EJ (1/2" Eye & jaw turnbuckle)	\$9.00
3/16" Preformed guy deadend	\$1.45
1/4" Preformed guy deadend	\$1.65
6" dia 4 ft long earth screw anchor	\$11.50
2" dia. 10-ft long heavy duty mast	\$35.00
500D Guy insulator (5/32" or 3/16" cable)	\$0.85
502 Guy insulator (1/2" cable)	\$1.80

COAXIAL CABLE AND CONNECTORS

RG213/U (Mil spec RG-8/U-Brand New)	\$0.29/ft.
RG-8X	\$0.15/ft.
1/2" 50 DHM Copper Hardline	\$1.10/ft.
1/2" Copper hardline connectors	\$22.00
1/2" 50 DHM Poly Jacketed alum. hardline	\$0.69/ft.
1/2" Alum. Hardline Connectors	\$10.00

HY-GAIN, TRISTAO-PRATT AND TELETOWER

CRANK-UP TOWERS

Call for our competitive quote - Shipped factory direct to save on freight.

Mike Mods for the KDK-2016A

— improved scanning

Robert E. East WB9WNU
7057 West Red Apple Drive
Michigan City IN 46360

For the price, the KDK-2016A is one of the finest two-meter rigs on the market today. I find it very easy to operate, and with the 4-channel, programmable memory scanner, it

is unlikely that you will ever miss a call.

The only area that I felt needed improvement was the location of the scanner's Close-Hold-Open switch. Located on the front panel, upper-left corner, third from the left, this switch controls the scanner functions. The Close position locks the scanner on a frequency that is occupied. The Hold position holds that frequency so that you can QSO on it. The Open position locks on a vacant frequency.

The location of this switch next to the Tone/PL and RF ATT switch was such that when trying to put the scanner in Hold I would accidentally bump the PL to the OFF position, making it impossible to bring up the repeater. If nothing else, this modification might

save you from having to take your eyes off the road, with consequent fender-repair and dentist bills.

The idea is to open the wire from P-12 and the middle pin on the scanner switch. This is done with a push/on and push/off switch located on the microphone. (*Caution:* The modification shown here is *only* for the CES-230A microphone, called the FMMC-1, when ordered with the KDK. This mike calls for +12 V dc to be applied to one of the microphone pins.) I have shown in Fig. 4 how a standard KDK mike is connected. I also caution you to remember Murphy when drilling the front panel!

See Figs. 1, 2, and 3 for the wiring of the CES-230A and the mating of the 6-conductor mike cord.

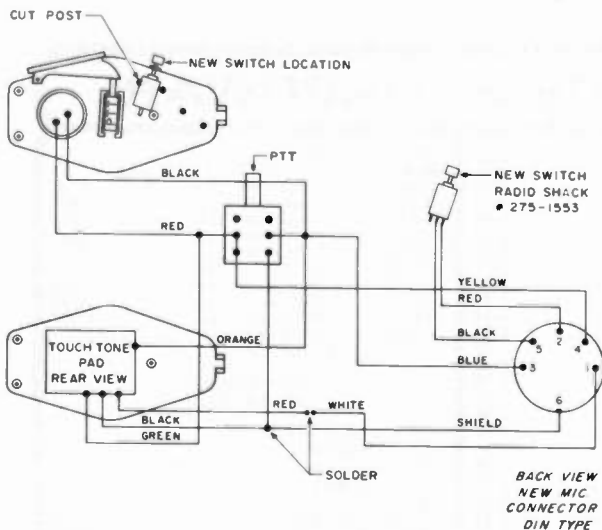

Fig. 1. Microphone wiring arrangement (CES-230A microphone only).

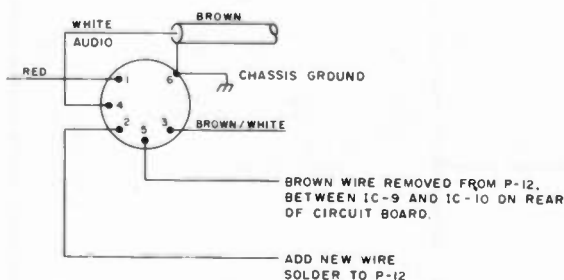

Fig. 2. Back view of new chassis socket (Radio Shack #274-1005).

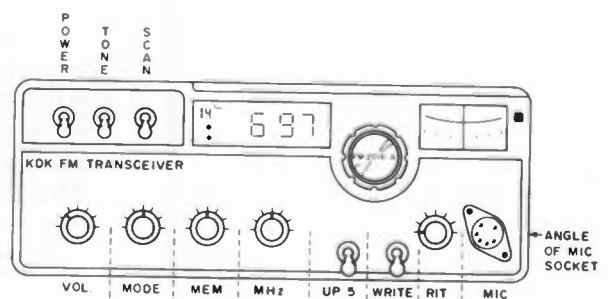
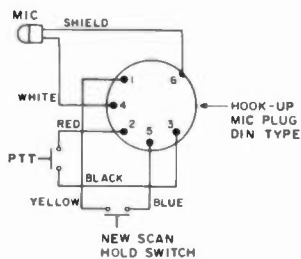

Fig. 3. Front view of KDK-2016A.

STANDARD KDK MICROPHONE
6 COND. CORD



BACK VIEW WIRING
DIN TYPE CHASSIS JACK
STANDARD MIC

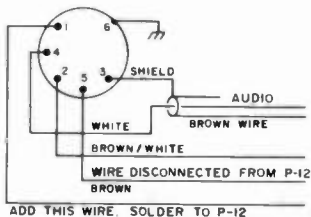

Fig. 4. Standard mike wiring arrangement.

Parts are from Radio Shack and are standard DIN type. Cost of the modification was on the order of \$5.00, and it took me about 2 hours.

If you are a 2-meter RTTY fan, this is the rig for you. There is a DIN receptacle mounted on the back of the radio that is made for hooking up the rig to a TU. With this hooked to the TU-170, I can still operate on phone. There is no need to unhook the TU connections, as keying and audio are fed into

the back of the rig and the mike can be left in the front jack.

I hope this article will help those of you who like to keep your eyes on the road. For you who have to look down at your rig to see what switch to throw, I would suggest that you make friends with someone in the auto repair business.

If you happen to be in the Michigan City area, please give me a shout on the .37/97 machine, or 14.090 RTTY. 73 and good luck. ■

S-100 S-100 S-100 S-100

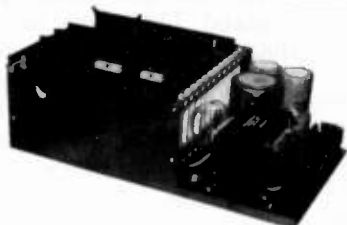

***\$249⁰⁰**

IN STOCK NOW

INTRODUCTORY
OFFER

PLACE QUANTITY
ORDERS NOW,
SAVE!

* Less Boards and Fans, Assembled Add \$45.00,
6 Slots Populated with Connectors

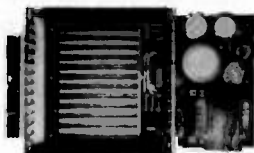
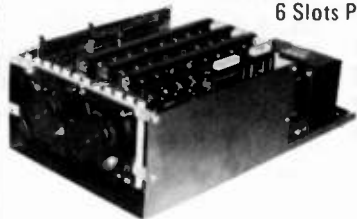

COMPLETE S-100 SYSTEM

ALL NECESSARY
POWER SUPPLIES

*12 Slot Motherboard
Fully Terminated

*30A of +8V
6A of ±16V

*Disc Power Supply
6A of +24V
5A of +5V
1A of -5V

*All Steel Frame

*220VAC or 110VAC
50 or 60 Cycle Operation

*Low Voltage Tap

*Nylon Card Guides

*Connectors Supplied
for up to 4 Drives

*Optional Fans Mount
Neatly on One Side

DELTA PRODUCTS ✓ 357

15392 Assembly Lane, Huntington Beach, CA 92649

(714) 898-1492

TIMETRAC

By Comus

the microcomputer-controlled
appointment clock

NEW
First Time Offer

— NOT A KIT —

Limited Offer by

HAL-TRONIX

only \$49.95

plus \$2.00

Shipping & handling charge



FEATURES:

- Sleek modern styling to complement any home or office decor.
- Tells the time.
- Tells the date and year.
- Up-timer to 60 minutes, 59 seconds with pause.
- Alarm to ring at the same time everyday.
- Daily appointment sets appointments for the next 23 hours, 59 minutes.
- Future appointments up to one year.
- Dimmer switch for display.
- Memory will hold up to 30 appointments.
- Lithium power cell to retain memory during power outage.
- Appointments entered out of chronological order will be stored in chronological order.
- Colon flashes once each second.
- A.M./P.M. indicator.
- Plugs into any wall outlet.
- Easy to read vacuum fluorescent display.
- Extremely accurate quartz crystal clock.

EFFICIENT. REMARKABLE.

TimeTrac sold and distributed by HAL-TRONIX. Dealers welcome.

Send 15¢ stamp or S.A.S.E. for information and flyer on other HAL-TRONIX products. To order by phone: 1-313-285-1782.



"HAL" HAROLD C. NOWLAND
W8ZXH

HAL-TRONIX ✓ 31

P.O. Box 1101
Southgate, MI 48195

SHIPPING
INFORMATION:

ORDERS OVER \$20.00 WILL BE SHIPPED POSTPAID EXCEPT ON ITEMS WHERE ADDITIONAL CHARGES ARE REQUESTED. ON ORDERS LESS THAN \$20.00 PLEASE INCLUDE ADDITIONAL \$1.50 FOR HANDLING AND MAILING CHARGES.

Clock Blocks

— a compendium of TTL and CMOS oscillators

Joseph J. Carr K4IPV
5440 South 8th Road
Arlington VA 22204

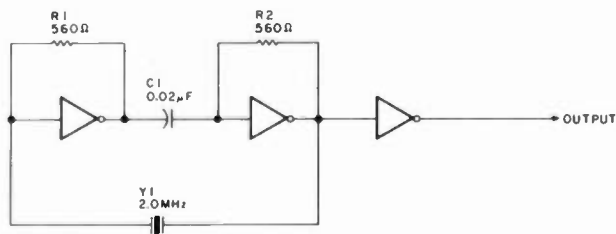

Fig. 1.

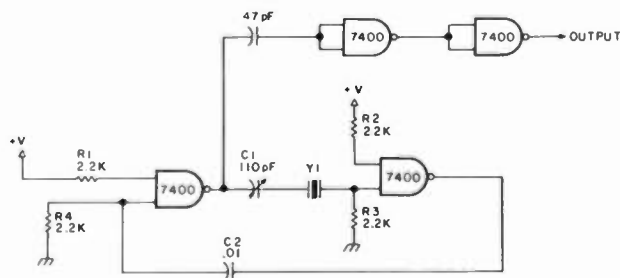

Fig. 2.

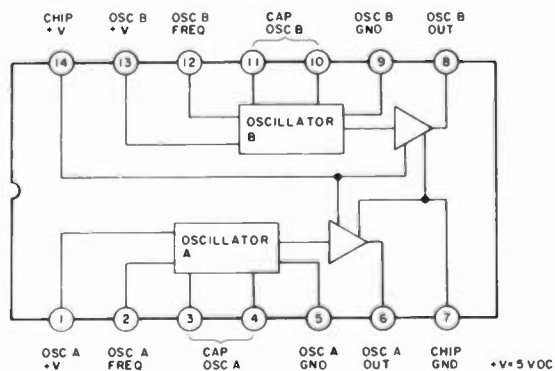

Fig. 3(a).

A lot of digital circuits require a clock, which is a square-wave oscillator running at some frequency. Some circuits might require only an RC square-wave oscillator of almost any output amplitude greater than a few volts. Other circuits require a more precisely controlled crystal-oscillator circuit (most UARTs require a crystal clock). In other cases, the output of the oscillator will have to be either TTL- or CMOS-compatible.

If you buy some type of digital kit or build a project from this magazine, then the clock oscillator circuit will be designed for you. But what do you do if you want to design or build your own digital circuit and a clock is needed? Say you want to interface a teletypewriter printer with your microcomputer and find that the UART you want to use needs a precisely controlled clock at a certain frequency. The circuits discussed below should help you out; they consist of both oscillator circuits and dividers.

TTL Clock Circuits

Many hobbyists who are confronted with the need for an oscillator circuit which generates square

waves head for the nearest 555 IC. But the 555 output is not always TTL-compatible and that can cause problems. TTL devices want to see only other TTL devices at their inputs, so the non-TTL output of the 555 may be incorrect (especially if $V+$ is greater than +5 V dc!).

We can use either specialized TTL chips or ordinary TTL logic devices. The most common configuration is to use an inverter or a NAND (or NOR) gate connected as an inverter. Fig. 1 shows one popular form of TTL crystal oscillator consisting of two inverters. Keep in mind that a 7400 NAND gate connected with both inputs tied together will operate as an inverter, and, in fact, is the most commonly seen IC in this type of circuit. Resistors R1 and R2 bias the inverters, while capacitor C1 provides dc isolation between the two stages. In this case, we do not want direct-coupled connection. The resonant frequency is set by crystal Y1.

This circuit will work in the range of 100 kHz to 3 MHz, although it is known to be a little balky (i.e., critical starting) at the lower end of this range.

Sometimes we must juggle the ICs and crystals used when these low frequencies are desired. While it is well known that crystals vary from one unit to another, most people are not aware that "standard" TTL devices also vary from one to another, especially those from different manufacturers.

It is common practice in all crystal oscillators to provide an output buffer stage. This is done to prevent loading of the oscillator by changes in the external load circuit. To overcome this problem, we provide another inverter at the output of the oscillator. This is such a good practice that it is recommended for all clock oscillators.

The crystal is shown here in the feedback path between the output and the input. We must accept whatever frequency the crystal chooses to produce unless we connect a small (15-30-pF) trimmer capacitor in series with the crystal. We will then be able to make small adjustments in the oscillator frequency.

Another approach to building TTL clock oscillators from ordinary TTL gates or inverters is shown in Fig. 2. This circuit is slightly different from the version shown in Fig. 1, but it is essentially the same idea. This particular circuit places the crystal in series between the two gates. This is not too different from the other example; the important thing is that the crystal is in a series loop with the two stages. The 110-pF capacitor provides control of the operating frequency. Note the double buffering used. This is easy to implement because a 7400 TTL NAND gate IC has four independent NAND gates inside.

I am not terribly fond of TTL inverter/gate clock oscillator circuits. All of them can be a little sticky some-

times. They may fail to start or may quit at an inopportune time. When I first bought my microcomputer, the darn thing would not operate and the trouble was traced to a flaky clock-oscillator circuit. It seems that certain brands of 7400s would not operate unless a 220-pF capacitor was added to increase the feedback. Problems like that I don't need. Because of these experiences, I prefer to use a nice little Motorola chip as an oscillator. This IC is the MC4024 oscillator IC (not to be confused with the CMOS 4024 device!). It is readily available from most of the mail-order hobbyist electronics suppliers.

Fig. 3(a) shows the MC4024 pinouts and a block diagram of the internal circuitry. Note that the two oscillators, labeled A and B, are independent of each other in several ways. There are overall chip ground and chip V+ terminals, as well as separate V+ for oscillator A and oscillator B. Also, the grounds for the respective oscillators are separate.

In order to make one of these oscillators operate, we must ground both the chip ground terminal (pin 7) and the ground for the particular oscillator that we want to use (pins 5 or 9, for A or B, respectively). Similarly, we need to apply +5 volts dc to both the chip V+ terminal (pin 14) and the particular oscillator V+ terminal (pins 1 or 13, for A or B, respectively). Fig. 3(b) shows the standard

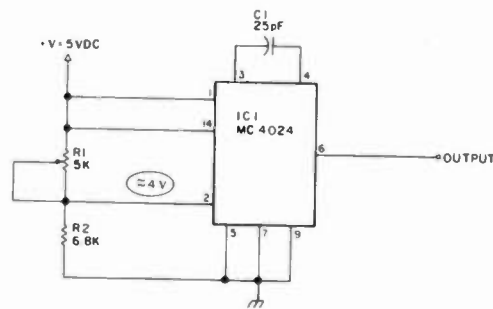

Fig. 3(b).

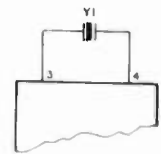

Fig. 3(c).

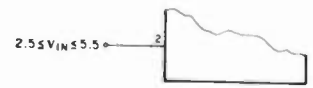

Fig. 3(d).

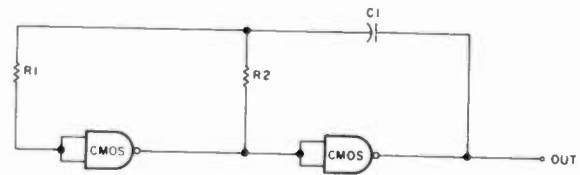

Fig. 4(a).

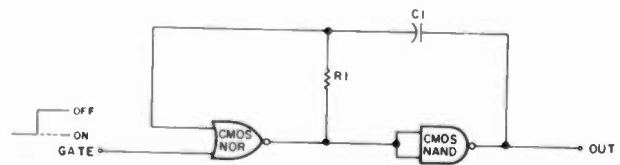

Fig. 4(b).

configuration for using a single capacitor to control the frequency of one of the oscillators. In this circuit we are using oscillator A, but the same circuit is also used for oscillator B; only the pinouts are changed.

This circuit will operate over the range of 1 Hz to 25 MHz, with some units capable of operation to 30 MHz. The voltage divider consisting of R1 and R2 sets the control voltage at pin 2 of the MC4024 and that allows control of the output frequency. Control is possible over a 3.5:1 range. In some cases, simplicity tells us simply to delete R1/R2 and connect pin 2 directly to V+.

We can obtain only a rough formula for determining the operating frequency of this circuit. In general, we can claim that the operating frequency will be (approximately): $F = 300/C1$, where F is the frequency in megahertz and C1 is in picofarads. This formula is valid only when

the voltage on pin 2 is +5 volts dc. At lower voltages (down to +2.5 volts dc), the frequency will be lower—this is a general rule of thumb. Additional formulas for different operating conditions are given in the Motorola data sheet for the device.

We also can crystal-control the MC4024, but the frequency range is narrower. The frequency of the crystal must be between 1 MHz and 25 MHz. In practice, if the frequency is less than 2 MHz it is best to parallel a small capacitor with the crystal. Many crystals fail to oscillate in the 1-2-MHz range, but there is little trouble at higher frequencies. All we do to crystal-control the oscillator is to replace the capacitor with a crystal. If the adjustable circuit of Fig. 3(b) is used, it will be possible to pull the frequency of the crystal just a little bit, enough to "net" it on the correct frequency with potentiometer R1.

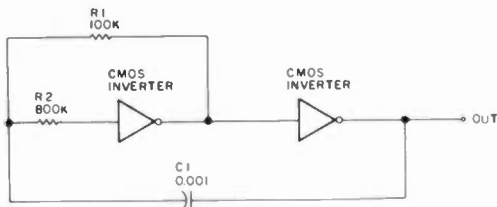

Fig. 5.

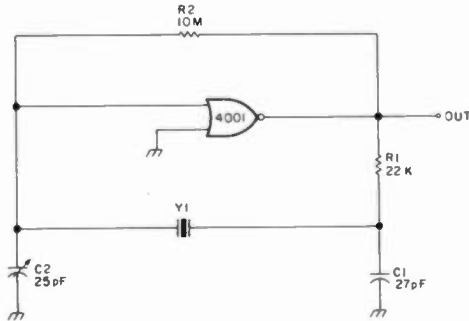

Fig. 6.

The MC4024 device can be used also, in either crystal or capacitor versions, as a voltage-controlled oscillator. In fact, it is as a vco that the device really earns its keep. We need only apply a control

voltage to pin 2. In the case of a sweep generator, we would replace R1 and R2 of Fig. 3(b) with a sawtooth voltage. Just connect pin 2 to a low-impedance output voltage source—see Fig. 3(d).

CMOS Circuits

Those who fancy CMOS digital ICs can make oscillator circuits from ordinary gates as well. Also, they may select specialized IC devices from several manufacturers.

Fig. 4(a) shows an RC CMOS oscillator which uses a pair of NAND gates, or inverters, as the active elements. The operating frequency is given roughly by $F = 1/1.4RC$, where F is the frequency in Hertz, R is the resistance of R2 (in Ohms), and C is the capacitance of C1 in farads. Resistor R1 is used to limit the current and is given a value of $R1 = (V_{dd} - V_{ss})/0.005$. If V_{dd}, the positive supply voltage, is +5 volts dc and V_{ss} is zero (i.e., grounded), then R1 will have a value of 1000 Ohms.

A related circuit, shown in Fig. 4(b), allows us to turn the oscillator on and off with an external logic level. This is very handy in many digital circuit applications. We do this neat trick by replacing one of the gates with a NOR gate. One input is used in a manner similar to that of Fig. 4(a), but the other input is used to gate the oscillator on and off. A high applied to this terminal turns off the oscillator, while a low turns it on.

Fig. 5 shows a variation on the circuit which makes it a little more free of frequency changes due to variations in power-supply voltages. Not all CMOS devices are used in a well-regulated power-supply environment, so this circuit may be necessary.

A CMOS crystal oscillator is shown in Fig. 6. This circuit uses the common CD4001 device as the active element—but notice the feedback network. It is a pi-network consisting of a crystal (Y1) and two capacitors, C1 and C2. This is relatively standard practice in CMOS circuits and is

recommended by at least one major CMOS manufacturer as the circuit of choice. Feedback and slight frequency variations are possible using trimmer C2.

CMOS is a slow, or low-frequency, if you prefer, logic family. It will not operate at the frequencies that TTL will handle easily. But, on the other hand, it does operate nicely at under 100 kHz!

Dividers

We don't always have an oscillator operating on exactly the frequency that we need. Alternatively, we might need several frequencies which are harmonically related. An example is the crystal calibrator used by amateurs, CBers, and SWLs to spot the correct frequency on a communications receiver dial. To provide these, it is common practice to operate the oscillator at some higher frequency (e.g., 1 MHz in the example of the crystal calibrator) and then divide down. The TTL 7490 device is a nice example of a divide-by-10 IC. Its output frequency is 1/10 the input frequency. A cascade chain of 7490s will provide all of the needed output frequencies down to any point that you require.

If division ratios other than 10 are needed, then other ICs are available. In TTL, there are divide-by-8 and -16 devices that cost peanuts. There also are several examples in CMOS, including one binary counter (CD4024) and a really big divider (4020). If you really want to get slick, then try one of the higher-cost (and often harder to obtain) divide-by-N counters. These will divide by any ratio up to 256 or 1024. The exact division ratio is set by applying an N-bit binary word to the programming inputs. These are usually called programmable divide-by-N counters. ■

the indispensable

BIRD 43

THRULINE® WATTMETER
0.45-2300 MHz / 0.1-10,000 watts
The Standard of the Industry
What more need we say... ✓ 359

BIRD Electronic Corporation
30303 Aurora Road, Cleveland (Solon) Ohio 44139
Phone: 216-248-1200
EAST: Lanc. PA 717-569-0467 WEST: Ojai, CA 805-646-7255

MICROWAVE ANTENNAS & KITS

- MICROWAVE TRANSISTORS
- AZ-EL OPTION KITS
- MICROWAVE DIODES
- PARABOLIC REFLECTORS
- ALUMINUM FEED-HORNS



Your source of supplies for the fastest growing field of communications. Here is a low cost entry into the fascinating area of microwave technology. We offer a complete line of antennas, receivers, pre-amps, power supplies, etc..... Call or write for details.



DATA SERVICE COMPANY
3110 Evelyn Street ✓ 346
Roseville, MN 55113
612-636-9469

**this publication
is available in
microform**

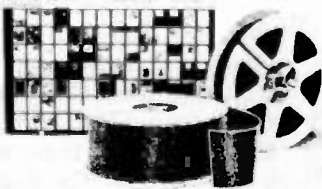

Please send me additional information.
University Microfilms International
300 North Zeeb Road Dept. P.R.
Ann Arbor, MI 48106 U.S.A.
18 Bedford Row Dept. P.R.
London, WC1R 4EJ England

**HAMS... with TRS-80* Computers
GET ON RADIOTELETYPE**



with **BIT-BYTER**

Complete system Includes BIT-BYTER interface AND the RTTY-80 computer program.

Great Features: split screen, level 1 and 2 4K computers, transmit buffer and countless others... all at this terrific price:

Only \$129.00

Order today... or for more information write to:

Vic Frump, KBEXJ
UHF SALES & SERVICE COMPANY
Rt. 1, Box 52A
Evans, West Virginia 25241 ✓ 361
(304) 372-2047

*TRADEMARK of The Tandy Corporation

Code reading Gets even better.



\$314.95

Introducing the versatile Kantronics Mini-Reader™

At last, you can have the code-reading functions for Morse, RTTY and ASCII combined in a miniature package price at just over \$300. The Kantronics **Mini-Reader** has all the functions of its larger counterpart, the **Field Day 2**, including code-speed display, automatic Morse speed tracking, demodulator output, a tuning eye, code-editing programs and a 24-hour clock.

But the **Mini-Reader** measures only 5.74" by 3.5" by 1" and runs on 12 volts! Its calculator size still leaves room for a 10-character, vacuum-tube fluorescent display.

Compare the features and price of the Mini-Reader to any similar device, and you'll find what a breakthrough in code-reading it is!

Both have full features!
See them at your Kantronics dealer.

- * Morse copying ability
- * 3 to 80 WPM Morse range
- * Computer programs for improving sloppy Morse
- * Radioteletype copying ability
- * 60, 67, 75 and 100 WPM Baudot
- * ASCII copying ability
- * 110 and 300 WPM baud (300 baud readable only at operator typing speed)
- * Copies any shift of RTTY or ASCII
- * 24-hour clock
- * Entire unit in single package

- * Automatic code-speed tracking
- * Morse-code speed display
- * Tuning eye
- * Full-year limited warranty
- * Demodulator output
- * Internal 200 Hz bandwidth filter
- * All letters, numbers and punctuation with special characters for Morse, RTTY and ASCII
- * 15-day trial period (if purchased from factory)
- * Self-test mode



Field Day 2[®]
\$449.95

115/230 volt AC
Internal speaker
Large, 14-segment
displays
10" by 9" by 3.5"

Kantronics (913) 842-7745
1202 E. 23rd Street
Lawrence, Kansas 66044

Build a Better Battery Tester

— test 'em under load

Everyone knows that batteries should be tested while loaded. Or does everyone know this? Many amateurs test batteries simply by grabbing a VOM and checking the voltage across the battery terminals.

Often one can get away with this procedure, and things will work fine if the batteries tested are fresh. There are many situations where this procedure will not work, however, and the few seconds saved by not testing a battery properly will end up costing hours trying to understand why some circuit does not operate properly.

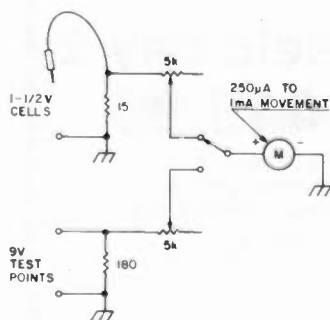

Fig. 1. Circuitry of the battery tester. It is designed for 9-volt batteries and AA/C/D-type cells only.

A good example of this happened when we were using a portable WWV receiver powered by a regular 9-volt transistor radio battery. The receiver exhibited low sensitivity. The battery was hastily checked (using the VOM method), and then a great deal of time was spent checking the rest of the circuit trying to find a fault. As it turned out, the battery was at fault. It would measure 9 volts using a VOM, but only around 5 volts when checked under a simulated load. A similar situation developed when a battery-powered electronic keyer started to perform erratically.

As the number of battery-powered pieces of equipment or accessory items grows in a shack, it pays, therefore, to get

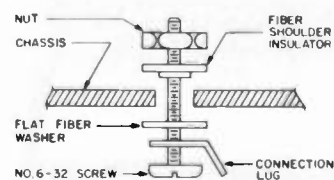

Fig. 2. Plain no. 6-32 hardware is used to form the necessary insulated test points.

away from the simple VOM method of checking batteries. This is true, of course, regardless of the type of battery being used — carbon/zinc, alkaline, nicad, or whatever.

There are many battery testers available, and some are not expensive. There is very little to the circuitry of any battery tester for small cells, however, and one usually can build a tester from parts on hand. This battery tester was made up just to test 9-volt batteries and AA/C/D-type cells. The heart of the tester is an old-fashioned 0-1 milliamperere meter rescued from a junk box.

Many other forms of surplus meters may be used, including some of the inexpensive tuning-types selling for a dollar or two. About the only requirement is that the meter have some combination of current deflection requirement and coil resistance so that it will indicate low voltages. This is easily met by many inexpensive meters which have current requirements below 1 milliamperere and coil resistances of a few hundred

Ohms, so that even a fraction of a volt will cause full-scale deflection.

The circuit of the tester is shown in Fig. 1. The 15-Ohm resistor provides about a 100-milliamperere load to a 1.5-volt type battery, and the 180-Ohm resistor provides about a 50-milliamperere load to a 9-volt battery. The two 5k variable resistors are used to set the full-scale deflection on the meter, using a known voltage source. For testing 1.5-volt batteries, the full-scale deflection is set for 2 volts, and for testing 9-volt batteries, the full-scale deflection is set for 10 volts. These were just convenient full-scale deflection values considering the scale on the 0-1 milliamperere meter used. One could just as well set the deflection using batteries known to be good and let it go at that.

The test points for the battery are not complicated. They are made by simply using no. 6 hardware. The 3/4"-long screws are filed to have a pointed end, and then they are mounted on the chassis using suitable fiber washers to provide insulation. The details

are shown in Fig. 2. The test points for 9-volt batteries are spaced $\frac{1}{2}$ " apart. There is only one test point for 1½-volt batteries, with connection to the positive terminal of the battery being made with a test lead. This arrangement has proven to be very handy in testing batteries, as opposed to using battery holders.

One could, of course, build a more elaborate battery tester by expansion of

the idea shown. One also might wish to make provisions for testing each type of battery under different types of load conditions which approach the load placed on a battery in actual service. Obviously, some batteries which are approaching the end of their lives if fully loaded can still be useful for an extended time if only lightly loaded.

There is a problem, how-

ever, in approaching a more sophisticated method of checking batteries: obtaining accurate data on a battery's rated capacity. Nicads in the AA size usually have a 10-hour discharge rate of 45/50 mA. The discharge rate is 190 mA for C cells, and 400 mA for D cells. For these types of batteries, or for other types where some data is known, one can tailor the test load used to corre-

spond to the performance the battery should deliver.

For the garden-variety forms and brands of batteries, however, the loading used in the battery tester as presented has worked very well.

A final note: When testing batteries, hold the battery on the tester for a few seconds. The true state of some batteries will not be revealed if they are loaded for only an instant. ■

H. H. Beebe W9RY
20035 Burr Oak Lane
Mokena IL 60448

Getting the SB-220 to Idle

— a final-saving mod for Heath's popular linear

Several articles have been written concerning modifications to the Heath SB-220 linear amplifier which will prevent current surges in the filament of the 3-500Z tubes. The surges can lead to grid/filament shorts and ultimate tube destruction.

This modification, while not eliminating the current surges, does much to cut down on the number of times that the amplifier is turned on and off and ultimately lessens the chance of tube destruction.

In checking over the specifications for the new Drake L7 linear amplifier, I noticed that a new feature had been incorporated that would allow you to have the L7 on, but in a standby condition. A quick check of the SB-220 diagram

showed that relay RL-1 is made operative by bringing terminal #10 to ground via the RCA connector on the rear apron of the amplifier. My Drake T-4XC, as well as any modern transmitter or transceiver, has a terminal provided which will ground the relay and make the amplifier operative.

The trick, then, is to open the line from the transmitter to the linear and put in a switch so that you can control what the SB-220 will do. Where to put the switch seemed to be the big question. A good "no-holes" location turned out to be at the sensitivity control on the front panel. The original control is replaced with one with a switch. A push-pull switch would be ideal since you would not disturb the set-

ting of the sensitivity when using the switch. Not being able to locate a push-pull at the local parts supply house (an ongoing problem), a regular switch was used.

The old control, R26, is removed from the front panel and the replacement is installed in its place. The wires are then connected as in the original installation. The blue wire coming from the RCA connector on the rear apron, marked "relay" and leading to terminal #10 of the relay, is removed. A new wire is run from the RCA connector to one of the terminals of the switch on the front panel. A second wire is run from the other terminal of the switch to terminal #10 of the relay. That's it!

To operate the SB-220, turn on the ac power

switch and then the switch on the sensitivity control. Your amplifier will then run just as it did before. When you key the transmitter, the linear comes on-line and the relative-power meter functions. If you want to place the SB-220 in the bypass condition, just turn off the switch on the sensitivity control. The filament and the high voltage are still on, but the relay is inoperative.

The filament current surges have not been eliminated, but you have cut down on the number of times that the amplifier is turned on and off. The chances of tube failure have been reduced by a good factor and you have an operating convenience found on one of the latest linear amplifiers on the market. ■

Weller Industrial & Service Equipment, Soldering Equipment, Accessories, & Other Tools for the Professional or Hobbyist



Model D550 Heavy-Duty Gun (260/200 Watts) \$24.65

Highest output gun with 2-position trigger selection of dual heats. Heavy gauge, high efficiency, pre-tinned copper tip comes up to temperature in 6 seconds. Balanced pistol-grip design with twin lights to illuminate work. Complete with Soldering Hints booklet 120V, 60Hz, 2-wire cord UL-listed. Boxed.



Model 8200W All-Purpose Gun (140/100 Watts) \$18.13

Fingertip, trigger selection of high or low output from this instant-heat gun that's ready to solder in 6 seconds. High efficiency tip of pre-tinned pure copper. Light illuminates work. Compact, balanced pistol-grip design. Soldering Hints booklet included. 120V, 60Hz, 2-wire cord UL-listed.



Model 250K Electronic Tool Kit \$35.58

Ideal 12-piece kit for the budding technician or for general use in countless electronic jobs. UL-listed. Housed in a compact, convenient plastic carrying case-storage tray and contains the following professional quality Weller and Xcelite tools:

- WP25 Soldering Iron with 1/16" screwdriver tip, 750°F
- ST2 Extra tip, 3/32" screwdriver
- Rosin-Core Solder
- #8 Nutdriver
- #R184 1/4" Blade driver for slotted screws
- #X101 No. 1 Phillips-type Screwdriver
- #41CG 4" Short Chain-Nose Pliers with cushion-grip
- #54CG 4" Diagonal Cutting Pliers with cushion-grip
- #100 Wire Stripper/Cutter with cushion-grip

Replacement and extra soldering tips Same as for Model WP25 Iron.



Model WTCPN, Controlled-Output Soldering Station \$70.80

Exclusive Weller closed loop, low-voltage circuit automatically controls output and temperature in three ranges: 600°F, 700°F and 800°F. Temperature selected simply by changing the grounded heat-sensing tip with knurled thumbscrew. Safe for IC soldering. Comfortable, lightweight pencil iron has heat shield, non-burnable silicone rubber cord and locking design for easy interchangeability. Power unit, with contemporary, impact-resistant case, has unswitched on/off toggle switch and neon indicator light. Non-heat-sinking iron holder, storage tray for extra tips, and tip-cleaning sponge with receptacle. 3-wire 6 ft. long cord, 120V, 60 Hz, 60W. Furnished with 1/16" screwdriver tip, 700°F. PTA7 UL-Listed.

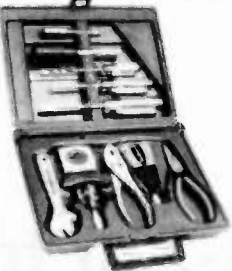

TKX-11 Multi-Purpose Tool Kit \$36.70

The versatile kit contains 11 quality tools, perfect for all types of routine repair and simple do-it-yourself projects. Everything comes neatly packaged in an attractive, easy to store case.

Tool Kit includes:

- R144 1/4" x 4" Round Blade Screwdriver
- R184 1/4" x 4" Round Blade Screwdriver
- X101 #1 Phillips x 3" Screwdriver
- 8 1/4" Hex Nutdriver
- P125 #0 Phillips x 2" Screwdriver
- 51CG 6" Long Nose Plier w Side Cutter
- 46CG 6" Adjustable Wrench
- S-141 1/4" x 1 1/4" Stubby Square Blade Screwdriver
- 100-X Wire Stripper & Cut. Adj. Screw Stop
- TM120 1/2" x 10" Metric English Tape Rule
- 76C 6" Combination Plier, Chrome Plated

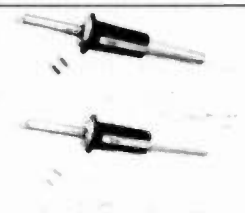

Models WP25 and WP40 Professional Soldering Irons

Top quality, industrial grade tools develop 750°F temperature. Rugged stainless steel barrel construction. Long life double coated tips. High efficiency. Popular pencil styling. Light blue handle with black heat shield. Only 7 1/2" long; 1 1/4 oz. 120V, 50-60 Hz. 4 Ft. Cord. UL-listed.

Model	Description	Tip	
WP25	25W	ST1 1/16" screwdriver	\$13.35
WP25-3	25W	3-Wire Cord	
WP40	40W	ST3 3/16" screwdriver	\$16.40
WP40-3	40W	3-Wire Cord	

Replacement and extra soldering tips

Top quality iron plated tips with anti-wetting chrome coating. All tips are pre-tinned.

Cat. No.	Tip Size	Description
ST1	1/16"	Screwdriver
ST2	3/32"	Screwdriver
ST3	1/8"	Screwdriver
ST4	3/16"	Screwdriver
ST5	1/32"	Single Flat
ST6	1/32"	Screwdriver
ST7	1/32"	Conical
ST8	1/16"	Narrow Screwdriver

Xcelite Versatile Series 99

Series 99 Service Kits and Sets Series 99 service kits and sets are made up primarily of various screwdriver, nutdriver, and other blades which can be used interchangeably in Series 99 handles. This saves space offers utmost economy.

All blades are high carbon steel with highly polished nickel chrome finish except Bristol and Allen Hex types which are precision-formed of alloy steel. Hex head sockets are precision-formed, cold drawn, case hardened steel. Plastic handles have a unique spring device that holds blades firmly, yet permits quick, easy insertion and removal. All handles accommodate all blades.



99SMW Service Kit \$84.24

Plastic-coated cover holds 26-piece set of handles and interchangeable screwdriver, nutdriver and other blades, plus wire stripper and cutter and Weller's soldering iron.

- Contents:
- WP25 — Soldering Iron
 - ST3 — Tip
 - 100-X — Wire Stripper and cutter
 - 52CG — 6" Long Nose Cushion Grip Plier
 - 55CG — 5" Diagonal Cushion Grip Plier

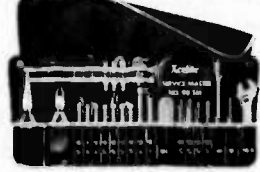

99SM Service Kit \$64.71

This versatile 23-piece set of quality tools in a durable, roll-up plastic-coated canvas case weighs only 2 1/2 pounds. Provides a variety of quick-change tools and tool combinations to speed up assembly and service work. Set includes:

- 52CG — 6" Long Nose Cushion Grip Plier
- 55CG — 5" Diagonal Cushion Grip Plier
- 46CG — 6" Thin-pattern Cushion Grip Adjustable Wrench
- 99-1 — Regular Handle
- 99-3 — Stubby Handle
- 99-6 thru 99-16 — Regular Nutdrivers (9)
- 99-58, 99-510, 99-512 — Stubby Nutdrivers
- 99-821, 822 — Phillips Screwdrivers
- 99-811, 99-250 — Slotted Screwdrivers
- 99-38 — Reamer
- 99-X10 — Extension Blade
- 99SMK — Canvas Case



46CG — 6" Thin-pattern Cushion Grip Adjustable Wrench

- 99-1 — Regular Handle
- 99-3 — Stubby Handle
- 99-6 thru 99-16 — Regular Nutdrivers (9)
- 99-821, 99-822 — Phillips Screwdrivers
- 99-58, 99-510, 99-512 — Stubby Nutdrivers
- 99-811, 99-250 — Slotted Screwdrivers
- 99-38 — Reamer
- 99-X10 — Extension Blade
- 99SMK — Canvas Case



Model D550PK Kit \$28.68

8-piece heavy-duty soldering kit featuring the versatile Weller Model D550 soldering gun with pre-tinned heavy copper tip. Kit also includes 2 spare un-tinned tips, tip-changing wrench, flux brush, soldering aid tool, coil of 60/40 rosin-core solder, and sturdy plastic carrying case, plus "Soldering Hints" booklet UL-listed.

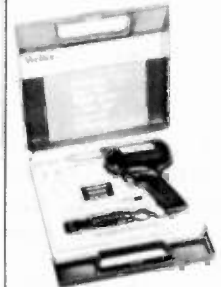

Model 8200 PK Kit \$21.15

8-piece kit includes Weller Model 8200 dual-heat soldering gun with pre-tinned copper tip, 2 extra un-tinned copper tips, tip-changing wrench, flux brush, soldering aid tool, coil of 60/40 rosin-core solder, and sturdy plastic carrying case, plus "Soldering Hints" booklet UL-listed.



MP Series Miniature Controlled-Output Soldering Stations \$47.22

Especially designed for printed circuit electronic work. The famous Weller closed-loop temperature control circuit and grounded tip protect sensitive components from heat damage. Tip temperature of 550°F or 750°F is selected by changing the plug-in iron, which operates on low voltage and has non-burnable silicone rubber cord for added safety and longer life. High impact-resistant housing has non-heat-sinking iron holder plus tip-cleaning sponge and receptacle. Variety of tips available for special applications. 3-wire cord, 120V, 60-400Hz, 22W. Furnished with 020° conical tip. MP131 UL-listed. Power Cord 6 Ft., Iron Cord 4 Ft.







Model 230K Hobby Kit \$14.58

Complete kit for hobbyists contains SP23 Soldering Iron in carrying case and tool tray, with 6 tips, cone soldering, screwdriver, chisel, smoothing, hot knife, and cone burning. Work sponge. Hot iron rest. Soldering aid tool. Rosin core solder. Instruction Booklet UL-listed. Carton weight 8 1/2 lbs. Carton quantity 6.

Tools, Parts, Accessories

Diagonal Pliers

-  **\$6.60**
Midget 4" size for close quarter work
-  **\$7.13**
5" Plier for most cutting needs
-  **\$8.87**
4" long for fast, clean, easy tip cutting of fine wires in close quarters
-  **\$7.48**
6" all-purpose diagonal plier
-  **\$7.33**
7" diagonal pliers for heavy duty cutting

Needle-Nose Pliers

-  **\$8.37**
6" size Long slim serrated jaws permit entry inaccessible to regular long nose plier
 -  **\$8.27**
5 1/2" size with fine serrated jaws and coil spring for firm gripping and looping of wire
- ### Long-Nose Pliers
-  **\$6.85**
Midget 4" pliers, serrated jaws, without side cutters
 -  **\$7.92**
6" long-nose pliers with side cutters
 -  **\$6.37**
6" long-nose pliers without side cutters

Xcelite® XST-5 — Super-Tru Tip (Phillips type) Screwdriver Set

Contains 5 pieces — all Phillips.

-  **\$13.97**
-  **\$14.76**
Contains 5 Square Blade Screwdrivers for sized screws. Catalog Nos S-141 S-3164 S-144 S-5166 S-388

Adjustable Wrenches

- Xcelite's exclusive thin-pattern design permits access where regular adjustables will not fit. Rugged construction, chrome-plated, polished heads, with quick one-hand adjustment and Cushion-Grip (CG)
- *44CG — 4" length 1/2" opening **\$6.38**
 - *46CG — 6" length 3/4" opening **\$6.45**
 - *48CG — 8" length 1" opening **\$7.28**

Wire Strippers & Cutters

- With Cushion Grip Handles
- *100-X **\$2.63**
Has adjustable screw stop for different wire sizes, and cushion grips. Cuts and strips both solid and stranded wire cleanly, neatly, hardened with ground blades.
 - *101-S **\$3.32**
Specifications same as 100, except with spring equipped self-opening handles.
 - *103-S **\$4.12**
Has unique cam stop adjustment for different wire sizes. Cam adjustment stays put, won't move even with screw loose. Fine for industrial use.
 -  **\$10.08**
Cutter, stripper and crimper for all types and sizes of wire, with a wide-size-range bolt cutter. Features scissor action-up front wire cutting and wire stripping, bolt cutters, cushion grips, plier nose, hardened pivot joint bushing and crimp stations.

Quality Coaxial Cable for All Applications

- LOW LOSS CABLE • NON TARNISHING CONNECTORS
- FACTORY ASSEMBLED, TESTED FOR 100% RELIABILITY

RG58/U Type

PART NUMBER	DESCRIPTION	APPLICATIONS
581-58018 *	18" length with UHF CB plugs on both ends	Used as patch cords for mobile & base station SWR & power meters, antenna switches, and SWR matchers.
\$3.20		
581-583 *	3' length with UHF CB plugs on both ends	Used to connect mobile CB sets to trunk, mirror, gutter or bumper mount antennas using spade lug terminations to the antenna.
\$3.70		
581-585i *	5' length with UHF CB plug & spade lugs	Used to connect mobile CB sets to trunk, mirror, gutter or bumper mount antennas requiring a UHF CB plug termination to the antenna.
\$4.10		
581-5812L *	12' length with UHF CB plug & spade lugs	Used to connect mobile CB sets with base antennas. Where loss is critical, these cables will out perform RG 58/U cables of the same length.
\$4.10		
581-5820L *	20' length with UHF CB plug & spade lugs	Used to connect base station CB sets with base antennas. Where loss is critical, these cables will out perform RG 58/U cables of the same length.
\$4.99		
581-5812 *	12' length with UHF CB plugs on both ends	Used where smaller diameter cable is required, and signal loss is not critical.
\$4.99		
581-5820-259 *	20' length with UHF CB plugs on both ends	Used where smaller diameter cable is required, and signal loss is not critical.
\$5.49		
581-5850-420 *	50' length with UHF CB plugs on both ends	Used where smaller diameter cable is required, and signal loss is not critical.
\$7.25		
581-5875-420 *	75' length with UHF CB plugs on both ends	Used where smaller diameter cable is required, and signal loss is not critical.
\$9.29		
581-58100-420 *	100' length with UHF CB plugs on both ends	Used where smaller diameter cable is required, and signal loss is not critical.
\$10.99		

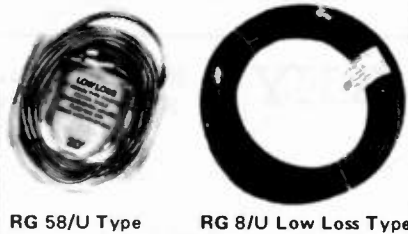



RG 58/U Type RG 8/U Low Loss Type

RG8/U Low Loss Type

PART NUMBER	DESCRIPTION	APPLICATIONS
581-83 *	3' lengths with UHF CB plugs on both ends	Used as patch cords for mobile and base station SWR and power meters, antenna switches, & SWR matchers.
\$4.10		
581-820	20' length with UHF CB plugs on both ends	Used to connect mobile or base stations with antennas requiring a UHF CB plug termination at the antenna.
\$8.50		
581-850-420 *	50' length with UHF CB plugs on both ends	Used to connect base station CB sets with base antennas. Where loss is critical, these cables will out perform RG 58/U cables of the same length.
\$14.99		
581-875-420 *	75' length with UHF CB plugs on both ends	Used to connect base station CB sets with base antennas. Where loss is critical, these cables will out perform RG 58/U cables of the same length.
\$22.50		
581-8100-420 *	100' length with UHF CB plugs on both ends	Used to connect base station CB sets with base antennas. Where loss is critical, these cables will out perform RG 58/U cables of the same length.
\$26.50		

LAB QUALITY CABLES

- BNC Test Voltage**
1500 vac; Frequency: 0-4 GHZ; Impedance: 50 Ohms nominal; Cable Retention Force: 60 lbs. minimum (RG-58C/U)
- UHF Test Voltage**
1500 vac; Frequency: 0-500 MHz; Impedance: Non Constant; Cable Retention Force: 60 lbs. minimum (RG-58C/U)

-  **50 ohm UHF Plug to UHF Plug**
 -  **50 ohm BNC Plug to UHF Plug**
 -  **50 ohm BNC Plug to BNC Plug**
- | | | | | | |
|---------|---------|---------|---------|---------|---------|
| No. 651 | 3 feet | \$ 6.52 | No. 651 | 3 feet | \$ 6.52 |
| No. 652 | 5 feet | \$ 7.05 | No. 652 | 5 feet | \$ 7.05 |
| No. 653 | 10 feet | \$ 8.34 | No. 653 | 10 feet | \$ 8.34 |
| No. 657 | 1 foot | \$ 7.20 | No. 657 | 1 foot | \$ 7.20 |
| No. 658 | 3 feet | \$ 7.72 | No. 658 | 3 feet | \$ 7.72 |
| No. 656 | 5 feet | \$ 8.24 | No. 656 | 5 feet | \$ 8.24 |
| No. 668 | 3 feet | \$ 8.91 | No. 668 | 3 feet | \$ 8.91 |
| No. 662 | 5 feet | \$ 9.43 | No. 662 | 5 feet | \$ 9.43 |
| No. 666 | 10 feet | \$10.73 | No. 666 | 10 feet | \$10.73 |

TUFTS Electronic Department Store TUFTS

TUFTS Electronic Department Store TUFTS

FINCO STINGER VHF/UHF Antennas



10 meter

STINGER A 10A DESCRIPTION
The model Stinger A 10A is a wide spaced, full size high gain four element 10 meter monobander designed for optimum DX performance. Utilizing the exclusive Stinger Square boom construction, the A 10A is light enough to be easily stacked for an additional 3 dB gain yet strong enough to withstand the most adverse weather conditions. The highly efficient gamma match system easily withstands 2,000 watts P.E.P. of power and maintains a relatively low V.S.W.R. across the entire 10 meter amateur band.

SPECIFICATIONS - A 10A

ELECTRICAL -	MECHANICAL -	
Forward Gain..... 10dB	Boom Length..... 16 ft.	
Front to Back Ratio..... 25dB	Longest Element..... 18 7/8 ft.	
V.S.W.R. (at resonance)..... 1.1:1	Turning Radius..... 7 1/2 ft.	
Half Power Beam Width..... 35°	Maximum Surface Area..... 4 1/2 sq. ft.	
Bandwidth..... 28 to 30 MHz	Wind Load at 80 MPH..... 110 lbs.	
Impedance..... 50 Ohms	Weight..... 12.5 lbs.	
Matching System..... Adjustable Gamma		

\$62.95



6 meter

STINGER A 6 DESCRIPTION
The model Stinger A 6 is a highly directional 6 meter five element beam specifically designed for maximum forward gain with a top cornering front to back ratio. The elements are constructed of high tensile strength aluminum at minimum tubing plus the exclusive Stinger square boom and bracket assemblies. For maximum power transfer and low V.S.W.R., a carefully designed gamma matching assembly capable of sustaining 2,000 watts P.E.P. is incorporated. Wide element spacing assures optimum DX performance and good operating efficiency across the entire 50 to 54 MHz 6 meter band. The square boom allows optional vertical mounting for increasing 6 meter repeaters.

SPECIFICATIONS - A 6

ELECTRICAL -	MECHANICAL -	
Forward Gain..... 11dB	Boom Length..... 13 ft.	
Front to Back Ratio..... 25dB	Longest Element..... 10 ft.	
V.S.W.R. (at resonance)..... 1.1:1	Turning Radius..... 8 3/4 ft.	
Half Power Beam Width..... 35°	Maximum Surface Area..... 3.23 sq. ft.	
Bandwidth..... 50 to 54 MHz	Wind Load at 80 MPH..... 40.2 lbs.	
Impedance..... 50 Ohms	Weight..... 11.5 lbs.	
Matching System..... Adjustable Gamma		

\$46.50

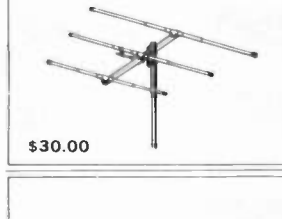

6 and 2 meter

STINGER A 6.3 DESCRIPTION
The model Stinger A 6.3 is a 3 element high gain 6 meter beam antenna. A 6.3 is especially designed for the 6 meter band and is the only antenna that finds excellent application for portable use as it is designed to be easily disassembled. Due to the unit's light weight and rugged construction, it is ideal for double stacked and quad stacked arrays. The A 6.3 is rated at 2,000 watts P.E.P. and incorporates high tensile strength aluminum elements.

SPECIFICATIONS - A 6.3

ELECTRICAL -	MECHANICAL -	
Forward Gain..... 10dB	Boom Length..... 6.0 ft.	
Front to Back Ratio..... 25dB	Longest Element..... 10 ft.	
V.S.W.R. (at resonance)..... 1.1:1	Turning Radius..... 5 1/2 ft.	
Half Power Beam Width..... 40°	Maximum Surface Area..... 1.75 sq. ft.	
Bandwidth..... 50 to 54 MHz	Wind Load at 80 MPH..... 17.6 lbs.	
Impedance..... 50 Ohms	Weight..... 7 lbs.	
Matching System..... Adjustable Gamma		

\$30.00



6 and 2 meter

STINGER A 82 DESCRIPTION
The model Stinger A 82 is a truly remarkable combination 6 and 2 meter beam designed for optimum performance on both bands yet only requiring ONE transmission line. This is accomplished through the use of exclusive phasing elements to accomplish dual band operation with no switches to either band - NO SWITCHING REQUIRED!

On 2 meters, the A 82 has 8 collinear elements - equivalent to three 1/2 λ 6 element yagi stacked side by side - thus giving outstanding performance. Maximum forward gain is assured on 6 meters through the use of four wide spaced elements. The heavy duty Stinger construction is used throughout so that the antenna will withstand 100 mph plus wind loads.

The A 82 is ideal for mounting on the same mast as your tri-band or other antennas thus easily opening up the world of 6 and 2 meter communications.

SPECIFICATIONS - A 82

ELECTRICAL -	MECHANICAL -	
Forward Gain..... 6 meters 9.5dB	Boom Length..... 10 1/2 ft.	
Front to Back Ratio..... 6 meters 12.0dB	Longest Element..... 10 ft.	
V.S.W.R. (6 & 2 meters)..... 1.1:1	Turning Radius..... 6 7/8 ft.	
Half Power Beam Width..... 40° to 55°	Maximum Surface Area..... 4.48 sq. ft.	
Bandwidth..... 6 meters 50 to 54 MHz	Wind Load at 80 MPH..... 43 lbs.	
Impedance..... 50 Ohms	Weight..... 13.8 lbs.	
Matching System..... Adjustable Gamma		

\$74.95

2 meter

STINGER A 2.10 DESCRIPTION
The model Stinger A 2.10 is a high performance wide spaced ten element 2 meter yagi designed for the serious VHF operator. Utilizing the Stinger construction features, the A 2.10 is almost indisputable no matter what weather conditions are encountered. Complete coverage of the 2 meter band and low V.S.W.R. is assured through the use of non-linear spaced elements thus also achieving maximum forward gain. Power rating - 2,000 watts P.E.P.

The A 2.10 can be mounted for vertical polarization, there by making the antenna quite useful in repeater operation, or mounted for horizontal polarization for station to station VHF DX work. Additional bays of the A 2.10 can be easily stacked for even greater gain and front to back ratio.

SPECIFICATIONS - A 2.10

ELECTRICAL -	MECHANICAL -	
Forward Gain..... 13.8dB	Boom Length..... 10 ft.	
Front to Back Ratio..... 25dB	Longest Element..... 42 in.	
V.S.W.R. (at resonance)..... 1.1:1	Turning Radius..... 7 1/2 ft.	
Half Power Beam Width..... 40°	Maximum Surface Area..... 2.36 sq. ft.	
Bandwidth..... 144 to 148 MHz	Wind Load at 80 MPH..... 26 lbs.	
Impedance..... 50 Ohms	Weight..... 9 lbs.	
Matching System..... Adjustable Gamma		

\$44.95



2 meter

STINGER A 2.8 DESCRIPTION
The model Stinger A 2.8 is a two element high gain antenna similar to the A 2.10 but having physically less of a gain. The A 2.8 finds excellent application in a portable antenna as it disassembles into a very compact package. Like the A 2.10, the antenna can be mounted for vertical or horizontal polarization for repeater or general coverage work. Constructed of the Stinger heavy duty materials, the A 2.8 is ideal for locations encountering adverse weather conditions. Power rating - 2,000 watts P.E.P.

SPECIFICATIONS - A 2.8

ELECTRICAL -	MECHANICAL -	
Forward Gain..... 9.5dB	Boom Length..... 5.5 ft.	
Front to Back Ratio..... 22dB	Longest Element..... 41 in.	
V.S.W.R. (at resonance)..... 1.1:1	Turning Radius..... 42 in.	
Half Power Beam Width..... 40°	Maximum Surface Area..... 1.23 sq. ft.	
Bandwidth..... 144 to 148 MHz	Wind Load at 80 MPH..... 13.3 lbs.	
Impedance..... 50 Ohms	Weight..... 6.8 lbs.	
Matching System..... Adjustable Gamma		

\$27.95



2 meter

STINGER A 2.7 DESCRIPTION
The model Stinger A 2.7 is a dual polarization 2 meter antenna designed for maximum forward gain and low V.S.W.R. The A 2.7 can be phased to operate on either horizontal or vertical polarization at the same time. This is not only possible, but it gives your station a dual polarization for ground communication.

The wide element spacing gives the A 2.7 superior gain, however, since it is a two element beam in one given plane the half power beam width does not make sensitive tracking difficult. Both of these features, the dual gamma match assemblies provide for a very low V.S.W.R. and will withstand 2,000 watts P.E.P.

The Stinger construction features make the A 2.7 extremely heavy duty. Provisions are made for mounting the antenna at the end of the boom - for applications central - or at the middle of the boom for normal applications.

SPECIFICATIONS - A 2.7

ELECTRICAL -	MECHANICAL -	
Forward Gain..... 9.5dB	Boom Length..... 6.1 ft.	
Front to Back Ratio..... 22dB	Longest Element..... 41 in.	
V.S.W.R. (at resonance)..... 1.1:1	Turning Radius..... 3.4 ft.	
Half Power Beam Width..... 40°	Maximum Surface Area..... 1.83 sq. ft.	
Bandwidth..... 144 to 148 MHz	Wind Load at 80 MPH..... 13.4 lbs.	
Impedance..... 50 Ohms	Weight..... 11 lbs.	
Matching System..... Adjustable Gamma		

\$46.50



1 1/4 meter

STINGER A 1.14 - DESCRIPTION
The model Stinger A 1.14 is a ten element 1 1/4 meter (1270 MHz) high performance yagi designed for all 1270 MHz communication needs. Designed to be mounted in either the vertical or horizontal plane, the A 1.14 is adaptable for OSCAR, repeater, or general coverage work. Incorporating the Stinger heavy duty elements, boom and boom to mast assemblies, the antenna easily withstands 120 mph wind loads under 114° ice conditions. A low loss gamma matching system assures a low V.S.W.R. and is power rated at 1,000 watts.

SPECIFICATIONS - A 1.14

ELECTRICAL -	MECHANICAL -	
Forward Gain..... 13.8dB	Boom Length..... 8 ft.	
Front to Back Ratio..... 25dB	Longest Element..... 28 in.	
V.S.W.R. (at resonance)..... 1.1:1	Turning Radius..... 1.3 ft.	
Half Power Beam Width..... 40°	Maximum Surface Area..... 1.32 sq. ft.	
Bandwidth..... 1270 to 1276 MHz	Wind Load at 80 MPH..... 17.0 lbs.	
Impedance..... 50 Ohms	Weight..... 6 lbs.	
Matching System..... Adjustable Gamma		

\$32.95



slinky

\$39.95

SLINKY! \$43.95 Kit A LOT of antenna in a LITTLE space New Slinky® dipole with helical loading radfates a good signal at 1/10 wavelength long!

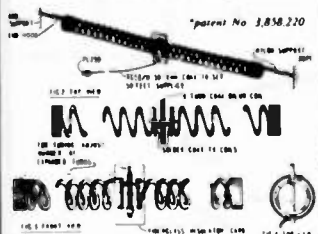

This electrically small 80/75, 40 & 20 meter antenna operates at any length from 24 to 70 ft. • no extra balun or transmatch needed • portable - erects & stores in minutes • small enough to fit in attic or apt. • full legal power • low SWR over complete 80/75, 40 & 20 meter bands • much lower atmospheric noise pick-up than a vertical & needs no radials • kit incl. a pr. of specially-made 4" dia. by 4' long coils, containing 335 ft. of radiating conductor, balun, 50 ft. RG58/U coax, PL259 connector, nylon rope & manual.

HAM-KEY

1 M

Model HK-3M

Model HK-1

Model HK-4

Model HK-5A Electronic Keyer

\$19.95

\$44.95

\$29.95

\$69.95

• Combination HE-1 & HK-3 on same base
• Straight key may be used conventionally or as a switch to trigger a memory
• CC-13P shielded cable with price for HK-4 \$5.95

• Dual level operate paddle
• For use with all electronic keyers
• Heavy base with non-slip rubber feet
• Paddle reversible for wide or close finger spacing

• Uses Curtis BD44 beyer chip
• Grid block or diode keying
• Speed, volume, tone & energy controls on front panel
• Built-in sidetone
• Battery operated with provisions for external power

RADIO TELEGRAPH SENDING DEVICES

Model HK-2

Model HK-3

Model HK-4

Model HK-5A

Model HK-6

Model HK-7

Model HK-8

Model HK-9

Model HK-10

Model HK-11

Model HK-12

Model HK-13

Model HK-14

Model HK-15

Model HK-16

Model HK-17

Model HK-18

Model HK-19

Model HK-20

Model HK-21

Model HK-22

Model HK-23

Model HK-24

Model HK-25

Model HK-26

Model HK-27

Model HK-28

Model HK-29

Model HK-30

Model HK-31

Model HK-32

Model HK-33

Model HK-34

Model HK-35

Model HK-36

Model HK-37

Model HK-38

Model HK-39

Model HK-40

Model HK-41

Model HK-42

Model HK-43

Model HK-44

Model HK-45

Model HK-46

Model HK-47

Model HK-48

Model HK-49

Model HK-50

Model HK-51

Model HK-52

Model HK-53

Model HK-54

Model HK-55

Model HK-56

Model HK-57

Model HK-58

Model HK-59

Model HK-60

Model HK-61

Model HK-62

Model HK-63

Model HK-64

Model HK-65

Model HK-66

Model HK-67

Model HK-68

Model HK-69

Model HK-70

Model HK-71

Model HK-72

Model HK-73

Model HK-74

Model HK-75

Model HK-76

Model HK-77

Model HK-78

Model HK-79

Model HK-80

Model HK-81

Model HK-82

Model HK-83

Model HK-84

Model HK-85

Model HK-86

Model HK-87

Model HK-88

Model HK-89

Model HK-90

Model HK-91

Model HK-92

Model HK-93

Model HK-94

Model HK-95

Model HK-96

Model HK-97

Model HK-98

Model HK-99

Model HK-100

DATONG

MODEL FL1

\$219.95

Frequency - Agile Audio Filter
The Datong Frequency-Agile Audio Filter is intended primarily for post-detector signal filtering in RF and LF communications receivers for SSB and CW. It offers an unusually versatile combination of benefits to the user including:

- Fast automatic suppression of interfering heterodyne whistles in the range 280-3000 Hz by a unique search-lock-and-track notch filter. The tracking notch can be left in circuit with no audible effect until a whistle appears in which case the whistle will 'disappear' within typically one second
- A continuously adjustable audio 'window' or a variable-width notch to improve reception in the presence of other off-tune SSB, RTTY or SSTV signals.

For the CW operator:

- Continuously variable center-frequency (280-3000 Hz) and bandwidth (25-1000 Hz) for perfect matching of receiver passband to changing band conditions, sending speeds, and personal preference.
- Flat-topped, steep-skirted response shape for optimum ease of tuning combined with excellent noise rejection.
- Linear tuning law with bandwidth independent of frequency and gain independent of bandwidth for natural 'feel'.



OSCAR

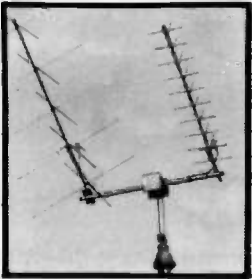

OSCAR Satellite Communications

Cushcraft offers complete antenna systems for OSCAR satellite communications on 2m and 70 cm. On 145 MHz the 10-element twist antenna (5 vertical elements, 8 horizontal yags) up to 10.8 dbd gain; the 20 element 4.35 MHz twist (10 vertical elements plus 10 horizontal) provides up to 13.6 dbd gain. For greater performance on 2m, choose the 20 element 145 MHz twist which offers 13.8 dbd gain. The half-power beamwidth of these antennas has been optimized for reliable satellite communications with minimum tracking requirements. All twist antennas come complete with coaxial matching harness for selectable horizontal, vertical, or circular polarization. Match 50 ohm feedlines.

ATV-5

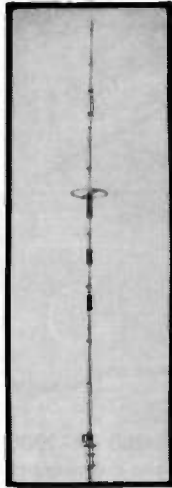

This tripod vertical antenna system has been engineered for five band operation on 80m-10m. The high Q traps are carefully optimized for wide operating bandwidths: 2:1 SWR bandwidth with 50 ohm feedline is approximately 1 MHz on 10m; more than 500 kHz on 15m and 20m; 160 kHz on 40m; and 75 kHz on 80m. Instructions are provided for adjusting resonance to your preferred part of the band. CW or SSB Built-in coaxial connector takes PL-259. Nominal height, 283 inches. Rated at 7000 watts PEP on all bands.

Two Meter Boomers

Whether you have the space for the 323 32-19 or the compact 223 2m Boomer are your best choice. They offer the maximum gain available for their boom length (See NBS no. 688). They feature 8 gain reflectors for additional front to back ratio and cleaner patterns. All antennas steel hard ware and heavy gauge heat treated aluminum are used throughout. Whatever your choice of 2m activity, the boomer will fill your needs. For Flat use the 228FB or 214FB. For CW/SSB on the low end use 32-19 or 214B, or EMF, DX or just reliable QSO. Boomer will perform for you.

Six Meter Boomers

The new 6m Yag offers more boom, more gain and fewer elements. Designed for the low end of the band, the 6m Boomer has Cushcraft's typical attention to detail; the Boomer's balanced feed with built-in and extra heavy duty mechanical construction. The secret behind its super performance and light weight is special element spacing and boom lengths.

Model	32-19	214B	214FB	228FB	617-6B
Frequency range (MHz)	144-146	146-148	146-148	146-148	50-50
Forward gain (dbd)	18.2	15.2	15.2	18.2	14
Front to back ratio (db)	24	26	24	24	30
E-plane Beamwidth (deg)	2x14	2x17	2x17	2x17	2x19
H-plane Beamwidth (deg)	2x17	2x18	2x18	2x9	N/A
Impedance (ohms)	-80	80	-80	80	80
SWR loss (db)	1.2	1.2	1.2	1.2	1.2
SWR loss (dB)	50	50	50	50	50
Max. element distance (ft)	14	10	10	10	N/A
E-plane (ft)	12	10	10	10	22.5
H-plane (ft)	17	8	8	22	26
Length (ft)	27	15	15	15	24
Longest element (in)	40L	40L	30L	30L	113L
Turns	11	7.5	7.5	9.5	17.7
Windload (lb)	35	17	17	40	48

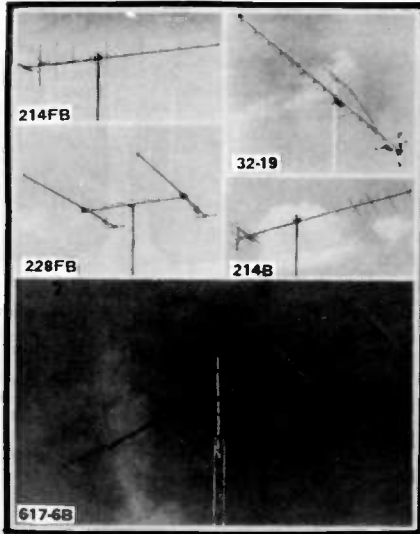

ALL PRICES SHOWN ARE LIST PRICES! CALL FOR SPECIAL PACKAGE PRICING!

Skywalker

3 and 4 Element Single Band Yagis

Skywalker

Heavy construction, no warping, less interference, and a better signal at the other end are yours with the Skywalker series of single band Yagis. The 10dbd forward gain of the 4 element models will put you first on the line. See the chart for all the details. Heavy well heat treated 6063 T832 aluminum tub ing, ruggedly plated steel fasteners, and carefully formed aluminum brackets. Assembly is simple with the new Cushcraft Boom Assembly Marking System.

Model	30-40CD	30-40SCD	35-40D	35-40S	35-40V	40-40V	40-40SCD
Frequency range (MHz)	14.0-14.5	14.0-14.5	21.0-21.45	21.0-21.45	28.0-29.7	28.0-29.7	28.0-29.7
Forward gain (dbd)	10.0	8.0	10.0	8.0	10.0	8.0	8.0
Front to back ratio (db)	30	30	30	30	30	30	30
E-plane Beamwidth (deg)	30	18	20	14	17	12	12
H-plane Beamwidth (deg)	35-10	35-8	23-4	23-2	17-10	17-8	17-8
E-plane (ft)	80	58	57	58	57	56	56
H-plane (ft)	-80	-80	-80	-80	-80	-80	-80
SWR loss (db)	1.2	1.2	1.2	1.2	1.2	1.2	1.2
Forward gain (db)	44	40	33	30	27	21	21
Longest element (in)	20	23	15-4	13-6	14	10	10
Weight (lbs)	55	30	25	20	18	11	11
Windload (lb)	81	55	45	34	31	21	21

ATB-34

ATB-34 - 10-15-20 Meters

The Cushcraft ATB-34 3 band antenna offers the no-compromise performance of a single band Yagi on 10m, 15m, and 20m, and represents the best in state-of-the-art antenna design. The antenna's rugged construction, broad bandwidth, and four active elements give superb performance. Quality workmanship and the use of the best available materials give an estimated wind survival rating of 80 mph. Forward gain is 7.5 dbd on all bands; 22 db on 10m; and 18 db on 15m. Nominal input impedance is 50 ohms; VSWR is 1.5:1 or less at resonance.

ATB-34



PRICE LIST

AMATEUR FM ANTENNAS		TWIST ANTENNAS	
A147-4	\$ 29.95	A147-4MB	\$ 24.95
A147-11	44.95	A144-10T	54.95
A147-20T	74.95	A144-20T	74.95
A147-22	129.95	A435-24T	64.95
A220-7	32.95	AT-413	129.95
A220-11	42.95	VHF/UHF BEAMS	\$ 84.95
A449-6	29.95	AS-5	74.95
A449-11	42.95	AS-5	59.55
AFM-4D	72.95	A144-7	32.95
AFM-4AD	67.95	A144-11	44.95
AR-2	27.95	A430-11	32.95
AR-6	44.95	VHF/UHF STACKING KITS	
AR-10	44.95	A11-SK	\$ 22.95
AR-220	24.95	A17-SK	22.95
AR-450	24.95	A11-SK	22.95
AR-2B	44.95	A335-SK	22.95
AR-2K	21.95	A361-SK	24.95
AR-3-20	44.95	AGK-144	119.95
AR-450	39.95	AGK-444	119.95
FM STACKING KITS		MOBILE ANTENNAS	
A14-SK	\$ 22.95	AMS-147	\$ 32.95
A16-VPK	32.95	ATC-147	32.95
A21-SK	22.95	AMS-220	32.95
A220-VPK	32.95	ATS-220	32.95
A147-SK	22.95	BOOMER ANTENNAS	
A147-VPK	49.95	32-19	\$ 99.95
A449-SK	22.95	214B	79.95
A449-VPK	32.95	220B	89.95
RLTZ BUGS		228FB	249.95
LAC-1	\$ 5.95	617-6B	229.95
LAC-2	5.95	BOOMER STACKING KITS	
DX ARRAYS-20 ELEMENT		22-SK	\$ 39.95
DX-120	\$ 67.95	32-SK	44.95
DX-220	54.95	20-SK	44.95
DX-420	44.95	220-QK	279.95
DX ARRAY BALUNS		224-QK	279.95
DX-18N	\$ 18.95	228-VPK	99.95
DX-28N	18.95	PD-1	32.95
DX-48N	18.95	PD-4	32.95
DX-ARRAY	179.95	PD-224	22.95
DKK-440	74.95	PD-244	22.95
40 ELEMENT STACKING KITS		SKYWALKER BEAMS	
DKK-440	\$ 329.95	20-3CD	\$ 319.95
DKK-ARRAY	149.95	13-4CD	219.95
80 ELEMENT STACKING KITS		15-3CD	109.95
DKK-180	\$ 629.95	10-4CD	99.95
DKK-480	149.95	10-3CD	79.95
MULTI-BAND HF ANTENNAS			
A-3	\$ 219.95		
ATB-34	319.95		
ATV-3	112.95		
ATV-4	112.95		
ATV-5	119.95		
A-2	299.95		
A-3SK	39.95		



The full power, full performance 20-15-10m beam.

Enjoy the thrill of working rare OX. Increase the pleasure of your daily contacts with A3 interference reducing front-to-back ratio. Use your linear amplifier with confidence with our new high power traps.

6 METER BEAMS

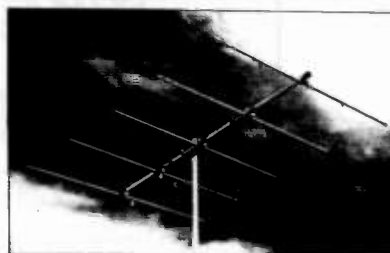

3-5-6-10 ELEMENTS

Description	3 element	5 element	6 element	10 element
Model No.	A50 3	A50 5	A50 6	A50 10
Boom Length	6'	12'	20'	24'
Longest El.	117"	117"	117"	117"
Turn Radius	6'	7'6"	11'	13'
Fwd. Gain	7.5 db	9.5 db	11.5 db	13 db
F/B Ratio	20 db	24 db	26 db	28 db
Weight	7 lbs.	11 lbs.	18 lbs.	25 lbs.

3/4, 1-1/4, 2 METER BEAMS

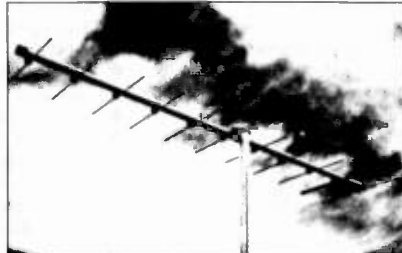

Model No.	A144 7	A144 11	A220 11	A430 11
Description	2m	2m	14m	14m
Elements	7	11	11	11
Boom Length	98"	144"	102"	57"
Weight	4	6	4	3
Fwd. Gain	11 db	13 db	13 db	13 db
F/B Ratio	26 db	28 db	28 db	28 db
Fwd. Lobe @				
% over pt.	46	42	42	42
SWR @ Freq.	1 to 1	1 to 1	1 to 1	1 to 1

TUFTS Electronic Department Store TUFTS

Panasonic



\$179.00
Panasonic RF-2200
International Band

Eight-band worldwide shortwave radio. AC or battery power. Includes AM, FM and six shortwave bands. Combination 2-stage selectivity and AFC switch. RF gain control. Separate bass, treble, and volume controls. FM/SW telescoping antennas. Four "D" batteries, AC power cord, and earphone included.



\$239.00
Command Series RF-2600

Six-band portable shortwave radio with all-band, five-digit fluorescent frequency display. SW frequencies from 3.9-28 MHz. FM/AM radio. Battery/signal strength meter. AFC on FM. RF gain control. 4" dynamic speaker. Comes with AC power cord, shoulder belt and earphone. Operates on 6 "D" batteries (not included).



\$249.00
Command Series RF-2900

Portable 5-band shortwave radio. Five-digit fluorescent display. SW from 3.2 to 30 MHz. RF gain control. BFO pitch control. Comes with AC power cord, shoulder belt, dial hood and earphone. Operates on 6 "D" batteries (not included).



\$399.00
Command Series RF-4900

Ten-band communications receiver with 5-digit, all-band fluorescent display. SW from 1.6 to 30 MHz. FM and AM frequencies. FET RF amplifier. BFO pitch control. RF gain control. Comes with earphone, AC power cord and headphone converter. Operates on 8 "D" batteries (not included).

Kantronics

Our smart machine reads sloppy copy.



NEW! INCLUDES 24-hour UTC Clock 110 and 300 baud ASCII, & tuning eye!

kantronics

Field Day[®] **\$399.00**

If someone tells you they offer the same features we do, check them out with the list below.

- Morse copying ability
- 3 to 80 WPM Morse range
- Computer programs for improving sloppy Morse
- Radioteletype copying ability - 60, 67.75 and 100 WPM Baudot
- ASCII radioteletype ability - 110 and 300 WPM baud
- Copies any shift of RTTY
- 24-hour UTC clock available in any mode
- Entire unit contained in one package
- Automatic code-speed tracking
- Full 10-character, large-size display
- Displays code speed
- Tuning eye for faster tuning
- Full year limited warranty
- Internal speaker
- Requires no TV set for use
- Advanced demodulator circuits
- Internal 200 Hz bandwidth filter
- All letters, numbers and punctuation plus special Morse characters and 5 special RTTY characters



DRAKE

See back cover for special!

Drake R-7 / DR-7

Synthesized, General Coverage Receiver

- Fully synthesized with a permeability tuned oscillator (PTO) for smooth, continuous tuning.
- Covers complete range 0-30 MHz. Both digital and analog readout.
- Special low distortion "synchro-phase" AM detector provides superior international shortwave broadcast reception.
- Tunable IF notch filter effectively reduces heterodyne interference from nearby stations.
- Multi-function antenna selector/50 Ohm splitter is switch-selected from the front



\$1299.00

panel. Provides simultaneous dual receive with the TR-7, making possible the reception of two different frequencies at the same time.

- Built-in power supply operates from 100, 120, 200, 140 Vac, 50/60 Hz, or nominal 13.8 Vdc.
- Much more!

See back cover for special!

YAESU



FRG-7000 **\$655.00**

Digital Display Communications Receiver, with CPU Digital Clock and Timer

- 0.25 Thru 29.9 MHz Coverage with 1 kHz Readout

Computer technology and convenience features are brought together in the FRG-7000, a digital-display general coverage receiver for the discriminating SWL. The digital clock and timer, controlled by a CPU (Central Processing Unit) chip, will read out both local and GMT time, and will control peripheral station equipment such as a tape recorder.



FRG-7 **\$370.00**

General Coverage Receiver

- 0.5-29.9 MHz Coverage with 10 kHz Readout

The FRG-7 is a precision-built all purpose communications receiver, featuring all solid state construction for long life and high performance. Utilizing the Wadley Loop drift cancellation system, in conjunction with a triple conversion superheterodyne circuit, the FRG-7 boasts high sensitivity along with excellent stability.



KENWOOD

...premier in amateur radio



Kenwood R-1000

\$499.00

The R-1000 is a highly advanced communications receiver. Up-conversion, PLL circuitry and other new technology provide optimum sensitivity, selectivity, and stability from 200 kHz to 30 MHz. Featuring easy-to-operate single-knob tuning and digital frequency display, it's perfect for listening to shortwave, medium-wave, and long-wave bands. Even SSB signals are received perfectly. Included is a quartz digital clock and timer.

R-1000 FEATURES:

- Continuous frequency coverage from 200 kHz to 30 MHz.
- 30 bands, each 1 MHz wide.
- Five-digit frequency display and illuminated analog dial.
- Quartz digital clock and ON/OFF timer.
- Multi-modes... AM (wide and narrow), SSB (USB and LSB), and CW.
- Three IF filters... 2.7 kHz for SSB and CW, 6.0 kHz for AM narrow, and 12 kHz for AM wide.
- Effective noise blanker, built-in speaker, three antenna terminals, rf step attenuator, tone control, recording terminal.
- Remote terminal, for access to timer relay ON/OFF circuit and muting circuit.
- SSB sensitivity of 0.5 μV from 2 to 30 MHz.
- More than 60 dB IF image ratio.
- More than 70 dB IF rejection.



THE IAMBIC KEYSER PADDLE.
Features include: adjustable jeweled bearings ("Deluxe" only); tension and contact spacing fully adjustable; large, solid, coin silver contact points; 2 1/2 lb. chrome plated steel base rests on non-skid feet; lifetime guarantee against manufacturing defects.
"Standard" model with textured grey base. \$49.50.
"Deluxe" model with chrome plated base. \$65.00

THE IMPROVED "ORIGINAL" VIBROPLEX. Suitable for All Classes of Transmitting Work Where Speed and Perfect Morse Are Prime Essentials. This great new Vibroplex is a smooth and easy working BUG. It has won fame on land and sea for its clarity, precision and ease of manipulation. Can be slowed down to 10 words per minute or less or geared to as high rate of speed as desired. Maintains the same high quality signal at whatever speed, insuring easy reception under all conditions. Weight 3 lbs. 8 oz. Standard \$56.95
DeLuxe - Chromium base and top parts, with jeweled movement. \$69.95



THE "LIGHTNING BUG" VIBROPLEX High Quality Signals at All Speeds. Flat pendulum model. Weight 3 lbs. 8 oz. Standard - Polished Chromium top parts, grey base. \$69.95
Standard \$56.95



THE "CHAMPION" VIBROPLEX
Weight 3 lbs. 8 oz. Without circuit closer. Standard finish only. Chromium finished top parts, with grey crystal base. \$56.95



VIBRO-KEYER
Over the years, we have had many requests for Vibroplex parts to be used for construction of a keying mechanism for an electronic transmitting unit. This beautiful and most efficient "Vibro Keyer" is ideal for this job.
FEATURES OF THE "VIBRO-KEYER"
● Beautiful beige colored base, size 3 1/2" x 4 1/2", weight 2 1/4 pounds
● Same large size contacts as furnished on Deluxe Vibroplex.
● Same main frame and super finished parts as Deluxe Vibroplex
Standard - \$49.50; Deluxe Finish \$65.00



No. SSK-1 \$23.95
No. SSK-1CP-Chrome - \$29.95

NYE VIKING SQUEEZE KEY
Extra-long, finger-fitting molded paddles with adjustable spring tension, adjustable contact spacing. Knife-edge bearings and extra large, gold plated silver contacts! Nickel plated brass hardware and heavy, die cast base with non-skid feet. Base and dust cover black crackle finished. SSK-1 - \$23.45.
SSK-1CP has heavily chrome-plated base and dust cover. Price - \$32.95

CODE PRACTICE SET

You get a sure, smooth, Speed-X model 310-001 transmitting key, linear circuit oscillator and amplifier, with a built-in 2" speaker, all mounted on a heavy duty aluminum base with non-skid feet. Operates on standard 9V transistor type battery (not included). Price - \$20.75
PHONE PATCH Model No. 250-46-1 measures 6-1/2" wide, 2-1/4" high and 2-7/8" deep. List price, \$36.50. Model 250-46-3, designed for use with transceivers having a built-in speaker, has its own built-in 2" x 6" 2 watt speaker. Measures 6-1/2" wide, 2-1/4" high and 2-7/8" deep. Price - \$46.50



No. 110-320-003 - \$11.70
No. 114-322-003 - "Brass" - \$12.10

No. 110-320-001 - \$9.70
No. 110-322-001 - "Brass" - \$10.15

No. 110-310-003 - \$9.45
No. 110-312-003 - "Brass" - \$10.25

NYE VIKING SPEED-X KEYS

NYE VIKING Standard Speed-X keys feature smooth, adjustable bearings, heavy-duty silver contacts, and are mounted on a heavy oval die cast base with black wrinkle finish. Available with standard, or Navy knob, with, or without switch, and with nickel or brass plated key arm and hardware.
Pamper yourself with a Gold-Plated NYE VIKING KEY!
Model No. 114-31C-004GP has all the smooth action features of NYE Speed-X keys in a special "presentation" model. All hardware is heavily gold plated and it is mounted on onyx-like jet black plastic sub-base. Price \$50.00

ALL BAND PREAMPLIFIERS



- 6 THRU 160 METERS
- TWO MODELS AVAILABLE
- RECOMMENDED FOR RECEIVER USE ONLY
- INCLUDES POWER SUPPLY

MODEL PLF employs a dual gate FET providing noise figures of 1.5 to 3.4 db., depending upon the band. The weak signal performance of most receivers as well as image and spurious rejection are greatly improved. Overall gain is in excess of 20 db. Panel contains switching that transfers the antenna directly to the receiver or to the Preamp. Model PLF 117V AC, 60 Hz. Wired & Tested \$49.95

Now you can receive the weak signals with the Ameco PT-2 pre-amplifier!

Model PT-2 is a continuous tuning 6-160 meter Pre-Amp specifically designed for use with a transceiver. The PT-2 combines the features of the well-known PT with new sophisticated control circuitry that permits it to be added to virtually any transceiver with no modification. No serious ham can be without one. Price: \$74.95.

- Improves sensitivity and signal-to-noise ratio.
- Boosts signals up to 26 db.
- For AM or SSB.
- Bypasses itself automatically when the transceiver is transmitting.
- FET amplifier gives superior cross modulation protection.
- Simple to install. ● Advanced solid state circuitry.
- Improves immunity to transceiver front-end overload by use of its built-in attenuator.
- Provides master power control for station equipment.



Larsen Kølrod Antennas

- Handle full 200 watts ● low loss V.S.W.R.
- Deliver 3 dB gain and more!
- Pick the one that best fits your needs:

MAGNETIC MOUNT

stays put even at 100 mph!
MM-JM-150 for 144 MHz use } Only \$42.00 complete
MM-JM-220 for 220 MHz use }
MM-JM-440 for 440 MHz use } complete



TRUNK LID MOUNT

No holes and low silhouette tool
TLM-JM-150 for 144 MHz use } Only \$42.00 complete
TLM-JM-220 for 220 MHz use }
TLM-JM-440 for 440 MHz use } complete
And 1/4 wave antenna for trunk and magnetic mount - \$18.50



ROOF or FENDER MOUNT

Goos on quick and easy in 3/8" or 3/4" with fewest parts.
JM-150-K for 144 MHz use } Only \$34.50 complete
JM-220-K for 220 MHz use }
JM-440-K for 440 MHz use } complete
And 1/4 wave antenna for roof and fender mounts \$11.50



TRAC \$89.95 "BRAND NEW"

DELUXE MESSAGE MEMORY KEYSER



- Features:** Model TE-104
● State-of-the-art CMOS Circuitry
● Three levels of message storage
 - Two 70 character each message memory
 - Four 25 character each message memory
● One 50 character and two 75 character message storage
● Accuracy of any word press at any speed
● Memory saving LED
● Laser dot QED in reverse
- PLUS:**
● Self-completing dots and dashes
● Dash dot and dash memory
● Number keying with any square paddle
● 5-50 wpm
● Solid volume tone tune and weight controls
● Low current drain CMOS battery operation—portable
● Deluxe quarter inch jacks for keying and output
● Keys grid block and solid state rigs
● WIRE D AND TESTED FULLY GUARANTEED—LESS BATTERY

MESSAGE MEMORY KEYSER Model # TE201 \$69.95



- Features:**
● Advanced CMOS message memory
● Two (50 char each) message storage
● Repeat function
● Records at any speed—plays back at any speed
● Longer message capacity
● 5-50 wpm
● Speed volume tone tune and weight controls
● Sidetone and speaker
● Low current drain CMOS battery operation—portable
● Deluxe quarter inch jacks for keying and output
● Keys grid block and solid state rigs
● WIRE D AND TESTED FULLY GUARANTEED—LESS BATTERY

"BRAND NEW" Model # TE144 59.95



- Features: Deluxe CMOS Electronic Keyer**
State-of-the-art CMOS circuitry
Self-completing dots and dashes
Both dot and dash memory
IAMBIC keying with any squeeze paddle 5-50 wpm
Speed, weight, tone, volume tune controls & sidetone and speaker
Semi-automatic "bug" operation & straight keying—rear panel switch
Low current drain CMOS battery operation—portable
Deluxe quarter inch jacks for keying and output
Keys grid block and solid state rigs
Wired and tested—fully guaranteed—less battery

MODEL TE133—same as TE144 with wgt and tone control internal, less semi-auto keying.
\$49.95

MODEL TE122—same as TE133 less wgt, tune, solid state keying.
\$36.50

ASTATIC MICROPHONES

- T-UP9-D104 transistorized w/push bar base \$67.50
- T-UG8-D 104 transistorized. \$55.50
- T-UG9-D 104 "Silver Eagle" transistorized. \$74.40
- UG-D 104 ceramic or crystal . . . \$49.50



TUFTS Electronic Department Store TUFTS

TUFTS Electronic Department Store TUFTS

PALOMAR ENGINEERS



\$299.95

ANTENNA TUNER

Here is a new tuner that puts more power into your antenna, works from 160m-10m, handles full legal power and then some, and works with coax, single wire and balanced lines. And it lets you tune up without going on the air.

All tuners lose some rf power, mostly in the inductance coil and the balun core. To avoid this we switched from No. 12 wire for the main inductor to 1/4" copper tubing. It can carry ten times the rf current. And we've moved the balun from the output, where it almost never sees its design impedance, to the input where it always does. Thus more power to your antenna.

The biggest problem with tuners is getting them tuned up. With three knobs to tune on your transceiver and three on the tuner and ten seconds to do it (see the warning in your transceiver manual) that's 1 1/2 seconds per knob. We have a better way; a built-in 50 Ohm noise bridge that lets you set the tuner controls without transmitting. And a switch that lets you tune your transmitter into a dummy load. So you can do the whole tuneup without going on the air. Saves that final; cuts QRM.



TEMPO
the first in synthesized portables gives you the broadest choice at the lowest price

... the new S-5

- ★ The only synthesized hand-held offering 5 watts output. (Switchable for 1 or 5 watt operation)
- ★ The same dependability as the time proven S-1. Circuitry that has been proven in more than a million hours of operation.
- ★ Heavy duty battery pack.
- ★ Telescoping whip antenna.
- ★ Ni-cad battery pack, charger.
- ★ External microphone capability.

the Tempo S-2

- ★ Tempo is first again. This time with a superior quality synthesized 220 MHz hand-held transceiver. With an S-2 in your car or pocket you can use 220 MHz repeaters throughout the U.S. It offers all the advanced engineering, premium quality components and exciting features of the S-1. The S-2 offers 1000 channels in an extremely lightweight but rugged case.

TEMPO

PRICE LIST

Tempo S-5	\$299.00
Tempo S-5 with touch tone pad	339.00
12 Button touch tone pad (not installed)	39.00
16 Button touch tone pad (not installed)	48.00
Tone burst generator	29.95
CTCSS sub-audible tone control	29.95
Rubber flex antenna	8.00
Leather holster	16.00
Cigarette lighter plug mobile charging unit	6.00
Matching 30 watt output 13.8 VDC power amplifier (S30)	89.00
Matching 80 watt output power amplifier (S80)	149.00
Tempo S-2	349.00
Tempo S-2 with touch tone pad	399.00
Tempo S-1	259.00
Tempo S-1 with touch tone pad	289.00

If you're not on 220 this is the perfect way to get started. With the addition of the S-25 (25W output) or S-75 (75W output) Tempo solid state amplifier it becomes a powerful mobile or base station. If you have a 220 MHz rig, the S-2 will add tremendous versatility. Its low price includes an external microphone capability, heavy duty ni-cad battery pack, charger, and telescoping whip antenna.

Tempo S-1

- ★ The first and most thoroughly field tested hand-held synthesized radio available. 800 channels in the palm of your hand.
- ★ Simple to operate. (You don't need a degree in computer programming).
- ★ Heavy duty battery pack allows more operating time between charges.
- ★ External microphone capability.

R-X NOISE BRIDGE \$55.00



- Learn the truth about your antenna.
- Find its resonant frequency.
- Find R and X off-resonance.
- Broadband 1-100 MHz.
- Simple to use. — Self contained.

VLF CONVERTER \$59.95



- New device opens up the world of VLF radio.
- Converts VLF to 80 meters. For use with any shortwave receiver covering 3.5-4 MHz.
- Advanced design for simple operation, high performance.
- Gives reception of the 1750 meter band.
- Also covers navigation radiobeacons, WWVB, ship-to-shore, and LF broadcast band.

LOOP ANTENNA

Loop Amplifier \$67.50
Plug-in loops \$47.50 ea.

- Plug-in loops available for:
1600-5000 KHz (160/80 meter amateur bands)
550-1600 KHz (Broadcast Band)
150-550 KHz (VLF, 1750 meter band)
40-150 KHz (WWVB, Loran)
10-40 KHz (Omega)
- Nulls out interference



IC KEYS \$97.50



- Sends Manual, Semi-Automatic, Full Automatic, Dot Memory, Dash Memory, Squeeze and lambic.
- More Features than any other keyer. Built-in sidetone, speaker, speed and volume controls.
- Fully Adjustable contact spacing and paddle tension. The perfect paddle touch will Amaze you.
- Battery Operated. Heavy shielded die-cast metal case. 3-in. steel base.
- By the World's oldest manufacturer of electronic keys.

FREQUENCY STANDARD \$42.50

- 100, 50, 25, 10 and 5 KHz. Markers selectable by panel switch.
- Crystal controlled.
- A true secondary frequency standard.
- Square Wave Signal. Rich harmonics usable from 5 kHz to 50 MHz.
- Sharp Clear Output. Exclusive circuit suppresses unwanted markers.
- Battery Operated. No line cord. Self contained battery.



RF TRANSFORMER \$42.50



- Full 2000 watt CW (5 Kw PEP).
- Matches 32, 28, 22, 18, 12, 8, 5 ohm antennas.
- For all verticals and mobile whip antennas.
- Smaller size. Higher efficiency.
- RF ferrite toroid core.

500 W. RF TRANSFORMER \$35.00



- Full 500 watt CW capability. No time limit.
- Convenient switch selection of impedance taps.
- Small size. High efficiency.
- RF ferrite toroid core.

CW FILTER \$39.95



- Steep skirts. No ringing.
- Simulated-stereo technique filters QRM, improves copyability of CW signals.
- 80 Hz bandwidth.
- Eight pole IC filter.

ALL BANDS PREAMPLIFIER \$89.50



- Tunes 1.8 to 54 MHz. Covers ALL amateur bands 160 to 6 meters. ALL shortwave broadcast bands.
- For receivers AND transceivers.
- Up to 20 db gain.
- Peps up that tired receiver.
- Reduces image and spurious response.

BEAM BALUN \$47.50



- 3 Kw CW, 6 Kw PEP input power.
- U bolt for 2" boom.
- 1.7-30 MHz.
- 1:1 or 4:1 ratio available.
- All stainless steel hardware.

MODEL 2K BALUN \$42.50



- 3 Kw CW, 6 Kw PEP input power.
- Replaces center insulator.
- 1.7-30 MHz.
- 1:1 or 4:1 ratio available.

MODEL 1K BALUN \$22.50



- 1.5 Kw CW, 3 Kw PEP input power.
- Replaces center insulator.
- 1.7-30 MHz.
- 1:1 or 4:1 ratio available.

PALOMAR ENGINEERS

BIRD Electronic Corporation

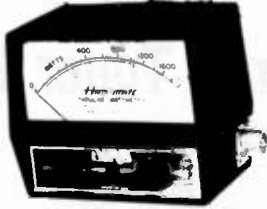

the indispensable
BIRD 43

THRULINE WATTMETER



\$99 VHF model 4362 (140-180 MHz)
\$99 HF model 4360 (18-30 MHz)

The 4360, 4362 HAM-MATE Directional Wattmeters are insertion type instruments for measuring forward or reflected power in 50-ohm coaxial transmission lines. They are direct descendants of the model 43 THRULINE® Wattmeter—the professional standard of the industry—and will accurately measure RF power flow under any load condition. Each wattmeter is made up of a precisely machined section of 50-ohm line, a rotatable sensing element and meter calibrated in watts, all mounted in a high-impact plastic housing. It is this type of solid construction and the directional THRULINE coupling circuit, without toroids, that account for the superiority of the HAM-MATE Wattmeters.

Power Range	Frequency Bands (MHz)			
	2-30	25-100	100-200	200-1000
1 watt	5A	5C	5D	5E
10 watts	10A	10C	10D	10E
25 watts	25A	25C	25D	25E
50 watts	50A	50C	50D	50E
100 watts	100A	100C	100D	100E
250 watts	250A	250C	250D	250E
500 watts	500A	500C	500D	500E
1000 watts	1000A	1000C	1000D	1000E
5000 watts	5000A	5000C	5000D	5000E

MODEL 43 Elements (Table 1) 2-30 MHz	\$135.00
Elements (Table 1) 25-1000 MHz	50.00
Carrying case for Model 43 & 6 elements	28.00
Carrying case for 12 elements	17.00

READ RF WATTS DIRECTLY! (Specify Type N or SO239 connectors) 0.45 — 2300 MHz, 1-10,000 Watts ±5%, low insertion VSWR — 1.05. Unequaled economy and flexibility. Buy only the element(s) covering your present frequency and power needs, add extra ranges later if your requirements expand.

AMPHENOL BUNKER BRAND

SERIES 31 — BNC CONNECTORS
Amphenol's BNC connectors are small, lightweight, weatherproof connectors with bayonet action for quick disconnect applications. Shells, coupling rings and male contacts are accurately machined from brass. Springs are made of beryllium copper. All parts in turn are ASTRO-plated® to give you connectors that can take constant handling, high temperatures and resist abrasion.

BNC BULKHEAD RECEPTACLE 31-221-385 UG-1094 Adapts any BNC plug. Receptacle can be mounted into panels up to 1/4" thick. \$1.25

BNC (M) TO UIIF (F) ADAPTER 309-2900-385 UG-255 Adapts any BNC jack to any UIIF plug. \$3.53

DOUBLE MATE ADAPTER 83-877-385 Both coupling rings are free turning. Connects 2 female components. \$2.72

JACK ADAPTER 81-95 575-102-385 Adapts 83-15P-385 to Motorola type auto antenna jack or pin jack.

PANEL RECEPTACLE 83-1R-385 SO239 Mounts with 4 fasteners in 21/32" diameter hole. \$1.17

PANEL RECEPTACLE 83-1R-385 SO239 Mounts with 4 fasteners in 21/32" diameter hole. \$1.17

BNC (F) TO UIIF (M) ADAPTER 31-028-385 UG-273 Adapts any BNC plug to any UIIF jack. \$2.39

PUSH-ON 83-55P-385 Features an unthreaded, springy shell to push fit on female connectors. \$2.27

LIGHTNING ARRESTOR 575-105-385 Eliminates static buildup from antenna. Protects your valuable equipment against lightning damage. \$4.80

RNC PLUG 31-002-385 UG-88 Commonly used for communications antenna lead cables. For RG 55/U & RG 58/U cables. \$1.59

RNC STRAIGHT ADAPTER 31-219-385 UG-914 1/9/32" long, allows length of cables to be joined. Mates with BNC plugs. \$2.12

BNC PANEL RECEPTACLE 31-003-385 UG-290 Mounts with 4 fasteners in 29/64" diameter hole. \$1.74

83-878-385 SO239SII Mounts in single 21/32" diameter hole. Knurled lock nuts prevent turning. \$1.59

BNC ANGLE ADAPTER 31-009-385 UG-306 Adapts any BNC plug for right angle use. \$4.23

BNC TEE ADAPTER 31-008-385 UG-274 Adapts 2 BNC plugs to 31-003-385 or other female BNC type receptacle. \$4.56



First is the Fox XK. It reads all bands and tucks away on the visor.



Our remote (RW) unit is "out of sight" when installed. Out-of-sight in performance, too.



And now there's Superfox!
The first remote, superheterodyne radar warning system. Superfox has 10 times the sensitivity capability of any conventional radar detector. It is ideal for custom installations.

Order No.	Description	Price
80	Fox XK All band detector w/self contained aural/visual alarm	\$109.00
80-2	Fox XK (RW) All band detector w/remote control, waterproof	\$139.00
80-3	Super Fox Super-Heterodyne remote radar warning system	\$299.95

HITACHI OSCILLOSCOPES

SPECIAL!
15% OFF ALL
HITACHI SCOPES

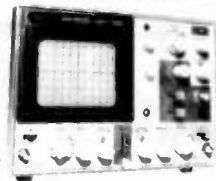

Single and dual trace, 15 and 30 MHz. All four high sensitivity Hitachi oscilloscopes are built to demanding Hitachi quality standards and are backed by a 2-year warranty. They're able to measure signals as low as 1mV/division (with X5 vertical magnifier). It's a specification you won't find on any other 15 or 30 MHz scope. Plus: X-axis modulation, trace rotation, front panel X-Y operation for all four scope models, and X10 sweep magnification. And, both 30 MHz oscilloscopes offer internal signal delay lines. For ease of operation, functionally-related controls are grouped into three blocks on the color coded front panel.

- V-302 30 MHz Dual Trace \$850.50
- V-301 30 MHz Single Trace \$670.50
- V-152 15 MHz Dual Trace \$625.25
- V-151 15 MHz Single Trace \$490.50

ALLIANCE



\$99.00

HD-73 HEAVY-DUTY ROTATOR

with exclusive Dual-Speed Control!

For antennas up to 10.7 sq. ft. of wind load area. Mast support bracket design permits easy centering and offers a positive drive no-slip option. Automatic brake action cushions stops to reduce inertia stresses. Unique control unit features DUAL-SPEED rotation with one five-position switch. SPECIFICATIONS: Max. wind load bending moment — 10,000 in.-lbs. (side-thrust overturning); Starting torque — 400 in.-lbs.; Hardened steel drive gears; Bearings — 100-3/8" diameter (hardened); Meter — D'Arsonval, taut band (back-lighted). There's much, much more.



Two NEW Rotors from Cornell-Dubilier

TAIL TWISTER™

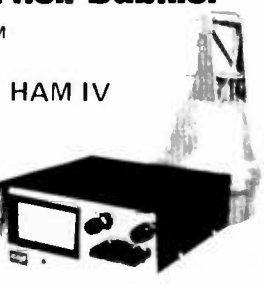
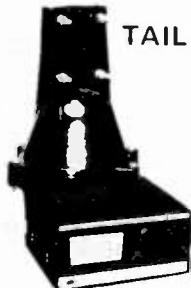

- For the New Super Communications Antennas
- New Thickwall Casting
- New Steel Ring Gear
- New Metal Pinion Gear
- New Motor Prebrake
- New Super Wedge Brake
- New L.E.D. Control Box
- Safe 26 Volt Operation

Designed for the newest of the king-size communications antennas, the TAIL TWISTER™ is the ultimate in antenna rotational devices. The TAIL TWISTER™ starts with a deluxe control box featuring snap action controls for brake and directional controls; L.E.D. indicators signal rotation and brake operation, while the illuminated meter provides direction readout. This new control box couples to the newest bell rotor. Using the time tested bell rotor principle, the TAIL TWISTER™ is a brand new design with thickwall castings and six bolt assembly. A brand new motor with prebrake action brings the antenna system to an easy stop, while the massive square front brake wedge locks the assembly in place. A new stainless steel spur gear system provides final drive

into a new steel ring gear for total reliability. Triple race, 138 ball bearing assembly carries dead weight and maintains horizontal stability. An optional heavy duty lower mast adaptor is available for lighter loads with mast mounting. Price: \$279.00

The HAM IV sets new levels of performance. Snap action switched wedge brake and rotational controls brings pinpoint accuracy to large directional arrays popular in communications. A new motor provides pre-brake action to assist in slowing down rotational mass, and the new thicker wedge brake offers far stronger lock-in phase action. To take full advantage of this new design, the HAM III is designed for in-tower mounting. A new optional heavy duty lower mast adaptor is available when the HAM III is to be mast mounted with smaller arrays. A stainless steel spur gear system multiplies the torque into the dual race 98 ball bearing support assembly assuring years of trouble free performance. Price: \$189.00

TUFTS Electronic Department Store TUFTS

MFJ INTRODUCES THE NEW! GRANDMASTER MEMORY KEYS

At \$139.95 this MFJ-484 GRANDMASTER memory keyer gives you more features per dollar than any other memory keyer available — and Here's Why . . .

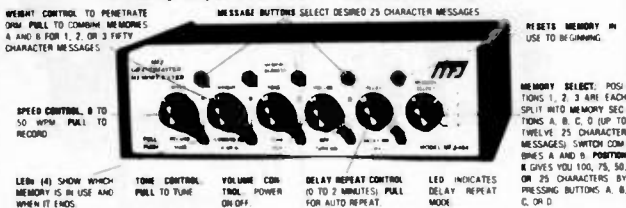

- MEMORY KEYS**
- MFJ-484 Grandmaster Memory Keyer. Up to twelve 25 character messages plus a 100, 75, 50, or 25 character message. 139.95
 - MFJ-482 Grandmaster Memory Keyer. Four 25 or a 50 and two 25 character messages. 99.95
 - MFJ-481 Grandmaster Memory Keyer. Two 50 character messages. 79.95
 - HK-1 Optional Squeeze Key. 29.95
- PROFESSOR MORSE**
- MFJ-410 Professor Morse, Random code generator/keyer. Morse code teaching computer. Sends alpha only or alphanumeric, full feature Curtis keyer, speed readout, delay for spacing letters up to three seconds. 149.95
- TELEPHONE PATCHES**
- MFJ-624 Crisp clear professional sounding audio, Vu meter for monitoring line level and for nulling for maximum separation of transmitter and receiver, easy patch in patch out connections. 59.95
 - MFJ-620 Same as MFJ-624 except without meter. 49.95

MFJ-40T QRP Transmitter \$29.95

- MISCELLANEOUS**
- MFJ-202 RF Noise Bridge. 59.95
 - MFJ-1030BX Receiver Preselector. 49.95
 - MFJ-200BX Frequency Standard. 29.95
 - MFJ-40T QRP Transmitter. 29.95
 - MFJ-40V Companion QRP VFO for 40T. 29.95
 - CPO-555 Code Practice Oscillator. 17.95
 - TK-555 Optional Telegraph Key. 1.95

LSP-520BX \$49.95 **LSP-520BX II** \$59.95

- SPEECH PROCESSOR**
- MFJ-525 RF Speech Processor. Plugs between microphone and rig. Powerful natural sounding speech. Vu meter for adjustment of processing, 4 pin mic jack, 6 dB more average SSB power, use with any rig and any mic, push button on-off/bypass. 119.95
 - LSP-520BX II Logarithmic Speech Processor. Deluxe model. 59.95
 - LSP-520BX Logarithmic Speech Processor. 49.95

CMOS-8043 Electronic Keyer \$54.95

State of the art design uses CURTIS-8043 Keyer-on-a-chip

- Built-in Key • Dot memory • Iambic operation with external squeeze key • 8 to 50 WPM • Sidetone and speaker • Speed, volume, tone, weight controls • Ultra-reliable solid state keying • 300 volts max • 4 position switch for TUNE OFF ON SIDETONE OFF
- Uses 4 penlight cells • 2-3/16" x 3-1/4" x 4 inches

- ELECTRONIC KEYS**
- MFJ-8044IC Deluxe Keyer. Dot and dash memory. 69.95
 - MFJ-404 Econo Keyer. Built-in paddle, plus extras. 59.95
 - MFJ-402 Econo Keyer. Built-in paddle. 44.95
 - MFJ-400 Econo Keyer. External Key. 49.95
 - MFJ-408 New Deluxe Electronic II, speed readout meter, socket for: Memory, random code generator, keyboard, 8044IC keyer chip dot and dash memory. Up to 50 WPM. 79.95
 - BY-1 Bencher Deluxe Iambic Paddles. Heavy steel base, non-skid feet. 39.95

MFJ ENTERPRISES DELUXE Versa Tuner II



- MFJ-984 Deluxe 3kW Versa Tuner IV. SWR, forward-reflected wattmeter, rf ammeter, dummy load, antenna switch, balun, 3kW PEP. 299.95
- MFJ-982 3kW Versa Tuner IV. 7 position antenna switch, balun, 3kW PEP. 199.95
- MFJ-981 3kW Versa Tuner IV. SWR, forward-reflected wattmeter, balun, 3kW PEP. 199.95
- MFJ-980 3kW Versa Tuner IV. Built-in balun, 3kW PEP. 169.95
- MFJ-962 1.5 kW Versa Tuner III. SWR, forward-reflected wattmeter, 6 position antenna switch, balun, 1.5kW PEP. 169.95
- MFJ-961 1.5kW Versa Tuner III. 6 position antenna switch, balun for balanced lines, 1.5kW PEP. 149.95
- MFJ-949 Deluxe Versa Tuner II. Ultimate in antenna tuners: SWR, dummy load, forward-reflected wattmeter, front panel antenna switch, balun, 300W output. 129.95
- MFJ-941B Versa Tuner II. Improved model with SWR/wattmeter, antenna switch, balun, mobile mounting bracket, 300W output. 79.95
- MFJ-940 Versa Tuner II. SWR/wattmeter, antenna switch, no balun, no mobile mount, 300W. 69.95
- 700-0014 Mobile mount for MFJ-940. 3.00
- MFJ-945 Versa Tuner II. With SWR/wattmeter and mobile mounting bracket, less 6 position antenna switch, 300W. 69.95
- MFJ-944 Versa Tuner II. With antenna switch and mobile mounting bracket, less SWR/wattmeter, 300W output. 69.95
- MFJ-943 Versa Tuner II. Less SWR/wattmeter, antenna switch mounting bracket, 300W output. 59.95
- MFJ-901 Versa Tuner. Matches anything. Coax, random wires, balance lines, 200W output. 49.95
- MFJ-900 Econo Tuner. Matches coax and random wires. 200W. 39.95
- MFJ-16010 Random Wire Tuner. For random and long wires, 200W. 29.95

24-HOUR DIGITAL CLOCK SOLID-STATE

24 HOUR DIGITAL CLOCK \$29.95

- MFJ-101 24 hour digital clock, totally solid state, 6" blue display (like TS-820S), ID time, lock function (prevents accidental missetting of time). 29.95

These MFJ active filters are the most copied in industry.

CWF-202 MFJ SUPER CW FILTER \$29.95 each **SBF-202 MFJ SSB FILTER**

For information on our digital filter and other products, please call MFJ-202 (800) 541-2222. MFJ-202 (800) 541-2222. MFJ-202 (800) 541-2222.

- SSB/CW FILTERS**
- MFJ-752 Dual tunable SSB/CW active filter Signal Enhancer II. 2 noise limiters, inputs for 2 rlg, 110VAC or 12 VDC. 79.95
 - MFJ-751 Tunable SSB/CW active filter Signal Enhancer. 110VAC or 12 VDC. 59.95
 - MFJ-721 Super CW/SSB Filter. 2W amplifier, noise limiters, inputs for 2 rlg. 12VDC or 110VAC with optional AC adapter. 59.95
 - MFJ-720 Deluxe Super CW Filter. 2W amplifier, 12VDC or 110VAC with optional AC adapter. 44.95
 - CWF-2BX Super CW Filter. 29.95
 - SBF-2BX Single Sideband Filter. 29.95
 - AC Adapter 12 VDC, 200 mA. 7.95
 - CWF-2PC Same wired and tested PC board as in CWF-2BX with 4 position switch. 19.95
 - SBF-2PC Same wired and tested PC board as in SBF-2BX with 4 position switch. 19.95
 - AC Adapter 6 VDC, 300 mA. 7.95

TUFTS Electronic Department Store™ TUFTS

KENWOOD



TR7600: 2m FM XCVR. 10 watts, LED readout, 144-147.995. Fully synthesized, any repeater offset possible, memory channel.

TR7600 VHF XCVR **\$375.00**
BLC 10/70 VHF Power Amplifier **149.95**



TOTAL REGULAR PRICE **\$524.95**
SALE PRICE **\$424.95**

Vhf engineering

SAVE \$100.00

Unarco-Rohn

COMPLETE 25G TOWER PACKAGES

50' Guyed Tower: Includes top section, 4 regular sections, base plate, rotor plate, 50' guy wire, 2 guy assemblies with torque bars, 3 concrete guy anchors and other miscellaneous hardware.

TOTAL REGULAR PRICE **\$594.02**
SALE PRICE **464.02**

SAVE \$130.00

50' Bracketed Tower: Includes top section, 4 regular sections, base plate, rotor plate and universal house bracket.

TOTAL REGULAR PRICE **\$366.15**
SALE PRICE **266.15**

SAVE \$100.00



BECKMAN



If you've ever been troubled by a faulty multimeter — or had one that wasn't quite up to the tougher jobs — your troubles are over.

Choice of Models

The TECH 310 has all above features, 7 functions, 29 ranges, plus 0.25% Vdc accuracy. The TECH 300 has a 0.5% Vdc accuracy and all the above features, but without Insta Ohms™ continuity function or the 10 amp current ranges.

Complete Multimeter Capability

DC volts: 100µV to 1500V
AC volts: 100µV to 1000V rms
Resistance: 0 Ω to 20MΩ
DC current: 100nA to 10A (TECH 310)
100nA to 2A (TECH 300)
AC current: 100nA to 10A (TECH 310)
100nA to 2A (TECH 300)
Diode/Semiconductor test function
Continuity function (TECH 310)

TECH 300 — \$110
TECH 310 — \$140

TEN-TEC



574



570

TUFTS NOVICE EXCLUSIVE

Purchase your Century 21 (570 or 574) from us and have up to one year to apply the full purchase price towards a new HF transceiver when you upgrade your station.

NOVICE SPECIAL

TEMPO KLM YAESU



Syncom S1 with TTP: From Tempo — the world's first synthesized 800 channel handheld transceiver. Includes battery pack, charger, telescoping antenna — and 800 channels!

KLM PA2-25B Power Amplifier: 2 watts in, 25 watts out.

PACKAGE 1

Tempo S1 w/TTP **\$339.00**
KLM PA2-25B Power Amplifier **92.95**

Total Regular Price **\$431.95**
SALE PRICE **\$396.95**

SAVE \$35.00

FT207R: From YAESU — 2m FM XCVR. Handheld completely synthesized, digital readout, keyboard access, 2 watts, 4 memories and much more.



PACKAGE 2

FT207R Synthesized 2m handheld **\$399.00**
KLM PA2-25B Power Amplifier **92.95**

Total Regular Price **\$491.95**
SALE PRICE **\$441.95**

SAVE \$50.00

KENWOOD

...pacesetter in amateur radio



TS520SE

TS520SE: 160-10 meters, 200 watts P.E.P., speech processor, noise blanker, excellent sensitivity and minimum cross-mod.

5BTV

TS520SE **\$629.95**
Hustler 5BTV Vertical **139.95**

TOTAL REGULAR PRICE **\$769.90**
SALE PRICE **\$649.90**

SAVE \$120.00

or

ATB34



TS520SE **\$629.95**
ATB34 Cushcraft TriBander **\$329.95**

TOTAL REGULAR PRICE **\$959.90**
SALE PRICE **\$793.90**

SAVE \$166.00



TL922A: 2kW P.E.P., 160-15 meters, 3-500Z tubes.

TL922A: **\$1199.00**
MBII Tuner **295.00**

Total Regular Price **\$1494.00**
Sale Price **\$1294.00**

SAVE \$200.00

KENWOOD



Model 43



MBII TUNER: 3kW, J60-10 meters.

TL922A: **\$1199.00**
Bird Model 43 with 2500H element and carrying case **201.00**

Total Regular Price **\$1400.00**
Sale Price **\$1200.00**

SAVE \$200.00

CALL AND CHECK OUR GREAT DEALS ON ALL YOUR AMATEUR RADIO NEEDS.
DIAL: 1-617-391-3200

Stock items shipped within 24 hours. Prices subject to change. Limited quantity on some items.

TUFTS Electronic Department Store TUFTS

P.O. Box 27, Medford, Massachusetts, 02155 — TEL. 1-617-391-3200

TUFTS Electronic Department Store TUFTS

JANEL LABORATORIES

CLASSIC 2 METER PREAMP

This widely used 2 meter preamp is probably the most sensitive available today. One model provides a uniformly low noise figure across the full band. Equally applicable for DX, AM, SSB, FM and OSCAR. 18 dB gain, 2 dB noise figure, 12 vdc power (5mA) BNC connectors. Aluminum box is 1 1/2"x4"x2".
Model 144PB 144-148MHz

MODEL	DESCRIPTION	PRICE
PREAMPS		
30PB	28-30 MHz (BNC)	\$ 21.95
50PB	50-52 MHz (BNC)	21.95
53PB	52-54 MHz (BNC)	21.95
137PB	135-139 MHz (BNC)	21.95
144PB	144-148 MHz (BNC)	21.95
PM-1	2m Preamp Module (Solder Terminals)	16.95
QSA 5	144-148 MHz for Transceivers (SO-239)	41.95
QSA 6	50-52 MHz (SO-239)	43.95
220PB	220-225 MHz (BNC)	21.95
432PA	420-450 MHz (BNC) 3.5 dB maximum NF	33.00
432PC	420-450 MHz (BNC) 2.0 dB maximum NF	54.95
432PE	1.0 dB typical NF	90.00
PB	Any single frequency between 30 and 50, or 148-174 MHz (BNC)	27.00
CONVERTERS		
144CF	144-146 MHz IN, 28-30 MHz OUT (BNC)	\$ 79.95
	2nd crystal for 144CF (146-148 IN, 28-30 OUT)	12.00
432CF	432-434 MHz IN, 28-30 MHz OUT (BNC)	79.95
	2nd crystal for 432CF (434-436 IN, 28-30 OUT)	10.00
	*Also available with 434-436 MHz IN and 28-30 MHz OUT. (Oscar B, Mode J)	79.95
OSCILLATORS		
01-A	Precision, Specify 4 or 10 MHz	\$ 79.95
D1-A	10 to 1 Digital Divider	11.95
DB-A	Eight, 10 to 1 Dividers	27.95
USEFUL ACCESSORIES		
17013	BNC to BNC, 36" RG-58C/U Cable	\$ 6.00
17010	BNC to UHF, 36" RG-58C/U Cable	6.00
17014	BNC to RCA Phono, 36" RG-58C/U Cable	6.00
03005	Adaptor, BNC Plug to UHF Jack	4.00
03006	BNC Connector, UG-88/U for RG-58 size cable	1.25
MISCELLANEOUS		
ISOLINE	Antenna Isolator, 144-174 MHz (SO-239)	\$ 14.95
432FA	Cavity Filter, .5 dB loss	105.00
432FA.2	Cavity Filter, .2 dB maximum loss	115.00



UHF PREAMPS \$33.00

Low Cost All Around Favorite

This two stage amplifier provides high sensitivity across the full 420 to 450 MHz band. A low 3.5 dB noise figure makes this preamp ideal for most amateur applications. Can be used for all modes: 170B gain, 12vdc power (10mA). BNC connectors (50 ohms) aluminum box 1 1/2"x4"x2".
Model 432PA 420-450MHz

Extremely Sensitive \$54.95

This preamp provides a low noise figure required for demanding applications. A premium state-of-the-art transistor is used to provide extremely high sensitivity. Two stages, 20 dB gain, 2 dB maximum noise figure (1.7 dB typical), 12 volt dc power BNC connectors. Model 432PC 420-450MHz

QSA5 PREAMP For Transceivers

The QSA 5 preamp is a high performance, low noise preamp for improving the receiving sensitivity of 2 Meter transceivers. This preamp features easy installation with no modification to the transceiver required. This preamp can be used with virtually all 2 meter transceivers and on all modes — FM, SSB, CW or AM. Relays in the QSA 5 automatically bypass the preamp when transmit power is sensed. A LED indicator shows the status of the QSA 5. A front panel switch allows the preamp to be bypassed while receiving. The low noise figure of the QSA 5 provides for exceptional sensitivity. The gain has been set to optimize the performance with 2 meter transceivers.



Model PM-1

PREAMP MODULE

This low noise preamp is designed to be easily incorporated into new or existing 2 meter equipment. Solder pins are provided for mounting to a PC board or for connection to wire or coax. Uses low noise JANEL MOSFET circuitry. Each unit is fully tested for gain and noise figure. Quantity prices are available for OEM's.



For 6 Meter Transceivers

\$43.95

All of the features of our popular QSA-5 but for 6 meters. Fully compatible with transceivers running 30 watts or less. All mode use. Noise Figure 2dB. Gain, 15dB VSWR (transmit) 1:2. Available for 50-52 or 52-54MHz (specify when ordering). UHF connectors. Model QSA-6.



\$90.00

Our Finest UHF Preamp—1.0 dB NF

This outstanding 432 MHz preamp provides the lowest practical noise figure. The finest transistors available today are combined with the ultimate in construction and alignment. Single stage. Gain 15dB (min) Noise Figure 1.2dB (max including measurement uncertainty). 0.8 to 1.0dB typical. Bandwidth 130 MHz, 12 volts at about 7 mA. Type N connectors. Size 1 1/2"x3 1/2", inches. Center Frequency 400 to 512 MHz (specify when ordering). Model 432PE



10 METER PREAMP

Oscar Special

Ideal for pulling weak satellite signals out of the noise. This preamp has been responsible for producing many "impossible" OSCAR QSO's. 18 dB gain, 2 dB noise figure, 12vdc power (5mA). BNC connectors. Aluminum box is 1 1/2"x2 1/2"x2". Model 30 PB 28-30MHz.

6 METER PREAMP

Ideal for DX

\$21.95

This low noise preamp significantly improves the sensitivity of most 6 meter receivers. Available in two frequency versions to cover DX and FM portions of the band. 18 dB gain, 2 dB noise figure, 12 vdc power. BNC connectors.
Model 50PB 50-52MHz. Model 53PB 52-54MHz.

220 MHz

Low Noise Preamp

\$21.95

1 1/2" Meters-Covers full 220-225 MHz range with 15 dB gain. 3 dB noise figure, 12 volt power and BNC connectors. Model 220PB.

\$65.95

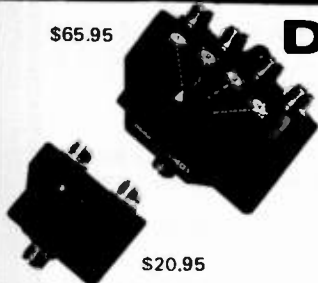

\$20.95

Coaxial Switches
2 Position/Model CS-201
4 Position/Model CS-401

SWR & Power Meters

Models CN-720, CN-620 and CN-630

Professionally engineered cavity construction. Power Rating: 2.5kW PEP, 1kW CW. Impedance: 50 Ohms. Connectors: SO-239. Insertion Loss: Less than 2 dB. VSWR: 1:1.2. Maximum Frequency: 500 MHz. Isolation: Better than 50 dB at 300 MHz; better than 45 dB at 450 MHz; adjacent terminal. Unused Terminals grounded.



CN-720 \$166.95

DAIWA

\$105.00



RF-440

\$135.95

RF Speech Processor

Models RF-400 & RF-660

Increases talk power with splatter free operation. RF clipping assures low distortion. Simply install between microphone and transmitter.
Talk Power: Better than 6 dB.
Frequency Response: 300-3000 Hz at 12 dB down.
Distortion: Less than 3% at 1 kHz, 20 dB clipping.
Power Requirement: RF-440 self contained, AC power supply; RF-660 13.5Vdc external supply.

CN-720 and CN-620

Frequency Range: 1.8-150 MHz
SWR Detection Sensitivity: 5W min.
Power: 3 Ranges (Forward, 20/200/100W) (Reflected, 4/40/200W)



\$140.50

CN-620

Interference Filters from J. W. Miller

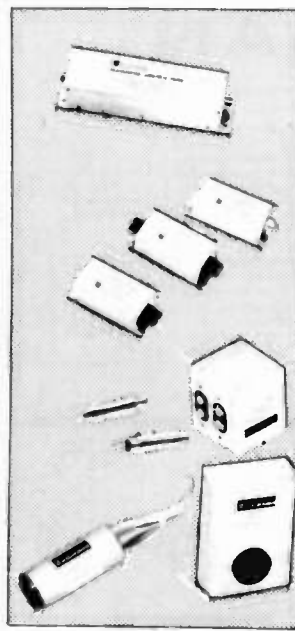

Low Pass Filters

Eliminate or greatly reduce interference to TV receivers by radio amateur stations when installed in antenna lines of those transmitters. Input and output impedance 50 ohms. Insertion loss .3dB max. VSWR 1.2:1. Attenuation greater than 75 dB above 41 MHz.
C-511-T: 25 W AM 50 W PEP SSB \$19.50
C-514-T: 1000 W AM 2000 W PEP SSB \$26.80

High Pass Filters

When installed in the antenna, eliminate or greatly reduce front end overload interference to TV or FM receivers caused by amateur radio transmitters and other high frequency radio services. Filter attenuates signals below 40 MHz by a power factor greater than 1,000,000:1. Impedance C-513-T: 1: 75/300 ohm. C-513-T: 75/75 ohm; C-513-T: 300/300 ohm. \$10.18 \$10.18

Audio Interference Filters

Eliminate interference caused in your audio equipment by radio amateur transmitters and other radio services. C-505-R installs in the input lines of audio equipment. Consists of 1 gain. C-506-R installs in speaker lines. Unit will take care of stereo speaker system. \$5.07 \$6.67

AC Power Line Filters

Eliminate or reduce interference to radio amateur receivers, TV's and radios, and prevent radio signals from entering power line.
C-508-L: 3 section LC filter, 3 A max \$ 6.33
C-509-L: 5 section LC filter (for more severe interference), 5 A max. \$18.35

CN-630
Frequency Range: 140-450 MHz
Power: 2 Ranges (Forward 20/200W) (Reflected 4/40W)

CN-630
\$139.00



Egad! An Easy-to-Build Synthesizer!

Have you ever been dissatisfied with having to buy a new crystal each time you wanted to change frequencies on that inexpensive receiver kit you bought?

This article will introduce you to an easily-built frequency synthesizer that can be adapted for two-meter ham band or weather satellite use.

If you are tired of being confined to the three or four channels in your crystal-controlled receiver, let me show you how you can have 299 channels for about twenty cents apiece.

That's really not bad considering that crystals cost from five to six dollars each these days, and 299-position rotary switches are even more expensive!

By now, I am sure that you have asked yourself just why you need a 299-channel receiver, anyhow. Let me tell you how it all got started for me. A couple of years ago the Soviet Union started leaving some of their Meteor-series weather satellites operating over the United States. This stirred up my interest considerably, since up until 1976 I had used only United

States satellites.

At that time, my receiver was all crystal controlled, and the Meteor spacecraft used different frequencies in the 136- to 138-MHz band. It took me two weeks to get a new crystal for the receiver; by that time the bird was programmed not to broadcast for a while, so I finally had the 137.3-MHz frequency available but no satellite. This really sounds like Murphy at work.

It was not until 1978 that things got stirred up again. The Soviets now had a Meteor operating over the United States with high resolution—about one nautical mile resolution. This was discovered by Bill Watt in Conyngham, Pennsylvania, using a scanner/synthesizer arrangement. Naturally, I contacted Bill and found out the new frequency in use as well as the type of equipment he was using. This time, the frequency in use was 137.15 MHz, and again I was stuck without a crystal.

It now was becoming rapidly obvious that I had to do something to give the receiver some frequency agility. For all I knew, the next Soviet satellite would be on yet another frequency. The idea for a synthesizer for use in the satellite band seemed reasonable. The synthesizer would

have the stability of a crystal with the agility of a variable-frequency oscillator.

First of all, I wrote down some specifications to shoot for in the design of the synthesizer addition.

1. The receiver will operate with inputs from 135 to 137.99 MHz.
2. Channel spacing will be 10 kHz to provide 299 channels. The 10-kHz spacing was deemed adequate since the receiver i-f is 30 kHz wide. This would give some desirable overlap.
3. Reference frequency feedthrough from the loop phase detector will be kept to a minimum since it would modulate the vco.
4. All spurious responses will be 50 dB below the carrier.
5. Vco output will be a minimum of 250-mV p-p in order to drive the SN76514 mixer located in the receiver.
6. The synthesizer lockup time between channels will be 0.5 seconds or better depending on final loop bandwidth and damping factor.
7. The loop damping will be between 0.707 and one.
8. Double power-supply regulation will be used on critical circuits.
9. Good rf construction practices will be used.

After this 1% of inspiration came the fun part!

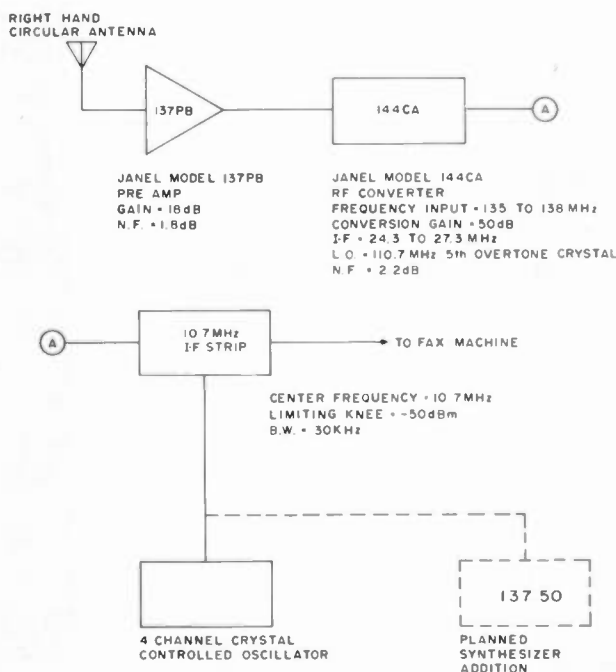

Fig. 1. Receiver block diagram.

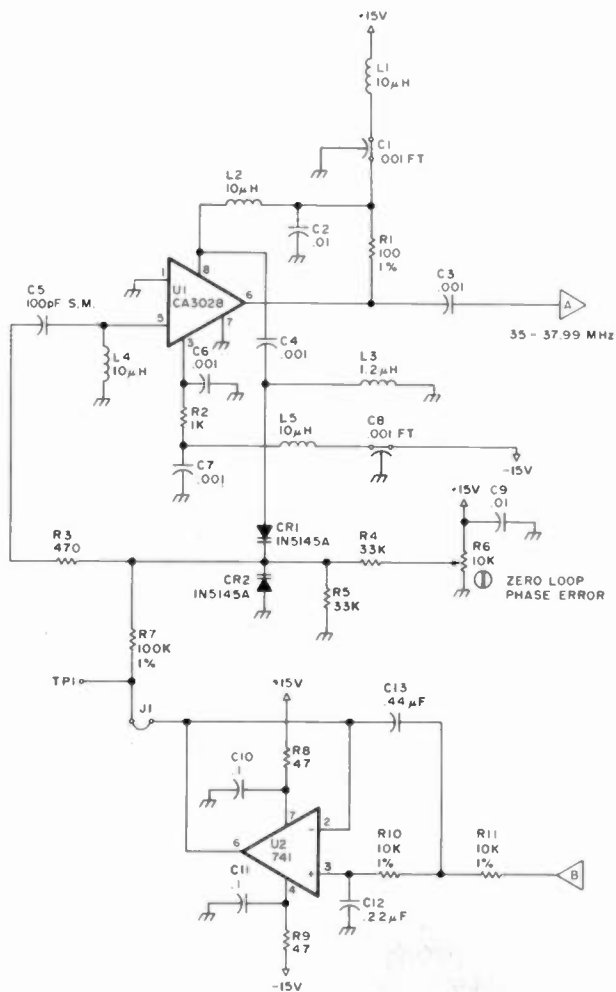

Fig. 2. Voltage-controlled oscillator and low-pass filter.

The work lasted several months.

In discussing the synthesizer design, each section of the loop is reviewed separately. A short loop analysis is also given. I began the design by making a block diagram of the existing station receiver. This appears in Fig. 1. A Janel converter is used in this receiver due to the excellent construction techniques and circuit design by Janel Labs. This converter has worked flawlessly for several years now, and it seems as good as the day it arrived. Recently, the 137PB preamp was added. The 1.8-dB noise figure allowed me to hear the ATS satellites quite well on a simple dipole.

From the block diagram comes the first vital information needed in the design of the synthesizer. This

information is the frequency range over which the device will operate. In my case, I changed the original 110-MHz crystal in the Janel to 110.7 MHz. This makes the synthesizer output frequency exactly 100



Photo A. A view of the dish antenna shows the usual tin-can feed. Three cast-iron barbell weights comprise the counterbalance. The S-band converter sits below the dish, shielded from the rain in its plastic trash bag. The dish diameter is six feet; the preamp is mounted at the feed.

MHz below the receiver input and simplifies the number crunching for the divide-by-n counter interface. Now, simple subtraction says that the vco in the synthesizer phase-locked loop will run from 35 MHz, corresponding to a 135-MHz input, to 37.99 MHz, corresponding to 137.99 MHz.

The vco was designed

around an RCA CA3028 differential amplifier IC, which appears in Fig. 2. One section of the IC is used in the oscillator circuit while the other side is used as an LO buffer. The circuit is useful up to 100 MHz or so by manipulating the tank circuit values. Also, it is quite linear over several MHz. In this case, the vco center frequency is 36.5

To divide by	Count loaded	Qa input	Qb input	Qc input	Qd input
9	0	L	L	L	L
8	1	H	L	L	L
7	2	L	H	L	L
6	3	H	H	L	L
5	4	L	L	H	L
4	5	H	L	H	L
3	6	L	H	H	L
2	7	H	H	H	L
1	8	L	L	L	H
0	9	H	L	L	H

Table 1.

	10 MHz section	1 MHz section	100 kHz section	10 kHz section	
	9	9	9	9	Terminal count
minus	6	4	9	9	Number counter sees to divide by 3500
equals	3	5	0	0	The number of counts to reach terminal count. The number the counter is dividing by.

Table 2.



Photo B. An overall view of the station. The receiver is at the left.

MHz, which corresponds to 136.5 MHz, or the center of the satellite band.

A graph of the vco linearity was plotted to determine its sensitivity, K_0 , in radians/sec./volt. The graph was made by disconnecting J1 and applying a precision dc bias voltage through R7 into CR1 and CR2. With TP1 at zero volts,

grounded, R6, the zero loop phase error pot, is adjusted to yield 36.5 MHz on point A.

The graph was then plotted in 100-kHz increments while noting the tuning voltage at TP1 required to produce the change. A plus voltage of 8.49 volts increased the frequency from 36.5 MHz to 38 MHz. In

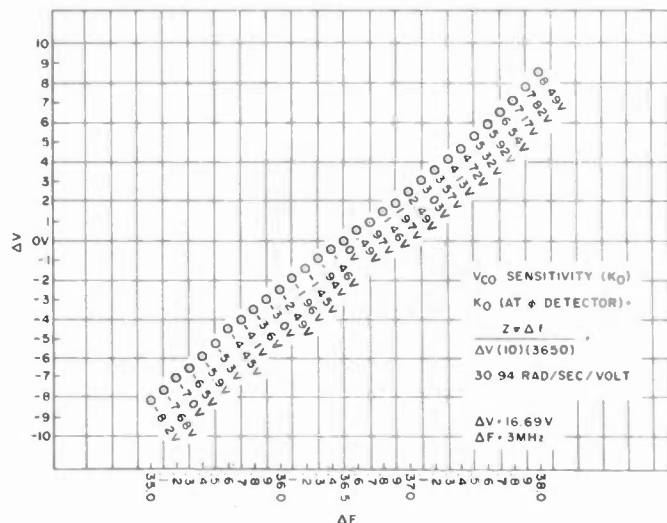

Fig. 3. Vco linearity curve.

order to go down to the low end, 35 MHz, a negative voltage must be used. A voltage of -8.2 volts was needed to go from 36.5 MHz to 35 MHz. The final curve appears in Fig. 3. The linearity of the vco is obvious.

Please note that L3, the 1.2- μ H inductor, is an optimum value. Using this value of inductance requires the zero loop phase error pot to place an optimum bias on the varactors. This bias gave the best linearity at this frequency range. The sensitivity of the vco was set by R7, the 100k-Ohm resistor. I decided on the 100k value and limited the vco tuning range to around eight volts either side of zero. This leaves a four-to-five-volt tuning margin on each side

of the loop filter at band-edge. Finally, the vco sensitivity was calculated from the graph, as follows, and is used in the analysis of the phase-locked loop.

Vco sensitivity in radians/sec./volt) is equal to $2\pi\Delta f/\Delta V$. Delta F is equal to 3 MHz, and Delta V is 16.69 volts. K_0 now works out to be 1.1293 times ten to the sixth power radians/sec./volt. This is the sensitivity of the vco alone. The vco sensitivity at the phase detector input must consider the divide-by-ten prescaler as well as the divide-by-n counter.

After completing the vco design, the high-frequency divide-by-ten prescaler and programmable 3500-to-3599 divider were thought out. These portions of the synthesizer appear in Figs. 4

2 METER AMPLIFIER

CLASS C
PA 1-10

\$79⁹⁵



Works with all hand held and portable units. ✓324
1-3 watts in, 10-25 watts out, 4MHz band width.
Operates from 12-14 VDC. Solid state RF switching.

THS ELECTRONICS

RD 1, Box 195, Greene, NY 13778
Phone 607-656-8071



LINEAR 2 to 400 MHz PLANBOOK

15 to
1000 WATT

13 Different Models, 96 pgs

A.P. Systems ✓362 \$11.95

Box 263sm,
Newport RI. 02840



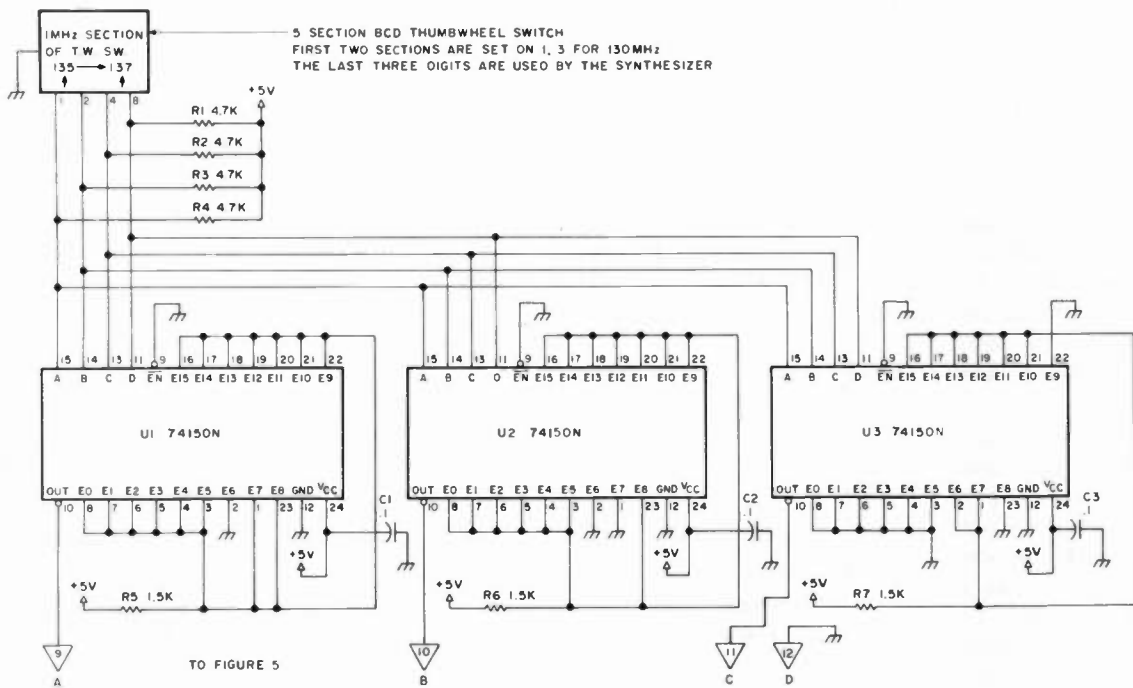

Fig. 6. 1-MHz thumbwheel switch decoder.

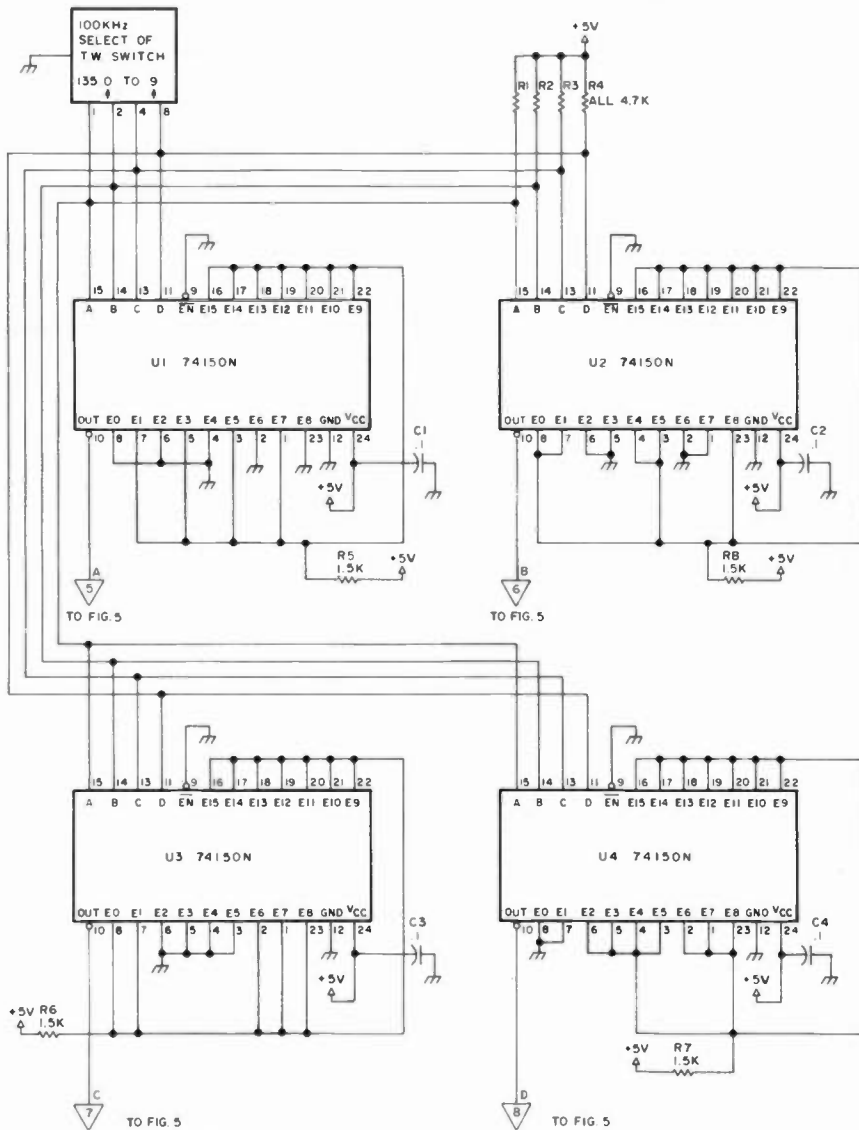

Fig. 7. 100-kHz and 10-kHz thumbwheel switch decoder. Two are required.

no choice about the frequency it takes when the loop is locked. When the loop is locked, the programmable counter output will be 1000 Hz and the 4044 phase detector will keep it and the reference in phase on the trailing edge of the two 1000-Hz waveforms. Any phase difference that occurs is used to steer the vco so that it remains locked to the reference. The nature of the loop is to reflect the stability of the low-frequency 1000-Hz reference to the high-frequency vco.

Next, I would like to give some insight into how the programmable counter functions. To begin, let me say that the counter actually counts between two numbers. One number is its maximum or terminal count while the other is a BCD start number. The terminal count is 9999 while the jam set inputs accept the BCD starting count. The BCD starting count comes from the thumbwheel switch decoder. This decoder converts the BCD data from the switches into the proper BCD number for the counters.

When the receiver is set to receive 135.00 MHz, the counter is doing division by

3500. To do this division by 3500, a count of 6499 is loaded into the jam set inputs. This 6499 becomes the counter's starting point. The count load line on the 74196 counters jams in the start count of 6499 and the ICs begin counting to terminal count. It will take 3500 counts to reach the terminal count of 9999. Therefore, the MSB on the last counter is a divide-by-3500 output.

To divide by larger numbers, the starting count is simply made smaller since more counts are needed. When the counter arrives at terminal count, the 7430 NAND gate senses the condition and clears flip-flop U6. This loads the starting number. Upon the next transition of the clock from zero to one, the Q output follows the D input and the counters count to terminal count once more. A sample truth table for one counter is given in Table 1.

This truth table is generated by the thumbwheel switch decoders (Figs. 6 and 7). The decoders drive the 10-kHz, 100-kHz, and the 1-MHz counters. The 10-MHz counter has a three hard-wired on its input since it does not change. An interesting feature of the 1-MHz decoder is that it has to change only from five to seven. Since the switch will rotate from zero to nine, the 74150 selectors are wired to insert a five into the counter if an illegal code is selected. If 0, 1, 2, 3, 4, 8, or 9 is selected, the synthesizer is operating in the 135 band.

Please remember that when I speak of numbers such as the above 5, 6, or 7, and the hard-wired three, these are numbers to divide by and not the actual counts to be loaded. In the 10-kHz and 100-kHz sections, the thumbwheel switch simply rotates zero to nine. The actual counts loaded here range from

zero-loaded for nine to nine-loaded for zero. The examples in Table 2 help illustrate the counter function.

When the counter is at 3799, the 6499 is simply changed to 6200. I have used this counter that I designed, along with variations of it, in many designs. It can operate at quite high speeds as well as perform some strange divide functions.

The next important portion of the synthesizer is the phase detector. This design utilizes the MC4044 phase detector; however, the charge-pump portion is not used. The phase detector generates an error that is related to the phase difference between the 1-kHz reference frequency and the 1-kHz output from the programmable counter. The phase detector has a certain gain in volts/radian. This value is known as K_d and was found to be 0.7 volts/radian for the 4044 used here.

The phase detector reference or sampling frequency of 1000 Hz is derived from a stable source. I have used a 10-MHz crystal oscillator as the system standard. The output is simply divided down with simple divide-by-ten stages to the desired frequency of 1 kHz. It is a good idea to build all of the reference frequency generating circuits in a highly shielded enclosure. In my case, the 10 MHz was only 700 kHz away from the receiver if so that the shielding was very necessary.

The two outputs from the phase detector are summed together in the loop filter. I use a differential summing loop filter. The loop filter has about a 10-Hz bandwidth, or ω_n . To keep the vco quiet, a two-pole post filter was added. This filter breaks at 50 Hz. It was necessary to keep the loop narrow so that the vco remained fairly pure. Any AM

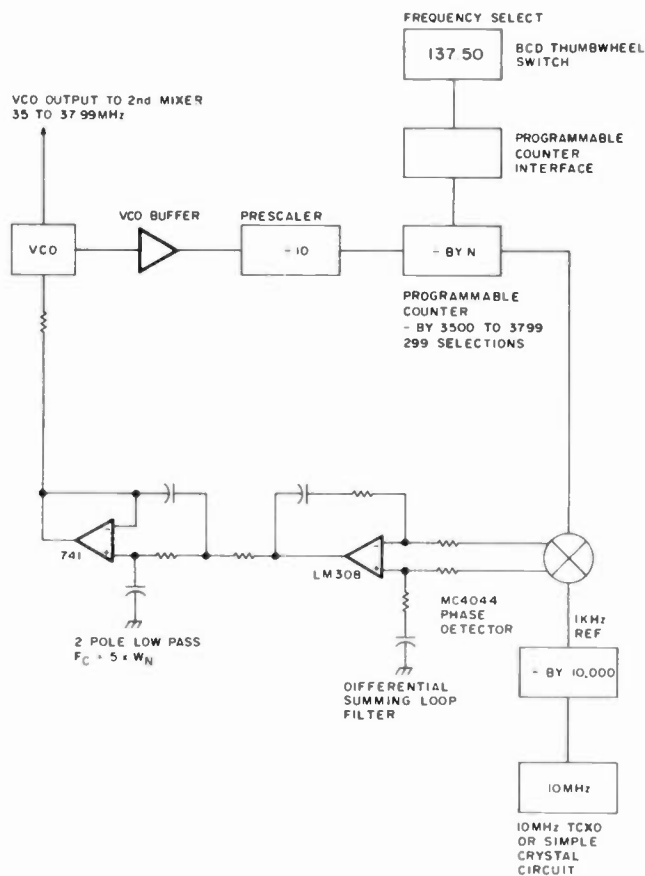

Fig. 8. Synthesizer block diagram.

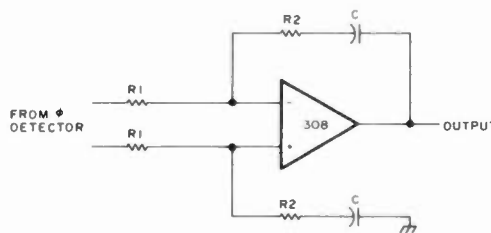

Fig. 9. Basic loop filter.

or FM modulation on the vco control line could render the synthesizer useless. I have not experienced any problems with 60- or 120-Hz modulation on the vco. If this were a problem, the loop bandwidth could be opened up a bit to track this out.

Finally, the output of the post filter connects back to the vco and closes the loop. The polarity of the tuning voltage is always such that the vco is driven until its counted-down output matches the 1-kHz reference. A block diagram of the synthesizer is shown in Fig. 8.

Next, I would like to

show how I derived the values for the loop filter. The calculations used were simple and can be looked at in greater detail in references one and two. A good place to begin is by looking at what is given.

1. Phase detector sensitivity, 0.7 volts/radian.
2. Vco sensitivity, 1.129 times ten to the sixth power radians/sec./volt.
3. Damping factor, 0.707.
4. Lock-up time, 0.5 sec. between channels.
5. Vco sensitivity at phase detector input is equal to 1.129 times ten to the sixth divided by 3650(10). This yields 30.94 radians/sec./volt.

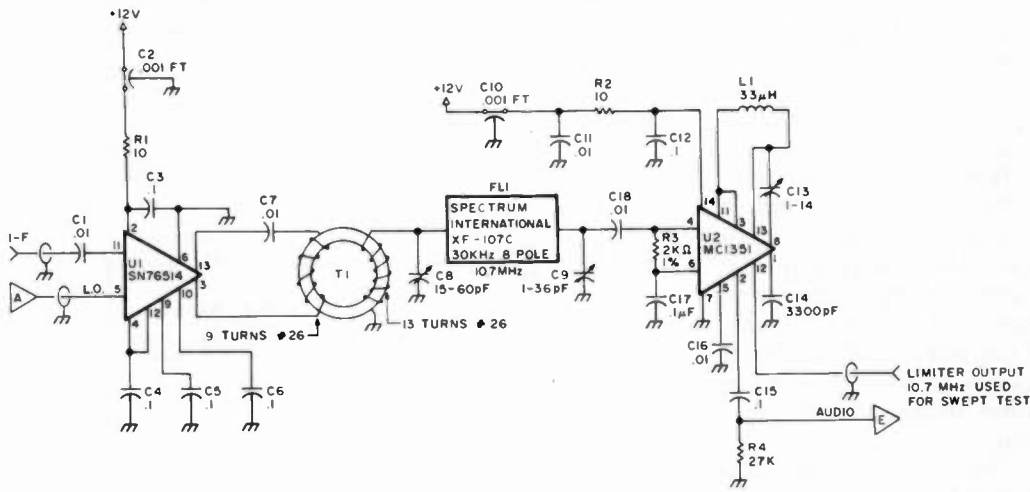

Fig. 10. 10.7-MHz FM i-f strip.

The sketch of the loop filter (Fig. 9) shows that a value is to be found for C plus R1 and R2.

The first thing I did was to determine the ω_n of the loop in rad/sec. First of all, it is necessary to consult a table of the second order loop step response. Knowing that the desired damping is 0.707, the time for the peak overshoot to settle out to 5% of its final value

is at $\omega_n(t)$ is equal to 4.5. The value for t is .5 seconds or the desired lock time. To determine the ω_n of the loop, the formula is arranged as follows: ω_n is equal to $4.5/0.5$ sec., which equals 9; $9(3.14)$ is equal to 28.2 rad/sec. To calculate the value for R1, the following formula can be used since ω_n is now known:

$$\omega_n = \sqrt{K_o K_d K_a / R1C}$$

The value for K_a is two, since a differential summing loop filter is used. In order to determine R1, the formula is rearranged to solve for R1. Also, a random value is picked for C. I chose to let C equal 2.2 uF so that the resistor values would remain reasonable.

$$\omega_n = \sqrt{K_o K_d K_a / R1C}$$

$$(\omega_n)^2 = (K_o K_d K_a / R1C)$$

$$R1C(\omega_n^2) = (K_o K_d K_a)$$

$$R1(1.749 \times 10^{-3}) = 30.94(.7)(2)$$

$$R1(1.749 \times 10^{-3}) = 43.316$$

$$R1 = 24.766k$$

Now that the value for R1 has been determined, R2 is calculated as follows:

$$R2C = 2(.707)/\omega_n$$

$$R2C = 1.414/28.2$$

$$R2C = .05014$$

Let C equal 2.2 uF
then R2 = 22.791k

Since it would be quite difficult to get exact values for R1 and R2, the closest value available is used. R1 is made the standard value of 24.9k, 1%, and R2 is made 22.6k, 1%. A point worth noting here is that the two-pole low-pass filter following the loop filter does add extra pole locations to the response. I have not had any instability problems from the fact that it is there. A more rigorous analysis for the loop could be done to include this filter for those who desire to do so. The

Parts List

Fig. 2

C1	.001- μ F feedthrough
C2	.01- μ F monolithic
C3	.001- μ F mono.
C4	.001- μ F mono.
C5	100-pF silver mica
C6	.001- μ F mono.
C7	.001- μ F mono.
C8	.001- μ F feedthrough
C9	.01- μ F mono.
C10	0.1- μ F mono.
C11	0.1- μ F mono.
C12	0.22- μ F mylar™
C13	0.44- μ F mylar
CR1	1N5145A
CR2	1N5145A
L1	10- μ H)
L2	10- μ H)
L3	1.2 μ H) shielded
L4	10- μ H)
L5	10- μ H)
R1	100 Ohms, 1%
R2	1k, 10%
R3	470 Ohms, 10%
R4	33k, 10%
R5	33k, 10%
R6	10k, 20-turn PCB pot
R7	100k, 1%
R8, R9	47 Ohms, 10%
R10	10k, 1%
R11	10k, 1%
U1	CA3028
U2	741

Fig. 4

C1	0.1- μ F mono.
C2	100-pF silver mica
C3	2.2- μ F mono.
C4	2.2- μ F mono.
C5	100-pF silver mica
C6	0.1- μ F mono.
C7	0.1- μ F mono.
C8-C11	0.1- μ F mono.
C12	0.1- μ F mono.
C13	.01- μ F mono.
C14	.01- μ F mono.
C15	3.15-pF variable
C16	0.1- μ F mono.
C17	0.1- μ F mono.

C18	.01- μ F mono.
R1	3.3k, 10%
R2	3.3k, 10%
R3	24.9k, 1%
R4	24.9k, 1%
R5	22.6k, 1%
R6	22.6k, 1%
R7, R8	47 Ohms, 10%
R9	22k, 10%
R10	10k, 10%
R11	1k, 10%
R12	100 Ohms, 10%
R13	820 Ohms, 10%
R14	47k, 10%
R15	1k, 10%
R16	3.3k, 10%
Q1	2N3947
U1	MC4044
U2	LM308
U3	7490
U4, U5	74LS90
U6	7490
U7	MC12013P

Fig. 5

C1, C2	0.1- μ F mono.
R1, R2	3.3k, 10%
U1-U4	74196
U5	7430
U6	7474

Fig. 6

R1-R4	4.7k, 10%
R5-R7	1.5k, 10%
C1-C3	0.1- μ F mono.
U1-U3	74150

Fig. 7

C1-C4	0.1- μ F mono.
R1-R4	4.7k, 10%
R5-R8	1.5k, 10%
U1-U4	74150

Fig. 8

CR1	VH148 bridge rectifier
CR2	VH148 bridge rectifier
C1	1100 μ F, 50 V
C2	1.0 μ F, 50 V
C3	100 μ F, 50 V
C4	1100 μ F, 50 V
C5	1.0 μ F, 50 V

C6	100 μ F, 50 V
C7	1.0 μ F, 50 V
C8	1.0 μ F, 50 V
C9	1.0 μ F, 50 V
C10	100 μ F, 25 V
C11	100 μ F, 25 V
C12	100 μ F, 25 V
C13	100 μ F, 25 V
C14	4800 μ F, 50 V
C15	1.0 μ F, 50 V
C16	100 μ F, 15 V
S1	DPDT toggle switch
F1	2A5B fuse
T1	F-203U/F-93X transformer series
U1	7824CP +24-V regulator
U2	7924CP -24-V regulator
U3	7812CK +12-V regulator
U4	7815CK +15-V regulator
U5	7912CK -12-V regulator
U6	7915CK -15-V regulator
U7	78H05 +5-V, 5-A regulator

Fig. 10

C1	.01- μ F mono.
C2	.001- μ F feedthrough
C3	0.1- μ F mono.
C4-C6	0.1- μ F mono.
C7	.01- μ F mono.
C8	15-60 pF variable
C9	1-36 pF variable
C10	.001- μ F feedthrough
C11	.01- μ F mono.
C12	0.1- μ F mono.
C13	1-14-pF variable
C14	3300-pF
C15	0.1- μ F mono.
C16	.01- μ F mono.
C17	0.1- μ F mono.
C18	.01- μ F mono.
L1	33- μ H inductor, 1R-2
T1	Yellow-dot toroid, 9 turns #26 primary, 13 turns #26 secondary
FL1	XF-107C Spectrum International
R1, R2	10 Ohms, 10%
R3	2.2k, 1%
R4	27k, 10%
U1	SN76514
U2	MC1351

Fig. 11

C1	0.1- μ F mono.
C2	0.1- μ F mono.
C3	0.1- μ F mono.
C4	1.0- μ F mono.
C5	22-pF silver mica
C6	25- μ F electrolytic
C7	100- μ F electrolytic
C8	0.1- μ F mono.
C9	1.0- μ F mono.
C10-C11	0.1- μ F mono.
C12	3900 pF silver mica
C13-C17	0.1- μ F mono.
CR1	1N914
CR2	1N914
CR3	1N2484
CR4	1.7-V, 20-mA LED
L1	10-mH inductor
Q1	2N3947
Q2	2N4093
Q3	2N3947
Q4	2N3947
Q5	2N2270
R1, R2, R11, R12	47 Ohms
R3	1k
R4	10k, 20-turn pot
R5, R6	10 Ohms
R7, R8, R20, R21, R29, R30, R32	10k
R9, R17	100k
R10	4.7k
R13	220 Ohms
R14	5k, 10-turn, panel mount
R15, R19	1 meg
R16	15k
R18	560k
R22, R24, R25, R26	4.7k
R23	3.3k
R27, R28	3.3k
R31	120 Ohms
R33	560 Ohms
U1	MC1458
U2	MC1454
U3	741
U4	7474
U5	4020
U6	4020
K1	24-V coil, 110-V ac DPDT contacts, 5 A
S1	SPST Push-button

synthesizer changes channels smoothly and settles out quite fast, so I feel that it works fine for me. It is most important to have this post filter in the circuit. This is where the majority of the undesirable components coming from the phase detector are finally removed.

When the loop was locked and checked out, the design goals were reviewed. The following results were obtained.

1. I have not found any spurious responses in the receiver from 135 to 137.99 MHz. The synthesizer is heavily shielded and plenty of bypassing is used on power rails.

2. The rf output level is around the desired 250-mV p-p range when the SN76514 mixer is driven.

3. The synthesizer output was looked at on a spectrum analyzer and the 1-kHz reference was not detectable above 50 dB below the carrier.

4. The loop lock time was around the 0.5-sec. value for total settling.

5. The programmable counter advances the vco in 10-kHz steps.

Finally, I have included the remainder of the schematics that complete the receiver package. First, a schematic of the 10.7-MHz i-f strip I use is given (Fig. 10). The SN76514 double-balanced mixer is used to convert the Janel converter i-f to the final i-f of 10.7 MHz. The toroidal transformer steps up the 1200-Ohm impedance of the mixer to about 2000 Ohms to drive the i-f filter. The i-f filter is an eight-pole 32-kHz model from Spectrum International. The filter feeds the limiter/discriminator IC. An MC1351 quadrature detector chip is used to demodulate the FM signal, and it drives the video processor through U1B. The MC1351 is a convenient IC to use since it has a special

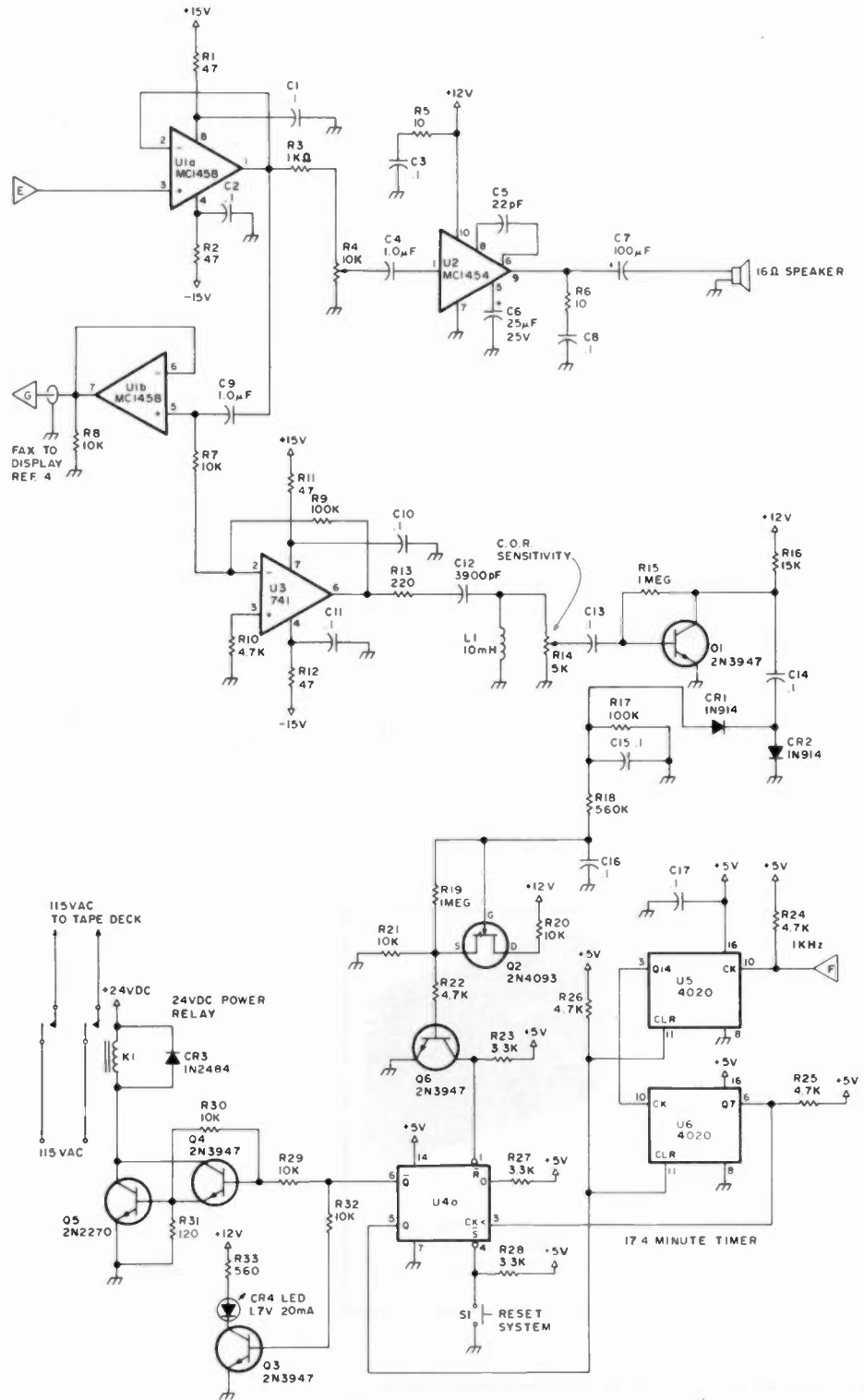

Fig. 11. Audio amp, carrier-operated relay, and pass timer.

limiter output on pin twelve. This low-impedance test point is invaluable during alignment with the sweep generator. The sweeper detector is placed here to monitor the shape of the i-f filter as well as to check limiter performance.

The next circuit that is included is the carrier-operated

relay and timer I use for automatic recording of passes (Fig. 11). This timing circuit was designed around the 4020 series counters. Since the clock for the counters is derived from the stable system reference, accurate timing is achieved. These counters will outperform the usual

NE555-type circuit in this application. The problem with the NE555 is that an accurate timing period cannot be achieved over long durations. The capacitor values become too large and so does the associated timing resistor. It is possible to use the large-value timing capacitors in the NE555

circuits; however, large precision capacitors are hard to come by. Anyway, I feel the NE555 is long overdue a rest.

The way the entire circuit functions is as follows. A sample of the receiver audio is amplified by U3 and passed through a high-pass filter. When noise is present in the receiver, no signal, the high-frequency component is rectified by the 1N914 diodes and applied to the gate of an N-channel FET. This condition will energize the carrier-operated relay, turns off LED CR4, and resets both 4020 counters. Once the receiver has acquired a live signal, the flip-flop is switched to its reset condition by the FET. This condition will energize the carrier-operated relay, turn on the LED, and allow the 4020 counters to begin counting.

Now, as the receiver begins to quiet down upon receipt of a signal, this dc voltage on the FET gate begins to rise towards zero. As the voltage rises, the FET will finally conduct and reset the flip-flop, U4. Please note here that prior to using the timer, the system reset button is usually depressed.

If this were not done, one would simply have to wait until the timer timed out.

At this time, reset is accomplished automatically. System reset is simply when the flip-flop is in the set condition. This de-energizes the carrier-operated relay, turns off LED CR4, and resets both 4020 counters. Once the receiver has acquired a live signal, the flip-flop is switched to its reset condition by the FET. This condition will energize the carrier-operated relay, turn on the LED, and allow the 4020 counters to begin counting.

It will take 17.4 minutes for the counters to produce a rising clock pulse to the flip-flop, U4. At this point in time, assuming the receiver is back to the noise condition, the flip-flop will be toggled back to the system-reset condition. The carrier-operated relay will turn off any equipment, such as a

tape recorder, and wait until the next pass of the satellite (or transmission period, in the case of WEFAX). The 17.4-minute interval was chosen to allow the satellite to have time to complete its pass and get over the horizon.

Other time intervals can be set easily simply by selecting another output from the 4020 counter. I have used this timer and carrier-operated relay circuit to automatically record TIROS N passes as well as the Soviet birds when I can catch them on. It is necessary to have an omnidirectional, circular-polarized antenna connected to the receiver for unattended logging of passes.

The power supply (Fig. 12) deserves some mention only in that both the ± 12 - and ± 15 -volt supplies use dual regulation. The approximate 32 V dc is first regulated to ± 24 volts and then to ± 12 and ± 15 . The

+5-volt supply has only one regulator.

In conclusion, I would like to say that the receiver has been a pleasure to operate. Combining all the circuits into a small compact unit makes the station much easier to live with. The synthesizer addition has not ceased to amaze me yet. Having 299 channels at your fingertips sure does beat swapping crystals.

If you address any questions to me, be sure to send me an SASE. ■

References

1. *Theory of Phase Lock Techniques*, Floyd M. Gardner, Steven S. Kent, and Raymond D. Dasenbrock.
2. Motorola Application Notes, AN-532A, AN-535, AN-541, AN-553, and AN-564.
3. "Autophasing for WEFAX," Roy Cawthon, *73 Magazine*, December, 1978.
4. "Attention Weather Watchers," Roy Cawthon, *73 Magazine*, October, 1978.

BETTER QUALITY TOUCH-TONE® DECODING

With this Touch-Tone® Decoder in your radio network, you can turn on transmitters, control antennae direction, and signal over public and private telephone networks.

The Teltone M-917 accepts push-button DTMF signals from a radio, telephone, or prerecorded tape.

Pin selectable, logic level, binary output can drive a Schottky TTL gate, a low power transistor, a CMOS or MOS device.

It's compact, complete, field tested, and proven.



✓ 363

The I-CAN Company
P.O. Box 1417
Orange Park, Florida 32073

Adirondack Radio...

Your Rockwell-Collins dealer for the northeast and Upstate New York—has the fabulous KWM-380 on display for your inspection.

For the amateur who is only satisfied with the finest, Adirondack Radio Supply will be happy to give you quotations for early delivery for a truly professional amateur station.

Adirondack Radio Supply, Inc.

185 WEST MAIN STREET
AMSTERDAM, NEW YORK 12010
TELEPHONE (518)842-8350 ✓1

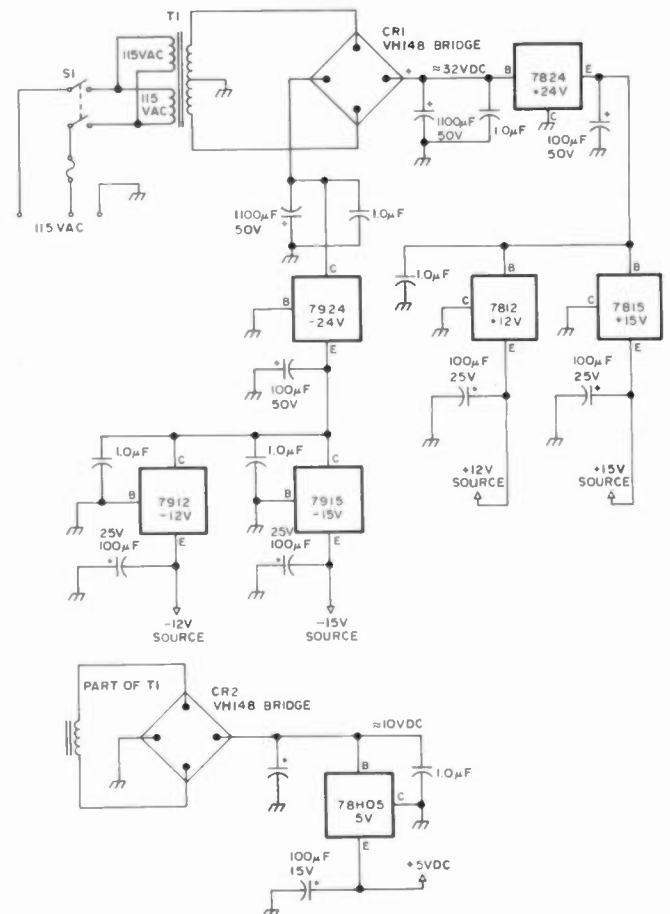

Fig. 12. Synthesizer power supply.

Radio Amateurs!

Tempo Handheld!

S-1	\$232.80	2 Meter
S-1T	\$260.90	With Tone Pad
S-2	\$315.00	220 MHz
S-2T	\$359.00	With Tone Pad
S-5	\$264.50	2 Meter 5 Watt
S-5A	\$299.95	With Tone Pad

AZDEN PCS 2000

2 Meter \$289.95 MARS CAPABILITY WITH MOD.

AZDEN PCS 2800

10 Meter \$289.95

SWAN ASTRO 102BX

160/10 Meters \$995.00

Astro 150 \$777.00

100 MX \$600.00

TEK-TEC OMNI C \$1025.50

TEK-TEC OMNI D \$795.00

Six others lower priced Limited Quantities.

Amateur equipment accessories & antennas.



COD's USA. Export Anywhere.

Amateur & commercial repair service.

2317 Vance Jackson Rd. San Antonio, TX 78213

(512) 734-7793 ✓ 301

WHY ARE ANTENNA MAKERS ANGRY ABOUT THE NEW AEA ISOPOLE™?

Introductory Price:

Isopole 144 - \$49.95

Isopole 220 - \$44.95

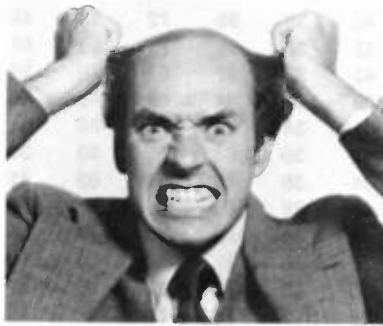

For the first time, ham operators are finding out just how poorly designed most vertical, omnidirectional VHF antennas really are.

AEA university level research has proven that most antennas now being offered create unwanted coupling of RF currents onto the antenna support structure and coaxial feedline shield from the transceiver.

Proper design and decoupling on the new AEA ISOPOLE™ virtually eliminates the RF spillover problem and can help you achieve the maximum attainable gain for the size of the antenna - equivalent to doubling your power in all directions on the horizon relative to an ideal half-wave dipole, or 6 db gain over a typical one quarter wavelength groundplane antenna. The most popular 2 meter omnidirectional "gain" antennas are unable to achieve the gain figures for an ideal half-wave dipole, resulting from poor feedline decoupling.

Plus! The new AEA ISOPOLE™:

- requires no tuning. ✓ 370
- is easy to assemble.
- covers a bandwidth nearly double the two meter ham band.

- has less than 2:1 SWR over the entire 2 meter band.
- has a beam pattern independent of feedline length.
- requires no ground plane.
- features completely weather protected RF connections.
- is designed for maximum legal power.
- mounts easily on a standard TV mast. (TV mast NOT supplied by AEA)

Prove it to yourself.

Let us send you a design for a simple tester you can use to see just how much RF spillover is coming off your own equipment.

The design is included in a copy of our free booklet: **FACTS ABOUT PROPER VHF VERTICAL ANTENNA DESIGN.** To get your copy, or information about ordering an AEA ISOPOLE™, write or call Advanced Electronic Applications, Inc., P.O. Box 2160, Lynnwood, Washington 98036. Call 206/775-7373.



AEA

Brings you the breakthrough!

MILITARY SURPLUS WANTED

Highest prices ever on recent U.S. Military surplus, especially on Collins equipment or parts. We Pay freight. Call collect for high offer. (201) 440-8787. 35 Ruta Court, S. Hackensack, N.J. 07606

SPACE ELECTRONICS CO.

✓ 317

THE LITTLE GIANT BRAKE
BEND & FORM
.060 ALUM. & STL.

CLEAN SMOOTH BENDS TO 90°
18" CAPACITY
EASY TO USE
BUILD CUSTOM CABINETS YOU'LL BE PROUD OF! COMMERCIAL QUALITY AT 1/10 THE COST!

GUARANTEED! 19.95
+1.50 SHIPPING
SORRY! NO CODA

Z ASSOCIATES
P O BOX 757
3050 NE 55 TH AVE. ✓ 336
SILVER SPRINGS, FLA. 32688

DX

from page 14

each callsign is followed by two numbers; the first is the credit for countries on the "active" list,

and the second number is the total of active plus deleted countries credited to each Honor Roller.

Presently, 310 active coun-

tries out of a possible 319 are required to make DXCC Honor Roll. While you may have a 310 sticker on your DXCC certificate, you probably aren't on the Honor Roll, because just about everyone has had a few countries moved from active status to deleted, lowering our "real" total. On December 1, 1980, the active total will drop to 318, as Japan's Okino Torishima reef,

7J1, will be deleted. It has counted since 1978. Here's the story...

In preparation for the WARC 79 frequency conference in Geneva, the ARRL began consolidating its position as early as the late 1960s. Japan, with its very powerful Japan Amateur Radio League, was obviously going to be an important partner in the ARRL's efforts at WARC

RANK	COUNTRY	W1	W2	W3	W4	W5	W6	W7	W8	W9	W0	VE	DX	TOTAL
	(# of respondents)	63	54	40	113	81	109	55	58	74	60	12	103	822
1	BY China	55	48	38	95	72	83	45	53	68	53	11	92	713
2	VU Kamarans	51	42	37	89	71	89	51	48	67	52	10	76	683
3	XZ Burma	52	42	35	87	67	79	39	50	63	50	10	78	652
4	ZA Albania	44	38	35	84	69	88	46	48	61	51	10	66	640
5	VU Laccadives	46	41	34	80	71	85	41	50	58	44	11	66	627
6	VK Heard	50	42	35	85	65	80	36	49	58	49	9	60	617
7	7O PDR Yemen	43	34	36	73	56	89	41	46	57	45	10	62	592
8	XU Khymer	50	45	35	85	61	65	30	44	58	42	11	41	567
9	FB8W Crozet	46	42	35	82	63	73	35	43	51	39	10	41	560
10	VU Andamans	43	38	36	76	63	68	30	43	49	45	9	39	539
11	CE0 San Felix	36	35	29	70	53	66	37	39	50	38	10	68	531
12	3Y Bouvet	31	35	27	70	60	73	42	37	50	40	10	50	525
13	3X Guinea	36	29	29	65	57	70	36	38	46	44	10	58	518
14	FR Juan de Nova	33	32	29	64	57	78	39	37	37	38	11	49	504
15	FR Glorioso	30	36	31	67	62	77	36	38	38	31	9	26	481
16	9U Burundi	33	21	29	59	48	66	32	32	44	40	9	52	465
17	XV Viet Nam	32	36	29	70	53	59	23	34	45	36	10	32	459
18	HK Malpelo	28	26	22	50	46	76	40	36	34	32	9	55	454
19	YA Afghanistan	34	28	29	75	51	58	25	33	42	34	9	31	449
20	4W N. Yemen	27	26	26	57	47	63	36	32	39	40	10	28	431
21	6O Somalia	26	20	27	47	46	74	32	30	28	34	9	29	402
22	5A Libya	22	17	21	48	39	65	23	27	35	31	9	36	373
23	5X Uganda	24	21	17	50	41	60	28	30	31	32	8	28	370
24	HK Bajo Nuevo	25	21	21	51	40	49	25	28	25	28	8	47	368
25	7J Okino Torishima	41	37	31	53	34	30	14	31	30	32	4	23	360
26	XW Laos	27	28	23	57	51	36	17	26	35	29	7	21	357
27	KS4 Serrana Bank	20	18	19	54	35	48	24	30	24	25	8	51	356
28	TN Congo	24	19	21	39	43	65	29	19	30	34	5	22	350
29	ZM Tokelau	43	31	20	51	32	40	15	33	28	22	5	37	348
30	A6 U.A.E.	26	23	23	42	40	54	27	29	30	26	6	16	342
31	5R Malagasy	24	19	21	52	44	50	19	26	29	30	5	21	340
32	7Q Malawi	24	20	22	48	33	46	24	27	28	27	7	19	325
33	TT Chad	15	15	19	30	41	59	31	21	20	31	3	28	313
34	TY Benin	20	13	17	38	44	50	26	18	24	27	5	30	312
35	ZD9 Tristan/Gough	20	13	16	41	42	49	19	22	27	31	7	23	310
36	PY Peter and Paul	21	22	16	37	34	53	33	25	9	21	5	33	309
37	VK Willis	29	25	23	37	36	38	16	27	21	26	4	16	298
38	FR Tromelln	21	16	17	40	37	48	18	17	21	21	6	14	276
39	3C0 Annobon	16	19	19	37	42	46	22	19	19	21	3	13	276
40	CE0 Juan Fernandez	19	14	16	34	24	42	24	23	20	12	5	38	271
41	YI Iraq	23	24	15	37	36	39	15	15	23	26	3	14	270
42	VP8 S. Sandwich	24	19	17	34	30	40	20	16	12	28	2	25	267
43	D6 Comoros	22	17	21	39	30	43	21	13	14	25	4	14	263
44	ZL Kermadec	25	22	17	37	27	38	12	24	12	19	5	21	259
45	5V Togo	15	14	12	30	30	48	26	16	14	25	4	22	256
46	SV Mt. Athos	12	11	12	28	40	57	29	12	12	26	3	9	251
47	Abu Ail	20	15	13	26	36	49	24	15	16	21	2	9	246
48	VP8 S. Shetlands	14	11	16	29	25	41	22	16	13	22	4	26	239
49	S2 Bangladesh	18	23	19	42	30	39	12	17	15	12	2	8	237
50	VK Mellish Reef	20	22	17	36	28	26	15	21	14	19	4	13	235

Table 1. 822 DXers responded to a survey conducted by The DX Bulletin; listed are the top fifty countries needed overall, worldwide. The figures are raw numbers, not percentages, of respondents needing each country. Under each heading, in italics, is the total number of surveys returned from that area.

79. Late in 1975, as the JARL looked toward its fiftieth anniversary the following year, the idea was hatched to make a new DXCC country which could be activated by the Japanese. From this idea came 7J1, which officially became a DXCC entity on May 31, 1976, and which was put on the air the following month by a massive JARL effort.

It was necessary to hire a very large ship for the trips to the reef; footings were made in the coral and a steel scaffold was constructed. The reef had turned out to be under water most of the time! One subsequent operation from Okino Torishima utilized the steel structure, but the demand continued and 7J1 still appears on many a DXer's "need list." Opposition to the creation of this DXCC entity by many DXers was based on the fact that Okino Torishima did not meet any of the DXCC country criteria; its status was purely political. Following the conclusion of WARC 79, as 7J1 had served its purpose, the matter came to a head, and in June, 1980, the ARRL's DX Advisory Committee of volunteers recommended deletion of 7J1. That was approved by League management and the deletion will become effective in a couple of months. Meanwhile, QSLs may continue to be submitted for credit for 7J1.

Other DXAC action in June concerned the African "homelands" of S8 Transkei, H5 Bophuthatswana, and T4 Venda; there have been operations from all three of these areas, using the special prefixes, and pressure has been building for a couple of years concerning their DXCC status. As these places are recognized by neither the United Nations nor the Organization of African Unity, and as only South Africa even has an embassy or consulate in them, DXAC recommended and ARRL concurred that country status at this time would be inappropriate. So continue working S8, H5, and T4, but the QSLs will count only for ZS South Africa. If and when country status is granted, credit for contacts prior to the status change will *not* be counted nor accepted for DXCC; there will be an official "starting date" for their DXCC status.

In April, *The DX Bulletin* (published in Vernon CT) surveyed its readers to determine the most-needed DXCC entities; over 800

readers responded. Naturally, in the middle of the survey, in April, an operation was conducted to one of the countries which would have otherwise appeared in the top ten: Glorioso Island. The survey showed BY China still topping the list, as it has for the past two decades. The basic survey results appear elsewhere in this column. Especially interesting is the breakdown by call area, showing that what is super rare from, say, the east coast of the USA may be only so-so rare from the west coast, and vice versa. Everyone suffers, maybe more or less equally!

PHONE BAND EXPANSION

Phone band expansion for U.S. amateurs is a hot topic, one affecting DXers dramatically. The Western Washington DX Club, among others, has circulated a letter requesting that the ARRL's Board of Directors consider the matter, and they did indeed, at their July 24 meeting in Seattle. The Board has now come out in favor of petitioning the FCC to consider the topic. While such may take several years and is still open to much discussion, at least two parts of the proposed changes are clear: The 20-meter phone band would be expanded, with the 14150-14175 segment for Extra class, 14175-14200 for Advanced, and 14200 and above for General

class (plus Extra and Advanced, of course). The other area of discussion is the 40-meter band; when Canadians received permission last fall to operate 7075-7100, which is where most of the rest of the world does its 40-meter phone operating, U.S. amateurs, contesters and DXers in particular, felt left out. Expect any phone band expansion proposal to include this prime territory for U.S. amateurs, probably Extra class only.

With those bands at 10, 18, and 24 MHz from WARC of a year ago still just a dream for amateurs worldwide, don't expect action on phone band expansion to happen soon. Discussions are still underway to decide if the new frequencies from WARC are to be wide open, mode restricted, class restricted, etc. Let's just hope we get those new bands by the time the sunspots recede in a couple of years!

ARRL DX CONTEST

Last fall, in this column, we carried on about new rules for the ARRL International DX Competition, rules which were to take effect in March, 1980, rules which were rammed down contesters' throats without proper discussion and without allowing time for due consideration of their impact.

What the action amounted to

was a total change in the basis for the contest, an activity with a 40-year history. The contest was run last March under the new rules, comments were then digested by the ARRL and by their Contest Advisory Committee, and the CAC voted in June to recommend that the major change in the rules, allowing DX-to-DX contacts, be rescinded. So, next year, the activity will be the same as in 1980, except that it will be "the world working the U.S. and Canada" only. That was the original intent in the 1930s and apparently contesters felt it was a valid basis for an operating activity. Single-band competition, another change for 1980, will be retained.

JULY DX HAPPENINGS

Guiseppe De Gasperin I2YDX operated three weeks from Somalia, signing 600DX, when time from his agricultural consultant duties permitted. Using low power, a vertical, and fighting poor band conditions, he worked 20 and 15 meters on both SSB and CW. With 600DX still active as this is written, those west of the Mississippi River were doing their best, but many will probably go away without Somalia's arrow in their DXCC quivers, due primarily to the lousy band conditions. Those lucky enough to have made the contact QSL to I2YAE,

<u>1</u>	<u>2</u>	<u>3</u>	<u>4</u>	<u>5</u>
BY 87 (1)	BY 89 (1)	BY 95 (1)	BY 84 (1)	BY 89 (1)
XZ 83 (3)	XU 83 (8)	VS9K 93 (2)	VS9K 79 (2)	VS9K 88 (2)
VS9K 80 (2)	XZ 78 (3)	7O 90 (7)	XZ 78 (3)	VU-L 88 (5)
VK9H 79 (6)	VK9H 78 (6)	VU-A 90 (10)	VK9H 75 (6)	ZA 85 (4)
XU 79 (8)	VS9K 79 (2)	XZ 88 (3)	XU 75 (8)	XZ 82 (3)
VU-L 73 (5)	FB8W 78 (9)	ZA 88 (4)	ZA 74 (4)	VK9H 80 (6)
FB8W 73 (9)	VU-L 76 (5)	VK9H 88 (6)	FB8W 73 (9)	FB8W 78 (9)
ZA 70 (4)	ZA 70 (4)	XU 88 (8)	VU-L 71 (5)	VU-A 78 (10)
7O 68 (7)	VU-A 70 (10)	FB8W 88 (9)	VU-A 67 (10)	FR-G 77 (15)
VU-A 68 (10)	7J 69 (25)	VU-L 85 (5)	7O 65 (7)	XU 75 (8)
<u>6</u>	<u>7</u>	<u>8</u>	<u>9</u>	<u>0</u>
VS9K 82 (2)	VS9K 98 (2)	BY 91 (1)	BY 92 (1)	BY 88 (1)
7O 82 (7)	ZA 84 (4)	XZ 86 (3)	VS9K 91 (2)	VS9K 87 (2)
ZA 81 (4)	BY 82 (1)	VU-L 86 (5)	XZ 85 (3)	ZA 85 (4)
VU-L 78 (5)	VU-L 75 (5)	VK9H 84 (6)	ZA 82 (4)	XZ 83 (3)
BY 76 (1)	7O 75 (7)	VS9K 83 (2)	VU-L 78 (5)	VK9H 82 (6)
VK9H 73 (6)	3Y 76 (12)	ZA 83 (4)	VK9H 78 (6)	7O 75 (7)
XZ 72 (3)	HK-M 73 (18)	7O 79 (7)	XU 78 (8)	VU-A 75 (10)
FR/E 72 (14)	XZ 71 (3)	XU 76 (8)	7O 77 (7)	VU-L 73 (5)
FR/G 71 (15)	FR/E 71 (14)	FB8W 74 (9)	FB8W 69 (9)	3X 73 (13)
HK-M 70 (18)	CE0X 67 (11)	VU-A 74 (10)	CE0X 68 (11)	XU 70 (8)

Table 2. This breakdown of the survey results, for the ten U.S. call areas only, shows the difference in needs on a geographical basis. The first number is the percentage of survey respondents needing each country; in parentheses is the rank that country had in the overall survey.

G. C. Brogini, Via Roma 1, Ispra Va 21017, Italy.

Several operators at Australia's Willis Island continued active, signing VK9ZG on 20 meters only. They will continue through 1980, after which the island's weather station will be automated and technicians from Australia will seldom be needed. That will increase Willis's rarity dramatically. QSL to VK3OT, Stephen Gregory, Box 622, Hamilton 3300, Australia.

San Hutson K5YY operated from ZK2 Niue, A35 Tonga, and KS6 American Samoa during July; it was his eighth expedition since 1969. Concentrating on 160, 80, 40, and 10 meters, San made nearly 12,000 contacts from the three spots, about one-third of them on CW. His only complaints were the constant requests for QSL information and for times when he might be found on certain bands. As this information was published in the various DX bulletins, San needlessly had to spend time answering questions. Otherwise, all went well and the demand for several countries, especially on the low bands, was reduced. QSL to San Hutson K5YY, Box 5299, Little Rock AR 72215 USA.

Dick Grantham VE1AI put Canada's Sable Island on the air for about 48 hours the last week-end of June; a longer stay was precluded by the authorities.

About 1300 contacts were made, including a fairly high percentage of Europeans and Japanese. Conditions for working Canadian and U.S. DXers were not so hot on the higher bands. Sable Island, by the way, is six square miles, has six permanent inhabitants operating a weather station, and is a difficult landing by boat.

Erik Sjolund SM0AGD has retired after eight years of traveling for the Swedish government and putting a number of rare countries on the air. His last operation was from Africa in the spring, including Guinea Bissau J5AG, Swaziland SM0AGD/3D6, Botswana A22GD, and Rwanda 9X5LE. Erik was in another half-dozen countries but could not secure operating permission. From the four above-mentioned spots he made 9500 contacts, 95 percent on CW. QSLs for all Erik's operations go to Joergen Svensson SM3CXS, Berghems-vagen 11, S-86021 Sundsburk, Sweden.

Another CW goodie in July was AI3E/KX6 on Kwajalein, Marshall Islands. Dwight Sipler was there about a week, used equipment already in place for the KX6DC club station, and made 1700 contacts...650 in the States, 550 in Japan, and the rest around the world. His previous operation in March from Kwaj netted 1900 contacts, also all on CW. SASE to Dwight Sipler,

1879 Shaw Ave., Pittsburgh PA 15217 USA.

QSLs are still eagerly sought by many DXers for contacts with Y11BGD Iraq and LU3ZY South Sandwich. Both take several months and probably more than one request. The previously published routes for these two are valid, but slow.

There is talk of an upcoming operation from Iraq, by Jordanian amateurs along with the Iraqis, to happen in September. If it happens, the call will be Y11JY and QSLs will be handled by WA3HUP. Nothing has been forthcoming on Heard Island, but expectations are for a December or January operation to last about two weeks. And there is talk of a possible operation from 7O South Yemen, also around December or January.

MAILBAG

Hugh Vandegrift WA4WME, a member of the 1978 Clipperton expedition team, responded to our suggestion back in August that DXCC credit might be granted to someone who puts a very rare spot on the air. Hugh says "the real thrill of being a DXpeditioner is *not* getting a 'freebie,' but hearing your own station (regardless of the operator) and knowing that you are hearing something that you put together yourself." Pretty hard to argue with that, Hugh. WA4WME has worked his own

station from 128 countries while abroad! His letter concludes with our quotation of the month: "There are only 19 countries that are DXpeditions... all the rest are vacations."

Comments on how easy it is to make DXCC these days brought a letter from another old-timer, W9ITV in Chicago. Joe has just completed working a hundred countries with his five-Watt Argonaut and nothing more than a vertical on 20, 15, and 10 meters. His list of the hundred is about half CW and half SSB, about two-thirds on 10 meters, one-third on 15, and a handful on 20. In conjunction with our work on *The DX Bulletin*, we get regular reports from WA2JOC, who uses an Argonaut and beam, and works really rare stuff, right through pileups and all.

Bob Beach W8LCZ penned a letter from 33,000 feet, on his way to Ascension Island. Bob travels on military transports to various worldwide assignments, but never knows enough in advance to publicize his upcoming operations. He has been on from Thule, Greenland, Guam, Hawaii, Peru, and as ZD8RB Ascension Island. He carries a transceiver and a collapsible whip antenna, getting on the air whenever possible.

Next month is QSL manager list time again. Until then, keep the letters and photos coming. Thanks!

CONTESTS

from page 16

Following details noted in the log: date/time, callsign of the VK/ZL station heard, callsign of the station he is working, RS(T) of the VK/ZL station heard, serial number sent by the VK/ZL station, band. Scoring is on the same basis as for the transmitting section and the summary sheet should be the same. Phone and CW is combined for the SWL section!

MONTANA QSO PARTY

Starts: 1800 GMT October 11

Ends: 2300 GMT October 12

Sponsored by the Butte Ama-

teur Radio Club and the Gallatin Ham Radio Club, the contest is open to all. Use all bands, CW and Phone. There will be a rest period from 0500 GMT to 1400 GMT on October 12th. The same station may be worked on each band and mode.

EXCHANGE:

RS(T) and state, province, country, or Montana county.

FREQUENCIES:

Phone—1820, 3935, 7235, 14280, 21380, 28575. CW—1810, 3555, 7055, 14055, 21055, 28055. Novice—3730, 7130, 21130, 28130.

SCORING:

Complete QSOs count 3 points. Out-of-state stations multiply the total number of QSO points by the number of Montana counties worked (56 maximum). Montana stations multiply the total number of QSO points by the sum of Montana counties, states, provinces, and countries.

ENTRIES & AWARDS:

Certificates will be awarded for the top score from each area. A plaque will be awarded to the highest-scoring Montana station and to the highest-scoring out-of-state station. Logs should show date and time in GMT, band, and emission. Logs, summary sheets, and an SASE for results should be sent by November 15th to: Gene P. Shea KB7Q, Gallatin Ham Radio Club, 417 Staudaher Street, Bozeman MT 59715.

JAMBOREE ON THE AIR

Starts: 0001 GMT October 18

Ends: 2400 GMT October 19

The World Scout Bureau sponsors this 23rd Jamboree on the Air. It is not a contest, just an opportunity for Scouts, former Scouts, or anyone interested in Scouting and kids to talk about Scouting. Hams invite members of Scout units, individually or as units, to visit, see, and hear ham radio. No score, no specific exchange, no logs required, but participation certificates are available from the USA/BSA JOTA Coordinator, H.A. Harchar W2GND, 216 Maxwell Avenue, Hightstown NJ 08520. Send an SASE!

FREQUENCIES:

3940, 7290, 14290, 21360, 28990, 50.5, 3590, 7030, 14070, 21040, 28190, 50.05, 3750, 7125, 21140. Also, all SSTV and RTTY frequencies!

QRP ARCI ANNUAL OCTOBER QSO PARTY

Starts: 2000 GMT October 18
Ends: 0200 GMT October 20

The contest is open to all amateurs and all are eligible for the awards. Stations may be worked once per band for QSO and multiplier credits.

EXCHANGE:

Members—RST, state/province/country, and QRP number.

Non-members—RST, state/province/country, power input.

SCORING:

Each member QSO counts 3 points. Non-member QSOs are 2 points, and stations other than W/VE count 4 points each. Multi-

pliers are as follows: more than 100 Watts input— $\times 1$; 30.1-100 Watts input— $\times 1.5$; 10.1-30 Watts input— $\times 2$; 3.1-10 Watts input— $\times 4$; 1.1-3 Watts input— $\times 6$; less than 1 Watt input— $\times 10$.

Stations are eligible for the following bonus points: +300 for solar or wind power (100% solar or wind power source), +100 for battery power (100% battery power), for duration of party. Use only one bonus, not both!

Final score is total QSO points times total number of states/provinces/countries per band times the power multiplier. Any bonus points are added last.

FREQUENCIES:

Novice—3710, 7110, 21110, 28110. SSB—1810, 3985, 7285, 14285, 21385, 28885, 50385. CW—1810, 3560, 7060, 14060, 21060, 28060, 50360.

Note: VHF/UHF contacts must be direct—no repeater contacts are allowed.

Try SSB on even hours and don't forget the Novice frequencies.

AWARDS:

Certificates to the highest-scoring station in each state, province, or country with 2 or more entries. Other places will be given depending on activity. One certificate to highest-scoring Novice/Technician overall.

One certificate for the station showing three skip contacts using the lowest power.

LOGS & ENTRIES:

Send full log data, including full name, address, and bands used, plus equipment, antennas, and power used. Include details on how bonus points were determined. Please indicate if you are a Novice or Technician station. Entrants desiring results sheet and scores, please enclose a business-size envelope with return postage. Logs must be received by November 20th to qualify. Send all logs and data to: QRP ARCI Contest Chairman, Edwin R. Lappi WD4LOO, 203 Lynn Drive, Carrboro NC 27510.

AWARDS

from page 20

DX AWARD FROM PUERTO RICO

I'm sure everyone recognizes the callsign KP4AM/D as the call used this past year for the great Desecheo Island DXpedition. Well, Dave KP4AM, President of the DX Club of Puerto Rico, just dropped me a line and advised me of the award being offered amateurs by this respectable Caribbean group.

8 x 8 x 8 Award

This award made available by the DX Club of Puerto Rico now has found a home with 350 recipients. Requirements are to work 8 stations in the Common-

wealth of Puerto Rico and 8 other DXCC countries in CQ Zone 8 (CO, HI, HH, 6Y5, KP2, KP1, VP2, etc.) for a total of 16 QSOs. There is no time limit and special endorsements will be given for single mode or band accomplishments.

A list of calls, countries, modes, and bands certified by a club's officers or 2 amateurs (GCR) should be sent with US \$1.00 or 4 IRCs to: Awards Manager, DX Club of Puerto Rico, PO Box 1061, San Juan, Puerto Rico 00902.

The club reserves the right to request any or all cards be sent the Manager before the award is issued. Note that KP4, NP4, and WP4 prefixes are issued in

Puerto Rico and that KP4AM/D counts for Desecheo Island, not for Puerto Rico.

DX AWARDS FROM MEXICO

The Mexico DX Club has two very attractive awards being offered to amateurs worldwide and I'd like to take this opportunity to share them with you.

100 X Award

This award is issued by the Mexico DX Club to licensed amateurs and SWL stations who confirm QSOs with stations that have in their callsign one or more "X" letters (XE1OW, W4LXX, W7UMX, EA3AX, K6AXC, KH6XX, etc.).

To apply for the award, you must accumulate 100 points as follows: 1 point is earned for stations (with X in their call) outside Mexico; 2 points for contacting stations in Mexico (with an X in their call). In addition, should you have a QSO with a member of the Mexico DX Club, 3 points will be earned. Should you QSO with the club station of the Mexico DX Club, XE1MDX, this will count 10 points credit.

Only contacts after January 1, 1973, will be valid. Award fee is 15 IRCs or \$3.00 US.

Mexico DX Club Award

This is issued to licensed amateurs and SWL stations who confirm QSOs with Mexican DX Club members' stations, located in Mexico. XE applicants need 10 QSOs with 10 different Mexico DX Club members. Zones 1 to 13 (North, Central, South America, and Caribbean), except Zone 6, need 5 QSOs. All

others need 3 different DX Club member QSOs. Award fee is 10 IRCs or \$2 US.

Applications and QSL cards must be sent to Awards Manager, Mexico DX Club, PO Box 21-167, Mexico City 21, Mexico.

DX AWARD FROM PORTUGAL

Attention County Hunters! From the national amateur radio society in Portugal comes word about the Portuguese "Counties" Award. Known as the DCP, this award is available in 4 levels of achievement, each dependent upon the type of station being used in making contacts: Class A—HF fixed; Class B—HF mobile; Class C—VHF fixed; Class D—VHF mobile. Depending on the number of Portuguese counties claimed, 7 different grades may be earned: Grade I—75 counties; Grade II—125 counties; Grade III—175 counties; Grade IV—200 counties; Grade V—225 counties; Grade VI—250 counties; Grade VII—274 counties.

DCP is available to licensed amateurs and club stations throughout the world and is issued to them for all contacts claimed, regardless of calls held or date of contact. The only stipulation is all contacts must be made from the same DXCC country. Counties worked under 2 or more classes may not be combined. QSL cards must be in the applicant's possession at the time application is made.

Unless otherwise indicated on QSL cards, the QTH printed will determine the county identity. When in doubt, the "Lista Do Codigo Postal" issued by the



Post Office will become the official guide. This booklet is available from Amateur Radio Club of Portugal at a cost of US \$2.00.

A special award booklet is available for \$1.00 US from either the sponsoring society or from WB9RCY. GCR apply in all instances. Mail your award application along with an awards fee of US \$2.50 to ARP. Their formal address is Associacao de Radioamadores Portugueses, PO Box 2145, 4021 Porto Codex, Portugal.

INTERNATIONAL ISLAND DX AWARD

The Whidbey Island DX Club takes special pleasure in announcing its Island DX Award program. Recognized throughout the world, this award has realized recipients from almost every major country on the globe.

Known as the IDX Award, this program recognizes those amateurs who can work a minimum of fifty (50) DX Islands of the World. Endorsements are also given for 100, 150, and the maximum islands possible.

All DXCC countries which are designated "islands" are the only qualifying contacts. A list of these islands is included here. Reprints of the IDX listing are available by sending an SASE to the club's address.

All contacts must be made after October 1, 1977, on either CW, SSB, SSTV, RTTY, OSCAR, or any mixed mode. Single-band accomplishments are also recognized on the award issued.

To apply, prepare a list of contacts in prefix order. Applications received in any other order will be returned to the applicant unprocessed. Indicate the station worked, IDX island, band, mode, date, and GMT.

Do not send QSL cards! Have your list verified by two amateurs, a local radio club secretary, or a notary public. Enclose your application with the award fee of US \$2.00 and a large SASE or 5 IRCs to: Whidbey Island DX Club, 2665 No. 1250 East, Oak Harbor WA 98277.

Rules governing this award are reviewed annually in the month of September.

To assist IDX Award seekers, during the month of January each year, rare DX stations appear for the International Island DX Contest.

A3
A9X
BV
C2
C6
CE0A
CE0X
CE0Z
CO,CM,KG4
CT2
CT3
D4
D6
DU
EA6
EA8
EI, GI
FB8W
FB8X
FB8Z
FC
FG (Gaud)
FG,FS
FH8
FK
FM
FO (Clip)
FO
FP
FR (Glor)
FR (Juan)
FR (Reun)
FR (Trom)
FW
G,GM,GW
GC,GU
GC,GJ
GD
GI,EI
H4,VR4
HC8
HH,HI

HK0 (Bajo)
HK0 (Malp)
HK0 (San An)
IS
J3,VP2G
JA-JR-KA
JD,KA1 (Mina)
JD,KA1 (Ogasa)
JD,7J1 (Okino)
JW
JX
KG4 (See CO)
KH1,KB (Baker)
KH2,KG6 (Guam)
KH3,KJ
KH4,KM
KH5K, KP6 (King)
KH5, KP6 (Palmy)
KH6,WH6,AH6,NH6
KH6,KH7 (Kure)
KH8,KS6
KH9,KW
KH0,KH2,KG6 (Mari)
KC6 (West)
KC6 (East)
KP (Desoth)
KP1 (Navassa)
KP2,KV
KP3,KS4, HK0 (Ran-Ser)
KP4, NP4
KX
OH0
OJ0
OX,XP
OY
P29
PJ (Neth Ant)
PJ (St. Martin)
PY0 (Fernando)
PY0 (Peter & Paul)
PY0 (Trinidad)
S7

S9,CR5
SV (Crete)
SV (Dodecanese)
T2,VR8
TF
TI9
UA1,UK1 (Franz Jo)
VE1 (Sable)
VE1 (St. Paul)
VK (Lord Howe)
VK9 (Willis)
VK9 (Christmas)
VK9 (Cocos)
VK9 (Mellish)
VK9 (Norfolk)
VK9 (Heard)
VK9 (Macquarie)
VP2A
VP2D
VP2E
VP2G (See J3)
VP2K
VP2L
VP2M
VP2S
VP2V
VP5
VP8 (Falkland)
VP8,LU (Ork)
VP8,LU (Geo)
VP8,LU (Shet)
VP8,LU (Sand)
VP9
VQ9
VR1 (Br. Phoenix)
VR1 (Gilbert)
VR3
VR4 (See H4)
VR6
VR7
VR8 (See T2)
VS5,9M6,9M8

VS6
VS9 (See 8Q)
VS9K
VU7 (Andaman)
VU7 (Laccadive)
XF4
XP
YB, YC, YD
YJ
YV0
ZD7
ZD8
ZD9
ZF
ZK1 (North)
ZK1 (South)
ZK2
ZL
ZL (Auck-Camp)
ZL (Chatham)
ZL (Kermadec)
ZM7
ZS2 (Marion)
1S
3B6,3B7
3B8
3B9
3C0
3D2
3Y
4S
5B,ZC
5R
5W
6Y
8P
8Q,VS9
9H
9M6,9M8 (See VS5)
9V
9Y

Island DX Listing. The IDX Award program depicts DXCC countries which are bona-fide "islands" as recognized by the National Geographic Society. First criterion, however: They must be a DXCC country as stated on the ARRL DX Countries List. Any qualifying DXCC countries either omitted from this list by error or those which have been recognized for DXCC after the release of this listing will be added to the IDX List when it is printed next.

HAM HELP

I need a schematic and/or user's manual for a Dumont type 350 oscilloscope. I will pay for copy or copy and return original promptly.

Elbert Drazy
6 Amherst Rd.
Amherst MA 01810

I have a VHF AM receiver that I would like to put on 121.5 for an ELT receiver. It is currently on 127.400. It is a military receiver model RC-3A. It was made by

Dorsett Electronics and purchased from Fair Radio. It is a solid-state receiver and appears to be of late production. Any help as far as a schematic, crystal frequencies, or any modifications anyone has done to this unit would be appreciated. The receiver is to be used for search and rescue applications.

Stan Gantz WB5TGL
PO Box 2802
Silver City NM 88061
(505)-538-5091

Due to a seemingly overwhelming demand for instruction/service manuals for various types equipment, rather than write to the other hams individually, I thought I'd just send a couple of addresses in as sources of such manuals.

For surplus equipment, contact: Fair Radio Sales, PO Box 1105, 1016 E. Eureka St., Lima OH 45802.

For commercial/amateur gear manuals, contact: HI, Inc., PO Box 864, 1601 Ave "D," Council Bluffs IA 51501.

I was once in the same position—I dang near would've killed for certain manuals!

D.L. Hildebrand N6BHU
Hollywood CA

FUN!

from page 28

5) The "Zepp" antenna is a type of halfwave dipole. How did it get its name?

- 1) It was named after its inventor, the Italian wireless pioneer, Prof. Hugo Zeppolini.
- 2) They were first used on zeppelins.
- 3) It's an acronym for Zero Efficiency Parallel Plane antenna.
- 4) The guy who invented it thought "Zepp" was a cute name.

ELEMENT 4—MATCH THE PREFIX

Instructions: Mate the country in Column A with the appropriate prefix in Column B.

Column A	Column B
1) United States	A) AH9
2) Montserrat	B) XE
3) Wake Isl.	C) KA5
4) Kingman Reef	D) AP
5) East Germany	E) NH5
6) Pakistan	F) DU
7) Bahama Isl.	G) G
8) England	H) EA
9) United Arab Emirates	I) PY
10) France	J) HH
11) Mexico	K) LU
12) Argentina	L) Y2
13) Philippine Isl.	M) EA6
14) Spain	N) 4W
15) Balearic Isl.	O) HB
16) Brazil	P) F
17) Switzerland	Q) C6
18) Haiti	R) 4X
19) Israel	S) A6
20) Denmark	T) VP2M
	U) OZ

ELEMENT 5—HAM ACROSTIC

Instructions: Guess the words defined and write them over the numbered dashes. Then place each letter in the correct square in the puzzle. The black squares show word endings. The completed puzzle will form a statement about amateur radio. (Illustration 2)

	1	C	2	AA		3	K	4	V	5	S	6	G	7	C	8	J	9	C	10	I		11	F	12	B	13	V	14	O	15	Y		16	R			
17	Y	18	E		19	W	20	U	21	X		22	H	23	Z	24	C		25	Q	26	J	27	J	28	D	29	V	30	I		31	P	32	I	33	W	
34	J		35	A		36	O	37	D	38	M	39	H	40	Q	41	I	42	F	43	Y		44	P	45	I	46	M		47	E	48	I	49	G	50	E	
51	F	52	B	53	C	54	V	55	T	56	B		57	V	58	AA	59	T	60	I		61	E	62	K	63	L	64	J	65	L		66	S	67	Y	68	J
69	A		70	X	71	Q	72	A	73	U	74	J	75	D	76	E	77	Z	78	N		79	T	80	U	81	I	82	V		83	W	84	Z		85	L	
86	A	87	J	88	A		89	X	90	R	91	L		92	V	93	N	94	X	95	F		96	J	97	M	98	I	99	Q	100	T	101	I	102	H	103	AA
	104	G	105	AA	106	K	107	H	108	F	109	D		110	C	111	D	112	D	113	G	114	K		115	G		116	Z	117	W	118	B					

Illustration 2.

A) To pass a message.....	72	69	86	35	88				
B) Beam.....	118	52	56	12					
C) License.....	7	1	24	53	9	110			
D) Bad season for skyhooks.....	111	112	28	75	37	109			
E) Antenna structure.....	76	18	61	50	47				
F) "Mr. Code".....	51	42	95	11	108				
G) Coaxial line.....	113	115	104	49	6				
H) Type of business.....	22	39	107	102					
I) Amplitude.....	81	45	30	48	101	98	60		
J) Ham time.....	41	32	10						
	26	34	74	68	8	27	96		
	87	64							
K) Gassy bulb.....	106	114	62	3					
L) Contest sheet.....	65	63	85	91					
M) Repeater (abbr.).....	46	97	38						
N) RTTY gadget (abbr.).....	93	78							
O) "Push to"-talk (abbr.).....	36	14							
P) Field Day (abbr.).....	44	31							
Q) Field Day shelter.....	25	71	99	40					
R) Small 2-meter rig (abbr.).....	90	16							
S) "One land" state (abbr.).....	5	66							
T) Getting "knack of it" code....	79	59	55	100					
U) . . . and cheese.....	20	80	73						
V) Incentive licensing decade..	92	4	13	57	54	29	82		
W) Power.....	33	117	83	19					
X) Record a QSO.....	89	94	70	21					
Y) Early morn contest reflex....	15	67	17	43					
Z) The Morse.....	23	84	116	77					
AA) You send with your.....	58	105	2	103					

THE ANSWERS

Unlike many other exams, we hope you actually enjoyed taking this one. Now for the answers. Here goes...



Element 1:

See diagram.

Element 2 (Reading from left to right):

AMATEUR, YAGI, RTTY, TUBE, DXCC, COAX, LID, COIL, ANTENNA, SSTV, DIPOLE, TVI, SSB, KEYS, SCOPE, VOX, DIODE, OSCAR, SOLDER, VTVM.

Element 3:

1-1 Yes, for the benefit of gangsters and spies everywhere, gentle old Hiram invented the gun silencer. However, like most inventors whose projects are put to ill use, Maxim felt his silencer got a bum rap. He originally invented it to help protect American soldiers.

2-3 According to international allocations, broadcasters aren't supposed to go below 7.100 MHz on our shared 40-meter band. But that hasn't stopped many of them from doing it. If you feel your few hundred Watts will overcome their megawatts, by all means feel free to transmit all over them.

3-2 Between 80-10 meters, RTTY is fair play on all CW frequen-

cies—if you stay within your license's limits, that is. While transmitting F1 on a Novice band may be ethically questionable, it's quite legal. Novices, of course, are restricted to A1.

4-1 Yes, the harmonica. Sir Charles transformed the instrument from a device consisting of a series of water goblets one played with a moistened finger (invented, incidentally, by another "electrical" scientist, Benjamin Franklin) into the familiar mouth organ we all know today.

5-2 The "Zepp" skyhook did in fact get its name from Count Zeppelin's airships. "Prof. Zeppolini," "Zero Efficiency"—indeed!

Element 4:

1-C, 2-T, 3-A, 4-E, 5-L, 6-D, 7-Q, 8-G, 9-S, 10-P, 11-B, 12-K, 13-F, 14-H, 15-M, 16-I, 17-O, 18-J, 19-R, 20-U.

Element 5:

See diagram.

SCORING

Now, let's try to make some sense out of all this. Starting with Element 1, score 20 points if you successfully completed the crossword puzzle; or, if you didn't finish it, 1/2 point for each question you got. On Element 2, award yourself 1 point for each word you untangled. Moving to the multiple choice questions, Element 3, each correct answer here nets you 4 points. On Element 4, every prefix connected to the right country adds 1 point to your total. And, to wrap things up, if you completed the Ham Acrostic, you get 20 points. Subtract 1/4 point for each unsolved definition if the puzzle stumped you. But a bonus 10 points to the experts who deciphered the message: "IN NINETEEN SIXTY-TWO THE FCC TURNED DOWN A PETITION FOR RULEMAKING THAT WOULD HAVE PERMITTED HAMS TO PLAY THE STAR SPANGLED BANNER TWICE A DAY." Incidentally, we'll leave anonymous the name and call of the patriotic ham who made that request. Perhaps he got a job playing the anthem on some broadcast station. Must listen for him on 40 meters someday.

So, how did you do? Let's see...

- 0-20 points = Novice material
- 21-40 points = Technician material
- 41-60 points = General material
- 61-80 points = Advanced material
- 80-110 points = Extra material

If you scored below your actual license class, don't feel too bad—maybe you're just hooked on the FCC's type of tests.

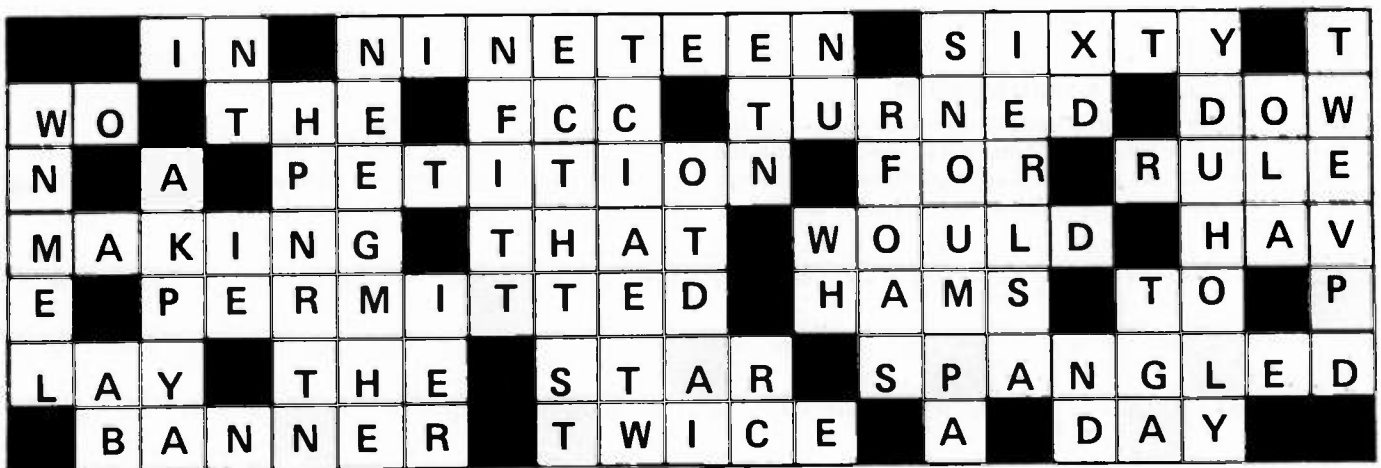

REVIEW

The Linear Amplifier Planbook II

While searching through a

box of junk purchased at a hamfest flea market, I found a

handful of Motorola engineering bulletins and application notes. The people at Motorola had taken the time and trouble to write short articles about the amplifiers they designed around their transistors. Each bulletin contains a description of the design strategy, a schematic with

parts values, and circuit board templates. Those amateurs not interested in the mathematics can skip over the theoretical parts of the text and concentrate on duplicating the design in their own workshop.

Now you don't have to rely on flea-market scrounging, nor do

you need a friend who works for Motorola to obtain these technical gems. A. P. Systems recently introduced *The Linear Amplifier Planbook II*. It contains a dozen application notes and bulletins that cover amplifiers for the amateur frequencies between 1.6 MHz and 450 MHz. Most of the designs are for amplifiers running using 12-volt station covers a one-kW, solid-perfect mate rig.

The A. P. S is a 100% re Motorola info enda includ ble. It costs : ested in h next ampli

A.P. Systems, PO Box 488, Milford PA 18337.

Tim Daniel N8RK
73 Magazine Staff

Single Sideband Engineering Practice

Edition II, published by American Crystal Supply

Rarely is there a week when

cations can help the would-be 10-meter fan make the move. The staff of American Crystal Supply has put the experience gained in converting more than 2000 rigs into their new book, *Single Sideband Engineering Practice* Edition II.

While this book emphasizes the conversion of popular SSB units, It also contains information to AMers. First, the crystal and phase-locked loop (PLL) frequency schemes are covered, individual chips are with modification in many cases. Tips on power output and clarifier operation be found.

CB fad diminishes, am-

ateurs are going to find themselves sitting on a goldmine of potential ham gear. Many of the late model CBs were intended for crowded bands and offer selectivity and sensitivity that puts the more expensive multi-band transceivers to shame. Don't be discouraged by the lack of detailed information on the inner workings of CB gear. Once you develop a basic understanding of the theory involved, you'll know which rigs are easily converted and those you should avoid. Conversion nuts, *Single Sideband Engineering Practice* Edition II is for you. This 96-page book is available from American Crystal Supply, PO Box 638, W. Yarmouth MA 02673, for \$14.95.

Tim Daniel N8RK
73 Magazine Staff

Be a good friend... Give 73 Magazine for Christmas
Be a smart friend... do it now and take advantage of 73's 20th Anniversary Special - 1 year for \$20.

Bill me for a one year gift subscription for \$20.00

My Name _____
Address _____
City _____

Please enter a one year gift subscription to:
Name _____ State _____ Zip _____
Address _____
City _____

Canadian \$22.00/1 year only, US funds Foreign \$30.00/1 year only, US funds

Please allow 4-6 weeks for delivery.
73 Magazine • PO Box 931 • Farmingdale NY 11737

This card expires November 15, 1990. All gift subscriptions begin with Jan. 1981 issue.

I wish to express my very deep gratitude to all the people who supplied information pertaining to my Ham Help needs. Now that I am on the semi-mend and settled down at the old QTH, I have found a pile of information, all helpful; those who have not yet received a thank-you QSL card (73 press, of course!) should be getting them now. The response was fantastic. My only regret is that the most detailed description of Link FM equipment I have ever seen or heard of came in an envelope with no return address, and it had been "eaten" by the express pony.

Fred Goldberg WA2BJZ
29 Clearview Road
E. Brunswick NJ 08816

I wish to express my very deep gratitude to all the people who supplied information pertaining to my Ham Help needs. Now that I am on the semi-mend and settled down at the old QTH, I have found a pile of information, all helpful; those who have not yet received a thank-you QSL card (73 press, of course!) should be getting them now. The response was fantastic. My only regret is that the most detailed description of Link FM equipment I have ever seen or heard of came in an envelope with no return address, and it had been "eaten" by the express pony.

Special thanks, too, to the people who are responding to the request for equipment for the East Valley ARC; we already have two teleprinter systems on

the line (not just two machines) and designs and modifications for improvements are pouring from the drawing boards—now if we receive more equipment... hope, hope.

Marc Leavey should be getting a RTTY Loop article I sent in April. It came back several times undelivered; this time things will work out—I found Murphy! Also, a couple of missed issues were double shipped so I am returning them under separate cover; my pleasure to help any publication related to amateur radio, especially the *best* one.

Finally, I am bewildered by the seemingly general amateur attitude that CBers are stealing the PR from services rendered especially in emergencies. Yes, we do well in hurricanes, tornadoes, quakes, etc. In checking my log, I find that in seven instances in the past six years I have been either first or second on the scene of an auto accident (no, I haven't been involved). I grabbed the amateur mics. Six times I got no answer, even on the repeaters, and one time the answerer joked about how silly I was to request police, ambulance, etc. In six instances I then switched to the eleven-meter channel nine mic and got through the QRN and M for emergency services—kind of makes you wonder, doesn't it? If we don't put out the effort, how can we expect any good PR?

Again thanks, and keep up the great projects and editorials.

John C. White WB6BLV
Porterville CA

I need owner's return w following:
1) Dig meter, r
2) Tim 704 mic
3) El model counter
4) H graph 423-15 help w to co

Baudot and ASCI. Thanks.

N. M. Callaghan, Jr. N2AUN
RD#3, Box 140
Rhinebeck NY 12572

I need a copy of the operations manual or other instructions for the Power Meter, TS-226A/AP, 115 V ac, 50-2400Ω. I will pay expenses.

Sidney L. Morgan KA9BAI
1048 Englewood Drive
Rantoul IL 61866

I badly need manuals/schematics for the following equipment: Hallicrafters model SX-140 ham band receiver; Heathkit HW-10 Shawnee, 6-meter transceiver; World Radio Labs Globe Scout model

The model PRC and the order number is 08709-Phila-55-93. I need the schematic of the unit, power requirements, and any crystal data such as load impedance and whether it is series or parallel operation. If anyone has a manual containing this unit, I would be glad to pay for a copy of this information. I am very much interested in getting some use out of this unit.

Rick Lucas WB0NQM
1922 Edgelea Road
Lawrence KS 66044

Does anyone have any information on a receiver that is very similar to, but not the same as, a Hammarlund HQ-129X? The circuitry and layout are almost

SOCIAL EVENTS

Listings in this column are provided free of charge on a space-available basis. The following information should be included in every announcement: sponsor, event, date, time, place, city, state, admission charge (if any), features, talk-in frequencies, and the name of whom to contact for further information. Announcements must be received two months prior to the month in which the event takes place. They should be sent directly to Editorial Offices, 73 Magazine, Pine Street, Peterborough NH 03458, Attn: Social Events.

CORNWALL NY OCT 4

The Orange County Amateur Radio Club will hold its annual auction on Saturday, October 4, 1980, at Munger Cottage, Cornwall NY. Admission is \$1.00. The auction begins at 11:00 am. Talk-in on 146.52. For more information, contact William Lazzaro N2CF, 11 Jefferson Street, Highland Mills NY 10930.

SYRACUSE NY OCT 4

The Radio Amateurs of Greater Syracuse will hold their annual hamfest on October 4, 1980, from 9:00 am to 6:00 pm at the Arts and Home Center, New York State Fairgrounds, Syracuse NY. Tickets are \$2.00. Flea market vendors may bring their own table or rent one. A women's program will be offered as well as an indoor and outdoor flea market and exhibits. Talk-in on .31/.91 and .90/.30. For further information, write to Box 88, Liverpool NY 13088.

BILOXI MS OCT 4-5

The Mississippi Coast Amateur Radio Association will hold its 4th annual Ham-SwapFest on Saturday and Sunday, October 4-5, 1980, at the International Plaza, Biloxi MS. Admission is free. Features will include a prize drawing Saturday afternoon, an old-time shrimp boil Saturday night, main prize drawings on Saturday afternoon, a flea market, commercial displays, forums, and prizes for

YLs, XYLs, and harmonics. Talk-in on 146.13/.73 and .52. For further information, contact Bob Wyatt WB5VCI, Hamfest Chairman, Box 114, Whispering Pines Drive, Waveland MS 39576.

VIRGINIA BEACH VA OCT 4-5

The ARRL Virginia State Convention and the fifth annual Tidewater Hamfest, Computer Show, and Flea Market will be held on October 4-5, 1980, in the Arts and Conference Center, Virginia Beach VA. Take Highway 64 to Highway 44, which passes right by the door and also into the beach resort area. Featured are ARRL, traffic, DX, and technical forums, as well as free bingo and a lounge for XYLs. Admission is \$3.50 and flea market spaces are \$3.00 per day. There will be an advance ticket drawing for a Kenwood FM transceiver. For tickets and more information, send an SASE to TRC, PO Box 7101, Portsmouth VA 23707.

WARRINGTON PA OCT 4-5

The Pack Rats fourth annual Mid-Atlantic States VHF Conference will be held on October 4, 1980, from 9:00 am to 5:00 pm at the Warrington Motor Lodge, Rte. 611, Warrington PA. Registration is \$3.00 in advance or \$4.00 at the door. The price includes admission to the ninth annual Hamarama flea market on October 5, 1980, from 8:00 am to 4:00 pm, rain or shine, at the Bucks County Drive-In Theatre, also on Rte. 611. The Saturday conference will include a cocktail hour and get-together at 6:30 pm and a buffet dinner, at \$9.00 each, at 7:30 pm. The cost for the flea market alone is \$2.00 and tailgating is \$2.00 per space (bring your own table). Featured will be amateur radio equipment, electronic parts, surplus, and door prizes. Talk-in on 146.52 (W3CCX). For information about both events, write Ron Whitsel WA3AXV, PO Box 353, Southampton PA 18966, or phone (215)-355-5730.

BENTON HARBOR MI OCT 5

The 1980 Blossomland Blast will be held on Sunday, October 5, 1980, from 8:00 am to 3:30 pm EDT at the Lake Michigan College Convention Center, one mile off exit 30 on I-94 near Benton Harbor MI. Prepaid tickets are \$2.00 each (\$3.00 at the door). XYLs, YLs, and children under the age of 16 are free. Features will include a gigantic flea market, an ARRL movie, an audio/visual tour of a Heathkit factory, a Novice forum, an XYL program, and a CW contest. Talk-in on 146.22/.82. For tickets or an information package, send an SASE to Box 164, St. Joseph MI 49085.

NEW YORK NY OCT 5

The Kings County Radio Club will hold its Hamfest 1980 on October 5, 1980 (rain date is October 12, 1980), at Manhattan Beach Park, Brooklyn NY. Take the Ocean Avenue exit from the belt parkway and follow the signs. Admission for sellers is \$3.00, buyers' admission is \$1.00, and spouses and children will be admitted free. There will be a large outdoor electronic flea market and plenty of parking. Sellers can bring their own tables or tailgate. Prizes will be awarded and a color TV will be raffled. Talk-in on .52.

ROCK HILL SC OCT 5

The York County Amateur Radio Society will hold its 29th annual hamfest on October 5, 1980, at Joslin Park, Rock Hill SC. A barbecue dinner, a snack bar, and a drink stand will be available in the park. For registration and prize information, write YCARS, PO Box 4141 CRS, Rock Hill SC 29730.

YONKERS NY OCT 5

The Yonkers Amateur Radio Club will hold Westchester's 4th annual flea market and hamfest on Sunday, October 5, 1980 (rain date: Sunday, October 12, 1980), from 9:00 am to 5:00 pm at Redmond Field, Yonkers NY. Admission is \$1.50 per person with children under 12 admitted free. Sellers must bring their own tables. Parking space is \$3.00 (which admits one person).

Features will include an auction starting at 3:00 pm, a raffle and 50/50 drawings every two hours, door prizes given every two hours, and a final door prize awarded at 5:00 pm. There will be plenty of free parking, refreshments, picnic tables, ball fields, swings, and sanitary facilities available. Talk-in on 146.865 and .52 starting at 8:00 am. For advance registration or information, call (914)-969-1053 after 3:00 pm and ask for Otto.

KENNER LA OCT 11-12

The Jefferson Amateur Radio Club will hold Amacom '80 on Saturday and Sunday, October 11-12, 1980, at the Airport Hilton Inn, across from the New Orleans International Airport, Kenner LA. Features will include forums, demonstrations, exhibits, and an outside flea market. Admission is \$3.00 for head-of-household and \$1.00 for each family member. Other tickets are six for \$5.00. There will be entertainment on both days for wives and others that are interested. For more details and arrangements for interviews, phone Wayne Knabb, publicity co-chairman, at 943-5889 (home) or 586-3560 (work); Robert Dunn, publicity co-chairman, at 866-3036; W. D. "Bill" Bushnell, Amacom chairman, at 887-5022; or Leon Lessard, program advertising chairman, at 469-0106.

EL PASO TX OCT 11-12

The El Paso Hamfest will be held on October 11-12, 1980, at the Missile Inn, 9487 Dyer Street (US 54), El Paso TX. Activities will include seminars, swap tables, a QCWA breakfast, contests, prizes, and more. Talk-in on 146.28/.88. For additional information, write El Paso Hamfest, PO Box 4573, El Paso TX 79914, or call Mary Ann or Roy Gould N5RG at (915)-751-7638.

WARNER ROBINS GA OCT 11-12

The Central Georgia ARC's second annual hamfest will be held October 11-12, 1980, at the City Recreation Center, Watson Boulevard, Warner Robins GA. Dealer displays and a flea market will be indoors. The annual meetings of the Georgia Single Sideband Association and the Georgia Cracker Net will be

held, and the Georgia State CW Association will have a Sunday morning breakfast. Prizes include an Icom IC-720 HF transceiver, an Icom IC-255A 2-meter mobile transceiver, and an Icom IC-2AT synthesized 2-meter handie-talkie. Activities will be available for YLs and harmonics. Talk-in on 146.25/.85. For more information, call or write John Robuck N4AMJ, 117 Avalon Drive, Warner Robins GA 31093, or phone (912)-922-4527.

LANSING MI OCT 12

The Central Michigan Amateur Radio Club and the Lansing CD Repeater Association will hold Hamfair '80 on Sunday, October 12, 1980, at Grand Ledge High School, 7 miles west of Lansing, off I-96, near M-43 and M-100, from 8:00 am to 3:00 pm. Donations are \$2.50. Free parking and lunches will be available, as well as fun for the whole family. Talk-in on .34/.94 and .22/.82. For more information, call (517)-372-5462.

BALTIMORE MD OCT 12

The Columbia Amateur Radio Association will hold its 4th annual hamfest at the Howard County Fairgrounds (15 miles west of Baltimore, just off I-70 on Rt. 144, 1 mile west of Rt. 32) on Sunday, October 12, 1980, at 8:00 am. Admission is \$3.00 and tailgating and tables are \$5.00. Food and prizes will be available. Talk-in on 147.735/.135 and 146.52/.52. For table reservations and information, write Dennis Parra, 6955 Spinning Seed, Columbia MD 21045.

LIMA OH OCT 12

The Northwest Ohio Amateur Radio Club will hold its annual hamfest on October 12, 1980, beginning at 7:00 am at the Allen County Fairgrounds, Rte. 309E (1 mile off I-75), Lima OH. Dealer tables will be available. Talk-in on .52/.52 and .07/.67. For more details, write NOARC, PO Box 211, Lima OH 45802.

PLYMOUTH IN OCT 12

The Plymouth, Indiana, Swap and Shop will be held on October 12, 1980, at the National Guard Armory in the west part of Plymouth IN. The doors will

open at 7:00 am for this 5th annual gathering. Tickets are \$2.00 in advance or \$2.50 at the door. There will be inside floor space available, snacks, and electronic goodies for sale or trade. Talk-in on 146.07/.67 and 146.52, or follow the signs. For more information, contact the Marshall County Amateur Radio Club (MCARC), PO Box 151, Plymouth IN 46563.

CHICAGO IL OCT 16-19

National Computer Shows (formerly Northeast Expositions) will hold the Midwest Personal and Business Computer Show from Thursday, October 16, through Sunday, October 19, 1980, at McCormack Place, Chicago IL. Show hours are: Thursday through Saturday, 11:00 am to 9:30 pm and Sunday, 11:00 am to 6:00 pm. General adult admission is \$5.00. For further information, contact National Computer Shows, PO Box 678 Brookline Village MA 02147, or phone (617)-524-0000.

PENNSAUKEN NJ OCT 19

The Moorestown Severe Weather Watch will sponsor the Greater Delaware Valley Hamfest on October 19, 1980, from 8:00 am to 5:00 pm at the Nashville East Cotillion Ballroom, Rte. 73, Pennsauken NJ. Advance tickets are \$2.00 with an SASE, \$2.50 at the gate, and ladies are free. There will be door prizes drawn hourly from 11:00 am until 3:00 pm; then, at 3:30 pm, the main door prizes will be drawn. Table spaces are \$5.00 indoors and \$3.00 for a 10' space outdoors. The outdoor flea market set-up will start at 2:00 am and will have space for over 300 vendors. The indoor exhibit space set-up will also start at 2:00 am and will have over 20,000 square feet available. RV parking and camping will be available Saturday night, as well as parking lot and exhibit area security from 6:00 pm Saturday to 6:00 pm Sunday. Features will include seminars on DX-P, MARS, ARPSC, ARRL, traffic, antennas, etc.; ladies' activities; and food and refreshments. Talk-in on 146.22/.82 and 146.52 simplex and monitoring Ecars, 146.19/.79 and 146.58 simplex. For advanced tickets, table reservations, or more information, contact Greater Delaware

Valley Hamfest, 15 E. Camden Avenue, Moorestown NJ 08057, (609)-234-3926.

REVERE MA OCT 19

The 19-79 Repeater Association of Malden MA will hold its first annual flea market on Sunday, October 19, 1980, from 11:00 am to 4:00 pm (sellers will be admitted at 10:00 am) at the Beachmont VFW Post, 150 Bennington Street, Revere MA. Admission is \$1.00. Sellers' tables are \$5.00 in advance and \$7.50 at the door, if available. Talk-in on .19/.79 and .52. For table reservations, send a check to 19-79 Repeater Association, PO Box 221, Malden MA 02148.

KALAMAZOO MI OCT 25

The 26th annual VHF Conference will be held on October 25, 1980, at Western Michigan University, Kalamazoo MI, from 2:00 pm through 9:00 pm. VHF topics will include Microprocessor Control of VHF Transceivers, Plotting Antenna Settings, and others. For more information, write Dr. Glade Wilcox, Professor of EE, Western Michigan University, Kalamazoo MI 49008.

CHATTANOOGA TN OCT 25-26

Hamfest Chattanooga will be held on October 25-26, 1980, at Chattanooga State Technical Community College, Chattanooga TN. Events include dealer exhibits, a flea market, forums, contests, and ladies' programs. Flea market spaces are \$2.00 per day or \$3.00 for both days. Talk-in on .19/.79 and 3980. For inside dealer space information or for pre-registration with a prize ticket (send \$1.00), write Hamfest Chattanooga, PO Box 3377, Chattanooga TN 37404.

LONDON ONT CAN OCT 26

The London Amateur Radio Club will hold its 3rd annual Swap 'n Shop on Sunday, October 26, 1980, from 9:00 am to 4:00 pm at Lord Dorchester High School. Admission for buyers is \$2.00, with children under 12 admitted free. Admission for vendors is \$3.00, which includes one table. Doors open at 8:00 am for vendors only. Featured will be forums on current topics, hourly prize drawings, free park-

ing, an expanded display area for both tables and dealer exhibits, and food, which will be available all day. The main area will be a synthesized voice radio. Talk-in on .52 and .07/.67. For table reservations (until October 22nd) and/or further information, contact Dick Miller, 417 Regal Drive, London Ontario, Canada N5Y 1J8.

MARION OH OCT 29

The 5th annual Feast of Our Lady Ham Fiesta will be held on October 29, 1980, at the Franklin County Fairgrounds, Columbus, Marion OH. Featured will be a flea market, prizes, and a drawing. Dealer spaces are available. Talk-in on .90/.90 and .92. For more information, contact Paul Kilzer W8GAY, 309 Pole Lane Road, Marion OH 43052.

MORRISTOWN TN NOV 1

The Lakeway Amateur Radio Club will operate from the David Crockett Tavern, Morristown TN, on Saturday, November 1, 1980, from 1300 UTC until 2300 UTC. SSB-only operation will be on the following frequencies: plus or minus QRM: 26.690, 21.360, 14.280, and 12.810. Amateurs and the general public are invited to visit the tavern and site, which is the birthplace and home of Davy Crockett. During regular operating hours (weekdays, 9:00 am to 5:00 pm, and Sundays, 2:00 pm to 5:00 pm). For a certificate commemorating the event, send \$1.00 plus a legal-size 3x5 or 5x8 IRC and an SASE to Davy Crockett DXpedition, PO Box 15, Box 28, Morristown TN 37814. The callsign will be W4DPE for this expedition.

ST. PETERSBURG FL NOV 1-2

The Florida Gulf Coast Amateur Radio Council, Inc., will hold the Suncoast Amateur Radio Convention on November 1-2, 1980, at the Brantley Course Hotel, downtown St. Petersburg FL. Close by to the Albert Whitted Airport, the St. Petersburg Marina, bus station, and many parking lots. Registration is \$3.00 each and children under 12 are admitted free. Two award tickets are from 1980 advance registration. Table spaces are \$10.00 each for both days.

(no one-day tables). Double booth space is available and all the swap area will be inside. Featured will be dealer displays, forums, a Saturday luncheon and banquet, and a Sunday luncheon and fashion show. FCC exams will be given. Send to the Tampa office for 610s. Talk-in on 147.96/36, 147.66/06, and 146.52. For more information, write FGCARC, PO Box 157, Clearwater FL 33517, or phone (813)-461-4267.

HICKSVILLE OH NOV 2

The Defiance County Amateur Radio Club is sponsoring its 3rd annual hamfest on Sunday, November 2, 1980, from 8:00 am until 4:00 pm at the Defiance County Fairgrounds at Hicksville OH. Tickets are \$1.50 in advance and \$2.00 at the gate. Table space is free on a first-come-first-served basis, inside or outside. Hourly drawings will be held, with the main event at

3:00 pm. Talk-in on 147.69/09 and .52. For more information, write Ed Ballard, Jr., RFD #1, Roland Road, Sherwood OH 43556.

SOUTH FALLSBURG NY NOV 7-9

On November 7, 8, and 9, 1980, the Hudson Amateur Radio Council will sponsor the ARRL Hudson Division Convention to be held at the Pines Hotel, South Fallsburg NY. The theme is "Good Times at the Pines," with emphasis on a mini-vacation type convention for both families and solo attendees. A full range of forums is planned along with an exhibit hall and flea market. Contact Mike Troy WA2TYV, 70 Ridge St., Rye NY 10580, for advance tickets at \$5.00 each through 10/27/80. Contact Mike Evans WB2RDD for flea market info at Box 143, White Sulphur Springs NY 12787, or call at night (914)-292-8630.

NEWMARKET ONT CANADA NOV 8

The York North Amateur Radio Club will hold its annual flea market on Saturday, November 8, 1980, at the Newmarket Community Centre, Newmarket, Ontario. General admission will be \$1.50, which includes a door prize ticket. Admission for exhibitors will be \$4, which includes a door prize ticket and one table. Additional tables will cost \$2. The flea market will run from 0800 to 1400 EST, but doors will be open earlier for exhibitors. The talk-in frequency will be 146.52 MHz simplex; the club call is VE3YNA.

SO GREENSBURG PA NOV 8

The Foothills ARC will hold its annual Swap & Shop on Saturday, November 8, 1980, at the St. Bruno's Church in South Greensburg PA. Doors will be open from 9:00 am until 5:00 pm. Dealers are welcome. The main prize is a complete HF antenna system, including a triband beam, a 40-foot tower, a rotor, thrust bearing, and cable. Second prize is an Icom IC-2A handheld. Talk-in on 146.07/67 and .52. For advance table reservations, phone Jim Yex WB3CQA at (412)-256-3531. For more information, phone Chuck Hamman WB3HZM at (412)-837-9194.

FRAMINGHAM MA NOV 9

The Framingham Amateur Radio Association will hold its annual fall flea market on Sunday, November 9, 1980, at the Framingham Police Station Drill Shed, Framingham MA. Admission is \$1.00 and sellers' tables are \$6.00. Sellers are advised to pre-register. Doors will open at 9:00 am. Talk-in on .75/.15 and .52. For more information or to register, contact Ron Egalka K1YHM, FARA, PO Box 3005, Saxonville MA 01701, or phone (617)-877-4520.

SELLERSVILLE PA NOV 9

The RF Hill Amateur Radio Club will hold its fourth annual hamfest on November 9, 1980, in the Sellersville National Guard Armory, Sellersville PA. Doors will open to sellers at 7:00 am and a \$2.00 donation will admit buyers after 8:00 am. Tickets are

on sale for the grand prize, a complete low-band station from key to antenna. The radio is the new 9-band Ten-Tec Model 580 DELTA with a 110-volt power supply and filters. The antenna is a model AP-3 from W6TIK. Talk-in on 146.28/.88 and 146.52. For further information, contact the RF Hill ARC, PO Box 29, Colmar PA, or Robert Bentley WB3EWP, RF Hill Hamfest, 334 Railroad Avenue, Souderton PA 18964, or phone (215)-723-8303.

MASSILLON OH NOV 16

The 23rd annual auction, Auctionfest '80, sponsored by the Massillon ARC will be held on Sunday, November 16, 1980, from 8:00 am until 5:00 pm at the Massillon Knights of Columbus Hall, Massillon OH. The flea market opens at 8:00 am with auction action to start at 11:00 am. Auctionfest '80 will feature three major prizes, plus a long list of door prizes to be given away hourly. Tickets are \$2.50 in advance and \$3.00 at the door. Extra prize tickets are available for \$1.00 each. For further information, tickets, or table reservations, contact Steve Nevel WD8MIJ, 1864 Massachusetts SE, Massillon OH.

OAK PARK MI NOV 30

The Oak Park High School Electronics Club will present its 11th annual Swap 'n Shop on Sunday, November 30, 1980, at the Oak Park High School, Oak Park MI, from 8:00 am to 4:00 pm. North and east doors will open at 6:00 am. Admission is \$1.50 in advance and \$2.00 at the door. Tables (8 feet long) are \$5.00 in advance, \$6.00 at the door, and \$3.00 for a half table. There will be door prizes, refreshments, and parking available. For more information, send an SASE to Herman Gardner, Oak Park High School, 13701 Oak Park Boulevard, Oak Park MI 48237, or call Bruce at 1-(313)-543-8569.

FARIBAULT MN DEC 6

The Handi-Ham System will hold its annual winter hamfest on Saturday, December 6, 1980, at the Eagles Club, Faribault MN. There will be a flea market, a dinner at noon, a program, and a prize drawing.

HAM HELP

I need conversion information on the T-20/ARC-5 command transmitter which covers 4 to 5.3 MHz. I would like to convert it to the 15-meter CW band, if possible, or to the 40-meter CW band.

Robert E. Bunn WA0LKE
Rt. 3, Box 565
West Plains MO 65775

I would like to thank 73 Magazine and the numerous hams who responded to my request for a manual for my HQ-100 receiver in the August, 1980, issue of 73. I have received letters, radiograms, and long-distance phone calls in answer to my request. Thanks again!

Marvin Rosen KA3EUY
20 W. Madlson Street
Baltimore MD 21201

I need a schematic and/or manual for a Johnson Viking 6N2 transmitter. I will copy and return or pay for your copy. I would also like to hear from anyone who has converted this transmitter for use as a 2-meter amplifier.

John Barclay N8ARC
1115 Talley Avenue
Zanesville OH 43701

I am trying to find a PC board and parts kit or an already assembled unit for the MXV-200 SSTV Scanner. I sent an SASE to W6MXV for prices and availability as suggested in the SSTV Handbook but had no response. Can anyone help me?

Bradley F. Hardin KB8OC
NRS, Box 92
Sugar Grove WV 26815

I would like to purchase a reasonably priced FV-101B external vfo for my Yaesu FT-101E.

Wayne F. Albert KB3KV
431 Greenlee Road
Pittsburgh PA 15227

I would like to find modifications that improve the performance of a Collins 75S-1 and Collins 32S-1.

John Gallivan III
9124 Ashmeade Drive
Fairfax VA 22030

I need a user's manual for a PAIA #2720 music synthesizer. I can copy and return it or I will buy a copy.

Jung Y. Lem KB6BO
5222 Coringa Drive
Los Angeles CA 90042

FREE!
RADIO AMATEURS
WORLD ATLAS
 with purchase of famous
CALLBOOK
MAP LIBRARY!

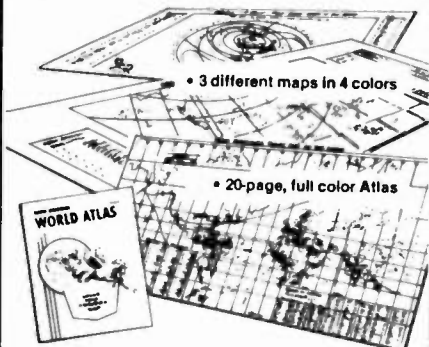

Here's an offer you can't refuse! You receive three, information-packed, Amateur Callbook maps, folded, plus the World Atlas for only \$3.75 plus \$1.50 shipping and handling. If purchased separately, total value of map/atlas offer would be \$6.25, plus shipping. You save \$2.50 and get these invaluable radio amateur aids!

- 1. Prefix Map of the World, folded.**
World-wide prefixes. Shows 40-zone map on one side, 90-zone map on the other. Size 40" x 28"
- 2. Map of North America, folded.**
Includes Central America and Caribbean to the Equator. Shows call areas, zone boundaries, prefixes, etc. Size 30" x 25"
- 3. Great Circle Chart of World, folded**
Centered on 40°N, 100°W. Shows cities, latitude, longitude, great circle bearings and more! Size 30" x 25"

Plus special FREE bonus!

The Callbook's own **Radio Amateur World Atlas**, **FREE** with the purchase of the 3 maps. Contains eleven full color maps of the world, looking at things from the radio amateurs point of view.

Callbook Map Library	\$3.75
Shipping	\$1.50
Total	\$5.25



Special Limited Offer!
Amateur Radio
Emblem Patch
 only \$2.50 prepaid

Pegasus on blue field, red lettering, 3" wide x 3" high. Great on jackets and caps. Sorry, no call letters.

ORDER TODAY!

Order from your favorite electronics dealer or direct from the publisher. All direct orders add \$1.50 for shipping. Illinois residents add 5% Sales Tax.

RADIO AMATEUR
callbook INC.
 Dept. B
 925 Sherwood Drive
 Lake Bluff, Ill 60044

STEP UP TO TELREX

Professionally Engineered Antenna Systems

"MONARCH" 10, 15, 20 Meter "Tri-Band"
 Model TB5EM/4KWP

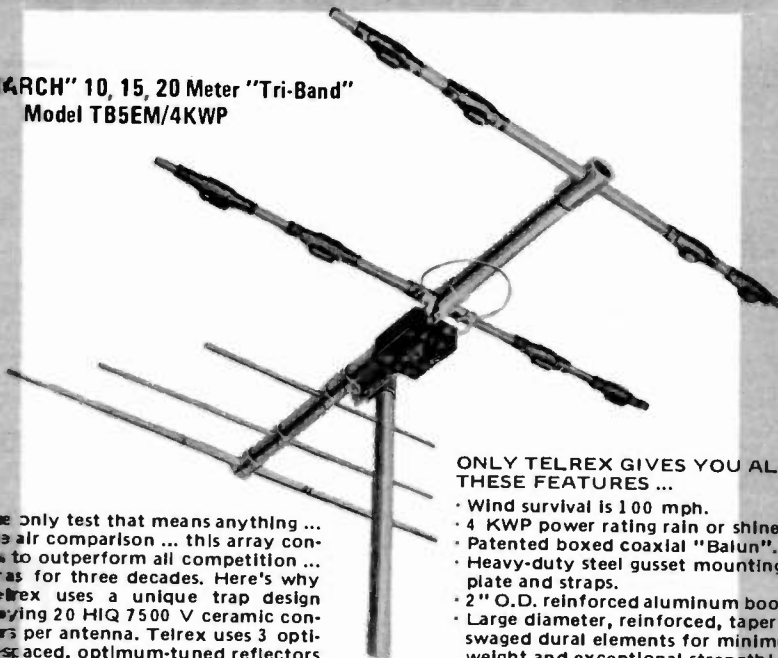

ONLY TELREX GIVES YOU ALL THESE FEATURES ...

- Wind survival is 100 mph.
- 4 KWP power rating rain or shine.
- Patented boxed coaxial "Balun".
- Heavy-duty steel gusset mounting plate and straps.
- 2" O.D. reinforced aluminum boom.
- Large diameter, reinforced, taper swaged dural elements for minimum weight and exceptional strength!
- Stainless steel electrical hardware.
- Phone and CW capability all bands!

By the only test that means anything ... on the air comparison ... this array continues to outperform all competition ... and has for three decades. Here's why - Telrex uses a unique trap design employing 20 HIQ 7500 V ceramic condensers per antenna. Telrex uses 3 optimum-spaced, optimum-tuned reflectors to provide maximum gain and true F/B Tri-Band performance.

A Telrex "Balun" fed "Inverted-Vee" kit is the ideal hi-performance inexpensive and practical to install low-frequency mono or multiple band, 52 ohm antenna system.



Better than optimum full sized Dipole performance in an antenna which can be set up within the hour, needing a minimal support structure. (existing tower, house tree etc.) The "Inverted-Vee" produces a low-angle "Balanced" Omni-Directional pattern, which increases the signal to noise, and signal to interference ratios. Complete simplified instructions are provided.

NO TUNERS NEEDED!

MIVD/2 frequencies \$75.95 Post Paid (U.S.)

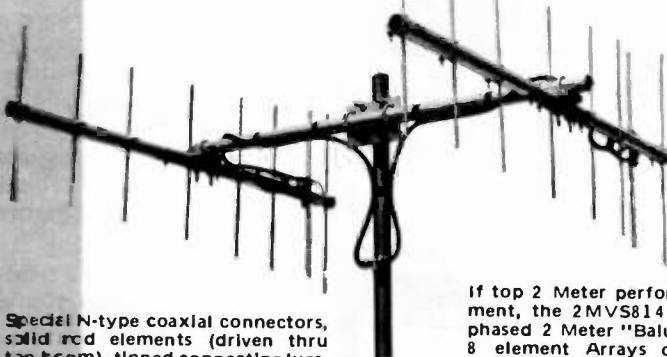

If top 2 Meter performance is your requirement, the 2MVS814 kit consisting of 2 ea. phased 2 Meter "Balun" fed precision tuned 8 element Arrays outperform even quad stacked antennas of other makes.

Special N-type coaxial connectors, solid rod elements (driven thru the boom), tinned connecting lugs, and 1/8" electrical hardware provide you with peace of mind for many years!

For technical data and prices on the complete Telrex line, write for Catalog PL-8

Communication Antennas Since 1921
 ✓ 328

telrex LABORATORIES

P.O. Box 879 - Asbury Park, N.J. 07712 Phone 201-775-7252

T
L
I

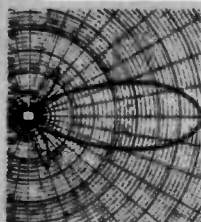

SLEP mail-order specials

ABA INC.

MM-1 MORSE MATIC WITH FREE AC-1 POWER SUPPLY 199.95
ISO POLE 144 VHF BASE STATION ANTENNA 49.95
ISO POLE 220 VHF BASE STATION ANTENNA 49.95

CDI ROTORS

AR22X1 (3 SQ FT) 49.00
HAM 4 (115 SQ FT) 119.00
TAIL TWISTER (30 SQ FT) 229.00
S1467-10 HEAVY DUTY LOWER MAST SECTION FOR HAM 4, TAIL TWISTER
8 CONDUCTOR ROTOR CABLE, PERKIT 20

DRAKE

TR-7DR-7 DIGITAL TRANSCEIVER 51,385.00
PS-7 POWER SUPPLY TR-7DR-7 DELUXE 269.00
PS-7S POWER SUPPLY TR-7DR-7 179.00
SP-75 SPEECH PROCESSOR TR-7DR-7 148.00
SE-300, SE-500, SE-1100, SE-4000, FL-6000 FILTERS TR-7DR-7 or R-7 (ea.) 49.00
FA-7 FAN, TR-7 29.00
RV-7 REMOTE VFO 175.00
MS-7 SPLICER 99.00
7077 DISK MIKE W/PLUG TR-7 46.00
ALU-7 RANGE PROGRAM BOARD TR-7 42.00
NB-7 NOISE BLANKER TR-7 82.00
AN-7 ANTENNA TUNER 250W, 160-10M 159.00
AN-7200 ANTENNA TUNER R-2EW 160-10M 269.00
CS-7 REMOTE CONTROLLED ANTENNA SWITCH 158.00
WH-7 WATTMETER 2KW 1.8-30 MHz 89.00
R-1000 BALUN 4:1 MIN-7, MAX-2700 29.00
DL-1000 DRY DUMMY LOAD 300W 26.95
DL-1000 DRY DUMMY LOAD 1KW 53.00
L-7 AMPLIFIER WITH PPS AND TUBES 1,175.00
TV-3000 LP LOW PASS FILTER 1KW 26.00
R-7DR-7 RECEIVER DIGITAL, 0-30 MHz 1,295.00
R-7TR-7 CABLE INTERFACE KIT 29.50
AK-75 MULTI BAND DIPOLE ANTENNA 160-10M 29.95
FL-250, FL-500, FL-1500, FL-6000 FILTERS FOR R-4C RECEIVER (ea.) 49.00

FINCO

A10-4 BEAM METER 4E1 58.00
A6-5 BEAM METER 5E L 42.00
A6-2 BEAM DUAL 6/2 METER 68.00
A2-10 BEAM 2 METER 10E L 39.00
A1-1/4 BEAM 220MHz 10E L 29.00

HUSTER

48TV VERTICAL 40-10 MTR 85.00
58TV VERTICAL 80-10 MTR 109.00
BRM-144A 58W MOBILE MAGNETIC MOUNT 143-149 MHz 17.71 COAX 37.50
RM-1 BUMPER MOUNT, W/STAINLESS STEEL STRAP 17.00
CG-144 TWO-METER COLINEAR WITHOUT MOUNT 26.00
CG-144 TWO-METER COLINEAR WITH TRUNK LIP MOUNT 39.00
CG-144 TWO-METER BASE STATION COLINEAR 109.00

ICOM

251A TRANSCEIVER 2M AC/12V MULTI-MODE 10W 625.00
551 TRANSCEIVER 6M AC/12V MULTI-MODE 10W 790.00
551D TRANSCEIVER 6M 80W, 12V W/EX 107, 108 585.00
720 HF TRANSCEIVER, GENERAL COVERAGE WITH PPS 1,168.00
255A 2M FM 25W TRANSCEIVER 12V 345.00
260A 2M FM 55B 10W 12V 429.00
PS-20 PPS 20 AMP 551D 170.00
ET108 FM OPTION 551, 551D 100.00
ET107 VOICE OPTION 551 49.00
ET108 BAND PASS TUNING OPTION 551 98.00
HM-8 TOUCH TONE MIKE, 251A, 255A, 260A 32.50
SM-2 DISK MIKE Z11, 701 32.50
IC-2A H T WITH NICADS CHARGER, ANT. 210.00
IC-2AT H T WITH TOUCH-TONE, NICADS ITC 235.00

MIRAGE

BT08 2 METER AMPLIFIER FM55B 10 IN 80 WATTS OUT 104.00
BT106 2 METER AMPLIFIER FM55B 10 IN 160 WATTS OUT 258.00
RC-1 REMOTE CONTROL W/RT CABLE FOR BT08, BT106 24.95
MP-1 HF PEAK READING WATTMETER 1.8 THRU 30 MHz, SWR, POWER RANGES 25, 200, 2000 WATTS 109.95
MP-2 VHF PEAK READING WATTMETER 50 THRU 200 MHz, SWR, POWER RANGES 50/500/5000 WATTS 109.99

MINI-PRODUCTS

HQ-1 MINIQUAD BEAM ANTENNA 139.00

NVE-VIKING

MB1101 ANTENNA TUNER WITH BALUN 298.00
046-003 AUTOMATIC PHONE PATCH W/LOAD SPLICER 62.00
114-33001 MASTER KEY, HEAVY DUTY BASE WITH NAVY KNOB 3 FT TWO CONDUCTOR CABLE AND 1/4" PLUG, THE FINEST STRAIGHT KEY 23.50
55K-1CP DUAL PADDOLE SQUEEZE KEY CHROME PLATED 37.95

SWAN

100MX TRANSCEIVER 12V 585.00
ASTRO 150 TRANSCEIVER 12V 795.00
ASTRO 102BX TRANSCEIVER 12V 995.00
PSU-5A POWER SUPPLY 13.8VDC 20 AMP FOR 100MX OR ASTRO 150 158.00
PSU-6 POWER SUPPLY 13.8VDC 20 AMP FOR ASTRO 102BX 168.00
1500Z LINEAR AMPLIFIER 545.00

SHURE

444D NEW MODEL BASE STATION MICROPHONE, DUAL HI/O IMPEDANCE PST AND VDC SWITCH 48.00
40C MOBILE MICROPHONE HI-Z 34.00

TEMPO

S-11 H T WITH TOUCH-TONE 2M 258.00
S-5 T H T WITH TOUCH-TONE 1/5W 2M 359.00
S-2 T H T WITH TOUCH-TONE 220 MHz 359.00
TS-CC CARRY CASE ALL MODELS 16.00
TS-MA HELICAL ANTENNA 2M 9.00
TS-HA2 HELICAL ANTENNA 220 MHz 9.00
HENRY 100'S LINEAR AMPLIFIER 675.00
HENRY 200'S LINEAR AMPLIFIER 925.00

TEN-TEC

515 ARGONAUT, SW 55B CW TRANSCEIVER 5 379.00
546 OMNI-DIGITAL, SERIES C NEW MODEL 1,045.00
570 CENTURY 21, 70W CW TRANSCEIVER 310.00
580 DELTA, 9 BAND NEW MODEL 745.00
444 HERCULES, 1KW LINEAR AMPLIFIER W/PS 1,395.00
210 POWER SUPPLY ARGONAUT 32.00
255 POWER SUPPLY, DELUXE, ALL-TRANS-CEIVERS 149.00
280 POWER SUPPLY, ALL TRANSCEIVERS 135.00
288 NOTCHW FILTER S15 37.00
214 ELECTRIC MIKE FOR 234 34.50
215 PC MIKE WITH PLUG, COILED CORD 32.00
217 500HZ FILTER 545/546 49.00
218 1.8 KHZ FILTER 545/546 49.00
219 250 KHZ FILTER 545/546 45.00
234 SPEECH PROCESSOR 112.00
243 REMOTE VFO 545/546 159.00
247 ANTENNA TUNER 61.00
248 NOISE BLANKER 545/546 44.00
249 NOISE BLANKER 540/544 28.00
276 CRYSTAL CALIBRATOR 570 26.00
277 ANTENNA TUNER/SWR BRIDGE 80.00
282 200HZ FILTER 580 45.00
283 REMOTE VFO 580 159.00
285 500HZ FILTER 580 42.00
289 NOISE BLANKER 580 37.00
685 ULTRAMIC RECEIVER ALL MODELS 80.00
700 KEYS/CONTROL 21 32.00

CONGRATULATIONS TO "73 MAGAZINE"

... WE HAVE BEEN ADVERTISING WITH YOU FOR 20 YEARS!

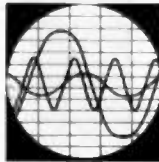

SLEP ELECTRONICS COMPANY
P.O. Box 100, Highway 441,
Dept 73
OTTO, NORTH CAROLINA
28763 ✓ 366

ORDER BY MAIL OR PHONE BILL SLEP, (704) 524-7519. WE PAY SHIPPING TO 50 STATES, APO, FPO—MASTER CHARGE, VISA OR CHECKS ACCEPTED. SAVE MONEY BY ORDERING TODAY AT THESE LOW DISCOUNT PRICES.

G133 HF RECEIVER



0.2 to 30 Mhz SSB, AM, CW in thirty continuously tuneable bands. Set is Collins 51S1 repackaged by LTV-Temco for military with added AM BFO, extra filtering, and Jack for 14-600 KHz tuner. 50 ohm input impedance; 600 or 4 ohm audio output. 16 tubes. Requires 115/230 VAC 50-400 Hz; 24 VDC for AM BFO. 6 1/4 x 18 1/4 x 13"; 40 lbs. sh. More info upon request. Used, repairable: **\$695**. Checked: **\$850**. Collins 51S1 manual, \$15 when purchased with G133

STACO 4 AMP POWER SUPPLIES

Solid state, new. #FPS-4, filtered 12 VDC; 5x3x5 1/2", 5 lbs. sh. **\$12.95 2/\$22**. #RPS-4, filtered, regulated 13.8 VDC, 5x3x6 3/4", 6 lbs. sh. **\$18.95 2/\$35**.



Prices F.O.B. Lima, O. • VISA, MASTERCARD Accepted. Allow for Shipping • Send for New FREE CATALOG! Address Dept. 73 • Phone: 419/227-6573

FAIR RADIO SALES ✓ 22
1016 E. EUREKA • Box 1105 • LIMA, OHIO • 45802

HAM HELP

I am in need of schematic and conversion info for an RCA "LD" Business Band radiotelephone, model CMCT-30B2-H, 159.60 MHz. Of course, I will pay any copying and postage costs. Thank you.

Roger Mason KA4JHC
4308 Faigle Road
Portsmouth VA 23703

I need a schematic and/or instruction manual for a Collins 310B-1 Exciter. I will pay for these or I can reproduce and return them. I also need a complete set of knobs for a Hallicrafters S76 receiver.

Herman F. Schnur KACTG
115 Intercept Avenue
North Charleston SC 29405

I recently purchased a Kenwood R-1000 receiver and would like to correspond with anyone who has used this receiver in

conjunction with a transceiver and/or separate transmitter.

Marvin Rosen KA3EUY
20 W. Madison St.
Baltimore MD 21201

I need a schematic drawing of a Hallicrafters model S-76-U. I also need one for a Gemtronics model V-258A. I wrote to Gemtronics about six months ago but I didn't receive an answer. Thank you.

David A. Carter WA4VHP
28 Alpine Drive
Savannah GA 31405

I would like to obtain a manual and schematic for a Midland model 13-505 2m transceiver. I will copy and return or pay a reasonable copy and mailing fee. Thank you.

Terry Jones KA6IYE
2945 Sequoia Avenue
Eureka CA 95501

Directional RF Wattmeter

Dielectric wattmeters are your best choice for making accurate RF measurements. These rugged, dependable wattmeters can discriminate between forward and reflected power in all types of 50 ohm coaxial transmission lines and RG type cables.

In addition, they:

- Measure from 100mW to 5kW
- Have $\pm 5\%$ full scale accuracy
- Measure from 2MHz to 1GHz
- Have an easy-to-read $4\frac{1}{2}$ " mirrored meter scale
- Feature a taut-band meter movement for longer life
- RF Elements available for all measurements

The 1000-A from Dielectric—you can't buy an easier reading, more accurate RF wattmeter.

A complete line of RF loads are also available.



A UNIT OF GENERAL SIGNAL **GS**
DIELECTRIC

RAYMOND, MAINE 04071 ✓17
TEL. 207/655-4555 • 800/341-9678

144 REPEATERS 220

BASIC AUTO PATCH

* Access, #Disable and adjustable Timer.
COMPLETELY ASSEMBLED—\$75.00.

EXTENSION BOARD

Antilasing, 3 digit sequential Touch Tone™ decoder with automatic reset, Antilasing Ring detector, reverse auto patch capability for basic auto patch and two, two-watt audio amplifiers.

COMPLETELY ASSEMBLED—\$140.00

Hi Pro Mk I REPEATERS

144 or 220 MHz \$849.95 ✓46



ON BOARD VOLTAGE PROTECTION

Now with courtesy beep and beacon capability

COR Identifier: All on one band, programmable, Fully adjustable, time out (.5-7 min.), hang time (0-1 min.), identifier (1-10 min.), tone, speed, volume, L.E.D. outputs, low current drain CMOS logic, plugs for easy installation and removal plus much more. \$99.95 COMPLETELY ASSEMBLED

Basic Repeater \$649.95 COMPLETELY ASSEMBLED
2M 130-175 MHz Basic Repeater for 2 meters with all the features of the Hi Pro MkI less the power supply and front panel controls and accessories.

PA Res. add 6% tax PLUS SHIPPING

Maggiore Electronic Laboratory

845 WESTTOWN RD.
WEST CHESTER, PA. 19380
PHONE 215 436-6051

BARRY ELECTRONICS . . .

New York's largest and best-stocked dealer.

Call the store with more!

COLLINS

KWM 380 . . . taking orders

DENTRON

Clipperton L . . . call

DRAKE

TR-7/DR-7 transceiver
R-7 Receiver . . . call



Yaesu FT-901D

DSI

Frequency counters . . . in stock

ENCOMM

HT-1200 . . . we have them

ICOM

IC2AT hand-held with pad . . . in stock

KEYS

Ham Key . . . in stock
NYE . . . in stock



Cubic Astro 150A

MFJ

Complete line . . . ask J.W. MILLER

J.W. MILLER

Daiwa CN-720 watt-meter/bridge
Daiwa CS-401 RF coaxial switch



Icom IC-2A

MIRAGE-KLM-TEMPO

two-meter amplifiers . . . in stock

ROBOT

800 and 400 . . . in stock

ROTORS

Ham IV . . . special. Call



Yaesu CP-2500RK

SWAN

Astro 150A . . . Barry has 'em

TEMPO

S1, 2, 5 . . . in stock



Yaesu FT-101ZD

TRIONYX

TR-1000 frequency counters \$159.95

YAESU

FT-101ZD
FT-107M
FT-207R
FT-227RB
FT-707
CPU-2500RK
All in stock . . . Call

Ask about our amateur radio licensing classes, NOVICE through EXTRA!

BARRY specializes in business band equipment.

BARRY specializes in world wide export, licensing, packing and shipping.

BARRY stocks most major brands . . . call or write.

¡ AQUI SE HABLA ESPAÑOL !

BARRY ELECTRONICS

512 Broadway, New York, N.Y. 10012

Telephone (212) 925-7000

Reprinted from the Federal Register

47 CFR Part 97

[Docket No. 19852; FCC 80-419]

Amendment of Rules To Provide for the Amateur-Satellite Service

AGENCY: Federal Communications Commission.

ACTION: Final rule.

SUMMARY: The Commission is adopting rules to govern stations operating in the Amateur-Satellite Service. These rules are needed to obviate requests for waivers of rules developed to regulate terrestrial radio communications. The effect of the adoption of these rules is to regularize amateur radio space operations which heretofore have been authorized on an *ad hoc* basis by rule waivers.

EFFECTIVE DATE: November 3, 1980.

ADDRESSES: Federal Communications Commission, Washington, DC 20554.

FOR FURTHER INFORMATION CONTACT: John B. Johnston or Maurice J. DePont, Private Radio Bureau, (202) 254-8884.

SUPPLEMENTARY INFORMATION:

Report and Order

Adopted: July 17, 1980.

Released: August 11, 1980.

In the matter of amendment of Part 97 of the Commission's rules to provide for the Amateur-Satellite Service, Docket No. 19852.

1. On February 14, 1973, the Commission adopted amendments to Part 2 of the Commission's rules in Docket No. 19547, published in the Federal Register on March 1, 1973 (38 F.R. 5562). These amendments incorporated into the rules the Amateur-Satellite Service (ASAT), as established by the World Administrative Radio Conference for Space Telecommunications, Geneva 1979. Certain frequencies already allocated to the Amateur Radio Service were also allocated to ASAT.

2. On October 25, 1973, the Commission adopted a Notice of Inquiry in Docket 19852, which was published in the Federal Register on November 6, 1973 (38 FR 30566). In our Notice of Inquiry, we indicated our desire to receive comments from interested parties concerning the structure for ASAT, technical standards, licensee qualifications, and other provisions that should be included in the rules.

3. On November 20, 1979, the Commission adopted a Notice of Proposed Rule Making in Docket 19852 which was published in the Federal Register on December 7, 1979 (44 FR 70499). The Notice discussed the comments filed in the Inquiry, the international regulations concerning ASAT, and the nature of the various waivers to Part 97 which have been necessary to make past and current space operations possible. Specific rules based upon these considerations were proposed for ASAT, and comments were solicited. They were due on February 5, 1980, with reply comments due on or before March 6, 1980.

Summary of Comments

4. Ten comments were filed in response to our Notice of Proposed Rule Making. All of them supported our objectives in developing rules for ASAT, and they agreed with our proposed rules in principle. They suggested helpful substantive improvements, and requested clarification of certain points

in the proposed rules.

5. Both the American Radio Relay League (ARRL) and the Radio Amateur Satellite Corporation (AMSAT), pointed out that since the release of our Notice of Proposed Rule Making, the World Administrative Radio Conference (WARC), Geneva, 1979, was held. At that Conference, additional frequencies were allocated to ASAT, and a resolution was adopted which would exempt ASAT earth stations from international coordination procedures. Both organizations recommended the rules adopted in this proceeding incorporate these changes.

6. Several respondents addressed the issue of the notifications for space operation proposed in the Notice. No one questioned the need for notifications (which are required to satisfy international advance publication and coordination requirements). Their concern, rather, is the long lead time proposed for the first notification to the Commission (27 months). While there was an understanding of the basis of the proposal, they claim that such a long lead time is unrealistic for ASAT. AMSAT commented, "... Previous amateur radio satellites have been launched on 'missions of opportunity', and the actual missions available are often not identified until a much later date * * *". They recommended that the rules adopted for first notification of intended space operation include the phrase "if possible".

7. Other respondents forecast the possibility of future manned space flight where an amateur radio operator in the spacecraft may be able to operate the station from space by means of local control. ARRL supported their prediction with reference to amateur radio operator Owen Garriot, a member of the Skylab crew. They recommended that the rules adopted for ASAT include provision for such an eventuality.

8. ARRL and AMSAT recommended deleting the requirement that third party traffic be logged, in the case of space operation. ARRL claims such logging (required for all types of amateur radio operation by § 97.103(b)(2), "... * * is impossible in the context of an amateur satellite. Because the signal is not actually demodulated within the satellite, it is not possible to place a recorder within the orbiting spacecraft, and it is not possible to monitor the entire passband of the satellite from a single or small number of points on earth * * *". AMSAT also recommended deleting third party logging requirements for stations in telecommand operation. Their comments included no rationale for their recommendation.

9. The Southern California Repeater and Remote Base Association (SCRRBA) requested the restrictions against repeater operation in the frequency bands 431-433 and 435-438 MHz be deleted. They said their understanding is that these restrictions were initially adopted by the Commission to protect satellite stations. They were concerned "... * * future petitioners may request that additional frequency spectrum be withdrawn from some or all ARS uses for AMSS-exclusive use * * *" and they "... * * believe that it is the amateur radio community itself which should determine the specific activities to be conducted on the amateur frequency bands * * *".

10. ARRL recommended a clarification

for proposed § 97.413 (Space operation requirements). They wanted to verify that the proposed section, if adopted, would supersede the requirements of present § 97.79 (Control operator requirements), and § 97.86 (Operation of a station by remote control).

11. AMSAT requested that provisions be made in the ASAT Rules which would permit amateur radio operators to accept pay for conducting earth operation and telecommand operation for periods when they are using a station in space operation for experiments and educational demonstrations. They also requested the definition of telemetry (proposed § 97.403(d)), and the rule for telemetry (proposed § 97.419), be expanded to include stored messages "... * * of an amateur radio nature * * *". Furthermore, they requested that proposed § 97.413, which requires the capability to effect a cessation of radio transmissions in case the Commission so orders, be modified to include the phrases "within a reasonable period of time" or "within 24 hours".

12. AMSAT commented on the provision in § 97.415 that stations in ASAT must not cause harmful interference to other stations between 435 and 438 MHz. They claimed this requirement should only apply in the case of interference to non-amateur services. AMSAT also suggested simpler wording for some of the technical parameters described in proposed § 97.427.

13. Mr. Frederick E. Wirth, Jr. commented that he found the definitions in proposed § 97.403 "confusing and not inclusive". He recommended the definitions also account for space-to-space operation.

Conclusions

14. Our objective in this proceeding is to develop rules for ASAT through the rulemaking process. A statement of ASAT requirements in the Commission's rules will relieve the licensee of an amateur radio station in space operation from the burden of applying to the Commission for a lengthy series of waivers to rules developed to regulate terrestrial amateur radio communications. All of the respondents agree with our objective. Therefore, we are adopting rules for ASAT substantially as we proposed. Individual paragraphs in those rules, in certain instances, are adopted with the improvements suggested in the comments.

15. It would be premature to include in this proceeding the results of the World Administrative Radio Conference (WARC) (Geneva, 1979). The final acts of the Conference are not scheduled to become effective until January 1982 and, in the United States, will not be binding until after Senate ratification. Moreover, additional public comment may be necessary through the rulemaking process before they can be incorporated into the rules. Therefore, we are not including the additional frequencies allocated to ASAT by the Conference, at this time.

16. Turning to the matter of international coordination of space operation, we are sympathetic to the problem a licensee could face in providing the necessary information over two years prior to operation. However, the international publication and coordination requirement does exist, and it is the responsibility of the Commission and its licensees to comply. Therefore, we are adopting the notification requirements as proposed. Again, we point out that we could waive the first notification (at 27 months), where justified. Possibly the second notification (at 15 months) could be justified for a waiver. But in either case, the licensee would run a risk, although probably a small one, of later being directed to cease space operation in favor of a prior space operation, or for the purpose of avoiding interference

with other radio services because of incomplete International coordination.

17. With a record of eight successful amateur radio space operations (under Commission authorizations), it is difficult to be skeptical over the predictions of future space operation where the control operator will also be aboard the spacecraft. Therefore, we are adopting proposed § 97.407 with wording to make it clearer that any amateur radio operator (with an FCC authorization) may be the control operator of a station in space operation. The same clarification is also added to § 97.409 to make it clearer that the same provision also applies to earth operation, a point suggested in the comments.

18. Because past and current amateur satellite designs have not provided for logging is insufficient reason, in itself, for deleting the requirement for logging third party traffic. However, we can see not useful purpose being served by requiring third party traffic passing through an amateur satellite to be logged. Therefore, the exception to § 97.103(b)(2) requested by ARRL and AMSAT is incorporated into § 97.417.

19. SCRRBA is partially correct in their understanding of the reasons for the prohibition against repeater operation in subbands 431-433 MHz and 435-438 MHz. The latter (435-438 MHz), was established to protect stations in space operation in Docket 18803 (Report and Order released September 8, 1972, and published in the Federal Register on September 13, 1972, (37 FR 18540)). The former (431-433 MHz) was established to protect weak signal experimentation in Docket 21033 (Memorandum Opinion and Order, released September 27, 1977, and published in the Federal Register on September 30, 1977, (42 FR 52418)). SCRRBA presented no new information in their comments over that which was considered by the Commission in those two proceedings. Inasmuch as weak signal experimentation is not a subject of this proceeding, their request to open 431-433 MHz to repeater operation is not being adopted. However, space operation is the subject, and their request to open 435-438 MHz to repeater operation is pertinent.

20. SCRRBA contends that frequencies allocated to both the Amateur Radio Service and ASAT should be jointly shared by all licensed operators, and should not be arbitrarily reserved for any particular sub-set. In principle, we concur with SCRRBA's contention. However, the 435-438 MHz ASAT/Amateur Radio Service frequency subband is unique. It is located within a relatively large band (420-450 MHz). It is a popular band, and is used for many diverse activities: Voice, television, experimentation, etc. Being an Ultra High Frequency band, a coordination organization such as SCRRBA can be very effective in achieving an orderly band plan for all of these varied activities, domestically. But ASAT is of International scope. There may be stations in space operation authorized by other governments. These stations may be used by amateur radio licensees of many countries. The characteristics of frequencies in this portion of the radio spectrum make them very useful for ASAT. To permit long term repeater operation in this subband could effectively remove them from space operation. Considering the remaining 25 MHz open to repeater operation, 3 MHz for space operation does not seem unreasonable. As far as SCRRBA's concern that future petitioners may be encouraged to request frequency spectrum be withdrawn from some or all amateur radio uses for ASAT-exclusive uses, those eventualities, if and when they occur, will be considered on their own merits. Therefore, SCRRBA's request to open 435-438 MHz to repeater operation is not being adopted.

21. Telecommand operation in ASAT is somewhat similar to radio remote

control of an amateur radio station. In both situations, the control operator of a distant station is using another station (telecommand or control) to transmit command signals to the distant station for the purpose of carrying out his/her responsibilities as control operator. The main difference is that the control operator of a remotely-controlled amateur radio station always has a functioning control link to the distant station while the control operator of a station in space operation may not. The position of the satellite with respect to the earth may not provide the telecommand station with a view of the satellite for much of the time. This is the case with low earth orbit amateur satellites. Thus, the control operator requirements (§ 97.79) and remote control requirements (§ 97.88) have not meaning to space operation. We are adopting proposed § 97.417 which will state that those two sections are not applicable. This will provide the clarification recommended by ARRL.

22. In considering the matter raised by AMSAT of permitting amateur radio operators to accept pay for conducting earth operations and telecommand operations, we must bear in mind that the present prohibition (§ 97.112: No remuneration for use of station) is based upon international agreement (Article 1, Radio Regulation No. 3044/78). Therein the Amateur Radio Service is defined as "A service of self-training, intercommunication and technical investigation carried on by amateurs, that is, by duly authorized persons interested in radio techniques solely with a personal aim and without pecuniary interest". This definition was the subject of proposed modifications at the WARC (Geneva 1979). These proposals were debated at length at the Working Group level and were in part considered again in full Committee. Although the definition was changed editorially to make clear that which was earlier implicit, namely, that the Amateur Radio Service is a radiocommunication service, the phrase "... solely with a personal aim and without pecuniary interest" was retained and thereby emphasized. Therefore, it is our obligation to help preserve this very distinctive characteristic of the service, which is at the root of the many and varied privileges afforded amateur radio operators worldwide. For this reason, we are most reluctant to make any further exceptions to the "no pay" policy over the singular exception listed in § 97.112(b). (Control operators of club stations transmitting telegraphy practices and bulletins may accept compensation in a very precisely defined situation. As far as we know, only a few employees of the ARRL have taken advantage of this provision). Having laid this foundation, we do not find the sketchy information provided by AMSAT, as justification for their request, sufficient to establish the need for amateur radio operators to accept payment for conducting earth operations and telecommand operations. For this reason, we are not adopting AMSAT's suggestion.

23. The American Radio Relay League requested, in its comments, a clarification of the matter of an amateur radio station retransmitting radio signals on frequencies reserved for higher operator classes. No amendments are necessary to make this clarification, which applies to repeater operation as well as space operation. As long as the control operator of the transmitting station is authorized (see § 97.7) for the frequency privileges being used, the fact that the station may retransmit from frequencies authorized to both higher and lower operator classes is of no consequence. For example, there is no prohibition, *per se*, for those types of operations where retransmission is permitted (repeater, auxiliary, and space) to retransmitting the signals from

a station with a Technician Class control operator on frequencies not authorized for the Technician Class.

24. We take exception to the statement in AMSAT's comments that the non-interference provisions to protect stations using frequencies between 435 and 438 MHz should apply only to non-amateur services. The prohibition in the International Radio Regulations (RR MOD 3644/320A) against Amateur Satellite Service stations causing harmful interference does apply to the Amateur Radio Service (ARS) since ARS frequencies are in the International Table of Frequency Allocations. Further, the Amateur-Satellite Service definition (RR NOC 3108/84ATA) was not changed at WARC, 1979. That definition does not say that the Amateur-Satellite Service is part of the Amateur Radio Service. Moreover, Article 35 of the International Telecommunications Union Convention provides that all stations, whatever their purpose, must be established and operated in such a manner so as not to cause harmful interference to other radio services.

25. As a result of the comments received, we are adopting some changes to the proposed rules. Specifically, we have provided for automatic control of stations in space operation; exemption from all logging requirements for space operation; and an improvement in the wording of § 97.405 suggested by R.P. Haviland. Mr. Haviland pointed out in his comments that future problems could arise with the definition of space operation because no distinction is made between existing operations and future operations. The rewording suggested overcomes this potential problem.

26. Accordingly, it is ordered, that effective November 3, 1980, Part 97 of

the Commission's rules is amended as shown in the Appendix, pursuant to the authority contained in Sections 4(i) and 303 of the Communications Act of 1934, as amended. The reporting requirement included herein is adopted subject to General Accounting Office clearance and, unless advised to the contrary, will be effective on the same date as these rules. It is further ordered, that this proceeding is terminated and the docket is closed. Further information on this matter may be obtained by contacting Maurice J. DePont, or John B. Johnston, Personal Radio Branch, at (202) 254-6884.

(Secs. 4, 303, 48 stat., as amended, 1066, 1082, (47 U.S.C. 154, 303))

Federal Communications Commission,
William J. Tricarico,
Secretary.

Appendix

Part 97 of Chapter I of Title 47 of the Code of Federal Regulations is amended, as follows:

§ 97.3 [Amended]

1. In § 97.3, paragraphs (j) and (k) are deleted and designated [Reserved].

2. A new Subpart H is added to Part 97, as follows:

Subpart H—Amateur-Satellite Service

General

Sec.

- 97.401 Purposes.
- 97.403 Definitions.
- 97.405 Applicability of rules.
- 97.407 Eligibility for space operation.
- 97.409 Eligibility for earth operation.
- 97.411 Eligibility for telecommand operation.
- 97.413 Space operations requirements.

Technical Requirements

- 97.415 Frequencies available.

Special Provisions

- 97.417 Space operation.
- 97.419 Telemetry.
- 97.421 Telecommand operation.
- 97.423 Notification required.

Authority: Secs. 4, 303, 48 Stat., as amended, 1066, 1082; (47 U.S.C. 154, 303).

Subpart H—Amateur-Satellite Service

General

§ 97.401 Purposes.

The Amateur-Satellite Service is a radiocommunication service using stations on earth satellites for the same purposes as those of the Amateur Radio Service.

§ 97.403 Definitions.

(a) *Space operation.* Space-to-earth, and space-to-space, amateur radio communication from a station which is beyond, is intended to go beyond, or has been beyond the major portion of the earth's atmosphere.

(b) *Earth operation.* Earth-to-space-to-earth amateur radiocommunication by means of radio signals automatically retransmitted by stations in space operation.

(c) *Telecommand operation.* Earth-to-space amateur radio communication to initiate, modify, or terminate functions of a station in space operation.

(d) *Telemetry.* Space-to-earth transmissions, by a station in space operation, of results of measurements made in the station, including those relating to the function of the station.

§ 97.405 Applicability of rules.

The rules contained in this subpart apply to radio stations in the Amateur-Satellite Service. All cases not specifically covered by the provisions of this Subpart shall be governed by the provisions of the rules governing

STAINLESS STEEL WHIP—FIBERGLASS LOADING COIL—NO COIL HEATING REVOLUTIONARY HYDRAULIC-POSITIONED HF MOBILE ANTENNA FOR HAMS, MILITARY, MARINE, AND COMMERCIAL USERS.

ANTECK, INC., introduces the MT-1RT 3.2 to 30 MHz inclusive, remote-tuned mobile or fixed-portable antenna. The "RT" incorporates a hydraulic cylinder in the mast section for position control, two miniature pumps and reservoir, and a control box with fast and slow scan operation at the operator's position.

Ratings are minus 40 degrees Fahrenheit in still air, 750 watts CW, 1500 watts p.e.p. 50-ohms input allows exact resonance and true operator convenience.

MT-1RT	\$225 Amateur Net, plus \$9 UPS
MT-1RTR	retrofit (all MT-1) \$102 plus \$7 UPS
MT-1	\$129.95 plus \$7 UPS
MT-1A Marine	\$179.95 plus \$7 UPS

Contact your local ANTECK dealer or ANTECK, INC.

HYD. TUNED —

NO COILS TO CHANGE—POSITIVE TUNING LOCK. LESS THAN 1.5 VSWR.

ANTECK, Inc.

Phone (208) 423-4100
Box 415, Route 1
Hansen, Idaho 83334



NO TUNERS REQUIRED

RESETTABLE TO EXACT FREQUENCY

IRON POWDER and FERRITE PRODUCTS

AMIDON
Associates

✓ 334

Fast, Reliable Service Since 1963

Small Orders Welcome

Free 'Tech-Data' Flyer

Toroidal Cores, Shielding Beads, Shielded Coil Forms
Ferrite Rods, Pot Cores, Baluns, Etc.

12033 OTSEGO STREET, NORTH HOLLYWOOD, CALIFORNIA 91607

144 REPEATERS 220

BASIC AUTO PATCH

* Access, #Disable and adjustable Timer.
COMPLETELY ASSEMBLED—\$75.00.

EXTENSION BOARD

Antifalsing, 3 digit sequential Touch Tone™ decoder with automatic reset, Antifalsing Ring detector, reverse auto patch capability for basic auto patch and two, two-watt audio amplifiers.

COMPLETELY ASSEMBLED—\$140.00

Hi Pro Mk I
REPEATERS

144 or 220 MHz \$849.95



ON BOARD VOLTAGE PROTECTION

Now with courtesy beep and beacon capability

COR Identifier: All on one band, programmable, Fully adjustable, time out (5-7 min.), hang time (0-1 min.), identifier (1-10 min.), tone, speed, volume, L.E.D. outputs, low current drain CMOS logic, plugs for easy installation and removal plus much more. \$99.95 COMPLETELY ASSEMBLED

Basic Repeater \$649.95 COMPLETELY ASSEMBLED
2M 130-175 MHz Basic Repeater for 2 meters with all the features of the Hi Pro Mk I less the power supply and front panel controls and accessories.

PA Res. add 6% tax PLUS SHIPPING

Maggiore Electronic Laboratory

845 WESTTOWN RD.
WEST CHESTER, PA. 19380
PHONE 215 436-6051

- (5) Number of satellites having the same orbital characteristics
- (4) Geographical longitudes marking the extremities of the orbital arc over which the satellite is visible at a minimum angle of elevation of 10° at points within the associated service area.
- (5) Geographical longitudes marking the extremities of the orbital arc within which the satellite must be located to provide communications to the specified service area.
- (6) Reason when the orbital arc of (5) is less than that of (4).

Technical Parameters. A description of the proposed technical parameters for:

- (1) The station in space operation; and
 - (2) A station in earth operation suitable for use with the station in space operation; and
 - (3) A station in telecommand operation suitable for use with the station in space operation.
- The description shall include:

(1) Carrier frequencies if known; otherwise give frequency range where carrier frequencies will be located.

- (2) Necessary bandwidth.
- (3) Class of emission.
- (4) Total Peak Power.
- (5) Maximum power density (watts/Hz).
- (6) Antenna radiation pattern.¹
- (7) Antenna gain (main beam).¹
- (8) Antenna pointing accuracy (geostationary satellites only).¹
- (9) Receiving system noise temperature.²
- (10) Lowest equivalent satellite link noise temperature.³

(c) **In-space operation notification.** Notification is required after space operation has been initiated. The notification shall update the information contained in the pre-space operation notification. In-space operation notification is required no later than seven days following initiation of space operation.

(d) **Post-space operation notification.** Notification of termination of space operation is required no later than three months after termination is complete. If the termination is ordered by the Commission, notification is required no later than twenty-four hours after termination is complete.

3. In Appendix 2 of Part 97, the undesignated paragraph following the headnote is revised, and a new paragraph Sec. 8 is added as follows:

Appendix 2

Extracts From Radio Regulations Annexed to the International Telecommunications Convention (Geneva, 1959), as revised by the World Administrative Radio Conference for Space Telecommunications, Geneva, 1971.

Article 41—Amateur Stations

Sec. 8. Space stations in the Amateur-Satellite Service operating in bands shared with other services shall be fitted with appropriate devices for controlling emissions in the event that harmful interference is reported in accordance with the procedure laid down in Article 15. Administrations authorizing such space stations shall inform the International Frequency Registration Board (I.F.R.B.) and shall insure that sufficient earth command stations are established before launch to guarantee that any harmful interference that might be reported can be terminated by the authorizing Administration.

¹These antenna characteristics shall be provided for both transmitting and receiving antennas.

²For a station in space operation.

³The total noise temperature at the input of a typical amateur radio station receiver shall include the antenna noise (generated by external sources (ground, sky, etc.) peripheral to the receiving antenna and noise re-radiated by the satellite), plus noise generated internally to the receiver. The additional receiver noise is above thermal noise, kT_B.

Referred to the antenna input terminals, the total system noise temperature is given by

$$T_s = T_a + (L-1) T_r + L T_r$$

where: T_a : antenna noise temperature
L : line losses between antenna output terminals and receiver input terminals
T_r : ambient temperature, usually given as 290° K
T_r : receiver noise temperature, this is also given as (NF-1)T_r, where NF is receiver noise figure.

amateur radio stations and operators (Subpart A through E of this part).

§ 97.407 Eligibility for space operation.

Amateur radio stations licensed to Amateur Extra Class operators are eligible for space operation (see § 97.403(a)). The station licensee may permit any amateur radio operator to be the control operator, subject to the privileges of the control operator's class of license (see § 97.7).

§ 97.409 Eligibility for earth operation.

Any amateur radio station is eligible for earth operation (see § 97.403(b)), subject to the privileges of the control operator's class of license (see § 97.7).

§ 97.411 Eligibility for telecommand operation.

Any amateur radio station designated by the licensee of a station in space operation is eligible to conduct telecommand operation with the station in space operation, subject to the privileges of the control operator's class of license (see § 97.7).

§ 97.413 Space operations requirements.

An amateur radio station may be in space operation where:

(a) The station has not been ordered by the Commission to cease radio transmissions.

(b) The station is capable of effecting a cessation of radio transmissions by commands transmitted by station(s) in telecommand operation whenever such

cessation is ordered by the Commission.

(c) There are, in place, sufficient amateur radio stations licensed by the Commission capable of telecommand operation to effect cessation of space operation, whenever such is ordered by the Commission.

(d) The notifications required by § 97.423 are on file with the Commission.

Technical Requirements

§ 97.415 Frequencies available.

The following frequency bands are available for space operation, earth operation, and telecommand operation:

Frequency Bands

kHz		
7000-7100		14000-14250
MHz		
21.00-21.45		28.00-29.70
144-146		435-438 ¹
GHz		
24-24.05		

¹ Stations operating in the Amateur-Satellite Service shall not cause harmful interference to other stations between 435 and 438 MHz (See International Radio Regulations, RR MOD 3644, 1.2D.A).

Special Provisions

§ 97.417 Space operation.

(a) Stations in space operation are exempt from the station identification requirements of § 97.87 on each frequency band when in use.

(b) Stations in space operation may automatically retransmit the radio signals of other stations in earth operation, and space operation.

(c) Stations in space operation are exempt from the control operator requirements of § 97.79 and from the provisions of § 97.88 pertaining to the operation of a station by remote control.

(d) Stations in space operation are exempt from the station log requirements of § 97.103.

§ 97.419 Telemetry.

(a) Telemetry transmission by stations in space operation may consist of specially coded messages intended to facilitate communications.

(b) Telemetry transmissions by stations in space operation are permissible one-way communications.

§ 97.421 Telecommand operation.

(a) Stations in telecommand operation may transmit special codes intended to obscure the meaning of command messages to the station in space operation.

(b) Stations in telecommand operation are exempt from the station identification requirements of § 97.87.

§ 97.423 Notification required.

(a) The licensee of every station in space operation shall give written notifications to the Private Radio Bureau, Federal Communications Commission, Washington, DC 20554.

(b) **Pre-space operation notification.** (1) Three notifications are required prior to initiating space operation. They are:

First notification. Required no less than twenty-seven months prior to initiating space operation.

Second notification. Required no less than fifteen months prior to initiating space operation.

Third notification. Required no less than three months prior to initiating space operation.

(2) The pre-space operation notification shall consist of:

Space operation date. A statement of the expected date space operations will be initiated, and a prediction of the duration of the operation.

Identity of satellite. The name by which the satellite will be known.

Service area. A description of the geographic area on the Earth's surface which is capable of being served by the station in space operation. Specify for both the transmitting and receiving antennas of this station.

Orbital Parameters. A description of the anticipated orbital parameters as follows:

Nongeostationary satellite	Geostationary satellite
(1) Angle of inclination	(1) Nominal geographical longitude
(2) Period	(2) Altitude
(3) Apogee (kilometers)	(2) Longitudinal tolerance
(4) Perigee (kilometers)	(3) Inclination tolerance

39⁹⁵
ADD \$7.50 OR POSTAGE

30 CHANNEL CABLE TV CONVERTER

ORDER No. 183AE047

ETCO ROUTE 9N,
PLATTSBURGH, N.Y. 12901
Tel.: (518) 561-8700.

FREE!
UNUSUAL 96 PAGE
ELECTRONIC PARTS
& IDEAS CATALOG!

✓ 91

Satellite TV

FOR THE HOME

Sick of Network TV?

Our receiver lets you get over 75 channels of television directly from earth-orbiting cable TV satellites! HBO, Showtime, super stations, sports and movies from around the world.



**We don't just sell information!
We Manufacture Hardware!**

Our 94-page catalog and information book tell the whole story! Inexpensive dishes, high profits, computer aiming software! Specs, kits and more! Send \$7.95 today!

24-hour C.O.D. Hotline
(305) 339-7600



SPACECOAST RESEARCH ✓310

Dept. S, P.O. Box 442, Altamonte Springs, FL 32701

SYNTHESIZED SIGNAL GENERATOR



• Covers 100 to 179.999 MHz in 1 kHz steps with thumb-wheel dial • Accuracy .00001% at all frequencies • Internal frequency modulation from 0 to over 100 kHz at a 1 kHz rate • Spurs and noise at least 60dB below carrier • RF output adjustable from 50 to 500mv across 50 ohms • Operates on 12vdc @ 1/2 amp • Price \$299.95 plus shipping.

In stock for immediate shipping. Overnight delivery available at extra cost. Phone: (212) 468-2720.

✓311

VANGUARD LABS
196-23 Jamaica Ave. Hollis, NY 11423

ATTENTION HAMS!

Earn a "FREE"
Antenna, Tower
or BOTH!

If you are employed by a company that could use a high lift work platform, as shown below, you may earn a new antenna system FREE.

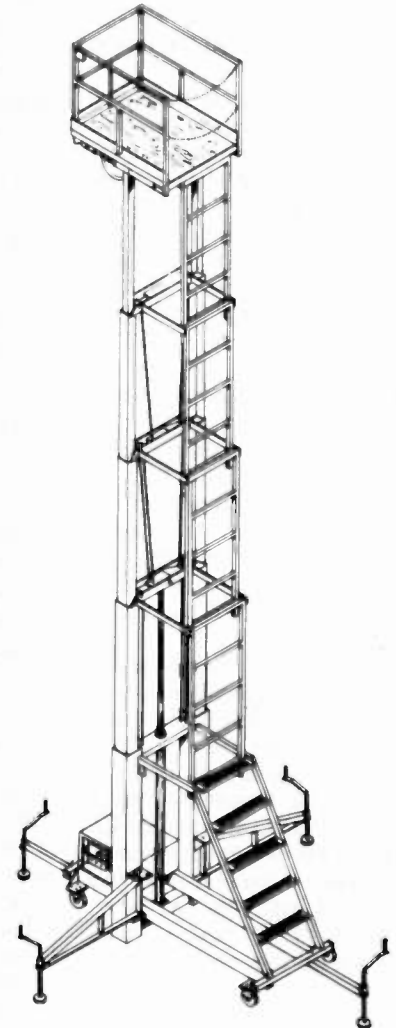

Wanted: Japanese Radio Amateur

Contact: **73 Magazine**
peterborough, n.h.03458
603-924-3873

ALL BAND TRAP ANTENNAS!



PRETUNED - COMPLETELY ASSEMBLED - ONLY ONE NEAT SMALL ANTENNA FOR UP TO 7 BANDS! EXCELLENT FOR CONGESTED HOUSING AREAS - APARTMENTS LIGHT - STRONG - ALMOST INVISIBLE!

FOR ALL MAKES & MODELS OF AMATEUR TRANSCEIVERS - TRANSMITTERS - GUARANTEED FOR 2000 WATTS SSB 1000 WATTS CW. INPUT FOR NOVICE AND ALL CLASS AMATEURS!

COMPLETE AS SHOWN with 90 ft. RG58U-52 ohm feedline, and PL259 connector, insulators, 30 ft. 300 lb. test dacron end supports, center connector with built in lightning arrester and static discharge - molded, sealed, weatherproof, resonant traps 1"X6"- you just switch to band desired for excellent worldwide operation - transmitting and receiving! Low SWR over all bands - Tuners usually NOT NEEDED! Can be used as inverted V's - slopers - in attics, on building tops or narrow lots. THE ONLY ANTENNA YOU WILL EVER NEED FOR ALL DESIRED BANDS - WITH ANY TRANSCEIVER - NEW - EXCLUSIVE! NO BALUNS NEEDED!

80-40-20-15-10-6 meter - 2 trap --- 104 ft. with 90 ft. RG58U - connector - Model 998BUA ... \$69.95
40-20-15-10 meter --- 2 trap --- 54 ft. with 90 ft. RG58U - connector - Model 1001BUA ... \$68.95
20-15-10 meter --- 2 trap --- 26ft. with 90 ft. RG58U - connector - Model 1007BUA ... \$67.95

SEND FULL PRICE FOR POSTPAID INSURED. DEL. IN USA. (Canada is \$5.00 extra for postage - clerical-customs etc.) or order using VISA - MASTER CHARGE - CARD - AMER. EXPRESS. Give number and ex. date. Ph 1-308-236-5333 9AM - 6PM week days. We ship in 2-3 days. ALL PRICES WILL INCREASE . . . SAVE - ORDER NOW! All antennas guaranteed for 1 year. 10 day money back trial if returned in new condition! Made in USA. FREE INFO. AVAILABLE ONLY FROM

WESTERN ELECTRONICS Dept. A7-10 ✓80 Kearney, Nebraska, 68847

**ICOM • BIRD • BECKMAN • CUSHCRAFT
AEA • B&W • VIBROPLEX • CDE • CES
HAM-KEY • ANTENNA SPECIALISTS
ASTRON • BELDEN • ARRL • W2AU/W2VS
AMECO • SHURE • AVANTI • AMPHENOL
SANKYO 24-HOUR DIGITAL CLOCKS
WELLER SOLDERING STATIONS
RADIO AMATEUR CALLBOOKS**

LaRUE ELECTRONICS

1112 GRANDVIEW STREET, SCRANTON, PA. 18509 - Ph. [717]343-2124

With today's inflationary times, this may be the perfect opportunity to upgrade your station with no drain on the family budget.

Contact Jerry Flatt at **WILSON SYSTEMS** for the details on this offer ... call Toll Free (800) 634-6898.

**W S I WILSON
SYSTEMS, INC.**

4286 Polaris Avenue
Las Vegas, Nevada 89103

(800) 634-6898

LETTERS

from page 24

and telling him that there was a two-letter prefix and a one-letter suffix. Even with this, he still insisted on moving me from the United States to Botswana by calling me A2FM. As a matter of fact, he even asked me if that was a stateside call!

I was about to put the blame for his inability to copy my call sign correctly on weak signal strength or QRM when another station broke in.

"K2---", he said, "This is W3---. He said his call was AF2M. I never heard of an AF2; must be a bootlegger!"

"I never heard of an AF2 either," replied the net control. "He's probably some chicken bander."

After this dialogue occurred, another amateur broke in to defend me. He informed the net control that AF2M was a legitimate call sign and that the FCC has been issuing calls in that format for the past two and a half years.

The net control paid no attention to this. He simply said that he had never heard of it, and therefore it was not a valid call!

Needless to say, I don't appreciate some Conditional class operator telling an Amateur Extra that his call sign is no good. This was not the first time I had problems with this net. When they don't get my call sign messed up, they have asked me to do such things as make a phone patch to a business so someone could place an order!

I think it is about time that the amateurs in this country become aware of the call sign prefix system used. Oddly enough, I've never had problems with DX stations getting confused over the call sign; most of them are well aware of the new prefixes that exist here.

The two-by-ones have been around for well over two years. I think it is disgusting that I am prevented from using my radio because of some ham who must have been living in a hole the past few years.

An amateur radio operator should keep up to date with the rule changes. In addition, they

should not "play FCC" and decide for themselves who is a bootlegger and who is not!

**Robert Swirsky AF2M
Cedarhurst NY**

Bob, the FCC does not give an intelligence test along with the ham exam or else some of the nets I've encountered would be underpopulated. Be thankful that those hams with a short deck are stacked up in nets instead of using up frequencies for one-on-one contacts. We have to have activities for our mentally underprivileged, so stop griping. There are undoubtedly some well-run nets; unfortunately, I've run into a lot of the others. One of the major problems encountered during the recent hurricane emergency was a net control station who had no business controlling a net. The net was almost as much of a disaster as the hurricane.—Wayne.

MENTAL TELEPATHY?

I just wanted to thank you and the many other Elmers for the help given on my way to getting my General ticket. The code is really the hardest thing for me and I sure like your 13+ tape. I used many books and tapes along the way and yours are great.

I would also like this to be a letter of encouragement to others who are working hard to upgrade or get a license; it can be done. At one point (actually many times), I had visions of hams perfecting telepathic communications before I ever got over 10 wpm. So far it has been one year as a Novice, one as a Tech... but the big one for me, along the way, was the General. If I could have mastered the code back when I first wanted to become a ham, I would only have to wait 6 more years to be eligible for the QCWA. As you can see, I am a slow learner.

Thank you again; keep up the good work. To any up-and-coming hams... also keep up the good work; you can do it.

**George Weber KA0CCY
Steamboat Springs CO**

KAYLA'S KIPLING

I have been re-reading Kipling and came across the following poem which may be the first literary reference to Morse code. The copyright date is 1892.

A CODE OF MORALS Rudyard Kipling

*Now Jones had left his new wed
bride to keep his house in
order,
And hied away to the Hurrum
Hills above the Afghan border,
To sit on a rock with a helio-
graph, but ere he left he taught
His wife the working of the Code
that sets the miles at naught.*

*And Love had made him very
sage, as Nature made her fair;
So Cupid and Apollo linked, per
heliograph, the pair.
At dawn across the Hurrum
Hills, he flashed her counsel
wise—
As e'en, the dying sunset bore
her husband's homilies.*

*He warned her 'gainst seductive
youths in scarlet clad and gold,
As much as 'gainst the blandish-
ments paternal of the old;
But kept his gravest warnings
for (hereby the ditty hangs)
That snowy-haired Lothario,
Lieutenant-General Bangs.*

*'Twas General Bangs, with Aide
and Staff, that tit-tipped on the
way,
When they beheld a heliograph
tempestuously at play.
They thought of border risings,
and of stations sacked and
burnt—
So stopped to take the message
down—and this is what they
learnt:*

(Here I take liberties and use dah dit, where Kipling said dash dot.)

*"Dah dit dit, dit, dit dah, dit dah
dit" twice. The General swore.
"Was ever General Officer ad-
dressed as 'dear' before?
'My Love', i' faith! 'My Duck,'
gadzooks! 'My darling popsy-
wop!'"*

*Spirit of great Lord Wolseley,
who is on that mountain top?"*

*The artless Aide-de-Camp was
mute; the gilded Staff were
still,*

*As, dumb with pent-up mirth,
they booked that message
from the hill;*

*For clear as summer-lightning
flare, the husband's warning
ran:*

*"Don't dance or ride with Gen-
eral Bangs—a most immoral
man."*

*(At dawn, across the Hurrum
Hills, he flashed her counsel
wise—
But, howsoever Love be blind,
the world at large hath eyes.)
With damnatory dot and dash
he heliographed his wife
Some interesting details of the
General's private life.*

*The artless Aide-de-Camp was
mute; the shining Staff were
still,
And red and ever redder grew
the General's shaven gill.
And this is what he said at last
(his feelings matter not):—
"I think we've tapped a private
line. Hi! Threes about there!
Trot!"*

*All honour unto Bangs, for ne'er
did Jones thereafter know
By word or act official who read
off that helio.;
But the tale is on the Frontier,
and from Michni to Mool-tan
They know the worthy General
as "that most immoral man."*

**Kayla Hale W1EMV/T15
Alajuela, Costa Rica**

*Hello, Kayla! For ham newcom-
ers, Kayla was the editor of 73
back before she got married...
golly... over ten years ago.—
Wayne.*

AUGUST KUDOS

I just want to say thanks for a hell of a good job you've been doing.

I've been a writer, professional type, for some 30 years or more. Over a thousand credits if you care to count 'em, so there are a few experiences with editors in the old memory sack. Why tell you all this?

Because, to make a point. You look back over your encounters and you start comparing. You remember articles you wrote to your own specs, only to have them bounced with the judge's decision of "lack reader interest." Trouble is, the readers never had a chance to put in their two-bits worth (2¢ inflated). The eds bounced the cream of an 8-hour stint at the mill on the basis of their taste.

Now, at 73 you run such articles as "Over There" by Julian N. Jablin W9IW1 in the August, 1980, issue. Who in the annals of hamdom would ever suspect that an article like this, with no

schematics, formulas, construction instructions, and the like, would ever get published, much less read and enjoyed? Want to know why 73 is the fattest, best-loved, and most read of any ham mag? Simple. Articles like this as well as the usual nuts and bolts! I was in the Navy, but had some inter-service experience with just such guys as Jablin made come to life again. I'll bet my keepsake Morse key that fastens on my knee with the knob on top that a lot of 73 readers enjoyed that story as much as I did! Maybe some or most of you are youngsters and couldn't get excited over that writing, but you had the good sense to publish it for those of us who could. That's good editing!

I've read every August article. Good balance. Every one interesting in its own way. They are warmly written, like talking to the guy across town on the 2-meter net. What more can I say, except "Keep up the good work!"

Waldo T. Boyd K6DZY
Geyserville CA

Thanks, Waldo, and it has been a pleasure to publish your articles for these many years. I was glad to see the article from Julian, too, for I've known him for some 25 years now and we've been good friends, but I haven't seen him writing much recently. I hope this will break it loose for him and we'll see more... and more from you, too, Waldo.—Wayne.

SSTV AND THE ARTS

The Amateur Radio Television System (ARTS) is a non-profit organization of amateur television (ATV) operators who are devoted to bringing together peoples of the world via slow scan television. ARTS operates on the commonly recognized SSTV frequencies and has a membership of hundreds of operators who come together for the exchange and relay of video traffic from all parts of the world. ARTS cooperates with the specialty networks of the Military Affiliate Radio System (MARS), providing full coverage of the military as well as the civilian population.

All 50 states and many DX countries have ARTS Directors who oversee video traffic han-

dling in their areas. Some Director positions remain to be filled and more operators are needed. Interested SSTVs are invited to contact me at the address given below. An SASE will be appreciated.

Mike Stone WB0QCD
Director,
ARTS Communications
PO Box ATV
Lowden IA 52255

HEYN AND WEST

My husband Fried Heyn WA6WZO (Extra class license) is running for ARRL SW Division Director in the October election, and Gordon West WB6NOA is running for Vice Director. Fried believes he and Mr. West have considerably *more time* to provide the Division with more leadership, more representation, more service, more ideas, more enthusiasm, more caring, and more courage, plus more qualifications and more experience in amateur radio.

Fried is a math teacher (20 hours a week) having BA, BS, and MA degrees. His past administrative experience includes Production Coordinator for Collins Radio. He is currently an ARRL Assistant Director, Section Communications Manager, chairman of the Orange County Council of ARO, founder (and past president) of the Southern California Amateur Radio Computer Club, honorary member (and past president) of the Orange County ARC, treasurer of the Southern California DX Club, and life member of the ARRL and AMSAT. In addition, he has had experience in public service, writing, lecturing, teaching, conventions, and public ham exhibits. He is very active on the air and has accumulated many awards, including the ARRL National Certificate of Merit, many contest wins, BPL, 5BWAS, WPX, and WAZ. He has over 300 countries confirmed (including DXCC). He is active in many local nets and organizations, including RACES, ARES, and NTS, and he is an active member of 220 SMA, TASMA, and the LA Area Council of ARC. Fried's other national memberships include NC DX Foundation, ISSB #9367, Ten-Ten #8011, MARAC #993, and ARNS #807.

Gordon holds both an Advanced amateur radio license and First Class radiotelephone



Fried Heyn WA6WZO (left) and Gordon West WB6NOA.

license (with radar endorsement). He has an MA degree in business administration from Chapman College and currently is an editor, lecturer, writer, and college instructor on marine, citizens band, and amateur radio electronics. He is an ARRL life member and holds field organization appointments of OBS and OVS as well as membership in ARES. He is the honorary president of the West Coast Amateur Radio Club as well as a supporter and member of many local repeater groups. Also, he is a member of the distinguished Radio Club of America and the interference committee of the Personal Communications Foundation. Mr. West is active on all bands from 160 meters through 1296 MHz.

Gordon believes that he and Fried will provide the SW ARRL Division with a "New Direction" in increased representation and service to their fellow amateurs.

Sandi Heyn WA6WZN
Costa Mesa CA

LOW VOLTAGE

Readers of the July, 1980, issue were treated to WD4KFF's unique semiconductor tester ("Multi-Media Bench Tester," page 106). I enjoy using mine.

I would like to suggest a battery supply of 4.5 to 5.5 volts (in place of the 6-volt supply indicated on the schematic) since these are the recommended operating limits of most transistor/transistor logic (TTL) devices to ensure proper performance. Thanks.

Mitch Cohen WB4RXB
Margate FL

HT OPPORTUNITIES

Just another letter to let you know how much I continue to enjoy your fine publications, *73* and *Microcomputing*. Both are a credit to the industry, the hobby, and to the professions and fields that they represent.

Sure would like to see some mention made that the hams in the field would like to see the radio manufacturers get on the ball and make some of the excellent hand-held units for some of the bands other than 2 meters. The industry has done wonders with the 2-meter band with the marked advancement of gear now available. With band conditions as they are in certain parts of the country, and with the concern that if "we don't use it, we will lose it," I would like to see some serious effort by the radio manufacturers to get some truly new products and hand-held units out for the 220- and the 440-MHz bands. Even a hand-held for 6 meters would be welcome on the market. I know I am interested in getting some new gear for these bands, but we need some help from the manufacturers!

Please devote some thought and comment to this subject. Two meters would not be what it is today without the gear that is available; now that we have opened and in some cases filled every space on two meters, let's open some of the other bands with some gear that is a pleasure to operate! The market is there — and we are out here just waiting to spend our money.

William D. Mauldin KA4JUL
Boca Raton FL

LOOKING WEST

from page 12

over, the same answer we used to protect the 220-MHz band: like it or keep six meters alive and healthy the same way 220 is these days. What about equipment? Except for some high-priced multi-mode transceivers, there is little around, and you do not want to front a bundle of these things for a band that may not pay off in contacts. Most of us are willing to bet that most of you have a remnant of the old rigs lying in the closet or on the shelf. Maybe it's an old Gonset I, II, III, or IV. Perhaps a vintage Clegg 99er, 66er, or Polycomm 6. How about a venerable Benton Harbor Lunch Box? Dig it out, plug it in, and see if it still works. If it bet it does. What about an antenna? Well, a simple dipole is more than adequate for local work. "But AM is dead. Nobody uses it anymore." True. AM on VHF is dead, but only because most of those who used to operate 6-meter AM went to 2-meter FM and deserted 6 meters entirely. While AM would not be welcome these days on the best bands, six is definitely the exception to the rule. Why? Because there is a lot of equipment and very little utilization on 50.25. Most six-meter SSB enthusiasts hang around 50.110 or thereabouts. Stay above 50.25 and you won't be bothering a soul. If enough of you dig out these relics of an era gone by and make use of them, you can literally have your own private channels to use as you wish. Your expense? That of a few feet of coax, some zip cord, and a few hours of work.

"But I don't want to go on AM. It's so out-fashioned." True, AM is out-fashioned by today's standards, but most old tube-type AM rigs can be easily converted to SSB. The simplest way is to use the existing AM modulator as an FM modulator by replacing it to modulate the transmitter oscillator. Careful... and the job control down... it does not take very much audio to get enough deviation for channels 5 kHz. Most crystal manufacturers can supply a universal rock for 52.525 which is

the place most FMers on 6 meters monitor. As far as the receiver goes, you can simply slope detect or convert the receiver to FM operation with the addition of a simple integrated circuit quad detector mounted on a small PC board. Many quad detector chips have built-in squelch and limiting.

Think such a conversion cannot be done? My new 6-meter FM rig is nothing but a 1960s Lafayette HE-45B with a quad detector powered with voltage stolen from the cathode of the audio output/modulator tube, with the receiver oscillator now crystal controlled. To FM the transmitter, I simply reconnected the modulator to supply modulated B plus to the original crystal oscillator and tied the 2E26 final plate directly to the unmodulated B supply. I picked up 4 extra Watts out in the bargain. Audio reports are good, and those I QSO seem shocked when I tell them what I am running. Even better, this unit looks nicer than some old boat anchor, especially sitting on my desk. The antenna is a simple coaxial vertical made from a length of RG-59/U. Nothing exotic, and a total investment of under \$14, including crystals. Not state of the art, but more than sufficient. I also have a vintage Polycomm 6 which I restored to perfect operating condition and left unmodified for other uses. Thus far I have had about a half dozen AM QSOs since returning to the band. The antenna on the Polycomm is also a dipole, but this one a traditional horizontal centered type.

Six meters seems dead because most people who operate the band listen rather than talk. They're waiting for the other guy to call CQ. Well, if everyone waits, there will be very few QSOs, won't there? It's up to people like you and me to wake up the band. Old equipment works, is plentiful, and is inexpensive. Even with the most rudimentary equipment, significant DX is possible during sporadic E and F₂ openings. Working extended groundwave, meteor scatter, tropo, and the like takes far more exotic equip-

ment. But you would be amazed at what can be worked with the oldies but goodies. On July 25th, 1961, using a Clegg 99er 7-Watt AM transceiver and an indoor dipole, I QSOed KP4AXC in San Juan, Puerto Rico, from Brooklyn, New York. On May 19th, 1965, while still in Brooklyn, I QSOed WA8BTR in Cincinnati, Ohio. He was running a Hallcrafters HT-40/SX-140 combo and I was using the same HE-45 Lafayette rig that has now become an FM base station. My antenna at the time was a halo atop a 6-story apartment house. Or how about St. Louis, Missouri, on May 30th, 1961? I QSOed W0WKG using my indoor dipole and a 15-Watt homebrew transmitter. Shall I go on? In all, some 42 states plus Puerto Rico worked and 38 confirmed prior to my going to SSB in the late 60s. It can be done, and I have the QSL cards to prove it. Many of you reading this probably do, too. Those were great days. Six-meter DX-ers cooperated with one another, rag chewing in a DX round table was common when the band was open, and there were none of those time-out timers, jammers, or politicians to concern oneself about. If you are as tired of the latter as I am and happen to have a relic of that era lying around, then why not fire it up? You might not hear much at first, but try calling a CQ. Who knows, if enough of us do this, we could repopulate the band and then move it toward bigger and better things. Most important of all, we can secure this band from potential invasion by illegals. If enough of us are there, they are not going to try anything. But if we leave the band vacant awaiting further FM deregulation for expanded repeater operation, we are inviting disaster. CU on 6... as we used to say... AM, FM, or SSB.

One final note to those of you who think that ITF is playing alarmist and who think that six meters will always be safe because of the TVI problem. In today's day and age, there is no such thing as safe amateur spectrum. Every kHz has a specific dollar value. There are those who look upon the spectrum devoted to amateur radio as potential income if they can steal it from us. At this moment, there is no more vulnerable amateur spectrum than that which lies between 50 and 54 MHz. It is

in the same position that 220 was some 5 years ago. I firmly believe that we have two choices. Either we utilize this spectrum or it will be lost to another service. "Six meters—Use It or Lose It."

JAMMER LOSES LICENSE DEPARTMENT

In late 1978, there appeared on the two-meter amateur band in Los Angeles a rather foul-mouthed individual using a phoney callsign. Using the call W6JAM, this individual tormented the users of the then WR6ABN repeater for many months. During this time, many letters were sent to the FCC and other government agencies in an attempt to obtain some form of relief from this menace, but in the end it was his peers who located him. Unfortunately, W6JAM was found to be a licensed amateur operator named Scott Lookholder, whose real callsign was WB6LHB. Lookholder was eventually brought to trial, given a year's suspended sentence, and fined. All this was reported here in LW and in other amateur publications.

In September of 1979, after an inordinate amount of pressure from the amateur community, the Commission acted to suspend Lookholder's license. They also issued a Show Cause Order as to why his license should not be revoked. In my possession is a copy of the final Revocation and Suspension Order issued against Lookholder on May 16th, 1980, with an effective date of June 16th, 1980. From it I have learned many things, including the fact that Lookholder never responded to the Show Cause Order.

What I found most interesting, however, were the "Conclusions of Law" upon which the revocation order was based. I got many clues into the thinking of the FCC, as well as a hint as to how similar matters might be handled by them in the future. After noting that Lookholder had been convicted in a Court of Law for repeated violations under 47 U.S.C. 502, and stating that they, the Commission, had a mandate to regulate radio communications based upon the Communications Act itself, they went on to cite some rather interesting legal interpretations that by this order have become possible legal precedent.

The Commission stated, "Lookholder's transmission cannot be treated the same as words spoken in private, words spoken in public, or printed words. The Courts, Congress, and the Commission have recognized that radio communications have special qualities which distinguish them from other modes of communication and expression." (At this point, the findings cited various cases in which broadcasters were involved, including the famed Pacifica case involving radio station WBAI in New York.) Continuing... "Thus while the use of certain expressions such as (expletive deleted) displayed in writing in public may be protected forms of speech, nevertheless, government may properly act in many situations to prohibit intrusion into the privacy of home of unwelcome views and ideas which cannot totally be barred from the public dialogue." In essence, you can say what you want in public, but if you do it on the radio, you can be held responsible for your words. Maybe my interpretation is a bit simple, but I think it fits.

The finding went on: "The Commission has determined that the transmission of radio communications containing certain explicit words (and forms thereof)... are patently offensive to listeners, and that radio communications containing such words fall within the prohibitions of 18 U.S.C. 1464. Consequently, these expressions are prohibited by Section 97.119 of the Commission's Rules. Because of the nature of the Amateur Radio Service and its broad band of frequencies instead of limited channels, the audience of 350,000 amateur radio licensees and in addition shortwave listeners and those studying for an amateur license are constantly tuning in and out of the radio bands and are subjected to unexpected contents of the communications. Like the broadcast in Pacifica, Lookholder's transmissions were uniquely accessible to children and could have enlarged a child's vocabulary in an instant, unlike written messages."

Unless I read something wrong, in this finding the Commission notes that the public has a right to be protected from being forced to listen via electromagnetic communication to anything it deems to be offen-

sive, and cites the case of Pacifica's WBAI in which listeners were "treated" to what some felt was offensive material. They then stated that the actions of Lookholder and those of Pacifica were one and the same, thus citing action in another service as precedence in the revocation of Lookholder's license.

"Moreover, Lookholder's repeated transmission of obscene, indecent, or profane language and its intentional interference with the transmissions of other amateur licensees establishes a record of disinclination to comply with Commission rules. Thus revocation is not only warranted, but essential." I think that no comment is necessary, as this section speaks for itself.

The anger of the amateur community was also noted: "Lookholder's transmissions have angered the amateur community. The amateur community must be assured that the Commission is prepared to act severely when its rules and regulations are blatantly disregarded by amateur licensees, such as Lookholder." Herein the Commission was obviously making reference to the myriad of communications sent to them on the matter by amateurs of this area who were more than a bit upset by the situation. Obviously I am not a lawyer, but I suspect that this finding may give credence to the viability of such complaints as the basis for investigating such instances as this.

The rest of the order was the necessary legalese to invoke the revocation of Lookholder's license. However, a footnote was added that is of extreme significance in that it ties together virtually all forms of radio transmission under the obscenity ban. It reads as follows:

"The Commission's enunciation that such words fell within the prohibition of 18 U.S.C. 1464 was within the context of Broadcast Radio Stations. Of particular concern was the protection of children and consenting adults who do not want such language transmitted into their homes. These considerations are equally true of the Amateur Radio Service where there are no minimum age requirements for licensing (97.9), where there are, as this case reveals, complaints against such language on amateur radio, and where the

potential reception of the transmission is widespread, as confirmed by the fact that Lookholder's transmissions were on frequencies with potential worldwide propagation."

I have stated in this column many times that it is my belief that an amateur license is not a license to say anything you want, when you want, whether your language is welcome or not. Your license is a permit granted to you by our government to communicate through the use of electromagnetic radiation on pre-determined spectrum in exact accordance with regulations as set forth by the governing body, i.e., the FCC. If you are a jammer or thinking of becoming a jammer, then I suggest you weigh the potential consequences. By this action, the Commission has set a long needed precedent that can be used against you. They can take your license. They can take other punitive action. You might even wind up in prison, or at least have to pay a stiff fine along with court costs.

When Lookholder pled guilty and was hence convicted, many amateurs were angered that it took so long for the FCC to even suspend his license, let alone revoke it. It was well over a year and a half from the time of the conviction until the time the revocation order took effect.

Many amateurs openly condemned the Commission for its slowness in acting on the matter, but with the publication of this document, it is apparent that this time was well spent in preparation. It is well thought out, well prepared, and, most important, it seems to set the legal precedent that the Commission needed to act against such offenders. Keep in mind that the next time, the Commission need only cite this case as grounds for a revocation action against a regulatory violator who fills our airwaves with his or her profanity. They obviously were looking to set an air-tight legal precedent, and in my untrained but optimistic view, I think they have. People versed in communications law with whom I have conversed tend to agree. The FCC now has a weapon to use against the foul mouth, and let's hope they go to it swiftly.

There is only one thing I wonder about. Does the real holder of a callsign such as W6JAM have any legal recourse against someone who has blasphemed said call and used it illegally? That's one that some of you legal types might want to look into. Meanwhile, scratch one jammer. He jammed; he got caught; he's no longer an amateur. The bureaucracy of Washington may move slowly, but once the steamroller gets going, there is seemingly no way to stop it.

HAM HELP

I'm looking for a used HF linear amplifier. I'd prefer one without tubes. Condition not important, price is! Please make offers.

Dante Ventriere KA4JRE
17831 NW 81 Ave.
Hialeah FL 33015

I need information on hints, kinks, and modifications for the Kenwood TR-7400A, especially for out-of-band operation. I also need information on a squelch circuit for the Motorola Pagecom low-band pager. I am willing to pay a reasonable price for information.

Richard McLaughlin, Jr.
WB8TOE
4237 Dickman 3B
Springfield MI 49015

I am in need of an operator's manual for a Tempo One transceiver. I also need an operator's manual for a Hallicrafters SR-150 transceiver. I will be glad to pay for postage and copying, but please send a postcard first. Thank you.

Claude Laroche KA1BNA
RFD 2, Georgia Road
St. Albans VT 05478

If anyone has cured an ignition noise problem, on transmit, in the KDK 2016A, I sure would like to know about it. Also, if anyone knows of an RIT mod for the Heath HW-101, please let me know.

Jerry Lynn WB7WBW
3017 First Ave. No.
Great Falls MT 59401

NEW PRODUCTS

from page 32

In addition to detecting motion, the Safe House may be used with optional door and window switches to provide perimeter protection. A normally open panic circuit is also offered. A panic switch will activate the alarm regardless of whether it is in the armed or standby mode. No matter what triggers the Safe House, its siren will run for eight minutes and then shut off if no more triggering occurs. This helps to prevent an annoying disturbance if you are away and the alarm is accidentally set off.

Our tests of the Safe House system indicate that its effective range is a bit less than what the owner's manual specifies.

When used in an apartment living room approximately 15 x 20 feet in size, the Safe House provided coverage for everything but the areas on its immediate left and right. Motion directly toward or away from the alarm immediately registers; however, lateral motion is less likely to be detected. While this rf disturbance alarm did not seem to be as sensitive as some ultrasonic units, it did not have the falsing problem associated with some of the less expensive units.

The Safe House alarm provides a compact, easily installed way to protect one room and, if the need arises, the system can be expanded. Features like the coded entry sequence and back-up battery are offset by a rather cheap looking plastic cabinet.

The operation of a low-level microwave signal like the Safe House's is contingent on the premise it does not interfere with licensed microwave users. By the way, there is no protection from interference resulting from other users of the alarm frequency.

The Safe House rf field disturbance alarm is available at Radio Shack stores. The alarm costs \$199.95 with a horn speaker, \$179.95 without. Reader Service number 478.

Tim Daniel N8RK
73 Staff

TEN-TEC OFFERS NEW THIRD GENERATION OF THEIR POPULAR "OMNI" TRANSCIVER

In addition to some interesting new performance features, Ten-Tec's new Omni Series C transceiver is one of the first amateur transceivers to have capability for all nine HF bands.

The Omni-C covers all amateur bands from 160 through 10 meters. Crystals are included for seven of the nine bands (crystals for the 18- and 24.5-MHz bands will be ready when the bands are).

Another unique new feature of the Omni-C is its three-mode, two-range offset tuning capability. It's the first to offer a choice of offset tuning for the receiver section, the transmitter section, or the combined transceiver. The three modes offer complete offset tuning flexibility for all needs, fine tuning interfering signals or chasing DX. The two ranges are ± 500 Hz or ± 4 kHz.

The Omni-C also offers new ease in using the seven response curves of its optimized bandwidth capability. New switching is provided for selecting the standard 2.4-kHz 8-pole SSB filter, the optional 1.8-kHz 8-pole SSB filter, the optional 250-Hz or 500-Hz 8-pole CW filters, cascading them for 16 poles of filtering or putting them in the signal path along with 450- and 150-Hz active audio filters.

New "hang" agc for smoother operation and a standard equipment noise-blanker (2-pole monolithic crystal filter) are other new features. For further information, contact *Ten-Tec, Inc.*, Highway 411 East, Sevierville TN 37862.

SPECTRUM COMMUNICATIONS' NEW UHF FM REPEATER

Spectrum Communications' new FCC type-accepted SCR4000 repeater is a 30 Watts minimum unit, with a 406-512-MHz frequency range. Its features include: excellent receiver sensitivity (0.3 μ V/12 dB SINAD), 8-pole front-end filter, very wide receiver dynamic range with double balanced mixer for superior intermod rejection, 8-pole i-f crystal filter plus 4-pole ceramic filter, built-in CW IDer and time-out timer, and all important operating parameters conveniently adjustable and measurable from the front panel. The unit is available complete with community tone panel, matching cabinet, and duplexer. For further information, contact *Spectrum Communications Corp.*, 1055 W. Germantown Pk., Norristown PA 19401. Reader Service number 477.



Spectrum's SCR4000 repeater.



Ten-Tec's Omni-C transceiver.

MFJ RECEIVER ANTENNA TUNER/PREAMPLIFIER

For years, hams have espoused the benefits of antenna tuners, match boxes, and transmatches for maximum transmitting antenna efficiency. But how about receivers? Don't they deserve some consideration, too? Certainly, if a transmitter/receiver combination is used, and an adjustable matching device is set for the most efficient signal transfer (nominally 50 Ohms) between the transmitter and antenna, then the same efficiency exists during receive as well.

But many hobbyists enjoy the passive reception of shortwave broadcast stations, utilities, and amateur communications without the intention of pushing rf back out through the antenna. Why pay for a large, expensive transmatch?

Is an antenna feedline matching device really necessary for reception? MFJ seems to think so, and their new model 959 receiver antenna tuner/preamplifier is designed to optimize the coupling between the receiver and its feedline. "Antenna tuner" is somewhat of a misnomer, since the only way one can tune an antenna is at the antenna itself. But assuming that the antenna and feedline are reasonably well matched at their union, there are ways to improve the match between the radio and the feedline for maximum signal transfer efficiency. A transmatch is one way.

The 959 is a flexible instrument, consisting of a fully-adjustable pi-section tuning stage followed by a stage of bipolar transistor amplification. The entire circuit may be bypassed with the rotation of a switch to direct the signal back to direct

receiver input from the transmission line.

Theoretically, since modern receivers are designed to accommodate 50 Ohms antenna line impedance, a resonant half-wave antenna cannot be improved upon with any matching device. But rare is the single-frequency application where a perfect match is possible. Most of us—probably *all* of us—tune our receivers for wide frequency excursions, hoping to snag some elusive DX. It would be nice if we had some guarantee that our receivers would be optimally matched throughout the chase. But just how essential is a perfect match for reception, anyhow? In transmitting we are concerned for every Watt of output, both for maximum signal emission as well as equipment safety from high vswr. But with reception, it would seem that a few dBs shouldn't make all that difference. We decided to test out this theory with the 959 tuner.

A harmonically-related off-center-fed window antenna cut for 80 meters was selected as the test antenna. Since it had large capture area (135 feet long) and was already close to resonance on several harmonically related bands, we knew that it would be hard to improve upon for receiving.

Results of this experiment were mixed. Below about 6 MHz, there was a distinct improvement in received signal strength when using the MFJ-959 tuner rather than operating the window straight through. Above that frequency, there was no noticeable difference. Naturally, with the 20-dB preamplifier switched in, signals came up, but that would be expected from

any additional rf amplifier stage.

Next, we tried a shorter random wire antenna about twenty feet in length. Results were identical. No improvement with the tuner above about 6 MHz.

But before we write off a receiver tuner as a worthless accessory, let's examine a few of its applications to show where it really makes a difference.

One of the problems encountered by receiver manufacturers is in the design of an inexpensive general coverage receiver with wide dynamic range. Strong signals have a tendency to do awful things to receiver circuitry, especially when cost-conscious engineers specify "cost effective" transistors. Inadequate front-end (rf) selectivity is another weakness in wide coverage receivers. The frequent result is the reception of signals which aren't really there! Intermodulation and images generate phantom signals that may interfere with reception all over the dial. This is where a good external preselector comes in handy.

The MFJ-959 also has a switch-selectable attenuator which is useful in reducing interference from nearby transmitters. The additional tuned circuitry provides the increased circuit Q to improve overall rf selectivity as well. Those strange whistles and annoying phantom signals from nowhere disappear when the tuner is peaked on the desired receive frequency.

True, you can't make a silk purse out of a sow's ear, but even the sow tastes pretty good when it's properly prepared! And you can't make a Collins 51S1 out of a Hallicrafters S-38, but you *can* improve the S-38—and other receivers as well!

The MFJ model 959 receiver antenna tuner/preamplifier sells for \$89.95. For further information, contact *MFJ Enterprises, POB 494, Mississippi State MS 39762*. Reader Service number 483.

Robert Grove WA4PYQ
Brasstown NC

HAMTRONICS' RECEIVING CONVERTERS

Hamtronics' receiving converters are housed in attractive wood grain aluminum cases and feature a low noise figure, less than 2 dB, for applications requiring exceptional sensitivity. That makes them ideal for reception of OSCAR satellite signals as well as conventional terrestrial activity. Called the "CA" series, these converters are available in a wide range of VHF and UHF bands and in several popular output ranges. VHF models use protected dual-gate MOSFETs in the front end and mixer. UHF models use two of the new MRF-901 bipolar transistors in the rf amplifier and a doubly-balanced Schottky diode mixer for broadband response. The converters are great for all modes of operation, including SSB, CW, FM, and ATV.

A whole new line of Hamtronics' receiver preamps has been added, using new technology similar to that of the converters. These are available either in a new drawn metal enclosure with mounting tabs or as a PC board module. Provisions have also been made to feed the B+ to the preamp via the output coax cable for remote mounting preamps at the antenna.

For further information, contact *Hamtronics, Inc., 65F Moul Rd., Hilton NY 14468*. Reader Service number 481.



The MFJ-959 receiver antenna tuner/preamplifier.



A Hamtronics receiving converter.

W2NSD/1 NEVER SAY DIE

editorial by Wayne Green

from page 8

you are aware that 73% of the business phone calls do not get through on the first try.

With some plans I have in mind, I think our entire educational system can be revamped. I envision a system whereby people start learning as early as they want and continue until they lose interest or die. The courses would be done so as to generate enough interest to attract students and get them to want to learn. I think this can be done via a combination of video recording and computers and it is my intention to have Instant Software pioneer this field. I'm not talking about just the US, but teaching the entire world.

If I can find people capable of running the publications, I'll be going off to Africa to push for ham clubs in as many countries as possible, as mentioned earlier. Between amateur radio and microcomputers, mighty changes can be made in many countries in a relatively short time.

YOUR HELP

The preceding is ambitious, but with your help I can do it. I need your support with as many subscribers as you can get for the magazines...with ads...and with club-run classes for new hams. I don't think we have to give away the ham ticket to get new hams...no code-free licenses...no digital licenses. It's hard work...and fun...to study and pass the ham exams. Get your club into the local high school and snare those 14- and 15-year-olds into your classes. And don't forget to tell them about Wayne Green and *73 Magazine*.

OFF TO SEE THE BLIZZARD

Well, the hurricane, anyway. When word of the destructive Allen hurricane came over the television, I held a hurried meeting of the *73* tech staff and suggested that our collection of a dozen or so HTs, chargers, and

assorted low-band rigs which could be run from 12 volts might be of use on St. Lucia.

Tim Daniel N8RK/1 got right to work packing the rigs into some Halliburton metal suitcases in case they would be needed. Next, we contacted Delta Airlines to see about getting the equipment down to Miami as the first step toward St. Lucia and found them extremely cooperative.

We'll have the details of the whole thing as soon as possible; however, it ended up with Tim grabbing a couple of cameras and a toothbrush and accompanying the gear to St. Lucia, where the HTs were put into immediate use.

INCENTIVE LICENSING?

There is a misunderstanding...and I notice that *73* has been contributing to this. A letter in the September issue, which was published without comment (I didn't see it), confused Incentive Licensing, which was the proposal made in 1963 by the ARRL to get the General class licensees off all the major phone bands, with the currently used Progressive Licensing system.

The additional privileges of our current system may indeed provide an incentive for stepping up your class of license, but this is *not* Incentive Licensing. The battle that *73* and a great number of hams put up against the League back in the 60s saved half of the phone bands for the General class.

One other point. The small number of additional frequencies now available to the Extra class was *not* the incentive which made that license class popular. Indeed, virtually no one upgraded to Extra until the funny call signs rule went through. Up until that time, only about 2% of the hams had upgraded to Extra. All this was reported in detail down through the years in *73* as these events happened. Most newcomers are unaware of our history...and a lot of old-

timers have rewritten history in their minds to protect the memory of our beloved League.

There goes Wayne with his ARRL hate campaign...no, not at all. I honestly don't hate the ARRL...contempt, maybe, for those directors who get elected for ego reasons (most of them) and for the HQ people who don't give a good damn about amateur radio but are professional bureaucrats. There are some exceptions at HQ...and there is no question but that some things the ARRL does are beneficial.

I've often lauded the DXCC program which drives most rare DX operators off the air in a matter of days. And I am right up front in complimenting their many contests which keep thousands of other amateurs off the air on weekends while dozens of fanatic contesters exchange numbers and vie for certificates of lasting value. And who could complain about the ARRL traffic system which beats the accursed phone company out of hundreds of thousands of dollars? No, in many ways I am as loyal an ARRL fan as they come.

DIGITAL LICENSES?

If you have read many of my editorials, you know that I feel it is important for us to have a lot more hams than we do. I think it will be valuable to amateur radio...and also to our country, in that the more hams we have, the more technicians and engineers we will have. The two do go hand in hand.

The code test...one can make a powerful case for or against it. It doesn't prove anything since it is merely a skill which is acquired. True, on the other hand, the achievement of this skill is an indication that a person has had enough interest in getting a ham license to put in a lot of hard work.

With the Bash cheat sheets, the written exams are virtually worthless as any indication of anything, so without the code test, anyone wanting a ham license can get one just for the work of memorizing a handful of questions and answers. But, to be fair to Bash, his series is not very much different from the ARRL *Q&A Manual*, only more accurate and thus more devastating.

The original idea for the Novice ticket was to encourage newcomers to get on the air and

practice their code instead of just listening. This scheme never did work out well. It couldn't, actually, because the whole basis of the idea was stupid. Novices working Novices, all at around five words per minute, is unlikely to train anyone to copy code at 13 per. All it does is develop acute frustration.

The Novice ticket, when it first was issued, included some two-meter phone channels, so naturally most Novices quickly bought two-meter rigs and gossiped their licenses away on two. When that was shut off, Novices went out and bought cheap CW rigs (why spend a lot of money if you might not get the General license?) and found life in the jam-packed Novice bands exceedingly aggravating. Their cheap receivers brought in half the band at once, and their transmitters didn't have enough power to clean off a channel. So they tried and tried to make decent contacts, but most of them were lost in the QRM. An awful lot of Novices never made it to General.

Then there was the Tech ticket...another bummer. Once started, this license kept tens of thousands of hams from ever discovering the low bands. To make matters worse, for the first few years the Tech ranks were packed with chaps who had cheated and didn't even know the code at 5 wpm. These people were not likely to make a serious effort at a General ticket. So they went through life talking on two meters, eventually either getting fed up and dropping out or else dying of apoplexy over a repeater kerchunker.

Yes, it was more difficult to get that first ham ticket before the Novice license was invented, but I seriously wonder if the FCC has done amateur radio any favors with the Novice and Tech licenses. It takes a bit more work to get the first ticket when you start with General, but you do, right off the bat, have the full range of ham bands available to you. Thus you can get a lot more out of hamming because you will tend to go out and buy a first class rig rather than try to make do with a klunker in case you fail to upgrade.

From a practical standpoint, the FCC is doing no one any favors by forcing everyone to first learn the code at 5 words per minute. More and more ham

classes are proving that it is possible to learn the code at 13 words per minute in almost the same time as 5 wpm... if you start right out at that speed and don't horse around with the slower speed. The lower speed tends to encourage people to use the ARRL system of gradual speed increase... which is one of the worst systems of learning the code ever devised and which has lost us hundreds of thousands of good prospective hams.

Which brings me to the digital license recently proposed in QST. Phooey. If clubs will set up classes, beat the bushes around high schools for impressionable youngsters in the 14-15 year age bracket, we'll have all the hams we and our country need. Kids that age are suckers for ham radio... they are too young to realize that they are being talked into a life involvement from which they will never really escape. Even if you told them about it they haven't enough experience to kick the habit before it becomes overpowering.

If we cut out everything below the General license, it might take a few weeks longer to graduate new hams, but we would end up with a lot more in the end and be a lot happier. We might get away from a lot of this kerchunking and bad language... and we might get a lot more newcomers into building and designing equipment. We can use more experimenters.

What do you think?

BALTIMORE

One of my three scheduled talks at hamfests this year was at Baltimore... and they sure managed to pull a great crowd for that show. A good part of the commercial exhibit area was computer-oriented... something I'm seeing more and more these days. In fact, at some hamfests the computer exhibits outnumber the ham exhibits.



I was not dismayed to see Instant Software prominently on display at one of the booths.



The best part of the hamfest was the indoor flea market... packed with good things and so many hams pawing over the stuff that it was difficult to even get close to the better bargains.



The heavy flea-market attendance seemed to detract from the sale of ham gear by ham dealers. I asked around late in the hamfest to see how they were doing on selling major pieces of ham gear and found that they were mostly doing business with small parts and the ham rigs were going begging. I think the money went for parts and second-hand gear this time.

RICHLAND HAMFEST/ COMPUTERFEST

At last! Wayne's name up in lights! A bit tacky, as might be expected, but definitely up there for all to see. That's show biz.



Considering the remoteness of the area, the tri-cities put on a darned good hamfest in July. I flew out to give a talk at the banquet on amateur radio and an afternoon talk on computing. The gossip at the hamfest was, of course, about Mount St. Helens, not very far away. They talked so much about it that I began to wonder what everyone talked

about before the mountain blew up.

Among the souvenirs laid out on me were pumice stones blown out of the mountain and picked up 18 miles away, a bottle of ash, a beautiful book on the mountain with a day-by-day account of the disaster, and a bumper sticker saying, "Chicken Little Was Right... Mt. St. Helens, May 18th."



Mary Lewis W7QGP, who has been trying for some years to get a fair shake from the League, was there... but I did not see the League director for the division. I guess he was just too busy to get to the hamfest and represent the League.

I hope that the full story of Mary gets into print. The League seems to be absolutely set on making sure that they never have a woman director, as some directors have bragged. The ARRL does a lot of good things, but when they stoop to underhanded stuff such as they have pulled on Mary, few people in the know have any respect for them. I gather that director Thurston stays in office by dint of this skulduggery... a shame on amateur radio.



Though RTTY was on display, the clattering old machine didn't get the attention of the new microcomputer-oriented units.



The computer-oriented exhibits outnumbered the ham exhibits by a wide margin... something which is happening more and more at hamfests lately. Here we see a TRS-80 all suited up in a custom made box.



One of the Washington area ham manufacturers is AEF, and they were there showing their latest antennas. How about that Tinker Toy portable two-meter quad?



The kids got a big kick out of the computers. Here is a PET entertaining one kid while a couple others are working on a TRS-80 next to it.



This Apple was kept busy all day with kids at the helm... here is a hangman program in progress.



There was also a demonstration of satellite reception of television signals, complete with a big dish set up outside of the exhibition area. This drew a lot of attention... and presumably some sales. I snapped a picture of a replay of an interview with me which was done by a local TV station.

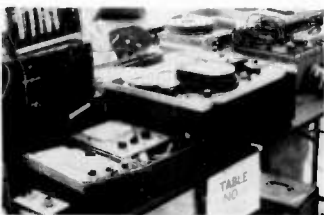

Among the flea-market goodies was this most reasonably priced early model reel-to-reel video recorder. I think I have one of those up in the attic somewhere. Black and white and with a 20-minute capacity, it is not relevant with today's VTR systems.



The local computer store was there with an exhibit, too. I also stopped off to see their store and was pleased to find Instant Software on display.

The committee did a nice job of organizing the hamfest. I think they might have pulled more hams if they had done a lot more PR work, getting the word on some of the special events out a few months before the hamfest so people could plan for the trip. I know that I got very little information on the hamfest in time to get it into *73 Magazine*.

The banquet was very well attended and was certainly one of the better banquets I've had as far as the food was concerned. First rate. The speaker... well...modesty forbids any comments.

BONUS TALK

In addition to my scheduled hamfest talks at Baltimore and Richland (WA) this year, I did take time off from work at computer shows to give short and relatively unannounced talks at Cerritos College in Cerritos (near Anaheim) and Triton College, near Chicago.



The Chicago Suburban Radio Association set up the details for my talk during the Summer Consumer Electronics Show in Chicago in June. They did a nice job of filling much of the room at the college and were kind enough not to snore too loudly as they dozed off. Nice group. I really hate it when people fall out of their chairs while I am talking.



This is the obligatory PR shot of the Powers That Be of the CSRA, flanking Sherry and me. On the left is Bill True WA9ASD and on the right Greg Johnson WB9ZHA, who made the arrangements for my appearance. Talk of his subsequent tar and feathering is merely rumor.

THOSE LOW GAS PRICES

Someone (WA6ILQ) mentioned the other day that gas prices have not really gone up, it's just that the value of the dollar has gone down with inflation.

That was a new idea, so I grappled with it for a bit and had to agree that there was much to the concept. Those of us who are getting on in years are able to remember the days of the nickel cone, the nickel hot dog, the nickel beer, the nickel subway ride, the nickel Coke, and so forth. Most of those nostalgic nickel items are now twelve to fifteen times as expensive, so a ten times increase in gas prices, which is about what we've had, seems hardly worth getting bent out of shape over.

In some cases, prices have gone down through the years... such as with electronics. Where technology has been able to cut labor costs, this makes sense... and packing the equivalent of a hundred thousand tube circuits on a chip a quarter inch square is quite a technological advance. But oil still is a resource with few technological improvements... and thus not amenable to significant lowering of costs. Larger ships and pipes have cut costs somewhat, but then we've had to get the oil from more distant and more expensive environments such as Alaska.

Where we ran into a lot of trouble was by keeping the oil prices from growing with inflation for several years, thus encouraging the building of poorly insulated buildings, inefficient power generation, and other oil wasters. Instead of pursuing more efficient uses of energy over the years, the artificial holding down of oil prices encouraged the use of oil. Thus we

have little research done in steam-powered cars, hybrid oil/electric cars, methane cars, hydrogen power, etc.

RADAR TEST

A team from Dave Bell Associates, the people who have been doing the fine amateur radio promotional films, came up one Sunday to do a bit on police radar. Since I probably have more radar detectors in the *73 Magazine* van than does any other car in the country, Peterborough was a natural spot to film.

We spent the best part of a whole day filming a four- or five-minute segment for showing on NBC in late August. You no doubt missed it. The New Hampshire state police cooperated by sending two patrol cars to hand out speeding tickets at the favorite Peterborough moneymaker... right in front of our Instant Software building. The filming team got fine pictures of the stopping and ticketing of the people... and a couple of interviews with the ticketees.

I showed the crew the difference in sensitivity between the regular radar detectors, which picked up the police signals just as the van came over the crest of the hill, barely giving time to avoid a heavy fine and loss of a driver's license... and the new superhet systems, such as the Escort and Super Whistler, which picked up the radar unit over a half mile further away... down at the bottom of the hill and far out of sight and range of the radar units.



NEW!



Tunable 420 MHz Fast Scan TV Converter

Receive Fast Scan Amateur TV in the 420 to 450 MHz Band with any TV set. Low noise, high gain rf Amp with Varactor tuned input and outputs. Built in AC supply. Comes in two tone walnut & beige cabinet measuring 1-7/8" x 4-1/4" x 4-1/8". Factory wired with 2-year guarantee. ATVC-10 \$49.95

Basic Varactor Tuner & PS Kit w/instructions

ATVC-10K \$39.95

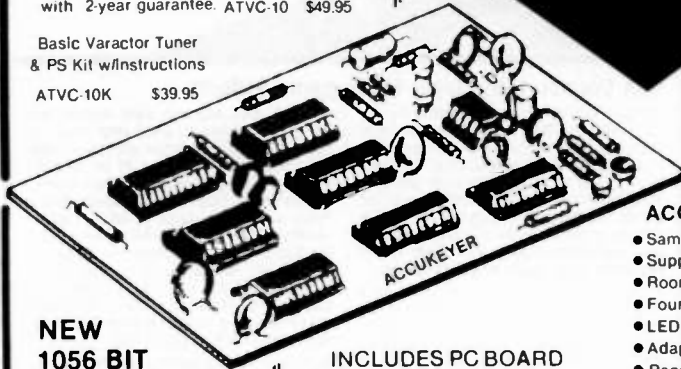

NEW 1056 BIT EXPANDABLE MEMORY KIT

INCLUDES PC BOARD AND PARTS STILL ONLY \$21.95

ALDELCO ELECTRONIC COMPANY

THE VERY POPULAR

TOPE ACCUKEYER KIT

- Self Completing Dots & Dashes
- Iambic Operation
- Single Dot & Dash Memories
- Provision for Attachment of Memory for DX or Contest Work

Revised version of the Accukeyer featured in the ARRL Handbook. Has more logical IC Layout and ON Board sidetone Oscillator. Includes PC Board, TTL ICs, 555 Timer, IC Sockets, Switch, Speaker, Transistors, capacitors and resistors. Requires 5VDC **\$21.95**
Use our PS-5 Power supply kit to power keyer & Memory only \$8.95

MEMORY ADD ON KIT

Four Position Switch 3-2102s, sockets, and resistors \$5.00

OV-12 Crow Bar Overvoltage Protection Circuit. Triggers App. 16 to 18 volts \$8.95
5 to 8 volts 9.95

ACCUKEYER MEMORY KIT

- Same size PC Board as Accukeyer
- Supplied with one 2102 Memory Chip
- Room on the board for three more
- Four chips will total 4224 BITS
- LED indicator for Programming
- Adaptable to other keyers
- Requires 5 volts DC

SEVEN DIGIT HAND HELD FREQUENCY COUNTER KIT

Accuracy: ± 0.0002%
Gate Times: 1 or 0.1 Seconds
Frequency: Typical to 148 Mhz
Sensitivity: 5.5 mv @ 27 Mhz
5 mv @ 50 Mhz
12 mv @ 135 Mhz

Power Required: 5VDC (4 AA nicads) Has input for batt. charger diode protected.

P.C. board measures 2 3/4" x 4" Aldelco supplies: ICs, sockets, P.C. board crystal capacitors, resistors, battery holder nat. A 1188A readouts 0.100" and instructions. (case & batteries not included) **\$49.00**

RF TRANSISTORS																					
SD1018-4	40W	4.5db	450MHz	380-4LFL	15.25	2N3375	3.0W	400 MHz	TO60	5.60	SD1074	50W	11db	30MHz	500-6LFL	21.15	2N3553	2.5W	175 MHz	TO39	1.40
SD1076	75W	13	50	500-6LFL	24.00	2N3866	1.0W	400 MHz	TO39	1.25	SD1088	25W	6	450	500-6LFL	23.25	2N4427	1.0W	175 MHz	TO39	1.35
SD1089	40W	5	450	500-6LFL	27.15	2N5589	3.0W	175 MHz	MT71	4.75	SD1143	10W	10	200	MT72	10.95	2N5590	10W	175 MHz	MT72	7.80
SD1158	12W	5.3	200	TO117	12.30	2N5591	25W	175 MHz	MT72	10.25	SD1272	30W	6	220	MT72	9.60	2N5913	1.75W	175 MHz	TO39	1.70
SD1278	50W	10	50	MT72	16.30	2N6080	4.0W	175 MHz	MT72	5.40	SD1416	70W	6.7	175	500-6LFL	26.80	2N6081	15W	175 MHz	MT72	8.45
SD1428	45W	6.5	175	500-6LFL	22.65	2N6082	25W	175 MHz	MT72	9.75	SD1433	8W	7.5	450	MT90	9.50	2N6083	30W	175 MHz	MT72	11.75
SD1434	50W	5	450	500-6LFL	34.00	2N6084	4.0W	175 MHz	MT72	12.95	SD1451	50	14	50	500-6LFL	18.10	2N6094	40W	175 MHz	X106	6.60
SD1477	100W	6	175	500-6LFL	52.85	2N6095	15W	175 MHz	X106	8.50	2N5945	4W	8	450	MT90	10.75	2N6096	30W	175 MHz	X106	10.35
2N5946	10W	6	450	MT90	13.00	2N6097	40W	175 MHz	X106	20.00											

ALDELCO JOINS - THE GLOBAL SPECIALTIES FAMILY
(formerly Continental Specialties)



3.579545 MHz Crystal Oscillator. Size 1.75" x 7.38" x 5.63". Requires 7.5 to 10 VDC. Operates on AA nicads or alkaline's (not supplied). \$134.95



Extends range 10 times compatible with most counters. Requires 7.5 - 10 VDC \$70.00.
ACCESSORIES
Charger adaptor 110V mod. 100 CA1. \$12.45
Mobile charger adaptor mod. 100 CLA \$5.95.

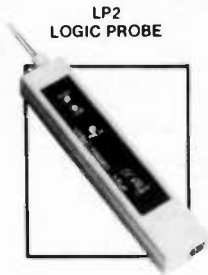

Use to 300 nsec 1.5 MHz. Shows logic state at a glance. Easy to use. Only \$24.95

Use up to 50nsec. 10 MHz. Memory feature. \$44.95

For complete GSC catalog send 50c handling & shipping.

PROTO CLIPS

- 14 pin PC 14 \$4.50
- 16 pin PC 16 \$4.75
- 24 pin PC 24 \$10.00

EXPERIMENTOR SERIES BREAD BOARDS

- EXP 600 \$10.95
- EXP 300 \$59.95
- EXP 4B \$4.00
- EXP 650 \$6.25
- EXP 350 \$5.50

BASIC 600 MHZ PRESCALER KIT

Includes: PC board 11C90, capacitors, diodes and instructions requires 5VDC \$29.95
12VDC option \$1.75

ALDELCO KITS

DUAL DIGITAL 12/24 HOUR CLOCK KIT NOW WITH A NEW WALNUT GRAIN WOOD CABINET

ONLY \$49.95



MODEL ALD 5-W 0.5 LEDS

- Features:
- 12 or 24 Hour Operation on either clock
 - Each Clock separately controlled
 - Freeze feature for time set
 - Easy assembly for clock and cabinet

ADJUSTABLE POWER SUPPLY KITS

- 5-15 Volts 500 MA Model PS5. \$8.95
- 12-20 Volts 500 MA Model PS12. 8.95

TWO METER TELESCOPING WHIP ANTENNA

with BNC male \$8.95 angle whip with BNC male \$9.50 (also good for freq. counters)

MODEL 951 ADAPTER \$2.95

UG255U BNC male to VHF female

12 or 24 HOUR DIGITAL CLOCK KIT

Uses 0.5 Display LED 5314 Clock Chip. Freeze feature for accurate set, fits our standard cabinet. **ONLY \$19.95**

CLOCK CABINETS

Woodgrain or black leather ea \$4.95

CRYSTAL TIME BASE KIT

Includes PC Board, Crystal, all parts and instructions \$4.95

ALDELCO

300

2789A MILBURN AVE, BALDWIN, N.Y. 11510
516-378-4555

Add 6% shipping. Add \$1.00 for orders under \$10.00. Out of U.S.A. add 15% shipping and certified check or money order in U.S. funds.

NO BULL SH



Over the past thirteen years that Spectronics has been in business, we've managed to achieve a few "firsts" that we are extremely proud of. So, we thought that we might spend a few dollars, and put 'em down in print. Now, we don't expect that you will be so emotionally moved with our self-bestowed pats on the back that you will immediately send us an order, but we do think that telling you a little bit about our commitment to excellence is worth a little of your time.

1st From 1967 to 1973 Spectronics was the first choice of Motorola to be the sole outlet for all of their surplus equipment being sold into the amateur radio market. How many of you remember that period of unprecedented growth in two meter activity?

1st We were the first company to manufacture and market a 400 channel synthesized two meter radio for the amateur market. The Spec II was introduced in 1972 and showed the way of the future. Spectronics didn't wait for the future to happen... we helped to create it.

1st A year later, we filled a crying need for a versatile battery charger that would charge your Motorola, Standard, or Clegg either in your car or at home. This was another industry first, and we were proud to be a part of the exploding amateur market with such a product. Also, how many of you remember where you could buy everything you needed to build your very own HT?

1st By 1976, the synthesized rigs were coming on strong (no surprise to us) and the Icom IC-22S was rapidly becoming "King Of The Hill". It wasn't long before we introduced our Specscaan full-feature scanner as an accessory for that radio. Here was the first scanner widely available that could search the two meter band for any and all activity in either direction with variable speed control. Our "Electronic Repeater Directory" was a success and a reality before full feature scanning became popular on synthesized radios.

1st Here we are in 1980 and we haven't lost our enthusiasm for being the first to introduce new products. At Dayton last April, we introduced Sony's two newest synthesized digital SWL receivers to the public. We thank Radio South Africa for the kind mention of that fact on 27 July 1980 at 0240 GMT. And only two short months ago, we introduced the Transcom 401 sub-audible tone deck specifically designed for Icom's highly popular new synthesized handheld, the IC-2A. Now, we know that some of you won't care about how hard we work to keep ourselves up front ahead of the rest of the pack, but we do. And we hope that we'll never get tired of trying so hard, because that's the way we like it. And that's what it takes to be the GREAT dealer that we are.



SPECTRONICS, INC.

1009 Garfield Oak Park, Ill. 60304

(312) 848-6778 Telex: 72-8310

✓67

<p>W2AU Balun World famous W2AU Balun. Full legal power - no TVI from your coax - built in lightning arrester - 3-40 MHz broad-banded - use on vees, doublets, quads, yagis, folded dipoles. Specify 1 to 1 or 4 to 1 models, both types are \$15.95.</p>	<p>U310, MRF901 U310 Transistor \$3.75 MRF901 Transistor \$4.35</p>	<p>SUPEREX HEADPHONES Superex headphones - APS-II features high sensitivity, crisp clear speech clarity, and comfort oriented design. \$29.95. The AVNS-7 "noise shield" headphones provide for improved communications by shutting out noises that interfere with reception - These comfortable headphones are designed with the purist in mind. \$59.95. The APS-M3 comms headphone is a useful all around headphone, at home in the ham shack or out on field day. This rugged model is \$34.95.</p>
<p>B&W COAX SWITCHES Model 375 5 position pill box configuration with coax conn on the back \$19.98, 376 five position with ground, radial configuration \$19.98, 550A five position radial basic \$17.98, 590G five position high reliability \$18.98, 593 square configuration with three positions and coax connectors at the top of the box, \$17.95, other B&W equipment available upon request.</p>	<p>73 CODE COURSES The excellent code tapes that "get you over the top". These tapes take you from just enough to a comfortable margin above the speeds required for the FCC exams. 6 + W.P.M. \$4.45; 13 + W.P.M. \$4.45.</p>	<p>AMECO DRAKE NYE Ameco - PLF-2 Preamp 160 through 6 Meters \$49.95. Drake - Low pass filters: 100W \$14.95 1000W \$26.95. Nye - 1000W low pass filter, \$22.95</p>
<p>TRAC DELUXE MESSAGE MEMORY KEYS This full featured memory keyer is only \$89.98. The Message Memory keyer with less features is \$69.95 but still is the best memory keyer available at V.A.R. at this low price.</p>	<p>RM KITS "RM" kits - are receiver improvement kits for the TS-520, TS-820, TS -820s and the FT-101 through the F models. The kit includes replacement parts for critical sections of your receiver and alignment instructions where applicable. The kits install in about one hour and require a small tool kit including a low wattage soldering iron. The improved "RM" kits are \$17.95. Order now for free delivery.</p>	<p>THEFT ALERT Pager type auto alarm system, can either be silent or set off alarm at the vehicle. Your expensive equipment deserves the best protection you can get. One mile model \$129.95. The EIGHT MILE RANGE model for maximum protection is only \$189.95. Includes transmitter/ interface and belt pager with full instructions.</p>
<p>MIRAGE MP1 HF or MP2 VHF precision wattmeter-SWR meters \$119.95. B108 10 in 80 out with pre-amp (2M) \$179.95, B1016 10 W in for 160 WATTs out with receive pre-amp \$279.95, B3016 30 watts in 160 watts out with pre-amp \$239.95.</p>	<p>PIPO TTP The Best Concept in touch tone pads (encoders) Pipo features reliability, ease of installation and high quality parts. Snap action push buttons eliminate mis-encoding due to intermittent switch contacts. PP-1 basic 12 key pad \$49.95 PP-1K with relay \$55.95, PP-2 basic 16 key pad \$58.00, PP-2K \$69.00, P-3 electronics and keyboard only \$39.95, P-3 16 key is \$43.95.</p>	<p>CUSHCRAFT Boomer antennas: 214FB (the FM boomer) \$69.95, A32-19 \$79.95, ATB-34 (tri-band beam) \$239.95, ARX-2 \$35.95 ARX-220 \$35.95. While stock lasts.</p>
<p>DUMMY LOADS (1.8 - 55 MHz) Standard 1 gal. "paint can special" handles 1kW ICAS. Oil not included. \$16.95. 250W DRY load, will handle 250 Watts ICAS. \$29.95.</p>	<p>RADAR DETECTORS SUPERFOX - superhetrodyne dual band really gives you the time to react. Much more sensitive than the cheaper diode type. \$299.95, Whistler Q-1000 another superhet with dual alarms - \$329.95, Fuzzbuster Elite \$199.95, Long Range Super Snooper - \$189.95.</p>	<p>L.N.A. 144MHz, 220MHz, 432-435MHz Low Noise Preamplifiers \$39.95. N.F. less than 2dB. Gain is 11-16dB. These are custom made inboard type preamps which will improve the performance of the FT-221 or TS-700 or other transceivers in the VHF and low UHF bands. 1296MHz amp. available, call direct for information on price and delivery.</p>

Prices available only while stock on hand lasts!

REMEMBER - V.A.R. PAYS THE SHIPPING (48 States)

Ten-Tec, Cushcraft, Yaesu, ICOM, Superex, Trackkeys, Bencher, Centurion ducks, Ameco, Callbook, Scelbi, ARRL, B & W, Bearcat, Berk-Tek, Lunar, Mirage, "RM" kits, Hanimex calculators, Comtronix, Midland, Phone Mate, Astatic, Turner, Vista, Fuzzbuster, Tri-Ex, Larsen, PIPO, Theft Alert Alarm.

C. O. D. add \$5.50



VINEYARD AMATEUR RADIO

Art(WA60YS) - Sales and Service - Jay (WB6YQN)

4407 Vineyard, Oxnard, CA 93030, (805) 485-0942

FOR YOUR VISA AND MASTER CHARGE ORDERS ONLY CALL

BANK AMERICARD

VISA

Orders accepted



7294 N.W. 54 STREET
MIAMI, FLORIDA 33166

SECC SURPLUS ELECTRONICS CORP.

PHONE: (305) 887-8228

TWX: 810-848-6085

WHOLESALE - RETAIL

SO239

10/\$5.00 100/\$35.00
50/\$20.00 1000/\$300.00

PL259

Amphenol
.60¢ ea.

E. F. Johnson S Meter

Edge Meter 250 UA. Fits in 5/8" x 1-3/8" hole. MTG holes on each end 1-1/4" behind panel. Black scale 0-5 bottom 1-20 top \$1.25 ea. 5/\$5.00

E. F. Johnson Signal Strength Meter 200 UA 2 1/2" x 2 1/2" Sq mounts in 1 1/4" hole 1" behind panel. Scale: 1-30 db top 0-5 bottom \$4.95 ea 5/\$20.00

PANEL METERS

\$4.00 ea 2 for \$7.00

25-0-25 dc Volts } 2 1/4" x 3"

0-25 dc Volts } 2 1/4" x 2 1/4"
0-50 ac Volts }

-Shunt Required-

Double Row/Wire Wrap .100

25 pins \$3.49 ea 10/\$30.00
30 pins \$3.96 ea 10/\$32.00
50 pins \$5.43 ea 10/\$45.00

Double Row/Solder Eyelet .156

6 pins \$1.10 ea 10/\$ 9.00
15 pins \$1.55 ea 10/\$12.50
22 pins \$2.08 ea 10/\$17.00
43 pins \$3.66 ea 10/\$30.00

C & K SWITCHES

PART #	MOVEMENT	CONTACTS	PRICE
7101	ON/NONE/ON	SPST	\$1.00 EA
7103	ON/OFF/ON	SPST	6 FOR \$5.00
7108	ON/NONE/(ON)	SPST	
7201	ON/NONE/ON	DPDT	

6 TV GAMES ON (1) CHIP
Gen Instr AY-3-8500-1
28 Pin Plastic Case
EVERYDAY LOW PRICE \$7.50 ea

CB SPECIAL

Brand new printed circuit board assembly. Used in all HyGain 40 Channel CB transceivers. Fits many other manufacturers' units also. Squelch pot/volume control/channel selector switch not included. Board Dimensions 6" x 6 1/2"

CB SPECIAL W/40 ch SW same as above
1-9 \$10.50 ea. 50-99 \$9.00 ea.
10-49 \$9.50 ea. 100-up \$8.50 ea.

Serviceman Special

New Hy-Gain 40ch CB Less Case, Speaker & Knobs (as is) \$14.95 ea

NEW Hy-Gain Remote 40ch CB Less Case, Speaker & Control Mic (as is) \$14.95 ea

ASTATIC T-UG8-D104

PREAMP Desktop microphone w/crystal element 3 Pin Plug \$35 ea.

NEW E.F. Johnson Power Mic/Less Cord, Desktop Style \$19.95 ea

CERAMIC IF FILTERS

EFC L455K
\$3.50 ea.

ILEX COPY LENS F:5.6,6.1
Focal Length (155MM) 1 1/4" D,
2 1/16" L, 1 1/16" Fixed iris.
\$7.50 ea.

8 Position Dip Switches
16 pin (AMP) \$1.50 ea.
10/\$13.50

15' MODEM CABLES
10#22ga wire w/shield,
DB25P conn & DB51226-1
cover on one end
\$5.50 ea. 10/\$50.00

25' MODEM CABLES
13#22ga wire w/shield,
DB25P conn & DB51226-1
cover on one end
\$6.50 ea. 10/\$60.00

12 Vdc RELAY
SPST 35 Amp Contacts
Open Frame
Rugged, great for mobile use
\$4.50 ea 5/\$20.00

12 Vdc RELAY
SPST Open Frame
5 Amp Contacts
Mfg-Magnecraft
\$1.50 ea 4/\$5.00

22 pins/Double Row/Dipped Solder
.156 \$2.08 ea 10/\$17.00

22 pins/Double Row/Wire Wrap
.156 \$2.44 ea 10/\$19.00

12 V DC Horn
2" diameter x 1 1/4" deep
.75 each
3/\$2.00

100 ASSORTED DISC CAPS
(FULL LEADS) 20 EA OF 5
DIFFERENT VALUES \$2.00
PER PACK

Autronic Elect Auto Alarm
Easy installation independent cir-
cuits solid state 12V neg ground
\$5.00 ea.

White Porcelain
Egg Insulator
1 1/2" x 1" 50¢ ea. 3 for \$1.25

CAPS RADIAL LEADS

2200 uF @ 16V
.25 ea. 10/\$2.00

SOLDER LUG-TYPE CAPS

50 uF @ 350V 1" D x 3" L
50 uF @ 450V 1" D x 2 1/2" L
50 uF @ 450V 1" D x 3" L
60¢ EA. 5 FOR \$2.50

15' MODEM CABLES
14#22ga wire w/shield,
DB25P conn & DB51226-1
cover on one end \$6.00 ea. 10/\$55.00

15' MODEM CABLES
10#22ga wire w/shield,
DB25S conn & DB51226-1
cover on one end \$6.50 ea. 10/\$60.00

EFJ CRYSTAL OVENS
6V/12V 75°
\$5.00 ea.

IC SOCKETS

Cambion

Gold Plated Wire Wrap
14 pin .35 ea 10/\$3.00
16 pin .38 ea 10/\$3.30

COMCO XTAL FILTER

23/8" x 1" x 3/4"
13KC BW \$10.00 ea.

Coax Connectors

UG-273/U BNC-F/UHF-M 2.50
UG-255/U BNC-M/UHF-F 3.00
UG-146A/U N-M/UHF-F 4.50
UG-83B/U N-F/UHF-M 4.50
UG-175 RG-58 Adapt. .20
UG-176 RG-59 Adapt. .20

TRIMMER CAPS

Can fit in your watch
3.5-20 pF & 5-30 pF
\$.75 ea., 2/\$1.25
5/\$3.00

POLY FOAM COAX 50 Ohm

Low Loss = to RG174
\$4.95/100' \$3.00/50'

ULTRASONIC TRANSDUCER

Detects sound above the range of human hearing! Transmits & receives \$2.50 ea. 5/\$10.00

MAGNETIC PICK UP TRANSDUCER

Converts motion to ac voltage without mechanical linkage
3/4" x 2" w/6' shielded cable
\$4.95 ea.

SOLDERLESS TEST PROD (BLACK)

Threaded type, molded handle
\$.40 ea. 10/\$3.50

USED MUFFIN FANS

3 blades, 110VAC, 4 1/4" sq.
\$5.95

CW MINI SLIDE SW

DPDT .15 ea. 10/\$12.25

ALL STAR AIR VARIABLE

24-275 pF .75 ea.

RED SEVEN SEGMENT DISPLAY

TIL 322P \$1.00 ea.

BOURNS' EDGE MOUNTING

5K pot single turn
3345W series \$1.50 ea.

12 VOLTS @ 1/2 AMP

Filament transformer
1 1/4" x 2" x 1" \$1.50 ea.

CTS DP6P ROT SWITCH

.50 ea. 5/\$2.00

AXIAL LEAD ELECTRO- LYTIC CAPACITORS

2 uF @ 15V	}	12 ea. for \$1.00		
10 uF @ 15V				
20 uF @ 15V				
50 uF @ 15V				
2.2 uF @ 25V				
3.3 uF @ 25V				
1 uF @ 35V				
2 uF @ 150V				
25 uF @ 25V			}	15 ea. for \$2.00
3 uF @ 50V				
5 uF @ 50V				
10 uF @ 50V				
250 uF @ 25V				
100 uF @ 50V	}	10 ea. for \$2.00		
50 uF @ 75V				

ASSORTED ELECTROLYTICS

VALUE/MFD	VOLTS	DIA	LENGTH	PRICE
63,000 @	15V	3"	5 1/2"	4.00 ea
10,000 @	20V	1 1/2"	5 3/4"	3.00 ea
2,700 @	25V	1 1/4"	2 1/4"	2.00 ea
2,900 @	25V	1 1/4"	2"	2.00 ea
3,000 @	25V	1 1/2"	4 1/2"	2.00 ea
18,000 @	25V	2"	4"	3.00 ea
21,000 @	25V	2 1/2"	3"	3.00 ea
1,000 @	50V	1 1/4"	3 1/4"	2.50 ea
34,800 @	50V	3"	5 1/2"	3.00 ea
450 @	75V	1 1/4"	2 1/4"	2.00 ea
500 @	100V	1 1/2"	3 1/2"	2.00 ea
240 @	300V	1 1/4"	3 1/4"	2.00 ea
50 @	450V	1 1/4"	2"	2.00 ea

TERMS: All material guaranteed • If for any reason you are not satisfied, our products may be returned within 10 days for a full refund (less shipping). Please add \$3 for shipping and handling on all orders. Additional 5% charge for shipping any item over 5 lbs. COD's accepted for orders totaling \$50.00 or more. All orders shipped UPS unless otherwise specified. Florida residents please add 4% sales tax. Minimum order \$15.00.

EQUIPMENT / COMPONENTS / WIRE & CABLE / ACCESSORIES

THE ZULU IS BACK!
 NATIONAL SEMICONDUCTOR MILITARY TIME FORMAT
JUMBO CLOCK MODULE MA1001C
BRAND NEW!



\$5.95

- FEATURES**
- FOUR JUMBO 1/2" INCH LED DISPLAYS
 - 12 HR REAL TIME FORMAT
 - 24 HR ALARM SIGNAL OUTPUT
 - 50 OR 60 HZ OPERATION
 - LED BRIGHTNESS CONTROL
 - POWER FAILURE INDICATOR
 - SLEEP & SNOOZE TIMERS
 - DIRECT LED DRIVE (LOW RFI)
 - COMES WITH FULL DATA

ASSEMBLED! NOT A KIT!

Add \$1.95 for AC XFMR

COMPARE AT UP TO TWICE OUR PRICE!

ZULU

PERFECT FOR USE WITH A TIMEBASE

MANUFACTURER'S CLOSEOUT!

MICRO MINI TOGGLE SWITCHES  **99¢ EACH**
 6 for \$5 with hardware.

***** CABLE TIES *****
 MAKE YOUR PROJECTS "NEAT & TIDY." 4" CABLE TIES AT A FANTASTIC PRICE. GET THIS BARGAIN AND "TIE" IT DOWN. **\$2.00 for 100 or better yet \$15.00 for 1000**

A Full Color* TV Game For The Family

Six exciting TV Games — Hockey, Tennis and Handball with one or two player capability for each game. Ball velocity doubles after the fourth player hit for an increasingly competitive game.

Adjustable paddle size for each player allows for handicapped play if desired. Paddles can give automatic ball spin with seven possible angles of ball deflection.

Automatic digital scoring appears after each point is scored. Game ceases automatically after one player scores 15 points. Serving is from the paddle of player who scored the last point, thus server can "place" his shot.

Video-Volley is designed to be installed, with a minimum of effort, to any standard television receiver, either color or black and white. Batteries are not required.

Small hand-held player modules with 15 foot cord length provides more comfort and versatility for players.

The compact command module sits atop the television receiver and has front panel control allowing effortless change from normal television reception to game play. Easy disconnection of the player hand-held modules facilitates easy set-up and take-down for storage.

Video-Volley™

Introductory Offer

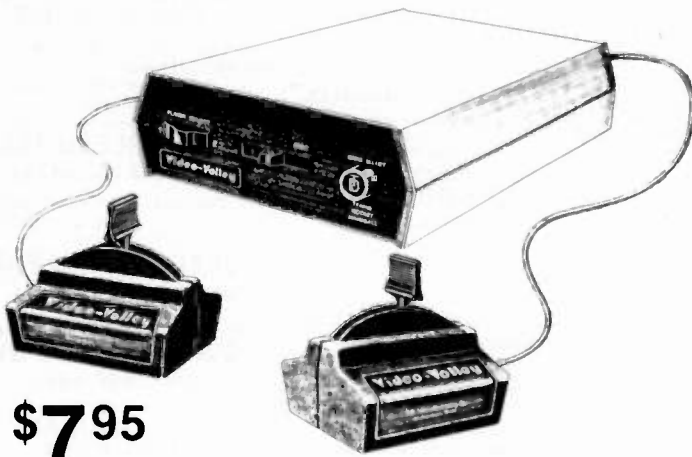

\$7.95

TD Manufacturing Co.
 Richardson, Texas

16K DYNAMIC RAM PARTIALS
 LOOK! INTEL 2108 8K X 1 RAMS LOOK!
8 FOR \$9.95 32 FOR \$35
FACTORY PRIME!

Huge special purchase of INTEL Dynamic RAM's. These are 2108-4, 300NS, 8K, Ceramic DIP. The 2108 is the INTEL 2116 (16K) tested for either upper or lower 8K only. These are factory prime. Full Spec. See INTEL 1978 Cat. for details or Memory Design Handbook for application data. Both IMSAI and EXTENSYS did mfg. S-100 RAM boards using these devices. — P.S. These devices will not work in the SD EPANDORAM™. Please specify upper or lower 8K. (S1626 or S1627). A super easy RAM to interface to a Z80, 16 PIN DIP.

LAB-BENCH VARIABLE POWER SUPPLY KIT **\$12.00 KIT SUPER SALE**
 5 to 20 VDC at 1 AMP. Short circuit protected by current limit. Uses IC regulator and 10 AMP Power Darlington. Very good regulation and low ripple. Kit includes PC Board, all parts, large heatsink and shielded transformer. 50 MV. TYP. Regulation.

RCA SENSITIVE GATE TRIAC
 TO-5 CASE. HOUSE #40531
 ALSO SAME AS T2300D.
 2.5 AMPS 400 PIV
5/\$1.19 
 Perfect for Dimmers, Color Organs, etc. PC LEADS

60 Hz CRYSTAL TIME BASE
\$4.95 (Complete Kit)
 Uses MM5369 CMOS divider IC with high accuracy 3.579545 MHZ Crystal. Use with all MOS Clock Chips or Modules. Draws only 1.5 MA. All parts, data and PC Board included. 100 Hz, same as above, except \$5.95

D.C. HORN VERY LOUD!
 6-12 VDC
 Like Used In Smoke Alarms.
FANTASTIC SAVINGS.
 Compare this true value. **.60 ea. 4 For \$2.00**

PMD-11K-60
 60 Volts. HFE 800-20K
 12 Amps. PNP TO-3
 150 Watts. By Lambda.
\$1.50 **BRAND NEW!**

Crystal Super Savings
 4.433618 MHZ
2/\$1.10

NATIONAL SEMICONDUCTOR
"COLOSSUS JR." JUMBO CLOCK MODULE MA1013
BRAND NEW!

\$8.50 **3 FOR \$15**
 (AC XFMR \$1.95)
ASSEMBLED! NOT A KIT!
MANUFACTURER'S CLOSEOUT! **PERFECT FOR USE WITH A TIMEBASE**
 • Bright 4 digit 0.7" LED Display
 • Complete. Add only Transformer and Switches
 • 24 Hour Alarm Signal Output
 • 12 Hour Real Time Format
 • 50 or 60 Hz Operation
 • Power Failure Indication
 • LED Brightness Control
 • Sleep and Snooze Timers
 • Alarm "on" and PM indicators
 • Direct Drive - No RFI
 • Direct Replacement for MA1012
 • Comes with Full Data

REPEAT OF A SELL-OUT!
 VECO PRECISION THERMISTOR. GLASS TYPE. VECO #41A72. 8.2K OHMS AT ROOM TEMP. VERY SENSITIVE. INDIVIDUALLY PACKAGED IN PLASTIC VIALS. \$3.00 VALUE
\$1.00 each or 3 FOR \$2.50

Digital Research: Parts

(OF TEXAS)
 P.O. BOX 401247 • GARLAND, TEXAS 75040 • (214) 271-2461

TERMS: Add 50¢ postage, we pay balance. Orders under \$15 add 75¢ handling. No C.O.D. We accept Visa, MasterCard and American Express cards. Tex. Res. add 5% Tax. Foreign orders (except Canada) add 20% P&H. 90 Day Money Back Guarantee on all items.

SEND FOR CATALOG WITH SUPER SAVINGS!!

These Low Cost SSB TRANSMITTING CONVERTERS

Let you use inexpensive recycled 10M or 2M SSB exciters on UHF & VHF!

- Linear Converters for SSB, CW, FM, etc.
- A fraction of the price of other units; no need to spend \$300 - \$400!
- Use with any exciter; works with input levels as low as 1 mW.
- Use low power tap on exciter or simple resistor attenuator pad (instructions included).
- Link osc with RX converter for transceive.

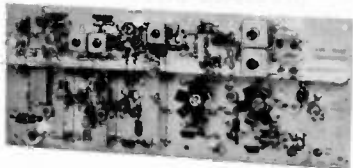

XV4 UHF KIT — ONLY \$99.95

28-30 MHz in, 435-437 MHz out; 1W p.e.p. on ssb, up to 1½W on CW or FM. Has second oscillator for other ranges. Atten. supplied for 1 to 500 mW input, use external attenuator for higher levels.

Extra crystal for 432-434 MHz range \$5.95
XV4 Wired and tested \$149.95

XV2 VHF KIT - ONLY \$69.95

2W p.e.p. output with as little as 1mW input. Use simple external attenuator. Many freq. ranges available.

MODEL	INPUT (MHz)	OUTPUT (MHz)
XV2-1	28-30	50-52
XV2-2	28-30	220-222
XV2-4	28-30	144-146
XV2-5	28-29 (27-27.4 CB)	145-146 (144-144.4)
XV2-7	144-146	50-52

XV2 Wired and tested \$109.95

XV28 2M ADAPTER KIT - \$24.95

Converts any 2M exciter to provide the 10M signal required to drive above 220 or 435 MHz units.



NEW! COMPLETE TRANSMITTING CONVERTER AND PA IN ATTRACTIVE CABINET

Far less than the cost of many 10W units!

Now, the popular Hamtronics® Transmitting Converters and heavy duty Linear Power Amplifiers are available as complete units in attractive, shielded cabinets with BNC receptacles for exciter and antenna connections. Perfect setup for versatile terrestrial and OSCAR operations! Just right for phase 3! You save \$30 when you buy complete unit with cabinet under cost of individual items. Run 40-45 Watts on VHF or 30-40 Watts on UHF with one integrated unit! Call for more details.

MODEL	KIT	WIRED and TESTED
XV2/LPA2-45/Cabt (6M or 2M)	\$199.95	\$299.95
XV4/LPA4-30/Cabt (for UHF)	\$229.95	\$349.95

Easy to Build FET RECEIVING CONVERTERS

Let you receive OSCAR and other exciting VHF and UHF signals on your present HF or 2M receiver



- NEW LOW-NOISE DESIGN
- ATTRACTIVE WOODGRAIN CASE
- Less than 2dB noise figure, 20dB gain

MODEL	RF RANGE	OUTPUT RANGE
CA28	28-32 MHz	144-148 MHz
CA50	50-52	28-30
CA50-2	50-54	144-148
CA144	144-146	28-30
CA145	145-147-or-144-144.4	28-30 27-27.4 (CB)
CA146	146-148	28-30
CA220	220-222	28-30
CA220-2	220-224	144-148
CA110	Any 2MHz of Aircraft Band	26-28 or 28-30
CA432-2	432-434	28-30
CA432-5	435-437	28-30
CA432-4	432-436	144-148

Easily modified for other rf and if ranges.

STYLE	VHF	UHF
Kit less case	\$34.95	\$49.95
Kit with case	\$39.95	\$54.95
Wired/Tested in case	\$54.95	\$64.95

Professional Quality VHF/UHF FM/CW EXCITERS

- Fully shielded designs
- Double tuned circuits for spurious suppression
- Easy to align with built-in test aids



T50-50	6-chan, 6M, 2W Kit	\$44.95
T50-150	6-chan, 2M, 2W Kit	\$44.95
T50-220	6-chan, 220 MHz, 2W Kit	\$44.95
T450	1-chan, 450 MHz, ¼W Kit	\$44.95

See our Complete Line of VHF & UHF Linear PA's

- Use as linear or class C PA
- For use with SSB Xmtg Converters, FM Exciters, etc.

LPA2-15	6M, 2M, 220; 15 to 20W	\$59.95
LPA2-30	6M, 2m; 25 to 30W	\$89.95
LPA2-40	220 MHz; 30 to 40W	\$119.95
LPA2-45	6M, 2M; 40 to 45W	\$119.95
LPA4-10	430MHz; 10 to 14W	\$79.95
LPA4-30	430MHz; 30-40W	\$119.95

See catalog for complete specifications

FAMOUS HAMTRONICS PREAMPS

Let you hear the weak ones too!
Great for OSCAR, SSB, FM, ATV. Over 14,000 in use throughout the world on all types of receivers.

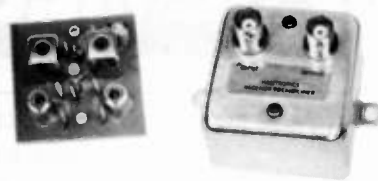

- NEW LOW-NOISE DESIGN
- Less than 2 dB noise figure, 20 dB gain
- Case only 2 inches square
- Specify operating frequency when ordering

MODEL P-30 VHF PREAMP, available in many versions to cover bands 18-300 MHz.

MODEL P432 UHF PREAMP, available in versions to cover bands 300-650 MHz.

STYLE	VHF	UHF
Kit less case	\$12.95	\$18.95
Kit with case	\$18.95	\$26.95
Wired/Tested in Case	\$27.95	\$32.95

NEW VHF/UHF FM RCVRs Offer Unprecedented Range of Selectivity Options

- New generation
- More sensitive
- More selective
- Low cross mod
- Uses crystal filters
- Smaller
- Easy to align

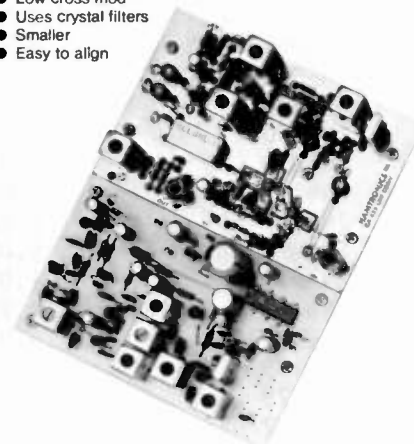

R75A* VHF Kit for monitor or weather satellite service. Uses wide L-C filter. -60dB at ± 30 kHz. \$69.95

R75B* VHF Kit for normal nbm service. Equivalent to most transceivers. -60dB at ± 17 kHz, -80dB at ± 25 kHz. \$74.95

R75C* VHF Kit for repeater service or high rf density area. -60dB at ± 14kHz, -80dB at ± 22kHz, -100dB at ± 30kHz. \$84.95

R75D* VHF Kit for split channel operation or repeater in high density area. Uses 8-pole crystal filter. -60dB at ± 9kHz, -100dB at ± 15 kHz. The ultimate receiver! ... \$99.95

* Specify band: 10M, 6M, 2M, or 220 MHz. May also be used for adjacent commercial bands. Use 2M version for 137 MHz WX satellites.

R450() UHF FM Receiver Kits, similar to R75, but for UHF band. New low-noise front end. Add \$10 to above prices. (Add selectivity letter to model number as on R75.)

A14 5 Channel Adapter for Receivers. \$9.95

NEW R110 VHF AM RCVR

AM monitor receiver kit similar to R75A, but AM. Available for 10-11M, 6M, 2M, 220 MHz, and 110-130 MHz aircraft band \$74.95. (Also available in UHF version.)

IT'S EASY TO ORDER! ✓ 33

- Write or phone 716-392-9430 (Electronic answering service evenings & weekends)
- Use Credit Card, UPS COD, Check, Money Order
- Add \$2.00 shipping & handling per order

Call or Write to get
FREE CATALOG
With Complete Details
(Send 4 IRC's for overseas mailing)

HAMTRONICS® IS A REGISTERED TRADEMARK

hamtronics, inc.

65J MOUL RD · HILTON, NY 14468

SEMICONDUCTORS SURPLUS

2822 North 32nd Street/Unit -1 Phoenix, Arizona 85008 (602) 956-9423

We accept checks, MasterCard, and Visa

Prices subject to change without notice



FOR OUT OF STATE USE OUR NEW 800 NUMBER FOR PHONE ORDERS (800)528-3611

NO ORDERS WILL BE ACCEPTED UNDER \$10.00, NOT INCLUDING SHIPPING!

NO C.O.D.'s. PHONE IN YOUR ORDER

NEW PRIME RF POWER TRANSISTORS

2N2270	\$ 1.00	2N6094	\$ 7.15	MRF901	\$ 3.99
2N2857	1.57	2N6095	11.77	MRF902	12.55
2N2857JAN	2.54	2N6097	29.54	MRF904	3.00
2N2947	17.25	2N6166	38.60	MRF911	4.29
2N3227	3.25	2N6368	26.52	MRF5177	21.62
2N3261	2.32	2N6439	45.77	MRF8004	1.60
2N3375/MM3375	9.32	40280	3.00	CD3495	19.99
2N3553	1.80	40281	11.90	CD3435	29.95
2N3818	8.00	40282	12.90	A50-12	29.95
2N3866	1.20	40894	1.20	BFR96	2.00
2N3866JAN	2.80	PT3551C/2N6082NS	5.00	MWA110	6.92
2N3866JANTX	4.49	(no stud)		MWA120	7.38
2N3925/M9477	8.00	PT3563	5.00	MWA130	8.08
2N3948	2.00	PT4571A	1.50	MWA210	7.46
2N3950	26.86	PT3607	5.00	MWA220	8.08
2N3959	3.88	PT3123E	5.00	MWA230	8.62
2N4072	2.00	MRF216	22.46	MWA310	8.08
2N4427	1.20	MRF221	10.08	MWA320	8.62
2N4429	9.00	MRF227	3.00	MWA330	9.23
2N4877	1.00	MRF238	10.00		
2N4959	2.23	MRF240	14.62	MICROWAVE DIODES	
2N5108	4.03	MRF245	33.30	1N21	\$ 2.85
2N5109	1.66	MRF247	33.30	1N21B	3.85
2N5179	1.05	MRF314	14.08	1N21D	3.85
2N5177/MRF5177	21.62	MRF412	23.83	1N21WE	2.85
2N5214	20.00	MRF421	31.38	1N23CR	4.85
2N5583	4.55	MRF422A	44.14	1N23F	5.50
2N5589	6.83	MRF426A	10.24	1N23WE	4.00
2N5590	8.15	MRF432	11.23	1N23FMR	6.95
2N5591	11.85	MRF449A	10.61	1N25	6.50
2N5635	6.86	MRF450	11.77	1N78	8.63
2N5636	13.38	MRF450A	11.77	1N446	12.00
2N5637	22.15	MRF452	15.00	1N3655A	3.85
2N5641/PT4132D	6.00	MRF452A	15.00	1N5711/2835	1.99
2N5642	12.38	MRF454	21.83	MBD101	1.99
2N5643	15.82	MRF454A	21.83	MB1101	4.99
2N5645	12.38	MRF455	14.08	1S1544A	3.00
2N5842/MM1607	8.78	MRF455A	14.08	P40075	3.85
2N5847	11.15	MRF474	3.00	1N41SEMR	7.85
2N5919	30.00	MRF475	3.25	MA41482	3.00
2N5946	14.69	MRF476	2.25	MA41482R	5.00
2N5849/MM1620	21.29	MRF477	10.06		
2N5862	51.91	MRF479	4.68	MOTOROLA RF MODULES	
2N6080	7.74	MRF485	3.50	MHW602	
2N6082	11.30	MRF502	1.08	20 W output at 174 MHz	
2N6083	13.23	MRF604	2.00	12.5 VDC 20.6 dB Gain	
2N6084	14.66	MRF629	3.00	\$42.00	

SEMICONDUCTORS SURPLUS

2822 North 32nd Street/Unit -1 Phoenix, Arizona 85008 (602) 956-8423

We accept checks, MasterCharge, and Visa

Prices subject to change without notice

(800)528-3611 (No C.O.D.)



64

HAM MICROWAVE RECEIVERS

2100-2400 MHz
28 dB Gain
2.5 to 3 dB Noise

Assembled and tested with 90 day guarantee \$ 209.99
\$5.00 shipping with charge card or money order.

RECEIVER KIT \$149.95; Includes Yagi antenna, power supply box, P.C.B. and parts, down converter P.C.B. and parts, and complete instructions.

MISCELLANEOUS PARTS FOR HMR

Yagi antenna	
Power supply box	\$ 49.95
Power supply P.C.B.	12.95
Power supply transformer	4.99
Power supply kit	3.99
Power supply assembled and tested	39.95
Down converter P.C.B.	49.95
Down converter kit	19.95
Down converter assembled and tested	79.95
Complete Instructions	114.95
MRF901	10.00
MRF902	3.99
MRF911	12.50
7812	4.29
MBD101	1.99
MB1101	1.99
2835/1N5711	4.99
1 K Pot	1.99
Matching transformers, 75 Ohm - 300 Ohm	3.00
Two-way splitters	1.99
Chassis type F connectors	2.99
Cable type F connectors	21.99
Barrel type F connectors	41.99
One 6 foot RG59 with connectors and	.76
one 50 foot RG59 with connectors	18.99

QUANTITY PRICES AVAILABLE FOR 10 AND UP

TUBES

2E26	\$ 5.00	12BY7A	\$ 4.50
3-500Z	100.00	811A	12.95
3B28	7.00	6146	5.00
3X2500A3	125.00	6146A	5.25
3X3000F1	200.00	6146B	7.95
4-65A	30.00	6146W	12.95
4-125A	40.00	6360	7.95
4-250A	60.00	6939	8.00
4-400A	80.00	8072	45.00
4-1000A	200.00	8295/PL172	300.00
4CX250B	43.00	8950	10.00
4CX250R	45.00	8877 OUT	300.00
4CX350A	50.00	7289	6.99
4CX1000A	150.00	6KD6	6.00
4X150A	20.00	6LF6	6.00
4X150G	30.00	6LQ6/6JE6	6.00
572B/T160L	39.00	8908	13.00
		6550A	8.00

Other numbers on request

NEW ELECTRICAL POWER STRIP
9 OUTLETS WITH BUILT IN CIRCUIT
BREAKER AND INDICATOR LAMP
\$21.95 each

Check, money order, or credit cards. (MasterCharge and VISA only) NO C.O.D.'s. No personal checks or certified personal checks for foreign countries accepted. Money order or cashier's check in U.S. funds only. Letters of credit are not acceptable. Minimum shipping by UPS is \$2.00 plus 35¢ insurance per \$100.00. Please allow extra shipping charges for heavy items. All parts returned due to customer error will be subject to a 15% restock charge.

If we are out of an item ordered we will try to replace it with an equal or better part unless you specify not to, or we will back order the item. PRICES ARE SUBJECT TO CHANGE WITHOUT NOTICE. Prices superseade all previously published. Some items offered are limited to small quantities and are subject to prior sale. FOR OUT OF STATE USE OUR NEW 800 NUMBER FOR PHONE ORDERS. 800 528-3611 (For charge orders only, NO C.O.D.)

We now have available a bunch of goodies too good to bypass. Items are limited so order today

Call Your Phone Order in Today

**MINI KITS - YOU HAVE SEEN THESE BEFORE NOW
HERE ARE OLD FAVORITE AND NEW ONES TOO.
GREAT FOR THAT AFTERNOON HOBBY.**



TERMS: Satisfaction guaranteed or money refunded. COD add \$1.50. Minimum order \$6.00. Orders under \$10.00 add \$.75. Add 5% for postage, insurance, handling. Overseas add 15%. NY residents add 7% tax.

CLOCK KITS

Your old favorites are here again. Over 7,000 Sold to Date. Be one of the gang and order yours today!

Try your hand at building the finest looking clock on the market. Its satin finish anodized aluminum case looks great anywhere, while six .4" LED digits provide a highly readable display. This is a complete kit, no extras needed, and it only takes 1-2 hours to assemble. Your choice of case colors: silver, gold, black (specify).
Clock kit, 12/24 hour, DC-5 **\$24.95**
Clock with 10 min. ID timer, 12/24 hour, DC-10 **\$29.95**
Alarm clock, 12 hour only, DC-8 **\$29.95**
12V DC car clock, DC-7 **\$29.95**

For wired and tested clocks add \$10.00 to kit price. SPECIFY 12 OR 24 HOUR FORMAT

Car Clock

The UN-KIT, only 5 solder connections

Here's a super looking, rugged and accurate auto clock, which is a snap to build and install. Clock movement is completely assembled — you only solder 3 wires and 2 switches, takes about 15 minutes! Display is bright green with automatic brightness control photocell — assures you of a highly readable display day or night. Comes in a satin finish anodized aluminum case which can be attached 5 different ways using 2 sided tape. Choice of silver, black or gold case (specify).
DC-3 kit, 12 hour format **\$22.95**
DC-3 wired and tested **\$29.95**

DC-3 kit, 12 hour format
DC-3 wired and tested

Calendar Alarm Clock

The clock that's got it all! 6-.5" LEDs, 12/24 hour, snooze, 24 hour alarm, 4 year calendar, battery backup, and lots more. The super 7001 chip is used. Size 5x4x2 inches. Complete kit, less case (not available) **\$34.95**
DC-9

Under Dash Car Clock

12/24 hour clock in a beautiful plastic case features 6 jumbo RED LEDs high accuracy (001%), easy 3 wire hook-up, display blanks with ignition, and super instructions. Optional dimmer automatically adjusts display to ambient light level.
DC-11 clock with mig bracket **\$27.95 kit**
DM-1 dimmer adapter **\$2.50**
Add \$10.00 Assy. and Test

Video Terminal

A completely self-contained stand alone video terminal card. Requires only an ASCII keyboard and TV set to become a complete terminal unit. Features are: single 5V supply, TTL controlled sync and baud rates (to 9600), complete computer and keyboard control of cursor, parity error control and display. Accepts and generates serial ASCII plus parallel keyboard input. The 6416 is 64 char. by 18 lines with scrolling, upper and lower case (optional), and has RS-232 and 20ma loop interfaces on board. Kits include sockets and complete documentation.
RE 6416 terminal card kit (add \$60.00 for wired unit) **\$189.95**
Liner: Case option **\$13.95**
Power Supply **\$14.95**
RF Modulator kit **\$1.95**

Audio Prescaler

Make high resolution audio measurements, great for musical instrument tuning, PL tones, etc. Multiplies audio UP in frequency, selectable x10 or x100, gives 0.1 Hz resolution with 1 sec. gate time! High sensitivity of 25 mv. 1 meg input z and built-in filtering gives great performance. Runs on 9V battery, all CMOS.
PS-2 kit **\$29.95**
PS-2 wired **\$39.95**

600 MHz PRESCALER

Extend the range of your counter to 600 MHz. Works with all counters. Less than 150 mv sensitivity, specify -10 or -100.
Wired, tested, PS-1B **\$59.95**
Kit, PS-1B **\$44.95**

30 Watt 2 mtr PWR AMP

Simple Class C power amp features 8 times power gain. 1 W in for 8 out, 2 W in for 15 out, 4 W in for 30 out. Max output of 35 W, incredible value, complete with all parts, less case and T-R relay.
PA-1, 30 W pwr amp kit **\$22.95**
TR-1, RF sensed T-R relay kit **6.95**

MRF-238 transistor as used in PA-1
8-10db gain 150 mhz **\$11.95**

Power Supply Kit

Complete triple regulated power supply provides variable 6 to 18 volts at 200 ma and -5 at 100 ma. Excellent load regulation, good filtering and small size. Less transformers, requires 6.3 V ra 1 A and 24 VCT.
Complete kit, PS-3LT **\$6.95**

RF actuated relay senses RF (1W) and closes DPDT relay.
For RF sensed T-R relay
TR-1 Kit **\$6.95**

OP-AMP Special

BI-FET LF 13741 - Direct pin for pin 741 compatible, but 500,000 MEG input z, super low 50 pa input current, low power drain.
50 for only **\$9.00** 10 for **\$2.00**

Regulators

78MG **\$1.25** 7812 **\$1.00**
79MG **\$1.25** 7815 **\$1.00**
723 **\$1.50** 7905 **\$1.25**
309K **\$1.15** 7912 **\$1.25**
7805 **\$1.00** 7915 **\$1.25**

Shrink Tubing Nubs
Nice precut pieces of shrink size 1" x 1/4" shrink to 1/8". Great for splices **50/\$1.00**

Mini TO-92 Heat Sinks
Thermalloy Brand
To-220 Heat Sinks **5 for \$1.00**
3 for **\$1.00**

Opto Isolators - 4N28 type
Opto Reflectors - Photo diode + LED **\$1.00 ea.**

Molex Pins
Molex already precut in length of 7. Perfect for 14 pin sockets. 20 strips for **\$1.00**

CDS Photocells
Resistance varies with light. 250 ohms to over 3 meg **3 for \$1.00**

Trimmer Caps
Sprague - 3-40 pf
Stable Polypropylene
.50 ea.

FM MINI MIKE



A super high performance FM wireless mike kit! Transmits a stable signal up to 300 yards with exceptional audio quality by means of its built in electric mike. Kit includes case, mike, on-off switch, antenna, battery and super instructions. This is the finest unit available.
FM-3 Kit **\$14.95**
FM-3 Wired and Tested **19.95**

Color Organ
See music come alive! 3 different lights flicker with music. One light each for, high, mid-range and lows. Each individually adjustable and drives up to 300 W runs on 110 VAC.
Complete kit, ML-1 **\$8.95**

Video Modulator Kit
Converts any TV to video monitor. Super stable, tunable over ch 4-6. Runs on 5-15V, accepts std. video signal. Best unit on the market! Complete kit, VD-1 **\$7.95**



Led Blinky Kit
A great attention getter which alternately flashes 2 jumbo LEDs. Use for name badges, buttons, warning panel lights, anything! Runs on 3 to 15 volts.
Complete kit, BL-1 **\$2.95**

Super Sleuth
A super sensitive amplifier which will pick up a pin drop at 15 feet! Great for monitoring baby's room or as general purpose amplifier. Full 2 W rms output, runs on 6 to 15 volts, uses 8-45 ohm speaker.
Complete kit, BN-9 **\$5.95**

CPO-1
Runs on 3-12 Vdc. 1 wall out, 1 KHZ good for CPO, Alarm, Audio Oscillator. Complete kit **\$2.95**

FM Wireless Mike Kit



Transmits up to 300' to any FM broadcast radio, uses any type of mike. Runs on 3 to 9V. Type FM-2 has added sensitive mike preamp stage.
FM-1 kit **\$3.95** FM-2 kit **\$4.95**

Whisper Light Kit
An interesting kit, small mike picks up sounds and converts them to light. The louder the sound, the brighter the light. Includes mike, controls up to 300 W, runs on 110 VAC.
Complete kit, WL-1 **\$6.95**

Tone Decoder
A complete tone decoder on a single PC board. Features: 400-5000 Hz adjustable range via 20 turn pot, voltage regulation, 567 IC. Useful for touch-tone burst detection, FSK, etc. Can also be used as a stable tone encoder. Runs on 5 to 12 volts.
Complete kit, TD-1 **\$5.95**

Universal Timer Kit

Provides the basic parts and PC board required to provide a source of precision timing and pulse generation. Uses 555 timer IC and includes a range of parts for most timing needs.
UT-5 Kit **\$5.95**

Mad Blaster Kit

Produces LOUD ear shattering and attention getting siren like sound. Can supply up to 15 watts of obnoxious audio. Runs on 6-15 VDC.
MB-1 Kit **\$4.95**

Siren Kit
Produces upward and downward wall characteristic of a police siren. 5 W peak audio output, runs on 3-15 volts, uses 3-45 ohm speaker.
Complete kit, SM-3 **\$2.95**
Runs on 5-15 VDC. Low current (2.5ma) 1 min/month accuracy TB 7 Kit **\$5.50**
TB 7 Assy **\$9.95**

PARTS PARADE

IC SPECIALS

LINEAR	TTL	SPECIAL
301 \$.35 324 \$1.50 380 \$1.50 555 \$.45 556 \$1.00 565 \$1.00 566 \$1.00 567 \$1.25 741 \$10.00 1458 \$.50 3900 \$.50 3914 \$2.95 8038 \$2.95	74S00 \$.40 7447 \$.65 7475 \$.50 7490 \$.50 7207A \$1.35 7216D \$2.00 7107C \$12.50 5314 \$ 2.95 5375AB/G \$ 2.95 7001 \$ 6.50	11C90 \$15.00 10116 \$ 1.25 7208 \$17.50 7207A \$ 5.50 7107C \$21.00 7216D \$12.50 5314 \$ 2.95 5375AB/G \$ 2.95 7001 \$ 6.50
CMOS	FERRITE BEADS	SOCKETS
4011 .50 4013 .50 4046 \$1.85 4049 .50 4059 \$9.00 4511 \$2.00 4518 \$1.35 5639 \$1.75	Win info and specs \$15.00 6 Hole Batten Beads \$11.00	8 Pin 10/\$2.00 14 Pin 10/\$2.00 16 Pin 10/\$2.00 24 Pin 4/\$2.00 28 Pin 4/\$2.00 40 Pin 3/\$2.00

Resistor Ass't
Assortment of Popular values - 1/4 watt. Cut lead for PC mounting. 1/8" center, 1/2" leads, bag of 300 or more. **\$1.50**

Switches
Mini toggle SPDT **\$1.00**
Red Pushbuttons N.O. **3/\$1.00**

Earphones
3' leads, 8 ohm, good for small tone speakers, alarm clocks, etc **5 for \$1.00**

Mini 8 ohm Speaker
Approx 2 1/4" diam Round type for radios, mike etc **3 for \$2.00**

Slug Tuned Coils
Small 3/16" Hex Slugs turned coil 3 turns **10 for \$1.00**

CAPACITORS
TANTALUM Dipped Epoxy 1000 uF 16V Radial **\$50**
500 uF 20V Axial **\$50**
150 uF 16V Axial **\$1.90**
22 uF 25V 3/\$1.00
1.8 uF 25V 3/\$1.00
10 uF 15V Radial **10/\$1.00**

Crystals
3.579545 MHZ **\$1.50**
10,000.000 MHZ **\$5.00**
5.248800 MHZ **\$5.00**

AC Adapters
Good for clocks, nicad chargers, all 110 VAC plug one end
8.5 vdc @ 20 mA **\$1.00**
16 vdc @ 160mA **\$2.50**
12 vdc @ 250mA **\$3.00**

Solid State Buzzers
small buzzer 450 Hz, 86 dB sound output on 5-12 vdc at 10-30 mA, TTL compatible **\$1.50**

AC Outlet
Panel Mount with Leads **4/\$1.00**

Audio Prescaler

Make high resolution audio measurements, great for musical instrument tuning, PL tones, etc. Multiplies audio UP in frequency, selectable x10 or x100, gives 0.1 Hz resolution with 1 sec. gate time! High sensitivity of 25 mv. 1 meg input z and built-in filtering gives great performance. Runs on 9V battery, all CMOS.
PS-2 kit **\$29.95**
PS-2 wired **\$39.95**

600 MHz PRESCALER

Extend the range of your counter to 600 MHz. Works with all counters. Less than 150 mv sensitivity, specify -10 or -100.
Wired, tested, PS-1B **\$59.95**
Kit, PS-1B **\$44.95**

30 Watt 2 mtr PWR AMP

Simple Class C power amp features 8 times power gain. 1 W in for 8 out, 2 W in for 15 out, 4 W in for 30 out. Max output of 35 W, incredible value, complete with all parts, less case and T-R relay.
PA-1, 30 W pwr amp kit **\$22.95**
TR-1, RF sensed T-R relay kit **6.95**

MRF-238 transistor as used in PA-1
8-10db gain 150 mhz **\$11.95**

Power Supply Kit

Complete triple regulated power supply provides variable 6 to 18 volts at 200 ma and -5 at 100 ma. Excellent load regulation, good filtering and small size. Less transformers, requires 6.3 V ra 1 A and 24 VCT.
Complete kit, PS-3LT **\$6.95**

RF actuated relay senses RF (1W) and closes DPDT relay.
For RF sensed T-R relay
TR-1 Kit **\$6.95**

OP-AMP Special

BI-FET LF 13741 - Direct pin for pin 741 compatible, but 500,000 MEG input z, super low 50 pa input current, low power drain.
50 for only **\$9.00** 10 for **\$2.00**

Regulators

78MG **\$1.25** 7812 **\$1.00**
79MG **\$1.25** 7815 **\$1.00**
723 **\$1.50** 7905 **\$1.25**
309K **\$1.15** 7912 **\$1.25**
7805 **\$1.00** 7915 **\$1.25**

Shrink Tubing Nubs
Nice precut pieces of shrink size 1" x 1/4" shrink to 1/8". Great for splices **50/\$1.00**

Mini TO-92 Heat Sinks
Thermalloy Brand
To-220 Heat Sinks **5 for \$1.00**
3 for **\$1.00**

Opto Isolators - 4N28 type
Opto Reflectors - Photo diode + LED **\$1.00 ea.**

Molex Pins
Molex already precut in length of 7. Perfect for 14 pin sockets. 20 strips for **\$1.00**

CDS Photocells
Resistance varies with light. 250 ohms to over 3 meg **3 for \$1.00**

Trimmer Caps
Sprague - 3-40 pf
Stable Polypropylene
.50 ea.

ATTENTION IC-2A OWNERS:

IC-2A TONE DECKS ARE HERE!

CUSTOM DESIGNED TO FIT WITH NO TROUBLE!

IT'S HERE NOW!

The question used to be, "When is Icom coming out with a hand-held?"...Now that it's become one of the hottest two meter rigs around, the big question now is, "When will a sub-audible tone option be available for my IC-2A?" The answer is: Spectronics has it now!



FULLY TUNABLE!

We are proud to be first in offering you a fully tunable miniature sub-audible tone deck specifically designed to fit the Icom IC-2A hand-held transceiver. If you own one of the other synthesized hand helds, you'll be delighted to know that you can put it in your unit as well.



QUALITY TO LAST!

This unit is manufactured by Transcom, Inc., to their exacting standards, and is guaranteed to be stable to within $\pm .1$ Hz, after proper tuning. All units are pre-set to your specified tone, and require no further adjustment for frequency.

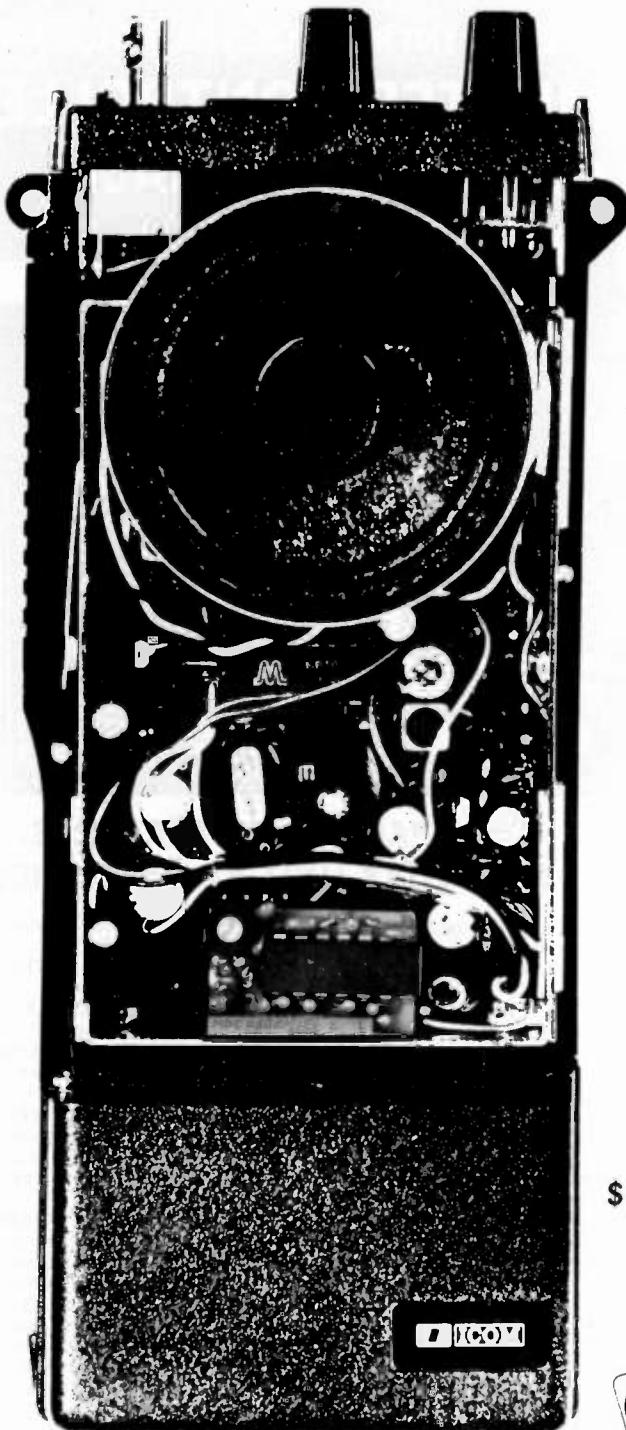

ANOTHER
SPECTRONICS
FIRST!

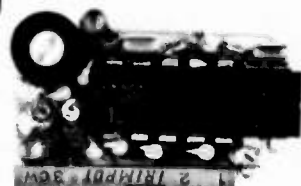

TOP VIEW



SIDE VIEW

- Fits plain or TT.
- Fully tunable! No tone elements to buy - ever!
- Also fits other synthesized hand-helds as well.
- Easy to install; no cutting, chopping, or remote parts!
- Accurate to $\pm .1$ Hz.

\$ **29**⁹⁵
Plus \$2.00
S & H



PHONE: (312) 848-6777



SPECTRONICS, INC. — 1009 GARFIELD ST.
OAK PARK, ILL.-60304

AZDEN ★ NEW! ★ AZDEN ★ NEW! ★ AZDEN ★ NEW! ★ AZDEN

THE GIANT **AZDEN** COMPANY

REVOLUTIONIZES THE STATE OF THE ART

AWE AND AZDEN. INTRODUCE THE BRILLIANT NEW PCS-2800

MICROCOMPUTER CONTROLLED

SUPERIOR COMMERCIAL GRADE

10 METER
FM TRANSCEIVER

FALL
SALE
239.00



COMPARE THESE FEATURES
WITH ANY UNIT AT ANY PRICE

- **FREQUENCY RANGE:** Receive and transmit: 28.000 to 29.995 MHz, 10KHz steps with built-in + 100 KHz repeater offset.
- **ALL SOLID STATE-CMOS PL DIGITAL SYNTHESIZED.**
- **SIZE: UNBELIEVABLE! ONLY 6 3/4" x 2 3/8" x 9 3/4". COMPARE!**
- **MICROCOMPUTER CONTROLLED:** All scanning and frequency-control functions are performed by microcomputer.
- **DETACHABLE HEAD:** The control head may be separated from the radio for use in limited spaces and for security purposes.
- **SIX-CHANNEL MEMORY:** Each memory is re-programmable. Memory is retained even when the unit is turned off.
- **MEMORY SCAN:** The six channels may be scanned in either the "busy" or "vacant" modes for quick, easy location of an occupied or unoccupied frequency. **AUTO RESUME. COMPARE!**
- **FULL-BAND SCAN:** All channels may be scanned in either "busy" or "vacant" mode. This is especially useful for locating repeater frequencies in an unfamiliar area. **AUTO RESUME. COMPARE!**
- **INSTANT MEMORY-1 RECALL:** By pressing a button on the microphone or front panel, memory channel 1 may be recalled for immediate use.
- **MIC-CONTROLLED VOLUME AND SQUELCH:** Volume and squelch can be adjusted from the microphone for convenience in mobile operation.
- **DIRECT FREQUENCY READOUT:** LED display shows operating frequency, NOT channel number. **COMPARE!**
- **TEN (10) WATTS OUTPUT:** Also 1 watt low power for shorter distance communications. LED readout displays power selection when transmitting.
- **DIGITAL S/R/F METER:** LEDs indicate signal strength and power output. No more mechanical meter movements to fall apart!
- **LARGE 1/2-INCH LED DISPLAY:** Easy-to-read frequency display minimizes "eyes-off-the-road" time.
- **PUSHBUTTON FREQUENCY CONTROL FROM MIC OR FRONT PANEL:** Any frequency may be selected by pressing a microphone or front-panel switch.
- **SUPERIOR RECEIVER SENSITIVITY:** 0.28 uV for 20-dB quieting. The squelch sensitivity is superb, requiring less than 0.1 uV to open. The receiver audio circuits are designed and built to exacting specifications, resulting in unsurpassed received-signal intelligibility.
- **TRUE FM, NOT PHASE MODULATION:** Transmitted audio quality is optimized by the same high standard of design and construction as is found in the receiver. The microphone amplifier and compression circuits offer intelligibility second to none.
- **OTHER FEATURES:** Dynamic Microphone, built in speaker, mobile mounting bracket, external remote speaker jack (head and radio) and much, much more. All cords, plugs, fuses, microphone hanger, etc. included. Weight 6 lbs.
- **ACCESSORIES:** 15' REMOTE CABLE...\$29.95. FMPS-4R A/C POWER SUPPLY...\$39.95. TOUCHTONE MIC. KIT...\$39.95. EXTERNAL SPEAKER...\$18.00.

AMATEUR-WHOLESALE ELECTRONICS ORDER NOW TOLL FREE

8817 S.W. 129th Terrace, Miami, Florida 33176

Telephone (305) 233-3631 • Telex: 80-3356

HOURS: 8-6, Mon. - Thurs.

U.S. DISTRIBUTOR

DEALER INQUIRIES INVITED

1-800-327-3102

CREDIT CARD HOLDERS MAY USE OUR TOLL FREE ORDERING NUMBER.

ramsey

the first name in Counters!



9 DIGITS 600 MHz \$129⁹⁵ WIRED

SPECIFICATIONS:

Range: 20 Hz to 600 MHz
 Sensitivity: Less than 10 MV to 150 MHz
 Less than 50 MV to 500 MHz
 Resolution: 0.1 Hz (10 MHz range)
 1.0 Hz (60 MHz range)
 10.0 Hz (600 MHz range)
 Display: 9 digits 0.4" LED
 Time base: Standard-10,000 mHz, 1.0 ppm 20-40°C
 Optional Micro-power oven-0.1 ppm 20-40°C
 Power: 8-15 VAC @ 250 ma

PRICES:
 CT-90 wired, 1 year warranty \$129.95
 CT-90 Kit, 90 day parts warranty 109.95
 AC-1 AC adapter 3.95
 BP-1 Nicad pack + AC Adapter/Charger 12.95
 OV-1, Micro-power Oven time base 49.95
 External time base input 14.95

The CT-90 is the most versatile, feature packed counter available for less than \$300.00! Advanced design features include: three selectable gate times, nine digits, gate indicator and a unique display hold function which holds the displayed count after the Input signal is removed! Also, a 10MHz TCXO time base is used which enables easy zero beat calibration checks against WWV. Optionally, an internal nicad battery pack, external time base input and Micro-power high stability crystal oven time base are available. The CT-90, performance you can count on!

7 DIGITS 525 MHz \$99⁹⁵ WIRED

SPECIFICATIONS:

Range: 20 Hz to 525 MHz
 Sensitivity: Less than 50 MV to 150 MHz
 Less than 150 MV to 500 MHz
 Resolution: 1.0 Hz (5 MHz range)
 10.0 Hz (50 MHz range)
 100.0 Hz (500 MHz range)
 Display: 7 digits 0.4" LED
 Time base: 1.0 ppm TCXO 20-40°C
 Power: 12 VAC @ 250 ma

The CT-70 breaks the price barrier on lab quality frequency counters. Deluxe features such as three frequency ranges - each with pre-amplification, dual selectable gate times, and gate activity indication make measurements a snap. The wide frequency range enables you to accurately measure signals from audio thru UHF with 1.0 ppm accuracy - that's .0001%! The CT-70 is the answer to all your measurement needs, in the field, lab or ham shack.



PRICES:

CT-70 wired, 1 year warranty \$99.95
 CT-70 Kit, 90 day parts warranty 84.95
 AC-1 AC adapter 3.95
 BP-1 Nicad pack + AC adapter/charger 12.95

7 DIGITS 500 MHz \$79⁹⁵ WIRED

PRICES:

MINI-100 wired, 1 year warranty \$79.95
 MINI-100 Kit, 90 day part warranty 59.95
 AC-Z AC adapter for MINI-100 3.95
 BP-Z Nicad pack and AC adapter/charger 12.95

Here's a handy, general purpose counter that provides most counter functions at an unbelievable price. The MINI-100 doesn't have the full frequency range or input impedance qualities found in higher price units, but for basic RF signal measurements, it can't be beat! Accurate measurements can be made from 1 MHz all the way up to 500 MHz with excellent sensitivity throughout the range, and the two gate times let you select the resolution desired. Add the nicad pack option and the MINI-100 makes an ideal addition to your tool box for "in-the-field" frequency checks and repairs.

SPECIFICATIONS:

Range: 1 MHz to 500 MHz
 Sensitivity: Less than 25 MV
 Resolution: 100 Hz (slow gate)
 1.0 KHz (fast gate)
 Display: 7 digits, 0.4" LED
 Time base: 2.0 ppm 20-40°C
 Power: 5 VDC @ 200 ma

8 DIGITS 600 MHz \$159⁹⁵ WIRED



SPECIFICATIONS:

Range: 20 Hz to 600 MHz
 Sensitivity: Less than 25 mv to 150 MHz
 Less than 150 mv to 600 MHz
 Resolution: 1.0 Hz (60 MHz range)
 10.0 Hz (600 MHz range)
 Display: 8 digits 0.4" LED
 Time base: 2.0 ppm 20-40°C
 Power: 110 VAC or 12 VDC

The CT-50 is a versatile lab bench counter that will measure up to 600 MHz with 8 digit precision. And, one of its best features is the Receive Frequency Adapter, which turns the CT-50 into a digital readout for any receiver. The adapter is easily programmed for any receiver and a simple connection to the receiver's VFO is all that is required for use. Adding the receiver adapter in no way limits the operation of the CT-50, the adapter can be conveniently switched on or off. The CT-50, a counter that can work double-duty!



PRICES:

CT-50 wired, 1 year warranty \$159.95
 CT-50 Kit, 90 day parts warranty 119.95
 RA-1, receiver adapter kit 14.95
 RA-1 wired and pre-programmed (send copy of receiver schematic) 29.95

DIGITAL MULTIMETER \$99⁹⁵ WIRED



PRICES:

DM-700 wired, 1 year warranty \$99.95
 DM-700 Kit, 90 day parts warranty 79.95
 AC-1, AC adaptor 3.95
 BP-3, Nicad pack + AC adapter/charger 19.95
 MP-1, Probe kit 2.95

The DM-700 offers professional quality performance at a hobbyist price. Features include: 26 different ranges and 5 functions, all arranged in a convenient, easy to use format. Measurements are displayed on a large 3 1/2 digit, 1/2 inch LED readout with automatic decimal placement, automatic polarity, overrange indication and overload protection up to 1250 volts on all ranges, making it virtually goof-proof! The DM-700 looks great, a handsome, jet black, rugged ABS case with convenient retractable tilt bail makes it an ideal addition to any shop.

SPECIFICATIONS:

DC/AC volts: 100uV to 1 KV, 5 ranges
 DC/AC current: 0.1 uA to 2.0 Amps, 5 ranges
 Resistance: 0.1 ohms to 20 Megohms, 6 ranges
 Input impedance: 10 Megohms, DC/AC volts
 Accuracy: 10.1% basic DC volts
 Power: 4°C cells

AUDIO SCALER

For high resolution audio measurements, multiplies UP in frequency.
 • Great for PL tones
 • Multiplies by 10 or 100
 • 0.01 Hz resolution!
 \$29.95 Kit \$39.95 Wired

ACCESSORIES

Telescopic whip antenna - BNC plug \$ 7.95
 High impedance probe, light loading 15.95
 Low pass probe, for audio measurements 15.95
 Direct probe, general purpose usage 12.95
 Tilt bail, for CT 70, 90, MINI-100 3.95
 Color burst calibration unit, calibrates counter against color TV signal 14.95

COUNTER PREAMP

For measuring extremely weak signals from 10 to 1,000 MHz. Small size, powered by plug transformer-Included.
 • Flat 25 db gain
 • BNC Connectors
 • Great for sniffing RF with pick-up loop
 \$34.95 Kit \$44.95 Wired

ramsey electronics



BOX 4072 • ROCHESTER, NY 14610 ✓ 62

PHONE ORDERS
 CALL 716-586-3950

TERMS

Satisfaction guaranteed - examine for 10 days, if not pleased, return in original form for refund. Add 5% for shipping - insurance to a maximum of \$10. Overseas add 15% COO, add \$2. Orders under \$10, add \$1.50. NY residents, add 7% tax.

THESE PRICES ARE NOT MISPRINTS

Here is a chance to stock up your lab at unprecedented prices... we've got to move these out to make room for our ever-expanding CompuPro™ division. **Limited quantities - first come, first served.** Sorry, at these low prices we cannot include spec sheets or accept COD/telephone orders. Part numbers must include the special -S suffix or you will be charged our regular prices. Parts may be house numbered or have dual markings. **This is your chance to save!**

TTL

7403-S	Quad 2 input OC	21/\$2
7410-S	Triple 3 input NAND	21/\$2
7413-S	4 to 16 line decoder/demux	6/\$2
7438-S	Quad 2 input NAND OC	21/\$2
7444-S	Gray to decimal decoder	8/\$2
7450-S	And-or-invert	21/\$2
7472-S	JK M-S flip flop	21/\$2
7493-S	4 bit binary counter	10/\$2
7496-S	5 bit shift register	12/\$2
74122-S	Retriggerable one-shot	18/\$2
74151-S	8 channel mux	8/\$2
74155-S	Dual 2/4 demux	8/\$2
74159-S	4 to 16 line decoder/demux OC	4/\$2
74161-S	Synchro 4 bit binary counter	8/\$2
74163-S	Synchro 4 bit binary counter	8/\$2
74164-S	8 bit shift register	6/\$2
74190-S	Up/down decade counter	4/\$2
74192-S	Up/down binary counter	4/\$2
74194-S	4 bit bidirectional shift reg	4/\$2
74195-S	4 bit parallel shift register	6/\$2
74198-S	8 bit shift register	4/\$2

CMOS

4012-S	Dual 4 input NAND	12/\$2
4020-S	14 stage counter	4/\$2
4023-S	Triple 3 input NAND	12/\$2
4044-S	Quad R-S latch	4/\$2
4046-S	Phase locked loop	2/\$2
4071-S	Quad 2 input OR	12/\$2
4093-S	Quad 2 in NAND Schmitt trig	4/\$2
4507-S	Quad EX-OR	4/\$2
4510-S	BCD up/down counter	2/\$2

LINEARS

(package type: H = T099, M = minidip, D = dip, TK = T066)

201H-S	Improved 301 op amp	10/\$2
308H-S	Micropower op amp	6/\$2
703H-S	RF/IF amp	6/\$2
723D-S	Voltage regulator	6/\$2
741M-S	Compensated op amp	15/\$2
1458M-S	Dual 741	10/\$2
4558M-S	Dual 741	12/\$2
4195TK-S	Dual track 15V reg w/data	2/\$2

TO-220 NEGATIVE VOLTAGE REGULATORS

7906-S	-6V regulator	2/\$2
7908-S	-8V regulator	2/\$2
7912-S	-12V regulator	2/\$2
79M15-S	-15V regulator	2/\$2
7918-S	-18V regulator	2/\$2
7924-S	-24V regulator	2/\$2

OTHER SEMICONDUCTORS

- General purpose silicon signal diodes 50/\$2
- GT5306 NPN darlington, min gain 17000, 25V 200 mA, T092 package 100/\$8.95
- NPN transistor similar 2N3904 100/\$7.95
- PNP transistor similar 2N3906 100/\$8.95
- 4N28-S opto-coupler 6 pin minidip. MCT-2/IL-1 pinout 5/\$2
- SN76477-S complex sound generator 1/\$2.50
- Opto-Isolator Grab Bag — 50 mixed opto-isolators from a major manufacturer. Unmarked 6 and 8 lead minidips include single and dual types with diode, transistor, and darlington outputs. Test them yourself and save! Not recommended for beginners. 50/\$4

SOLDERTAIL SOCKET SPECIAL

Now that you've got the ICs, get some sockets at a fantastic price!

14 pin:	50/\$4.95	20 pin:	40/\$4.95
16 pin:	50/\$4.95	24 pin:	30/\$4.95
18 pin:	50/\$4.95	28 pin:	30/\$4.95
		40 pin:	20/\$4.95

74LS TTL

74LS00	\$0.34	74LS154	2.10
74LS01	0.34	74LS155	1.87
74LS02	0.34	74LS157	1.57
74LS04	0.38	74LS160	2.20
74LS05	0.44	74LS161	2.18
74LS08	0.34	74LS162	2.20
74LS10	0.34	74LS163	2.18
74LS11	0.40	74LS168	3.75
74LS12	0.34	74LS169	3.75
74LS14	2.20	74LS173	2.08
74LS15	0.40	74LS174	2.05
74LS20	0.34	74LS175	1.95
74LS21	0.40	74LS181	3.50
74LS22	0.40	74LS192	3.05
74LS26	0.48	74LS195	1.87
74LS27	0.42	74LS221	1.70
74LS30	0.34	74LS240	2.50
74LS32	0.46	74LS241	2.50
74LS33	0.60	74LS244	2.50
74LS37	0.48	74LS257	1.95
74LS38	0.48	74LS258	2.02
74LS42	1.56	74LS266	0.69
74LS47	1.68	74LS273	2.91
74LS48	1.68	74LS283	2.02
74LS74	0.54	74LS365	0.88
74LS75	0.82	74LS366	0.88
74LS76	0.50	74LS367	0.88
74LS86	0.58	74LS368	0.88
74LS109	0.62	74LS386	0.69
74LS123	1.70	80LS95	0.88
74LS125	0.87	80LS96	0.88
74LS126	0.87	80LS97	0.88
74LS132	1.50	80LS98	0.88
74LS136	0.69	81LS95	2.10
74LS138	1.87	81LS96	2.10
74LS139	1.87	81LS97	2.10
74LS151	1.66	81LS98	2.10

MORE TRANSISTORS AND FETS

2N2221	NPN TO-18 unmarked	7/\$1.00
2N2222	PNP TO-18 unmarked	5/\$1.00
2N2907A	PNP plastic house #	5/\$1.00
2N3055	NPN TO-3 house #	1/50.75
2N3904	NPN TO-105 house #	5/\$1.00
2N3906	PNP TO-105 house #	5/\$1.00
2N4124	30V/350 mW TO-92	3/\$1.00
2N4304	TO-18 plastic N-JFET gen purp	2/\$1.00
2N4400	NPN plastic house #	5/\$1.00
2N4917	PNP TO-106	5/\$1.00
2N4946	NPN TO-106	6/\$1.00
2N5227	PNP TO-92 30V	6/\$1.00
2N5306	NPN TO-92 darlington	3/\$1.00
2N5449	NPN	6/\$1.00
2N5484	RF N-JFET	3/\$1.00
D41D1	PNP TO-202 1A max	1/50.50
D44C4	NPN TO-220 4A/55V	1/50.75
D45C4	PNP TO-220 4A/55V	1/50.75
D45H8	PNP TO-220 10A/60V	3/\$2.00
MPS3694	NPN gen purp	4/\$1.00
FPT100	Phototransistor	1/50.50
FET-2	Dual N-JFET TO-18 slm 2N4416	3/\$1.00
FET-3	Dual N-JFET lo noise audio	2/\$1.00
FET-6	Gen purp dual gate MOSFET house #	3/\$2.00

CLOSEOUT 'H8 MEMORY 32K for \$549!

Limited quantity: 32K of static memory in kit (not unkit) form. Includes all parts, sockets for all ICs, documentation, mounting bracket, etc. With solder-masked, double-sided, fully legended board for easy assembly. If you own an H8, this is your chance to obtain top-notch memory — without paying top-notch prices.

16K DYNAMIC RAMS NEW LOW LOW PRICE! — 8/\$39!!

Lowest price ever on one of our most popular items. Expands memory in TRS-80* -I and -II, as well as machines made by Apple, Exidy, Heath H89, newer PETS, etc. Low power, speed (4 MHz). Add \$3 for dip shunts plus TRS-80* conversion instructions. **Limited quantity — first come, first served.** *TRS-80 is a trademark of the Tandy Corporation

MA1003 CLOCK MODULE — \$14.95

Our very best clock module operates from 12V DC and includes an internal timebase accurate to 0.01%, making it ideal for mobile applications in your car, van, or boat. Blue-green fluorescent readouts don't wash out during the day, and look great at night. Easy to build; just hook up power, add two time-setting switches, and you've got one of the best clock modules on the road. With application note that shows you how to get the most out of your MA1003.

Also available: clock/case combination. For \$19.95, we'll include a matching case, with mounting hardware and optical filter, along with the MA1003.

TERMS: Cal res add tax. Allow 5% for shipping; excess refunded. Orders under \$15 add \$1 handling. VISA®/Mastercard® orders (\$25 min) call our 24 hour order desk at (415) 562-0636. COD OK with street address for UPS. **PLEASE NOTE: TELEPHONE ORDERS AND CODS ARE NOT ALLOWED ON SPECIALS LISTED ABOVE.** Sale prices good through cover month of magazine; other prices subject to change without notice.



free flyer

FREE FLYER: This ad is only the tip of the iceberg; our catalog tells the rest of the story. Add 41 cents in stamps for 1st class delivery. Outside USA, include \$2 to cover postage (refundable with order). Thank you for your business!

SAVE! SAVE! SAVE!

ASSOCIATED RADIO

913-381-5900

8012 CONSER BOX 4327

OVERLAND PARK, KANSAS 66204



CALL US WITH YOUR REQUIREMENTS
AMERICA'S NO. 1 Real Amateur Radio Store



**(Associated Wants to TRADE - BUY - SELL
GOT YOUR BEST DEAL? THEN CALL US AT
913-381-5900 - NO TRADE? ASK FOR EXT. 12)**

**NOTE: SEND \$1.00 FOR OUR CURRENT CATALOG
OF NEW AND RECONDITIONED EQUIPMENT.**

***ALSO WE PERIODICALLY PUBLISH A LIST OF
UNSERVICED EQUIPMENT AT GREAT SAVINGS.
A BONANZA FOR THE EXPERIENCED OPERATOR.
TO OBTAIN THE NEXT UNSERVICED BARGAIN LIST,
SEND A SELF ADDRESSED STAMPED ENVELOPE.**

ALDELCO ELECTRONIC COMPANY

PROUDLY PRESENTS

the GLOBAL SPECIALTIES CORPORATION

Logic Probes and Digital Pulser

LOGIC PROBES

Our logic probes are the ultimate tools for digital design and testing. These hand-held units provide an instant overview of circuit conditions. Simple to use; just clip power leads to circuit's power supply, set logic family switch to TTL/DTL or CMOS/HTL. Touch probe to test node. Trace logic levels and pulses through digital circuits. Even stretch and latch for easy pulse detection. Instant recognition of high, low or invalid levels, open circuits and nodes. Simple, dual-level detector LEDs tell it quickly, correctly, HI (Logic "1"); LO (Logic "0"). Also incorporates blinking pulse detector, e.g., HI and LO LEDs blink on or off, tracking "1" or "0" states at square wave frequencies up to 1.5 MHz. Pulse LED blinks during pulse transition. Choice of three models to meet individual requirements; budget, project and speed of logic circuits.

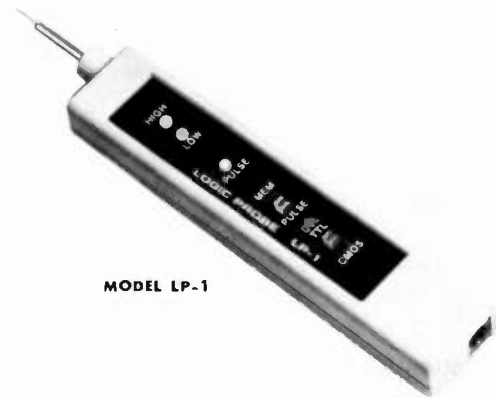

MODEL LP-1

Model LP-1 Logic Probe—Hand-held logic probe provides instant reading of logic levels for TTL, DTL, HTL or CMOS. **Input Impedance:** 100,000 Ohms. **Min. Detectable Pulse:** 50 ns. **Max. Input Signal (Frequency):** 10 MHz. **Pulse Detector (LED):** High speed train or single event. **Pulse Memory:** Pulse or level transition detected and stored. **Net Each..... \$50.00**

Model LP-2 Logic Probe—Economy version of Model LP-1. Safer than a voltmeter. More accurate than a scope. **Input Impedance:** 300,000 Ohms. **Min. Detectable Pulse:** 300 ns. **Max. Input Signal (Frequency):** 1.5 MHz. **Pulse Detector (LED):** High-speed train or single event. **Pulse Memory:** none. **Net Each..... \$28.00**



MODEL LP-3

High speed logic probe. Captures pulses as short as 10 ns. **Input Impedance:** 500,000 Ohms. **Minimum Detectable Pulse:** 6 ns. **Maximum Input Signal (Frequency):** 60 MHz. **Pulse Detector (LED):** High speed train or single event. **Pulse Memory:** Pulse or level transition detected and stored. **Model LP-3 Logic Probe—Net Each..... \$77.00**

DIGITAL PULSER



MODEL DP-1

The ultimate in speed and ease of operation. Simply connect clip leads to positive and negative power, then touch DP-1's probe to a circuit node; automatic polarity sensor detects a circuit's high or low condition. Depress the push-button and trigger an opposite polarity pulse into the circuit. Fast troubleshooting includes injecting signals at key points in TTL, DTL, CMOS or other popular circuits. Test with single pulse or 100 pulses per second via built-in dual control push-button; button selects single shot or continuous modes. LED indicator monitors operating modes by flashing once for single pulse or continuously for a pulse train. Completely automatic, probe-size lab field pulse generator for any family of digital circuits. **Output:** Tri-state. **Polarity:** Pulse-sensing auto-polarity. **Sync and Source:** 100 mA. **Pulse Train:** 100 pps. **LED Indicator:** Flashes for single pulse; stays lit for pulse train. **Model DP-1 Digital Pulser—Net Each..... \$83.00**

LOGIC PROBE KIT



Compact logic probe checks IC's: CMOS, TTL, HTL, DTL and more. Unique circuitry combines functions of level detector, pulse detector and pulse stretcher, makes one-shot, low-rep-rate, narrow pulses (nearly impossible to see, even with a fast scope) easily detectable and visible. "HI" LED indicates logic "1"; "LO" LED indicates logic "0". All pulse transitions, positive and negative, as narrow as 300 nsec, are stretched to 1/10 second and displayed on the PULSE LED. High input impedance virtually eliminates loading; impedance is constant for all states. Over-voltage and reverse-polarity protection standard. **Input Impedance:** 300K Ohms. **Thresholds:** Logic "1" (HI LED), 70% Vcc; logic "0" (LO LED), 30% Vcc. **Min. Detectable Pulse Width:** 300 nsec. **Max. Input Signal Frequency:** 1.5 MHz. **Pulse Detector (PULSE LED):** Hi speed pulse train or single events (+ or - transitions) activate 1/10 second pulse stretcher. **Max. Input Voltage:** \approx 50 V continuous; 120 VAC for less than 15 seconds. **Power Required:** 5 Volt Vcc, 30 mA; 15 Volt Vcc, 40 mA; 25 Volt max. power lead reversal protected. **Operating Temperature:** 0° to 50° C. **Size:** 5.8" l. x 1" w. x 0.7" d. **Weight:** 3 oz. Complete with 36" power leads with color-coded, insulated clips. **Logic Probe Kit—Net Each..... \$21.95**

ALDELCO ✓ 300

2789A MILBURN AVE, BALDWIN, N.Y. 11510
516-378-4555

Add 6% shipping. Add \$1.00 for orders under \$10.00. Out of U.S.A. add 15% shipping and certified check or money order in U.S. funds.



TOLL FREE # (800) 528-0180
(for orders only)

electronics ✓48

1900 MHz to 2500 MHz DOWN CONVERTER

This receiver is tunable over a range of 1900 to 2500 mc and is intended for amateur radio use. The local oscillator is voltage controlled (i.e.) making the i-f range approximately 54 to 88 mc (Channels 2 to 7).

PC BOARD WITH CHIP CAPACITORS 13	\$44.99
PC BOARD WITH ALL PARTS FOR ASSEMBLY	\$79.99
PC BOARD ASSEMBLED AND TESTED	\$120.00
PC BOARD FOR 3.7 TO 4.2 GC SATELLITE CONVERTER WITH DATA.....	\$100.00
PC BOARD FOR I-F AMPLIFIER WITH DATA	40.00
PC BOARD FOR DEMOD WITH DATA	55.00
POWER SUPPLY KIT	\$44.99
POWER SUPPLY ASSEMBLED AND TESTED	59.99
YAGI ANTENNA 4' LONG APPROX. 20 TO 23 dB GAIN	\$59.99
YAGI ANTENNA 4' WITH TYPE (N, BNC, SMA Connector)	\$64.99
2300 MHz DOWN CONVERTER	
Includes converter mounted in antenna, power supply, antenna, 75' and 3' RG59 cable with connectors, 75 to 300 ohm adapter, Plus 90 DAY WARRANTY	\$299.99
OPTION #1 MRF902 in front end. (7 dB noise figure)	\$349.99
OPTION #2 2N6603 in front end. (5 dB noise figure)	\$400.00
2300 MHz DOWN CONVERTER ONLY	
10 dB Noise Figure 23 dB gain in box with N conn. Input F conn. Output	\$149.99
7 dB Noise Figure 23 dB gain in box with N conn. Input F conn. Output	\$169.99
5 dB Noise Figure 23 dB gain in box with SMA conn. Input F conn. Output	\$189.99
DATA IS INCLUDED WITH KITS OR MAY BE PURCHASED SEPARATELY	\$15.00
2 FOOT DISH WITH FEED AND MOUNT	59.99
PC BOARD WITH ALL PARTS FOR ASSEMBLY PLUS 2N6603	89.00

Shipping and Handling Cost:

Receiver Kits add \$1.50, Power Supply add \$2.00, Antenna add \$5.00, Option 1/2 add \$3.00, For complete system add \$7.50.

Replacement Parts:	MRF901	\$5.00	MBD101	\$2.00
			.001 chip caps	\$2.00
	2N6603	\$12.00	PC Board only	\$25.00 with data

***INTRODUCING THE HOWARD/COLEMAN
TVRO CIRCUIT BOARDS
(Satellite Receiver Boards)**

DUAL CONVERSION BOARD.....	\$25.00
This board provides conversion from the 3.7-4.2 band first to 900 MHz where gain and bandpass filtering are provided and, second, to 70 MHz. The board contains both local oscillators, one fixed and the other variable, and the second mixer. Construction is greatly simplified by the use of Hybrid IC amplifiers for the gain stages. Bare boards cost \$25 and it is estimated that parts for construction will cost \$270. (Note: The two AvanteK VTO's account for \$225 of this cost.)	
47 pF CHIP CAPACITORS.....	6.00
For use with dual conversion board. Consists of 6-47 pF.	
70 MHz IF BOARD.....	25.00
This circuit provides about 43 dB gain with 50 ohm input and output impedance. It is designed to drive the HOWARD/COLEMAN TVRO Demodulator. The on-board band pass filter can be tuned for bandwidths between 20 and 35 MHz with a passband ripple of less than 1/2 dB. Hybrid ICs are used for the gain stages. Bare boards cost \$25. It is estimated that parts for construction will cost less than \$40.	
.01 pF CHIP CAPACITORS.....	7.00
For use with 70 MHz IF Board. Consists of 7-.01 pF.	

DEMODULATOR BOARD.....	40.00
This circuit takes the 70 MHz center frequency satellite TV signals in the 10 to 200 millivolt range, detects them using a phase locked loop, deemphasizes and filters the result and amplifies the result to produce standard NTSC video. Other outputs include the audio subcarrier, a DC voltage proportional to the strength of the 70 MHz signal, and AFC voltage centered at about 2 volts DC. The bare board cost \$40 and total parts cost less than \$30.	
SINGLE AUDIO.....	15.00
This circuit recovers the audio signals from the 6.8 MHz frequency. The Miller 9051 coils are tuned to pass the 6.8 MHz subcarrier and the Miller 9052 coil tunes for recovery of the audio.	
DUAL AUDIO.....	25.00
Duplicate of the single audio but also covers the 6.2 range.	
DC CONTROL.....	15.00
This circuit controls the VTO's, AFC and the S Meter.	
TOTAL COSTS	
Using the HOWARD/COLEMAN boards and the recommended parts, it is easily possible to build the complete receiver (excluding LNA) for less than \$600. Construction time is a few evenings and the tune up is minimal.	

We no longer accept Bank Cards.

PLEASE SEND POSTAL MONEY ORDER, CERTIFIED CHECK, CASHIER'S CHECK OR MONEY ORDER.
PRICES SUBJECT TO CHANGE WITHOUT NOTICE. WE CHARGE 15% FOR RESTOCKING ON ANY ORDER.
ALL CHECKS AND MONEY ORDERS IN US FUNDS ONLY.

ALL ORDERS SENT FIRST CLASS OR UPS.

ALL PARTS PRIME AND GUARANTEED.

WE WILL ACCEPT COD ORDERS FOR \$25.00 OR OVER, ADD \$1.50 FOR COD CHARGE.

PLEASE INCLUDE \$1.50 MINIMUM FOR SHIPPING OR CALL FOR CHARGES.

(602) 242-3037

(602) 242-8916

WE ALSO ARE LOOKING FOR NEW AND USED TUBES,
TEST EQUIPMENT, COMPONENTS ETC.

WE ALSO SWAP OR TRADE.

FOR CATALOG SEE JANUARY, 1980, 73 Magazine, 10

Pages.

**2111 W. Camelback
Phoenix, Arizona 85015**

TOLL FREE # (800) 528-0180
(for orders only)

FAIRCHILD VHF AND UHF PRESCALER CHIPS

95H90DC	350 MHz Prescaler Divide by 10/11	\$9.50
95H91DC	350 MHz Prescaler Divide by 5/6	9.50
11C90DC	650 MHz Prescaler Divide by 10/11	16.50
11C91DC	650 MHz Prescaler Divide by 5/6	16.50
11C83DC	1 GHz Divide by 248/256 Prescaler	29.90
11C70DC	600 MHz Flip/Flop with reset	12.30
11C58DC	ECL VCM	4.53
11C44DC/MC4044	Phase Frequency Detector	3.82
11C24DC/MC4024	Dual TTL VCM	3.82
11C06DC	UHF Prescaler 750 MHz D Type Flip/Flop	12.30
11C05DC	1 GHz Counter Divide by 4	74.35
11C01FC	High Speed Dual 5-4 input NO/NOR Gate	15.40

WISPER FANS

This fan is super quiet, efficient cooling where low acoustical disturbance is a must. Size 4.68" x 4.68" x 1.50", Impedance protected, 50/60 Hz. 120 Vac.

\$9.99

TRW BROADBAND AMPLIFIER MODEL CA615B

Frequency response 40 MHz to 300 MHz
Gain: 300 MHz 16 dB Min., 17.5 dB Max.
50 MHz 0 to -1 dB from 300 MHz
Voltage: 24 volts dc at 220 ma max.

\$19.99

CARBIDE — CIRCUIT BOARD DRILL BITS FOR PC BOARDS

Size: 35, 42, 47, 49, 51, 52	\$2.15
Size: 53, 54, 55, 56, 57, 58, 59, 61, 63, 64, 65	1.85
Size: 66	1.90
Size: 1.25 mm, 1.45 mm	2.00
Size: 3.20 mm	3.58

CRYSTAL FILTERS: TYCO 001-19880 same as 2194F

10.7 MHz Narrow Band Crystal Filter
3 dB bandwidth 15 kHz min. 20 dB bandwidth 60 kHz min. 40 dB bandwidth 150 kHz min.
Ultimate 50 dB: Insertion loss 1.0 dB max. Ripple 1.0 dB max. Ct. 0 +/- -5 pf 3600 ohms.

\$5.95

MURATA CERAMIC FILTERS

Models: SFD-455D 455 kHz	\$3.00
SFB-455D 455 kHz	2.00
CFM-455E 455 kHz	7.95
SFE-10.7 10.7 MHz	5.95

TEST EQUIPMENT — HEWLETT PACKARD — TEKTRONIX — ETC.

Hewlett Packard:

491C	TWT Amplifier 2 to 4 Gc 1 watt 30 dB gain	\$1150.00
608D	10 to 420 mc .1 uV to .5 V Into 50 ohms Signal Generator	500.00
616B	1.8 to 4.2 Gc Signal Generator	400.00
618B	3.8 to 7.2 Gc Signal Generator	400.00
620A	7 to 11 Gc Signal Generator	400.00
623B	Microwave Test Set	900.00
624C	Microwave Test Set	950.00
614A	900 to 2100 MC. Signal Generator	\$500.00
8691A	1 to 2 Gc Plug In For 8690A Sweeper	800.00
8692A	2 to 4 Gc Plug In For 8690A Sweeper	800.00
8693A	4 to 8 Gc Plug In For 8690A Sweeper	800.00
8742A	Reflection Test Unit 2 to 12.4 Gc	1800.00
695A	12.4 to 18GC Sweep Generator	900.00
1702A	Storage Oscilloscope	1800.00

Alltech:
473 225 to 400 mc AM/FM Signal Generator 750.00

Singer:
MF5/VR-4 Universal Spectrum Analyzer with 1 kHz to 27.5 mc Plug In 1200.00

Keltek:
XR630-100 TWT Amplifier 8 to 12.4 Gc 100 watts 40 dB gain 9200.00

Polarad:
2038/2436/1102A
Calibrated Display with an SSB Analysis Module and a 10 to 40 mc Single Tone Synthesizer 1500.00

ATLAS CRYSTAL FILTERS FOR ATLAS HAM GEAR

- 5.52-2.7/B
- 5.595-2.7/B/U
- 5.595-500/4/CW
- 5.595-2.7LSB
- 5.595-2.7USB
- 5.645-2.7/B
- 9.0USB/CW

YOUR CHOICE \$24.95

RF TRANSISTORS

TYPE	PRICE	TYPE	PRICE	TYPE	PRICE
2N1561	\$15.00	2N5590	8.15	MM1550	\$10.00
2N1562	15.00	2N5591	11.85	MM1552	50.00
2N1692	15.00	2N5637	22.15	MM1553	56.50
2N1693	15.00	2N5641	6.00	MM1601	5.50
2N2632	45.00	2N5642	10.05	MM1602/2N5842	7.50
2N2857JAN	2.52	2N5643	15.82	MM1607	8.65
2N2876	12.35	2N6545	12.38	MM1661	15.00
2N2880	25.00	2N5764	27.00	MM1669	17.50
2N2927	7.00	2N5842	8.78	MM1943	3.00
2N2947	18.35	2N5849	21.29	MM2605	3.00
2N2948	15.50	2N5862	51.91	MM2608	5.00
2N2949	3.90	2N5913	3.25	MM8006	2.23
2N2950	5.00	2N5922	10.00	MMCM918	20.00
2N3287	4.30	2N5942	46.00	MMT72	1.17
2N3294	1.15	2N5944	8.92	MMT74	1.17
2N3301	1.04	2N5945	12.38	MMT2857	2.63
2N3302	1.05	2N5946	14.69	MRF304	43.45
2N3304	1.48	2N6080	7.74	MRF420	20.00
2N3307	12.60	2N6081	10.05	MRF450	11.85
2N3309	3.90	2N6082	11.30	MRF450A	11.85
2N375	9.32	2N6083	13.23	MRF454	21.83
2N3553	1.57	2N6084	14.66	MRF458	20.68
2N3755	7.20	2N6094	7.15	MRF472	2.50
2N3818	6.00	2N6095	11.77	MRF475	5.00
2N3866	1.09	2N6096	20.77	MRF476	5.00
2N3866JAN	2.80	2N6097	29.54	MRF502	1.08
2N3866JANTX	4.49	2N6136	20.15	MRF504	6.95
2N3924	3.34	2N6166	38.60	MRF509	4.90
2N3927	12.10	2N6265	75.00	MRF511	8.15
2N3950	26.86	2N6266	100.00	MRF901	3.00
2N4072	1.80	2N6439	45.77	MRF5177	21.62
2N4135	2.00	2N6459/PT9795	18.00	MRF8004	1.60
2N4261	14.60	2N6603	12.00	PT4186B	3.00
2N4427	1.20	2N6604	12.00	PT4571A	1.50
2N4429	7.50	A50-12	25.00	PT4612	5.00
2N4430	20.00	BFR90	5.00	PT4628	5.00
2N4957	3.62	BLY568C	25.00	PT4640	5.00
2N4958	2.92	BLY568CF	25.00	PT8659	10.72
2N4959	2.23	CD3495	15.00	PT9784	24.30
2N4976	19.00	HEP76/S3014	4.95	PT9790	41.70
2N5090	12.31	HEPS3002	11.30	SD1043	5.00
2N5108	4.03	HEPS3003	29.88	SD1116	3.00
2N5109	1.60	HEPS3005	9.95	SD1118	5.00
2N5160	3.49	HEPS3006	19.90	SD1119	3.00
2N5179	1.05	HEPS3007	24.95	TA7993	75.00
2N5184	2.00	HEPS3010	11.34	TA7994	100.00
2N5216	47.50	HEPS5026	2.56	TRWWMRA2023-1.5	42.50
2N5583	4.55	HP35831E/		40281	10.90
2N5589	6.82	HXTR5104	50.00	40282	11.90
		MM1500	32.20	40290	2.48

CHIP CAPACITORS

	1pf	27pf	220pf	1200pf
	1.5pf	33pf	240pf	1500pf
	2.2pf	39pf	270pf	1800pf
	2.7pf	47pf	300pf	2200pf
	3.3pf	56pf	330pf	2700pf
	3.9pf	68pf	360pf	3300pf
	4.7pf	82pf	390pf	3900pf
	5.6pf	100pf	430pf	4700pf
	6.8pf	110pf	470pf	5600pf
	8.2pf	120pf	510pf	6800pf
	10pf	130pf	560pf	8200pf
	12pf	150pf	620pf	.010mf
	15pf	160pf	680pf	.012mf
	18pf	180pf	820pf	.015mf
	22pf	200pf	1000pf	.018mf

We can supply any value chip capacitors you may need.

PRICES

1 to 10	\$1.99
11-50	1.49
51-100	1.00
1 0 1 - 1 0 0 0	.75
1001 up	.50

POR = CALL FOR PRICE

HAMLIN SOLID STATE RELAYS

120vac at 40Amps.
Input Voltage 3 to 32vdc.

240vac at 40Amps.
Input Voltage 3 to 32vdc.
Your Choice \$4.99



The RF Line

MRF454

\$21.83

NPN SILICON RF POWER TRANSISTORS

... designed for power amplifier applications in industrial, commercial and amateur radio equipment to 30 MHz.

- Specified 12.5 Volt, 30 MHz Characteristics –
Output Power = 80 Watts
Minimum Gain = 12 dB
Efficiency = 50%

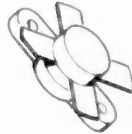

MRF458

\$20.68

NPN SILICON RF POWER TRANSISTOR

... designed for power amplifier applications in industrial, commercial and amateur radio equipment to 30 MHz.

- Specified 12.5 Volt, 30 MHz Characteristics –
Output Power = 80 Watts
Minimum Gain = 12 dB
Efficiency = 50%
- Capable of Withstanding 30:1 Load VSWR @ Rated P_{out} and V_{CC}

NPN SILICON RF POWER TRANSISTOR

... designed primarily for use in large-signal output amplifier stages. Intended for use in Citizen-Band communications equipment operating at 27 MHz. High breakdown voltages allow a high percentage of up-modulation in AM circuits.

MRF472

\$2.50

- Specified 12.5 V, 27 MHz Characteristics –
Power Output = 4.0 Watts
Power Gain = 10 dB Minimum
Efficiency = 65% Typical



MRF475

NPN SILICON RF POWER TRANSISTOR

... designed primarily for use in single sideband linear amplifier output applications in citizens band and other communications equipment operating to 30 MHz.

- Characterized for Single Sideband and Large-Signal Amplifier Applications Utilizing Low-Level Modulation.
- Specified 13.6 V, 30 MHz Characteristics –
Output Power = 12 W (PEP)
Minimum Efficiency = 40% (SSB)
Output Power = 4.0 W (CW)
Minimum Efficiency = 50% (CW)
Minimum Power Gain = 10 dB (PEP & CW)
- Common Collector Characterization



\$5.00

MHW710 - 2

\$46.45

440 to 470MC

UHF POWER AMPLIFIER MODULE

... designed for 12.5 volt UHF power amplifier applications in industrial and commercial FM equipment operating from 400 to 512 MHz.

- Specified 12.5 Volt, UHF Characteristics –
Output Power = 13 Watts
Minimum Gain = 19.4 dB
Harmonics = 40 dB
- 50 Ω Input/Output Impedance
- Guaranteed Stability and Ruggedness
- Gain Control Pin for Manual or Automatic Output Level Control
- Thin Film Hybrid Construction Gives Consistent Performance and Reliability



Tektronix Test Equipment

B	Wideband High Gain Plug In	51.00
CA	Dual Trace Plug In	150.00
K	Fast Rise DC Plug In	63.00
N	Sampling Plug In	200.00
R	Transistor Rise/Time Plug In	116.00
W	High Gain Differential Comparator Plug In	283.00
TU-2	Test Load Plug In for 530/540/550 Main Frames	50.00
1A2	Wideband Dual Trace Plug In	216.00
1S1	Sampling Unit With 350PS Rise/Time DC to 1GHz	730.00
2A61	AC Differential Plug In	133.00
3S3	Dual Trace Sampling DC to 1GHz Plug In	250.00
3S7A	Dual Trace Sampling DC to 875MHz Plug In	250.00
3T7A	Sampling Sweep Plug In	250.00
3L10	Spectrum Analyzer 1 to 36MHz Plug In	1000.00
50	Amplifier Plug In	50.00
51	Sweep Plug In	50.00
53B	Wideband High Gain Plug In	25.00
53/54B	Wideband High Gain Plug In	45.00
53/54C	Dual Trace Plug In	112.50
53/54D	High Gain DC Differential Plug In	38.00
53/54G	Wideband DC Differential Plug In	68.00
53/54L	Fast Rise High Gain Plug In	68.00
84	Test Plug In For 580/581 Main Frames	75.00
107	Square Wave Generator, 4 to 10MHz	48.00
RM122	Preamplifier, 2Hz to 40kHz	63.00
123	AC Coupled Preamplifier	25.00
127	Power Supply For 2 Plug In's	148.00
131	Current Probe Amplifier	50.00
184	Time Mark Generator	363.00
R240	Program Control Unit	150.00
280	Trigger Countdown Unit	84.00
455	Portable Dual Trace 50MHz Scope	2000.00
465	Portable Dual Trace 100MHz Scope	2500.00
503	DC to 450kHz Scope Rack Mount	250.00
535A	DC to 15MHz Scope Rack Mount	253.00
543	DC to 33MHz Scope	300.00
561	DC to 10MHz Scope Rack Mount	150.00
561A	DC to 10MHz Scope Rack Mount	200.00

Scopes with Plug-ins

567	Digital Readout Scope with a 6RIA Digital Unit and a 3S3 Dual Trace DC to 1GHz Sampling Plug In and a 3T7A Sweep Plug In.	750.00
561A	DC to 10MHz Scope with a 3S7A Dual Trace DC to 875MHz Sampling Plug In and a 3T7A Sweep Plug In. Rack Mount	600.00
565	DC to 10MHz Dual Beam Scope with a 2A63 Diff. and a 2A61 Diff. Plug In's	900.00
581	DC to 80MHz Scope with a 82 Dual Trace High Gain Plug In	650.00
661	Sampling Scope with a 5T3 Timing Plug In and a 4S2 Dual Trace DC to 3.5GHz Sampling Plug In.	575.00

Tubes

2E26	\$ 5.00	4CX350FJ	\$116.00	6146M	12.00
3-500Z	102.00	4CX1000A	300.00	6159	10.60
3-1000Z	268.00	4CX1500B	350.00	6161	75.00
3B2B/866A	5.00	4CX15000A	750.00	6293	18.50
3R2500A3	150.00	4E27	50.00	6360	6.95
4-65A	45.00	4K150A	41.00	6907	40.00
4-125A	58.50	4K150D	52.00	6939	14.75
4-250A	68.50	4K150G	74.00	7360	12.00
4-400A	71.00	5Y25/1160L	39.00	7984	10.40
4-1000A	184.00	6LF6	5.00	8072	49.00
5-500A	145.00	6L06	5.00	8106	2.00
4CX250B	65.00	811A	12.95	8156	7.85
4CX250F/G	55.00	813	29.00	8226	127.70
4CX250K	113.00	8894/A	42.00	8295/PL172	328.00
4CX250R	92.00	6146	5.00	8458	25.75
4CX300A	147.00	6146A	6.00	8560A/AS	50.00
4CX350A	107.00	6146B/8298A	7.00	8908	9.00
				8950	9.00

MICROWAVE COMPONENTS

ARRA

2416	Variable Attenuator	\$ 50.00
3614-60	Variable Attenuator 0 to 60dB	75.00
KU520A	Variable Attenuator 18 to 26.5 GHz	100.00
4684-20C	Variable Attenuator 0 to 180dB	100.00
6684-20F	Variable Attenuator 0 to 180dB	100.00

General Microwave

Directional Coupler 2 to 4GHz 20dB Type N	75.00
---	-------

Hewlett Packard

H487B	100 ohms Neg. Thermistor Mount (NEW)	150.00
H487B	100 ohms Neg. Thermistor Mount (USED)	100.00
477B	200 ohms Neg. Thermistor Mount (USED)	100.00
X487A	100 ohms Neg. Thermistor Mount (USED)	100.00
X487B	100 ohms Neg. Thermistor Mount (USED)	125.00
J468A	100 ohms Neg. Thermistor Mount (USED)	150.00
478A	200 ohms Neg. Thermistor Mount (USED)	150.00
B478A	200 ohms Balanced Neg. Thermistor Mount (USED)	175.00
J382	5.85 to 8.2 GHz Variable Attenuator 0 to 50dB	250.00
X382A	8.2 to 12.4 GHz Variable Attenuator 0 to 50dB	250.00

X885A	8.2 to 12.4 GHz Phase Shifter +/- 360°	250.00
394A	1 to 2 GHz Variable Attenuator 6 to 120dB	250.00
NK292A	Waveguide Adapter	65.00
K422A	18 to 26.5 GHz Crystal Detector	250.00
K375A	18 to 26.5 GHz Variable Attenuator	300.00
B436A	Bandpass Filter 8 to 12.4 GHz	75.00
B439A	2 GHz Notch Filter	75.00
B471A	RF Detector	50.00
342A	WHF Noise Source	100.00
X347A	8.2 to 12.4 GHz Noise Source	250.00
H532A	7.05 to 10 GHz Frequency Meter	300.00
G532A	3.95 to 5.85 GHz Frequency Meter	300.00
J532A	5.85 to 8.2 GHz Frequency Meter	300.00

809A	Carriage with a 444A Slotted Line Untuned Detector Probe and 809B Coaxial Slotted Section 2.6 to 18 GHz	175.00
809B	Carriage with a 442B Broadband Probe 2.6 to 12.4 GHz and a X810B Slotted Section	200.00
809B	Carriage with a X810B Slotted Section and a PBD 250A Detector Mount 2.4 to 12.4 GHz	200.00

Merrimac

AU-25A/	801115 Variable Attenuator	100.00
AU-26A/	801162 Variable Attenuator	100.00

Microlab/FXR

Y410A	Frequency Meter 12400 - 18000 MC	250.00
N414A	Frequency Meter 3950 - 11000 MC	350.00
X6385	Horn 8.2 - 12.4 GHz	60.00
601-B18	X to N Adapter 8.2 - 12.4 GHz	35.00
Y6100	Coupler	75.00

Narda

3095/	22909 Directional Coupler 7 to 12.4 GHz 10dB Type N	250.00
4013C-10/	22540A Directional Coupler 2 to 4 GHz 10dB Type SMA	90.00
4014-10/	22538 Directional Coupler 3.85 to 8 GHz 10dB Type SMA	90.00
4014C-6/	22876 Directional Coupler 3.85 to 8 GHz 6dB Type SMA	90.00
4015C-10/	22539 Directional Coupler 7.4 to 12 GHz 10dB Type SMA	95.00
4015C-30/	23105 Directional Coupler 7 to 12.4 GHz 30dB Type SMA	95.00
3044-20	Directional Coupler 4 to 8 GHz 20dB Type N	125.00
3040-20	Directional Coupler 240 to 500 MC 20dB Type N	125.00
3041-20	Directional Coupler 500 to 1000 MC 20dB Type N	125.00
3043-20/	22006 Directional Coupler 1.7 to 4 GHz 20dB Type N	125.00
3003-10/	22011 Directional Coupler 2 to 4 GHz 10dB Type N	75.00
3003-30/	22012 Directional Coupler 2 to 4 GHz 30dB Type N	75.00
3042-20	Directional Coupler 950 to 2 GHz 20dB Type N	125.00
3043-30/	22007 Directional Coupler 1.7 to 3.5 GHz 30dB Type N	125.00
22574	Directional Coupler 2 to 4 GHz 10dB Type N	125.00
3033	Coaxial Hybrid 2 to 4 GHz 3dB Type N	125.00
3032	Coaxial Hybrid 950 to 2 GHz 3 dB Type N	125.00
784/	22380 Variable Attenuator 1 to 90dB 2 to 2.5 GHz Type SMA	550.00
22377	Waveguide to Type N Adapter	35.00
720-6	Fixed Attenuator 8.2 to 14.4 GHz 6 dB	50.00
3503	Waveguide	25.00

PRD

U101	12.4 to 18 GHz Variable Attenuator 0 to 60dB	300.00
X101	8.2 to 12.4 GHz Variable Attenuator 0 to 60dB	200.00
C101	Variable Attenuator 0 to 60dB	200.00
205A/367	Slotted Line with Type N Adapter	100.00
195B	8.2 to 12.4 GHz Variable Attenuator 0 to 50dB	100.00
185B51	7.05 to 10 GHz Variable Attenuator 0 to 40dB	100.00
196C	8.2 to 12.4 GHz Variable Attenuator 0 to 45dB	100.00
170B	3.95 to 5.85 GHz Variable Attenuator 0 to 45dB	100.00
588A	Frequency Meter 5.3 to 6.7 GHz	100.00
140A,C,D,E	Fixed Attenuators	25.00
109J,I	Fixed Attenuators	25.00
WEINSCHEL ENG.	Z692 Variable Attenuator +30 to 60dB	100.00

COMPUTER I.C. SPECIALS

MEMORY	DESCRIPTION	PRICE
2708	1K x 8 EPROM	\$ 7.99
2716/2516	2K x 8 EPROM 5Volt Single Supply	20.00
2114/9114	1K x 4 Static RAM 450ns	6.99
2114L2	1K x 4 Static RAM 250ns	8.99
2114L3	1K x 4 Static RAM 350ns	7.99
4027	4K x 1 Dynamic RAM	3.99
4060/2107	4K x 1 Dynamic RAM	3.99
4050/9050	4K x 1 Dynamic RAM	3.99
2111A-2/8111	256 x 4 Static RAM	3.99
2112A-2	256 x 4 Static RAM	3.99
2115AL-2	1K x 1 Static RAM 55ns	4.99
6104-3/4104	4K x 1 Static RAM 320ns	14.99
7141-2	4K x 1 Static RAM 200ns	14.99
MCM6641L20	4K x 2 Static RAM 200ns	14.99
9131	1K x 1 Static RAM 300ns	10.99

C.P.U.'S ECT.

MCM6800L	Microprocessor	13.80
MCM6810AP	128 x 8 Static RAM 450ns	3.99
MCM68A10P	128 x 8 Static RAM 360ns	4.99
MCM68B10P	128 x 8 Static RAM 250ns	5.99
MC6820P	PIA	8.99
MC6820L	PIA	9.99
MC6821P	PIA	9.99
MC68B21P	PIA	9.99
MCM6830L7	Milbug	14.99
MC6840P	PTM	8.99
MC6845P	CRT Controller	29.50
MC6845L	CRT Controller	33.00
MC6850L	ACIA	10.99
MC6850P	ACIA	4.99
MC6852P	SSDA	5.99
MC6852L	SSDA	11.99
MC6854P	ADLC	22.00
MC6860CJCS	0-600 BPS Modem	29.00
MC6862L	2400 BPS Modem	14.99
MK3850N-3	FB Microprocessor	9.99
MK3852P	FB Memory Interface	16.99
MK3852N	FB Memory Interface	9.99
MK3854N	FB Direct Memory Access	9.99
8008-1	Microprocessor	4.99
8080A	Microprocessor	8.99
Z80CPU	Microprocessor	14.99
6520	PIA	7.99
6530	Support For 6500 series	15.99
2650	Microprocessor	10.99
TMS1000NL	Four Bit Microprocessor	9.99
TMS4024NC	9 x 64 Digital Storage Buffer (FIFO)	9.99
TMS6011NC	UART	9.99
MC14411	Bit Rate Generator	11.99
AY5-4007D	Four Digit Counter/Display Drivers	8.99
AY5-9200	Repertory Dialler	9.99
AY5-9100	Push Button Telephone Diallers	7.99
AY5-2376	Keyboard Encoder	19.99
AY3-8500	TV Game Chip	5.99
TR1402A	UART	9.99
PR1472B	UART	9.99
PT1482B	UART	9.99
B257	DMA Controller	9.99
B251	Communication Interface	9.99
B228	System Controller & Bus Driver	5.00
B212	8 Bit Input/Output Port	5.00
MC14410CP	2 of 8 Tone Encoder	9.99
MC14412	Low Speed Modem	14.99
MC14408	Binary to Phone Pulse Converter	12.99
MC14409	Binary to Phone Pulse Converter	12.99
MC1488L	RS232 Driver	1.00
MC1489L	RS232 Receiver	1.00
MC1405L	A/D Converter Subsystem	9.00
MC1406L	6 Bit D/A Converter	7.50
MC1408/6/7/8	8 Bit D/A Converter	4.50
MC1330P	Low Level Video Detector	1.50
MC1349/5D	Video IF Amplifier	1.17
MC1733L	LM733 OP Amplifier	2.40
LMS65	Phase Lock Loop	2.50

MHz

TOLL FREE #
(800) 528-0180
(for orders only)

electronics

(602) 242-3037
(602) 242-8916

2111 W. Camelback
Phoenix, Arizona 85015

BULLET ELECTRONICS

P.O. Box 401244-E

Garland, TX. 75040

(214) 278-3553

Special Buy!



RF POWER TRANSISTORS

2N5591 25 W @ 13.6 VDC
to 240 mhz. minimum
gain 4.4 db.
6.95

Limited Qty.
Limit 5 of
each type
per customer

2N6081 / MRF221
15W @ 13.6 VDC to 240 mhz.
Minimum gain 6.3 db.
4.95

Units are marked with special mfg's. part number, however, all are new and guaranteed.

TO-3 P.C. BOARD HEATSINK

Perfect for power transistors, or 309 and 340K series voltage regulators.

3/1.10



Thermoloy H6014
Black Anodized

LM395 High gain power transistor with built in current limiting, power limiting and thermal overload making it virtually impossible to destroy with overload. VCEO = 36V IC = 2A HFe 3000. Will drive directly off TTL and CMOS. **1.65**

TRANSFORMER

A good transformer for TTL, linear, and smaller computer systems.
Primary 117VAC Sec #1 15V@1A
Sec #2 15V@1A Sec #3 8V@2A
Size: 2x3x2.25 Wt 1.5 lbs
Construction: Open Frm w/MI flang; wire leads
Order BET-0005
\$2.95

200V 4A SCR

Sensitive
Gate
7/\$1.00

Special Purchase
Order BES-0025

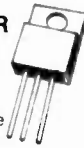

THE PERFECT TRANSFORMER

117VAC primary, 12VAC secondary @ 200ma
Great for all you CMOS, or low power TTL projects. PC board mount.
99c ea. 3/\$2.50
Size: 1.5" W x 1.25" D x 1.25" H



AY3-8910 PROGRAMMABLE SOUND GENERATOR

The AY3-8910 is a 40 pin LSI chip with three oscillators, three amplitude controls, programmable noise generator, three mixers, an envelope generator, and three D/A converters that are controlled by 8 BIT WORDS. No external pots or caps required. This chip hooked to an 8 bit microprocessor chip or Buss (8080, Z80, 6800 etc.) can be software controlled to produce almost any sound. It will play three note chords, make bangs, whistles, sirens, gunshots, explosions, bleats, whines, or grunts. In addition, it has provisions to control its own memory chips with two IO ports. The chip requires +5V @ 75ma and a standard TTL clock oscillator. A truly incredible circuit.

\$14.95 w/Basic Spec Sheet (4 pages)
60 page manual with S-100 interface instructions and several programming examples, **\$3.00** extra

OVP-2 OVERVOLTAGE PROTECTOR **6.95**

Provides cheap insurance for your expensive equipment. Trip voltage is adjustable from 3 to 30 volts. Overvoltage instantly fires a 25A SCR and shorts the output to protect equipment. Should be used on units that are fused. Directly compatible with the PS-12 and PS-14. All electronics supplied. Drilled and plated PC board.

ULTRASONIC RELAY KIT

Invisible Beam Works Like A Photo Electric Eye. **COMPLETE KIT**. All Parts & PC Board. Use Up To 25 Ft. Apart.
\$21.50

Optional entry delay and Alarm Timeout Circuit will source or sink up to 200 MA DC.
\$3.95

AUTO/VAN CLOCK KIT

- 12 Hr. Format
 - 6 Digit 1/2" LED Readouts
 - Quartz XTAL Timebase
 - Alarm & Snooze Options
 - Noise Filtering
 - Easy Assembly • 12 VDC
 - 4 5/8" x 3" x 1 1/2"
 - All Parts!
- \$16.95**

X-RATED! ZULU II CLOCK KIT

X-TRA VALUE: All the components and high quality plated G-10 PC Boards are provided.

X-TRA CARE IN DESIGN: Easy Assembly! Large open layout
X-CELLENCE IN IDEAS: 5 years of designed products for the amateur radio market.

X-CELLENCE IN INSTRUCTIONS: Clear step-by-step instructions with quality illustrations and schematic.

X-TRA FEATURES: There has never been a clock kit with so many features — at any price!

- Unit operates on either 12 VAC or 12 VDC.
- On board **QUARTZ XTAL TIMEBASE** or 60Hz AC line freq. can be used.
- Automatic **BATTERY BACKUP!**
- Reads true 24 HOUR TIME and 31 DAY CALENDAR.
- Unique **NOX™** CIRCUIT activates readouts with a handclap followed by the date for 4 seconds. Or they can be turned on constantly.
- When used mobile readouts blank when ignition is off.
- Special **NOISE SUPPRESSION** and battery reversal circuits
- Bright 1/2" LED's show hours, minute and seconds.

WITH CALENDAR
AND NOX™ CIRCUIT

19.95

LESS CASE

ACCESSORIES

Custom High Impact
Molded Case with Ruby
Lens. Available in Blue or
Tan.

\$6.50

117 VAC to 12 VAC
Transformer.

\$1.35

*9V Battery Not Included

Sound Effects Kit **\$18.50**

The **SE-01 Sound Effects Kit** is a complete kit; all you need to build a programmable sound effects machine except a battery and speaker. Our kit is designed to really ring out the **TI 76477** Sound Chip. Only the **SE-01** provides you with additional circuitry that includes a **PULSE GENERATOR, MUX OSCILLATOR and COMPARTOR** to make more complex sounds a snap. We help you in building the kit with a clear, easy-to-follow construction manual and we show you how to easily program the unit. Other dealers will sell you the chip or a "kit" of parts but you are on your own to do the most difficult part...make neat sounds! Within a short time after you build the **SE-01** you can easily create **Gunshots, Explosions, Space Sounds, Steam Trains** and much more. We think the **Bullet SE-01** is the best deal on the market but don't ask us, — ask the 15,000 happy **SE-01** owners!

Complete Kit With Quality Plated PC Board **\$18.50**
(Less battery & speaker)

Users Group Notes: Includes additional programming charts plus quarterly updates **\$5.00**

7 WATT AUDIO AMP KIT

SMALL SINGLE HYBRID IC AND COMPONENTS FIT DN A 2" x 3" PC BOARD (INCLUDED) RUNS ON 12VDC GREAT FOR ANY PROJECT THAT NEEDS AN INEXPENSIVE AMP. LESS THAN 3% THD @ 5 WATTS. COMPATIBLE WITH SE-01 SOUND KIT **\$5.95**

PARTS

LM3046	(CA3046) Xistor Array75
RCA 40430	400V 6A TRIAC TO-6675
LM567	Tone Decoder99
CD4046	PLL CMOS99
LM3302	Quad Comparator89
25C 1849	High Freq. NPN TO-92	6/1.00
MPS A 20	NPN General Purpose	8/1.00
TL490	Bar/Graph Driver w/specs	2.50
7812	12V 1A Regulator99
7805	5V 1A Regulator99
78M05	5V 1/2A Reg. TO-5 (Hse #)60
LM3911	Temp. Transducer w/specs	1.10
555	Timer IC49
2N6028	P.U.T. w/specs50
IL-1	Opto Isolator w/specs60
LM380	2W Audio IC w/specs50
LM377	Dual LM380 w/specs	1.09
TIP-30	PNP Power TO-220	3/1.00
SCR	Sensitive Gate 200V 4A	7/1.00
SCR	Sensitive Gate 600V 4A RCA	3/1.00
LM317	Variable Reg. 3-35V 1A w/specs	1.69
DIAC	Trigger diode for triacs in AC phase control operation29

NEW!

MUSIC FOR YOUR EARS

Bullet's Electronic Music Machine™ Kit has a single **28 Pin Microprocessor Chip** with **ROM** that has been programmed to play the first 6 to 10 notes of the **25 popular tunes** listed below. Each tune can easily be addressed individually or played sequentially at the push of a button. The 3 chime sequences are activated at any time by separate switch closures so when used as a doorbell, one door can play songs while two others will play different chimes. The unit has a **5 watt audio Amp** and will run on either **12VAC** or **12VDC**. Optional 117VAC transformer is available. Construction is very simple, works with any 8 or 16 ohm speaker, or horn speaker. (Not included.) Tunes can be remotely programmed using a single rotary switch. (not included), if desired.

Complete Kit \$16.95 Transformer **\$1.35**
For Operation
on 117VAC

Tunes: Toreador * William Tell * Hallelujah Chorus * Star Spangled Banner * Yankee Doodle * America, America * Deutschland Leid * Wedding March * Beethoven's 5th and 9th * Hell's Bells * La Vien En Rose * Star Wars Theme * Clementine * Augustine * Jingle Bells * God Save The Queen * Colonel Bogey * Marsellaise * O Sole Mio * Santa Lucia * The End * Blue Danube * Brahms Lullaby * Westminster Chime * Simple Chime * Descending Octave Chime.

★ CALL OR WRITE TODAY FOR FREE CATALOG ★

- * NO C.O.D.
- * SEND CHECK, M.O., OR CREDIT CARD #
- * PHONE ORDERS ACCEPTED ON VISA/MASTER CHARGE ONLY (214) 278-3553

P
O
L
I
C
I
E
S

- * ADD 5% FOR SHIPPING
- * ORDERS UNDER \$10 ADD .75 HANDLING
- * TEX. RES. ADD 5% TAX
- * FOREIGN ORDERS (EXCEPT CANADA) ADD 10% (20% FOR AIRMAIL).

Radio Bookshop

LICENSE STUDY GUIDES & TAPES

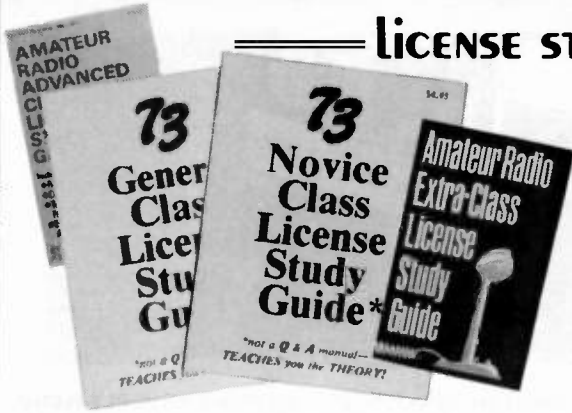

● **NOVICE STUDY GUIDE**—SG7357—Here is a completely new study guide and reference book for the potential ham. This is not a question/answer memorization course. Electronic and radio fundamentals are presented and explained in an easy-to-understand fashion, preparing the beginner for the Novice exam. Includes the latest FCC amateur regulations, as well as application forms. Easily the best path into the exciting world of ham radio! \$4.95.*

● **GENERAL CLASS STUDY GUIDE**—SG7358—A complete theory course for the prospective General or Technician. This reference explains transistor, amplifier, and general radio theory, while preparing the Novice for the "big" ticket. After getting your ticket, you'll use this guide again and again as an electronics reference source. Not a question/answer guide that becomes dated when the FCC updates the amateur exams. Under revision, expected availability is December 1980. \$5.95*

● **ADVANCED CLASS LICENSE STUDY GUIDE**—SG1081—Ready to upgrade your license? To prevent retaking the FCC theory exam, you need the 73 Advanced theory guide. SSB, antenna theory, transmitters, and electronics measuring techniques are covered in detail in this easy-to-follow study guide. Special modes and techniques, such as RTTY, are also treated. An engineering degree is *not* necessary to master the Advanced theory—try this book before visiting the examiner's office! \$6.95.* (Published by TAB Books previous to recent changes in FCC exam material.)

● **EXTRA CLASS LICENSE STUDY GUIDE**—SG1080—Before going for your 1 x 2 call, it pays to be a master of the Extra class electronics theory. This study guide is the logical extension of the 73 theory course. All the theory necessary to pass the exam is presented. Antennas, transmission lines, swr are discussed, as well as noise, propagation, and specialized communication techniques. This book is not a classroom lecture or memorization guide, but rather a logical presentation of the material that must be understood before attempting the Extra exam. Save yourself a return trip to the FCC and try the 73 method first! \$5.95.*



NOVICE THEORY TAPES Startling Learning Breakthrough



● **NOVICE THEORY TAPES**—CT7300—Startling Learning Breakthrough. You'll be astounded at how really simple the theory is when you hear it explained on these tapes. Three tapes of theory and one of questions and answers from the latest Novice exams give you the edge you need to breeze through your exam. 73 is interested in helping get more amateurs, so we're giving you the complete set of our tapes for the incredibly low price of **ONLY \$15.95.***

Scientists have proven that you learn faster by listening than by reading because you can play a cassette tape over and over in your spare time—even while you're driving! You get more and more info each time you hear it. You can't progress without solid fundamentals. These four hour-long tapes give you all the basics you'll need to pass the Novice exam easily. You'll have an understanding of the basics which will be invaluable to you for the rest of your life! Can you afford to take your Novice exam without first listening to these tapes? Set of 4—\$15.95.*

These tapes were made previous to recent changes in FCC rules. These minor changes do not affect the theory involved. A new set of tapes reflecting these rule changes is being developed. Expected availability is December 1980.



SSTV

● **SLOW SCAN TELEVISION TAPE**—CT7350—Prize-winning programs from the 73 SSTV contest. Excellent for Demo! \$5.95.*



73 CODE TAPES

"GENESIS"

5 WPM—CT7305—This is the beginning tape for people who do not know the code at all. It takes them through the 26 letters, 10 numbers and necessary punctuation, complete with practice every step of the way using the newest blitz teaching techniques. It is almost miraculous! In one hour many people—including kids of ten—are able to master the code. The ease of learning gives confidence to beginners who might otherwise drop out.

"THE STICKLER"

6+ WPM—CT7306—This is the practice tape for the Novice and Technician licenses. It is made up of one solid hour of code, sent at the official FCC standard (no other tape we've heard uses these standards, so many people flunk the code when they are suddenly—under pressure—faced with characters sent at 13 wpm and spaced for 5 wpm). This tape is not memorizable, unlike the zany 5 wpm tape, since the code groups are entirely random characters sent in groups of five.

Any Four Tapes For \$15.95!*

\$4.95 Each!*

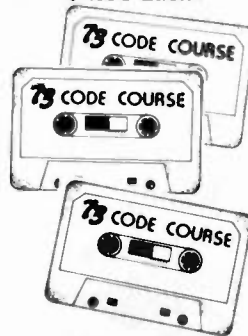

"BACK BREAKER"

13+ WPM—CT7313—Code groups again, at a brisk 13 per so you will be at ease when you sit down in front of the steely-eyed government inspector and he starts sending you plain language at only 13 per. You need this extra margin to overcome the panic which is universal in the test situations. When you've spent your money and time to take the test, you'll thank heavens you had this back-breaking tape.

"COURAGEOUS"

20+ WPM—CT7320—Code is what gets you when you go for the Extra class license. It is so embarrassing to panic out just because you didn't prepare yourself with this tape. Though this is only one word faster, the code groups are so difficult that you'll almost fall asleep copying the FCC stuff by comparison. Users report that they can't believe how easy 20 per really is with this fantastic one hour tape.

"OUTRAGEOUS"

25+ WPM—CT7325—This is the tape for that small group of overachieving hams who wouldn't be content to simply satisfy the code requirements of the Extra Class license. It's the toughest tape we've got and we keep a permanent file of hams who have mastered it. Let us know when you're up to speed and we'll inscribe your name in 73's CW "Hall of Fame."

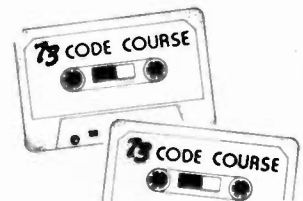

*Use the order card in the back of this magazine or itemize your order on a separate piece of paper and mail to: 73 Radio Bookshop • Peterborough NH 03458. Be sure to include check or detailed credit card information. No C.O.D. orders accepted. *Add \$1.00 handling charge. Note: Prices subject to change on books not published by 73 Magazine. Questions regarding your order? Please write to Customer Service at the above address. Please allow 4-6 weeks for delivery.

FOR TOLL FREE ORDERING CALL 1-800-258-5473

Radio Bookshop

73 TECHNICAL LIBRARY

● **BEHIND THE DIAL**—BK7307—By Bob Grove. Get more fun out of shortwave listening with this interesting guide to receivers, antennas, frequencies and interference. \$4.95.*

● **THE CHALLENGE OF 160**—BK7309—is the newest book in the 73 technical library, dedicated to 160 meter operating. Si Dunn provides all necessary information to get started on this unique band. The all-important antenna and ground systems are described in detail. The introduction contains interesting photos of Stew Perry's (the King of 160) shack. This reference is a must for new and experienced "Top Band" operators. Price: \$4.95.*

● **IC OP-AMP COOKBOOK**—BK1028—by Walter G. Jung. Covers not only the basic theory of the IC op amp in great detail, but also includes over 250 practical circuit applications, liberally illustrated. 592 pages, 5½ x 8½, softbound. \$12.95.*

● **THE POWER SUPPLY HANDBOOK**—BK7305—Need a power supply for a gadget you're building? In the **POWER SUPPLY HANDBOOK** there are dozens ready-to-build, plus detailed steps for designing your own. There are circuits and parts lists for all kinds of supplies, ranging from simple DC types to highly stable regulated versions. If you need a circuit to convert a DC voltage to a higher or lower voltage, turn DC into AC, or AC to DC—then this is the book you need. With more than 400 pages, you should be able to find just the circuit you need. Without a doubt one of the best power supply source books available, compiled by the editors of 73. \$9.95.*

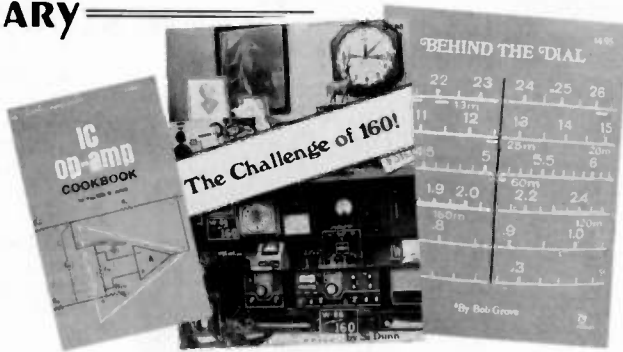

● **WEATHER SATELLITE HANDBOOK**—BK7370—Simple equipment and methods for getting good pictures from the weather satellite. Antennas, receivers, monitors, facsimile you can build, tracking, automatic control (you don't even have to be home). Dr. Taggart WB8DQT. \$4.95.*

● **THE NEW RTTY HANDBOOK**—BK7347—is a new edition and the only up-to-date RTTY book available. The state of the art has been changing radically and has made all previous RTTY books obsolete. It has the latest circuits, great for the newcomer and expert alike. \$5.95.

● **PROPAGATION WIZARD'S HANDBOOK**—BK7302—by J. H. Nelson. When sunspots riddled the worldwide communications networks of the 1940's, John Henry Nelson looked to the planets for an answer. The result was a theory of propagation forecasting based upon interplanetary alignment that made the author the most reliable forecaster in America today. The book provides an enlightened look at communications past, present, and future, as well as teaching the art of propagation forecasting. \$6.95.*



● **SSB . . . THE MISUNDERSTOOD MODE**—BK7351—by James B. Wilson. Single Sideband Transmission . . . thousands of us use it every day, yet it remains one of the least understood facets of amateur radio. J. B. Wilson presents several methods of sideband generation, amply illustrated with charts and schematics, which will enable the ambitious reader to construct his own sideband generator. A must for the technically-serious ham. \$5.50.*

● **MASTER HANDBOOK OF HAM RADIO CIRCUITS**—BK1033—This is an encyclopedia of amateur radio circuits, gleaned from past issues of 73 Magazine and carefully selected according to application. You'll find many you've never seen before, some new twists on the tried and true, and several that have been long forgotten but are well worth remembering. Where your interest ranges from ragchewing to EME, from CW to slow-scan TV, from DX to county nets, this handbook will be a welcome addition to your shack. \$8.95.*

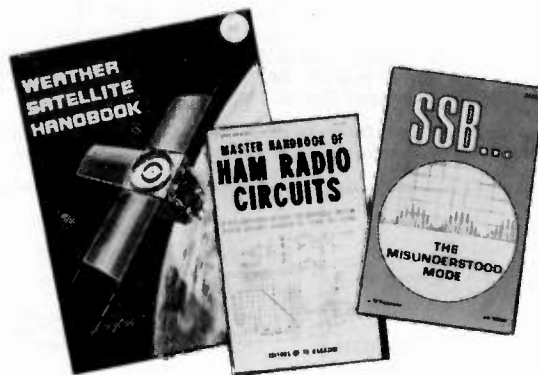

● **OWNER REPAIR OF RADIO EQUIPMENT**—BK7310—Frank Glass K6RQ shares over 40 years of operating, servicing, and design experience in this book which ranges from the elementary to the highly technical written for the top engineers in the field. It is written in narrative style on the subjects of electronic servicing, how components work, and how they are combined to provide communication equipment. This book will help you understand the concepts required to service your own station equipment. \$7.95.*

● **TOOLS & TECHNIQUES FOR ELECTRONICS**—BK7348—is an easy-to-understand book written for the beginning kit builder as well as the experienced hobbyist. It has numerous pictures and descriptions of the safe and correct ways to use basic and specialized tools for electronic projects as well as specialized metal working tools and the chemical aids which are used in repair shops. \$4.95*

● **THE CONTEST COOKBOOK**—BK7308—reveals the secrets of the contest winners (Domestic, DX and specialty contests), complete with photos and diagrams of equipment used by the top scorers. Find out how to make 150 contacts in one hour. \$5.95*



*Use the order card in the back of this magazine or itemize your order on a separate piece of paper and mail to: 73 Radio Bookshop • Peterborough NH 03458. Be sure to include check or detailed credit card information. No C.O.D. orders accepted. *Add \$1.00 handling charge. Note: Prices subject to change on books not published by 73 Magazine. Questions regarding your order? Please write to Customer Service at the above address. Please allow 4-6 weeks for delivery.

FOR TOLL FREE ORDERING CALL 1-800-258-5473

Radio Bookshop

TEST EQUIPMENT

● **RF AND DIGITAL TEST EQUIPMENT YOU CAN BUILD**—BK1044—Rf burst, function, square wave generators, variable length pulse generators—100 kHz marker, i-f and rf sweep generators, audio osc, al/rf signal injector, 146 MHz synthesizer, digital readouts for counters, several counters, prescaler, microwave meter, etc. 252 pages. \$5.95.*

● **VOL. I COMPONENT TESTERS**—LB7359—... how to build transistor testers (8), diode testers (3), IC testers (3), voltmeters and VTVMs (9), ohmmeters (8 different kinds), Inductance (3), capacity (9), Q measurement, crystal checking (6), temperature (2), aural meters for the blind (3) and all sorts of miscellaneous data on meters... using them, making them more versatile, making standards. Invaluable book. \$4.95.*

● **VOL. II AUDIO FREQUENCY TESTERS**—LB7360—... jam packed with all kinds of audio frequency test equipment. If you're into SSB, RTTY, SSTV, etc., this book is a must for you... a good book for hi-fi addicts and experimenters, too! \$4.95.*

● **VOL. III RADIO FREQUENCY TESTERS**—LB7361—Radio frequency waves, the common denominator of Amateur Radio. Such items as SWR, antenna impedance, line impedance, rf output and field strength; detailed instructions on testing these items includes sections on signal generators, crystal calibrators, grid dip oscillators, noise generators, dummy loads and much more. \$4.95.*

● **VOL. IV IC TEST EQUIPMENT**—LB7362—Become a troubleshooting wizard! In this fourth volume of the 73 TEST EQUIPMENT LIBRARY are 42 home construction projects for building test equipment to work with your ham station and in servicing digital equipment. Plus a cumulative index for all four volumes of the 73 TEST EQUIPMENT LIBRARY. \$4.95.*



THE WELL-EQUIPPED HAM SHACK

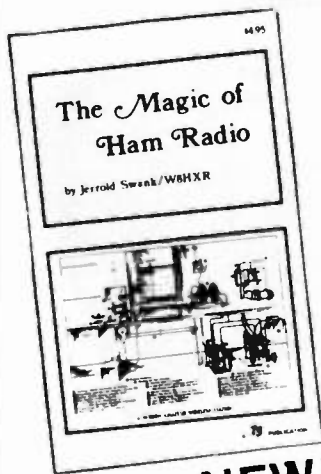

NEW!

● **THE MAGIC OF HAM RADIO**—BK7312—by Jerrold Swank, WB2NXL begins with a brief history of amateur radio and of Jerry's involvement in it. Part 2 details many of ham radio's heroic moments. Hamdom's close ties with the continent of Antarctica are the subject of Part 3. In Part 4 the strange and humorous sides of ham life get their due. And what of the future? Part 5 peers into the crystal ball. \$4.95.*

● **A GUIDE TO HAM RADIO**—BK7321—by Larry Kahaner WB2NEL. What's Amateur Radio all about? You can learn the basics of this fascinating hobby with this excellent beginner's guide. It answers the most frequently asked questions in an easy-going manner, and it shows the best way to go about getting an FCC license. A Guide to Ham Radio is an ideal introduction to a hobby enjoyed by people around the world. \$4.95.*

● **HOW TO BUILD A MICROCOMPUTER—AND REALLY UNDERSTAND IT**—BK7325—by Sam Creason. The electronics hobbyist who wants to build his own microcomputer system now has a practical "How-To" guidebook. This book is a combination technical manual and programming guide that takes the hobbyist step-by-step through the design, construction, testing and debugging of a complete microcomputer system. Must reading for anyone desiring a true understanding of small computer systems. \$9.95.*

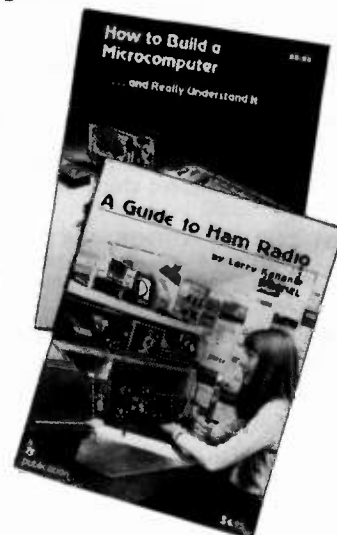

● **LIBRARY SHELF BOXES**—These sturdy white, corrugated, dirt-resistant boxes each hold a full year of 73, *Kilobaud Microcomputing* or *80 Microcomputing*. With your order, request self-sticking labels for any of the following: 73, *Kilobaud Microcomputing*, *80 Microcomputing*, *CQ*, *QST*, *Ham Radio*, *Personal Computing*, *Radio Electronics*, *Interface Age*, and *Byte*. Order 1—BX1000—for \$2.00*; order 2-7—BX2002—for \$1.50 each*; order 8 or more—BX1002—for \$1.25 each*.



Style Y



Style W

● **QSL CARDS**—73 turns out a fantastic series of QSL cards at about half the cost of having them done elsewhere because they are run as a fill-in between printing books and other items in the 73 Print Shop. 250 Style W—QW0250—for \$8.95*; 500 Style W—QW0500—for \$13.95*; 250 Style X—QX0250—for \$8.95*; 500 Style X—QX0500—for \$13.95*; 250 Style Y—QY0250—for \$8.95*; 500 Style Y—QY0500—for \$13.95*. Allow 6-12 wks. for delivery.



Style X

● **BACK ISSUES**—Complete your collection; many are prime collectables now, classics in the field! A full collection is an invaluable compendium of radio and electronics knowledge!

Single back issue—ST0000—\$3.00*;
25 our choice—ST2500—\$12.00*;
25 your choice—ST2501—\$25.00*;
5 your choice—ST0500—\$8.75*;
10 your choice—ST1000—\$14.00.*

● **FREE BACK ISSUE CATALOGS** are yours for the asking... specify 73 Magazine and/or Kilobaud Microcomputing back issue catalog when you send your name and address to us on a postcard.

73 MAGAZINE BINDERS

● Preserve and protect your collection for a lifetime! Order these handsome red binders with gold lettering. \$7.50 for 1, 3 for \$21.75, 6 for \$42.00. (Postpaid within USA, please add \$2.50 per order outside USA.) Check or money orders only, no phone or C.O.D. orders. 73 Binders, P.O. Box 5120, Philadelphia, PA 19141.

*Use the order card in the back of this magazine or itemize your order on a separate piece of paper and mail to: 73 Radio Bookshop • Peterborough NH 03458. Be sure to include check or detailed credit card information. No C.O.D. orders accepted. *Add \$1.00 handling charge. Note: Prices subject to change on books not published by 73 Magazine. Questions regarding your order? Please write to Customer Service at the above address. Please allow 4-6 weeks for delivery.

FOR TOLL FREE ORDERING CALL 1-800-258-5473

Radio Bookshop

● **73 DIPOLE AND LONG-WIRE ANTENNAS**—BK1016—by Edward M. Noll W3FQJ. This is the first collection of virtually every type of wire antenna used by amateurs. Includes dimensions, configurations, and detailed construction data for 73 different antenna types. Appendices describe the construction of noise bridges, line tuners, and data on measuring resonant frequency, velocity factor, and swr. \$5.50.*



● **THE GIANT BOOK OF AMATEUR RADIO ANTENNAS**—With the **GIANT Book of Amateur Radio Antennas**—BK1104—by your side, antennas will become the least of your worries. Over 450 pages of design ideas, theory and reference data make this book live up to its title. The 7 chapters cover everything from basic antenna theory through designs for DIY accessories, as well as dozens of antenna designs. Whether planning to build or buy, design or admire, test or enjoy a ham antenna—this is the book for you. From the editors of 73; published by Tab Books. Hardcover \$12.95.*

● **73 VERTICAL, BEAM AND TRIANGLE ANTENNAS**—BK1069—by Edward M. Noll W3FQJ. Describes 73 different antennas for amateurs. Each design is the result of the author's own experiments covering the construction of noise bridges and antenna line tuners, as well as methods for measuring resonant frequency, velocity factor, and standing-wave ratios. 160 pages. \$5.50.*

● **VHF ANTENNA HANDBOOK**—BK7368—The **NEW VHF Antenna Handbook** details the theory, design and construction of hundreds of different VHF and UHF antennas... A practical book written for the average amateur who takes joy in building, not full of complex formulas for the design engineer. Packed with fabulous antenna projects you can build. \$5.95.*

● **PRACTICAL ANTENNAS FOR THE RADIO AMATEUR**—BK1015—A manual describing how to equip a ham station with a suitable antenna. A wide range of antenna topics, systems, and accessories are presented giving the reader some food for thought and practical data for construction. Designed to aid the experienced ham and novice as well. Only \$9.95.*

● **TTL COOKBOOK**—BK1063—by Donald Lancaster. Explains what TTL is, how it works, and how to use it. Discusses practical applications, such as a digital counter and display system, events counter, electronic stopwatch, digital voltmeter and a digital tachometer. \$9.50.

● **CMOS COOKBOOK**—BK1011—by Don Lancaster. Details the application of CMOS, the low power logic family suitable for most applications presently dominated by TTL. Required reading for every serious digital experimenter! \$10.50.*

● **TVT COOKBOOK**—BK1064—by Don Lancaster. Describes the use of a standard television receiver as a microprocessor CRT terminal. Explains and describes character generation, cursor control and interface information in typical, easy-to-understand Lancaster style. \$9.95.*

● **RTL COOKBOOK**—BK1059—by Donald Lancaster. Explains the how and why of RTL (Resistor-Transistor Logic) and gives design information that can be put to practical use. Gives a multitude of digital applications ranging from the basic switch to the sophisticated counter. 240 pages; \$6.50.*

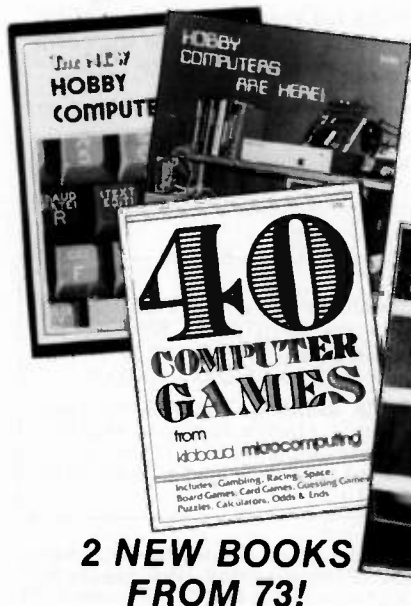

2 NEW BOOKS FROM 73!

NEW ● **40 COMPUTER GAMES FROM KILOBAUD MICROCOMPUTING**—BK7381—Forty games in all in nine different categories. Games for large and small systems, and even a section on calculator games. Many versions of BASIC used and a wide variety of systems represented. A must for the serious computer gamesman. \$7.95*

NEW ● **UNDERSTANDING AND PROGRAMMING MICROCOMPUTERS**—BK7382—A valuable addition to your computing library. This two part text includes the best articles that have appeared in 73 and Kilobaud Microcomputing magazines on the hardware and software aspects of the new microcomputing hobby. Well known authors and well structured text helps the reader get involved in Americas fastest growing hobby. \$10.95*

● **HOBBY COMPUTERS ARE HERE!**—BK7322—If you want to come up to speed on how computers work... hardware and software... this is an excellent book. It starts with the fundamentals and explains the circuits, the basics of programming, along with a couple of TVT construction projects, ASCII-Baudot, etc. This book has the highest recommendations as a teaching aid for newcomers. \$4.95.*

● **THE NEW HOBBY COMPUTERS**—BK7340—This book takes it from where **Hobby Computers Are Here!** leaves off, with chapters on Large Scale Integration, how to choose a microprocessor chip, an introduction to programming, low cost I/O for a computer, computer arithmetic, checking memory boards, a Baudot monitor/editor system, an audible logic probe for finding those tough problems, a ham's computer, a computer QSO machine... and much, much more! \$4.95*

*Use the order card in the back of this magazine or itemize your order on a separate piece of paper and mail to: 73 Radio Bookshop • Peterborough NH 03458. Be sure to include check or detailed credit card information. No C.O.D. orders accepted. *Add \$1.00 handling charge. Note: Prices subject to change on books not published by 73 Magazine. Questions regarding your order? Please write to Customer Service at the above address. Please allow 4-6 weeks for delivery.

FOR TOLL FREE ORDERING CALL 1-800-258-5473

DEALER DIRECTORY

San Jose CA

Bay area's newest Amateur Radio store. New & used Amateur Radio sales & service. We feature Kenwood, ICOM, KDK, Yaesu, Ten-Tec, VHF Engineering & many more. Shaver Radio, Inc., 1378 So. Bascom Ave., San Jose CA 95128, 998-1103.

San Leandro CA

Specializing in Amateur Radio Test Guides. F.C.C. Advanced Class test is a snap with our manual. Bash Educational Services, 15373 Edgemore St., P.O. Box 382, San Leandro CA 94577.

Denver CO

Experimenter's paradise! Electronic and mechanical components for computer people, audio people, hams, robot builders, experimenters. Open six days a week. Gateway Electronics Corp., 2839 W. 44th Ave., Denver CO 80211, 458-5444.

Uncasville CT

Cushcraft, Bencher, Hy-Gain, Telex, Barker & Williamson, Nye-Viking, Hustler, MFJ, Callbook, Murch, Unadilla, OK, Saxton, ARRL Books, Used equipment, Electronic parts and accessories, free catalog. Donovan Electronics, Inc., 2510 Norwich, New London Tpk, Uncasville CT 06382, 848-3434.

New Castle DE

ICOM, Ten-Tec, Swan, KDK, NDI, Tempo, Wilson; Authorized dealer: 1 mile off I-95. No sales tax. Delaware Amateur Supply, 71 Meadow Road, New Castle DE 19720, 328-7728.

Columbus GA

KENWOOD—YAESU—DRAKE
The world's most fantastic amateur show-room! You gotta see it to believe it! Radio Wholesale, 2012 Auburn Avenue, Columbus GA 31906, 561-7000.

Boise ID

Azden, Amidon, Ameco, ARRL, B&W, Callbook, Collins, Cushcraft, Dentrone, Hustler, ICOM, Jim-Pak, KDK, MFJ, NPC, Nye, Sams, SST, Swan, Ten-Tec, Wanzer, Wilson. Custom Electronics, 1209 Broadway, Boise ID 83706, Bob W7SC 344-5084.

Preston ID

Ross WB7BYZ, has the Largest Stock of Amateur Gear in the Intermountain West and the Best Prices. Call me for all your ham needs. Ross Distributing, 78 So. State, Preston ID 83263, 852-0830.

Terre Haute IN

Your ham headquarters located in the heart of the midwest. Hoosier Electronics, Inc., 43B Meadows Shopping Center, P.O. Box 2001, Terre Haute IN 47802, 238-1456.

Littleton MA

The ham store of N.E. you can rely on. Kenwood, ICOM, Wilson, Yaesu, DenTron, KLM anps, B&W switches & wattmeters, Whistler radar detectors, Bearcat, Regency, antennas by Larsen, Wilson, Hustler, GAM. TEL-COM Inc. Communications & Electronics, 675 Great Rd., Rt. 119, Littleton MA 01460, 486-3040.

Laurel MD

Kenwood, Drake, ICOM, Ten-Tec, Swan, DenTron, Tempo and many ham accessories. Also computers by Apple and Exidy. The Comm Center, Inc., Laurel Plaza—Rt. 198, Laurel MD 20810, 792-0600.

St. Louis MO

Experimenter's paradise! Electronic and mechanical components for computer people, audio people, hams, robot builders, experimenters. Open six days a week. Gateway Electronics Corp., 8123-25 Page Blvd., St. Louis MO 63130, 427-6110.

Syracuse-Rome-Utica NY

Featuring: Yaesu, ICOM, Drake, Atlas, DenTron, Ten-Tec, Swan, Tempo, KLM, Hy-Gain, Mosley, Wilson, Larsen, Midland Southwest Technical Products. You won't be disappointed with equipment/service. Radio World, Oneida County Airport-Terminal Building, Oriskany NY 13424, 337-2622.

Phila. PA/Camden NJ

Waveguide & coaxial microwave components & equipment. Laboratory grade test instruments, power supplies. Buy, sell & trade all popular makes, HP, GR, FXR, ESI, Sorensen, Singer, etc. Lectronic Research Labs., 1423 Ferry Ave., Camden NJ 08104, 541-4200.

Columbus OH

All major brands featured in the biggest and best ham store for miles around. Come in and twist the knobs before you buy. Universal Amateur Radio, Inc., 1280 Aida Dr., Reynoldsburg (Columbus) OH 43068, 866-4267.

Houston TX

Experimenter's paradise! Electronic and mechanical components for computer people, audio people, hams, robot builders, experimenters. Open six days a week. Gateway Electronics Inc., 8932 Clarkcrest, Houston TX 77063, 978-6575.

San Antonio TX

Complete 2 way service shop. Call Dee, W5FSP. Selling Antenna Specialists, Avanti, Azden, Bird, Hy-gain, Standard communications, Genave, Henry, Cushcraft, Dielectric, Hustler, ICOM, MFJ, Nye, Shure, Swan, Tempo, Ten-Tec and others. Appliance & Equipment Co., Inc., 2317 Vance Jackson Road, San Antonio TX 78213, 734-7793.

DEALERS

Your company name and message can contain up to 25 words for as little as \$150 yearly (prepaid), or \$15 per month (prepaid quarterly). No mention of mail-order business or area code permitted. Directory text and payment must reach us 60 days in advance of publication. For example, advertising for the December issue must be in our hands by October 1st. Mail to 73 Magazine, Peterborough NH 03458. ATTN: Nancy Ciampa.

PROPAGATION

J. H. Nelson
4 Plymouth Dr.
Whiting NJ 08759

EASTERN UNITED STATES TO:

GMT: 00 02 04 06 08 10 12 14 16 18 20 22

ALASKA	14A	16	7	7	7	7	7	7	14	16	21	21A
ARGENTINA	14A	16	7A	7	7	7	14A	21A	21A	21A	21A	21
AUSTRALIA	21	14	7B	7B	7B	7B	7B	7B	14	14	21A	21A
CANAL ZONE	21	14	7	7	7	7	14	21A	21A	21A	21A	21A
ENGLAND	7A	7	7	7	7	7A	14	21A	21A	21	14A	14
HAWAII	21A	14	7B	7	7	7	7	7B	14A	21A	21A	21A
INDIA	14	7B	7B	7B	7B	7B	14	21	14	14	14	14
JAPAN	21	14	14	7B	7B	7	7	7B	7B	7B	14	21A
MEXICO	14	14	7	7	7	7	7A	14	21	21A	21A	21
PHILIPPINES	21	14	7B	7B	7B	7B	7B	14B	14	14	14B	14
PUERTO RICO	14	7A	7	7	7	7	7A	21	21A	21A	21	14A
SOUTH AFRICA	14	14	7	7B	7B	14	21	21A	21A	21A	21A	21
U. S. S. R.	7	7	7	7	7B	7B	14	21A	21A	14	14	7
WEST COAST	21A	14	7	7	7	7	7	14	21A	21A	21A	21A

CENTRAL UNITED STATES TO:

ALASKA	21	14	7	7	7	7	7	7	14	14	21	21A
ARGENTINA	21	14	14	7	7	7	14	21A	21A	21A	21A	21
AUSTRALIA	21A	14	14B	7B	7B	7B	7B	14	14	14	21A	21A
CANAL ZONE	21	14	7	7	7	7	14	21A	21A	21A	21A	21A
ENGLAND	7	7	7	7	7	7	14	21	21A	21	14A	14
HAWAII	21A	14A	7B	7	7	7	7	7	14A	21A	21A	21A
INDIA	14	14	7B	7B	7B	7B	7B	14	14	14	14	14
JAPAN	21A	14	14	7B	7B	7	7	7	7B	7B	14	21A
MEXICO	14	14	7	7	7	7	7	14	21	21	21A	21A
PHILIPPINES	21	14	7B	7B	7B	7B	7B	7	14	14	14	21
PUERTO RICO	21	14	7	7	7	7	14	21	21A	21A	21A	21
SOUTH AFRICA	14	14	7	7B	7B	7B	14	21	21A	21A	21A	21
U. S. S. R.	7	7	7	7	7B	7B	7B	21	21	14	14	7B

WESTERN UNITED STATES TO:

ALASKA	21	14	14	7	7	7	7	7	7	14	21	21
ARGENTINA	21A	21	14	7	7	7	7B	14	21A	21A	21A	21
AUSTRALIA	21A	21	14	14	14	7	7B	7	14	14	21A	21A
CANAL ZONE	21A	14A	7	7	7	7	7A	21	21A	21A	21A	21A
ENGLAND	7B	7B	7	7	7	7	7B	14	21A	21	14A	14
HAWAII	21A	21A	14A	14	7	7	7	7	14A	21A	21A	21A
INDIA	14	14	14	7B	7B	7B	7B	7B	14	14	14	14
JAPAN	21A	21	14	7B	7B	7	7	7	7	7	14	21A
MEXICO	21	14	14	7	7	7	7	7A	21	21	21A	21A
PHILIPPINES	21A	21	14	7B	7B	7B	7B	7	14	14	14	21
PUERTO RICO	21	14	7A	7	7	7	7	14A	21A	21A	21A	21
SOUTH AFRICA	14	14	7	7B	7B	7B	7B	14	21	21A	21A	21
U. S. S. R.	7	7	7	7	7B	7B	7B	7B	14	14	14	7B
EAST COAST	21A	14	7	7	7	7	7	14	21A	21A	21A	21A

A = Next higher frequency may also be useful
B = Difficult circuit this period
F = Fair G = Good P = Poor
SF = Chance of solar flares

october

sun	mon	tue	wed	thu	fri	sat
			1 G	2 G	3 G/SF	4 F/SF
5 P/SF	6 F/SF	7 G	8 G	9 G	10 G	11 G
12 G	13 G	14 G	15 G	16 G	17 G	18 G
19 G	20 F	21 G	22 G	23 G	24 G	25 F
26 F	27 F	28 G	29 G	30 G	31 G	

List of AdvertisERS

*Please contact these advertisers directly.

To receive full information from our advertisers please complete the following postage-paid card.

R.S. No.	Page	R.S. No.	Page	R.S. No.	Page	R.S. No.	Page
369	AEA/Advanced Elect. Applica., Inc.	305	Hustler, Inc.	481	Hamtronics, NY	*	Radio World
	187		102		243		148
370	AEA/Advanced Elect. Applica., Inc.	363	I-Can Company	*	Hamtronics, Trevoise/AEA	62	Ramsey Electronics
	219	*	IRL	479	Heath Co		256, 259
			116		30	372	Robot Research, Inc.
3	AED Electronics	*	ICOM	34	Henry Radio	*	Ross Distributing Co/AEA
	181		9, 33		Cov. II		29
*	AGL Electronics/AEA	35	Info-Tech, Inc	*	Henry Radio/AEA	*	Rush Electronics, Inc/AEA
	44	337	Instant Software		118	65	S-F Amateur Radio Services
362	A.P. Systems	36	International Crystal Mfg	476	Hickok Electrical Instrument Co.		185
	212		114		32	64	Semiconductors Surplus
1	Adirondack Radio Supply, Inc.	*	JR Amateur Radio/AEA	*	House of Electronics/AEA		254, 255
			57		139		
	218	38	Jameco Electronics	47	MFJ Enterprises	*	73 Magazine
300	Aldelco		261		142, 143		109, 118, 123, 135, 195, 269-272, 274
314	Alliance Mfg. Co.	39	Jan Crystals	483	MFJ Enterprises		66
	21		36		243		Signalcrafters, Inc.
5	Amateur-Wholesale Elect.	40	KLM Electronics	48	MHZ Electronics		372
	22, 258		31		264-267		366
482	Amateur-Wholesale Elect.	*	Kantronics	26	M & M RF Distributors		Slep Electronics Co.
	30		195		115		177, 232
7	American Crystal Supply	*	KB Microcomputing	56	Macaw Electronics, Inc.		371
	185		118		71		Slep Electronics Co/AEA
334	Amlidon Associates	*	Kennedy Associates/AEA	44	Macrotronics		360
	235		102		136, 183		Soundpower
356	Anteck, Inc.	*	Kenwood	45	Madson Electronics		148
	235		Cov. IV, 7		73		317
301	Appl. & Equip. Co., Inc.	*	Kryder Electronics/AEA	46	Maggiore Electronic Lab		Spacecoast Research
	187, 219		127		233, 236		237
8	Apron Laboratories	*	LaRue Electronics	*	Memphis Hamfest		67
	111		237		145		Spectronics
*	Associated Radio	357	Delta Products	49	Micro Control Specialties		249, 257
	262		191		116		68
358	Astron Corporation	365	Larry Dennison	313	Micro Management Systems		Spectrum Comm.
	183		36		26		54, 55
10	Avanti Research & Develop.	92	DenTron Radio Co., Inc.	50	Microcraft Corp.		477
	111		3		148		Spectrum Comm.
11	Barker-Williamson	17	Dielectric Comm.	51	Microlog Corp.		69
	133		57, 233		59, 93		Surplus Electronics
*	Barry Electronics	*	Digital Research Parts	52	MidCom Electronics, Inc.		251
	163, 233		252		81		73
*	Ben Franklin Electronics/AEA	18	Digitrex Electronics	364	Mirage Communications Equip-ment, Inc.		TET, USA
	53		44		85		324
359	Bird Electronic Corp.	91	ETCO Electronics	318	National Comm. Group Co.		THS Electronics
	194		236		102		212
*	Britt's 2-Way Radio Service/AEA	*	80 Microcomputing	*	New England ARRL		328
			118		43		Telrex Laboratories
	21	*	Erickson Comm/AEA	54	OK Machine & Tool		173, 231
	268		183		131		Ten-Tec, Inc.
12	Bullet Electronics	22	Fair Radio Sales	55	Optoelectronics, Inc.		13, 242
	268		177, 232		15		74
306	Burghardt Amateur Center	23	Flesher Corp.	55	Outdoor Outfitters		Texas Towers
	25		181		185		189
*	C. Comm/AEA	323	Fox-Tango Corp.	57	P.C. Electronics		76
	85		53		21		Trac Electronics
*	CW Electronic Sales Co/AEA	*	G&K Amateur Supply/AEA	480	P.C. Electronics		17
	67		109	348	Palom Engineers		335
368	Circuit Electronics	27	G.I.S.M.O.		17, 27		Tri-Ex Tower
	187		91		27		327
13	Clegg	*	G.I.S.M.O./AEA		85		Trionyx Industries
	44, 87, 173		111		27		37
89	Clutterfree Modular Consoles	25	Germantown Amat. Supply		44		Tufts Radio Electronics
	36		29		44		198-209
*	The Comm. Center, Inc/AEA	*	Germantown Amat. Supply/AEA	58	P.C. Electronics		361
	136		87		30		UHF Sales & Service
14	Comm. Center, NE	28	Godbout Electronics	58	P.C. Electronics		37
	75, 83		260		30		UPI Comm. Systems, Inc.
15	Comm. Specialists	352	Grove Enterprises		37		Universal Amat. Radio, Inc/AEA
	10, 11		29		85		159
367	Conley Radio Supply	345	Hal Comm	60	Quest Electronics		351
	107		19, 97		247		Universal Communications
*	Conley Radio Supply/AEA	31	Hal-Tronix	347	RCA Service Co.		185
	112		109, 191		87		311
16	Crown Micro Products	32	Ham Radio Center	63	RF Power Labs, Inc.		Vanguard Labs
	181		103		31		237
41	Cushcraft Corp.	353	Ham Radio Center	61	Radio Amateur Callbook, Inc.		373
	151		58		163, 231		Van Gorden Engineering
330	Debco Electronics	*	Ham Radio Center/AEA		32		86
	112		145		32		Vineyard Amateur Radio
346	Data Service	33	Hamtronics, NY	478	Radio Shack		250
	195		253		32		90

Books, ETC.

To order, complete the following postage-paid card, or itemize your order including detailed credit card information or check and mail to:
73 Magazine/Mail Order Dept./Peterborough NH 03458.

Catalog #	Item	Price	Catalog #	Item	Price	Catalog #	Item	Price
BK1016	73 DIPOLE & LONG WIRE ANTENNAS	\$ 5.50	BK1033	MASTER HANDBOOK OF HAM RADIO CIRCUITS	\$ 8.95	SG1080	STUDY GUIDE—EXTRA CLASS	\$ 5.95
ST0000	73 BACK ISSUE	\$ 3.00	BK7340	THE NEW HOBBY COMPUTERS	\$ 4.95	SG7358	STUDY GUIDE—GENERAL CLASS	\$ 5.95
ST2500	73 BACK ISSUES—25 OUR CHOICE	\$12.00	CT7300	NOVICE THEORY TAPES	\$15.95	SG7357	STUDY GUIDE—NOVICE CLASS	\$ 4.95
ST0500	73 BACK ISSUES—5 YOUR CHOICE	\$ 8.75	BK7310	OWNER REPAIR OF RADIO EQUIPMENT	\$ 7.95	LB7359	TEST EQUIP LIB V1—COMPONENT TESTERS	\$ 4.95
ST1000	73 BACK ISSUES—10 YOUR CHOICE	\$14.00	BK7305	POWER SUPPLY HANDBOOK	\$ 7.95	LB7360	TEST EQUIP LIB V2—AUDIO TESTERS	\$ 4.95
ST2501	73 BACK ISSUES—25 YOUR CHOICE	\$25.00	BK1015	PRACTICAL ANTENNAS FOR THE RADIO AMATEUR	\$ 9.95	LB7361	TEST EQUIP LIB V3—RADIO EQUIP.	\$ 4.95
BK7307	BEHIND THE DIAL	\$ 4.95	BK7302	PROPAGATION WIZARD'S HANDBOOK	\$ 6.95	LB7362	TEST EQUIP LIB V4—IC TEST EQ.	\$ 4.95
BK7309	CHALLENGE OF 160	\$ 4.95	QW0250	QSL CARDS—STYLE W—250	\$ 8.95	BK7348	TOOLS & TECHNIQUES	\$ 4.95
CT7305	CODE TAPE—5 WPM	\$ 4.95	QW0500	QSL CARDS—STYLE W—500	\$13.95	BK1063	TTL COOKBOOK	\$ 9.50
CT7306	CODE TAPE—6+ WPM	\$ 4.95	QX0250	QSL CARDS—STYLE X—250	\$ 8.95	BK1064	TVT COOKBOOK	\$ 9.95
CT7313	CODE TAPE—13+ WPM	\$ 4.95	QX0500	QSL CARDS—STYLE X—500	\$13.95	BK7382	UNDERSTANDING & PROGRAMMING MICROCOMPUTERS	\$10.95
CT7320	CODE TAPE—20+ WPM	\$ 4.95	QY0250	QSL CARDS—STYLE Y—250	\$ 8.95	BK1069	VERTICAL BEAM & TRIANGLE ANTNS	\$ 5.50
CT7325	CODE TAPE—25+ WPM	\$ 4.95	QY0500	QSL CARDS—STYLE Y—500	\$13.95	BK7368	VHF ANTENNA HANDBOOK	\$ 5.95
CT7394	CODE TAPES (ANY FOUR ABOVE)	\$15.95	BK1044	RF & DIGITAL TEST EQUIPMENT	\$ 5.95	BK7370	WEATHER SATELLITE HANDBOOK	\$ 4.95
BK7308	THE CONTEST COOKBOOK	\$ 5.95	BK7347	RITTY HANDBOOK	\$ 5.95			
BK7381	40 COMPUTER GAMES	\$ 7.95	BK1059	RTL COOKBOOK	\$ 6.50			
BK7304	GIANT BOOK OF AMATEUR RADIO ANTENNAS	\$12.95	BX1000	SHELF BOX—1	\$ 2.00			
BK7322	HOBBY COMPUTERS ARE HERE	\$ 4.95	BX1001	SHELF BOXES—2-7	\$1.50 each			
BK7325	HOW TO BUILD A MICROCOMPUTER & REALLY UNDERSTAND IT	\$ 9.95	BX1002	SHELF BOXES—8 AND UP	\$1.25 each			
BK1028	IC OP AMP COOKBOOK	\$12.95	BK7351	S&B THE MISUNDERSTOOD MODE	\$ 5.50			
BK7312	MAGIC OF HAM RADIO	\$ 4.95	CT7350	SSTV TAPE	\$ 5.95			
			SG1081	STUDY GUIDE—ADV. CLASS	\$ 6.95			

73 magazine
peterborough, n.h. 03458

READER SERVICE

73 Magazine, P.O.B. 2739, Clinton, IA 52735

This card is valid until **January 31, 1981.**

Please help us to bring you a better magazine—by answering these questions:

I. What is your age?

- A. under 18
- B. 18-22
- C. 23-40
- D. 41-60
- E. over 60

II. ARRL

- 1. Love it
- 2. Don't care
- 3. Hate it

III. If you are not a subscriber please circle number 500.

Reader Service: Return this card to receive full information on the products advertised in this issue. Refer to the ad. You will find numbers near the logo of each advertiser. Each represents the advertiser's individual Reader Service Number. Circle the corresponding numbers on one of the cards on this page, include your name, address & zip, and drop in a mailbox. In 4-6 weeks you'll hear from the advertiser directly.

1	6	11	16	21	126	131	136	141	146	251	256	261	266	271	376	381	386	391	396
2	7	12	17	22	127	132	137	142	147	252	257	262	267	272	377	382	387	392	397
3	8	13	18	23	128	133	138	143	148	253	258	263	268	273	378	383	388	393	398
4	9	14	19	24	129	134	139	144	149	254	259	264	269	274	379	384	389	394	399
5	10	15	20	25	130	135	140	145	150	255	260	265	270	275	380	385	390	395	400
26	31	36	41	46	151	156	161	166	171	276	281	286	291	296	401	406	411	416	421
27	32	37	42	47	152	157	162	167	172	277	282	287	292	297	402	407	412	417	422
28	33	38	43	48	153	158	163	168	173	278	283	288	293	298	403	408	413	418	423
29	34	39	44	49	154	159	164	169	174	279	284	289	294	299	404	409	414	419	424
30	35	40	45	50	155	160	165	170	175	280	285	290	295	300	405	410	415	420	425
51	56	61	66	71	176	181	186	191	196	301	306	311	316	321	426	431	436	441	446
52	57	62	67	72	177	182	187	192	197	302	307	312	317	322	427	432	437	442	447
53	58	63	68	73	178	183	188	193	198	303	308	313	318	323	428	433	438	443	448
54	59	64	69	74	179	184	189	194	199	304	309	314	319	324	429	434	439	444	449
55	60	65	70	75	180	185	190	195	200	305	310	315	320	325	430	435	440	445	450
76	81	86	91	96	201	206	211	216	221	326	331	336	341	346	451	456	461	466	471
77	82	87	92	97	202	207	212	217	222	327	332	337	342	347	452	457	462	467	472
78	83	88	93	98	203	208	213	218	223	328	333	338	343	348	453	458	463	468	473
79	84	89	94	99	204	209	214	219	224	329	334	339	344	349	454	459	464	469	474
80	85	90	95	100	205	210	215	220	225	330	335	340	345	350	455	460	465	470	475
101	106	111	116	121	226	231	236	241	246	351	356	361	366	371	476	481	486	491	496
102	107	112	117	122	227	232	237	242	247	352	357	362	367	372	477	482	487	492	497
103	108	113	118	123	228	233	238	243	248	353	358	363	368	373	478	483	488	493	498
104	109	114	119	124	229	234	239	244	249	354	359	364	369	374	479	484	489	494	499
105	110	115	120	125	230	235	240	245	250	355	360	365	370	375	480	485	490	495	500

Name _____
 Address _____
 City _____ State _____ Zip _____

73 Magazine ● October 1980

BOOKS

73 Magazine, Pine Street, Peterborough, N.H. 03458

Please send me the following 73 products:

Qty.	Catalog #	Title	Unit Price	Total

Add \$1 shipping/handling _____
 Total _____

Please allow 4-6 weeks for delivery.
 No C.O.D. orders accepted.
 Enclosed \$ _____ Check M.O.
 Bill: AE MC Visa

Card # _____ Exp. date _____
 Signature _____ Interbank # _____
 Name _____
 Address _____
 City _____
 State _____ Zip _____

SUBSCRIPTION

73 Magazine P.O. Box 931 Farmingdale, N.Y. 11737

73 subscribers
CELEBRATE 73's 20th ANNIVERSARY WITH A YEAR FOR \$20.

New subscription Renewal
 1 year—\$20
 Enclosed \$ _____ Check M.O.
 Bill: MC Visa AE me

Card # _____ Exp. date _____
 Signature _____ Interbank # _____
 Name _____
 Address _____
 City _____ State _____ Zip _____

Canada—\$22, 1 year only, US funds.
 Other foreign—\$30, 1 year only, US funds.

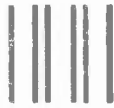

NO POSTAGE
NECESSARY
IF MAILED
IN THE
UNITED STATES

BUSINESS REPLY CARD

FIRST CLASS PERMIT NO. 73 PETERBOROUGH NH 03458

POSTAGE WILL BE PAID BY ADDRESSEE

73 MAGAZINE
Subscription Dept.
POB 931
Farmingdale NY 11737

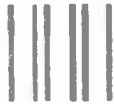

NO POSTAGE
NECESSARY
IF MAILED
IN THE
UNITED STATES

BUSINESS REPLY CARD

FIRST CLASS PERMIT NO. 73 PETERBOROUGH NH 03458

POSTAGE WILL BE PAID BY ADDRESSEE

73 MAGAZINE
Peterborough
NH 03458

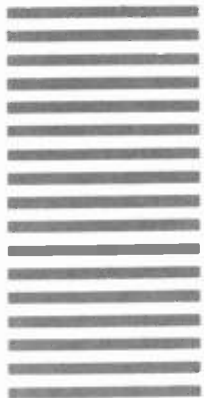

73



BUSINESS REPLY CARD

FIRST CLASS PERMIT NO. 217 CLINTON IA 52735

POSTAGE WILL BE PAID BY ADDRESSEE

73 MAGAZINE
POB 2739
Clinton IA 52735

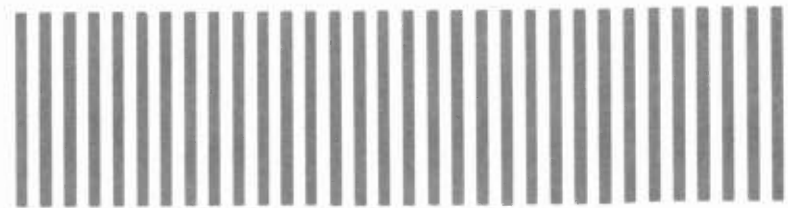

NO POSTAGE
NECESSARY
IF MAILED
IN THE
UNITED STATES

Att. Mail Order

Tomorrow's Technology—Here Today!

THE YAESU FT-207R

The "horse-and-buggy" days of crystal-controlled handies are gone! Yaesu's engineers have harnessed the power of the microprocessor, bringing you 800 channels, digital display, memory, and scanning from a hand-held package. Only with Yaesu can you get these big performance features in such a compact package.

FALL \$349 SPECIAL!
includes
FT-207R

NBP-9 BATTERY PACK
NC-9B WALL CHARGER
AND MINI EARPHONE



SPECIFICATIONS:

GENERAL

Frequency coverage: 144-148 MHz
 Number of channels: 800
 Emission type: F3
 Batteries: NiCd battery pack
 Voltage requirement: 10.8 VDC
 ± 10%, maximum
 Current consumption:
 Receive: 35 mA squelched (150
 mA unsquelched with maximum
 audio)
 Transmit: 800 mA (full power)
 Case dimensions: 68 x 181 x 54 mm
 (=1WD)
 Weight (with batteries): 680 grams

RECEIVER

Circuit type: Double conversion
 superheterodyne
 Intermediate frequencies:
 1st IF = 10.7 MHz
 2nd IF = 455 kHz
 Sensitivity: 0.32 µV for 20 dB quieting
 Selectivity: ± 7.5 kHz at 60 dB down
 Audio Output: 200 mW at 10% THD

Price And Specifications Subject To
 Change Without Notice Or Obligation

TRANSMITTER

Power Output: 2.5 watts minimum / 200mW
 Deviation: ± 5 kHz
 Spurious radiation: -60 dB or better
 Microphone: Condenser type
 (2000 ohms)

OPTIONS

LC-C7 Leather Carrying Case
 YM-24 Remote Speaker/Microphone
 Tone Squelch Unit

YAESU
The radio.



180

YAESU ELECTRONICS CORP., 6851 Waltham Way, Paramount, CA 90723 • (213) 633-4007
 YAESU ELECTRONICS Eastern Service Ctr., 9812 Princeton-Glendale Rd., Cincinnati, OH 45246

Easy selection.

15 memories/offset recall, scan, Touch-Tone[®], priority

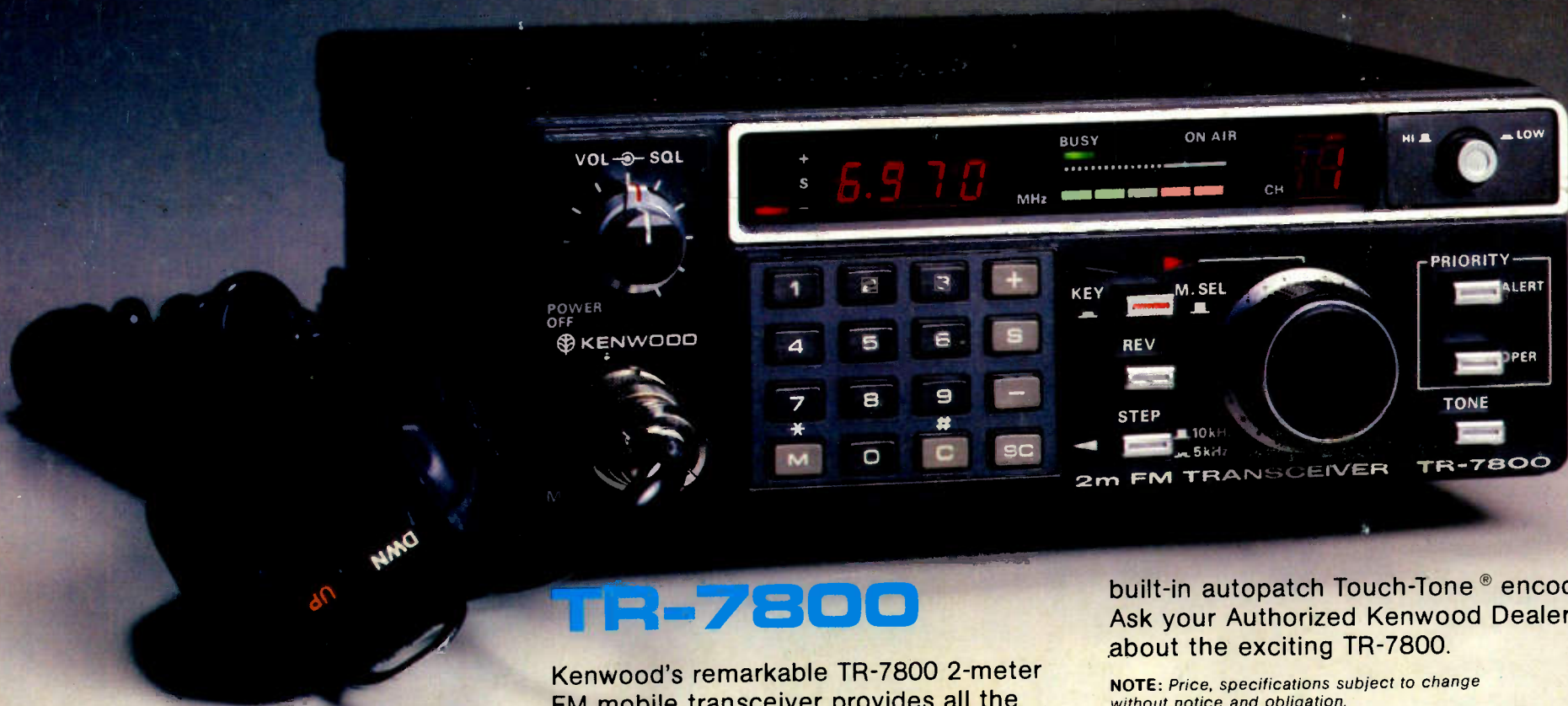

TR-7800

Kenwood's remarkable TR-7800 2-meter FM mobile transceiver provides all the features you could desire for maximum operating enjoyment. Frequency selection is easier than ever, and the rig incorporates new memory developments for repeater shift, priority, and scan, and includes a

built-in autopatch Touch-Tone[®] encoder. Ask your Authorized Kenwood Dealer about the exciting TR-7800.

NOTE: Price, specifications subject to change without notice and obligation.

 **KENWOOD**
...pacesetter in amateur radio

TRIO-KENWOOD COMMUNICATIONS INC.
1111 WEST WAI NUT / COMPTON, CA 90220