

73 Magazine

for Radio Amateurs

- 32 Enjoy All Five Bands**
— with this novice no-trap antenna W8FX/4
- 40 Reincarnating Old Test Equipment**
— a 1942 capacitance meter is born
again W3KBM
- 42 Finding Radio Pests**
— basics WA1UUK
- 44 Video Magic For Your Home**
— to make boredom disappear K4TWJ
- 48 Novice Guide To Phased Antennas**
— part II W8HXR
- 52 Can A \$20 FM Rig Work?**
— testing the VHF Engineering TX150 2m
xmtr. WB4LJM, WA4WDL
- 54 Hiss Exterminator**
— an ear-saver for the TS-700A K9POX
- 58 Instant Engraving**
— to protect your equipment W7RXV
- 60 The New, Improved Automatic
Thermostat**
— adding a night thermostat W9YBU
- 62 Give 'Em A Break**
— with a cheaper repeater beeper WB6JPI
- 64 It's Flora Clock!**
— and all is well W8FX/4
- 66 Build Your Own Digital Dial**
— great update for your receiver W1OOP
- 72 The FM Rebroadcaster**
— flexibility for the FRG-7 W8FX/4
- 74 J. B. Fields, Radioman**
— now it's the Navy's turn WB7S2C
- 76 Counter Accuracy For Perfectionists**
— updating the K2OAW counter
updates K0KDT/5
- 78 The New Op Amps**
— better, lower cost WA0UVX
- 80 22 Remote**
— outside programming for your IC-22S W8FX/4
- 84 Handling Ole George**
— is amateur radio ready? K5GNZ
- 86 The IC-22S Scanner**
— still another 22S mod W9LIJ
- 88 Computerized Capacity Meter**
— cost: \$1 plus a computer Eccleston
- 90 A Much Needed Micoder Power Supply**
— beats that lily-livered battery K3MPJ
- 92 Your 'Scope Can Be Improved**
— simple calibrator N5KR
- 96 How About SSB CB Conversions?**
— no strain W4GBB
- 98 The Universal Notcher**
— easy as pi W9CGI
- 100 The \$5 Memory Keyer**
— for lazy cheapskates WA2EBY
- 102 Should Repeaters Use Subaudible
Tones?**
— theological argument K9XI
- 110  RAMmed By Morrow**
— ECONORAM III lauded Hallen
- 112  Six Said His First Words Today!**
— and you taught him how WA3MWM
- 114  The 22S Programmer Program**
— diode selection in BASIC W6OVP, K6MAR
- 116  The Occult Computer**
— test for ESP with a micro WA6VIY
- 118  A Baudot Program For Your Micro**
— simulated Vegas visit Fricke
- 123 VHF Notch Filter**
— rejection can be beautiful WA4WDL, WB4LJM
- 124 Yes, You Can Build A Synthesizer!**
— 220 MHz synthesizer for under \$50 K2DVQ
- 134 Beat the Microphone Blahs**
— more oomph for FM audio K1HQW/4
- 136 Forbidden Contacts**
— 19 countries off limits to 4X4 amateurs Nobel
- 142 A Darn Good IDer**
— repeaters get smarter every day K5OM
- 146 Pick A Frequency . . . Any Frequency**
— ultra-flexible crystal calibrator W8FX/4
- 150 Sometimes A Kit Is Best**
— Bullet power supply kit exposed W6SWZ
- 154 Coming In Out Of the Cold**
— power supply for your mobile rig W6GXN
- 156 Roy Rogers Special: Triggered Sweep**
— lab scope performance for less than a
gigabuck Renaud
- 168 VHF Transverters and the FT-101**
— quickie FM conversion W6OJF
- 170 Instant Paddle**
— cheap, too W3IHA
- 172 Watch the Wind!**
— with this junk box anemometer WA4FWR/5
- 176 The War Against Rust**
— some good news for radio towers K8AO

Before you buy an amplifier



Lift the Lid

Before you invest your hard earned money in a linear amplifier, consider what's inside. That's where the difference in quality is obvious. No lightweight, cheaply built components... In Henry amplifiers you will find only the best quality, heavy duty components. We build our amplifiers to perform at peak level month after month, year after year. Both the 2KD-5 and the 2K-4 will operate full legal power continuous duty on all modes. We offer the amateur the linear amplifier that we would want in our own stations.

At Henry Radio we know how to build only one kind of amplifier... the best!

2KD-5 GENERAL SPECIFICATIONS:

- * The 2KD-5 is a 2000 watt PEP input (1200 watt PEP nominal output) RF linear amplifier, covering the 80, 40, 20, and 15 meter amateur bands.
- * Two Eimac 3-500Z glass envelope triodes operating in a grounded grid circuit.
- * Pi-L plate circuit with a rotary silver plated tank coil for greatest efficiency and maximum attenuation of unwanted harmonics.
- * Full legal input in all modes. 2000 watts PEP input for SSB. 1000 watts DC input for CW, RTTY and AM.
- * Jumper for 115 or 230 VAC. 3 wire single phase.
- * 10.5" high x 15" wide x 17.5" deep
- * Price... \$895.00

2K-4...LINEAR AMPLIFIER. Offers engineering, construction and features second to none. Provides a long life of reliable service, while its heavy duty components allow it to loaf along even at full legal power. Operates on all amateur bands, 80 thru 15 meters. If you want to put that strong clear signal on the air that you've probably heard from other 2K users, now is the time. Move up to the 2K-4. Floor console...\$1095.00

TEMPO 6N2 brings the same high standards to the 6 and 2 meter bands. A pair of advanced design Eimac 8874 tubes provide 2,000 watts PEP input on SSB or 1,000 watts on FM or CW. Complete with self-contained solid state power supply, blower and RF relative power indicator. ...\$895.00

TEMPO 2002. The same fine specs and features as the 6N2, but for 2 meter operation only ...\$745.00

TEMPO 2006. Like the 2002, but for 6 meter operation. ...\$795.00

TEMPO VHF/UHF AMPLIFIERS. Solid state power amplifiers for use in most land mobile applications. Increases the range, clarity, reliability and speed of two-way communications. FCC type accepted also.

Model	Drive Power	Output Power	Price
-------	-------------	--------------	-------

LOW BAND VHF AMPLIFIERS (35 to 75 MHz)

Tempo 100C30	30W	100W	\$159
Tempo 100C02	2W	100W	\$179
Tempo 100C10	10W	100W	\$149

HIGH BAND VHF AMPLIFIERS (135 to 175 MHz)

Tempo 130A30	30W	130W	\$189
Tempo 130A10	10W	130W	\$179
Tempo 130A02	2W	130W	\$199
Tempo 80A30	30W	80W	\$149
Tempo 80A10	10W	80W	\$139
Tempo 80A02	2W	80W	\$159
Tempo 50A10	10W	50W	\$ 99
Tempo 50A02	2W	50W	\$119
Tempo 30A10	10W	30W	\$ 89
Tempo 30A02	2W	30W	\$ 69

UHF AMPLIFIERS (400 to 512 MHz)

Tempo 70D30	30W	70W	\$210
Tempo 70D10	10W	70W	\$240
Tempo 70D02	2W	70W	\$270
Tempo 40D10	10W	40W	\$145

Tempo 40D02	2W	40W	\$165
Tempo 40D01	1W	40W	\$185
Tempo 25D02	2W	25W	\$125
Tempo 10D02	2W	10W	\$ 85
Tempo 10D01	1W	10W	\$125

TEMPO 100AL10 VHF LINEAR AMPLIFIER.

Completely solid state, 144-148 MHz. Power output of 100 watts (nom.) with only 10 watts (nom.) in. Reliable and compact... \$199.00

TEMPO 100AL10/B BASE AMPLIFIER...\$349.00

Henry Radio also offers a broad line of commercial and FCC type accepted amplifiers covering the range of 3 MHz to 500 MHz. Henry amplifiers are in use all around the world. Commercial and export inquiries are invited.

Tempo solid state amplifiers are available at Tempo dealers throughout the U.S.

please call or write for complete information

Henry Radio

11240 W. Olympic Blvd., Los Angeles, Calif. 90064 213/477-6701
 931 N. Euclid, Anaheim, Calif. 92801 714/772-9200
 Butler, Missouri 64730 816/679-3127

Prices subject to change without notice.

All of the above except the 6N2, 2002, and 2006 are available at Tempo dealers throughout the U.S.

THE NEW INDUSTRY STANDARD OF PERFORMANCE... IS THE **Wilson** SYSTEM ONE!

A DX'er's delight operating 20 meters on a full 26' boom with 4 elements, 4 operational elements on 20-15-10, plus separate reflector element on 10 meters for correct monoband spacing. Featured are the large diameter High-Q traps, Beta matching system, heavy duty taper swaged elements, rugged boom to element mounting . . . and value priced! Additional features: • SWR less than 1.5 to 1 on all bands • 10 dB Gain • 20-25 dB Front-to-Back Ratio.

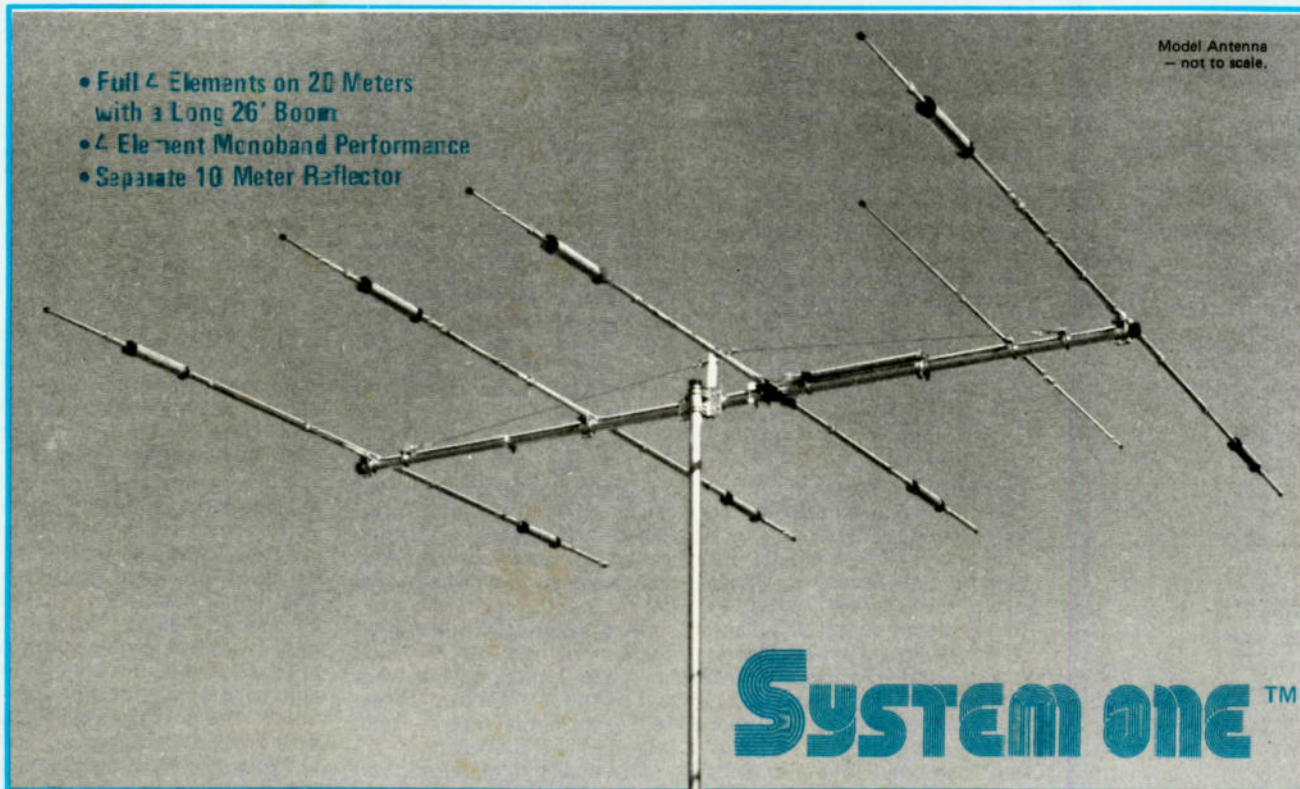

- Full 4 Elements on 20 Meters with a Long 26' Boom
- 4 Element Monoband Performance
- Separate 10 Meter Reflector

Model Antenna
— not to scale.

SYSTEM ONE™

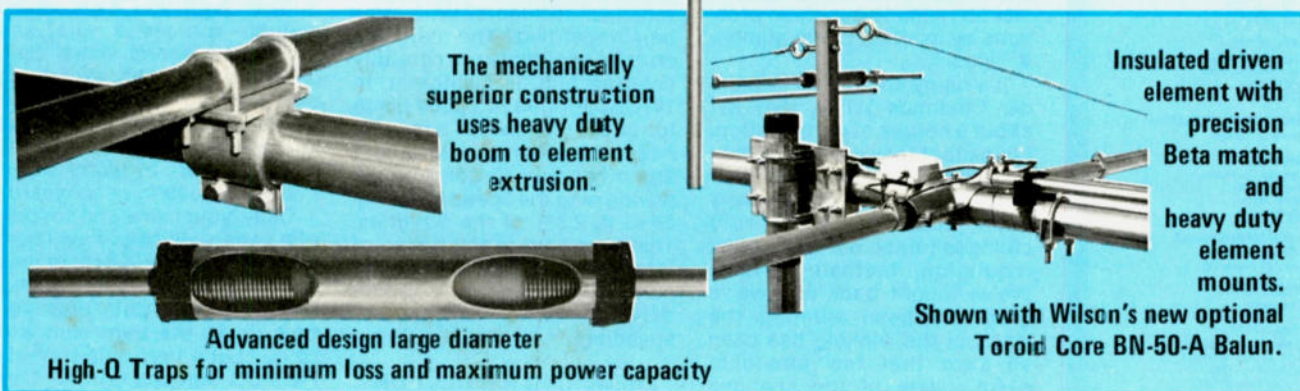

The mechanically superior construction uses heavy duty boom to element extrusion.

Insulated driven element with precision Beta match and heavy duty element mounts.

Shown with Wilson's new optional Toroid Core BN-50-A Balun.

Advanced design large diameter High-Q Traps for minimum loss and maximum power capacity

SPECIFICATIONS: SY-1

Matching Method Beta
Band MHz 14-21-28
Maximum Power Input Legal Limit
VSWR (at Resonance) 1.5 to 1
Impedance 50 ohms
Gain 10 dB

Boom Length 26'
Boom Diameter 2" O.D.
No. of Elements 5
Longest Element 26' 7"
Turning Radius 18' 6"
F/B Ratio 20-25 dB

Required Mast Diameter 2" O.D.
Surface Area 8.6 sq. ft.
Windload at 78 mph 215 lbs.
Shipping Weight 65 lbs.
UPS Shipment in 2 Cartons

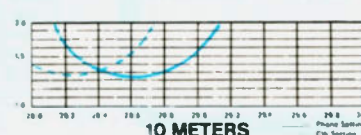
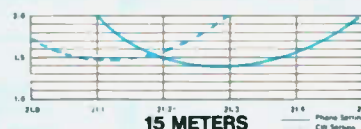
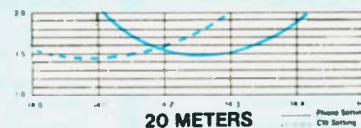

DEALERSHIPS AVAILABLE!!!
We are looking for new Dealers for certain areas of the country. If you are interested, contact us for details.

Wilson Electronics Corp.

4288 So. Palaris • P. O. Box 19000 • Las Vegas, Nevada 89119
Phone (702) 739-1931 • Telex 684-522

W2

EDITOR/PUBLISHER
Wayne Green W2NSD/1

EXECUTIVE VICE PRESIDENT
Sherry Smythe

ASSISTANT PUBLISHER
Jeffrey O. Detry WB8BTM/1

ADMINISTRATIVE ASSISTANT
Dotty Gibson

ASSISTANT BUSINESS MANAGER
Robert R. LaPointe

MANAGING EDITOR
John C. Burnett

ASSISTANT MANAGING EDITOR
Susan G. Philbrick

NEWS EDITOR
Gene Smarte WB8TOV/1

VO EDITOR
John Craig

BOOK PUBLICATIONS
Christopher E. Smith

PRODUCTION MANAGER
Lynn Panciera-Fraser

ART DEPARTMENT
Craig Brown
Gayle Cabena
Bob Drew
Bruce Hedin
Carl Jackson
James Lamothe
Dion Owens
Noel R. Self WB1ARP
Robin M. Sloan

PRINTING
Gary Steinbach
Andy Comeau
Oan Morgan

PHOTOGRAPHY
Bill Heydolph
Tedd Cluff

TYPESETTING
Barbara J. Latti
Jennifer Johansson
Mary Kinzel
Marie Walz

BOOKKEEPER
Knud E. M. Kellner KV4GG/1

CIRCULATION
Barbara Block

DATA ENTRY
Judy Waterman
Judy Brumaghim
Linda Gate
Mary Kinzel

DIRECTOR OF MARKETING
Daniel O. Savage

SHIPPING
Theresa Toussaint
Sus Chandler
Ethan Perry
Bill Barry

PLANT MAINTENANCE
Michael Coult
Lorraine Pickering

RECEPTIONIST
Doni Jarvis

ASSOCIATES
Robert Baker WB2GFE
E. H. Barnett WB8IX
Schley Cox WB9LHO
Tom DiBiase WB8KZO
Terry Fox WB4JF1
W. Sanger Green
Dave Ingram K4TWJ
Larry Kahner WB2NEL
Joe Kasser G3CZC
Bill Pasternak WA8ITF
John Schultz W4FA
Waller Scott K8DIZ
Peter Stark K2OAW
Bill Turner WABAB1

COMPUTER PROGRAMMING
Richard J. Dykema
Ron Cooke
Steven B. Lionel

ADVERTISING
Aime Coult
Marcia Stone
William G. York
Nancy Ciampa



EDITORIAL BY WAYNE GREEN

ANARCHY VS. GOVERNMENT REGULATION

The ten meter linear amplifier ban is the first concrete example of radio amateurs being punished by the FCC for the transgressions of CBers. This means that, in the future, an amateur wanting to run a reasonable amount of power on ten meters will be in trouble one way or another.

Sure, we'll be permitted to build a maximum of one amplifier per year of our own, but no kits are permitted. I don't know about you, but I hate to think of the TVI a lot of poorly built and filtered amplifiers can create. Or, we can buy a rig with a kilowatt amplifier built in, and that isn't going to be cheap because the regs, with regard to preventing 27 MHz retuning, will run the costs up, as will the time-consuming and expensive FCC acceptance hurdles.

In terms of FCC regulations, I lean towards anarchy... that is, the fewer rules, the better. This is being called populism, of late. No matter what you call it, I've seen it work over and over with amateur radio, and I am disappointed (but not surprised) at the number of hams who have been unable to learn from history and who, thus, insist on trying to cure ham problems by increasing the number of rules.

It's funny about the FCC. Under Chairman Wiley, they set about a course of deregulation. I think that they were sincere in believing that this was their goal. Yet, in just about every case, their proposed rule changes turned out to be more regulation, instead of less. We've fought back and we've gradually been winning the war, but the winning has been so slow that few amateurs seem aware of the changes we've brought about.

How do you fight the government? It's difficult, obviously. They are the ones printing our money, and they will use any amount of our money to get

their way, no matter how indefensible their way is. If their way turns out to be particularly bad, they set themselves up as the scorekeepers and issue periodic releases to the press and TV as to how great things are going.

A fine example of this is the National Highway Traffic Safety Administration (NHTSA) and their 55 mph speed limit. The May issue of *Car and Driver* exposes the NHTSA statistics on traffic safety to show, rather conclusively, that, using the government's own figures, there has been an increase in traffic deaths at 55 mph vs. those at 70 mph, after some other obvious factors have been taken into consideration.

Oh, yes, the gas saving... heh. It turns out, using the government's figures again, that the saving has amounted to about 1%, which is less than we could expect if we increased the pressure in our tires by two psi.

So, if the 55 mph speed limit costs more lives than a 70 mph limit, and it saves no gas, what is it there for? To make money. To make a lot of money... and, in that, it is a success.

Speed kills, right? Would you say it is the number one killer in vehicular accidents? Well, maybe number two? The statistics on fatal accidents are carefully checked and, in California, in 1976 (California is a good place to check, because everyone has to drive there... there isn't any other way to get around), driving over the speed limit was cited in 2.3% of the fatalities. That was 11th in the cause of fatalities. It is almost insignificant compared to drunken drivers (who were not speeding).

PREACHING REVOLUTION

There was a time in this country when citizens were able to get outraged over gross violations of their privilege of doing what they wanted as long as it didn't hurt others. There

was a time when the people of the United States of America were so proud of their country that they took personal pride in its being first-rate, and they did something about it when lousy laws were pushed through. Today, I keep hearing on all sides that we must obey all laws, no matter how unjust or unreasonable... and we must not rock the boat. Remember that it is a waste of time to fight city hall, so knuckle under and play Uncle Tom.

It is seldom productive to openly refuse to obey the law. This gets you in jail, with a bunch of people jeering at you, and little else. But there are ways you can fight back, even today... heck, especially today. In these days of The Media, you want to take advantage of every edge you can get to turn things around.

FIGHTING THE FCC

First, do you intend to take the restrictions on amplifiers lying down? Aren't you the least bit irked at the injustice of it all? Are you really so dead inside that you don't give a damn?

If that reached you, then you are wondering what you might be able to do and probably hoping that it won't be much trouble and won't force you to put your name on anything... after all, no sense taking chances... right? I've seen people afraid to put their name on a petition to nominate a man for a political office. *Afraid!* Look here! If you care much about anything, you put your name out there where the politicians can see it. This is one thing you have which counts—you are a vote, and politicians spend more time getting votes than everything else they do combined. Their whole life revolves around the next election, even though you may not start to worry about that for two, four, or six years.

Okay, your name and support of a cause will help. It will help a lot. But you can do more than say "here, here" when someone with more guts than you gets up in the ham club and says, "Let's fight this travesty the FCC dumped on us." One man can do a lot. Two can do much, much more, if they cooperate so as not to duplicate the work.

Getting down to the nitty-gritty, what can you and your club do about the situation? Your first step is to read the rules and the recent changes. See any copy of a 73 license study guide for the rules, and read the complete unexpurgated FCC regulation changes in 73. Decide what changes you think should be made... hopefully toward deregulation. Then start your campaign. You want to write to your congressmen and

73 Magazine is published monthly by 73, Inc., Peterborough NH 03458. Subscription rates in the U.S. and Canada are \$15 for one year, \$26 for two years, and \$36 for three years. Outside the U.S. and Canada, write for rates. Second class postage paid at Peterborough NH 03458 and at additional mailing offices. Publication No. 700420. Phone: 603-924-3873. Entire contents copyright 1978 by 73, Inc. INCLUDE OLD ADDRESS AND ZIP CODE WITH ADDRESS CHANGE NOTIFICATION. Microfilm edition—University Microfilm, Ann Arbor MI 48106.

The TS-820S... known worldwide as the Pacesetter. Amateur Radio Operators universally respect its superb quality, proven through thousands of hours of operating time under all environmental conditions. The TS-820S has every feature any Amateur could desire for operating enjoyment, on any band from 160 through all of 10 meters.

TS-820S

You can always tell who's running a TS-820S. Its superb quality stands out from all the other rigs on the band... and when the QRM gets heavy, the TS-820S's adjustable RF speech processor, utilizing a 455-kHz circuit to provide quick-time-constant compression, will get the message through. RF negative feedback is applied from the final to the driver to improve linearity, and third-order products are at least -35 dB. Harmonic spurious emissions are less than -40 dB and other spurs are less than -60 dB. RF input power is 200 W PEP on SSB, 160 W DC on CW, and 100 W DC on FSK. Receiver sensitivity is better than 0.25 μ V for 10 dB S/N. The TS-820S is known for its superb receiver selectivity, and its famous IF shift easily eliminates heavy QRM. That's why the TS-820S is the DXer's choice.

See your local Authorized Kenwood Dealer today.



TS-820S VFO-820S SP-820

Kenwood's unbeatable combination. The VFO-820 solid state remote VFO adds greatly to the versatility of your TS-820S. It has its own RIT circuit and control switch and is a perfectly matched accessory. The SP-820 deluxe external matching speaker includes audio filters for added versatility on receive and two audio inputs.

The TS-520S . . . the most popular Amateur Radio transceiver in the world . . . provides a foundation for an expanding series of accessories designed to please any ham . . . from Novice to Amateur Extra.

TS-520S

The TS-520S transceiver provides full transmit and receive coverage of all Amateur bands from 160 through 10 meters. It also receives 15.0 (WWV) to 15.5 MHz and another 500-kHz range of your choice in the auxiliary band position. With the optional DG-5, you have a large digital frequency readout when transmitting and receiving, and the DG-5 also doubles as a 40-MHz frequency counter. The TS-520S includes a built-in AC power supply, and, with the addition of the optional DS-1A DC-DC converter, it can function as a mobile rig. It features a very effective noise blanker, RIT, eight-pole crystal filter, 25-kHz calibrator, front-panel carrier level control, semi-break-in CW with sidetone, built-in speaker, heater switch, 20-dB RF attenuator and easy phone-patch connection. RF input power is 200 W PEP on SSB and 160 W DC on CW. Carrier suppression is better than -40 dB and sideband suppression is better than -50 dB. Spurious radiation is less than -40 dB. Receiver sensitivity is 0.25 μ V for 10 dB (S+N)/N. Selectivity is 2.4 kHz at -6 dB/4.4 kHz at -60 dB and, with the optional CW-520 CW filter, is 0.5 kHz at -60 dB.

See your local Authorized Kenwood Dealer for more information, and a super deal!



A great station . . . at an affordable price! The TS-520S with its companion accessories . . . including two new units. The AT-200 antenna tuner provides a versatile tool in any station. The other is the TV-520S, Kenwood's 2 meter transverter for SSB and CW operation from 146 to 148 MHz.

The 599D "Twins" are offered to the discriminating Amateur who appreciates the advantages of operating a separate transmitter and receiver.

The R-599D receiver and T-599D transmitter provide greater flexibility with more features than found in a transceiver.

The R-599D receiver is all solid-state, covering all Amateur bands from 160 through all of 10 meters, as well as auxiliary band and WWV (10 MHz). With optional converters it also receives 6 meters and 2 meters. Modes include LSB, USB, CW, AM, and FM. A 2.2-kHz eight-pole filter is built-in for SSB, as well as a 500-Hz eight-pole CW filter and a 5.0-kHz six-pole AM filter. An optional 14.0-kHz six-pole FM filter is available. Also featured are an AGC control (slow/fast/off), 25-kHz calibrator, RIT, noise blanker, ANL (AM), squelch, monitor, VFO selector, and RF gain control which does not affect S-meter reading.

The T-599D transmitter is solid-state except for the driver and final tubes. It covers the 80 through 10-meter Amateur bands, on LSB, USB, CW, and AM. An AC power supply is built-in. Also included are VOX, anti-VOX, PTT, semi-break-in CW with sidetone, ALC, transmitter terminal.

Enjoy split frequency control in four separate/transceiver combinations with the 599D "Twins". See your local Authorized Kenwood Dealer for more information.

R-599D/T-599D



R-300

The R-300 all-band communications receiver covers the following ranges: (A) 170-410 kHz; (B) 525-1,250 kHz; (C) 1.25-3.0 MHz; (D) 3.0-7.5 MHz; (E) 7.5-18.0 MHz; and (F) 18.0-30.0 MHz. It receives AM, SSB, and CW. The receiver features large, easy-to-read drum dials. Bandspeed is calibrated for 10 foreign-broadcast shortwave bands, and a replacement bandspeed calibration is available for the 80-10-meter Amateur bands. Included is a three-way power supply (AC/batteries/external DC). Wide and narrow ceramic filters are employed for high selectivity. Also included is a 500-kHz calibrator.

IT'S NEW . . . IT'S UNIQUE . . . AND IT'S TRULY USEFUL. IT'S KENWOOD'S SM-220 STATION MONITOR. THE SM-220'S UNEXCELLED VERSATILITY ALLOWS YOU TO MONITOR YOUR TRANSMISSIONS, MONITOR INCOMING SIGNALS, AND MONITOR THE AMOUNT AND STRENGTH OF BAND ACTIVITY* AND PERFORMS AS A GENERAL-PURPOSE 10 MHz OSCILLOSCOPE, AS WELL.

Kenwood offers this totally unique unit as a perfect compliment to your TS-820S or TS-520S station.** The SM-220, based on a wideband oscilloscope (2 Hz to 10 MHz), permits you to monitor your transmitted signals, thus assuring optimum linearity and maximum performance. With the addition of the BS-5 or BS-8 Pan Display option you will be able to determine visually the location and strength of adjacent signals without tuning your receiver off frequency. The choice of options allows you to adapt the SM-220 to either the TS-820 series or TS-520 series.

The SM-220 has a built-in two-tone audio generator with full provisions for tuning your exciter and linear amplifier (160 m through 2 m).

All this costs little more than a general-purpose oscilloscope. And, of course, it's pure Kenwood quality.

*With BS-5 or BS-8 option

**For other models check with appropriate manufacturer for compatibility.

SM-220



Function: Selects operation mode: OSC/RTTY: General testing of station equipment, experimental design of new equipment, or troubleshooting; display of receiver IF output allows you to give signal quality reports.

Power ON indicator
Power switch

Intensity: Controls brightness of scope display.

Band Scope: (Pan Display) With BS-5 or BS-8 option, shows you to "see" the signals on both sides of your operating frequency without tuning your receiver off frequency. Useful for determining "band conditions", band crowding, source of interference from adjacent stations . . . a visual display of what you would hear if you tuned across the band, without having to touch your receiver's dial.

Focus: Controls sharpness of scope display.

Vertical Attenuator: Precision step attenuator (gain control) switch adjusts vertical input level.

Vertical Input: Accepts IF input, RTTY input or oscilloscope input.

Vertical Gain: Potentiometer to fine-adjust vertical input level.

Adjusts display along vertical axis.



RF Attenuator: Level control used in MONI/TRAP mode.

Tone: Step switch selects Wien bridge tone generators; 1000 Hz, 1575 Hz or both tones simultaneously.

Out: Output of the audio generator can be connected to the transceiver's microphone input for "two-tone test"; Also for trapezoidal test of transceiver linear amplifier.

Synchronization Marker: Selects internal or external sync (similar to horizontal hold on TV. Turns On or Off the built-in marker which shows operator where his receiver is actually tuned.

Scan Width: Selects width of "window" or receive band display when using the Pan Display option (100 kHz or 20 kHz).

Variable sweep control/External gain: Controls (1) sweep speed of display in any sweep range, (2) optional Pan Display (Band Scope) speed of display, (3) level of horizontal input/external synchronization input when sweep range is in RTTY/Ext or Trap.

Horizontal Input/External Sync: Accepts either (1) RTTY input for tuning, (2) external sync input for test (oscilloscope functions), (3) external oscillator for Lissajous display.

Sweep Range: Step switch controls sweep band width or switches horizontal input/external sync terminal ON.

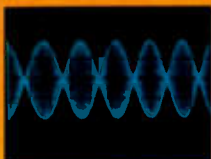

Two-Tone Wave Envelope
For "performance" tune-ups or checking proper transceiver operation.



Pan Display Use to check source of interference during "QSO" without moving off-frequency. Also determines location and strength of adjacent frequencies. (Requires BS-5 or BS-8 option)



Keyed Waveform Shows detail of CW keying. Use to monitor the quality of your CW note. (Photo shows ideal waveform produced by TS-B205.)

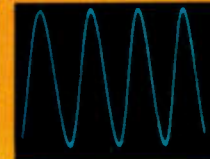

Oscilloscope Operation (1 kHz) Oscillator function allows Sine, square wave, Lissajous patterns for testing or design work.



Trapezoid (TS-B20S w/ TL-922) Shows linearity of power amplifier. Used primarily for testing.

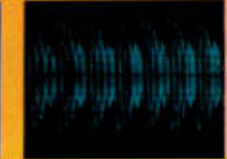

Wave Envelope shows full SSB voice modulation with processor on (full compression), and "clean signal" at full power.

STILL THE SAME FINE, TIME PROVEN RIG. BUT NOW WITH THE SIMPLE ADDITION OF A PLUG-IN CRYSTAL, THE TS-700SP WILL BE ABLE TO UTILIZE THE NEW REPEATER SUB-BAND (144.5 to 145.5 MHz) STILL FEATURES ALL OF THE FINE ATTRIBUTES OF THE TS-700S: A DIGITAL FREQUENCY DISPLAY, RECEIVER PRE-AMP, VOX, SEMI-BREAK IN, AND CW SIDETONE. OF COURSE, IT'S ALL MODE, 144-148 MHZ, VFO CONTROLLED... AND KENWOOD QUALITY THROUGHOUT.

Features: 4 MHz band coverage (144 to 148 MHz)
• Automatic repeater offset capability on all FCC authorized repeater subbands including 144.5 - 145.5 MHz • Simply dial receive frequency and radio does the rest... simplex, repeater, or reverse. Same features on any of 11 crystal positions • Transmit/Receive capability on 44 channels with 11 crystals • Operates all modes: SSB (upper and lower), FM, AM and CW • Digital readout with "Kenwood Blue" digits • Receiver pre-amp • Built-in VOX • Semi break-in on CW • CW sidetone • All solid-state • AC and DC capability. 10 watts RF output on SSB, FM, CW • 3 watts on AM • 1 watt FM low-power switch • 0.25 μ V for 10 dB (S+N)/N SSB/CW sensitivity • 0.4 μ V for 20 dB quieting FM sensitivity.

10 watts RF output on SSB, FM, CW • 3 watts on AM • 1 watt FM low-power switch • 0.25 μ V for 10 dB (S+N)/N SSB/CW sensitivity • 0.4 μ V for 20 dB quieting FM sensitivity.

TS-700SP



TS-600

The luxury all-mode transceiver for 6 meters. All solid-state. SSB, FM, AM, and CW.

It's easy to work VHF DX on 6 meters with the TS-600 all-mode transceiver. The 10-watt, solid-state rig covers 50-54 MHz, with built-in VFO and 20 fixed channels. The main tuning dial is calibrated every 1 kHz for precise tuning. The built-in AC/DC power supply allows base and mobile operation. Other features include a noise-blanker circuit and RIT (receiver incremental tuning).

The fully-synthesized TR-7400A 2-meter FM transceiver operates on 800 channels and features repeater offset over the entire 144-148-MHz range, dual frequency readout, six-digit display, and subaudible tone encoder and decoder. RF output is at least 25 watts!

The TR-7400A 2-meter FM transceiver provides fully synthesized operation, including 600-kHz repeater offsets, over the entire 144-148-MHz range. It can operate on any of 800 channels, spaced 5 kHz apart. RF output is at least 25 W, and typically 30 W. A low power position produces 5-15 W (adjustable). Included is a dual frequency readout with large six-digit LED display plus a dial readout. The subaudible CTCSS signaling feature may be used on transmit and receive, or transmit only. Optional tone-burst modules are available. Receiver sensitivity is better than 0.4 μ V for 20 dB quieting. Large, high-Q, helical resonators minimize interference from outside the band. A two-pole 10.7-MHz monolithic crystal filter provides excellent selectivity. Optional active filters are available for 15-kHz "split" operation. Intermodulation distortion is down more than 66 dB, spurious rejection is better than -60 dB, and image rejection is better than -70 dB.

See your local Authorized Kenwood Dealer today, for a demonstration of the fantastic TR-7400A.

TR-7400A



TR-8300

FM transceiver for 70-cm Amateur band. 23 crystal-controlled channels (three supplied). Transmitter output is 10 watts.

The TR-8300 450-MHz FM mobile transceiver provides 10 watts output (switchable to 1 watt) on 23 crystal-controlled channels (three pairs of crystals supplied). The transmitter covers 445 to 450 MHz, and the

receiver covers 442 to 447 MHz. The receiver includes a five-section helical resonator and a two-pole crystal filter in the IF for improved intermod rejection. Sensitivity is 0.5 μ V for 20-dB quieting. A front-panel switch may be used to activate tone-signaling or other user-provided function. An LED indicates receive crystal functioning. A monitor circuit allows user to listen to his own modulation.

INTRODUCING THE ULTIMATE IN RECEIVER DESIGN ...THE KENWOOD R-820

With more features than ever before available in a ham-band receiver. This triple-conversion (8.33 MHz, 455 kHz, and 50 kHz IFs) receiver, covering all Amateur bands from 160 through 10 meters, as well as several shortwave broadcast bands, features digital as well as analog frequency readouts, notch filter, IF shift, variable bandwidth tuning, sharp IF filters, noise blanker, stepped RF attenuator, 25 kHz calibrator, and many other features, providing more operating conveniences than any other ham-band receiver. The R-820 may be used in conjunction with the Kenwood TS-820 series transceiver, providing full transceive frequency control.

R-820

- A S-METER** Easy-to-read, calibrated to S9 + 40 dB full scale and dB/μV
- B STANDBY/RECEIVE SWITCH** Disables audio circuits during transmit mode with associated transmitter.
- C CALIBRATOR SWITCH** Built-in crystal calibrator, settable to WWV, provides signal every 25 kHz
- D NOISE-BLANKER SWITCH** A specially designed crystal filter eliminates noise pulses such as ignition-noise interference
- E MONITOR SWITCH** RF sampling allows user to hear his own voice when using associated transmitter.
- F AGC SWITCH** Automatic-gain-control circuit switchable to slow or fast response, or completely off
- G RECORD JACK** Makes recording off the air simple.
- H HEADPHONE JACK** Provision for plugging in headphones
- I MODE SWITCH** Selection of AM, CW, upper or lower sideband, or RTTY
- J RF-ATTENUATOR SWITCH** 10 dB steps of attenuation from 0 to 40 dB, to prevent overloading from nearby stations, and for precise signal comparison.
- K DIGITAL HOLD** Locks counter and display while VFO is tuned to another frequency. Helps return to "hold" frequency.
- L VFO/CRYSTAL SWITCH** Permits VFO control or crystal control on four selectable frequencies.
- M LED INDICATORS** Light-emitting diodes indicate activation of notch filter, crystal-controlled reception, VFO control, and RIT
- N DRS DIAL** Satin-smooth VFO tuning dial system provides easy analog frequency readout (useful when digital hold is activated). LSB, USB, and CW frequencies are accurately read from the same pointer.
- O NOISE-BLANKER LEVEL CONTROL** Controls level of blanking, for maximum effect in eliminating noise interference.
- P MONITOR CONTROL** Adjusts level of RF sampling
- Q TONE CONTROL** Varies audio-output frequency response
- R TRANSCIVE SWITCH** Selects frequency tuning from either the receiver or TS-820 series transceiver.
- S VBT/SELECTIVITY CONTROLS** Separate controls on the same shaft provide variable bandwidth tuning as well as selection of four IF filters: 250 Hz*, 500 Hz*, 2.4 kHz, and 6 kHz* (optional). CW filters function in 455-kHz IF for superior shape factor.
- T PRESELECTOR** Peaks tuned circuits in RF amplifier stage for increased selectivity and sensitivity. RF amplifier coil is dual-tuned.
- U RIT/NOTCH CONTROLS** RIT allows receiver to be tuned off frequency, while not affecting transmit frequency, when in transceive mode with TS-820. Notch control tunes notch within IF passband for eliminating interference. Notch frequency remains the same, even when IF shift is utilized.

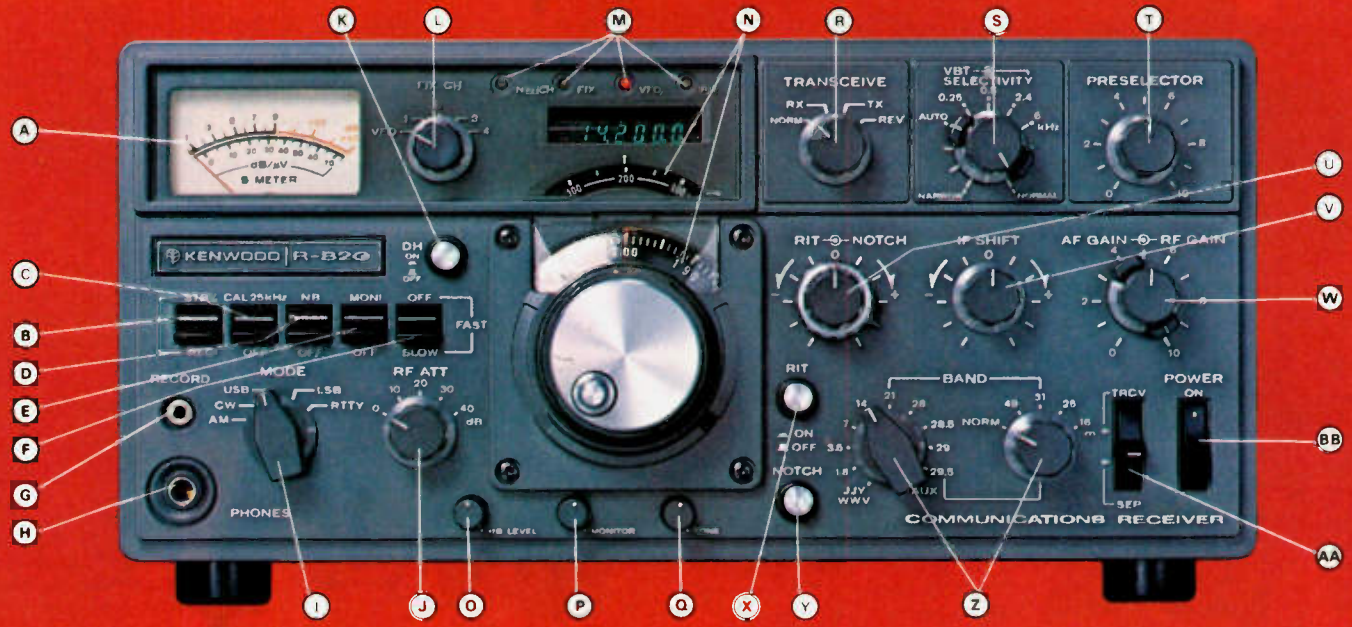

- V IF SHIFT** Varies (shifts) IF passband away from interfering signal.
- W AF GAIN / RF GAIN** Separate controls adjust volume and RF gain.
- X RIT SWITCH** Allows tuning off frequency with RIT control, and return immediately to VFO frequency by pushing switch.
- Y NOTCH SWITCH** Takes variable notch filter in and out of circuit.
- Z BAND SWITCHES** Selects frequency bands from 15 MHz (WWV), 160 through 10 meters, the 49, 31, 25, and 16-meter shortwave broadcast bands, and an auxiliary band.
- AA TRANSCIVE/SEPARATE SWITCH** Enables receiver VFO to control the receiver and TS-820 (or TS-820S) frequency (or the TS-820 VFO to control both), or both can function independently.
- BB POWER SWITCH** Turns receiver on and off.

R-820 PERFORMANCE SPECIFICATIONS

Frequency Range:

160 meters (1.8-2.0 MHz)
80 meters (3.5-4.0 MHz)
40 meters (7.0-7.5 MHz)
20 meters (14.0-14.5 MHz)
15 meters (21.0-21.5 MHz)
15 meters (21.0-21.5 MHz)
10 meters (28.0-28.5 MHz)
10 meters (28.5-29.0 MHz)
10 meters (29.0-29.5 MHz)
10 meters (29.5-30.0 MHz)
19 meters (15.0 (WWV)-15.5 MHz)
49 meters (5.9-6.4 MHz)
31 meters (9.4-9.9 MHz)
25 meters (11.5-12.0 MHz)
16 meters (17.7-18.2 MHz)
Auxiliary band

Modes AM, CW, USB, LSB, RTTY
 Sensitivity: 160-10 m, 19 m, SSB, 0.25 μV at 10 dB S+N/N
 AM 1.5 μV at 10 dB S+N/N
 49, 31, 25, 16 m, SSB, 0.5 μV at 10 dB S+N/N
 AM, 3.0 μV at 10 dB S+N/N

Selectivity CW (with optional 250-Hz filter), 250 Hz (-6 dB), 500 Hz (-60 dB)
 CW (with optional 500-Hz filter), 500 Hz (-6 dB), 850 Hz (-60 dB)
 SSB (2.4-kHz filter), 2.4 kHz (-6 dB), 4.4 kHz (-60 dB)
 AM (6-kHz filter), 6 kHz (-6 dB), 12 kHz (-60 dB)

Image Ratio: 160-10 m, 19 m, 80 dB
 49, 31, 25, 16 m, 60 dB

IF Rejection: 160-10 m, 19 m, 90 dB
 49, 31, 25, 16 m, 50 dB

Power Requirements: 100/120/220/240 VAC 50/60 Hz, or 12-15 VDC
 Dimensions: 13-1/8" (333 mm)W x 6" (153 mm)H x 13-3/16" (335 mm)D
 Weight: 26.4 lbs (12 kg)



AT-200

The AT-200 is an antenna tuner, but it's also much more. It's an antenna switch, an SWR bridge and an in-line wattmeter. The AT-200 reduces the clutter and increases the operating efficiency of your station... and at a surprisingly moderate price.

The AT-200 features a seven position rotary switch that selects 1 of 3 antennas and connects it through the antenna tuner circuit or directly to the transceiver. The 7th position allows you to connect a dummy load directly to your transceiver for tune up and testing. Two of the antenna inputs are fitted with SO-239 type coax connectors. A third input allows for easy hook up of a wire antenna with an impedance of 10 to 500 ohms. The AT-200 may be used on all HF amateur bands from 160 to 10

meters. It's handsomely styled to match the TS-820S and TS-520S Series (and TS-820 and TS-520), but can also be used with any HF transceiver or transmitter with less than 200 watts output.

Frequency coverage: Amateur bands 1.8 to 30 MHz • Input impedance: 10 to 500 ohms • Maximum power capability: 200 watts • Insertion loss: 0.5 dB • Power meter: 20 watt/200 watt full scale • SWR meter measures up to 10:1 • Dimensions: 6-1/2"W x 7-3/8"D x 6-9/16"H • Weight: 6.2 lbs.



TV-506

The TV-506 6-meter transverter produces 10 watts on SSB and CW. Simply plug it into your TS-520 or TS-820 Series transceiver. It works with most other transceivers, too.

TV-502S

The TV-502S 2-meter transverter produces 8 watts on SSB and CW. It easily hooks up to the TS-520 and TS-820 Series transceivers.



HS-4

The HS-4 headphone set is comfortably padded and is completely adjustable for extended periods of wear. Frequency response is designed for Amateur communications (300 to 3000Hz). Impedance is 8 ohms.

MC-50

The MC-50 dynamic microphone is perfect for any ham shack, and is ideal for all Kenwood equipment as well as many other brands. It includes PTT and LOCK switches, as well as a microphone plug wired for instant connection to any Kenwood rig. It is easily converted to high or low impedance (600 Ω or 50 k Ω).

MC-30S & 35S

The MC-30S and MC-35S dynamic mobile microphones provide 150-5000 Hz frequency response (150-4000 Hz when operated as noise-cancelling microphones). The MC-30S impedance is 500 Ω and the MC-35S is 50 k Ω .

OTHER KENWOOD PRODUCTS

ACCESSORIES

FOR TS-820 Series
160-10-m transceiver
DG-1 digital frequency display
VFO-820 deluxe remote VFO
CW-820 500-Hz CW filter
DS-1A DC-DC converter
SP-820 external speaker with audio filters

ACCESSORIES

FOR TS-520 Series
160-10-m transceiver
DG-5 digital frequency display
DK-520 digital adaptor kit for TS-520
VFO-520 remote VFO
SP-520 external speaker
CW-520 500-Hz CW filter

ACCESSORIES

FOR 599D Series
160-10-m transmitter and receiver
S-599 external speaker
CC-29A 2-m converter
CC-69 6-m converter
FM-599A FM filter

ACCESSORIES

FOR TS-700SP
2-m all-mode transceiver
VFO-700S remote VFO
SP-70 matching speaker
Other products:
PS-6 power supply for TR-7500 and TR-8300
PS-8 power supply for TR-7400A
VOX-3 VOX for TS-600/TS-700A
Active filter elements for TR-7400A



TRIO-KENWOOD COMMUNICATIONS INC.
1111 WEST WALNUT/COMPTON, CA 90220

your senators, to the FCC commissioners individually, with copies to your congressmen. You want to get releases out to the papers, to TV stations, and to talk-show hosts. Get club members to personally visit congressmen either in Washington (if they happen to be there), or when the congressmen come home for a visit.

If you have any idea that petitions don't work, just try one on a politician and be amazed. Your congressional representative knows well that those signatures are votes... the things he has devoted his life to getting, at almost any cost. If getting the vote of you and your friends means bisecting the FCC, then the FCC will get bisected.

WE CAN SELF-GOVERN

Yes, I know all about the crazies. We've always had 'em. But one of the reasons I never miss a "Silent Keys" column is to watch for my favorite bad guys to make that final honor. But despite these mentally handicapped irritations, the mainstream of amateur radio manages to progress... particularly when the FCC acts so slowly that it does not have an opportunity to screw things up... which, fortunately, is a lot of the time.

In recent years, we had the transition from AM phone to sideband. This was accomplished by way of a "gentlemen's agreement" that sideband would use the top part of the 20m band and AM the lower part. Sideband gradually crept down until there was no AM left. Not without skirmishes with Those Who Fight Progress. FM repeaters also developed reasonably, when left alone.

In the early days of repeaters, we had wars between groups, but, after a while, reason prevailed and the repeater groups got together, forming coordinating committees and repeater councils. By the time the FCC came along with repeater rules, they were totally unneeded. Repeater wars were about 90% coordinated throughout the country. Most of the wars had been cooled and things were relatively peaceful. One of the last things we needed were those repeater regulations.

Is it possible that amateurs could get together and develop their own rules? I think it would work. I think the FCC could get out of the ham business completely and amateurs would be able to govern themselves, with or without the ARRL. We could agree on allocations for the different modes, on band plans, and even on setting up our own licensing exams. We could also do a lot more to free ourselves from problems brought on by

the crazies.

If we were self-governing, we could call out-of-line amateurs to task and put peer pressure to work. Repeaters would not spring up without coordination, if all of the repeater users would work together to discourage this. Uncoordinated repeaters could be forced to get off the air if amateurs would refuse to use them. We could take the time to get on and announce our desire that a repeater be coordinated before being opened for general use.

It comes down to this: democracy or dictatorship. And excessive government regulation certainly does not qualify as democracy. The rules we've been getting from the FCC could even be challenged in court—if we had an organization with the money and the guts to do it. Lacking any such, it is up to us as individuals to fight the only way we can... with letters to congress, letters to the Commissioners, with group actions through our clubs, and with releases to the papers and media. Yes, I'm preaching revolution against the FCC, using the tools which we know work and which are within the laws of our country.

WASTING TIME

Somewhere on my desk is a letter from a reader who says he has been trying to learn Morse code since 1914. Now he has bought my code tapes and hopes this will make the difference. It won't.

The only way I've found to get things done is go ahead and do them, whether I like it or not. Buying a code tape and putting it in a drawer is not going to do much, obviously. Even going to the extent of putting it under your pillow for mental assimilation will not increase code speed. Sure, my tapes make it easier to learn the code than any other way, but only if you take the time to use them.

Fifteen or twenty minutes a day is not much to spend on something as valuable and fun as a ham ticket. When you get up from some stupid television show you've been watching, ponder, if you will, on how much value this is going to have for you ten years hence. Hell, you won't remember the dumb thing very clearly next week, unless you go back under hypnotic regression. By next year, you'll be able to watch the rerun and wonder if you saw that particular episode during the first run.

As a registered procrastinator, I feel free to pass along gratuitous advice on getting things done. If I hadn't done exactly the same thing with the code, I would have had my ham ticket a couple of years earlier

than I did. Two years of precious ham time was wasted because I wouldn't spend a few hours practicing the code.

Let's be honest for a moment. How many things that you consider important have you done in your life which didn't take a lot of time and trouble? I can't think of anything I'm proud of which didn't take a good deal of effort and determination. Now, how about getting going on your code?

MAKING MONEY

Every now and then, a ham says that he really can't afford to buy a subscription to *73* because he doesn't have the money. With all of the opportunities there are to make money, this is almost beyond understanding. Hell's bells! All it takes is the gumption to actually do some of the things which are obvious to us all.

Some years ago, I suggested that hams were ideally suited to getting into the security business. Several dozen readers took me up on that and I've had letters from many of them saying that they tried it and have done splendidly. It's certainly easy to get started, with several firms catering to your security supply needs with mail-order catalogs (such as Mountain West Alarm Supply, Box 10780, Phoenix AZ 85064; Emel Electronics, Box 146, Sheffield MA 01257; Ellin Alarm, 161 Bonad Road, Chestnut Hill MA 02167).

Businesses which can be run in spare time are great and they can be expanded to take over full time if they are more profitable than the old button factory.

Another great spare-time possibility is distributing magazines and books. There are thousands of smaller magazines which are looking desperately for help with this. Our experiments with local newsstand distribution of *73* and *Kilobaud* indicate that if the magazines are on display, they will sell. Unfortunately, most of the magazine wholesalers don't want to be bothered with small circulation magazines, so they won't deal with publishers. This is an opening for spare-time money-making. Just in the town of Peterborough (4500), an area representative can make about \$25 per month, with one afternoon's work.

Our area rep program has shown that reps in many areas are able to make \$300 or more a month with one or two days' work. That will buy a lot of magazine subscriptions, and could even build up your ham shack pretty fast. Contact our Marketing Manager, Dan Savage, and find out if your area is available for representation. You'd represent *73* and *Kilobaud* for sales

on newsstands, radio and computer store counters, bookstores, hamfests, computerfests, etc. Some reps have made over \$1000 in one week-end at hamfests!

With amateur radio equipment sales growing by leaps and bounds, you might be able to work part-time in a local radio store, managing their ham department. Almost every ham store has a desperate need for part-time help in servicing, too, if you're handy at that.

There are so many money-making opportunities in micro-computing that it is difficult to even suggest where to start. One thing is for sure: You should get your feet wet with one of the lower cost systems such as the KIM. These are expandable, and you'll end up understanding the things which will be of value to you in the long run... both in hardware and software. Teenagers are having a ball with this stuff, so it doesn't take a scientist to catch on.

In computing, people are making money by manufacturing, by opening computer stores, by servicing, and there is a big future in writing programs for the more popular systems. Programmers may eventually be the highest paid people in the business. One single program could easily bring in over \$1 million in royalties as this field gets going.

If you put off doing things like this, life can slip away from you before you realize it. If you've got plenty of money and are living the life you like, then you're all set. But, if you have to worry about how much that new rig from Icom is going to cost, or whether you can afford to buy a new tower, or go on a DXpedition to Bonaire, then get the juices running and get into action.

You don't have to run with my ideas... you can think up your own. Once you start thinking in these terms, the opportunities are all around you.

MARCH WINNER

Solar power is in the forefront of the news these days, a fact somewhat reflected by the overwhelming vote for "The Solar-Powered Ham Station" as the best article in our March issue. Thanks for author Brian Kassel W5VBO's \$100 check from *73* should go to the many people who cast reader service card ballots in favor of his article.

Speaking of the sun, we hope that Brian will consider spending a little of his loot for *The Propagation Wizard's Handbook*, written by our own John Nelson (73 Inc., \$6.95).

LETTERS

RADAR AND RAPE

Along with my order for back issues, I would like to commend you on a fine magazine.

Besides the large number of practical articles by genuine electronics enthusiasts, the latest series of articles on the 10 GHz band has prompted this letter.

As I received the May issue today, I was pleasantly surprised to find the long awaited article (by John Franke) on countermeasures to police radar. As you may know, police use of radar in Ohio has been carried to the extreme. This has made the investment in anti-radar equipment a very practical move.

Please continue your policy of numerous and varied articles on new ideas in all phases of electronics.

Michael Niklas
Columbus OH

I just finished reading "Can Hams Counter Police Radar?" by John M. Franke WA4WDL.

I am anxiously awaiting your next articles on "How to Conduct a Successful Murder and Not Get Caught," "Rape in One Easy Lesson and Not Have a Worry," and "How To Hold Up a Bank and Never Get Caught." Of course, they will all have your approval.

Frankly, the article by Franke stinks and your approval brings 73 Magazine to a new low.

You can argue till hell freezes over about the so-called possible damages of microwaves. But until the laws are changed, it's still the law, and contrived disregard for the law by writers like Franke and your approval add one more straw to breaking the American idea of law and order.

There would be no need for police radar if the driving public obeyed the 55 mph limit. That includes the trucker, the hot rodder, me and you, and all the rest who have a lead foot.

73 can certainly do much better than Franke's article.

Col. W. T. McAninch W4IIA
Falls Church VA

I find it hard to believe that 73 Magazine would publish an article like "Can Hams Counter Police Radar?" To me, a ham radio magazine is about ham

radio! In Mr. Franke's article, he has four methods of deception. Each of his four "methods" is a jamming system. So when did ham operators become interested in jamming? I personally would not like to be known as one of those ham jamming stations!

Most hams, I believe, try to do things the legal way. That's why we hams are hams, not DX CBers!

There is no reason for a ham to ever need a radar jamming device if he does not break any speed laws, which is what it boils down to. If a ham needs to jam radar, he is probably breaking the law. And hams do not need an image of lawbreaking.

If a person needs to jam or get "Smokey reports," let him get on 11 meters. Do not use the image of ham radio to pretty up these actions.

So leave the radar detectors and jamming systems out of ham radio. They have *nothing* to do with radio as an art!

Victor Curtis WA3YUV
Oxon Hill MD

The article in the May issue of 73, "Can Hams Counter Police Radar?", proves that anarchy is alive and well in the United States. Never have I seen a more needless article published in the pages of your fine magazine. The author, John M. Franke, in his statement that there is a growing interest among the ham community in jamming police radar, makes a general assumption which I have yet to encounter. At last count, the proper way to change an alleged unfair, dangerous, or unpopular law was by the democratic process of the vote, not by the open advocacy of disobedience. It comes as a considerable surprise to me that the editor of 73 would show such a lack of regard for the principles that make a democracy great. As to the author's question of the legal ramifications, it does not take a lawyer to observe that he is in violation of not only part 97, subpart E (Prohibited Practices and Administrative Sanctions) with regard to unidentified communications and interference, but he is also probably in violation of the various laws regarding the willful interference of a policeman in the performance of his duty. And the author is most certainly in

violation of using a car marked "for official use only," as pictured in the article, for an obviously personal matter. I would hope that in the future 73 would concentrate more on the quality of the articles presented and less on the quantity.

Thomas E. Verkler
Peoria IL

Police radar jammer?
Telephone "blue box," with national news coverage?

Calling IRS "bastards" in print?

Non-amateur computer and airplane columns?

And you expect me to renew?

This magazine has done more to harm amateur radio than any other source.

Steve Noll WA6EJO
Ventura CA

I am writing this letter in reference to your article on police radar jamming, May, 1978, issue, pages 80-82.

I wish to preface my letter by telling you that I am a Kentucky State Police Trooper and a licensed Technician class amateur.

I am somewhat amazed that your fine magazine would publish an article that I conclude is not an exercise in electronics, but an open statement that our national 55 miles per hour speed limit should be ignored. I do not wish to quote morbid statistics that show a decrease in highway deaths after the imposition of the 55 mph law, nor that the deaths have steadily risen since the CB boom, after the truck strike of 1973. But these are fact, though there may be other factors to consider. Ideally, we would need no laws, radar, or police for that matter, but we have shown we must be controlled to some extent.

I speak for myself and not the Kentucky State Police. In Kentucky, we enforce the speed law because it is the law and because we care about the people who travel our highways. We enforce the law with a degree of flexibility to allow for speedometer error, although this is not a written rule.

I would suggest that if we as drivers do not want the 55 mph speed limit, we change it. The money spent on radar detectors, CB radios, etc., could be spent to organize and influence Congress to repeal this law.

I would suggest, even though I have not researched this matter, that intentional interference with a licensed frequency may be illegal. All our radars are FCC licensed to operate on an assigned frequency and are checked to make sure they are maintained on frequency.

In closing, let me state that I enjoy your magazine, but feel

that this type of article does not need to be part of it.

M. G. Stevens WA4SUV
Olive Hill KY

In the May, 1978, issue of your magazine, you published an article by John Franke WA4WDL of Norfolk, Virginia. This article encouraged the act of, and explained a procedure for, jamming radar devices used by law enforcement officials to detect speed limit violations.

Mr. Franke indicates in this article that his idea does not violate FCC rules, since the transmitter operates within assigned amateur frequencies. He therefore concludes that an amateur's license is not in jeopardy for using such a device.

Mr. Franke obviously has not read the regulation governing amateur radio operation. Such a device is in direct violation of at least two of the paragraphs found in Subpart E of the U. S. Rules and Regulations.

Paragraph 97.116: "The transmission of radio communication or messages by an amateur radio station for any purpose, or in connection with any activity, which is contrary to Federal, State, or local law is prohibited."

Paragraph 97.125: "No licensed radio operator shall willfully or maliciously interfere with or cause interference to any radio communication or signal."

Your magazine states: "73 takes no stand in the developing warfare between police radar and hams interested in countermeasures. The more we read about it, the more convinced we are that police radar should be outlawed..." The last sentence, coupled with the publishing of an article which actively promotes illegal countermeasures, is an *obvious* stand.

A responsible publisher verifies the facts before printing. Is 73 so uninformed on amateur rules and regulations that it accepts without question the alleged legality of such a device?

Your ignorance of amateur regulations is inexcusable. The shadow you have cast over the amateur fraternity is despicable. With WARC close at hand, the last thing amateur radio needs is for a magazine such as yours to display regulatory ignorance and to encourage willful violation of the law.

This censure was requested by and unanimously approved by the membership at the May meeting of the Triangle Ama-

Continued on page 41

IC-211, the 2meter Maximizer

COMPUTER-COMPATIBLE 4 MHz TRANSCEIVER WITH 2 VFO'S



ICOM's IC-211 maximizes band coverage, speed, performance and convenience like no other transceiver in the 2 meter world. This Maximizer's single-knob dial provides all 4 MHz in a flash, right to your single fingertip! The IC-211 maximizes read-out speed with positively no time lag or backlash in display stability, even in modes using 100 Hz steps. The IC-211's freewheeling dial, with its superb inertia clutch, is instantly coordinated with the high speed, computer circuitry controlled synthesizer's seven digit read-out using an optical chopper. There is absolutely no mechanical connection between the smooth, bearing mounted flywheel knob and the two dual-tracking VFO's, which come built into your IC-211.

- **Single knob frequency selection:** The IC-211 is synthesized with convenient single knob frequency selection over the entire 4 MHz. No more fussing with two or more knobs just to check what is going on around the band. One easy spin of the dial does it all.
- **Two VFO's built in:** The second VFO, which is an optional tack-on with most other transceivers, is an integral feature in every IC-211.
- **Variable offset:** Any offset from 10 KHz through 4 MHz, in multiples of 10 KHz, can be programmed with the LSI synthesizer.
- **Remote programing:** The IC-211 LSI chip provides for input of touch tone and programing data from an external source, such as the microprocessor controlled accessory which will also provide scan and other functions (available summer '78). Computer control from a PIA interface is also possible (data available on request).
- **FM stability on SSB and CW:** The IC-211 synthesis of 100 Hz steps makes SSB as stable as FM. This extended range of operation is attracting many FM'ers who have been operating on the direct channels and have now discovered SSB.

The IC-211 is the very best and most versatile 2 meter transceiver made: that's all. For more information and your own hands-on demonstration, see your ICOM dealer. While maximizing performance, the IC-211 minimizes impatience: yours is ready for delivery now.

Maximize the new repeater band: both the IC-211 and the IC-245/SSB operate the new FCC repeater spectrum with no modification.

All ICOM radios significantly exceed FCC specifications limiting spurious emissions.

Specifications: Frequency Coverage: 144.00 to 148.00 MHz Modes: SSB (A3J), FM (F3), CW (A1) Supply Voltage: DC 13.8V \pm 15%; AC 117V \pm 10% Size: 111mm(h) x 241mm(w) x 264mm(d) Weight: 6.8 Kg TX Output: A3J, 10W (PEP); A1 & F3, 10W Spurious Radiation: -60 dB below Carrier Microphone Impedance: 600 Ohms Sensitivity: A3J & A1, 0.5 microvolt 10 dB S+N/N; F3, 0.6 microvolt for 20 dB quieting Spurious Response: -60 dB or better Synthesizer Frequency Range: 144.00 MHz to 148.00 MHz Synthesizer Step Size: 100 Hz or 5 KHz for SSB, 5 KHz for FM

Supplied with hand held microphone, AC cord, DC cord, fuses and owner's manual.

Specifications are subject to change without notice.

HF/VHF/UHF AMATEUR AND MARINE COMMUNICATION EQUIPMENT

DISTRIBUTED BY:



ICOM

ICOM WEST, INC.
Suite 3
13256 Northrup Way
Bellevue, Wash. 98005
(206) 747-9020

ICOM EAST, INC.
Suite 307
3331 Towerwood Drive
Dallas, Texas 75234
(214) 620-2780

ICOM CANADA
7087 Victoria Drive
Vancouver B.C. V5P 3Y9
Canada
(604) 321-1833

Editor:
Robert Baker WB2GFE
15 Windsor Dr.
Atco NJ 08004

CONTESTS

ARRL STRAIGHT KEY NIGHT

Complete rules in the June issue of *QST!* If no changes over last year's rules, contest runs full 24-hour period, 0000 GMT to 2400 GMT July 4. Use a straight key only! Suggested frequencies are 60 to 80 kHz up from bottom edges of 80-40-20 meter bands or 10 kHz up from bottom of Novice bands. Send "SKN" instead of RST during QSOs to identify stations working the contest. After the contest period, send a list of the stations worked plus your vote for the best "fist" heard (not necessarily worked) or most interesting QSO. All entries should be addressed to: ARRL, 225 Main Street, Newington CT 06111.

10-10 NET SUMMER QSO PARTY

Starts: 0000 GMT July 15
Ends: 2400 GMT July 16

Open to all amateurs, but only members are eligible for awards. All contacts to be made on 10 meters, any mode. A station may be counted only once.

EXCHANGE:

Name, QTH, 10-10 number. Be sure to log date and time of each contact!

SCORING:

1 point for each contact; add

1 point if with a 10-10 member. Maximum of 2 points per contact; no multipliers. Give name of your chapter.

AWARDS:

1st and 2nd place certificates to each US dist, KL7, KH6, and US Pacific Island, each VE dist, Central America and Caribbean, South America, Europe, Africa and S. Atlantic, Asia, Australia, New Zealand, and S. Pacific.

ENTRIES:

Members only—send log information to: Grace Dunlap K5MRU, Box 13, Rand CO 80743, no later than August 30. Results will be published in the Net Fall Bulletin.

VHF SPACE NET CONTEST

Contest period is from
6 pm Saturday, July 15 to
9 pm Sunday, July 16
YOUR LOCAL TIME!

This event commemorates the 9th anniversary of Apollo 11, man's first landing and walk on the moon, with activity on 50, 144, 20 MHz, etc., in all modes except repeaters.

EXCHANGE:

Signal report and zip code or PO locations if out of country.

SCORING:

Each contact is worth 2 points. The same station may be reworked on a different

mode for added 2 points, and reworked again on different bands for additional 2 points. Each different zip code worked is one multiplier with all out of country contacts using the PO location as a zip code. Scoring is total of all QSO points multiplied by the total of different zip codes and PO locations.

CATEGORIES:

Class 1—100 to 500 Watts; Class 2—25 to 100 Watts; Class 3—5 to 25 Watts; Class 4—1 to 5 Watts; Class 5—CW only with any power; Class 6—XYL only with any power; Class 7—club participation.

AWARDS AND ENTRIES:

Highest score in each category receives a trophy plaque; all second and third high scores will receive a space net certificate. Mailing deadline of logs is August 10. Mail all entries to: VHF Space Center, K4AWS, Box 15, Sumterville FL 33585. There will be a special bonus surprise for all stations working the space net center during the contest.

THE COLOMBIAN INDEPENDENCE DAY CONTEST

This activity commemorates the 167th independence anniversary and is intended to promote and increase the DX activity of HK radio amateurs. Entry classifications include: single-op/single band, single-op/multiband, and multi-op/multiband/one rig. Band used may be any amateur band from 80 to 10 meters, phone, SSB, or CW modes. Contest call is "CQ HK CONTEST."

EXCHANGE:

RS(T) plus 3-digit serial QSO number, HK station's RS(T) and HK prefix.

SCORING:

Each HK QSO counts 5 points. QSOs with another continent count 3 points. QSOs in same continent but different country are 2 points, and same country are 1 point each. Multiplier is total number of different countries worked on all bands. Final score is sum of QSO points on each band multiplied by the sum of different countries worked on each band.

AWARDS:

Sterling silver cup trophy to world winner of the contest; silver plates to continental winners and class winners.

RESTRICTIONS:

Minimum of 50 QSOs must be shown in logs to be eligible

for any award. Only one contact per band with the same station will be permitted. No cross-band or crossmode contacts. Club stations can only take part as multi-op/multi-band/single transmitter class. Violation of the regulations of amateur radio in the country of the contestants, or the rules of the contest, or taking credit for incorrect QSOs or multipliers, or duplicate contacts in excess of 2% of the total made, will be deemed sufficient cause for disqualification. The LCRA Contest Awards Committee decision shall be final.

ENTRIES:

Logs must show date/time in GMT; keep separate log sheets for each band. Enter country only the first time it is contacted. Each entry must be accompanied by a summary sheet listing all scoring information. All logs must be postmarked no later than Sept. 30 and mailed to: LCRA—Concurso Independencia, C/O Contest Committee Manager, Apartado Postal 584, Bogota, Colombia, S.A.

RHODE ISLAND QSO PARTY

Contest Periods:
1700 GMT Saturday, July 22 to
0500 GMT Sunday, July 23
1300 GMT Sunday, July 23 to
0100 GMT Monday, July 24

Sponsored by the East Bay Amateur Wireless Association. RI stations work other RI stations and the rest of the world—others work RI only. The same station may be worked once per band and mode.

EXCHANGE:

RS(T), QTH—state, province, or country; RI send county.

SCORING:

RI stations score 2 points per QSO; RI Novice and Tech stations score 5 points per QSO. Others score 2 points per RI QSO and 5 points per QSO with RI Novice or Tech. RI Novice and Tech sign with /N or /T to designate license class. RI multiply total QSO points by the number of RI counties, states, provinces, and DX countries worked. Others multiply total QSO points by the number of RI counties worked (5 max.). All stations—score 10 points for QSO with multi-op station operated by club members N1RI.

FREQUENCIES:

Phone—3920, 7260, 14300, 21360, 28600, 50.3, 145.1.

CW—1810, 3550, 3710, 7050, 7110, 14050, 21050, 21110,

CALENDAR

July 1-2*	Seven Land QSO Party
July 4	ARRL Straight Key Night
July 8-9	IARU Radiosport Competition
July 15	Colorado YL Field Day
July 15-16	10-10 Net Summer QSO Party VHF Space Net Contest Colombian Independence Day Contest
July 22-24	Rhode Island QSO Party
July 29-31	CW County Hunters Contest New Jersey QSO Party
Aug 19-20	SARTG Worldwide RTTY Contest
Sept 9-10	ARRL VHF QSO Party Pennsylvania QSO Party
Sept 16-18	Washington State QSO Party Scandinavian Activity Contest—CW
Sept 23-24	Scandinavian Activity Contest—SSB Delta QSO Party
Oct 7-8	VK/ZL/Oceania DX Contest—Phone & RTTY
Oct 14-15	VK/ZL/Oceania DX Contest—CW ARRL CD Party—CW
Oct 21-22	ARRL CD Party—Phone
Nov 4-5	ARRL Sweepstakes—CW
Nov 11	OK DX Contest
Nov 18-19	ARRL Sweepstakes—Phone
Dec 2-3	ARRL 160 Meter Contest
Dec 9-10	ARRL 10 Meter Contest

* = described in last issue

28050, 28110.

Use of FM simplex is encouraged, but no repeaters!

AWARDS:

Certificates will be awarded to the top scoring station in each RI county, state, province, and DX country; the top scoring Novice and Technician station in each RI county and state; and the ARC in each state, province, and DX country that submits the highest aggregate score (min. 3 logs per club).

ENTRIES:

Logs must show date/time in GMT, call, exchange, band, and mode. On a separate sheet show name, call and mailing address, club affiliation, if any, total QSO points, multiplier, claimed and final scores. Send logs and summary postmarked no later than Aug. 31 to: East Bay Amateur Wireless Assoc., PO Box 392; Warren RI 02885. Include a SASE for results.

CW COUNTY HUNTERS CONTEST

Starts: 0000 GMT July 29
Ends: 0200 GMT July 31

The CW County Hunters Net invites all amateurs to participate in the 1978 CW County Hunters Contest with all mobile and portable operation in less active counties welcomed and encouraged. General call is "CQ CH." Stations may be worked once per band and again if the station has changed counties. Portable/mobile stations changing counties during the contest may repeat contacts for QSO points. Stations on county lines give and receive only one QSO number per contact, but each county counts for a multiplier.

EXCHANGE:

QSO number, category (P = portable, M = mobile), RST, state, province, or country, and county if US.

FREQUENCIES:

3575, 7055, 14070, 21070, 28070. It is requested that only P or M category stations call CQ or QRZ on 40 meters below 7055 and on 20 meters below 14070, with all stations spreading out above those frequencies.

SCORING:

QSOs with fixed stations count 1 point, portable/mobile stations = 3 points; multiply QSO points times number of US counties worked for final score. Mobiles/portables calculate their score on the basis of total contacts within a state.

AWARDS:

Certificates awarded to highest scores in three categories: F—highest fixed or fixed portable in each state, province, and country with 1,000 or more points; P—highest station operating portable (not normal point of

RESULTS

RESULTS OF THE 10-10 INTERNATIONAL NET WINTER QSO PARTY FEB. 11-12, 1978

<i>Top Ten</i>					
W7ZR	1391/2497	5. WA5JDU	600/1059	6. WB6JPY	870/1583
VE7CMN	1313/2334	7. W7ZR	1391/2497	8. WB8EDG	625/1097
K7CZ	1035/1793	9. WB9WFZ	314/565	0. K0GU	859/1433
WB7ERF	924/1651	KG6. KG6JIA	949/1196	KH6. WB4OGP/KH6	432/746
VE7CML	899/1609	KL7. KL7GRP	292/533		
WB6JPY	870/1583	<i>Multi-Op Stations</i>			
WB7BFK	818/1493	W8WD	808/1351		
K7PVZ	817/1480	W9NIN	617/1077		
K3LYW	833/1442	VE2DZE/VE3	196/360		
K0GU	859/1433	<i>Canadian and DX Leaders</i>			
<i>Top Ten Chapters</i>		VE1. VE1ASU	176/313		
Cal. Bay Area	11293/21479	VE2. VE2DZO	381/641		
So. N.E. Nutmeg	11447/21459	VE3. VE3IDJ	166/310		
Colorado	11475/20851	VE4. VE4OY	300/561		
Gateway	8748/16474	VE5. VE5QY	205/373		
Sky Blue Waters	7848/14838	VE6. VE6ATT	246/441		
White House	7707/14024	VE7. VE7CMN	1313/2334		
C.A.T.T.	6387/11829	Cen. America	TI2NA	588/1056	
Minute Man	4213/7825	So. America	LU7FAG	163/386	
Grand Canyon	3645/6477	Europe	DK5UG	219/410	
King Salmon	3378/6101	Africa	EL2AK	74/138	
<i>U.S. District Leaders</i>		Asia	JA3XOG	215/401	
1. W1GUC	509/909	ZL-VK	ZL3SW	144/269	
2. K9EGA/2	836/1389				
3. K3LYW	833/1442				
4. WB4NDX	605/1025				

operation) with 1,000 or more points; M—highest mobile in each state operating from 3 or more counties with a minimum of 10 QSOs per county.

Trophies to highest single-operator station in categories P and M in the USA. Additional awards where deemed appropriate.

ENTRIES:

Logs must show category, date/time in GMT, station worked, exchanges, band, QSO pts, location, and claimed score. All entries with 100 or more QSOs must include a check sheet of counties worked or be disqualified from receiving awards. Enclose a large SASE if results are desired. Logs must be postmarked by Sept. 1 and sent to: CW County Hunters Net, c/o Jeffrey P. Bechner W9MSE, 673 Bruce St., Fond du Lac WI 54935.

NEW JERSEY QSO PARTY Contest Periods:

2000 GMT Saturday, July 29 to 0700 GMT Sunday, July 30
1300 GMT Sunday, July 30 to 0200 GMT Monday, July 31
(Please note the date change from the original announced weekend)

Sponsored again by the Englewood ARA, all amateurs the world over are invited to take part in the 19th annual event. Phone and CW are considered the same contest. A

station may be contacted once on each band; phone and CW considered separate bands, but CW contacts may not be made in phone band segments. NJ stations may work other NJ stations. General call is "CQ NJ" and NJ stations are requested to identify themselves by signing "DE NJ." Stations planning active participation in NJ are requested to advise the EARA by July 8 of their intentions so that plans can be made for full coverage from all counties. Portable and mobile operation is encouraged.

EXCHANGE:

RS(T), QSO number and ARRL section or country, NJ county for NJ stations.

FREQUENCIES:

1810, 3535, 3905, 7035, 7135, 7235, 14035, 14280, 21100, 21355, 28100, 28600, 50-50.5, and 144-146. Suggest phone activity on the even hours, 15 meters on the odd hours (1500 to 2100 GMT), 160 meters at 0500 GMT.

SCORING:

Out-of-state stations multiply number of QSOs with NJ stations times the number of NJ counties worked (21 max.). NJ stations: W-K/VE-VO count 1 point, DX count 3 points per QSO. Multiply total number of QSO points times the number of ARRL sections (including NNJ and SNJ—max. 75). KP4, KH6, KL7, KZ5, etc., count as 3-point DX contacts and as section multipliers.

AWARDS:

Certificates will be awarded to the first place station in each NJ county, ARRL section, and country. In addition, a second place certificate will be awarded when 4 or more logs are received. Novice and Technician certificates will be awarded as well.

ENTRIES:

Logs must show GMT date and time, band, mode, and be received not later than Aug. 26. The first contact for each claimed multiplier must be indicated and numbered and a checklist of contacts and multipliers should be included. Multi-op stations should be noted and calls of participating operators listed. Logs and comments should be sent to: Englewood ARA, Inc., PO Box 528, Englewood NJ 07631. A size #10 SASE should be included for results.

COLORADO YLs SYLVER DOLLAR AWARD

Contact and QSL 5 Colorado YL members; DX only need 3. Award has pictures of station worked with endorsement credit and pictures for additional contacts. Send list of contacts made and QSLed showing log data along with 50¢; DX send 2 IRCs. For endorsements, send as above with 10¢ and SASE. Mail to Club Station Trustee, WA0ESM, 15715 N. 107th, Longmont CO 80501.

Looking West

Bill Pasternak WA6ITF
24854-C Newhall Ave.
Newhall CA 91321

SUN DAY IN THE SOUTHLAND

How did you celebrate Sun Day? A number of Los Angeles area amateurs went all out to make Sun Day in L.A. one to be remembered. The WR6AUG Solar Power Amateur Radio Repeater Group, the Canyon Repeater Association, and a number of other area amateurs joined forces, and through their efforts Los Angeles Mayor Tom Bradley was treated to his first solar-powered autopatch telephone conversations.

The idea of demonstrating a solar-powered amateur radio telephone link was conceived by the Atlantic Richfield Solar Technology Company and the WR6AUG Solar Power Amateur Radio Repeater Group. For the demonstration, Atlantic Richfield provided the solar panels, Pacesetter Systems, Inc., provided all necessary electronic test equipment, and the Canyon Repeater Association of Sylmar, California, made available the WR6AWQ 220 MHz autopatch repeater. WR6AWQ is located atop a "bump" known as Loop Canyon Summit (4500' plus) and has the ability to reach almost anywhere. This ability was to be well tested during the Sun Day demonstration.

The plan seemed simple enough. Two telephone calls were to be placed which would permit Mayor Bradley to speak with Deputy Secretary of Energy John O'Leary and Congressman Ryan, Chairman of the Congressional Subcommittee on Energy and Energy Resources, both in Washington DC. To be sure that the demonstration could take place, a test run was made on the Monday prior to the actual event by WR6AUG trustee Dr. Joseph Schulman K6BWA. For the test, a 220 MHz Wilson hand-held was fitted to an external Larsen 5/8-wave antenna. All seemed to work well. Looked like a snap, according to Joe. Then, on Tuesday evening when a full duplex test involving the public address system was attempted, the fickle finger of fate struck. The "path" from downtown LA at the park across from City Hall to Loop Canyon Summit had gone sour. While the repeater was only about 25 miles from the demonstration site, rf in both directions had to cross some rugged terrain which included a few "bumps" that cast rf shadows of the worst kind. To

remedy this situation, two steps were taken. First, Jim Hendershot WA6VQP, trustee of WR6AWQ, drove up to the Loop Canyon site at a bit past midnight and disabled AWQ's final power amplifier. This was to minimize any desensitization to the repeater's receiver. Secondly, the Wilson/Larsen combo was replaced by a Midland 13-509 10-Watt radio and an 11-element Hy-Gain beam. Another 13-509 was jeeped (wired directly) to the PA system so that both sides of the conversation could be heard at once by the spectators . . . full duplex!

To add to all the rest of the problems, when Sun Day morning came, it brought with it a distinct lack of California's most notable commodity, sunlight. Lou WA6EPD, Roy W6TSL, and Norm WB6DGF formed an instant antenna-pointing committee, and after a number of tests found a way to make the path cooperate. Somehow it all came together, and at the appointed hour the calls were placed through the WR6AWQ autopatch from a Midland 13-509 at LA City Hall Park operating off power provided by Mother Nature herself.

It should also be mentioned that there were contingency plans just in case the path to Loop Canyon had gone completely out. Both the WR6AYY and WR6ABC repeaters, located in the nearby Hollywood hills, were on "standby alert." While their facilities were not needed as it turned out, it was comforting for all to know that they were there just in case. AWQ, at a far greater distance and with its circularly-polarized antenna array, came through and made the overall demonstration far more dramatic, but none of this would have happened at all had not a group of amateurs from many repeaters gotten together and worked as a team to make everything tick like a well-oiled clock. The Mayor was happy, the people in Washington were happy, and once again amateurs had proved that anything could be done.

THANK YOU, OTTO; WELCOME, DENNIS

On or about June 1, 1978, Otto Arnosht WA6RMX will step down from the post of SCRA Two Meter Technical Committee chairman, one which he has held for the past year and a half. As a research psychologist, Otto brought a

VHF-UHF COORDINATION AND TECHNICAL SYMPOSIUM

TENTATIVE AGENDA

- I. INTRODUCTORY SESSION: Bob Buaas, 9:00 to 10:00 AM September 23, 1978
- Welcoming
 - Introduction of special guests and Session leaders.
 - Overview of the sessions that will be running con-currently throughout the day
- II. BREAK: Coffee and snacks provided by _____ Club.
10:00 to 10:20
- III. PARALLEL SESSIONS RUNNING UNTIL LUNCH AND AFTER LUNCH to 4:30 PM

COORDINATION SESSION Chaired by Bill Pasternak

- National Input from represented areas of U.S. as to how Coordination is now done.
- Protection of Non-Relay Interests
 - Sideband
 - Satellite
 - FM Simplex
 - Weak Sig., EME, ATV, etc.
- Enforcement of Coordination
 - Amateur - DFing
 - Peer Pressure
 - FCC
- Looking at Spectrum Management
 - Present uses of spectrum
 - How could spectrum space be better conserved?
 - Looking 10 years ahead

NON-RELAY COMMUNICATIONS SESSION Chaired by Lou Anxiaux

- Simplex: Sideband & FM
- EXOTIC MODES: EME, OSCAR, ATV, RTTY, CP/PUTERS

REPEATER SESSION Chaired by Bob Thornburg

- Repeater Techniques
 - Circular Polarization
 - Beeps for re-set
 - Hi/Low beeps
 - Semi tone squelch
 - Specialized: RTTY, ATV, Sideband, etc.
- Repeater User Control
 - Open vs Closed Repeaters
 - Open PL
 - Jamming, Bad Language, Offensive interjections
 - Westlink
 - Autopatch Control
- Remote Control Techniques
 - CACTUS: What is it?
 - Telemetry
 - HF Tranceivers//antennas
 - Simplex Autopatch
 - Microprocessor Control
- Advances in DF Techniques
 - T-Hunts
 - Commercial units
 - Amateur built units

new dimension to the world of voluntary frequency coordination: knowledge of the science of people. Otto has become known as the "peace maker" around these parts, and in the time he has served as chairman, he has never had a problem for which he and his committee could not find a solution. Otto will be missed by many of us who have learned much by watching him. He resigned in order to attend to other pressing matters outside amateur radio. He will be missed. The SCRA has announced that Dennis Romack WA6OYI will be the new Two Meter Technical Committee chairman. Dennis is from San Diego and is best known in amateur circles as Marketing Vice President of DSI. Dennis has in the past served on the Board of Directors for the San Diego Amateur Repeater Association (SAN-

DRA), and is currently president of the 220 Club of San Diego, one of the nation's largest organizations dedicated to furthering the development of 220 MHz. LW joins with the rest of the southern California amateur community in welcoming Dennis to his new post.

THE BIG MEETING

I recently promised that as soon as a tentative agenda for the September 23, 1978, National Voluntary Coordination, Band Planning, and Technical Advances Seminar in San Diego was available, I would bring it to you. If, after reading it, you wish to take part, drop a note to SCRA, PO Box 2606, Culver City CA 90230, for a complete information packet on the meeting and the convention it is a part of. Hope to see you in San Diego.

Ham Help

I'm interested in hooking up a low-frequency multiband antenna that operates efficiently and effectively on a motor home. I would like the system to be usable, if possible, while in motion. Any help would be appreciated.

James V. Devilbiss WA3FUJ
915 Pine Ave.
Frederick MD 21701

Can anyone loan (to be

copied and returned, with postage paid both ways by me) an instruction book and/or schematics for a Knight T-60 transmitter and a Heathkit HR-10B receiver? Any help concerning the loading of the Knight T-60, which is equipped with a relative power meter, will be especially appreciated.

Edwin R. Lappi WD4LOO
109 Lynn Drive
Carrboro NC 27510

think of yourself as an **antenna expert!** —you select your components!

1 Get optimum performance band for band. Choose from medium or high power resonators for your favorite bands.

2 Fold over, 360° swivel mast for quick band change or easy garaging. Select from two versions, fender/deck or bumper mount location.

3 Stainless steel ball mount, 180° adjustable, commercial duty for superior mechanical and electrical performance.

4 Get exceptional reports, broadest bandwidth, lowest SWR. Use with any convenient length 50 ohm coax. Matching devices not required.

5 For convenience, use the Hustler stainless steel resonator spring, and special design quick disconnect.

...and you'll mobile with the experts' foremost choice...

HUSTLER

Get fixed station reports from your mobile—operate 6-10-15-20-40-75 or 80 meters with the experts and join the vast majority using Hustler for nearly two decades.



Model SSM-2 Ball Mount



Model BM-1 Bumper Mount



Model QD-1 Quick Disconnect

Model RSS-2 Resonator Spring



Model L-14-240 Mil Spec 50 Ohm Feedline



Model MO-1 For Deck or Fender Location

Model MO-2 For Bumper Mount Location

Standard Resonators RM 400 Watts PEP

Super Resonators RM(S) 2 KW PEP Greatest Coverage

"the home of originals"

HUSTLER

Available from all distributors who recognize the best.

new-tronics corporation
15800 Commerce Park Drive
Brookpark, Ohio 44142
(216) 267-3150

N2

HUSTLER ANTENNA PRODUCTS—for sixteen years—original designs—created and manufactured by American Ingenuity, labor and materials—used by communicators throughout the world.

Hustler designs are patented under one or more of the following assigned to New-Tronics Corporation 3287732, 3513472, 3419869, 3873985, 3327311, 3599214, 3582951.

RTTY Loop

Marc I. Leavey, M.D. WA3AJR
4006 Winlee Road
Randallstown MD 21133

The more observant among you have probably noticed that there is a computer listing printed in this month's column. This is the implementation of the simple Baudot receiving program outlined last month. I realized that, although RTTY and computers are natural partners, some of you are not at all interested in reading any more about microprocessors. You all may skip to the end of the column, where some questions from readers are answered. For the bulk of you, here we go!

The program, as written, is configured for the SWTPC 6800 computer, and resides in RAM at addresses 0020H to 015AH. (Throughout this article, hexadecimal numbers will be identified with the suffix "H", as 1234H. Numbers without an "H" are decimal.) It assumes that a parallel interface (MP-L or MP-LA PIA card) is located at port #7, address 801CH, and that the B side is configured as an input. Two routines from MIKBUG, or SWTBUG, the resident ROM monitor, are called. OUTEEE, at E1D1H, puts the data in the A accumulator out to the terminal as an ASCII character. PDATA, at E07EH,

puts the data pointed to by the index register out to the terminal as an ASCII string, until an EOT (04) character is read, which terminates the routine. Users of other 6800 systems may implement the program by changing necessary addresses as needed to suit their systems.

As described last month, the required input is to bit 0 of the PIA, side B, as written. A reed relay inserted in the loop and connected to the PIA, with an appropriate pull-up resistor as outlined last month, is one way to interface a TTY loop. Users of demodulators which have an RS-232 output, such as the ST-6, may connect them directly. With the ST-6, for example, the appropriate line is labeled the "FSK" output, and is standard RS-232C logic. It measures about five volts negative on

mark and five volts positive on space. This is exactly what we want; no pull-up or other components are required.

Examining the program, we find that the first 256 bytes are used for tables, strings, and storage. The Letters and Figures tables carry the Baudot data in the binary progression detailed in "RTTY Loop" last July. Remember, however, that the data is complemented. That is, while "R" is 01010, binary, the encoded table form is 10101, with marks and spaces reversed. This is 15H, and if you add that to the starting address of the Letters table, 0020H, you get 0035H. The data at 0035H is 52H, and that is ASCII for "R". Okay? That's how the table works.

The main program starts at 0100H. After setting up the

```

00010      JAL      B/A: 3-0
00020      JPT      0

00040      *****
00050      * BAUDOT RECEIVING PROGRAM *
00060      * FOR THE SWTPC 6800 *
00070      * VER 3.0 -- 18 APR 78 *
00080      * MARC I. LEAVEY, M.D. *
00090      * WA3AJR *
00100      *****

00120      ***** EXTERNAL ROUTINES
00130      E1D1  JUTEL EQU $E1D1
00140      E07E PDATA EQU $E07E
00150      801E PDRB EQU $801E * PIA DATA REG B - PORT 7
00160      801F PICRB EQU $801F * PIA CTRL REG B - PORT 7
00170      A043 PGCTR EQU $A043 * PROGRAM COUNTER

00170      ***** TABLES AND STORAGE
00200      * THE ASCII ENCODED DATA
00210      * IS IN BAUDOT ORDER IN
00220      * TWO TABLES: LTRS AND
00230      * FIGS. NULL IS USED FOR
00240      * CHARACTERS NOT DECODED
00250      *****
00260      0020      JRG      $2C
00270      0020      7F      LTRTAB FCB $7F [LETTERS]
00280      0021      4B      FCC      \A\B\C\
00290      0022      55
00300      0024      00      FCB      0 [FIGURES]
00310      0025      4A      FCC      \J\K\X\F\S\B\D\Z\E\V\C\P\I\G\L\
00320      0026      57
00330      0027      41
00340      0028      53
00350      0029      46
00360      002A      52
00370      002B      53
00380      002C      42
00390      002D      44
00400      002E      5A
00410      002F      45
00420      0030      56
00430      0031      43
00440      0032      50
00450      0033      47
00460      0034      47
00470      0035      52
00480      0036      4C
00490      0037      00      FCB      0 [LINE FEED]
00500      0038      4D      FCC      \A\B\C\
00510      0039      4E
00520      003A      43
00530      003B      20      FCB      $20 [SPACE]
00540      003C      4F      FCC      \ \
00550      003D      00      FCB      0 [CAR RET]
00560      003E      54      FCC      \T\
00570      003F      00      FCB      0 [BLANK]

00370      0040      7F      FIGTAB FCB $7F [LETTERS]
00410      0041      23      FCC      \ (17\
00420      0042      31
00430      0043      37
00440      0044      00      FCB      0 [FIGURES]
00450      0045      27      FCC      \ '2- / 16\
00460      0046      32
00470      0047      2D
00480      0048      2F
00490      0049      21
00500      004A      36
00510      0043      07      FCB      7 [BELL]
00520      0044      3F      FCC      \?*"3:10844\
00530      004D      24
00540      004E      22
00550      004F      33
00560      0050      3B
00570      0051      3A
00580      0052      30
00590      0053      33
00600      0054      26
00610      0055      34
00620      0056      29

00450      0057      00      FCB      0 [LINE FEED]
00460      0058      2E      FCC      \... \
00470      0059      2C
00480      005A      23
00490      005B      20
00500      005C      37
00510      005D      00      FCB      0 [CAR RET]
00520      005E      35      FCC      \5\
00530      005F      00      FCB      0 [BLANK]

00510      0060      0D      CR/LFST FCB $D,$A,$15,$0,$0,$4
00520      0061      0A
00530      0062      15
00540      0063      00
00550      0064      00
00560      0065      04

00530      0066      0002      ASTJHE EQU 2

00550      ***** MAIN PROGRAM STARTS
00560      ***** HERE
00570      0100      JRG      $100
00580      0100      8E      A070 START LDS $A070 * SET UP STACK
00590      0103      86      04 LDA A $4 * INITIALIZE THE PIA
00600      0105      E7      3C1F STA A PICRB * AS AN INPUT
00610      0108      B6      301E SLJJP LDA A PDRB * L J O P UNTIL
00620      0108      4D      TST A * START PULSE
00630      010C      27      FA BEQ SLJJP * IS LOCATED
00640      010E      8D      44 BSR .4SEC10 * DELAY 1/2 PULSE
00650      0110      C6      05 LDA B $5 * SET UP COUNTER
00660      0112      4F      CLR A * CLEAR ACCUMULATOR A
00670      0113      48      CLJJP ASL A * SHIFT ACCUM-A LEFT ONE
00680      0114      3D      3E BSR .4SEC20 * DELAY ONE PULSE
00690      0116      BA      301E JRA A PDRB * GET THE DATA INTO "A"
00700      0119      5A      DEC A * DECREMENT THE COUNTER
00710      011A      5D      TST B * COUNT = 0 ?
00720      011B      26      F6 BJE CLJJP * NO -> GET NEXT BIT
00730      011D      31      1D CMP A $1D * IS IT BAUDOT CAR-RET?
00740      011F      27      28 BEQ CR/LF * YES, DO A CR/LF
00750      0121      31      04 CIP A $4 * IS IT BAUDOT FIGS?
00760      0123      27      0F BEQ FIGS * YES, SHIFT TABLES
00770      0125      31      00 CAP A $0 * IS IT BAUDOT LTRS?
00780      0127      27      04 BEQ LTRS * YES, SHIFT TABLES
00790      0129      31      15 CAP A $15 * IS IT BAUDOT SPACE?
00800      012B      26      10 BIE GETCHR * JJ, PUT IT JUT NOW.
00810      012D      CE      0020 LTRS .LDX #LTRTAB * LOAD INDEX WITH LTRS TABLE
00820      0130      EF      66 STA XSTORE * STORE THAT AT MARKER
00830      0132      E0      07 BHA GETCHR * JJJ CJ PUT IT JUT
00840      0134      CE      0040 FIGS .LDX #FIGTAB * LOAD INDEX WITH FIGS TABLE
00850      0137      DF      66 STA XSTORE * STORE THAT AT MARKER
00860      0139      3E      17 BSH .4SEC10 * DELAY 1/2 PULSE
00870      013B      20      CE BRA SLJJP * WAIT FOR NEXT INPUT
00880      013D      B7      0143 GETCHR STA A .JCCATE+1 * SET POINTER FOR TABLE
00890      0140      DE      66 .LDX XSTORE * GET CURRENT TABLE INDEX
00900      0142      A6      G0 .JCCATE LDA A X * LOAD ACC-A AT POINTER
00910      0144      ED      E1D1 JSH JUTEL * PUT JUT TO TERMINAL
00920      0147      20      BF BHA SLJJP * START ALL OVER AGAIN

00740      ***** SUBROUTINES
00760      0147      CE      0060 CR/LF .LDX #CR/LFST * INDEX TO CR/LF STRING
00770      014C      B1      E07E JSR PDATA * PUT JUT TO TERMINAL
00780      014F      E0      07 BRA SLJJP * RETURN TO WAIT ROUTINE

01000      0151      8D      01 .4SEC20 BSR .4SEC10 * TWO .4SEC10'S=.4SEC20
01010      0153      01 .JJP
01020      0154      CE      0430 .4SEC10 LDA $430 * ADJUST DELAY FOR BEST COPY
01030      0157      G7 .DLJJP DEB
01040      0158      26      FD .DLE
01050      015A      37 .RTS

01070      ***** PROGRAM COUNTER SET-UP
01080      A043 JRG PGCTR
01090      A043 0100 FCB START
01100      END

TOTAL ERRORS 0000
ENTER PASS : 1P,2P,3P,2T

```

stack and initializing the PIA, the program loops while waiting for the start pulse, which is always a space. Once located, the program loads the A accumulator with the five data bits, as detailed last month. That data is loaded into an offset located at 0143H, which serves as the pointer for the appropriate table. The current table in use is stored at XSTORE: two bytes located at 0066H and 0067H. After the data is acquired, but before it is put out, several special cases are tested for. A 1DH is carriage return, and causes a branch to a routine to put out a carriage return, line feed string which can be customized to the system. Here, a 15H is included to perform an erase to the end of the line. Receipt of LTRS or FIGS (00H or 04H) causes the data at XSTORE to be updated accordingly, and SPACE (1BH) forces Letters case, a software "downshift-on-space." Because of the special routines, several codes appear as 00 in the tables. FIGS, LINE FEED, and CARRIAGE RETURN are all ignored in the table decoding.

The delay routines, MSEC20 and MSEC10, depend on a counting loop from 0154H to 0159H. The DEX (Decrement Index Register) instruction requires four machine cycles, as does the BNE (Branch If Not Equal). Thus, the set of two instructions requires eight cycles per loop. If the cycle time is 1.1 μ s, as with the SWTPC 6800, the execution of this loop 480H (1152) times would result in a 10.1376 ms delay—close enough to 11 ms when allowing for the rest of the program time. However, users of different systems may find adjustment of this value necessary to produce good copy, and it is suggested that it be used much as a Range adjustment on an old Model 15. Take the minimum and maximum values which give good copy and find the mean. Watch out for the hexadecimal arithmetic! Place the determined value at 0155H as the optimum delay value.

To use the program, set the program counter to 0100H and hit "G". With input on the PIA, the terminal should follow the incoming RTTY signal. Because the entire character should be completed during the STOP pulse, a terminal running at 300 baud works best. For faster terminals, an additional delay is needed to insure that when the character is finished, the STOP is being sent.

A note received from Norm Monro K4FRY touches on his hopes of putting the Kenwood

Corrections

You recently published an article of mine in the April issue entitled, "Build this Digital Ball Game." It has been brought to my attention that the schematic printed in the article has a couple of problems. On IC2, ground connections should be 2, 3, 6, 7, and 10. On IC3, the LEDs should be inverted and their anodes connected to +5 V. I can only attribute the error to my "newness" to digital electronics at the time of its writing. In the subsequent proofreadings, the error went unnoticed. I am sorry.

Ralph A. Giffone N2RG
Brooklyn NY

Please note a few corrections to my "FCC Math," May issue, p. 18 and p. 130:

599D pair on RTTY. Any reader with experiences along these lines is invited to write Norm or this column. Another Kenwood owner, Manuel Marrero KP4EHE, Box 1828, Aquadilla PR 00603, needs help putting his Kenwood TS-520S on RTTY. I'm including Manuel's complete address to help those who might want to drop him a line.

In general, any information pertaining to putting this type of equipment on RTTY is welcome, and will be included in future columns, as received.

Another reader, David Baxter WA4JHH of Grenville KY, writes, in part:

"I have a Knight R-100A general coverage receiver. Is it

(1) On p. 18, in the left-hand column, second paragraph from bottom, four lines down, "and that is about 9.2×10^1 or 92 " should read "and the square root of that is about 9.2 ", etc.

(2) In the same column, last paragraph, fifth line down, there is a problem with " $(100/10) \cdot (100/10) = 10$ ". The dot should be down, a period, not a multiplication as indicated.

(3) And, on p. 130, in the left-hand column, the square root sign in that asterisked footnote should have continued on over the numbers following the minus sign in both cases.

John Leahy WB6CKN
Gonzales CA

possible to copy TTY with this receiver? What would be the most economical printer I could obtain ... that I could later use ... on the ham bands?"

First off, David, my recollection of the R-100A is that it was a budget receiver sold about ten years ago by Allied. The ones I saw were quite able to do a reasonable job copying sideband, and thus should be able to copy TTY without too much trouble. What you are looking for most is *stability*. After warming up, drifting 50 Hz or so would be intolerable. This is roughly the same degree of stability demanded for SSB, so if it is adequate for one, it should do for the other.

Two versions of the MK-III were constructed before I submitted the article ("Build This Excitingly Simple Receiver") which was published in the May issue on page 76. One version had the bias resistors for the MFE521 gate #1 (2.2k and 4.7k) connected as shown in the schematic, and the other had them connected to the bottom end of the secondary of T1. Unfortunately, I mixed them up and the printed circuit layout is for the latter method—it does not match the schematic. The receiver works equally well with either method, but I prefer the circuit incorporated in the printed circuit layout.

A 10 μ F tantalum bypass capacitor should be shown on the schematic from the 7-volt line (regulated) to ground. It is incorporated in the printed circuit.

Ray Megirian K4DHC
Deerfield Beach FL

As to the printer, the most realistic answer is anything you can get that you can afford that works! I suspect that if you scout around at hamfests and ads, you may be able to pick up a Model 15 for less than \$50. This is an entirely satisfactory printer, and can do quite well for many years. After you look around a bit, and perhaps after this column lets the Greenville community know you are looking, who knows what bargains you will stumble upon.

In future months, we will delve into some specific machines and phenomena, and answer more readers' questions. Drop me a line; let me know what you would like to see.

OSCAR Orbits

The listed data tells you the time and place OSCAR crosses the equator in an ascending orbit for the first time each day. To calculate successive orbits, make a list of the first orbit number and the next twelve orbits for that day. List the time of the first orbit. Each successive orbit is 115 minutes later (two hours less five minutes). The chart gives the longitude of the first crossing. Add 29° for each succeeding orbit. When OSCAR is ascending on the other side of the world, it will descend over you. To find the equatorial descending longitude, subtract 166 degrees from the ascending longitude. To find the time it passes the North Pole, add 29 minutes to the time it passes the equator. You should be able to hear OSCAR when it is within 45 degrees of you. The easiest way to do this is to take a globe and draw a circle with a radius of 2480 miles (4000 kilometers) from the home QTH. If it passes right overhead, you should be able to hear it for about 24 minutes total. OSCAR will pass an imaginary line drawn from San Francisco to Norfolk about 12 minutes after passing the equator. Add about a minute for each 200 miles that you live north of this line. If OSCAR passes 15 degrees from you, add another minute; at 30 degrees, three minutes; at 45 degrees, ten minutes. Mode A: 145.85-.95 MHz uplink, 29.4-29.5 MHz downlink, beacon at 29.502 MHz. Mode B: 432.125-.175 MHz uplink, 145.975-.925 MHz downlink, beacon at 145.972 MHz.

Oscar 7 Orbital Information

Orbit	Date (July)	Time (GMT)	Longitude of Eq. Crossing "W"
16579	8bn	1 0134:12	81.6
16591	Abn	2 0033:32	66.4
16604	8bn	3 0127:50	80.0
16616	8bn	4 0027:10	64.9
16629	Abn	5 0121:27	78.5
16641	8bn	6 0020:48	63.3
16654	8bn	7 0115:05	76.9
16666	Abn	8 0014:26	61.7
16679	8bn	9 0108:43	75.3
16691	8bn	10 0008:04	60.2
16704	Abn	11 0102:21	73.8
16716	8bn	12 0001:41	58.6
16729	8bn	13 0055:59	72.2
16742	Abn	14 0150:16	85.8
16754	8bn	15 0049:36	70.6
16767	8bn	16 0143:54	84.2
16779	Abn	17 0043:14	69.1
16792	8bn	18 0137:31	82.7
16804	8bn	19 0036:52	67.5
16817	Abn	20 0131:09	81.1
16829	8bn	21 0030:30	66.0
16842	8bn	22 0124:47	79.5
16854	Abn	23 0024:08	64.4
16867	8bn	24 0118:25	78.0
16879	Abn	25 0017:45	62.8
16892	Abn	26 0112:03	76.4
16904	8bn	27 0011:23	61.3
16917	8bn	28 0105:41	74.9
16929	Abn	29 0005:01	59.7
16942	8bn	30 0059:18	73.3
16955	8bn	31 0153:36	86.9

New Products

TELEX'S NEW PROCOM ELECTRET MIKES

I recently received two of Telex's new electret hand-held mikes, a ProCom I (which they recommend for use with the popular 2 meter FM transceivers), and a ProCom II (recommended for SSB operation). Replacing the original equipment mikes on my HF band and 2 meter transceivers with the ProComs has proved to be a smart move. Signal reports indicate that both mikes produce excellent speech quality and improved readability under difficult conditions.

The ProCom I and II are amplified microphones using electret elements. The amplifier in both mikes is powered by a 1.5-volt alkaline battery or by a 1.4-volt mercury battery. Amplifier gain is fixed in the ProCom I and adjustable in the ProCom II.

If you're considering a hand-held mike for a new rig or to replace an existing mike, you could be doing yourself a favor by trying one of the ProCom models. The mikes are light and fit comfortably in the hand, something that unfortunately can't be said for all hand-helds.

While the ProCom mikes do not incorporate noise cancelling, they do an excellent job in situations where there is typically a high noise level to contend with. For example, using the ProCom I for 2 meter mobile operation not only produced excellent speech quality, but also there was negligible pickup of road and wind noise.

The ProCom I was clearly superior in terms of overall performance, particularly in respect to speech quality and noise pickup, when compared to the original equipment mike it replaced.

On-the-air tests of the Pro-

Com II were made on SSB using several of the HF bands using no more than 200 Watts and simple dipole antennas. The results were very favorable and any notions I might have had about the unsuitability of preamplified mikes were promptly dispelled after the first half dozen or so contacts. While signal strength reports were often as low as two or three, readability was consistently Q5 unless or until someone dropped a hefty signal on top of mine.

The ProCom I with fixed level output has a suggested retail price of \$19.95. The ProCom II features a variable gain control and sells for \$29.95. For further information, contact *Telex Communications, 9600 Aldrich Avenue South, Minneapolis MN 55420*.

Morgan W. Godwin W4WFL
Peterborough NH

STUART TOWER/TUNER

The Stuart Tower/Tuner is a modern rf matching device designed to match virtually any antenna tower system to 50-Ohm coax. It is currently available in two models: the 40 and 80 meter model (#4080), and the 80 and 160 meter model (#8160).

Each system comes complete with the following:

Tower/Tuner matching device: This device matches nominal 50-Ohm coax to the lower portion of a vertical tower, pole, or other object of similar shape. Rf radiation is then emitted from, and received by, the entire tower-beam/quad system. The device is housed in an all-aluminum box which has been sealed by mechanical means as well as a chemical sealer to provide a weatherproof enclosure. The box is then painted "communications gray" with an epoxy-based paint to give a truly at-

tractive and mar-resistant finish. All tuning shafts are rubber sealed to present an effective moisture barrier.

All outside connections are made through technically-correct hardware which is sealed by the best sealant available.

In addition, all hardware necessary to mount the Stuart Tower/Tuner on almost any standard tower is supplied. The hardware supplied is either stainless steel or aluminum depending on the usage.

The horizontal support members are made of aluminum to minimize corrosion as well as to enhance the already tidy looks of the Stuart Tower/Tuner.

The hardware provided will accommodate mounting on either vertical or horizontal members of the tower.

The Stuart Tower/Tuner has been tested on towers from 35 to 100 feet in height supporting both beams and quads. Rotor cables and existing coaxial lines have not interfered with performance.

In our testing, the Stuart Tower/Tuner has *not* ever required the use of a radial system at the base of the tower to give both a good swr and excellent signal reports.

Tuning of the system is a simple direct procedure. In most cases, one setting of the tuning knobs will cover either 80 CW, 75 phone, or the entire 40 meter band or the entire 160 meter band, depending on which model you have, with an swr of less than 2:1.

Stuart Electronics provides a 30-day money-back trial period. If you are not satisfied, you may return it within 30 days for a full refund. The Stuart Electronics Tower/Tuner is guaranteed for a period of one year from date of purchase. If anything goes wrong with the unit within that time, simply return the matching device prepaid with proof of purchase. They will take whatever steps are necessary to restore your Tower/Tuner to new specs and return it to you prepaid.

The Stuart Tower/Tuner is available from Stuart Electronics for \$129.95 including shipping. To order, call (216)-798-9431, or mail order to *Stuart Electronics, 578 Kennedy Road, Akron, Ohio 44305*.

THE GENAVE GTX-4

Darned if Genave hasn't come up with a surprising little hand transceiver in their GTX-4. The "4" stands for the four crystal-controlled channels it can handle. Considering the \$200 price tag and the fact that it is made in the U.S., the unit is astounding.

When you open the rig up to insert the six nicads, you'll be

pleased to see that the interstices look nothing like a Motorola HT-220, even though the whole unit is about the same size as the 220 Slimline. I always remember Mr. Inoue, the president of Icom, when he opened my HT-220 and looked inside for the first time—there was a long gasp when he saw the micro components used. . . "We couldn't build *that!*" The Genave rig uses normally miniature components, not the almost invisible micro stuff Motorola uses which has a lot to do with the fascinating price of the 220. This also makes it a lot more practical to contemplate servicing the Genave. You need a microscope and very, very steady hands for the 220 . . . and probably a 1/10th Watt iron with a pin for a tip.

Genave has taken a leaf out of the Motorola book and put in a separate microphone instead of using the speaker as the mike. Motorola learned that, so you'll find the separate mike on their later units. It makes for much better voice quality.

One feature that I like infinitely better than the 220 is the Genave charging plug. They use the same system as is used on calculators such as the SR-52 with a small mike plug coming from the 6 V 47 mA charger. I travel a lot and like to take my HTs with me . . . and while they aren't so bad on space, those great big charging stands take up a lot of suitcase room and have made one arm a half inch longer than the other already. A couple little calculator charging units fit in anywhere and do the job fine, with no worry about whether the rig is sitting on the pins in the charger or not—on some you can't tell for sure.

Lugging HTs around can get to be a bore, as handy as they are to use. They get heavy after a while. The rigs I usually use weigh in at two pounds each. This isn't too bad in my parka pocket when I'm skiing, but it is a terrible load in a suit jacket breast pocket. The Genave weighs in at exactly one pound . . . half the weight of my Standard. It's about 3/4" shorter in length, which isn't a big deal. It is a half inch thinner, which is a big deal, and about the same width.

You probably already know as much about using HTs as I do. I find them incredibly useful. They are like several other gadgets . . . until you have them, you don't realize what you have been missing and they get used every day.

A pair of HTs is ultra handy to have in the car, so if you and your Tech-licensed XYL are going shopping, you can keep in touch without having to set up exact meeting times and



Telex's electret microphones, ProCom I and ProCom II.

NEW! IC KEYER

The World's Greatest
Sending Device

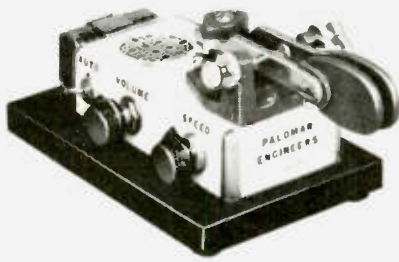

Adjustable to Any
Desired Speed

Now available from Palomar Engineers — the new Electronic IC KEYER. Highly prized by professional operators because it is **EASIER, QUICKER, and MORE ACCURATE.**

It transmits with amazing ease **CLEAR, CLEAN-CUT** signals at any desired speed. Saves the arm. Prevents cramp, and enables anyone to send with the skill of an expert.

◀ SPECIAL
RADIO MODEL ▶

Equipped with large specially constructed contact points. Keys any amateur transmitter with ease. Sends Manual, Semi-Automatic, Full Automatic, Dot Memory, Squeeze, and Iambic — **MORE FEATURES** than any other keyer. Has built-in sidetone, speaker, speed and volume controls, **BATTERY OPERATED**, heavy shielded die-cast metal case. **FULLY ADJUSTABLE** contact spacing and paddle tension. The perfect paddle touch will **AMAZE** you.

Every amateur and licensed operator should know how to send with the IC KEYER. **EASY TO LEARN.** Sent anywhere on receipt of price. Free brochure sent on request.

Send check or money order. IC KEYER \$97.50 in U.S. and Canada. IC KEYER LESS PADDLE and non-skid base \$67.50. Add \$3.00 shipping/handling. Add sales tax in California.

Fully guaranteed by the world's oldest manufacturer of electronic keys. **ORDER YOURS NOW!**

PALOMAR ENGINEERS P1
BOX 455, ESCONDIDO, CA 92025
Phone: (714) 747-3343



It's easier
Dx'er
Contester • Trafficman
Ragchewer

Telex headphones and headsets make it easier to enjoy the hobby. Whether you prefer lightweight or full cushioned comfort, there's a high performance Telex product that will help make you a better operator. See yours...at better ham outlets everywhere, or write...

T33
PRODUCTS OF SOUND RESEARCH
TELEX
COMMUNICATIONS, INC.

9600 ALDRICH AVE. SO., MINNEAPOLIS, MN 55420 U.S.A.
telephone: 612-884-4051, telex: 29-7053
Europe: 22 rue de la Legion-d'Honneur, 93200 St. Denis, France,
telephone: 820-98-46, telex: 63-0013

TOWER//TUNER

RESONATES YOUR TOWER
ON 40, AND 80 !
pat. pending

NOW available for 160
meters

Imagine using your entire tower and present beam system as a complete low angle radiator on 40 and 80 meters. It is common knowledge that a dipole or inverted-vee must be at least 1/2 wave length high (120 feet high on 80 meters!) in order for it to be a low angle radiator. But your existing tower, if fed with the Stuart Electronics **TOWER TUNER** can be made to be an optimum low angle radiator on 40 and 80 meters. The Stuart

TOWER TUNER can be installed and easily adjusted to a low swr on any tower no matter what the size or type. Tower can be grounded or not. Radials not necessary. No more haywire appearance of dipoles and I-V's. Even your wife will love it. The Stuart **TOWER TUNER** takes up virtually no extra space but greatly outperforms dipoles and I-V's at the same height plus it is easily adjustable from ground level. Start making better contacts on the 40 and 80 meter bands with an antenna system that really gets out. The Stuart **TOWER TUNER** will handle 500 watts output.



We are so confident that you will like it that we offer a 30 day money back guarantee if you are in any way dissatisfied. Price of \$129.95 includes shipping in continental United States.

STUART ELECTRONICS

578 KENNEDY RD.
AKRON, OHIO 44305
(216) 798-9431

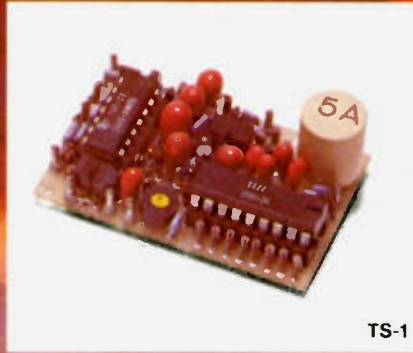

TS-1

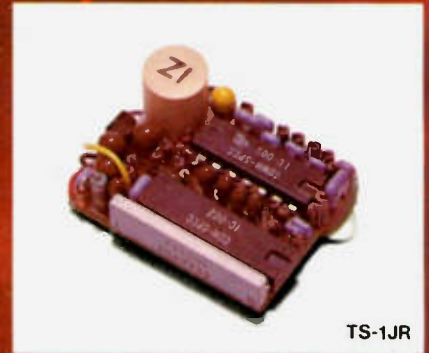

TS-1JR



PE-2



SD-1

THE DAWNING

The age of tone control has come to Amateur Radio. What better way to utilize our ever diminishing resource of frequency spectrum? Sub-audible tone control allows several repeaters to share the same channel with minimal geographic separation. It allows protection from intermod and interference for repeaters, remote base stations, and autopatches. It even allows silent monitoring of our crowded simplex channels.

We make the most reliable and complete line of tone products available. All are totally immune to RF, use plug-in, field replaceable, frequency determining elements for low cost and the most accurate and stable frequency control possible. Our impeccable 1 day delivery is unmatched in the industry and you are protected by a full 1 year warranty when our products are returned to the factory for repair. Isn't it time for you to get into the New Age of tone control?



ME-3

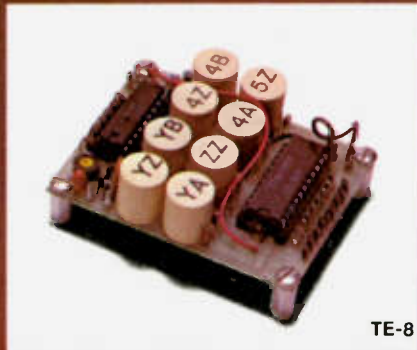

TE-8



TE-12



ST-1

OF A NEW AGE.

TS-1 Sub-Audible Encoder-Decoder • Microminiature in size, 1.25" x 2.0" x .65" • Encodes and decodes simultaneously • **\$59.95** complete with K-1 element.

TS-1JR Sub-Audible Encoder-Decoder • Microminiature version of the TS-1 measuring just 1.0" x 1.25" x .65", for hand-held units • **\$79.95** complete with K-1 element.

ME-3 Sub-Audible Encoder • Microminiature in size, measures .45" x 1.1" x .6" • Instant start-up • **\$29.95** complete with K-1 element.

TE-8 Eight-Tone Sub-Audible Encoder • Measures 2.6" x 2.0" x .7" • Frequency selection made by either a pull to ground or to supply • **\$69.95** with 8 K-1 elements.

PE-2 Two-Tone Sequential Encoder for paging • Two call unit • Measures 1.25" x 2.0" x .65" • **\$49.95** with 2K-2 elements.

SD-1 Two-Tone Sequential Decoder • Frequency range is 268.5 - 2109.4 Hz • Measures 1.2" x 1.67" x .65" • Momentary output for horn relay, latched output for call light and receiver muting built-in • **\$59.95** with 2 K-2 elements.

TE-12 Twelve-Tone Sub-Audible or Burst-Tone Encoder • Frequency range is 67.0 - 263.0 Hz sub-audible or 1650 - 4200 Hz burst-tone • Measures 4.25" x 2.5" x 1.5" • **\$79.95** with 12 K-1 elements.

ST-1 Burst-Tone Encoder • Measures .95" x .5" x .5" plus K-1 measurements • Frequency range is 1650 - 4200 Hz • **\$29.95** with K-1 element.



**COMMUNICATIONS
SPECIALISTS**

426 W. Taft Ave., Orange, CA 92667
(714) 998-3021

places. You can consult on purchases. We often use them for talking with someone on the roof or a tower working on an antenna.

A group of us go skiing, each with an HT in the pocket. It makes it a whole lot more fun.

A few years ago, I used to have an HT on my belt at hamfests, but now that almost every ham has one, it is too difficult to find an unused channel, so I seldom even try. It sure used to be fun at Saroc a few years ago, keeping in touch with the FM gang, complete with the mysterious workings of the Gronk Network, which would let you talk all the way from Vegas to San Diego or out to Phoenix. Those were the years before Saroc got ruined by commercial exploitation.

Wayne Green W2NSD/1
Editor/Publisher

PALOMAR ELECTRONICS DC-30 ANSWERS NEED FOR REGULATED 12-VOLT HIGH-CURRENT POWER SUPPLY

The Palomar DC-30 is a power supply for regulated 12-volt high-current requirements.

Its modular concept in a heat-sink chassis design delivers more efficient performance and longer life than old-style power supplies.

The Palomar DC-30 is designed and built to handle continuous loads up to 30 Amperes, with a momentary load capability 20% above the 30 Amp rating. Line voltage and load changes are fully compensated by the regulator. No overshoot on turn-on/turn-off or power failure.

The DC-30 is another example of the advanced technology from Palomar Electronics, 665 Oppen Street, Escondido, California 92025.



Palomar's DC-30 power supply.



CSC's LP-2 logic probe.

CSC LP-2 LOGIC PROBE

Most economical of the three logic probes in Continental Specialties Corporation's *The Logical Force™* is the versatile, inexpensive multi-family LP-2.

The LP-2 boasts a 300,000-Ohm input impedance, separate high and low LED logic state readouts, switch-selectable DTL/TTL or HTL/CMOS operation, and a pulse-stretching pulse-readout LED that responds with a blink to single pulses as fast as 300 nsec, and flashes at a 3 Hz rate to pulse trains up to 1.5 MHz.

Power is drawn from the circuit under investigation. Probe tips and power connectors are interchangeable with optional accessory configurations.

The Continental Specialties Corporation LP-2 logic probe is available at leading electronics dealers and distributors worldwide or direct from factory. For further information, contact Continental Specialties Cor-

poration, 70 Fulton Terrace, New Haven, Connecticut 06509; (203)-624-3103; TWX (710)-465-1227.

HELHIWHIP DIPOLES FOR FIXED STATION OPERATION

Since joining the ranks of apartment dwellers a few years ago, as well as doing an increasing amount of operation from hotels and other temporary locations in Europe, I have experimented with many antennas of all sorts in an effort to find something capable of producing a useful signal while being small and easy to install and, at the same time, keeping TVI and RFI to a minimum.

After working my way through countless endfed wires, dipoles, and verticals with consistently disappointing results, I discovered the Anixter-Mark model HWD Heliwhip dipoles for fixed station operation. The Heliwhip antennas combine reasonable performance with a high degree of portability and ease of installation, providing an excellent answer to HF operation where space is restricted or it is not possible to put up a full-sized antenna.

The Heliwhip's end load concept reduces the overall length of the antenna to a manageable size which can be fixed mounted or rotated manually or

Table 1. Note 1: Since the operating bandwidth of the HWD-40 is not sufficient to cover the entire 40 meter band, a tuning sleeve is provided to allow the selection of the desired portion of the band.

Model	Length	Center Frequency	Bandwidth for 2:1 swr
HWD-10	8 ft.	29 MHz	1000 kHz
HWD-15	12 ft.	21.250 MHz	500 kHz
HWD-20	12 ft.	14.150 MHz	300 kHz
HWD-40	16 ft.	7.050 MHz	100 kHz (note 1)

with even the smallest TV rotator. The antenna is a true dipole so it is not necessary to provide a ground plane for it to work against. Construction of the dipoles is rugged, weather-proofed, and they will handle a full kilowatt.

The end loaded concept allows the length of the antenna to be reduced with only a slight loss in efficiency compared to a full-sized dipole. The dipoles are helically wound sections so proportioned as to result in a current distribution on the shortened dipoles which is essentially uniform and which produces a 50-Ohm match at the resonant frequency. When mounted in the clear, the antennas show very low reflected power.

Either vertical or horizontal polarization can be used, the important consideration being to avoid the closeness of metal objects which detune the dipoles. In restricted installation such as attics or near the ground, the Heliwhip dipoles show less coupling and detuning effects than do full-sized dipoles or ground-plane-type antennas.

The HWD dipoles come with a clamp which allows clamping to a 1-inch mast. For optimum match, the mast should be insulated, such as a wood pole. An SO-239 connector is mounted on the dipole's center block for easy connection to the coax feedline.

For horizontal polarization, a typical installation would use a 1-inch mast to raise the dipole clear of the tower or other supporting structure and any other nearby antennas or other objects which could have a detuning effect. If it is not possible to mount the antenna in the clear and, instead, it must be placed in an attic or an apartment room, the detuning effects can be tuned out.

One end of the dipole is permanently attached to the center mounting block. This is the "hot" side of the antenna and the tuning is done on this element. The tuning sleeve can consist of a 7-inch piece of aluminum tubing slipped over the dipole. Any conducting metal can be used in place of the aluminum. Also, a piece of aluminum foil can be used and wrapped around the dipole element. The sleeve should be slipped over the end loading coil to the point where the edge of the sleeve just covers the start of the loading coil and most of the sleeve is resting on the covered fiberglass rod.

WE'LL KEEP YOUR COMMUNICATIONS NEEDS FROM GETTING OUT OF HAND.

Introducing the PALOMAR MINI-1 VHF FM TRANSCEIVER . . . the Amateur Hand-Held set that's small enough to fit in your palm.

You're never out of touch with thousands of repeaters, so you're never out of touch with home . . . associates . . . friends. The PALOMAR

MINI-1 operates normally in the Amateur 144-148 VHF region and with the AUTO-PATCH OPTION, you can access the telephone repeater and communicate through the telephone system.

The PALOMAR MINI-1 VHF FM TRANSCEIVER is only 152 mm high by 67 mm wide. Transmitter minimum output is one watt of power, with a total of 18 channels available, utilizing up-down split, down-up split or simplex, all with only 6 crystals.

The PALOMAR MINI-1 VHF FM TRANSCEIVER . . . it has all your communications needs well in hand.



*Worth every dollar.
(And about the same size!)*



Send for your spec sheet of the MINI-1 VHF FM Transceiver to: PALOMAR ELECTRONICS, 665 OPPER STREET, ESCONDIDO, CA 92025

The parameters of the Palomar PTR-130k are the outer perimeters of logic technology.

Never before has any transceiver approached the capabilities of the Palomar PTR-130k!

It's the first completely multi-functional transceiver ever made available to the public!

The Palomar PTR-130k is a miniaturized mobile transceiver

capable of operating in 100 cycle resolution from 100 KHz to 30 MHz in all modes of transmission and reception. Instant frequency selection is available with the touch of a finger.

The Palomar PTR-130k

technology is pure space age . . . the price is strictly down-to-earth.

Send for our full color brochure to:
Palomar Electronics Corporation
665 Opper Street
Escondido, CA 92025
Telephone: (714) 746-2666



TECHNOLOGY AT THE SPEED OF SOUND

The new Nye Viking "Master Key," representing the first major improvement in telegraph key design in 50 years.

Connect an swr meter in the line and, using low power, tune the transmitter to the desired center frequency of operation. While carefully observing the reflected power, slowly slide the sleeve from its present position to cover more of the loading coil. Somewhere in this adjustment, a minimum swr will be reached. The swr will depend upon the degree of detuning from nearby objects in the field. Better than 1.5 to 1 should be possible in any condition with careful adjustment.

The above procedure will permit easy adjustment to any frequency in the band. With the sleeve removed, the frequency will be as shown in the table. As the sleeve is moved towards the end of the dipole, the inductance is decreased and the resonant frequency is increased.

Heliwhip dipoles really work. Using the 15 meter model temporarily mounted about 25 feet above ground and using approximately 10 Watts during a period of rather spotty conditions, WAC was easily made and more than 30 countries worked in the course of a couple of weeks of casual operation. The 10, 20, and 40 meter models have displayed a comparable level of performance.

For further information on the HWD Heliwhip dipoles, write Anixter-Mark, 5439 West

Heath's new bidirectional wattmeter.



Fargo Avenue, Skokie IL 60076.
Morgan W. Godwin W4WFL
Peterborough NH

NEW BIDIRECTIONAL WATTMETER FROM HEATH

Heath Company, the world's largest manufacturer of electronic kits, has released a new wideband bidirectional wattmeter.

The IM-4190 (SM-4190 assembled version) is a self-contained unit that measures transmitted radio power up to 300 Watts and reflected power up to 30 Watts. Covering the 100 MHz to 1 GHz spectrum, the IM-4190, according to Heath, is an ideal tool for two-way radio service and repair or for the amateur radio enthusiast. The IM-4190 is capable of withstanding full power overloads on its lower scales without damage to the meter movement. A single 9-volt battery powers the IM-4190 so it may be used portably. N-type coax connectors are utilized for minimal high-frequency insertion loss. Adaptors for use with rf-type connec-

tors are included.

The IM-4190 kit retails for \$114.95 and the SM-4190 assembled version \$195.00 (mail order Benton Harbor). For more information on the IM/SM-4190, write Heath Company, Dept. 350-630, Benton Harbor, Michigan 49022.

NYE VIKING MASTER KEY

The William M. Nye Company announces another new addition to their Nye Viking line of products with the introduction of the "Master Key"—the first major design change in telegraph keys in over 50 years. It is designed for the expert and perfect for the beginner!

Prime feature of the Master Key is a contact assembly isolated to keep the keying circuit separated from the base, the key arm assembly, and all exterior metallic parts. Thus,

shock hazard is greatly reduced. With its heavy die-cast body and non-skid feet, the key does not need to be secured to the operating desk, nor does it require a sub-base. As with all Nye Viking keys, the contacts are gold-plated silver for sharp, sure sending. The base of the Master Key has a black wrinkle finish with nickel-plated exterior hardware. The adjustable action key arm is fitted with a Navy knob. The Master Key comes complete with 3 feet of two-conductor cord with attached 1/4" plug at a list price of \$19.50.

This new product joins the famous-for-quality Nye Viking line that includes: Speed-X and Super Squeeze Keys, iambic keyers, low-pass filters, antenna impedance matching networks, and phone patches. All are manufactured by Wm. M. Nye Company, Inc., 1614-130th Avenue N.E., Bellevue, WA 98005, and are available at dealers throughout the U.S.A.

CHEMTRONICS ANNOUNCES THE SD5 MODULAR SOLDER/DESOLDER SYSTEM

Chemtronics, Inc., a leading manufacturer of solder and aerosol chemicals for industry, recently announced its new SD5 modular solder/desolder system. Designed to place both solder and desoldering wick right at the user's fingertips,

The Chemtronics SD5 solder/desolder system.

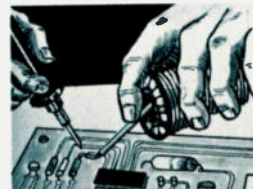

Telescoping Teflon* probe for precision application in high-density circuits



Snap D5 out of solder spool and pocket it for maximum convenience

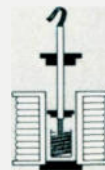

Modular construction—D5 tool is removable; 2 1/2" probe snaps into wick refill



With D5, you can shape or web the wick for greater absorbency

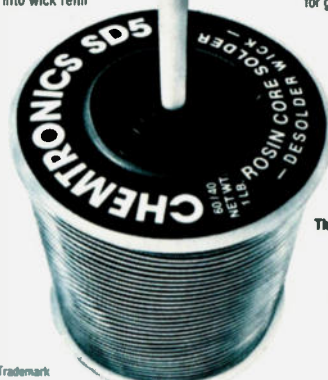

The "System".

*Teflon is a registered DuPont Trademark

EXPERIENCE. There's no substitute for it. And TEN-TEC has it. More experience in solid-state HF technology than any other amateur radio manufacturer. Because TEN-TEC produced the *first* all solid-state HF transceiver for amateur radio. So, it stands to reason that the latest generations (the 540/544 models) benefit the most from that experience — in features, reliability, and operating ease. They are the "voices of experience."

TAKE MECHANICAL DESIGN. Experience tells us: make it rugged. So, like all fine solid-state devices such as computers and good test equipment, the 540/544 transceivers have their strength built into the chassis — the case is merely a cover. Ruggedness is carried over into the circuit boards as well. Component leads are "clinched," not just inserted, to give additional strength and to prevent annoying intermittents.

TAKE PHYSICAL APPEARANCE. Experience tells us: keep it simple. WWII is over, so is its technology, so why should your transceiver look like war surplus? The 540/544 transceivers look like tomorrow — small because technology makes it possible — few controls for the same reason. And they're elegantly handsome with black cases and brushed aluminum front panels.

TAKE ELECTRICAL DESIGN. Experience tells us: push the state-of-the-art. Example: we pioneered high power solid-state design for HF amateur radio gear. The advantages are numerous: efficient, small size, no lethal voltages, less heat, longer life, greater reliability. Example: broadband design. The advantages: easier operation for everyone, rag-chewers, DX chasers, even net operators. No out of reasonance danger, no need for a dummy load to prevent tune-up QRM, no boring, time-consuming "tune-up" procedures. Another example: computer aid. In circuit design, in manufacturing, for speed and optimization. Example: computer compensating oscillator drift to achieve rock-like stability.

TAKE SERVICING. Experience tells us: make it easy, for everyone. So the 540/544 transceivers have modular design with plug-in circuit boards. And trouble-shooting (if it's ever needed) can be done by you with ordinary test equipment. (Of course, Ten-Tec service people are ready to help).

TAKE OPERATING CONVENIENCE. Experience tells us: everyone wants it. Examples: high sensitivity with low internal noise makes the 540/544 transceivers great for DX, especially during poor band conditions. Full break-in on CW turns conventional QSOs into interesting conversations. Pre-selectable ALC gives automatic level control at various input powers (40-200 watts) plus optimized input power for linear amplifiers. "Semi-hard" keying effectively penetrates pileups, QRM, and QRN, yet is highly articulate and pleasant to copy. Pulsed calibrators are easy to identify. VOX that eliminates "anti-VOX" by triggering on a tone present in your voice but not in the transceiver speaker. (There are even more conveniences in the following "features" list.)

FEATURES —

- Instant Band Change (no xmtr. tune-up)
- Covers 3.5 to 30 MHz (plus One-Sixty with option)
- 200 Watts Input — *all* bands
- Receiver Sensitivity 0.3 μ V
- VFO changes less than 15 Hz per F° after 30 min. warm-up
- 8-pole Crystal IF Filter
- Direct Readouts — choose LED digital model or 1 kHz dial model
- Optional 150 Hz CW filter
- Optional Noise Blanker
- Offset Tuning
- WWV at 10 & 15 MHz
- Separate Receive Capability
- Automatic Sideband Selection, Reversible
- Sidetone Level and Pitch control
- Pre-Settable ALC
- 100% Duty Cycle
- S Meter and SWR Bridge
- LED indicators for ALC and OFFSET
- Modular Plug-In Circuit Boards
- Broad Accessory Line

544 Digital — \$869 540 Non-Digital — \$699

Give your voice the Ten-Tec "Voice of Experience" treatment. See the 540/544 transceivers at your Ten-Tec dealer or write for full details.



TEN-TEC, INC.
SEVIERVILLE, TENNESSEE 37862
EXPORT 5715 LINDEN AVE CHICAGO, ILL 60646

THE VOICE OF EXPERIENCE



SD5 consists of a pound spool of the company's hermetically-sealed MIL-spec solder with the unique D5 desolder wick dispenser tool snapped into the core of the spool.

SD5 is a simple, practical solution to the problems of service people, technicians, and production-line workers who must often alternate between soldering and desoldering. Since the unit is completely refillable, it will generate consistent traffic in refill sales.

The ingenious design of the removable D5 desoldering tool allows it to retract or snap in or out of the solder spool for the convenience of the user. This feature is also especially beneficial to the distributor whose customers are already stocking Chemtronics solder, as the D5 tool is compatible with all pound and half-pound spools. The tool has a 2½" heat-resistant Teflon™ probe, permitting pinpoint wick application, even in densely-packed circuitry. This makes it marketable to those users involved in miniature devices who could never use desoldering wick before. The probe also facilitates "webbing" or shaping of the wick for greater solder absorption, another popular selling point.

All components of the SD5 system are available packaged for sale separately, as well as complete SD5 units. Solder is provided in 16, 18, and 21 gauge in the following alloys: 63/37 (eutectic), 60/40, 50/50, and 40/60. Wick, which is manufactured of the finest materials to exacting specifications, is available in two gauges, .06" and .10", to cover all desoldering requirements. Its pure copper color enables users to see the absorption of solder, so they never overheat boards and components by working with a used portion of braid. In addition,

it is treated with a vacuum-applied, pure, non-activated flux for high efficiency without corrosive residue. Wick refills snap into the D5 tool as easily as the D5 tool snaps into the solder spool core, making the entire SD5 unit simple and economical to refill. Both Chemtronics solder and Chemtronics desoldering wick meet all applicable federal and MIL-specs.

Like all Chemtronics products, SD5 is sold exclusively through distributors, with no competition from direct factory sales. Details are available from Chemtronics representatives or directly from Chemtronics, Inc., Solder Products Division, 45 Hoffman Avenue, Hauppauge, N.Y. 11787; (516)-582-3322; (212)-895-1930.

RADIO SHACK VARIABLE DC SUPPLY

With the growing volume of equipment and accessory items requiring low-voltage, low-current power sources, one of the handiest things an amateur can have around the shack is a variable voltage power supply. Radio Shack's Micronta variable dc power supply is just the ticket for such applications. Whether it's a low power transceiver or transmitter, receiver, keyer, speech processor, a piece of test equipment, or anything else requiring a well-regulated power source within the range of 0-24 volts and up to 1 Amp, the Radio Shack supply will handle it.

The unit features a large, easy-to-read meter to let you monitor the output voltage or current, and a precision IC voltage regulator and silicon transistor assure maximum dependability and long life. Operating from a 120 V ac, 60 Hz power source, the supply provides an output voltage con-

tinuously variable from 0-24 V dc at up to 1 Amp, with automatic current limiting. Load regulation is less than 480 mV ($\pm 2\%$) change at the output terminals from 0 to 1 Amp at 24 V dc. Line regulation is less than 150 mV change at the output terminals at 24 V dc at 1 Amp with line variation from 105 to 135 V ac. Ripple is less than 25 mV at 24 V dc at 1 Amp.

The power supply is electrically protected so that any load over 1 Amp will cause the current to limit at approximately 1 Amp maximum, eliminating the need for any external fuses or circuit breakers to replace or reset. The unit has adequate internal heat sinking so that it will run continuously—even with a short circuit across its output terminals. However, care must be taken not to block any of the ventilation holes by laying something on top of the cabinet. If the voltage drops when a load is connected, it is an indication that the power supply has gone into "constant current limiting."

Both terminals of the power supply are floating with respect to ground, so you can electrically stack power supplies such as for a positive and negative supply. If two supplies are to be connected in parallel, a 1 Amp diode should be placed in series with the output of each supply to prevent the current from flowing back into the supply. The unit's three-way binding posts take wires, banana plugs, or dual banana plugs with 0.75 inch centers.

Attractively packaged in a 3-7/8" x 8-3/16" x 6-1/2" cabinet, the Radio Shack Micronta variable dc supply (catalog number 22-123) sells for \$39.95 and is available at Radio Shack stores.

Morgan W. Godwin W4WFL
Peterborough NH

SCANBE PATENTS DIP SOCKET MODULE

A recently developed DIP socket module has been issued U.S. Patent No. 4,072,380, announced Bob Miller, president and general manager of Scanbe Division of Zero Corporation.

The unique DIP socket module, developed by Engineering Manager E. G. Freehauf, incorporates both a power and ground pin within the socket housing and is available through local Scanbe distributors.

Modules are also available with a built-in recessed cavity with exposed contacts for purposes of mounting a decoupling capacitor. Use of the socket module in medium production quantities is said to result in savings of up to 25 per-

cent per position. The patented design concept not only saves on circuit-board real estate, but also eliminates need for separate decoupling capacitors and the cost of installing separate wrap posts for power and ground connections.

Two 16-pin models are currently available. The discrete socket model not only offers the advantage of the integral power and ground connections, but it also offers greater reliability and performance of the sort associated with the company's ME-2 series solderless wrap sockets. The socket module also offers all advantages of the ME-2 series socket, plus the added benefit of the integral decoupling capacitor. It may be purchased without capacitor if desired.

The Scanbe Division of Zero Corporation manufactures a complete line of standard and custom electronic packaging products, including circuit card files, socket panels, socket cards, and dual-inline sockets. Scanbe Division of Zero Corporation, 3445 Fletcher Avenue, El Monte CA 91731; (213)-579-2300.

HEATH HD-1984 MICROPHONE/AUTOPATCH ENCODER KIT

The Heath Company has improved upon its original Micoder kit. The new version features a touchtone™ encoder with a crystal standard and single chip circuit. The microphone has a response from 300 to 3000 Hz that is tailored for clean voice transmission. Assembly took only an hour and a half and no special equipment was needed for alignment. The only adjustments needed are to set the deviation of your transceiver to match the microphone's output and then to adjust the single pot on the PC board for the same deviation when using the touchtone pad.

The unit comes complete with a six-foot coiled microphone cable and hanger clip. Power is obtained from a standard 9-volt battery (not supplied); Heath claims battery life to be approximately six months with normal use. The HD-1984 should be very popular with mobile operators since it is so quick and convenient to use—you can hold the microphone at the steering wheel and work the encoder while keeping an eye on the road.

The HD-1984 measures 3-3/4" x 2-5/8" x 1-3/4" and weighs in at just 9 ounces (including battery). The kit price is \$39.95. Heath Company, Benton Harbor MI 49022.

Morgan W. Godwin W4WFL
Peterborough NH

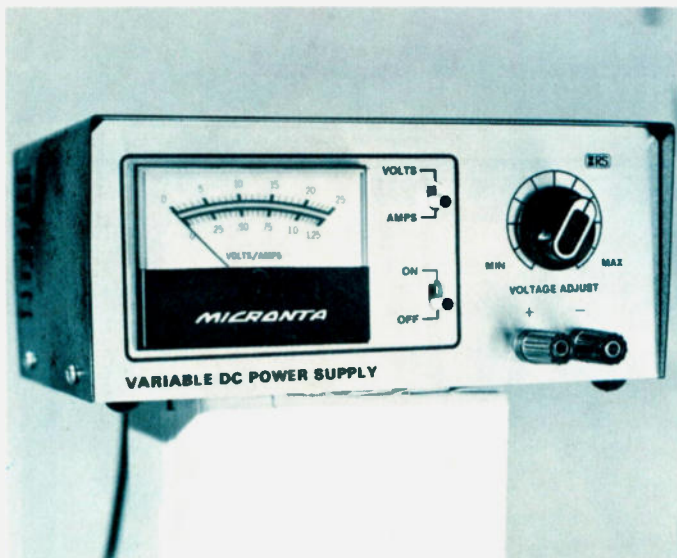

Radio Shack's Micronta variable dc power supply.

The evolution of the MLA

When the MLA-2500 was first introduced it was a new concept in high performance amplifiers. Low and sleek yet powerful enough for the military. Some wondered . . . needlessly.

A promise kept.

The MLA-2500 promised 2000 watts PEP input on SSB. A heavy duty power supply. Two Eimac 8875's. And as thousands of Amateurs across the world have proven, the MLA-2500 delivers!

Now DenTron is pleased to bring you **The new MLA-2500 B.** Inherently the same as the original MLA-2500, the B model includes all of the above specifications plus a few refinements. New high-low power switching for consistent efficiency at both the 1KW and 2KW power levels, and 160 - 15 meters.

Tested and proven.

What better test for an amplifier than the Clipperton DXpedition? Even after 32,000 QSO's, and an accidental dunk in the ocean, the same 3 MLA-2500's are still amplifying other rare DXpeditions around the world - listen for them.

Convinced? Isn't it time you owned the amplifier that powered Clipperton and thousands upon thousands of radio stations throughout the world?

MLA-2500 B \$899.50.



Dentron[®]
Radio Co., Inc.

2100 Enterprise Parkway
Twinsburg, Ohio 44087
(216)425-3173

Enjoy All Five Bands

— with this
novice no-trap antenna

Karl T. Thurber W8FX/4
233 Newcastle Lane
Montgomery AL 36117

If there is a fundamental rule about getting the most from your radio equipment, regardless of the size of your pocket-book, it is this: *Don't skimp*

on your antenna.

For top-notch DX work, a well-designed and properly installed skyhook is nearly as important as the transmitter or transceiver itself. You simply can't get maximum efficiency and radiated power output using a poor antenna system. Particularly with the relatively low power limitation of 250 Watts placed on the Novice, a good antenna is the best hope for the newcomer to work his fair share of DX.

Many hams (and not just beginners) run into problems in erecting just one antenna, so the thought of constructing antennas for each of the five HF bands seems ridiculous, not to mention the effect on your neighbors. But, with about 66 feet of antenna space, you can erect a single five-band (80/75, 40, 20, 15, and 10 meter) antenna — one that uses a separate dipole for each band and which uses no traps.

First, before describing this antenna in detail, let's take a look at some common single and multiband antennas that are often

suggested for the Novice and beginner, noting the advantages and disadvantages of each.

Old Faithful: The Half-Wave Dipole

You can cut a separate antenna for each band you want to work, although a 40 meter dipole will also work fairly well on 15 meters (due to an "odd half-wave harmonic" relationship existing between the 7 and 21 MHz dipoles). This is the only case where a dipole cut for one band will also work on another. Normally, trying to use a half-wave dipole on another band results in mismatches, high swr, increased possibility of BCI and TVI, and other problems, the least of which is poor efficiency.

The half-wave dipole shown in Fig. 1 is normally run in a straight line and centered with 75-Ohm coaxial cable or even 75-Ohm twinlead (though the latter appears to be going out of favor because it radiates and is harder to handle). The total length of the antenna is calculated by dividing the desired center



This antenna tuner, or matching network, is representative of current designs, incorporating a built-in wattmeter which allows accurate and continuous power measurement and swr indication. Rated at 200 Watts rf power-handling capability, this tuner enables feedline swrs of 5:1 to be matched to the transmitter, being designed primarily for coax-to-coax matching. Other wider-range tuners enable loading of balanced-line (twinlead) or single-wire antennas to the low-impedance coax output of modern transmitters and transceivers. An antenna coupler should always be used in conjunction with multiband antennas for good harmonic suppression. (Photo courtesy of R. L. Drake Co.)

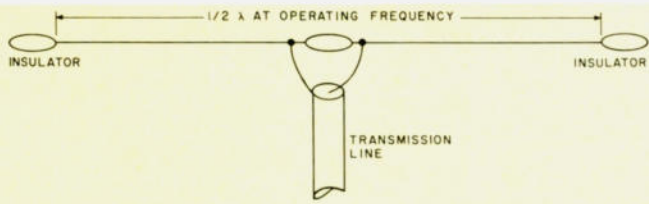

Unquestionably the world's most popular and most commonly used antenna, it is probably next to the single-wire in simplicity. However, its use is normally limited to the band for which it is designed. An exception to this is that an antenna resonant in the 40 meter band will also operate with a low swr (standing wave ratio) on 15 meters, three times the basic operating frequency.

The half-wave dipole offers a good match to 75-Ohm coaxial cable or transmitting type twinlead. At the fundamental design frequency, the swr should be under 2:1 over a range of plus or minus 2 percent of resonance.

The dipole is basically a balanced antenna, both sides being symmetrical in nature. For this reason, a balun (or "balanced-to-unbalanced") transformer coil is often used to feed the dipole with coax, which is inherently an unbalanced cable (center conductor plus grounded outer shield).

The five-band antenna described in this article is a variation of the basic half-wave dipole. Other versions of the dipole are possible, such as the folded dipole, designed to directly match 300-Ohm feedlines. Again, the folded dipole is also a single-band affair.

Multiband operation is also possible using so-called "tuned feeders" (open-wire or twinlead transmission lines), coupling the transmitter to the antenna through a wide-range coupler or matching network. The flattop is usually cut to the lowest operating frequency to be used and transmission line lengths selected to give the least problems with the high line swr and antenna currents flowing on the line.

Fig. 1. Basic half-wavelength dipole antenna.

operation frequency in megahertz (MHz) into 468. Therefore, a dipole for the Novice segment of 40 meters (7.10 to 7.15 MHz) would be about 65' 8" long. But an 80 meter CW dipole cut for the low end of the band would be all of 133' 8", a length not all suburban lots can easily accommodate, even using the so-called inverted vee configuration where the center insulator is mounted at a fairly high point and the ends of the antenna are brought down close to the ground.

In practice, the center impedance of the half-wave antenna varies slightly with the antenna's height above the ground, wire diameter, proximity to other objects such as trees and buildings, etc. But it is safe to assume a close impedance match to 70- or 75-Ohm coax or twinlead; you can use 50-Ohm coax with only a slight swr increase. Furthermore, most recent transmitters and

transceivers are specifically designed to work into 50- to 75-Ohm transmission lines, so tuning or matching is usually no problem with this kind of one-band, one-antenna setup. (You might be interested to know that RG-11/U and RG-8/U coax have about a 6% loss per 100 feet on 75 meters, while the smaller RG-59/U and RG-58/U cables have a loss of about 11%. Foam-type coax has less loss, while 73-Ohm balanced twinlead has about an 8% loss. Those losses tend to increase at higher frequencies and with impedance mismatches.)

Although the basic half-wave dipole, being very straightforward in design and not relying on any gimmicks, gives the least trouble of any antenna, a separate antenna must be constructed for each band (except 15 meters). And that's not usually possible in most urban and suburban locations.

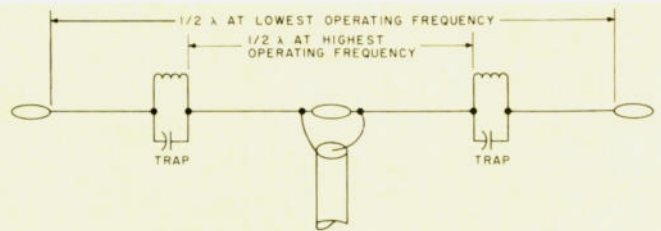

The trap antenna operates on two or more bands with practically the same efficiency as if a separate antenna was constructed for each band. In the two-band trap antenna shown, each parallel-resonant trap consists of a capacitor and coil placed at the ends of the shorter dipole section. The traps completely isolate the rest of the antenna (including other traps for other bands) from this section, thereby acting as insulators for rf energy at their design frequency. At lower frequencies, however, they will pass rf with little effect.

The same principle follows on up to the lowest frequency band on which the multiband trap antenna is designed to operate. The lowest frequency band doesn't require a set of traps, of course — it's simply the entire length of flattop end to end. A 160 through 6 meter trap antenna, for example, would require six traps on each side, for a total of twelve, to allow 7-band operation.

Note that, when traps are installed, there is some shortening of the antenna, due to the inductive loading effect of each trap. For example, the typical half-wavelength 75 meter dipole section would only have to be about 100 feet long because of the effects of the traps. The exact degree of shortening depends on the ratio of inductance to capacity in the traps; the more the capacity in the traps relative to the inductance, the closer the antenna will be to standard formula length.

Like the basic dipole, the trap is a balanced-type antenna and may be fed by coax through a balun transformer.

Fig. 2. Simple trap antenna configuration.

A Fair Compromise: The Trap Dipole

The "trap" antenna is a good choice for the operator who has the space for one full-sized dipole and wants multiband operating capability. It is similar to a regular wire dipole but has tuned traps that electrically isolate part of the antenna length. In a simple two-band example, if the antenna length from trap to trap in Fig. 2 is cut for 20 meters, then, from end to end, the same antenna can cover the 75 meter band as well, if its full length is a half wavelength on that band.

Two traps are needed for each band, one on each side of the feedline connection, except for the lowest band. They are parallel-tuned circuits enclosed in a waterproof casing, designed to resonate at the center frequency of the band. At their resonant frequency, they represent a high impedance to rf (thereby ef-

fectively acting as insulators), so the portion of the antenna beyond the traps will be out of the circuit, electrically speaking. As the traps are difficult to construct and properly adjust (not to mention making them waterproof), they're best purchased commercially. They are not terribly expensive. About a dozen manufacturers make amateur band traps. Most can be obtained complete with precut flattop, though just the traps alone are available for anyone who prefers to construct his own antenna.

The main advantage of the trap dipole over other multiband antennas is that a single antenna length will do for several bands. However, as is the case with all multiband antennas, the trap introduces a problem in harmonic radiation. If, for example, a transmitter is operating in the 80 meter Novice band, the second harmonic of the

BASIC QUARTER WAVELENGTH VERTICAL ANTENNA

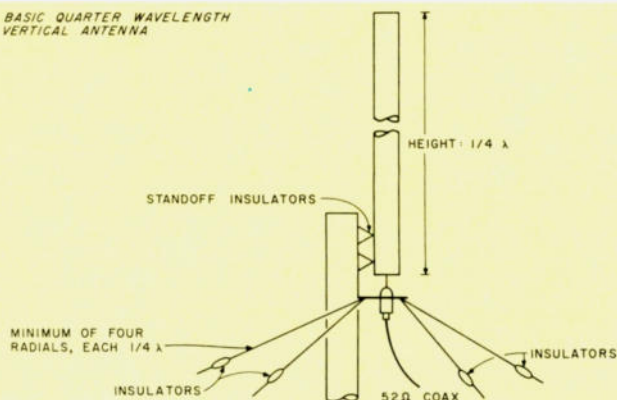

The quarter-wavelength antenna shown above is frequently used on the HF bands to put out a signal with a low radiation angle, especially good for DX work. It's also a good choice when there is insufficient room to support full half-wave flattops at the desired operating frequency.

A vertical antenna may be fed as a so-called "ground plane" as shown above, with at least four wires, each a quarter wavelength, extending radially from the base. The radials form an "artificial" metallic ground, allowing good low-angle radiation regardless of height above the ground. The vertical can also be fed directly against ground, eliminating the above-ground radials, as long as the antenna has a good low-resistance ground connection in the form of at least a half-dozen buried radials and several ground rods installed at the base.

At HF frequencies, the physical lengths required usually limit the vertical height to a maximum of a quarter wavelength at the operating frequency, whereas the smaller dimensions at VHF frequencies allow lengthening the antenna for some gain; 5/8-wavelength and even 3 half-wavelength in-phase configurations are common, giving several dB of effective gain over the basic quarter-wavelength antenna.

The vertical, like the dipole, is essentially a single-band affair, although traps may be inserted at appropriate points for multi-band use.

Fig. 3. Vertical ground-plane antenna.

signal will also be radiated very nicely by the antenna — but it will be out of the top end of the 40 meter band, representing illegal operation and inviting a so-called "pink ticket" from the FCC.

Usually, you can stay out of trouble with multi-band antennas by always feeding the antenna through an antenna coupler, which can offer an added 20 to 30 dB or more of harmonic suppression.

The problem of increased harmonic radiation and TVI applies also to the five-band antenna which will be described later on. It, too, should be fed through an antenna coupler, although most transmitter pi-network output circuits have fairly good second and third harmonic rejection characteristics if not "loaded" too

heavily in an effort to get out that last Watt of rf. (If you suspect excessive harmonic radiation, check with a friend a few miles away, having him tune to your second or third harmonic — it should be received very weakly, if at all. It's a fairly good test for harmonic radiation, provided he's at least a few miles away.)

Using a multiband antenna may also aggravate TVI problems. So be sure to use a low-pass TVI filter installed in the coax between the transmitter and the antenna tuner and use the minimum grid drive necessary for full power output.

DXer's Choice: The Ground Plane

The ground-plane vertical is an excellent choice when horizontal space is a

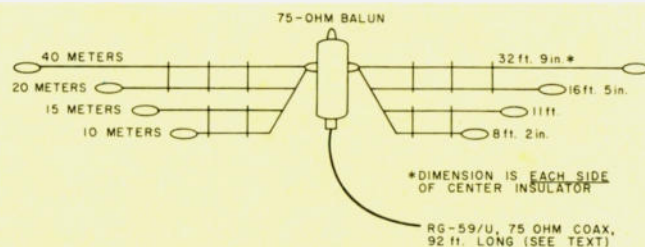

The antenna system pictured above is an adaptation of the basic dipole antenna; a group of centered dipoles are connected in parallel where the transmission line joins them.

On 40, 20, 15, and 10 meters, the antennas act as ordinary dipoles. There is fairly little interaction between the separate flattops. On 75 and 80 meters, the antenna is fed through the shorted ends of the coax (see text) as a single-wire-type antenna.

As the antenna, like the basic dipole, is essentially a balanced system, a balanced feedline would normally be used, such as 75-Ohm transmitting-type twinlead. However, direct coax feed will present little in the way of problems, or the balun transformer can be used as shown in the illustration to prevent possible imbalances in the system introduced by using the unbalanced coaxial cable.

As described in the text, the antenna itself is constructed of 450-Ohm open-wire TV transmission line, although other variations are suggested, such as the use of 300-Ohm twinlead or "ladder line."

Note that, in the configuration shown above, the 20 and 10 meter dipoles are the cutaway lower halves of the 40 and 15 meter dipoles, respectively. Each set of dipoles should be separately supported on the ends to minimize strain on the open wire line.

The physical design is flexible and may be varied to suit individual operating needs and available space, as suggested in the article.

Fig. 5 shows how the coax is jumpered at the transmitter end for 75 and 80 meter operation, while Fig. 6 shows details of the center insulator mechanical support connections.

Fig. 4. Short five-band no-trap antenna.

problem and if you're mainly interested in working DX. This type of antenna has a very low radiation angle, can be either ground- or mast-mounted, and can be directly fed with coaxial cable. It is shown in Fig. 3.

The quarter-wave vertical radiator must be insulated from ground for coax feed, presenting a feedpoint impedance of around 25 to 40 Ohms. This allows a reasonable match to 52-Ohm coax without using matching stubs or other devices in the transmission line. The antenna can also be fed with 70- or 75-Ohm coaxial line using a quarter-wavelength section of 50-Ohm coax between the line and antenna.

The vertical can be fed "against ground" rather than using the ground-plane radials running above ground (a little

inconvenient on 80 and 40 meters because of their length). In this case, care is taken to get a good ground "mirror" by using several six- to eight-foot ground rods and using at least a half-dozen buried radials of various lengths to obtain the ground-plane effect and a low rf ground resistance.

While it's a particularly good DX antenna, the vertical sometimes doesn't work as well at the medium distances typically worked on 75 and 40 meters. Also, installing the radial system often presents a problem. Then, too, the ground-plane vertical is normally a one-band affair that also has a nasty tendency to aggravate TVI and RFI problems because of its vertical polarization and consequent low angle of radiation, which tends to direct your signal down and into the neighbors' TV, stereo,

and other electronic equipment.

A hybrid-type antenna that is becoming increasingly popular is the trap vertical, which uses tuned traps much like those used in the trap dipole, but which are inserted into the vertical antenna elements at the proper isolation points to allow multiband operation.

The multiband trap vertical — some designs are as short as 30 feet or less for full 80-10 meter operation — is an excellent all-around antenna and a fine DX choice when worked against a good ground system, but it is a lot more expensive than the simple wire flattop. Also, due to the complicated mechanical problems introduced by the traps, it's usually not practical to build your own trap vertical from scratch, whereas single-band verticals and dipoles are "snaps" for ease of construction.

Another popular and inexpensive multiband vertical is base-loaded, the antenna usually being 20-35 feet long and in one continuous length. With this antenna, a tap on the base-loading coil is manually moved to different positions on the coil until a good coax match is obtained. While 80 through 10 meters can be worked using one antenna and coil combination, the tap must be changed manually, a distinct disadvantage in inclement weather. The coil must also be waterproofed and otherwise protected from the elements.

A Short Multiband Antenna Using No Traps

As shown in Fig. 4, this antenna is a complete, easy-to-build, coax-fed, five-band, separate-dipole system. As with the basic half-wave dipole antennas discussed earlier, the dipoles are individually cut to any desired frequency

within a particular band using the familiar dipole equation $L = 468/F$, where L is in feet and F in MHz. For general all-around operation, each dipole should be resonant in the center of its band. (On 10 meters, however, the antenna is cut for 28.5 MHz to cover the CW segment and the lower end of the phone band starting at 28.5 MHz.)

With this setup, on the band you're working, the transmitter and coax feedline "see" a good 75-ohm match; the other paralleled dipoles — having a high impedance on other than the band they're designed for — just aren't there, electrically speaking, so they don't much affect operation on the other bands.

You'll find that, on 40, 20, and 15 meters, the antenna maintains a fairly consistent SWR of less than 2:1. On the 10 meter band, the "bandwidth" of the antenna is roughly 500 kHz either side of the design center frequency (28.5 MHz) before the SWR starts to become excessive. On ten, however, if a wide-range antenna tuner is used, the antenna may be made to load fairly well over the entire band.

Using paralleled dipoles with one common feedline is a very common practice, but the fact is that it still takes about 125' of flattop to radiate effectively on 80 meters. Even using commercially-designed trap dipoles, the length needed for 80 is usually at least 100 feet, with a very narrow operating frequency range due to the high "Q" of the traps. Again, this kind of space often is not available.

Here's how to get to 75 and 80 meters with this antenna: First, recall that the basic antenna length at 7.15 MHz is determined from the formula of $468/F$, or 65' 6". Dividing this by two gives us the 32' 9"

length on each side of the center insulator. Now, adding a length of coax of about 92 feet to the 32' 9" gives an effective antenna length of 124' 9", which represents a half wavelength resonant at the approximate center of the 75/80 meter band.

On 75 and 80, you should find that the SWR is fairly low for about 150 to 200 kHz around the design frequency and shouldn't

exceed 3:1 or so at these limits. But on this band — and this band only — the inner and outer conductors of the coaxial cable are connected together at the transmitter or antenna tuner end and fed like a single-wire antenna. (Note that a good ground connection for the transmitter or transceiver is important for good results when the antenna is, in effect, fed as a single wire against

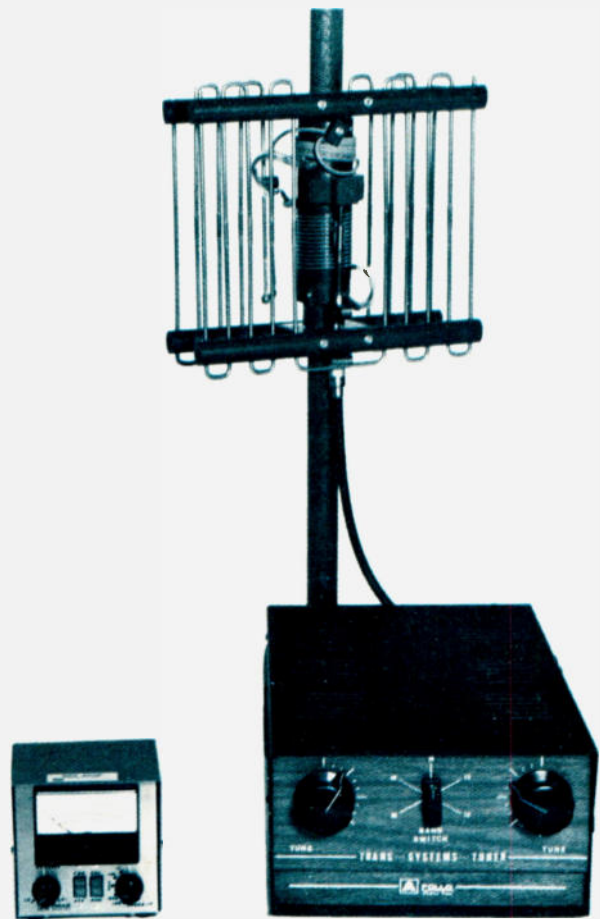

One of the few antenna tuner kits on the market today, the 5-band Apollo Trans System tuner kit is a wide-range coupler based on the classic design by Lew McCoy which appeared several years ago in QST. The tuner will match low-impedance coax cable or open-wire lines. It will also handle random-wire antennas. The kit sells for about \$125. Also shown here is a combination wattmeter and direct-reading standing wave ratio bridge, a useful device in tuning up and adjusting any antenna. The device behind the antenna coupler is the Apollo "Little Giant" beam antenna, a very unusually-configured mini-antenna designed for single-band operation on 40, 20, 15, or 10 meters. It measures just 27" high and 22" wide. A slightly larger version is designed for 80 meter operation. (Photo courtesy of Apollo Products, Box 245, Vaughnsville OH 45893.)

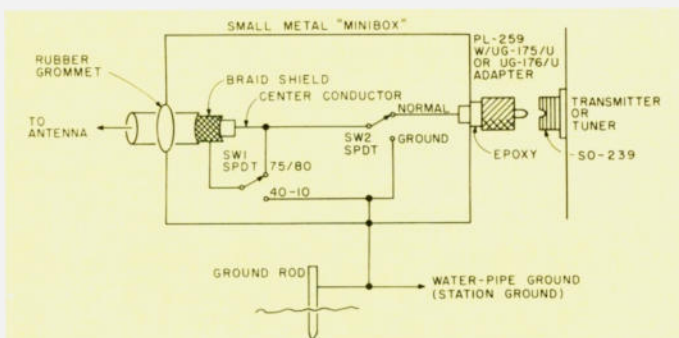

This device allows convenient switching from a 75/80 meter single-wire configuration to straight multiple-dipole operation.

SW1, in the upper position, shorts the coax shield to the inner conductor for 75 and 80 meter operation, while, in the lower position, it is connected to ground in regular fashion. (Note that the coax is not grounded to the metal box where it enters but, rather, is routed through a rubber grommet.)

SW2, when in the normal position, connects the antenna system to the transmitter or antenna tuner for regular operation. In the ground position, the antenna is grounded for lightning protection. The antenna should always be grounded when not in use for maximum protection.

The PL-259 connector is mounted to the minibox by drilling a hole just large enough to accommodate a UG-175/U or UG-176/U reducer adapter, screwing the reducer onto the PL-259 through the cabinet wall. It can be epoxied into place if desired.

The two SPDT switches can be ordinary electrical switches for low-power work. However, heavy-duty ceramic rotary switches are suggested for more than 100 Watts or so power levels.

The jumper box should be connected to a good ground system. This is particularly important when working the antenna as a single-wire on the lowest band.

Fig. 5. 75/80 meter jumper box pictorial diagram.

ground.)

The jumpering can be done manually using alligator clips, or you can construct a jumper box for the purpose, as shown in Fig. 5. The box also provides for

grounding the antenna when not in use, for lightning protection, and for discharge of static buildup on the antenna.

Since the antenna operates with a fairly low swr,

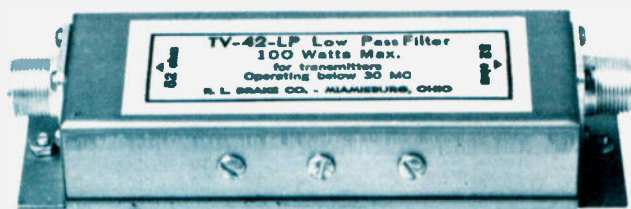

This low-pass filter provides extremely high attenuation of signals higher than 43 MHz, effectively eliminating the possibility of radiating undesirable harmonics in the TV bands through the antenna. Multiband antennas tend to aggravate harmonic radiation problems, including TVI, but the use of a low-pass filter and antenna coupler in the transmission line will do a great deal to reduce the possibility of TVI problems. While the particular Drake filter shown is rated at only 100 Watts, other filters by Drake and a number of other manufacturers will handle all amateur power levels. (Photo courtesy of R. L. Drake Co.)

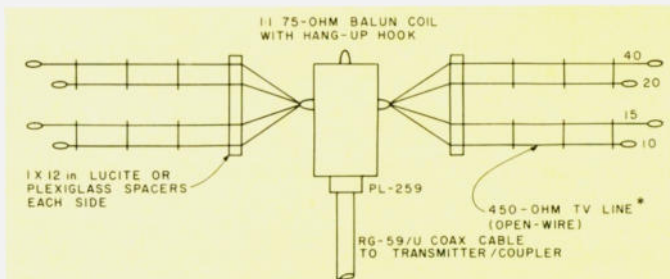

A commercially-manufactured 1:1 balun is used as a convenient center insulator for the antenna; the hang-up hook may be used if you want to tilt the antenna for space into the inverted vee arrangement mentioned in the text.

The 450-Ohm open-wire line may be run directly to the balun, but a neater and stronger antenna results if you run the dipole sets to a 1" x 12" Lucite™ or Plexiglas™ bar, firmly anchoring the line ends to the bar. Short (6-8") wires may be run from the bar to the anchoring hooks on either side of the balun coil. Note that all wires on each side of the balun are connected to each other, resulting in each dipole being electrically paralleled with the others.

For maximum strength, each dipole set should be separately supported, minimizing strain on the antenna as a whole. Most baluns are equipped with a coax receptacle; therefore, the cable should be fitted with a PL-259 connector for easy connection to the antenna.

As discussed in the text, 300-Ohm heavy-duty twinlead may also be used to construct the antenna, as may polyethylene "ladder line." Solid copper wire may also be used to form the 40 meter antenna with the other dipoles being suspended from it. The ARRL Antenna Book gives a number of mechanical techniques for multiple-dipole center support and may be consulted for more information.

If you prefer, the balun coil may be eliminated and replaced with a standard center insulator with little effect on performance.

Fig. 6. Center insulator mechanical support connections for 5-band antenna. *Burstein-Applebee catalogue no. 2A9967-9.

even on 75 and 80, the transmission line could be fed directly by the pin-network output circuit of the transmitter or transceiver without using an external antenna tuner or coupler. But, an antenna tuner or coupler should in fact be used to reduce the very real possibility of radiating out-of-band harmonics — something a multiband antenna will do very well, as mentioned previously. The tuner also does a nice job tuning out any reactance at the band edges, which is particularly useful on both 75/80 and 10 meters where swr may get a bit ragged at the band edges.

On the top four bands, the radiation pattern will closely resemble the familiar "broadside" half-wave dipole pattern, while on 75 and 80 meters, the pattern is essentially omnidirec-

tional with elements of both vertical and horizontal polarization caused by the radiating coax which is now an integral part of the antenna. If your space is even more limited, you can mount the antenna in inverted vee fashion, which requires only a single high support and less horizontal space. By doing this, you very slightly reduce the antenna's resonant frequency, feedpoint impedance, and bandwidths, as the angle between the two parts of the dipole is decreased. As long as you don't make the angle at the apex smaller than about 90 degrees, you should have no problems using the vee, and the slightly lowered angle of radiation should be a plus for DX work.

Build It

The five-band antenna is made of good-quality TV-

type 450-Ohm open-wire transmission line, heavy-duty 300-Ohm twinlead, or commercially-available polyethylene "ladder line" sold by many large mail-order electronic suppliers, such as Burstein-Applebee, Lafayette Radio, and others. In most situations, the open-wire line or twinlead is strong enough to support the antenna, if the lower dipoles are run separately to a support and if the coax is also supported at some point so the full weight of its entire length doesn't fall on the antenna flattop. (You can also use #12 or #14 copper wire for the main 40 meter flattop if you like—I'll discuss that variation later on.)

Each end of the 40 and 15 meter dipoles (the top halves of the open-wire) is connected to an insulator, with the centers being tied through a Lucite™ or Plexiglas™ support bar to the main center insulator. The 15 meter dipole should be separately supported on the ends and run to a nearby tree or any available mast or pole. The 20 and 10 meter dipoles are simply the cutaway lower portions of the 40 and 15 meter open-wire line or twinlead. The center of each dipole is connected in parallel with the one above it at the center insulator. Fig. 6 is a close-up view showing how all this is done.

When hanging the antenna, you should place it as high as you possibly can above the ground (at least 25 to 30 feet) and far away from other objects that might detune it or block its radiation path. You can

orient it for the direction you're mainly interested in covering, but it will still radiate fairly well in all directions. Maximum radiation will be in a "doughnut pattern" lying at right angles to the wire.*

Getting down to the nitty-gritty of actually constructing the antenna, your best bet is to use a commercial 1:1, 75-Ohm balun coil as the center insulator. While a balun isn't absolutely necessary, it's helpful in getting a symmetrical radiation pattern and keeping down antenna currents on the coax (except on 75 and 80, where the coax is part of the antenna itself). If you want to use a balun — and it is a good idea to do so — they are hard to build and waterproof yourself, so it's probably best to buy a commercial model, costing anywhere from \$10 to \$20. Unadilla Radiation, Green Insulator, Kaufman Industries, Barker and Williamson, Palomar Engineers, and a host of others make them. Their ads can be found each month in the various amateur publications.

They're all good products. Two added pluses for the baluns are that, first, they usually come equipped with a built-in SO-239-type coax connector for easy feedline attachment, and second, their internal construction usually places the antenna at dc ground potential, affording some degree of built-in lightning protection for the antenna. Just make sure that you use the one-to-one (1:1) kind of balun, not the 4:1 type, which is designed to trans-

form a 300-Ohm folded dipole's impedance to match standard 75-Ohm coax.

Whether or not the inherently balanced dipole should always be fed through a balun is a moot technical point that is likely never to be decided with any finality. I have never found it absolutely necessary to use one, though you will find that many antenna purists insist that baluns are necessary to keep current from flowing on the outside of the coax transmission line. (Some operators prefer to use balanced 75-Ohm twinlead and mount the balun at the transmitter end — take your pick.)

While on the subject of baluns and dipole center connectors, some balun manufacturers also sell the connectors less the balun "innards." These connectors are very handy even if you don't want the balun feature, making it easier to build a professional-looking antenna with a good weatherproof feedpoint connection. They're well worth the cost — usually less than \$9 or \$10 — and are a lot less hassle than building your own center connectors. Of course, since they are weatherproof, they can be reclaimed and used again and again with future antennas.

To complete the installa-

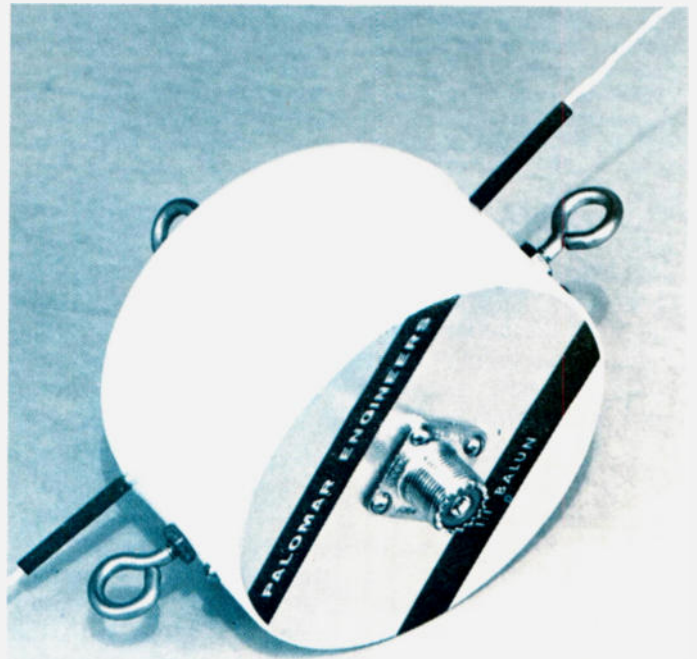

This Palomar balun is designed to match unbalanced coaxial line to balanced dipole antennas over the range of 1.7 to 30 MHz. According to the manufacturer, dipoles fed directly with coax cable are susceptible to cable radiation which can lead to TVI, BCI, rf feedback in the station, and noise pickup when receiving. The balun (balanced-to-unbalanced transformer) converts from the essential unbalanced coax to a balanced output by transformer action. Note the "hang-up" hook useful in supporting inverted-vee-type antennas. Baluns are made by numerous manufacturers, such as Unadilla Radiation, Kaufman Industries, Greene Insulator, and others. (Photo courtesy of Palomar Engineers)

*Note: A centered, horizontal half-wave dipole radiates in a fairly wide pattern broadside to its length and poorest off the ends of the wire. However, from a practical standpoint, it's really not that important in what direction you run a dipole, especially on 80 or 40 meters, although orienting its ends in a

north-south direction is a pretty fair compromise for stateside contacts. On the 20, 15, and 10 meter bands, directivity is somewhat more pronounced, so, if DX is your forte, you might want to route it with this in mind. In any case, don't be overly concerned about its orientation.

1. Keep horizontal antennas as high as possible — at least 25 or 30 feet above the ground or buildings.
2. Bend the dipole into a vee if you like, but avoid bending the ends if at all possible. Don't be overly concerned with the antenna's orientation.
3. Feed horizontal flattops at the center rather than at the ends; balun matching coils are nice, but are not absolutely necessary.
4. Use high-quality coax feedline; its advantages far outweigh its disadvantages. Small-diameter coax is okay up to about 500 Watts.
5. Vertical antennas are good, provided they are worked against a good ground system. But they tend to be noisy on receiving and may aggravate TVI and BCI.
6. Protect your antenna against lightning and ground it whenever you're not using it. You may be very sorry if you don't!
7. Use an swr meter or R-X antenna bridge to check out and adjust your antenna, but don't get hung up on swr. It can't always work out to 1:1.
8. Install a good station ground using connections to cold-water pipes and/or ground rods driven into the earth. (This goes hand in hand with lightning protection.)
9. Use an antenna coupler or matching network in the coax line if for no other reason than getting added harmonic suppression. The ones with built-in swr bridges and rf power meters are very handy and allow continuous monitoring.
10. Use a low-pass filter between the transmitter or transceiver and the antenna coupler — don't give harmonic-caused TVI a chance!
11. Multiband trap antennas are fine, but can be frustrating to adjust if you've never "pruned" an antenna before. Be prepared to do some tweaking to get consistent performance from band to band.
12. Beams, rhombics, and other advanced antennas will add punch to your signal, but cut your teeth on some basic types first.
13. If your antenna doesn't work properly, check for continuity and look for shorts in the line; also check the swr carefully. Double check all solder joints and make sure all connections are mechanically sound. Above all, don't try to force power into an antenna that doesn't want to load up — find out what the problem is before ruining a final output tube or messing up your final tank circuit.

Table 1. Antenna installation tips for the beginner. Summarized here are a baker's dozen rules of thumb that should help you in getting the maximum results from that HF skyhook. Take heed! While not everyone would agree with all the items of my "laundry list," they do represent some 20-plus years of observations in experimenting with a wide range of antennas, from short indoor single-wires to multi-element beams.

tion, you can connect the ends of the dipole to good-quality ceramic, glass, or porcelain insulators and support the ends with weatherproof rope, heavy-duty plastic clothesline, or wire (broken up with strain insulators at random intervals to prevent undesired resonances near the antenna which may affect its performance or swr). Also, don't pull the antenna too tight; leave just enough sag to keep it flexible in the wind. In very limited space, you can hang the center of the antenna on any available high support (preferably nonmetallic) and let the ends droop in inverted vee style. You can also run the center portion

of the antenna horizontally between two closely-spaced supports, bending the ends and hanging them vertically. (I don't recommend the latter with this antenna unless absolutely necessary, as it will result in a reduction in efficiency and is a bit tricky if open-wire is used to make up the dipoles. But supporting the center is a good idea, especially if you use open-wire line for the main 40 meter section, which has to bear a good deal of weight.)

The coax transmission line is best kept away from trees, power lines, and buildings, particularly since, on 75 and 80 meters, it is being fed as a resonant

or tuned line. It should be run outdoors as much as possible, at right angles to the dipoles, if possible, to minimize undue distortion of the radiation pattern by the coax. Use TV-type standoff insulators in routing the coax to the shack.

Incidentally, RG-59/U coax is suitable for up to 500 or 600 Watts input if the swr is low, while you should use RG-11/U if you're running more power than that. Be wary of using cheap CB-type coax, as the shielding tends to be poor. The cable also tends to become very lossy at the higher frequencies.

The dipoles will interact with one another to a very small extent. If you experience problems in keeping the swr fairly consistent from one band to another, you can try pruning the antenna slightly for each band using a grid-dip meter, R-X antenna bridge, or swr meter. You can also experiment by adding about 4 feet of 75-Ohm coax to the specified 92-foot length and then trimming off about 4" of coax at a time, until the swr becomes fairly consistent from band to band. The extra length of coax won't adversely affect 75 and 80 meter operation, but it will shift the resonant frequency somewhat lower than originally designed.

Do your initial antenna tune-up without the coupler or tuner being in the line, so that you'll be sure that you're measuring the antenna's characteristics, not the coupler's ability. After you have attained an acceptable swr on all bands, move the swr bridge to between the coupler and the transmitter for routine tune-up and band changing.

One point before leaving the subject of tuning: Tweak the antenna all you like, but, if it works well on all bands and shows a rea-

sonable swr on your favorite band segments, leave it alone. Tuning any multiband antenna for a perfect 1:1 match on all bands is almost impossible and probably won't make much difference in overall performance anyway. Actually, from a practical standpoint, an swr of even 4 or 5 to 1 doesn't cause a great signal loss or necessarily cause loading problems at the transmitter. This would start to matter at 6 and 2 meters with a long feedline, but, as a rule, if the power is going into the line, the antenna has to get most of it. Spending a lot of time trying to get the swr down to exactly 1:1 at all points in the band just won't help your signal that much.

Don't Be Afraid To Experiment

The antenna should work well as designed, but by no means must it be constructed exactly as described. After all, a good deal of the fun in amateur radio is experimenting to determine what works best for your own purposes.

For example, you may want to use a nonbalun center insulator instead of the balun coil. Or, you may, for added strength, want to use #12 or #14 copperweld steel wire for the 40 meter section, using the open-wire line or twinlead for the 20 and 10 meter dipoles and skipping the 15 meter section entirely, since the 40 meter antenna will do a fairly good job on 15. Many variations are possible. Refer to the *Radio Amateur's Handbook*, the *ARRL Antenna Book*, or the book *73 Dipole and Long-Wire Antennas* for more ideas on multiband antenna configurations.

You may even elect to forget the 75/80 feature, if that band isn't important to you. In that case, the lowest band you have to

consider is 40 meters, so the length of the coax is unimportant, since it operates as an untuned line on all bands covered.

Then, too, each dipole's length can be set to favor a particular portion of the band. For instance, you might want to cut them for the CW portions of 40 and 20, but make them resonant in the middle of the 15 and 10 meter phone bands instead, depending on your interests and the operating

privileges your class of license conveys.

Bear in mind that, if you want to carefully tune the antenna for a particular band segment, it's best to start with lengths several inches longer than calculated from the dipole formula to give yourself a little play when pruning the antenna. Also, if the 92 feet of coax specified seems a bit long, there's nothing magic in the length. It was chosen to make up a half

wavelength on 75 and 80 when combined with each leg of the antenna for ease in loading. You can experiment with shorter lengths. With other lengths of coax, however, on 75 and 80 the antenna may behave more like a random wire, and a wide-range antenna coupler may have to be used to tune out the large amounts of reactance you can expect.

In any case, make all measurements carefully

and be sure to solder all joints properly. A cold solder joint can wreak all kinds of havoc, with intermittent operation, TVI, and RFI very likely results.

This is a simple antenna, but one not involving too many performance-robbing compromises. And, you will very likely find that, in general, the simpler the antenna, the better the results and the fewer operating problems you're going to have. ■

The "ULTIMATE" in CW Reception!

ACTUAL SIZE
3 1/2" WIDE
2 3/8" HIGH
4 3/8" DEEP

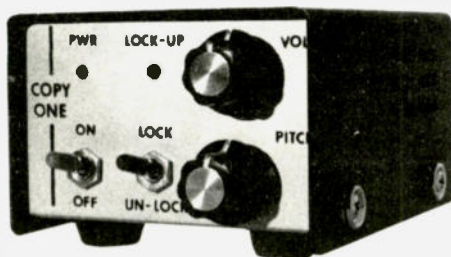

COPY ONE®

\$99.95

COPY ONE IS NOT A FILTER! This station accessory is a must for the discriminating amateur who operates CW, whether he is an avid CW op or one who engages in CW for proficiency. The CW signal is **processed** (not filtered) in a manner which allows true **ULTIMATE STATION REJECTION**, a mode which has been previously unavailable. The circuitry* is **totally unique** (patent pending), a must for emergency CW operations. If you haven't had the opportunity to operate a **COPY ONE**, ORDER YOURS TODAY!

COPY ONE CW PROCESSOR SPECIFICATIONS & FEATURES:

- **Ultimate station rejection** (almost unbelievable but true!)
- **Pitch & volume independent** of receiver or transceiver
- **Full quieting** (i.e., no background noise) without squelch
- **COPY ONE is not a filter**, there is absolutely no ringing or background noise
- **Plugs into** transceiver or receiver/transmitter combo without modification
- **Discriminates signals** in 80 to 100 cycle increments
- **Full break-in** CW operation
- **Includes** 115 volt AC power supply or may be battery operated
- **Built in** code practice oscillator
- **LED lock-up controls** front panel mounted

ORDER YOURS TODAY!
send \$99.95 by check
or money order to:

LOGITRONICS, INC.® L11

3135 North Cole Road Boise, Idaho 83704 [208] 377-1562

50 144 REPEATERS 220 450 Mhz

THE NEW Hi Pro Mk I

* State-of-the-art, full-feature repeaters that boast broad range temperature and electrical stability for use in an uncontrolled environment

* Low current drain — A plus for emergency 12 volt standby battery operation

* The receivers develop maximum usable sensitivity and sideband rejection

* The transmitters develop 15 Watts Minimum of clean rf and a faithful reproduction of the input signal insuring an extremely good sounding repeater.

* Includes a high quality dynamic microphone and a detailed instruction manual

PA Res. add 6% tax

50 MHz \$789.95 450 MHz 799.95

144 + 220 MHz \$699.95 PLUS SHIPPING

5 1/4" x 19" x 13"

OPTIONS

Duplexers

Basic auto patch

Matching cabinet

.0005% High stability crystals



Maggtore Electronic Laboratory

845 WESTTOWN RD.

WEST CHESTER, PA. 19380 PHONE 215 436-6051

M36

Reincarnating Old Test Equipment

—a 1942 capacitance meter is born again

Photos by WA3PTC

My Cornell-Dubilier capacitance bridge had served long and well. Purchased in 1942, the model BN cost about \$12.00. Eighteen years later, the 12A7 failed and was replaced. In 1972, a resistor failed, and then, in May, 1977, the “new” 12A7 failed. Ob-

viously such an unreliable piece of gear was begging for replacement ... until the price of an equivalent unit revealed the true extent of inflation.

Examination of the problem called for recycling, something we hams had been doing for years before the idea caught on in the popular press. The only item needed

to bring the unit back to life was a bridge balance amplifier and an indicator of balance. I had always been less than thrilled with the magic eye indicator, as it had to be shaded from ambient light to really see when balance was achieved.

In my case, I decided on a new housing, since the old one had been cracked while proving that gravity was still a viable force. The cabinet from an old five-inch Sony TV was mated to a panel made out of a formica cutoff from a woodworking project. Fig. 1 shows the original schematic.

Electrically (as shown in Fig. 2), all parts associated with the old bridge amplifier and magic eye indicator were discarded, keeping the basic bridge components intact. The voltage divider, consisting of a ten-megohm resistor and a one-megohm resistor (across the output of the bridge), serves two purposes — first, to keep the impedance high at this point to allow the bridge to function, and second, to control the amplitude of the input to the op amp used as a bridge amplifier.

The output of the bridge when unbalanced can run as high as thirty volts, and at balance, depending on the range in use, can be as low as a few tenths of a volt. The divider reduces this variation of amplitudes by a factor of eleven to avoid real problems with the op amp, which is set up for a gain of ten.

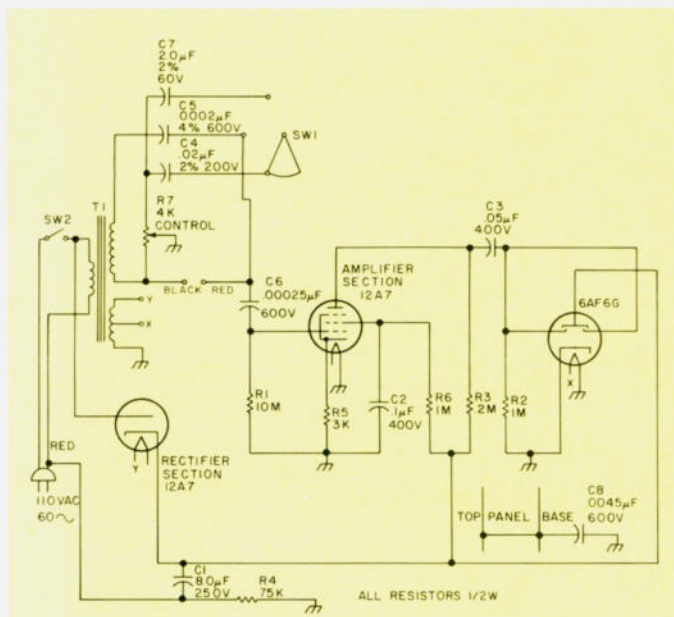

Fig. 1. Circuit diagram for capacitor bridge model BN.

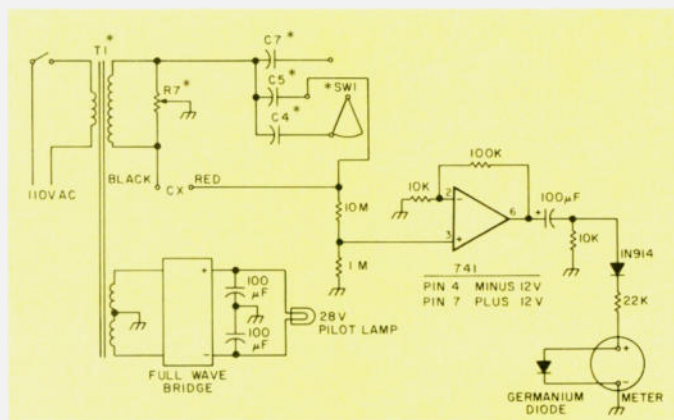
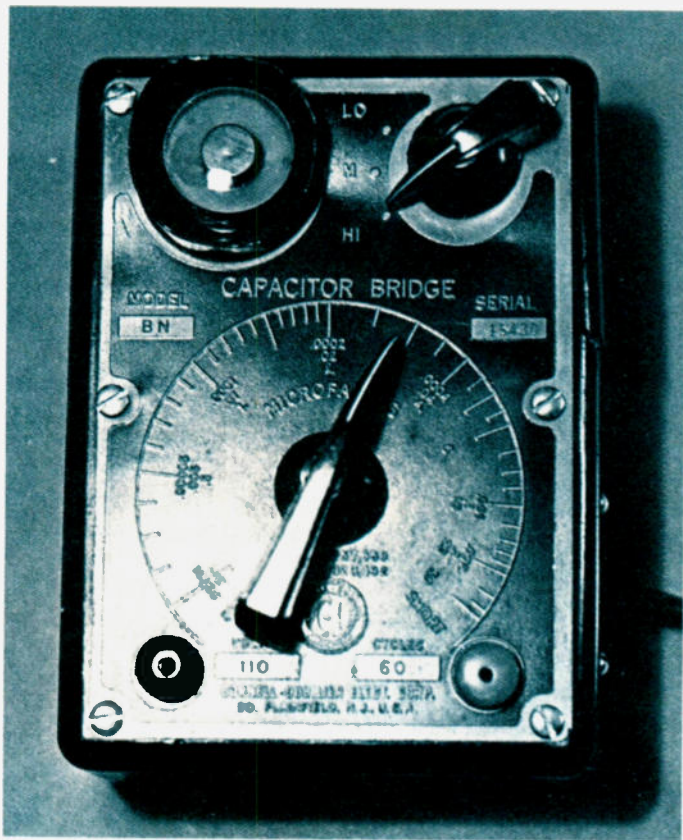

Fig. 2. *Original components.



The balance indicator is a meter salvaged from an old tape machine and serves quite nicely in this function with the advantage over the old magic eye in that it does not need to be shielded from ambient light. Since the meter you may use may vary in sensitivity from the orphan I wound up using, here is a simple way to set up the proper series resistor to scale the meter. Unbalance the bridge and insert just enough series resistance so that the meter pins full scale. Then shunt the meter with the germanium signal diode, as

shown in Fig. 2, and the meter indication should drop about one or two scale divisions. This simple method obviates any fuss and feathers log amp problems to handle the signal variations that the op amp handles. It allows for a very nice null reading to show balance, while saving the meter from overload.

The original transformer has two windings — one driving the bridge and the other a center-tapped winding which formerly lit the filaments of the tubes. This latter winding is used to feed a full-wave bridge, producing

the dc voltages needed for the 741 op amp. I put a 28-volt pilot lamp across the output of the supply, which serves the second purpose of acting as a bleeder.

Be sure to ground the dial plate of the bridge to the ground terminal of the supply. If you use a metal cabinet, keep the bridge

circuitry isolated from it, as it may upset bridge calibration on the low capacity scale.

Many times, I have seen similar units at flea markets or hamfests selling for a five-dollar bill. They are well worth recycling in this manner, considering the current cost of an equivalent bridge. ■

LETTERS

from page 14

teur Radio Club of Durham NC.
Charles W. Bryan WA4VKX
Durham NC

We know that articles about the 10 GHz band are of growing interest to amateurs. That's

why we publish them. It's up to individuals to decide how they will use this expanding technology.

We feel that it is our obligation and the obligation of every citizen to speak out against a law so obviously foolish and useless as the 55 mph speed

limit. For a couple of years now, the National Highway Traffic Safety Administration has been touting the 55 mph limit as a lifesaving measure. In fact, a close look at the NHTSA's own statistics shows that the reduction in traffic fatalities since 1973 can be credited to such factors as safer automobile design and increased use of seatbelts... but not the 55 mph speed limit. Check the May issue of Car and Driver for a discussion of this topic.

Although the government has set standards for exposure to microwave radiation, there is considerable informed opinion that the standards are not near-

ly stringent enough. I, for one, object to being irradiated against my will by police radar until it's been proven beyond a doubt that such irradiation is harmless. Thus far, the jury is still out.—Jeff DeTray WB8BTH/1, Asst. Publisher.

MICROWAVES

I was glad to find the article on microwave safety by Bob Thornburg in the April, 1978, issue of 73. However, I was concerned that the article mentioned only the thermal

Continued on page 43

Finding Radio Pests

—basics

It's now Thursday afternoon and that donkey who has been kerchunking the repeater since Sunday night is still making a pest of himself. What's worse is that he's adding an occasional "word" to his kerchunks. If your patience is now as short as the repeater's squelch tail, then it may be time for a fool hunt.

The only difference between a fool hunt and a fox hunt is the beast you're chasing. I respect foxes!

Almost all hunters agree that the fun's in the chase, not in the capture or kill. Also, the police and the courts usually frown on any creature, even a jammer, being physically abused or having its den vandalized. I

haven't met a junior jammer yet worth a kilobuck fine and two years in a cage.

So if, after considering all the legal ramifications of assault, your group still wants to find the nuisance, here's a reasonably inexpensive and fairly accurate method of radio direction-finding. It may not be the fastest way (no microprocessor support), but the techniques have proved reliable over many years of practical application.

Maps

First of all, no attempt at radio direction-finding (RDF) will be successful unless accurate maps of the repeater coverage area are available. The center spot on your RDF map should be the repeater

site. The more detailed the map, the better. Road maps can be used, but they are usually off scale. This will affect the accuracy of the RDF attempt.

Equipment

Next you need stations with the minimum equipment necessary to conduct RDF. Since you can't rely on the entire net being available when you need it, try to designate as many stations as possible as RDFers. Each RDF station must have a receiver with a signal strength meter, a rotatable unidirectional antenna, and a means of precisely determining the direction of the antenna.

The receiver must be capable of receiving the repeater's input frequency. It does no good to try to RDF the pest on the repeater's output frequency, unless you want to make sure he hasn't run off with your repeater.

The antenna array does not have to be exotic. Any commercially-made beam will perform admirably. The most important thing is to be able to determine the exact direction the beam is pointed at any given time. The simplest system to use is the 360° circle with 0° as north. Some maps contain a grid, true and magnetic north. It

doesn't matter which north your RDF net uses, just as long as everyone in the net uses the same one. Otherwise, the results of your RDF attempt will not be usable.

Antenna director calibration can be as simple or complex as you want to make it. The KISS (keep it simple, stupid) principle is usually the best to follow in situations where elaborate equipment is not available. Simply determine the exact direction of each RDF station from the repeater site using your designated north and the 360° circle. Now that you know this direction, the next step is to compute the direction of the repeater from the RDF station. This can be accomplished using the old pathfinder's trick of finding the back azimuth to a known location.

The formula for computing a back azimuth is: $X^\circ = Y^\circ + 180^\circ$ (if $Y^\circ < 180^\circ$) or $X^\circ = Y^\circ - 180^\circ$ (if $Y^\circ > 180^\circ$) ("X" being the desired back azimuth; "Y" being the bearing of the RDF station from the repeater site).

As an example, if station A is on a bearing of 70° from the repeater site, then the repeater site will be on a bearing of 250° from station A. If station B's bearing from the repeater is 310°, then the repeater's bearing from station B is 130°. So, whenever either station wants to calibrate its antenna director, the operator simply tunes in the repeater, adjusts the antenna direction until the strongest reading is indicated on the receiver's signal strength meter, and aligns the rotor director dial to read the predetermined back azimuth.

RDF Net Operations

The successful RDF activity can be divided into three parts: target notification, line bearing acquisition, and plotting.

1. Target notification.

The person designated as the controller of the RDF net should be the one to contact

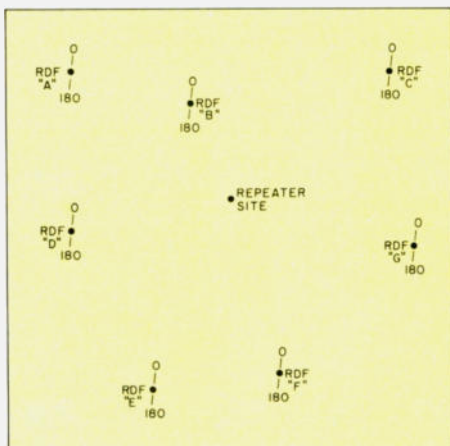

Fig. 1. RDF station overlay.

the RDF stations with RDF requests. Since the repeater will probably be ineffective due to the jammer, and FM simplex may not reach everyone, the most logical means of communications may be Ma Bell's telephone system. If you really want to go through the efforts of RDF, then be prepared to spend a few bucks for phone calls.

2. Line bearing acquisition.

This is when the fun starts. After receiving an RDF request, the station performs a quick antenna director calibration on the repeater output frequency. Not only does this allow the RDF station a chance to insure the accuracy of his "shot," but it also lets him observe what the jammer is actually doing (ker-chunking, swearing, etc.). The next step is to change to the repeater input frequency and try to hear the jammer. If the jammer's signal can be received, adjust the direction of your beam for maximum reading on the receiver's signal strength meter. The bearing indicated on the antenna director is then reported to the net controller.

Don't be surprised if a number of RDFers cannot receive the jammer. This is another good reason to have as many stations as possible involved in the RDF net.

3. Plotting.

Now we're getting down to the nitty-gritty. The net controller has now received the line bearings from the RDFers. He then goes to the RDF map which shows the locations of all the RDF stations on a plastic overlay (Fig. 1). Each RDF station location will have bench marks indicated above and below with 0° and 180° , respectively. These bench marks are necessary to orient a protractor on the map at each RDFer's location.

Let's follow the steps of a normal RDF plot. The controller has received a line bearing acquisition from RDF station A. He takes a protractor and orients it on the bench marks at A's map location. He makes a grease pencil mark on the protractor scale corresponding to the received bearing report. He then draws a straight line from A's location through the

bearing mark and beyond. These steps are repeated for each RDF report.

At some spot on the map, a number of the bearing lines will intersect. It's a rare occurrence to have three or more lines intersect at the same spot. As a result, a process known as "triangulation" is employed.

Triangulation is the most commonly accepted method of determining a transmitter location based on RDF. However, it is only as precise as the accuracy and reliability of the equipment used by the RDFers.

Fig. 2 shows a situation in which three line bearings have been plotted on a map, forming a triangle. In order to determine the location of the jammer, place the point of a compass (the kind used for drawing circles) in the center of the triangle. Adjust the compass so the pencil part reaches the furthest angle of the triangle. Now make a circle with the compass. Your mystery station will be located somewhere within this circle (Fig. 3).

If the net controller receives more than three RDF

reports, he uses the ones that form the smallest triangle.

While this system may not seem too precise, it's about as accurate as you'll find for the size of the investment. Remember, the system will be used by radio amateurs, not the Coast Guard or NASA. Very few hams have the loose capital to establish an elaborate locating station. The hobby forces us to use whatever we can afford to accomplish what we desire.

If a more precise location of the joker is desired, then out with the mobiles and DF loops. At least the triangulation method will narrow the search area dramatically.

The next problem comes with identification of the jammer. Now that you know who he is, what are you going to do about it? Any action outside the law will only lead you, not the jammer, to the clink. Take whatever advice that the FCC and any lawyer hams in your group are willing to give concerning any post-identification activity. Playing vigilante can be hazardous to your future. "If you can't do the time, don't do the crime." ■

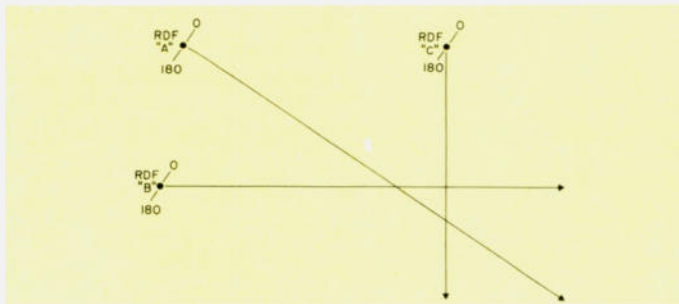

Fig. 2. RDF plot.

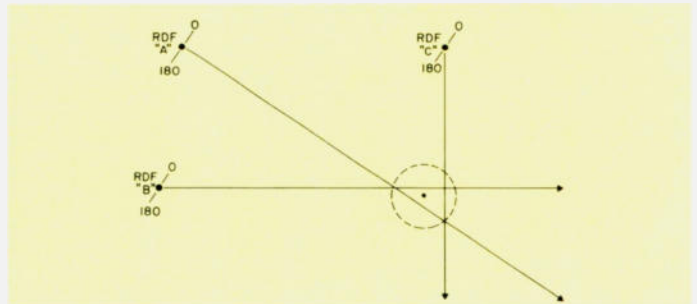

Fig. 3. Final RDF plot.



from page 41

dangers of microwaves. Although thermal, or heating effects, can be severe—such as the rapid cooking of skin and corneas—there are other, *non-thermal* effects which can, over time, produce their own serious

results. These effects are called nonthermal because they do not occur by the *heating* of tissue, but instead by the interaction of certain radio frequencies with molecules or chemical reactions which occur in the body. We are already familiar with many nonthermal

effects in our daily lives: radioactivity (radiation "burns," organ damage from ingestion, cancer), x-rays (cell damage, birth defects, cancer), and ultraviolet rays (sunburn, eye damage, skin cancer).

In the Dec. 13, 20, 1976, issues of the *New Yorker* magazine, author Paul Brodeur described in a long and scholarly article the frightening history of microwave research in the United States. He also described the long-term effects of microwave radiation (illnesses, eye problems, and more) which have plagued the lives of many who were at one time in their lives involved with

microwaves. Although the U.S. armed forces were very slow, even resistant, to the idea of this type of nonthermal danger (indeed, the proper safety precautions would have made the cost of research considerably higher), the Russians very early showed an awareness of the possibility of such danger by setting their safety limits far below those of the U.S.

Even though the power levels involved in amateur radio are small, and the effects of these particular frequencies are not fully known, the experimenter should be aware that:

Continued on page 46

Video Magic For Your Home

—to make boredom disappear

If you like working with unique aspects of modern electronics, there's an unlimited amount of enjoyment awaiting you in the world of home video equipment. Although this fascinating area

of entertainment has previously been relatively expensive, today's market now offers low-priced closed circuit TV systems, cartridge video tape recorders, and a variety of TV games which

can be assembled and used in your own home. A minuscule combination of these units can quickly turn your den or recreation room into a personalized "Aladdin's Castle" of fun. Technical expansions

of these systems are limited only by one's imagination, desires, and available time.

As the area of "non-radiating video systems" is quite diversified, this article will attempt to describe some of its capabilities and assets on an informative basis. Specific construction projects, like interface circuits, converters, etc., vary with individual setups, thus precise technical details have been kept to a minimum. I'm sure, however, the ideas presented here will give you an accurate overall view of home video fun.

TV Games

A quick glance through the advertisements in any recent issue of *73 Magazine* will verify that this field has expanded substantially since the days of TV ping-pong and hockey.

Modern game ICs generate auto races, airplane dog fights, duck shoots (a modified BB gun with a photo-transistor down its barrel does the "firing"), and much more. The games are easily assembled on foolproof printed circuit boards, and you're ready for action. The usual cost of these game chips

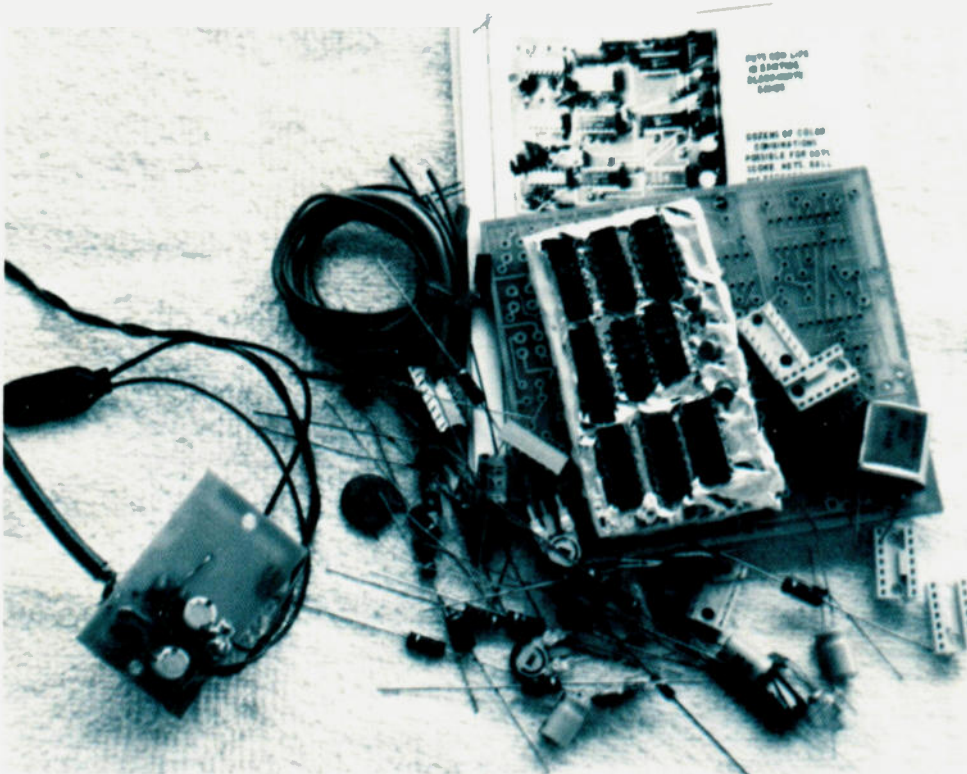

Home brew haven! Here's the ATV Research Chroma-plex 7700 color converter for home video games ready for construction. Highly detailed instructions make this affair just a few hours long. The unit on the left is the ATV Research Pixe-Verter which permits video to modulate a simple VHF oscillator.

is between 10 and 20 dollars.

If you build a game that has video only output, you'll need to tap into your home TV at a point on the first video amplifier's input. Carefully check the schematic of your television before deciding on this point. Locate a place which is after the 4.5 MHz and 920 kHz traps and doesn't upset any biasing arrangements of the video amplifier's input. Problems with local TV stations "feeding through" video stages and mixing with game displays can be eliminated by using a switch to temporarily disconnect b-plus from rf and i-f stages.

As an alternate solution to modifying the home TV, an externally modulated VHF oscillator (commonly known as an rf modulator) may be connected between a TV game's video output and the antenna terminals of any television for instant action. One example of such a converter is the Pixe-Verter which costs approximately 9 dollars and is manufactured by ATV Research, 13 and Broadway, Dakota City, Nebraska 68731.

If you tire of viewing any of your TV games in black and white, ATV Research also manufactures a Chroma-Plex 7700 digital color converter which performs beautifully. The unit connects between a game's video output and a VHF oscillator or TV's video amplifier and generates dozens of color combinations. The cost of this kit ranges from 20 to 35 dollars, depending on the size of your junk box.

CCTV Systems

There's a kaleidoscope of useful applications for the presently popular and comparatively inexpensive closed circuit TV systems. These units are available from sources like Advance Video, 5835 Herma, San Jose, California 95123. The systems can be used for video babysitting, for implementing hands-off magazine reading

(close-up lenses permit 6x magnification), for monitoring outdoor activities, for amateur fast scan and slow scan TV operations, and much more (sunbathing enthusiasts will find their standard equipment zoom lens an absolute necessity!). Let your wit and humor be your guide.

Most CCTV cameras are basically inexpensive fast scan units which output with 4 MHz of conventional TV video. You'll need another one of the previously mentioned modulated VHF oscillators if you want to connect it to the antenna terminals of a regular TV set. That, incidentally, brings to mind a quick and easy means of getting CCTV signals from one end of your house to the other. Simply disconnect your outdoor antenna (you surely don't want the neighbors to confirm their vicious suspicions of you) and use your antenna leads to convey the signal between rooms. Be sure your TV signal doesn't radiate further than a hundred feet, however, or the

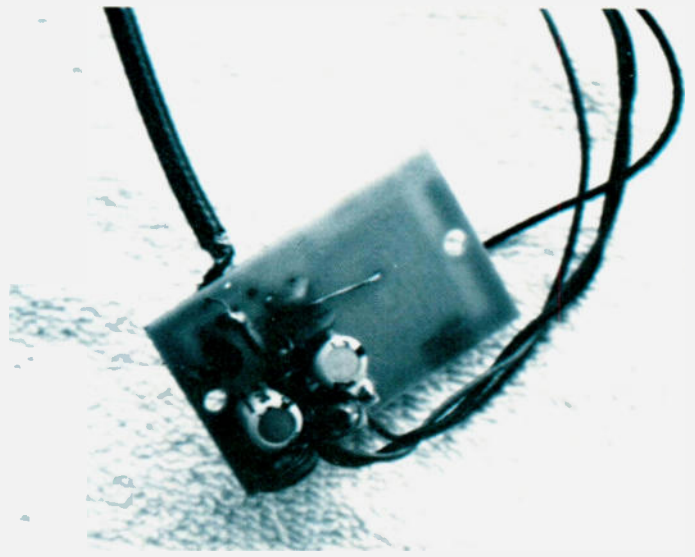

Close-up of ATV Research Pixe-Verter. This unit is a miniature TV transmitter which may be modulated with conventional video. Output is selectable — channels 2 through 6.

FCC gang will hunt you with a 5-ton ax.

Video Tape Recorders

Until recent times, one could merely dream of owning his personal video taping system. The typical cost of such units was definitely in the kilobuck range, and specific information on their

use was rare as slippers for snakes' feet. Today, however, that situation has changed radically. Companies like Advance Video now distribute high quality color video cassette recorder/players which sell for approximately 300 dollars and perform very well. Advance Video's matching CCTV

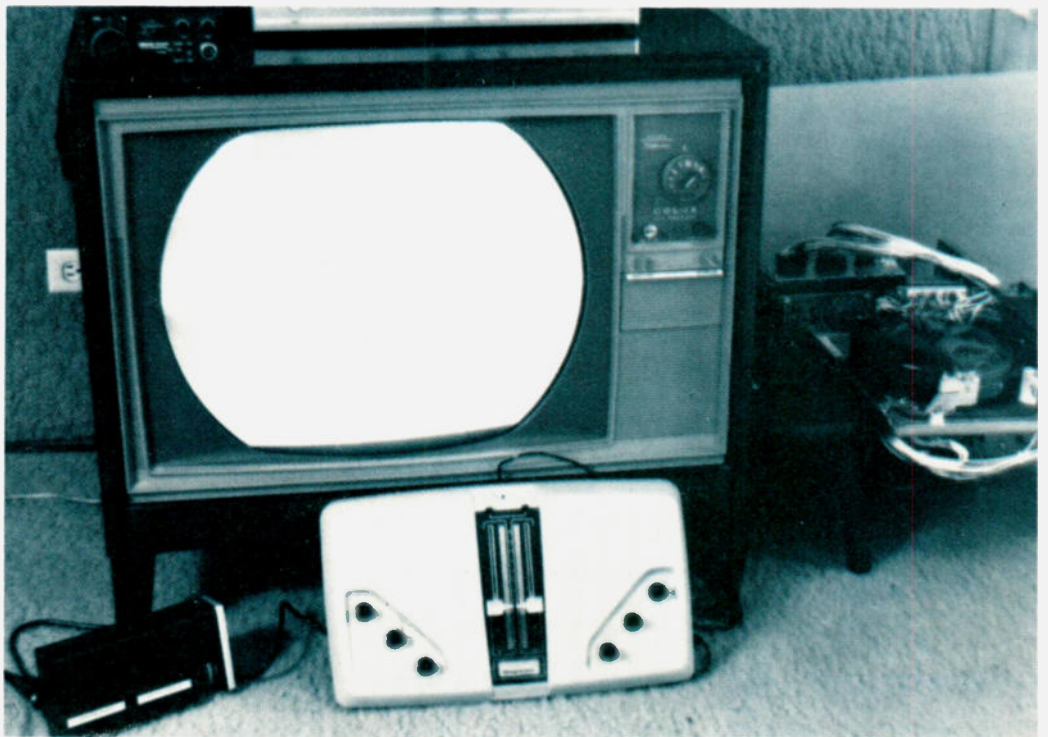

Video entertainment gear set up and ready for action. The cartridge tape deck is propped on the footstool and support circuitry is behind it. The CCTV camera and TV game can drive either television or tape recorder. The recorder can also tape programs during the operator's absence.

camera sells for 150 dollars. These units can be preset to view household functions or record TV programs during your absence and replay them as desired. A fantastic variety of prerecorded programs for these units is also available from Advance Video. The time required to set up one of these cassette video tape recorders is a brief evening's activity. You'll need another modulated-VHF oscillator if you want the VTR's output to feed the antenna terminals of your TV set. However, you must connect the VTR's input to the video detector output in your TV for recording off-the-air programs (remember the previously described bias considerations before diving into your TV's circuitry). Advance Video Company distributes an inexpensive interface board and detailed instructions for correctly making these connections, so there's very little chance of going wrong if you follow their instructions.

Once the tape system is working smoothly, you can have a ball taping programs, viewing special interest tapes, watching the family, and practically anything else your imagination can devise (let's see . . . football replays are on channel 3, the next door neighbor's on 4, the Friday movie's on 6, the TV game's on 8 — there's still room for more activity on channels 9 and 11).

Tying Everything Together

Once you've acquired a

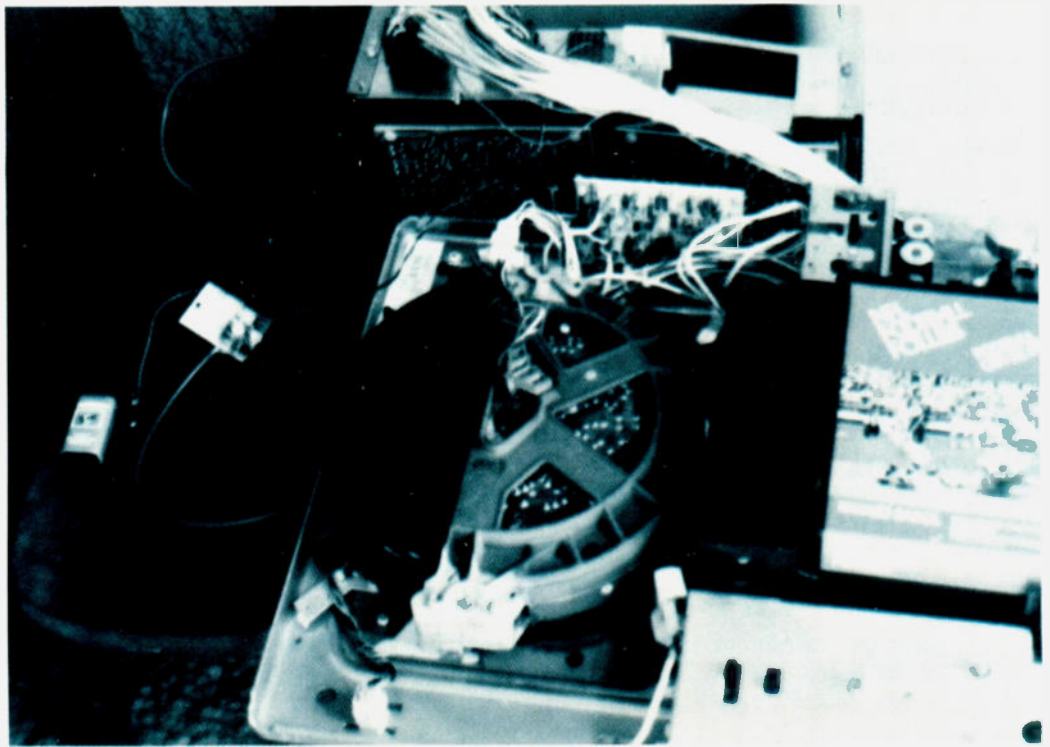

Close-up of Advanced Video's cartridge tape system during use. Deck assembly contains rotating pickup heads, tape transport, and main controls. The electronics unit is the separate "fish tank" behind the deck. The small unit on the footstool is the VHF oscillator which interfaces video outputs to the television's antenna terminals.

small arsenal of video equipment and get it scattered around the living area, you'll need a means of housing everything in one place. A large home brew cabinet with controls on the top and input/output connections on the rear should fill the bill perfectly. If you plan this construction project with an eye toward future expansions, a complete video entertainment center will be the final result. You can then sit back and play games while recording the best shots (plus adding a variety of colors for

special effects), produce instant replays of televised shows, tape record your own home movies, and much more without stopping every few minutes to rewire patch cables. Later you might interface your pet computer to the TV for video readouts or modify a tape cartridge module to act as an analog storage device for generating unusual TV games. Ideas like "SSTV Slalom Game" (May, 1977, *73 Magazine*, page 58) can also be implemented on fast scan TV, if you care to experiment with new

methods.

In conclusion, I would like to emphasize that non-radiating video systems are tremendous fun, relatively inexpensive, and require only minor technical expertise to construct and operate. They can be enjoyed for an indefinite length of time and depreciate only slightly in value. They are also a perfect means of getting started in two other fascinating fields: amateur fast scan television and slow scan TV. Now, wouldn't you rather be operating video, too? ■



from page 43

1. nonthermal radiation damage occurs over a long period of time and is not felt immediately;

2. the exact safety limits and the mechanisms of damage are not known, although long-term

evidence from numerous sources shows that danger does exist; and

3. should long-term effects be proven for amateurs working with microwave equipment, this may be used as firepower to further curtail the frequencies available for amateur radio

enthusiasts.

I think anyone working with microwave radiation would do well to take as many precautions as possible to minimize exposure, even beyond the thermal safety limits suggested by Mr. Thornburg.

Further information may be obtained in the book *Microwaves: The Deadly Radiation*, based on the original articles.

**Bob Silberstein
Cambridge MA**

DE-ZAP STRAP ZAP

I am writing you regarding

the unexpected safety hazard in the design of the "De-Zap Strap" article in the May issue. If the strap is made as shown in the article, the wearer will be hard (low resistance) grounded anytime the strap touches the case of a grounded piece of equipment, metal bench, etc. At this point, the stage is set for a serious, possibly fatal, accident. All that is needed now is to accidentally touch a voltage source with the other hand. The ideal electrocution path now exists across the chest cavity and less than .1 Amp current flow will be fatal.

Continued on page 53

FREQ OUT. FOR LESS.



100 Hz to 50 MHz.
\$89.95*

Introducing CSC's new Mini-Max. It brings down the cost of counting up the frequency for CB-ers, hams, computer enthusiasts, audiophiles... just about any engineer, technician or hobbyist will find it indispensable. It's "mini"-sized, too — a pocketable 3 x 6 x 1½ inches.

But when it comes to performance, Mini-Max means maximum value. Measuring signals as low as 30 mV from 100 Hz to a *guaranteed* 50 MHz, with ± 3 ppm timebase accuracy and better than 0.2 ppm/°C stability from 0 to 50°C. *Completely automatically.* Advanced LSI circuitry with a crystal controlled timebase provides precise frequency readings on a bright, six-digit LED display, with automatic KHz/MHz indications. Mini-Max is versatile, too. You can connect it directly to the circuit under

test, or use its matching mini antenna for easy RF checking. Either way, the input is protected against overload to 50V (100V below 1 KHz).

Mini-Max is as inexpensive to use as it is to own. An ordinary 9 volt alkaline battery gives up to 8 hours of intermittent operation, and you have the flexibility of a battery eliminator for AC operation. For increased versatility, there's a complete line of accessories, including standard clip-lead cable and mini antenna — eliminator and carrying case are optional.

CSC's new, all-American made Mini-Max is everything you need for highly-accurate checking of frequencies up to 50 MHz. At a price that will Freq you out. *Order today.* Call 203-624-3103, 9 a.m. – 5 p.m. Eastern Standard Time. Major credit cards accepted. Or see your CSC dealer. Prices slightly higher outside U.S.A.

CONTINENTAL SPECIALTIES CORPORATION



C9

*Manufacturer's suggested retail price.
© 1978 Continental Specialties Corporation

70 Fulton Terrace, Box 1942, New Haven, CT. 06509, 203-624-3103 TWX 710-465-1227
WEST COAST. 351 California St., San Francisco, CA 94104, 415-421-8872 TWX 910-372-7992
GREAT BRITAIN. CSC UK LTD., Spur Road, North Feltham Trading Estate, Feltham, Middlesex, England, 01-890-0782 Int'l Telex. 851-881-3669
CANADA. Len Finkler Ltd., Ontario

Novice Guide To Phased Antennas

— part II

Many hams have been intrigued by the idea of phasing three cardioid patterns, as shown in Fig. 1. It seems as though that would make a good beam which could be electronically rotated. The idea is usually seen with antennas spaced a quarter wave apart and with a quarter-wave delay to make possible firing in six directions for complete 180° rotation.

I have talked to quite a few hams who have tried this, and, while it is impressive to hear the signal go down and up as the pattern is rotated, there are some problems.

For one thing, the pattern for quarter-wave spacing and quarter-wave, or 90°, delay is 120° between half-power points, as you

can see in Fig. 2. This means that you can get pretty complete coverage—better than a single antenna in any direction—with just two antennas.

Another problem is that the third antenna, which ever one is unused, causes distortion of the pattern unless it is completely detuned. This means, usually, that both the main coax lead and the shield must be disconnected. In addition, if the lead-in is near an odd multiple of a quarter wave at the frequency in use, the disconnected lead may still show an electrical short, and the antenna will still cause trouble. This problem does not occur with two antennas, since both are driven.

It is, however, easy and profitable to phase three antennas with half-wave spacing, as shown in Fig. 3. All can be driven broad-

side, causing three figure-eight patterns, covering six directions, with very good nulls in the unwanted directions. All three leads are identical, and there is no necessity to add or subtract delay lines. The swr is low with no matching problems. By making all the lines multiples of a half wave, the disconnected antenna effectively opens the unused antenna, detuning it completely. At a half wave apart, there is little effect on the other two antennas.

A figure-eight pattern is useful for stations in the U.S.A. so that stations in the east and the west can be joined in a rag chew. You can easily apply the pattern to your location and see if it would be good for you.

The inverted-vee dipole can easily be phased, either end fire as in Fig. 4,

or collinear as in Fig. 5. The collinear array takes a long space, but not much width. It could, for example, be installed on a fence line, without taking up any appreciable yard space. Fed to a T-connector between the two antennas, it would give a figure-8 pattern with about 3.8 dB gain. It would not be practical to switch a delay line in, as the ends of an inverted vee have a loss of about 6 dB.

The end-fire array can be spaced a quarter wave and arranged with a delay line of 90°, or a quarter-wave delay line. If two feedlines are brought into the shack, the delay line can be switched into either line, thus reversing the array. The pattern will be the cardioid similar to Fig. 2.

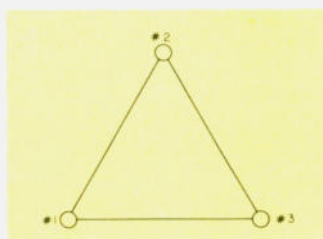

Fig. 1.

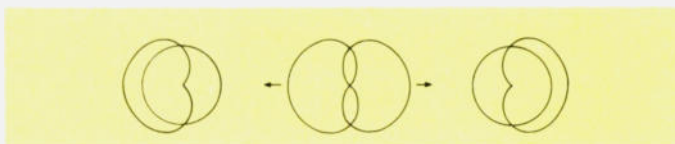

Fig. 2.

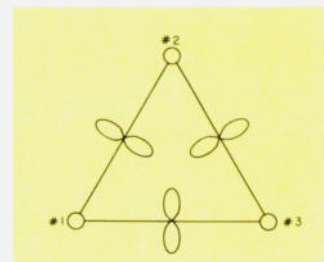

Fig. 3.

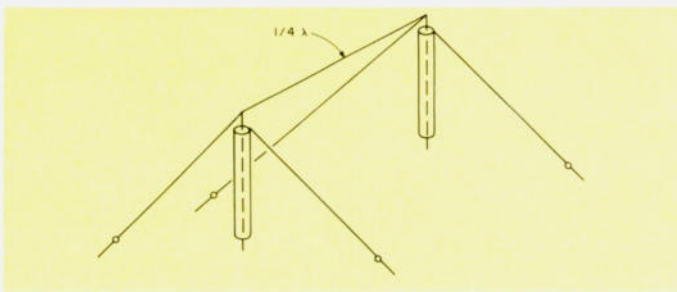

Fig. 4.

Any of the delays and patterns shown for vertical antennas in part I of this article can be used with these antennas. Both the collinear and end-fire arrays can be suspended either from two push-up masts or a nylon cord strung between two towers or poles.

By using eighth-wave spacing, and a $3/8$ -wavelength (135°) delay, it is possible to support a pair of inverted vee dipoles from a single tower using a piece of masting as a spreader, as shown in Fig. 6. On 40 meters, this would be 17', and the delay line would be 33'10". The gain would be close to that of a 2-element beam.

Of course, the ultimate array is the one shown in Fig. 7 with two end-fire pairs in broadside, which combines the figure-eight pattern of the broadside connection with the end-fire unidirectional pattern to obtain a narrower and higher gain unidirectional lobe.

In the May, 1975, *Ham Radio*, this array was written up in detail, after I designed the array for use in Antarctica at McMurdo Station. Combining the 3.8 dB gain of the broadside array with the 4.5 dB of the end-fire array gave nearly a 9 dB gain, as shown in the pattern at C. This is better than most 3-element beams, and the angle is lower than a beam unless it is installed at least a half wave above ground.

This array was made up

of verticals, but the same plan could be used with inverted-vee dipoles. Using the pair shown in Fig. 5 and placing a similar pair a quarter wavelength behind them with four push-up masts, you would have a potent arrangement. You could feed the broadside pair with a T-connector, and bring the two feedlines into the shack. By inserting a quarter-wave piece of coax in either line, you could reverse the array as needed.

This would take a little space—about 140 feet long and 34 feet wide—but the four masts and the wire would cost less than a beam, and you would not have any concrete to pour or towers to climb. It would be less subject to man-made electrical interference than verticals, and, by using a pulley at the top of each mast, you could make tuning adjustments or change antenna lengths easily.

The principles of phasing can also be used for two meter antennas and CB antennas to advantage. I once had a pair of CLR CB antennas mounted on a piece of $1\frac{1}{4}$ " water pipe with ells at each end and a T in the center. The whole thing mounted on a TV antenna rotator. The pipe was 9 feet long for quarter-wave spacing at 27 MHz, and it really made an excellent beam. See Fig. 8.

That was where I found that the two antennas used must be identical. I used an older CLR vertical and added a new one. In the meantime, Hy-Gain had

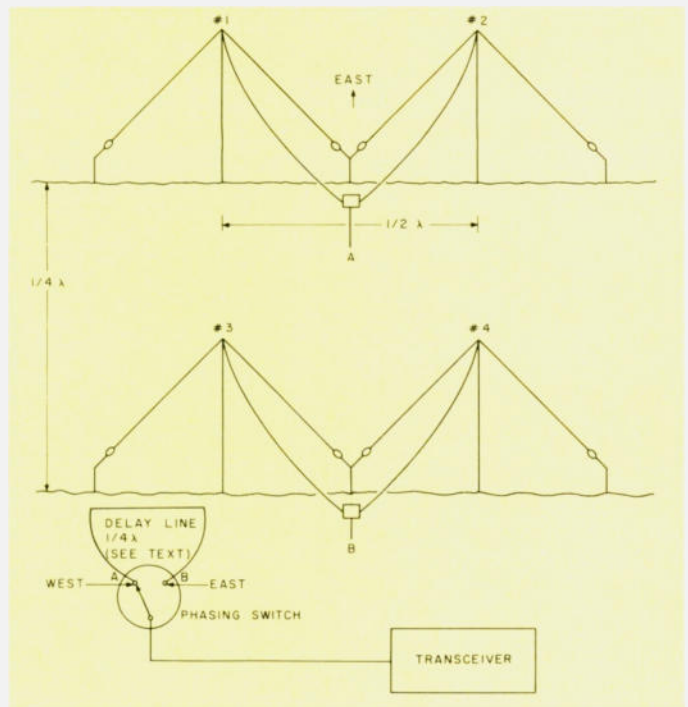

Fig. 5.

added an rf coil in the base, and the pattern was not at all what I wanted. I phoned them, and they explained the change, after asking me if I had used an old one and a new one. I got a second new one, and then it worked perfectly.

The coil in the base threw the phase out 180° , and that made a cardioid pattern impossible.

Picture a pair of two meter verticals spaced $9\frac{1}{2}$ " (quarter wave) or 19" (half wave). If a repeater needs to fire from an outlying area into a city or to give coverage along a highway, this is the easy way to do it. A CB station in a service area can make a figure-eight pattern to aim up and down a highway and cut down interference from stations in town by using half-wave spacing.

You have probably seen the pairs of CB verticals on cars, with one on each side of a car and the antennas fed by equal lines to each antenna. This gives a slightly elongated pattern in the direction of the highway and cuts down the signal from the sides.

There are several popular antennas which

use the phasing principle, such as the ZL special, the 8JK, the Sterba curtain, and the Bruce and the bobtail curtain, among others. Even the quad can be driven as a phased array.

There is one basic difference between a parasitic array and a driven array. The antennas in a parasitic array are either shorter, for a director, or longer, for a reflector. The antennas in a driven phased array are of identical size. This makes it possible to use antennas which it would be difficult or impossible to lengthen or shorten, such as trap-

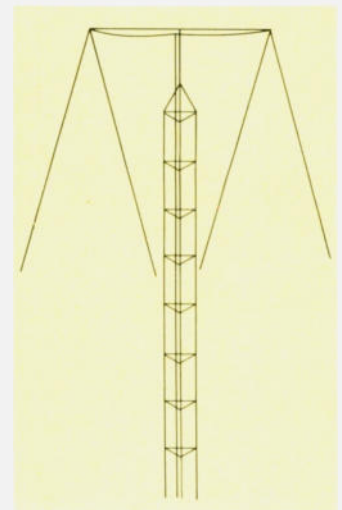

Fig. 6.

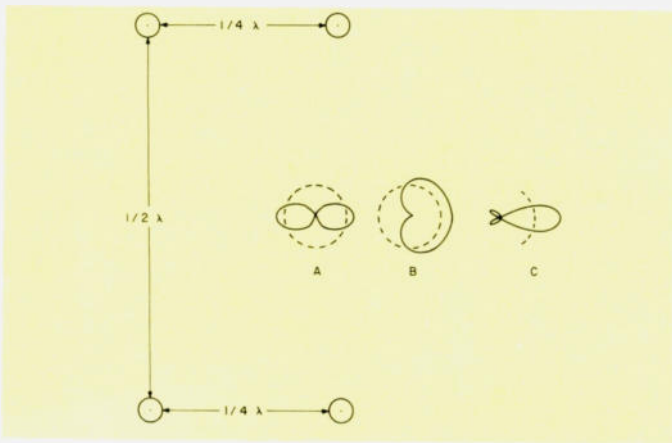

Fig. 7. Horizontal radiation pattern of half-wavelength spaced antennas is shown at A. The pattern at B is that of quarter-wavelength spaced antennas. At C is the pattern of the four-element phased array.

type antennas. It also makes possible instant reversal of direction without a rotator or complicated switching.

One example is a pair of Mor-Gain antennas which I used with excellent results as a phased pair. A Mor-Gain antenna is a shortened design which reduces the length by nearly half and allows the use of two or more bands with the same antenna. See Fig. 9.

The ones I used are shown here. Each consisted of a 40/20 arrangement, with the 40 meter section being reduced from 66 feet to about 37 feet, and had interlaced a full length 20 meter antenna. I used them very successfully in Antarctic phone patch traffic as a

pair of slopers on forty meters, with half-wave spacing. I often used to pin the meter on the KWM2A at South Pole Station with this antenna.

A friend of mine, K7PPQ in Las Cruces, New Mexico, is preparing to use the same two antennas as a pair of phased verticals suspended from a 17' boom. The shortness of the antennas makes it possible to use a 40' mast. To suspend a full-size 40 meter vertical dipole would take a 70' mast. The lead-in from each antenna will be brought into the shack, so delay lines can be inserted for either reversal or to change the pattern to a broadside figure-eight when desired.

Rodney O'Rourke K5VYJ used a pair of Mor-Gain

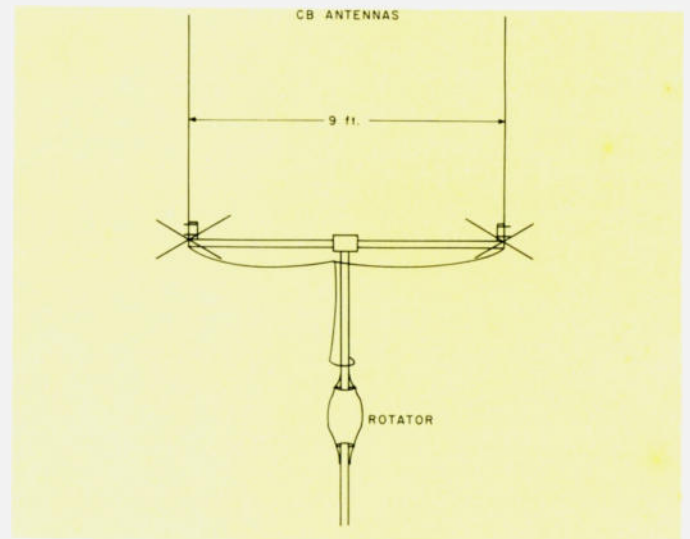

Fig. 8.

antennas as a two-element 40/20 beam with excellent results by spacing them 17' with a quarter-wavelength delay on 40 meters, which was a half-wavelength on 20 meters.

At this point, I had better explain a few things about delay lines in phased arrays, as well as some matching methods. I won't make it very difficult, as this applies to all phased arrays, unless you use a tuner to take care of the matching.

When a pair of antennas are spaced a quarter wavelength and a coaxial delay line is used to feed the leading antenna, the coax line will not reach between the two antennas. This is because the .66 velocity factor makes a quarter wave of coax too short. For example, if two antennas on forty meters are spaced 34', which is the free-space distance, the coax, with a velocity factor

of .66, will be only 22'6".

There are two solutions. One is to use a 3/4-wavelength delay line, which will be 67'6", and will reverse the direction. The other is to bring the two lines into the shack, or at least away from the antennas, and then insert the delay line.

I usually bring the lines into the shack, where I have complete control over the phasing. As long as the two lines are equal, they can be any length.

The next thing is the matching. While a 50-Ohm line is a pretty good match for a single vertical, when two are connected in parallel, the impedance falls to 25 Ohms. To counteract this, we often use a quarter wavelength of 72-Ohm line to raise the 50 Ohms to 100 Ohms in each line so that, when they are paralleled, they would be 50 Ohms again.

When you use four

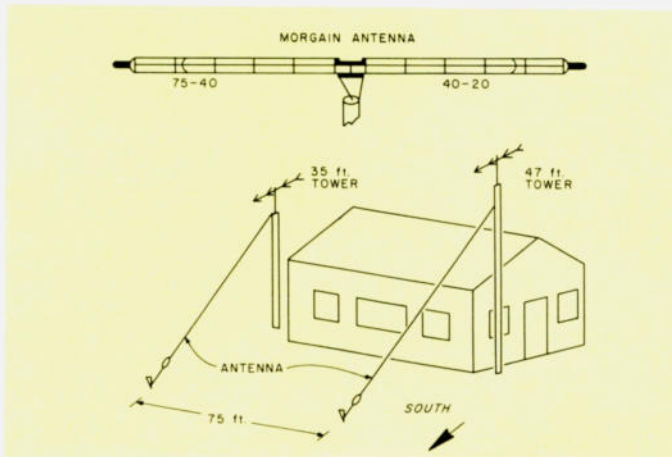

Fig. 9.

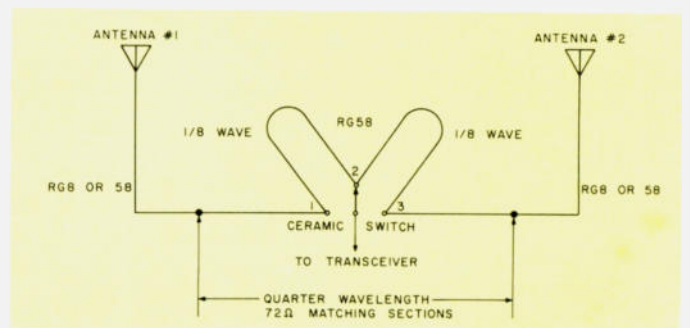

Fig. 10.

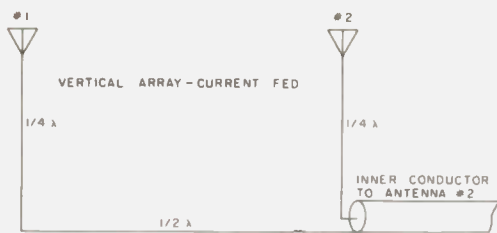

Fig. 11.

antennas, you can go through the same procedure. You can put a 72-Ohm section in each line from the pair of antennas. Of course, if you have a good matchbox, you won't need to use this method.

Switching is another problem. Fig. 10 shows a simple method of moving a delay line from one direction to the other and also of feeding the pair in phase for broadside operation.

When the switch is on position 1, the quarter-wavelength delay is in series with antenna #2, and the reverse is true on position 3. On position 2, the

signals are fed into both antennas at the same level. This is for quarter-wave spacing. For antennas a half wave apart, two sections of quarter-wave length coax can replace the eighth-wave sections.

Of course, with half-wave spacing, putting the switch on either position 1 or position 3 will have the same effect, merely changing from broadside to end fire.

For a really unusual method of feeding a pair of phased verticals, see Fig. 11. This array is used by Tom W7DND in Breerton, Washington, with a parasitic reflector behind it

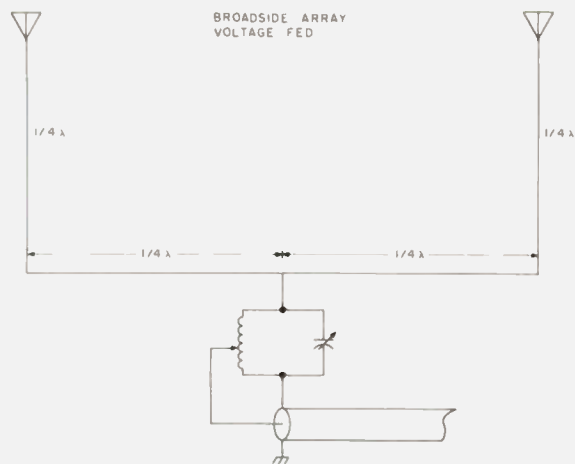

Fig. 12.

and does a fine job. Note that the antennas are fed in phase by turning over the coax line, with one antenna going to the center conductor and the other to the shield. The half-wave line feeding antenna #1 puts that antenna back in phase with #2. Notice that no radials or ground connections are used.

In Fig. 12, the same array is used with a voltage feed

in the center, using link coupling to the coax feedline. This is a sort of upside-down bobtail array.

I hope all this has not made phasing seem complicated, but it shows that there are many types of phased arrays, none of which are very complicated.

Pick one which suits your purpose and good luck. ■

The book that turns businessmen into best sellers.

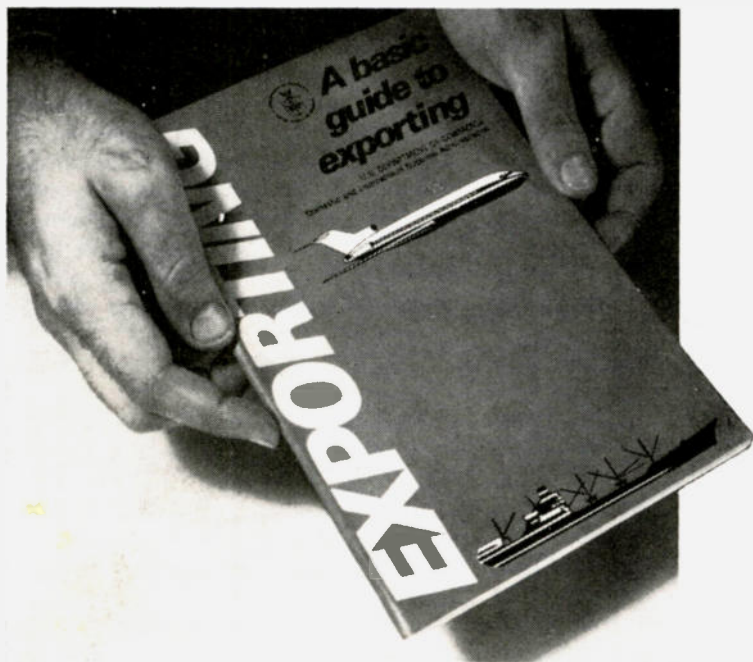

Many who've read it are now reaping the rewards. Because they've found that U.S. exports are a more than \$100 billion a year business, that exporting creates both company profits and company growth, that U.S. goods have never been more competitive in international markets. Above all, they've found that, with the help available from the U.S. Commerce Department, selling overseas is no more difficult than selling at home. And this fact-filled book can prove the same to you. Write The Secretary of Commerce, U.S. Dept. of Commerce, BIC 8B, Washington, D.C. 20230.

U.S. Department of Commerce

A Public Service of This Magazine
& The Advertising Council



N. V. Cohen WB4LJM
7719 Sheryl Drive
Norfolk VA 23505

J. M. Franke WA4WDL
1006 Westmoreland Ave., Apt. 225
Norfolk VA 23508

Can A \$20 FM Rig Work?

— testing the VHF Engineering
TX150 xmtr

Neither of us has ever written a review article before, but, after building several TX150s, we felt that other amateurs would be interested in our findings. The TX150 is a low-power two meter FM transmitter. It consists of three sections — a modulator, an oscillator multiplier, and a final multiplier output stage.

The first problem became

apparent when the kits arrived. The only instruction is a single page showing the schematic, parts list, and layout. While this presents no great drawback for experienced builders, the beginner should realize that this is not a Heathkit-type project. The schematic has one omission — there should be a jumper from the junction of C12 and L1 to the junction of R9 and

RFC2. The parts are of high quality, and the coils are pre-wound with the exception of RFC1. The beginner might have a problem recognizing RFC2; it appears the same as a 1/2-Watt resistor, but has a tan body. The board is glass epoxy, and the copper is tin plated for easy soldering. There are no mounting holes, so plan to drill some before assembly is started. The circuit board is only 25.4 mm by 115 mm.

Assembly is easiest if all the capacitors are mounted and soldered first, followed

by the single jumper with its insulating tubing and the two rf chokes. Next, the coils are mounted and soldered after clipping off the small plastic tabs on the bases. Then the audio components and resistors are mounted and soldered. The resistors are mounted vertically with one end flush with the circuit board. R12 is mounted under the board. Finally solder in all of the semiconductors after double checking their orientation. The entire transmitter strip can be assembled in two or three hours.

Inserting an 18 MHz crystal, testing began. Tune-up is simple. Using a 50-Ohm, 1-Watt resistor for a load with a diode detector as in Fig. 1, the oscillator and then the final and output coils are peaked for maximum output. Table 1 gives the measured output power, input current, and total input power for supply voltages of 6 to 13 volts. Note that the output power with a 13-volt supply is an impressive 300 milliwatts.

What about harmonics? A series of tests were made using a Hewlett-Packard model 8554L spectrum analyzer set up as in Fig. 2. The photographs show that the multiplier frequencies are more than 30 dB down from the carrier. The second harmonic is 50 dB down, and the third is 48 dB below the carrier level. The relatively good harmonic suppression is due to the double tuned output. Next, a 2 kHz tone was applied to the microphone input. The modulation spectra are included in the photographs. Photo C is with 3

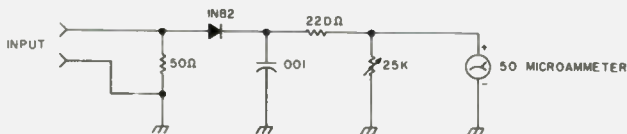

Fig. 1. Simple relative power meter for tuning the TX150.

Supply voltage	Current	Input power	Output power
13.0 V	0.11 A	1.43 W	300 mW
12.0 V	0.10 A	1.20 W	250 mW
11.0 V	0.095 A	1.05 W	200 mW
10.0 V	0.09 A	0.90 W	160 mW
9.0 V	0.06 A	0.54 W	100 mW
8.0 V	0.05 A	0.40 W	40 mW
7.0 V	0.03 A	0.21 W	12 mW
6.0 V	0.02 A	0.12 W	2 mW

Table 1.

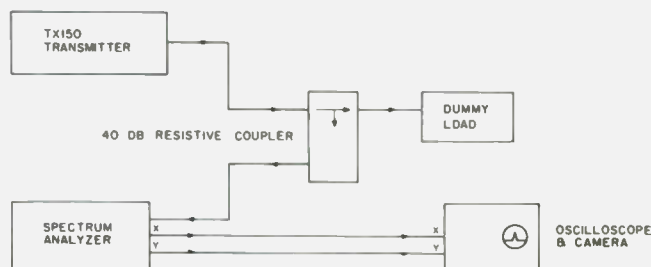

Fig. 2. Setup used for spectrum analysis.

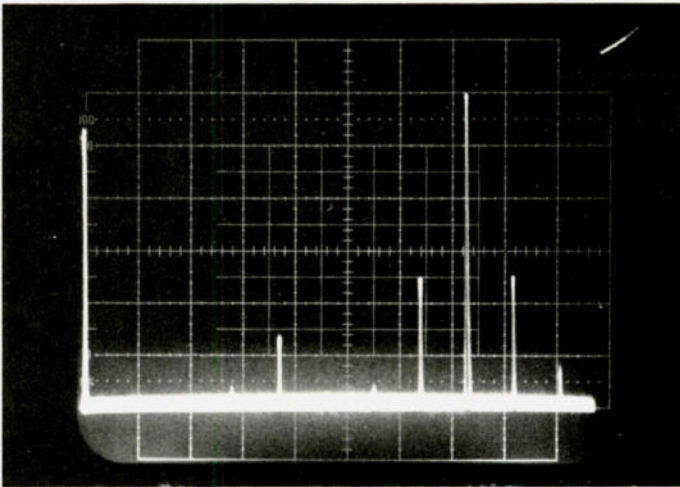

Photo A. Spectrum of TX150. Horizontal — 20 MHz/division; vertical — 10 dB/division. (Spike on left is 0 frequency mark.)

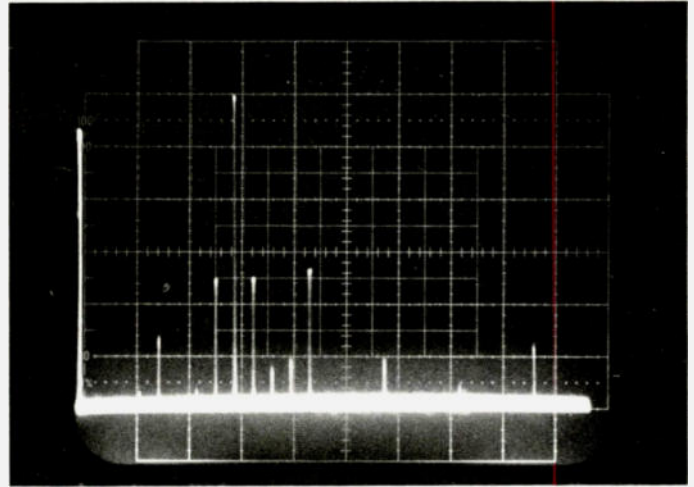

Photo B. Spectrum of TX150. Horizontal — 50 MHz/division; vertical 10 dB/division. (Spike on left is 0 frequency mark.)

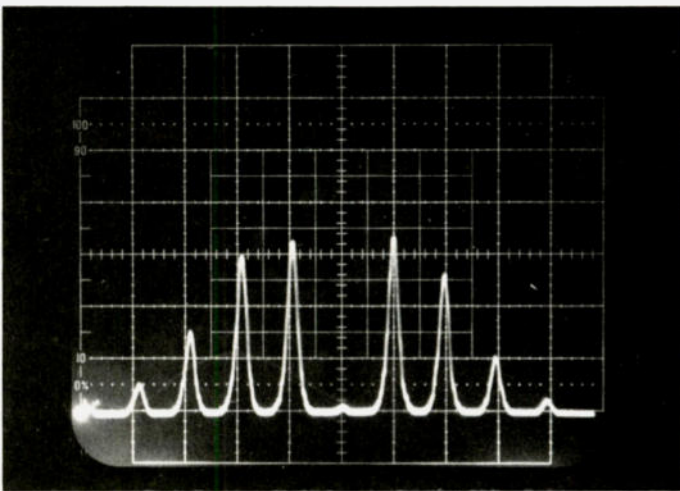

Photo C. Modulation with 3 millivolts peak-to-peak 2 kHz tone. Horizontal — 2 kHz/division; vertical — linear.

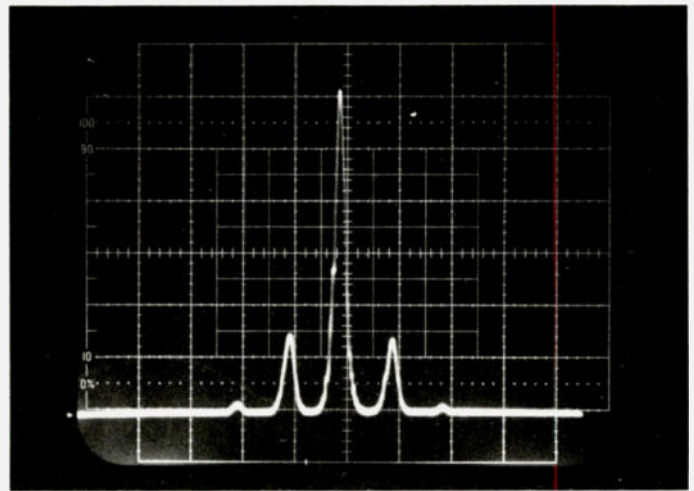

Photo D. Modulation with 10 millivolts peak-to-peak 2 kHz tone. Horizontal — 2 kHz/division; vertical — linear.

millivolts peak-to-peak input, and Photo D is with 10 millivolts peak-to-peak input. In Photo D, the carrier is near zero, or, in other words, the zero order Bessel function is zero, indicating a modulation index of 2.4. Since the modulation index is the ratio

of the peak deviation to the modulating frequency, multiplying the 2 kHz tone by 2.4 yields a peak deviation of 4.8 kHz with 10 millivolts peak-to-peak audio input. This is close to the desired 5 kHz deviation. Distortion becomes evident when the audio input

exceeds 20 millivolts peak-to-peak. The transmitter was run key-down for three hours with a 12-volt supply with no adverse effects. The final transistor got warm, but the output remained constant.

All things considered, the TX150 is well worth the

\$19.95 price tag. It is an economic answer for projects requiring a stable low-power transmitter strip that is very compact. With the present proliferation of repeaters, it presents an easy starting point for beginners to join in the fun on two meter FM. ■

ou moons don't ever proofo
lousy manuscripts from bar
burh LETTERS
get liard
I insist that you print ev
tell Ma Bell that she show

from page 46

A method of discharging static buildup is certainly a necessity when working with MOS and many other devices, but it must be made so that the wearer's safety hazard is not significantly increased. The

resistance must be located at the wrist so that accidental shorting of the grounding wire will not bypass the isolation resistance. The resistance value should be designed to limit the worst case current exposure to 1 to 2 milliamperes (i.e., the resistance value

should be selected so that with the highest voltage in the work area passing through the isolation resistor and the person, assuming the person has zero resistance, the current in the circuit will not exceed 1 or 2 milliamperes).

The design must also consider the voltage rating of the resistors. A typical 1/4 Watt resistor is limited by a voltage rating of 250 V; therefore, several resistors in series may be required to safely handle a voltage equal to the highest voltage in the work area (don't forget those scope and video terminal HV supplies). Once the resistance value is deter-

mined and located at the wrist, the exposed braid conductors should be replaced by a good piece of test lead which is flexible enough but much lighter and will not be a source of short circuits as arm movements cause it to be dragged across items on the bench.

J. K. Galleher
Bowie MD

GETTING GEAR

There have been several articles written lately about the

Continued on page 55

Hiss Exterminator

— an ear-saver
 for the TS-700A

If you rather enjoy monitoring noise while waiting for the local SSB gang to sign on for the evening or while parked on the DX frequency awaiting those elusive skip signals on 2 meter sideband, then this modification is not for you. Personally, however, I find continuous background hiss (noise) very distracting, and, after five or ten minutes of it, my ears seem to become numb (perhaps I spent too many years on FM where effective squelch circuits are commonplace). At any rate, I began looking around for a reasonably inexpensive solu-

tion to the problem, and the circuit to be described was the result of that effort.

I'm running the Kenwood TS-700A transceiver on 2 meter sideband (as are many others) along with Kenwood's VOX-3 voice operated transmit/receive switch, so it seemed logical to attempt to utilize as much of the existing circuitry as possible for the audio squelch feature.

If you're not familiar with the Kenwood VOX-3, it's a compact (1-5/8" x 5-1/8" x 4-1/2"), good-looking, and well-engineered box full of electronic goodies, which is

directly usable with the TS-700A and adaptable to other rigs. Its price qualifies it as one of the best bargains in town.

It has "VOX gain," "anti-VOX gain," and "delay time" controls all up front, and it derives its operating voltage from the mating transceiver via a 9-pin miniature tube socket (shades of the good old days) located on the rear apron. But, best of all, it also has about half of the circuitry that's needed for an audio squelch system, namely, the anti-VOX audio detector and its associated amplifier. What I added in the circuit diagram shown is a Darlington connected relay driver amplifier,

a sensitive (and quiet) reed relay, and a way to reroute the audio to an external speaker through this circuitry. Yes, an external speaker must be used when the audio squelch feature is desired (you're probably already using one, though), and a miniature 1/8" phone jack is added to the rear apron of the VOX-3, next to the 9-pin socket, for this purpose. A dummy 1/8" miniature phone plug (the one supplied with the TS-700A) is inserted in the "external speaker" jack at the rear of the TS-700A in order to disable the built-in speaker when using the audio squelch feature.

For purposes of circuit operation details, speaker level audio is tapped off pin 1 on the 9-pin VOX-3 rear socket, fed through the normally-open contacts of the reed relay, and fed back out to the external speaker via the new 1/8" phone jack. The 13-Ohm, 1-Watt resistor shown as R20 acts as a constant load for the audio output stage of the transceiver. The only control on the VOX-3 that has any bearing on the audio squelch circuitry is the anti-VOX gain, which sets the threshold of the squelching action. The hold-in time of the reed relay is determined by C11, the 500 uF electrolytic capacitor across the relay coil. Diodes D9 and D10 will protect the transistors in the relay driver stage from transients, and R21 drops the Vcc (operating voltage) to about 12 V dc,

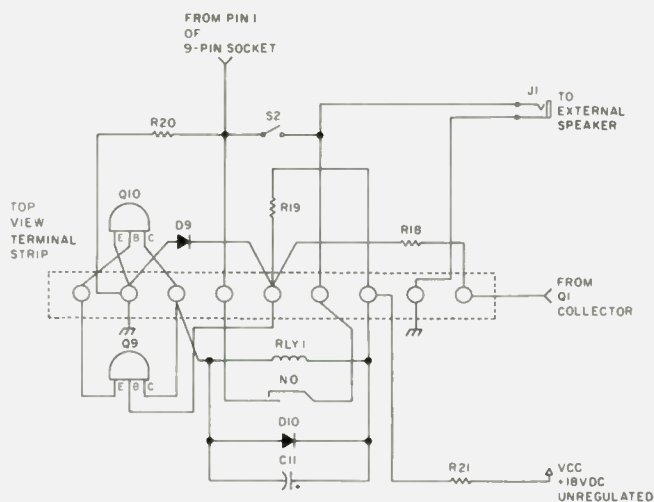

Fig. 1. Pictorial diagram for the VOX-3 audio squelch circuit.

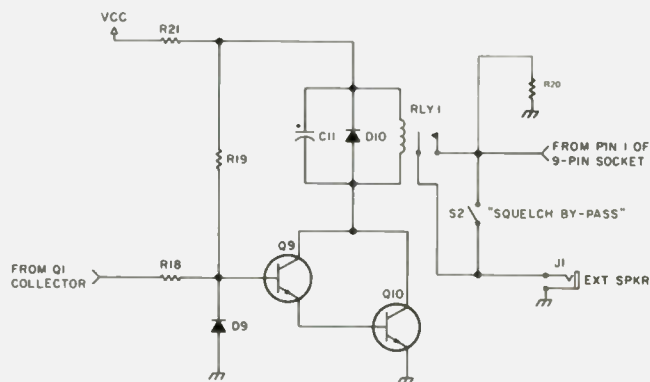
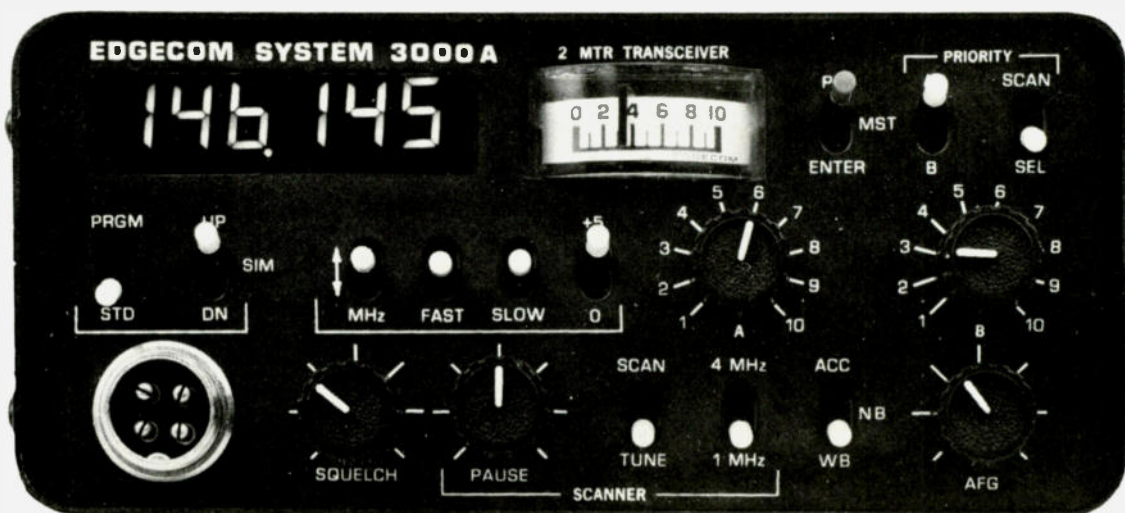

Fig. 2. Schematic diagram for the VOX-3 audio squelch circuit.

THE INCOMPARABLE SYSTEM 3000A



HAS A BUILT-IN \$450 DISCOUNT

\$450 discount? When you buy SYSTEM 3000A, you're getting \$1000+ worth of unequaled performance for \$549. Examine the unique features of SYSTEM 3000A, add up what it would cost to duplicate (if you could) this small, feature-filled radio and you will quickly realize what a remarkable bargain you're getting. By marrying the best transceiver available to a microcomputer-controlled PLL synthesizer, Edgecom has produced a 2-meter FM system with such unique and incomparable operating flexibility it is almost unbelievable. A few of the extraordinary features of SYSTEM 3000A found in no other transceiver are:

- **TWENTY FRONT-PANEL-PROGRAMMABLE CHANNELS.** Just dial in the frequency and transmitter offset, press the Enter switch and you're in memory. Two channels are instantly recallable as priority channels at the flip of a switch.
- **TWO BUILT-IN SCANNERS** with adjustable pause and pause-defeat features. One scanner lets you tune the band in one or four MHz segments. The other scans the memory.
- **MEMORY-CHANNEL MONITOR.** Lets you operate on one frequency while monitoring one or more others.
- **ANY TRANSMITTER OFFSET.** In addition to the standard ± 600 kHz you can program any offset from 5 kHz to 4 MHz.
- **FULL TWO-YEAR WARRANTY.** Every SYSTEM 3000A is warranted to be free of defects for two years. And it is American made so servicing is no problem.

Combine these, and the other unique operating features of SYSTEM 3000A with a receiver of unsurpassed selectivity and intermod performance, a transmitter that produces over 25 watts of (adjustable) power and you have a fantastic \$1000+ transceiver for the remarkable price of \$549.

SYSTEM 3000A . . . PERFORMANCE THAT CHALLENGES YOUR IMAGINATION

See one at selected dealers or write for more information.

Edgecom Inc.

2909 Oregon Ct.—A3 • Torrance CA 90503 • (213) 533-0433

EXPORT INQUIRIES H & H Industries • Box 639 • Redondo Beach CA 90277

E19

NEW FROM EDGECOM . . . ANOTHER INCREDIBLE BARGAIN



THE FMS-25 . . . ONLY \$399

For the discriminating amateur desiring the maximum operating flexibility at the lowest possible price, **EDGECOM** proudly presents the **FMS-25** 2-meter FM transceiver. Featuring the same receiver/transmitter and several of the outstanding features that have made the **EDGECOM SYSTEM 3000A** the industry standard, the **FMS-25** provides superior performance for the same price you would normally pay for a "bare-bones" radio. Compare the fantastic features of the **FMS-25** with the other transceivers on the market and you will quickly conclude that there is no question of which one offers the most for the least amount. Some of the many features of the **FMS-25** are:

- **BUILT-IN SCANNER**
- **TEN FRONT-PANEL-PROGRAMMABLE MEMORY CHANNELS**
- **ANY TRANSMITTER OFFSET**
- **ELECTRONIC PUSH-BUTTON TUNING**
- **25 WATTS OUTPUT**
- **SUPERIOR INTERMODULATION PERFORMANCE**

Like the **SYSTEM 3000A**, the **FMS-25** also enjoys a full two-year warranty, it's American made and it is small (the photo above is full size). The **FMS-25** . . . at the introductory price of \$399 you're getting the best transceiver available with free scanner, a free amplifier, and a free ten channel memory. See the fantastic **FMS-25** at selected dealers or write for a descriptive brochure.

FMS-25 . . . PERFORMANCE THAT CHALLENGES YOUR IMAGINATION

Edgecom Inc.

2909 Oregon Ct.—A3 • Torrance CA 90503 • (213) 533-0433

EXPORT INQUIRIES H & H Industries • Box 639 • Redondo Beach CA 90277

Instant Engraving

— to protect your equipment

It has been shown that those who participate in one of the "operation identification" type of programs are less likely to have their property ripped off, and, for those who still manage to lose things to the midnight suppliers, the chances for recovery are improved if the property has been indelibly marked. Since it isn't always convenient to borrow an engraving tool, here is a simple way to make a throw-it-away marking tool.

This system leaves a rather permanent mark, as may be seen in Photos A, B, and C. It may not be as deep as the one made by an engraver, but it seems to weather quite well.

The main ingredient for

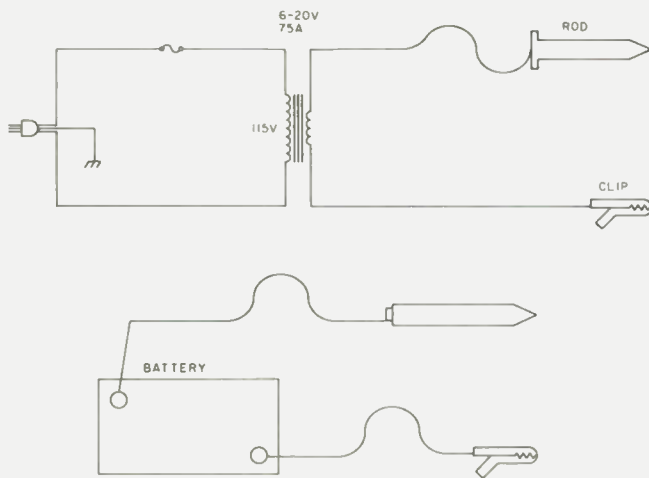

Fig. 1.

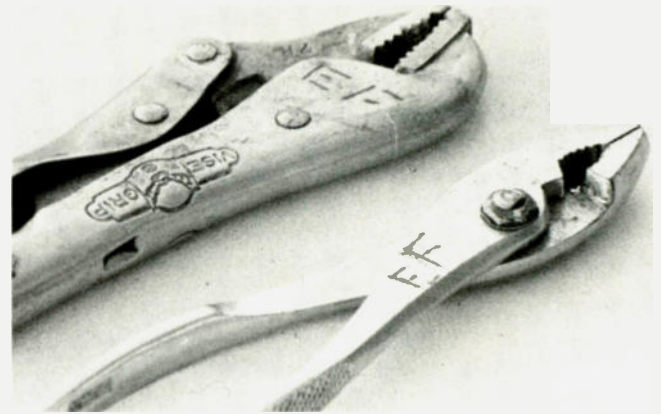

Photo A.

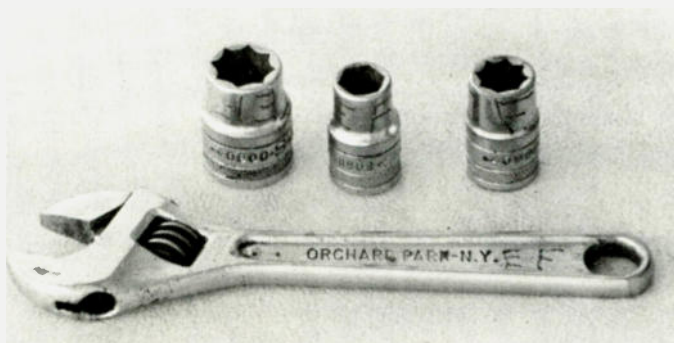

Photo B.

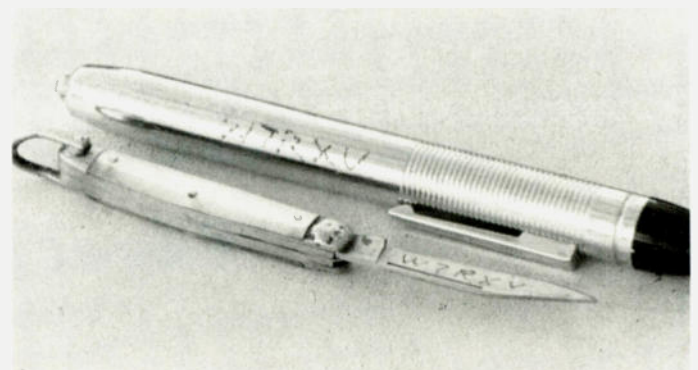

Photo C.

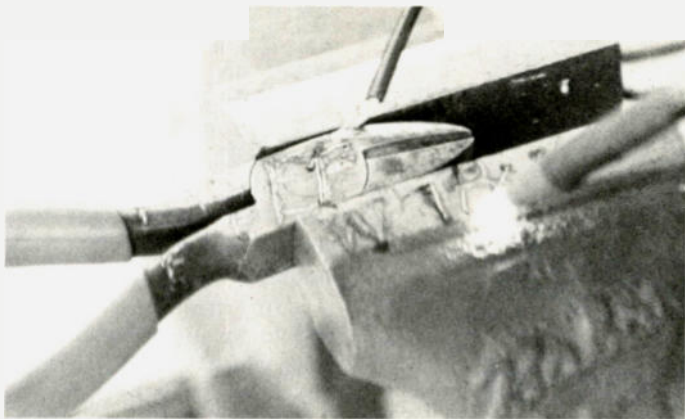

Photo D.

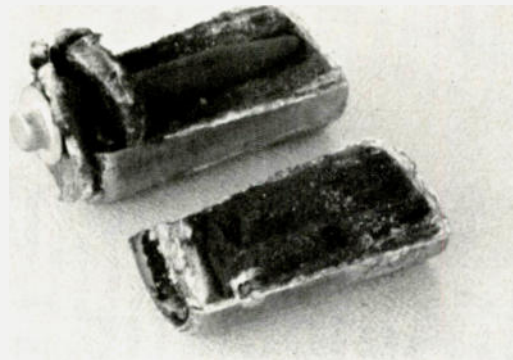

Photo E.



Photo F.

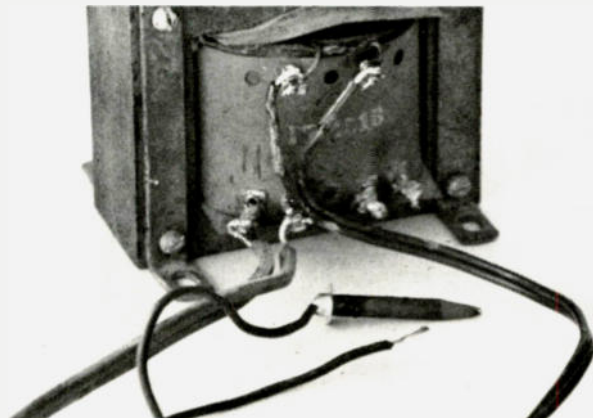

Photo G.

this system is the carbon rod from a used size-D flashlight cell. As Photo E shows, a hacksaw may prove most helpful in removing the rod from its container. After the rod is removed and cleaned up, it is fed into a pencil sharpener. The point should be medium fine. (Note Photo F.)

Reasonably heavy leads are connected to a suitable power source with the other

ends connected to the cap on the rod and the item which is to be marked. If the cap becomes detached, the wire may be wrapped around the top of the rod and held in place with pliers while it is being used.

The power source may be either ac or dc. A filament transformer rated at five Amps or more and able to deliver from 6-18 volts would be a suitable power source. If

there is a heavy-duty dc supply around the shack, that will work, too. A 12-volt car battery would be nice, but not necessarily convenient. In any case, the voltage should be kept below the point where an arc can be struck and maintained.

Since a small amount of the carbon rod may be oxidized during the marking process, this procedure should be done in a relatively

well ventilated area.

Note the glowing rod in Photo D. This gives an idea of what the system looks like in action.

If you are something less than artistically inclined, then you may want to practice making your mark on a piece of scrap material until you get the hang of it.

Fig. 1 gives the diagram for those who are technically inclined. ■

our rooms don't ever provide
lousy manuscripts from all
but in the case of the
you should be
I insist that you print ev
tell Ma Bea that she shou

LETTERS

from page 55

abbreviation for your state and the letters DL. Example: TX DL 3193921. It takes about three minutes to trace any person anywhere in the continental United States through his driver's license number, with

the use of NLETS, which is a nationwide network of computers that you wouldn't believe. There is one exception: The state of New Mexico requires a person's full name and date of birth before you can get a computer hit on his driver's license. Of course, you should

have your current address on your driver's license, which is required by law in most states.

The number should be on the outside of the case as well as the inside. Some of our better police officers don't have the technical ability to take the case off equipment to check inside for identification numbers.

This won't keep your equipment from being stolen, but it will keep it from sitting on a shelf in a back room of some police department because they couldn't determine who the owner is.

Scott McDowell
N5SM/WB5JJN
Amarillo TX

SPEAKING OF QRM

I would like to take friendly exception to WD5HYN's letter (May issue) concerning QRM. In 16 years of operating, I have rarely, if ever, heard deliberate interference to any QSO. I believe that most QRM is a result of propagation anomalies, beam antenna patterns, and other phenomena, including our very crowded bands.

Take, for example, a ham transmitting on the HF bands from New York City with 1000

Continued on page 60

The New, Improved Automatic Thermostat

—adding a night thermostat

James C. French W9YBU
Country School Rd.
Dundee IL 60118

December, 1976, set a low temperature record not matched in the last 96 years. The gas company warns that gas bills may be as

much as 45% higher than last year. So, here in the midwest, "An Automatic Thermostat," by George R. Allen W1HCL in the January, 1977, 73, presented an urgent and immediate project.

I made certain modifications which simplify his system and offer a fail-safe operation.

I used a small timer called a Time-All™ to cut the system over at night to a night thermostat. A 120 V ac relay, SPDT, shorts out the night thermostat during the day.

During daylight hours, the normal thermostat controls the temperature. At night, the night thermostat is put in series with the day thermostat. The night thermostat is set to open when the night

temperature has reached, say, 55°. If the thermostats are in series, the night thermostat will set the temperature, since it opens before the "day" thermostat.

During the day, the relay will short out the night thermostat, and it will effectively not be in the circuit.

The night thermostat should be mounted in some area which is removed from the furnace but not affected by drafts or the outside temperature.

The Time-All timer is plugged into any convenient ac outlet. The 120 V ac relay is suitably mounted in a cabinet near the timer. The relay is wired so that, when the timer is off, the relay (de-energized) shorts out the leads to the night thermostat. See Fig. 1. When the timer kicks in, the relay pulls in, and the short is removed from the night thermostat. It then controls the temperature.

Settings for temperature may have to be by the cut-and-try method to achieve the overall house temperature you wish for the night.

The timer has a switch which will defeat its timing function when you wish a warmer temperature late at night or early in the morning. Should the timer fall out of the ac outlet, or should the fuse on that circuit blow, the day thermostat remains in control of the house temperature.

Good sleeping and a reduced heating bill to you. ■

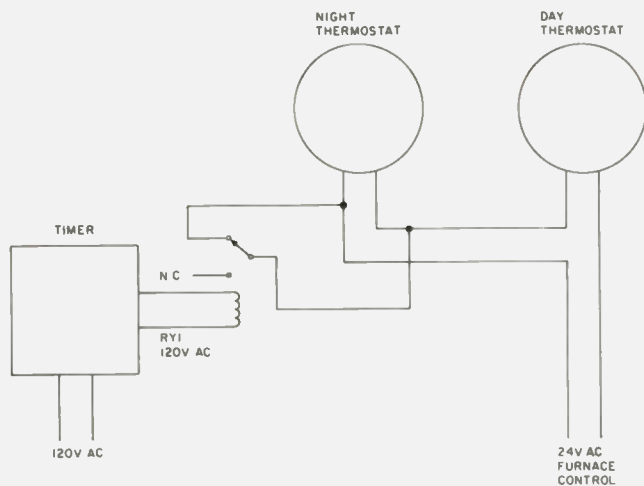

Fig. 1.

LETTERS

from page 59

Watts and a good tribander aimed at Miami. While a good portion of his signal is being radiated in a 15° fan along the New York-Miami axis, some of that power is also being radiated around the other 345°

of arc. Now, let us postulate another ham, say in Seattle, with a beam (or a dipole) aimed at Chicago, in QSO with a W9 with a beam and 250 Watts. The residual signal of the New York City ham may, due to propagation conditions and the fact of higher power, be as strong or

stronger in Seattle than the W9's signal, yet, due to the orientation of the New York ham's beam, he will be unable to hear either the Seattle or the Chicago ham! In addition, the Chicago ham, with the beam, will probably hear very little of the New Yorker's signal due to the New York ham being in the deepest part of the null of his beam.

Changing band conditions, particularly during heavy sunspot activity and during dawn and dusk periods on 20, 15, and 10 meters, can also play havoc. Every ham, I'm sure, has had the experience of being in solid QSO with a distant sta-

tion, and, upon turning it over, has heard nothing or has found himself or herself in the middle of another QSO between two hams in another part of the country (with one of these two complaining about the QRM). A quick study of the propagation characteristics of the HF bands will show that reliable communication (as shown by the Maximum Usable Frequency) is highly dependent upon time of day and the period of the sunspot cycle. This can be worked backwards, too: The usable distance of any given frequency varies, depending

Continued on page 63

YAESU'S NEWEST RECEIVER THE FRG-7000



The FRG-7000—Yaesu's newest receiver features improved selectivity, wider frequency coverage, digital readout, with Yaesu's superb quality of construction.

— SPECIFICATIONS —

Frequency Range: 0.25-29.9 MHz	Selectivity: SSB/CW ± 1.5 KHz (-6 dB), ± 4 KHz (-50 dB)
Modes of Operation: AM, SSB, CW	AM ± 3 KHz (-6 dB), ± 7 KHz (-50 dB)
Stability: Less than ± 500 Hz drift for any 30 minute period after warmup.	Power Requirements: 100/110/117/200/220/234 VAC, 50/60 Hz
Sensitivity: SSB/CW-Better than $0.7\mu\text{V}$ for S/N	Power Consumption: 25 VA
10dB AM-better than $2\mu\text{V}$ for S/N	Size: 360 mm (W) \times 125 mm (H) \times 295 mm (D)
10dB (400 Hz 30% modulation)	Weight: approximately 7 kg.

**GOT YOUR HAM TICKET ALREADY?
Then Be Sure To Write Us For Our Complete Catalog
Of Modern Amateur Equipment.
Known WORLD WIDE As "THE RADIO"**



Price And Specifications Subject To
Change Without Notice Or Obligation

YAESU
The radio. Y1 478



YAESU ELECTRONICS CORP., 15954 Downey Ave., Paramount, CA 90723 (213) 633-4007
YAESU ELECTRONICS CORP., Eastern Service Ctr., 613 Redna Ter., Cincinnati, OH 45215

set the carrier dropout at about 5 seconds. If the repeater is not in use for five seconds, then it goes away. It perhaps could ID for the last 1-2 seconds of this delay. Second, reset the timer at one-half second after the COR opens, and indicate that the timer has been reset by transmitting a half-second tone. This beep tone clearly indicates to the user that the timer has reset and the one-half second delay between the squelch tail and the tone is ample for breakers to use. For the initial applications, the reset time should be longer — say, one second to “train” the users — but very soon the rhythm of the operation is learned and one-half second has been found to be adequate. The tone should be between 600 and 1000 Hz at about 1-2 kHz deviation.

The beep tone solves the first problem described above by a physiological phenomenon. To not wait for the beep is treated by the users as a cardinal sin. No matter how sloppy operation becomes, it is unthinkable to not wait for the beep. If someone “beats the beep,” they are immediately chastised or “educated” by their fellow users. The peer pressure has been very effective, mainly because the beep tone is a clear and unambiguous indicator and to jump the tone is an obviously discourteous act. To continue to fail to wait is clearly an overt and malicious act.

The second problem is

solved since the repeater doesn't drop off during a continued conversation. It requires five seconds of no talking to drop off, yet the beep tone allows full and orderly exchange between your users without inadvertent interjections by your co-channel.

The third problem is also solved in that the repeater doesn't drop off nearly as often. Instead of 1,000 times per day, the number is reduced to 30-50 times per day. The reliability is significantly increased, even with the added complexity of the beep circuitry.

Once the above basic beep concept is comprehended, there are several extensions in usefulness that can be discussed. The pitch of the beep is unique to one repeater and quickly identifies to someone who casually tunes in that it is this repeater he has stumbled upon. This uniqueness can be extended by using a chime tone or other clever sound for your “beep.” We have one repeater in southern California (WR6AFR) that sounds like a broken watch spring.

Another clever idea is to do away with the squelch tail. We're all used to the sound, but imagine how that blast of noise called a squelch tail must sound to the uninitiated. Present technology allows the repeater to eliminate (without degradation in performance) the squelch tail. But, without a tail, the user doesn't know

when to talk. Why not two beeps, one instead of the squelch tail and one at some different pitch on the timer reset. Done right, it would sound like a front-door chime and send casual observers scurrying to answer.

The pinnacle of useful beeps is that of WR6ABN. (See *QST*, May, 1974.) This beep consists of two simultaneous tones. The high tone alone indicates that the previously received signal was high in frequency; the low tone alone indicates that it was low in frequency. Both tones together mean the user was “on channel.”

Beeps are not great saviors of all repeater problems. They tend to create problems, too, one of which often overshadows any benefits. We are almost all aware of the user syndrome known as kerchunking. This obnoxious procedure is to continuously key up the dormant repeater just to hear it come on. Now give this astute individual a beep to play with, and he will drive you and other monitoring people batty. Kerchunk-beep, kerchunk-beep, kerchunk-beep, etc., and soon you're ready for a complete rebuild. If the repeater is busy enough, he doesn't have time to play with his new toy and will do other things to entertain himself.

The beep solves some problems, and it creates some new ones. But such is life. At least the new ones are new and different, and maybe this is progress.

Beep Circuit Description

The circuit diagram for a beep generator is shown in Fig. 1. The input signal comes from the COR used to turn on the transmitter. The signal here is before the 5-second time-out timer. A negative-going edge during the squelch tail is satisfactory. The starting level can be almost anything, as long as it goes below 2 volts to start the beep cycle. The diode, D1, will protect the circuitry even for 2-300-volt tube COR levels.

The 556 dual timer, U1, is triggered by the COR. The first section times the delay from COR to beep, and the second section, triggered by the end of the first section timing, generates the beep gate pulse. This pulse enables an analogue gate consisting of D2 and D3. The beep tone is continuously generated by U2 to insure that it won't change frequency during the beep. This also allows some filtering on the tone to remove the sharp corners. This simple filter consists of K1 and C1. The output level can be set by the beep deviation set, and R2 insures the beep circuit will not load the other audio circuitry. The output level of the beep is variable from zero to about 1 volt rms for a 12-volt power supply.

Care should be used in construction to insure that the continuously running tone generator, U2, does not couple into the low-level audio circuitry where it will appear as an annoying tone. ■

ou moons don't ever profit
lousy manuscripts don't bat
burh
you li...
I insist that you print or
tell Ma beal that she show

from page 60

upon the ionization characteristics of the various layers of the ionosphere.

Finally, it occurs to me that, through no fault of the operator, a well-intentioned ham can listen on a frequency

for several minutes before calling CQ, and, hearing nothing, go ahead with his call. This operator, unless he can hear both sides of a QSO, has no way of knowing that there is a 5 wpm QSO going on the frequency between two Novices (or between two rusty old-

timers).

So, let's not be too quick to yell “interference” when our QSOs get clobbered. Ninety-nine plus percent of the time there is no deliberate interference. Chalk it up to experience, use the opportunity to improve your “difficult copy” technique, move up or down a few Hertz, or shut the thing off and go watch the evil eye in the living room until the band opens up.

And, speaking of QRM, did I ever tell you about *my* Novice days, working rockbound on a 7125 kHz rig with a Halli-scratchers S-20R Sky Cham-

pion with a Q-multiplier ... ?

Warren S. Kirkland WD0EZO
Security CO

KIM CW

Scanning a bibliography prepared by Wm. Dial, *Micro*, April-May, 1978, I ran across the reference to “Receive CW with a KIM,” 73, Nov., 1977. Having written a send/receive program myself (*Micro*, April-May, 1978), I was interested in the algorithm used by Shattuck and Schmidt.

Continued on page 65

It's Flora Clock!

—and all is well

One day, while visiting a local supermarket with the XYL, I happened upon an eye-catching display of Rubbermaid "Windowsill Planters" which, I thought, if turned upside down, just might make dandy equipment consolettes for miscellaneous small projects that might not require mounting in regular minibox or other shielded equipment cabinets.

The display I saw featured a variety of sizes, ranging from quite small to full windowsill size, in several different woodgrain colors, including walnut, tan, and green. I selected a walnut unit, 3¼" x 5" x 3" (No. 3451), for experimentation and set to work just the *opposite* way from regular construction practice, i.e., starting with a good-looking box and finding some gadget to build into it to put the

little gem to good use!

After a bit of thought as to what was missing or otherwise needed at my operating console, I decided to make use of the planter (after nearly having it usurped for its intended purpose by the XYL) by installing a digital clock "atop" it (when viewed upside down) and installing a small source of 9 V dc (nominal) inside the box to power accessories and to provide a source of power for an LED "blinky."

I turned the planter upside down and installed some very small rubber mounting feet on each corner. The result was a very attractive consolette-type enclosure which would be a convenient housing for this or any similar project, such as calibrators and other applications where shielding isn't important. The

flat upper surface of the box (when turned upside down) provides a convenient mounting place for a small LED readout digital clock. I used a Babylon Electronics "Space Age" digital clock, which is a completely self-contained miniature unit featuring a large 4-digit LED display and which comes with its own line cord-type ac transformer. This unit, which uses the popular 5314 clock IC, comes with easy-to-follow instructions and goes together quickly. It is particularly adaptable to ham shack use as it can be set up for either 12- or 24-hour time format. Although it does not display seconds directly, seconds are readable as a specially-coded dot pattern readout between the hours and minutes groups of LED digits. While I built the Babylon unit, a similar clock has recently been introduced by Hobb-Y-Tronix, Inc. (Box 511, Edison NJ 08817), known as the "Super

Compact," a unit featuring .4" LEDs, interchangeable 12- or 24-hour format, and an optional temperature-indicating front panel. Either clock should be suitable; in fact, any clock which will fit the 2¼" x 4¼" "table" atop the flower box will do. The clock is simply epoxied into place, and the power cord to the ac transformer is run through a hole drilled in the top of the box.

The inverted flower box proper houses the ac transformer for the clock, the LED blinky kit, a 6 or 9 V dc adapter to power the blinky, an SPST switch for the blinky power, and a miniature phone jack supplying power for any accessories that I may desire to run off the consolette. The ac transformer and dc adapter are epoxied into place inside the box, while the blinky module is supported by the two LEDs protruding through the front of the cabinet.

The blinky kit I selected was the BL-1 "Mini-Kit" sold by Ramsey Electronics, P.O. Box 4072, Rochester NY 14610. The blinky alternately flashes the two LEDs furnished — the flashing rate being determined by the values of C1 and C2 (referring to the manufacturer's instruction sheet). Larger values of C1 and C2 cause the blink rate to decrease, while smaller values will increase the rate. The blinky kit runs off source voltages as high as 20 volts without damage, though a 9 V dc power source was most convenient for me due

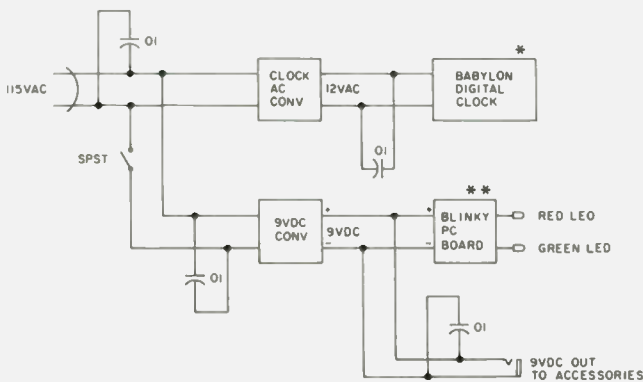

Fig. 1. Flower-box console. *Babylon "Space Age" digital clock kit or equivalent, such as the Hobb-Y-Tronix "Super Compact" kit with ac transformer. **Ramsey BL-1 blinky module or equivalent (see alternate circuit of Fig. 2).

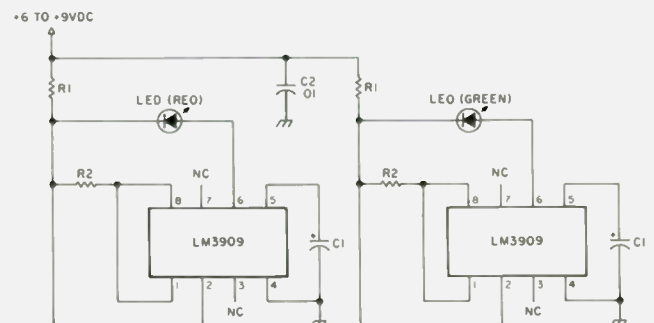

Fig. 2. Alternate home brew blinky module. C1 = 350 uF; R1 = 1000 Ohms, ½ W; R2 = 1500 Ohms, ½ W; all values nominal. Separate LM3909 circuits allow independent flashing.

to the availability of an old (but serviceable) 9 V transistor radio battery eliminator. Substituting a green LED for one of the two red ones furnished with the kit adds a bit of class, and increasing the values of C1 and C2 to about 75 uF slows down the blink rate to a reasonable one with 9 V dc applied. No special precautions are required when building the unit on the PC board supplied, other than the usual necessary care in assembly when dealing with highly miniaturized units. Hobb-Y-Tronix also sells a similar blinky flasher kit which uses a 555 timer and is specifically designed to work off 9 V dc. I used a 100 mA dc adapter, though any 6- or 9-volt unit should work well with either module as only a few mA are required. At the price levels involved (less than \$3 for either kit), it hardly pays to make up the PC board for a completely home brew blinky, though the circuit shown in Fig. 2 could be used. Both ac and dc lines should be bypassed with .01 uF disc ceramic capacitors to suppress any floating rf which might seek a home in the digital clock or blinky board. Also, if a hum problem is encountered when running accessories off the unit, try connecting a high-value (500 uF) electrolytic capacitor across the output, observing correct polarity. Whichever blinky circuit is used, the 9-volt power adapter and ac transformer

for the digital clock easily fit into the shell of the inverted flower box and can be epoxied into place. Two small holes are drilled in the front of the box to allow the two LEDs to protrude through the front. A hole is drilled in the front for mounting the SPST mini toggle switch, and holes are drilled in the rear of the box to accommodate the accessory miniature phone jack and 115-volt ac power cord. A custom nameplate (which can be made at any nameplate engraving service or at the next local hamfest) indicating the station callsign may be glued to the front panel to complete the installation.

One caution when scrounging a dc adaptor: If accessories are to be powered by the unit, make sure that the adapter used doesn't have one side of the dc output line connected to the ac line. Some of the cheaper imports may and should not be used, as they would present a shock hazard.

While, admittedly, this project started out as little more than a novelty, putting it together was a good deal of fun, and I have found that it is actually quite attractive and draws a good number of compliments. And, best of all, no one has yet guessed that the cabinet is a flower box!

The larger boxes are a bit oversize for typical ham shack applications, but the smaller units such as the one I used have good potential. They are just about right for small construction projects such as clock housings, high-intensity lamp bases, selector switch boxes, and the like. The fibrous composition plastic material is a bit difficult to work with, however, and is not very suitable for intricate drilling and punching. Just keep what you try to install in the boxes simple, and you'll be rewarded with a good-looking finished product certain to add an extra touch of class to the shack. ■



ou rooms don't ever prooffe
lousy manuscripts from lat
burh
LETTERS
I insist that you print or
teli Ma had that she show
from page 63

There are some fundamental differences between our algorithms. Our dot-dash, element space, character space, and word space decisions seem to be basically the same. However, my program rejects

as false any mark elements (key down) less than one-half the dot length, giving additional noise discrimination on the air.

There are a few other points of comparison which I would like to make.

1. They have a wide variety

of display formats; my program requires some kind of video module to convert ASCII to a video format and display it on a CRT.

2. My program has greater time resolution for character decisions. Their basic time unit was about 4 ms and mine was 1 ms. This probably makes no difference until excessively high code speeds are reached.

3. They use an automatic calibration routine which tracks variations in code speed. I enter the code speed from the keyboard, and the 7-segment display on the KIM indicates whether the speed is

too slow or too fast. In an earlier attempt at a Morse code reader, I found that static crashes tend to foul up auto-cal circuits.

The point in writing this letter, in addition to bringing attention to some possible variations and improvements in CW receive programs, is to suggest that someone with the appropriate equipment try both programs "on the air" and make evaluations and suggestions for improvements. I will be glad to furnish an interested individual with a reprint of my

Continued on page 69

Build Your Own Digital Dial

—great update for your receiver

Every shack needs a general-coverage receiver, if only to tune down to find where the harmonics are

likely to be coming from. If your general-coverage receiver is anything less than an R-390, it needs a digital dial.

A readout to even kHz will be a great help, provided the last digit is useful, rather than indecisive.

An article by Jon Hagen in the December, 1972, *QST* told what to do and how to do it (except for how to make LED displays work right), and my unit was based on that, on his personal comments (he talked me into building one), and on a lot of cut and try on my part. Some of the features that I have tried aren't included here, as they are not worth the effort involved. But what is in this article is essential to make a useful display. Albert Ingalls cautioned amateur astronomers "not to make their last telescope first," and, unless you are a digital nut rather than a ham or SWL who needs a digital dial, I suggest keeping things simple. If you want something better, see Jack Regula WA3YGJ's system in the October, 1976, *73* (corrections 5/77) and something similar in the ARRL 1976 *Handbook* as part of a communications receiver. Regula's article uses a multiplexed display with a CMOS driver suitable for common-cathode LED numbers. Mine uses 7447s and common-anode displays, and the two other articles avoid the issue.

The difficult questions involve human engineering (now I need reading glasses for the red numbers at arm's length, but not for green or yellow!), where to put the readout (close to the knob you turn), and how to keep the digital hash in the box and out of the receiver. If the box is put together with a dozen screws or more, the

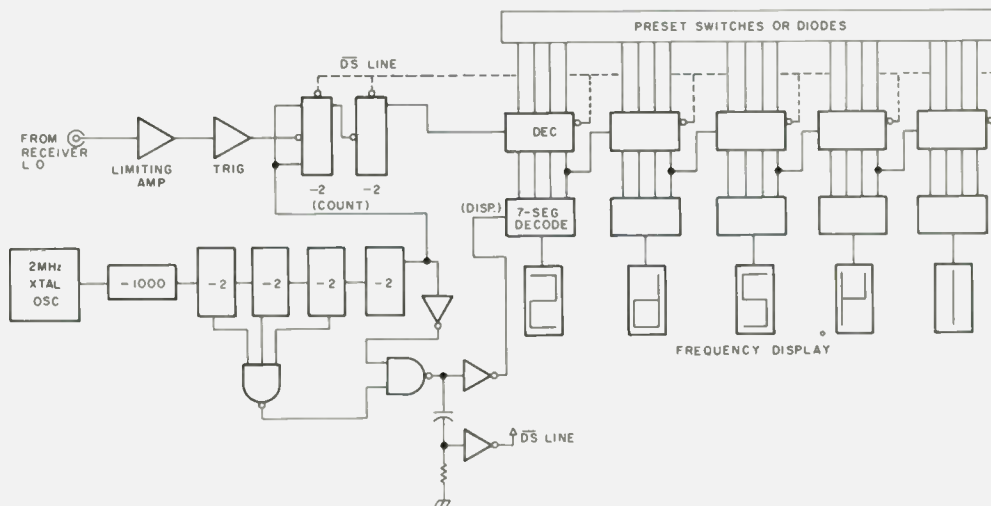

Fig. 1. Digital dial logic diagram. Frequency display is shown from back.

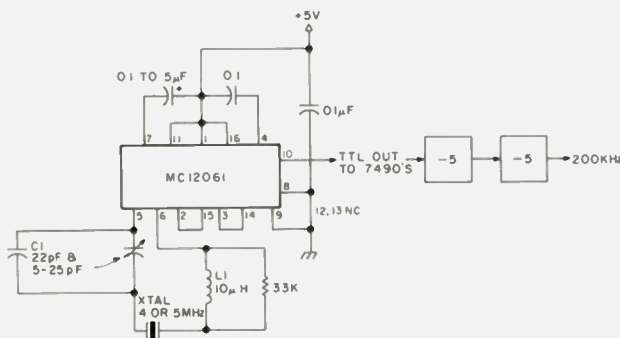

Fig. 2. An IC 5 MHz oscillator (Motorola MC12061). This IC consists of an ECL oscillator, a buffer, and an ECL-TTL converter. If the crystal won't pull to frequency, modify C1 or L1.

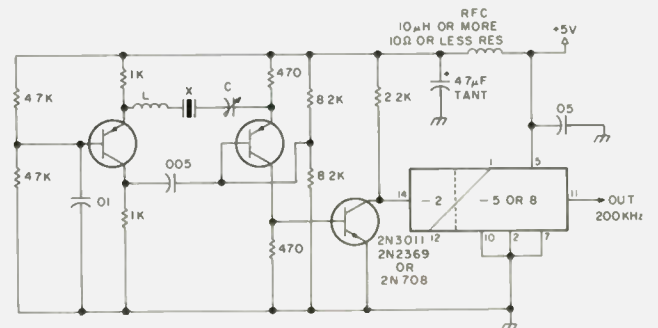

Fig. 3. 2 MHz crystal oscillator. PNPs — 2N3012, 2N3906, 2N4121, and 2N963. For 2 MHz crystal — L = 10 uH, C = ~ 30 pF.

only way for hash to get out is via the readout window (mine is 0.787 by 3 inches), the input coax, or the ac line. The input amplifiers should be somewhat separate from the rest of the counter, and the lead to them should be coax inside as well as outside the box.

Because the 7447s are not multiplexed, the 7-segment output lines can be bypassed at the LED end with up to .01 uF, if needed. I found that the ac line was what took the effort and I didn't filter the display.

It is important to realize that the dial will read right, even if you have two-dial electrical bandspread or a helipot-and-varicap fine tuning system. Also, as long as you read the LO frequency, the fact that it drifts a few kHz is something not easy to notice. Subjectively, your receiver no longer drifts (how to save \$495).

The preset system is similar to that used in the GLB synthesizer (up to 15 diodes per wired-in frequency), and any number can be supplied, or you can use thumbwheel switches, BCD switches, or toggle switches. For my purposes, an SPDT center-off type (as shown) takes care of LO high, LO low, and operation as a straight counter in the "off" position. Experience suggests that the last digit preset might be best brought out to a panel switch, as not every "455" i-f is on that exact frequency.

For antiblink purposes, Hagen used an undisplayed decade. Mine divides by four, so I can use J-K gating and cycle a bit faster (125 blinks per second, rather than 50). No latches are used, although they would be needed if you read down to 100 Hz. Count period is 4 milliseconds, display 3.5 milliseconds, reset takes two microseconds, and the rest of the time is wasted.

Because the preset ("data") inputs are on 0.02 percent of the time only, the input pull-down resistors can be 4.7k or higher, if .01

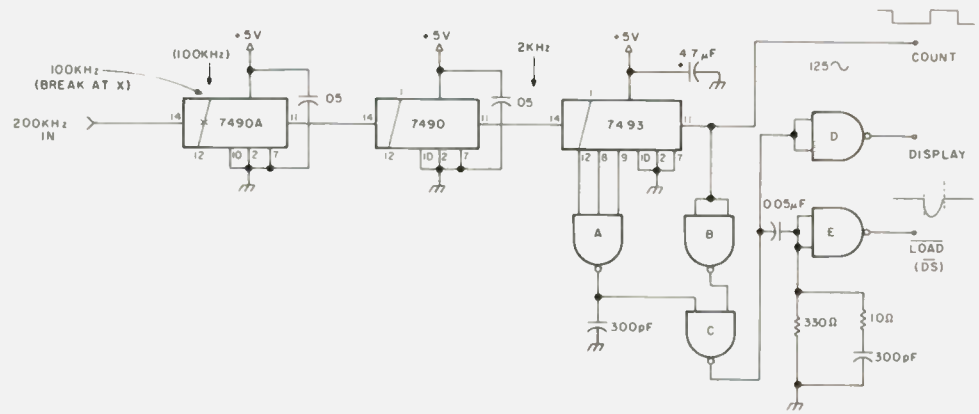

Fig. 4. Sequence generator. A — 1/3 7410; B and C — 1/4 74S00; D and E — 1/3 7410 or 1/4 74S00. One section of 74S00 is used in the input. This is the only place high speed is required. B should be at least as fast as A.

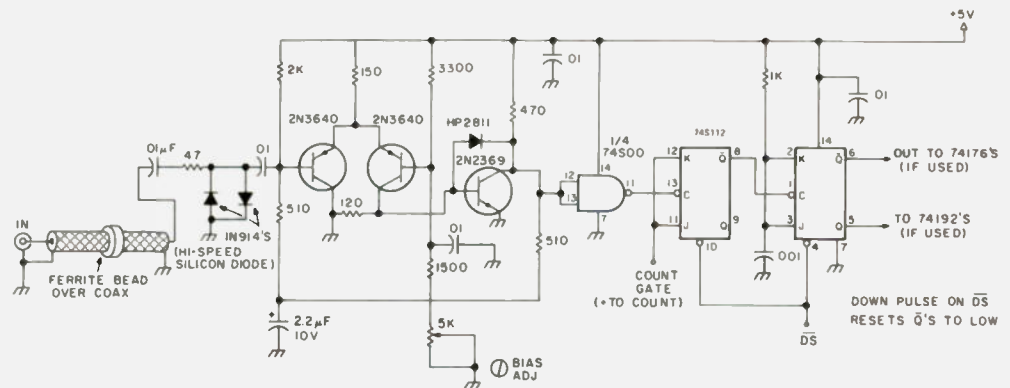

Fig. 5. Input amplifier and ÷4. Count sensitivity: 5 MHz — 2 mV rms to 1 V; 50 MHz — 25 to 40 mV; 70 MHz — 90 to 200 mV. Pins for 74S112: J — 3, 11; K — 2, 12; Q — 5, 9; Q̄ — 6, 7; preset — 4, 10; +5 — 16; ground — 8.

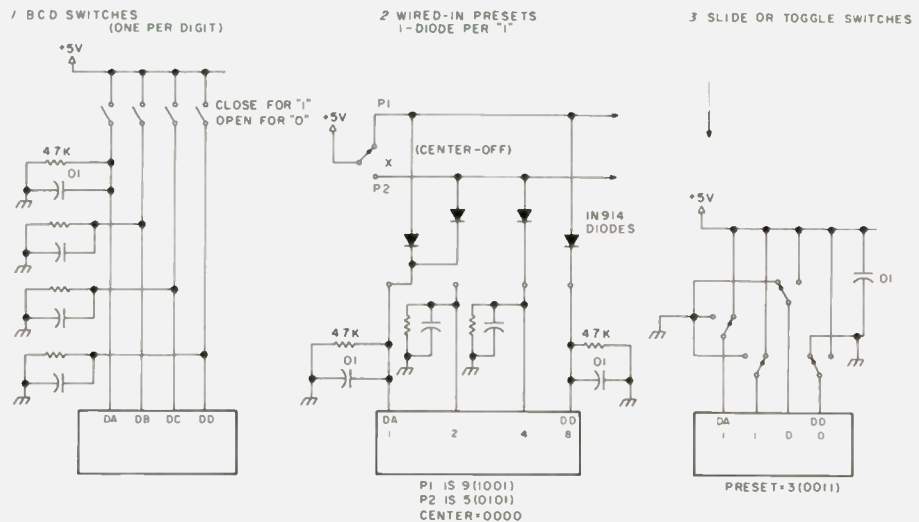

Fig. 6. Preset circuits. Receiver i-f = 454 kHz. Oscillator high — preset to 100,000-454 = 99546. If the oscillator is on the low side on the 12-30 band, then preset is 00454. (That's why there are two "preset" frequencies.)

capacitors are also across the resistors. Thus the preset switch takes only about 15 mA, but the decades will not reset properly if the "preset" down pulse is longer than a few microseconds. If your

receiver "tunes backwards" on some ranges, you will need 74192 up/down counters, but, if it's strictly single conversion or has a fixed first i-f, there is a money and power saving from using

74176/8280 up counters. (The 74196, which counts up to 50 MHz and uses more power, can be plugged into the same socket.)

The input string shown takes a tenth volt at the coax

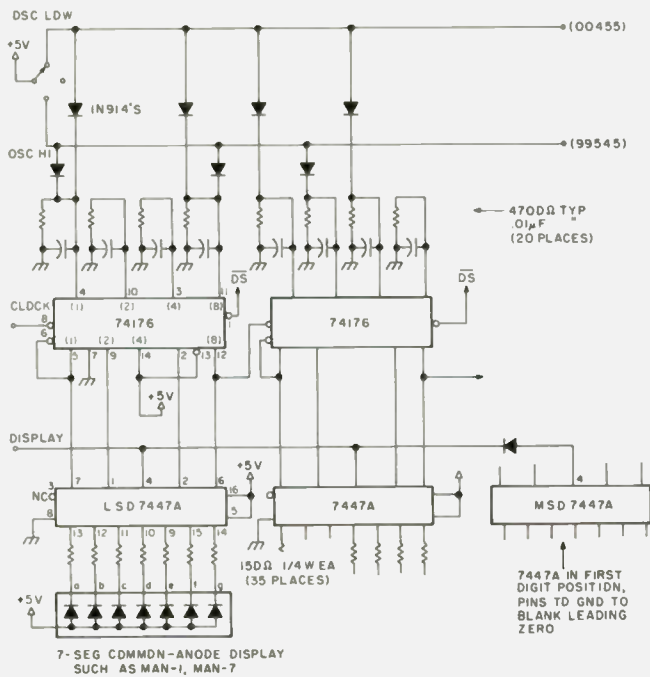

Fig. 7. Up-counter detail.

jack and will count up to about 70 MHz. Getting the signal into the coax should be solved at the receiver end. I use a transformer in the mixer drain lead and have used emitter followers, etc. The coax will only be a few feet long, anyway, so it may not be desirable to terminate it. All those amplifiers hold the signal down when it's strong and also reduce the gating hash that comes out the input (most commercial counters and scopes feed sync or gate pulses back into the

circuit you're measuring) and thus into the receiver's signal path. Gating the J-K inputs to the 7S113 (a 74S112 is also okay) is the neatest way to turn a counter on and off, and it wasn't the only way I tried.

Almost any AT-cut crystal will be more stable than a 100 kHz unit and good enough for this. I used 2 MHz, but 1, 1.6, 3.2, 4, 5, or 10 MHz will do (James lists 2, 4, and 5 MHz, for instance). Input to the divider string is shown at 200 kHz, but, by

unhooking the first flip-flop and going into pin 1 of the second 7490, 100 kHz can be used. The output of the third 7490 is at 2 kHz into a 7493, which provides the 4-millisecond count gate and drives the sequence gates for display and reset. Remember that the output of the 7493 must go up and down fast enough to gate the highest frequency to be counted. That's why the divider string doesn't have 74L90s or CMOS in it (74LS90s work fine, though).

There are 6 gates in the system if you don't have to switch the 74192s from up to down with a remote signal. At the input, a 74S00 drives the first flip-flop, a three-input gate is needed at the 7493, and a two-input gate is used. I used a 7410, but a 7420 (and the 74S00) would also do the job. Unused gates waste power; unused inputs can be strapped to used inputs with no problems.

The 74S113 is preset each time the decades are loaded, so that the number of counts in before the first pulse out is not a matter of chance (something I forgot the first try).

The three-input gate turns off about 0.1 microseconds before the output of the 7493 changes, so I put the 300 pF capacitor on it to

make the waveforms come out right, though it isn't critical to the way things work.

The input amplifier transistors should be very fast digital types. The NPN can be a 2N2368, 2N2369, or 2N3011. If you can't get a Schottky diode (shown as HP2811), don't use a diode there. The PNP pair could be 2N4403s, although 2N3640s/MPS3640s are better. The bias adjustment is set up for best sensitivity at the high end of the receiver's range. I used a signal generator. The 2.2 μF capacitor is important. The transistors in the crystal oscillator can be the same types or 2N3904s and 2N3906s.

To keep the hash at a minimum and inside the box, be sure each IC has a bypass cap across its terminals (0.01 μF or larger) from plus 5 volts to ground so that the gulp of current that it takes when switching comes from a nearby source. Little dipped tantalum caps work okay here. Filter the ac line where it comes into the box, make the power supply and regulator somewhat separate from the rest, and slip ferrite beads on any wires between boards.

I used the power supply I described in *73 Magazine*, February, 1977, p. 41.

Adding Varactor Fine Tuning

If you have a digital receiver frequency readout, adding fine electrical bandspread or incremental tuning becomes more attractive because the readout tells you the actual frequency without the need for adding the readings of two dials. Even some ham-band-only receivers could use a little more vernier action than they have.

To do a neat job of adding a fine tuning dial, I used a ten-turn helipot and a variable capacitance tuning diode. The voltage I had was plus 12.6, so the tuning bias was about 2 to 12. Because the range I wanted was about 25 kHz, the thermal drift of the diode was large enough to

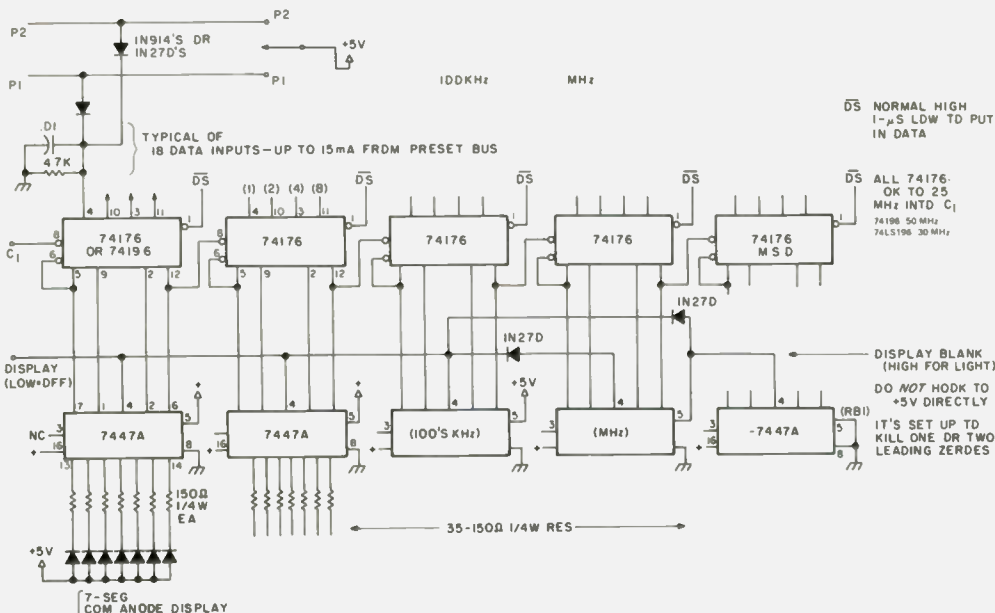

Fig. 8. Preset counter for digital dial (up-count only). 74176s use half as much power as 74192s, count on falling edge. Presets — 00455, 99545, 00915, 99085, 02215, 97785, etc.

A Amateur Radio Supply of Nashville, Inc.

ARSON, INC. Announces The Opening Of

615 South Gallatin Road, Madison, Tennessee 37115 • (615) 868-4956

A40

Authorized dealer for: Kenwood • Yaesu • Drake • Icom •
 • Dentron • Ten-Tec • Wilson • Tempo • Swan • Standard •
 • KLM • Larsen • Cushcraft • B & W • CDE • Newtronics
 (Hustler) • NYE • and others.

These ARSON, INC. policies have satisfied thousands nationwide.

1. Credit cards Welcome (except on "specials")
2. Trades invited.
3. Fast — to your door — delivery via UPS.
4. Large inventory of major lines — most items are in stock NOW!
5. Free Catalog
6. Cost of telephone calls will be deducted from your order.
7. Assurance of fair dealing through our nationwide reputation.
8. We're "burning" to make Hot Deals at A.R.S.O.N., Inc.

NOW - - - - A full line Ham Store with these
 Same Policies in ATLANTA - - ARSON ATLANTA, INC.

TRADE WITH US AND BENEFIT FROM OUR VOLUME BUYING

These are a few of our "HOT" Grand OPENING Specials

YAESU



101E Buy at \$799.00
 Get Free FV101B
 Remote VFO List \$125.00
 Send cashiers check or M.O.
 Shipping will be collect.

The Memorizer



Yaesu FT 227R
 Fully Syn 2M FM
 List \$315.00
 Call for Super Quote

Kenwood



7400A 25 watts
 Fully syn. 2M FM
 List \$399.00
 Call for Super Quote

CDE Ham III



Ham III rotor \$124.00
 Shipping included to Cont. USA
 Ham III rotor plus 100 ft. rotor
 cable \$139.00
 Ham III rotor plus 100 ft. each -
 rotor cable and RG-8U foam
 coax \$162.00
 Send cashiers check or M.O.

We can't advertise most of our special prices - - Call or Write

KENWOOD



TS 520S List \$739.00
Buy at \$739.00
 Get Free: 1. CW Filter \$49.00
 2. Ext. Speaker \$30.00
 3. Shipping Included
 Send cashiers check or M.O.

Dentron



Dentron Super Tuner
 List \$129.95
Buy For \$116.00
 Send cashiers check or M.O.
 Shipping will be collect.

ICOM



IC-211
 4 MEG. MULTI-MODE
 2 METER TRANSCEIVER
Buy at \$749.00 Get:
 Gift Certificate for \$125.00
 Send cashiers check or M.O.
 Shipping included.

DRAKE



Drake W4 **WV4**
 List \$79.00 List \$89.00
 Sell \$67.00 Sell \$76.00

WB4DXH • W4LTX • WA4CDX

Amateur Radio Supply of North Atlanta, Inc.

ARSON ATLANTA, INC.

Pinetree Plaza Shopping Center • 5269-6 Buford Highway, Doraville GA 30340 • (405) 455-1771 A56

DRAKE'S New STATE OF THE ART RIG IS HERE! !

- THE TR-7
List 886.00
- DR-7 Dig Readout
List 186.00
- PS-7 Power Supply
List 166.00
- MS-7 Speaker
List 33.00
- Full Line of
Accessories
- Call For Yours Now



K4JSR • WA4HUG • WD4LGF

KENWOOD



TS-820S
Deluxe 160-10M CW; SSB
List \$1098.00



TR-7500
2M 100 Ch. Programmable
List \$299.00

DRAKE



R4C Rcvr
160-10M List \$699.00



T-4XC TX
160 10M List \$699.00

YAESU



FT-901 DM
160-10M all Mode HF
List \$1299.00



FRG-7
Broadcast to 30 MHz
List \$315.00

STORE HOURS
Mon. - Fri. 9 AM - 5 PM
Sun. 1 PM - 6 PM

**All Prices Subject to Change
Without Notice.**

**MASTER CHARGE
& VISA ACCEPTED**

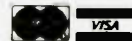

**CALL US and see why if you're not buying from us
We're Losin' and You're Losin'**

ATLANTA (404) 455-1771

NASHVILLE (615) 868-4956

We're "burning" to make "HOT" deals at ARSON ATLANTA, INC.

The FM Rebroadcaster

— flexibility for the FRG-7

I have acquired a Yaesu FRG-7 synthesized 500 kHz to 30 MHz general-coverage receiver. It fulfills a real need for a good continuous-coverage portable communications monitor and SWL receiver for my shack, supplementing the ham-bands-only coverage of the Tempo 2020 in use at W8FX/4. A dual-purpose accessory that would rebroadcast on the commercial FM band (88-108 MHz) what was received on the FRG-7 (affectionately known as the "Frog-seven"), combined with a code practice oscillator to keep up the code speed on long Air Force

TDY (temporary duty) trips, became a highly desirable addition to my station.

I used a small 1" x 1" PC board FM wireless mike kit, available from Ramsey Electronics (P.O. Box 4072, Rochester NY 14610) for \$2.95, which, along with a Cordover Model CWM-1 code module obtained from Burstein-Applebee Co. (3199 Mercier St., Kansas City MO 64111), meets this dual requirement.

The FM unit sold by Ramsey runs a mighty 100 mW output, can easily be tuned anywhere in the FM band,

and will work off 3 to 9 volts dc. As the code module is designed for low-voltage operation, an old 6 V battery eliminator was scrounged from the junk box. When plugged into the rear of the unit through a miniature phone jack, it provides a convenient source of power for operating both the wireless mike and the CW module. A 3000 uF 16-volt electrolytic across the B+ line provides a high degree of hum suppression often lacking in run-of-the-mill transistor radio battery eliminators. A 9-volt-type 2U6 battery can be used as a power source, increasing

the value of the series dropping resistor to the CW module, though battery life would be somewhat limited. A 6 to 9 V dc tap-off could be taken from the FRG-7 power supply, but I decided that going into the receiver was undesirable as it would be necessary to drill into the back panel to bring out the B+ wiring to the "Frog" box.

No particular construction precautions need be observed. I mounted a small 1½", 8-Ohm speaker in the bottom of the 3-¼" x 2-3/16" x 4" Radio Shack #250-251 equipment cabinet and epoxied the CW module (a solid-encased unit) to the magnet frame of the speaker. The FM PC board can be mounted to a piece of copper bus bar wire and squeezed into any convenient place in the cabinet. A front-panel mini toggle switch is used as a power ON-OFF switch, and another mini toggle serves to switch between the code practice oscillator and rebroadcaster functions. The rear panel houses a BNC antenna jack, miniature phone jack for dc power input from the 6 V dc battery eliminator (a J. C. Penny model 681-6542 swiped off an old portable which had long since given up the ghost), an audio-level adjust control for the FM unit, and a miniature Amphenol-type mike jack for audio input from the "Frog." The unit works particularly well with this receiver, as the Ramsey unit is designed for medium-to-high impedance input, and the FRG-7 has a medium impedance fixed-level audio output available on the front panel of the receiver. This fixed output is, of course, independent of receiver audio gain settings and therefore does not interfere with regular speaker or head-
 phone operation. The FRG-7 tape output is, however, taken off prior to the audio filtering network, so that switchable audio selectivity is not available to the output. The audio has also been fed

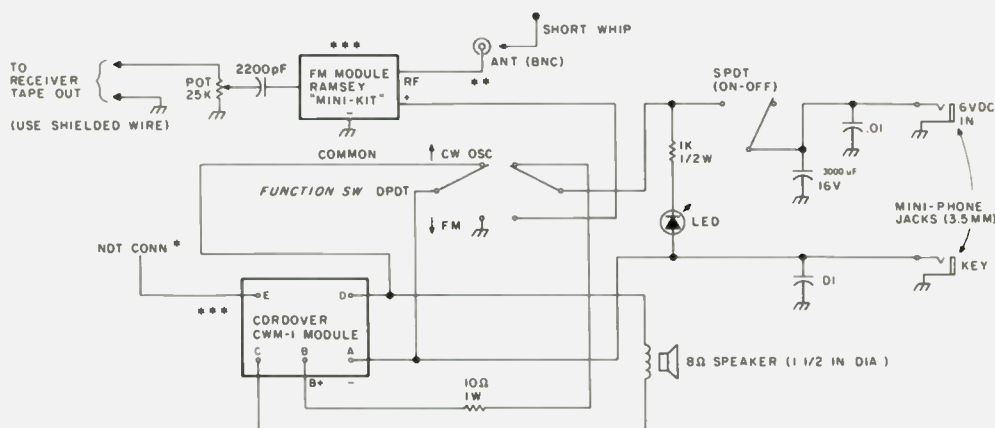

Fig. 1. FRG-7 "Frog" box. *Used for rf pickup if the unit is to be used as an on-the-air rf-actuated monitor (not used in this project). **If connecting a short whip causes the unit to "pull" frequency excessively or to stop oscillating, insert a small-value capacitor in series with the antenna lead, or make a "gizmo" coupling on a few turns of insulated hookup wire and inductively couple. ***Refer to manufacturer's instructions for proper PC board/module connections.

through an Autek QF-1 filter to the rebroadcaster with excellent results.

The CW module (obtained from Burstein-Applebee but also available from Poly Paks and others) is actually both a code practice oscillator and rf-actuated CW monitor, but I have not been able to obtain reliable results when trying to use the unit as a true on-the-air monitor. On-the-air CW monitoring is best obtained by use of a keyer relay, having the key actuate a relay which keys both the transmitter and the FRG-7 box simultaneously.

While others may have better luck in getting the rf function of the CW module to work, I've found from experience that getting dependable results from direct rf-actuated keying monitors is very difficult — performance usually varies considerably from band to band and depends also on such factors as power input, antenna loading, swr, and amount of rf floating around the shack. It's best to go to indirect monitoring for consistent results. The use of the FM unit is fairly straightforward. Once a short (10" to 20") antenna is fabricated from a length of bus bar or an old walkie-talkie whip and a BNC connector, the unit is adjusted simply by tuning a nearby FM receiver to a clear spot anywhere in the 88 to 108 MHz region and adjusting coil L1 of the FM unit (Fig. 1) until a strong, clear signal is received on the FM receiver.

Of course, the frequency should be selected so as to not interfere with local FM stations (no need to induce further BCI problems). One should note that the antenna affects the transmitter output frequency, and, therefore, close movement next to it should be avoided. The little unit should easily transmit up to 300' or more, depending on location and length of the antenna hooked to the BNC output. It has been used for various purposes at W8FX/4, both in conjunction with a pair of lightweight FM cordless radio earphones and for general receiver monitoring while puttering around the house and yard. The tone of the CW module is dependent on the voltage applied; it is designed to operate with a nominal 1 to 1½ V dc power source (penlite cell), but will work well and produce a considerably louder and cleaner sound with a slightly higher voltage applied. The value of the dropping resistor in the 6-volt dc line (Fig. 1) will determine both the level of audio output and tone of the oscillator. Under no circumstances should more than 4 or 5 volts be applied to the module, as damage may result. A miniature phone jack installed on the rear panel provides a convenient key jack for code practice use, and a front-panel-mounted LED is wired so as to flash with CW keying when the unit is used as a code oscillator and to glow steadily when the unit is used in the FM



rebroadcast mode, indicating that the unit is radiating.

Be sure that the dc adapter scrounged to power the unit isn't one of the cheapies with one lead of the dc output connected to one side of the ac line. Use of such a unit would present hum and grounding-out problems, not to mention the shock hazard involved.

I have found the FRG-7 "Frog" box to be a very handy device, and, of course, it can be used with other receivers not having a tape output by either connecting to the high side of the receiver's volume control (the preferred way), or by simply bridging across the low impedance headphone or speaker output of the receiver (at the risk of distortion due to impedance mismatching and/or overdriving). Also, although I didn't do it, the unit can be wired so that both the FM rebroadcaster and CW module

are activated at the same time with audio from the CW module output also routed to the audio input of the rebroadcaster for group code practice sessions through individual portable FM receivers.

One further cost-effective tip for those who may construct the "Frog" box: If you intend to use it with a set of FM headphones for cord-free work, get a high-quality unit (such as one made by Archer or Panasonic) and install a mini phone jack on the headset so that it can also be fed audio directly from the receiver for use as an ordinary pair of headphones, eliminating the need for another set of headphones around the shack.

For an extra bit of class, use gray and black Dymo™ Label Maker strips for both front and rear panel labeling. As can be seen in the photo, both ¼" and 3/8" size strips are used for nomenclature. ■

LETTERS

from page 69

organizing a road rally and possibly another small event in August, and we are publishing a rapidly expanding newsletter. As newsletter editor, I am trying to recruit new members and subscribers.

Although our group is not yet in the same ranks as the ARRL, and our newsletter has a few more issues to go before we can compete with 73, our newsletter does offer many features not found in other publications.

The newsletter, published

monthly, offers several pages of coming events listings, in addition to a list of many 2-way radio clubs' regular meeting dates, and general information about various happenings in the two-way radio world. We are very much interested in knowing about other groups' meeting dates and events, including hamfests, flea markets, auctions, or field days.

At the present time, we have more CB members than hams, but we do not feel that it is fair to categorize the association as strictly a CB or ham group—we are neither. We are certainly in need of members of all kinds, and certainly could not com-

plain if we had more ham members to help out on the many technical aspects of radio, and in fund-raising events.

The present membership rates are \$10.00 (1st year only) and \$7.00 renewal, and additional members at the same house \$7 plus \$4 per year renewal. Newsletter subscription only is \$4 per year (single copy 35¢ plus postage). Copies of our by-laws and constitution are included in the membership, or are available for \$1.00.

Anyone with any information for the newsletter or the Mass 2-Way Radio Association is en-

Continued on page 75

J. B. Fields, Radioman

—now it's the Navy's turn

All of us who read 73 are united by a common interest — amateur radio, of course. I have not been a ham for long, but I have had much valuable and enjoyable experience in the Philippines as a volunteer operator (MARS). As soon as I get back to the states ... well, we'll see!

Amateur radio is getting more sophisticated every day. High quality receivers, micro-computers, and heaven knows what next are all combining to expand the horizons — for those who have the bucks.

Money is the universal problem here, or, rather, a lack of it is. How do we alleviate this problem? Usually the answer is work, and this means time away from our favorite pastime — amateur radio.

What I propose, therefore, is a way to spend more time with our hobby and earn money at the same time. Well, the law prohibits us from doing that, but there is a second best answer — a career in communications.

If this sounds like I'm trying to recruit you, perhaps I am, but it isn't as if someone is paying me to. Let me point out the recent article about Merchant Marine radio officers, or "sparks,"* as a description of one fine example of a hobby-related

occupation. Let me also inform you that the State of California has openings for telecommunications specialists (particularly those with experience in UHF), and other states likely have similar needs. All you have to do is contact your state employment agency. Most nonmilitary employers will require that you hold a Second Class FCC ticket, but after the amateur tests ... well, we should all be fairly adept at passing the candy-man's exams. Right?

Maybe you don't feel very confident about passing the Second Class exam, or perhaps that twenty plus code business shakes you up. What next? Just what I've been leading up to — submarines.

Notice, I did not say "the military" or even "the Navy," though one of these may be an answer and, perhaps, be the right one for you. I am talking about what I think is the best all-around answer for the amateur today: the job of a radioman aboard a submarine.

In this article you are not going to read any new performance data, any technical information, or even very much about submarine communications. If that is what you want to know, go see a Navy recruiter, sign up for subs, and, once you are doing the job, somebody may have the courtesy to explain to you what it is you're doing. The purpose of this article is

to be entertaining and informative about how to pay for our hobby by doing something we like.

What is it you like most about your hobby? Do you like to have the latest in equipment? Do you enjoy troubleshooting and repairing electronic equipment? Or do you prefer operating the equipment or sitting on a net? Let me tell you about Hog Heaven.

Sign up in the Navy, but make sure you are guaranteed RM "A" school. Recruiters are pretty sharp cookies, and they may have other places they need people more. If you stick to your guns, the recruiter will take you sooner or later to fill a quota, even if he has to guarantee you RM school.

Next, you breeze through boot camp — you're good at copying a message the first time around, and, if you're on your toes, this skill will whisk you right through boot camp.

RM "A" school is just another formality, but make sure you volunteer for submarines when you fill out your dream sheet. Once you've volunteered, there will be all kinds of instructors in the school who served in submarines and who will help see to it that you get there.

Next is Morse code school. If you can already copy thirteen, you may have a bit of fun here — get in a huff

with an instructor, and wind up by betting him that you will be copying thirteen within a week. Upon graduation, you will be copying 22 wpm without even thinking about it.

Now you're getting closer to the Second Class FCC ticket. There can be even more help with the technical side of it, if you play your cards right.

After code school, there's sub school. That's four weeks of elbow-bending exercises in New London, Connecticut, and, after that, your first boat. Ask them, beg them, or even twist their arms, but make sure you get to the Radioman Electricity and Electronics school to get heavy on theory!

So far there haven't been any surprise tests — a few weekly quizzes and whatnot, but nothing like the FCC exams. Everything you need to know is presented so that you understand it. All you have to do is remember.

Now you are ready for that Second Class exam. Take it. You only have two years left in the service, and it will open doors for you later in civilian life. In the meantime, you are going to see some interesting times in the submarine service.

My first boat was the *USS Barb* (SSN-596), a nuclear-powered, fast attack class boat, home ported in Pearl Harbor, Hawaii! I was excited to see my orders, for the *Barb* had only recently made headlines by rescuing the crew of a downed B-52 in the middle of a hurricane. Here is the story as I later learned it ...

Barb, en route to the position of the downed aircraft, was traveling at a depth of 120 feet. The force of the storm suddenly became sufficient to actually suck the *Barb* right to the surface! Once on the surface, all hell broke loose. The towering waves and gale winds caused the *Barb* to take rolls of up to 60 degrees from side to side. The first roll was to starboard and caught everyone by sur-

*"See the World and Get Paid!", Gerald J. Hargett, 73 Magazine, November, 1976, December, 1976.

prise. All the men sleeping in bunks on the port side of our single passageway were thrown out of their racks and onto the deck. As the rudely awakened sleepers greeted the day with appropriate remarks and tried to stand up on the heaving deck, the boat suddenly rolled to port, throwing all the remaining sleepers in starboard bunks atop the first group. Quite a tangle it was!

Meanwhile, back in the galley, Freddy, our salty head cook, could be heard invoking all the spirits of heaven and earth in his frantic attempt to keep dinner on the stove. The crew could visualize the beans pouring into the mashed potatoes. As if this were not enough, the ship was nosed into the waves to reduce the rolling, but the scramble continued. As the bow climbed skyward in the face of a mountainous wave, Freddy's cherry pies and sizzling roasts smartly departed the oven on a voyage aft across the mess decks. But, living up to his reputation, Freddy got it all together for an excellent meal.

The bridge was manned. Only the stoutest could survive the waves that engulfed the boat. The job of lookout fell to Richard Spaulding, a giant of a man, who until now was satisfied looking after our nuclear propulsion system. He held on, as time and time again waves nearing a hundred feet high broke over the bridge and tried to tear

him away. All we had to direct us now was the helmsman's ability to interpolate the swinging compass in an effort to stay on course. But luck was with us: Richard spotted the liferafts between two swells. He fired a lifeline to the aircrew, but they were too exhausted to grab it. So, to cap the whole event off, the chief torpedoman, TMCS Hentz, lashed a line around his own waist and swam through the seas to reach them. On the first attempt, they timed it correctly. Chief Hentz successfully negotiated the seas and managed to tie the line fast to the liferafts.

Of the entire aircrew, only one man was lost to the sea. The bombardier was perhaps the most exceptional of the crew. He had managed to tie himself into one of the liferafts and, amazingly, caught a few moments of sleep while the storm raged around him!

Needless to say, I was anxious to join these men when I saw my orders. I flew to Pearl Harbor to meet the *Barb*, but she was still at sea. So I spent a month working for Submarine Flotilla Five and vacationing on Waikiki Beach. Then, early one morning, I was roused out of the rack and told to pack my seabag and report to the airport for a flight to Guam to meet the *Barb*.

The next twelve months were filled with "submarine qualifications" — tracing pipes and wires, and learning everything about the boat. At

the end of this period of study, I went through a series of exams with my shipmates, the ship's engineer, the executive officer (XO — second in command) and finally with the captain, who pinned on the coveted dolphins — happy day!

Now, three years since reporting to the *Barb*, I'm stationed aboard the *USS Grayback* (SS-574). The *Grayback* is an amphibious assault submarine, home ported in Subic Bay, Republic of the Philippines. The story is the same — good friends, good chow, good pay, and terrific liberty in foreign ports such as Pusan in Korea, Yokosuka in Japan, Hong Kong, Kelung and Kaosung in the Republic of China, and Singapore.

Recently, the *Grayback* completed a trip around the Philippines, called the 1976 "Bayanihan" Cruise. Bayanihan is a Philippine word meaning "helping hand." Our mission was one of good will; we distributed school books and medical supplies in six Philippine cities we visited. With the help of the American and Philippine Special Warfare Teams (Seals and UDT), we blasted out two coral beds to help construct a new pier and deepen a shipping channel. During the Bayanihan Cruise we visited several unusual ports. Some of the people had never before seen Americans. We were greeted like great explorers and heroes in

every port, with an ensemble of parties, dancing, and fun! Think it was all fun? During the trip we gave over twelve thousand people their first tour aboard a submarine. That was the hard part!

Submarine life entails a lot of hard work but yields a commensurate amount of pleasure. A side benefit of duty aboard submarines is the close relationship between the officers and the crew. The wardroom is as elite a group among officers as the crew is among other Navy enlisted men. The submariner gets to watch from a ringside seat some of our nation's dynamic leaders. I, for one, have developed a considerable appreciation for the job they do.

The submarine Navy is referred to as "The Silent Service." This is because we seldom talk about our jobs. Qualified members of the crew are trained to perform the jobs of any other crew member, with the exception of the radioman. The radioman's knowledge is shared, at times, with only the captain himself. If you are an outsider, you will be welcome as a guest aboard for a tour in port, but your questions will be met either with a pat answer that reveals nothing or, if you persist, silence. Communications spaces are strictly off limits, so, if you want to learn more, don't ask questions — join us, and be a member of an exclusive organization. ■

all rooms for a very great
lousy management for the
but it is not a good thing
you should be aware of
I think that you print on
tell Ma that she should

from page 73

couraged to contact us.

Mark J. Welch
M2WRA Newsletter Editor
PO Box 203
Northborough MA 01532
(617)-366-1266

BREAKING 80

On page 98 of your February, 1978, issue of 73, you published a very good project article by Walt Patterson WB6LQE on conversion of a CB rig to 10 meters. I had a Publicom I on

hand, unused, and decided to try out the conversion.

I am so inept, and such a rotten technician, that I really had no hope of success. My storage area is replete with unworkable ham magazine projects, mute testimony to such and other deficiencies best left unmentioned. Some of them have been costly failures.

So I went ahead with Walt's plan, ordering the required crystals, with high hopes. I might say that his directions were simple and crystal clear (no reference to the electronic crystals, because two came bad and had to be remanufactured, which Cal Crystal Lab

cheerfully took care of at no further expense to me). If you play golf, you will remember how you start off 18 holes of cow-pasture polo with the firm belief that you are going to break 80, only to drag up to the clubhouse with a score closer to 180! That parallels my experience on ham radio build-it-yourself projects.

This time, however, I broke 80! The little rig took off like a wild banshee, with 4 Watts output, after I realigned the receiver rf and mixer coils and the five transmitter coils. On my first 10 meter QRP CQ call, I

Continued on page 77

Counter Accuracy For Perfectionists

— updating the K20AW counter updates

With measurement getting more precise and with the occasional availability of crystal ovens and other stable oscillator devices for clocks, the gain of another digit of precision on a counter can be desirable. Such can be the case for the K20AW counter in the series of articles which started in May, 1972, in *73 Magazine*. If you think you have a very stable clock in your counter, so all kinds of numbers dis-

played aren't just random digits to impress the unaware counter believer, try this. (Refer to Fig. 1.)

Further inspired by an article by W4CUG (March, 1974, *73 Magazine*), where 62 MHz was achieved on the "barefoot" (low frequency) input, I decided to do the same for direct measurement of 6 meters to the nearest cycle. The project started just for fun. With the substitution of a 74S04 (for IC1) at the

output of the (new and improved) 5 V dc MPF102, an HEP S0020 input amplifier in place of the regular 7404, and then a 74S00 (for IC2) in the input selector circuit in place of the regular 7400, the stage was set for speed. The 7473 input divide-by-two gate was replaced with a 74H73. Measurements were made to almost 45 MHz. As a 74S73 could not be found at the time, a 74S112 similar type dual JK was inserted with

minor rewiring (with the count enable and reset A all used just as before) — and, lo and behold, a marginal 65 MHz was counted. (See Fig. 2.)

Having done what W4CUG had reported before, my objective became: Just how fast will the thing go with simple modifications? I scrounged a couple of 74196 chips and installed them in the IC6 position, which is a divide-by-five (this is the least significant digit BCD coder). I found that these two 74196s running divide-by-fives were not as fast as a carefully selected 7490, which was there in the first place.

A 74S196 opened a whole new world, however. Incidentally, don't forget to change the reset line to the chip from B to A, or it won't even open a gate! When the thing was turned on, it promptly leaped to above 90 MHz, but slowly fell to 80 and then 70 MHz. Careful checking found the 74S04 (IC1) to be quite hot when, and only when, switching fast. Another 74S04 did the same thing. A 15 Ohm 1 Watt resistor was placed in the Vcc line to this chip, dropping the voltage to 4.1 to 4.2 (this value was carefully chosen by testing for maximum count). When turned on, the counter leaped to 107 MHz and settled to 100 to 101 MHz, with very stable count. Heat sinking the 74S04 with epoxy to a piece of 1/8-inch aluminum allowed a stable count to 105

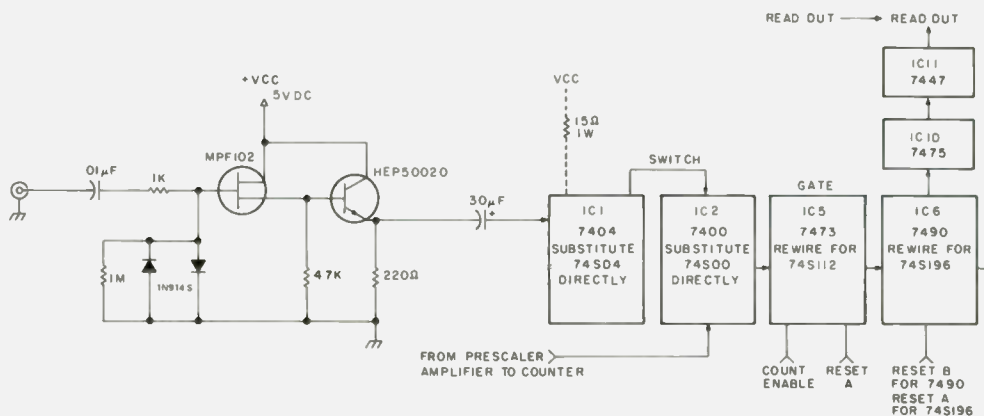

Fig. 1. This is the standard improved type input circuit. It uses an FET and a regular transistor with no odd voltages. The TTL interfacing is achieved with a 7404 type chip. This arrangement is very sensitive. The rest of the chips in this counter front end are shown as they relate to this article.

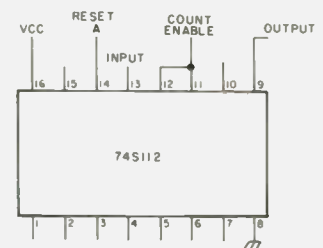

Fig. 2. This is how I wired in the 74S112 to replace the 7473 chip in the divide-by-two input gating circuit. There are two JK flip-flops in this chip — only one is used. This is an essential substitution for high speed counting.

The New Op Amps

—better, lower cost

A new breed of operational amplifier has appeared which has advanced the state of the art significantly and again put former "mil spec" devices within the realm of common amateur application. Until now, common operational amplifiers (741, 709, etc.) have been fabricated using only bipolar technology. At least three manufacturers, Texas Instruments, RCA, and National Semiconductor, have now introduced operational amplifiers with both field effect and bipolar transistors fabricated on a single monolithic chip. (National's process uses JFETs, while RCA uses PMOS transistors.) This has

resulted in a relatively inexpensive, moderately fast operational amplifier with super low bias currents and an almost immeasurably high input resistance.

First, a word about bias currents, offset voltage, and input impedance (this all assumes at least a passing familiarity with operational amplifiers to begin with, which you probably have or you wouldn't have read this far), and then a sketchy comparison of the industry standard, the 741, and the new BI-FET (National) and BIMOS (RCA) devices.

Basic operational amplifier

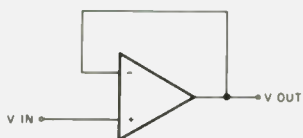

Fig. 1(a).

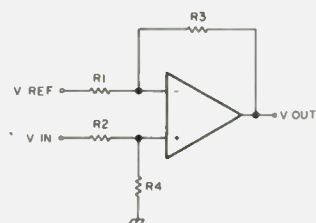
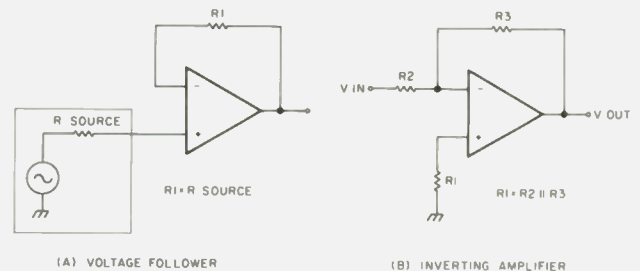

Fig. 1(b).

theory assumes that the two operational amplifier inputs have an infinite resistance, i.e., no electrons flow into these terminals. In truth, all operational amplifiers (at least any that I've ever heard about) have some finite input

resistance and some finite current, called bias current, into these input terminals. The average of these two currents, one into each input, is called "input bias current." Spec sheets normally list this input bias current as both a maximum allowable at 25° C. and as a max. over the full temperature range of the device, the latter current being higher by a factor of 3 or 4. The difference in the actual bias current into each input of the operational amplifier is termed the "input offset current." Again, the maximum input offset current is specified at both 25° C. and over the full guaranteed operating temperature range.

The current which sneaks into those input terminals obviously must come from somewhere. I have yet to find this current source discussed specifically, but the universal implication is that any source will do. Any dc-coupled source which is connected in any way to either input of the operational amplifier will act to contribute to this bias current. To illustrate, check Fig. 1(a), a voltage follower configuration. The bias current for the inverting input is supplied by the operational amplifier output; that for the noninverting input is supplied by the V_{IN} source. Fig. 1(b) illustrates a differential amplifier with four bias cur-



(A) VOLTAGE FOLLOWER

(B) INVERTING AMPLIFIER

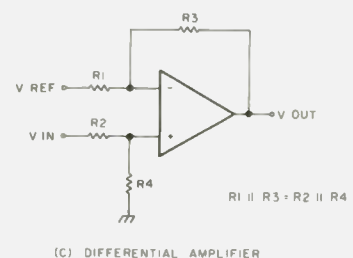

(C) DIFFERENTIAL AMPLIFIER

Fig. 2. Bias current compensation.

	741C ⁷	CA3140 ⁶	LF356 ⁷	Units
Input offset voltage	6	5	10	mV
Input offset current	2×10^5	0.1	50	picoamps
Input bias current	5×10^5	2	200	picoamps
Input resistance	0.3	10^9	10^6	megohms
Slew Rate	0.5	7	12*	volts/us
Gain — bandwidth	1*	3.7	5*	MHz
Supply Current	2.8	1.6	10	mA

Table 1. * = typical value; others are worst case.

rent sources. The inverting input receives current from the operational amplifier output through R3, and from the V_{ref} supply through R1, while the noninverting input receives bias current from ground through R4 and from the V_{in} supply through R2. So much for the bias current sources. I should also point out that bias currents and input impedances are not directly related. The bias currents are drawn by constant current sources in the operational amplifier, and will be present no matter how large the external impedances which may be connected to the operational amplifier inputs. The input resistance is the resistance between the two input terminals of the operational amplifier. I don't pay much attention to this when designing operational amplifier circuits, since it only affects circuit gain if the external resistances used are much larger than this input resistance.³ Even with a 741, keeping external resistors to 100k or less will allow you to neglect its influence.

To compensate for input bias currents, design in such a way as to present an equal resistance to each operational

amplifier input terminal. Note the examples in Fig. 2.

By forcing the input bias currents into each input to pass through equivalent resistance values, equal voltage drops are produced at each input, and errors introduced will be minimal. Note that we cannot compensate for the input offset current, as we don't know which input terminal will have the larger current.

The third parameter of interest here is "offset voltage" or "input offset voltage," which is defined as that voltage which must be applied between the input terminals to obtain zero output voltage.¹ What this means to us is that with a circuit as shown in Fig. 3, a unity-gain voltage follower, connecting the input to ground will produce an output equal to the offset voltage.²

In most voltage follower applications (gain = 1), this offset voltage is probably negligible. The catch is this: The offset voltage multiplied by the gain of the circuit is the error voltage appearing at the output of the operational amplifier⁴; thus, a 741 operational amplifier with an offset voltage of 5 mV and a gain of

20 would exhibit an output 0.1 V (100 mV) different than that calculated for an assumed perfect operational amplifier. Fortunately, offset null terminals (and various circuit configurations⁵) are available to null out, or remove, the effects of input offset voltage.

Table 1 compares the 741, CA3140 (RCA), and LF356 (National). Texas Instruments also makes the LF356, with apparently the same specs. All data listed is valid at 25° C.; these devices are the commercial- or consumer-grade products. The LF356 is available as an LF356, LF356A, LF256, LF156, and LF156A, with ever-tightening specs. The CA3140 likewise ascends to CA3140A, and then CA3140B. Package style for the CA3140 is 8-lead TO-5 can only; a T-suffix specifies a common 8-lead can, but an S-suffix specifies leads which have been formed to match a mini-DIP socket. National's LF356N comes in a mini-DIP plastic package, while the LF356N is packaged in an 8-lead can. From the data in the table, the RCA device appears to be a bit slower than the LF356, but otherwise looks like a better

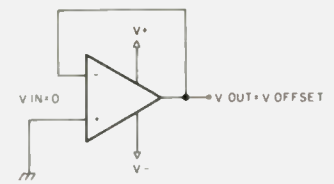

Fig. 3. Follower offset.

choice. Two further points concerning selection: The minimum supply voltage (single-ended) for the CA3140 is 4 volts, but the LF356 is not recommended for operation at less than ± 5 V. The CA3140 is a steal at \$1.10 (from Tri-Tek). The LF356N is available from National distributors at \$3.75 in singles. Last comment: An RCA dope sheet is available free from RCA (see reference 6). National's linear data book (see reference 7) is available from Tri-Tek (as is RCA's dope sheet, for \$0.60). ■

References

- ¹Underwood, Robert K., *New Design Techniques for FET Operational Amplifiers*, National Semiconductor Application Note AN-63, March, 1972.
- ²RCA Corporation, "Integrated-Circuit Operational Amplifiers," published in RCA's 1975 data-book, *Linear Integrated Circuits: Application Notes*, SSD-202C, page 191.
- ³Texas Instruments, Inc., *Linear and Interface Circuits Applications*, 1974, page 8.
- ⁴*Ibid.*, page 9.
- ⁵Dobkin, Robert C., *Universal Balancing Techniques*, National Semiconductor Linear Brief LB-9, August, 1969.
- ⁶RCA Corporation, file number 957, April, 1976.
- ⁷National Semiconductor, *Linear Data Book*, 1976.

on moon don't even profit
lousy manuscripts for the
burial of K...
I insist that you print or
tell Ma Bell that she show

LETTERS

from page 77

strictions when such goods offer heavy competition to American-made products. But what I believe is unknown to you is that the Japanese tax American goods 45% to 55%. And when goods that even with this

stiff tax on them threaten domestic production, they are promptly banned from Japan.

A fine example of this is the new Atlas 210X which I recently purchased. The stateside price for my radio, from a local dealer, was \$850. The same radio in Japan was a little over \$1300.

And this is wholesale in both countries.

Another example is the ban on American leather products that, even with the tax, offered competition to the domestic leather production. Thus, a quick ban was enacted.

Oh sure, in time, things will balance out as you have pointed out. But, in the meantime, what about the value of the American dollar and the Americans out of work because of all the imports that almost kill American production?

But the biggest thing that bothers me is the unfairness of the entire thing. I'm all for international trade as long as it's

done in a fair matter. But the one-sided trade agreements that are now practiced are certainly not fair to American producers.

Personally, I'm for higher import taxes until the offending nations lower their import taxes to allow American-made goods to compete fairly. If they don't, that's alright, too, for American businesses will grow and prosper. And to do my part, from now on I'm buying American-made goods!

George Cochran
Cherry Point NC

Continued on page 85

22 Remote

— outside programming for your IC-22S

The Icom 22S has proved to be one of the most versatile FM transceivers around today and is, indeed, becoming even more so by virtue of being the subject of many customizing modifications, particularly with

respect to its substantial programming capabilities.

A previous article in 73 Magazine ("The New 88

Channel IC-22," Jan., 1977) describes a unique means of extending the programming capabilities of the 22S using only two toggle switches. Not wanting to reprogram the board (a tedious, tricky job) and not wishing to drill into the case to mount the two switches, I decided to leave the board programmed for the 22 most popular repeater and simplex frequency channels likely to be encountered. I would use the unused 23rd channel strip on the matrix board for an out-board programmer, building eight individual diode selector switches into a remote box.

In the IC-22S, channels are selected by switching in one of 22 (or 23, if you count the unused channel strip) pre-programmed diode matrices. The diodes are normally soldered into position on each channel strip according to a chart furnished by the manufacturer. Depending on the base frequency desired, from one to eight diodes can be cut into the synthesizer circuit, as shown in the matrix arrangement of Fig. 1.

To remotely program the IC-22S, the programmer described in this article can be built with very little effort or special technique. How-

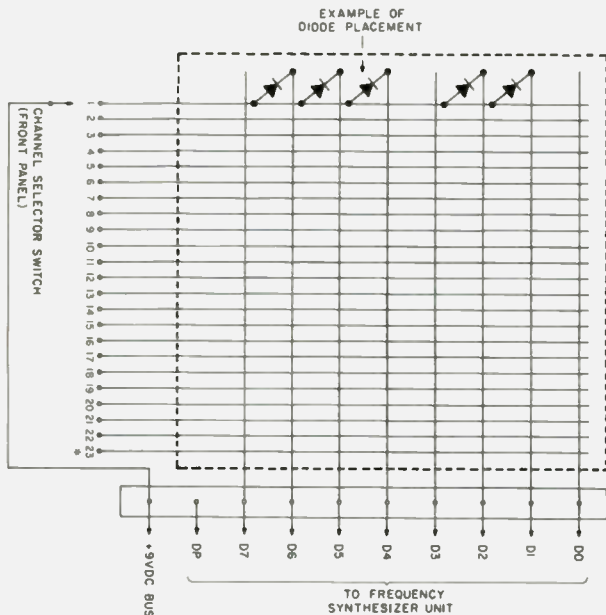

Fig. 1. Diode matrix arrangement. *Connection added from channel selector switch to matrix board.

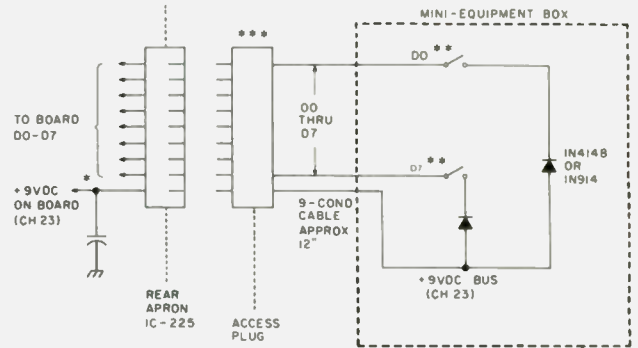

Fig. 2. Remote programmer circuit. *Each pin bypassed to ground with .01 uF disc ceramic capacitor. **Only D0 and D7 switches and diodes are shown. D1 through D6 are wired in the same manner using the +9 V dc bus from channel 23 line on board as common. Total of eight SPST toggle switches required. ***Changing to a 24-pin connector set (plug and socket) would allow enough connections for a zero-center discriminator meter and TT pad, in a somewhat larger minibox. The meter would use connections already brought to the rear apron: TT audio across mike input and TT dc from any convenient point.

ever, running the internal wiring must be done with extreme care because of the compactness of the unit and the delicacy of the matrix PC board. (I am speaking from experience, having carelessly damaged the board in the initial programming process.)

To set up the Icom for remote programming, first run a wire from the unused 23rd position on the rotary channel selector switch carrying the +9 V dc bus to the channel 23 line on the matrix board. This position, though unnumbered on the dial selector switch, appears as the first dot past channel 22. Making this connection energizes the 23rd-channel matrix bank. Then, using 9-conductor cable (unshielded is okay), run wiring from D0, through D7 and the +9 V dc bus, to the nine-pin connector on the rear apron. (The present wiring to the connector, a ground lead on pin 8 and a discriminator takeoff on pin 1, should be disconnected.) Each pin should be bypassed to ground using a nominal .01 uF disc ceramic capacitor.

A 12" length of 9-conductor cable can be connected to the 9-pin accessory plug supplied with the unit and run to a small equipment cabinet (Radio Shack #270-251 or equivalent). There, a bank of eight 1N4148 or 1N914 diodes can be switched in or out of the circuit using eight SPST mini toggle switches, as shown in Fig. 2. (If SPDT toggles are available, the unused position provides a convenient mounting post for one end of the diode.) Although the diodes could be mounted to the board, you'll probably have fewer problems mounting them in the box on the switches.

I take the remote programmer along in my mobile installation only when traveling to an area which has a repeater combination pair or oddball simplex channel not already programmed into one of the regular 22

Fig. 3. Remote programming. Frequency versus diode placement. *Switch position numbers are keyed to numbers shown in the programmer photograph.

SWITCH POSITION*↑		8	7	6	5	4	3	2	1
Frequency	Total 'N'	D7	D6	D5	D4	D3	D2	D1	D0
146.010	108		x	x		x	x		
146.025	109		x	x		x	x		x
146.040	110		x	x		x	x	x	
146.055	111		x	x		x	x	x	x
146.070	112		x	x	x				
146.085	113		x	x	x				x
146.100	114		x	x	x			x	
146.115	115		x	x	x			x	x
146.130	116		x	x	x		x		
146.145	117		x	x	x		x		x
146.160	118		x	x	x		x	x	
146.175	119		x	x	x		x	x	x
146.190	120		x	x	x	x			
146.203	121		x	x	x	x			x
146.220	122		x	x	x	x		x	
146.235	123		x	x	x	x		x	x
146.250	124		x	x	x	x	x		
146.265	125		x	x	x	x	x		x
146.280	126		x	x	x	x	x	x	
146.295	127		x	x	x	x	x	x	x
146.310	128	x							
146.325	129	x							x
146.340	130	x						x	
146.355	131	x						x	x
146.370	132	x					x		
146.380	133	x					x		x
146.400	134	x					x	x	
146.415	135	x					x	x	x
146.430	136	x							
146.445	137	x				x			x
146.460	138	x				x		x	
146.475	139	x				x		x	x
146.490	140	x				x	x		
146.505	141	x				x	x		x
146.520	142	x				x	x	x	
146.535	143	x				x	x	x	x
146.550	144	x			x				
146.565	145	x			x				x
146.580	146	x			x			x	
146.595	147	x			x			x	x
146.610	148	x			x		x		
146.625	149	x			x		x		x
146.640	150	x			x		x	x	
146.655	151	x			x		x	x	x
146.670	152	x			x	x			
146.685	153	x			x	x			x
146.700	154	x			x	x		x	
146.715	155	x			x	x		x	x
146.730	156	x			x	x	x		
146.745	157	x			x	x	x		x
146.760	158	x			x	x	x	x	
146.775	159	x			x	x	x	x	x
146.790	160	x							
146.805	161	x			x				x
146.820	162	x			x			x	
146.835	163	x			x			x	x
146.850	164	x			x		x		
146.865	165	x			x		x		x
146.880	166	x			x		x	x	
146.895	167	x			x		x	x	x
146.910	168	x			x				
146.925	169	x			x				x
146.940	170	x			x			x	
146.955	171	x			x			x	x
146.970	172	x			x		x		
146.985	173	x			x		x		x
147.000	174	x			x		x	x	
147.015	175	x			x		x	x	x
147.030	176	x			x				
147.045	177	x			x				x
147.060	178	x			x			x	

Continued.

147.105	181	x		x	x		x		x
147.120	182	x		x	x		x	x	
147.135	183	x		x	x		x	x	x
147.150	184	x		x	x	x			
147.165	185	x		x	x	x			x
147.180	186	x		x	x	x		x	
147.195	187	x		x	x	x		x	x
147.210	188	x		x	x	x	x		
147.225	189	x		x	x	x	x		x
147.240	190	x		x	x	x	x	x	
147.255	191	x		x	x	x	x	x	x
147.270	192	x	x						
147.285	193	x	x						x
147.300	194	x	x					x	
147.315	195	x	x					x	x
147.330	196	x	x				x		
147.345	197	x	x				x		x
147.360	198	x	x				x	x	
147.375	199	x	x				x	x	x
147.390	200	x	x			x			
147.405	201	x	x			x			x
147.420	202	x	x			x		x	
147.435	203	x	x			x		x	x
147.450	204	x	x			x	x		
147.465	205	x	x			x	x		x
147.480	206	x	x			x	x	x	
147.495	207	x	x			x	x	x	x
147.510	208	x	x		x				
147.525	209	x	x		x				x
147.540	210	x	x		x			x	
147.555	211	x	x		x			x	x
147.570	212	x	x		x		x		
147.585	213	x	x		x		x		x
147.600	214	x	x		x		x	x	
147.615	215	x	x		x		x	x	x
147.630	216	x	x		x	x			
147.645	217	x	x		x	x			x
147.660	218	x	x		x	x		x	
147.675	219	x	x		x	x		x	x
147.690	220	x	x		x	x	x		
147.705	221	x	x		x	x	x		x
147.720	222	x	x		x	x	x	x	
147.735	223	x	x		x	x	x	x	x
147.750	224	x	x	x					
147.765	225	x	x	x					x
147.780	226	x	x	x				x	
147.795	227	x	x	x				x	x
147.810	228	x	x	x			x		
147.825	229	x	x	x			x		x
147.840	230	x	x	x			x	x	
147.855	231	x	x	x			x	x	x
147.870	232	x	x	x		x			
147.885	233	x	x	x		x			x
147.900	234	x	x	x		x		x	
147.915	235	x	x	x		x		x	x
147.930	236	x	x	x		x	x		
147.945	237	x	x	x		x	x		x
147.960	238	x	x	x		x	x	x	
147.975	239	x	x	x		x	x	x	x
147.990	240	x	x	x	x				

to be switched on (diode in) for each desired base frequency. Any 15 or 30 kHz channel can be programmed from 146 to 148 MHz. Actually, frequencies well into the 145 MHz region can be programmed if time is taken to do the binary calculations required. Of course, only standard 600 kHz channel spacing is possible without further modification of the unit's innards. The duplex/simplex switch is normal with the remote programmer selecting the base frequency, as in the case of internal channelizing.

The remote programmer adds considerable flexibility to an already exceptionally versatile two meter transceiver and is well worth the small added cost — and it requires no defacing of the cabinet. At trade-in time (1999?), the 22S can easily be restored to its original configuration.

Another variation of the "no irreversible mods" policy that I adhere to, to protect the unit's trade-in value, involves obtaining an extra matrix board from Icom (for \$3), a few dozen extra 1N4148/1N914 diodes, and a rotary selector switch (23-channel CB type?). The auxiliary board can be permanently programmed for an additional 22 or 23 channels, mounted in a mini equipment cabinet, and wired into the channel 23 unused switch position, as indicated previously. A near ultimate low-cost programmer would combine both the auxiliary board and the eight selector switches into a single programmer box (slightly larger, such as Radio Shack #270-252 or equivalent) for 44-channel preprogrammed capability, plus the added flexibility of all-channel programming when required. Such a combination would be particularly useful in the northeast or in southern California, where there are more repeater channels in use than most rigs can conveniently handle. ■



channels. A few strong magnets are epoxied to the bottom of the mini equipment cabinet (in lieu of the rubber mounting feet) to allow the unit to be firmly attached to the Icom when mobilizing. For convenience, the manufacturer's "D0" through "D7" matrix board designations are re-labeled simply 1 through 8 and marked as such on the box, as indicated in Fig. 3. A small 3" x 5" card is made up showing which switches are



IC-215 FM PORTABLE/MOBILE

- 15 channels (12 on dial/3 priority)
- Fully collapsible antenna or "rubber duck"
- Compatible mount for mobile operation
- Dual power (3 watts high/400mw low)
- External power and antenna easily accessible for mobile operation
- Lighted dial and meter
- Double-size, long-lasting internal batteries with optional Ni-Cd pack and charger available

ICOM's **IC-215** is the FM radio that puts good times on the go. Now an outstanding mobile mount and quick-change features for external power, speaker and antenna conversions make moving from base, to vehicle, to hill top fast and easy: and the **IC-215 portable/mobile** provides continuous contact for even the busiest FM enthusiast.

The **IC-215's** three narrow filters provide quality not usually found in portable VHF equipment. With 15 channel capacity and an MOS FET RF amp with 5 tuned circuits in the front end, the **IC-215** gives optimum FM portable performance.

You'll be carrying quality, performance and versatility with your **IC-215 FM portable/mobile**.

Specifications: Frequency Range: 146-148 MHz Voltage: 13.8 VDC negative ground Size: 183mm(h) x 61mm(w) x 162mm(d)
 Weight: 1.9 kg Number of Channels: 15 total, 12 on main switch, 3 priority Power Output: 3.0 W or 0.5 W Microphone
 Impedance: 600 ohms Spurious Level: lower than -60 dB Receiver Sensitivity: 4 dB below 1 UV or lower Spurious Response:
 60 dB or better

All ICOM radios significantly exceed FCC specifications limiting spurious emissions.



This new mobile mount is now available for your **IC-215**. Fast insertion and removal is a snap, and the mount is collapsible when not in use.

HF/VHF/UHF AMATEUR AND MARINE COMMUNICATION EQUIPMENT

DISTRIBUTED BY:



ICOM

ICOM WEST, INC.
 Suite 3
 13256 Northrup Way
 Bellevue, Wash. 98005
 (206) 747-9020

ICOM EAST, INC.
 Suite 307
 3331 Towerwood Drive
 Dallas, Texas 75234
 (214) 620-2780

ICOM CANADA
 7087 Victoria Drive
 Vancouver B.C. V5P 3Y9
 Canada
 (604) 321-1833

Handling Ole George

— is amateur radio ready?

The newspaper classified ad was explicit . . .

For sale: Ham radio Novice station — transmitter, receiver, PS . . . \$150.00.

End of ad.

The equipment consisted of an AF-68 transmitter, a PMR-8 receiver with matching power supply, and all manuals. The Dow Key relay and speaker were not included, but, for a cash deal to a really sincere amateur enthusiast, they would be included for the original asking price.

The calls I received were numerous. Ten percent were from knowledgeable amateurs trying to make a deal for the power supply and receiver. A number were from people who wanted the transmitter. Several callers wanted to know the output and whether or not the transmitter would work on the CB band.

And then "Ole George" called. George didn't know what he wanted. George is not a kid. He is a forty-nine-year-old grandfather who teaches for a living. He has operated illegally on the CB band for the past two years, or, I should say, operated *out*

of the CB band, with a few more Watts than the legal power limits on SSB.

It was a short introductory conversation over the phone, a brief description of the coverage of the units and their condition, followed by an invitation to come and look at the merchandise. The invitation was accepted. Ole George proved to be a perfect example of many who are attempting to make the transition to amateur radio from the ranks of the great unknowing. He had never talked to an amateur, did not know one, and had never opened a book to learn what ham radio was all about. I gave him a brief rundown of a general nature on what a Novice needs to know — easy (?) ways to learn code, the five-word Novice requirement, information needed to pass a Novice test — and I answered his questions:

"What bands are open to a Novice?"

"What number is that on the dial?"

"What can I use for an antenna?"

"Can I use the same antenna that I use on CB?"

"Can I throw away my CB

license after I get my amateur license and still operate CB legally?"

And on and on and on . . .

At the end of our three-hour discussion, I had successfully sold an excellent Novice and standby rig to someone I thought might someday wind up as a good working amateur.

One question kept popping up during our discussion:

"Would the expensive Citizens Band antenna that is positioned over my (George's) house work with the AF-68 transmitter?"

I told him that, with a few slight modifications, it would work on a ham band of higher frequency.

George's overwhelming desire to learn about amateur radio was inspiring, except for the constant referrals to the operation of the units he was about to buy.

"Could they be operated on CB or ten meters? How?"

These questions were interspersed with:

"I have been studying the code for some time now. I'll pay you to teach me on a regular basis. I'll do anything you ask; just help me get a

Novice license."

Now, my technical ability is limited to the extent that I have a tough time maintaining my own personal equipment, but I am also of the belief that a Novice doesn't have to be a wizard in electronics to get a license. However, the applicant should have the ability and desire to learn the technical side of amateur radio after he gets his Novice license. That's where the largest number of newcomers are discouraged. It's difficult to find classes designed to teach the Novice how to increase his technical skills.

George's apparent sincerity to become an amateur led me to the kitchen table and a pad and pencil. This would be my first attempt at setting up a simple lesson or routine to follow in order to obtain a Novice license. I even found the old schematic of a one-tube (6L6) crystal-controlled 40 meter transmitter that I had built on a plastic sandwich box. I powered it from my receiver and spent two weeks trying to make it work. I didn't have anyone to help me in technical matters.

In my ignorance, I was so busy trying to get on the air that I forgot how to listen to a receiver. After a few slow movements of the radio dial, I discovered my sandwich box was getting answers from a distance of a thousand miles or more. I had been so intent on transmitting that the basics of operating a receiver were forgotten. I even went as far as building three separate sandwich boxes, thinking that none were working. It would be interesting to see how many Novices can open one of the new 250-Watt transceivers, work on the vfo, or tear down and rebuild the transmitter if it suddenly goes "whacko!"

My second thoughts lingered on a "quicky" application of an antenna that would work with almost any-

thing. I settled on my favorite, a 15 meter dipole. Its 22-foot length is applicable to most houses without extra devices for installation. My first Novice station used a similar antenna. Again, without proper supervision, I installed the antenna about eight inches above the roof, which is not exactly a good practice if you want the most effective power from your transmitter. But I did work 37 states and four countries before someone told me I should raise the antenna away from the rooftop. I never have.

I soon realized that a person could get carried away in trying to cram too much material into one lesson. Rules and regulations and a run-through of standard operating procedures on the Novice bands were the next step. All this must go on while practicing code.

I got another phone call from Ole George. Still enthusiastic, he informed me that he would soon be by with the money for the Novice rig.

Meanwhile, I had decided that I wasn't a teacher after all, and I proceeded to tell George that I would help all I could, but I would not program instructions on how to become an amateur radio operator. I suddenly realized that amateur radio is dealing with a different breed of individuals who are attempting to become hams. I am referring to the thousands of CBers who want more than

CB has to offer. And I was not prepared to deal with them.

No longer are the majority of applicants thirteen-, fourteen-, or fifteen-year-olds studying for the thrill of getting on the air and throwing the big switch to communicate through the magic medium of radio. A majority of this age group who normally would have been lured into the amateur radio service entered the world of communication with 60-100 milliwatt transceivers received Christmas morning and used to play scenes from Star Trek. The thrill of two-way radio is no longer an incentive to become an amateur.

Individual incentives have changed, as has the age group. Basic training is apparently going to have to be more preliminary than ever. The standard prepared Novice material may be too advanced for many. Ole George's education in communication indicated that a lot more is needed than studying for a Novice test to insure proper operation on the amateur frequencies.

One publication reported recently that each month as many as 30,000 new Novices were joining the ranks of amateur radio. Growth and numbers were the most important factors mentioned, not how qualified the numbers were.

I got another phone call from Ole George. I listened to his latest efforts at learning

Morse code — four new letters, all printable: E, I, S, and H. He also informed me that he couldn't pay the rest of the money he owed me until the next week.

That took care of George.

The current deregulation efforts by the FCC are beginning to accomplish what a lot of amateurs have been trying to prevent for years — obtaining a license without a great amount of effort — or, in effect, giving away what has been protected through the years. There is no question that the introduction of two-way communication through the Citizens Band has sparked the desired interest to boost licensing in amateur radio and has created more sales for manufacturers, more dues for organizational efforts, more magazine sales, and more political bargaining power. That's the name of the game. But for the serious amateur, it may be too much.

The word "serious" is the word most often used in much of the text written today when describing a ham diehard. Maybe it's time to change that word to "creative." Some individuals tried this approach with the last major proposal concerning the creation of new types of licensing: Communicator, etc., creating a basic separation. It's becoming more apparent that a definite separation presently exists between operators and technicians. It always has, and, with the influx of new blood,

this separation will be greater. The loud cry about and finger-pointing at the long list of new license applicants and who deserves the credit (or blame) for them doesn't have much of a bearing on the eventual outcome. Most of these new amateurs are being "created." Most will be operators, not technicians. Many will not have the pride that comes with earning the right to use the frequencies designated by each license.

Enforcing rules and regulations, servicing complaints, and ferreting out violators will soon be the problems facing amateur radio on a much larger scale than ever experienced at any other time. Will amateur radio be ready for it?

There are many amateurs and CB operators who deserve every consideration given with the license they hold, because they have earned the right to speak when and where they please simply by gaining the required knowledge. This article is not intended to belittle their accomplishments nor serve as a deterrent to the many new licensees who have a sincere desire to become good operators ... but then ... listen to 75-80 meters for a while ... what rules and regulations?

Ole George just called. He said, "I learned three new letters, T, M, and O. Dah, dah dah, dah dah dah."

You know, Ole George, you may make it yet. ■

... rooms don't even profit
lousy management from the
burn in the fire
I insist that you find out
tell Ma Bell that she should

from page 79

THANKS

A terrible thing happened on March 12, 1978: Our house caught fire, and my husband

and I received second and third degree burns, plus he was overcome with smoke. We lost almost all we owned. My husband was in critical condition in the ICU for nine days. He came home from the hospital April 7, 1978. My husband is Walt—WB5MWP.

We want to take this way to say thanks and God Bless to each and every one who was concerned about us.

A group on 40 meters opened a special bank account in our names at our bank. Hams from everywhere sent in donations. We have no way of knowing their addresses so we could even send a "Thank You" note.

The money was spent to hire a trained sitter for Walt at night, while in the hospital, so I could come home to the apartment to rest and take care of my burns.

We also bought a new oxygen gauge and oxygen for Walt to use at home. His had been destroyed in the fire.

We thank everyone for all of the get well cards and words of encouragement. We thought this would be a good way to say "Thanks."

Some money that was sent to the bank was from hams we have not talked with. A radio club in Ft. Worth, Texas, "passed the hat" at a meeting and sent the collection to the special account.

The Central States Traffic Net and The Kadiddle Hopper Bunch have been wonderful.

The local hams here just took over and moved some of our things we didn't lose to

Continued on page 87

stopping the clock pulses. The clock resumes 8 seconds or so later when the ground is no longer present, and the 50 mF capacitor recharges toward 5 V through the 150k resistor.

The output pulses from the 555 drive the clock input of a 7476 dual J-K flip-flop which toggles at the scanning rate. The second flip-flop is driven by the first, by connecting pin 15 to pin 6, causing the second flip-flop to toggle at one half this rate. Four outputs are available from the two flip-flops. Two of these are merely upside-down versions of the other two. To produce a sequence of four from these available waveforms will require some crude processing. The 7400 IC, a quad dual gate, available for even less than the 7476, proved to be the answer.

Refer to Fig. 2. Output 1 is produced whenever inputs a and c are in logic state 1 (up). This occurs only once out of four clock pulses. Similarly, output 2 is produced by the 7400 whenever inputs b and c are up, three when a and d are up, four when b and d are up. The four outputs of the 7400 on pins 11, 8, 3, and 6 each are in the 0 (down) state in rotation 1, 2, 3, and 4.

To produce a channel selection, each diode matrix must have +9 V applied to it in rotation. As can be seen, the output of the 7400 is inverted from what is desired, and does not swing from 0 to +9 V, but swings from 2.8 V

to about .8 V. Since most IC inverters would swing through the .8 to 2.8 V range, they are unsuitable. So a series of four general purpose NPN 300 mW transistors were utilized to provide the inversion and a series of outputs swinging between 0 and 9 V. They are cut off one at a time, providing 9 volts to only one diode matrix at a time, in sequence.

Four LED pilot lamps are shown connected to the 7400 outputs to provide conventional scanner indication, conducting one at a time as the scanner operates, stopping to indicate an active channel.

Q6 acts as a switch and emitter follower to produce 9 V for the output transistors from the 13.8 V source, so as not to load the IC-22S 9 V bus as supplied from its channel selector. Q5 senses the presence of 9 V and switches on 5 V to the IC circuits, the voltage drop being almost entirely across the 180 Ohm 1 Watt resistor, thus minimizing its dissipation. The entire unit draws about 100 mA from the 13.8 V supply. About half this current is required by the ICs and LEDs, the balance being shared by the three conducting output transistors. Adding 4 emitter followers would have permitted larger collector resistors and provided a low impedance source to the diode matrix, but the power wasted did not seem worth saving, and 390 Ohms was tolerated by the diode

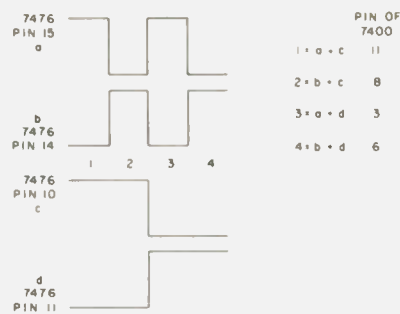

Fig. 2.

matrix.

Interconnection of the scanner and the 22S to accomplish channel selection can be done in alternate ways; some forethought is indicated depending on how one intends to use the accessory socket. A minimal modification could be employed, using the 9-pin accessory socket to bring out 7 diode leads, omitting the D0 diode (sacrificing offset 15 kHz scanning capability), and having the remaining leads be used by the 9 V common brought out from the channel assigned to external scanner, and for the active channel stop control lead. I devote channel 23 to mine. Just above the channel indicator window at the back-side of the switch is a blank pin which has the required 9 V when switched to the green dot which follows channel 22. I covered the other green dot with a small strip of electrical tape to eliminate the confusion of the two green dots.

Probably the preferable method of modification is to install the 24-pin molex

connector available from the Icom distributor or service depot to whom the warranty was mailed. A complete connector set is available for about five dollars. Then you can touchtone, too.

If the scanner is to be your only accessory, another method would be to bring out leads from the four channels already programmed in the Icom to the scanner via the 9-pin accessory socket along with the other two. These are numbered along the long edge of the matrix board, as anyone who has programmed his unit knows. Those diodes already on the matrix board can just as well be used for the dual purpose; after all, the selector is on channel 23 to make the scanner run, and they are just sitting in there.

If you decide upon this method, it is recommended that diodes be inserted in each of the four leads to the IC-22S matrix board with their cathodes facing the matrix. This will prevent current being drawn by the scanner when the 22S is used in its conventional manner. ■

on moons don't even people
lousy manuscripts that can
burn in the rocks
you should
I insist that you print on
tell Ma he'll that she should

from page 85

storage. Hams we used to talk to a few years ago, when we were Novices in Texas, also sent in money to the bank.

Local people brought in food, clothing, bedding, etc. When our home is repaired, we will

move back into it.

Our rigs were mostly destroyed, but we hope to get back on the air sometime soon.

Maybe someday, in some way, we can help someone in return for the help we have received.

Thanks again and God Bless.
Sue Kinney WB5MWO
Norman OK

SOUTH SHORE SUPPORT

The 110 members of the South Shore Repeater Association are fully and completely in support of your effort to keep present amateur radio frequencies from being allocated to non-amateurs. The present requirements for amateur radio licenses and the incumbent privileges are not prohibitive or unattainable for any segment of our population. They do

serve the positive functions listed below, among others:

1. They require one to *earn* the privilege of operating on these frequencies, and therefore to appreciate and respect these privileges.

2. They encourage more people to acquire related skills and knowledge, thereby increasing the nation's resources in these important areas.

3. Organized amateur radio operators have proven themselves to be very efficient, effective, and valuable in disasters and emergency situations, such as the great blizzard of

Continued on page 89

Computerized Capacity Meter

— cost: \$1 plus a computer

Jim Eccleston
1999 Cardinal Crescent
North Vancouver, BC
Canada V7G 1Y3

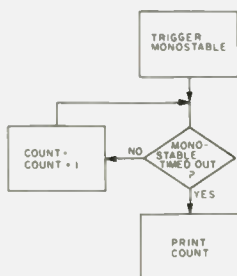

Fig. 1.

I was caught up in the hacker frenzy while attempting the design of

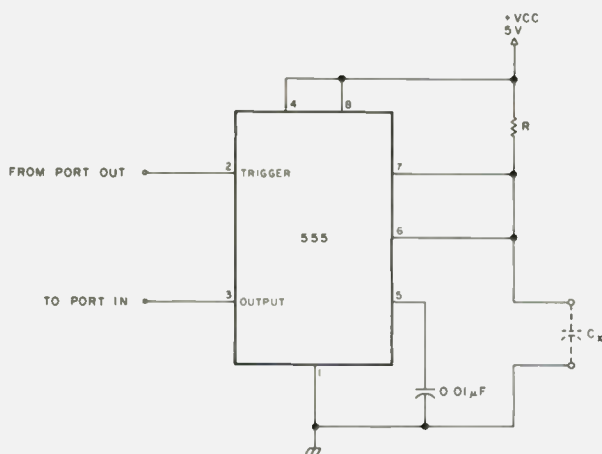

Fig. 2.

some higher-order active filters. Having spent more than a few hours programming my SR-52 to solve cubic and quartic equations, I realized that some heavier-duty number-crunching was called for if I really wanted to obtain those steep skirts. So off I headed to my local friendly computer store, from where I returned several hours later with several heavy boxes and one extremely light wallet.

The kits went together surprisingly well and produced only a couple of minor bugs. I ran in my number-

cruncher and design programs and settled back to enjoy the fruit of my labors. Everything was fine and dandy, except for the fact that I now needed several close-tolerance capacitors, but I did not have any kind of a bridge for measurement. Since the state of my wallet precluded the purchase of such an instrument (or even the cost of several 1% capacitors for a one-off filter), I decided to make use of whatever I could find in my junk box to build something that would do the job with a little assistance from the computer.

Overall Design Considerations

The design considerations were simple:

1. It had to be extremely cheap to build.
2. It had to be extremely easy to build.
3. It had to use a minimum of both hardware and software.
4. It had to be reasonably accurate.

The resulting circuit uses only three readily-available components, a small machine language routine (which can be called from BASIC), and the accuracy is limited only by the clock speed of the computer system being used (see Table 1). Rather than give specific details, I thought it best to give a thorough description of the method used together with a flow-chart (Fig. 1). This would enable the system to be tailored to any computer, although I have included some code for 8080-based systems as an example.

Circuit Design

The circuit consists of a

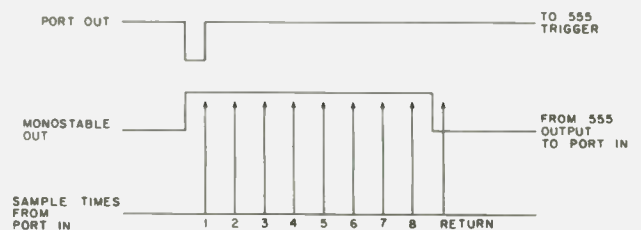

Fig. 3.

```

Top    3E FF      MVI A,OFFH      Make sure trigger
        D3 xx      OUT PORT         is not active.
        21 00 00   LXI H,00        Clear counter.
        3E 00      MVI A,00        Send bit to
        D3 xx      OUT PORT         trigger monostable.
        3E FF      MVI A,OFFH      Reset the
        D3 xx      OUT PORT         trigger.
LOOP   DB xx      IN PORT         Watch the monostable.
        FE FF      CPI OFFH      Is it active?
        C2 xx xx   JNZ OUT        No — go end routine.
        23         INX H         Yes — increment counter.
        C3 xx xx   JMP LOOP       Loop some more
OUT    7C         MOV A,H        routine to pass
        45         MOV B,L        value in H, L back
        CD 9C 0C   CALL 0C9C       to BASIC (MITS).
        C9         RET          Return to BASIC.

```

Program A.

555 timer chip wired in a standard monostable configuration (Fig. 2).

Circuit Operation

The monostable is triggered under control of an output port bit. Triggering the 555 requires a trigger signal going from a high (+5) level to a low (0) level for a brief period and then returning the trigger signal to a high level (see Fig. 3). The monostable now switches its output to a high level, and this level is sampled at an input port until the monostable times out. While the monostable is timing out, a count is made, and this count is software scaled to equal the value of capacitance that

determined the length of the monostable (see Program A).

Software

The whole program can be written in machine language using very little memory, or the count routine can be inserted in memory and called from BASIC via a USR or CALL statement. The example shown in Program B uses a simple BASIC routine which can be expanded to the desired esoteric level. The count from the monostable is averaged over ten triggerings, and the resultant count is then multiplied by a calibration factor to give the value of capacitance used. This count may then be out-

Capacitance in pF	Accuracy
10	40%
100	4%
1000	0.4%
10000	0.04%
100000	0.004%

Table 1. Assuming count loop for one count is approximately 20 microseconds.

```

10 PRINT"CAPACITANCE METER"
20 A = 0
30 FOR I = 1 TO 10
40 X = USR(0)

50 A = A+X
60 NEXT I
70 B = A/10
80 B = B*C
90 PRINT B
100 END

```

Program B.

```

10 X = USR(0)
20 INPUT"ENTER KNOWN CAPACITANCE IN pF";Z
30 PRINT"CALIBRATION FACTOR C=";Z/X
40 END

```

Program C.

may choose.

Calibration

Insert a known value of capacitance in the circuit, and run the calibration program (Program C). Enter the result from this program into statement 80 of the main program (Program B). Stray capacitance in the test leads can be calculated by running the program without a capacitor in the test leads and changing the BASIC program to compensate. (Don't forget that you are averaging ten triggerings!)

The representative listing shown (Program A) is from my own breadboarded setup attached to a parallel port, using the high-order data in/out bits. For breadboard purposes, I ran a line from the bit 7 data out to the trigger input and fed the monostable output to the bit 7 data in. The other lines were left floating, which accounts for the bit structures you see

addressed to the port in the machine language listing.

Using a 4.7 megohm resistor, my breadboard setup measures from less than 100 picofarads to better than 0.1 microfarads. If you need to cover a larger range, you need only change the value of the resistor and recalibrate. Out-of-range detection can, of course, be accomplished by inserting a software routine to check for a carry during the count and return you a message to change ranges when this occurs. Again, be cautioned, any increase in the size of the count loop will affect the accuracy of measurement.

Timing considerations for the 555 in a monostable configuration are given by $T = 1.1 RC$. Because of this relationship, this circuit can also be used to measure resistance, though it then needs to be calibrated with a fixed value of capacitance. ■

ou moons don't ever prooffic
lousy manuscripts from bat
burh...
you liard...
I insist that you print ev
tell Ma bell that she shou

from page 87

February, 1978, in the north-east. Their well-developed and competently handled communications systems were of inestimable value, and they provided selfless sacrifice in time and comfort to provide service and

save lives.

4. Because of their technological interests, amateur radio operators continue to improve themselves by constant interchange of technical information, and they often pioneer in new fields such as microprocessors, satellite communica-

tions, and other related frontiers.

5. Communications with radio amateurs in other countries have been on a very high plane and have done much to foster good will and understanding around the world.

There are many fine people who operate on Citizens Bands today. Unfortunately, there are too many others who are undisciplined and uncontrollable and use these bands with complete disregard for the rights and feelings of others. They would do much to degrade the frequencies they are now prohibited from using, if these were allocated for general use.

We reiterate that there are no insurmountable restrictions placed in the way of earning radio amateur privileges; anyone of any race or creed can earn the license.

Francis J. DiSabatino K1WGJ
Weymouth MA

NO BREAKERS

I just completed a 2 meter AM QSO with WB2LLV. It was old-fashioned by today's standards—full of reminiscence of the good ole days and 5 minute monologues. There were no

Continued on page 91

A Much Needed Micoder Power Supply

— *beats that lily-livered battery*

James R. Avoli K3MPJ
1261 Brinton Road
Pittsburgh PA 15221

My umpteenth embarrassment at reaching a

wrong number through the autopatch was sworn to be my last . . . well, almost my last, anyway.

At first, I thought the problem was coming from road noise inside the car being transmitted along with the tones because of an open (live) microphone. But I kept getting unreliable results while trying to cover the mike while dialing.

The real problem became more obvious when I noticed that the LED tone indicator glowed unusually dim one night. It seems that, with daily use during rush hours and a few QSOs from the QTH throughout the week, the internal battery voltage falls off to about 8 volts within a month. The microphone still works fine, but the tone generators run slightly off frequency, and that's the most deceitful way to get wrong numbers through any autopatch. The repeater's decoders gave the benefit of the doubt when accessing the autopatch, but Ma Bell was just too critical.

The folks at Heath have chosen to power their cleverly-designed Micoder from an internal 9 V transistor radio battery. If I may, I'd like to second-guess that the reason for this was so that it

could sell on the amateur market as an accessory item for any transceiver. But, in their infinite wisdom, they forgot about their primary prospects — the owners of the HW-2036, one of the best kits I have known them ever to have marketed (but that's another story). What they forgot was that, for the small cost of one more conductor in the coiled cord and a couple of additional components, they could have produced a far more superior product. And that's exactly what this article is all about.

Bye-Buy Battery

My solution was to replace the coiled cord with one having an extra (shielded) conductor, Belden's #8491, which retails for \$3.98 plus tax. Using that extra conductor proved to be an easy task. I channeled it past the transmitter, grounded the shield to C155, and connected the center conductor to the wire leaving pin W. This now supplies 11 volts

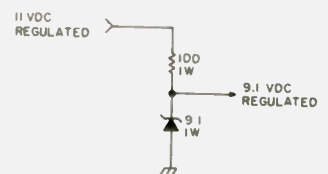

Fig. 1.

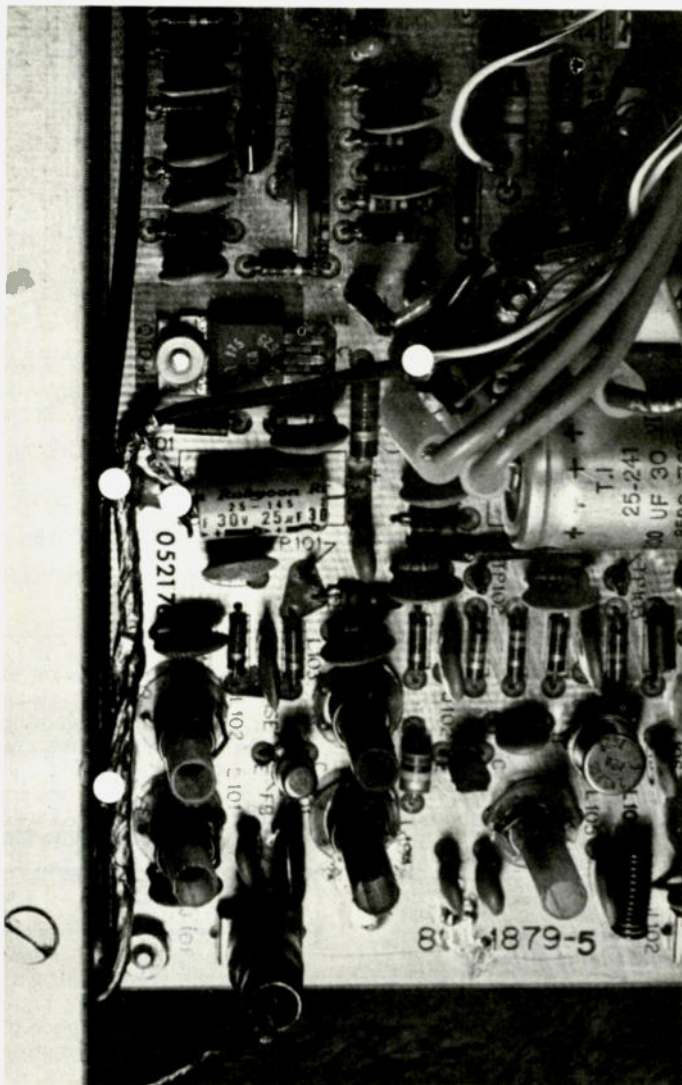

Photo A. Points of interest are indicated by the white dots.

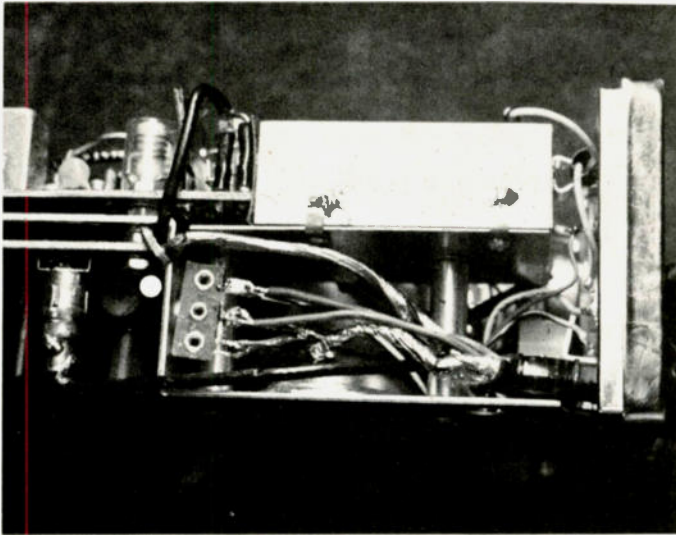

Photo B. Detail of the routing of the additional conductor.

(regulated) to the Micoder. Since it will draw less than 10 mA, Q104 is still within its safety rating. Since the HW-2036 is primarily a mobile unit, my better judgment forced me to tack this wire and the "long cable" (as the assembly instructions called it) to the chassis with two dabs of epoxy glue, as illustrated in Photo A. When the remaining wires of the replacement coiled cord are connected to terminal strip AT, be careful of two things: (1) Don't damage C1 (22 uF tantalum), and (2) pay careful attention to which shielded lead was used for the audio conductor and which one was used for the voltage conductor (one black center conductor is solid black, while the other black center conductor is black over white). See Photo B.

Meanwhile, back at the

Micoder, I removed the battery and its connector and grounded both shields from the coiled cord. Then I constructed the secondary 9 V regulator, as shown in Fig. 1. I used a General Electric GEZD-9.1, which retails for 90¢ plus tax, and, for no other reason than that the zener diode has a 1-Watt rating, I used a junk box variety 1-Watt, 100-Ohm resistor (where a 1/4 Watt would have sufficed). Then I packed both components in the crevice beneath the PTT switch actuator, as shown in Photo C.

Now comes the smoke test. I attached a voltmeter to the nine-volt point and powered up. Success! I transmitted — still nine volts, and the repeater keyed up. Success again!

I announced myself and got a response, so I knew the

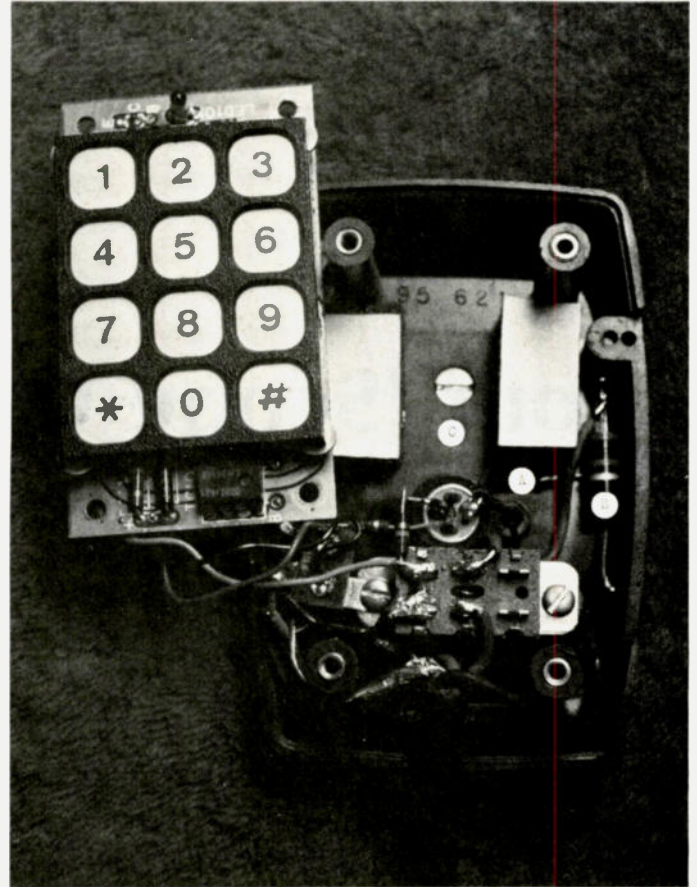

Photo C. Interior of upgraded Micoder: (a) zener diode, (b) 1-Watt resistor, and (c) no battery.

microphone worked. I calibrated the tone generators and brought up the auto-patch. Ah, total triumph at last — no more wrong numbers, no more embarrassments. And it had cost me only about five dollars, which is cheap by anybody's standards.

Enter Dr. Murphy

In my own inimitable way of patting my own back, I had forgotten all about

Murphy's Law #719 (Italian fingers can still dial incorrectly), #722 (phono-plug-style antenna connectors can still fall off when the transceiver is accosted by a Pittsburgh pothole after the number is dialed but before the connection is established), and #745 (at least 5000 other hams are reading the mail during the time frame that the above embarrassments are being perpetrated). Humbug! ■

our rooms don't even provide
lousy manning for the
but the
you
I insist that you print or
tell Ma Bell that she should

LETTERS

from page 89

breakers, time outs, QRM, QSB, TVI, or BCI. Now, it's been a long time since I have had a 1-hour QSO and years since I've had a QSO without the "normal" hassle we have grown to accept. Wayne was mentioned

in the remembrances of the big pileup and the signal that W2NSD/1 would belt out from N.H.

This note is not intended to get you thinking of the old days, but rather to point out that there are a lot of operators who don't know of the old days.

I rather suspect that a small percent of all present 2 meter operators really know the capability of the band. Their experience is limited to the local repeater range. The jerks in Washington have now set the conditions to put the local repeater everywhere. It's small wonder that I bought a mint Gonset III for \$10 last weekend (my II is still a better rig). I also bought a Clegg Thor 6 for \$75. Now, how many of the kids, lids, and school bus riders have felt the thrill of a 6 meter opening (or even know of 6m)? Get your typewriter going, Wayne, and tell the kids what is available. Put NSD/1 on the

VHF/UHF bands 2 or 3 nights a month to remind the northeast what can be done.

No, I am not the recluse hanging on to youth. I operate 160 through 3/4 meter SSB, CW, AM, SSTV, and 2 FM, and Oscar A and B. The lost art of rag chewing can be best practiced on VHF AM.

Chris Schlotz W2HKW/K2PGB
Ringoes NJ

P.S. CW within 25 kHz of the lower band edge is a great place for DX. The CB converts will buy linears, but they refuse to practice CW. Both of my converts have virtually forgotten the code.

Your 'Scope Can Be Improved

— simple calibrator

The oscilloscope is one of the most versatile instruments in the ham shack, and it would probably take an entire book just to list its many uses. Quite a few of the lower priced instruments, however, are handicapped by the fact that, though they can faithfully display the shape of the waveform under examination, they cannot be used to accurately measure the amplitude or the frequency of the signal. This is true not because there is anything wrong with the instruments themselves, but simply because most of them do not have built-in calibration circuits, or they have only very rudimentary ones.

Amplitude calibration is normally carried out by applying a signal or voltage of

known amplitude to the vertical input of the oscilloscope and adjusting the vertical gain control until the displayed signal spans a given number of divisions on the reticle. You then have a known calibration value in volts per division (V/div.), and the amplitude of any unknown signal or voltage can be read directly from the screen.

The scope's vertical input attenuator can be used to accurately measure higher voltages. For example, if you calibrate the scope to read 1 V/div., then, by simply turning the attenuator switch to the X10 position, it will be calibrated at 10 V/div. You can go the other way, too. For example, start out with the attenuator in the X10

position and calibrate the scope to display 1 V/div. Then turn the attenuator back to X1, and the scope will be calibrated at 0.1 V/div. (i.e., 100 mV/div.).

Frequency measurements are handled in a similar fashion, but by using the horizontal sweep frequency and/or gain controls to calibrate the horizontal axis such

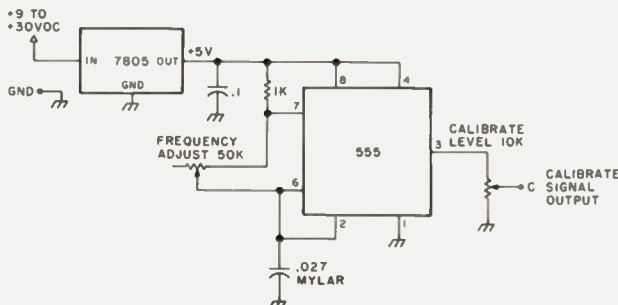

Fig. 1. Circuit diagram of the N5KR oscilloscope calibrator. It uses only seven components, all of which are readily available.

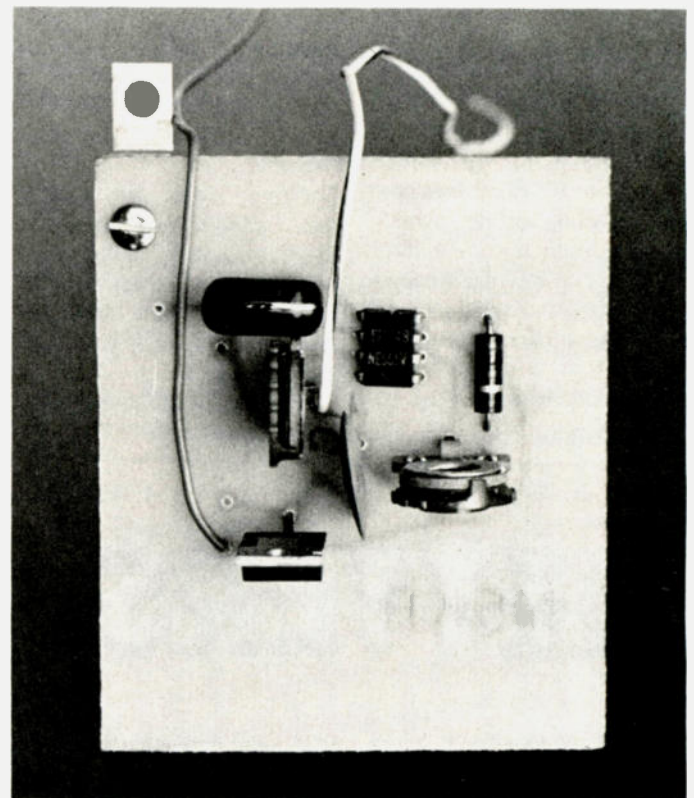

Fig. 2. Photograph of the finished board ready for installation in the scope. The trimpot at the lower right sets the frequency, while the one toward the left sets the amplitude of the calibrate signal.

that the signal of known frequency is displayed with a given number of cycles per division. The frequency of an unknown signal can then be measured by noting the number of cycles per division it occupies on the screen.

My own oscilloscope had a built-in calibration signal, but it consisted of nothing more than an extra winding on the power transformer to supply 1 volt peak-to-peak at 60 Hz. Consequently, any line voltage changes would cause the amplitude of the calibration signal to change by the same percentage, which was entirely unacceptable for accurate measurements. The frequency was that of the line itself and, consequently, extremely accurate. However, 60 Hz is such a low frequency compared to the signals normally being measured in the audio range that the measurements which are possible in theory are not possible in practice because of the great percentage difference (that is, the ratio) between the reference signal and the unknown signal.

The solution to all these problems is the circuit shown in Fig. 1, which generates a stable square wave calibration signal and costs less than \$3.00 to build. The component values shown have been selected to provide a symmetrical 1-volt p-p signal at 1000 Hz when the two trim pots are calibrated. The 555 timer generates the signal at a stable frequency, while the 7805 regulator ensures a fixed amplitude. The entire

circuit contains only seven components, which are mounted on a small PC board as shown in Fig. 2. The 1 V p-p signal enables fast and simple calibration of the scope in the vertical (amplitude) axis, and the 1000 Hz frequency is a nice round reference frequency for analysis of most audio signals. The circuit board is small enough to mount inside of the oscilloscope itself, with the few milliamps of power required being supplied from the scope's existing power supply.

Construction

The circuit is simple enough to build on perf-board, and parts layout is not critical. I built mine on a small PC board, the layout for which is shown in Fig. 3. Part's placement, as viewed from the component side, is given in Fig. 4.

Component tolerances of 20% are satisfactory, since the two trim pots are used to make the final amplitude and frequency adjustments. In fact, the .027 uF capacitor can be substituted for with any value from .02 to .047, if you don't have a .027, but it would be better to go lower in value rather than higher, if you have a choice. The important thing is that this capacitor be of mylar or other temperature-stable type. The PC layout shown in Fig. 3 has two different solder pads (one on an extension) on the ground side of this capacitor to accommodate whatever capacitor

you select, since its physical size may be different from the one I used. There are also a couple of extra solder pads for making an external ground connection, if desired.

The 7805 regulator may be substituted for with an LM340T-5, which is the same device. On rare occasions, these regulators have been known to go into self-oscillation. Should you encounter this problem, replacing the .1 uF disc capacitor with a 1 uF tantalum capacitor should clear it up.

Mounting and Power Connections

The circuit is so small that it can be mounted almost anywhere in the scope. In fact, you can trim the PC board down a lot smaller than the one shown in Fig. 2, which has a lot of blank space around the edges. You should, however, make it a point to mount it as far as possible from major heat sources so that the calibrator's frequency stability won't be impaired.

Fig. 5 shows my own installation, where the calibrator board is supported by a single Z-bracket fastened to the chassis (in the lower right-hand corner, toward the rear of the scope).

The input voltage can be anywhere from +9 to +30 volts dc, and you won't have any trouble finding a supply voltage somewhere in this range in a solid state oscilloscope. If your scope is tube type, you might still find a voltage of the proper value, but if not, you can obtain it

from a higher voltage through an appropriate voltage divider. The supply voltage doesn't have to be regulated, but, on the other hand, you want to avoid one that fluctuates widely. The negative (ground) connection can be made through the mounting bracket, if desired.

If your scope has an existing jack on the front panel for a calibrate signal, just disconnect the wire from the existing calibrate signal and run a new wire from the jack to the calibrate signal output (C) on the circuit board. If you don't already have a jack or if you want to retain your existing calibrate signal, you will need to mount a small pin jack on the front panel for this connection.

Calibration

In order for the calibrator to be of any use, it must itself be calibrated in an accurate manner, and the circuit has been designed for simplicity in that respect. First, set the two trim pots to mid-scale. Now, with power applied to the calibrator circuit, use a VTVM or other accurate voltmeter to measure the calibrate signal at C. Set the voltmeter to read "dc volts," and adjust the 10k pot until the meter reads exactly one-half volt (0.5 V). Fig. 6 shows the reading being taken for this adjustment. The square wave at the output now has a peak-to-peak amplitude of exactly 1 volt.

What you have done here is used the dc voltmeter to measure the average output voltage, and, since the signal

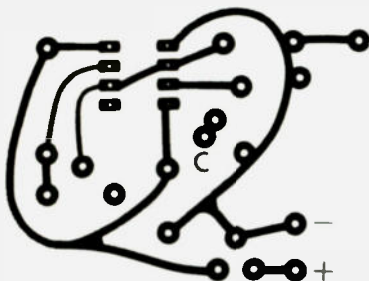

N5KR

Fig. 3. PC layout, foil-side view.

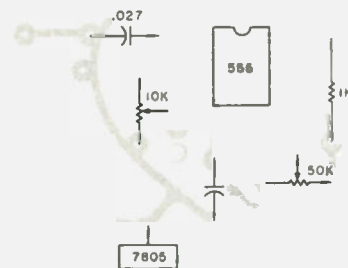

R5KR

Fig. 4. Parts placement, component-side view.

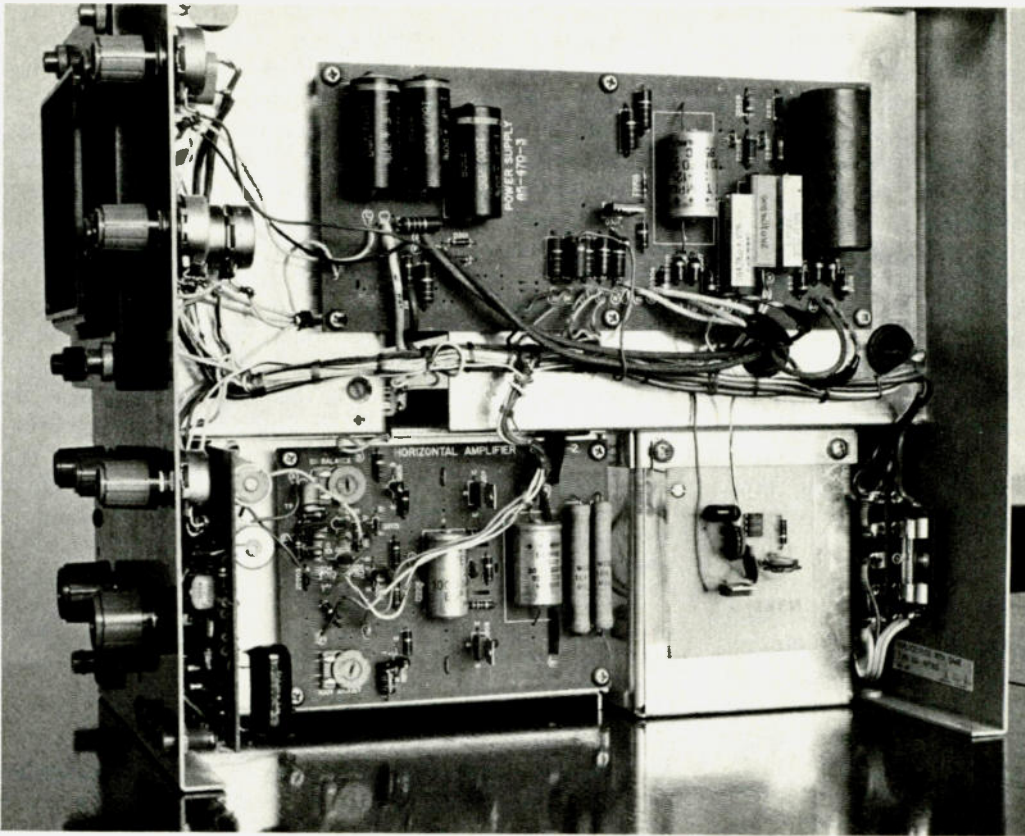

Fig. 5. A typical installation of the finished calibrator in an oscilloscope (lower right corner, toward the rear of the scope). Placement is not critical, but you should avoid areas of high temperature so that its frequency stability won't be impaired.

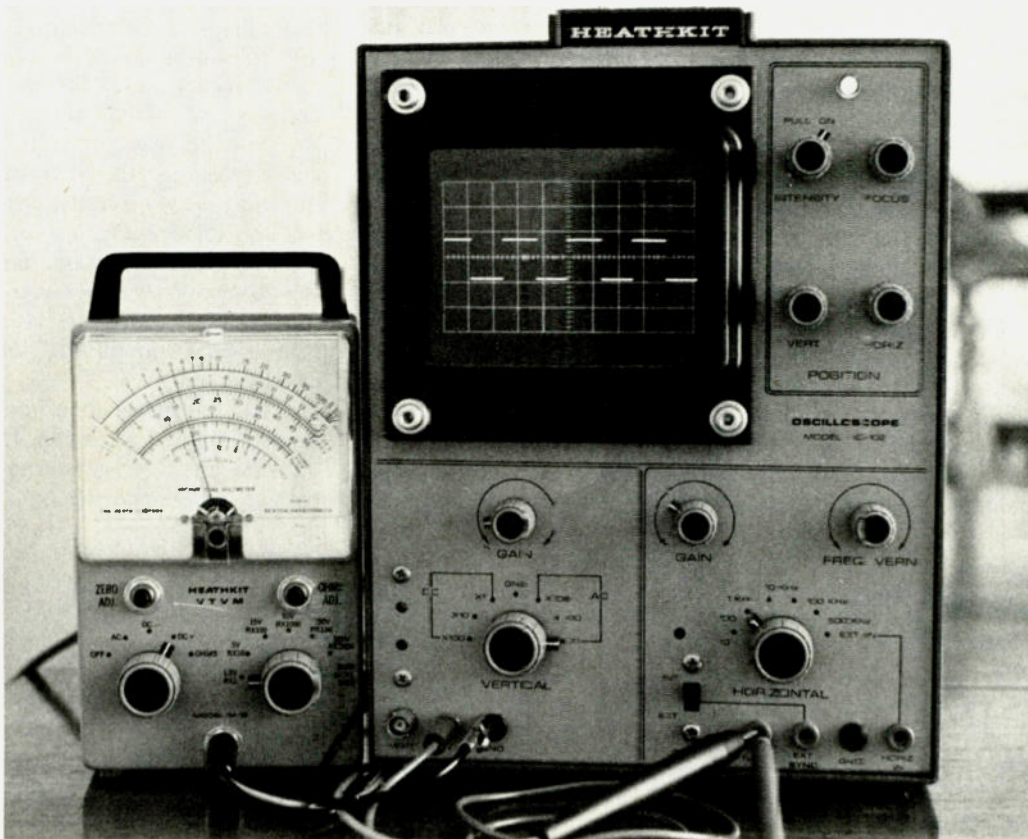

Fig. 6. Adjusting the calibrator output to 1 V p-p gives a reading of exactly 0.5 volts when the voltmeter is set to read "DC VOLTS." This eliminates the need for an expensive instrument to accurately set the amplitude of the calibrator waveform.

is switching back and forth between 0 volts and 1 volt, the average value you read on the meter is 0.5 volts. This is true only for a symmetrical square wave, of course, and the component values in this circuit have been chosen such that any error in symmetry is less than 1% at 1000 Hz. You also have to be assured that the negative (low) half cycle of the signal is actually at zero volts, which it is, for all practical purposes, when the 555 is operated at the 5 V input voltage supplied by the 7805 regulator.

The easiest way to set the frequency is to measure the calibrate signal with a digital counter. If you don't have access to one, an accurate audio signal generator can be used, with the calibrate signal frequency being adjusted to match the known signal while they are being watched on the scope. In any case, the frequency of the calibrate signal is adjusted with the 50k pot.

If you prefer a frequency other than 1000 Hz, you can set the pot for a lower frequency without hurting anything. If you set the pot to a higher frequency, though, the symmetry of the waveform will be upset. To go to a higher frequency, you should lower the value of the .027 capacitor instead, using the formula:

$$C = 28/F,$$

where C is the value in microfarads of the new capacitor, and F is the desired signal frequency.

Summary

This is one of those satisfying projects that you can put together in an hour or so, at a cost of only two or three dollars, and see the results immediately. It consists of only seven components, which are available from any retail or mail-order electronics dealer. It's a handy little device that will enhance the utility of lower cost oscilloscopes, and you can sit back and enjoy using it for years to come. ■

144 MHz, 220 MHz, 432 MHz
You have tried the rest...

NOW TRY THE BEST! 6 METERS

WHY SIX METERS?

1. Consistent coverage of over 100 miles is not unusual with use of modern equipment.
2. The variety of propagation affords an opportunity of working lots of DX-Stations from 400-2,000 miles away on multi-hop sporadic E, F₂ Skip during the upcoming peak sunspot cycle of over 2,000 miles. Plus transequatorial propagation is good up to several thousand miles.

Vhf engineering offers a complete line of six meter FM kits and equipment.

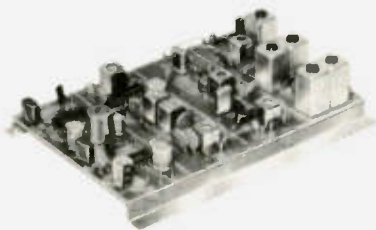

The RX50 is a NBFM 30-60 MHz Receiver Kit. Sensitivity is .3uV for 20 db squelch threshold .2uV Audio output, 2 watts.
 Kit \$64.95

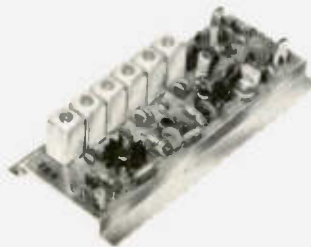

TX50 1 watt true fm 6 meter transmitter
 Kit \$44.95

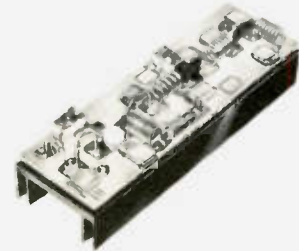

PA50/25 6 meter power amp
 1 watt in, 25 watt out
 Kit \$54.95



THE RPT50
 SIX METER
 NBFM
 REPEATER
 Kit \$499.95
 wired & tested .. \$799.95

THE NEW RPT 50 IS A COMPLETELY SELF-CONTAINED ALL SOLID STATE REPEATER. It is conservatively rated, and built of high quality components. Much care and attention to make this repeater versatile as well as reliable.

The Model RPT 50 is supplied as complete repeater system. The receiver, transmitter, control circuitry, C.W. Identifier & 115/230 Volt AC power supply are all contained on a standard relay-rack panel and chassis unit. For most installations a user supplies AC

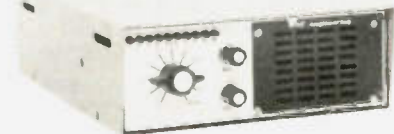

TRX50 complete 6 meter transceiver kit.
 25 watt out, 10 channel scan.
 (Less mike and crystals.)
 Kit \$244.95

power and suitable antennas with 50 OHM coaxial feed (PL 259 fittings). External connections for autopatch, tone control, etc. are provided. Built-in identifier programmed with up to 159 bits. Automatic emergency battery power changeover capability.

To best take advantage of the DX as well as the extended range capabilities we recommend our optional tone squelch board TS-1 and TD-3 touch tone decoder.

Export prices slightly higher. Prices and specifications subject to change.



DIVISION OF BROWNIAN ELECTRONICS CORP.
 320 WATER ST. / BINGHAMTON, N.Y. 13901 / Phone 607-723-9574

How About SSB CB Conversions?

— no strain

After almost 20 years of hamming on the low-frequency bands, I have become very disillusioned with the QRM and crowded conditions that exist. After a short time with 40 meter QRP and 2m, I decided to explore the new frontiers of the 10 meter band. Since I am a QRP advocate and a member of the QRP Club International (QRP #3214), I began my 10 meter activities with a converted AM CB rig and a vertical CB antenna. The results were very rewarding, and, in January of this year, I began looking for an SSB CB rig to convert.

The Kraco Model KB-2355 described in this article was

selected because of its price (under \$140 at a local department store sale), and closer examination revealed features that are desirable in a modern ham rig. (See Table 1.)

In addition to those features, the Kraco has dual meters for received signal and power/swr, a switchable noise blanker for SSB, and a switchable noise limiter for AM. Although the unit is larger than most CB rigs (13" x 4" x 10"), it is an excellent size for base station operations and leaves enough room internally for those who wish to add a receiver preamp or a small linear amplifier.

Since this unit uses 10

crystals in the 23 MHz and 14 MHz range to achieve synthesis action, it is only necessary to change the four 14 MHz crystals to achieve 10 meter coverage. Table 2 shows the original frequency scheme and the new crystals added to give you 10 meter coverage. You may wish to use different crystal frequencies for the high end of the band, since there has been increased activity above 29

MHz. Fig. 1 indicates the location of the crystals on the 23-channel switch deck.

The crystals in the Kraco are the HC-18/U type, and, in order to gain access for soldering, it will be necessary to remove the front panel and remove the 2 Phillips-head screws holding the push-button switch deck in place. Once this is done, the switch deck can be moved aside to allow access to the underside of the crystal board.

Once the 4 new crystals have been installed and the switch deck and front panel have been put back in place, you must retune the transmitter and receiver sections. The only equipment necessary is an rf signal generator, and the procedure should take no longer than 30 minutes.

With the signal generator tuned to the center of the frequency range that you have chosen, proceed as follows:

Crystal switch: Ch. 11 or 12
 Mode switch: AM

Tune the following coils, in the sequence listed, for a maximum indication on the S-meter:

1. L202
2. L203
3. L204

General

Frequency control: 10-crystal synthesis configuration
 Mode of operation: AM, USB, and LSB
 Power source: 110 V, 50-60 Hz, 11-16 volts dc, negative ground

Receiver

Sensitivity: AM — 1 μ V for 10 dB (S+N)/N
 SSB — .25 μ V for 10 dB (S+N)/N
 Bandwidth: 4 kHz at 6 dB down for SSB and AM
 Image Rejection: 40 dB
 Offset tuning: \pm 1 kHz
 Audio output: 3 Watts at 8 Ohms
 i-f frequency: 11.2735 MHz for SSB and AM

SSB Transmit

SSB generation: Balanced ring modulator with crystal lattice filter
 Rf output: 12 Watts PEP
 Carrier: 40 dB down
 Suppression: Harmonic 50 dB down

AM Transmit

Modulation: High level class B
 Rf output: 4 Watts
 Harmonic Suppression: 50 dB down

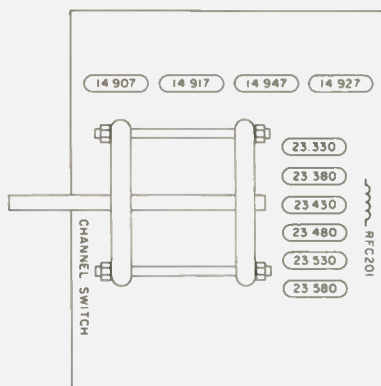

Fig. 1. Placement of crystals on the crystal board. The original crystal frequencies are indicated.

Table 1.

	Channel	ORIGINAL			CONVERSION		
		X201 through X206	X207 through X210	CB Frequency	X201 through X206	X207 through X210	10 meter Frequency
4. L18	1	23.330	14.907	26.9635	23.330	16.492	28.5485
5. L19	2		14.917	26.9735		16.502	28.5585
6. L20	3		14.927	26.9835		16.512	28.5685
	4		14.947	27.0035		16.532	28.5885
	5	23.380	14.907	27.0135	23.380	16.492	28.5985
	6		14.917	27.0235		16.502	28.6085
	7		14.927	27.0335		16.512	28.6185
	8		14.947	27.0535		16.532	28.6385
	9	23.430	14.907	27.0635	23.430	16.492	28.6485
	10		14.917	27.0735		16.502	28.6585
	11		14.927	27.0835		16.512	28.6685
	12		14.947	27.1035		16.532	28.6885
	13	23.480	14.907	27.1135	23.480	16.492	28.6985
	14		14.917	27.1235		16.502	28.7085
	15		14.927	27.1335		16.512	28.7185
	16		14.947	27.1535		16.532	28.7385
	17	23.530	14.907	27.1635	23.530	16.492	28.7485
	18		14.917	27.1735		16.502	28.7585
	19		14.927	27.1835		16.512	28.7685
	20		14.947	27.2035		16.532	28.7885
	21	23.580	14.907	27.2135	23.580	16.492	28.7985
	22		14.917	27.2235		16.502	28.8085
	23		14.947	27.2535		16.532	28.8385

Table 2. With an i-f frequency of 11.2735 MHz, final frequency generation is offset 1.5 kHz for SSB. Only the four 14 MHz crystals need to be changed for 10 meter coverage.

This completes the receiver alignment for all modes. Now disconnect the signal generator and connect a dummy load or two 100-Ohm, 2-Watt resistors across the coaxial antenna jack. With the mode switch in the AM position and while pushing the mike switch for short durations, tune the following coils in the sequence listed for a maximum indication on the rf meter:

1. L1
2. L2
3. L3
4. L4
5. L5
6. L6
7. L7
8. L601

This completes the basic conversion, and, if you have used the same crystals that I have, you are now ready to work 10 meters on any 23 channels between 28.55 and 28.83 MHz. However, you are rockbound and the success of any QRP rig is its ability to move around with continuous coverage. This problem is solved with the following modification:

1. Remove the front panel and push-button switch deck as previously indicated.

2. Place short jumper wires across the miniature netting capacitors associated with the four added 16 MHz crystals. These are indicated as TC201 through TC204.

3. Remove the end of RFC 201 (on crystal board) which connects to the low side of the netting capacitors you just shorted out.

4. Connect a miniature tuning capacitor (approximately 170 pF) in series with RFC 201 and its original connection on the board. I used a miniature tuning capacitor from a transistor broadcast radio for this purpose.

5. Remember that this capacitor must be insulated from ground, so I will leave the physical mounting up to you. A method that worked well for me and did not disturb the appearance of the front panel too much was to mount the capacitor on a small U-shaped bracket and bring an insulated shaft through the pilot light hole at the right of the crystal switch.

With the addition of this capacitor in series with the low side of the 16 MHz crystals, you will achieve approximately an 8 to 10 kHz swing on each of the 23 channels. You have advanced from rockbound to vxo-con-

trolled and have achieved the flexibility necessary for QRP.

I have been using this rig with much success for the past year and have worked six continents and all fifty states. As most of my contacts have stated, the rig has excellent audio quality and, with my 4-element 10 meter beam, has a good punch.

After having so many inquiries on the air and after reading the comment by Wayne in the June issue of *73 Magazine*, I decided to share this information with you. My final modification on the rig will be to add a CW mode, and I would welcome any comments or suggestions on this. ■

* 10 thru 80 the easy way !!! *

"BIG SIGNAL" W2AU BALUN *
"OLD RELIABLE" W2VS ANTENNA COILS *

ANTENNA KIT

These two old friends* get together with 120 feet of high quality # 14-7 strand copper antenna wire and a pair of "END-SULATORS" end insulators to create a superior 80 through 10 meter, 108 foot long, full power (1,000 watts/2,000 watts P.E.P.) antenna. Instructions included. Price \$48.25 plus \$1.00 handling charge. In Calif. add 6% sales tax. Mastercharge & Visa accepted.



Order from: S-F AMATEUR RADIO SERVICES
4384 KEYSTONE AVE., CULVER CITY CALIFORNIA 90230 Ph. (213) 837-4870

The Universal Notcher

— easy as pi

I have long been thinking about writing articles on construction projects whose main advantages are the use of a PC board for error-free and repeatable circuits, the neatness of a PC board, because it cleans up the inevitable wiring that accumulates in any ham shack, and its high use-to-simplicity

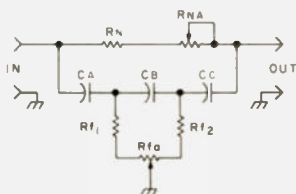

Fig. 1. Schematic (one channel). $R_N = R_{null}$; $R_{Na} = null$ adjust; R_{f1} and $R_{f2} = f_{limit}$; $R_{fa} = frequency$ adjust. General formulas; 1) $f_o = 1/2\pi C_x \sqrt{3(R_x)^2}$, where R is in Ohms, $R_x = R_{f1} + R_{fa}/2$, and $C_x = any$ $C_a, C_b,$ or C_c . This allows f_o of interest at R_{fa} centered. 2) $R_x = 1/(\sqrt{3})(2\pi)(f_o)(C_x)$. 3) $C_x = 1/(\sqrt{3})(2\pi)(f_o)(R_x)$. 4) $R_N + R_{Na} = 6[(R_{f1} + R_{fa}/2) + (R_{f2} + R_{fa}/2)]$.

ratio (one board: many uses). This is the first article of that type, describing an audio notch filter. The board is laid out for 2 channels of audio (stereo) for my use, but it can be half built or split down the lettering on the board for two separate filters.

Anything I have come up with on this lesser-used type of audio RC filter I will list in the references for those who want further history on it.

I use this filter at the phono inputs of a stereo amplifier/

cassette tape deck combination to eliminate any hum (60 Hz stray) picked up over long lines (6-12 feet) from the EME rack to the console, where the amplifier and tape deck reside in a drawer for easy use. Those of you who are CW-operator types may see its obvious use as a notch filter that can be ganged in parallel to knock out 2 adjacent beats or used to bracket the desired signal in a bandpass style. Other possible uses are: with an op amp IC

bandpass style as an easily tuned/no coil i-f amplifier; as the oscillator frequency determining element in a bfo or variable frequency audio generator; as slot filters at other frequencies than 60 Hz (notch out Ioran signals at VLF?); and the list goes on! Perhaps the best thing this RC network has over others, the twin-tee for example, is the fact that it "tunes" with only the single pot, R_{fa} in the schematic.

The very simplicity of the

	R_{fa}	R_{f1}	R_{f2}	C_a	C_b	C_c	R_N	R_{Na}	$R_N + R_{Na}$
Example 1:									
60 Hz									
calculated	10k	[5672.1 Ω - ($R_{fa}/2$)]	[.30629 $\times 10^{-6}$]						68160 Ω
Actual used	10k	680	680	.27	.27	.27	56k	25k	
Example 2:									
500 kHz									
calculated	10k	[5568.9 - ($R_{fa}/2$)]	[3.6 $\times 10^{-11}$]						66826.8 Ω
Actual	10k	560 Ω	560 Ω	33 pF	33 pF	33 pF	56k	25k	

Table 1. Use good quality mylar capacitors and 5% resistors for filter performance. Example 1: 1 dB insertion loss and 62 dB notch @ $f_o = 60$ Hz. Pots used were PC thumbwheels, but R_{fa} can be panel mounted. Using actual values in example 1, null frequency at R_{fa} center = 59.9166 Hz. The filter is an RC phase shift type and works best in moderate- to high-impedance circuits (i.e., phono inputs, etc., of 50k to 1 meg). This can be used in loop of op amps like the twin-tee variety. Example 2: insertion loss = 1 dB; null = 42 dB.

filter allows me the brief following description of its operation. Picture the sine wave 60 Hz example entering the input. It travels through R_N and R_{Na} and appears in phase at the output at some level dependent on the setting of R_{Na} . Meanwhile, the same sine wave travels through C_a and $R_{f1} + R_{fa}/2$ to ground, causing a phase-shifted voltage to appear at the junction of C_a , C_b , and R_{f1} . This second voltage passes through C_b and $R_{f2} + R_{fa}/2$ to ground, causing a further phase shift at the junction of C_b , C_c , and the output load impedance to ground for the final shift. Ideally, this shift amounts to 180° at f_0 (60 Hz), and the signals totally cancel each other at the output when R_{Na} is adjusted to equal the amplitude passing through the capacitor string. Or, again ideally, $(+V \text{ null leg}) + (-V \text{ capacitor leg}) = 0$ V. Board leakage, component tolerance, etc., prevent the ideal as in most electronic circuits, but 40 to 60 dB+ isn't too shaggy!

Try your own ideas out, and don't be afraid of frequencies at least up to middle i-f range (500 kHz or so), as all mine seemed to do fine. Above this, leakage and shielding become a definite problem, but, if you are brave, plug on. My main reason for this article is to give you the idea and a PC board layout to play with. I'm sure that as hams you can imagine the rest. ■



Fig. 2. Copper foil pattern.

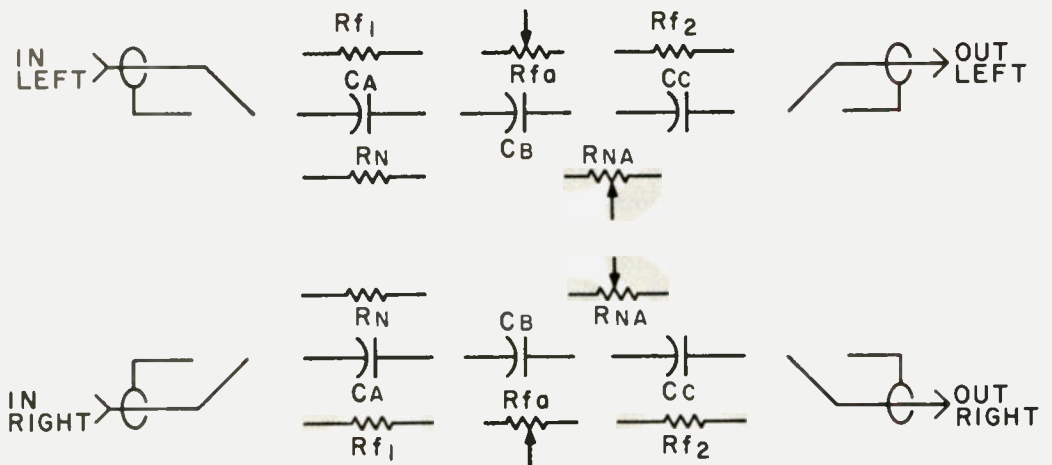

Fig. 3. Bottom view, copper side. Board may be split along lettering for two separate filter boards.

References

EE Designer, Spring, 1963.
Early GE design notes, date un-

known.
WASSNZ, Ham Radio, September, 1975, p. 16.
IRE Transactions, September,

1955.
General Radio Experimenter, July, 1961.
EEE Magazine, October, 1969.

solid state continuous coverage

THE COMM CENTER

The Drake TR-7 C75

INC. AREA CODE (301) WASHINGTON 953-9535 - BALTIMORE 792-0600
9624 FT. MEADE RD. LAUREL, MD. 20810

The \$5 Memory Keyer

— for lazy cheapskates

Sending CQ can become a tedious task. Some people really indulge and buy an auto-keyer with a memory to do the job for them. But, if you don't have at least one hundred dollars to spend, it's doubtful that you will find one at all.

The following project is not a keyer. It cannot be used with a paddle. However, it

does have the capability of storing several hundred bits of information in its memory which can be used to key a transmitter with a key terminal voltage of up to four hundred volts and as high as six Amps, which covers just about all modern equipment on the market.

With a regular auto-keyer, many coils and complex

circuitry are used to achieve its operation. The device described in this article is considerably less expensive than these units and will allow the operator to send CQ just as quickly and easily. Instead of complex circuitry, this device uses information stored on magnetic tape, which most of you probably already have.

The circuit takes audio pulses from a tape recorder and changes them into on-off keying pulses to key the transmitter. Therefore, whatever you can put on tape, you can put into the "memory" of this new tape keyer. Additionally, a repeating cassette tape can be used, so no rewinding of the tape is necessary. After the tape has completed the CQ, just stop it. If there is no answer, just start the tape again. However,

a standard cassette will work fine.

Hookup and Operation

The tape keyer is assembled on a printed circuit board and enclosed in a small box. Parts placement is not critical, and the tape keyer may be hand wired, if desired.

A standard code practice oscillator is used for programming. CQ or anything else is recorded on the tape. Once programmed, the audio output of the tape recorder is fed into the tape keyer. The outputs of the tape keyer are connected to the key terminals of the transmitter (refer to Fig. 1, the block diagram). Polarity of the key terminals must be observed so that SCR1 stays reverse biased until turned on by Q1.

The volume of the tape recorder should be turned up until full keying is achieved and complete dots and dashes are heard. For best results, when programming the tape, record directly using no microphone from the oscillator output to the recorder's microphone input.

Circuit Theory

When the audio signal is positive at the anode of D1, capacitor C1 is charged and Q1 is forward biased. This turns SCR1 on and keys the transmitter. When the polarity reverses, C1 discharges, keeping Q1 forward biased. When the audio signal ceases, resistor R1 is used to discharge the capacitor at a fast rate, so that Q1 turns off, which stops SCR1 from conducting. ■



Fig. 1. Block diagram.

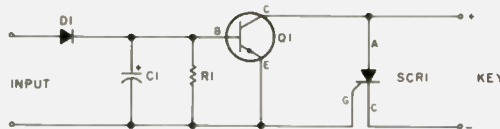

Fig. 2. Schematic diagram of the tape keyer. C1 — 1000 uF, 16 V dc electrolytic; D1 — 1N4004 diode; Q1 — RS 2020 (Radio Shack); R1 — 1/2 Watt, 22 Ohms; SCR1 — RS 1020 (Radio Shack).

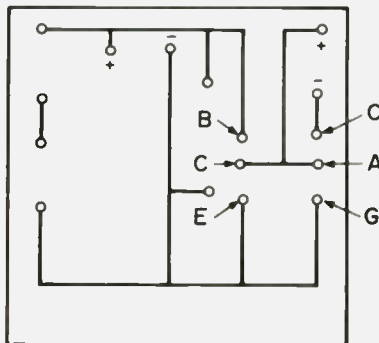

Fig. 3. PC board — foil side.

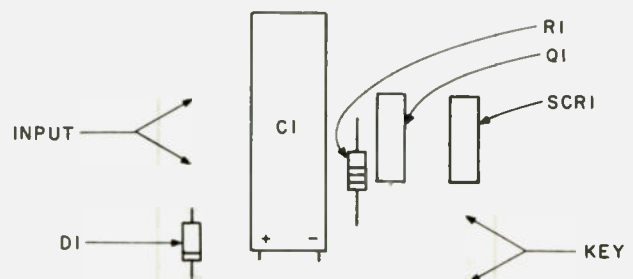

Fig. 4. PC board — parts placement.

New YAESU FT-7 20 Watt Solid State 80-10 Meter HF Transceiver



The all-solid state FT-7 transceiver provides high performance on the 80 through 10 meter bands. The operator may select upper or lower sideband or CW operation, and the compact package provides many features engineered for convenience while mobile. A single knob provides all transceiver tuning, and the state-of-art noise blanker minimizes impulse-type noise often found in mobile applications. The FT-7 is designed for operation directly from 12 volt car battery or Yaesu's FP-7 DC Power Supply.

YAESU FT-227R

144-148 MHz 800 Channel "Memorizer"



- One knob channel selection, 144-148 MHz
- Memory circuit that allows instant return to any frequency selected
- Fully synthesized in 5 KHz steps
- 600 KHz offset plus any split using memory circuit
- Built-in tone burst
- Optional tone squelch encoder/decoder
- Selectable 10 watt/1 watt output
- Operates directly from 12 volt car battery or Yaesu's FP-4 Power Supply



Price And Specifications Subject To
Change Without Notice Or Obligation

YAESU
The radio.



Y1

578

YAESU ELECTRONICS CORP., 15954 Downey Ave., Paramount, CA 90723 (213) 633-4007
YAESU ELECTRONICS CORP., Eastern Service Ctr., 613 Redna Ter., Cincinnati, OH 45215

Should Repeaters Use Subaudible Tones?

—*theological argument*

This article was written with two purposes in mind. First, it tells the average VHF repeater user that PL need not be a barrier to accessing a local repeater, but can be a tool for improving the operation of both repeater and user station. Second, it is an approach to improving the problems of mutual repeater interference, particularly during band openings, which should be studied by repeater owners and repeater councils alike. Various aspects of this approach have been proposed by repeater councils and owners in the past, and a few machines are using something similar to this approach now. This article tells about two machines in Illinois, both on the same frequency pair,

which have reduced their mutual interference by using the system described here.

Mention subaudible coded access or Private Line (PL)* to any mixed group of VHF repeater oriented hams, and you're likely to get widely divergent reactions. The average repeater user hates it, the average *private* repeater user or owner considers it to be God's gift to ham radio, and the average repeater control operator is likely to be ambivalent about it.

*Private Line is a trademark of Motorola, Inc. Other names for such continuous subaudible tone coded access systems are Channel Guard (GE) and Quiet Channel (RCA). Since amateurs are most familiar with the term PL, however, I will be using this throughout the article.

On the positive side, PL and its related coded access systems provide a means of keeping out transmissions that do not intend to access the system. This keeps the extraneous key-ups at bay and thus provides a measure of sanity insurance for the control operator. It also partially insures keeping the private system private. That is also a negative, to the outsider, but that argument is beyond the scope of this article.

On the negative side, there is the problem of emergency traffic attempting to access the system and the problems which that presents to the control operator involved. And, there are the twin hassles of the cost of PL (to the stingy) and the various

problems involved in installing it in the average small VHF rig.

However, there are times when the repeater owner or control operator, especially in crowded repeater areas, sees the need for some form of coded access for his machine. Just think for a moment about repeaters located near seacoasts or other areas where tropo ducting on VHF is common. One tropo duct can equal one mess.

Here is how one repeater organization, with the help of another, took a big step toward resolving both the PL and the interference problems, to the benefit of both machines.

WR9ABQ is owned by the Valley Amateur Repeater Association (VARA) of Elgin, Illinois. Their two meter system operates on the 19/79 pair. Other "neighbor" repeaters on that pair are WR9ADF in Normal/Bloomington, WR8ABI at Oshtemo/Kalamazoo, and WR0AJC in Burlington, Iowa. In the early days of "ABQ," when the band would open up, users of these machines would unintentionally "drop in" on the Elgin machine's input frequency, with the usual disruptive results.

That's not happening nearly as often anymore. The technical committee at VARA, after facing these frustrations for some time but not wishing to "close" their repeater via PL, came up with the idea of using PL as a carrier squelch *loosener*, rather than as a squelch of its own. The user who keys up the machine using its PL frequency automatically buys himself an added 6 dB of carrier squelch threshold. That feature alone brings down the number of key-ups from distant, tropo-propagating stations which do not intend to access the system. Without the right PL, they have a much harder time getting in.

Any repeater which chooses to use the PL system just described has the flexi-

bility of choosing how much to loosen the squelch with detected PL or, rather, how much to tighten things down when carrier and no PL are present. How much is, of course, up to the individual repeater's particular interference situation. The best setting is determined experimentally.

In addition to the foregoing, WR9ABQ also makes judicious use of anti-PL, which, for the uninitiated, denies access for the user of the anti-PL tone rather than assures it. At the present time, WR9ABQ has one anti-PL frequency, which is the access tone frequency used at WR9ADF in Bloomington. Fixed stations and high-powered mobiles use this frequency both to enhance their chances of getting into their home repeater and as a courtesy to the next repeater on the same pair. Such users simply do not get into WR9ABQ. The people at WR9ADF have also installed their own anti-PL system, which is tuned to the VARA PL frequency. This results in a lot less mutual interference between these two repeaters than VARA faces from its other near neighbors on the frequency pair. As these other machines add their own PL frequencies in the future, VARA will add anti-PLs to complement them as well.

A couple of notes here. First, as you may have guessed, it is possible for a control operator at WR9ABQ to switch the repeater to PL-only operation with a simple control code. That this is very seldom necessary is a tribute to the effectiveness of the mode of PL use described here. Second, the proper PL tone, when received by the repeater, is regenerated at the output frequency for use by the tone-activated squelches of the local control stations. This prevents them (assuming they have PL decoders) from having to hear the outputs of other machines on the frequency during band openings — more sanity insurance.

None of these ideas are new, of course. However, the combination of these ideas seems to be something new to amateur radio repeater systems, and it's about time we seriously considered using it. The reason is compelling. In these days of crowded repeater channels, "PL-loosening carrier squelch" plus "anti-PL" can create a far more livable situation on a repeater for everyone concerned, including the user with PL, the user without PL, the control operator, everyone at the next repeater (assuming they have a like system), and, ultimately, the state or regional repeater council.

The key to all these good things, on a major scale, lies not just with the local machine, but also in two other directions: 1) cooperation from the other neighboring machines on the frequency pair, either on a one-to-one basis or through the state or regional repeater council, and 2) cooperation from the majority of repeater users, particularly the well-equipped VHF FM operator.

For example, WR9ABQ has been able to work out a cooperative agreement with the WR9ADF machine in Bloomington, wherein each machine's access PL tone is the other's anti-PL. As mentioned earlier, VARA hopes that the other nearby repeaters on its frequency pair (at least) will follow suit sometime in the near future.

State and regional repeater councils can be of great assistance here by drawing up a plan of PL assignments to go along with their frequency pair assignments. One idea is to divide up a state or region into PL areas, with each area having its own PL frequency. All open repeaters in that area would utilize the same PL frequency in a PL carrier squelch loosener system, along with anti-PLs for all the surrounding areas. Users would need only one PL frequency determining element (reed or twin-T) to work any

open local repeaters, while reaping the full benefits of repeater communication. Or, a user could skip PL entirely (say, for operation outside of his home area) without danger of being completely shut out of repeater operation, though with reduced benefits. This eliminates the need for a "universal" mobile PL on all repeaters, as at least one state repeater council has proposed.

With 32 PL frequencies, there are certainly more than enough to go around for any given region or state to allocate for all of their discreet areas, with enough left over for the private repeater crowd. I envision using, say, six to eight of these PL frequencies for this purpose, since common sense dictates that "checkerboarding" of areas can cut down on the number of anti-PL reeds (or whatever) needed by any given repeater. Coordination of PL frequencies within a state or region should not be a problem with competent administration at the council level.

While we're on the subject of quality administration, it must be noted here that a plan of this sort cannot and will not effectively replace the use of common sense in frequency coordination at the council level. The two cooperating repeaters referred to in this article are one hundred twenty miles apart. Had they been closer than, say, eighty miles, this plan simply would not have worked. Any coordinator is asking for trouble when he tries to use this system to shoehorn coordinations for co-channel machines into the same area. Basically, we're trying to solve problems that are already here, rather than find an excuse to create new ones.

Cooperation by the well-equipped fixed station and the high-power mobile station is also essential. VHF repeater users are generally divided into two groups: the low-budget, low-power guy with

the rice-box class rig and not much else, and the sophisticated, high-power fixed station or mobile. The latter usually has a lot of money sunk into frequency synthesis, amplifiers (upwards of a hundred Watts worth), and a superb antenna system, often with hard line feed. Too often, however, the one thing that money did not buy is a way to turn the power down, usually in a mobile situation. And, let's face it, it's impossible to try to adjust your power up and down, while you're driving, to accommodate for constantly changing terrain conditions. It just can't be done. However, the use of the PL system which is described here can provide the kind of control needed to keep your signal accessing only the machine you wish to access.

Even turning the beam at the fixed station cannot insure that your signal will stay out of an unwanted place, because of the number of minor side lobes in any directional antenna pattern (there are 44 such lobes in the typical 22-element block-buster). Again, the answer is the PL system described in this article.

The experiences of WR9ABQ and WR9ADF have shown that PL can be used on a repeater without shutting out the non-PL user. These experiences suggest that the same idea will work just about anywhere that moderate repeater crowding is a problem. What is now needed is a determined effort by repeater councils (or in lieu of that, between repeaters on the same frequency pair) to coordinate and by repeater users to utilize some sort of PL plan to make such a system fully effective. It is not hard to do, and the ultimate reward is a saner time for all on those crowded repeater channels.

My sincere thanks to Bob Swoger K9WVY for his inspiration and assistance in the preparation of this article. ■

May We Suggest... Kenwood-Call Toll Free 1-800-633-3410

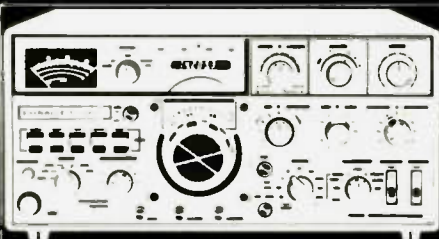
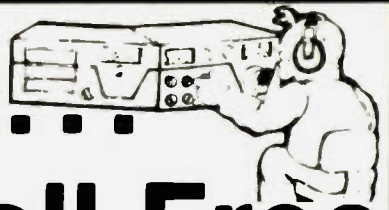

KENWOOD TS-820S transceiver

The NEW Kenwood TS-820S features a factory installed digital frequency readout. • 160 thru 10 meter coverage • Integral IF shift • RF speech processor • VOX • Noise blanker • PLL • Built-in 25 KHz calibrator • CW side tone & semi-break-in • IF OUT, RTTY, & XVTR • Phone patch IN and OUT terminals.

1098.00 list price. Call for quote.

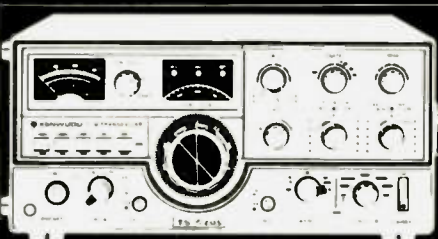

KENWOOD TS-520S SSB transceiver

TS-520S features: • 160 thru 10 meter coverage • Optional DG-5 frequency display (on top of unit) • New speech processor with audio compression amplifier • Built-in AC power supply (DC-DC converter, optional) • RF attenuator • Provision for separate receive antenna & phone-patch.

739.00 list price. Call for quote.

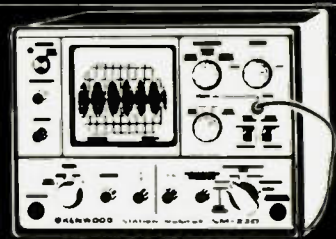

KENWOOD SM-220 station monitor scope

Features: • Built-in two-tone generator • Monitors SSB waveforms • Useful in adjusting mic gain & speech-processor compression level & monitoring key clicks on CW • Provides trapezoidal waveforms for testing linearity of linear amps • Observes signals transmitted from 1.8-150 MHz • Based on wide band oscilloscope (2 Hz to 10 MHz).

To Be Announced

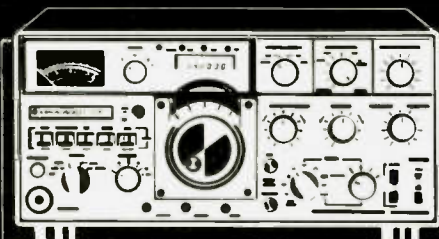

The NEW KENWOOD R-820 triple-conversion receiver

The R-820 covers 160 thru 10 meters plus several shortwave broadcast bands. Features: • 8.33 MHz, 455 kHz, & 50 kHz IFs • Digital readout • Notch filter • IF shift • Variable bandwidth tuning • Noise blanker • Stepped RF attenuator • 25 kHz calibrator • RIT switch • Modes: AM, CW, USB, LSB, RTTY • Transceive/separate switch.

To Be Announced

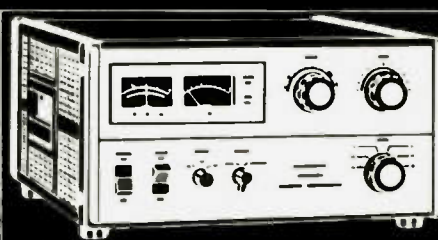

KENWOOD TL-922 linear amplifier

The TL-922 features: • 160 thru 10 meter coverage • Uses two EIMAC 3-500Z tubes • Grounded-grid AB2 • Time delay fan circuit • Drive requirements: 80W or more for full output • RF input power: 2000W PEP on SSB, 1000W DC on CW, RTTY • Power requirements: 120/220/240 VAC, 50/60 Hz • Thermal protected transformer.

1100.00 list price. Call for quote.

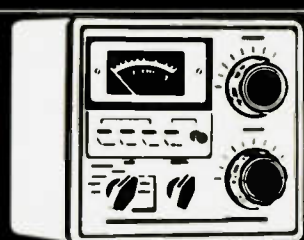

KENWOOD AT-200 antenna tuner

The NEW AT-200 is designed for your TS-820 or TS-520 series rig. It features: • Antenna coupler • Thru-line RF watt meter • SWR meter • Antenna switch • Band coverage: 1.8 to 30 MHz • Watt meter has 2 ranges: 20W and 200W • 4 outputs: 2 coax, 1 wire antenna and 1 dummy load.

149.00 list price. Call for quote.

Remember, you can Call Toll Free: 1-800-633-3410 in the U.S.A. or call 1-800-292-8668 in Alabama for our low price quote. Store hours: 9:00 AM til 5:30 PM, Monday thru Friday.



Long's Electronics



MAIL ORDERS P O BOX 11347 BIRMINGHAM, AL 35202 • STREET ADDRESS 2808 7TH AVENUE SOUTH BIRMINGHAM ALABAMA 35233

May We Suggest...

Yaesu - Call Toll Free

1-800-633-3410



YAESU FT-901 DM HF transceiver

Check these: • Reject tuning
• Variable IF band width tuning
• Audio peak frequency tuning
• Digital LED frequency display w/memory for TX & RX, no external VFO required for split frequency operation • Built-in Curtis keyer
• Rugged GE 6146B final tubes • 160 thru 10 meter coverage & much more!

1299.00 list price. Call for quote.



YAESU FT-7 HF transceiver

The NEW FT-7 features: • Frequency coverage: 10 thru 80 meters • Sensitivity: 0.5 micro volts for S/N 20 dB
• Emissions: LSB, USB, CW • Input power: 20 watts DC • Completely solid-state, single knob tune-up • X tal calibrator built-in • Semi-break-in with sidetone • Receiver offset tuning • Extremely compact for installation under dashboard.

499.00 list price. Call for quote.

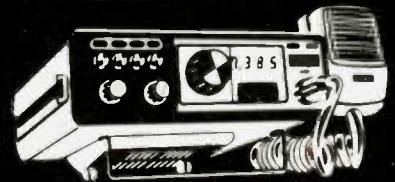

YAESU FT-227R "MEMORIZER"

• One knob channel selection using optical sensing to select 800 channels
• Memory circuit allows instant return to any frequency selected between 144-148 MHz • 4 digit LED frequency readout • Fully synthesized frequency control • Automatic final protection, PLL "unlock" protection circuit and busy channel indicator • Selectable 10 watt HI/1 watt LOW output.

319.00 list price. Call for quote.

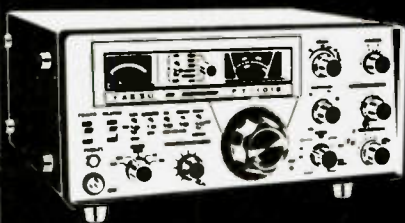

YAESU FT-101E transceiver

FT-101E is completely solid-state
• Coverage: 160 thru 10 meters • Built-in AC/DC power supplies • Built-in RF speech processor • 260 watts PEP on SSB, 180 watts on CW, 80 watts on AM
• Solid-state VFO • VOX • Auto break-in CW sidetone • WWV/JJY reception
• Heater switch.

799.00 list price. Call for quote.

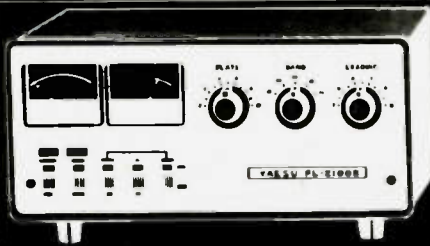

YAESU FL-2100B linear amplifier

The FL-2100B has: • 1200W PEP • Input on 80-10 meters • Easy primary voltage change: 117 to 234 VAC • Dual meters for plate current & voltage • Adjustable SWR meter • Individually tuned input coils on each band • Drive requirement: 30 to 100W.

479.00 list price. Call for quote.



YAESU FRG-7 receiver

FRG-7 features: Covers 4 bands, 0.5 to 29.9 MHz • SSB (selectable USB or LSB), AM, AM/ANL, CW • Exceptional sensitivity and stability from the Wadley Loop System • 3-position selectable RF attenuator • Auto noise suppression • AC, DC or internal battery power supply.

283.50 list price. Call for quote.

Remember, you can Call Toll Free: **1-800-633-3410** in the U.S.A. or call **1-800-292-8668** in Alabama for our low price quote. Store hours: 9:00 AM til 5:30 PM, Monday thru Friday.



Long's Electronics



MAIL ORDERS: P.O. BOX 11347 BIRMINGHAM, AL 35202 • STREET ADDRESS: 2808 7TH AVENUE SOUTH BIRMINGHAM, ALABAMA 35233

May We Suggest... Drake - Call Toll Free 1-800-633-3410

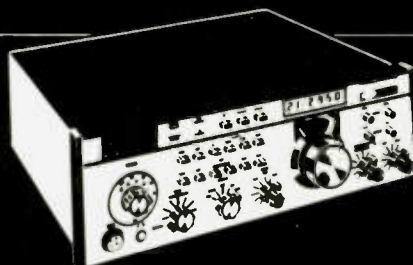

DRAKE TR-7/DR7 HF transceiver

NEW TR-7 is solid-state, continuous coverage and synthesized. TX or RX SSB, CW, RTTY, or AM independently. Noise blanker. Special high power solid-state PA. Internal test facilities: S-meter, RF wattmeter, VSWR bridge, and digital freq. counter reads to 150 MHz for tests. RIT. Power: 250W PEP input. Frequency: 1.5 to 30 MHz.

1072.00 list price. Call for quote.



DRAKE MN-4C matching network

New MN-4C features: 160 thru 10 meters coverage • Matches coax FED, long wire, or balanced line antennas with optional 4:1 balun (24 95) • Handles 250 watts continuous RF output • Built-in RF watt meter/VSWR bridge • Unique "low-pass filter" design provides significant harmonic reduction to fight TVI.

165.00 list price. Call for quote

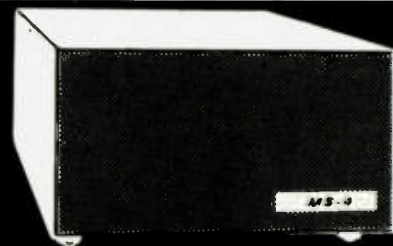

DRAKE MS-4 matching speaker

The MS-4 is designed for use with the Drake R-4C, R-4B, R-4A, & R-4 receivers. It has space inside for the Drake AC-4 power supply • The 8-ohm speaker will always come through loud and clear.

33.00 Call for yours today.



DRAKE 1525 EM microphone

The auto-patch encoder and microphone are a single unit, fully wired and ready to use • High accuracy IC tone generator, no frequency adjustments • High reliability Digitran™ keyboard • Power for tone encoder from transceiver via mic cable • Encoder audio level adjustable from 1mV to 5mV with internal potentiometer • Low output impedance • 4-pin plug.

49.95 Call for yours today.

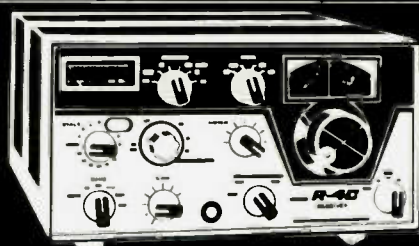

DRAKE R-4C receiver

R-4C has same coverage as the T-4XC, plus any 500 KHz range between 1.5 and 30 MHz • Also use for MARS, WWV, CB, Marine & Shortwave reception • Linear permeability-tuned VFO • 3 AGC release times • Crystal lattice filter in first IF prevents cross-modulation.

699.00 List Price. Call for quote



DRAKE T-4XC transmitter

• Coverage: 80, 40, 20, 15m & 28.5 to 29.0 MHz of 10 meters • Covers 160 meter w/accessory crystal • Two 8-pole crystal lattice filters for SSB selection • Controlled carrier modulation for AM • Built-in VOX or PTT on SSB or AM • TX AGC prevents flat-topping • RTTY easy adaption, AFSK or FSK.

699.00 List price. Call for quote.

Remember, you can Call Toll Free: 1-800-633-3410 in the U.S.A. or call 1-800-292-8668 in Alabama for our low price quote. Store hours: 9:00 AM til 5:30 PM, Monday thru Friday.



Long's Electronics



May We Suggest...

Icom - Call Toll Free

1-800-633-3410



ICOM IC-211 2m transceiver

Features: • 144 to 148 MHz coverage
• Modes: SSB, CW, FM • LSI synthesizer PLL • 4-digit LED readout
• Pulse-type noise blanker • VOX, anti-vox • Semi-break-in CW • Built-in SWR bridge • CW monitor and more!

749.00 list price. Call for quote.

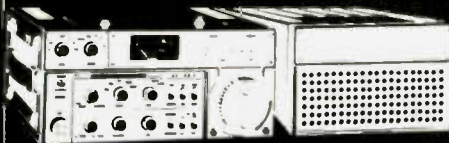

ICOM IC-701 HF transceiver

The NEW IC-701 features: • Solid-state • RF speech processor • 100 W continuous on all bands, all modes
• USB, LSB, CW, CW-N, RTTY operation • Double balanced Schottky Diode Mixer used in both RX/TX • Dual built-in digital VFO • Price includes mic & power supply.

1495.00 list price. Call for quote.



ICOM IC-22S FM transceiver

• Frequency range: 146 to 148 MHz
• Present any 15 KHz channel in the frequency synthesizer by diode matrix board • Output: 10 W HI, 1 W LOW
• Excellent spurious attenuation • 22 channels.

299.00 list price. Call for quote.

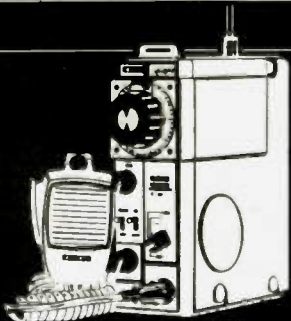

ICOM IC-215 2m FM transceiver

• 2 meter FM • 3W PEP • 15 channels, 12 by selector, 3 by function switch
• Dual power level, 3W HI for long distance, 0.5W LOW for local • Dial illumination for night use • Power pilot lamp • Frequency range: 146 to 148 MHz.

229.00 list price. Call for quote.

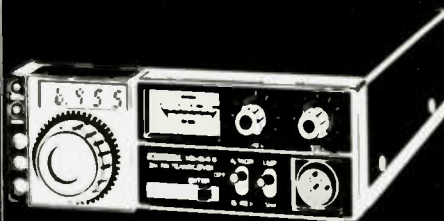

ICOM IC-245 2m transceiver

The IC-245 features: • LSI synthesizer PLL • 4-digit LED readout • TX & RX frequencies are independently programmable on any separation
• Receiver front-end is a balance of low noise, high-gain MOS-FET & 5 section filter • TX output: 10W PEP.

499.00 list price. Call for quote.

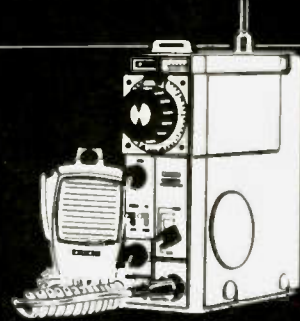

ICOM IC-502 6m SSB, CW portable

The 502 is a 6 meter SSB and CW portable with telescoping antenna & hand mic. • Frequency coverage: 50 to 51 MHz • Modulation: A3J and A1 • RF output power: A3J, 3 watts PEP and A1, 3 watts • Sensitivity: 4 microvolts for 20 dB quieting • Virtually no intermod.

249.00 list price. Call for quote.

Remember, you can Call Toll Free: **1-800-633-3410** in the U.S.A. or call **1-800-292-8668** in Alabama for our low price quote. Store hours: 9:00 AM til 5:30 PM, Monday thru Friday.



Long's Electronics



MAIL ORDERS P.O. BOX 11347 BIRMINGHAM, AL 35202 • STREET ADDRESS 2808 7TH AVENUE SOUTH BIRMINGHAM ALABAMA 35233

May We Suggest...



Dentron - Call Toll Free 1-800-633-3410



DENTRON MT-3000A antenna tuner

- 160 thru 10 meter coverage
- Handles a full 3KW PEP
- Continuous tuning 1.8-30 mc
- Built-in dual watt meters
- Built-in 50 ohm dummy load for proper exciter adjustment
- Antenna selector switch enables you to by-pass the tuner direct or select the dummy load or 5 other antenna systems

349.50 list price. Call for quote



DENTRON MT-2000A antenna tuner

An economical full power tuner, designed to handle virtually any type of antenna. Features • Continuous tuning 1.8 to 30 MHz • Handles a full 3 KW PEP • Front panel coax bypass switching • Built-in 3-core balun • Front panel grounding switch • Sleek styling to match other Dentron units

199.50 list price. Call for quote

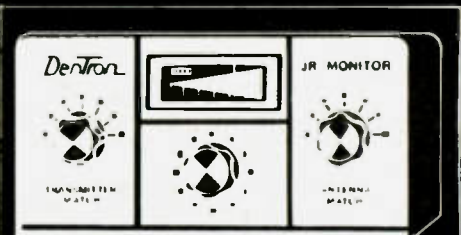

DENTRON Jr. Monitor

Call it what you will antenna tuner, transmatch, matchbox or matching network, the Jr. Monitor has it all wrapped up in one neat, little cabinet. • Continuous tuning 1.8 to 30 MHz • Forward reading relative output power meter • 300 watt power capability • Built-in encapsulated balun

79.50 Call for yours today



DENTRON 160-10AT super tuner

Balanced line, coax cable, random, or long wire antennas, the 160-10AT will match it—160 thru 10 meters • Continuous tuning, 1.8-30 mc • 3 inputs • Handles 500 watts DC, 1000 watts PEP • Heavy duty, 2-core Balun (3" dia. x 3" H) • Tapped inductor #12 ga. wire

129.50 list price. Call for quote



DENTRON MLA-2500 linear amplifier

Features • 160 thru 10 meters • 2000 watts PEP input on SSB • 1000 watts DC input on CW RTTY SSTV • Self-contained continuous duty power supply • Covers MARS w/o modification • 50 ohm input/output impedance

799.50 list price. Call for quote



DENTRON W-2 wattmeter

The W-2 lets you read forward and reflected watts at the same time. • Forward watt scale 2000 or 200 • Reflected watt scale: 200 watts • Low insertion loss • Frequency range 1.8 to 30 MHz • Accuracy: 5% • Two 50-239 connectors • Sensor box may be extended 4 feet

89.55 Call for yours today

Remember, you can Call Toll Free: **1-800-633-3410** in the U.S.A. or call **1-800-292-8668** in Alabama for our low price quote. Store hours: 9:00 AM til 5:30 PM, Monday thru Friday.



Long's Electronics



MAIL ORDERS P.O. BOX 11347 BIRMINGHAM AL 35202 • STREET ADDRESS 2808 7TH AVENUE SOUTH BIRMINGHAM ALABAMA 35233

May We Suggest...



Mosley - Call Toll Free

1-800-633-3410

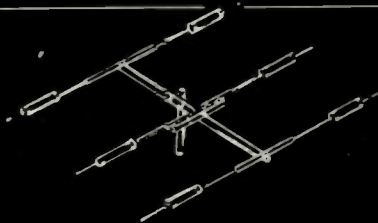

MOSLEY TA-33 3-element tri-band beam

The TA-33 has 10.1 dB forward gain (over isotropic source) • Front-to-back ratio: 20 dB • Power rating: 2 KW PEP SSB input • Exceptional broadband — gives excellent results over full ham bandwidth • VSWR at Resonance 1.5:1 or better • Boom length 14' • Longest element 28' • Wind surface area 5.7 sq ft

206.50 list price. Call for quote

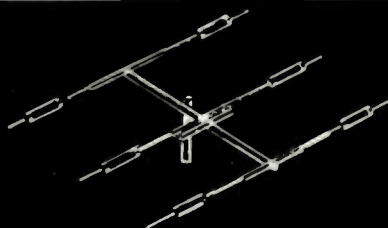

MOSLEY CL-33 3-element beam

The CL-33 has 10.1 dB forward gain (over isotropic source) • Front-to-back ratio: 20 dB • Power rating 2 KW PEP SSB input • VSWR at Resonance 1.5:1 or better • Boom length 18' • Longest element 27' • Wind surface area 6 sq ft • Patented Classic Feed System

232.50 list price. Call for quote

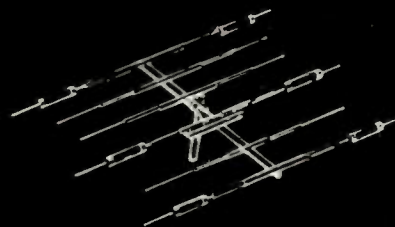

MOSLEY TA-36 6-element tri-band beam

The TA-36 features 10.1 dB forward gain (over isotropic source) • Front-to-back ratio: 20 dB • Power rating 2 KW PEP SSB input • VSWR at Resonance 1.5:1 or better • Boom length 24' • Longest element 29' • Wind surface area 10.7 sq ft • 10, 15, 20 meters

335.25 list price. Call for quote

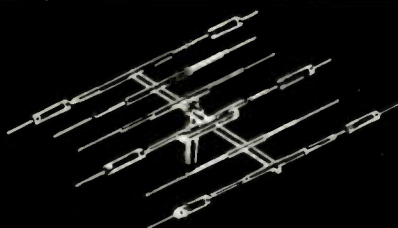

MOSLEY CL-36 6-element tri-band beam

The CL-36 features 10.1 dB forward gain (over isotropic source) • Front-to-back ratio: 20 dB • Power rating: 2 KW PEP SSB input • VSWR at Resonance 1.5:1 or better • Boom length 24' • Longest element 29'9" • Wind surface area 10.7 sq ft • 10, 15, 20 meters • Patented Classic Feed System

310.65 list price. Call for quote

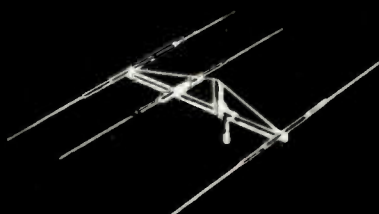

MOSLEY CL-203 3-element 20m beam

The CL-203 has 10.1 dB forward gain (over isotropic source) • Front-to-back ratio: 20 dB • Power rating 2 KW PEP SSB input • VSWR at Resonance 1.5:1 or better • Boom length 24' • Longest element 37'8" • Wind surface area 6.8 sq ft

235.65 list price. Call for quote

MOSLEY RV-4C vertical antenna

The RV-4C self-supporting vertical features: • Power rating 2000 watts PEP SSB input • Feet Point Impedance 52 ohms • VSWR at Resonance 1.5:1 or better • Height 22' • Max. radial length 34'7" • Wind surface area 2.049 sq ft • Covers 10, 15, 20 & 40 meters

63.35 Call for yours today.



Remember, you can Call Toll Free: **1-800-633-3410** in the U.S.A. or call **1-800-292-8668** in Alabama for our low price quote. Store hours: 9:00 AM til 5:30 PM, Monday thru Friday.



Long's Electronics

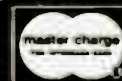

MAIL ORDERS P.O. BOX 11347 BIRMINGHAM, AL 35202 • STREET ADDRESS 2808 7TH AVENUE SOUTH BIRMINGHAM, ALABAMA 35233

RAMmed By Morrow

—ECONORAM III lauded

It wasn't long after I put my ECONORAM II (ER II) memory board into service that I decided that 8K was just not enough RAM. I was about to order another ER II when I saw the ad for the

ECONORAM III (ER III). For the same price (\$188), Thinker Toys* was selling an assembled 8K dynamic RAM

*Thinker Toys, 1201 10th Street, Berkeley CA 94710.

board. Since I had not had any experience with dynamic memory boards, I ordered one.

Imagine my surprise when I received not only my ER III, but also a check for

thirty-nine dollars, because the price had been reduced to \$149! Thinker Toys' ad states a kit price of \$159, which means that you have to pay a premium of ten dollars if you wish to assemble it yourself. How's that for a switch? If it won't work with your S-100 computer, a complete refund is offered.

In comparing it to the ER II, I find that they both are configured in 4K blocks that can be addressed separately anyplace in memory. ER II has a software and hardware read-only feature, while ER III can be protected only with a built-in switch. The ER III has on-board refresh which is transparent to the CPU. This means that it looks like a static RAM board, as far as the processor is concerned.

Whereas the ER II comes with a four-page instruction sheet, the ER III arrives with a twenty-six page manual. This manual has sections on theory, operation, memory diagnostic tests (in both hex and octal), parts, schematics, and assembly instructions. This last section seems superfluous. I can't quite see them selling too many kits.

Since ER III arrives completely assembled, all that is necessary to put it to work is to set the desired addresses on the switches and make sure that the read-write switch is placed on write. A long run of both my memory diagnostic test and theirs failed to indicate any problems, and none has shown up since.

Three advantages of dynamic RAM, as opposed to the static type, are higher bit density, lower power consumption, and lower cost per bit. I have used ER II and ER III interchangeably and have not noticed any differences between them. Apparently, neither has my processor.

ECONORAM II and ECONORAM III offer the memory buyer a choice of static or dynamic RAM and a very good value for his money. ■

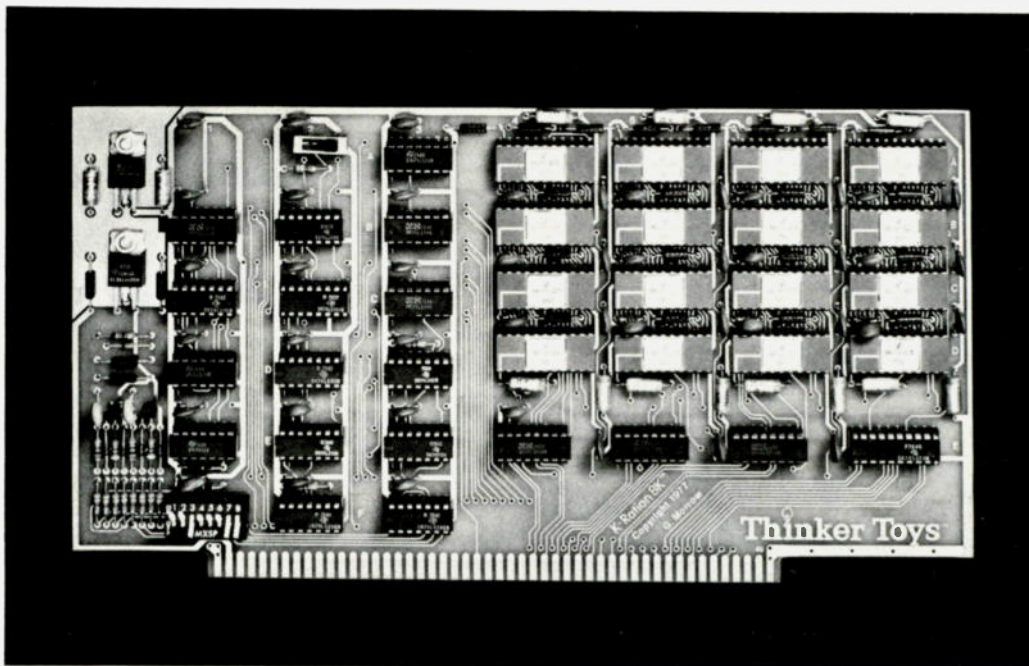

ECONORAM III 8K dynamic memory board. 4K memory chips can be seen in the upper right corner of the board. Note the lack of heat sinks on the voltage regulators. The low current requirements of the board make them unnecessary. Designed by George Morrow.

NEW!

"INDUSTRIAL" WIRE-WRAPPING TOOL

MODEL BW928

\$49⁹⁵

BATTERIES NOT INCLUDED
BIT & SLEEVE NOT INCLUDED

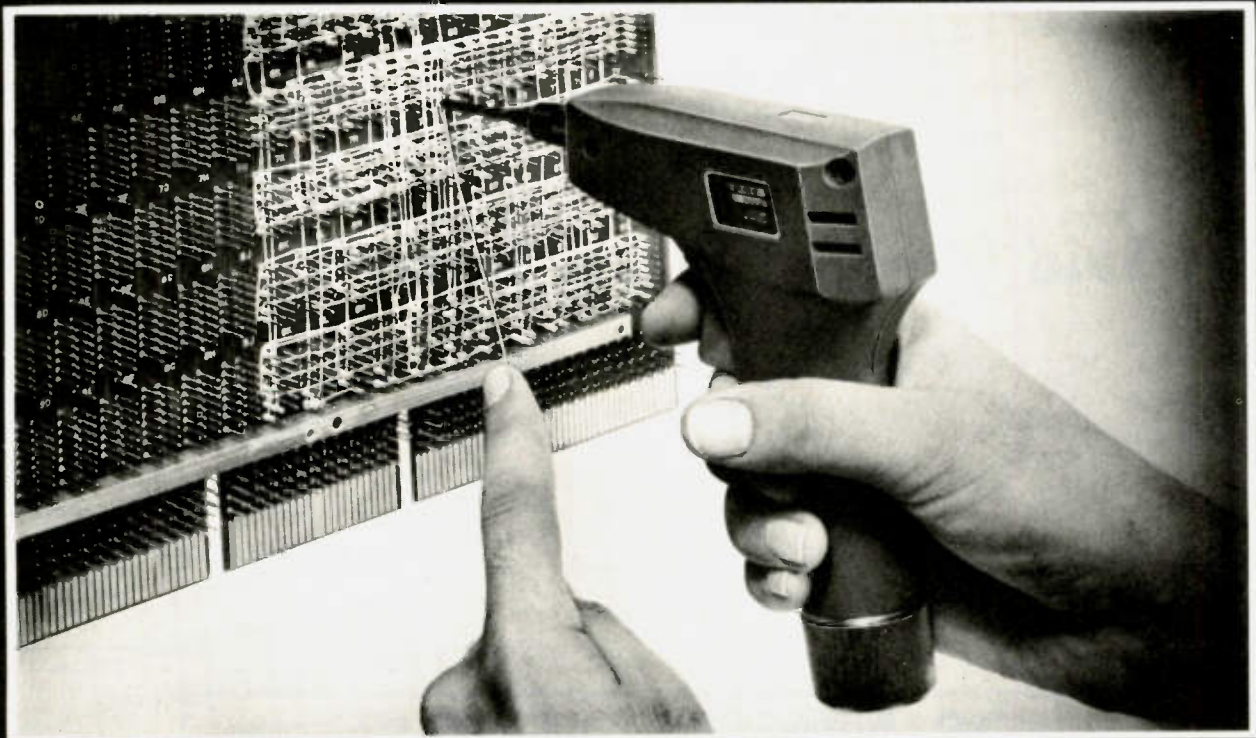

- BATTERY OPERATED
(2) Standard "C" Ni Cad Batteries (not included)
- INTERCHANGEABLE BITS & SLEEVES
(not included)
- REVERSIBLE ROTATION
For unwrapping, reverse batteries
- BACKFORCE OPTIONAL
Model BW928-BF \$52.95
- POSITIVE INDEXING
- LIGHT WEIGHT
*LEXAN™ Housing

*LEXAN™ GENERAL ELECTRIC



OK MACHINE & TOOL CORPORATION 05
3455 Conner St., Bronx, N.Y. 10475 • (212) 994-6600 • TELEX 125091

A048	0100									Set program counter
0100	CE	0200								LDX message pointer
0103	A6	00								LDA A O,X
0105	81	04								CMP A EOT
0107	26	06								BNE
0109	7F	A049								CLR
010C	7E	EOE3								JMP to control
010F	BD	E1D1								JSR OUTEEE
0112	08									INX
0113	20	EE								BRA
0200	48	45	4C	4C	4F					HELLO
0205	20									Space
0206	49									I
0207	20									Space
0208	41	4D								AM
020A	20									Space
020B	41									A
020C	20									Space
020D	53	57	54	50	43					SWTPC
0212	20									Space
0213	36	38	30	30						6800
0217	20									Space
0218	43	4F	4D	50	55	54	45	52		COMPUTER
0220	21									!
0221	04									EOT

Fig. 1. Program listing.

The big moment is at hand. Your 6800-based microprocessor from Southwest Technical is finally assembled. You've sprung for the MP-68 computer and the CT-64 terminal with monitor. You are all set! You have convinced yourself you'll be

Charles E. Thomas WA3MWM
7022 Blackhawk
Pittsburgh PA 15218

satisfied with machine language for a long time or at least until your BASIC arrives.

Well, surprise! After running diagnostic programs through the memory ten different ways, it still hasn't done or said anything. Even tic-tac-toe is an anticlimax when it takes two hours to be typed in by hand.

This short machine-language program allows you to print out a short message on your monitor. To place a message in the computer, you must refer to the ASCII hexadecimal chart supplied with your documentation notebook. This is necessary to translate your message in English into the ASCII code. Just to be sure that you get the idea, I will provide you with an example. The program will print the message, "HELLO I AM A SWTPC 6800 COMPUTER!" The message can be as long as you wish — just be sure to terminate it with 04. This tells the computer the message is over.

The program instructions are found in memory locations 0100 through 0114. The actual message is found between locations 0200 and 0221.

Now it does do something! Now you have just begun . . . ■

Six Said His First Word Today!

—and you taught him how

*G HELLO I AM A SWTPC 6800 COMPUTER!

Fig. 2. Sample run.

IDS

INTERNATIONAL DATA SYSTEMS, INC.
400 North Washington Street, Suite 200, Falls Church, Virginia 22046 U.S.A.

Telephone
(703) 536-7373

MORSE CODE TRAINER/KEYER! The MCTK is a hardware/software package which allows your computer to TEACH Morse Code, key your transmitter, and send prestored messages. Uses "New Code Method" for Morse training. The MCTK is optically isolated from your computer and is also mechanically isolated from your transmitter! BASIC programs are included written in MITS BASIC, PTCO BASIC5, and North Star BASIC. Kit Price \$29.00. Delivery is from stock.

110

Write or call for detailed product brochures. Many other items available. Payment with order shipped prepaid. Master Charge.



wire wrapping center

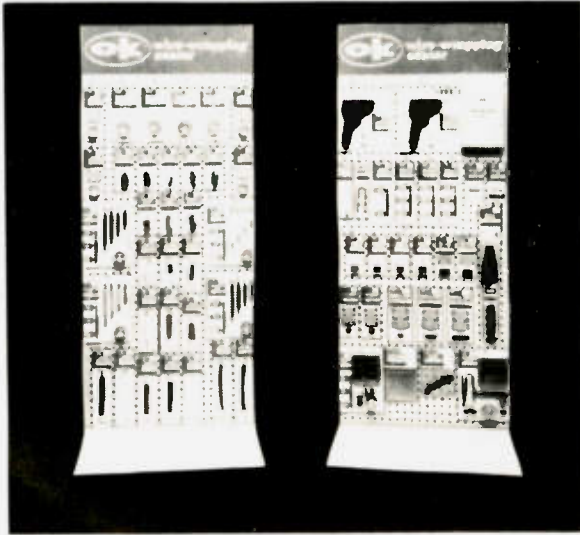

for quality electronic parts and tools.

DIP/IC INSERTION TOOL WITH PIN STRAIGHTENER



STRAIGHTEN PINS RELEASE PICK-UP INSERT

14-16 Pin Dip IC Inserter INS-1416

DIP/IC EXTRACTOR TOOL

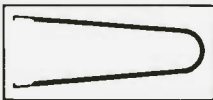

The EX-1 Extractor is ideally suited for hobbyist or lab engineer. Featuring one piece spring steel construction. It will extract all LSI, MSI and SSI devices of from 8 to 24 pins.

Extractor Tool EX-1

WIRE-WRAPPING KIT

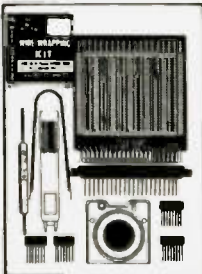

Contains: Hobby Wrap Tool WSU-30 M, Wire Dispenser WD-30-B, (2) 14 DIP's, (2) 16 DIP's, Hobby Board H-PCB-1, DIP/IC Insertion Tool INS-1416 and DIP/IC Extractor Tool EX-1

Wire-Wrapping Kit WK-4B (Blue)

STRIP WRAP UNWRAP

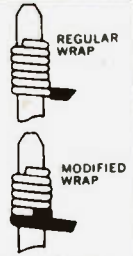

HOBBY WRAP
TOOL

Wire-wrapping, stripping, unwrapping tool for AWG 30 on .025 (0.63mm) Square Post.

Regular Wrap	WSU-30
Modified Wrap	WSU-30M

NEW

HOBBY WRAP
Model: BW-630



Battery
wire
wrapping
tool
COMPLETE
WITH BIT
AND SLICE

WIRE-WRAPPING TOOL

For .025" (0.63mm) sq. post "MODIFIED" wrap, positive indexing, anti-overwrapping device.

For AWG 30	BW-630
For AWG 26-28	BW-2628

Bit for AWG 30	BT-30
Bit for AWG 26-28	BT-2628

*USE "C" SIZE NI-CAD BATTERIES

(NOT INCLUDED)

ROLLS OF WIRE

Wire for wire-wrapping AWG-30 (0.25mm) KYNAR® wire, 50 ft. roll, silver plated, solid conductor, easy stripping.



1/2" AWG Blue Wire 50ft Roll	R 30B 0050
3/4" AWG Yellow Wire 50ft Roll	R 30Y 0050
1" AWG White Wire 50ft Roll	R 30W 0050
3/4" AWG Red Wire 50ft Roll	R 30R 0050

WIRE DISPENSER



- With 50 ft. Roll of AWG 30 KYNAR® wire-wrapping wire.
- Cuts the wire to length.
- Strips 1" of insulation.
- Refillable (For refills, see above)

Blue Wire	WD-30-B
Yellow Wire	WD-30-Y
White Wire	WD-30-W
Red Wire	WD-30-R

RIBBON CABLE ASSEMBLY SINGLE ENDED



With 14 Pin Dip Plug 24" Long (609mm)	SE14-24
With 16 Pin Dip Plug 24" Long (609mm)	SE16-24

RIBBON CABLE ASSEMBLY DOUBLE ENDED

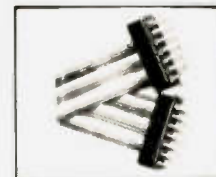

With 14 Pin Dip Plug - 2" Long	DE 14-2
With 14 Pin Dip Plug - 4" Long	DE 14-4
With 14 Pin Dip Plug - 8" Long	DE 14-8
With 16 Pin Dip Plug - 2" Long	DE 16-2
With 16 Pin Dip Plug - 4" Long	DE 16-4
With 16 Pin Dip Plug - 8" Long	DE 16-8

OK MACHINE & TOOL CORPORATION

3455 CONNER STREET, BRONX, N. Y. 10475 U.S.A.

PHONE (212) 994-6600 TELEX NO. 125091

As you can see from the absence of schematics or block diagrams, this is not a construction article. Many articles have appeared in hobbyist and professional computer magazines regarding interfacing to and from micro-computers. You can find data about communicating with a keyboard, a printer, a cassette recorder, and many other devices including your TV.

A big difference with the interface described here is that no additional hardware will need to be built. The interface is bidirectional, using the same "terminal" for input and output, and you already have the terminal. The data transfer rate is instantaneous.

The terminal is the most complicated data-processing device in existence — your

The Occult Computer

— test for ESP with a micro

LIST

```

10 REM PROGRAM TO EVALUATE ESP
15 REM WRITTEN BY G.W.FLEMMING
20 REM 18 MAY 1977
25 CLEAR 100
30 DIM DS(25),CS(25)
40 Z=0:T=0
50 PRINT" THIS PROGRAM IS USED TO EVALUATE THE POSSIBILITY"
55 PRINT"OF ESP ( EXTRA-SENSORY PERCEPTION ) IN AN"
60 PRINT"INDIVIDUAL. THE TEST IS PATTERNED AFTER TESTS"
65 PRINT"BEING RUN IN PARAPSYCHOLOGY LABORATORIES."
70 PRINT
80 INPUT"NAME OF PERSON DOING TEST"JNS
90 PRINT"DO YOU WANT TO GUESS BEFORE OR AFTER THE"
95 INPUT"COMPUTER SETS-UP THE DECK (BEFORE OR AFTER)"JAS
110 IF LEFTS(AS,1)="A" THEN GOSUB 500
113 PRINT
120 PRINT"YOUR GUESSES (* + = $ #):"
125 PRINT" ....I....I....I....I....I"
130 INPUT GS
135 GOTO 1100
140 IF LEFTS(AS,1)<>"A" THEN GOSUB 500
200 REM COMPARISON ROUTINE
210 N=0
220 FOR I=1 TO 25
230 IF MIDS(GS,I,1)=DS(I) THEN N=N+1
240 NEXT I
300 REM OUTPUT RESULTS
310 PRINT:PRINT"RESULTS:"
320 PRINT"MY DECK:  "
330 FOR I=1 TO 25
340 PRINTDS(I);
350 NEXT I
360 PRINT
370 PRINT"YOUR GUESSES:"JGS
375 GOSUB 999
380 PRINT"YOU HAD"JN;"CORRECT, WHICH IS"JN/25*100;"%."
400 Z=Z+N:T=T+1
450 INPUT"ANOTHER TRY (Y OR N)"JTS
460 IF LEFTS(TS,1)="Y" THEN 110
465 PRINT:PRINT
470 PRINT"THE RESULTS FOR ALL OF THE TRIES FOR "JNS
475 PRINT"ARE "JZ;"CORRECT OUT OF"JT*25;"CARDS."
480 PRINT"THIS IS AN AVERAGE OF"JZ/T/25*100;"%."
485 PRINT"REMEMBER, CHANCE WOULD BE 20%."
486 PRINT"TRY AGAIN SOME TIME....."
487 PRINT:PRINT:PRINT
490 END
500 REM ROUTINE TO CREATE A 25 CARD DECK
510 REM FIRST FILL DECK WITH LETTER A'S
515 FOR I=1 TO 25
520 DS(I)="A"
525 NEXT I
530 REM PLACE 5 *'S AT RANDOM IN DECK
535 FOR Q=1 TO 5
540 R=INT(25*RND(8))+1
550 IF DS(R)<>"A" THEN 540
560 DS(R)="*"
570 NEXT Q
600 REM PLACE 5 +'S AT RANDOM IN DECK
610 FOR Q=1 TO 5
620 R=INT(25*RND(8))+1
630 IF DS(R)<>"A" THEN 620
640 DS(R)="+"
650 NEXT Q
700 REM PLACE 5 #'S AT RANDOM IN DECK
710 FOR Q= 1TO5
720 R=INT(25*RND(8))+1
730 IF DS(R)<>"A" THEN 720
740 DS(R)="#"
750 NEXT Q
800 REM PLACE 5 $'S AT RANDOM IN DECK
810 FOR Q= 1TO5
820 R=INT(25*RND(8))+1
830 IF DS(R)<>"A" THEN 820
840 DS(R)="$"
850 NEXT Q
900 REM FILL REMAINING CARDS AS #'S
910 FOR Q=1 TO 25
920 IF DS(Q)="A" THEN DS(Q)="#"
930 NEXT Q
940 REM RETURN TO PROGRAM WITH 25 CARD DECK
950 RETURN
999 REM ROUTINE FOR ADDING ; TO MARK CORRECT MATCHES
1000 FOR I=1 TO 25
1001 CS(I)=" "
1002 NEXT I
1005 FOR I=1 TO 25
1010 IF DS(I)=MIDS(GS,I,1) THEN CS(I)="#"
1020 NEXT I
1030 PRINT"RIGHT....."
1040 FOR I=1 TO 25
1050 PRINTCS(I);
1060 NEXT I
1070 PRINT
1080 RETURN
1100 REM ERRDR ROUTINE FOR INPUT
1110 IF LEN(GS)<25 THEN 1150
1120 IF LEN(GS)>25 THEN 1180
1130 GOTO 140
1150 PRINT"YOU DID NOT ENTER ENOUGH CHARACTERS...TRY AGAIN."
1155 GOTO 120
1180 PRINT"YOU PUT IN TOO MANY CHARACTERS. ONLY THE FIRST"
1185 PRINT"25 WILL COUNT."
1190 GOTO 140
OK

```

Fig. 1. Program listing.

A Baudot Program For Your Micro

— simulated Vegas visit

Anyone who has ever been to Las Vegas is familiar with one of the most fiendish machines known to the mind of man. This ubiquitous device, designed to separate the victim from his change, is the slot machine, alias the "one-armed bandit."

The slot machine is everywhere — casinos, motels, banks, restaurants, even (rumor has it) pay toilets. They are designed to accept

coins of all denominations except pennies.

Since casino gambling has been approved by the New Jersey legislature, it will no longer be necessary for us east coast people to travel to Las Vegas to dispose of our spare cash.

However, with this program, it is possible to enjoy the thrill of victory and the agony of defeat at the hands of an inanimate object with-

out the normally attendant cash flow problems. The money saved by using this program could easily pay for another peripheral for your computer.

I got the idea for this program when I was browsing through a paperback book entitled *Gambler's Digest*. The Wang 2200 minicomputer which I have been using had several gambling game programs on a diskette, but

the one for the slot machine had some kind of bug in it which made it inaccessible (at least to me) on the floppy. I had been toying with the idea (no pun intended) of programming the Wang to simulate a slot machine, but I wanted it to be realistic. I needed a list of relative probabilities for cherry, orange, bell, etc., and the normal payoffs. I found them in the *Gambler's Digest*.

There are many different slot machine configurations. The one I used is typical of many. It has three reels, and each reel has twenty symbols. This leads to $20 \times 20 \times 20 = 8,000$ possible combinations. A jackpot is three bars. Since the bar appears once on the first reel, three times on the second reel, and once on the third reel, there are $1 \times 3 \times 1 = 3$ possible ways to hit the jackpot in 8,000 combinations. To get some idea of the house odds, consider the winning combinations and their payoffs as shown in Table 1. For each 8,000 dollars that go into the slot, only \$5,957 are returned as

Fig. 1. Program listing.

```

10 REM*****SLOT MACHINE*****
150 REM INITIALIZE REELS
20 REM PROGRAM WRITTEN BY VICTOR R. FRICKE
160 FOR I=1 TO 3:FOR J=1 TO 20:READ R(I,J):NEXT
    J:NEXT I
30 REM BASED ON LAS VEGAS ODDS AND PAYOFFS
170 REM INSTRUCTIONS
40 REM DATA FOR REELS 1,2,AND 3
180 PRINT HEX(03):PRINT "I AM THE COMPUTER SLOT
    MACHINE."
50 REM 1=BELL, 2=CHERRY, 3=LEMON, 4=BAR, 5=ORANGE,
    6=PLUM
190 FOR I=1 TO X1:NEXT I
60 DATA 2,6,3,2,6,5,2,3,6,2,4,2,6,5,2,3,6,2,5,1
200 PRINT :PRINT "I AM DIRECTLY CONNECTED TO THE
    PAYROLL COMPUTER."
70 DATA 2,4,5,2,1,5,2,4,5,2,1,2,5,4,2,1,5,2,6,5
210 FOR I=1 TO X1:NEXT I
80 DATA 5,6,1,5,3,6,5,3,1,5,6,4,5,3,5,6,1,5,6,3
220 PRINT :PRINT "WIN, AND I WILL PAY YOU HANDSOMELY."
90 DIM S$(6)8,R(3,20),X$8,Y$8,Z$8
230 FOR I=1 TO X1:NEXT I
100 X1=700:A=1:B=1:C=1
240 PRINT :PRINT "LOSE, AND I SHOW NO MERCY."
110 D=100
250 FOR I=1 TO X1:NEXT I
120 REM SET UP LIST OF SYMBOLS
260 PRINT HEX(03):PRINT "YOU ARE STARTING WITH A
    STAKE OF $100."
130 S$(1)="**BELL**":S$(2)="*CHERRY*":S$(3)="*LEMON**"
140 S$(4)="**BAR**":S$(5)="*ORANGE*":S$(6)="**PLUM**"

```

```

270 PRINT "TO START THE GAME, PRESS 'EXECUTE'.
      EACH TIME YOU"

280 PRINT  PRESS 'EXECUTE', YOU ARE FEEDING ME A
      DOLLAR AND"

290 PRINT  PULLING MY ONE-ARM"

300 INPUT A$

310 REM ROLL THE REELS

320 PRINT HEX(03):PRINT TAB(19);"=====
      ====="

330 R1=INT(RND(1)*35):R2=INT(RND(1)*35)+R1:R3=
      INT(RND(1)*35)+R2:I=1

340 IF I>R1 THEN 370

350 GOSUB 840

360 A=A+1:B=B+1:C=C+1:GOTO 430

370 IF I>R2 THEN 400

380 GOSUB 840

390 B=B+1:C=C+1:GOTO 430

400 IF I>R3 THEN 490

410 GOSUB 840

420 C=C+1

430 I=I+1

440 IF A<21 THEN 450:A=1

450 IF B<21 THEN 460:B=1

460 IF C<21 THEN 470:C=1

470 GOTO 340

480 REM CALCULATE PAYOFFS

490 X$=S$(R(1,A)):Y$=S$(R(2,B)):IF C<>1THEN
      500:C=21

500 C=C-1:Z$=S$(R(3,C))

510 IF X$<>"**BAR**"THEN 550

520 IF Y$<>"**BAR**"THEN 550

530 IF Z$<>"**BAR**"THEN 550

540 D=D+85:GOTO 780

550 IF X$<>"**BELL**"THEN 600

560 IF Y$<>"**BELL**"THEN 600

570 IF Z$<>"**BELL**"THEN 590

580 D=D+18:GOTO 780

590 IF Z$="**BAR**"THEN 580

600 IF X$<>"**PLUM**"THEN 650

610 IF Y$<>"**PLUM**"THEN 650

620 IF Z$<>"**PLUM**"THEN 640

630 D=D+14:GOTO 780

640 IF Z$="**BAR**"THEN 630

650 IF X$<>"**ORANGE**"THEN 700

660 IF Y$<>"**ORANGE**"THEN 700

670 IF Z$<>"**ORANGE**"THEN 690

680 D=D+10:GOTO 780

690 IF Z$="**BAR**"THEN 680

700 IF X$<>"**CHERRY**"THEN 770

710 IF Y$<>"**CHERRY**"THEN 770

720 IF Z$<>"**LEMON**"THEN 740

730 D=D+5:GOTO 780

740 IF Z$="**BELL**"THEN 730

750 D=D+3:GOTO 780

760 REM PRINT RESULTS

770 D=D-1

780 IF D<200 THEN 800

790 PRINT "MY COIN TRAY IS FULL. PLEASE PUT SOME
      COINS IN YOUR POCKET.":GOTO 820

800 IF D>10 THEN 820

810 PRINT "SAVE A BUCK FOR CAB FARE, SUCKER!":STOP

820 PRINT "$";D;" LEFT"

830 GOTO 300

840 PRINT TAB(19);"!";S$(R(1,A));S$(R(2,B));S$(R(3,C));
      "!";HEX(0D)

850 PRINT HEX(0A);TAB(19);"=====
      HEX(0D0C):RETURN

860 END

```

Combination	Reel 1	Reel 2	Reel 3	Total	Payoff	Total Paid
BarBarBar	1	3	1	3	85	255
BellBellBell	1	3	3	9	18	162
BellBellBar	1	3	1	3	18	54
PlumPlumPlum	5	1	5	25	14	350
PlumPlumBar	5	1	1	5	14	70
OrangeOrangeOrange	3	6	7	126	10	1260
OrangeOrangeBar	3	6	1	18	10	180
CherryCherryLemon	7	7	4	196	5	980
CherryCherryBell	7	7	3	147	5	735
CherryCherryAny	7	7	13	637	3	1029

Total amount paid in 8,000 tries
House odds 2043/8000 = 25.5%

5,957

Table 1. Payoff combinations in 8,000 tries.

payoffs, giving the house an edge of more than 25%. And

that doesn't take into account the fact that nearly

all of the payoff money is fed right back into the machine.

Program Features

The program simulates the operation of a slot machine and keeps a running total of funds remaining. On the Wang 2200, it takes about 3.2K words of memory. Hex codes are used on the Wang for cursor control. HEX(03) clears the screen and homes the cursor (top left). HEX(0D) returns the cursor to the left end of the current line. HEX(0C) moves the cursor up one line. HEX(0A) moves it down one line. ■

Ham Help

May I take advantage of this column to put out a CQ for any YL pen pals (age 21-22)? I'd like to correspond with, and possibly meet, any YLs having an interest in ham radio. I am presently in the merchant navy working as an electronics officer on the large supertankers "drifting" between Europe and the Gulf states. As of yet, I haven't been allowed to work/MM but would very much like

to do so, if it became possible. I'd also like to hear from any PET users in the USA, especially any with Morse/RTTY encoder/decoder software.

All replies will be answered.

Nigel R. Huntley G4CDU
212 St. Stephens Road
Saltash
Cornwall PL12 4NL
England

I would like to invite all hams

employed by Hewlett-Packard to join with us at the Eastern Regional Repair Center (ERRC) and Sales Office, Paramus NJ, in the formation of an active H-P Amateur Radio Club. We are just getting started and are open to new members and new ideas. We have in mind nets, field days, and fun, as well as getting to know others in the worldwide H-P organization. Anyone interested in signing up and/or starting their own chapter should contact me at the ERRC.

Geoffrey K. Doll WB2KJF
H-P ERRC
Paramus NJ 07652

mitter? I have one, and want to convert it to use on CW, as it does cover three of the ham bands. It uses two 1625s in the final, two 1625s as modulators, and three 12A6s, too. If you have anything on this transmitter and will mail it to me, I will purchase it from you by return mail. Anything helpful would be appreciated.

Olen Craig W6DIG
2248 Gale Ave.
Long Beach CA 90810

I am in need of a schematic and manual for a Knight Model T-175 6/10 meter linear amplifier. I have tried every place I can think of. This column is my last hope!

Charles Weatherbee WD4CGX
6220 E. 4th Ave.
Hialeah FL 33013

I would like to get in touch with licensed amateurs in the USA who are railwaymen like myself.

Martin Michaelis DK1MM
Waldvereinsweg 5a
D 8400 Regensburg
West Germany

I am looking for a schematic for a crystal receiver for the AM broadcast band—the simpler, the better.

Hersh Goldberg VE3JBU
PO Box 913 Sta. B
Ottawa
Ontario K1P 5P9
Canada

I need any information available (schematic, manual, etc.) on the ARC-33/RT-173 surplus transceiver. I'm particularly interested in modification for use on 220 MHz.

Tom Workman K0TW
8656 W. 66th Place
Arvada CO 80004

I'm looking for someone who can repair an old McElvoy (standard model Mac key) bug.

Tom Schlechte
1021 Hunt Ave.
Lakeland FL 33803

TELETYPE® MODEL 33 ASR

COMPUTER I/O COMPLETE WITH:

- Tape Punch
- Ready to Go
- Tape Reader
- Line/Local Wired
- Guaranteed 30 Days

\$840⁰⁰

INCLUDING PACKING
F.O.B. - N.J. FACTORY

COMPLETE COVER READY TO INSTALL \$ 35.00
COPY HOLDER (182036) \$ 14.00
TAPE UNWINDER (12" NEW) \$ 56.00
WIND UP PAPER TAPE WINDER (1") \$ 52.00
ELECTRIC PAPER WINDER (LPW-300 NEW) \$ 50.00
DEC TYPE READER RUNCARD \$ 45.00
ACOUSTIC COUPLER \$ 160.00
OMNITEK 501A (NEW) \$ 35.00
READER POWER PACK (182134) \$ 55.00
EIA RS-232 INTERFACE \$ 55.00
ACOUSTIC COVERS with FAN (NEW) \$258.00

If its for TELETYPE® We Have It.

If you don't see what you need. CALL or WRITE!



TELETYPEWRITER COMMUNICATIONS SPECIALISTS

550 Springfield Avenue • Berkeley Heights, N. J. 07922
(201) 464-5310 • TWX: 710-986-3016 • TELEX: 13-6479

T13

SUBSIDIARY OF VAN'S W2DLT ELECTRONICS.

I desperately need any circuit diagrams, ideas, or technical suggestions for the construction of any audio oscillator, signal generator, or similar gadget that could transmit over short distances (300-400 feet) and be received at, or through, a mobile tape player. The gadget should be similar to a "wireless microphone," but for tape players. Basic modulation, such as a tone beep, would be more than enough.

Dennis P. Sladen VE3DPS
17 Glenshephard Dr.
Scarborough
Ontario M1K 4N2
Canada

I'm having problems hooking up my Tempo 2020 without causing TVI in my townhouse. The closely-run townhouse complex will not allow outside antennas, so I am relegated to a dipole, or something, in the attic. Also, I'm a Technician and desperately need someone to help me get in gear with my code, so I can upgrade. Can someone help this fledgling amateur?

Nolan E. Kienitz WB5WAX
497 Madison Drive
East Windsor NJ 08520
(609)-443-3433

Does anyone have any info on a surplus Navy TCS trans-

ELECTRONIC SYSTEMS

P.O. Box 9641 San Jose, CA 95157 (408) 374-5984

FOR CATALOG INCLUDING PARTS LISTS AND SCHEMATICS,
SEND A SELF ADDRESSED ENVELOPE WITH 24¢ POSTAGE.

RS-232/TTY* INTERFACE **NEW**

- Part no. 600
- Converts RS-232 to 20mA current loop, and 20mA current loop to RS-232
 - Two separate circuits
 - Requires +12 and -12 volts
 - Board only \$4.50, with parts \$7.00

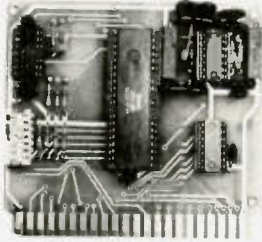

UART & BAUD RATE GENERATOR*

- Part no. 101
- Converts serial to parallel and parallel to serial
 - Low cost on board baud rate generator
 - Baud rates: 110, 150, 300, 600, 1200, and 2400
 - Low power drain +5 volts and -12 volts required
 - TTL compatible
 - All characters contain a start bit, 5 to 8 data bits, 1 or 2 stop bits, and either odd or even parity.
 - All connections go to a 44 pin gold plated edge connector
 - Board only \$12.00; with parts \$35.00

RS-232/TTL INTERFACE*



- Part no. 232
- Converts TTL to RS-232, and converts RS-232 to TTL
 - Two separate circuits
 - Requires -12 and +12 volts
 - All connections go to a 10 pin gold plated edge connector
 - Board only \$4.50; with parts \$7.00

DC POWER SUPPLY*



- Part no. 6085
- Board supplies a regulated +5 volts at 3 amps., +12, -12, and -5 volts at 1 amp.
 - Power required is 8 volts AC at 3 amps., and 24 volts AC C.T. at 1.5 amps.
 - Board only \$12.50; with parts \$42.50 excluding transformers

Part no. 111

TAPE INTERFACE*

- Play and record Kansas City Standard tapes
- Converts a low cost tape recorder to a digital recorder
- Works up to 1200 baud
- Digital in and out are TTL-serial
- Output of board connects to mic. in of recorder
- Earphone of recorder connects to input on board
- Requires +5 volts, low power drain
- Board \$7.60; with parts \$27.50
- No coils

Part no. 107

RF MODULATOR*

- Converts video to AM modulated RF, Channels 2 or 3
- Power required is 12 volts AC C.T., or +5 volts DC
- Board \$7.60; with parts \$13.50

Apple II Serial I/O Interface*

- Part No. 2
- Baud rates up to 30,000
 - Plugs into Apple Peripheral connector
 - Low-current drain
 - RS-232 Input and Output
- SOFTWARE**
- Input and Output routine from monitor or BASIC to teletype or other serial printer.
 - Program for using an Apple II for a video or an intelligent terminal. Board only — \$15.00; with parts — \$42.00; assembled and tested — \$62.00.

TELEVISION TYPEWRITER

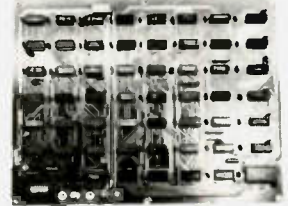

- Part no. 106
- Stand alone TVT
 - 32 char./line, 16 lines, modifications for 64 char./line included
 - Parallel ASCII (TTL) input
 - Video output
 - 1K on board memory
 - Output for computer controlled cursor
 - Auto scroll
 - Non-destructive cursor
 - Cursor inputs: up, down, left, right, home, EOL, EOS
 - Scroll up, down
 - Requires +5 volts at 1.5 amps, and -12 volts at 30 mA
 - All 7400, TTL chips
 - Char. gen. 2513
 - Upper case only
 - Board only \$39.00; with parts \$145.00

8K STATIC RAM



- Part no. 300
- 8K Altair bus memory
 - Uses 2102 Static memory chips
 - Memory protect
 - Gold contacts
 - Wait states
 - On board regulator
 - S-100 bus compatible
 - Vector input option
 - TRI state buffered
 - Board only \$22.50; with parts \$160.00

TIDMA*

- Part no. 112
- Tape Interface Direct Memory Access
 - Record and play programs without bootstrap loader (no prom) has FSK encoder/decoder for direct connections to low cost recorder at 1200 baud rate, and direct connections for inputs and outputs to a digital recorder at any baud rate.
 - S-100 bus compatible
 - Board only \$35.00; with parts \$110.00

MODEM*



- Part no. 109
- Type 103
 - Full or half duplex
 - Works up to 300 baud
 - Originate or Answer
 - No coils, only low cost components
 - TTL input and output-serial
 - Connect 8 ohm speaker and crystal mic. directly to board
 - Uses XR FSK demodulator
 - Requires +5 volts
 - Board \$7.60; with parts \$27.50

To Order:

E21



Mention part number and description. For parts kits add "A" to part number. Shipping paid for orders accompanied by check, money order, or Master Charge, BankAmericard, or VISA number, expiration date and signature. Shipping charges added to C.O.D. orders. California residents add 6.5% for tax. Parts kits include sockets for all ICs, components, and circuit board. Documentation is included with all products. Dealer inquiries invited. 24 Hour Order Line: (408) 374-5984.* Designed by John Bell.

FREE PROBES FREE PROBES FREE PROBES

NLS MS-215 DUAL TRACE MINISCOPE \$395.00

NLS MS-215 DUAL TRACE MINISCOPE \$395.00



1c SALE

LM3A 3 dig 1% DC \$125.
 LM3.5A 3 1/2 dig .5% DC \$147.
 LM40A 4 dig .1% DC \$190.
 LM44 A 4 dig .03% DC \$227

- Rechargeable batteries and charger included
- Measures DC Volts, AC Volts, Ohms and Current
- Automatic polarity, decimal and overload indication
- Rechargeable batteries and charger
- Measures DC Volts, AC Volts, Ohms and Current
- Automatic polarity, decimal and overload indication
- No zero adjustment and no full-scale ohms adjust
- Battery-operated — NiCad batteries; also AC line operation.
- Large LED display for easy reading without interpolation
- Size: 1.9" H x 2.7" W x 4" D
- Parts & labor guaranteed 1 year
- Tilt stand option \$ 3.50
- Leather case \$16.00

Purchase any of the LM series Meters and buy the LEATHER CASE for 1c



\$289

MS-15 MINISCOPE With Rechargeable Batteries & Charger Unit

- 15 megahertz bandwidth.
- External and internal trigger.
- Time base — 1 microsec. to 0.5 Sec/div - 21 settings - 3%
- Battery or line operation
- Automatic & line sync modes
- Power consumption - C-15 watt/hrs.
- Vertical Gain — 01 to 50 V/div 12 settings ± 3%
- Viewing area 1 1/2" x 1 3/8"
- Cable size 27 W x 6.4" W x 7 5/8" D, 3 pounds
- Parts & Labor guaranteed 1 year
- 10 to 1 10 mag probe
- Leather carrying case

PROBE 1c
 PROBE 1c with the purchase of SCOPE and this MAGAZINE

MS-215 Dual Trace Version of MS-15 \$395.00

3 LEVEL GOLD WIRE WRAP SOCKETS

1-24	25-49	50-99	100-249	250-999	1K-5K
3 pin	41	38	35	31	23
4 pin	39	36	33	32	23
10 pin	42	42	39	35	30
18 pin	63	58	54	47	36
20 pin	80	75	70	63	53
24 pin	90	85	80	70	61
24 pin	90	84	78	68	58
28 pin	110	100	90	84	75
36 pin	150	140	130	120	104

Sockets purchased in multiples of 50 per type may be combined for better price.

All sockets are GOLD 3 level closed entry End & Side stackable. 2 level, Solder Tail, Low Profile, Tin Sockets and Dip Plugs available. CALL FOR QUOTATION



SALE S-100 BUS EDGE CONNECTORS SALE

S100-WWG 50/100 Cont. .125 ctrs. 3 LEVEL WIRE WRAP .025" sq. posts on .250 spaced rows. GOLD plated.
 1-4 5-9 10-24
 \$4.00 \$3.75 \$3.50

S100-WWN 50/100 Cont. .125 ctrs. 3 LEVEL WIRE WRAP .025" sq. posts on .250 spaced rows. NASGLO tin-nickel plated.
 1-4 5-9 10-24
 \$3.50 \$3.25 \$3.00

S100-STG 50/100 Cont. .125 ctrs. DIP SOLDER TAIL on .250 spaced rows for VECTOR and IMASI motherboards GOLD plated.
 1-4 5-9 10-24
 \$4.00 \$3.75 \$3.50

S100-STN 50/100 Cont. .125 ctrs. DIP SOLDER TAIL on 250 spaced rows for VECTOR and IMASI motherboards NASGLO tin-nickel plated.
 1-4 5-9 10-24
 \$3.50 \$3.25 \$3.00

RG81G 50/100 Cont. .125 ctrs. DIP SOLDER TAIL on .140 spaced rows for ALTAIR motherboards GOLD plated.
 \$5.00

R681-3 50/100 Cont. .125 ctrs. PIERCED SOLDER EYELET tails. GOLD \$7.35

Other Popular Edge Connectors

R644-G 22/44 Cont. .156 ctrs. PIERCED SOLDER EYELES tails. GOLD plated.
 1-4 5-9 10-24
 \$3.00 \$2.75 \$2.50

R644-3 22/44 Cont. .156 ctrs. WIRE WRAP tails. GOLD \$4.71

ATTN: OEM'S and Dealers, many other connectors available call or quotation.

8803 MOTHER BOARD FOR S100 BUS MICRO COMPUTERS

Price: **\$29.50**

- Kit includes 12 tantalum capacitors for +5, +12, -12 buses and other vital measuring boards
- Wiring is shown. Components are labeled with glass white markings for component location.
- 610 epoxy glass board with 138 copper solder coated and 138 copper holes for leads
- Solder mask with solder windows on etched circuits to avoid accidental short circuits
- Mounts 11 sockets with 100 contacts (2 rows on 125 pin) with 250 row loading
- Vector part number 8803-2 or modules 10 recap boards plus interconnectors to simplify mother board for modules
- Includes etched circuits and instructions for option of active pull-up or floating terminations
- Large board - 12V and 0V (0.1 AMP) - 12V or 16V (1 AMP) Current ratings are per MIL-STD-275 with 100% test
- Four vector probe enclosures
- Fits all IMSA 8080 microcomputer as expander board

Vector Plugboards

8800V Universal Microcomputer/processor plugboard use with S100 bus. Complete with heat sink & hardware 5 3/4" x 10" x 1/16"

1-4	5-9	10-24
\$19.95	\$17.95	\$15.95

8801-1 Same as 8800V except plain, less power buses & heat sink

1-4	5-9	10-24
\$14.95	\$13.95	\$11.95

3677 9.6" x 4.5" \$10.90
 3682 9.6" x 4.5" \$10.97
 3682-2 6.5" x 4.5" \$9.81

Hi-Density Dual-In-Line Plugboard for Wire Wrap with Power & Grd. Bus Epoxy Glass 1/16" x 44 pin con. spaced 156

3677 9.6" x 4.5" \$10.90

3682 9.6" x 4.5" \$10.97

3682-2 6.5" x 4.5" \$9.81

Hi-Density Dual-In-Line Plugboard for Wire Wrap with Power & Grd. Bus Epoxy Glass 1/16" x 44 pin con. spaced 156

3677-26.5" x 4.5" \$9.74

Gen. Purpose D.I.P. Boards with Bus Pattern for Solder or Wire Wrap. Epoxy Glass 1/16" x 44 pin con. spaced 156

3662 6.5" x 4.5" \$7.65
 3662-2 9.6" x 4.5" \$11.45

P pattern plugboards for IC's Epoxy Glass 1/16" x 44 pin con. spaced 156

3690-12 CARD EXTENDER Has 100 contacts-50 per side on .125 centers-Attached connector-is compatible with S-100 Bus Systems.....\$25.00
 3690 6.5" x 22/44 pin .158 ctrs. Extenders.....\$12.00

1/16" Vector BOARD.042 dia holes on .01 spacing for IC's

Phenolic

PART NO.	SIZE	1-9	10-19
64P44XXX	4.5x6.5"	\$1.49	1.34
169P44XXX	4.5x17"	\$3.51	3.16

Epoxy Glass

64P44	4.5x6.5"	\$1.70	1.53
84P44	4.5x8.5"	\$2.10	1.89
169P44	4.5x17"	\$4.30	3.87
169P84	8.5x17"	\$7.65	6.89

ELLI-TEK Wraps insulated wire on .025" square posts. FOUR TIMES FASTER than regular manual wrap tools

P180 with two 100' spools of 28 ga wire \$24.50

P180-4T includes charger, wire \$75.00

NO PRE STRIPPING* NO PRE CUTTING* SPOOL FEED WIRE*

*The spooler wire passes through the tool past a cutting edge next to the wrap post. A narrow longitudinal cut is made in the insulation where it overlaps the square post. Center the square spooler in between the sharp edge of the wire & the contact.

SLIT-N-WRAP WIRE NO. 28 GAGE INSULATED WIRE, 100' SPOOLS

W28 24 Pkg. 3 Green W28 20 Pkg. 3 Clear W28 28 Pkg. 3 Red W28 20 Pkg. 3 Blue

2708 8K 450 ns

EPROM FACTORY PRIME \$10.00 EA.

25 + Call For Price

14 & 16 PIN GOLD 3 LEVEL WIRE WRAP SOCKETS

14 - G3 100 for \$30.00
 16-G3 100 for \$30.00
 50 of each for \$32.00

Sockets are End & Side stackable, closed entry.

LIQUID CRYSTAL DIGITAL CLOCK-CALENDAR

For Auto, Home, Office
 Small in size (2 1/2 x 1 1/2)
 Push button for seconds lighting for date.
 Clocks mount anywhere with either 3M double sided tape or VELCRO. Included

2 MODELS AVAILABLE

LCD-101, portable model runs on self-contained batteries for better than a year
 LCD-102, runs on 12 Volt system and is back lighted
 LCD-101 or LCD-102 your choice

Clear desk stand for \$2.00

\$34.95

LEDU MG 10A List \$72

Perfectly balanced, fluorescent lighting with precision magnifier lens. For prof, techni & hobbyist. Has die cast projective shade that starts 3 drooper lens .42" each.

\$44.95

SPECIAL

SC-5 With Rechargeable Batteries & Charger Unit \$89

FM-7 With Rechargeable Batteries & Charger Unit \$195

Features include: • By using the new NLS SC-5 Prescaler, the range of the FM-7 Frequency Meter, which is 10 Hz to 60 MHz, may be extended to 512 MHz (the upper MF & UHF frequency bands). • The FM-7 utilizes an LED readout, providing 7-digit resolution • The FM-7 can be calibrated to an accuracy of 0.00001%. • The SC-5 is accurate to one part per million • Each unit has 30 millivolt sensitivity, is battery powered and has a charger unit included • Dimensions of each are 1.9" H x 2.7" W x 3.9" D • The units may be obtained separately or as a "Frequency Dup" • Parts & Labor guaranteed 1 year
 Tilt stand option \$ 3.50
 Leather case \$18.00

MICRO-KLIP for .042 dia. holes (all boards on this page)
 T-44 1-pkg 100 \$ 1.50
 T-42 1-pkg 1000 \$11.00
 P-149 hand installing tool \$ 2.03

12:28 .8" LED ALARM CLOCK

12 hr LED Alarm Clock uses 3 1/2 digit 8 LED Display with AM/PM indicators and colors. Direct drive. Pin to PIN interface with **8799A** IC. Just add switches, AC Supply, Alarm. Display and IC only

\$7.95 or 2/\$15.00

Price Breakthrough! \$17.50

MA1003 CAR CLOCK

Bright Green Fluorescent Display Crystal Time Base Assembled, just add switches and 12 VDC.

SPECIAL

14CS2 100 for \$14.00
 16CS2 100 for \$16.00
 14 pin CS2 10 for \$2.00
 16 pin CS2 8 for \$2.00

These low cost DIP sockets will accept both standard width plugs and chips. For use with chips, the sockets offer a low profile height of only .125" above the board. These sockets are end & side stackable.

PRIORITY ONE ELECTRONICS

10031W Woodley Ave. Sepulveda CA. 91343

Terms: VISA, MC, BAC, check, Money Order, C.O.D., U.S. Funds Only CA residents add 6% sales tax. Minimum order \$10.00. Orders less than \$75.00 include 10% shipping and handling; excess refunded. Just in case please include your phone no. "Sorry, no over the counter sales" Good thru Aug 15, 1978

phone orders welcome (213) 893-8202 OEM and Institutional Inquiries invited

24 PIN DIP PLUGS WITH COVERS 3 / \$1.00

FREE PROBES FREE PROBES FREE PROBES

John M. Franke WA4WDL
1006 Westmoreland Ave.
Norfolk VA 23508

Norman V. Cohen WB4LJM
7719 Sheryl Drive
Norfolk VA 23505

Having been reintroduced to VHF by modifying an old FM receiver to cover the weather satellite frequencies, I eagerly awaited crystals for a two meter FM rig that I had recently purchased at a hamfest. After plugging the crystals in and erecting a quarter-wave whip in my operating room, I was encouraged to hear the local 19-79 repeater come booming in. Waiting for a pause, I pressed the mike switch to call Norman WB4LJM for an air check. However, the immediate response was noise from the other side of the room.

The weather satellite receiver squelch was being keyed by overload from the two meter rig. It did not take long to determine that the two meter signal was entering the weather satellite receiver through its antenna, all other leads being shielded and filtered. Separating the satellite receiver antenna further from the two meter antenna to reduce coupling is nearly impossible, so I called Norman on the land line to see if we could cook up a filter for the weather satellite receiver. Our first thoughts were for a narrow bandpass cavity, but that idea was

rejected for several reasons. First, I am basically lazy and could envision that as a several week project. Second, my operating room, the bedroom, has very limited space and my wife does not think that a copper pipe is as beautiful as I do. Third and finally, the high Q of such a filter would prevent using the weather satellite receiver to monitor police and other services without a coax switch. What was needed was a rejection filter tuned to 146.19 MHz.

A very effective rejection or notch filter can be formed from a wavemeter, i.e., a tuned circuit coupled to the transmission line to couple power out of the line at only

one frequency. It was decided that high enough Q could be obtained by using coaxial lines for the resonators. A simple circuit was wired together in a minibox with BNC input and output connectors. Then Norman made a swept frequency response curve. The tap position was changed, and a new curve was measured. The fancy name for this cut-and-try development method is "an empirical investigation."

The actual circuit consists of a shorted one-eighth wave coaxial line that is capacitively tuned to resonance with a small trimmer. The input and output taps are made by cutting the cable

and splicing it back together, as shown in Fig. 1. Fig. 2 is the response curve of the filter for various tap positions. The rejection bandwidth, or Q, becomes sharper as the tap is moved towards the shorted end of the coax. The final filter has an insertion loss of about 1.6 dB at 137.5 MHz and a rejection of almost 23 dB at 146.19 MHz. The insertion loss might be reduced if rigid coax having a solid outer conductor is used. The rejection frequency is tunable from 127 MHz to 163 MHz. This filter is easily constructed and will probably find more applications as more systems are added to my station. ■

VHF Notch Filter

—rejection can be beautiful

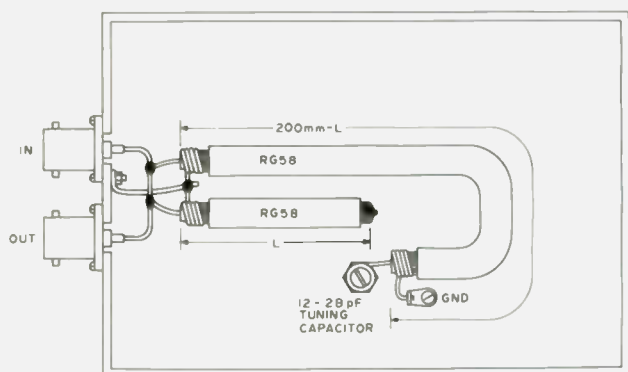

Fig. 1. Construction of the rejection filter.

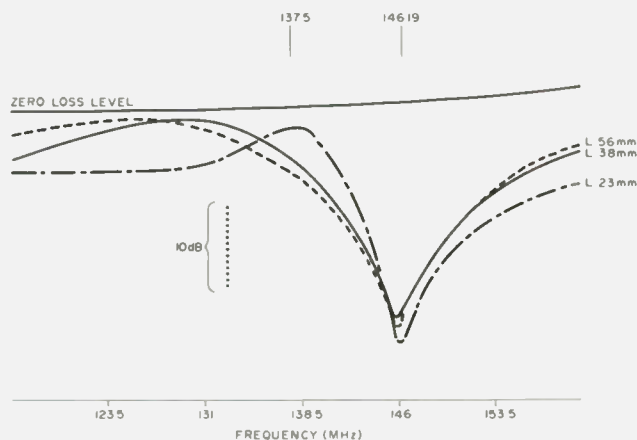

Fig. 2. Response of the filter for various tap positions.

Yes, You Can Build A Synthesizer!

— 220 MHz synthesizer for under \$50

A host of articles published in the past years have stated, "Use it or lose it." They are referring to the 220-225 MHz amateur band.

The 550 Amateur Radio Club of Oakland, New Jersey, put a repeater on 223.34 MHz (in) and 224.94 MHz (out). I heard WR2AHD, and my interest in the 220-225 MHz band began. I found the choice of 220-225 MHz rigs

limited. Using parts from my junk box and a few added dual-gate MOSFETs, I built a receiver with a first i-f of 10.7 MHz and the second i-f of 455 kHz. The transmitter consists of a modified VHF Engineering TX220B and PA220/15 power amplifier.

I did not want to limit my scope of operation to one or two frequencies. I researched the available synthesizer kit

manufacturers in search of a 220-225 MHz synthesizer. As a result of the search, I decided to build my own.

The criteria of design were:

1. Cost — design goal less than \$50;
2. Construction — T²L — PC board;
3. Control switches must indicate frequency of operation

- in the 220-225 MHz band with 10 kHz steps;
4. Frequency synthesizer must operate in the car, i.e., +12 to 15 V dc;
5. Output frequency must be limited so that out-of-band signals cannot be programmed;
6. Receiver local oscillator injection is on the low side (high-side injection modification as per Figs. 14, 15, and 16).

The synthesizer output frequency was selected to drive the VHF Engineering TX220B transmitter kit. This kit requires 18 MHz crystals (18.333 to 18.750 MHz). The synthesizer output frequency is one-twelfth of the 220-225 MHz band. When used in the receive mode, the synthesizer output frequency is one-twelfth of the 220-225 MHz band minus 10.7 MHz. Receive range is 17.441666 to 17.858333 MHz. The format I decided upon is a heterodyne digital mixer with receiver digital offset.

Theory of Operation

This frequency synthesizer generates frequencies from 17.441666 MHz to 18.750 MHz in 833.3333 Hz steps, selectable via the frequency select switches and the transmit/receive mode select signal. The output signal has the ability to be frequency modulated.

This synthesizer is a heterodyne mode phase locked system. (See Fig. 1.) Frequency stability is generated at the crystal reference oscillator. The frequency of the crystal oscillator is 19.083333 MHz. The output of the crystal oscillator is fed to the input of the ÷11,450 counter and to the digital mixer.

The ÷11,450 counter is programmed to count 11,450 pulses at its input and generate a pulse at its output. The counter resets itself after generating an output pulse and counts another 11,450 pulses. This cycle repeats. Each second, 19,083,333 pulses appear at the input and

Photos by John Maio WB2ARS and Matt Maio WB2LHG

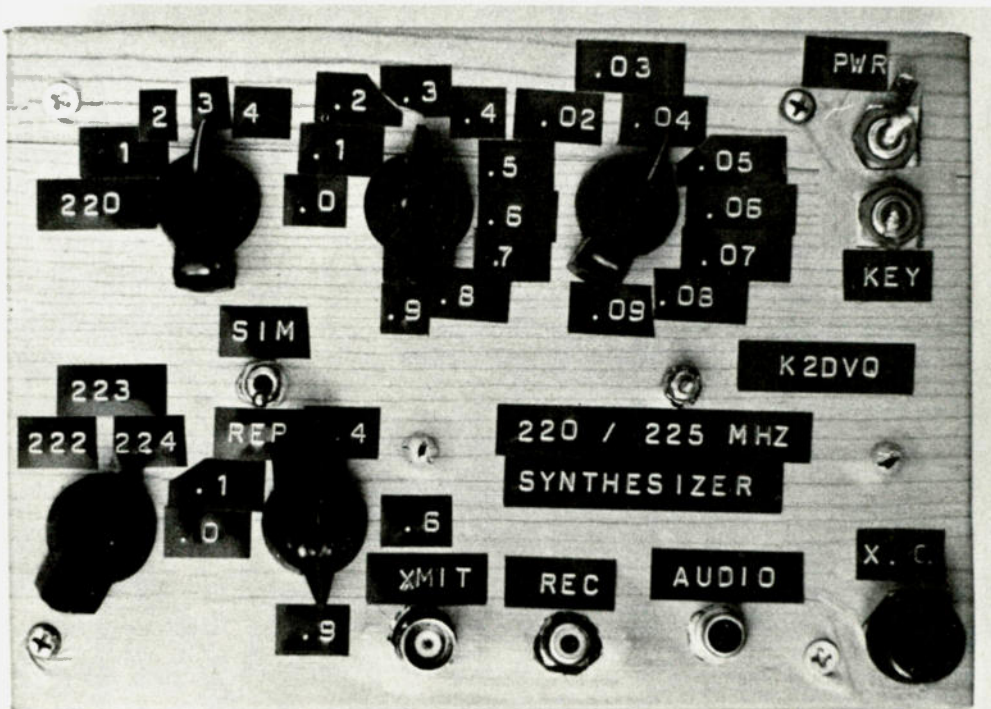

This photo shows the controls and input/output ports. The upper switches are set at 223.34 MHz, the transmitter setting. The synthesizer mode switch is in the repeat mode. The lower switches are set at 224.94 MHz, the receiver frequency. The upper .04 setting is common to both sets of switches. (Refer to Fig. 10.)

19,083,333 ÷ 11,450, or 1666.6666, pulses appear at the counter's output terminal. The ÷11,450 counter output is fed to a single-shot chip where the pulse is conditioned and passed to one input of the phase comparator. This constant 1666.6666 Hz signal is the comparator reference signal. The output of the phase comparator is a dc signal which varies the frequency of the voltage controlled oscillator (vco). The output of the phase comparator will continue to change until the frequency and phase of the second input to the phase comparator are equal to the reference input. When and only when both inputs of the phase comparator are equal in phase and frequency, the output signal of the phase comparator will come to rest at some voltage and hold the output frequency of the vco constant. The phase locked mode now exists.

Transmit Mode

Frequency select switches are set to 224.00 MHz. When a ground is applied at the transmit/receive input jack, the synthesizer is in the transmit mode. The output of gate #3 is high (2.4 to 5.4 V dc), driving the control input of gate #1 high. With the frequency select switches set at 224.00 MHz, the 400-to-900 variable counter is programmed to count 500 pulses.

In the phase locked mode, the frequency present at the output of the programmable 400-to-900 counter must be 1666.6666 Hz. The input frequency at the 400-to-900 counter must be 500 times 1666.6666 Hz, or 833.333 kHz. The digital mixer output frequency must be ½ times 833.333 kHz, or 416.666 kHz.

At the output of the digital mixer is a low-pass filter which only passes the difference frequency between its two input signals. One input signal to the digital mixer is the crystal oscillator, 19.083333 MHz. The second

input signal to the digital mixer is the vco frequency, 17.4 to 18.75 MHz.

The digital mixer output frequency equals 19.083333 MHz minus the vco frequency. Therefore, the vco frequency equals 19.083333 MHz minus the digital mixer output frequency. With the digital mixer output frequency of 416.666 kHz, the vco frequency must be 19.083333 MHz minus 416.666 kHz, or 18.666666 MHz.

The vco 18.666666 MHz signal is passed through a low-pass filter to the transmit output jack. This 18.666666 MHz signal is multiplied times twelve in the transmitter to obtain the final frequency of 224.00 MHz.

Receive Mode

Frequency select switches are set to 224.00 MHz. When the transmit/receive input jack is left open circuit, or a voltage up to +15 V dc is applied, the synthesizer is in the receive mode.

The reset state sets the output of the JK flip-flop to be high, +2.4 to +5.4 V dc. The output of gate #3 is driven low, 0 to 0.4 V dc. The control input at gate #1 is held low. The pulse train present at the signal input of gate #1 is inhibited and does not pass to the 400-to-900 counter until the control input of gate #1 is high. The pulse train present at the output of the x2 multiplier is fed to the signal input of gate #2. The pulse train is fed to the 1070 counter. When 1070 pulses are counted, the 1070 counter generates an output pulse which sets the JK flip-flop output low, driving the output of gate #3 high, and gate #1 is enabled. The pulse train at gate #1 will now pass to the 400-to-900 counter. After 500 pulses are counted, a reset pulse will reset both the 1070 and 400-to-900 counters. This cycle repeats again and again.

The frequency present at the output of the 400-to-900 counter must be 1666.6666

Mz. The frequency at the output of the times 2 multiplier is the sum of the two counters times 1666.6666 Hz, or 1666.6666 Hz (1070 + 500). 1666.6666 Hz x 1570 = 2.616666 MHz. The frequency at the output of the digital mixer is 2.616666 MHz divided by 2, or 1.308333 MHz. The vco frequency is 19.083333 MHz minus 1.308333 MHz, or 17.775 MHz. When this 17.775 MHz signal is multiplied times 12 in the receiver local oscillator/multiplier chain, it will produce a 213.3 MHz signal to the receiver's first mixer stage. 213.3 MHz is 10.7 MHz less than 224.00 MHz.

Therefore, using a receiver with a 10.7 MHz first i-f, having oscillator injection to the first mixer on the low side (i.e., injection frequency is below the frequency to be received), the receiver will be

set to receive 224.00 MHz. The vco frequency is amplified and fed through the filter to the receive output jack. The signal does not pass to the transmit output jack in the receive mode.

Note: If an i-f frequency other than 10.7 MHz is desired, the 1070 counter can be reprogrammed to generate the offset. To compute the number of pulses to be counted, divide the i-f frequency by 10 kHz, i.e., 12 MHz ÷ 10 kHz = 1200. For a first i-f of 12 MHz, the counter is to be programmed to count 1200 pulses. The vco may be modulated to produce a true frequency modulated signal. Power required is 12 to 15 V dc, 400 mA.

Reference Oscillator

The reference oscillator is a single-stage (Q1) crystal oscillator. (See Fig. 2.) The crystal is parallel resonant

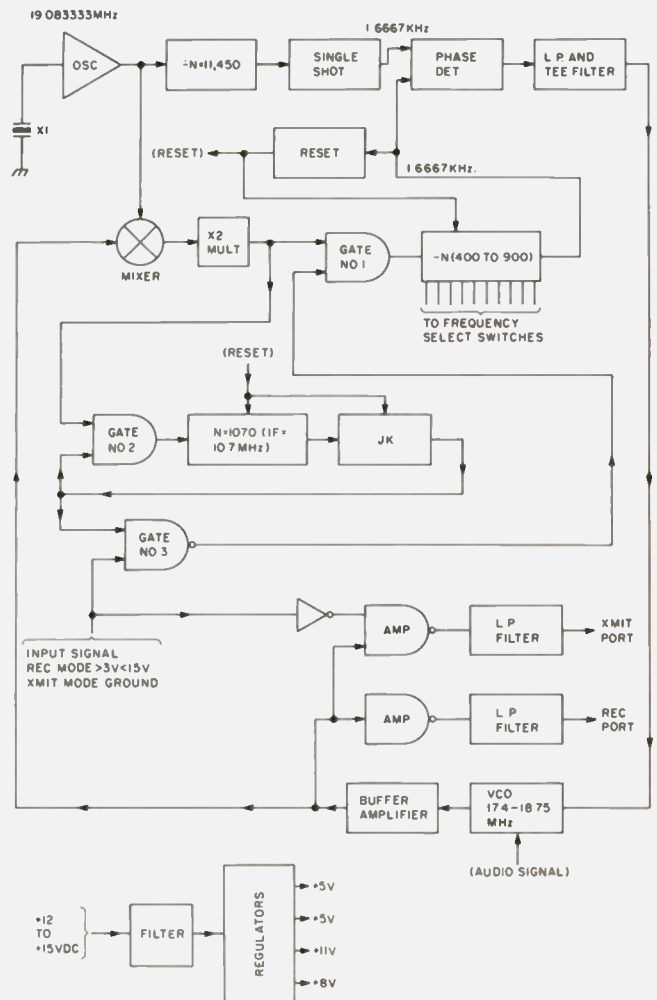
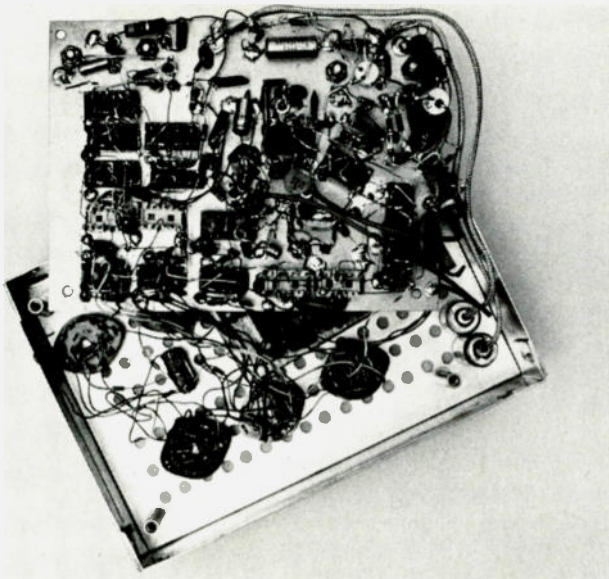

Fig. 1. Block diagram of 220-225 MHz frequency synthesizer.



This photo shows the switches and part of the vco board which are below the main board. Some of the wires from the switches to the main board were cut in order to take this view. The holes shown in the bottom view of the top cover should not be there. This box was retrieved from my junk box and used to contain the synthesizer.

“AT” cut for the fundamental mode at 19.083333 MHz (19083.333 kHz). $C_p = 32 \text{ pF}$.

The oscillator frequency is pulled or adjusted via the VVC diode C7. A 500 Hz change in oscillator frequency will change the frequency of operation (220 to 225 MHz) by $\approx 6 \text{ kHz}$. R5 controls the bias applied to C7. This adjustment is used to compensate for temperature changes as well as allow for split (5 kHz) channel operation.

Capacitors used were silver mica; C5 is a ceramic trimmer. Capacitor voltage ratings are not critical — any value greater than 25 V may be used.

Q2 is a buffer amplifier. Frequency at C10 is 19.083333 MHz $\pm \Delta f$ of 500 Hz.

Note: The value of R5 is not critical. Its range is 2k to 50k. C5 is adjusted with R5 near center range for 19.083333 MHz at C10. Unless otherwise specified, all resistors are $\pm 5\%$, $\frac{1}{4}$ Watt.

The part (or equivalent) used from my junk box: C7 — FC-54 or 1N5144 or MV1404 or MV109 (same as C45).

$\div 11,450$ Presettable Decade Counter

Refer to Fig. 3. The 19.083333 MHz signal is fed to U13-13, shaped, and fed to U1-8. U1 through U5 form a $\div N$ counter. U1 is operated as a straight $\div 10$. Due to the high input frequency, 19 MHz, any reset function at U1 would introduce counting error.

The frequency present at U2-8 is 19.083333 MHz $\div 10$, or 1.9083333 MHz. U2 through U5 form a $\div N$ of 1145. For every 1145 pulses present at U2-8, one pulse appears at U5-12. C13 couples the edge of each pulse at U5-12 to the reset gates of U2, 3, 4, and 5, pin 1.

The frequency present at U5-12 is the frequency at U2-8 $\div 1145$, or 1.9083333 MHz $\div 1145 = 1666.6666 \text{ Hz}$. U19 is a single-shot used to

condition the narrow pulse at U5-12. The signal at U19-6 is a pulse train; frequency is 1.666666 kHz.

Digital Mixer, Low-Pass Filter, $\times 2$ Multiplier

Refer to Fig. 4. The reference oscillator signal, 19.083333 MHz, is fed to U13-1. The vco signal, 17.441666 MHz to 18.750 MHz, is fed to U13-2. U13 is an SN7486 2-input exclusive OR gate. The output signal at U13-3 includes the difference frequency between the two inputs at pins 1 and 2. ($f_{\text{pin 1}} - f_{\text{pin 2}} = \text{signal at pin 3}$.) To eliminate or reduce $f_{\text{pin 1}}$, $f_{\text{pin 2}}$, and $f_{\text{pin 1}} + f_{\text{pin 2}}$ present at pin 3, the output signal is passed through a low-pass filter consisting of R13, 14, and C15, 16, and 17. The 0.333333 MHz to 1.641667 MHz pulse train is amplified by Q6 and U13, pin 9 in, pin 8 out. The signal at U13-8 is fed to U11-11 and, via C20, to U12-12. The signal at U13-8 is inverted at U11-10 and fed via C19 to U12-13. The pulse train present at U12-11 is twice the frequency present at U13-8.

U12 inputs pins 12 and 13 are biased high ($\approx 3 \text{ V}$), and U12, pin 11 is held high. When U13-8 goes low (changes state), the high-to-low transition is coupled to U12-12, and U12-11 will go low for ≈ 50 nanoseconds and return high. When U13-8 changes state from a low state to the high state, U11-10 will change from a high to a low state. This transition is coupled to U12-13, and U12-11 will go low for ≈ 50 nanoseconds. The signal at U12-11 is a pulse train consisting of 50 nanosecond pulses at a repetition frequency twice that present at U13-8. Frequency range at U12-11 is 0.666666 MHz to 3.283334 MHz.

Controllable Presettable Decade Counter

Refer to Fig. 5. U8, U9, and U10 are presettable decade counter chips. The data input pins, 3, 4, 10, and 11,

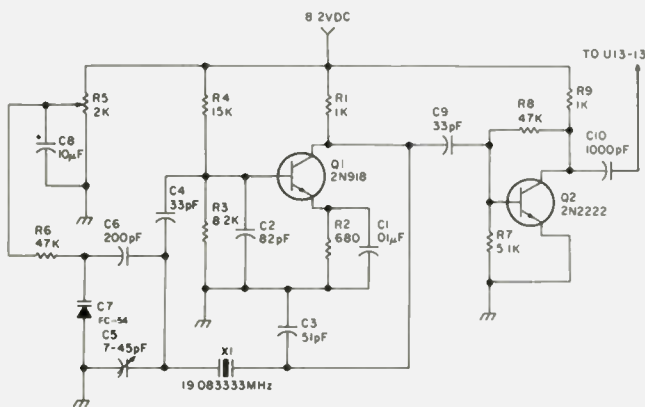

Fig. 2. Reference oscillator.

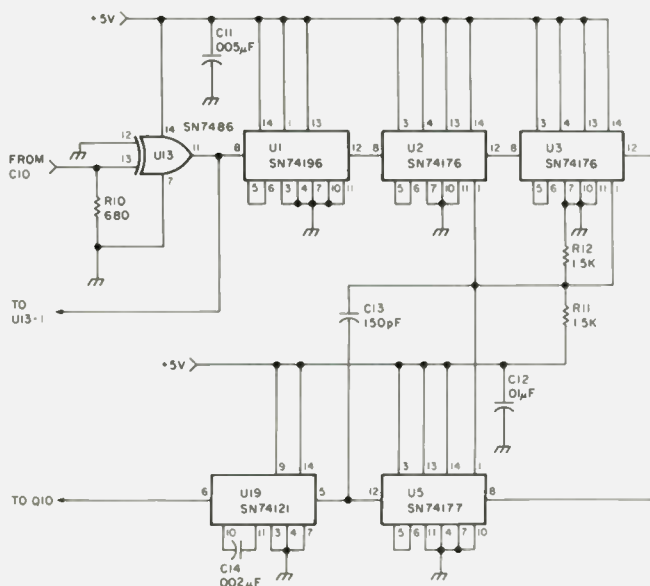

Fig. 3. Divide-by-11,450 presettable decade counter.

are wired to the frequency select switches. These counters are so wired that when the frequency select switches are set to 220.00 MHz, U10, U9, and U8 will count 900 pulses, generate a pulse at U8-12, reset the data inputs, and then count to 900 again. With the frequency select switches set to 224.00 MHz, the counters are programmed to count 500 pulses and generate a pulse at U8-12.

N = number of pulses to be counted. The vco frequency = $19.083333 \text{ MHz} - (1666.666 \text{ Hz} \times N)/2$.

When $N = 900$, vco = 18.333334 MHz . $18.333334 \text{ MHz} \times 12 = 220.00 \text{ MHz}$.

When $N = 500$, vco = 18.666667 MHz . $18.666667 \text{ MHz} \times 12 = 224.00 \text{ MHz}$.

The signal at U12-1 is a pulse train within the frequency range of 0.666666 MHz to 3.283334 MHz. The signal at U12-2 is held high, 2.4 to 5.25 volts, in the transmit mode. In the receive mode, U12-2 is held in the low state, less than 0.4 volts, until the receiver offset counter of Fig. 9 sets U18-2 to the high state, which drives U12-2 high. The pulse train at U12-1 cannot pass to U12-3 with U12-2 held low. When U12-2 is at a high state, the pulse train will pass to U10-8 and be counted in U8, U9, and U10. When the counters count the number of pulses programmed via the frequency select switches, U8-12 will change state from a high of 2.4 to 5.25 volts to a low of less than 0.4 volts. This high-to-low transition is coupled to U11-1 via C32. A pulse of approximately 50 nanoseconds is generated at U11-2 and U11-4. This pulse is used to reset counters U8, U9, U10, U14, U15, U16, U17, and U18. There is more than ample time for the counters to be reset to their data inputs before the next pulse is present at U12-1. The maximum frequency at U12-1 is 3.283334 MHz, with a period of 304 nanoseconds.

Note: If cost is not a

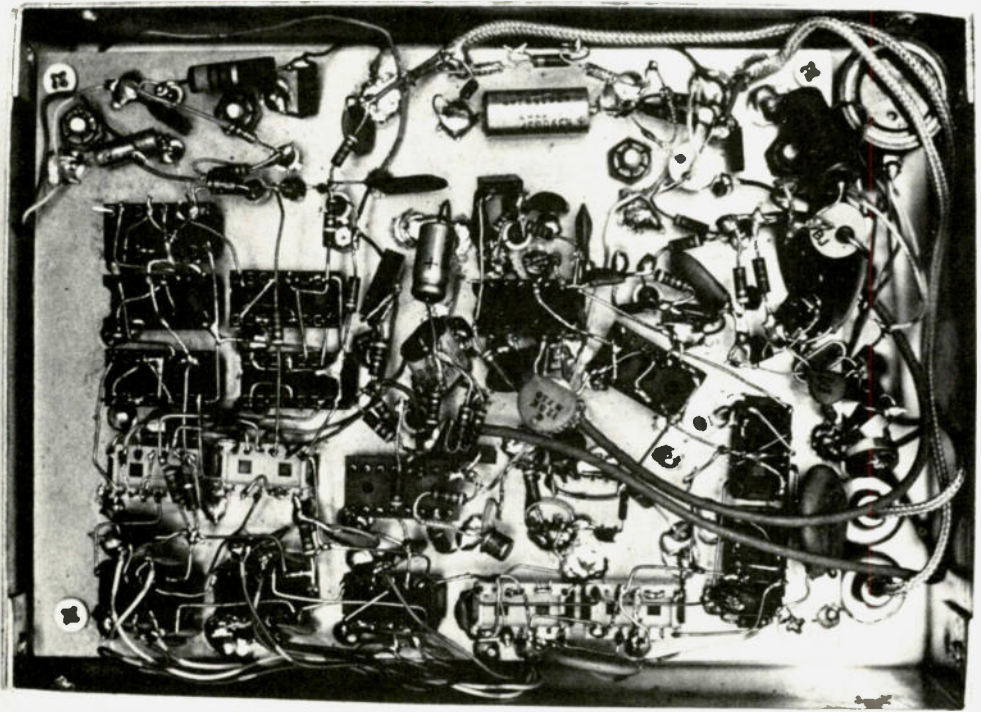

This photo is a close-up of the main board. You are looking down at the IC socket pins. See Fig. 12 for IC locations. This board is held above the frequency select switches on four standoffs.

factor, use SN74LS196 chips in place of SN74176 chips at U8, U9, and U10. If you wish to save a few dollars, use selected SN74176 chips at U8, U9, and U10.

To select the ICs with low input current at the data inputs, build a test fixture consisting of a 14-pin IC socket and four 1k Ohm $\pm 5\%$ 1/4-Watt resistors. Connect +5 volts to pins 1, 13, and 14. Connect ground to pin 7. Connect a 1k Ohm resistor to pin 3, pin

4, pin 10, and pin 11. The other end of each resistor connects to ground.

Install the SN74176 chip to be tested into the test fixture. Apply +5 volts. Using a high impedance voltmeter, measure the voltage drop across each 1k Ohm resistor. Any SN74176 with all four voltage readings below 0.6 volts is okay to use at U8, U9, and U10. Since you have taken the time to make the test fixture, record readings

on all the SN74176 ICs, and use the three with the lowest readings at U8, U9, and U10. The remaining SN74176s can be used as required at U2, U3, U4, U5, U14, U15, U16, and U17. In these positions, the data inputs are hard wired to +5 volts or ground. The input current can be larger and not influence operation.

Phase Comparator, Low-Pass Filter, Twin-Tee Filter

Refer to Fig. 6. The signal

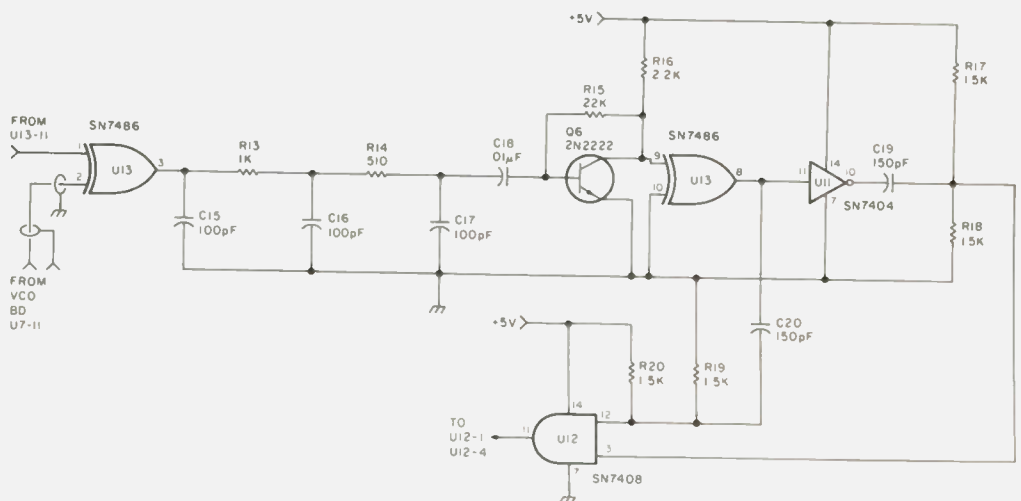

Fig. 4. Digital mixer, low-pass filter, x 2 multiplier.

at R34 consists of a pulse train at a 1666.666 Hz rate.

This 1666.666 Hz signal is the phase comparator's refer-

ence signal. The signal at R36, when the system is in

the locked condition, shall be equal in frequency and in phase to the reference signal at R34. Q10 and Q11 are level shifters. The output levels at U19-6 and U8-12 are TTL; each pulse changes from a low state of less than 0.4 volts to a high state of 2.4 to 5.25 volts. The input levels required at U6-3 and U6-14 are a low state of less than 2 volts and a high state of 8 to 11 volts. Q10 and Q11 switch levels between 0.2 volts and approximately 11 volts.

U6 is a COS/MOS-type IC phase comparator. This chip compares the frequency and phase of the pulse trains present at its inputs, U6-3 and U6-14. If the input signals are not equal in frequency and in phase, the phase comparator output U6-13 is driven more positive or less positive. The phase comparator output is a dc bias voltage which is fed to C45, the vco VVC diode. As the voltage level at U6-13 changes, the bias on C45 changes, and the frequency of the vco changes. When the inputs at U6-3 and U6-14 are of equal frequency and they are phase locked, the output level at U6-13 will remain constant, holding the vco frequency constant until the operator changes the frequency select switches.

The output of U6-13 passes through a low-pass filter — R38, R39, R40, C35, C36, and C37. The signal then passes through a twin-tee filter to remove any 1666.666 Hz ripple present. The twin-tee filter consists of R41, R42, R43, C38, C39, and C40. R45, C41, and C42 comprise a charge storage network to hold the dc voltage constant until the next information update. R46 passes the dc level to the VVC diode, C45, while it isolates the capacity of C42.

Note: The value of R39 is 68,000 Ohms. If a value near 40,000 Ohms is used, response time is decreased with a trade-off in greater ripple present at C45. C34 was added to eliminate cross-talk present in the CD4046 chip.

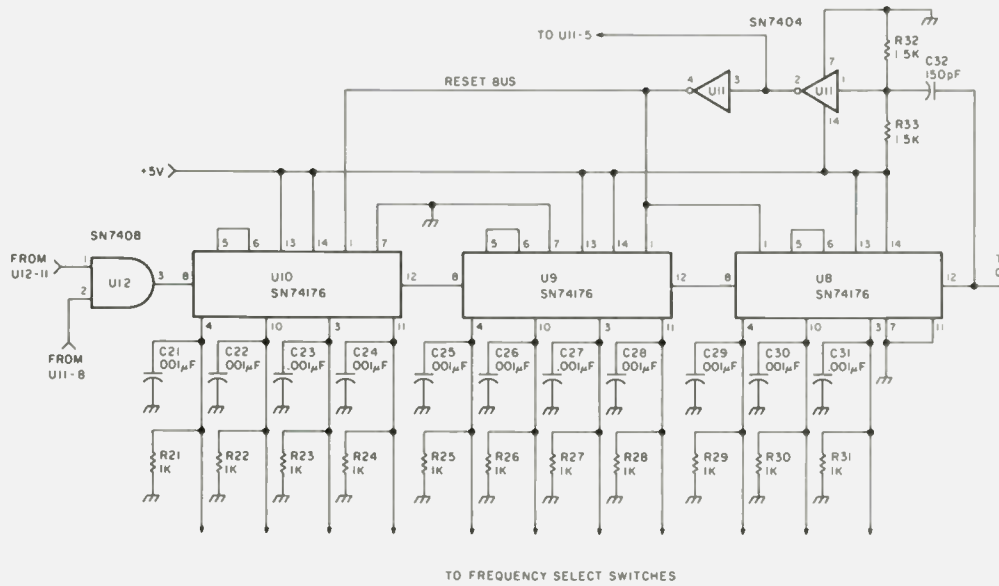

Fig. 5. Controllable presettable decade counter.

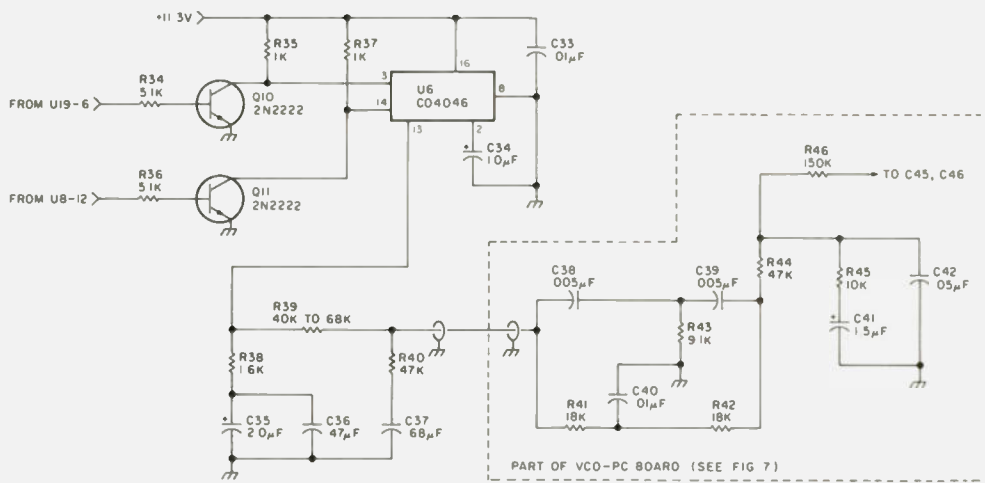

Fig. 6. Phase comparator, low-pass filter, twin-tee filter.

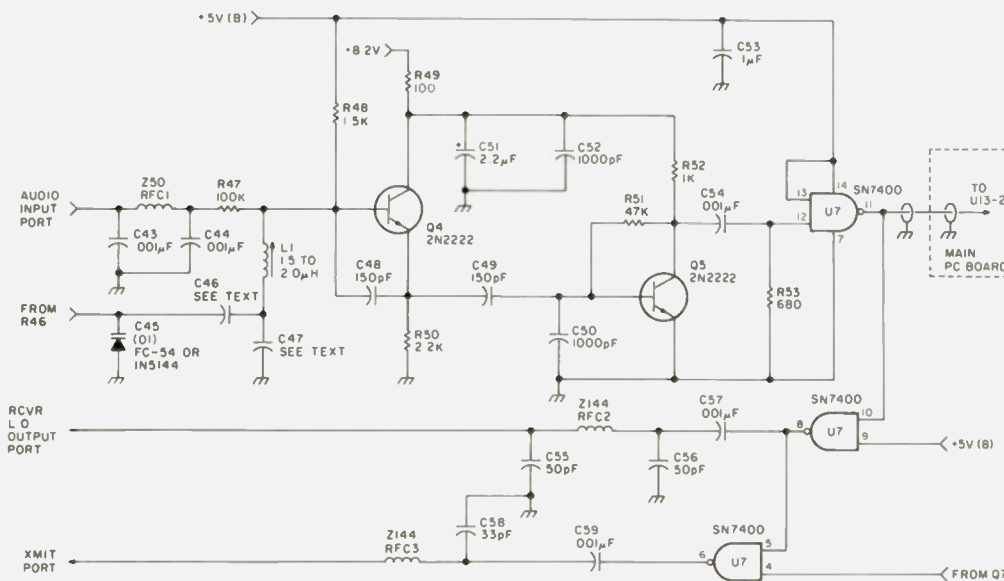

Fig. 7. Vco and output circuits (vco PC board).

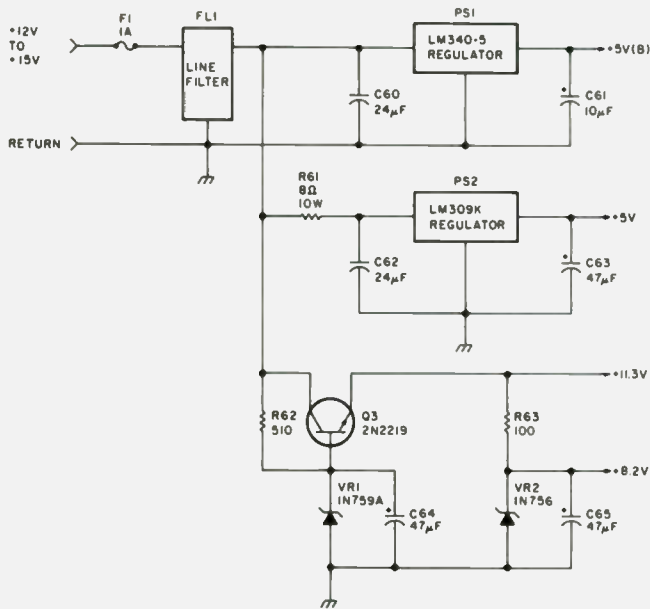

Fig. 11. Voltage regulators.

ground is present at the R/T mode port. A ground is present at the R/T mode port only in the transmit mode. (See Fig. 8.) Only in the transmit mode is the vco signal present at U7-6 and at the transmit port.

Note: I used G.E. clear silicone compound to reduce vibration effects. Coat L1 and all components in the area of L1. The parts (or equivalent) I used from my junk box are:

- Audio input port – RCA phono jack;
- Receiver L.O. output port – BNC chassis mount;
- Transmit port – BNC chassis mount;
- RFC1 – ohmite Z50;
- RFC2, RFC3 – ohmite Z144;
- C45 (D1) – FC-54 Fujitsu,

Nissho America Corp., 80 Pine Street, New York NY 10005; or 1N5144, MV1404, or MV109.

Transmit/Receive Mode Control Circuits

Refer to Fig. 8. The range of signal levels to be applied at the R/T mode select port is zero or ground to 15 volts or an open circuit. In the receive mode, the R/T mode port should see an open-circuit condition, or you can apply a voltage between 3 and 15 volts. In the receive mode, Q7 is in the on state; Q7's collector is at less than 0.4 volts. U11-12 is at a high state, 2.4 to 5.25 volts. In the transmit mode, a ground is applied at the R/T mode port. Q7 is in the off state, and its collector

is at a level between 2.4 and 5.25 volts. U11-12 is low, less than 0.4 volts. In this mode, U12-8 is held low, and U11-8 is at a high state, holding U12-2 high. U12-2 is the count-enable gate to the controllable presettable counter. (See Fig. 5.)

In the receive mode, the level at U12-9 is held high until the receiver offset counter counts 1070 pulses and U18-2 is driven low. U12-8 then goes low and drives U11-8 high, which enables the controllable presettable counter.

The part (or equivalent) used from my junk box is: RFC4 – Erie, part number 1270-009, 1270-024, or 1201 or 1202.

Receiver Offset Presettable Decade Counter

Refer to Fig. 9. The signal at U12-11 is a pulse train. The frequency of the pulse train varies between 666,666 Hz and 3.283334 MHz. This signal is fed to the input gate of U12-4. With U18 in the reset mode, U18-2 is at a high state, and U12-5 is at a high state. The pulse train at U12-4 will pass to U12-6 to be counted by U14, U15, U16, and U17. When U17-12 changes state, U18-2 will go to the low state and remain low until a reset pulse is present at U11-5.

As shown in Fig. 9, U14, U15, U16, and U17 are wired to count 1070 pulses. Each pulse at U12-4 has the effect of a 10 kHz offset at 220-225

MHz. The effect of adding the presettable counter to the controllable counter (see Fig. 5) is to force the vco in the receive mode to change frequency by a fixed amount. The fixed amount of offset is equal to the receiver's first i-f, 10 kHz.

As an example, set the frequency select switches to 224.94 MHz. In the transmit mode, the vco frequency is 224.94 MHz/12, or 18.745 MHz. In the receive mode, the vco must shift to (224.94 MHz - 10.7 MHz)/12, or 17.853333 MHz. For any frequency selected, the -10.7 MHz term is a constant. The vco in the receive mode will be forced to shift lower due to the phase comparator seeking locked condition. The frequency at U6-14 must equal the frequency at U6-3, which is a constant 1666.666 Hz.

As the offset of 1070 pulses is added to the scaled count of U8, U9, and U10, the frequency at U12-11 must increase. The frequency out of the mixer U13-3 can increase only when the frequency difference between U13-1 and U13-2 increases. The signal at U13-1 is a fixed 19.083333 MHz from the crystal oscillator. Therefore, the vco frequency at U13-2 must be driven lower.

If your receiver has a first i-f other than 10.7 MHz, the counters U14, U15, U16, and U17 must be reprogrammed: i-f/10 kHz = number of pulses to be counted.

As an example, if an i-f of 12 MHz is used, 12 MHz/10 kHz = 1200 pulses, and U14, U15, U16, and U17 must be programmed to count 1200 pulses.

This scheme as shown is for low-side injection. Frequency at mixer U13-3 = (1666.666 Hz x N)/2. Frequency of the vco = 19.083333 MHz - frequency at U13-3. N is the total number of pulses that the counters are programmed to count.

Frequency Select Switching

Refer to Fig. 10. The data input code required to pro-

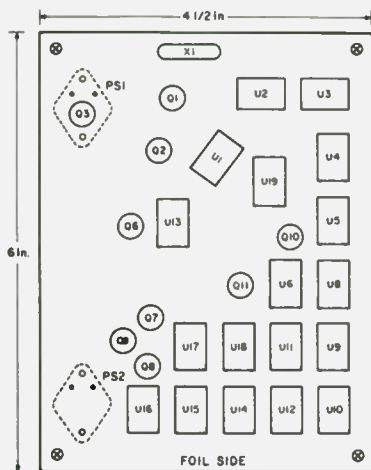

Fig. 12. Main circuit board IC layout.

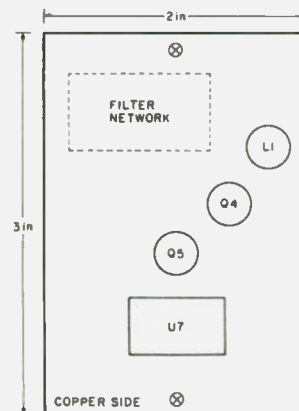

Fig. 13. Vco board parts layout.

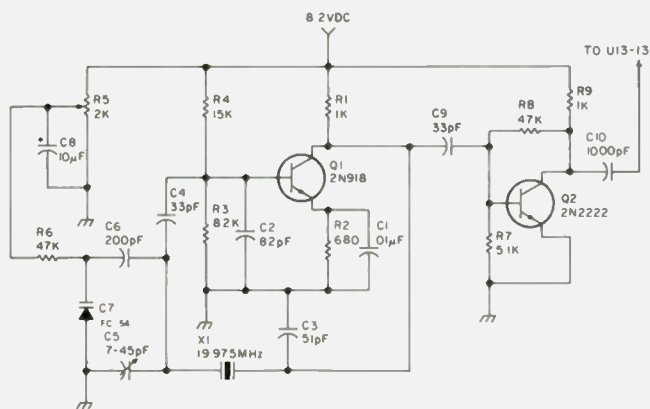

Fig. 14. Reference oscillator (high-side injection).

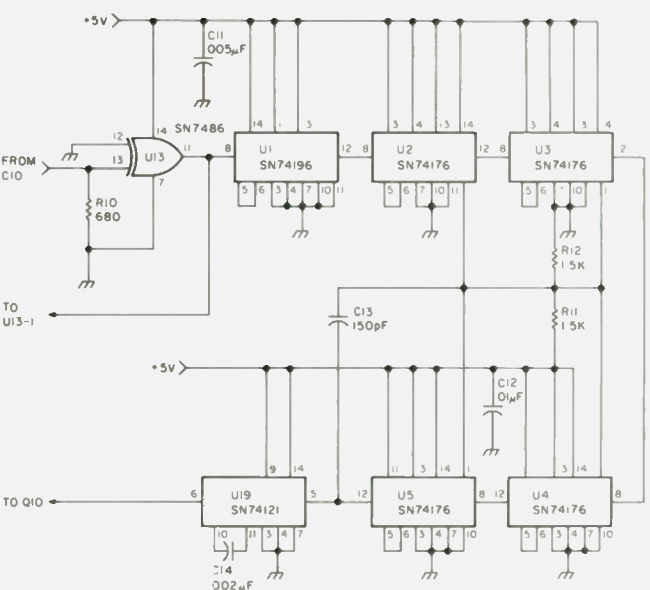

Fig. 16. Divide-by-11, 985 presetable decade counter (high-side injection).

gram the presetable decade counters U8, U9, and U10 of Fig. 5 is binary coded decimal (BCD). I did not locate BCD switches for less than \$2.00. I purchased five single-pole 10-position switches for \$0.99 each from Radio Shack. Using the diode-switch scheme shown in Fig. 10, the switches were converted to BCD. Only five switches were used. The .01 MHz switch, S6, is common to both banks of switches. Another switch can be added to the S2, S4 bank wired as S6 is, with a diode in series with its arm common with the diodes from the arms of S2 and S4. Add a diode in series with the arm of S6, and wire its anode to the anodes of the diodes from the arms of S3 and S5. Now the operator can offset both transmit and receive fre-

quencies in the 0.01 MHz range.

The REC select switch, S1, selects the frequency in the receive mode. The XMIT select switch, S7, selects the frequency in the transmit mode. The operator sets the transmit and receive frequencies as a direct readout of the frequency select switches. With S2 set to 2, S4 set to 3, and S6 set to 5, the frequency of operation is 222.350 MHz. With S3 set to 2, S4 set to 3, S5 set to 5, and S6 set to 0, the frequency of operation is 223.500 MHz.

In the receive mode, 2.4 to 5.25 volts is applied to R60. Q8 will conduct and Q9 will be off. When Q9 is off, greater than 3 volts is applied at the arm of S1. The data gates of U8 and U9 will then come under control of S2 and 4 or

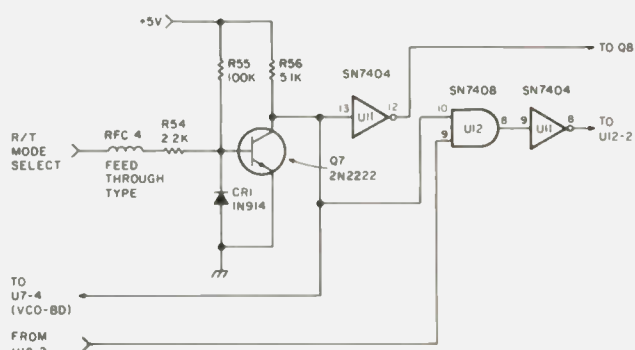

Fig. 15. Transmit/receive mode control circuits (high-side injection).

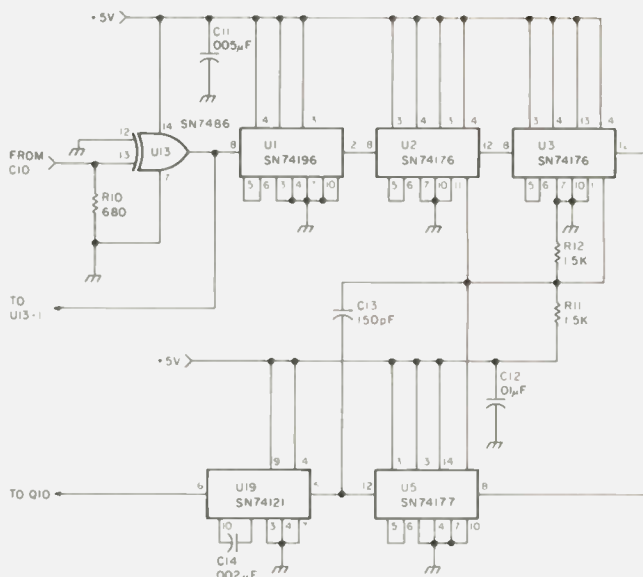

Fig. 17. Divide-by-11, 450 presetable decade counter — alternate circuit to replace Fig. 3. This circuit requires one less chip (U4).

S3 and 5, as controlled by the position of S1. In the transmit mode, Q8 is off and Q9 is on. Between 3 and 5 volts is applied to the arm of S7. The position of S7 will select the transmit and receive frequencies to U8 and U9. When Q8 is on, Q9 is off, and when Q8 is off, Q9 is on. In the on state, less than 0.4 volts is applied to the diode at its collector, so the switch connected to the on transistor has no effect on the frequency programming.

Power Requirements

See Fig. 11. TTL logic requires 4.75 to 5.25 volts. Two 5-volt regulators were used. One would be ample, but I used a second 5-volt regulator to power the vco output chip. R61 is not required if PS2 is attached to

the metal frame, heat sink of the synthesizer. I mounted PS2 to the PC board. R61 will limit the power dissipation of PS2. FL1 is a line input filter. Q3 is an emitter follower used to generate and filter the 11.3-volt source. This synthesizer was designed to operate from a source of 12 to 15 volts.

The part (or equivalent) used from my junk box is: FL1 — Erie, low-pass/high-frequency filter, type 1270-009, 1270-024, or feed-through-type 1201 or 1202, etc.

Construction

Refer to Figs. 12 and 13. The transistors and the integrated circuit chips (IC) are mounted on two copperclad boards. The copper is used as a ground plane. The ICs are

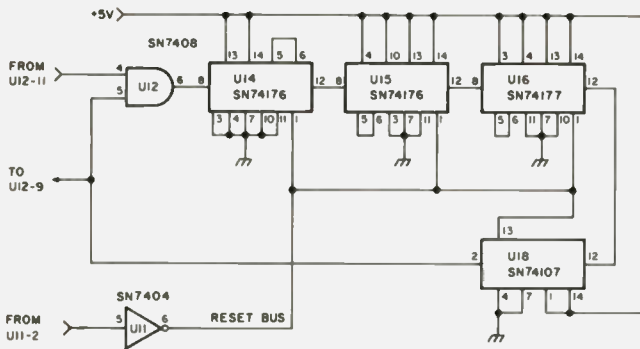

Fig. 18. Receiver offset presettable decade counter (i-f of 10.7 MHz) — alternate circuit to replace Fig. 9. This circuit requires one less chip (U17).

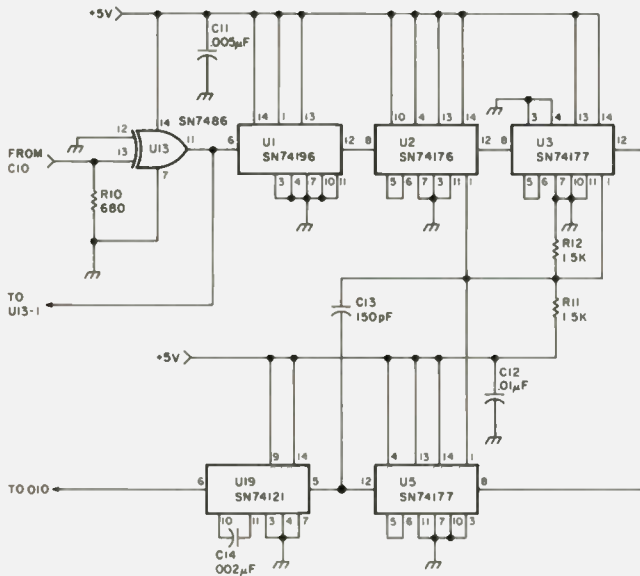

Fig. 19. Divide-by-11,985 presettable decade counter. This circuit is used with high-side injection. It is an alternate circuit to replace Fig. 16. This circuit requires one less chip (U4).

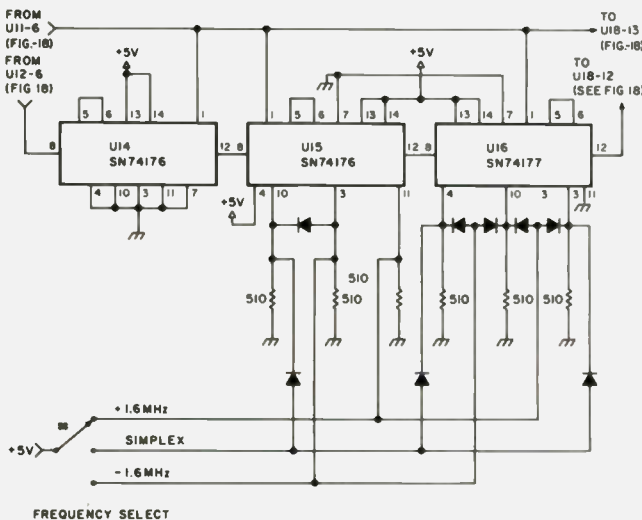

Fig. 20. Alternate circuit to eliminate the second set of frequency select switches. This circuit allows one switch selection of repeater or simplex modes (i-f 10.7 MHz). Note: Diodes are 1N914. Resistors are 510 Ohms, ±5%, 1/4 W. Add .001 µF across each 510Ω resistor.

installed in 14 or 16 pin dual in-line sockets, then mounted upside down. The IC top is up against the copper with the socket pins up away from the board. All ground connections are as short as possible from the copper ground plane to the ICs' socket pins. The 5-volt regulators are mounted to the main copperclad board. Due to ground loops, the vco and the output IC (U7) are located on a small separate copperclad board. I suggest that this vco board be mounted in the enclosure to position the coil (L1) form parallel to the Earth's surface when in use. The vco frequency is less susceptible to shock or vibration with the coil windings perpendicular to the direction of induced shock.

The two boards were mounted in a 5" x 7" x 3" aluminum box with a bottom plate. The frequency select switches are accessible at the top. I did not experience the presence of rf feed-through problems when driving the 15-Watt transmitter.

The enclosure should be rf tight. Use rf feedthrough decoupling for both power and mode select (transmit/receive) inputs.

Note 1 — Crystal Oscillator R5 Adjustment

Crystal oscillator R5 adjustment is made using the receiver audio or discriminator meter as a guide.

Note 2 — Receiver High-Side Injection

If your QTH is in an area where television transmission in the 198 to 204 MHz range presents image problems, you can shift the image frequency above 240 MHz by using high-side local oscillator injection in the receiver. The following changes are required to convert the synthesizer to high-side injection for use with a receiver with a first i-f of 10.7 MHz:

- 1) Crystal X1 should be 19.975 MHz, parallel mode, 32 pF load capacity, funda-

mental mode.

2) Program the presettable decade counter to ÷11,985 as follows:

- Remove the jumper between U1 pins 5 and 6;
- Remove the input at U1-8 and connect it at U1-6;
- Remove the connection at U2-3;
- Remove the connection at U2-10;
- Connect U2-3 to ground;
- Connect U2-10 to +5 volts;
- Remove the connection at U3-3;
- Remove the connection at U3-4;
- Connect U3-3 and U3-4 to ground;
- Remove the connection at U4-3;
- Remove the connection at U4-10;
- Remove the connection at U4-11;
- Connect U4-3 to +5 volts;
- Connect U4-10 to +5 volts;
- Connect U4-11 to ground;
- Remove the connections at U5 pins 3, 4, 10, and 11;
- Connect U5 pins 3, 4, and 10 to +5 volts;
- Connect U5-11 to ground;
- Remove the connection at U12-10;
- Connect U12-10 to U11-13;
- Retune vco L1 to cover 18.3 to 19.7 MHz. If required, retune your receiver local oscillator/multiplier chain.

Cost

As of the January, 1978, issue of 73 Magazine, the cost of all ICs, diodes, transistors, regulators, and VVCs was \$25.01.

Options

Figs. 2 through 13 define the basic 220 to 225 MHz frequency synthesizer. The following schematics are options which may be used in place of Figs. 2 through 13, as desired.

1. High-side injection — Replace Fig. 2 with Fig. 14; replace Fig. 3 with Fig. 16; and replace Fig. 8 with Fig. 15.
2. Single-frequency select switching with simplex repeater mode switch (repeater offset — 1.6 MHz) — refer to

Fig. 10. Delete the following parts: S1, S2, S4, Q9, Q8, R57, R58, R59, R60, S7, and the diodes in series with the arms of S3 and S5. Connect the arm of S3 to +5 volts. Connect the arm of S5 to +5 volts. S3, S5, and S6 are the frequency select switches.

The mode select switch is added as follows: Replace Fig. 9 with Fig. 18. Modify Fig. 18 by adding S8, the diodes, capacitors, and resistor of Fig. 20.

Note that with low-side

injection, the frequency select switches set the transmitter frequency in the repeat mode. The receiver frequency will be offset 1.6 MHz.

Note that with high-side injection, the frequency select switches set the receiver frequency in the repeat mode. The transmitter frequency will be offset 1.6 MHz.

3. *Parts reduction* — The number of ICs can be reduced by two. U4 and U17 can be

eliminated. Replace Fig. 3 with Fig. 17. Replace Fig. 9 with Fig. 18. Note that U5 and U16 are changed from SN74176 to SN74177.

If you use high-side injection, replace Fig. 16 with Fig. 19 and replace Fig. 9 with Fig. 18. Note that U3, U5, and U16 are now SN74177.

As you can see, a PC board is not required to make this synthesizer. This scheme can be modified for use on 2 meters or at 440 MHz.

If you have any specific

questions related to this 220-225 MHz frequency synthesizer, send me the questions and a stamped self-addressed envelope. ■

References

1. *RCA COS/MOS Integrated Circuits*, SSD-203C, 1975 Data Book Series, pages 227 through 233.
2. "The RCA COS/MOS Phase Locked Loop . . .", *COS/MOS Micropower Phase Locked Loop*, pages 471 through 478.
3. *The TTL Data Book*, Texas Instruments, 1973, pages 62, 63, 64, 79, 82, 86, 94, 120, 134, 209, 369, and 451.

Social Events

RAPID CITY SD JUL 1-2

The annual South Dakota hamfest will be held on July 1 and 2, 1978, at Surbeck Center on the campus of the South Dakota School of Mines and Technology, Rapid City, South Dakota. There will be technical forums, an ARRL forum, a flea market, and industrial tours. The grand prize will be a Kenwood TS-520S; the preregistration prize will be a Kenwood TR-7500. Admission is \$4.50 in advance (before June 1) or \$5.00 at the door. Plan to include this on a vacation to the Black Hills for the July 4th weekend. We recommend early reservations for accommodations. For more information and/or assistance with reservations, write to Black Hills ARC, Box 1014, Rapid City SD 57709.

BRIDGETON MO JUL 6-8

The ICHN/MARAC 10th annual convention will be held July 6, 7, and 8 at the Holiday Inn, 4545 N. Lindburg Blvd., Bridgeton MO. This convention will involve amateur radio operators from every part of the United States and several DX stations, all sharing a common interest in county hunting and mobile operation. The election of MARAC officers, meetings, workshops, and some important social activities will highlight this year's convention. Of course, there will be prizes and awards to add spice to the festivities. Those interested in attending this year's convention can send for information from Convention Director Jim Glascock W0FF, 3416 Manhattan Ave., St. Louis MO 63143.

WELLINGTON OH JUL 8

The NOARSFEST will be held

on Saturday, July 8, from 7:00 am to 6:00 pm, at the Lorain County Fairgrounds, Wellington OH. There will be a well-marked, paved flea market area. A DenTron DTR-1 transceiver will be given away as well as 100 other prizes. Tickets are \$1.50 before July 1 and \$2.00 at the gate. Talk-in on 146.10/70. Mobile check-in for prizes on 146.52. For further info, contact NOARSFEST, PO Box 354, Lorain OH 44052.

CUMMINGTON MA JUL 8-9

The Northern Berkshire Amateur Radio Club's hamfest will be held on July 8th and 9th at the Cummington Fair Grounds, Cummington, Massachusetts. There will be free overnight camping, technical talks, demonstrations, and dealers. The flea market will cost \$1. Admission will be \$4 or, with spouse, \$6. Advanced tickets are \$3 and \$5. For information write: Hildy Sheerin WA1ZNE, 89 Greylock Terrace, Pittsfield MA 01201.

CHARLESTON SC JUL 8-9

The Charlestowne Hamfest will be held July 8-9 at Gaillard Municipal Auditorium, 77 Calhoun Street, beginning on Saturday, July 8, at 8:00 am. Events include FCC exams on Saturday at 8:00 am, planned ladies' activities, and a Social Room Saturday at 7:30 pm. Admission charge is \$3.00. Tables are available for \$3.00. Free refreshments. Talk-in on 34/94. For further information, write to PO Box 4555, Charleston SC 29405.

INT'L PEACE GARDENS MANITOBA JUL 8-9

The 15th annual International Hamfest at the Canadian

Pavilion in the International Peace Gardens will be held on Saturday and Sunday, July 8-9, beginning at 2:00 pm. Transmitter hunts, contests, door prizes, and lots of other social activities. Admission is \$5.00 for hams, \$2.00 for non-hams, and children are free. Plenty of camping facilities. Talk-in on 34/94, 3990, and 3778 kHz. For further info, contact Lynn A. Nelson WA0WB6, 1301 2nd Ave. W., Devils Lake ND 58301 or Reginald G. Edworthy VE4RW, 449 7th St., Brandon, Man. R7A 3S9.

INDIANAPOLIS IN JUL 9

The Indianapolis hamfest will be held on Sunday, July 9, 1978. The gates will be open from 6:00 am to 4:30 pm. The place is the Marion County Fairgrounds, S.E. corner, in Indianapolis, Indiana. There will be professional commercial exhibiting, a covered flea market, and an unlimited outside flea market. Overnight camping facilities with hookup are available. For information, write to Indianapolis Hamfest, PO Box 1002, Indianapolis IN 46206.

ESSEX MT JUL 15-16

The International Glacier-Waterton Hamfest will be held on July 15-16, 1978, in the West Glacier Area, Montana. The location will be at the Three Forks Campground, 10 miles east of Essex MT on U.S. Highway 2. Registration begins at 9:00 am MST.

BOWLING GREEN OH JUL 16

The Wood County, Ohio, 14th annual Ham-a-Rama will be held on Sunday, July 16, at the fairgrounds in Bowling Green (just off I-75). Gates open at 10:00 am. Admission and parking are free. Tables are available for \$3.00 or 8-foot spaces for \$2.00 (advance table or space rental to dealers only).

Trunk-sale space and food will also be available. There will be a main prize drawing and lots of door prizes. K8TIH talk-in on 146.52 simplex. Tickets are \$1.50 in advance, \$2.00 at the door. Write to Wood County Amateur Radio Club, c/o Eric Willman, 14118 Bishop Road, Bowling Green, Ohio 43402.

ARLINGTON VA JUL 22-23

The Amateur Computing 78 microcomputer festival will be held July 22-23 at the Sheraton National Motor Hotel, Columbia Pike and Washington Blvd., Arlington VA. The show will feature commercial exhibits, personal computer displays, seminars, and club activities. Computer hobbyists and the general public are welcome. Registration at the door for two full days is \$5.00 (spouse and children of ticket holder admitted free). If not sold out, Saturday night banquet tickets are \$14.00 per person if purchased at the show. Admission tickets are \$4.00 and the banquet tickets are \$12.00 per person, if ordered in advance by mail. Send check payable to AMRAD to PO Box 682, McLean VA 22101.

MARSHALL MO JUL 23

The Indian Foothills Amateur Radio Club, Inc., will hold its third annual hamfest on July 23, 1978, in an air-conditioned multipurpose building at the Saline County Fairgrounds in Marshall, Missouri. There will be flea markets for the OM and XYL (tables—\$2.00 for first table; \$1.00 for each additional table). Many prizes are to be awarded and there will be old and new equipment displays. Campgrounds (no connections for utilities) are available. The timetable is 8:00 am—registration; 8:00 am to 10:00 am—breakfast rolls and coffee; 11:30 am—lunch—all you can

Continued on page 144

Beat the Microphone Blahs

— more oomph
for FM audio

George K. Fallenbeck K1HQW/4
1008 Pine Lake Drive
Niceville FL 32578

Are you plagued by a microphone which generates insufficient output? Do you have to darn near swallow the thing to obtain decent modulation? Is your FM rig's deviation control

wide open, and you're still getting reports of low audio? Read on, for the cure is at hand!

The Heath Micoder has an output of 30 mV, which is supposedly enough to drive the input speech clipper of the HW-2036 into limiting. This would tend to hold the audio level constant over a reasonable range. My

HW-2036 was not being driven sufficiently. If I backed off from the mike the least bit, the modulation dropped drastically. The transceiver input seemed sensitive enough, since the touchtone™ level was perfect for the rather finicky local repeater's autopatch with the touchtone level pot in the Micoder set at only 50% of maximum. That left the fancy electret capacitor mike in the Micoder as the culprit. Its output was already boosted by an integral preamp, but it wasn't sufficient. A fair proportion of the HW-2036 owners in the area have the same problem. What quick, dirty fix would boost the gain?

A quick scan through IC literature resulted in the following preamp. They don't get much simpler. The original version used miniature pots for symmetry and gain adjusts and wouldn't fit into the Micoder case. It also generated hum. The second

version dispensed with the pots in lieu of fixed resistors, eliminated the hum, and is set for adequate gain for the 2036 application.

Tantalum capacitors and quarter-Watt resistors are recommended, since they form a very compact unit. All wiring is lead to lead (dead bug). Circuit ground is the case of the 741 IC metal case. In this case, you will probably find that the case is internally grounded to V-, so you won't have to make the connection externally. If you use a DIP-style IC, use whatever pin is V- as circuit ground. Use thin shielded lead, such as the type used in phonograph tone arms, for the input and output leads. It is very flexible and easy to work with. You'll pick up hum if you don't use the shielded lead. Strive for the smallest resultant package. After you have tested the unit, either in the mike or using some convenient audio amp, pot the entire module in

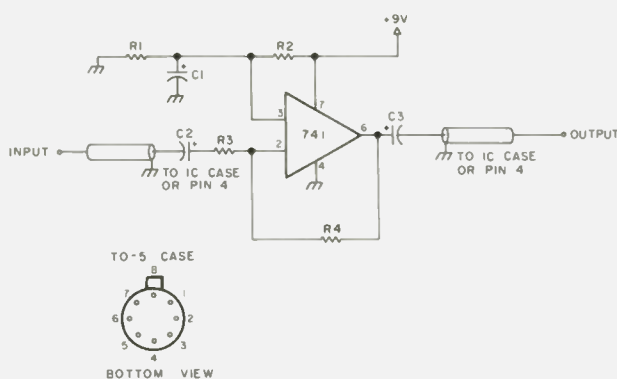

Fig. 1. IC — LM741CH, TO-5 metal case style, available from James Electronics (if different case configuration is used, pinout may be different); C1 — 5 uF or larger tantalum; C2, C3 — .1 uF tantalum; R1, R2 — 4.7k, ¼ W; R3 — 47k, ¼ W; R4 — 330k, ¼ W.

a blob of 5-minute quick-setting epoxy. The unit will be insulated and physically protected, and you will prevent shorts between components or to the Micoder terminals.

Installation in the Micoder is simple. Disassemble the Micoder case, and set the touchtone generating board aside. Remove the 9 V battery because you will zap the push-to-talk input transistor in the HW-2036 if you accidentally get 9 V on the push-to-talk line. All you need do is short the two middle lugs on the PTT switch. I did. Disconnect the 2.2k, 1/4-Watt resistor from pin 2 of the mike element. Connect the preamp input lead center conductor to pin 2 and the shield to pin 3. Connect the 9 V supply lead to SW-101, lug 4. Connect the ground lead to terminal strip D, lug 1. Connect the output lead center conductor to the end of the 2.2k resistor previously disconnected from

lug 2 of the mike. Let the shield float. Cram the preamp against and under terminal strip D, and glue it down. Reinstall the battery, and reassemble the Micoder case.

The preamp is set for a voltage gain of about 8 (gain = $|R4 + R3|/R3$).

The gain can be adjusted (before potting) by varying R4. Decrease R4 to decrease gain and vice versa. With R4 set at 1 meg, you'll realize a gain of about 22, or an output of about 660 mV for 30 mV in.

While thrown together for the Micoder, this preamp should be applicable to any other low-level mike. Just supply a source of 9 V or less. High-level mikes, such as crystal or certain ceramic types, will overdrive this preamp. Also, there is no reason why you can't mount it inside the rig to more conveniently access a source of voltage.

You probably never drove your FM transceiver into the

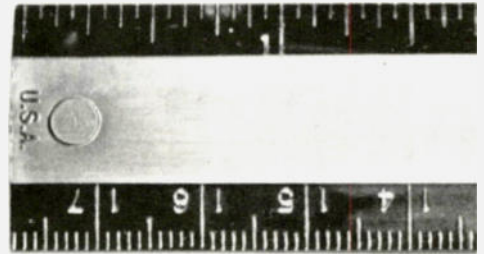

Example of construction. This unit was constructed using 1/2-Watt resistors and is larger than necessary.

proper speech clipping mode if your mike output was previously inadequate. You now will and with the mike at quite reasonable distances

from your mouth. Be prepared to reduce the deviation limiting control on the rig or face the wrath of the local rabble. ■

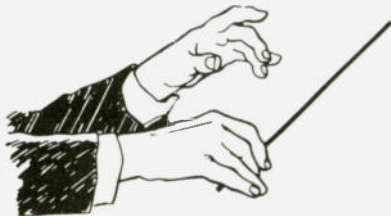

The LEADER In the Northwest!

ATLAS • ICOM • KENWOOD • YAESU



Kenwood TS-520S
\$739.00



Atlas 350-XL
\$995.00



Yaesu
FT-101E \$799.00
FT-101EE \$759.00



Kenwood TS-820S
\$1098.00



ABC
COMMUNICATIONS

A46

17550 15th Ave. N.E. • Seattle WA 98155 • (206) 364-8300



Yaesu FT-301D - \$935.00



TO PLACE ORDER
CALL TOLL FREE
IN STATE OF WASH.
1-(800) 562-7625

Other locations: (Walk-in customers only) • Bellevue - 12001 N. E. 12th • Everett - 6920 Evergreen Way • Open Mon. thru Sat.

Forbidden Contacts

—19 countries off limits to 4X4 amateurs

I found the house of Ricky Kline 4X4NJ as one might expect. I told some of his neighbors in Gan Yavne, a removed little town to the south of Tel Aviv, that I was looking for the amateur radio operator. When that did not bring directions, I added that I was sure that he had a giant antenna on his house. "Oh, that one," responded my informants, and within

minutes I was at Ricky's gate.

He showed me into his large attractive split-level house while the dog I had read about at the front gate made his presence known from somewhere in the backyard. We sat briefly in the sunken living room and then climbed past two more immaculate floors and finally reached his shack. Towering bookcases with the stacked

books forming random geometric patterns, jumbled equipment, and three large cardboard boxes stashed in a corner with QSL cards slipping out formed a hurricane-like periphery to his orderly and sophisticated station in the center.

I, formerly WA2JPN and looking in on the Israeli amateur scene, asked to see what was happening on the

4X4 net, the 20 meter meeting place for those wanting to make contact with Israeli stations. There were no local contacts in progress. Afterwards, I recalled being told that activity stops almost completely from 8:00, when Arab language broadcasting on the television ends, until 9:30, the end of the news.

While fruitlessly looking for local hams on the band, Ricky, eight years in the country and K7NJ during his visits home, came across an Algerian station. "Watch this. He won't answer." Sure enough, the 7X2 station was suddenly silent after Ricky's call. "That's typical," he said. "He probably has some clerk in his country who forbids him to." Ricky next tried a CN8 station, who tacked on to his call with precise diction that he was "broadcasting from the Kingdom of Morocco," and met with the same reception.

The next time that Ricky renews his license, some clerk will make it illegal for him, also, to try to bridge the gap between himself and his North African counterparts. The Ministry of Communications recently announced that it was "updating" the current ban on contacts with seven Arab countries to "match the present reality," and that, henceforth, nineteen North African and Middle Eastern states would be off bounds for amateurs. The decision followed the raising of the ban issue some months earlier in *The Wave*, the bimonthly magazine of the Israel Amateur Radio Club, by Rami 4X4LX. After reviewing the question of the ban in general terms, he closed his letter by suggesting that "the club act to have the Ministry of Communications erase this restriction from the terms of the license, quietly and without a lot of fanfare. This does not mean that immediately upon removal of the limitation we have to court the Arab hams, for they certainly will not respond. Removal of the restriction will prove that



"We must act to topple the artificial walls in the ether waves," wrote Ricky Kline 4X4NJ, in the IARC's magazine, *The Wave*, as he called for a cancellation of the ban on contact with Arab countries.

we are not hatemongers.”

The following month, the normally bland letters column of *The Wave*, which is published in Hebrew, came alive with a universally favorable response to Rami's suggestion. Erez 4Z4QE stated that “contact between us and Arab amateurs can only be a positive factor on the road to peace.” His sentiment was echoed in stronger language by Ricky 4X4NJ, who wrote, “We must act to topple the artificial walls in the ether waves. Amateur radio is based upon friendship, help, and cooperation — principles which are in accordance with the ‘open bridges’ policy of the government of Israel ... There is no justifiable reason for the existence of the ban today.”

Ricky went on to fantasize a conversation between “Hussein” and “Yitzhak” which closed, “‘4X1 this is JY1. Yitzhak, you have a nice signal. My name is Hussein. I've been waiting to talk to you for a long time. This is indeed a pleasure — over.’”

“‘JY1, this is 4X1. Hussein, it is a pleasure for me, too. It's wonderful meeting you this way ...’”

The decision was announced several months later in a letter from the Ministry of Communications printed in *The Wave*. It drew disappointed notice from Doron Arad 4Z4BR, editor of the organ. “The new ban on Arab states, as published in this issue, will certainly set up a far-reaching repercussion amongst us, and we hope that this sad order will be canceled. Just a short time ago, many members spoke of canceling the ban on the seven original Arab countries, and now they have ‘generously’ added more.”

The Ministry of Communications, explained M. Shaked from the section which was responsible for the handling of amateur affairs, was only acting in accordance with instructions that it received from the Ministry of Security. While unwilling to

state his personal opinion, Shaked implied that he was in favor of the amateurs' position.

Although the notion of the ban being justified for security reasons was termed “ludicrous” by the amateurs, the decision to broaden the ban was apparently made at a high level in the Ministry of Security — “probably by

misinformed people who mean well,” noted Ricky. He said that there were presently efforts being made through “quiet diplomacy” to have the decision rescinded. “We don't want to force anyone to make a case they can't back out of.”

In spite of the ban, contacts with Arab countries take place. They usually

occur during contests and are of short duration. One of Israel's most competent hams, who proudly displayed an aging QSL from Jordan on his wall, worriedly requested to remain anonymous. The ban is taken quite seriously by the amateurs, and there was a great hesitancy to confirm the existence of such contacts. The Ministry of



Secretary of the IARC, David Ben-Basat 4X4WH, places a call on a telephone, with a memory dialing circuit and loudspeaker produced by his electronics firm. He felt that “there is not another country that compares with us in the friendship among Israel's fraternity.”



Israel Kass 4Z4IK stands outside the Tel Aviv showrooms of his Volvo distributorship. Israel is the president of the IARC and has his staff take care of much of the club's bulk work, such as the mailing of its magazine and handling shipments of donated surplus equipment.

Communications is ready to enforce the ban with a violation report, three of which lead to license revocation.

Russian amateurs are forbidden by their government to talk with Israeli amateurs, a situation which the secretary of the IARC, David Ben-Basat 4X4WH, indignantly termed "a real scandal, for we are not in a state of war with them." There are, however, Russian amateurs who are willing to risk reprisals from the authorities and make contact with Israelis. Ricky 4X4NJ showed me a letter he received from a young Russian amateur with whom he had talked. "Band conditions here are very bad," read part of the letter,

"especially on 40 and 20 meters because of jamming broadcast stations a mile away from us." Many such venturesome amateurs are Jews who have been sent to Siberia. One such amateur used to contact Israel every day for months on 20 meters. Suddenly, he disappeared from the air, and it was assumed that the authorities had finally caught up with him. Several months later, he surfaced in Israel as a new immigrant, and, soon after, he received his 4X4 callsign.

Generally, there is mutual cooperation and respect between Israeli amateurs and the Ministry of Communications. Israelis have a high degree of sensitivity to the

concept of things being "good for the country" and amateur radio is so considered. Both from the IARC and the Ministry of Communications, I heard the identically expressed sentiment that the measuring rod for the level of technological development of a country is its relative number of amateur radio operators.

Licensing examinations are given twice a year. The Ministry allows an observer from the IARC to sit in on the tests for each of the three license levels. The observers check the questions on the exams, and, if something appears unclear, they ask the examiner to explain the question more completely. On occasion, a question is removed from the examination if it is pointed out as unsuitable.

The lowest level of license, class C, is presently held by eighty amateurs. Operation is severely restricted, with an output of ten Watts allowed and transmission confined to CW on portions of the 15 and 40 meter bands. However, the license is renewable. The class B license is held by 300 amateurs and permits 200-Watt output transmission on slightly more frequencies than the American General class license. The highest class license, class A, is obtained after a code test and a demanding verbal theory test that causes a high rate of failure each time the test is given. One hundred and eighty Israeli amateurs hold class A licenses.

The Ministry of Communications is strikingly cooperative with tourists and new immigrants. Tourists from one of the six countries with whom Israel has a reciprocal licensing agreement, including the United States, who arrive at the Ministry's office with all the required information, are granted a temporary license on the spot. Tourists who arrive from most other friendly countries receive the same treatment. New immi-

grants may have a wait of several weeks before receiving their permanent new call. I remarked to David 4X4WH that, in the United States, the process is more complex. "You're telling me!" he exploded and pulled out a carefully worded request that he had sent to the FCC far in advance of his intended trip to the States, and, several days before setting out, he was still unsure if he would receive a positive response.

The Ministry of Communications provides another "extra" to the amateurs by channeling surplus equipment to them through the IARC. The army and police are large sources for such equipment, as in Motorola of Israel. The equipment is distributed by the IARC to its members through raffles. Much of such equipment is dated two meter equipment.

The first shipment of surplus equipment was received in late 1972 and consisted of one-Watt walkie-talkie police radios. Their distribution served to open up the two meter band in Israel, a movement that has continued until today when virtually all eligible hams have two meter capability, and the band has assumed the character of the local corner meeting place. It provided an easy way for making domestic contacts, a capability that served to unite the amateur fraternity in the country. The operating practice of many of the hams on the band, however, draws comparisons to the notoriously bad traffic on the highways.

Two meters has also become the focal point of local development work. There are several groups that meet regularly and work on modification plans or the design for some new component, and there is hardly an issue of *The Wave* that does not appear with some of the fruits of their labor.

The IARC has actively participated in the development of the band by erecting and maintaining five

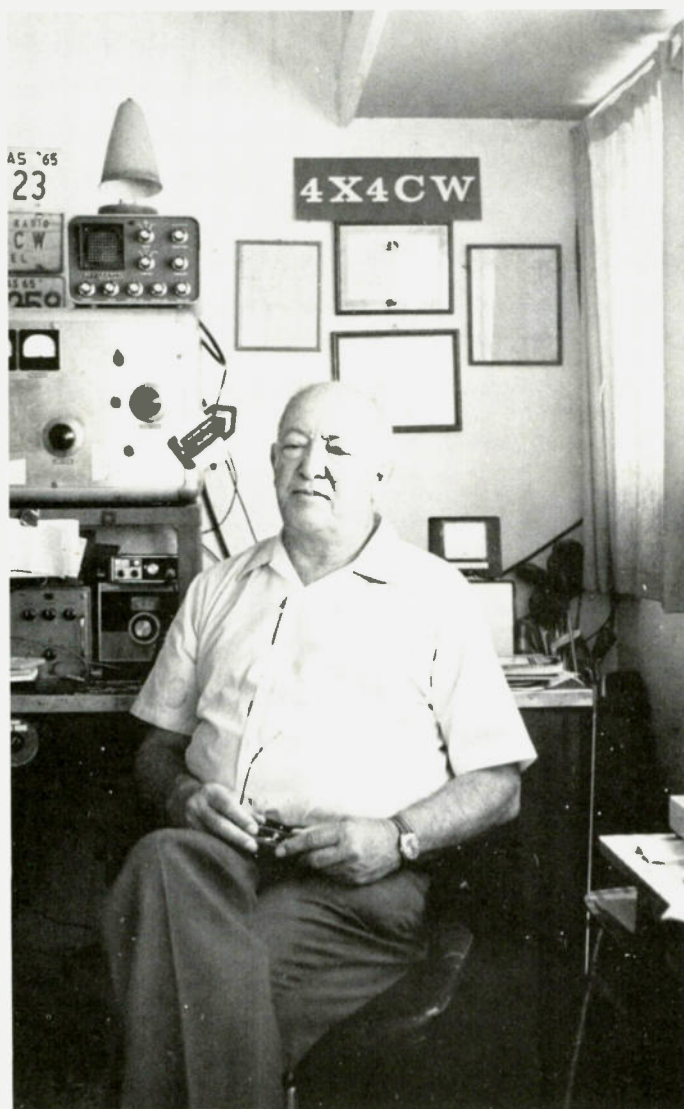

Ozzie Osrin 4X4CW received his call in 1948 and is the holder of the first amateur radio license issued by Israel. He recently founded an old-timers' club and hopes to enlist eligible members in the Quarter Century Wireless Association.

repeaters scattered throughout the country, from Beer Sheva in the south to Safed in the north. The coastal repeaters at Haifa and Tel Aviv have opened them up to two meter DX. With favorable conditions, Cyprus can be contacted.

Most of Israel's active hams, and some who are not, are members of the IARC, according to the club's president Israel Kass 4Z4IK. Their ranks are swelled by 100 SWLs, often youngsters who are in the process of studying for their licenses. The club members meet each other in person at the annual meeting, which is attended by virtually all of the members. The close-knit fraternity, most of whom know each other, also gathers for field days sponsored by the club.

Israel Kass enlists the services of his Volvo distributorship to aid in the distribution of the club's bi-monthly magazine, *The Wave*. When the magazines arrive from the printers, he sets the entire staff to work stuffing them into envelopes and attaching computer-printed postal stickers, an operation that lasts several hours. He will also soon add Kenwood amateur equipment to his posh Tel Aviv showrooms, establishing one of the very few organized distributorships of amateur equipment in Israel.

Amateurs generally have to rely on friends coming from abroad or business trips which have taken them out of the country in order to obtain equipment. A thirty-percent tax is levied on amateur gear being brought into the country, which, steep as it may sound, is in sharp contrast to the usual two-hundred-percent tax on electronic equipment.

Friends are also used to circumvent the difficulties in obtaining equipment. There is a tremendous willingness among the Israeli amateurs to help one another, and a great amount of equipment is lent or just given as an outright

gift. "When I go out and take something from somebody, I do it because I feel better, not because I can't buy it," explained David 4X4WH. "A friend will hear that I want to buy a certain piece of equipment and he'll say, 'Why waste good money? Come over to my place and I'll give it to you.'" He pointed out his teleprinter as a gift he

received, while he himself had lent out thousands of dollars of equipment before leaving on an extended trip abroad.

There are two primary sources of Israeli amateur radio operators. Many are high school students studying in technical programs. They join one of the many clubs (one hundred clubs have valid licenses, although not all are

active), and, by the time they are in the tenth grade, they have the theoretical knowledge to pass the licensing test. Even the most critical observer of the Israeli ham scene had words of praise for the level of technical knowledge among such youths. Many other amateurs join the ranks after serving in the army's communication corps. The

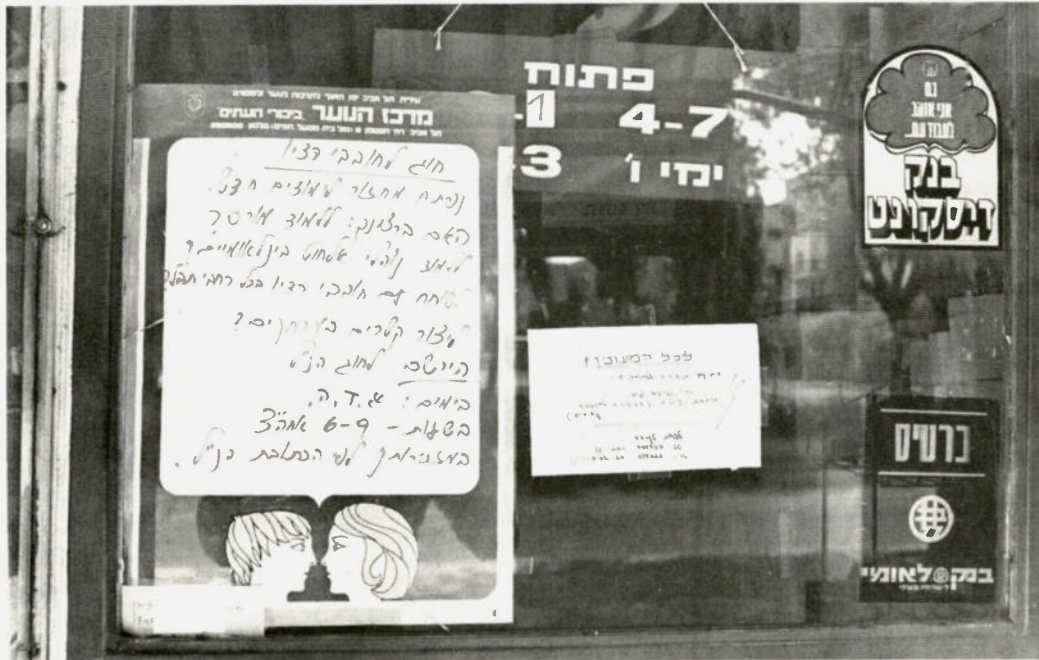

"Do you want to learn Morse? To learn international wireless procedures?" asks the Youth Center poster. The announcement was posted by brother and sister, Oded 4Z4RL and Irit 4Z4UE in the family's shoe store in North Tel Aviv.



Numero Uno – the lively meeting place of Israeli and foreign hams just off the bustling Dizengoff Circle in Tel Aviv. In the background, visiting Maurice Kiek PAØCI and Jack Izhaki 4X4AH are seated at Jack's habitual table.

army fosters the hobby and sponsors several clubs that have stations and offer instruction for passing the licensing tests.

Israeli amateurs may be contacted via the 4X4 net. The net, located at 14.320 MHz, grew out of the consistent contact between Hal Crystal K2BYB and 4X4 amateurs. Hal also formed a group of Jewish amateurs called Chaverim ("friends," in Hebrew), which has as its aim, according to its monthly

newsletter, "to promote a closer association between Jewish amateur radio operators the world over." While most members of the group must pay a five-dollar subscription fee in order to receive the newsletter, all members of the IARC receive it free of charge. The newsletter is mailed bulk to Israel 4X4IK, who simply has his staff include it in his mailings of *The Wave*.

Amateurs coming to Israel for a visit also have a fixed

place where they can meet up with Israeli amateurs. In the center of Tel Aviv, just off Dizengoff Circle, Jack Izhaki 4X4AH has set up an unofficial reception center in a sidewalk cafe called Numero Uno. Taking regularly scheduled breaks from his nearby electronics store, he stations himself at what he calls "my reserved table," just off the sidewalk, and, almost daily, is joined by amateurs visiting from abroad.

The cafe is usually only

the starting point of the tour, as Jack often invites his guests home or puts them in touch with other amateurs in the area. Aided by the liberal rules concerning tourist operation and the hospitality of the hosts, the visits are usually quite successful, as warmly confirmed by Maurice Kiek PAØCI as he chatted with Jack at the cafe. "Words can't describe my reception here," he said. "I feel like the prince of the royal family." ■

FT901DM

IN STOCK

\$ 1299⁰⁰



WANT TO TRADE — UPGRADE? Call us — for best quote. Large assortment of clean used equipment on hand.

50th Year Serving Amateurs

W4WL   **W4VOV**

FRECK radio & supply co., inc.

38—40 Biltmore Ave. F3
Asheville, N C 28801
PHONE: (704) 252-8000

Special of the Month

MASTER I/O BOARD
(space time productions)

Contains: 6 Parallel I/O Ports (8255)
1 Serial I/O Port (8251)
3 Counter Timers (8253)
1K RAM (2114)
3K ROM (one 2708 supplied)
Fully Buffered S-100 BUS

ALL ON ONE BOARD

Assembled, Tested & Burnt in . . . \$369.00
Bare Board (with documentation) . . . 47.50
Complete Kit of Parts Only 135.00

6" COLOR CODED RIBBON CABLE
With 14 Pin Dual In Line Gold Plated Plugs on Each End.



\$1.00 Each 5/\$4.00

CRYSTAL — 1.344 MHz — \$1.50
FERRITE SLEEVE — \$1.25/Dozen
4.7 uH Coils — 6/\$1.00
2N 3819 FET — 3/\$1.00

DATAK CORP'S ER-2 DIRECT ETCH DRY TRANSFER RESIST PATTERNS.
Package of 8 sheets includes transistors, ICs, edge card connectors, pads, lines, circles, jogs, 1/16" and 1/32" PC tapes. Simply transfer from sheet to copper clad board and etch.

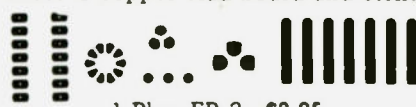

1 Pkg. ER-2 — \$3.95

CHICAGOLAND — We invite you to visit our retail store, open daily at 10:00 A.M.
WRITE US FOR FREE FLYER.

R.W. ELECTRONICS, INC.
3203 North Western Avenue R18
Chicago, Illinois 60618
312-248-2480

... at last ...

your shack organized!

A beautiful piece of furniture — your XYL will love it!

\$13995 S-F RADIO DESK
Deluxe - Ready to Assemble



Designed with angled rear shelf for your viewing comfort and ease of operation.

FINISHES: Walnut or Teak Stain.
Also available in Unfinished Birch, \$124.95.

Additional Information on Request.
Checks, Money Orders, BankAmericard and Master Charge Accepted.

F.O.B. Culver City. (In Calif. Add 6% Sales Tax.) **S33**

S-F AMATEUR RADIO SERVICES
4384 KEYSTONE AVENUE • CULVER CITY, CALIF. 90230 — PHONE (213) 837-4870

Radio equipment not included
Floor Space: 39" Wide 30" Deep

HAMTRONICS USED GEAR • TEST EQUIPMENT • SPECIALS

30-DAY GUARANTEE ■ 90-DAY FULL CREDIT TRADE-IN ■ FREE SHIPPING VIA UPS ONLY

Limited quantities. First come, first served. (if weight or size exceeds UPS max., we will ship freight collect)

Allied AX-190 Receiver \$159 Ameco PV-50 \$ 9 CN-50 29 CN-144 39 TX-62 79 621 VFO 45 B&W Waters Nuvertor 2+6 Conv. \$ 75 6100 SSB Xmitter 395 670 SSB Adaptor 39 Co-Dax Keyer 95 Central Electronics 100V Transmitter 325 MM-2 Scope 69 20-A SSB Adaptor 79 Clogg 22'er FM \$129 66'er 6M Xcvr 115 99'er 6M Xcvr 59 Interceptor BR CUR 275 Ant Pre Amp 22 All Bander 69 HT-146 125 2 Vess 259 FM-27-B Xcvr 325 Collins 75 A4 Receiver \$395 7553B Receiver 695 7551 Receiver 349 KWA-2 Xcvr 95 3251 Xmitter 349 PM-2 AC Supply 349 516 F2 AC Supply 139 312B5 Console 425 361D2 Mount 29 Drake 2A Receiver \$149 2B Receiver 189 2AQ SPKR QMULT 29 R4 Receiver 289 R4-B Receiver 349 R4-C Receiver 399 MS-4 Speaker 19 2NT Transmitter 125 2NT Transmitter 99 TR 6 695	TR-222 Meter 140 T-4X Transmitter 339 TR-72 Meter FM 225 AC-4 AC Supply 95 TR-4-C Transceiver 449 CC-1 Console CPS-1 Supply SC-2 Conv SC-6 Conv SC-1 Calibrator The above all assembled complete pkg. Only \$200	Dycomm 10-0.2 M Ampl \$125 35-0 401N 110 Out 130 470-25 450 MC 120 P-1416 16 Amp Supply 95 Eico 720 Transmitter \$ 49 722 VFO 39 730 Modulator 39 Eimac AF-67 Transmitter \$ 45 PMR-8 Receiver 79 Genave GTX22M FM \$165 GTX-200 2M FM 149 Globe/Galaxy VHF 6+2 Transm \$ 39 Chief Transmitter 39 Galaxy III Xcvr 159 Galaxy V Xcvr 189 Galaxy V Mk II 239 GT-550 Xcvr 279 GT-500A Xcvr 329 AC-400 Supply 79 FM-210 2M FM 95 Gonset Com II 2M \$ 75 Com II 6M 69 Com IV 2M 129 GC-105 2M 115 G-28 Xcvr 149 G-50 Xcvr 149 Hallicrafters S-108 Receiver \$ 99 SX-101 Receiver 159 HT-32 Transmitter 179 HT-32B Transmitter 269 SX-99 Receiver 79 SX-115 Receiver 349	HT-37 Transmitter 159 HT-40 Transmitter 49 SX-99 Receiver 99 SX-117 Receiver 189 SR-150 Xcvr 259 SR-160 Xcvr 159 SX-146 Receiver 175 HT-44 Transmitter 159 SX-111 Receiver 149 SX-122 Receiver 249 S-36 UHF Receiver 125 Hammarlund HQ-110 A VHF Receiver \$189 HQ-110C Receiver 119 HQ-110AC Receiver 149 HQ-145X Receiver 169 HQ-170C Receiver 159 HQ-180 Receiver 379 HQ-215 Receiver 259 SP-600 Receiver 179 HX-50 Transmitter 169 Heathkit SB-300 Receiver \$199 SB-301 Receiver 229 HR-10-B Receiver 69 SB-303 Receiver 269 SB-220 Linear Amp 449 SB-102 Trivcwr 379 DX-60B Transmitter 69 HW-32 Transmitter 85 HW-100 Transceiver 249 SB-100 Transceiver 299 SB-401 Transmitter 249 SB-101 Transceiver 349 SB-650 Digital Freq. Display 149 HW-30 Twoer 29 Also Sixer 29 H-10 Monitor 69 VHF-1 Seneca 79 HW-12 Transmitter 75 AC-500 AC Supply 49 HP-23 AC Supply 59 HW-202 2M FM Xcvr 159 SB-620 Spectrum Analyz 120 SB-102 Xcwr 369 SB-610 Scope 95 HA-20 6m Linear 125 SB-634 Console 175 SB-604 Spkr 29.50 SB-644 VFO 129.50 SB-230 Linear 359 SB-104 Transceiver 625	Johnson 1-KW Matchbox/SWR \$195 Courier Linear 139 Ranger I Transmitter 85 Ranger II Transmitter 139 Vallant I Transmitter 129 Invader 2000 Xmitt 495 Kenwood T-599 Transmitter \$289 R-599 Receiver 289 TS-520 Tranc 429 QR-666 259 QR-666 Receiver 239 TV-502 Transvertor 179 Knight T-60 Transmitter \$ 39 r-100 Receiver 59 TR-108 Trancur 2M 79 Lafayette HA-800 Receiver \$ 89 HP-350 Receiver 149 HE-45 Transceiver 49 Midland 509 H.T. \$149 Millen 92200 Transmatch \$149 90651-A Grid Dipper 95 National NC-270 Receiver \$119 NC-300 Receiver 129 NCX-5 Transceiver 279 NCX-5MK II Transcwr 299 NC-303 Receiver 199 AC-500 AC Supply 69 NCX-500 Transceiver 199 NCX-3 Transceiver 169 NC-190 Receiver 149 NC-105 Receiver 69 Regency HR-2B 2M FM \$169 HR-220 FM 220 MC 185 AR-2 2M Amplifier 85 HR-25 2M FM 225 HR-6 Meter FM 189 SBE SB-34 Transceiver \$249 SB-33 Transceiver 189 SB-144 2M FM 175 SBZ-LP Linear 179	Standard SRC-146 HT \$149 826 M Trnscvr 195 SRC-144 395 SRC-851T 250 Swan 700-CX Xcvr \$459 260 Cygnel 289 279 Cygnel 329 500 Xcvr 299 500 CX Xcvr 389 117-XC AC Supply 95 14X DC Module 39 MK-11 Linear 475 KK-V16 Meter 550 250 C 6M Xcvr 349 FM-2X2M Xcvr 169 FM-1210A 2M 249 350 Transceiver 269 350C Xcvr 299 600R Receiver 139 600T Transmitter 399 410 VFO 79	Tempo Tempo one Xcvr \$299 AC One Supply 79 FMH 2M H.T. 149 CL-220 Trncur 220 MC 179 FMH 2M w/Talkie 149 Ten Tec PM-3 Trnscr \$ 49 Argonaut Xcvr 199 KR-40 Keyer 79 RX-10 Receiver 49 S-30 Signalizer 29 Triton II 479 Yaesu FT-401 Xcvr \$499 FRDX 400SD Rec 325 FT 2 Auto 2M FM 249 FT-101B Xcvr 549 FL-2100B Linear 295 FV-101 VFO 79 101E Xcvr Demo 695
--	--	---	---	---	--	--

Test Equipment Bargains

Boonton "Q" Meter	\$295
Tektronix 5140	249
Tektronix 545A	950
5 3/54A Plug-in wide band preamp	75
Hickok 695 Generator	69
Bendix BC221 Freq Meter	39
Polarad Spectrum Analyzers A84T	1695
Hewlett Packard 400C	75
Precision E-400 Signal Generator	125
Electro Impulse Spectrum Analyzer	395
Dyna/Sciences Model 330 Digital Multimeter	195
Hewlett Packard 4905A Ultra Sonic Detector	550
Hewlett Packard 120A Scope	250
TS-323/UR Frequency Meter	175
Hewlett Packard 4910B Open Fault Locator	650
Bird Mod 43	80
General Radio 650A	150
Measurements Mod 80	195
Nems Clark 1400	495
Ballantine 300H	175
PACO Scope Mod-S-50	75
Singer FM-10C	3495
Simpson 260 V.O.M.	49.50



ICOM IC22S
 Regular \$299, save \$50; buy an ICOM IC22S for \$299 (no trades) and take a \$50 credit for another purchase.



KENWOOD TR-2200A
 Regular \$229, save \$30; buy a Kenwood TR2200A for \$229 (no trades) and take a \$30 credit for another purchase.



MIDLAND 13-510
 Regular \$399, save \$50; buy a Midland 13-510 for \$399 (no trades) and take a \$50 credit for another purchase.



KENWOOD
 TS820 \$ 919.00
 TS80S \$1098.00



YAESU
 FT101E - 799.00
 FT101EE - 759.00
 FT101EX - 699.00



DRAKE
 TR4CW - \$799.00

MAIL & PHONE ORDERS WELCOMED. BANK AMERICARD ACCEPTED. ALL UNITS GUARANTEED

HAMTRONICS

DIVISION OF
Trevoze Electronics

4033 BROWNSVILLE ROAD
 TREVOZE, PA. 19047
 Telephone: Toll Free:
 (215) 357-1400 1 800-523-8998
 (215) 757-5300

A Darn Good IDer

—repeaters get smarter every day

Did you ever feel that if someone else could do something, then you could, too, and, if not better, then at least in your own way?

Ever since putting together a diode matrix CW identifier, I felt there must be a better (or at least different) way of doing things. The area that

needed the most attention was programming the call and later changing the program or perhaps just correcting an error made in the "R" of

WR5...

So, I sat down with a box of CMOS and decided to do something. The final result is depicted in Fig. 1. I thought of using a shift register first, but the junk box did not have any. All I could find were some memory chips I had been hoarding for a computer project. I tried several memory chips, and an MM2102 1024-bit RAM (Random Access Memory) worked best.

The resulting design is a programmable CW identifier which can hold a varying length message of up to more than 1000 bits. The circuit has the following features: 1) low power, 2) low parts count, 3) variable length message, 4) end-of-message detector, 5) easy programming, 6) easy modification for holding several messages, and 7) can be used as memory in a programmable CW keyer.

The identifier requires a negative-going pulse to start and provides a voltage level out when operating. When the end of message is detected, the IDer stops and resets.

How Does It Work?

The heart of the system is the clock oscillator. In order to use CMOS wherever possible, I decided to forego the urge to build a simple 555-type clock and instead used a simpler Schmitt trigger inverter. Due to the fact that a Schmitt trigger has a certain voltage at which it detects a logic high and another at which it detects a logic low, an oscillator can easily be made out of one. Referring to Fig. 2, you can see that as the output switches, the input drifts between these two voltage levels. The rate of drift, or frequency of oscillation, is then determined by the values of the resistor and capacitor. A pot is included to allow changing the clock speed. This oscillator is fed into a series of gates used to select either the free-running

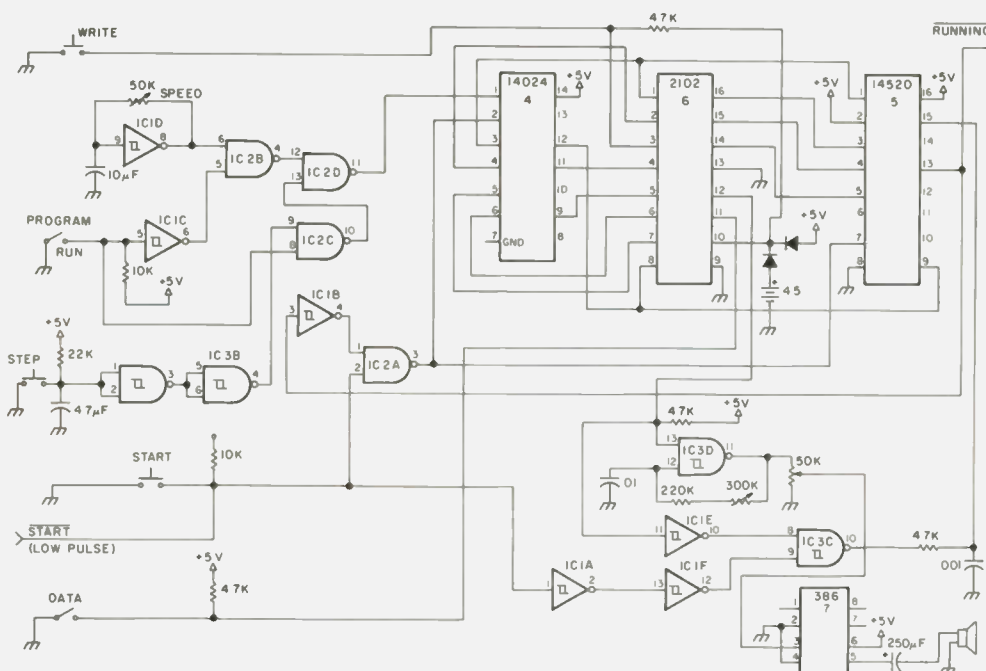

Fig. 1. IC1: MC14584; IC2: MC14011; IC3: MC14093; IC4: MC14024; IC5: MC14520; IC6: MM2102; IC7: LM386.

bination corresponds to one of the four pages, and each page may be loaded and used separately.

An optional extra included in this circuit is an audio monitor. For simplicity, I went over to the nearby Radio Shack store and purchased an LM386N 1-Watt audio amp IC. It works very well, but it does load the audio oscillator slightly, and changing the volume level will affect the pitch a little.

Another option is a

standby battery for the memory. The solid state memory will forget all it knows if power is removed. The two diodes are included to allow the battery to power only the memory and not the rest of the circuit. The pull-up resistor for the write line is also tied in here to keep a false write pulse from occurring during system power up.

The prototype circuit I built draws about 20 mA in standby. The drain on the memory battery during

power off is about 11 mA. (I used a 2102, not a low power 21L02. I don't know what the current requirement will be for a 21L02 in this application.) Without the audio chip, standby current is about 17 mA.

Several of these IDers are in use here in Texas — one locally. A few bugs were found before writing this article. A few problems persisted, but, by trying several different 2102s in the circuit, they went away. We

feel that all the problems were related to the bargain 2102s we used. A double-sided, plated-through circuit board will be made available if sufficient interest is generated.

While this article purports this to be an identifier, it could very easily be made into the memory portion of an electronic keyer. But knowing that my way may not be your way, I leave it up to you to take this circuit and use it the best way. ■

Social Events

from page 133

eat; 2:30 pm—drawing. Tickets are \$2.00 in advance, \$2.50 at the door. For information and tickets, write James H. Little WD0BPG, 405 East Rosehill, Marshall, Missouri 65340. Talk-in on 52, 28/88.

MCKEESPORT PA JUL 23

The Two Rivers Amateur Radio Club of McKeesport PA will hold its 14th annual hamfest on Sunday, July 23, at the Green Valley Volunteer Fire Company grounds in North Versailles, just off Route 30. Talk-in on 22/82. Free parking. Registration required for setup in swap and shop. Home-style food and refreshments. For more info, write to Andrew Salitros W3OFM, 2901 Stewart St., McKeesport PA 15132.

GOLDEN CO JUL 23

The RMRL picnic will be held at the QTH of WA0HJZ (Rt. 6) on July 23, starting at noon. Please bring food, swapping goodies, and the kids. Talk-in on 34/94. For further info, contact Charles Kaufman WA0GUN, 3734 South Poplar St., Denver CO 80237.

SALEM OH JUL 23

The Kent State Salem Amateur Radio Club will hold a hamfest on July 23, 1978. The door prize will be a Ten-Tec #540 transceiver, courtesy of KenMar Industries; there will be many others for the whole family as well as a hot air balloon, a ramp for wheel chairs, and plenty of free parking. Wives and kids under 12 free. XYL drawing and recreation facilities available on beautiful campus. Open at 9

am; main drawing at 3 pm. Admission: \$2.00; flea market: \$1.00; tables: \$5.00. Talk-in on 146.10-.70. For information, write W8JPG 147.27, Milhoan Electronics, 1128 West State Street, Salem OH 44460; (216)-337-9275.

INDIANAPOLIS IN JUL 26

The IEEE Computer Society of Central Indiana and the Central Indiana section of IEEE will sponsor the third annual Indy Microcomputer Show on Wednesday, July 26, 1978, from 11:00 am to 9:00 pm at the Holiday Inn located at I-70 and Shadeland Avenue in Indianapolis. There will be exhibits, demonstrations, and technical seminars addressing the engineering, industrial, scientific, business, and personal applications of microcomputer systems.

OKLAHOMA CITY OK JUL 28-30

Central Oklahoma Radio Amateurs will present Ham Holiday '78 on July 28, 29, and 30, in the Lincoln Plaza Forum, 4345 North Lincoln Boulevard, Oklahoma City. Preregistration closes July 14 with a fee of \$3.00; \$4.00 at the door. Non-commercial flea market tables are free in the ten-thousand-square-foot flea market area. Commercial exhibitors contact K5MB at (405)-787-9545 or 787-9292. Technical programs are scheduled throughout the hamfest. Many prizes will be given away, including a special preregistration prize. Mail preregistrations to Ham Holiday '78, PO Box 14604, Oklahoma City OK 73113.

FT TUTHILL AZ JUL 28-30

The Amateur Radio Council

of Arizona will present the annual Ft. Tuthill Hamfest on July 28, 29, and 30, 1978. Come on out in the cool pine country of Arizona, and join our western barbeque, prize drawings, and tech sessions. For further details or preregistration forms, contact PO Box 11642, Phoenix AZ 85061.

KINGSFORD MI JUL 29-30

The 30th annual U.P. hamfest, cosponsored by the Great Northern Repeater Association and the Mich-Con ARC of Iron Mountain-Kingsford, Michigan, will be held on Saturday, July 29, and Sunday, July 30, 1978, at the Dickinson County Armory on M-95 in Kingsford, Michigan. Registration will begin at 9:00 am on both days. Tickets are \$2.50 in advance and \$3.00 at the door. Saturday night banquet tickets are \$6.50, and reservations should be received by July 1. Daily activities include: U.P. net meeting, U.P.R.A. meeting, YL net meeting, ARRL directors' meeting, computers, DX and contests, slow scan, satellite, RTTY, moonbounce, FAX, 2m SSB, a swap and shop, and a special discussion on "Antennas—Legal Aspects" by George Goldstone W8AP, vice-director of the Great Lakes Division. Planned family activities will be held both days. Plenty of parking is available. Prizes galore! Talk-in on 146.25/85 and 3922. For information, write UPHAMFEST 78, Box 2056, Kingsford, Michigan 49801.

BALTIMORE MD JUL 30

The Baltimore Radio Amateur Television Society will hold its annual Maryland hamfest on Sunday, July 30, 1978, from 8 am to 4 pm at the Howard County Fairgrounds off Interstate 70, 12 miles west of I-695 (exit 16). Talk-in on 146.52 MHz, and on 63/03, 16/76,

and 52.76/52.525. Admission is \$2 in advance and \$4 at the door. Tailgating space is \$2. There will be door prizes, and refreshments will be available. ATV and computers will be demonstrated. Checks should be made payable to the club. For table reservations or further information, contact Mayer Zimmerman W3GXX, c/o BRATS, PO Box 5915, Baltimore, Maryland 21208.

HOUSTON TX AUG 4-6

On August 4, 5, and 6, 1978, the Houston Echo Society will host the annual Texas VHF-FM Society Summer Convention in the Galleria Plaza Hotel, just off interstate loop 610 at Westheimer Rd. While primarily devoted to the VHF-FM spectrum, attractions will also include microprocessors/microcomputers, the annual Texas champion hidden transmitter hunt, OSCAR communications, and much more, covering all phases of amateur radio. There will be forums conducted by both the ARRL and the FCC. A banquet/dance is planned for Saturday night. The featured speaker will be William A. Tynan W3XO, editor of "The World Above 50 MHz" column in QST. Exhibitors will be displaying their wares all day Saturday and Sunday. Several excellent prizes will also be given away. The main prize will be the choice of an HF rig or an allmode VHF rig, with the second prize being the rig which is not given away as the main prize. There will also be a preregistration prize as well as hourly door prizes. More information can be obtained by writing to: FM Society Summer Convention, PO Box 717, Tomball, Texas 77375.

MACKS INN ID AUG 4-6

The 46th Annual WIMU (Wyoming, Idaho, Montana,

Continued on page 214

SCR 1000 - Standard of Comparison

In Repeaters - Now Available with Autopatch!

Autopatch Features:

- Normal patch, or secure "reverse" patch
- 3 digit anti-falsing access — single digit disconnect
- 3 digit on-off control of repeater transmitter
- 4 sec. time limit on access
- Built-in adjustable time-out function — patch shuts down in 30-90 sec. if no carrier is received
- Wide range audio AGC on input and output.
- User can mute phone line audio simply by keying his mic button — prevents embarrassing language from being repeated
- Patch access and repeater control — either over the air or over the land line



2Mtr. & 220 MHz!

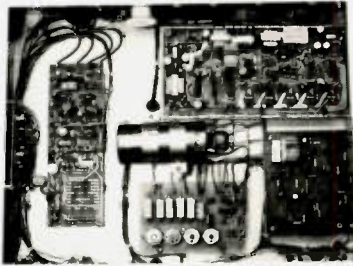

Under chassis view of SCR1000 with Autopatch installed.

Now Spec Comm has taken the hassle out of putting an autopatch repeater on the air! The SCR1000/SCAP is a fully self-contained 30 watt repeater with built-in autopatch and land line control. You simply plug in the phone line, hook up the duplexer, and you're on the air! The usual months of problems are eliminated! The SCR1000/SCAP has been meticulously engineered to provide the smoothest performing patch together with a positive land line control of the repeater. The system is fully assembled, set-up and checked-out in our lab.

- The SCR1000—simply the finest repeater available on the amateur market ... and often compared to "commercial" units selling for 3-4 times the price! This is a 30 Wt. unit, with a very sensitive & selective receiver. Included is a built-in AC Supply, CW IDer, full metering and lighted status indicators/control push-buttons, crystals, local mic, etc. Also provided are jacks for emergency power, remote control, autopatch, etc.
- A full complement of options are available: Duplexers, Cable, 'PL', Touch Tone Control, HI/LO Power, Autopatch, Racks, etc. Please inquire.
- The Spec Comm Repeater System ... a sound investment ... available only by direct factory order. Get your order in A.S.A.P.

SCR 1000 Specifications

RF Output 30 Watts typ.
 Infinite VSWR proof
 Sensitivity 0.3uV/20dB Qt.
 Selectivity... -6dB @ ± 6.5 kHz;
 -55dB @ ± 15 kHz;
 -90dB @ ± 30 kHz.
 (Sharper 8 Pole Filtr, Available)
 Desense/Overload ... W/1uV
 desired signal, desense just
 begins @ approx. 50,000uV @
 ± 600 kHz.
 Spurious Response . -70dB min.

FEATURES

- Full Metering of critical levels.
- Front Panel Controls for timers & AF levels.
- Lighted push-buttons for control/test functions & status indicators
- State of the Art CMOS control logic & timers—No Relays!
- Built-in CW IDer—Low current draw. Fully adjustable speed, pitch, time, etc.
- Exclusive Spec Comm MOS-FET/Hot Carrier Diode rcvr. front end—greatly reduces 'desense' & IM problems!
- Built-in AC Supply w/instant btry. switchover for emergency pwr.
- Supplied with .0005% Sentry xtals and a Turner local mic.
- Jacks Provided for Remote Control, Auto-Patch, DC out, AF in/out, COR Switch, etc.
- True FM—For Rpt. Audio so good, it "sounds like direct"!

SCR 1000 WITH FL-6 PRESELECTOR \$1035.00
 SCR 1000 WITHOUT PRESELECTOR \$ 950.00
 SCR 1000 SCAP & FL-6 PRESELECTOR \$1585.00
 SCR 1000 SCAP FL-6 WP641 DUPLEXER \$2080.00

SPEC-COMM REPEATER BOARDS, SUB-ASSEMBLIES & ACCESSORIES

2M
&
220
MHz!

- FL-6 Preselector. Rcvr. Front-End Filter/Preamp. Exc. rejection of strong "out of band" sigs. + improves sensitivity. \$85.00
- SCR100 Receiver Bd. w/ xtal. \$115.00 (8 Pole IF Filter + \$18.95)
- SCR100 Receiver Assembly. SCR100 mounted in shielded housing. \$185.00
- SCT110 Xmtr./Exciter Bd. 7 or 10 Wt. bd. \$135.00 w/xtal. BA-10 30 Wt. Amp. bd. & Ht. Sink. \$51.95
- SCT110 Transmitter Assembly. SCT110 mounted in shielded housing. \$199.95 (30 Wt. Amp. + \$62.00)
- CTC100 COR/Timer/Control Bd. \$35.00
- ID250 CW ID/AF Mixer Bd. Programmed \$65.00
- SCAP Autopatch Bd. \$225.00
- RPCM "Reverse Patch" & control bd. \$79.95
- TTC100 Touch Tone Control bd. 3 digit ON, 3 digit OFF. \$85.00
- TRA-1 Timer Reset Annunciator Bd. \$20.95
- WP641 Duplexer. \$495.00

Commercial prices somewhat higher.

See our April 73 Ad for more details!
 (Add \$3.75 ship/handling. PA residents add 6% tax.)

Send for Data Sheets!



SPECTRUM COMMUNICATIONS S8

1055 W. Germantown Pk., Norristown PA 19401 (215) 631-1710

Pick A Frequency . . . Any Frequency

— *ultra-flexible crystal calibrator*

While making the rounds at the Dayton Hamvention, pockets lined with moderate amounts of ready cash for those once-in-a-lifetime good deals, I came upon a very unique crystal calibrator manufactured and sold by Rainbow Industries

(P.O. Box 2366, Indianapolis IN 46206), which was on display and available for immediate sale. Being presold on the unit, having previously read an advertisement extolling its virtues, I grabbed one for the W8FX/4 shack.

What makes the Rainbow

FS-200 calibrator so different from the usual circuit providing calibration markers down to every 1000, 100, and sometimes 25 or 10 kHz is that it does all this and goes much further. It provides strong switch-selected, square wave markers every 1 MHz, 500, 250, 100, 50, 25, 10, 5, 2.5, and 1 kHz, as well as every 500, 250, 100, 50, and 25 Hertz! Thus, it can be used for a number of additional applications, such as an oscilloscope timebase calibrator, audio generator, frequency counter timebase, accurate signal source for analog and digital projects, hi-fi response testing, and, yes, even code practice. It features CMOS (complementary metal oxide semiconductor) integrated circuitry, constructed on a 3¼" x 2½" board, and has a trimmer capacitor for precise frequency adjustment. It will operate on any power source from 6.5 V dc to 15 V dc at about 15 mA. A front-panel BNC connector is provided for connecting to the

output stage directly or for using a short piece of wire as an "antenna." Desired output frequency is switch-selectable from the front-panel "range" and "multiplier" switches.

The calibrator is available either fully wired and tested (Model FS-200C, for \$34.95) in a minibox enclosure or as a prewired printed circuit board (Model FS-200B, for \$19.95) less controls, switch, connectors, and cabinet. I bought one of the fully-assembled units and, upon hooking it up to a 9-volt battery, was pleasantly surprised to discover that it worked just as advertised, providing strong markers at practically any desired internal frequency well into the VHF region (over 100 MHz for my unit). The unit was easily calibrated against WWV by adjustment of a trimmer capacitor on the PC board. You could also calibrate and cross-check against a frequency counter of known accuracy. If you calibrate by zero-beating against WWV,



it's best to use the highest frequency receivable so that you would be using a high-order harmonic of the basic oscillator in the calibrator, for highest accuracy. One point to remember is that, as you approach zero-beat, the audio "beat note" becomes lower and lower, so it may be difficult to detect true zero-beat. Try using the receiver's S-meter; it will usually try to "track" the swing through zero-beat and can generally be relied on to get down to within a few cycles accuracy.

The fact that the FS-200 can produce markers down to 25 Hz suggests other uses for it — perhaps as an oscilloscope calibrator/timebase and audio signal generator. By interrupting its supply voltage, it could even be used as a code practice oscillator (making an interesting initial dual investment for the serious SWL who's about to become a Novice).

As fine an instrument as the FS-200 is, it did present a minor problem. It was another little convenience gadget for the shack that needed another 9-volt transistor radio battery. Though they're inexpensive and easily available free at Radio Shack (using their "Battery Club" card, of course), each time one poops out, I have to open up the cabinet and replace the battery, a slightly inconvenient task when done repeatedly. The addition of the FS-200 brought into focus the need for a small "cheapie" power supply, providing a source of multiple low-voltage outputs. The FS-200 could provide the "piggyback" vehicle for it, along with some simple interface circuitry for the calibrator. The only modifications required on the calibrator were mounting two rear-apron miniature phone jacks (external power and key), running leads to the battery clips, and mounting an RCA phono jack on the rear apron for rf output (wired in parallel with the front-panel BNC jack). Be sure to remove the PC board

while drilling to prevent possible damage to the components.

The circuit in Fig. 1 is what evolved. Mounted in a 3-1/4" x 2-3/16" x 4" minibox (Radio Shack #270-251 or equivalent) and connected to the FS-200 by a short length of cable, it provides interface circuitry for the calibrator and a means of low-voltage power distribution. The circuit provides direct receiver rf output coupling for the FS-200, a small antenna or auxiliary rf output, and adjustable rf and audio outputs. Also provided are nonregulated 6- and 12-volt outputs, as well as regulated 9-volt outputs to power various and sundry gadgets; regulated power for the FS-200 is simply routed back to it through a short length of cable. Using a closed-circuit jack on the FS-200 rear apron allows internal 9-volt battery operation when external power is removed. An LED provides

power-on indication for the interface/distribution box. Wiring follows conventional point-to-point practice.

The power source used for the unit is simple. I located two junk box ac adapters (battery eliminators). One provides about 12 V dc (no load) at 300 mA, and the other supplies about 6.2 V dc at 300 mA. The 12-, 9-, and 6-volt circuits are kept separate to keep interaction down and regulation simple. Zener diodes in the 9-volt circuit provide a small degree of voltage regulation. Though the output of the battery eliminator (ac adapter) doesn't have enough real current reserve for good regulation under heavy loads, it can easily power most of the small low-current accessory devices which require four penlight cells or 9-volt transistor radio batteries as power sources. A 9-volt adapter can be used if a 12-volt unit can't be located, with the dropping resistor values changed accordingly.

Voltage regulation would, of course, be minimal. No attempt was made to regulate the 6-volt circuit, though this could be done if necessary for your purposes.

In any case, ensure that the adapters used are not cheapies having a direct connection to the ac line, which would present shock and grounding-out problems. Also, most adapters are not adequately filtered to provide good dc output. High-value electrolytics (1000-3000 uF) across the supply lines will do much to filter out any trace of hum or ripple.

Various types of connectors can be used on the piggyback box for audio, rf, and power connections, whichever meet your needs. I used RCA-type phono jacks for rf (routing the receiver coax antenna lead through the unit for signal injection), RCA-type phone jacks and miniature Amphenol-type mike connectors for audio, and miniature phone jacks for dc

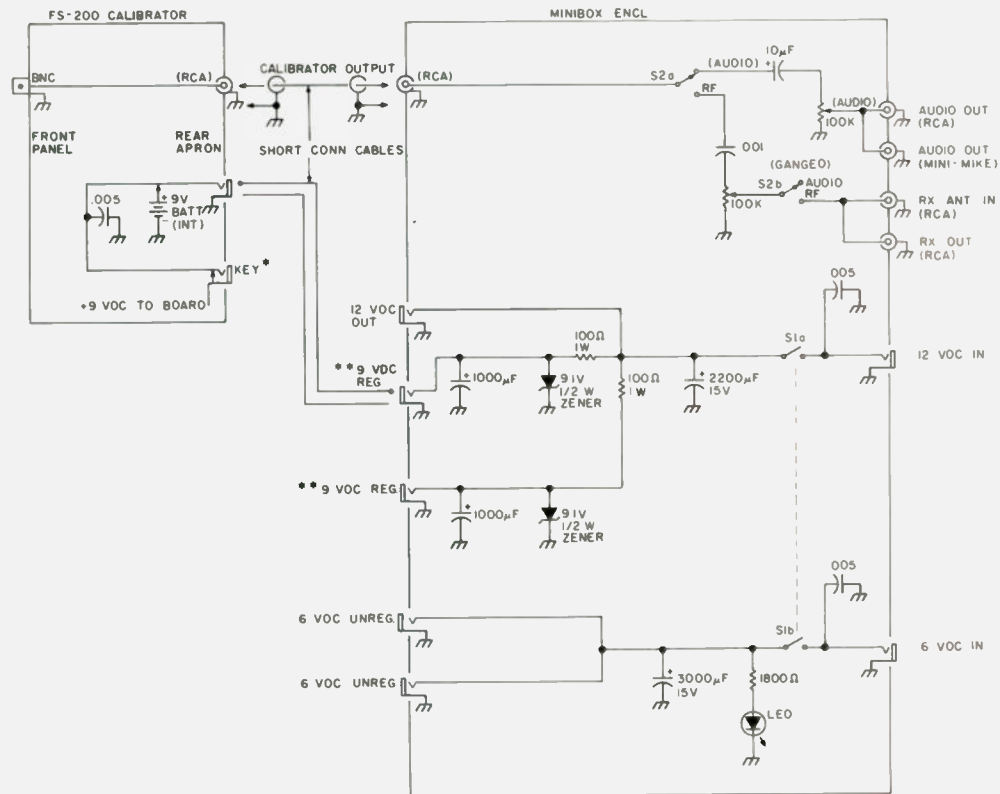

Fig. 1. Interface diagram. Additional 6-, 9-, and 12-volt outputs may be added as desired. All values are nominal. You may have to experiment with zener and LED dropping resistors for best performance. *Insulated from the chassis (mounted on the plastic rear apron of the FS-200). **Low-current drain (20-30 mA). Use high-wattage zeners and dropping resistors for higher current capacity. Use separate zener circuitry for each regulated device.

power input and output. (Note that if you use the calibrator with a transceiver, you will have to provide some means of switching it out of the circuit on transmit to prevent transmitter output from damaging the unit. If your transceiver has an "external receiving antenna" input, you can usually route the output there — check your transceiver's schematic first!)

Suggested application notes and circuitry are furnished by the manufacturer

or can be found in good texts, such as the ARRL *Radio Amateur's Handbook*, Bill Orr's *Radio Handbook*, and 73's *Radio Frequency Testers* or *Audio Frequency Testers*. These can be consulted for interface ideas for your particular purposes.

For code practice, it's easiest to simply run the rf output directly into the receiver. The FS-200 is acting, in effect, as a mini CW oscillator. The receiver doesn't even need a bfo. By playing

around with the "range" and "multiplier" switches, you can come up with MCW (modulated CW). Try it for code practice — it really works.

Don't try to use the piggyback supply for IC circuits requiring good regulation under heavy load; it isn't designed for such use. But, for the multitude of simple projects and gadgets (audio filters, compressors, preamps, signal generators, etc.) requiring but a nominal source of

low-voltage dc, it fills a real need at a minimum investment, not tying up an expensive, heavy-duty regulated dc supply. If you don't own an FS-200, try building the power distribution box anyway. You'll find it will interface well with other less versatile calibrators, signal and marker generators, and audio generators, and the power supply will indeed come in very handy when the battery in your speech compressor or keyer fails! ■

NEW
for '78

The FM Deviation Meter Anyone Can Afford

\$189

less batteries and crystals

ECM-5B MK-II fm modulation meter

- Now used by the U.S. Government in over 50 locations
- All new unbreakable A.B.S. cabinet
- 0-6 kHz peak reading linear scale
- Operates 25 MHz to 500 MHz
- Crystal controlled for easy operation
- Audio/Scope output with earphone
- Options: NICAD power PAK \$34.95
Charger \$39.95

Write or call for complete information. Send check or money order for \$189. Shipping prepaid in U.S. Indiana residents add 4% sales tax. Crystals \$7.95 each.

ECM ECM Corporation
412 N. Weinbach Ave.
Evansville IN 47711
812-476-2121 E1



Sere-Rose & Spencer
Electronics S39

1465 WELLS STATION ROAD
MEMPHIS, TENN. 38108
PH (901) 683-9125—685-8461

Authorized Dealer

DRAKE—ICOM—KENWOOD
REGENCY—TEMPO—DENTRON

CALL OR WRITE
FOR BEST DEAL

1315 BLUFF CITY HWY., BRISTOL, TN. 37620

Rusk Electronics Inc.
Quality Electronics Department Store R21



FT-101E
YAESU HF SSB FT-101E
160 thru 10M \$799.00 Retail

COMPLETE LINES
TEMPO
KOK
HYGAIN
DENTRON
CUSHCRAFT
LARSEN



WRITE FOR SPECIAL PRICES

CALL BOB BROWN WA4HAA
FOR SPECIAL QUOTE
615-764-0831 or 968-5343

FOR THE HAM
A BELT BUCKLE
From The COLORADO SILVER CO



APPROX. SIZE 2 1/2 x 3 1/2 INCHES
CAST IN SOLID BRONZE
ENGRAVED WITH CARE

This buckle can be yours for only \$12.50, plus \$1.00 for postage.

COLORADO SILVER CO., DEPT. H
P.O. BOX 1755, ASPEN, CO. 81611
COLO. RES. ADD 3%

 C63

Serving amateurs in
Southern New Jersey,
Delaware, and Maryland

WITH
the largest stock of
amateur equipment and
accessories in Delaware.

Paul WA3QPX
Rob WA3QLS

Delaware Amateur Supply
D31

71 MEADOW ROAD
NEW CASTLE, DELAWARE 19720
(302) 328-7728

RADIO WORLD
CENTRAL NEW YORK'S FASTEST
GROWING HAM DEALER





Featuring Yaesu, Icom, Drake, Atlas, Dentron, Ten-Tec, Swan, Regency, Standard, Tempo, KLM, Hy-Gain, Mosley, Larsen, Midland, Wilson, Southwest Technical Products. We service everything we sell! Write or call for quote. YOU WON'T BE DISAPPOINTED.

We are just a few minutes off the
NYS Thruway (I-90) Exit 32 R19

RADIO WORLD
ONEIDA COUNTY AIRPORT
TERMINAL BUILDING
ORISKANY, NY 13424
315-337-2622

Warren K21XN Bob WA2MSH

DSI

Be the one who's on FREQUENCY!!

With your *DSI Counter*. . .save the shop cost of tweaking xtals. . . know your frequency. . .from 160 meters through 450 MHz. Now *DSI* offers *the most* counter for your dollar. Latest state-of-the-art technology. . .*DSI* advanced LSI design far exceeds outdated TTL. Go with the leader . . .buy a *DSI FREQUENCY* counter and **SAVE TIME & MONEY!!**

NOT A KIT



MODEL 3500 \$139.95



MODEL 3600A \$189.95

Includes oven timebase

500 MHz Frequency Counter

- Includes 500 MHz Prescaler — Not an addon
- 7 Large bright — 1/2 inch LED Readouts
- Temperature compensated crystal timebase
- Accuracy 1 PPM Typ
- Sensitivity 50 MvRms 150 & 250 MHz 150 MvRms 450 MHz
- Gate time light
- No direct RF connection Required
- AC or DC operation
- 50 Hz to 500 MHz typ
- Comprehensive owners manual with complete accurate schematics
- Factory assembled & tested

600 MHz Frequency Counter

- Includes over: compensated crystal timebase
- Includes built-in 600MHz Prescaler-Not and addon
- 8 Large bright — 1/2 inch LED Readouts
- Two timebases 0.1 sec & 1. sec
- Resolution 1 Hz Direct 10 Hz Prescaled
- Sensitivity 20 MvRms @ 150 & 220 MHz 100 MvRms 450 MHz
- Accuracy .5 PPM over temperature
- Oven light & Gate time light
- Automatic Decimal point placement
- **NO DIRECT RF CONNECTION Required.**
- Comprehensive owners manual with complete accurate schematics
- AC or DC operation
- 50 Hz to 600 MHz Typ.
- Factory assembled & tested

Use it in the car or on the bench. . .take it to the repeater site. . .high-impact case. . .light weight—but rugged. . .Designed with the latest readily available LSI, CMOS, Schottky, Mecl-integrated circuits.

NEW PRODUCTS

- 250 MHz 7 Digit Battery operated hand held counter \$109.95 available mid-January.
- 3 1/2 Digit Bench Digital Multi-meter AC or Battery operated \$99.95 available mid-February.

Strongest Warranty in the Counter Field. ONE Year Parts and Labor we pay the return shipping. Plus . . . Satisfaction guaranteed . . . Dennis Romack . . . WA6OYI . . . VP-Marketing, DSI.

D25

TO ORDER CALL COLLECT (714) 565-8402

Name _____ Call _____
 Address _____
 City _____ State _____ Zip _____
 Phone: _____
 Order: _____
 Check enclosed Please send more information on your full line of Instruments and Accessories.
 BankAmericard MasterCharge VISA R.E.
 Credit card # _____ Card expiration date _____ Signature _____

DSI INSTRUMENTS INC.
 Div. Diversified Security Ind, Inc.

We pay shipping charges anywhere in the U.S.A. UPS Brown or P.P. — CA Residents please add 6% state sales tax.

- American Express
- Bank of America
- MasterCharge
- VISA

7914 Ronson Road No. G, San Diego, CA 92111

Sometimes A Kit Is Best

— *Bullet power supply kit exposed*

A. A. Wicks W6SWZ
30646 Rigger Road
Agoura CA 91301

As more and more amateurs upgrade their 2 meter transceivers to 20- to 35-Watt output units, there has been a corresponding increase in interest in higher-current power supplies for base station use of this mobile equipment.

Unless your junk box is stocked with late-model

parts, it is usually necessary to purchase expensive components, in addition to designing or researching a proven supply circuit. The job of assembling a suitable power supply has been simplified by some firms offering kits of parts, but in only a few instances have these suppliers come up with adequate kits for the higher current needs with amateur transmitter applications in mind.

Aware of this problem,

Bullet Electronics is now offering a new kit which meets the essential needs of tested design, quality parts, and low cost. In fact, I was amazed, upon receiving this very complete kit, to see the careful attention that has been given to the preparation of it — especially as it would benefit the person who has few facilities at his disposal. As an example, even the mica insulators for the power transistors are supplied precoated with silicone grease and in

leakproof envelopes. This, at first, caused me to think that the insulators were missing and that the envelopes contained only compound; however, I was happy to discover that all of the "dirty work" had also been done for me.

Nothing, including miscellaneous hardware, has been omitted from the kit. But the user must provide his own chassis (which may be anything from a board to a chassis-cabinet combination) and any optional items which may enhance the user's needs, such as meters, switches, etc.

The electronic parts are premium brand-name units, and, probably as a result of this, Bullet provides a 90-day warranty on all of them, including the heavy-duty power transformer. An excellent quality fiberglass printed circuit board is used for all of the control and regulation component circuitry. Plating is smooth and even, and all traces are sharply etched. Bullet has certainly overcome some of the problems in this respect that were evident two years ago.

The technical manual provided with the PS-14 is very complete, comprising 12 pages of theory, parts list, tools required, constructional details, testing information, and a troubleshooting guide. The latter section, contrary to the usual kit manuals, provides not only information regarding difficulties caused by improper assembly, but also extensive information in the event of component failures at some time in the future. Eight line illustrations are included in the manual, as well as one printed circuit board layout drawing and a total schematic containing all necessary test point voltage references. One additional general information sheet provides valuable information to guide the constructor in installing parts (good for any kit), handling integrated circuit devices, soldering techniques, and component color coding.

As will be noted in the

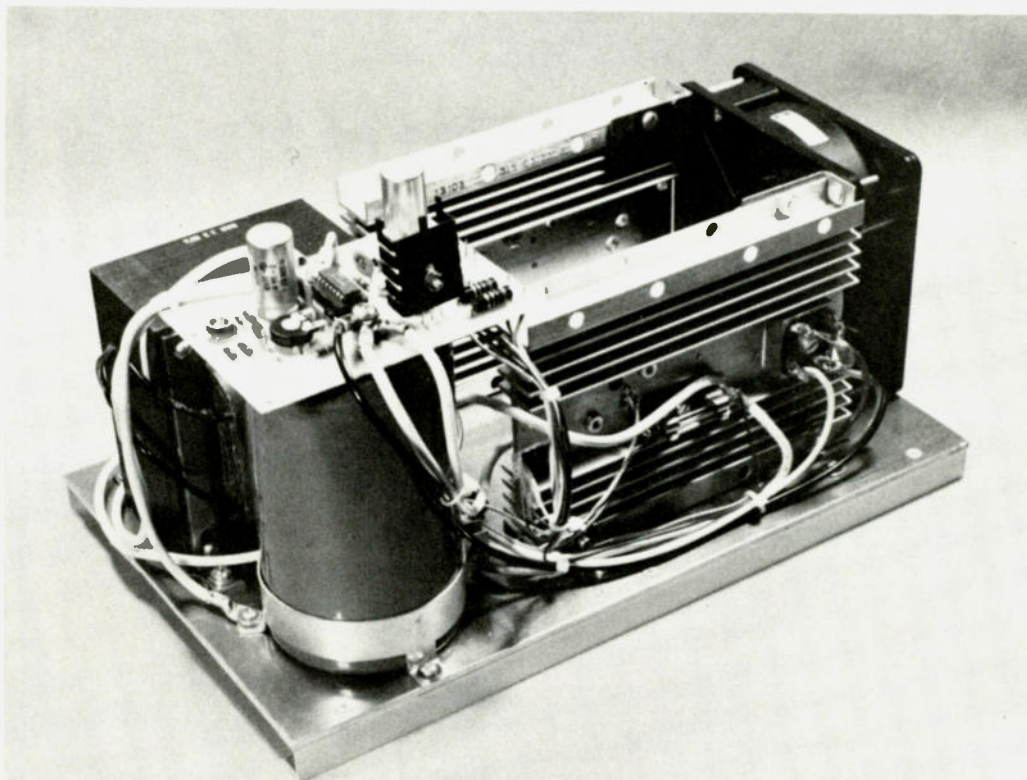

Bullet Electronics PS-14 power supply assembled. All parts shown are supplied with the kit, except the fan and base.

schematic, the heart of this closely-regulated power supply is a type-723 integrated circuit precision voltage regulator. The term "regulated" is really significant here — with 200 millivolts being the variation between no-load and full-load conditions. The 723 is a silicon monolithic device, which can provide voltage regulation at any voltage between 2 and 37 volts. However, this supply is designed to provide voltages between 11.6 and 13.5 volts, specifically. This useful IC includes within its circuitry a temperature-compensated reference amplifier, an error amplifier, a power series transistor, and a current-limiting circuit. In addition, a 723 provides independently accessible inputs for adjustable current limiting and remote shutdown.

Bullet has taken advantage of these attributes and has put it all together in this power supply. Their specifications for the PS-14 power supply are shown in Table 1.

Briefly, the operational theory of this supply is described in the following (refer to Fig. 1).

A reference voltage is obtained at the 723 pin terminal 6, V_{ref} , which is used to provide a stable voltage to the noninverting input, N_i , at pin 5. The latter is an input error amplifier within the IC. R4 and C4 provide noise filtering for this reference voltage.

A voltage divider (R14, R15, R16), permits the inverting input, I_{nv} , pin 4 of the error amplifier, to "look at" some percentage of the output voltage. Variable potentiometer R15 allows the voltage to be adjusted approximately 20%.

The result is that the voltage at I_{nv} matches the voltage at N_i as long as the voltage remains at a constant value. However, should the output voltage commence to increase, the voltage at I_{nv}

increases, and the internal drive transistor starts to shut down. In turn, the drive is reduced to the series-pass regulators Q1, Q2, and Q3, thus reducing the output voltage. Conversely, the output voltage will be increased if it has commenced to fall.

Q3, Q1, and Q2, mentioned above, form a Darlington circuit that acts as a single PNP transistor. R6 and R7 assist in controlling current "hogging." C5 prevents the high-gain series pass circuitry from oscillating.

Usually in voltage-regulated supplies that use a 723, the current limiting on the 723 is provided by a resistor in series with the output, which develops 0.65 volts at the desired maximum current. This current switches on the current-limit transistor to reduce the output. Bullet concluded that this would have two disadvantages — one, at 17 Amperes the calculated resistor would be 0.038 Ohms at 12 Watts, which is not exactly your corner-store

Output voltage:	11.6 to 13.5 dc volts
Output current:	15 Amperes (continuous) 20 Amperes (intermittent)
Current limit:	10-20 Amperes (guaranteed range)
Regulation:	200 millivolts no load to full load
Short-circuit current:	10 Amperes maximum, 3 Amperes typical
Ripple:	Less than 1% at full load
Thermal shutdown:	Variable from ambient temperature to greater than 200° Celsius (392° F)

Table 1.

resistor; two, the total dissipation of the pass transistors would reach 300 Watts in a short-circuit condition. The circuitry selected for the PS-14, then, uses a unique foldback current-limiting design which uses the output fuses as the series current-limit "resistors," with a current adder circuit.

Once again referring to Fig. 1, note that R5 is across the base-emitter junction of Q3. This provides a fairly constant voltage drop of 0.6 volts. Inversely proportioned to the value of R5, a current flows into V_C (pin 11) of the 723. Additionally, a current that has a value of I_{out} divided by the gain (H_{fe}) of the Q3-Q2-Q1 configuration

is present at the base of Q3. Since this total current enters V_C , it will exit via V_O (pin 10) and go into the current-limit transistor at C_i, pin 2.

The component values in the PS-14 allow the current flowing out of V_O to be approximately 25 mA (R5 plus Q3 current). This current then flows into the junction of R10 and R11, causing a voltage to appear across these two resistors. This will make the junction about 0.6 volts greater than V and C_s . Normal turn-on voltage required is 0.65 to 0.7 volts.

As the current increases, the additional voltage drop across fuses F1 and F2 is required to activate the current limit — the closer the

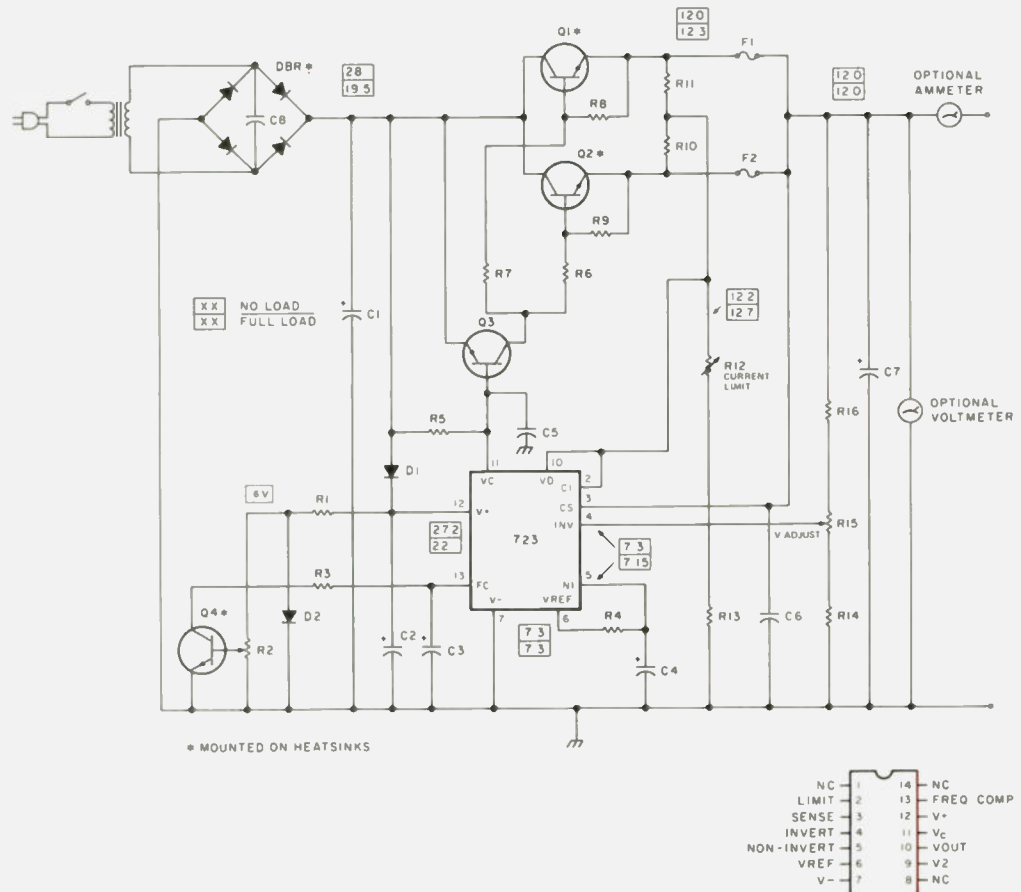

Fig. 1. Schematic of Bullet Electronics' P-14 high-current regulated power supply.

wiper of R12 to R13, the higher the current limit will be.

In addition to the foregoing, R10, R11, R12, and R13 also function as part of the foldback current circuit. A fraction of the output voltage is used to oppose the voltage across the current-limiting fuses and the voltage generated by the circuit described in the preceding paragraph. Current limiting does not occur until the voltage across the sense resistor is higher than this opposing voltage. When the output is shorted to ground, the opposing voltage is no longer present; therefore, current limiting occurs at a lower level.

The thermal shutdown circuitry is standard. Theoretically, the base-to-emitter voltage (V_{be}) of a transistor decreases with temperature. For instance, turn-on for a silicon transistor at room temperature may be about 0.6 volts. As the temperature

proximate to the transistor increases, this turn-on value decreases because of electron-hole breakdown. Now the turn-on voltage of the transistor at, let us say, 100° C. (212° F.) may be 0.4 volts.

In this configuration, D2, acting as a zener diode, provides 0.65 volts of regulated voltage to the upper point of potentiometer R2. The latter bias is adjusted below the turn-on point of Q4, for normal ambient temperature. Q4 turns on at approximately 4.8 volts, and this point is reached at 75° C. (167° F.). As Q4 conducts, the 723 at pin 13 shunts current from the base of Q4 via the collector, which in turn causes the 723 to operate, and the output voltage of the supply goes to zero.

Assembly of the power supply was very straightforward and was completed in six hours. Testing took another two hours, but this included some troubleshooting time because I had

inadvertently connected the wires between the circuit board and the thermal shutdown transistor incorrectly. A very minor "operation" is required on the power transformer and takes about five minutes. The transformer was originally manufactured for another purpose, and this modification provides a winding configuration that produces 20 volts ac.

The PCB was a pleasure to assemble, due to the excellent soldering characteristics of the board, as mentioned. In my installation, I included a cooling fan, even though my present requirements will not exceed a 10-Ampere load. But, by building for possible future needs, I was able to do the necessary hardware and packaging at this time. Open-frame construction was used, which permits the aluminum "breadboard," as shown in the photograph, to be installed in a cabinet with a slip-on cover. The "optional meter" positions, as shown

on the schematic, will be used with the meters installed on the front panel of the cover, together with switches for ac and the fan. (It would be very simple to arrange it so that the fan starts at some predetermined thermal point.) Incidentally, Bullet has meters available for this power supply, if desired. They also sell an overvoltage-protection kit that is directly compatible with the PS-14. Although not installed at this time, one of these will become part of my PS-14 very shortly, as it is very desirable to limit potentially dangerous voltages to expensive equipment. Incidentally, the PS-14 may also be used as a battery charger — with suitable diode protection, of course.

The PS-14 is priced at \$39.95, including UPS charges (foreign orders should add \$10 for shipping and insurance). It's available from Bullet Electronics, PO Box 19442H, Dallas TX 75219. ■

73 CODE SYSTEM TAPES

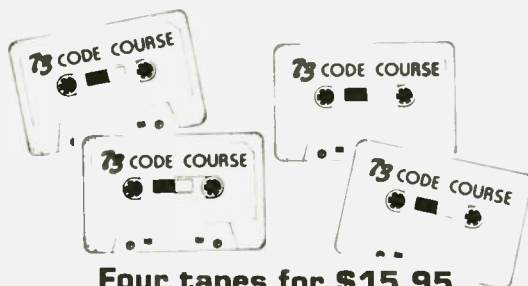

Four tapes for \$15.95
\$4.95 each!

"Genesis" — 5 WPM — Introduces the alphabet, 10 numbers, and necessary punctuation. Plenty of practice gives plenty of confidence to every beginner!

"The Stickler" — 6+ WPM — Practice tape for Novice and Technician licenses — random code groups of five characters sent at official FCC standard. You'll find the exam a snap!

"Back Breaker" — 13+ WPM — Mastering these random code groups at this fast pace gives you a tremendous edge when you hear plain English at this same pace!

"Courageous" — 20+ WPM — Conquer this 1-hour tape and the Extra Class license exam will be a breeze! When you can copy these code groups, nothing can stop you!

73 magazine Peterborough NH 03458

BRITT'S

2-Way Radio Service

B29

2508 North Atlanta Road
Belmont Hills Center
Smyrna,
Georgia 30080
Phone (404) 432-8006

North Georgia's

only Authorized Yaesu Dealer

Yaesu
Mosley Antenna
Cush-Craft
Rohn-Tower
C.D.E. Rotors
Shure
Wilson
M F J

Vibroplex keys
B & W
Swan meters
Hustler
Saxton
ARRL Books
Call Books
Tempo

TPL 2 Meter Amplifiers

Complete service facilities

Call toll free 1-800-241-9961



Get into "220" Mobile the Easy Way with Midland

Midland has a pair of proven performers, crystal controlled or P.L.L. synthesized . . . both designed to be easy on the pocketbook

To start with, here's Midland's Model 13-509. It's a compact, rugged mobile with capacity for 12 crystal-controlled channels. The "509" transmits with 10-watt or 1-watt output. Its receiver has a dual gate MOS FET front end with hi-Q resonator and ceramic filters. There are SWR and polarity protection circuits, internal DC filtering and electronic switching. With its jack for optional tone burst and discriminator meter, the "509" has even been the basis for many repeaters.

Midland's choice alternative in "220" is P.L.L. synthesized Model 13-513. Here's advanced design with modular construction and digital frequency readout. It's programmed for 500

frequencies between 220 and 225 MHz, with a 5 KHz shift up giving 500 more . . . and 4 offsets are available for repeater use. The receiver has a multiple FET front end with monolithic crystal and ceramic filters. The transmitter switches for 20-watt, 10-watt or 2-watt output. With automatic SWR and polarity protection, internal DC filtering, electronic switching and a jack for tone burst and discriminator meter, the "513" is a very desirable "220" mobile . . . or base.

Pair either of Midland's "220" mobiles with Midland's trunk/roof mount or magnet mount antennas (Models 18-950 and 18-951) for top-notch performance on the band.



For more about Midland "220" Mobile, write: Midland Amateur,
P.O. Box 1903, Kansas City, Missouri 64141

Coming In Out Of the Cold

—power supply for your mobile rig

Henry Olson W6GXN
P.O. Box 339
Menlo Park CA 94025

One of the largest areas of growth in the amateur radio and CB market in recent years is that of small transceivers for automobile use. Some of these have built-in 117 volt ac supplies, and some have them as op-

tions in a separate package. But there are certainly many around which either were never meant to operate on the ac mains or for which the ac supply was not bought at the time of initial purchase and is no longer available.

The regulated supply described here will provide a substitute for your car's +12.6 volt dc battery system

for equipment that draws up to 3 Amps. This will enable you to bring the rig in the house and continue operation, if you don't have a separate home station. In fact, such a supply is even worth having around only for those moments when the mobile rig is "sick" and needs repair, so it's on the workbench, in the house. It's also

handy when the other types of auto electronics (radios, tape players, etc.) go on the fritz.

The main things that this supply has that many simpler commercial transceiver supplies do not have are good electronically-regulated output and current limiting. The output voltage is adjustable from 11 to 15 volts, so low, normal, and high battery voltages can be simulated. At currents over 3 Amps, the supply drops out of regulation, and no more current can be drawn from it.

The circuit of the supply is shown in Fig. 1. Note that the power transformer (one of the most expensive items in most supplies) is made up of three old filament transformers. This technique is not as neat and compact as having a special transformer that delivers just the right voltage and current for the job, but most hams and experimenters have lots of old transformers around from the tube era. The three transformers, when connected in phase, produce about 15 volts ac, which gives more than +21 volts dc using a full-wave bridge rectifier and capacitor-input filtering.

The regulator is the old reliable National LM305H with 2N4037 and 2N3055 added to increase the current capability. The 2N3055 is still the cheapest high-current silicon power transistor around, and thus it has been chosen here. The 2N3055 must be well heat sink mounted, of course, since, at the worst thermal case (11 volts out at 3 Amps), it must dissipate nearly 20 Watts! For this reason, the 2N3055 has been mounted on a large finned aluminum heat dissipator. Just heat sinking it to the chassis or a small plate for dissipation is probably asking for thermal runaway problems to develop.

The regulator circuitry, excluding the 2N3055, is built on a small PC board which I use as a sort of

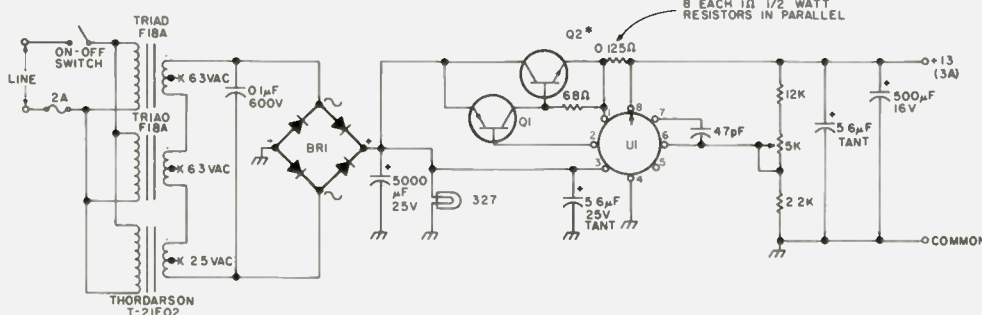

Fig. 1. Regulated supply for small transceiver (with current limiting). *Heat sink Q2 to adequate finned aluminum dissipator.

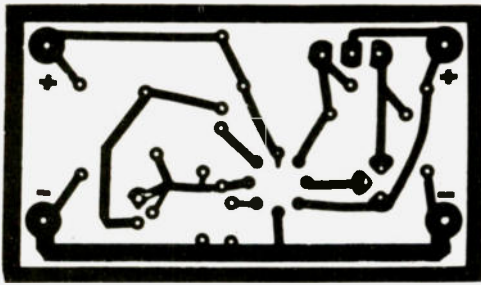

Fig. 2(a). Regulator board.

general purpose regulator card. I have these made up for my own experimental use, at a quantity price, and use them as needed. The layout of this PC board and the parts placement on it are shown in Fig. 2. This board is useful with an NPN-PNP pair of transistors, as in Fig. 1, a single PNP transistor, as in Fig. 3, or with the LM305H alone, as in Fig. 4. These three cases reflect decreasing magnitudes of output current. The details of how to design for the three cases are discussed in detail in references 1, 2, and 3. Note that the PC board is laid out so that a multiturn linear trimpot (such as a Beckman 78PR5K) can be put directly on it. A single-turn trimpot (such as a Beckman 62PR5K) can also be mounted directly on the board. If a standard pot is used off the PC board, care should be taken to mount it only a few inches away to prevent the regulator from becoming unstable.

There is, of course, some flexibility in the types of power transformer you use for this supply. You might use one 6.3-volt and one 10-volt transformer (16.3 V ac total) or one 10-volt and one 5-volt transformer (15 V ac total), but whatever you use, the dc output voltage across the filter capacitor *must not drop below about 17 volts*. By this I mean *absolutely* not below 17

volts, even at the bottom points of the ripple, or the regulator will drop out of regulation.

If you're in doubt as to whether your particular transformer(s) will work, haywire up transformers, bridge rectifier, and filter capacitor and put a resistive 3-Amp load on this rectifier-filter combination. A dc scope on the load should look like Fig. 5, and the minimum voltage, as shown, should not drop below about 17 volts. You ought to consider using one of the older TV power transformers, which have a high current 6.3-volt winding plus a 5-volt winding (usually 3 Amps, to operate a 5U4G), as one source of part of the series ac voltage. The high-voltage windings would be carefully taped up in this usage.

On the semiconductor list, there are a number of substitutes, including the widely-available Motorola HEP types for the discrete components. The one IC originated by National Semiconductor is second-sourced by Advanced Micro Devices, Fairchild, Intersil, Motorola, Raytheon, Silicon General, and Texas Instruments.

The supply was built on a 7" x 9" x 2" aluminum chassis with the three transformers to the rear. The wiring of the ac primary switch and fuse and the wiring of the rectifier-filter

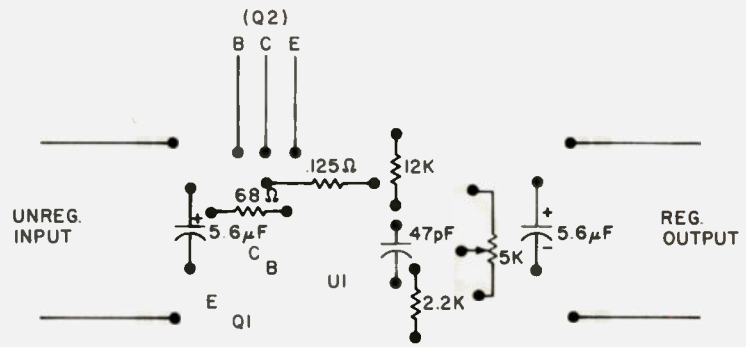

Fig. 2(b). Parts placement.

section are underneath the chassis. The regulator board and heat sink with the 2N3055 are on top of the chassis (for ease of voltage trimpot adjustment and air convection, respectively). No meters or enclosed cabinet were used in this supply, because they would increase the cost considerably. Judicious choice of meters from surplus emporiums and similar cabi-

net procurement could allow you to have a nicely-finished bench supply. This detail is, of course, up to the builder. ■

References

1. National Semiconductor, *Linear Data Book*, June, 1976, pages 1-7 to 1-11.
2. National Semiconductor, *Voltage Regulator Handbook*, May, 1975.
3. National Semiconductor, *Linear Applications*, Feb., 1973, pages AN-23, LB-7, LB-10.

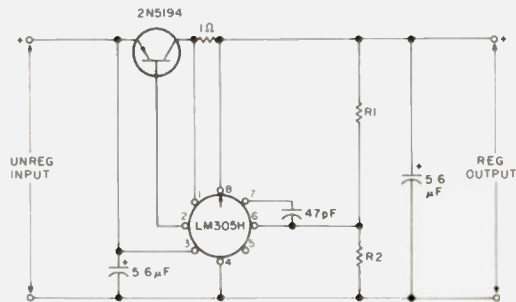

Fig. 3. LM305H with PNP medium-power transistor used as medium-current regulator.

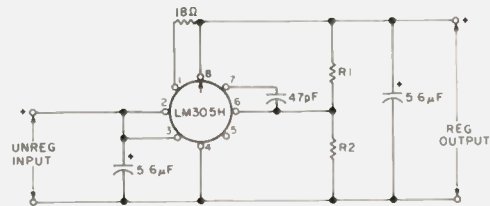

Fig. 4. LM305H without external transistor used as low-current regulator.

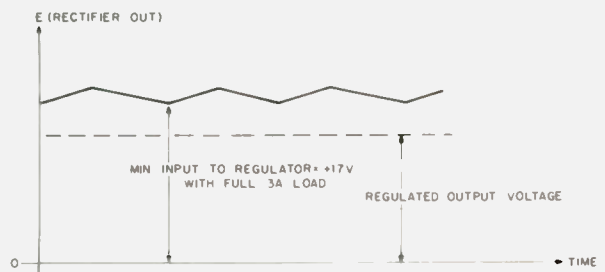

Fig. 5.

Parts List

BR1	3-Amp bridge rectifier, Motorola MDA970-2 or HEPR0876, or 4 each 1N4720 or HEPR0091 (wired as bridge)
Q1	2N4037 or HEPS3012 (Motorola)
Q2	2N3055, MJE3055, or HEPS7004 (Motorola)
U1	LM305H (National) or MLM305G (Motorola)

Roy Rogers Special: Triggered Sweep

*— lab scope performance
for less than a gigabuck*

In any shack, lab, or shop, the most important test instrument is the oscilloscope. However, most scopes used by the home experimenter, unless funded by grants from the Rockefeller Foundation, are the "service" type — not too fast, and cursed with recurrent sweep. For that problem, this article offers a solution.

Before going further, let's look at the two types of sweep used in scopes. The most common is called the "recurrent" sweep and is, when all is said and done, a glorified sawtooth oscillator with provisions for injecting sync pulses to warp its free-running frequency slightly. To achieve a stable display, the input frequency must be equal to or a multiple of the sweep's frequency, and drift in either will result in the familiar swirling miasma of traces.

The "triggered" sweep, used in lab-type scopes, is also a sawtooth-generating circuit, but is not an oscillator. It might be compared to a one-shot, initiated by a pulse that represents a particular point on the input signal.

When the sweep is complete, it retraces and waits for the next pulse, however long it might take.

It can be seen, then, that the input frequency or rep rate is irrelevant because the sweep is locked to it at all times, and the display is rock steady. Interestingly, the period of the input may be far longer than the actual sweep, which is impossible with the recurrent sweep.

For digital work, the triggered sweep is just about imperative for any serious observation, and, in any case, it's the way to go. Unfortunately, modifying a service scope's internal circuitry to achieve it is apt to evince the omnipotence of Mr. Murphy's famous law, in spades.

The QD-1 triggered sweep adapter (short for Quick and Dirty) is designed to avoid that hassle. It plugs into the scope's horizontal input jack and uses its X-amplifier to drive the trace. The internal sweep circuits are unaffected.

Offered by this plug-in are such niceties as ac/dc input coupling, selectable slope

(rising or falling), trigger point selectable by switch to either ground or a variable level, a very linear ramp, excellent stability, dc-coupled sweep voltage output, a blanking output, and a mini-sized price tag (practically zip if your goodies box is fat and happy).

You won't wind up with a Tektronix or a Hewlett-Packard, but your wallet will thank you.

Circuit Description

The operation of the sweep is straightforward, with no cute little subtleties hidden amongst the resistors. The input signal is coupled via C1 (S1 for dc), through sensitivity pot R1 and resistor R2, to one common of S2. The trigger level signal, either ground or a voltage from level pot R5, is selected by S3 and applied to the other common of S2. When R2 is connected to IC1A, pin 3, the circuit is set to positive slope; it's negative when tied to pin 4.

In either position, when the "+" input becomes more positive than the "-" input, the output of the comparator goes high (note the absence

of a pull-up resistor to pin 1; the circuit operates more stably without it), and the one-shot, IC2, pulses. Its \bar{Q} output emits a 25-30-nano-second negative pulse, which sets latch IC3A, B.

When set, IC3B's output goes low, turning off Q2, Q4, and Q5. In order: Q2 releases the ramp line from ground, and the timing capacitor begins to charge through constant current source Q3; Q4 allows divider R10-R11 to set a 13-volt reference to the "+" input of IC1B; and Q5 collector voltage rises to 15 volts, unblanking the scope.

When the ramp voltage rises sufficiently, it forward biases D1, and the "-" input becomes more positive than the "+" (reverse of IC1A). IC1B's output goes low. This resets the bistable latch and turns on Q2, Q4, and Q5. Again, in order: Q2 shorts out C_T and the sweep voltage plunges toward ground, retracing the sweep; Q4 grounds the reference voltage, the purpose being to assure that the comparator output remains low until the retrace is fully completed (without Q4, as soon as the ramp voltage became less than V_{ref}, the comparator output would go high, making the latch susceptible to re-triggering pulses before the sweep has time to retrace, resulting in erratic foreshortened sweeps); and Q5 goes to ground, and the 15-volt negative change, coupled by the scope's Z-axis capacitor, would blank the scope as though the cathode itself were made that much more negative.

Once the ramp-line voltage becomes lower than the forward voltage of D1, with respect to the "+" input, the comparator output goes high, the latch is opened to the next trigger pulse, and the cycle repeats.

The sweep output is coupled via emitter-follower Q1 and is of low enough impedance to resist loading by most scope X-axis inputs.

The 13-volt ramp is more than adequate for full-screen sweeping at a moderate setting of the horizontal gain control.

Miscellaneous Information

The ramp voltage is positive going, and your scope may well trace from right to left as a result. This is cured by a DPDT switch to reverse the CRT's horizontal plates when using the QD-1.

If your scope is not equipped with a Z-axis input, locate the lead tied to the cathode of the CRT and connect it via a .1 microfarad capacitor to a jack for the blanking input. Be sure the capacitor is rated for the cathode voltage, which can reach positively transistor-frying levels.

On ac-coupled scopes, a lateral drift of the trace will be noticed as the sweep rate or input frequency/period is changed. This is due to the variable duty cycle of the triggered sweep (the ramp is constant, but the rest time varies) and is unavoidable. It's a minor nuisance and can be lived with in view of the superiority of the triggered sweep. Dc-coupled scopes have no such problems, of course.

If the bandwidth of the X-axis amplifier in your scope is limited, you'll notice shortening and distortion of the trace at very fast sweep rates, typically less than about 2 microseconds per centimeter. This is a minor problem, and you'll learn at what point your scope can't hack it any more. Rest assured, though, that your QD-1 is putting out the correct sweep waveform even up at those whiz-bang speeds, as a faster scope will verify.

In ac-coupled scopes, very slow ramp speeds will distort due to the inability of the internal coupling capacitors to pass the signal without differentiating it. If you want to use yours for a medical monitor, get a dc scope and go as slowly as you please.

The value of the timing

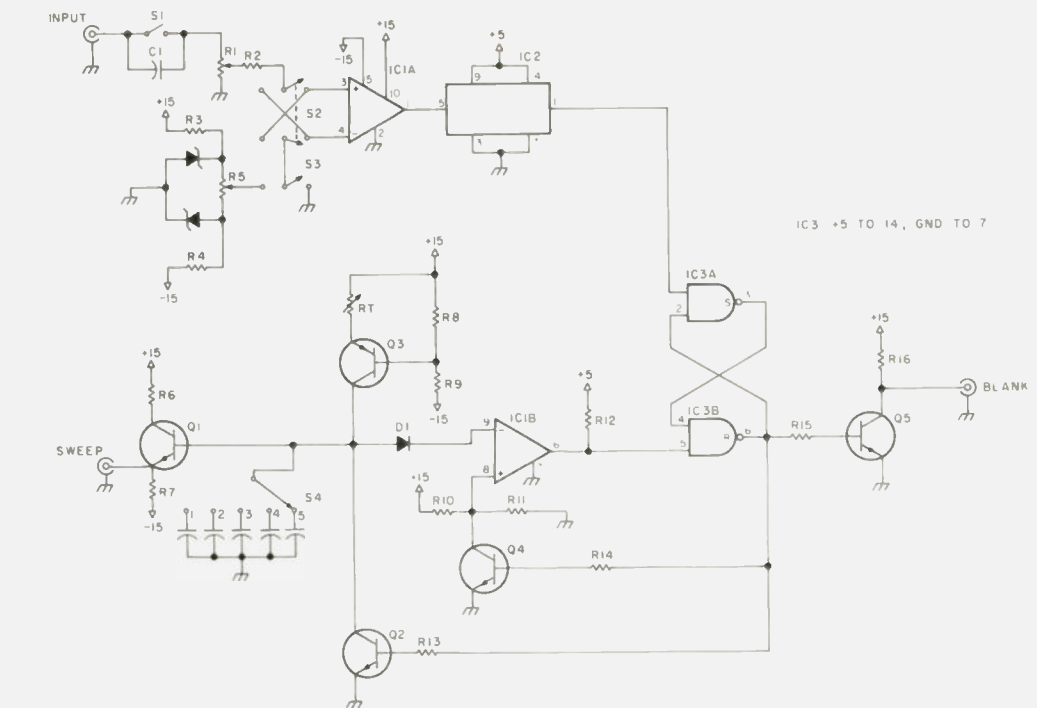

Fig. 1.

resistor, R_T , is given as a 220-Ohm resistor plus a 2k pot. If you're of an ambitious bent, you can set up a series of R_T/C_T combinations, each set to a calibrated sweep rate such as found on the better scopes. The values of C_T given in the parts list will cover the usable range that can be passed by the typical service scope.

If you elect to use different voltages than the plus/minus 15 of the schematic, dividers R8-R9 and R10-R11 will require tweaking to establish operating points at the new voltages.

The zener diodes used in the reference circuits for the level pot are from 3 to 5 volts, whatever you have handy. Don't go too much higher, though, because the allowable operating differential voltage between LM319 inputs is ± 5 volts. (This is the other function of D1, by the way. It keeps destructive differential voltages off the inputs of IC1B.)

Construction can be by any suitable technique. I used wire-wrapping for ease of modification and assembly, but, if you wish to whip up a PC board, go to it. The only high-speed stuff in the circuit is the pulse from the one-

shot, and whether or not it's capacitively coupled to something else is of no particular importance.

Although a pull-up resistor is omitted at the output of IC1A (pin 1) for stability, it is required at the output of IC1B (pin 6) if proper operation is desired. Hours of hair-yanking and spasms of voluminous purple prose preceded both of these discoveries.

As the input frequency/rep rate rises, it will be seen

that the leading edge of the displayed signal is clipped or truncated. This is due to the inevitable response delays in the sweep circuitry and the horizontal amplifier.

In expensive scopes, a delay line is inserted in the vertical signal circuitry, which, as the frequency increases and the sweep rate in use goes faster, effectively delays the input to the Y-plates until the sweep has time to react to the trigger

Parts List

IC1	LM319 dual comparator
IC2	SN74121 one-shot
IC3	SN7400 quad 2-input NAND
Q1, Q2, Q4, Q5	2N2222 NPN transistors
Q3	2N2907 PNP transistor
R1	100k pot
R2	100k, 1/4-Watt resistor
R3, R4, R13, R14, R15	2.2k, 1/4-Watt resistor
R5	10k pot
R6	510-Ohm, 1/4-Watt resistor
R7, R9, R11	10k, 1/4-Watt resistor
R8	390-Ohm, 1/4-Watt resistor
R10	1.5k, 1/4-Watt resistor
R12	1k, 1/4-Watt resistor
R16	5.1k, 1/4-Watt resistor
C1	1 μ F, 50 V ceramic capacitor
Zeners	See text
D1	Silicon switching diode, e.g., 1N914
R_T	220-Ohm, 1/4-Watt plus 2k pot.
C_T	0.001, 0.01, 0.1, 1, 10 μ F
S1	SPST switch
S2	DPDT switch
S3	SPDT switch
S4	5-position rotary switch

Input/output jacks, ± 15 -volt and 5-volt supplies, etc.

pulse. The delay itself is fixed, but it can be seen that it is needed less as the frequency goes down, more as it increases, and it's sufficient to display the trigger point of the input at any frequency.

If you'd like to try it, get a reel of coax, such as RG-58/U, and put a connector on each end. Take the trigger point from the INPUT and the feed to the vertical from the OUTPUT. If you know the length of the coax and the propagation speed,

you can calculate the approximate delay.

Operation

The input signal to the sweep may be obtained by teeing from the vertical input of the scope, or by a separate lead tied to whatever trigger signal is required. Begin with the sensitivity at minimum, the level select switch to ground for ac-type signals, or with the input switch to ac for TTL-type signals, for example, that are above true

ground. Bring the sensitivity control up slowly until a trace appears, then advance it until a steady trace is seen. If it's a logic signal, for example, switch the input to dc, the level switch to variable, and adjust the level pot to obtain the trace again.

While overloading the input isn't recommended, don't be afraid to crank up the sensitivity until a solid image is obtained. At very low frequency inputs, some instability may be obtained

when the input's period is a multiple of the sweep's, but adjusting the sweep rate should cure it.

Other than those points already noted, I haven't any particular precautions to offer, except maybe a reiteration of the warning about the CRT cathode voltage and the capacitor ratings. A thousand volts running amuck amongst ICs and transistors can create a lot of silicon refuse in micro-short order. ■

KEY ELECTRONICS K14
P. O. BOX 3506 SCHEENECTADY, N. Y. 12303

GOOD PRICES

Same day service - New Merchandise - No Surplus

Linear ICs

CA3240-Dual CA3140 op amp \$1.95 ea.
CA3189-FM IF System 3.95 ea.

Zener Diodes 1 Watt 10%

1N4735	6.2 V	.28 ea.	1N4743	13.0 V	.28 ea.
1N4739	9.1 V	.28 ea.	1N4746	18.0 V	.28 ea.
1N4742	12.0 V	.28 ea.	1N4749	24.0 V	.28 ea.

Transistors:

MPS 2222A	.25 ea.	5/\$1.00	2N3904	.25 ea.	5/\$1.00
MPS 2907A	.25 ea.	5/\$1.00	2N3906	.25 ea.	5/\$1.00

Send check or money order. N.Y.S. residents add 4% sales tax. \$1.00 shipping and handling charge for orders under \$15.00.

Send .25 for complete list of merchandise.
\$5.00 minimum order.

DISCOUNT SCANNERS

The Touch™



\$ 255.00

Prepaid USA **Regency**

CHECK, M.O., MASTERCHARGE, VISA

BAY-COM B32

196 FRONT STREET
SCITUATE MA 02066
617-545-9700

Other Regency models at similar savings—send for list

...Mass. residents please add 5% tax...

ROTOR SPECIAL

Wilson WR500.....\$109.95
CDE Ham III.....124.95

ANTENNA SPECIAL

Cuchcraft ATB-34.....\$209.95
Wilson Sys 1.....219.95
Wilson Sys 2.....179.95

HF SPECIAL

Kenwood TS-820S.....\$998.00
Kenwood TS-520S.....679.00
Yaesu FT-101E.....715.00
Yaesu FT-901DM.....1199.00*

*(order now)

2 METER SPECIAL

Tempo VHF/ONE PLUS.....\$349.00
Yaesu FT-227R.....289.95
Wilson WE800.....439.95

Jim WB2JON Wayne N2WK

CALL FOR YOUR PRICE TODAY FOR YOUR NEEDS **A51**

Amateur Radio of Rochester

1185 SCOTTSVILLE ROAD ROCHESTER NEW YORK 14624 (716) 235 7540

PET OWNERS

Send-Receive RTTY & CW

- Automatic send & receive: RTTY and CW
- Complete hardware and software package
- Connects to your PET User Port and the key/headphone jacks of your rig
- Eight message memories—255 char. each
- Keyboard buffer—allows typing ahead
- Uses built-in PLL or external TU
- Morse trainer—random 5 letter words
- Includes cassette and user's manual
- TRS-80 version available soon

Write or call for detailed brochure

\$69.95 **Microtronics** \$99.95
KIT **Box 5** M48 WIRED

Hughson, CA 95326 • (209) 634-8888

PCP™ TYPE-A PATENT PENDING

PCP TYPE-A TRANSFER FILM lifts the ink DIRECTLY from printed paper!
(NO CHEMICALS or PHOTOGRAPHY required!)

Only additional materials required are: Sensitized boards, developer, & etchant!

SEE POPULAR ELECTRONICS FEB '78 ISSUE!

FINALLY you can make HIGH QUALITY printed circuit boards directly from magazine construction articles! Can also be used to make specialized meter faces, front panel decals, component placement decals & others.

Small Pkg.	6pcs	4x6	\$5.49
Med. Pkg.	4pcs	6x9	\$6.95
Large Pkg.	3pcs	9x12	\$7.95

PCP P26 PRINTED CIRCUIT PRODUCTS CO.
P.O. BOX 4034
HELONA, MT 59601

REGULATED POWER SUPPLY

- Fully regulated, dual protected, 13.8 volts
- Illuminated on/off switch
- Hammertone metal case

33 Amp (30 Amp continuous)	\$119.95
20 Amp (16 amp. cont.)	\$74.95
8 Amp (6 amp. cont.)	\$39.95

TIMES CABLE

RG-8U - 100' multiples 18c/ft.
RG-213U - (Non-contaminating jacket)	
- 100' multiples 22c/ft.
1/2" Aluminum Jacketed hardline - 75 ohm.	
1000' rolls only 29c/ft.
PL259 connectors 25/50c ea.
or 100/45c ea.	POSTPAID

UNIVERSAL TOWERS

SUPER DISCOUNTS —
S.A.S.E. for brochure and prices!

Send S A S E for additional information. Include shipping charges with check or money order. (Ohio residents add 4 1/2% sales tax)

JRS ELECTRONICS JB
P.O. Box 1893—Cincinnati, Ohio 45201

slinky

SLINKY! \$43.95 Kit A LOT of antenna in a LITTLE space New Slinky® dipole* with helical loading radiates a good signal at 1/10 wavelength long!

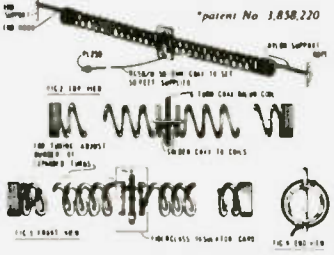

This electrically small 80/75, 40 & 20 meter antenna operates at any length from 24 to 70 ft. • no extra balun or transmatch needed • portable — erects & stores in minutes • small enough to fit in attic or apt. • full legal power • low SWR over complete 80/75, 40 & 20 meter bands • much lower atmospheric noise pick-up than a vertical & needs no radials • kit incl. a pr. of specially-made 4" dia. by 4" long coils, containing 335 ft. of radiating conductor, balun, 50 ft. RG58/U coax, PL259 connector, nylon rope & manual.

ASTATIC MICROPHONES

T-UPB-D104 transistorized w/push bar base \$64.20
 T-UGB-D104 transistorized \$52.80
 T-UGB-D104 "Silver Eagle" transistorized \$71.40
 UG-D104 ceramic or crystal \$46.80

HY-GAIN'S MODEL 269

Continuously loaded VHF antenna designed for portable and walkie-talkie applications. Constructed to withstand rough handling, completely insulated with special vinyl coating, it can be bent at all angles without destroying or cracking protective finish. Cannot be accidentally shorted out.

RUBBER DUCKIES

No. 269 — Fits Standard, Motorola, Hy Gain \$8.00
 No. 274 — BNE Base \$9.00
 No. 226 — TNC Base Wilson 5 Watts \$10.00
 No. 228 — "F" Base & Wilson 2 Watt & Tempo \$10.00
 No. 273 — 50' 239 Base, Kenwood, Drake \$9.00

YAESU



FT-301 or FT-301D

FT101E	160-10M XCVR	\$799
FT101EE	160-10MXCVR	759
FT101EX	160-10M XCVR	699
FL2100B	Linear Amplifier	479
FTV500B	6M Transverter	239
FTV250	2M Transverter	275
FV101B	External VFO	125
SP101B	Speaker/Patch	25
FA-9	Cooling Fan	18
RFP102	RF Proc. Early 101EE	79
XF30C	CW Filter	40
DC-1	AM Filter	40
RFP104	DC-DC Converter (EX)	50
	RF Proc. Late 101EE	79
FT7	FT101 Service Manual	25
	80-10 M XCUR 40W PEP	499
	ALL SOLID STATE TRANSCEIVERS	
FT301S	160 10M 40W PEP	559
FT301SDig	160 10M 40W PEP	750
FT301	160 10M 240W PEP	769
FT301Dig	160 10M 240W PEP	935
	ACCESSORIES	
FDX50	52 Diplex Filter	34
FC301	Ant. Tuner	159
ERB	Ext. Relay Box	17
LL301	Phone Patch	49
FL110	Wide Band SSB/CW Amp.	125
VFO	VFO	125
FP301	AC P/S FT301/301S	157
FP301D	AC P/S w/clock and CW Identifier	239
YO301	Monitor Scope	263
SP120	Speaker FT301/221R	25
XF90B	AM Filter	40
XF90C	FM Filter	40
XF92A	SSB & Proc. Filter	45

FR101S	160 2M/SW RCVR	599
FR101SDig	160 10M/SW RCVR	749
FC-6	6M Converter	24
FC-2	6M Converter	25
FA-1	FM Detector	21
XF30D	FM Filter	40
	AUX/SW Crystals	5
RFP101	RF Proc. (FL101)	79
FL101	SS 160 10M XMTTR	649
	VHF FM & SSB XCVR	
FT227B	2M FM Mobile XCVR	\$319
FT221R	2M AM/FM/CW/SSB XCVR	688
FT620B	6M AM/CW/SSB	365
PB1424	Marker Unit 620B	25
	FT221 Service Manual	15
	MOBILE MOUNT BRACKETS	
MMB-1	FT101	23
MMB-2	FT2A	23
MMB-4	620B 221 301	23
	MONITOR TEST EQUIPMENT	
YO100	Monitor Scope	\$246
YP150	Dummy Load Watt Meter	38
YC601	Dig. Readout 101/401	199
YC221	Dig. Readout 221/221R	119
	FREQUENCY COUNTERS	
YC500J	500 MHz 10 PPM	239
YC500S	500 MHz 1 PPM	399
YC500E	500 MHz 0.02 PPM	537
	MICROPHONES — MISCELLANEOUS	
YH55	L-2 Headphone	15
YD844	H-Z Base Mike	29
YD844L	L-Z Base Mike	29
YD846	H-Z Mike 101E/401B	16
YH85	L-Z Hand Mike	16
SP401PB	Speaker/Patch (401)	59
XF31C	600 Hz CW Filter 401	40
FRG-7 Receiver	1 to 9	\$315
	10 to 25	315
	26 to 49	315
	50 and up	315
QTR-24 World Clock	1 to 9	30
	10 to 25	30
	26 to 49	30
	50 and up	30
	FT 901DM	\$1299
	FT-901D	1149
	FT-901DE	1149
	FT-901SD	1115
	FM Unit	40
	AM or CW Filter	40
	Keyer Unit	40
	Memory Unit	125
	OC DC	50

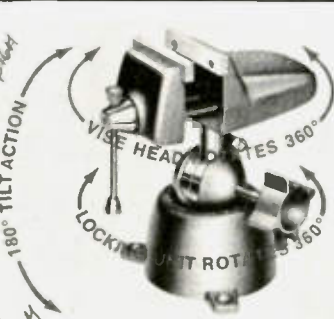

PANAVISE offers a variety of interchangeable work holding heads, bases and accessories for every imaginable function. But, just because it's small, doesn't mean you can't use PANAVISE for some pretty rugged work. It's a vise every craftsman deserves.

MODEL 300 Original Base
 Designed for all normal permanent installations. Three lugs spaced 120 degrees apart provide maximum mounting stability. Overall height: 3-13/16" (97 mm). Base diameter: 5" (127 mm).

MODEL 303 Original Vise Head
 Wide 2 1/2" (63 mm) jaws open to 2 1/4" (57 mm). Head is pressure diecast aluminum alloy, with steel and brass inserts. Hammertone gray/green finish. Replaceable nylon jaws. Package includes both Models 300 & 303 for \$21.95.

TUFTS SELECTED TITLES OF SAMS PUBLICATIONS



IC OP-AMP COOKBOOK
 by Walter D. Jung. The first book of its kind to be published. Covers not only the basic theory of the IC op amp in great detail, but also includes over 250 practical circuit applications, tables and general considerations, practical circuit applications, and appendices of manufacturers' reference material. 582 pages, 5 1/2" x 8 1/2" softbound. No. 20965 \$19.95

IC TIMER COOKBOOK
 by Walter D. Jung. Provides an excellent introduction to the field of IC timers by presenting a collection of various circuit recipes, useful in applying the devices. Arranged in three parts: the first part gives basic and generalized information; Part II, the applications section, is the meat of the book and includes over 100 different circuits for a wide range of uses; Part III contains reproductions of manufacturer's data sheets, second source manufacturers, and more. This book is a valuable reference for the hobbyist, the technician or engineering student or professional. 288 pages, 5 1/2" x 8 1/2" softbound. No. 21116 \$9.95

RADIO HANDBOOK (20th Edition)
 by William F. Colwell. A completely updated 20th edition of the famous communications handbook that is the electronics industry standard for engineers, technicians, and other end users. Equipped with authoritative detail from the design and build of radio communications equipment. Contains a greatly enlarged section on semiconductor and IC circuit design, including logic and equipment circuitry, linear amplifiers, both solid state and tube types, and all transmitters and converters, as well as special purpose and logic circuitry, plus completely revised chapters on electronics mathematics. 1080 pages, 8 1/2" x 11" hardbound. No. 24072 \$19.95

CMOS COOKBOOK
 by Don Lancaster. Tells all you need to know to understand and probably use this increasingly popular technology to work with digital logic. Features an expansion of what CMOS is, how it works and how to power it, plus a new section on static testing, troubleshooting, interface and other topics. Then a methodology of over 100 devices, including pinouts and use descriptions is given. Subjects covered include gate fundamentals, in-state logic, combinational logic design techniques, multi-state logic, volatile memory techniques, clocked JK and D flip-flops, counters, and register techniques, op amps, analog switches, phase-locked loops and much more. A must for the student, hobbyist, teacher, technician or engineer who wants to learn about CMOS. Filled with practical applications. 416 pages, 5 1/2" x 8 1/2" softbound. No. 21236 \$9.95

Master Charge
 American Express
 VISA
 Visa

Name _____ Call _____
 Address _____
 City _____ State _____ Zip _____
 Order: _____
 Check enclosed Visa Master Charge American Express
 Credit card # _____
 Signature _____ Card expiration date _____

TUFTS CATALOG INDEX

Advanced Electronics — 2
 AMECO — 7
 Amphenol — 17
 Astatic — 1
 Atlas — 8, 12
 Autek Research — 2, 5
 Bencher — 17
 Bird — 7
 Bomar — 4
 B & W — 16
 CDE — 5
 CES — 9
 CIR — 18
 Covercraft — 9
 Cushcraft — 10, 11
 Data Signal — 2, 8
 Dentron — 4, 16
 Drake — 3
 ETO — 18
 Finco — 6
 Ham Key — 13
 Hustler — 12
 HyGain — 1
 ICOM — 15
 JMR — 17
 KLM — 5, 8, 15
 Kenwood — 7
 Larsen — 15
 Midland — 17
 MFJ — 13
 Microwave Filter — 8
 Morgain — 15
 Mosley — 19
 Nemaarc — 17
 NPC — 2
 NPC — 2
 Nye Viking — 2, 19
 OK Tools — 9
 Pana Vise — 1
 Pipo Communications — 17
 Radio Amateur Callbook — 19
 Regency — 2
 Rohm — 6
 Sams — 1
 Save Your Radio — 19
 Slinky — 1
 SST — 10
 Stinger — 6
 Swan — 4
 Tee/Ax — 17
 Teletower — 5
 Telex — 7
 Tempo — 8
 Ten Tec — 18
 Texas RF — 17
 Triplett — 2
 Tri Ex — 10
 Van Gorden — 9
 Vibroplex — 19
 VISTA — 5
 VHF Eng — 14
 Wilson Electronics Corp. — 19
 World Radio TV Handbook — 10
 W2AU — 8
 W2VS — 8
 Yaesu — 1

TUFTS

Radio Electronics
 209 Mystic Avenue
 Medford MA 02155
 (617) 395-8280

TUFTS RADIO CATALOG



THE TEMPO 2020

- Phase lock-loop (PLL) oscillator circuit minimizes unwanted spurious responses.
- Hybrid Digital Frequency Presentation.
- Advanced Solid-state design, only 3 tubes.
- Built-in AC and 12 VDC power supplies.

- CW filter standard equipment, not an accessory.
- Rugged 6146-B final amplifier tubes.
- Cooling fan standard equipment, not an accessory.
- High performance noise-blanker is standard equipment, not an accessory.
- Built-in VOX and semi-break in CW keying.
- Crystal Calibrator and WWV receiving capability.
- Microphone provided.
- Dual RIT control allows both broad and narrow tuning.
- All band 80 through 10 meter coverage.
- Multi-mode USB, LSB, CW and AM operation.
- Extraordinary receiver sensitivity (.3u S/N 10 db) and oscillator stability (100 Hz 30 min. after warm-up).
- Fixed channel crystal control on two available positions.
- RF Attenuator.
- Adjustable ALC action.
- Phone patch in and out jacks.
- Separate PTT jack for foot switch.
- Built-in speaker.
- The TEMPO 2020, \$759.00.
- Model 8120 external speaker, \$29.95 Model 8010 remote VFO, \$139.00.



TEMPO ONE - HF Transceiver 80-10M USB, CW & AM - \$399.00

AC/ONE - Power supply for TEMPO ONE - \$99.00
 VF/ONE - External VFO for TEMPO ONE - \$109.00
 TEMPO SSB/ONE
 SSB adapter for the Tempo VHF/One
 *Selectable upper or lower sideband * Plugs directly into the VHF/One with no modification * Noise blanker built-in. * RIT and VXO for full frequency coverage * \$225.00

ATLAS 350-XL

- ALL SOLID STATE
- 350 WATTS P.E.P. OR CW INPUT
- SSB TRANSCEIVER
- 10 THROUGH 160 METER COVERAGE



Illustrated with optional AC supply, Auxiliary VFO, and Digital Dial.

The all new Atlas 350-XL has all the exciting new features you want, plus superior performance and selectivity control never before possible. Price: \$1195.00

- 10-160 Meters
- Full coverage of all six amateur bands in 500 kHz segments. Primary frequency control provides highly stable operation. Also included is provision for adding up to 10 additional 500 kHz segments between 2 to 22 MHz by plugging in auxiliary crystals.
- 350 WATTS P.E.P. and CW input. Enough power to work the world barefoot!

IDEAL FOR DESKTOP OR MOBILE OPERATION
 Measuring just 5 in. high x 12 in. wide x 12 1/2 in. deep, and weighing only 13 pounds, the Atlas 350-XL offers more features, performance and value than any other transceiver, regardless of size, on the market today!

- 350-PS matching AC supply - \$225.00
- DD-6XL plug-in digital dial readout - \$229.00
- 305 plug-in auxiliary VFO - \$155.00
- 311 plug-in crystal oscillator - \$135.00
- DMK-XL plug-in mobile mounting kit - \$65.00

DELUXE RECEIVER PREAMPLIFIERS

Ideal for Receivers - Converters
 High Gain - Low Noise

- FEATURES:
- Small size
 - Increases sensitivity of most receivers
 - Gold-plated copper shielding
 - Single or double stage models
 - Diode protected, dual-gated FETs

SPECIFICATIONS:
 Power: 6 VDC to 18 VDC (12 VDC recommended)
 Size: a. Single stage: 1" x 1 1/4" x 1/2"
 b. Double stage: 2" x 1 1/4" x 1/2"
 MOSFET: FT 0601, 500 MHz, dual-gate diode protected MOSFET



When ordering be sure to specify
 1. frequency of operation
 2. single or double band stage
 3. kit or assembled version

FREQ. (MHz)	USE	STAGES	DELUXE PREAMPLIFIER GAIN dB	NF dB	WIRED
50 to 54	6 METER	SINGLE	25	2	\$15.50
		DOUBLE	48	2	\$28.50
108 to 144	VHF AIRCRAFT	SINGLE	20	2.5	\$14.50
		DOUBLE	40	2.5	\$26.50
135 to 139	SATELLITE	SINGLE	20	2.5	\$14.50
		DOUBLE	40	2.5	\$26.50
144 to 148	2 METER	SINGLE	20	2.5	\$14.50
		DOUBLE	40	2.5	\$26.50
146 to 174	HIGH BAND	SINGLE	20	2.5	\$14.50
		DOUBLE	40	2.5	\$26.50
220 to 225	1 1/4 METER	SINGLE	18	2.5	\$14.50
		DOUBLE	35	2.5	\$26.50
225 to 300	UHF AIRCRAFT	SINGLE	15	2.5	\$14.50
		DOUBLE	30	2.5	\$26.50

DATA SIGNAL, INC.



KLM RF Power Amplifiers

- A simple, add-on-immediately RF amplifier.
- Merely coax-connect amplifier between antenna and transceiver.
- No tuning! Efficient strip-line broad band design.
- Automatic! Internal RF-sensor-controlled relay connects amplifier whenever transmitter is switched on.

Highest quality, American-made "brand" transistors are fully protected for VSWR, short and overload, reverse polarity. Highly effective heat sinking assures long life, reliable performance. Black anodized containers... exclusive KLM extrusions, have seven, full length fins on both sides!

- Manual, remote-position switching is optional.
- Models for 6, 2 1/4 meters, 70CM amateur bands plus MARS coverage.
- Two types: Class C for FM/CW. Linear for SSB/AM/FM/CW.
- Negligible insertion loss on receive.
- American made by KLM.

New Model	List Price
PA 2-25B	\$ 69.95
PA 4-70BL	189.95
PA 15-40BL	109.95
PA 15-80BL	179.95
PA 15-160BL	259.95
PA 45-140BL	219.95

PA 4-70BC	189.95
PA 15-60BC	164.95
PA 45-120BC	209.95
PA 4-40C	169.95
PA 15-35CL	154.95
PA 15-110CL	279.95

TEMPO VHF/ONE PLUS

The Tempo/ONE PLUS offers full 25 watt output or a selectable 3 to 15 watt low power output, remote tuning on the microphone, sideband operation with the SSB/ONE adapter, MARS operation capability, 5 kHz numerical LED, and all at a lower price than its time tested predecessor... the Tempo VHF ONE.

The Tempo VHF/One Plus is a VHF/FM transceiver for dependable communication on the 2 meter amateur band • Full 2 meter coverage, 144 to 148 MHz for both transmit and receive •



Full phase lock synthesized (PLL)

- Automatic repeater split - selectable up or down
- Two built-in programmable channels
- All solid state
- 800 selectable receive frequencies with simplex and +600 kHz transmit frequencies for each receive channel

Price: \$399.00

THE BIG SIGNAL



\$14.95

- World Famous Among Hams Armed Forces Communicators Industry, Why?
- Each BALUN 2KW P.E.P. tested
 - Lightning Arrester
 - 600" Full No Insulator Needed
 - Only 7/8" and 6 - 1 1/2" diameter
 - Reduces TVI
 - Improves S/B ratios
 - Weatherproof
 - Complete instructions
 - Antenna Length Table

THE OLD RELIABLE



\$21.95 pair

- Turns Your Antenna Into A Multi-Band Professional Demand Receptor, Why?
- Frequency Matched Pairs
 - Only 5/8" and 5/4" diameter
 - Rugged - Over 300" Pull
 - Weatherized
 - Models for 10 15 20 40 Meters
 - Complete Instructions
 - Multi-Band Length/Tuning Data

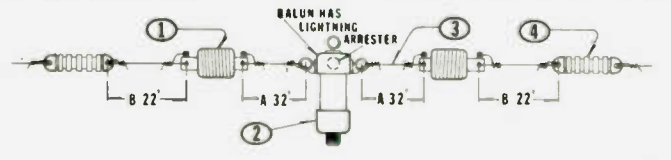

W2AU/W2VS • 5 BAND 10/80 METER ANTENNA KIT by UNADILLA/REYCO

GIVES YOU OPERATION ON 10 • 15 • 20 • 40 • 80 METERS (DESIGNED CLOSELY TO 5 BAND TRAP DIPOLE PARAMETERS PER A.P.R.L. HANDBOOK, HF ANTENNA CHAPTER 21 'A MULTIBAND TRAP ANTENNA')

& ARMED FORCES FACILITIES - AROUND THE WORLD - FOR OVER 10 YEARS!

- COMPLETE KIT (Nothing else needed)
- 2 ea. W2VS REYCO KW-40 TRAPS
 - 1 ea. W2AU 'BIG SIGNAL' BALUN 1:1
 - 120 Ft RUGGED #14-7 Strand Copper Wire
 - 2 ea. W2AU SHATTERPROOF END-sulators
 - INSTRUCTIONS
 - \$48.25

Every Component of This Kit is a Highly Crafted, old Line UNADILLA/REYCO Product Time Tested by HAMS, COMMERCIAL





DIP/IC INSERTION TOOL with PIN STRAIGHTENER

STRAIGHTEN PINS RELEASE PICK UP INSERT

14-16 Pin Dip IC inserter INS-1416 **\$4.49**

DIP/IC EXTRACTOR TOOL

The EX-1 Extractor is ideally suited for hobbyist or lab engineer. Featuring one piece spring steel construction. It will extract all LS1, MSI and SSI devices of from 8 to 28 pins.

Extractor Tool EX-1 **\$1.49**

P.C. BOARD

The 4 x 5 1/2 inch board is made of glass coated EPOXY Laminates and features solder coated 1 air copper pads. The board has provision for a 27/44 two sided edge connector, with contacts on standard .156 spacing. Edge contacts are non-decorated for maximum flexibility.

The board contains a matrix of 040 in diameter holes on 100 inch centers. The component side contains 76 hole pads that can accommodate any DIP size from 640 pins, as well as discrete components. Typical density is 18 of 14-Pin or 16-Pin DIP's. Components may be soldered directly to the board or intermediate sockets may be used for soldering or wire wrapping.

Two independent bus systems are provided for voltage and ground on both sides of the board in addition, the component side contains 14 individual buses routing the 140 pins. These buses feature unique standing up flexibility. These buses enable access from edge contacts to distant components. These buses can also be used to augment the voltage or ground buses, and may be cut to length for particular applications.

Hobby Board H-PCB-1 **\$4.99**

PC CARD GUIDES

TR-1 consists of 2 guides precision milled with unique spring finger action that dampens shock and vibration, yet permits smooth insertion or extraction. Guides accommodate any card thickness from .040 to .100 inches.

QUANTITY - ONE PAIR (2 pcs) Card Guides TR-1 **\$1.89**

PC CARD GUIDES & BRACKETS

TRS-2 kit includes 2 TR-1 guides plus 2 mounting brackets. Support brackets feature unique standing post that permits secure mounting with only 1 screw.

Guides & Brackets TRS-2 **\$3.79**

QUANTITY - ONE SET (4 pcs)

PC EDGE CONNECTOR

44 Pin, dual end, .156" (3.96 mm) Contact Spacing. .025" (0.63 mm) square wire-wrapping pins.

P.C. Edge Connector CON-1 **\$3.49**

P.C.B. TERMINAL STRIPS

The TS series provides fast, secure, unclamped action. Accommodate wire sizes 14-30 AWG (1.80 - 2.00mm) Pins are silver plated copper. .042 inch (1.07mm) diameter on .200 inch (5.08mm) centers.

4-Pole	TS-4	\$1.39
8-Pole	TS-8	\$1.99
12-Pole	TS-12	\$2.59

WIRE-WRAPPING KIT

Contains: Hobby Wrap Tool WSU-30 M, Wire Dispenser WD-30 B, (2) 14 DIP's, (2) 16 DIP's, Hobby Board H-PCB-1, DIP/IC Insertion Tool INS-1416 and DIP/IC Extractor Tool EX-1.

Wire-Wrapping Kit WK-4B (Blue) **\$25.99**

WIRE-WRAPPING TOOL

Wire-wrapping, stripping, unwrapping tool for AWG 30 on .025 (0.63mm) Square Post.

Regular Wrap	WSU-30	\$4.95
Modified Wrap	WSU-30M	\$7.95

WIRE-WRAPPING TOOL

For .025" (0.63mm) sq. post "MODIFIED" wrap, positive indexing, anti-overwrapping device.

For AWG 30	BW-630	\$34.95*
For AWG 26-28	BW-2628	\$39.95*

Bit for AWG 30	BT-30	\$3.95
Bit for AWG 26-28	BT-2628	\$7.95

*USE "C" SIZE Ni-CAD BATTERIES (NOT INCLUDED)

ROLLS OF WIRE

Wire for wire-wrapping AWG-30 (0.25mm) KYNAR® wire, 50 ft. roll, silver plated, solid conductor, easy stripping.

AWG Blue Wire 50ft. Roll	R 10R 0050	\$1.99
AWG Yellow Wire 50ft. Roll	R 30Y 0050	\$1.99
AWG White Wire 50ft. Roll	R 30W 0050	\$1.99
AWG Red Wire 50ft. Roll	R 30R 0050	\$1.99

WIRE DISPENSER

- With 50 ft. Roll of AWG 30 KYNAR® wire-wrapping wire.
- Cuts the wire to length.
- Strips 1" of insulation.
- Refillable (For refills, see above)

Blue Wire	WD-30-B	\$3.99
Yellow Wire	WD-30-Y	\$3.99
White Wire	WD-30-W	\$3.99
Red Wire	WD-30-R	\$3.99

PRE CUT PRE STRIPPED WIRE

Wire for wire-wrapping AWG 30 (0.25mm) KYNAR® wire, 50 wires per package stripped 1" both ends.

30 AWG Blue Wire 1' Long	30 B 50 010	\$1.99
30 AWG Yellow Wire 1' Long	30 Y 50 010	\$1.99
30 AWG White Wire 1' Long	30 W 50 010	\$1.99
30 AWG Red Wire 1' Long	30 R 50 010	\$1.99
30 AWG Blue Wire 2' Long	30 B 50 020	\$1.99
30 AWG Yellow Wire 2' Long	30 Y 50 020	\$1.99
30 AWG White Wire 2' Long	30 W 50 020	\$1.99
30 AWG Red Wire 2' Long	30 R 50 020	\$1.99
30 AWG Blue Wire 3' Long	30 B 50 030	\$1.99
30 AWG Yellow Wire 3' Long	30 Y 50 030	\$1.99
30 AWG White Wire 3' Long	30 W 50 030	\$1.99
30 AWG Red Wire 3' Long	30 R 50 030	\$1.99
30 AWG Blue Wire 4' Long	30 B 50 040	\$1.99
30 AWG Yellow Wire 4' Long	30 Y 50 040	\$1.99
30 AWG White Wire 4' Long	30 W 50 040	\$1.99
30 AWG Red Wire 4' Long	30 R 50 040	\$1.99
30 AWG Blue Wire 5' Long	30 B 50 050	\$1.99
30 AWG Yellow Wire 5' Long	30 Y 50 050	\$1.99
30 AWG White Wire 5' Long	30 W 50 050	\$1.99
30 AWG Red Wire 5' Long	30 R 50 050	\$1.99
30 AWG Blue Wire 6' Long	30 B 50 060	\$1.99
30 AWG Yellow Wire 6' Long	30 Y 50 060	\$1.99
30 AWG White Wire 6' Long	30 W 50 060	\$1.99
30 AWG Red Wire 6' Long	30 R 50 060	\$1.99

WIRE-WRAPPING KIT

Contains: Hobby Wrap Tool WSU-30, Roll of wire R-30B-0050, (2) 14 DIP's, (2) 16 DIP's and Hobby Board H-PCB-1.

Wire-Wrapping Kit WK-3B (Blue) **\$16.95**

DIP SOCKET

Dual-in-line package. 3 level wire-wrapping, phosphor bronze contact, gold plated pins. .025 (0.63mm) sq. .100 (2.54mm) center spacing.

14 Pin Dip Socket	14 Dip	\$0.79
16 Pin Dip Socket	16 Dip	\$0.89

RIBBON CABLE ASSEMBLY SINGLE ENDED

With 14 Pin Dip Plug	24" Long (609mm)	SE14-24	\$3.55
With 16 Pin Dip Plug	24" Long (609mm)	SE16-24	\$3.75

DIP PLUG WITH COVER FOR USE WITH RIBBON CABLE

14 Pin Plug & Cover	14-PLG	\$1.45
16 Pin Plug & Cover	16-PLG	\$1.59

QUANTITY: 2 PLUGS, 2 COVERS

RIBBON CABLE ASSEMBLY DOUBLE ENDED

With 14 Pin Dip Plug 2" Long	DE 14-2	\$3.75
With 14 Pin Dip Plug 4" Long	DE 14-4	\$3.85
With 14 Pin Dip Plug 8" Long	DE 14-8	\$3.95
With 16 Pin Dip Plug 2" Long	DE 16-2	\$4.15
With 16 Pin Dip Plug 4" Long	DE 16-4	\$4.25
With 16 Pin Dip Plug 8" Long	DE 16-8	\$4.35

TERMINALS

- .025 (0.63mm) Square Post
- 3 Level Wire-Wrapping
- Gold Plated

Slotted Terminal	WWT-1	\$2.98
Single Sided Terminal	WWT-2	\$2.98
IC Socket Terminal	WWT-3	\$3.98
Double Sided Terminal	WWT-4	\$1.98

25 PER PACKAGE

TERMINAL INSERTING TOOL

For inserting WWT-1, WWT-2, WWT-3, and WWT-4 Terminals into .040 (1.01mm) Dia. Holes.

INS-1 **\$2.49**

WIRE CUT AND STRIP TOOL

Easy to operate - place wires (up to 4) in stripping slot with ends extending beyond cutter blades - press tool and pull wire is cut and stripped to proper wire-wrapping length. The hardened steel cutting blades and sturdy construction of the tool insure long life.

Strip length easily adjustable for your application.

DESCRIPTION	MODEL NUMBER	ADJUSTABLE STRIPPER LENGTH OF STRIPPED WIRE INCHES TO INCHES	Price
24 ga. Wire Cut and Strip Tool	ST-100-24	1 1/2" - 1 3/4"	\$ 8.75
26 ga. Wire Cut and Strip Tool	ST-100-26	1 1/2" - 1 3/4"	\$ 8.75
28 ga. Wire Cut and Strip Tool	ST-100-28-1/8"	1 1/2" - 1 3/4"	\$ 8.75
28 ga. Wire Cut and Strip Tool	ST-100-28	1 1/2" - 1 3/4"	\$11.50
30 ga. Wire Cut and Strip Tool	ST-100-30	1 1/2" - 1 3/4"	\$11.50

THE ABOVE LIST OF CUT AND STRIP TOOLS ARE NOT APPLICABLE FOR WIRE OF 18 TO 22 GA. INSULATION

WIRE-WRAPPING KITS

Contains: Hobby Wrap Tool WSU-30, (50 ft.) Roll of wire, Prestripped Wire 1" to 4" lengths (50 wires per package) stripped 1" both ends.

Wire-Wrapping Kit (Blue)	WK-2 B	\$12.95
Wire-Wrapping Kit (Yellow)	WK-2 Y	\$12.95
Wire-Wrapping Kit (White)	WK-2 W	\$12.95
Wire-Wrapping Kit (Red)	WK-2 R	\$12.95

HI-Q BALUN

- For dipoles, yagis, inverted vees, doublets & quads
- For full legal power & more
- Puts power in antenna
- Broadbanded 3-40MHz.
- Small, light, weather-proof
- 1:1 Impedance ratio
- Replaces center insulator
- Helps eliminate TVI
- Fully Guaranteed

\$9.95 PPD U.S.A.

Van Gorden Engineering

DUST COVERS

Our covers are custom designed to protect all popular equipment models. They are made of rugged high quality vinyl and are machine stitched for extra strength. They add that professional look to your station. \$3.95.

COVER CRAFT

CES Touch Tone Pads

Model 200 V, Model HT 220, Model 220

- Model 300 - acoustic coupling \$49.95
- Model 210 - for mounting on walkies or hand helos \$39.95
- Model 220 - CES can now offer you a TOUCH TONE back for Standard Communications hand-held radios. This is the complete back assembly with the TOUCH TONE encoder mounted and ready to plug into the private channel connector. Also included is a LED tone generator indicator and an external tone deviation adjustment. \$59.95
- Model 215 (miniature version of 210) - \$39.95
- Model 221 long - \$59.95
- Model 221 short - \$59.95

ATB-34



4 ELEMENT BEAM

10-15-20 METERS

Cushcraft engineers have incorporated more than 30 years of design experience into the best 3 band HF beam available today. **ATB-34** has superb performance with three active elements on each band, the convenience of easy assembly and modest dimensions. Value through heavy duty all aluminum construction and a price complete with 1-1 balun.

SPECIFICATIONS

FORWARD GAIN -	EXCELLENT	LONGEST ELEMENT -	32 ft
F/B RATIO -	30 db	TURNING RADIUS -	18 ft
VSWR -	1.5:1	WIND SFC -	5.4 Sq Ft
POWER -	2000 WATTS PEP	WEIGHT -	42 lbs
HANDLING -	2000 WATTS PEP	WIND SURVIVAL -	90 MPH
BOOM LENGTH/DIA -	18' x 2 1/8"		

UPS SHIPPABLE \$239.95 COMPLETE

ENJOY A NEW WORLD OF DX COMMUNICATIONS WITH ATB-34

VHF - UHF DX-ARRAYS 144, 220, 430 mhz

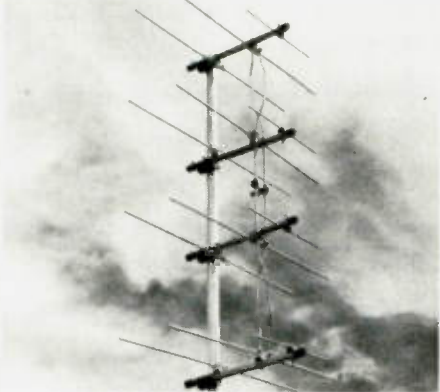

20 ELEMENT DX - ARRAYS

20 ELEMENT SPECIFICATIONS

Forward Gain -----	14.2 db	Impedance -----	52 ohms
F/B Ratio -----	20 db	VSWR at Frequency -----	1 - 1
Fwd. Lobe at 1/2 Pwr. Point		Bandwidth W/VSWR	
horizontal -----	48°	Less than 2 - 1 -----	4 mhz
vertical -----	26°	Power Handling --	2 KW PEP
Height	144 Mhz	220 Mhz	432 Mhz
118"	78"	42"	42"
Width x Depth	75" x 30"	53" x 20"	29" x 11"
Turning Radius	48"	32"	18"
Maximum Mast Dia.	1 1/2"	1 1/2"	1 1/2"
Net Weight Lbs.	8	7	6

Vertical support mast not supplied

2 METER DX-120	1 1/4 METER DX-220	3/4 METER DX-420
Am. Net \$42.95	\$37.95	\$32.95

40 ELEMENT DX - ARRAYS

40 ELEMENT SPECIFICATIONS

Forward Gain -----	17 db	Impedance -----	52 ohms
F/B Ratio -----	20 db	VSWR at Frequency -----	1 - 1
Fwd. Lobe at 1/2 Pwr. Point		Bandwidth W/VSWR	
horizontal -----	32°	Less than 2 - 1 -----	4 mhz
vertical -----	26°	Power Handling --	2 KW PEP
Height	144 Mhz	220 Mhz	432 Mhz
118"	78"	42"	42"
Width x Depth	192" x 30"	132" x 20"	72" x 11"
Turning Radius	101"	65"	38"
Maximum Mast Dia.	2 1/2"	2 1/2"	2 1/2"
Net Weight Lbs.	32	22	12
Wind Rating	90 mph	90 mph	90 mph
Stack Kit No.	DXK-140	DXK-240	DXK-440
Amateur Net	\$59.95	\$54.95	\$39.95

80 ELEMENT DX - ARRAYS

80 ELEMENT SPECIFICATIONS

Forward Gain -----	20 db	Impedance -----	52 ohms
F/B Ratio -----	20 db	VSWR at Frequency -----	1 - 1
Fwd. Lobe at 1/2 Pwr. Point		Bandwidth W/VSWR	
horizontal -----	32°	Less than 2 - 1 -----	4 mhz
vertical -----	12°	Power Handling --	2 KW PEP
Height	144 Mhz	220 Mhz	432 Mhz
275"	182"	97"	
Width x Depth	192" x 30"	132" x 20"	72" x 11"
Turning Radius	101"	65"	38"
Maximum Mast Dia.	2 1/2"	2 1/2"	2 1/2"
Wind Rating	90 mph	90 mph	90 mph
Net Weight Lbs.	64	43	24
Stack Kit No.	DXK-180	DXK-280	DXK-480
Amateur Net	\$109.95	\$89.95	\$79.95

HF MONOBEAMS 10 15 20 METERS

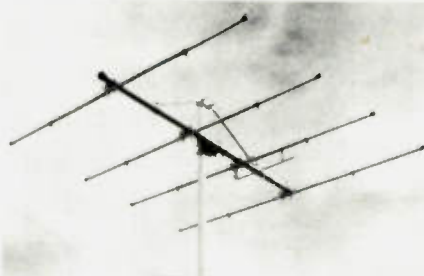

10 METERS

3 ELEMENT BEAM: You can have an outstanding signal using this compact three element beam. It is easily mounted on a lightweight rotator and takes only a limited amount of space. MODEL NO. A28-3 \$69.95

4 ELEMENT BEAM: A real DX'er's beam for the active ham who wants a top signal on 10 meters. Mount on a good ham rotator. MODEL NO. A28-4 \$79.95

SPECIFICATIONS

	A28-3	A28-4
BOOM	1 1/2" x 10"	1 5/8" x 18"
LONGEST ELEMENT	17' 6"	18'
ELEMENT DIAMETER	7/8" - 1/2"	7/8" - 3/4"
TURNING RADIUS	10"	14' 3"
FORWARD GAIN	8 db	10 db
FRONT TO BACK	22 db	25 db
SWR @ FREQUENCY	1 to 1	1 to 1
WEIGHT	11 lbs.	21 lbs.

15 METERS

3 ELEMENT BEAM: A high quality beam which can be mounted on a mast with other antennas. A heavy duty TV rotator will handle it. MODEL NO. A21-3 \$89.95

4 ELEMENT BEAM: For the 15 meter enthusiast this beam will give real DX performance. When mounted on a good ham rotator it will withstand the most adverse weather conditions. MODEL NO. A21-4 \$119.95

SPECIFICATIONS

	A21-3	A21-4
BOOM	1 5/8" x 12"	1 3/4" x 21' 6"
LONGEST ELEMENT	22' 10"	22' 10"
ELEMENT DIAMETER	7/8" - 3/4"	7/8" - 3/4"
TURNING RADIUS	13' - 3"	15' - 8"
FORWARD GAIN	8 db	10 db
FRONT TO BACK	22 db	25 db
SWR @ FREQUENCY	1 to 1	1 to 1
WEIGHT	16 lbs.	32 lbs.

20 METERS

2 ELEMENT BEAM: Full size beam performance for the active 20 meter ham with limited space and budget. MODEL NO. A14-2 \$109.95

3 ELEMENT BEAM: A real DX'er's beam with full 1.15 wave-length element spacing. The heavy duty construction gives years of trouble free service. MODEL NO. A14-3 \$139.95

SPECIFICATIONS

	A14-2	A14-3
BOOM	1 5/8" x 10"	1 3/8" x 20' 6"
LONGEST ELEMENT	35' 10"	35' 10"
ELEMENT DIAMETER	1 1/8" - 3/4"	1 1/8" - 3/4"
TURNING RADIUS	18'	21'
FORWARD GAIN	5 db	8 db
F/B RATIO	13 db	22 db
SWR @ FREQUENCY	1 to 1	1 to 1
WEIGHT	20 lbs.	35 lbs.

World Radio TV Handbook 1978
A Complete Directory of International Radio and Television

The most extensive and authoritative guide to broadcasting and television stations around the world today. **WORLD RADIO TV HANDBOOK 1978** is an indispensable manual for anyone with a working interest in radio and television. Features:

- Names and addresses of broadcast companies and stations by country
- Names and titles of leading officials and personnel
- Listing by frequency of short-wave stations around the world
- Program data including frequencies, wave lengths, transmitter power, call signs, times, announcement events (in each language)

Plus a special in-depth editorial section with professional articles, suggestions and tips—and much, much more. **WORLD RADIO TV HANDBOOK 1978** is available now for only \$11.95.

HF Verticals 10-80 Meters

- efficient top ring • fiberglass trap forms • enameled wire coils • solid aluminum capacitors • no tuning required • full compression clamps • omnidirectional coverage • reinforced base • mast or ground mounting • pre-marked sections • easy assembly • superior quality

3 BAND 20-15 meters/Model ATV-3 \$49.95
4 BAND 4'20"15'10 meters/Model ATV-4 \$89.95
5 BAND 8'40"20'15'10 meters/Model ATV-5 \$109.95

Speak up.

We know all about up. In fact, we're number one from the ground up when it comes to amateur communications towers. We've been building them for HAMs for more than two decades.

Whether you're thinking crank-up, guyed or free-standing, check with us first. We're Tri-Ex. Reliable, dependable.

When we say number one from the ground up, we're talking about towers like Tri-Ex's new "Big W" shown here. It's a free-standing crank-up with a height of 80 ft., providing good DX capability at low cost. Ideal for serious HAMs.

Model W51 (51' Self-supporting) \$850.00

SST T-1 RANDOM WIRE ANTENNA TUNER

All band operation (160-10 meters) with any random length of wire. 200 watt output power capability — will work with virtually any transceiver. Ideal for portable or home operation. Great for apartments and hotel rooms — simply run a wire inside, out a window, or anyplace available. Toroid inductor for small size: 4-1/4" x 2-3/8" x 3". Built-in neon tune-up indicator. SO-239 connector. Attractive bronze finished enclosure. Only \$29.95

SST T-2 ULTRA TUNER

Tunes out SWR on any coax fed antenna as well as random wires. Works great on all bands (160-10 meters) with any transceiver running up to 200 watts power output. Increases usable bandwidth of any antenna. Tunes out SWR on mobile whips from inside your car. Uses toroid inductor and specially made capacitors for small size: 5/4" x 2 1/4" x 2 1/4". Rugged, yet compact. Attractive bronze finished enclosure. SO-239 coax connectors are used for transmitter input and coax fed antennas. Convenient binding posts are provided for random wire and ground connections. Only \$49.95

SST T-3 IMPEDANCE TRANSFORMER

Matches 52 ohm coax to the lower impedance of a mobile whip or vertical. 12 position switch with taps spread between 3 and 52 ohms. Broadband from 1-30 MHz. Will work with virtually any transceiver — 300 watt output power capability. SO-239 connectors. Toroid inductor for small size: 2-3/4" x 2" x 2-1/4". Attractive bronze finish. Only \$19.95

6 METER BEAMS

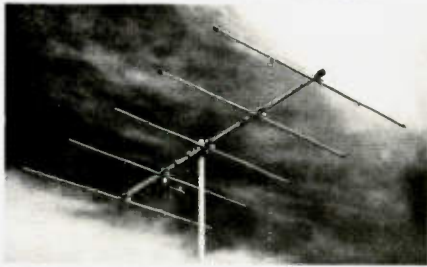

3-5-6-10 ELEMENTS

Proven performance from rugged, full size, 6 meter beams. Element spacings and lengths have been carefully engineered to give best pattern, high forward gain, good front to back ratio and broad frequency response.

Booms are .058 wall and elements are 3/4" - 5/8" .049 wall seamless chrome finish aluminum tubing. The 3 and 5 element beams have 1 3/8" - 1 1/4" booms. The 6 and 10 element beams have 1 5/8" - 1 1/2" booms. All brackets are heavy gauge formed aluminum. Bright finish cad plated bolts are adjustable for up to 1 5/8" mast on 3 and 5 element and 2" on 6 and 10 element beams. All models may be mounted for horizontal or vertical polarization.

New features include adjustable length elements, kilowatt Reddi Match and built-in coax fitting for direct 52 ohm feed. These beams are factory marked and supplied with instructions for quick assembly.

Description	3 element	5 element	6 element	10 element
Model No.	A503	A505	A506	A5010
Boom Length	6'	12'	20'	24'
Longest El.	117"	117"	117"	117"
Turn Radius	6'	7' 6"	11'	13'
Fwd. Gain	7.5 dB	9.5 dB	11.5 dB	13 dB
F/B Ratio	20 dB	24 dB	26 dB	28 dB
Weight	7 lbs	11 lbs	18 lbs	25 lbs

COAXIAL DUAL STACKING KITS

Double your effective radiated power by stacking 6 meter beams. Cush Craft coaxial stacking kits provide a simple and efficient method for realizing 3 db additional gain while maintaining the superior characteristics of our single beams. The stacking kits are complete with RG-59/U cable and preassembled fittings for direct 52 ohm feed.

MODEL NO.	FOR STACKING	AMATEUR NET
A535-SK	A50-3 or A50-5	\$15.95
A561-SK	A50-6 or A50-10	\$17.95



4.5 dB* - 6 dB**
Omnidirectional GAIN
BASE STATION ANTENNAS FOR MAXIMUM PERFORMANCE AND VALUE

Cush Craft has created another first by making the world's most popular 2 meter antenna twice as good. The new Ringo Ranger is developed from the basic AR-2 with three half waves in phase and a one eighth wave matching stub. Ringo Ranger gives an extremely low angle of radiation for better signal coverage. It is tunable over a broad frequency range and perfectly matched to 52 ohm coax.

- ARX-2, 137-160 MHz, 4 lbs., 112"
- ARX-220, 220-225 MHz, 3 lbs., 75"
- ARX-450, 435-450 MHz, 3 lbs., 39"

* Reference 1/4 wave dipole.
** Reference 1/2 wave whip used as gain standard by many manufacturers.

Work off quieting into more repeaters and extend the radius of your direct contacts with the new Ringo Ranger.

You can up date your present AR-2 Ringo with the simple addition of this extend. kit. The kit includes the phasing network and necessary element extensions. The only modifications required are easy to make saw slits in the top section of your antenna.

ARX-2K CONVERSION KIT

2 METER FM ANTENNAS

A.F.M. RINGO 3.75 dB Gain (reference 1/4 wave whip) Half wave length antennas with direct 52 ohm feed takes PL-259, low angle of radiation with 1:1 SWR. Factory preassembled and ready to install. 6 meter partly preassembled, all but 450 MHz take 1 1/2" mast. There are more Ringos in use than all other FM antennas combined.

Model Number	AR-2	AR-25	AR-6	AR-220	AR-450
Frequency MHz	135-175	135-175	50-51	220-225	440-460
Power-Hdly Watts	100	500	100	100	250
Wind area sq. ft.	21'	31'	37'	20'	10'

B-1 POLE Up to 9 dB Gain over a 1/2 wave dipole. Overall antenna length 147 MHz - 23' 220 MHz - 15', 435 MHz - 8', pattern 360° - 6 dB gain, 180° - 9 dB gain. 52 ohm feed takes PL-259 connector. Package includes 4 complete dipole assemblies on mounting booms, harness and all hardware. Vertical support mast not supplied.

AFM-4D	144 - 150 MHz, 1000 watts, wind area 2.58 sq ft
AFM-24D	220 - 225 MHz, 1000 watts, wind area 1.85 sq ft
AFM-44D	435 - 450 MHz, 1000 watts, wind area 1.13 sq ft

D-POWER PACK The big signal 122 element array for 2 meter FM, uses two A147-11 yagis with a horizontal mounting boom, coaxial harness and all hardware. Forward gain 16 dB, F/B ratio 24 dB, 1/2 power beamwidth 42°, dimensions 144" x 80" x 40", turn radius 60", weight 15 lbs. 52 ohm feed takes PL-259 fitting.

A147-22 146 - 148 MHz, 1000 Watts, wind area 2.42 sq ft

O-YAGI STACKING KITS VPK includes horizontal mounting boom, harness, hardware and instructions for two vertically polarized yagis gives 3 dB gain over the single antenna.

A14-VPK	complete 4 element stacking kit
A14-SK	4 element coax harness only
A147-VPK	complete 11 element stacking kit
A147-SK	11 element coax harness only
A449-SK	6 - 11 element coax harness only

E-4-6-11 ELEMENT YAGIS The standard of comparison in VHF/UHF communications, now cut for FM and vertical polarization. The four and six element models can be tower side mounted. All are rated at 1000 watts with direct 52 ohm feed and PL-259 connectors.

Model Number	A147-11	A-147-4	A449-11	A449-6	A220-11
Boom Length etc.	14' 40"	4' 40"	60' 13"	35' 26"	102' 26"
Wght Turn radius	6 lbs. 72"	3 lbs. 44"	4 lbs. 60"	3 lbs. 18"	5 lbs. 51"
Gain F/B ratio dB	13.2 28	9 20	13.2 28	11 25	13.2 28
1/2 Power beam	48	66	48	60	48
Wind area sq. ft.	1 21	1 13	29	30	50
Frequency MHz	146-148	146-148	440-450	440-450	220-225

F-FM TWIST 12.4 dB Gain. Ten elements horizontal polarization for low end coverage and ten elements vertical polarization for FM coverage. Forward gain 12.4 dB, F/B ratio 22 dB, boom length 130", weight 10 lbs., longest element 40", 52 ohm Reddi Match driven elements take PL-259 connectors, uses two separate Feed lines.

A147-20T 145 - 147 MHz, 1000 watts, wind area 1.42 sq ft.

HIGH PERFORMANCE VHF YAGIS



3/4, 1-1/4, 2 METER BEAMS

The standard of comparison in amateur VHF/UHF communications Cush Craft yagis combine all out performance and reliability with optimum size for ease of assembly and mounting at your site.

Lightweight yet rugged, the antennas have 3/16" O.D. solid aluminum elements with 5/16" center sections mounted on heavy duty formed brackets. Booms are 1" and 7/8" O.D. aluminum tubing. Mast mounts of 1/8" formed aluminum have adjustable u-bolts for up to 1-1/2" O.D. masts. They can be mounted for horizontal or vertical polarization. Complete instructions include data on 2 meter FM repeater operation.

New features include a kilowatt Reddi Match for direct 52 ohm coaxial feed with a standard PL-259 fitting. All elements are spaced at .2 wavelength and tapered for improved bandwidth.

Model No	A144 7	A144 11	A220 11	A430 11
Description	2m	2m	1 1/2m	1 1/2m
Elements	7	11	11	11
Boom Length	98"	144"	102"	57"
Weight	4	6	4	3
Fwd. Gain	11 dB	13 dB	13 dB	13 dB
F/B Ratio	26 dB	28 dB	28 dB	28 dB
Fwd. Lobe @				
1/2 pwr pt	46	42	42	42
SWR @ Freq	1 to 1	1 to 1	1 to 1	1 to 1

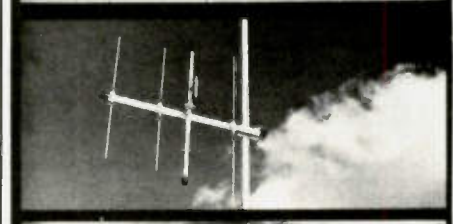
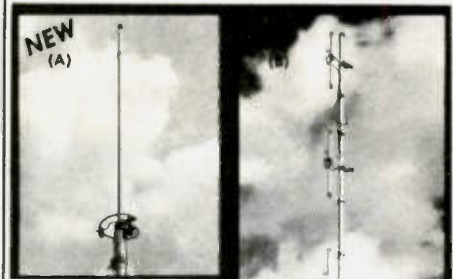

AMATEUR FM ANTENNAS	DX VPB	DX ARRAY 40 ELEMENT	
A147-4	\$ 19.95	DXX-140	\$ 59.95
A147-11	29.95	DXX-240	54.95
A147-20T	54.95	DXX-440	39.95
A147-22	84.95	DXX-80 ELEMENTS	
A220 7	21.95	DXX-180	\$109.95
A220-11	27.95	DXX-280	89.95
A220-22	74.95	DXX-480	79.95
A449-6	21.95	HF MONOBEAMS	
A449-11	27.95	A14-2	\$109.95
AFM-4D	59.95	A14-3	139.95
AFM-24D	57.95	A21-3	89.95
AFM-44D	54.95	A21-4	119.95
AR-2	21.95	A28-3	69.95
AR-6	32.95	A28-4	79.95
AR-25	29.95	PROLINE VHF BEAMS	
AR-220	21.95	APL-25K	\$ 21.95
AR-450	21.95	APL-65K	24.95
ARX-2	32.95	APL-65	129.95
ARX-2K	13.95	APL 210	99.95
ARX-220	32.95	TRI BAND BEAM	
ARX-450	32.95	AF8 1	\$ 14.95
AMATEUR FM STACKING		AT8 34	239.95
A14-SK	\$ 15.95	23.95 TWIST ANTENNAS	
A14 VPK	23.95	A14T-MB	\$ 15.95
A21-SK	15.95	A320-VPK	34.95
A220-VPK	23.95	A50-10	54.95
A147-SK	15.95	A144-800T	349.95
A147 VPK	29.95	A432-20T	49.95
A449-SK	15.95	VHF/UHF BEAMS	
A449 VPK	23.95	A50-3	\$ 32.95
BIG WHEEL ANTENNAS		A50-5	49.95
ABW 125	\$ 12.95	A50-6	69.95
ABW-145	24.95	A50 10	99.95
ABW-144	27.95	A144-7	21.95
BLITZ BUG		A144-11	32.95
LAC 1	\$ 4.50	A430-11	24.95
LAC 2	4.50	VHF/UHF STACKING KITS	
DX ARRAYS-20 ELEMENT	\$ 42.95	A11-SK	\$ 15.95
DX-120	37.95	A17-SK	15.95
DX-220	32.95	A41-SK	15.95
DX-420	32.95	A55-SK	15.95
DX-ARRAY BALUNS		A561-SK	17.95
DX-18N	\$ 12.95	AQK-144	89.95
DX-28N	12.95	AQK-444	69.95
DX 48N	12.95		

TUFTS RADIO CATALOG TUFTS RADIO

For all you hams with little cars ... We've got the perfect mobile rig for you.



The Atlas 210x or 215x measures only 9 1/4" wide x 9 1/4" deep x only 3 1/4" high, yet the above photograph shows how easily the Atlas transceiver fits into a compact car. And there's plenty of room to spare for VHF gear and other accessory equipment. With the exclusive Atlas plug-in design, you can slip your Atlas in and out of your car in a matter of seconds. All connections are made automatically.

BUT DON'T LET THE SMALL SIZE FOOL YOU!

Even though the Atlas 210x and 215x transceivers are less than half the size and weight of other HF transceivers, the Atlas is truly a giant in performance.

200 WATTS POWER RATING!

This power level in a seven pound transceiver is incredible but true. Atlas transceivers give you all the talk power you need to work the world barefoot. Signal reports

constantly reflect great surprise at the signal strength in relation to the power rating.

FULL 5 BAND COVERAGE

The 210x covers 10-80 meters, while the 215x covers 15-160 meters. Adding the Atlas Model 10x Crystal Oscillator provides greatly increased frequency coverage for MARS and network operation.

NO TRANSMITTER TUNING OR LOADING CONTROLS

with Atlas' total broadbanding. With your Atlas you get instant QSY and band change.

MOST ADVANCED STATE OF THE ART SOLID STATE DESIGN

not only accounts for its light weight, but assures you years of top performance and trouble free operating pleasure.

PLUG-IN CIRCUIT BOARDS

and modular design provides for ease of servicing.

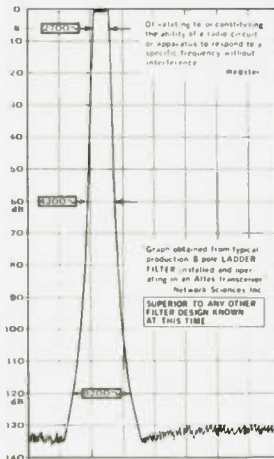

PHENOMENAL SELECTIVITY

The exclusive 8 pole crystal ladder filter used in Atlas transceivers represents a major breakthrough in filter design, with unprecedented skirt selectivity and ultimate rejection. As the above graph shows, this filter provides a 6 db bandwidth of 2700 Hertz, 60 db down of only 4300 Hertz, and a bandwidth of only 9200 Hertz at 120 db down! Ultimate rejection is in excess of 130 db, greater than the measuring limits of most test equipment.

EXCEPTIONAL IMMUNITY TO STRONG SIGNAL OVERLOAD AND CROSS MODULATION. The exclusive front end design in the receiver allows you to operate closer in frequency to strong neighboring signals than you have ever experienced before. If you have not yet operated an Atlas transceiver in a crowded band and compared it with any other receiver or transceiver, you have a real thrill coming.



A WORLD WIDE DEALER NETWORK TO SERVE YOU.

Whether you're driving a Honda in Kansas City or a Mercedes-Benz in West Germany, there's an Atlas dealer near you.

Atlas 210X or 215X	\$765.00
w/ noise blanker	\$810.00
Accessories:		
AC Console 110/220 V	\$155.00
Portable AC supply 110/220 V	\$105.00
Plug-in mobile kit	\$55.00
10X Osc. less crystals	\$65.00
Digital Dial DD-6B	\$235.00

For complete details see your Atlas dealer, or drop us a card and we'll mail you a brochure with dealer list.



HUSTLER

"the home of originals"

STANDARD GAIN MOBILES

Two Meters

- 5/8 wavelength — 34 db gain over 1/4 wave mobile
- Frequency coverage—143 to 149 MHz
- SWR at resonance—1.1:1 typical
- Power rating—200 watts FM

MODEL BBL-144

47" antenna complete with easy to install, no holes to drill, trunk lip mount, impact spring and 17 MIL SPEC RG-58-U and PL-259 Antenna removable from mount Price: \$33.75

MODEL BBL-144

47" antenna mounts on any flat surface, roof, deck or fender in 3/4" hole. Includes impact spring, 17 MIL SPEC RG-58-U and PL-259 Antenna removable from mount Price: \$31.65

HUSTLER "BUCK-BUSTER"

MODEL SF-2

51" two meter, 5/8 wavelength, 34 db gain over 1/4 wave mobile. Designed with 3/4" 24 base to fit your mount or a wide selection of Hustler mobile mounts (Mount or cable not included) Price: \$9.00

DELUXE MOBILE MOUNTS

For medium length, light weight antennas with 3/4" 24 base

MODEL TLM
Trunk lip mount for no holes installation on side or edge of trunk lid. Includes 17 RG-58-U connectors attached. Price: \$14.85

MODEL MLM
Deluxe trunk lip mount with 180 degree swivel ball for positioning antenna to vertical. Easy — no holes — installation. Includes 17 RG-58-U cable and connectors attached. Price: \$17.20

MODEL GCM-1
Rain gutter mount fits all shapes, angles even latest trim line gutters. Includes 180° swivel ball. Price: \$9.00

MODEL TGM-1
Trunk groove mount installs in hidden area of groove under trunk lid. Mounting hardware included. Price: \$8.00

MODEL MM-1
Cowl mount installs in 1" hole. Includes 180° swivel ball and SO-239 connectors. Price: \$7.50

MODEL C-32
Ball mount complete with mounting hardware. Price: \$8.20

SUPER GAIN MOBILES

Two Meters

- 5/2 db gain over 1/4 wave mobile antenna
- Frequency coverage—143-149 MHz
- SWR at resonance—1.1:1 typical
- Power rating—200 watts FM

TWO AND SIX METERS—TRUNK LIP MOUNT

MODEL HFT

Four section telescopic antenna permits separate adjustment for simultaneous resonance on two and six meters. Operational height: 40". Complete with trunk lip mount, 17 MIL SPEC RG-58-U and factory attached PL-259 Price: \$22.55

VHF/UHF ANTENNA—ROOF MOUNT

MODEL UHT-1

Field trimmable radiator for 1/4 wave operation on any frequency from 110 to 500 MHz. Cutting chart included. Mounts on any flat surface, roof, deck, fender in 3/4" hole. Includes 15 RG-58-U Price: \$9.95

MODEL THF

Field trimmable radiator permits quarter wave operation on any frequency from 140 to 500 MHz. Cutting chart included. Complete with trunk lip mount, 17 RG-58-U and PL-259. Price: \$16.55

MODEL SSM-2

Heavy 3" reinforced stainless steel 180° adjustable ball mount easily supports any amateur mobile antenna. Includes captive base, steel backup plate and mounting hardware. Price: \$19.20

MODEL QD-1

Remove antenna from mount with easy press and twist release. Compression spring and all parts 100% stainless steel. 3/4" 24 thread—female one end, male the other. Price: \$16.95

FEED LINE MODEL L-14-240

Get top performance maximum SWR in the MIL SPEC 70 length of RG-58-U cable. Supplied with connectors at both ends for use with ball or bumper mount and transceiver. Price: \$6.55

MODEL G6-144A

Deluxe Two Meter Colinear for Repeater or 6 db gain over a wave dipole. Maximum radiation at the horizon. Shunt fed with D.C. grounding. Radiator 3/4" wave lower section, 1 1/2" wave phase 3/4" wave upper section. Height 117". SWR at resonance 1.2:1. D.D. SO-239 connector. Power rating 1,000 Watts FM. Wind survival 100 MPH. Installs on vertical pipe up to 1 1/2" O.D. SO-239 coax connector. Price: \$67.55

AMATEUR ANTENNAS

MODEL CGT-144

Get big signal performance, superior receiving capability with this 85° colinear antenna. Easy installation on side or edge of trunk lip without drilling — complete with 17 MIL SPEC RG-58-U and PL-259 Price: \$41.30

MODEL CG-144

Same characteristics as CGT-144 supplied with 3/4" 24 base to fit all mobile ball mounts. Length is 85". Mount and cable not included. Price: \$25.50

VHF/UHF ANTENNA—TRUNK LIP MOUNT

MODEL THF

Field trimmable radiator permits quarter wave operation on any frequency from 140 to 500 MHz. Cutting chart included. Complete with trunk lip mount, 17 RG-58-U and PL-259. Price: \$16.55

MODEL SSM-2

Heavy 3" reinforced stainless steel 180° adjustable ball mount easily supports any amateur mobile antenna. Includes captive base, steel backup plate and mounting hardware. Price: \$19.20

MODEL QD-1

Remove antenna from mount with easy press and twist release. Compression spring and all parts 100% stainless steel. 3/4" 24 thread—female one end, male the other. Price: \$16.95

FEED LINE MODEL L-14-240

Get top performance maximum SWR in the MIL SPEC 70 length of RG-58-U cable. Supplied with connectors at both ends for use with ball or bumper mount and transceiver. Price: \$6.55

MODEL G6-144A

Deluxe Two Meter Colinear for Repeater or 6 db gain over a wave dipole. Maximum radiation at the horizon. Shunt fed with D.C. grounding. Radiator 3/4" wave lower section, 1 1/2" wave phase 3/4" wave upper section. Height 117". SWR at resonance 1.2:1. D.D. SO-239 connector. Power rating 1,000 Watts FM. Wind survival 100 MPH. Installs on vertical pipe up to 1 1/2" O.D. SO-239 coax connector. Price: \$67.55

All resonators are precision wound with optimized design for each band. Assembly includes 17-7 PH stainless steel adjustable tip rod for lowest SWR and band edge marker. Choose for medium or high power operation.

STANDARD HUSTLER RESONATORS
Power Rating: 400 Watts SSB

Model	Band	Price
RM-10	10 meters	\$ 6.50
RM-15	15 meters	6.95
RM-20	20 meters	7.30
RM-40	40 meters	13.20
RM-75	75 meters	15.50
RM-80	80 meters	15.95

SUPER HUSTLER RESONATORS
Power Rating: Legal Limit SSB
Supers have widest bandwidth

Model	Band	Price
RM-10S	10 meters	\$11.30
RM-15S	15 meters	12.65
RM-20S	20 meters	13.00
RM-40S	40 meters	15.50
RM-75S	75 meters	30.00
RM-80S	80 meters	30.40

For 6-10-15-20-40-75-80 Meters

Fold over mast for quick and easy interchange of resonators or entering a garage. When operating, mast is held vertical with shakeproof sleeve clutch. 5/8" mast also serves as 1/4 wavelength 6 meter antenna. Stainless steel base has 3/4" 24 threads to fit mobile ball mount or bumper mount.

MODEL MO-2
For bumper mounting—Fold in at roof line 27" above base. Price: \$22.00

MODEL MO-1
For deck or fender mounting—Fold in at roof line 15" above base. Price: \$22.00

Covers 10 - 15 - 20 - 40 Meters
Only Hustler Gives One Setting for Whole Band Coverage

MODEL 4-BTV
• Lowest SWR—PLUS
• Bandwidth at its broadest! SWR 1.6 to 1 or better at band edges!
• Guaranteed to be easiest assembly of any multi-band vertical antenna has 3/4" 24 stud at top to accept RM-75 or RM-75-S Hustler resonator for 75 meter operation when desired.
• Top loading on 75 meters for broader bandwidth and higher radiation efficiency!
• Feed with any length 50 ohm coax.
• Power capability—full legal limit on SSB or CW.
• Mounting: Ground mount with or without radials, or roof mount with radials.
Weight: 15 lbs.
Price: \$99.95

MODEL 4-BTV
Length: 21" 5"
MODEL 4-BTV

This NEW MFJ Versa Tuner II . . .



has SWR and dual range wattmeter, antenna switch, efficient airwound inductor, built-in balun. Up to 300 watts RF output. Matches everything from 160 thru 10 meters: dipoles, inverted vees, random wires, verticals, mobile whips, beams, balance lines, coax lines. \$79.95.

Antenna matching capacitor. 208 pf. 1000 volt spacing.

Sets power range, 300 and 30 watts. Pull for SWR.

Meter reads SWR and RF watts in 2 ranges.

Efficient airwound inductor gives more watts out and less losses.

Transmitter matching capacitor. 208 pf. 1000 volt spacing.

Only MFJ gives you this MFJ941 Versa Tuner II with all these features at this price.

A SWR and dual range wattmeter (300 and 30 watts full scale) lets you measure RF power output for simplified tuning.

An antenna switch lets you select 2 coax fed antennas, random wire or balance line, and tuner bypass.

A new efficient airwound inductor (12 positions) gives you less losses than a tapped toroid for more watts out.

A 1:4 balun for balance lines. 1000 volt capacitor spacing. Mounting brackets for mobile installations (not shown).

With the NEW MFJ Versa Tuner II you can run your full transceiver power output — up to 300 watts RF power output — and match your

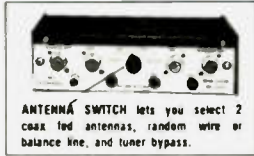

ANTENNA SWITCH lets you select 2 coax fed antennas, random wire or balance line, and tuner bypass.

transmitter to any feedline from 160 thru 10 Meters whether you have coax cable, balance line, or random wire.

You can tune out the SWR on your dipole, inverted vee, random wire, vertical, mobile whip, beam, quad, or whatever you have.

You can even operate all bands with just

one existing antenna. No need to put up separate antennas for each band.

Increase the usable bandwidth of your mobile whip by tuning out the SWR from inside your car. Works great with all solid state rigs (like the Atlas) and with all tube type rigs.

It travels well, too. Its ultra compact size 5x2x6 inches fits easily in a small corner of your suitcase.

This beautiful little tuner is housed in a deluxe eggshell white Ten Tec enclosure with walnut grain sides.

SO-239 coax connectors are provided for transmitter input and coax fed antennas. Quality five way binding posts are used for the balance line inputs (?), random wire input (?), and ground (!).

THE HAM-KEY NOW 5 MODELS

NEW MODEL HK-5 ELECTRONIC KEYS \$69.95



- Iambic circuit for squeeze keying.
- Self completing dots & dashes.
- Dot memory.
- Battery operated with provisions for external power.
- Built-in side-tone monitor.
- Speed, Volume, tone & weight controls.
- Grid-block or direct keying.
- Use with external paddle such as HK-1.



Model HK-1 \$29.95

- Dual lever squeeze paddle.
- Use with HK-5 or any electronic keyer.
- Heavy base with non-slip rubber feet.
- Paddles reversible for wide or close finger spacing.



Model HK-2 \$19.95

- Same as HK-1, less base for those who wish to incorporate in their own Keyer.

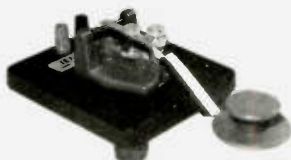

Model HK-3 \$16.95

- Deluxe straight key.
- Heavy base, no need to attach to desk.
- Velvet smooth action.



Model HK-4 \$44.95

- Combination of HK-1 & HK-3 on same base.



\$59.95 BRAND NEW

MFJ-901 VERSA TUNER

More efficient air wound coil for more watts out!

Only MFJ uses an efficient air wound inductor (12 positions) in this class of tuners to give you more watts out and less losses than a tapped toroid. Matches everything from 160 thru 10 Meters: dipoles, inverted vees, random wires, vee cans, mobile whips, beams, balance lines, coax lines. Up to 200 watts RF output. 1:4 balun for balance lines. Tune out the SWR of your mobile whip from inside your car. Works with all rigs. Ultra compact 5x2x6 inches. SO-239 connectors. 5 way binding posts. Ten Tec enclosure.



\$49.95 BRAND NEW

MFJ-900 ECONO TUNER

Same as MFJ901 Versa Tuner, but does not have built-in balun for balance lines, Tuner coil (one) and random lines.



\$39.95

MFJ-16010 RANDOM WIRE TUNER

Operate 160 thru 10 meters. Up to 200 watts RF output. Matches high and low impedances. 12 position inductor. SO-239 connectors. 7x2x4 inches. Matches 75 to 200 ohm at 1.8 MHz.



\$49.95 BRAND NEW

MFJ-202 RF NOISE BRIDGE

This MFJ RF Noise Bridge lets you adjust your antenna quickly for maximum performance. Measures resistance to SWR, radiation resistance and reactance. Extensive range extender and expanded capacitance range (2.150 pF) give you much extended measuring range.

16th resonant frequency and whether to shorten or lengthen your antenna for maximum SWR. Adjust your single or multi-band dipole, inverted vee, beam, vertical, mobile whip or random system for maximum performance. 1 to 100 MHz. SO-239 connectors. 2x3x4 inches. 9 volt battery.

400% MORE RF POWER

PLUGS BETWEEN YOUR MICROPHONE AND TRANSMITTER



\$49.95

LSP-520BX. 30 db dynamic range IC log amp and 3 active filters give clean audio. RF protected. 9 V battery. 3 conductor, 1/4 phone jacks for input and output. 2-3/16 x 3-1/4 x 4 inches.



\$59.95

LSP-520BX II. Same as LSP-520BX but in a beautiful 2 1/8 x 3 5/8 x 5 9/16 inch Ten-Tec enclosure with uncommitted 4 pin Mic jack, output cable, rotary function switch.



\$29.95

CWF-2BX Super CW Filter

By far the leader. Over 5000 in use. Razor sharp selectivity. 80 Hz bandwidth, extremely steep skirts. No ringing. Plugs between receiver and phones or connect between audio stage for speaker operation.

- Selectable BW 80, 110, 180 Hz
- 60 dB down one octave from center freq. of 750 Hz for 80 Hz BW
- Reduces noise 15 dB
- 9 V battery
- 2-3/16 x 3-1/4 x 4 in



\$54.95

CMOS-8043 Electronic Keyer

State of the art design uses CURTIS-8043 Keyer-on-a-chip.

- Built-in Key
- Dot memory
- Iambic operation with external squeeze key
- 8 to 50 WPM
- Sidetone and speaker
- Speed, volume, tone, weight controls
- Ultra reliable solid state keying — 300 volts, max
- 4 position switch for TUNE OFF ON SIDETONE OFF
- Uses 4 penlight cells
- 2-3/16 x 3-1/4 x 4 inches



\$17.95 NEW

CPD-555 Code Oscillator

For the Newcomer to learn the Morse code. For the Old Timer to polish his fist. For the Code Instructor to teach his classes.

- Send crisp clear code with plenty of volume for classroom use
- Self contained speaker, volume, tone controls, aluminum cabinet
- 9 V battery
- Top quality U.S. construction
- Uses 555 IC timer
- 2-3/16 x 3-1/4 x 4 inches



\$29.95

MFJ-40T QRP Transmitter

Work the world with 5 watts on 40 Meter CW.

- No tuning
- Matches 50 ohm load
- Clean output with low harmonic content
- Power amplifier transistor protected against burnout
- Switch selects 3 crystals or VFO input
- 12 VDC
- 2-3/16 x 3-1/4 x 4 inches

MFJ-40V, Companion VFO \$27.95

MFJ-12DC, IC Regulated Power Supply 1 amp, 12 VDC \$27.95



\$29.95

SBF-2BX SSB Filter

Dramatically improves readability.

- Optimizes your audio to reduce sideband splatter, remove low and high pitched QRM, hiss, static crashes, background noise. 60 and 120 Hz hum
- Reduces fatigue during contest, DX, and ragchewing
- Plugs between phones and receiver or connect between audio stage for speaker operation
- Selectable bandwidth IC active audio filter
- Uses 9 volt battery
- 2-3/16 x 3-1/4 x 4 inches



\$27.95

MFJ-200BX Frequency Standard

Provides strong, precise markers every 100, 50, or 25 KHz well into VHF region.

- Exclusive circuitry suppresses all unwanted markers
- Markers are gated for positive identification. CMOS ICs with transistor output
- No direct connection necessary
- Uses 9 volt battery
- Adjustable trimmer for zero beating to WWV
- Switch selects 100, 50, 25 KHz or OFF
- 2-3/16 x 3-1/4 x 4 inches



\$49.95

MFJ-1030BX Receiver Preselector

Clearly copy weak unreadable signals (increases signal 3 to 5 "S" units).

- More than 20 dB low noise gain
- Separate input and output tuning controls give maximum gain and RF selectivity to significantly reject out-of-band signals and reduce image responses
- Dual gate MOS FET for low noise, strong signal handling abilities
- Completely stable
- Optimized for 10 thru 30 MHz
- 9 V battery
- 2-1/8 x 3-5/8 x 5-9/16 inches

TUFTS RADIO CATALOG TUFTS RADIO

Vhf engineering

THE WORLD'S MOST COMPLETE LINE OF VHF-FM KITS AND EQUIPMENT

RX28C	28-35 MHz FM receiver with 2 pole 10.7 MHz crystal filter	\$ 64.95
RX28C W/T	same as above—wired & tested.	117.95
RX50C Kit	30-60 MHz rcvr w/2 pole 10.7 MHz crystal filter	64.95
RX50C W/T	same as above—wired & tested	117.95
RX144C Kit	140-170 MHz rcvr w/2 pole 10.7 MHz crystal filter	74.95
RX114C W/T	same as above—wired & tested	119.95
RX220C Kit	210-240 MHz rcvr w/2 pole 10.7 MHz crystal filter	74.95
RX220C W/T	same as above—wired & tested	117.95
RX432C Kit	432 MHz rcvr w/2 pole 10.7 MHz crystal filter	84.95
RX432C W/T	same as above—wired & tested	129.95

RECEIVERS



RXCF	accessory filter for above receiver kits gives 70 dB adjacent channel rejection	8.95
RF28 Kit	10 mtr RF front end 10.7 MHz out	13.50
RF50 Kit	6 mtr RF front end 10.7 MHz out	13.50
RF144D Kit	2 mtr RF front end 10.7 MHz out	18.50
RF220D Kit	220 MHz RF front end 10.7 MHz out	18.50
RF432 Kit	432 MHz RF front end 10.7 MHz out	29.50
IF 10.7F Kit	10.7 MHz IF module includes 2 pole crystal filter	29.50
FM455 Kit	455 KHz IF stage plus FM detector	18.50
AS2 Kit	audio and squelch board	16.00

TX50	transmitter exciter, 1 watt, 6 mtr.	44.95
TX50 W/T	same as above—wired & tested	64.95
TX144B Kit	transmitter exciter—1 watt—2 mtrs	34.95
TX144B W/T	same as above—wired & tested.	59.95
TX220B Kit	transmitter exciter—1watt—220 MHz	34.95

TRANSMITTERS



TX220B W/T	same as above—wired & tested	59.95
TX432B Kit	transmitter exciter 432 MHz	49.95
TX432B W/T	same as above—wired & tested	79.95
TX150 Kit	300 milliwatt, 2 mtr transmitter	24.95
TX150 W/T	same as above—wired & tested	39.95

PA2501H Kit	2 mtr power amp—kit 1w in—25w out with solid state switching, case, connectors	64.95
PA4010H Kit	2 mtr power amp—10w in—40w out—relay switching	64.95
PA50/25 Kit	6 mtr power amp, 1w in, 25w out, less case, connectors & switching	54.95
PA144/15 Kit	2 mtr power amp—1w in—15w out—less case, connectors and switching	44.95
PA144/25 Kit	same as PA144/15 kit but 25w	54.95
PA220/15 Kit	similar to PA144/15 for 220 MHz	44.95
PA432/10 Kit	power amp—similar to PA144/15 except 10w and 432 MHz	54.95
PA140/10 W/T	10w in—140w out—2 mtr amp	219.95
PA140/30 W/T	30w in—140w out—2 mtr amp	189.95

POWER AMPLIFIERS

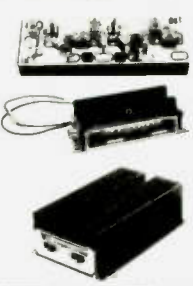

Blue Line	RF power amp, wired & tested, emission—CW-FM-SSB/AM			
	Model	BAND	Power Input	Power Output
	BLC 10/70	144 MHz	10W	70W
	BLC 2/70	144 MHz	2W	70W
	BLC 10/150	144 MHz	10W	150W
	BLC 30/150	144 MHz	30W	150W
	BLD 2/60	220 MHz	2W	60W
	BLD 10/60	220 MHz	10W	60W
	BLD 10/120	220 MHz	10W	120W
	BLE 10/40	420 MHz	10W	40W
	BLE 2/40	420 MHz	2W	40W
	BLE 30/80	420 MHz	30W	80W
	BLE 10/80	420 MHz	10W	80W

PS15C Kit	15 amp—12 volt regulated power supply w/case, w/fold-back current limiting and overvoltage protection.	94.95
PS15C W/T	same as above—wired & tested.	124.95
PS25M Kit	25 amp—12 volt regulated power supply w/case, w/fold-back current limiting and ovp, with meter	154.95
PS 25M W/T	same as above—wired & tested.	179.95

POWER SUPPLIES



O.V.P.	adds over voltage protection to your power supplies, 15 VDC max.	12.95
PS3A Kit	12 volt—power supply regulator card with fold-back current limiting	10.95
PS3012 W/T	new commercial duty 30 amp 12 VDC regulated power supply w/case, w/fold-back current limiting and overvoltage protection	249.95

RPT50 Kit	repeater—6 meter	499.95
RPT50	repeater—6 meter, wired & tested	799.95
RPT144 Kit	repeater—2 mtr—15w—complete (less crystals)	499.95
RPT220 Kit	repeater—220 MHz—15w—complete (less crystals)	499.95
RPT432 Kit	repeater—10 watt—432 MHz (less crystals)	579.95
RPT144 W/T	repeater—15 watt—2 mtr	799.95
RPT220 W/T	repeater—15 watt—220 MHz	799.95
RPT432 W/T	repeater—10 watt—432 MHz	849.95

REPEATERS



DPLA50	6 mtr close spaced duplexer	575.95
DPLA144	2 mtr, 600 KHz spaced duplexer, wired and tuned to frequency	379.95
DPLA220	220 MHz duplexer, wired and tuned to frequency	379.95
DPLA432	rack mount duplexer	319.95
DSC-U	double shielded duplexer cables with PL259 connectors (pr.)	25.00
DSC-N	same as above with type N connectors (pr.)	25.00

TRX50 Kit	Complete 6 mtr FM transceiver kit, 20w out, 10 channel scan with case (less mike and crystals).	244.95
TRX144 Kit	same as above, but 2 mtr & 15w out	234.95
TRX220 Kit	same as above except for 220 MHz	234.95
TRX432 Kit	same as above except 10 watt and 432MHz	254.95
TRC-1	transceiver case only	29.95
TRC-2	transceiver case and accessories	49.95

TRANSCEVERS



CD1 Kit	10 channel receive xtal deck w/diode switching	\$ 7.95
CD2 Kit	10 channel xmit deck w/switch and trimmers	15.50
CD3 Kit	UHF version of CD1 deck, needed for 432 multi-channel operation	13.50
COR2 Kit	carrier operated relay	22.75
SC3 Kit	10 channel auto-scan adapter for RX with priority	19.95
Crystals	we stock most repeater and simplex pairs from 146.0-147.0 (each)	5.00
CWID Kit	159 bit, field programmable, code identifier with built-in squelch tail and ID timers	39.95
CWID	wired and tested, not programmed	54.95
CWID	wired and tested, programmed	59.95
MIC-1	2,000 ohm dynamic mike with P.T.T. and coil cord	12.95
TS1 W/T	tone squelch decoder	59.95
TS1 W/T	installed in repeater, including interface accessories	89.95
TD3 Kit	2 tone decoder	35.95
TD3 W/T	same as above—wired & tested	59.95
HL144 W/T	4 pole helical resonator, wired & tested, swept tuned to 144 MHz ban	29.95
HL220 W/T	same as above tuned to 220 MHz ban	29.95
HL432 W/T	same as above tuned to 432 MHz ban	29.95

SYNTHESIZERS



SYN II Kit	2 mtr synthesizer, transmit offsets programmable from 100 KHz—10MHz, (Mars offsets with optional adapters).	169.95
SYN II W/T	same as above—wired & tested.	239.95
SYN 220 Kit	same as SYN II Kit except 220-225 MHz	169.95
SYN 220 W/T	same as above—wired & tested	239.95

SST T-1 RANDOM WIRE ANTENNA TUNER

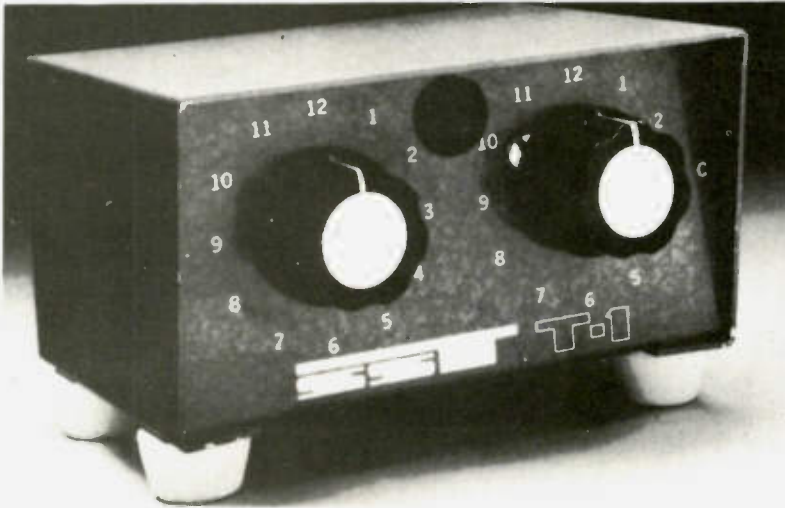

All band operation (160-10 meters) with any random length of wire. 200 watt output power capability—will work with virtually any transceiver. Ideal for portable or home operation. Great for apartments and hotel rooms—simply run a wire inside, out a window, or anyplace available. Efficient toroid inductor for small size: 4-1/4" x 2-3/8" x 3", and negligible loss. Built-in neon tune-up indicator. SO-239 connector. Attractive bronze finished enclosure.

only **\$29.95**

THE ORIGINAL Random Wire Antenna Tuner... in use by amateurs for 6 years.

SST T-2 ULTRA TUNER

Tunes out SWR on any coax fed antenna as well as random wires. Works great on all bands (80-10 meters) with any transceiver running up to 200 watts power output.

Increases usable bandwidth of any antenna. Tunes out SWR on mobile whips from inside your car.

Uses efficient toroid inductor and specially made capacitors for small size: 5-1/4" x 2-1/4" x 2-1/2". Rugged, yet compact. Negligible line loss. Attractive bronze finished enclosure. SO-239 coax connectors are used for transmitter input and coax fed antennas. Convenient binding posts are provided for random wire and ground connections.



only **\$39.95**



only **\$19.95**

SST T-3 Mobile Impedance Transformer

Matches 52 ohm coax to the lower impedance of a mobile whip or vertical. 12-position switch with taps spread between 3 and 52 ohms. Broadband from 1-30 Mhz. Will work with virtually any transceiver—300 watt output power capability. SO-239 connectors. Toroid inductor for small size: 2-3/4" x 2" x 2-1/4". Attractive bronze finish.

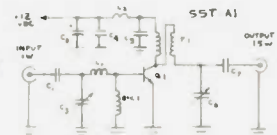
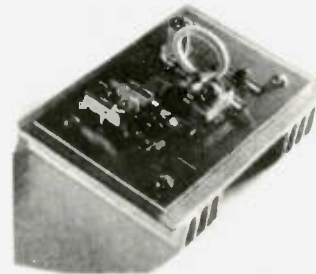

only **\$29.95**
\$49.95 wire and tested

SST A-1 VHF Amplifier Kit

1 watt input gives you 15 watts output across the entire 2 meter band without re-tuning. This easy-to-build kit (approx. 1/2 hr. assembly) includes everything you need for a complete amplifier. All top quality components. Compatible with all 1-3 watt 2-meter transceivers. Short and open protected—not damaged by high SWR.

Kit includes:

- Etched and drilled G-10 epoxy solder plated board.
- Heat sink and mounting hardware. All components—including pre-wound coils.
- Top quality TRW RF power transistor.
- Complete assembly instruction with details on a carrier operated T/R switch.



GUARANTEE

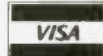

All SST products are guaranteed for 1 year. In addition, they may be returned within 10 days for a full refund (less shipping) if you are not satisfied for any reason. Please add \$2 for shipping and handling. Calif. residents, please add sales tax. COD orders OK by phone.



S10

ELECTRONICS

P.O. BOX 1 LAWNOLE, CALIF.
90260 (213) 376-5887

VHF Transverters and the FT-101

— quickie FM conversion

Glenn Malme W6OJF
9337 Gotham Street
Downey CA 90241

Converting the popular Yaesu FT-101 series of transceivers in order to provide FM for use with a two meter transverter is a relatively simple job. Similarly, the Yaesu FT-620B six meter SSB, CW, and AM transceiver may be put on FM with the addition of nothing more than a few wires and a single-pole double-throw switch.

The modification of the FT-101 series will allow the

user to have NBFM on ten meters and, when coupled with a transverter, to supply drive from the FT-101 for use with 6, 2, 220 or 432 MHz transverters with FM output.

All that this amounts to is that you switch the output of the audio board between its normal position (driving the modulator board) and the clarifier circuit, thus causing the vfo to change frequency in accordance with the superimposed voice frequency.

The surgery consists of wiring in an SPDT switch, as shown in Fig. 1, with a wire going to pin eight on PB-1315 and switching the white wire from pin eight to pin nine on PB-1183. One leg of the

switch will have a wire running to the "Clari" pin on PN-1344 on the top of the set. The wire jumpers are accessed from the bottom of the radio.

The switch may be mounted at any convenient location, so don't drill a hole in the front panel. In one position, you have NBFM, and in the other, things are back to normal. When operating FM, you drive your transverter from the ten meter position, and you slope detect in receiving FM on the ten meter position. An AM filter in the FT-101 makes this quite acceptable.

The same basic scheme will allow the six meter

FT-620B to generate good quality FM. Again, it consists of coupling the speech amplifier output to the clarifier circuit, so that the vfo is modulated. The mike gain control has to be properly set in both cases to provide anywhere from 3 to 7 kHz deviation.

First you mount a small SPDT switch on the rear apron of the transceiver. In looking at the bottom of the relay socket, the center pin (green wire) is the line that goes to the clarifier. Then lift the center conductor of the red shielded wire from pin 7 of PJ-301. Run two shielded wires to the SPDT switch, as shown in the diagram. Ground the shields, replace the covers, and test. In "normal," the AM, CW, and SSB are unaffected; however, switching to FM on the rear and AM on the front panel will give you 3 to 7 kHz deviation. This mode affects transmit only. Reception must be by slope detection, of course.

By following the diagrams, these simple changes should not present any problem. Be sure to use a small soldering iron in order to do the job properly. FM reception can be achieved by connecting a Signetics 5111A chip to the output of the last i-f stage and feeding it to the audio stage. The use of this chip eliminates slope detection. Instructions come with the chip when it is purchased and can be adapted to any type of AM receiver. ■

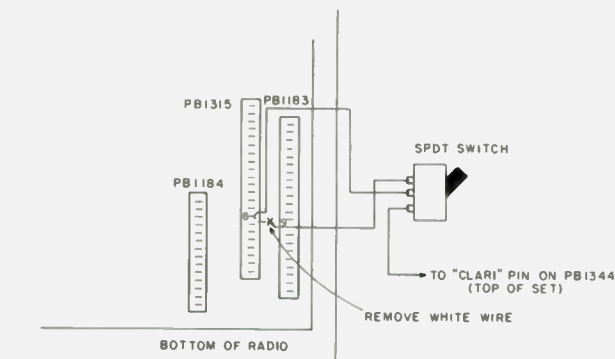

Fig. 1.

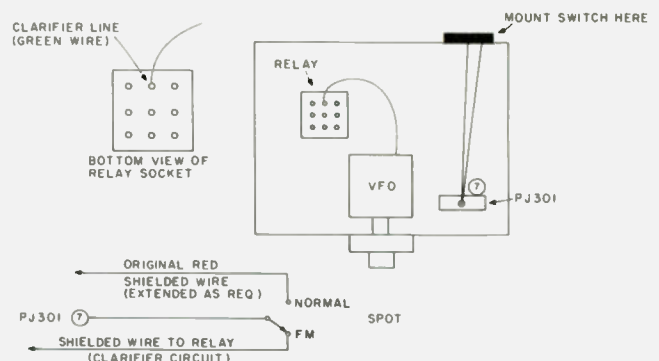

Fig. 2.

Clegg FM-28

Now only \$329.95!*

Thousands of 2 Meter FM'ers have made this Clegg FM-28 the most popular transceiver in many areas of the country. Compare these specifications and you can see why!

- 144-148 MHz coverage on both receive and transmit
- 25 Watts output
- Digitally synthesized
- Non-standard repeater splits
- 5 KHz steps
- Modular construction
- Compact, rugged design
- .25 uv receiver sensitivity
- Large "S" meter
- Bright 6 digit frequency display
- Super selectivity with 15 poles IF filtering plus 5 pole front end filter
- Multi-purpose accessory receptacle

ORDER NOW AND SAVE!

Because Clegg wants to give this FM-28 extra exposure, here's a special, limited-time offer. Place your order today and you can purchase this exceptional transceiver at \$30.00 off the regular low price. That's right—you can own this FM-28 for only \$329.95!*

DON'T HESITATE!

Call Clegg today for full details on this and all the other advanced Clegg products. Toll-free 1-800-233-0250. In Pennsylvania call collect 717-299-7221.

Clegg Communications Corp., 1911 Old Homestead Lane, Greenfield Industrial Park East, Lanc. PA 17601.

TEST IT YOURSELF AT OUR RISK!

Try this FM-28 in your own shack for ten days. If you're not completely satisfied with this superior transceiver, simply return it for full refund of purchase price.

Clegg

C3

FOR RELIABILITY



***SPECIAL PRICE OFFER EXPIRES JULY 31. ACT NOW!
CALL 1 (800) 233-0250 TODAY**

Instant Paddle

— cheap, too

If you can drill a few holes in some junk box materials, that is all the skill you need to fabricate an adjustable keyer paddle. In fact, even drilling can almost be eliminated by some alternative construction methods, if you do not have a well-equipped shop or if your junk box does not contain all the needed items.

The materials you will need for this economy paddle are two pieces of one-sixteenth-inch brazing rod about 4 inches long, 3 one-

quarter-inch-diameter by three-quarter-inch-long brass spacer rods that are tapped for machine screws, and whatever pieces of Masonite™, Lucite™, Bakelite™, etc., you choose for the base and the paddles.

Shape the material you have selected for the paddles into a design that is appealing to your eye. A #51 hole should be drilled in the rear edge of the paddles, so they can be glued to the brazing rods. If edge drilling the paddles is too much of a

challenge for your limited shop equipment, make the paddles from scraps of copperclad circuit board, and solder the rods to the foil.

The supports for the paddle rods are made by drilling #51 holes about one-quarter inch from one end of two of the brass spacers. A simplified alternative to the drilled spacers is to utilize binding posts that already have a hole drilled for holding wires by turning down a thumbscrew.

The base dimensions are shown in the sketch, but none is critical. Mark a centerline on the base and a spot for the ground post mounting screw about a half inch from the front edge. Locate the paddle rod mounting posts about 1½ inches back from the ground post and to each side of the centerline a distance of one-eighth inch plus the gap you expect to leave between the paddle arms and the ground post. This means that, when the holes are drilled and the components mounted, the paddle arms will be parallel to each other.

If you are using binding posts instead of the brass spacers and you want the paddle arms parallel, you may have to stagger the positions of the fatter posts so they do not touch each other. This, however, should not cause an appreciable difference in sensitivity between the two paddles.

Drill the three holes for the post mounting screws and attach the posts, using a solder lug on each screw for convenience in attaching wires. Insert the paddle rods into the two posts, and tighten the top holding screws. Your paddle is now complete, except for adjusting the contact gap by rotating the paddle posts and obtaining the desired sensitivity by sliding the paddle rods back and forth in the posts. If the desired sensitivity cannot be achieved with the dimensions shown, drill a new hole for the ground post mounting screw about one-quarter inch backward or forward from the original position, depending on whether you want a stiff or pliant action.

Obviously this quickie prototype paddle takes no great prize for aesthetics, and you may want to convert it to a more permanent fixture in your shack. Once you have used it for awhile and determined the length of paddle rods for the preferred sensitivity, solder the rods in the posts and clip off the excess. You can also make adjustment of the paddle rods somewhat easier by soldering a screw head or sawing a screwdriver slot on the top of each of the two paddle posts. If you are concerned about contact resistance, go one step further and silver plate the contact area of the paddle rods and the paddle post. Polish these components and remount them on a heavy steel base finished with wrinkle or hammertone paint and you will have a paddle that has good performance characteristics and is pleasing to the eye as well. ■

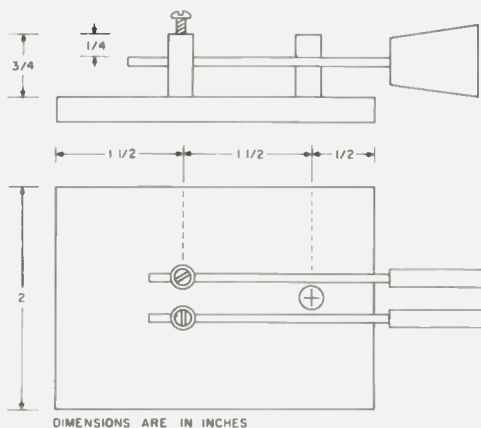

Fig. 1.

CALL TOLL FREE

1-800-228-4097
Communications Center
 443 N 48th Street C58
 Lincoln, Nebraska 68504
 In Nebraska Call (402)466-8402

1-800-634-6227
Communications Center
West C58
 1072 N. Rancho Drive
 Las Vegas, Nevada 89106
 In Nevada Call (702)647-3114

Antenna Sale!



CUSHCRAFT
ATB-34

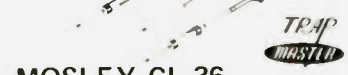

MOSLEY CL-36

HY-GAIN

		Regular	Special
TH6-DXX	Super Thunderbird	\$249.95	\$209.95
TH3-MK3	3 ele. 10, 15, 20 Mtr. beam	199.95	169.95
Hy-Quad	2 ele. Quad 10, 15, 20 Mtr.	219.95	189.95
TH3-Jr.	3 ele. 10, 15, 20 Mtr. beam	144.50	129.95
18 HT	Hy-Tower 10-80 Mtr. Vertical	279.95	239.95
14AVQ/WB	10-40 Mtr. Trap Vertical	67.00	57.00
18AVT/WB	10-80 Mtr. Trap Vertical	97.00	84.95
203	3 ele. 2 Mtr. beam	12.95	
205	5 ele. 2 Mtr. beam	16.95	
208	8 ele. 2 Mtr. beam	19.95	
214	14 ele. 2 Mtr. beam	26.95	

MOSLEY

Classic 33	3 ele. 10, 15, 20 Mtr. beam	232.50	189.95
Classic 36	6 ele. 10, 15, 20 Mtr. beam	310.65	249.95
TA-33	3 ele. 10, 15, 20 Mtr. beam	206.50	169.95
TA-36	6 ele. 10, 15, 20 Mtr. beam	335.25	279.95
TA-33 Jr.	3 ele. 10, 15, 20 Mtr. beam	151.85	129.95
TA-40KR	40 Mtr. add on	92.25	74.95

CUSHCRAFT

ATB-34	4 ele. 10, 15, 20 Mtr. beam	259.95	209.95
ARX-2	2 Mtr. Ringo Ranger	36.95	32.95
A147-20T	2 Mtr. Twist	59.95	52.95
A144-10T	10 ele. Twist 2 Mtr.	39.95	32.95
A144-20T	20 ele. Twist 2 Mtr.	59.95	52.95

HUSTLER

4BTV	10-40 Mtr. Trap Vertical	99.95	82.95
RM-75	75 Meter Resonator	15.50	13.50
RM-75s	75 Meter Super Resonator	30.00	26.50
G6-144-A	6 db. 2 Mtr. Base Colinear	67.55	57.95

WILSON

System One	5 ele. 10, 15, 20 Mtr. beam	274.95	239.95
System Two	4 ele. 10, 15, 20 Mtr. beam	219.95	189.95

CDE ROTORS

Ham III	\$125.00
T2X Tail Twister	\$249.00
CD-44	\$105.00



RINGO RANGER

4BTV



18HT

We carry all major brands of ham radios AT DISCOUNT PRICES

Yaesu — Kenwood — Drake — ICOM — Dentron —
 Ten-Tec — Swan — Tempo — Midland — E.T.O. — Wilson



Watch the Wind!

— with this junk box anemometer

While most hams are worrying about their antennas, my concern is my newly hewn wind generator propeller. Since my garage

doesn't come close to a machine shop, and my frugal nature abhors expenditure for an air brake or complex feathering device, the natural thing to do is crank down the tower or immobilize the prop

for the high winds. But, when you can't spend all of your time in the yard watching the weather or stay awake all night listening, the first step is a wind indicator. Then, if you have a counter and an alarm circuit, you've got the system down pat. Well, the counter alarm comes next, but here's my answer to the indicator. This is an adaptation of one by Hank Olson W6GXN. Almost any small signal NPN transistors will do, and Olson's Electronics (Akron, Ohio) has the Fairchild μ L914 for \$1.39 (part TR 297). The RTL circuit is a little antiquated but very effective. It is easily mounted on the small printed circuit board from Radio Shack that accommodates the 914 and most of the smaller parts nicely. In case you are thinking of adapting to TTL, the circuit for the μ L914 is in Fig. 2.

The wind spinner is made from three small kitchen funnels (49¢ each) attached using a pop-rivet tool. The spinner plate may be cut

from 1/16" aluminum plate. A layout drawing (NTS) is in Fig. 3.

The mast can be any type you choose, but aluminum is best since it will not affect the field of the small magnets that pulse the reed switch. This was a small worry for me, however.

The reed switch was mounted in a hole through an expired felt-tip pen. It is offset mounted from the spinner pipe shaft by a bracket to be under and ¼" below the magnets.

Silicone compound from the hardware store filled the holes in the funnels (tips cut off) and weatherproofed the reed switch in its pen mounting. Silicone was found to be better than epoxy for holding the magnets to the aluminum spinner. Epoxy kept weathering loose no matter how clean the aluminum spinner was. An overall mounting detail is provided in Fig. 4.

Try several NPN transistors from your junk box,

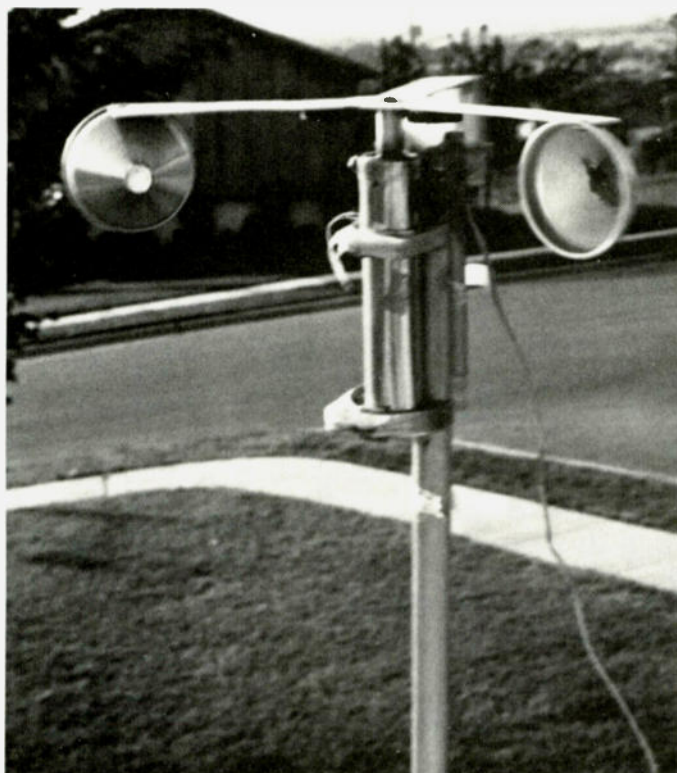

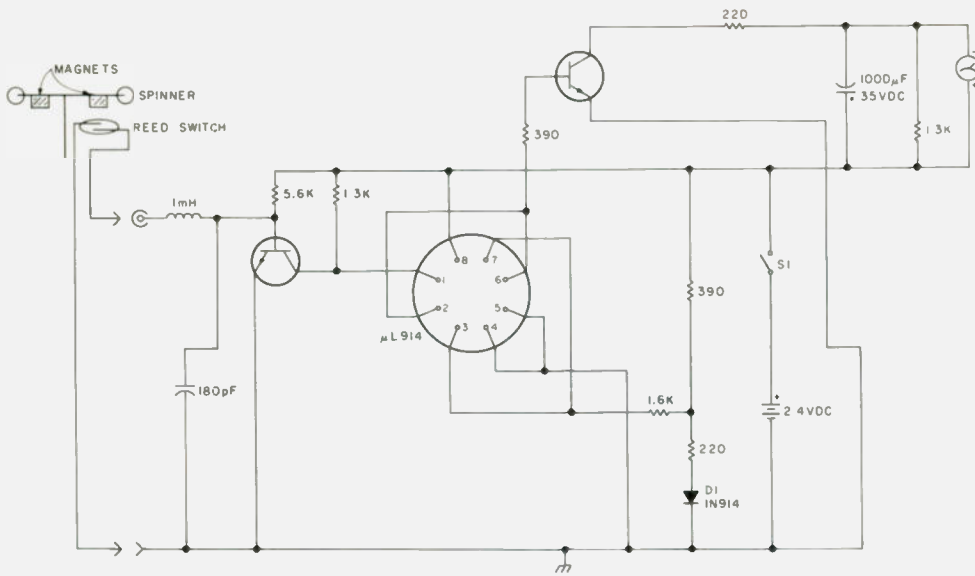

Fig. 1. Adapted from Ham Radio, June, 1968, p. 52.

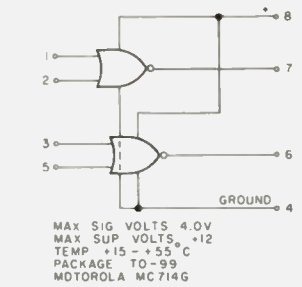

Fig. 2. µL914 detail (or Motorola HEP584).

since some are more responsive than others. The wire connecting the reed switch is your own choice, though coax is probably best. I used speaker wire, expecting to replace it every year or so. Rf induction did not appear to be a problem with the choke inside a 4" x 4" x 5" minibox along with the circuit.

Parts and Assembly

The single greatest problem in this design is the bearing. The original concept was to use a simple teflon bearing similar to the drill stop used for 1/4-inch drills. This idea was not satisfactory. A perfect solution was

the discovery that a standard (1 1/4") thin-wall chrome-plated drop pipe for a bathroom sink drain (about 6" long) would accept the standard roller bearing used in the bottom of sliding glass patio doors. Two of these bearings with 1/4" center holes fit exactly into the drop pipe. The bottom one stops inside about 3 1/2" down. The top one is held in place with a stainless pipe clamp tightened to hold. These bearings come in a brass version and an aluminum-teflon version. I used the teflon at the bottom and the brass one at the top. A 1/4" shaft for the spinner was attached with a sheet-metal screw and "Lock Tite"

compound. You may want to use a hole and cotter pin in the bottom of the spinner shaft to keep the spinner from crawling out of the bearing holes at higher speeds. The drop pipe was \$1.67, and the bearings were \$1.00 each, plus tax. My total investment was less than \$6.00, not counting parts from my junk box.

Calibration

I used Hank's technique of a calm Sunday morning, family in auto, father with anemometer protruding over the top of the car from the rear of the station wagon,

pencil and paper in hand, and mother driving and calling mph at speeds of 10, 20, 30, 40, 50, and 60. I stopped at 55 and found the relationship linear, and, with the plots for the five points, I extrapolated a curve on some of my daughter's school graph paper. I use the graph, but a scale could be drawn and glued to the meter face.

I'm really pleased with my creation and use it quite often, since the meter sits on top of my antenna coupler. To read it, I just flip the switch, read the meter, and turn off the switch to conserve batteries. It's been in service for more than a year now. ■

References

1. *Ham Radio Magazine*, "An Amateur Anemometer," June, 1968, p. 52.
2. *Ham Radio Magazine*, "An Experimenter's Guide to IC Substitution," September, 1971, p. 28.

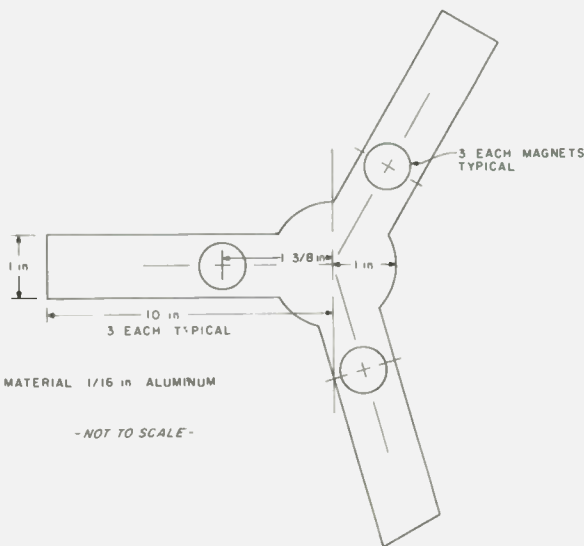

Fig. 3. Spinner details layout.

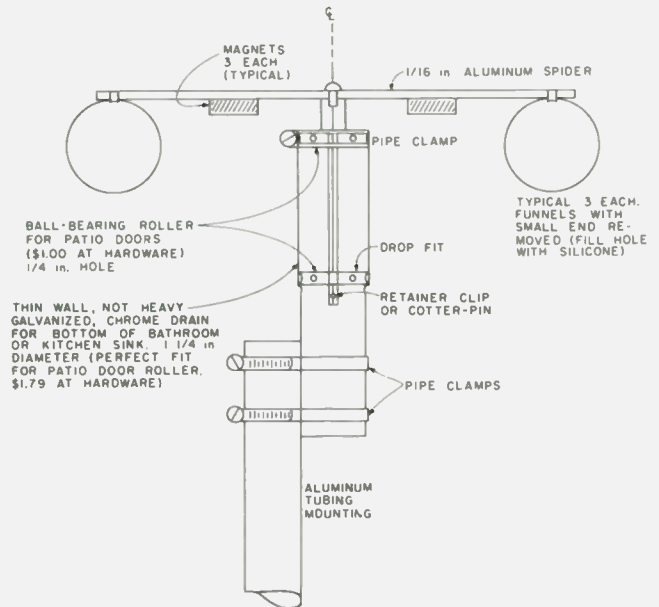

Fig. 4. Anemometer assembly detail.

JBW

SPECIALIZES IN 220 MHz EQUIPMENT!

NEW JBW 220 MHz REPEATER NOW AVAILABLE!

The JBW 220 MHz Repeater is an expandable unit. Tested in the Los Angeles area, the JBW Repeater has proven itself reliable in the midst of heavy interference by many TV stations and other repeaters. Options and accessories available to meet most specifications.

Contact JBW for pricing!



CRYSTALS IN STOCK:

MIDLAND 13-509

COBRA 200

CLEGG 76

WILSON HAND-HELD

\$10.00 per pair

GUARANTEE

If any of our crystals go bad at any time, JBW Electronics will exchange at no charge with crystals out of stock. Proof of purchase is required.

JBW ELECTRONICS ALSO FEATURES:

ESC 220 MHz Synthesizers (Synthecoders)

LUNAR Amplifiers, Preamps & Antennas

MIDLAND Product Line

Contact JBW for prices!

IN STOCK!

PIPO TOUCHTONE PADS — COAX — ROTORS
CONNECTORS — GUY WIRE — POLES — AND MUCH MORE!

CALL US! WRITE US! SEE US! DO SOMETHING!

JBW

ELECTRONICS, INC.

18618-2 PARTHENIA ST. • NORTHRIDGE, CA 91324

(213) 993-5159

J9

DREAMING OF A NEW RIG?
YOU'VE COME TO THE RIGHT PLACE!

OVERSTOCK
SALE

THOMAS COMMUNICATIONS

NEWINGTON, CONNECTICUT



"OVER 40 BRANDS IN STOCK"

KENWOOD ★ YAESU ★ KDK ★ DENTRON ★ WILSON ★ MFJ ★ SWAN ★ DRAKE
LARSEN ★ TEMPO ★ BEARCAT ★ B&W ★ ARRL PUBLICATIONS
MOSLEY ★ REGENCY ★ ASTATIC ★ AND MUCH MORE!

★ COMPLETE RADIO SERVICE SHOP ★

—FAST EFFICIENT SERVICE—WE REPAIR ALL BRANDS
—ALL WORK GUARANTEED—AMATEUR EXTRA/FIRST CLASS LICENSES

'YOU SHIP IT—WE FIX IT'

- ★ NEW AND USED Equipment
- ★ TRADES WELCOME
- ★ FREE Catalog
- ★ Same Day U.P.S. Shipping



THOMAS COMMUNICATIONS T34

95 KITTS LANE, Newington, Connecticut 06111 (203) 666-6225 or 667-3135

OPEN MON.-FRI. 10-6 • THUR. 10-8 • SAT. 10-4

Easy Directions: RT. 91 to RT. 15 South—2 Blocks Past McDonald's (Berlin Turnpike)

The War Against Rust

—some good news for radio towers

Hams always are on the lookout for new products or new uses for old ones. That's why I was so interested in a recent West Virginia exhibition for coal miners. There were many interesting product exhibits, but one in particular was truly showstopping.

Bruce Weeber, president of Totally Dependable Products, Incorporated, was demonstrating the company's line of lubricants, penetrants, and protectors. Two beautifully

finished pistols were installed on a revolving mount, so they could be dipped automatically in a salt water solution about twice a minute. Both weapons had been treated with TDP's "SS 2" Lubricant "Plus." Going around with the pistols were two untreated metal plates. I attended the exhibit on the second of three days, and the untreated plates were well rusted. Neither of the pistols showed any sign of rust or corrosion.

Weeber told me that even after days of such abuse, "SS 2"-treated metal isn't rusted or damaged. He showed me a variety of products with slightly different chemistry for different applications. I carried home sample cans of the "SS 2" Lubricant "Plus" and "SS P" Super Penetrant ("If you put that on a frozen nut, stand back so you won't be hit by flying metal," Weeber jokes) for some tough tests other sprays had failed.

First I tried a little experi-

ment. I used a sander on my electric drill to buff clean four high-carbon hex-head cap screws, and I arranged them on a piece of ½-inch Styrofoam®, as in Photo A. I treated the first with "SS 2," the next one with "WD-40," the third with General Electric Silicone Lubricant, and left the fourth one untreated. The whole arrangement went outside in a drizzling rain. After only three hours, the untreated screw head was almost completely rusted over. The GE Silicone-treated screw was showing signs of rust. The other two still were bright and shiny. At five hours, the silicone-treated screw head was definitely rusting, but the "WD-40" and "SS 2" had maintained their protective coatings.

After 48 hours, it was still raining. Both the untreated and silicone-treated screw heads were solidly rusted. Rust spots had appeared on the "WD-40" screw, but the "SS 2"-treated screw head still was clear. Rust spots finally were visible on the "SS 2" screw after 72 hours.

Next I wiped the "SS 2" and "WD-40" screw heads clear of moisture and reapplied coatings of protective film. Eight days later there had been no noticeable change in either screw (see Photo B), so, apparently, both "WD-40" and "SS 2" give pretty good static moisture protection with maybe a slight edge going to the "SS 2" in light of the few hours of extra protection it gave in the beginning.

Next I tried some more practical tests. I've been looking for years for an all-weather, long-lasting, non-gumming lubricant for my bicycle chain. I had tried "WD-40" and "LPS-3," but, in damp weather, daily applications were a must. The "SS 2," however, soon proved itself. I ride through rain, mud, and grime, making frequent cleaning necessary. But with the TDP lubricant, I don't

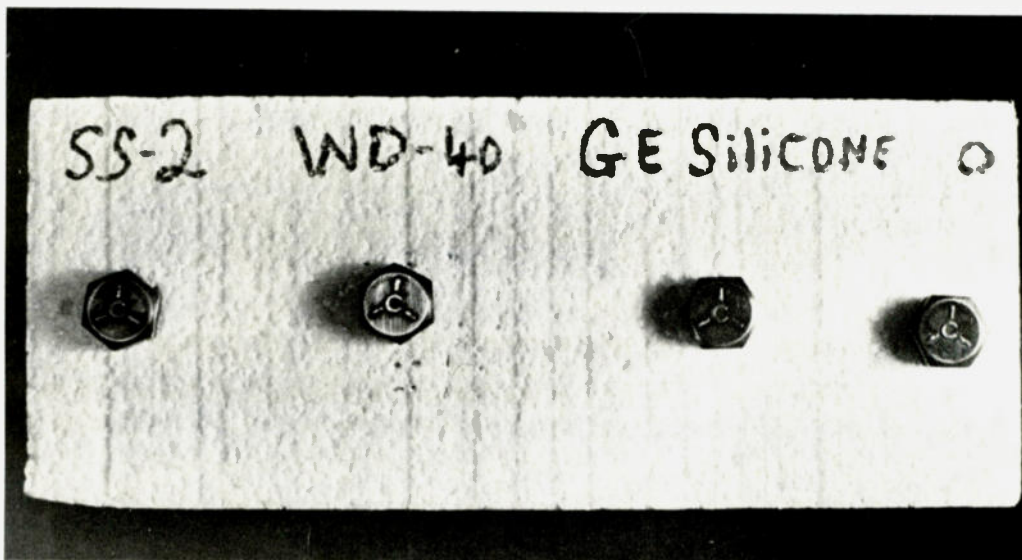

Photo A. The screw heads after cleaning but before treatment with any lubricant/protective film.

have to worry about rust, and the time between cleanings is longer.

I've carried a pocketknife for years, and I've always believed in nonstainless steel blades. But that presents another problem: rust due to pocket moisture. Regular cleanings at short intervals have been my practice. I've found that treating the knife first with "SS P" to clean off everything and then spraying on "SS 2" about once a month will keep my knife blades clean and bright.

I'm finding many ham shack applications for "SS 2," which seems to be the best general-purpose product. Feeler gauges, pliers, wrenches, and other tools prone to rust stay clean a lot longer, even under heavy use, with an "SS 2" coating. It keeps nails, screws, and other hardware bright and clean before and after use and prevents fingerprint tarnish on equipment chassis and circuit boards. The darn stuff seems to fill about any lubricating/protecting need you can think of.

The TDP line is varied, each formula slightly different for specific needs. For example, "SS 1" is primarily a penetrant, designed to loosen frozen parts and dislodge grease, dirt, light rust, and tar. It has the "plus" of leaving a light (0.04 mil) dry lubricating and protective film. "SS 2," on the other hand, is primarily a lubricant. It still has penetrating power, but it has four times the

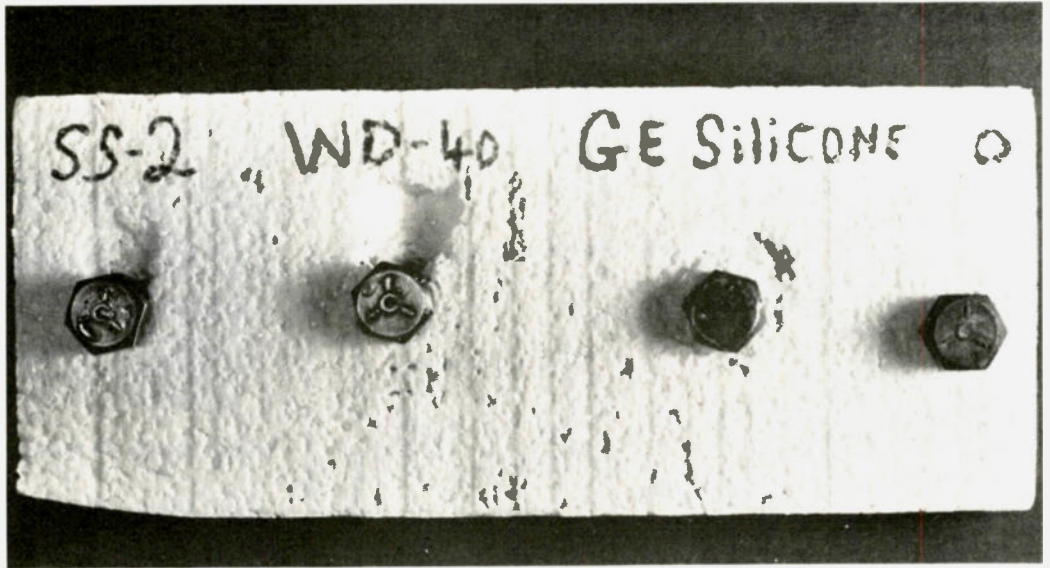

Photo B. The experiment after 11 days. Rust spotting is evident on both "SS 2"- and "WD-40"-treated screw heads, but the spots showed up under the "SS 2" coating at least 24 hours later than on the "WD-40" treated screw. Both products appear to offer adequate protection against spreading rust. I stepped on the experiment on the last day, causing the impressions under the "SS 2" and "WD-40" screws. The dimpling around the silicone-treated screw, however, was caused by the spray itself; it "melted" the Styrofoam®.

lubrication and protection of "SS 1." Both products are nonconductive and are harmless to metals, wood, rubber, painted surfaces, and "most plastics." So far I haven't noticed that the "SS 2" has harmed any plastics. And there's "SS P" which has even more penetrating power than "SS 1."

I've noted a few of the TDP products in Table 1. My personal experience is limited to "SS P" and "SS 2," but reports from other users tell me the various preparations are equally reliable. Everyone who uses the products becomes an immediate convert, as did Bruce Weeber. He is an accountant by training and

trade, but jumped on the bandwagon when chemist Earle Bidgood, developer of the original formula, first showed him the product. TDP apparently is a new company, and the products

may not be widely distributed through retail outlets. You can get more information from Totally Dependable Products, 513 High Street, Pottstown, Pennsylvania 19464. ■

"SS 1"	Penetrant "Plus"
"SS 2"	Lubricant "Plus"
"SS P"	Super penetrant
"OR 1"	Rust remover
"RS 2"	Rust stopper
"PE 1"	Precision electrical cleaner (volume controls, tape heads, relays, etc.)
"PE 2"	Special electrical cleaner for use with Polycarbonate plastics
"MP 1"	Dry-formula machinery parts cleaner
"MP 2"	Wet-formula machinery parts cleaner
Stock Slick	Wood cleaner and preservative, primarily intended for gun stocks

Table 1. Most TDP products come as aerosol sprays at about \$2.25 for 6 ounces. Twelve-ounce, gallon, five-gallon, and 55-gallon sizes also are available. All products are nonconductive and generally safe to use on electrical circuits.



Photo C. Handy 2-ounce spray cans of TDP chemicals also are available. This size fits nicely in a tool box, bicycle bag, or glove compartment. A plus for many applications, these sprays don't produce the usual fine mist, but rather a powerful stream of lubricant which gets where it's needed in a hurry.

CUSTOM TRANSFORMERS



HEAVY DUTY REPLACEMENT TRANSFORMERS *

Collins 30S-1 Plate Transformer	\$165.00
Collins 516F-2 Power Transformer	95.00
Hunter 2000B Plate Transformer	125.00
ETO A-77D Plate Transformer	125.00
Henry 2K Plate Transformer	140.00
Henry 2K-2 Plate Transformer	165.00
Henry 2K-2A Plate Transformer	135.00
Henry 2K-4 Plate Transformer	165.00
Henry 3K-A Plate Transformer	165.00
Heath Marauder HX-10 Transformer	95.00
Gonset GSB-100 Transformer	95.00
National NCL-2000 Power Transformer	125.00
Gonset GSB-201 Power Transformer	135.00

SPECIALS

Plate XFMR. 4600 VAC @ 1.5A ICAS 230 VAC 60 Hz primary, Wt. 60 LB	\$195.00
Plate XFMR. 3500 VAC @ 1.0A ICAS 230 VAC 60 Hz primary, Wt. 41 LB	125.00
Plate XFMR. 3000 VAC @ 0.7A ICAS 115/230 VAC 60 Hz pri, Wt. 27 LB	95.00
Plate XFMR. 6000 VCT @ 0.8A CCS 115/230 VAC 60 Hz pri, Wt. 41 LB	135.00
FIL XFMR. 7.5 VCT @ 21A CCS 117 VAC 60 Hz primary Wt. 8 LB	29.95
FIL Choke bifilar wound 30 AMP RF Filament Choke on 1/2x7 rod	8.95
DC Filter Choke 8.0 Hy @ 1.5 ADC	150.00
DC Swinging Choke: 30 Hy @ 0.15A to 5.0 Hy @ 1.0ADC	100.00
DC Filter Capacitors 100 MFD @4000 VDC	\$75.00

*All heavy duty replacement transformers are electrically superior to original equipment(s). All transformers are manufactured to rigid commercial quality specifications and each carries a 24 month guarantee!

Write today for a free quotation on any transformer, Choke, or saturable reactor.

Peter W. Dahl Co.

4007 Fort Blvd. • El Paso, Texas 79930 D6
Telephone (915) 566-5365 or (915) 751-4856

New!

Better than a pet rock!



Kantronics Freedom VFO

only
\$69.95

With almost 350,000 licensed amateurs on the air, variable frequency operation isn't a luxury, it's a necessity.

If you've tried to operate a rock-bound transmitter on the HF bands today, you know there must be a better way. There is.

The **Kantronics Freedom VFO** will drive the high impedance oscillator tubes of transmitters like the HW-16, DX-60, DX-35 and other "oldie-but-goodies."

The **Freedom VFO** sets you free to roam from 3.650 to 3.750 MHz and 7.000 to 7.200 MHz.

Give your pet rocks to a trusted friend and order a Freedom VFO today. Or write us for information and a list of authorized Kantronics dealers.

Order now!

KANTRONICS
The Lightweight Champs

1202 East 23rd St
Lawrence, Kansas 66044

Telephone 913 842 7745

2 METER CRYSTALS MANY IN STOCK

FOR THESE RADIOS ON
STANDARD ARRL REPEATER
FREQUENCIES

Clegg HT-146	Regency HR-212
Drake TR-22	Regency HR-2B
Drake TR-33 (rec only)	Regency HR-312
Drake TR-72	Regency HR-2MS
Genova	S.B.E.
Heathkit HW-2021 (rec only)	Sonar 1802-3-4, 3601
Heathkit HW-202	Standard 146/826
Icom/VHF Eng	Standard Horizon
Ken/Wilson	Swan FM 2X
Lafayette HA-146	Tempo FMH
Midland 13-505	Trio/Kenwood
Regency HR-2	Trio/Kenwood TR2200
	Trio/Kenwood TR7200

\$3.95 EACH — IN QUANTITIES
OF 10 OR MORE, \$3.50 EACH

Certified check or money order only —
NO CODs

ROLIN DISTRIBUTORS
P.O. Box 436 R15
Dunellen NJ 08812
(201)469-1219

HIGH PERFORMANCE PRE-AMP FOR OSCAR



Model
201-29 **\$29.95**

Low Noise • High Gain Pre-Amp For 29 MHz.

- 35 to 40 dB power gain at 29 MHz with a noise figure of only 2.0 dB and a bandwidth of 1 MHz.
- Makes reception of OSCAR possible even with low cost receivers or old receivers with poor sensitivity at 29 MHz.
- Two RF stages using dual-gate MOSFETS
- Manual gain control and provision for AGC
- Requires 12 volts DC at 10 mA.

See our other products in the full page ad of the Jan. '78 Issue or write for catalog sheet. For immediate shipment call (212) 468-2720 or mail your order with payment plus \$1.00 for air mail to:

VANGUARD LABS • 196-23 Jamaica Ave. • Hollis NY 11423 v1

ALL BAND TRAP ANTENNAS!



PRE-TUNED - COMPLETELY ASSEMBLED - ONLY ONE NEAT SMALL ANTENNA FOR UP TO 6 BANDS! EXCELLENT FOR CONGESTED HOUSING AREAS - APARTMENTS LIGHT - STRONG - ALMOST INVISIBLE!

FOR ALL MAKES & MODELS OF AMATEUR TRANSCEIVERS - TRANSMITTERS - GUARANTEED FOR 2000 WATTS SSB 1000 WATTS CW. FOR NOVICE AND ALL CLASS AMATEURS!

COMPLETE AS SHOWN with 90 ft. RG58U-52 ohm feedline, and PL259 connector, insulators, 30 ft. 300 lb. test dacron and supports, center connector with built in lightning arrester and static discharge - molded, sealed, weatherproof, resonant traps 1"X6"- you just switch to band desired for excellent worldwide operation - transmitting and receiving! WT. LESS THAN 5 LBS.

160-80-40-20-15-10 bands 4 trap--138 ft with 90 ft. RG58U - connector - Model 1060BU...\$89.95
80-40-20-15-10 bands 2 trap --- 102 ft. with 90 ft. RG58U - connector - Model 998BU...\$49.95
40-20-15-10 bands 2 trap --- 54ft. with 90 ft. RG58U coax - connector - Model 1001BU...\$49.95
20-15-10 bands 2 trap --- 26 ft. with 90 ft. RG58U coax - connector - Model 1007BU...\$47.95

SEND FULL PRICE FOR POST PAID INSURED DEL. IN USA. (Canada is \$5.00 extra for postage - clerical - customs - etc.) or order using VISA Bank Americard - MASTER CHARGE - AMER. EXPRESS. Give number and ex. date. Ph 1-308-236-5333 9AM - 6PM week days. We ship in 2-3 days. PRICES MAY INCREASE SO - ORDER NOW AND SAVE! All antennas guaranteed for 1 year. Money back trial! Made in USA. FREE INFO. AVAILABLE ONLY FROM.

W18 WESTERN ELECTRONICS Dept. A7-7 Kearney, Nebraska, 68847

MICROCOMPUTER MADNESS*



*OR YOUR MONEY BACK!

(use coupon below and your enjoyment is guaranteed)

224 ARTICLES

Kilobaud has more articles than any other microcomputer magazine. During 1977, for instance, there were 224 articles in Kilobaud—880 pages of articles—a veritable encyclopedia of microcomputing. There will be even more articles in 1978.

FOR THE BEGINNER

Though Kilobaud covers both the technical and programming sides of microcomputers, each article is written to be understandable for the beginner. No other magazine makes it as easy to learn more about microcomputers.

THE BEST PROGRAMS

Only Kilobaud offers programmers both the publication of their programs in the magazine plus a large royalty for the program if it's issued on cassettes. Is it any wonder all of the really good programs are being published in Kilobaud? You'll find the best in software... games, diagnostics, teaching, music, business, etc. We're very heavy on programs.

HOBBY OR BUSINESS?

Both businessmen and hobbyists want the same thing: to understand microcomputers... and this is the purpose of Kilobaud. KB also has articles aimed at the businessman to help him know what is available and what it will do.



Understandable for beginners... Interesting for experts.

peterborough nh 03458

MONTHLY COLUMNS

Keep up with the latest developments and readers' programs through the letters column. The editorials will keep you up to date on money-making ideas, the progress of the industry and more. The New Products column is particularly useful, including the results of tests of the latest equipment in the Kilobaud microcomputer laboratory—the most complete in the industry.

SUBSCRIBE TO KILOBAUD

Since Kilobaud is the fastest selling microcomputer magazine on the newsstand, it's sometimes hard to find a copy. Why not subscribe today and get the convenience of mail delivery, plus a big cash savings... \$9 over newsstand for a 1-year subscription and a \$36 savings when you subscribe for 3 years. If you are in a hurry, call Toll Free 1-800-258-5473, and enter your subscription right away... we'll bill you later.

KILOBAUD

100% GUARANTEE OF EXTREME SATISFACTION!

That's right! After trying KILBAUD for 60 days you are willing to cancel your subscription, we'll refund your money begrudgingly. We work 16 hours a day, seven days a week, to put out the best microcomputer magazine the world has ever seen, jam packed with great articles and fantastic programs and won't pretend to be happy about being rejected. Your check will be in the next day's mail.

1 year \$15
 3 years \$36
 Bill me
 Payment enclosed

Ms / Mr _____ (please print)

Address _____

City _____ State _____ Zip _____

For Instant Subscriptions call 1-800-258-5473 or write to KILBAUD / Peterborough NH 03458.

YOUR GUARANTEE

cancel your subscription within 60 days for any reason and we'll get your money back.

Please allow 4-6 weeks for shipment of your first issue.

PEOPLE BUY BIRD FROM US



Model 43: \$120
CC-1 Leather Case: \$25
Elements: \$36 to \$42

who live in Florida, Georgia and Louisiana.

We have regular Bird customers in Texas, Alaska, Minnesota and dozens of other states as well as Washington. They come to us because they know we have a gigantic stock of Bird and that we ship the same day and that we prepay Bird orders over \$145. Add to this the fact that we are the oldest and largest Amateur store in the Pacific Northwest and you get a glimpse of why we're so popular —

AMATEUR RADIO SUPPLY SEATTLE

A55

6213 13th Ave. So., 98108 (206) 767-3222

Washington Residents: To order, CALL TOLL-FREE 1-800-562-8326.

The RF testing kit for professionals.

The WATT-KIT puts RF equipment testing all together. Kit consists of a Type 1000 RF Directional Wattmeter, 100 watt plug-in elements to measure from 25 MHz to 1 GHz, UHF connector, two-foot patch cable with connectors and luggage style carrying case.

Available with 100 watt dry terminating load.

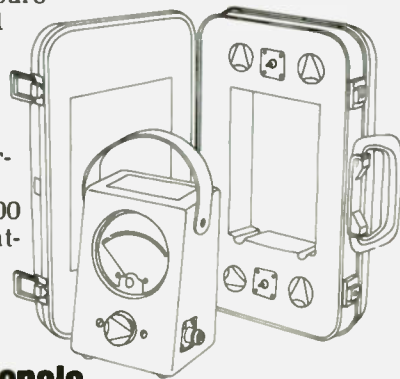

Wattmeters for professionals.

GS DIELECTRIC COMMUNICATIONS
A UNIT OF GENERAL SIGNAL
RAYMOND, MAINE 04071 • TEL 207 655 4555 **D29**

a warm & sunny welcome
at the 5th Annual

JACKSONVILLE

* MUNICIPAL AUDITORIUM
JACKSONVILLE BEACH
FLORIDA

HAMFEST

WHERE U.S. 90 MEETS THE SEA!

August 5 & 6, 1978

HUGE INDOOR SWAP AREA!
LATEST COMMERCIAL EXHIBITS!
ONE BLOCK FROM THE OCEAN AND BOARDWALK!

Features

DX PROGRAM BY NFDXA
MICROPROCESSOR SEMINAR
SOLAR POWER DEMO

Forums

ARRL ANTENNA
CONTEST VHF
TECHNICAL REPEATER

Events

OLY CONTEST PILE-UP CONTEST
OCWA TRAFFIC NETS
MARS PRIZES

Admission \$ 2.50 ADVANCE
\$ 3.00 AT 000R

ADVANCE TICKETS AND
SWAP TABLES SEND CHECK
PAYABLE TO JACKSONVILLE
HAMFEST, 911 RIO ST. JOHNS
JACKSONVILLE, FL 32211

Swap Tables \$ 5.00 PER DAY

Headquarters FOR LODGING AND MEETINGS

IS THE RAMADA INN
OF Jacksonville Beach

CALL TOLL FREE 800-228-2828

New!

QSO tape for the new exams.



Code kit
\$19.95

Tape only
\$4.95

Kantronics Speed-Building Kit

Get prepared!

To pass the new FCC code exams, you'll need to identify unusual names, places, antenna heights, rig types and a variety of other items garnered from simulated QSOs.

Now you can really study for the new exams with the **Kantronics QSO Tape!** Our C-60 cassette sends simulated "on-the-air" transmissions at 7½, 10, 13, and 15 WPM.

The QSO Tape generates sharp, crisp code to exact Morse specifications, just as the FCC does. Order your QSO Tape with **Speed-Building Kit**, or separately, today! Our other fine tapes are also available at 5, 7½, 10, 13, 16 and 20 WPM speeds.

KANTRONICS
The Lightweight Champs.

Telephone 913-842 7745

K13 Lawrence, Kansas 66044

1202 East 23rd St

COAKIT
 COMPLETE
 RF ASSORTMENT
 NUMBER ONE

CONNECTOR ASSORTMENT
\$25.00 **\$23.50** each
 Postpaid lots of three

Includes: 5- PL259, 5- SO239, 5- UG175, 5- UG176, 2- PL258, 1- DM, 1- M358, 2- M359, 1- UG255, 1- UG273, 2- PL259PO, 1- 1021-20, 1- Lightning Arrestor.

Master Charge & Visa accepted / Send for Free Catalog

COAKIT
 P.O. Box 101-A Dumont, N. J. 07628
 Circle C21 on Reader Service Card

AMATEUR TELEVISION ON 439.25 MHz

INTERESTED? ACTIVITY IS INCREASING EVERYWHERE YOU CAN GET ACTIVE IN YOUR AREA WITH OUR PRODUCTS—

AM1B FSTV CONVERTER complete \$150.00
AX10B FSTV TRANSMITTER complete \$385.00

CALL 812-336-4775, OR WRITE US, FOR COMPLETE DETAILS

APTRON LABORATORIES A6
 PO BOX 323
 BLOOMINGTON, INDIANA, 47401

GermanTown Amateur Supply, Inc.
 G-12
 MEMPHIS, TENNESSEE

NO MONKEY BUSINESS!

- (A) Complete Service Facilities
- (B) Good Deals on most Brands
- (C) Shipping within 24 Hours
- (D) All inquiries handled by Active Hams with over 20 years experience in ham radio

CALL TOLL FREE
1-800-238-6168

IN TENNESSEE, CALL 901-452-4276
 MONDAY - SATURDAY 8:30-5:30
 FOR YOUR SPECIAL.

Write: 3202 Summer Ave., Memphis, Tennessee 38112

THE CRITIC'S CHOICE

DM-170
Active Filter Demodulator

Critical buyers are choosing the CM 170 PTTY demodulator to give them more features at lower cost. Write for information and compare. Discover what the critics have. \$39.95 Kit \$59.95 Wired

FLESHER CORP.
 P.O. Box 976 F5
 Topeka, Kansas 66601
 (913) 234-0198

The only REALLY NEW 80-10 meter vertical design in 20 years!

Completely automatic bandswitching 80 through 10m (160-10m with optional TBR-160 add-on unit.)
 Low V.S.W.R. over entire 40, 20, 15, & 10m bands plus ANY 60-100 KHZ segment of 80/75m. **NO ANTENNA TUNER NEEDED!**
 ENTIRE 26 ft length active on 80, 40, 20, & 10m with full 1:4 wave resonance on 15m for greater bandwidth & superior DX performance. Ground, roof, or tower mount—no guys needed.

HIGHEST QUALITY CONSTRUCTION & WORKMANSHIP THROUGHOUT. HIGH STRENGTH ALUMINUM ALLOY AND FIBERGLASS DESIGN. Complete with 1 1/8 in. O.D. tubular mounting post, RG-11 U matching line, and connector for PL-259. Use any length of 50-52Ω coax.

V.S.W.R. at resonance: 1.5:1 or less; all bands.
 Power rating: Legal limit SSB CW 40-10m; 1200 W P.E.P. / 500 W CW on 80/75m.

AT YOUR DEALER OR DIRECTLY FROM

BUTTERNUT ELECTRONICS CO. B31
 ROUTE ONE DEPT. 4
 LAKE CRYSTAL, MN. 56055
 PHONE 507-947-3126

OTHER MODELS, TOO! FREE INFORMATION.

15m trap

80m coil

Base

Model HF5V-II \$74.50 PPD. IN CONT. USA (BY UPS). MN RESIDENTS ADD TAX.

VHF



We have a portable direction finder that REALLY works—on AM, FM, pulsed signals and random noise! Unique left-right DF allows you to take accurate bearings even on short bursts, with no 180° ambiguity. Its 3 dB antenna gain and .06 uV typical DF sensitivity allow this crystal-controlled unit to hear and positively track a weak signal at very long ranges—while built-in RF gain control with 120 dB range permits DF to within a few feet of the transmitter.

The DF is battery-powered, can be used with accessory antennas, and is 12/24V for use in vehicles or aircraft. This is a factory-built, guaranteed unit—not a kit. It has been successful in locating malicious interference, as well as hidden transmitters in "T-hunts," ELTs, and noise sources in RFI situations.

Prices start at under \$175. Write or call for information on our complete line of portable, airborne, vehicle, and fixed DF systems.

5546 Cathedral Oaks Rd.,
Amateur Dept.
Santa Barbara, CA 93111

L-TRONICS

W6GUX WD6ESW L10

ZZZ Electronics Z1
422 Armour Circle N.E.
ATLANTA, GEORGIA 30324
OWNER - JOHN FEARON W4WKP

SWAN
TEN-TEC
STONER PRO 80-10
LARSEN
ALUMA TOWERS
MARDEN
2 MTR STALS
Lifetime Guar. \$500 ea.
GOLD LINE
SHURE MICS
SIXTON WIRE PRODUCTS
TAB BOOKS
COLUMBIA WIRE
LENTRON
ICOM

WILSON
KLM
CUSH CRAFT
KDK FM 2015R
TURNER MICS
MOSLEY
CDE ROTORS
TELEX HEADSETS
WAHL ISOTIP
ARRL BOOKS
PRIMO MICS
UNGAR
NEWTRONICS
HUSTLER

NEW IN ATLANTA!
COME BY OR CALL
WJM-WA4SVY
Charlotte - WB4GTU
PHONE 404-8760631

RG8X
12 ft per ft.

MASTER CHARGE
AND
VISA ACCEPTED

CALLBOOK MAG

MLA 2500 \$799.50

"THE PROFESSIONALS"

NEW

MODEL CTR-2A • 500 MHz & 1 GHz

COUNTERS

NEW
Period
Measurement

NEW
Built-in
Pre-Amp

1 us to
1 sec.

10 mv @
150 MHz

The New Model CTR-2A Series Counters are designed and built to the highest standards to fulfill the needs of commercial communications, engineering labs and serious experimenters. With an accuracy of + .00005% (oven option) the CTR-2A can handle the most critical measurements and is about half the cost of other commercial counters.

If you need a reliable counter at an affordable price, the CTR-2A is the answer.

- Built-in Pre-Amp 10 mv @ 150 MHz
- Period Measurement (Optional)
- 8 Digit .3" LED Display
- Input Diode Protected
- High Stability TCXO Time Base
- 12V-DC Operation (Optional)
- Built-in VHF-UHF Prescaler
- Oven Controlled Crystal (Optional) ± .5 ppm
- Automatic Dp Placement
- Selectable Gate Times - .1 & 1 sec.
- TCXO Std. ± 2 ppm

500 MHz Kit CTR-2A-500K	\$249.95
500 MHz Assembled CTR-2A-500A	349.95
1GHz Kit CTR-2A-1000K	399.95
1GHz Assembled CTR-2A-1000A	549.95

OPTIONS

02) Oven Crystal	\$49.95	05) 10 sec. Time Base	\$ 5.00
03) .43" LED	10.00	06) Period	15.00
04) 12 V-DC	10.00	07) Handle	10.00

D10

PROBES
Hi-Z
\$15.00
•
Low Pass
\$15.00

DAVIS ELECTRONICS 636 Sheridan Dr., Tonawanda, N.Y. 14150 716/874-5848

QUASAR VIDEO TAPE RECORDER SALE!

We are constantly testing ham and other electronic equipment for review in 73 Magazine. In order to be able to keep this not inexpensive project going we have to sell off the equipment used for test. Most of it has been used for a few days and is in every way as good as new. In many cases it is better than new since 95% of the equipment failures come within the first few hours of operation.

In this case we are running a series of tests of VTR systems, using them for regular, ham TV, SSTV, and even micro-computer programming tests. One of the best we've found so far is the Quasar system, but we still have to go on and test the RCA, JVC, and many other systems . . . so our Quasar is up for sale. We paid well over \$1,000 for the Quasar . . . used it for a few days and have gone on to test more systems.

Quasar VTR System special like new \$675.
Quasar two hour cassettes, each (new \$25), special like new \$12.50

Major Credit Cards Accepted.
73 Magazine • Peterborough NH 03458

NEW! 5-Band Trap Dipole (80 thru 10 Meters)



Pre-assembled.
Model 370-11

Kit (illustrated).
Model 370-12

Power rated 2kW PEP, approx. 110-ft span

Complete with • wire • traps •
end insulators • 50 ft RG-8/U,
PL-259 connector • heavy
duty cast aluminum and stea-
tite center connector.

At your
B&W dealer.

4-Band (40 thru 10M),
55 ft model 370-13
also available, pre-
assembled only.



Made in Bristol, Pennsylvania, by

Barker & Williamson Inc.

10 Canal Street □ Bristol, PA 19007

73 Magazine will have a Dealer Directory section
beginning with the August issue.



Your company
name and message
can contain as many
as 25 words for as
little as \$150 yearly
(prepaid), or \$15
per month (prepaid
quarterly). No men-
tion of mail order
business or area
code permitted.

Ads will be set in
standard listing
typography. Direc-
tory text and pay-
ment must reach us
45 days in advance
of publication. For
example, advertising
for the August issue
must be in our
hands by June 15th.

Mail your directory listing to: 73 Magazine
DEALER DIRECTORY, PETERBOROUGH NH 03458

More Economical RTTY



The ST-5000 from HAL

The HAL ST-5000 sets the pace for an economical demodulator/keyer for radio-teletype (RTTY). All the features you need for reception and transmission of HF and VHF RTTY are here.

The demodulator features a hard-limiting front end, active filter discriminator, and active detector circuitry for wide dynamic range. Autostart and motor control circuitry make for easy VHF and HF autostart operation.

Convenient front panel switches are provided for 850 and 170 Hz shift, normal or reverse sense, autostart on/off, print - line or local, and power on/off. 425 Hz press transmissions may also be copied with the ST-5000. High voltage 60 ma. loop output as well as low level RS-232 compatible output are provided by the demodulator.

The audio keyer section of the ST-5000 generates stable, phase-coherent audio tones. Transmission is a simple matter of applying these tones to your HF SSB or VHF FM transmitter.

The ST-5000 is housed in an attractive blue and beige cabinet and is backed by the HAL Communications one year warranty.

For complete specs on the HAL ST-5000, write or call HAL today.

\$275.00



HAL Communications Corp., Box 365, 807 E. Green St.
Urbana, Illinois 61801 • Telephone (217) 367-7373

H6

VHF
Power
Duo!

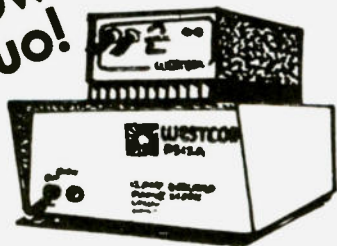

Max power for the \$
Extends weak signal range
Base or mobile use

What a combination! Westcom's new 2-meter, 90 watt linear amplifier, coupled with Westcom's ruggedized 12 amp. DC power supply. Now, base or mobile, you'll have power for that weak signal work. A natural for the OSCAR uplink. The amplifier, model number 2M 15X90L, is an add-on unit, no internal connections or adjustments required. Operates all modes: SSB, FM, AM, RTTY, and, CW. "microstrip" design provides high stability and optimum performance over wide bandwidth. The tough DC power supply, model number RS-12A, has computer grade components. Looks great with its matched linear amplifier! This "Power Duo" has been specially priced for a limited time, only. Order today, and get both units for **JUST \$198**

Immediate delivery - order today. W17



MADISON SUPER SUMMER BUYS

NEW OMNI-J 2-meter mobile or portable antenna.

3/8" thread. 5-dB gain (1.5-dB gain over conventional 5/8-wave mobile whip antenna). \$29.95, 220-MHz \$27.95. 450 MHz \$27.95. Guaranteed results.

KLIM: Antennas, Linears, Accessories All In Stock. Free balun w/2 meter base antenna.

FINCO AMATEUR BEAMS In Stock—Call! A62 6 and 2 Meter \$61.00

BIRD 43 Wattmeter plus slugs, In stock, prepaid freight.

BENCHER keyer paddles in stock \$39.95; chrome \$49.95

MIDLAND 23-138 dual meter, reads SWR and relative

POWER handles 1kW from 3-150 MHz. \$21.95

YAESU FT-901D series Call for Quote

TELE-TOWER: 40' w/breakover \$299

55' w/breakover \$399

MICROWAVE MODULES In stock

F9FT TONNA antennas 144/16 el. \$55.95

9/19 OSCAR \$53.00

JANEL Preamps in stock

TECHNICAL BOOKS: ARRL, Sams, TAB, TI, Rider, Radio

Pub., Callbook, Cowan, TEPABCO, many others. .call

HAM X ROTOR (New Model) Turns 28 sq. ft. of antenna.

List \$325. In stock. Your Price \$249

CDE HAM-III \$129.00

SWAN METERS: WM 6200 VHF Wattmeter. \$49.95

SWR 3 Mobile \$9.95

TELEX HEADSETS: In stock

CETRON 572B \$27.95 ea.

ADEL nibbling tool, \$645; punch \$3.50

CABLE 5/32", 6-strand, soft-drawn guy cable. For mast

or light tower, 3e foot.

BELDEN COAX CABLE: 9888 double shield RG8 foam

coax, 100% braid, su table for direct bury 39e ft., 8237

RG8 21e ft., 8214 RG3 foam 25e/ft., 8448 8-wire rotor

cable 16e ft., 8210 72 ohm kw twinlead \$19/100 ft., 8235

300 ohm kw twinlead \$12/100 ft., Amphenol PL-259,

silverplated 59e, UG175 adapter e19, PL-258 dbl

female \$1.00. BNC female chassis mount 59e ea;

BELDEN 14 gauge cop. stranded antenna wire. \$5/100 ft.

TIMES 1/2" foam hardline 60e/ft. connectors \$15 ea.

KESTER SOLDER 1 lb. 60/40. .062. \$6.50

LEADER — Amateur Test Equip. — 10% off list.

MALLORY 2.5A/1000 PIV epoxy diode 19e ea.

.001 MFD 20KV CAP \$1.95

GE receiving tubes 50% off list

GE6146B, 8950 \$7.95 ea.

SAY Electronic Power Supplies

Completely Regulated 13.8 to 20 volts dc, variable. Separate volt and amp meters. Dual protection against over voltage and over current.

4 amp \$59.95

8 amp \$109.95

20 amp \$159.95

CALL FOR QUOTES ON: YAESU FT-301D, FT301, FT-227R, KENWOOD TS520S, TS820S, FT-901DM. FT-101E, ALDA, AMCOMM, VHF-ONE PLUS & ETO-ALPHA. ALL IN SEALED CARTONS. CALL FOR QUOTES ON ITEMS NOT LISTED. THIS MONTH'S SPECIAL: BEARCAT 210 SCANNER \$249. BEARCAT 250 —SOON!

**CALL FOR FAST QUOTES
SPECIAL ORDERS WELCOME**

TERMS: All prices FOB Houston. Prices subject to change without notice. All Items Guaranteed. Some items subject to prior sale. Send letterhead for Amateur dealers price list. Texas residents add 5% tax. Please add postage estimate.

MADISON M35 ELECTRONICS SUPPLY, INC.

1508 MCKINNEY
713/658-0268

HOUSTON, TEXAS 77002
Nites 713/497-5683

FREQUENCY COUNTERS

FREE

By popular demand we are continuing to offer a Fairchild Clock, Module FCS-8100A (suggested retail \$20) with any purchase of \$99 or more from 73 advertisements.



Previously kitted for Crescomm Inc. by Hal-Tronix

COMPLETE KITS: CONSISTING OF EVERY ESSENTIAL PART NEEDED TO MAKE YOUR COUNTER COMPLETE. HAL-600A 7-DIGIT COUNTER WITH FREQUENCY RANGE OF ZERO TO 600 MHz. FEATURES TWO INPUTS: ONE FOR LOW FREQUENCY AND ONE FOR HIGH FREQUENCY; AUTOMATIC ZERO SUPPRESSION. TIME BASE IS 1.0 SEC OR .1 SEC GATE WITH OPTIONAL 10 SEC GATE AVAILABLE. ACCURACY ± .001%. UTILIZES 10-MHz CRYSTAL 5 PPM.

COMPLETE KIT was 149.00 now 129.00

HAL-300A 7-DIGIT COUNTER WITH FREQUENCY RANGE OF ZERO TO 300 MHz. FEATURES TWO INPUTS: ONE FOR LOW FREQUENCY AND ONE FOR HIGH FREQUENCY; AUTOMATIC ZERO SUPPRESSION. TIME BASE IS 1.0 SEC OR .1 SEC GATE WITH OPTIONAL 10 SEC GATE AVAILABLE. ACCURACY ± .001%. UTILIZES 10-MHz CRYSTAL 5 PPM.

COMPLETE KIT was 124.00 now 109.00

HAL-50A 8-DIGIT COUNTER WITH FREQUENCY RANGE OF ZERO TO 50 MHz OR BETTER. AUTOMATIC DECIMAL POINT, ZERO SUPPRESSION UPON DEMAND. FEATURES TWO INPUTS: ONE FOR LOW FREQUENCY INPUT, AND ONE ON PANEL FOR USE WITH ANY INTERNALLY MOUNTED HAL-TRONIX PRE-SCALER FOR WHICH PROVISIONS HAVE ALREADY BEEN MADE. 1.0 SEC AND .1 SEC TIME GATES. ACCURACY ± .001%. UTILIZES 10-MHz CRYSTAL 5 PPM.

COMPLETE KIT was 124.00 now 109.00

SUMMER SALE

HAL-TRONIX BASIC COUNTER KITS STILL AVAILABLE

THE FOLLOWING MATERIAL DOES NOT COME WITH THE BASIC KIT: THE CABINET, TRANSFORMER, SWITCHES, COAX FITTINGS, FILTER LENS, FUSE HOLDER, T-03 SOCKET, POWER CORD AND MOUNTING HARDWARE.

HAL-600X (Same Specifications as HAL-600A) \$124.00

HAL-300X (Same Specifications as HAL-300A) \$89.00

HAL-50X (Same Specifications as HAL-50A) \$89.00

PRE-SCALER KITS

HAL-0-300PRE (Pre-drilled G10 board and all components) \$19.95

HAL-0-300P/A (Same as above but with preamp) \$24.95

HAL-0-600PRE (Pre-drilled G10 board and all components) \$34.95

HAL 600PA (same as 600PR except with pre-amp) \$39.95

ATTN: RADIO CLUBS

Please feel free to inquire about quantity discounts on any of the HAL-TRONIX kits for your Club projects. Discount schedule ranges from 10% to 25% depending upon how many kits will be required.



"HAL" HAROLD C. NOWLAND
WBZXH

HAL-TRONIX H24

P. O. BOX 1101

SOUTHGATE, MICH. 48195

PHONE (313) 285-1782

SHIPPING INFORMATION: ORDERS OVER \$15.00 WILL BE SHIPPED POSTPAID EXCEPT ON ITEMS WHERE ADDITIONAL CHARGES ARE REQUESTED. ON ORDERS LESS THAN \$15.00 PLEASE INCLUDE ADDITIONAL \$1.00 FOR HANDLING AND MAILING CHARGES.

SEND SASE FOR FREE FLYER

HATRY H15 electronics

500 Ledyard St., Hartford CT 06114
203-527-1881

(1 block east of Wethersfield Ave. off Airport Rd.
Rte. 6)

See Ward W1WRQ — John W1JJR
or
Dave WA1HFE

HEADQUARTERS for 2M FM

Tempo VHF/ONE, SSB/ONE adaptor, Tempo
VHF amplifiers, FMH-2, FMH-5; Drake TR 33C,
AA 10, AC 10; Regency HR 2B, HR 312, AR 2,
P 110 & crystals for all lines listed above.

FM GAIN ANTENNAS

For mobile, fixed or portable operation by Cush-
Craft, Hy-Gain, Antenna Specialists & New-
Tronics.

ANTENNA STUFF

Open wire feedline — #18, #14, #12 ga. bare
copperweld wire — #14, #12 enamel copper —
insulators — W2AU baluns 1-1 or 4-1 — lowloss
coax cable — Rohn 25G towers & accessories —
Blitzbug lightning arrestors — glassline guy — B&W
antenna switches — Belden 72 & 300 ohm KW
twinlead — Amphenol UHF & BNC connectors.

AMATEUR GEAR

Drake, Swan, Tempo, Ten-Tec, Dentron, Regency,
Mosley, Hy-Gain, CushCraft.

(Canadian Amateurs Send U.S. Funds Only)
F.O.B. Hartford
Please include postage

CONNECTICUT'S OLDEST HAM STORE

SEND FOR THESE GREAT BOOKS

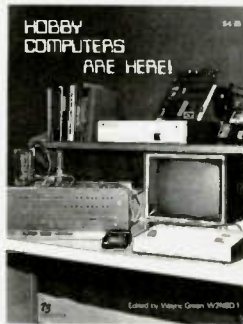

T O D A Y !

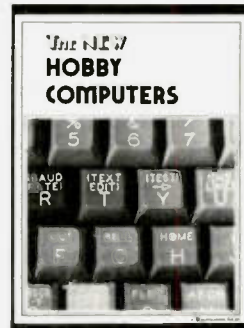

• **HOBBY COMPUTERS ARE HERE!** If you (or a friend) want to come up to speed on how computers work . . . hardware and software . . . this is an excellent book. It starts with the fundamentals and explains the circuits, the basics of programming, along with a couple of TVT construction projects, ASCII-Baudot, etc. This book has the highest recommendations as a teaching aid for newcomers. \$4.95

• **THE NEW HOBBY COMPUTERS** This book takes it from where "HOBBY COMPUTERS ARE HERE!" leaves off, with chapters on Large Scale Integration, how to choose a microprocessor chip, an introduction to programming, low cost I/O for a computer, computer arithmetic, checking memory boards, a Baudot monitor/editor system, an audible logic probe for finding those tough problems, a ham's computer, a computer QSO machine . . . and much, much more! Everything of interest is there in one volume. Don't miss this tremendous value! Only \$4.95

Have your credit card handy and call toll-free
800-258-5473, or use the card in the back of this magazine
and send your check to:

73 Book Dept. • Peterborough, NH 03458

Revised Repeater Atlas of the entire world

MORE LISTINGS THAN EVER BEFORE!

Our NEW edition is 150% as big as any list ever available — nearly 900 more listings than the previous editions. Plus new improved maps show the location by frequency of every repeater in the states.

Only \$1.95

Use order card in the back of this magazine or itemize your order separately. Add \$1.00 shipping & handling per order, and send to:

73 Radio Bookshop
Peterborough NH 03458

PART 97—AMATEUR RADIO SERVICE

Increase in the Frequencies Available for Use by General Class Amateur Radio Operators

AGENCY: Federal Communications Commission.

ACTION: Final rules.

SUMMARY: The FCC is amending its amateur radio rules to permit General Class operators to operate their stations between 50.0 MHz and 50.1 MHz. We are taking this action in order to give General Class operators the same privileges as Technician Class operators in the very high and ultra high frequency bands.

EFFECTIVE DATE: May 15, 1978.

ADDRESS: Federal Communications Commission, 1919 M Street NW., Washington, D.C. 20554.

FOR FURTHER INFORMATION CONTACT:

Mr. Gregory M. Jones, Personal Radio Division, 202-634-6619 (Not a toll-free telephone number).

SUPPLEMENTARY INFORMATION:

ADOPTED: April 20, 1978.

RELEASED: May 3, 1978.

Order. In the matter of increase in the frequencies available for use by General Class amateur radio operators.

1. This Order makes all authorized amateur operating privileges available to General Class amateur radio operators between 50.0 MHz and 50.1 MHz.

2. On March 22, 1978 the Commission adopted a Second Report and Order in Docket 20282. The Second Report and Order (1) Made the Novice Class amateur operator license valid for a period of five years and renewable and (2) extended full amateur operating privileges to Technician Class amateur operators above 50.0 MHz. The new rule amendments were given an effective date of May 15, 1978.

3. It has come to our attention that in making 50.0 MHz to 50.1 MHz available to Technician Class licensees, we may have acted unfairly towards General Class licensees, who are prohibited from operating their amateur stations between 50.0 MHz and 50.1 MHz. Since the General Class license is more difficult to obtain than the Technician Class license, it does not appear reasonable to afford Technician Class licensees greater operating privileges than General Class licensees. Indeed, one of the principles upon which the current amateur licensing system is based is that each successive "higher" amateur operator license conveys all operating privileges of all "lower" class operator licenses. The Rules as amended by the Second Report and Order in Docket 20282, are anomalous: a licensee "upgrading" the class of his operator license from Technician to General would lose the privilege of operating between 50.0 MHz and 50.1 MHz.

4. We believe General Class licensees should have all privileges afforded Technician Class licensees. Accordingly, we are amending Section 97.7 of the rules to make 50.0 MHz to 50.1 MHz available to General Class licensees.

5. Authority for this action, which we believe to be in the public interest, is contained in sections 4(i) and 303 of the Communications Act of 1934, as amended. Because the amendment we are adopting is minor in character, merely increasing slightly the frequencies available for the use of General Class amateur radio operators, we find, for good cause, that the prior

¹The Novice Class operator license had been valid for a period of two years and was not renewable.

²Section 97.7(a) of the Commission's Rules limits operation between 50.0 MHz and 50.1 MHz to Amateur Extra Class and Advanced Class operators.

notice and public procedure provisions of the Administrative Procedures Act, 5 U.S.C. 553, are unnecessary.

6. For the foregoing reasons, the Commission orders amendment of Part 97 of its rules, as such attached below effective May 15, 1978.

(Secs. 4, 303, 48 Stat., as amended, 1066, 1082; (47 U.S.C. 154, 303).)

FEDERAL COMMUNICATIONS COMMISSION,
WILLIAM J. TRICARICO,
Secretary.

The FCC is amending Part 97 of Chapter 1 of Title 47 of the Code of Federal Regulations, as follows:

1. Section 97.7(a) is amended to read, as follows:

§ 97.7 Privileges of operator licenses.

(a) *Amateur Extra Class and Advanced Class.* All authorized amateur privileges including exclusive frequency operating authority in accordance with the following table:

Frequencies	Class of license authorized
3500-3525 kHz	Amateur extra only.
3775-3800 kHz	Do.
7000-7075	Do.
14,000-14,025 kHz	Do.
21,000-21,025 kHz	Do.
21,250-21,270 kHz	Do.
3800-3890 kHz	Do.
7150-7225 kHz	Amateur extra and advanced.
14,200-14,275 kHz	Do.
21,270-21,350 kHz	Do.

PART 97—AMATEUR RADIO SERVICE

Editorial Amendments Concerning Novice Class Amateur Radio Operators

AGENCY: Federal Communications Commission.

ACTION: Editorial rule amendments.

SUMMARY: The FCC is amending its amateur radio rules to bring them into conformity with action the FCC took in March 1978. In a report and order adopted in March 1978 the FCC made the novice class amateur radio operator license valid for a 5-year term and renewable. At that time only the rule about renewability was amended, however. This order amends the rule about the term of the novice class license.

EFFECTIVE DATE: May 15, 1978.

ADDRESS: Federal Communications Commission, 1919 M Street NW., Washington, D.C. 20554.

FOR FURTHER INFORMATION CONTACT:

Mr. Gregory M. Jones, Personal Radio Division, 202-634-6619.

SUPPLEMENTARY INFORMATION:

Adopted: April 11, 1978.

Released: April 12, 1978.

1. On March 22, 1978, the Commission adopted a second report and order in Docket 20282. In the second report and order the Commission, among other things, said it was amending its rules to make the novice class amateur operator license valid for a period of 5 years and renewable. The novice class operator license had previously been valid for a period of 2 years and was not renewable. The new rules were given an effective date of May 15, 1978.

2. The second report and order in Docket 20282 amended § 97.13 of the rules to state that all amateur operator licenses could be renewed upon proper application. Regulations concerning the license terms of amateur licenses are contained in § 97.59 of the rules, however. This order amends § 97.59 of the rules to implement the Commission's express intention in Docket 20282; namely, that all ama-

teur licenses, including those issued to novice class operators, are normally to be valid for 5 years from the date of issuance or renewal.

3. Since the amendment we are adopting is editorial in character, merely amending the rules to ensure their conformity with prior Commission action, the prior notice and public procedure provisions of the Administrative Procedures Act, 5 U.S.C. 553, are not applicable. Authority for this action appears in sections 4(i), 5(d), and 303 of the Communications Act of 1934, as amended.

4. Accordingly, it is ordered that § 97.59 of the Commission's rules is amended as set forth below effective May 15, 1978.

(Secs. 4, 5, 303, 48 Stat., as amended, 1066, 1068, 1082; 47 U.S.C. 154, 155, 303.)

FEDERAL COMMUNICATIONS COMMISSION,

RICHARD D. LICHTWARDT,
Executive Director.

Part 97 of chapter I of Title 47 of the Code of Federal Regulations is amended, as follows:

1. § 97.59 (a) and (b) are amended to read, as follows:

§ 97.59 License term.

(a) Amateur operator licenses are normally valid for a period of 5 years from the date of issuance of a new or renewed license.

(b) Amateur station licenses are normally valid for a period of 5 years from the date of issuance of a new or renewed license. All amateur station licenses, regardless of when issued, will expire on the same date as the licensee's amateur operator license.

PART 97—AMATEUR RADIO SERVICE

Operator Classes, Privileges, and Requirements in the Amateur Radio Service

AGENCY: Federal Communications Commission.

ACTION: Final rules.

SUMMARY: The FCC is amending its Amateur Radio Service rules to make all amateur frequencies above 50 MHz available to Technician Class amateur operators and to make the Novice Class amateur operator license renewable and valid for five years. We are taking this action to give Technician Class operators more flexibility in their operations and to make it easier for Novice Class operators to remain licensed amateur operators. We expect our action will result in both more efficient use of the spectrum above 50 MHz by amateur operators and an increase in the number of Novice Class amateur operators.

EFFECTIVE DATE: May 15, 1978.

ADDRESSES: Federal Communications Commission, Washington, D.C. 20554.

FOR FURTHER INFORMATION CONTACT:

Joseph M. Johnson, Personal Radio Division, Safety and Special Radio Services Bureau, 202-632-7250 (This is not a toll-free telephone number.)

SUPPLEMENTARY INFORMATION:

Adopted: March 22, 1978.

Released: April 6, 1978.

By the Commission: Commissioner White dissenting.

In the matter of amendment of Part 97 of the Commission's Rules concerning operator classes, privileges, and requirements in the Amateur Radio Service (41 FR 25013).

Docket No. 20282; RM-1016, 1363, 1454, 1456, 1516, 1521, 1526, 1535, 1568, 1572, 1602, 1615, 1629, 1633, 1656, 1724, 1793, 1805, 1841, 1920, 1947, 1976, 1991, 2030, 2043, 2053, 2149, 2150, 2162, 2166, 2216, 2219, 2256, 2284, 2449; FC 78-212.

1. On December 16, 1974, the Commission released a Notice of Proposed Rulemaking in this proceeding which

was published in the FEDERAL REGISTER on December 20, 1974 (39 FR 44042). A First Report and Order was released on June 15, 1976 (41 FR 25013). This Second Report and Order is a further step in the resolution of the very complex and far reaching proposals of the Notice.

2. In the Notice, the Commission proposed to expand the frequencies available to Technician Class licensees. Presently, Technicians may operate in the bands 50.1-54.0 MHz, 145-148 MHz, and on all amateur frequencies above 220 MHz. The proposed rules would have permitted operation on all amateur frequencies above 50 MHz. This proposal was supported by the American Radio Relay League (ARRL) in its comments, and by numerous individual amateurs.

3. In light of actions now being taken in Docket 21033 concerning frequencies available for repeater station use, we believe the time has come to grant expanded frequency privileges to Technicians. Specifically, we will amend Section 97.7(d) of the Amateur Radio Service Rules to permit Technician Class licensees to operate on all frequencies above 50 MHz. We believe this action will give greater flexibility to such licensees who wish to do experimental and weak-signal work in the 50 MHz and 144 MHz bands.

4. In Docket 20282 the Commission also proposed to make the Novice Class operator license, which is currently a two year non-renewable license, a five year renewable license. There was strong support for this proposal in the comments, and we are adopting it as proposed. We are amending Section 97.13 of the Rules accordingly. Licensees now holding Novice Class licenses may renew them upon proper application.

5. In view of the foregoing, we believe that the amended rules, as discussed above, are in the public interest. Accordingly, pursuant to authority contained in Sections 4(i) and 303 of the Communications Act of 1934, as amended, it is ordered that Part 97 of the Commission's Rules is amended as set forth in the attached Appendix. It is further ordered that this proceeding is continued. The rule amendments adopted herein become effective May 15, 1978.

(Secs. 4, 303, 48 Stat., as amended, 1066, 1082; 47 U.S.C. 154, 303.)

FEDERAL COMMUNICATIONS COMMISSION,
WILLIAM J. TRICARICO,
Secretary.

Part 97 of Chapter 1 of Title 47 of the Code of Federal Regulations is amended, as follows:

1. § 97.7(d) is amended to read, as follows:

§ 97.7 Privileges of operator licenses.

(d) *Technician Class.* All authorized amateur privileges on the frequencies 50.0 MHz and above. Technician Class licensees also convey the full privileges of Novice Class licensees.

2. In § 97.13, paragraph (b) is deleted, paragraphs (c) through (f) are redesignated paragraphs (b) through (e), and paragraph (a) is amended, as follows:

§ 97.13 Renewal or modification of operator license.

(a) An amateur radio operator license may be renewed upon proper application.

PART 97—AMATEUR RADIO SERVICE

Simplification of the Licensing and Call Sign Assignment Systems in the Amateur Radio Service

AGENCY: Federal Communications Commission.

ACTION: Final rules.

SUMMARY: The FCC is eliminating the availability of special call signs prefixed by the letters "WR" for stations in repeater operation in the Amateur Radio Service. We think each amateur radio operator should have one station license and one call sign.

"WR" call signs are unnecessary. We expect the elimination of "WR" call signs for stations in repeater operation will have no significant effect on operations conducted in the Amateur Radio Service.

EFFECTIVE DATE: Non-Applicable.

ADDRESSES: Federal Communications Commission, Washington, D.C. 20554.

FOR FURTHER INFORMATION CONTACT:

Gregory M. Jones, Personal Radio Division, Safety and Special Radio Services Bureau, 202-634-6619. (This is not a toll-free telephone number.)

SUPPLEMENTARY INFORMATION:

Adopted: March 22, 1978.

Released: April 6, 1978.

By the Commission: Commissioner White dissenting.

In the matter of the simplification of the licensing and call sign assignment systems in the Amateur Radio Service (43 FR 7332).

WHAT IS THE BACKGROUND OF THIS PROCEEDING?

1. In a Notice of Proposed Rulemaking in Docket 21135, released March 11, 1977, 42 FR 15438 (1977), the Commission acted on its own initiative and proposed several major revisions of its Amateur Radio Service regulations, 47 CFR §97.1, et seq. Comments on our proposals were due no later than June 2, 1977. Reply comments were due no later than June 30, 1977. The American Radio Relay League, Incorporated (ARRL) petitioned for an additional thirty days in which to submit comments and reply comments. On May 19, 1977 the Chief, Safety and Special Radio Services Bureau, acting under delegated authority, denied the ARRL's petition, stating that the eighty-three day comment period the Commission provided was adequate, and that rapid resolution of the issues raised in the Notice of Proposed Rulemaking in Docket 21135 was essential.

2. In the Notice of Proposed Rulemaking in Docket 21135 we proposed to simplify greatly the licensing and call sign assignment systems in the Amateur Radio Service. We proposed to discontinue the issuance of all amateur station licenses, except primary station licenses and space station licenses. Specifically, we proposed to eliminate Radio Amateur Civil Emergency Service (RACES) stations, special event stations, club stations, military recreation stations, secondary stations, repeater stations, auxiliary link stations and control stations. We also proposed to amend the Amateur Service rules to state that all amateur station call signs would be assigned on a systematic basis. As part of our call sign proposal, we proposed to eliminate the availability of distinctive call signs for repeater stations (call signs prefixed by the letters "WR") and RACES stations (call signs prefixed by the letters "WC").

3. The Commission adopted a First Report and Order in Docket 21135 on February 8, 1978. In the First Report and Order the Commission eliminated the availability of secondary stations and special event stations. We also amended the amateur rules to eliminate existing special call sign programs. We did not adopt our proposal to eliminate separate club, military recreation and RACES station licenses. Instead, we proposed to adopt new rules restricting the eligibility for such licenses. We did not act at all on our proposals to eliminate repeater, auxiliary link and control stations licenses or to eliminate the availability of distinctive call signs for repeater stations.

4. Our proposals to eliminate separate repeater, auxiliary link and control station licenses duplicated a proposal we made in a Notice of Inquiry and Notice of Proposed Rulemaking in Docket 21033, 42 FR 2089 (1977). In a Report and Order in Docket 21033, released September 27, 1977, FCC 77-651, the Commission amended its rules to eliminate the availability of repeater, auxiliary link and control station licenses. On November 4, 1977 these regulations were stayed pending disposition of several petitions requesting reconsideration of our action in Docket 21033. In a Memorandum Opinion and Order in Docket 21033, also adopted today, we are affirming

our original decision to delete the availability of repeater, auxiliary link and control station licenses. Further discussion of these issues in connection with this proceeding is therefore not necessary. Rather, we will consider the one remaining unaddressed issue in Docket 21135, namely, "WR" call signs for stations in repeater operation.

WHAT WERE OUR SPECIFIC PROPOSALS AND WHY DID WE MAKE THEM?

5. In our Notice of Proposed Rulemaking in Docket 21135 we proposed to eliminate the availability of station call signs prefixed by the letters "WR" for stations in repeater operation. We made this proposal, which involves a change in Commission policy rather than an amendment to a specific rule, to bring our regulatory programs into closer alignment with our existing resources. We said we could discern no compelling reason to continue our complex system of call sign assignment in the Amateur Service, a system which requires an allocation of our limited resources sufficient to degrade significantly the services we offer to amateur licensees in other areas. We indicated that we were aware that our proposal in Docket 21135 to eliminate the availability of "WR" call signs entirely conflicted with a proposal we made in Docket 21033 to make "WR" call signs available in certain instances to stations in repeater operation.¹ We concluded that our proposal to eliminate "WR" call signs, when taken with our other call sign proposals, would, if adopted, result in a simpler and fairer call sign assignment system and would permit us to concentrate our resources on areas more productive for the Amateur Radio Service.²

WHAT DID THE COMMENTS SAY?

6. The majority of those commenting on our proposed simplification of the amateur station call sign system did not address the question of the elimination of "WR" call signs for stations in repeater operation. Rather, most respondents focused their comments on other aspects of the call sign proposals, such as the proposals to eliminate the provisions of the rules which permitted former holders of specific call signs to acquire those call signs and which permitted licensees holding so-called "preferred" call signs (i.e., call signs consisting of one or two letters, followed by one digit, followed by two letters, or call signs consisting of one letter, followed by one digit, followed by three letters) to retain preferred call signs when changing their station locations from one call sign region to another call sign region.

7. The comments about the proposed elimination of "WR" call signs were, for the most part, negative. Although we cannot discuss each comment individually, because of the number we received, the following were representative of the arguments advanced against the elimination of "WR" call signs:

a. Programming of automatic identification equipment to transmit the call sign of a station in repeater operation would be difficult, particularly if the call signs of more than one amateur station are to be used for identifying the station placed in repeater operation.

b. No one would be willing to "lend" his primary station call sign to a station in repeater operation, since to do so would make the person "lending" his call sign responsible for the transmissions of all users of the station in repeater operation, including those transmissions which violate the Commission's rules.

c. Many amateur licensees travel extensively around the United States. In order to make effective use of existing repeater stations, amateur licensees who travel must use published directories listing repeater stations in oper-

¹In both our Notice of Proposed Rulemaking and Report and Order in Docket 21033 we recognized the desirability, both from the user's standpoint and the enforcement standpoint, of providing a mechanism by which one monitoring a frequency knows whether or not he is listening to a station in repeater operation. We adopted a rule requiring a station in repeater operation to transmit either the letters "RPT" or the word "repeater" after the station call sign when identifying.

ation. Elimination of "WR" call signs would diminish the utility of such directories and make operation away from home more difficult for amateur licensees.

d. The call signs of existing repeater stations are well known. To eliminate distinctive call signs for repeater stations would unnecessarily complicate repeater operation.

e. It is important in situations involving interference to or from a station in repeater operation that the station in repeater operation be readily identifiable. To eliminate "WR" call signs should make identification and location of stations in repeater operation more difficult than it is today.

WHAT ACTION ARE WE TAKING AND WHY?

8. We have carefully reviewed all the comments we received addressing the issue of "WR" call signs for stations in repeater operation, and have concluded that the arguments against elimination of "WR" call signs, although far from frivolous, are outweighed by other, more compelling considerations, namely, the extension of the principle adopted in the First Report and Order that each amateur operator should have one station license and one station call sign. Accordingly, we will no longer issue "WR" call signs to stations in repeater operations.³ Licensees of stations with "WR" call signs will not be permitted to retain those call signs after the expiration of their station licenses.

9. In eliminating the availability of "WR" call signs for stations in repeater operation, we emphasize our firm belief that our action will not adversely affect operations conducted in the Amateur Service. The elimination of "WR" call signs, taken in connection with our simultaneous elimination of separate licenses for repeater stations in Docket 21033, means that any station may be placed in repeater operation, using its existing call sign, without prior Commission authorization. Amateur stations were operated as repeater stations for many years before the Commission adopted regulations governing the licensing and operation of repeater and associated stations in Docket 18803, 37 FCC 2d 225 (1972). Thus, until little more than five years ago, the Commission had issued no "WR" call signs whatsoever. Moreover, the Commission's decision in 1972 to require separate licenses and call signs for stations in repeater operation was not particularly well received by the amateur community at that time. We found it odd, to say the least, that there is now so much opposition to action which just five years ago would have been overwhelmingly approved by amateur licensees. In sum, what we are doing in this proceeding and in Docket 21033 is to relieve unnecessary restrictions on amateur licensees, to make it easier for amateurs to place stations in repeater operation, and to relieve the Commission of an administrative burden which has proven to be unnecessary.⁴

10. We do not think the arguments against eliminating the availability of "WR" call signs are persuasive.

a. Programming of automatic identification equipment to transmit primary, secondary or club station call signs, instead of "WR" call signs, should not present licensees with a significant problem. Indeed, after the Commission adopted new repeater operations regulations on September 1977, but before those regulations were stayed in November 1977, many amateurs prepared to place new stations in repeater operation. We are not aware of such substantial difficulty encountered by the licensees of such stations in programming their automatic identifiers to transmit non-"WR" call signs, although it has been brought to our attention that some automatic programming equipment cannot retain

²The processing of repeater station licenses has been "frozen" since September 21, 1977. The last "WR" call sign has, therefore, already been issued.

³In this connection, we refer the reader to paragraphs 7-9 of our First Report and Order in this proceeding, in which we indicate that elimination of all special call sign programs will have a substantial beneficial effect on the efficiency of our amateur processing system.

all the characters (e.g., WB6XXX/RPT) our rules require to be transmitted as station identifying by stations in repeater operation.⁵

b. We believe the contention that no one would be willing to permit his primary station call sign to be used by a station in repeater operation has no merit. It is true that the licensee of such a station would be responsible for all transmissions of the station, including those in violation of our rules; however, the licensee is always responsible for the proper operation of his station, whether or not it has a "WR" call sign. If an existing repeater station is affiliated with a club, the station trustee is legally responsible for the station's transmissions. If a repeater station is licensed to an individual amateur, he is as responsible for the proper operation of the repeater station as he is for the proper operation of his primary station. In this regard, whether a station is assigned a "WR" call sign or not makes no legal difference whatsoever. The licensee is always responsible for the proper operation of his station.

c. We are aware that many amateurs travelling around the United States make use of open-access repeater stations when they are away from home. We are also aware that amateurs who are away from home rely frequently on published repeater directories to determine the frequencies and call signs of repeater stations in various parts of the country. We do not believe, however, that elimination of the availability of "WR" call signs will significantly affect the utility or reliability of repeater directories. Nor do we believe that elimination of "WR" call signs will make it more difficult for amateurs travelling away from home to make use of stations in repeater operation. We presume that the frequencies used by new stations placed in repeater operation, without "WR" call signs, will be coordinated as they have been in the past, with amateur repeater councils. We further presume that most new stations placed in repeater operation will, upon successful frequency coordination, be listed in the various published repeater directories, in the same way a station with a "WR" call sign is listed. The absence of a "WR" call sign simply makes no difference from an operational standpoint.

d. It may be true that the call signs of some existing repeater stations are well known. We do not believe, however, that elimination of "WR" call signs for stations in repeater operation would cause much, if any, confusion. Firstly, most amateur operators are accustomed to dealing with many different call signs in their everyday operations. Amateur operators will, we believe, experience no difficulty adapting to new call signs for stations in repeater operation. Secondly, and more importantly, it has been our experience that many amateurs are, for the most part, unaware of repeater station call signs, or, if they are aware, tend to downplay their significance. That is, most amateurs place much greater importance on the frequencies on which a repeater station operates than on the call sign of a repeater station. For example, most amateur operators would refer to WR3XXX, operating on 146.31 MHz/146.91 MHz, not as WR3XXX, but as the "31/91 machine." Our respondents in this proceeding therefore appear to have greatly overemphasized the importance of "WR" call signs for stations in repeater operation.

e. We agree that it is very important in cases in which a station in repeater operation causes radio frequency interference that it be easy to identify and locate the station in repeater operation. We do not believe, however, that a "WR" call sign makes any perceptible difference one way or the other in the resolution of interference complaints. If a station is in repeater operation with a non-"WR" call sign and is causing interference, it should be no more difficult to contact the licensee than if a station with a "WR" call sign were causing the interference.

⁵In Docket 21033 we are amending our identification rule to permit licensees employing telegraphy for identification to append either "R" or "RPT" to their station call signs.

The mailing address of the licensee and the station's location are contained in Commission records both for stations with "WR" call signs and stations without "WR" call signs. Resolution of interference complaints would, therefore, not be made any more difficult by permitting stations in repeater operation to use non-"WR" call signs.

CONCLUSION

11. In conclusion, we have shown that the issuance of "WR" call signs constitutes an unnecessary drain on our limited resources, that elimination of "WR" call signs will have no significant effect on amateur repeater operations, and that the arguments of those objecting to the elimination of "WR" call signs are without merit. Accordingly, we order that no new "WR" are to be issued. Licensees now assigned "WR" call signs may continue to use those call signs until the expiration dates of their station licenses. (We note that stations assigned "WR" call signs are exempt from the station identification requirements of Section 97.84(d)(1) of the Rules.)

12. We are continuing Docket 21135.

FEDERAL COMMUNICATIONS
COMMISSION,
WILLIAM J. TRICARICO,
Secretary.

PART 97—AMATEUR RADIO SERVICE

Deregulation of Rules To Simplify the Licensing and Operation of Complex Systems of Stations and Modify Repeater Subbands in the Amateur Radio Service

AGENCY: Federal Communications Commission.

ACTION: Final rules.

SUMMARY: The FCC is amending its Amateur Radio Service rules to eliminate the availability of repeater, auxiliary link, and control station licenses. We are also making several other changes in the rules governing the operation of repeater and associated stations. We are taking this action in response to several petitions requesting that we reconsider action we had originally taken in September 1977. We expect our action will make it much easier for amateur operators wishing to place their stations in repeater operation to do so.

EFFECTIVE DATE: May 15, 1978.

ADDRESS: Federal Communications Commission, Washington, D.C. 20554.

FOR FURTHER INFORMATION CONTACT:

Robert Cassler, Personal Radio Division, Safety and Special Radio Services Bureau, 202-634-6620. (This is not a toll-free number.)

SUPPLEMENTARY INFORMATION:

Adopted: March 22, 1978.

Released: April 6, 1978.

By the Commission: Commissioner White dissenting.

In the matter of deregulation of part 97 of the Commission's rules to simplify the licensing and operation of complex systems of stations and modify repeater subbands in the Amateur Radio Service.

1. The Commission has before it eight petitions for reconsideration of the action it took in Docket 21033 on September 21, 1977. These petitions were filed by the American Radio Relay League, Newington, Conn.; Robert Bingham, Elgin, Ill.; Laurent J. Blouin, Derry, N.H.; The Chicago FM Club, Arlington Heights, Ill.; Corwin D. Moore, Jr., on behalf of the Michigan Area Repeater Council, Ann Arbor, Mich.; Joseph H. Reisert, Jr., of Chelmsford, Mass.; The San Antonio Repeater Organization (SARO), San Antonio, Tex.; and Paul Wade, Somerville, N.J., all according to section 1.429 of the Commission's rules.

BACKGROUND

2. The Commission proposed in a notice of inquiry and notice of proposed rulemaking in Docket 21033, released January 6, 1977 (42 FR 2089), to substantially change many of the rules governing the licensing and operation of repeater stations and associated stations in the Amateur Radio Ser-

vice. We proposed at that time to end the separate licensing of repeater, auxiliary link, and control stations, to open up nearly all amateur bands for repeater operations and to reduce the station identification and logging requirements for repeater operation. These proposals were in furtherance of the Commission's policy of deregulation of the Amateur Radio Service, and simplification of licensing of Amateur radio stations. The Commission also cited progress amateurs had made toward self-regulation in the operation and development of complex systems of stations.

3. Final regulations in Docket 21033 were adopted by the Commission, and released September 27, 1977 (42 FR 52418). In this action, the Commission changed the amateur rules to allow amateurs to operate repeaters without requiring a separate license. It opened all frequencies above 220 MHz to repeater operation (except for 435-438 MHz) and added 144.5 to 145.5 MHz as a repeater subband in the 144-148 MHz amateur band. The Commission increased Technician Class operating privileges to include this new repeater subband. Logging and station identification requirements were relaxed. The Commission said that elimination of separate repeater, auxiliary link and control stations will enable it to provide the public with better service in processing primary station and operator license applications.

4. The Commission received eight petitions to reconsider the rule changes adopted in Docket 21033. The rule changes were to have taken effect on November 4, 1977. However, the American Radio Relay League filed a petition for stay of the effective date of the rule changes, citing the possibility of irreparable harm if the rules were to take effect before the Commission had an opportunity to consider the eight petitions for reconsideration. Therefore, by action of the Commission the effective date of the regulations adopted in the report and order in Docket 21033 was stayed until further order of the Commission.

5. The American Radio Relay League subsequently filed a petition to modify the stay order on November 23, 1977. In the petition it states that it had become clear that the content of the petitions for reconsideration indicated only three areas of controversy, and that the public interest would be served by modifying the stay order so that the noncontroversial changes in the rules can become effective at an early date. On February 9, 1978, the Chief, Safety and Special Radio Services Bureau, acting under delegated authority, waived sections, 97.40, 97.43, 97.88, and 97.126 of the Commission's rules to permit licensed amateurs to operate repeater, auxiliary link, control or remotely controlled stations without prior Commission approval.

THE PETITIONS

6. There were three areas of controversy raised by the petitions for reconsideration: The licensing of repeater stations and "WR" call signs; the expansion of the repeater subbands; and the effect of the rule changes on the operating privileges of the Technician Class license holder.

7. *Repeater licensing.* Five petitioners urged the Commission to reconsider its decision which ended separate licensing for repeater, auxiliary link, and control stations and discontinued the issuance of "WR" call signs for repeater stations. The American Radio Relay League argues that repeater stations, by their nature, must operate on fixed frequencies, and that these fixed frequencies must be coordinated. Voluntary frequency coordination has been extremely effective under the present system where an amateur must get a separate repeater license and call sign. The ARRL feels that by removing the requirement of a repeater license it will "substantially decrease the possibility that voluntary cooperation and coordination by amateurs will continue to be effective and practical." The Michigan Area Repeater Council agrees with the ARRL that coordination is important and asserts that the Commission's contention in its report and order in Docket 21033 that "fly-by-night" operations will not occur because of the expense and planning involved in setting up a repeater station is "unfortunate and

mistaken." "Very inexpensive repeaters could be built out of junk-box parts . . . a transmitter and receiver strip . . . and a moderate dose of that infamous Amateur home-brew ingenuity." The Michigan Area Repeater Council is concerned that without the identifying factor of a license or a "WR" call sign, the amateur community's capability of self-enforcement will be impaired.

8. Similar fears of disorderly use of the frequencies by amateurs are expressed by petitioners Laurent Blouin, Robert Bingham, and Joseph Reisert, Jr. All three point to the increased risk of interference from unlicensed repeater operation.

9. The ARRL also asserts that ending "WR" call signs for currently licensed repeater stations was not within the scope of our original proposal. It cites the notice of proposed rulemaking in which we said, "We propose to discontinue our policy of assigning call signs prefixed with the letters 'WR'." Stations presently assigned such call signs would be permitted to retain them indefinitely. A licensee wishing to engage in repeater operation and wishing to obtain a "WR" call sign would be required to request the prefix." In the final draft of the rules, the Commission stated that those holding "WR" call signs would not be able to renew them, nor could anyone get one on request. The ARRL petition states that this action was contrary to the Administrative Procedure Act by failing to give notice to the public that "WR" call signs would be discontinued entirely.

10. *Repeater subbands.* Five petitioners requested reconsideration of the Commission's expansion of the repeater subbands. The major thrust of the arguments was that allowing repeater operation on all amateur frequencies above 220 MHz would significantly interfere with a number of amateur activities in the VHF and UHF bands. According to petitioner Joseph Reisert, Jr., the amateur frequencies 144 through 450 MHz are all used for weak signal reception, experimental communications systems, EME (Earth Moon Earth, or moon bounce) communications, tropospheric propagation and state-of-the-art equipment design. All these activities, he says are examples of amateurs contributing "to the advancement of the radio art." one of the bases and purposes of amateur radio as stated in section 97.1(b). Petitioner Paul Wade adds that "the weak-signal communications are obviously subject to interference by strong signals; the capability of a well-located repeater to unwittingly disturb weak-signal communications at distances far removed from its normal service area illustrates the incompatibility of the two modes." Laurent Blouin states that it is impossible to do "any serious work on weak signal detection if high power FM operations were within 1 MHz of the serious operator."

11. The ARRL, Laurent Blouin, Joseph Reisert, Jr., and Paul Wade mentioned specific subbands they would like to see protected. All four argued that 220.0 to 220.5 MHz, and 431-433 MHz should be set aside (432 MHz is the frequency currently being used for satellite and moon bounce communications), and protected from repeater operation. The ARRL, Joseph Reisert, Jr., and Laurent Blouin also want protection for 222.0 to 222.5 MHz. Paul Wade and the ARRL want 1290 to 1300 MHz protected for future amateur satellite use.

12. The ARRL further argues that when the Commission added 144.5 to 145.5 as a repeater subband, it had done so without adequate notice to the public. The ARRL states that because the notice of proposed rulemaking invited comments only on the proposal to make all frequencies allocated to the Amateur Radio Service except 435 to 438 MHz available for repeater and auxiliary operation, alternatives, such as additional subbands, could not be considered.

13. *Technician class privileges.* Four petitioners are concerned with how the expansion of the repeater subbands to include 144.5 to 145.5 MHz will affect Technician Class operators.

Traditionally, 145 MHz has been used by Technician Class operators for single sideband (SSB) and telephony operation. Joseph Reisert, Jr. states that the report and order in Docket 21033 "actually takes away rather than gives the technicians any extra privileges since the present c.w. area of 145 to 145.3 MHz will now be open to repeaters and FM." The Chicago FM Club states that "repeater councils across the country are working on a band plan that would provide 'protected' space on a voluntary basis from 144.9-145.1 MHz for SSB/CW operation. But the voluntary plan has some limitations." They go on to state that the only effective solution would be to allow Technician Class operators to operate from 144.2-148.0 MHz.

14. The San Antonio Repeater Organization (SARO) argues that FM repeater use of 144.5 to 145.5 MHz "displaces established SSB use by Technicians without providing new spectrum where they may relocate along with higher class licensees." SARO would extend radiotelephony privileges for Technician Class operators downward to 144.1 MHz. Laurent Blouin argues that if Technician Class operators must share 144.5 to 145.5 MHz with FM repeater operation, there would be no incentive for the holder of the Technician Class license to upgrade. He would allow Technician Class operators telephony privileges from 144.0-148.0 MHz and radio telephony privileges from 144.2 to 148.0 MHz.

15. *Comments.* There were 18 comments filed in response to the 8 petitions for reconsideration. Three of the comments opposed the petitions. Fifteen of the comments supported the petitions on at least one of the three issues they raised. The breakdown of support was as follows: Eight commenters were for protection of weak-signal activities, nine commenters wanted to retain separate licensing for repeater stations and "WR" call signs, seven commenters were for added operating privileges for Technician Class license holders. The total adds to more than 15 because many commenters commented on more than one issue.

DISCUSSION

16. *Repeater licensing.* The requirement that amateurs who want to operate a repeater station first obtain a separate repeater license from the Commission was imposed originally in 1972 in Docket 18803. 37 FCC 2d 225 (1972). Before 1972, repeaters were not specifically mentioned in the amateur rules. Amateurs who operated repeaters before 1972 did so under the general guidance of the rules which applied to amateur operation and without a separate repeater license. The Commission, in Docket 18803, sought to emphasize that repeater operation required special rules. To ensure that these new rules were adhered to, the Commission required a separate license based on a substantial showing by the amateur applicant. The information required by the Commission from an applicant included a system network diagram, antenna radiation patterns, certain calculations for effective radiated power and height above average terrain, and technical data relating to remotely controlled stations, control stations, and auxiliary link stations. The requirements for these showings were intended "to verify that the applicant has given careful consideration to the planning and design of his repeater station, addressing particular attention to the geographical area to be covered." 37 FCC 2d 225, 228 (1972).

17. In a long line of rulemaking proceedings beginning in 1974, the extensive showings required by the Commission and several of the more restrictive rules governing repeater operation were gradually dropped. For example, in an Order adopted January 10, 1974, we deleted the requirement that the applicant supply the Commission with his calculations of the effective radiated power and antenna height above average terrain of his proposed station. In Docket 20073, adopted May 28, 1975, the Commission permitted the linking of amateur repeater stations. In Docket 20112, adopted June 11, 1975, the Commission authorized the automatic control of repeater stations under certain conditions. In Docket 20113, adopted October 29, 1975, the Commission permitted crossband oper-

*Neither 432 MHz nor 1290 MHz-1300 MHz is available to the Amateur satellite Service.

ation of repeater stations. In addition, by Order of the Commission on November 17, 1975, we removed the requirement that the repeater applicant file certain technical data relating to remotely controlled stations, control stations, and auxiliary link stations, and we allowed portable/mobile operation of remotely controlled stations.

18. This policy of deregulation has brought us to the point where, at present, an applicant for a repeater station need show no more than he is an amateur, and holds at least a Technician Class license. This tremendous shift in regulatory policy has been based on conditions in amateur radio as the Commission has perceived them. Before 1972, the privilege of operating through a repeater was abused by some amateurs, partially out of an unfamiliarity with what new ground rules should apply to this type of operation. Gradually, as conditions stabilized, and as the amateurs learned more about self-regulation and local frequency selection, the Commission deregulated by relieving rule restrictions, and simplifying application procedures. The cooperation amateurs have shown in the use of the amateur frequencies was recognized by the ARRL in comments it filed to the Notice of Proposed Rule Making in this proceeding. In response to our proposal to establish principles of priority of use of amateur frequencies, it argued that the number of troublesome situations in amateur radio were infinitesimal. The ARRL went on to say that all but a few of the "disagreements over repeater frequencies have been effectively resolved by voluntary frequency coordination." Comments, ARRL at 30.

19. In Docket 21033 we proposed to take the next logical step and end the requirement for a separate license for repeaters. This was done in recognition that the original function of repeater licensing, namely, the stabilization of a new situation, had been served. However, the petitioners in this docket argue that a repeater license is still necessary and still serves a function. The expressed fear is that the situation will become chaotic if any amateur, Technician Class or above, can set up a repeater. However, the state of affairs at present is that any amateur, Technician Class or above, can set up a repeater simply by checking off the appropriate box on the Form 610 and waiting for a repeater license. There is simply no longer any practical purpose served by the licensing process. We should also note that some amateurs have also expressed the fear that, without separate repeater licenses, amateurs who operate their primary stations as repeaters might place their primary station licenses in jeopardy for rule violations committed by users of the repeater. In this regard, the Commission intends to treat the repeater users as being primarily liable for operational rule violations, and will look to the repeater licensee only to the extent that he fails to meet his obligation to provide adequate control of his repeater. As a practical matter, our enforcement efforts in the past have proceeded on this basis. In many instances, we have worked with repeater licensees in tracking down users who commit rule violations through repeaters.

20. To do away with repeater licensing is to do more than relieve the amateur of an exercise he has shown he can do without. It also means the Commission will be able to allocate its resources more efficiently and process other applications in a timely manner. When the Commission announced its freeze on new repeater applications in September, 1977, the Commission had over 3,000 unprocessed repeater license applications on hand. Each application would have required special processing apart from the normal handling given an amateur application, and represented a sizable diversion of Commission manpower from the processing of primary station and operator licenses. Yet, even when the repeater application is finally processed, a large number of these new repeater licenses go unused. We estimate that some 1,500 of the repeater licenses granted by the Commission in the past 5 years were for stations that were never built. Clearly, this amounts to a waste of valuable manpower which could be used much more profitably in

other areas.

21. However, the ARRL and others argue that regardless of whether licensing serves a practical function, it does serve a psychological function in that it makes the amateur aware that he is responsible for the proper operation of his repeater. We believe, though, that an amateur is psychologically aware of his responsibilities when he becomes an amateur, and it is not necessary for the Commission to remind the amateur of his responsibilities each time he enters a new field of operation. Would this type of psychological reminder be necessary for sending radio teletypewriter signals? slow-scan television signals? or communicating through the amateur satellites?

22. We are therefore affirming the decision made by the Commission in the First Report and Order in Docket 21033 to end the requirement of a separate license for repeater, auxiliary link and control stations.

23. "WR" call signs. We agree with the ARRL's contention that adequate notice was not given in the Notice of Proposed Rule Making in Docket 21033 that "WR" call signs for repeaters stations might be discontinued. That proposal was made in Docket 21135, not Docket 21033. The Commission today is adopting a Second Report and Order in Docket 21135 specifically on the issue of "WR" call signs, which deletes the availability of "WR" call signs for repeater operation. For a discussion of that issue, the reader is referred to the Second Report and Order in Docket 21135. The station identification rules adopted in the First Report and Order in Docket 21033 in lieu of "WR" call signs have been modified in response to the petition filed by the Chicago FM Club. The rules, as originally adopted, required that a station, when identifying by telegraphy, transmit the amateur's call sign followed by "RPT" if in repeater operation, or "AUX" if in auxiliary operation. The Chicago FM Club argues that this method of station identification "constitutes an excessive number of characters" and that the "majority of repeater identification devices lack the capacity to add the characters "RPT" without extensive rebuilding." We agree with the Chicago FM Club. The new rules will give amateurs a choice. They may add either the suffix "R" or the suffix "RPT" when identifying a repeater operation by telegraphy. Similarly, amateurs will be given the choice of "A" or "AUX" when identifying an auxiliary operation.

24. In addition, in response to requests from two petitioners, the Chicago FM Club and the Michigan Area Repeater Council, we are making clear exactly when the repeater identifier is to be used. If an amateur is operating a repeater under the remaining term of his repeater license, he may identify his station either under his "WR" call sign, or he may identify under his primary station call sign followed by the repeater identifier ("R" or "RPT"), if telegraphy, "repeater", if telephony. There is no requirement to add the repeater identifier to a "WR" call sign. Of course, amateurs operating new repeaters must use the new repeater identification, because "WR" call signs are no longer available.

25. Repeater subbands. Before the question of repeater subbands can be resolved, there is the issue of notice raised by the ARRL: did the Commission give adequate notice to the public that new repeater subbands might be created when it proposed to make all amateur frequencies available to repeater operation? The Administrative Procedure Act requires that the notice of the proposed rule include, "either the terms or substance of the proposed rule, or a description of the subject and issued involved." 5 U.S.C. 553(b)(3). In the Notice of Proposed Rulemaking in this proceeding, the Commission proposed to make all amateur frequency bands, except 435-438 MHz, available for repeater operation. The comments which the Commission received indicated that problems existed with the proposed rule because it would create the danger of incompatibility with other amateur activities. Accordingly, the Commission, in its First Report and Order in Docket 21033, adopted a partial expansion of the repeater subbands, limiting it to amateur frequencies above 220 MHz

and adding a one megahertz repeater subband in the two meter band, 144.5-145.5 MHz.

26. The ARRL argues that the creation of a one megahertz repeater subband at 144.5-145.5 MHz was not proposed originally. It contends that rules setting aside repeater subbands can not be adopted when the public is only given notice that the Commission is considering making all amateur frequencies available to repeaters. Yet, it is well established that "a notice of rulemaking is sufficient if it provides a description of the subjects and issues involved." *California Citizens Band Ass'n v. United States*, 375 F. 2d 43, 49, certiorari denied, 389 U.S. 844 (1967). See also, *Mt. Mansfield Television, Inc. v. FCC*, 442 F. 2d 470 (1971), and *Buckeye Cablevision, Inc. v. FCC*, 128 U.S. App. D.C. 262, 387 F. 2d 220 (1967). Further, the Administrative Procedure Act "does not require an agency to publish in advance every precise proposal which it may ultimately adopt as a rule." *California Citizens Band Ass'n*, supra, at 48. The position taken by the ARRL denies the purpose of a rulemaking proceeding—to allow an agency the flexibility it needs to shape the final rule on the basis of the comments it receives. The Administrative Procedure Act does not require an agency to either adopt or reject a proposal in total. This would be too rigid a restriction on the capability of an agency to act. The public comments indicated that in the two meter band, 144.0-144.5 MHz and 145.5-146.0 MHz were not appropriate for repeater activity, and therefore we declined to make those frequency ranges available to repeater operation. It seems clear that the public was on notice as to our proposed actions, and wanted us to consider alternative solutions, short of a total expansion of the repeater bands. We therefore find that proper notice was given the public on the issue of repeater subbands.

27. We turn now to the arguments of the petitioners on repeater subbands. In our First Report and Order in Docket 21033, we stated that we believed that weak signal work and other amateur activities should be afforded protection from repeater transmissions, and accordingly set out the 144.0-144.5 and 145.5-146.0 MHz ranges as ranges which would not be available to repeater operation. It has become apparent from the several Petitions for Reconsideration that we should set aside additional frequency ranges that would be free from repeater operation. We will therefore not allow repeater or auxiliary operation in the 220.0-220.5 MHz and 431-433 MHz ranges. According to the petitioners, these subbands contain the bulk of the experimentation with moon bounce and satellite transmissions being carried out today.

28. At the same time, we do not feel that the other two subbands mentioned by the petitioners require protection. 222.0-222.5 MHz was a part of the original repeater subband of 222-225 MHz when repeater subbands were established in 1972, and we can see no reason to afford it any protection now. 1290-1300 MHz was cited by two petitioners as requiring protection for future satellite activity. To the best of our knowledge, there are no repeaters in the United States in that band, nor is there any satellite activity. We would prefer, given these circumstances, to await future development of the band by amateurs, fully expecting that the band is wide enough to accommodate many amateur activities.¹

29. Technician Class privileges. The Commission has proposed in Docket 20282 to give Technician Class operators full privileges in the two meter band, 144-148 MHz. This would, in effect, give to Technician Class amateurs the privileges sought by the petitioners in this docket. Therefore, the Commission today is adopting a Second Report and Order in Docket 20282 granting, among other things, full privileges to Technician Class operators in the 144-148 MHz band.

30. Accordingly, in view of the foregoing, it is ordered, That the Petitions for Reconsideration of the Commission's action in Docket 21033 submit-

ted by the American Radio Relay League, Robert Bingham, Laurent J. Blouin, the Chicago FM Club, the Michigan Area Repeater Council, Joseph H. Reiser, Jr., the San Antonio Repeater Organization, and Paul Wade are granted to the extent indicated in paragraphs 23, 27, and 29, supra, and are otherwise denied. It is further ordered, That the Petition to Modify the Stay Order filed by the American Radio Relay League is dismissed as moot. It is further ordered, That pursuant to authority contained in Sections 4(i) and 303 of the Communications Act of 1934, as amended, Part 97 of the Commission's Rules IS AMENDED as set forth in the attached Appendix, effective May 15, 1978. It is further ordered, That the Stay Order in Docket 21033, adopted November 4, 1977, and the "freeze" announced in that Stay Order on the filing of applications for new repeater, auxiliary link and control station licenses are continued until the effective date of these regulations.

(Secs. 4, 303, 307, 48 Stat., as amended, 1066, 1082, 1083; 47 U.S.C. 154, 303, 307.)

FEDERAL COMMUNICATIONS
COMMISSION,
WILLIAM J. TRICARICO,
Secretary.

Part 97 of Chapter 1 of Title 47 of the Code of Federal Regulations is amended, as follows:

1. In §97.3, paragraph (i) is deleted, paragraphs (j), (k), and (l) are redesignated (i), (j), and (k), respectively, paragraph (m) is redesignated paragraph (l) and in that paragraph, the definition of amateur radio operation is amended, and new definitions of repeater operation and auxiliary operation are added, paragraph (n) is redesignated paragraph (m) and in that paragraph, the definitions of control and automatic control are amended, and paragraphs (o), (p), (q), (r), (s), (t), (u), (v), (w), (x), (y), (z), and (aa), are redesignated (o), (p), (q), (r), (s), (t), (u), (v), (w), (x), (y), and (z) respectively.

§ 97.3 Definitions.

(l) *Amateur radio operation.* Amateur radio communication conducted by amateur radio operators from amateur radio stations, including the following:

Mobile operation. Radiocommunication conducted while in motion or during halts at unspecified locations.

Repeater operations. Radiocommunication, other than auxiliary operation, for retransmitting automatically the radio signals of other amateur radio stations.

Auxiliary operations. Radiocommunication for remotely controlling other amateur radio stations, for automatically relaying the radio signals of other amateur radio stations in a system of stations, or for intercommunicating with other amateur radio stations in a system of amateur radio stations.

(m) *Control* means techniques used for accomplishing the immediate operation of an amateur radio station. Control includes one or more of the following:

(3) *Automatic control* means the use of devices and procedures for control so that the control operator does not have to be present at the control point at all times. (Only rules for automatic control of stations in repeater operation have been adopted.)

§ 97.40 [Amended]

2. In § 97.40, paragraphs (c), (d), and (e), are deleted.

§ 97.41 [Amended]

3. In § 97.41, paragraphs (b) and (c) are deleted, and paragraph (d) and (e) are redesignated paragraphs (b) and (c) respectively.

4. § 97.43 is revised to read, as follows:

§ 97.43 Location of station.

Every amateur radio station shall

¹ See n. 1, supra at 4.

have one land location, the address of which appears in the station license, and at least one control point.

5. In §97.61, paragraphs (a) and (c) are revised and a new paragraph (d) is added, as follows:

§97.61 Authorized frequencies and emissions.

(a) The following frequency bands and associated emission are available to amateur radio stations for amateur radio operation, other than repeater and auxiliary operation, subject to the limitations of Section 97.85 and paragraph (b) of this section. * * *

(c) All amateur frequency bands above 29.5 MHz are available for repeater operation, except 50.0-52.0 MHz, 144.0-144.5 MHz, 145.5-146.0 MHz, 220.0-220.5 MHz, 431.0-433.0 MHz, and 435.0-438.0 MHz. Both the input (receiving) and output (transmitting) frequencies of a station in repeater operation shall be frequencies available for repeater operation.

(d) All amateur frequency bands above 220.5 MHz, except 431-433 MHz, and 435-438 MHz, are available for auxiliary operation.

6. In §97.63, the headnote is revised and the text amended, as follows:

§97.63 Selection and use of frequencies.

(a) An amateur station may transmit on any frequency within any authorized amateur frequency band.

(b) Sideband frequencies resulting from keying or modulating a carrier wave shall be confined within the authorized amateur band.

(c) The frequencies available for use by a control operator of an amateur station are dependent on the operator license classification of the control operator and are listed in §97.7.

7. In §97.67, paragraph (c) is revised to read, as follows:

§97.67 Maximum authorized power.

(c) Within the limitations of paragraphs (a) and (b) of this section, the effective radiated power of an amateur radio station in repeater operation shall not exceed the power specified for the antenna height above average terrain in the following table:

Antenna height above average terrain	Maximum effective radiated power for frequency bands above			
	52 MHz	144.5 MHz	420 MHz	1215 MHz
	Watts	Watts	Paragraphs (a) and (b).	Paragraphs (a) and (b).
Below 50 ft	100	800dodo
50-99 ft	100	400dodo
100-499 ft	50	400	800 Wdo
500-999 ft	25	200dodo
Above 1,000 ft	25	100	400 Wdo

8. §97.83 is redesignated §97.82, as follows:

§97.82 Availability of operator license.

9. §97.85 is redesignated §97.83, as follows:

§97.83 Availability of station license.

10. §97.87 is redesignated §97.84, and paragraphs (c), (d), and (e) are revised, as follows:

§97.84 Station identification.

(c) An amateur radio station in repeater operation or a station in auxiliary operation used to relay automatically the signals of other stations in a system of stations shall be identified by radiotelephony or radiotelegraphy at a level of modulation sufficient to be intelligible through the repeated transmission at intervals not to exceed ten minutes.

(d) When an amateur radio station is in repeater or auxiliary operation, the following additional identifying information shall be transmitted:

(1) When identifying by radiotelephony, a station in repeater operation shall transmit the word "repeater" at the end of the station call sign. When

identifying by radiotelegraphy, a station in repeater operation shall transmit the fraction bar DN followed by the letters "RPT" or "R" at the end of the station call sign. (The requirements of this subparagraph do not apply to stations having call signs prefixed by the letters "WR".)

(2) When identifying by radiotelephony, a station in auxiliary operation shall transmit the word "auxiliary" at the end of the station call sign. When identifying by radiotelegraphy, a station in auxiliary operation shall transmit the fraction bar DN followed by the letters "AUX" or "A" at the end of the station call sign.

(e) A station in auxiliary operation may be identified by the call sign of its associated station.

11. A new §97.85 is added, as follows:

§97.85 Repeater operation.

(a) Emissions from a station in repeater operation shall be discontinued within five seconds after cessation of radiocommunications by the user station. Provisions to limit automatically the access to a station in repeater operation may be incorporated but are not mandatory.

(b) Except for operation under automatic control, as provided in paragraph (e) of this section, the transmitting and receiving frequencies used by a station in repeater operation shall be continuously monitored by a control operator immediately before and during periods of operation.

(c) A station in repeater operation shall not concurrently retransmit amateur radio signals on more than one frequency in the same amateur frequency band, from the same location.

(d) A station in repeater operation shall be operated in a manner ensuring that it is not used for one-way communications, except as provided in §97.91.

(e) A station in repeater operation, either locally controlled or remotely controlled, may also be operated by automatic control when devices have been installed and procedures have been implemented to ensure compliance with the rules when a duty control operator is not present at a control point of the station. Upon notification by the Commission of improper operation of a station under automatic control, operation under automatic control shall be immediately discontinued until all deficiencies have been corrected.

12. A new §97.86 is added, as follows:

§97.86 Auxiliary operation.

(a) A station in auxiliary operation, either locally controlled or remotely controlled, may also be operated by automatic control when it is operated as part of a system of stations in repeater operation operated under automatic control.

(b) If a station in auxiliary operation is relaying signals of another amateur radio station(s) to a station in repeater operation, the station in auxiliary operation may use an input (receiving) frequency in frequency bands reserved for auxiliary operation, repeater operation, or both.

(c) A station in auxiliary operation shall be used only to communicate with stations shown in the system network diagram.

13. In Section 97.88, the headnote, introductory paragraph, paragraphs (a), (b), (c), and (e) are amended to read as follows:

§97.88 Operation of a station by remote control.

An amateur radio station may be operated by remote control only if there is compliance with the following:

(a) A photocopy of the remotely controlled station license shall be—
(1) Posted in a conspicuous place at the remotely controlled transmitter location, and
(2) Placed in the station log of each authorized control operator.

(b) The name, address, and telephone number of the remotely controlled station licensee and at least one control operator shall be posted in a conspicuous place at the remotely controlled transmitter location.

(c) Except for operation under automatic control, a control operator shall be on duty when the station is being remotely controlled. Immediately before and during the periods the remotely controlled station is in operation, the frequencies used for emission by the remotely controlled station shall be monitored by the control operator. The control operator shall terminate all transmissions upon any deviation from the rules.

(e) A station in repeater operation shall be operated by radio remote control only when the control link uses frequencies other than the input (receiving) frequencies of the station in repeater operation.

§97.89 [Amended].

14. In §97.89, paragraphs (c) and (d) are deleted.

15. Section 97.95(a)(1) is revised to read, as follows:

§97.95 Operation away from the authorized fixed station location.

(a) * * *

(1) When there is no change in the authorized fixed operation station location, an amateur radio station, other than a military recreation station, may be operated portable or mobile under its station license anywhere in the United States, its territories or possessions, subject to Section 97.61.

16. In Section 97.103, paragraph (c)(5) is deleted, paragraphs (c), (c)(1), (c)(2), (c)(3), (c)(4), (d), (e), (e)(1), (e)(2), (e)(3), (e)(4), (e)(5) are amended, and (e)(6) and (e)(7) are added; paragraph (f) as amended, is redesignated as paragraph (g), and a new paragraph (f) is added to read as follows:

§97.103 Station log requirements.

(c) In addition to the other information required by this section, the log of a remotely controlled station shall have entered the names, addresses, and call signs of all authorized control operators and a functional block diagram of, and a technical explanation sufficient to describe the operation of the control link. Additionally, the following information shall be entered:

(1) A description of the measures taken for protection against access to the remotely controlled station by unauthorized persons;

(2) A description of the measures taken for protection against unauthorized station operation, either through activation of the central link, or otherwise;

(3) A description of the provisions for shutting down the station in the case of control link malfunction; and

(4) A description of the means used for monitoring the transmitting frequencies.

(d) When a station has one or more associated stations, that is, stations in repeater or auxiliary operation, a system network diagram shall be entered in the station log.

(e) In addition to the other information required by this section, the log of a station in repeater operation transmitting with an effective radiated power greater than the minimum effective radiated power listed in §97.67(c) for the frequency band in use shall contain the following:

(1) The location of the station transmitting antenna, marked upon a topographic map having a scale of

1:250,000 and contour intervals¹;

(2) The antenna transmitting height above average terrain²;

(3) The effective radiated power in the horizontal plane for the main lobe of the antenna pattern, calculated for maximum transmitter output power;

(4) The transmitter output power;

(5) The loss in the transmission line between the transmitter and the antenna, expressed in decibels;

(6) The relative gain in the horizontal plane of the transmitting antenna; and

(7) The horizontal and vertical radiation patterns of the transmitting antenna, with reference to true north (for horizontal pattern only), expressed as relative field strength (voltage) or in decibels, drawn upon polar coordinate graph paper, and the method used in determining these patterns.

(f) In addition to the other information required by this section, the log of a station in auxiliary operation shall have the following information entered:

(1) A system network diagram for each system with which the station is associated;

(2) The station transmitting band(s);

(3) The transmitter input power; and

(4) If operated by remote control, the information required by paragraph (c) of this section.

(g) Notwithstanding the provisions of §97.105, the log entries required by paragraphs (c), (d), (e), and (f) of this section shall be retained in the station log as long as the information contained in those entries is accurate.

§97.109 [Deleted]

17. §97.109 is deleted.

§97.110 [Deleted]

18. §97.110 is deleted.

§97.111 [Deleted]

19. §97.111 is deleted.

20. §97.126 is revised to read, as follows:

§97.126 Retransmitting radio signals.

(a) An amateur radio station, except a station in repeater operation or auxiliary operation, shall not automatically retransmit the radio signals of other amateur radio stations.

(b) A remotely controlled station, other than a remotely controlled station in repeater operation or auxiliary operation, shall automatically retransmit only the radio signals of stations in auxiliary operation shown on the remotely controlled station's system network diagram.

21. §97.181(b) is amended to read as follows:

§97.181 Availability of RACES station license and operator licenses.

(b) In addition to the operator license availability requirements of §97.82, a photocopy of the control operator's amateur radio operator license shall be posted in a conspicuous place at the control point of the RACES station.

AMATEUR RADIO SERVICE

Amateur Station Call Sign Assignment System

MARCH 30, 1978.

Effective March 24, 1978, section 97.51 of the Amateur Radio Service regulations requires amateur station call signs to be issued systematically, with details of the system to be made public. The following system will be effective until further notice.

WHICH PAST POLICIES AND RULES HAVE BEEN ELIMINATED?

(a) All prior call sign policies and procedures, written or unwritten, are cancelled and are hereby replaced.

(b) No requests for specific call signs will be honored.

WHAT WILL HAPPEN TO EXISTING STATIONS?

¹Indexes and ordering information for suitable maps are available from the U.S. Geologic Survey, Washington, D.C. 20242, or from the Federal Center, Denver, Colo. 80255.

²See Appendix 5.

(c) All amateurs may continue to hold their existing primary station call signs unless they request a change, even if they are moving to new call sign areas.

(d) Section 97.40 of the Commission's Rules permits only one primary station per operator. Although this is not a new limitation, licensees may have received more than one primary call sign due to processing errors. Any such licensees must choose one of the primary call signs for their sole primary station, and submit the other license for cancellation by October 1, 1978.

(e) No new secondary or special event station licenses will be issued. Existing licenses will not be renewed or modified, but may continue to operate until their expiration dates. We will permit a holder to transfer an existing secondary station call sign to the primary station anytime prior to expiration. The secondary station license will be cancelled at that time.

HOW WILL FUTURE CALL SIGNS BE ASSIGNED?

(f) (1) Initial assignment of call sign digits will conform to Table A in the contiguous 48 states and the District of Columbia:

TABLE A

Digit	Location
1	Maine, New Hampshire, Vermont, Massachusetts, Rhode Island, Connecticut.
2	New York, New Jersey.
3	Pennsylvania, Delaware, Maryland, District of Columbia.
4	Virginia, North Carolina, South Carolina, Georgia, Florida, Alabama, Tennessee, Kentucky.
5	Mississippi, Louisiana, Arkansas, Oklahoma, Texas, New Mexico.
6	California.
7	Oregon, Washington, Idaho, Montana, Wyoming, Arizona, Nevada, Utah.
8	Michigan, Ohio, West Virginia.
9	Illinois, Indiana, Wisconsin.
0	Colorado, Nebraska, North Dakota, South Dakota, Minnesota, Iowa, Missouri.

(2) Initial assignment of call sign prefixes will conform to Table B outside the contiguous 48 states:

TABLE B

Prefix	Location
AH1, KH1, NH1, WH1	Baker, Canton, Enderbury, Howland Islands.
AH2, KH2, NH2, WH2	Guam.
AH3, KH3, NH3, WH3	Johnston Island.
AH4, KH4, NH4, WH4	Midway Island.
AH5K, KH5K, NH5K, WH5K	Kingman Reef.
AH5, KH5, NH5, WH5	(Except K suffix) Palmyra, Jarvis Islands.
AH6, KH6, NH6, WH6	Hawaii.
AH7, KH7, NH7, WH7	Kure Island.
AH8, KH8, NH8, WH8	American Samoa.
AH9, KH9, NH9, WH9	Wake, Wilkes, Peale Islands.
AL7, KL7, NL7, WL7	Alaska.
KP1, NP1, WP1	Navassa Island.
KP2, NP2, WP2	Virgin Island.
KP3, NP3, WP3	Rancador Key, Quita Sueno Bank, Serrana Bank, Serranilla Bank.
KP4, NP4, WP4	Puerto Rico.

The digit or prefix from the Tables will be determined by the location of the licensee's bona fide mailing address. When the mailing address is modified, the station will automatically retain the current call sign even if the new address no longer conforms to the digit or prefix for that location. However, a licensee may request a new systematically assigned call sign conforming to the Tables. Counterpart call signs will not be issued.

Although some call sign prefixes in Table B may not be assigned for lack of a bona fide mailing address, the entries are provided for future reference, and to enable amateurs to have a distinct identifier when operating a portable station from these locations.

WHAT TYPES OF CALL SIGNS WILL BE AVAILABLE?

(g) Amateur call sign blocks will be categorized into five major groups. For the contiguous United States:

- (1) Group A contains all 1 x 2, most 2 x 1, and most "A" prefixed 2 x 2 call signs;
- (2) Group B contains most "K", "N", and "W" prefixed 2 x 2 call signs;
- (3) Group C contains all 1 x 3 call signs;
- (4) Group D contains most "K" and "W" prefixed 2 x 3 call signs; and
- (5) Group X contains "WC", "WK", "WM", "WR", and "WT" prefixed 2 x 3 call signs.

For the noncontiguous United States:

- (1) Group A contains "AH", "KH", "NH", "WH", "AL7", "KL7", "NL7", "KP", "NP", and "WP" prefixed 2 x 1 call signs;
- (2) Group B contains "AH", "AL7", and "KP" prefixed 2 x 2 call signs;
- (3) Group C contains "KH", "NH", "WH", "KL7", "NL7", "WL7", "NP", and "WP" prefixed 2 x 2 call signs;
- (4) Group D contains "KH", "WH", "KL7", "WL7", "KP", and "WP" prefixed 2 x 3 call signs; and
- (5) Group X contains "WC", "WK", "WM", "WR", and "WT" prefixed 2 x 3 call signs.

(See Appendix attached to this release which lists all Groups and the call sign blocks which are contained within each Group.)

WHO IS ELIGIBLE TO REQUEST A NEW CALL SIGN MARCH 24?

(h) To apportion workload to a manageable level and to gain experience in implementing the new system, we will accept requests for call sign changes only from the following four groups:

- (1) Newly licensed operators;
 - (2) Amateur Extra Class licensees;
 - (3) Licensees who upgrade their operator privileges; and
 - (4) Licensees who change their mailing addresses to new call sign areas.
- In future phases, we anticipate permitting Advanced Class licensees to request Group B or Group C call signs, and General and Technician Class, Group C call signs.

WHAT ABOUT AMATEUR EXTRA CLASS LICENSEES?

(i) Amateur Extra Class licensees holding Group B call signs may request Group A call signs; Amateur Extra Class licensees holding Group C call signs may request Group B or Group A call signs; and Amateur Extra Class licensees holding Group D call signs may request Group C, Group B, or Group A call signs.

(j) Amateur Extra Class licensees who now hold Group A 2 x 2 call signs beginning with "AA" may request a change within Group A. Such requests must be submitted by October 1, 1978. A 2 x 1 call sign will be issued in exchange for the 2 x 2 "AA" call sign.

WHAT ABOUT LICENSEES WHO UPGRADE?

(k) A licensee who upgrades his license to a higher operator class may request a new call sign according to the following. If no request is made, his station will retain its present call sign.

- (1) Upgrades to Amateur Extra:
 - (a) Now holding Group B may request Group A;
 - (b) Now holding Group C may request Group A, or Group B; and
- (c) Now holding Group D may request Group A, or Group B; or Group C.
- (2) Upgrades to Advanced:
 - (a) Now holding Group C may request Group B; and
 - (b) Now holding Group D may request Group C or Group B.
- (3) Upgrades to General and Technician Class now holding Group D may request Group C.

WHAT ABOUT NEWLY LICENSED OPERATORS?

(1) Newly licensed operators who do not presently have a station call sign will have no choice of format. Their stations will automatically be assigned call signs per Table C.

TABLE C

- (1) Amateur Extra Class operators receive Group A call signs;
- (2) Advanced Class operators receive Group B call signs;
- (3) General Class operators receive Group C call signs;
- (4) Technician Class operators receive Group C call signs; and
- (5) Novice Class operators receive Group D call signs;

WHAT ABOUT A LICENSEE MOVING TO A NEW CALL SIGN AREA?

(m) A licensee who changes his permanent mailing address to a new call sign area may request a call sign change. In these cases, a station will be assigned a call sign from the same Group (A, B, C, or D) as the call sign now held. The only exceptions are the following:

- (1) Advanced Class operators holding Group A may request only Group

B; and
(2) General or Technician Class operators holding Group A or Group B may request only Group C.

WHAT ABOUT LICENSEES WHO RENEW?

(n) Upon renewal, the station will retain the same call sign, unless the li-

GROUP A

AMATEUR RADIO SERVICE—CALL SIGN ASSIGNMENT ORDER

Block No.	CONTIGUOUS USA	PACIFIC AREA	ALASKA AREA	ATLANTIC AREA
1.0	K # ee	AH # e	AL 7 # e	KP # e
2.0	N # ee	KH # e	KL 7 # e	NP # e
3.0	W # ee	NH # e	NL 7 # e	WP # e
4.0	AA # ee	WH # e	WL 7 # e	GP # B
5.0	AB # ee	GROUP B	GROUP B	
6.0	AC # ee			
7.0	AD # ee			
8.0	AE # ee			
9.0	AF # ee			
10.0	AG # ee			
11.0	AJ # ee			
12.0	AI # ee			
13.0	AK # ee			
14.0	KA # ee			
15.0	KB # ee			
16.0	KC # ee			
17.0	KD # ee			
18.0	KE # ee			
19.0	KF # ee			
20.0	KG # ee			
21.0	KH # ee			
22.0	KI # ee			
23.0	KJ # ee			
24.0	KK # ee			
25.0	KL # ee			
26.0	KM # ee			
27.0	KN # ee			
28.0	KO # ee			
29.0	KP # ee			
30.0	KQ # ee			
31.0	KR # ee			
32.0	KS # ee			
33.0	KT # ee			
34.0	KU # ee			
35.0	KV # ee			
36.0	KW # ee			
37.0	KX # ee			
38.0	KY # ee			
39.0	KZ # ee			
40.0	NA # ee			
41.0	NB # ee			
42.0	NC # ee			
43.0	ND # ee			
44.0	NE # ee			
45.0	NF # ee			
46.0	NG # ee			
47.0	NH # ee			
48.0	NI # ee			
49.0	NJ # ee			
50.0	NK # ee			

Block No. CONTIGUOUS USA

51.0	NR # ee
52.0	NS # ee
53.0	NT # ee
54.0	NU # ee
55.0	NV # ee
56.0	NW # ee
57.0	NX # ee
58.0	NY # ee
59.0	NZ # ee
60.0	WA # ee
61.0	WB # ee
62.0	WC # ee
63.0	WD # ee
64.0	WE # ee
65.0	WF # ee
66.0	WG # ee
67.0	WH # ee
68.0	WI # ee
69.0	WJ # ee
70.0	WK # ee
71.0	WL # ee
72.0	WM # ee
73.0	WN # ee
74.0	WO # ee
75.0	WP # ee
76.0	WQ # ee
77.0	WR # ee
78.0	WS # ee
79.0	WT # ee
80.0	WX # ee
81.0	WY # ee
82.0	WZ # ee
83.0	AA # ee
84.0	AB # ee
85.0	AC # ee
86.0	AD # ee
87.0	AE # ee
88.0	AF # ee
89.0	AG # ee
90.0	AI # ee
91.0	AJ # ee
92.0	AK # ee
93.0	GROUP B

GROUP B

AMATEUR RADIO SERVICE—CALL SIGN ASSIGNMENT ORDER

Block No.	CONTIGUOUS USA	PACIFIC AREA	ALASKA AREA	ATLANTIC AREA
1.0	KA 1 # ee	AH # ee	AL 7 # ee	KP # ee
2.0	KB # ee	GROUP C	GROUP C	GROUP C
3.0	KC # ee (EXCEPT KC6)			
4.0	KD # ee			
5.0	KE # ee			
6.0	KF # ee			
7.0	KG # ee (EXCEPT KG4, KG6R, KG6S)			
8.0	KH # ee			
9.0	KI # ee			
10.0	KJ # ee			
11.0	KK # ee			
12.0	KL # ee			
13.0	KM # ee			
14.0	KN # ee			
15.0	KO # ee (EXCEPT KR6)			
16.0	KS # ee			
17.0	KT # ee			
18.0	KU # ee			
19.0	KV # ee			
20.0	KW # ee			
21.0	KX # ee (EXCEPT KX6)			
22.0	KY # ee			
23.0	KZ # ee (EXCEPT KZ5)			
24.0	NA # ee			
25.0	NB # ee			
26.0	NC # ee			
27.0	ND # ee			
28.0	NE # ee			
29.0	NF # ee			
30.0	NG # ee			
31.0	NI # ee			
32.0	NJ # ee			
33.0	NK # ee			
34.0	NL # ee			
35.0	NN # ee			
36.0	NO # ee			
37.0	NQ # ee			
38.0	NR # ee			
39.0	NS # ee			
40.0	NT # ee			
41.0	NU # ee			
42.0	NV # ee			
43.0	NW # ee			
44.0	NX # ee			
45.0	NY # ee			
46.0	NZ # ee			
47.0	WA # ee			
48.0	WB # ee			
49.0	WC # ee			
50.0	WD # ee			

Block No. CONTIGUOUS USA

51.0	WE # ee
52.0	WF # ee
53.0	WG # ee
54.0	WH # ee
55.0	WI # ee
56.0	WJ # ee
57.0	WK # ee
58.0	WL # ee
59.0	WM # ee
60.0	WN # ee
61.0	WO # ee
62.0	WP # ee
63.0	WQ # ee
64.0	WR # ee
65.0	WS # ee
66.0	WT # ee
67.0	WX # ee
68.0	WY # ee
69.0	WZ # ee
70.0	GROUP C

censee qualifies for and requests a call sign change.

WHICH CALL SIGNS WILL BE ASSIGNED?

(o) Call sign assignments will begin as follows:

Group:	Contiguous U.S.		Non-contiguous U.S.	
	Block 4	Block 1	Do	Do
A.....	Block 4	Block 1	Do	Do
B.....	Block 1	Do	Do	Do
C.....	Block 2	Do	Do	Do
D.....	Block 1	Block 2	Do	Do

(p) Available call sign suffixes will be assigned in alphabetical sequence; for 2x3 and 1x3 call signs, this would involve the sequences AAA, AAB, AAC, and so on, through ZZZ; for 2x2 and 1x2 call signs, the sequences AA through ZZ, for 2x1 call signs, the sequence A through Z

(q) When all assignments have been made from a particular block, the next assignment will be made from the next consecutive block within the group. Periodically, the licensee data base will be scanned to recover the unassigned call signs from prior blocks. These will be added to the lists of call signs available for immediate assignment.

HOW DO AMATEURS APPLY FOR CALL SIGN CHANGES?

(r) Licensees must request a call sign Group for which they are eligible on FCC Form 610, Item 13. The only request which may be made is for a particular Group. No request will be honored for specific call signs, call sign blocks, prefixes, or suffixes within a block. If a group preference is not indicated in Item 13 or the applicant is

not eligible for the group he requests, the group will be assigned systematically according to Table C.

(s) When a licensee's permanent station location is changed, a Form 610 must be filed giving the new location. (Station location is no longer used in determining the selection of call sign digits; therefore, a change of station location may not be used as the basis for requesting a change of call sign.)

(t) Applicants requesting exchange of secondary call signs for primary call signs must attach a written request to their Forms 610.

GROUP X.—Amateur radio service—call sign assignment order

	All Areas
Races.....	WT # 000
Club.....	WK # 000
Military recreation.....	WM # 000
Repeaters.....	WR # 000
Temporary licenses.....	WT # 000

FEDERAL COMMUNICATIONS COMMISSION,
WILLIAM J. TRICARICO,
Secretary.

PERMITTING SHIP RADIOTELEGRAPH STATIONS TO COMMUNICATE WITH AMATEUR STATIONS

AGENCY: Federal Communications Commission.

ACTION: Proposed rule making.

SUMMARY: This document proposes the deletion of certain sections of the Commission's rules and regulations relating to the granting of licenses, modification of licenses, renewal of license, or special temporary authorization permitting a ship radiotelegraph station to communicate with amateur stations. These rules no longer serve any useful purpose in the present reg-

ulatory scheme, consequently, the Commission is proposing to delete them from the regulations.

DATES: Comments must be received on or before June 12, 1978, and Reply Comments must be received on or before June 22, 1978.

ADDRESSES: Federal Communications Commission, Washington, D.C. 20554.

FOR FURTHER INFORMATION CONTACT:

John C. K. Hays, Safety and Special Radio Services Bureau, 202-632-7197.

SUPPLEMENTARY INFORMATION:

Adopted: April 26, 1978; Released: May 9, 1978. By the Commission:

1. Notice of Proposed Rulemaking in the above-entitled matter is hereby given.

2. Under sections 83.50 and 83.70 of the rules, the Commission may grant a license, modification of license, renewal of license, or special temporary authorization permitting a ship radiotelegraph station on board a vessel not engaged in commerce or a vessel used, or intended to be used, for scientific research or expedition, to transmit by means of Class A1 or A2 emission on authorized ship telegraph frequencies within the band 2000 kHz to 25,000 kHz, for the purpose of exchanging radiotelegraph communications directly with licensed amateur stations on land. This authorization may only be granted upon a showing that: (1) Unusual circumstances make direct communications with amateur stations extremely beneficial to persons on board or to persons responsible for the scientific expedition; (2) messages will not relate to commercial communications; and (3) no harmful interference will result to stations in the maritime mobile service nor to stations in the radiolocation service.

3. It now appears that these rule sections, which were adopted in 1939, serve no useful purpose under the present regulatory scheme. A review of our license file disclosed that no ship station is presently authorized under these sections to communicate with amateur stations. Moreover, if communications between a vessel and

amateur stations is desired, an amateur mobile station, which is a radio installation separate from the ship station, can be operated aboard the vessel provided the operator is a licensed amateur and the requirements of sections 97.101 and 97.114 of the Amateur Rules are observed. We, therefore, are proposing to delete sections 83.50 and 83.70, as shown in the attached Appendix.

4. The proposed amendments to the rules as set forth in the Appendix are issued pursuant to the authority contained in sections 4(i) and 303(r) of the Communications Act of 1934, as amended.

5. Pursuant to applicable procedures set forth in section 1.415 of the Commission's rules, interested persons may file comments on or before June 12, 1978, and reply comments on or before June 22, 1978. All relevant and timely comments and reply comments will be considered by the Commission before final action is taken in this proceeding. In reaching its decision in this proceeding, the Commission may also take into account other relevant information before it, in addition to the specific comments invited by this Notice.

6. In accordance with the provisions of Section 1.419 of the Commission's rules, an original and 5 copies of all statements, briefs or comments filed shall be furnished to the Commission. Responses will be available for public inspection during regular business hours in the Commission's Public Reference Room at its headquarters in Washington, D.C.

FEDERAL COMMUNICATIONS COMMISSION,
WILLIAM J. TRICARICO,
Secretary.

Part 83 of Chapter I of Title 47 of the Code of Federal Regulations is amended as follows:

§ 83.50 [Deleted]

1. Section 83.50 is deleted and designated as [Reserved].

§ 83.70 [Deleted]

2. Section 83.70 is deleted and designated as [Reserved].

GROUP C

AMATEUR RADIO SERVICE—CALL SIGN ASSIGNMENT ORDER

Block No.	CONTIGUOUS USA	PACIFIC AREA	ALASKA AREA	ATLANTIC AREA
1.	K # 000	KI # 00	KL 7 00	NP # 00
2.	N # 000	NH # 00	NL 7 00	WP # 00
3.	W # 000	WH # 00	WL 7 00	GROUP D
4.	GROUP D	GROUP D	GROUP D	

GROUP D

AMATEUR RADIO SERVICE—CALL SIGN ASSIGNMENT ORDER

Block No.	CONTIGUOUS USA	PACIFIC AREA	ALASKA AREA	ATLANTIC AREA
1.	KA # 000	KH # 000	KL7 000	KP # 000
2.	KB # 000	KI # 000	WL7 000	WP # 000
3.	KC # 000 (*)			
4.	KD # 000			
5.	KE # 000			
6.	KF # 000			
7.	KG # 000			
8.	KI # 000			
9.	KJ # 000			
10.	KK # 000			
11.	KM # 000			
12.	KN # 000			
13.	KO # 000			
14.	KQ # 000			
15.	KR # 000			
16.	KS # 000			
17.	KT # 000			
18.	KU # 000			
19.	KV # 000			
20.	KW # 000			
21.	KX # 000			
22.	KY # 000			
23.	KZ # 000			
24.	WA # 000			
25.	WB # 000			
26.	WD # 000			
27.	WE # 000			
28.	WF # 000			
29.	WG # 000			
30.	WI # 000			
31.	WJ # 000			
32.	WK # 000			
33.	WO # 000			
34.	WQ # 000			
35.	WS # 000			
36.	WU # 000			
37.	WV # 000			
38.	WW # 000			
39.	WX # 000			
40.	WY # 000			
41.	WZ # 000			

*EXCEPT KC4AAA-AAP, KC4USA-USZ

Ham Help

I need some "Ham Help." Recently, I purchased a Johnson Viking Invader 2000 transmitter in mint condition, but without the manual. Does anyone have a manual for this rig that I could purchase outright? If not, I will pay the owner to make a photostatic copy for me. If a manual or copy of one isn't available, I'd still like to hear from past or present owners of this rig who might be able to give me the proper tune-up alignment procedure, and meter readings during operation.

Rod Robbins WA7IRY
14980 SW 96th
Tigard OR 97223

I have a Knight R-100A general coverage receiver that has a bad main tuning capacitor. The capacitor has (R/C) stamped on the rear, upper left-hand corner. Does anyone know who might have made this capacitor? Does anyone know where I might get parts for Knight radio equipment? I also need a schematic of the

R-100A. Any information would help.

Frederick J. Erickson
105 G St.
Turners Falls MA 01376

I need an operating manual and schematic for the Phase-master IIB transmitter made by Lakeshore Industries in 1959. Hi, Inc., doesn't have it in their catalog of old manuals. I will pay for photocopy and postage.

Frederick John Onucki WA2SKP
63 Highland Ave.
Metuchen NJ 08840

At a recent hamfest, I acquired a large, transistorized six-digit multimeter, Model 882, made by Electro Instruments, which is now out of business. The meter is autoranging and works fine, but I have no schematic or calibration information. If anyone can provide this info, I will be happy to pay the costs.

Fred Snow W2IFR
Big Look Trail
Medford NJ 08055



ETCO

T.M.

DON'T FORGET **it's**
TO CIRCLE THE
INFORMATION
CARD OR WRITE
US FOR OUR No.
AA SUMMER 1978
SURPLUS FLYER. **FREE!**

BARGAIN BUYS

12 volt, 2 amp

POWER SUPPLY

PRICE BREAK!

Sensational Purchase of European inventory! Easily capable of 3-4 amp. surges! Excellent for CB, car stereo and general hobby applications. Makes an excellent battery charger! Incredible value. Dealers - Stock up NOW! (2 lb.) M233HP

\$9.95
10/\$89.95

LIQUIDATION

With each order of \$10.00 or more - 20 premium quality accountants ball point pens!

FREE!

Request 20 No. M037MS (20 oz.)

One Gift per order, please!

CLOSEOUT!

SPECTACULAR PURCHASE!

HAWKEYE

RADAR WARNING SYSTEM

PRICE CUT
NOW ONLY - **29.95**
3/\$79.95
WORTH THREE TIMES OUR AMAZING LOW PRICE!



MONEY BACK GUARANTEE - You have to be pleased or return it within 10 days for refund.

ETCO scoops the industry - buys up closeout inventory of fine, sophisticated X-band radar detectors - and brings them to you at the lowest price ever! Sealed factory display cartons (excellent dealer item). Audio/visual warning. Sensitivity control. Dual brackets. Picks up radar signals at twice the distance that radar operator is able to "sight" you! Easily worth 3 times our low price. Order today while inventory lasts. (1 lb.) M013HM

39.95
2/\$69.95

TELEPHONE OPERATORS HEADSETS

PHONE COMPANY QUALITY!

BUILD INDUSTRIAL "HANDS-FREE" INTERCOMS! Telephone company surplus - factory reconditioned - as new - with full warranty. 100 ohm carbon microphone, 200 ohm dynamic headset. Plug terminated cord. Ideal for "hands-free" telephone or radiotelephone operation. In series with a battery, makes industrial quality "hands-free" intercom for crane operators, theatrical prompting, sports, maintenance, antenna crews, etc. Hard to find it this fine condition at any price - and ETCO has them in stock! (1 lb.) M017PH

SPECIAL PURCHASE

CDS PHOTOCELL BUYOUT!

ETCO SCOOP!

VALUE

29.95
10/\$2.39

National NSL4962 photoconductive cells, 3/8" diameter. Changes resistance with light intensity. 4 megohms in total darkness - 45,000 ohms in bright light. Plastic encapsulated. (2 oz.) M418DR

HOME CONVERTER FOR CAR STEREO!

40% in stock!

SALE

29.95

AUTOMATIC RADIO

3/\$79.95

A sensational ETCO purchase! Designed to accept and power AR Automatic Radio Car stereo models SPC-5002 & SPC-5004, but can be adapted to just about any car stereo or car radio (could power CB sets and scanners, too!) 2 speakers included. Exactly as pictured, less car stereo unit. AR No. HCS-5103. Walnut woodgrain finish. Built in 110 VAC power supply. Pilot light. On-off switch. Stereo headphone jack. Original factory sealed cartons. An excellent dealer item. (9 lb.) M725HP

12VDC SOLENOID VALVE!

We believe this cute little valve will handle liquids or air. Made by "Carter Carburetor", they seem to have been interred for automotive use. Terminals are 1/4" quick-connect tabs, input and output spigots are 3/16" o.d. and 1/8" long. I.d. of spigot is 1/16". A super little valve with many applications. Brand New factory surplus at a fraction of regular price! (5 oz.) M080MS

\$1.99
10/\$16.95

EXPERIMENTERS!

10 FT. STEREO HEADSET CABLE

\$1.69
10/\$14.95
100/\$119.95

Beautiful brand new factory surplus. 30" retracted - opens to 10 feet! 3 conductor cable with quality stereo phone plug attached. Great for headsets, speakers or what have you. (4 oz. M148AA



INVENTORY HIIT

10/\$1.59
50/\$6.95
100/\$12.95
1000/\$95.00

50,000 MINI CLOSED CIRCUIT JACKS MUST BE SOLD! We cleared out the factory on this one. A project builder's delight - an everyday useful item. Two standard sizes to choose from. Plastic encased as pictured. With nut and washer. M400MS (1 oz.)..... 3.5mm (mini) M117JK (1 oz.) - 2.5mm (ultramini)

as low as **9.95** 1/2 oz. in 1000's! 19c ea.

99.95
10/\$8.95
100/\$79.95

12 VDC HORN! BARGAIN SCOOP IT SHRIEKS!



2" diameter a 1" thick! Great for all kinds of alarm and alerting applications. Performs on 12v dry cells or in cars, boats - or use with 12v/500ma xfmr. and diode. The shrieker with a thousand uses! (4 oz. M216HP. Brand New Factory Surplus!

DPST (N.O.) 12-14 VDC PC BOARD RELAYS

5000 in stock! **Buy Right! Why Pay More?**

1/2 AMP CONTACTS! Sensational value. Brand new production surplus. Electro-Br. No. R4422-2 (Amtron 37963). 420 ohm coil - reed switching. A valuable and popular item for a multitude of projects. (1 oz.) M066RL

99.95
10/\$8.95
100/\$69.95

PRIME DIALIGHT MICRO-LEDS!

Exactly as pictured - axial leads - real tiny! 1/16" dia. x 1/16" H. Red. Dialight No. 521-9186. Operates on 1.6-2 volts. (1 oz.) M155DR

10,000 in stock! **ETCO SCOOP!** **19.95**
10/\$1.79
100/\$15.95

TELEPHONE YOUR ORDERS - Phone in your charge-card orders at low station-to-station rates! CALL: 1-518-561-8700.

SURPLUS WANTED - Contact our buying office at 1-514-695-0400 or send list and samples to Plattsburgh address below

CANADIANS - Ordering from this ad is simple. Please remit in U.S. funds (or add 10% to overall total and remit in Canadian funds) - (ChargeX and Mastercharge welcome). We do the paperwork and ship to you direct from the U.S.A. at low American prices. You pay duty and tax to Canadian Customs (Canadian schools are exempt) We have stores in Canada, too! Write for Canadian catalogs. We invite you to visit our Plattsburgh store - just 50 minutes from Montreal on U.S. 87!

DEALERS WANTED
Write us on your letterhead for attractive discounts

ETCO

ELECTRONICS

Rush Your Order Today ETCO ELECTRONICS CORP. U.S.A.
Shipped to you direct from our new mailorder headquarters and warehouse (total) North Country Shopping Center, Route No. 9, Plattsburgh, N.Y. 12901.
MERCHANDISE SUBJECT TO PRIOR SALE. Full remittance with each order, please. Money Order, Certified check, BANKAMERICARD, VISA, MASTERCHARGE or CHARGE. Add 15% for UPS (for postage) and handling (we refund excess). Please try to bring your order total to \$10 or more. Worldwide export orders solicited. Open account to Government agencies, schools, institutions and triple "A" rated industrial & commercial accounts. Special quotes for quantities. N.Y. state residents: add 7% sales tax.

"The TOUCH" by *Regency*

- ▶ AUTOMATIC CONTINUOUS SEARCH!
- ▶ FIND "SECRET" FREQUENCIES
- ▶ SEVERE WEATHER ALERT!
- ▶ NEVER BUY CRYSTALS!
- ▶ PRIORITY CHANNEL!
- ▶ LO, HI, & UHF BANDS!
- ▶ SIXTEEN CHANNELS!
- ▶ 2 METERS & 450 MHz



\$249 Shipped Prepaid in USA

Check with order MASTER CHARGE or VISA — sorry, no COD

GERKEN'S

Frequency Ranges
 LOW VHF 30-50 MHz
 HIGH VHF 146-174 MHz
 UHF 440-512 MHz

37 Park Ave. (603) 352-7329
 Keene, New Hampshire 03431

DOVETRON



MPC-1000C

Multipath Correction
 In-Band Diversity &
 AFSK Tone Keyer

Amateur Net: \$545.00

Standard features include CONTINUOUSLY tuneable Mark and Space channels (1000 Hz to 3200 Hz), Dual Mode (MARK or FSK) Autostart and internal high level neutral loop keyer (20 to 60 ml). Both EIA and MIL FSK outputs are provided for direct interface to microprocessor and video terminal peripherals.



MPC-1000CR

Signal Regeneration &
 Speed Conversion

Amateur Net: \$645.00

A front panel switch permits internal TSR-200 Signal Regenerator-Speed converter assembly to electronically "gear-shift" between 60, 67, 75 and 100 WPM. All incoming and outgoing signals are regenerated to less than 0.5% bias distortion. Also available with DIGITAL Autostart (TSR-200D): Amateur Net: \$695.00



MPC-1000R/- TSR-500

Dual UART Regeneration,
 Speed Conversion, 200
 Char. Memory, Word Cor-
 rection & DIGITAL
 Autostart

Amateur Net: \$895.00*

The MPC-1000R/TSR-500 provides Preloading and Recirculation of the 200 character FIFO Memory, a keyboard-controlled Word Correction circuit, Variable Character Rate, Tee Dee Inhibit, Blank/LTRS Diddle, a Triple Tone-Pair AFSK Tone Keyer and a Character Recognition/Speed Determination DIGITAL (DAS-100) Autostart mode.

*The MPC-1000R is also available without a TSR assembly and functions as a MPC-1000C with a Triple Tone-Pair AFSK Tone Keyer. This "Basic-R" permits future expansion with a TSR-100, TSR-200, TSR-200D or TSR-500 by simply lifting the lid and plugging in the appropriate TSR assembly: Amateur Net (Basic-R): \$595.00

Your QSL will bring complete specifications, or call: 213-682-3705.

D23



627 FREMONT AVENUE
 (P. O. BOX 267)
 SOUTH PASADENA, CA. 91030

DUPLEXERS



*Patent Pending

OUR NEW BANDPASS-REJECT DUPLEXERS WITH OUR EXCLUSIVE

BpBr CIRCUIT*

... provides superior performance, especially at close frequency spacing.

Models available for all Ham bands. Special price for Amateur Repeater Clubs

CALL OR WRITE FOR DETAILS:

WACOM PRODUCTS, INC.



Box 7307
 Waco, Texas 76710
 817/776-4444

JAN CRYSTALS HOLD THE FREQUENCY



- CB
- CB standard
- 2 meter
- Scanners
- Amateur Bands
- General Communication
- Industry
- Marine VHF
- Micro processor crystals

easy to charge



Send 10¢ for our latest catalog
 Write or phone for more details
 2400 Crystal Drive
 Ft. Myers, Florida 33901
 all phones (813) 936-2397

J2 | |

23 ways to help assure your company's future.

If you believe that a continuous flow of new ideas is absolutely necessary to assure your company's future — and the future of the country as well — then you'd better send for this free booklet today

It describes twenty-three different ways you can help guarantee a continuous flow of college-trained minds and college-based research — minds and research that have been responsible for many of the most important ideas of our times: Computers, Radio Television, Synthetics, Antibiotics. The list is almost endless.

If you'd like a copy of *How Corporations Can Aid Colleges and Universities*, write on your company letterhead to Council for Financial Aid to Education, Inc., 680 Fifth Ave., New York, N.Y. 10019.

We can't afford to run out of ideas.

Council for Financial Aid to Education, Inc.
680 Fifth Avenue, New York, N.Y. 10019

A Public Service of This Magazine
& The Advertising Council

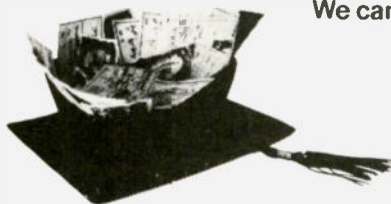

**Make America smarter.
Give to the college of your choice.**

CIRCUIT BOARDS

- REPEATER CONTROL
- COMPUTER PROJECTS
- SENSITIZED BLANKS
- NEGATIVES/POSITIVES
- PROTO-TYPE BOARDS
- PARTS KIT
- CUSTOM ETCH/DRILL

We can supply many of the items you need to make a p-c board. Send SASE + 25 cents for catalog.

O.C. Stafford s50

Electronic Service and Development
427 S. Benbow Rd.
Greensboro, NC 27401
919-274-9917 DAY/NITE

New from Island Antennas . . .

A 20 M BEAM FOR MARITIME MOBILES

Extremely rugged and lightweight, this is the first beam specifically engineered for the demands of service at sea. Using helically wound fiberglass mobile whips as elements, it can withstand 130 mph winds, yet weighs only 4 lbs. and has 1/2 sq. ft. area, so it can be relied on under storm conditions. Electrically, the whips provide two 12' elements, large enough for 10-15 db attenuation off the back and sides. Cuts QRM, lets you work signals you never knew existed. Broadbanded helical windings let you cover the band without a tuner. While helical beams usually are expensive, the "Mickey Mouse" is only \$75, with a two week money back guarantee. Owners manual, charts, gain, fb, SWR vs frequency, one dollar. SASE for info.

gain 3dbi boom 8'
power 500w VSWR 1.5 200 khz
fec 50Q direct

Island Antennas
Block Island, RI 02807

Custom antennas our specialty.

119

NEW!

\$36.50

plus \$1.50 s/h
NY res. add tax



Features: CMOS Electronic Keyer

- State-of-the-art CMOS circuitry
- Self completing dots and dashes
- Dot and dash memory
- Iambic keying with any squeeze paddle
- 5.50 WPM
- Speed, volume, tone controls, side tone and speaker
- Low current drain CMOS battery operation
- Deluxe quarter inch jacks for keying and output
- Handsome eggshell white base — woodgrain top
- Compact and portable — 1 7/8 x 4 1/4 x 6 1/4
- Grid block keying
- Wired and tested — fully guaranteed — less battery

BRAND NEW!

\$25.95

Plus \$2.00 S/H
NY res. add tax



Features:

- Twin paddle squeeze key
- Extra heavy base — non skid feet
- Adjustable contact spacing
- Touch tension — comfort keying
- Smooth friction free paddle movement
- Handsome crinkle finish base and rich red paddles
- Five way binding posts
- Use with Trac CMOS keyer or any keyer

TRAC - KEY

TRAC

Electronics, Inc.
1106 Rand Bldg.
Buffalo NY 14203

T18

Pace-Traps
P15

Box 234
Middlebury CT 06762

ICOM-22S OWNERS!!

Get rid of the CB dial. Go to direct frequency read-out in 30 minutes and minimum cost. PACE-DIAL will do the job. An accurately silk-screened replacement dial and enough dry-transfer numbers to make hundreds of frequency combinations. Tailors the dial to exactly the frequencies you have set-up in your ICOM. Complete dial-kit and full instructions furnished. \$3.25 ppd.



Check or MO to
Box 234
Middlebury CT 06762
(203) 758-9228

DIODES/ZENERS				SOCKETS/BRIDGES				TRANSISTORS, LEDS, etc.						
1N914	100v	10mA	.05	8-pin	pcb	.20	ww	.35	2N2222	NPN (2N2222 Plastic .10)	.15	2N2907	PNP	.15
1N4005	600v	1A	.08	14-pin	pcb	.20	ww	.40	2N3906	PNP (Plastic - Unmarked)	.10	2N3904	NPN (Plastic - Unmarked)	.10
1N4007	1000v	1A	.15	16-pin	pcb	.20	ww	.40	2N3054	NPN	.35	2N3055	NPN 15A 60v	.50
1N4148	75v	10mA	.05	18-pin	pcb	.25	ww	.75	T1P125	PNP Darlington	.35	LED Green, Red, Clear, Yellow		.15
1N4733	5.1v	1 W Zener	.25	22-pin	pcb	.35	ww	.95	D.L.747	7 seg 5/8" High com-anode	1.95	MAN72	7 seg com-anode (Red)	1.25
1N753A	6.2v	500 mW Zener	.25	24-pin	pcb	.35	ww	.95	MAN3610	7 seg com-anode (Orange)	1.25	MAN82A	7 seg com-anode (Yellow)	1.25
1N758A	10v	"	.25	28-pin	pcb	.45	ww	1.25	MAN74A	7 seg com-cathode (Red)	1.50	FND359	7 seg com-cathode (Red)	1.25
1N759A	12v	"	.25	40-pin	pcb	.50	ww	1.25	Molex pins .01	To-3 Sockets	.25	2 Amp Bridge	100-prv	.95
1N5243	13v	"	.25						25 Amp Bridge	200-prv	1.95			
1N5244B	14v	"	.25											
1N5245B	15v	"	.25											

C MOS			- T T L -								
4000	.15	7400	.10	7473	.25	74176	.85	74H72	.35	74S133	.40
4001	.15	7401	.15	7474	.30	74180	.55	74H101	.75	74S140	.55
4002	.20	7402	.15	7475	.35	74181	2.25	74H103	.55	74S151	.30
4004	3.95	7403	.15	7476	.40	74182	.75	74H106	.95	74S153	.35
4006	.95	7404	.10	7480	.55	74190	1.25			74S157	.75
4007	.20	7405	.25	7481	.75	74191	.95	74L00	.25	74S158	.30
4008	.75	7406	.25	7483	.75	74192	.75	74L02	.20	74S194	1.05
4009	.35	7407	.55	7485	.55	74193	.85	74L03	.25	74S257 (8123)	1.05
4010	.35	7408	.15	7486	.25	74194	.95	74L04	.30		
4011	.20	7409	.15	7489	1.05	74195	.95	74L10	.20	74LS00	.20
4012	.20	7410	.15	7490	.45	74196	.95	74L20	.35	74LS01	.20
4013	.40	7411	.25	7491	.70	74197	.95	74L30	.45	74LS02	.20
4014	.75	7412	.25	7492	.45	74198	1.45	74L47	1.95	74LS04	.20
4015	.75	7413	.25	7493	.35	74221	1.00	74L51	.45	74LS05	.25
4016	.35	7414	.75	7494	.75	74367	.75	74L55	.65	74LS08	.25
4017	.75	7416	.25	7495	.60			74L72	.45	74LS09	.25
4018	.75	7417	.40	7496	.80	75108A	.35	74L73	.40	74LS10	.25
4019	.35	7420	.15	74100	1.15	75491	.50	74L74	.45	74LS11	.25
4020	.85	7426	.25	74107	.25	75492	.50	74L75	.55	74LS20	.20
4021	.75	7427	.25	74121	.35			74L93	.55	74LS21	.25
4022	.75	7430	.15	74122	.55			74L123	.85	74LS22	.25
4023	.20	7432	.20	74123	.35	74H00	.15			74LS32	.25
4024	.75	7437	.20	74125	.45	74H01	.20	74S00	.35	74LS37	.25
4025	.20	7438	.20	74126	.35	74H04	.20	74S02	.35	74LS38	.35
4026	1.95	7440	.20	74132	.75	74H05	.20	74S03	.25	74LS40	.30
4027	.35	7441	1.15	74141	.90	74H08	.35	74S04	.25	74LS42	.65
4028	.75	7442	.45	74150	.85	74H10	.35	74S05	.35	74LS51	.35
4030	.35	7443	.45	74151	.65	74H11	.25	74S08	.35	74LS74	.35
4033	1.50	7444	.45	74153	.75	74H15	.45	74S10	.35	74LS86	.35
4034	2.45	7445	.65	74154	.95	74H20	.25	74S11	.35	74LS90	.55
4035	.75	7446	.70	74156	.70	74H21	.25	74S20	.25	74LS93	.55
4040	.75	7447	.70	74157	.65	74H22	.40	74S40	.20	74LS107	.40
4041	.69	7448	.50	74161	.55	74H30	.20	74S50	.20	74LS123	1.00
4042	.65	7450	.25	74163	.85	74H40	.25	74S51	.25	74LS151	.75
4043	.50	7451	.25	74164	.60	74H50	.25	74S64	.15	74LS153	.75
4044	.65	7453	.20	74165	1.10	74H51	.25	74S74	.35	74LS157	.75
4046	1.25	7454	.25	74166	1.25	74H52	.15	74S112	.60	74LS164	1.00
4049	.45	7460	.40	74175	.80	74H53J	.25	74S114	.65	74LS193	.95
4050	.45	7470	.45			74H55	.20			74LS367	.75
4066	.55	7472	.40							74LS368	.65

4069/74C04	.25
4071	.25
4081	.30
4082	.30
MC 14409	14.50
MC 14419	4.85
4511	.95
74C151	1.90

9000 SERIES			
9301	.85	95H03	1.10
9309	.35	9601	.20
9322	.65	9602	.45

MICRO'S, RAMS, CPU'S, E-PROMS			
74S188	3.00	8214	8.95
1702A	4.50	8224	3.25
MM5314	3.00	8228	6.00
MM5316	3.50	8251	8.50
2102-1	1.45	8255	10.50
2102L-1	1.75	8T13	1.50
2114	9.50	8T23	1.50
TR1602B	3.95	8T24	2.00
TMS 4044	9.95	8T97	1.00
		2107B-4	4.95
8080	8.95	2708	9.50
8212	2.95	280 PIO	8.50

LINEARS, REGULATORS, etc.							
MCT2	.95	LM320T5	1.65	LM340K15	1.25	LM723	.40
8038	3.95	LM320T12	1.65	LM340K18	1.25	LM725N	2.50
LM201	.75	LM320T15	1.65	LM340K24	1.25	LM739	1.50
LM301	.45	LM324N	1.25	78L05	.75	LM741 (8-14)	.25
LM308 (Mini)	.95	LM339	.75	78L12	.75	LM747	1.10
LM309H	.65	7805 (340T5)	.95	78L15	.75	LM1307	1.25
LM309K (340K-5)	.85	LM340T12	.95	78M05	.75	LM1458	.65
LM310	.85	LM340T15	.95	LM373	2.95	LM3900	.50
LM311D (Mini)	.75	LM340T18	.95	LM380 (8-14 PIN)	.95	LM75451	.65
LM318 (Mini)	1.75	LM340T24	.95	LM709 (8, 14 PIN)	.25	NE555	.35
LM320K5 (7905)	1.65	LM340K12	1.25	LM711	.45	NE556	.85
LM320K12	1.65					NE565	.95
						NE566	1.25
						NE567	.95

INTEGRATED CIRCUITS UNLIMITED 19

7889 Clairemont Mesa Boulevard, San Diego, California 92111
(714) 278-4394 (Calif. Res.)

All orders shipped prepaid No minimum
Open accounts invited COD orders accepted

Discounts available at OEM Quantities California Residents add 6% Sales Tax
All IC's Prime/Guaranteed. All orders shipped same day received.

SPECIAL DISCOUNTS	
Total Order	Deduct
\$35 - \$99	10%
\$100 - \$300	15%
\$301 - \$1000	20%

24 Hour Toll Free Phone 1-800-854-2211 American Express / BankAmericard / Visa / MasterCard



POLY PAKS' 1c REVOLUTION

THIS SPECIAL ONE CENT SALE IS FOR MAGAZINE ADS ONLY

THESE ONE-CENTERS ARE THE CENT-CIBLE WAY TO SHOP AND SAVE!

LED WATCH GUTS

Cat. No. 7A5267 Men's LED

\$1.95 2 for 1.96



Order By Cat. No. 7A1981 & Type No.

TTL'S AT "CENT-CIBLE" PRICES

Type	Each	2 For	Type No.	Each	2 For	Type No.	Each	2 For
SN7400	\$ 1.19	\$ 2.20	SN74132	1.35	2 for 1.36			
SN7401	.19	.20	SN74136	.49	.50			
SN7403	.25	.26	SN74140	.49	.50			
SN7405	.19	.20	SN74141	1.79	1.80			
SN7406	.19	.20	SN74145	.69	.70			
SN7407	.39	.40	SN74151	1.29	1.30			
SN7409	.39	.40	SN74154	1.75	1.76			
SN7410	.25	.26	SN74155	.79	.80			
SN7411	.59	.60	SN74156	.39	.40			
SN7413	.69	.70	SN74157	.99	1.00			
SN7414	.39	.40	SN74158	.99	1.00			
SN7416	.35	.36	SN74161	1.25	1.26			
SN7417	.35	.36	SN74162	.79	.80			
SN7420	.32	.33	SN74165	.99	1.00			
SN7421	.49	.50	SN74166	1.99	2.00			
SN7422	.39	.40	SN74173	.99	1.00			
SN7426	.19	.20	SN74174	1.49	1.50			
SN7430	.29	.30	SN74175	.99	1.00			
SN7432	.32	.33	SN74177	.79	.80			
SN7437	.19	.20	SN74179	1.49	1.50			
SN7438	.25	.26	SN74182	.49	.50			
SN7440	.19	.20	SN74190	1.99	2.00			
SN7442	.69	.70	SN74191	1.75	1.76			
SN7443	.59	.60	SN74192	.85	.86			
SN7444	.39	.40	SN74193	.99	1.00			
SN7445	.99	1.00	SN74194	1.25	1.26			
SN7446	1.25	1.26	SN74195	.29	.30			
SN7447	1.25	1.26	SN74197	.85	.86			
SN7448	1.35	1.36	SN74199	1.50	1.51			
SN7450	.19	.20	SN74200	3.50	3.51			
SN7451	.19	.20	SN74251	.79	.80			
SN7453	.19	.20	SN74284	6.00	6.01			
SN7454	.29	.30	SN74298	3.75	3.76			

POP-AMPS AT "CENT-CIBLE" PRICES

Case code: 1 TO 220 Power Lab. V Mini dip. K TO 3.1 TO 5. N DIP.

Type No.	Each	2 For	Type No.	Each	2 For	Type No.	Each	2 For
LM300H	\$.79	\$.80	LM340T-5	1.49	1.50	LM703N	.59	.60
LM300N	.49	.50	LM340T-6	1.49	1.50	LM704N	.19	.20
LM301V	.45	.46	LM340T-8	1.49	1.50	LM709N	.19	.20
LM301H	.45	.46	LM340T-12	1.49	1.50	LM709N	.49	.50
LM307V	.45	.46	LM340T-18	1.49	1.50	LM710N	.39	.40
LM308V	.69	.70	LM340T-24	1.49	1.50	LM713N	.79	.80
LM308H	.69	.70	LM350N	2.99	3.00	LM741V	.25	.26
LM309H	1.50	1.51	LM370N	1.99	2.00	LM741H	.30	.31
LM311V	1.49	1.50	LM377N	.29	.30	LM743V	.69	.70
LM318V	.99	1.00	LM387N	2.25	2.26	LM1310	1.79	1.80
LM320M-5	.99	1.00	LM388N	1.49	1.50	LM1312	2.49	2.50
LM320M-12	.99	1.00	LM389N	1.99	2.00	LM1414V	.19	.20
LM320M-15	.99	1.00	LM386N	1.49	1.50	LM1458V	.39	.40
LM320T-5	1.49	1.50	LM531H	1.49	1.50	LM1800N	.79	.80
LM320T-6	1.49	1.50	LM532H	2.25	2.26	LM3832H	.65	.66
LM322N	1.19	1.20	NE532H	2.25	2.26	LM3900N	.49	.50
LM324N	1.79	1.80	NE540	5.95	5.96	LM3909V	1.75	1.76
LM339N	1.79	1.80	LM555V	.75	.76	LM4250	1.20	1.21
LM340M-5	1.49	1.50	LM556V	1.39	1.40	LM75451	.69	.70
LM340M-6	1.49	1.50	LM558V	.39	.40	LM75453	.69	.70
LM340M-8	1.49	1.50	LM558H	.39	.40	LM75491	.80	.81
LM340M-12	1.49	1.50	LM561N	1.00	1.01	LM75492	.80	.81
LM340M-15	1.49	1.50	LM562N	2.00	2.01	LM75494	.60	.61
LM340M-18	1.49	1.50	LM565H	1.00	1.01	PA263	1.50	1.51
LM340M-24	1.49	1.50	LM566	2.49	2.50	OM8664N	1.29	1.30

RIBBON CABLE:

Order by Cat. 7A 3939 and Conductors

Cond.	Size	1c Sale
20	7-RL	\$1.98 14-RL \$1.99
26	4-RL	1.98 8-RL 1.99
34	3-RL	1.98 6-RL 1.99
40	3-HL	1.98 6-RL 1.99

25 AMP BRIDGE RECTIFIERS

Order by Cat. No. 7A2273 & Voltage

V	Each	1c Sale
50	\$1.95	2 for \$1.96
100	1.49	2 for 1.50
200	1.69	2 for 1.70
400	1.99	2 for 2.00
600	2.29	2 for 2.30
800	2.50	2 for 2.51

25 AMP POWER STUD SCRS, TRIACS

Cat. No. 7A-14A147 (SCRs)
Cat. No. 7A-60B86A (Triacs)

V	Each	1c Sale
50	\$.95	2 for \$.96
100	1.25	2 for 1.26
200	1.95	2 for 1.96

1N4000 Epoxy Rectifiers

Miniature - 1.5 Amp
Order by Cat. No. and Type No.

Cat. No.	Type No.	PIV	Price
7A2377	1N4001	50	10 for \$.65 20 for .66
7A2378	1N4002	100	10 for .76 20 for .77
7A2379	1N4003	200	10 for .85 20 for .86
7A2380	1N4004	400	10 for .99 20 for 1.00
7A2381	1N4005	800	10 for 1.29 20 for 1.30
7A2382	1N4006	800	10 for 1.39 20 for 1.40
7A2383	1N4007	1000	10 for 1.49 20 for 1.50

10 AMP POWER TRIACS

Order by Cat. No. and Type No.

PRV	Each	1c Sale
50	\$.55	2 for \$.56
100	.69	2 for .70
200	.89	2 for .90
400	1.19	2 for 1.20

15 AMP BULLET RECTIFIERS!

Order by Cat. No. 7A6088A & voltage

Volt	10 for	20 for	30 for
50V	10 for \$.59	20 for \$.60	30 for \$.61
100V	10 for .69	20 for .70	30 for .71
200V	10 for .79	20 for .80	30 for .81
400V	10 for .89	20 for .90	30 for .91

MICRO MINI TOGGLE SWITCHES!

3 Amps. 125 VAC contacts with chrome handles, complete with mounting hardware.

Cat. No.	Type	Each	1c Sale
7A3936	SPDT	\$1.19	2 for 1.20
7A5085	SPDT	1.39	1.40
7A4037	DPDT	1.45	1.46

LYTIC KLINIC Electrolytic capacitors

Order by Cat. No. 7A3269 & value

UF	V	Style	1c Sale
10	15	P.C.	10 for \$1.00
15	15	P.C.	10 for 1.01
15	25	P.C.	8 for 1.00
50	25	P.C.	6 for 1.00
20	15	AXIAL	10 for 1.00
20	15	P.C.	10 for 1.00

6 AMP CARTWHEEL RECTIFIERS

Cat. No. 7A3584

V	Each	1c Sale
100	\$.45	2 for .46
200	.61	2 for .62
400	.79	2 for .80
600	.90	2 for .91
800	1.19	2 for 1.20
1000	1.39	2 for 1.40

7-SEGMENT READOUTS

Order by Cat. No. and Type No.

Digit	Each	1c Sale
3 1/2	\$1.19	6 for \$1.20
2	1.19	6 for 1.20
3	1.19	6 for 1.20
4	1.19	6 for 1.20
5	1.19	6 for 1.20
6	1.19	6 for 1.20
7	1.19	6 for 1.20

LED'S!

YOUR CHOICE \$5 for \$1.01
1c SALE 10 for \$1.01

Order by Cat. No.

7A2135	JUMBO RED LEDs	5 for 1.01
7A2137	MICRO RED LEDs	5 for 1.01
7A2190	JUMBO RED CLEAR LEDs	5 for 1.01

ZENERS!

Order by Cat. No. 7A5210 & voltage & wattage

Watt	5 for	1c Sale
1	5 for \$1.10	10 for \$1.01
5	5 for 1.10	10 for 1.01
15	5 for 1.10	10 for 1.01
50	5 for 1.10	10 for 1.01
12.5	5 for 1.10	10 for 1.01
15.0	5 for 1.10	10 for 1.01

5 WATTS SALE

Order by Cat. No. 7A5210B

Watts	3 for	1c Sale
3.3V	3 for \$1.60	10 for \$1.01
6.0V	3 for 1.60	10 for 1.01
6.2V	3 for 1.60	10 for 1.01
12.0V	3 for 1.60	10 for 1.01
12.0V	3 for 1.60	10 for 1.01
15.0V	3 for 1.60	10 for 1.01
25.0V	3 for 1.60	10 for 1.01
30.0V	3 for 1.60	10 for 1.01

4 DIGIT

Easy to build. Both units are 12 or 24 hours. Easy to bread and use. MM516 clock chip and a minimum of external components. AM PM indicator, clock radio, snooze, and alarm. Basic kits include IC's, sockets, transistors, resistors and all other necessary components and line cord not included. Fluorescent clock includes 17 BRIGHT BLUE MIXIE TUBES. LED base includes RED LED READOUTS.

Cat. No. #7A3791 Fluorescent Basic Clock Kit \$9.95 2 for \$9.96
Cat. No. #7A4093 LED Basic Clock Kit 9.95 2 for 9.96
Cat. No. #7A3792 12V 300 ma Transformer 2.99 2 for 1.50 (no 1c sale)

FLUORESCENT - LED CLOCK BASICS

BUY ONE AT SALE PRICE. GET 2ND FOR ONLY 1c MORE.

Parts & Semi One Centers

Quant.	Description (Order by Cat. No. in parenthesis)	Sale	1c SALE
5	PANCAKE PHOTOCELLS, 600 to 15K ohms (7A2935)	1.00	10 for 1.01
1	100KHZ MARKER CRYSTALS, approx for meter gen. (7A3896)	1.95	2 for 1.96
1	MOTHERBOARD EDGE CONNECTOR, 106 pins, 1.25" (7A3987)	3.50	2 for 3.51
1	48 PIN EDGE CONNECTOR, .156" spacing (7A3963)	1.95	2 for 1.96
2	LCD THERMAL INDICATORS, BB-106 F, 7x1", readable (7A5195)	1.00	4 for 1.01
1	DUAL GATE MOSFET, 30 gate, for ICs, low noise (7A2747)	1.49	2 for 1.50
1	ECCD THERMOWHEEL SWITCH, BCD, 0-7 (7A2870A)	1.95	2 for 1.96
1	B-TRACK TAPE TRANSPORT, with preamp (7A3010)	9.95	2 for 9.96
1	PLESSEY TV SIDEBAND FILTER, for chan. 3 or 4 (7A3975)	1.95	2 for 1.96
300-R	WIRE WRAP WIRE, 30 gauge, for ICs, low noise (7A3803)	1.00	60-R for 1.01
1	METER, 50uA, 1 1/2" square, D-20db (7A3705)	1.19	2 for 1.20
1	SPST RELAY, norm. open 12-24 VDC, 1250 ohms, dip style (7A5175)	1.00	2 for 1.01
1	VEEDER RODDY COUNTER, 000-999, resettable, panel mt. (7A5081)	1.49	2 for 1.50
1	B-TRACK TAPE HEAD, with plug n' cord (7A3468)	2.50	2 for 2.51
10	CALCULATOR KEYBOARDS, 20 keys and more (7A3524)	\$2.00	20 for \$2.01
10	CRYSTALS, may include CB, Ham & more (7A3250)	2.00	20 for 2.01
150	MOLEX IC SOCKETS, on a strip, cut to length (7A3144)	2.00	200 for 2.01
100	TERMINAL STRIPS, from 2 lugs up (7A3136)	2.00	200 for 2.01
30	NE-ZEON LAMPS, all 100% good (7A2613)	2.00	60 for 2.01
40-R	SHIELDED CABLE, 1 cond, mikes, phones, (7A3577)	2.00	80-R for 2.01
200	TRANSISTOR ELECTRODES, 300, 400, 500 (7A2747)	2.00	100 for 2.01
3	SOUND TRIGGERS, sound triggers scr w/amp (7A3625)	2.00	6 for 2.01
10	CB CRYSTALS, for phase lock loop, Ham, HC/18 (7A5050)	2.00	20 for 2.01
100	DISC CAPACITORS, long leads, marked, ass'd (7A2598)	2.00	200 for 2.01
200	HALF WATT RESISTORS, mica compression, piston, ass'd (7A3144)	2.00	400 for 2.01
10	VOLTAGE REGULATORS, hobby LM320, 340, TO-3 (7A3330)	2.00	20 for 2.01
30	PANEL SWITCHES, slides, rotaries, mod. etc. (7A3268)	2.00	60 for 2.01
200	RESISTOR SPECIAL, 1/4 to 1W, carbon, metal (7A3054)	2.00	400 for 2.01
100	NATIONAL IC BONANZA, linears, 7400s, ROMS (7A2860)	2.00	200 for 2.01
15	LM340T VOLTAGE REGULATORS, 5 to 24V, TO-220 (7A2635)	2.00	30 for 2.01
100	TWO WATERS, resistors, carbon-metal marked (7A2735)	2.00	200 for 2.01
200	MIXED RESISTORS, 1/4, 1/2, 1W, carbon, hi-Q (7A2729)	2.00	400 for 2.01
50			

ADVA

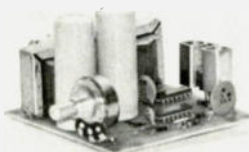

KIT \$11⁹⁵

ASSEMBLED \$17.95
ADD \$1.25 FOR
POSTAGE/HANDLING

VARIABLE POWER SUPPLY

- Continuously Variable from 2V to over 15V
- Short-Circuit Proof
- Typical Regulation of 0.1%
- Electronic Current Limiting at 300mA
- Very Low Output Ripple
- Fiberglass PC Board Mounts All Components
- Assemble in about One Hour
- Makes a Great Bench or Lab Power Supply
- Includes All Components except Case and Meters

OTHER ADVA KITS:

LOGIC PROBE KIT Use with CMOS, TTL, DTL, RTL, HTL, HML and most MOS IC's. Built in protection against polarity reversal and overvoltage. Draws only a few mA from circuit under test. Dual LED readout. Complete kit includes case and clip leads. **ONLY \$7.85**

FIXED REGULATED POWER SUPPLY KITS—Short-circuit proof with thermal current limiting. Compact size and typical regulation of 0.5% make these ideal for most electronic projects. Available for 5V @ 500mA, 6V @ 500mA, 9V @ 500mA, 12V @ 400mA, 15V @ 300mA. Specify voltage when ordering. **\$8.95 ea.**

These easy to assemble kits include all components, complete detailed instructions and plated fiberglass PC boards. Power supply kits do not include case or meters. Add \$1.25 per kit for postage and handling.

1 MAIL NOW! FREE DATA SHEETS supplied with many items from this ad. **FREE ON REQUEST** 741 Op Amp with every order of \$5 or more. 749 Dual Op Amp or two E100 FET's with every order of \$10 or more, postmarked prior to 12/31/77. One free item per order. **ORDER TODAY!** All items subject to prior sale and prices subject to change without notice. All items are new surplus parts. 100% functionally tested.

WRITE FOR FREE CATALOG #77 offering over 700 semiconductors carried in stock. Send 13¢ stamp.

TERMS: Send check or money order (U.S. funds) with order. Add 5% postage for U.S., Canada and Mexico; \$1.00 handling charge on orders under \$10. Calif. residents add 6% sales tax. Foreign orders add 10% postage. COD orders add \$1.00 service charge.

MORE SPECIALS:

RC4195DN · 15V @ 50mA VOLTAGE REGULATOR IC. Very easy to use. Makes a neat Highly Regulated -15V Supply for OP AMP's, etc. Requires only unregulated DC (18-30V) and 2 bypass capacitors. With Data Sheet and Schematics. 8-pin MDIP **\$1.25**

RC4136 Quad 741 Low-Noise Op Amp MDIP **\$0.95**

LM1304 FM Multiplex Stereo Demodulator DIP **0.99**

LM2111 FM IF Subsystem (IF Amp, Det., Limiter) DIP **0.99**

1N6263 Hot Carrier Diode 0.4V @ 1mA 0.1ns DO-35 **1.00**

ZENERS—Specify Voltage 3.3, 3.9, 4.3, 5.1, 6.8, 8.2 **400mW 4/\$1.00**
9.1, 10, 12, 15, 16, 18, 20, 22, 24, 27, or 33V (·10%) **1 Watt 3/\$1.00**

- MONEY-BACK GUARANTEE
- ALL TESTED AND GUARANTEED

ADVA

ELECTRONICS
BOX 4181 EP, WOODSIDE, CA 94062
Tel. (415) 851-0455

FREE

IC or FET's WITH
\$5 & \$10 ORDERS.†
DATA SHEETS
WITH MANY ITEMS.

DIODES	TRANSISTORS	TRANSISTORS	TRANSISTORS	LINEAR IC'S
ZENERS & RECTIFIERS	2N706 50 24	2N4001 3/51	2N6530 2/21	LM390K 5 \$1.20
1N458 6/51	2N718 24	2N4002 50 25	2N75 2/21	LM390S 1 1.20
1N458 6/51	2N729 46	2N4121 3/51	CP643 50 80	LM390T 12 1.20
1N483 10	2N1013 30 20	2N4124 5/51	CP651 50 80	LM390T 15 1.20
1N484 6/51	2N1111 29	2N4241 5/51	E110 4/21	LM390T 24 1.70
1N744 10	2N1090 38	2N4240 5/51	E191 3/51	LM3700 55
1N750 4/51	2N1093 38	2N4250 4/51	E182 3/51	LM3770 2.50
1N814* 16/51	2N2219 24	2N4274 5/51	E175 3/51	LM3800 1.20
1N922 6/51	2N2222 6/51	2N4302 50 20	MPF182** 3/51	NE555V* 2/51
1N974 4/51	2N2222A 6/51	2N4303 29	MPF184 3/51	NE560A 00 90
1N3004 6/51	2N2300 6/51	2N4330 51	MPF112 4/51	LM7000C 20
1N3008 6/51	2N2906 10	2N4304 2/51	MPF0515 3/51	LM7002C 20
1N4001* 12/51	2N2906 10	2N4305 51	SE1001 4/21	LM723H 3/51
1N4002 12/51	2N2905 00 24	2N4302 50 90	SE1002 4/51	LM723M* 3/51
1N4003 12/51	2N2906A 24	2N4416 2/51	SE2001 4/51	LM7330 51 00
1N4004 12/51	2N2907* 6/51	2N4416A 50 80	SE2002 4/51	LM741CH 3/51
1N4005 18/51	2N3161 51 80	2N4606 10	SE5001 3/51	LM741CB* 4/51
1N4006 18/51	2N3563 6/51	2N4601 51	SE5003 3/51	LM741CB1 3/51
1N4007 18/51	2N3564 4/51	2N4607E 2/51	SE5820 53 80	LM747C 85
1N4140 16/51	2N3565 10	2N4608E 2/51	T1573 10 35	7402C DIP 35
1N4154* 25/51	2N3566 6/51	2N4601 52 50	T1575 3/51	7403C DIP 1 00
1N4370 10 2/51	2N3638 6/51	2N4680 51	DIGITAL IC'S	844C DIP 80
1N4372 10 2/51	2N3638A 6/51	2N4695 3/51	MM5738 52 85	LM1304H 1.15
1N4545 15/51	2N3641 6/51	2N4901 4/51	MM5738B 52 85	LM1458H 3/51
1N4726 10 2/51	2N3642 5/51	2N5000 4/51	SN74000 10	LM2111H 51 40
1N4753 3/51	2N3643 6/51	2N5129 10 5/51	SN7401 10	XR2500C 1 55
1N4863 10 2/51	2N3644 4/51	2N5135 5/51	SN74200 10	27400 1 85
1N5238 4/51	2N3646 4/51	2N5136 6/51	SN74400 10	CA3026A 1 75
	2N3680 10 3/51	2N5139 6/51	SN7451H 10	CA3040 84
	2N3800 3/51	2N5163 3/51	SN7470 30	LM307501 1 45
	2N3801 10 4/51	2N5187 55 00	SN7470A 35	CA3000 82
	1N5144 52	2N5190 2 50	SN7470B 44	LM3090H 50
	2N3802 10 80 80	2N5210 3/51	SN7490 35	RC4194D 1 50
	D5 16000Hz 55	2N5200 2/51	LINEAR IC'S	RC4194TK 2 50
	F7 43500Hz 51	2N5207 51 50	LM100H 57 50	RC4195DN 1 25
	MP2510 78	2N5232 1 90	LM3001A 27	RC4195TK 2 25
	MP2510 78	2N5232 1 90	LM3001B 27	RC4195TK 2 25
	MP2510 78	2N5232 1 90	LM3001C 27	RC4500H 2 00
	MP2510 78	2N5232 1 90	LM3001D 27	RC4500H 2 00
	MP2510 78	2N5232 1 90	LM3001E 27	RC4500H 2 00
	MP2510 78	2N5232 1 90	LM3001F 27	RC4500H 2 00
	MP2510 78	2N5232 1 90	LM3001G 27	RC4500H 2 00
	MP2510 78	2N5232 1 90	LM3001H 27	RC4500H 2 00
	MP2510 78	2N5232 1 90	LM3001I 27	RC4500H 2 00
	MP2510 78	2N5232 1 90	LM3001J 27	RC4500H 2 00
	MP2510 78	2N5232 1 90	LM3001K 27	RC4500H 2 00
	MP2510 78	2N5232 1 90	LM3001L 27	RC4500H 2 00
	MP2510 78	2N5232 1 90	LM3001M 27	RC4500H 2 00
	MP2510 78	2N5232 1 90	LM3001N 27	RC4500H 2 00
	MP2510 78	2N5232 1 90	LM3001P 27	RC4500H 2 00
	MP2510 78	2N5232 1 90	LM3001Q 27	RC4500H 2 00
	MP2510 78	2N5232 1 90	LM3001R 27	RC4500H 2 00
	MP2510 78	2N5232 1 90	LM3001S 27	RC4500H 2 00
	MP2510 78	2N5232 1 90	LM3001T 27	RC4500H 2 00
	MP2510 78	2N5232 1 90	LM3001U 27	RC4500H 2 00
	MP2510 78	2N5232 1 90	LM3001V 27	RC4500H 2 00
	MP2510 78	2N5232 1 90	LM3001W 27	RC4500H 2 00
	MP2510 78	2N5232 1 90	LM3001X 27	RC4500H 2 00
	MP2510 78	2N5232 1 90	LM3001Y 27	RC4500H 2 00
	MP2510 78	2N5232 1 90	LM3001Z 27	RC4500H 2 00
	MP2510 78	2N5232 1 90	LM3001AA 27	RC4500H 2 00
	MP2510 78	2N5232 1 90	LM3001AB 27	RC4500H 2 00
	MP2510 78	2N5232 1 90	LM3001AC 27	RC4500H 2 00
	MP2510 78	2N5232 1 90	LM3001AD 27	RC4500H 2 00
	MP2510 78	2N5232 1 90	LM3001AE 27	RC4500H 2 00
	MP2510 78	2N5232 1 90	LM3001AF 27	RC4500H 2 00
	MP2510 78	2N5232 1 90	LM3001AG 27	RC4500H 2 00
	MP2510 78	2N5232 1 90	LM3001AH 27	RC4500H 2 00
	MP2510 78	2N5232 1 90	LM3001AJ 27	RC4500H 2 00
	MP2510 78	2N5232 1 90	LM3001AK 27	RC4500H 2 00
	MP2510 78	2N5232 1 90	LM3001AL 27	RC4500H 2 00
	MP2510 78	2N5232 1 90	LM3001AM 27	RC4500H 2 00
	MP2510 78	2N5232 1 90	LM3001AN 27	RC4500H 2 00
	MP2510 78	2N5232 1 90	LM3001AO 27	RC4500H 2 00
	MP2510 78	2N5232 1 90	LM3001AP 27	RC4500H 2 00
	MP2510 78	2N5232 1 90	LM3001AQ 27	RC4500H 2 00
	MP2510 78	2N5232 1 90	LM3001AR 27	RC4500H 2 00
	MP2510 78	2N5232 1 90	LM3001AS 27	RC4500H 2 00
	MP2510 78	2N5232 1 90	LM3001AT 27	RC4500H 2 00
	MP2510 78	2N5232 1 90	LM3001AU 27	RC4500H 2 00
	MP2510 78	2N5232 1 90	LM3001AV 27	RC4500H 2 00
	MP2510 78	2N5232 1 90	LM3001AW 27	RC4500H 2 00
	MP2510 78	2N5232 1 90	LM3001AX 27	RC4500H 2 00
	MP2510 78	2N5232 1 90	LM3001AY 27	RC4500H 2 00
	MP2510 78	2N5232 1 90	LM3001AZ 27	RC4500H 2 00
	MP2510 78	2N5232 1 90	LM3001BA 27	RC4500H 2 00
	MP2510 78	2N5232 1 90	LM3001BB 27	RC4500H 2 00
	MP2510 78	2N5232 1 90	LM3001BC 27	RC4500H 2 00
	MP2510 78	2N5232 1 90	LM3001BD 27	RC4500H 2 00
	MP2510 78	2N5232 1 90	LM3001BE 27	RC4500H 2 00
	MP2510 78	2N5232 1 90	LM3001BF 27	RC4500H 2 00
	MP2510 78	2N5232 1 90	LM3001BG 27	RC4500H 2 00
	MP2510 78	2N5232 1 90	LM3001BH 27	RC4500H 2 00
	MP2510 78	2N5232 1 90	LM3001BI 27	RC4500H 2 00
	MP2510 78	2N5232 1 90	LM3001BJ 27	RC4500H 2 00
	MP2510 78	2N5232 1 90	LM3001BK 27	RC4500H 2 00
	MP2510 78	2N5232 1 90	LM3001BL 27	RC4500H 2 00
	MP2510 78	2N5232 1 90	LM3001BM 27	RC4500H 2 00
	MP2510 78	2N5232 1 90	LM3001BN 27	RC4500H 2 00
	MP2510 78	2N5232 1 90	LM3001BO 27	RC4500H 2 00
	MP2510 78	2N5232 1 90	LM3001BP 27	RC4500H 2 00
	MP2510 78	2N5232 1 90	LM3001BQ 27	RC4500H 2 00
	MP2510 78	2N5232 1 90	LM3001BR 27	RC4500H 2 00
	MP2510 78	2N5232 1 90	LM3001BS 27	RC4500H 2 00
	MP2510 78	2N5232 1 90	LM3001BT 27	RC4500H 2 00
	MP2510 78	2N5232 1 90	LM3001BU 27	RC4500H 2 00
	MP2510 78	2N5232 1 90	LM3001BV 27	RC4500H 2 00
	MP2510 78	2N5232 1 90	LM3001BW 27	RC4500H 2 00
	MP2510 78	2N5232 1 90	LM3001BX 27	RC4500H 2 00
	MP2510 78	2N5232 1 90	LM3001BY 27	RC4500H 2 00
	MP2510 78	2N5232 1 90	LM3001BZ 27	RC4500H 2 00
	MP2510 78	2N5232 1 90	LM3001CA 27	RC4500H 2 00
	MP2510 78	2N5232 1 90	LM3001CB 27	RC4500H 2 00
	MP2510 78	2N5232 1 90	LM3001CC 27	RC4500H 2 00
	MP2510 78	2N5232 1 90	LM3001CD 27	RC4500H 2 00
	MP2510 78	2N5232 1 90	LM3001CE 27	RC4500H 2 00
	MP2510 78	2N5232 1 90	LM3001CF 27	RC4500H 2 00
	MP2510 78	2N5232 1 90	LM3001CG 27	RC4500H 2 00
	MP2510 78	2N5232 1 90	LM3001CH 27	RC4500H 2 00
	MP2510 78	2N5232 1 90	LM3001CI 27	RC4500H 2 00
	MP2510 78	2N5232 1 90	LM3001CJ 27	RC4500H 2 00
	MP2510 78	2N5232 1 90	LM3001CK 27	RC4500H 2 00
	MP2510 78	2N5232 1 90	LM3001CL 27	RC4500H 2 00
	MP2510 78	2N5232 1 90	LM3001CM 27	RC4500H 2 00
	MP2510 78	2N5232 1 90	LM3001CN 27	RC4500H 2 00
	MP2510 78	2N5232 1 90	LM3001CO 27	RC4500H 2 00
	MP2510 78	2N5232 1 90	LM3001CP 27	RC4500H 2 00
	MP2510 78	2N5232 1 90	LM3001CQ 27	RC4500H 2 00
	MP2510 78	2N5232 1 90	LM3001CR 27	RC4500H 2 00
	MP2510 78	2N5232 1 90	LM3001CS 27	RC4500H 2 00
	MP2510 78	2N5232 1 90	LM3001CT 27	RC4500H 2 00
	MP2510 78	2N5232 1 90	LM3001CU 27	RC4500H 2 00
	MP2510 78	2N5232 1 90	LM3001CV 27	RC4500H 2 00
	MP2510 78	2N5232 1 90	LM3001CW 27	RC4500H 2 00
	MP2510 78	2N5232 1		

ALL PRICES INCLUDE FREIGHT PREPAID ANYWHERE IN CONTINENTAL USA

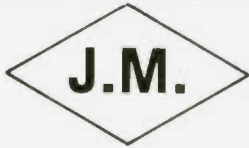

J.M. INDUSTRIES

J10

ELECTRONIC COMPONENTS
EQUIPMENT HARDWARE
1922 N.E. 148th STREET
N. MIAMI, FLA. 33181
(305) 947-1479

ZENER DIODES	MYLAR CAP	DIODES	TIMING MOTORS	RESISTORS	SLIDE SWITCH	We guarantee it to be worth \$25.00 \$3.95	GRAB BAG #1
5.1V 400mw 5% 8.2V 400mw 5% 11V 1w 5% Any 10—1 value \$1.00—\$.15 each	West-Cap-Axial 1.5 mF—400V 2/1.00 5/2.00	IN4000 12/1.00 IN4001 12/1.00 IN4002 12/1.00 IN4003 12/1.00 IN4004 12/1.00 IN4005 10/1.00 IN4006 10/1.00 IN4007 10/1.00	Haydon 120V 60C 4RPM 5W or 2.5W Your Choice \$.95 ea RFE	Assorted bag of 100 peices Most popular values— ¼ & ½ w 1.95/bag 2/\$3.50	5 Amp—125 V ac/dc 2 pole—3 pos. Has holes for mounting w/ 1¼" mtg. center 12 10/1.00		
POLYSTYRENE CAPS	AXIAL ELECTROLYTICS	REED RELAY	FUSES	TRANSFORMER	BLOWERS	We guarantee it to be worth \$50.00 \$8.95	GRAB BAG #2
6200 pF 33V 5% 7500 pF 33V 5% 7500 pF 100V 5% 12000 pF 100V 5% 15000 pF 33V 5% 15000 pF 100V 5% 12000 pF 33V 5% 10/1.00	50/100 V \$.25 ea. 150/105 V \$.50 ea. 220/25 V \$.25 ea. 330/60 V \$.50 ea. 400/75 V \$.50 ea. 500/50 V \$.50 ea. 1000/50 V \$.75 ea. 2000/25 V \$.50 ea.	Gordos-F811156 2000 Ohm Coil SPST No -Special- \$1.25 ea 2/2.00	Littlefuse 3AG ¼ A 250V ½ A 250V .30 ea. 4/1.00	Constant voltage 115/220 V In. 40 V CT 1.3 Amp 20 V CT 2 Amp \$2.95 each 2/\$5.00	Open frame type motor, quick connect terminals. Input: 120 V, 60 Hz, 100 Watts. Rated 120 CFM @ "0" static pressure. Size: Inlet, 3" x 8½"; Outlet, 2" x 8½"; O/A Size: 11-¼" long x 3-¼" x 3-½"; 6 lbs. *RFE \$9.95		
METERS	TRANSISTORS	TRANSFORMER	SIGNAL DIODE	MICRO SWITCH	MICRO-SWITCHES	We guarantee it to be worth \$50.00 \$8.95	GRAB BAG #2
Weston #131 Edgewise-Panel 0-100 ua dc Retailers for over \$30.00 \$.65 ea.	2N914 .30 2N2222 .25 2N3055 .50 2N3725 .90 2N3905 4/1.00 2N3906 4/1.00 2N5086 4/1.00	Input 120 V @ 60 Hz with Elec- trostatic shield 1.) 30V tap at 4V 2A 2.) 30V tap at 4V 2A 3.) 10V CT at 5V 50A 29.95	1N4148 20 for \$1.00 50 for \$2.00 100 for \$3.00 250 for \$6.00 500 for \$10.00 1000 for \$18.00	#BA-2RV137T 20A 125V or 480V 10A-125Vac 1 HP @ 125Vac 2 HP @ 250Vac \$1.25	New-pulled from equip. assorted sizes consists of E-33's, 23's etc. 15 for \$1.00		
LAMPS/BULBS	TRANSISTORS	7 SEG LED	Circuit Breaker	CONNECTORS	RIBBON CABLE ASSEMBLY	We guarantee it to be worth \$50.00 \$8.95	GRAB BAG #2
NE-2 Long Lead Chic. min. #327 Your Choice 10/\$1.00	House No. 2N 1991 PNP 2N 1984 NPN .15 ea. 10/1.25	TI L322P .5" RED common cathode \$1.10 ea 2/2.00	Littlefuse #230 3.0 A Hold .25 ea 5/1.00	PL 259 SO 239 Your Choice .65	Has P.C. Board with 56 pin edge connector and 2 lengths of 2½' 40 conductor ribbon cable with 2 ea. 40 pin connectors new \$2.95		
BOURNS TRIMPOT	HANDLES	BATTERY HOLDERS	FUSE CLIPS	KESTER SOLDER	TRANSISTOR MOUNTING PAD	We guarantee it to be worth \$50.00 \$8.95	GRAB BAG #2
#200L-1-201m 200 Ohm \$1.25 ea 2 FOR 2.25 3 FOR 3.00	Cambion #1252-1 Brass-nickle Finish—3" mtg. Centers—Retail \$4.95 your cost \$1.00	Keystone #140 Dual AA Size .35 ea 3/1.00 10/2.50	Littlefuse#101002 for 3AG Fuses 25/1.00 100/3.00	63/37 or 60/40 1lb. spools .032D \$7.25/lb.	Milton Ross #10044 100—2.95 250—3.95 500—4.95		
PANEL LIGHT ASS'Y	DIPPED TANTALUM	RF DEVICES	MICROPHONE	PISTON CAP	UNIVAC PC Bd ASSEMBLY	We guarantee it to be worth \$50.00 \$8.95	GRAB BAG #2
Grimes #A7075-5 Blue w/cap & all hardware 4/\$1.00	.1/35 V } \$.25 .15/35 V } each .22/35 V } .33/35 V } .68/35 V } 10/ 1.0/35 V } \$2.25	Special This Month Only 2N—5590 \$5.95	Panasonic #RP-8130 20K Ohm impedance with cord, plug & stand retail—over \$18.00 ea your cost \$7.95	JFD #VC-24G 1 to 30 mF .75 2/1.25	Has 14 mot. SC14211L 90 TI SN28188J 32 Fair FSA 2812M 32 Fair FSA 2813M 3 56 pin connectors 19 Beckman Pts. Plus: Over 200 other parts to include tantalum caps, etc. ICs with full leads easily removed. Cost Univac over \$1900.00 New \$16.95 only 50		
MIN. TRANSFORMER	DIODE	COUNTERS	RESISTORS-CC	BANANA PLUG	We guarantee it to be worth \$50.00 \$8.95	GRAB BAG #2	
Primary 400 Ohm Secondary— 300 Ohm .60 ea 2/1.00	Microwave Diode IN23B—Sylvania 100 MC—150 KMC \$.60 2/1.00	Veeder Root 120V 50/60 Cycle 5 place—approx. 1¼"W x 1"H x 2"L *RFE \$2.50	¼W—5% Ay Value 20—1.00 50—2.00 100—3.50 Please State Value	Red or Black .30 4/1.00 10/2.25			
WHAT'S IT	TIP PLUGS	DISC CAPS	POTS	BINDING POST	BOURNS TRIMPOT	We guarantee it to be worth \$50.00 \$8.95	GRAB BAG #2
We don't know but maybe you do. Has motors gears, micro switch *RFE \$1.50	Red and Black .12 each 10/1.00 25/2.00	.01—100V ¼" Lead Spacing ARCO TCP-RO1 20/\$1.00	CTS ½" Bushing ½" shaft 10K—\$.35 100K—\$.35 4 meg/40K dual \$.75	5 Way Red 5 Way White Your Choice .40 ea 3/1.00	#3260H 10K—10 Turn ¼" Square—Wirewound Retailers for \$11.55 Special this month only \$5.95		

TERMS: Orders under \$15.00 add 2.00 for handling—cods accepted with 25% deposit on orders over \$25.00. Fla. residents add 4% sales tax—
all material fully guaranteed. *rfe-removed from equipment

NEW

Frequency Counter

\$89.95 kit



UTILIZES NEW MOS-LSI CIRCUITRY

You've requested it, and now it's here! The CT-50 frequency counter kit has more features than counters selling for twice the price. Measuring frequency is now as easy as pushing a button, the CT-50 will automatically place the decimal point in all modes, giving you quick, reliable readings. Want to use the CT-50 mobile? No problem, it runs equally as well on 12 V dc as it does on 110 V ac. Want super accuracy? The CT-50 uses the popular TV color burst freq. of 3.579545 MHz for time base. Tap off a color TV with our adapter and get ultra accuracy - .001 ppm! The CT-50 offers professional quality at the unheard of price of \$89.95. Order yours today!

- CT-50, 60 MHz counter kit \$ 89.95
- CT-50 WT, 60 MHz counter, wired and tested 159.95
- CT-600, 600 MHz prescaler option for CT-50, add 29.95

SPECIFICATIONS

- Sensitivity: less than 25 mv.
- Frequency range: 5 Hz to 60 MHz, typically 65 MHz
- Gatetime: 1 second, 1/10 second, with automatic decimal point positioning on both direct and prescale
- Display: 8 digit red LED .4" height
- Accuracy: 2.0 ppm, .001 ppm with TV time base!
- Input: BNC, 1 megohm direct, 50 Ohm with prescale option
- Power: 110 V ac 5 Watts or 12 V dc @ 1 Amp
- Size: Approx. 6" x 4" x 2", high quality aluminum case

Color burst adapter for .001 ppm accuracy

CB-1, kit \$14.95

MINI-KITS



CLOCK KIT

6 digit 12/24 hour

Want a clock that looks good enough for your living room? Forget the competitor's kludges and try one of ours! Features: jumbo .4" digits, Polaroid lens filter, extruded aluminum case available in 5 colors, quality PC boards and super instructions. All parts are included, no extras to buy. Fully guaranteed. One to two hour assembly time. Colors: silver, gold, black, bronze, blue (specify).

- Clock kit, DC-5 \$22.95
- Alarm clock, DC-8, 12 hr only 24.95
- Mobile clock, DC-7 25.95
- Clock kit with 10 min ID timer, DC-10 25.95

Assembled and tested clocks available, add \$10.00

VIDEO TERMINAL KIT \$149.95

A compact 5 - 10 min PC (and) that requires only an ASCII keyboard and a TV set to become a complete interactive terminal for connection to your microprocessor asynchronous interface. Its many features are single 5 volt supply, crystal controlled sync and burst rates (up to 9600 baud), 2 pages of 32 characters by 16 lines, read to and from memory, computer and keyboard operated cursor and page control, parity error display and control, power on initialization, full 16 character ASCII display, block type set thru cursor, keyboard/computer control backspaces, forward spaces, line feeds, row line feeds, home returns cursor. Also clears page clears to end of line, sets page 1 or 2, reads from or to memory. The card requires 5 volts at approx. 900 ma and outputs standard 75 ohm composite video.

- TH3216 Kit \$149.95
- TH3216, Assembled and Tested 239.95
- VD 1, Video to RF Modulator Kit 6.95

CAR CLOCK KIT \$27.95



- 12/24 Hour 12 Volt AC or DC
- High Accuracy (1 minute/month)
- 6 jumbo .4" LED readouts
- Easy no polarity hookup
- Display blanks with ignition
- Basic mounting brackets included
- Basic instructions
- Complete Kit, DC 11 \$27.95

AUTO-DIMMER \$2.50

Automatically adjusts display brightness according to ambient light level. For DC 11 Car Clock.

CHEAP CLOCK KIT \$8.95

- DC-4 Features: Does not include board or transformer
- 6 digit .4" LED
- 12 or 24 format
- PC Board \$2.95
- Transformer \$1.49

600 MHz PRESCALER



Extend the range of your counter to 600 MHz. Works with all counters. Less than 150 mv sensitivity. Specify 10 or 100. Wired, tested, PS 1B \$59.95 Kit, PS 1B \$44.95

30 watt 2 meter Power Amp

The famous RE class C power amp now available mail order! Four Watts in for 30 Watts out, 2 in for 15 out, 1 in for 8 out, incredible value, complete with all parts, instructions and details on T-R relay. Case not included.

Complete Kit, PA 1 \$22.95

CALENDAR ALARM CLOCK

Has every feature one could ever ask for. Kit includes everything except case, build it into wall, station or even car!

- FEATURES:
- 6 Digits, 5" High LED
 - Calendar shows mo./day
 - True 24 Hour Alarm
 - Battery back up with built in on chip time base
 - 12/24 Hour Format
 - Snooze button
 - 1001 chip does all!
- Complete Kit, less case, DC-9 \$34.95

TONE DECODER KIT

A complete tone decoder on a single PC Board. Features: 400-5000 Hz adjustable frequency range, voltage regulation, 567 IC. Useful for touch-tone decoding, tone burst detection, FSK demod, signaling, and many other uses. Use 7 for 12 button touchtone decoding. Runs on 5 to 12 volts.

Complete Kit, TD 1 \$4.95



SUPER SLEUTH AMPLIFIER

A super-sensitive amplifier which will pick up a pin drop at 15 feet! Great for monitoring baby's room or as a general purpose test amplifier. Full 2 watts of output, runs on 6 to 12 volts, uses any type of mike. Requires 8-45 ohm speaker.

Complete Kit, BN-9 \$4.95

FM WIRELESS MIKE KIT

Transmit up to 300' to any FM broadcast radio, uses any type of mike. Runs on 3 to 9 V. Type FM-2 has added super sensitive mike preamp.

FM-1 \$2.95 FM-2 \$4.95

COLOR ORGAN/MUSIC LIGHTS

See music come alive! 3 different lights flicker with music or voice. One light for lows, one for the mid-range and one for the highs. Each channel individually adjustable, and drives up to 300 watts. Great for parties, band music, nite clubs and more.

Complete Kit, ML-1 \$7.95

LED BLINKY KIT

A great attention getter which alternately flashes 2 Jumbo LEDs. Use for name badges, buttons, or warning type panel lights. Runs on 3 to 9 volts.

Complete Kit \$2.95

POWER SUPPLY KIT

Complete triple regulated power supply provides variable 15 volts at 200 mA and 45 volts at 1 Amp. 50 mV load regulation good filtering and small size. Kit less transformers. Requires 6-8 V at 1 Amp and 18 to 30 VCT.

Complete Kit, PS-3LT \$6.95



LINEAR		REGULATOR		TRANSISTORS	
5314 Clock	\$2.95	555	\$.50	MRF 238 30W VHF	\$11.95
74S00	.35	556	.75	NPN 2N3904 type	10/\$1.00
74S112	.75	566	1.49	PNP 2N3906 type	10/\$1.00
7447	.79	567	1.49	NPN Power Tab 40W	3/\$1.00
7473	.35	1458	.50	PNP Power Tab 40W	3/\$1.00
7475	.50	LED DRIVER	.89	FET MPF 102 type	3/\$2.00
7490A	.55	75491	.50	UJT 2N2646 type	3/\$2.00
74143	3.50	75492	.50	2N3055 NPN Power	.75

DIODES: 1KV,2.5A 5/\$1.00 100V,1A 10/\$1.00 1N914A type 50/\$2.00

LED DISPLAYS

- FND 35975
- FND 510 1.25
- DL 707 1.25
- HP 7730 1.25
- Red Polaroid Filter 4.25" X 1.125"59

741 OP-AMP SPECIAL

Factory prime mini dip with both Xerox and 741 part numbers

10 for \$2.00

SOCKETS

- 14 PIN 5/\$1.00
- 16 PIN 5/\$1.00
- 24 PIN 2/\$1.00
- 40 PIN 3/\$2.00

FERRITE BEADS

- with info and specs 15/\$1.00
- 6 hole Balun Beads 5/\$1.00

SIREN KIT

Produces upward and downward wail characteristic of police siren. 5 watts audio output, runs on 3-9 volts, uses 8-45 ohm speaker.

Complete Kit, SM-3 \$2.95

DECADE COUNTER PARTS

Includes: 7490A, 7475, 7447, LED readout, current limit resistors, and instructions on an easy to build low cost frequency counter.

Kit of parts, DCU-1 \$3.50

ramsey electronics

P.O. Box 4072 Rochester NY 14610

(716) 271-6487

TELEPHONE ORDERS WELCOME



Satisfaction guaranteed or money refunded. COO, add \$1.00. Orders under \$10 add \$.75. NY residents add 7% tax. Add 5% for postage, insurance, and handling. Minimum order \$6.00.

THINKING ABOUT OSCAR?

Here are some helpful suggestions -

FAMOUS HAMTRONICS PREAMPS let you hear the weak ones!

Great for OSCAR, SSB, FM, ATV. Over 10,000 in use throughout the world on all types of receivers.

P9 Kit \$12.95
P14 Wired \$24.95

Deluxe vhf model for applications where space permits.



- 1-1/2 x 3" • Covers any 4 MHz band • 12 Vdc
- Ideal for OSCAR • Diode protection • 20dB gain

MODEL	RANGE
P9-LO	26-88 MHz
P9-HI	88-172 MHz
P9-220	172-230 MHz
P14 Wired	Give exact band



P8 Kit \$10.95
P16 Wired \$21.95

- Covers any 4 MHz band
- 20 dB gain • 12 Vdc
- Miniature VHF model for tight spaces - size only 1/2 x 2-3/8 inches.

MODEL	RANGE
P8-LO	20-83 MHz
P8-HI	83-190 MHz
P8-220	220-230 MHz
P16 Wired	Give exact band

P15 Kit \$18.95
P35 Wired \$34.95

- Covers any 6 MHz band in UHF range of 380-520 MHz
- 20 dB gain • Low noise



FM/CW TRANSMITTER KITS

BUILD UP YOUR OWN GEAR FOR OSCAR CW OPERATION, FM REPEATERS, CONTROL LINKS

- Professional Sounding Audio • Free of Spurs
- Completely Stable • Built-in Testing Aids



T40 11 Channel 200 MW Exciter Kit for 2M or 6M band..... \$39.95
T20 Tripler/Driver Kit. Use with T40 for operation on 432-450 MHz band..... \$19.95

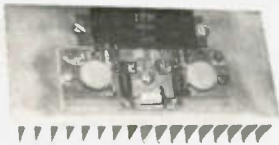

T80 RF POWER AMPLIFIER MODULES FOR ABOVE
• No tuning • VSWR Protected • Wired and Tested
• Rated for Continuous Duty - Great for Repeaters
T80-150: 140-175 MHz, 20-25W output \$79.95
T80-450: 430-470 MHz, 13-15W output \$79.95

AT LAST! A 2 METER SSB TRANSVERTER

At a price you can afford

Use inexpensive recycled 10 or 11 meter ssb exciter on 2 meters.

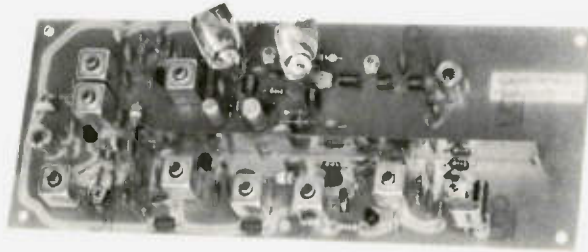

FEATURES:

- Linear Converter for SSB, CW, FM, etc.
- A fraction of the price of other units
- 2W p.e.p. output with 5 MW of drive
- Use low power tap on exciter or attenuator pad
- Easy to align with built-in test points

Frequency Schemes Available:

VX2-4	28-30 = 144-146	□ Other frequency
VX2-5	28-29 = 145-146	□ ranges available
VX2-6	26-28 = 144-146	□ on special order

2M LINEAR POWER AMPLIFIERS:

LPA 2-15 Kit	15 W p.e.p.	\$69.95
LPA 2-70 Kit	70 W p.e.p.	\$139.95

VX2-() TRANSVERTER KIT \$59.95
A25 Optional Cabinet for Xverter & PA \$20

New VHF&UHF Converter Kits

let you receive OSCAR signals and other exciting SSB, CW, & FM activity on your present HF receiver.



either one
- ONLY \$34.95
including crystal



MODEL	RF RANGE (MHZ)	I-F RANGE
C50	50-52	28-30
C144	144-146	28-30
C145	145-147 (OSCAR)	28-30
C146	146-148	28-30
C110	Aircraft	28-30
C220	220 band	28-30
Special	Other i-f & rf ranges available	

MODEL	RF RANGE (MHZ)	I-F RANGE
C432-2	432-434	28-30
C432-5	435-437 (OSCAR)	28-30
C432-7	427.25	61.25
C432-9	439.25	61.25
Special	Other i-f & rf ranges available	
A9 Extruded Alum Case/Connectors		\$12.95

VHF/UHF FM RCVR KITS

- ★ NEW GENERATION RECEIVERS
- ★ MORE SENSITIVE ★ MORE SELECTIVE (70 or 100 dB)
- ★ COMMERCIAL GRADE DESIGN
- ★ EASY TO ALIGN WITH BUILT-IN TEST CKTS
- ★ LOWER OVERALL COST THAN EVER BEFORE



R70 6-channel VHF Receiver Kit for 2M, 6M, 10M, 220 MHz, or com'l bands..... \$69.95
Optional xtal filter for 100 dB adj chan 10.00



R90 UHF Receiver Kit for any 2 MHz segment of 380-520 MHz band..... \$89.95

* FREE 1978 CATALOG *

40 PAGE CATALOG IS YOURS FOR THE ASKING!

IT'S EASY TO ORDER!

- ☎ CALL OR WRITE NOW FOR FREE CATALOG OR TO PLACE ORDER!
- ☎ PHONE 716-663-9254. (Answering service evenings and weekends for your convenience. Personal service 9-5 eastern time.)
- ☎ Use credit card, c.o.d., check, m.o.
- ☎ Add \$2.00 shipping & handling.

IN CANADA, send to Comtec; 5605 Westluxe Ave; Montreal, Que H4W 2N3 or phone 514-482-2640. Add 28% to cover duty, tax, and exchange rate.

hamtronics, inc.

182-D Belmont Rd; Rochester, NY 14612 H16

BULLET ELECTRONICS

P.O. Box 19442E Dallas, TX. 75219 (214)823-3240



MC3301P HOUSE #
4 OP AMPS IN ONE PACKAGE USES SINGLE SUPPLY. (4 to 28VDC). INTERNALLY COMPENSATED. SIMILAR TO MC3401, BUT HIGHER GAIN. **49c**

MC1437P DUAL 709 OP AMP
HIGH OPEN LOOP GAIN, LOW NOISE. 14 PIN DIP **3/1.00**

MC1351P FM-IF AMP AND DISCRIMINATOR

USED IN FM & TV SOUND CIRCUITS. REQUIRES MINIMUM EXTERNAL COMPONENTS. 14 PIN DIP. DIRECT REPLACEMENT FOR HEPC 6060, ECG 748 AND MANY OTHERS. HOUSE # **50c** WITH SPECS

HOUSE #
LM3900 QUAD NORTON AMP

WE BOUGHT A LARGE QUANTITY OF THESE HOUSE NUMBERED PARTS AT A BARGAIN PRICE THAT ALLOWS US TO SELL THEM AT A LOW. LOW **39c**

TIL312 COMMON ANODE READOUT



3" CHARACTER SIZE WITH PINOUT **.65 6/3.00**

MPF131 N-CHANNEL DUAL GATE MOSFET



50c

DESIGNED FOR AMPLIFIER AND MIXER APPLICATIONS TO 200 MHZ. PLASTIC CASE. UNITS ARE HOUSE NUMBERED WITH SPECS.

IL-1 OPTO ISOLATORS

BY LITRONIX 6 PIN DIP STANDARD PINOUT LED-TRANSISTOR COMBINATION. **50c** WHILE THEY LAST!



SMALL SKIRTED BLACK INSTRUMENT KNOB.

FITS 1/8" SHAFT WITH SET SCREW.

5/1.00



MJ900 - MJ1000

COMPLIMENTARY PNP, NPN DARLINGTON POWER TRANSISTORS. 8 AMPS. WE SUPPLY A SCHEMATIC TO BUILD A HIGH POWER (35W) LOW DISTORTION AUDIO AMP WITH ONLY ONE ADDITIONAL TRANSISTOR AND A DOZEN INEXPENSIVE COMPONENTS! TO-3 CASE STYLE. BUY A PAIR FOR **\$3.00!**

1N4148 DIODES

LEADS ARE TARNISHED BUT CLEAN UP EASILY. THE BOSS SAYS "DUMP 'EM"... SO CHECK THIS PRICE!

50/1.00



HOUSE # PNP POWER

TO-3

150 WATTS
80 VCEO
10 AMPS



IDENTICAL TO 2N3790 **1.00**

MC1469R POSITIVE VOLTAGE REGULATOR

1/2 AMP COMPLETE SPECS AND APPLICATIONS SHOW HOW TO BUILD FIXED OR VARIABLE POWER SUPPLIES FROM 3 TO 30VDC. DRIVE EXTERNAL SERIES PASS FOR CURRENT TO 20 AMPS!

1.25 EA. 10/10.00

HOUSE #



FANTASTIC SOUND EFFECTS CHIP

AVAILABLE ONLY FROM BULLET!

THIS 28 PIN MARVEL CONTAINS A LOW FREQUENCY OSCILLATOR, VCO, NOISE OSCILLATOR, ONE SHOT, MIXER AND ENVELOPE CONTROL. WITH 8 PAGE MANUAL. 5 to 9VDC **3.95**

ALL COMPONENTS 100% GUARANTEED



CA3011 WIDEBAND IF AMP w/specs **50c**
2N3569 NPN EPOXY 1W **6/1.00**
741 OP AMP 8 PIN DIP **5/1.00**
723 VOLTAGE REG. 14 PIN DIP **50c**
MPS6530 NPN HOUSE # **8/1.00**
725 OP AMP LOW NOISE HOUSE # **99c**
7815 15V 1A REGULATOR HOUSE # **69c**
LM340T-12 12V 1A VOLT. REG w/specs **75c**
TCA430 QUAD OSCILLATOR 1/specs **69c**
2N4343 P CHANNEL J FET **4/1.00**
2N6111 PNP MED PWR 40W TO-220 **3/1.00**
2N6028 PROGRAMMABLE UNIJUNCTION w/specs **50c**
TRIAC 200V 8A UNMARKED **3/1.00**



INCANDESCENT PANEL LAMP

WITH TINNEMAN NUT YOUR CHOICE OF RED, GREEN, YELLOW. WHITE 12-24VDC **15c**

POWER SUPPLY METERS

Quality 3 1/2" meters for the P-514, 0-15VDC & 0-25A. Matched set, individually packaged. NOT SURPLUS! **12.95/set**

CAPACITORS

SMALL SIZE!

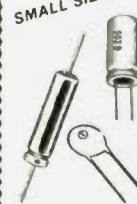

2200 MFD @ 16 VDC RADIAL **3/1.00**
500 MFD @ 35VDC **5/1.00** AXIAL
220 MFD @ 25VDC **7/1.00** AXIAL
1 MFD @ 20VDC DISC CERAMIC **15/1.00**

FND510 69c

COMMON ANODE READOUT 1/2" CHARACTER **LIMIT 24 PER CUSTOMER!**



Miniature 7K Pot w/switch PC Mount or panel mount 1/8" shaft 49 Black plastic knob for above price

LIMITED QTY Computer Grade FILTER CAP 5Watt Terminals 2 x 5/16" 9500 micro75v 2.95 or 4.95

NEW! **ULTRASONIC SENDER RECEIVER KIT US-02**

TOTAL SECURITY! Completely invisible ultrasonic (23KHZ) sound beam works like a photoelectric beam but is unaffected by light, heat or noise. Separate Transmitter and Receiver can be used from 6 inches to 25 feet! A solid object breaking the beam causes an output to go low that will sink up to 150 mA to drive a Relay, TRIAC, etc. Complete electronics are provided. Works on 12VDC (unregulated) and draws less than 100 mA. Use 1 for burglar alarms, object counters, automatic door openers, automatic door bells, electronic rat trap! and more.

COMPLETE KIT LESS CASES **21.50**

Optional entry delay and Alarm Timeout Circuit **3.95** will source or sink up to 200 MA DC

LED'S JUMBO: RED 5/.89 GREEN 4/.89

MEDIUM: RED .15 MINI: GREEN .16 RED .10 YELLOW .16

1.5V 10-30 ma

POWER SUPPLY KIT PS-14

- Better than 200MV load and line regulation
- Foldback Current Limiting
- Short Circuit Protected
- Thermal Shutdown
- Adjustable Current Limiting
- Less than 1% ripple
- 15 amps 11.5 to 14.5V
- All parts supplied including heavy duty transformer.
- Quality plated fiberglass PC board.

UPS SHIPPING PAID!
39.95

Less Case, meters & jacks

Public Notice!

THE PS-14 HIGH CURRENT POWER SUPPLY KIT HAS BEEN SELLING FOR 39.95 FOR OVER A YEAR. IN EXCESS OF ONE THOUSAND KITS HAVE BEEN SOLD AT THIS PRICE.

WE WOULD LIKE TO GIVE OUR CUSTOMERS A CHANCE TO PURCHASE THE KIT AT THIS PRICE BEFORE A SCHEDULED INCREASE TO 43.00 IN SEPTEMBER.

MINI GRANDFATHER CLOCK KIT

Complete Electronics!
Chimes the hour (ie: 3 times for 3 O'clock)
Unique "swinging" LED pendulum
Tick tock sound matches pendulum swing
Large 4 digit .5" LED readout
All CMOS construction
Complete electronics including transformer & speaker; drilled and plated PC boards measure 4 5/8" x 6 5/8"

BEAUTIFUL SOLID WALNUT
Custom case for above kit. Over 9 1/2" tall. **19.95**

WARBLE ALARM Kit

A fun EASY kit to assemble that emits an ear piercing 10 watt dual tone scream. Resembles European siren sound. Great for alarms or toys. Operates from 5-12VDC at up to 1 amp (using 12VDC & 8 ohm speaker). Over five thousand have been sold. All parts including PC board, less speaker. ORDER WB-02

2.50

OVERVOLTAGE PROTECTION KIT 6.95

Provides cheap insurance for your expensive equipment. Trip voltage is adjustable from 3 to 30 volts. Overvoltage instantly fires a 25A SCR and shorts the output to protect equipment. Should be used on units that are fused. Directly compatible with the PS-12 and PS-14. All electronics supplied. Drilled and plated PC board. (Order OVP-1)

MK-03A CLOCK/TIMER KIT

Features 24 hour Zulu time and up to 24 hours of elapsed time on the same set of six digit LED readouts. Totally independent operation of both functions. Clock has presettable alarm with 10 minute snooze. Timer has reset, hold, and count functions. Full noise and overvoltage protection. 24 hour only. Readouts has dimmer feature or they can be turned off without disturbing the clock or timer. Timebase included (.01% accuracy). Because of the many options and mounting considerations the case and switches are not included. Switches are standard types. Will fit inside standard aircraft instrument case.

9-14VDC **28.95**

* NO C.O.D.'S
* SEND CHECK M.O. OR CHARGE CARD NO.
* PHONE ORDERS ACCEPTED ON VISA AND MASTERCARD ONLY.

* ADD 5% FOR SHIPPING
* TX. RES. ADD 5% STATE SALES TAX
* ORDERS OF 550. & OVER TAKE 10% DISCOUNT
* FOREIGN ORDERS ADD 10% (20% AIRMAIL) U.S. FUNDS ONLY.

600 MHZ. FREQUENCY COUNTER ±0.1 PPM TCXO

OPTO-8000.1

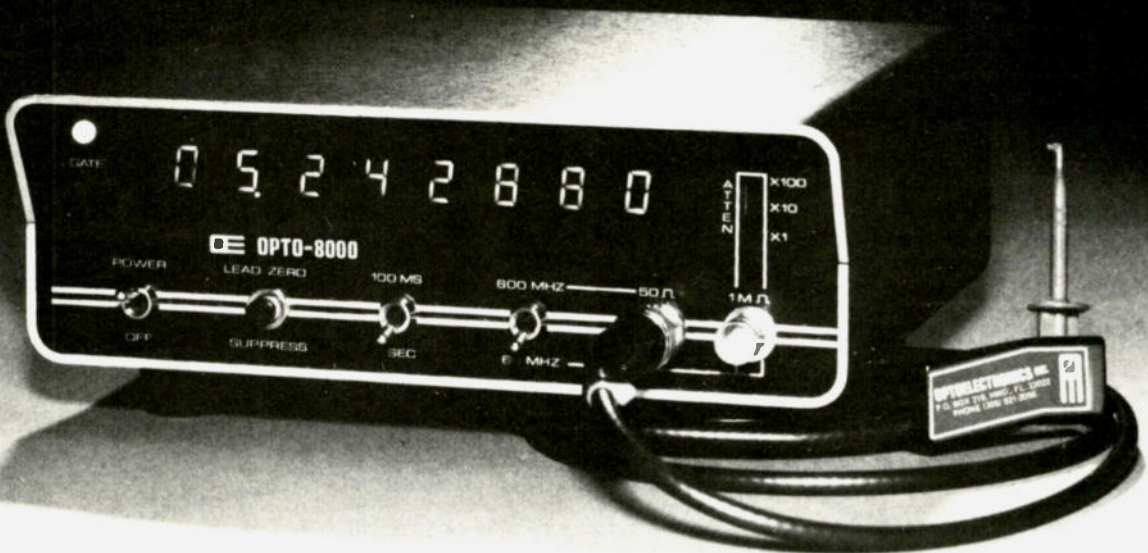

This new instrument has taken a giant step in front of the multitude of counters now available. The Opto-8000.1 boasts a combination of features and specifications not found in units costing several times its price. Accuracy of ± 0.1 PPM or better — *Guaranteed* — with a factory-adjusted, sealed TCXO (Temperature Compensated Xtal Oscillator). **Even kits require no adjustment for guaranteed accuracy!** Built-in, selectable-step attenuator, rugged and attractive, black anodized aluminum case (.090" thick aluminum) with tilt bail. 50 Ohm and 1 Megohm inputs, both with amplifier circuits for super sensitivity and both diode/overload protected. Front panel includes "Lead Zero Blanking Control" and a gate period indicator LED. AC and DC power cords with plugs included.



OPTOELECTRONICS, INC.

5821 NE 14 Avenue
Ft. Lauderdale, FL 33334
Phones: (305) 771-2050 771-2051
Phone orders accepted 6 days, until 7 p.m.

03



SPECIFICATIONS:

Time Base—TCXO ± 0.1 PPM GUARANTEED!
Frequency Range—10 Hz to 600 MHz
Resolution—1 Hz to 60 MHz; 10 Hz to 600 MHz
Decimal Point—Automatic
All IC's socketed (kits and factory-wired)
Display—8 digit LED
Gate Times—1 second and 1/10 second
Selectable Input Attenuation—X1, X10, X100
Input Connectors Type —BNC
Approximate Size—3" h x 7 1/2" w x 6 1/2" d
Approximate Weight—2 1/2 pounds
Cabinet—black anodized aluminum (.090" thickness)
Input Power—9-15 VDC, 115 VAC 50/60 Hz
or internal batteries
OPTO-8000.1 Factory Wired **\$299.95**
OPTO-8000.1K Kit **\$249.95**

ACCESSORIES:

Battery-Pack Option—Internal Ni-Cad Batteries and charging unit **\$19.95**
Probes: P-100—DC Probe, may also be used with scope **\$13.95**
P-101—LO-Pass Probe, very useful at audic frequencies **\$16.95**
P-102—High Impedence Probe, ideal general purpose usage **\$16.95**

VHF RF Pick-Up Antenna-Rubber Duck w/BNC #Duck-4H **\$12.50**
Right Angle BNC adapter #RA-BNC **\$ 2.95**

FC-50 — Opto-8000 Conversion Kits:

Owners of FC-50 counters with #PSL-650 Prescaler can use this kit to convert their units to the Opto-8000 style case, including most of the features.
FC-50 — Opto-8000 **Kit \$59.95**
*FC-50 — Opto-8000F **Factory Update \$99.95**
FC-50 — Opto-8000.1 (w/TCXO) **Kit \$109.95**
*FC-50 — Opto-8000.1F **Factory Update \$149.95**
*Units returned for factory update must be completely assembled and operational

TERMS: Orders to U.S. and Canada, add 5% to maximum of \$10.00 per order for shipping, handling and insurance. To all other countries, add 10% of total order. Florida residents add 4% state tax. C.O.D. fee: \$1.00. Personal checks must clear before merchandise is shipped.

NATIONAL SEMICONDUCTOR JUMBO CLOCK MODULE

**MA1008A
BRAND NEW!**

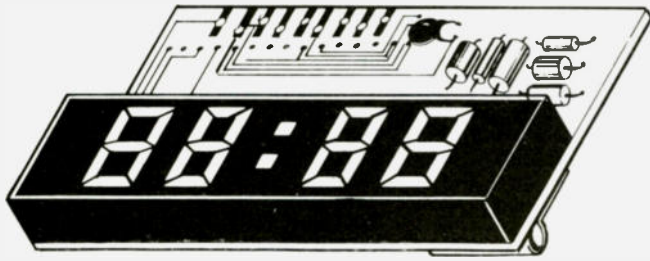

\$6⁹⁵

2 FOR
\$13

(AC XFMR \$1.95)

FEATURES:

- * FOUR JUMBO 1/2 INCH LED DISPLAYS
- * 12 HR REAL TIME FORMAT
- * 24 HR ALARM SIGNAL OUTPUT
- * 50 OR 60 Hz OPERATION
- * LED BRIGHTNESS CONTROL
- * POWER FAILURE INDICATOR
- * SLEEP & SNOOZE TIMERS
- * DIRECT LED DRIVE (LOW RFI)
- * COMES WITH FULL DATA

ASSEMBLED! NOT A KIT!

ZULU VERSION!

We have a limited number of the 24 HR Real time version of this module in stock.

#MA1008D — \$9.95

**PERFECT FOR USE
WITH A TIMEBASE.**

**COMPARE AT UP TO TWICE
OUR PRICE!**

MANUFACTURER'S CLOSEOUT!

SALE! THIS MONTH ONLY!

INSTRUMENT CASE

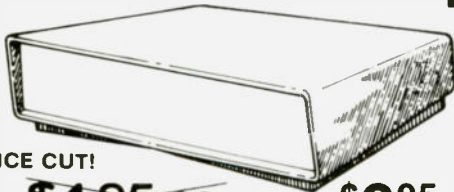

PRICE CUT!

~~\$4.95 ea.~~

\$2⁹⁵

The perfect project enclosure. High impact plastic with aluminum front plate. Front plate can be removed for drilling. 8x2½x4¼ inches. These were originally used for bank security equipment. They are Beautiful! Optional mounting bracket swivels from top to bottom for easy mounting. Knurled thumb screws lock the bracket in any position.

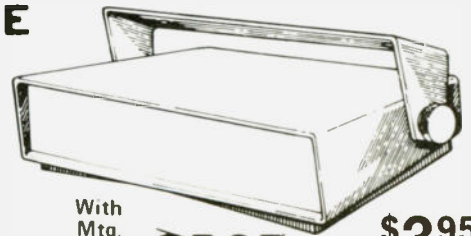

With
Mtg.
Bracket

~~\$5.95 ea.~~

\$3⁹⁵

HIGH FREQUENCY TRANSISTOR



House #2N2369A. NPN Silicon. TO-18 VCE0-20. HFE-100 Typical. Super for RF. FT = 500 MHz. Brand new by ITT. Also subs for the popular 2N706.

10 for
\$1

EXPERIMENTER'S CRYSTAL



262.144KHZ This frequency is 2 to the 18th power. Easily divided down to any power of 2, and even to 1HZ. New by CTS-Knight. A \$5 value!

\$1.25 each

MALLORY ELECTROLYTIC FILTER CAPACITOR



1500 MFD. 16 WVDC.
Radial Leads. Factory Fresh!

3 FOR \$1 10 FOR
\$2.95

Perfect for Power Supplies!
Small Size: 1¼ x ¾ Inches.

VARIABLE INDUCTOR #2

By Seimens. Pot Core Style.
50 To 75 MH. High Q.

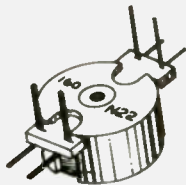

3 FOR \$2
75¢

NI-CAD CHARGER

MFG. FOR ROCKWELL. USED ON 5
VDC (4 CELL) PACKS. MAKES A
GOOD, CHEAP, DC SUPPLY. PLUGS
INTO WALL.

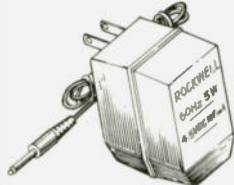

\$1⁴⁹
EACH

LIMITED STOCK!

MICRO-MINI TOGGLE SWITCH



99¢
EACH

SPDT. By RAYTHEON
MADE IN USA! WITH HDWR.

6 FOR \$5

MINIATURE DIP SWITCH
NEW BY CTS. 8 POSITIONS.
FITS A 16 PIN DIP.

\$1⁹⁵ BACK IN STOCK!
EACH



CMOS SPECIAL!

CD4001—5 for \$1 00 CD4011—5 for \$1 00
CD4013—3 for \$1 00 CD4040—\$1 00 each
CD4042—2 for \$1 00 CD4049—3 for \$1 00

MOTOROLA VOLTAGE REGULATOR

MC1469R House Number TO-66 case 3 to 30 V at
600 MA output WITH SPECS

\$1.59

CERAMIC CAPS FOR R.F.

Axial leads. 5% Tolerance 1 0 or 10 0 PF 500V

YOUR CHOICE



8/\$1

741C OP AMPS

MINI DIP Prime new units. Has computer
MFG's house number.

12/\$2. — 100/\$15.

MOTOROLA DUAL MOS-FET GATE



MPF-131. HIGH FREQUENCY.
DIODE PROTECTED GATES!
DEPLETION MODE. VDS-35V
N-CHANNEL. YFS-10,000
MMHOS LOW NOISE.

2 FOR \$1

Digital Research Corporation

(OF TEXAS)
P. O. BOX 401247 • GARLAND, TEXAS 75040 • (214) 271-2461

TERMS: Orders under \$15 add 75c. No COD's. We
accept VISA, MasterCard and American Express
Cards. Money Back Guarantee on all items! Texas
Residents add 5% Sales Tax WE PAY POSTAGE!

New!

16K E-PROM CARD

IMAGINE HAVING 16K OF SOFTWARE ON LINE AT ALL TIME!

S-100 (Imsai/Altair) Buss Compatible!

KIT FEATURES:

1. Double sided PC board with solder mask and silk screen and gold plated contact fingers.
2. Selectable wait states.
3. All address lines & data lines buffered!
4. All sockets included.
5. On card regulators.

KIT INCLUDES ALL PARTS AND SOCKETS (except 2708's). Add \$25. for assembled and tested.

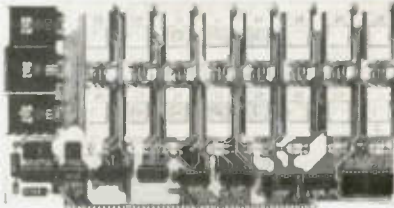

DEALER INQUIRIES INVITED!

*Uses
2708's!*

PRICE CUT!

\$57.50 kit

WAS \$69.95

SPECIAL OFFER:

Our 2708's (450NS) are \$12.95 when purchased with above kit.

Fully Static!

ADD
\$20 FOR
250 NS

KIT FEATURES:

1. Doubled sided PC Board with solder mask and silk screen layout. Gold plated contact fingers.
2. All sockets included.
3. Fully buffered on all address and data lines.
4. Phantom is jumper selectable to pin 67.
5. FOUR 7805 regulators are provided on card.

(450NS)

8K LOW POWER RAM KIT - \$149.00

S-100 (Imsai/Altair) Buss Compatible!

2 KITS FOR \$279

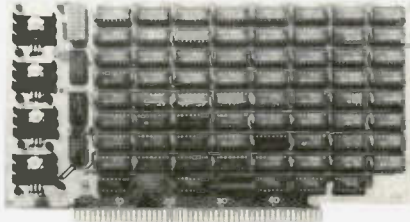

USES 21L02 RAM'S!

Fully Assembled & Burned In
\$179.00

Blank PC Board w/ Documentation
\$29.95

Low Profile Socket Set 13.50
Support IC's (TTL & Regulators)
\$9.75

Bypass CAP's (Disc & Tantalums)
\$4.50

MOTOROLA QUAD OP - AMP
MC 3401 PIN FOR PIN SUB
FOR POPULAR LM 3900.

3 FOR \$1

ALARM CLOCK CHIP
N S MM5375AA Six Digits
With full Data *New!*

\$1.95 each

FULL WAVE BRIDGE

4 AMP. 200 PIV.

69¢ 10 FOR \$5.75

NOT ASSOCIATED WITH DIGITAL
RESEARCH OF CALIFORNIA. THE
SUPPLIERS OF CPM SOFTWARE.

MOTOROLA 7805R VOLTAGE REGULATOR
Same as standard 7805 except 750 MA output.
TO-220. 5VDC output.
44c each or 10 for \$3.95

450 NS! 2708 EPROMS
Now full speed! Prime new units from a major U.S. Mfg. 450 N.S.
Access time. 1K x 8. Equiv. to 4-1702 A's in one package.

\$15.75 ea.

4 FOR \$50⁰⁰

OUR LATEST COMPUTER KIT!

FULLY S-100 COMPATIBLE!

FULLY STATIC, AT DYNAMIC PRICES!

16K STATIC RAM KIT

WHY THE 2114 RAM CHIP?
We feel the 2114 will be the next industry standard RAM chip (like the 2102 was). This means price, availability, and quality will all be good! Next, the 2114 is FULLY STATIC! We feel this is the ONLY way to go on the S-100 Buss! We've all heard the HORROR stories about some Dynamic Ram Boards having trouble with DMA and FLOPPY DISC DRIVES. Who needs these kinds of problems? And finally, even among other 4K Static RAM's the 2114 stands out! Not all 4K static Rams are created equal! Some of the other 4K's have clocked chip enable lines and various timing windows just as critical as Dynamic RAM's. Some of our competitor's 16K boards use these "tricky" devices. But not us! The 2114 is the ONLY logical choice for a trouble-free, straightforward design.

BRAND NEW!

\$359⁰⁰
COMPLETE KIT

SPECIAL
INTRODUCTORY OFFER!
Buy 2 KITS (32K) for \$650
450 NS

Blank PC Board with Documentation

\$33.00

LOW PROFILE SOCKET SET - \$12.00

ASSEMBLED & TESTED - ADD \$30.00

2114's 4K RAM's - 8 for \$85.00

KIT FEATURES:

1. Addressable as four separate 4K Blocks.
2. ON BOARD BANK SELECT circuitry. (Cromemco Standard!) Allows up to 512K on line!
3. Uses 2114 (450NS) 4K Static Rams.
4. ON BOARD SELECTABLE WAIT STATES.
5. Double sided PC Board, with solder mask and silk screened layout. Gold plated contact fingers.
6. All address and data lines fully buffered.
7. Kit includes ALL parts and sockets.
8. PHANTOM is jumpered to PIN 67.
9. LOW POWER: under 2 amps TYPICAL from the +8 Volt Buss.
10. Blank PC Board can be populated as any multiple of 4K.

Z-80 PROGRAMMING MANUAL

By Mostek. The major Z-80 second source. The most detailed explanation ever on the working of the Z-80 CPU CHIPS. At least one full page on each of the 158 Z-80 instructions. A MUST reference manual for any user of the Z-80. 300 pages. Just off the press.

\$12.95

HEAVY DUTY!

Full Wave Bridge
25AMP 50PIV

\$1.25

GE 10 AMP Triac
SC146D. House no.
To-220 case. Rated
10 amps 400PIV.
75c ea. 3/\$2.

Tantalum Capacitors

1 MFD. .35V. By
Kemet. Axial Lead.
Best Value! 10/\$1.

New! REAL TIME Computer Clock Chip

N.S. MM5313. Features
BOTH 7 segment and
BCD outputs. 28 Pin
DIP. \$4.95 with Data

LS SERIES TTL

74LS00 - 33c	74LS74 - 49c
74LS02 - 35c	74LS90 - 69c
74LS04 - 35c	74LS138 - 89c
74LS08 - 35c	74LS154 - 1.49
74LS10 - 33c	74LS175 - 1.10
74LS20 - 33c	74LS367 - 75c
74LS73 - 49c	74LS368 - 85c

Digital Research Corporation

(OF TEXAS)

P. O. BOX 401247 • GARLAND, TEXAS 75040 • (214) 271-2461

TERMS: Orders under \$15. add 75c. No COD's. We accept VISA, MasterCard and American Express Cards. Money Back Guarantee on all items! Texas Residents add 5% Sales Tax. WE PAY POSTAGE!

ETCETERA, ETCETERA!

SEMICONDUCTORS FOR THE EXPERIMENTER

LM373	AM/FM/SSB IF detector (DIP)	\$1.95
LM566	Square/triangle oscillator (minidip)	\$1.75
LM567	PLL tone decoder (minidip)	\$1.85
uA706	DIP audio power amp	\$0.75
FET-1	Dual NJFET, VHF/UHF amp, package	3/\$1
FET-2	NJFET VHF/UHF amp similar to 2N4416	3/\$1
G103	Power transistor (equiv 2N3055)	\$0.75

Something Special

RELAY SPECIAL: Beautiful little Electro reed relays. DPST, N.O., 12V coil; 1" mounting center with 1/10" spaced leads. Now on special at 2/\$1.50

ELECTRIC MOTOR SPECIAL: From time to time we luck out and pick up a True Gizmo. This time, we're offering some of those small DC motors (run on about 1 to 5V DC) you find toys, games, window displays, electric toothbrushes, etc. Now they're on special at 10/\$2.95... how can you go wrong?

TRANSISTOR SPECIAL: NPN, house numbered TO-92 package replaces 2N3904 and similar. Min Beta 250, goes up to 500; reasonable saturation voltage. Priced at 10/\$1.

SOMETHING TO MAKE LIFE EASY: We carry AP test clips for both 14 pin and 16 pin ICs. Gold plated wiping action; sturdy pins for scope probes; also removes ICs from sockets without damage. Model TC-14 (14 pin): \$4.50; Model TC-16 (16 pin): \$4.75. We also carry the A.C.E. 201K breadboarding kit (with 1,032 solderless plug-in tie point capacity) for only \$24.95.

TRIMMER CAPACITORS

CV2/8P	2 — 8 pF	5/\$2.00
CV2.5/11P	2.5 — 11 pF	5/\$2.00
CV3/15P	3 — 15 pF	4/\$2.00
CV3.5/14P	3.5 — 14 pF	4/\$2.00
CV4/12P	4 — 12 pF	4/\$2.00
CV5/25P	5 — 25 pF	4/\$2.00
CV5/30P	5 — 30 pF	4/\$2.00
CV5.5/18P	5.5 — 18 pF	4/\$2.00
CV6/30P	6 — 30 pF	4/\$2.00
CV7/25P	7 — 25 pF	4/\$2.00
CV8/50P	8 — 50 pF	3/\$2.00
CV9/35P	9 — 35 pF	3/\$2.00
CV9/45P	9 — 45 pF	3/\$2.00
CV15/60P	15 — 60 pF	3/\$2.00
CV/ASST.	10 assorted (no choice)	10/\$2.00

RF TRANSISTORS

(All specs for the following taken at 25 degrees C at 2 GHz)

- #2NRF1 (\$4.95) 2 GHz power transistor. Pd max 3.5W, Pout minimum 1.0W, Pin 310 mW, efficiency 30%. Similar to RCA 2N5470.
- #2NRF2 (\$5.95) 2 GHz power transistor. Pd 8.7W, Pout 2.5W, Pin 300 mW, efficiency 33%. Similar to RCA TA8407.
- #2NRF3 (\$6.95) 2 GHz power transistor. Pd 21W, Pout 5.5W, Pin 1.25W, efficiency 33%. Similar to RCA 2N6269.
- #2NRF4 (\$7.95) 2 GHz power transistor. Pd 29W, Pout 7.5W, Pin 1.5W, efficiency 33%. Factory selected prime 2N6269.

YES, WE HAVE COMPONENTS . . . not just some components, either, but a truly wide-range selection. From resistors to sophisticated ICs to experimenter and hobbyist items, before you do any shopping check with us . . . you'll be glad you did.

TERMS: Please allow up to 5% for shipping; excess refunded. Add \$1 handling for orders under \$10. Cal res add tax. COD OK with street address for UPS. For VISA® /Mastercharge® orders call our order desk (24 hrs) at (415) 562-0636. Prices good through cover month of magazine.

JUST IN TIME — NATIONAL'S 12V CLOCK! \$16.50 or 3/\$46

The MA1003 clock module is a complete unit . . . just put it in a package and you're on your way. A built-in time base, along with 12V DC operation, make this unit a natural for no-hassle car clock installations. Includes fluorescent readouts (not LEDs) for easy visibility under adverse ambient lighting conditions.

SENTRY CRYSTALS . . . these are series mode, fundamental, wire leads, HC18 package. \$4.95 for any of the following: 4 MHz, 5 MHz, 8 MHz, 9MHz, 10MHz, 12 MHz, 15 MHz, 18 MHz, 20 MHz.

OTHER CRYSTALS: 1.8432 MHz Baud rate generator crystal; HC6 package with wire leads, \$5.95. 500 KHz, series mode, fundamental, wire leads, HC6/U package, \$4.95. 1 MHz, series mode, fundamental, wire leads, HC6/U package, \$5.95. 2 MHz, series mode, fundamental, wire leads, HC6/U package, \$5.90.

CW AUDIO FILTER: Project #17A. Originally designed as a filter for electronic music applications, our manager Reo Pratt (who is also a ham) reports that his unit gives excellent results as a CW filter with variable range and notch width. Kit form only, \$10.50.

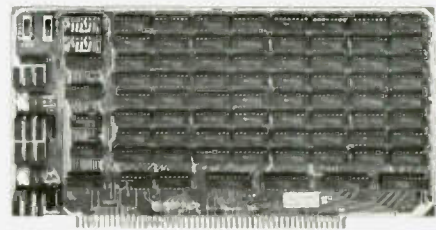

8K x 8 ECONORAM II™ KIT (\$135)

A truly cost-effective package that has drawn raves from both owners and reviewers (see the 1/78 Kilobaud for an example). If you have the space in your motherboard, there's no better way to get 24K of memory than taking advantage of our quantity offer (3 kits for \$375). Add \$20 to single kit price for assembled/tested.

H8 COMPATIBLE ECONORAM VI™ KIT (\$235)

12K x 8 for the H8, with the same features that have made our S-100 boards so popular. Additionally, all sockets and bypass capacitors are already soldered in place so you can get right into the best part of kit building.

TRS-80 16K CONVERSION KIT!

JUST IN — NO TIME TO SET TYPE. CONTAINS 8μPD 416 1x16K DYNAMIC MEMORIES, AND INSTRUCTIONS ON CONVERTING YOUR 4K TRS-80 TO A 16K MACHINE. SAVE \$100.

ONLY \$190.00!!

GODBOUT

BILL GODBOUT ELECTRONICS
BOX 2355, OAKLAND AIRPORT, CA 94614 G4

SOCKET JUMPERS

Mates with two rows of .025" sq. or dia. posts on patterns of 100 centers and shielded receptacles. Probe access holes in back. Choice of 6" or 18" length.

Part No.	No. of Contacts	Length	Price
924003-18R	26	18"	\$ 5.38 ea.
924003-06R	26	6"	4.78 ea.
924005-18R	40	18"	8.27 ea.
924005-06R	40	6"	7.33 ea.
924006-18R	50	18"	10.31 ea.
924006-06R	50	6"	9.15 ea.

JUMPER HEADERS

Solder to PC boards for instant plug-in access via socket-conductor jumpers. .025" sq. posts. Choice of straight or right angle.

Part No.	No. of Posts	Angle	Price
923863-R	26	straight	\$1.28 ea.
923873-R	26	right angle	1.52 ea.
923865-R	40	straight	1.94 ea.
923875-R	40	right angle	2.30 ea.
923866-R	50	straight	2.36 ea.
923876-R	50	right angle	2.82 ea.

DIP JUMPERS

Mates with standard IC sockets. 24" length • Fully Assembled & Tested

COUNTS DESCRIPTION PART NO.	PRICE
14 sgl. end 924-102-24	\$ 1.92
14 zbl. end 924-106-24	3.02
16 sgl. end 924-112-24	2.13
16 zbl. end 924-118-24	3.34
24 sgl. end 924-122-24	3.30
24 zbl. end 924-126-24	5.20
40 sgl. end 924-132-24	5.53

Also Available in 12" and 36" lengths

MICROPROCESSOR COMPONENTS

P8085 CPU	\$29.95	COP 1802 CPU	\$19.95
8080A CPU	10.95	Z80 CPU	24.95
8212 8-Bit Input/Output	4.95	2650 MPU	26.50
8214 Priority Interrupt Control	7.95	MC6800 MPU	19.95
8216 Bi-Directional Bus Driver	4.95	MC6810API 128 x 8 Static Ram	5.95
8224 Clock Generator/Driver	5.95	MC6820 Periph. Interface Adapter	7.95
8228 System Controller Bus Driver	5.95	MC6821 Periph. Interface Adapter	11.50
8251 Prog. Comm. Interface	9.95	MC6850A 1024 x 8 Bit ROM	14.95
8255 Prog. Periph. Interface	10.95	MC6850 Asynchronous Comm. Adapter	14.95

RAM'S		PROMS	
1101 256 x 1 Static	5.149	1702A 2048 x 1 Famous	5.595
1103 1024 x 1 Dynamic	99	2048 x 1 Famous	14.95
2101 256 x 4 Static	5.95	82523 32 x 8 Open C	5.00
2102 1024 x 1 Static	1.75	825115 4096 x 1 Bipolar	19.95
2107-5290 4096 x 1 Dynamic	4.95	825213 32 x 8 Tristate	5.00
2111 256 x 4 Static	6.95	745287 1024 x 1 Static	7.95
7112 256 x 4 Static	5.95	2708 8K EPROM	10.95
7114 4K x 1 Static 450ns	9.95	2716 16K EPROM	29.95
2114L 4K x 1 Static 450ns Low Power	10.95	2716 Intel 16K EPROM	59.98
2114-3 4K x 1 Static 300ns	10.95	6301-1 1024 x 1 Tri-State Bipolar	3.49
2114L-3 4K x 1 Static 300ns Low Power	11.95	6301-1 256 x 1 Open C Bipolar	9.95
7489 16 x 4 Static	1.75	74186 512 x 1 TTL Open Collector	3.95
8101 256 x 4 Static	5.95	74188 256 x 1 TTL Open Collector	3.95
8111 256 x 4 Static	6.95		
8599 16 x 4 Static	3.49		
21102 1024 x 1 Static	1.95		
74200 256 x 1 Static	2.95		
93421 256 x 1 Static	2.95		
MM5226 1K x 1 Dynamic	3.100		
MK4027 (UPD474) 8K DYNAMIC 16 PIN	3.95		
MK4116 (UPD416) 16K DYNAMIC 16 PIN	7.95		
TMS4044-45N 4K STATIC	14.95		

ROM'S		SHIFT REGISTERS	
25132140J Character Generator (upper case)	9.95	MM5013N 1024 Bifurcable Dynamic	2.95
25132021J Character Generator (lower case)	9.95	MM5012B 500512 Bit Dynamic	8.99
2516 Character Generator	10.95	MM5017N Dual 500512 Bit Dynamic	2.95
MM5230N 2048 Bit Read Only Memory	1.95	MM5017N 1024 Dynamic	2.95

USER MANUALS		UART'S	
1802M COP1802 Manual	\$ 7.50	4 K 4 Register	1.95
780M Z80 Manual	7.50		
2650M 2650 Manual	5.00		

SPECIAL REQUESTED ITEMS

TELEPHONE KEYBOARD CHIPS	ICM CHIPS	MEMORIES	MISCELLANEOUS
AY-5-9100 \$14.95	ICM7045 \$24.95	MC166571 \$13.50	11030 \$19.95
AY-5-9200 14.95	ICM7207 19.95	MC166574 13.50	MC3061P 11.95
AY-5-9500 4.95	ICM7208 19.95	MC1408L7 4.95	DS0026CH 3.75
AY-5-2376 14.95	ICM7209 6.95	MC1408L7 4.95	TL308 10.20
HD0165 7.95	TV GAMING CHIP SET	MC1408L7 4.95	95980 11.95
AC922 9.95	AY-5-8800 1 Chip and 3 310 MHz Chips	LD110/111 \$25.00/ea.	
		MC4016(74416) 7.50	
		4N33 3.95	

PARATRONICS Logic Analyzer Kit Model 100A

\$229.00/kit

- Analyzes any type of digital system
- Checks data rates in excess of 8 million words per second
- Trouble shoot TTL CMOS DTL RTL Schottky and MOS families
- Displays 16 logic states up to 8 digits wide
- See ones and zeros displayed on your CRT octal or hexadecimal format
- Tests circuits under actual operating conditions
- Easy to assemble — comes with step-by-step construction manual which includes 80 pages on logic analyzer operation (Model 100A Manual - \$4.95)



- Some applications are:
 - Troubleshooting microprocessor access instruction and data flow
 - Examining contents of ROMS
 - Tracing operation of control logic
 - Checking counter and shift register operation
 - Monitoring I/O sequences
 - Verifying proper system operations during testing

PARATRONICS TRIGGER EXPANDER - Model 10
 Adds 16 additional bits. Provides digital delay and qualification of input clock and 24-bit trigger word. — Connects direct to Model 100A for integrated unit.
 Model 10 Kit - \$229.00
 Baseplate — \$9.95
 Model 10 Manual — \$4.95

TRIMPOTS

Single-Turn - 1/2 Watt
 Square - Top Adjust - 3/8" Size
 Part No. 1-9 10-24 25-49 50-99
 63P(value) 99 89 80 70

Resistance Values 50 100 500 1K 2K 5K 10K 20K 50K 100K 200K 500K 1Meg

15-Turn - 3/4 Watt

Rectangular Side Adjust 3/4" x 1/4" Size
 Part No. 1-9 10-24 25-49 50-99
 43P(value) 135 125 120 115

Resistance Values 50 100 500 1K 2K 5K 10K 20K 50K 100K 200K 500K 1Meg

1/16 VECTOR BOARD

PHENOLIC	64P44 062KXP	4.50	6.50	1.72	1.54
64P44 062KXP	4.50	17.00	3.69	3.32	
64P44 062WE	4.50	5.50	2.07	1.86	
64P44 062WE	4.50	8.50	2.56	2.31	
64P44 062WE	4.50	17.00	5.04	4.53	
64P44 062WE	8.50	17.00	9.23	8.26	
64P44 062WEC1	4.50	17.00	6.80	6.12	

ELI WRAP

Model P180 includes 2-100' spools #28 AWG wire wrap wire
 Supplies insulated wire from spool to wrap posts without stripping and precision wire delivery method
 Model P180 \$24.50

REPLACEMENT WRAP BIT

For P180 Slit N Wrap
 No. P180A \$12.95 each

INSTRUMENT/CLOCK CASE

Injection molded unit. Complete with red bezel. 4 1/2" x 4" x 1 9/16"
 \$3.49

KEYBOARDS

63-Key Unencoded Hexadecimal Encoder
 This is a 63-key, terminal keyboard newly manufactured by a large computer manufacturer. It is unencoded with SPST keys, unattached to any kind of PC board. A very solid molded plastic 13 x 4" base suits most application. IN STOCK \$29.95/each

19-key pad includes 1-10 keys, ABCDEF and 2 optional keys and a shift key. \$10.95/each

\$5.00 Minimum Order - U.S. Funds Only
 California Residents - Add 6% Sales Tax
 Spec Sheets - 25¢
 1978A Catalog Available - Send 35¢ stamp

The Incredible

"Pennywhistle 103"



\$129.95 Kit Only

The Pennywhistle 103 is capable of recording data to and from audio tape without critical speed requirements for the recorder and it is able to communicate directly with another modem and terminal for telephone, hamming and communication. For the deaf. In addition, it is free of critical adjustments and is built with non-precision readily available parts.
 Data Transmission Method... Frequency Shift Keying full-duplex (half duplex selectable)
 Maximum Data Rate... 300 Baud
 Data Format... Asynchronous Serial return to mark level required between each character
 Receive Channel Frequencies... 2025 Hz for space, 2225 Hz for mark
 Transmit Channel Frequencies... Switch selectable Low (normal) 1070 space, 1270 mark, High - 025 space, 2225 mark
 Receive Sensitivity... -46 dbm acoustically coupled
 Transmit Level... 15 dbm nominal Adjustable from 6 dbm to 20 dbm
 Receive Frequency Tolerance... Frequency reference automatically adjusts to allow for operation between 1800 Hz and 2400 Hz
 Digital Data Interface... EIA RS 232C or 20 mA current loop (receiver is unipolar and non-polar)
 Power Requirements... 120 VAC, single phase, 10 Watts
 Physical... All components housed on a single 5" x 9" printed circuit board. All components included.
 Package... VDM Acrylic Enclosure, Frequency Counter and 1/4" Headset to align

the 3rd Hand

\$9.95 each
 "Leaves two hands free for working"
 • Clamps on edge of bench, table or work bench
 • Position board on angle or flat position for soldering or clipping
 • Sturdy aluminum construction for hobbyist, manufacturer or school rooms

DIGITAL STOPWATCH

• Bright 6 Digit LED Display
 • Times to 99 minutes, 59.99 seconds
 • 120 VAC, single phase, 10 Watts
 • Three Stopwatches in One
 • Times Single Event - Split & Taylor
 • Size 4.5" x 2.15" x .90 (14 1/2 ounces)
 • Uses 3 Penrite Cells
 Kit — \$39.95
 Assembled — \$49.95
 Heavy Duty Carry Case \$5.95

Stop Watch Chip Only (7205) \$19.95

3 1/2 DIGIT OPM KIT

• New Bipolar Unit
 • Auto Zeroing
 • 5" LED
 • Auto Polarity
 • Low Power
 • Single IC Unit

Model KB500 OPM Kit \$49.00

Model KB503 5V Power Kit \$17.50

JE700 CLOCK

The JE-700 is a new digital clock that is a very high quality unit. The unit features a simulated animal clock with its dimensions 6 1/2" x 2 1/2" x 1 1/2" inches. MA-314 high brightness readout uses the MA-314 clock chip.
 115 VAC KIT ONLY \$16.95

JE803 PROBE

The Logic Probe is a unit which for the most part is indispensable in troubleshooting logic families. TTL, DTL, RTL, CMOS. It derives the gate level to operate directly on the circuit under test drawing a current 10 mA max. It uses a MAX98 resistor to indicate any of the following states by the probe symbols: 1= Logic 0, 0= Logic 1, P= Pulse. The Probe can detect high frequency pulses to 50 MHz. It can be used in MOS levels or CMOS damage free level.
 \$9.95 Per Kit
 printed circuit board

T²L 5V 1A Supply

This is a standard TTL power supply using the well known LM109 regulator IC to provide a solid 1 AMP @ 5V. We try to make things easy for you by providing everything you need in one package, including the hardware for assembly.
 JE225 \$9.95 Per Kit

PROTO BOARDS

PROTO BOARD 6	Price
PB100 - 4.5 x 6	\$ 19.95
PB101 - 5.8 x 4.5	29.95
PB102 - 7 x 4.5	39.95
PB103 - 9 x 6	59.95
PB104 - 9.5 x 8	79.95
PB203 - 9.75 x 6 1/2 x 2 1/4	80.00
PB203A - 9.75 x 6 1/2 x 2 1/4	129.95

PROTO CLIPS	Price
14 PIN	\$4.50
16 PIN	4.75
24 PIN	8.50
40 PIN	13.75

Jameco ELECTRONICS
 PHONE ORDERS WELCOME (415) 592-8097
 MAIL ORDER ELI ELECTRONICS - WORLDWIDE
 1021 HOWARD AVENUE, SAN CARLOS, CA 94070
 Advertised Prices Good Thru July

\$95 Stand Alone Video Terminal

0123456789:;<=>?
 !"#\$%&'()*+,-./0123456789:;<=>?
 @ABCDEFGHIJKLMNPOQRSTUVWXYZ[\]^_
 `abcdefghijklmnopqrstuvwxyz{|}~*

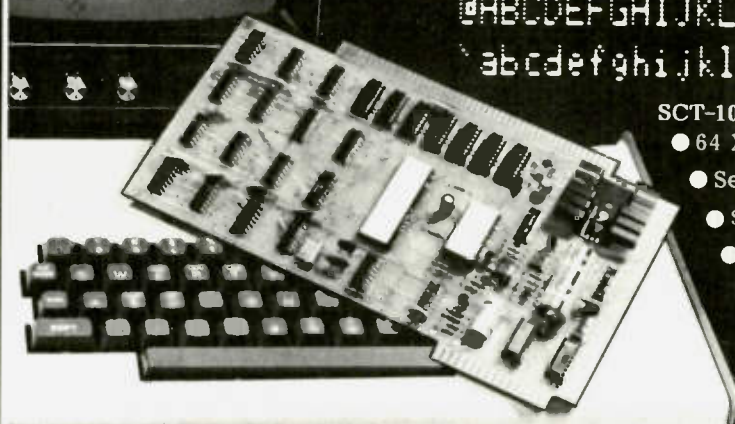

SCT-100 FEATURES:

- 64 X 16 line format with 128 displayable characters
- Serial ASCII or BAUDOT with multiple Baud rates
- \$187 Assembled or \$157 Kit (Partial Kit \$95)
- Full cursor control with scrolling and paging
- On board power supply
- Many additional features

Call or write today. MC/VISA accepted

XITEX CORP. P.O. Box #20887

Dallas, Texas, 75220 • Phone (214) 386-3859

x1 Overseas orders and dealer inquiries welcome.

ALUMA TOWERS

A47

VERO BEACH, FLORIDA 32960

MFG'S OF ALUMINUM TOWERS

- ★ TELESCOPING (Crank Up)
- ★ WALL MOUNTED
- ★ TILT-OVER
- ★ GUYED MODELS (to 100 Ft.)

Excellent for Ham Communications.

HIGH QUALITY — LOW PRICES

MADE IN LONG-LASTING NO-RUST ALUMINUM!

McCLARAN SALES TAKES IN ANYTHING ON TRADE FOR NEW ALUMA TOWERS.

NEED: Scanners, CB, 2 Meter, Marine, Antiques, Coins, Ham Gear.

We accept Master Charge & Visa Cards

FOR SALES & TRADES CONTACT **R.D. McCLARAN SALES**

430 Franklyn at Beach
 Indialantic, Florida 32903
 (305) 723-4793

electronic calculators

LIST
 \$299.95
 124.95
 79.95
 59.95
 59.95
 79.95
LIST
 \$750.00
 450.00
 345.00
 195.00
 160.00
 325.00
 100.00
 80.00
 60.00
 495.00
 120.00
 75.00

HAM NET
 \$269.95
 112.45
 71.95
 53.95
 53.95
 71.95
HAM NET
 \$675.00
 405.00
 310.50
 175.50
 144.00
 292.50
 90.00
 72.00
 54.00
 445.50
 108.00
 67.50

TEXAS INSTRUMENTS ELECTRONIC CALCULATORS
 T.I.-59, 960 STEP PROGRAMMABLE SCIENTIFIC
 T.I.-58, 480 STEP PROGRAMMABLE SCIENTIFIC
 T.I.-57, 150 STEP PROGRAMMABLE SCIENTIFIC
 T.I.-55, 32 STEP PROGRAMMABLE SCIENTIFIC
 T.I. PROGRAMMER, CONVERTS DECIMAL/OCTAL/HEX
 T.I. MBA, SUPER PREPROGRAMMED FINANCIAL
HEWLETT-PACKARD ELECTRONIC CALCULATORS
 H.P.-97, 224 STEP PROG SCIENTIFIC PRINT/VISUAL
 H.P.-67, 224 STEP PROG SCIENTIFIC
 H.P.-19C, 98 STEP PROG SCIENTIFIC PRINT/VISUAL
 H.P.-29C, 98 STEP PROG SCIENTIFIC
 H.P.-25C, 49 STEP PROG SCIENTIFIC
 H.P.-91, PREPROGRAMMED SCIENTIFIC PRINT-VISUAL
 H.P.-33E 49 STEP PROG SCIENTIFIC
 H.P.-32E PREPROGRAMMED SCIENTIFIC WITH STAT
 H.P.-31E PREPROGRAMMED SCIENTIFIC
 H.P.-92, PREPROGRAMMED FINANCIAL PRINT/VISUAL
 H.P.-38, 8 STEP PROGRAMMABLE SUPER FINANCIAL
 H.P.-37, PREPROGRAMMED FINANCIAL

WE STOCK ALL HEWLETT-PACKARD AND T.I. CALCULATOR SOFTWARE AND ACCESSORIES

SEND ME THE CALCULATOR(S) INDICATED BELOW, COMPLETE WITH INCLUDED ACCESSORIES, INSTRUCTIONS, AND MANUFACTURERS WARRANTY. I UNDERSTAND THAT IF I AM NOT COMPLETELY SATISFIED, I MAY RETURN IT WITHIN 10 DAYS FOR A COMPLETE REFUND (LESS SHIPPING)

MODEL(S) _____ QUANTITY _____ AMOUNT ENCLOSED \$ _____

WE HONOR _____ VISA _____ MASTERCARD _____ MONEY ORDERS _____ COD _____

ADD \$2.00 FOR POSTAGE AND HANDLING. PLEASE ALLOW 10 DAYS FROM DATE OF RECEIPT OF ORDER FOR DELIVERY. TEXAS RESIDENTS ADD 5% SALES TAX

CARD NUMBER _____ EXPIRATION DATE _____

FULL NAME _____ CALL _____

STREET _____ CITY _____ STATE _____ ZIP _____

MORE LITERATURE MODEL(S) _____

*****DEALER INQUIRIES INVITED*****



Hartwells Office World, Inc.

H26

MAIL TO: 6810 LARKWOOD
 HOUSTON, TEX 77074
 ATTN: STEVE, WASOEN
 PHONE: A.C. (713) 777-2673

ALDELCO ELECTRONIC CENTER

NEW!

THE FUTURE NOW! FM2015R



Does Your Unit Cover The New
Sub Band 144.6 - 149.8 MHz?
The FM2015R Does. PLUS MARS-CAP!

TRANSFORMERS

110/18 VAC 1 Amp	\$1.50
110/12 VAC 300 mA	1.25
110/20-40 VAC 200 mA	2.50
110/5 VAC 6 Amps	4.95
SPECIAL 110/12 VAC plug in 500 mA	1.50
For each 1-5 Xmftrs add \$1.00 shipping	

TURNER HAND MICROPHONE

DYNAMIC PTT MODEL J360 DM
Medium Impedance (600-5000
Ohms)
Freq. Resp. 100-5000 Hz.
ONLY \$10.95

40 Channel CB Switch

Cherry #R40B-00AA ONLY \$9.95

All Solid State-CMOS PLL digital synthesized - No Crystals to Buy! 5KHz steps -
144 - 149 MHz-LED digital readout PLUS MARS-CAP *

• 5 MHz Band Coverage - 1000 Channels (instead of the usual 2MHz to 4MHz: 400
to 800 Channels) • 4 CHANNEL RAM IC MEMORY WITH SCANNING •
MULTIPLE FREQUENCY OFFSETS • ELECTRONIC AUTO TUNING - TRANSMIT
AND RECEIVE • INTERNAL MULTIPURPOSE TONE OSCILLATOR • RIT •
DISCRIMINATOR METER - 15 Watts Output - Unequaled Receiver Sensitivity and
Selectivity - 16 POLE FILTER, MONOLITHIC CRYSTAL FILTER AND
AUTOMATIC TUNED RECEIVER FRONT END, COMPARE! • Superb Engineering
and Superior Commercial Avionics Grade Quality and Construction Second to
None at ANY PRICE

INTRODUCTORY
PRICE

\$399.00

Regular AC PS
Model FM2015R \$499.00



MINIATURE SWITCHES

SPST on off on	\$.99
DPDT on off on	1.59
DPDT on off	1.59
DPDT on off (wire wrap leads)	1.99

SPEAKERS

2 1/4"	8 Ohm Round	... 75
2 1/2"	8 Ohm Round	... 1.00
2 1/2"	100 Ohm Round	... 1.25
2 1/2" x 5"	8 Ohm Oval	... 1.95
add 10¢ per speaker shipping		

MALLORY POTS 1/8" Shaft

50 K Ohms #4 Taper	\$.99
100 K Ohms #1 Taper99
50 K Ohms 1/4" Shaft59
100 K Ohms 1/4" Shaft59
Ansley 16 PIN PLUG	
609-M161 with cover	... \$.79

CRYSTAL SOCKETS

holds 8 HC25U	... \$.89
Single HC25U39

MURATA FILTER

10.7 mA	... \$1.49
---------	------------

RECTIFIERS

2 amp 50 volt 20 for \$1.00	
2 amp 1000 volt 10 for \$1.00	
2 amp 1500 volt .5 for 1.00	
10 amp stud 50 volt	... 1.50
10 amp stud 600 volt	... 4.50
40 amp stud 50 volt	... 1.20
40 amp stud 750 volt	... 2.05
100 amp. stud 200 v.	... 8.50

BRIDGES

2 amp T05 50 volt35
2 amp T05 200 volt50
2 amp T05 600 volt	... 1.25
3 amp. 50 volt50
3 amp. 400 volt	... 1.10
25 amp. 200 volt	... 1.50
25 amp. 600 volt	... 5.50
25 amp. 1000 volt	... 8.50

LEDs

Monsanto MAN 72 Red LED Readout .300" High, Common Anode.	ONLY \$.89
Monsanto MV5053 JUMBO LED and Holder only25
LED Holders10
Jumbp Red LEDs 6 for \$1.00	
Jumbo Green, Orange or Yellow LEDs 5 for \$1.00	

FETS

40673	1.55
MPF102	.55
2N3819	.35
2N5457	.50
2N5458	.50
2N5459	.55
2N5485	.50

TTL SPECIALS

740317
740417
740517
747332
747432
749049
74116	... 2.60
7419398
74283	... 1.65
7450025
74H1025
74H4022
74S7445
74L175	... 1.25

We have more items listed.
Send stamp for our catalog

CMOS SPECIAL

401128
------	---------

ALDELCO KITS

ALARM CLOCK KIT

6 Big 0.5 LED Displays * On Board AC Transformer
* 12 Hour Format with 24 Hour Alarm * Snooze
Feature * Elapsed Timer. Timer feature makes this
Popular in Broadcast Stations. It's a natural for
cars, boats and campers when used with optional
crystal time base. Fits our standard cabinet. \$19.95
Crystal time base when purchased with clock \$2.95

12 or 24 HOUR DIGITAL CLOCK KIT

Uses 0.5 Display LED. 5314 Clock Chip.
Freeze feature for accurate set, fits our
standard cabinet. ONLY \$18.95

CLOCK CABINETS

ea. \$4.95

WOODGRAIN OR BLACK LEATHER CRYSTAL TIME BASE KIT.

Includes PC Board, Crystal, all parts and
instructions. \$4.95

CLOCK FILTERS. Blue, Red, Green, Amber or Smoke

\$.60

ADJUSTABLE POWER SUPPLY KITS

5-15 Volts 500 MA \$6.95

12-28 Volts 500 MA 6.95

RF DEVICES

2N2876	18W	200 MHz	T060	\$12.35
2N3375	3.0W	400 MHz	T060	5.80
2N3553	7.5W	175 MHz	T039	1.40
2N3866	1.0W	400 MHz	T039	1.25
2N3926	7.0W	175 MHz	T060	6.30
2N4427	1.0W	175 MHz	T039	1.35
2N5589	3.0W	175 MHz	MT71	4.75
2N5590	10W	175 MHz	MT72	7.80
2N5591	25W	175 MHz	MT72	10.25
2N5913	1.75W	175 MHz	T039	1.70
2N6080	4.0W	175 MHz	MT72	5.40
2N6081	15W	175 MHz	MT72	8.45
2N6082	25W	175 MHz	MT72	10.95
2N6083	30W	175 MHz	MT72	12.30
2N6084	40W	175 MHz	MT72	16.30
2N6094	4.0W	175 MHz	X106 PNP	6.60
2N6095	15W	175 MHz	X106 PNP	8.50
2N6096	30W	175 MHz	X106 PNP	10.35
2N6097	40W	175 MHz	X106 PNP	20.00
GE28	12W	50 MHz	X51	2.15
GE46	6.0W	27 MHz	T05	6.42
GE215	5.5W	50 MHz	T0220	4.65
GE216	15W	50 MHz	T0220	8.97
GE226	10W	50 MHz	X81	2.00

SPARE PARTS IN STOCK FOR EBC PRODUCTS.

Cabinets, Components etc.
for EBC Jr. CB, Marine, Avia-
tion & DFs.

2N3055	99
2N3904 or 2N3906	25
2N5496 or 2N6108	70
741 or 709 14 Pin DIP	25
555 Timer	49
1N914 1N4148	15 to 99
1N34 1N60 1N64	10 to 99
CA 3028 Dif Amp	1.50
LM309K Volt Reg	1.10
2N5401 (rep 2N4888)	95
2N2369	20
2N6103	89
LM709 or 741 Min DIP Op Amp	45
14 or 16 Pin IC Sockets	30

DUAL DIGITAL 12/24 HOUR CLOCK KIT NOW WITH A NEW WALNUT GRAIN WOOD CABINET



Features:

- 12 or 24 Hour Operation on either clock
- Each Clock separately controlled
- Freeze feature for time set
- Easy assembly for clock and cabinet

MODEL ALD 5-W ONLY \$49.95

Same kit as above in unassembled Black
Plastic cabinet with Red Filter.

Model ALD 5-P

Only \$44.95



NEW!

Tunable 420 MHz
Fast Scan TV
Converter



NEW

TURNABLE HAM TV CONVERTER

Receive Fast Scan Amateur TV in the 420 to 450 MHz Band
with any TV set. Low noise, high gain rf Amp with Varactor
tuned input and outputs. Built in AC supply. Comes in two tone
walnut & beige cabinet measuring 1 7/8" x 4 1/4" x 4 1/8".
Factory wired with 2 year guarantee. \$49.95
Kit (critical circuits prewired) \$39.95

ACCUKEYER KIT

- Self Completing Dots & Dashes
- Iambic Operation
- Single Dot & Dash Memories
- Provision for attachment of 256 or 512
Bit Memory for DX or Contest work



Board measures 2-5/8" x 4-3/8"

Revised version of the Accukeyer featured in the ARRL
Handbook. Has more logical IC Layout and ON Board
sidetone Oscillator. Includes PC Board, TTL ICs, 555
Timer, IC Sockets, Switch, Speaker, Transistors,
capacitors and resistors. Requires 5 VDC. ONLY \$19.95

ACCUKEYER MEMORY KIT

Simple low cost Memory Kit. Uses 2 programmable 1101
Memory chips. Provides 2 canned messages of 30
Characters each. Adaptable to Handbook and other Ac-
cukeyers. Includes PC board (same size as accukeyer
board) and all parts. Requires 5 VDC, 9 VDC

ALDELCO

A2

2281A BABYLON TURNPIKE, MERRICK NY 11566

516-378-4555

Add 5% Shipping, Add \$1.00 for orders under \$10.00. Out of U.S.A., Mexico or Canada add 15% shipping and certified check or money order in U.S. Funds

ASSOCIATED RADIO

AMERICA'S #1 Real Amateur Radio Store



OUR
32ND
YEAR

Actual current photos of some of our reconditioned equipment.

We have hundreds of reconditioned items. Save big with confidence. Reconditioned units carry a guarantee.
We trade - USED on NEW or USED on USED
We sell - ALL major brands NEW & USED
We buy - Many types of amateur equipment.

ASSOCIATED RADIO

8012 CONSER BOX 4327
OVERLAND PARK, KANSAS 66204

913-381-5900



CALL US WITH YOUR REQUIREMENTS

NOTE:

WE ALSO SELL MUCH OF OUR TRADE-IN EQUIPMENT BEFORE WE RECONDITION IT. THIS WE SELL AT GREATLY REDUCED PRICE. REAL BARGAINS FOR THE EXPERIENCED HAM. SEND \$1.00 AND YOUR NAME - CALL LETTERS AND ADDRESS TO US AND WE'LL SEND YOU NOT ONLY OUR REGULAR CATALOG BUT A CURRENT LIST OF UNSERVICED BARGAINS.

A50

(Cut on dotted line and keep next to your radio equipment)

(Cut on dotted line and keep next to your radio equipment)

DIAL DIRECT ...

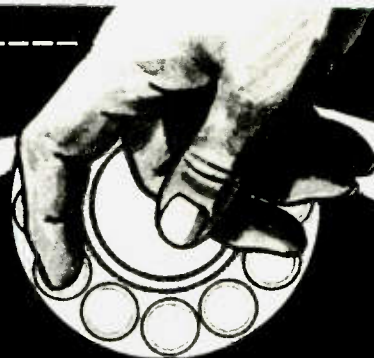

... **DIAL FREE!**

NO CHARGE TO CALLING PARTY

1-800-325-3636

The ONLY NUMBER you'll ever need!

*** FOR THE FAMOUS
HAM-KEY™ AND
HAM-KEYER™**

We make squeeze-paddle and straight-key models... all for use with our brand-new, improved electronic keyer.

*** FOR NEW OR USED
AMATEUR RADIO
GEAR**

... we're specialists and carry *in stock* most of the famous-brand lines. Or, we will talk trade.

*** FOR FAST, DOOR-
STEP DELIVERY**

... give us a call. You'll be amazed; for we guarantee we'll ship your equipment the same day. Plus, most shipments are PRE-PAID.

*** TO SAVE MONEY**

... join thousands of our satisfied customers who buy from us as easily as from their local supplier. So, remember your call is *Toll Free*.



TM Trade-Mark

HAM RADIO CENTER

8340-42 Olive Blvd. P.O. Box 28271 St. Louis, MO 63132 H2



7294 N.W. 54 STREET
MIAMI, FLORIDA 33166

SURPLUS ELECTRONICS CORP. S43

PHONE: (305) 887-8228
TWX: 810-848-6085
WHOLESALE - RETAIL

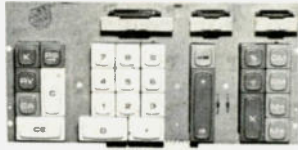
<p>RADIO TRANSMITTER Type T-20/ARC-5 5.3 to 7 MC or 4-5.3 MC Brand new—Never used— Tubes alone are worth the price \$24.95 only 30 left less cover</p>	<p>— NORTH ELECTRIC TRANSFORMER — 2470—9024 117 V 50/60 Hz—Multiple windings will produce: + 24 V dc—50 Amp + 12 V dc—100 Amp - 12 V dc—50 Amp Other voltages can be obtained, complete with specification sheets—Limited Qty. \$49.95</p>		<p>KESTER #44—SOLDER 63/37 Alloy .032 diameter. —5lb. Spools Only— \$6.00 per lb. 12 Vdc SIRENS Very Loud \$8.95</p>
<p>SURPRISE PACKAGE Resistors, Caps, Semis, Pots, Relays, etc. We guarantee it to be \$25.00 worth of material. Every package is different. \$5.00</p>	<p>TEXAS INSTRUMENT KEYBOARD \$1.95 ea., 5 for \$8.00 10 for \$13.95  Has 3 slide switches—28 different keys— keypads re- movable by removing 4 screws.</p>		<p>CERAMIC PRECISION CAPS-ERIE 47 pF—100 V 220 pF—100 V \$.10 ea. 470 pF—100 V 500 pF—100 V 15 for \$1.00 560 pF—100 V 1000 pF—100 V 50 for \$3.25 2000 pF—100 V</p>
<p>White Porcelain Egg Insulator 1 1/2" x 1" 50¢ ea 3 for \$1.25</p>	<p>SIGNAL DIODE 1N4148 \$ 5.00 per hundred \$25.00 per thousand or, 15 for \$1.00</p>	<p>POWER MATCH CONVERTER Pearce-Simpson —Max Loads 30 Watts converts: for positive 6 to 12 Vdc or negative 6 to 18 Vdc ground systems 12 to 24 Vdc 3 1/2" x 3 1/2" x 2" \$7.95</p>	<p>STANCOR TRANSFORMER #P-818OB—117 V in— 25.2 V ct at 1 Amp \$3.00 ea., 2 for \$5.00 3 for \$6.50</p>
<p>Neon Panel Light 110 Vac Amber, w/ built in resistor & wire leads—3 for \$1.50</p>	<p>WIRE WOUND RESISTORS .1 Ohm—5 W .10 Ohm—10 W @ 15¢ each</p>		<p>MUFFIN FANS 3 Blades, 110 Vac, 4 3/4" sq. Removed from equipment— Excellent condition—\$4.95 "New" Muffin Fans 3 Blades-110 Vac, 4 3/4" sq. \$9.95</p>
<p>PANEL METERS 2 1/4" x 2 1/4" also 2 1/4" x 3" 10-0-10 dc Amps } \$4.00 ea 0-20 dc Volts } 25-0-25 dc Volts } 2 for 0-25 dc Volts } \$7.00 0-50 ac Volts } -Shunt Required-</p>	<p>New Dry Nickel-Cadmium Battery 2 1/4" x 2 3/4" x 8 3/4" General Electric 12.0 Volts dc @ 4.0 Amp hrs. \$19.95 while they last.</p>		<p>TRIMMER CAPS Small enough to fit in your watch— 3.5 to 20 pF 5 to 30 pF 7 to 40 pF \$.75 ea., 2 for \$1.25 5 for \$3.00</p>
<p>POWER SUPPLY 110 AC to 12 VDC 550 mA 23 Watts 3 1/2" w x 4" h x 6 1/2" d \$9.95</p>	<p>HOOK-UP WIRE Size 20 or 22— various colors— no color selection solid \$6.00/1000' \$10.00/2000'</p>	<p>POLYFOAM COAX—50R Equal to RG174 \$4.95/100' Low Loss Polyfoam Coax Cable</p>	<p>JOY STICK For TV games and hi fi with four, 100K pots 2 3/4" X 2 3/4" X 1" with 1" handle—\$3.95</p>
<p>Heavy Duty Instrument Case Grey vinyl over wood—inside also lined w/ vinyl & foam padding. Flip- top w/ handle and keylock w/ key. inside dem. 4 1/2" D x 8 1/4" W x 10" H \$25.00 value — \$9.95</p>	<p>E2000 Memory 52 x 52 200 WD 12 DG \$4.95</p>		<p>New Boxer Fans 5 Blades 110V ac 4 3/4"—\$11.95</p>
<p>Varo Bridge Rectifier 10 amps. 220 Vdc—\$1.50</p>	<p>JOY STICK For TV games and hi fi with four, 100K pots 2 3/4" X 2 3/4" X 1" with 1" handle—\$3.95</p>		

SPECIALS—SPECIALS—SPECIALS—SPECIALS—SPECIALS—SPECIALS—SPECIALS—SPECIALS—SPECIALS

<p>Computer Grade Caps 1000 mf—50 V 10,000 mf—20 V 8200 mf—25 V 30,000 mf—15 V 21,000 mf—25 V \$2.50 ea.</p>	<p>CTS DIP Switches 8 position \$1.25 ea., 2 for \$2.00</p>	<p>Trimmer Cap Arco/Elmenco PC-402 2 to 20 pF \$.60 ea. 5 for \$2.50, 15 for \$5.00</p>	<p>MASSA Ultrasonic Transducer 37 or 40 kHz \$1.50 ea. 2 for \$2.50, 5 for \$5.00</p>	<p>Relay—P & B 4 PDT—110 Vdc 6050 Ohm coil 10 Amp contacts \$1.50 ea., 2 for \$2.75, 3 for \$3.25</p>	<p>Bourns Trimpot #200L—1—201M 200 Ohm \$1.50 ea., 2 for \$2.50, 5 for \$6.75</p> 	<p>Stancor Transformer #P-8650 Step down/Isolation 117Vpai-12V6.5Amp. w/cord & receptacle \$5.95</p>
--	---	---	---	---	---	--

TERMS: All material guaranteed • If for any reason you are not satisfied, our products may be returned within 10 days for a full refund (less shipping). Please add \$3 for shipping and handling on all orders. Additional 5% charge for shipping any item over 5 lbs. COD's accepted for orders totaling \$50.00 or more. All orders shipped UPS unless otherwise specified. Florida residents please add 4% sales tax. Minimum order \$15.00.

EQUIPMENT / COMPONENTS / WIRE & CABLE / ACCESSORIES

Be Old Fashioned — —



Try it Before You Buy it

ADIRONDACK Radio Supply

185-191 West Main Street • P.O. Box 88
Amsterdam, N.Y. 12010 Tel. (518) 842-8350
Just 5 minutes from N.Y. Thruway — Exit 27

P.O. Box 44300 Santa Clara, CA 95054

For will call only: (408) 988-1640
2322 Walsh Ave.

Same day shipment. First line parts only. Factory tested. Guaranteed money back. Quality IC's and other components at factory prices.

INTEGRATED CIRCUITS

74001	74LS00	41	LM309	12	110	CMOS	50	74101	4.95
74002	74LS00	25	LM309	18	110	CMOS	50	74102	4.95
74003	74LS00	39	LM309	18	110	CMOS	50	74103	4.95
74004	74LS00	39	LM309	18	110	CMOS	50	74104	4.95
74005	74LS00	39	LM309	18	110	CMOS	50	74105	4.95
74006	74LS00	39	LM309	18	110	CMOS	50	74106	4.95
74007	74LS00	39	LM309	18	110	CMOS	50	74107	4.95
74008	74LS00	39	LM309	18	110	CMOS	50	74108	4.95
74009	74LS00	39	LM309	18	110	CMOS	50	74109	4.95
74010	74LS00	39	LM309	18	110	CMOS	50	74110	4.95
74011	74LS00	39	LM309	18	110	CMOS	50	74111	4.95
74012	74LS00	39	LM309	18	110	CMOS	50	74112	4.95
74013	74LS00	39	LM309	18	110	CMOS	50	74113	4.95
74014	74LS00	39	LM309	18	110	CMOS	50	74114	4.95
74015	74LS00	39	LM309	18	110	CMOS	50	74115	4.95
74016	74LS00	39	LM309	18	110	CMOS	50	74116	4.95
74017	74LS00	39	LM309	18	110	CMOS	50	74117	4.95
74018	74LS00	39	LM309	18	110	CMOS	50	74118	4.95
74019	74LS00	39	LM309	18	110	CMOS	50	74119	4.95
74020	74LS00	39	LM309	18	110	CMOS	50	74120	4.95
74021	74LS00	39	LM309	18	110	CMOS	50	74121	4.95
74022	74LS00	39	LM309	18	110	CMOS	50	74122	4.95
74023	74LS00	39	LM309	18	110	CMOS	50	74123	4.95
74024	74LS00	39	LM309	18	110	CMOS	50	74124	4.95
74025	74LS00	39	LM309	18	110	CMOS	50	74125	4.95
74026	74LS00	39	LM309	18	110	CMOS	50	74126	4.95
74027	74LS00	39	LM309	18	110	CMOS	50	74127	4.95
74028	74LS00	39	LM309	18	110	CMOS	50	74128	4.95
74029	74LS00	39	LM309	18	110	CMOS	50	74129	4.95
74030	74LS00	39	LM309	18	110	CMOS	50	74130	4.95
74031	74LS00	39	LM309	18	110	CMOS	50	74131	4.95
74032	74LS00	39	LM309	18	110	CMOS	50	74132	4.95
74033	74LS00	39	LM309	18	110	CMOS	50	74133	4.95
74034	74LS00	39	LM309	18	110	CMOS	50	74134	4.95
74035	74LS00	39	LM309	18	110	CMOS	50	74135	4.95
74036	74LS00	39	LM309	18	110	CMOS	50	74136	4.95
74037	74LS00	39	LM309	18	110	CMOS	50	74137	4.95
74038	74LS00	39	LM309	18	110	CMOS	50	74138	4.95
74039	74LS00	39	LM309	18	110	CMOS	50	74139	4.95
74040	74LS00	39	LM309	18	110	CMOS	50	74140	4.95
74041	74LS00	39	LM309	18	110	CMOS	50	74141	4.95
74042	74LS00	39	LM309	18	110	CMOS	50	74142	4.95
74043	74LS00	39	LM309	18	110	CMOS	50	74143	4.95
74044	74LS00	39	LM309	18	110	CMOS	50	74144	4.95
74045	74LS00	39	LM309	18	110	CMOS	50	74145	4.95
74046	74LS00	39	LM309	18	110	CMOS	50	74146	4.95
74047	74LS00	39	LM309	18	110	CMOS	50	74147	4.95
74048	74LS00	39	LM309	18	110	CMOS	50	74148	4.95
74049	74LS00	39	LM309	18	110	CMOS	50	74149	4.95
74050	74LS00	39	LM309	18	110	CMOS	50	74150	4.95
74051	74LS00	39	LM309	18	110	CMOS	50	74151	4.95
74052	74LS00	39	LM309	18	110	CMOS	50	74152	4.95
74053	74LS00	39	LM309	18	110	CMOS	50	74153	4.95
74054	74LS00	39	LM309	18	110	CMOS	50	74154	4.95
74055	74LS00	39	LM309	18	110	CMOS	50	74155	4.95
74056	74LS00	39	LM309	18	110	CMOS	50	74156	4.95
74057	74LS00	39	LM309	18	110	CMOS	50	74157	4.95
74058	74LS00	39	LM309	18	110	CMOS	50	74158	4.95
74059	74LS00	39	LM309	18	110	CMOS	50	74159	4.95
74060	74LS00	39	LM309	18	110	CMOS	50	74160	4.95
74061	74LS00	39	LM309	18	110	CMOS	50	74161	4.95
74062	74LS00	39	LM309	18	110	CMOS	50	74162	4.95
74063	74LS00	39	LM309	18	110	CMOS	50	74163	4.95
74064	74LS00	39	LM309	18	110	CMOS	50	74164	4.95
74065	74LS00	39	LM309	18	110	CMOS	50	74165	4.95
74066	74LS00	39	LM309	18	110	CMOS	50	74166	4.95
74067	74LS00	39	LM309	18	110	CMOS	50	74167	4.95
74068	74LS00	39	LM309	18	110	CMOS	50	74168	4.95
74069	74LS00	39	LM309	18	110	CMOS	50	74169	4.95
74070	74LS00	39	LM309	18	110	CMOS	50	74170	4.95
74071	74LS00	39	LM309	18	110	CMOS	50	74171	4.95
74072	74LS00	39	LM309	18	110	CMOS	50	74172	4.95
74073	74LS00	39	LM309	18	110	CMOS	50	74173	4.95
74074	74LS00	39	LM309	18	110	CMOS	50	74174	4.95
74075	74LS00	39	LM309	18	110	CMOS	50	74175	4.95
74076	74LS00	39	LM309	18	110	CMOS	50	74176	4.95
74077	74LS00	39	LM309	18	110	CMOS	50	74177	4.95
74078	74LS00	39	LM309	18	110	CMOS	50	74178	4.95
74079	74LS00	39	LM309	18	110	CMOS	50	74179	4.95
74080	74LS00	39	LM309	18	110	CMOS	50	74180	4.95
74081	74LS00	39	LM309	18	110	CMOS	50	74181	4.95
74082	74LS00	39	LM309	18	110	CMOS	50	74182	4.95
74083	74LS00	39	LM309	18	110	CMOS	50	74183	4.95
74084	74LS00	39	LM309	18	110	CMOS	50	74184	4.95
74085	74LS00	39	LM309	18	110	CMOS	50	74185	4.95
74086	74LS00	39	LM309	18	110	CMOS	50	74186	4.95
74087	74LS00	39	LM309	18	110	CMOS	50	74187	4.95
74088	74LS00	39	LM309	18	110	CMOS	50	74188	4.95
74089	74LS00	39	LM309	18	110	CMOS	50	74189	4.95
74090	74LS00	39	LM309	18	110	CMOS	50	74190	4.95
74091	74LS00	39	LM309	18	110	CMOS	50	74191	4.95
74092	74LS00	39	LM309	18	110	CMOS	50	74192	4.95
74093	74LS00	39	LM309	18	110	CMOS	50	74193	4.95
74094	74LS00	39	LM309	18	110	CMOS	50	74194	4.95
74095	74LS00	39	LM309	18	110	CMOS	50	74195	4.95
74096	74LS00	39	LM309	18	110	CMOS	50	74196	4.95
74097	74LS00	39	LM309	18	110	CMOS	50	74197	4.95
74098	74LS00	39	LM309	18	110	CMOS	50	74198	4.95
74099	74LS00	39	LM309	18	110	CMOS	50	74199	4.95
74100	74LS00	39	LM309	18	110	CMOS	50	74200	4.95

QUEST ELECTRONICS

74101	4.95	74101	4.95
74102	4.95	74102	4.95
74103	4.95	74103	4.95
74104	4.95	74104	4.95
74105	4.95	74105	4.95
74106	4.95	74106	4.95
74107	4.95	74107	4.95
74108	4.95	74108	4.95
74109	4.95	74109	4.95
74110	4.95	74110	4.95
74111	4.95	74111	4.95
74112	4.95	74112	4.95
74113	4.95	74113	4.95
74114	4.95	74114	4.95
74115	4.95	74115	4.95
74116	4.95	74116	4.95
74117	4.95	74117	4.95
74118	4.95	74118	4.95
74119	4.95	74119	4.95
74120	4.95	74120	4.95
74121	4.95	74121	4.95
74122	4.95	74122	4.95
74123	4.95	74123	4.95
74124	4.95	74124	4.95
74125	4.95	74125	4.95
74126	4.95	74126	4.95
74127	4.95	74127	4.95
74128	4.95	74128	4.95
74129	4.95	74129	4.95
74130	4.95	74130	4.95
74131	4.95	74131	4.95
74132	4.95	74132	4.95
74133	4.95	74133	4.95
74134	4.95	7	

Social Events

from page 144

Utah) Hamfest will be held on August 4, 5, and 6, 1978, at Macks Inn, Idaho, 25 miles south of West Yellowstone, Montana. Talk-in on 146.34/94 and 3935. Advance registration is \$6.00 for adults and \$2.00 for children, before July 25th, 1978. Late/regular registration is \$7.00 and \$2.50. There will be a special prize drawing for preregistration. Please send preregistration to: WIMU Hamfest, 3645 Vaughn Street, Idaho Falls, Idaho 83401; phone (208)-522-9568.

PETOSKEY MI AUG 5

The 3rd annual Straits Area Radio Club swap and shop will be held on Saturday, August 5, at the Emmet County Fairgrounds, Charlevoix Avenue, Petoskey, Michigan, from 9 am to 3 pm. Talk-in on 146.52. Food services, prizes. Tickets will be \$1.50 at the door. Campsites nearby. For information, write to SARC in care of W8IZS, Box 416, Pellston MI 49769.

JACKSONVILLE FL AUG 5-6

The Jacksonville Hamfest Association is happy to announce the 5th annual Jacksonville hamfest which will be held on August 5 and 6, at the Jacksonville Beach Municipal Auditorium. Activities will include the usual swap tables and exhibitors' displays. Featured programs include a DX presentation by the North Florida DX Assn. on that group's recent DXpedition to Haiti at the invitation of the Haitian government. Shortly after the trip, amateur radio was legalized in Haiti after being outlawed for many years. NFDXA also has two CQ Magazine world championships to their credit. A complete seminar on microprocessors will also be featured, along with a "pileup" contest, hidden transmitter hunt, QLF contest, and ARRL meeting. Advanced tickets are now available for \$2.50 per person (\$3 at

the door), with swap tables available for \$5 per day. The hamfest site is only one block from the Atlantic Ocean, and those attending can bring their families for a weekend of fun on the beach. Door prizes and hourly drawings will be conducted. All inquiries should be directed to N4UF, Hamfest Chairman, 911 Rio St. Johns Dr., Jacksonville FL 32211. Phone is 744-9501.

SALINE MI AUG 6

The Arrow Repeater will sponsor its 3rd Annual Swap and Shop on Sunday, August 6, 1978, at the Saline MI fairgrounds. Indoor and outdoor exhibits, refreshments, and prizes will be featured. Doors open at 8:00 am. Check-in on 146.37/97 and 146.52. Admission is \$1.50 advance; \$2.00 at the door. Display space is \$.50/ft. For more info, advance tickets, or table reservations, write Arrow, Box 1572, Ann Arbor MI 48106.

UPPER ST. CLAIR TOWNSHIP PA AUG 6

The 41st annual hamfest of the South Hills Brass Pounders and Modulators will be held on August 6, 1978, from noon to dusk, at St. Clair Beach on Route 19 south, Upper St. Clair Township. There will be a swap and shop, picnic area, and swimming for the family. Mobile check-in on 29.0 MHz and 146.52 simplex. Information and preregistration for \$1.50 (\$2.00 at the door) are available from Bruce Banister, 5954 Leprechaun Dr., Bethel Park PA 15102. Vendors must register.

LEVELLAND TX AUG 6

The 13th annual Northwest Texas Emergency Net Picnic and Swapfest will be held Sunday, August 6, in the city park, Levelland TX. Registration begins at 8 am. Lunch at 12:30 pm. Bring your own picnic basket. Swapping all day with tables provided. This is a family

event and is jointly sponsored by the Hockley County Amateur Radio Club and the Northwest Texas Emergency Net. Talk-in on 146.28/88. A \$2.00 donation will be appreciated but not required.

DUTZOW MO AUG 6

The annual Zero-Beaters Amateur Radio Club Hamfest will be held on Sunday, Aug. 6, at the Washington City Park. There is a large area for traders' row; no extra charge to exhibitors for displays. There is a picnic area, refreshments and lunches are available, and there are lots of prizes and activities for the ladies. Ham pilots can fly into our airport. Free transportation will be provided. For more info, write WA0FYA, Dutzow MO 63342.

CHARLOTTE VT AUG 12-13

The International Field Days and Hamfest sponsored by the Burlington Amateur Radio Club will be held on August 12-13. Door prizes, raffles, contests, bingo for ladies, a two-day flea market, and much more. Chairman Bob W1DQO suggests early reservations for camping sites on site at Old Lantern, Charlotte VT 05445. Early bird registration at \$3.00, with gate cost of \$3.50. For other info, please write BARC, PO Box 312, Burlington VT 05402.

AMARILLO TX AUG 11-13

The 1978 edition of the Golden Spread Amateur Radio Convention will be held at the Holiday Inn West Motor Hotel, 601 Amarillo Blvd. West, Amarillo, Texas, on Friday evening, Saturday, and Sunday, August 11, 12, and 13, 1978. It is sponsored by the Panhandle Amateur Radio Club of Amarillo. An area has been set aside for amateurs to display their trading and swapping gear. Two Hospitality Hours are slated: one for early arrivals the evening of Aug. 11 and the second for Saturday evening, Aug. 12. Six technical sessions will be held, featuring the very latest in communications expertise. Special activities for the ladies will be available so that there will be something for everyone. Preregistration will be \$4.00 per person; registration at the door will be \$6.00.

LEXINGTON KY AUG 13

The Bluegrass Amateur Radio Club annual hamfest will be held at the National Guard Armory on August 13, starting at 8:00 am. There will be major prizes, forums, refreshments, a paved flea market area, a large

indoor exhibit space, and plenty of free parking. Advance tickets are \$2.50; \$3.00 at the door. Flea market space is \$1.00 extra. Talk-in on .16/.76. For more info, contact Paul Hefflin WA4PAB, 434 Potomac Dr., Lexington KY 40503, (606)-278-0646.

CEDARTOWN GA AUG 13

The Cedar Valley Amateur Radio Club of Cedartown, Georgia, will sponsor the Cedar Valley Hamfest, which will be held on August 13, 1978, from 9 am to 4 pm, at the Polk County Fairgrounds located one mile east of Cedartown on US 278. Talk-in frequency will be (WR4AZU) 147.72/.12. Food, drinks and lots of prizes! For more information, please contact Jim T. Schliestett, Pres. W4IMQ, Cedar Valley ARC, PO Box 93, Cedartown GA 30125; telephone: (404)-748-5968.

POMONA CA AUG 13

The Tri-County Amateur Radio Association will hold its annual hamfest on Sunday, August 13, 1978. Several prizes will be awarded including a Midland 220 MHz transceiver. Drawing tickets are 50¢ each. The winner need not be present. The hamfest/picnic will be at Westmont Park, West 9th Street, 1/2 mile west of Highway 71. For tickets or info, write to Box 142, Pomona CA 91769.

WILLOW SPRINGS IL AUG 13

The Hamfesters 44th annual picnic and hamfest will be held on Sunday, August 13, 1978, at Santa Fe Park, 91st and Wolf Road, Willow Springs, Illinois, a southwest suburb of Chicago. There will be exhibits for OMs and XYLs and the famous swappers' row. Tickets at the gate will be \$2.00; in advance, \$1.50. For hamfest information or advance tickets, send check or money order (SASE appreciated) to Bob Hayes, 18931 Cedar Ave., Country Club Hills, Illinois 60477.

ROCHESTER MN AUG 18-20

The Central States VHF Society will hold its twelfth annual conference on August 18, 19, and 20, 1978, at the Midway Motor Lodge, Rochester MN. This conference is specifically oriented to operation above 50 MHz. An excellent technical program is planned. A dinner for the conferees and their families, an evening speaker, and prizes are included in the program. For further information, contact the Central States VHF Society, c/o Mr. Mel Larson, 2429 N.W. Viking Court, Rochester MN 55901.

Ham Help

I'm looking for a Heathkit TS-4 TV alignment generator schematic, alignment instructions, voltage chart, and circuit operation description.

Bill Mollenhauer N2FZ
Box 3 RD1
Glassboro NJ 08028

I would like to contact anyone who has successfully converted a Sears SSB CB, model 934 36771 500, to 10 meters.

Robin D. Huckaby WB4GKI
2855 Green Valley Rd.
Snellville GA 30278

Build Your Own CW Keyboard Keyer



Save Over \$175

QSL for full details

ECM

ECM Corporation
412 N. Weinbach Ave.
Evansville, IN 47711
812-476-2121

E1

TRANSCEIVERS

RT-70/GRC TRANSCEIVER COMBINATION

Includes RT-70 FM transceiver, 47-58.4 Mhz continuously tunable or two preset channels, 500 MW transmitter output, AM-65 audio amplifier, and PP-282 24 VDC power supply. Sh. wt: 50 lbs. Used, **\$35.** CONNECTORS 1/above: **\$2.50 ea.**, H-33/PT HANDSET, used: **\$5.95**, LS-166 SPEAKER, used, checked: **\$9.95**. MANUALS for RT-70 or AM-65: **\$5.00 ea.**



RT-427/ARC-39 TRANSCEIVER

Replaces Command Sets; covers 2.0 to 9.1 Mhz in two bands, six crystal-controlled channels per band, 10 watts min. RF power output. Power required: 28 VDC 9 amps. 7 1/4 x 10 1/4 x 2 1/4.

Sh. wt: 42 lbs. Used, **\$49.50**. MANUAL for ARC-39, partial reproduction: **\$10.**

SPDT ANTENNA CHANGEOVER RELAY

Heavy silver contacts good for at least 500 watts. Coil, 6 V 60 Hz 1 ohm. Requires three "N" connectors. 3x3 1/2 x 1; 2 lbs sh. wt. #0-901/T-282. Used, **\$9.95**



Write for New Catalog WS-78 - Government and Commercial Electronic Surplus

All Prices F.O.B., Lima, Ohio

Please make allowance for shipping charges! Use your VISA, BAC or Master Charge card.

Address: Dept. 73 • Phone: 419/227-6573

FAIR RADIO SALES F1
1016 E. EUREKA • Box 1105 • LIMA, OHIO • 45802

23 ways to help assure your company's future.



Our country and your company depend on new ideas. College-trained minds produce new ideas. And colleges need your help. Write on your company letterhead to CFAE for 23 ways companies can aid colleges. We can't afford to run out of ideas.

Council for Financial Aid to Education Inc.
680 Fifth Avenue, New York, NY 10019

CFAE

A Public Service of This Magazine & The Advertising Council

Ad Council



Make America smarter. Give to the college of your choice.

Next time you light up a cigarette, get a look at your kid's face

AMERICAN CANCER SOCIETY

THIS SPACE CONTRIBUTED BY THE PUBLISHER

& giant demo & clearance sale

FULL FACTORY WARRANTY!

DRAKE:	SALE PRICE
T4X-C SMTR	\$525.00
R4-C RCVR	525.00
AC-4 AC SUPPLY	115.00
DC-4 DC SUPPLY	120.00
TR4-CW XCVR	600.00
FS-4 SYNTHESIZER	225.00
SSR-1 RCVR	200.00
SPR-4 RCVR	525.00
MS-4 SPKR	25.00
MN-4C ANT TUNER	125.00
MN-2000 ANT TUNER	190.00
B-1000 BALUN	19.00
W4 SWR/WATTMETER	60.00
WV-4 VHF SWR/WATTMETER	69.00
UV3-144 2M FM XCVR	450.00
PS-3 AC SUPPLY	69.00

TEN-TEC:	SALE PRICE
540 XCVR	525.00
544 XCVR	660.00
252G AC SUPPLY (18 AMP)	90.00
251 AC SUPPLY (9 AMP)	74.00
245 CW FILTER	20.00
207 METER	11.00
215P MIC	23.00
276 XTAL CAL	23.00
249 NOISE BLANKER	22.00
KR-50 KEYS	84.00

TEMPO:	SALE PRICE
2020 XCVR	625.00
VHF/ONE PLUS 2M FM XCVR	325.00
DM-20 MIC	30.00
BIRD HAM-MATE SWR/WATTMETER	77.00

YAesu:	SALE PRICE
FR-101S RCVR	469.00
FR-101S DIG. RCVR	599.00
FL-101 XMTR	499.00
FRG-7 RCVR	249.00

ICOM:	SALE PRICE
IC-30A 440 FM XCVR	299.00
IC-215 2m FM XCVR	175.00
SM-2 MIC	28.00
IC-202 2M SSB XCVR	210.00
IC-502 6M SSB XCVR	210.00
IC-20L 2M LINEAR	75.00
IC-3PS AC SUPPLY	75.00
BC-20 900 MAH BATT/CHGR	40.00

WILSON:	SALE PRICE
WE-800 2M FM SYNTH XCVR	429.00
WR-1000 ROTOR	359.00
2202-SM 220 FM HANDHELD	219.00
4502-SM 440 FM HANDHELD	329.00
SM-2 SPEAKER MIC	27.00

MIDLAND:	SALE PRICE
13-513 220 FM SYNTH XCVR	359.00

VHF ENGR.:	SALE PRICE
TRX 144 XCVR KIT	220.00
TRX 220 XCVR KIT	220.00
TRX 432 XCVR KIT	260.00
TX 432B XMTR KIT	34.00
RX 432C RCVR KIT	65.00
TX 220B XMTR KIT	25.00
TX 220C RCVR KIT	60.00
SYN 220 SYNTH KIT	170.00

WHILE THEY LAST!



universal
amateur
radio inc

1280 AIDA DRIVE
COLUMBUS, OHIO
(Reynoldsburg) 43068

(614)-866-HAMS

NEW ADDITIONS TO THE 73 RADIO BOOKSHOP



● **A GUIDE TO HAM RADIO—BK7321**—by Larry Kahaner WB2NEL. What's Amateur Radio all about? You can learn the basics of this fascinating hobby with this excellent beginner's guide. It answers the most frequently asked questions in an easy-going manner, and it shows the best way to go about getting an FCC license. A Guide to Ham Radio is an ideal introduction to a hobby enjoyed by people around the world. \$4.95.*

● **VOLUME IV—IC TEST EQUIPMENT—BK7362**—It's easy and fun to build your own test equipment with ICs! Here in this fourth volume of the 73 TEST EQUIPMENT LIBRARY are 42 home construction projects for building test equipment to work with your ham station and in servicing digital equipment. Counters, scalars, frequency standards, synthesizers, logic probes . . . JUST ABOUT EVERYTHING you need and can build with ICs. \$4.95.*

SPECIAL: PRE-PUBLICATION OFFER (orders will be filled on a first-in, first-out basis)

● **HOW TO BUILD A MICROCOMPUTER—AND REALLY UNDERSTAND IT—BK7325**—by Sam Creason. The electronics hobbyist who wants to build his own microcomputer system now has a practical "How-To" guidebook. Sam Creason's book is a combination technical manual and programming guide that takes the hobbyist step by step through the design, construction, testing, and debugging of a complete microcomputer system. This book is must reading for anyone desiring a true understanding of small computer systems. \$9.95.*

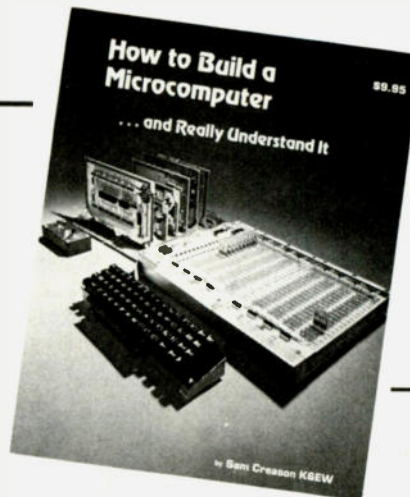

● **SSB . . . THE MISUNDERSTOOD MODE—BK7351**—by James B. Wilson. Single Sideband Transmission . . . thousands of us use it every day, yet, it remains one of the least understood facets of amateur radio. J. B. Wilson presents several methods of sideband generation, amply illustrated with charts and schematics, which will enable the ambitious reader to construct his own sideband generator. A must for the technically-serious ham. \$5.50.*

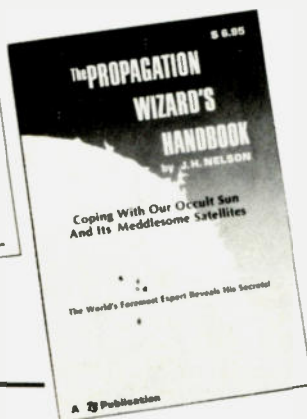

● **PROPAGATION WIZARD'S HANDBOOK—BK7302**—by J. H. Nelson. When sunspots riddled the worldwide communications networks of the 1940's, John Henry Nelson looked to the planets for an answer. The result was a theory of propagation forecasting based upon interplanetary alignment that made the author the most reliable forecaster in America today. The book provides an enlightened look at communications past, present, and future, as well as teaching the art of propagation forecasting. 6.95.*

Use the order card in the back of this magazine or itemize your order on a separate piece of paper and mail to:
73 Radio Bookshop • Peterborough NH 03458. Be sure to include check or detailed credit card information.

* Add \$1.00 handling charge for orders under \$10.00. Note: Prices subject to change on books not published by 73 Magazine.

FOR TOLL FREE ORDERING CALL 1-800-258-5473

Radio Bookshop

license study guides & tapes

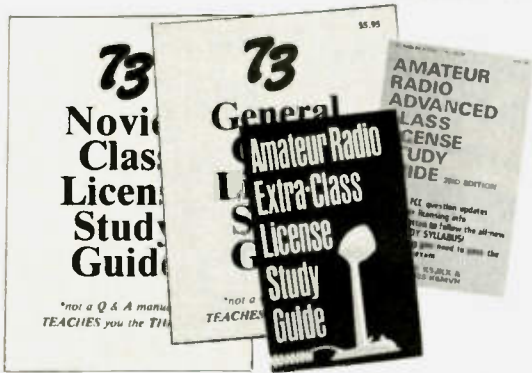

● **NOVICE STUDY GUIDE—SG7357**—Here is a completely new study guide and reference book for the potential ham. This is not a question/answer memorization course. Electronic and radio fundamentals are presented and explained in an easy-to-understand fashion, preparing the beginner for the Novice exam. Includes the latest FCC amateur regulations, as well as application forms. Easily the best path into the exciting world of ham radio! \$4.95.*

● **GENERAL CLASS STUDY GUIDE—SG7358**—A complete theory course for the prospective General or Technician. This reference explains transistor, amplifier, and general radio theory, while preparing the Novice for the "big" ticket. After getting your ticket, you'll use this guide again and again as an electronic reference source. Not a question/answer guide that becomes dated when the FCC updates the amateur exams. \$5.95.*

● **ADVANCED CLASS STUDY GUIDE—SG1081**—Ready to upgrade your license? To prevent retaking the FCC theory exam, you need the 73 Advanced theory guide. SSB, antenna theory, transmitters, and electronics measuring techniques are covered in detail in this easy-to-follow study guide. Special modes and techniques, such as RTTY, are also treated. An engineering degree is not necessary to master Advanced theory—try this book before visiting the examiner's office! \$5.95.*

● **EXTRA CLASS LICENSE STUDY GUIDE—SG1080**—Before going for your 1 x 2 call, it pays to be a master of the Extra class electronic theory. This study guide is the logical extension of the 73 theory course. All the theory necessary to pass the exam is presented. Antennas, transmission lines, swr are discussed, as well as noise, propagation, and specialized communication techniques. This book is not a classroom lecture or memorization guide, but rather a logical presentation of the material that must be understood before attempting the Extra exam. Save yourself a return trip to the FCC and try the 73 method first! \$5.95.*



NOVICE THEORY TAPES Startling Learning Breakthrough

● **NOVICE THEORY TAPES—CT7300**—Startling Learning Breakthrough. You'll be astounded at how really simple the theory is when you hear it explained on these tapes. Three tapes of theory and one of questions and answers from the latest Novice exams give you the edge you need to breeze through your exam. 73 is interested in helping get more amateurs, so we're giving you the complete set of our tapes for the incredibly low price of **ONLY \$15.95.***

Scientists have proven that you learn faster by listening than by reading because you can play a cassette tape over and over in your spare time—even while you're driving! You get more and more info each time you hear it.

You can't progress without solid fundamentals. These four, hour-long tapes, give you all the basics you'll need to pass the Novice exam easily. You'll have an understanding of the basics which will be invaluable to you for the rest of your life! Can you afford to take your Novice exam without first listening to these tapes? Set of 4—\$15.95.*



SSTV

● **SLOW SCAN TELEVISION TAPE—CT7350**—Prize winning programs from the 73 SSTV contest. Excellent for Demo! \$5.95.*

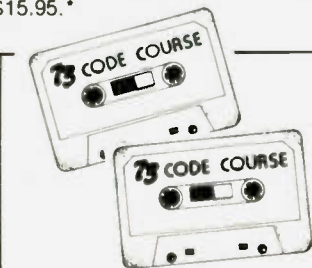

**Four tapes for \$15.95
\$4.95 each!**

"GENESIS"

5 WPM—CT7305—This is the beginning tape for people who do not know the code at all. It takes them through the 26 letters, 10 numbers and necessary punctuation, complete with practice every step of the way using the newest blitz teaching techniques. It is almost miraculous! In one hour many people—including kids of ten—are able to master the code. The ease of learning gives confidence to beginners who might otherwise drop out.

"THE STICKLER"

6 + WPM—CT7306—This is

73 CODE SYSTEM TAPES

the practice tape for the Novice and Technician licenses. It is made up of one solid hour of code, sent at the official FCC standard (no other tape we've heard uses these standards, so many people flunk the code when they are suddenly—under pressure—faced with characters sent at 13 wpm and spaced for 5 wpm). This tape is not memorizable, unlike the zany 5 wpm tape, since the code groups are entirely random characters sent in groups of five. Practice this one during lunch, while in the car, anywhere, and you'll be more than prepared for the easy FCC exam.

"BACK BREAKER"

13 + WPM—CT7313—Code groups again, at a brisk 13 per so you will be at ease when you sit down in front of the steely-eyed government inspector and he starts sending you plain

language at only 13 per. You need this extra margin to overcome the panic which is universal in the test situations. When you've spent your money and time to take the test, you'll thank heavens you had this back-breaking tape.

"COURAGEOUS"

20 + WPM—CT7320—Code is what gets you when you go for the Extra Class license. It is so embarrassing to panic out just because you didn't prepare yourself with this tape. Though this is only one word faster, the code groups are so difficult that you'll almost fall asleep copying the FCC stuff by comparison. Users report that they can't believe how easy 20 per really is with this fantastic one hour tape. No one who can copy these tapes can possibly fail the FCC test. Remove all fear of the code forever with these tapes.

Use the order card in the back of this magazine or itemize your order on a separate piece of paper and mail to:
73 Radio Bookshop • Peterborough NH 03458. Be sure to include check or detailed credit card information.

* Add \$1.00 handling charge for orders under \$10.00. Note: Prices subject to change on books not published by 73 Magazine.

FOR TOLL FREE ORDERING CALL 1-800-258-5473

RADIO BOOKSHOP

73 TECHNICAL LIBRARY

● **BEHIND THE DIAL**—BK7307—By Bob Grove. Get more fun out of shortwave listening with this interesting guide to receivers, antennas, frequencies and interference. \$4.95.*

● **THE CHALLENGE OF 160**—BK7309—is the newest book in the 73 technical library, dedicated to 160 meter operating. Si Dunn provides all necessary information to get started on this unique band. The all-important antenna and ground systems are described in detail. The Introduction contains interesting photos of Stew Perry's (the King of 160) shack. This reference is a must for new and experienced "Top Band" operators. Price: \$4.95.*

● **IC OP-AMP COOKBOOK**—BK1028—by Walter G. Jung. Covers not only the basic theory of the IC op amp in great detail, but also includes over 250 practical circuit applications, liberally illustrated. 592 pages, 5½ x 8½, softbound. \$12.95.*

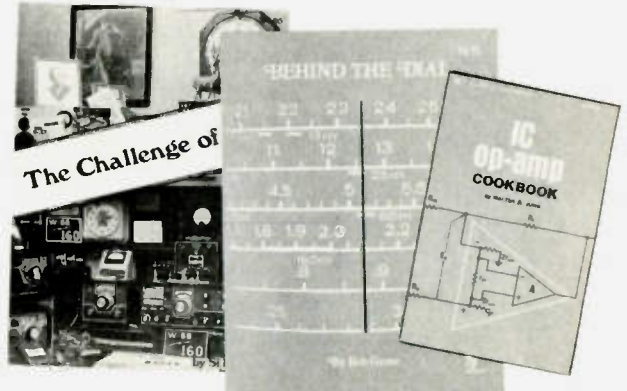

● **INTRODUCTION TO RTTY**—BK7380—A beginner's guide to radioteletype including teletypewriter fundamentals, signals, distortion and RTTY art. You can be a RTTY artist! A 73 publication. \$2.00.*

● **THE NEW RTTY HANDBOOK**—BK7347—is a new edition and the only up-to-date RTTY book available. The state of the art has been changing radically and has made all previous RTTY books obsolete. It has the latest circuits, great for the newcomer and expert alike. \$5.95.*

● **PROPAGATION WIZARD'S HANDBOOK**—BK7302—by J. H. Nelson. When sunspots riddled the worldwide communications networks of the 1940's, John Henry Nelson looked to the planets for an answer. The result was a theory of propagation forecasting based upon interplanetary alignment that made the author the most reliable forecaster in America today. The book provides an enlightened look at communications past, present, and future, as well as teaching the art of propagation forecasting. *6.95.*



● **SSB . . . THE MISUNDERSTOOD MODE**—BK7351—by James B. Wilson. Single Sideband Transmission . . . thousands of us use it every day, yet, it remains one of the least understood facets of amateur radio. J. B. Wilson presents several methods of sideband generation, amply illustrated with charts and schematics, which will enable the ambitious reader to construct his own sideband generator. A must for the technically-serious ham. \$5.50.*

● **SSTV HANDBOOK**—BK7354(hardcover), BK7355(softcover)—This excellent book tells all about it, from its history and basics to the present state of the art techniques. Contains chapters on circuits, monitors, cameras, color SSTV, test equipment and much more. Hardbound \$7.00, softbound \$5.00.*

● **WEATHER SATELLITE HANDBOOK**—BK7370—Simple equipment and methods for getting good pictures from the weather satellite. Antennas, receivers, monitors, facsimile you can build, tracking, automatic control (you don't even have to be home). Dr. Taggart WB8DQT. \$4.95.*



ANTENNAS



● **73 DIPOLE AND LONG-WIRE ANTENNAS**—BK1016—by Edward M. Noll W3FQJ. This is the first collection of virtually every type of wire antenna used by amateurs. Includes dimensions, configurations, and detailed construction data for 73 different antenna types. Appendices describe the construction of noise bridges, line tuners, and data on measuring resonant frequency, velocity factor, and swr. \$5.50.*

● **73 VERTICAL, BEAM AND TRIANGLE ANTENNAS**—BK1069—by Edward M. Noll W3FQJ. Describes 73 different antennas for amateurs. Each design is the result of the author's own experiments covering the construction of noise bridges and antenna line tuners, as well as methods for measuring resonant frequency, velocity factor, and standing-wave ratios. 160 pages. \$5.50.*

● **VHF ANTENNA HANDBOOK**—BK7368—The NEW VHF Antenna Handbook details the theory, design and construction of hundreds of different VHF and UHF antennas . . . A practical book written for the average amateur who takes joy in building, not full of complex formulas for the design engineer. Packed with fabulous antenna projects you can build. \$4.95.*

Use the order card in the back of this magazine or itemize your order on a separate piece of paper and mail to:
73 Radio Bookshop • Peterborough NH 03458. Be sure to include check or detailed credit card information.

* Add \$1.00 handling charge for orders under \$10.00. Note: Prices subject to change on books not published by 73 Magazine.

FOR TOLL FREE ORDERING CALL 1-800-258-5473

Radio Bookshop

TEST EQUIPMENT

● **RF AND DIGITAL TEST EQUIPMENT YOU CAN BUILD**—BK1044—Rf burst, function, square wave generators, variable length pulse generators—100 kHz marker, i-f and rf sweep generators, audio osc, af/rf signal injector, 146 MHz synthesizer, digital readouts for counters, several counters, prescaler, microwave meter, etc. 252 pages. \$5.95.*

● **VOL. I COMPONENT TESTERS**—LB7359—... how to build transistor testers (8), diode testers (3), IC testers (3), voltmeters and VTVMs (9), ohmmeters (8 different kinds), inductance (3), capacity (9), Q measurement, crystal checking (6), temperature (2), aural meters for the blind (3) and all sorts of miscellaneous data on meters... using them, making them more versatile, making standards. Invaluable book. \$4.95.*

● **VOL. II AUDIO FREQUENCY TESTERS**—LB7360—... jam packed with all kinds of audio frequency test equipment. If you're into SSB, RTTY, SSTV, etc., this book is a must for you... a good book for hi-fi addicts and experimenters, too! \$4.95.*

● **VOL. III RADIO FREQUENCY TESTERS**—LB7361—Radio frequency waves, the common denominator of Amateur Radio. Such items as SWR, antenna impedance, line impedance, rf output and field strength; detailed instructions on testing these items includes sections on signal generators, crystal calibrators, grid dip oscillators, noise generators, dummy loads and much more. \$4.95.*

● **VOL. IV IC TEST EQUIPMENT**—LB7362—Become a troubleshooting wizard. All you need to know about pulse, audio and sync generators, frequency counters, digital component testers, logic probes and more! Plus a cumulative index for all four volumes of the 73 Test Equipment Library. \$4.95.*



THE WELL-EQUIPPED HAM SHACK



● **NEW REPEATER ATLAS OF THE ENTIRE WORLD**—BK7345—150% as big as any list ever available—nearly 900 more repeaters listed. New improved maps show the locations by frequency of every repeater in the States. Only \$1.95.*

● **QSL CARDS**—73 turns out a fantastic series of QSL cards at about half the cost of having them done elsewhere because they are run as a fill-in between printing books and other items in the 73 Print Shop. 250 Style W—QW0250—for \$8.95*; 500 Style W—QW0500—for \$13.95*; 250 Style X—QX0250—for \$8.95*; 500 Style X—QX0500—for \$13.95*; 250 Style Y—QY0250—for \$8.95*; 500 Style Y—QY0500—for \$13.95.*

● **73 MAGAZINE BINDERS**—Preserve and protect your collection for your lifetime! There's no excuse for lost issues when you have these handsome red binders with gold lettering. Order 1—BN1001—for \$6.50*; 2 or more—BN1002—for \$6.00 each.*



Style X



Style W



Style Y

● **BACK ISSUES**—Complete your collection—many are prime collectibles now, classics in the field! A full collection is an invaluable compendium of radio and electronics knowledge! \$2.00 each*, or 5 for \$5.00.*

● **LIBRARY SHELF BOXES**—These sturdy white, corrugated, dirt-resistant boxes each hold a full year of 73 or Kilobaud. With your order, request self-sticking labels for any of the following: 73, Kilobaud, CQ, QST, Ham Radio, Personal Computing, Radio Electronics, Interface Age, and Byte. Order 1—BX1000—for \$2.00*; order 2-7—BX1001—for \$1.50 each*; order 8 or more—BX1002—for \$1.25 each*.



Use the order card in the back of this magazine or itemize your order on a separate piece of paper and mail to:
73 Radio Bookshop • Peterborough NH 03458. Be sure to include check or detailed credit card information.

* Add \$1.00 handling charge for orders under \$10.00. Note: Prices subject to change on books not published by 73 Magazine.

FOR TOLL FREE ORDERING CALL 1-800-258-5473

Radio Bookshop

BEGINNER'S • INTRODUCTORY

● **THE STORY OF COMPUTERS**—BK1056—by Donald D. Spencer, is to computer books what *Dick and Jane* is to novels... elementary, gives the non-computerist a fair idea of what the hobbyist is talking about when he speaks computer lingo. Attempts to explain what computers are and can do to a spouse, child or any un-electronics-minded friend. \$4.95.*

● **HOBBY COMPUTERS ARE HERE!**—BK7322—If you want to come up to speed on how computers work... hardware and software... this is an excellent book. It starts with the fundamentals and explains the circuits and the basics of programming, along with a couple of TVT construction projects, ASCII-Baudot, etc. This book has the highest recommendations as a teaching aid for newcomers. \$4.95.*

● **THE NEW HOBBY COMPUTERS**—BK7340—This book takes it from where "Hobby Computers Are Here!" leaves off, with chapters on Large Scale Integration, how to choose a microprocessor chip, an introduction to programming, low cost I/O for a computer, computer arithmetic, checking memory boards, a Baudot monitor/editor system, an audible logic probe for finding those tough problems, a ham's computer, a computer QSO machine... and much, much more! \$4.95.*

● **HOME COMPUTERS: 2nd QUESTIONS & ANSWERS** by Rich Didday. Two books aimed exclusively at the novice computer hobbyist/home computer user. Written in a rather unusual style which has a beginner asking questions which are answered by a person with a substantial background in computers and personal computing. The questions are just the kind beginners come up with... and the answers are presented in easy-to-understand terms (usually with a diagram to illustrate the point). Both the hardware and software aspects of home computing are covered from A to Z. An index in both books makes them ideal as reference material for anyone. Volume I: Hardware—BK1023—\$7.95*; Volume II: Software—BK1024—\$6.95.*

● **MICROCOMPUTER PRIMER**—BK1035—by M. Waite and M. Pardee. Describes basic computer theory, explains numbering systems, and introduces the reader to the world of programming. Describes the world of microcomputing in "real world" terminology. \$7.95.*

● **A STEP BY STEP INTRODUCTION TO 8080 MICROPROCESSOR SYSTEMS**—BK1054—by D. L. Cohn & J. L. Melsa. The step-by-step presentation does not require any computer or electronics background, so anyone who is interested can follow it. However, the book is not only intended for beginners. Engineers and technicians who are familiar with electronics will find the software descriptions valuable in updating their skills. Computer professionals will find the detailed treatment of the 8080 architecture and instructions set useful. \$7.95.*

● **HOW TO BUY & USE MINICOMPUTERS AND MICROCOMPUTERS**—BK1025—by Wm. Barden, Jr. This book discusses these smaller brethren of computers and shows how the reader can become a part of the revolution—how he can own and use a functioning computer system in his home to do a variety of practical or recreational tasks. \$9.95.*

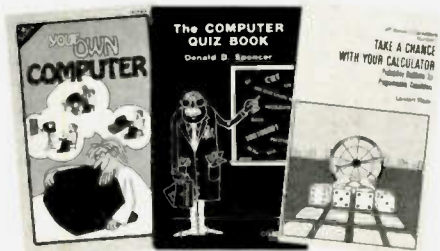
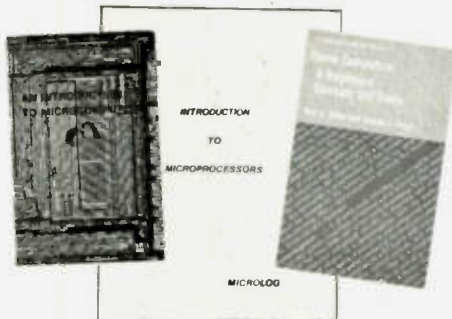
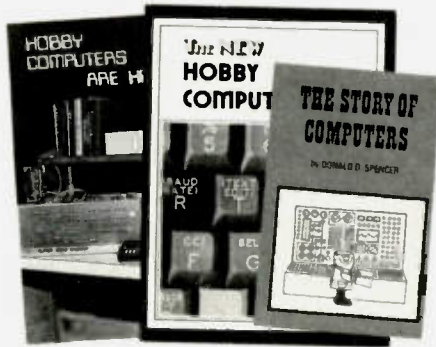

● **MICROPROCESSORS FROM CHIPS TO SYSTEMS**—BK1036—by Rodney Zaks, is a complete and detailed introduction to microprocessors and microcomputer systems. No preliminary knowledge of computers or microprocessors is required to read this book, although a basic engineering knowledge is naturally an advantage. Intended for all wishing to understand the concepts, techniques and components of microprocessors in a short time. \$9.95.*

● **INTRODUCTION TO MICROPROCESSORS**—BK1032—by Charles Rockwell of MICROLOG, is an ideal reference for the individual desiring to understand the hardware aspects of microprocessor systems. Describes the hardware details of computer devices in terms the beginner can understand, instead of treating the micro chip as a "black box." Specific systems are not described and programming is only briefly discussed. \$17.50 US and Canada. \$20 elsewhere.*

● **AN INTRODUCTION TO MICROCOMPUTERS, VOLS. 1 AND 2**, by Adam Osborne Associates, are references dealing with microcomputer architecture in general and specifically with details about most of the common chips. These books are not software-oriented, but are invaluable for the hobbyist who is into building his own interfaces and processors. Volume I is dedicated to general hardware theory related to micros, and Volume II discusses the practical details of each micro chip. (Detailed review in Kilobaud #2) Volume I—BK1030—\$7.50*; Volume II—BK1031—\$12.50.*

● **HOME COMPUTERS: A BEGINNER'S GLOSSARY AND GUIDE**—BK1022—This book is intended as a quick reference source for beginners. Included is a general introduction to microcomputers, a simple application & sample system, the history of microcomputers & their uses, and an introduction to some actual equipment. A chapter on number systems includes a number conversion chart, binary arithmetic from conversions to divisions, and a discussion of octal and hexadecimal numbers. A good background to read technical literature and computer equipment specifications. \$6.95.*

● **YOUR OWN COMPUTER**—BK1072—by M. Waite and M. Pardee. The personal computer has been touted as the next consumer product, but most individuals still wonder why. Much technical material has been written, but there is little material for the average individual without an extensive background in electronics. This book removes the stigma of complexity that surrounds the computer and has succeeded in providing a simple, easy-to-understand guide to these units. \$1.95.*

● **TAKE A CHANCE WITH YOUR CALCULATOR**—BK1002—Lennart Rade wrote this book to help you to discover the world of probability with your programmable calculator. You will need NO previous experience either in probability theory or in programming to learn both from this book. \$8.95.*

● **THE COMPUTER QUIZ BOOK**—BK1112—by Donald D. Spencer, is written for readers who would like to test themselves on basic computer concepts. It may be used effectively by anyone interested in checking his knowledge of computer concepts. \$5.95.*

Use the order card in the back of this magazine or itemize your order on a separate piece of paper and mail to:
73 Radio Bookshop • Peterborough NH 03458. Be sure to include check or detailed credit card information.

* Add \$1.00 handling charge for orders under \$10.00. Note: Prices subject to change on books not published by 73 Magazine.

FOR TOLL FREE ORDERING CALL 1-800-258-5473

Radio Bookshop

SOFTWARE • PROGRAMMING

● **DISCOVERING BASIC—A PROBLEM SOLVING APPROACH**—BK1017—by Robert E. Smith, deals with progressively more complex problems which allow the reader to discover the vocabulary of BASIC language as he develops skill and confidence in putting it to work. Clear and concise explanations. Problems used cover a wide range of interests—insurance, geometry, puzzles, economics, etc. \$6.85.

● **BASIC NEW 2ND EDITION**—BK1081—by Bob Albrecht. Self-teaching guide to the computer language you will need to know for use with your microcomputer. This is one of the easiest ways to learn computer programming. \$4.95.*

● **A QUICK LOOK AT BASIC**—BK1043—by Donald D. Spencer. A perfect reference for the beginning programmer. Assumes that the reader has no previous programming experience and is a self-teaching guide for the individual desiring to learn the fundamentals of BASIC. \$4.95.*

● **MY COMPUTER LIKES ME... WHEN I SPEAK BASIC**—BK1039—An introduction to BASIC... simple enough for kids. If you want to teach BASIC to anyone quickly, this is the way to go. \$2.00.*

● **FUN WITH COMPUTERS AND BASIC**—BK1021—by Donald D. Spencer, contains an easy-to-understand explanation of the BASIC Programming Language and is intended for persons who have had no previous exposure to computer programming. Over half the book is devoted to problems using games, puzzles, and mathematical recreations. A superior book for self-teaching and learning computer programming. \$6.95.*

● **SIXTY CHALLENGING PROBLEMS WITH BASIC SOLUTIONS**—BK1073—by Donald Spencer, provides the serious student of BASIC programming with interesting problems and solutions. No knowledge of math above algebra required. Includes a number of game programs, as well as programs for financial interest, conversions and numeric manipulations. \$6.95.*

● **THE SECRET GUIDE TO COMPUTERS** Parts 1, 2, and 3 by Russ Walter. Part One describes computers in general, and after reading for ten minutes you will be writing simple BASIC programs! Part Two discusses computer applications. It's one thing to master the syntax of the language such as BASIC and another to solve problems using the new tool. Part Three describes programming languages. Ever heard of APL and QLISP? BASIC is not the only language used to program computers. 7th Edition. Part I—BK1050—\$2.75*; Part II—BK1051—\$2.50*; Part III—BK1052—\$3.50.*

● **SOME COMMON BASIC PROGRAMS**—BK1053—published by Adam Osborne & Associates, Inc. Perfect for non-technical computerists requiring ready-to-use programs. Business programs, plus miscellaneous programs. Invaluable for the user who is not an experienced programmer. All will operate in the stand-alone mode. \$8.50 paperback.*

● **ADVANCED BASIC**—BK1000—Applications and problems by James Coan is for those who want to extend their expertise with BASIC. Offers advanced techniques and applications. \$7.95.*



● **SCIENTIFIC RESEARCH INSTRUMENTS' BASIC SOFTWARE LIBRARY** is a complete do-it-yourself kit. Written in everybody's BASIC immediately executable in ANY computer with 4K, no other peripherals needed. **Volume I** contains business and recreational programs and is 300 pages. **Volume II** is 260 pages and contains math, engineering, statistics and plotting programs. **Volume III** contains money managing, advanced business programs such as billing, A/R, inventory, payroll, etc. **Volume IV** contains general purpose programs like loans, rates, retirement, plus games: Poker, Enterprise (take charge while Capt. Kirk is away), Football and more! **Volume V** is filled with experimenter's programs including games, pictures and misc. problems like "logic." Volume I—LB1002—& Volume II—LB1003—\$24.95* each; Volume III—LB1004—\$39.95*; Volume IV—LB1005—& Volume V—LB1006—\$9.95* each; Volume VI—LB1007—\$49.95*; Volume VII—LB1008—\$39.95.*

● **MICROPROCESSOR PROGRAMMING FOR COMPUTER HOBBYISTS**—BK1038—by Neill Graham is for the hobbyist interested in intermediate and advanced techniques of programming and data structuring. Written to take up where the computer manufacturers' instruction manuals and the introductory programming language texts leave off. \$8.95.*

● **8080 PROGRAMMING FOR LOGIC DESIGN**—BK1078—Ideal reference for an in-depth understanding of the 8080 processor. Application-oriented and the 8080 is discussed in light of replacing conventional, hard-wired logic. Practical design considerations are provided for the implementation of an 8080-base control system. \$8.50.*

● **8080 SOFTWARE GOURMET GUIDE AND COOKBOOK**—BK1102—If you have been spending too much time developing simple routines for your 8080, try this new book by Scelbi Computing and Robert Findley. Describes sorting, searching, and many other routines for the 8080 user. \$9.95.*

● **6800 PROGRAMMING FOR LOGIC DESIGN**—BK1077—Oriented toward the industrial user, this book describes the process by which conventional logic can be replaced by a 6800 microprocessor. Provides practical information that allows an experimenter to design a complete micro control system from the "ground up." \$8.50.*

● **6800 SOFTWARE GOURMET GUIDE & COOKBOOK**—BK1075—If you have been spending too much time developing routines for your 6800 microprocessor, try the new book by Scelbi Computing and Robert Findley. Describes sorting, searching, and many other routines for the 6800 user. \$10.95.*

● **FORTRAN PROGRAMMING**—BK1019—by Donald Spencer. FORTRAN was designed for complex numeric calculations, and possesses extended I/O capability. It is easily learned, as it is an English-like computer language. \$7.95.*

● **FORTRAN WORKBOOK**—BK1020—by Donald Spencer. Provides practical examples and problems to solve. Flowcharting is also discussed. Almost all micros support BASIC—it won't be long before FORTRAN is commonplace. \$4.95.*

Use the order card in the back of this magazine or itemize your order on a separate piece of paper and mail to:
73 Radio Bookshop • Peterborough NH 03458. Be sure to include check or detailed credit card information.

* Add \$1.00 handling charge for orders under \$10.00. Note: Prices subject to change on books not published by 73 Magazine.

FOR TOLL FREE ORDERING CALL 1-800-258-5473

Radio Bookshop

SOFTWARE • PROGRAMMING ... continued

● **PAYROLL WITH COST ACCOUNTING—IN BASIC**—BK1001—by L. Poole & M. Borchers, Includes program listings with remarks, descriptions, discussions of the principle behind each program, file layouts, and a complete user's manual with step-by-step instructions, flowcharts, and simple reports and CRT displays. Payroll and cost accounting features include separate payrolls for up to 10 companies, time-tested interactive data entry, easy correction of data entry errors, job costing (labor distribution), check printing with full deduction and pay detail, and 16 different printed reports, including W-2 and 941. \$12.50.*

● **CHEMISTRY WITH A COMPUTER**—BK1010—by Paul A. Cauchon, contains a collection of tutorial, simulation and problem-generation computer programs. Usable with almost any chemistry course in the high school or college level. \$9.95.*

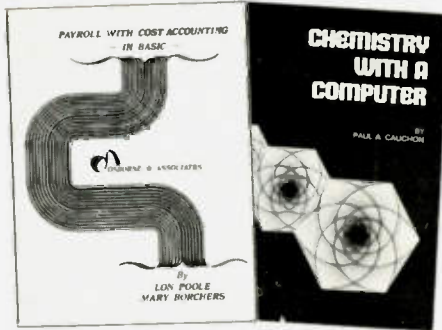

● **HOW TO PROGRAM MICROCOMPUTERS**—BK1027—by Wm. Barden, Jr. Here is a guide to assembly language programming of the Intel 8080, Motorola MC6800, and MOS Technology MCS6502 microprocessors. It is written especially for beginning programmers with hobbyist microcomputers based on one of these three chips. The topics covered range from data manipulations at the bit level up to data handling of tables and lists, and from simple adds and subtracts up to floating-point operations. \$8.95.*

● **BEGINNING BASIC**—BK1007—by Dr. Paul Chirlian, provides a really basic BASIC that covers all the topics in simple, easy-to-understand language. Nothing is left out, everything is presented in clear, step-by-step fashion. This book will make a good BASIC programmer of any reader. \$9.95.*



HARDWARE

● **MICROPROCESSOR INTERFACING TECHNIQUES**—BK1037—by Austin Lesea & Rodney Zaks will teach you how to interconnect a complete system and interface it to all the usual peripherals. It covers hardware and software skills and techniques, including the use and design of model buses such as the IEEE 488 or \$100. \$9.95.*

● **TTL COOKBOOK**—BK1063—by Donald Lancaster. Explains what TTL is, how it works, and how to use it. Discusses practical applications, such as a digital counter and display system, events counter, electronic stopwatch, digital voltmeter, and a digital tachometer. \$8.95.*

● **CMOS COOKBOOK**—BK1011—by Don Lancaster. Details the application of CMOS, the low power logic family suitable for most applications presently dominated by TTL. Required reading for every serious digital experimenter! \$9.95.*

● **TVT COOKBOOK**—BK1064—by Don Lancaster, describes the use of a standard television receiver as a microprocessor CRT terminal. Explains and describes character generation, cursor control and interface information in typical, easy-to-understand Lancaster style. \$9.95.*

● **BUILD-IT BOOK OF DIGITAL ELECTRONIC TIMEPIECES**—BK1008—by Robert Haviland is a data-packed guide to building every timekeeping device you can imagine: rugged shipboard clocks, second-splitting digital IC chronometers, decorator digital IC chronometers, decorator digital clocks, a precision timer, a frequency-period meter, a tide and moon clock, an automatic alarm setter, etc. Including full-size printed circuit board layouts. \$6.95.*

● **THE "COMPULATOR" BOOK—BUILDING SUPER CALCULATORS & MINI COMPUTER HARDWARE WITH CALCULATOR CHIPS**—BK1012—by R. P. Haviland, provides ideas, design info and printed circuit boards for calculator chip projects. Tie it in with a Teletype to create a virtually infinite memory system. \$7.95.*

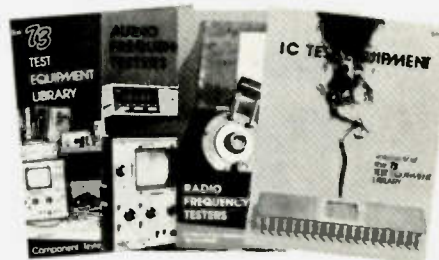

73 TEST EQUIPMENT LIBRARY

● **VOLUME I COMPONENT TESTERS**—LB7359—Build your own test equipment and save a bundle (and have a lot of fun). Volume I of the 73 Test Equipment Library shows you how to build and use transistor testers (8 of 'em), three diode testers, 3 IC testers, 9 voltmeters and VTVMs, 8 ohmmeters, 3 inductance meters, and a raft of other gadgets for checking temperature, crystals, Q, etc. \$4.95.*

● **VOLUME II AUDIO FREQUENCY TESTERS**—LB7360—If you're into audio such as digital cassette recording, RTTY, Baudot vs. ASCII, SSTV, SSB, Touchtone or even hi-fi, you'll want to have this book full of home-built test equipment projects. \$4.95.*

● **VOLUME III RADIO FREQUENCY TESTERS**—LB7361—This is of more interest to hams and CBers: test equipment you can build for checking out transmitters and receivers, signal generators, noise generators, crystal calibrators, GDOs, dummy loads. \$4.95.*

● **VOLUME IV IC TEST EQUIPMENT**—LB7362—Become a trouble-shooting wizard. All you need to know about pulse, audio and sync generators, frequency counters, digital component testers, logic probes and more! Plus a cumulative index for all four volumes of the 73 Test Equipment Library. \$4.95.*

● **LSI-11 REFERENCE CARD**—CC 2011—A must for Heath H11 users. Contains listings of all instructions by mnemonic and opcode, console ODT commands, trap and interrupt vector locations and more. From Digital Equipment Corporation. \$1.00.*

Use the order card in the back of this magazine or itemize your order on a separate piece of paper and mail to:

73 Radio Bookshop • Peterborough NH 03458. Be sure to include check or detailed credit card information.

* Add \$1.00 handling charge for orders under \$10.00. Note: Prices subject to change on books not published by 73 Magazine.

FOR TOLL FREE ORDERING CALL 1-800-258-5473

GET YOUR NEW RADIO AMATEUR CALLBOOKS

1978

ALL OF THESE EXTRA FEATURES INCLUDED

The **U.S. Callbook** has over 350,000 W & K listings. It lists calls, license classes, names and addresses plus the many valuable back-up charts and references you come to expect from the **Callbook**.

\$14.95
PLUS SHIPPING

Specialize in DX? Then you're looking for the **Foreign Callbook** with over 280,000 calls, names and addresses of radio amateurs outside the USA plus many valuable, additional features of interest to the DX'er.

\$13.95
PLUS SHIPPING

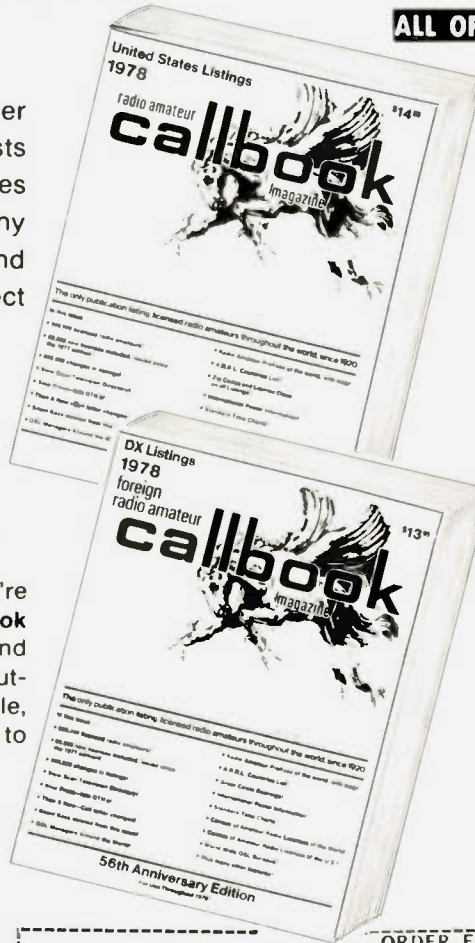

- International Radio Amateur Prefixes!
- Radio Amateur Prefixes by Countries!
- A.R.R.L. Phonetic Alphabet!
- Great Circle Bearings and Charts!
- International "Q" and "Z" Signals!
- World Standard Time Charts!
- International Postal Information!
- World Prefix Map!
- F.C.C. Examination Points!
- Where to Buy!
- Telegraphers' Abbreviations!
- DX Operating Code!
- A.R.R.L. Countries List!
- At Your Service — Amateur Radio Dealers!
- QSL Managers Around the World!
- World Wide QSL Bureaus!
- Census of Radio Amateurs of the World!
- Telegraph Codes!
- AMSAT — Oscar Users Directory!
- Slow Scan Television Directory!
- Reciprocal Licenses!
- Hawaii Included!
- Many Other Features!

*Respected worldwide as
the only complete authority
for radio amateur
QSL and QTH information.*

Save \$1.50 order both send \$30.40

See your favorite electronics dealer or write direct for free catalog to the publisher.

RADIO AMATEUR
callbook INC
Dept. B 925 Sherwood Drive
Lake Bluff, Ill. 60044

R1

ORDER FORM

Item	Price Each	Shipping	Total Price
<input type="checkbox"/> U. S. CALLBOOK	\$14.95	\$1.50	\$16.45
<input type="checkbox"/> FOREIGN CALLBOOK	\$13.95	\$1.50	\$15.45

Illinois residents only add 5% sales tax _____

Name _____ Total _____

Address _____

City _____

State _____ Zip _____ Total Enclosed _____

Charge: BankAmericard Master Charge Interbank # _____

Credit card # _____ Expiration date _____

Signature _____

BAG-A-BUNCH OF 73 BACK ISSUES!*



Your Choice/Our Choice Special
\$1 per Issue
 (Minimum order 5 issues, your choice)
OR 25 Issues Our Choice—\$10.00

- Vintage—1960 thru 1965**
- Mid-years—1966 thru 1971**
- Nearly New—1972 thru 1977**

*** pre-1978 issues.**

<input type="checkbox"/> JUNE 63 <input type="checkbox"/> AUG 63 <input type="checkbox"/> OCT 63 <input type="checkbox"/> FEB 64 <input type="checkbox"/> MAY 67 <input type="checkbox"/> JULY 67 <input type="checkbox"/> OCT 67 <input type="checkbox"/> JUNE 68 <input type="checkbox"/> JULY 68 <input type="checkbox"/> SEPT 68 <input type="checkbox"/> JAN 69 <input type="checkbox"/> FEB 69 <input type="checkbox"/> MAR 69 <input type="checkbox"/> APR 69 <input type="checkbox"/> MAY 69 <input type="checkbox"/> JUNE 69 <input type="checkbox"/> JULY 69 <input type="checkbox"/> AUG 69 <input type="checkbox"/> SEPT 69 <input type="checkbox"/> OCT 69 <input type="checkbox"/> NOV 69 <input type="checkbox"/> DEC 69 <input type="checkbox"/> JAN 70 <input type="checkbox"/> FEB 70 <input type="checkbox"/> MAR 70 <input type="checkbox"/> APR 70	<input type="checkbox"/> MAY 70 <input type="checkbox"/> JUNE 70 <input type="checkbox"/> DEC 70 <input type="checkbox"/> JAN 71 <input type="checkbox"/> FEB 71 <input type="checkbox"/> MAR 71 <input type="checkbox"/> MAY 71 <input type="checkbox"/> JUNE 71 <input type="checkbox"/> JULY 71 <input type="checkbox"/> AUG 71 <input type="checkbox"/> SEPT 71 <input type="checkbox"/> OCT 71 <input type="checkbox"/> NOV 71 <input type="checkbox"/> AUG 72 <input type="checkbox"/> SEPT 72 <input type="checkbox"/> OCT 72 <input type="checkbox"/> NOV 72 <input type="checkbox"/> DEC 72 <input type="checkbox"/> JAN 73 <input type="checkbox"/> APR 73 <input type="checkbox"/> JUNE 73 <input type="checkbox"/> AUG 73 <input type="checkbox"/> SEPT 73 <input type="checkbox"/> OCT 73	<input type="checkbox"/> NOV 73 <input type="checkbox"/> DEC 73 <input type="checkbox"/> FEB 74 <input type="checkbox"/> APR 74 <input type="checkbox"/> MAY 74 <input type="checkbox"/> JULY 74 <input type="checkbox"/> AUG 74 <input type="checkbox"/> SEPT 74 <input type="checkbox"/> OCT 74 <input type="checkbox"/> NOV 74 <input type="checkbox"/> DEC 74 <input type="checkbox"/> FEB 75 <input type="checkbox"/> APR 75 <input type="checkbox"/> AUG 75 <input type="checkbox"/> SEPT 75 <input type="checkbox"/> OCT 75 <input type="checkbox"/> NOV/DEC 75 <input type="checkbox"/> JAN 76 <input type="checkbox"/> FEB 76 <input type="checkbox"/> MAR 76 <input type="checkbox"/> MAY 76 <input type="checkbox"/> JUNE 76 <input type="checkbox"/> JULY 76 <input type="checkbox"/> AUG 76 <input type="checkbox"/> SEPT 76 <input type="checkbox"/> OCT 76 <input type="checkbox"/> NOV 76 <input type="checkbox"/> DEC 76 <input type="checkbox"/> HOLIDAY 76	<p>73 Magazine Back Issue Classics (All 1977 issues are still available!)</p> <input type="checkbox"/> \$5.00* - 5 Issues (indicate your choice at left) <input type="checkbox"/> \$10.00* - 25 issues - our choice \$ _____ Enclosed. <input type="checkbox"/> Cash <input type="checkbox"/> Check <input type="checkbox"/> Money order <input type="checkbox"/> American Express <input type="checkbox"/> BankAmericard/VISA <input type="checkbox"/> Master Charge Credit Card # _____ Expiration date _____ Signature _____ <input type="checkbox"/> Vintage <input type="checkbox"/> Mid-years <input type="checkbox"/> Nearly new Name _____ Address _____ City _____ State _____ Zip _____
--	---	---	--

*Add \$1.00 shipping and handling charge.

73/7/78

73 magazine
 Peterborough NH
 03458

IS HARD COPY STORAGE A PROBLEM?



73, as thick as it is, is more like a floppy when it comes to standing on the bookshelf. Try the 73 Library Shelf Boxes, . . . sturdy corrugated white dirt resistant cardboard boxes which will keep them from flopping around. We have self-sticking labels for the boxes, too, not only for 73, but also for Kilobaud . . . and for CQ, QST, Ham Radio, Personal Computing, Radio Electronics, Interface Age, and Byte. Ask for whatever stickers you want with your box order. They hold a full year of 73 . . . or Kilobaud. Your magazine library is your prime reference, keep it handy and keep it neat with these strong library shelf boxes . . . One box is \$2.00, 2 boxes are \$3.00 and eight boxes are \$10.00. Be sure to specify which labels we should send. Have your credit card handy and call our toll-free order number 800-258-5473, or use the order card in the back of the magazine and mail to:

73 magazine
PETERBOROUGH NH 03458

PROPAGATION

by
J. H. Nelson

EASTERN UNITED STATES TO:

	00	02	04	06	08	10	12	14	16	18	20	22
ALASKA	14	14	7A	7	7	7	7	14	14	14	14	14
ARGENTINA	14	14	14	7	7	7	14	14	14	14	14A	14A
AUSTRALIA	14	14	7A	7	7	7	7	7	7	7	14	14
CANAL ZONE	14	14	7A	7	7	7	7A	14	14	14	14	14A
ENGLAND	14	7A	7	7	7	7	14	14	14	14A	14A	14
HAWAII	14	14	7A	7	7	7	7	7	14	14	14	14
INDIA	14	7A	7B	7B	7B	7B	14	14	14	14	14	14
JAPAN	14	14	7A	7	7	7	7	7	7A	14	14	14
MEXICO	14	14	7A	7	7	7	7	14	14	14	14	14
PHILIPPINES	14	14	7B	7B	7B	7B	7	7A	14	14	14	14
PUERTO RICO	14	7A	7	7	7	7	7	14	14	14	14	14
SOUTH AFRICA	7B	7	3A	7	7B	14	14	14	14A	14A	14B	7B
U. S. S. R.	14	7A	7	7	7	7	14	14	14	14	14	14
WEST COAST	14	14	7A	7	7	7	7	14	14	14	14	14

CENTRAL UNITED STATES TO:

	00	02	04	06	08	10	12	14	16	18	20	22
ALASKA	14	14	7A	7	7	7	7	14	14	14	14	14
ARGENTINA	14	14	14	7A	7	7	7A	14	14	14	14A	14A
AUSTRALIA	14	14	14	7A	7	7	7	7	7	7	14	14
CANAL ZONE	14A	14	14	7	7	7	14	14	14	14	14	14A
ENGLAND	14	7A	7	7	7	7	7	14	14	14	14	14
HAWAII	14	14	14	7A	7	7	7	7	14	14	14	14
INDIA	14	7A	7B	7B	7B	7B	7B	7A	14	14	14	14
JAPAN	14	14	7A	7	7	7	7	7	7A	14	14	14
MEXICO	14	14	7	7	7	7	7	7	7A	14	14	14
PHILIPPINES	14	14	7B	7B	7B	7B	7	7	7A	14	14	14
PUERTO RICO	14	14	7A	7	7	7	7A	14	14	14	14	14
SOUTH AFRICA	7B	7	3A	7	7B	7B	14	14	14	14	14B	7B
U. S. S. R.	14	14	7A	7	7	7	7	14	14	14	14	14

WESTERN UNITED STATES TO:

	00	02	04	06	08	10	12	14	16	18	20	22
ALASKA	14	14	7A	7	7	7	7	7	7	7A	7A	14
ARGENTINA	14A	14	14	7A	7	7	7	14	14	14	14	14A
AUSTRALIA	14	21	21	14	14	7	7	7	7	7	7	14
CANAL ZONE	14	14	7A	7	7	7	7	14	14	14	14	14
ENGLAND	14	7A	7	7	7	7	7	14	14	14	14	14
HAWAII	14	14	14A	14	14	7	7	7	7A	14	14	14
INDIA	14	14	14	7B	7B	7B	7B	7A	14	14	14	14
JAPAN	14	14	14	7A	7	7	7	7	7A	14	14	14
MEXICO	14	14	7A	7	7	7	7	14	14	14	14	14
PHILIPPINES	14	14	14	14	7B	7B	7	7	7A	14	14	14
PUERTO RICO	14	14	7A	7	7	7	7	14	14	14	14	14
SOUTH AFRICA	7	7	3A	7	7B	7B	7B	14	14	14	14B	7B
U. S. S. R.	14	14	7A	7	7	7	7	14	14	14	14	14
EAST COAST	14	14	7A	7	7	7	7	14	14	14	14	14

- A = Next higher frequency may also be useful
- B = Difficult circuit this period
- F = Fair
- G = Good
- P = Poor
- SF = Solar Flares

July

sun	mon	tue	wed	thu	fri	sat
☉	☉	☉	☉			1 G
2 G	3 G	4 G	5 G	6 F/SF	7 F/SF	8 F/SF
9 P/SF	10 P/SF	11 F	12 G	13 G	14 G	15 G
16 F	17 F	18 G	19 G	20 G	21 G	22 G
23 G	24 G	25 G	26 G	27 F	28 F	29 G

Hot Item!!

WEATHER SATELLITE HANDBOOK \$4.95

Weather Satellite Antenna Systems, Receivers, How To Find & Track Satellites . . .



A complete satellite ground station can be built for less than the cost of a good television set! And you don't have to be a mechanical or electrical genius, either. This text is fully illustrated and you will find information on simple equipment, methods for producing good pictures from the weather satellite, antennas, receivers, monitors, tracking & automatic control.

73 magazine
PETERBOROUGH NH 03458

MOVING?

Let us know 8 weeks in advance so that you won't miss a single issue of 73 Magazine. Attach old label where indicated and print new address in space provided. Also include your mailing label whenever you write concerning your subscription. It helps us serve you promptly. Write to:

73 magazine
PETERBOROUGH NH 03458

- | | |
|---|---|
| <input type="checkbox"/> Address change only | <input type="checkbox"/> Payment enclosed |
| <input type="checkbox"/> Extend subscription | (1 extra BONUS issue) |
| <input type="checkbox"/> Enter new subscription | <input type="checkbox"/> Bill me later |
| <input type="checkbox"/> 1 year \$15.00 | |

If you have no label handy, print OLD address here.

AFFIX LABEL

Name _____ Call _____

Address _____

City _____ State _____ Zip _____

print NEW address here:

Name _____ Call _____

Address _____

City _____ State _____ Zip _____

TICKETS TO COMPETENCE!

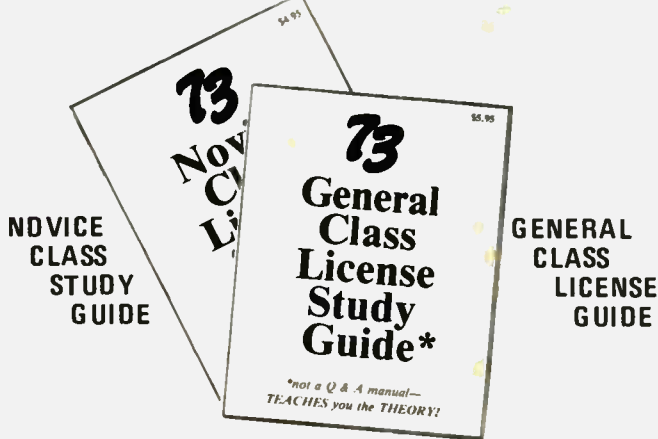

NOVICE CLASS STUDY GUIDE

GENERAL CLASS LICENSE GUIDE

Novice Guide — This excellent reference will launch you into the exciting world of ham radio! Covers radio and electronic fundamentals, preparing you to pass the Novice exam; also includes the latest FCC amateur regulations and application forms. \$4.95

General Guide — If you're looking ahead to your General or Technician exam, or are already licensed, this excellent reference work is a must for you! Covers completely transistor, amplifier, and general radio theory; you'll use it again and again! \$5.95.

73 Magazine
peterborough, n.h. 03458

73 magazine

ADVERTISER index

A46	ABC Communications 135
A1	Adirondack Radio Supply 213
A24	Adva Electronics 198
A2	Aldico 209
A47	Aluma Tower Company 208
A40	Amateur Radio Supply of Nashville, Inc. 70
A56	Amateur Radio Supply of North Atlanta, Inc. 71
A51	Amateur Radio Supply Seattle 180
A55	Amateur Radio Supply Seattle 180
A8	Apron Laboratories 181
A50	Associated Radio 210
B23	Barker & Williamson 183
B32	BayCom 158
B29	Britt 2 Way Radio 152
B8	Bullel Electronics 202
B31	Butternut Electronics Company 181
C3	Chgo 169
C21	Coakit 181
C83	Colorado Silver Company 148
C75	Comm Center, MD 99
C58	Communications Center, NE 171
C6	Communications Specialists 24, 25
C9	Continental Specialties 47
D6	Peter W. Dahl Company 178
D10	Davis Electronics 182
D31	Delaware Amateur Supply 148
D15	DenTron 31
D29	Delectric 180
D20	Digital Research Corporation 204, 205
D25	Diversified Security Industries (DSI) 149
D23	Dovertron 184
E1	ECM Corporation 140, 215
E18	Edgicrom 58, 57
E21	Electronic Systems 121
E31	ETCO Electronics 193
F1	Fair Radio Sales 215
F5	Fisher Corporation 181
F3	Freck Radio & Supply 140
G18	Garkens, Inc. 184
G12	Georgetown Amateur Supply 181
G4	Goodhout Electronics 208
H1	HAL Communications 183
H24	Hal-Tronix 184
H2	Ham Radio Center 211
H16	Hamtronics, NY 201
H8	Hamtronics, PA 141
H26	Hartwell's Office World 208
H15	Hatry 185
H3	Henry Radio CII
I1	ICOM 18,83
I8	Integrated Circuits 196
I10	International Data Systems 112
I10	Island Antennas 195
J1	Jackonville Hamfest 180
J1	Jameco 207
J2	Jan Crystals 184
J1	JBW Electronics, Inc. 174
J8	J. M. Industries 188
J8	JRS Electronics 150
K13	Kantronics 178,180
K13	Kenwood CIV, 5-12
K14	Koy Electronics 158
L11	Logitronics 39
L9	Long's Electronics 104-109
L10	L-Tronics 182
M35	Madison Electronics Supply 184
M36	Maggiore Electronic Labs 39
M68	Microtronics 158
M41	Midland International 183
N2	New-Tronics 19
O5	OK Machine & Tool 111,113
O3	Optoelectronics 203
P15	Pace-Traps 195
P10	Palomar Electronics 27
P1	Palomar Engineers 23
P2	Poly Pak 187
P26	Printed Circuit Products 158
P21	Priorly One 122
O3	Quest Electronics 213
R1	Radio Amateur Callbook, Inc. 223
R1	Radio World 148
R8	Ramsay Electronics 200
R15	Robin Distributors 178
R21	Rush Electronics 140
R18	RW Electronics, Inc. 140
S33	Sera-Rose & Spencer 148
S33	S-F Amateur Radio Services 87,140
S8	Spectrum Communications 145
S10	SST Electronics 187
S50	S.C. Stafford Electronics 195
S38	Stuart Electronics 23
S43	Surplus Electronics 212
T13	Teletypewriter Communications Specialists 120
T30	Television Equipment Association 213
T33	Telex Communications, Inc. 23
T1	Ten-Tec 29
T34	Thomas Communications 175
T18	Trac Electronics 195
T3	Turtis Radio Electronics 150-186
U6	Universal Amateur Radio Service, Inc. 215
V1	Vanguard Labs 178
V5	VHF Engineering 95
W15	Wacom 184
W17	Westcom Engineering 163
W18	Western Electronics 178
W2	Wilson Electronics 3
X1	Xitex 208
Y1	Yasu Electronics Corporation CII,81,101
Z1	ZZZ Electronics, Inc. 182

From 73... 152,178,182,183,185,216,226

*Reader Service inquiries not honored.

CATALOG #	MERCHANDISE	PRICE
BK1082	1001 PRACTICAL ELECT. CIRCUITS	\$ 9.95
BK7386	100 QUESTIONS & ANSWERS	\$ 1.95
BK1073	60 PROBLEMS W/BASIC SOLUTIONS	\$ 6.95
BK1077	6800 PROG. FOR LOGIC DESIGN	\$ 7.50
BK1075	8800 SOFTWARE GOURMET GUIDE	\$10.95
BK1018	73 DIPOLE & LONG WIRE ANTENNAS	\$ 5.50
BK1078	8080 PROG. FOR LOGIC DESIGN	\$ 7.50
BK1102	8080 SOFTWARE GOURMET GUIDE	\$ 9.95
BK1000	ADVANCE CLASS	\$ 7.95
BK1081	BASIC 2ND EDITION	\$ 4.95
BK1074	BASIC COMPUTER GAMES	\$ 7.50
LB1002	BASIC SOFTWARE LIBRARY VOL 1	\$24.95
LB1003	BASIC SOFTWARE LIBRARY VOL 2	\$24.95
LB1004	BASIC SOFTWARE LIBRARY VOL 3	\$39.95
LB1005	BASIC SOFTWARE LIBRARY VOL 4	\$ 9.95
LB1006	BASIC SOFTWARE LIBRARY VOL 5	\$ 9.95
LB1007	BASIC SOFTWARE LIBRARY VOL 6	\$49.95
LB1008	BASIC SOFTWARE LIBRARY VOL 7	\$39.95
BK1007	BEGINNING BASIC	\$ 9.95
BK7307	BEHIND THE DIAL	\$ 4.95
BN1001	BINDER—73—1	\$ 6.50
BN1002	BINDER—73—2&3P	\$ 6.50
BN1011	BINDER—KB—1	\$ 6.50
BN1012	BINDER—KB—2&3P	\$ 6.50
BK1008	BUILD IT BOOK OF DIG ELEC TMPC	\$ 6.95
BK7309	CHALLENGE OF 180	\$ 4.95
BK1010	CHEMISTRY WITH A COMPUTER	\$ 9.95
BK1011	CMOS COOKBOOK	\$ 9.95
CT7305	CODE TAPE—5 WPM	\$ 4.95
CT7306	CODE TAPE—6 WPM	\$ 4.95
CT7310	CODE TAPE—10 WPM	\$ 4.95
CT7313	CODE TAPE—13 WPM	\$ 4.95
CT7320	CODE TAPE—20 WPM	\$ 4.95
CT7325	CODE TAPE—25 WPM	\$ 4.95
CT7399	CODE TAPE—LEARN MORSE CODE	\$ 4.95
CT7384	CODE TAPES—(ANY FOUR OF ABOVE)	\$15.95
NC7301	COMPLETE NOVICE STUDY KIT	\$25.00
BK1012	COMPUTER BOOK	\$ 7.95
BK1013	COMPUTER DICTIONARY	\$ 9.95
BK1014	COMPUTER PROGRAMMING HANDBOOK	\$ 9.95
BK1112	COMPUTER QUIZ BOOK	\$ 5.95
T8263	COMPUTERMANIAC T-SHIRT—LARGE	\$ 5.50
T8262	COMPUTERMANIAC T-SHIRT—MED	\$ 5.50
T8261	COMPUTERMANIAC T-SHIRT—SMALL	\$ 5.50
T8264	COMPUTERMANIAC T-SHIRT—XL	\$ 5.50
BK1017	DISCOVERING BASIC	\$14.95
BK1018	FASCINATING WORLD OF RADIO COM	\$ 8.95
BK1048	FIRST BOOK OF COMPUTER GAMES	\$ 6.95
BK1019	FORTAN PROGRAMMING	\$ 7.95
BK1020	FORTAN WORKBOOK	\$ 4.95
BK1021	FUN WITH COMPUTERS AND BASIC	\$ 4.95
BK7321	GUIDE TO HAM RADIO	\$ 4.95
BK7322	HOBBY COMPUTERS ARE HERE	\$ 4.95
BK1023	HOME COMPUTERS O-A VOL 1	\$ 7.95
BK1024	HOME COMPUTERS O-A VOL 2	\$ 7.95
BK1022	HOME COMPUTERS—GLOSSARY/QUIZ	\$ 6.95
BK7325	HOW TO BUILD A MICROCOMPUTER	\$ 9.95
BK1025	HOW TO BUY & USE MICROCOMPS	\$ 9.95
BK7326	HOW TO MAKE BETTER TAPES	\$ 2.50
BK1027	HOW TO PROGRAM MICROCOMPUTERS	\$ 8.95
BK1028	IC OP AMP COOKBOOK	\$12.95
BK1029	IC TIMER COOKBOOK	\$ 9.95
BK1131	INSTANT BASIC	\$ 6.00
BK1130	INTRO TO MICROCOMPUTERS VOL 0	\$ 7.50
BK1030	INTRO TO MICROCOMPUTERS VOL 1	\$ 7.50
BK1031	INTRO TO MICROCOMPUTERS VOL 2	\$12.50
BK1032	INTRO TO MICROPROCESSORS	\$17.50
BK7380	INTRO TO RTTY	\$ 4.95
CC2011	LSI-11 REFERENCE CARD	\$ 1.00
MP7303	MAP OF US WITH CALL AREAS	\$ 1.00
MP7302	MAP OF WORLD WITH DX PREFIXES	\$ 2.00
BK7333	MASTER BOOK OF HAM RADIO CIRC	\$ 9.95
BK1037	MICRO INTERFACING TECHNIQUES	\$ 9.95
BK1038	MICRO PROG. FOR HOBBYISTS	\$ 8.95
BK1034	MICROPROCESSOR DICTIONARY	\$15.95
BK1035	MICROPROCESSOR PRIMER	\$ 7.95
BK1137	MICROPROCESSOR LEXICON	\$ 2.95
BK1036	MICROS FROM CHIPS TO SYSTEMS	\$ 9.95
BK1038	MY COMPUTER LIKES ME	\$ 2.00
BK7340	NEW HOBBY COMPUTERS	\$ 4.95
CT7300	NOVICE THEORY TAPES	\$15.95
BK1001	PAYROLL AND COST ACCOUNTING	\$12.00
BK1041	PERIODICAL GUIDE—1878	\$ 3.00
BK1042	PERIODICAL GUIDE—JAN—JUN 1877	\$ 3.00
BK1100	PRACTICAL TEST INSTRUMENTS	\$ 4.95
BK1146	PROGRAMMING IN PASCAL	\$ 6.95
OW250	OSL CARDS—STYLE W—250	\$ 8.95
OW950	OSL CARDS—STYLE W—500	\$13.95
OX250	OSL CARDS—STYLE X—250	\$ 8.95
OX500	OSL CARDS—STYLE X—500	\$13.95
OY250	OSL CARDS—STYLE Y—250	\$ 8.95
OY500	OSL CARDS—STYLE Y—500	\$13.95
BK1043	QUICK LOOK AT BASIC	\$ 4.95
BK7345	REPEATER ATLAS	\$ 1.95
BK1044	RF DIGITAL TEST EQUIPMENT	\$ 5.95
BK1048	RTL COOKBOOK	\$ 5.50
BK7347	RTTY HANDBOOK	\$ 9.95
BK1050	SECRET GUIDE TO COMPUTERS V 1	\$ 2.75
BK1051	SECRET GUIDE TO COMPUTERS V 2	\$ 2.50
BK1052	SECRET GUIDE TO COMPUTERS V 3	\$ 3.50
BK1000	SELF BOX—1	\$ 2.00
BK1001	SELF BOX—2	\$ 1.50
BK1002	SELF BOX—8 UP	\$ 1.25
BK7350	SIMPLIFIED MATH	\$ 0.50
BK1053	SOFTWARE FOR BASIC PROGRAMS	\$ 8.95
BK7351	SSB THE MISUNDERSTOOD MODE	\$ 5.50
BK7354	SSTV HANDBOOK (HARDCOVER)	\$ 7.00
CT7350	SSTV HANDBOOK (SOFTCOVER)	\$ 5.00
BK1054	STEP BY STEP INTRO TO 8080	\$ 7.95
SG1081	STUDY GUIDE—ADVANCED CLASS	\$ 5.95
SG1080	STUDY GUIDE—EXTRA CLASS	\$ 5.95
SG7356	STUDY GUIDE—GENERAL CLASS	\$ 5.95
SG7357	STUDY GUIDE—NOVICE CLASS	\$ 4.95
BK1002	TAKE A CHANCE W/OUR CALCULATOR	\$ 8.95
LB7359	TEST EQUIP LIB V1—COMP TESTERS	\$ 4.95
LB7360	TEST EQUIP LIB V2—AUDIO TESTERS	\$ 4.95
LB7361	TEST EQUIP LIB V3—RADIO EQUIP	\$ 4.95
LB7362	TEST EQUIP LIB V4—IC TEST EQUIP	\$ 4.95
BK1056	THE STORY OF COMPUTERS	\$ 9.95
BK1063	TFT COOKBOOK	\$ 4.95
BK1064	TVT COOKBOOK	\$ 4.95
CC1065	TYCHON'S 8080 HEX CODE CARD	\$ 3.00
CC1066	TYCHON'S 8080 OCTAL CODE CARD	\$ 3.00
BK1067	UNDERGROUND BUYING GUIDE	\$ 4.95
BK1079	UNDERSTANDING MICROCOMPUTERS	\$ 8.30
BK1069	VERTICAL BEAM & TRIANGLE ANTNS	\$ 5.50
BK7368	VHF ANTENNA HANDBOOK	\$ 4.95
BK7370	WEATHER SATELLITE HANDBOOK	\$ 8.95
BK1071	WHAT TO DO AFTER YOU HIT RETURN	\$ 8.00
WW7300	WORK THE WORLD PACKAGE	\$ 5.95
BK1172	YOUR HOME COMPUTER	\$ 6.00
BK1072	YOUR OWN COMPUTER	\$ 1.95

WIN A LIFETIME OF 73!

Here is your chance to win a Lifetime Subscription to 73 in our monthly reader service drawing. Circle the appropriate reader service # for desired company brochures, data sheets or catalogs and mail to 73. Include your zip code, please. LIMIT: 25 requests. Check if you subscribe to 73.

- A46 B23 C9 E21 H8 J8 05 R15 T30 W2
- A1 B32 D6 E31 H26 K13 03 R21 T33 X1
- A24 B29 D10 F1 H15 K 1 4 P15 R18 T34 Y1
- A2 B8 D31 F5 H3 L11 P30 S39 T18 Z1
- A47 B31 D15 F3 I1 L9 P1 S33 T3 **73**
- A40 C3 D29 G18 I9 L10 P2 S8 U6
- A56 C21 D20 G12 I10 M35 P26 S10 V1 kilobaud
- A51 C63 D25 G4 J1 M36 P21 S50 V5
- A55 C75 D23 H24 J2 M48 Q3 S38 W15
- A6 C58 E1 H2 J9 M41 R1 S43 W17
- A50 C6 E19 H16 J10 N2 R8 T13 W18

This month's ARTICLE WINNER (title page number): _____

Name _____

Address _____

City _____ State _____ Zip _____

S7

PLACE
STAMP
HERE

73

magazine
44 Main Street
Peterborough NH 03458

Attn: Mail Order

SUBSCRIBE!

- 73 Magazine
- 1 year @ \$15*
- 3 years @ \$36*
- Kilobaud
- Life Sub @ \$195**
- Renewal—Expira. date _____ *U.S. & Canada only.
- New subscription (U.S. currency, please)
- **U.S. only

Please send me the following 73 products: (please print or type!)

Qty.	Catalog #	Description	Unit Price	Total

Add \$1.00 shipping & handling for orders under \$10.00

Coupon expires in 60 days.

Enclosed \$ _____ Check Money order Bill me (subs only)

Bill: BankAmericard/Visa Master Charge

Credit Card # _____

Expiration date _____ Signature _____

Name _____

Address _____

City _____ State _____ Zip _____

S7

reader service

order form

73 magazine

73 magazine

73 magazine

PLACE
STAMP
HERE

73 magazine

Peterborough NH

Attn: Reader Service

SUBSCRIBE! 1 year @ \$15* Renewal—Expira. date _____ *U.S. & Canada only.
 73 Magazine 3 years @ \$36* New subscription (U.S. currency, please)
 Kilobaud Life Sub @ \$195** **U.S. only

Please send me the following 73 products: (please print or type!)

Qty.	Catalog #	Description	Unit Price	Total

Add \$1.00 shipping & handling for orders under \$10.00

Coupon expires in 60 days.

Total:

Enclosed \$ _____ Check Money order Bill me (subs only)

Bill: American Express BankAmericard/Visa Master Charge

Credit Card # _____

Expiration date _____ Signature _____

Name _____

Address _____

City _____ State _____ Zip _____

57

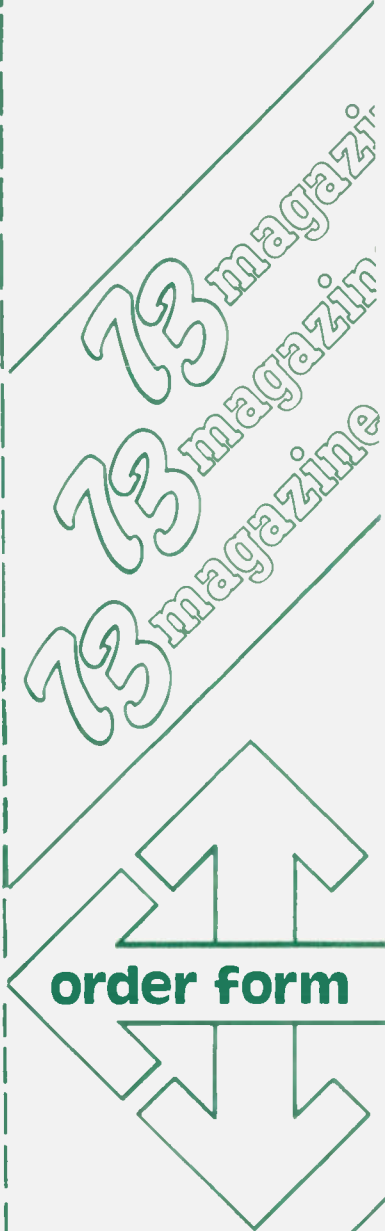

PLACE
STAMP
HERE

73 magazine

44 Main Street
Peterborough NH 03458

Attn: Mail Order



NEW ON 2 FROM YAESU

THE MEMORIZER "PLUS"

Yaesu presents: The finest, compact, versatile transceiver designed for the active 2 meter enthusiast. The FT-225RD features all mode operation—SSB/FM/CW/AM—with repeater offset capability and a memory! Modular, computer-type construction offers reliability and ease of service. The FT-225RD provides the super selectivity and performance needed on today's active 2 meter band. Join the fun on FM, DX, or OSCAR, with the new FT-225RD transceiver—another winner from the world's leader in amateur communications equipment.



Features

- Digital frequency display
- Complete 144-148 MHz coverage in four 1 MHz band segments
- \pm 600 KHz or optional auxiliary repeater split
- Built-in memory unit
- Variable power output
- Noise blanker
- Selectable AGC
- Three way metering: S meter, power output and FM discriminator
- Built-in AC & DC power supplies and speaker
- Built-in tone burst—adjustable 1500-2000 Hz
- Front panel display/lamp dimmer
- Twenty-five watts output.



Price And Specifications Subject To
Change Without Notice Or Obligation

YAESU
The radio.



678

YAESU ELECTRONICS CORP., 15954 Downey Ave., Paramount, CA 90723 (213) 633-4007
YAESU ELECTRONICS CORP., Eastern Service Ctr., 613 Redna Ter., Cincinnati, OH 45215

R-820

THE ULTIMATE IN RECEIVER DESIGN! MORE FEATURES THAN EVER BEFORE AVAILABLE IN A HAMBAND RECEIVER. THE R-820 IS A TRIPLE-CONVERSION RECEIVER, COVERING ALL AMATEUR BANDS FROM 160 THROUGH 10 METERS, AS WELL AS SEVERAL SHORTWAVE BROADCAST BANDS. IT FEATURES DIGITAL AS WELL AS ANALOG FREQUENCY READOUTS, NOTCH FILTER, IF SHIFT, VARIABLE BANDWIDTH TUNING, SHARP IF FILTERS, NOISE BLANKER, STEPPED RF ATTENUATOR, 25 KHz CALIBRATOR, AND MANY OTHER FEATURES, PROVIDING MORE OPERATING CONVENIENCES THAN ANY OTHER HAMBAND RECEIVER.

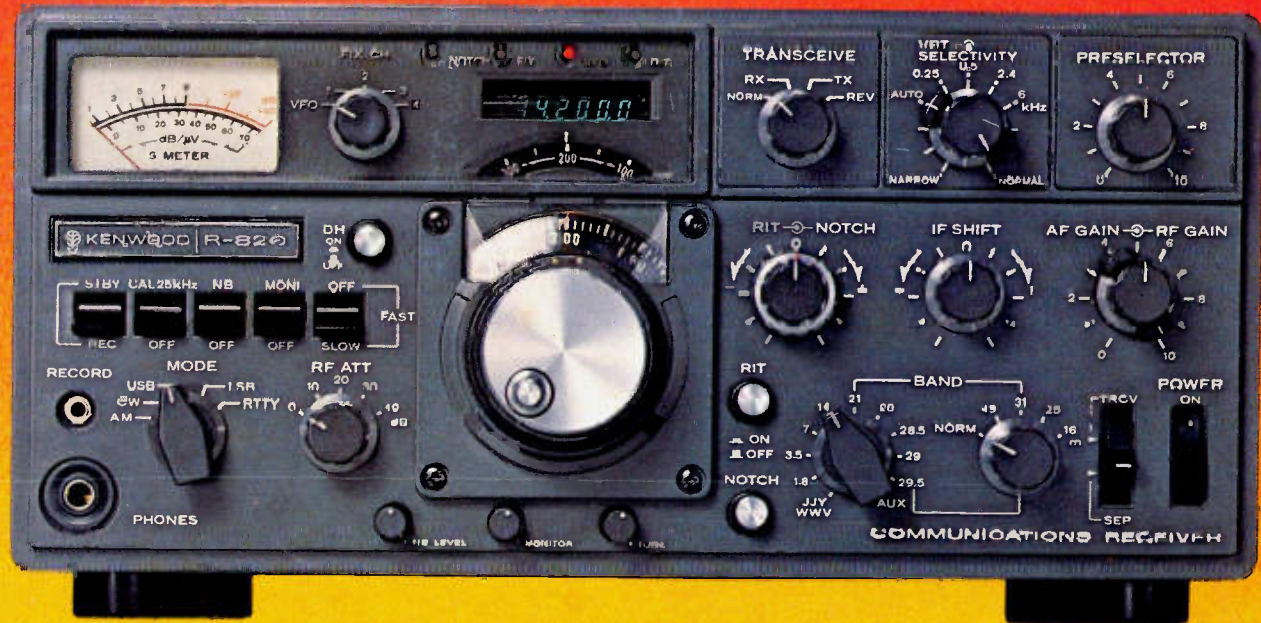

TS-820S

AMATEUR RADIO OPERATORS UNIVERSALLY RESPECT THE TS-820S FOR ITS SUPERB QUALITY, PROVEN THROUGH THOUSANDS OF HOURS OF OPERATING TIME UNDER ALL ENVIRONMENTAL CONDITIONS. THE TS-820S, WHICH COVERS 160 THROUGH ALL OF 10 METERS, HAS EVERY FEATURE ANY AMATEUR COULD DESIRE, INCLUDING THE FAMOUS IF SHIFT, RF SPEECH PROCESSOR AND NOISE BLANKER.



TRIO-KENWOOD COMMUNICATIONS INC. 1111 WEST WALNUT/COMPTON, CA 90220

