

73

AMATEUR RADIO

**Don't Miss
the
Petition
on
page 10**

- | | | |
|-----|-----------------------------------------------------------------------------|---------------|
| 22 | The New, Improved "Best Keyer Yet"
—updating MINI-MOS | K4JEM |
| 26 | The Powerful Grounded Antenna
—thrives on poor soil | W0SII |
| 36 | Old Receivers — A Hidden Gold Mine
—updating those '40s receivers | W6GXN |
| 44 | Novices, Paddle Your Way To Happiness
—super deluxe Novice keyer | W0OGX |
| 76 | New Protection For Your Car
—simple force field system | WA4GIM |
| 92 | At Last! An RFI-free Computer!
—the Cromemco Z-2 | WB6JYK |
| 146 | The Solar-Powered Ham Station
—one hundred Watts, yet! | W5VBO |
| 154 | A 2m Antenna for the Perfectionist
—with considerable details | WB2AWG |
| 164 | A Brass Horn For X-Band
—simple 10.5 GHz antenna | W1SNN |
| 172 | Good Grief, Not the 22S Again?
—yes, even more flexibility | WB2LEI |
| 178 | The Amazing Zener Sweeper
—big deal gadget tests zener diodes | WB4YOD |

**PLUS 32 More Exciting
Feature Articles
(see page 5)**

Complete Contents—5, Never Say Die—6, Ham Help—11, W1BNN—11, Letters—12, Contests—15, New Products—16, RTTY Loop—18, Oscar Orbits—18, FCC Math—20, Corrections—65, Ham Help—65, Social Events—142, Propagation—226

TEMPO

VHF / ONE PLUS



MORE POWER / 25 OR 5 WATTS OUTPUT SELECTABLE

REMOTE TUNING / ON MICROPHONE

NEW LOWER PRICE / NOW ONLY \$399.00

SIDEBAND OPERATION WITH SSB/ONE ADAPTER / MARS OPERATION CAPABILITY / 5 KHz NUMERICAL LED

The Tempo VHF / One Plus is a VHF / FM transceiver for dependable communication on the 2 meter amateur band • Full 2 meter coverage, 144 to 148 MHz for both transmit and receive • Full phase lock synthesized (PLL) • Automatic repeater split—selectable up or down • Two built-in programmable channels • All solid state • 800 selectable receive frequencies with simplex and +600 KHz transmit frequencies for each receive channel.



TEMPO FMH-2, FMH-5 & FMH-42 (UHF)

6 channel capability • selectable 1 or 2 - 1 or 5 Watts output • Solid-state • Battery level meter • Earphone jack • Built-in charging terminals and separate charging jack for Ni-cad batteries • Flex antenna • Carrying case standard • Excellent frequency stability allows use with booster amplifier for high power output over 100 Watts • 8 AA batteries or 10 AA Ni-cads*.

*Not furnished.
FCC Type accepted models available

TEMPO VHF & UHF AMPLIFIERS

VHF (135 to 175 MHz)			
Drive Power	Output	Model No.	Price
2W	130W	130A02	\$199
10W	130W	130A10	\$179
30W	130W	130A30	\$189
2W	80W	80A02	\$169
10W	80W	80A10	\$149
30W	80W	80A30	\$159

UHF (400 to 512 MHz)			
Drive Power	Output	Model No.	Price
2W	70W	70D02	\$270
10W	70W	70D10	\$250
30W	70W	70D30	\$210
2W	40W	40D02	\$180
10W	40W	40D10	\$145
2W	10W	10D02	\$125

FCC Type accepted models available.

TEMPO POCKET RECEIVERS

MS-2, 4 channel scanning receiver for VHF high band, smallest unit on the market. MR-2 same size as MS-2 but has manual selection of 12 channels. VHF high band. MR-3, miniature 2-channel VHF high band monitor or paging receiver. MR-3U, single channel on the 400 to 512 UHF band. All are low priced and dependable.

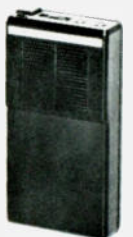

Sold at Tempo dealers throughout the U.S. and abroad. Please call or write for further information.

Prices subject to change without notice

11240 W. Olympic Blvd., Los Angeles, Calif. 90064
931 N. Euclid, Anaheim, Calif. 92801
Butler, Missouri 64730

213/477-6701
714/772-9200
816/679-3127

Henry Radio

This is the amplifier you have been waiting for



The new 2KD-5 linear amplifier... a one piece desk model with the power and reliability of a console

At Henry Radio, we know how to build only one kind of amplifier... the best. We want you to compare the 2KD-5 with any other desk model at any price. Remember, the 2KD-5 is only one model in the world's broadest line of amplifiers... both vacuum tube and solid state... for HF, VHF and UHF... fixed station and mobile... low power and high power. Never before has any one company offered such a cornucopia of high power RF amplifiers. Remember also that Henry Radio offers a broad line of commercial and FCC type accepted amplifiers covering the range of 3 MHz to 500 MHz. Henry amplifiers are

in use all around the world. Commercial and export inquiries are invited.

- The 2KD-5 is a 2000 watt PEP input (1200 watt PEP nominal output) RF linear amplifier, covering the 80, 40, 20, 15 and 10 meter amateur bands.
- Two Eimac 3-500Z glass envelope triodes operating in a grounded grid circuit.
- Pi-L plate circuit with a rotary silver plated tank coil for greatest efficiency and maximum attenuation of unwanted harmonics.
- Full legal input in all modes. 2000 watts PEP input for SSB. 1000 watts DC input for CW, RTTY and AM.
- Jumper for 115 or 230 VAC. 3 wire single phase.
- 10.5" high x 15" wide x 17.5" deep
- Price...\$895.00

2K-4...LINEAR AMPLIFIER. Offers engineering, construction and features second to none. Provides a long life of reliable service, while its heavy duty components allow it to loaf along even at full legal power. Operates on all amateur bands, 80 thru 10 meters. If you want to put that strong clear signal on the air that you've probably heard from other 2K users, now is the time. Move up to the 2K-4. Floor console...\$995.00

TEMPO 6N2 brings the same high standards to the 6 and 2 meter bands. A pair of advanced design Eimac 8874 tubes provide 2,000 watts PEP input on SSB or 1,000 watts on FM or CW. Complete with self-contained solid state power supply, blower and RF relative power indicator. ...\$895.00

TEMPO 2002. The same fine specs and features as the 6N2, but for 2 meter operation only. ...\$745.00

TEMPO 2006. Like the 2002, but for 6 meter operation. ...\$795.00

TEMPO VHF/UHF AMPLIFIERS. Solid state power amplifiers for use in most land mobile applications. Increases the range, clarity, reliability and speed of two-way communications. FCC type accepted also.

Model	Drive Power	Output Power	Price
-------	-------------	--------------	-------

LOW BAND VHF AMPLIFIERS (35 to 75 MHz)

Tempo 100C30	30W	100W	\$159
Tempo 100C02	2W	100W	\$179
Tempo 100C10	10W	100W	\$149

HIGH BAND VHF AMPLIFIERS (135 to 175 MHz)

Tempo 130A30	30W	130W	\$189
Tempo 130A10	10W	130W	\$179
Tempo 130A02	2W	130W	\$199
Tempo 80A30	30W	80W	\$149
Tempo 80A10	10W	80W	\$139
Tempo 80A02	2W	80W	\$159
Tempo 50A10	10W	50W	\$ 99
Tempo 50A02	2W	50W	\$119
Tempo 30A10	10W	30W	\$ 69
Tempo 30A02	2W	30W	\$ 89

UHF AMPLIFIERS (400 to 512 MHz)

Tempo 70D30	30W	70W	\$210.
Tempo 70D10	10W	70W	\$240
Tempo 70D02	2W	70W	\$270

Tempo 40D10	10W	40W	\$145
Tempo 40D02	2W	40W	\$165
Tempo 40D01	1W	40W	\$185
Tempo 25D02	2W	25W	\$125
Tempo 10D02	2W	10W	\$ 85
Tempo 10D01	1W	10W	\$125.

TEMPO 100AL10 VHF LINEAR AMPLIFIER. Completely solid state, 144-148 MHz. Power output of 100 watts (nom.) with only 10 watts (nom.) in. Reliable and compact...\$199.00

TEMPO 100AL10/B BASE AMPLIFIER ...\$349.00

Tempo solid state amplifiers are available at Tempo dealers throughout the U.S.

please call or write for complete information.

Henry Radio

11240 W Olympic Blvd., Los Angeles, Calif. 90064 213/477-6701
931 N Euclid, Anaheim, Calif. 92801 714/772-9200
Butler, Missouri 64730 816/679-3127

Prices subject to change without notice



IC-245/SSB, the Mobile Maximizer

MULTI-MODE MOBILE TRANSCEIVER

ICOM's new, fully synthesized **IC-245/SSB** maximizes mobile FM, SSB and CW operations with a very compact dash mounted transceiver like nothing else in the mobile world. This Maximizer's single knob dial makes the most of the mobile modes while totally minimizing manipulations. One fast moving detent knob gives the **IC-245/SSB** accurate tuning in all modes with positively no time lag or backlash in display stability, even when flying through steps of 100 Hz at 5 KHz per second. **And just as easily, you can work the new 144.5-145.5 repeaters regardless of splits or spacing.**

- **Single knob frequency selection:** The **IC-245/SSB** is synthesized with convenient single knob frequency selection over the entire band. No more fussing with two or more knobs just to check what is going on around the band. One easy spin of the 50-position detent knob does it all.
- **Two VFO's built-in:** The second VFO, which is a more money tack-on with most other transceivers, is a standard item with every **IC-245/SSB**.
- **Variable offset:** Any offset from 10 KHz through 4 MHz, in multiples of 10 KHz, can be programmed with the LSI synthesizer.
- **Remote programming:** The **IC-245/SSB** LSI chip provides for the input of programming digits from a remote key pad, which can be combined with Touch Tone circuitry to provide simultaneous remote program and tone. Computer control from a PIA interface is also possible.
- **FM stability on SSB and CW:** The **IC-245/SSB** synthesis of 100 Hz steps makes mobile SSB as stable as FM. This extended range of operation is attracting many FM'ers who have been operating on the direct channels and have discovered SSB.

The **IC-245/SSB** is the very best and most versatile mobile transceiver made: that's all. For more information and your own hands-on demonstration, see your ICOM dealer. When you mount your **IC-245/SSB**, you'll have the very maximum in multi-mode mobile.

Maximize the new repeater band: both the **IC-245/SSB** and the **IC-211** operate the new FCC repeater spectrum with no modification. They always have.

All ICOM radios significantly exceed FCC specifications limiting spurious emissions.

Specifications: Frequency Coverage: 144.00 to 148.00 MHz Modes: FM (F3), SSB (A3J), CW (A1) Supply Voltage: DC 13.8V \pm 15% Size: 90mm (h) x 155mm(w) x 235mm(d) Weight: 6.8 Kg TX Output: F3, 10W; A3J, 10W (PEP); A1, 10W Spurious Radiation: -60 dB below Carrier Microphone Impedance: 600 Ohms Sensitivity: A3J & A1, 0.5 microvolt input gives 10 dB S+N/N; F3, 0.6 microvolt or less for 20 dB quieting S+N+D/N, at 1 microvolt input, 30 dB Spurious Response: -60 dB or better Synthesizer Frequency Range: 144.00 MHz to 148.00 MHz Synthesizer Step Size: 5 KHz for FM, 100 Hz or 5KHz for SSB

VHF/UHF AMATEUR AND MARINE COMMUNICATION EQUIPMENT

Distributed by:



ICOM

ICOM WEST, INC.
Suite 3
13256 Northrup Way
Bellevue, Wash. 98005
(206) 747-9020

ICOM EAST, INC.
Suite 307
3331 Towerwood Drive
Dallas, Texas 75234
(214) 620-2780

ICOM CANADA
7087 Victoria Drive
Vancouver B.C. V5P 3Y9
Canada
(604) 321-1833



#210 MAR 1978

- 22 The New, Improved "Best Keyer Yet" - updating MINI-MOS K4JEM
- 26 The Powerful Grounded Antenna - thrives on poor soil W0SII
- 28 How To Cut Costs On Power Supplies - using Radio Shack components W9HDA
- 31 The Quicker, Slicker Transistor Checker - diodes, too Sergo
- 32 You, Too, Can Go Digital - simple digital display for the HW-2036 K2RB
- 36 Old Receivers - A Hidden Gold Mine - updating those '40s receivers W6GXN
- 40 Old Rigs Can Live Again! - a guide to their resurrection K4IPV
- 44 Novices, Paddle Your Way To Happiness - super deluxe Novice keyer W0OGX
- 48 How Many pF Is That Capacitor, Really? - build this simple C-meter WA0ZCR
- 52 Exorcising Power Supply Demons - what to do when Murphy visits K4IPV
- 58 Meet the Plastic Wonder - quad antenna K00XB/5
- 62 Don't Miss the Excitement of QRP - HW-8 mods let you have a ball K9SGZ
- 66 Is Your Repeater Up-To-Date? - ways to modernize your repeater W4VGZ
- 72 1220 MHz - Use It Or Lose It! - simple gear you can build and enjoy K1CLL
- 76 New Protection For Your Car - simple force field system WA4GIM
- 78 The Great Cover-Up - a fiendish way to simplify schematics W4FXE
- 82 The World Of Tone Control - a virtual encyclopedia on the subject K3JE/2
- 88 Solve Those Parallel Problems - with HP-25 programs N3IE
- 92 At Last! An RFI-free Computer! - the Cromemco Z-2 WB6JYK
- 96 Another Approach To the ASCII/Baudot Headache - a Model 15 and an SWTP system K4HBG
- 98 Programming Coil Design - at last... a use for computers! K7SBK
- 104 Outstanding Computer Bargain Exposed - the BYT-8 WA6JSF
- 110 Do Biorhythms Really Work? - HP-55 program W4KFT
- 114 From CB To Amateur Radio - copy this article for CBers WB4POH
- 131 How Much Power Does It Draw? - build this simple ac wattmeter Fowler
- 132 Surprisingly Low-Cost Lab Supply - an IC regulator does it! W6GXN
- 134 Wireless Monitoring For the Bionic Ham - always be in touch W8FXJ4
- 138 I Need A Contact! - shooting for WAN/C WB2DYU/2
- 140 Flash Project For Camera Fiends - powerful electronic flash WA6UNK
- 143 Kerchunk Counter - monitor your repeater's activity W6NUI
- 146 The Solar-Powered Ham Station - one hundred Watts, yet! W5VBO
- 150 A Cheaper Chip W7JSW
- 152 The Go Pro HT Mod - adding a telephone handset to your HT W8FXJ4
- 154 A 2m Antenna for the Perfectionist - with considerable details WB2AWG
- 156 Are You Afraid To Build? - how to get organized... and started W4RYO
- 164 A Brass Horn For X-Band - simple 10.5 GHz antenna W1SNN
- 168 A Cheapskate's Circuit Board - for those on unemployment WA1BVD
- 172 Good Grief, Not the 22S Again? - yes, even more flexibility WB2LEI
- 176 Avoid An Overvoltage Catastrophe - protective circuit W7RXV
- 178 The Amazing Zener Sweeper - big deal gadget tests zener diodes WB4YOD
- 182 How To Use A Varactor - And Why - semi-exhaustive article W8JB
- 184 Can A Diode Replace A Relay? - antenna switching with a diode! Staff
- 185 Shock the Car-Burglar - give him the gong W1DIS

73 Magazine is published monthly by 73, Inc., Peterborough NH 03458. Subscription rates in the U.S. and Canada are \$15 for one year, \$26 for two years, and \$36 for three years. Outside the U.S. and Canada, write for rates. Second class postage paid at Peterborough NH 03458 and at additional mailing offices. Publication No. 700420. Phone: 603-924-3873. Entire contents copyright 1978 by 73, Inc. INCLUDE OLD ADDRESS AND ZIP CODE WITH ADDRESS CHANGE NOTIFICATION.

Microfilm edition - University Microfilms, Ann Arbor MI 48106.

73 STAFF

EDITOR/PUBLISHER
Wayne Green W2NSD/1

EXECUTIVE VICE PRESIDENT
Sherry Smythe

ASSISTANT EDITOR/PUBLISHER
Morgan W. Godwin W4WFL

ADMINISTRATIVE ASSISTANT
Dotty Gibson

MANAGING EDITOR
John C. Burnett

ASSISTANT MANAGING EDITOR
Susan G. Phibbrick

EDITORIAL ASSISTANT
Beth Turin-Weston

I/O EDITOR
John Craig

PUBLICATIONS EDITOR
Jeffrey D. DeFray WB8BTH/1

PRODUCTION MANAGER
Lynn Parcellera-Frase

ART DEPARTMENT
Craig Brown
Gayle Cabana
Bob Drewe
Michael Murphy
Winston Parker
Bob Sawyer
Noel R. Self WB1ARP
Robin M. Sloan

BOOK PRODUCTION
Cynthia Gray

PRINT SHOP MANAGER
Michael Potter

PRINTING
William Cering
Dwight Perry

PHOTOGRAPHY
Bill Heydolph
Terdi Cluff

TYPESETTING
Barbara J. Latti
Pauline Halvoni
Jannifer Johansson
Mary Kinzel
Marie Walt

COMPTROLLER
Krud E. M. Keller KV4GG/1
Frances Marion
Nancy Dupuis
Cada Teixeira

CIRCULATION
Barbara Block
Fran Dillon
Florence Gorrman
Becky Warren
Rhonda Ramsey

DATA ENTRY
Judi Waterman
Judy Brumaghim
Valerie Horn
Daimonius Smith
Linda Galt

MARKETING DIRECTOR
Sherry Smythe

MARKETING MANAGER
Jack Shimes

SHIPPING
Theresa Toussaint
Sue Chanille
Ethan Perry
Maureen Toussaint

PLANT MAINTENANCE
Bill Barry
Michael Goutu
Lorraine Pickering

RECEPTIONIST
Doni Jarvis

ASSOCIATES
Robert Baker WB2GFE
E. H. Barnett WB8HX
Schley Co. WB8LHO
Tom DiBaise WB8KZD
Terry Fox WB4JFI
W. Sanger Green
Dave Ingram K4TWJ
Larry Kahane WB2NEE
Joe Kasser G2GZ
Bill Pasternak WA6ITF
John Schultz W4FA
Walter Scott K8DIZ
Peter Stark K2QAW
Bill Turner WA8AB1

COMPUTER PROGRAMMING
Richard J. Dykema
Ron Cooke
Steven B. Lionel

ADVERTISING
Aline Goutu
Mary Jo Spornier
Heidi Kulissh
Marissa Stone

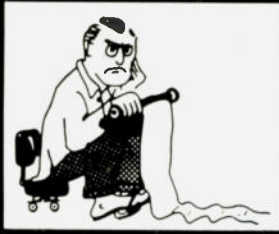

NEVER SAY DIE

...de W2NSD/1

EDITORIAL BY WAYNE GREEN

COMPUTERIZED HEADACHE

Along in early 1975, when it became obvious that we were spending more money buying computer service to handle our subscriptions than it would cost to do the same job at 73, we started shopping for a computer.

It was the frustration of this search which resulted in our starting *Byte* magazine and then *Kilobaud*. The search continued on into 1976 and eventually our data processing "expert" settled on a Prime computer system. Prime is a small outfit in Framingham, Massachusetts, a spin-off of people from Honeywell.

After some six months of in-house programming of the Prime system to handle subscriptions, the data processing department announced that they were ready to take over the 73 mailing list. What followed during the next few months was a disaster. Subscriptions, renewals, billing, address changes — all were screwed up and attempts to get things straight were frustrated. The excuses flew fast and furious . . . the system kept breaking down . . . too damp . . . too hot . . . too dirty . . . lousy programs . . . and so forth.

We finally gave up and moved the subscriptions back to an outside contractor and set about rewriting the programs and seeing what could be done about the constant equipment failures. Getting rid of the head of the department, an incurable smoker, coincided with an end to equipment failures . . . mostly disk head crashes. Recent failures have been few.

Eventually we'll try handling subscriptions here at 73 again . . . when we're sure things are ready for it.

My apologies and many more from everyone at 73 for any difficulties subscribers have had. Everything is working smoothly right now, but we'll probably screw it up again. On the bright side, we think everyone eventually got all of the 73 issues.

ARRL WAFFLING

The Amateur Radio Manufacturer's

Association met at Las Vegas in early January and put the ARRL on the spot. Present were Lee Aurick, the *QST* advertising manager, and Baldwin, League Poo Bah. The January *QST* editorial said that the ARRL had had nearly a hundred firms sign their Code of Ethics. Since not one of the manufacturers in ARMA had signed it, they demanded to know who the hundred were. Aurick didn't remember . . . not even one single name. Baldwin also had a sudden attack of memory loss. When pushed hard, he admitted that no manufacturers had signed up, and said that he thought they had had signatures from a number of small dealers. After the meeting, I tried to find one single person who believed either Aurick or Baldwin. No luck.

The general impression of the audience was that the January *QST* editorial was a self-serving bunch of baloney.

SAROC

Fewer and fewer hams seem to be coming to this tired and boring hamfest. More and more hams complained to me that even though they had confirmed prepaid reservations at the hotel, they still were turned away. Not many hams want to pay \$16 (plus another \$16 for the wife) just to see a handful of exhibits . . . with virtually no program. SAROC is run during the dead season at Vegas, with the result that the shows are dull. Everyone was grumbling about the lack of names. A few days later, the stars came to Vegas.

One of the largest ham dealers in the country said that this was positively the last time he would ever exhibit at SAROC. Vegas is a long and expensive way from anywhere, so most of the hams who do go are there more for Vegas than for any hamfest. It's a curious crowd.

I stopped bothering to have a booth at SAROC several years ago. Now I stop off there every couple of years just to see if it is getting better. My

own feeling is that the hamfest has been going downhill for six years . . . ever since the heyday of FM. If the Winter Consumer Electronics Show and Personal Communications Show hadn't been at Vegas at the same time, I wouldn't have bothered this year.

CODE OF ETHICS

It is unfortunate that a lot of amateurs are so emotionally involved with this business of CBers. I bow to no one in my love of amateur radio and my interest in its survival, yet I have some serious reservations about the Code of Ethics.

Firstly, I'd sure like to hear some tapes of CBers invading our 10m band. I've talked to a couple of hams who have heard this happen with their own ears, but most of the stories I've heard have been tenth hand and not very credible. It is interesting that the FCC has come out with a statement in writing that there is no significant problem with CBers coming into the ham bands. Despite the terror that this possibility brings to many amateurs, the fact seems to be that this is imaginary.

Okay, but what about the hundreds of thousands of CBers who are using ham gear for DXing in the HF band, those frequencies between 27.5 and 28 MHz? What about them? If the FCC considers this a serious problem, then I suspect they would ask for some help in solving it. Despite my many suggestions that they get hams to help with this, the FCC has been strangely silent. I asked the FCC at a recent media meeting whether HFers were interfering with any other service and they said no. I suggested that either the FCC come to grips with the problem . . . possibly enlisting the aid of amateurs and ham clubs . . . or else legalize the HF band . . . the way they did rag chewing on the CB channels.

Let's suppose the FCC starts having trouble with the CAP operators . . . that they start spilling over into adjacent channels. Should amateurs take this as their personal responsibility to cure? Suppose the police operators start using bad language on their channels . . . should hams get involved to clean this up? The Citizens Band service is just as separate as CAP, police, or any of a hundred other services . . . so why do hams feel a responsibility to get involved?

If the HFers were buying up ham gear to the extent that hams couldn't get it, I might get my back up. If they were turning up in the ham bands in any numbers, I'd get all upset. If the FCC asked hams to help them curb this unlawful bunch, I'd be delighted

READER RESPONSIBILITY

One of your responsibilities, as a reader of 73, is to aid and abet the increasing of circulation and advertising, both of which will bring you the same benefit: a larger and even better magazine. You can help by encouraging your friends to subscribe to 73. Remember that subscriptions are guaranteed — money back if not delighted, so no one can lose. You can also help by tearing out one of the cards just inside the back cover and circling the replies you'd like to see . . . catalogs, spec sheets, etc. Advertisers put a lot of trust in these reader requests for information.

To make it even more worthy your while to send in the card, a drawing will be held each month and the winner will get a LIFE subscription to 73!

 **KENWOOD**
...pacesetter in amateur radio

The TR-7500 is a 100 channel PLL synthesized 146-148 MHz mobile transceiver offering the dependability you've come to expect from Kenwood products.

ALL THE FREQUENCIES YOU NEED FOR MOST REPEATER OPERATION AND RECOMMENDED SIMPLEX CHANNELS ARE PRE-PROGRAMMED. 88 channels are pre-programmed for use on all standard repeater frequencies (as per ARRL Band Plan) and most simplex channels. For added flexibility, there are 6 diode-programmable switch positions. The 15 KHz shift function makes these 6 positions into 12 channels.

THE 7500 FEATURES AN EASY TO READ, LED DIGITAL FREQUENCY DISPLAY... unlike the difficult to read mechanical displays on many mobile units.

ALSO, A SINGLE KNOB CHANNEL SELECTOR makes the TR-7500 one of the most convenient units to operate while driving.

Its output is a full 10 watts and it offers ± 600 KHz offset, along with other worthwhile features.

The man to see... your local Authorized Kenwood Dealer. He can give you all the information you need and the best deal.

THE TR-7500 IS AN ADVANCED 2 METER FM TRANSCEIVER OFFERING EXCITING FEATURES AND EXTREME RELIABILITY AT A REASONABLE PRICE

TR-7500



AND PS-6

... matching power supply for the TR-7500. Regulated 13.8 VDC @ 3.5 amps... built in speaker... perfect companion for home use of the TR-7500.



TR-2200A

A high performance portable 2-meter FM transceiver. Provides superior performance for the active outdoorsman... portable, mobile or airborne... pleasure or emergency. 12 channel capacity (6 supplied). Telescoping antenna can be easily replaced by a "rubber duck" antenna. Connections for external antenna, 12 VDC or internal ni-cad batteries. Battery-saving "light-off" position. Hi-Lo power switch. Includes batteries, charger, carrying case and microphone. A mobile mounting bracket (MB-1A) is also available.

TRIO-KENWOOD COMMUNICATIONS INC.
1111 WEST WALNUT/COMPTON, CA 90220

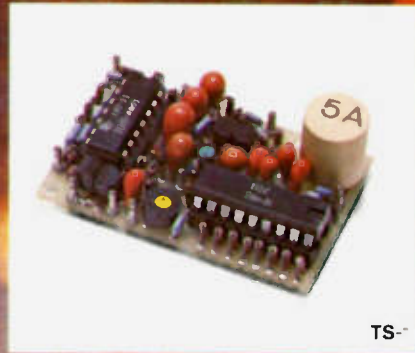

TS-1

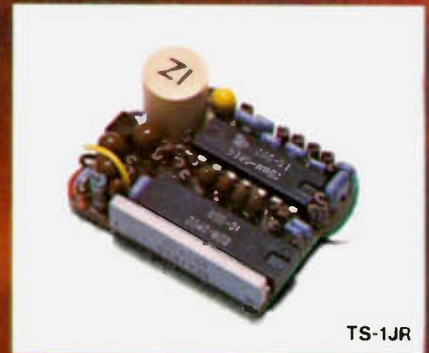

TS-1JR



PE-2



SD-1

THE DAWNING

The age of tone control has come to Amateur Radio. What better way to utilize our ever diminishing resource of frequency spectrum? Sub-audible tone control allows several repeaters to share the same channel with minimal geographic separation. It allows protection from intermod and interference for repeaters, remote base stations, and autopatches. It even allows silent monitoring of our crowded simplex channels.

We make the most reliable and complete line of tone products available. All are totally immune to RF, use plug-in, field replaceable, frequency determining elements for low cost and the most accurate and stable frequency control possible. Our impeccable 1 day delivery is unmatched in the industry and you are protected by a full 1 year warranty when our products are returned to the factory for repair. Isn't it time for you to get into the New Age of tone control?

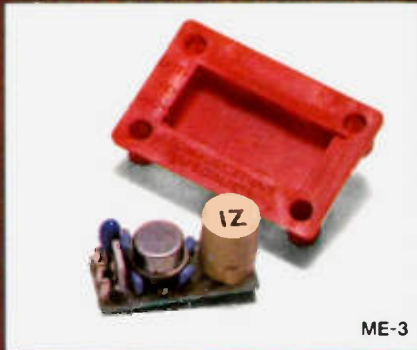

ME-3

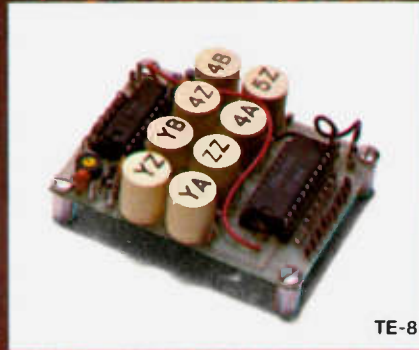

TE-8



TE-12

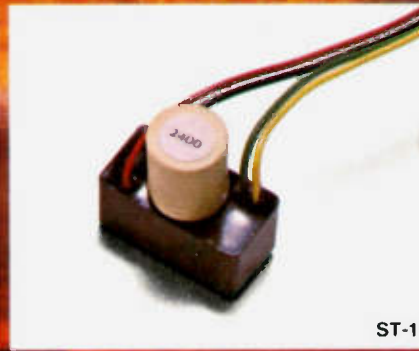

ST-1

OF A NEW AGE.

TS-1 Sub-Audible Encoder-Decoder • Microminiature in size, 1.25" x 2.0" x .65" • Encodes and decodes simultaneously • \$59.95 complete with K-1 element.

TS-1JR Sub-Audible Encoder-Decoder • Microminiature version of the TS-1 measuring just 1.0" x 1.25" x .65", for hand-held units • \$79.95 complete with K-1 element.

ME-3 Sub-Audible Encoder • Microminiature in size, measures .45" x 1.1" x .6" • Instant start-up • \$29.95 complete with K-1 element.

TE-8 Eight-Tone Sub-Audible Encoder • Measures 2.6" x 2.0" x .7" • Frequency selection made by either a pull to ground or to supply • \$69.95 with 8 K-1 elements.

PE-2 Two-Tone Sequential Encoder for paging • Two call unit • Measures 1.25" x 2.0" x .65" • \$49.95 with 2K-2 elements.

SD-1 Two-Tone Sequential Decoder • Frequency range is 268.5 - 2109.4 Hz • Measures 1.2" x 1.67" x .65" • Momentary output for horn relay, latched output for call light and receiver muting built-in • \$59.95 with 2 K-2 elements.

TE-12 Twelve-Tone Sub-Audible or Burst-Tone Encoder • Frequency range is 67.0 - 263.0 Hz sub-audible or 1650 - 4200 Hz burst-tone • Measures 4.25" x 2.5" x 1.5" • \$79.95 with 12 K-1 elements.

ST-1 Burst-Tone Encoder • Measures .95" x .5" x .5" plus K-1 measurements • Frequency range is 1650 - 4200 Hz • \$29.95 with K-1 element.



**COMMUNICATIONS
SPECIALISTS**

426 W. Taft Ave., Orange, CA 92667
(714) 998-3021

FIGHT THE DICTATORSHIP!

Rick Cooper, who operates out of a post office box in southern California, says he has over two million petitions backing him in his drive to take the ham bands and give them to the CBers. When he was asked about the structure of his group, which he claims has over 7,000 local officers around the country, he answered: "It's a dictatorship and I'm the dictator."

Cooper further claims that he has received over 100,000 paid (\$25 each) subscribers to his Communications Attorney Service (not to be confused in any way with the Personal Communications Foundation) . . . if so, he has plenty of money to back up his seemingly outrageous demands.

Amateurs have a choice right now . . . ignore all this and take a chance that Cooper may not be able to use all that money and the millions of petitions to get Congress to go along with him . . . or FIGHT BACK! If you are willing to live with a dictatorship, then no problem. If you want to do something about this . . . you can . . . right now.

Cooper has been getting his millions of petitions via a chain letter system . . . and we can do the same. If you will make at least five copies of the petition below, get five other people to sign them, and send them to me, I'll see that they are used where they will do the most good.

When the FCC refused to listen to us back in 1973, we got thousands of ham petitions and presented them to the FCC at a hearing - and it changed the whole rules and regulations picture completely. We can do it again, but we need hundreds of thousands or even millions of petitions this time. We need petitions from amateurs, from friends, family, neighbors, co-workers . . . everyone. We don't want to be run over roughshod by a dictator . . . we must fight back . . . fight back in the way Congress and the FCC understands - votes. Vote for amateur radio by sending in a petition right



now . . . and then get as many copies signed and sent in as possible. Flood me with them.

Your *only* registered lobbyist for amateur radio is me . . . Wayne Green. I am the only person officially authorized to represent you before Congress. With your petitions in hand, our voice will ring out loud and clear in Congress and with the FCC. This is your big chance to back up amateur radio . . . if you want to see it like it is instead of the way dictator Cooper wants.

Chain Letter Petition in Support of Amateur Radio

Before doing anything else, make at least five photocopies of this petition and give or send these copies to friends, neighbors, radio club members, hams you have contacted, etc. They do not have to be radio amateurs, but just people who realize the importance to the community, to our country, and to the world of amateur radio. We don't want to lose our bands to CBers and a dictatorship.

The Petition

We, the undersigned, being American citizens, do hereby indicate our support of amateur radio and our opposition to any efforts to destroy this valuable service. Since radio amateurs have been directly responsible for developing and pioneering virtually every communications technique in use today, furnish an invaluable source of engineers and technicians for our government and industry, and furnish efficient communications during any emergencies, we cannot afford to let this important resource be wiped out.

Name _____ Address _____ City _____ State _____ Zip _____

Name _____ Address _____ City _____ State _____ Zip _____

Name _____ Address _____ City _____ State _____ Zip _____

Name _____ Address _____ City _____ State _____ Zip _____

Name _____ Address _____ City _____ State _____ Zip _____

Support this political action to preserve amateur radio. Send your petition to:

Wayne Green

73 Magazine, Peterborough NH 03458

73/3/78

to pitch in. But the fact is that outside of having a lot of fun and being a major source of new hams, the HFers are not doing much harm.

Speaking of new hams, I'm getting more and more reports from clubs with ham classes that HFers make by far the best hams . . . that they seldom drop out of classes. Almost 100% of the newcomers to hamming are CBers and about 75% of them in many areas are HFers . . . who are, for the most part, the elite of the CB gang.

The pages of 73 are open for ideas and argument on this . . . but not to emotional bigoted blasts. The above is the bottom line of the input I've had on the situation . . . I'm always open for more data.

A CHALLENGE

Frankly, in a way I'm disappointed that the CB pirate menace has turned out to be mostly smoke. This is the

sort of thing which could help to bring amateurs together and perhaps rekindle pride in amateur radio in the hearts of some of our more lost souls. I had in mind that clubs could have the fun of getting turkey hunting teams set up . . . something which would be fun and a challenge . . . teams which could design and build direction-finding equipment to quickly hunt down the invaders. For years the Russian amateurs have gone about this aspect of amateur radio in a big way, complete with national finals in Moscow for top teams. I think American amateurs, if they would take an interest in transmitter hunting, would soon come up with circuits and techniques which could win any international contest.

A couple of New Orleans readers got very hot under the collar when they felt I put them down for taking so long to catch the two hams who had been jamming their repeater with

bad language. I would rather they respond with the full story of their hunt and the difficulties involved instead of keeping the whole thing a secret. Sure, it's hard to track down two moving turkeys who are alternating transmissions, but if the FCC has instant direction-finding equipment, then there is nothing to stop hams from building the same . . . or better. I'd love to have articles in 73 on the latest in DF gear . . . it might get things moving.

BE NICE

Should you run across a CBer who is trying out a ham band, whether it is someone who has bought a 2m rig at a flea market, someone blundering on our new channelized 10m band, or a wandering HFer, why not try a friendly first approach? Explain the situation and offer to get the chap into a local ham class. Tell him that not only is it illegal for him to use a

ham channel, but also that hams get very uptight over this and just won't allow it. You might go into how proud hams are of their self-policing reputation and invite him over for a visit and further details. With most people, being nice helps a lot.

DECEMBER WINNER

"Run, Sheila, Run!", a super story about real-life radio control, up and ran away with our December Best Article contest, so Edward Mulvin WB0IFF will be receiving a bonus of \$100 from us for writing the article. Don't forget to vote for your favorite article every month by filling in the appropriate slot on our Reader Service card at the back of the magazine. You get the info you request from advertisers, and you might also help your favorite author pick up a quick hundred. A no-lose proposition for only 13¢!

Ham Help

I have been interested in QRP circuit diagrams for some time now and am looking for the diagram for the Herring-Aid 5, the plans for which appeared in the July, 1976, *QST*. I also need the Tuna-Tin 2 circuit which appeared in the May, 1976, *QST*. I have been trying to get on the air on a budget and haven't yet succeeded. I am 15 years old and have been having trouble trying to find QRP circuits, and would greatly appreciate them.

I am also having trouble trying to find an i-f module (J.W. Miller 8902-B) for the HF receiver described in the December, 1977, issue.

David Gagne WB1DCR
143 Millville St.
Salem NH 03079

I would like to get in touch with other Orthodox Jews interested in a net and/or hobby computers.

David Eisenberg WB2LQQ
POB 358, Cath. St. Stn.
New York NY 10025

I am working on my Novice license and am attempting to restore a B&W 5100S transmitter and sideband adaptor, although the latter can wait awhile. I am also working on a Hallicrafters Skyrider 32 receiver.

I would appreciate any information, particularly schematics and alignment procedures, on either or both. Of course I will cover any costs involved.

F. L. McClellan
8007 Peach Point
San Diego CA 92126

I am a newsstand purchaser of your *73 Magazine* for ham radio and enjoy it very much while pursuing my hobby.

My Allied radio model A2517 transceiver takes about 20 minutes to put out signals on USB, LSB, and CW. In the receive condition, the audio output is very low, after changing the

tubes and transistors. I would like to hear from anyone who has similar problems.

Clarence Grimm W9NJZ
193 S. Mason St.
Bensenville IL 60106

Do you have any technical information on the famous National SW-3-3 tube receiver that came out back in the '30s? I had one back in '38 when I was first licensed, and I wanted to try and build one up if I could get some dope on it. I do have the manual, but that doesn't give much dope on building it, information on the coils, etc. If you have anything that is available, please let me know as I would like to obtain it. Or, could you tell me where I might find one of the little sets?

Olen Craig W6DIG
2248 Gale Ave.
Long Beach CA 90810

I wonder if one of the solid state experts can give me a bit of info. I would like very much to find a source from which I can buy some series ME8900 tone generator ICs, such as those manufactured by Microsystems International of Ottawa, Canada. Does anyone know of a retailer who handles them, or the mailing address of Microsystems Int.?

Any help will be appreciated.

Almon A. Gray W1KA
RFD Box 67A
Brooksville ME 04617

Help! I've just passed my code test and am anticipating passing the written test for my Novice ticket. I bought a Hammarlund model HQ 110-C receiver. Do you know of anyone that may have operator instructions, manuals, schematics, etc., for this receiver?

D. E. Eaton
Box 334
Levittown PA 19058

CQ Morgantown, West Va. — I would like to set up a phone patch schedule to contact my brother in Morgantown. Name the best day, time, and band, and I'll be there! Drop me a note to arrange a sked.

Fred Goldenson K9TOS
311 Devlin Court
Naperville IL 60540

Several years ago, I purchased a Hallicrafters model HT-40 transmitter from an amateur friend of mine who

could not locate the schematic diagram or any information on the unit.

The transmitter is defective and I need a schematic to insure that my repairs will conform to the original circuitry.

I am willing to pay a reasonable amount for a true and legible circuit, copy or otherwise.

Frank Galdes W3EEV
3675 Forbes Trail Dr.
Murrysville PA 15668

W7BNN



"Now remember, you guys, these hams and their people only have two eyes. Don't embarrass them by staring."

LETTERS

BLEEP?

The amateur fraternity is presently experiencing the most activity on 2 meter FM in our history, and it most probably will increase. We have shown, by our use of the band, that we like this means of local communication.

For some reason of which I am unaware, we don't use the letters CQ on two meter FM. We say "monitoring the frequency," "listening on 94," "QRZ the frequency" (which is totally incorrect), etc. We could, of course, state that we are looking for a contact, but I have seldom heard that done.

I would suggest that possibly some word or combination of letters be used on 2 meters to indicate that we would like a contact with some station that may be listening. Perhaps the innocuous word "Bleep" might be used to indicate our desire for a contact. One could simply say "W5XXX Bleep." This would keep it short and, if locally or nationally recognized, would accomplish the purpose desired.

Perhaps other readers can suggest something more appropriate. I submit this for your comment and possible generation of other ideas or discussion on the subject.

Bob McClain W5QFH
Oklahoma City OK

Um, yes, Bob... what happened here was that CQ Magazine was about the last of the ham magazines to recognize two meter FM... so naturally the FMers would rather stay off the air than call "CQ." There has been a move to have FMers call "73" as a general call, but we have not encouraged this recognition of the part played by 73 in the popularizing of FM and repeaters. — Wayne.

TRACING THE BERTANI

Ken Cole W7IDF
PO Box 3
Vashon WA 98070

Dear Ken,

I wonder if I have the answer to your question, "What happened to Paolo of the *Agostino Bertani*?"

Idly leafing through some old magazines left on the mess table, as an old ex-amateur I was interested to see that someone had left a copy of 73 (the November, 1976, edition). I took it back to my bungalow to read and came across your article.

I was particularly interested, as I sailed on the *Agostino Bertani* from Mombasa to Genoa in September, 1961. She was the same, and while on board, as a passenger, I got this story from the Italian master: She was still with the Lloyd Tristino Line and registered in Genoa. The *Bertani* had apparently eventually finished up on the seabed in Tripoli, and there she lay until after the war, when she was salvaged and, presumably, returned to her owner. She'd been underwater for a couple of years at least, but the need for ships during that period was so severe that it was considered worth the salvage.

Anyway, when I boarded her in Mombasa, en route to the U.K., was then on a regular run, Genoa, Mediterranean ports including Beirut, Suez, east coast of Africa, down to Durban, where she turned around. I was greatly interested in your narrative as I was in North Africa during 1941/43, although I didn't get to Tripoli. I was with the RAF.

I think, when I left her in Genoa, she was doing one or maybe two more trips and then was destined for the scrap yard. I had an interest in ships at the time, still have, and was an active member of the World Shipping Society. The old *Bertani* has a special place in my heart, too, as it was on board her that my daughter, now approaching her 16th birthday, was conceived!

As regards Paolo, I hope he made it and is, indeed, happily married in North Africa or Italy, maybe with a dozen bambinos. I got to know several Italian POWs during my time in North Africa, and all of them felt the same as your Paolo.

Stephen Ghent
Box 2070
Konedobu
Papua, New Guinea

REVERSE AUTOPATCH

As a member of the Tri-County Repeater Association of the Silver Spring, Maryland, area, I have been asked to investigate the past experiences of fellow amateur radio operators who have operated or used repeaters with reverse autopatch.

By reverse autopatch I mean an autopatch setup where a person, knowing the phone number of the repeater and a special access code, can (on the telephone) call a repeater and either get on the air directly or cause a tone or other sound to be transmitted by the repeater, which is then answered by either a control operator or anyone listening to the repeater, by transmitting an access code, which, in

effect, answers the phone on the air.

We are interested in hearing from anyone who has had experiences operating a repeater with reverse autopatch or from persons who have used such machines. In particular, we would like to know answers to as many of the following questions as possible. Every little bit of information will be of help.

1. What techniques are used to enable telephone callers to gain access to the repeater?
2. What is transmitted by the repeater when access is achieved?
3. Who is permitted access by telephone?
4. How do you limit who can access the repeater by phone?
5. When a telephone caller is not able to speak over the air when he first calls (accesses the repeater), that is, when only a tone or other signal is transmitted when the caller accesses the repeater, how is the call answered?
6. Has anyone had oral or written communication with the FCC regarding reverse autopatch? What was the result of such communication?
7. Has anyone personal knowledge of an amateur repeater which has or had reverse autopatch where the FCC has asked or required that repeater to terminate operation of a reverse autopatch? Please provide details.

Any additional information or details concerning this subject known to readers of 73 Magazine will also be appreciated.

Please address all replies concerning this matter to: Tri-County Repeater Association, PO Box 718, Seabrook MD 20801.

E. C. Wenzinger WA3ZFK
Beltsville MD

CRYING OVER TVI

I have just signed up to take your magazine for another year, mostly because of your editorials and letters.

It is too bad that the amateur journals cannot be for the radio amateur and not for the advertisers. However, I can understand that the magazine's existence depends on advertising!

We complain about CB rigs, yet shut our eyes to most of the manufactured ham gear that radiates. The ads show glowing harmonic attenuations but fail to say anything about the leakage out of the cabinet and power line cord or 12-volt lead.

During the past year I have purchased numerous sets, trying to find one that does not cause TVI, and have sold them at a loss. Many of the sets are paint-to-paint bonding, have no filter in the 12-volt lead, and the ac line picks up rf. In one set in particular, the fan motor is parallel to and within an inch of the tank coil, and the leads go right out of the cabinet. Instead of screen shielding, there are castings with large slots.

The amateur journals could do one thing. They do not have to publish the discrepancies in their glowing evaluations of the sets, but they could contact the manufacturer and point

out the problems. Perhaps they might cooperate and try to fix the problem, and give credit where due to those who have done a good job of bonding the cabinets and filtering.

I, for one, am tired of being ripped off purchasing equipment after reading evaluation reports in the amateur journals. The only way you can know is to buy a set, try it, and compare it with sets that you know do not cause TVI. This should be a service of amateur organizations to which we pay dues to look out for our interests.

Ed Marriner W6XM
La Jolla CA

Ed, put your typewriter where your mouth is. I haven't had any problems with TVI from ham rigs and I've tested a lot of 'em. I've been able to operate a TV set right on top of my linear amplifier without problems, even in the far fringe area. If you've had trouble, you have not taken the trouble to write any details down and send them to me... nor has any other ham in the country. If there really is a problem, which I doubt, I'd like to see some data on it... and some cures to the problem. Some grounding and shielding should be a lot simpler and less expensive than selling the set. — Wayne.

MAKE IT MEDTRONIC

In the December issue of 73, pages 17 and 32, are two letters from W9VFG on his problems with the General Electric pacemakers. He also mentioned that 15 other models by GE were also bad.

One Oct. 22, 1974, three years ago, I had a Medtronic pacemaker installed. As soon as I got home, I found that I could monitor the pacemaker with a Heathkit signal tracer, set on rf. A week later, I went to my surgeon and asked him about operating my ham rig. I also wrote to Medtronic. The surgeon, when he found I could monitor the pacer, told me to try operating while using the tracer. So I checked with the exciter, and found no effect on the pacer. I turned on the linear, and still no problem.

Anyhow, at the visit with the surgeon he showed me a model like I had. It was completely shielded, with a single coaxial lead about ten inches long. This went through a vein to the bottom of the heart, with a button on the end. This button was to be in contact with the bottom of the heart; the ground came from the shield and the case. After three years, my interval is .855. Divide this into 60 to get my pulse rate per minute.

My gear consists of a KWM2, a Heath SB-220 linear, a coax switch above them, three coax leads about 75 feet long, and a home brew three element quad, about 30 feet up. I operate three to ten hours a week, both SSB and CW. CW is barefoot. I have no effect on the pacemaker of any kind, operating either full power or barefoot.

I am due for a new one, when the

Continued on page 27

This one's for you.

Because you asked for it . . . we built it. The all-new JR. MONITOR™ Antenna Tuner.

Call it what you will — antenna tuner, matchbox, or matching network, the JR. MONITOR™ has it all wrapped up in one neat 5½" W x 2½" H x 6" D all metal cabinet.

Here are the features you said you wanted:

Continuous tuning from 1.8-30 MHz. 300 watt power capability. Forward reading relative output power meter — simply tune JR. MONITOR™ controls for maximum RF output on the meter. Built-in balun. Mobile mounting bracket. Ceramic rotary 12-position switch. Capacitor spacing 1000 volts. Tapped toroid inductor. Antenna inputs: coax unbalanced SO 239, random wire, balanced feed line 75-660 ohm. Weight: 2½ pounds.

With so many special features — think of the unlimited possibilities you'll have for experimenting with dozens of antennas! For instance, the Dentron All Band Doublet fed with balanced feed line hooked to the JR. MONITOR™ covers 1.8-30 MHz in one antenna. . . or try this mobile suggestion: 108" mobile whip fed with coax to the JR. MONITOR™ located under the dash will give you 10-40 meter mobile coverage and no coils to change!

It's easy to understand the excitement the JR. MONITOR™ has created. Wherever you are — home, boat, car, plane, or campsite you'll always be in contact. It's a fun little tuner that easily fits in a briefcase or coat pocket — but why would anyone want to smuggle it into their radio room?

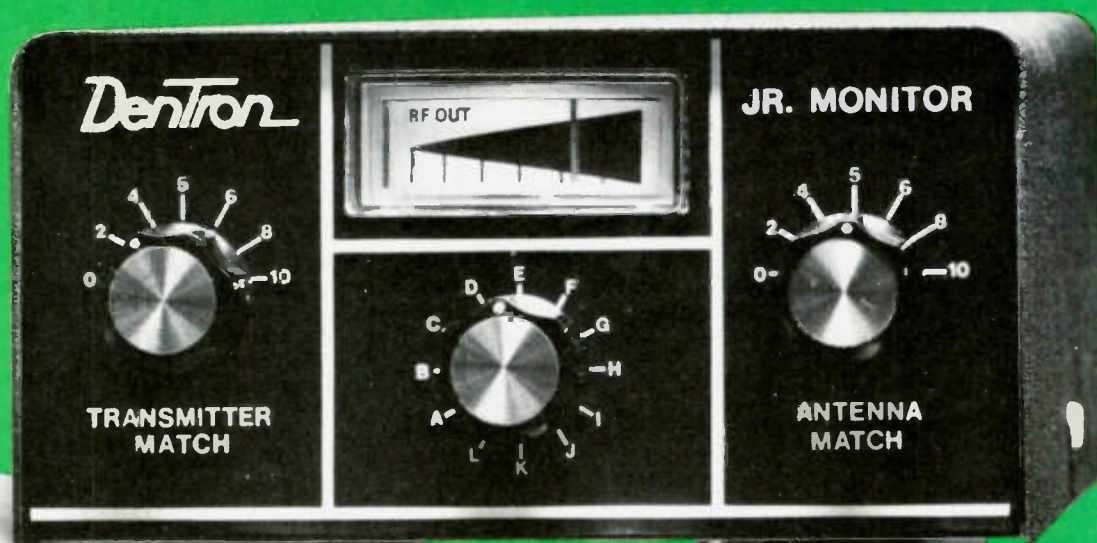

JR. MONITOR™ \$79.50
ALL BAND DOUBLET \$24.50

Dentron

Radio Co., Inc.

2100 Enterprise Pkwy.,
Twinsburg, Ohio 44087

(216) 42E-3173



BOARDS INSIDE CABINET

- 1 CARR OSC unit
- 2 VOX unit
- 3 AF unit
- 4 IF unit
- 5 Filter unit
- 6 Noise Blanker/RF Processor
- 7 Rectifier unit
- 8 Rectifier unit
- 9 Power XFMR
- 10 Final Amplifier unit
- 11 VCO unit
- 12 TUNE control
- 13 PLL unit
- 14 RF unit
- 15 Counter Display unit
- 16 FM unit

FT-901DM

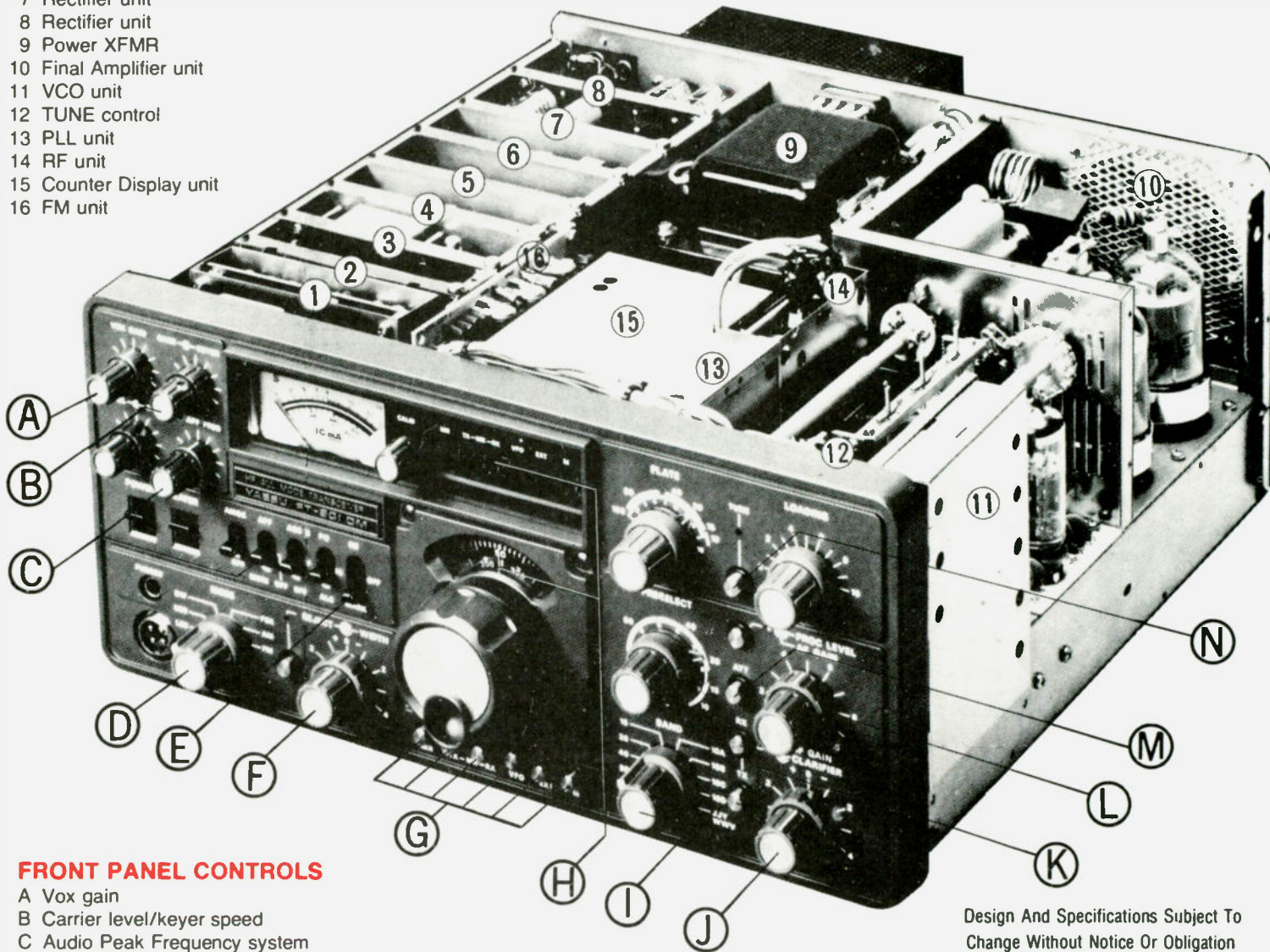

FRONT PANEL CONTROLS

- A Vox gain
- B Carrier level/keyer speed
- C Audio Peak Frequency system
- D MODE switch (SSB, CW, FSK, AM, FM)
- E Crystal calibrator/Noise blanker
- F Rejection tuning/variable IF passband tuning
- G Frequency memory system
- H Digital plus analog frequency readout
- I Band switch (160-10 meters + WWV/JJY receive)
- J Clarifier control
- K RX/TX Clarifier selector
- L RF Processor level
- M RF attenuator
- N TUNE control (Places transmitter in "TUNE" condition for ten seconds, then returns to "receive" condition to protect final tubes from excessive key-down time)

Design And Specifications Subject To Change Without Notice Or Obligation



THE SYMBOL OF TECHNICAL EXCELLENCE

YAESU The smart radio



YAESU ELECTRONICS CORP., 15954 Downey Ave., Paramount, CA 90723 (213) 633-4007
YAESU ELECTRONICS CORP., Eastern Service Ctr., 613 Redna Ter., Cincinnati, OH 45215

Editor:
Robert Baker WB2GFE
15 Windsor Dr.
Atco NJ 08004

CONTESTS

CQ WORLDWIDE WPX SSB CONTEST

Starts: 0000 GMT Saturday,
March 25
Ends: 2400 GMT Sunday,
March 26

Only 30 hours of the 48-hour contest period permitted for single-operator stations. The 18 hours off may be taken in up to 5 periods during the contest, but must be clearly indicated in the log. Multi-operator stations may operate the entire 48 hours. All bands, 1.8 to 28 MHz, may be used, but all QSOs must be 2xSSB only.

ENTRY CLASSES:

Single-operator, allband or single-band; multi-operator (all band only), single- or multi-transmitter; multi-operator, multi-transmitter only allowed one signal per band.

EXCHANGE:

RS and 3 digit progressive QSO number starting at 001; use 4 digit number over 1000; multi-transmitter stations use separate numbers for each band.

POINTS:

QSOs with stations on different continent - 3 points on 14 to 28 MHz, 6 points on 7 to 1.8 MHz. Contacts between North American countries (not your own) count 2 points on 14 to 28 MHz, 4 points on 1.8 to 7 MHz. Contacts between stations in the same continent but not in the same country count 1 point on

14 to 28 MHz, 2 points on 1.8 to 7 MHz. Contacts between stations in the same country count only for multipliers, not for QSO points.

MULTIPLIER:

The multiplier is the total number of different prefixes worked regardless of band. Each prefix may be counted only once.

SCORING:

Single-op, allband and multi-operated stations - total number of QSO points from all bands times the total multiplier. Single-op, single-band - total number of QSO points from that band times the multiplier. NOTE: A station may be worked once on each band for QSO points, but the prefix multiplier is only counted once.

AWARDS:

Certificates will be awarded in each category in each country, and each call area in US, Canada, and Australia. Other special awards and trophies will be awarded as listed in *CQ Magazine*. To be eligible for awards, single-operator stations must work a minimum of 12 hours; multi-operator stations must work a minimum of 24 hours.

LOGS:

Show all times in GMT; use a separate sheet for each band. Prefix multipliers should be entered only the first time they are contacted. Logs should be checked for duplicate QSOs and prefix multipliers. It is recommended that you use a prefix check sheet and include it with your entry.

Each entry must be accompanied by a summary sheet listing all scoring information, category, and your name and mailing address in block letters. Also, a signed declaration that all contest rules and regulations for amateur radio in your country have been observed should be included. Official logs and summary sheets are available from *CQ Magazine*. Send a large self-addressed envelope with sufficient return postage or IRCs to: CQ WW WPX SSB Contest Committee, 14 Vandeventer Avenue, Port Washington, LI, NY 11050. All entries should be postmarked no later than May 1 and addressed to the address shown above. The deadlines will be made more flexible in rare isolated areas.

Please check the January issue of *CQ Magazine* for complete rules and changes made at the last minute.

BARTG SPRING RTTY CONTEST

Starts: 0200 GMT Saturday,
March 25
Ends: 0200 GMT Monday,
March 27

Only 30 hours of the total 48-hour contest period may be operated. The 18 hour rest period can be taken at any time, but off periods may not be less than 3 hours at a time. Times on and off the air must be summarized on the log and score sheets. There will be separate categories for multi-operator and SWLs. Use all amateur bands from 3.5 to 28 MHz. Stations may not be contacted more than once on any one band. In addition to the ARRL country list, each W/K, VE/VO, and VK call area will be counted as a separate country.

EXCHANGE:

Time in GMT, must be a full 4 figure group - use of "same" or "same as yours" will not be permitted. RST and message number. Message number must consist of a 3 figure group starting with 001 for the first contact.

POINTS:

All 2-way RTTY contacts with

stations within one's own country will count 2 points. All 2-way RTTY contacts with stations outside one's own country will count 10 points. All stations will receive a bonus of 200 points per country worked including their own. NOTE: Any one country may be counted again if worked on another band, but continents are counted only once.

SCORING:

The total score is the sum of (the 2-way exchange points times the number of countries worked) plus (the number of countries worked times the country bonus points times the number of continents).

LOGS & SCORE SHEETS:

Use one log sheet for each band and indicate any rest periods. Logs must contain: date and time in GMT, call sign of station worked, RST report and message number sent, RST report and message number received, and exchange points clarified. The judges' decision will be final. Send contest logs to: Ted Double G8CDW, 89 Linden Gardens, Enfield, Middlesex, England EN1 4DX. Logs must be received by May 31st.

AWARDS:

Certificates will be awarded to the leading stations in each class and to the top stations in each continent and each W/K, VE/VO call area. The final positions in the Results Table will be valid for entry in the "World Champion of RTTY" Championship.

If any contestant contacts 25 or more different countries (W/K, VE/VO, and VK call areas do not count as separate countries for award) on 2-way RTTY during this contest, a claim may be made for the Quarter Century Award issued by the British Amateur Radio Teleprinter Group and for which a charge of \$2.00 or 8 IRCs is made. Make your claim at the same time as you send in a contest log. Holders of existing QCA awards will automatically have any new additional countries added to their records.

Continued on page 60

CALENDAR

*Mar 4-5	ARRL DX Contest - Phone
Mar 4-5	YL-OM CW Contest
*Mar 18-19	ARRL DX Contest - CW
Mar 25-26	CQ WW WPX SSB Contest
Mar 25-27	BARTG Spring RTTY Contest
Apr 1-2	TENN QSO Party
Apr 1-3	ORP QSO Party
Apr 8-9	Open ARRL CD Party - CW
Apr 11-12	DX to W/VE YL CW Party
Apr 15-16	ARRL CD Party - Phone
Apr 22-23	Zero District QSO Party
Apr 25-26	DX to W/VE YL Phone Party
Apr 29-30	PACC Contest
June 3-4	IARS/CHC/FHC/HTH QSO Party
June 10-11	ARRL VHF QSO Party
June 24-25	ARRL Field Day
June 24-25	First REF Ten Day
July 4	ARRL Straight Key Night
July 8-9	IARU Radiosport Competition
Aug 19-20	NJ QSO Party
Sept 9-10	ARRL VHF QSO Party
Oct 14-15	ARRL CD Party - CW
Oct 21-22	ARRL CD Party - Phone
Nov 4-5	ARRL Sweepstakes - CW
Nov 18-19	ARRL Sweepstakes - Phone
Nov 18-19	Second REF Ten Day
Dec 2-3	ARRL 160 Meter Contest
Dec 9-10	ARRL 10 Meter Contest

* = described in last issue

RESULTS

RESULTS OF THE 1977 OHIO QSO PARTY

Ohio State Winners:

W8KIC (WB8MZZ operator)	82620 points	(trophy winner)
WB8JBM	79299	
WB8OFR	53475	
K8MR	34103	
WB8SVN	32488	

Out-of-State Winners:

W4VF	8410 points	(trophy winner)
WA4QIT	6880	
K3HXS	6733	
WA1UWR	5588	
WA1FCN	4181	

New Products

NEW ASTATIC 877L OMNIDIRECTIONAL DYNAMIC MICROPHONE

Astatic's new 877L public address and paging microphone is engineered for quality performance, styled for contemporary appearance, and priced for economy.

The omnidirectional dynamic desk microphone has a smooth peak-free wideband frequency with a slight rise above 2000 Hz for natural highly intelligible sound. Frequency response is 50 to 12,000 Hz; nominal impedance is 400 Ohms.

Built for years of trouble-free service, the 877L features a long-life DPDT leaf switch with easy push-bar control and locking capabilities. The rugged high-impact molded housing withstands abuse. The 877L also has environmental resistance.

Supplied with seven feet (2.1m) of four-conductor two-shielded cable wired normally open for relay control, the attractively styled microphone is available in black, white, and beige.

For more information on the 877L public address and paging microphone, write *The Astatic Corporation, Commercial Sound Division, Conneaut OH 44030*.

THE MODEL C6500 GENERAL- COVERAGE COMMUNICATIONS RECEIVER

The model C6500 synthesized, general-coverage communications receiver is a new "Standard" in high-quality, low-cost performance that will please the most critical listener. Reception capability is provided for AM, CW, USB, and LSB. Unusual stability is achieved by utilizing a synthesized, drift-cancelling first mixer injection system giving 30 tunable ranges, covering the entire broadcast band from 500 kilohertz through 30 megahertz, from a single 10 MHz crystal oscillator, thus ensuring the frequency stability necessary for excellent SSB reception. Dial accuracy is better than 5 kHz readout, which is sufficient to locate and identify stations with known frequencies. There are two separate detectors, product and diode, to provide excellent performance for both SSB and AM signals. A mode switch provides wideband reception for AM and nar-

rowband for SSB signals. The sideband filter is used to copy CW. A peaking preselector allows the user to manually achieve maximum sensitivity and interference rejection. Completely solid state in design, the Standard C6500 operates off both ac mains as well as eight internal type "D" flashlight battery cells. Automatic switch-over to battery operation, internal or external source, is accomplished if the ac power should fail. For information, write *Standard Communications Corp., P.O. Box 92151, Los Angeles CA 90009*.

VERSATILE LOGIC MONITORS SEE INSIDE ICs

Continental Specialties Corporation offers a very nice way to peek inside the black box of digital DIPs: 16-channel clip-on logic monitors. An LED at each pin indicates the state of that pin by lighting or remaining dark.

One of the biggest problems in troubleshooting modern digital systems is that there is virtually no practical way to directly monitor the performance of both the inputs and outputs of individual gates, or of the packages of gates.

By monitoring an entire 14- or 16-pin DIP at once, CSC's logic monitors reveal the action of the package as a whole, permitting easy and often instant insight into its behavior or misbehavior.

The model LM-1 logic monitor tests DTL, TTL, HTL, and CMOS logic families. It automatically seeks out the highest positive and lowest negative voltage levels and draws its power from the IC under test. Individual comparators at each pin (100,000 Ohm input impedance) drive individually labeled LEDs "on" for a high, and "off" for a low logic level. It carries a suggested resale price of \$74.95.

The model LM-2 logic monitor includes a fully isolated line-operated power supply to eliminate test circuit loading. Clip leads ride the supply rails of the circuit under test to derive the proper comparator levels. A switch selects RTL, DTL, TTL, HTL, or CMOS family operation. Suggested resale price is \$129.95 for standard 117 V ac 50/60 Hz operation, 10% more for 220 V ac 50/60 Hz operation.

Application of these logic monitors has been compared to the use of a 16-channel oscilloscope. CSC logic monitors are elements of the digital troubleshooting family CSC calls The Logical Force™.

Information about CSC logic monitors and The Logical Force is available from CSC dealers and distributors, or from *Continental Specialties Corporation, 70 Fulton Terrace, New Haven, Connecticut 06509, (203) 624-3103, TWX (710)-465-1227*.

NEW SERIES OF MFJ ANTENNA TUNERS

MFJ Enterprises introduces a series of three brand new antenna tuners that uses efficient air-wound coils to give less losses than a tapped toroid for more Watts out.

The versatile, top-of-the-line MFJ-941 Versa Tuner II features built-in swr and dual-range wattmeter (300 and 30 Watts full scale), antenna switch for selecting two coax-fed antennas, random wire or balance line, tuner bypass, and a 1:4 balun for balance lines. It handles up to 300 Watts of rf output power and matches dipoles, inverted vees, random wires, verticals, mobile whips, beams, balance lines, and coax lines continuously from 1.8 through 30 MHz.

This beautiful little tuner is housed in a deluxe eggshell white Tea Tec enclosure with walnut grain sides and is a compact 8 x 2 x 6 inches.

SO-239 coax connectors are provided for transmitter input and all coax-fed antennas. Quality five-way binding posts are used for balance lines (2), random wire (1), and ground (1). Included are mobile mounting brackets.

The MFJ-941 Versa Tuner II sells for \$79.95.

The MFJ-901 Versa Tuner also uses an efficient air-wound coil, handles up to 200 Watts, and has a built-in 1:4 balun for balance lines. It matches all types of transmission lines (coax, balance lines, random wire) and virtually all types of antennas continuously from 1.8 through 30 MHz. It is an ultra-compact 5 x 2 x 6 inches, uses SO-239 coax connectors, and quality five-way binding post for random wire and balance lines.

The MFJ-901 Versa Tuner sells for \$59.95.

The MFJ-900 Econo Tuner is the same as the MFJ-901 Versa Tuner except that it does not have the built-in 1:4 balun for balance lines.

Price is \$49.95.

The MFJ-941 Versa Tuner II, MFJ-901 Versa Tuner, and the MFJ-900 Econo Tuner are all available from MFJ Enterprises, and have a 30-day money-back trial period. If you are not satisfied, you may return them within 30 days for a full refund (less shipping). MFJ also provides a one-year unconditional warranty.

To order, call toll-free (800)-647-8660, or mail the order to *MFJ Enterprises, P.O. Box 494, Mississippi State MS 39762*.

NEW CDE ROTOR FOR SUPER ANTENNAS

Cornell-Dubilier Electric Company has introduced a new heavy-duty rotor, the Tail Twister™, to handle antennas with up to 28 square feet of wind load area. A new control box was designed for the rotor to complete the system.

The rotor incorporates the highly successful Ham II design with a new thicker cast aluminum bell housing. Wider reinforced webs of the housing permit easy support of the largest antenna. On this model, the upper mast support is predilled to have a bolt-through installation for positive locking. Also new is a three-ring ball bearing assembly to provide increased side thrust control and vertical load-carrying capacities.

The motor is a new design with an automatic coast-down prebrake action and a metal pinion gear to guard against stripping.

The control box features a full metered indication of the antenna direction with front panel control for calibration and brake. A separate on/off switch is provided for instant antenna location and brake operation. LEDs provide a positive signal for rotational power and brake operation. The unit is attractively housed in a black satin case. Low voltage control assures safe operation for the user and installer.

The Tail Twister™ system is designed for tower mounting as required for most "super" communications antennas. Weighing slightly over 18 pounds with a height of 14-1/16 inches and a diameter of 9-5/16 inches, the unit is secured with six 5/16-inch bolts provided. The mast diameter is a hefty 2 inches.

For further information, please contact Mr. W. Carlson, *Cornell-Dubilier Electric Co., 150 Avenue L, Newark NJ 07101; call (201)-589-7500*.

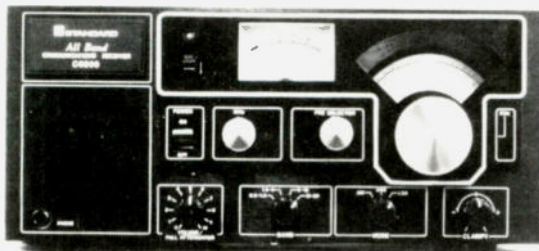

Standard's model C6500 general-coverage receiver.



The MFJ-941 Versa Tuner II.

TEN-TEC CENTURY 21 GOES DIGITAL!

Century 21, the exciting 70-watt, 5-band CW transceiver that surprised everyone with its super performance and low cost, has another surprise for you. A second model with digital readout (and a mod kit for those who would like to convert their dial model). Both Models 570 and 574 have the same unique circuitry that has won raves from everyone — both have the same fine features:

- Direct Frequency Readout (Model 574: 5 red LED digits, 0.3" high, accurate to nearest 1 kHz. Model 570: marked in 5 kHz increments from 0-500 kHz, MHz markings for each band displayed, tuning rate typically 17 kHz per tuning knob turn.
- Full Break-In • Full Band Coverage on 3, 5, 7, 14, 21 MHz Bands, 1 MHz on 28 MHz Band • 70 Watts Input • Total Solid-State • Receives SSB and CW • Receiver Sensitivity 1 μ V • Instant Band Change, No Tune-up • Offset Receiver Tuning • 3-Position Selectivity • Adjustable Sidetone Level • Linear Crystal-Mixed VFO • Overload Protection • Built-In AC Power Supply • Black & Gray Styling • HWD: 6 $\frac{1}{8}$ " \times 12 $\frac{1}{2}$ " \times 12", 15 $\frac{1}{2}$ lbs. • Matching Accessories

THE RECEIVER. Double-Direct-Conversion. Easy tuning. Just select the frequency and set the audio level. Excellent cross-modulation characteristics. Offset tuning so you can tune either side of zero beat to reduce QRM. Front panel control selects one of 3 selectivity curves: 2.5 kHz for SSB reception, 1 kHz for normal CW, and 500 Hz for when the QRM gets rough. Plus separate AF and RF controls, headphone jack, and built-in speaker.

THE TRANSMITTER. Total solid-state. Push-pull Class C final amplifier. Individual low-pass filters are switched into the antenna line to reduce unwanted radiations, minimize TVI. No tune-up needed when changing frequencies or bands. And full break-in allows incoming signals to be heard between transmitted characters. Now CW is real conversation!

THE VFO. Common to receiver and transmitter. Permeability tuned. Linear scale on model 570; 5-5.5 MHz basic frequency is crystal-mixed to the desired frequency so bandwidth and stability are the same on all bands (crystals included for 3.5, 7, 14, 21, and 28-28.5 MHz segment of the 10 meter band).

THE POWER SUPPLY. Built-in, AC operated, and regulated. Monitors current demand, shuts down automatically when necessary for protection. Lighted input current meter shows proper Drive setting.

MATCHING ACCESSORIES. Model 277 Antenna Tuner/SWR Meter. Model 670 Electronic Keyer, 6-50 wpm, self-completing characters. Model 276 Calibrator for markers at every 25 and 100 kHz. Model 273 Crystal for 28.5-29 MHz. Model 1170 12 VDC Circuit Breaker for mobile operation of models 574 and 570.

574 Century 21 Digital Transceiver	\$399.00
570 Century 21 Non-Digital Transceiver	\$299.00
277 Antenna Tuner/SWR Meter	\$ 85.00
670 Century 21 Keyer	\$ 29.00
276 Century 21 Calibrator	\$ 29.00
273 Crystal for 28.5-29 MHz	\$ 5.00
274 Digital Mod. Kit for Model 570	\$ 90.00
1170 DC Circuit Breaker	\$ 8.75

See both Century 21 surprises at your TEN-TEC dealer — or write for full details.

TEN-TEC, INC.
SEVIERVILLE, TENNESSEE 37862
EXPORT 5715 LINCOLN AVE. CHICAGO, ILL. 60646

THE SECOND SURPRISE OF THE CENTURY: DIGITAL

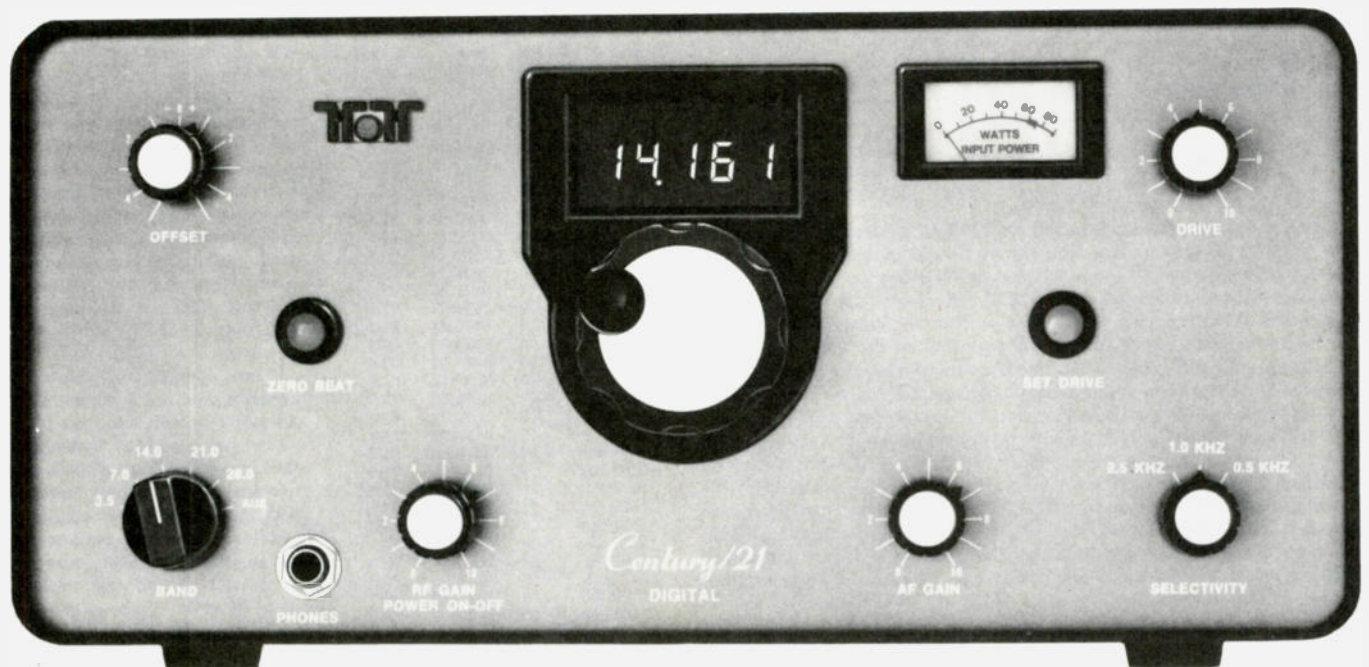

RTTY Loop

Marc I. Levey, M.D. WA3AJR
4006 Winlee Road
Randallstown MD 21133

If you spent the winter in your shack and have done much RTTY operation, you may have discovered one stunning truth about this mode: It generates reams of material! A good deal of this information has some retention value, and preservation of certain items may be legally required, as in the case of third-party traffic. The next few columns will deal with information storage and retrieval for the RTTY station.

There are several factors you need to concern yourself with when you consider information storage systems. They include:

1. Ease of entering data into storage;
2. Ease of inspecting stored data;

3. Ease of editing stored data;
4. Ease of removing data from storage;
5. Viability of storage form;
6. Cost and availability of techniques;
7. Interchangeability between users.

The ideal storage medium would optimize all these factors. Such a medium, of course, does not exist, although many come close. You might find, however, that, by using complementary techniques, the gaps can be filled with a minimum effort. But wait, I am getting ahead of myself. First, let's look into just what each of these criteria involves.

You are faced with converting a stream of incoming Teletype® data, marks and spaces fleeting by in millisecond tempo, into a static record. This record must be flexible enough to accommodate one character or one hundred pages. Initiation of recording should be as uncomplicated as pos-

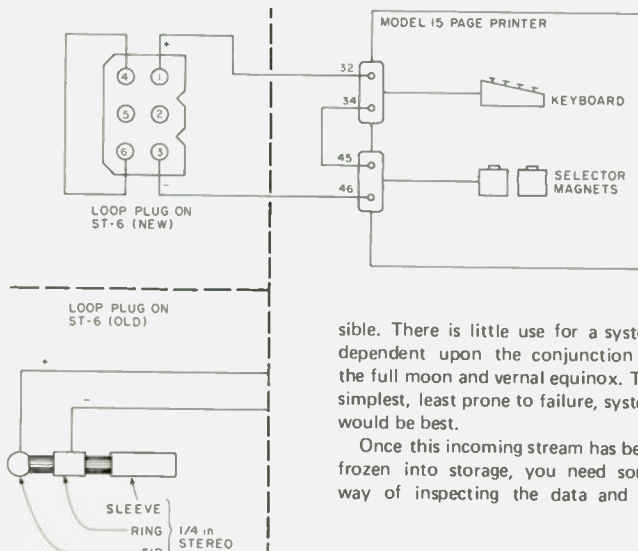
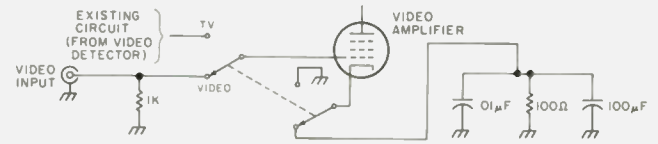

Fig. 1. Model 15(19) - ST-6 interconnection.

sible. There is little use for a system dependent upon the conjunction of the full moon and vernal equinox. The simplest, least prone to failure, system would be best.

Once this incoming stream has been frozen into storage, you need some way of inspecting the data and re-

TUBE SET



TRANSISTOR SET

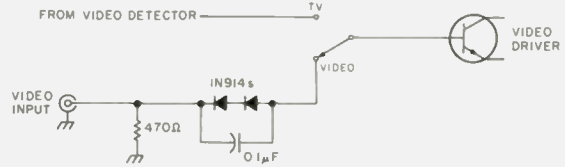

Fig. 2. Modifying a TV set for video input.

vising or editing it. Such inspections should be nondestructive, i.e., the act of looking should leave the original record intact, and editing should be painless with revised data available for immediate use.

Transmission of this stored information should be accomplished with the same facility as recording it. As with the storage, the transmission link should operate at the maximum speed of the system.

Whatever the system, the records, once produced, should be as permanent as possible, with little chance of accidental loss of data. The system should be cheap, with all components readily available to the amateur from several sources. And it should be a system which would permit exchanges of data in the recorded form, as through the mail or at meetings.

Sounds like a lot to order, doesn't it? Well, it is, but there are systems around now which can neatly fill the bill. Next month, I will begin a detailed look at those techniques. Right now, let's turn to some readers' questions.

Johnny Carr, of Rockmart, Georgia, needs information on hooking up a model 19 and an ST-6 demodulator. Johnny, the model 19 set consists of the model 15 page printer and a paper tape reader called a transmitting distributor (TD). You need four power

sources to get this machine up and running: 115 V ac for the motors; 60 mA loop for the selector magnets; and dc supplies for the tape punch and TD clutch. You indicate that you have the tape punch supply, and I will bet that the TD clutch is also taken care of. If you refer to the side diagram of the model 15 in the September, 1977, edition of this column, you will find that these same contacts can be found on your model 19. Instead of a separate loop supply, the ST-6 has a built-in supply which is available at the rear skirt. Newer versions of the ST-6 use a six-pin molex connector for the loop, while older models used a 1/4-inch phone plug. Just hook the loop leads from the machine to the appropriate terminals on the ST-6, and you're off and running. Fig. 1 is a diagram to show you how.

Velio Buccicone W9IL passes along the information that he is attempting to receive RTTY using an Infotech M75 and a video monitor. He wants to know how to hook the two together. I can refer you to what is probably the best book around for information along that line, the *TVT Cookbook* by Don Lancaster. Fig. 2 shows two ways of coupling the video to the i-f stage of a standard TV, depending on whether the TV is tube or transistor. One major caution to anyone contemplating such a hookup, whether for RTTY or computers: Make sure the TV is transformer-powered and isolated from ground! Failure to do so can easily put 115 V ac on the ground bus of your system. Another way to do it, and the only way if you have an ac/dc TV that is not isolated, is to use any of the small rf modulators available. Less than ten dollars can buy one from any of several sources, several of which advertise in this magazine. Just feed the video in and the rf out to the antenna terminals. You lose some fine resolution, but, for RTTY, it is entirely adequate.

I look forward to receiving your questions, and try to answer as many as possible here in the pages of 73. If you want a personal reply, a self-addressed stamped envelope is a must. This goes not only for me, but also for most authors whose writing you enjoy. Also welcomed are suggestions and questions to be used as springboards for future columns. Some topics now in development include having fun with RTTY and the use of computers in the shack.

Oscar Orbits

FINDING OSCAR

The listed data tells you the time and place OSCAR crosses the equator in an ascending orbit for the first time each day. To calculate successive orbits, make a list of the first orbit number and the next twelve orbits for that day. List the time of the first orbit. Each successive orbit is 115 minutes later (two hours less five minutes). The chart gives the longitude of the first crossing. Add 29° for each succeeding orbit. When OSCAR is ascending on the other side of the world, it will descend over you. To find the equatorial descending longitude, subtract 166 degrees from the ascending longitude. To find the time it passes the North Pole, add 29 minutes to the time it passes the equator. You should be able to hear OSCAR when it is within 45 degrees of you. The easiest way to do this is to take a globe and draw a circle with a radius of 2480 miles (4000 kilometers) from the home QTH. If it passes right overhead, you should be able to hear it for about 24 minutes total. OSCAR will pass an imaginary line drawn from San Francisco to Norfolk about 12 minutes after passing the equator. Add about a minute for each 200 miles that you live north of this line. If OSCAR passes 15 degrees from you, add another minute; at 30 degrees, three minutes; at 45 degrees, ten minutes. Mode A: 145.85-95 MHz uplink, 29.4-29.5 MHz downlink, beacon at 29.502 MHz. Mode B: 432.125-175 MHz uplink, 145.975-925 MHz downlink, beacon at 145.972 MHz.

Oscar 7 Orbital Information

Orbit	Date (Mar)	Time (GMT)	Longitude of Eq. Crossing °W
15050	Abn	1 0023:01	62.1
15063	Bbn	2 0117:18	75.7
15075	Bbn	3 0016:38	60.5
15088	Abn	4 0110:56	74.1
15100	Bbn	5 0010:16	59.0
15113	Bbn	6 0104:33	72.6
15125	Abn	7 0003:54	57.4
15138	Bbn	8 0058:11	71.0
15151	Bbn	9 0152:28	84.6
15163	Abn	10 0051:49	69.4
15176	Bbn	11 0146:06	83.0
15188	Bbn	12 0045:27	67.9
15201	Abn	13 0139:44	81.4
15213	Bbn	14 0039:04	66.3
15226	Bbn	15 0133:22	79.9
15238	Abn	16 0032:42	64.7
15251	Bbn	17 0126:59	78.3
15263	Bbn	18 0026:20	63.2
15276	Abn	19 0120:37	76.7
15288	Bbn	20 0019:58	61.6
15301	Bbn	21 0114:15	75.2
15313	Abn	22 0013:35	60.0
15326	Bbn	23 0107:53	73.6
15338	Bbn	24 0007:13	58.5
15351	Abn	25 0101:30	72.1
15363	Bbn	26 0000:51	56.9
15376	Bbn	27 0055:08	70.5
15389	Abn	28 0149:25	84.1
15401	Bbn	29 0048:46	68.9
15414	Bbn	30 0143:03	82.5
15426	Abn	31 0042:24	67.4

if the **HUSTLER** 4-BTV weighs 39% more... what do others leave out?



HUSTLER FIXED STATION FOUR BAND VERTICAL

The 4-BTV is longer for greater aperture, larger in diameter for strength and bandwidth, heavier traps for precision and safety factor. Individually, each subassembly weighs more to collectively give you an antenna designed for convenience of assembly and installation, a wide margin in mechanical stability and far superior electrical performance.

- **Lowest SWR**—PLUS!
- Bandwidth at its **broadest!** SWR 1.6 to 1 or better at band edges.
- Hustler exclusive trap covers "**Spritz**" extruded to otherwise unattainable close tolerances assuring accurate and permanent trap resonance.
- Solid one inch **fiberglass trap forms** for optimum electrical and mechanical stability.
- Extra heavy duty aluminum mounting bracket with **low loss—high strength** insulators.
- All sections **1 1/4" heavy wall**, high strength aluminum. Length 21'5".
- **Stainless steel clamps** permitting adjustment without damage to the aluminum tubing.
- Guaranteed to be **easiest assembly** of any multi-band vertical.
- Antenna has 3/8"-24 stud at top to accept RM-75 or RM-75-S Hustler resonator for **75 meter operation** when desired.
- Top loading on 75 meters for broader bandwidth and **higher radiation efficiency!**
- Feed with **any length** 50 ohm coax.
- Power capability—**full legal limit** on SSB and CW.
- Ground mount with or without radials; roof mount with radials.

one setting for total band coverage! 40 THROUGH 10 METERS



"the home of originals"

New Tronics patents 3287732, 3513472, 3327311, 3419869, 3599214, 3873985, 3582951, 1017857 (Canada)

**MODEL
4-BTV
15 POUNDS**

**new
tronics
corporation**

ANTENNA Engineers, Designers, Manufacturers
15800 commerce park drive
brookpark, ohio 44142
(216) 267-3150

*Available from all distributors
who recognize the best!*

FCC Math

John F. Leahy WB6CKN
P.O. Box 539
Gonzales CA 93926

By the completion of the last installment in this series, we had purchased just about all the math tools we need to survive FCC exams. In this and the following, we'll put these tools to work in order to gain the experience which alone will assure success on those exams.

Let's start by applying some algebra to that inductive reactance formula, $X_L = 2\pi fL$, we saw last time. Suppose we know the reactance of a particular coil is 700 Ohms at 3.725 MHz. Can we use our formula to determine the coil's inductance? We sure can!

We know that X_L is 700 Ohms, f is 3.725 MHz, and π is, as always, about 3. Putting these into our formula, we have: $700 = 2(3)(4 \times 10^6)L$, where the parentheses show we are multiplying. Note that we've rounded the frequency, 3.725 MHz, to 4×10^6 (mega, remember, means times a million, times 10^6). We're after inductance, L . How the dickens do we get L by itself on one side of the equation, with everything else on the other?

This brings us back to playing around with numbers. $120 = 2(3)(4)(5)$ — again, parentheses around the 3 and 5 are enough to indicate that what we have here is multiplication and not the number two thousand three hundred forty-five or something — is a true equation in the same form as $X_L = 2\pi fL$. The 5 is in the same place as L . Can we get 5 by itself and still have the same five numbers in a true equation? Because whatever technique works with this *number* equation (to isolate the 5 on one side with everything else on the other) will no doubt work with the *letter* equation, to isolate L by *itself*. After a bit of playing around, you may notice that $120/2 = 3(4)(5)$, and $120/[2(3)] = 4(5)$, and finally $120/[2(3)(4)] = 5$ (120 divided by 24 equals 5). Voilà! 5 by itself! We've done it! By moving everything that was with the 5 down to the bottom of the other side, we have a true equation and have isolated 5 by itself. That must mean that we can move the things with L in our reactance equation down to the bottom of the other side to get L by itself in a true equation. Doing just that gives us: $X_L/2\pi f = L$. And we can quickly use this transposed formula to solve our problem, $L = 700/[2(3)(4 \times 10^6)]$, which is $(7 \times 10^2)/(24 \times 10^6)$. 24×10^6 rounded is $2 \times 10^1 \times 10^6$ or 2×10^7 , so we have $(7 \times 10^2)/(2 \times 10^7)$, or about $3 \times 10^{-2} = 3 \times 10^{-5}$, 30 microhenrys. (Can you change that to millihenrys and nanohenrys? Answer below.*) Incidentally, the calculator gives 29.9 microhenrys. Look how close we come with these relaxed, rounded-out computations — plenty close for FCC exams! The answer tells us that it is a 30 μ H inductor which will give us 700 Ohms resistance to a 3.725 MHz current.

Notice that we can just as easily take that final number equation, $120/[2(3)(4)] = 5$ and work backwards to get, for example, $120/[2(4)] = 3(5)$ and all kinds of other combinations, as long as we put what's on top of one side of the equal sign on the bottom of what's on the other side.

That's another important tool! Whenever there's just multiplication and/or division in an equation or formula (no additions or subtractions), we can (with complete freedom) move what's on the top of one side to the bottom of the other and vice versa. This little device allows one to change a great many formulas into alternate forms which are necessary in solving electronics problems, as we shall see in a few seconds.

And the logic of it is quite simple. What we're really doing is just multiplying and dividing both sides of an equation by the same thing. If we start off with numbers that are equal and then do the same thing to both numbers, doesn't it seem logical that we'll end up with numbers that are still equal? Let me illustrate. $120 = 2(3)(4)(5)$. Divide both sides of that equality by 4: $120/4 = [2(3)(4)(5)]/4$. What we didn't see earlier was that division on the right-hand side, 4 into 4 is 1, and 1 times something is just that something. So the 4s disappear on the right, and we get a 4 on the bottom of the left (which, of course, I can divide into the 120 if I want to). The same holds for letters. $X_L = 2\pi fL$. Divide both sides by 2 and π and f : $X_L/2\pi f = 2\cancel{\pi}L/2\cancel{\pi}$. The 2π s on the right divide out and disappear, but there's nothing for them to disappear into on the left, so they stay (until they're changed into numbers in a real problem and can then be divided into the number on top). What's left after the division is a *changed* formula, but it's still a *correct* one because everything was done on the up-and-up, with flawless logic!

In the above, we *divided* both sides by the same thing. As I indicated, we can also multiply. Remember our capacitive reactance formula, $X_C = 1/(2\pi fC)$. Suppose we wanted to know the frequency at which a 12 pF capacitor had a reactance of 1 M Ω . Here we're after f , the frequency, so we want to get it by itself, *on top*, on one of the sides. We already have the rule that what's on top on one side can be put on the bottom of the other and vice versa. And we must remember that anything that's by itself on one side is *on top*. You can think of it as being on top of an invisible 1. Thus in this case we move X_C from the top of the left side down to the bottom of the right, and f , frequency, which is what we're after, up from the bottom of the right to the top of the left, giving

us: $f = 1/(2\pi X_C C)$. Now we just plug in numbers: $f = 1/[2(3)(1 \text{ M}\Omega)(12 \text{ pF})]$, which, with powers of 10, is $1/[2(3)(1 \times 10^6)(12 \times 10^{-12})]$. 12×10^{-12} is $1.2 \times 10^1 \times 10^{-12}$, which, rounded, becomes 1×10^{-11} . So the bottom of the fraction is $2(3)(1)(1) \times 10^6 \times 10^{-11}$, which is 6×10^{-5} . Change the 1 on top to 10×10^{-1} , and the fraction becomes $(10 \times 10^{-1})/(6 \times 10^{-5})$. 6 into 10 you might guess to be about 1.7, which can be simply rounded to 2. And since we're dividing, we subtract exponents of 10. $-1 - -5$ is $-1 + 5$, or 4. Hence the answer is about 2×10^4 , 20 kHz. The calculator gives 13 kHz. These rounded out calculations are somewhat off, but still in the right ballpark. If you need more accuracy, you can have π be 3.1 and leave the 1.2 for capacitance (instead of rounding to 1). That'll give 7.4 into 10 instead of 6 into 10, and you'll be right on the money. Again, you determine how accurate your computations have to be by looking at how close to each other the multiple-choice answers are in the actual FCC exam.

We're now ready for an exercise with which we'll finish this installment. It's a long exercise introducing many of the formulas you need for FCC exams. Consequently, even though it may be a bit painful, I recommend you go through it quite carefully (and leisurely, if possible). Work and answers can again be checked at the end.

EXERCISES

In each of the exercises that follow, a formula will be given to you with a brief explanation of the letters used. Following that, you will be asked to solve for one of the letters (get it by itself on one side of the equation) and then use this transformed formula in an actual computation using values given.

(1) $P = I^2R$, where P is power in Watts, I is current in Amperes (the I^2 just means we have $I \times I$, so the formula could be written: $P = I \times I \times R$), and R is resistance in Ohms.

- Solve for R .
- Find the resistance where the power is 250 Watts and the current is 300 mA.

(2) $P = E^2/R$, where again P is power in Watts, E is volts, and R is again Ohms.

- Again, solve for R .
- Find the resistance where E is 950 V and P is 125 W.

(3) $E_s = (n_s/n_p)E_p$. This is a transformer formula. E_s is primary volts, E_p is secondary volts, n_s is the number of turns on the secondary winding, n_p is the number on the primary winding.

- Solve for n_s .
- How many turns should the secondary have if the primary voltage is 120 V, the secondary is 12.6 V, and the primary has 100 turns?

(4) $Q = X/R$, where Q is the quality factor of a coil or capacitor in a *series* circuit, called, simply, the "Q" of the coil or circuit. X is the reactance in Ohms of the coil or capacitor, R is the resistance in Ohms in series with the coil and/or capacitor.

- Solve for X .
- If R is 27 Ohms and $Q = 78$, what is X ?

(5) $2\pi fL = 1/(2\pi fC)$. This is the formula for resonance of a coil/capacitor combination. You've seen both sides of this formula before. The left side is the reactance of a coil (X_L) and the right side is the reactance of a capacitor (X_C). What this formula says, then, is that at resonance the two reactances are equal, $X_L = X_C$. You already know what each letter stands for.

- Solve for C .
- What is the capacitance of a resonant circuit where the frequency is 7130 kHz and the inductance is 8.5μ H?

(6) $T = RC$. Here T is the time constant (the time in seconds it takes for a capacitor to charge to 63% of the full emf with a resistor of R Ohms in series with it). C is the capacitance in farads.

- Again, solve for C .
- If R is 800 Ohms and T is 0.2 seconds, what is C ?

(7) $T = L/R$ is a like formula for a *coil* and resistor in series, only this time T is the time (in seconds again) it takes for *current* (not voltage) to reach 63% of its final value. L is inductance in Henrys.

- Solve for L .
- If T is 0.003 seconds and R is 35 Ohms, what is L ?

(8) Bandwidth = f_0/Q . Here bandwidth is the "half-power" or "3-dB-down" bandwidth of a resonant circuit. The center frequency is f_0 and Q is the Q of problem 4.

- Solve for Q .
- What is the Q of a circuit whose center frequency is 1 kHz and bandwidth is 80 Hz?

(9) $Q = E_{out}/E_{in}$. Another Q formula, frequently quite useful! E_{out} is the output voltage (of course) and E_{in} is the input voltage to a particular circuit.

- Solve for E_{in} .
- If $Q = 60$ and E_{out} is 18 mV, what is E_{in} ?

(10) $Q = Z_t/X_L$. Yet another Q formula (gads!), this time for a parallel resonant circuit, and again quite useful. Z_t is the impedance (in Ohms) across the parallel circuit and X_L is the coil's reactance in Ohms.

- Solve for X_L .
- If the Q is 35 and Z_t is 50 k Ω , what is X_L ?

(11) $\mu = \Delta e_b/\Delta e_c$. This is a tube amplifier formula. μ (the Greek letter mu, the

* $3 \times 10^{-5} = 30 \times 10^{-6}$ (30 microhenrys) = 0.03×10^{-3} (0.03 millihenrys) = $30,000 \times 10^{-9}$ (30,000 nanohenrys). Good practice!

TOWER // TUNER

RESONATES YOUR TOWER
ON 40, AND 80 !

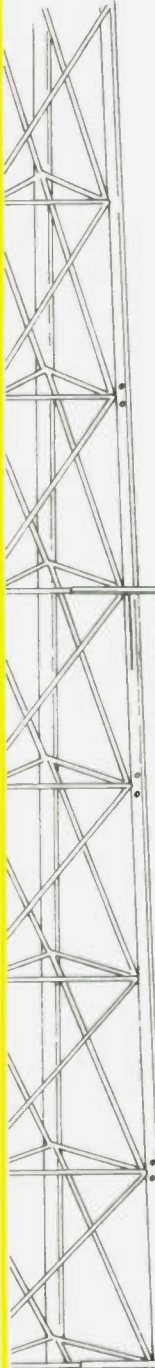

Imagine using your entire tower and present beam system as a complete low angle radiator on 40 and 80 meters. It is common knowledge that a dipole or inverted-vee must be at least 1/2 wave length high (120 feet high on 80 meters!) in order for it to be a low angle radiator. But your existing tower, if fed with the Stuart Electronics **TOWER TUNER** can be made to be an optimum low angle radiator on 40 and 80 meters. The Stuart **TOWER TUNER** can be installed and easily adjusted to a low swr on any tower no matter what the size or type. Tower can be grounded or not. Radials not necessary. No more haywire appearance of dipoles and I-V's. Even your wife will love it. The Stuart **TOWER TUNER** takes up virtually no extra space but greatly outperforms dipoles and I-V's at the same height plus it is easily adjustable from ground level. Start making better contacts on the 40 and 80 meter bands with an antenna system that really gets out. The Stuart **TOWER TUNER** will handle 500 watts output.



We are so confident that you will like it that we offer a 30 day money back guarantee if you are in any way dissatisfied. Price of \$129.95 includes shipping in continental United States.

STUART ELECTRONICS

Dept. 1
755 N. MAIN ST.
AKRON, OHIO 44310 S38

TOROID CORES



- ✓ All the popular sizes and mixes.
- ✓ Fast Service. Same day shipment via first class mail or air.
- ✓ No minimum order.

IRON POWDER TOROIDS:

CORE SIZE	MIX 2 5-30 MHz u = 10	MIX 6 10-80 MHz u = 8.5	MIX 12 80-200 MHz u = 4	SIZE OD (in.)	PRICE USA \$
T 200	120			2.00	3.25
T 106	135			1.06	1.50
T 80	55	45		.80	.80
T 68	57	47	21	.68	.65
T 50	51	40	18	.50	.55
T 25	34	27	12	.25	.40

RF FERRITE TOROIDS:

CORE SIZE	MIX Q1 u = 125 .1-70 MHz	MIX Q2 u = 40 10-150 MHz	SIZE OD (in.)	PRICE USA \$
F-240	1300	400	2.40	6.00
F-125	900	300	1.25	3.00
F-87	600	190	.87	2.05
F-50	500	190	.50	1.25
F-37	400	140	.37	1.25
F-23	190	60	.23	1.10

Chart shows uH per 100 turns.

FERRITE BEADS:

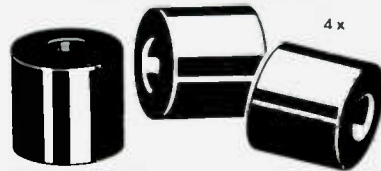

\$2.00 DOZEN

WIDE BAND CHOKES



95¢ EACH

TO ORDER: Specify both core size and mix for toroids. Packing and shipping 50 cents per order USA and Canada. Californians add 6% sales tax.

Fast service. Free brochure and winding chart on request.

P1

PALOMAR ENGINEERS
BOX 455, ESCONDIDO, CA 92025
Phone: (714) 747-3343

30 years
of serving
the mid-west
with
all major brand
names of
amateur
radio
equipment
and supplies

- KDK • B&W • YAESU • DRAKE
- HEIGHTS • ICOM • MFJ • NYE
- SWAN • TELREX • TEN-TEC
- VHF ENG • WILSON • MOSLEY
- KLM • CUSHCRAFT • LARSEN
- REGENCY • HUSTLER • CDE
- ANT. SPEC. • DENTRON
- ... and many more.

- full factory authorized service
- immediate delivery
- competitive prices



- large inventory

**universal
amateur
radio inc**

1280 AIDA DRIVE
COLUMBUS, OHIO
(Reynoldsburg) 43068

(614)-866-HAMS

The New, Improved "Best Keyer Yet"

— updating MINI-MOS

When I became the owner of a brand new TS-520D, I became somewhat ashamed of my Radio Shack straight key. I looked around at several different keyers and decided that the best I had seen, by far, was the MINI-MOS by WA6EGY.¹ I left fingerprints

all over the article for quite a while, and then Santa Claus delivered a beautiful new HK-1 dual-lever squeeze paddle from Ham Radio Center.² I was now forced to quit fingering the pages and start building.

Now, being the type of person I am, I can't leave a

perfectly good design alone, even one as beautiful as the MINI-MOS. After much searching, I was finally able to make two changes that, I think, add the icing to the cake. The two changes are independent of each other, so both, either, or neither can be incorporated.

Photos by Jim Gerritz WA4FMA



Final happy combination: MINI-MOS+, HK-1 squeeze paddle, and TS-520D.

Mod. 1 is quite simple. In the original keyer, the base of the paddle, if an external paddle is used, is not at ground but at -9 volts. If you are as violent on CW as I am, or if your shack is as messy as mine, there is a very real possibility that the paddle base could come in contact with ground, vastly reducing battery life. By replacing the cross-coupled NAND gates used for dot and dash storage with a dual type D flip-flop, used for set-reset, the paddle base is now at +V_{DD}, which is chassis ground. The only thing that is not obvious is the fact that, with both the set and reset inputs to the 4013 flip-flop high, both the Q and Q outputs go high. This feature is necessary to make the keyer work as originally designed.

Mod. 2 is a little more complex. One thing I had noticed when working CW is that, as the speed goes higher, character spacing seems to disappear. I hoped that my CW didn't exhibit this phenomenon, but I wanted to be sure. I wanted automatic character spacing. I also decided that I didn't need, or want, the built-in sidetone oscillator, since there was already one in the TS-520D. This freed up two 2-input NOR gates and one 2-input OR gate for other uses. By adding one quad 2-input NAND gate (4011), I could get my automatic character spacing.

Now for those of you who may have forgotten, the MINI-MOS does not just generate dots and dashes, but dot/space and dash/space pairs. When U3A is set, an element two dot lengths is sent, first a dot (1 dot length) and then a space (1 dot length). When U3B is set, an element four dot lengths long is sent, first a dash (3 dot lengths) and then a space (1 dot length). In order to get a character space (3 dot lengths), a space 2 dot lengths long had to be added to the end of the element being sent

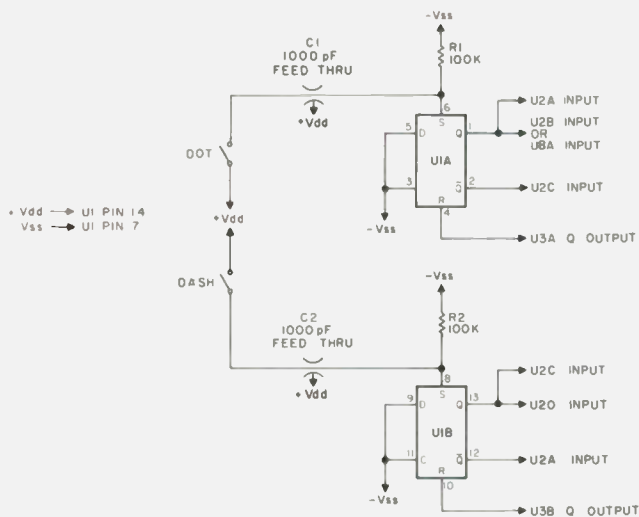

Fig. 1. Mod. 1 to place paddle base at chassis ground (+V_{dd}). Second U1A Q output goes to U2B if Mod. 2 is not incorporated or to U8A if Mod. 2 is incorporated. U1: 4013.

at the appropriate time. This is done by telling the keyer to send a dot element, but inhibiting the output.

Referring to Fig. 2, the operation is really quite simple. Whenever an element is sent by the MINI-MOS, the output of U4D goes low. This is fed to a set-reset flip-flop consisting of U8C and U8D. This flip-flop sets with the first element sent and remains set until it is reset by the initiation of the character space. This flip-flop says, "Something has been sent, and a character space needs to be sent." The output of this flip-flop is sent to AND gate U2B. The other input to U2B comes from the output

of U4A, the clock control line. As long as a dot or dash element is being sent, this line is low, but, when all elements have been sent, it goes high. Therefore, the output of U2B says, "Something has been sent, and the sending is over. Start a character space." The output of U2B sets another set-reset flip-flop formed by U7C and U7D.

When this flip-flop is set, several things happen. First, the low output of U7C goes through U8B (which, along with U8A, has replaced U2B in the original circuit) and sets U3A, starting the dot element sequence. Second, the high output from U7D goes to U6D (which has been

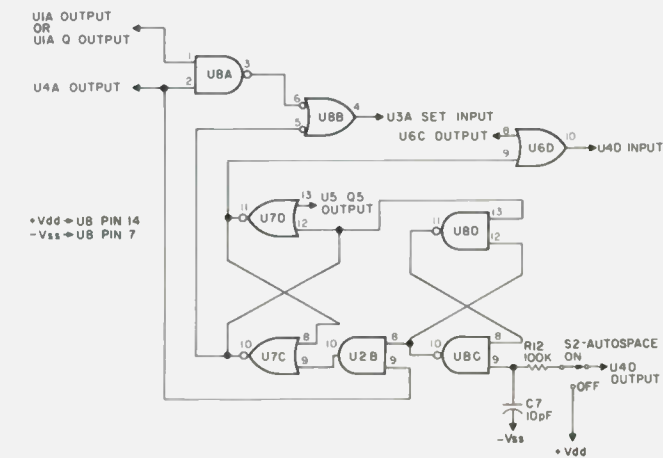

Fig. 2. Mod. 2 to add automatic character spacing (also removes sidetone oscillator). U8A and U8B replace U2B in the original circuit. Pin 1 of U8A comes from U1A Q output if Mod. 1 is incorporated. U6D is inserted between U6C output and U4D input. U8: 4011.

inserted between U6C and U4D in the original circuit), inhibiting the dot that would normally be sent at this time. Third, the low output from U7C is also sent to the U8C/U8D flip-flop, resetting it. Now, after one dot length, the Q5 output of U5 goes high, indicating that a dot was sent (except that we inhibited it at U6D) and that a space is now being sent. This signal is used to reset the U7C/U7D flip-flop. When U5Q5 goes back low, the sequence is complete, and

normal operation may now proceed. The auto space can be disabled by removing the set input to the U8C/U8D flip-flop. This is done with S2.

If you wish to retain the sidetone oscillator, you'll have to add another IC, as shown in Fig. 3.

As you can see from the photographs, I built my MINI-MOS+ using wire-wrap. I was not particularly interested in making it very small. I used mine for a while just

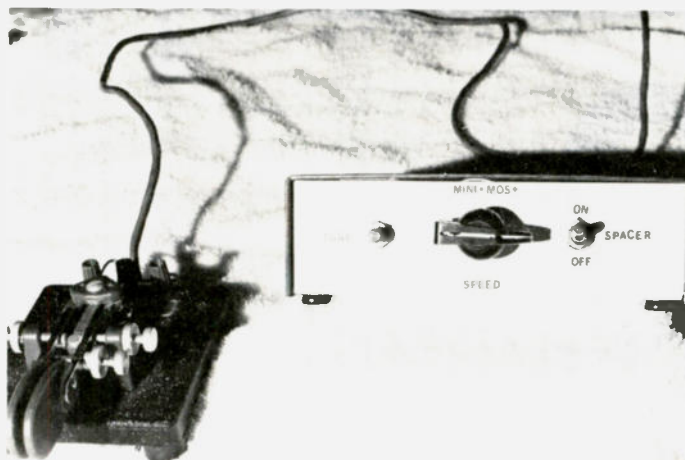

Front panel view. It's nice and uncluttered. Note the lack of power switch.

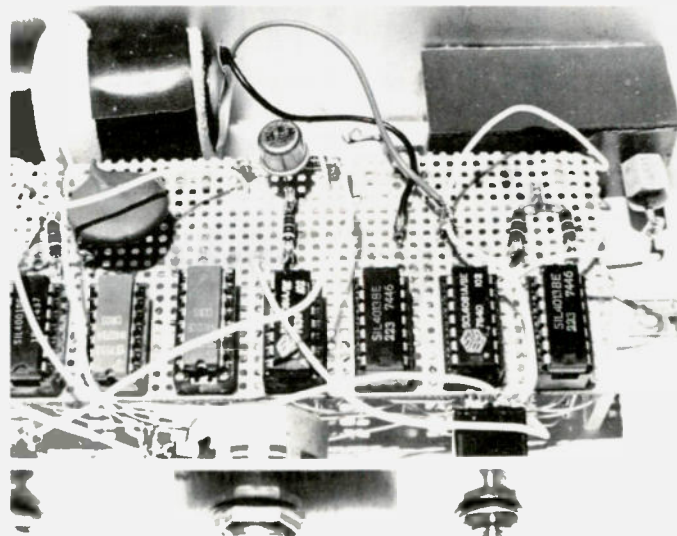

Inside view. MINI-MOS+ was built mostly with wire-wrap. IC sockets were glued to the perfboard and flea clips were used for discrete components. U1 is on the right, and U8 is out of the picture on the left. The little box in the right rear is an r_f filter made of single-clad circuit board and 1000 pF feedthroughs on the dot, dash, and key lines. Battery is at the left rear, wrapped in foam.

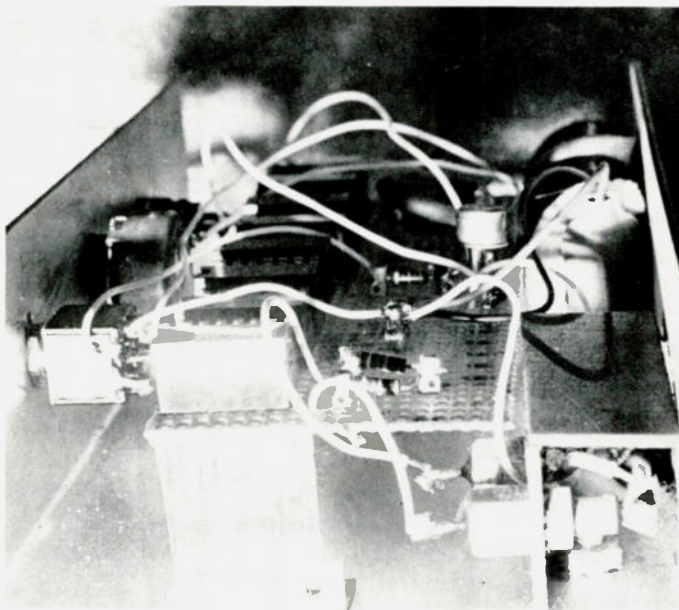

Close-up of perfboard mounting and rf filter. Perfboard was mounted using 3/4-inch squares of Plexiglas™ glued to the perfboard and chassis.

loose on the desk and had no trouble with rf, except occasionally on 10 meters. Once in the metal box, no problems were encountered. For you guys with sharp eyes, the 16-pin IC is a 4020 that I

used in place of the 4024 in the original circuit. I just happened to have a 4020, and there is no difference in the operation.

Operation is straightforward with no glitches. The

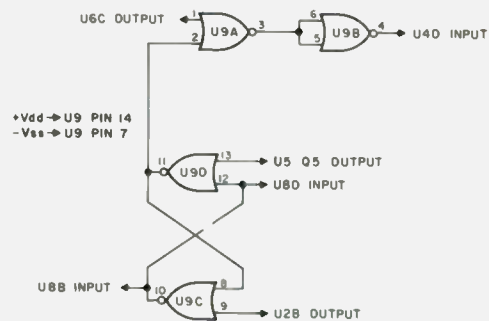

Fig. 3. Change to Mod. 2 if sidetone oscillator is to be retained. A second new IC (U9) must be added. U9: 4001.

only idiosyncrasy is that only a dash may be stored while the keyer is sending a character space. This is because the keyer thinks it is sending a dot while sending a character space. The automatic character spacing forces you to use the squeeze paddle properly. Not only does it do what it is designed to do, force proper spacing between characters, but, if you allow a little extra time between elements, it will throw in a character space. Sending MARMI instead of QRZ during a contest is embarrassing.

However, if you persist with the automatic character spacing, you will notice a dramatic improvement in the quality of your CW.

With these two minor mods, the MINI-MOS+ will do anything any other keyer will and will do it cheaper and with much less power consumption. Build one — you'll like it. ■

References

- 1 Erich A. Pfeiffer WA6EGY, "MINI-MOS — The Best Keyer Yet?", 73, Aug., 1976, page 38.
- 2 Ham Radio Center, Inc., 8342 Olive Blvd., St. Louis MO 63132.

HAMVENTION®

April 28, 29, 30.
At Hara Arena,
Dayton, Ohio

This year's Dayton Hamvention promises to be the biggest and best yet!

Start with more exhibit and flea market space than before. Then:

- informative programs
- new products
- technical sessions
- ARRL and FCC forums
- special and group meetings
- ladies' programs
- transmitter hunts
- total value of prizes exceeds \$15,000.

Top it all off with the Grand Banquet, Saturday evening April 29.

'78

If you have registered within the last 3 years you will receive a program and information brochure in March.

Admission \$3 in advance, \$4 at the door. Saturday night banquet \$8 per person. Flea Market space \$5 to \$8 per space depending on number of spaces. At door only. Make check payable to: Dayton Hamvention, P.O. Box 44, Dayton, Ohio 45401.

For special hotel/motel rates and reservations information write to above address. Inquiries: call 513-854-4126.

See you at the world's largest Ham Convention!

GET YOUR GROUP TOGETHER!

If you're in one of the many areas saturated with 2 meter repeaters, select 220 as your logical alternative.

If you've been holding back because of the "Class E" threat you need wait and worry no longer. It's off the docket.

If you've been afraid of the cost — your fears are unfounded.

For less than \$200 per member your group can acquire a complete 200MHz repeater system including Clegg FM-76 and mobile antenna for each participant.

Phone toll free today for complete details on the Model 376 repeater, 652 Duplexer, ASP antenna and Clegg FM-76 transceiver group program!

Toll free 1-800-233-0250.
In Pennsylvania call collect 717-299-7221.

Or write:

Clegg Communications Corp.
1911 Old Homestead Lane
Greenfield Industrial Park East
Lancaster, PA 17601

Clegg

c3

FOR FASTER SERVICE!

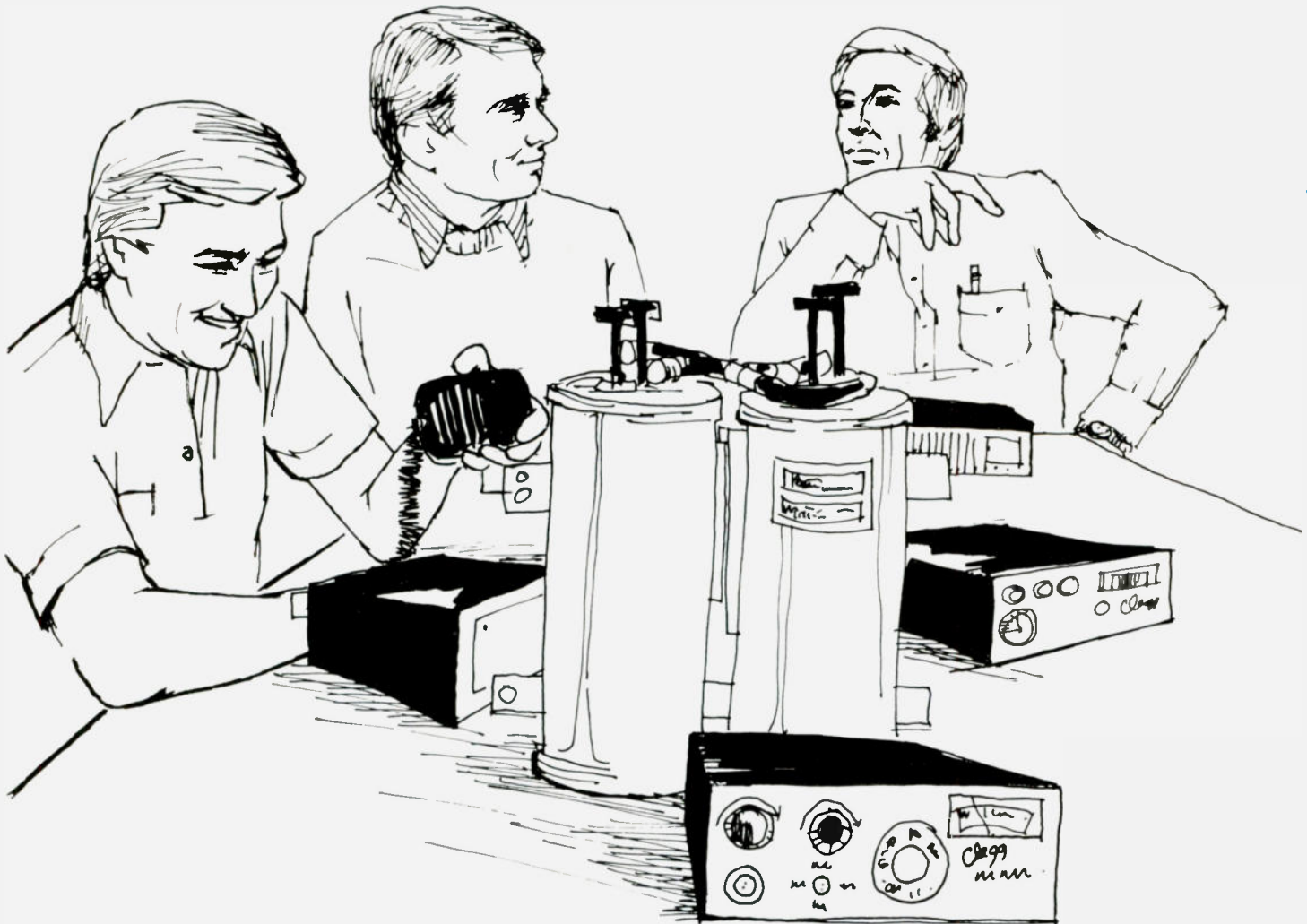

**Let Clegg engineer and supply
your 220 system now!**

The Powerful Grounded Antenna

— *thrives on poor soil*

H. Warren Lufkin W0SII
1219 Racine St.
Aurora CO 80011

The Beverage, or wave antenna,¹ has been around for a long time and, over the past several decades, has been employed by commercial, military, and, to a lesser extent, radio amateur users.² The Beverage is basically a specialized antenna system which is normally uti-

lized at low frequencies or on the lower part of the high-frequency spectrum.

The Beverage belongs to the family of longwire antennas and can be considered a cousin of antennas such as the longwire, V-beam, rhombic, and fishbone. The characteristic that makes the Beverage different from its "cousins" is the way that it operates. These differences become apparent when one considers its unusual wave-

generating properties, rather than its physical makeup.

At first glance, the Beverage seems to be nothing more than a longwire with a resistor at the far end. (See Fig. 1.) Examination of its electrical properties reveals that this longwire-type antenna can be excited or fed the same way as any other antenna with a similar feedpoint impedance. So what we have here is an antenna that looks similar to and can be driven

like any other array of similar physical and electrical properties.

So far so good, but Mr. H. Beverage and a couple of his colleagues modified the antenna to operate in a manner quite different from the normal longwire. Let's have a further look at this antenna to see just how different it really is.

First, the antenna, positioned horizontally over the ground on Earth, transmits not a horizontal wave, but a vertical wave.³ Secondly, this antenna does not rely on good earth conductivity for efficient operation, as do other antennas, but quite the opposite. In other words, the poorer the earth's conductivity, the better the Beverage works. For example, dry, sandy, or rocky earth under the antenna produces good results, and, conversely, moist or swampy ground or sea water produces poor results. The theory of operation of the Beverage antenna is that the wave traveling down the antenna wire moves faster (further) in a given time frame than the wave in the earth under the antenna,⁴ causing the wave front to tilt forward toward the terminated end. This wave tilt produces a low vertical angle or radiation, which, of course, enhances its DX capability. When the antenna is used for both transmission and recep-

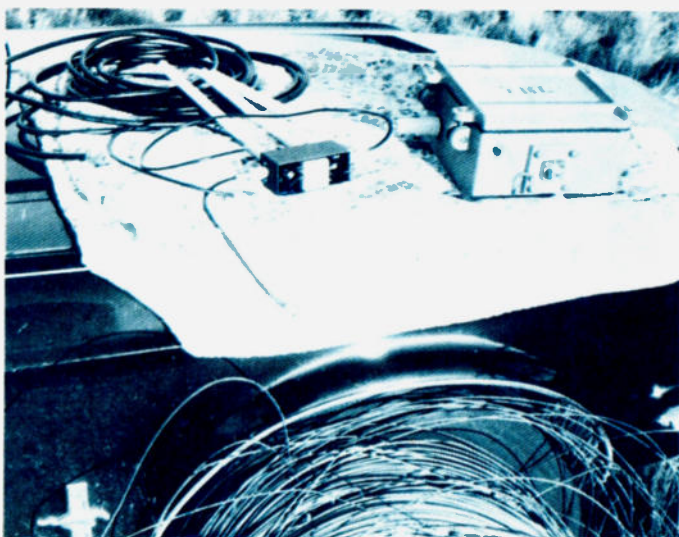

Some of the bits and pieces for the Beverage.



Installing the 1 kW broadband balun on the feed pole. The first two poles of my rhombic are used to support the beverage. The remaining poles are 20' long.

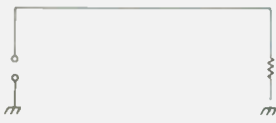

Fig. 1.

tion, the low vertical angle is, as might be expected, fully reciprocal.

Amateurs using the Beverage on the low-frequency bands, such as 160, 80, and even on 40 meters, have found the antenna's low vertical wave angle very beneficial in bringing in low-angle DX signals and, at the same time, attenuating the "local" or high-angle interference. (See Fig. 2.)

The Beverage will give good performance with a length as short as one wavelength. As with the standard longwire, V-beam, or rhombic, the more wavelengths, the greater the gain, up to a point. That is to say that extremely long Beverage antennas exhibit a drop-off in gain. The best height for the antenna is from about 12 feet (3.7 meters) to 15 feet (4.6 meters) above ground. Below 12 feet, the gain falls off rapidly, and above 15 feet, there is little increase in gain.

The characteristic impedance of the single-wire antenna is approximately 500

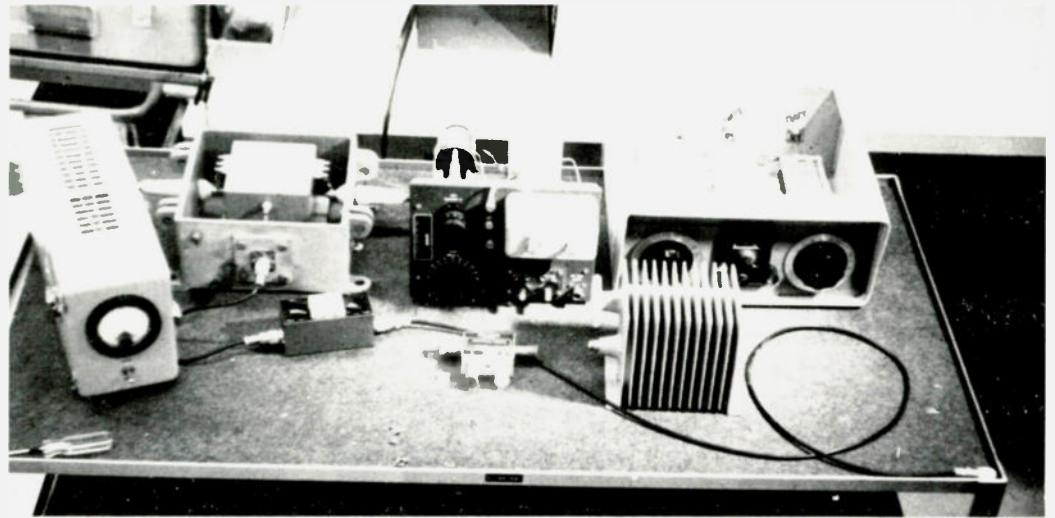

Left to right, front row — wattmeter, vswr meter, wattmeter coupler, and dummy load. Second row — balun, commercial single-wire tuner, and home-built transmatch.

Ohms. Two- or three-wire models can be employed, with a corresponding reduction in antenna impedance. Inasmuch as the antenna is terminated with a noninductive resistor of a value equal to the characteristic impedance, it is nonresonant and therefore is efficient over a very wide frequency range. The terminating resistor need dissipate only about one-third of the power fed to the antenna. The antenna can be fed in a number of ways, some of which are shown in Fig. 3.

How well does the Bever-

age perform? It does unusually well when operating on the lower frequencies. For example, a four-wavelength Beverage, operating on 80 meters, outperformed a Doublet 200 feet (60 meters) above ground, when I operated them in a recent DX contest. For the city-dwelling amateur,⁵ the length of even a one-wavelength Beverage may prove a bit of a squeeze, but there may well be some ways to overcome this problem, such as the "loan" of some extra space by a friendly neighbor. Put up a

Beverage if you can; it is a fine antenna. ■

References

1. H.H. Beverage, C.W. Rice, and E.W. Kellogg, "The Wave Antenna," *Trans. A.I.E.E.*, Vol. 42, pp. 215-266.
2. *The ARRL Handbook*, 13th Edition, Chapter 16, p. 294.
3. The wave front is actually elliptical because a small amount of the horizontal component is out of phase.
4. Not just the surface soil, but also the earth to a considerable depth under the antenna contributes to the conductivity.
5. My Colorado QTH is urban, but the Wyoming QTH is 5,000 acres, allowing almost anything in the way of antennas and towers.

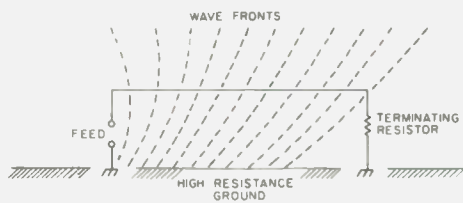

Fig. 2.

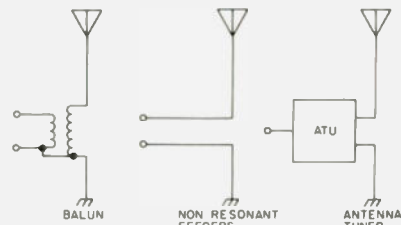

Fig. 3.

my rooms don't ever profit
lousy manuscripts then but
LETTERS
I insist that you print or
tell Ma Bell that she should

from page 12

batteries run down, and you may be sure it will be the same as the one I now have. No GE, even if free. I have written to QST on this, but have no knowledge that they ever passed it on. I am now using a Radio Shack 22-010 transistorized signal tracer. To use

one, set it on rf, hold the clip on the lead about two inches below the left nipple, and hold the case firmly against the left ear, so as to get a good ground connection.

It is always a great pleasure to have a very good result from any product, and I want to say I am most happy with the Medtronic, and with their

prompt answer to any question I have asked them.

Charles R. Green K4KBH
Englewood FL

SUPPORTING A SLEEPER

One of our members, Don Sleeper W1ONK, who has a future retirement home in Dennis, has appealed to the courts after losing his appeal to the Regional Historic Commission to keep his 68' Rohn 25G fold-over tower on that property.

Labeling it "visual pollution," the Old King's Highway Historic District Committee, on August 11, 1977, ordered the removal of the tower

despite the fact that it fully complied with the Dennis zoning bylaw. When Sleeper asserted his constitutional rights to maintain his antenna in pursuit of his hobby, the Historic Commission ruled: "There is no such right where the structure involved is as grossly inappropriate as that under consideration."

Sleeper's appeal to the courts is a test of the authority of the local committee and the Regional Historic Commission. Losing the appeal could establish a detrimental precedent on the "appropriateness" of amateur towers in historic districts.

To date, the ARRL Legal Kit has been most helpful, and there is a

Continued on page 34

How To Cut Costs On Power Supplies

— using Radio Shack components

While at my local electronics department store (also known as Radio Shack), I discovered a new kind of kit that is available. The one in particular that appealed to me was the Dual Variable Power Supply, catalog number 277-112. The official listing in the catalog is 0-18 volts with plus or minus operation at 1 Amp. It also has variable current-limiting with dual or independent voltage tracking for the plus and minus supplies. Also, it stated, an optional 5-volt 1-Amp fixed output is available. The complete package, with all parts except hardware and case, sells for \$77.17. However, the project board (PC board), front panel label, meter scales, and instructions can be purchased for \$4.99. It is these latter items that were of interest to me.

Since I have been doing considerable experimenting with op amps and IC receivers, I decided to give the kit a try. The dual 12- to 15-volt range was badly needed.

The worst part of any home construction project is the etching of a circuit board. With the PC board already etched, drilled, and labeled, the worst part of the project is over.

Having a large junk box and not much ready cash like most hams, I proceeded to go through the parts list in the manual, locating all readily available parts that I might have. Most of the resistors except the low values, most capacitors except the large capacities, switches, pots, transformers, and hardware were located in the junk box. After a total expenditure of \$23.47 plus sales tax, I had the remainder of the parts required.

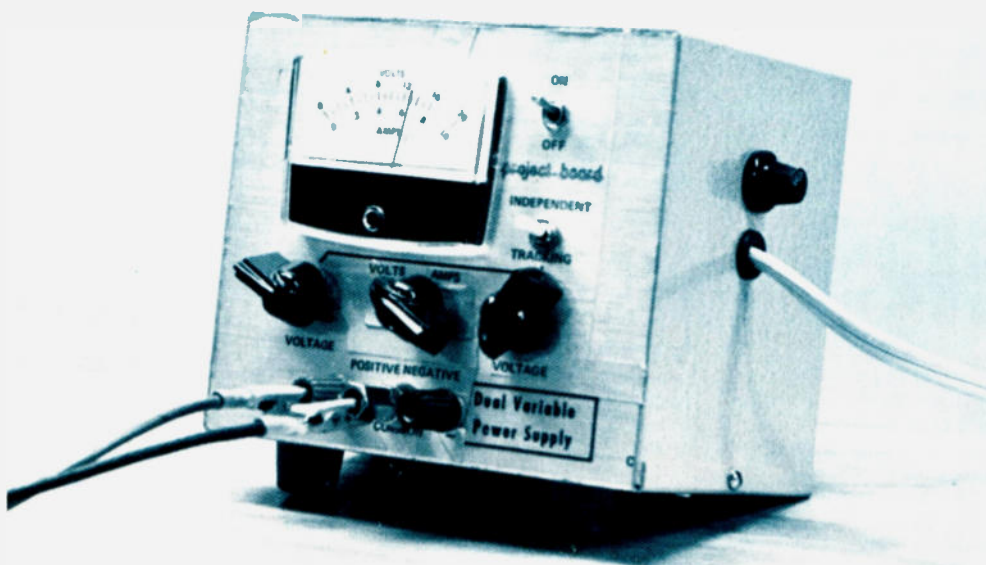

1. Metering — see Fig. 1.
2. Current limiting — see Fig. 2.
3. Output transistors
 - + supply — Q10 and R45 eliminated
 - supply — Q9 and R46 eliminated
 No wiring changes are required except to leave out parts.
4. Output terminals — see Fig. 3.
5. Output power transistors are mounted directly to heat sinks (collector). Sinks are attached to cabinet with nylon screws and nuts to provide electrical isolation.
6. Transformers T1 and T2 are wired the same but changed from 2 Amp to 1 Amp, 25.2 V ac output.

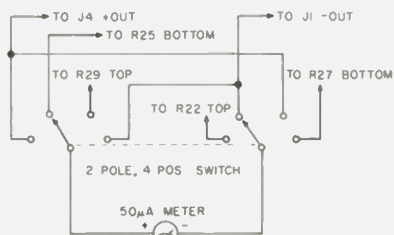

Fig. 1. Metering circuit changes. Arrangement: Pos. 1 — + voltage; Pos. 2 — - voltage; Pos. 3 — + current; Pos. 4 — - current.

Table 1. Circuit changes.

Several items should be pointed out at this stage. If the existing parts are used, make sure that the part is good and really the value that you think it is. A switch I used from the junk box had badly burned contacts and caused no end of problems and burned-out transistors during the initial checkout. Parts can be substituted for the actual RS part number. Do make sure that the size of the substitute part is the same, or the holes will be wrong on the PC board. The transistors are readily substitutable, provided that the same type (NPN or PNP), power dissipation, and approximate gain are used. Mechanically, the transistors should also be the same, for reasons given above.

The assembly of the PC board is presented well in the manual, with each part listed and pictures of the board also included. There is plenty of room for the parts, and everything goes together nicely if the parts are the same or similar to those recommended. It took several hours to locate, check, and install all the parts on the board, but it is a professional-looking package when finished.

The meter used should be the same as listed, since the package contains a stick-on decal scale to convert from the existing microamps to volts and Amps. It is a little tricky getting the new scale under the meter needle, but the result is an immediately calibrated scale that really looks sharp.

A complete review of the circuit diagram revealed no place to add the so-called

optional 5-volt supply. In fact, there is no provision on the board nor is anything mentioned in the manual in

this regard. It appears that a design change was made along the way, and the correction was never made in the catalog

description. Any 5-volt supply should probably be built separately anyway.

The major difference

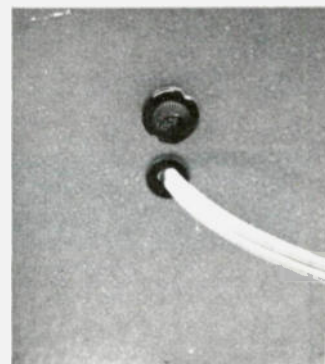
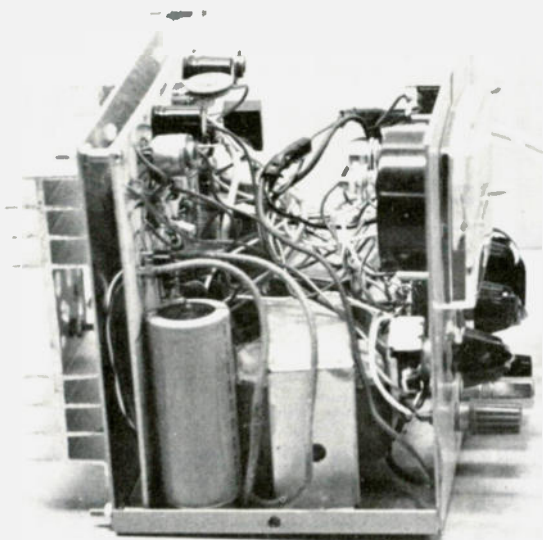
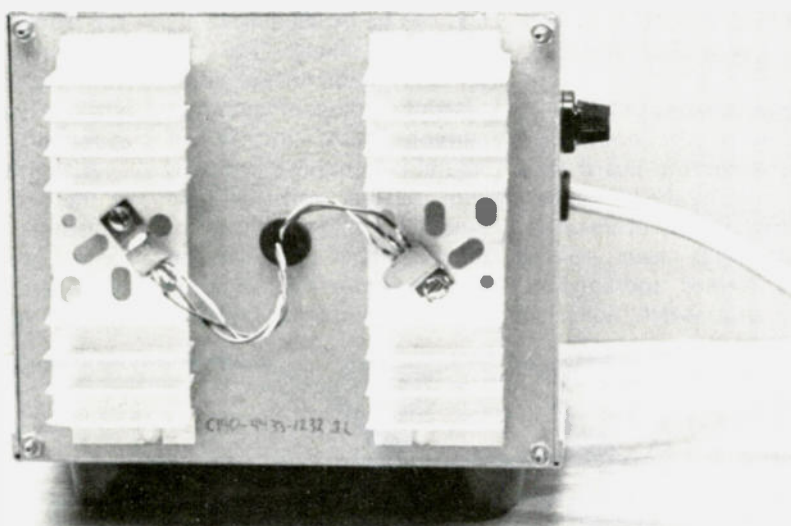

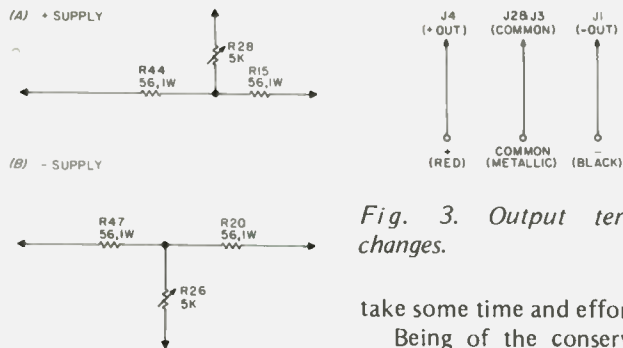

Fig. 3. Output terminal changes.

Fig. 2. Current limiting changes. Delete R51, R52, R53, R54, R55, R32, R33, R48, R49, and R50. (a) S6 is eliminated and replaced as shown. Values give current limiting at about 500 mA. (b) S5 is eliminated and replaced as shown, also 500 mA current limiting.

between this and other kits is that all of the mechanical parts except the board have to be done by the kit builder. The case and any of the other related parts have to be drilled, reamed, and lined up. Meter and switch holes do

take some time and effort.

Being of the conservative and innovative type, several improvements occurred to me during the construction. Instead of two \$8 meters, a single meter and a 99¢ 2-pole 4-position switch were used. This also eliminated the two volt-Amp switches. The two voltage and two current readings can be handled nicely by this switch change. The only drawback is the loss of simultaneous readings of voltage or current. Also, instead of several current-limit positions and related resistors and switches, a maximum current limit of about one-half Amp was substituted with a saving in size, current-limit resistors,

and transformer rating. Instead of 2-Amp transformers, a 1-Amp was used in each supply. By reducing the available output current, the need for the second output transistor in parallel in each supply is eliminated. The binding posts were changed to red for positive output, metallic for ground, common for each supply, and, lastly, black for minus.

A 4" x 5" x 6" case was used to house the entire power supply instead of the high-price case listed. The final unit contains one meter, a voltage-current selector switch, and only one power transistor for each output. The front decal provided was modified with some cutting, trimming, and pasting over, but it definitely improved the appearance of the box.

After the early problems of the bad switch and blown transistors, the unit performed well. In fact, it has been used for four months without any problems. The

checkout of the unit is easy, if good or new parts are used. The calibration is also easy, if any kind of a standard VOM or similar meter is available. The voltages are easily set, as are the current readings. Ripple voltage is almost unmeasurable, and the regulation is excellent.

That is about the whole story of the new kit. What is intriguing about this concept is that all of the parts or none of the parts can be provided from the junk box, and yet the result is the same. Also, changes can be made by the kit builder to better suit his requirements or pocketbook. The end result is a fine-performing power supply, with the actual cash outlay dependent upon the quality and quantity of available parts. The power supply design is excellent. The remaining question is: How well stocked is your junk box? Or, how well stocked is your pocketbook? The choice with this kit is yours! ■

VERTICALS - DIPOLES - TRAPS - BALUNS

TRAP VERTICAL ANTENNAS

No antenna tuner needed — Full legal power limit — Fully assembled and ready for operation — No radials required — 1:1 VSWR to 50 Ohm coax

MODEL	BANDS	HT	PRICE
TV-215	20 15	13'	\$34.95
TV-4215	40 20 15	22'	\$44.95
TV-84215	80 40 20 15	30'	\$69.95

HIGH PERFORMANCE

COMPACT VERTICAL ANTENNAS

Uses "top loading" for reduced size and maximum efficiency — Use 2 or more to form a phased array — No antenna tuner needed — Folds to 5' package

MODEL	BANDS	HT	PRICE
CV-160	160	23'	\$44.95
CV-80	80	20'	\$39.95
CV-40	40,15	15'	\$34.95
CTV-8040	80/40/15	20'	\$59.95

AO-1 — 10 Meter Conversion Kit — add 10 meter coverage to any Antenna Sup. vertical . . . \$9.95

All verticals include ground post plus all mounting hardware

TO ORDER — Write or Phone — Include Shipping — Dipoles \$2.50 — Verticals \$3.00 — Florida residents please add 4% sales tax

— Phone Orders Welcome — 9:30 to 5:00 — Monday thru Saturday 813/585-9688

Include Interbank No. and expiration date on credit card orders — 24 hour shipment, 30 day guarantee — For more info: SASE or 1st class stamp

APARTMENT - PORTABLE - TRAILER

AV-1 ALLTENNA

Use this portable antenna anywhere — Mounts on window sill or patio railing — Solves landlord problems — 80-10 meters — Change bands by switching preset inductance — Adjustable to 1:1 VSWR at any frequency — 13' maximum extended height — Light weight — Under 10 lbs. — Use on travel campers and vans — Mounts easily on ground post (included) or on side of camper or van — No antenna tuner needed — Full legal power limit — Fully assembled & ready for operation — No radials required — Folds to 5' package for easy storage — Export version folds to 3'

MODEL	BANDS	HT	PRICE
AV-1	80-10	13' (max)	\$49.95

FULL SIZE VERTICAL ANTENNA

Full quarter wave which can be configured for 10, 15 or 10 — No coils or traps — No tuner needed — VSWR less than 1.2:1 over each entire band — Folds to 5' package

MODEL	BANDS	HT	PRICE
FV-201510	20,15,10	16'	\$29.95

Z-1 BALUN \$9.95 postpaid
1:1 ratio, takes place of center insulator, helps eliminate TVI coax fitting, full legal power

Coaxial cable & connector — RG58AU	50'	5.95
	100'	9.95
Aluminum radial wire — No. 8 heavy duty	100'	3.99
Nylon guy rope	100'	3.49

FULL SIZE OIPOLES

Model	Bands	Length	Price
D-80	80/75	130'	\$31.95
D-40	40,15	66'	\$28.95
D-20	20	33'	\$26.95
D-15	15	22'	\$25.95
D-10	10	16'	\$24.95

FULL SIZE PARALLEL OIPOLES — ONE FEEO LINE

PD8040	80/75,40,15	130'	\$36.95
PD4020	40,20,15	66'	\$30.95
PD8010	80/75,40,20,15,10	130'	\$41.95
PD4010	40,20,15,10	66'	\$35.95

LIMITED SPACE OIPOLES

SP-160	160	130'	\$36.95
SP-80	80/75	63'	\$31.95
SP-40	40,15	33'	\$28.95

MSP-1 SHORT POLE COMPACT SYSTEM

MSP-1	80/75,40,15	70'	\$41.95
-------	-------------	-----	---------

ANTENNA SHORTENER KITS —

Same coils as the SP & MSP series — use with your own antenna

S-160	160	130'	\$12.95
S-80	80/75	63'	\$11.95
S-40	40,15	33'	\$10.95

TRAP OIPOLES — Adjusted — ready to go — Rated legal limit
TD-8040 80/75,40 78' \$41.95
TD-4020 40,20 40' \$36.95

TRAPS ALONE

T-8040	80/75,40	78'	\$12.95
T4020	40,20	40'	\$ 9.95

(All above are complete with balun, No. 14 antenna wire, ceramic, insulators, 100' nylon support rope, rated for full legal limit. Can be used as inverted V, MARS, SWL.)

ANTENNA SUPERMARKET P.O. Box 1682 Largo, Fl. 33540 813/585-9688

The operating controls on oscilloscopes have become so complex that many technicians are reluctant to use them. It takes a great deal of encouragement to get them to approach the "beasts." Here is a very simple device that needs none of the synchronizing or delay features of an oscilloscope.

When used with a more complex oscilloscope, the device is connected to the vertical and horizontal inputs, and the amplitude or gain controls are set for approximately .25 to .5 volts per cm. The testing device has no controls and can be mounted in a small shielded box. The test leads are standard red and black, with the black lead grounded to the box. The box ground is common with the chassis of the scope.

Looking at Fig. 1., it is evident that, if the test leads are shorted, the vertical input of the scope is grounded, and the one-volt (rms) ac source appears across the 1000-Ohm resistor and is applied to the horizontal input. The result on the CRT screen is a horizontal line. If the test leads are not shorted (open), the vertical input sees the one volt, but the horizontal sees practically zero volts (because the only current through the 1000-Ohm resistor is leakage through the approximately one-megohm input to the vertical amplifier). Hence the result on the CRT screen is a vertical line.

Now, if a good diode is connected to the test leads, the picture on the CRT will be a combination of both open and short conditions, since the diode will conduct one way but not the other with respect to the ac test voltage source. This combination results in an L-shaped pattern. Its orientation depends on the polarity of the diode.

Reverse leakage or forward resistance in the diode will cause the lines to tilt from their normal vertical or horizontal orientation. The degree of this tilt, estimated

against the CRT reference graticule, will give an idea of the severity of the leakage seen. Known values of resistance, placed across the test leads, can be used to calibrate the angles for reference purposes.

Diodes in a circuit can also be tested. The device in which the diode is mounted must be disconnected from all power and must be grounded. This is important, because the common ground is the chassis of the test device and the chassis of the oscilloscope. You must be free to place red and black test leads from the tester anywhere within the circuit being tested without interference from another ground.

When testing diodes already in another circuit, the horizontal line, if tilted, will accurately measure any forward resistance in the diode under test. Reverse leakage indications, however, are equivocal, due to unknown parallel resistances which may be in the circuit. If parallel capacity exists across the diode, the straight lines will

become curved or will "open up" to show the more familiar Lissajous patterns obtained with out-of-phase conditions.

Transistors, of course, can also be tested, one diode section at a time. The results will immediately indicate leaky, open, or shorted transistors. When testing out-of-circuit transistors from emitter to collector, the usual reading on this device would be open.

Most technicians are familiar with the usual diode tests which use an ohmmeter. Once having used this device with a handy simple or not-so-simple oscilloscope, however, the technician is not likely to go back to the ohm-

meter method. This is so much quicker, and the picture on the CRT is fascinating.

After a bit of practice with this device, the technician can quickly spot the polarity of diodes and can tell whether an unknown transistor is PNP or NPN and which lead is the base.

In summary, this device can be constructed for less than \$10. It tests diodes and transistors quickly and safely, and immediately indicates shorts, opens, leakage, forward resistance, and polarity. And, most importantly, it is a painless inducement to get more people to use their oscilloscopes. ■

The Quicker, Slicker Transistor Checker

— diodes, too

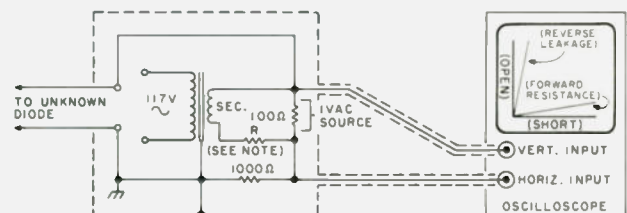

Fig. 1. Simple diode or transistor tester. Use any small filament transformer for ac test voltage source. Secondary must be isolated from ground. Value of R in Ohms equals [(sec. volts x 100) - 100].

You, Too, Can Go Digital

— simple digital display
for the HW-2036

Here is an easy-to-build digital readout for your Heath HW-2036. It features .8" displayed digits, timed display, and mode indication while transmitting.

The circuit uses five IC chips — four BCD-to-seven-

segment decoder/drivers (7447) and one 74121 one-shot multivibrator — and the four seven-segment LED digits.

The 7447s, the 74121, and the common anode digits were obtained from James

Electronics. I also found there a plastic instrument/clock case with red filter, which makes an ideal housing for the unit.

The circuit is shown in Fig. 1. The BCD data from the three thumbwheel switches is fed to three of the digit drivers. The 0/5 kHz toggle switch supplies logic information to the fourth driver.

Because the digits are only required at night and when changing frequency, they are normally blanked by the Q output of the 74121 one-shot. Depressing the push-button momentarily turns on the one-shot. Its period is 12 seconds, and the high on the Q output unblanks the display. The use of the digit blanking also reduces the power requirement from the HW-2036's +11-volt supply. The added 220 mA is only required during the unblanking period. The +5-volt supply has an added continuous drain of about 230 mA. However, as the normal load on this supply in the HW-2036 is about 220 mA, and the U7805 regulator is rated for 1 Amp, the total required 450 mA of +5-volt power is not a major concern.

In order to show the

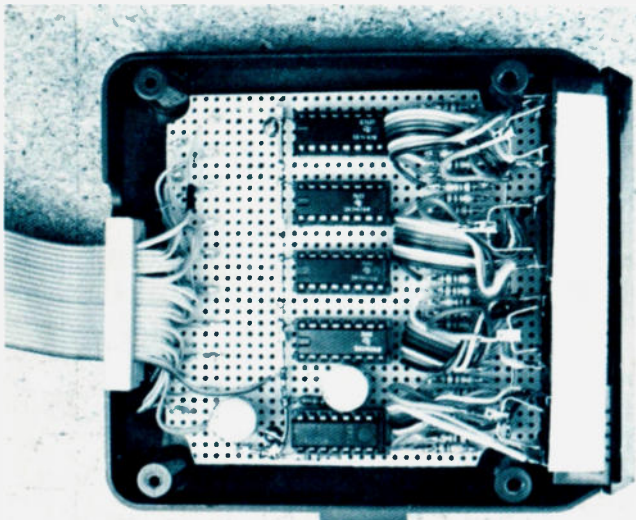

View of top side of perfboard. The four 7447 decoder/drivers are mounted in line behind the 1k Ohm, ¼-Watt LED segment current-limiting resistors. The 74121 one-shot is separated from the 7447s by the 220 uF timing capacitor. The 100 uF filter in the +5-volt supply lead is in the lower left-hand corner. The +5-volt bus runs directly behind the IC chips. A ribbon cable socket (with the pins removed) is clamped around the ribbon cable as a strain relief. The LED display units are held in line by a piece of masking tape.

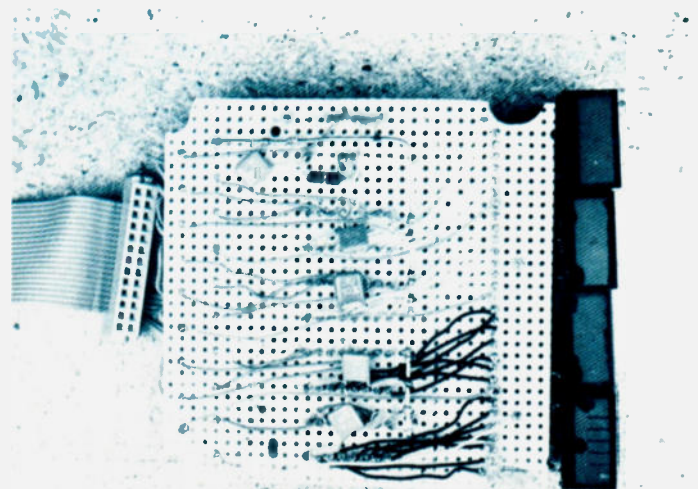

View of wiring side of perfboard, showing the ground bus running around the IC socket pins. All caps are .1 bypass, connected between the +5-volt IC supply and the ground bus. The resistor in the upper center is the 50k Ohm timing resistor in the 74121 one-shot circuit.

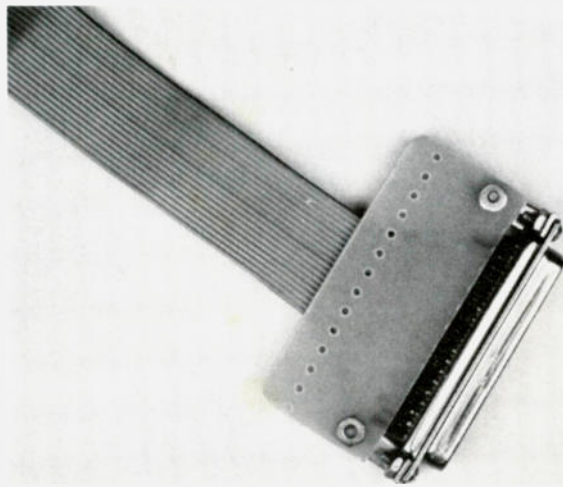
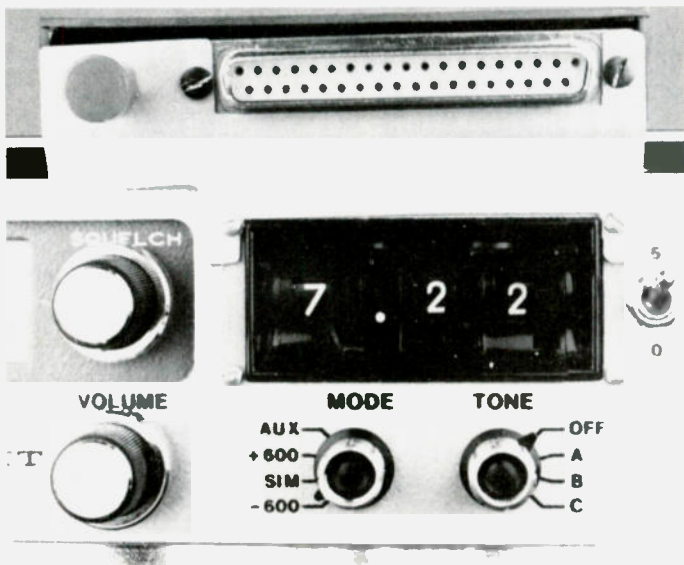

Mounting bracket attached to the HW-2036. The push-button and connector are in line. The parts projecting behind the aluminum bracket are covered with a housing glued to the top of the HW-2036 slide-on cover. The housing is made from copperclad circuit board and is sprayed with matching green paint.

Close-up of the plug mounted on the end of the ribbon cable from the display unit. The clamp is constructed from a couple of pieces of epoxy circuit board bolted together through small brackets bolted to the plug.

transmitting mode, the available decimal points on the LED digits are used. By inverting the 0/5 kHz digit, the decimal point is now in the upper left-hand corner of the LED display. This is used as the +600 kHz indication.

The decimal point of the next digit is wired as the -600 kHz indication, and the simplex indicator is the next decimal point. To turn on the mode indicator LED, the cathode of the DP is wired through a 1k Ohm resistor to the proper

position of the mode selector switch. When the PTT button is operated, the selected crystal is enabled by means of a transistor switch. The ground thus supplied also lights the LED DP.

display unit is straightforward and uncomplicated. As the photographs show, the IC chips are in line behind the row of 1k Ohm segment current-limiting resistors.

Buses for the +5, +11, and ground power leads are made using 22 gauge bare wire. All chips are inserted in sockets

Construction

The construction of the

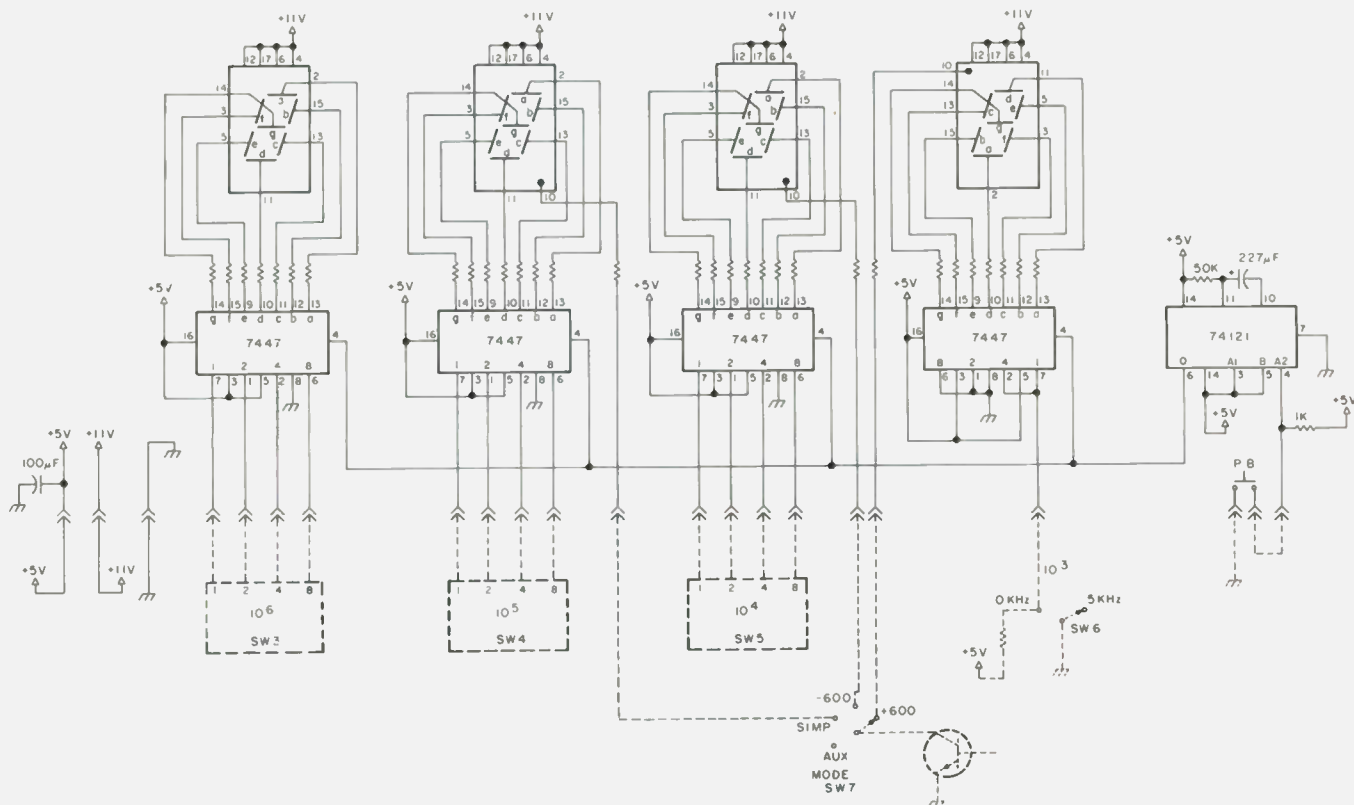
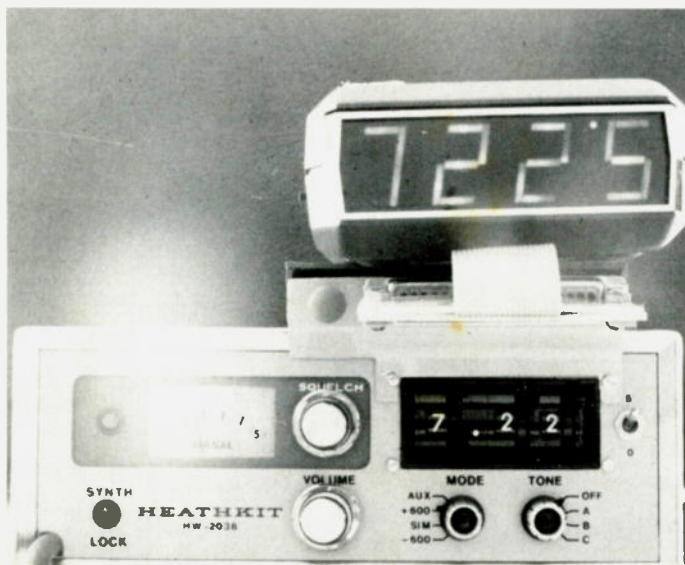

Fig. 1. Note: All segment resistors = 1k Ω 1/4 W. Dotted lines indicate HW-2036 components.



View of completed unit connected to transceiver. For this photo, the display was turned on and the PTT button operated to show mode indication LED. The dot at the upper left corner of the 5 indicates +600 kHz mode. The unit is resting on top of the transceiver for the photo. In the car, the unit attaches to the dashboard by means of Velcro strips glued to the dash and the top of the display unit.

mounted on .1" perfboard. The +5-volt supply requires a 100 uF electrolytic bypass where it enters the housing. Without this capacitor, the synthesizer goes out of lock. All chips are bypassed with a .1 uF capacitor.

The hardest job is the hardware. In order to avoid drilling in the front panel, I constructed an aluminum bracket with two ears spaced apart the width of the thumbwheel switch assembly. Inserting the top two mounting screws through holes in the ears holds the bracket to the front panel. It extends above the panel far enough to allow mounting a surplus multi-

contact plug and the trigger push-button.

A slot cut in the front edge of the slide-on aluminum cover of the HW-2036 allows the flat ribbon cable from the plug into the interior of the transceiver. In order to connect the wires to the mode switch, it is necessary to completely remove the thumbwheel switch assembly. This requires removing the front panel.

The +5-volt supply is picked up from the output terminal of the 5 V regulator. The +11-volt power lead is soldered directly to the emitter terminal of the +11-volt regulator transistor.

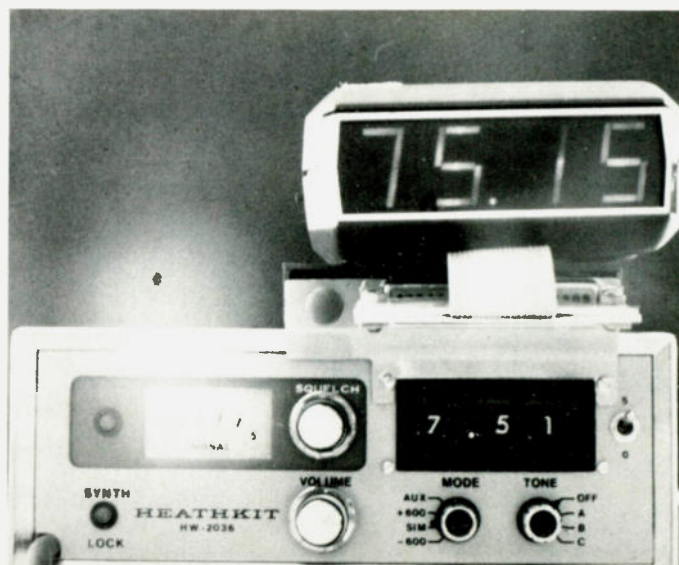

View of completed unit connected to transceiver. The dot in the lower center of the display between 5 and 1 indicates simplex mode.

As the 0/5 kHz digit is operated from the toggle switch, it is necessary to wire ground to the 2 and 8 inputs of the 7447 decoder/driver (pins 1 and 6).

The 1 and 4 inputs (pins 2 and 7) are paralleled, and they connect to the 0 kHz terminal of the toggle switch. Throwing the switch from the 0 to the 5 kHz position removes the ground on these two inputs, changing the digit from 0 to 5. (Attention must be paid to the segment pins on this digit, as it is inverted.)

The mating jack for the transceiver plug has a 20-conductor ribbon cable running to the display unit. A homemade clamp keeps any strain from the cable connections at the jack end, and the plastic housing is flexible enough to

clamp down on the ribbon to keep that end in place. A plug and jack specifically designed for ribbon cable would have made a much neater installation, but they are expensive and hard to come by in single quantities.

A strip of Velcro™ glued to the top of the housing, with its hook mating surface glued beneath the dashboard, is all that's required for mounting the unit in the car. If desired, the transceiver can be hidden away under the front seat with just the thumbwheel and mode switches accessible.

Total cost for the unit was under \$20. The convenience of changing frequency at night is well worth the effort expended in constructing this unit. ■



from page 27

possibility of some financial assistance from the ARRL should the case reach the Superior Court.

All this makes interesting reading, but the fact remains that, even if Don successfully defends his case, he will have sustained legal costs in his own

defense which will run into several thousand dollars. Pretrial costs alone have already cost him nearly \$3000. He can use financial help now!

The Radio Operators' Association of New Bedford (ROANB) is accepting contributions for the "ROANB-W10NK Defense Fund." (Our 14-member club has already

started the fund rolling with a \$100 donation.) Any donations would be greatly appreciated. They can be made payable and sent to: ROANB-W10NK Defense Fund, c/o Leland R. Crowell K1AIK, Bay Road, North Falmouth MA 02556.

Leland R. Crowell K1AIK
Radio Operators' Association
of New Bedford
North Falmouth MA

COMMON SENSE?

Scanning the January, 1978, issue of 73, I stumbled across F. J. Soxman's article, "Ham Shack Anthropometrics." I welcomed the article

because it confirms my hypothesis that human engineers are specialists in using scientific principles and mathematical analysis to optimize the inefficiency and uselessness of a system.

In Fig. 5 of his article, Mr. Soxman sketches for us an anthropometrically-optimized ham station layout. The first thing that caught my eye is the teletypewriter (TTY) situated on the shelf above the linear amplifier. This is real handy:

1. You can stand up and lean over the desk to type at the keyboard.
2. Perhaps with the aid of a chair or stepladder you can read the copy as it is being printed.

Continued on page 50



IC-215 FM

PORTABLE/MOBILE

- 15 channels (12 on dial/3 priority)
- Fully collapsible antenna or "rubber duck"
- Compatible mount for mobile operation
- Dual power (3 watts high/400mw low)
- External power and antenna easily accessible for mobile operation
- Lighted dial and meter
- Double-size, long-lasting internal batteries with optional Ni-Cd pack and charger available

ICOM's **IC-215** is the FM radio that puts good times on the go. Now an outstanding mobile mount and quick-change features for external power, speaker and antenna conversions make moving from base, to vehicle, to hill top fast and easy: and the **IC-215 portable/mobile** provides continuous contact for even the busiest FM enthusiast.

The **IC-215's** three narrow filters provide quality not usually found in portable VHF equipment. With 15 channel capacity and an MOS FET RF amp with 5 tuned circuits in the front end, the **IC-215** gives optimum FM portable performance.

You'll be carrying quality, performance and versatility with your **IC-215 FM portable/mobile**.

Specifications: Frequency Range: 146-148 MHz Voltage: 13.8 VDC negative ground Size: 183mm(h) x 61mm(w) x 162mm(d)
 Weight: 1.9 kg Number of Channels: 15 total, 12 on main switch, 3 priority Power Output: 3.0 W or 0.5 W Microphone
 Impedance: 600 ohm Spurious Level: lower than -60 dB Receiver Sensitivity: 4 dB below 1 UV or lower Spurious Response:
 60 dB or better

All ICOM radios significantly exceed FCC specifications limiting spurious emissions.



This new mobile mount is now available for your **IC-215**. Fast insertion and removal is a snap, and the mount is collapsible when not in use.

HF/VHF/UHF AMATEUR AND MARINE COMMUNICATION EQUIPMENT

DISTRIBUTED BY:



ICOM WEST, INC.
 Suite 3
 13256 Northrup Way
 Bellevue, Wash. 98005
 (206) 747-9020

ICOM EAST, INC.
 Suite 307
 3331 Towerwood Drive
 Dallas, Texas 75234
 (214) 620-2780

ICOM CANADA
 7087 Victoria Drive
 Vancouver B.C. V5P 3Y9
 Canada
 (604) 321-1833

Old Receivers— A Hidden Gold Mine

—updating those '40s receivers

Hank Olson W6GXN
P.O. Box 339
Menlo Park CA 94025

After I wrote an article on the resurrection of the Hallicrafters S38 (73

Magazine, Nov., 1976, p. 88), I was simply astounded by the volume of reader mail and general interest that was stimulated. It was apparent that nearly every ham who had been practicing the art in the period when S38s were avail-

able had owned one at one time or another. The same is probably true for several other less expensive receivers of the day, like the National NC57 and the Hallicrafters S40A. These two receivers represent a step up from the

S38, in that they are transformer operated (not ac/dc) and also have rf amplifier stages. Referring to a 1949 copy of the *ARRL Handbook*, both the NC57 and the S40A are found in the advertising section, at the respective prices of \$89.50 and \$99.50.

The two receivers that I had to work with were obtained at ham auctions for nearly nothing. A non-working receiver is only worth a few dollars at most ham auctions, since few hams seem to have the guts to dig into them and put them back into working order. My own motivation for buying and fixing old receivers is obscure, even to myself; it probably is my inherent sadness at seeing something once highly prized in such bad shape. (I also have three old Austin Healey sports cars that are slowly approaching original condition.) Also, there's the other consideration: What else am I going to do with that pile of tube-type components that I've been squirreling away for two or three decades?

The S40A was the first receiver that I had to work with, and its rebuilding reflects an earlier stage of semiconductor availability. This is not necessarily useless (to show one rebuilding job with a relatively obsolete circuit), since different areas of the country and the world have different parts availability. The S40A rebuilding job was started about 10 years ago and finished only recently. The NC57 was attacked only about two months ago. For reference, Fig. 1 shows the block diagrams of the two receivers. Note how very similar the two of them are. Both sets have nine tubes. (The total number of tubes in a receiver was an early figure for judging the "power" of a receiver, and such notions had some market value, even in the forties.) However, except for the slight stability advantage the OD3 voltage regulator

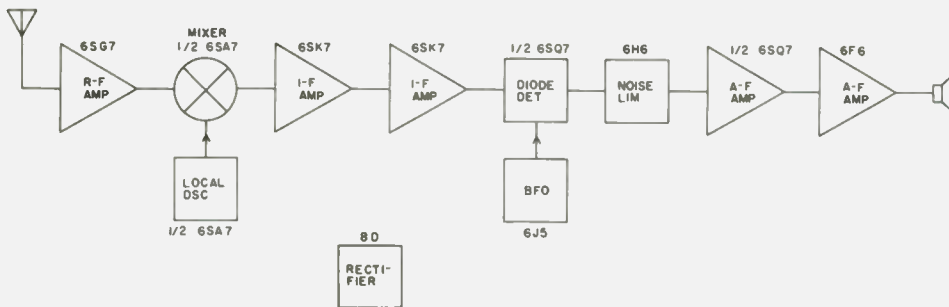

Fig. 1(a). Hallicrafters S40A.

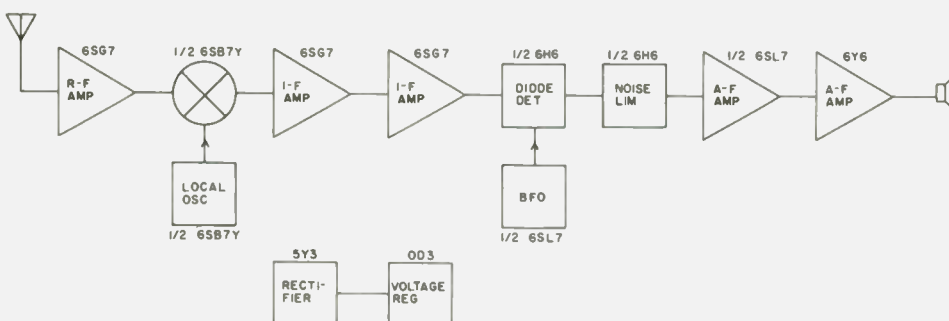

Fig. 1(b). National NC57.

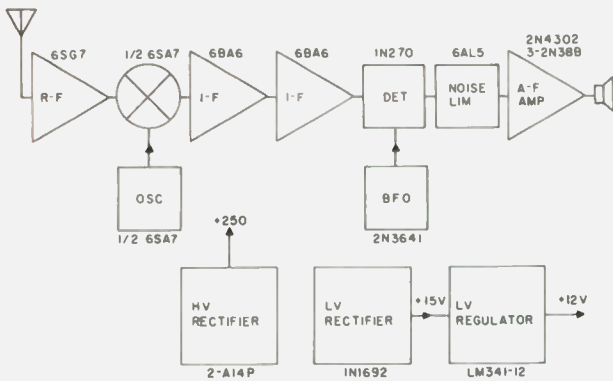

Fig. 2(a). Hallicrafters S40A, as modified.

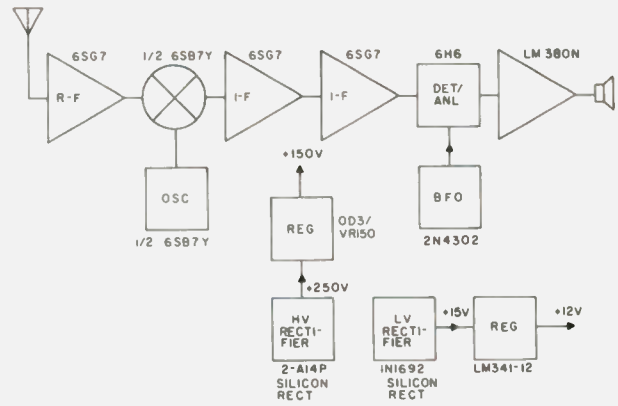

Fig. 2(b). National NC57, as rebuilt.

gives the NC57, the two receivers are like peas in a pod.

The two receivers were in rather bad shape when I obtained them. The S40A had been essentially gutted, except for the front end coils and the front panel mounted components. The modification which had been started on it apparently called for sawing out the section of the original chassis that contained the i-f and af parts of the circuit. The NC57 had been worked over considerably, too, with plenty of haywire-style rewiring, all of it apparently done with a tin-smith's copper. An S-meter had been installed in the mid-

dle of the speaker grill, the hole apparently having been cut with a can opener. In both the receivers, unfortunately, no sign of the original power transformers could be found.

The aim in the rebuilding job was to get the receiver working again, in more or less the same shape as it had originally been advertised. Once one starts down the road of improvement, the options are endless, and finally one finds out that he should have started from scratch. So, the rf, i-f, and detector blocks of the receivers were left intact, with tubes and the avc loop undisturbed. The only

thing done in this area was to replace all the old paper capacitors (mostly bypass capacitors) with newer ceramic disc or mylar types.

Since these newer capacitors are quite small, compared to their dripping wax and paper predecessors, this step really opens up a lot of room under the chassis. The decision to leave the rf, i-f, and detector block intact means that you're going to end up with at least a five-tube receiver. It also means that you're going to need the original high-voltage power supply or something equivalent to power the tube section. So save your HV supply transformer and choke, as they will be needed. The HV rectifier tube and filter capacitors will be replaced anyway, so it's not necessary to save

them.

In my own particular case, since I had no HV power supply components, I had to make new supplies. The receivers' rf and i-f sections draw only about 60 mA, so modest sizes of power transformer and choke are required. The particular Triad R10A power transformers used were 525-volt secondary types (with center taps), so choke input filtering was used to obtain approximately the correct output voltages. The 90 mA rating of the R10A is larger than required (so is that of the Triad C5X choke), but I had to use whatever I had on hand. By using silicon rectifiers in lieu of rectifier tubes, considerable heat is taken out of the inside of the receivers, and the 5-volt rectifier filament windings of

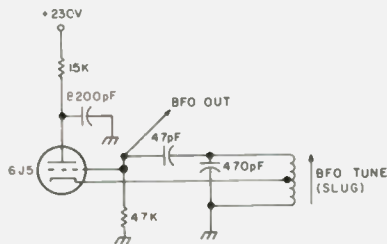

Fig. 3(a). Original bfo in S40A.

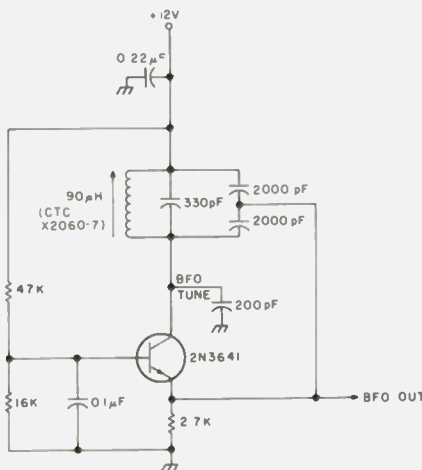

Fig. 3(b). New transistor bfo for S40A.

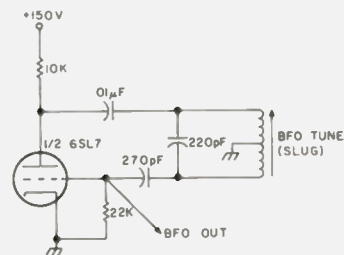

Fig. 4(a). Original bfo in NC57.

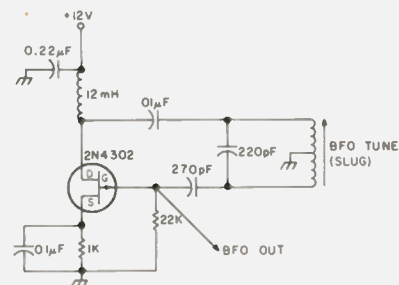

Fig. 4(b). New bfo for NC57 using N-channel FET.

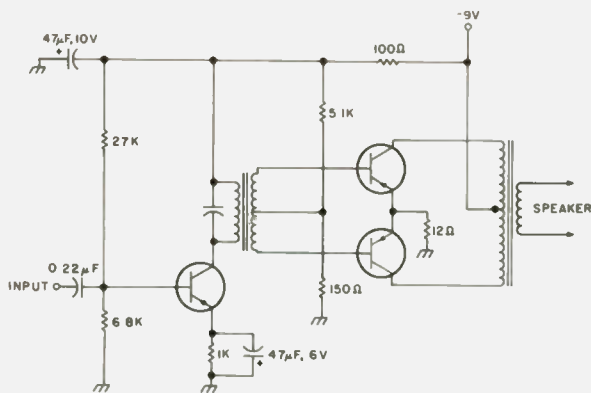

Fig. 5(a). Original audio amp from AM receiver. All transistors are original PNP germanium types.

the power transformers are made available to be put in series with the 6.3-volt heater windings for low-voltage dc supplies. Simple half-wave rectifiers produce +15 volts for the new solid state circuitry to be added and can be regulated down to provide +12 V or lower voltages, as required.

The S40A rebuilding was a bit more extensive than the NC57 job, simply because the entire i-f chassis area had been sawed out of the receiver. Since I had no i-f transformers or sockets, I had to build this area up from scratch. It turned out to be easier to use miniature tubes and i-f cans for the job (new holes had to be cut in the replacement chassis plate, anyway). I must stress, however, that this step improves the receiver in no way; it was simply necessary in my particular case. The 6BA6s and 6AL5 are merely the miniature equivalents of the replaced 6SK7s and 6H6. The only possible advantage of using these newer tubes is that they may be more easily procurable nowadays and in the future. Fig. 2 shows the modified block diagrams.

The S40A rebuilding was

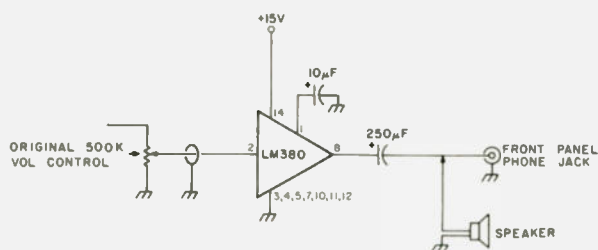

Fig. 6. New audio amplifier as used in NC57.

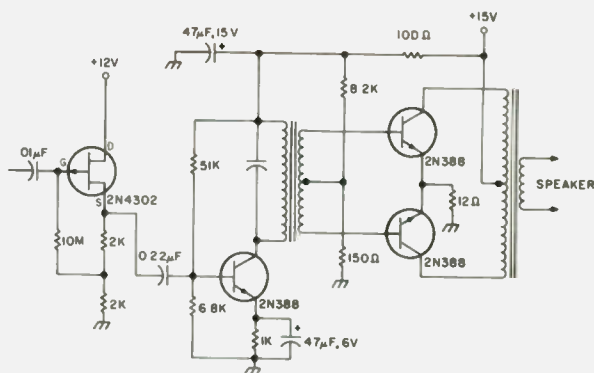

Fig. 5(b). Audio amp as rebuilt with added FET source follower.

also complicated by the fact that the bfo control (a tapped coil with front panel adjustable slug) was missing. This meant a complete redesign of the bfo using the only kind of control readily available, a variable capacitor. The bfo circuits for the S40A are shown in Fig. 3; note that the new one uses a bipolar transistor, since we no longer need to duplicate the original tube impedances. Actually, the capacitor-tuned bfo turns out to be better than the original, because the threads on the slug-tuned bfo coil are inherently sloppy and had given a rather erratic frequency versus angular variation.

The bfo in the NC57 is almost exactly the same circuit as was used originally with the half 6SL7 (triode) tube. The tube section is replaced with an FET (N-channel), and a low-voltage (+12 V) supply is used to power it. In this way, the original bfo control coil and tuning capacitor can be retained without a major change in frequency. This is due to the FET having similar impedances to those of the tube that it replaces. The circuit of the new NC57 bfo is shown in Fig. 4(b).

The solid state audio amplifier sections of the receivers are quite different, reflecting the 10-year difference in "starts of rebuilding." The S40A has an audio section that was taken from an old Japanese 5-transistor radio of the type that has virtually dominated small portable AM radio sales in this country. It originally had three 2SA-type PNP germanium transistors in the audio portion; these were replaced with 2N388 NPN germanium types to assure future replacements.

Minor circuit changes make it possible to operate the audio amplifier on the +15 V supply. Since the three-transistor audio amplifier, as removed from an existing AM receiver, is designed

to have low input impedance, I had to add a high-impedance to low-impedance stage ahead of it. This allowed interfacing to the S40A circuitry directly, even using the original volume control. The source follower (2N4302), which is similar to a tube-type cathode follower, is used for this purpose. The complete schematic of the FET source follower and transistor amplifier is shown in Fig. 5(b).

The audio stage of the NC57 is very simple, consisting of a National Semiconductor LM380N and a couple of peripheral parts. The circuit is shown in Fig. 6. Note that the LM380N has high enough input impedance that it can operate directly from

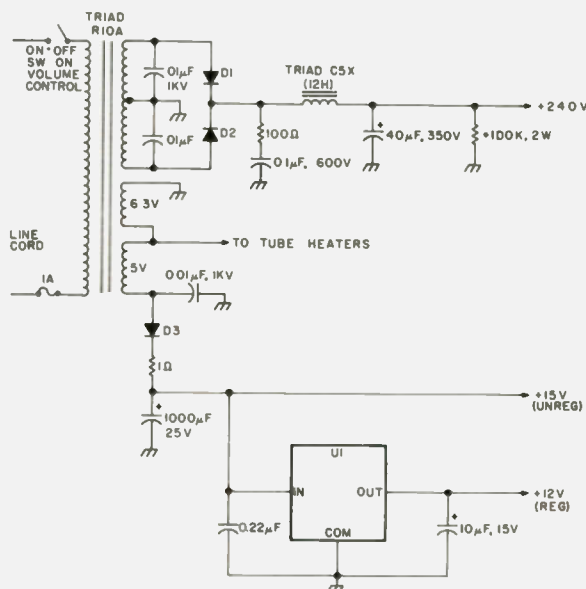

Fig. 7. New power supply for NC57 or S40A. D1, D2 — Motorola HEPR0056; D3 — Motorola HEPR0051; U1 — Motorola HEPC6113P. *100k bleeder resistor not required in S40A.

the NC57 circuitry.

The new power supply that was designed for use in either the NC57 or S40A is shown in Fig. 7. The 100k bleeder resistor is used in the NC57, but not in the S40A. This is due to the S40A using a 10k, 12k voltage divider across the +240-volt bus to get its +105 V line. The silicon rectifiers listed are the readily-available Motorola HEP types, but any 1000-volt, 1-Amp type could be used for D1 and D2. The 12-volt regulator (U1) is one of the newer three-terminal fixed-output types and could be replaced by any of the 7812 types as made by Fairchild, Lambda, Motorola, National, Raytheon, Signetics, or Silicon General.

Fig. 8 shows the S40A rebuilt i-f, Det, ANL section using miniature tubes in place of the original octal types. There is one correction here, where *Sams Photofact* (Set 33, folder #483-10) was in error. The difference is the

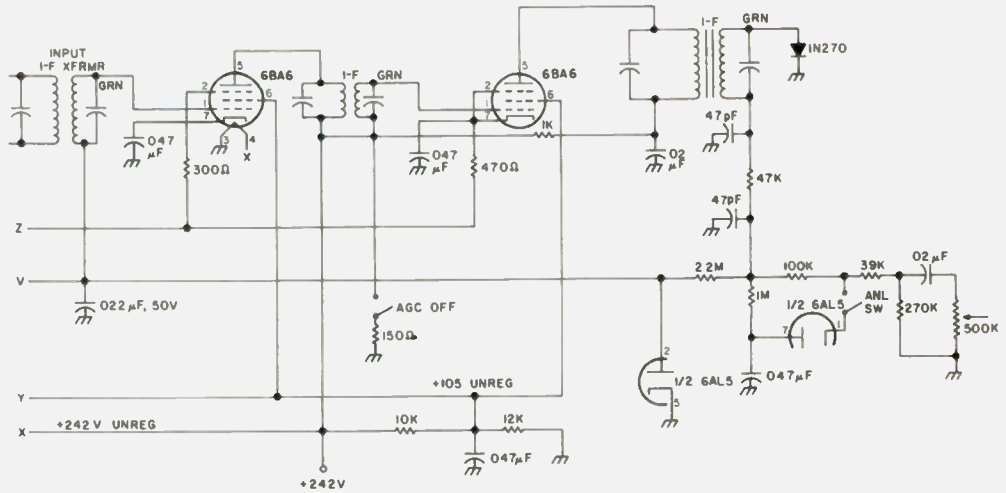

Fig. 8. I-f, Det, ANL from S40A after conversion.

avc line connects to the junction of the 2.2 meg resistor and the plate of one half of the 6AL5 or 6H6, instead of as it is shown in *Sams*. There is also another error in the *Sams Photofact* (Set 48, folder #14) on the NC57; the original bfo circuit should be as in Fig. 4(a).

Once all the circuit modifications and a check of voltages have been made, you

should hear some life in the old receiver. The i-f should be aligned first, using an accurate 455 kHz generator. The bfo should then be set so as to give zero beat in the center of its tuning range. Finally, the rf section should be aligned as per instructions given in the appropriate *Sams Photofact*.

At this point, you should have a communication receiver

at least as good as the one the original purchaser had back in 1949. The main difference will be that about 20 Watts of heat dissipation has been removed, more highly reliable components have been installed, and you have three fewer tubes to replace. Furthermore, you now have a general coverage receiver, an animal nearly extinct in these days of specialization. ■

FREQUENCIES IN STOCK

146.01T	
6.61R	6.52R
6.04T	6.55T
6.64R	6.56R
6.07T	6.58T
6.67R	6.58R
6.10T	6.58R
6.70R	6.94T
6.115T	7.60T
6.715R	7.00R
6.13T	7.63T
6.73R	7.03R
6.145T	7.66T
6.745R	7.06R
6.16T	7.69T
6.76R	7.09R
6.175T	7.72T
6.775R	7.12R
6.19T	7.75T
6.79R	7.15R
6.22T	7.78T
6.82R	7.18R
6.25T	7.81T
6.85R	7.21R
6.28T	7.84T
6.88R	7.24R
6.31T	7.87T
6.91R	7.27R
6.34T	7.90T
6.94R	7.30R
6.37T	7.93T
6.97R	7.33R
6.40T	7.96T
6.46T	7.36R
6.46R	7.99T
6.52T	7.39R

2 meter CRYSTALS

for these radios



Clegg HT-146
Drake TR-22
Drake TR-33 rec. only
Drake TR-72
Genave
Heathkit HW-2021 rec. only

Regency HR-2, A
Regency HR-212
Regency HR-2B
Regency HR-312
Regency HR-2MS
Heathkit HW-202

Icom/VHF Eng
Ken/Wilson
Lafayette HA-146
Midland 13-505

Standard 146/826
Tempo FMH
Trio/Kenwood TR2200
Trio/Kenwood TR7200

Note: If you do not know type of radio, or if your radio is not listed, give fundamental frequency, formula and loading capacitance.

CRYSTALS FOR THE IC-230 SPLITS IN STOCK 13.851111 MHz. 13.884444 MHz. 13.917778 \$5.00 Each

Any two meter crystal not listed above can be specially ordered for \$5.00.

SHIPPING

We can ship C.O.D. first class mail. Orders can be paid by: check, money order, Master Charge, or BankAmericard. Orders prepaid are shipped postage paid. Phone orders accepted. Crystals are guaranteed for life. Crystals are all \$3.45 each (Mass. residents add 18¢ tax per crystal). U.S. FUNDS ONLY.

SOUTHEASTERN COMMUNICATIONS

2729 Independence Ave.
Quincy MA 02169
(617) 479-8900
Store Hours
Daily 9-9
Sat. 9-5

PRICES SUBJECT TO CHANGE WITHOUT NOTICE

S37



Old Rigs Can Live Again!

—a guide to their resurrection

A few months ago, you received your Novice license and proceeded to go on the air. In the weeks between passing the test and actually receiving your license, you may have scrounged around hamfests, club auctions, local ham supply stores, and the basements of more seasoned veterans of the airwaves in order to locate and purchase a low-power transmitter of suitable design. In most cases, you would have dug up any of a dozen or more models popular with Novices and new Generals over the past twenty years or so. Suitable types include Heathkit models DX-60, DX-40, DX-35, and DX-20, Johnson's "Adventurer," the Eico 720, and even a Knight T-60.

And now, with that fresh license hanging on your wall,

you decide to try your first contact — nothing — absolutely nothing — the old transmitter simply won't work! What do you do now?

After you recover from the jolt of disappointment, you could call another ham and ask for assistance. In fact, knowing the way hams are, it is a good bet that the help you need will be forthcoming. But how does "Tommy Troubleshooter" go about finding the cause of your problems?

The neophyte troubleshooter may watch the more seasoned veteran and marvel at the seemingly deep knowledge on display. Ol' Tommy sure knows some smoke about transmitters, doesn't he? Or does he? It may be that he knows only a little more than you and that your own grasp of theory is even

better.

The level of knowledge required to troubleshoot the simple transmitter is about that required to pass the General/Technician class license examination. Of course, when dealing with high technology types of SSB transceivers, you might be right in saying that a somewhat higher technical savvy is required, but, for the present problem, any General or Technician class operator should be able to find the trouble. The only real difference between Tommy Troubleshooter and less experienced amateurs is that ol' Tommy has been nailed to the floor a few more times, figuratively speaking. Often as not, unless he makes his living in electronic servicing,

he has picked up what he knows because he dared to troubleshoot his own equipment and was successful. Tommy's confidence stems from the fact that he knows that it is within the realm of possibility that he could fix something.

The MOPA Transmitter

Fig. 1 shows the block diagram of the basic *master oscillator power amplifier* transmitter design that forms the usual so-called "Novice" rig. The basic MOPA consists of two stages — a crystal oscillator and a power amplifier (also called the "final" amplifier). When the Novice of yesterday upgraded to General class status, he usually added an outboard variable frequency oscillator (vfo). An example is the popular Heathkit DX-60B transmitter coupled with their HG-10 vfo.

The crystal oscillator generates the signal using a quartz crystal resonant on the frequency of operation. This signal is then fed to the final amplifier, where it is amplified and passed on to the antenna. When a vfo is added, it simply replaces the crystal, and the oscillator circuit then acts as a buffer amplifier. Two other sections of the transmitter are the keying and power supply circuits. The keying circuit is used to turn the transmitter on and off by a telegraph key. The power supply does just that — it supplies power to the rest of the stages in the transmitter.

Fig. 2 shows a typical crystal oscillator stage such as those used for simple MOPA transmitters. In most such

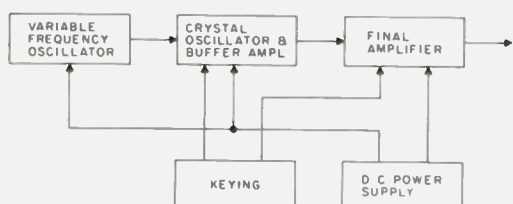

Fig. 1. Block diagram of a simple MOPA transmitter.

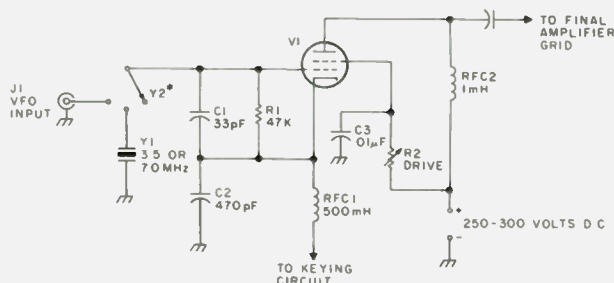

Fig. 2. Typical crystal oscillator circuit.

transmitters, a Colpitts oscillator circuit was used. The crystal switch will select from two or three crystals and the vfo input jack. In other designs, they did not use a crystal switch but, instead, mounted the crystal socket on the transmitter's front panel. Frequency changes meant removing the existing crystal and substituting another. When the vfo was used, a special plug that would fit the crystal socket was obtained. In some transmitters there was a "drive control" that set the amplitude of the signal applied to the grid of the final amplifier tube. This was merely a variable resistor in the screen circuit of the oscillator tube.

A typical final amplifier stage is shown in Fig. 3. The tube could be any of several popular types, such as the 6146, 807 (or military versions of same), and TV horizontal sweep tubes, such as the 6DQ6, 6CD5, etc. If you have to replace a tube, it is good practice to use the original type. Of course, you can replace them with others that are equivalent, but know what you are doing. You will see some tubes with the same prefix letters and numbers, but a different suffix. The rule of thumb (and it is often violated) is to replace a tube with only those with the same or later suffix letter. For example, you may use a 6146B to replace the 6146A or 6146. Try to avoid using a 6146 or 6146A to replace the 6146B. In some cases, the change in tube design that spawned the change in suffix is irrelevant, but, in others, it could be important.

All components in the final amplifier were put there for a specific purpose. Capacitors C1 and C6 were used because they will keep dc potentials out of the antenna and V1 grid circuits, respectively. Capacitor C10 resonates the coil L1 to tune the grid circuit of the final amplifier tube. Similarly, C2 tunes the plate of the tube,

and C3 is the antenna loading control. Meters M1 and M2 are used to monitor dc currents in the plate and grid circuits. In actual practice, though, meters are expensive, so one meter is used for both functions. A switch labeled "grid plate" or something similar will select the current being monitored. It is also true, in many cases, that the plate meter will actually be in the cathode circuit. The cathode current is actually the sum of the plate and screen currents, but the error is small. Placing the meter in the V1 cathode circuit would avoid placing the entire plate voltage on the meter and meter switch. Resistors R3 and R4, in conjunction with capacitors C8 and C9, and rf choke RFC3 form a filter to reduce or, hopefully, eliminate key clicks.

Keying a Novice-type transmitter is usually accomplished by using one of two popular methods. In Fig. 3, the cathode keying method is used. In that type of circuit, the telegraph key acts as an SPST switch to complete the path to ground for the final amplifier and oscillator tube cathodes. This is easy and low cost, but it can result in having a relatively high voltage placed across the key terminals when the key is up — and that can deliver a nasty shock if you accidentally come in contact with the

telegraph key terminals.

The alternate method is to use "grid-block" keying, such as is shown in Fig. 4. This circuit requires a dc supply that is negative to ground, often called a "C supply." When the key is in the up position, the negative bias from the C supply is applied through resistors R1 and R2 to grids of the final amplifier and oscillator circuits. This cuts off those stages and prevents their operation. When the key is down, the switch is closed, and the C supply is shorted to ground. In this condition, the stages operate normally and a signal is transmitted.

There is actually one other form of keying based on the grid-block technique. It is called "differential keying" and will use a timing circuit to turn on the oscillator a split second before the final amplifier. This will allow the oscillator to stabilize before connecting a signal to the antenna.

A typical power supply circuit is shown in Fig. 5. Although some more recent designs, or the modifications of previous owners, use a solid-state rectifier in place of the vacuum-tube type shown, most rigs will have the tube. Most transmitters in the 50- to 75-Watt class used rectifier tubes, such as the 5U4GB, the 5R4GTB, etc.

The filter section is almost

always capacitor input on this class of transmitter and may or may not have a choke. In those transmitters which do not use a choke, then a resistor will take the place of L1 in Fig. 5. There may also be no voltage regulator tube in many designs.

Some low-cost transmitters do not have a fuse, incredible as that may seem. If you own one of those which does not, then install one. For about 50¢ you can obtain a good quality chassis or rear-apron-mounted fuse holder. Or you could buy one of those special line cord plugs that will accept type 3AG fuses. In fact, they will not pass current unless the fuse is in place! I personally prefer the type that mounts on the rear apron. They have a cap that comes off with a twist or two, allowing easy fuse changing.

The circuits presented thus far are considered representative of those found in the Novice transmitter. If you do not know exactly how they work, let me refer you to the ARRL publication, *The Radio Amateur's Handbook*. These circuits may or may not be the ones used in your transmitter, so obtain a circuit diagram before attempting to troubleshoot the beastie. If a letter to the manufacturer does not bring results, then try other sources. A few, very few, will be found in old

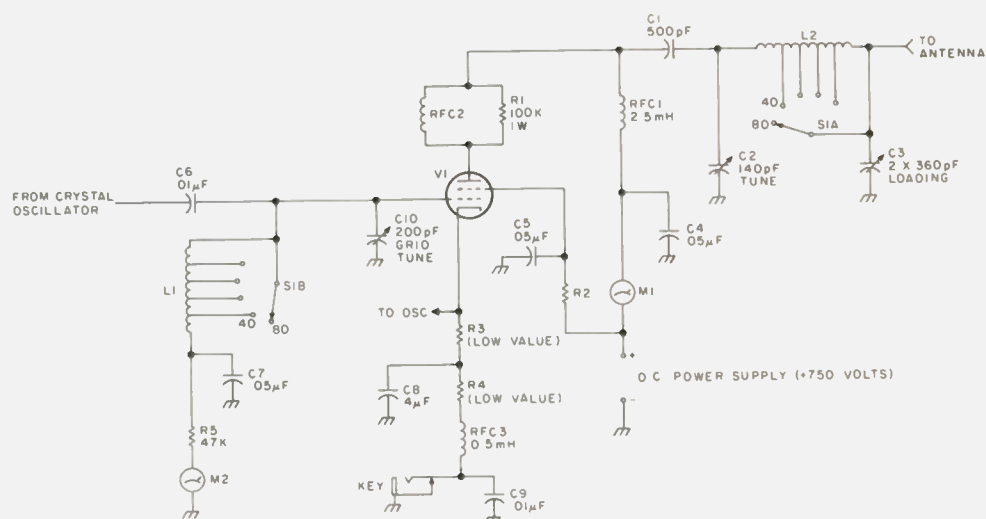

Fig. 3. Typical final amplifier circuit.

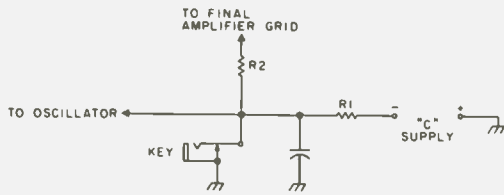

Fig. 4. Grid-block keying circuit.

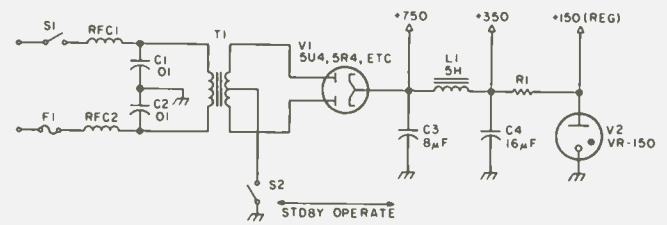

Fig. 5. Typical power supply circuit.

issues of the Howard W. Sams and Co., Inc., *Photofact* folders. Or you could bug the service or PR people at local and national amateur equipment dealers. Alternatively, there might be a local ham who owns or owned the same model. In any event, should you not be able to locate an original that you can keep, then borrow one and photocopy it at the local library or superfast print shop. It is good practice to keep service manuals for all of your ham equipment on file — just in case.

Test Equipment

Before proceeding with several actual case histories, let me offer a quick note on test equipment for MOPA service. It is not necessary to have a multikilodollar laboratory to make simple transmitter diagnoses. One item that should be available, though, is the volt-ohm-milliammeter (VOM). Although some prefer one or more of the various electronic multimeters (VTVM, FETVM, DVM, etc.), I do not like them for transmitter work. In other types of service, I not only use the electronic voltmeter, but prefer it. But, in transmitter service, there are high rf fields surrounding the meter, and that can cause many problems. The EVM class of multimeters require special probes or adapters before they will work satisfactorily in a transmitter. Low-cost imported VOM instruments can be had for something on the order of \$20 to \$50. Lower cost types are also available, but they tend to be too small or of inappropriate ranges for this application. The one I use was purchased for about \$29 at a local ham

store and is made by Calectro.

One other necessary piece of equipment is the dummy load. This takes the place of the antenna, but does not radiate power. It is discourteous, and downright illegal, to troubleshoot a transmitter while it's connected to an antenna. Some amateurs will use a 100-Watt light bulb as a dummy load. The bulb is connected to a short length of coaxial cable that is also connected to the antenna jack on the back of the transmitter. This works, but only poorly. For one thing, the bulb does not present a proper load to the transmitter. Another thing is that it is possible for that "dummy load" to radiate. Several times I have worked stations across town (5-10 miles away) which were connected to a light-bulb load. A low-cost alternative is the Heathkit Cantenna, which, as an added advantage, has a little detector circuit built in that delivers a dc voltage proportional to the rf power applied to the load.

In the desirable-but-not-essential category are several other instruments. The swr bridge/rf wattmeter (e.g., Heath's HM-102) is a low-cost example. A dip oscillator and absorption wavemeter are also good items to have. Of course, at the risk of seeming to "blue sky" too much, a wideband oscilloscope is a fine idea.

Some Case Histories

John was an enterprising fellow who camped out all night before George Washington's birthday to be first in line to buy a pile of Novice transmitters that would be sold for \$1. He actually got three of them, but none of

them worked, which is why they were selected to sell for \$1 each. One of them would not work on 40 meters, another blew fuses as soon as the power switch was turned on, and the third produced a "T-nothing" buzz instead of the expected CW "beep-beep."

The first transmitter was fixed quickly. A little thinking goes a long way in cases like this, as do some quickie observations. It was found that the transmitter would work properly on every band except 40 meters. This kind of information will usually excite the seasoned servicer, because he knows that everything is alright except something common only to 40 meter operation. In the simple MOPA-type transmitter, it could only be something in the bandswitching or tuning inductors. We know that the oscillator is working because the upper bands work. The oscillator frequency for most transmitters in the 20, 15, and 10 meter bands is 7 MHz, the same as for 40 meters. Besides that, we can confirm that the oscillator works on 40 meters by listening to our communications receiver. The oscillator signal will appear when the key is pressed.

In this particular case, it was noted that the grid current was almost nonexistent and would not peak up. This almost entirely exonerates the plate tank and bandswitch, but it points to the grid tank. The actual problem was a poor solder connection (see Fig. 6) at the switch terminal going to the 40 meter inductor tap. This is not an unusual occurrence, actually. In fact, it may have gone unnoticed for several

years, since the transmitter was assembled from a kit. Even though the original builder had failed to solder this point, it probably made good contact until corrosion took its toll and prevented the connection from passing current. To the owner, it probably looked like a "sudden" fault, so the rig was unloaded, fast.

The fuse-blowing problem could have come from any of several sources. One of course, is the power supply, but you should also be ready to consider the final amplifier tube or loss of drive from the oscillator.

Before attempting to troubleshoot a power supply, give it a looking over — eyeball it. Look for signs of damage. Potential spots might be the filter capacitors, chokes, and resistors. In the case of the capacitors, look for swelling or the leakage of inside material. Although this material may be a thick liquid, it is usually a brownish-grayish powder on the end caps of a tubular capacitor or insulator of a can type. In other components, look for signs of charring or burning. Look at the paper insulation on the chokes for charring of resistors. If this inspection fails to reveal the way to go, then it is necessary to become a little more clever.

If the fuse blows immediately when the set is turned on, then it is permissible to use a handful of sacrificial fuses as a troubleshooting technique. I know this sounds very inelegant. In fact, to some purists, it may seem kind of crude in a supposedly scientific technical field. But, while they are being pure, we will fix the rig and go back on

the air!

Remove the rectifier tube from its socket, or disconnect any solid state rectifiers. Replace the fuse and turn on power. In this last respect, let me caution you to not use the power switch, but physically unplug the set when working on the chassis. Turning it on then becomes a matter of plugging it in. If the new fuse blows with the rectifier removed, then you know for certain that the problem is on the transformer side of the rectifier. Referring to Fig. 5, disconnect capacitors C1 and C2, the rf bypass capacitors. Replace the fuse, and then plug the set back into the ac power. If the fuse blows again, then you can be certain that the problem is the power transformer. If it did not blow, however, then the trouble is either C1 or C2. An ohmmeter will tell which.

If the fuse did not blow when the rectifier was out of the socket, then the problem is on the dc side of the rectifier. At this point, I want to reiterate the fact that, though these transmitters may be low power, potentially lethal voltages lurk on that chassis. As the ARRL keeps saying, "switch to safety." When you work on a high-voltage dc power supply, there is a possibility that you will come in contact with a high dc voltage stored in the filter capacitors. This voltage may stay around for some time after the set is turned off, despite any bleeder resistors that may (or may not!) be in use. It is best to assume that the bleeder is defective and use an alligator clip lead to discharge them. Connect one alligator clip of the lead to chassis. Then connect the other end (using an insulated tool) to the positive side of the filter capacitors. Leave it there for about ten seconds and move on to the next capacitor. If you are working on a rig that has a negative power supply, or positive supplies with two or more filters in series, discharge each filter separately. I

hope it doesn't have to be mentioned that it is safe to discharge filters only after the power is turned off — the plug pulled from the wall.

Before digging out the voltmeter or ohmmeter to find out where the short is located, it is necessary to try one more divide-and-conquer routine. Remove the final amplifier tube from its socket, after going through the proper discharge procedure. When the final amplifier tube is out of its socket, replace the fuse and reapply power. If the fuse does not blow, then you have found the problem. Replace that tube with a known good type. In the case of John's transmitter, a new 6146 cured the problem. In that case, the filament had sagged against the cathode and created a short circuit. This is especially likely if the transmitter had not been used for some time. In the case quoted, it was even more likely, because the tube was operated in a horizontal, rather than vertical, position. This type of defect will cause the fuse to blow immediately when the power is applied, and it may not depend upon whether or not the transmitter is in "standby" or "transmit." In some cases, though, the filament supply might not normally be grounded, so the defect does not show up until the telegraph key is depressed.

In a few cases, you will find that the problem only appears to be associated with the final amplifier tube. When the final tube is removed from its socket, the fuse blowing stops. This could be caused by a loss of drive from the oscillator. Most low-cost MOPA transmitters use grid-leak bias rather than fixed bias. If the drive signal should fail, the tube becomes unbiased, and a high plate current will flow. In most instances, though, the fuse will not blow immediately, but will take a few seconds. You will be able to see the plate current milliammeter

rise or the tube glow red hot.

A new troubleshooter might be tempted to troubleshoot his MOPA by replacing all of the tubes, one by one. Although I could be burned at the stake by my professional colleagues for saying so, this is a technique used by many of them. It is called "shotgunning the problem." All amateurs should make it their habit to keep one each of every tube type used in their equipment — new tubes, not hamfest specials of uncertain parentage.

The last transmitter had a CW note that was T-nothing-minus. It sounded like raw ac on the plates. Although you may hear your own note on a receiver, it is possible that your first indication of trouble will be a love letter from the feds, or an ARRL "official observer." That notice of violation from the FCC may at first snap your mind clean out of its socket, but fear not — a cure is at hand.

Even if your receiver note normally sounds like about T6 because of overload, it is still possible to hear a clean note. Operate the transmitter into a dummy load, turn off the receiver avc, and turn down the rf gain. If your note sounds less than T9, then look to the filter capacitors. One of them is probably open. Bridge a known good filter capacitor across each power supply filter in turn. If the note cleans up when any particular capacitor is bridged, then that is the one; replace it. Of course, turn off the power and discharge all of the filters before making each connection with the bridging capacitor. Also, remember that the bridging capacitor also contains a charge, so it must be discharged, too.

Rules, Rules, Rules

It would not be decent of me to convince you that it is possible to fix your own MOPA transmitter without also giving you some appropriate words of wisdom and warning: That transmitter can

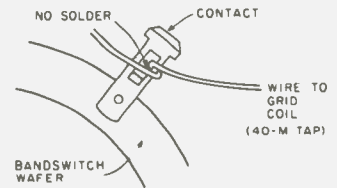

Fig. 6. No solder on the 40 meter tap killed this transmitter.

kill you! It contains lethal potentials, so be very careful, please. You would be surprised how many times I have heard some malarkey from supposedly knowledgeable people about "alleged" safety problems. One person made the comment that the ac mains power could not kill you, because it is too low a voltage, and, besides, it takes current to kill, not voltage. That reasoning can get him killed. Most electrocutions every year in the U.S. are from 110-volt mains power! Another false, and very dangerous, idea is that the +750-volt supply is harmless because it is dc. It can kill, make no mistake about that — it is a perfectly good widow(er)-maker.

A Few Simple Rules

1. Before touching anything inside the transmitter, (a) disconnect the ac power plug — do not depend upon the switch — and (b) use an alligator clip lead to discharge the filter capacitors in the power supply.
2. Never work alone. Even if your partner isn't an expert in cardiopulmonary resuscitation (CPR), he can at least pull the emergency switch and call for an ambulance.
3. Use only insulated tools and test equipment.
4. Never work when fatigued.
5. Work on a neat bench; otherwise safety could get lost in the shuffle.
6. Use a proper schematic.

One last note: Whenever a rectifier is found defective, test the power supply and final amplifier for shorts. It is possible that the rectifier didn't give up the ghost, but it was pushed by a short circuit. ■

Novices, Paddle Your Way To Happiness

— *super deluxe Novice keyer*

Rev. Michael Windolph W0OGX
218 W. 2nd St.
Chaska MN 55318

The Novice just getting into ham radio is often overwhelmed by the amount of equipment that is available

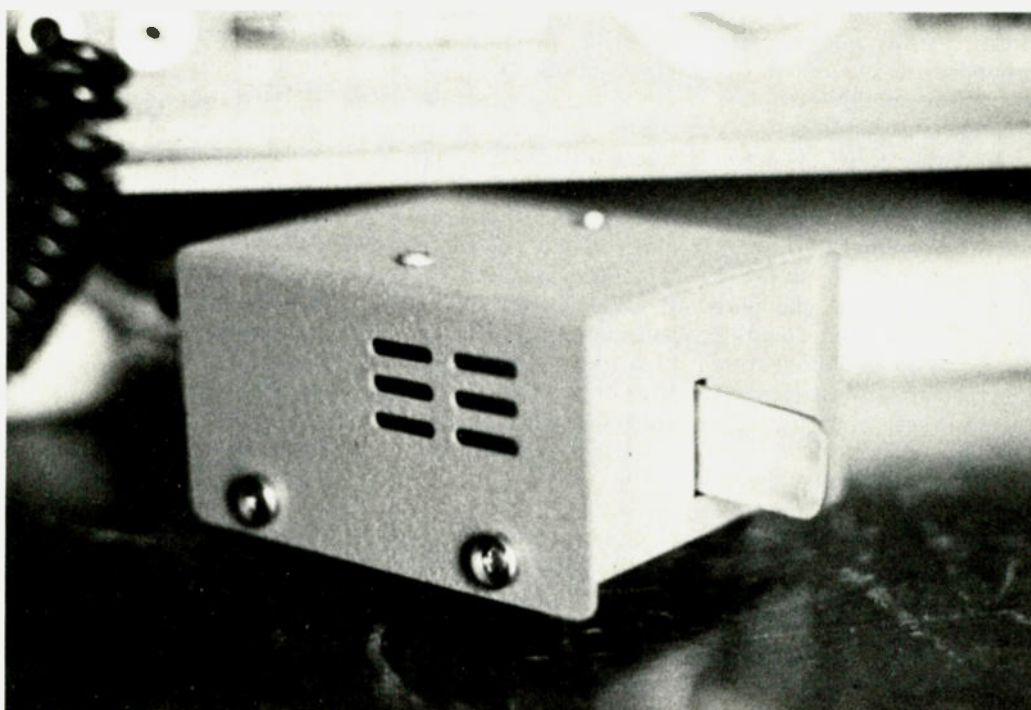

and the high price for that equipment. It is no longer possible for the beginner to make his own receiver unless he has a ham friend to help him. Even then, he would probably settle for the regenerative beginner's model only until he could afford or borrow a better one.

It is still possible to build your own transmitter (also with a little help from a friendly ham) as long as you are going to work CW only. But going sideband is just out of reach, unless you can get your hands on a commercial rig.

Even the experienced ham today usually depends on commercial or kit receivers and transmitters, except for CW, and does his building and experimenting with other ham gear, gadgets to improve the shack or make operating more convenient, etc. Among these extra items, and one that the Novice might easily dream of graduating to, is a bug, or, even more high class, an electronic keyer.

The one described here is a good electronic keyer, one a Novice can build and get working, and even one that he can afford. The only parts you will have to buy (providing you have dismantled a few TV sets or have a supply of resistors, capacitors, wire, etc.) will be the four cheap ICs (integrated circuits), sockets for same, and a piece of perforated board (which could be made at home, if necessary). Add to these a half-dozen transistors and a couple FETs (field effect transistors), if you want the deluxe version, and you can probably buy all the parts for less than the price of a good hand key, which will cost up to \$8.00.

I call it a deluxe keyer because it has touch control — which even your ham friends probably don't have unless they spent a lot of money on their keyers or are pretty good ham experimenters. Although you should have no trouble making a regular paddle

(much, much cheaper than buying one), it is even easier to make the solidly-mounted paddle for the deluxe version, as it needs no pivots or contact points — no moving parts at all. All you have to move are your finger and thumb to work this keyer. There's no paddle to push or squeeze — just a touch will do it.

The Novice, of course, has learned code at the rate of five words a minute. But it is often pretty sloppy code (witness the Novice on the air). With this electronic keyer that you can build yourself, you can learn quickly to send perfect code and take pride in that accomplishment. Anyone who has some knowledge of soldering (with a soldering pencil) and an ability to read and follow diagrams can build this keyer. It requires no printed circuit board, and all the parts can be bought very economically by mail from ads in *73 Magazine* or from your local Radio Shack.

A good feature of an electronic keyer like this is that you can set the speed of the characters at about thirteen words per minute and still send as slowly as you wish by your spacing between letters and words. This is recognized as a better way to learn the code than learning it by sending slow dits and slower dahs. Sending each character at a thirteen word-per-minute rate and slowing down only the spaces prepares you for increasing your code speed without the learning plateaus that will slow up progress to your higher class license.

There is a special feature to this keyer: It uses ordinary transistor logic, TTL, which is cheap and readily available by mail. I could have used CMOS chips and the keyer would use less current. But one big disadvantage of CMOS chips is that they are very sensitive and can easily be burned out just by handling! After zapping a few of them myself, I decided

that that was just not the way to go.

Also, because the newcomer (and a lot of us old-timers too!) isn't into making printed circuit boards, I used point-to-point wiring. It might seem more time-consuming (unless you count the time making the printed board), but the equipment works just as well once it is finished. It also provides for the possibility of changing wiring, changing parts for bigger or smaller parts, etc., which you can't very well do with a printed circuit. Sockets for the ICs are, however, recommended. This makes it much easier to change chips in case one or the other gate in one IC is bad. They don't go bad often, but they are cheap, so it's better to be on the safe side.

The whole keyer can be made quite small, smaller than some of the kits on the market. I put mine in a 3 x 4 x 2 inch cabinet. If you want to include the power supply,

you might want it a bit larger, however. If you make a wooden cabinet, it would be a good idea to make it in such a way that you can add some shielding (ordinary window screening) in case the rf from your rig affects the keyer. Use shielded leads from the keyer to the transmitter for the same reason, if you can find any. I had no shielding problems with my SB-104 transceiver, but you have to remember that, with the touch paddle feature, this keyer is more sensitive than other keyers. You have to be careful about what you touch — even the power leads have to be left "untouched." Touch the paddle only.

Building the keyer is made quite simple by the fact that all the parts can be anything close to the value given. There is a good 50% tolerance allowable, and the keyer will still work. So, if you don't happen to have the value that is called for on the diagram, just try something that is as

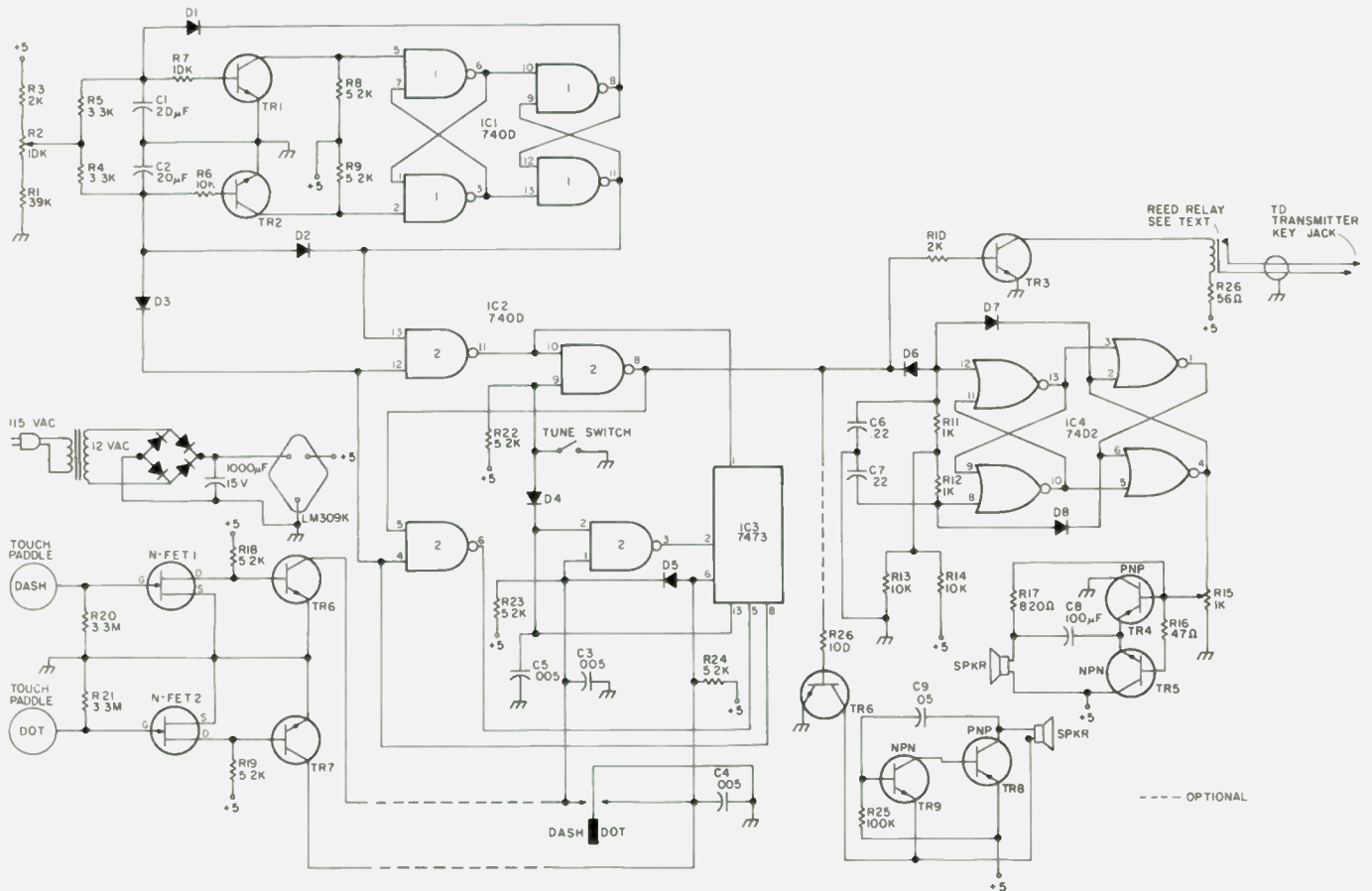

Fig. 1. Super deluxe Novice keyer. Power connections: IC1 — connect 7 to ground and 14 to +5 V; IC2 — connect 7 to ground and 14 to +5 V; IC3 — connect 11 to ground and 3, 4, 7, 10, and 14 to +5 V; IC4 — connect as IC2.

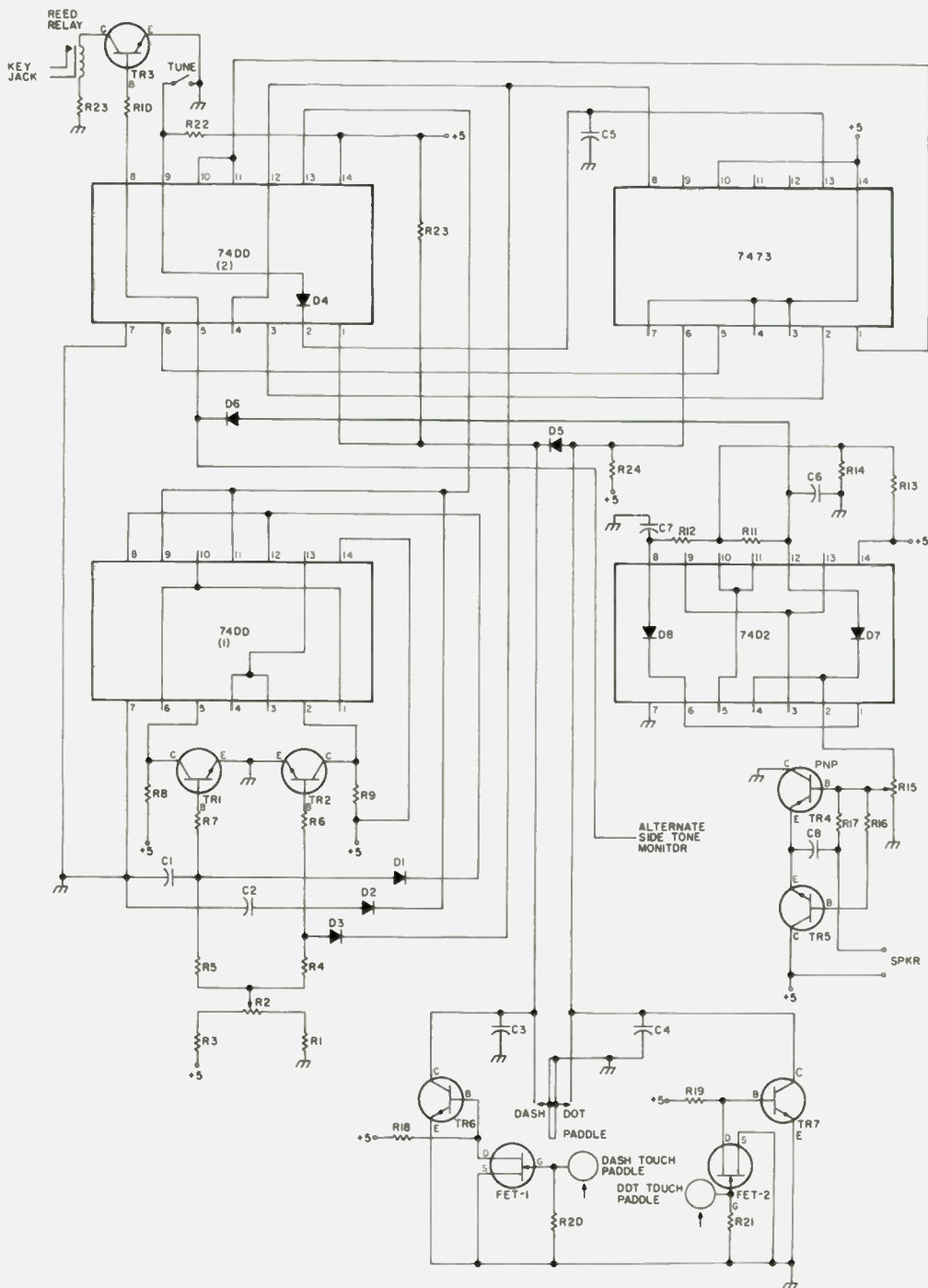

Fig. 2. Deluxe keyer wiring layout.

close as you have. It is fun to vary the parts, too — for instance, you could change the timing resistor (R2) and capacitors (C1 and C2) to get various rates of keying. Different values of resistance in the tone control (R13 and R14) also can give you a tone that you like. Use any NPN transistors you happen to have (gain is not particularly important) and, also, any PNP transistors for TR4 or TR8. This goes for the diodes used, too. I got mine by

stripping computer boards. They were all FD10 types (whatever that might mean!), but any small signal diode should work well. Just be sure you install the diodes with the right polarity, as indicated on the diagram. The rectifier diodes, however, have to be capable of 500 mA, so don't use ordinary signal diodes here.

The reed relay is a mini relay sold by Poly Paks. Find the thinnest magnet wire you have around, say #34 or so,

and wind about 800 turns around the glass-enclosed relay. For R26, try a couple different resistors, until you find one that gives a good closure of the relay on keying. Or skip the resistor altogether, if you don't mind drawing a little extra current.

The whole keyer, with sidetone at high volume, should not draw more than 250 mA. Of course, this will be lessened if you use the optional sidetone monitor shown on the diagram. And,

of course, you will draw even less current if you skip the sidetone feature altogether and depend on an rf keying monitor on your rig for monitoring. The keyer, as good as it is, is still just a simple three-IC keyer, so it can be reduced to these first three ICs, if you wish the basic keyer alone.

The sidetone monitor, as given, is coupled directly to the last IC in the keyer itself (IC2), so the tone might change with a change of volume. If this is undesirable, you could add another IC and use two or three gates as buffers, or, preferably, find a transistor output transformer and skip the OTL (output-transformer-less) circuit used. I used it to increase the volume, as I didn't happen to have an output transformer available at the time. I've included another sidetone circuit which skips the last IC altogether — you'll have to experiment, however, to get the volume you want.

The paddle is homemade, constructed from a piece of plastic that is fairly stiff. Cut two pieces of thin aluminum to the shapes shown, one for each side of the paddle, and glue them on each side of the paddle. Note that the bolts are offset from each other. These bolts are used for mounting — using any kind of bracket you can think of — and they are also used as contacts for the paddle. One bolt contacts one piece of aluminum, and the other bolt contacts the aluminum on the other side. Then from the bolts come the leads that go to the gates of the FETs on each side of the paddle. If you don't use the touch feature, you can fabricate a paddle out of a piece of stiff aluminum or iron (like a table knife blade) by bolting the far end onto the keyer ground and putting contacts (small bolts through brackets) at the front end just inside the keyer enclosure, close to each side of the paddle. After a little use, you will find that you want the contacts very

close to the paddle so that you barely have to move the paddle between dots and dashes.

I power my keyer from my SB-104 transceiver 5-volt supply, but I've included the diagram of a simple power supply consisting of a twelve-volt transformer, rectifier bridge, capacitor, and an LM309K voltage regulator. This last insures you will get only five volts on the keyer. The ICs are not very tolerant of much higher voltages. Don't try to use a six-volt transformer, as you will have to use much more capacitance, and the keying will be erratic.

The complete diagram of the keyer is given in Fig. 1. Fig. 2 is perhaps even more important, as it gives you the actual wiring layout to wire the parts on the board. A parts placement I used for the top of the board is given, but placement is mostly up to you. What is not indicated above chassis (board) is put in somewhere below. Don't crowd the parts. Bring out wires from the IC sockets and place the parts well away. Parts placement is not at all critical, and leaving plenty of room will make it easier to check voltages, etc., for debugging.

After wiring comes the debugging. If you go about this in a systematic way, you will have no trouble. Of course, if the keyer works as

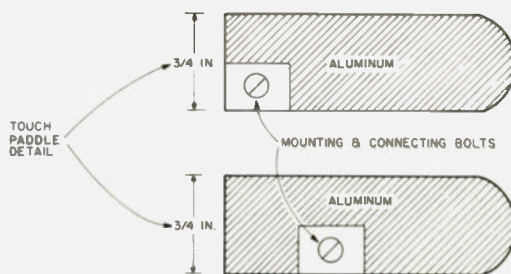
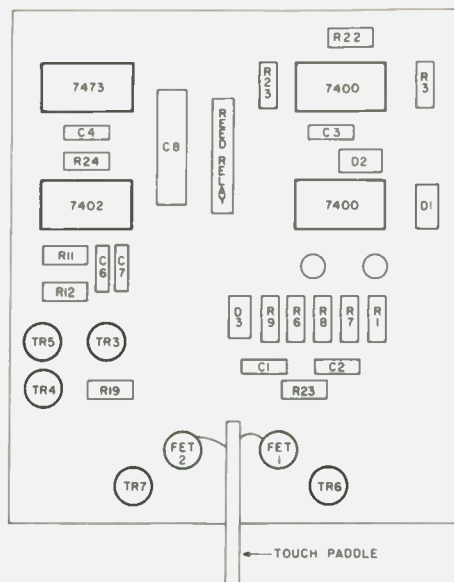

Fig. 3. Deluxe keyer parts layout.

soon as you put it together, all you have to do is put it in a cabinet, and that's it. But it's possible there will be some part wired wrongly or forgotten.

First check out your input wiring. Is it really 5 volts or close to it? Then check that all the ICs are actually getting this 5 volts on all the pins listed for 5 volts. If some IC doesn't have five volts where it should, trace down your wiring till you find where the five volts disappear — it may be a capacitor that is shorted, or it may be that you forgot to wire that particular pin on the IC. After making sure of the power to all ICs, check voltages, as given in the debugging chart, for the rest of

the pins with the power connected but, at first, without touching the paddle. See if the pins are high (close to 5 volts, that is, anywhere between 3.5 V to 4.5 V) or low (less than 2 V). If these are not as the chart indicates, again check the IC itself (by substituting another one, if you have one, or by begging one off some ham friend), perhaps by having a ham friend who has worked with ICs check it out for you.

If you have to check out the ICs yourself, there have been a number of good articles on ICs in *73 Magazine* that you would do well to study. Once you know about gates and flip-flops, it isn't hard to make simple checks to see if they are working or not. Remember that the IC has to have its five volts and ground connected before you can get a gate to work like it should.

Once the static condition of the keyer is checked out, you connect the paddle to ground or touch the touch paddle and check again according to the chart. On several pins, the voltages will fluctuate between zero and your full high voltage (close to five volts). However, your meter will be unable to indicate this at the keying speed. It will wobble around some intermediate voltage. This is

what I mean by voltage varying with keying speed. Some pins, however, will change abruptly from high to low and vice versa, and, of course, the power connections will remain high.

The whole keyer is actually a lot simpler than the diagram indicates. I put together a demonstration model on a protoboard first, and it worked right off, even though it looked a big mess. If you leave yourself plenty of room to check it out, it will go together in a surprisingly short time. And it will make your keying sound very good once you practice a little and get to know how an electronic keyer works. Here's hoping I'll hear a lot of good CW on the bands very soon. ■

Parts List

R1	39k
R2	10k pot
R3, 10	2k
R4, 5	3.3k
R6, 7, 13, 14	10k
R8, 9, 18, 19	
22, 23, 24	5.2k
R11, 12	1k
R15	1k pot
R16	47 Ohm
R17	820 Ohm
R20, 21	3.3 megohm
R25	100k
R26	56 Ohm
C1	20 uF
C2	20 uF
C3, 4, 5	.005 uF
C6, 7	.22 uF
C8	100 uF 10 V
C9	.05 uF

First: Check all pins that should be connected to +5 volts to see if the 5 volts are reaching these pins.

With power applied but key not contacting, check for the following:

IC1 — High (near 5 volts): pins 1, 2, 5, 6, 9, 10, and 11.

Low (near zero): pins 3, 4, 8, 12, and 13.

IC2 — High (near 5 volts): pins 1, 5, 6 (grounded when dot is sent), 9, and 13.

Low (near zero): pins 2, 8, and 12.

Power applied and either dot or dash paddle grounded:

IC1 — Pins 1, 2, 3, 4, 5, 6, 8, 9, 10, 11, 12, and 13 vary at an intermediate voltage while keying, depending on keying speed.

IC2 — Pin 1 goes low on dash.

Pins 4 and 12 go high and remain thus while keying.

Pins 5, 6, 8, 10, 11, and 13 vary at an intermediate voltage while keying.

IC3 — Pins 1 and 5 vary in voltage with keying speed.

Pin 6 goes low when dot is sent.

Pin 8 goes high and remains there while keying.

Pin 9 goes low and remains there while keying.

Table 1. Debugging chart for super deluxe keyer.

How Many pF Is That Capacitor, Really?

—build this simple PLL C-meter

Tucked away in our junk box someplace, most of us have jars, boxes, paper bags, or whatever of surplus capacitors — capacitors that are perfectly usable but not particularly useful because we can't decipher the color code or numbering system that designates their value. Many of us have also had occasions when we wished to twist up a "gimmick," or check the value of an unmarked air-variable, or determine the exact

value of a ceramic disc before we install it in a particularly critical circuit. The more sophisticated tinkers may recall a time when they wanted to measure the stray capacitance between the leads in a wire bundle or between the foils on a printed circuit board. If any of the above situations sound familiar, read on, because here is a project to help you out of all those dilemmas. When completed, it will provide you

with the capability to measure any value of capacitance between 0 pF and 1 uF by merely pushing a button and reading a meter. Not only that, the cost is reasonable, construction is quick and easy, and the parts are available from your nearest Radio Shack or mail-order parts supplier if they aren't already in your junk box.

The circuit is an adaptation of an old principle which, simply stated, says

that the ac current flow through a capacitor is dependent upon the voltage applied, the frequency of the waveform, and the value of the capacitance. In this case, use of a square wave allows the capacitor to charge to its full potential and permits measurement of current flow as a linear function of capacitance.

In operation, depressing the read button applies the regulated 15-volt output of the LM78L15 to the LM566 phase locked loop voltage controlled oscillator (VCO). Regulating the Vcc input to the VCO insures that the calibration of the capacitance meter will be stable as long as the battery voltage remains above approximately 16 volts. The frequency at which the VCO oscillates is determined by selection of the proper RC combination (R1/C1, R2/C2, etc.) with the rotary switch. The square wave output from pin 3 is fed directly to the unknown capacitor whose value determines the current flow and subsequent meter reading. Rectification and filtering are provided by diodes D1 and D2 and the 30 uF electrolytic capacitor. The switch selected RC combinations provide six linear scales: 0-10 pF, 10-100 pF, 100-1000 pF, 1000

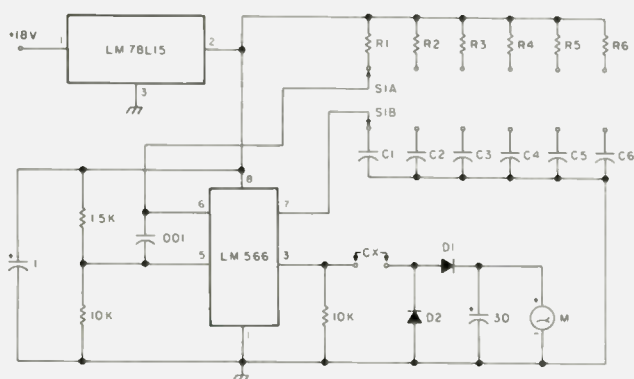

RANGE	R	C
x1 pF	10k var.	100 pF (C1)
X10 pF	"	.001 (C2)
x100 pF	"	.01 (C3)
x.001	"	.1 (C4)
x.01	"	1 (C5)
x.1	"	10 (C6)

Parts List

- Bakelite box — 6-1/4" x 3-3/4" x 2"
- Rotary switch — 2-pole, 6-position
- Momentary switch — SPST, NO
- *Precision panel meter — 100 microamps
- Knob
- Binding posts — red & black
- LM566 — 8-pin DIP VCO IC
- LM78L15 — 15 V regulator, TO-92
- 8-pin IC socket
- Small signal diodes (2)
- Printed circuit trim pots, 10k (6)
- 100 pF
- .001 uF
- .01 uF
- .1 uF
- 1 uF
- 10 uF
- 1 uF ceramic disc/electrolytic
- .001 uF ceramic disc capacitor
- 30 uF, 16 V electrolytic capacitor (20 uF-50 uF suitable)
- 1.5k 1/4 W resistor
- 10 k 1/4 W resistors (2)
- Circuit board (available from author for \$5.00)
- 9 V batteries (2)
- 9 V battery clips (2)
- 9 V battery holders (2)/double-sided tape/Super Stuff/etc.
- *Note: A 50 or 150 microamp meter can be substituted if desired.

Fig. 1. Note: All capacitance in microfarads unless otherwise annotated.

pF-.01 uF, .01-.1 uF, and .1-1 uF. Accuracy, dependent primarily upon the tolerance of the meter and the capacitors used for calibration, is approximately $\pm 5\%$. If a high quality meter is used and 1% tolerance capacitors are available for calibration, an accuracy of $\pm 2\%$ or better is possible.

For the most part, component selection is non-critical. The values of frequency-determining capacitors C1 through C6 may deviate from those specified by as much as 50%, but should be as stable as you can find to insure that the accuracy of the instrument is maintained under changing environmental conditions. The prototype used an aluminum electrolytic for C6 and ceramic discs for the remainder. After a night in the car at 15°F, the .1-1 uF scale read 10% low and the other scales were in error to some lesser degree until the instrument warmed up to room temperature. Diodes D1 and D2 can be either silicon or germanium, and the value of the 30 uF electrolytic can vary from 22 to 50 uF. The higher value will provide better filtering action at the low operating frequency of the .1-1 uF range, but slows the meter response when the circuit is activated. For R1 through R6, the fancier multiturn trimpots are nice and ease calibration, but the cheaper single-turn variety are more than adequate and are what the circuit board was designed for. If you're going to splurge anywhere, capacitors C1 through C6 and the meter movement are where quality counts most in this project.

Construction is accomplished by referring to Figs. 1 through 3 and the suggested front panel layout. Begin by drilling and lettering the front panel. For professional-looking results, the panel can be roughed with a stainless steel pad, or, if you prefer, sprayed with the background color of your choice.

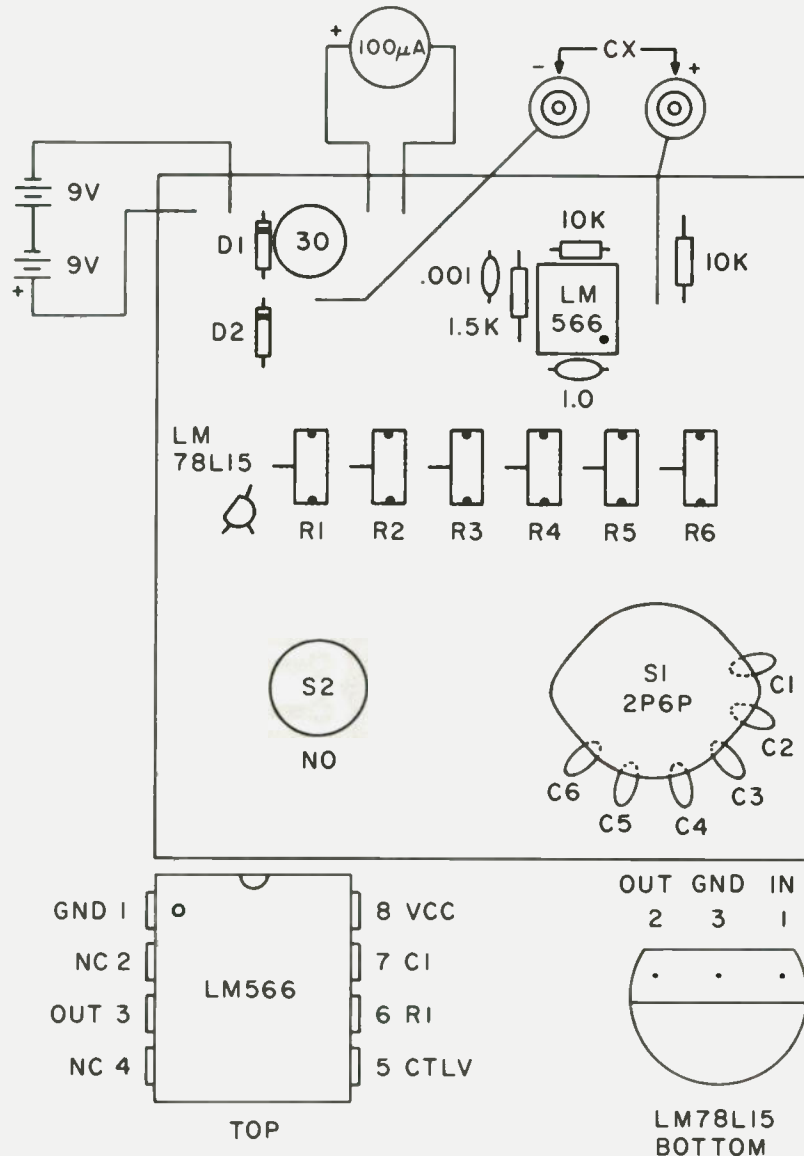
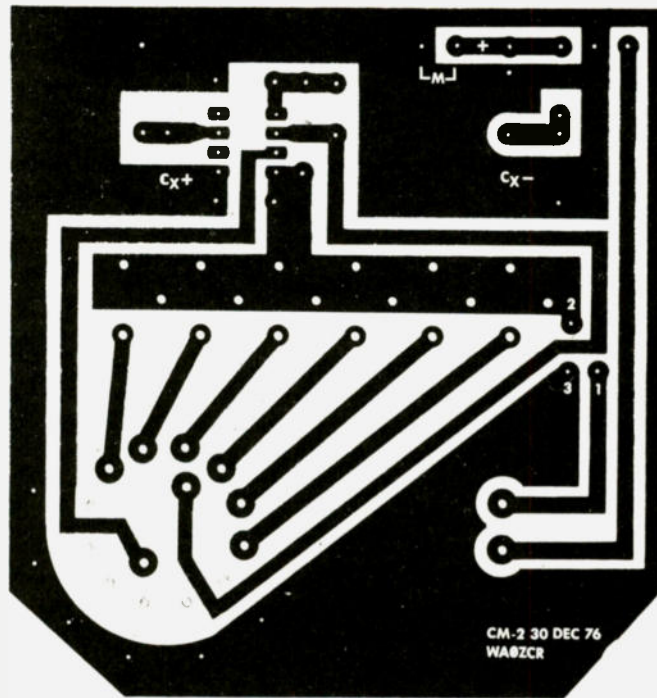

Fig. 2. Component placement. R1 through R6 and C1 through C6 mount on foil side of board, all other components on reverse.

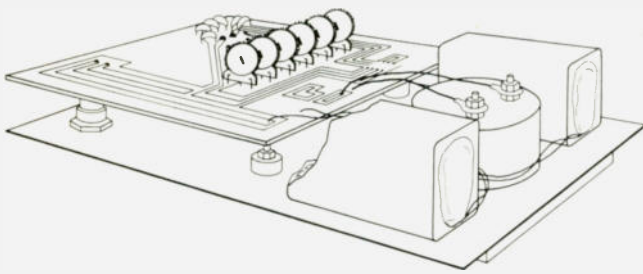

Fig. 3.

Lettering is most easily accomplished using "Dri-Transfer" letters available from Radio Shack, stationery stores, and other sources. For durability, the lettering should be sprayed with a clear protective coating such as Krylon. After lettering, install the meter, binding posts, and push-button switch, and then put the case aside for the moment.

Next install the remaining components, including the rotary switch, on the circuit board. R1 through R6 and C1 through C6 mount on the foil side, the remaining components on the reverse. The circuit board is supported by the switches and the leads from the binding posts. Solder a short length of solid conductor (a clipped-off resistor lead will do fine) directly to the tip of the screw end of each five-way binding post. Fit the board into position over the binding posts and push-button switch terminals and install the nut on the shaft of the rotary switch. Solder the leads from the binding posts and lugs from the push-button switch to the board. Connect the meter

leads to the points indicated and connect and install the batteries using double-sided tape or "Super Stuff" to hold them in position next to the meter.

After admiring your handiwork, you're ready for calibration. Use the most accurate capacitors available and begin with the x1 scale (0-10 pF). Connect the calibration capacitor to the terminals and adjust R1 for a meter reading that matches its value. When you have completed this procedure for the other five scales, install the completed instrument in the case and grab a handful of those previously unusable capacitors out of your junk box. Fun, isn't it? What's really interesting, though, is to measure some that are clearly marked with the value they are supposed to be.

When measuring values of less than 10 pF, stray capacitance can be a problem, so connect the capacitor leads directly to the terminals if possible. If not, plug in a set of extension leads with banana plugs on one end and alligator clips on the other. Position them as they will be

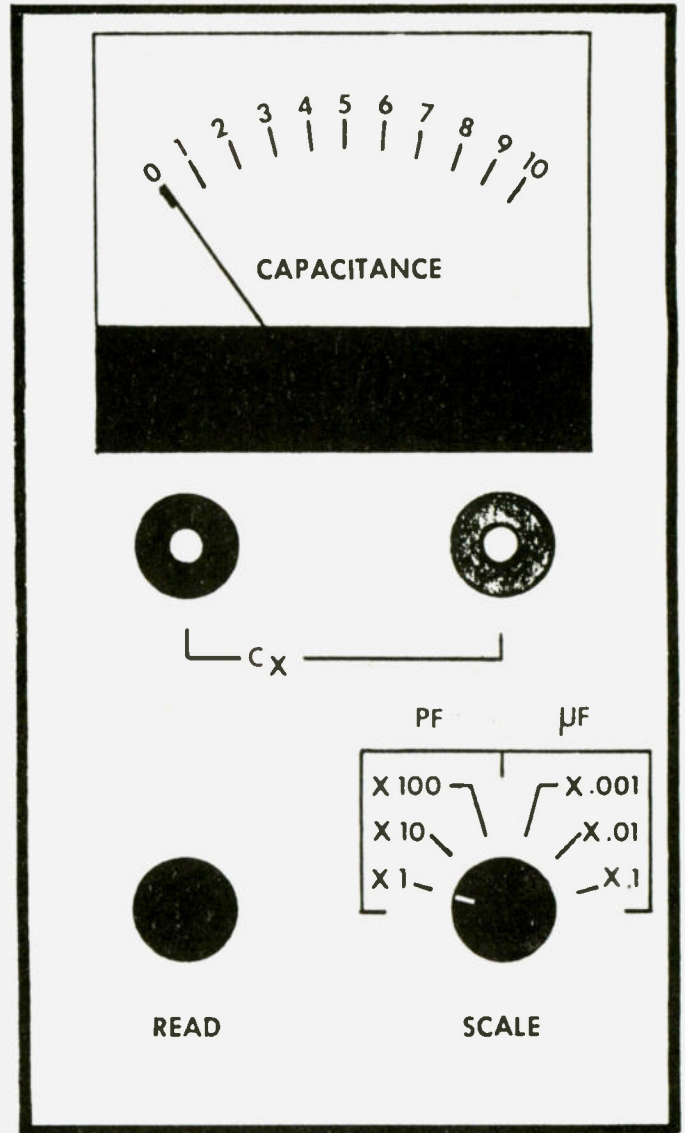

Fig. 4. Suggested front panel layout.

when you are making the measurement and check the stray capacitance. Subtract this reading from the indicated value of the unknown capacitor to obtain the actual value. If extension leads of more than two inches are

required, the same procedure should also be used on the x10 (10-100 pF) scale.

There it is — hope you enjoy building and using it as much as I have. Now, if I could just measure inductance with it... ■

...rooms don't ever provide
lousy manuscripts from the
burial...
I insist that you print or
tell Ma Bell that she should

from page 34

3. The fact that there is no room to hang the chad box is no problem, because the linear amplifier is an ideal receptacle for oily chad.

Perhaps Mr. Soxman intended just to store the TTY in that location and move it to the operating surface when

needed. A good idea for keeping in shape... an ASR-33 only weighs about 80 pounds.

I also notice that the linear amplifier is placed at the opposite end of the console from the transmitter. The fact that these units are used together functionally is no excuse to put them together physically. After all, lazy

hams need to stretch their bones every now and then. What better way than to stretch out across the console while adjusting the drive to the linear amplifier?

Mr. Soxman provides us with a very interesting formula for laying out a man-machine interface. Unfortunately, a vital term has been omitted from the equation: common sense.

William L. Mahood
Falls Church VA

HERESY

As a Novice, I presume I should be seen and not heard. However, I will risk bringing the QRM down around

my head by proposing additional use of CB transceivers on ten meters.

While all you good old Elmers are trying to get more activity going on ten and find a use for all the good transceivers lying around, why not carry your frequency allocation proposals a little further than 28.965, 28.255, etc., etc.?

I would propose an expansion of the ten meter Novice frequencies to include 28.2-28.4 as crystal control, 10 Watts max. input, AM phone operation. My reasoning for this proposal is based upon my belief that it would create additional activity on ten and thereby possibly ward off loss through WARC rulings. It would provide addi-

Continued on page 55

WITH COMPETITIVE PRICES GOING SKY-HIGH THE YAESU FT-101 SERIES IS STILL YOUR BEST BUY!



FT-101E

Top of the series, the FT-101E has everything—RF speech processor, AC and DC operation, plug-in PC boards for easy servicing—nothing has been omitted for excellent 160-10 meter performance.



FT-101EE

Just one step down is the FT-101EE identical in every respect—but less the RF speech processor—an item many hams can live without, thus saving a few dollars.



FT-101EX

The FT-101EX is the same basic unit, less DC/DC converter, 160M, WWV, and three of four 10 meter crystals and the RF speech processor. Many hams do not need these features and would just as soon save the money. All accessories may be added later and the "EX" can then become an "E".

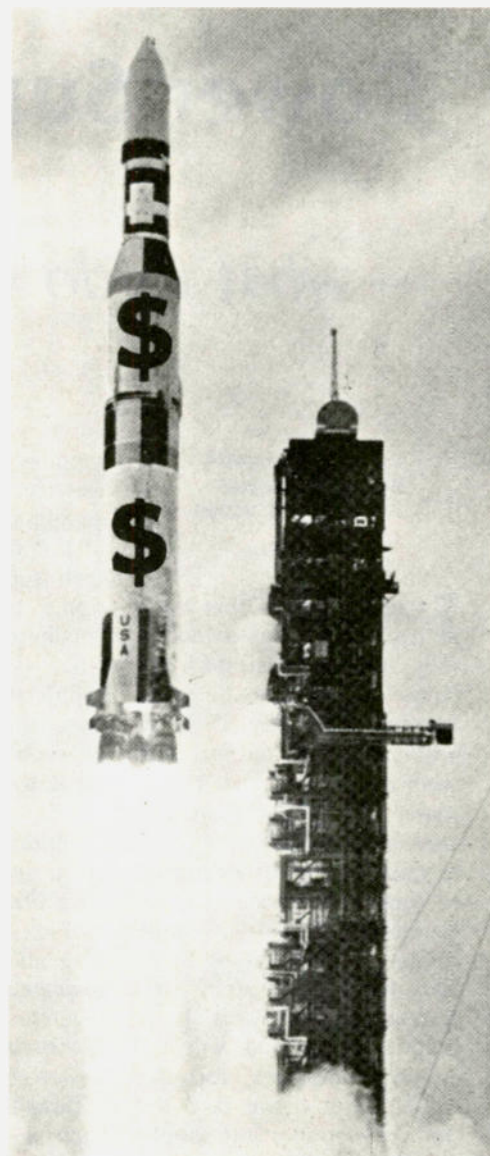

Amateur radio's first all plug-in PC board transceiver, the FT-101 series has a long pedigree of success dating back to the FT-101 and FT-101B. More than a quarter million are in use all over the world! Refinements have been added over the years to update the equipment and we believe it is the most thoroughly satisfactory and trouble-free transceiver money can buy. Compare price and features with any "Brand X" and you'll choose Yaesu!



YAESU
The radio.



Exorcising Power Supply Demons

— what to do when Murphy visits

Joseph J. Carr K4IPV
5440 So. 8th Road
Arlington VA 22204

It seems absurd that most novice troubleshooters will usually overlook the power supply as a source of trouble, especially if it is producing a dc output. The truth is, however, that the dc power supply is implicated in a majority of the faults found in most classes of electronic equipment, which includes equipment found in most amateur stations. Most of us take the power supply for granted, especially if it is producing dc, and will try looking elsewhere for the trouble. But if we take the trouble to look at the supply waveforms with an oscilloscope — and know what we are looking for — we can solve many of the trouble-shooting problems that previously seemed difficult.

Modern electronic equipment is operated from voltage-regulated power

supplies far more often than was true of the vacuum tube equipment of yesteryear. One of the most useful features of such supplies is that the ac ripple component normally encountered in rectifier circuits is almost completely suppressed by the regulator. Even those unregulated supplies which have a large filter capacitor will not hold a candle to "less-well-filtered" supplies that have lower value electrolytic filters but do have a regulator section.

Fig. 1 shows the block diagram of an electronically-regulated power supply. The regulator circuit might be any of several well-known multi-device circuits, or it might be a three-terminal IC regulator, such as the LM309, LM323, LM340, or 7800-series devices.

The waveforms to be found at points A and B are shown in Fig. 2. We can legitimately compare these voltages, because the oscilloscope was a dual-trace type, and the vertical amplifiers

were adjusted to have the same sensitivity (vertical volts/cm).

The top waveform in Fig. 2 shows the ripple waveform present at point A in Fig. 1. This is the output of the bridge rectifier, although the same waveform is also found with regular full-wave rectifiers. The bottom waveform in Fig. 2 shows the ripple component at the output of the regulator circuit. This is the waveform of the voltage actually applied to the circuits being served by this power supply. Note that, on the same voltage scale, this

waveform appears to be very nearly pure dc. Of course, if we increased the amplification of the vertical amplifier on the oscilloscope, we would see some ripple. It is, though, so low as to be almost ineffectual in most applications. This phenomenon is the basis for the claim by some manufacturers that they have an electronic circuit in their power supply that acts like a very large capacitor. One power supply used extensively as a battery eliminator by mobile servicers was touted as having the "equivalent of one farad of filter capacitance," but what they really had was a very effective voltage regulator circuit!

Whether IC or discrete components are used, it is usually the case that most low-cost regulators use a series pass transistor with its base controlled by a zener diode. If the regulator were to become defective because the series pass transistor shorted or the zener diode opened up, then we would find a high ripple component at both points A and B. Also, the dc voltage at point B would be excessive. The symptoms this causes will vary, depending mostly upon the type of equipment the supply serves and the nature of its circuitry.

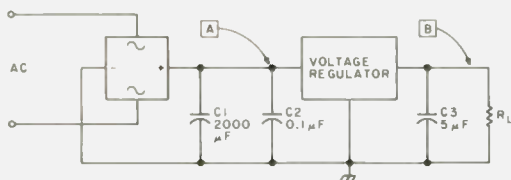

Fig. 1. A block diagram of an electronically-regulated (voltage) power supply typical of most modern solid state equipment.

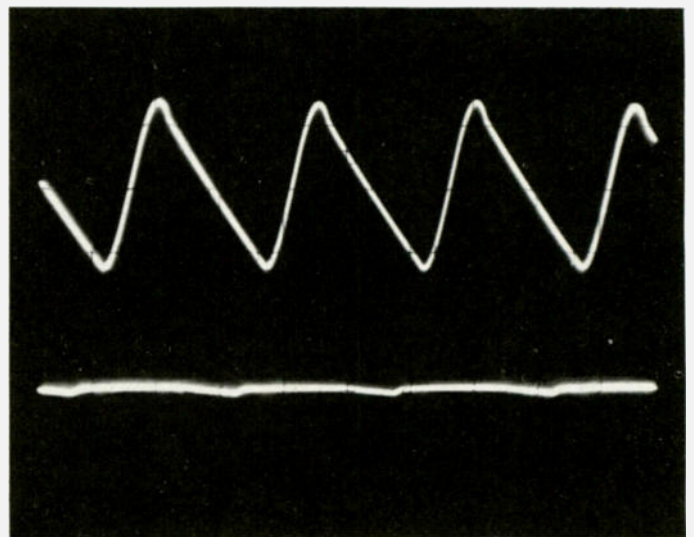

Fig. 2. Waveforms produced by the circuit in Fig. 1. The top waveform shows the ac ripple component at point A in Fig. 1. The lower one shows the ripple waveform at B, after the regulator.

In a receiver, for example, you might notice an audio hum in the output or a shift in dial calibration, because the local oscillator was "pulled." In a TV receiver, there might be one or two black "hum bars" slowly rolling up the picture. A side-band transmitter might produce out-of-calibration output for the same reason, or there might be hum on the modulation. On other types of equipment, there might be any of a wide variety of symptoms too numerous to catalog here. The one underlying common ground for many of them, though, is that they are weird and seem unexplained by the failure expected of standard parts in the circuits themselves. For this reason, it is recommended that the power supply be checked first. I keep service records on medical electronic equipment and have found, for a full year's work, that the power supply was the culprit in over half of the cases!

Another set of gremlins appears as a result of power supply turn-on and turn-off. We should be very interested in just what happens to the power supply at the instant of turn-on, because it is a very dynamic time for many electronic circuits. The turn-on waveform often reveals some very difficult-to-

locate problems.

Fig. 3 shows the normal rising waveform of a positive power supply that is mostly resistive (little filtering). Fig. 4, on the other hand, shows the damped waveform to expect when turning on a high-capacitance power supply that has a high time constant. This particular waveform was taken in a supply that used a 3000 uF capacitor and a 68-Ohm resistor (in place of the choke).

Ordinarily, this type of information is of little interest, but occasionally we see a piece of equipment or a circuit where it becomes an important factor. Two different types of problems are involved here: latch-up on t/on and intermittently blowing certain solid state devices. Such circuits generally use dual-polarity power supplies and may have operational amplifiers or other linear IC devices. In other cases, though, the performance of the IC version is approximated by a discrete circuit of diodes and transistors.

The root source of the problem is having two opposite-polarity power supplies, one of which lags a little bit behind its companion at either turn-on or turn-off. An open capacitor will substantially reduce the time constant of a power supply. Figs. 3 and 4 show

the rise characteristics of resistive and capacitive power lines, respectively. Ordinarily, power supplies for solid state circuits will more likely resemble the latter, unless the power supply capacitor is open. This type of problem can be diagnosed best on an oscilloscope, preferably a dual-trace type with one input on each of the two supplies. Examine the rise times to see if they are approximately equal.

Similarly, you should also consider what happens at turn-off. This is especially true in dual-supply IC circuits; in fact, it is often critical.

Most IC devices have PN junctions between the active transistors and other components of the device and the substratum of the IC on which it is built. In normal operation, these PN junctions (in effect, diodes) are reverse biased, so they are inert in the circuit, save for a minute leakage current, if any.

In certain IC circuits, particularly those with dual-polarity dc power supplies, certain conditions can cause this PN junction, or diode, if you prefer, to become inadvertently forward biased. Under this condition, if sufficient current flows, the IC will be destroyed.

A common type of linear

IC circuit configuration is shown in Fig. 5. Device U1 is any of a number of IC amplifiers or signal processor devices. For purposes of this discussion, though, we will not worry which it is, because the problem is generic to a large class of circuits and devices that uses dual-polarity supplies.

In this particular circuit, there are three sources of rather substantial current flow: Vcc (+), Vee (-), and the charge stored in capacitor C1. If the Vcc and Vee supplies decay unequally, then there might exist a brief moment in which the voltage between one power supply terminal and the top of C1 is opposite its normal relationship. In most cases, especially op amp circuits, the particular failure mode seen most often is reversal of the relationship of the Vee-C1 voltage. This may forward bias the substratum diode and allow a current to flow that is great enough to destroy the IC. In this type of failure, the probability of damage is directly related to the decay-time lag and the value of C1. Large values for C1 mean that more charge can be stored and will be discharged more slowly. This type of problem is seen most often in those circuits in which either Vcc or Vee is a lot less loaded than the other supply. An

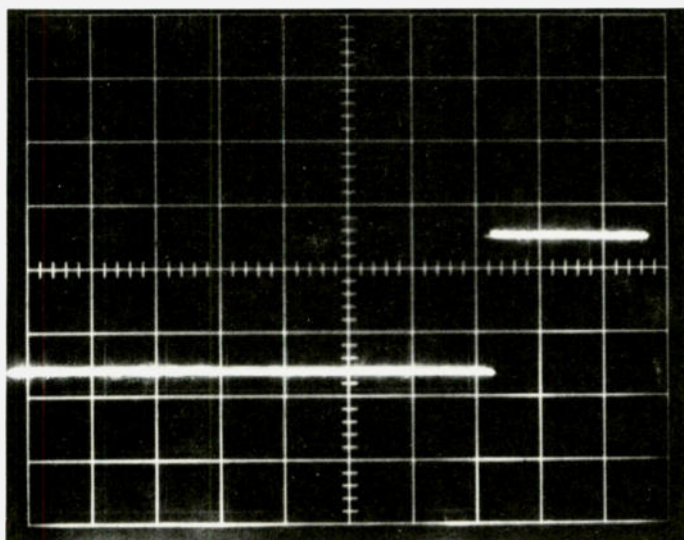

Fig. 3. Normal waveform of a positive power supply with a short time constant.

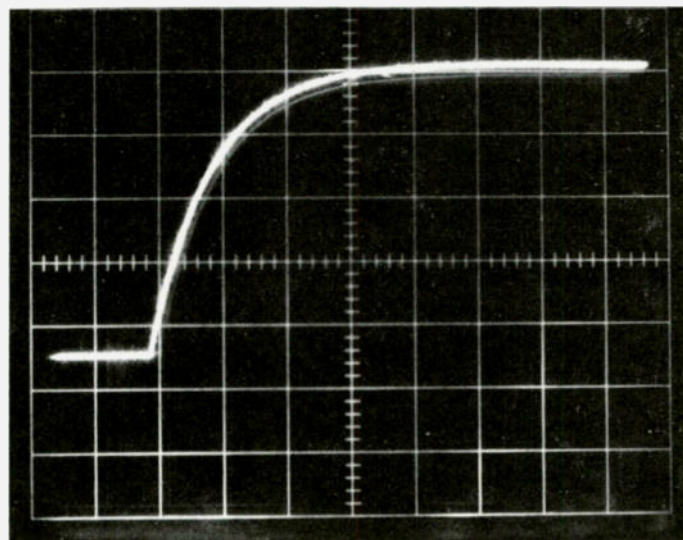

Fig. 4. Waveform of a power supply with a long time constant, as might be found in most circuits.

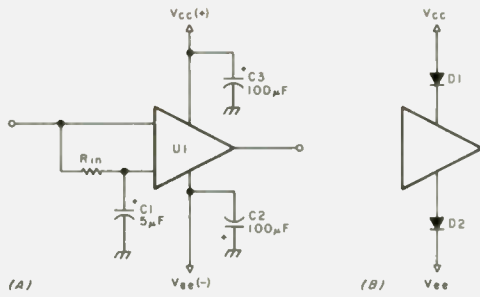

Fig. 5. (a) Common type of linear IC circuit configuration. (b) Diode protection against reverse current flow if V_{cc} or V_{ee} decay too slowly relative to the other. D1, D2 - any of the 1N4000 series.

example, of course, might be microprocessors that use ± 12 V dc supplies and load the -12 less.

If an oscilloscope examination reveals substantially different power supply rise or fall times, especially the latter, then suspect this as a possible cause of recurrent IC failure.

The best cure for the problem is to find out exactly why the two supplies decay in an uneven manner. In normal operation, we can reasonably expect both supplies to decay more or less equally. A defect in an electronic regulator circuit or an open filter capacitor may tend to upset this balance.

Another cure may be to modify the circuit to prevent the reverse current flow through the IC. It is, after all, that current flow that causes the damage. This may be

especially appealing if there is nothing wrong with the supplies and it is suspected that the uneven decay is due to either their respective designs or an unbalanced load requirement. The particular modification is shown in Fig. 5(b), and consists of two solid state diodes connected with their polarity arranged so that only current of the correct polarity can pass. If you inspect the circuits of many pieces of equipment using dual supplies with either operational amplifier or discrete circuitry, you will often see diodes that seem about as effective as a block of wood, because they are reverse biased in normal operation. It is precisely this type of thing that those diodes are used to guard against.

Now let us look at one last class of gremlin that can arise

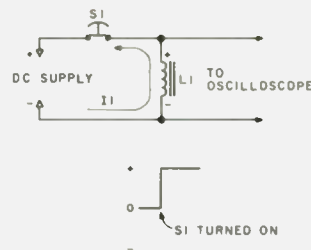

Fig. 6(a). When S1 is closed, current I1 flows through L1, creating a magnetic field around the coil.

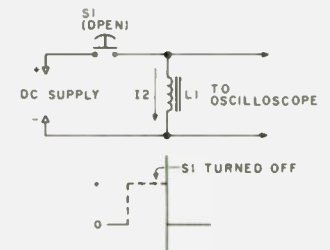

Fig. 6(b). When the switch is opened, the field around L1 collapses and a reverse current flows, creating the inductive kick spike.

from either the power supply, electromechanical devices in circuit, or from situations where a squarish blast of current is applied to an inductive component such as a TV receiver yoke or power supply choke.

A phenomenon called by some "inductive kick" is shown in Figs. 6(a)-6(c). Consider a series circuit consisting of an SPST push-button switch (for rapid, pulse-like action) and an inductor. This circuit, as shown in Figs. 6(a) and 6(b), is connected across a dc power supply. When switch S1 is closed, a current, I1, will flow, and this builds up a magnetic field around L1. But when S1 is released, as in Fig. 6(b), the current flow ceases, and a reverse current is found to flow in L1 that creates a large voltage spike across L1. This is not the fault of the CEMF, for, by Lenz' Law, the CEMF will oppose the decay, so it is

series-aiding. The voltage spike is of opposite polarity, so it is due to the fact that electrons had tended to pile up at the inductor's upper end while the dc power was applied. When the power is removed, these electrons seek to reestablish neutrality, so they rush through the coil in the opposite direction from the initial current flow. Since the voltage is equal to L (di/dt), and the rate of change (di/dt) is typically very high, then the voltage is also very high. An oscilloscope photograph of the circuit action is shown in Fig. 6(c). I used a heavy 5 H choke for L1. Note the voltage spikes on the trailing edge of each pulse.

Next let's consider the type of circuit shown in Fig. 7. This is essentially the same as that of Fig. 6, except that a capacitor is in parallel with the inductor, and that complicates matters a little. Keep in mind that the coil in these examples could be a relay coil, solenoid, or other electromechanical device, or a TV monitor flyback transformer hit by horizontal deflection

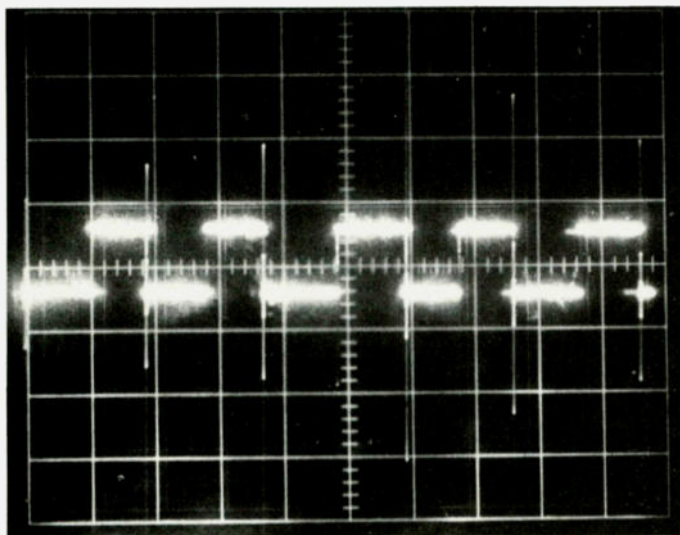

Fig. 6(c). Oscilloscope photograph showing the voltage across L1 as S1 is repeatedly pressed several times in a row.

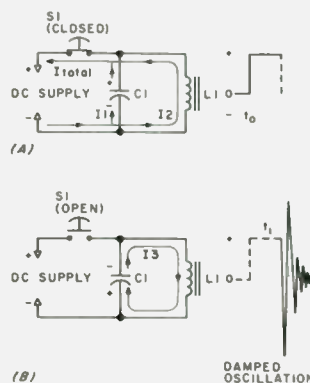

Fig. 7. (a) When S1 is closed, we have the same action as in Fig. 6(a), but the capacitor also charges. (b) In addition to the inductive kick, we get a damped oscillation on the trailing edge of the waveform.

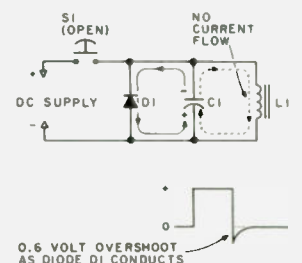

Fig. 8. A diode is used to suppress the inductive kick spike.

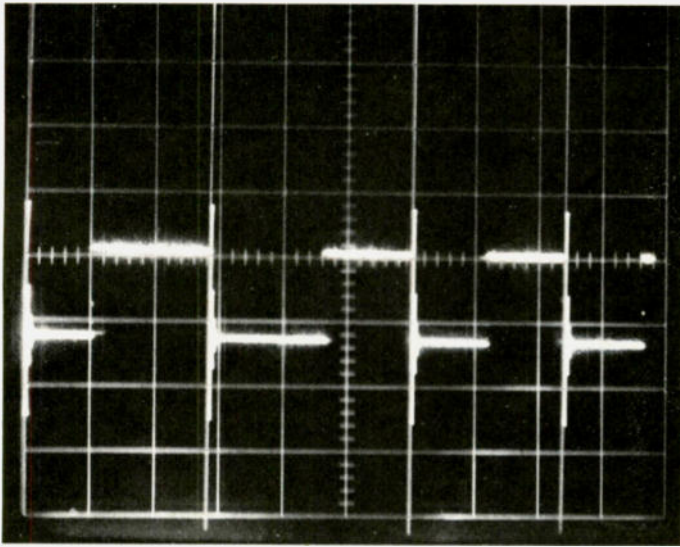

Fig. 9(a). Waveform produced if D1 (Fig. 8) is open or missing.

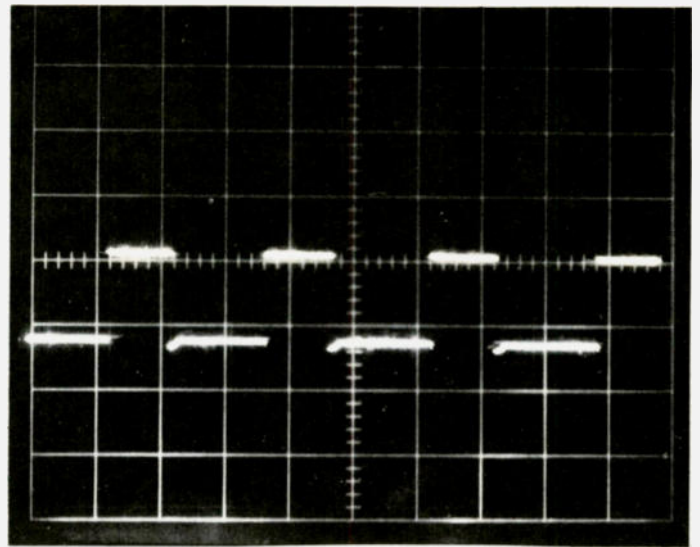

Fig. 9(b). Normal waveform when D1 is doing its job. The spikes produced in (a) will reset flip-flops, increment counters, and may destroy some IC and discrete semiconductor devices.

pulses.

In Fig. 7(a), the switch S1 is depressed, and the current is turned on. The applied voltage charges capacitor C1 and creates a magnetic field around L1. The output voltage at this point is the battery voltage. The waveform occurring at the instant of turn-on is shown in the figure.

In Fig. 7(b), the switch is released and the current from the supply is turned off. The capacitor C1 discharges, and the magnetic field around the coil collapses. The combined current from the coil's collapsing field and the capacitor discharge will conspire to produce not only the inductive kick phenomenon, but also a brief damped oscillation.

A diode (D1 in Fig. 8) is usually placed in such circuits to eliminate or suppress the so-called inductive kick. If

the diode were to open (and that does happen), the spike would be allowed to get into the circuit, because it is not suppressed. This could easily create a "glitch" that scrambles the brains of finicky high-frequency digital circuitry and may destroy some types of solid state devices. In the digital case, we find the spike getting into, and resetting at inopportune moments, flip-flops and counters. In other cases, especially where MOSFETs or CMOS chips are used, the device might be destroyed. The spikes shown in the waveform photographs only appear to be about 50 volts, but this is deceiving because the Polaroid film I used would not "write" fast enough to capture the whole spike amplitude. In actuality, it was over 200 volts! This could easily destroy unpro-

tected CMOS or MOSFET devices.

In Fig. 8, a diode (D1) has been added to suppress the spike. Now when the switch is released and the current is turned off, the capacitor discharge and inductive kick will forward bias the diode. Once the spike voltage gets to approximately 0.6 volts, the diode will start to conduct and effectively clamps the voltage. The waveform produced by this action is also shown in Fig. 8. Actual oscilloscope waveforms produced by a circuit such as that described are shown in Fig. 9. In each case, the push-button was pulsed on and off a few times while the scope swept across the screen once. Note that the leading edges are missing, but this is due to the

rise time of my elderly Tektronix plug-in and the speed of the film emulsion. Fig. 9(a) shows what is seen if diode D1 were open, or missing, while Fig. 9(b) shows the waveform in a normally operating circuit.

At this point, let me point out that these problems are real-life, not textbook, problems which I encountered in my day-to-day work. They are also very difficult, perhaps almost impossible, to find without an oscilloscope. Mine is only an old 650 kHz model, so no high-technology, multi-kilodollar investment is required. For this reason, let me nudge you toward ownership of such an instrument — even if only in partnership with another amateur or your local club. ■

...rooms don't ever profit
lousy manuscripts from that
buried in the...
LETTERS
...I insist that you print ev
tell Ma bell that she shou

from page 50

tional incentive, as in "incentive licensing," provide practical application of theory vs. appliance operation via the reworking of low-cost available equipment, and provide valuable training in the fine art of proper phone operation!

Now that I have voiced unmentionable heresy, I will dismantle my antennas, pull my finals out of the old B&W, and hide in the basement until the wrath of my peers hath dissipated.

By the way, Wayne, you and the *Drum* look to be in pretty good shape.

Bill James WD0AUU
Denver CO

EXTEND 20

With regard to your idea to extend the 20 meter phone band to 14.1, I am for it 100%.

I have done considerable operating from Gibraltar as ZB2CS. Much to my surprise, I found most Europeans and Africans above 14.2, and very light activity in 14.1/14.2. In trying to work other DX, the main problem was powerful Italians and Germans dominating the frequencies — not Americans. I would like to see the American section extended to 14.125, and 14.100 to 14.125 reserved for low-power split DXpedition operation and "rest-of-the-world" types who don't want W/K breakers. Most of the

"rest of the world" is talking to W/K a lot of the time, anyway, and the variations in propagation provide a curtain of privacy at other times. I would be glad to serve as an originator of a petition for this purpose and receive mail in support of the idea.

Ronald C. Williams
1147 N. Emerson
Indianapolis IN 46219

BETTER FROGS

My two 73 articles concerning the Yaesu FRG-7 receiver have drawn considerable mail, indicating a wide-

Continued on page 87

The Full Spectrum of VHF

SCR 1000 - Standard of Comparison In Repeaters - Now Available with Autopatch!



**2M
&
220 MHz!**

Optional Cabinet
\$130.00

The SCR1000/SCAP Combination — A New Dimension in Autopatch Repeater Performance

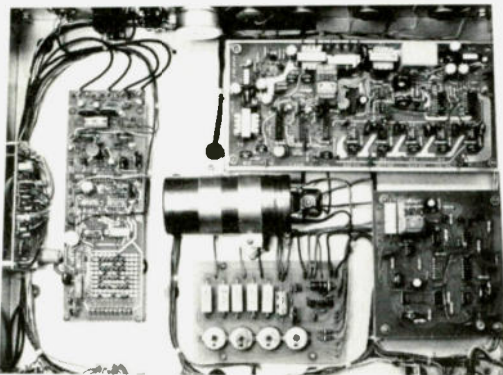

Under chassis view of SCR1000 with Autopatch installed.

Now Spec Comm has taken the hassle out of putting an autopatch repeater on the air! The SCR1000/SCAP is a fully self-contained 30 watt repeater with built-in autopatch and land line control. You simply plug in the phone line, hook up the duplexer, and you're on the air! The usual months of problems are eliminated! The SCR1000/SCAP has been meticulously engineered to provide the smoothest performing patch together with a positive land line control of the repeater. Just look at all these features:

Features:

- Normal patch, or secure "reverse" patch
- 3 digit anti-falsing access — single digit disconnect
- 3 digit on-off control of repeater transmitter
- 4 sec. time limit on access

- Built-in adjustable time-out function — patch shuts down in 30-90 sec. if no carrier is received
- Wide range audio AGC
- User can mute phone line audio simply by keying his mic button — prevents embarrassing language from being repeated
- Patch access and repeater control — either over the air or over the land line

The SCR1000/SCAP is a complete Autopatch Repeater — fully assembled, set-up and checked-out in our lab. As with all Spec Comm products, all workmanship and components are of the very highest quality. The price? A very reasonable \$1499.95 — complete! (\$1995.00 w/WP641 Duplexer). Get you order in A.S.A.P.

Call or write today and get the details!

(Ship./Handl. — \$3.50. PA residents add 6% tax)



SPECTRUM

1055 W. Germantown Pk.,

/FM Repeater Equipment

Quality Speaks For Itself!

See what our customers have to say about the SCR 1000

"... The quality of the audio is unbelievable — a true reproduction of the input. It really does sound like simplex. The receiver sensitivity of our Spectrum system is at least twice the Motorola system we had in service. We have 24 Watts out of our duplexer. We all have fallen in love with your machine... Again, thank you for an excellent piece of equipment. We are certainly glad that we purchased a Spectrum 1000 Repeater."

Jim Wood W3WJK
Mars, PA 16046

"You have a product that more than meets the specifications you claim... In the receiver you have a winner, the intermod is negligible... We have many other repeaters both amateur and commercial in the area and as of yet no problem... In closing, I would like to thank you for producing a product that does what is expected of it. In this world one seldom gets what he pays for; I feel our group has bought and received our moneys worth."

Jim Todd WA5HTT
Dallas TX

"The receiver is excellent: typically, if a 25-watt mobile can hear the machine (running 100 watts out of the duplexer), he can get into it. That's pretty good, I must say. Although I'm on a 15-kHz "splinter" between two BIG repeaters, we don't have any adjacent-channel problems with the SCR1000's receiver... although the "local" 19/79 group has headaches from their repeater's receiver whenever a mobile operating 146.205, (our

freq.), in their area keys up. And their machine is totally "commercial"! Needless to say, the audio quality of the SCR1000 is pretty spectacular. Switching from input to output, even Melissa Manchester can't tell the difference — and neither can I."

S. Katz WB2WIK

- The SCR1000 — simply the finest repeater available on the amateur market... and often compared to "commercial" units selling for 3-4 times the price! This is a 30Wt. unit, with a very sensitive & selective receiver. Included is a built-in AC Supply, CW IDer, full metering and lighted status indicators/control push-buttons, crystals, local mic, etc. Also provided are jacks for emergency power, remote control, autopatch, etc.
- A full complement of options are available: Duplexers, Cable, 'PL', HI/LO Power, Autopatch, Racks, etc. Please Inquire.
- The Spec Comm Repeater System... a sound investment... available only by direct factory order. \$950.00 Amateur Net. Commercial price somewhat higher.

SPEC COMM REPEATER BOARDS, SUB-ASSEMBLIES & ACCESSORIES

All equipment assembled & tested. For 2M & 220 MHz.

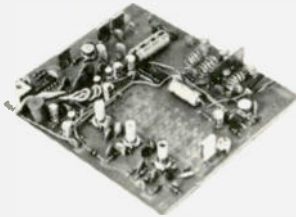

SCR100 Receiver Board

- Ext. wide dynamic range! Greatly reduces overload, 'desense', and IM.
- Sens. 0.3uV/20dB Q1.
- Sel. -6dB @ ± 6.5 KHz, -90dB @ ± 30KHz, (-110dB w/opt. 8 Pole Fitr.)
- Exc. audio quality! Fast squeeze! \$115.00 w/xtal.

SCR100 Receiver Assembly

- SCR100 mounted in shielded housing
- Same as used on SCR1000
- Completely asmbld. w/F.T. caps, S0239 conn., AF Gain Pot \$185.00

TRA-1 Timer Reset Annunciator Board

- Puts out a tone "beep" on rptr. xmtr. apx. 1 sec. after rcvd. signal drops — thus allowing time for breakers
- Resets rptr. time-out timer when tone is emitted
- Adjustable time delay and tone duration
- Typically used with CTC100 and ID100
- \$20.95 (Add \$18.00 for inst. & ck. out in SCR1000)

CTC100COR/Timer/Control Board

- Complete COR circuitry
- Carrier 'Hang' & T.O. Timers
- Remote xmtr. control
- 100% Solid State CMOS logic
- Many other features \$35.00



FL-6 Rcvr. Front-End Filter/Preamp

- Low-noise preamp combined with 6 section filter
- Provides tremendous rejection of "out-of-band" signals
- Extremely helpful at sites with many nearby transmitters
- Gain: apx. 12dB
- Selectivity: -20dB @ ± 1.7 MHz; -60dB @ ± 4 MHz (typ.)
- \$69.95 (Add \$10.00 for installation & ck.-out in SCR1000)



SCAP Autopatch Board

- Provides all basic autopatch functions
- See features on opposite page. \$225.00

RPCM Board

- Used w/SCAP board to provide "Reverse Patch" and land-line control of rptr.
- Includes 1-1 "answering" circuitry. \$95.00

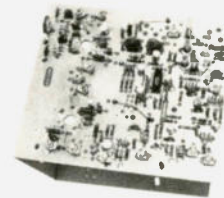

SCT 110 Xmtr/Exciter Board

- 7 or 10 Wts. Output
- Infinite VSWR proof
- True FM for exc. audio quality
- New Design — specifically for continuous rptr. service
- Very low in "white noise"
- Spurious -70 dB
- With .0005% xtal. \$115.00
- BA-10 30 Wt. Amp board & Heat Sink. 3 sec. LPF & rel. pwr. sensor. \$51.95

SCT110 Transmitter Assembly

- SCT110 mounted in shielded housing
- Same as used on SCR1000
- Completely asmbld. w/F.T. caps, S0239 conn.
- 7 or 10 Wt. unit \$199.95. Add \$62.00 for 30 Wt. unit.

WP641 Duplexer

- Superior Band Pass/Band Reject design
- Provides great rejection of "out-of-band" signals
- Extremely easy to adjust
- -93dB typ. isolation. \$495.00 (fully ckd. out w/SCR1000).

ID100 ID & Audio Mixer Board

- Diode programmable memory
- Adjustable ID tone, speed, level, timing cycle
- 4 Input AF Mixer & Local Mic amp
- COR input & xmtr. hold
- All CMOS logic
- Many other features Programmed \$65.00

COMMUNICATIONS

Send for Data Sheets!



S8

Norristown PA 19401 (215) 631-1710

Meet the Plastic Wonder

— quad antenna

Why not glue your next antenna together? The cubical quad antenna uses a quick and easy method of construction that provides an almost ideal quad structure, yet bypasses traditional materials and metalwork altogether. Cubical quad antennas offer a combination of DX performance and economy of construction that's hard to beat, especially at modest antenna heights. The use of plastic water pipe and fittings is the key to an antenna of exceptional per-

formance, long life, and a construction cost of less than \$25.00, using readily-available materials from any lumber yard or building supply.

A new QTH provided the challenge to design an efficient HF antenna system from scratch, yet stay within a total outlay of \$100. From a review of current antenna literature, especially Bill Orr's excellent work on quads,¹ it seemed a dual-band 10/15 meter quad offered the best compromise between physical

size, cost, antenna height, and expected performance. Quad construction articles usually suggest two alternatives to the crossarm problem — bamboo or fiberglass. Since both materials were unavailable locally, I decided to adapt common polyvinyl plastic pipe, known as CPVC, to fashion a sturdy framework. A check with the local building supply revealed standard 10-foot lengths were less than \$1.50 per section and that a complete assortment of fittings to fashion

any desired configuration was available. PVC boasts many useful characteristics for antenna construction, including excellent strength and dielectric properties. Its only drawback is a lack of rigidity in very long lengths.

I chose half-inch PVC for the prototype antenna as the best compromise between weight and rigidity. Cross-braces constructed of T-fittings on each arm provide the key not only to achieving the extra crossarm length, but also to a rigid and sturdy structure. Standard quad dimensions were used, as indicated in Fig. 1, with a boom spacing of 5 feet chosen to coincide nicely with standard lengths of PVC stock. See the parts list for the materials I selected.

Construction is quick and easy, since no metalwork or fabrication is involved. In fact, this quad is literally glued together with PVC cement — a joint that is extraordinarily strong. Construction begins by sawing the stock to proper length with an ordinary hacksaw. Saw two 10-foot sections in half, and lay them aside as four crossarm braces. Saw eight 4-foot sections from four 10-foot sections, and lay them aside for end extensions. Saw the 10-foot section of conduit in half, and save a 5-foot section for the boom. Carefully mark the center of the four remaining 10-foot sections of PVC, and drill 2¼-inch holes corresponding to the TV mast clamp U-bolt ends and straddling the center line. These sections will be the basic crossarms and are attached perpendicularly to the boom and one another.

Carefully study the quad diagram, Fig. 2, once more, and visualize how the structure will appear when finished. Once the gluing begins, mistakes are tough to correct, because PVC cement is quick and permanent. All rough saw cuts on the PVC ends should be smoothed with a file and knife to avoid interference

	Side dimension	Point of loop attachment (from boom center)
10 meter director	8'8"	6'2"
10 meter reflector	9'1"	6'5"
15 meter director	11'8"	8'3"
15 meter reflector	12'3"	8'7"

Boom length is 5', allowing a few extra inches on each end to accommodate clamp attachment. Holes for passing quad tie loop anchors through the crossarms should be drilled approximately 2" beyond the dimensions given above for points of loop attachment to allow for loop straightening and tension adjustment. The reflector dimensions above are for a closed-loop reflector — once the loop is stretched in place on the crossarms, the wire ends should be joined with a securely soldered joint.

Fig. 1. Dual-band quad construction dimensions.

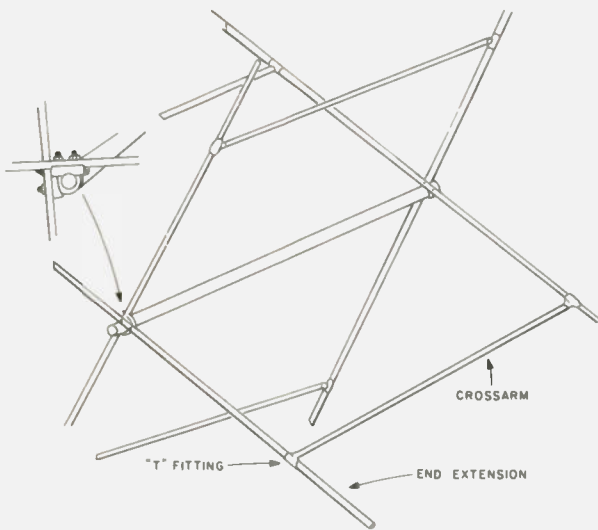

Fig. 2. Quad assembly via glued T-fittings.

and possible misalignment during the gluing process.

Begin the actual assembly by bolting the director and reflector crossarms to each end of the conduit boom, keeping each arm in the same plane as its opposite counterpart and perpendicular to the others for quad symmetry. Snug the TV clamps tight enough to prevent rotation, but don't overdo it — the plastic pipe can be split.

With a 5-foot crossbrace in hand, glue the center opening of a T-fitting to each end of the pipe, remembering to keep the straight-through openings in line with each other. Otherwise, misalignment here will ruin final quad symmetry. Follow cementing directions on the can, and don't overdo it, as the cement truly welds the pipe and fittings together.

Each crossbrace is then glued to join opposite ends of the basic quad framework, forming two large intermeshed rectangles. Finish the structure by attaching the

eight 4-foot extensions to the remaining opening in each T-fitting.

Suggested measurements for points of wire attachment are noted in Fig. 1. The quad wires are attached to the frame by a length of solid copper wire passing through a small hole drilled through the crossarm and tightly wrapped as shown in Fig. 3. If the quad loops for director and reflector are premarked for points of attachment, it's easy to lay the loop on the frame, snug up the loop evenly with the wire attachments, and then twist the loop anchors snugly when things look symmetrical. No soldering of the quad loops is necessary, as a firm twist of the loop anchor provides all the security required.

After using various methods of feeding the director loop, I've settled on tying the 10 and 15 meter loops together via a W2AU balun and using a single 52-Ohm coax feedline. Although gamma-matching through

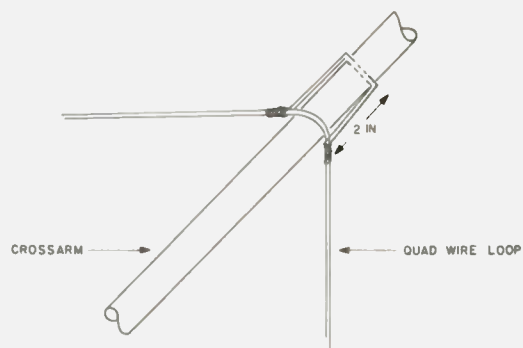

Fig. 3. Suggested method of loop attachment to crossarm.

separate feedlines is the preferred method, the extra expense and bother are not justified by the increase in efficiency. The swr bridge is happier, to be sure, but actual on-the-air signal reports show absolutely no difference between the two methods.

The light weight and small wind load area characteristic of quads become important advantages when a supporting structure is considered. In my particular installation, only a 50-foot telescoping TV mast and light-duty rotator would allow me to stay within the proposed \$100 budget. Since the quad configuration will not allow guying any closer than 6 to 7 feet from the

mast top, don't try to gamble on the strength of the mast top section. Rather, telescope the top two sections together, pin with a bolt, and rest assured that proper and secure guying will keep the antenna in place in anything short of a hurricane. The quad boom is attached to the rotator shaft via a 1/4-inch drilled iron plate mating to a 1 1/4-inch pipe flange welded to the rotator shaft top and joined by two TV mast clamps. If the stark white color of CPVC is bothersome, various types of spray paints do stick well to a clean surface. It would be wise to avoid the metallic pigment paints — no sense introducing

Parts list

- 10 10-foot lengths of 1/2-inch CPVC pipe
- 1 10-foot section of 1 1/2-inch electrical conduit (known as EMT) for the boom
- 8 1/2-inch PVC T-fittings
- 1 small can of CPVC cement
- 4 TV mast clamps (Radio Shack clamps at \$.69 each do the job well)
- 167 feet of heavy-gauge stranded (preferred) or solid copper wire for the quad loops
- 10 feet of heavy-gauge solid copper wire to anchor quad wires to the crossarms

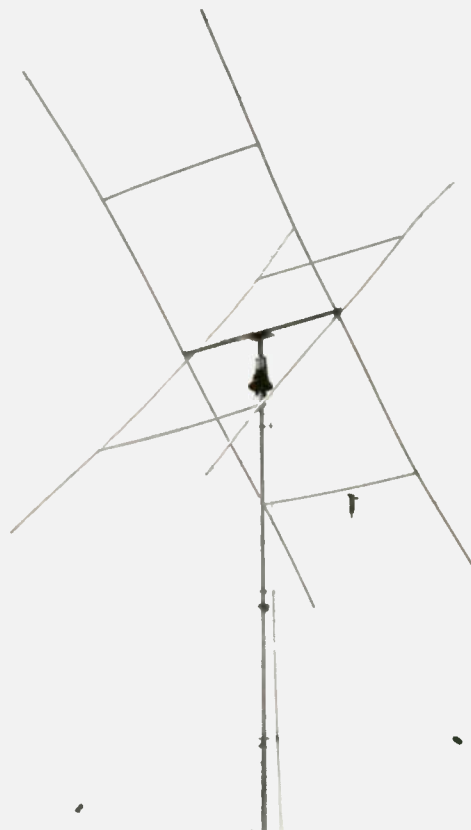

any electrical headaches or possible compromise of performance at this point.

So, how does the project work? After being a confirmed beam fan for many years, the performance of this simple design has been most gratifying. Barefoot operation with a Kenwood TS-520 has provided the fun of DX operation on a limited budget — if only 10 meters were open more often! Sure, it's necessary to stand in line when the band is open, but now the

stations heard are also worked as well. Using appropriate dimensions, there is no reason why a tri-band 10-15-20 meter quad could not be built using the same basic design. Such a structure would, however, require a stronger support and heavier rotator as well as several eager assistants during both construction and erection. As it stands, the dual-band quad can be handled by one man — just make sure you pick a calm day to do the antenna

juggling. Since the climate here in south-central Texas is moderate year round, survival of this antenna under conditions of severe icing and high winds has not been tested. It could pose a problem, especially since PVC becomes increasingly brittle as the temperature drops. An obvious solution might be construction using larger diameter PVC and fittings. I can vouch for the sturdiness of 1/2-inch stock in two years of use surviving 65 mph

winds and temperatures occasionally in the teens with no deterioration of strength. So, if the prospect of weatherproofing bamboo poles or fabricating a metal quad spider has kept you from experimenting with this popular and efficient antenna, follow these construction ideas and join the multitude of satisfied quad users. ■

Reference

¹William Orr, *All About Cubical Quads*, 2nd Edition, 1976.

CONTESTS

from page 15

If any contestant contacts stations on 2-way RTTY with all six continents and the BARTG Contest Manager receives contest logs from the operators in those six continents, a claim may be made for the WAC Award issued by the *RTTY Journal*. The necessary information will be sent on to the *RTTY Journal*, who will issue the WAC award free of charge.

DIPLOMA DES NATIONS FRANCOPHONES (DNF) AWARD RULES

The DNF award was created by the

Reseau des Emetteurs Francais and issued by the F-DX-Club. Its purpose is to extend radio amateur activity with countries using French as their "official" language or in which French is the main dialect.

The DNF may be claimed by any licensed radio amateur who can submit proof of the required number of contacts, or to any SWL who can submit evidence of having heard the required number of stations. QSOs since January 1, 1960, are valid and any mode may have been used for the contacts.

Applications may be for only one band or mode or mixed bands/modes.

REPEATER, WHERE ART THOU?

One of the reasons why there are still some errors in the *73 Repeater Atlas of the World* is that a few repeater owners don't bother to let us know what they are doing. Repeater users and clubs are requested to send in lists of all area repeaters with the location (town) of the repeater, call, and frequencies. It's fun to find all of the repeaters in your area . . . the next step is to send in your list for us to coordinate with our computer.

You can make amateur radio more enjoyable for visiting hams by getting all of your repeaters on our list. The *73 Atlas* is by far the most complete listing of repeaters available . . . let's try to make it as perfect as possible.

Send repeater lists and info to: *73 Magazine*, Repeater Atlas, Peterborough NH 03458.

In the case of any dispute concerning the rules, the decision of the Award Manager will be final.

There are 2 parts for the DNF: Part 1 is to any amateur who can submit evidence of 30 2-way contacts with "Francophones" nations; Part 2, "Excellence," is to any claimant who can submit evidence of 45 2-way contacts with "Francophones" nations in 6 continents.

Same rules apply for SWL applications. For VHF, Part 1 is issued for 4 contacts and Part 2 is issued for 5 contacts. The continents counted for the purposes of this award are: Asia, Africa, Europe, Oceania, North America, South America, and Antarctica. It is not necessary to send

QSLs with application. A list certified by 2 other licensed amateurs is sufficient. Each application must clearly indicate the name, call, address, and mode or band. The list of QSLs must show the nation and continent. The fee is 12 IRCs. Send applications and fee to: Monsieur Rene Duret F9TE, Villa La Vergnade, 15190 Condat en Feniers, France.

List of "Francophones" nations: C3, CN8, DL5/DA, F, FB8W, FB8X, FB8Y, FB8Z, FC, FG7, FH8, FK8 (ea), FL8, FM7, FO8 (ea), FP8, FR7, FS7, FU8/YJ8, FW8, FY7, HB, HH, LX, OD5, ON, TJ, TN, TR, TT, TU, TY, TZ, VE2, VO8, XT, XU, XW, 3A, 3V8, 5R8 (ea), 5T5, 5U7, 5V, 6W8, 7X, 9Q5, 9U5, 9X5, TL, OR4, 4U1, FO8, D6, 3X.

RESULTS

RESULTS OF THE 1977 YLAP

Phone — YLRL		CW — YLRL	
K6KCI	11,943.75 points	VE7DTO	761.25 points
WA9TVM	11,433	YV5CKR	570
WA3HUP	11,316	W8YL	531.25

Corcoran Award — WA9TVM — combined 11,523 points

Hager Award — VE1AMB — combined 8178 points

HB9ARC — combined 5481 points

Non-YLRL Winners:

Phone		CW	
W1WS	10,809 points	W1GAI	440 points
WA6HEL	5,916		
G4GAJ	5,880		



Vhf engineering

THE WORLD'S MOST COMPLETE LINE OF VHF-FM KITS AND EQUIPMENT

RX28C	28-35 MHz FM receiver with 2 pole 10.7 MHz crystal filter	\$ 64.95
RX28C W/T	same as above—wired & tested	117.95
RX50C Kit	30-60 MHz rcvr w/2 pole 10.7 MHz crystal filter	64.95
RX50C W/T	same as above—wired & tested	117.95
RX144C Kit	140-170 MHz rcvr w/2 pole 10.7 MHz crystal filter	74.95
RX114C W/T	same as above—wired & tested	119.95
RX220C Kit	210-240 MHz rcvr w/2 pole 10.7 MHz crystal filter	74.95
RX220C W/T	same as above—wired & tested	117.95
RX432C Kit	432 MHz rcvr w/2 pole 10.7 MHz crystal filter	84.95
RX432C W/T	same as above—wired & tested	129.95

RECEIVERS



RXC1	accessory filter for above receiver kits gives 70 dB adjacent channel rejection	8.95
RF 28 Kit	10 mtr RF front end 10.7 MHz out	13.50
RF 50 Kit	6 mtr RF front end 10.7 MHz out	13.50
RF 144D Kit	2 mtr RF front end 10.7 MHz out	18.50
RF 220D Kit	220 MHz RF front end 10.7 MHz out	18.50
RF 432 Kit	432 MHz RF front end 10.7 MHz out	29.50
IF 10.7F Kit	10.7 MHz IF module includes 2 pole crystal filter	29.50
FM455 Kit	455 KHz IF stage plus FM detector	18.50
AS2 Kit	audio and squelch board	16.00

TX50	transmitter exciter, 1 watt, 6 mtr.	44.95
TX50 W/T	same as above—wired & tested	64.95
TX144B Kit	transmitter exciter—1 watt—2 mtrs	34.95
TX144B W/T	same as above—wired & tested	59.95
TX220B Kit	transmitter exciter—1 watt—220 MHz	34.95

TRANSMITTERS



TX 220B W/T	same as above—wired & tested	59.95
TX 432B Kit	transmitter exciter 432 MHz	49.95
TX 432B W/T	same as above—wired & tested	79.95
TX 150 Kit	300 milliwatt, 2 mtr transmitter	24.95
TX 150 W/T	same as above—wired & tested	39.95

PA2501H Kit	2 mtr power amp—kit 1w in—25w out with solid state switching, case, connectors	64.95
PA4010H Kit	2 mtr power amp—10w in—40w out—relay switching	64.95
PA50/25 Kit	6 mtr power amp, 1w in, 25w out, less case, connectors & switching	54.95
PA144/15 Kit	2 mtr power amp—1w in—15w out—less case, connectors and switching	44.95
PA144/25 Kit	same as PA144/15 kit but 25w	54.95
PA220/15 Kit	similar to PA144/15 for 220 MHz	44.95
PA432/10 Kit	power amp—similar to PA144/15 except 10w and 432 MHz	54.95
PA140/10 W/T	10w in—140w out—2 mtr amp	219.95
PA140/30 W/T	30w in—140w out—2 mtr amp	189.95

POWER AMPLIFIERS

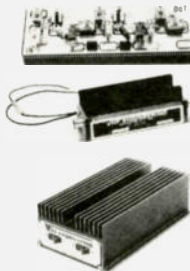

Blue Line	RF power amp, wired & tested, emission—CW FM SSB/AM				
	Model	BAND	Power Input	Power Output	
BLC 10/70		144 MHz	10W	70W	149.95
BLC 2/70		144 MHz	2W	70W	169.95
BLC 10/150		144 MHz	10W	150W	259.95
BLC 30/150		144 MHz	30W	150W	239.95
BLD 2/60		220 MHz	2W	60W	164.95
BLD 10/60		220 MHz	10W	60W	159.95
BLD 10/120		220 MHz	10W	120W	259.95
BLE 10/40		420 MHz	10W	40W	179.95
BLE 2/40		420 MHz	2W	40W	179.95
BLE 30/80		420 MHz	30W	80W	259.95
BLE 10/80		420 MHz	10W	80W	289.95

PS15C Kit	15 amp—12 volt regulated power supply w/case, w/fold-back current limiting and overvoltage protection	94.95
PS15C W/T	same as above—wired & tested	124.95
PS25M Kit	25 amp—12 volt regulated power supply w/case, w/fold-back current limiting and ovp, with meter	154.95
PS 25M W/T	same as above—wired & tested	179.95

POWER SUPPLIES



O.V.P.	adds over voltage protection to your power supplies, 15 VDC max.	12.95
PS3A Kit	12 volt—power supply regulator card with fold-back current limiting	10.95
PS3012 W/T	new commercial duty 30 amp 12 VDC regulated power supply w/case, w/fold-back current limiting and overvoltage protection	249.95

RPT150 Kit	repeater—6 meter	499.95
RPT150	repeater—6 meter, wired & tested	799.95
RPT144 Kit	repeater—2 mtr—15w—complete (less crystals)	499.95
RPT220 Kit	repeater—220 MHz—15w—complete (less crystals)	499.95
RPT432 Kit	repeater—10 watt—432 MHz (less crystals)	579.95
RPT144 W/T	repeater—15 watt—2 mtr.	799.95
RPT220 W/T	repeater—15 watt—220 MHz.	799.95
RPT432 W/T	repeater—10 watt—432 MHz.	849.95

REPEATERS



DPLA50	6 mtr close spaced duplexer	575.95
DPLA144	2 mtr, 600 KHz spaced duplexer, wired and tuned to frequency	379.95
DPLA220	220 MHz duplexer, wired and tuned to frequency	379.95
DPLA432	rack mount duplexer	319.95
DSC-U	double shielded duplexer cables with PL259 connectors (pr.)	25.00
DSC-N	same as above with type N connectors (pr.)	25.00

TRX50 Kit	Complete 6 mtr FM transceiver kit, 20w out, 10 channel scan with case (less mike and crystals)	244.95
TRX144 Kit	same as above, but 2 mtr & 15w out	234.95
TRX220 Kit	same as above except for 220 MHz	234.95
1RX432 Kit	same as above except 10 watt and 432MHz	254.95
1RC-1	transceiver case only	29.95
1RC-2	transceiver case and accessories	49.95

TRANSCIVERS



SYN II Kit	2 mtr synthesizer, transmit offsets programmable from 100 KHz—10MHz, (Mars offsets with optional adapters)	169.95
SYN II W/T	same as above—wired & tested	239.95
SYN 220 Kit	same as SYN II Kit except 220-225 MHz	169.95
SYN 220 W/T	same as above—wired & tested	239.95

SYNTHESIZERS



OTHER PRODUCTS BY VHF ENGINEERING

CD1 Kit	10 channel receive stal deck w/diode switching	\$ 7.95
CD2 Kit	10 channel xmit deck w/switch and trimmers	15.50
CD3 Kit	UHF version of CD1 deck, needed for 432 multi-channel operation	13.50
COR2 Kit	carrier operated relay	22.75
SC3 Kit	10 channel auto scan adapter for RX with priority	19.95
Crystals	we stock most repeater and simplex pairs from 146.0-147.0 (each)	5.00
CWID Kit	159 bit, field programmable, code identifier with built-in squelch tail and ID timers	39.95
CWID	wired and tested, not programmed	54.95
CWID	wired and tested, programmed	59.95
MIC 1	2,000 ohm dynamic mike with P.E.T. and coil cord	12.95
ISI W/T	tone squelch decoder	59.95
ISI W/T	installed in repeater, including interface accessories	89.95
113 Kit	2 tone decoder	35.95
113 W/T	same as above—wired & tested	59.95
HI 144 W/T	4 pole helical resonator, wired & tested, swept tuned to 144 MHz band	29.95
HI 220 W/T	same as above tuned to 220 MHz band	29.95
HI 432 W/T	same as above tuned to 432 MHz band	29.95



Vhf engineering

DIVISION OF BROWNIAN ELECTRONICS CORP.

BOX S / 320 WATER ST. / BINGHAMTON, N.Y. 13901 / Phone 607-723-9574

Prices and specifications subject to change without notice. Export prices slightly higher. 502 3100-1.78



Don't Miss the Excitement of QRP

— *HW-8 mods*
let you have a ball

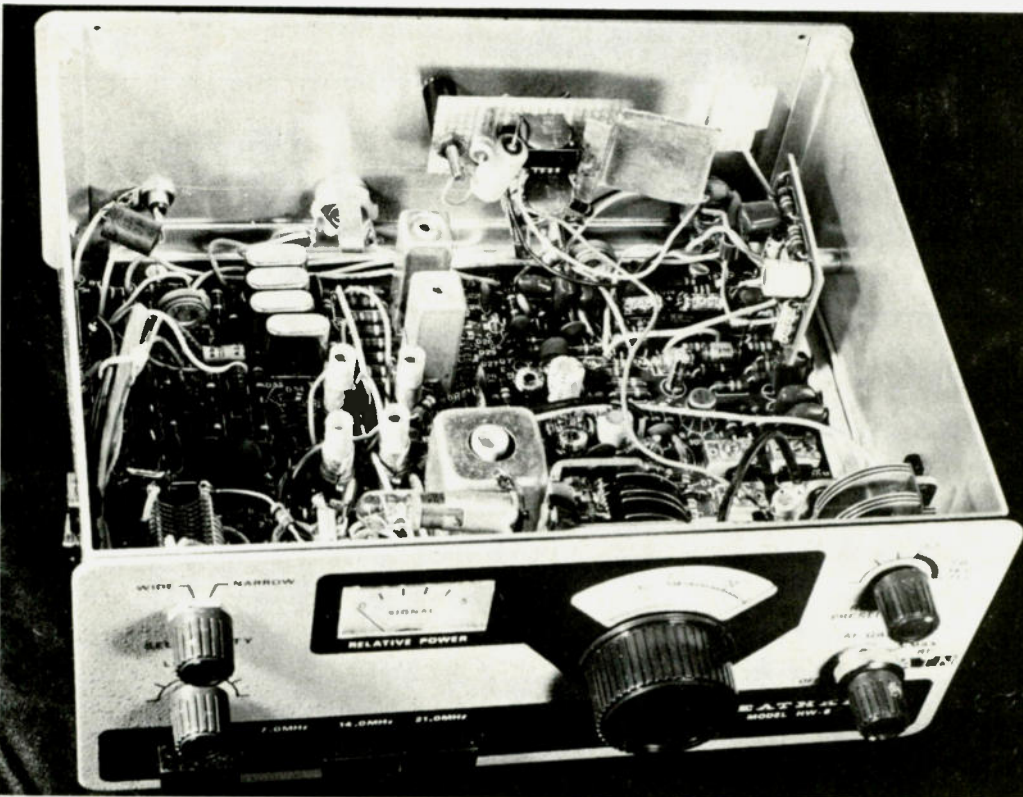

Photo A. Top view. The metal fin on the af IC is a piece of galvanized sheet metal soldered to the heat sink tab on the IC for a heat sink. The switch shown in Fig. 1 was not in place when the photo was taken.

I'd like to tell you about some changes I have made to my little QRP kW, the Heath HW-8. It seems that lots of people are deciding that it doesn't take a QRO kW to get across the big pond any more, and I am one of them. Having fond memories of a little 100 mW rig on 80 meters that I had back in 1962, I recently decided to try some QRP operation again. The HW-8 seemed to fit the bill, so Heath took some of my green stamps, and I took delivery of a very fine little CW transceiver. Nine construction hours later, there I was, banging away on 40 meters, when it became apparent that the little rig needed some things that it didn't have if I was ever to get across the pond again. So off went the 12-volt power supply, out came the old soldering iron and schematic, and on went the thinking cap.

First of all, I like to hear those CW signals ringing out of a good-sized speaker (when the XYL and harmonics are away from home) rather than on phones. The HW-8 has headphone audio only, so, after looking around for some way to get a speaker hooked up, I decided that it was maybe time to try one of those newfangled integrated circuits. After a short trip to the parts store, I came home with something by Sylvania called an ECG717 af output IC. The man there said that it will drive a speaker as long as I keep it at at least 8 Ohms or more. Since that seemed reasonable, I decided to give it a try. (See Fig. 1.)

After haywiring it together and using a time-honored cut-and-try method of resistor selection, lo and behold, the thing really worked! I then cleaned up the mess of haywire and mounted the whole thing on the back panel. An SPDT phone jack was mounted near the board, and a sort of dummy-load resistor was added to keep some load on the chip when the speaker was unplugged

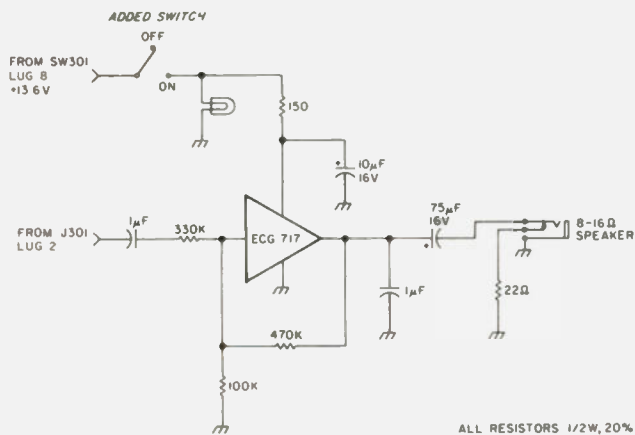

Fig. 1. Audio output stage.

(see photos).

At this point, several beers went by the board, and some good stateside DX was worked on 40 meters. In fact, I made coast-to-coast the first evening with the little peanut whistle. More beers and congratulations were in order, until I realized that the one thing that I really missed was QSK (full break-in). The Apache-75A1 combination worked well — why not this little thing? After all, an old-timer who remembers 872A rectifiers should be able to do a simple thing like make the HW-8 switch from transmit to receive faster!

Well, back off went the 12 volts, out came the schematic and soldering iron again, and the neat little HW-8 got its first real taste of a determined home brewer in action. First of all, it was apparent that, no matter what else happened, the mechanical relay would have to go, or the noise would drive me batty. Also, there should be an easier way to switch the antenna than that thing. So, for starters, I removed the relay and threw it in the junk box. Also, I removed the short piece of yellow wire connecting the relay to the output coax connector and threw the wire in the junk box next to the relay. Now that the antenna no longer had any connection, it had to be hooked somewhere. I found the PC pad on the relay socket which is connected to hole "L" on the PC board, and connected a wire from that pad to the

center conductor of the antenna coax connector. That connected the antenna permanently to the transmitter portion of the transceiver. I added a 270-Ohm 1/2-Watt resistor to ground from the relay pad connected to hole "J." This replaced the relay coil.

I seemed to recall a scheme of coupling used on an old rig of mine, using a small value of coupling capacitor right off the plate of the output tube, going to a high-impedance point in the rf stage in the receiver. Since

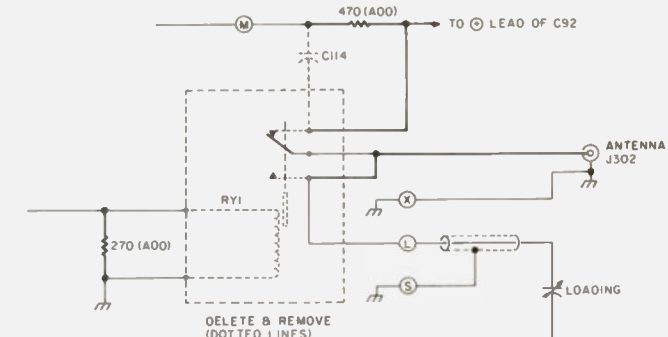

Fig. 2. Relay circuit modifications. Parts shown in heavy lines are to be added after removing the relay.

this rig uses an FET as the rf stage, the input tuned circuits to the FET should be fairly high impedance. I wondered about finding a high-impedance point in the transmitter matching network and coupling right to the input tuned circuits. I decided to try 80m first, since the lower frequencies are normally easier to goof with. After several values and points were tried, it seemed to work the best by connecting an 8.2 pF disc capacitor from the junction of C95 and L26 over to terminal 4 on input coil L1. (See Figs. 3 and 4 and Photo B.) When sensitivity was mea-

sured, I found it to be essentially the same as before the modification. When I tried the transmitter, it also loaded up the same as before, and the power output was the same as before modification. Adding a couple of 1N914 diodes from the gate of Q1 to ground should protect the FET from stray rf. I placed these on the bottom side of the PC board.

Using the same technique, 40 meters (8.2 pF from junction of C99 and L28 to terminal 4 of input coil L2) and 20 meters (5.5 pF from junction of C103 and L31 to terminal 4 of input coil L3) were

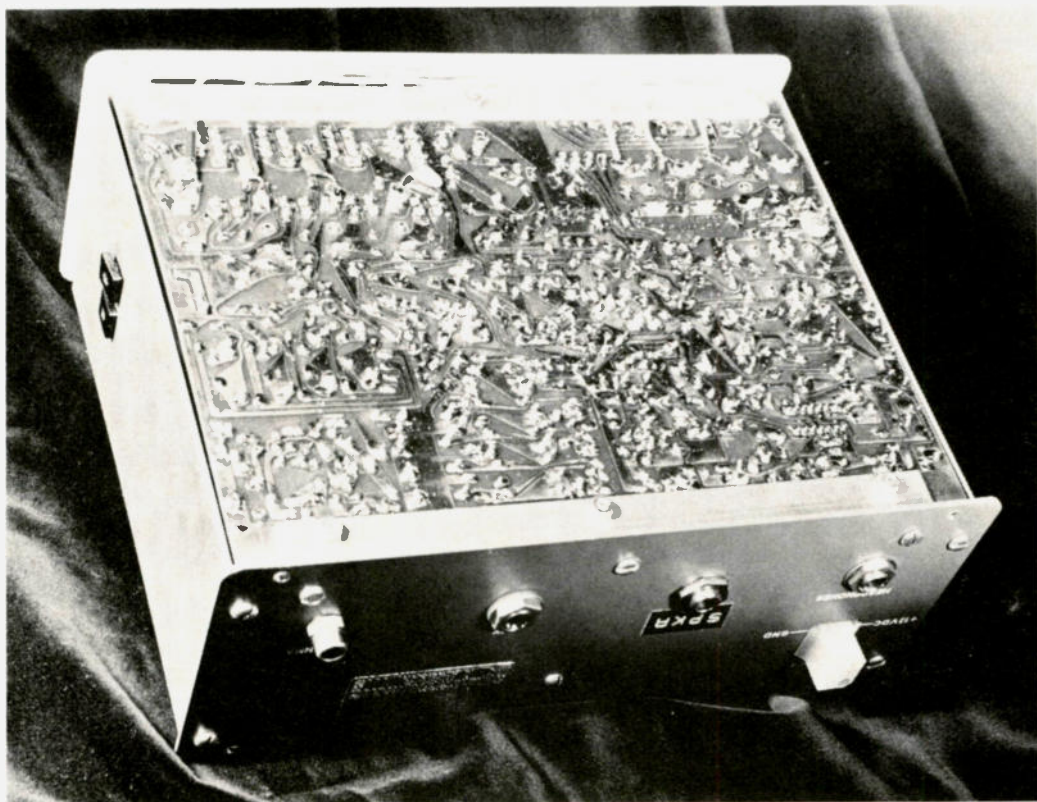

Photo B. Bottom view. Note the placement of four coupling capacitors and the placement of C13. The diodes added to the rf stage are mounted next to C13 on the bottom of the PC board.

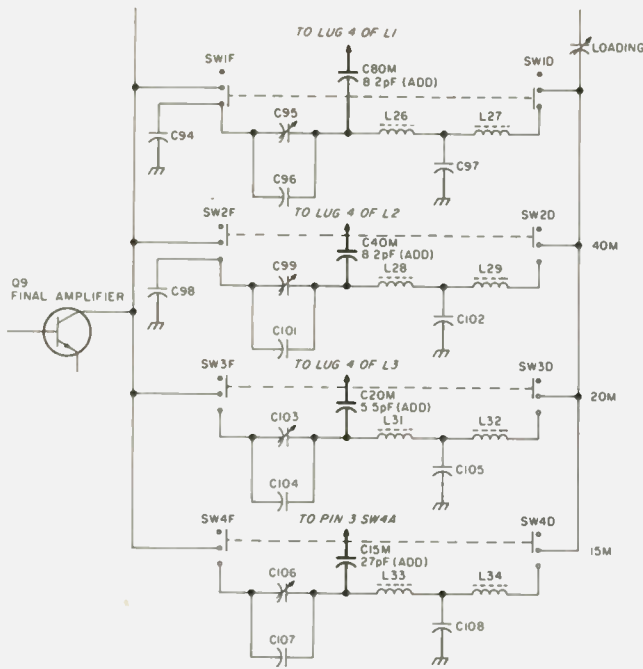

Fig. 3. Modifications to rf output stage. Components shown in heavy lines are added.

modified.

All was well, until I tried this technique on 15 meters. No matter what value of coupling capacitor I tried, the loading control would not peak at the same point on transmit as it did on receive. In fact, if the transmitter was tuned up for normal operation, the receiver sensitivity was degraded by 15 to 20 dB. This was definitely not a desired condition, so another method was arrived at for 15 meters. By connecting a 27

pF capacitor from the junction of C106 and L33 to the primary of input coil L4 (via terminal 3 of switch SW4A), the transmitter and receiver peak on the same setting of the loading control, and the receiver sensitivity is essentially the same as before modification.

It is advisable, at this point, to repeat the entire alignment procedure in the manual. The transmitter power output should be the same as before modification,

also. A small instability on the 15m receiver was cured at this point by adding a 50 uF 6-volt capacitor in parallel with C13. I put C13 on the underside of the board and the 50 uF unit in C13's old holes, (+) lead to the source. By this time, I was feeling pretty good. The next task of speeding up the transmit to receive switchover looked like it would be duck soup.

The manual says that the delay time from transmit to receive is determined by the value of C92, which is 10 uF in the factory version. I wanted it to be really fast, so, I decided, why not take out the capacitor completely? To make a long story short, I soon found out that it needed some capacity there to prevent the clicks reported to me by W9EIU in Sister Lakes, Wisconsin.

A value of 0.47 uF for C92 was arrived at after some more cut and try, and that seemed to eliminate the clicks. The recovery time of the audio was still quite long, however, and I finally traced that to the time constant of R27 and C39. Reducing the value of R27 from 1 megohm down to 270k Ohms caused the audio to recover slightly later than the rest of the switching that takes place, making for almost "pop-free"

audio. The sidetone is still used in this scheme, so that good feature is retained.

Another problem became apparent, once the rig was fired up on 40 meters in the evening. When the relay was removed, it killed the action of the rf gain control. An rf gain control is a must on 40 meters, so one had to be added. Since there was already an rf gain control on the front panel, it was merely a task of figuring out how to use it. First, the coax cable which goes from the rf gain control over to pins 2 and 4 of SW4A was removed at the SW4A end *only* and pulled out of the tie-wrap. Also, at this time, all of the yellow jumper wires connecting the #2 pins of SW1A, SW2A, SW3A, and SW4A were removed and discarded.

Now that the cable was loose, I had to decide what to do with it. First, I lifted the ground end of R6, the Q1 source resistor, out of the board. Then I connected this free end to the center conductor of the coax from the rf gain control. I connected the ground braid of this coax to the hole that R6 was removed from. This added the resistance of the rf gain control to the source of Q1. As this, by itself, was not enough additional biasing for Q1, some positive voltage was added. This was done by removing capacitor C114 (next to the old antenna relay) and replacing it with a 470-ohm 1/2-Watt resistor. One end of this resistor was connected, via the PC board, to one of the PC pads of the old relay. I ran an insulated wire from this PC pad over to the + end of C92. This put 12 volts across the combination of the new 470-ohm resistor and the rf gain control. The rf gain control worked. True, it worked backwards, but it worked! Interchanging the two outside leads on the rf gain control made the control work in the right direction. Be sure to move the ground of the volume control along with the ground of the rf gain

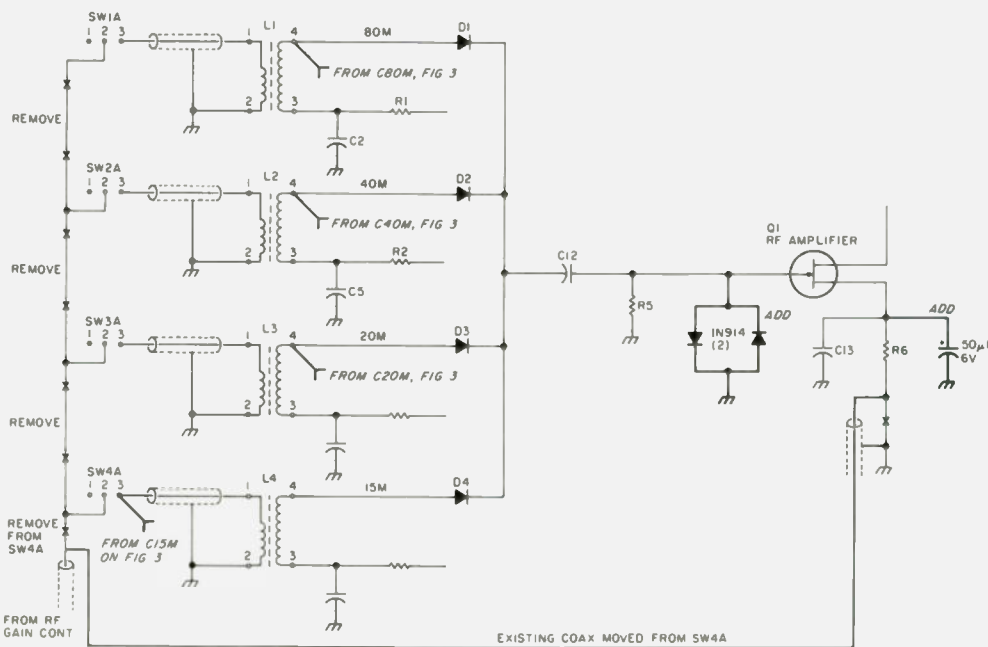

Fig. 4. Receiver rf stage modifications (shown in heavy lines).

control, or the volume control will be inoperative. In my case, that seemed like a lot of extra work, so I just relabeled the front panel to read "rf attenuation" instead of "rf gain."

Another problem which popped up after some on-the-air time was the fact that the vfo shift during transmit was too great with the 6 pF capacitor furnished with the kit for C55. I changed that capacitor to 3.3 pF, and found that the shift was just

about right for the majority of other ops.

One last refinement was added — a dial light on the "relative power" meter. (See Photo A.) I like lights to tell me when something is turned on. To keep the low current drain for battery operation, I added a small toggle switch to the rear panel to switch off the 12 volts to the light and the af output IC. (See Fig. 1.) This allows minimum current drain for battery operation, even though headphones

must be used.

The QSK is really not quite full QSK, since you cannot hear between dots. Any slight pause, though, however small, will cause the receiver to be active, and the QSK is just as good as my old Apache-75A1 combination ever was, due to the receiver overload on the A1.

After completing these mods on a Saturday morning, I worked G4, VP2, DJ6, EA6, and ON5 on that Saturday and the following Sunday

afternoon. These contacts were made on 20 meters through the kW's and no more-satisfying contacts were ever made by this station!

I heartily endorse QRP operation as the answer to the bored amateur who is tired of the same old thing. It is great sport to "dig" the big guns about how much air conditioning must be required to cool off the shack with all those big old bottles glowing. You should really try QRP sometime. ■

Corrections

In reference to my article, "How Do You Use ICs? — part VIII," 73, December, 1977: I have received a letter from Jim Willis WA4CCA pointing out what may be a serious design mistake in my article concerning LEDs used with TTL ICs.

For convenience, I had the LED indicators hooked to ground (Fig. 1). This appears to be poor practice and may, as I said, damage some TTL ICs. His letter pointed out that connection to the voltage source was far better — and safer for the devices.

The basic problem is contained in the statement that TTL logic is designed to sink current, not to source it. This really does not tell it right. When hooked up as in Fig. 1, the LED draws its current from the 7400 (or other 7400 series IC). Thus this IC must supply (source) the current for the LED. Hooked up the other way, as in Fig. 2, the current is supplied by the Vcc source and is merely handled by the IC. The device can dissipate (sink) the current without problem. The TTL's problem is that it has rather husky transistors to dissipate, or sink, the current, but its other transistors are not built to supply or source that much current.

Once that is explained, it goes a long way toward explaining why, even though the specs call for so much current, some ICs got blown when tied to the LEDs. They just couldn't take the current demand.

This also put me on the track of another error that got in. I said that with my hookup, the LED was lit when the output was high. This is not correct. The only time the 16 mA IC current was available was when it was in a low state. If the switching rate is slow enough (as it was with my test

circuit), it can be checked with a voltmeter. My meter showed clearly when the IC changed state. With my hookup, the meter went high as the LED went off and low as the LED lit. Thus the LED was the reverse of the logic state of the IC.

So there are other advantages to the Vcc hookup besides safety. Using the Fig. 2 hookup, the logic state and the LED are in phase. The LED is lit when high and off when low. That's as it should be. This also appears to be the correct LED hookup for the other TTL ICs shown, and should allow for more of the outputs than the one I chose to be displayed without damage.

There is another consideration. When using the Fig. 1 hookup, the current is rather marginal. The IC is straining. Not so with Fig. 2.

This affects the output voltage swing of the IC, too. When you drag down the IC input with a current load, you also drag down the output voltage. The voltage measured on the high output, even though the LED was off, was not as high a peak on the meter as the Fig. 2 hookup was.

While a dc meter may not be the last word at measuring a peak square wave voltage, it still means there is not as much voltage available at the output. This does not matter so much when the termination is just an LED indicator, but if you are also driving another IC at the same time, you may not have enough actual high voltage to reliably key the IC. If you are riding at a marginal point on the IC's ability to switch at that voltage, you may have all sorts of erratic switching operation. There is only a slight difference in the hookup — not enough to be really confusing — so go for the

best.

While it has been a long time since I did the article and all is not clear about what I did at the time, I do not see any reason why this change will seriously affect the material in the article. Some of the specific phase or polarity info will be off, but your meter will show you what is what. The circuit's operation will still be visually apparent, and that was the basic purpose of the article.

To restate the corrective action as a simple pragmatic rule, LED output indicators should be connected in the correct polarity between the desired TTL output pin and the Vcc pin or voltage source.

Don't forget the series dropping resistor. Without it you can blow the diode and the IC.

I would like to thank Mr. Willis for his letter pinpointing the error and the specific technology behind it — now we have one more safety rule to keep our ICs healthy and perking away like they should. I hope my error has not caused trouble for readers trying the circuits.

Alexander MacLean
WA2SUT/NNNØZVB
Denville NJ

In addition to an address change, please note a few corrections to Fig. 3 of my article, "Clean Up Your Touch-tone™ Act," which appeared in your February issue. "TO SOLID STATE SW. Q2" should read "TO SOLID STATE SW. Q1". "AUDIO IN"

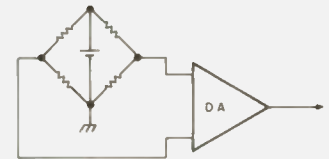

Revised Fig. 9: "The Op Amp Encyclopedia — part II."

should be "AUDIO IN FROM PAD". Also, the +12 V line should be +13 V.

E. Doren WA6THG/KH6GSA
58 Manaolana Place
Hilo HI 96720

In part II of my article, "The Op Amp Encyclopedia" (February, 1978), the Wheatstone bridge in Fig. 9 is incorrectly drawn. It should be shown as in the accompanying Revised Fig. 9.

Joseph J. Carr K4IPV
Arlington VA

Several small errors managed to creep into my article in your January, 1978, issue ("Tune Your Tower To 80/160"). First, the tubing was joined as shown in Fig. 2, not as in Fig. 1, as stated on page 119. Also, 3/4-inch PVC materials are used in Fig. 3 — not 1/2-inch as shown. Finally, the radials are not buried 2 to 4 feet underground, as stated on page 120, but 2 to 4 inches underground.

Evan P. Rolek K9SQG/B
Dayton OH

Ham Help

Does anyone have any information on how to use the Model 33 as a "stupid" teleprinter? It should include TU and some memory, as my typing speed exceeds 60 wpm.

Nico de Jong OZ1BMC
Halls Alle 9
1802 Kobenhavn V
Denmark

I need information on a model 77 signal generator, date of manufacture unknown, but with data plate marked "Wireless Egert Engineering, Inc., New

York City; type No. 99, S/N 350." It appears to have been self-contained (battery-powered), with two pair of pin-jacks on the front for audio frequency output and radio frequency output; range switch (rotary) marked 1 through 7; pot marked "microvolts"; with off position, plus markings 80/150/300/600/1200/2500/5m/10m/20m/40m/80m.

John W. Asherbranner
6101 E. 147th St.
Grandview MO 64030
(816)-331-2590

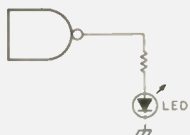

Fig. 1. Incorrect way to connect LED to TTL IC (may damage IC).

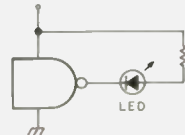

Fig. 2. Correct way to connect LED to TTL IC.

Is Your Repeater Up-To-Date?

—several ways to modernize your repeater

E. E. Buffington W4VGZ
2736 Woodbury Dr.
Burlington NC 27215

The April and June, 1977, issues of *73 Magazine* had articles of mine concerning autopatch and building a repeater. I was not satisfied with the design in a couple of places, so this arti-

cle will clear up some of the problem areas that have developed.

The Touchtone™ Control Circuit

The circuit suggested in

the April issue and given without a PC board layout is presented here with a few changes.

I found that (*) on the phone line would trigger a disconnect on phone com-

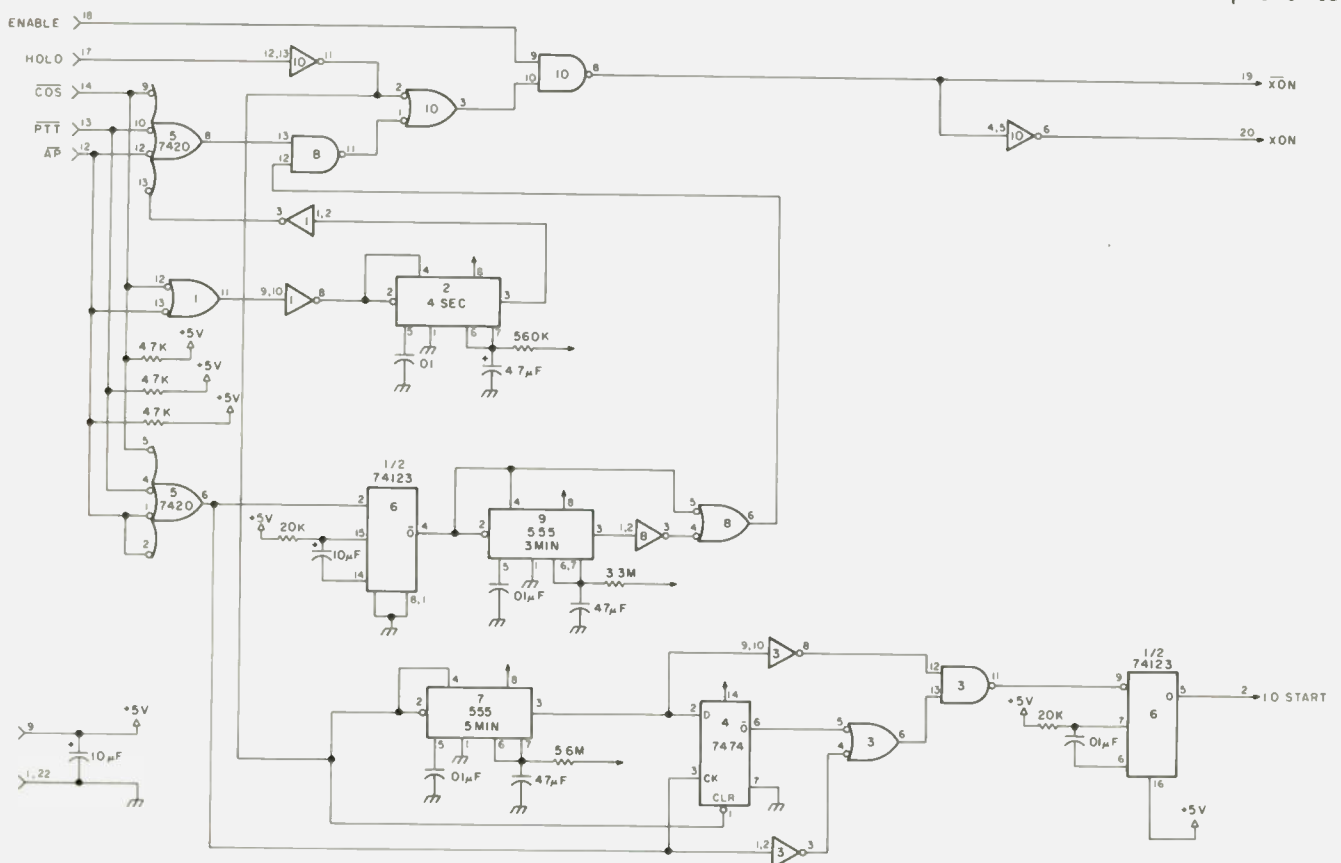

Fig. 1. Timer. This circuit boasts resettable timers and improved identifier control.

pany equipment, so the logic was implemented to connect to the phone line after the (*) button was released. This change and other circuit simplifications were made in my final version.

The operation of the circuit is as follows:

Depressing the (*) button causes the (*), (R4), and (C1) inputs to be low. IC4, pin 9 will be low before the row-column match is sensed (as a high level at IC4, pin 10), due to the 1.5-millisecond debouncer delay. This means that (*) or (#) will not be recognized as digits. After depressing (*) for a time greater than one second, IC6-8 will go low, starting the 3-minute timer and clearing the J-K flip-flop IC7. If the first digit is a (1) or (0), the 3-minute timer will be reset, and the phone will disconnect. If the first digit is not a (1) or (0), then a row-column match will clock the J-K flip-flop, causing IC7-13 to go low and remain low during subsequent digits.

The old circuit had some drawbacks. The timers would not reset 100%, and too many IDs could be generated.

This new timer circuit has overcome both these drawbacks. The timers reset 100%, and the ID comes on at the beginning and IDs 5 minutes later (with no IDs closer than 5 minutes). This new board will not plug into the same socket as the old board. I tried, but the number of jumpers required to do this was ridiculous.

The operation of the 4-second "tail" timer and the 3-minute "timeout" timer are pretty straightforward. The single-shot 74123 is used to generate a reset pulse for the 3-minute timer, and, while the 3-minute timer is being reset, the single-shot pulse is fed forward to keep the transmitter enabled.

The operation of the ID logic is not so easy to explain in a step-by-step fashion. First, note that the 5-minute timer is triggered by the ID hold command, which also clears the type D flip-flop (Q

Parts List

Touchtone control

1	7420
5	7400
1	74121
1	74123
1	74123
1	555
1	7473
3	.1 uF 10 V disc ceramic
3	47 uF 10 V tantalum
1	1 uF 10 V tantalum
1	.01 uF disc ceramic
2	33k ¼ W
1	2.2k ¼ W
1	2N3904
1	relay C. P. Claire MR3MF 1008
1	220 ¼ W
1	3 meg ¼ W
1	1N4001
1	10 uF 10 V dipped tantalum

New timer

4	7400
3	555
1	7474
1	7420
1	74123
3	4.7k ¼ W
1	3.3 meg ¼ W
2	20k ¼ W
1	5.6 meg ¼ W
1	560k ¼ W
4	.01 uF disc ceramic
2	10 uF 10 V dipped tantalum
1	4.7 uF 10 V tantalum
2	47 uF 10 V tantalum

Circuit boards and parts can be obtained from Stafford Electronics, 427 South Benbow Road, Greensboro NC 27401, (919) 274-9917.

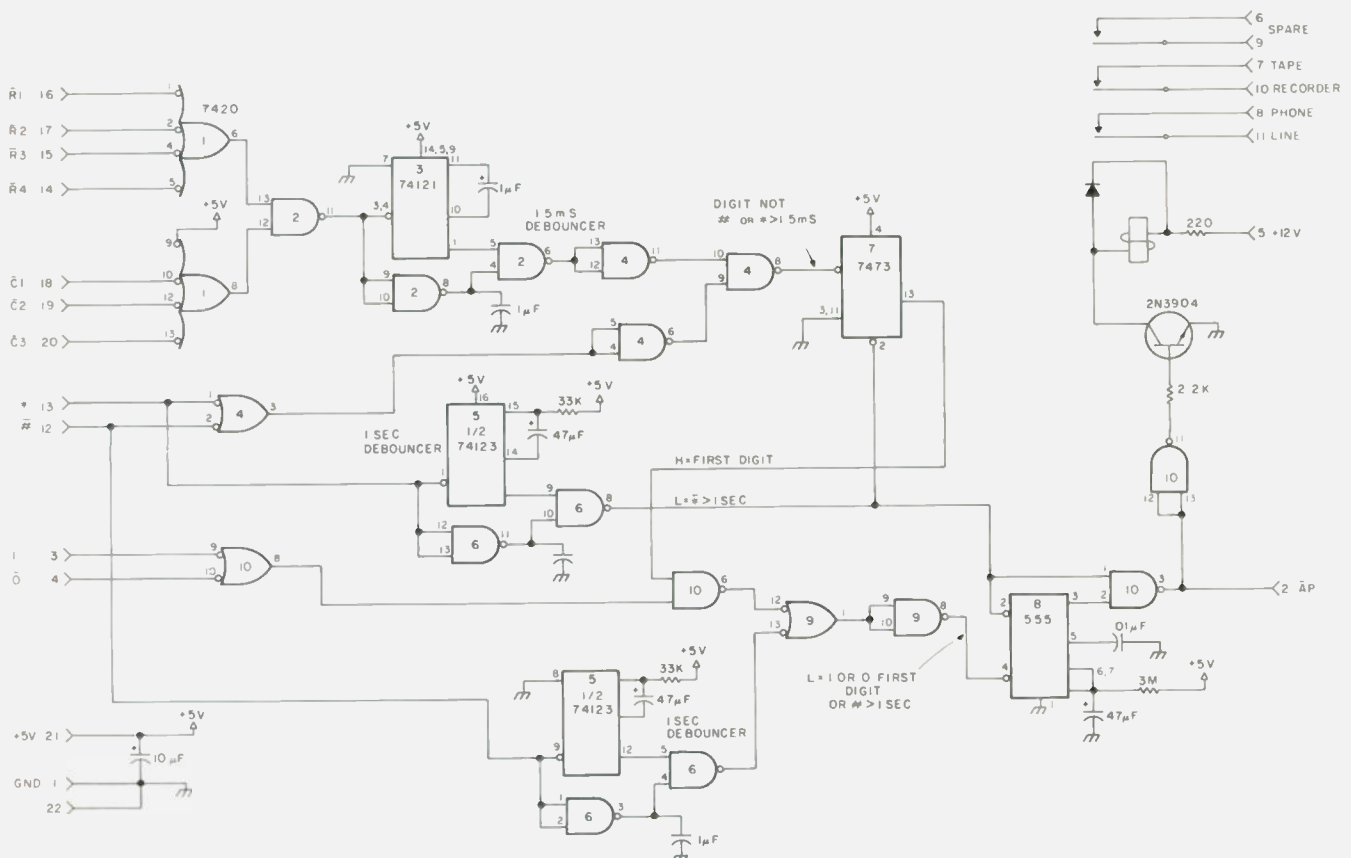

Fig. 2. Touchtone control. Single digit access and disconnect with lockout of toll calls.

= H). Now, if at any time during this 5-minute period the transmitter is commanded on (COS, PTT, or AP going low), the D flip-flop will clock data at IC4, pin 2 inverted to the output pin 6. Now, whenever the 5-minute

timer runs down, an ID will be generated. Conversely, if no command for transmitter on was made during the run-down of the 5-minute timer, then no ID would be generated.

Some had trouble with the

repeater control (shutdown) board. One complaint was that dial pulses were detected by the ring detector. The cure for that is to put a .1 uF capacitor across the neon and increase the series resistor to 100k Ohms or so.

Another problem was that the fourth column touchtone signaling would not clock the J-K flip-flop. The clock input would not go low enough. This condition was fixed by a 4.7k Ohm resistor connected from ground to the clock

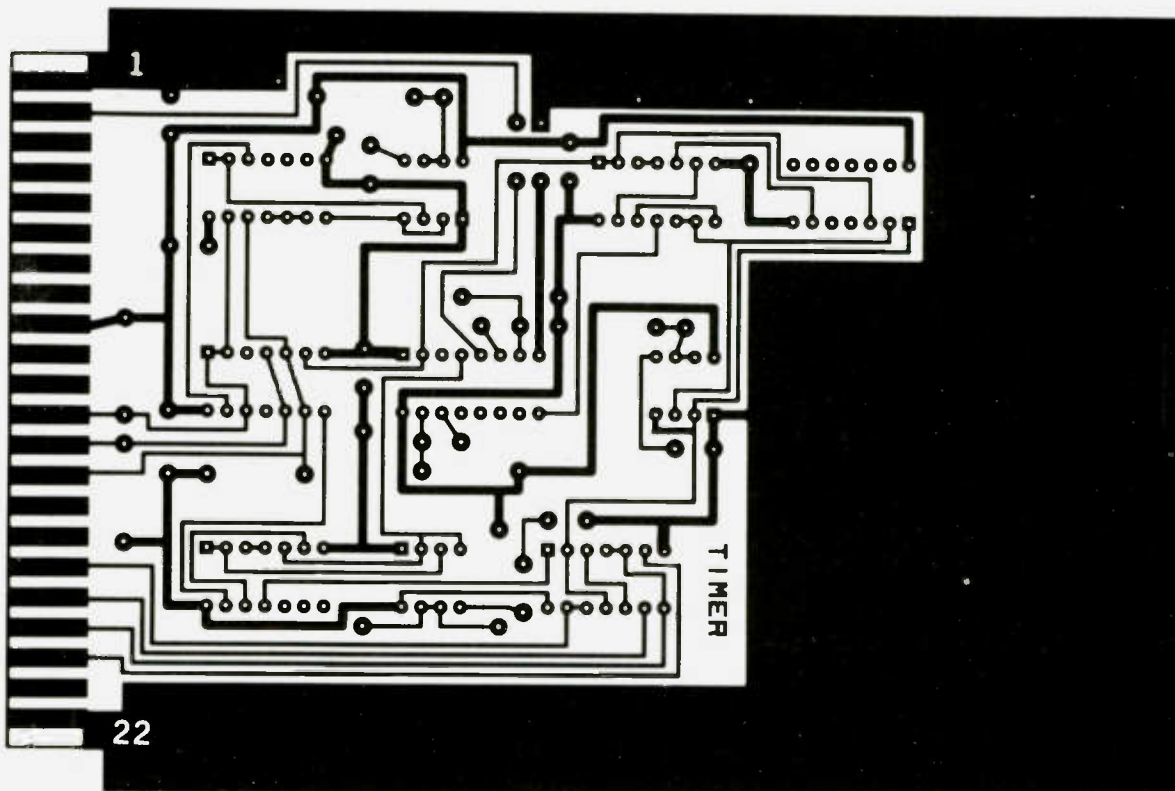
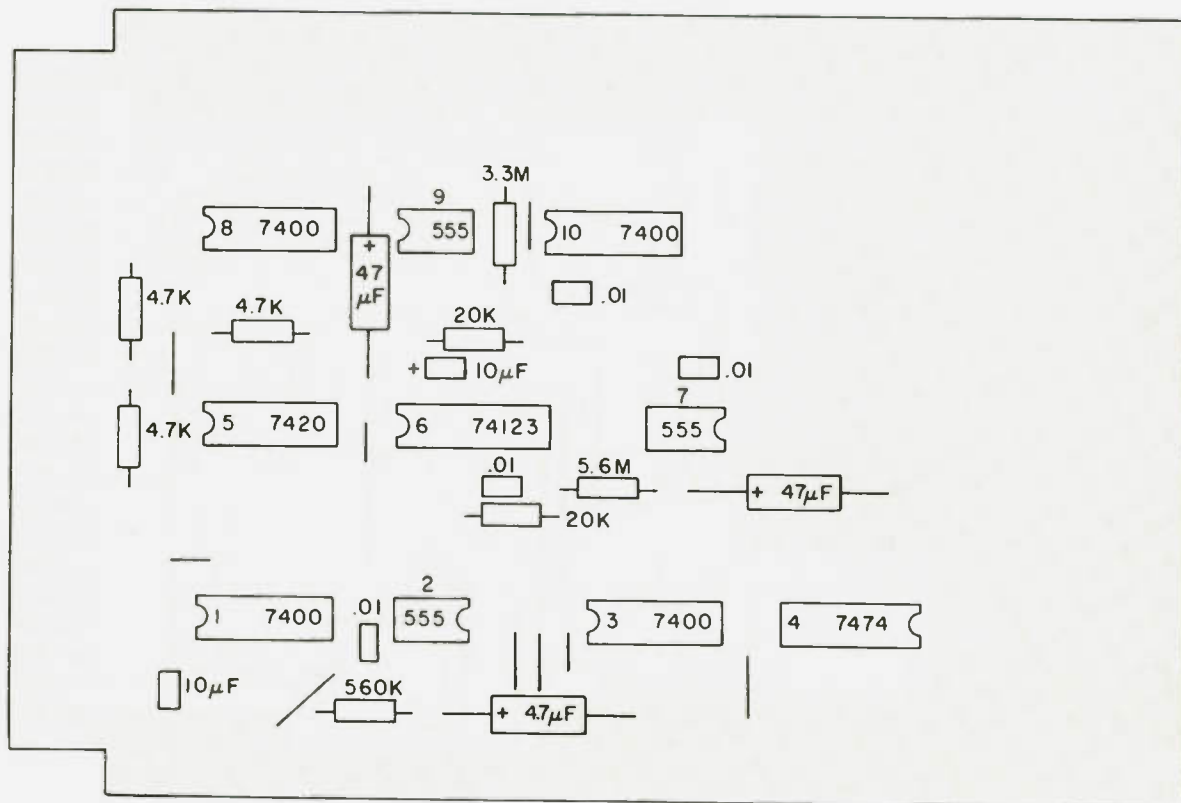

Fig. 3. Timer PC board.

input (collector of Q1) to pull down the quiescent voltage to slightly less than 3 volts. Others reported their ring had a shorter interval than I found locally. Changing the 47 uF to 22 or 10 uF will fix that.

Others reported phone line loop current of 60 mA, instead of the 20 mA I found on the few lines that I checked. This will weld the contacts of all but the most hardy of reed relays. I recommend dc isolation of the

coupler, if this is a problem. Fig. 5 shows isolation with a 2 to 4 uF nonpolarized capacitor and a resistor as the dc load for the phone line. This resistor should be adjusted for 20 mA of loop current.

Some have reported that

they need more or less gain from the audio board. The audio board was designed for 20 dB gain from the receiver to the transmitter. You can change the feedback resistor on the op amp to do this, as the stage gain varies directly

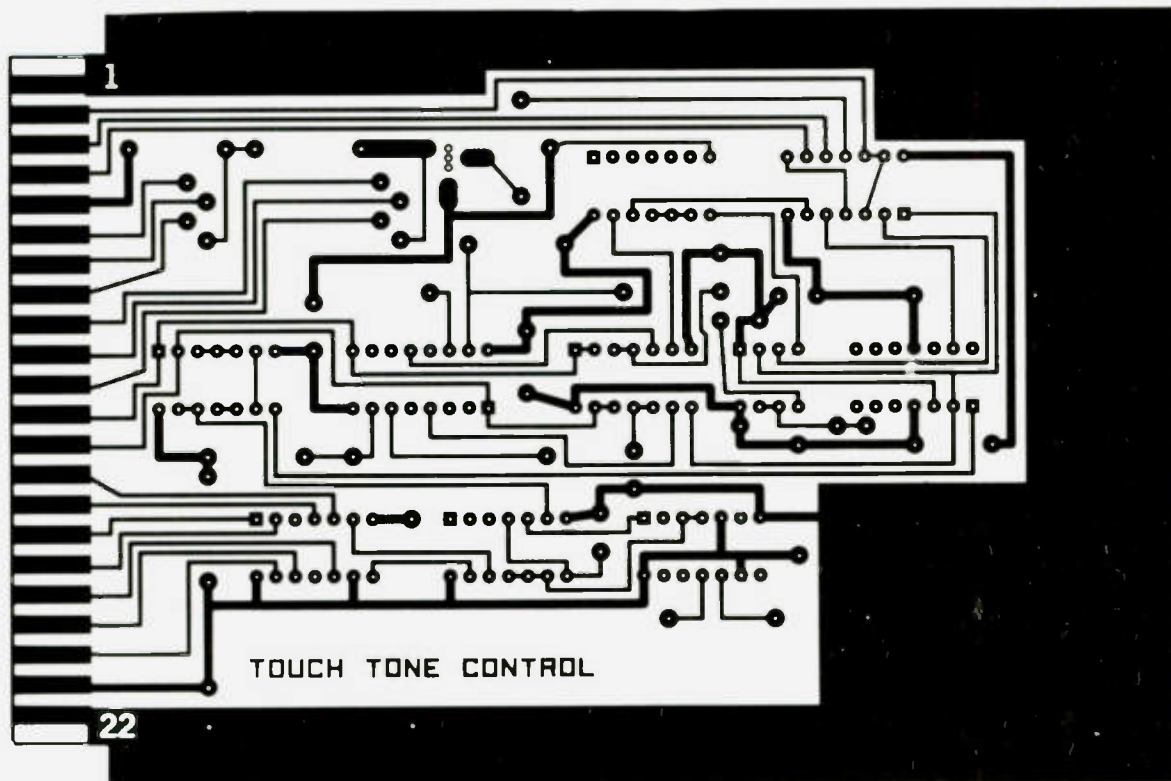
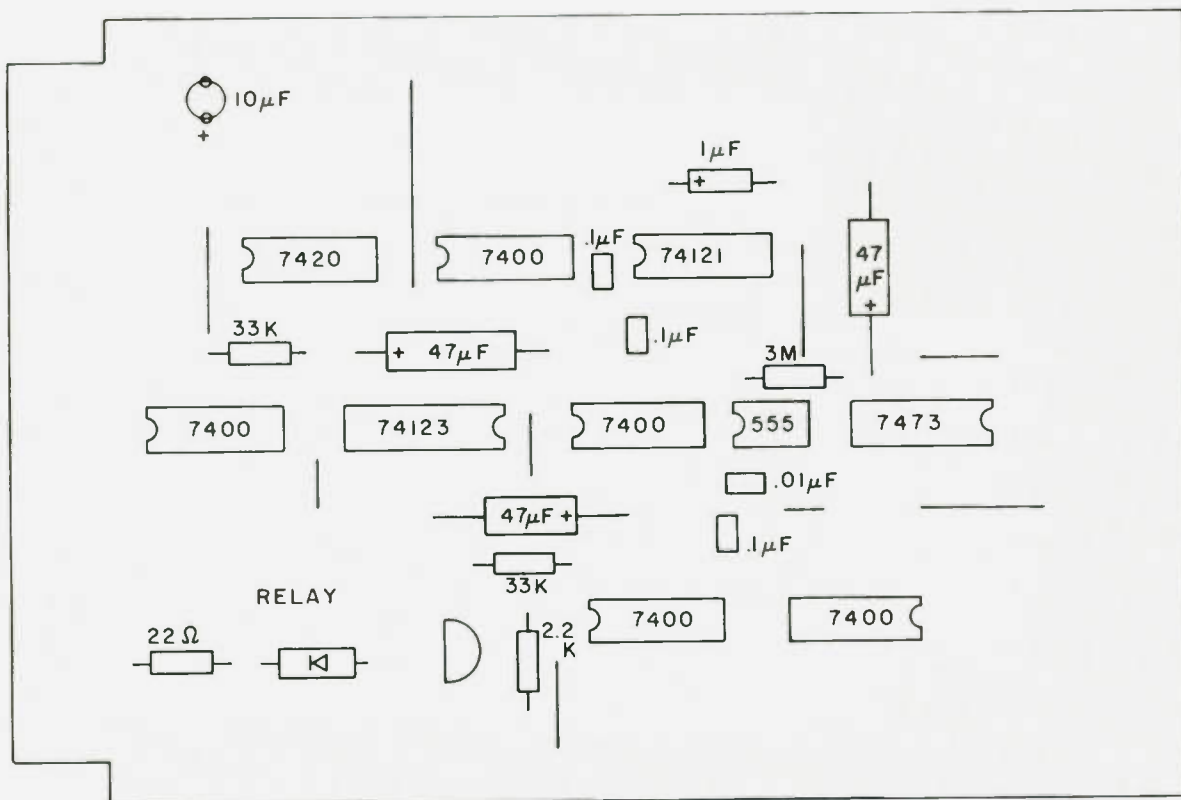

Fig. 4. Touchtone control PC board.

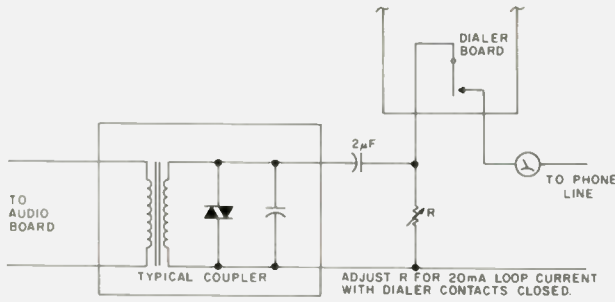

Fig. 5. Dc isolation and reduction of loop current.

with this resistor. For a gain reduction of half the present gain, you should reduce the

feedback resistor to half its present value.

There are two 220 MHz

repeaters in this area that have been built using this system of circuits. These fellows have taken Clegg FM-76 rigs and removed and re-mounted the transmitter and receiver boards in separate boxes. After interfacing with this system of circuits, they have a very fine repeater. The ease with which this can be done is just fantastic!

Future Goodies

A three- or four-tone sequential control system is

high on the priority list. With this you could key a recorded message for new repeater users. You could select preset squelch (COS) threshold levels for those times when the band is open. You could switch a 6 dB pad in the receiver for those repeaters that are troubled by intermod from time to time. You could set up links with other repeaters to increase your range. Okay, there's the next project — a sequential tone decoder. ■

ALL BAND TRAP ANTENNAS!

ALL 5 BAND OPERATION - ONLY ONE NEAT SMALL ANTENNA. FOR CONGESTED HOUSING AND APARTMENT DWELLERS! LIGHT, NEAT - ALMOST INVISIBLE!

FOR ALL MAKES AMATEUR HF TRANSMITTERS - TRANSCEIVERS - GUARANTEED FOR 2,000 WATTS PEP. POWER. FOR NOVICE AND ALL CLASS AMATEURS!

COMPLETE Ready to put up with 30 ft. Dacron end support cords! Wt. 3 lbs., 1"X5" MOLDED RESONANT TRAPS - just switch your transmitter to desired band for EXCELLENT PERFORMANCE!
NO TUNERS OR BALUNS NEEDED! CAN BE USED IN ATTICS, TOPS OF BUILDINGS, INVERTED V's IN MINIMUM SPACE. NO CENTER SUPPORT NEEDED, NO HAYWIRE HOUSE APPEARANCE COMPLETELY ASSEMBLED. No tuning - cutting - soldering - measuring - JUST HANG IT, AND USE IT! SWR IS 1.2 AT RESONANCE. THOUSANDS IN USE - EASIEST INSTALLATION!

80-40-20-15-10 meter bands---102 ft. with 90 ft. RG58U coax - connector -Model 998BU... \$49.95
 40-20-15-10 meter bands---54 ft. with 90 ft. RG58U coax - connector -Model 1001BU... \$48.95
 20-15-10 meter bands--- 26ft. with 90 ft. RG58U coax - connector -Model 1007BU... \$47.95

Send only \$5.00 (cash, ck., mo.) and pay postman balance plus COD postage OR SEND FULL PRICE FOR POST PAID DEL. IN USA (Canada is \$5.00 extra) or order by MAIL OR PHONE with Bank-Amercard VISA - MASTER CHARGE - OR AM EXP. Give number and ex. date. Ph 1-308-236-5333 week days. We ship in 2-3 days. INFLATION? PRICES MAY INCREASE - SAVE - ORDER NOW!
INFO. AVAILABLE FROM: WESTERN ELECTRONICS Dept. A7-3 Kearney, Nebraska, 68847

TRANSFORMERS			COAX-RELAY	
115vAC				
12 V	.2 A	\$1.00	SPDT-115vAC-100W RF	
6.3	.6	1.25	BNC Conn. R.F.E.	
12.6 ct	3	3.00		\$4.95
17.7	4	4.95		
25.2 ct	2	3.00		
36 ct	.065	1.00		
40 ct	2	3.50		

Please include postage

Write for our FREE flyer. Contains hundreds of different items:

- 7400 TTL Series I.C.'s, Linears, Voltage Regulators
- Used Test Equipment
- Continental Spec. Sockets & Bus Strips
- Datak Corp's Complete Line of Photo Etch Supplies
- I.C. Sockets, Ribbon Cable
- Capacitors, LED's, etc., etc.

R18

R.W. ELECTRONICS, INC.
 3203 North Western Avenue
 Chicago, Illinois 60618 312-248-2480

ANNOUNCING

NEW: AUTOCALL DECODER

4-Digit Touchtone® Decoder for paging and control.
 CMOS Redesign Based on Autocall 76 (June 76 73 Mag)

Features:

- HI-Z Input, will connect to any available audio
- Self-adjusting Input Amplifier
- Will not false
- Absolutely reliable
- Low power consumption
- Thousands of possible codes
- Field Programmable
- Operate from single 12V Power Supply

Price: Kit \$39.95 Wired \$75.00

NEW: AUDIO LIMITING AMPLIFIER

For use in applications such as repeater decoders where a constant audio level is desirable.

Features:

- Will take any input from 100 MV to greater than 6V PP
- Maintains constant level output over Range ± 2DB
- Low distortion over range
- Range 100 Hz - 25 KHz
- Operates from single 12V Power Supply

Price: Kit \$14.95 Wired \$25.00

Calif. residents add 6% sales tax

NEW: PROGRAMMABLE C.W. ID'R

For use in repeaters, links, or any place where a CW ID is required.

Features:

- Simple "key-in" programming
- Extremely low power consumption
- Self-completing after trigger
- Low Z audio tone output
- Output for keying external CW device
- "mic" key output for keeping transmitter on while ID in progress

Price: Kit \$29.95 Wired \$39.95

J9
 ELECTRONICS, INC. 18618-2 PARTHENIA ST. NORTHRIDGE CA. 91324 PHONE (213) 993-5159

Add SSTV for \$695

\$695! That's all it costs to add a total new dimension of activity to your station.* That's the price of the Robot Model 400 Converter, that converts the SSTV signal picked up by your transceiver to a video image on your home TV set.

SSTV contacts are easy to make, since there are over 3000 SSTV stations already operating in over 100 radio countries, and the list is growing daily.

DX'ING ON SSTV.

DX'ing is a whole new ball game on SSTV. You can actually see the fellow you're working, as well as his station, his equipment, even his family. SSTV is a very personal communication, and with over 100 countries to work, the challenge is definitely there.

WRITE FOR THE FREE SSTV FACT PACK.

We've assembled a whole package of literature on SSTV, including reprints of magazine articles, data sheets on our equipment, and our new 3 page brochure on SSTV. Just drop us a note and we'll send your SSTV Fact Pack by return mail.

*The Robot 400 Converter can be connected to the antenna terminal of a home TV set by means of the Robot RF Adapter kit option for \$25.

ROBOT

ROBOT RESEARCH

7591 Convoy Court, San Diego, CA 92111 (714) 279-9430



"Use a ROBOT equipment exchange"
GARY RADIO • 3199 Clairemont Mesa Blvd. • San Diego, CA 92111 • (714) 292-1440

1220 MHz — Use It Or Lose It!

— simple gear
you can build and enjoy

This article, for the genuine amateur radio and electronics experimenter, details the construction of a crystal-controlled exciter, an oscillator, a tuned diode detector, and an eleven-element beam covering the amateur band of 1215 to 1300 MHz. In these days of "store-bought" rigs on lower frequencies, there is a particular fascination in working

with circuits which cannot be found down on "Radio Row."

This particular amateur band is about the last one, going up in frequency, on which a Yagi beam is still useful. At 2400 MHz, almost any kind of a dish is better, but, here on 1220, long Yagis will still give plenty of gain — like close to 20 dB. And, look at the low cost! A piece of

for 1220 MHz, can be made out of copperclad and brass sheet, although spring copper or beryllium copper make better sliding contact springs, of course.

First there's the ¼-wave open-ended circuit. I have made some of these operate on 1220, but you're right on the end of nothing as far as a decent tuned circuit goes. Fig. 1 shows a tuned diode detector circuit which is good up to about 800 MHz. Actually, this one is about all through at 1000 MHz, so don't try to use it for 1220 unless you want to just play around.

Then there's the ½-wave "double-short" circuit. This one, shown in Fig. 3(a), works fine on 1220. I've even used it right up to and including X-band (10,000 MHz), although there it really needs a ¼-inch i.d. cavity with a one-eighth-inch center conductor, but that's another story.

As in Fig. 3(a), the ever-useful copperclad forms the baseboard, with another piece one inch wide for L1 fastened down at both ends with insulation. I made the sliding shorts out of brass sheet, although spring copper is better. It is also supposed to work better if silver-plated (and, of course, it will, at least a little). I have not

PVC tubing, a chunk of no. 12 bare copper wire cut into little pieces, some Elmer's glue, and you've got it.

Of course, finding the lengths and spacings of each one of those elements is very important, but I've already done that part for you.

The tuned circuit itself,



Fig. 2(a).

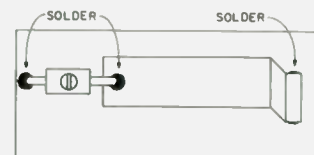

Fig. 2(b).

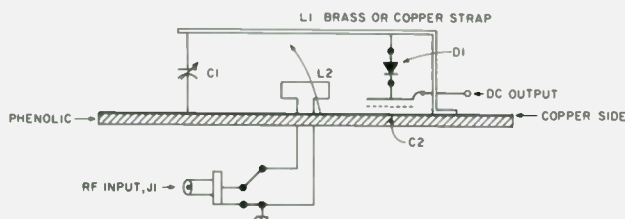

Fig. 1. ¼-wave circuit. Do not use above 800 MHz.

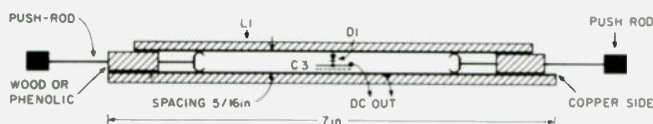

Fig. 3(a). Completed diode detector. Tunes 1000 to 1400 MHz. C3 — see Fig. 3(b).

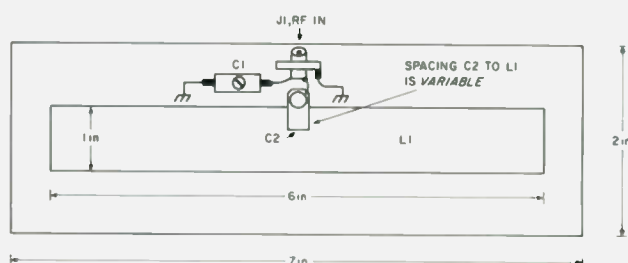

Fig. 3(b). Top view. C2 is variable (about ½ pF). J1 is a phono jack. C3 is 1 inch square, insulated from baseboard. Use nylon bolt to hold C3 to base.



Fig. 4. Sliding shorts.

silver-plated mine yet. Just be sure to make the brass shine.

You will have to put a little effort into making the sliders, as shown in Fig. 4. I was doubtful at first about making them myself, but, after the first few you make, it's not so hard. They do work, if you handle them with care. In Fig. 3(a) I show handles on the push rods, but if you leave these off or make them readily detachable, you can take the sliders out quite easily and adjust them for a good fit, taking care to make the pressure on each finger as nearly equal as you can.

Fig. 4 shows the flat cut, with the fingers, before bending. Fig. 5(a) shows the finished shape, after bending, with push rod soldered in place. Fig. 5(b) shows details of the contacting surfaces bent for best contact operation.

Now that you have a tuned diode detector, you need something to detect, and the oscillator of Fig. 6 will give you just that, although you may wish to proceed directly to the crystal-controlled exciter. Figs. 6(b) and 6(c) give further details on the oscillator.

Good transistors begin to

be a problem for 1220 MHz. I used the old standby 918, which must be at least ten years old by now. I found that tuning on 1220 is remarkably sharp as soon as you get things running at all well. An oscillator is a lot of fun and quite useful for certain purposes, such as tuning up beams (especially when followed by an amplifier for more power), isolation, and modulation. The crystal-controlled exciter is, of course, the unit to use for serious work on the air.

In order to make the multiplier tuning simpler and a sure thing, I decided to stick to doubling in the UHF and microwave stages. If you have had any experience with frequency multiplying at UHF and up into microwaves, you will be acquainted with the fact that the times-two harmonic (doubling) is always the most powerful.

You can start on 50.9 MHz, as in Fig. 7, triple to 152.7, double to 305.4, double to 610.8, and, finally, double to 1221.6 MHz in the amateur band. Note that tripling from 50 to 150 is not too hard, but from then on

up, you should double only for the simplest and surest results. Of course, if you want to, using very high Q circuits and very careful attention to wavemeters, calibrated tuned detectors, and well-calibrated microwave receivers, you can do almost any amount of multiplying. For instance, I worked with a large company in New Hampshire in the late 1960s which was building X-band equipment for the ill-fated F-111 jet fighter. Someone had designed a little unit which was supposed to multiply by *ten!* At X-band! Needless to say, I advised elimination of that unit and came up with a Gunn diode oscillator on X-band. They had been using several X-band spectrum analyzers to find that elusive little tenth harmonic. So stick to doubling; you'll have fewer grey hairs!

You can start in this exciter with almost any good VHF transistor as the 50.9 MHz oscillator, using the well-tried and proven circuit of Fig. 7. Though tripling to 152.7 isn't too difficult, you will need to make up or borrow some VHF and UHF absorption wavemeters. Do not use a receiver to determine which harmonic you are on. Better are the tuned diode types shown in Fig. 1.

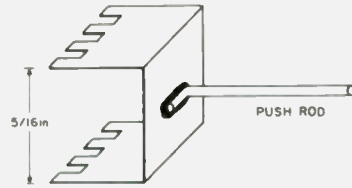

Fig. 5(a).

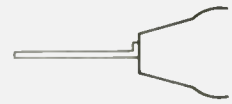

Fig. 5(b). Bending detail of shorts.

They are also excellent for checking AM modulation with a small af amplifier and padded earphones, so you can hear your own modulation as it sounds on the air.

You will have enough to do getting a microwave rig and beams running for interesting DX tests without going to other than AM modulation, at least to start with, so be happy with it. It also works very well and gives you the same or better DX.

The doubler from 152.7 to 305.4 MHz is still easy enough, if you have some experience and frequency calibration available to help you. For the next doubler to 610.8 MHz, I had to use the old reliable 918, and, just to be sure of getting the doubling frequency harmonic on 610.8, I made up a lecher line quickie, as in Fig. 9. This one is really indispensable for checking frequencies over 1000 MHz. Couple J1 to the oscillator or stage under test with a short piece of RG-58/U cable, and observe peaks and/or dips as shown

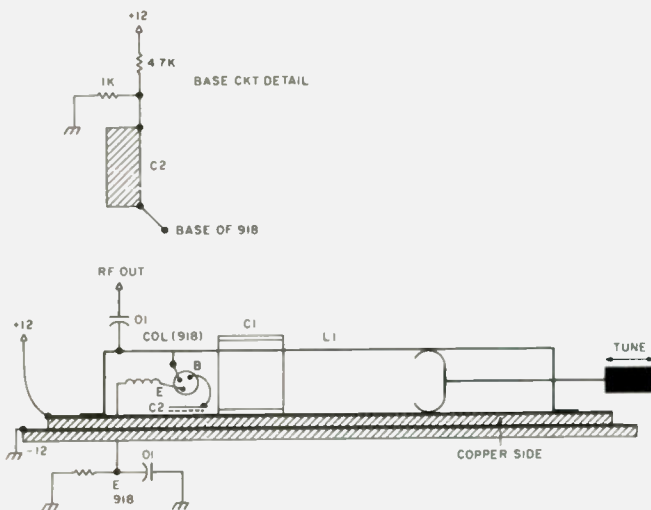

Fig. 6(a). Oscillator, 1220 MHz.

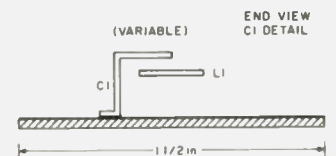

Fig. 6(c). Collector tap at 1/2" from end of L1.

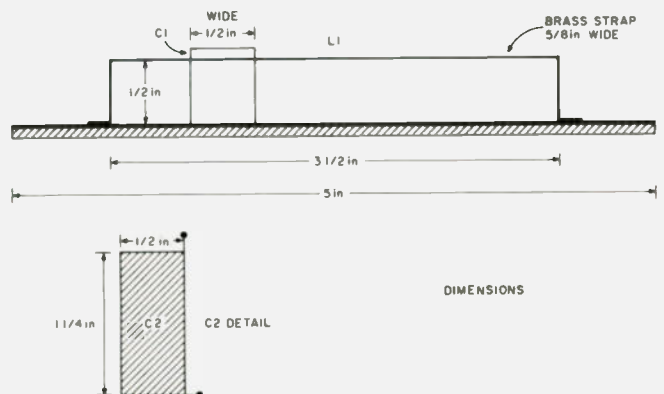

Fig. 6(b).

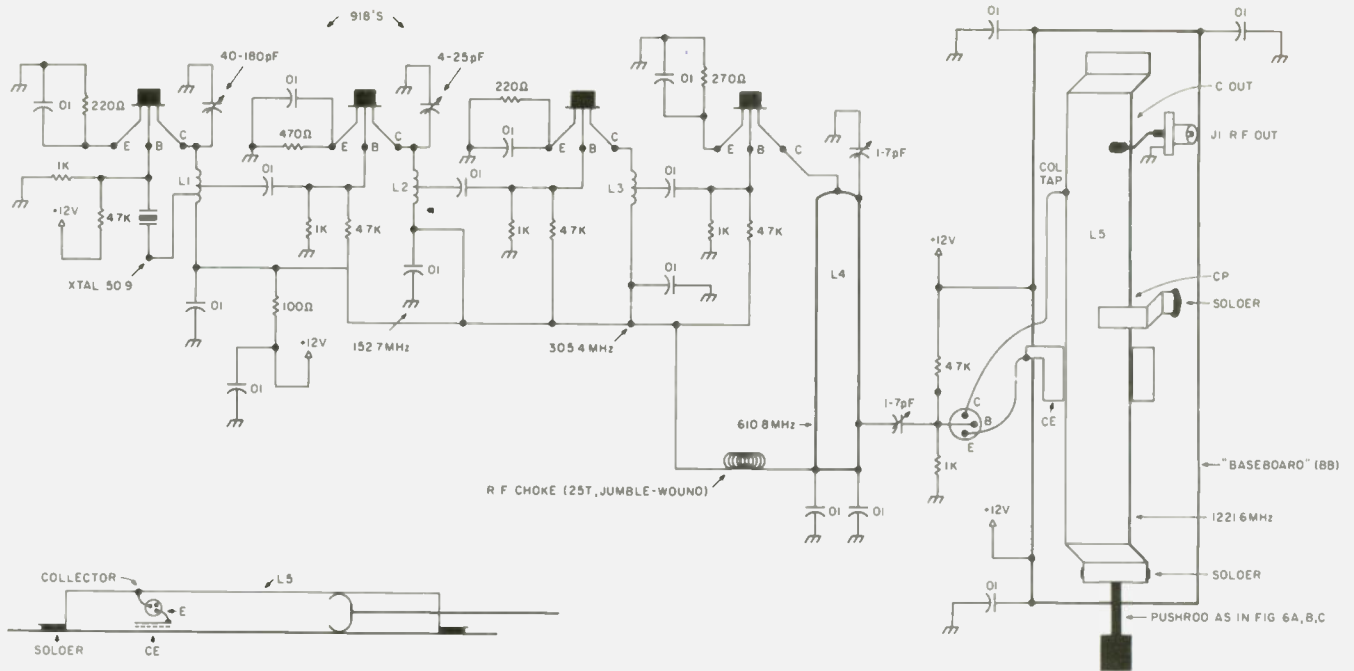

Fig. 7. Crystal exciter, 1220 MHz. Note that BB is connected to +12 V along with L5, as in Figs. 6(a), 6(b), and 6(c). (See lower left: L5 detail — 1220 doubler.) C out is placed $7/8$ " from end of L5 and is variable. The col. lead to L5 is only $1/4$ " long. CE is also similar to the emitter cap of Figs. 6(a), 6(b), and 6(c). BB is $5\frac{1}{2}$ " long, $1\frac{1}{2}$ " wide, and insulated from ground. L1 = 4 turns no. 16 bare, $3/4$ " long; tap at $1\frac{1}{2}$ turns from cold end, $5/8$ o.d. L2 = 4 turns, $7/16$ o.d., output tap at $1/2$ turn from cold end. L3 = 3 turns; tap at $1/2$ turn. L4 = brass or copper strap, $1/2$ " wide, $1-7/8$ " long, output tap at $1/2$ " from cold end, spaced $3/8$ " from baseboard.

on the diode wavemeter. Fasten a ruler to the baseboard (be sure it has a centimeter scale), and, as you slide the short along the lecher line, take an average of several peaks. These peaks or dips are found at the half-wave points, so multiply by two for the wavelength. Easy-to-remember centimeter-to-MHz conversion points are 30 cm = 1000 MHz, 20 cm = 1500 MHz, 15 cm = 2000 MHz, and 10 cm = 3000 MHz.

I had to start using strap-line circuitry here at 610.8 MHz, as shown in Fig. 7. Around 400 to 500 MHz is where you have to give up on coils. From then on up, shape

begins to play an ever-increasing role in frequency determination.

The last stage of the exciter is where things get a little tricky if you are not used to half-wave double-short circuitry. However, once you get it running, you will find it tunes very sharply and provides you with good output on 1221 MHz. Note the small-value trimmers found between the base and ground of the last three doublers. These are quite important, as you will find, serving to match the base input impedance to the previous collector circuit, along with the tap-down on its induc-

tance. There is also a parallel capacitor, CP, across L5, the 1200 MHz tuned circuit. This is the same as on the lower frequencies, only a great deal smaller. A certain amount of parallel C combined with the L gives the best Q for a given frequency. A few minutes of trial, varying the C against the length of L5, will show you that that principle still holds true even on 1220 MHz.

The collector connection is shown tapped down on L5, also as usual. Note also the use of +12 volts on the ground line of L5. This method avoids the use of "zero inductance" capacitors at the ends of L5. Such capacitors do not exist in

stores, although certain expensive coaxial types do attain quite low values of L in the "leads."

The emitter bypass, CE, uses the brass-plate method to achieve the desired low inductance for use at 1220 MHz. The oscillator, Figs. 6(a) and 6(b), shows more detail of this type of flat-plate cap. In those figures, it is labeled C2 and is used as the base bypass. Note that to make an oscillator, you "lift" the emitter off ground and ground the base (to rf, that is). To make an amplifier or doubler, you ground the emitter and use the off-ground base as the open input.

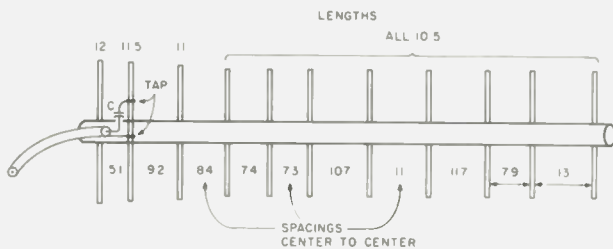

Fig. 8. 11-element beam, 1220 MHz. (All measurements are in cm.) Boom = PVC grey plastic tubing, $7/8$ o.d. Elements = bare copper, no. 12. C = $1/2$ to 1 pF. Tap, center to center = 19 mm. Spacing, C, and leads to element = approximately 2 mm. Elements fastened with push-fit and white glue.

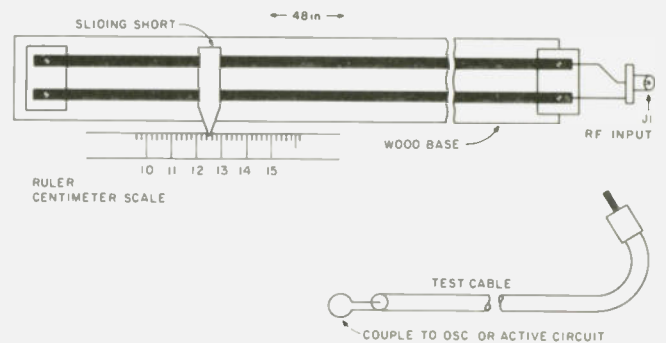

Fig. 9. Lecher line.

source would be a good loud automobile horn. An old, but usable, automobile horn can be obtained from a junk yard quite reasonably. However, a horn of this type requires a lot of current, and that means running heavy wiring and using a heavy relay in the alarm system.

A mechanical siren is another possibility, but requires time to come up to full speed, can be jammed, and may not produce the most effective frequency.

The best sound generator for use inside the car is probably an electronic siren. These are available commercially for around \$25, but a very effective siren can be built using two NE-555 integrated circuits and a PNP power transistor.

The circuit in Fig. 1 is a siren that I built. This circuit produces a square wave output that sweeps up and down in frequency, producing an effective deterrent sound. The operation of this circuit

is straightforward. The first NE-555 timer (IC1) produces a very low-frequency rectangular output, which is shaped to a roughly triangular waveform by R1, D1, and C1. This signal modulates the audio frequency square wave oscillator formed by IC2 and associated components. Finally, the sweep frequency output from IC2 drives the base of a PNP power-switching transistor through a current-limiting potentiometer. The emitter circuit of the transistor has the speaker going to the positive supply with a flyback diode across the speaker. Don't be afraid to play with this circuit; in fact, I recommend it.

For best results, the circuit should be adjusted while in your car to produce the most effective sound. For testing at low volume, just omit the power transistor and connect the free speaker lead to the 500-Ohm pot.

If you live in a state that prohibits the sweep-

frequency-type siren alarm on vehicles, the circuit in Fig. 1 can be converted to produce a two-tone (high/low) sound. All you have to do is remove C1. While I do not think this is quite as effective as the sweep sound, it is far better than nothing.

The most expensive part of the home-built siren is the horn speaker. You can sometimes find these on sale for \$8 to \$10, but, in any case, you need an efficient speaker, capable of handling 8 to 10 Watts. You can have a switch (well hidden) or a relay to let you use the speaker with your rig, if that will help you justify the cost.

Regardless of what type of horn or siren you use, there are some things you should do to make it and your entire alarm system as reliable as possible. First, you should have some way to lock the hood of your car, and you should wire the alarm system to sense the operation of the hood latch. This will

provide some protection for the car battery and alarm wiring. However, you may also need a separate alarm power lead and ground from the car battery run so as to be inaccessible from outside the engine compartment. These precautions are for the more professional thief who notices the key switch and then tries to beat the system.

Also, there are some simple nontechnical things you can do to increase your protection. Try to pick your parking spot where your alarm will attract the attention you want and where there will be little time for the thief to try and find a way to beat your system.

Finally, remember that an alarm is not a perfect answer. There is only one sure way of protecting your rig — always take it with you. However, when that is not possible, and you recognize the risk, a loud siren or horn inside the car is the best protection I know of. ■

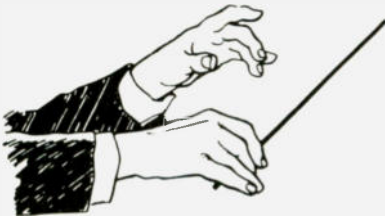

The LEADER In the Northwest!

ATLAS • ICOM • KENWOOD • YAESU



Kenwood TS-520S
\$649.00



Atlas 350-XL
\$995.00



Yaesu
FT-101E \$799.00
FT-101EE \$759.00



Kenwood TS-820S
\$1048.00



Yaesu FT-301D — \$935.00



ABC
COMMUNICATIONS

A46

17550 15th Ave. N.E. • Seattle WA 98155 • (206) 364-8300

TO PLACE ORDER
CALL TOLL FREE
IN STATE OF WASH.
1-(800) 562-7625



Other locations: (Walk-in customers only) • Bellevue — 12001 N. E. 12th • Everett — 6920 Evergreen Way • Open Mon. thru Sat.

The Great Cover-Up

— a fiendish way
to simplify schematics

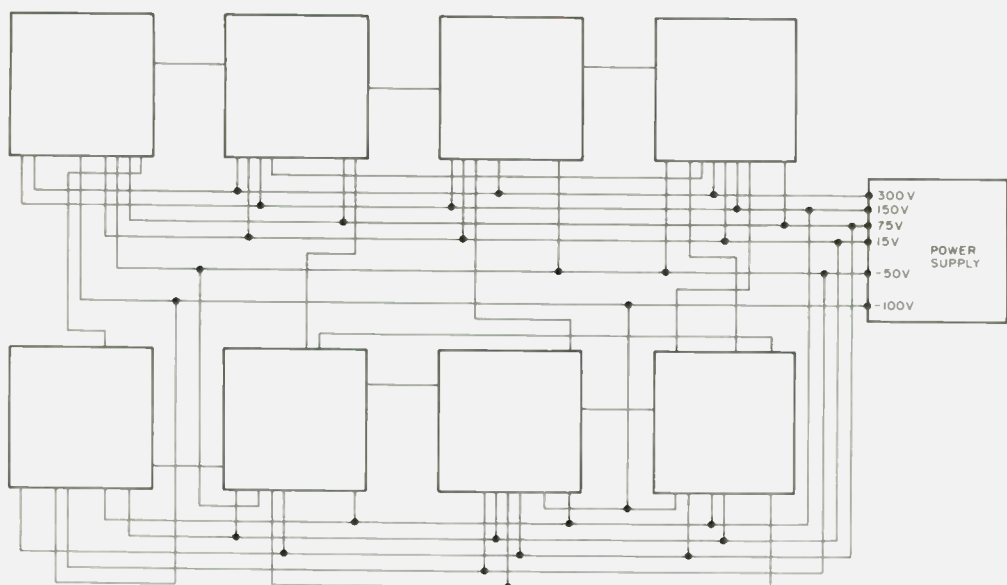

Fig. 1. Before.

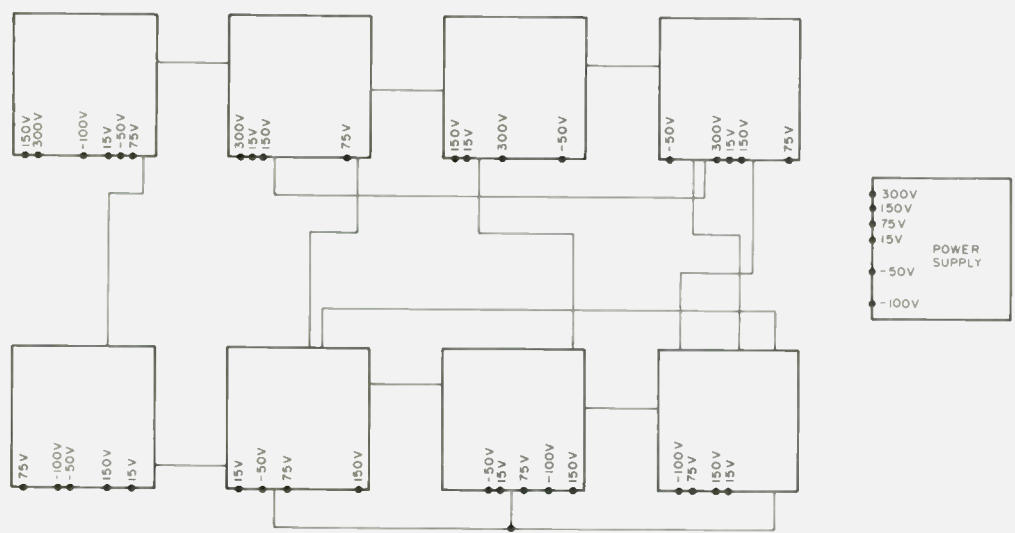

Fig. 2. After.

It is unfortunate that, over the years, not enough emphasis has been placed on the importance of a well-designed schematic diagram and its role in intelligent circuit analysis as a prelude to troubleshooting.

Since the beginning of multistage communication equipment, one of the most useful tools for the skilled technician has been the schematic diagram. However, too many schematics are improperly designed, representing an obstacle course and a time-consumer to the troubleshooter. The well-designed schematic diagram enhances the value of a piece of equipment to the user. With it, he can visualize the circuitry and see the signal paths with ease, which enables him to operate his equipment with a clear understanding of what is going on behind that beautiful panel. Also, he can appreciate better the unique features incorporated into his equipment . . . manufacturers, please take note.

There are a great many hams who have the technical knowledge and skills needed to service the rather sophisticated communication equipment available to them. These hams usually have a fine ac-

accumulation of test equipment and know how to use it, not only when repairs are necessary, but also for continuing checks on the performance of their rigs.

Such a ham quite often can take a studied look at a well-designed schematic diagram and, after digesting a few operational cues, can quickly localize trouble to a particular stage. In many cases, he can even pinpoint the specific component without the use of any test equipment other than his own senses.

It is surprising, indeed, that so many otherwise astute hams will tolerate a poorly-designed schematic and will tediously labor with it throughout the life of their equipment. They seem to be saying, "A schematic . . . is a schematic . . . is a schematic" (apologies to Gertrude Stein) and just letting it go at that.

A poorly-designed schematic diagram is one in which it is difficult to visualize the signal paths, voltage paths, and control paths. These schematics, correct in every detail as far as wiring is concerned, are needlessly cluttered with myriads of long lead lines from common voltage sources to the various stages, like railroad tracks in and out of a busy terminal. In addition, there are just as many wiring crossovers to contend with. Fortunately, chassis ground symbols are used extensively, and filament lines disappeared from most schematics many years ago. Otherwise, we would really have a mess.

More often than not, the

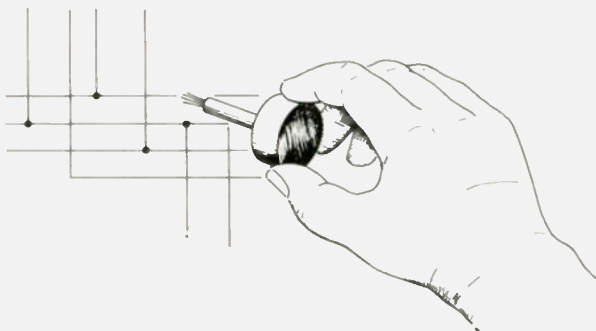

Fig. 3.

draftsman is not at fault; he is drawing a wiring diagram that is correct. He is usually not technically qualified to design the schematic from a comprehensive analytical viewpoint. Proper guidance in these matters should come from the engineering department, where this type of know-how exists. Diagrams become further cluttered as the draftsman has to make changes, additions, and deletions as production progresses from model A to model B and so on. The draftsman looks for a clear spot on the schematic for that additional component, draws it in, and just runs long lead lines to it from its related circuit.

At this time, you may be asking, "What can I do about it?" Well, you can do quite a bit to that schematic to make it the useful tool that it should be. You can eliminate most of the clutter and use the resultant open space to

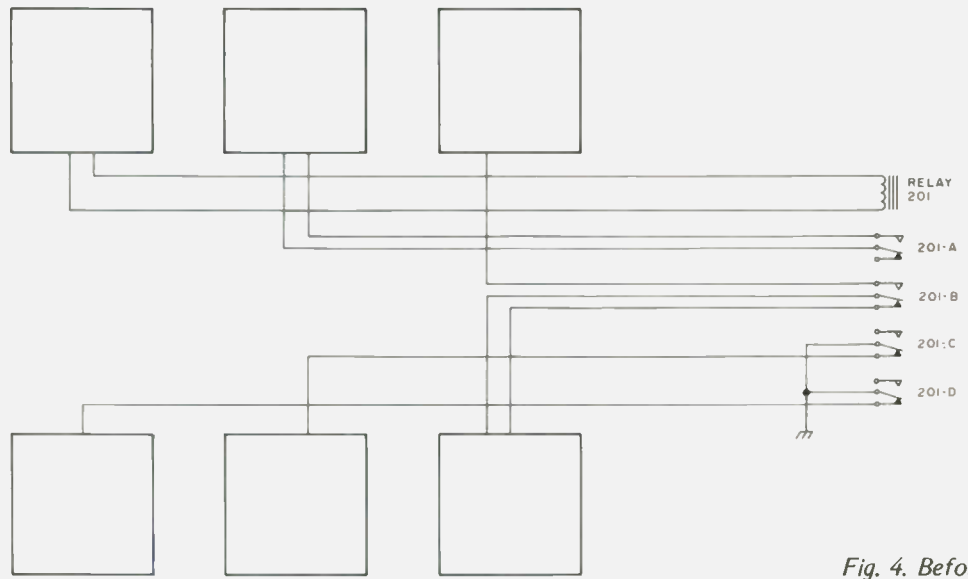

Fig. 4. Before.

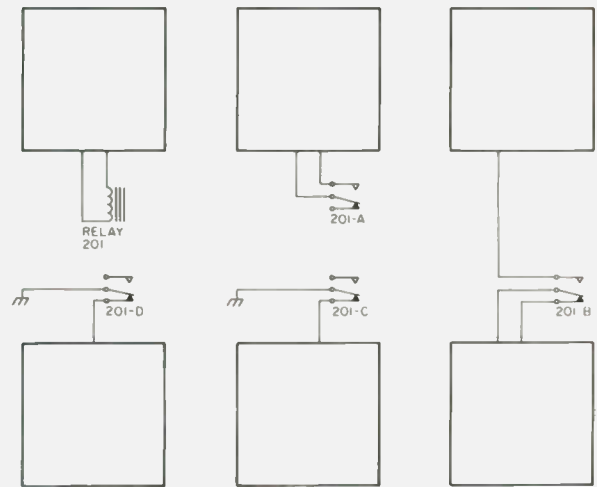

Fig. 5. After.

relocate some of those remotely-placed components near their associated circuits. These revisions can be made leisurely, before the need for troubleshooting arises. As a bonus, the very act of uncluttering the schematic allows the ham to gain an intimate familiarity with the circuit, providing for greater appreciation and more enjoyment of his equipment.

The first step in improving the visibility on the schematic is to erase all common-voltage bus lines. Starting with one voltage source at a time, carefully erase the lead lines, one at a time, and label the termination points with the appropriate voltage designation. This applies to all negative and positive voltages. Look around for other com-

mon bus lines, such as age voltages, and erase them, too. When you are finished with the above, you will be utterly amazed to see all the empty space on the schematic, and you should now be able to see circuitry and interstage connections that were completely hidden in the maze before. Figs. 1 and 2 show an example of before and after, using block diagrams for simplicity.

I imagine that, at this time, a lot of eyebrows are being raised . . . "Erase those long lines on the schematic? Is this guy for real? How?"

Well, there is a simple and practical way of "erasing" those long lead lines — just cover them up with the white correction fluid used by typists to correct errors. It

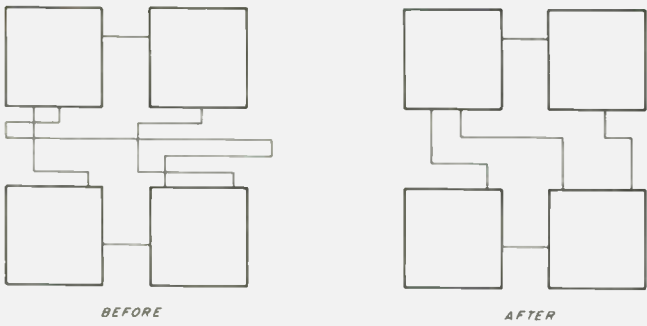

Fig. 6.

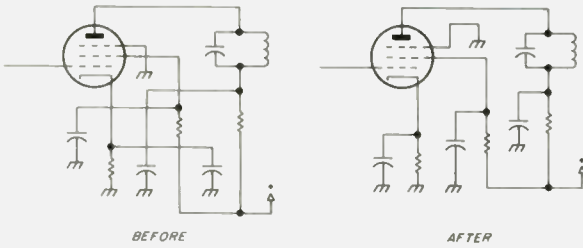

Fig. 7.

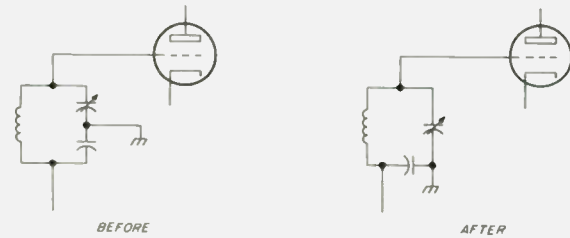

Fig. 8.

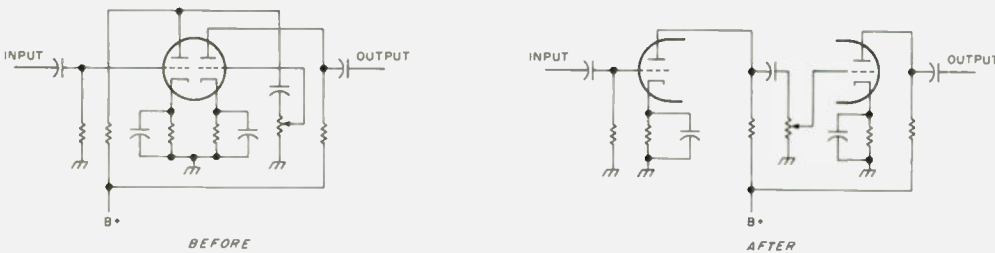

Fig. 9.

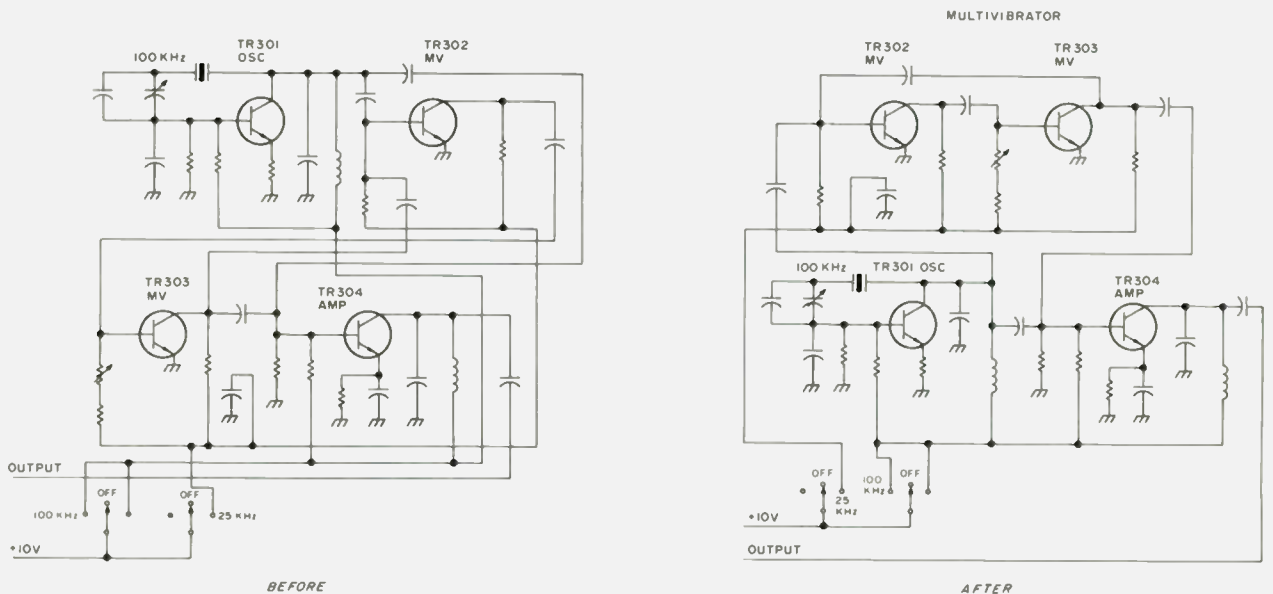

Fig. 10.

comes in a small convenient bottle, with a fine brush attached to the lid. I use a product called Mistake Out, made by Liquid Paper Co. of Dallas. It has a water base and dries fast, so you can draw over it as if it was blank paper (Fig. 3). A fine-point black ball-point pen and a transparent straightedge do the trick nicely for such drawing.

Since the average schematic diagram supplied with today's complex equipment occupies several pages, it is convenient to mount the opened schematic on a large piece of corrugated cardboard while working on it. Also, it is wise to xerox copy the original for reference.

Getting back to the nitty-gritty, there are more long lines that you can eliminate to further improve the visibility on the schematic. For example: Multiple relay contacts are usually clustered together in a convenient place, and long leads are then run to the circuits they control. In this case, we just cover up the clustered as-

semblies and relocate them individually, close to their associated circuits. See Figs. 4 and 5 for a simplified before and after. Don't worry about having enough space, since the previous elimination of bus lines has left plenty of room available.

Relocating components serves two purposes — you not only cover up more long lead-line clutter, but also, by placing the component close to its related circuit, you provide for better analytical visibility. Of course, be sure to label items like relay contacts with the original letters and numbers.

An examination of the circuitry remaining after the major cover-up just completed will reveal that many leads that had to be detoured can now be routed directly through a shorter path, eliminating many crossovers at the same time. Fig. 6 shows an example of rerouting.

Now that a lot of clutter has been removed and some components relocated on the schematic, you might find that those two or three resistors scattered about really are part of a voltage divider and should be reunited.

Until now, I have dealt mainly with interstage items and have used block diagrams for illustration purposes. Now take a look at examples of

modifications that can be made to individual stage circuitry. Fig. 7 shows a typical mess that results when a draftsman pays no attention to the visual hazards of unnecessary crossovers. Sometimes part number lettering is in the way. That, too, can be covered up and redrawn. Improved visibility is the name of the game.

Fig. 8 shows a tuned circuit where the tuning capacitor is grounded, but not the coil. To complete the tuned

circuit, a greater value fixed capacitor is used to place the coil at rf ground potential. It's a little easier to understand when redrawn as shown.

Fig. 9 shows a common-place dual triode arrangement in a basic resistance coupled amplifier circuit, which can be made a lot easier to visualize by redrawing as shown.

Now, here is a rather complex modification: Fig. 10 shows a crystal calibrator as

used in one of the popular transceivers. It uses a 100 kHz crystal oscillator feeding a buffer amplifier. When 25 kHz output is desired, voltage is applied to a multivibrator circuit consisting of TR-302 and TR-303 which is placed between the crystal oscillator and the amplifier. The original circuit can be fairly confusing until it is redrawn as shown, with the multivibrator untangled from the rest of the circuit. The same amount of space on the sche-

matic is used. Note the reduction in crossovers.

As you progress through the circuitry, you will find that one simplification opens the door to another. When you finally compare your "great cover-up" to the xerox copy of the original schematic, you will wonder how you were ever able to cope with it. It is quite a revelation.

You now have a schematic diagram designed by an expert — YOU! ■

BRIGHTEN YOUR SHACK IMPROVE YOUR CW

with the new **Shavney keybase**.
Keeps your wrist up where it belongs!



White, black or grey base—\$7.95 ppd.
Matching or brass callplate—add \$2.00
Brass code key installed—add \$5.00
(PA residents add 6% tax)
ORDER NOW FROM:

Shavney Imports
111 S. Easton Rd.
Glenside PA 19038 S45

COAKIT
RF ASSORTMENT
NUMBER 1241

CONNECTOR ASSORTMENT
\$25.00 **\$23.50** each
 Postpaid lots of three

Includes: 5- PL259, 5- SO239, 5- UG175, 5- UG176, 2- PL258, 1- DM, 1- M358, 2- M359, 1- UG255, 1- UG273, 2- PL259PO, 1- 1021-20, 1- Lightning Arrestor.

Master Charge & Visa accepted / Send for Free Catalog

COAKIT

P.O. Box 101-A Dumont, N. J. 07628
Circle C21 on Reader Service Card

ANTENNA PROBLEM ON 20?

Anyone who has used a 'mini' beam knows how performance disappears once you're a little bit off resonance.

Island Antennas has the answer.

Using log periodic feed with loaded elements is how Island did it. Not only full band coverage, but an antenna that weighs half as much as other 'mini' beams.

It makes an ideal companion for those no tune em solid state mini rigs. Never needs tuning or matching and folds compactly for airline travel. It's so rugged, we've got a 2-week unconditional refund policy, plus a year's guarantee.

gain - 6 db	VSWR - 1.5 max	band - 14-14.5 MHz
weight - 8 lb	power - 1 kW	(tribander soon)
wind area - 1 sq ft	feed - 50 Ohm	f/b - 8 db
elements - 4	torque at - 12	boom - 10"

\$149 info on request

Island Antennas
Block Island, RI 02807
Custom antennas our specialty

119

IC22S FREQUENCY DISPLAY KIT

Why squint at your channel selector or check charts to know where you are on the band?

- Shows the programmed frequency, tracks the simplex-duplex function
- Works with ANY external programming system, as well as the internal channel selector
- Full six digit display, not 3 1/2 like the others
- No-hole mount - Small size (5.5wx1.2Hx2O) box mounts inconspicuously in the mobile, or under the radio as a stand
- Plugs into the 9 pin accessory socket, can be removed at any time
- Easy one night construction and installation, sockets provided for all ICs, very comprehensive instruction manual
- A perfect match for our scanner kit

COMPLETE KIT \$59.95
CABINET EXTRA \$8.05
PREASSEMBLED AND TESTED UNIT (CABINET INCLUDED) \$89.95

ADD 5% FOR POSTAGE AND HANDLING - DEALER INQUIRIES INVITED



V16



750 LUCERNE RD
SUITE 120
TEL 514 737 7293
MONTREAL, QUEBEC
CANADA H3R 2H6

Pace-Traps

Box 234
Middlebury CT 06762

MULTI-BAND ANTENNA TRAPS

FG-5 kW rated traps for 80-10 meter systems . . . \$17.95 pair ppd.
FG-4 kW rated traps for 40-10 meter systems . . . \$17.95 pair ppd.
Complete two band trap dipole systems, kw rated, factory tuned to suit your operating habits and ready to install! Includes #12 stranded copper-weld, center-insulator, end-insulators, 70 feet of RG59 coax with FT-259! Each band can be tuned to your specification! Specify combination desired . . . phone-phone, phone-cw . . . cw-cw in any combination desired!

PT80-40 two band system approximately 105' long . . . \$44.95 ppd.
PT140-20 two band system approximately 55' long . . . \$42.50 ppd.
PT120-15 two band system approximately 28' long . . . \$37.50 ppd.
PT15-10 two band system approximately 18' long . . . \$35.95 ppd.
* Length depends on frequency combination chosen.

PS-2 weather-proof center-insulator . . . \$5.95 ea. ppd.
Stranded Copper-weld cut to length

5 band \$6.50 + \$1 UPS
4 band \$3.50 + \$1 UPS

TWO METER MOBILE OPS

Convert to the low-profile FLYING-DUCKY! Magnetic mount designed to use a rubber-ducky (short quarter-wave vertical) as an external mobile antenna. Super magnet holds even on hard-top. Designed to go with any HT but with adapter plugs available, matches any mobile rig. Provides solid mobile coverage even with the low-power HT. Better than 1/4 wave or 5/8 wave trunk-mounted whips. 10 second install and remove!

Complete mount and cable to suit HT or mobile. Specify either F-type BNC or SO 239 plugs \$13.95 ppd.
Adapter plug to match cable to rig \$2.50 ppd.
Rubber-Ducky to suit \$6.95 ppd.
Roll-up whip for easy packing \$5.95 ppd.

Check or MO to
Box 234
Middlebury CT 06762
(203) 758-9228

P15

IC22S OWNERS SCANNER KIT

- Your scanner shouldn't cost almost as much as your rig.
- Continuously scans 2m band from 145.35 - 147.975 in 15 kHz steps
- LED indicator tells when rig is scanning
- Switch modification on mike allows you to scan past or lock on to any occupied frequency
- Memory circuit allows scanner to hold last frequency locked in for at least 2 hours after power is turned off
- Uses one matrix position leaving the other 21 usable for manual programming
- Complete kit with detailed instructions, installs inside rig, no abrasive external connections, no drilling, rig could be returned to original condition if desired

COMPLETE KIT \$29.95

PREASSEMBLED AND TESTED BOARD \$39.95

ADD 5% FOR POSTAGE AND HANDLING - DEALER INQUIRIES INVITED



V16



750 LUCERNE RD
SUITE 120
TEL 514 737 7293
MONTREAL, QUEBEC
CANADA H3R 2H6

The World Of Tone Control

*—a virtual encyclopedia
on the subject*

Most active hams know of the widespread use of tone signaling in amateur radio these days. VHF FM and repeaters often require signaling other than voice or CW for repeater access, remote control, and autopatch functions. However, most of us think only of touch-tone™ when we think of tone signaling. Undoubtedly, touchtone is the system most widely employed by hams. This is so because the encoders (pads) and decoders are fairly easy to build or obtain, and, more importantly, the number of different codes available is great. A single-digit system allows 12 signals (0-9, # and *), two digits gives 144 (ex. 12, 5#, 76, etc.), and so on. But in amateur usage, as in commercial two-way radio systems, this versatility is not always necessary. For simple control systems and for sub-audible squelch, a single tone

is adequate, allowing both encoder and decoder to become extremely simple. This article examines single-tone signaling and some simple high-performance encoder circuits.

Single-Tone Systems

As two-way VHF FM communications developed in the early 1950s, the need for a nonvoice signaling method on voice channels became apparent. A voice channel provided the vehicle for transmission of remote control information (for utilities, oil-pipeline companies, weather-monitoring equipment, and other unattended remote sites), or for selective calling (either paging or selectively calling one or more users of a radio system). Stripped down to fundamentals, the systems all relied on the transmission and decoding of predetermined highly stable tone frequencies throughout the audio spectrum, from approx-

imately 50 Hz to 10,000 Hz.

The tones from 157.0 Hz to 250.3 Hz were standardized by the Electronic Industries Association (EIA) in their publication RS-220 for use in continuous tone-controlled squelch systems (CTCSS). These low-frequency tones are less audible to human ears than higher frequencies (and compatible receivers filter them out before the loudspeaker), so CTCSS is commonly referred to as sub-audible squelch. Motorola's trade name is Private Line, GE's is Channel Guard, and RCA calls it Quiet Channel Squelch. CTCSS is frequently used on channels where several systems use the same channel or share a repeater. Each user has an individual tone, which is transmitted continuously while his transmitter is on the air. His own units respond to only his tone. Thus, the channel can be used by several groups, but

only those who are being called will hear the calling station. Obviously, only one station can transmit at one time, but when other stations are on the channel, they will not be heard. Amateur repeaters with overlapping coverage area on the same channel can use different CTCSS tones on their input receivers, so adjacent area amateurs will not be retransmitted.

Tones above 250 Hz are used for a variety of purposes. Most are channelized, although the channels selected vary among different equipment manufacturers. The most common usage is for paging systems, which usually use two or more sequential tones and are not widely employed by radio amateurs. Finally, these higher frequency tones can be used for selective repeater access or for remote-control applications using tone bursts. The tone burst selective repeater access is like the CTCSS selective access. Each repeater recognizes a specific tone frequency and will not respond to signals with no tone or a different tone. The tone is sent as a short burst (100 ms to 1 sec) at the beginning of a transmission, which tells the repeater a valid user is present. The repeater will then operate with normal carrier access for a preset length of time. After this time period elapses, the burst must again be sent to "bring up" the machine. By this method, the burst need not be repeated for each transmission, and, once accessed, the repeater can be used by stations without the tone equipment.

Remote-control applications in commercial service are numerous. They occur whenever some action must take place at an unattended location where it is time-consuming or physically difficult to send a person. The most common amateur usage is for control of a remote base or repeater station from a separate control station loca-

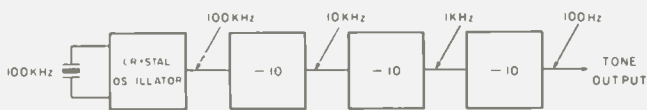

Fig. 1. Crystal-controlled audio tone generator.

tion.

Frequency Control Techniques

In most single-tone signaling systems and in sequential multiple-tone systems, the tone frequencies are spaced only a short distance apart. Thus, good stability is required in the encoders, so they do not drift from one tone channel into the next. Similarly, the decoders must be very selective, so they respond to only the desired tone frequency. This high degree of performance must remain unchanged over wide temperature and power supply voltage variations and under severe shock and vibration conditions (in mobile and hand-held radios), and they cannot degrade with age. Commercial equipment designers found that the most practical means of obtaining good frequency stability and selectivity was by using resonant reeds in both their encoders and decoders.

So, 20 years ago, the tone systems were developed with reeds in mind. And, since the standards of operation were set then, tone systems now in use must be compatible with the older (and newer) reed systems. Recent equipment uses a variety of frequency-control devices, such as active filters, piezoelectric fork resonators, and crystal-controlled digital circuits, but they all are basically designed to operate to the same standards established for the reed-type systems. Circuitry using resonant reeds still is probably the simplest means of encoding and decoding tone signals in two-way FM service.

But reeds tend to be expensive (15-20 dollars apiece), and a new one must be used for each tone frequency. To the commercial user, \$20 is not at all ex-

pensive, but to me, as a ham, it's bad, particularly since it's \$20 per tone channel, per tone encoder/decoder. For hams, decoders aren't too bad, since few of us need them. Usually, they are used only at a repeater, for access or control, and, perhaps, occasionally at home. Most repeater groups can afford to use reeds for their decoders "on the hill." And, if an individual wants a decoder, he can afford one using reeds. It's nice to be flexible, though, for encoders, since they are more common.

With these considerations in mind, I decided to look for a relatively inexpensive way of building a reed-system compatible encoder. As a starting point, I set the following conditions:

1. The encoder must be fairly cheap.
2. It must maintain $\pm 1\%$ stability to be compatible.
3. Wide temperature performance is desirable, at least $0\text{-}50^\circ\text{C}$., -30 to $+60^\circ\text{C}$. preferable.
4. The encoder must not require extensive modification to operate on any audio frequency.
5. Power drain must be as low as possible.
6. The encoder should not use any expensive or hard-to-get components.
7. Critical component matching or selection must not be needed.
8. Output waveshape has to be sinusoidal.

So much for my "dream list." The next few paragraphs give some possible choices.

Reeds, of course, were discounted because of their cost and the need for a new unit for each tone frequency. Piezoelectric forks, made by Murata and Iwata, among others, are more difficult to ignore, if you can afford the minimum charge per order;

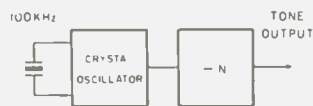

Fig. 2. Sophisticated crystal-controlled tone generator.

For $N = 100$, $f = 100,000$ Hz; for $N = 966$, $f = 103,519$ Hz; for $N = 933$, $f = 107,181$ Hz.

they are less than \$10 apiece. A local repeater group has bought several dozen Murata forks at a time, for control encoders and decoders. For a single frequency, this is fine, though it's awkward for small-quantity orders or for multiple-tone usage.

Another possible approach is to use an RC sine wave oscillator, such as a Wein-bridge or bridged-tee circuit.

I have used twin-tee networks for their tone needs much more than they have used reeds. Others, such as Aerotron, Vega, Ferritronics, Johnson, Alpha, and Bell and Howell use either RC oscillators or active filters for tone equipment. For equipment manufacturers, this approach is fine, since the components are relatively inexpensive in large quantities, factory-made circuits are stable, and (in some cases) retuning is easy. Duplication by the home builder, though, is not so easy. Precision components are difficult and expensive to get when you only want a few. And, often, precision component matching or critical circuit adjustments are required. Well-equipped and experienced amateurs can duplicate the performance with these circuits, and many do. What I wanted, however, was simplicity, not headaches.

LC oscillators like the Colpitts, Hartley, Clapp, etc., are not at all attractive for audio frequencies. First, the inductors are large and expensive. Above 1 kilohertz or so, the 88 MHz Bell Tel surplus toroids work, and those with money can buy pot-core inductors. Even then, though, the required capacitors can be quite large. Careful com-

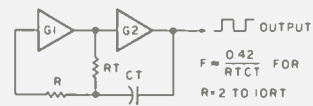

Fig. 3. CMOS gate astable multivibrator.

ponent selection (temperature coefficient matching) is a confining requirement. Finally, frequency adjustment is difficult. The large values of capacitance (often $.01\ \mu\text{F}$ to $1\ \mu\text{F}$) preclude the use of trimmer capacitors. Pot cores are adjustable over about a 10% range, but they are difficult to get.

One extremely attractive way to generate precision tones is to do it digitally. Avcom and Communication Specialists both market tone equipment that does just that. They use a quartz crystal or ceramic resonator to generate a very stable signal somewhere above the audio range, usually between 100 kHz and 5 MHz. This signal is then passed through a digital circuit to bring the frequency down to the desired range. There are several ways to do this. One way is shown in Fig. 1. All amateurs should be familiar with the stability of 100 kHz crystals — most of us have used them as receiver calibrators. This highly stable source is fed to three digital dividers, each of which divides its input frequency by 10. Thus, the total division is 1000, and 100 kHz divided by 1000 produces 100 Hz. The output frequency stability (in percent) is identical to the crystal stability. Either CMOS or TTL frequency dividers can be used for a fairly simple circuit. This scheme suffers the same drawback as the reed encoders. For each different tone frequency, a new crystal is required. They are less expensive than reeds, but they are still a nuisance to use for more than a few frequencies.

A different approach can be used to get around this shortcoming. Fig. 2 shows how. Here, instead of changing the crystal fre-

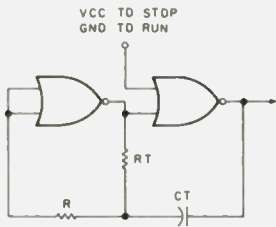

Fig. 4(a). NOR gate multivibrator with on-off control.

quency, we can change the division ratio of the divider. Digital types call this a $\div N$ circuit, where N is a programmable preset number. As shown, for $N = 1000$, we can get 100.000 Hz out. With $N = 966$, $f_{out} = 103.519$ Hz, and $N = 933$ gives $f_{out} = 107.181$. The desired CTCSS tones shown are 100.0 Hz, 103.5 Hz, and 107.2 Hz, but those shown are only about .02% away. By setting the crystal frequency high enough, N can be chosen to get any desired output frequency.

With increased circuit complexity, a more sophisticated frequency synthesizer can be made to generate virtually any audio frequency from a single crystal-controlled oscillator. The digital approach, though, is still a rather expensive means to build a tone decoder. Undoubtedly the semiconductor people will eventually change this, but for now, it's too complex and expensive for me. Incidentally, the above circuits still don't produce a sine wave, but a square (or rectangular) wave.

Some special-function ICs can be used as tone encoders

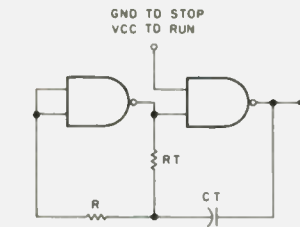

Fig. 4(b). NAND gate multivibrator with on-off control.

— specifically, the Signetics NE566 and NE567. The 566 is the same IC chip that is used for the NE565 phase locked loop, but the 566 brings out only the oscillator pins. It generates both triangular and square waves and can be tuned over a 10 to 1 frequency range with a single potentiometer. However, it has several shortcomings. First, it requires at least 10 volts for its power source. This means that it is difficult to power from 12 volts using a voltage regulator. Secondly, current consumption is a little high — 6 to 10 mA at 10 volts. Third, the frequency stability with temperature (even with perfectly stable tuning components) can cause problems. Finally, the required capacitance is too large. Even at 1 kHz it needs at least a .01 μF capacitor. At 100 Hz, 0.1 μF would be needed, and .1 μF temperature stable capacitors are huge! The NE567, a tone decoder, is more useful, since it needs only 5 volts and is fairly temperature stable. But it, too, uses large value tuning capacitors. (Yes, I said it's a tone decoder, but it can also be used to generate tones).

R_T	C_T	Frequency	R_T	C_T
102k	.082 μF	50 Hz	470k	.018 μF
108k	.039 μF	100 Hz	460k	9100 pF
105k	.02 μF	200 Hz	450k	4700 pF
102k	8200 pF	500 Hz	470k	1800 pF
108k	3900 pF	1000 Hz	460k	910 pF
105k	2000 pF	2000 Hz	450k	470 pF
117k	1200 pF	3000 Hz	424k	330 pF

Table 1. Calculated tuning component values.

Function generator ICs, such as the Intersil 8038 and Exar 2206, can generate sine waves directly. I discounted them, because they are relatively expensive, need at least 10 volts dc, and are current-hungry.

The NE555 timer can be used as an oscillator down to 5 volts with several advantages. It needs only a few milliamperes, and the tuning components can be chosen to use small value capacitors. Its major deficiency for encoder usage is its fairly poor temperature stability.

Now for the circuit I did use: When RCA Semiconductor Division published their ICAN-6267 application note,¹ they included a very interesting circuit, shown in Fig. 3. This circuit is basically a square wave generator, called an astable multivibrator. It is composed of two CMOS logic gates, G1 and G2, with timing components R_T and C_T to set its operating frequency, and another resistor, R. Resistor R affects operating frequency only indirectly, but, as described in the RCA note, it enhances the circuit's stability. Because of the CMOS gates' excellent char-

acteristics, the multivibrator exhibits extremely good frequency stability. Its output frequency remains constant over wide temperature and supply voltage variation.

When I first saw the circuit, I had little use for tone encoders, but I did use it in lots of applications where I needed a good, simple, stable digital circuit frequency source. Then WA9VGS wrote an article for 73 using the same multivibrator in a tone encoder.² He also pointed out the quite desirable stability, as mentioned by RCA. Now then, let me expand on using the CMOS multi in tone encoders, lest you think this is just a rehash of WA9VGS's ideas.

Tone Encoder Pieces

To fulfill the goals set many words ago, I'll describe several building block circuits that can be used in combination to make a few different kinds of tone encoders. Naturally, the oscillator is the keystone to this project, so let's look at it first.

Fig. 3 is my implementation of the basic tone source. It is the same as RCA's and, thus, the one that WA9VGS presented. I've shown the

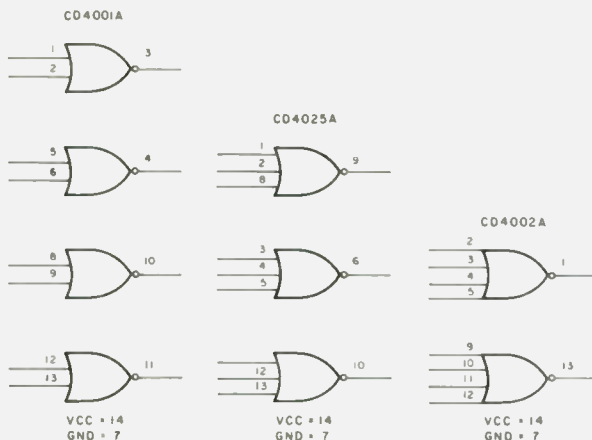

Fig. 5(a). CMOS NOR gate pinouts.

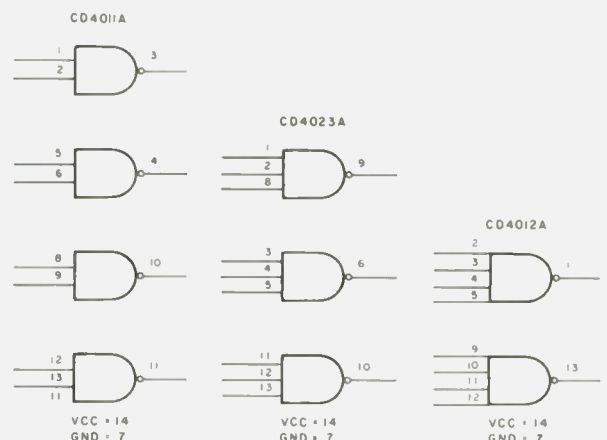

Fig. 5(b). CMOS NAND gate pinouts.

individual gates as inverters — more about that later. The multivibrator's output frequency is determined primarily by the timing components R_T and C_T . You can choose these components by using the formula $f = 0.42/R_T C_T$, which I have found to hold true to within 5 percent if resistor R is at least twice as large as R_T . R 's value is not critical. I've used values of 2 to 10 times R_T with no difficulties, but be sure to keep to that range for best stability. Table 1 shows some typical values of R_T and C_T across the audio spectrum.

To retain the inherent stability of this oscillator, a few precautions are necessary in selecting the R_T and C_T components. Resistors should be temperature stable, such as the tin film precision resistors you see listed in the industrial electronics catalogs. The types with "RN" numbers are preferred, though the less expensive "RL" models are what I usually use. A little shopping around at hamfests and surplus houses can get you a good selection of these at low cost. The capacitors needed are slightly easier to get. Ideally, they should be NPO ceramics (zero temperature coefficient) or dipped silver mica. Polystyrenes are also suitable at lower cost. The Mallory SX series polystyrene capacitors are widely available at reasonable cost. Polycarbonate capacitors can also be used, if you are careful in selecting them. Mylar and paper dielectric capacitors are definitely not adequate for high stability over wide temperatures, but they can be used in room-tempera-

ture applications.

These restrictions on the types of components limit the resistance and capacitance range that can be used. Precision resistors are usually difficult to get higher than 470k, and stable capacitors are large (and expensive) above .022 μ F. So I recommend that you use resistors between 100k and 470k for R_T and capacitors between 820 pF and .022 μ F for C_T . If you have good components outside these limits, use them. The limitation is not due to the multivibrator, but component availability.

What I've shown as inverters in Fig. 3 can be any CMOS gates that include an inversion function. Thus, NAND and NOR gates, as well as inverters, can be utilized. There are several reasons for doing this. One might be that you have some NOR gates and don't want to buy inverters. Or, alternatively, maybe you have a circuit that needs a stable oscillator, and somewhere in your system you have a few free gates available. One big advantage to using a gate is that you can use one of the unused inputs to turn the oscillator on and off. WA9VGS used this function to generate a tone burst. It can also be used to make a dual-tone encoder.

Fig. 4(a) shows how to use NOR gates, and 4(b) demonstrates the NANDs. Be aware, though, that there will be a short "chirp" as the oscillator is turned on and off. Usually this causes no problems, but keep it in mind. Also, if you use gates rather than inverters, connect unused inputs together, as in Fig. 4.

Fig. 5 shows pin connections for various 4000 series

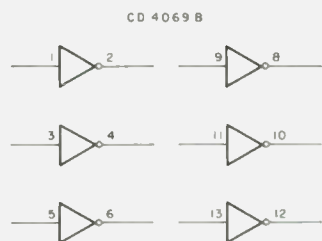

Fig. 5(c). CMOS inverter pin-outs.

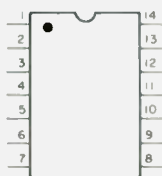

Fig. 5(d). Dual in-line package — top view.

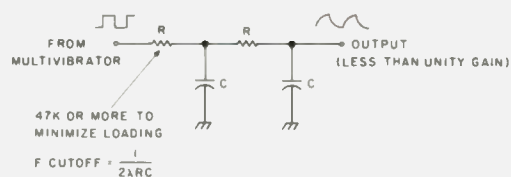

Fig. 6. Passive low pass filter.

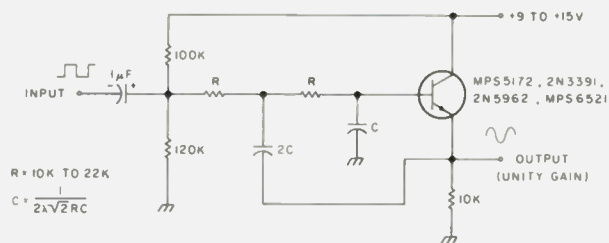

Fig. 7. Single-transistor active low pass filter.

gates that can be used. RCA's application note¹ gives some pertinent advice, particularly that the "B" series gates (including the inverter CD4069B) have different characteristics and may not perform as well as the "A" series devices shown. Also, they warn that the buffers such as the CD4009A, CD4049A, and CD4041A are *not* recommended for multivibrators, due to their higher power consumption. Devices from other manufacturers may also behave differently, so beware.

I've used the "A" series RCA gates (not inverters) successfully, but a Japanese CD4001 was not as stable. Note that the availability of multiple gates can let you make more than one oscillator per IC package. Using a 4001 or 4011, you can generate two different frequencies. But don't use gates from different packages for the same oscillator, because the two chips may not have characteristics that track with voltage and temperature.

Now I've shown a stable frequency source, but it has a square wave output, so one of my criteria hasn't been fulfilled. To get a sine wave from a square wave, the har-

monics must be filtered out.

If you're wondering why I want a sine wave, I'll tell you. In my applications, the tone encoder has been used with FM radio transmission. In the usual FM systems, the audio spectrum is shaped before transmission, then limited. This is called pre-emphasis, because the higher frequencies in the voice range are accentuated before clipping. At the receiving end, the higher frequencies are then attenuated to give flat audio response. At high deviation levels, the pre-emphasis causes a square wave's higher frequency components to predominate before going into a limiter, causing a loss of the low-frequency components. When this signal is received and reprocessed, the desired tone is then much weaker than its harmonics, causing severe distortion. And even at low deviation, an imbalance in pre-emphasis and de-emphasis can produce distortion. Additionally, in CTCSS or subaudible tone squelch usage, the harmonics from a square wave produce an annoying "buzz" at the receiving end.

I've used a few simple methods to "round off" the square waves' corners. The

Frequency range	Capacitor C
50 to 100 Hz	0.1 μ F
100 to 200 Hz	0.047 μ F
200 to 400 Hz	0.022 μ F
400 to 800 Hz	0.01 μ F
800 to 1600 Hz	0.0047 μ F
1600 to 3200 Hz	0.0022 μ F

Table 2. Capacitor values for bandpass filter.

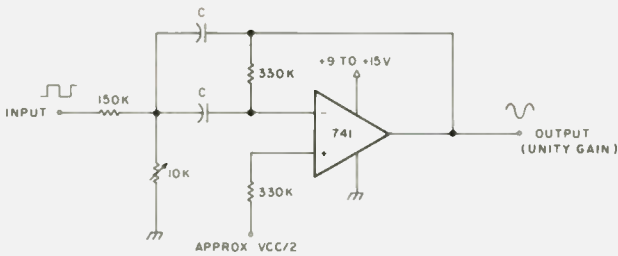

Fig. 8(a). Tunable active bandpass filter.

first and simplest way is to use an RC low pass filter, shown schematically in Fig. 6. The resultant output is not really a sine wave, but a rounded triangular waveform. Using a two-section filter gives better results than a single R and C, although even this is not the ultimate. Another low pass filter, using an active filter section, can improve the waveshape. See Fig. 7. Here, the attenuation of higher frequency components is improved at the cost of more components. The active low pass filter provides the

added advantage of not attenuating the desired frequency as the passive version does. References 3 and 4 give more detailed data on designing simple active low pass filters. Either low pass filter can work over a 20 or 30 percent range without retuning.

A more sophisticated means of converting a square wave to a sinusoid is to use a bandpass filter. In this case, a simple transistor circuit isn't enough. Fig. 8 is a multiple-feedback bandpass filter using one operational amplifier. Table 2 gives component values for the 50 to 3000 Hz range. Each set of components uses identical resistors; only the capacitors need be changed. A 10k potentiometer allows a 2 to 1 tuning arrangement for each set of capacitors. The bandpass filter does a much better job of filtering out harmonics, but has to be retuned to pass

frequencies more than 5 to 10% apart. For design information, see reference 5.

The CMOS oscillator is relatively insensitive to power supply voltage changes, with less than a 1% frequency shift for a supply voltage change of one volt. But operation in portable or mobile service often means widely varying power supplies. The obvious way to handle this case is by using a voltage regulator. Fig. 9(a) is the simplest regulator, using only a current-limiting resistor, a zener diode, and a filter capacitor. The resistor should be chosen to pass at least 15 mA, to ensure proper zener action. The zener diode's breakdown voltage can range from 5.1 volts to 10 volts or so. My experience has shown that the best regulation and frequency stability can be gotten with a 5.1- to 6.2-volt zener. Noise from the unregulated voltage line and zener diode-generated noise are bypassed by the electrolytic capacitor. A 5 or 10 uF tantalum capacitor is ideal, although an electrolytic of the same value can be used if it is paralleled with a .01 to .1 uF disc ceramic. For somewhat better regulation and much less wasted power, refer to Fig. 9(b). This is a pretty basic regulator that will operate from at least 7.5 volts to 18 volts with no component changes and uses only a few mA. Integrated circuit regulators, such as the 78L series manufactured by Fairchild, can also be used, although they sometimes misbehave with loads drawing less than 5 mA.

circuits in this article are the same as for most audio frequency circuits. Either perforated board or printed wiring techniques are adequate, so long as good components are used. CMOS integrated circuits do need careful handling to prevent damage from static electricity. I suggest that you read the handling recommendations in RCA's CMOS data-book to avoid trouble.

For optimum encoder stability, high quality parts are needed for R_T and C_T in the CMOS multivibrator. To ease tuning, R_T can be made up of two resistors in series. One can be large in value, as a coarse adjustment. Then a lower resistance can be selected for the fine adjustment. If you want to use a potentiometer for the fine adjustment, a 10- to 20-turn cermet or wire-wound trimpot will ensure stability. Since precision is the goal, precise measurement of the encoder's operating frequency should be made with a frequency counter during initial setup.

The low pass filters shouldn't need any tuning. Just calculate the desired R and C values, and, if you're cautious, check the output waveshape with an oscilloscope. The bandpass filter is adjusted by setting its 10k potentiometer for maximum output. Filter components are not critical. Carbon composition resistors and mylar capacitors are fine.

Proven Examples

The building-block circuits described can be interconnected in several ways. Fig. 10 is the schematic for a CTCSS encoder. It operates

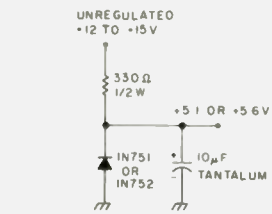

Fig. 9(a). Zener diode voltage regulator.

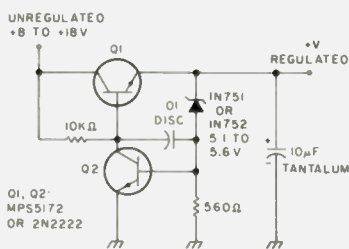

Fig. 9(b). Power-conserving voltage regulator.

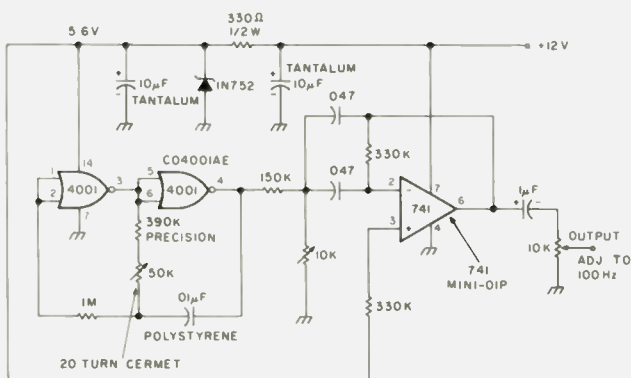

Fig. 10. 100 Hz CTCSS encoder.

Construction Tips

In general, component placement and wiring of the

in the area of 100 Hertz, and I've installed it in a Motorola T-44 UHF transceiver. Power is taken from the 12-volt filament line with a simple half-wave rectifier and an electrolytic filter capacitor. Since power consumption need not be minimized, a zener diode regulator is adequate. The CMOS multivibrator uses a CD4001AE, because I had one. The low-distortion output, desirable for CTCSS operation, is provided by using a bandpass active filter. Total current drain is about 25 mA.

A portable tone encoder for remote control is shown in Fig. 11. It is intended to be coupled to a transmitter by holding its loudspeaker a few inches from the transmitter's microphone. I built it into the case of a transistor radio whose audio output stage and loudspeaker had been salvaged. Since the cheapest, easiest way of getting the amplifier is by cannibalizing one of these imported jobs, I haven't bothered to indicate the amplifier schematic. There are two separate oscillator sections at two different frequencies around 2 kHz which can be switched for two separate control functions. For simplicity and minimum power drain, the active low pass filter is used. To get low power drain, the two-transistor voltage regulator is used. Output level is set with the radio's volume control. The multivibrator sections draw about 300 uA

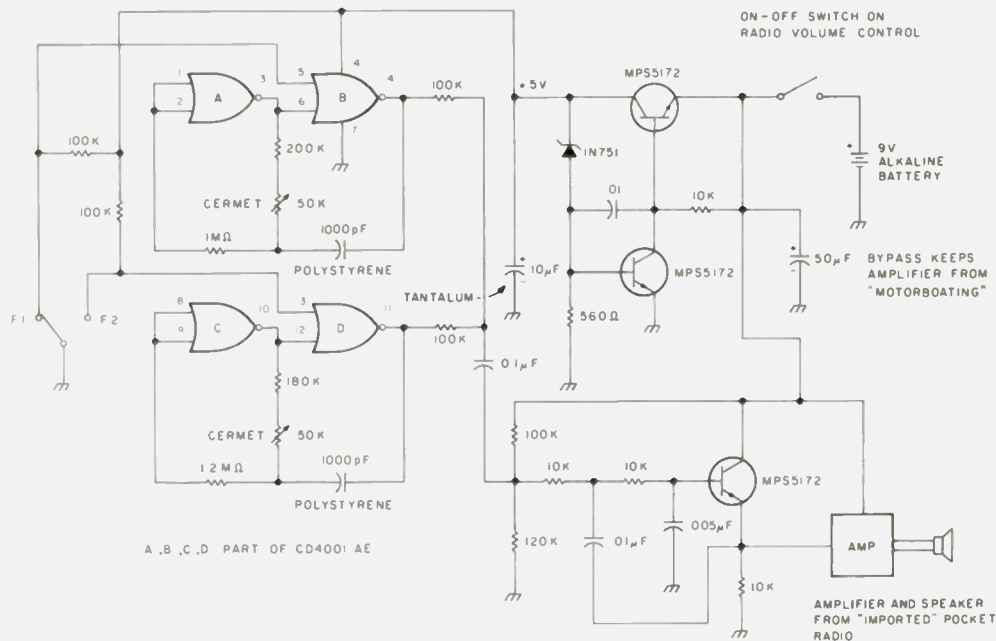

Fig. 11. Selectable two-frequency pocket "beeper" encoder.

each (only one is energized at a time), the active filter draws about 0.5 mA, and the regulator consumes about 2 mA. Total current drain is about 10 to 15 mA, primarily because of the current-hungry audio amplifier. To maximize battery life, I use alkaline 9-volt batteries, Radio Shack 23-553. They're \$1.59 apiece, but it's nice to have a good, reliable battery when you need it.

Closing Comments

If my many cautions, warnings, and recommendations are taken into account, a good stable reed-compatible tone encoder can be built for much less than the cost of a single reed. I estimate maximum cost of

either encoder described to be \$10. Performance is pretty close to the desired goals mentioned earlier. I built and tested a number of these circuits, and the stability has been excellent. Encoders using polystyrene capacitors can hold $\pm 0.5\%$ stability over a 0 to 50° C. range and be within $\pm 1\%$ over the -30° C. to +60° C. range. NOP ceramic and dipped mica capacitors gave a total drift of 1% over the -30° C. to 60° C. range with almost all of my CMOS oscillators. Out of a dozen or so breadboarded encoders, one showed excessive drift at cold temperature. This was due to a screwy CMOS chip, and it went outside the specified range only past -15° C.

I've tried to be very con-

servative in design, in hopes of providing some guidelines for high-performance circuitry. Take me with a grain of salt, and have fun with good reliable encoders. ■

References

- 1 ICAN-6267, "Astable and Monostable Oscillators Using RCA COS/MOS Digital Integrated Circuits," RCA Semiconductor Div., Somerville, N.J.
- 2 Way WA9VGS, "The MOS Tone Encoder," *73 Magazine*, Dec., 1972.
- 3 Hayward W7ZO1, "Simple Active Filters for Direct-Conversion Receivers," *Ham Radio*, April, 1974.
- 4 Schmitzer DJ4BG, "Active Audio Filters," Part 1 and Part II VHF Communications, 1 (1969), Edition 4.
- 5 Tobey Graeme and Huelsman, *Operational Amplifiers, Design and Applications*, McGraw-Hill, N.Y., 1971, Chapter 8.

LETTERS

from page 55

spread interest in that receiver and possible modifications to it. You might want to pass on to your readers some information as to where they can obtain versions of the FRG-7 that have enhanced capability of SSB and CW reception.

Gilfer Associates, Inc. (a 73 advertiser), PO Box 239, Park Ridge NJ 07656, sells the FRG-7 with a 4 kHz i-f filter installed for \$308. With a 3 kHz filter, the price is \$315. For those wanting even better selectivity, Radio West, 3417 Purer Road, Escondido CA 92025, will install a Collins filter and realign the FRG-7

for \$85.

In neither instance is it specified whether these filters are switchable. Of course, for only SSB or CW, this would not be of importance, but, for those who would like to listen to shortwave broadcast programs, it would be desirable to be able to switch to the normal i-f bandwidth characteristic of the unmodified FRG-7.

Carl C. Drumeller W5JJ
Warr Acres OK

CONVERT TO GREEN

In addition to being a very active amateur, I am professionally an

optometrist. Almost all of the new PLL LED readout equipment today is red. Almost without exception, red LEDs are difficult to read in bright ambient light. In addition, at night, all farsighted people (hyperopes) who do not have their glasses on or people who do not wear glasses and who show some hyperopia have great difficulty distinguishing red figures and letters. This is because red is at the far end of the visible light spectrum. The peak visibility area is yellow-green.

It would be most helpful if manufacturers realized this human limitation and converted to green or slightly blue-green readouts for all equipment.

J. H. Robinson O.D., F.C.O.V.D.
Creston IA

anticipation of the ritual of soldering and scenting the air with flux vapors, you find that you're short by one lousy resistor? A quick shuffle over to the junk box turns up only a couple of transistors from someone's pocket radio, and a few moldy-looking resistors that were probably last touched with electric current when Morse was busy trying to devise a more confusing code to foist upon an unsuspecting world. Of course, these old resistors couldn't possibly be the right value, could they? After all, when they talked about resistors in those days, they were talking about megohms and not a measly 1.2k. Okay. Sit back, relax, and try to reason this out like a rational being. "Let's see, those transistors seem to show a forward resistance of about six hundred Ohms, and there are two of them. Wonder what hours and hours of full-volume rock music has done to the resistance characteristic of these audio devices? Drats, too big to fit on the PC board. Oh, well . . . none of these resistors wants to add together in the right way, anyway. Hey! Orange-blue-red — gee, that looks pretty. Ah, yes, three point six . . . and the lowest value here is one point eight kilohms . . ."

Sound all too familiar? It

Solve Those Parallel Problems

— HP-25 programs choose the values

Have you ever found yourself in the situation where, after collecting the parts for your favorite project and laying them out on the bench in anxious

STEP	KEY	CODE
01	RCL 0	24 00
02	$g \frac{1}{x}$	15 22
03	STO 1	23 01
04	STO 2	23 02
05	$g \frac{1}{x}$	15 22
06	STO 5	23 05
07	1	01
08	STO +6	23 51 06
09	RCL 6	24 06
10	RCL 7	24 07
11	f x=y	14 71
12	GTO 17	13 17
13	RCL 1	24 01
14	RCL 2	24 02
15	+	51
16	GTO 04	13 04
17	0	00
18	STO 6	23 06
19	RCL 5	24 05

MEMORY REGISTER

* M 0	— R	(resistance)
M 1	— $\frac{1}{R}$	working register
M 2	— $\frac{1}{R}$	incremented working register
M 3	— $\frac{1}{R_n}$	FREE
M 4	—	FREE
M 5	— R_T	incremented working register
M 6	— n	incremented working register
* M 7	— n	(number resistors in parallel)

Asterisk (*) denotes user-entered data in this register location.

STEP	INSTRUCTION	INPUT	KEY	OUTPUT
1	Key in program			
2	Store resistance value	R	STO 0	
3	Store number of resistors in parallel	n	STO 7 f PRGM	
4	Run program		R/S	R_T
5	Values of R and n can be changed after any run			

Program 1. $R_T = 1 / [(1/R_1) + (1/R_2) + \dots + (1/R_n)]$, where $R_1 = R_2 = \dots = R_n$, n any whole number less than infinity, given R and n, to find R_T .

has happened to me more times than I care to remember. Of course, the moral of the foregoing story is to connect the 3600 and 1800 Ohm resistors *in parallel* to arrive at an effective total resistance of 1200 Ohms. The only trouble with this solution is that it is not intuitively obvious just what values in parallel will yield a desired total. Well, I sat down and pondered this problem for some time, with various and sundry possible solutions presenting themselves. None possessed the necessary features of being quick and easy to use, while demanding a minimum of preparation and bothersome detail to execute.

Then one day a friend of mine dropped by to show off his newly-acquired "toy," an HP-25 pocket programmable calculator. To make a long story short, the calculator proved to be just the tool needed to remove the mask of unfamiliarity from the parallel resistor combination. This article will hopefully provide you with the pro-

grams necessary to be able to solve some fairly complex parallel problems in your own everyday electronic work.

The first two programs are rather straightforward treatments of simple combinations. Program 1 provides the total resistance when a given number of equal value resistors are paralleled. Program 2 provides for the solution of two to eight different value resistors in parallel. In these two programs, as in all the rest of them, the execution sequence is to first key in the program in write mode, switch to read, and store the appropriate variables in the designated memory registers. (Note the use of M instead of R to denote register locations, in order to prevent confusion with R signifying resistance.) While possibly taking a little more time than simply stopping the run and having the user key the necessary data into the display at critical points, this alternate process allows for repeated runs of the same program

while allowing one variable to be changed at a time — a very convenient characteristic, indeed.

Programs 3 and 4 are really the essence of this collection, and are probably the most useful. To demonstrate Program 3, let's assume you want to build a dummy load for your transmitter and have a few handfuls of common value resistors lying around going unused. To find out how many resistors would be needed to present a 52 Ohm match, simply enter the value of one resistor in memory location 0 and the desired total resistance (52 Ohms) in memory 6. The program operates by adding resistors in parallel one at a time and comparing the total resistance arrived at after every addition to your desired total. When the actual total becomes less than the target total, the program stops the addition process, subtracts one resistor, looks at that total, and compares the two. It then displays the number of resistors that will

give a value closest to the desired one. Pressing the Run button again displays the actual resistance you would get from connecting this many resistors in parallel. If you are indeed solving a dummy load problem like this one, or a termination problem of some kind, you can add the Swr Tag onto the end of the program. Then, when you hit Run yet a third time, the display will show the swr caused by the use of that actual total resistance rather than the ideal one.

Program 5 is actually the core of Program 4, simply pulled out and set aside by itself to handle the very straightforward problems that do not require the complexity of Program 4. Such a case would occur when you know the total resistance desired and the value of one of the two resistors to be used to arrive at that total. However, when you don't know either of the two values, as in the situation of our opening episode, then Program 4 can

STEP	KEY	CODE	31	RCL 7	24 07	
01	RCL 0	24 00	32	g x=0	15 71	
02	g $\frac{1}{x}$	15 22	33	GTO 37	13 37	
03	RCL 1	24 01	34	g $\frac{1}{x}$	15 22	
04	g $\frac{1}{x}$	15 22	35	+	51	
05	+	51	36	GTO 38	13 38	
06	RCL 2	24 02	37	x \approx y	21	
07	g x=0	15 71	38	g $\frac{1}{x}$	15 22	
08	GTO 37	13 37	MEMORY REGISTER * M 0 — Enter R values * M 1 — starting at M 0 * M 2 — and proceeding up. * M 3 — Be certain * M 4 — no values are left * M 5 — from previous * M 6 — calculations * M 7 — in upper registers.			
09	g $\frac{1}{x}$	15 22				
10	-	51				
11	RCL 3	24 03				
12	g x=0	15 71				
13	GTO 37	13 37				
14	g $\frac{1}{x}$	15 22				
15	+	51				
16	RCL 4	24 04				
17	g x=0	15 71				
18	GTO 37	13 37	STEP INSTRUCTION	INPUT	KEY	OUTPUT
19	g $\frac{1}{x}$	15 22	1	Key in program		
20	+	51	2	Store resistances	R ₁	STO 0
21	RCL 5	24 05	3	Store resistances	R ₂	STO 1
22	g x=0	15 71	4 to 9	Store resistances	etc.	etc.
23	GTO 37	13 37	10	Run program		f PGRM
24	g $\frac{1}{x}$	15 22				R/S
25	+	51				R _T
26	RCL 6	24 06	11	Program reads linearly up		
27	g x=0	15 71		registers from M 0 to M 7		
28	GTO 37	13 37		and stops at the first		
29	g $\frac{1}{x}$	15 22		register containing 0.		
30	+	51				

Program 2. $R_T = 1 / [(1/R_1) + (1/R_2) + \dots + (1/R_n)]$, where $R_1 \neq R_2 \neq \dots \neq R_n$, $n \leq 8$, given R_1 and n , to find R_T .

become just the cure the doctor ordered. Basically, all you need do is enter your desired total resistance in memory 0 and a search increment in memory 1. When you push Run, the calculator will happily sit there, purring along, just churning out various possible combinations of resistances that will give the desired total. It does this by looking at the R_T you specified, adding delta, the search increment, onto R_1 and then using this value as R_2 to arrive at a corresponding value for R_1 . It then goes back, takes this new value of R_2 , and, adding delta to it again, continues

on. Since this program is written as an endless loop, if you forget about hitting Stop after starting it, our faithful little servant, the calculator, will eat its heart out (i.e., deplete its batteries) trying to provide you with a combination you'll like. Please don't be cruel. Just remember to always stop when the display is showing the value of R_1 (signified by three pauses, which appear in the display as three blinks) and you won't encounter any difficulties. If you want to hold any two values, enter Go To 21 and Run. The display will show R_2 and stop. Press Run again to get the corresponding

value of R_1 to hold in the display. The program shows values of R_2 normally incremented upwards in value, while the corresponding R_1 values increment downwards. This can be changed, and the program run backwards, by going to step 26. The values of delta and the resistance value used as the starting point for the search can be changed after any stop command, by carefully following the execution instructions printed with the program.

And there you have it — the solution I have been using to try to get a grasp on these slippery parallel problems

that crop up every now and then in my electronic endeavors. At this point, your only complaint is probably that it just takes too long to load a program into the calculator every time one of these problems comes up. If only you had a fancier, card-programmable one. You most likely have the equivalent and you may not even know it. It's called a cassette tape recorder — those little demons that have been turning up everywhere someone wants to put something on tape. No, no special circuits are needed to read and write, either. Just sit down with the programs in front of

STEP	KEY	CODE
01	RCL 0	24 02
02	$g \frac{1}{x}$	15 22
03	STO 1	23 01
04	STO 2	23 02
05	$g \frac{1}{x}$	15 22
06	STO 5	23 05
07	1	01
08	STO + 7	23 51 07
09	RCL 6	24 06
10	RCL 5	24 05
11	f x=y	14 71
12	GTO 19	13 19
13	f x < y	14 41
14	GTO 19	13 19
15	RCL 1	24 01
16	RCL 2	24 02
17	+	51
18	GTO 04	13 04
19	RCL 7	24 07
20	1	01
21	-	41
22	STO 4	23 04
23	RCL 1	24 01
24	X	61
25	$g \frac{1}{x}$	15 22
26	STO 3	23 03
27	RCL 6	24 06
28	-	41
29	RCL 6	24 06
30	RCL 5	24 05
31	-	41
32	f x < y	14 41
33	GTO 40	13 40
34	0	00
35	STO 7	23 07
36	RCL 4	24 04
37	R/S	74
38	RCL 3	24 03
39	GTO 00	13 00
40	RCL 7	24 07
41	R/S	74
42	0	00
43	STO 7	23 07
44	RCL 5	24 05

MEMORY REGISTERS

- * M 0 — R (resistance)
- M 1 — $\frac{1}{R}$ working register
- M 2 — $\frac{1}{R_n}$ incremented working register
- M 3 — R_T at n-1 working register
- M 4 — n-1 working register
- M 5 — R_T at n incremented working register
- * M 6 — R_T (total resistance desired)
- M 7 — n incremented working register

STEP INSTRUCTION

- | STEP INSTRUCTION | INPUT | KEY | OUTPUT |
|------------------|--------------------------------------------------------------------------------------------------------------------------------|-------|-------------------------------------------------------------|
| 1 | Key in program | | |
| 2 | Store resistance | R | STO 0 |
| 3 | Store total resistance desired | R_T | STO 6 |
| 4 | Run program | | f PGRM |
| | | R/S | n or n-1
whichever gives R_T closest to R_T desired. |
| 5 | Run again | | R/S |
| 6 | Values can be changed after any run, but, note well, the R/S button is pressed twice to complete one run | | R_T actual at n or n-1. |
| 7 | If differences between R_T 's at n and n-1 are equal, program opts for n-1, i.e., the least number of resistors | | |
| 8 | Can add Swr Tag to program to compute swr caused by the use of R_T actual instead of the ideal R_T desired if appropriate. | | |

STEP	KEY	CODE
Change 39 to GTO 45		13 45
Add 45	R/S	74
46	RCL 6	24 06
47	f x ≥ y	14 51
48	x ≥ y	21
49	÷	71
9	To execute Swr Tag, press R/S again after keying in step additions and changes	
	R/S	Swr Ratio

Program 3. $R_T = 1 / [(1/R_1) + (1/R_2) + \dots + (1/R_{n-1}) + (1/R_n)]$, where $R_1 = R_2 = \dots = R_{n-1} = R_n$, given R and desired R_T , to find n (and R_{Tn}) or n-1 (and R_{Tn-1}), whichever is closest to R_T desired.

STEP	KEY	CODE					
01	RCL 0	24 00					
02	RCL 1	24 01	M 5	—	FREE		
03	+	51	M 6	—	FREE		
04	STO 2	23 02	M 7	—	FREE		
05	f Pause	14 74					
06	RCL 0	24 00	STEP	INSTRUCTION	INPUT	KEY	OUTPUT
07	X	61	1	Key in program			
08	RCL 2	24 02	2	Store desired total resistance	R_t	STO 0	
09	RCL 0	24 00	3	Store incremental change	Δ	STO 1	
10	—	41				f PRGM	
11	\div	71				R/S	(R_2)
12	STO 3	24 03	4	Run program. Display will pause on R_2 for 1 blink, then pause on R_1 for 3 blinks.			(R_1)
13	f Pause	14 74					
14	f Pause	14 74	5	Stop program run on 3 blinks. If want to hold the values just seen (i.e., see them again without running program), key in			
15	f Pause	14 74					
16	RCL 4	24 04					
17	$g \times \neq 0$	15 61				GTO 2 1	
18	GTO 28	13 28	6	Push run and will hold R_2 until Step 7		R/S	R_2
19	RCL 2	24 02					
20	GTO 02	13 02	7	Push run again and will hold R_1 until decide on Step 8 or Step 9		R/S	R_1
21	RCL 2	24 02					
22	R/S	74	8	If decide R_2 to increment up once more, go to Step 4			
23	RCL 3	24 03					
24	R/S	74	9	If decide R_2 to increment backwards (over values just seen), Press and Run			incremented backwards
25	GTO 16	13 16				GTO 2 6	(R_2)
26	1	01				R/S	(R_1)
27	STO 4	23 04					
28	RCL 2	24 02	10	Can hold while counting backwards by going to Step 5. If want to continue going backwards after hold, push Run again after Step 7		R/S	
29	RCL 1	24 01					
30	—	41					
31	GTO 04	13 04	11	Can turn around and count up again by stopping run, pressing and going to Step 4		R/S	
32	0	00					
33	STO 4	23 04				GTO 3 2	
34	GTO 19	13 19					

MEMORY AD

MEMORY REGISTER

- * M 0 — R_t (total resistance)
- * M 1 — Δ (incremental change in resistance)
- M 2 — R_2 incremented working register
- M 3 — R_1 incremented working register
- M 4 — direction flag

Program 4. A controlled endless loop program that runs through the possible resistor parallel combinations that give the desired total resistance. $R_1 = R_t R_2 / (R_2 - R_t)$, where $R_t < R_1$ and $R_t < R_2$, given only R_t and Δ (delta — incremental change in R_2 for every run) but not given R_1 or R_2 .

you and read the programming steps (just the steps, one after the other, sequentially) into the mike. Now, note the marking on the tape counter at the beginning, file it, and

you're ready at a moment's notice to load the program. With practice, you can load a 49-stepper in under a minute (two at the outside, if you're not used to doing it).

Last but not least, has anyone figured out an easy way of doing problems of this nature on a slide rule? No, don't laugh! I don't own one of those little calculators yet,

but I must admit to constantly trucking on down to my friend's house with an armload of problems and a pocketful of programs on assorted cassette tapes! ■

STEP	KEY	CODE					
01	RCL 0	24 00	M 4	—	FREE		
02	RCL 1	24 01	M 5	—	FREE		
03	X	61	M 6	—	FREE		
04	RCL 1	24 01	M 7	—	FREE		
05	RCL 0	24 00	STEP	INSTRUCTION	INPUT	KEY	OUTPUT
06	—	41	1	Key in program			
07	\div	71	2	Store total resistance	R_t	STO 0	
08	STO 2	23 02	3	Store value of one of parallel resistances	R_2	STO 1	
			4	Run program		f PRGM	
						R/S	R_1
			5	Can change R_t and/or R_2 at the end of any run			

MEMORY REGISTER

- * M 0 — R_t (total resistance)
- * M 1 — R_2 (one of parallel resistances)
- M 2 — R_1 (calculated value of second resistance)
- M 3 — FREE

Program 5. $R_1 = R_t R_2 / (R_2 - R_t)$, where $R_t < R_1$ and $R_t < R_2$, given R_t and R_2 , to find R_1 .

At Last! An RFI-free Computer!

—report on the Cromemco Z-2

I volunteered to put together a Cromemco Z-2 for the express purpose of doing a review of it for 73. I picked up the unit one day from Mike Sannes at the Byte Shop in Fresno. The unit was ready to go back down the hill to Mike the next afternoon. That should tell you something about how it went together.

The Cromemco Z-2 is a computer system. The portion of the system that I

assembled would be called the mainframe. The mainframe of a computer is the power supply, the mother board (a bus in which all the plug-in cards plug into sockets), and the cabinet that houses these assemblies.

When you pick up the boxes (there are two — the power transformer is in a separate box), your first thought is going to be, "How am I going to get that big box into the car?" It is big, but it

will go in. Don't drop the small box on your toes; you won't hurt the transformer very much, but you will have a very sore, or broken, foot.

One way to get an idea of the value of a product is to note how it is packed by the manufacturer. The more the manufacturer thinks of his product, the better he packs it for shipment. When you open the big box, you are going to find a smaller box inside floating on styrofoam.

You get your first inkling of the quality that is coming at this point. Not only does this manufacturer think a lot of his product, but he has gone to no little effort to see that when you get it, it will still be in the same condition that it was when it left the factory. Everything is wrapped and protected from *everything* and *everybody*.

I have an area about 4 feet by 6 feet that I use to shoot photos on. I had difficulty getting everything into this area, in order to get a shot of the kit contents. The photo doesn't really do the kit contents justice. Everything is big and heavy — heavy, thick aluminum panels, rails, and side panels. No wonder the big box is so heavy.

When you open the power transformer box and fish the rascal out of the packing in that box, you are going to see quite a power transformer — 600 Watts of iron!

Assembly starts with the construction of the power supply on the rear panel. The machine work is superb. Everything fits. The manual is not Heathkit style, but it is good and very easy to follow. You can do the whole thing if you can read and follow directions, even though nobody tells you what a KEP nut is. (It's a nut that has a serrated lock washer attached to it. I figured this out, so you should be able to, also.)

The mother board is assembled next. Cromemco calls this a Blitz Buss and it's really neat. They just barely etched the board. Almost all the copper is still on the board. This places a shield around every interconnector on the bus system, and it is probably why their computer can run at 4 MHz without problems. However, because they removed the bare minimum of copper from the circuit board, you will get to see just how well you really can solder. I think you'll find out that it presents a real challenge. Use a heat-con-



The completed Z-2. Photo courtesy of Cromemco.

trolled iron with a small point, and do the job very carefully. The manual suggests ohmmeter tests after every solder connection. I used the Squawker ("Kilobaud Klassroom," *Kilobaud*, October, 1977, p. 70). It's much faster for this purpose than an ohmmeter.

One thing that probably should be mentioned here is computers and RFI. The digital logic circuits in computers use lots of fast square wave pulses. Square waves are very rich in harmonic content. Keeping this radiation under control is of primary concern to hams. The Blitz Buss and the tightly enclosed metal box go a long way toward containing this potential source of RFI.

Cromemco goes even one step farther in this respect. A very substantial line filter is "bonded" into the system to keep the potential RFI inside the metal box and off the ac lines. Cheers to Cromemco for this foresight!

Assembly

Assembly proceeded smoothly, with the metalwork sliding together as if it had silicone lube on it. I like quality workmanship. At this point, the assembled mainframe looks like something you find only in the military. The cabinet work is extremely rugged and good-looking.

Now it's time for the initial tests. Everything is okay so far. But where's the line cord? I don't even remember seeing it. It's not listed in the parts list, either, that I can find. This has to be an oversight. Nobody would put out this kind of quality and leave out a line cord. But the line cord off my spouse's comptometer fit, and the power supply checked out.

The mainframe is all assembled now. Another test of a product is how it looks after it is assembled. Does it really look like the photos in the ads? This one does. In fact, the real thing looks even better than the ads.

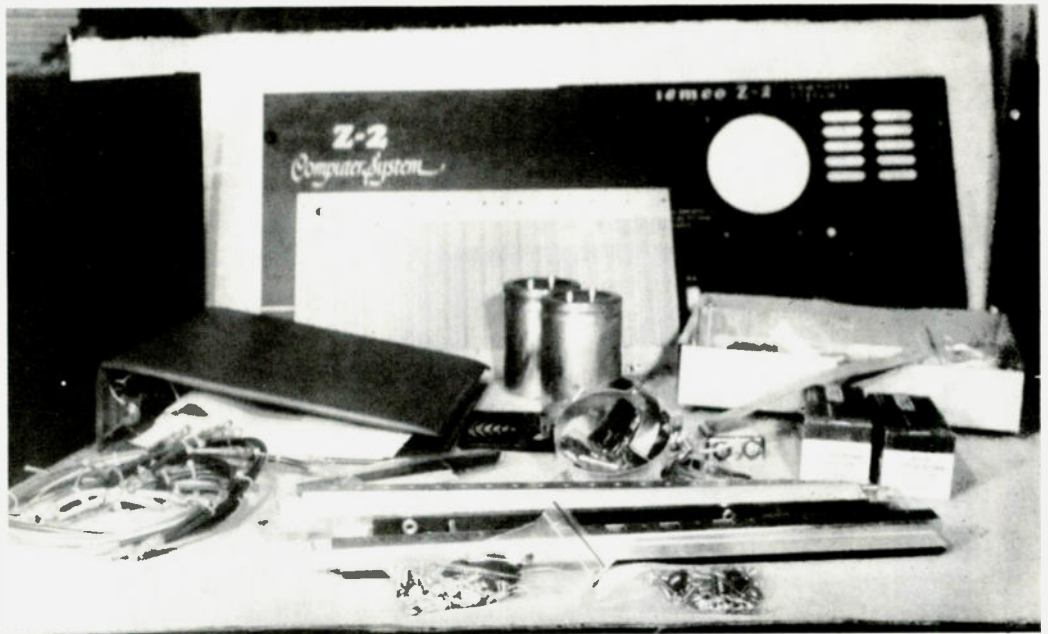

The kit contents unpacked.

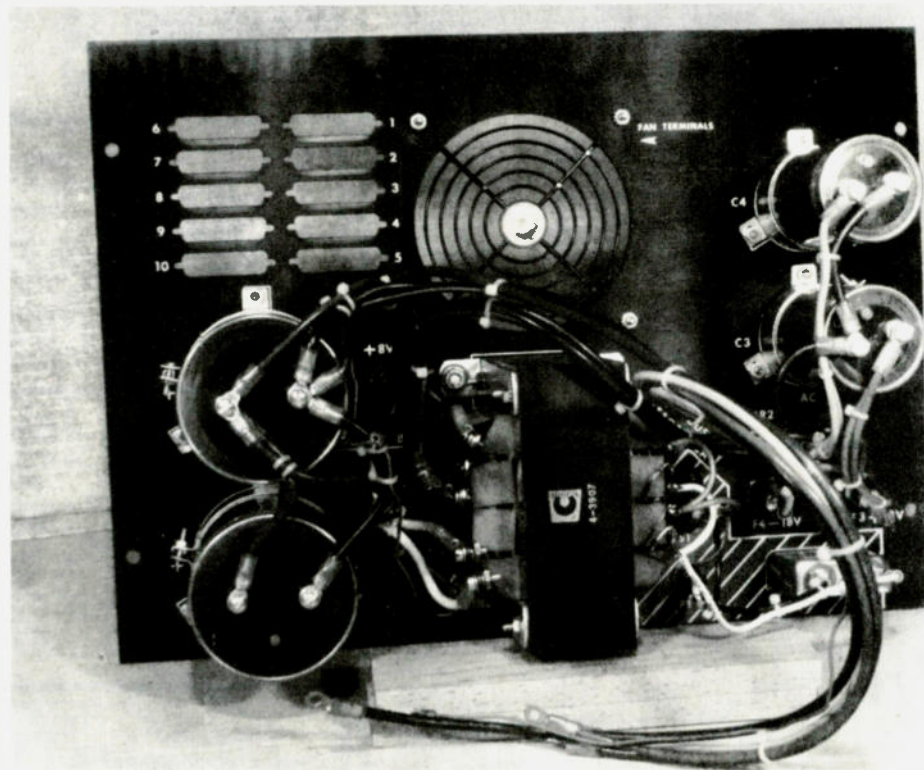

The completed power supply on the rear panel.

The processor board is next. The manual says it's an evening's work. Either I got lucky, or the manual is wrong, because 2½ hours later the board was complete. Again, your soldering skills will be taxed. Things are really compact on the board, but, with reasonable care, the job can be done. There was only one problem here — one IC has no markings on it.

When all the ICs are inserted in their sockets (everything is socketed), the empty one is 7400.

How Does It Work?

Darned if I know. When you only have a mainframe and a processor board, you are a long way from having a computer. You still need memory, you need an input device, and you need an

output device. This is what is meant by a computer system. What we have here is a beautiful and rugged cabinet, a very husky power supply, and a microprocessor board. This is the foundation upon which to build your system.

I sometimes wish that I wasn't such a die-hard home brewer, because this would be the foundation that I'd use to build my system. ■



wire wrapping center

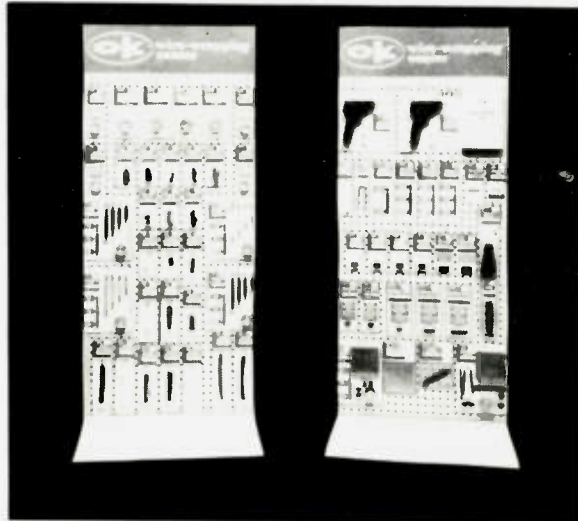

for quality electronic parts and tools.

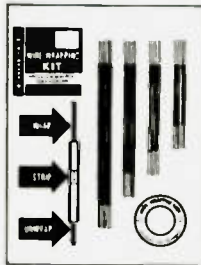

WIRE-WRAPPING KITS

Contains: Hobby Wrap Tool WSU-30. (50 ft.) Roll of wire Prestripped wire 1" to 4" lengths (50 wires per package) stripped 1" both ends.

Wire Wrapping Kit (Blue)	WK 2 B	\$12.95
Wire Wrapping Kit (Yellow)	WK 2 Y	\$12.95
Wire Wrapping Kit (White)	WK 2 W	\$12.95
Wire Wrapping Kit (Red)	WK 2 R	\$12.95

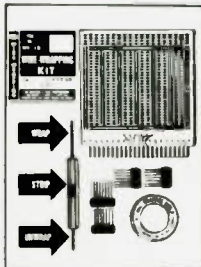

WIRE-WRAPPING KIT

Contains: Hobby Wrap Tool WSU-30, Roll of wire R-30B-0050, (2) 14 DIP's, (2) 16 DIP's and Hobby Board H-PCB-1.

Wire-Wrapping Kit	WK-3B (Blue)	\$16.95
-------------------	--------------	---------

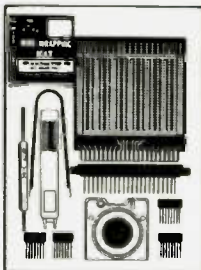

WIRE-WRAPPING KIT

Contains: Hobby Wrap Tool WSU-30 M, Wire Dispenser WD-30-B, (2) 14 DIP's, (2) 16 DIP's, Hobby Board H-PCB-1, DIP/IC Insertion Tool INS-1416 and DIP/IC Extractor Tool EX-1

Wire-Wrapping Kit	WK-4B (Blue)	\$25.99
-------------------	--------------	---------

STRIP WRAP UNWRAP

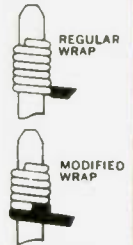

HOBBY WRAP TOOL

Wire-wrapping, stripping, unwrapping tool for AWG 30 on .025 (0.63mm) Square Post.

Regular Wrap	WSU-30	\$6.95
Modified Wrap	WSU-30M	\$7.95

NEW

HOBBY-WRAP Model BW-630



Battery wire wrapping tool COMPLETE WITH BIT AND SLIVER

WIRE-WRAPPING TOOL

For .025" (0.63mm) sq. post "MODIFIED" wrap, positive indexing, anti-overwrapping device.

For AWG 30	BW-630	\$34.95*
For AWG 26-28	BW 2628	\$39.95*

Bit for AWG 30	BT-30	\$3.95
Bit for AWG 26-28	BT-2628	\$7.95

*USE "C" SIZE NI-CAD BATTERIES (NOT INCLUDED)



ROLLS OF WIRE

Wire for wire-wrapping AWG-30 (0.25mm) KYNAR® wire. 50 ft. roll, silver plated, solid conductor, easy stripping.

30 AWG Blue Wire 50ft. Roll	R-30B-0050	\$1.98
30 AWG Yellow Wire 50ft. Roll	R-30Y-0050	\$1.98
30 AWG White Wire 50ft. Roll	R-30W-0050	\$1.98
30 AWG Red Wire 50ft. Roll	R-30R-0050	\$1.98

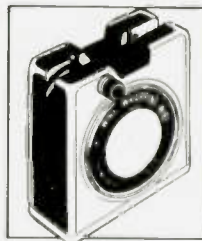

WIRE DISPENSER

- With 50 ft. Roll of AWG 30 KYNAR® wire-wrapping wire.
- Cuts the wire to length.
- Strips 1" of insulation.
- Refillable (For refills, see above)

Blue Wire	WD-30-B	\$3.95
Yellow Wire	WD-30-Y	\$3.95
White Wire	WD-30-W	\$3.95
Red Wire	WD-30-R	\$3.95

PRE CUT PRE STRIPPED WIRE

Wire for wire-wrapping AWG-30 (0.25mm) KYNAR® wire, 50 wires per package stripped 1" both ends.



30 AWG Blue Wire 1' Long	30 B 50 010	\$.99
30 AWG Yellow Wire 1' Long	30 Y 50 010	\$.99
30 AWG White Wire 1' Long	30 W 50 010	\$.99
30 AWG Red Wire 1' Long	30 R 50 010	\$.99
30 AWG Blue Wire 2' Long	30 B 50 020	\$1.07
30 AWG Yellow Wire 2' Long	30 Y 50 020	\$1.07
30 AWG White Wire 2' Long	30 W 50 020	\$1.07
30 AWG Red Wire 2' Long	30 R 50 020	\$1.07
30 AWG Blue Wire 3' Long	30 B 50 030	\$1.16
30 AWG Yellow Wire 3' Long	30 Y 50 030	\$1.16
30 AWG White Wire 3' Long	30 W 50 030	\$1.16
30 AWG Red Wire 3' Long	30 R 50 030	\$1.16
30 AWG Blue Wire 4' Long	30 B 50 040	\$1.23
30 AWG Yellow Wire 4' Long	30 Y 50 040	\$1.23
30 AWG White Wire 4' Long	30 W 50 040	\$1.23
30 AWG Red Wire 4' Long	30 R 50 040	\$1.23
30 AWG Blue Wire 5' Long	30 B 50 050	\$1.30
30 AWG Yellow Wire 5' Long	30 Y 50 050	\$1.30
30 AWG White Wire 5' Long	30 W 50 050	\$1.30
30 AWG Red Wire 5' Long	30 R 50 050	\$1.30
30 AWG Blue Wire 6' Long	30 B 50 060	\$1.38
30 AWG Yellow Wire 6' Long	30 Y 50 060	\$1.38
30 AWG White Wire 6' Long	30 W 50 060	\$1.38
30 AWG Red Wire 6' Long	30 R 50 060	\$1.38

® KYNAR PENNVALT

MINIMUM ORDER \$25.00. SHIPPING CHARGE \$1.00. N.Y. CITY AND STATE RESIDENTS ADD TAX

OK MACHINE & TOOL CORPORATION

3455 Conner St., Bronx, N.Y. 10475 ■ (212) 994-6600 ■ Telex 125091



O5

DIP/IC INSERTION TOOL WITH PIN STRAIGHTENER

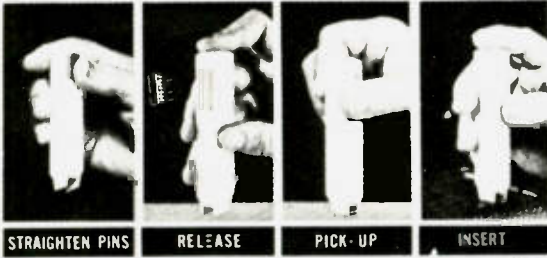

STRAIGHTEN PINS RELEASE PICK-UP INSERT

14-16 Pin Dip IC Inserter INS-1416 \$3.49

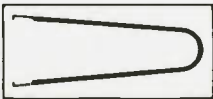

DIP/IC EXTRACTOR TOOL

Extractor Tool EX-1 \$1.49

P.C. BOARD

The 4 x 4.5 x 1/16 inch board is made of glass coated EPOXY Laminate and features solder coated 1 oz. copper pads. The board has provision for a 22/44 two sided edge connector, with contacts on standard .156 spacing. Edge contacts are non-dedicated for maximum flexibility.

The board contains a matrix of .040 in. diameter holes on .100 inch centers. The component side contains 76 two-hole pads that can accommodate any DIP size from 6-40 pins, as well as discrete components. Typical density is 18 of 14-Pin or 16-Pin DIP's. Components may be soldered directly to the board or intermediate sockets may be used for soldering or wire-wrapping.

Two independent bus systems are provided for voltage and ground on both sides of the board. In addition, the component side contains 14 individual busses running the full length of the board for complete wiring flexibility. These busses enable access from edge contacts to distant components. These busses can also serve to augment the voltage or ground busses, and may be cut to length for particular applications.



Hobby Board H PCB-1 \$4.99



PC CARD GUIDES

Card Guides TR-1 \$1.89

QUANTITY - ONE PAIR (2 pcs.)



PC CARD GUIDES & BRACKETS

Guides & Brackets TRS-2 \$3.79

QUANTITY - ONE SET (4 pcs.)

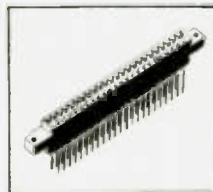

P.C. EDGE CONNECTOR

44 Pin, dual read out, .156" (3.96 mm) Contact Spacing, .025" (0.63 mm) square wire-wrapping pins.

P.C. Edge Connector CON 1 \$3.49

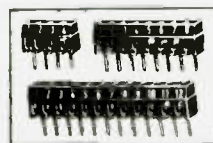

P.C.B. TERMINAL STRIPS

The TS strips provide positive screw activated clamping action, accommodate wire sizes 14-30 AWG (1.8-0.25mm). Pins are solder plated copper, .042 inch (1mm) diameter, on .200 inch (5mm) centers.

4-Pole	TS- 4	\$1.39
8-Pole	TS- 8	\$1.89
12-Pole	TS-12	\$2.59

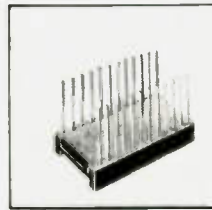

DIP SOCKET

Dual-in-line package, 3 level wire-wrapping, phosphor bronze contact, gold plated pins .025 (0.63mm) sq., .100 (2.54mm) center spacing.

14 Pin Dip Socket	14 Dip	\$0.79
16 Pin Dip Socket	16 Dip	\$0.89

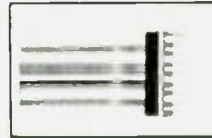

RIBBON CABLE ASSEMBLY SINGLE ENDED

With 14 Pin Dip Plug 24" Long (609mm)	SE14-24	\$3.55
With 16 Pin Dip Plug 24" Long (609mm)	SE16-24	\$3.75



DIP PLUG WITH COVER FOR USE WITH RIBBON CABLE

14 Pin Plug & Cover	14-PLG	\$1.45
16 Pin Plug & Cover	16-PLG	\$1.59

QUANTITY: 2 PLUGS, 2 COVERS

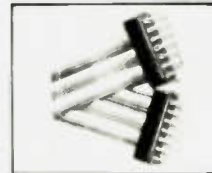

RIBBON CABLE ASSEMBLY DOUBLE ENDED

With 14 Pin Dip Plug - 2" Long	DE 14-2	\$3.75
With 14 Pin Dip Plug - 4" Long	DE 14-4	\$3.85
With 14 Pin Dip Plug - 8" Long	DE 14-8	\$3.95
With 16 Pin Dip Plug - 2" Long	DE 16-2	\$4.15
With 16 Pin Dip Plug - 4" Long	DE 16-4	\$4.25
With 16 Pin Dip Plug - 8" Long	DE 16-8	\$4.35

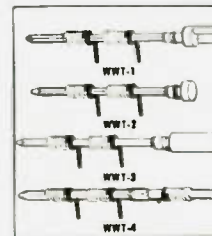

TERMINALS

- .025 (0.63mm) Square Post
- 3 Level Wire-Wrapping
- Gold Plated

Slotted Terminal	WWT-1	\$2.98
Single Sided Terminal	WWT-2	\$2.98
IC Socket Terminal	WWT-3	\$3.98
Double Sided Terminal	WWT-4	\$1.98

25 PER PACKAGE



TERMINAL INSERTING TOOL

For inserting WWT-1, WWT-2, WWT-3, and WWT-4 Terminals into .040 (1.01mm) Dia. Holes.

INS-1 \$2.49

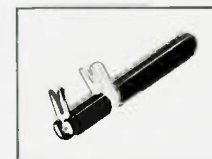

WIRE CUT AND STRIP TOOL

Easy to operate - place wires (up to 4) in stripping slot with ends extending beyond cutter blades... press tool and pull wire is cut and stripped to proper "wire-wrapping" length. The hardened steel cutting blades and sturdy construction of the tool insure long life.

Strip length easily adjustable for your applications.

DESCRIPTION	MODEL NUMBER	ADJUSTABLE "SMINER" LENGTH OF STRIPPED WIRE		Price
		INCHES	TO INCHES	
24 ga. Wire Cut and Strip Tool	ST-100-24	1 1/4"	1 1/4"	\$ 8.75
26 ga. Wire Cut and Strip Tool	ST-100-26	1 1/4"	1 1/4"	\$ 8.75
26 ga. Wire Cut and Strip Tool	ST-100-26-875	7/8"	1 1/8"	\$ 8.75
28 ga. Wire Cut and Strip Tool	ST-100-28	7/8"	1 1/8"	\$11.50
30 ga. Wire Cut and Strip Tool	ST-100-30	7/8"	1 1/8"	\$11.50

THE ABOVE LIST OF CUT AND STRIP TOOLS ARE NOT APPLICABLE FOR WYLENE OR TEFLON INSULATION

MINIMUM ORDER \$25.00, SHIPPING CHARGE \$1.00, N.Y. CITY AND STATE RESIDENTS ADD TAX

OK MACHINE & TOOL CORPORATION
3455 Conner St., Bronx, N.Y. 10475 ■ (212) 994-6600 ■ Telex 125091

Another Approach To the ASCII/Baudot Headache

—marriage between a Model 15 and an SWTP system

Garry O. Caudell K4HBG
3125 Robin Lynn
Ashland KY 41101

One Saturday afternoon, my friend Doug WA4ZVI and I were on 52 doing some "microprocessing." We normally get off the local repeater for this, since we tend to get carried away and bore our local hams to death when we get off on computing.

Doug and I have nearly identical systems for information exchange purposes (SWTPC 6800, CT-1024, KC Standard tapes, Model 15 hard copy).

We had just received the latest SWTPC program (co-resident editor assembler) and we were trying to figure out how to patch the program to give hard copy on our old Model 15 Teletypes (ham radio compatible).

Southwest Technical had given us some places to look, but it turned out that they were largely in error.

After we spent quite a considerable time dumping program listings and searching

Fig. 1. Search program.

00010				NAM	SEARCH	
00020	2000			ORG	\$2000	
00030				OPT	0	
00040				'THIS PROGRAM SEARCHES ANY BLOCK OF MEMORY		
00050				'FOR A TWO BYTE STRING		
00060				'STARTING AND STOPPING ADDRESSES ARE ENTERED		
00070				'FROM THE KEYBOARD' G.O. CAUDELL JUN 77		
00080		E0		BADDR	EQU	\$E047
00090		E0		OUTS	EQU	\$E0GC
00100		E0		OUT4HS	EQU	\$E0C8
00110		E0		PDATA1	EQU	\$E07E
00120		A0		ASTART	EQU	\$A002
00130		A0		ASTOP	EQU	\$A004
00140		A0		ASEARC	EQU	\$A000
00150		A0		PADDR	EQU	\$A006
00160		A0		ASTRNG	EQU	\$A000
00170	2000	CE	204E	SEARCH	LDX	⌊PSTART
00180	2003	BD	E07E	JSR	PDATA1	
00190	2006	BD	E047	JSR	BADDR	'PRINT START MESSAGE
00200	2009	FF	A002	STX	ASTART	GET START ADDRESS
00210	200C	CE	2055	LDX	⌊PSTOP	STORE START ADDRESS
00220	200F	BD	E07E	JSR	PDATA1	PRINT STOP MESSAGE
00230	2012	BD	E047	JSR	BADDR	
00240	2015	FF	A004	STX	ASTOP	STORE STOP ADDRESS
00250	2018	CE	205B	NEXT	LDX	⌊PSEARCH
00260	201B	BD	E07E	JSR	PDATA1	SEARCH FOR MESSAGE
00270	201E	BD	E047	JSR	BADDR	GET TWO BYTE STRING
00280	2021	FF	A000	STX	ASTRNG	STORE STRING
00290	2024	FE	A002	LDX	ASTART	
00300	2027	A6	00	REPEAT	LDA A 0,X	GET CHARACTER
00310	2029	B1	A000	CMP	A ASTRNG	
00320	202C	26	16	BNE	TESTX	
00330	202E	A6	01	LDA	A 1,X	
00340	2030	B1	A001	CMP	A ASTRNG+1	
00350	2033	26	0F	BNE	TESTX	
00360	2035	FF	A006	STX	PADDR	STORE PRESENT ADDRESS
00370	2038	CE	A006	LDX	⌊PADDR	PRINT PRESENT ADDRESS
00380	203B	BD	E0CC	JSR	OUTS	

```

00010          NAM    PATCH
00020          'THIS PATCHES THE SWTPC CO-RESIDENT
00030          'EDITOR/ASSEMBLER FOR HARD COPY ON
00040          'BAUDOT TELETYPE
00050          'G O CAUDELL        JUNE 77
00060 00FE          ORG    $00FE
00070 00FE    1C    FCB    $1C,$80    MAKE ROOM FOR CONVERSION
          00FF    80
00080          ORG    $17A2
00090 17A2    BD    1BF0          JSR    $1BF0          BAUDOT INITIATE
00100 17A5    01    FCB    $01,$01,$01,$01,$01,$01,$01,$01
          17A6    01
          17A7    01
          17A8    01
          17A9    01
          17AA    01
          17AB    01
          17AC    01
00110 1A83          ORG    $1A83
00120 1A83    7E    1BFE          JMP    $1BFE          BAUDOT OUTEEE
00130          END
TOTAL ERRORS 00000

```

Fig. 2. Patch program.

through with Mikbug,* we were not getting anywhere. It occurred to me that we should be making our computers do at least some of this work for us.

*Mikbug is a registered trademark of Motorola.

About this time, Doug had to go off and do some chores, so I proceeded to write a search program (see Fig. 1).

Although I would really like to have a search program that searches for any length string, I decided to write a simple search program that

would search for a two-byte string. Once I got that working, I would complicate it later.

As it turned out, the simple program worked so well that I never saw fit to add to it. It first asks for a starting address, then a stop address,

and then what to search for. Response is almost instantaneous for my 12K of memory. All addresses at which the string appears are displayed (don't clear memory and then ask for 0000 unless you have a lot of time). It will then ask you what to search for with the same memory limits as before. In fact, if you want to look at an area of memory, type a non-hexadecimal character when it asks what to search for and you will go to Mikbug (I find an M appropriate). Examine memory with Mikbug, and then you can return to the search program without having to set new limits simply by typing G.

Armed with the above, things started falling out right and left. To prove it works, I am including the patch for the co-resident editor assembler. Both of these programs were listed on the Model 15 Teletype.

The Teletype acts the same as SWTPC intended the PR-40 to work. That is, the Teletype only works after a "Print" command.

The hardest thing to find was the \$00FE location, which is the top of the SWTPC program. By changing this location, it makes room for my Baudot/ASCII and allows the entire program to be one block (\$0000-\$1C7F). See Fig. 2. ■

```

00390 203E    BD    E0C8          JSR    OUT4HS
00400 2041    FE    A006          LDX    PADDR    RESTORE PRESENT ADDRESS
00410 2044    BC    A004    TESTX  CPX    ASTOP
00420 2047    27    03          BEQ    DONE
00430 2049    08          INX
00440 204A    20    DB          BRA    REPEAT
00450 204C    20    CA          DONE  BRA    NEXT
00460 204E    53          PSTART FCC    /START /
          204F    54
          2050    41
          2051    52
          2052    54
          2053    20
00470 2054    04          FCB    $04
00480 2055    53          PSTOP  FCC    /STOP /
          2057    4F
          2058    50
          2059    20
00490 205A    04          FCB    $04
00500 205B    0D          PSEARC FCC    $0D,$0A
          205C    0A
00510 205D    53          FCC    /SEARCH FOR /
          205E    45
          205F    41
          2060    52
          2061    43
          2062    48
          2063    20
          2064    46
          2065    4F
          2066    52
          2067    20
00520 2068    04          FCB    $04
00530 A048          ORG    $A048
00540 A048    20          FCB    $20,00
          A049    00
00550          END
TOTAL ERRORS 00000

```

Programming Coil Design

—at last . . .
a use for computers!

The next time you're faced with winding a small coil needed to add inductance to your pet project, why not put your microcomputer to work as an assistant? Make sure your BASIC interpreter is resident, and then load the coil design program described here. Sit back and start designing single layer, close-wound coils, using enameled copper (magnet) wire.

Program Execution

Let's work our way through a typical run, and I think you'll wind up (pun) agreeing it's a pretty useful design tool.

Inductance or Reactance?

The designing of a coil begins with a need for a specific quantity of inductive reactance. This program will accept either required inductance in microhenrys or required inductive reactance at a specified frequency. If you select the latter, then the program simply calculates the inductance in microhenrys, which will result in the reac-

tance you require.

Coil Form

Next you're asked to select a coil form. Composition resistor bodies are excellent small coil forms, with consistent diameters and a built-in set of leads to solder to. Coil form options, therefore, include 1/4, 1/2, one and two Watt resistor bodies, as well as a fifth option called "other form." Select it and you can enter the diameter of any form you intend using. Incidentally, if you choose a resistor body as the coil form, keep the value of the resistor as high as possible.

Wire Size

Now enter wire size in gauge. The program handles any wire size from 12 to 40 gauge. The section of the program which handles the gauge to diameter conversion is easily modified to expand or reduce capability. The diameter of the wire obtained from the appropriate "If-Then" statement determines the number of close-wound turns of wire per inch of coil

length.

Design Output

Your computer now performs a few mathematical manipulations and outputs:

1. A recap of wire size for your information.
2. The diameter of the coil form in inches (even if you chose a resistor body as a form).
3. The number of turns of wire required to yield the desired inductance.
4. The length of the single close-wound layer of turns in inches.
5. The length to diameter ratio.
6. Any recommendations which are appropriate.

If the length to diameter ratio is less than one or greater than ten, you will receive an error message, recommending a change in either wire size or coil form diameter. If the coil is too long to fit on the body of a resistor you have selected, then this information will be displayed at this time. You're then asked if you would like to select another coil form

and/or wire size combination.

Program Discussion

I thought about incorporating a recommendation for wire size and form diameter to yield an optimum length to diameter ratio. This is certainly possible, and you may want to try it. Most people won't have the large selection of wire sizes or even standard-size coil forms required to implement the recommendations. Therefore, I left the wire size and form diameter inputs up to the operator. Look at line sixty-eight. The variable H represents the required inductance in microhenrys. This is increased by twenty-five percent in line sixty-eight. If you find that the coils wound using this program yield a relatively high inductance, just change line sixty-eight to read, perhaps:

$$H = 1.15 * H,$$

and vice versa for the other way around.

In line eighty-six, note the function ASC (string name). This returns the ASCII code of the first character in the specified string. In our case, the string is only one character long, and, if A\$ is equal to A, then T will be set equal to 65. If you don't have this function, simply delete lines 86, 88, and 90, as they represent only a check to assure validity of the input in line 84.

System Requirements

The program occupies approximately 2.5K of RAM, not counting the BASIC interpreter. I have it running on an 18K, Z-80 Digital Group system, with thirty-two characters per line video display. The latter is the reason for line twenty-six, which is just a loop to allow time to read the scrolled presentation.

Potential Changes

How about altering this program to allow the operator to input the coil forms and wire sizes he has available, and let the computer

output the best combination? It is also quite possible to expand the program to include "non-close-wound" coils by inputting turns-per-inch information. If you try this, watch out for that multi-

plier in line sixty-eight. It's probably too big.

This program will allow you to quickly optimize coil specifications using your microcomputer. It additionally incorporates readily avail-

able resistor bodies as coil form options. Even if you're not into home brewing equipment, I think you'll enjoy trying and expanding on this application of a microcomputer. ■

References

¹ *Mark's Mechanical Engineering Handbook*, 6th Edition, McGraw-Hill Publishers.

² "Graphical Coil Winding Aid," E.E. Palmer, *Ham Radio Magazine*, April, 1977.

PROGRAM LISTING

```

#= PRINT
10 FOR X=1 to 16:#####NEXT
12 # "      SMALL COIL DESIGN"
14 #####:#"PROGRAM LIMITATIONS:"
16 # " 100 MICROHENRIES MAX. INDUCT."
18 # " WIRE SIZE 12 GAGE MAX."
20 # "      40 GAGE MIN."
22 # " RESISTORS USED AS FORMS MUST"
24 # " BE COMPOSITION TYPE."
26 FOR X=1 TO 1500:NEXT
28 #####:#####
30 GOSUB 254
32 # "WANT TO START WITH: ":#####
34 # " 1-REQUIRED INDUCTANCE"
36 # " 2-REQUIRED INDUCTIVE REACTANCE"
38 INPUT C
40 GOSUB 254
42 IF C=1 THEN 62
44 IF C>2 THEN 38: IF C<0 THEN 38
46 INPUT"WHAT IS THE DESIRED INDUCTIVE
    REACTANCE IN OHMS",I
48 INPUT"WHAT FREQ. IN MHZ. ",F
50 H=I/(2*3.14159*F)
52 # "REQUIRED INDUCT.= ";H
54 # "MICROHENRIES": IF H>100 THEN
    # "100 MICRO-H MAX. PLEASE REENT
    ER" ELSE GOTO 68
56 GOTO 46
58 FOR X=1 TO 16:#####NEXT
60 GOSUB 254
62 INPUT"WHAT IS THE DESIRED COI
    L INDUCTANCE IN MICROHENRIES?",H
64 IF H>100 THEN # " 100 MICRO-H MAX.
    PLEASE REENTER" ELSE 68
66 GOTO 62
68 H=1.25*H
70 GOSUB 254
72 # "SELECT COIL FORM"
74 # "  A- 1/4 W RESISTOR"
76 # "  B- 1/2 W RESISTOR"
78 # "  C- 1  W RESISTOR"
80 # "  D- 2  W RESISTOR"
82 # "  E- OTHER FORM"
84 INPUT"?",A$
86 T=ASC(A$)
88 IF T<65 THEN 84
90 IF T>69 THEN 84
92 IF A$="A" THEN D=.090
94 IF A$="B" THEN D=.140
96 IF A$="C" THEN D=.220
98 IF A$="D" THEN D=.312
100 IF A$="E" THEN 102 ELSE 110
102 # "WHAT IS THE DIAMETER OF THE"
104 # "COIL IN INCHES?"
106 #####: INPUT"?",D
108 GOSUB 254
110 INPUT "WHAT GAGE ENAMELED WIRE
    IS TO BE USED?",G
112 IF G=12 THEN W=.081
114 IF G=13 THEN W=.072
116 IF G=14 THEN W=.064
118 IF G=15 THEN W=.057
120 IF G=16 THEN W=.051

```

```

122 IF G=17 THEN W=.045
124 IF G=18 THEN W=.040
126 IF G=19 THEN W=.036
128 IF G=20 THEN W=.032
130 IF G=21 THEN W=.0285
132 IF G=22 THEN W=.0253
134 IF G=23 THEN W=.0226
136 IF G=24 THEN W=.0201
138 IF G=25 THEN W=.0179
140 IF G=26 THEN W=.0159
142 IF G=27 THEN W=.0142
144 IF G=28 THEN W=.0126
146 IF G=29 THEN W=.0113
148 IF G=30 THEN W=.01
150 IF G=31 THEN W=.0089
152 IF G=32 THEN W=.008
154 IF G=33 THEN W=.0071
156 IF G=34 THEN W=.0063
158 IF G=35 THEN W=.0056
160 IF G=36 THEN W=.005
162 IF G=37 THEN W=.0045
164 IF G=38 THEN W=.004
166 IF G=39 THEN W=.0035
168 IF G=40 THEN W=.0031
170 IF G<12 THEN 110
172 IF G>40 THEN 110
174 N=((40*H*W)+SQRT(((4*H*W)*(4
    *H*W))+(4*D*D*D*18*H)))/(2*D*D)
176 N1=((40*H*W)-SQRT(((4*H*W)*(4
    *H*W))+(4*D*D*D*18*H)))/(2*D*D)
178 IF N>N1 THEN N2=N ELSE N2=N1
180 N2=(INT(N2*10))/10
182 FOR X=1 TO 14:#####NEXT
184 GOSUB 254
186 #WIRE SIZE = ";G;" GAGE"
188 #COIL DIA. = ";D;" INCHES"
190 #NUMBER OF TURNS = ";N2
192 #COIL LENGTH = ";(INT(N2*W*100))
    /100;" INCHES"
194 R=INT(N2*W*100/D)/100
196 IF A$="A" THEN 242
198 IF A$="B" THEN 246
200 IF A$="C" THEN 248
202 IF A$="D" THEN 250
204 #THE LENGTH TO DIA. RATIO IS"
206 #R
208 IF R<1 THEN GOSUB 228
210 IF R>10 THEN GOSUB 236
212 FOR X=1 TO 5:#####NEXT
214 GOSUB 254
216 INPUT"SELECT ANOTHER FORM?
    (Y OR N)",C$
218 IF C$="y" THEN 70
220 INPUT "DESIGN ANOTHER COIL?
    (Y OR N),B$
222 IF B$="Y" THEN 30
224 #PROGRAM TERMINATED"
226 END
228 #RECOMMEND THAT YOU USE EITHER"
230 #LARGER WIRE OR A SMALLER COIL"
232 #FORM."
234 RETURN
236 #RECOMMENDED THAT USE SMALLER WIRE"
238 #OR A LARGER COIL FORM."
240 RETURN
242 IF N2*W>.250 THEN #COIL TOO LONG
    FOR 1/4 W FORM" ELSE GOTO 201
244 GOTO 214
246 IF N2*W>.385 THEN #COIL TOO LONG
    FOR 1/2 W FORM" ELSE GOTO 204:
    GOTO 214
248 IF N2*W>.567 THEN #COIL TOO LONG
    FOR 1 W FORM" ELSE GOTO 204:
    GOTO 214

```

250 IF N2*W>.678 THEN # "COIL TOO LONG
 FOR 2 W FORM" ELSE GOTO 204:
 GOTO 214
 252 GOTO 214
 254 # "-----"
 256 RETURN
 RUN

SMALL COIL DESIGN

PROGRAM LIMITATIONS:

100 MICHOHENRIES MAX. INDUCT.

WIRE SIZE 12 GAGE MAX.

40 GAGE MIN.

RESISTORS USED AS FORMS MUST

BE COMPOSITION TYPE

 WANT TO START WITH:

1- REQUIRED INDUCTANCE

2- REQUIRED INDUCTIVE REACTANCE

? 2

 WHAT IS THE DESIRED INDUCTIVE RE

ACTANCE IN OHMS 1500

WHAT FREQ. IN MHZ 14.230

REQUIRED INDUCT.=16.776712

MICROHENRIES

SELECT COIL FORM

A- 1/4 W RESISTOR

B- 1/2 W RESISTOR

C- 1 W RESISTOR

D- 2 W RESISTOR

E- OTHER FORM

? B

WHAT GAGE ENAMELED WIRE IS TO

BE USED? 30

WIRE SIZE = 30

COIL DIA. = .14 INCHES

NUMBER OF TURNS = 270.1

COIL LENGTH = 2.70 INCHES

COIL TOO LONG FOR 1/2 W FORM

SELECT ANOTHER FORM? (Y OR N) Y

SELECT COIL FORM

A- 1/4 W RESISTOR

B- 1/2 W RESISTOR

C- 1 W RESISTOR

D- 2 W RESISTOR

E- OTHER FORM

? B

WHAT IS THE DIAMETER OF THE

COIL IN INCHES?

? 1.5

WHAT GAGE ENAMELED WIRE IS TO BE

USED ? 30

WIRE SIZE = 30 GAGE

COIL DIA. = 1.5 INCHES

NUMBER OF TURNS = 17.7

COIL LENGTH = .17 INCHES

THE LENGTH TO DIA. RATIO IS

.11

RECOMMEND THAT YOU USE EITHER

LARGER WIRE OR A SMALLER COIL

FORM.

SELECT ANOTHER FORM? (Y OR N) Y

SELECT COIL FORM

A- 1/4 W RESISTOR

B- 1/2 W RESISTOR

C- 1 W RESISTOR

D- 2 W RESISTOR

E- OTHER FORM

?D

WHAT GAGE ENAMELED WIRE IS TO BE USED? 32

WIRE SIZE = 32 GAGE

COIL DIA. = .312 INCHES

NUMBER OF TURNS = 69.4

COIL LENGTH = .55 INCHES

THE LENGTH TO DIA. RATIO IS

1.77

SELECT ANOTHER FORM? (Y OR N) N

DESIGN ANOTHER COIL? (Y OR N) N

PROGRAM TERMINATED

READY

TELETYPE® MODEL 33 ASR

COMPUTER I/O COMPLETE WITH:

- Tape Punch
- Ready to Go
- Tape Reader
- Line/Local Wired
- Guaranteed 30 Days



\$840⁰⁰

INCLUDING PACKING
F.O.B. - N.J. FACTORY

COMPLETE COVER READY TO INSTALL \$ 35.00
COPY HOLDER (182036) \$ 14.00
TAPE UNWINDER (12" NEW) \$ 56.00
WIND UP PAPER TAPE WINDER (1") \$ 52.00
ELECTRIC PAPER WINDER (LPW-300 NEW) \$ 50.00
DEC TYPE READER RUNCARD \$ 45.00
ACOUSTIC COUPLER	
OMNITEK 501A (NEW) \$180.00
READER POWER PACK (182134) \$ 35.00
EIA RS-232 INTERFACE \$ 55.00
ACOUSTIC COVERS with FAN (NEW) \$258.00

If its for TELETYPE® We Have It.

If you don't see what you need. CALL or WRITE!



TELETYPEWRITER COMMUNICATIONS SPECIALISTS

550 Springfield Avenue • Berkeley Heights, N. J. 07922
(201) 464-5310 • TWX: 710-986-3016 • TELEX: 13-6479

T13

SUBSIDIARY OF VAN'S W2DLT ELECTRONICS.

THE CRITIC'S CHOICE

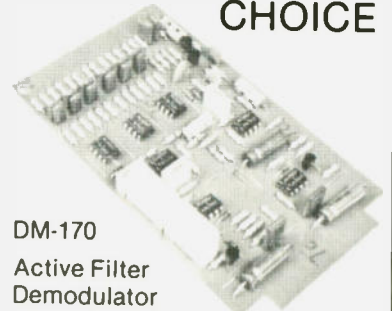

DM-170
Active Filter
Demodulator

Critical buyers are choosing the DM 170 RTTY demodulator to give them more features at lower cost! Write for information and compare. Discover what the Critics have \$39.95 Kit \$59.95 Wired

FLESHER CORP.

P.O. Box 976

Topeka, Kansas 66601

(913) 234-0198 F5



CANADIANS!

Eliminate the Customs Hassles. Save Money and get Canadian Warranties on IMSAI and S-100 compatible products.

IMSAI 8080 KIT \$ 838.00
ASS. \$1163.00

(Can. Duty & Fed. Tax Included).

AUTHORIZED DEALER

Send \$1.00 for complete IMSAI Catalog.

We will develop complete application systems.

Contact us for further information.

Rotundra Cybernetics



Box 1448, Calgary, Alta. T2P 2H9
Phone (403) 283-8076

R13

IDS INTERNATIONAL DATA SYSTEMS, INC.

400 North Washington Street, Suite 200, Falls Church, Virginia 22046 U.S.A.

Telephone

(703) 536-7373



MORSE CODE TRAINER/KEYER! The MCTK is a hardware/software package which allows your computer to TEACH Morse Code key your transmitter, and send prestored messages. Uses "New Code Method" for Morse training. The MCTK is optically isolated from your computer and is also mechanically isolated from your transmitter! BASIC programs are included written in MITS BASIC, PTCO BASIC5, and North Star BASIC. Kit Price \$29.00. Delivery is from stock.

I10

Write or call for detailed product brochures. Many other items available. Payment with order shipped prepaid. Master Charge

Outstanding Computer Bargain Exposed

—a novice builds the BYT-8

Have you seen the BYT-8 on display in the Byte Shops? This little machine, with its rather plain black and beige aluminum cabinet with wraparound top, is not much larger than a portable typewriter case,

measuring approximately 15" wide, 7" high, and 11" deep. Inside it contains a 10-slot, S-100 bus mother board and has a 10 Amp power supply (+8 V dc, ± 18 V dc) and an MWRITE logic circuit. It uses an optionally provided fan.

The front panel is uncluttered, having a start/restart switch and an LED to indicate that the power is on. The power master switch is located on the back panel to lessen the temptation of curious switch flippers who



Photo A. BYT-8 cabinet. It's not fancy, but it's functional and nicely sized for tabletop operation.

may visit the computer room.

At first glance the kit appears simple, so putting it together should be a snap, even for the novice. However, the manner in which the assembly instructions are written makes it more of a challenge. If you can spare the time, I'll tell you all about it.

My BYT-8 is the first of several building projects which I hope will provide me with a fully-operational home computing system in the near future. I must point out that I have not yet accumulated all the components necessary to get it operational, so that, at this point, it hasn't been fully tested. Therefore, all the comments made here relate strictly to my experience in selecting and building the mainframe assembly.

I was attracted to the BYT-8 initially because of its compactness and apparent simplicity. It affords one the opportunity to get started in this new hobby in a modular way without a large initial capital outlay. It also gave me some time to study various optional paths I might take while getting my feet wet in kit-building activity. Once I had taken the initial plunge, I was reasonably certain I would pursue the activity until I had a complete system. That first commitment, for me, was a difficult hurdle to overcome.

The First Steps

Before making my initial selection, I suppose I did the normal amount of agonizing over the offerings of the many computer companies which advertise in the popular home computing magazines. I even attended two large home computer shows on the West Coast and hung out at the local computer shops. I joined a computer club at work. I read everything I could get on the subject; little did it matter that I understood only a small part of what I read. In the end I was confused and indecisive,

but I did know lots of buzzwords and could smile and nod knowingly when people spoke of such things as dynamic memories, EPROMs, machine cycles, and the like. By doing some home studying, I even got to know something about BASIC programming. I became aware of BASIC's general capabilities, though I still cannot claim any proficiency in the language. The point of this is that I began to look at the various systems offered in terms of both their hardware and software capabilities.

After considerable soul-searching, I finally narrowed my selection down to equipment offered by The Digital Group, Processor Technology, and Technical Design Laboratories. All of these systems appeared to best meet my basic objectives for a system, both from the standpoint of the hardware and from software availability. In the end, TDL's Z-80 CPU (ZPU), with its S-100 bus compatibility, won out over the others. However, this immediately posed another problem, since, at that time, TDL did not offer a complete package to house their card. I had to seek a solution to that problem.

At this point, I recalled having seen the BYT-8 at a nearby store, and I really became interested in it as a possible part of my system. I wondered if a 10-slot mother board would be large enough to meet my ultimate needs. The arguments of the Byte Shop people convinced me that it would do. I currently envision my initial system as comprised of the Z-80 CPU board supported by the TDL Z-80 monitor board (this contains 2K ROM, 2K RAM, 2 serial and 1 parallel input/output ports, plus a cassette interface). To this I plan to add a 16K memory board and a video interface. This should afford me plenty of expansion room, especially in light of the high-density memory boards which are currently available. Since

most boards use one Amp or less per board, the 10-Amp power supply should be sufficient.

Before making the decision to buy the BYT-8, however, I looked at the possibility of purchasing an Imsai mainframe assembly without the front panel. I am convinced that the front panel is not needed for my application and is simply a source of additional trouble. It appeared to be cost-effective to eliminate the front panel if I could. The Imsai sans the front panel would have cost about \$70 more than the BYT-8 (priced at \$299). Since I had convinced myself that I only needed 10 slots, the larger cabinet and 28-Amp power supply didn't hold much appeal for me. The only other alternative was to pick up a mother board here and a power supply there and find a cabinet somewhere to mount it all in. Since I am new in the hobby, I wanted someone to hold my hand a bit, so I opted for the BYT-8 kit. I slapped down my Mastercharge card and walked out

of the Byte Shop with the kit under my arm.

Now the Fun Begins . . .

Once I had the box home, I opened it and began to read the instructions. I was prepared for the worst, since I had heard from others that computer kits are a far cry from Heathkits. At this point I can say they were not exaggerating with respect to the BYT-8. (Since constructing the BYT-8, I have put the TDL ZPU together and found it to be almost Heathkit-like in its approach.) At this point, I want to make it clear that the criticism presented here is aimed principally at helping the novice builder — either directly, by giving him the benefit of my experience, or indirectly, by prompting the manufacturer to improve his assembly instructions to make them easier to follow. Those experienced in this field may feel I am nit-picking, but I feel this is not so. I have thrown out a number of lesser criticisms which I felt were too inconsequential to mention here, but which, in the interest of

product improvement, should be considered. The kit manufacturer states early in his instruction manual, "For the most part, our discussion will be aimed at the Intermediate, but we will constantly give references and repeat things for the Neophyte and Novice." At times, the instructions fail to keep this promise. The manual defines five categories of builders, from the neophyte and novice through intermediate, advanced, and expert. By Byte Shop definitions, I should be classified as a novice.

My criticisms fall into two classes — those dealing with hardware design and those relating to documentation. I feel that those in the first class are not of a serious nature, if one is aware of them, and that those in the latter are mainly a nuisance which tends to take some pleasure out of the kit-building experience and could cause those unfamiliar with electronics to blow a few components if they are not careful and observant. The hardware aspects will be

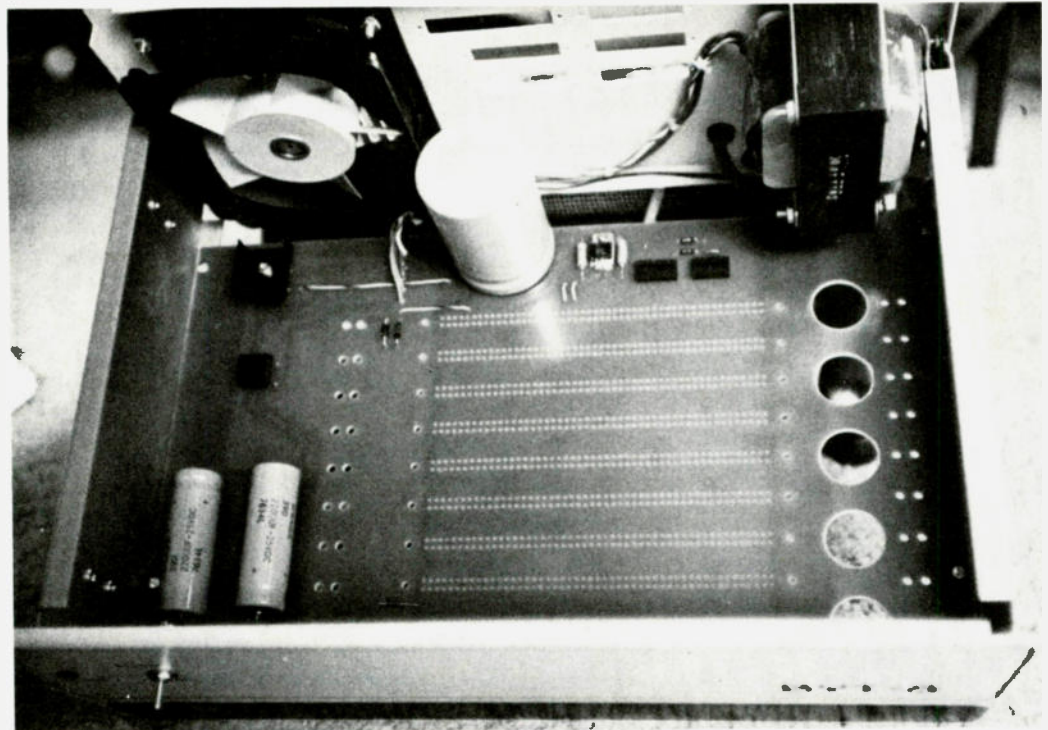

Photo B. BYT-8 top view. This shows the power supply and optional fan. MWRITE circuit consists of the two ICs and the voltage regulator between the power transformer and filter capacitor.

covered first, followed by the documentation deficiencies.

Hardware Shortcomings

The most serious hardware problem results from the manufacturer's recent change to a PC board which is twice as thick as that used in his original design. This change is noted in the errata sheet, where it is stated that the change was made to provide proper board rigidity without the use of supporting struts, since the struts were found to be a source of short circuits to the mother board. While the substitution appears reasonable, the manufacturer has not properly considered the consequences of this decision on the IC sockets provided. The pins on the sockets are too short to penetrate the board far enough for reliable soldering. It is extremely difficult to apply heat to these short pins to assure a good solder joint. Since the traces are on only one side of the board, the holes are not plated through, and solder does not tend to wick up the hole along the socket pins. This condition occurs only in the MWRITE logic portion of the board. If

this optional circuit is going to be used, the builder should exercise care here or purchase wire-wrap sockets whose longer pins will easily penetrate the board. The pins on the 100-pin edge connector present no problem, since they are long enough to properly penetrate the board.

However, I should caution that the mother board requires the 100-pin connectors to have a lateral (across-the-connector dimension) pin spacing of $5/32$ of an inch. This proved to be rather costly for me, since I found a ready supply of the $1/4$ -inch dimension connectors for only \$3.50 each, but the only $5/32$ -inch connectors I could acquire cost \$7.35 each! (Maybe I should have bought the Imsai! Half of my saving by not buying the Imsai went for the more expensive connectors.)

Apparently, when the new board was manufactured, two errors crept into the design regarding the connections to the power-on LED. The first of these is minor. The pads for the plus voltage supply, obtained through a dropping resistor, were changed to a new location, and the pic-

torials were not properly updated. The other problem results from neglecting to drill the hole for the LED ground return. This simple operation must be done by the builder.

One other design deficiency relates to the power-on LED. The BYT-8 design solders the two leads of the LED to wires running to the mother board without any terminal strip to provide proper support of the leads. The unsupported leads are subject to damage or shorting whenever one works in the chassis or inserts or removes boards. To eliminate this problem of hanging leads, I installed a two-lug terminal strip on a nearby chassis attach screw. (See Photo D.) This strip is close enough to the LED so that the leads would reach, and no additional holes were required in the chassis. Only one note of caution: One should take care that the solder lugs of the terminal used are not grounded through the terminal's mounting lug, in order to preserve the BYT-8's ground independent of the cabinet.

When it came time to in-

stall the top and bottom covers of the cabinet, I discovered that the top was about $1/32$ inch too short! The top is a wraparound affair, and the curvature was slightly off, so two of the mounting holes for the attaching screw didn't quite line up with the threaded holes on the chassis side rails. I attempted to fix this condition by reaming the holes out slightly, but this failed to give enough relief to line the screws up with the holes. To have continued on this tack would have required holes too large for the screw heads and would have necessitated the use of large washers. Instead, I elongated the holes on one side, drifting them down and back with a small file. This made the top fit acceptably well, but still, there is a narrow gap along one side.

My final hardware comment is directed to the manufacturer. I recommend strongly that the mother board be solder masked to make it less likely that we novices will bridge the traces when we solder in the bus sockets. Those traces are really very close together!

Software Shortcomings

None of the documentation deficiencies cited below are considered highly critical, but, by being aware of them, the inexperienced builder may avoid time-consuming, if not costly, pitfalls.

The construction notes are contained in an attractive vinyl loose-leaf notebook. Unfortunately, the instructions are somewhat disorganized. The manufacturer should hire a programmer to write the assembly instructions, since programmers should be orderly in their thinking processes and would appreciate the need for logical progression in assembling the kit. The writer of the instructions provided apparently did not put organization very high in his order of priorities. The document contains much irrelevant text

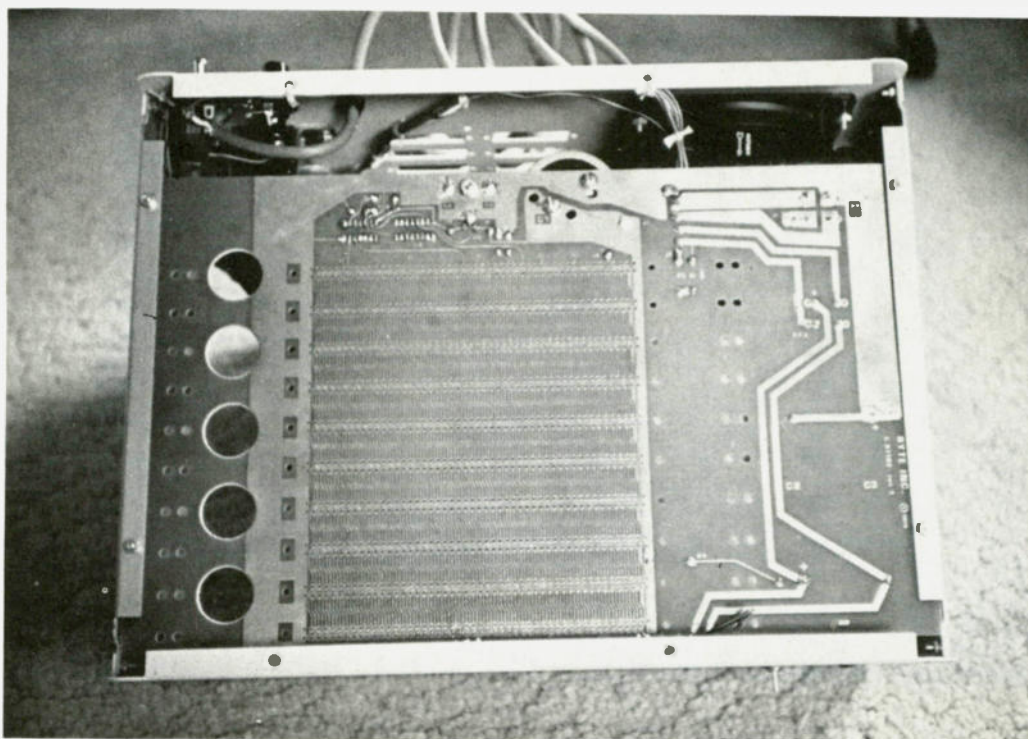

Photo C. BYT-8 chassis -- bottom view of mother board.

and a number of meaningless photographs and sketches. These and a number of redundancies can be overlooked. However, some of the photographs needed for an understanding of the assembly are of poor quality, and proper highlighting of necessary details has been omitted. For example, the master diagram is a top view photograph of the mother board installed in the cabinet. Most of the components show up well enough in this view, but the jumpers blend into the background and are difficult to see. Small (less than 1/16 inch) labels are penned in, but even these are difficult to see — in some cases, they are black written on dark grey. This is one area that the manufacturer should seriously consider for improvement.

At this point, follow me as I flip through the pages of the instruction manual and point out some of the areas where problems may be avoided. Parenthetical numbers refer to the page numbers in my instruction manual. (Possibly, later editions will have different page numbers and will, hopefully, have clarified these points.)

The assembly instruction section has an overview which lists the steps from unpacking the kit through the final testing (ASI-4). This overview is important, since it is the only place where I found an unambiguous description of the construction steps required to assemble the kit. It was here, for example, that I found that I should have mounted the power transformer to the back panel before I assembled the cabinet. Unfortunately, I hadn't remembered that bit of wisdom at the critical point and proceeded to put the cabinet together first, as later instructions implied. This out-of-step assembly caused only a little difficulty in bolting in the transformer and making the solder connections that otherwise would have been easy. Therefore, I suggest to

those building this kit that they take this list of steps out of the book and consult it for each major operation along the way.

Several pages in the overview of the assembly are devoted to explaining the electrical characteristics of a number of the components, such as capacitors, diodes, etc. (ASI-8). These pages may be of value to the neophyte kit builder, but they are not complete enough with respect to diodes, as I will explain later.

The expenditures for the two pictures showing how to unpack the kit could have been better used elsewhere to clarify construction steps (ASI-17 and 18).

The detailed installation pictorial (ASI-26) contains an error on the bridge rectifier polarity (BR2). This picture shows the BR2 plus pin as a minus. However, this should cause only minor confusion, as the PC board has the correct polarity printed on it, as does the pictorial on page ASI-25. Also on page ASI-26, the builder should be aware that the center tap of the 30 V ac winding of the power transformer (white/red) is in-

serted in the top-most hole on the PC board, while the 9 V ac and 30 V ac leads are installed below it in that order. This detail is not shown clearly anywhere in the instructions and only is apparent if one refers to the wiring schematic and compares it with the PC board. In the earlier discussion of diodes, the instructions failed to tell the neophyte how to identify the anode and cathode of the diode. When he comes to the point where he must insert it into the PC board, he has a 50-50 chance of being right. It would be helpful if he were told (back on page ASI-8) that the diode has a band on one end of its package which corresponds with the straight bar (cathode) on the symbolic representation of the diode. One last comment about page ASI-26 — the document persists in saying that the transformer 30 V ac leads are orange, except for one place, the schematic of the transformer, where they are correctly identified as red.

On the next page (ASI-27), the voltage regulator circuit components are photographed and super-

imposed on the photograph as a schematic of the circuit. As so frequently happens in kits, components change in physical shape from time to time. In my kit, the 10-uF capacitors were not the same type as those shown in the pictorial. Instructions such as "caution polarity" are not very enlightening if one is unaware of what the polarity is supposed to be. It would be helpful if the polarity were indicated explicitly on the photograph. The schematic, while helpful to some, may be confusing to the uninitiated, since the relationships between the components in the photograph and those in the schematic are upside down.

Page ASI-28 is a photograph of the bottom of the mother board which is captioned "inspect and clean away residue." The text relating to this step (ASI-24a) is only slightly more informative than the picture. The builder should be told to thoroughly clean the resin residue and solder splashes from the board with alcohol and a small stiff bristle brush (acid brush obtainable at the local hardware store). The

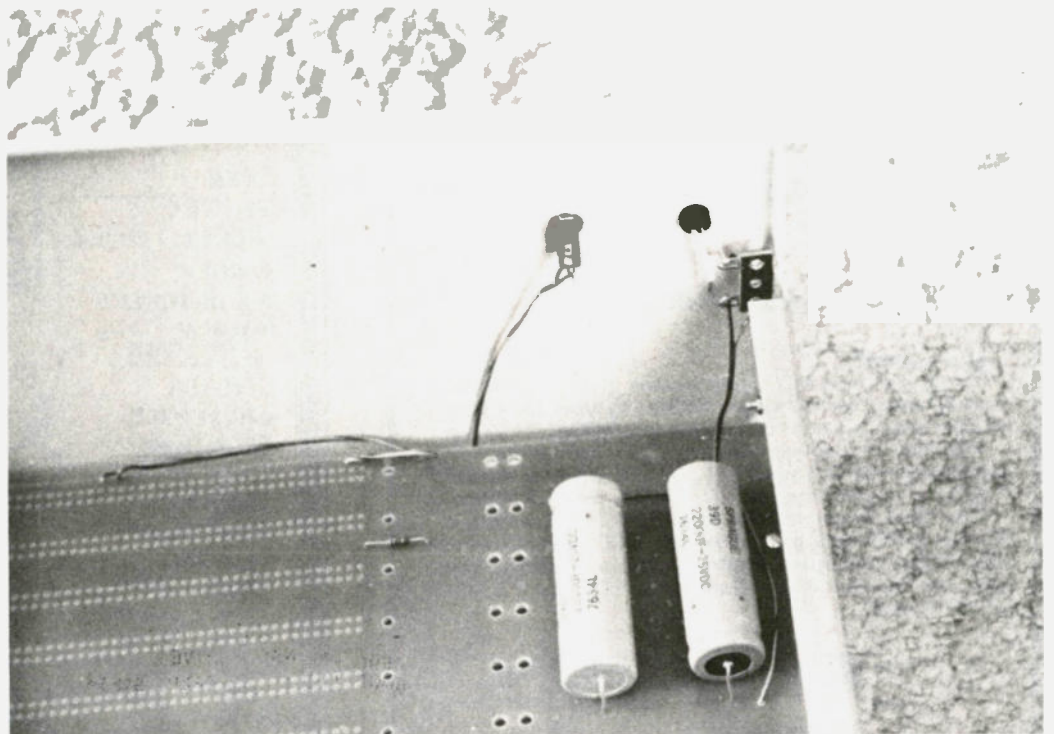

Photo D. Close-up of the power-on LED lead supports added (see text).

board should be wetted thoroughly with the alcohol in a small area and brushed until all resin is dissolved. Before the alcohol dries, the board should be blotted with a clean absorbent cloth. Several cleanings may be necessary to remove all residue. After cleaning, each solder joint should be inspected with a magnifying glass for solder bridges and cold solder joints. Cold solder joints may be identified as areas where the solder has a frosted appearance.

The transformer installation is indicated on page ASI-32. Here one gets the impression that the transformer is installed after the front and back panels are in place. This is wrong! This impression stems from a picture showing the back panel already in place.

After reading page ASI-33, the neophyte may have some trouble installing the power cord grommet/strain relief, if he has never installed one before. He should have a pic-

torial to go by and a bit of encouragement that the task is at least possible. Attempting to push the two parts of this grommet together with the heavy line cord between them and to insert the entire assembly in the hole in the chassis is almost like trying to put a one-inch-square peg in a ½-inch-round hole!

The schematic of the power transformer (ASI-34) should have a note to instruct the builder to scrape the paint away from the lug mounting screw hole so a good connection can be made for the ground wire of the line cord. This isn't made clear, and I imagine that some builders may wonder why there is no ground on the chassis when they come to that part of the checkout in later steps.

Page ASI-40 has a much better view of the jumpers that were installed earlier in the assembly process (ASI-25). The photo has increased contrast, and the details stand out more visibly.

Here one realizes that the board has some changes in the location of the LED power connections from those pictured. Also on this page, one is instructed to connect the start/restart switch. The switch in my kit was a double-throw spring-loaded center switch. The picture doesn't make it clear whether the second connection to the switch is made to the top or bottom terminal. Since the function implemented here is the restart, and the front panel shows this in the "up" position, I reasoned that the connection should be made to the lower terminal on the switch. This means that the "start" position has no effect. Possibly this puzzle is the result of substituting a double-throw switch for what was originally a single-throw switch.

There is one last item. In providing instructions for the cabinet assembly, very little text is available; the manual relies almost totally on the pictorials. This is fine. How-

ever, it would be helpful if the size of the screws was specified in the drawings. I found that I used a wrong screw size when I later discovered that the remaining screws wouldn't work. Thus, I had to disassemble a few things and reassemble them with different size screws.

I Like It

One might gather from all the gripes above that I would hesitate to recommend the BYT-8 to my friends. This is not the case. In spite of the above, I feel that it is worth what I paid for it, and, for those forewarned of the deficiencies, it should pose no real problems. At this point, I have tested every part of the board that I can without the rest of the computer components, and it appears to work as advertised. But who knows what I'll find when I plug in all the other components? If I feel there is more to tell at that time, I'll let you know. In the meantime, happy soldering! ■

New! QSO tape for the new exams.

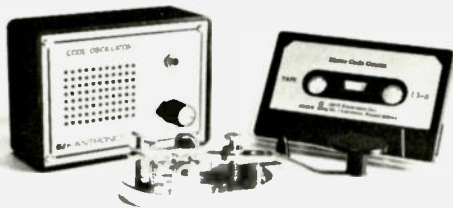

Code kit
\$19.95

Tape only
\$4.95

Kantronics Speed-Building Kit

Get prepared!

To pass the new FCC code exams, you'll need to identify unusual names, places, antenna heights, rig types and a variety of other items garnered from simulated QSOs.

Now you can really study for the new exams with the **Kantronics QSO Tape!** Our C-60 cassette sends simulated "on-the-air" transmissions at 7½, 10, 13, and 15 WPM.

The QSO Tape generates sharp, crisp code to exact Morse specifications, just as the FCC does. Order your QSO Tape with Speed-Building Kit, or separately, today! Our other fine tapes are also available at 5, 7½, 10, 13, 16 and 20 WPM speeds.

KANTRONICS
The Lightweight Champs.

Telephone 913-842-7745
Lawrence, Kansas 66044

1202 East 23rd St

ZZZ Electronics
422 Armour Circle N.E.
ATLANTA, GEORGIA
30324
OWNER - JOHN FEARON
W4WKD

SWAN
TEN-TEC
STONER PRO 80-10
LARSEN
ALUMATOWERS
MARDEN
2 MTR. XTALS
LifeTime Guar. 15 yrs. ea.
GOLD LINE
SHURE MICS
SAXTON WIRE
PRODUCTS
TAB BOOKS
COLUMBIA WIRE
LENTRON
ICOM

WILSON
KLM
CUSH CRAFT
KDK FM 2015R
TURNER MICS
MOSLEY
CDE ROTORS
TELEX HEADSETS
WAHL ISOTIP
ARRL BOOKS
PRIMO MICS
UNGAR
NEWTRONICS
HUSTLER

NEW IN ATLANTA!
COME BY OR CALL

W.M.-WA4SVY
Charlie - WB4GJU
PHONE 404-8760631

RG8X
Mini RGB
12¢ per ft

**MASTER CHARGE
AND
VISA ACCEPTED**

CALLBOOK MAG.

MLA-2500 \$799.50

ELECTRONIC SYSTEMS

p.o. box 212 Burlingame CA 94010
(408) 374-5984

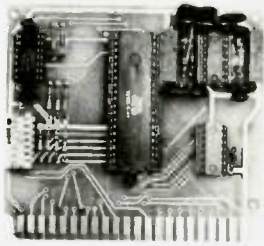

UART & BAUD RATE GENERATOR

- Part no. 101
- Converts serial to parallel and parallel to serial
 - Low cost on board baud rate generator
 - Baud rates: 110, 150, 300, 600, 1200, and 2400
 - Low power drain +5 volts and -12 volts required
 - TTL compatible
 - All characters contain a start bit, 5 to 8 data bits, 1 or 2 stop bits, and either odd or even parity.
 - All connections go to a 44 pin gold plated edge connector
 - Board only \$12.00; with parts \$35.00

8K STATIC RAM

- Part no. 300
- 8K Altair bus memory
 - Uses 2102 Static memory chips
 - Memory protect
 - Gold contacts
 - Wait states
 - On board regulator
 - S-100 bus compatible
 - Vector input option
 - TRI state buffered
 - Board only \$22.50; with parts \$160.00



RS-232/TTL INTERFACE



- Part no. 232
- Converts TTL to RS-232, and converts RS-232 to TTL
 - Two separate circuits
 - Requires -12 and +12 volts
 - All connections go to a 10 pin gold plated edge connector
 - Board only \$4.50; with parts \$7.00

DC POWER SUPPLY

- Part no. 6085
- Board supplies a regulated +5 volts at 3 amps., +12, -12, and -5 volts at 1 amp.
 - Board has filters, rectifiers, and regulators
 - Power required is 8 volts AC at 3 amps., and 24 volts AC C.T. at 1.5 amps.
 - Board only \$12.50



TIDMA

- Part no. 112
- Tape Interface Direct Memory Access
 - Record and play programs without bootstrap loader (no prom) has FSK encoder/decoder for direct connections to low cost recorder at 625 baud rate, and direct connections for inputs and outputs to a digital recorder at any baud rate.
 - S-100 bus compatible
 - Comes assembled and tested for \$160.00

TAPE INTERFACE

- Part no. 111
- Play and record Kansas City Standard tapes
 - Converts a low cost tape recorder to a digital recorder
 - Works up to 1200 baud
 - Digital in and out are TTL-serial
 - Output of board connects to mic. in of recorder
 - Earphone of recorder connects to input on board
 - Requires +5 volts, low power drain
 - Board \$7.60; with parts \$27.50
 - No coils



RF MODULATOR

- Part no. 107
- Converts video to AM modulated RF, Channels 2 or 3
 - Power required is 12 volts AC C.T., or +5 volts DC
 - Board \$4.50; with parts \$13.50

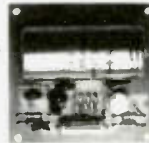

APPLE I MOTHER BOARD

- Part no. 102
- 10 slots - 44 pin (.156) connectors spaced 3/4" apart
 - Connects to edge connector of computer
 - Pin 20 and 22 connects to X & Z for power and ground
 - Board has provisions for by-pass capacitors
 - Board cost \$15.00



TELEVISION TYPEWRITER

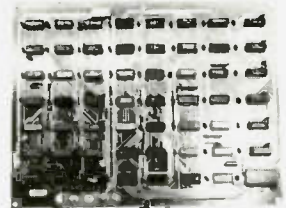

- Part no. 106
- Stand alone TVT
 - 32 char/line, 16 lines, modifications for 64 char/line included
 - Parallel ASCH (TTL) input
 - Video output
 - 1K on board memory
 - Output for computer controlled cursor
 - Auto scroll
 - Non-distructive cursor
 - Cursor inputs: up, down, left, right, home, EOL, EOS
 - Scroll up, down
 - Requires +5 volts at 1.5 amps, and -12 volts at 30 mA
 - Board only \$39.00; with parts \$145.00

MODEM

- Part no. 109
- Type 103
 - Full or half duplex
 - Works up to 300 baud
 - Originate or Answer
 - No coils, only low cost components
 - TTL input and output-serial
 - Connect 8 ohm speaker and crystal mic. directly to board
 - Uses XR FSK demodulator
 - Requires +5 volts
 - Board \$7.60; with parts \$27.50



To Order:

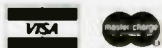

Mention part number and description. For parts kits add "A" to part number. Shipping paid for orders accompanied by check, money order, or Master Charge, BankAmericard, or VISA number, expiration date and signature. Shipping charges added to C.O.D. orders. California residents add 6.5% for tax. Parts kits include sockets for all ICs, components, and circuit board. Documentation is included with all products. Dealer inquiries invited. 24 Hour Order Line: (408) 374-5984.

Do Biorhythms Really Work?

HP-55 program you can use

Do you know what is meant by biorhythm? This article describes a basic method to compute the values for calculating your biorhythms. A flowchart and a program for the HP-55 programmable calculator are provided. You should be able to use this information, rewrite it for other calculators, or develop a program for your micro. If you haven't been exposed to this fascinating subject . . . hang in there, and I'll tell all!

The word biorhythm literally means movement characterized by regular recurrence of beat, or a pattern of this, in living things. In a more strict sense, it means the study of biological cycles of man. Proper understanding and use of these cycles may help you plan for future events and forecast good days and bad days. It is one of our newer scientific disciplines and concentrates on three natural cycles that influence our physical, emotional, and intellectual actions or behavior patterns.

Scientists state that our biological cycles are set in

motion at birth. From then until death, we are influenced by these three cycles. (More are acknowledged, but biorhythm study seems to be limited to these three.) The physical cycle, requiring 23 days, is said to affect such things as strength, speed, resistance to disease, coordination, and other bodily functions. (It is easy to understand why this is one of the more popular cycles!) The emotional cycle has a period of 28 days and is given reign over our mental health, mood, creativity, sensitivity, and our perception of ourselves and others. Last is the intellectual cycle, which requires 33 days to be completed. It affects our ability to recall memorized facts, to learn, to be logical, and to analyze.

When the three cycles start at birth, they start at a zero reference, or baseline, and proceed on a positive slope on the positive half of the full cycle. Halfway through the cycle, they return to the baseline and enter the negative half of the cycle. At the end of the negative portion of the

cycle, the zero reference line is crossed again, and the process will then repeat itself.

There are, therefore, three main parts to consider: the positive half cycle, the negative half, and the zero reference. The theory states that, during the positive portion, all capacities, energies, talents, and skills will be enhanced. The negative portion is described as a rehabilitation period during which all attributes of the rhythms are of reduced magnitude. When any cycle crosses the zero reference line, that day is referred to as a *critical day*. It is during this period that we are most likely to experience accidents, physical harm, arguments, depression, inability to learn, poor judgment, etc. All would depend on the cycle or cycles involved.

It is possible to have single, double, and triple critical days. Double critical days are to be approached with extra caution. Such days occur when two cycles cross the zero reference line on the same day. They may both be on a negative slope or on a positive slope, or one may be

positive while the other is negative. So far as I know, there seems to be no evidence to indicate a need to differentiate between the three types. Triple critical days occur at birth and once every 21,252 days, when all three are on a positive slope. So you can expect to be "born again" every 58 years and 67 days. By the way, the number 21,252 is derived from the product of the three cycles.

Without going into detail beyond the scope and intent of this article, it should be noted that a great number of well-documented cases have been recorded to support the biorhythm theory. Airplane crashes, train wrecks, automobile accidents, and other tragedies have occurred in very abnormal numbers when the responsible people had critical days. Theory tells us to use extra caution, self-control, and restraint on critical days. Expect things to be subnormal on the negative half cycle. You may not beat world's records, but you will do your best during the positive half of the cycle, especially if two or all three cycles are so positioned. All other days will be "mixed." I'll get to more about these later in the article.

Now let's get to the program itself. The theory states that we complete a physical cycle every 23 days, an emotional cycle in 28 days, and our intellectual cycle requires 33 days. It also states that all three start in phase at birth on the positive slope. It is obvious that the three will immediately start to go out of phase with each other. Thereafter, the composite biorhythm situation will vary from day to day. Small numerical values for each of the cycles would seem to be the best method to appraise them.

In order to arrive at some suitable numerical value, we must first divide the total number of days alive (TDA) by the number of days in the rhythm cycle of interest. For

DISPLAY		KEY ENTRY	COMMENTS	REGISTERS
LINE	CODE			
00.			(TDA Entered)	R 0 (Used)
01.	33	Sto	TDA stored in memory # 1.	Product
02.	01	1		R 1 (Used)
03.	34	RCL	"360" recalled from memory # 2.	TDA
04.	02	2		
05.	71	x	TDA & 360 multiplied and stored in memory 0. (Deg. Product)	R 2 360
06.	33	STO		
07.	00	0		R 3 23
08.	34	RCL	"23" recalled from memory 3 & divided into Deg. Product.	
09.	03	3		R 4 28
10.	81	÷		
11.	31	f	Sin of resultant angle calculated & stored in memory # 6.	R 5 33
12.	12	SIN		
13.	33	STO		R 6 (Used)
14.	06	6		Avg. reading.
15.	84	R/S	Physical Value Disp.	
16.	34	RCL	Deg. product recalled from memory 0.	R 7
17.	00	0		
18.	34	RCL	"28" recalled from memory 4 & divided into Deg. Product.	R 8
19.	04	4		
20.	81	÷		R 9
21.	31	f	Sin of resultant angle calculated & added to memory # 6.	R.0
22.	12	SIN		
23.	33	STO		R.1
24.	61	+		
25.	06	6		R.2
26.	84	R/S	Emotional Value Disp.	
27.	34	RCL	Deg. product recalled from memory 0.	R.3
28.	00	0		
29.	34	RCL	"33" recalled from memory 5 & divided into Deg. Product.	R.4
30.	05	5		
31.	81	÷		R.5
32.	31	f	Sin of resultant angle calculated & added to memory # 6.	
33.	12	SIN		R.6
34.	33	STO		
35.	61	+		R.7
36.	06	6		
37.	84	R/S	Intellectual Value Disp.	R.8
38.	34	RCL	Sum of readings recalled from memory 6 & divided by 3.	
39.	06	6		R.9
40.	03	3		
41.	81	÷		
42.	84	R/S	Avg. Reading Disp.	
43.	01	1	1 added to the contents of memory 1 (TDA)	
44.	33	STO		
45.	61	+		
46.	01	1		
47.	34	RCL	TDA recalled from memory 1.	
48.	01	1		
49.	-03	GTO 03	Program goes to line 3.	

Fig. 1. HP-55 biorhythm program.

example, if the TDA = 10,000, and we are interested in the physical cycle (23 days), the result would be $10,000/23 = 434.78+$. In this case, the person would have lived through 434 complete physical cycles and is into the current cycle by .78+. It is this fraction of a cycle that we are interested in. To convert this decimal number to degrees, we multiply it by 360, the number of degrees in one complete cycle. This yields approximately 281 degrees.

With this figure, we can see how far into the cycle we

are, but the figure is awkward and, for some, would be hard to position in the mind. If, however, we now take the sine of that angle, we arrive at $-.98$. This final figure gives us magnitude and polarity in a very succinct way. By using the sine of the resultant angle, the numerical value will start at zero, increase to $+1.00$ at the top of the positive half cycle, decrease to zero at 180 degrees (a critical day), drop to -1.00 at 270 degrees (the negative peak), and return to zero at 360 degrees for another critical day and the start of another

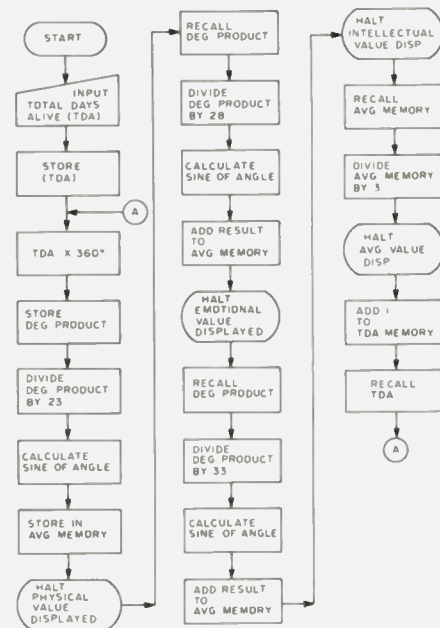

Fig. 2. Biorhythm flowchart.

1. Enter the program.
2. In the run mode, store "360" in memory register number 2.
3. In the run mode, store 23 in memory register number 3.
4. In the run mode, store 28 in memory register number 4.
5. In the run mode, store 33 in memory register number 5.
6. Enter total days alive (TDA) in the x operating register.
7. Press BST to place the program pointer to the start of the program.
8. Press R/S to obtain the physical value.
9. Press R/S to obtain the emotional value.
10. Press R/S to obtain the intellectual value.
11. Press R/S to obtain the average reading of the P, E, and I values.
12. For the next day reading and subsequent days, repeat steps 8 through 11. The program automatically increments the TDA value by 1 after each set of readings.

Fig. 3. The procedure. Note: If you forget what day you are reading, you may obtain the current TDA figure by simply recalling memory number 1. This may be done at any time without affecting the integrity of the program.

cycle.

The math may be simplified to: $\text{sine}(TDA \times 360/\text{number of days in cycle})$. This is true because the sine of x degrees or any multiple of $360 + x$ degrees would give the same result. This method saves steps. Using this formula and the 10,000 TDA figure, the emotional value would be $+0.78$ and the intellectual value $+0.19$. These figures provide us with a mathematical evaluation for each of the three cycles for one particular day. They do not tell us whether the slope is positive or negative.

To find this out, we must take a second set of readings for the following day. In this case the TDA would be 10,001, the physical value

$-.89$, the emotional value $+0.90$, and the intellectual value $+0.37$. If we compare these figures with the previous day, it becomes evident that all three are increasing in value. The P value is becoming less negative, the E value will reach its peak value of 1 in two days, and the I value is on the way to a positive peak. The program (Fig. 1) automatically increments the TDA value by 1 each time a set of readings is calculated with the above formula. With this program, you can obtain a set of readings for a given day and for succeeding days as far in the future as you like. A linear plot of these values will, of course, result in a perfect sine wave.

One additional "refinement" has been added to this

program. It is my personal opinion that it is the totality of all forces acting upon a person that best describes his situation. Which is to say that many factors in addition to biorhythms affect our overall well-being. Those factors are not to be dealt with here, but I felt that an average of the three values might be the best expression of this concept. For this reason, the program will also provide an average reading for each day, after the separate readings have been displayed. With the average reading, we can give a value to a "mixed day" and give it an overall rating. It is very interesting to watch the cyclic gyrations of these average figures. Unlike the other cycles, the frequency and magnitude are constantly varying and might deserve greater study.

As previously mentioned, the critical day happens when the cycle passes through the zero reference line. This will occur when the slope is negative (going from the positive

half cycle to the negative half) and when the slope is positive. This should be indicated by zero, but on the HP-55 with this program, you get things like $-3.18927540 \times 10^{-9}$ and other weird figures close to zero but not absolute. This, I believe, is due to inherent limitations of accuracy. It should also be noted that a critical day occurs not only at the end of a cycle but also at the half-cycle point.

In the case of the emotional cycle, this would be at the 14- and 28-day points and doesn't cause a problem. The P and I values do, because half of 23 is 11.5 and half of 33 is 16.5. For this reason, on these two rhythms, every other critical day point will not be indicated by zero (or a figure very close to it), but rather will be indicated by two contiguous days of low, equal-but-opposite polarity values. .14 and -.14 are good examples. How do we interpret this condition? For the moment, let us assume that birth occurred at 12 noon.

Presumably, the critical point of each critical day would then be at noon. This is fine for the emotional cycle, but in the case of the other two, we are forced to assume that the critical time of the half-cycle critical day is positioned $\frac{1}{2}$ day after the birth hour. In this example, that would be at 12 midnight, splitting two days. In any event, you may assume that the critical day, under these conditions, resides between the two low, equal-but-opposite polarity values.

One problem with this subject is the task of determining the TDA figure. You can do this by counting the number of days in your first partial year of life. To this add all the normal 365-day years and the 366-day leap years plus the number of days in the current year. Or you can use one of several "Days Between Two Dates" programs, such as the one in the HP-55 mathematics programs booklet. Texas Instruments also have a similar program

for their calculators. However you calculate it, be sure to make a note of the date and TDA figure. For future calculations, you then need only add the intervening days.

A flowchart (Fig. 2) is included in this article in hopes that it will be of assistance to those of you who own microcomputers. I believe that, with proper graphics, you should be able to display each cycle for a month at a time and all three with colors to represent each. The flowchart should also help those with programmable calculators of divergent operations.

So there you have it — a rather uncomplicated procedure to obtain easily-understood numerical values for biorhythm cycles. For greater depth of interpretation, I suggest the local library or a small investment in one or more of the books available on the subject... which is to say — don't ask me; I just wrote the program! ■

VHF-FM RECEIVER

Compact — High Performance

LOW COST KIT

Model 144-5

Sensitivity under .15 μ V SINAD

\$59⁹⁵



Ask for details on case/speaker/control kit, available soon

- 5 channels, remote switchable
- 6 pole crystal filter provides better than 75dB adjacent channel rejection
- Image rejection better than 75 dB; all other spurious better than 100 dB
- Audio output 250 mW
- Compact — 2.35 x 4" board, ideal for pocket receiver or can be built into existing equipment, home-brew transceiver
- Operates from 8-20 VDC; 15 mA nominal drain, squelched

ESP E27

Electronic Signal Products, Inc. Also models for 29, 50, 220 and 440 MHz
2250 G Landmeier Rd., Elk Grove, IL 60007 (312) 364-0080

Commercial versions for other frequencies can also be supplied

ESP Electronic Signal Products, Inc.
2250 G Landmeier Rd., Elk Grove, IL 60007

BANK AMERICARD

Please ship

Illinois residents add 5% sales tax
144-5 receiver kits at \$59.95 each

VISA

Please ship

29 50 220 receiver kits at \$59.95 each 440 price information

Name _____ Call _____

Address _____

City _____

State _____ Zip _____

Check or money order for \$ _____ enclosed

Charge my VISA/BankAmericard # _____

Card expires _____ Signature _____

23 ways to help assure your company's future.



Our country and your company depend on new ideas. College trained minds produce new ideas. And colleges need your help. Write on your company letterhead to CFAE for 23 ways companies can aid colleges. **We can't afford to run out of ideas.**

Council for Financial Aid to Education, Inc.
680 Fifth Avenue, New York, NY 10019

A Public Service of This Magazine & The Advertising Council



Make America smarter. Give to the college of your choice.

THE SYSTEM 3000A TRANSCEIVER



AN ADVANCED CONCEPT IN 2M FM

Edgcom Inc. proudly presents a totally new concept in amateur radio: **SYSTEM 3000A** — a microcomputer-based two-meter FM transceiver that provides you with operational flexibility found in no other transceiver. Some of the extraordinary features of **SYSTEM 3000A** are:

- ★ **TWENTY FRONT-PANEL-PROGRAMMABLE PRIORITY CHANNELS.** Just dial in the frequency and transmitter offset, press the Enter Switch and you're in the memory. A battery backup is used to retain the memory when power is removed.
- ★ **DUAL BUILT-IN SCANNERS.** One for automatically tuning the the band in one or four MHz bands, the other for scanning the priority channels. Adjustable pause from 3-10 sec.
- ★ **PRIORITY CHANNEL MONITOR** so you can operate on one frequency while periodically monitoring one or more priority channels.
- ★ **ANY TRANSMITTER OFFSET.** In addition to the standard ± 600 kHz, **SYSTEM 3000A** can be front-panel programmed to provide any transmitter offset from 5 kHz to 4 MHz.
- ★ **ADVANCED PLL SYNTHESIZER** covers 144-147.995 MHz in 5 kHz steps with electronic push-button (two-speeds) tuning.
- ★ **25 WATTS OUTPUT.** Selectable High/Low power output with adjustable low power.
- ★ **FULL TWO-YEAR WARRANTY.** Every **SYSTEM 3000A** is warranted to be free from defects for two years, and it is American made so servicing is no problem.
- ★ **VERY COMPETITIVELY PRICED—\$549.**

For more details on these and the many other fine features of **SYSTEM 3000A**, see one at selected dealers or write or phone for a brochure.

Edgcom Inc. 2909 OREGON CT.-A3
TORRANCE CA 90503
(213) 533-0433

From CB To Amateur Radio

— article for CB acquaintances

Out of the noise of channel 19 at rush hour comes:

"Breaker for local information."

Pause. Your radio emits a curious garble of voices, none of which seem interested in helping the breaking station.

"Breaker, 19, for local info."

Well, the noise level is about S9, but he's coming over it okay, so he must be close by. You squeeze the D104.

"Go ahead, local info breaker. This is K1Y3470 base."

"Thanks for the comeback. This is KGY8 (garble) ... on the bypass near (squeeeeeeel) ... of fuel. Can you lay a landline to a service st (H O W B O U T Y E H O D D O B B E R ! H O W B O U T T H A T H O D D O B B E R O N E T I M E ! B R E A K E R B R O K E !) ... if you will?"

Hmmmm — you tell the mobile to stand by while you look for a clean channel. You try channel 9:

"... and I'll talk on any channel I want to!"

So much for that. Try the mobile again on 19. You know he's coming back to you, but you're catching 40-channel bleedover from "Halfwatt," whose radio certainly is not two blocks away. Now you're getting steamed, but all you can do is call a service truck and hope for the best.

Sound familiar? You bet it does. Serious CBers have been grappling with such problems since the CB boom caught on a few years ago, and, with the new sunspot cycle beginning soon, no relief is in sight. Forty channels won't ease the situation much, either. What's the serious CB enthusiast to do? If you think I've got the answer, you're right.

The answer is ham radio. Now, hang on. Before you put down these hallowed pages and decide to watch a "Star Trek" rerun, reflect for a moment. Everyone knows ham radio operators are an elite group of electronic wizards possessing thousands of dollars worth of electronic gear, who magically read sense into a curious chirping known as Morse code. Right? Wrong.

I know hams who barely know one end of a diode from the other. But it's no matter; their interest is in communicating. And communicate one can. I confess to deriving not a little satisfaction from an incident a few weeks ago. I was chatting with a fellow in Knoxville about 60 miles away on 2 meter FM, and stopped at a gas station frequented by a lot of local CBers. The attendant, an old CB buddy of mine, got curious. I explained to a growing crowd that, sure, he was in Knoxville, and sure, he was running a 2-Watt walkie-talkie, and sure, I was

running 10 Watts, and no, this is not unusual at all. I was even obliged to open the trunk to demonstrate the absence of a linear. (I considered making a phone call from the car, but one doesn't want to overdo it.)

OK, ham radio is great, you say, but the code ...

Ah, yes, the code. The bane of every would-be ham since Marconi. Consider this: A five-year-old boy passed the five-words-per-minute code test last year. Even more incredible, so did I. Understand, I'm no expert at anything, just an old CBer who decided to get into ham radio. I did it. You can do it. A year ago the code sounded to me like it does to you — incomprehensible.

Radio theory? As a serious CBer, you have a good head start here. Granted, it takes some study of theory and regulations to pass the written test, but excellent help is available.

Actually, there are four hurdles to clear to become a ham. You just cleared the first by being interested enough to read this far. Then there are the code and the written tests. But, and I speak from experience, the most difficult hurdle, by far, is getting started. Decide to do it now.

In my opinion, your first goal should be a Technician ticket. It permits voice work as well as Novice code privi-

leges on the HF bands. It requires the five-words-per-minute code test (remember the five-year-old kid?) and a multiple-choice test on general radio theory and regulations. Here's what you get in return:

1. All amateur privileges on 6 meters (50 megahertz) and higher frequencies. This includes the fascinating world of 2 meter FM and repeaters. A kilowatt is legal, but a few Watts will do fine.

2. CW (code) privileges on parts of 80, 40, 15, and 10 meters (250-Watt limit for all hams in your band segment). A few Watts will work the world.

3. Fun and friends. You will find a large number of people on the air, eager to help you with any problems. Incidentally, never have I felt put down or ill at ease since becoming a ham. You may have heard that hams look down on CBers; that's not true in my experience. Hams need you.

4. Lots more. Ham radio is forever new. New bands, new modes, new rigs, new technology, amateur TV, teletype, satellite communication, and more to come.

5. Satisfaction. Nothing helps the old ego like setting a goal and then reaching it.

OK, here's what to do. Turn to the rear of this magazine, and you will find that its editor, Wayne Green, has paved the way for your entry into ham radio. *73 Magazine* offers code and theory tapes at low prices to help you get your ticket. Now there's a right way and a wrong way to do anything. Thousands of hams learned the code the wrong way, including me. Believe me, these tapes will save you a lot of grief later on.

So get started. There's a wide world of fun out there in ham radio, and we need you to be a part of it. There are thousands of ham radio clubs conducting code and theory classes. Join one. Order your tapes. It sure beats putting a pin in old Halfwatt's coax. ■

**HY-GAIN'S
MODEL 269**

Continuously loaded VHF antenna designed for portable and walkie-talkie applications. Constructed to withstand rough handling, completely insulated with special vinyl coating, it can be bent at all angles without destroying or cracking protective finish. Cannot be accidentally shorted out.

RUBBER DUCKIES

- No. 269 — Fits Standard, Motorola, Hy Gain \$8.00
- No. 274 — BNE Base \$9.00
- No. 226 — TNC Base Wilson 5 Watts \$10.00
- No. 228 — "F" Bas & Wilson 2 Watt & Tempo \$10.00
- No. 273 — SO 239 Base. Kenwood. Drake \$9.00

SLINKY! \$43.95 Kit A LOT of antenna in a LITTLE space New Slinky® dipole* with helical loading radiates a good signal at 1/10 wavelength long!

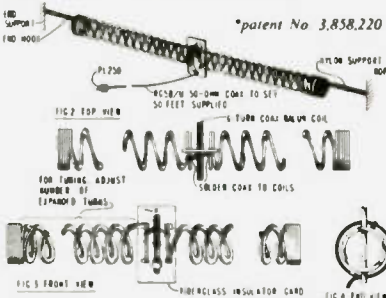

* This electrically small 80/75, 40, & 20 meter antenna operates at any length from 24 to 70 feet! • no extra balun or transmatch needed • portable—erects & stores in minutes • small enough to fit in attic or apartment • full legal power • low SWR over complete 80/75, 40, & 20 meter bands • much lower atmospheric noise pickup than a vertical and needs no radials • kit includes a pair of specially-made 4-inch dia. by 4-inch long coils, containing 335 feet of radiating conductor, balun, 50 ft RG58/U coax, PL259 connector, nylon rope & instruction manual

**TUFTS
CATALOG
INDEX**

- Alda — 30
- Alpha — 2
- AMECO — 19, 26
- Antenna Specialists — 1, 2
- ARRL — 4
- Astatic — 1
- Atlas — 16, 24
- Avtec — 30
- B&W — 28, 29
- Bird — 26
- Bomar — 4
- Callbook — 13
- CDE — 30
- CES — 30
- CIR — 2
- Covercraft — 27
- Cushcraft — 8, 9
- Data Signal — 27
- Dentron — 4, 5
- Drake — 5, 10, 11
- ETO — 2
- Finco — 22
- Ham Key — 15
- Hi-Q — 27
- Hustler — 16
- HyGain — 1, 20, 21
- Icom — 17
- JMR — 3
- KDK — 2
- KLM — 12, 24
- Kenwood — 7
- Larsen — 29
- MFJ — 15
- Microwave Filter — 26
- MorGain — 13
- Mosley — 12
- Newtronics — 16
- NPC — 23
- Nye Viking — 13, 27
- OK Tools — 27
- Rohn — 22
- Sams — 18
- Shure — 17
- Slinky — 1
- SST — 21
- Stinger — 22
- Swan — 3, 4
- TEE/AX — 7
- Telex — 6
- Tempo — 24
- Teletower — 30
- Ten Tec — 19
- TPL — 30
- Triplet — 23
- Tri Ex — 27
- Van Gorden — 27
- VHF Eng — 14
- Wilson — 25
- W2AU — 26
- W2VS — 26
- Yaesu — 1, 13

**ASTATIC
MICROPHONES**



SILVER EAGLE — \$69.95

- T-UG8-D104, transistorized \$48.60
- T-UG9-D104, "Silver Eagle," transistorized .. \$69.95
- UG-D104, ceramic or crystal \$42.60



YAESU



- FT101E 160-10M XCVR \$799
- FT101EE 160-10MXCVR 759
- FT101EX 160-10M XCVR 699
- FL2100B Linear Amplifier 479
- FTV650B 6M Transverter 239
- FTV250 2M Transverter 275
- FV101B External VFO 125
- SP101B Speaker 25
- SP101PB Speaker/Patch 64
- FA-9 Cooling Fan 18
- RFP102 RF Proc. Early 101EE 79
- XF30C 600 Hz CW Filter 40
- XF30B AM Filter 40
- DC-1 DC-DC Converter (EX) 50
- RFP104 RF Proc. Late 101EE 79
- FT101 Service Manual 25
- FT7 80-10 M XCVR 40W Pep 499
- ALL SOLID STATE TRANSCEIVERS**
- FT301S 160-10M 40W PEP 559
- FT301SDig 160-10M 40W PEP 750
- FT301 160-10M 240W PEP 769
- FT301Dig 160-10M 240W PEP 935
- ACCESSORIES**
- FFDX50 52 Low Pass Filter 34
- FC301 Ant. Tuner 159
- ERB Ext. Relay Box 17
- LL301 Phone Patch 49
- FL110 Wide Band SSB/CW Amp. 165
- FV301 VFO 125
- FP301 AC P/S FT301/301S 157
- FP301D AC P/S w/clock and CW Identifier 239
- YO301 Monitor Scope 263
- SP120 Speaker FT301/221R 25
- XF90B AM Filter 40
- XF90C FM Filter 40
- XF92A SSB & Proc. Filter 45
- FR101S 160-2M/SW RCVR 599
- FR101SDig 160-10M/SW RCVR 749
- FC-6 6M Converter 24
- FC-2 2M Converter 25
- FM-1 FM Detector 20

- XF30D FM Filter 40
- RFP101 AUX/SW Crystals 5
- FL101 RF Proc. (FL101) 79
- S/S 160-10M XMTR 649
- VHF FM & SSB XCVR**
- 2M FM Mobile XCVR \$319
- 2M AM/FM/CW/SSB XCVR 688
- 6M AM/CW/SSB 365
- Marker Unit 620B 25
- FT221 Service Manual 15
- MOBILE MOUNT BRACKETS**
- FT101 23
- FT-2A 23
- 620B, 221, 301 23
- MONITOR TEST EQUIPMENT**
- Monitor Scope \$246
- Dummyload Watt Meter 78
- Dig. Readout 101/401 199
- Dig. Readout 221/221R 119
- FREQUENCY COUNTERS**
- 500 MHZ 10 PPM 239
- 500 MHZ 1 PPM 399
- 500 MHZ 0.02 PPM 537
- MICROPHONES — MISCELLANEOUS**
- YH55 Lo-Z Headphone 15
- YD844 Hi-Z Base Mike 29
- YD844L Lo-Z Base Mike 29
- YD846 Hi-Z Mike 101EX/401B 16
- YM86 Lo-Z Hand Mike 16
- SP401PB Speaker/Patch (401) 59
- XF31C 600 Hz CW Filter 401
- FRG-7 Receiver
- 1 to 9 \$315
- 10 to 25 315
- 26 to 49 315
- 50 and up 315
- QTR-24 World Clock
- 1 to 9 30
- 10 to 25 30
- 26 to 49 30
- 50 and up 30
- FT-901DM \$1299
- FT-901D 1149
- FT-901DE 1149
- FT-901SD 1115
- FM Unit 40
- AM or CW Filter 40
- Keyer Unit 40
- Memory Unit 125
- DC-DC 50



Radio Electronics
209 Mystic Avenue
Medford MA 02155
(617) 395-8280

**FREE Gift With
Every Order!**

Name _____ Call _____
 Address _____
 City _____ State _____ Zip _____
 Order: _____
 Check enclosed Visa Master Charge American Express
 Credit card # _____
 Signature _____ Card expiration date _____

*Dealer Programs
NOW Available*

**Master Charge
American Express
Visa**

Prices FOB Medford MA. MA residents add 5% sales tax. Minimum \$3.00 for shipping & handling on all orders.

**Dealer programs
NOW available!**

TUFTS RADIO CATALOG TUFTS RADIO



For all you hams with little cars ...
We've got the perfect mobile rig for you.



The Atlas 210x or 215x measures only 9 1/2" wide x 9 1/2" deep x only 3 1/2" high, yet the above photograph shows how easily the Atlas transceiver fits into a compact car. And there's plenty of room to spare for VHF gear and other accessory equipment. With the exclusive Atlas plug-in design, you can slip your Atlas in and out of your car in a matter of seconds. All connections are made automatically.

BUT DON'T LET THE SMALL SIZE FOOL YOU!
 Even though the Atlas 210x and 215x transceivers are less than half the size and weight of other HF transceivers, the Atlas is truly a giant in performance.

200 WATTS POWER RATING!
 This power level in a seven pound transceiver is incredible but true. Atlas transceivers give you all the talk power you need to work the world barefoot. Signal reports

constantly reflect great surprise at the signal strength in relation to the power rating.

FULL 5 BAND COVERAGE
 The 210x covers 10-80 meters, while the 215x covers 15-160 meters. Adding the Atlas Model 10x Crystal Oscillator provides greatly increased frequency coverage for MARS and network operation.

NO TRANSMITTER TUNING OR LOADING CONTROLS
 with Atlas' total broadbanding. With your Atlas you get instant QSY and band change.

MOST ADVANCED STATE OF THE ART SOLID STATE DESIGN
 not only accounts for its light weight, but assures you years of top performance and trouble free operating pleasure.

PLUG-IN CIRCUIT BOARDS
 and modular design provides for ease of servicing.

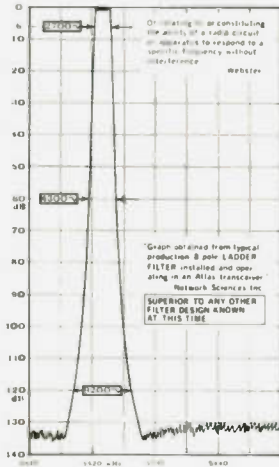

PHENOMENAL SELECTIVITY
 The exclusive 8 pole crystal ladder filter used in Atlas transceivers represents a major breakthrough in filter design, with unprecedented skirt selectivity and ultimate rejection. As the above graph shows, this filter provides a 6 db bandwidth of 2700 Hertz, 80 db down to only 4300 Hertz, and a bandwidth of only 9200 Hertz at 120 db down! Ultimate rejection is in excess of 130 db, greater than the measuring limits of most test equipment.

EXCEPTIONAL IMMUNITY TO STRONG SIGNAL OVERLOAD AND CROSS MODULATION. The exclusive front end design in the receiver allows you to operate closer in frequency to strong neighboring signals than you have ever experienced before. If you have not yet operated an Atlas transceiver in a crowded band and compared it with any other receiver or transceiver, you have a real thrill coming.



A WORLD WIDE DEALER NETWORK TO SERVE YOU.

Whether you're driving a Honda in Kansas City or a Mercedes Benz in West Germany, there's an Atlas dealer near you.

Atlas 210x or 215x	\$675.00
W/Noise Blanker	719.00
ACCESSORIES:	
AC Console 110/220 V	\$147.00
Portable AC supply 110/220 V	100.00
Plug-In Mobile Kit	48.00
10x Oxc. less crystals	59.00
Digital Dial DD-5B	229.00

For complete details see your Atlas dealer, or drop us a card and we'll mail you a brochure with dealer list.



HUSTLER

"the home of originals"

STANDARD GAIN MOBILES

Two Meters

- 5/8 wavelength — 34 db gain over 1/4 wave mobile
- Frequency coverage—143 to 149 MHz
- Power rating—200 watts FM

MODEL BBL-144
 47" antenna complete with easy to install, no holes to drill, trunk lip mount, impact spring and 17 MIL SPEC RG-58-U and PL-259. Antenna removable from mount. Price: \$33.75

MODEL BBL-144
 47" antenna mounts on any flat surface, roof, deck or fender in 1/2" hole. Includes impact spring 17 MIL SPEC RG-58-U and PL-259. Antenna removable from mount. Price: \$31.65

HUSTLER "BUCK-BUSTER"

MODEL SF-2
 51" two meter, 5/8 wavelength, 34 db gain over 1/4 wave mobile. Designed with 1/2" x 24 base to fit your mount or a wide selection of Hustler mobile mounts. (Mount or cable not included). Price: \$9.00

DELUXE MOBILE MOUNTS
 For medium length, light weight antennas with 1/2" x 24 base

MODEL TLM
 Trunk lip mount for no holes installation on side or edge of trunk lid. Includes 17 RG-58-U connectors. Price: \$14.85

MODEL MLM
 Deluxe trunk lip mount with 180 degree swivel ball for positioning antenna vertically. Easy — no holes — installation. Includes 17 RG-58-U cable and connectors attached. Price: \$17.20

MODEL GCM-1
 Rain gutter mount fits all shapes, angles even latest trim line gutters. Includes 180° swivel ball. Price: \$9.00

MODEL MM-1
 Cowel mount installs in 1" hole. Includes 180° swivel ball and SO-239 connectors. Price: \$7.50

MODEL TGM-1
 Trunk groove mount installs in hidden area of groove under trunk lid. Mounting hardware included. Price: \$8.00

MODEL C-32
 Ball mount complete with mounting hardware. Price: \$8.20

AMATEUR ANTENNAS

SUPER GAIN MOBILES

Two Meters

- 52 db gain over 1/4 wave mobile antenna
- Frequency coverage—143-149 MHz
- SWR at resonance—1:1:1 typical
- Power rating—200 watts FM

TWO AND SIX METERS—TRUNK LIP MOUNT

MODEL MFT
 Four section telescopic antenna permits separate adjustment for simultaneous resonance on two and six meters. Operational height: 40". Complete with trunk lip mount, 17 MIL SPEC RG-58-U and factory attached PL-259. Price: \$22.55

VHF/UHF ANTENNA—ROOF MOUNT

MODEL UHF-1
 Field trimmable radiator for 1/4 wave operation on any frequency from 140 to 500 MHz. Cutting chart included. Mounts on any flat surface, roof, deck, fender in 1/2" hole. Includes 15 RG-58-U and PL-259. Price: \$9.95

MODEL CGT-144
 Get big signal performance, superior receiving capability with this 85° conical antenna. Easy installation on side of edge of trunk lip without drilling — complete with 17 MIL SPEC RG-58-U and PL-259. Price: \$41.30

MODEL CG-144
 Same characteristics as CGT-144 supplied with 1/2" x 24 base to fit all mobile ball mounts — Length is 85". Mount and cable not included. Price: \$25.50

VHF/UHF ANTENNA—TRUNK LIP MOUNT

MODEL THF
 Field trimmable radiator permits quarter wave operation on any frequency from 140 to 500 MHz. Cutting chart included. Complete with trunk lip mount, 17 RG-58-U and PL-259. Price: \$16.55

RESONATOR SPRING—STAINLESS STEEL

MODEL RSS-2
 Installs between Hustler mast and resonator. Absorbs shock when antenna sways, overloading support. Supplied ready for easy installation. Price: \$8.50

QUICK DISCONNECT—100% STAINLESS STEEL

MODEL QD-1
 Remove antenna from mount with easy push and twist release. Compression spring and all parts 100% stainless steel. 1/2" x 24 threads—female one and male the other. Price: \$16.95

FEED LINE MODEL L-14-240
 Get known performance, maximum shielding for minimum noise pick-up in this MIL SPEC 20 length of RG-58-U cable. Supplied with connectors at each end for use with ball or bumper mount and transceiver. Price: \$6.55

MODEL G6 144A — Deluxe Two Meter Conical for Resonator or any fixed station operation. 6 db gain over a 1/2" wave dipole. Maximum radiation at the horizon! Shunt fed with DC grounding. Radiator 1/2" wave lower section, 1/2" wave phasing, 1/2" wave upper section. Height 117". SWR at resonance: 1.2:1 or better. Power rating: 1000 Watts FM. Wind survival: 100 MPH. Installs on vertical pipe up to 1 1/2" O.D. SO-239 coax connector. Price: \$67.55

All resonators are precision wound with optimized design for each band. Assembly includes 17-7 PH stainless steel adjustable tip rod for lowest SWR and band edge marker. Choose for medium or high power operation.

STANDARD HUSTLER RESONATORS

Power Rating: 400 Watts SSB

Model	Band	Price
RM-10	10 meters	\$ 6.50
RM-15	15 meters	6.95
RM-20	20 meters	7.30
RM-40	40 meters	13.20
RM-75	75 meters	15.50
RM-80	80 meters	15.95

SUPER HUSTLER RESONATORS

Power Rating: Legal Limit SSB
 Supers have widest bandwidth

Model	Band	Price
RM-10S	10 meters	\$11.30
RM-15S	15 meters	12.65
RM-20S	20 meters	13.00
RM-40S	40 meters	15.50
RM-75S	75 meters	30.00
RM-80S	80 meters	30.40

For 6-10-15-20-40-75-80 Meters

Fold over mast for quick and easy interchange of resonators or entering a garage. When operating mast is held vertical with shakeproof sleeve clutch. S4 mast also serves as 1 1/4 wavelength 6 meter antenna. Stainless steel base has 1/2" x 24 threads to fit mobile ball mount or bumper mount.

HUSTLER MASTS

The Majority Choice of Amateurs Throughout the World!

MODEL MD-2
 For bumper mounting—Fold is at roof line 27" above base. Price: \$22.00

MODEL MD-1
 For deck or fender mounting—Fold is at roof line 15" above base. Price: \$22.00

Covers 10 - 15 - 20 - 40 Meters
 Only Hustler Gives One Setting for Whole Band Coverage

MODEL 4-8TV

- Lowest SWR—PLUS
- Bandwidth at its broadest! SWR 1.6 to 1 or better at band edges
- Hustler exclusive trap covers "Sprite" extruded to otherwise unattainable close tolerances assuring accurate and permanent trap resonance.
- Solid one inch fiberglass trap forms for optimum electrical and mechanical stability
- Extra heavy duty aluminum mounting bracket with low loss, high strength insulators. Mounting hardware included
- All sections 1 1/4" heavy wall, high strength aluminum
- Stainless steel clamps permitting adjustment without damage to the aluminum tubing
- Guaranteed to be easiest assembly of any multi-band vertical
- Antenna has 1/2" x 24 stud at top to accept RM-75 or RM-75-S Hustler resonator for 75 meter operation when desired
- Top loading on 75 meters for broad band bandwidth and higher radiation efficiency!
- Feed with any length 50 ohm coax
- Power capability—full legal limit on SSB or CW
- Mounting: Ground mount with or without radials, or roof mount with radials.

Length: 21' 5"
 MODEL 4-8TV
 Price: \$99.95



Now It's Crystal Clear

Yes, now ICOM helps you steer clear of all the hassles of channel crystals. The new IC-225 is the same surprising radio you've come to know and love as the IC-22A, except that it is totally crystal independent. Zero crystals. Solid state engineering enables you to program 23 channels of your choice without waiting. Now the ICOM performance you've demanded comes with the convenience you've wanted, with your new IC-225. Price: \$289.00



IC-245 Transceiver

The VFO Revolution goes mobile with the unique, ICOM developed LSI synthesizer with 4 digit LED readout. The IC-245 offers the most for mobile on the market. The easy to use tuning knob moves accurately over 50 detent steps and assures excellent control as easily as steering the vehicle. With its optional adapter, the IC-245 puts you into all mode operation on 12V DC power with a compact dash-mounted transceiver. In FM, the synthesizer command frequency is displayed in 5 kHz steps from 146 to 148 MHz, and with the side band adapter the step rate drops to 100 Hz from 144 to 146 MHz. For maximum repeater flexibility, the transmit and receive frequencies are independently programmable on any separation. The IC-245 even comes equipped with a multiple pin Molex connector for remote control. The IC-245 is a product of the revolution in VFO design, from its new style front panel, to its excellent mechanical rigidity and Large Scale Integrated Circuitry. Your IC-245 will give you the most for mobile. \$499.00



THE NEW ICOM 4 MEG, MULTI-MODE, 2 METER RADIO — IC 211

ICOM introduces the first of a great new wave of amateur radios, with new styling, new versatility, new integration of functions. You've never before laid eyes on a radio like the IC-211, but you'll recognize what you've got when you first turn the single-knob frequency control on this compact new model. The IC-211 is fully synthesized in 100 Hz or 5 kHz steps, with dual tracking, optically coupled VFOs displayed by seven-segment LED readouts, providing any split. The IC-211 rolls through 4 megahertz as easily as a breaker through the surf. With its unique ICOM developed LSI synthesizer, the IC-211 is now the best "do everything" radio for 2 meters, with FM, USB, LSB and CW operation. \$749.00



Hold it!

Take hold of SSB with these two low cost twins. ICOM'S new portable IC-202 and IC-502 put it within your reach wherever you are. You can take it with you to the hill top, the highways, or the beach. Three portable watts PEP on two meters or six!

Hello, DX! The ICOM quality and excellent receiver characteristics of this pair make bulky converters and low band rigs unnecessary for getting started in SSB-VHF. You just add your linear amp, if you wish, connect to the antenna, and DX! With the 202 you may talk through OSCAR VI and VII! Even transceive with an "up" receiving converter! The IC-502, similarly, makes use of six meters in ways that you would have always liked but could never have before. In fact, there are so many things to try, it's like opening a new band.

Take hold of Single Side Band. Take hold of some excitement. Take two.

IC-202
2 Meter SSB - 3 Watts PEP - True IF Noise Blanker
Switched Dial Lights - Internal Batteries - 200KHz
VFO Tuning - 144.0 - 144.2 - 2 Meters - RTT
Price: \$259.00

IC-502
6 Meter SSB - 3 Watts PEP - True IF Noise Blanker
Switched Dial Lights - Internal Batteries - 800KHz
VFO - RTT
Price: \$249.00

Now ICOM Introduces 15 Channels of FM to Go! The New IC-215: the FM Grabber

This is ICOM's first FM portable, and it puts good times on the go. Change vehicles, walk through the park, climb a hill, and ICOM quality FM communications go right along with you. Long lasting internal batteries make portable FM really portable, while accessible features make conversion to external power and antenna fast and easy.

Grab for flexibility with the new IC-215 FM portable.

- Front mounted controls and top mounted antenna
- Narrow filter (15KHz — compatible spacing)
- 15 channels (12 on dial / 3 priority)
- Fully collapsible antenna
- Compatible mount feature for flexible antenna
- Dual power (3 watts high / 400 mw low, nominal)
- External power and antenna easily accessible
- Lighted dial and meter

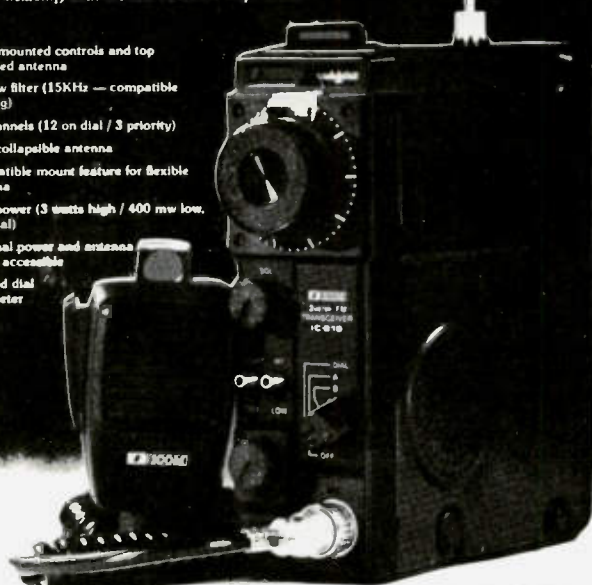

Price: \$229.00

†Your new IC-215 comes supplied with 3 popular channels, handheld mic., with protective case, shoulder strap, connectors for external power and speaker, 9 long-life C batteries.



ICOM

TUFTS RADIO CATALOG TUFTS RADIO

TUFTS SELECTED TITLES OF POPULAR SAMS PUBLICATIONS

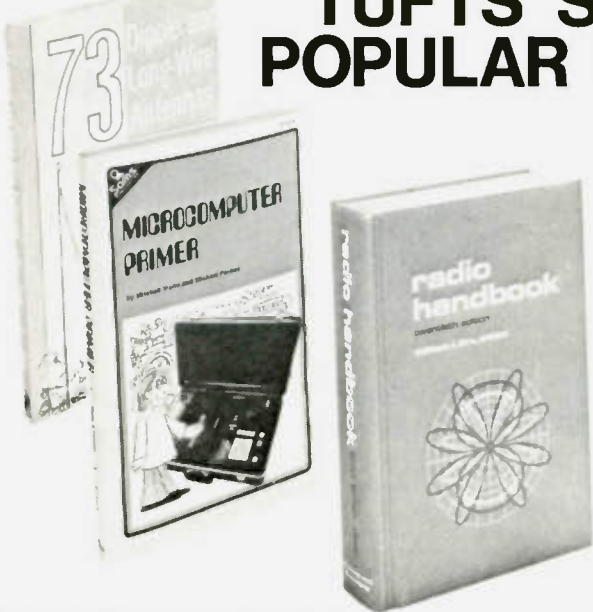

RADIO HANDBOOK (20th Edition)

by William I. Orr, W6SAI. A completely updated 20th edition of the famous communications handbook that is the electronics industry standard for engineers, technicians, and advanced amateurs. Explains in authoritative detail how to design and build all types of radiocommunications equipment. Contains greatly enlarged section on semiconductor and IC circuit design. Includes ssb design and equipment; rty circuits; linear amplifiers, both solid-state and tube types; vhf and uhf transmitters and converters; as well as special-purpose and logic circuitry plus completely revised chapter on electronics mathematics. 1080 pages; 6 1/2 x 9 1/4, hardbound.

No. 24032 \$19.50

HAM AND CB ANTENNA DIMENSION CHARTS

by Edward M. Noll, W3FQJ. Tabulates dimension information in feet and inches for all the popular antenna configurations. Gives data for dipole antennas, quarter-wave verticals, two-element beams, quads, triangles, inverted dipoles, and inverted vees. Includes information for cutting transmission lines to a preferred wavelength, dimensioning phasing lines, cutting a matching stub, and spacing antenna elements. 64 pages, 6 x 9, softbound.

No. 24023 \$2.75

COMMERCIAL RADIOTELEPHONE LICENSE QUESTION & ANSWER STUDY GUIDE (3rd Edition)

by Edward M. Noll. Prepares the reader to take the examinations for the various grades of radiotelephone licenses. Emphasizes those subjects that are most important or most likely to be misunderstood. The questions are representative of those used in the FCC examinations. 304 pages; 6 x 9; softbound.

No. 24033 \$8.50

RADIO TRANSMITTER PRINCIPLES AND PROJECTS

by Edward M. Noll, W3FQJ. Devoted entirely to the subject of radio transmitters, this book is a helpful gathering of modern transmitter principles, ideas, circuits, techniques, and learn-by-doing projects. Covers Bipolar CW and A-M Transmitter Circuits, Transistor Tube Circuits, Basic Principles of SSB-DSB Generation, Integrated Circuit Fundamentals, VHF VHF Circuits and Principles, Frequency Modulation, and more. 320 pages; 5 1/2 x 8 1/2; softbound.

No. 24031 \$6.95

73 DIPOLE AND LONG-WIRE ANTENNAS

by Edward M. Noll, W3FQJ. Covers practically every type of wire antenna used by amateurs. Gives dimensions, configurations, and construction data for 73 different antennas, plus appendices covering construction of noise bridges, line tuners, and data on measuring resonant frequency, velocity factor, and swr. 160 pages; 5 1/2 x 8 1/2; softbound.

No. 24006 \$5.50

73 VERTICAL, BEAM, AND TRIANGLE ANTENNAS

by Edward M. Noll, W3FQJ. The second book in a series of practical antenna construction and design methods. Contains data on practically all types used by amateurs. Not a rehash of previously published data, but a compilation of the author's own experiments with various antenna configurations. The 73 different antennas have all been built and air-tested by the author. 160 pages; 5 1/2 x 8 1/2; softbound.

No. 24021 \$5.50

FIRST-CLASS RADIOTELEPHONE LICENSE HANDBOOK (4th Edition)

by Edward M. Noll. An excellent study guide for the first-class radiotelephone license examination. Contains all the material needed to pass Element IV of the FCC examination, including all the questions and answers found in the latest FCC Study Guide. Has three simulated examinations, presented in the multiple-choice form of the FCC tests, as well as answers and evaluations to help the reader find his weak areas. 416 pages; 5 1/2 x 8 1/2; softbound.

No. 21144 \$7.95

SECOND-CLASS RADIOTELEPHONE LICENSE HANDBOOK (5th Edition)

by Edward M. Noll. Provides all the study material needed to pass the FCC second-class radiotelephone license examination (Elements I, II, and III). All material is based on the FCC Study Guide and Reference Material for Commercial Operator Examination. Two tests are included to simulate the actual examination. 448 pages; 5 1/2 x 8 1/2; softbound.

No. 21111 \$7.95

THIRD-CLASS RADIOTELEPHONE LICENSE HANDBOOK (4th Edition)

by Edward M. Noll. Serves as a practical study guide for the aspiring radio operator as well as a ready reference for those working in the field. Designed as a study aid for obtaining licenses up to and including the Radiotelephone Third-Class Operator Permit with Broadcast Endorsement, this newest edition contains questions and answers similar to those given on the actual examination. 208 pages; 5 1/2 x 8 1/2; softbound.

No. 21353 \$5.95

CMOS COOKBOOK

by Don Lancaster. Tells all you need to know to understand and profitably use this inexpensive and genuinely fun to work with digital logic family. First an explanation of what CMOS is, how it works, and how to power it, plus usage rules, state testing, breadboarding, interface, and other basics is given. Then a minicatalog of over 100 devices, including pinouts and use descriptions is given. Subjects covered include gate fundamentals, tri-state logic, redundant logic design techniques, multivibrators, non-volatile memory techniques, clocked JK and D flip-flops, counter and register techniques, op amps, analog switches, phase-locked loops and much more. A must for the student hobbyist, teachers, technician, or engineer who wants to learn about CMOS. Filled with practical applications. 416 pages; 5 1/2 x 8 1/2; softbound.

No. 21398 \$9.95

IC OP-AMP COOKBOOK

by Walter G. Jung. The first book of its kind to be published. Covers not only the basic theory of the IC op amp in great detail, but also includes over 250 practical circuit applications, liberally illustrated. Organized into three basic parts: introduction to the IC op amp and general considerations, practical circuit applications, and appendices of manufacturers' reference material. 592 pages; 5 1/2 x 8 1/2; softbound.

No. 20969 \$12.95

IC TIMER COOKBOOK

by Walter Jung. Provides an excellent introduction to the field of IC timers by presenting a collection of various circuit "recipes" useful in applying the devices. Arranged in three parts: the first part gives basic and generalized information. Part II, the applications section, is the "meat" of the book and includes over 100 different circuits for a wide range of uses. Part III contains reproductions of manufacturers data sheets, second-source manufacturers, and more. This book is a valuable reference for the hobbyist, the technical or engineering student, or professional. 288 pages; 5 1/2 x 8 1/2; softbound.

No. 21416 \$9.95

TTL COOKBOOK

by Donald Lancaster. A complete and detailed guide to transistor-transistor logic (TTL). Explains what TTL is, how it works, and how to use it. Discusses practical applications, such as a digital counter and display system, events counter, electronic stopwatch, digital voltmeter, and a digital tachometer. 336 pages; 5 1/2 x 8 1/2; softbound.

No. 21035 \$8.95

HOW TO BUY & USE MINICOMPUTERS & MICROCOMPUTERS

by William Barden, Jr. Discusses these smaller computers and shows how they can be used in a variety of practical and recreational tasks in the home or business. Explains the basics of minicomputers and microcomputers, their hardware and software, peripheral devices available, and the various programming languages and techniques. Includes selection, buying, and programming your own system and gives detailed descriptions of currently available systems. 240 pages; 8 1/2 x 11; softbound.

No. 21351 \$9.95

MICROCOMPUTER PRIMER

by Mitchell Waite and Michael Pardee. Introduces the beginner to the basic principles of the microcomputers. Discusses the five main parts of a Computer—Central processing unit, memory, input/output interfaces, and programs. The important characteristics of several well-known microprocessors are given and a chapter is included on programming your own microcomputer. 224 pages; 5 1/2 x 8 1/2; softbound.

No. 21404 \$7.95

THE 8080A BUGBOOK: MICROCOMPUTER INTERFACING AND PROGRAMMING

by Peter H. Rony, David G. Larsen, and Jonathan A. Titus. The principles, concepts, and applications of an 8-bit microcomputer based on the 8080 microprocessor IC chip. The emphasis is on the computer as a controller. Covers the four fundamental tasks of computer interfacing: (1) generation of strobe and device select pulses; (2) latching of accumulator output; (3) acquisition of input data by the accumulator; (4) generation of interrupt signals to the computer. Intended to help develop the skills needed to use an 8080-based breadboard microcomputer system. 5 1/2 x 8 1/2; softbound.

No. 21447 \$9.95



ARGONAUT
#509

AMPLIFIER
#405

TEN-TEC

Dealer Programs
NOW Available

ARGONAUT, MODEL 509
Covers all Amateur bands 10-80 meters. 9 MHz crystal filter. 2.5 kHz bandwidth. 1.7 shape factor @ 6/50 dB points. Power required 12-15 VDC @ 150 mA receive, 800 mA transmit at rated output. Construction: aluminum chassis, top and front panel, molded plastic end panels. Cream front panel, walnut vinyl top and end trim. Size: HWD 4 1/2" x 13" x 7". Weight 6 lbs.

LINEAR AMPLIFIER, MODEL 405
Covers all Amateur bands 10-80 meters. 50 watts output power, continuous sine

wave. RF wattmeter. SWR meter. Power required 12-15 VDC @ 8 A, max. Construction: aluminum chassis, top and front panel, molded plastic side panels. Cream front panel, walnut vinyl top and end trim. Size: HWD 4 1/2" x 7" x 8". Weight 2 1/2 lbs.
Argonaut, Model 509 \$359.00
Linear Amplifier, Model 405 . 159.00
Power Supply, Model 251 (Will power both units) 85.00
Power Supply, Model 210 (Will power Argonaut only) . . 30.00

The new ultra-modern fully solid-state TRITON makes operating easier and a lot more fun, without the limitations of vacuum tubes.

For one thing, you can change bands with the flick of a switch and no danger of off-resonance damage. And no deterioration of performance with age.

But that's not all. A superlative 8-pole i-f filter and less than 2% audio distortion, transmitting and receiving, makes it the smoothest and cleanest signal on the air.

The TRITON IV specifications are impeccable. For selectivity, stability and receiver sensitivity. And it has features such as full CW break-in, pre-selectable ALC, off-set tuning, separate AC power supply, 12 VDC operation, perfectly shaped CW wave form, built-in SWR bridge and on and on.

For new standards of SSB and CW communication, write for full details or talk it over with your TEN-TEC dealer. We'd like to tell you why "They

Don't Make 'Em Like They Used To" makes Ham Radio even more fun.

TRITON IV \$699.00

ACCESSORIES:
Model 240 One-Sixty Converter. . . \$ 97.00
Model 244 Digital Readout 197.00

Model 245 CW Filter \$25.00
Model 249 Noise Blanker 29.00
Model 252G Power Supply 109.00
Model 262G Power Supply/VOX . . 139.00



TEN-TEC
TRITON IV
Digital Model 544
\$869.00

KR20-A ELECTRONIC KEYS

A fine instrument for all-around high performance electronic keying. Paddle actuation force is factory adjusted for rhythmic smooth keying. Contact adjustments on front. Weighting factor factory set for optimum smoothness and articulation. Over-ride "straight key" conveniently located for emphasis, QRS sending or tune-up. Reed relay output. Side-tone generator with adjustable level. Self-completing characters. Plug-in circuit board. For 117 VAC, 50-60 Hz or 6-14 VDC. Finished in cream and walnut vinyl. Price \$69.50

KR5-A ELECTRONIC KEYS

Similar to KR20-A but without side-tone oscillator or AC power supply. Ideal for portable, mobile or fixed station. A great value that will give years of troublefree service. Housed in an attractive case with cream front, walnut vinyl top. For 6-14 VDC operation. Price \$39.50

KR1-A DELUXE DUAL PADDLE

Paddle assembly is that used in the KR50, housed in an attractive formed aluminum case. Price \$35.00

KR2-A SINGLE LEVER PADDLE

For keying conventional "TO" or discrete

character keys, as used in the KR20-A. Price \$17.00

KR50 ELECTRONIC KEYS

A completely automatic electronic keyer fully adjustable to your operating style and preference, speed, touch and weighting, the ratio of the length of dits and dahs to the space between them. Self-controlled keyer to transmit your thoughts clearly, articulately and almost effortlessly. The jambie (squeeze) feature allows the insertion of dits and dahs with perfect timing.

An automatic weighting system provides increased character to space ratio at slower speeds, decreasing as the speed is increased, keeping the balance between smoothness at low speeds and easy to copy higher speed. High intelligibility and rhythmic transmission is maintained at all speeds, automatically.

Memories provided for both dits and dahs but either may be defeated by switches on the rear panel. Thus, the KR50 may be operated as a full iambic (squeeze) keyer, with a single memory or as a conventional type keyer. All characters are self-completing. Price \$110.00

SPECIFICATIONS

Speed Range: 6-50 w.p.m.
Weighting Ratio Range: 50% to 150% of classical dit length.

Memories: Dit and dah. Individual defeat switches.
Paddle Actuation Force: 5-50 gms.
Power Source: 117VAC, 50-60 Hz, 6-14 VDC.
Finish: Cream front, walnut vinyl top and side panel trim.
Output: Reed relay. Contact rating 15 VA, 400 V. max.
Paddles: Torque drive with ball bearing pivot.
Side-tone: 500 Hz tone.
Adjustable output to 1 volt.
Size HWD: 2 1/4" x 5 1/2" x 8 1/4"
Weight: 1 3/4 lbs.



KR50

THE SURPRISE OF THE CENTURY

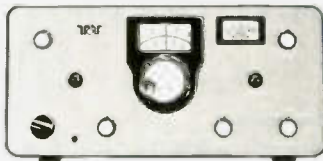

TEN-TEC CENTURY 21. The Exciting New 70-

Watt, 5-Band CW Transceiver That's Surprising Everyone, Beginner and Old Timer. With Its Super Performance and Low Cost.

- Full Break-In • Full Band Coverage on 3, 5, 7, 14, 21 MHz Bands, 1 MHz on 28 MHz Band • 70 Watts Input
- Total Solid State • Reverses SSB and CW • Receiver Sensitivity 1.0 • Instant Band Change, No Tune-up • Offset Receiver Tuning • 3-Position Selectivity • Adjustable Sidetone Level • Linear Crystal-Mixed VFO • Overload Protection • Built-In AC Power Supply • Black & Gray Styling • HWD 6 1/2" • 12 1/2" • 12.15 lbs. • Matching Accessories

THE RECEIVER. Double Direct Conversion. Easy tuning. Just select the frequency and set the

audio level. Excellent cross-modulation (harmonic) immunity. Offset tuning so you can tune either side of zero beat to reduce QRM. Front panel control selects one of 3 selectivity curves. 2.5 kHz for SSB reception, 1 kHz for normal CW and 500 Hz for when the QRM gets rough. Plus separate AF and RF controls, headphone jack, and built-in speaker

THE TRANSMITTER. Total solid state. Push pull Class C final amplifier. Individual low-pass filters are switched into the antenna line to reduce unwanted radiations, minimize TVI. No tune up needed when changing frequencies or bands. And full break in allows incoming signals to be heard between transmitted characters. Now CW is real conversation!

THE VFO. Common to receiver and transmitter. Permeability tuned. Linear scale. 5.5-5.5 MHz basic frequency is crystal mixed to the desired frequency so

bandspread and stability are the same on all bands (crystals included for 3.5, 7, and 14 MHz bands)

THE POWER SUPPLY Built in AC operated and regulated. Monitors current demand, shuts down automatically when necessary for protection. Lighted input element meter shows proper line setting.

MATCHING ACCESSORIES. Model 670 Electronic Keyer 6-50 w.p.m. self-completing characters, powered by the Century. Model 270 Calibrator for markers at every 100 and 25 kHz. Model 271 Crystal for 21.215 MHz. 272 Crystal for 28.285 MHz. 273 Crystal for 28.529 MHz.

- 570 Century 21 Transceiver \$289
- 670 Century 21 Keyer \$ 29
- 276 Century 21 Calibrator \$ 29
- 271 272 273 Crystals ea \$ 5



Now You Can Receive The Weak Signals With The ALL NEW AMECO PREAMPLIFIER

Model PT-2 is a continuous tuning 6-160 meter Pre-Amp specifically designed for use with a transceiver. The PT-2 combines the features of the well-known PT with new sophisticated control circuitry that permits it to be added to virtually any transceiver with No modification. No serious ham can be without one.

- Improves sensitivity and signal-to-noise ratio.
- Boosts signals up to 26 db.
- For AM or SSB.
- Bypasses itself automatically when the transceiver is transmitting.
- FET amplifier gives superior cross modulation protection.
- Advanced solid state circuitry.
- Simple to install.
- Improves immunity to transceiver front-end overload by use of its built-in attenuator.
- Provides master power control for station equipment.

MODEL PT 2

\$69.95



TUFTS RADIO CATALOG TUFTS RADIO

There is no substitute for quality, performance, or the satisfaction of owning the very best.

Hence, the incomparable Hy-Gain 3750 Amateur transceiver. The 3750 covers all amateur bands 1.8-30 MHz (160-10 meters). It utilizes advanced Phase-Lock-Loop circuitry with dual gate MOS FET's at all critical RF amplifier and mixer stages.

There's a rotating dial for easy band-scanning and an electronic frequency counter with digital readout and a memory display that remembers frequencies at the flip of a switch. And that's just the beginning.

Matching speaker unit (3854) and complete external VFO (3855) also available.

See the incomparable Hy-Gain 3750 at your radio dealer or write Department MM. There is no substitute.



3854 - \$59.95

3750 - \$1895.00

3855 - \$495.00

There is no substitute.

hy-gain
Amateur Radio Systems.

Dealer Programs
NOW Available

**Super
3-Element Thunderbird
for 10, 15 and 20 Meters
Model TH3Mk3 - \$199.95**

Hy-Gain's Super 3-element Thunderbird delivers outstanding performance on 10, 15 and 20 meters. The TH3Mk3 features separate and matched Hy-Q traps for each band, and feeds with 52 ohm coax. Hy-Gain Beta Match presents tapered impedance for most efficient 3 band matching, and provides DC ground to eliminate precipitation static. The TH3Mk3 delivers maximum F/B ratio, and SWR less than 1.5:1 at resonance on all bands. Its mechanically superior construction features taper swaged slotted tubing for easy adjustment and larger diameter. Comes equipped with heavy tiltable boom-to-mast clamp. Hy-Gain ferrite balun BN-86 is recommended for use with the TH3Mk3.

Electrical	TH6DXX	TH3Mk3
Gain—average	8.7dB	8dB
Front-to-back ratio	25dB	25dB
SWR (at resonance)	Less than 1.5:1	Less than 1.5:1
Impedance	50 ohms	50 ohms
Power rating	Max legal	Max legal

Mechanical	TH6DXX	TH3Mk3
Longest element	31.1'	27'
Boom length	24'	14'
Turning radius	20'	15.7'
Wind load at 80 MPH	156 lbs.	103.2 lbs.
Maximum wind survival	100 MPH	100 MPH
Net weight	57 lbs.	36 lbs.
Mast diameter accepted	1 1/4" to 2 1/2"	1 1/4" to 2 1/2"
Surface area	6.1 sq. ft.	4.03 sq. ft.

6-Element Super Thunderbird DX for 10, 15 and 20 Meters Model TH6 DXX \$249.95 Separate HY-Q traps, featuring large diameter coils that develop an exceptionally favorable L/C ratio and very high Q, provide peak performance on each band whether working phone or CW. Exclusive Hy-Gain beta match, factory pretuned, insures maximum gain and F/B ratio without compromise. The TH6DXX feeds with 52 ohm coaxial cable and delivers less than 1.5:1 SWR on all bands. Mechanically superior construction features taper swaged, slotted tubing for easy adjustment and re-adjustment, and for larger diameter and less wind loading. Full circumference compression clamps replace self-tapping sheet metal screws. Includes large diameter, heavy gauge aluminum boom, heavy cast aluminum boom-to-mast clamp, and heavy gauge machine formed element-to-boom brackets. Hy-Gain's ferrite balun BN-86 is recommended for use with the TH6DXX.

**HY-GAIN'S INCOMPARABLE
HY-TOWER
FOR 80 THRU 10 METERS**

- Model 18HT**
- Outstanding Omni-Directional Performance
 - Automatic Band Switching
 - Installs on 4 sq. ft. of real estate
 - Completely Self-Supporting

By any standard of measurement, the Hy-Tower is unquestionably the finest multi-band vertical antenna system on the market today. Virtually indestructible, the Model 18HT features automatic band selection on 80 thru 10 meters through the use of a unique stub decoupling system which effectively isolates various sections of the antenna so that an electrical 1/4 wavelength (or odd multiple of a 1/4 wavelength) exists on all bands. Fed with 52 ohm coax, it takes maximum legal power... delivers outstanding performance on all bands. With the addition of a base loading coil, it also delivers outstanding performance on 160 meters. Structurally, the Model 18HT is built to last a lifetime. Rugged hot-dipped galvanized 24 ft. tower requires no guyed supports. Top mast, which extends to a height of 50 Ft., is 6061ST6 tapers aluminum. All hardware is iridite treated to MIL specs. If you're looking for the epitome in vertical antenna systems, you'll want Hy-Tower, Shpg. Wt., 96.7 lbs. Order No. 182, Price: \$279.95.

NEW Special hinged base assembly on Model 18HT allows complete assembly of antenna at ground level... permits easy raising and lowering of the antenna.

**BROAD BAND DOUBLET BALUN
for 10 thru 80 meters
Model BN-86
\$15.95**



The model BN-86 balun provides optimum balance of power to both sides of any doublet and vastly improves the transfer of energy from feedline to antenna. Power capacity is 1 KW DC. Features weatherproof construction and built-in mounting brackets. \$15.95 Shpg. Wt. 1 lb. Order No. 242



**MULTI-BAND HY-Q TRAP DOUBLETS
Hy-Q Traps**

- Install Horizontally or as Inverted V
- Super-Strength Aluminum Clad Wire
- Weatherproof Center and End Insulators

Installed horizontally or as an inverted V, Hy-Gain doublets with Hy-Q traps deliver true half wavelength performance on every design frequency. Matched traps, individually pretuned for each band feature large diameter coils that develop an exceptionally favorable L/C ratio and very high Q performance. Mechanically superior solid aluminum trap housings provide maximum protection and support to the loading coil. Fed with 52 ohm coax, Hy-Gain doublets employ super-strength aluminum clad single strand steel wire elements that defy deterioration from salt water and smoke... will not stretch... withstand hurricane-like winds. SWR less than 1.5:1 on all bands. Strong, lightweight, weatherproof center insulators are molded from high impact cycloac. Hardware is iridite treated to MIL specs. Heavily serrated 7-inch end insulators molded from high impact cycloac increase leakage path to approximately 12 inches.

MODEL 2BDQ for 40 and 80 meters. 100' 10 1/2" overall. Takes maximum legal power. Shpg. Wt., 7.5 lbs \$49.95

Order No. 380

MODEL 5BDQ for 10, 15, 20, 40 and 80 meters. 94' overall. Takes maximum power. Shpg. Wt., 12.2 lbs. \$79.95

Order No. 383

CENTER INSULATOR for Multi-Band Doublets Model CI



Strong lightweight, weatherproof Model CI is molded from high impact cycloac. Hardware is iridite treated to MIL specs. Accepts 1/4" or 3/4" coaxial. Shpg. Wt., 0.6 lbs. \$5.95 Order No. 155

**MULTI-BAND ANTENNA
Dipole Antenna - Model DIV-80
\$13.95**

For 10 thru 80 meters - choice of one band

A dipole antenna for the individuals who prefer the "do-it-yourself" flexibility of custom-designing an antenna for your specific needs. (Work the frequencies you wish in the 10 through 80 meters bands).

The DIV-80 features: Durable Copperweld wire for greater strength, Mosley Dipole Connector (DPC-1) for RG-8/U or RG-58/U coax and all the technical information you will need to construct your custom-designed antenna.



END INSULATORS for Doublets Model EI

Rugged 7-inch end insulators are molded from high impact cycloac that is heavily serrated to increase leakage path to approximately 12 inches. Available in pairs only. Shpg. Wt., 0.4 lbs. \$3.95 Order No. 156

WIDE BAND VERTICAL for 80-10 Meters Hy-Gain's 18 AVT/WB

Take the wide band, omni-directional performance of Hy-Gain's famous 14AVQ/WB, add 80 meter capability plus extra-heavy duty construction—and you have the unrivalled new 18AVT/WB. In other words, you have quite an antenna.

- Automatic switching, five band capability is accomplished through the use of three beefed-up Hy-Q traps (featuring large diameter coils that develop an exceptionally favorable L/C ratio).
- Top loading coil.
- Across-the-band performance with just one furnished setting for each band (10 through 40).
- True 1/4 wave resonance on all bands.
- SWR of 2:1 or less at band edges.
- Radiation pattern has an outstandingly low angle whether roof top or ground mounted.



CONSTRUCTION . . . of extra-heavy duty tapered swaged seamless aluminum tubing with full circumference, corrosion resistant compression clamps at slotted tubing joints . . . is so rugged and rigid that, although the antenna is 25' in height, it can be mounted without guy wires, using a 12" double grip mast bracket, with recessed coax connector.

Order No. 386 Price: \$97.00

The Versatile Model 18V for 80 thru 10 Meters

The Model 18V is a low-cost, highly efficient vertical antenna that can be tuned to any band 80 thru 10 meters, by a simple adjustment of the feed point on the matching base inductor. Fed with 52 ohm coax, this 18 ft. radiator is amazingly efficient for DX or local contact. Constructed of heavy gauge aluminum tubing, the Model 18V may be installed on a short 1 1/2 inch mast driven into the ground. It is also adaptable to roof or tower mounting. Highly portable, the Model 18V can be quickly knocked down to an overall length of 5 ft. and easily re-assembled for field days and camping trips. Ship. Wt. 5 lbs.
Order No. 193 Price: \$33.00

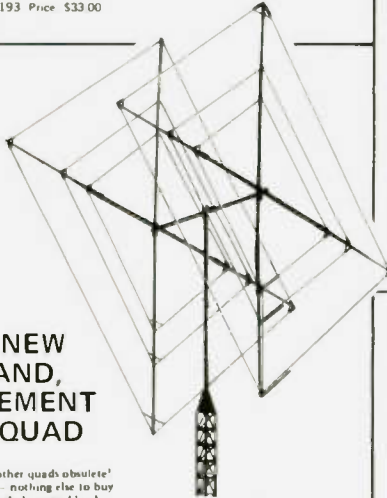

ALL NEW 3-BAND, 2 ELEMENT HY-QUAD

- Makes all other quads obsolete!
 - Complete — nothing else to buy
 - High strength, low wind load
- The Hy-Quad from Hy-Gain makes all other quads obsolete! Here's why: First, it's the only quad that is complete. There is nothing more to ship for or buy. Secondly, it is uniquely designed so that it overcomes all of the previously undesirable features inherent in quads. The all aluminum structure stays up! The single feed line and diamond shape simplifies feed line routing. Hy-Gain's all new Hy-Quad will outdo all other quads because it's engineered to do just that. The Hy-Quad is new, it's superior, it's complete. It's the first quad to have everything — spreaders are broken up at strategic electrical points with Cycloac insulators / In-band 2 element construction with individually resonated elements with no interaction. / Hy-Quad requires only one feed line for all three bands / individually tuned gamma matches on each band with Hy-Gain exclusive vertec feed / full wave element loops require no tuning stubs, traps, loading coils or baluns / heavy duty mechanical construction of strong swaged aluminum tubing and die formed spreader-to-boom clamps / extra heavy duty universal boom-to-mast clamp that fits and mounts on any mast 1 1/2" to 2 1/2" in diameter / aluminum stranded wire. You can open and close the bands with this antenna. You'll experience the thrill of real DX.
- Order No. 244 Price: \$219.95

SPECIFICATIONS

Overall length of spreaders	25' 5"	Forward gain	8.5 db
Turning radius	13' 6"	Input impedance	52 ohms
Weight	42 lbs	VSWR	1.2:1 or better at resonance on all bands
Boom diameter	2"	Power	Maximum
Boom length	8'		
Mast diameter	1 1/2" to 2 1/2"		legal
Wind surfmast	100 mph	Front-to-back ratio	25:35 db
Surface area	6.4 sq. ft.	depending upon electrical height	
Wind load at 100 mph	256.0 lbs	Polarization	Horizontal



For 10, 15, and 20 Meters
New Hy-Gain Model 12 AVQ

Completely self-supporting, the Model 12AVQ features Hy-Q traps...12" double-grip mast bracket...taper swaged seamless aluminum construction with full circumference compression clamps at tubing joints. It delivers outstanding low angle radiation. SWR is 2:1 or less on all bands. Overall height is 13'6". Shipping weight 7.2 lbs. Price: \$47.00
Order No. 384

New, improved successor to the world's most popular vertical!
Hy-Gain Model 14 AVQ/WB for 40-10 Meters.

- Wide band performance with one setting (optimum settings for top performance furnished)
- New Hy-Q Traps • New 12" Double-Grip Mast Bracket • Taper Swagged Seamless Aluminum Construction

The Model 14AVQ/WB, new improved successor to the world famous Model 14AVQ, is a self-supporting, automatic band switching vertical that delivers omni-directional performance on 40 through 10 meters. Three separate Hy-Q traps featuring large diameter coils that develop an exceptionally favorable L/C ratio and a very high Q, provide peak performance by effectively isolating sections of the antenna so that a true 1/4 wave resonance exists on all bands. Outstandingly low angle radiation pattern makes DX and other long haul contacts easy. Superior mechanical features include solid aluminum housing for traps using air dielectric capacitor...heavy gauge taper swaged seamless aluminum radiator...full circumference compression clamps at tubing joints that are resistant to corrosion and wear...and a 12" double-grip mast bracket that insures maximum rigidity whether roof-top or ground mounted. The Model 14AVQ/WB also delivers excellent performance on 80 meters using Hy-Gain Model LC-80Q Loading Coil. Overall height is 18 feet. Shipping weight 9.2 lbs. Unsurpassed portability...outstanding for permanent installations. Price: \$77.00
Order No. 385

TYPICAL 14AVQ/WB VSWR CURVES

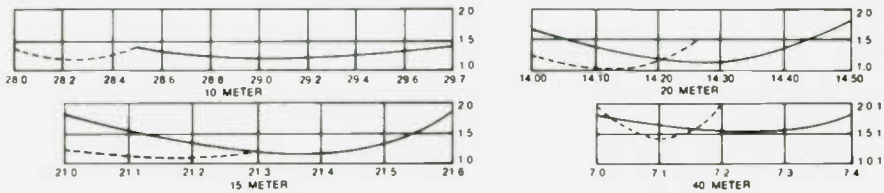

ROOF MOUNTING KIT—Model 14RMQ provides rugged support for Model 14AVQ/WB.
Order No. 184. Price: \$28.95

Hy-Gain REEL TAPE PORTABLE DIPOLE for 10 thru 80 Meters Model 18TD

The most portable high performance dipole ever...

The Model 18TD is unquestionably the most foolproof high performance portable doublet antenna system ever developed. It has proven invaluable in providing reliable communications in vital military and commercial applications throughout the world. Two stainless steel tapes, calibrated in meters, extend from either side of the main housing up to a total distance of 132 feet for 3.5 mc operation. 25 ft. lengths of polypropylene rope attached to each tape permits installation to poles, trees, buildings...whatever is available for forming a doublet antenna system. Integrated in the high impact housing is a frequency to length conversion chart calibrated to meter measurements on the tapes...makes installation foolproof. Feeds with 52 ohm coax. Delivers outstanding performance as a portable or permanent installation. Measures 10x5x2 inches retracted. Wt., 4.1 lbs.
Order No. 228 Price: \$94.95



SST T-1 RANDOM WIRE ANTENNA TUNER

All band operation (160-10 meters) with any random length of wire. 200 watt output power capability — will work with virtually any transceiver. Ideal for portable or home operation. Great for apartments and hotel rooms — simply run a wire inside, out a window, or anywhere available. Toroid inductor for small size: 4-1/4" x 2-3/8" x 3". Built-in neon tune-up Indicator. SO-239 connector. Attractive bronze finished enclosure. Only \$29.95

sst t-2 ULTRA TUNER

Tunes out SWR on any coax fed antenna as well as random wires. Works great on all bands (160-10 meters) with any transceiver running up to 200 watts power output. Increases usable bandwidth of any antenna. Tunes out SWR on mobile whips from inside your car. Uses toroid inductor and specially made capacitors for small size: 5 1/4" x 2 1/4" x 1 1/2". Rugged, yet compact. Attractive bronze finished enclosure. SO-239 coax connectors are used for transmitter input and coax feed

antennas. Convenient binding posts are provided for random wire and ground connections. Only \$49.95

sst t-3 IMPEDANCE TRANSFORMER

Matches 52 ohm coax to the lower impedance of a mobile whip or vertical. 12 position switch with taps spread between 3 and 52 ohms. Broadband from 1-30 MHz. Will work with virtually any transceiver — 300 watt output power capability. SO-239 connectors. Toroid inductor for small size: 2-3/4" X 2" X 2-1/4". Attractive bronze finish. Only \$19.95

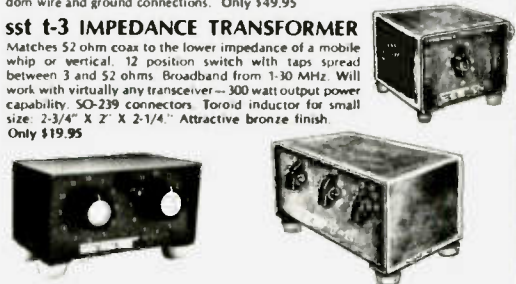

Pipo Communications TROUBLE FREE TOUCH-TONE ENCODER



PP-1

POSITIVE TOUCH (KEYS DEPRESS) • MOBILE • HANDHELD
DESK MOUNT • NO POTTED PARTS (SERVICEABLE)
MIL. SPEC. COMPONENTS • NO RFI • SELF CONTAINED
XTAL CONTROLLED • LEVEL ADJUSTABLE FROM FRONT
Pat. Pend.

Model is for mounting to surfaces inaccessible from the rear: walls, mobiles, systems interface panels, test equipment, etc.
Relay is self contained with a relay inside the encoder. When keys are pressed contact closure occurs with a 2 sec. delay. (adjustable). Contacts are rated at 110ma @ 28 Volts switched, 500ma carry. PP-2K contains delay exclusion for the fourth column. However, by jumpering D 5, 4th column delay is restored.

Pipo Communications has developed a trouble free reliable instrument to be free of any defects for years. Unit is constructed with the best components available, without compromise in quality. Unit is operable from 4.5 - 60 Volts at temperatures from below 0 to +140°F. Output level will drive any transmitter or system. Adjustable output level is controlled with an extremely slide multi-turn trimmer, with access from the front of the encoder (not behind), saving time for level setting, which amounts to hours when employed with a system.

PP-1: \$55 12 Keys PP-2: \$58 16 Keys PP-1A: \$68 For Standard Comm. Hand Held
PP-1M: \$55 12 Keys w/Mod PP-2M: \$58 16 Keys w/Mod
PP-1K: \$66 12 Keys w/Mod PP-2K: \$69 16 Keys w/Mod

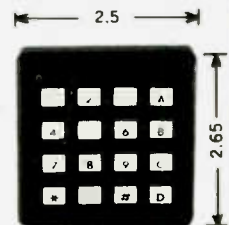

PP-2

TUFTS RADIO CATALOG TUFTS RADIO

FINCO

2 meter

The model Stinger A 210 is a high performance wide spaced ten-element 2-meter yagi designed for the serious VHF operator. Utilizing the Stinger construction features, the A 210 is almost indestructible no matter what weather conditions are encountered. Complete coverage of the 2-meter band and low V.S.W.R. is assured through the use of non-linear spaced elements thus also achieving maximum forward gain. Power rating - 2,000 watts P.E.P.
The A 210 can be mounted for vertical polarization, there by making the antenna quite useful in repeater accessing, or mounted for horizontal polarization for station to station VHF DX work. Additional bays of the A 210 can be easily stacked for even greater gain and front-to-back ratio.

SPECIFICATIONS - A 210	
ELECTRICAL	MECHANICAL
Forward Gain 13.8dB	Boom Length 10 ft.
Front-to-Back Ratio 25dB	Longest Element 42 in.
V.S.W.R. (at resonance) 1.1	Turning Radius 71 in.
Half Power Beam Width 40°	Maximum Surface Area 2.36 sq. ft.
Bandwidth 144 to 148 MHz	Wind Load at 80 MPH 28.2 lbs.
Impedance 50 Ohms	Weight 9.8 lbs.
Matching System Adjustable Gamma	

The model Stinger A 25 is a five-element high gain antenna similar to the A 210 but having physically less of a profile. The A 25 finds excellent application as a portable antenna as it disassembles into a very compact package. Like the A 210, the antenna can be mounted for vertical or horizontal polarization for repeater or general coverage work. Constructed of the Stinger heavy duty materials, the A 25 is ideal for locations encountering adverse weather conditions. Power rating 2,000 watts P.E.P.

SPECIFICATIONS - A 25	
ELECTRICAL	MECHANICAL
Forward Gain 9.5dB	Boom Length 5.5 ft.
Front-to-Back Ratio 22dB	Longest Element 41 in.
V.S.W.R. (at resonance) 1.1	Turning Radius 42 in.
Half Power Beam Width 51°	Maximum Surface Area 1.23 sq. ft.
Bandwidth 144 to 148 MHz	Wind Load at 80 MPH 13.3 lbs.
Impedance 50 Ohms	Weight 6.5 lbs.
Matching System Adjustable Gamma	

The model Stinger A 2x2 is a ten-element, dual polarization 2 meter antenna designed for OSCAR communications or where switching from horizontal to vertical polarization is required. The A 2x2 can even be phased to operate on both horizontal and vertical polarization at the same time. This is not only ideal for OSCAR work but gives your station versatility for ground communication.

Wide, non-linear element spacing gives the A 2x2 superior gain, however, since it is a five element beam in one given plane, the half power beam width does not make satellite tracking difficult because of sharp directivity. The dual gamma match assemblies provide for a very low V.S.W.R. and will withstand 2,000 watts P.E.P.

The Stinger construction features make the A 2x2 extremely heavy duty. Provisions are made for mounting the antenna at the end of the boom - for azimuth control - or at the middle of the boom for normal applications.

SPECIFICATIONS - A 2x2	
ELECTRICAL	MECHANICAL
Forward Gain 9.5dB	Boom Length 6 ft.
Front-to-Back Ratio 10.5dB	Longest Element 41 in.
Circular Gain 22dB	Turning Radius 5.5 ft.
Horizontal Polarization 58°	Center Mount 3.4 ft.
Vertical Polarization 52°	Maximum Surface Area 1.51 sq. ft.
E Plane 52° H Plane 52°	Wind Load at 80 MPH 13.4 lbs.
Circular Polarization 52°	Weight 11 lbs.
Bandwidth 144 to 148 MHz	
Impedance 50 Ohms	
Matching System Adjustable Gamma	

1 1/4 meter

The model Stinger A 1 1/4 is a ten element 1 1/4 meter (220 MHz) high performance yagi designed for all 220 MHz communication needs. Designed to be mounted in either the vertical or horizontal plane, the A 1 1/4 is adaptable for OSCAR, repeater, or general communication work. Incorporating the Stinger heavy duty elements, boom and boom to mast assemblies, the antenna easily withstands 120 mph wind loads under 1/4" ice conditions. A low loss gamma matching system assures a low V.S.W.R. and is power rated at 1,000 watts.

SPECIFICATIONS - A 1 1/4	
ELECTRICAL	MECHANICAL
Forward Gain 13.8dB	Boom Length 8 ft.
Front-to-Back Ratio 25dB	Longest Element 28 in.
V.S.W.R. (at resonance) 1.2	Turning Radius 4.3 ft.
Half Power Beam Width 40°	Maximum Surface Area 1.32 sq. ft.
Bandwidth 220 to 226 MHz	Wind Load at 80 MPH 17.9 lbs.
Impedance 50 Ohms	Weight 8 lbs.
Matching System Adjustable Gamma	

STINGER

10 meter

The model Stinger A 10-4 is a wide spaced, full size, high gain four element 10 meter monobander designed for optimum DX performance. Utilizing the exclusive Stinger Series square boom construction, the A 10-4 is light enough to be easily stacked for an additional 3 dB gain yet strong enough to withstand the most adverse weather conditions. The highly efficient gamma match system easily withstands 2,000 watts P.E.P. of power and maintains a relatively low V.S.W.R. across the entire 10 meter amateur band.

SPECIFICATIONS - A 10-4	
ELECTRICAL	MECHANICAL
Forward Gain 10dB	Boom Length 16 ft.
Front-to-Back Ratio 25dB	Longest Element 18 ft.
V.S.W.R. (at resonance) 1.1	Turning Radius 7.4 ft.
Half Power Beam Width 55°	Maximum Surface Area 4.4 sq. ft.
Bandwidth 28 to 30 MHz	Wind Load at 80 MPH 118 lbs.
Impedance 50 Ohms	Weight 12.5 lbs.
Matching System Adjustable Gamma	

6 meter

The model Stinger A6-5 is a highly directional 6 meter five element beam specifically designed for maximum forward gain with a "no compromise" front to back ratio. The elements are constructed of high tensile strength seamless aluminum tubing plus the exclusive Stinger square boom and bracket assemblies. For maximum power transfer and low V.S.W.R., a carefully designed gamma matching assembly capable of withstanding 2,000 watts P.E.P. is incorporated. Wide element spacing assures optimum DX performance and good operating efficiency across the entire 50 to 54 MHz 6 meter band. The square boom allows optional vertical mounting for accessing 6 meter repeaters.

SPECIFICATIONS - A 6-5	
ELECTRICAL	MECHANICAL
Forward Gain 11dB	Boom Length 13 ft.
Front-to-Back Ratio 25dB	Longest Element 10 ft.
V.S.W.R. (at resonance) 1.1	Turning Radius 8.3 ft.
Half Power Beam Width 52°	Maximum Surface Area 3.23 sq. ft.
Bandwidth 50 to 54 MHz	Wind Load at 80 MPH 40.2 lbs.
Impedance 50 Ohms	Weight 11.5 lbs.
Matching System Adjustable Gamma	

The model Stinger A 6-3 is a 3 element high gain 6 meter beam similar to the A 6-5 but expressly designed for the casual 6 meter enthusiast. The A 6-3 also finds excellent application for portable use as it disassembles into a compact package. Due to the lights weight and minimal wind load, the antenna is ideal for double stacked and quad stacked arrays for the real 6 meter DXer. The A 6-3 is rated at 2,000 watts P.E.P. and incorporates a square boom and high tensile strength aluminum elements.

SPECIFICATIONS - A 6-3	
ELECTRICAL	MECHANICAL
Forward Gain 7.0dB	Boom Length 6.0 ft.
Front-to-Back Ratio 21.0dB	Longest Element 10 ft.
V.S.W.R. (at resonance) 1.1	Turning Radius 5.4 ft.
Half Power Beam Width 60°	Maximum Surface Area 1.75 sq. ft.
Bandwidth 50 to 54 MHz	Wind Load at 80 MPH 17.6 lbs.
Impedance 50 Ohms	Weight 7 lbs.
Matching System Adjustable Gamma	

6 and 2 meter

The model Stinger A 62 is a truly remarkable combination 6 and 2 meter beam designed for optimum performance on both bands yet only requiring ONE transmission line. This is accomplished through the use of exclusive phasing elements to accomplish dual band operation with no sacrifice to either band - NO SWITCHING REQUIRED!
On 2 meters, the A 62 has 6 collinear elements - equivalent to three 1/2 λ element yagis stacked side by side - thus giving outstanding performance. Maximum forward gain is assured on 6 meters through the use of four wide spaced elements. The heavy duty Stinger construction is used throughout so that the antenna will withstand 100 mph plus wind loads.
The A 62 is ideal for mounting on the same mast as your tri-bander or other antenna thus easily opening up the world of 6 and 2 meter VHF communication.

SPECIFICATIONS - A 62	
ELECTRICAL	MECHANICAL
Forward Gain 6 meters 9.5dB 2 meters 12.0dB	Boom Length 10.1 ft.
Front-to-Back Ratio 6 meters 19dB 2 meters 22dB	Longest Element 10 ft.
V.S.W.R. (6 & 2 meter) 1.1	Turning Radius 6.7 ft.
Half Power Beam Width 40° to 55°	Maximum Surface Area 4.48 sq. ft.
Bandwidth 6 meters 50 to 54 MHz 2 meters 144 to 148 MHz	Wind Load at 80 MPH 43 lbs.
Impedance 50 Ohms	Weight 13.8 lbs.
Matching System Adjustable Gamma	

ENGINEERING FEATURES

□ Antenna design engineering is a specialty at FINCO. Top quality lab standard test equipment is used throughout the development and design of all antennas. The FINCO antenna test range has been carefully checked for erroneous reflection characteristics that could cause errors in antenna designs. Shown is the sophisticated stub and matching system that has been developed for the Stinger A62, 6 and 2 meter dual band beam. No traps or coils to burn out or detune, thus assuring you of the highest possible performance on both 6 and 2 meters.

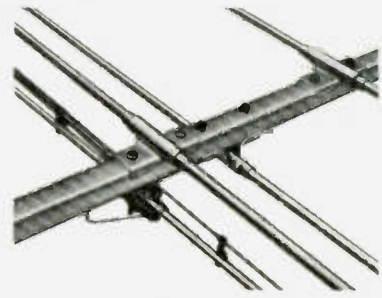

□ Exclusive Stinger square boom construction is used on all amateur antennas. The 1 1/4" square booms are of .064 wall high tensile strength aluminum which is many times stronger than its round counterpart. Also, special bracket assemblies have been developed to allow instant element to boom alignment - plus they stay aligned in the highest wind and ice loads. All elements are of thick wall high tensile strength aircraft quality aluminum.

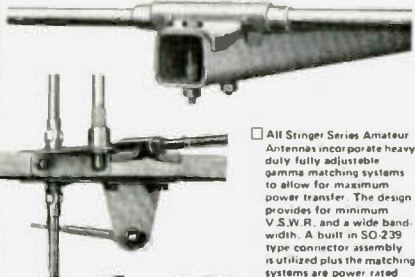

□ All Stinger Series Amateur Antennas incorporate heavy duty fully adjustable gamma matching systems to allow for maximum power transfer. The design provides for minimum V.S.W.R. and a wide bandwidth. A built in SO-239 type connector assembly is utilized plus the matching systems are power rated at 2,000 watts P.E.P.

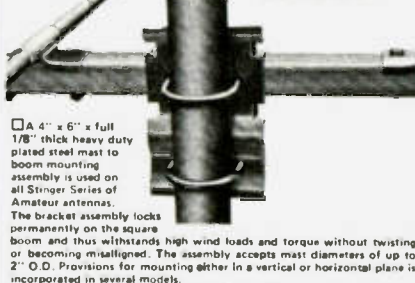

□ A 4" x 6" x 1/8" thick heavy duty plated steel mast to boom mounting assembly is used on all Stinger Series of Amateur antennas. The bracket assembly locks permanently on the square boom and thus withstands high wind loads and torque without twisting or becoming misaligned. The assembly accepts mast diameters of up to 2" O.D. Provisions for mounting either in a vertical or horizontal plane is incorporated in several models.

ROHN NO. 25G TOWER & ACCESSORIES



- SB25G 3'4" SHORT BASE section for concrete - \$17.00
- SBh25G* 3'4" HINGED SHORT BASE section for concrete - \$28.00
- HGB25G* 3' HINGED GROUND BASE (use without concrete) - \$50.00
- SDB25G* SINGLE DRIVE-IN BASE - \$25.00
- BPH25G* HINGED BASE PLATE for concrete - \$41.65
- FR25G* FLAT ROOF MOUNT - \$31.90
- PR25G* PEAK ROOF MOUNT - \$25.00
- *Note: Towers mounted on these bases must be bracketed or guyed.
- RP25G ROTOR POST - \$4.15
- AS25G ACCESSORY SHELF (for mounting Ham-M rotor) \$8.35
- GA25G GUY ASSEMBLY with torque bars - \$15.00
- GB25G GUY BRACKET ONLY without torque bars - \$9.60
- Adjustable House Brackets
- HB25AG 0-15" - \$13.35
- HB25BG 0-24" - \$16.65
- HB25CG 0-36" - \$20.00
- Eave Brackets
- EB2515G 15" \$7.50
- EB2524G 24" \$8.35
- EB2525G UNIVERSAL EAVE BRACKET 10.00
- TB-2 THRUST BEARING \$4.65
- TB-3 HEAVY DUTY THRUST BEARING - \$58.35
- WP25G WORK PLATFORM - \$23.35
- Side Arm
- SA25G-224 - \$43.50
- SA25G-524 - \$43.50
- 24" SIDE ARM
- SAB25G-2 - \$27.50
- SIDE ARM BRACKET - \$27.50
- SA25G-67 67" SIDE ARM - \$43.50
- UHF25G SIDE ARM MOUNT (for UHF & FM antenna) - \$6.25
- BPC25G* CONCRETE BASE PLATE - \$28.40
- 25G - (10' straight section of tower) \$43.95
- 25AG-3 - (top section 2 1/4" tube type; 2' most fits snugly inside) \$49.95
- 25AG-4 - (top section, upper end terminates in 11" flat plate for mounting TB-2 or TB-3 thrust bearing) \$49.95
- 3/8" TBE&J - (turnbuckles 3/8" x 6"; 6,000 lbs ultimate strength) \$7.75 each.
- 3/16" CCM - cable clamps - 45¢ ea.
- 1/4" TH - thimbles - 30¢ ea.
- 1/2" TBE&J - (1/2" x 12" turnbuckles; 11,000 lbs. ultimate strength) \$13.00 each
- 3/16" EHS - Guy wire: 250' - \$27.50
500' - \$55.00
1000' - \$110.00
- GAC-25-3 - concrete guy anchor \$16.65 each

TUFTS RADIO CATALOG

HAM RADIO / MOBILE COMMUNICATIONS



MODEL	NET PRICE	103R	\$39.95
12V4	\$19.95	* 13 HM 4	\$41.95
600	\$20.50	104R	\$49.95
102	\$24.95	12/115	\$69.95
612	\$27.95	108RA	\$79.95
107	\$28.95	108RM	\$99.95
12 HM 4	\$29.95	109R	\$149.95

MODEL 12HM4

NPC 2.5 Amp Regulated Power Supply. Solid State. Short Circuit Protected.



ALSO! Available as 13 HM 4 with built-in loudspeaker.

	TYPICAL	MAXIMUM
Output Voltage	13.5 ± 5VDC	14VDC
Continuous Current	1.5 Amp	
Regulation	2.5 Amp	
Ripple/Noise	5 mV RMS	10 mV RMS

Case 3" (H) x 4" (W) x 5 1/2" (D) Shipping Weight: 3 lbs.



MODEL 103R

NPC 4 Amp Regulated Power Supply. Solid State. Dual Overload Protection.



Converts 115 volts AC to 13.6 volts DC ± 200 millivolts. Handles 2.5 amps continuous and 4 amps max. Ideally suited for applications where no hum and DC stability are important such as CB transmission, small Ham radio transmitter, and high quality eight-track car stereos. Can also be used to trickle-charge 12 volt car batteries.

	TYPICAL	MAXIMUM
Output Voltage	13.6 ± 2VDC	13.6 ± 3VDC
Line/Load Regulation	20 mV	50 mV
Ripple/Noise	2 mV RMS	5 mV RMS
Transient Response	20 uSec	
Current Continuous	2.5 Amp	
Current Limit	4 Amp	
Current Foldback	1 Amp	

Case: 3" (H) x 4" (W) x 5 1/2" (D) Shipping Weight: 4 lbs.

MODEL 107

NPC 4 Amp Power Supply, 6 Amp Max. Solid State. Overload Protected



Functions silently in converting 115 volts AC to 12 volts DC. 4 amps continuous. 6 amps max. Enables anyone to enjoy CB radio, car 8-track cartridge, cassette player or car radio in a home or office.

	TYPICAL	MAXIMUM
Continuous Current (Full Load)	4 Amp	
Output Voltage (No Load)	16 V max	
Output Voltage (Full Load)	12 V min	
Filtering Capacitor	10,000 uF	
Ripple (Full Load)	5 V RMS	
Short Circuit Protection	Thermal Breaker	

Case 3" (H) x 4" (W) x 5 1/2" (D) Shipping Weight: 5 lbs.

MODEL 109R

NPC 25 Amp Regulated Power Supply. 4-Way Protected. Output Voltage and Current Meters.

Extra heavy-duty unit quietly converts 115 volts AC to 13.6 volts DC ± 200 millivolts. 10 amps continuous, 25 amps max. All solid state. Features dual current overload, overvoltage and thermal protection. Ideally suited for operating mobile Ham radio and linear amplifier in your home or office. Excellent bench power supply for testing and servicing of mobile communications equipment.

	TYPICAL	MAXIMUM
Output Voltage	13.6 ± 2VDC	13.6 ± 3VDC
Line/Load Regulation	50 mV	100 mV
Ripple/Noise	5 mV RMS	10 mV RMS
Transient Response	20 uSec	
Current Continuous	10 Amp	
Current Limit	26 Amp	
Overvoltage Protection	14.5 V	15 V
Thermal Overload	180° F	

Case 4 1/2" (H) x 9" (W) x 8 1/2" (D) Shipping Weight: 15 lbs.

MODEL 12V4

NPC 1.75 Amp Power Supply. 3 Amp Max.



Functions silently in converting 115 volts AC to 12 volts DC. Ideally suited for most applications including 8-track stereo, burglar alarm, car radio and cassette tape player within power rating.

	TYPICAL	MAXIMUM
Continuous Current (Full Load)	1.75 Amp	1.75 Amp
Output Voltage (No Load)	16 V max	16 V max
Output Voltage (Full Load)	12 V min	12 V min
Filtering Capacitor	5,000 uF	5,000 uF
Ripple (Full Load)	4 V RMS	4 V RMS
Short Circuit Protection	Thermal Breaker	Thermal Breaker

Case 3" (H) x 4" (W) x 5 1/2" (D) Shipping Weight: 3 lbs.

MODEL 108RM

NPC 12 Amp Regulated Power Supply. Solid State. 3 Way Protected. Current Meter.



This heavy duty unit quietly converts 115 volts AC to 13.6 volts DC ± 200 millivolts. 8 amps continuous, 12 amps max. All solid state. Features dual current overload and overvoltage protection. Ideally suited for operating mobile Ham radio 2 meter AM-FM-SSB transceivers in your home or office. Can also be used to trickle-charge 12 volt car batteries.

	TYPICAL	MAXIMUM
Output Voltage	13.6 ± 2VDC	13.6 ± 3VDC
Line/Load Regulation	20 mV	50 mV
Ripple/Noise	2 mV RMS	5 mV RMS
Transient Response	20 uSec	
Current Continuous	8 Amp	
Current Limit	12 Amp	
Current Foldback	2.5 Amp	
Overvoltage Protection	14.5 V	15 V

Case 4 1/2" (H) x 7 1/2" (W) x 5 1/2" (D) Shipping Weight: 9.5 lbs.

ALSO AVAILABLE AS MODEL 108RA WITHOUT METER AND OVERVOLTAGE PROTECTION.

MODEL 104R

NPC 6 Amp Power Supply Regulated. Solid State. Dual Overload Protection.



Converts 115 volts AC to 13.6 volts DC ± 200 millivolts. Handles 4 amps continuous and 6 amps max. Ideally suited for applications where excellent DC stability is important, such as CB transmission, small Ham radio transmitter, and high quality eight-track car stereos. Can be used to trickle-charge 12 volt car batteries.

	TYPICAL	MAXIMUM
Output Voltage	13.6 ± 2VDC	13.6 ± 3VDC
Line/Load Regulation	20 mV	50 mV
Ripple/Noise	2 mV RMS	5 mV RMS
Transient Response	20 uSec	
Current Continuous	4 Amp	
Current Limit	6 Amp	
Current Foldback	2 Amp	

Case 3 1/2" (H) x 5" (W) x 6" (D) Shipping Weight: 6 lbs.



MODEL 102

NPC 2.5 Amp Power Supply. 4 Amp Max. Solid State. Overload Protected.

Functions silently in converting 115 volts AC to 12-volts DC. 2.5 amps continuous, 4 amps max. Enables anyone to enjoy CB radio, car 8-track cartridge, cassette tape player or car radio in a home or office.

	TYPICAL	MAXIMUM
Continuous Current (Full Load)	2.5 Amp	2.5 Amp
Output Voltage (No Load)	16 V max	16 V max
Output Voltage (Full Load)	12 V min	12 V min
Filtering Capacitor	5,000 uF	5,000 uF
Ripple (Full Load)	6 V RMS	6 V RMS
Short Circuit Protection	Thermal Breaker	Thermal Breaker

Case 3" (H) x 4" (W) x 5 1/2" (D) Shipping Weight: 4 lbs.

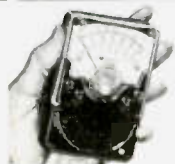

- General Multi-purpose V-O-Ms
- Drop Resistant
- Hand Size
- Model 310 V-O-M
- Type 3

1. Drop-resistant, hand-size V-O-M with high-impact thermoplastic case.
2. 20,000 Ohms per volt DC and 5,000 Ohms per volt AC; diode overload protection with fused Rx1 Ohms range.
3. Single range switch; direct reading AC Amp range to facilitate clamp-on AC Ammeter usage.

RANGES

DC Volts: 0-3-12-60-300-1,200 (20,000 Ohms per Volt).

AC Volts: 0-3-12-60-300-1,200 (5,000 Ohms per Volt).
Ohms: 0-20k-200k-2M Ω -20M Ω (200 Ohm center scale on low range).

DC Microamperes: 0-600 at 250 mV.
DC Milliamperes: 0-6-60-600 at 250 mV.
Accuracy: ± 3% DC; ± 4% AC; (full scale).
Scale Length: 2-1/8"

*Dealer Programs
NOW Available*

Meter: Self-shielded; diode overload protected; spring backed jewels.
Case: Molded, black, high impact thermoplastic with slide latch cover for access to batteries and fuse, 2-3/4" w x 1-5/16" d x 4-1/4" h.
Batteries: NEDA 15V 220 (1), 1 1/2V 910F (1): Complete with 42" leads, alligator clips, batteries and instruction manual. Shpg. Wt. 2 lbs.

Model 310 Cat. No. 3018 \$53.00

TUFTS RADIO CATALOG TUFTS RADIO

KLM RF Power Amplifiers



- A simple, add-on-immediately RF amplifier.
 - Merely coax-connect amplifier between antenna and transceiver.
 - No tuning! Efficient strip-line broad band design.
 - Automatic! Internal RF-sensor-controlled relay connects amplifier whenever transmitter is switched on.
- Highest quality, American-made "brand" transistors are fully protected for VSWR, short and overload, reverse polarity. Highly effective heat sinking assures long
- Manual, remote-position switching is optional.
- Models for 6,2,1¼ meters, 70CM amateur bands plus MARS coverage.
 - Two types: **Class C** for FM/CW. **Linear** for SSB/AM/FM/CW.
 - Negligible insertion loss on receive.
 - American made by KLM.
- life, reliable performance. Black anodized containers...exclusive KLM extrusions. **have seven, full length fins on both sides!**

FREQ. (MHz)	MODEL NUMBER	PWR INP. (watts)	NOM. PWR OUT. (watts)	NOM. CUR. (amps) †	SIZE	PRICE	FREQ. (MHz)	MODEL NUMBER	PWR INP. (watts)	NOM. PWR OUT. (watts)	NOM. CUR. (amps) †	SIZE	PRICE	FREQ. (MHz)	MODEL NUMBER	PWR INP. (watts)	NOM. PWR OUT. (watts)	NOM. CUR. (amps) †	SIZE	PRICE
50-54	PA4-80AL	4	80	10A	C*	164 95	144-148	PA10-80BL	5-15	80	10	C*	159 95	400-470	PA2-40C	1-4	40	7	C*	149 95
144-148	PA2-12B	1-4	12	2	A	59 95	..	PA10-140B	5-15	140	18	D*	199 95	..	PA10-35C	5-15	35	6	B*	119 95
..	PA2-70B	1-4	70	10	C*	159 95	..	PA10-140BL	5-15	140	18	D*	215 95	..	PA10-35CL	5-15	35	6	B*	139 95
..	PA2-70BL	1-4	70	10	C*	169 95	..	PA10-160BL	5-15	160	22	D*	229 95	..	PA10-70C	5-15	70	13	D*	229 95
..	PA2-140B	1-4	140	20	D	229 95	..	PA30-140B	15-45	140	15	D*	179 95	..	PA10-70CL	5-15	70	18	D*	249 95
..	PA10-40B	5-15	40	5	B	83 95	..	PA30-140BL	15-45	140	15	D*	189 95	<small>SIZES: Inches: *A. 2.25 x 5-2 *B. 6.5 x 5-2 *C. 6.5 x 7.5 x 2 *D. 6.5 x 10 x 2 MM: 57 x 127 x 50.8 165 x 127 x 50.8 165 x 190 x 50.8 165 x 254 x 50.8 †LINEAR AMPLIFIER †At 13.5VDC.</small>						
..	PA10-40BL	5-15	40	5	B*	94 95	219-226	PA2-70BC	1-4	70	10	C*	169 95							
..	PA10-70B	5-15	70	8	C*	139 95	..	PA10-60BC	5-15	60	8	C	149 95							
..	PA10-70BL	5-15	70	8	C*	149 95	..	PA30-120BC	15-45	120	15	D*	189 95							

TEMPO

Dealer Programs NOW Available



THE TEMPO 2020

- Phase lock-loop (PLL) oscillator circuit minimizes unwanted spurious responses.
- Hybrid Digital Frequency Presentation.
- Advanced Solid-state design...only 3 tubes.
- Built-in AC and 12 VDC power supplies
- CW filter standard equipment...not an accessory
- Rugged 6146-B final amplifier tubes
- Cooling fan standard equipment...not an accessory.
- High performance noise-blanker is standard equipment...not an accessory.
- Built-in VOX and semi-break in CW keying.
- Crystal Calibrator and WWV receiving capability
- Microphone provided.
- Dual RIT control allows both broad and narrow tuning
- All band 80 through 10 meter coverage
- Multi-mode USB, LSB, CW and AM operation.
- Extraordinary receiver sensitivity (3u S/N 10 db) and oscillator stability (100 Hz 30 min. after warm-up)
- Fixed channel crystal control on two available positions
- RF Attenuator
- Adjustable ALC action
- Phone patch in and out jacks.
- Separate PTT jack for foot switch
- Built-in speaker
- The TEMPO 2020...\$750 00
- Model 8120 external speaker...\$29 95 Model 8010 remote VFO...\$130 00

ATLAS 350-XL



- ALL SOLID STATE
- SSB TRANSCEIVER
- 350 WATTS P.E.P. OR CW INPUT
- 10 THROUGH 160 METER COVERAGE



Illustrated with optional AC supply, Auxiliary VFO, and Digital Dial.

The all new Atlas 350-XL has all the exciting new features you want, plus superior performance and selectivity control never before possible. Price: \$995.00

- 10-160 METERS
- Full coverage of all six amateur bands in 500 kHz segments. Primary frequency control provides highly stable operation. Also included is provision for adding up to 10 additional 500 kHz segments between 2 to 22 MHz by plugging in auxiliary crystals.
- 350 WATTS
- P.E.P. and CW input. Enough power to work the world barefoot!
- IDEAL FOR DESKTOP OR MOBILE OPERATION
- Measuring just 5 in. high x 12 in. wide x 12½ in. deep, and weighing only 13 pounds, the Atlas 350-XL offers more features, performance and value than any other transceiver, regardless of size, on the market today!

- 350-PS matching AC supply — \$225.00
- DD-6XL plug-in digital dial readout — \$229.00
- 305 plug-in auxiliary VFO — \$155.00
- 311 plug-in crystal oscillator — \$135.00
- DMK-XL plug-in mobile mounting kit — \$65.00

TEMPO VHF/ONE PLUS



The Tempo/ONE PLUS offers full 25 watt output or a selectable 3 to 15 watt low power output, remote tuning on the microphone, sideband operation with the SSB/ONE adapter, MARS operation capability, 5 KHz numerical LED, and all at a lower price than its time tested predecessor... the Tempo VHF ONE.

The Tempo VHF/One Plus is a VHF/FM transceiver for dependable communication on the 2 meter amateur band • Full 2 meter coverage, 144 to 148 MHz for both transmit and receive • Full phase lock synthesized (PLL) • Automatic repeater split — selectable up or down • Two built-in programmable channels • All solid state • 800 selectable receive frequencies with simplex and +600 kHz transmit frequencies for each receive channel. Price: \$399.00



TEMPO ONE AC/ONE VFO/ONE HF Transceiver. 80-10M. USB, CW & AM — \$399.00
 Power supply for TEMPO ONE — \$99.00
 External VFO for TEMPO ONE — \$199.00

TEMPO SSB/ONE SSB adapter for the Tempo VHF/One
 • Selectable upper or lower sideband. • Plugs directly into the VHF/One with no modification. • Noise blanker built-in. • RIT and VXO for full frequency coverage. • \$225.00

Wilson Electronics Corp.



WE-800
2 METER PORTABLE AMATEUR 800 CHANNEL SYNTHESIZED RADIO
 1 AND 12 WATTS RF OUTPUT
 144 - 148 MHz
\$439.00

Riding the crest of the new wave of multi-channel two-meter rigs is the Wilson WE-800. Designed as an all-purpose mobile or portable unit, the WE-800 is loaded with enough features to satisfy even the most discriminating amateur. The "800" is for channels, from 144 to 148 MHz in 5 KHz steps, up or down 500 KHz for your local repeater. There are even provisions for pre-programming five of your favorite frequencies or changing to two optional offsets, in case your area repeater is non-standard. Add to these features; internal rechargeable power pack optional (uses 10 AA NiCad cells, not included), detachable rubber flex antenna, built-in S-meter/output indicator, built-in high-low power option switch (1 or 12 watts, when used mobile or base), built-in connectors for external antenna, speaker and power. Whether you're just getting your feet wet on two-meters, or a seasoned amateur, you'll find the WE-800 to be the most light-weight, versatile base/mobile/portable rig on the market today.

The WE-800 comes complete with plug-in speaker-microphone, mobile mounting bracket/handle, rubber flex antenna, 12V DC Charger Cord, instruction booklet and 90 day limited warranty. Rechargeable internal battery pack optional.

GENERAL SPECIFICATIONS

- Frequency range: 144.000 - 147.995 MHz
- No. of channels: 799 @ 5 kHz, or 399 @ 10 kHz
- Operating mode: Direct frequency modulation
- Type of communication: Simplex or transmitter offset 1600 KHz
- Operating voltage: 13.6 VDC negative ground (10 to 15 VDC range)
- Current drain: Transmit: 290 mA @ 1 watt output
2 amps @ 12 watt output
Receive: 45 mA squelched
250 mA at full AF rated output
- Antenna impedance: 50 ohms nominal
- Size: 8-1/4 x 6 3/4 x 1-7/8 inches (209.6 x 171.5 x 47.6 mm)
- Weight: 1 lb. 15 oz. (4.13 Kg.)
(3 lb. 11 oz. (8.16 Kg.) with batteries)
- Frequency determination method: CMOS phase locked loop
- Offset Option: Two optional offset TX positions also available

PERFORMANCE SPECIFICATIONS

- Transmitter**
- RF output: Hi... 12 W
Lo... 1 W
 - Frequency stability: .001% -10°C ~ +60°C
 - Local oscillator: Simplex... 21.4 MHz
Offset +600 kHz... 22.2 MHz
600 kHz... 20.8 MHz
(Options for two more offsets other than 600 kHz)
 - Harmonics & Spurious: More than 60 dB below carrier
 - Deviation: ±5 kHz
 - Audio response: +1; -3 dB of 6 dB/Octave
Pre-emphasis characteristics from 300 to 3000 Hz

Receiver

- Receiving system: Double conversion Superheterodyne
- First local oscillator: PLL output of (F-21.4 MHz)
- First IF: 21.4 MHz (with 2 pole monolithic filter)
- Second IF: 455 kHz (with a ceramic filter)
- Stability: .001% -10° ~ +60°C
- Sensitivity: .3 µV for 20 dB quieting
- Squelch sensitivity: .2 µV
- Spurious and Image Rejection: Better than 80 dB
- Intermodulation: 60 dB
- Selectivity: ±6 kHz at 3 dB
±15 kHz at 80 dB
- Channel Spacing: 15 kHz
- Audio Output: 2 W (10% distortion to 4 ohm)

the First Name in Amateur Hand-Helds

New 2 Meter Mark II and Mark IV

The new arrivals to the Wilson family of quality high performing hand-held radios are the small American-made MARK II and MARK IV. The ultimate hand-held for the amateur who demands quality, performance and value.

As the smallest size hand-helds ever marketed, the radios feature excellent adjacent channel selectivity, and intermod/image rejection. The attractive blue-gray Lexan® outer case is rugged and durable.

Features:

- 6 channel operation • individual trimmers on all TX/RX Xtals
- microswitch control of TX/RX
- includes improved rubber flex antenna and one pair Xtals 146.52/.52 installed
- built-in microswitch speaker-mic
- 90 day warranty
- BNC type antenna connector
- can be modified for MARS or CAP
- inexpensive rechargeable Ni-Cad battery power source
- easily accessible circuitry
- a variety of accessories and tone options are available.



Illustrated is the Mark IV 4 watt unit with optional touch tone pad.

Mark II (2.5 watt) \$199.95; Mark IV (4 watt) \$239.95

The standard of Amateur Hand-Helds is Wilson's line of VHF and UHF radios as follows:

Three models in the 144-148 range include the 1402SM - 2.5 watt, 1405SM - switchable 1 and

5 watt, and 1407SM - 7 watt units, one unit in the 220 band: Model 2202SM - 2.5 watt, and Model 4502SM - switchable 1 and 1.8 watt unit is in the 450 range.

COMMON FEATURES

- 6 Channel Operation
- Individual Trimmers on all TX/RX Xtals
- All Xtals plug in
- Microswitch control of TX/RX
- Rubber Flex Antenna furnished
- Convenient Size... Fits in hip pocket
- 90 Day Warranty
- Can be modified for MARS or CAP
- Built for rugged use
- Inexpensive power source with rechargeable Ni-Cad
- Easily accessible circuitry
- One pair Xtals furnished with each radio installed.

1402SM: 146.52/.52 4502SM: 446.00/.00
 1405SM: 146.52/.52 2202SM: 223.50/.50

HAND-HELD OPTIONS AND ACCESSORIES

- **LEATHER CARRYING CASE**
 - LC-1 for 1402 SM - \$18.95
 - LC-3 for Mark II, IV - \$16.95
 - LC-2 - all others - \$18.95

- **110V-AC DESK BATTERY CHARGER**
 For new units Mark II, IV - use the Model BC-2; for Models 1402, 1405, 1407, 2202 and 4502, use Model BC-1. \$40.95

- **WALL BATTERY CHARGER**
 110 V-AC Charger... use WC-12 (\$19.95) for 1402, 1405, 1407, 2202, 4502; use WC-14 (\$15.95) for Mark II, IV.

- BC12 - \$14.95
CIGARETTE LIGHTER MOBILE POWER PLUG

- **SPEAKER MIC**
 SM1 - for Models 1402, 1405, 1407, 2202, 4502.
 SM3 (Mark II, Mark IV)
 SM 2 for Models 1402, 1405, 1407, 2202, 4502. (\$30.95).

- **RECHARGEABLE BATTERY PACKS**
 Use the following Ni-Cad Packs for the unit you select:
 BP-1 - 10 loose cells - 500 mA (1402, 1405) - \$18.95
 BP-2 - strapped cells - 600 mA (1405, 2202, 4502) - \$24.95
 BP-4 - Mark II, Mark IV pack - \$20.95
 BP-7 - 1407 SM high power pack - \$24.95

- **MOBILE AMPLIFIER/CHARGER**
 The Model 1420A is a mobile amplifier/charger for the hand-held models 1405SM and 1407SM. Produces 20 watts on the 1405 and 25 watts on the 1407 when engine is charging above 12V-DC, and charges internal Ni-Cad battery pack. \$129.00

- Other options include:
- Touch Tone® Pad (installed only)
 - XF-1 Monolithic Filter (1402, 1405, 1407)
 - TE-1 Eone Encoder
 - TE-2 Encoder/Decoder
 - BNC Rubber Duck Antenna
 - TNC Rubber Duck Antenna

TUFTS RADIO CATALOG TUFTS RADIO

BIRD

The indispensable BIRD model 43 THRULINE® Wattmeter



Read RF Watts Directly.

0.45-2300 MHz, 1-10,000 watts ±5%, Low Insertion VSWR—1.05.

Unequalled economy and flexibility: Buy only the element(s) covering your present frequency and power needs, add extra ranges later if your requirements expand.

Dealer Programs NOW Available

Table 1 STANDARD ELEMENTS (CATALOG NUMBERS)

Power Range	Frequency Bands (MHz)				
	2-30	25-60	100-250	200-500	400-1000
5 watts	—	5A	5C	5D	5I
10 watts	—	10A	10C	10D	10I
25 watts	—	25A	25C	25D	25E
50 watts	50H	50A	50C	50D	50E
100 watts	100H	100A	100C	100D	100E
250 watts	250H	250A	250C	250D	250E
500 watts	500H	500A	500C	500D	500E
1000 watts	1000H	1000A	1000C	1000D	1000E
2500 watts	2500H	—	—	—	—
5000 watts	5000H	—	—	—	—

MODEL

43

PRICE

\$120

Elements (Table 1) 2-30 MHz 42

Elements (Table 1) 25-1000 MHz 36

Carrying case for Model 43 & 6 elements 26

Carrying case for 12 elements 16

(Specify Type N or SO239 connectors)

THRULINE® RF Directional Wattmeter

model 4431

Power Rating 5000 watts - 2 to 30 MHz
 1000 watts - 30 to 1000 MHz*
 Impedance 50 ohms nominal
 Insertion VSWR 1.07 to 1.0 max.*
 (with N Connectors)
 Insertion Loss 0.1 dB Max. (2 - 512 MHz)
 0.2 dB Max. (512 - 1000 MHz)*
 RF Coupling 15 to 70 dB
 Accuracy of Wattmeter ± 5% of F.S.
 RF Coupling Connector Female BNC
 Primary Line Connector Female N
 (Normally Supplied)
 (Other QC Connectors can be supplied)
 Price \$175 Element \$30 - \$75

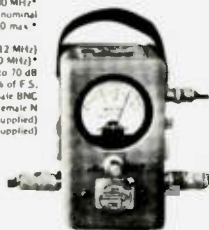

- Model 43 Power Measurement Versatility
- Variable RF Signal Sampler (built-in)

Model 4431 provides an RF signal sample for use with counters, oscilloscopes, spectrum analyzers, etc., at the same time a power measurement is made.

Amplitude of the RF sample is adjustable by depth-of-insertion control knob on the front of the wattmeter.

Model 4431 uses the same Plug-in Elements as the Model 43 (within its frequency and power limitations).

THE BIG SIGNAL

UNADILLA "W2AU" BALUN

\$14.95



- World Famous Among Ham, Armed Forces, Communications Industry, Why?
- Each BALUN "KW PEP tested"
 - Lightning Arrestor
 - 600" Pull - No Insulator needed
 - Only 1/2" and 6" in diameter
 - Reduces TVI
 - Improves F/B ratios
 - Weatherproof
 - Complete instructions
 - Antenna Length Table

THE OLD RELIABLE

REYCO "W2VS" ANTENNA COILS

\$21.95



- Turns Your Antenna Into A Multi-Band Professional Demand Rec'd. Why?
- Precision Matched Pairs
 - Frequency Matched Pairs
 - One 1/2" and 3" in diameter
 - Plugged Over 300+ Pull
 - Weathered
 - Models for 10, 15, 20, 40 Meters
 - Complete Instructions
 - Multi-Band Lengths
 - Tuning Data

DEALERS WANTED - NOW OVER 200 WORLD-WIDE

SERIES 31 - BNC CONNECTORS

Amphenol's BNC connectors are small, lightweight, weatherproof connectors with bayonet action for quick disconnect applications.

Shells, coupling rings and male contacts are

accurately machined from brass. Springs are made of beryllium copper. All parts in turn are ASTRO-plated® to give you connectors that can take constant handling, high temperatures and resist abrasion.

BNC BULKHEAD RECEPTACLE 31-221-385 UG-1094
 Mates with any BNC plug. Receptacle can be mounted into panels up to 104" thick. \$1.25

BNC (M) TO UHF (F) ADAPTER 309-2900-385 UG 255
 Adapts any BNC jack to any UHF plug. \$3.63

DOUBLE MATE ADAPTER 83-877-385 Both coupling rings are free turning. Connects 2 female components. \$2.72

JACK ADAPTER \$1.95 575-102-385 Adapts 83-1SP-385 to Motorola type auto antenna jack or pin jack.

PANEL RECEPTACLE 83-1R-385 SO239 Mounts with 4 fasteners in 21/32" diameter hole. \$1.17

PANEL RECEPTACLE 83-878-385 SO239SII Mounts in single 21/32" diameter hole. Knurled lock nuts prevent turning. \$1.59

BNC ANGLE ADAPTER 31-009-385 UG-306 Adapts any BNC plug for right angle use. \$4.23

BNC TEE ADAPTER 31-008-385 UG-274 Adapts 2 BNC plugs to 31-003-385 or other female BNC type receptacle. \$4.56



BNC(F) TO UHF (M) ADAPTER 31-028-385 UG-273
 Adapts any BNC plug to any UHF jack. \$2.39

PUSH-ON 83-5SP-385 Features an unthreaded, springy shell to push fit on female connectors. \$2.27

LIGHTNING ARRESTOR 575-105-385 Eliminates static build-up from antenna. Protects your valuable equipment against lightning damage. \$4.80

BNC PLUG 31-002-385 UG-88 Commonly used for communications antenna lead cables. For RG 55/U & RG 58/U cables. \$1.59

BNC STRAIGHT ADAPTER 31-219-385 UG-914 1 9/32" long, allows length of cables to be joined. Mates with BNC plugs. \$2.12

BNC PANEL RECEPTACLE 31-003-385 UG-290 Mounts with 4 fasteners in 29/64" diameter hole. \$1.74



83-877-385



SO239



UG-290



SO239SH

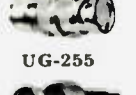

UG-306

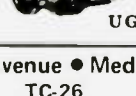

UG-255

PL-259 ... 90¢
 UG-175 (Adapter for RG 58U) ... 25¢



UG-274



83-5SP-385



575-105-385



UG-88



UG-914



ALL BAND PREAMPLIFIERS



- 6 THRU 160 METERS
- TWO MODELS AVAILABLE
- RECOMMENDED FOR RECEIVER USE ONLY
- INCLUDES POWER SUPPLY

MODEL PLF employs a dual gate FET providing noise figures of 1.5 to 3.4 db., depending upon the band. The weak signal performance of most receivers as well as image and spurious rejection are greatly improved. Overall gain is in excess of 20 db. Panel contains switching that transfers the antenna directly to the receiver or to the Preamp. Model PLF 117V AC, 60 Hz. Wired & Tested \$44.00

Model PCLP Uses nuvistor \$44.00

TUFTS RADIO CATALOG

DUST COVERS

•Our covers are custom designed to protect all popular equipment models. •They are made of rugged high quality vinyl and are machine stitched for extra strength. •They add that professional look to your station. •Most covers are priced at \$3.95.

From Texas... "I would like to say how surprised I was as to how much quality you put into your covers" ... Mr. Mark Canada

From Calif. ... "Not only did they fit exactly as specified, but the quality of workmanship is most satisfactory" ... Mr. Dwight Baum

From Pa. ... "That special order cover is excellent! Your the greatest!" ... Mr. Rod Phillips



HI-Q BALUN

- For dipoles, yagis, inverted vees, doublets & quads
- For full legal power & more
- Puts power in antenna
- Broadbanded 3-40Mhz.
- Small, light, weather-proof
- 1:1 Impedance ratio
- Replaces center insulator
- Helps eliminate TVI
- Fully Guaranteed



\$9.95
PPD
U.S.A.

Van Gorden Engineering

Speak up.

We know all about up. In fact, we're number one from the ground up when it comes to amateur communications towers. We've been building them for HAMS for more than two decades.

Whether you're thinking crank up, guyed or free-standing, check with us first. We're Tri-Ex. Reliable. Dependable.

When we say number one from the ground up, we're talking about towers like Tri-Ex's new "Big W" shown here. It's a free-standing crank-up with a height of 80-ft. providing good DX capability at low cost. Ideal for serious HAMS.

Write today. We'll help you speak up. As high as you want to go. Act now.

Model W51
(51' Self-supporting)
\$850.00



Ideal for Receivers - Converters
High Gain - Low Noise

DELUXE RECEIVER PREAMPLIFIERS

FEATURES:

- Small size
- Increases sensitivity of most receivers
- Gold-plated copper shielding
- Single or double stage models
- Diode protected, dual-gated FETs

SPECIFICATIONS:

Power: 6 VDC to 18 VDC (12 VDC recommended)

Size: a. Single stage: 1" x 1 1/4" x 1/2"
b. Double stage: 2" x 1 1/4" x 1/2"

MOSFET: FT 0601, 500 MHz, dual-gate diode protected MOSFET

When ordering be sure to specify
1. frequency of operation
2. single or double band stage
3. kit or assembled version

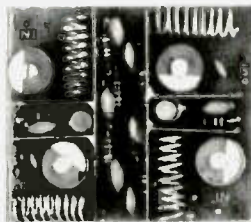

FREQ. (MHz)	USE	STAGES	DELUXE PREAMPLIFIER			
			GAIN dB	NF dB	KIT	WIRED
14, 21 or 28	HIGH FREQ.	SINGLE	25	2	\$11.50	\$15.50
		DOUBLE	48	2	\$21.50	\$28.50
28 to 30	OSCAR SPECIAL	SINGLE	25	2	\$13.50	\$17.50
		DOUBLE	48	2	\$25.50	\$32.50
50 to 54	6 METER	SINGLE	25	2	\$11.50	\$15.50
		DOUBLE	48	2	\$21.50	\$28.50
108 to 144	VHF AIRCRAFT	SINGLE	20	2.5	\$10.50	\$14.50
		DOUBLE	40	2.5	\$19.50	\$26.50
135 to 139	SATELLITE	SINGLE	20	2.5	\$10.50	\$14.50
		DOUBLE	40	2.5	\$19.50	\$26.50
144 to 148	2 METER	SINGLE	20	2.5	\$10.50	\$14.50
		DOUBLE	40	2.5	\$19.50	\$26.50
146 to 174	HIGH BAND	SINGLE	20	2.5	\$10.50	\$14.50
		DOUBLE	40	2.5	\$19.50	\$26.50
220 to 225	1 1/4 METER	SINGLE	18	2.5	\$10.50	\$14.50
		DOUBLE	35	2.5	\$19.50	\$26.50
225 to 300	UHF AIRCRAFT	SINGLE	15	2.5	\$10.50	\$14.50
		DOUBLE	30	2.5	\$19.50	\$26.50
1 thru 30	HF BROADBAND		19-36	3	—	\$19.95

BATTERY WIRE-WRAPPING TOOL MODEL BW-630



\$34.95

STRIP / WRAP / UNWRAP TOOL MODEL WSU-30



\$5.95

DIP IC INSERTION TOOL WITH PIN STRAIGHTENER MODEL INS-1416



\$3.49

WIRE DISPENSER MODEL WD-30-B

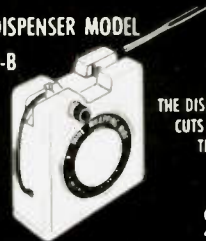

THE DISPENSER WHICH CUTS AND STRIPS THE WIRE

\$3.45

ok wire wrapping center



Model MB II \$285 (with Balun) \$315

The NEW NYE
"Matchmaker!"
VIKING MB II

Antenna Impedance-matching Network assures maximum perfectly matched power to your antenna!

MB II provides:

- Constant SWR monitoring. • Precision tuning of final amp. • Harmonic suppression.
- Receiver input impedance-matching. • Maximum power transfer to antenna. • Continuous frequency coverage 1.6 to 30 MHz. • Precision tuning of any wire 1/8 wavelength or longer, with SWR of 1:1.

MB II features:

- Finest quality, made-in-USA components. • Large, precision, easy-to-read dials with 360 readout. • Optional 3000 watt Balun for twin lead antennas.



WM. M. NYE COMPANY, INC.



**model 333
dummy load
wattmeter**

**Favorite Lightweight Portable—250 WATT RATING—
Air Cooled**

Ideal field service unit for mobile 2-way radio—CB, marine, business band. Best for QRP amateur use, CB, with zero to 5 watts full scale low power range.

• specifications

Frequency Range	DC to 300 MHz
VSWR	Less than 1.3:1 to 230 MHz
Power Range	250 watts intermittent
Wattmeter Ranges	0-5, 0-50, 0-125, 0-250
Connector	SO-239
Size	4" x 7" x 8"
Shipping Weight	2 lbs.
Price	\$98.50



—model 374 dummy load wattmeter—

Top of the Line—1500 WATT RATING—Oil Cooled

Our highest power combination unit. Rated to 1500 watts input (intermittent). Meter ranges are individually calibrated for highest accuracy.

• specifications

Frequency Range	DC to 300 MHz
VSWR	Less than 1.3:1 to 230 MHz
Power Range	1500 watts DC intermittent. Warning light* signals maximum heat limit.
Wattmeter Ranges	0-15, 0-50, 0-300, 0-1500
Input Connector	SO-239 (hermetically sealed)
Size	4-3/4" x 9" x 10-1/4"
Shipping Weight	12 lbs.
Price	\$215.00

LITTLE DIPPER



**model 331A
transistor dip meter—**

Portable RF single generator, signal monitor, or absorption wavemeter. Lightweight (1 pound, 6 ounces with all coils), battery-powered unit is ideal for field use in testing transceivers, tuning antennas, etc. Can also be used to measure capacity, inductance, circuit Q, and other factors. Indispensable for experimenters, it is easily the most versatile instrument in the shop. Continuous coverage from 2 MHz to 230 MHz in seven ranges.

Unit consists of a transistorized RF dip oscillator and 100-microampere meter circuit. Meter circuit uses a single-transistor DC amplifier with a potentiometer in the emitter circuit to control meter sensitivity. A 3-position slide switch connects the meter circuit to the oscillator for dip measurements, to a diode for absorption wavemeter peak measurements, or provides audio modulation of the RF signal.

Frequency dial has a calibrated reference point for Q and bandwidth measurements. Each coil has its own frequency dial—there's no confusion with multiple markings or small, hard-to-read scales near the center of the dial.

• specifications

Frequency Coverage	2 MHz to 230 MHz in 7 overlapping ranges by plug-in coil assemblies: 2 MHz—4 MHz, 4 MHz—8 MHz, 8 MHz—16 MHz, 16 MHz—32 MHz, 32 MHz—64 MHz, 50 MHz—110 MHz, 110 MHz—230 MHz
Accuracy	±3%
Modulation	1000 Hz, 25% to 40%
Power	9 volt transistor battery, Burgess 2U6 or equivalent
Size	7" x 2-1/4" x 2-1/2"
Shipping Weight	1 lb., 6 oz.
Price	\$120.00



BARKER & WILLIAMSON, INC.



**Economy High Power Load—1500 WATT RATING—
Oil Cooled
model 384 dummy load**

For high power when all you need is the load.

• specifications

Frequency Range	DC to 300 MHz
VSWR	Less than 1.3:1 to 230 MHz
Power Range	1500 watts intermittent. Warning light* signals maximum heat limit.
Connector	SO 239 (hermetically sealed)
Size	4-3/4" x 9" x 10-1/2"
Shipping Weight	12 lbs.
Price	\$94.50



**High Power—1000 WATT RATING—Oil Cooled
model 334A dummy load wattmeter.**

Our most popular combination unit. Handles full amateur power. Meter ranges individually calibrated. Can be panel mounted.

• specifications

Frequency Range	DC to 300 MHz
VSWR	Less than 1.3:1 to 230 MHz
Power Range	1000 watts CW intermittent. Warning light* signals maximum heat limit.
Wattmeter Ranges	0-10, 0-100, 0-300, 0-1000
Input Connector	SO 239 (hermetically sealed)
Size	4-3/4" x 9" x 10-1/4"
Shipping Weight	12 lbs.
Price	\$174.00

WIDE RANGE ATTENUATOR



Model 371-1

Protect your receiver or converter from overload, or provide step attenuation of low-level RF signals from signal generators, preamplifiers, or converters. Seven rocker switches provide attenuation from 1 dB to 61 dB in 1 dB steps. Switches are marked in dB, 1 2 3-5-10-20-20. Sum of actuated switches (IN position) gives attenuation. With all switches in OUT position, there is NO insertion loss. Attenuator installs in coaxial line using UHF connectors.

• specifications

Power Capacity	1/4 watt
VSWR	1.3:1 maximum, DC to 225 MHz
Impedance	50 ohms
Accuracy	1 dB/dB, DC to 60 MHz 0.1 dB/dB -0.5 dB, DC to 160 MHz 0.1 dB/dB -1.0 dB, DC to 225 MHz
Size	8-1/2" x 2-1/2" x 2-1/4"
Shipping Weight	1-1/2 lbs.
Price	\$49.50

TUFTS RADIO CATALOG

• Handle full 200 watts • low-low V.S.W.R. • Deliver 3 dB gain and more! • Pick the one that best fits your needs:

Larsen Kūlrod® Antennas

MAGNETIC MOUNT
stays put even at 100 mph!



MM-JM-150 for 144 MHz use }
MM-JM-220 for 220 MHz use } **Only \$38.50**
MM-JM-440 for 440 MHz use } complete

TRUNK LID MOUNT

No holes and low silhouette too!
TLM-JM-150 for 144 MHz use }
TLM-JM-220 for 220 MHz use } **Only \$38.50**
TLM-JM-440 for 440 MHz use } complete



And 1/4 wave antenna for trunk and magnetic mount — \$18.50

ROOF or FENDER MOUNT

Goes on quick and easy in 3/8" or 3/4" with fewest parts.

JM-150-K for 144 MHz use }
JM-220-K for 220 MHz use } **Only \$31.50**
JM-440-K for 440 MHz use } complete



And 1/4 wave antenna for roof and fender mounts \$11.50

Above antennas all complete with mounting hardware, coax, connector plug, allen wrench and complete instructions.

model 372 CLIPREAMP

Get maximum legal modulation without danger of splatter. Solid state speech preamplifier and clipper for transmitters, public address systems, and tape recorders needs no external power.

- specifications
- Input Impedance 100,000 ohms
- Input Level 5 millivolts to 20 millivolts
- Voltage Gain 10 dB
- Output Level 60 millivolts
- Output Impedance 50,000 ohms
- Power 9 watt transistor battery, Burgess ZUB or equivalent
- Size 2 3/4" x 3" x 4 1/2"
- Shipping Weight 7 oz
- Connectors Terminal strip



Model 372 — \$27.50

COAXIAL ANTENNA CHANGEOVER RELAY

model 377

Economical and reliable. Can be operated from VOX circuit for completely automatic operation or from PTT or manual T-R switch. Receiver input is automatically grounded when the relay is in the Transmit position. Wide AC operating voltage range and low operating current.

- specifications
- Power Rating 1000 watts CW (2000 watts SSB)
- VSWR Less than 1.15, 1 DC to 150 MHz
- Power Requirements 0.815 Ampere, 48 to 130 volts AC
- Connectors UHF Type 50 238
- Dimensions 3 1/2" x 1 1/2"
- Shipping Weight 1 lb.



Model 377 — \$17.95

UNIVERSAL HYBRID COUPLER II PHONE PATCH

model 3002W and model 3001W

Connect your station to the telephone lines. Five switch selectable modes give complete flexibility for patching the station to the line and for tape recording and playback to or from the line or the station. The hybrid circuit provides for effortless VOX operation of the phone patch. A built-in *Compreamp* speech preamplifier/limiter (in Model 3002W) increases the level of weak phone signals and also prevents overmodulation when the local telephone is used as the station microphone. (The *Compreamp* also functions as a preamplifier/limiter with the station microphone, if desired.)

- specifications
- Inputs from: Line 500 ohms, Receiver 4 ohms, Microphone High impedance (50,000 ohm) crystal or dynamic, Tape Recorder 4 ohms
- Outputs to: Transmitter 50,000 ohms, Receiver Speaker 4 ohms, Tape Recorder 0.5 megohm
- Size 8-1/2" x 7-1/2" x 3"
- Shipping Weight 3-1/2 lbs.
- Power 9 watt battery, Burgess ZUB or equivalent
- Connectors Phone



Model 300 2W with *Compreamp* — \$125.00

Model 300 1W without *Compreamp* — \$85.00



BARKER & WILLIAMSON, INC.

Model 359 — \$37.50



Increase your transmitter's effective speech power up to four times. Or use it with your tape recorder or patch address system for improved performance. This two-stage Transistorized Audio Preamplifier/Limiter can be used with all types of transmitters. Powered by a long-lasting dry cell battery—no external power needed. Installs without any wiring changes in your transmitter. Just connect the *Compreamp* between your microphone (50,000 ohm dynamic or high impedance ceramic) and your transmitter's microphone input connector. Front panel rocker switch lets you bypass the *Compreamp* when you want to. Compression level is adjustable, too.

- specifications
- Input Impedance 100,000 ohms
- Input Level 5 millivolts to 20 millivolts
- Voltage Gain 10 dB
- Output Level 60 millivolts
- Output Impedance 50,000 ohms
- Power 9 watt transistor battery, Burgess ZUB or equivalent
- Size 2-3/4" x 3" x 4 1/2"
- Shipping Weight 6-1/2 oz.
- Connectors Terminal strip

COAXIAL SWITCHES AND ACCESSORIES

for antenna selection and RF switching

These high-quality switches have set the standard for the industry for years. Ceramic switches with silver alloy contacts and silver-plated conductors give unmatched performance and reliability from audio frequencies to 150 MHz.

B&W coaxial switches are designed for use with 52 to 75 ohm non-reactive loads, and are power rated at 1000 watts AM, 2000 watts SSB. Connectors are UHF type. Insertion loss is negligible, and VSWR is less than 1.2:1 up to 150 MHz.

Crosstalk (measured at 30 MHz) is -45 dB between adjacent outlets and -60 dB between alternate outlets.

Models are available for desk, wall, or panel mounting, and with or without protective grounding of inactive outputs. Radial (side-mounted) connector models can be either wall or panel mounted, axial (backplate-mounted) connector models are for panel mounting only, save panel space.

Use the selector chart below to choose the models you need.



Model 550A



Model 590



Model 590G



Model 551A



Model 592



Model 595

COAXIAL SWITCH SELECTOR CHART

Model	PRICE	Outputs	Connector Placement	Mounting			Automatic Grounding	Dial Plate	Remarks
				Panel	Wall	Desk			
375	18.95	6	Axial	x			x	Supplied	PROTAX switch. Grounds all except selected output circuit.
376	18.95	5	Radial	x	x		x	Supplied	PROTAX switch. Grounds all except selected output circuit. Sixth switch position grounds all outputs.
550A	14.00	5	Radial	x	x			DP 5	
550A-2	12.50	2	Radial	x	x			DP 2	
551A	17.50	2	Radial	x	x			DP 2	Special 2 pole, 2 position switch used to switch any RF device in or out of series connection in a coaxial line. See figure (over).
556	.95	-	-		x				Bracket only, for wall mounting of radial connector switches.
590	17.95	5	Axial	x				OP 5	
590G	17.95	5	Axial	x			x	Supplied	Grounds all except selected output circuit.
592	16.50	2	Axial	x				DP 2	
595	18.50	6	In-line		x	x	x		Grounds all except selected output circuit.

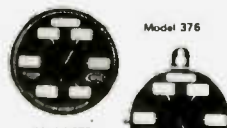

Model 376



Model 556A-2

TUFTS RADIO CATALOG TUFTS RADIO

PROGRAMMABLE CMOS KEYS



AUTEK RESEARCH
CALLS CQ WHILE YOU RELAX!

Also remembers name, QTH, contest exchanges, etc

MODEL MK-1

ONLY \$99.50 ppd. U.S.A.

Plus Sales Tax in Calif.

- 4 Messages
- Instant record or reprogram
- Designed for Novice, as well as CW "Pro" and Contest OP

An Advanced Programmable Keyer - Yet Priced Lower Than Many Ordinary Keyers

Programmable memory keyers are the biggest advance to come along in years for CW. When you use one, CW truly becomes FUN again! Until the MK-1, quality memory keyers cost \$150 to \$400. But now, anyone can afford a "miniature computer," instead of an ordinary keyer. It's an investment in enjoyable operation for years to come. And an incredible bargain at our breakthrough low price!

ADVANCED "MOS" MEMORY

- Just tap button to start any of four messages
- You record CQ, contest exchanges, name, QTH, or any thing you want in the four messages
- Record instantly by simply sending the message
- Play out recording as often as desired
- Change by simply recording over the old message. No factory programmed extra cost IC's to buy
- Large 1024 bit total memory stores about 100 characters. Each message holds about 25 characters, depending on character length and pauses, e.g., "CQ CQ DE W6DYD W6DYD CQ TEST K"
- "Combine CQ" switch combines 2 of the 4 messages for extra length of about 50 characters, e.g., "QTH IS LA LA NAME IS BILL BILL RIG HR IS KWES BEAM ES NEW MEMORY KEYS"
- REPEAT SWITCH repeats message forever until reset. Very useful for longer CQ's or leave a moderate pause at end of CQ. If no answer, the keyer automatically repeats the CQ until answered. YOU SIT BACK AND WAIT FOR A CALL!
- ADDED CONTEST FEATURES: Instant memory reset with button, or by tapping paddle when playing. Tapping message button restarts message

PLUS A GREAT AUTOMATIC KEYS

- Dot AND dash memories "forgive" your minor timing mistakes. Most keyers have just a dot memory or none at all. The MK-1 makes timing easier
- IAMBIC OPERATION: Squeezing dot and dash paddles produces alternate dots and dashes, making it easier to send letters such as C, F, K, Q, R, etc. Most keyers put out only dots, or only dashes when paddles are squeezed, making you work harder
- FULL CMOS construction. No TTL logic to heat up or draw heavy current. Battery operation if desired. (50 ma @ 9V, 60 ma @ 12 V, typical)
- SELF-COMPLETING characters. Jamproof
- Extensive RFI protection. 8-50 WPM
- Silent transistor output. No clicking relays to fail (Max. 300 V, 15 ma grid blocked rigs, #200 ma. cathode keyed rigs, at key)
- TRIGGERED CLOCK (except when recording) starts instantly at key closure. No confusing wait, or need for you to "keep time," as with many keyers.
- Built-in monitor/speaker. Volume control (panel). Widely adjustable tone (internal trimpot).

To prevent loss of recorded messages when AC power is lost a 9 V. battery may be connected to the rear battery input. No power is drawn from a battery if AC power is on. This makes the MK-1 ideal for hand day or e-position. The MK-1 may be left on continuously in fixed stations; if desired. (Do not use more than 3 weeks AC). The MK-1 may be used with any paddle. A dual level (squeezed) paddle is recommended to take advantage of iambic operation, but a single level paddle will also work.

115 VAC or 8-14 VDC. 8x3 1/2x5 1/2. 2.5 lbs. Handsome light grey panel with silver lettering. Black steel case. Comes assembled and tested with full instructions, 15 day home trial, and the famous Autek 1 year parts and labor warranty. Made in U.S.A.

introducing the unbelievable

ALDA 103

Totally solid state SSB Transceiver • 80 through 20 meters • 250 watts

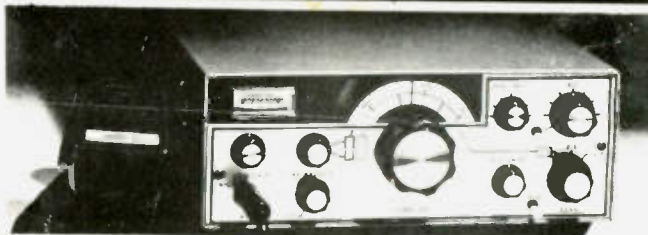

Now, for under \$500, you can get the best deal in the ham radio market today for compactness, power and performance — the new ALDA 103. Unbelievable, but true.

Both brand new novices looking for that ideal first transceiver and seasoned hams wanting to treat themselves to a great second unit for mobile operation will turn on to the ALDA 103's totally broad-based features. Can you believe fully automatic CW keying with automatic side step and RIT, too, so you can QSO with any make of transceiver without constant frequency corrections? Or an intermod intercept point of better than 10 dbm? Or the tremendous stability of a VFO oscillator covering 5 to 5.5 MHz (not switched)? And that's just a sampling of the 103's superlative specs.

You won't believe the ALDA 103's clean, simplified engineering and serviceability until you see it for yourself. So see the ALDA 103 today.

Price: \$495 including microphone and mobile mount, too.

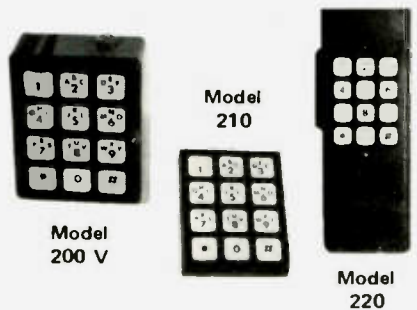

CES Touch Tone Pads

- Model 200 V — acoustic coupling. \$49.95
- Model 210 — for mounting on walkies or hand-helds. \$39.95
- Model 220 — CES can now offer you a TOUCH TONE back for Standard Communications hand-held radios. This is the complete back assembly with the TOUCH TONE encoder mounted and ready to plug into the private channel connector. Also included is a LED tone generator indicator and an external tone deviation adjustment. \$59.95

talk power by **TPL**

TPL for an Economy Price? THAT'S RIGHT!

introducing the **ECONO-LINE**

Model	Input	Output	Typical	Frequency	Price
702	5-20W	50-90W	10 in/70 out	143-149 MHz	\$139.00
702B	1.4W	60-80W	1 in/70 out	143-149 MHz	\$169.00

Now get TPL COMMUNICATIONS quality and reliability at an economy price. The new Econo-Line gives you everything that you've come to expect from TPL at a real cost reduction. The latest mechanical and electronic construction techniques combine to make the Econo-Line your best amplifier value. Unique broad-band circuitry requires no tuning throughout the entire 2-meter band and adjacent MARS channels. See these great new additions to the TPL COMMUNICATIONS product line at your favorite amateur radio dealer.

For prices and specifications please write for our Amateur Products Summary! FCC type accepted power amplifiers also available. Please call or write for a copy of TPL's Commercial Products Summary.

TELE-TOW'R Manufacturing Co.

Old-fashioned value. Until just a short time ago, Orville Bond made his living hanging things in the sky — mostly signs, on steel poles. You can imagine what stress a 200 square foot sign goes through hanging 90 feet off the ground. Orville knew there must be a better way to build a tower, based on the principles he'd worked out in sign erection. He found it. A way to produce a much better tower than anything else on the market at a reasonable price. Our prices start at \$199.95 — delivered. One-piece price. When you buy one of these towers, you get the whole tower ready to install. No accessory charges, no extra costs for guy wire, base plates, etc. etc. And even our complete one-piece price is considerably lower — hundreds of dollars lower — than any comparable tower on the market.

Totally free-standing. No guy wires, no brackets. In fact, our towers MUST NOT BE TIED TO ANY STRUCTURE IN ANY MANNER. Guying or bracketing them only weakens them. Our towers are designed to withstand 60 mile winds, with 30 pounds of antenna with a vertical area of 6 square feet. Think about a fishing rod. When you're holding it at the end, it'll withstand tremendous pressure. Put that same pressure on it when you're holding it in the middle, it'll snap. Our towers spread windstrain over the entire length of the tower — ours stay up when others go down.

Put it right where you want it. With one hand, raise the tower from 23' to as high as 55'. Find exactly the right receiving level for CB, Ham or TV. When you want to adjust your antenna, install a new one, or pull maintenance, crank it down again. No more climbing up in the sky to repair or replace antennas. With the exception of our breakerover models, this is the most convenient tower you can buy.

Breakover — your feet never have to leave the ground. The ultimate in convenience. Our breakerover towers not only telescope, they lie down for you. One man can crank it down, then lay it down so your feet never have to leave the ground when you adjust, service, or pull maintenance on even our tallest towers.

Model 40	[extends from 23'-40']\$195.50
Model 55	[extends from 23'-55']\$366.22
Breakover Model 40	[extends from 23'-40', with breakerover at ground level]\$340.46
Breakover Model 55	[extends from 23'-55', with breakerover at ground level]\$498.10



CDE HAM III ROTOR SYSTEM
\$139.00



The Ham III is rated for antennas with up to 12.5 square feet of wind surface area when properly mounted in a tower.



Have you ever wondered how many Watts of power a piece of equipment actually consumed? I have pondered this question many times in my career. The solution necessitates a relatively large outlay of money to get an accurate answer. In order to get a true answer, it requires the measurement of input voltage, input current, and power factor.

In none of my cases do I require the exact answer. A relative answer would serve my purpose. So, by utilizing a current transformer method and my junk box, I get a more-than-adequate answer, and it doesn't require any more effort than reading a simple meter scale.

The basic circuitry is as shown in Fig. 1.

The formula I used to determine the milliammeter range is: $\text{Watts} \div \text{line voltage} \div 1.414 \div \text{ratio} = \text{meter current in Amps}$.

To construct your unit, you will need to decide what are the minimum and maximum wattages you will want to measure. Since the meter scale is not a linear function, the meter scale will be compressed at the lower end. I settled on a multirange unit.

The fuse should be of the household variety, since the 15-Amp size of type 3AB is difficult to find, and the type 3AG will vaporize on the interior of the glass and provide no protection.

The bridge rectifiers can be made of type 1N4001 diodes, since they only supply the meter movement current.

To have a multirange instrument, you can use either multiple outlets, one for each range, or a heavy-duty (15-Amp) switch.

The current transformer is the heart of the instrument and must be wound to suit your desires, as it is not commercially available unless you want it custom made. To wind one yourself is not a big undertaking and only requires some wire, tape, and an old core. I used old speaker out-

put transformers for my cores. The size is not too critical, since there is only miniscule wattage requirement of the meter movement. You should ascertain that you will have ample winding space. I wound my transformers with 604 turns of #36 on the secondary for 117 volts line voltage. If you have 120 volts, use 590 turns, and, for 115 volts, use 615 turns. The primary was wound as follows: 10 turns #18, tap, 6 turns #18, tap, 2 turns #18, tap, 1 turn #14, tap, 1 turn #14. This gave me a total of 20 primary turns which, with the secondary of 604 turns, resulted in the following ratios: 100 Watts = 604:20 or 30.2, 200 Watts = 604:10 or 60.4, 500 Watts = 604:4 or 151, 1000 Watts = 604:2 or 302, 2000 Watts = 604:1 or 604.

The meter used had a full-scale value of 20 milliamperes. A recalculation of turns ratio may be made to accommodate another meter range. A simple solution for the utilization of, say, a 0-1 milliammeter is to put a 100-Ohm trimmer pot across the meter movement and adjust it to read 100 Watts for full scale deflection.

To calibrate my units, I used several 25-50-100 Watt light globes to provide me

with loads to calibrate the meter scale. By using them in parallel, I was able to acquire enough plot points to make a new meter scale. I made my meter scale on white paper, then inked the marks to suit and reinstalled it. I pasted the scale on the reverse side of the original scale using rubber cement.

An error of $\pm 5\%$ can be expected, since the line volt-

age will vary by this amount. This error should not be objectionable, since the equipment will be subject to the varying line voltage in operation anyway. In order to lower the error rate, it would be necessary to utilize an electrodynamic meter movement, whereby the electromagnetic field of the meter could vary with the varying line voltages. ■

How Much Power Does It Draw?

—build this simple ac wattmeter and find out

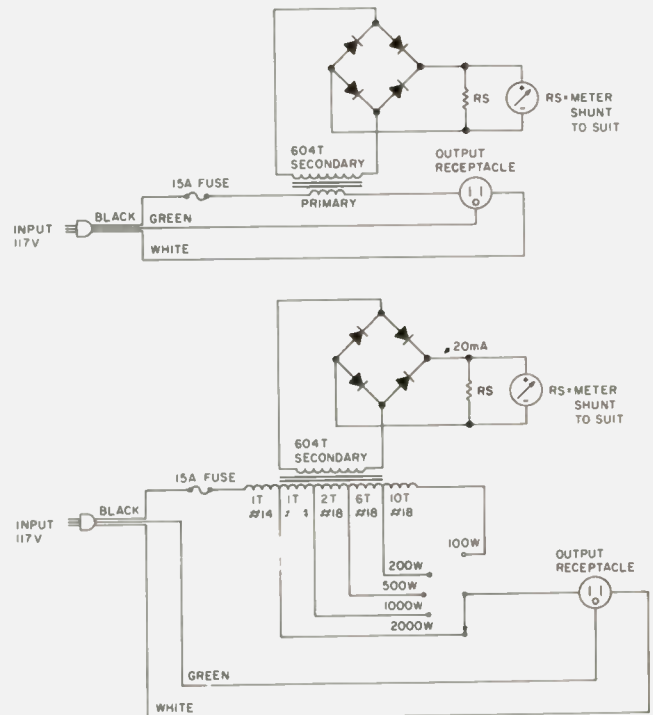

Fig. 1. Multirange circuitry.

Surprisingly Low-Cost Lab Supply

—an IC regulator does it!

accepted regulator ICs in the industry. The $\mu A723$ is second-sourced by almost every linear IC house in the U.S. and still enjoys enormous usage. Thus, this IC has become about as inexpensive as a linear IC can be. The $\mu A723$ equivalent circuit is shown in Fig. 1.

Because V_{ref} (the internal reference voltage) is about 7 volts, the $\mu A723$ is usually configured in one of two basic circuits — one for output voltages below 7 volts and the other for output voltages above 7 volts. These basic circuits are shown in Fig. 2. The usual external current-increasing transistors are not shown here, in order to keep the circuits simple.

One of the linear IC houses which makes the equivalent of the $\mu A723$, Teledyne, has published an application note in which is shown a novel circuit that allows output voltages above and below 7 volts.¹ That basic circuit is shown in Fig. 3. This circuit has in it a correction that was made from the original (which would have prevented the "current limit" from functioning). A complete lab-regulated supply providing 2 to 20 volts dc with current-limiting at 300 mA is shown in Fig. 4, with an NPN power transistor to increase current capability. The IC pin connections in Fig. 4 are for the dual inline package version of the $\mu A723$ only; the "TO-5 can" packaged 723 would

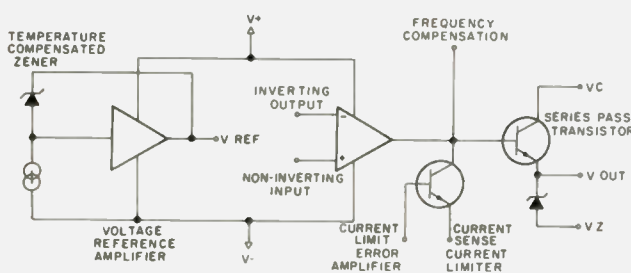

Fig. 1.

Hank Olson W6GXN
P.O. Box 339
Menlo Park CA 94025

The $\mu A723$, as first introduced by Fairchild, is one of the oldest and most

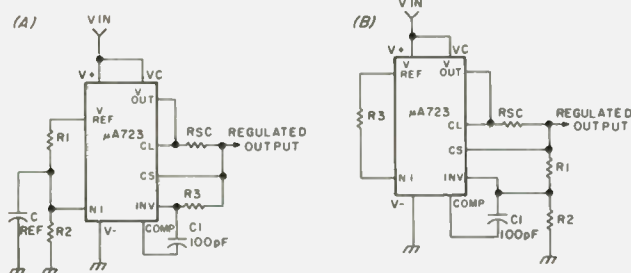

Fig. 2. (a) Basic low-voltage regulator ($V_{out} = 2$ to 7 volts). (b) Basic high-voltage regulator ($V_{out} = 7$ to 37 volts).

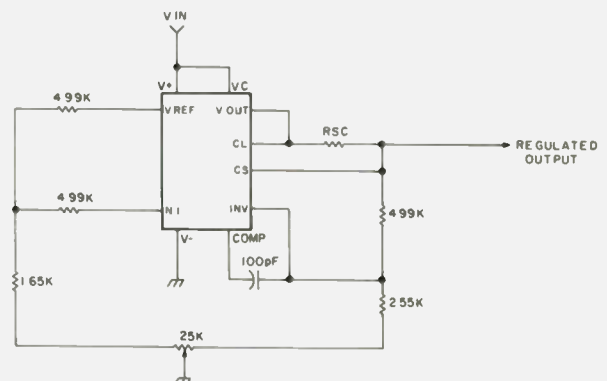

Fig. 3. Basic wide output voltage regulator circuit with 723.

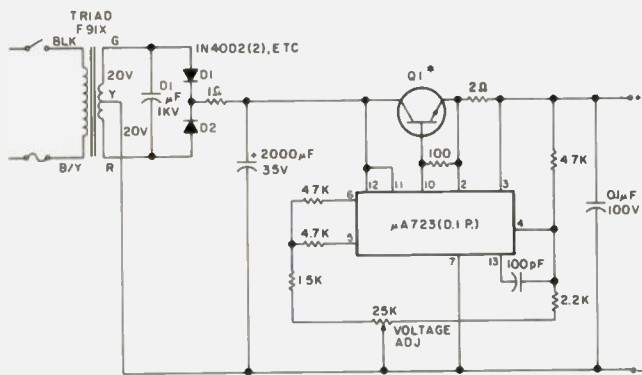

Fig. 4. Regulated lab supply. D1, D2 = Motorola HEP R0051; Q1 = Motorola HEP S5000. *Heat sink with washer and silicone grease.

work as well, but pin numbers would have to be changed. The rectifier-filter section utilizes a Triad F91X transformer and a full-wave rectifier with capacitor input. The rectifier diodes are Motorola HEP R0051s, but almost any two 1 Amp silicon rectifier diodes (1N4002s, for instance) could also be used. Q1 is a Motorola HEP S5000, but it has several equivalents — RCA SK3041, Sylvania

ECG152, or 2N5191.

All the parts are board mounted, with the exception of the transformer, filter capacitor, and 25k voltage-control pot. In off-board mounting of the 25k pot (say on the front panel of one's own power supply cabinet), the lead lengths of the wires to the pot should be minimized.

It is intended that the ac

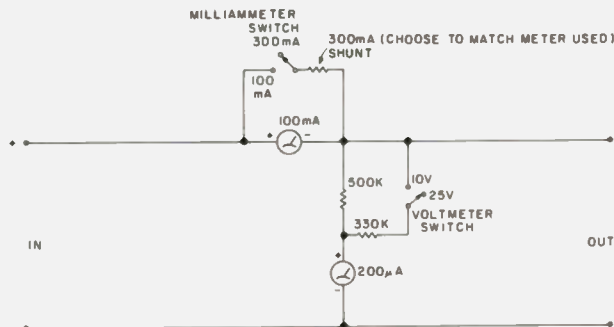

Fig. 5. Metering section.

switch, fuse holder, meters (if used), and binding posts also be mounted on the cabinet housing the circuit board. LMB and Bud each have a line of small box cabinets that would be suitable for making a finished bench supply using this circuit. The choice of which particular cabinet will usually be dictated by the meters one has on hand, because the circuit board is only 2 x 2½ inches. I used an LMB W1N box cabinet (10" x 4" x 3½"). The metering circuit, using meters that were on

hand, is shown in Fig. 5.

For all its use of inexpensive or available parts, this regulated supply has more than proven itself on the bench. The 2-volt lower limit allows even RTL and low-voltage CMOS logic to be operated from the supply, and the 20-volt maximum output voltage allows for most other logic and linear IC circuits. ■

Reference

¹ Teledyne, *Linear Microcircuits Application Note 2: 723/823 Voltage Regulators*, 1971.



Yes!! Now we are authorized dealers for

KENWOOD

We also carry:

Yaesu • Drake • ICOM • Dentron • HyGain • Wilson
Ten-Tec • Tempo • Swan • Standard • KLM
Larsen • Cushcraft • Newtronics (Hustler)
B & W • CDE • Shure • NYE • Pipo • Belden
and others.

Ray WB4DXH Pudge W4LTX Jim WA4CDX Bill WD4LGF

Together we have more than 50 years experience in Ham Radio.

Call us and see why if you're not buying from us.

We're Losin' and You're Losin'.

1. Credit cards Welcome, except on specials.
2. Trades invited.
3. Fast — to your door — delivery via UPS.
4. Large inventory of major lines — most items are in stock NOW!
5. Send for our free catalog.
6. Cost of telephone calls will be deducted from your order.
7. We're "burning" to make Hot deals at A.R.S.O.N., Inc.

Call us at (615) 868-4956

"Cash Deal"

Kenwood 7400A List \$399.00
2 Meter FM fully Synth 25 watts
Buy at \$399.00 and for only \$11.00
additional we will supply and install the
Drake 1525 EM encoding mike
Total Price \$410.00
Shipping prepaid Cont. USA

"Cash Deal"

DRAKE PACKAGE
Latest TR4CW with Rit List \$799.00
Matching Speaker MS-4 List \$33.00
AC Power Supply AC-4 List \$150.00
Total package price is \$799.00
Shipping prepaid Cont. USA
Limited Quantities - 1st 5 orders
will be filled.

"Cash Deal"

Ten Tec Century 21
All Solid State-broad band tuning
CW Transceiver
Buy at \$299.00 get free 10 & 15M
XTALS and your choice:
(1) 670 keyer (2) 276 extal cal.
Shipping prepaid Cont. USA

"Cash Deal"

CDE HAM III Rotor
\$124.00

Shipping Prepaid Cont. USA

Check These Super Deals!

A40

Amateur Radio Supply of Nashville, Inc.

615 South Gallatin Road, Madison, Tennessee 37115 Phone (615) 868-4956

Store Hours

Mon. - Fri.

9 a.m. - 5 p.m.

Sun.

1 p.m. - 6 p.m.

Wireless Monitoring For the Bionic Ham

— be in touch all the time

I have always been intrigued with the fun potential as well as the practical value of the little home wireless broadcasters, from the earliest tube-type ("Hear your own voice from your radio") AM BC-band jobs to the newest solid state miniaturized modules.

Several solid state FM wireless mike PC board kits

require nothing more than a source of low-voltage dc, a short antenna, and a microphone or other source of audio input. I evaluated several units for use as a general-purpose scanner rebroadcaster (among other things). By far, the most interesting of these is the Model SI-36 FM wireless mike kit, available from

Sabtronics International in Dallas. This unit, which features a unique PC board layout eliminating the need for wire-wound coils, covers 50 MHz to 150 MHz with a typical power output of 100 mW using a 9-volt transistor radio-type battery.

The module I selected is the Sabtronics Mini-Kit. The 1.8" x 1.8" PC kit goes

together in a few minutes, comes complete with all components and very good instructions, and, using a 9 V dc power source, will transmit to any nearby FM broadcast receiver up to 300' or more away. It has a sensitive 25k Ohm mike input which will accept practically any crystal, dynamic, or ceramic mike of medium-to-high impedance and runs on nine to 12 volts dc. That makes it handy to use a couple of penlight cells or a 9-volt battery as the power source or to tap off a convenient source of voltage from the transceiver or receiver with which it is to be used.

I built one of the Sabtronics units into a Radio Shack #270-251 miniature equipment case (3¼" x 2-3/16" x 4"), incorporating into the design such convenience features as a more-or-less standard four-pin CB-type mike jack on the front panel, a BNC external antenna jack and short whip inserted in an F-type connector on top, and provisions for external power on the rear panel apron. (The PC board is simply epoxied into place in the center of the case, using ¼" standoffs.) An SPST miniature toggle switch installed on the front panel serves as the on-off switch, and another SPDT miniature toggle allows selection of either microphone or external audio input.

The wiring of the mike jack can be selected to match the pin connections of whatever ham or CB mike happens to be conveniently surplus to current ham shack needs! In the schematic shown in Fig. 1, only the audio and ground leads are connected, the mike not being wired for PTT, which probably would serve no useful purpose. Depending on the mike used and its internal wiring, the PTT switch may have to be depressed to make it "hot." At W8FX, a 50k Ohm high-impedance Tempo mobile mike was used with good

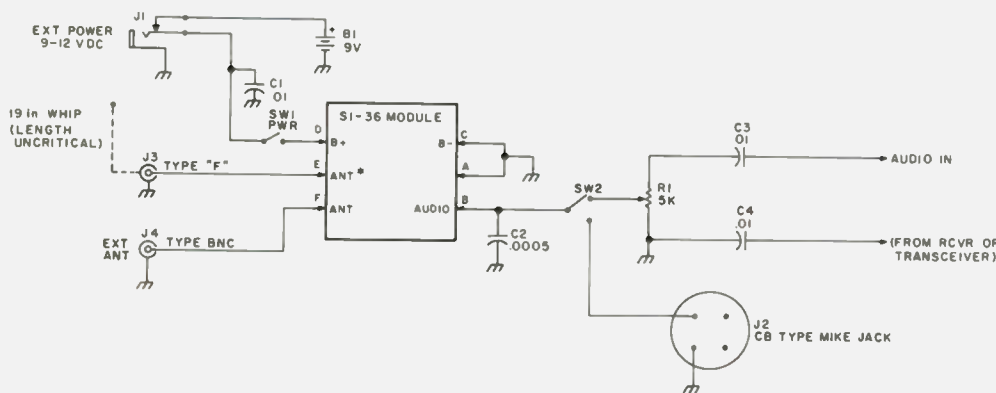

Fig. 1. Using the Sabtronics FM module. Letters refer to wiring points on the PC board. All component values are nominal. SI-36 module sold by Sabtronics International, P.O. Box 64683-E, Dallas TX 75206. *An alternate antenna is a 3-foot length of flat TV-type twinlead connected to points E and F on the PC board, as recommended by the manufacturers, instead of the 19" whip I used. (Twinlead can be routed through a grommet on the rear panel.)

results. Almost any mike could probably be used, as the audio gain of the two-transistor module is very high.

Note that the transmitted frequency is somewhat dependent on supply voltage. Therefore, switching from internal battery to an external power source will cause the frequency to change, and it may be necessary to readjust the trimmer condenser. Note also that the antenna affects transmitter output frequency, so any close movement next to it should be avoided.

Although I used the Sabtronics module, a similar module (limited to 88-108 MHz coverage and 100 mW maximum power) is offered by Ramsey Electronics, Rochester NY. This unit will operate off 3-9 V dc and can accommodate either a dynamic, crystal, or ceramic microphone. Alternate wiring connections for using the Ramsey module are shown in Fig. 2. I have built one of the Ramsey units, but I use the Sabtronics module in the wireless box of Fig. 1.

The extremely small size of the Ramsey minikit, 1" x 1" square, opens up additional possibilities, such as permanent internal installation inside a receiver or transceiver. In fact, the Ramsey module is small enough to mount in a plastic minibox along with a 9-volt battery or two AA penlight cells, with a phone plug installed in one end of the enclosure, allowing use with practically any receiver with an external speaker or headphone jack. It can even be connected to the audio output of a mobile 2 meter transceiver to take advantage of high-quality external speakers usually installed with the newer AM-FM car radios, transmitting an FM BC signal from the transceiver to the car radio. Similar ultracompact modules are available from Poly Paks, Inc., South Lynnfield MA, in both AM

and FM broadcast band designs. The Poly Paks AM unit, Model WM-5, is designed for high-impedance input and runs off a 9 V dc power source. The FM version, Model FMM, requires 1.5 volts for operation and is available in both high- and low-impedance models. Similar modules are sold by Burstein-Applebee Co. and other large distributors.

I have found a number of interesting uses for the unit; individual constructors may want to modify the design somewhat, depending on the exact purpose intended. I will discuss some of the more readily apparent uses.

Scanner rebroadcaster — At my QTH, the unit is normally left connected to a Bearcat 101 synthesized scanner, which is programmed to receive eight of the local 2 meter repeater and simplex frequencies and eight local fire/police channels. The Bearcat has an accessory terminal strip which provides a source of 12 V dc on the rear panel apron, which can be used to power the unit. The wireless box can be left "on" whenever the scanner is operating, retransmitting whatever the scanner intercepts on the FM band. I find this particularly handy in monitoring local repeater channels around the house

and find it works particularly well when used in conjunction with an FM receiver having afc, as there is a slight frequency drift. (If you plan to use the unit with the Bearcat, note that terminal strip TB1 on the rear of the cabinet has three terminals. Unswitched 12 V dc is available between pin 2 and pin 1, the latter being at ground potential.) Good results have been obtained using the Bearcat as a source of external power. If hum proves to be a problem, try connecting a 25-50 uF 15-volt electrolytic across the terminals. (On my Bearcat, pin 3 of TB1 provides a source of 12 V dc, which is available only when a signal is present which rises above the squelch threshold, for use with accessories sold by the manufacturer. I tried using this source of dc power, making the rebroadcaster something of a repeater itself; however, doing this was not practical, apparently due to insufficient current being available at the terminal. The possibilities are interesting, however, and deserve further experimentation.)

Wireless headphones — The little unit can be connected to the station receiver or transceiver and used in conjunction with one of the new lightweight FM radio headphones, allowing cord-free flexibility. Although I

have not made use of this application with this particular unit, it has been done in the past using other wireless mikes and has been found to be a great convenience. One possible advantage would be in multi-op contest work, where a number of operators can listen in to what's being worked for logging, backup CW copying, etc., without being connected in to the usual rat's nest of cables around the rig. Of course, a set of radio phones would have to be available for each operator, though these are coming out of the novelty stage and are now fairly plentiful and inexpensive, being available in both AM and FM models.

General-purpose monitoring — The rebroadcaster can be connected to any receiver around the shack, such as a 2 meter receiver or transceiver tuned to a favorite repeater or simplex channel, to a VHF weather receiver, to the HF receiver tuned to a traffic net frequency, or even to a local CB channel. REACT CB team members might find this feature useful in monitoring channel 9. A small portable transistor radio tuned to the rebroadcaster FM channel will alert you if a call is received on your communications gear. Since the radio can travel with you, you're never far from the

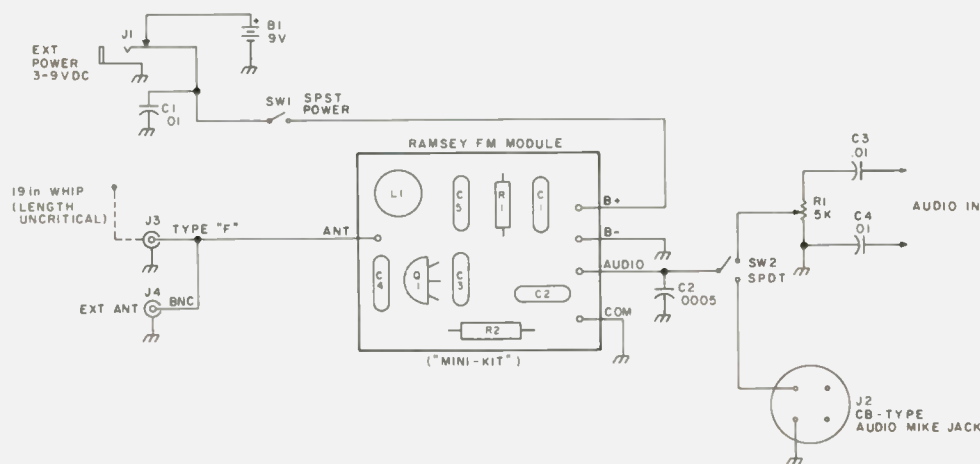

Fig. 2. Using the Ramsey FM module. All component values are nominal. Enclosure is Radio Shack #270-251. FM module sold by Ramsey Electronics, P.O. Box 4072A, Rochester NY 14610. As the PC board connectors are not numbered, this diagram indicates the orientation of the board (from top, looking down) and proper external connections.

shack, whether tinkering in the garage, in the yard, or mowing the lawn. The unit, as configured in Fig. 1 or 2, will work with practically any impedance equipment (low-impedance speaker outputs, medium-impedance tape outputs, etc.); just adjust the receiver that is to be used with the wireless box to its normal audio level and adjust the pot inside the rebroadcaster (while monitoring on an FM broadcast receiver) for a strong, undistorted trans-

mission from the rebroadcaster. Fine adjustment of audio levels can be made using the audio gain control of the input receiver. I found a cheap Weathercube fixed-tuned weather monitor at a local discount store for \$6.95, which is excellent as a monitor — the 162 MHz receiver can be readjusted easily to cover the FM BC band.

Test signal generator — Connecting an audio signal generator to the audio input

of the unit, the 50-150 MHz range of my SI-36 module has been very useful as a wide-band VHF signal source for receiver peaking, etc.

For fun — The mike input feature, coupled with the portability of the unit, makes it suitable for children's use or in just about any other situation where an FM wireless mike might be useful. However, a word of caution is in order. Output levels may considerably exceed 100 mW and, as frequency excursions

well outside of 88-108 MHz FM are possible with the unit, connecting it to a real antenna could wreak havoc with local TV, FM, aircraft, and even 2 meter communications, and as such, should be used very carefully to avoid serious RFI problems. Stay in the FM band!

Building this unit, which consists of off-the-shelf readily-available components, was truly a fun project and has been even more fun to use. ■

**AMATEUR
TELEVISION
ON
439.25 MHz**

**INTERESTED? ACTIVITY IS
INCREASING EVERYWHERE
YOU CAN GET ACTIVE IN YOUR
AREA WITH OUR PRODUCTS—**

**AMIB FSTV CONVERTER
complete \$150.00**

**AX10B FSTV TRANSMITTER
complete \$385.00**

**CALL 812-336-4775, OR WRITE US,
FOR COMPLETE DETAILS**

**APTRON
LABORATORIES**
PO BOX 323
BLOOMINGTON, INDIANA, 47401

*Sere-Rose & Spencer
Electronics*

1465 WELLS STATION ROAD
MEMPHIS, TENN. 38108
PH (901) 683-9125—685-8461

Authorized Dealer

**DRAKE—ICOM—KENWOOD
REGENCY—TEMPO—DENTRON**

CALL OR WRITE
FOR BEST DEAL S39

1315 BLUFF CITY HWY., BRISTOL, TN. 37620

Rusk Electronics Inc.
Quality Electronics Department Store



FT-101E
YAESU HF SSB FT-101E
160 thru 10M \$799.00 Retail

COMPLETE LINES
TEMPO
KDK
HYGAIN
DENTRON
CUSHCRAFT
LARSEN



WRITE FOR
SPECIAL PRICES

**CALL BOB BROWN WA4HAA
FOR SPECIAL QUOTE**
615-764-0831 or 968-5343 R21

*Silver Mica Capacitor DM19 270
or 300PF, 500DC -----20/1.00*

*Sub-min Lamp Wire Term 5V
CM8-715 red or blue ---- 4/1.00*

*GE 2156 3V - 2171 4.5V - 2112
6.3V ----- 6/1.00*

*Telephone type slide base
12 or 48 volt ----- 10/1.00*

*Clarostat Power Resistor
50 ohm, 20 watt, 5% ---- 2/1.00*

*Capacitor 1-1/8x1x1/2
.25UF-600VDC ----- 2/1.00*

*CP65 Oil Capacitor
1UF-600VDC ----- 2/1.50*

1N4004, 400PIV, 1A --- 12/1.00

*Bath Tub Bottom Term.
22UF-150VDC ----- 2.50*

INSCHO'S ELECTRONICS
P.O. BOX 143 OWEGO NY 13827
607-687-4332 FREE FLYER 13

**ATTENTION GARY AND SABTRONIX
OWNERS!**

...Come let us tweak your pots! If you just built the Gary Model 101 or the Sabtronix model 2000 we can calibrate it for you to factory specs.

We use custom built lab calibration equipment designed expressly for these meters. You get a professional job!

Sabtronix 2000 \$24.95
Gary model 101 \$10.95

Also add \$3.95 per unit for special delicate equipment packing, insurance, and postage.

Send via Air Mail or Parcel Post to:

custom cal service

G10

Gary McClellan and Co.
PO Box 2085
1001 W. Imperial Hwy.
La Habra CA 90631

KENWOOD 'S TS-520S



**YAESU 'S
FT301D**

**WANT TO TRADE — UP-
GRADE?** Call us — for best
quote. Large assortment of
clean used equipment on hand.

50th Year Serving Amateurs
W4WL — W4VOV — K4RJY
Visa Master Charge

FRECK radio & supply
252 Patton Ave., co., inc.
Asheville, N.C. 28801 F3
PHONE: (704) 254-9551

HAMTRONICS USED GEAR • TEST EQUIPMENT • SPECIALS

30-DAY GUARANTEE ■ 90-DAY FULL CREDIT TRADE-IN ■ FREE SHIPPING VIA UPS ONLY

Limited quantities. First come, first served. (if weight or size exceeds UPS max., we will ship freight collect)

Allied AX-190 Receiver \$159 Ameco PV-50 \$ 9 CN-50 29 CN-144 39 TX-62 79 621 VFO 45 B&W Waters Nuvertor 2+6 Conv. \$ 75 6100 SSB Xmitter 395 670 SSB Adaptor 39 Co-Oax Keyer 95 Central Electronics 100V Transmitter 325 MM-2 Scope 69 20-A SSB Adaptor 79 Clegg 22'er FM \$129 66'er 6M Xcvr 115 99'er 6M Xcvr 59 Interceptor BRCUR 275 Ant Pre Amp 22 All Bander 69 HT-146 125 2 Vess 259 FM-27-B Xcvr 325 Collins 75 A4 Receiver \$395 75S3B Receiver 695 75S1 Receiver 349 KWM-2 Xcvr 595 32S1 Xmitter 95 PM-2 AC Supply 349 516 F2 AC Supply 139 312B5 Console 425 361D2 Mount 29 Drake 2A Receiver \$149 2B Receiver 189 2AQ SPK QMUL 29 R4 Receiver 289 R4B Receiver 349 R4C Receiver 399 MS-4 Speaker 19 2NT Transmitter 125 2NT Transmitter 99 TR-6 695	TR-222 Meter 140 T-4X Transmitter 339 TR-722 Meter FM 225 AC-4 AC Supply 95 TR-4-C Transceiver 449 CC-1 Console CPS-1 Supply SC-2 Conv SC-6 Conv SC-1 Calibrator The above all assembled complete pkg. Only \$200 Dycomm 10.0 2 M Ampl \$125 35-0 401N 110 Out 130 470-25 450 MC 120 P-1416 16 Amp Supply 95 Eico 720 Transmitter \$ 49 722 VFO 39 730 Modulator 39 Elmac AF 67 Transmitter \$ 45 PMR-8 Receiver 79 Genave GTX22M FM \$165 GTX 200 2M FM 149 Globe/Galaxy VHF 6+2 Transm \$ 39 Chief Transmitter 39 Galaxy III Xcvr 159 Galaxy V Xcvr 189 Galaxy V Mk II 239 GT-550 Xcvr 279 GT-500A Xcvr 329 AC-400 Supply 79 FM-210 2M FM 95 Gonset Com II 2M \$ 75 Com II 6M 69 Com IV 2M 129 GC-105 2M 115 G-28 Xcvr 149 G-50 Xcvr 149 Hallcrafters S-108 Receiver \$ 99 SX-101 Receiver 159 HT-32 Transmitter 179 HT-32B Transmitter 269 SX-99 Receiver 79 SX-115 Receiver 349	HT-37 Transmitter 159 HT-40 Transmitter 49 SX-99 Receiver 99 SX-117 Receiver 189 SR-150 Xcvr 259 SR-160 Xcvr 159 SX-146 Receiver 175 HT-44 Transmitter 159 SX-111 Receiver 149 SX-122 Receiver 249 S-36 UHF Receiver 125 Hammarlund HQ-110 A VHF Receiver \$189 HQ-110C Receiver 119 HQ-110AC Receiver 149 HQ-145X Receiver 169 HQ-170C Receiver 159 HQ-180 Receiver 379 HQ-215 Receiver 259 SP-600 Receiver 179 HX-50 Transmitter 169 Heathkit SB-300 Receiver \$199 SB-301 Receiver 229 HR-10-B Receiver 69 SB-303 Receiver 269 SB-220 Linear Amp 449 SB-102 Trivcwr 379 DX-60B Transmitter 69 HW-32 Transmitter 85 HW-100 Transceiver 249 SB-100 Transceiver 299 SB-401 Transmitter 249 SB-101 Transceiver 349 SB-650 Digital Freq. Display 149 HW-30 Twoer 29 Also Sixer 29 H-10 Monitor 69 VHF-1 Seneca 79 HW-12 Transmitter 75 HP-23 AC Supply 49 HP-23B AC Supply 59 HW-202 2M FM Xcvr 159 SB-620 Spectrum Analyz 120 SB-102 Xcvr 369 SB-610 Scope 95 HA-20 6m Linear 125 SB-634 Console 175 SB-604 Spkr 29.50 SB-644 VFO 129.50 SB-230 Linear 359 SB-104 Transceiver 625	Johnson 1-KW Matchbox/SWR \$195 Courier Linear 139 Ranger I Transmitter 85 Ranger II Transmitter 139 Vallant I Transmitter 129 Invader 2000 Xmitt 495 Kenwood T-599 Transmitter \$289 R-599 Receiver 289 TS-520 Tranc 429 QR-666 259 QR-666 Receiver 239 TV-502 Transvertor 179 Knight T-60 Transmitter \$ 39 r-100 Receiver 59 TR-108 Trancur 2M 79 Lafayette HA-800 Receiver \$ 89 HP-350 Receiver 149 HE-45 Transceiver 49 Midland 509 H.T. \$149 Millen 92200 Transmatch \$149 90651-A Grid Dipper 95 National NC-270 Receiver \$119 NC-300 Receiver 129 NCX-5 Transceiver 279 NCX-SMK II Transcwr 299 NC-303 Receiver 199 AC-500 AC Supply 69 NCX-500 Transceiver 199 NCX-3 Transceiver 169 NC-190 Receiver 149 NC-105 Receiver 69 Regency HR-2B 2M FM \$169 HR-220 FM 220 MC 185 AR-2 2M Amplifier 85 HR-25 2M FM 225 HR-6 Meter FM 189 SBE SB-34 Transceiver \$249 SB-33 Transceiver 189 SB-144 2M FM 175 SBZ-LP Linear 179	Standard SRC-146 HT \$149 826 M Trncsvr 195 SRC-144 395 SRC-851T 250 Swan 700-CX Xcvr \$459 260 Cygnet 289 279 Cygnet 329 500 Xcvr 299 500 CX Xcvr 389 117-XC AC Supply 95 14X OC Module 39 MK II Linear 475 KK V1 6 Meter 550 348 250 C 6M Xcvr 169 FM 2K3A Xcvr 249 FM-1210A 2M 269 350 Transceiver 299 350C Xcvr 299 600R Receiver 339 600T Transmitter 399 410 VFO 79	Tempo Tempo one Xcvr \$299 AC One Supply 79 FMH 2M H.T. 149 CL-220 Trncur 220 MC 179 FMH 2M w/Talkie 149 Ten Tec PM-3 Trnsur \$ 49 Argonaut Xcvr 199 KR-40 Keyer 79 RX-10 Receiver 49 S-30 Signalizer 29 Trlton II 479 Yaesu FT-401 Xcvr \$499 FRDX 400SD Rec 325 FT 2 Auto 2M FM 249 FT-101B Xcvr 549 FL-2100B Linear 295 FV-101 VFO 79 101E Xcvr Oemo 695
---------------------------------------------------------------------------------------------------------------------------------------------------------------------------------------------------------------------------------------------------------------------------------------------------------------------------------------------------------------------------------------------------------------------------------------------------------------------------------------------------------------------------------------------------------------------------------------------------------------------------------------------------------------------------------------------------------------------------------------------------------------------------------------------------------------------------------------------------------------------------------------------------------------------------------------------------------------------------------------------	---------------------------------------------------------------------------------------------------------------------------------------------------------------------------------------------------------------------------------------------------------------------------------------------------------------------------------------------------------------------------------------------------------------------------------------------------------------------------------------------------------------------------------------------------------------------------------------------------------------------------------------------------------------------------------------------------------------------------------------------------------------------------------------------------------------------------------------------------------------------------------------------------------------------------------------------------------------------------------------------------------------------------------------------------------------------------------------------------------------------	-----------------------------------------------------------------------------------------------------------------------------------------------------------------------------------------------------------------------------------------------------------------------------------------------------------------------------------------------------------------------------------------------------------------------------------------------------------------------------------------------------------------------------------------------------------------------------------------------------------------------------------------------------------------------------------------------------------------------------------------------------------------------------------------------------------------------------------------------------------------------------------------------------------------------------------------------------------------------------------------------------------------------------------------------------------------------------------------------------------------------------------------------------------------------------------------------------------------------------------------------------------------	-----------------------------------------------------------------------------------------------------------------------------------------------------------------------------------------------------------------------------------------------------------------------------------------------------------------------------------------------------------------------------------------------------------------------------------------------------------------------------------------------------------------------------------------------------------------------------------------------------------------------------------------------------------------------------------------------------------------------------------------------------------------------------------------------------------------------------------------------------------------------------------------------------------------------------------------------------------------------------------------------------------------------------------------------------------------------------------------------------------------------------------------------------------------------------------	------------------------------------------------------------------------------------------------------------------------------------------------------------------------------------------------------------------------------------------------------------------------------------------------------------------------------------------------------------------------------------------------------------------------------------------------------------------	------------------------------------------------------------------------------------------------------------------------------------------------------------------------------------------------------------------------------------------------------------------------------------------------------------------------------------------------------------------------------------------------------------------------------------------------------

Test Equipment Bargains

Boonton "Q" Meter	\$295
Tektronix 5140	249
Tektronix 545A	950
5 3/4A Plug-in wide band preamp	75
Hickok 695 Generator	69
Bendix 8C221 Freq Meter	39
Polarad Spectrum Analyzers A84T	1695
Hewlett Packard 400C	75
Precision E-400 Signal Generator	125
Electro Impulse Spectrum Analyzer	395
Dyna/Sciences Model 330 Digital Multimeter	195
Hewlett Packard 4905A Ultra Sonic Detector	550
Hewlett Packard 120A Scope	250
TS-323/UR Frequency Meter	175
Hewlett Packard 4910B Open Fault Locator	650
Bird Mod 43	80
General Radio 650A	150
Measurements Mod 80	195
Nems Clark 1400	495
Ballantine 300H	175
PACO Scope Mod-S-50	75
Singer FM-10C	3495
Simpson 260 V.O.M.	49.50



ICOM IC22S

Regular \$299, save \$50; buy an ICOM IC22S for \$299 (no trades) and take a \$50 credit for another purchase.



KENWOOD TR-2200A

Regular \$229, save \$30; buy a Kenwood TR2200A for \$229 (no trades) and take a \$30 credit for another purchase.



MIDLAND 13-510

Regular \$399, save \$50; buy a Midland 13-510 for \$399 (no trades) and take a \$50 credit for another purchase.



KENWOOD

TS820 \$ 919.00
TS80S \$1098.00



YAESU

FT101E - 799.00
FT101EE - 759.00
FT101EX - 699.00



DRAKE

TR4CW - \$799.00

MAIL & PHONE ORDERS WELCOMED. BANK AMERICARD ACCEPTED. ALL UNITS GUARANTEED

HAMTRONICS

DIVISION OF

Trevoze Electronics

4033 BROWNSVILLE ROAD
TREVOSÉ, PA. 19047

Telephone:
(215) 357-1400
(215) 757-5300

I Need A Contact!

—shooting for WAN/C

CQ, CQ, CQ ... still no answer. Try again ... CQ, CQ, CQ ... wonder if my antenna has fallen down again, or maybe my tubes have finally given up? CQ, CQ, CQ ... is that an answer? Nope, still nothing. CQ, CQ, CQ ...

Such is a rather typical evening for me, while playing at being a ham. I think that I may hold the record for more "N/C" (no contact) entries in my log than anyone since Marconi. And, somehow, it doesn't soothe my wounded pride in the slightest to read about some other fellow who just worked moonbounce with a .001 milliwatt rig that was powered by his pet hamster running on a treadmill, or learning that a six-month-old child just got his Extra class license. After reading such articles, I de-

cidated that it was time that someone told the other side of the story, someone who has tasted the agony of defeat.

Back to the beginning, though, and let's see if some of this doesn't sound rather familiar to you all. I've had a curiosity and interest in radio, TV, tubes (remember them?), and wires since I was old enough to stick my tongue into a wall plug. But, somehow, the process of learning the code and theory always seemed to be a bit too overwhelming to tackle. After putting it off time and time again, I was looking through the want ads in the local paper, and there, big as life, was an ad for a garage sale which featured "used ham radio gear!" With visions of a mint Collins rig being disposed of for \$50 or \$60, I

argued to myself, "If I get the rig, that will force me to learn the code and get my ticket, so I can use the bargain that I'm about to buy." The circular reasoning of that logic escaped my notice, as I rushed off to find the bargain that awaited me.

Needless to say, there was no mint Collins rig. But, there was a Globe DSB 100 for only \$25, a nonmatching and nonfunctioning vfo, and one out-of-Novice-band crystal. Being a sucker for a bargain, I began to dicker with the owner and finally settled on the price of \$25 for the lot. Cradling the rig gently, I trotted home and set it reverently on my table.

Now, what do you do with a transmitter when you have no license to use it? You get a dummy load and play like it is really an antenna, just for

the fun of watching "your rig" at work. A quick trip to Sears netted a dummy load, a porcelain socket, and a 50 Watt light bulb. Never has the feeble glow of a light bulb met with such excitement! But in my haste to illuminate, I forgot rule #1 — ground everything!

As I tuned the Globe with one hand, my other hand came to rest on my receiver, and the next thing that I remember was waking up on the other side of the room, lying on the floor. "I think something is wrong," I thought profoundly. A check with the voltmeter confirmed my suspicions, showing the case of the transmitter to be a bit warm, running 115 volts, in fact. This seemed to be a rather uncomfortable way to run a shack, so I felt some investigating was in order. There was no need to unplug the rig, as the power cord had been blown out of the wall socket, leaving its charred remains quietly smoldering. After deftly removing the chassis from the case, a quick and intense one-hour search pinpointed the problem; an rf bypass capacitor on the power line had been bent, shorting directly to the chassis. Conveniently, it was on the hot side of the fuse, so I was spared the 49¢ for replacing a blown fuse.

In spite of this inauspicious beginning, the ham bug had bitten, and that Novice ticket was inevitable, though not quick in coming. All sorts of minor delays kept cropping up, like job, new son, earning enough to keep everyone fed, etc. But, finally, the little slip of paper arrived, telling me that the FCC, in its goodness, had christened me WN2DYU. But that blasted piece of paper led to more and bigger problems. To wit, how do you string an antenna when you live in an apartment (no holes in walls or roofs), surrounded by trees carefully arranged to make it impossible to hang any wire longer than twenty

feet? Solution . . . you hang twenty feet and try.

What I now realize is that I had stumbled onto a variation of the most frequently used and most underpublicized type of antenna, the diode antenna. Now I'm sure that everyone has had experience with this electronic marvel — you can hear anyone and everyone on it, but your signal is swallowed up into that wire, never to be heard from again. And so the N/C contacts began to accumulate in my log. My best (in fact, only) contact netted me a signal report of 349 on 80 meters, from a station literally within line of sight of my basement shack. But, so what . . . it was a contact, and my first!

Several months, and several pages of log sheets full of N/C later, a move to a new city was ordained. At last, I had a house with a backyard big enough for a *real* antenna! But it seemed that the power company had thought of that. They had carefully strung the power lines to the house diagonally across the entire yard, leaving me the choice of risking stringing an antenna where it would fall onto their lines or trying something new. Considering my past experiences with line voltages, I decided on the latter alternative and erected a beautiful (to me) 30-foot vertical (war surplus, \$0.50 per 3-foot section). Look out, DX, here I come! So what if the guy wires looked like the

workings of a psychotic spider, and my wife cringed every time she walked into the backyard . . . I had an antenna. The only catch was that I had built another diode antenna, and my only DX (and only contact) was one out-of-state station.

"It's obviously a problem with the swr," I said, as I pored over the *ARRL Handbook*, an antenna handbook, and other learned texts. So I whipped up a transmatch, wired it into the feedline, and succeeded in making the finals in the Globe glow a pretty, cherry red with a mismatch that can only be guessed at. More coils, more wiring, more variable capacitors, and more soldering only seemed to compound the problem. Then, an article appeared in 73, and things began to clear up a bit. If I can summarize the article, whose author I don't remember, but to whom I am forever indebted, "If the rig loads up properly, forget the swr." Out came the transmatch, the coils, the capacitors, everything. And lo and behold, the finals stopped glowing and the transmitter stopped smoking, and all was right with the world . . . almost. I still got no contacts. Finally, I got a contact and a new, personal DX record of about 100 miles, and right in the middle of the contact, my antenna came crashing gracefully to the ground!

I will admit to a touch of discouragement at that

moment, and publicly apologize to Mr. Marconi, Mr. DeForest, and the other founding fathers of amateur radio for the names that I called them and their invention.

Before another antenna could be erected, another move, to my present location, transpired, and, again, I was faced with the problem of space for my antenna. Why is it that everyone else has a backyard of 5 acres, complete with two towers spaced exactly one-half wavelength apart and 600 feet tall? For me, nothing comes that easily, and I am presently set up with the faithful Globe DSB 100 (by the way, to ease the suspense, it is a double sideband, with a nominal 50 Watt input) in my unheated and uncooled attic. The antenna is a random wire (that is the correct way to describe an assortment of copper, steel, aluminum, and heaven knows what other kind of scrap all soldered together into a mass that has a built-in knack for tangling itself into a huge knot at a moment's notice) that runs across the attic and out of a gable vent. From there it dangles across my yard, beside the ever-present power lines, to a "tower" of scrap lumber that is bent and ready to snap at the most inopportune moment. The rig is grounded, but that required another line out of the other gable, across the roof, down the side of the house, into a cellar window, across the

cellar and, finally, to a cold water pipe.

Does it work? I don't know, as I have yet to hit the key and try it. But, to be quite honest, I'll be surprised, and somewhat disappointed, if it does.

Where does this all leave me? I still love radio, still am practicing my code to try for General, and still love the old Globe that started me off and is still serving well. And I still feel a tinge of jealousy when I see the photos and read the articles about other hams with their 1000 Watt, megadollar rigs, capable of contacts as far removed from me as intergalactic communication. But I also feel a little bit of pride and can't help feeling a little bit like a second pioneer on the threshold of the rediscovery of shortwave radio communication. Anyone can flip a switch, turn a knob, or whatever, and fire up a 2000 Watt PEP rig hitched to a 79-element 200-foot-high super squawk antenna and talk to the other side of the world. How many can claim the experiences that I've had or have gotten the fun and feeling of accomplishment that I've gotten in my brand of ham radio? All the N/Cs in my log are like purple hearts to me, and each one has a tale to tell and scars to show. And, at the present rate, I'll soon be eligible for WAN/C (you guessed it . . . worked all no contacts)! ■

FCC Math

from page 20

same as for the prefix for *micro*) is the symbol for the *amplification factor* (which tells how well a tube amplifies). ΔE_B is the *change* in plate voltage (Δ is the capital or upper case Greek delta, commonly used to indicate *change in*) that produces the same change in plate current as ΔE_C , which is the change in control-grid voltage.

(a) Solve for ΔE_B .

(b) What change in plate voltage (ΔE_B) is equivalent to a control-grid voltage change of 2 V in a tube that has a μ of 20?

(12) $\beta = I_C/I_B$. β is the *current transfer ratio* of a transistor in common-emitter configuration. Don't worry about the verbiage. We're just dealing with a transistor's gain here, current gain (as compared to a tube's *voltage* gain). I_C is collector current and I_B is base current. This is our final formula in this installment, so let's just take it as it is. What's the beta (that's what the Greek β

is called) where I_C is 6 mA and I_B is 0.1 mA?

WORK AND ANSWERS TO EXERCISES

(1) Move the 12 from the top of the right side to the bottom of the left, getting $P/I^2 = R$. 300 mA is 0.3 Amps, so we have $250/[(.3)(.3)] = 250/0.09$, which is 2800 Ohms.

(2) $R = E^2/P$, so here it equals $[(950)(950)]/125 = 7200$ Ohms.

(3) $n_s = (E_s n_p)/E_p$, which here is $[(12.6)(1000)]/120 = 10.5$ turns.

(4) $X = QR$, which is $78(27)$ or 2100 Ohms.

(5) $C = 1/(2\pi^2 f^2 L)$, which is

$$\frac{1}{4(9.87)(7.13 \times 10^6)(7.13 \times 10^6)(8.5 \times 10^{-6})}$$

Rounding out, etc., we get

$$\frac{1}{4(10^1)(7 \times 10^6)(7 \times 10^6)(9 \times 10^{-6})}$$

which gives $1/(1764 \times 10^7)$, which is, rounded out, $1/(2 \times 10^3 \times 10^7)$. That's $(10 \times 10^{-1})/(2 \times 10^{10})$, which gives, finally, 5×10^{-11} or 50 pF, approximately!

(6) $C = T/R$, which here is $0.2/800 = 250 \mu\text{F}$.

(7) $L = TR$, which is $(0.003)(35)$ or 110 mH.

(8) $Q = f_0/\text{bandwidth}$. Here $Q = 1000/80$ or 12.5.

(9) $E_{in} = E_{out}/Q$, which here is $18/60$ (our answer will be in millivolts, since that 18 is millivolts), which is 0.3 mV.

(10) $X_L = Z_T/Q$. Here, it's $50,000/35$ or about 1500 Ohms.

(11) $\Delta E_B = \mu \Delta E_C$, which is $(20)(40)$ or 800 volts.

(12) Beta here equals 6 mA/.1 mA or 60 (the mA's cancel out, so the answer has no units).

Flash Project For Camera Fiends

—powerful electronic flash you can build

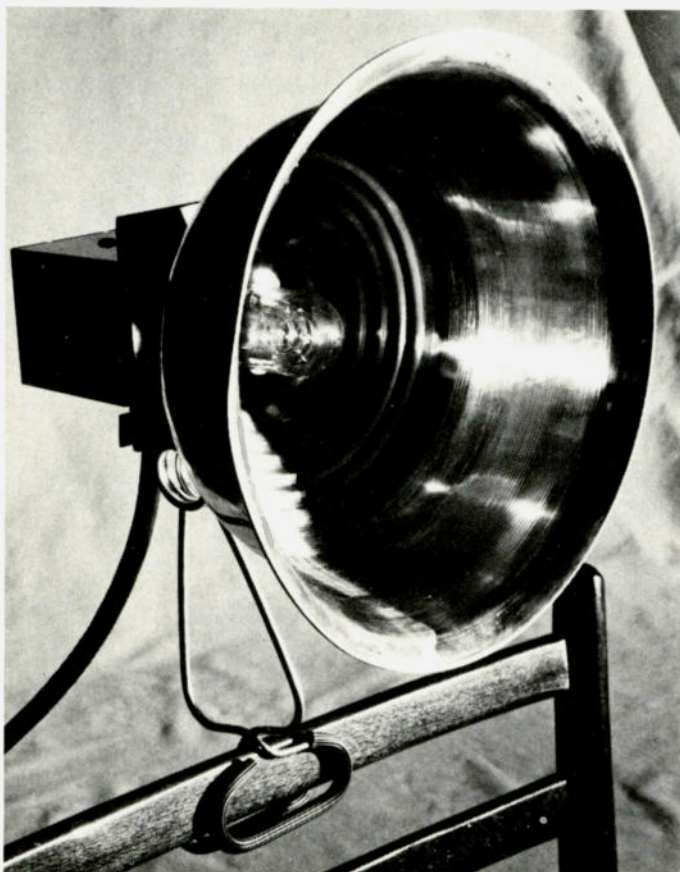

David D. Blackmer WA6UNK
Rt. 1, Willow Road
Nipomo CA 93444

Photos of an electronic project always add considerable impact to a good construction article, so an electronic flash and ham radio can go together well. Several of the parts for the flash described here should be in the average ham junk box. The most expensive parts are

the flash lamps, photo flash capacitors, and the lamp trigger assembly. Sources for these parts are listed in the notes.

Refer to Fig. 1 for the basic flash information. Applying power to transformer T1 causes diode D1 to conduct through protective resistor R1, charging capacitor C1 to about 450 volts. This voltage also appears across the flash lamp electrode's pins 2 and 4. The voltage across resistors R5 and R6 charges capacitor C5 to about 360 volts. The components are now ready to fire the flash lamp, FL1. Momentarily closing the sync contacts discharges capacitor C5 through the primary of transformer T2, causing a very high voltage pulse (20,000-plus volts) to ionize the gas in the flash lamp. The lamp emits a very short powerful flash and discharges capacitor C1 below the conduction voltage of the flash lamp. In a few seconds, capacitors C1 and C5 recharge and the cycle is ready to be repeated.

See Fig. 2 and the photos. This unit can be built with one, two, or three lamps. Three lamps give the best results with back, side, and front lighting. Decide, then assemble all the parts required. Transformer T1 was a rather hefty unit with 320 volts at 200 mA, 6 volts, and 12 volts. Relay RY1 was a sensitive fast-acting miniature Iron Fireman with a 10k coil. The voltage doubler gave about 30 volts and provided

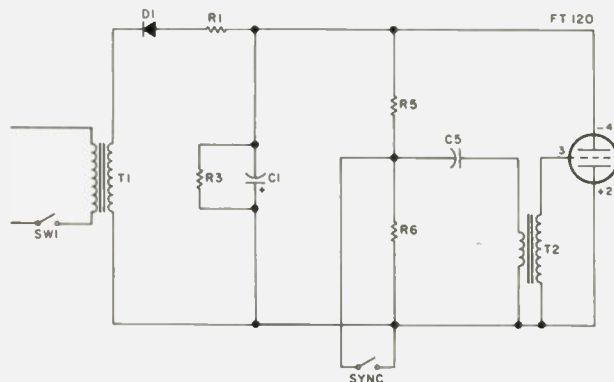
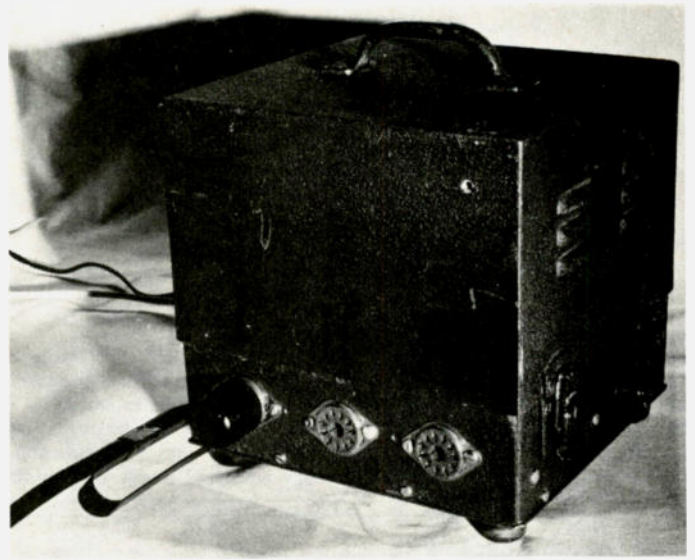
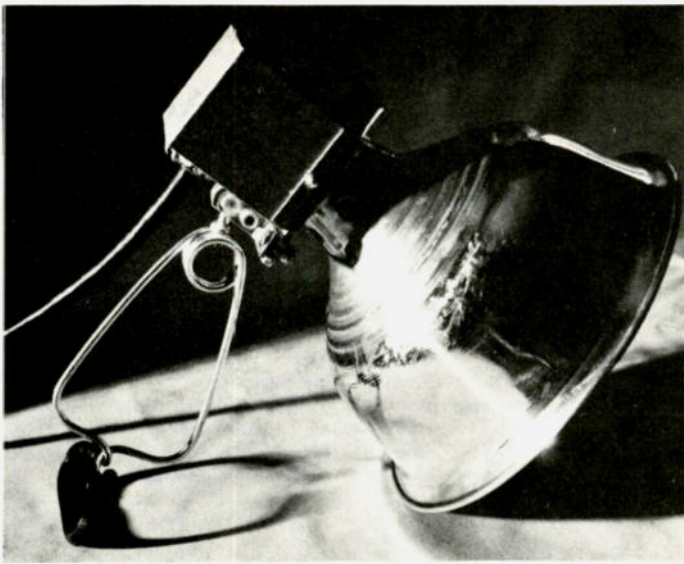

Fig. 1. Basic flash.



good sync for a Cannon camera (focal plane shutter) at 1/30 of a second (see notes). The sync cord is ordinary zip cord about 15 feet long.

See Fig. 3. The flash heads were assembled with ordinary aluminum reflectors from the local hardware store, mini-boxes, and spring clamps for universal mounting. Trigger transformer T2 gives a very high voltage pulse, so lamp socket SO4 should be the best quality available to prevent arc-over. Sync assembly output to pin three of the lamp socket should be short. The trigger assembly consists of transformer T2 and capacitor C5 mounted on a small printed card with foil and drilled holes to accept

diode D5 (not provided with the trigger assembly). The ready light, NE1, is not necessary but is nice to have. If you make more than one flash head, only one needs the ready light. Initial charge time is approximately 10 to 15 seconds, with 5 to 6 seconds between flashes. Juggle resistor R8 to have NE1 flash when the high voltage reaches about 425 volts. Note the jumper between pins 1 and 2 of the flash head socket. This jumper completes the charge path for the capacitors in the power supply section. There is no need to charge the capacitors if the second and third heads are not plugged in.

Remember that the dc voltage on a lightly-charged

capacitor reaches 1.41 times the rms voltage of the source. 1.41 times 320 equals approximately 450 volts. The Watt-second rating of each lamp is approximately 70. Ws equals $(E^2C)/2$, which is very good light output.

Safety note: A 700 μ F capacitor charged to 450 volts is very dangerous. Be careful.

The lamp cords are 600 V 3-conductor extension cord, about 12 feet long. The case to hold the power supply components can be wood or metal, plain or fancy, as you wish.

To add a third flash lamp, add one more photo flash capacitor, socket, diode rectifier, and protective resistor, and connect the pin 3s of each lamp cord socket together to provide sync to the lamp heads.

A guide number can be obtained by exposing a couple of rolls of black and white film at progressive f-stops and distances, and

then noting the results of normal development. Note that, if only one of the two or three constructed lamps is needed for a photo project, it must be plugged into lamp socket no. 1. This unit was intended for studio work and not made very portable, so the size of the components was not a factor. ■

Notes

1. Photo flash capacitors cost about \$11.00 each. QC Components, 8913 Lankershim Blvd., Sun Valley CA 91352.
2. Flash lamps, FT120 GE, cost about \$16.00 each. Lamp trigger assemblies cost about \$10.00 each. Norman Enterprises, Inc., 2627 W. Olive Ave., Burbank CA 91505.
3. All diodes, about 10 for \$1.00. S. D. Sales Co., P.O. Box 28810A, Dallas TX 75228.
4. Focal plane shutters are only wide open at speeds up to about 1/30 sec. to 1/50 sec. Electronic flash pictures made at shutter speeds above about 1/50 sec. will have only part of the film area exposed because shutter aperture is progressively narrow as shutter speed is increased. Between-the-lens shutters close sync contacts when the shutter is

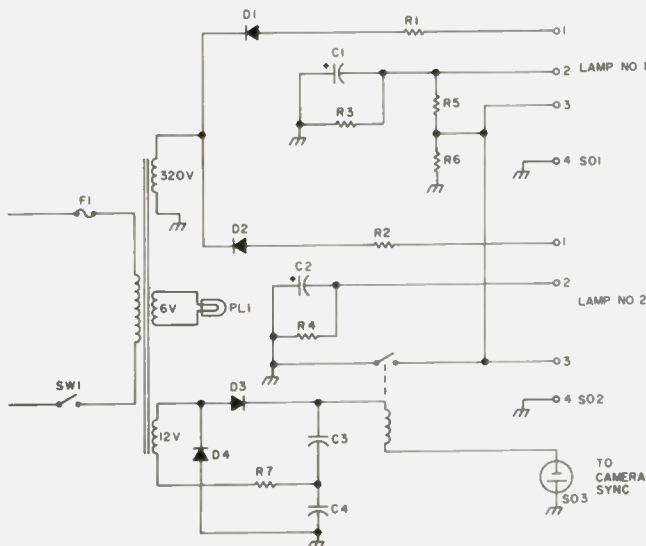

Fig. 2. Power supply and sync.

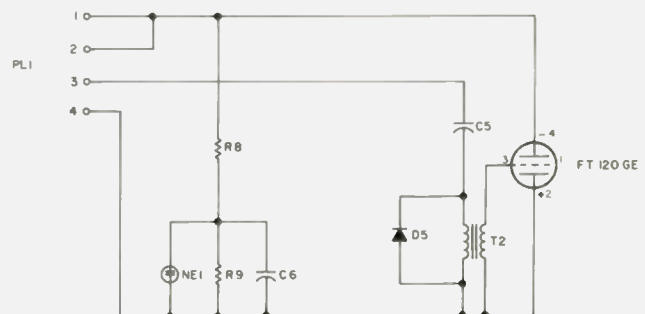

Fig. 3. Flash head.

Parts List

C1, C2	700 uF, 450 volt (photo flash quality)
C3, C4	3 to 4 uF, 50 volt
C5	.22 uF, 400 volts (part of trigger assembly)
C6	.1 uF, 100 volts
D1, D2	1 Amp, 1,000 volts
D3, D4	.5 Amp, 100 volts
D5	1 Amp, 600 volts
FL1	FT120 GE
NE1	neon lamp
R1, R2	320 Ohm, 5 W
R3, R4	220k Ohm, 2 W

R5	390k Ohm, 1 W
R6	2.2 megohms, 1 W
R7	5 Ohm, 1 W
R8	6.8 megohms, ½ W
R9	2.7 megohms, ¼ W
RY1	Iron Fireman 10k Ohm coil (or equivalent)
T1	Surplus replacement 150 mA min. at 320 volts, 6 V and 12 V.
T2	High voltage transformer (part of trigger assembly)
Misc.	Fuse, switch, sockets, plugs, pilot light, lamp cord, reflectors, miniboxes, ac cord.

wide open at X setting. Cameras without sync contacts can be used in the "open flash" configuration. Set the camera to "bulb," open the shutter, fire the flash (a normally-open push-button switch at

end of sync cord), close the shutter, all in rapid succession, and the film will be exposed.

5. High voltage can be increased or decreased over a considerable range by using 6-volt or 12-volt

windings in series, aiding or bucking the primary winding. Don't use the winding going to sync.

6. Photo flash capacitors should be charged and discharged at

60-day intervals to protect the dielectric film.

7. The FT120 lamp will provide over 10,000 flashes.

8. Photo credits: Barbara Richards, Hopkinton NH.

Social Events

BRIDGMAN MI MAR 5

The Blossomland Amateur Radio Association will hold the 12th Annual Spring Swap-Shop, Sunday, March 5th, at Bridgman Middle School Gym, Lake St. at Tower, Bridgman MI. Exit 16 on I-94. Large facilities, refreshments, prizes, and fun. Talk-in on 22/82 and 94. Table space restricted to radio and electronic items only. Advance ticket donation is \$1.50; tables, \$2. Write: John Sullivan, PO Box 345, St. Joseph MI 49085. Make checks payable to Blossomland Hamfest.

STERLING IL MAR 5

The Sterling-Rock Falls Amateur Radio Society hamfest will be held March 5, 1978, at the Sterling High School Field House, 1608 4th Avenue, Sterling IL. Indoor flea market restricted to radio and electronic items only. No advance sale of tables — they may be obtained at the door, or you may bring your own (\$3.00 for ½ table, \$6.00 for full table). Plenty of free parking available, including area to accommodate campers and mobile trailers. Admission: \$1.50 advance, \$2.00 after Feb. 15th, 1978, or at the door. Write Don Van Sant WA9PBS, 1104 5th Avenue, Rock Falls IL 61071. Make checks payable to the Sterling-Rock Falls Amateur Radio Society. Talk-in 146.94 simplex.

CIRCLEVILLE OH MAR 5

The King of the Pumpkin Ham Fiesta, sponsored by the Teays Amateur Radio Club, will be held from 9:00 am to 5:00 pm, Sunday, March 5, 1978, at the fairgrounds coliseum in Circleville, Ohio. Indoor flea market, new and used equipment, door prizes, refreshments, and free parking. Tables are available at \$3.00 each. Advance admission is \$1.00; at the door, \$2.00. For advanced reservations and information, contact Dan

Grant W8UCF, 22150 Smith Hulse Road, Circleville OH 43113, (614)-474-6305.

FLEMINGTON NJ MAR 11

The Cherryville Repeater Association will hold its annual hamfest on March 11, 1978. The location this year is the Field House at Hunterdon Central High School, located just north of Flemington, New Jersey, on Route 31. Major equipment manufacturers will be on hand to display their latest equipment. This is an indoor hamfest with over 20,000 square feet of heated area for displays. There will be informative seminars throughout the day on subjects related to amateur radio. Admission for buyers is \$2.00 at the door and an additional \$1.00 for flea market sellers. Time: 10 am-5 pm.

FT. WALTON BEACH FL MAR 11-12

The 8th Annual North Florida Swapfest will be held 11-12 March 1978 at Ft. Walton Beach FL. For more information, contact John Lakin W4MMW, Secy., Playground Amateur Radio Club, Box 873, Ft. Walton Beach FL 32548.

GURNEE IL MAR 12

The Libertyville and Mundelein Amateur Radio Society (LAMARS) will hold its first annual Lamarsfest on Sunday, March 12, 1978, from 9 am to 5 pm, at American Legion Post 711 in Gurnee, Illinois, located at the intersection of Illinois Routes 21 and 132, just east of Marriott's Great America theme park. There'll be lots of free parking, lots of door prizes, and no charge for setups. Tickets are \$1.50 at the door, \$1.00 in advance. Refreshments will be available from 9 to 5. Talk-ins will be on 146.52 and 146.94. For further information, contact W. H. ("Bill") Stumphy WB9PGQ, 504 W. Hawley Street, Mundelein IL 60060.

EAST RUTHERFORD NJ MAR 18

The Knight Raiders VHF Club, Inc., will present its auction and flea market at St. Joseph's Church, East Rutherford NJ, on Saturday, March 18, 1978. Doors open at 10 am. Free admission, free parking. Refreshments will be available. Flea market tables: \$5.00 for a full table or \$3.00 for a half table, *in advance*; or \$6.00 for a full table or \$3.50 for a half table, *at the door*. Talk-in on 146.52. For further information, call Bob Kovalski at (201)-473-7113 (evenings only). Send reservations and checks payable to: Knight Raiders VHF Club, Inc., PO Box 1054, Passaic NJ 07055.

MIDLAND TX MAR 18-19

The Midland Amateur Radio Club will have a swapfest on Saturday and Sunday, March 18 and 19. It will be held in the County Exhibit Building on Highway 80 just east of Midland, Texas. Pre-registration fees are \$3.50 per person, and it's \$4.00 at the door. There will be door prizes. Please send registration fees to: Midland Amateur Radio Club, Box 4401, Midland TX 79701.

GREENVILLE SC MAR 18-19

The Blue Ridge Amateur Radio Society will hold its annual Greenville, S.C., hamfest on March 18-19, 1978. The hamfest will be held in the exhibit hall of the Greenville Memorial Auditorium. Free paved parking for 1000 cars in the auditorium parking lot.

JEFFERSON WI MAR 19

The Tri County ARC hamfest will be held on March 19, 1978, in the Activities Building at the Jefferson County Fairgrounds at the west city limits of Jefferson on Highway 18. A limited number of reserved tables are available for \$2.00 in advance. Loads of room for your table. Tickets are \$1.50 in advance, \$2.00 at door. Extra door prize for advance tickets. Write Glenn Eisenbrandt WA9VYL, 711 East Street, Fort Atkinson WI 53538.

TOLEDO OH MAR 19

The 23rd Toledo Mobile Radio Association, Inc., auction/hamfest will be held on March 19, 1978, at the Lucas County Recreation Center. Bring your items for sale, and we'll auction them for you at no charge. Hours will be 8 am to 5 pm. Tickets are \$2.50 at the door, and \$2.00 in advance. Talk-in on 147.87/27; 146.01/61; 34/94; 52/52. For information, write to Box 273, Toledo OH 43696.

CHARLOTTE NC APR 1-2

The Mecklenburg Amateur Radio Society, W4BFB, will hold its 1978 Metrolina Hamfest on April 1-2, 1978, in Charlotte's new Civic Center. Plenty of parking will be available. The Roanoke Division of the ARRL will hold its annual convention in conjunction with this hamfest.

PITTSBURGH PA APR 2

The University of Pittsburgh Amateur Radio Association's (W3Y1) second annual hamfest will be held on Sunday, April 2, 1978. Festivities will be from 10 am to 5 pm in the Student Union Building across from the Cathedral of Learning. (Note: Meter parking is free on Sundays!) Check-ins on .69/.09 and .52/.52. For detailed information (and a map), send an SASE to the University of Pittsburgh Amateur Radio Association W3Y1, Box 304 Schenley Hall, Pittsburgh PA 15260, or call Mark Bell WA3VJL at (412)-931-6700 or Harry Bloomberg WA3TBL at (412)-624-7768.

TOWSON MD APR 2

The Greater Baltimore Hamboree will be held on Sunday, April 2, at 8 am at Calvert Hall College, Goucher Blvd. and LaSalle Road, Towson MD 21204 (1 mile south of exit 28, Beltway-Interstate 695). There will be food service, prizes, and a giant flea market. Admission charge is \$2.50. 250 tables inside the gym and cafe.

Continued on page 149

Repeater coordinating committees are faced with the chore of monitoring assigned repeater channels after an interval, to determine if the channel is actually being used. This is difficult to do if the assigned frequency is for a closed repeater and the access method is unknown. For monitoring purposes, all that is needed is some sort of indicator to show whenever the repeater transmitter has been keyed up, even though it may have been turned on momentarily by a "kerchunker" familiar with the access code.

With this in mind, Warren Andraesen WA6JMM was consulted, and he came up with a suggested circuit for an indicating device that was subsequently built and placed into service. Warren is known to most 73 readers for his past articles therein.

This device, which has been named the "kerchunk counter," is merely an event counter which reads out in a row of six LEDs in binary, to a total of 63 counts. On the 64th count, the overflow LED lights, and the entire sequence can be repeated by momentarily closing the overflow switch. At any time between a count of 1 and 63, the readouts can be turned off by momentarily closing the counter reset switch.

The counter is made to operate by connecting pins 8 and 9 of IC1 to ground. This is done by connecting to the relay output of a COR relay, which would have to be installed in the receiver. Methods of connecting a COR relay into receivers have been covered in the literature and so will not be repeated here.

Parts used in this counter are readily obtainable, and the three integrated circuits are common CMOS devices. Layout is not critical, and hand wiring was used, although a printed circuit board would perhaps be easier for the builder to use. This device was laid out on a piece of perfboard measuring

about 1" x 4". A piece of double-sided printed circuit board was used as a panel on which the LEDs and switches were mounted. The whole assembly was installed in a plastic cabinet measuring 2½" x 5" x 1½" deep, with the panel fitting on the top.

Three connections are needed to the counter — plus 12 volts, ground, and connection from normally open contact on the COR. The other contact on the COR has to be ground. The plus 12 volts can be obtained from the receiver. To place into operation, turn on the receiver and set to the desired repeater you wish to monitor.

Leave the receiver and counter on for as long as you wish, maybe hours or days or even a week or two. Each time you pass by, look to see if one or more lights are on. If more than two or three counts are indicated, then it is to be assumed that the repeater transmitter has been turned on. Just one or two counts may not be proof enough, as random noise or radar could possibly trigger a count or two. On the other hand, a couple of long-winded rag chews over the repeater would indicate only a count of two. Be sure to set the squelch up fairly tight to prevent random noise from

triggering a count.

As this device is an event counter, it can be used for purposes other than checking on a repeater operation. It is no doubt used in industry and laboratories for counting operations. At the moment, nothing comes to mind for use of this counter around the home, but there must be something it could be applied to.

With respect to the SCR used in the overflow circuit, this is shown as a type MCR-103, which should be readily available. Any small SCR can be used here, as long as it will light up the LED. ■

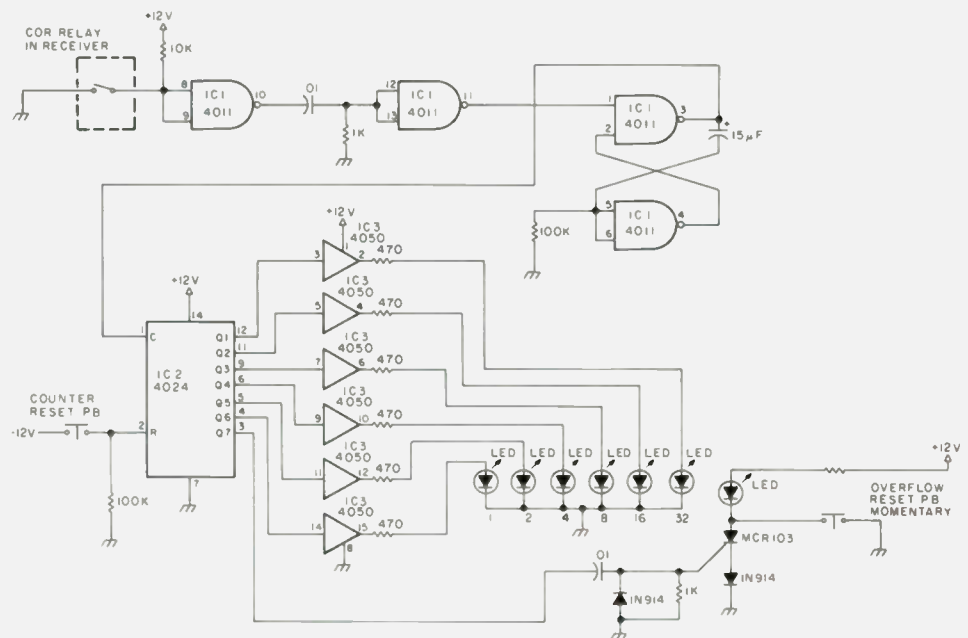
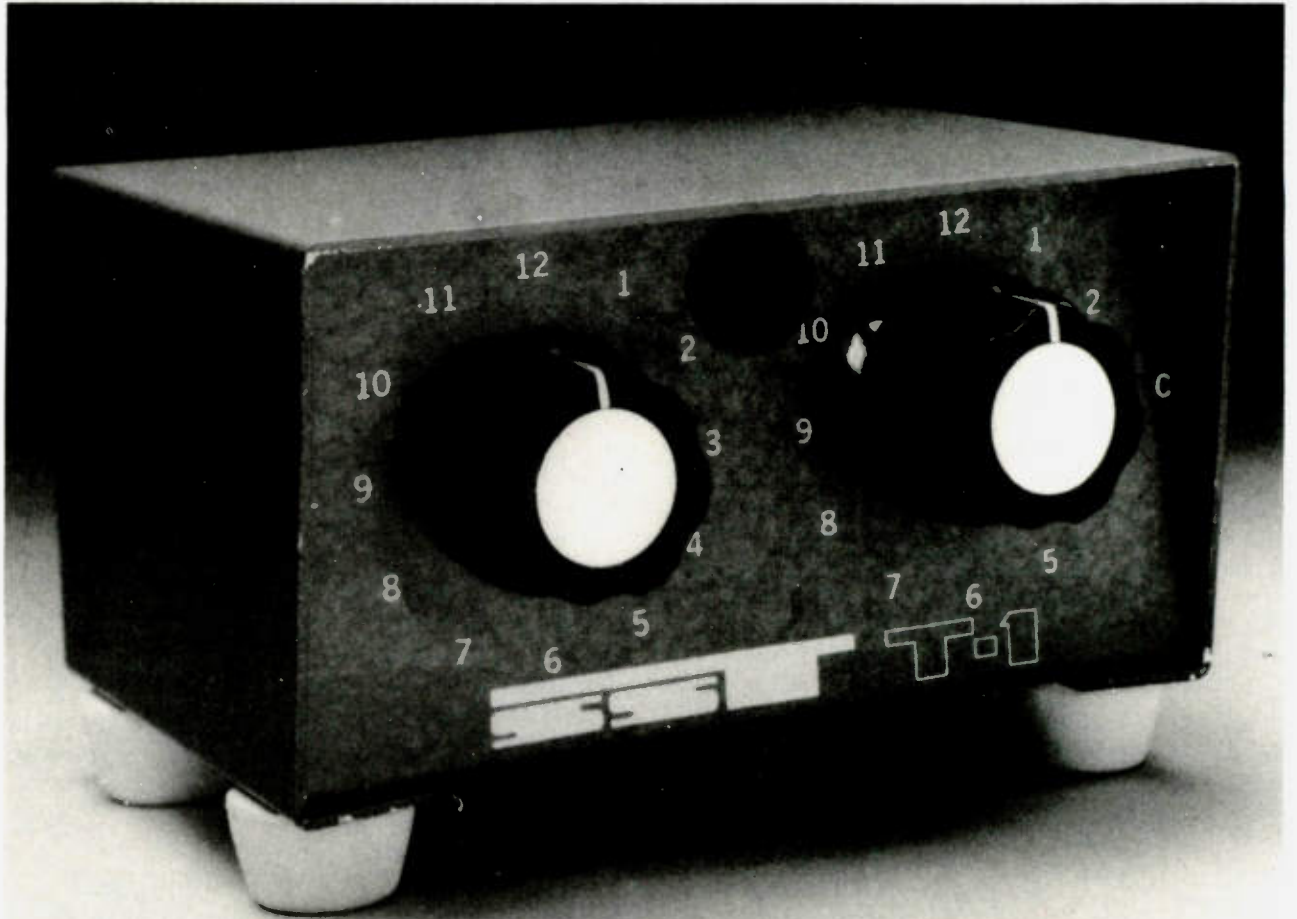

Fig. 1. Kerchunk counter.

SSS T-1 RANDOM WIRE ANTENNA TUNER



only **\$29.95**

All band operation (160-10 meters) with any random length of wire. 200 watt **output** power capability—will work with virtually any transceiver. Ideal for portable or

home operation. Great for apartments and hotel rooms—simply run a wire inside, out a window, or anyplace available. Toroid inductor for small size: 4-1/4" X 2-3/8"

X 3." Built-in neon tune-up indicator. SO-239 connector. Attractive bronze finished enclosure.



sst t-3 IMPEDANCE TRANSFORMER

Matches 52 ohm coax to the lower impedance of a mobile whip or vertical. 12 position switch with taps spread between 3 and 52 ohms. Broadband from 1-30 MHz. Will work with virtually any transceiver—300 watt output power capability. SO-239 connectors. Toroid inductor for small size: 2-3/4" X 2" X 2-1/4." Attractive bronze finish.

only **\$19.95**

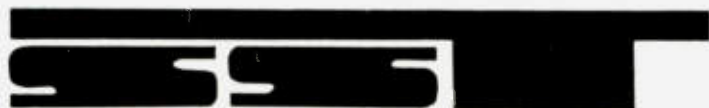

ELECTRONICS

P.O. BOX 1 LAWNSDALE, CALIF.
90260 (213) 376-5887

SST T-2 ULTRA TUNER



only **\$49.95**

Tunes out SWR on any coax fed antenna as well as random wires. Works great on all bands (160-10 meters) with any transceiver running up to 200 watts power output.

Increases usable bandwidth of any antenna. Tunes out SWR on mobile whips from inside your car.

Uses toroid inductor and specially made capacitors for small size: 5¼" x 2¼" x 2½." Rugged, yet compact. Attractive bronze finished enclosure. SO-239 coax connectors are used for transmitter input and coax fed antennas. Convenient binding posts are provided for random wire and ground connections.

SPECIAL 10% OFF COUPON SALE

Send the coupon below with your order and take 10% off our regular prices. Or, take the coupon to an

SST dealer. For phone orders, just mention the coupon for the discount.

CHECK MODEL(S) DESIRED AND TAKE 10% OFF REGULAR PRICES:

- SST T-1 REG. \$29.95
- SST T-2 REG. \$49.95

- SST T-3 reg. \$19.95

PLEASE ADD \$2 PER ITEM FOR SHIPPING.

NAME _____
 ADDRESS _____
 CITY _____ STATE _____

GUARANTEE

All SST products are guaranteed for 1 year. In addition, they may be returned within 30 days for a full refund (less shipping) if

you are not satisfied for any reason. Please add \$2 for shipping and handling. Calif. residents, please add sales tax. COD orders OK by phone.



ELECTRONICS

P.O. BOX 1 LAWNOLE, CALIF.
 90260 · (213) 376-5887

S10

The Solar-Powered Ham Station

— one hundred Watts, yet!

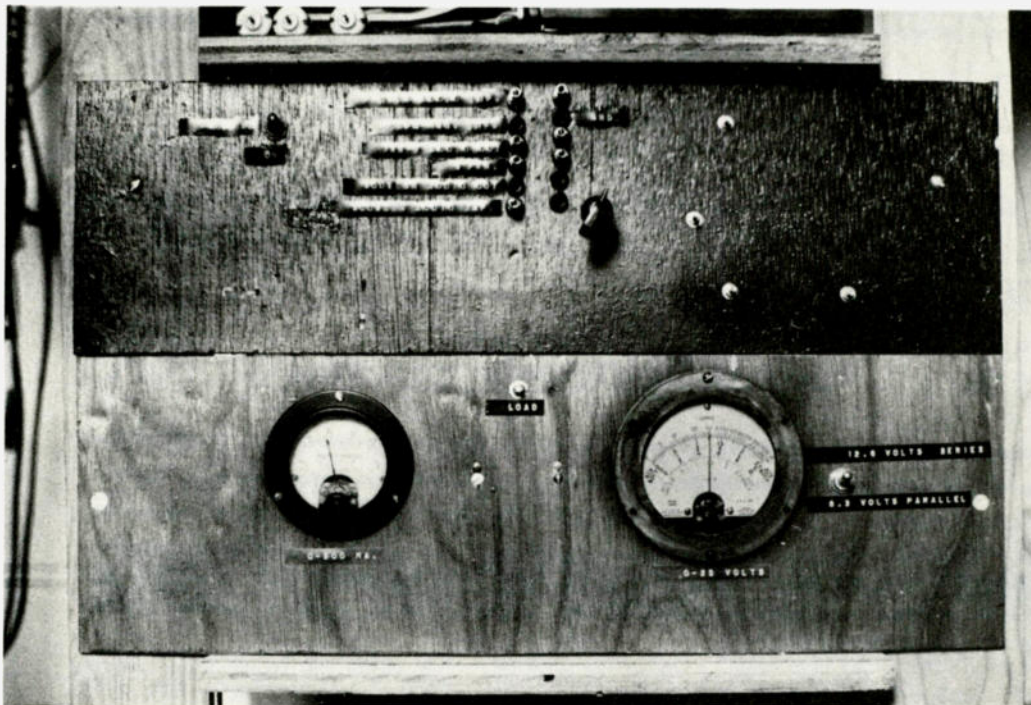

Solar monitoring facilities of W5VBO. The panel is 1/4" plywood, clear varnished. The meter on the left is 0 to 500 mA. The meter on the right is 0 to 25 volts. This scale places the normal 12.6 volts nominal at about midscale. Both meters are surplus units with homemade shunts. The series/parallel toggle switch is on the right. At the top of the panel is a 500-Ohm pot used to test the power output of the array under variable solar radiation conditions. The panel above the monitoring panel is the station audio patch panel.

For many years, the idea of completely solar powering a ham station has fascinated me. A few previous articles have described how to use a few low-current cells to power small QRP transmitters in the 1- to 5-Watt class. This article describes a system, in use for almost 3 years at this QTH, which consists of 36 solar cells mounted on a panel, each supplying 500 mA and charging a storage battery.

This setup powers a Ten-Tec Argonaut and 405 linear to the tune of 100 Watts PEP input. This is a power level which is quite adequate for most work on the HF bands. To help you build your own system, this article also includes the basic elements for designing a system for practically any power requirement, but won't get too involved in theory or mountains of data.

The first question one may ask is: "Why use solar cells in the first place? Aren't they terribly expensive?" Well, as will be shown, 36 cells supplying 500 mA each are about right for a 12-volt system powering a 100-Watt transmitter. The cost of the solar system at this writing is \$165 for the 36 cells, plus another \$20 to \$30 for the 12-volt lead-acid storage battery. 12-volt auto batteries are still available on sale for close to \$20. On the other hand, an 8-Amp to 10-Amp 12-volt supply costs between \$100 and \$130. Furthermore, the solar cell system with the lead-acid storage battery still gives several days of operation when no sunlight is available. In times of emergency or disaster, this feature can make your ham rig invaluable. With your ac supply, your shiny expensive rig is of little more value than a paper-weight during a power failure.

The two main reasons usually given to justify ham radio's existence are:

1. Communications capability in times of disaster.

2. Advancement of the state of the art.

Aren't both of the above criteria fulfilled with solar power?

Before looking at the solar power side of the system, though, we need to first look at the other side: How much power do you require? This depends on 2 main factors:

1. How much do you operate?
2. Ratio of listen time to transmit time.

In my station, I find that the rig is turned on 20 to 30 hours a week. Of that time, only about 20%, or 2 to 3 hours, is actually transmitting time. This, of course, is far from key-down conditions. In the CW mode, maybe 50% of the time is actually key down. In the SSB mode, probably roughly the same percentage exists. Since the Argonaut/linear draws about 300 mA on receive and about 8 Amps key down, we can make a rough estimate of how much power, or Amp-hours (Ah), are actually consumed. Using somewhat worst-case conditions, we come out with:

$$30 \text{ hours} \times .3 \text{ A} = 9 \text{ Ah}$$

$$(50\% \text{ of } 8 \text{ A} = 4 \text{ A})$$

$$3 \text{ hours} \times 4 \text{ A} = \frac{12 \text{ Ah}}{21 \text{ Ah}}$$

This means 21 Amp-hours per week are drawn from the

storage battery. It happens that two 6-volt, 150-Ah batteries are used at this station, giving 12 volts and 150 Ah each. This works out to 150 Ah/21 Ah = 7.01, or about 7 weeks of normal operation with no charge from the solar cells. This is probably too much storage capacity, but the two 6-volt batteries were obtained almost brand new at very little cost, so they were placed into operation. Besides, this leaves a lot of reserve power available for contests and/or long periods of overcast days.

This brings us to the storage system. Although the more efficient nicad batteries can be used for storage, they become very expensive to use at this power level. They are, however, ideal for small QRP setups. Thus, lead-acid batteries are used in my system.

A 12-volt lead-acid battery (or two 6-volt batteries in series) should be charged to around 14 to 15 volts.

Now, knowing approximately how much power we are going to extract from the system and at what voltage, we can make a pretty good estimate of what size solar battery is required.

Since one solar cell produces between .4 volts and .55 volts in full sunlight, regardless of rated current output, let's talk about the

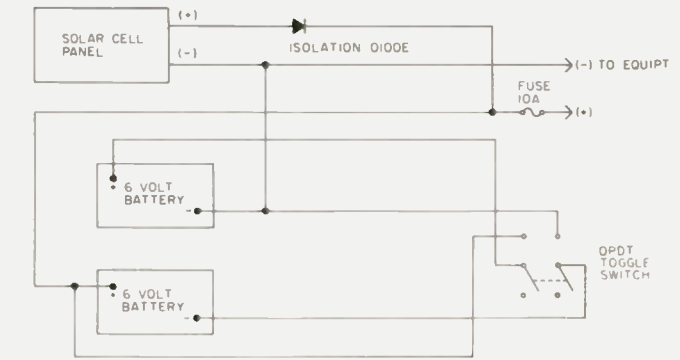

Fig. 1. 6 V to 12 V switch wiring. All wiring is #10 or larger.

number of series-connected cells we need. With a 12-volt system charging at 15 volts and each solar cell generating .4 volts, we end up with 15/.4, or 37 cells required. Since price breaks exist for even dozens of cells ordered, 36 cells would be adequate.

We are just about done designing, except for one last little bit of arithmetic — the current rating of each cell required to keep the storage battery up to snuff. We can really get very involved here because many, many variables exist. Some of these are the season of the year, latitude, and even, to some very slight degree, temperature. In keeping with our rule-of-thumb approach, let's keep it simple and dive in. Using my setup again as an example, we found that 21 Ah per week were removed from the storage battery. So, naturally, we've got to replace this amount of power plus some, due to the lead-acid battery being less than 100% efficient. In fact, 60% to 75%

efficiency is what I seem to get. So, being conservative, let's use 60%, which means we'll lose 40% in the chemical-to-electrical conversion processes of the lead-acid battery. Therefore, 21 Ah x .4 = 8.4 Ah. Then, 21 Ah + 8.4 Ah = 29.4 Ah per week. Disregarding the periods of overcast days, night, dusk, and dawn, about 4 to 5 hours per day can be expected to produce the rated output of our solar battery. So 7 days per week x 4 hours = 28 hours per week charging time. At 29.4 Ah per week required, this means we finally end up with 28/29.4, or about 1 Amp rated solar cells.

So much for theory. We can get quite a bit more actual charging time by using a simple technique. During periods of low solar radiation (dawn, overcast, dusk, etc.), the solar cell output voltage will be something less than the storage battery voltage. This means no current will be drawn, and, therefore, no charging takes place. If we

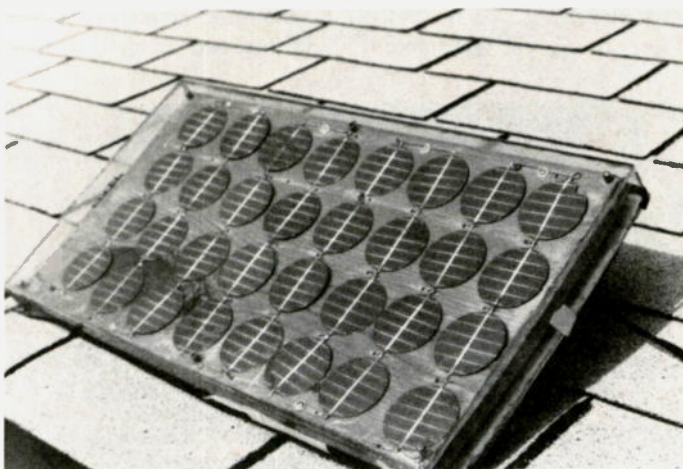

Solar cell array mounted on the roof. The dimensions are 24" x 12". These photos show my original 32-cell system. I later added four more cells to make the system described in the text.

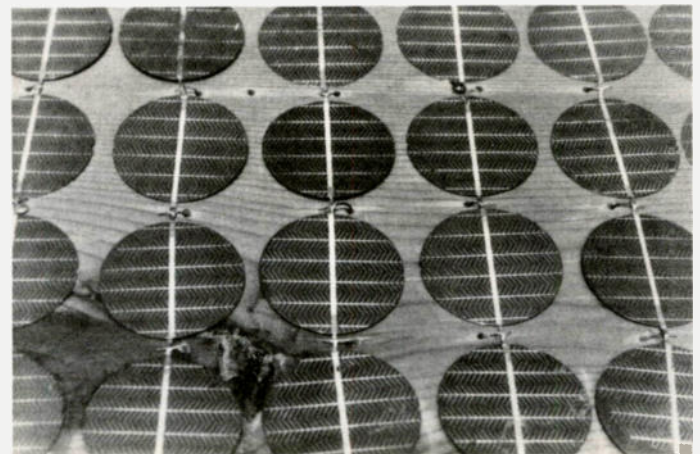

Central view of solar cell array.

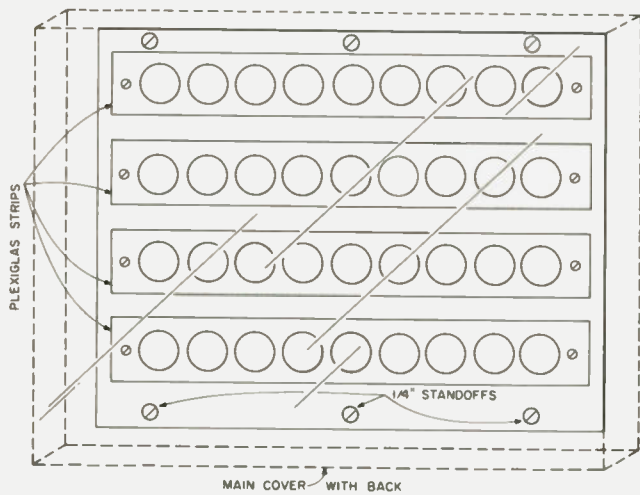

Fig. 2. Solar cell enclosure. The four horizontal Plexiglas™ strips are attached to the mounting board with wood screws. Six 1/4" standoffs secure the main Plexiglas cover. Epoxy glue is used to bond the sides and back of the main cover.

use two 6-volt batteries hooked in parallel, the solar cells will give us 6 volts or more, much more of the time, than 12 volts. So in my installation, two 6-volt batteries, hooked up with a DPDT switch, as shown in

Fig. 1, are used. When the rig is not turned on, the switch is thrown to parallel. This enables much more charge to be delivered to the storage battery when I'm at work during the day, 5 days a week. Since most hams operate by night

and work by day, except for weekends, this scheme should work out quite well for most fellows. So well, in fact, that at this QTH, as mentioned before, 500 mA cells are used and work out very well under the operating conditions outlined.

Remember that solar cells can be connected in series (for more voltage) and in parallel (for more current), just like storage-type batteries and cells. If you find that because of lack of sunshine, or because more current is consumed than you had planned, your storage battery loses more power than is gained, take heart. Another bank of like cells can be added at any time, doubling the current output. Of course, there's always the dastardly unpure approach of occasionally hooking up an ac charger to take up the slack, but, to me, anyway, it seems better to limit operating activity than to give in! At this station, however, this has never been necessary.

Another gimmick you can use to squeeze out a little more juice is the isolation diode. This is required to keep the storage battery from feeding power to the solar battery during times when the solar battery's voltage output is less than the storage battery. If a silicon diode is used, .6 to .7 volts will be lost across the diode. This almost represents 2 solar cells! Therefore, a germanium

Solid State Sales
P.O. Box 74-A
Somerville MA 02143

Edmund Scientific Co.
300 Edscorp Building
Barrington NJ 08007

John Meshna
P.O. Box 62
E. Lynn MA 01904

Poly Paks
P.O. Box 942-E
Lynnfield MA 01904

Table 1. Distributors of solar cells.

diode is used, keeping the loss to about .3 volts. Actually, I used a power germanium transistor, hooked up as a diode, with a heat sink. Just make sure, of course, that the transistor or diode is capable of handling the full current and voltage output of the solar cells.

Ok, now we have our cells selected, bought, and hooked up to our storage battery (at least on paper). Although many cells have a clear weatherproof finish sprayed on, we still really need to protect them in some kind of transparent enclosure. Fig. 2 shows how I did it. As long as it's really weathertight, just about any design can be used. Some manufacturers even sell complete solar batteries, all enclosed and ready to hook up to your storage system. Building your own will save you a bit of money, however.

The completed unit should be mounted facing the south, and inclined from the hori-



The multiconductor cable hanging from the left of the solar cell array is used to measure individual cell output, if desired.

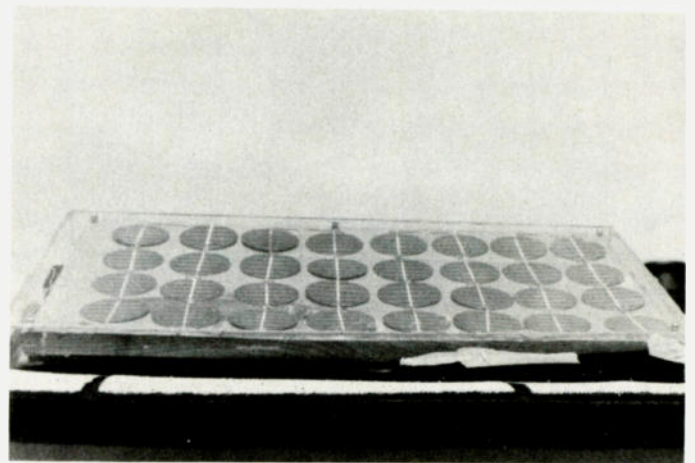

Solar cell array, front view.

zontal about the same number of degrees as your latitude. This dimension is by no means critical; 10° either way has only a slight effect.

You'll probably want to monitor voltage and current independently. I used two very cheap 3" surplus meters with my own shunts to give me 500 mA and 15 volts full scale.

Operation of the system is quite easy and almost maintenance-free. When using the 6/12-volt system, flip the

switch each night to series to make sure the batteries are not over 15 volts, as this will indicate that the batteries are overcharging. This condition will shorten the life of the storage battery. Make sure that the storage battery has plenty of water, but do not overfill it. If you have a long time without rain, you might want to spray your garden hose up on the surface of the enclosure to make sure it is fairly clean. Also, don't mount the storage battery in

an enclosed area, as hydrogen gas is given off and this gas is very explosive (remember the Hindenburg). Since heavy charges and discharges do not take place, not much gas is given off, but better safe than sorry!

Apart from ecological and disaster communication advantages, when I mention that I am running a completely solar-powered 100-Watt station on the air, the conversation almost never dies with a weather report!

Opinions range from pessimism to euphoria to disbelief, but there are always opinions!

Lastly, watch out for the solar power "bug." Several pessimistic hams who have seen the setup have found themselves caught up with the same strange fascination I have — watching the current meter wave up and down as the sun passes behind and out of cloud banks. Whoever thought a power supply could be fun? ■

Social Events

from page 142

teria. Over 2000 attended last year. For information and table reservation, contact Bro. Gerald Malseed W3WVC at the school or call (301)-825-4266.

COLUMBUS GA APR 8-9

The Columbus Amateur Radio Club will hold its annual hamfest on April 8-9, 1978, at the Columbus Municipal Auditorium at the fairgrounds. Spacious, air-conditioned exhibit area, prizes, flea market, Saturday night banquet, FCC exams, and a luncheon will be featured. For further information, please contact Eddie Kosobucki K4JNL, 5525 Perry Ave., Columbus GA 31904.

MADISON WI APR 9

The Madison Area Repeater Association's 6th annual swapfest will be held, rain or shine, on Sunday, April 9, 1978, at the Dane County Expo Center Youth Building, Madison WI. Electronic equipment and components for hams, computer hobbyists, and experimenters. Delicious food, free movies, arts and crafts — Bring the whole family for delicious food and entertainment. Tickets are \$1.50 in advance, \$2.00 at the door. Tables are \$2.00 in advance, \$3.00 at the door. Excellent overnight camping accommodations. Make check or money order payable to MARA, Box 3403, Madison WI 53704. Reservations must be in by April 1, 1978.

NEWINGTON CT APR 9

The Pioneer Valley Repeater Association (PVRA) flea market and auction will be held on Sunday, April 9, 1978, from 10:00 am to 5:00 pm at Newington High School, Willard St., Newington CT. Setup time starts at 9:00 am. This is an event for everyone. There will be planned family activities, food available, and free parking. The flea market and

auction will run simultaneously in separate rooms. The auction will be held at regular posted intervals, with all items to be sold at each time slot on display before each auction. The ARRL Club and Training Department will have a Novice information booth to answer questions and provide League information. A guided tour of the League's new headquarters building will start at 2:00 pm. Those planning to take this tour should drop Arnie K1NFE a note indicating how many will be in their party. Talk-in will be on 19/79, 04/64 and 52 simplex. Admission will be \$1.00, tables \$5.00, and auction commission 10%. For additional information and guaranteed flea market space, contact: Arnie DePascal K1NFE, 20 Iowa Pl., Bristol CT 06010.

ROCHESTER MN APR 15

The Rochester Repeater Society will hold its hamfest on April 15, 1978, at St. John's Grade School, 420 West Center Street, Rochester, Minnesota. Doors open at 9:00 am. Door prize donations \$1.00; admission \$1.00; children under 12 free; \$2.50 for tables. Plenty of parking available. Talk-in on 146.22/82 WR0AFT and 52. Take I-90 to Rt. 52 or Rt. 63 and go north. For advance ticket sales and information, contact Joe Fishburn K0TS, 2514 4th Avenue, N.W., Rochester, Minn. 55901, (507)-288-2676, or Gary Sharp W8BAMA, 1610 34th St., N.W., Rochester, Minn., (507)-282-5119.

MOBILE AL APR 15-16

The Mobile Amateur Radio Club will hold its annual hamfest and computerfest at the University of South Alabama in Mobile AL on Saturday and Sunday, April 15 and 16, 1978. Swap and shop indoors both days from 9 am 'til 5 pm. Activities will be for the ladies and children. Campsites are available. Over 2000 are expected for the biggest fest on the Gulf Coast. For more information,

contact: Ed Coker WA4VPI, 7650 Ashley Court, Mobile AL 36619.

POMONA NJ APR 16

The Shore Points Amateur Radio Club will hold its first annual hamfest on Sunday, April 16, 1978, at Stockton State College, Pomona NJ. It will be from 9 am to 4 pm, rain or shine (sellers come at 7 am). There will be more than 200 indoor table spaces (\$4 each) and 400 tailgating spaces (\$2 each), an auction at 3 pm, food, a picnic area, and seating. Free parking for 1000 cars and spotless restroom facilities. The many great prizes will include a Wilson HT as the grand prize and lots more. There will also be new gear from professional dealers. Registration is \$1.50 at the gate, \$1.00 in advance. Children under 12 free. Make advance checks payable to SPARC. Advance sales space registration for indoor area only. Talk-in on 146.34/94 WR2AFL/SPARC, 146.52 WA2ESD. For information and tickets, write SPARC, P.O. Box 142, Absecon NJ 08201 or phone (609)-641-8795.

MONTGOMERY AL APR 22

The Alabama Forestry Festival will be held April 22, 1978. The Twin Base Amateur Radio Club station WA4PRY will be operating on site in conjunction with the Alabama Forestry Festival at the State Fair Grounds, Montgomery, Alabama. Any ARS completing a two-way contact will receive a special certificate in exchange for a QSL card and SASE. Operations will be conducted from 1600 hours to 2300 hours UTC on frequencies 14.300 MHz and 3.950 MHz normal SSB; slow CW (5 to 10 wpm) on 7.125 MHz during even hours UTC and 21.150 MHz during odd hours UTC. QRM frequency adjustments will be up band. For more information, contact Bruce W. Mertz WA8K1H/4, President, Twin Base Amateur Radio Club, CMR 80x 9748, Gunter AFS AL 36114.

GRIFFITH IN APR 22

On April 22, 1978, the Lake County Amateur Radio Club will hold

its Silver Anniversary/Herbert S. Brier Memorial Banquet at the Griffith Knights of Columbus Hall, 1400 S. Broad St., Griffith IN.

The evening begins at 6:00 with a cocktail hour, followed by a delicious family-style "all you can eat" dinner.

Guest speakers will be the Central Division director of the ARRL, Mr. Don Miller, and Chicagoland's famous radio personality, Mr. Clark Weber W9FFM/WIND.

The door prize list will feature a Wilson Mark II 2m hand-held transceiver, calculators, and gifts for the entire family. Special awards and the "Ham of the Year" award will also be presented. Two hours of dancing to music as you like it will conclude the evening's entertainment.

Tickets are \$8.00 each in advance — no door purchases. Make check payable to LCARC. Write to Joel G. Iacono WA9DJP, 634 Osage Dr., Dyer IN 46311.

SULLIVAN IL APR 23

The Moultrie Amateur Radio Club's 17th annual hamfest will be held on Sunday, April 23, 1978, at Wyman Park, Sullivan IL. There will be a heated indoor and outdoor flea market at no charge to vendors. For information, write: Box 327, Mattoon IL 61938. Talk-in on 146.94.

DAYTON OH APR 28

The 9th Annual FM B*A*S*H will be held on the Friday night of the Dayton Hamvention, April 28, 1978, at the Dayton Biltmore Towers Hotel, Main at First Streets, from 8 pm until midnight. Admission is free to all hams and their friends. Sandwiches, beverages, snacks, and COD bar will be available. A live floor show will be presented by TV personality Rob Reider WA8GFF and his group. A fabulous prize drawing featuring a complete Drake UV-3, including 144, 220, and 440 MHz synthesized modules, power supply, encoder mike and antenna, plus many other prizes will be held. Winner of the first prize need not be present. For further information, contact: Miami Valley FM Assn.,

Continued on page 167

A

Cheaper Chip



Until Intersil joined the ranks of IC manufacturers producing touch-tone™ encoder integrated circuits, most of my experience had been with the Motorola IC which uses a 1 MHz crystal and normally sells in the \$8 to \$10 price bracket. When Intersil entered the market, I immediately became interested in the Intersil chip. I had learned that it was selling for about \$2 less than the Motorola and that it used a 3.58 MHz color TV crystal, which is about a dollar less than the 1 MHz variety.

Intersil is making two versions of the IC — the ICM7206 and the ICM7206A. Most of us who are using readily available switches such as Chomerics or Bowmar will want the 7206A, since that matches their type of switch contacts.

Circuits

I will only go into device operation in the barest detail, since I'm not an IC engineer, and it's the end result that counts anyway. The device requires one switch closure each for a row and a column to generate a digit tone. The switch closure is to the plus supply line. The chip requires a 3.58 MHz crystal, which is readily available at most supply houses. The only other basic components required are two capacitors to filter the high and low group tones and reduce harmonic distortion.

The basic circuit is shown in Fig. 1. I have shown pin 16 connected to diodes going to the column inputs. This is to conserve power drain when not sending tones. In many applications, this would not be necessary; the device would be connected directly to the supply, and the diodes would be eliminated. Also, the 78L05 regulator is optional, but, if it's not used, a zener should be placed in series to keep the voltage across the IC to less than six volts. There is not really any more to say, except to remind those of you used to working with the 14410 that the 7206A switch common is the plus supply instead of the minus (ground) side.

I also wanted a portable tone generator so that I could control my repeater from my office, which does not have touchtone phones. With this in mind and an MC1306P in hand, I built an audio amplifier out of the *Motorola Linear Handbook*. The circuit is shown in Fig. 2. You remember that I said I wanted this portable. I wanted to put a nine-volt transistor battery in it and not need an on/off switch. The diodes I mentioned earlier will take care of turning the device on, but I still had to turn on the audio amplifier.

Intersil helped solve the problem by providing a pin out, which they call "dis-

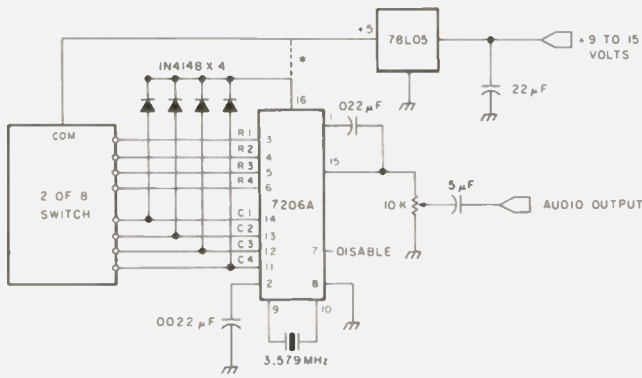

Fig. 1. Schematic diagram of the basic tone encoder. None of the parts are critical, and the .22 uF at the input of the 78L05 could probably be left off if space is a problem. Pin 7 is a switch output, which Intersil calls "disable"; it can be used for turning on an audio amplifier. *If a couple mA of standby current can be tolerated and battery operation is not required, the diodes can be eliminated and pin 16 connected to +5.

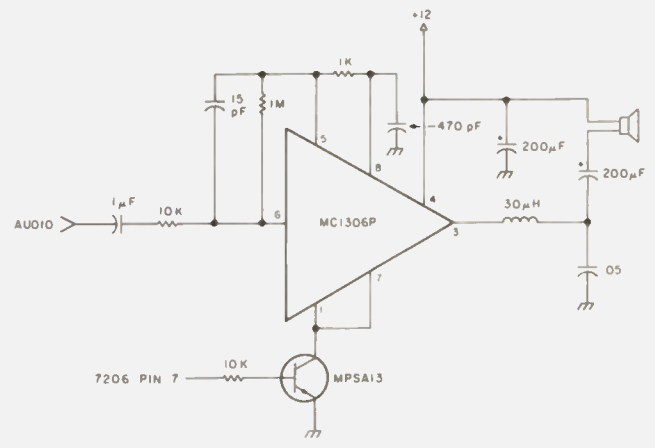

Fig. 2. Schematic diagram of the audio amplifier. If this current is to be connected to the circuit of Fig. 1, leave out the .1 uF coupling capacitor.

able." This pin goes from ground to plus supply voltage when any of the keyswitches are closed. Therefore, I just used that pin to turn on a transistor which grounds the audio amplifier. Notice that I have called out an MPS-A13 transistor for that switch. I did that since it is very high gain and it doesn't take much

current to turn it on.

I built up an encoder with this circuit and enclosed it in a box with a Digitran key-switch.

Construction

The circuit is so simple that point-to-point wiring is easy to do. I do like circuit board construction, however,

so I am preparing two different printed circuit boards. One will be about 1/2 inch wide and 2 1/4 inches long to fit in hand transceivers. The other board, about 2" x 3", will contain the encoder plus audio amplifier. These boards will be available from CONTACT Electronic Research and Development, 35 W. Fairmont Dr., Tempe, Arizona 85281. Since we don't have

the boards in production as of writing time, you will have to write for prices.

Also, at the time I wrote this, it took me about two weeks to get the 7206A from the manufacturer. If I haven't seen any of the usual advertisers listing it by the time this gets into print, I will try to get some and have them on hand to sell along with the boards. ■

CALL TOLL FREE

1-800-228-4097

for Quality Ham Radio Products at Discount Prices

YAESU SUPER DEALS
- limited supply

DEAL #1

Buy a Yaesu FT-301 (dial) for only \$769.00 and you get a FP-301 AC Power Supply and a CW Filter absolutely FREE. Total Value \$966.00
SAVE \$197.00

DEAL #2

Buy a Yaesu FT-301d (digital) for only \$935.00 and you get a FP-301 AC Power Supply and a CW Filter absolutely FREE. Total Value \$1132.00
SAVE \$197.00

Call for similar savings on all these excellent lines

- Kenwood
- Yaesu
- Drake
- Hy-Gain
- ICOM
- Ten-Tec
- Dentron
- Swan
- Tempo
- Wilson
- Midland
- Bearcat
- CDE Rotors
- ETO Alpha

Communications Center

The Radio Store

443 N. 48th, Lincoln, Nebraska 68504 In Nebraska Call (402)466-8402

The Go Pro HT Mod

—adding a telephone handset to your HT

For most amateur applications, the standard mobile mike and speaker combination is almost ideal, with one possible drawback being the fact that one hand is always required to hold the microphone and operate the push-to-talk switch.

Occasionally, however, the telephone handset would be the preferred instrument, offering some degree of privacy, and, for those interested in "image," the handset

is rather impressive and readily identifiable as a bona fide two-way radio-telephone installation — assuming such identification is desirable. The telephone-type mike-and-speaker handset can help to eliminate background noise on transmission and allows reception of messages clearly and privately, even in high-noise locations.

The earpiece or "receiver," in telephone company jargon, is designed for low-impedance

applications and will usually work quite well with most hand-held or mobile transceivers without modification. However, the carbon element generally used in the mouthpiece or "transmitter" unit is incompatible with the low-impedance dynamic mike

input found in the vast majority of contemporary solid state equipment. Specially-manufactured handsets, designed for CB and amateur use alike, are available but expensive, running \$40-50 and more.

The typical telephone-type handset can be readily adapted to amateur use by replacing the carbon element with a low-impedance replacement-type dynamic microphone element and installing a miniature, momentary-on SPST push-button PTT (push-to-talk) switch in the handset, as shown in Fig. 1.

On the surplus market, I found a new Western Electric #G3A4W handset for \$3, though I could have used any similar unit. A Radio Shack #270-093 dynamic mike element, having a nominal impedance of 600 Ohms and an output level of -65 dB, was easily installed by drilling out a 5/8"-diameter hole in the plastic mouthpiece, fitting a large rubber grommet into the hole, and inserting the mike element into the grommet from the inside. I epoxied the grommet and mike element firmly into place.

The handset must be rewired. Of the four coiled-cord wires coming from the handset, one is selected as ground or common and is connected to the mike and receiver element as ground. A second lead is connected to the ear-

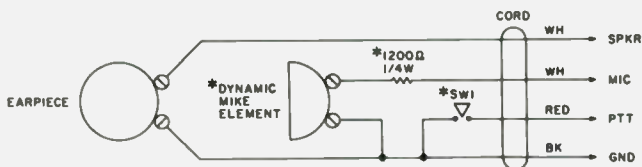
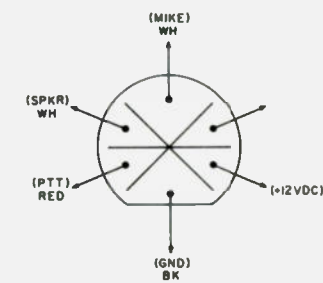

Fig. 1. Modified handset (Western Electric #G3A4W or something similar). *Added parts. The carbon element is discarded. The dynamic mike element is Radio Shack #270-093 — 600 Ω nominal impedance.



TOP VIEW OF 6-PIN SPECIAL PLUG, LOOKING DOWN TOWARD TOP OF H-T.

Fig. 2. Wilson HT accessory plug. (For proper pin connections on your transceiver, check the instruction manual and schematic diagram.)

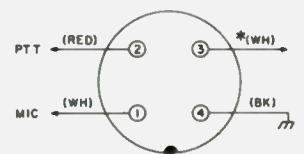

Fig. 3. IC-22S mike plug. (For proper pin connections on your transceiver, check the instruction manual and schematic diagram.) *Pin 3 is presently unused. Run wire from pin 3 to the "hot" audio lead on the external speaker jack on the rear apron of the IC-22S. (The speaker audio can be muted if a miniature phone plug is inserted.)

phone "hot" terminal. A third lead is connected, through a series resistor, to the mike "hot" terminal. The fourth lead becomes the PTT bus.

A miniature, momentary-on, normally-open push-button switch is mounted behind the mike element, a 1/4" hole being drilled into the back of the mouthpiece cavity, as shown in the photo. For most transceivers which simply ground the PTT line for transmit, the switch should be connected between the coiled-cord "hot" PTT lead and ground. No hum or interaction problems have been encountered despite the fact that the coil is unshielded, due primarily to the low impedances involved and the fact that, during transmit, two of the four wires in the cable are at ground potential, forming a shield of sorts around the mike lead. Of course, a shielded cable (3 conductor plus the shield) could be used, if one is available or if hum and noise pick-up prove to be a problem.

Initial on-the-air checks indicated that the audio was somewhat bassy and muffled, apparently the result of a slight impedance mismatch between the 600-Ohm microphone element and the 2000-Ohm mike impedance of the Wilson HT. A little experimentation resulted in the addition of the 1200-Ohm, 1/4-Watt resistor in series with the mike element. Use of the series resistor removed most of the bassy quality of the audio when using the handset. The exact value of resistance to use in any particular installation will depend on the mike input impedance you're trying to match and will have to be determined by trial. If the mismatch isn't too great, the resistor may be eliminated altogether. And, although I have not used the handset with a high-impedance input transceiver (such as the Heath HW-202 or HW-2036), it probably could be adapted

for use by mounting a sub-miniature low-to-high impedance matching transformer of the type sold by Lafayette Radio and Radio Shack in the mouthpiece cavity (yes, there's enough room, providing an ultras-small transformer is used!). No adjustment of the deviation on the Wilson was required, though deviation might have to be touched up when used with some transceivers.

The type of connector or connectors used at the other end of the coiled cord will, of course, depend on the type of transceiver used and its mike jack pin wiring. Fig. 2 shows the pin connections for use with the Wilson 1402SM Handie-Talkie, which was the unit I used. Fig. 2 shows typical connections for use with the Icom 22S or similar transceiver using the standard CB-type four-pin mike connector. For proper pin connections on your transceiver, check the instruction manual and schematic diagram provided with the unit. Addition of a hang-up bracket, which came off an old junk box mike, to the handset completes construction.

I have modified my Wilson HT to include a miniature closed-circuit phone jack for external headphones and/or speaker. The phone jack is wired such that installing a dummy miniature phone plug into the jack disables the internal speaker so that audio is routed exclusively to the handset, affording private listening, particularly handy in the high-noise areas likely to be encountered when using the HT. In the case of the Icom, to avoid extensive internal transceiver rewiring, the unused pin on the front panel microphone jack is connected to the rear panel external speaker jack to route receiver audio to the handset, as shown in Fig. 3. Inserting the miniature phone plug into the auxiliary speaker jack disables the Icom's internal speaker.

One precaution: As the mike element is exposed, care

should be taken to prevent foreign particles (dirt, dust, etc.) from getting into it. If desired, a small piece of fine speaker grille cloth can be cemented over the element to protect it.

On-the-air results have been gratifying, particularly

considering the very low cost of modifying the handset when compared with the cost of a similar commercially-available unit and the minimum of transceiver modification required. Construction cost is less than \$8, plus the cost of the mike connector. ■

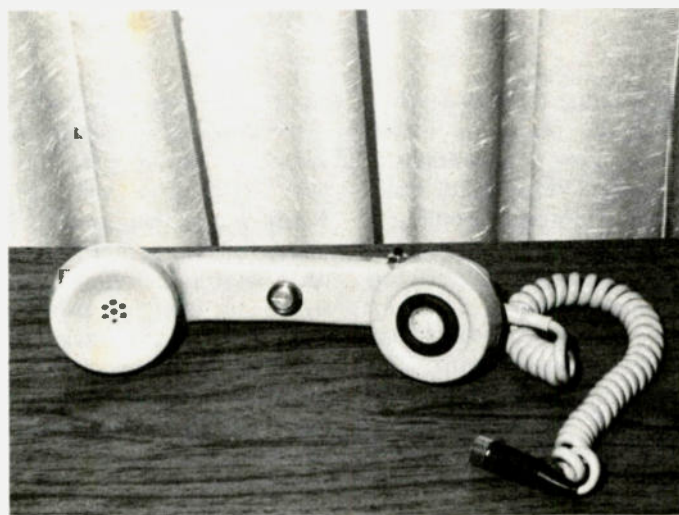
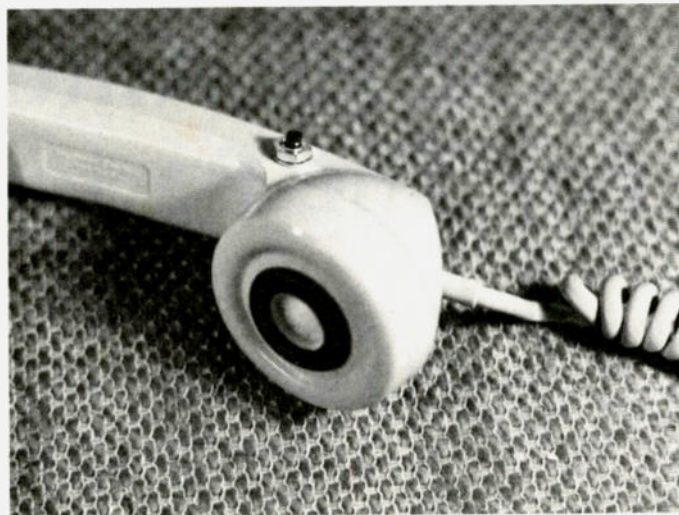

A 2m Antenna For The Perfectionist

— with considerable details

Having recently received my Technician license, I started my ham station with a 2 meter Heathkit 202 transceiver. I decided to build my own aerial and, after comparing the many different 2 meter aerial designs, settled for the vertical 5/8-wavelength ground plane antenna. This setup gives a power gain of almost 3 dB, as opposed to the 1/4-wavelength vertical, and is easy to construct, allowing omnidirectional communication.

Many articles have been published in amateur journals on antenna construction, but many just supply cookbook

construction recipes, often without telling you how the various measurements of wire, etc., were obtained. Furthermore, you are at the mercy of the author's parts list. Because of this, I designed my own 5/8 antenna and, through the equations presented here, modified my construction to go with the materials I had on hand. You, too, can build this (design it) around *your* junk box, modifying things to suit your own list of materials for construction.

Where the Numbers Come From

Since $1/2 \lambda = 468/f\text{MHz}$,¹ by simple ratios, $5/8 \lambda = 585/f\text{MHz}$. For 147 MHz, $\lambda = 3.979$ ft. or 47.75 in. This is the vertical radiator length.

The ground plane reflectors are $1/4 \lambda$ at the lowest frequency.¹ Since $1/4 \lambda = 234/f\text{MHz}$, for 147 MHz, $1/4 \lambda = 1.5918$ ft. or 19.1 in. This is the horizontal reflector length.

Since we are matching the

antenna to an RG-58/U coaxial cable (transmission line), we need a loading coil to match this impedance (approximately 52Ω). Then $X_L = 52\Omega$, or, at 147 MHz, $X_L = 2\pi (f\text{MHz})(L) = 52\Omega$; $L = 52\Omega/2\pi (147 \text{ MHz}) = .05629$

μH . Note: Make the coil inductance .06 μH to allow for trimming.

Using the equation for a free-air solenoid coil, $L = a^2 n^2/9a + 10b$, where $a =$ coil radius in., $b =$ coil length in., $n =$ coil turns/b. Solving for n : $n = \sqrt{L(9a + 10b)/a^2}$.

Here is where one can modify the coil to any desired specification. Since I had a lucite rod of $a = .75$ in. and $b = 2$ in., my design proceeded with n being calculated to equal 2.25 turns/2 in. Again, for adjustment and trimming, I made $n = 2.5$ turns/2 in. and picked #14 AWG enameled copper wire for the coil, although almost any large gauge wire will do (10-15 AWG).

My design followed that shown in Fig. 1. Construction is not critical, since final trimming gives the lowest swr. Incidentally, adjustment of the coil will compensate for slight variations in the radiator length, but don't exceed the calculated maximum value.

Construction

Since construction is not critical, parts are either your own junk-box variety or those listed in the parts list.

The construction of the

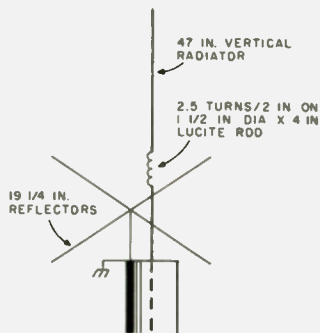

Fig. 1.

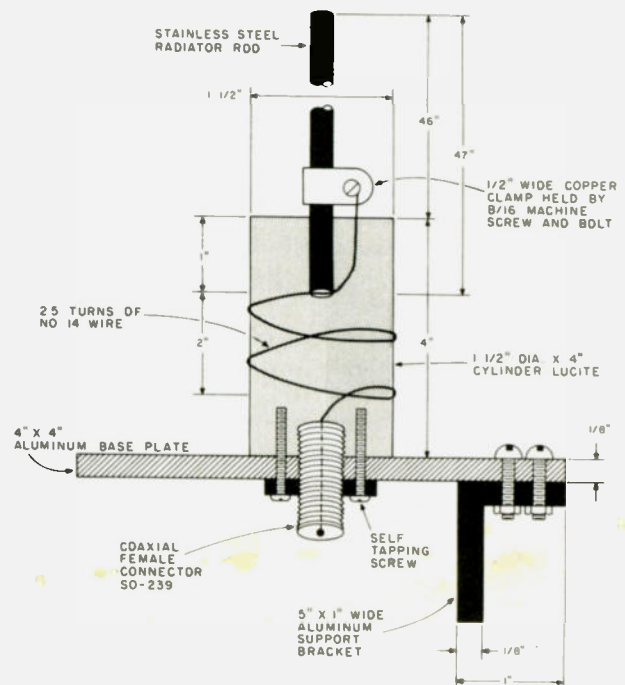

Fig. 2.

antenna is shown in Figs. 2 and 3. Details of the construction will not be given here, since construction always depends on materials on hand and the ingenuity of the person doing the building. However, complete details of this construction and parts availability will be gladly furnished on request.

Tuning

I used a Clegg FM-DX 2m transceiver for final tuning and a Heathkit HW-2102 VHF wattmeter to adjust the antenna to the lowest swr. Tuning was accomplished by adjusting the spacing between the coil windings until an swr of about 1:1 was obtained. In some cases, 1/2 to 1 turn of the coil wire may be needed to be added or subtracted from the original coil winding to achieve the lowest possible swr.

In a ground plane installation, the position of the reflectors will affect the swr obtained. Therefore, if neces-

sary, the reflectors may be bent down at about a 45° angle and slowly moved upward to again obtain the lowest swr reading possible.

Final Comments

In my construction, it turned out to be unnecessary to bend the reflectors down on an angle. Also, a clear dope was used to seal the coils in place, once they were adjusted for the lowest swr reading.

As I originally stated, the main purpose of this article was to show you where some of the numbers came from in the design of a 5/8-wavelength antenna. Thus, this allows you the freedom to modify the design to the materials you have at hand. ■

References

1. *ARRL Handbook*, 1975.
2. "A 5/8 Wave Vertical For 2," Herbert S. Brier W9EGQ, *CQ*, February, 1964.
3. "5/8 Wavelength Vertical Antenna For Two Meters," Ed Spadoni W1RHN, *Ham Radio*, March, 1976.

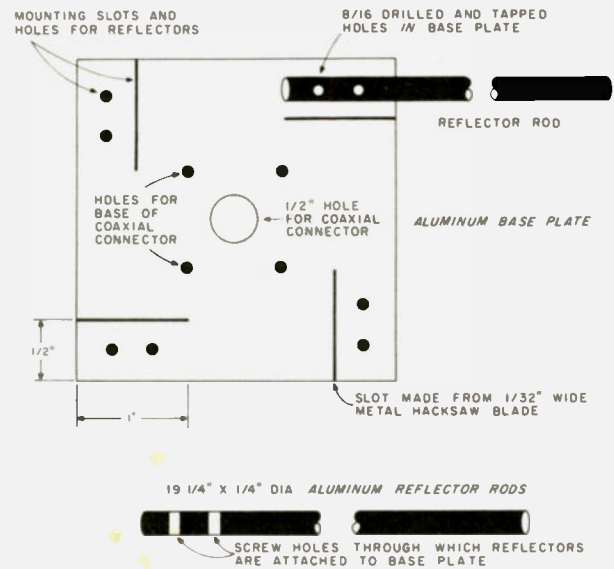

Fig. 3.

Parts List

- 1 47" stainless steel rod for the vertical radiator (or 1/4"-diameter aluminum rod)
- 4 19 1/4"-long x 1/4"-diameter aluminum rods for the reflectors
- 1 4" x 4" x 1/8" base plate of aluminum
- 1 1 1/2"-diameter x 4"-long rod of lucite (or equivalent)
- 1 #14 AWG copper enameled wire
- 1 female SO-239 coaxial connector
- assorted self-tapping screws
- 1 5" x 1" x 1/8" aluminum support bracket



We have a portable direction finder that REALLY works—on AM, FM, pulsed signals and random noise! Unique left-right DF allows you to take accurate bearings even on short bursts, with no 180° ambiguity. Its 3 dB antenna gain and .06 uV typical DF sensitivity allow this crystal-controlled unit to hear and positively track a weak signal at very long ranges—while built-in RF gain control with 120 dB range permits DF to within a few feet of the transmitter.

The DF is battery-powered, can be used with accessory antennas, and is 12/24V for use in vehicles or aircraft. This is a factory-built, guaranteed unit—not a kit. It has been successful in locating malicious interference, as well as hidden transmitters in "T-hunts," ELTs, and noise sources in RFI situations.

Prices start at under \$175. Write or call for information on our complete line of portable airborne, vehicle, and fixed DF systems.

L-TRONICS

5546 Cathedral Oaks Rd.,
Amateur Dept.
Santa Barbara, CA 93111
805-967-4859

L10

144 and 220 REPEATERS

INTRODUCING
THE **Hi Pro Mk I**
By **Maggiore Electronic Laboratory**

50 MHz and 450 MHz also available

- A state-of-the-art, full-feature repeater that boasts broad range temperature and electrical stability for use in an uncontrolled environment
- Low current drain — A plus for emergency 12 volt standby battery operation
- The receiver develops maximum usable sensitivity and sideband rejection
- The transmitter develops 12.5 Watts (220) 16 Watts (144) of clean rf and a faithful reproduction of the input signal insuring an extremely good sounding repeater
- Includes a high quality dynamic microphone and a detailed instruction manual

PA Res. add 6% tax
INTRODUCTORY PRICE \$597.50 PLUS SHIPPING

Maggiore Electronic Laboratory M36
845 WESTTOWN RD.
WEST CHESTER, PA. 19380 PHONE 215 436-6051

Are You Afraid To Build?

—how to get organized . . .
and started

Whatever the experimenter looks for today, it will involve electrical hookups in most designs.

The best way to start on constructing new circuits is to be organized. You'll save time and be ready for any testing, data gathering, and diagramming you need to do for your own record. Breadboards can also add to efficiency. They are not new, but they still are useful as hookups and circuit test boards.

Hunting for parts is time-consuming, if they are located in a full junk box or just lying somewhere around the station. So, first, your junk box system should be improved. Look around for another location for storing electronic parts, so they can

be found just like in a small stockroom. One way to do this is to obtain a dresser with five drawers to use for storage. It does not have to be extremely large — say, about 23" x 40" x 13".

Remove the top four drawers. The spaces can be made into shelves by putting plywood boards in on the drawer runners. Glue the runners when you put in the shelves, or drive two small finishing nails horizontally through the cabinet into the shelf edges on each side. Put this "stockroom" in a convenient place near your bench, next to a window, or angled in a corner, for example.

Dump the contents of your junk box on your bench and sort out all the panels,

chassis, transformers, sheet metal, wires, and huge bolts. Put those large items back in the junk box.

Obtain fifteen plastic food boxes, a pint or larger, depending on your estimate of the volume of resistors, etc., that you will have. Put the boxes on the cabinet top, and throw the tops into the junk box.

Here is one way to sort the electronic parts and hardware. First, save all those magnets from discarded loudspeakers and TV sets to hold up orbit charts, frequency lists, etc., on a magnetic sheet-metal bulletin board. The radio parts can be rinsed off with warm water to remove dust and then air dried. Pick out all the tuning capacitors and put them in a box for storage elsewhere. Tubes should be in their own cardboard box, in their own location, and a reference on-hand list should be made. Other parts not mentioned are stored the same way.

There should be a plastic

box for each of the following: small resistors; large resistors; fixed condensers and trimmers; coupling coils, transistors, and printed circuits; nuts; short machine screws and sheet-metal screws; long wood and sheet-metal screws; large sheet-metal screws; stainless and hardened "coffee pot" machine screws; assorted bolt washers; small star and copper washers; springs; insulated washers, grommets, rings, and grid and plate caps; pilot bulbs, switches, snaps, plugs, and jacks; variable resistors; and knobs. Coin boxes to contain the very fine size hardware, tuner hardware, and slugs are suggested also. The plastic food containers may be covered with a large poster sign card stock to keep the dust out.

Next, the shelf spaces are filled with important items. Shelf number one is for the circuits you want to make, plastic bags and little boxes of unassembled circuits, drill bits, solder, first-aid kit, magnet, register rolls, and instrument batteries, for example.

The second shelf is used for all abrasives, drill arbors, sanding discs, welder's wire brush for cleaning off terminal boards, extra hacksaw blades, and a bar of wax.

The third shelf is used for panel and dial paints, small brushes, contact cement for plastic items, powdered wood glue, rubber cement, plastic rubber (for covering exposed soldered joints, to cement together small objects, and to put neoprene patches on small holes in the generator fuel tank), and glycerine soap with a paint brush for equipment cleaning.

The fourth shelf is for bearings, pulleys, couplings, copper tube cutter, flare tool and spring benders, a box of plastic sheets, etc.

The drawer is used for threaded brass tubes, electrician's bits, and various electrical parts you had made.

The shelf stockroom may be provided with side nails to hold hacksaws, hammer, tri-square for chassis layout, etc.

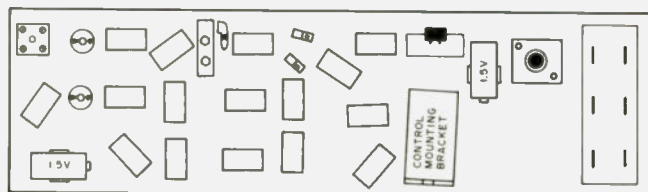

Fig. 1.

A second such storage aid for tubes should have a drawer for them, to avoid roll-out and breakage.

With the convenience of the shelf stockroom, you can now begin to design a circuit assembly board. It may include almost any item for holding the radio parts you want. With care, burnouts probably will be a thing of the past using this board. You will be working over exposed leads, so you must pull the plug when working on the circuits.

This circuit testing board is great because you can construct any circuit on it that is not too extensive. The circuit can be observed first without wiring a potential electrical short in a chassis. You can change any part quickly and conveniently, watch for hot parts, and avoid assembly and disassembly damage.

Select a plank about 24" x 3/4" x 5/2", and sand it smooth. Do not paint or oil this board — just keep it dry.

Wood is easier to mount items on and less expensive than insulator panels.

The top area of the board consists of the devices which hold wires, such as a terminal strip post board, terminal block, two small ceramic lamp sockets, large brass clips, cheater cord bracket for obtaining 115 V ac, regular ceramic light bulb socket, DPDT knife switch, a bracket with 3/8" diameter hole for carbon control and variable capacitor mounting, and fifteen miniature barrier strips separated by about 3/4" and angled for convenience. Those barrier strips have two terminals and four screws.

One flashlight battery is mounted with soldered leads at each end of the board. Other brackets may be added to hold other parts, such as a bayonet pilot lamp socket. All items are attached to the board with 6/8" pointed sheet-metal screws.

Fig. 1 is the experimental hook-up board. It offers con-

venience when working with low voltages and line voltage circuits and holds parts for higher voltages. A thermal plug fuse should be in the house circuit or on the board in series with the cheater line.

The component leads are attached to the barrier strips. Work with enameled and insulated wires for other connections, and keep each lead clear of touching another. You can see what you want to connect next and demonstrate the circuit any time. Always disconnect input wires before working on your circuits or soldering suggested parts connections. Pull the plug!

Radio and electronic experimenters could find a small part-forming board useful when bending conductors for special switches and slider fingers, for example. See Fig. 2.

The metal-forming and -curving board is made from plywood or subfloor chip-board about 11" x 10". A

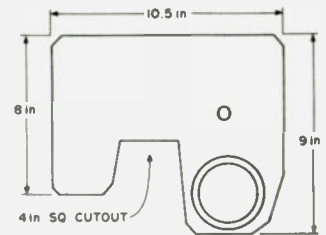

Fig. 2.

test bulb and battery should be near the board's back edge. About 4" from the back edge, a 3/8" diameter metal post is mounted in a partly drilled hole. The post is at least 2" high. It is used to aid in bending strips of metal by pushing the strip down on its top. Next, toward the front on the right, attach a truck door stop bumper. The bumper is a rubber dome mounted on a round aluminum base. Mount it in front on the right side about 1/2" in from the corner. Working clearance is improved by sawing a 4" x 4" piece out on the left side of the bumper. ■

**Germantown
Amateur
Supply,
Inc.**

MEMPHIS, TENNESSEE

NO MONKEY BUSINESS!

- (A) Complete Service Facilities
- (B) Good Deals on most Brands
- (C) Shipping within 24 Hours
- (D) All inquiries handled by Active Hams with over 20 years experience in ham radio

CALL TOLL FREE
1-800-238-6168

IN TENNESSEE, CALL 901-452-4276
MONDAY - SATURDAY 8:30-5:30
FOR YOUR SPECIAL.

CUSTOM HIGH POWER AMPLIFIERS G-12

Write: 3202 Summer Ave., Memphis, Tennessee 38112

NEW!

\$36.50

plus \$1.50 s/h
NY res. add tax

Features: **CMOS Electronic Keyer**

- State-of-the-art CMOS circuitry
- Self completing dots and dashes
- Dot and dash memory
- Iambic keying with any squeeze paddle
- 5-50 WPM
- Speed, volume, tone controls, side tone and speaker
- Low current drain CMOS-battery operation
- Deluxe quarter-inch jacks for keying and output
- Handsome eggshell white base — woodgrain top
- Compact and portable — 1-7/8 x 4-1/4 x 6-1/4
- Grid block keying
- Wired and tested — fully guaranteed — less battery

Dealer inquiries invited

TRAC

Electronics, Inc.
1106 Rand Bldg.
Buffalo NY 14203 T18

Call Toll Free 1-800-633-3410 for Dentron

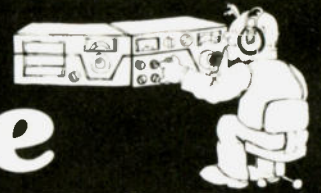

DENTRON MLA-2500 linear amplifier

Features: • 160 thru 10 meters • 2000 + watts PEP input on SSB • 1000 watts DC input on CW, RTTY, SSTV • Self-contained continuous duty power supply • Covers MARS w/o modification • 50 ohm input/output impedance.

799.50 list price. Call for quote.



DENTRON MT-3000A antenna tuner

The MT-3000A is Dentron's "ultimate tuner". Tunes 3 coax, random wire and balanced feed system, just select the one. Handles in excess of 3KW PEP • Built-in 50 ohm - 250W dummy load • Dual watt meters • 3 core heavy-duty Balun.

349.50 list price. Call for quote.



DENTRON MT-2000A antenna tuner

An economical, full power tuner designed to handle virtually any type of antenna. Features: • Continuous tuning 1.8 to 30 MHz • Handles a full 3 KW PEP • Front panel coax bypass switching • Built-in 3-core balun. Front panel grounding switch.

199.50 list price. Call for quote.

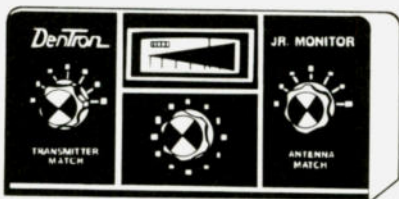

DENTRON Jr. Monitor tuner

Call it what you will—antenna tuner, transmatch, matchbox, or matching network, the Jr. Monitor has it all wrapped up in one neat little cabinet. • Continuous tuning: 1.8 to 30 MHz • Forward reading relative output power meter • 300 watt power capability • Built-in encapsulated balun.

79.95 Call for yours today.

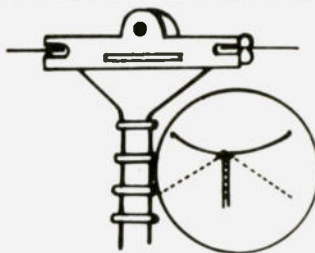

DENTRON all band HF doublet antenna

This all band doublet or inverted antenna covers 160 thru 10 meters. It has a total length of 130 ft. of 14 gauge stranded copper wire. Tuned & center fed thru 100 ft. of 460 ohm PVC covered transmission line. Assembly is complete.

24.50 Call for yours today.



DENTRON'S NEW Big Dummy Load

Now you can tune-up off the air with Dentron's Big Dummy Load. All full power dummy load, it has a flat SWR, full frequency coverage from 1.8 to 300 MHz. A high grade industrial cooling oil is furnished with the unit. Built to last! Fully assembled and warrantied. Help cut out the QRM factor NOW!

29.50 Call for yours today.

Remember, you can call TOLL-FREE: 1-800-633-3410 in U.S.A. or call 1-800-292-8668 in Alabama for our low price quote. Store hours: 9:00 AM til 5:30 PM, Monday thru Friday



Long's Electronics



L9

MAIL ORDERS: P.O. BOX 11347 BIRMINGHAM, AL 35202 • STREET ADDRESS: 2808 7TH AVENUE SOUTH BIRMINGHAM, ALABAMA 35233

Call Toll Free 1-800-633-3410 for Drake

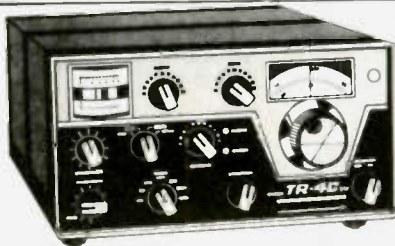
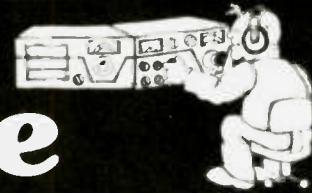

DRAKE TR-4CW transceiver

- Coverage: 80 thru 10 meters • 300W PEP on SSB, 260W on CW & AM • 500 Hz CW filter • RIT • Wide-range receiving AGC • Solid-state VFO • Shifted-carrier CW • VOX or PTT • Output impedance is adjustable • CW semi-break-in • Transceive or separate PTO.

799.00 list price. Call for quote.



DRAKE T-4XC transmitter

- Coverage: 80, 40, 20, 15m & 28.5 to 29.0 MHz of 10 meters • Covers 160 meter w/accessory crystal • Two 8-pole crystal lattice filters for SSB selection • Controlled carrier modulation for AM • Built-in VOX or PTT on SSB or AM • TX AGC prevents flat-topping • RTTY easy adaption, AFSK or FSK.

699.00 list price. Call for quote.

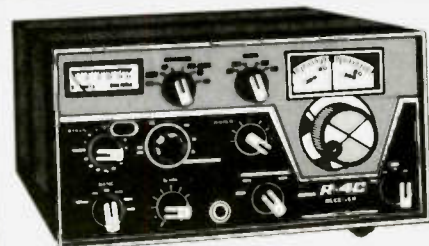

DRAKE R-4C receiver

R-4C has same coverage as the T-4XC, plus any 500 KHz range between 1.5 and 30 MHz. • Also use for MARS, WWV, CB, Marine & Shortwave reception • Linear permeability-tuned VFO • 3 AGC release times • Crystal lattice filter in first IF prevents cross-modulation.

699.00 list price. Call for quote.



DRAKE MN-2000 matching network

Great where peak performance is a must! • Coverage: 3.5 to 4.0 MHz, 7.0 to 7.3 MHz, 14.0 to 14.35 MHz, 21.0 to 21.45 MHz, 28.0 to 29.7 MHz. • Insertion loss: 0.5 dB or less • Watt-meter accuracy 5% of reading • 1000 watts RF continuous, 2000W PEP.

250.00 list price. Call for quote.



DRAKE MS-4 matching speaker

The MS-4 is designed for use with the Drake R-4C, R-4B, R-4A, & R-4 receivers. It has space inside for the Drake AC-4 power supply. The 8-ohm speaker will always come through loud and clear.

33.00 Call for yours today.

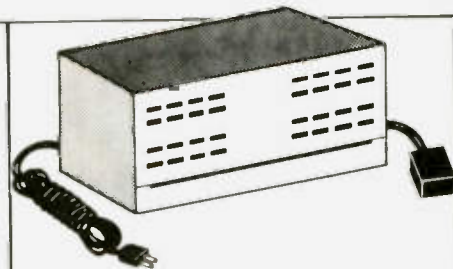

DRAKE AC-4 power supply

The AC-4 power supply works with all Drake 4-line transceivers and transmitters. Fits inside the MS-4 speaker cabinet • Input: 120 or 240 VAC • Output: 650 VDC at 300 mA average, 500 mA peak, also: 12.6 VAC at 5.5 amps.

150.00 list price. Call for quote.

Remember, you can call TOLL-FREE: 1-800-633-3410 in U.S.A. or call 1-800-292-8668 in Alabama for our low price quote. Store hours: 9:00 AM til 5:30 PM, Monday thru Friday



Long's Electronics



L9

MAIL ORDERS: P.O. BOX 11347 BIRMINGHAM, AL 35202 • STREET ADDRESS: 2808 7TH AVENUE SOUTH BIRMINGHAM, ALABAMA 35233

Call Toll Free 1-800-633-3410 for Kenwood

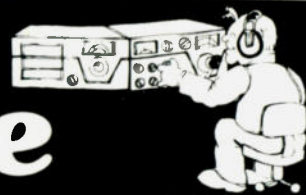

KENWOOD TS-820S transceiver

TS-820S features: • Factory installed digital frequency readout • 160 thru 10 meter coverage • Integral IF shift • RF speech processor • VOX • Noise blanker • PLL • Built-in 25 KHz calibrator • CW sidetone & semi-break-in • IF OUT, RTTY, & XVTR • 200 W PEP input

1048.00 list price. Call for quote.



KENWOOD TS-520S transceiver

Features: • 160-10 meter coverage • Optional DG-5 digital frequency display • New speech processor w/audio compression amplifier • AC power supply (DC optional) • RF attenuator, front-panel activated • Provisions for sep. receive antenna & phone patch • 200 W PEP input.

649.00 list price. Call for quote.

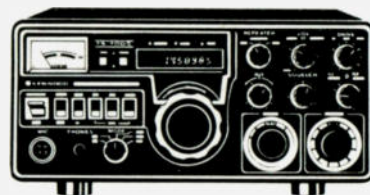

KENWOOD TS-700S 2m transceiver

TS-700S has these features: • Digital readout • Receiver pre-amp • VOX • Semi-break-in & CW sidetone • Solid-state construction • AC or DC operation • 4 band (144 to 148 MHz) coverage • 11 fixed channels • 600 KHz repeater offset.

679.00 list price. Call for quote.



KENWOOD TR-7500 2m FM transceiver

Check these: • PLL synthesized • 100 channels (88 pre-programmed, 12 extra diode programmable) • Single knob channel selection • 2-digit LED frequency display • Powered tone pad connection • Helical resonators • 10 watts HI output, 1 watt LOW output.

299.00 list price. Call for quote.



KENWOOD TR-7400A 2m FM transceiver

Features: • CTCSS provisions, encode and decode • 25 watt output RF • Solid-state final stage • LED readout • PLL gives 800 discrete channels • Repeater offset circuit • PLL unlock protection circuit • MOS FET.

399.00 list price. Call for quote.



KENWOOD SP-820 speaker

Now you can have an external speaker in your shack that's designed just for your TS-820S transceiver. Matching appearance, plus built-in selectable tone filters, 2 channel selectable headphone output switchable through the tone filters.

49.00 Call for yours today.

Remember, you can call TOLL-FREE: 1-800-633-3410 in U.S.A. or call 1-800-292-8668 in Alabama for our low price quote. Store hours: 9:00 AM til 5:30 PM, Monday thru Friday



Long's Electronics



L9

MAIL ORDERS: P.O. BOX 11347 BIRMINGHAM, AL 35202 • STREET ADDRESS: 2808 7TH AVENUE SOUTH BIRMINGHAM, ALABAMA 35233

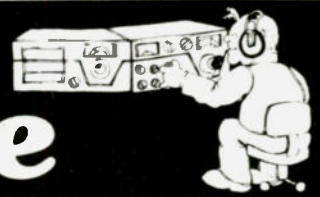

Call Toll Free 1-800-633-3410 for Ten-Tec

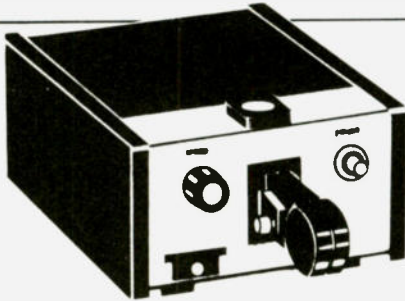

TEN-TEC KR-20A electronic keyer

A fine, all-round keyer. • Keyed output: Reed relay: 15 volt-amp contacts, 400 volts max. • Speed range: 6 to 50 WPM • Time base: keyed to start with paddle actuation • Character generation: self-completing dits & dahs, plus a lot more!

69.50 Call for yours today.

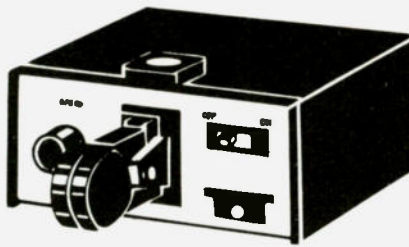

TEN-TEC KR-5A electronic keyer

Ideal for any station. • Keyed output: Reed relay: 15 volt-amp contacts, 400 V max. • Range: 6 to 50 WPM • Time base: keyed to start with paddle actuation • Self-completing dits & dahs • Weighting: Dit length increased approx. 10% @ 20 WPM.

39.50 Call for yours today.

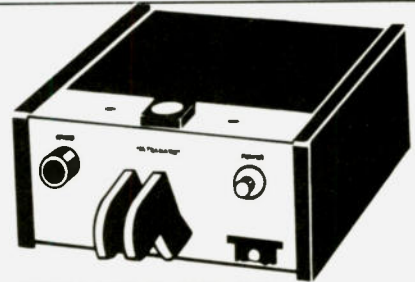

TEN-TEC KR-50 electronic keyer

Completely automatic and fully adjustable • Speed range: 6-50 WPM • Weighting ratio range: 50% to 150% of classic dit length • Memories: Dit & dah w/individual defeat switches • Actuation force: 5 to 50 grams • Sidetone: 500 Hz tone.

110.00 list price. Call for quote.

LONG'S ELECTRONICS INVITES YOU TO ATTEND THE METROLINA HAMFEST, CHARLOTTE, NC, APRIL FIRST & SECOND, 1978, AT THE CIVIC CENTER

We at Long's Electronics hope to see all of our old friends and customers at the METROLINA HAMFEST in Charlotte NC. We will be there with our full-line displays of Kenwood, Yaesu, ICOM, Drake, Dentron, Ten-Tec, MFJ, CDE, B & W, plus many others. We will bring plenty of NEW equipment for sale, but orders will be taken for units if our supplies are exhausted.

Don't wait too long. Make plans to attend now. For information, contact the Mecklenburg Amateur Radio Society, Inc. at 2425 Park Road, Room 023, Charlotte NC 28203. The METROLINA HAMFEST will once again be held in the beautiful and spacious Charlotte Civic Center. Hamfest HQ will be the Radisson Plaza Hotel just across the street from the Civic Center. So, get on the stick and make your plans NOW! See you there!

Remember, you can call TOLL-FREE: 1-800-633-3410 in U.S.A. or call 1-800-292-8668 in Alabama for our low price quote. Store hours: 9:00 AM til 5:30 PM, Monday thru Friday



Long's Electronics



MAIL ORDERS: P.O. BOX 11347 BIRMINGHAM, AL 35202 • STREET ADDRESS: 2808 7TH AVENUE SOUTH BIRMINGHAM, ALABAMA 35233

Call Toll Free 1-800-633-3410 for MFJ

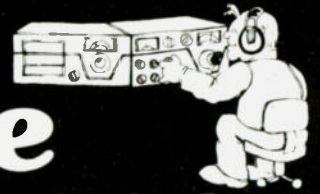

MFJ 16010-ST antenna tuner

The 16010-ST features: • Efficient air-wound inductor, for more watts out • 12 position coil inductor • The tuner will match everything from 160 to 10 meters • 200W RF out • 1:4 balun and SO-239 connectors.

59.95 Call for yours today.

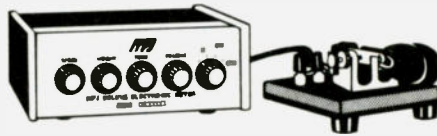

MFJ-8043IC deluxe keyer

Great features! Based on the Curtis 8043 IC "keyer-on-a chip". Sends iambic, automatic, semi-automatic, or manual. Iambic squeeze key operation w/dot & dash insertion. Dot memory, plus weight and tone controls. Optional key available, 29.95.

69.95 Call for yours today.



MFJ-CMOS-8043 electronic keyer

Features: • Built-in key w/adjustable contact travel • Dot memory • Iambic operation w/external squeeze key • Instant start with keyed time base • Self-completing dots & dashes • Jam-proof spacing • Variable weight control • 8 to 50 WPM.

54.95 Call for yours today.



MFJ-CPO-555 code oscillator

For the Newcomer to learn the code, the Old Timer to polish his fist, and the Instructor to teach his classes. Sends crisp, clear code with plenty of volume for classroom use. Has self-contained speaker.

17.95 Call for yours today.



MFJ-LSP-520 BX II speech processor

Get 400% more RF power with this speech processor. 30 dB dynamic range IC log amp & 3 active filters give you clean audio. RF protected. 4-pin mic. jack, output cable, and rotary function switch.

59.95 Call for yours today.



MFJ-CWF-2BX super CW filter

The CWF-2BX gives you 80 Hz band width and extremely steep skirts with no ringing for razor sharp selectivity. Hear just one CW signal in a crowd! Selectable band width 80, 110, or 180 Hz. Up to 15 dB S/N ratio.

29.95 Call for yours today.

Remember, you can call TOLL-FREE: 1-800-633-3410 in U.S.A. or call 1-800-292-8668 in Alabama for our low price quote. Store hours: 9:00 AM til 5:30 PM, Monday thru Friday



Long's Electronics



L9

MAIL ORDERS: P.O. BOX 11347 BIRMINGHAM, AL 35202 • STREET ADDRESS: 2808 7TH AVENUE SOUTH BIRMINGHAM, ALABAMA 35233

Call Toll Free 1-800-633-3410 for ICOM

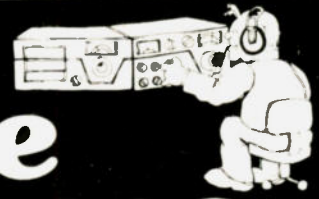

ICOM IC-22S FM transceiver

• 22 channel radio • Frequency range: 146 to 148 MHz • Preset any 15 KHz channel in the frequency synthesizer by the diode matrix board • Excellent spurious attenuation • IDC type circuit controls modulation bandwidth • Output: 10W HI, 1W LOW.

299.00 list price. Call for quote.



ICOM IC-211 2m transceiver

Features: • 144 to 148 MHz coverage • Modes: SSB, CW, FM • LSI synthesizer PLL • 4-digit LED readout • Pulse-type noise blanker • VOX, anti-vox • Semi-break-in CW • Built-in SWR bridge • CW monitor and much more!

749.00 list price. Call for quote.



ICOM IC-245 2m transceiver

• LSI synthesizer PLL • 4-digit LED readout • TX & RX frequencies are independently programmable on any separation • Receiver front-end is a balance of low noise, high-gain MOS-FET & 5 section filter • TX output: 10W PEP and more!

499.00 list price. Call for quote.



ICOM IC-30A FM transceiver

IC-30A is a mobile 450 MHz rig with 22 channels • Modulation F3 • Output: 10 watts HI, 1 watt LOW • TX bandwidth: 15KHz with 5KHz deviation • Low intermodulation from a low noise MOS-FET RF amp coupled with a 5 section filter.

399.00 list price. Call for quote.



ICOM IC-701 HF transceiver

The NEW 701 features: • Solid-state • 100W continuous on all bands, all modes • USB, LSB, CW, CW-N, RTTY operation • Double balanced Schottky Diode Mixer used in both RX/TX • Dual built-in digital VFO and much more!

1495.00 list price. Call for quote.



ICOM IC-31 FM transceiver

• Frequency range: 440-450 MHz • Modulation: phase F3 • Output: 10W HI or 1W LOW • Contains both 110/220 VAC and 13.8 VDC regulated power supplies • Built-in SWR bridge & front panel discriminator meter and more!

549.00 list price. Call for quote.

Remember, you can call TOLL-FREE: 1-800-633-3410 in U.S.A. or call 1-800-292-8668 in Alabama for our low price quote. Store hours: 9:00 AM til 5:30 PM, Monday thru Friday



Long's Electronics



L9

MAIL ORDERS: P.C. BOX 11347 BIRMINGHAM, AL 35202 • STREET ADDRESS: 2808 7TH AVENUE SOUTH BIRMINGHAM, ALABAMA 35233

A Brass Horn For X-Band

— simple 10.5 GHz antenna

Articles I've written about antennas for an X-band (10.5 GHz) transmitter and the "Smokey Detector"^{1,3} have brought many questions to my desk. One question in particular, asking where the horn used in the tune-up procedure for the Smokey Detector was procured, was the impetus for this construction article. Another question asked about the use of rectangularly-shaped waveguide anten-

nas as signal sources for equipment using circular polarized horns.

When microwave communications in the amateur segment of X band became my prime interest, equipment — mostly waveguide components — was easily found on the surplus market. Signal generators consisting of klystrons and power supplies were readily available after World War II, as were all of the nice goodies like slotted

lines, detectors, and precision attenuators. Many gain standard horns found their way to this market but were ignored, and the famous Polaplexor was used instead. That wonderful source of components has dried up, and so we are now forced to borrow from a friendly microwave man or do our own construction.

Horn antennas and all of the other equipment you will need to operate in this ex-

citing band, you can construct yourself. You don't need a machine shop and a lot of cash to buy the parts. Patience and careful use of simple hand tools provided the first experimenters with these items, and so they can provide for you. I made my own pyramidal horn, and here is how you can make a copy of it.

Before I get into the construction details, I will answer the second question mentioned above. Certainly there will be a signal loss over the path between a circular polarized horn and a rectangular or linear transmitter. The Smokey Detector tune-up procedure used these dissimilar polarizations because path loss was not a problem over the short distance used. This practice is not encouraged for regular communication unless you feel that long CQs will afford you the answers from the mid-night DX on this band.

A search through well-known references related to microwave antennas revealed that a pyramidal horn would provide a pattern in either plane which is nearly uniform. This is the reason why

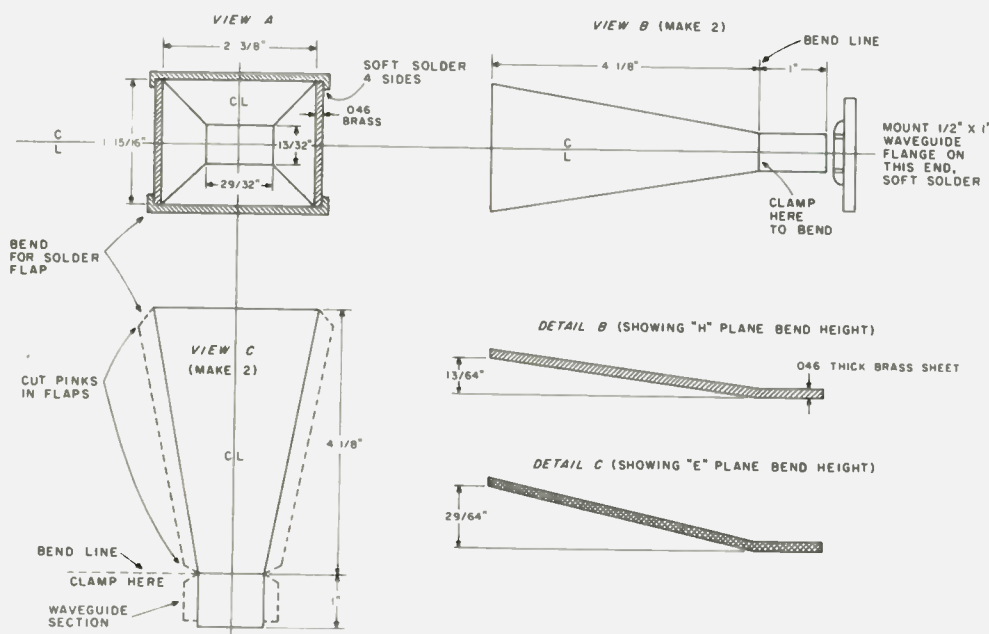

Fig. 1.

it was chosen over the more easily constructed sectoral horn. These references are listed at the conclusion of this article and will also assist you in confirming the pattern measurement.

The construction materials needed are .046"-thick brass sheet, soft solder, and one 1/2" x 1-inch waveguide flange (UG-135/U). The inside dimensions of the flange are exactly 1/2" x 1 inch. (A 1.25" departure from the dimensions shown will result in a lot of file waving at the corners of the waveguide end of the horn.) The dimensions of the waveguide end are exactly those of a section of WR-90 small X-band waveguide.

A piece of hardwood two inches long, cut to a rectangular shape which will slide fit into a section of small X-band guide, will be required. This piece will serve as a clamping support when the final assembly and soldering takes place. Be sure that the piece is true over the full length and that the corners are smooth, or it will stick when you try to remove it. Starting dimensions for this jig are those shown at the throat of the horn in View A of Fig. 1.

The sheet brass for the sidewalls of the horn must be flat. If it is not, you will find that the horn will be very hard to assemble, because all edge surfaces must touch during the final assembly. Be sure that this material is clean and shiny. A small ball of steel wool can be used on the edge surfaces to insure that it is. When you attempt the final assembly, you will appreciate this extra effort.

Lay out the plates for all sides on the clean sheet brass. Scribe the positions of the bend lines clearly. If possible, use DyChem, a blue dye, on the brass so that the lines can be seen easily. Remember to wash off the dye with alcohol before attempting to solder. Allow twice the thickness of the material for each bend point.

The dimensions given in View C (Fig. 1) do not in-

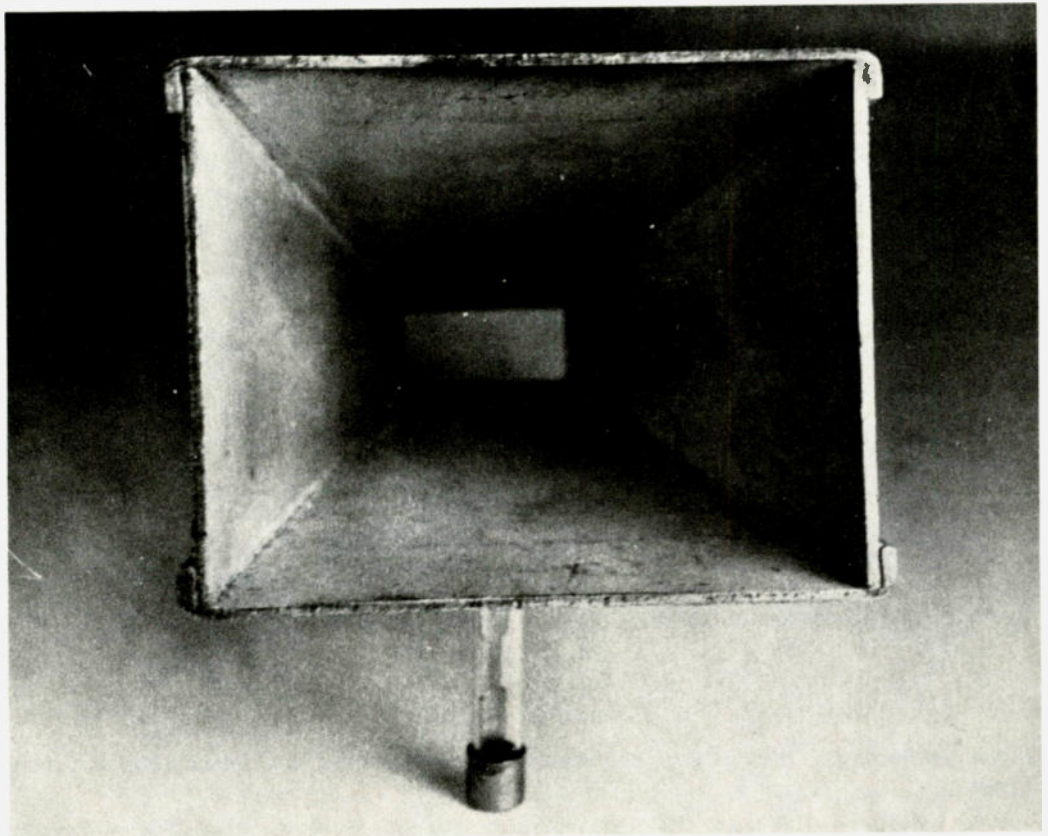

Mouth view of an X-band horn. This shows how the folds are made. Note the smooth inside surface.

clude the material needed for a solder flap, so allow at least 3/8" more material for this purpose. Also, cut 45 degree "pinks" in the flaps at the junction of the horn flare and the beginning of the 1-inch waveguide section.

The use of a sheet metal shear and brake will simplify the next few operations, but, if these tools are not available, two pieces of 1" angle iron and a large vise will serve to do the job. The cutting should be done with a fine-bladed hacksaw. The edges of the cuts can then be smoothed with a file.

Cut two pieces, as shown in View B (Fig. 1), for the H-plane sides of the horn. Place one of these pieces on a flat surface, and clamp it securely to the surface with a C-clamp located at the intersection of the waveguide section and the end of the flare. Place a thick piece of metal under the C-clamp foot on the bending line, as indicated in View B. Now, using another larger piece of metal or a large putty knife, lift up

sharply at the mouth end of this section to produce a bend at the clamped end. The height of the bend must be 13/64". The metal is springy and will take some pushing and pulling to achieve the correct height. Care must be exercised during this process so that you don't deform the walls with bends or deep scratches.

Follow the same procedure for the three remaining sections of brass.

When all of the forming bends have been completed, the solder flap bends are next. This job is done in two moves. Place the aforementioned sections of angle iron in the vise jaws. Then station the waveguide end of one E-plane plate between the angle irons so that the bend line of the flap is in position for a bend to 90 degrees.

To make this bend, allowances have been made for the thickness of the material, if you have followed the layout instructions. If not, the width dimension will come out wrong. Check now, and save

some grief. When you have determined that the measurements are the proper dimensions, make these bends so that they are square, right-angle bends. If the bend is too shallow, it will make the horn flare wider in one plane, and, of course, if it is too great a bend, the opposite effect will be the result. A 90-degree bend, therefore, is the desired angle.

After completing the waveguide bends just described, complete the horn flare flap bends on the E-plane section. Do both pieces at this time.

Check that the bending you've done has resulted in square and true wall sections, and make sure all the edges are clean and ready for solder. Apply a moderate amount of acid soldering paste to the inside of the flap bends. Now place the previously-prepared wood jig inside of the E-plane waveguide bends of one section. Slip the two H-plane wall sections into place on each side of the jig block. The last piece is the

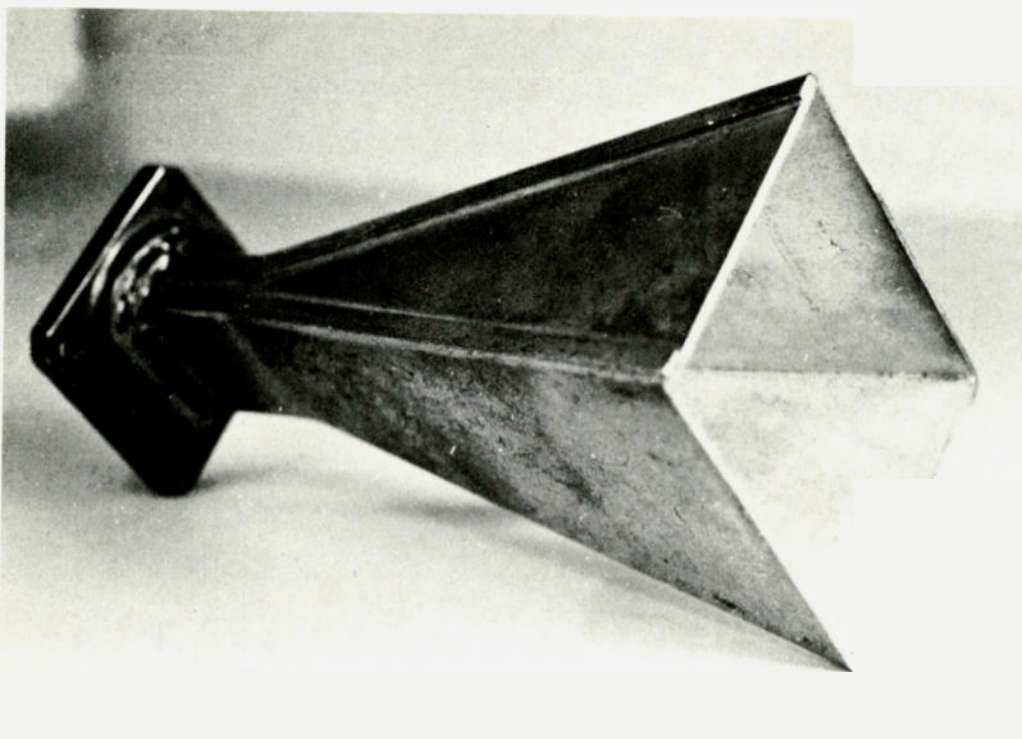

Pyramidal horn. This oblique view of the horn shows the assembly and the addition of a choke flange.

other section of the E-plane wall. Use a C-clamp to hold the whole assembly together by clamping across the E-plane section of the waveguide. Small pieces of thin aluminum sheet can be bent to form cross braces at the inside of the mouth of the horn and will aid in the soldering process. (A piece of wood shaped to fit in position will also do the trick.)

Clamp the outside edges near the end of the flare where the flaps meet the matching side. If you do not provide a firm clamp at these points, when the metal is heated for soldering, it will flex. If you are satisfied that the horn is clamped well enough, you are ready to solder it.

The easiest way to solder the assembled horn is to stand it up on the face of the open-flared end on an electric hot plate. It will take much longer to do the job than with a blowtorch or propane soldering iron, but the heat will be more uniform and the control over the way the solder will flow is better.

When the horn has been heated enough, which will be

indicated by the color of the metal where the soldering paste makes contact, place a piece of wire solder on one seam in a stroking action. The solder will run into the seam and down to the open flare. Make sure that just enough solder has filled up each seam to join electrically the seam edges. Use the solder sparingly; too much will cause lumps which will have to be removed. Control the heat by lowering the stove temperature, but keep it just hot enough so that the solder will run.

When this task is complete, turn off the heat and let the whole assembly cool off. Do not lift it off the heater and cool it quickly under water; flexure of the seams can open them.

Remove all jigs and clamps. Carefully inspect the seams to see that there are no gaps in the solder. If there are, the assembly will have to be reheated and the soldering trick repeated. If the soldering procedure has provided a solid connection between all parts of the seams and there are no gaps, fit the flange to the open waveguide end and

solder it in place squarely. Be careful not to disturb the previously soldered seams.

The completed horn should be washed in very hot water to remove all traces of the acid solder paste. It then may be painted with Krylon paint to keep the brass from corroding. Do not paint the flange face.

Testing the horn to determine its gain and field pattern requires the use of a signal generator, an attenuator, and two other similar radiating devices.

Connect one of the radiators to the signal source output and the second to the attenuator and a suitable receiving indicator. The separation between the two test setups at this frequency must be 10 feet. The path between them should be free from obstructions and reflections. A pair of ladders six feet high will serve, if two flat surfaces are placed on the top of them. Fasten the radiating horn firmly directed toward the second platform where the second setup must be arranged so that it can be rotated horizontally about the axis of the transmitting

horn. A scale laid out on a piece of polar graph paper will assist in locating the half-power points of the horn.

Turn on the equipment. Check that the receiving setup is performing and that sufficient signal is detected when the attenuator is set to 10 dB. Now find the true axis, and make a mark on the plot sheet. Turn the attenuator to the 10 dB position, and note the indicator level. Now rotate the receiving device to approximately 10 degrees off the true axis and note the level. Readjust the attenuator to bring up the level to equal what it was when the device was on the true axis, and note the attenuator difference. You are looking for the level which corresponds to the 3 dB or half-power points. It will probably take several tries using this technique to locate this position. When it is located, move in the opposite direction from the true axis, and locate the opposite half-power point. Mark this on the polar plot sheet.

When the measurements of the two similar radiating devices have been completed, substitute your new horn for the receiving device. Make sure that it is receiving in the correct plane. When it is in place, direct it toward the transmitting radiator centering the true axis through the center of the horn. You will see that the receiving indicator is off scale, or at least reading upscale, showing that the horn has gain. Reduce the indicator reading by adjusting the attenuator so that the indicator reads the same level as the original measurement. Note the attenuator reading, and be sure to note which plane the measurement was taken in. This difference is roughly the gain over the original radiator. If the comparison radiator's gain is known, then you may quote accurately the gain which will be near 13 dB power gain.

Repeat the same procedure in the other plane, al-

ways making sure that the antennas are in the same plane. Cross polarization will be easily detected by the very weak signal received.

This completes the construction of the horn and its measurements. You should have an antenna with a beamwidth of nearly ten degrees to the half-power points in the E-plane and a little wider in the H-plane.

The references which appear at the end of the article are required reading if you

are going to attempt this project.

I must sound a note of caution regarding a problem which may be encountered when power exceeds the milliwatt region. It is a well-known fact that radiation from antennas or waveguides which produce an illumination over human tissues in excess of 10 milliwatts per square centimeter can cause serious damage to exposed tissues. Persons who work on military radar can appraise

you of this danger and the many lectures they receive about the subject. The most important warning I remember, which I received during my training, was "Don't look into the antenna or into a waveguide." Cataracts on your eyes may be the result. So be careful; don't look into horns or waveguides or, for that matter, any of the UHF antennas you use. Some excellent reading on the subject is listed in the references.

I hope to hear you on

10.445 GHz. I keep a sked with WA1IKR at 0010 UCT on Thursdays to beat the QRM problems. See you there. ■

References

1. Silver, *Radiation Lab Series*, Vol. 12, Sections 15-9.
2. Krauss W8JK, *Antennas*, Chapter 13, Section 13-6.
3. Olberg W1SNN, "Mobile Smokey Detector," 73, Holiday, 1976.
4. Brodeur, "A Reporter At Large - Microwaves," December 13 and 20, 1976, *New Yorker Magazine*.

Social Events

from page 149

c/o Sue Hagedon WB8GWO, 1340 Brainard Woods Drive, Dayton OH 45459.

TUCSON AZ APR 28-30

The Tucson Hamfest will be held on April 28-30, at the Ramada Inn (just off north I-10). It will feature technical sessions with demonstrations, microprocessors, solar poser, QRP, fast/slow scan, RTTY, remote base, etc. There will be prizes, ladies' programs, a banquet, exhibits, and a swap meet. It is sponsored by the Old Pueblo Radio Club. For information, write: OPRC, 1361 E. Edlin, Tucson AZ 85711.

SPOKANE WA APR 29

SWAP-FEST '78 will be held all day on Saturday, April 29, at the Spokane Interstate Fairgrounds. Flea market, mini-auctions throughout the day, contests, family picnic, major evening auction, some most-unusual radio exhibits, valuable prizes. Sponsored by the Inland Empire area amateur clubs. Talk-in on any area repeater. Write: SWAP-FEST '78, PO Box 3606, Spokane WA 99220.

MEADVILLE PA MAY 6

The 4th Annual Northwestern Pennsylvania Hamfest will be held on May 6th at the Crawford County Fairgrounds, Meadville PA. Gates open at 8:00. \$2 prize ticket required for admission - \$1 to display. Children free. Hourly door prizes; refreshments; commercial displays welcome. Indoors if rain. Talk-in on 04/64 and 52. Details: CARS, PO Box 653, Meadville PA 16335.

LAS VEGAS NV MAY 12-14

The 23rd Annual West Coast VHF Conference will be held at the Star-

dust Hotel, Las Vegas Strip at Convention Center Drive.

Conference highlights: technical program arranged by the San Bernardino Microwave Society, hospitality room, informal technical and operating sessions, noise figure measurements contest, antenna gain measurements contest, prize drawing, 24-hour adult entertainment! World-famous resort hotel with all facilities. Look for the Stardust sign east of I-15. Take the Sahara Ave. or Dunes-Flamingo exit. Advance registration fee is \$4.00 per person (\$5.00 at the door). Make checks payable to: West Coast VHF Conference, 510 South Rose St., Las Vegas NV 89106.

DEERFIELD NH MAY 13

The Hosstraders net will hold its fifth annual tailgate swapfest Saturday, May 13, at the Deerfield, New Hampshire, fairgrounds (covered building in case of rain). Admission is one dollar; no commission or percentage. Commercial dealers are welcome at the same rate. Excess revenues benefit Boston Burns Unit of the Shriners' Hospital for Crippled Children. Last year we donated \$430.80. Talk-in on .52, 146.40-147.00, 3940 kHz. If you have questions, send SASE to Joe Demaso K1ROG, Star Rt., Box 56, Bucksport, ME 04416 or Norm Blake WA1IVB, P.O. Box 32, Cornish, ME 04020 or check the Hosstraders net on Sundays at 4 pm on 3940 kHz.

WEST LIBERTY OH MAY 14

The Champaign Logan Amateur Radio Club, Inc., will hold its annual hamfest on Sunday, May 14, 1978, at the West Liberty Lions Park, West Liberty, Ohio. Free admission; trunk sales; tables are \$1.00. Door prizes. Talk-in on 146.52.

WARMINSTER PA MAY 14

The Warminster Amateur Radio

Club's fourth annual "HAMMART," flea market, and auction will be held on Sunday, May 14, from 9 am to 4 pm at William Tennent Senior High School, Street Road (Route 132), 2 miles east of York Road (Route 263), Warminster, Bucks County PA. Registration is \$1.00, tailgating \$2.00 additional. No indoor selling; bring your own tables. Talk-in on 146.16-76 and 146.52. For further information, write: Horace Carter K3KT, 38 Hickory Lane, Doylestown PA 18901 or call (215)-345-6816.

WABASH IN MAY 21

The Wabash County Amateur Radio Club's 10th annual hamfest will be held on Sunday, May 21, 1978, rain or shine, at the Wabash County 4-H fairgrounds in Wabash. Large flea market (no table or setup charge), technical forums, bingo, free parking, and lots of good food at reasonable prices. Advance admission is \$2.00; \$2.50 at the gate. Children under 12 free. Write Dave Nagel WD9BDZ, 555 Valley Brook Lane, Wabash, IN 46992.

COLUMBIA SC MAY 21-22

The Carolina Repeater Society is sponsoring the Columbia Hamfest on Saturday and Sunday, May 21 and 22, from 9 am to 5 pm at the Jamil Shrine Temple located 1 mile west of I-20 on

I-26. Large air-conditioned building with plenty of free on-site parking, a flea market, dealers, and activities. Talk-in on 34/94. Combined admission and drawing tickets are available for \$3.00 in advance or \$3.50 at the door. Contact Larry Johnson WA4VOJ, 1520 Atlantic Dr., Columbia SC 29210, or phone (803)-772-7984 or (803)-788-1308.

ERLANGER KY MAY 28

The Kentucky Ham-O-Rama will be held on Sunday, May 28 (Memorial Day weekend), at Erlanger Lions Club Park, Erlanger, Kentucky. It's 7 minutes south of Cincinnati, Ohio, 1 mile off I-75 south, the Donaldson Road exit. Talk-in on 146.19-79 repeater, 52-52 simplex. There will be prizes, exhibits, and a flea market. For information: NKARC, Box 31, Ft. Mitchell KY 41017, or phone (606)-331-4922.

FT TUTHILL AZ JULY 28-30

The Amateur Radio Council of Arizona will present the annual Ft. Tuthill Hamfest on July 28, 29, and 30th, 1978. Come on out in the cool pine country of Arizona, and join our western barbeque, prize drawings, and tech sessions. For further details or pre-registration forms, contact PO Box 11642, Phoenix AZ 85061.

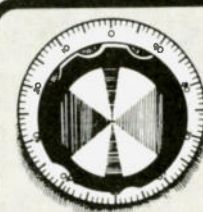

**Adirondack
has it!**

Amateur Headquarters for the Northeast

ADIRONDACK Radio Supply
185-191 West Main Street • P.O. Box 88
Amsterdam, N.Y. 12010 Tel. (518) 842-8350
Just 5 minutes from N.Y. Thruway - Exit 27

A Cheapskate's Circuit Board

— for those
on unemployment

Gary Sweatt WA1BVD
c/o PO Box 128
Farmington ME 04938

What? Another printed circuit board article? Yup! Only in this one I'll show you a way you can

produce good quality photo artwork without spending a lot of bucks on all sorts of fancy stick-'em-ons (which, by the way, are great for those without the time and who have the money).

The Basic Problems

Since it appears that the accepted way to make quality printed circuits involves the use of photographic techniques, it seems that we must have a piece of artwork to start with. For practical purposes, photo artwork must be:

1. Neat and clean (this part's easy enough, so I won't embarrass anyone by reminding them not to use greasy fingers).
2. Accurate enough so that the parts will fit the finished board (assuming that the negative made from the artwork is produced with good equipment).
3. Cheap.

The Solutions

Neglecting problem 1, if we review the accuracy re-

quirements, we discover that with the exception of dual inline packages (DIPs), relays, trimpots, and a few others, the parts used by digital experimenters have flexible leads which can be bent into the desired positions. This eliminates any stringent accuracy requirements in pad location for these components. For the rest, DIPs, etc., most if not all are available with their pins related to a .100 inch grid (ah ha — the common factor). Two things become apparent to me: First, this grid should be quite accurate as far as the artwork is concerned, and second, it only needs to be this accurate where the parts stick through the circuit board. That is, less accuracy is perfectly acceptable for conductor spacing and so on for most any board of interest to the experimenter. How accurately the centerlines of the grid are located depends upon how much clearance you are willing to accept in the drilled holes plus the dimensional stability of the artwork and negative. Let's examine this more closely, since here is where the crux of the matter lies.

If we consider a typical DIP,¹ then the holes should be .030 diameter more or less. You can see from Fig. 1 that this allows for the ± 0.005 typical implied lead position tolerance. If we assume that the average package is actually more accurate than this and/or if we accept a little careful lead bending, then we can get good results by splitting this tolerance between the package and the center to center hole spacing on the finished board. This thinking should minimize required lead bending while allowing for some error in pad positioning. By distributing the tolerance, the result is that we can stand an error of about ± 0.0025 from theoretical centers on the finished artwork. Certainly this is finer work than I would care to lay out by hand at actual or twice size, and it wouldn't

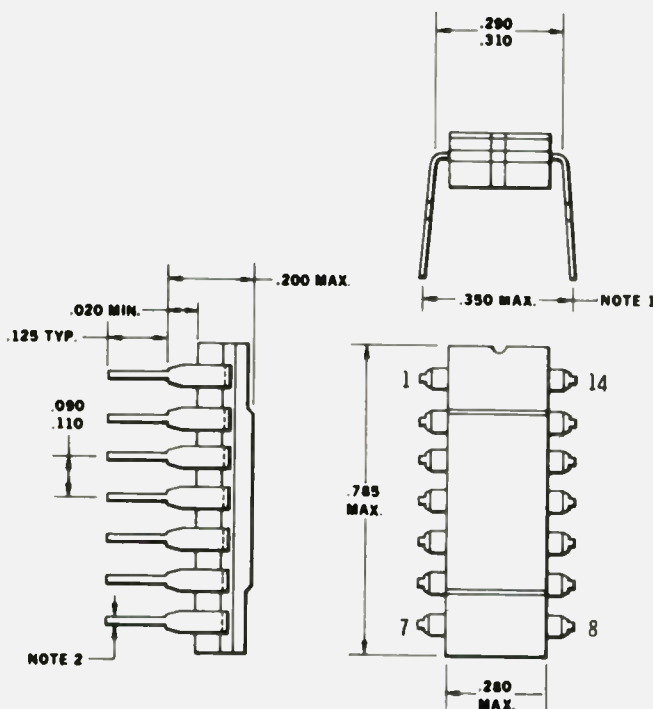

Fig. 1. Dimensional drawing of a typical dual in-line package. Notes: 1. Leads are intended for insertion in hole rows on .300" centers. They are purposely shipped with "positive" (.350) misalignment to facilitate insertion. 2. Board drilling dimensions should equal your practice for a conventional .020 inch diameter lead.

be very much fun maintaining this tolerance at 4 times actual size (.010 = about 2/3 of 1/64 inch). Problem — how do I accurately locate .100 grid component pads without an awful lot of bother (meaning expense and frustration)?

Perhaps now is the time to digress long enough to qualify expense. By reading the Dig-Key catalog of Bishop Graphics' materials, it appears that it would be very easy to spend about \$36.00 for a very basic assortment of pads and tapes to use in producing photo artwork (not to mention the cost of a stable base material). I might mention that this assortment doesn't include .600 pin space DIPs (24 and 40 pin) and that it costs just as much every time you run out of one thing or another. Now, since I tend to be somewhat of a Yankee cheapskate, I wanted a system which would cost, say, no more than \$20, have a much cheaper than cost replenishment, and would produce usable quality artwork.

After much thought, I wondered if the old unreliable standby, pen and ink, could be whipped into shape — if I discounted time of application (I can be awfully clumsy, so I usually take it real slow and easy with a pen). It appears that the primary shortcomings of this method are maintaining accuracy and repeatability, and hence the absence of popularity for this method. The problem has now reduced itself to the point where obviously an inexpensive guide of some sort would be nice — enter the universal precision DIP printed circuit layout template. For lack of a better idea, this at least was not too unreasonable, so I had my machine shop make one for me to experiment with.

The Template

For ease of handling and ruggedness, I wanted a good thick piece of transparent

material and finally decided on 3/16" acrylic sheet as being suitable. I also wanted to be able to locate all common DIP and similar packages. The final version of the template now accommodates DIPs with 40 or fewer pins on a .600 x .100 spacing, 22 or fewer pins with .400 x .100 spacing, and 18 or fewer pins that have .300 x .100 spacing. Also on the template is a square grid of holes (7 x 7) which I use to locate conductor corners and other components on the standard .100 grid. For ease of understanding, I show a complete tracing of this template in Fig. 2.

Other template features include ± 0.001 center to center and ± 0.002 center to edge of template tolerances at room temperature. To eliminate some of the inaccuracies which are bound to enter the drawing (Edsel Murphy et al), the template is twice size so that photo reduction to actual size will eliminate 1/2 the error (neglecting camera error). So that the template will work with ink, it is undercut on the bottom side to prevent ink from being drawn under it by capillary action. The edges to the nearest holes are $.400 \pm 0.002$ inches — handy for aligning a known centerline with the next set of holes.

Finally, the holes in the template are of the proper size so that when the right drafting pen is used (a #3), an open center pad is formed with a center diameter of about .040. This dimension reduces to .020, which forms a reasonable guide of free hand drilling of .030 (more or less) holes.

Other Stuff and Technique

As with any template, it must be held at the correct angle to the work (usually square). I use a drafting table with a machine for this, but a drawing board and T-square should work as well. Other systems which might be used (although I haven't tried them) are a portable drafting

machine or the use of ruled (.100 grid) inkable medium where the ruling is done in non-photo blue or similar (the rulings won't photograph but the ink will). With this last system, all one should need would be a straight edge which works with ink (i.e., is undercut) and the template.

For stable base material upon which to draw, I have found experimentally that for small circuits (4 x 6 final size or so), instability from normal temperature and humidity change has been negligible with many "unstable" materials, providing they don't warp or shrink severely during inking. I have had very good results with 3 ply white Bristol board. For larger drawings, it is probably a good idea to obtain a stable material suitable for use with ink. Speaking of which, I have used nothing so much as Higgins black India ink very successfully on my Bristol

board drawings, but there are some stable bases that require a different ink for good results (India ink won't stick well to some of these, even if it looks like it is wetting the surface when it is being applied). To apply the ink, I use a K&E "Acetograph" with a number 3 point, but any similar precision drafting pen should work as well.

Where the components go is up to you as determined by preplanning — techniques for this have been covered in many articles.^{2,3} Using the template to locate as many holes as possible frequently can result in maximum copper, minimum etch boards (handy if you're not recovering your chemicals). To accurately locate component pads, they should be drawn in one operation for any component — once you start, don't move the template until all pads for that component are located. Also, use good

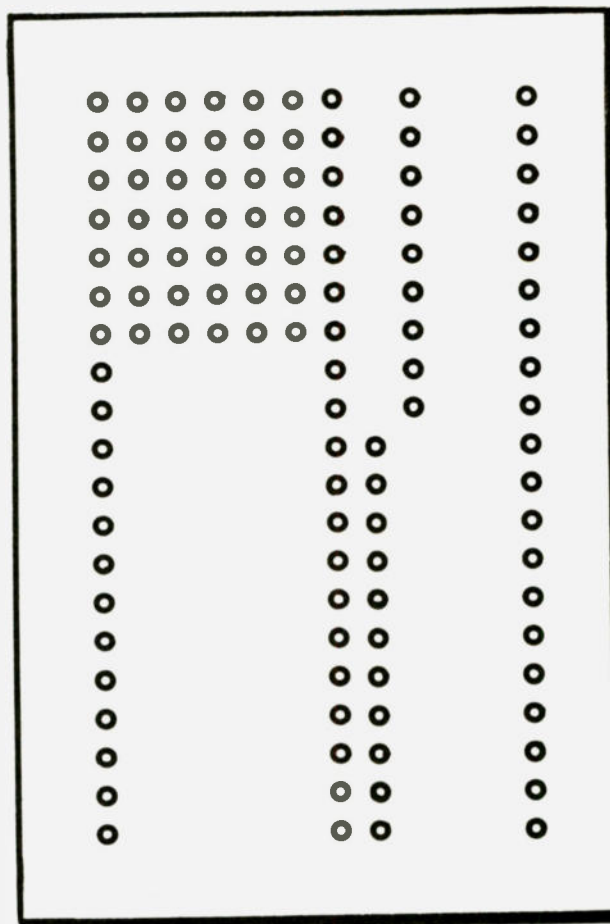

Fig. 2. Actual hole pattern of template; border location shows the approximate edge of the template.

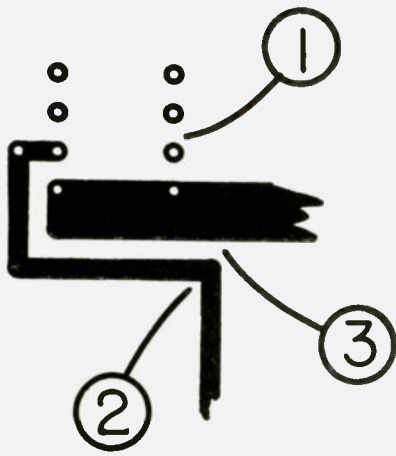

Fig. 3. Partial sample artwork showing (1) 8 pin DIP with conductors the same width as the pads. Also shown are sharp corners (2) and the concept of maximum copper, minimum etch as laid out on the .100 grid (3).

pen technique by holding the pen vertically, and be careful to rest it against the template while marking.

The artwork should be drawn as you look at the foil side of the board (backwards from the component side) unless you are making artwork to use in screen printing. This makes it easy for a

photolithographer to make a right reading, emulsion down negative. This type of negative gets the emulsion where you want it, next to the photosensitive circuit board.³

And Finally . . .

I have shown you an inexpensive method for producing photo artwork in

which the supply replenishment cost is minor and the initial investment for materials can be kept under \$20 as follows:

Pen	\$8.25	(approximate cost)
Ink	\$1.50	(approximate cost of small bottle)
Template	\$8.95	
	\$18.70	(approximate total)

The system is effective with perhaps two minor drawbacks. First, it is very easy to do complete layouts with the conductors the same width as the pad diameter. This tends to make solder flow along the conductor. Experience shows that for hand-soldered work where there is independent control over the results of each joint, this isn't a real problem. Secondly, by using the grid to lay out corners, it is very easy to get square internal corners somewhat prone to undercutting when etched. Both of

these problems are diagrammed in Fig. 3. Experience shows that these corners can be carefully filleted by hand or neglected since the material (copper) at the corners (diagonally across them) is thicker than the conductor anyway. These drawbacks are offset by the versatility and low cost of pen and ink. For those who may be interested in using this method, pens, ink, and stable base materials are available at most any drafting supply shop. The precision DIP template is available from Interrotech, PO Box 128, Farmington ME 04938. ■

References

¹ Fairchild — DTL Composite Data Sheet, 1967. (Note that this figure actually represents a JEDEC TO-116 package configuration.)

² "Secret PC Layout Method," Silas Smith Jr., *73 Magazine*, Holiday, '76.

³ "Make Your Own PC Boards," Charles Smith, *73 Magazine*, March, '77.

The Lightweight Champ.



only
\$79.95

Kantronics 8040-B Receiver

The **8040-B** is a versatile CW receiver at a modest price! This **battery-powered** unit makes a great camping and vacationing rig.

Prospective hams can **copy real QSOs** with a reasonable investment. Watch for our **companion transmitter**, available soon!

Coverage runs from 3.650 to 3.760 MHz, and 7.050 to 7.150 MHz. **Write us for more details!**

KANTRONICS
K13 *The Lightweight Champs.*

Telephone 913-842-7745
Lawrence, Kansas 66044

1202 East 23rd St

BUILD YOUR OWN VIDEO TERMINAL FOR \$95 "PLUS"*

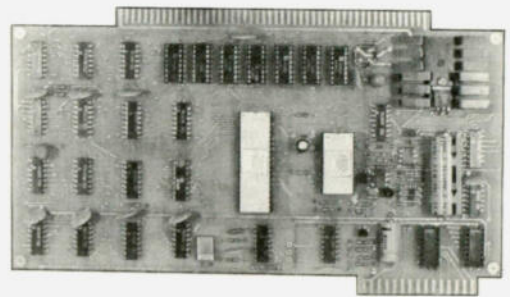

- Serial ASCII or BAUDOT
- Full X-Y Cursor control
- 128 Characters, including upper and lower case
- 16 lines X 64 characters
- S100 Compatibility
- No Supporting Software required

* The SCT-100 Single Card Terminal interfaces directly to any computer or modem having serial ASCII or BAUDOT capability. It requires only the addition of a standard ASCII keyboard, and a TV monitor. It is available as a partial kit for \$95.00 including the PC board, character generator ROM, and the 3870 micro-computer. The complete SCT-100 kit is \$155.00 (\$185.00 prewired & tested).

To order, call or write today. MC, BAC Accepted.

XITEX CORP. P.O. Box #20887, Dallas, Texas, 75220
Phone (214) 620-2993

X1

Clegg FM-28

ACCOMMODATE ANY BAND PLAN

- 144-148 MHz • 25 WATTS OUTPUT •



ONLY \$359.95 COMPLETE WITH MICROPHONE, MOBILE MOUNT ETC.
AVAILABLE ONLY FROM CLEGG. PHONE TOLL FREE TO ORDER

- Digitally Synthesized •Non-Standard Repeater Splits
- 5 KHz Steps •Modular Construction •Compact •Rugged
- 25 Watts Output •.25 uv Receiver •Large S Meter
- Full Coverage 144-148 MHz on Both Receive and Transmit
- Bright 6 Digit Numeric Frequency Display
- Super Selectivity with 15 Poles IF Filtering + 5 Pole Front End Filter •Multi-purpose Accessory Receptacle

Recent and future FCC regulations changes have left the 2 Meter gang hanging. But not the FM-28 owners! This superbly performing unit can accommodate any conceivable band plan. And the 25 watts of cleanly modulated output plus the .25uv receiver give you several big decibels of advantage. Works great as a CW uplink for OSCAR and the RS satellites too! Try one in your shack for 10 days on us!



Clegg COMMUNICATIONS CORP.
1911 Olde Homestead Lane, Lancaster, PA 17601
Toll free sales & service. Phone (800) 233-0250
In Pa. call (717) 299-7221 (collect)

C3

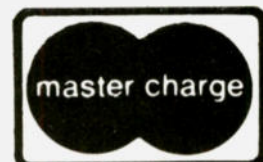

Good Grief, Not the 22S Again?

— *yes, even more flexibility*

Frequency	HEX	Binary	147.00	AE	10101110
146.01	6C	011101100	03	B0	10110000
04	6E	011101110	06	B2	10110010
07	70	011110000	09	B4	10110100
10	72	011100010	12	B6	10110110
13	74	011101000	15	B8	10111000
16	76	011101010	18	BA	10111010
19	78	011110000	21	BC	10111100
22	7A	011110100	24	BE	10111110
25	7C	011111000	27	C0	11000000
28	7E	011111100	30	C2	11000010
31	80	100000000	33	C4	11000100
34	82	100000010	36	C6	11000110
37	84	100001000	39	C8	11001000
40	86	100001010	42	CA	11001010
43	88	100010000	45	CC	11001100
46	8A	100010010	48	CE	11001110
49	8C	100011000	51	D0	11010000
52	8E	100011010	54	D2	11010010
55	90	100100000	57	D4	11010100
58	92	100100010	60	D6	11010110
61	94	100101000	63	D8	11011000
64	96	100101010	66	DA	11011010
67	98	100110000	69	DC	11011100
70	9A	100110010	72	DE	11011110
73	9C	100111000	75	E0	11100000
76	9E	100111010	78	E2	11100010
79	A0	101000000	81	E4	11100100
82	A2	101000010	84	E6	11100110
85	A4	101001000	87	E8	11101000
88	A6	101001010	90	EA	11101010
91	A8	101010000	93	EC	11101100
94	AA	101010010	96	EE	11101110
97	AC	101011000	99	FO	11110000

Fig. 1.

One of the most versatile 2 meter transceivers to grace the marketplace is also one of the more popular acquisitions, namely the Icom IC-22S. Freedom from purchasing crystals accounts for most of its popularity, but it also inspires frustration and confusion in new owners. The confusion sets in for those persons who are not familiar with programming a diode matrix, and the frustration occurs when one wishes to program more frequencies than the 23 slots provided. There are invariably just a few more frequencies than room. It sounds like something out of Murphy's law. However, some solutions do exist.

The most obvious choice is to reluctantly remove a few frequencies by exchanging some diodes. This solution is limited in the total number of frequencies, which is the same as what you started with, and, most importantly,

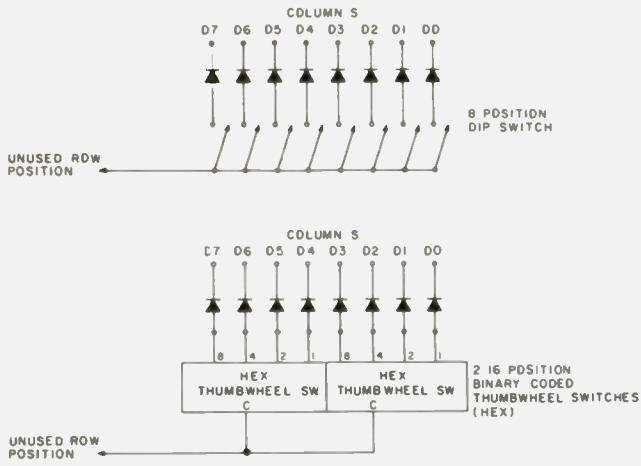

Fig. 2. Diodes are 1N914 or equivalent.

it can only be accomplished a couple of times. It seems that after the little solder pads are stroked more than twice by your soldering iron, they promptly jump right off the board, leaving nothing to solder to.

The next solution is a little more lasting. It consists of either an 8-bit mini-DIP switch or a pair of binary coded 16-position thumbwheels wired to a full set of diodes in a specific switch position. The switch can be mounted internally, and thereby accessed only when needed by opening the case. It also could be mounted externally in its own box or as part of your touchtone™ pad box. It is now fully accessible, but you still must remember all of the coding. For the computer buffs, Fig.

1 lists the coding for HEX switches, as well as the binary format.

Mechanical mounting can be customized in any form to suit the user. Fig. 2 shows the necessary electrical connections for hooking up either type of switch. Wiring can be routed through the 9-pin accessory socket or the optional 24-pin accessory socket, as well as through a slot in the case.

Perhaps the above scheme is too complicated or too cumbersome. The next solution is the simplest one. It seems that the right-most column of diode positions on the program board will increment the frequency by 15 kHz. This is the column labeled "D0." The next column to the left, "D1," will increment the frequency by 60

kHz. If you were to program all repeater frequencies that did not use that diode position, you would have every other standard pair and simplex frequency. Now all you need to do is electrically switch in a diode in column D1 in the matrix, and you have the other half of all standard repeater pairs and simplex frequencies. One diode and one SPST switch shouldn't tax even the newest Novice for complexity. Nor will you need to memorize weird combinations to determine what frequency you're on.

Fig. 3 shows schematically how the diode and switch are wired. An optional indicator circuit is shown for night mobile application or just plain idiot lights. Fig. 4 is a suggested list of frequencies

to be programmed in the conventional manner. The diode positions are indicated for simplicity. This list will cover all standard band plan frequencies, both repeater pairs, simplex, and optional repeater pairs. For split-split pairs, one more switch and one more diode will give you 44 more frequency combinations. Split-split operation is primarily found in California, New York City, and large urban areas. It is only about 3% of the total repeater population and probably not of interest to the majority of users. I have mentioned it for the sake of completeness. Fig. 5 indicates the additional frequencies available with the additional switch and diode.

There are a number of approaches you may take to implement this scheme. A

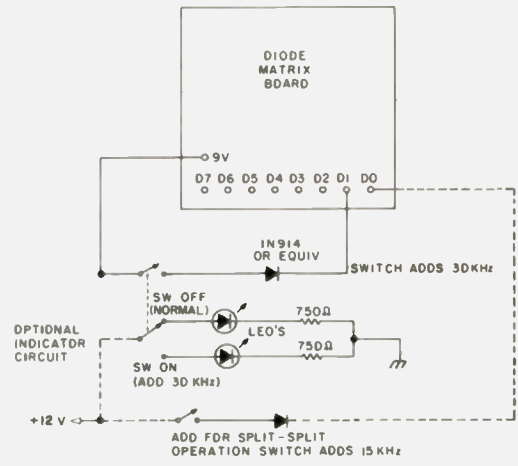

Fig. 3.

Dial position	Switch OFF	position ON	Diode Placement	D7	D6	D5	D4	D3	D2	D1	D0
1.	146.01	146.04		o	x	x	o	x	x	o	o
2.	07	10		o	x	x	x	o	o	o	o
3.	13	16		o	x	x	x	o	x	o	o
4.	19	22		o	x	x	x	x	o	o	o
5.	25	28	Standard Low In, High Out Use DUP A	o	x	x	x	x	x	o	o
6.	31	34		x	o	o	o	o	o	o	o
7.	37	40		x	o	o	o	o	x	o	o
8.	43	46		x	o	o	o	x	o	o	o
9.	49	52	Standard Simplex Frequencies	x	o	o	o	x	x	o	o
10.	55	58		x	o	o	x	o	o	o	o
11.	91	94		x	o	x	o	x	o	o	o
12.	97	147.00		x	o	x	o	x	x	o	o
13.	147.03	06		x	o	x	x	o	o	o	o
14.	09	12		x	o	x	x	o	x	o	o
15.	15	18		x	o	x	x	x	o	o	o
16.	21	24	Standard High In, Low Out Use DUP B	x	o	x	x	x	x	o	o
17.	27	30		x	x	o	o	o	o	o	o
18.	33	36		x	x	o	o	o	x	o	o
19.	39	42	Simplex	x	x	o	o	x	o	o	o
20.	45	48		x	x	o	o	x	x	o	o
21.	51	54		x	x	o	x	o	o	o	o
22.	57	60		x	x	o	x	o	x	o	o

Fig. 4. Suggested frequency list. x = diode; o = space.

Dial Position	Off	On
1.	146.025	146.055
2.	085	115
3.	145	175
4.	205	235
5.	265	295
6.	325	355
7.	385	415
8.	445	475
9.	505	535
10.	565	595
11.	925	955
12.	985	147.015
13.	147.045	075
14.	105	135
15.	165	195
16.	225	255
17.	285	315
18.	345	375
19.	405	435
20.	465	495
21.	525	555
22.	585	615

Fig. 5. Split-split frequencies with second switch. (Second switch ON.)

few will be described below, but they do not approach all of the possibilities that each user can invent to suit his own personal taste and habits.

The conservative approach: This scheme is for those persons who wish to preserve the "unmodified

look" on their equipment. The two conductors for the switch leads can be connected through the empty pins in the accessory socket. The switch can be mounted anywhere that's convenient, such as in the touchtone box or taped to the top of the rig. Use your imagination.

The daring approach: Above the channel selector switch at the top of the plastic front bezel, there is just enough room to mount a subminiature toggle or slide switch right where it would be most convenient to use. It is a little tricky and definitely not recommended for the fat-finger set. If you have real dexterity, you can mount a DPDT switch and a couple of LEDs to indicate which way the switch is thrown. Again, your imagination is the limit.

The subtle approach: For those who like to customize their rigs without being obvious, replace the squelch or volume control with one having a push-pull switch built in. No holes are drilled, the switch position is obvious, and the rig is not defaced in any way. Both switches can be changed for those wanting 15 kHz splits.

Since each user must decide what is best for him, and since an infinite number of schemes exist, the above

1. 01
3. 13
5. 25
7. 37
9. 49
11. 91
13. 03
15. 15
19. 39
21. 51

ideas should provide enough mental stimulation without belaboring the point. The schemes described above were compiled through discussions with many IC-22S owners and users. I specifically want to thank WA2KTJ, WB2HQE, and WB2HQC, who contributed and modeled most of these ideas on their rigs. ■

ideas should provide enough mental stimulation without belaboring the point.

The schemes described above were compiled through discussions with many IC-22S owners and users. I specifically want to thank WA2KTJ, WB2HQE, and WB2HQC, who contributed and modeled most of these ideas on their rigs. ■



146 - 148 MHz ALL 2-METER FM CHANNELS

with your
IC-22S

- SINGLE KNOB CHANNEL SELECTION
- DIRECT FREQUENCY READOUT
- SIMPLE, EASY INSTALLATION
- LOW COST
- INSTALLS IN PLACE OF ORIGINAL SWITCH

These repeater pairs are programmed in the switch:

146.01-61	146.22-82	147.60-80	147.81-21
146.04-64	146.25-85	147.63-83	147.84-24
146.07-67	146.28-88	147.66-86	147.87-27
146.10-70	146.31-91	147.69-89	147.90-30
146.13-73	146.34-94	147.72-12	147.93-33
146.16-76	146.37-97	147.75-15	147.96-36
146.19-79	146.40-00	147.78-18	147.99-39

PLUS: The following simplex channels are also programmed in the switch:

146.43	146.55	147.48
146.46	146.58	147.51
146.49	147.42	147.54
146.52	147.45	147.57

PLUS: Two user programmed channels

Now you can have all the 2-meter FM frequencies from 146.01 thru 147.99 on your IC-22S. The basic VIP-42 conversion provides 42 channels, including all the repeater pairs, all of the standard simplex frequencies, and any two other desired user programmed channels. The VIP-600 option adds simplex capability on channels 600kHz above the indicated channel, while the VIP-15 option provides the capability of moving the IC-22S 15kHz up from the indicated frequency for split operation.

Kp Valley Instrument Products
V11

(312) 741-8820 — P.O. BOX 339 BARTLETT, ILLINOIS 60103

VIP-42 kit

\$29⁹⁵

VIP-600 option - \$3.50
VIP-15 option - \$3.50

Next time you light up a cigarette, get a look at your kid's face

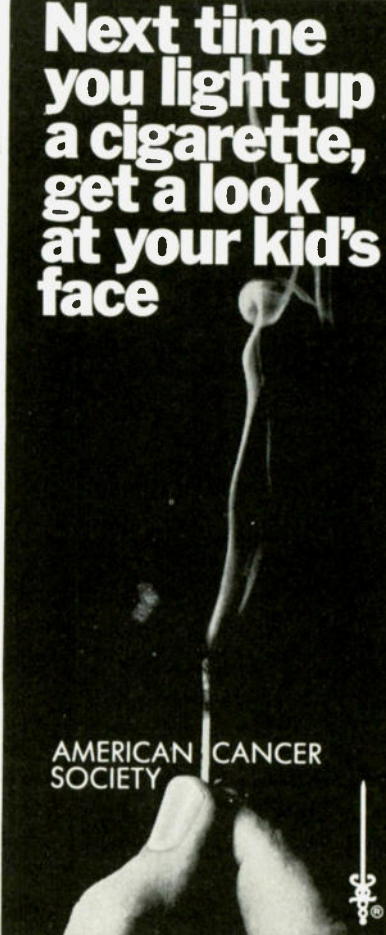

AMERICAN CANCER SOCIETY

© 1988

THIS SPACE CONTRIBUTED BY THE PUBLISHER

PLEASE SHIP _____ VIP-42 conversion kit(s) at \$29.95 each. BANK AMERICARD

ALSO INCLUDE _____ VIP600 option(s) at \$3.50 each. VISA

and _____ VIP15 option(s) at \$3.50 each. MONEY ORDER

Name _____ Coll _____ I enclose \$ _____ check or money order.

Address _____ Please charge my VISA/Bank-Americard \$ _____

City _____ Card number _____ Expiration date _____

State _____ ZIP _____ Signature _____

ILLINOIS RESIDENTS ADD 5% SALES TAX

FREQUENCY COUNTERS

FREE

By popular demand we are continuing to offer a Fairchild Clock, Module FCS-8100A (suggested retail \$20) with any purchase of \$99 or more from 73 advertisements.



Previously kitted for Crescomm Inc. by Hal-Tronix

COMPLETE KITS: CONSISTING OF EVERY ESSENTIAL PART NEEDED TO MAKE YOUR COUNTER COMPLETE. HAL-600A 7-DIGIT COUNTER WITH FREQUENCY RANGE OF ZERO TO 600 MHz. FEATURES TWO INPUTS: ONE FOR LOW FREQUENCY AND ONE FOR HIGH FREQUENCY; AUTOMATIC ZERO SUPPRESSION. TIME BASE IS 1.0 SEC OR .1 SEC GATE WITH OPTIONAL 10 SEC GATE AVAILABLE. ACCURACY \pm .001%. UTILIZES 10-MHz CRYSTAL 5 PPM.

COMPLETE KIT \$149.00

HAL-300A 7-DIGIT COUNTER WITH FREQUENCY RANGE OF ZERO TO 300 MHz. FEATURES TWO INPUTS: ONE FOR LOW FREQUENCY AND ONE FOR HIGH FREQUENCY; AUTOMATIC ZERO SUPPRESSION. TIME BASE IS 1.0 SEC OR .1 SEC GATE WITH OPTIONAL 10 SEC GATE AVAILABLE. ACCURACY \pm .001%. UTILIZES 10-MHz CRYSTAL 5 PPM.

COMPLETE KIT \$124.00

HAL-50A 8-DIGIT COUNTER WITH FREQUENCY RANGE OF ZERO TO 50 MHz OR BETTER. AUTOMATIC DECIMAL POINT, ZERO SUPPRESSION UPON DEMAND. FEATURES TWO INPUTS: ONE FOR LOW FREQUENCY INPUT, AND ONE ON PANEL FOR USE WITH ANY INTERNALLY MOUNTED HAL-TRONIX PRE-SCALER FOR WHICH PROVISIONS HAVE ALREADY BEEN MADE. 1.0 SEC AND .1 SEC TIME GATES. ACCURACY \pm .001%. UTILIZES 10-MHz CRYSTAL 5 PPM.

COMPLETE KIT \$124.00

HAL-TRONIX BASIC COUNTER KITS

STILL AVAILABLE

THE FOLLOWING MATERIAL DOES NOT COME WITH THE BASIC KIT: THE CABINET, TRANSFORMER, SWITCHES, COAX FITTINGS, FILTER LENS, FUSE HOLDER, T-03 SOCKET, POWER CORD AND MOUNTING HARDWARE.

HAL-600X (Same Specifications as HAL-600A) \$124.00
 HAL-300X (Same Specifications as HAL-300A) \$99.00
 HAL-50X (Same Specifications as HAL-50A) \$99.00

PRE-SCALER KITS

HAL-0-300PRE (Pre-drilled G10 board and all components) \$19.95

HAL-0-300P/A (Same as above but with preamp) \$29.95

HAL-0-600PRE (Pre-drilled G10 board and all components) \$39.95

PRE-BUILT COUNTERS AVAILABLE

(HAL-600A — \$229.00) (HAL-300A — \$199.00) HAL-50A — \$199.00). ALLOW 4- TO 6-WEEK DELIVERY ON PRE-BUILT UNITS.

See you at DAYTON!



"HAL" HAROLD C. NOWLAND
 WBZXH

HAL-TRONIX

P. O. BOX 1101

SOUTHGATE, MICH. 48195

PHONE (313) 285-1782

SHIPPING
 INFORMATION:

ORDERS OVER \$15.00 WILL BE SHIPPED POSTPAID EXCEPT ON ITEMS WHERE ADDITIONAL CHARGES ARE REQUESTED. ON ORDERS LESS THAN \$15.00 PLEASE INCLUDE ADDITIONAL \$1.00 FOR HANDLING AND MAILING CHARGES.

SEND SASE FOR FREE FLYER

H24

HATRY electronics

500 Ledyard St., Hartford CT 06114
 203-527-1881

(1 block east of Wethersfield Ave. off Airport Rd. Rte. 6)

See Ward W1WRQ — John W1JJR

or

Dave WA1HFE

HEADQUARTERS for 2M FM

Tempo VHF/ONE, SSB/ONE adaptor, Tempo VHF amplifiers, FMH-2, FMH-5; Drake TR 33C, AA 10, AC 10; Regency HR 2B, HR 312, AR 2, P 110 & crystals for all lines listed above.

FM GAIN ANTENNAS

For mobile, fixed or portable operation by Cush-Craft, Hy-Gain, Antenna Specialists & New-Tronics.

ANTENNA STUFF

Open wire feedline — #18, #14, #12 ga. bare copperweld wire — #14, #12 enamel copper — insulators — W2AU baluns 1-1 or 4-1 — lowloss coax cable — Rohn 25G towers & accessories — Blitzbug lightning arrestors — glassline guy — B&W antenna switches — Belden 72 & 300 ohm KW twinlead — Amphenol UHF & BNC connectors.

AMATEUR GEAR

Drake, Swan, Tempo, Ten-Tec, Dentron, Regency, Mosley, Hy-Gain, CushCraft.

(Canadian Amateurs Send U.S. Funds Only)

F.O.B. Hartford

Please include postage

CONNECTICUT'S OLDEST HAM STORE

H15

Avoid An Overvoltage Catastrophe — protective circuit

When the spare car battery under the table began giving way to regulated power supplies to run the mobile rig in the house, the specter of creamed, frapped, and fried rigs started to rear its ugly head. This was

brought about by the possibility of power supply component failure. With this in mind (not to mention the smell of the smoke), I worked out and tested several methods of protecting the delicate equipment. They are pre-

sented here. Fig. 1 shows a typical series-regulated power supply suitable for use with 12- to 14-volt equipment drawing up to 4 Amps. Although state-of-the-art systems would use at least one or more ICs, most of the

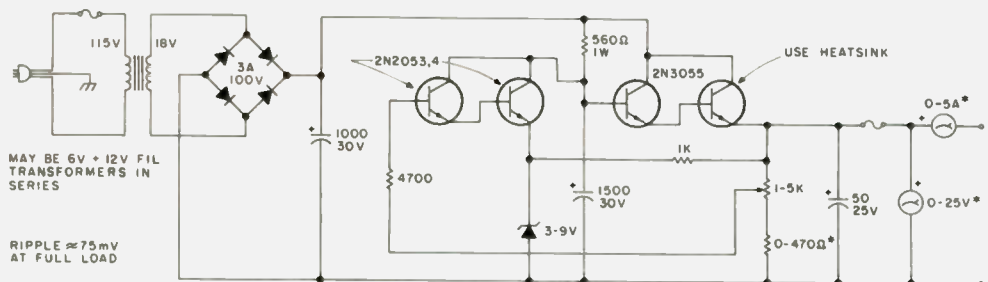

Fig. 1. Typical regulated power supply. This may be built for \$20 to \$30 with some surplus parts. *Typical values.

parts for this supply might be found in the junk box.

In order to obtain 13 volts out of the supply, about 18 volts must go into the bridge. The voltage out of the first filter may exceed 25 volts. A component failure in the control circuit could place excessive voltage on your unsuspecting rig. That could unduly stress some of the semiconductors and cause them to fall by the wayside. Fuses and other protection circuits could operate, but they would probably be too slow. Those protection circuits that are internally connected to keep the series-pass transistor from passing more than a predetermined amount of current or voltage depend upon said transistor remaining in good health under all conditions. That isn't a safe assumption!

Fig. 2 shows one of the simplest protection systems of all. When the voltage reaches the breakdown or zener voltage of VR, the diode goes into conduction. There is no current limit other than the fuse, which blows. VR is picked to have a value just above the normal operating voltage of the home supply, but well below the upper limit of the rig. (Mobile equipment has been rated to withstand upwards of 16 volts.)

The good news about this system is that it is simple; the bad news is that, unless a very heavy-duty zener is used, every time it operates, the fuse and the diode must be replaced. When the diode goes into heavy conduction due to an overvoltage condition, it shorts out and thereby blows the fuse. This system is as effective as it is simple and may be found in commercially-manufactured equipment.

One alternative is a string of low-voltage high-current zeners in series. They would be able to carry enough current to blow the fuse without shorting out. This method is fairly economical and still re-

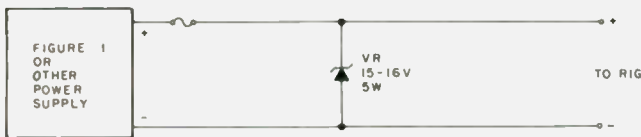

Fig. 2. Simplest overvoltage protection. (Use should be restricted to low current supplies.)



Fig. 3. Heavier-duty protection system.

tains a high degree of simplicity. Remember, in case of a malfunction, only the fuse should have to be changed, not the zeners. See Fig. 3.

Going one step up the complexity ladder, the next method amounts to a diode amplifier. A low-current zener is used to tell a heavy-duty transistor when to turn on and blow the fuse. This is a nondestructive system and still clamps the output voltage to a safe level. Only the fuse need be replaced after the system operates. It still does not have a really sharp turn-on characteristic, though. It is probable that it will bleed some current all of the time if it is operated near the zener's voltage rating. It leaves something to be desired, but it certainly would provide protection. It is

shown in Fig. 5.

Another approach is shown in Fig. 6. A pot is adjusted to fire an SCR when the voltage reaches a pre-determined point. The SCR system needs a suitable RC network to prevent accidental triggering by transients or glitches. (Go ahead, ask me how I know!) This one seems to have been dropped from general use.

Fig. 7 shows a very effective overvoltage system. With the values shown, it may be adjusted to dump anywhere from 7 to 30 volts, and it may be set to within 1/2 volt of the desired trip point. It may be used on power supplies delivering upwards of 30 Amps. There is no "bleed" current through the power transistors and only about 20 mA in the control circuit.

VR1 and the 4700-Ohm resistor provide a stable reference voltage for the base of Q1, which is one-half of a differential amplifier. The 1k resistor and 10k pot sense the voltage level and feed a portion of it to the base of Q2, where it is compared to the reference voltage.

Q2's collector voltage shifts from 5 to 9 volts, depending upon the setting of

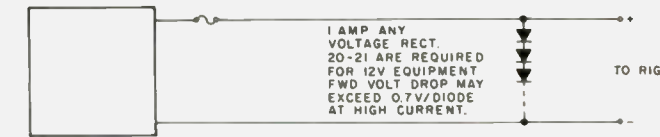

Fig. 4. Heavy-duty protection system (similar to Fig. 3). Some 73 advertisers have been selling 1N4001s for 15/\$1. 3- to 5-Amp diodes would be better, but they would raise the cost.

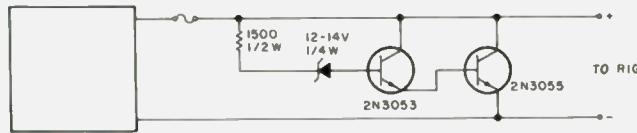

Fig. 5. Improved heavy-duty protection system.

the pot. This 4-volt change is coupled to the base of Q3 via the 5600-Ohm current-limiting resistor and the second zener, which is used to get rid of the 5-volt offset coming in from Q2's collector. With this arrangement, Q3's collector will go suddenly from 0 to 13 volts, until it is tied to the base of Q4.

With Q3's collector low, Q4 and Q5 are just quietly sitting there waiting for some forward bias. When Q3's collector swings high, Q4 and Q5 (a Darlington pair) are driven into "hard" conduction. Since Q5 is connected across the power supply, the fuse blows. Until it opens up, the voltage is clamped very close to the value determined by the setting of the pot.

Additional 2N3055s should be paralleled with Q5 for each additional 10 Amps of fuse rating. Since Q5 is turned on only long enough to blow the fuse, there is no need to put it on a heat sink.

The layout is not critical and neither are most of the parts values, but try to stay within 20% of the listed values if you want it to work as well as possible.

Initial setup is fairly simple. Connect a voltmeter across the power supply. Replace the fuse with a 12-volt 150-mA (or higher current) lamp. If the power supply is adjustable, set it for about 14 1/2 to 15 1/2 volts. Adjust the 10k pot until the light snaps on. Double-check that adjustment. Slowly back down the power supply voltage and note the point at which the lamp goes off. This should be within 1/2 volt, and typically within 1/4 volt, of the desired trip point. (That's why you should stay within 20% of the values given in the parts list.) If the power supply is not adjustable, then place one or two flashlight batteries in series with it for initial setup.

If all of the parts are purchased new from some of the surplus dealers found in the back of this magazine, the whole thing shouldn't cost \$5.00. Of course, that price could be trimmed with a little help from the junk box.

One more thing: This unit could be built into a small box and added to the mobile rig in the car to protect it from possible automotive voltage regulator malfunctions. ■

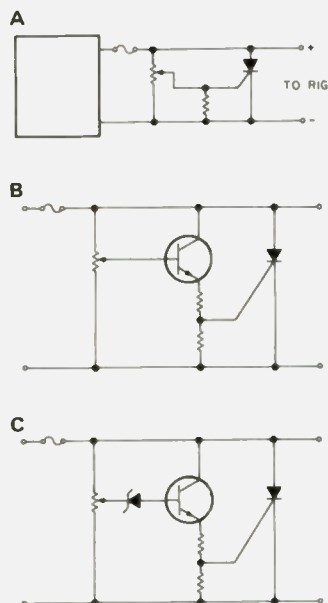

Fig. 6. Overvoltage protection with SCRs.

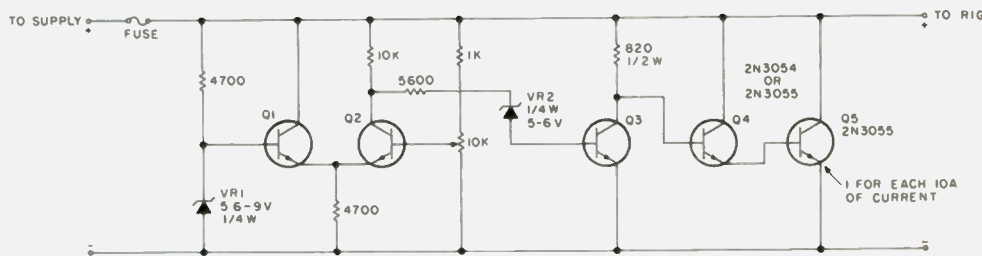

Fig. 7. Sensitive, adjustable overvoltage protection system. Q1, Q2, and Q3 are 2N2926, 2N3414, etc.

The Amazing Zener Sweeper

— big deal gadget tests zener diodes

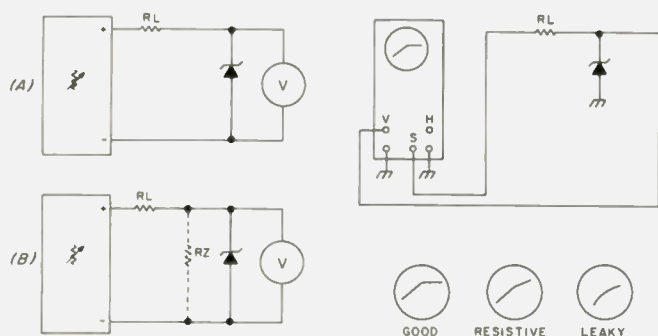

Fig. 1.

Fig. 2.

Richard Need WB4YOD/PY8ZAF
 Summer Institute of Linguistics
 Caixa Postal 129
 78.900 Porto Velho, Rondonia
 Brazil

Have you ever acquired a packet of unmarked, untested zener diodes from one of the surplus dealers who advertise in *73 Magazine*? (Of course, you wouldn't buy from one who doesn't advertise in *73*!) Per-

haps you have discovered that sorting and testing 100 such zener diodes is a rather formidable task.

The common method of testing a zener diode is by connecting the zener in series with a limiting resistor across a variable voltage source and metering the zener voltage. See Fig. 1(a). As the supply voltage is increased, the voltage across the zener diode will be equal to the supply voltage until the zener point is reached. At that point, the voltage across the zener will cease to rise with further increase in the supply voltage, and the meter will indicate the zener voltage. This test, however, does not make it readily apparent whether or not the zener under test is leaky. In Fig. 1(b), this zener diode leakage is represented by RZ in parallel with the diode. The applied voltage will divide across RL and RZ until the zener point is reached, at which time it will stabilize. In this case, the voltage across the zener diode increased with increasing supply voltage, as it should, but it was less than the supply voltage. A careful observer may notice this, but I have been known to miss it.

The shortcomings of this method can be overcome by using a sawtooth test voltage and monitoring the zener voltage with an oscilloscope whose horizontal sweep is driven by that sawtooth. This is possible with an oscilloscope that provides front-panel access to its internally-generated sweep voltage, as shown in Fig. 2. The displayed ramp will rise to the zener point, beyond which it will be a horizontal line. If the zener passes current before the zener point is reached (is leaky), the ramp will be curved. If the zener does not go into complete conduction at its zener point (is resistive), the horizontal trace will continue to rise. This would seem the ideal method, but it does have several disadvantages:

1. Not all oscilloscopes pro-

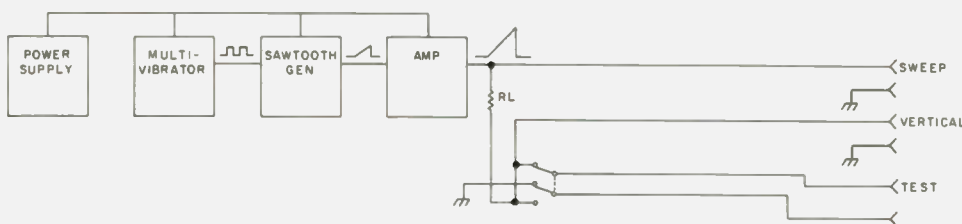

Fig. 3.

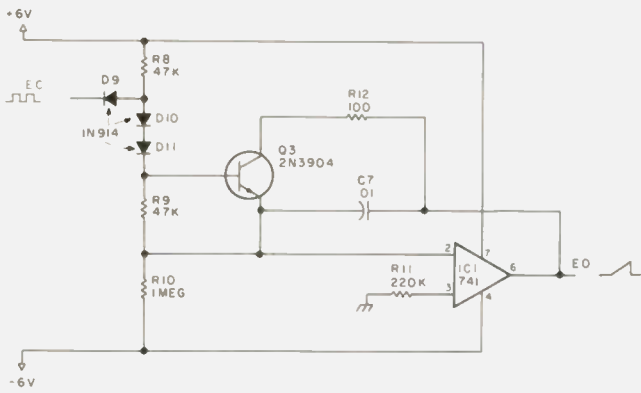

Fig. 4.

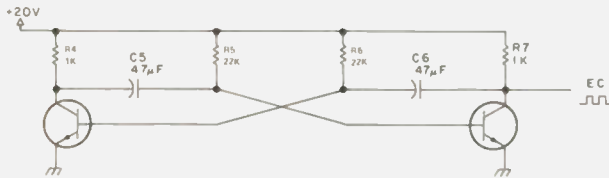

Fig. 5.

vide front-panel access to the sweep voltage.

2. The trace on the screen often begins after the voltage on the sweep output terminals has risen to some value, making it impossible to test zeners of voltages lower than that value.

3. It is somewhat time-consuming for use in testing any great number of devices. (Remember that packet of 100 unmarked, untested zeners?)

Perhaps you have anticipated the next step. A sawtooth generator whose output has a zero baseline and sufficient amplitude to exceed the voltage of the zeners to be tested will do nicely. Described hereafter is a tester that provides these features. The circuits, far from original, have been borrowed from various sources and modified as necessary to utilize the contents of my

particular junk box.

Fig. 3 is a block diagram of the tester, controlled by a multivibrator, is amplified and applied to the test circuit. Jacks are provided for connections to the oscilloscope inputs and for leads to connect to the zener under test.

The heart of the tester is an integrator with a clamping transistor to reset the timing capacitor at the end of its timing cycle, which produces a sawtooth (Fig. 4). The required control voltage, EC, is obtained from an astable

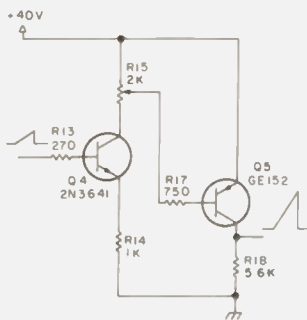

Fig. 6.

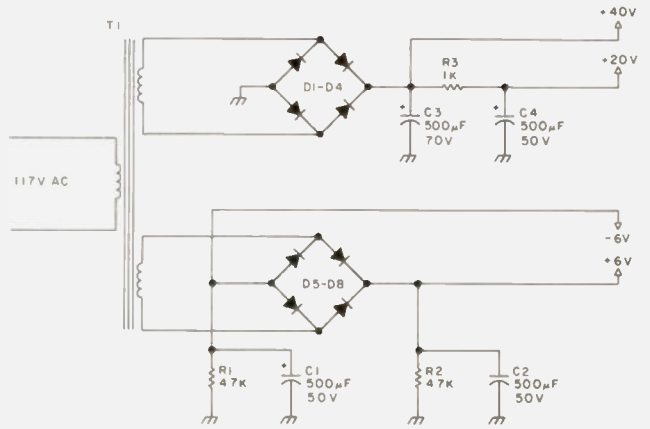

Fig. 7.

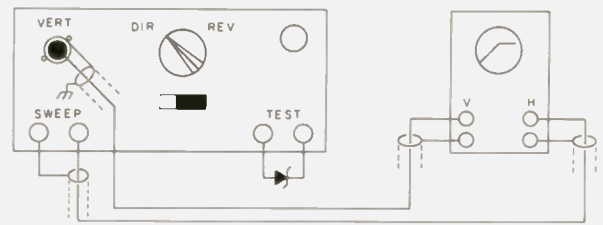

Fig. 8.



Fig. 9.

multivibrator. When EC is high, D9 is reverse biased, and the positive voltage, applied through R8, holds Q3 in saturation. R12 is thus in parallel with C7, the timing capacitor. EO is then essentially zero. When EC goes low, D9 conducts, and D10

and D11 are reverse biased. Q3 turns off, and the circuit begins to integrate at the rate of $1/R_{10} \times C_7$ volts per second. This rise continues until the control voltage again goes high, driving Q3 to saturation and discharging C7. With the components

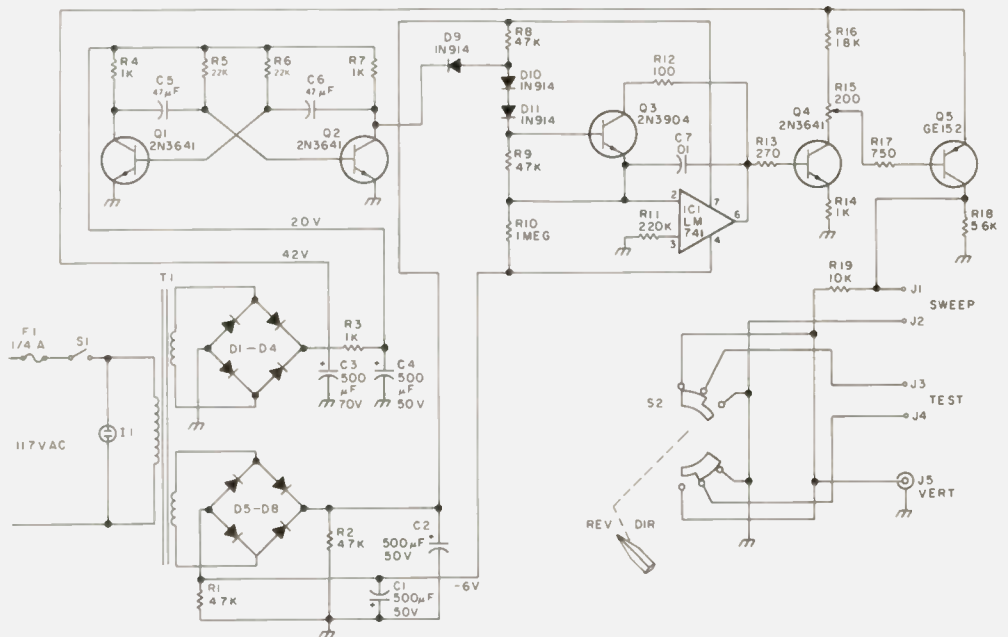

Fig. 10. Zener diode tester.

shown, the rise is approximately 560 volts per second. The amplitude of the ramp produced is dependent on the timing rate, limited by the voltage applied to the integrated circuit.

Fig. 5 shows the astable multivibrator that produces the control voltage. The timing components are C5, R5 and C6, R6. The time

interval of conduction of the transistors is given by: $T = 0.692 \times C \times R$.

With the components shown, pulses of approximately 7 milliseconds duration are obtained with an amplitude of 18 volts. This is quite adequate to control the sawtooth generator.

The sawtooth from IC1, approximately 4 volts in

amplitude and of 7 milliseconds duration, is applied to a two-stage direct-coupled amplifier (Fig. 6). Output from the amplifier section is a 40-volt sawtooth whose duration is somewhat less than 7 milliseconds, having lost a bit due to the bias on transistors Q4 and Q5. Q5, a GE152, is the only critical component in the tester. It must have good linearity, low leakage, and an adequate voltage rating.

The power supply, Fig. 7, is designed to provide both positive and negative 6 volts from a single low-voltage secondary. A bridge rectifier is connected with equal loads on its positive and negative outputs. Equal current flows in both loads; hence, equal voltages of opposite polarity are developed. These power the LM741. The high-voltage secondary provides +40 volts for the output amplifier, which ensures that the test sawtooth will be of sufficient amplitude for the range of zener diodes normally encountered in the shop where this tester is in use. R3 is used to drop the +40 volts to +20 volts to power the multivibrator.

The zener diode tester is quite simple to use. Connections are made from the tester to the vertical and horizontal inputs of an oscilloscope whose vertical amplifier is set for "dc" and whose horizontal amplifier is set for "external." The zener diode is connected to the test

terminals and a graphic representation of the zener characteristics is displayed on the oscilloscope screen. The zener voltage may be read on the screen if the oscilloscope is calibrated. A polarity-reversing switch is provided for convenience in switching the polarities of the test terminals. A normal zener will produce a distinctive trace, while a defective device will be readily apparent (Fig. 9), thus facilitating rapid testing.

Figs. 11 and 12 show the layout used in the prototype of this tester. Nothing in the layout is critical, which means a great deal of variation is possible, so you can make use of any available parts.

Though constructed only recently, this tester already has proven of tremendous value. Several previously inexplicable power supply problems have been resolved by demonstrating that a zener knee was not sharp. Additionally, more than 100 unmarked, untested zener diodes, purchased from one of the surplus dealers who advertise in *73 Magazine*, have been tested and sorted. I have found it well worth my time. ■

References

IC Op Amp Cookbook, Walter G. Jung, Sams, p. 388, "Low Frequency Sweep Generator."
Electronic Circuit Design Handbook, Tab, p. 141, "Power-Less Pulse Amplifier."
Handbook of Semiconductor Circuits, Tab, p. 243, "Basic Saturated Astable Multivibrator."

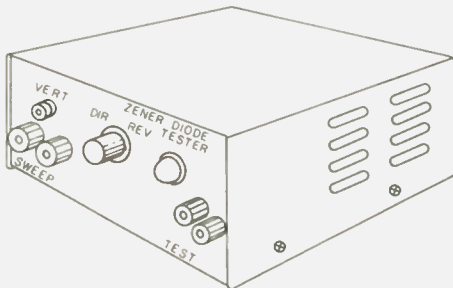

Fig. 11. Panel layout.

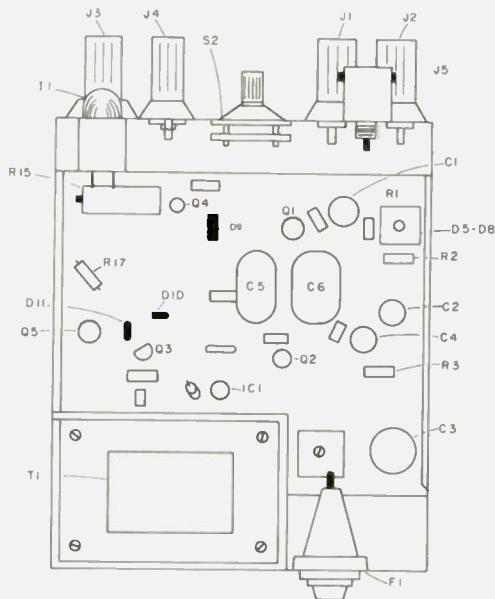

Fig. 12. Component location.

RF ENGINEER

An immediate opportunity exists with our well-established, growing electronics firm, located in beautiful San Diego.

Requires a BSEE with a minimum of 5 years experience in HF, VHF, and UHF RF design. Candidates must be comfortable with independent state-of-the-art transceiver design and PLL servo theory. Licensed amateur operator desired.

Our offer includes excellent salary and a full range of company sponsored benefits.

CALL WILL GORDON (717) 277-6780, Ext. 245

Or send resume to:

SWAN ELECTRONICS

A Division of Cubic Corporation

9233 Balboa Ave., San Diego, CA 92123

YOU ASKED FOR IT-

BOTH MORSE AND RTTY



ST-6000



DS-3000 KSR

The ULTIMATE in coded communications can now be yours with the new DS-3000 KSR TERMINAL (Version 3) and ST-6000 DEMODULATOR. Enjoy the convenience of composing and editing your messages BEFORE transmitting; decode and display CW as well as RTTY signals. Connect the HAL ST-6000 and DS-3000 KSR to your transceiver and antenna and work the world on RTTY and CW.

ST-6000

- 170-425-850 Hz Shift
- Low or High tones
- Crystal tone keyer
- Active band-pass filters
- Autostart and antispace
- ATC and DTH
- KOS for keyboard break-in
- Scope or meter tuning indicator
- AM or FM limiter modes
- Table or rack mounting
- I/O interface to current loop, RS-232, MIL-188, and CMOS

ST-6000M (Meter) \$495.00
 ST-6000S (Scope)..... \$595.00

DS-3000 KSR

- MORSE, BAUDOT, and ASCII codes
- Full 72 character lines
- 16 lines of display
- Word wrap-around
- Edit with WORD, LINE, & PAGE modes
- Keyboard programmable HERE IS message
- Up to 175 WPM CW, 5 speeds BAUDOT & ASCII
- 8080A microprocessor controlled
- MORSE also output as ASCII or BAUDOT
- I/O interface to current loop or RS-232
- New streamlined 12 inch display
- On-screen indicators of WORD & PAGE modes

DS-3000 KSR V3 \$1575.00
 DS-3000 KSR V2 (NO MORSE) . \$1195.00

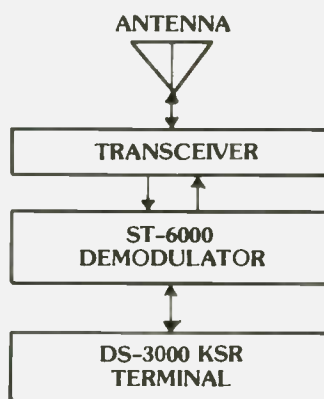

Write or call us for our new amateur catalog.



HAL COMMUNICATIONS CORP.
 Box 365
 Urbana, Illinois 61801
 217-367-7373

For our European customers
 see HAL equipment at:
 Richter & Co.; Hannover
 I.E.C. Intereko; Bissone
 Primetek Systems; Handen, Sweden
 Radio Shack of London

How To Use a Varactor — And Why

—semi-exhaustive article

Jim Barnett W6JB
1163 Calle Las Trancas
Thousand Oaks CA 91360

This article is written to acquaint anyone who has not used voltage-variable capacitors (varactors) with their most important characteristics. Varactor diodes are about the same size as the popular 1N914 diode. They can be used to replace larger and slower-reacting mechanically-variable capacitors and are easily remotely controlled.

For example, a circuit to be tuned using a mechanically-variable capacitor has to be carefully located in a place where the shaft is ac-

cessible to, for example, a front panel. The varactor and the circuit it tunes, on the other hand, can be located anywhere, with no regard for the front panel. A potentiometer to derive the control voltage for the varactor can be mounted anywhere on the front panel, and the dc control wire can be routed at a great distance from the varactor and tuned circuit.

Varactors can be ohmmeter tested for forward and reverse resistance to determine if they are good. However, the varactor diode does not operate as a zener diode or as a rectifier diode. It is biased in the reverse direction, as is a zener diode, but does not go into avalanche breakdown. It is, in fact, operating in a cutoff condition. As the reverse voltage (bias) is varied, the junction capacitance varies, providing a voltage-variable capacitor. Fig. 1(a) shows a mechanically-variable capacitor, and Fig. 1(b) shows a varactor (voltage-variable capacitor). It is notable that any diode can be used as a varactor, although capacity range, unloaded Q , and nominal capacitance values may fall short of some amateur project requirements.

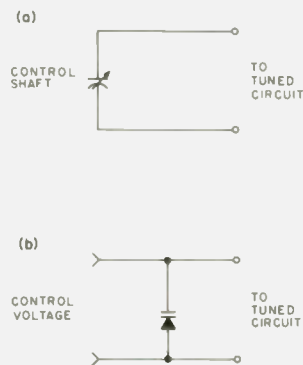

Fig. 1. (a) A mechanically-variable capacitor. (b) A voltage-variable capacitor (varactor).

Applications

Varactors can be used in small signal-tuned circuit applications where space, layout restrictions, speed of tuning, and reliability are important. Some typical applications are FM generation, remote vfos, remotely-tuned filters, and remotely-tuned amplifiers. The varactor shows true superiority over mechanically-variable capacitors in situations demanding rapidly changing capacitance values; two examples are electronic scanners and FM demodulators using phase locked loop techniques.

Control Voltage (Bias) Requirements

There are two ways to

provide the control voltage to varactors used in tuning applications. One way, as in Fig. 2(a), is to use a radio frequency choke. The other way, as in Fig. 2(b), is to use a carbon resistor. The rf choke is frequency sensitive and can load the circuit to be tuned with undesired reactances. The carbon resistor is a better choice, because it is frequency insensitive, and almost no control voltage is dropped across a 100k resistor. 100k of resistance will not load tuned circuits using varactors, and it is the varactor's own Q_U that will normally determine the overall circuit loaded Q . Q_U is the unloaded varactor Q and is mathematically approximated by dividing its capacitive reactive value by its series resistive losses.

Typical Control Voltages

Varactors typically are controlled by voltages in the 2- to 30-volt range and are rated for their nominal capacitance value at 4 volts. See Fig. 3(a). Fig. 3(b) shows how Q_U degrades for low voltages and illustrates why most varactors seldom are controlled by less than 2 volts. At less than 2 volts, the varactor Q_U becomes so poor that the selectivity of the tuned circuits is quickly degraded. In the circuit shown in Fig. 3(d), the circuit loaded Q is controlled by the inductor's relatively low Q of 100. Fig. 3(c) shows how only a small change in control voltage at the 3-volt level has

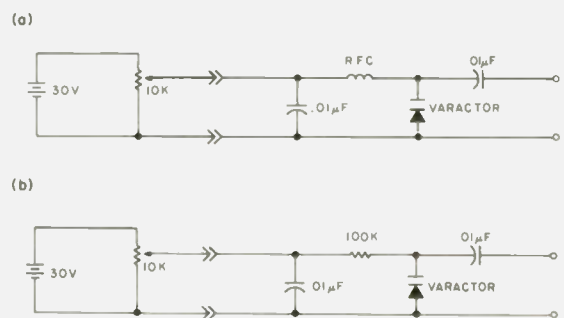

Fig. 2. (a) The rfc isolates the rf-tuned circuits from the low-impedance control voltage circuitry. The .01 uF capacitors provide bypassing and dc blocking. (b) The 100k resistor works better than the rfc for isolation.

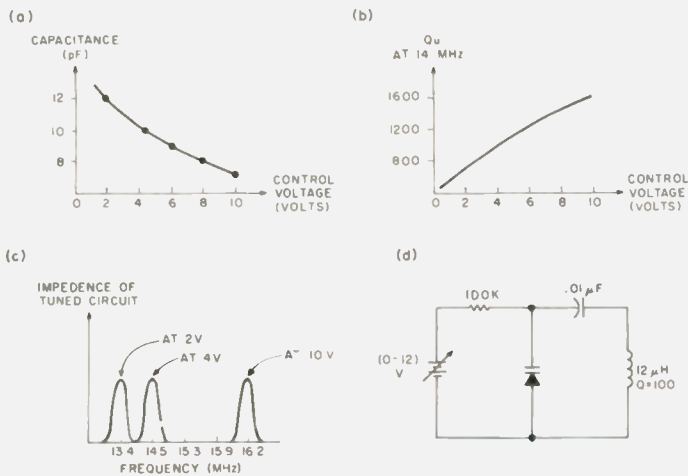

Fig. 3. Hypothetical varactor curves and circuit.

a greater effect on moving the tuned circuit's center frequency than the same small change would have at the 9-volt level.

Hyperabrupt and Abrupt Junction Varactors

Hyperabrupt junction varactors typically have nominal capacitance (at 2 volts) around 200 pF to 500 pF. They have 10-to-one capacity change ability but have poor Q_U values at frequencies above 1 MHz. They do find use in broadcast AM receiver circuits where the 500 kHz to 1500 kHz frequency band must be tuned. It is seen from:

$$f_{1500} = \frac{1}{2\pi\sqrt{L \times C}} \text{ that}$$

$$f_{500} = \frac{f_{1500}}{3} = \frac{1}{2\pi\sqrt{L \times 9 \times C}} \text{ and}$$

that a 10-to-one capacity change will more than tune the entire broadcast AM band.

Abrupt junction varactors typically have nominal capacitance (at 4 volts) around 1 pF to 50 pF. They have 2- or 3-to-one capacity change ability and have good Q_U values usable up to the VHF bands. The amateur ham bands are

so narrow that the 2- or 3-to-one capacity change ability is more than adequate to tune any of them.

Tracking

Varactors can be used in gang-tuned circuits or in isolated circuitry tuned to the same frequency (Fig. 4), but now attention to the details such as stray capacitances and electrical sameness of all varactors used must be considered. The inductors are identical, and so must the values of varactor capacities be identical for any control voltage to get good tracking. Incorrect tracking would cause the input-tuned circuit to tune at, for example, 14 MHz, while the output circuit might tune at 14.5 MHz. This would be an example of poor tracking or misalignment. Careful curve matching, as in Fig. 3(a), to insure that one varactor has the same capacity as its matching varactor at the same control voltages will, along with matching stray capacitances, provide good tracking.

Temperature Stability

The varactor barrier poten-

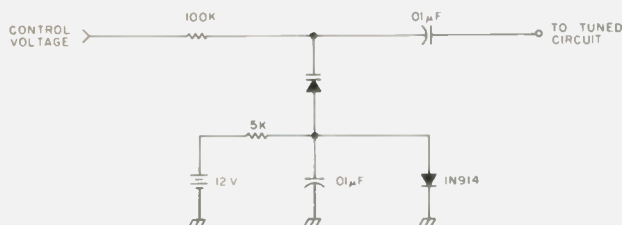

Fig. 5. Temperature-compensated varactor circuit.

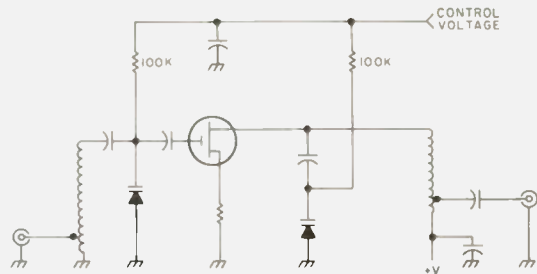

Fig. 4. A hypothetical radio frequency amplifier with two identical tuned circuits.

tial will change with temperature at about $-2 \text{ mV}/^\circ\text{C}$. This could be significant at low control voltages and can be compensated for as shown in Fig. 6. The extra diode should have an alloy structure similar to the varicap junction. For most amateur applications, one can ignore temperature stability problems.

Nonlinearity Precautions

Cross modulation in a receiver front end using varactors could be a problem if care is not taken. A strong signal being amplitude modulated a few kHz away from the varactor-tuned circuit's center frequency could alter the control voltage on the varactor. The rapidly changing control voltage could cause amplitude variation of a desired signal at the strong signal's modulation rate.

Intermodulation distortion products could occur when two strong signals are added to the varactor control voltage. Two circuits used to combat these effects are shown in Fig. 6. It is seen that large alternating control voltage variations cause one varactor to increase in capacity and the other varactor to decrease in capacity, in effect canceling the total network capacity change.

Summary

The basic properties of voltage-variable capacitors (varactors) and some circuitry used with varactors has been presented. The varactor is a rugged, reliable, small, remotely tunable, fast, and easy-to-use device for tuned-circuit applications. For beginning amateur projects using varactors, no special attention to details is required. For advanced amateur projects, some areas of special care have been identified and some solutions offered. I hope that your interest has been sufficiently stimulated so you will try varactors in amateur projects of your own.

These devices are available at most large electronic distributors and are not too expensive. It has been pointed out that any diode can be used as a varactor. It was noted that Q_U , nominal capacity, and capacity tuning range of the ordinary diode isn't as good as specially-manufactured varactors, but it could be fun to start pulling diodes out of your junk box, isolate them with a 100k resistor, provide dc blocking and bypassing with .01 uF capacitors, and, say, build your own RIT (receiver incremental tuner). ■

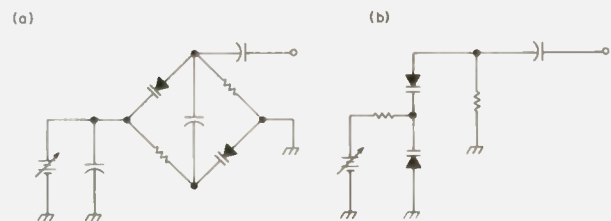

Fig. 6. (a) This is the parallel arrangement. (b) This is the series arrangement. All resistors are 100k, and all fixed capacitors are .01 uF. These circuits compensate for strong signal effects on varactors biased at low voltages.

Can A Diode Replace A Relay?

— antenna switching
with a diode!

73 Magazine Staff

Solid state antenna transmit/receive switching is

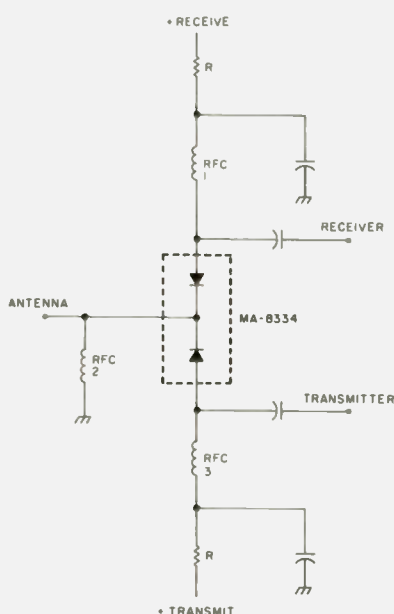

Fig. 1. Electrical diagram for the diode T/R switch. The values for the rf chokes and capacitors must be those applicable for the frequency band being used from 20 to 420 MHz. Note that the circuit places a small dc voltage on the antenna (drop across RFC2). If the antenna is of the type where it is at dc ground, RFC2 may not be required.

not a new idea and is employed in many low-power 2 meter transceivers. At low power levels, garden-variety diodes can be employed, so such a method of transmit/receive switching

as efficient.

It would be desirable to employ diode-type antenna switching at higher power levels also. Such switching is essentially instantaneous and avoids the mechanical and electrical problems associated with relays. Relays are certainly reliable devices, but, in mobile and outdoor installations, they can develop problems over a period of time. Diode switching is especially advantageous in any outdoor antenna switching scheme, since problems associated with weather-proofing disappear.

This article describes a new transmit/receive diode, developed by Microwave Associates, which is in the same price class as a relay. It will handle 50 Watts of CW/FM output or about twice that much for SSB. Unfortunately for the HF CW gang, it is only usable over the 20 to 450 MHz range. Otherwise, they would have found the perfect antenna switching device for break-in CW on the low frequency bands.

The electrical diagram of the device is shown in Fig. 1. Operation is simple in that it operates as the diode equivalent of a single-pole double-throw switch. When a positive voltage is applied to the "+ receive" terminal, the top diode is forward biased, via

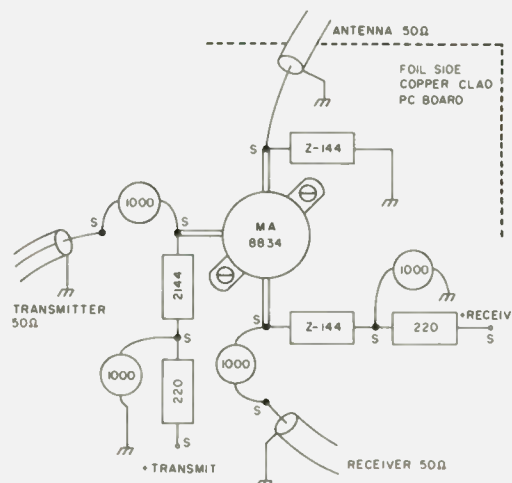

Fig. 2. This shows how the parts were laid out on a 2" x 2" PC board. The points marked "S" indicate insulated miniature standoffs. The ground signals indicate direct soldering to the board. Component layout is not at all critical, although leads must be kept short, as in any VHF circuit.

current flow, through RFC1 and RFC2. The same happens, of course, when the "+ transmit" terminal is used for the transmit line. A great advantage of this device is that when transmit/receive switching is done, a positive voltage need only be applied to the applicable terminal. The other terminal is left open-circuited; no bias voltage need be applied, as in some other diode switching schemes. The device is designed for 50-Ohm coaxial line or input/output impedance.

A practical realization of an antenna switching arrangement for 2 meters using the MA8334 switching diode is shown in Fig. 2. The details concerning its construction/operation are applicable when using it on other bands also.

The three rf chokes necessary have to be chosen for the band being used. For 2 meters, ohmite Z-144 chokes were used along with 1000 pF disc ceramic bypass capacitors and coupling capacitors.

The circuit was constructed on a piece of single-sided copper-plated PC board. Short lead dress is necessary, and, if the circuit is used on frequencies above 144 MHz, feedthrough-type bypass capacitors should be used with the rf chokes in the "+ receive" and "+ transmit" lines. The positive voltage that must be applied to make the diode switch is that which will cause 50 mA of current to flow through the diode. So, a wide variety of positive voltages can be used. The resistors were chosen so that 50 mA of current flow takes place. In the unit shown, with its type of rf chokes and which operates from a 12-volt supply, the resistors are 220 Ohms.

An interesting characteristic of any rf switching device is the isolation provided between the two switched lines. This characteristic is not very important in the usual type of antenna transmit/receive switching operation as long as

it is sufficient to prevent loading of input/output circuits and as long as enough transmitter power doesn't feed back into the receiver to do harm. However, this characteristic is important when switching such things as low-level filter circuits and, possibly, in some antenna selection switches. A properly-designed and expensive power-type coaxial switch will provide anything from 30 to 60 dB isolation in the VHF range. The MA-8334 provides 38 dB isolation at 144 MHz and about 29 dB at 420 MHz. Both figures assume careful circuit layout. It goes up to 45 dB at lower frequencies. So, it checks out quite well in this regard and will be much better than any of the power-type relays sometimes used for economy.

With all this performance, one might imagine that there is a wee price to pay. The price is insertion loss. Expensive coaxial switches and relays can do a bit better than the 0.2 dB loss the MA-8334

has up to 420 MHz. The loss means heat, of course, so the diode has to be connected to some heat-conductive surface. Very little surface is needed, since, even at the 50-Watt level, the loss is several Watts at the most. The metal tabs on the diode are not connected to any switch arm, so, as shown in Fig. 2, they can be bolted directly to a PC board or chassis. The layout shown in Fig. 2 was made to check the diode switch. In reality, of course, the components can be compacted much more around the switch, so the total volume occupied will be less than that taken up by a relay of similar power-handling capability.

This type of diode switch is being widely used now in commercial equipment, so it, or an equivalent, is available from distributors. However, you can write Microwave Associates, Northwest Industrial Park, Burlington MA 01803, if you have difficulty locating a source for the diode. ■

James F. Hartley W1DIS
U.S. Route 302
Raymond ME 04071

In the Holiday, 1976, issue of 73, David Johnson WB6QDS had the burglar alarm system I had been waiting for. Only, on inspection of my 1971 Ford Torino, I found not ground at the door switch, but plus 12 volts. A change in attack was needed.

Also, the hood of my car unlocks at the front, allowing any burglar instant access to removing the wires from the horns. I didn't want to bother with wiring a hood alarm switch. I also thought that an alarm not sounding like a car with a stuck horn relay might be better. Then too, this car doesn't have a horn relay.

Radio Shack has a very loud gong-type of bell. This, located under the car out of reach, with or without the flasher in the circuit, sure

makes enough noise to wake the dead and scare most thieves away.

I suppose the two fuses are unnecessary, actually, but I feel better with them in the circuit. Be sure the relay contacts used will carry the current expected of them by the alarm device. ■

Shock the Car-Burglar!

—give him the gong

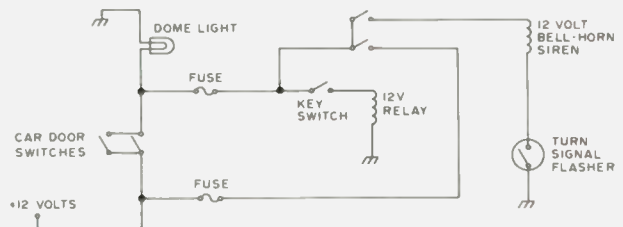

Fig. 1.

REGULATED POWER SUPPLY

- Fully regulated, dual protected, 13.8 volts
- Illuminated on/off switch
- Hammertone metal case

33 Amp (30 Amp continuous)... \$99.95
 20 Amp (16 amp. cont.) \$64.95
 8 Amp (6 amp. cont.) \$39.95

TIMES CABLE

RG-8U - 100' multiples 18c/ft.
 RG-213U - (Non-contaminating jacket)
 -100' multiples 22c/ft.
 1/2" Aluminum Jacketed hardline - 75 ohm.
 1000' rolls only 29c/ft.
 PL259 connectors 25/50c ea.
 or 100/45c ea. POSTPAID

UNIVERSAL TOWERS

SUPER DISCOUNTS —

S.A.S.E. for brochure and prices!

Send S.A.S.E. for additional information. Include shipping charges with check or money order. (Ohio residents add 4 1/4% sales tax).

JRS ELECTRONICS JB
 P.O. Box 1893—Cincinnati, Ohio 45201

PCP™ TYPE-A

PATENT PENDING

PCP TYPE-A TRANSFER FILM lifts the ink DIRECTLY from printed page!
 (NO CHEMICALS or PHOTOGRAPHY required!)

Only additional materials required are: Sensitized boards, developer, & etchant!

SEE POPULAR ELECTRONICS

FEB '78 ISSUE!

FINALLY you can make HIGH QUALITY printed circuit boards directly from magazine construction articles! Can also be used to make specialized motor faces, front panel decals, component placement decals & others.

Small Pkg. 6pcs 4x6 \$5.49
 Med. Pkg. 4pcs 6x9 \$6.95
 Large Pkg. 3pcs 9x12 \$7.95

PCP

PRINTED CIRCUIT PRODUCTS CO.
 P.O. BOX 4834
 HELENA, MT 59601

DISCOUNTS

MIDLAND • CUSHCRAFT
 NYE • STANDARD • TEMPO
 HUSTLER • TRI-EX TOWER
 CDE Rotors • Shure • Astatic
 Antenna Inc. • BW • Hy-Gain

Monthly Specials!

PREPAID MIDLAND SHIPPING

13-510 2M 25w Synthesizer 339²²
 13-509 220 Mhz 10w 12ch 138⁹⁷
 13-505 2M 30w 12 ch 189¹¹

SEND FOR: FREE CATALOG

ADVANCE (516) 667-0973
A41 SOUND 781 DEER PARK RD
 COMPANY, INC. DIX HILLS NY 11746

NO TRAPS — NO COILS — NO STUBS — NO CAPACITORS

MOR-GAIN HD DIPOLES . . . • One half the length of conventional half-wave dipoles. • Multi-band, Multi-frequency. • Maximum efficiency — no traps, loading coils, or stubs. • Fully assembled and pre-tuned — no measuring, no cutting. • All weather rated — 1 KW AM, 2.5 KW CW or PEP SSB. • Proven performance — more than 15,000 have been delivered. • Permit use of the full capabilities of today's 5-band xcvs. • One feedline for operation on all bands. • Lowest cost/benefit antenna on the market today. • Fast QSY — no feedline switching. • Highest performance for the Novice as well as the Extra-Class Op.

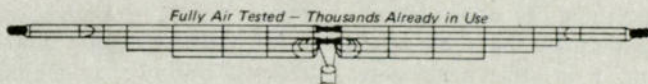

#16 40% Copper Weld wire annealed so it handles like soft Copper wire — Rated for better than full legal power AM/CW or SSB-Coaxial or Balanced 50 to 75 ohm feed line — VSWR under 1.5 to 1 at most heights — Stainless Steel hardware — Drop Proof Insulators — Terrific Performance — No coils or traps to break down or change under weather conditions — Completely Assembled ready to put up — Guaranteed 1 year — ONE DESIGN DOES IT ALL: 75-10HD — ONLY \$12.00 A BAND!

EXCLUSIVE 66 FOOT, 75 THRU 10 METER DIPOLES

NOTES

- All models above are furnished with crimp/solder lugs.
- All models can be furnished with a SO-239 female coaxial connector at additional cost. The SO-239 mates with the standard PL-259 male coaxial cable connector. To order this factory installed option, add the letter 'A' after the model number. Example: 40-20 HD/A.
- 75 meter models are factory tuned to resonate at 3950 kHz. (SP) models are factory tuned to resonate at 3800 kHz. 80 meter models are factory tuned to resonate at 3650 kHz. See VSWR curves for other resonance data.

MODEL	BANDS (Meters)	PRICE	WEIGHT (Oz/Kg)	LENGTH (Ft/Mtrs)
40-20 HD	40/20	\$49.50	26/73	36/10.9
80-40 HD	80/40 + 15	57.50	41/1.15	69/21.0
75-40 HD	75/40	55.00	40/1.12	66/20.1
75-40 HD (SP)	75/40	57.50	40/1.12	66/20.1
75-20 HD	75/40/20	66.50	44/1.23	66/20.1
75-20 HD (SP)	75/40/20	66.50	44/1.23	66/20.1
75-10 HD	75/40/20/15/10	74.50	48/1.34	66/20.1
75-10 HD (SP)	75/40/20/15/10	74.50	48/1.34	66/20.1
80-10 HD	80/40/20/15/10	76.50	50/1.40	69/21.0



2200T South 4th Street
 Leavenworth, Kansas 66048
 (913) 682-3142

Manufactured & Guaranteed by



Specifically Designed for the Novice or Technician
 69' overall length
 80-10 HD (N/T) . . . for 80/40/20/15/10 meter coverage \$84.50
 69' overall length
 80-40 HD (N/T) . . . for 80/40 meter coverage . . . \$63.75

High Accuracy Synthesized VHF Signal Generator



vanguard Labs

196-23 Jamaica Ave.
 Hollis, NY 11423

V1

- Covers 100 MHz to 179.999 MHz in 1 KHz steps with thumbwheel dial (Use an IC divider for lower frequencies)
- .0005% accuracy on all frequencies
- Clean spurious free output—VCO operates at fundamental frequency with no mixing
- Noise-free CW and adjustable 1000 Hz FM modulation from 0 to 100 KHz
- Adjustable rf output from .1 to over 1.0 volts (use an external attenuator for precise sensitivity measurements)
- Excellent as a marker generator, frequency comparator, local oscillator for superhet receivers, transmitter oscillator driver, etc.
- Operates on 12 Volts DC or 110 Volts AC
- One year warranty—low cost service after warranty period and fast repair turn around at all times
- Measures 1 1/2" high, 5" wide, and 8" long
- Model SG-100 price—\$249.95

SEE OUR OTHER PRODUCTS IN THE FULL PAGE AD OF THE DECEMBER 1977 ISSUE.

P.O. Box 44300 Santa Clara, CA 95054
For will call only: (408) 988-1640
2996 Scott Blvd.

GILFER

G6

Same day shipment. First line parts only. Factory tested. Guaranteed money back. Quality IC's and other components at factory prices.

INTEGRATED CIRCUITS

74007TL	74LS130N	25	LM3401	15	110	CD4001	21	MM5320	5.95
74008	74LS131N	30	LM3401	16	110	CD4002	21	MM5320	5.94
74009	74LS132N	30	LM3401	17	110	CD4003	21	MM5320	5.94
74010	74LS133N	30	LM3401	18	110	CD4004	21	MM5320	5.94
74011	74LS134N	30	LM3401	19	110	CD4005	21	MM5320	5.94
74012	74LS135N	30	LM3401	20	110	CD4006	21	MM5320	5.94
74013	74LS136N	30	LM3401	21	110	CD4007	21	MM5320	5.94
74014	74LS137N	30	LM3401	22	110	CD4008	21	MM5320	5.94
74015	74LS138N	30	LM3401	23	110	CD4009	21	MM5320	5.94
74016	74LS139N	30	LM3401	24	110	CD4010	21	MM5320	5.94
74017	74LS14N	30	LM3401	25	110	CD4011	21	MM5320	5.94
74018	74LS145N	30	LM3401	26	110	CD4012	21	MM5320	5.94
74019	74LS146N	30	LM3401	27	110	CD4013	21	MM5320	5.94
74020	74LS147N	30	LM3401	28	110	CD4014	21	MM5320	5.94
74021	74LS148N	30	LM3401	29	110	CD4015	21	MM5320	5.94
74022	74LS149N	30	LM3401	30	110	CD4016	21	MM5320	5.94
74023	74LS150N	30	LM3401	31	110	CD4017	21	MM5320	5.94
74024	74LS151N	30	LM3401	32	110	CD4018	21	MM5320	5.94
74025	74LS152N	30	LM3401	33	110	CD4019	21	MM5320	5.94
74026	74LS153N	30	LM3401	34	110	CD4020	21	MM5320	5.94
74027	74LS154N	30	LM3401	35	110	CD4021	21	MM5320	5.94
74028	74LS155N	30	LM3401	36	110	CD4022	21	MM5320	5.94
74029	74LS156N	30	LM3401	37	110	CD4023	21	MM5320	5.94
74030	74LS157N	30	LM3401	38	110	CD4024	21	MM5320	5.94
74031	74LS158N	30	LM3401	39	110	CD4025	21	MM5320	5.94
74032	74LS159N	30	LM3401	40	110	CD4026	21	MM5320	5.94
74033	74LS160N	30	LM3401	41	110	CD4027	21	MM5320	5.94
74034	74LS161N	30	LM3401	42	110	CD4028	21	MM5320	5.94
74035	74LS162N	30	LM3401	43	110	CD4029	21	MM5320	5.94
74036	74LS163N	30	LM3401	44	110	CD4030	21	MM5320	5.94
74037	74LS164N	30	LM3401	45	110	CD4031	21	MM5320	5.94
74038	74LS165N	30	LM3401	46	110	CD4032	21	MM5320	5.94
74039	74LS166N	30	LM3401	47	110	CD4033	21	MM5320	5.94
74040	74LS167N	30	LM3401	48	110	CD4034	21	MM5320	5.94
74041	74LS168N	30	LM3401	49	110	CD4035	21	MM5320	5.94
74042	74LS169N	30	LM3401	50	110	CD4036	21	MM5320	5.94
74043	74LS170N	30	LM3401	51	110	CD4037	21	MM5320	5.94
74044	74LS171N	30	LM3401	52	110	CD4038	21	MM5320	5.94
74045	74LS172N	30	LM3401	53	110	CD4039	21	MM5320	5.94
74046	74LS173N	30	LM3401	54	110	CD4040	21	MM5320	5.94
74047	74LS174N	30	LM3401	55	110	CD4041	21	MM5320	5.94
74048	74LS175N	30	LM3401	56	110	CD4042	21	MM5320	5.94
74049	74LS176N	30	LM3401	57	110	CD4043	21	MM5320	5.94
74050	74LS177N	30	LM3401	58	110	CD4044	21	MM5320	5.94
74051	74LS178N	30	LM3401	59	110	CD4045	21	MM5320	5.94
74052	74LS179N	30	LM3401	60	110	CD4046	21	MM5320	5.94
74053	74LS180N	30	LM3401	61	110	CD4047	21	MM5320	5.94
74054	74LS181N	30	LM3401	62	110	CD4048	21	MM5320	5.94
74055	74LS182N	30	LM3401	63	110	CD4049	21	MM5320	5.94
74056	74LS183N	30	LM3401	64	110	CD4050	21	MM5320	5.94
74057	74LS184N	30	LM3401	65	110	CD4051	21	MM5320	5.94
74058	74LS185N	30	LM3401	66	110	CD4052	21	MM5320	5.94
74059	74LS186N	30	LM3401	67	110	CD4053	21	MM5320	5.94
74060	74LS187N	30	LM3401	68	110	CD4054	21	MM5320	5.94
74061	74LS188N	30	LM3401	69	110	CD4055	21	MM5320	5.94
74062	74LS189N	30	LM3401	70	110	CD4056	21	MM5320	5.94
74063	74LS190N	30	LM3401	71	110	CD4057	21	MM5320	5.94
74064	74LS191N	30	LM3401	72	110	CD4058	21	MM5320	5.94
74065	74LS192N	30	LM3401	73	110	CD4059	21	MM5320	5.94
74066	74LS193N	30	LM3401	74	110	CD4060	21	MM5320	5.94
74067	74LS194N	30	LM3401	75	110	CD4061	21	MM5320	5.94
74068	74LS195N	30	LM3401	76	110	CD4062	21	MM5320	5.94
74069	74LS196N	30	LM3401	77	110	CD4063	21	MM5320	5.94
74070	74LS197N	30	LM3401	78	110	CD4064	21	MM5320	5.94
74071	74LS198N	30	LM3401	79	110	CD4065	21	MM5320	5.94
74072	74LS199N	30	LM3401	80	110	CD4066	21	MM5320	5.94
74073	74LS200N	30	LM3401	81	110	CD4067	21	MM5320	5.94
74074	74LS201N	30	LM3401	82	110	CD4068	21	MM5320	5.94
74075	74LS202N	30	LM3401	83	110	CD4069	21	MM5320	5.94
74076	74LS203N	30	LM3401	84	110	CD4070	21	MM5320	5.94
74077	74LS204N	30	LM3401	85	110	CD4071	21	MM5320	5.94
74078	74LS205N	30	LM3401	86	110	CD4072	21	MM5320	5.94
74079	74LS206N	30	LM3401	87	110	CD4073	21	MM5320	5.94
74080	74LS207N	30	LM3401	88	110	CD4074	21	MM5320	5.94
74081	74LS208N	30	LM3401	89	110	CD4075	21	MM5320	5.94
74082	74LS209N	30	LM3401	90	110	CD4076	21	MM5320	5.94
74083	74LS210N	30	LM3401	91	110	CD4077	21	MM5320	5.94
74084	74LS211N	30	LM3401	92	110	CD4078	21	MM5320	5.94
74085	74LS212N	30	LM3401	93	110	CD4079	21	MM5320	5.94
74086	74LS213N	30	LM3401	94	110	CD4080	21	MM5320	5.94
74087	74LS214N	30	LM3401	95	110	CD4081	21	MM5320	5.94
74088	74LS215N	30	LM3401	96	110	CD4082	21	MM5320	5.94
74089	74LS216N	30	LM3401	97	110	CD4083	21	MM5320	5.94
74090	74LS217N	30	LM3401	98	110	CD4084	21	MM5320	5.94
74091	74LS218N	30	LM3401	99	110	CD4085	21	MM5320	5.94
74092	74LS219N	30	LM3401	100	110	CD4086	21	MM5320	5.94

ELECTRONICS

Q3

74093	74LS220N	30	LM3401	101	110	CD4087	21	MM5320	5.95
74094	74LS221N	30	LM3401	102	110	CD4088	21	MM5320	5.94
74095	74LS222N	30	LM3401	103	110	CD4089	21	MM5320	5.94
74096	74LS223N	30	LM3401	104	110	CD4090	21	MM5320	5.94
74097	74LS224N	30	LM3401	105	110	CD4091	21	MM5320	5.94
74098	74LS225N	30	LM3401	106	110	CD4092	21	MM5320	5.94
74099	74LS226N	30	LM3401	107	110	CD4093	21	MM5320	5.94
74100	74LS227N	30	LM3401	108	110	CD4094	21	MM5320	5.94
74101	74LS228N	30	LM3401	109	110	CD4095	21	MM5320	5.94
74102	74LS229N	30	LM3401	110	110	CD4096	21	MM5320	5.94
74103	74LS230N	30	LM3401	111	110	CD4097	21	MM5320	5.94
74104	74LS231N	30	LM3401	112	110	CD4098	21	MM5320	5.94
74105	74LS232N	30	LM3401	113	110	CD4099	21	MM5320	5.94
74106	74LS233N	30	LM3401	114	110	CD4100	21	MM5320	5.94
74107	74LS234N	30	LM3401	115	110	CD4101	21	MM5320	5.94
74108	74LS235N	30	LM3401	116	110	CD4102	21	MM5320	5.94
74109	74LS236N	30	LM3401	117	110	CD4103	21	MM5320	5.94
74110	74LS237N	30	LM3401	118	110	CD4104	21	MM5320	5.94
74111	74LS238N	30	LM3401	119	110	CD4105	21	MM5320	5.94
74112	74LS239N	30	LM3401	120	110	CD4106	21	MM5320	5.94
74113	74LS240N	30	LM3401	121	110	CD4107	21	MM5320	5.94
74114	74LS241N	30	LM3401	122	110	CD4108	21	MM5320	5.94
74115	74LS242N	30	LM3401	123	110	CD4109	21	MM5320	5.94
74116	74LS243N	30	LM3401	124	110	CD4110	21	MM5320	5.94
74117	74LS244N	30	LM3401	125	110	CD4111	21	MM5320	5.94
74118	74LS245N	30	LM3401	126					



7294 N.W. 54 STREET
MIAMI, FLORIDA 33166

SURPLUS ELECTRONICS CORP.

PHONE: (305) 887-8228

TWX: 810-848-6085

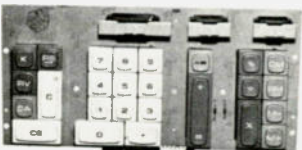
WHOLESALE · RETAIL

<p>RADIO TRANSMITTER Type T-20/ARC-5 5.3 to 7 MHz Brand new—Never used— Tubes alone are worth the price \$24.95 ONLY 50 LEFT</p>	<p>—NORTH ELECTRIC TRANSFORMER— 117 V 50/60 Hz—Multiple windings will produce: + 24 V dc—50 Amp + 12 V dc—100 Amp - 12 V dc—50 Amp Other voltages can be obtained, complete with specification sheets—Limited Qty. \$49.95 \$49.95</p>		<p>KESTER #44—SOLDER 63/37 Alloy .032 diameter. —5lb. Spools Only— \$6.00 per lb.</p>			
<p>SURPRISE PACKAGE Resistors, Caps, Semis, Pots, Relays, etc. We guarantee it to be \$25.00 worth of material. Every package is different. \$5.00</p>	<p>TEXAS INSTRUMENT KEYBOARD  Has 3 slide switches—28 different keys— keypads re- movable by removing 4 screws. \$1.95 ea., 5 for \$8.00 10 for \$13.95</p>	<p>CERAMIC PRECISION CAPS-ERIE 47 pF—100 V 220 pF—100 V \$.10 ea. 470 pF—100 V 500 pF—100 V 15 for \$1.00 500 pF—100 V 1000 pF—100 V 50 for \$3.25 2000 pF—100 V</p>				
<p>STANCOR TRANSFORMER #P-6463 Filament Style 117V in—Multiple 6.0-6.5- or 7.0 Volts 13 Amps center tapped— \$5.95 ea. 2 for \$10.00</p>	<p>SIGNAL DIODE 1N4148 same as 1N914 \$25.00 per thousand</p>		<p>STANCOR TRANSFORMER #P-8180R—117 V in— 25.2 V ct at 1 Amp \$3.00 ea., 2 for \$5.00 3 for \$6.50</p>			
<p>PANEL METERS 2 1/4" x 2 1/4" 0-10 DC Amps \$4.50 ea 0-5 DC Amps 0-20 DC Volts 2 for 0-25 DC Volts \$7.50 0-5 AC Amps</p>	<p>—STANCOR TRANSFORMER— #GSD 200 or #GSD 400 Auto Isolation 230 V in—115 V out 1500 RMS test voltage—GSD 200 is 200 VA—GSD 400 is 400 VA— complete with cord and receptacle— YOUR CHOICE \$11.95</p>		<p>WIRE WOUND RESISTORS 500 Ohm—3 W Any 6 6 Ohm—3 W 25k Ohm—8 W \$1.00 .1 Ohm—5 W .1 Ohm—10 W Any 15 \$1.75</p>			
<p>POWER SUPPLY 110 AC to 12 VDC 550 mA 23 Watts 3 1/2" w X 4" h X 6 1/2" l \$9.95</p>	<p>HOOK-UP WIRE Size 20 or 22— various colors— no color selection solid \$6.00/1000' \$10.00/2000'</p>	<p>POLYFOAM COAX—50R Equal to RG174 \$4.95/100' Low Loss Polyfoam Coax Cable</p>	<p>TRIMMER CAPS Small enough to fit in your watch— 3.5 to 20 pF 5 to 30 pF 7 to 40 pF \$.75 ea., 2 for \$1.25 5 for \$3.00</p>			
<p>TANTALUM CAPS—AXIAL .015 M—35 V .47 M—35 V 10 M—25 V 1.2 M—20 V 4.7 M—35 V 33 M—35 V 1 mF—50 V Any 10—your choice—\$1.95 Any 20—your choice—\$3.50</p>	<p>—STANCOR TRANSFORMER— #P-8158 Power—117V—200 dc mA 6.3 V at 2.0-4.0—or 4.25 Amps #P-8155 Power—117V—90 dc mA 5 V at 2 Amps or 6.3 V at 5.15 Amps YOUR CHOICE \$7.95</p>		<p>JOY STICK For TV games and hi fi with four, look pots 2 3/4" X 2 3/4" X 1" with 1" handle—\$4.95</p>			
<p>SPECIALS—SPECIALS—SPECIALS—SPECIALS—SPECIALS—SPECIALS—SPECIALS—SPECIALS—SPECIALS</p>						
<p>Computer Grade Caps 1000 mf—50 V 10000 mf—20 V 8000 mf—50 V 76000 mf—15 V \$2.50 ea.</p>	<p>CTS DIP Switches 6 position 7 position 8 position \$1.25 ea., 2 for \$2.00</p>	<p>Trimmer Cap Arco/Elmenco PC-402 2 to 20 pF \$.60 ea. 5 for \$2.50, 15 for \$5.00</p>	<p>MASSA Ultrasonic Transducer 37 or 40 kHz \$1.50 ea. 2 for \$2.50, 5 for \$5.00</p>	<p>Relay—P & B 4 PDT—110 Vdc 6050 Ohm coil 10 Amp contacts \$1.50 ea., 2 for \$2.75, 3 for \$3.25</p>	<p>Bourns Trimpot #200L—1—201M 200 Ohm \$1.50 ea., 2 for \$2.50, 5 for \$6.75</p> 	<p>Stancor Transformer #P-8650 Step down/Isolation 117Vpai-12V6.5Amp. w/cord & receptacle \$5.95</p>
<p>TERMS: All material guaranteed • If for any reason you are not satisfied, our products may be returned within 10 days for a full refund (less shipping). Please add \$3 for shipping and handling on all orders. Additional 5% charge for shipping any item over 5 lbs. COD's accepted for orders totaling \$50.00 or more. All orders shipped UPS unless otherwise specified. Florida residents please add 4% sales tax. Minimum order \$15.00.</p>						

EQUIPMENT / COMPONENTS / WIRE & CABLE / ACCESSORIES

BANK AMERICARD AND AMERICAN EXPRESS CARDS WELCOME. CALL US (617) 531-5774

AM/FM stereo TUNER/AMPS/ISSIS CHASSIS - \$18.88



New surplus stereo tuner & amp, 4 watts RMS per channel. Super-slim unit measures only 2 1/2" H x 12 1/2" L x 8" D. Controls include bal., tone, vol.-on/off, AM/FM stereo AFC/Aux. selector and tuning. Dial has red needle and black face with no markings. Sh. Wt. 6 Lbs. 7HU70397 \$18.88 each

Stereo Power Amp 16 Watts RMS Total



A complete kit of parts, including 2 PC boards, already wired, which make up a stereo amplifier. Plus a power transformer, line cord and instructions. You add inputs, controls, case and speakers for a complete working stereo system. Sh. Wt. 5 Lbs. . . 8Z30015 Only \$12.88

I/O Terminal



COMPLETE UNIT AS LOW AS \$23.88!

At one time these data terminals were used by stock brokers for keeping track of stock quotations. They tied in to a central system which has now been updated, leaving these surplus units behind. Use this unit as a basis for building your own computer input/output station or to build a compact scope . . . or simply take it apart for the components within. Sold complete or in parts, prices and descriptions listed below:
 † 3" CRT, with Hi-volt. supply (+3315 vdc; -1730 vdc), and low-volt. supply +440V; +225V; +125V; +28V; +1.2V; +0.6V; 6.3VDC; 6.3VAC. Also - ramp generator card & some drive circuits (15 Lbs.) \$19.88
 † 50 key Block keyboard, with diode matrix on 2 cards.(15 Lbs.) \$9.88
 † Handsome desk-top, slope front case, suitable for up to an 11" CRT, overall 10 1/2" w x 16" d x 9" h.(10 Lbs.) \$9.88
 † Plus: 3 wire line cord, brown, 7'lg for \$1.00; 14 wire connector cable for \$2.50.
 † COMPLETE UNIT Sh. Wt. 35 Lbs.
 † COMPLETE UNIT, Checked out, ready to go. 6NB60336 (checked out) . \$39.88
 † COMPLETE UNIT, Not checked out, (we simply pull from our stock room and ship - most are good. 6NB60336 (AS IS) \$23.88
 † Also available is a complete tech. manual covering operating procedure, theory disassembly (& reassembly), troubleshooting techniques and schematics. With complete unit - \$1.00 or sold separately for \$3.50 each. Sh. Wt. 8 oz.

WHEN ORDERING:

Specify part, use order no. 6NB60336

10 to 24V @ 5A P.S.KIT

All the parts you'll need to wire up a fantastic 5 amp, variable, regulated power supply. We supply full schematic you supply the case and "cosmetics". Super! Sh. Wt. 15 Lbs. . . 6MI60301 . \$14.88 ea.

SPEAKER KITS

Build your own and save! These kits are made up of quality components intended for use by a big-name mfr. (who we can't mention). Over \$2-million in inventories

SUPER SURPLUS SAVINGS!

were closed out! His loss your gain! Kits are 1st quality, all U.S. made. Cabinets are vinyl-clad with pre-cut holes, grill cloth is included. Perfect for those do-it-yourself-ers!

SPEAKER SYSTEMS KIT NO. 1 Our deluxe model . . .

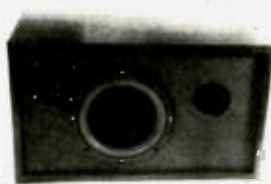

Super cabinets, size 21x12x8". Includes 8" woofers w/whizzer; 4" dome tweeters; crossovers; damping; hardware & instructions. Systems sells for \$198 if bought ready-to-go, B&F kit price only \$69.95 per pair. Quality need not be costly! 7ZU70283 . . . (45 Lbs.) . . . \$69.95/pr. Kit No. 1/CABINETS Only (45 Lbs.) 70B70197 \$25.00/pair

SPEAKER SYSTEMS KIT No. 2

Fantastic cabinets designed for direct dispersion of high frequency sounds and wide dispersion of bass tones. Size: 17x 10 1/2"x9 1/2". Sold with 8" woofers, 4" dome tweeters, crossovers & instructions. 7ZU70242 . . . (35 Lbs.) . . . \$49.50/pair Kit No. 2/CABINETS Only (25 Lbs.) 70B70200 \$25.00/pair



More SPEAKERS & COMPONENTS . . . are available through our catalog!

FULL SIZE 3-WAY SPEAKER SYSTEMS KIT

SPECIAL limited edition! We have a fantastic combination of components from a series of special purchases. Full size cabinets measure 26 1/2 x 14 1/2 x 11 1/2", and are high quality, walnut vinyl-clad with all holes pre-cut. 10" air suspension woofers, 8" mid-ranges and 4" dome tweeters make up the speaker parts. Crossover networks, hardware, sound-damping material, grill cloth & instructions complete the ensemble. Some parts of this kit are available to us in limited quantities, thus making this a limited offer . . . So order soon! Shipping: allow for two (2) 40 Lb. packages. Qty. Ltd. 8Z30094 \$88.88/pair

3 way system



KIT - ONLY \$88.88/Pair

Full Size System 26 1/2 x 14 1/2 x 11 1/2"



Singer/Perfec systems with display station, keyboard, 7 track magnetic data recorder, controller, etc. Singer closes out its computer products division and these unit become surplus! Their loss (\$460x10⁶) is your gain . . . you can buy this super recorder for pennies on a dollar. They are late design models of recent mfg., and are still being serviced with

Key-to-Tape Recorder

Unit has internal memory/buffer for 80 or 200 character storage. Units show character, character no., and record no. Read back circuits allows search on record key, editing, duplicating, etc. Units were working when taken out of service and are complete & ready-to-go, but may require minor adjustments. Sold on an "AS IS" basis only. . . data not supplied with unit, available separately. Size: 19" H x 21 1/2" W x 19 1/2" D. Tape not supplied.

Md. 4301-7 7-track Data Recorder, our catalog no. 7SF70296 \$218.88 Data Package . . . 7SF70296-M . \$28.50

All Magnetic Tape Data Recorders are shipped via truck, freight collect to you. Customer pays shipping.

OTHER SINGER/FRIDEN MACHINES ARE AVAILABLE - SEND FOR CATALOG!

BATTERY OPERATED CLOCK With 12 and 24 HOUR MARKING

This is a handsome addition to any wall, be it in your den or ham shack! Great for hams! The accurate battery powered movement runs on one "C" cell for up to a year. All in weather-proof brass plated cast metal case, with a dial that reads 1 to 12 as well as 00 to 23. 6" diameter, 3" deep, 4" dial. 6 Lbs. Order "1023" Clock \$39.88



Weatherproof Sweep Hand Brass Plated Battery Oper. 12 & 24 Hr. Scales

SEISMIC SENSOR/XMITTER

A what?! This unique looking & operational intruder detector/xmitter was used by the U.S. army to detect troop movements. It looks like a rock or glob of mud, but contains a transmitter with a range of 300 meters that sends out coded pulses on 150 MHz; a built-in dipole antenna; seismic sensor; & 3 mercury cells. Weighs about 1 ounce, measures less than 2" across. Fantastic! Sh. Wt. 3 oz. 7MI70365 . . . \$4.00 ea . . . \$10.00 for 3

TV Interface



Neat, complete checked-out video modulator permits direct connection of composite video signals from TV games and micro computers to any standard TV set. This is NOT A KIT! Includes instructions, 12' cable, ready-to-go. Compact "white box" attaches to antenna terminals. Operates on 5 to 12VDC (see below). Sh. Wt. 2 Lbs. . . 8Z30015 . . \$12.88 ea. POWER SUPPLY FOR ABOVE: Actually part of incomplete TV games, with all parts necessary for a complete regulated power supply (less case). Sh. Wt. 2 Lbs . . 8Z30021 . . \$3.50 ea.

12" Video Monitor

This solid state monitor will display 80 characters x 16 lines for a total of 1,280 characters. These are ready to attach to your computer or CCTV. Operates on 115VAC, video input to 75 ohm, 50-239 co-ax connector. Qty. Ltd. Used, working, "AS IS". Sh. Wt. 35 Lbs. 7HU70398 \$68.88 each

12" GRAPHIC DISPLAY MONITOR

This very high performance X,Y display features a 12" TV-CRT with a very bright green-blue trace and medium persistence. Vector scope, was working when taken out of service, but we must sell "AS IS". Sh. Wt. 80 Lbs.: shipped via truck, freight collect, to you. 7HU70458 \$78.88 ea

TV GAME PARTS \$7.88

We have some TV hockey games that were not quite finished by the mfr. All electronics are on PC boards, which are mounted in an 18x7 1/2x3" case. Parts include: 2 joystick controls (two 10K pots on each); 2" 8 ohm speaker; 10V 200ma xformer; 2 - LED 7-seg displays; about 25 low power IC's, like LS or CD CMOS etc., plus line cord, 5 slide switches & more! Qty. Ltd. 5 Lbs. 8G30028 . . . \$7.88 each . . \$38.88 for 6

JOYSTICKS Two 10K POT'S

Super for X-Y functions: audio, computer, remote control, graphics, etc. Sh. Wt. 8 oz. 7J70163 \$4.95

Joystick: Four 100K Pot's; by ALPS The best controls on the market. . . 8 oz. 7J70293 \$5.95 ea

10% OFF

10% OFF ANY ORDER FOR MERCHANDISE IN THIS AD! Simply say that you saw it in 73 and we will take 10% off any order over \$10.00. Order Soon! PHONE ORDERS WELCOME! Call (617) 531-5774 and use your Charge: BA-MC-AE

POSTAGE: PLEASE remit for postage and insurance. F.O.B. Peabody, Ma. 01960. Mass. residents add 5% sales tax.

SEND FOR OUR FREE CATALOG! Or, receive our catalog in an order and insure yourself of a place on our mailing list

PHONE ORDERS WELCOME!

Bank Americard, Master Charge and American Express Accepted. Phone (617) 531-5774 \$10.00 Minimum on Charge Orders Send orders & inquiries to:

B&F ENTERPRISES
 Dept. S-3
 119 Foster Street
 Peabody, Ma. 01960
 Phone (617) 531-5774



TELEPHONE ORDERS WELCOME! CREDIT CARDS ACCEPTED - MASTER CHARGE, BANK AMERICARD AND AMERICAN EXPRESS CARDS WELCOME. CALL US (617) 531-5774

NEW! THE FUTURE NOW! FM2015R



Does Your Unit Cover The New
Sub-band 144.5 - 145.5 MHz?
The FM2015R Does, PLUS MARS-CAP!*

All Solid State-CMOS PL digital synthesized - No Crystals to Buy! 5KHz steps - 144-149 MHz-LED digital readout PLUS MARS-CAP and MULTIPLE OFFSET.*

● 5 MHz Band Coverage - 1000 Channels (instead of the usual 2MHz to 4MHz-400 to 800 Channels) ● 4 CHANNEL RAM IC MEMORY WITH SCANNING ● MULTIPLE FREQUENCY OFFSETS ● ELECTRONIC AUTO TUNING - TRANSMIT AND RECEIVE ● INTERNAL MULTIPURPOSE TONE OSCILLATOR ● RIT ● DISCRIMINATOR METER - 15 Watts Output - Unequaled Receiver Sensitivity and Selectivity - 15 POLE FILTER, MONOLITHIC CRYSTAL FILTER AND AUTOMATIC TUNED RECEIVER FRONT END, COMPARE! ● Superb Engineering and Superior Commercial Avionics Grade Quality and Construction Second to None at ANY PRICE.

INTRODUCTORY
PRICE

\$399⁰⁰

Regulated AC/PS
Model FMPS-4R ... \$49.00



FMMC-1* Micro-
phone with Built-in
Touch Tone Pad
WHY BUY LESS?
THE FMMC-1
HAS IT ALL!
● New! Auto key-up
● LED indicator
● Adj. level and tone
balance
● Use with any
transceiver
● Only 3-3/4" x 2"
\$49⁹⁵

- **FREQUENCY RANGE.** Receive and Transmit: 144.00 to 148.995 MHz, 5KHz steps (1000 channels) INCLUDING NEW BAND 144.5-145.5MHz + MARS-CAP and MULTIPLE OFFSET.*
- **LED DIGITAL READOUT.**
- **4 CHANNEL RAM SCANNER WITH IC MEMORY.** Program any 4 frequencies and reprogram at any time using the front panel controls—search for occupied (closed) channel or vacant (open) channels. Internal Ni-Cad included to retain memory (no diode matrix to wire or change).
- **MULTIPLE FREQUENCY OFFSETS:** Three positions A,B,C, provided for installation of optional crystals: EXAMPLE - 1 MHz offset. Duplex Frequency Offset Built in - 600 Khz PLUS or MINUS 5 KHz steps, plus simplex, any frequency.
- **INTERNAL MULTIPURPOSE TONE OSCILLATOR BUILT IN:** 1750Hz tone burst for "whistle on operation" and sub-audible tone operation possible by simply adding a capacitor across the terminals provided. Internal 2 position switch for automatic and manual operation, tone burst or sub audible tone PL - adjustable 60-203Hz (100 Hz provided).
- **AIRCRAFT TYPE FREQUENCY SELECTOR.** Large and small coaxially mounted knobs select 100KHz and 10KHz steps respectively. Switches click-stopped with a home position facilitate frequency changing without need to view LED's while driving and provides the sightless amateur with full Braille dial as standard equipment.
- **FULL AUTOMATIC TUNING OF RECEIVER FRONT END AND TRANSMITTER CIRCUITS:** DC output of PLL fed to varactor diodes in all front end RF tuned circuits provides full sensitivity and optimum intermodulation rejection over the entire band. APC (AUTO POWER CONTROL) - Keeps RF output constant from band edge to band edge. NO OTHER AMATEUR UNIT AT ANY PRICE has these

- features which are found in only the most sophisticated and expensive aircraft and commercial transceivers
- **TRUE FM.** Not phase modulation - for superb emphasized hi-fi audio quality second to none
- **RIT CONTROL.** Used to improve clarity when contacting stations with off frequency carrier.
- **MONITOR LAMPS:** 2 LED's on front panel indicate (1) incoming signal-channel busy, and (2) Transmit.
- **FULLY REGULATED INTEGRAL POWER SUPPLY.** Operating voltage for all 9v circuits independently regulated. Massive Commercial Mesh Filter.
- **MODULAR COMMERCIAL GRADE CONSTRUCTION** 6 Unitized modules eliminate stray coupling and facilitate ease of maintenance.
- **ACCESSORY SOCKET** Fully wired for touch tone, phone patch, and other accessories. Internal switch connects receiver output to internal speaker when connector is not in use.
- **MULTI-PURPOSE METER.** Triple Function Meter Provides Discriminator Meter, "S" Reading on receive and Power Out on Transmit.
- **RECEIVE:** Better than .25uv sensitivity, 15 POLE FILTER as well as monolithic crystal filter and AUTOMATIC TUNED LC circuits provide superior skirt selectivity - COMPARE!
- **HIGH/LOW POWER OUTPUT.** 15 watts and 1 watt, switch selected. Low power may be adjusted anywhere between 1 and 15 watts. Fully protected-short or open SWR.
- **OTHER FEATURES:** Dynamic Microphone built in speaker, mobile mount, external 5 pin accessory jack, speaker jack, and much, much more. Size 2½ x 7 x 7½. All cords, plugs, fuses, microphone hanger, etc. included. Weight 5 lbs.

Manufactured by one of the world's most distinguished Avionics manufacturers, Kyokuto Denshi Kaisha, Ltd.
First in the world with an all solid state 2 meter FM transceiver.



AMATEUR-WHOLESALE ELECTRONICS

8817 S.W. 129th Terrace, Miami, Florida 33176
Telephone (305) 233-3631 ● Telex: 51-5628
U.S. DISTRIBUTOR

DEALER INQUIRIES INVITED.

PLEASE ORDER FROM YOUR LOCAL
DEALER OR DIRECT IF UNAVAILABLE.

Regional Sales & Service Centers.

East: Sanford Communications, Inc.
Colonial, N.J.
(201) 574 3003
Northeast: Buzzards Bay Electronics
Buzzards Bay, Mass.
(617) 759 3376
West: The Radio Shop
Riverton, Utah
(801) 254 0991
Northwest: Action Supply, Inc.
Boise, Idaho
(208) 344 5084
Midwest: Universal Service
Columbus, Ohio
(614) 221 2335

The New Sigma XR3000D Linear Amplifier Compare!

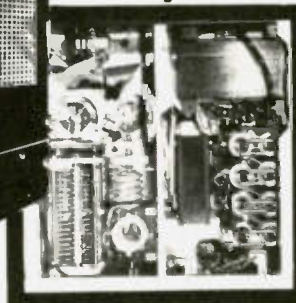
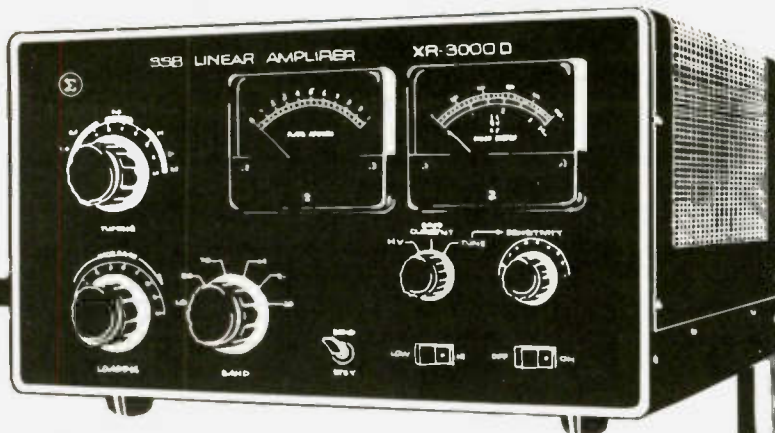

INTRODUCTORY SALE

\$699

2 Day Air Shipment
Anywhere in U.S.
Airport to Airport \$35
Alaska and Hawaii Slightly Higher

Features:

Custom computer grade commercial components, capacitors, and tube sockets manufactured especially for high power use—heavy duty 10kw silver plated ceramic band switches • Silver plated copper tubing tank coil • Huge 4" easy to read meters—measure plate current, high voltage, grid current, and relative RF output • Continuous duty power supply built in • State of the art zener diode standby and operating bias provides reduced idling current and greater output efficiency • Built in hum free DC heavy duty antenna change-over relays • AC input 110V or 220V AC, 50-60Hz • Tuned input circuits • ALC-rear panel connections for ALC output to exciter and for relay control • Double internal shielding of all RF enclosures • Heavy duty chassis and cabinet construction and much, much more.

- Full band coverage 160-10 meters including mars.
- 2000 watts P.E.P. SSB input. 1000 watts input continuous duty, CW, RTTY & SSTV.
- Two Eimac 3-500Z conservatively rated finals
- All major HV and other circuit components mounted on single G-10 glass plug in board. Have a service problem? (Very unlikely) Just unplug board and send to us
- Heavy duty commercial grade quality and construction second to no other unit at any price!
- Weight: 90 lbs. Size: 9 1/2" (h) x 16" (w) x 15 3/4" (d).

INTRODUCTORY SPECIAL!

New! Sigma Model AF250L Deviation/Modulation Meter

Fully Certifiable for Commercial Use

Features:

Extremely stable local oscillator for easy measurement of HF, VHF, and UHF bands employing negative feedback to insure extremely high stability • Easy to read, accurate linear scale • Direct off the air signal measurement capability • Optional DC Power Kit

Specifications:

Frequency 1 8MHZ-520MHZ 3 range select (A, B, C, EXT). A range 26.5 MHZ-40MHZ, B range 48MHZ-60MHZ, C range 140MHZ-156MHZ, EXT range 1 8MHZ-520MHZ (Need Signal Generator) • Generous overranges-Input level (1) Through type input level 1W-200W (RF Input Terminal) (2) Direct input level. More than 80db 50ohm impedance • Amplitude modulation degree: 0-100% • Frequency deviation 0-20KHZ • Accuracy -3% of full scale • Intermediate frequency: 10.7MHZ • Local input frequency (EXT Range) • Measuring frequency -10.7MHZ • RF Attenuator 0-60db variable • Audio signal oscillator (1) Audio Frequency—1,000HZ (1 KHZ), (2) Output level—More than 1V RMS • Power Source AC117V • Dimensions H-5 1/2" (140mm), W-10 1/4" (260mm), D-7 1/4" (184mm) • Weight: 7 lbs.

INTRODUCTORY SALE

\$169



SIGMA RF-2000 SWR & POWER METER



Cal PWR Scales 200W-2000W Freq Range 3.5-150 MHz Please do not confuse the RF2000 with similar appearing lower priced units. RF2000 is an individually calibrated professional quality instrument Unequaled at many times the price Size 7" (w) x 2 1/3" (d)

\$29

Introductory Price

SHIPPING ANYWHERE - \$1

GO PRIVATE! on 2 meters with the FMTD-1*



SPECIAL INTRODUCTORY PRICE \$75.00

Touch tone pad (encoder) actuated. Quiets your receiver until other station sends private 3 digit code, selected from front panel 999 Channels Receiver can be muted or opened manually or remotely with a touch tone pad. Bright led's indicate muting and reset. State of the art digital circuitry. Works with the KDK FM2015R or any 2-meter rig. 5 pin din plug supplied. Size 5 1/2" D x 6 1/2" W x 1" H. Wt. 12 oz

FMSS	FM2015R Accessories	KDK	SPECIAL SALE FM144 Accessories
	SUPER SCANNER 1000 Total Scanning Capability		FMOF-1 Offset Option Kit - 2 Extra Positions, Crystals Required \$10
	Regulated AC/PS		FMOF-2 1 MHz Offset Option Kit (No Crystals to Buy) \$10
	FMPS-4R Microphone with Built-in Touch Tone Pad		MARS-CAP Option Kit - Any Frequency Any Split \$12
	FMCC-1 Touch Tone Pad \$49.95		
	FMTD-1 Private Call Decoder for use with and Programmed by any Touch Tone Pad \$75		
	MARS-CAP and Multiple Offset Kit* Any Frequency Any Split, No Crystals \$5		
	FMAT-1 1/2 Wave Portable Antenna for Hotel, Motel or Apartment \$7.95		
	Extra DC Cord & Plug \$4.00		
	Service Manual \$4.00		
	Mounting Bracket (Extra) \$6.00		
			NEW!! ADD 5 CHANS (TOTAL 10) TO SRC 146A
			• Simple 10 min installation
			• Same color and quality as SRC 146A
			• Completely WIRED & TESTED
			• ALSO usable with most other hand helds
			Price \$29

New Standard 2 Meter FM Transceivers Model SRC 146A

Special Package	Price
SRC 146A	\$314
4 Xials 34 94 and 94 94	NC
USA 2 Deluxe Base Charger	\$47
PT3644 Leather Case	\$12
AT 19 Rubber Ant and Whip	\$10
N1 cards	\$30
Reg	\$413

NEW!!! Touch Tone pad completely wired and ready to plug in - \$59.95

Our Price **\$289** COMPARE!

NEW! 6 METER FM50-10SXRII

REG \$389 — SPECIAL SALE \$289

51.00-53.995 MHz. 600 channels

NEW CDE HAM III ROTATORS

Reg. \$159.95—\$125

AMATEUR-WHOLESALE ELECTRONICS

8817 S.W. 129th Terrace, Miami, Florida 33176
COURTEOUS PERSONAL SERVICE—SAME DAY SHIPMENT • Prices subject to change without notice.
Telephone: (305) 233-3631 • Telex 51-5628 • Store Hours: 10-5 Mon. - Fri.

A21



ALDA 103 HF TRANS-CEIVER

Please write for detailed information

GET YOUR NEW RADIO AMATEUR CALLBOOKS

1978

The **U.S. Callbook** has over 350,000 W & K listings. It lists calls, license classes, names and addresses plus the many valuable back-up charts and references you come to expect from the **Callbook**.

\$14.95
PLUS SHIPPING

Specialize in DX? Then you're looking for the **Foreign Callbook** with over 280,000 calls, names and addresses of radio amateurs outside the USA plus many valuable, additional features of interest to the DX'er.

\$13.95
PLUS SHIPPING

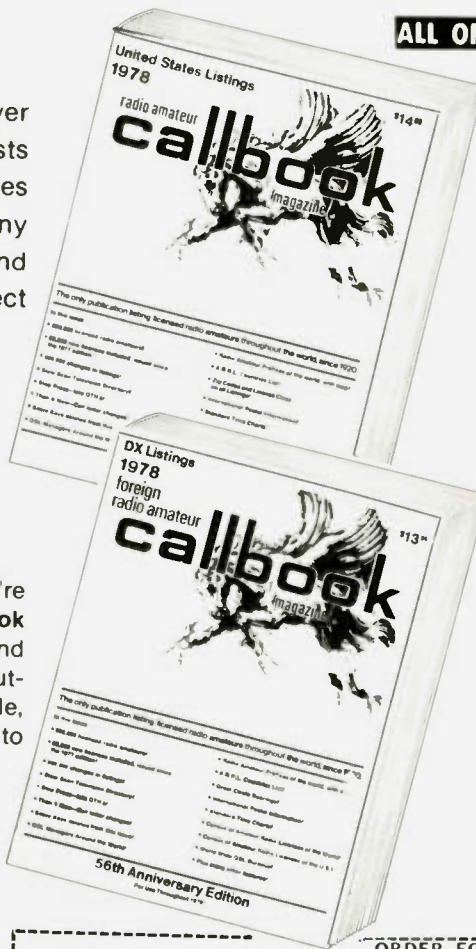

ALL OF THESE EXTRA FEATURES INCLUDED

- International Radio Amateur Prefixes!
- Radio Amateur Prefixes by Countries!
- A.R.R.L. Phonetic Alphabet!
- Great Circle Bearings and Charts!
- International "O" and "Z" Signals!
- World Standard Time Charts!
- International Postal Information!
- World Prefix Map!
- F.C.C. Examination Points!
- Where to Buy!
- Telegraphers' Abbreviations!
- DX Operating Code!
- A.R.R.L. Countries List!
- At Your Service — Amateur Radio Dealers!
- QSL Managers Around the World!
- World Wide QSL Bureaus!
- Census of Radio Amateurs of the World!
- Telegraph Codes!
- AMSAT — Oscar Users Directory!
- Slow Scan Television Directory!
- Reciprocal Licenses!
- Hawaii Included!
- Many Other Features!

*Respected worldwide as
the only complete authority
for radio amateur
QSL and QTH information.*

Save \$1.50 order both send \$30.40

See your favorite electronics dealer or write direct for free catalog to the publisher.

RADIO AMATEUR callbook INC
Dept. B 925 Sherwood Drive
Lake Bluff, Ill. 60044

R1

ORDER FORM

Item	Price Each	Shipping	Total Price
<input type="checkbox"/> U. S. CALLBOOK	\$14.95	\$1.50	\$16.45
<input type="checkbox"/> FOREIGN CALLBOOK	\$13.95	\$1.50	\$15.45

Illinois residents only add 5% sales tax _____

Name _____ Total _____

Address _____

City _____

State _____ Zip _____ Total Enclosed _____

Charge: BankAmericard Master Charge Interbank # _____
Credit card # _____ Expiration date _____

Signature _____

California Industrial

Post Office Box 3097 A • Torrance, California 90503

Point Of Sale COMPUTER

\$1795.00 set



Manufactured by TRW Data Systems for the fast food industry. Designed for error-free data entry. The operator simply blackens the appropriate box on a mark sense card and inserts it into the form reader. The CPU searches internal programable drum memory for unit price and extends it by quantity, displaying the customer's grand total on the LED module. Memory system is capable of retaining over 40 register items. Accumulated data may be pulled by a master computer. This point of sale computer makes a super mark sense data terminal. The TRW 1336 is shipped complete with cables and self-contained +5 & +12v. power supply. Brand new in factory cartons. Original cost \$7,000. Weight 100 lbs., shipped freight collect. Complete documentation not secured at press time.

HEXADECIMAL KEYBOARD

\$34.95

Maxi-Switch hexadecimal keyboards are designed for microcomputer systems that require 4-bit output in standard hex code. Each assembly consists of 16 hermetically sealed reed switches and TTL "one shot" debounce circuitry. Reliable low friction acetal resin plungers are credited for the smooth operation and long life of this premium keyboard. Requires single +5 volt supply.



TELETYPE MODEL 43

New from Teletype, the Model 43 is capable of printing 132 ASCII characters per line. Send and receive data at 10 or 30 char. per second. Keyboard generates all 128 ASCII code combinations. RS-232 interface, same as the popular Model 33. Data sheet sent upon request. Manufacturer suggested price \$1377.00.



IMMEDIATE DELIVERY \$1199

We also have for sale a limited quantity of used Model 35's. Priced at only \$449.50

BARREL STOCK™ TEST 'EM YOURSELF 'N SAVE

15 NE555 Timers, 100% functional
TRW Power Darlingtons, TO3
50 2N3055 & 2N3772 NPN power trans.
15 General Purpose TO92 Transistors
100 Silicon Signal Diodes

SPECIAL
GENERAL INSTRUMENT ASCII Keyboard Encoder AY-53600 Prime but house marked only \$4.95



REGULATED POWER SUPPLY

Delivers 5 volts at 8 Amperes along with three other regulated outputs. This used supply is sold "as is," but we still feel that this is the best buy you'll ever see in a regulated power supply. 75 lbs., Schematics included.



Used \$495.00
Shipped Freight Collect

CONNECTORS

RS-232
DB25P male plug & hood \$395
DB25S female \$395

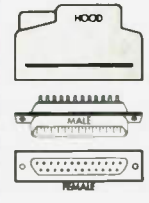

Edge Connectors

100 PIN IMSAI/ALTAIR
S-100 • GOLD PLATED • .125" CENTERS
Altair .140 row, soldertail. \$5.98 3/\$16.50
Imsai .250 row, soldertail. \$4.98 3/\$13.00
3 Level Wire Wrap .250 row. \$4.98 3/\$13.00
SPECIALS
WWW same as above without ears \$3.50 3/\$10.72 (dual 36) W/W .156" centers. \$2.50 3/\$6



UNIVAC KEYBOARD

The famous Sperry Univac 1710 high-speed keyboard assembly is now available from California Industrial for only \$24.88. The ideal computer input device for accountants and mathematicians. The numeric keys are placed on the lower edge to resemble a ten key adding machine. This format allows one-handed numeric data entry. Original cost was \$385. Used but guaranteed in excellent condition. Complete with documentation.



\$24.88

Quiet Buss S-100 MOTHER

The Quiet Buss from California Industrial is quality engineered. No short cuts have been taken to produce this mother board. Active termination circuitry prevents noise and crosstalk. Manufactured from extra heavy FR-4 epoxy glass. Features 2 ounce double thickness copper traces.



18 29.95 SLOTT

FREE MANUAL GRAPHITE DISPLAY GENERATOR

Modern technology has pioneered the development of this unique character printer. Our Manual Graphite Display Generator has the capability of producing the full upper and lower case ASCII set. Self-contained cursor assembly allows the operator to eliminate erroneously entered information. Manufactured to manufacturer's strict tolerances as prescribed by standards set forth by California Industrial. One free with every order.

\$498
10 for \$45.

Scotch BRAND DISKETTES

Please specify IBM 3740 series or 32 sector. also MINIDISKS

2102
LOW POWER 450 NS
\$119
SUPER BUY! Lowest Price Anywhere

Our low power static RAMs are factory prime. Purchased, on contract, directly from one of California's leading semiconductor manufacturers.

7400	13	7442	59
7401	19	7443	79
7402	19	7445	89
7403	19	7446	99
7404	19	7447	99
7405	19	7448	99
7406	19	7449	99
7407	25	7450	99
7408	25	7451	99
7409	25	7452	99
7410	25	7453	99
7411	25	7454	99
7412	35	7455	99
7413	45	7456	99
7414	79	7457	99
7415	39	7458	99
7416	39	7459	99
7417	39	7460	99
7418	39	7461	99
7419	39	7462	99
7420	39	7463	99
7421	39	7464	99
7422	49	7465	99
7423	49	7466	99
7424	49	7467	99
7425	49	7468	99
7426	49	7469	99
7427	49	7470	99
7428	49	7471	99
7429	49	7472	99
7430	49	7473	99
7431	49	7474	99
7432	49	7475	99
7433	49	7476	99
7434	49	7477	99
7435	49	7478	99
7436	49	7479	99
7437	49	7480	99
7438	49	7481	99
7439	49	7482	99
7440	49	7483	99

Certified Digital CASSETTES
Won't drop a BIT!

California Industrial is an Authorized Dealer of Scotch Brand Data Products

LM741 \$0.09

4033	199	3401-24	179
4034	169	350N	99
4040	199	351CM	65
4041	149	370A	129
4042	149	370B	129
4043	149	370C	129
4044	149	370D	129
4045	249	370E	129
4046	249	370F	129
4047	249	370G	129
4048	249	370H	129
4049	249	370I	129
4050	249	370J	129
4051	199	370K	129
4052	199	370L	129
4053	199	370M	129
4054	199	370N	129
4055	199	370O	129
4056	199	370P	129
4057	199	370Q	129
4058	199	370R	129
4059	199	370S	129
4060	199	370T	129
4061	199	370U	129
4062	199	370V	129
4063	199	370W	129
4064	199	370X	129
4065	199	370Y	129
4066	199	370Z	129
4067	199	370AA	129
4068	199	370AB	129
4069	199	370AC	129
4070	199	370AD	129
4071	199	370AE	129
4072	199	370AF	129
4073	199	370AG	129
4074	199	370AH	129
4075	199	370AI	129
4076	199	370AJ	129
4077	199	370AK	129
4078	199	370AL	129
4079	199	370AM	129
4080	199	370AN	129
4081	199	370AO	129
4082	199	370AP	129
4083	199	370AQ	129
4084	199	370AR	129
4085	199	370AS	129
4086	199	370AT	129
4087	199	370AU	129
4088	199	370AV	129
4089	199	370AW	129
4090	199	370AX	129
4091	199	370AY	129
4092	199	370AZ	129
4093	199	370BA	129
4094	199	370BB	129
4095	199	370BC	129
4096	199	370BD	129
4097	199	370BE	129
4098	199	370BF	129
4099	199	370BG	129
4100	199	370BH	129

JOYSTICK \$4.50
3 for \$10.00

This joystick features four 100K potentiometers, that vary resistance proportional to the angle of the stick. Perfect for television games. Quad stereo and radio controlled aircraft.

int'l 2708 450ns \$14.95
8K UV Erasable MEMORY

CALCULATOR WRIST WATCH
\$149.50

30 RIBBON WIRE SPECTRA-STRIP \$0.69
Transistors
2N2222A .20 .18 .16 .15
2N3055 .69 .65 .59 .55
MJ3055 .79 .75 .69 .65
2N3772 .15 .149 .139 .129
2N3904 .15 .11 .09 .07
2N3906 .15 .11 .09 .07

Diodes
1N4002 100v. .08 .06 .05
1N4005 600v. .10 .08 .07
1N4148 signal .07 .05 .04

UART AY 5-1013A \$4.98

BRIDGE RECTIFIER MOTOROLA 12 Amp. 50v. \$1.95

SPEAKERS \$69
6 for \$300
2 1/4 Miniature
Perfect for TV games, alarm systems, speech synthesizer or intercom. 8 ohms
5" HiFidelity \$298

TRIMMER POTENTIOMETERS
2K 5K 10K 50K
5 for \$9.98
20 50 100
16" 14" 12"

Power Adapter
6 vdc, 140mA \$1.39
7 dc, 1.4 A. 5.50
9 vdc, 15mA. 1.19
9 vdc, 175mA. 1.95
12 vdc, 600mA 2.95

RELAYS SPDT MINIATURE \$139
10 25 100
ea. \$115 104 .89
Coil 12 Volt dc.
7 Amp Contacts
P.C. Board Mount

9 foot \$149
Heavy duty grounded power cord and mating chassis connectors.

SOLAR CELLS \$119
20 for \$98
10 100
\$98 \$85
125mA at 43V Ideal for powering radio receivers or charging batteries.

R.F. MODULATOR from Atari \$1395
Converts signal from APPLE II and other video sources into TV frequency. Complete with directions and metal case. Assembled

Thumbwheel switch \$139 ea.
10 50
\$119 .89

MINIATURE SWITCHES \$0.98
10 50 100 1k
\$.88 .81 .73 .66

DISCOUNT Wire Wrap Center
IC SOCKETS
wire wrap low profile
pin ea. 25 50 ea. 25 50

WIRE WRAP \$29.95
50ft \$98
100 500 1k
450 20. 35

NEW!

Synthacoder 509



ONLY
\$129⁹⁵
postpaid

Take Command of 220 MHz!

The Synthacoder 509 represents the first of a totally new generation of frequency synthesizers, based on the latest advances in CMOS-LSI techniques. "Matrix Modules", which contain programming diodes, make adding new channels a cinch. Simply snip the leads on the diodes not needed, plug it in, and you are **On The Air!** Our unique interface design allows you to use your existing crystal positions even though the synthesizer has been installed. The Synthacoder is also easily adapted for **Scanning** and **External Frequency Control**. To sum it up—We are sure that you will find the new Synthacoder 509 **Everything You Want** in a 220 MHz synthesizer—And at a **Price Comparable to Crystals!**

- * SIMPLE TO INTERFACE - Three wires and no holes!
- * FULL COVERAGE - 220-225 MHz in 20 KHz steps
- * MATRIX PROGRAMMABLE - No more crystals
- * EXCLUSIVE "MATRIX MODULES" - Program in seconds
- * FULL MODE CONTROL - Simplex, Repeater, Reverse
- * LOW POWER CMOS - Draws only 60 ma
- * FULLY ASSEMBLED AND CALIBRATED - Not a kit
- * FITS MIDLAND, COBRA, and CLEGG 220 MHz transceivers

Engineering Specialties

P.O. BOX 2233
1247 COMMERCIAL AVENUE
OXNARD, CA 93030
(805) 486-0817

- I'LL BITE! Please send more info.
 I'M HOOKED! Please RUSH my Synthacoder.

YES, I would like to purchase a Synthacoder for my 220 radio. Enclosed please find my \$129.95 (Price includes postage and handling). California residents add 6% sales tax.

\$ _____ enclosed. Cash Check Money Order

Please charge my Master Charge BankAmericard

Credit card # _____

Interbank # _____

Expiration date _____

Signature _____

Name _____

Address _____

City _____

Call _____

State _____

Zip _____



Expedition 'round the world

Meet adventure head on. Shipmates wanted who yearn to achieve for themselves rather than be pampered aboard plush, pretentious cruise ships. Share this adventure with a small congenial group in a highly informal atmosphere without regimentation or timetable. In this age of luxury and self-indulgence our expedition offers a unique, exciting opportunity.

YANKEE TRADER
(Famous oceanographic vessel)
Length 180. Beam 31.5, 1106 tons
9 MONTHS — SHARE EXPENSES

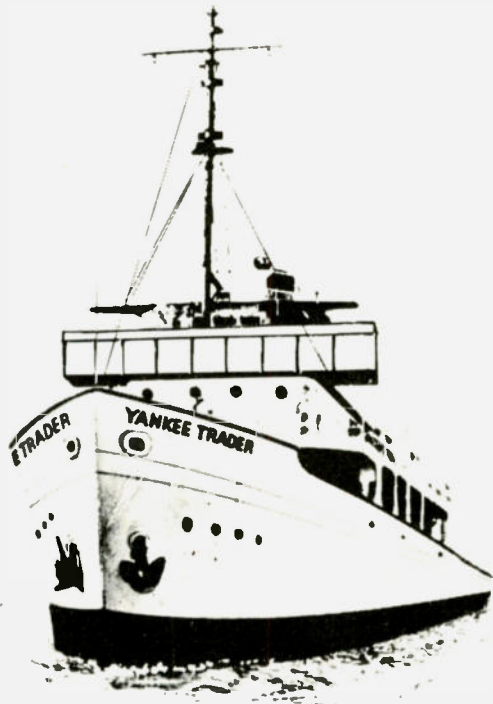

Ports of call

**Cape Haitien.
San Salvador.
Panama.
Pitcairn Island.
Easter Island.
Rapa. Tahiti.
Ahe. Moorea.
Galapagos.
Samoa. Tutuila.
Danger Island.
Guadacanal.
Tulagi. Bali.
New Guinea. Java.
Madagascar.
Zanzibar. Beira.
Capetown.
St. Helena.
Ascension Island.
Rio. Devil's Island.
Paramariba.
Martinique.
Antigua. Exuma.
Nassau.**



**Please send me
your free 'round
the world
expedition
booklet.**

Name _____

Address _____

City _____

State _____ Zip _____

**P. O. Box 120, Dept. RW
Miami Beach, Florida 33139**

 Windjammer Cruises.

DIODES/ZENERS

1N914	100v	10mA	.05
1N4005	600v	1A	.08
1N4007	1000v	1A	.15
1N4148	75v	10mA	.05
1N753A	6.2v	z	.25
1N758A	10v	z	.25
1N759A	12v	z	.25
1N4733	5.1v	z	.25
1N5243	13v	z	.25
1N5244B	14v	z	.25
1N5245B	15v	z	.25

SOCKETS/BRIDGES

8-pin	pcb	.25	ww	.45
14-pin	pcb	.25	ww	.40
16-pin	pcb	.25	ww	.40
18-pin	pcb	.25	ww	.75
22-pin	pcb	.45	ww	1.25
24-pin	pcb	.35	ww	1.10
28-pin	pcb	.35	ww	1.45
40-pin	pcb	.50	ww	1.25
Molex pins	.01	To-3 Sockets		.45
2 Amp Bridge		100-prv		1.20
25 Amp Bridge		200-prv		1.95

TRANSISTORS, LEDS, etc.

2N2222	NPN	(Plastic .10)	.15
2N2907	PNP		.15
2N3906	PNP		.10
2N3054	NPN		.35
2N3055	NPN	15A 60v	.50
T1P125	PNP	Darlington	.35
LED Green, Red, Clear			.15
D.L.747		7 seg 5/8" high com-anode	1.95
XAN72		7 seg com-anode	1.50
FND 359		Red 7 seg com-cathode	1.25

C MOS

4000	.15
4001	.20
4002	.20
4004	3.95
4006	1.20
4007	.35
4008	.95
4009	.30
4010	.45
4011	.20
4012	.20
4013	.40
4014	1.10
4015	.95
4016	.35
4017	1.10
4018	1.10
4019	.60
4020	.85
4021	1.35
4022	.95
4023	.25
4024	.75
4025	.35
4026	1.95
4027	.50
4028	.95
4030	.35
4033	1.50
4034	2.45
4035	1.25
4040	1.35
4041	.69
4042	.95
4043	.95
4044	.95
4046	1.75
4049	.70
4050	.50
4066	.95
4069	.40
4071	.35
4081	.70
4082	.45

7400	.15
7401	.15
7402	.20
7403	.20
7404	.15
7405	.25
7406	.35
7407	.55
7408	.25
7409	.15
7410	.10
7411	.25
7412	.30
7413	.45
7414	1.10
7416	.25
7417	.40
7420	.15
7426	.30
7427	.45
7430	.15
7432	.30
7437	.35
7438	.35
7440	.25
7441	1.15
7442	.45
7443	.85
7444	.45
7445	.65
7446	.95
7447	.95
7448	.70
7450	.25
7451	.25
7453	.20
7454	.25
7460	.40
7470	.45
7472	.40

7473	.25
7474	.35
7475	.35
7476	.30
7480	.55
7481	.75
7483	.95
7485	.95
7486	.30
7489	1.35
7490	.55
7491	.95
7492	.95
7493	.40
7494	1.25
7495	.60
7496	.80
74100	1.85
74107	.35
74121	.35
74122	.55
74123	.55
74125	.45
74126	.35
74132	1.35
74141	1.00
74150	.85
74151	.75
74153	.95
74154	1.05
74156	.95
74157	.65
74161	.85
74163	.95
74164	.60
74165	1.50
74166	1.35
74175	.80

- T T L -

74176	1.25
74180	.85
74181	2.25
74182	.95
74190	1.75
74191	1.35
74192	1.65
74193	.85
74194	1.25
74195	.95
74196	1.25
74197	1.25
74198	2.35
74221	1.00
74367	.85
75108A	.35
75110	.35
75491	.50
75492	.50
74H00	.25
74H01	.25
74H04	.25
74H05	.25
74H08	.35
74H10	.35
74H11	.25
74H15	.30
74H20	.30
74H21	.25
74H22	.40
74H30	.25
74H40	.25
74H50	.25
74H51	.25
74H52	.15
74H53J	.25
74H55	.25

74H72	.55
74H101	.75
74H103	.75
74H106	.95
74L00	.35
74L02	.35
74L03	.30
74L04	.35
74L10	.35
74L20	.35
74L30	.45
74L47	1.95
74L51	.45
74L55	.65
74L72	.45
74L73	.40
74L74	.45
74L75	.55
74L93	.55
74L123	.55
74S00	.55
74S02	.55
74S03	.30
74S04	.35
74S05	.35
74S08	.35
74S10	.35
74S11	.35
74S20	.35
74S40	.25
74S50	.25
74S51	.45
74S64	.25
74S74	.40
74S112	.90
74S114	1.30

74S133	.45
74S140	.75
74S151	.35
74S153	.35
74S157	.80
74S158	.35
74S194	1.05
74S257 (8123)	.25
74LS00	.35
74LS01	.35
74LS02	.35
74LS04	.35
74LS05	.45
74LS08	.35
74LS09	.35
74LS10	.35
74LS11	.35
74LS20	.35
74LS21	.25
74LS22	.25
74LS32	.40
74LS37	.35
74LS40	.45
74LS42	1.10
74LS51	.50
74LS74	.65
74LS86	.65
74LS90	.95
74LS93	.95
74LS107	.85
74LS123	1.00
74LS151	.95
74LS153	1.20
74LS157	.85
74LS164	1.90
74LS367	.85
74LS368	.85

9000 SERIES

9301	.85
9309	.35
9322	.85
95H03	.55
9601	.75
9602	.50

8266	.35
MCT2	.95
8038	3.95
LM201	.75
LM301	.25
LM308 (Mini)	.75
LM309H	.65
LM309K (340K-5)	.85
LM310	1.15
LM311D (Mini)	.75
LM318 (Mini)	.65

LINEARS, REGULATORS, etc.

LM320K5 (7905)	1.65
LM320K12	1.65
LM320T5	1.65
LM320T12	1.65
LM320T15	1.65
LM339	.95
7805 (340T5)	.95
LM340T12	1.00
LM340T15	1.00
LM340T18	1.00

LM340T24	.95
LM340K12	2.15
LM340K15	1.25
LM340K18	1.25
LM340K24	.95
LM373	2.95
LM380	.95
LM709 (8,14 PIN)	.25
LM711	.45

LM723	.50
LM725	1.75
LM739	1.50
LM741 (8-14)	.25
LM747	1.10
LM1307	1.25
LM1458	.95
LM3900	.50
LM75451	.65
NE555	.50
NE556	.95
NE565	.95
NE566	1.75
NE567	1.35

INTEGRATED CIRCUITS UNLIMITED

7889 Clairemont Mesa Boulevard, San Diego, California 92111
(714) 278-4394 (Calif. Res.)

All orders shipped prepaid

No minimum

Open accounts invited

COD orders accepted

Discounts available at OEM Quantities California Residents add 6% Sales Tax

All IC's Prime/Guaranteed. All orders shipped same day received.

24 Hour Toll Free Phone 1-800-854-2211

MasterCharge / BankAmericard / AE

SPECIAL DISCOUNTS

Total Order	Deduct
\$35 - \$99	5%
\$100 - \$300	10%
\$301 - \$1000	15%
\$1000 - Up	20%

POLY
PAKS

COMPUTER PERIPHERAL & PARTS WORKSHOP

MAIL
ORDER

POLY PAKS INTRODUCES THE FIRST MAGAZINE RETAIL STORE FOR THE ELECTRONIC MAIL-ORDER HOBBYIST!

"MICRO-TONE"

AUTOPACK ENCODER KIT

28.88

- Emergency!
- Family!
- Friendly!
- Complete in its own mini-cabinet!

Only 2 1/8 x 1 5/8 x 1/2" small enough to mount in a mikel! Snap action bubble key contact. Features output level control, xtal controlled digitally synthesized tones, on-chip oscillator. Requires 6 to 5.5 VDC. Complete kit! Nothing else to buy! Wt. 12 oz. Cat. No. 3A4086 kit \$28.88 Cat. No. 3A4087 wired \$34.95



HEXADECIMAL MICROPROCESSOR AND CONTROL KEYBOARD KIT! 29.95

Address microprocessors, control computer operated equipment. 2 key rollover. Has 20 keys, 16 encoded, 16 external to be assigned by user. Output 4 bit binary. Also, an EXCLUSIVE FEATURE: 4 LEDs display the binary output. CMOS compatible. Requires -5, 12VDC. Complete kit! Nothing else to buy! With instructions. Cat. No. 3A5009 Hexadecimal Kit \$29.95 Cat. No. 3A5010 Hexadecimal Wired \$34.95



POLY PAKS SPECIAL

BUY \$15 WORTH Take **10%** DISCOUNT

BUY \$100 WORTH Take **25%** DISCOUNT

FROM THIS AD ONLY

MICROPROCESSORS! MEMORIES! SUPPORT!

Order by Cat. No. 3A3459 and type

Type	Description	Sale
MC6800L	8 bit CPU	\$24.95
8080A	8 bit CPU	14.95
Z80A	8 bit CPU	34.95
8008	CPU	9.95
1101	256 x 1 stat. RAM	1.29
1103	1K Dyn RAM	5.95
1702A	256 x 8 EPROM	5.95
2102-1	1K x 1 Lo-power RAM	1.69
2111	256 x 4 Stat. RAM	5.95
2701	8K EPROM	19.95
MM4116	16K Dyn RAM	32.00
MM4200P11	4K x 1 Dyn RAM, 350nsec	3.95
MM5202	2K EPROM	6.95
MM5203	2K EPROM	8.95
MM5260	1K Dyn RAM	.99
MM5262	2K x 1 Dyn RAM	3.95
8212	8 bit I/O port	3.95
8216	Bi-direct bus driver	3.95
8224	Clock Gen	4.95
8228	System cont.	9.95
8251	Communication int	11.50
8255	Periph inter	11.95

FULL WAVE BRIDGE RECTIFIERS!

WAVE	2 AMP	6 AMP	10 AMP	25 AMP
PIV (#3A1346)	(#3A2456)	(#3A2447)	(#3A2273)	
50	\$.59	\$.88	\$ 1.05	\$ 1.20
100	.65	.99	1.15	1.25
200	.69	1.19	1.29	1.95
400	.89	1.40	1.79	2.95
600	.99	1.69	1.95	3.95
800	1.19	1.95	2.45	4.95
1000	1.25	2.25	2.50	5.50

Order by Cat. No. Amperage and Voltage

POLY PAKS "CHIPS" AWAY IC AND CRYSTAL PRICES!

Order by Cat. No. 3A4048 and Type No!

Type	Description	Sale
ICM7205	Stopwatch	\$14.95
AY3-8500-1	6 TV Games	9.95
MM5330	4% Digit DVM	4.95
8038C	Volt Control Osc.	4.95
NR2376-139	ICD Encoder Rom	14.95
NR2376-5T	ASCII Encoder Rom	14.95
11C90DC	650MHz Prescaler	14.95
095H90DC	350MHz Prescaler	8.88
MC14410	Touch Tone Chirp	9.95
MM2002P	Char Gen. (sim 2513)	3.95
7207A/7208	Freq Counter pair	24.95
ICM7107	3% Digit DVM/DCM	12.50
MM5316	Alarm	9.95
MM5369	60 Hz Timebase IC	1.95
03.579MHz	Timebase Xtal	1.95
1.00MHz	Touchtone Xtal	5.95
3.276MHz	Stopwatch Xtal	4.95

HANDY COMPUTER MULTITESTER

1000 ohms per Volt
1% precision movement
diodes protected against burnout. Measure DC volts 0-15-150-1000; AC volts 0-1.5-15-100; DC current 0-100ma; resistance X1000. Sensitivity 1000 ohms/volt AC-DC. Uses penlite cell, not included. Size 2 1/2 x 3 1/2 x 1 3/4". Wt. 5 oz. Cat. No. 3A3921

SPECTROL "SKINNY-TRIMS"

Ohms	3/8" square, screwdriver shaft.	Your Choice
50	2 1/2" tol. 14 watt. Cermet. P3	2 for \$1
100	500 leads. Order by Cat. No. and value.	
1K	10K	
2K	20K	Cat. No. 3A3863 25 turn upright, type 64
5K	50K	Cat. No. 3A3866 single turn, flat, type 63

GIANT SALE! MICRO-MINI TOGGLE SWITCHES

	Cat. No.	Contacts	Sale
3A, 125VAC contacts or better	3A3936	SPST	\$1.19
Complete with mounting hardware! "Center off"	3A4036	SPDT	1.29
	3A5085	SPDT	1.39
	3A4037	DPDT	1.45
	3A5087	4PDT	1.95

"TIE PIN" MIKE 4.95

Complete with mounting hardware! "Center off"

SILICON POWER STUD RECTIFIERS!

Order by Cat. No. Amperage and voltage.

	12 AMP	50 AMP	250 AMP
PIV (#3A727)	(#3A727)	(#3A685)	
50	\$.29	\$.75	\$4.95
100	.35	1.10	6.50
200	.45	1.35	7.50
400	.61	1.75	8.50
600	.79	2.25	10.50
800	.90	2.75	11.50

"GEL-SEL" POWER PAK

Rechargeable! Perfect for back-up power for computers, alarms, and more. Sealed, spill-proof, leak-proof. Better than Ni-CADs, recharges to 100% capacity. Compact, only 2 1/2 x 1 1/2 x 2 1/2". Stack 'em in series or parallel. Lead or lead/antimony gel (sorry, no choosing!). Wt. 16 ozs. Cat. No. 3A4088 \$4.95

NEW \$49.95 KEYBOARD & ENCODER KIT

Cat. No. 3A5001 Kit \$49.95
Cat. No. 3A5002 Wired \$59.95

Outputs standard 7 bit ASCII; interfaces with most data systems. Uses MOS Encoder ROM! 7 LED Test Feature! Key-board pre-assembled onto PC board. 2 key rollover. Electronic shift lock and carriage return. 4 modes: Normal, control, shift, shift/control. Additional functions can be assigned by user. 64 key keyboard! Encodes 128 ASCII Characters. Interfaces with ALTAIR, IMSAI, and more!

1st Time Offered! It's Different! It's Inflation Fighting! New!

KIT KING

KITS BY POLY PAKS

SUPER ECONO KITS

ONLY \$1.98 BUY 10 KITS & CHOOSE 11TH FREE!

* MONEY BACK GUARANTEE * AVG WT. 6 OZS.

Quantity	Description	(Order by Cat. No., see parenthesis)	Sale
10	CALCULATOR KEYBOARDS, up to 20 keys	(3A1524)	1.98
8	LINE CORDS, N-ft. ig. twin 218 wire, plug	(3A3843)	1.98
30	NEON LAMPS, NIP-2 style, red glow, leads	(3A2613)	1.98
1	707A ROMs, floppy failures, hobby, usable	(3A237)	1.98
40	FT SHIELD CABLE, cond., n-shield, #22 wire, vinyl jack	(3A577)	1.98
50	TRANSISTOR ELECTRO'S, asst values, upright, axial	(3A2747)	1.98
3	SOUND TRIGGERS, handrail triggers ser. w/amplifier	(3A623)	1.98
40	PC SOCKETS, in 1-14 and 4-18 hole prof.	(3A3621)	1.98
15	6V TEST INDICATORS, w/leads, grain-o-wheat	(3A1526)	1.98
3	GLOW'N PANELS, 3 1/2" x 1 1/2", 110vac, glow-n-drnk, green	(3A3650)	1.98
400	PARTS ON A BOARD, great! asst. parts, usable	(3A2859)	1.98
150	METAL FILM RESISTORS, 1/4 watt, color-coded, leads	(3A3413)	1.98
15	JUMBO "LED'S" RED, prime, leads, like M55054	(3A3369)	1.98
30	MINI TRIM POTS, 1/2 in. x 1/2 in., 1/4 W	(3A3345)	1.98
10	VOLTAGE REGULATORS, TO-3 case, 300K etc. hobby	(3A3330)	1.98
30	PANEL SWITCHES, rotaries, slide, mod, 110vac, etc.	(3A3268)	1.98
200	PC RESISTOR SPECIAL, 1/4 to 2W, metal, carbon	(3A3054)	1.98
40	AXIAL ELECTRO'S, asst values to 100 mf, volts	(3A3227)	1.98
100	UPRIGHT ELECTRO'S, asst volts, values to 100mf	(3A3226)	1.98
150	MOLEX SOCKETS, pins fit all IC's, most pop'l	(3A1444)	1.98
100	TERMINAL STRIPS, tie, to R lug, for solder	(3A3136)	1.98
15	SLIDE CONTROLS, asst values, rot, tribl, base, etc.	(3A3057)	1.98
10	PHOTO ELECTRIC CELLS, CDS, package styles, asst	(3A3052)	1.98
200	HALF WATTERS, color coded, carbon, prec, metal	(3A3046)	1.98
100	NATIONAL IC BONAZIA, linear, 7400's, rom, clocks, untested	(3A2860)	1.98
20	THERMISTORS, a resistor that changes with temp, protect!	(3A2048)	1.98
15	LM340T VOLTAGE REGS hobby, usable, 5 to 24V, TO-220	(3A2635)	1.98
100	CAPACITOR SPECIAL, poly'a, disc, molded, mica, discs	(3A2735)	1.98
100	TWO WATTERS, carbon, metal, prec, etc, marked, leads	(3A2735)	1.98
100	POLYSTYRENE CAPS, asst values, voltages, hi Q	(3A2729)	1.98
30	SLIDE SWITCHES, spat to dipit, many types	(3A2726)	1.98
15	NPN POWER TRANSISTORS, TO-3 2N3055 rejects, unseal	(3A2617)	1.98
200	PRE-FORMED RESISTORS, color-coded, p.e. work, asst values	(3A2604)	1.98
100	DISC CAPS, npn's, N750, long leads	(3A2598)	1.98
60	DIPPED MYLAR CAPS, asst values & voltages, 5ment	(3A2597)	1.98
200	PRECISION RESISTORS, 1/8, 1/4 to 2, marked, leads	(3A2428)	1.98
30	VOLUME CONTROLS, single, double, asst shafts values	(3A2421)	1.98
150	SWITCHING DIODES, 1N4148, most pop'l, mostly good	(3A2418)	1.98
75	SN7400 IC's, marked, mostly unseal, wide asst of SN's	(3A2415)	1.98
100	1N4000 RECTIFIERS, 1 amp, all most pop, asst, mostly good	(3A2417)	1.98

"KIT KING" \$1.19 KITS - "The Econo's"

BUY 5 KITS - CHOOSE THE 6TH FREE! MONEY BACK GUARANTEE!

Quantity	Description	(Order by Cat. No., see parenthesis)	Sale
30	RADIO-N.T. KNOBS, asst sizes, colors, ahsp's	(3A217)	\$1.19
10	PRS PHONO PLUGS-N JACKS, ICA style, 10 plugs, 10 jacks	(3A35-402)	1.19
35	DIPPED SILVER MICA CAPS, includes ree type too, asst	(3A485)	1.19
75	PRE-FORMED DISC CAPS, for p.e. use, asst values, up to 2KV	(3A2859)	1.19
10	NE-2 WITH RESISTOR, for TO-9, neon, leads	(3A1222)	1.19
12	TO-5 HEAT SINKS, for TO-5 metal & plastic transistors, fin type	(3A1832)	1.19
12	TRANSISTOR SOCKETS, asst styles for NPN & PNP types	(3A1905)	1.19
20	THERMISTORS, a resistor that changes with temp, protect!	(3A2048)	1.19
40	INSULATED RF CHOKES, resistor n sq. styles, coded	(3A3203)	1.19
30	WIRE NUTS, tie, 2 bare ended wires together	(3A3724)	1.19
3	BLANK PC BOARDS, 4 1/2" x 6 1/2", double sided, G-10	(3A3824)	1.19
2	BLANK PC BOARDS, 5 1/2" x 6 1/2", double sided, G-10	(3A3824)	1.19
10	OPEN FACE READOUTS, singlen, doubles, some missing segs	(3A3952)	1.19
3	"PIGGY-BACK" IC SOCKETS, will hold 2-14 pin IC's on-a-slub	(3A3486)	1.19
10	FIBER OPTIC LIGHT PIPE, 12" long highly polished end, 1/8" pin jack	(3A2693)	1.19
4	"ERIE" TEST ANTENNA, 100' length, Scott, Fisher hi-fi eqpt	(3A3400)	1.19
60	TUBULAR CAPS, asst molded, plastic, mylar, values, volts	(3A219)	1.19
55	LOW NOISE RESISTORS, for hi-fi, metal films 5% 1/4 to 2W	(3A3220)	1.19
50	POWER RESISTORS, wirewound, 1/4, 1/2, 1, 2, 5, 10, 20 w. asst	(3A2428)	1.19
60	COILS & CHOKES, r.f. ant, parasitic, i-f, etc. (3A297)		1.19
75	HALF WATTERS, resistors, color-coded, carbon, hi Q, most pop	(3A454)	1.19
10	SOLAR CAPS, silicon, "broken energy", each chip 0.5v, asst mila	(3A5083)	1.19

TTL'S

Type	Description	Sale
SN7400	4	\$0.14
SN7401	14	.14
SN7402	17	.17
SN7403	3	.17
SN7404	17	.17
SN7405	18	.19
SN7406	19	.19
SN7407	18	.19
SN7408	18	.19
SN7410	14	.18
SN7411	19	.19
SN7412	3	.18
SN7414	61	.19
SN7417	26	.24
SN7420	14	.18
SN7427	14	.18
SN7430	14	.18
SN7432	24	.24
SN7433	24	.24
SN7434	24	.24
SN7441	79	.79
SN7442	49	.49
SN7445	69	.69
SN7446	79	.79
SN7447	75	.75
SN7450	14	.14
SN7451	14	.14
SN7452	28	.28

LINEARS

Type	Description	Sale
LM301M	V	\$2.25
LM307M	V, N	.25
LM308M	V	.79
LM309M	V	1.19
LM311M	V	1.19
LM320T	5V	1.19
LM320T	15V	1.19
LM320T	12V	1.19
LM320M	15V	1.19
LM340T	5V	1.19
LM340T	12V	1.19
LM340T	15V	1.19
LM340M	15V	1.19
LM340M	12V	1.19
LM340M	15V	1.19
LM322M	1.19	1.19
LM324M	.99	1.19
LM339M	1.09	1.19
LM377M	1.50	1.50

COMPUTER GRAPHICS 2 for \$8 "JOYSTICK" \$4.50

- 4 Four 100k pots!
 - Chrome handle and knob
- Wt. 10 oz. Cat. No. 3A3808A

WRITE FOR POLY PAKS CATALOG FEATURING BEST BARGAINS IN ELECTRONICS

TERMS: Add postage. Rated: net 30
Phone: Wakefield, Mass. (617) 245-382
Retail: 16-18 Del Carline St., Wakefield.

MINIMUM ORDER - \$6.00

POLY PAKS

C.O.D.'s MAY BE PHONED

P.O. BOX 942A LYNNFIELD, MA.

ADVA

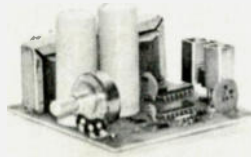

KIT \$11⁹⁵

ASSEMBLED \$17.95
ADD \$1.25 FOR
POSTAGE/HANDLING

VARIABLE POWER SUPPLY

- Continuously Variable from 2V to over 15V
- Short-Circuit Proof
- Typical Regulation of 0.1%
- Electronic Current Limiting at 300mA
- Very Low Output Ripple
- Fiberglass PC Board Mounts All Components
- Assemble in about One Hour
- Makes a Great Bench or Lab Power Supply
- Includes All Components except Case and Meters

OTHER ADVA KITS:

LOGIC PROBE KIT Use with CMOS TTL, DTL, RTL, HTL, HiZIL and most MOS IC's. Built in protection against polarity reversal and overvoltage. Draws only a few mA from circuit under test. Dual LED readout. Complete kit includes case and clip leads. **ONLY \$7.95**

FIXED REGULATED POWER SUPPLY KITS Short-circuit proof with thermal current limiting. Compact size and typical regulation of 0.5% make these ideal for most electronic projects. Available for 5V @ 500mA, 6V @ 500mA, 9V @ 500mA, 12V @ 400mA, 15V @ 300mA. Specify voltage when ordering. **\$9.95 ea**

These easy to assemble kits include all components, complete detailed instructions and plated fiberglass PC boards. Power supply kits do not include case or meters. Add \$1.25 per kit for postage and handling.

1 MAIL NOW! FREE DATA SHEETS supplied with many items from this ad. FREE ON REQUEST 741 Op Amp with every order of \$5 or more—749 Dual Op Amps or two E100 FET's with every order of \$10 or more. Postmarked prior to 12/31/77. One free item per order. **ORDER TODAY!** All items subject to prior sale and prices subject to change without notice. All items are new surplus parts. 100% functionally tested.

WRITE FOR FREE CATALOG #77 offering over 700 semiconductors carried in stock. Send 13¢ stamp.

TERMS Send check or money order (U.S. funds) with order. Add 5% postage for U.S. Canada and Mexico. \$1.00 handling charge on orders under \$10. Calif. residents add 6% sales tax. Foreign orders add 10% postage. COD orders add \$1.00 service charge.

MORE SPECIALS:

RC4195DN ·15V @ 50mA VOLTAGE REGULATOR IC. Very easy to use. Makes a neat Highly Regulated ·15V Supply for OP AMP's, etc. Requires only unregulated DC (18-30V) and 2 bypass capacitors. With Data Sheet and Schematics. 8-pin mDIP. **\$1.25**

RC4136 Quad 741 Low-Noise Op Amp mDIP. **0.99**

LM1304 FM Multiplex Stereo Demodulator DIP. **0.99**

LM2111 FM IF Subsystem (IF Amp, Det., Limiter) DIP. **0.99**

1N6263 Hot Carrier Diode 0.4V @ 1mA 0.35 DO 35. **1.00**

ZENERS—Specify Voltage 3.3, 3.9, 4.3, 5.1, 6.8, 8.2, 9.1, 10, 12, 15, 16, 18, 20, 22, 24, 27, or 33V (-10%) 1 Watt 3/\$1.00

- MONEY-BACK GUARANTEE
- ALL TESTED AND GUARANTEED

ADVA

ELECTRONICS
BOX 4181 EP, WOODSIDE, CA 94062
Tel. (415) 851-0455

FREE

IC or FET's WITH
\$5 & \$10 ORDERS.†
DATA SHEETS
WITH MANY ITEMS.

DIODES & RECTIFIERS	TRANSISTORS	TRANSISTORS	TRANSISTORS	LINEAR IC's
1N4561 to 0.75	2N700 30 24	2N4001 3/81	2N6630 2/81	LM340K 5 \$1.20
1N4562 0.75	2N718 24	2N4002 30 75	2N6640 2/81	LM340T 5 1.20
1N4563 0.75	2N720 45	2N4011 3/81	CPM43 54.00	LM340T 6 1.20
1N4564 0.75	2N721 3/81	2N4122 3/81	CPM50 55.00	LM340T 12 1.20
1N4565 0.75	2N1613 30 29	2N4124 5/81	CPM51 54.00	LM340T-10 1.20
1N4566 0.75	2N1711 29	2N4240 5/81	E100 4/81	LM340T-20 1.20
1N4567 0.75	2N1800 33	2N4240 5/81	E101 3/81	LM340T-24 1.20
1N4568 0.75	2N1803 33	2N4250 6/81	E102 3/81	LM340T-28 1.20
1N4569 0.75	2N2210 24	2N4274 6/81	E175 3/81	LM340N 1.20
1N4570 0.75	2N2222 0.75	2N4302 30 26	MPP 102 10 3/81	NE555V 2/81
1N4571 0.75	2N2222A 0.75	2N4302 30 26	MPP 104 10 3/81	NE556A 30 90
1N4572 0.75	2N2903 5/81	2N4330 31	MPP 112 4/81	LM700C 30
1N4573 0.75	2N2905 5/81	2N4300 2/81	MPP 0515 3/81	LM700C 20
1N4574 0.75	2N2906 5/81	2N4301 31	SE1001 4/81	LM721H 2/81
1N4575 0.75	2N2906 5/81	2N4302 30 30	SE1002 4/81	LM721H 3/81
1N4576 0.75	2N2906 5/81	2N4302 30 30	SE2001 4/81	LM723H 3/81
1N4577 0.75	2N2906 5/81	2N4302 30 30	SE2002 4/81	LM741C 3/81
1N4578 0.75	2N2906 5/81	2N4302 30 30	SE2003 4/81	LM741C 4/81
1N4579 0.75	2N2906 5/81	2N4302 30 30	SE2004 4/81	LM741C 5/81
1N4580 0.75	2N2906 5/81	2N4302 30 30	SE2005 4/81	LM741C 6/81
1N4581 0.75	2N2906 5/81	2N4302 30 30	SE2006 4/81	LM741C 7/81
1N4582 0.75	2N2906 5/81	2N4302 30 30	SE2007 4/81	LM741C 8/81
1N4583 0.75	2N2906 5/81	2N4302 30 30	SE2008 4/81	LM741C 9/81
1N4584 0.75	2N2906 5/81	2N4302 30 30	SE2009 4/81	LM741C 10/81
1N4585 0.75	2N2906 5/81	2N4302 30 30	SE2010 4/81	LM741C 11/81
1N4586 0.75	2N2906 5/81	2N4302 30 30	SE2011 4/81	LM741C 12/81
1N4587 0.75	2N2906 5/81	2N4302 30 30	SE2012 4/81	LM741C 13/81
1N4588 0.75	2N2906 5/81	2N4302 30 30	SE2013 4/81	LM741C 14/81
1N4589 0.75	2N2906 5/81	2N4302 30 30	SE2014 4/81	LM741C 15/81
1N4590 0.75	2N2906 5/81	2N4302 30 30	SE2015 4/81	LM741C 16/81
1N4591 0.75	2N2906 5/81	2N4302 30 30	SE2016 4/81	LM741C 17/81
1N4592 0.75	2N2906 5/81	2N4302 30 30	SE2017 4/81	LM741C 18/81
1N4593 0.75	2N2906 5/81	2N4302 30 30	SE2018 4/81	LM741C 19/81
1N4594 0.75	2N2906 5/81	2N4302 30 30	SE2019 4/81	LM741C 20/81
1N4595 0.75	2N2906 5/81	2N4302 30 30	SE2020 4/81	LM741C 21/81
1N4596 0.75	2N2906 5/81	2N4302 30 30	SE2021 4/81	LM741C 22/81
1N4597 0.75	2N2906 5/81	2N4302 30 30	SE2022 4/81	LM741C 23/81
1N4598 0.75	2N2906 5/81	2N4302 30 30	SE2023 4/81	LM741C 24/81
1N4599 0.75	2N2906 5/81	2N4302 30 30	SE2024 4/81	LM741C 25/81
1N4600 0.75	2N2906 5/81	2N4302 30 30	SE2025 4/81	LM741C 26/81
1N4601 0.75	2N2906 5/81	2N4302 30 30	SE2026 4/81	LM741C 27/81
1N4602 0.75	2N2906 5/81	2N4302 30 30	SE2027 4/81	LM741C 28/81
1N4603 0.75	2N2906 5/81	2N4302 30 30	SE2028 4/81	LM741C 29/81
1N4604 0.75	2N2906 5/81	2N4302 30 30	SE2029 4/81	LM741C 30/81
1N4605 0.75	2N2906 5/81	2N4302 30 30	SE2030 4/81	LM741C 31/81
1N4606 0.75	2N2906 5/81	2N4302 30 30	SE2031 4/81	LM741C 32/81
1N4607 0.75	2N2906 5/81	2N4302 30 30	SE2032 4/81	LM741C 33/81
1N4608 0.75	2N2906 5/81	2N4302 30 30	SE2033 4/81	LM741C 34/81
1N4609 0.75	2N2906 5/81	2N4302 30 30	SE2034 4/81	LM741C 35/81
1N4610 0.75	2N2906 5/81	2N4302 30 30	SE2035 4/81	LM741C 36/81
1N4611 0.75	2N2906 5/81	2N4302 30 30	SE2036 4/81	LM741C 37/81
1N4612 0.75	2N2906 5/81	2N4302 30 30	SE2037 4/81	LM741C 38/81
1N4613 0.75	2N2906 5/81	2N4302 30 30	SE2038 4/81	LM741C 39/81
1N4614 0.75	2N2906 5/81	2N4302 30 30	SE2039 4/81	LM741C 40/81
1N4615 0.75	2N2906 5/81	2N4302 30 30	SE2040 4/81	LM741C 41/81
1N4616 0.75	2N2906 5/81	2N4302 30 30	SE2041 4/81	LM741C 42/81
1N4617 0.75	2N2906 5/81	2N4302 30 30	SE2042 4/81	LM741C 43/81
1N4618 0.75	2N2906 5/81	2N4302 30 30	SE2043 4/81	LM741C 44/81
1N4619 0.75	2N2906 5/81	2N4302 30 30	SE2044 4/81	LM741C 45/81
1N4620 0.75	2N2906 5/81	2N4302 30 30	SE2045 4/81	LM741C 46/81
1N4621 0.75	2N2906 5/81	2N4302 30 30	SE2046 4/81	LM741C 47/81
1N4622 0.75	2N2906 5/81	2N4302 30 30	SE2047 4/81	LM741C 48/81
1N4623 0.75	2N2906 5/81	2N4302 30 30	SE2048 4/81	LM741C 49/81
1N4624 0.75	2N2906 5/81	2N4302 30 30	SE2049 4/81	LM741C 50/81
1N4625 0.75	2N2906 5/81	2N4302 30 30	SE2050 4/81	LM741C 51/81
1N4626 0.75	2N2906 5/81	2N4302 30 30	SE2051 4/81	LM741C 52/81
1N4627 0.75	2N2906 5/81	2N4302 30 30	SE2052 4/81	LM741C 53/81
1N4628 0.75	2N2906 5/81	2N4302 30 30	SE2053 4/81	LM741C 54/81
1N4629 0.75	2N2906 5/81	2N4302 30 30	SE2054 4/81	LM741C 55/81
1N4630 0.75	2N2906 5/81	2N4302 30 30	SE2055 4/81	LM741C 56/81
1N4631 0.75	2N2906 5/81	2N4302 30 30	SE2056 4/81	LM741C 57/81
1N4632 0.75	2N2906 5/81	2N4302 30 30	SE2057 4/81	LM741C 58/81
1N4633 0.75	2N2906 5/81	2N4302 30 30	SE2058 4/81	LM741C 59/81
1N4634 0.75	2N2906 5/81	2N4302 30 30	SE2059 4/81	LM741C 60/81
1N4635 0.75	2N2906 5/81	2N4302 30 30	SE2060 4/81	LM741C 61/81
1N4636 0.75	2N2906 5/81	2N4302 30 30	SE2061 4/81	LM741C 62/81
1N4637 0.75	2N2906 5/81	2N4302 30 30	SE2062 4/81	LM741C 63/81
1N4638 0.75	2N2906 5/81	2N4302 30 30	SE2063 4/81	LM741C 64/81
1N4639 0.75	2N2906 5/81	2N4302 30 30	SE2064 4/81	LM741C 65/81
1N4640 0.75	2N2906 5/81	2N4302 30 30	SE2065 4/81	LM741C 66/81
1N4641 0.75	2N2906 5/81	2N4302 30 30	SE2066 4/81	LM741C 67/81
1N4642 0.75	2N2906 5/81	2N4302 30 30	SE2067 4/81	LM741C 68/81
1N4643 0.75	2N2906 5/81	2N4302 30 30	SE2068 4/81	LM741C 69/81
1N4644 0.75	2N2906 5/81	2N4302 30 30	SE2069 4/81	LM741C 70/81
1N4645 0.75	2N2906 5/81	2N4302 30 30	SE2070 4/81	LM741C 71/81
1N4646 0.75	2N2906 5/81	2N4302 30 30	SE2071 4/81	LM741C 72/81
1N4647 0.75	2N2906 5/81	2N4302 30 30	SE2072 4/81	LM741C 73/81
1N4648 0.75	2N2906 5/81	2N4302 30 30	SE2073 4/81	LM741C 74/81
1N4649 0.75	2N2906 5/81	2N4302 30 30	SE2074 4/81	LM741C 75/81
1N4650 0.75	2N2906 5/81	2N4302 30 30	SE2075 4/81	LM741C 76/81
1N4651 0.75	2N2906 5/81	2N4302 30 30	SE2076 4/81	LM741C 77/81
1N4652 0.75	2N2906 5/81	2N4302 30 30	SE2077 4/81	LM741C 78/81
1N4653 0.75	2N2906 5/81	2N4302 30 30	SE2078 4/81	LM741C 79/81
1N4654 0.75	2N2906 5/81	2N4302 30 30	SE2079 4/81	LM741C 80/81
1N4655 0.75	2N2906 5/81	2N4302 30 30	SE2080 4/81	LM741C 81/81
1N4656 0.75	2N2906 5/81	2N4302 30 30	SE2081 4/81	LM741C 82/81
1N4657 0.75	2N2906 5/81	2N4302 30 30	SE2082 4/81	LM741C 83/81
1N4658 0.75	2N2906 5/81	2N4302 30 30	SE2083 4/81	LM741C 84/81
1N4659 0.75	2N2906 5/81	2N4302 30 30	SE2084 4/81	LM741C 85/81
1N4660 0.75	2N2906 5/81	2N4302 30 30	SE2085 4/81	LM741C 86/81
1N4661 0.75	2N2906 5/81	2N4302 30 30	SE2086 4/81	LM741C 87/81
1N4662 0.75	2N2906 5/81	2N4302 30 30	SE2087 4/81	LM741C 88/81
1N4663 0.75	2N2906 5/81	2N4302 30 30	SE2088 4/81	LM741C 89/81
1N4664 0.75	2N2906 5/81	2N4302 30 30	SE2089 4/81	LM741C 90/81
1N4665 0.75	2N2906 5/81	2N4302 30 30	SE2090 4/81	LM741C 91/81
1N4666 0.75	2N2906 5/81	2N4302 30 30	SE2091 4/81	LM741C 92/81
1N4667 0.75	2N2906 5/81	2N4302 30 30	SE2092 4/81	LM741C 93/81
1N4668 0.75	2N2906 5/81	2N4302 30 30	SE2093 4/81	LM741C 94/81
1N4669 0.75	2N2906 5/81	2N4302 30 30	SE2094 4/81	LM741C 95/81
1N4670 0.75	2N2906 5/81	2N4302 30 30	SE2095 4/81	LM741C 96/81
1N4671 0.75	2N2906 5/81	2N4302 30 30	SE2096 4/81	LM741C 97/81
1N4672 0.75	2N2906 5/81	2N4302 30 30	SE2097 4/81	LM741C 98/81
1N4673 0.75	2N2906 5/81	2N4302 30 30	SE2098 4/81	LM741C 99/81
1N4674 0.75	2N2906 5/81	2N4302 30 30	SE2099 4/81	LM741C 100/81

*SUPER SPECIALS:

1N34 Germanium Diode	10/81	FSA2501M Diode Array	2/81
1N914 100V/10mA Diode	20/81	MPP 102 200MHz RF Amp	3/81
1N4001 50V/1A Rectifier	15/81	40673 MOSFET RF Amp	\$1.75
1N4154 30V 1N914	25/81	LM324 Quad 741 Op Amp	.94
BR1 50V 1/4 Bridge Rec	4/81	LM376 Pos Volt Reg mDIP	.55
2N2222 NPN Transistor	6/81	NE555 Timer mDIP	.38
2N2907 PNP Transistor	6/81	LM723 2.7V Reg DIP	3/81
2N3056 Power Xistor 10A	\$0.75	LM741 Comp Op Amp mDIP	6/81
2N3904 NPN Amp/Sw 100	6/81	LM1458 Dual 741 mDIP	3/81
2N3906 PNP Amp/Sw 100	6/81	CA3086 5 Trans Array DIP	.62
CP650 Power FET 1/2 Amp	\$5	RCA229 Pwr Xistor 1A 30W	.70
RF391 RF Power Amp Transistor 10.25W @ 3.30MHz TO 3	\$5.00		
565X Timer 1/2 1hr Different pinout from 555 (w/data)	3/81		
RC4194T K Dual Tracking Regulator ·0.2 to 30V @ 200mA TO-66	\$2.50		
RC4195T K Dual Tracking Regulator ·15V @ 100mA (TO-66)	\$2.25		
8038 Waveform Generator ~ 1A Wave With Circuits & Data			

For once in your life...live.

A sleek graceful sailing vessel glides across the sometimes green, sometimes blue Caribbean. The cargo: you. And an intimate group of lively, fun-loving shipmates.

Uniform of the day: Shorts and tee shirts. Or your bikini if you want. And bare feet.

Mission: A leisurely cruise to remote islands with names like Martinique, Grenada, Antigua—those are the ones you've heard of. Before the cruise ends, you'll



know the names of many more. You'll know intimately the enchanting different mood of each...and its own beauty and charm.



Life aboard your big sailing yacht is informal. Relaxed. Romantic.

There's good food. And 'grog.' And a few pleasant comforts... but any resemblance to a plush pretentious resort hotel is accidental.

Spend 6 days exploring paradise.

Spend six nights watching the moon rise and getting to know interesting people. It could be the most meaningful experience of your life...and it's easily the best vacation you've had.



A cruise is forming now. Your share from \$290. Write Cap'n Mike for your free adventure booklet in full color.

Come on and live.



Windjammer Cruises.

W10

Name _____

Address _____

City _____ State _____ Zip _____

Phone _____

P.O. Box 122, Dept. 622 Miami Beach, FL 33139

NEW

Frequency Counter

\$79.95 kit



UTILIZES NEW MOS-LSI CIRCUITRY

You've requested it, and now it's here! The CT-50 frequency counter kit has more features than counters selling for twice the price. Measuring frequency is now as easy as pushing a button, the CT-50 will automatically place the decimal point in all modes, giving you quick, reliable readings. Want to use the CT-50 mobile? No problem, it runs equally as well on 12 V dc as it does on 110 V ac. Want super accuracy? The CT-50 uses the popular TV color burst freq. of 3.579545 MHz for time base. Tap off a color TV with our adapter and get ultra accuracy — .001 ppm! The CT-50 offers professional quality at the unheard of price of \$79.95. Order yours today!

- CT-50, 60 MHz counter kit \$79.95
- CT-50 WT, 60 MHz counter, wired and tested 159.95
- CT-600, 600 MHz prescaler option for CT-50, add 29.95

SPECIFICATIONS

- Sensitivity: less than 25 mv.
- Frequency range: 5 Hz to 60 MHz, typically 65 MHz
- Gate time: 1 second, 1/10 second, with automatic decimal point positioning on both direct and prescale
- Display: 8 digit red LED .4" height
- Accuracy: 10 ppm, .001 ppm with TV time base!
- Input: BNC, 1 megohm direct, 50 Ohm with prescale option
- Power: 110 V ac 5 Watts or 12 V dc @ 1 Amp
- Size: Approx. 6" x 4" x 2", high quality aluminum case

- Color burst adapter for .001 ppm accuracy
- CB-1, kit \$14.95

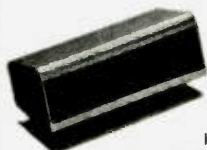

CLOCK KIT 6 digit 12/24 hour

Want a clock that looks good enough for your living room? Forget the competitor's kludges and try one of ours! Features: jumbo .4" digits, Polaroid lens filter, extruded aluminum case available in 5 colors, quality PC boards and super instructions. All parts are included, no extras to buy. Fully guaranteed. One to two hour assembly time. Colors: silver, gold, black, bronze, blue (specify).

- Clock kit, DC-5 \$22.95
- Alarm clock, DC-8, 12 hr only 24.95
- Mobile clock, DC-7 25.95
- Clock kit with 10 min ID timer, DC-10 25.95

Assembled and tested clocks available, add \$10.00

VIDEO TERMINAL KIT \$149.95

A compact 5 x 10 inch PC card that requires only an ASCII keyboard and a TV set to become a complete interactive terminal for connection to your microprocessor asynchronous interface. Its many features are single 5 volt supply, crystal controlled sync and baud rates (up to 9600 baud), 2 pages of 32 characters by 16 lines, read to and from memory, computer and keyboard operated cursor and page control, parity error display and control, power on initialization, full 64 character ASCII display, block type see thru cursor. Keyboard/computer control backspace, forward spaces, line feeds, rev. line feeds, home, returns cursor. Also clears page, clears to end of line, selects page 1 or 2, reads from or to memory. The card requires 5 volts at approx. 900 ma and outputs standard 75 ohm composite video.

- TH3216 Kit \$149.95
- TH3216, Assembled and Tested 239.95
- VO 1, Video to RF Modulator Kit 6.95

CAR CLOCK KIT \$27.95



- 12/24 Hour 12 Volt AC or DC
- High Accuracy (1 minute/month)
- 6 jumbo .4" LED readouts
- Easy, no polarity hookup
- Display blanks with ignition
- Case, mounting bracket included
- Super instructions
- Complete Kit, DC 11 \$27.95

AUTO-DIMMER \$2.50

Automatically adjusts display brightness according to ambient light level. For DC 11 Car Clock.

CHEAP CLOCK KIT \$8.95

- DC-4 Features:
 - 6 digit .4" LED
 - 12 or 24 format
- Does not include board or transformer
- PC Board \$2.95
- Transformer \$1.49

600 MHz PRESCALER



Extend the range of your counter to 600 MHz. Works with all counters. Less than 150 mv sensitivity. Specify 10 or 100. Wired, tested, PS-1B \$59.95
Kit, PS-1B \$44.95

30 watt 2 meter Power Amp

The famous RE class C power amp now available mail order! Four Watts In for 30 Watts out, 2 in for 15 out, 1 in for B out, Incredible value, complete with all parts, instructions and details on T-R relay. Case not included.

- Complete Kit, PA-1 \$22.95

CALENDAR ALARM CLOCK

Has every feature one could ever ask for. Kit includes everything except case, build it into wall, station or even car!

- 6 Digits, .5" High LED
 - Calendar shows mo./day
 - True 24 Hour Alarm
 - Battery back up with built in on chip time base
 - 12/24 Hour Format
 - Snooze button
 - 7001 chip does all!
- Complete Kit, less case, DC-9 \$34.95

LINEAR		REGULATOR		TRANSISTORS	
5314 Clock	\$2.95	555	\$.50	78MG	\$1.49
74S00	.35	556	.75	309K	.89
74S112	.75	566	1.49	309H	.99
7447	.79	567	1.49	340K-12	.99
7473	.35	1458	.50	7805	.89
7475	.50	LED DRIVER		7812	.89
7490A	.55	75491	.50	7815	.89
74143	3.50	75492	.50	7818	.89

DIODES: 1KV 2.5A 5/\$1.00 100V, 1A 10/\$1.00 1N914A type 50/\$2.00

LED DISPLAYS

- FND 35975
- FND 510 1.25
- DL 707 1.25
- HP 7730 1.25



Red Polaroid Filter ... 4.25" X 1.125"59

741 OP-AMP SPECIAL

Factory prime mini dip with both Xerox and 741 part numbers
10 for \$2.00

SOCKETS

- 14 PIN 5/\$1.00
- 16 PIN 5/\$1.00
- 24 PIN 2/\$1.00
- 40 PIN 3/\$2.00

FERRITE BEADS

- with info and specs 15/\$1.00
- 6 hole Balun Beads 6/\$1.00

ramsey electronics

P.O. Box 4072 Rochester NY 14610

(716) 271-6487

TELEPHONE ORDERS
WELCOME



Satisfaction guaranteed or money refunded. C.O.D. add \$1.00. Orders under \$10.00 add \$.75. NY residents add 7% tax.

MINI-KITS

TONE DECODER KIT

A complete tone decoder on a single PC Board. Features: 400-5000 Hz adjustable frequency range, voltage regulation, 567 IC. Useful for touch-tone decoding, tone burst detection, FSK demod, signaling, and many other uses. Use 7 for 12 button touchtone decoding. Runs on 5 to 12 volts.

- Complete Kit, TD-1 \$4.95



SUPER-SNOOP AMPLIFIER

A super-sensitive amplifier which will pick up a pin drop at 15 feet! Great for monitoring baby's room or as a general purpose test amplifier. Full 2 watts of output, runs on 6 to 12 volts, uses any type of mike. Requires 8-45 ohm speaker.

- Complete Kit, BN-9 \$4.95

FM WIRELESS MIKE KIT

Transmit up to 300' to any FM broadcast radio, uses any type of mike. Runs on 3 to 9 V. Type FM-2 has added super sensitive mike preamp.

- FM-1 \$2.95
- FM-2 \$4.95

COLOR ORGAN/MUSIC LIGHTS

See music come alive! 3 different lights flicker with music or voice. One light for lows, one for the mid-range and one for the highs. Each channel individually adjustable, and drives up to 300 watts. Great for parties, band music, nite clubs and more.

- Complete Kit, ML-1 \$7.95

LED BLINKY KIT

A great attention getter which alternately flashes 2 Jumbo LEDs. Use for name badges, buttons, or warning type panel lights. Runs on 3 to 9 volts.

- Complete Kit \$2.95

POWER SUPPLY KIT

Complete triple regulated power supply provides variable ±15 volts at 200 mA and ±5 volts at 1 Amp. 50 mV load regulation good filtering and small size. Kit less transformers. Requires 55 V at 1 Amp and 18 to 30 VCT.

- Complete Kit, PS-3LT \$6.95

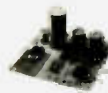

SIREN KIT

Produces upward and downward wail characteristic of police siren. 5 watts audio output, runs on 3-9 volts, uses 8-45 ohm speaker.

- Complete Kit, SM-3 \$2.95

DECADE COUNTER PARTS

Includes: 7490A, 7475, 7447, LED readout, current limit resistors, and instructions on an easy to build low cost frequency counter.

- Kit of parts, DCU-1 \$3.50

THINKING ABOUT OSCAR?

Here are some helpful suggestions -

FAMOUS HAMTRONICS PREAMPS

let you hear the weak ones!

Great for OSCAR, SSB, FM, ATV. Over 10,000 in use throughout the world on all types of receivers.

P9 Kit \$12.95
P14 Wired \$24.95



Deluxe vhf model for applications where space permits.

- 1-1/2 x 3" • Covers only 4 MHz band • 12 Vdc
- Ideal for OSCAR • Diode protection • 20dB gain

MODEL	RANGE
P9-LO	26-88 MHz
P9-HI	88-172 MHz
P9-220	172-230 MHz
P14 Wired	Give exact band



P8 Kit \$10.95
P16 Wired \$21.95

- Covers only 4 MHz band
- 20 dB gain • 12 Vdc
- Miniature VHF model for tight spaces - size only 1/2 x 2-3/8 inches.

MODEL	RANGE
P8-LO	20-83 MHz
P8-HI	83-190 MHz
P8-220	220-230 MHz
P16 Wired	Give exact band

P15 Kit \$18.95
P35 Wired \$34.95



- Covers only 6 MHz band in UHF range of 380-520 MHz
- 20 dB gain • Low noise

FM/CW TRANSMITTER KITS

BUILD UP YOUR OWN GEAR FOR OSCAR CW OPERATION, FM REPEATERS, CONTROL LINKS

- Professional Sounding Audio • Free of Spurs
- Completely Stable • Built-in Testing Aids



T40 11 Channel 200 MW Exciter Kit for 2M or 6M band..... \$39.95
T20 Tripler/Driver Kit. Use with T40 for operation on 432-450 MHz band..... \$19.95

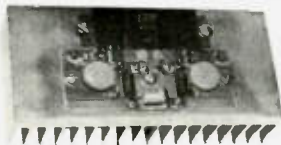

T80 RF POWER AMPLIFIER MODULES FOR ABOVE
• No tuning • VSWR Protected • Wired and Tested
• Rated for Continuous Duty - Great for Repeaters
T80-150: 140-175 MHz, 20-25W output \$79.95
T80-450: 430-470 MHz, 13-15W output \$79.95

AT LAST! A 2 METER SSB TRANSVERTER

At a price you can afford

Use inexpensive recycled 10 or 11 meter ssb exciter on 2 meters.

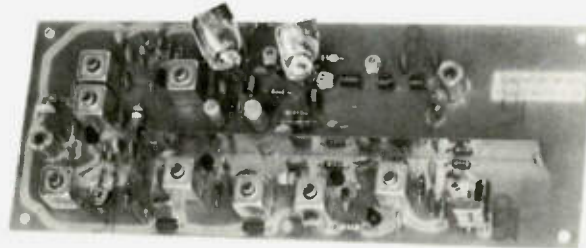

FEATURES:

- Linear Converter for SSB, CW, FM, etc.
- A fraction of the price of other units
- 2W p.e.p. output with 5 MW of drive
- Use low power tap on exciter or attenuator pad
- Easy to align with built-in test points

VX2-() TRANSVERTER KIT \$59.95
A25 Optional Cabinet for Xverter&PA \$20

Frequency Schemes Available:

VX2-4 28-30 = 144-146 □ Other frequency ranges available on special order
VX2-5 28-29 = 145-146 □
VX2-6 26-28 = 144-146 □

2M LINEAR POWER AMPLIFIERS:

LPA 2-15 Kit 15 W p.e.p. \$69.95
LPA 2-70 Kit 70 W p.e.p. \$139.95

New VHF&UHF Converter Kits

let you receive OSCAR signals and other exciting SSB, CW, & FM activity on your present HF receiver.



either one
- ONLY \$34.95
including crystal



MODEL	RF RANGE (MHZ)	I-F RANGE
C50	50-52	28-30
C144	144-146	28-30
C145	145-147 (OSCAR)	28-30
C146	146-148	28-30
C110	Aircraft	28-30
C220	220 band	28-30
Special	Other i-f & rf ranges available	

MODEL	RF RANGE (MHZ)	I-F RANGE
C432-2	432-434	28-30
C432-5	435-437 (OSCAR)	28-30
C432-7	427.25	61.25
C432-9	439.25	61.25
Special	Other i-f & rf ranges available	
A9 Extruded Alum Case/Connectors		\$12.95

VHF/UHF FM RCVR KITS

- ★ NEW GENERATION RECEIVERS
- ★ MORE SENSITIVE ★ MORE SELECTIVE (70 or 100 dB)
- ★ COMMERCIAL GRADE DESIGN
- ★ EASY TO ALIGN WITH BUILT-IN TEST CKTS
- ★ LOWER OVERALL COST THAN EVER BEFORE



R70 6-channel VHF Receiver Kit for 2M, 6M, 10M, 220 MHz, or com'l bands..... \$69.95
Optional xtal filter for 100 dB adj chan 10.00



R90 UHF Receiver Kit for any 2 MHz segment of 380-520 MHz band..... \$89.95

* FREE 1978 CATALOG *

40 PAGE CATALOG IS YOURS FOR THE ASKING!

IT'S EASY TO ORDER!

- ☛ CALL OR WRITE NOW FOR FREE CATALOG OR TO PLACE ORDER!
- ☛ PHONE 716-663-9254. (Answering service evenings and weekends for your convenience. Personal service 9-5 eastern time.)
- ☛ Use credit card, c.o.d., check, m.o.
- ☛ Add \$2.00 shipping & handling.

IN CANADA, send to Comtec; 5605 Westluxe Ave; Montreal, Que H4W 2N3 or phone 514-482-2640. Add 28% to cover duty, tax, and exchange rate.

hamtronics, inc.

182-D Belmont Rd; Rochester, NY 14612 H16

BULLET ELECTRONICS

B8

P. O. BOX 19442E DALLAS, TEXAS 75219

- * No COD S
- * Send check or MO
- * MasterCard or VISA accepted
- * Texas Residents add 5% sales tax
- * Foreign orders add 10% (20% airmail)
- * Catalog included with each order
- * Orders over \$50. take 10% discount.

PHONE ORDERS (214/823-3240) ON MASTERCARD & VISA

PS-14 12V, 15A Power Supply Kit

If its **POWER** you need, than look no further. The PS-14 gives you a highly regulated power supply with features only the commercial units offer at a fraction of the cost. Compare our specs with any other unit on the market and then compare our price!

YOU GET:

- * Heavy duty 12 lb. transformer
- * 2 large finned heatsinks
- * Regulator PC board with all parts.
- * Huge 34,000 mfd computer grade filter cap.
- * 40 amps of series pass transistors
- * Wire, transistor mounting kits, line cord.

SPES:

Output: 11.5-14.5 adjustable
Current: 15A continuous; 20A int.
Current Limit: Adjustable Foldback type
Ripple: Less than 1% @ 15A
Regulation: Better than 200 millivolts from no load to full load
Thermal: Adjustable thermal shut down protects series pass.

\$39.95

Less Case & Meters

THE LAST CHANCE!

THAT'S RIGHT! THE LAST CHANCE TO BUY OUR SUPER POPULAR MK-05 MINI MOBILE SIX DIGIT CLOCK KIT at this super low price. The response has been great but supplies are starting to run low. So order NOW!

Features:

- * Quartz crystal timebase
- * Toroid & zener noise & over-voltage protection.
- * Magnified .15": 6 digit LED readout
- * Complete with presettable 24 hr. alarm.
- * 9-14 VDC @ 40 to 50 ma.
- * Readouts can be suppressed
- * EASY, QUICK ASSEMBLY!
- * All components required included (you supply the speaker).
- * Top quality drilled & plated PC Boards
- * Clock board: 2.6" x 2"
- * Readout board: 2 3/8" x .75"

Small enough to mount in the instrument panel.

\$12.95

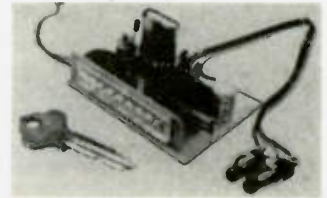

METERS: Quality 3 1/2" meters for PS 14. 0-15VDC. 0-25 ACD matched set. Individually packaged. **NOT SURPLUS!**

12.50/set

OVERVOLTAGE PROTECTION KIT: \$6.95

Provides cheap insurance for your expensive equipment. Trip voltage is adjustable from 3 to 30 volts. Overvoltage instantly fires a 25A SCR and shorts the output to protect equipment. Should be used on units that are fused. Directly compatible with the PS-12 and PS-14. All electronics supplied. Drilled & plated PC board. (Order OVP1)

2N6028
Programmable uni-
junction super for
oscillators, timers,
time delay etc. 50c



SPECIAL!
Limited Qty!
LM567 Tone
Decoders
while they last!
99c



2N6111
PNP
Transistors
40Watt 3A
TO 220 case
2/\$1.00

ROCKER
SWITCHES
DPDT Rocker
Switches
5/\$1.00

220mfd
@25V
Axial Cap
7/\$1.00

741 Amps
8 pin mini dip
5/\$1.00
1458 Dual 741's
8 pin mini dip
3/\$1.00

MICRO TRIMMER
CAPS
Tiny 4.40 pfd
trimmer used orig-
inally in watches!
3/\$1.00

MJ900; MJ1000
Complimentary Dar-
lington. PNP. NPN
power transistor. 8
amps. pair for \$3.

Multicolored
26 Conductor
Ribbon Cable
No. 28 wire with
a woven binder. Su-
per Flexible!
10' roll - \$2.95
50' roll - \$9.95

500mfd
@35V
Axial Cap
5/\$1.00

1100mfd @ 35
Axial Capacitor
4/\$1.00
Sprague

Heatshrink
Tubing
A very good asst.
of 3/32", 1/8",
3/16", 1/4" & 7/16",
6" lengths 12 pcs.
75c

MC1469R
500ma postive regu-
lator. 3 to 30 volts.
with complete specs
and applications.
\$1.25 - house no.

MC1351P FM IF
AMP. 14 pin IC.
Complete FM sound
subsystem, similar to
LM2111. house no.
5/\$1.00

WESTON MICRO
PC mount trim
pots. Single turn
K. 3/\$1.00

Above item
FREE!
with \$15.00
purchase or
more!

No. 30 Wirewrap
Wire. Kynar jacket.
4 colors. 100 ft.
of each color. \$4.00
(400')

CA3011 Wideband
IC 50c

2N3569 NPN
epoxy TO-5 case.
VCE=60; Hfe=300
800MW power
6/\$1.00



BULLET LUCKY
NUMBER FOR FEB.
IS: 158501. (Num-
ber worth \$100.; num-
bers are in catalogs.)

FANTASTIC NEW SOUND SYNTHESIZER IC \$3.95 each
Make any sound under the sun with this 28-pin marvel!
Single IC contains: Noise generator, super low frequency
OSC, VCO, one shot, mixer envelope control and amp.
works from a single 5 to 9 VDC source. With 8 page manual.

Mini Grandfather Clock Kit - \$39.95

Just in case you have spent the last six months in Siberia, we will tell you one more time that Bullet has the **ONLY** Completely Electronic Grandfather Clock Kit in the world that has all the below listed features. The biggest problem we have is to try and describe how unique and fascinating this clock really is! The Swinging LED Pendulum and Matching Tick-tock sound are available only on our clock. In addition the electronic chime notes each hour (ie: 3 times for 3 o'clock). Housed in the optional Solid Hardwood Case, the unit makes a beautiful addition to any room as well as a great gift.

- * 1/2" 4 digit LED readout
- * Adjustable tone & duration on chime
- * Simulated swinging pendulum uses LEDs
- * All CMOS construction
- * All electronics, switches and transformer included
- * Quality plated PC boards (2) 6.5" x 4.5"

BEAUTIFUL HARDWOOD CASE FOR MG-01: Case is cut, grooved and finished for clock. Includes ruby front filter. Quick, easy assembly requires only 4 screws (inc.) \$19.95

You've read the reviews on our MK-03 clock/Timer Kit. Wait till you see the new MK-03A 6 Digit Clock/Timer Kit:

- * Separate 24 hour clock and 24 hour elapsed timer functions.
- * Presettable alarms on both clock and timer
- * Smaller more compact kit is 2 1/4" wide x 3 5/8" long x 1 1/2" high
- * Super revised manual makes assembly easy
- * Many options available by adding switches.
- * Sold less case & switches.

\$28.95 (Will fit standard 3 1/8" instrument case)

MK-06 Clock/Calendar Auto Home Clock Kit

We designed this to be a **SUPER CLOCK** with ALL the features you want. Quality double sided PC boards make assembly easy. Mobile (12VDC) or home (12VAC)

- * Large 1/2" LED Readout
- * AM/PM Indication
- * 28/30/31 day calendar displays automatically or manually
- * Display can be dimmed
- * Intimid
- * Flashing Colon counts 1/10 seconds
- * Integral Timebase is adjustable
- * Presettable Alarm with Snooze Feature.
- * Noise and voltage protection circuits
- * Single front mounted rotary switch selects all functions

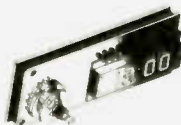

21.50

NEW LSI TECHNOLOGY
FREQUENCY COUNTER

TAKE ADVANTAGE OF THIS NEW STATE-OF-THE-ART COUNTER FEATURING THE MANY BENEFITS OF CUSTOM LSI CIRCUITRY. THIS NEW TECHNOLOGY APPROACH TO INSTRUMENTATION YIELDS ENHANCED PERFORMANCE, SMALLER PHYSICAL SIZE, DRASTICALLY REDUCED POWER CONSUMPTION (PORTABLE BATTERY OPERATION IS NOW PRACTICAL), DEPENDABILITY, EASY ASSEMBLY AND REVOLUTIONARY LOWER PRICING!

- KIT #FC-50C 60 MHZ COUNTER WITH CABINET & P.S. **\$119⁹⁵ COMPLETE!**
- KIT #PSL-650 650 MHZ PRESCALER [NOT SHOWN] 29.95
- MODEL #FC-50WT 60 MHZ COUNTER WIRED, TESTED & CAL. 165.95
- MODEL #FC-50/600 WT. 600 MHZ COUNTER WIRED, TESTED & CAL. 199.95

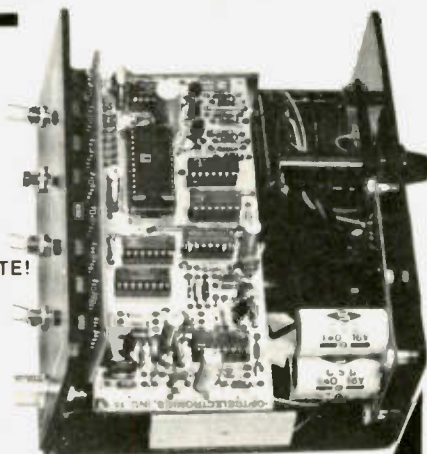

SIZE:
3" High
6" Wide
5 1/2" Deep

FEATURES AND SPECIFICATIONS:

DISPLAY: 8 RED LED DIGITS .4" CHARACTER HEIGHT
GATE TIMES: 1 SECOND AND 1/10 SECOND
PRESCALER WILL FIT INSIDE COUNTER CABINET
RESOLUTION: 1 HZ AT 1 SECOND, 10 HZ AT 1/10 SECOND.
FREQUENCY RANGE: 10 HZ TO 60 MHZ. [65 MHZ TYPICAL].
SENSITIVITY: 10 MV RMS TO 50 MHZ, 20 MV RMS TO 60 MHZ TYP.
INPUT IMPEDANCE: 1 MEGOHM AND 20 PF.
[DIODE PROTECTED INPUT FOR OVER VOLTAGE PROTECTION.]
ACCURACY: ± 1 PPM [± .0001%] AFTER CALIBRATION TYPICAL.
STABILITY: WITHIN 1 PPM PER HOUR AFTER WARM UP [0.001% XTAL]
IC PACKAGE COUNT: 8 [ALL SOCKETED]
INTERNAL POWER SUPPLY: 5 V DC REGULATED.
INPUT POWER REQUIRED: 8-12 VDC OR 115 VAC AT 50/60 HZ.
POWER CONSUMPTION: 4 WATTS

KIT #FC-50C IS COMPLETE WITH PREDRILLED CHASSIS ALL HARDWARE AND STEP-BY-STEP INSTRUCTIONS WIRED & TESTED UNITS ARE CALIBRATED AND GUARANTEED.

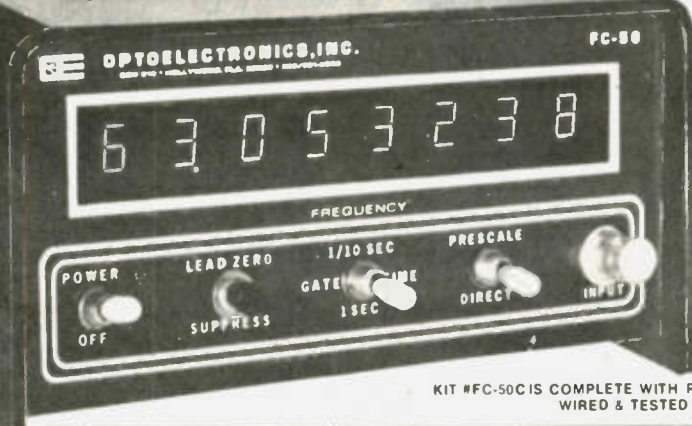

PLEXIGLAS CABINETS

Great for Clocks or any LED Digital project Clear-Red Chassis serves as Bezel to increase contrast of digital displays.

- CABINET I**
3"H, 6 1/4"W, 5 1/2"D Black, White or Clear Cover
- CABINET II**
2 1/2"H, 5"W, 4"D \$6.50 ea

RED OR GREY PLEXIGLAS FOR DIGITAL BEZELS
3"x6"x1/8" 95¢ ea 4/83

SEE THE WORKS Clock Kit
Clear Plexiglas Stand

- 6 Big 4" digits
- 12 or 24 hr time
- 3 set switches
- Plug transformer
- all parts included

Plexiglas is Pre-cut & drilled
Kit #850-4CP

Size 6"H, 4 1/2"W, 3"D
Assembled \$29⁹⁵
\$23⁵⁰ ea 2/45.

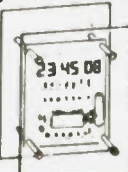

60 HZ. XTAL TIME BASE:
Will enable Digital Clock Kits or Clock-Calendar Kits to operate from 12V DC
1"x2" PC Board
Power Req. 5-15V (2.5 MA TYP.)
Easy 3 wire hookup
Accuracy ± 2PPM
#TB-1 (Adjustable)
Complete Kit \$4⁹⁵
Wir & Cal \$9.95

SPECIAL PRICING!
PRIME - HIGH SPEED RAM

21L02-3 400 NS
LOW POWER - FACTORY FRESH
1-24 \$1.75 ea. 100-199 \$1.45 ea.
25-99 1.60 ea. 200-999 1.39 ea.
1000 AND OVER \$1.29 ea.

5-DIGIT LED CLOCK CALENDAR KIT
DATE-TIME-SNOOZE ALARM & MORE... KIT 7001

FOR THE BUILDER THAT WANTS THE BEST. FEATURING 12 OR 24 HOUR TIME — 29-30-31 DAY CALENDAR. ALARM, SNOOZE AND AUX. TIMER CIRCUITS

Will alternate time (8 seconds) and date (2 seconds) or may be wired for time or date display only, with other functions on demand. Has built-in oscillator for battery back-up. A loud 24 hour alarm with a repeatable 10 minute snooze alarm, alarm set & timer set indicators. Includes 110 VAC/60Hz power pack with cord and top quality components through-out.

- KIT - 7001B WITH 6 - 5" DIGITS \$39.95
- KIT - 7001C WITH 4 - 6" DIGITS & 2 - 3" DIGITS FOR SECONDS \$42.95
- KIT - 7001X WITH 6 - 6" DIGITS \$45.95

KITS ARE COMPLETE (LESS CABINET)

ALL 7001 KITS FIT CABINET I AND ACCEPT QUARTZ CRYSTAL TIME BASE KIT #TB-1

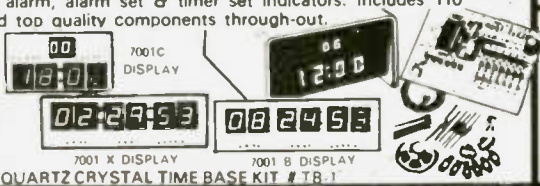

PRINTED CIRCUIT BOARDS for CT 7001 Kits sold separately with assembly info. PC Boards are drilled Fiberglass, solder plated and screened with component layout.

Specify for 7001
B, Car X - \$7.95

AUTO BURGLAR ALARM KIT

EASY TO ASSEMBLE AND EASY TO INSTALL ALARM PROVIDING MANY FEATURES NOT NORMALLY FOUND. REFLEX ALARM HAS PROVISION FOR PDS & GROUNDING SWITCHES OR SENSORS WILL PULSE HORN RELAY AT 1/2 RATE OR DRIVE SIREN KIT PROVIDES PROGRAMMABLE TIME DELAYS FOR EXIT ENTRY & ALARM PERIOD UNIT MOUNTS UNDER DASH - REMOTE SWITCH CAN BE MOUNTED WHERE DESIRED. CMOS RELIABILITY RESISTS FALSE ALARMS & PROVIDES FOR ULTRA DEPENDABLE ALARM. DO NOT BE FOOLED BY LOW PRICES! THIS IS A TOP QUALITY COMPLETE KIT WITH ALL PARTS INCLUDING DETAILED DRAWINGS AND INSTRUCTIONS OR AVAILABLE WIRED AND TESTED.



KIT #ALR-1 \$9.95
#ALR-1WT WIRED & TESTED \$19.95

VARIABLE REGULATED 1 AMP POWER SUPPLY KIT

- VARIABLE FROM 4 TO 14V
- SHORT CIRCUIT PROOF
- 723 IC REGULATOR
- 2N3055 PASS TRANSISTOR
- CURRENT LIMITING AT 1 AMP
- KIT IS COMPLETE INCLUDING DRILLED & SOLDER PLATED FIBERGLASS PC BOARD AND ALL PARTS (LESS TRANSFORMER) KIT #PS-01 \$8.95
- TRANSFORMER 24V CT will provide 300MA at 12V and 1 Amp at 5V. \$3.50

MOBILE LED CLOCK

12/24 HR 4" DIGITS!

MODEL 12 VOLT AC OR DC POWERED #2001



- 6 JUMBO 4" RED LED'S BEHIND RED FILTER LENS WITH CHROME RIM
- SET TIME FROM FRONT VIA HIDDEN SWITCHES • 12/24-Hr. TIME FORMAT
- STYLISH CHARCOAL GRAY CASE OF MOLDED HIGH TEMP. PLASTIC
- BRIDGE POWER INPUT CIRCUITRY — TWO WIRE NO POLARITY HOOK-UP
- OPTIONAL CONNECTION TO BLANK DISPLAY (Use When Key Off In Car, Etc.)
- TOP QUALITY PC BOARDS & COMPONENTS - INSTRUCTIONS.
- MOUNTING BRACKET INCLUDED
- KIT #2061 \$27⁹⁵ 3 OR \$25⁹⁵ 115 VAC Power Pack \$250
COMPLETE KIT EA MORE ea. #AC-1
- ASSEMBLED UNITS WIRED & TESTED ORDER #2001 WT (LESS 9V. BATTERY) \$37⁹⁵ 3 OR \$35⁹⁵ MORE ea.
- Wired for 12-Hr. Op. if not otherwise specified.

ORDER BY PHONE OR MAIL
COD ORDERS WELCOME

OPTOELECTRONICS, INC.

BOX 219 HOLLYWOOD, FLA. 33022
PHONE (305) 921-2056 / 921-4425

ORDERS TO USA & CANADA ADD 5% FOR SHIPPING, HANDLING & INSURANCE. ALL OTHERS ADD 10%. ADDITIONAL \$1.00 CHARGE FOR ORDERS UNDER \$15.00 - COD FEE \$1.00. FLA. RES. ADD 4% STATE TAX.





ALL AMERICAN IC COUNTER KIT



TTL Decade Counter with LED Readout

INCLUDES: 1-7490 Decade Counter

1-7475 BCD Latch

1-7447 Display Driver

1-OPCOA SLA-1 LED R.O.

No Dealers Please!



All This For \$1.99!

3 AMP RECTIFIER

1N4721. Axial Lead. 200 PIV. HEAVY DUTY! House numbered

4 for

Metal Case

\$1.00



8 Amp 200 PIV Triac

TO-220 Case. 3 for \$1.00

SALE!

Prime New

TTL IC's!

7401 - 12c

7447 - 59c

7448 - 59c

7473 - 25c

7474 - 25c

7475 - 49c

7490 - 49c

7491 - 49c

7492 - 42c

7493 - 42c

74194 - 95c



FULL WAVE BRIDGE

4 AMP - 200 PIV



Super Deal!

69¢ ea.

10 for \$5.75!

COMPUTER MFG. OVERRUN!

BYPASS CAPS

.1MFD 10WVDC. Long Leads by Centralab.

New! 15 for \$1.

.25" Lead Spacing

Dual 741 O.P. Amps

#5558 by T.I.

Mini Dip Package

4 for \$1.

POWER RESISTORS

1 OHM 15W. 5%

3/\$1.00

3.16 OHM 2W. 5%

5/\$1.00

T.I. Military Transistor

Government Contractor's Surplus. Originally cost \$3.97 each. TO-18 Metal Case. NPN Silicon VCEO-40 V. ICBO-10 N.A. HFE at 100 ua is 250 to 700. Collector-base capacitance is 4 PF MAX. Spot Noise Figure is 2 DB. MAX. All parts subjected to 200 degrees C for 24 hours minimum. All parts were also burned in for 168 hours at 25 degrees C. All parts RETESTED after burn in. These are super HI-REL, 100 MHZ transistors. Uncle Sam's loss is your gain. We can provide a Ten-page spec. sheet set for 35c extra. (to cover copying cost).

3 for \$1. HIGH BETA!

More Tantalum Caps

4.7MFD 20V-6/\$1.

22MFD 20V-4/\$1.

CMOS SPECIAL!

CD4001 - 5 for \$1.00 CD4011 - 5 for \$1.00
CD4013 - 3 for \$1.00 CD4040 - \$1.00 each
CD4042 - 2 for \$1.00 CD4049 - 3 for \$1.00

2N2904A Transistor

PNP Silicon. TO-5. House no. VCEO-60V. 3 watts. HFE is 40 to 120 at 150 MA. 100 MHZ.

GREAT BUY!

4/\$1.00

Super Brute Rectifier (limited stock)

160 Amps 100 PIV

Stud mount by Motorola

\$6.95 ea. or 4/\$25.



5 Volt NI-CAD Pack Prime new units.

4-AA Cells rated 500 MA HR. are

\$3.95 (pk. of 4) in series.

LS Series TTL

74LS00-33c
74LS02-35c
74LS04-35c
74LS08-35c
74LS10-33c
74LS20-33c
74LS73-49c
74LS74-49c
74LS90-69c
74LS154-1.49
74LS175-1.10
74LS367-75c
74LS368-85c

DIGITAL RESEARCH CORP. P.O. Box 401247 (Of Texas)

FAST CHARGE!

Garland, Tex. 75040 214/271-2461

MOTOROLA QUAD OP - AMP
MC 3401. PIN FOR PIN SUB.
FOR POPULAR LM 3900.
3 FOR \$1

RECTIFIER SPECIAL
1.5 AMP 100PIV
EPOXY CASE AXIAL LEADS
15 FOR \$1

FULL WAVE BRIDGE
4 AMP. 200 PIV.
69c ea. 10 FOR \$5.75

NOT ASSOCIATED WITH DIGITAL
RESEARCH OF CALIFORNIA, THE
SUPPLIERS OF CPM SOFTWARE.

16K E-PROM CARD

S-100 (IMSAI/ALTAIR) BUSS COMPATIBLE

\$69.95 (KIT)

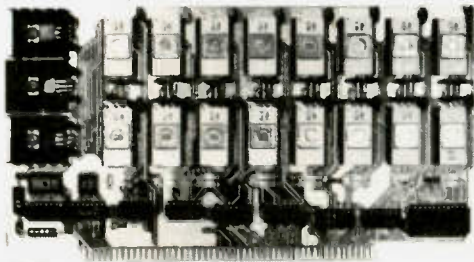

IMAGINE HAVING 16K
OF SOFTWARE ON LINE AT ALL TIME!

KIT FEATURES:

1. Double sided PC Board with solder mask and silk screen and Gold plated contact fingers.
2. Selectable wait states.
3. All address lines and data lines buffered!
4. All sockets included.
5. On card regulators.

USES
2708's!

WOW! DEALER INQUIRES INVITED

KIT INCLUDES ALL PARTS AND SOCKETS! (EXCEPT 2708's)

SPECIAL OFFER: Our 2708's (450 NS) are \$12.95 when purchased with above kit.

ADD \$25 FOR
ASSEMBLED AND TESTED

FULLY STATIC! **\$149.00** KIT

KIT FEATURES:

1. Double sided PC Board with solder mask and silk screen layout. Gold plated contact fingers.
2. All sockets included!
3. Fully buffered on all address and data lines.
4. Phantom is jumper selectable to pin 67.
5. FOUR 7805 regulators are provided on card.

S-100 (IMSAI/ALTAIR)
BUSS COMPATIBLE

8K LOW POWER RAM KIT!

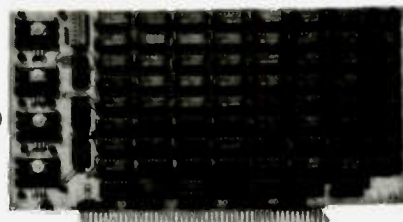

USES
21L02-1
RAM'S.

PRICE WAR!

For a limited time only:
Buy two 8K Kits for **\$129 ea.**

Fully Assembled and Burned In — **\$179.00**
Blank PC Board With Documentation — **29.95**
Low Profile Socket Set — **13.50**
Support IC's (TTL and Regulators) — **9.75**
Bypass CAP's (Disc and Tantalums) — **4.50**



3W AUDIO AMP MODULE

Fully assembled and tested.
With schematic. 4, 8 or 16
OHMS.

\$3.95 NEW!

JUMBO RED LED'S

New by G.E. Like MV5024
#SSL-22

6 FOR \$1 25 FOR \$3.75

POWER RECTIFIER

Stud Mount. 1N1204A. Has
an NCR House number. 12
AMP 400 PIV.

75c ea. 4/\$2.50

NEW!

4K STATIC RAM'S

NEW!

2114. The industry standard. 18 PIN DIP. Arranged as 1K X 4. Equivalent to
FOUR 21L02's in ONE package! TWO chips give 1K X 8. with data.

2 FOR \$24

450 N.S.!

8 FOR \$85

MOTOROLA 7805R VOLTAGE REGULATOR

Same as standard 7805 except 750 MA
OUTPUT. TO-220. 5VDC OUTPUT.
\$.44 each 10 FOR \$3.95

450 NS!

2708 EPROMS

450 NS!

Now Full Speed! Prime new units from a major U.S. Mfg. 450 N.S. Access
time. 1K x 8. Equiv. to 4 1702 A's in one package!

\$15.75 ea.

Special Offer: **\$12.95 ea.** when purchased with our
16K EPROM Kit.

Z - 80 PROGRAMMING MANUAL

By MOSTEK, the major Z - 80 second source. The most detailed explanation
ever on the workings of the Z - 80 CPU CHIPS. At least one full page on each
of the 158 Z - 80 instructions. A MUST reference manual for any user of the
Z - 80. 300 pages. Just off the press! A D.R.C. exclusive! **\$12.95**

CMOS SPECIAL

CD 4001 - 5 For \$1 CD 4040 - \$1 Each
CD 4011 - 5 For \$1 CD 4042 - 2 For \$1
CD 4013 - 3 For \$1 CD 4049 - 3 For \$1

TERMS: ORDERS UNDER \$15 ADD \$.75. NO C.O.D. WE ACCEPT VISA, MASTER CHARGE AND AMERICAN
EXPRESS CARDS. MONEY BACK GUARANTEE ON ALL ITEMS. TEXAS RESIDENTS ADD 5% SALES TAX.

Digital Research Corporation

CALL FOR OUR CATALOG!

WE PAY POSTAGE!

P. O. BOX 401247 • GARLAND, TEXAS 75040 • (214) 271-2461 D20

EXCERPTS FROM OUR FLYER,

8K x 8 Econoram II™

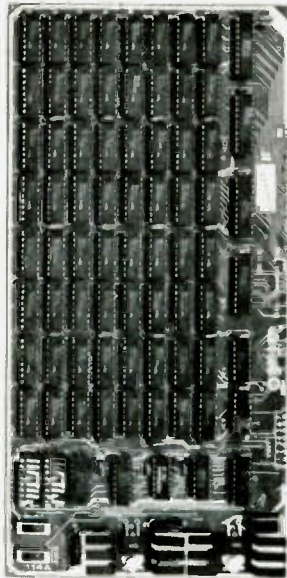

Kit \$135
Assembled \$155
3 kits for \$375

This is the board that thousands of owners swear on, not at. There are lots of reasons, such as unique addressing options, reliability, full buffering, static operation, fast access time, a full set of sockets . . . but probably the most popular feature is the price, which is all the more remarkable because of the high level of quality. One owner reviewed this board in the 1/77 issue of *Kilobaud*, closing with the words "If you're not convinced by now that the Econoram II is one of the best memory buys on the market today, you really have to be one tough cookie—either that or you work for someone else who makes memory boards".

BOOKS

"Some Common BASIC Programs" by Lon Poole and Mary Borchers. If you've got BASIC, here are some programs to play with. #BK-21002, \$7.50.

The Adam Osborne and Associates Books: We offer "An Introduction to Microcomputers", volumes 1 and 2, plus "8080 Programming for Logic Design" at a special combination price of \$25.00 (order #BK-1001). Also available: "6800 Programming for Logic Design". #BK-5001, \$7.50.

"Electronic Projects for Musicians" by Craig Anderson. Now in its third printing. This book has shown musicians and non-musicians alike the basics of home electronic construction. #BK-001, \$7.95.

12K Econoram VI: \$235 (Kit)

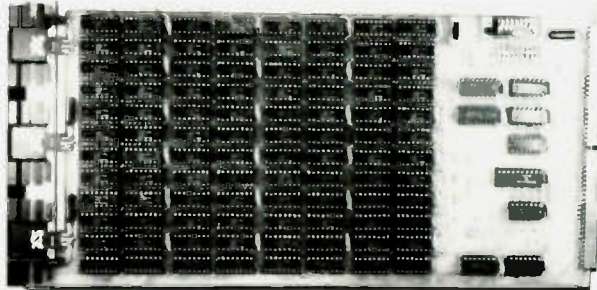

We proudly welcome our newest memory board family member, designed from the ground up for full compatibility with the Heath Company H8. Organized as two independent blocks, one 8K and one 4K. Has the same basic features as our Econoram II™—all static design, switch selected protect and phantom,

sockets for all ICs, full buffering on address and data lines—plus the required hardware and edge connector to mate mechanically with the H8. You can have our 12K board for the price of the Heath Company's 8K . . . with the performance you have come to expect from products carrying the Econoram trade mark.

8K Econoram III: \$149



Fully assembled

The first 8K x 8 dynamic RAM that performs well enough to merit the Econoram™ name. Not a kit; it's assembled, tested, and ready to run in your S-100 machine (Altair, IMSAI, etc.). Low power. Configuration as 2 separate 4K blocks. Zero wait states with 8080 CPU. Includes 1 year warranty.

OTHER POPULAR ITEMS

"Altair/IMSAI Extender Board Kit". We are proud to distribute this Mullen Computer Boards product for the S-100 buss. A must for servicing, taking measurements, burning in, and so on. Integral logic probe, with 7 segment display, needle point non-skid tip, and special edge connector for easy probing; #CK-006, \$35.00. Kit form. Also available: "Relay/Opto-Isolator Control Board Kit". 8 reed relays respond to an 8 bit word; 8 opto-isolators accept inputs for handshaking or further control. With applications notes. #CK-011, \$117.00. Kit form.

"CPU Power Supply". Gives you a full 5V @ 4A with crowbar overvoltage protection, along with +12V @ 1/2A and -12V @ 1/2A . . . and an adjustable (-5 to -10V) 10mA supply for the bias required by some CPUs. Although intended for use with small computer systems, it's also a dandy little bench supply for digital work. #CK-014, \$50.00. Kit form.

"10 Slot Motherboard". Use with the IMSAI microcomputer as an add-on with room for 10 peripherals, or for starting an 11 slot stand-alone system. Comes with all edge connectors, and includes an on-board active termination circuit to minimize the crosstalk, noise, overshoot, and ringing that can occur with unterminated boards. Epoxy glass, solder masked board, with bypass caps and heavy power traces. #CK-015, \$90.00. Kit form.

"18 Slot Motherboard". Same as the 10 Slot Motherboard except with 18 slots. #CK-016, \$124.00. Kit form.

DB-25 RS-232 SUBMINI-D CONNECTORS
 Male plug, #CK-1004, \$3.95; female jack, #CK-1005, \$3.95; plastic hood for male connector, #CK-1006, \$0.90.

"Active Terminator Board". For those of you who have a motherboard without active terminations, plug in this card and obtain the benefits of improved signal transfer, thanks to less noise, crosstalk, ringing, and overshoot. Same circuitry as used in our motherboards. #CK-017, \$29.50. Kit form.

"12V 8A Power Supply". Handles 12A peaks with 50% duty cycle. Includes crowbar overvoltage protection, current limiting, adjustable output 11-14V, custom wound transformer. Easy assembly: all parts except transformer/filter cap/diodes mount on circuit board, including heat sinks and power transistors. While designed for powering automotive equipment in the home, many users report success using these for powering some disk drive systems. #HK-104, \$44.50. Kit form. Please include sufficient postage.

"Interdesign Model 1101 Pulse Generator". Ideal for clocking TTL circuits, from 1 Hz to 2 MHz, 20 to 1 frequency spread for each band. 20% to 80% duty cycle minimum, fully triggerable. Portable for field use, and includes rechargeable nicads and charger for either battery charge or AC operation. If you don't have a pulse generator, here's one at a good price. #Z-006, \$90.00. Fully assembled and tested.

EDGE CONNECTORS
 #CK-1001: 100 pin edge conn. for with gold plated 3 level wrap posts. Mates with Altair/IMSAI peripherals. \$5 each or 5/\$22.
 #CK-1002: Same as above, but with solder tail pins on 0.25" centers (mates with IMSAI motherboard). \$5 each or 5/\$22.
 #CK-1003: Same as above, but with solder tail pins on 0.14" centers (mates with Altair motherboard). \$6 each or 5/\$27.50.

74 LS TTL

74LS00	0.30
74LS01	0.30
74LS02	0.30
74LS04	0.33
74LS08	0.36
74LS10	0.30
74LS11	0.36
74LS12	0.33
74LS14	1.38
74LS15	0.30
74LS20	0.30
74LS21	0.33
74LS22	0.33
74LS26	0.43
74LS27	0.36
74LS30	0.30
74LS32	0.38
74LS37	0.45
74LS38	0.45
74LS42	0.98
74LS47	1.00
74LS48	0.98
74LS74	0.50
74LS75	0.68
74LS76	0.50
74LS86	0.50
74LS109	0.50
74LS125	0.63
74LS126	0.63
74LS132	1.25
74LS138	1.10
74LS139	1.15
74LS151	0.95
74LS155	1.38
74LS157	0.95
74LS160	1.40
74LS161	1.40
74LS162	1.40
74LS163	1.40
74LS168	1.87
74LS169	1.87
74LS173	1.65
74LS174	1.25
74LS175	1.15
74LS240	1.88
74LS257	1.25
74LS258	1.25
74LS266	0.53
74LS283	1.20
74LS365/80LS95	0.75
74LS366/80LS96	0.75
74LS367/80LS97	0.75
74LS368/80LS98	0.75
74LS386	0.55
74LS95	1.13
74LS96	1.13
74LS97	1.13
74LS98	1.13

Many computer stores now stock our products

TERMS: Please allow up to 5% for shipping; excess refunded. Californians add tax. COD orders accepted with street address for UPS. For VISA®/Mastercharge® orders call our 24 hour order desk at (415) 562-0636. Prices good through cover month of magazine.

GODBOUT

G4
 BILL GODBOUT ELECTRONICS
 BOX 2355, OAKLAND AIRPORT, CA 94614

FREE FLYER: These are just a few of the items we carry for the computer enthusiast. We also stock a broad line of semiconductors, passive components, and hobbyist items. We will gladly send you a flyer describing our products upon receipt of your name and address.

BREAD BOARD JUMPER WIRE KIT



Each kit contains 350 wires cut to 14 different lengths from 0.1" to 5.0". Each wire is stripped and the leads are bent 90° for easy insertion. Wire length is classified by color coding. All wire is solid tinned 22 gauge with PVC insulation. The wires come packed in a convenient plastic box.

JK1 ... \$10.00 / kit

SOCKET JUMPERS

Mates with two rows of 025" sq or dia posts on patterns of 100 centers and shielded receptacles. Probe access holes in back. Choice of 6" or 18" length.

Part No.	No. of Contacts	Length	Price
924003-18R	26	18"	\$ 5.38 ea.
924003-06R	26	6"	4.78 ea.
924005-18R	40	18"	8.27 ea.
924005-06R	40	6"	7.33 ea.
924006-18R	50	18"	10.31 ea.
924006-06R	50	6"	9.15 ea.

JUMPER HEADERS

Solder to PC boards for instant plug-in access via socket-conductor jumpers. 025" sq posts. Choice of straight or right angle.

Part No.	No. of Posts	Angle	Price
923863-R	26	straight	\$1.28 ea.
923873-R	26	right angle	1.52 ea.
923865-R	40	straight	1.94 ea.
923875-R	40	right angle	2.30 ea.
923866-R	50	straight	2.36 ea.
923876-R	50	right angle	2.82 ea.

INTRA-CONNECTOR

Provides both straight and right angle functions. Mates with standard 10" x 10" dual row connectors (i.e. 3M, Amstey, etc.). Permits quick testing of inaccessible lines.

Part No.: 922576-26 No. of contacts: 26 Price \$6.90 ea.

INTRA-SWITCH

Permits instant line-by-line switching for diagnostic or DA testing. Switches actuated with pencil or probe tip. Mates with standard 10" x 10" dual-row connectors. Low profile design. Switch buttons recessed to eliminate accidental switching.

Part No.: IS-26 No. of contacts: 26 Price \$13.80 ea.

CRYSTALS

THESE FREQUENCIES ONLY

Part #	Frequency	Case Style	Price
CY1A	1 000 MHz	HC33 U	\$5.95
CY2A	2 000 MHz	HC33 U	\$5.95
CY2 DT	2 010 MHz	HC33 U	\$ 9.90
CY3A	4 000 MHz	HC18 U	\$4.95
CY7A	5 000 MHz	HC18 U	\$4.95
CY12A	10 000 MHz	HC18 U	\$4.95
CY14A	14 318.18 MHz	HC18U	\$4.95
CY19A	18 000 MHz	HC18 U	\$4.95
CY22A	20 000 MHz	HC18 U	\$4.95
CY30B	32 000 MHz	HC18 U	\$4.95

CONNECTORS PRINTED CIRCUIT EDGE-CARD

156 Spacing-Tin-Double Read-Out

Bifurcated Contacts — Fits 054 to 070 P.C. Cards

15.30	PINS (Solder Eyelet)	\$1.95
18.36	PINS (Solder Eyelet)	\$2.49
22.44	PINS (Solder Eyelet)	\$2.95
50/100	PINS (Wire Wrap)	\$6.95
50/100A (100 Spacing)	PINS (Wire Wrap)	\$6.95

25 PIN-D SUBMINATURE (RS232)

DB25P	PLUG	\$3.25
DB25S	SOCKET	\$4.95

SWITCHES

Part No.	Type	Condition	Price
JM1121	SPDT	on-off-on	\$1.95
JM1122	SPDT	on-none-on	1.65
JM1123	OPDT	on-off-on	2.55
JM1123	OPDT	on-none-on	2.15

MPC121	SPDT	on-off-on	\$2.05
MPC123	SPDT	on-none-on	1.75
MPC201	OPDT	on-off-on	2.65
MPC223	OPDT	on-none-on	2.25

PB123	SPDT	maintained	1.95
PB126	SPDT	momentary	1.95

MS102	OPST	momentary open	35
MS103	SPST	momentary closed	35

206-4	8 pin dip	4 switch	1.75
206-7	14 pin dip	8 switch	1.95
206-8	16 pin dip	8 switch	2.25

1/16 VECTOR BOARD

Part No.	Material	Size	Price
64P44	062X13P	4.50	6.50
64P44	062X13EP	4.50	17.00
64P44	062WE	4.50	6.50
64P44	062WE	4.50	8.50
64P44	062WE	4.50	17.00
64P44	062WE	4.50	17.00
64P44	062WFC1	4.50	17.00

INSTRUMENT/CLOCK CASE

Injection molded unit. Complete with red bezel. 4 1/2" x 4" x 1-9/16"

\$3.95 ea.

MICROPROCESSOR COMPONENTS

8080A	CPU	\$16.00	COP1802	CPU	\$19.95
8212	8 Bit Input/Output	4.95	MC6800	8 Bit MPU	24.95
8214	Priority Interrupt Control	15.95	MC6820	Periph Interface Adapter	15.00
8216	Bi-Directional Bus Driver	6.95	MC6810AP1	128 x 8 Static RAM	6.00
8224	Clock Generator/Driver	9.95	MC6830L8	1024 x 8 Bit ROM	15.00
8228	System Controller Bus Driver	10.95	Z80	CPU	29.95

Part No.	RAM S	Price
8080A	Super 8088	16.00
2650	8 Bit MPU	26.50
7805	CPU	29.95

Part No.	SR S	Price
2514	1024 Dynamic	\$ 3.95
2516	Hex 32 BIT	5.95
2519	Hex 40 BIT	7.95
2522	Dual 132 Bt SSR	2.95
2524	512 Dynamic	9.99
2525	1024 Dynamic	3.00
2527	Dual 256 Bit	7.95
2529	Dual 512 Bit	11.95
2530	Dual 40 Bit	3.95
2531	1024 Static	5.95
2534	16 x 1	3.95
74LS573	16 x 1	3.95

Part No.	UART S	Price
25131013	30K Baud	\$ 3.95

Part No.	ROM S	Price
251312140	Char Gen upper case	\$ 9.95
2513130211	Char Gen lower case	9.95
2516	Char Gen	10.95
MM5230	2048 Bit (512 x 4 on 256 x 8)	1.95

SPECIAL REQUESTED ITEMS

FCM3817	\$5.00	11090	19.95	7805	19.95	9186	3.95
AY-3-8500-1	9.95	4433	3.95	ICM7045	24.95	LD110111	25.00
AY-5-9100	17.50	8720	7.50	ICM7207	7.50	95990	11.95
AY-5-9200	14.95	8197	2.00	ICM7208	22.00	MC3061P	3.50
AY-5-9500	4.95	HD0165	7.95	ICM7209	7.50	MC4016 (74416)	7.50
AY-5-2376	14.95	MC46571	13.50	MM52040	17.50	MC140817	8.95
9374	1.95	MC46574	13.50	DS90C06CM	3.75	MC140818	9.95
825315	25.00	MC46575	13.50	TIL308	10.50	74CS22	9.95

PARATRONICS

Featured on February's Front Cover of Popular Electronics

Logic Analyzer Kit Model 100A \$229.00/kit

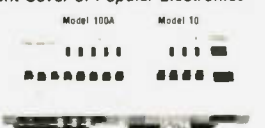

- Analyzes any type of digital system
- Checks data rates in excess of 8 million words per second
- Trouble shoot TTL, CMOS, DTL, RTL, Schottky and MOS families
- Displays 16 logic states up to 8 digits wide
- See ones and zeros displayed on your CRT, octal or hexadecimal format
- Tests circuits under actual operating conditions
- Easy to assemble — comes with step-by-step construction manual which includes 80 pages on logic analyzer operation.

(Model 100A Manual - \$4.95)

PARATRONICS TRIGGER EXPANDER - Model 10

Adds 16 additional bits. Provides digital delay and qualification of input clock and 24-bit trigger word — connects direct to Model 100A for integrated unit!

Model 10 KH - \$229.00
 \$29.95 — \$9.95
 Model 10 Manual — \$4.95

BK PRECISION 3 1/2-Digit Portable OMM



- Overload Protected
- 3 high LED Display
- Battery or AC operation
- Auto Zeroing
- 1mv, 1µV, 0.1mV resolution
- Overrange reading
- 10 meg input impedance
- 100 Accuracy 1% typical
- Ranges: DC Voltage -0-1000V AC Voltage -0-1000V Freq. Response 50-400 Hz DC/AC Current -0-100mA Resistance -0-10 meg ohm Size 6.4 x 4.5 x 2

Model 2800 \$99.95

Accessories:
 AC Adapter BC-28 \$9.00
 Rechargeable Batteries BP-26 20.00
 Carrying Case LC-28 7.50

CONTINENTAL SPECIALTIES PROTO BOARD 6

Other CS Proto Boards

PB100 - 4.5 x 6	\$ 19.95
PB101 - 5.8 x 4.5	29.95
PB102 - 7 x 4.5	39.95
PB103 - 9 x 6	59.95
PB104 - 9.5 x 8	79.95
PB203 - 9.75 x 6 1/2 x 2 1/2	80.00
PB203A - 9.75 x 6 1/2 x 2 1/2	129.95

DESIGN MATES

DM1 - Circuit Designer	\$69.95
DM2 - Function Generator	\$74.95
DM3 - RC Bridge	\$74.95

LOGIC MONITOR for DTL, HTL, TTL or CMOS Devices \$84.95

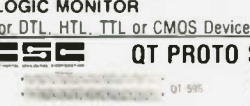

QT PROTO STRIPS

QT 595	101 Holes	1.50
QT 598	101 Holes	2.50
QT 475	101 Holes	10.00
QT 478	101 Holes	2.25
QT 355	350 Holes	8.50
QT 358	350 Holes	2.00
QT 185	180 Holes	4.75
QT 125	120 Holes	3.75
QT 85	80 Holes	3.25
QT 75	70 Holes	3.00

Experimenter 300 \$ 9.95
 Experimenter 600 \$10.95

James ELECTRONICS

1021-A HOWARD AVE., SAN CARLOS, CA. 94070
 PHONE ORDERS WELCOME — (415) 592-8097
 Advertised Prices Good Thru March

1978 CATALOG NOW AVAILABLE

Spec Sheets - 25¢ — Send 35¢ Stamp for 1978 Catalog
 California Residents — Add 6% Sales Tax
 Dealer Information Available

NOW OPEN SATURDAYS

The Incredible "Pennywhistle 103"



\$129.95 Kit Only

The Pennywhistle 103 is capable of recording data to and from audio tape without critical speed requirements for the recorder and it is able to communicate directly with another modem and terminal for telephone "homing" and communications for the day. In addition, it is free of critical adjustments and is built with non-precision ready available parts.

Frequency Shift Keying, Full duplex (half-duplex selectable)
 Maximum Data Rate 300 Baud
 Data Format Asynchronous Serial (return to mark level required between each character)
 Receive Channel Frequencies 2025 Hz for space 2225 Hz for mark
 Transmit Channel Frequencies Switch selectable Low (normal) - 1070 space 1270 mark 1600 - 025 space 2225 mark
 Receive Sensitivity 45 dbm acoustically coupled
 Transmit Level 15 dbm nominal Adjustable from 6 dbm to 20 dbm
 Receive Frequency Tolerance Frequency reference automatically adjusts to allow for operation between 1600 Hz and 2400 Hz
 Original Data Interface EIA RS-232C or 20 mA current loop (receiver is optoisolated and non-polar)
 Power Requirements 120 VAC single phase, 10 Watts
 Physical All components mount on a single 5" by 9" printed circuit board. All components included.

Requires a VOM, Audio Oscillator, Frequency Counter and/or Oscilloscope to align.

NEW! BULB-ENERGY SAVER



BULB-ENERGY SAVERS used for years by major industrial users — now available for home or office use. Bulb Savers can cut electrical bills by as much as 30%. Bulb-Savers lengthens light life by 1. Acting as an electrical "shock absorber", turns the bulb on slowly, eliminating the "thermal shock". Bulb life increases 300 percent.
 2. Banishes Current "Surges". Cushions line voltage surges when other loads cut power line.
 3. Reduces Energy Consumption

Bulb lasts 3 or more times longer
 Fits Standard Socket
 6 watts to 700 watts

BES-1 1-9 10+
 \$1.50 ea. \$1.25 ea.

DIGITAL STOPWATCH



- Bright 6 Digit LED Display
- Times to 59 minutes 59.99 seconds
- Crystal Controlled Time Base
- Three Stopwatches in One
- Times, Single Event — Split & Taylor
- 5 Size 4.5 x 2.15 x .90 (14% ounces)
- Uses 3 Penrite Cells

Kit only — \$39.95
 Assembled — \$49.95
 Heavy Duty Carry Case \$5.95

Stop Watch Chip Only (7205) \$19.95

3 1/2 DIGIT DPM KIT



Kit only \$39.95
 Assembled \$49.95
 Heavy Duty Carry Case \$5.95

JE700 CLOCK



The JE700 is a low cost digital clock that is a very high quality unit. The unit features a semi-rigid walnut case with dimensions of 6" x 2 1/2" x 1". It utilizes a MAN22 high brightness readout and the MM5313 clock chip.

12 @ 24 Hour
 115 VAC
 KIT ONLY \$16.95

HEXADECIMAL ENCODER 19-KEY PAD



- 1 0
- ABCDEF
- Shift Key
- 2 Optional Keys

\$10.95 each

New 63 KEY KEYBOARD \$29.95 IN STOCK



This keyboard features 63 unenclosed SPST keys, unattached to any kind of P.C.B. A very solid unkeyed plastic 11 x 4 base (keys must be attached).

H06785 Encoder (Keys attached to Keys) \$7.95 ea.
 A7-5-2316 Encoder (Keys attached to Keys) \$14.95 ea.

JE803 PROBE

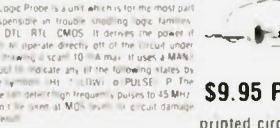

The Logic Probe is a unit essential for the most part indispensable in trouble shooting logic families. TTL, DTL, RTL, CMOS. It derives the power it needs to operate directly off of the circuit under test. Thinking in terms of 10 mA max. It uses a MAN22 decoder to indicate any of the following states: High, Low, 1/2 (VOLT), or PULSE. The Probe will determine frequency pulses to 45 MHz. It can't be used at MOS levels to prevent circuit damage will result.

\$9.95 Per Kit
 printed circuit board

TTL 5V 1A Supply
 This is a standard TTL power supply using the well known LM309A regulator IC to provide a solid 1 AMP of current at 5 volts. We try to make things easy for you by providing everything you need in one package. Including the hardware for only **\$9.95 Per Kit**

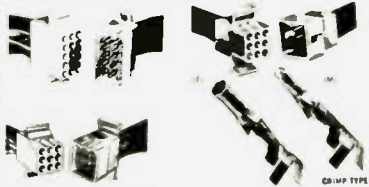

Complete Nylon Connectors Mfg. by Moles

Part No.	Type No.	Class	Description	Eq. Pkg.	Price
5	1625-1PRT	Min. (.062")	1 Circuit		\$1.75
3	1625-2PRT	"	2 Circuit		1.90
3	1625-3PRT	"	3 Circuit		2.10
2	1625-4PRT	"	4 Circuit		2.10
2	1625-5PRT	"	5 Circuit		2.20
2	1625-6PRT	"	6 Circuit		2.35
1	1649-8PRT	"	8 Circuit		1.55
1	1625-9PRT	"	9 Circuit		1.75
1	1625-12PRT	"	12 Circuit		1.90
1	1625-15PRT	"	15 Circuit		2.30
1	1625-24PRT	"	24 Circuit		3.25
1	1772-36PRT	"	36 Circuit		4.55
5	1619PRT	Std. (.093")	1 Circuit		1.75
3	1545PRT	"	2 Circuit		1.90
3	1396PRT	"	3 Circuit		2.10
2	1490PRT	"	4 Circuit		2.10
2	1653PRT	"	5 Circuit		2.20
2	1261PRT	"	6 Circuit		2.35
1	1292PRT	"	9 Circuit		1.80
1	1360PRT	"	12 Circuit		1.90
1	1375PRT	"	15 Circuit		2.45

Prototype hand tools combine efficiency with economy. Ideal for prototype or limited production runs.

HT 1919 for .093" pin dia terminals \$8.95 each
HT 1921 for .062" pin dia terminals \$8.95 each



Econo-Extractor removes terminal from nylon connector housing with smoothness and ease.
HT 2054 for extracting .093" pin dia terminals \$2.25 each
HT 2023 for extracting .062" pin dia terminals \$2.25 each



Deluxe extractor tools: spring loaded for simple, efficient removal of terminal from nylon connector housing; extracts either male or female terminals of same pin diameter.
HT 2038 for extracting .093" pin dia terminals \$6.70 each
HT 1010 282 replacement for HT 2038 \$2.50 each
HT 2285 for extracting .062" pin dia terminals \$6.70 each
HT 1672 3 replacement for HT 2285 \$2.50 each



INTEGRATED CIRCUITS

555 Timer 8 pin mini-DIP	.49
741 Compensated OP-Amp 8 pin DIP	.37
LM 1889N RF Video Modulator	7.45
CA3130 Bipolar/Mos-FET Op Amp	1.19
CA3140 MOS-FET Op Amp, Bipolar out	.99
LM3909 La Voltage Led Pulsar	1.50
LM3911 Temp. Control CHIP	1.50
Signetics 2501TA 1024 bit S.R. memory (1404A)	\$1.75
MCM 8571P Character Generator	9.95
MCM6571AP Character Generator	9.95
MCM6575P Character generator	\$14.88
50240 Top octave generator	\$14.95
LH0070-1H Precision (.3%) 10V Reference Amp	5.35
LH0070-2H Extra Precision (.05%) 10V Reference Amp	10.55
LM399H Temp Stabilized Zener	5.95
AF100-1CJ Active Filter, State Variable	7.50
LM2907N Tachometer F/V Converter	2.65
LM1812N Ultrasonic Transceiver	9.15
LM1815 Adaptive Sense Amp for Tachometer	5.73
TL170 TO-97 Hall effect switch w/spec sheets	1.25
MC14409P Telephone Rotary Pulsar	10.98
MC14419P Touch Pad Converter for 14409	4.25
MC14411P Baud Rate Generator	11.98
MC14412VP CMOS Madem Chip	16.95
MM57109N Number Cruncher Micra	18.95
74C915 7 Segment to BCD Converter	2.99
74C922 16 Key Keyboard Encoder	6.35
74C923 20 Key Keyboard Encoder	6.45
74C925 4 Decade Counter w/latches	12.00
74C926 4 Decade Counter w/carry	12.00
74C935 1 3/8 Digit DVM CMOS Chip	16.98
9601 Retriggerable One shot	.50
MC4015P Hi Speed quad "D" low power TTL	\$1.00

New UHF Prescaler IC. Nationals' DS8629 is a fixed ratio, divide by 100 counter combining ECL and low-power Schottky. Single end or differential mode. Operates from D.C. to typically 160 MHz (135 Guaranteed minimum) TTL compatible, single supply, positive or negative edge trigger. 100mV to 1V input.
DS8629N\$6.14
Specs......40



If your project time and money are being flown away by poor quality and slow delivery, you'll find doing business with TRI-TEK a breeze!



Unique Features of the Welcon Zero Insertion Force Dual-In-Line Sockets . . .

- Capability to accept devices with up to .070" lead spread variation.
- Accepts lead lengths as short as .075".
- Sturdy terminals that fit .025" diameter printed circuit board holes.
- "Zero" insertion, positive wiping contacts.
- "ZIF" eliminates costly damage to fragile LSI devices.

Why struggle to insert DIP's into sockets when you can do it the easy way - the Welcon way - with a new design concept that provides "zero insertion force" and positive wiping.

The "604" series of sockets, with all of its positive features and higher reliability, is small in size. High density packaging can be achieved for burn-in and production.

OPERATION: Lid is moved to up position stop (Fig. 2). This cams contacts into "open" position. DIP device can then be dropped into open contacts. In Fig. 3 DIP is pushed downward and contacts begin to close. When tip of device lead is past contact point (Fig. 4), contacts close and wipe on lead for remaining distance.

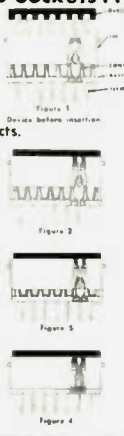

5-100 BUS CONNECTORS (IMSAI TYPE)

2x50x.125 x .25 Rows.
Gold, Solder tail for Mother boards \$4.50, 4/\$17.00
Tin-Nickel, (NASGLO) Solder tail \$3.75, 4/\$14.00
Gold, wire-wrap.....\$4.50, 4/\$17.00
Tin-Nickel, (NASGLO) wire-wrap \$3.75, 4/\$14.00

I.C. SOCKETS

Lo Profile Tin Solder Tail Dip Sockets

8 pin	10/\$1.50	100/\$14.00	1000/\$120.00
14 pin	10/\$1.70	100/\$16.00	1000/\$140.00
16 pin	10/\$1.90	100/\$18.00	1000/\$160.00

VOLTAGE REGULATORS

7805-06 08 12-15-24 TO220	95c	5/\$4.50
7805-06 08 12-15-24 TO 220	95c	5/\$4.50
78L05A-12 15 4% 100 mA TO-92 Plastic		50c
78H05KC 5V 5A TO-3		9.15
78H12KC 12V 5A TO-3		9.15
78H15KC 15V 5A TO-3		9.15
Lm317K 1.5A Adjustable TO-3		4.99
Lm317T 1.5A Adjustable TO-220		3.99
Lm317MP 5A Adjustable TO-202		13.95
TL430C Adjustable Zener Think About It		1.50
TL497C Switching Reg. & Inductor		9.50
RCA CA 3085 100 mA Adjustable		.60

Adjustable 3A Regulator. LM350 is an adjustable 3-terminal regulator capable of supplying in EXCESS of 3 Amps over a 1.2V to 33V range. Standard TO-3 package for easy mounting. Full protection from thermal, current and safe area overload. Completely floating and can be used to regulate at any voltage level as long as input-output difference is less than 35Volts. 0.1% regulation!
LM350K.....\$10.95
Specs......80

DIODES AND BRIDGES

IN4003 200 V 1 amp		12/\$1.00
IN4004 400 V 1 amp		10/\$1.00
IN4148 Hi-Speed Signal	15/\$1.00	100/\$5.00
D 600 115 V, 100 mA Hi-Speed Signal		20/\$1.00
D2131 200 V, 25A Stud		85c
D2135 400 V, 25A Stud		1.00
D2138 600 V, 25A Stud		1.55
D3289R 200 V, 160A Stud Anode		5.85
D3909-4 50 V, 45A Fast Recovery		2.00
IN4732A-47A 1W 5% Zeners		4/\$1.00
13 Assorted Brand New Zener Diodes		1.00
50V 3 amp Epoxy Bridge		79c
200V 30 amp Bridge		2.00
600V 4 amp Epoxy Bridge		1.49
600V 3 amp Stud Bridge		89
SI-2 200V, 1.5A Gold Leads		15/\$1.00
D1A 0030 30V DIAC		10/\$1.00

MISCELLANEOUS

RG 174 Miniature 50Ω coax		50/4.25
WSU 30 Wire Wrap/unwrap tool		5.95
WSU 30M Modified Wrap/unwrap tool		6.95
BW 630 Battery Operated Wrap Tool		34.95
-Free Wire with any Wrap Tool-		
Miniature Square .05/100V Manolithic Cap		10/2.00
2N4036 90V, 1A PNP Silicon TO-5		.50
2N6101 80V, 10A NPN HI GAIN TO-220		.50
SE7005 250V, 5A NPN Silicon TO-5 W/Flange		.60
6.3 VCT, 1.2A Transformer F41X		2.49
12V, 1A Transformer with 6" Power Card		2.88

Fairchild Linear Data Book. Huge volume has 17 chapters of data, applications and definitions. Probably the biggest volume of its type today.....\$4.50ppd
Fairchild Bipolar Memory Data Book. ROMS, PROMS and RAMS are covered in this work with full engineering data. Price includes shipping!.....\$3.75

Raytheon Linear Data Book. Covers many of the familiar as well as those for which Raytheon is the innovator. Contains valuable applications data as well as complete specifications.....\$2.95ppd

Raytheon Micro Computer Components Book. Covers Raytheon's offerings in the field from the micro-puter to memories and adapters.....\$2.95ppd



TRI-TEK, INC.
7608 North 27th Avenue
Phoenix, Arizona 85021
(602) 995-9352

- * Please give street address for UPS shipping when applicable.
- * C.O.D. NO orders out of C.O.D.
- * UPS C.O.D. add \$3.00 to order.
- * Any correspondence not connected with your order, please use separate sheet and include SASE for reply.
- * Orders less than \$10 (\$13 foreign) please add \$1 handling.
- * Prices are subject to change without notice.
- * Any refunds will be by check, not credit vouchers.
- * Terms: Check, money order, credit card, Net 30 days to rated firms, schools and government agencies.

- * If we should be temporarily out of stock on an item, it will be placed on back order. If we cannot ship in 30 days, you will be notified of the expected shipping date and furnished with a postage paid card with which to cancel your order if desired.
- * We pay surface shipping only in USA, Canada and Mexico.
- * For premium shipping (first class, special handling, etc.) add extra. & call will be refunded.
- * Foreign orders (except Canada and Mexico) estimate and add shipping. Excess will be refunded.

Charge card telephone orders (\$20 min.) will be accepted 9:30 P.M. except weekends.
Telephone 995-9352. No collect calls please.

ALDELCO ELECTRONIC CENTER

NEW!
THE FUTURE NOW!
FM2015R



Does Your Unit Cover The New Sub band 166.0 - 168.8 MHz? The FM2015R Does. PLUS MARS-CAP*

TRANSFORMERS

110/18 VAC 1 Amp	\$1.50
110/12 VAC 300 mA	1.25
110/20-40 VAC 2 Amps	2.50
110/5 VAC 6 Amps	4.95
SPECIAL 110/12 VAC plug in 500 mA	1.50
For each 1-5 Xfmrs add \$1.00 shipping	

POWER SUPPLY "KITS OF PARTS"

Model PS 1 5 Volt 6 Amps	\$17.95
Model PS 2 + 15 Volt & - 15 Volt	\$16.95
Includes Schematic	

PUSH BUTTON SWITCHES

S.P. N/O	3 for \$1.00
S.P. N/O & N/C	\$.65
MOLEX PINS	.60 for \$1.00

CAPACITOR ASSORTMENT

5 pf to .1 Discs 50 for \$1.49	
.047 400 Volt Ceramic Radial	\$.10
50 MFD @ 150 VDC	3 for \$1.00
3 MFD @ 12 VDC	15 for \$1.00
.01 30 Volt Disc	.25 for \$1.00

SPEAKERS

2" 8 Ohm Round	\$.65
2 1/4" 8 Ohm Round	.75
2 1/2" 8 Ohm Round	1.00
2 1/2" 100 Ohm Round	1.25
add 10 cents per speaker shipping	

All Solid State-CMOS PLL digital synthesized - No Crystals to Buy! 5KHz steps - 144 - 149 MHz-LEO digital readout PLUS MARS-CAP *

• 5 MHz Band Coverage - 1000 Channels (instead of the usual 2MHz to 4MHz-400 to 800 Channels) • 4 CHANNEL RAM IC MEMORY WITH SCANNING • MULTIPLE FREQUENCY OFFSETS • ELECTRONIC AUTO TUNING - TRANSMIT AND RECEIVE • INTERNAL MULTIPURPOSE TONE OSCILLATOR • RIT • DISCRIMINATOR METER - 18 Watts Output - Unequaled Receiver Sensitivity and Selectivity - 15 POLE FILTER, MONOLITHIC CRYSTAL FILTER AND AUTOMATIC TUNED RECEIVER FRONT END, COMPARE! • Superb Engineering and Superior Commercial Avionics Grade Quality and Construction Second to None at ANY PRICE

INTRODUCTORY PRICE

\$399.00

Requires AC 115V, Model 1200, 60 148 00



- 100' Spool Green #30 wire
- Wrap Wire \$2.75
- OK Wire Hand Tool
- WSU 30 5.95
- WSU30M (modified wrap) . 6.95
- Battery operated wire-wrap tool
- BW 630 Wraps #30 wire 34.95
- Uses 2 C Batt. not inc.
- 2 General Electric C Batteries and plug-in charger 11.95

RECTIFIERS

- 2 amp 50 volt 20 for \$1.00
 - 2 amp 1000 volt 10 for \$1.00
 - 2 amp 1500 volt .5 for 1.00
 - 10 amp stud 50 volt . 1.50
 - 10 amp stud 60 volt . 4.50
 - 40 amp stud 50 volt . 1.20
 - 40 amp stud 750 volt . 2.05
 - 100 amp. stud 200 v. 8.50
- BRIDGES**
- 2 amp T05 50 volt35
 - 2 amp T05 200 volt50
 - 2 amp T05 600 volt . . 1.25
 - 3 amp. 50 volt50
 - 3 amp. 400 volt1.10
 - 25 amp. 200 volt1.50
 - 25 amp. 600 volt5.50
 - 25 amp. 1000 volt . . . 8.50

LOGIC PROBE KIT

Aidelco is now the sole distributor of the **OIGAPEAKE-A** logic probe kit. Now you can buy direct and save. Probe measures logic 1, logic 0, and pulsing circuits conditions formerly sold for \$14.95.

SPECIAL \$11.95

FETS

40673	1.55
MPF102	.55
2N3819	.35
2N5457	.50
2N5458	.50
2N5459	.55
2N5485	.50

DARLINGTON

MPSA 13	.80
MPSA 14	.40
2N5306	.50

SCR

C 106A	.55
C 106B	.65
C 122B	.85

CLOCK CHIPS

5313	3.49
5314	3.49
5316	3.95
5375	3.95
CT7001	6.95

NEW IMPROVED ALARM CLOCK KIT

Digital alarm clock • Six big .5 display LEDs • New on board AC Transformer • 12 Hour format with 24 hour Alarm • Snooze Feature • Elapsed time indicator. A natural for cars, campers and mobile homes. Use on 12 volt dc with optional crystal time base (not including cabinet) \$19.95

CRYSTAL TIME BASE KIT \$4.95

- Cabinets In simulated walnut grain or black leather. \$4.95
- Plastic Cabinets — blue, black, white or smoke. \$3.95
- RED CLOCK FILTERS. \$.60
- 12 or 24 hour DIGITAL CLOCK KIT uses .5 display LED. 5314 clock chip fits our standard cabinet. Freeze feature. \$18.95

ADJUSTABLE POWER SUPPLY KITS

5 to 15 Volts 500 mA	\$6.95
12 to 20 Volts 500 mA	\$6.95

RF DEVICES

2N2876	18W	200 MHz	T060	\$12.35
2N3375	3.0W	400 MHz	T060	5.60
2N3553	2.5W	175 MHz	T039	1.40
2N3866	1.0W	400 MHz	T039	1.25
2N3926	7.0W	175 MHz	T060	6.30
2N4427	1.0W	175 MHz	T039	1.35
2N5589	3.0W	175 MHz	MT71	4.75
2N5590	10W	175 MHz	MT72	7.80
2N5591	25W	175 MHz	MT72	10.25
2N5913	1.75W	175 MHz	T039	1.70
2N6080	4.0W	175 MHz	MT72	5.40
2N6081	15W	175 MHz	MT72	8.45
2N6082	25W	175 MHz	MT72	10.95
2N6083	30W	175 MHz	MT72	12.30
2N6084	40W	175 MHz	MT72	16.30
2N6094	4.0W	175 MHz	X106 PNP	6.60
2N6095	15W	175 MHz	X106 PNP	8.50
2N6096	30W	175 MHz	X106 PNP	10.35
2N6097	40W	175 MHz	X106 PNP	20.00
GE28	12W	50 MHz	X51	2.15
GE46	6.0W	27 MHz	T05	6.42
GE215	5.5W	50 MHz	T0220	4.65
GE216	15W	50 MHz	T0220	8.97
GE226	10W	50 MHz	X81	2.00

ZENERS

1N746 to 1N759	400 Mw	ea	25
1N4728 to 1N4764	1 watt		28
1N5333 to 1N5378	5 watt		2 10
1N2970 to 1N3005	10 watt		2 40
1N3305 to 1N3340	50 watt		4 75
2N3055			99
2N3904 or 2N3906			25
2N5496 or 2N6108			70
741 or 709 14 Pin DIP			25
555 Timer			.49
1N914 1N4148		15 for	99
1N34 1N60 1N64		10 for	99
CA 3028 Di1 Amp			1 50
LM309K Volt Reg			1 10
2N5401 (rep 2N4888)			95
2N2369			20
2N6103			89
LM709 or 741 Min DIP Op Amp			45
14 or 16 Pin IC Sockets			30

ALDELCO KITS

ALDELCO DOES IT AGAIN—ANOTHER UNBELIEVABLE VALUE—OUR BATTERY OPERATED FREQUENCY COUNTER & DIGITAL CLOCK NOW AVAILABLE—ASSEMBLED AND TESTED AT THE KIT PRICE ONLY! \$99.95



COMPARE OUR FEATURES—COMPARE THEIR FEATURES THEN—COMPARE OUR PRICE AGAINST THEIRS

- Portable use when 8 AA Batteries are installed
- Comes in attractive Black & White metal cabinet
- Leds turn off to conserve battery power
- Freq. Range 100 Hz to 40 MHz Typical
- Mobile use 12 Volt DC input makes ideal mobile set up
- .00005% accuracy and rock stable
- Switchable from counter to clock without losing time
- 110 Volt Power Supply/Battery Charger option—perfect for use in Ham Shack
- Clock can be either 4 or 6 digit, 12 or 24 hour
- Clock keeps time even in off position
- Six big 0.4 Display leds.
- 8 Gould or GE size AA NiCad Batteries \$17.50
- 110 Volt AC Plug In Power Supply & Battery Charger 4.95
- Coming Soon 600 MHz Presealer

DUAL DIGITAL 12/24 HOUR CLOCK KIT NOW WITH A NEW WALNUT GRAIN WOOD CABINET



Features:

- 12 or 24 Hour Operation on either clock
- Each Clock separately controlled
- Freeze feature for time set
- Easy assembly for clock and cabinet

MODEL ALD 5-W ONLY \$49.95

Same kit as above in unassembled Black Plastic cabinet with Red Filter.

Model ALD 5-P

Only \$44.95



NEW!

Tunable 420 MHz Fast Scan TV Converter



NEW TURNABLE HAM TV CONVERTER

Receive Fast Scan Amateur TV in the 420 to 450 MHz Band with any TV set. Low noise, high gain rf Amp with Varactor tuned input and outputs. Built in AC supply. Comes in two tone walnut & beige cabinet measuring 1 7/8" x 4 1/4" x 4 1/8". Factory wired with 2 year guarantee. \$49.95 Kit (critical circuits prewired) \$39.99

ACCUKEYER KIT



ACCUKEYER KIT Similar to the famous ARRL Handbook version, Kit includes PC board, IC sockets, ICs, speaker switch and all parts and instructions.

ONLY \$19.95

ACCUKEYER MEMORY KIT

Adaptable to many keyers. Can store 2 canned messages of 30 characters each. PC board IC sockets, ICs instructions and all parts. \$19.95

ALDELCO

2281A BABYLON TURNPIKE, MERRICK NY 11566
516-378-4555

Add 5% Shipping. Add \$1.00 for orders under \$10.00. Out of U.S.A., Mexico or Canada add 15% shipping and certified check or money order in U.S. Funds



S.D. SALES NEW EXPANDABLE EPROM BOARD

16K or 32K EPROM \$49.95 w/out EPROM
Allows you to use either 2708's for 16K of Eprom or 2716's for 32K of Eprom.

KIT FEATURES:

1. All address lines & data lines buffered.
2. Quality plated through P.C. Board, including solder mask and silk screen.
3. Selectable wait states.
4. On board regulation provided.
5. All sockets provided w/board.

WE CAN SUPPLY 450ns 2708's AT \$11.95 WHEN PURCHASED WITH BOARD.

32K FOR \$475 EXPANDORAM KIT 24K FOR \$367.00

MEMORY CAPACITY MEMORY ADDRESSING MEMORY WRITE PROTECTION

8K, 16K, 24K, 32K using Mostek MK4115 with 8K Mosdies and protection. Utilizes DIP switches. PC board comes with sockets for 32K operation. Orders now being accepted. Allow 6 to 8 weeks for delivery.

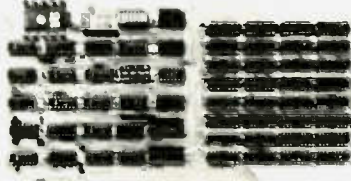

Buy an S100 compatible 8K Ram Board and upgrade the same board to a maximum of 32K in steps of 8K at your option by merely purchasing more ram chips from S.D. Sales! At a guaranteed price - Look at the features we have built into the board.

INTERFACE CAPABILITY

Control, data and address inputs utilizes low power Schottky devices
POWER REQUIREMENTS
+8VDC 400MA DC
+18VDC 400MA DC
-18VDC 30MA DC
on board regulation is provided. On board (invisible) refresh is provided with no wait states or cycle stealing required.
MEMORY ACCESS TIME
IS 375ns
Memory Cycle Time is 500ns.

16K FOR \$259.00

8K FOR \$151.00

Z-80 CPU BOARD KIT — \$139.

CHECK THE ADVANCED FEATURES OF OUR Z-80 CPU BOARD Expanded set of 158 instructions, 8080A software capability, operation from a single 5VDC power supply, always stops on an M1 state, true sync generated on card (a real plus feature!), dynamic refresh and NMI available, either 2MHZ or 4MHZ operation, quality double sided plated through PC board, parts plus sockets priced for all IC's *Add \$10 extra for Z-80A chip which allows 4MHZ operation
Z-80 chip with Manual — 29.95



NEW FROM S.D. "VERSAFLOPPY"™ KIT THE VERSATILE FLOPPY DISK CONTROLLER ONLY \$149.00

Features: IBM 3740 Soft Sectors Compatible S-100 BMS Compatible for Z-80 or 8080. Controls up to 4 Drives (single or double sided). Directly controls the following drives:
1. Shugart SA400/450 Mini Floppy.
2. Shugart SA800/850 Standard Floppy.
3. PERSCI 70 and 277.
4. MFE 700/750.
5. CDC 9404/9406.

34 Pin Connector for Mini Floppy. 50 Pin Connector for Standard Floppy. Operates with modified CP/M operating system and C-Basic Compiler.
The new "Versafloppy" from S.D. Computer Products provides complete control for many of the available Floppy Disk Drives. Both Mini and Full Size. At the heart of "Versafloppy" is the powerful Western Digital FD1771B-1 Single Density Controller Chip. This allows a great flexibility via Control Software. Listings for Control Software are included in the price.

FD 1771B-1 CHIP ALONE \$39.95

4K LOW POWER RAM KIT

Fully Buffered — on board regulated — reduced power consumption utilizing low power 21L02 — 1 500ns RAM's — Sockets provided for all IC's Quality plated through PC board *Add \$10 for 250ns RAM operation



The Whole Works - \$79.95

Low Cost Cassette Interface Kit

Features: Play and record K.C. Standard 2400/1200 Hz tapes. 300 Beud. TTL I/O Compatible. Phase Lock Loop, Both 22 Pin Connector and 8 Pin Meigs Connector. Comes partially assembled. Oscillator and phase lock loop pre-tuned to K.C. Standard. Selector switch sends cassette data or auxiliary input data to microcomputer. LED indicators logic 1 level.



\$19.95

6 DIGIT ALARM CLOCK KIT

Features: Litronix dual 1/2" displays, Mostek 50250 super clock chip, single I.C. segment driver, SCR digit drivers. Kit includes all necessary parts (except case). Xfmr optional. Eliminate the hassle.
AC XFMR — \$1.50 Case \$3.50

\$12.95

8K LOW POWER RAM — \$159.95

Fully assembled and tested. Not a kit. Imsai — Altair — S-100 Buss compatible, uses low power static 21L02-500ns fully buffered on board regulated, quality plated through PC board, including solder mask 8 pos. dip switches for address select.



DIGITAL LED READOUT THERMOMETER — \$29.95

Features: Litronix dual 1/2" displays Uses Siliconix LD131 single chip CMOS A/D converter. Kit includes all necessary parts (except case). AC line cord and power supply included. 0-149° F.



Bowmar 4 Digit LED Readout Array Full 1/2" Litronix Jumbo Dual Digit LED Displays

4 JUMBO 50" DIGITS ON ONE STICK! WITH COLONS & AM/PM INDICATOR

DL 722 - C.C. DL 728 - C.C.
DL 721 8 C.A. DL 727 - C.A.
99c \$1.29

MUSICAL HORN

One tune supplied with each kit. Additional tunes — \$6.95 each. Special tunes available. Standard tunes now available: — Dixie — Eyes of Texas — On Wisconsin — Yankee Doodle Dandy — Notre Dame — Pink Panther — Aggie War Song — Anchors Away — Never on Sunday — Yellow Rose of Texas — Deep in the Heart of Texas — Boomer Sooner — Bridge over River Kwai.

CAR & BOAT KIT \$34.95 HOME KIT \$26.90 Special Design Case \$3.50

Jumbo LED Car Clock Kit

FEATURES:
A. Bowmar Jumbo .5 inch LED array
B. MOSTEK — 50250 — Super clock chip
C. On board precision crystal time base
D. 12 or 24 hour Real Time format.
E. Perfect for cars, boats, vans, etc.
F. PC board and all parts (less case) inc.
Alarm option — \$1.50
AC XFMR — \$1.50



\$16.95

RAMS

21L02 500NS	8 11 50
21L02 250NS	8 15 95
2114 — 4K	14 95
1101A — 256	8 54 00
1103 — 1K	35
MK 4115 8K	15 45
74S 200 256	3 95

CPU's

Z-80 includes manual	29 95
Z-80A includes manual	34 95
8080A CPU 8 BIT	11 95
8008 CPU 8 BIT	6 95

PROMS

1702A - 1K - 1.5us	3.95 or 10/35.
2708 - 8K - 450ns	14.95
5204 - 4K	7.95
82S129 — 1K	2.50
2708U 8K signetics 650ns	9.95

COUNTER CHIPS

MK50397 6 Digit elapsed timer	8 95
MK50250 Alarm clock	4 99
MK50380 Alarm chip	2 95
MK50395 6 digit up/dn count.	12 95
MK5002 4 digit counter	8 95
MK5021-Cal. chip sq. root	2 50

★ ★ ★ ★ SUPER FLOPPY SPECIAL ★ ★ ★ ★

S. D. SALES' VERSAFLOPPY S-100 CONTROLLER BOARD PLUS SHUGART SA 400 FLOPPY DISK DRIVE INCLUDING CABLE FOR ONLY \$479.00

MICRO-DIP \$1.95

New — Series 2300
The World's Smallest Coded BCD Dual-In-Line Switch! PC Mount
2300 02G BCD 1-2-4-8
2300 12G BCD 1-2-4-8
Compliment

★ ★ JOY STICKS ★ ★

FOUR 100 K-OHMS POTS
Ideal for electronic games \$3.95

Z-80

Programming Manual IN DEPTH DETAIL OF THE Z-80 CPU MICRO-COMPUTER S. D. SALES SPECIAL \$9.95

- * Thermistors 1.5K ohm 5/\$1.00
- * Tantulum Caps 1 mfd. 20VOC P.C. Leads 15/\$1.00
- * Flat Pack IC Assort. 20/\$1.00
- * Electrical Coil 13T Type C - 10T Type C 12/\$1.00
- * 2 Transistor Audio 8/\$1.00
- * Trimmer Pots 10K, 20K, 25K, Mini 10/\$1.00
- * Disc Caps For Bypass .01 mfg - 100 WUCC PC Leads 40/\$1.00
- * New Cambion Jacks Part #450-4352 Gold Plated 50/\$1.00

- * Silicon Rectifier Special 1N4007. 1 amp 1000 PN. 10/\$1.00
- * Photocell Assortment 12/\$1.00
- * Plastic Readout Filters Amber 6/\$1.00
- * Disc Cap Assortment 60/\$1.00
- * P.C. Lead Diodes 1N4148 1N 914 100/\$2.00
- * 1N4002-1A-100 PN 40/\$1.00
- * MICA Trimmer PC402 Miniature 1.5 20 P.C. P.C. Mount .4/\$1.00
- * Resistor Special 22 ohm Carbon Comp. 25/\$1.00
- * Resistor Assortment 1/4 W 5% & 10% PC leads 200/\$1.50

MICROPROCESSOR CHIPS

8212 - I/O port	3.50
8214 — P.I.C.	12.95
8216 — Non Invert Bus	4.95
8224 — Clock Gen.	4.95
8226 — Invert Bus	3.95
P10 for Z-80	14.95
CTC for Z-80	14.95
8228 Sys. Controller	8 20
8251 Prog. comm. Interface	10.95
8255 prog. prep. interface	13.50
8820 Dual Line Recv	1.75
8830 Dual Line Dr.	1.75
2513 Char. Gen.	7.50
8838 Quad Bus. Recvr.	2.00
74LS138N — 1/8 decoder	.99
8197-Hex Tri-State Buffer	1.25
1488/1489 RS232	1.50
TR 1602B Uart	3.95
TR 1853 Uart	8.50
FD 1771B-1	39.95

CMOS

4001	19	4029	99
4002	19	4042	69
4011	19	4047	1.50
4013	32	4049	35
4016	32	4069	23
4017	95	4071	19
4020	97	4076	97
4022	97	1451B	1.10
4024	75	1452B	85
4027	39	14529	85

CALL IN YOUR BANKAMERICARD (VISA) OR MASTER CHARGE ORDER IN ON OUR CONTINENTAL TOLL FREE WATTS LINE:

1-800-527-3460

Texas Residents Call Collect: 214/271-0022

DEALER INQUIRIES INVITED!



NO COD'S. TEXAS RESIDENTS ADD 5% SALES TAX. ADD 5% OF ORDER FOR POSTAGE & HANDLING. ORDERS UNDER \$10. ADD 75c HANDLING FOREIGN ORDERS — U. S. FUNDS ONLY!

(Cut on dotted line and keep next to your radio equipment)

(Cut on dotted line and keep next to your radio equipment)

DIAL DIRECT ...

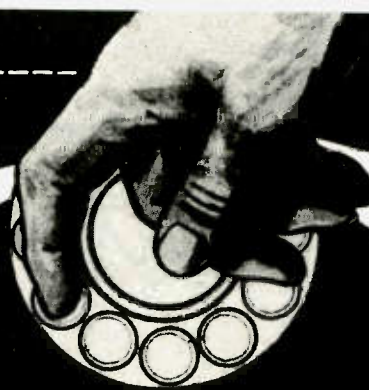

... **DIAL FREE!**

NO CHARGE TO CALLING PARTY

1-800-325-3636

The ONLY NUMBER you'll ever need!

*** FOR THE FAMOUS HAM-KEY™ AND HAM-KEYER™**

We make squeeze-paddle and straight-key models ... all for use with our brand-new, improved electronic keyer.

*** FOR NEW OR USED AMATEUR RADIO GEAR**

... we're specialists and carry *in stock* most of the famous-brand lines. Or, we will talk trade.

*** FOR FAST, DOOR-STEP DELIVERY**

... give us a call. You'll be amazed; for we guarantee we'll ship your equipment the same day. Plus, most shipments are **PRE-PAID**.

*** TO SAVE MONEY**

... join thousands of our satisfied customers who buy from us as easily as from their local supplier. So, remember your call is *Toll Free*.



TM Trade - Mark

HAM RADIO CENTER

8340-42 Olive Blvd. P.O. Box 28271 St. Louis, MO 63132



DSI

Be the one who's on FREQUENCY!!

With your *DSI Counter*. . .save the shop cost of tweaking xtals. . . know your frequency. . .from 160 meters through 450 MHz. Now *DSI* offers *the most* counter for your dollar. Latest state-of-the-art technology. . .*DSI* advanced LSI design far exceeds outdated TTL. Go with the leader . . .buy a *DSI FREQUENCY* counter and **SAVE TIME & MONEY!!**

NOT A KIT



MODEL 3500 \$139.95



MODEL 3600A \$189.95

Includes oven timebase

500 MHz Frequency Counter

- Includes 500 MHz Prescaler — Not an addon
- 7 Large bright — 1/2 inch LED Readouts
- Temperature compensated crystal timebase
- Accuracy 1 PPM Typ
- Sensitivity 50 MvRms 150 & 250 MHz 150 MvRms 450 MHz
- Gate time light
- No direct RF connection Required
- AC or DC operation
- 50 Hz to 500 MHz typ
- Comprehensive owners manual with complete accurate schematics
- Factory assembled & tested

600 MHz Frequency Counter

- Includes oven compensated crystal timebase
- Includes built-in 600MHz Prescaler-Not and addon
- 8 Large bright — 1/2 inch LED Readouts
- Two timebases 0.1 sec & 1. sec
- Resolution 1 Hz Direct 10 Hz Prescaled
- Sensitivity 20 MvRms @ 150 & 220 MHz 100 MvRms 450 MHz
- Accuracy .5 PPM over temperature
- Oven light & Gate time light
- Automatic Decimal point placement
- NO DIRECT RF CONNECTION Required.
- Comprehensive owners manual with complete accurate schematics
- AC or DC operation
- 50 Hz to 600 MHz Typ.
- Factory assembled & tested

Use it in the car or on the bench. . .take it to the repeater site. . .high-impact case. . .light weight—but rugged. . .Designed with the latest readily available LSI, CMOS, Schottky, Mecl-integrated circuits.

NEW PRODUCTS

- 250 MHz 7 Digit Battery operated hand held counter \$109.95 available mid-January.
- 3 1/2 Digit Bench Digital Multi-meter AC or Battery operated \$99.95 available mid-February.

Visit us at ORLANDO, FLA. ARC ARRL Convention Feb. 17, 18, 19
Booths 37, 39, 40 (Sheraton Towers)

Strongest Warranty in the Counter Field. ONE Year Parts and Labor we pay the return shipping plus. . .if not satisfied, return in ten days for full refund. . . Dennis Romack. . .WA60YI.
VP-Marketing, DSI

D25

TO ORDER CALL COLLECT (714) 565-8402

Name _____ Call _____
 Address _____
 City _____ State _____ Zip _____
 Phone: _____
 Order: _____
 Check enclosed Please send more information on your full line of Instruments and Accessories.
 BankAmericard MasterCard VISA R.E.
 Credit card # _____ Card expiration date _____ Signature _____

DSI INSTRUMENTS INC.
 Div. Diversified Security Ind, Inc.

We pay shipping charges anywhere in the U.S.A. UPS Brown or P.P. — CA Residents please add 6% state sales tax.

- American Express
- Bank of America
- MasterCharge
- VISA

7914 Ronson Road No. G, San Diego, CA 92111



Your Business can be one too.

Red Cross needs individual volunteers, and donors of blood and money, by the millions.

But we need even more help. We need the solid support of American Business. And we never needed it more.

If your business is already helping, by organizing blood drives, and by supporting payroll deductions—either directly for the Red Cross, or through the local combined fund drive—the whole community owes you thanks. And we thank you, too.

Last year, with help from our friends, we offered major aid at over 30,000 disasters—from typhoons, to local (but just as devastating) house fires.

We were able to help the elderly with practical programs, we helped veterans by the hundreds of thousands, we taught people by the millions to swim or swim better. And that's just the tip of the iceberg.

Think of America without The American Red Cross.

And you'll know why we need your business as a Red Cross Volunteer. In your community. And all across America. Contact your local Red Cross Chapter to see how your company can become a volunteer.

Red Cross is counting on you.

How You Can Convert Your Rohn 25G Tower to a FOLD-OVER

CHANGE, ADJUST OR JUST PLAIN WORK ON YOUR ANTENNA AND NEVER LEAVE THE GROUND.

If you have a Rohn 25G Tower, you can convert it to a Fold-over by simply using a conversion kit. Or, buy an inexpensive standard Rohn 25G tower now and convert to a Fold-over later.

Rohn Fold-overs allow you to work completely on the ground when installing or servicing antennas or rotors. This eliminates the fear of climbing and working at heights. Use the tower that reduces the need to climb. When you need to "get at" your antenna . . . just turn the handle and there it is. Rohn Fold-overs offer unbeatable utility.

Yes! You can convert to a Fold-over. Check with your distributor for a kit now and keep your feet on the ground.

AT ROHN YOU GET THE BEST

Do not attempt to raise antenna or antenna support near power lines— You can be KILLED.

 **Unarco-Rohn**
Division of Unarco Industries, Inc.
P.O. Box 2000 Peoria, Illinois 61601

U2

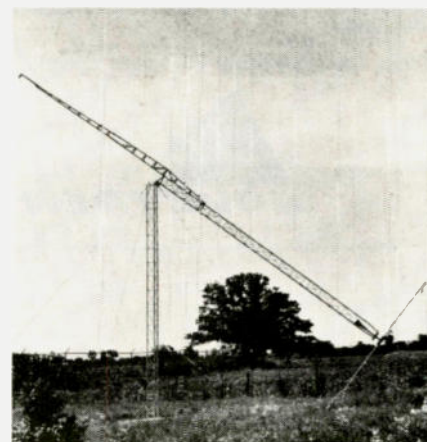
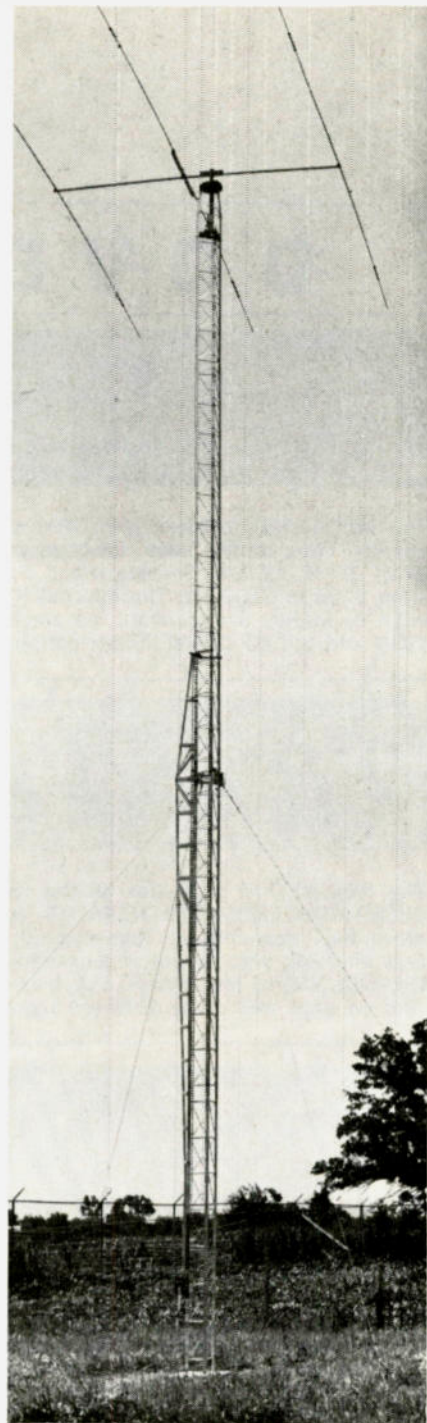

DOVETRON



MPC-1000C
Multipath-Diversity
Amateur Net: \$495.00

The MPC-1000C features MULTIPATH CORRECTION, IN-BAND DIVERSITY (single channel copy during deep selective fades) Operation and a PHASE-CONTINUOUS AFSK TONE KEYS. The Mark and Space channels are CONTINUOUSLY tuneable from 1200 to 3100 Hz. The internal RY GENERATOR and DUAL-MODE AUTOSTART (FSK or MARK) are standard, as are rear panel provisions for SIGNAL REGENERATION and SPEED CONVERSION peripherals.



MPC-1000CR
Signal Regeneration &
Up-Down Speed Conversion
Amateur Net: \$595.00

The MPC-1000CR combines all the features of the MPC-1000C with the TSR-200 SPEED CONVERTER-REGENERATOR. A front panel SIGNAL SPEED switch provides electronic "gear-shifting" between 60, 66, 75 and 100 WPM speeds. All incoming and outgoing signals are regenerated by a CMOS UART and a crystal-controlled DUAL-CLOCK to less than 0.5% bias distortion, providing an extremely low error rate on weak and badly distorted signals.



MPC-1000R
Dual-Uart Regeneration,
200 Character Fifo
Memory & Word Correction.
Amateur Net: \$820.00

The MPC-1000R combines the features of the MPC-1000CR with the TSR-500 SPEED CONVERTER-REGENERATOR and offers 200 characters of FIFO MEMORY, a DUAL-UART REGENERATOR that also provides local copy during all PRELOAD-RECIRCULATE functions, a WORD CORRECTION circuit that permits an incorrect word to be erased from memory by depressing the local keyboard's BLANK key, VARIABLE CHARACTER RATE and automatic BLANK/LTRS DIDDLE. Character OVER-RUN during down-speed conversion is prevented by an automatic CHARACTER RATE OVER-RIDE and TEE DEE INHIBIT circuit. Three preset AFSK TONE/SHIFT combinations are selectable from the front panel.

The MPC-1000R (80 characters of memory), MPC-1000CA (Tri-tone AFSK), MPC-1000CRA (Tri-tone Regenerator) and MPC-1000CS (Crypto-Scrambler) are also available.

Your QSL will bring complete specifications, or call: 213-682-3705.



627 Fremont Ave.
(P. O. Box 267)
South Pasadena, Ca. 91030

D23

SURPLUS TRANSFORMERS

ALL 115 VAC 60 Hz PRIMARIES

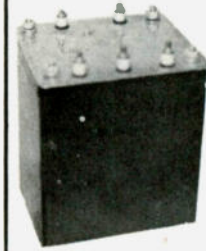

#SS-HW-201P;
2000 VCT 500 MA (700
MA intermittent); 7x5½
x5", 32 lbs.
Used \$27.50

#SS-S-P243;
900 VCT 250 MA; 4½x4¼x
3¾", 15 lbs. Used, \$9.95

#84103AD1;
500 VCT 250 MA; one side tapped 50, 75, 120, 175 V;
12.6 V 3 A; 4½x3½x4½", 15 lbs. Unused, \$9.95

#25D84455DC1; 40 V 15 A; 5¼x5¼x4½",
18 lbs. Unused \$9.95

#PV-175-9; 15 V 3 A; 13 V 2 A; 6.3 V 7 A; with
regulator capacitor; 4½x3¾x3¾", 13 lbs.
Unused \$5.95

#P601719; 12 V 9 A; 44 V 2.5 A; 12.9 V 3.2 A;
12.9 V 2 A; 5¼x4¼x4¼", 22 lbs. Unused, \$12.95

WE ALSO STOCK
COMPUTER GRADE CAPACITORS,
STUD RECTIFIERS, and HEATSINKS.

WRITE FOR NEW '78 CATALOG.

All prices F.O.B. Lima, Ohio.

Please allow for shipping charges.

Use your B/A, VISA, or M/C Card.

Address Dept. 73 • Phone: 419/227-6573

FAIR RADIO SALES

1016 E. EUREKA • Box 1105 • LIMA, OHIO • 45802

HIGH PERFORMANCE SMOKE DETECTOR

FRAZER & ASSOCIATES

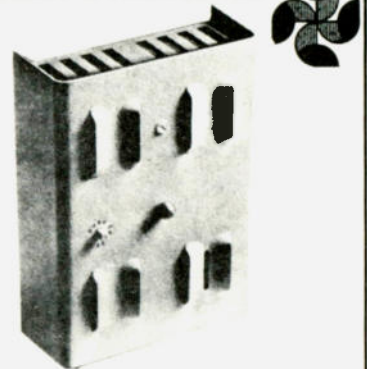

HIGH PERFORMANCE SMOKE DETECTOR
NOW — at an Extraordinary \$23.00

Savings. List price \$49.95 our special sale
price only \$26.95 Postpaid to your door.

The Case for home and office Smoke
Detectors is overwhelming: (1) Fire
Spreads 1100% in the first 4 minutes. (2)
74% of dwelling victims die upstairs from
downstairs fires. (3) Most home fires start
between midnight and 6 A.M. while the
family sleeps. (4) Someone's home burns
every 55 seconds. These and other facts
are compelling millions of wise Americans
to protect their families and homes
against the horrible consequences of fire.
Smoke Detectors are now required for all
new residential occupancies. With UL
Listed High Performance Detectors, you
can comply. Free Catalog. HURRY —
Supply limited. Frazer & Associates
Consulting Engineers, 1888 Century Park
East, Century City, CA 90067. F7

ALUMA TOWERS

VERO BEACH, FLORIDA 32960

MFG'S OF ALUMINUM TOWERS

- ★ TELESCOPING (Crank Up)
- ★ WALL MOUNTED
- ★ TILT-OVER
- ★ GUYED MODELS (to 100 Ft.)

Excellent for Ham Communications.

HIGH QUALITY — LOW PRICES

MADE IN LONG-LASTING NO-RUST ALUMINUM!

McCLARAN SALES TAKES IN ANYTHING ON TRADE FOR NEW ALUMA TOWERS.

NEED: Scanners, CB, 2 Meter, Marine, Antiques, Coins, Ham Gear. A47

We accept Master Charge & Visa Cards

FOR SALES & TRADES CONTACT **R.D. McCLARAN SALES**

430 Franklin at Beach
Indalantic, Florida 32903
(305) 723 4793

JAN CRYSTALS HOLD THE FREQUENCY

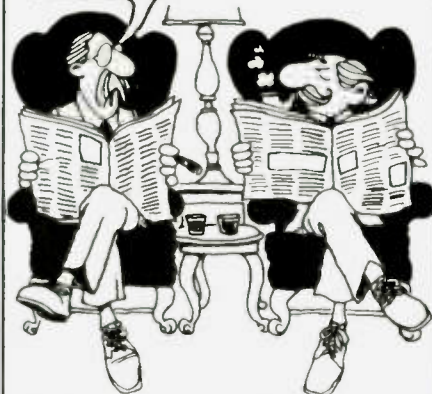

- CB
- CB standard
- 2 meter
- Scanners
- Amateur Bands
- General Communication
- Industry
- Marine UHF
- Micro processor crystals

easy to charge



Send 10¢ for our latest catalog
Write or phone for more details
2400 Crystal Drive
Ft. Myers, Florida 33901
all phones (813) 936-2397

J2

MADISON BIG SIGNAL BUYS

OMNI-J 2-meter mobile or portable antenna. 3/8" thread, 5-dB gain (1.5-dB gain over conventional 5/8-wave mobile whip antenna). \$29.95; 450 MHz \$27.95. Guaranteed results.

BIRD 43 WATTMETERS PLUS SLUGS IN STOCK. PREPAID FREIGHT

PREMAX 4 ft. ground rod + clamp \$4.50
MIDLAND 23-136 dual meter reads SWR and relative power. Handles 1 kW from 3-150 MHz. \$21.95
YAESU FT 301 + FP301 AC Supply

\$750.00

YAESU FT-301D + FP301 AC Supply

\$935.00

HY GAIN 18AVT/WB + 100 feet RG8

coax \$100.00

HY GAIN 18V vertical \$19.95

Model 214 2m Yagi \$21.50

HY-Gain 208 2m Yagi \$15.95

VHF SPECIALS: Kenwood TS 700S

List . . . \$679 Call for quote

KLM: Antennas, Linears, Accessories

All In Stock — FREE balun w/2

meter base antenna.

JANEL PREAMPS: In Stock. Technical

Books (ARRL, Sams, Tab, RCA, T.I.,

etc.)

HAM X ROTOR (New Model) Turns 28

sq. ft. of antenna List . . . \$325 Order

Now Your Price — \$249.00

CDE HAM 3 \$129.00

SWAN METERS: WM 6200 VHF Watt-

meter \$49.95; SWR 3 Mobile \$9.95

TELEX HEADSETS: In Stock

CETRON 572B \$24.95 ea.

RAYTHEON 811A

Sealed Cartons \$16.00/pair

ADEL nibbling tool, \$6.45; punch \$3.50

CABLE 5/32", 6-strand, soft-drawn guy

cable. For mast or light tower, 34 foot.

BELDEN COAX CABLE: 8237 RG8

214 ft. 8214 RG8 foam 254 ft., 8448

8-wire rotor cable 164 ft., 8210 72 ohm

kw twinlead \$19/100 ft., 8235 300 ohm

kw twinlead \$12/100 ft., Amphenol

silver-plate PL 259 594 ea. UG175 adapt-

er 194, PL-258 dbl female \$1.00.

NYLON CORD 5000 ft. + per roll

\$15.00

BELDEN 14 gauge copper stranded ant-

enna wire. \$5.00/100 ft.

BELDEN 9888 Double Shield RG8

Foam-direct bury — 100% braided 394/ft.

22 gauge plastic covered ant. wire for

long wire, radials. \$3.50/1000 ft.

KESTER SOLDER 1 lb. 60/40, .062

. \$6.50

Leader — Amateur Test Equip. — 10%

off list.

Mallory 2.5A/1000PIV epoxy diode 194

ea. .001 MFD 20KV CAP \$1.95

CALL FOR QUOTES ON:

Yaesu FT301D, FT301, Kenwood

TS520S, TS820S, TS600A, TR7400A,

TR7500, FT227B & ETO-ALPHA. All in

sealed cartons. Call for quotes on items

not listed.

CALL FOR FAST QUOTE, OR WRITE

AND INCLUDE TELEPHONE NUM-

BER. IF WE HAVE YOUR BARGAIN,

WE'LL CALL YOU PREPAID.

TERMS: All prices FOB Houston. Prices

subject to change without notice. All

items Guaranteed. Some items subject to

prior sale. Send letterhead for Amateur

dealers price list. Texas residents add 5%

tax. Please add postage estimate, excess

refunded.

MADISON

ELECTRONICS SUPPLY, INC.

1508 McKinney • Houston TX 77002

(713) 658-0268 • Niles (713) 497-5683

"THE PROFESSIONALS"

NEW

MODEL CTR-2A • 500 MHz & 1 GHz

COUNTERS

NEW
Period
Measurement

1 us to
1 sec.



NEW
Built-in
Pre-Amp

10 mv @
150 MHz

The New Model CTR-2A Series Counters are designed and built to the highest standards to fulfill the needs of commercial communications, engineering labs and serious experimenters. With an accuracy of + .00005% (oven option) the CTR-2A can handle the most critical measurements and is about half the cost of other commercial counters.

If you need a reliable counter at an affordable price, the CTR-2A is the answer.

- Built-in Pre-Amp 10 mv @ 150 MHz
- 8 Digit .3" LED Display
- High Stability TCXO Time Base
- Built-in VHF-UHF Prescaler
- Automatic Dp Placement
- TCXO Std. ± 2 ppm
- Period Measurement (Optional)
- Input Diode Protected
- 12V-DC Operation (Optional)
- Oven Controlled Crystal (Optional) ± .5 ppm
- Selectible Gate Times - 1 & 1 sec.

500 MHz Kit CTR-2A-500K	\$249.95
500 MHz Assembled CTR-2A-500A	349.95
1GHz Kit CTR-2A-1000K	399.95
1GHz Assembled CTR-2A-1000A	549.95

OPTIONS

02) Oven Crystal	\$49.95	05) 10 sec. Time Base	\$ 5.00
03) .43" LED	10.00	06) Period	15.00
04) 12 V-DC	10.00	07) Handle	10.00



D10



PROBES
Hi-Z
\$15.00
•
Low Pass
\$15.00

DAVIS ELECTRONICS 636 Sheridan Dr., Tonawanda, N.Y. 14150 716/874-5848

THE CHALLENGE OF 160

ARE YOU IN A RUT? Tired of talking to the same characters on 75 every evening? If so, perhaps it's time to try a new band – something different and exciting. Consider 160 meters. The "Top Band" is different from any other amateur allocation. Its propagation characteristics are unique, resembling the standard AM broadcast band. Amateur radio's roots can be traced to 160, as it was there (actually, 200 meters) that amateur radio began.

If you are remotely interested in 160 meter operation, 73's newest book, *The Challenge of 160*, is for you. Si Dunn, the author, has compiled a complete reference for the new and experienced 160 operator. Eleven chapters cover everything from receiving and transmitting equipment to antenna and ground systems. Weather effects upon propagation are discussed, as well as operating tips. An interesting introduction provides an insight into the origins of amateur radio – complete with pictures and comments about Stew Perry W1BB, the "King of 160."

This reference is heavily illustrated . . . and complete schematics are provided for construction projects. An additional reading index of related articles and publications is provided – as you are sure to become excited with 160 operating after reading *The Challenge of 160*. Price: \$4.95.

Use the order card in the back of the magazine or itemize your order on a separate paper & mail to: 73 Radio Bookshop/ Peterborough NH 03458. Be sure to include check or detailed credit card information.



Think DIGITAL!

Here in this fourth volume of the 73 TEST EQUIPMENT LIBRARY are 42 home construction projects for building test equipment to work with your ham station and in servicing digital equipment. Counters, scalars, frequency standard, synthesizers, logic probes . . . JUST ABOUT EVERYTHING you need and can build with ICs. IC TEST EQUIPMENT contains the following chapters: Pulse Generators . . . Audio Generators . . . Sync Generator . . . Digital SWR Computer . . . Frequency Counters . . . Digital Component Testers . . . Logic Probes . . . Accessories.

... \$4.95 *



Use the order card in the back of the magazine or itemize your order on a separate piece of paper. Be sure to include check or detailed credit card information. *Add \$1.00 shipping and handling charge for each order.

73 Radio Bookshop, Peterborough NH 03458

**NEW
BOOK!**
...\$4.95*

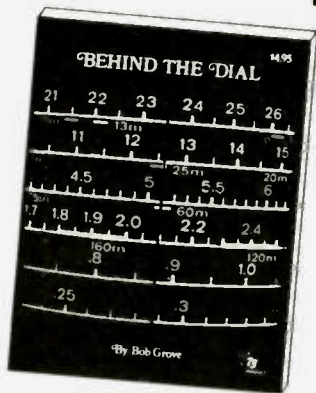

BEHIND THE DIAL

By Bob Grove

Get more fun out of shortwave listening with this interesting guide to receivers, antennas, frequencies, and interference. Contains the following chapters:

- *The Electromagnetic Spectrum: A Review*
- *Users of the Radio Spectrum*
- *Surveillance*
- *Station Layout Considerations*
- *Antenna Systems*
- *Interference*

Use the order card in the back of this magazine or itemize your order on a separate piece of paper. (Be sure to include check or detailed credit card information.) *Add \$1.00 shipping & handling charge for each order and mail to:

73 Radio Bookshop • Peterborough NH 03458

For a little bit extra YOU CAN go first class!

... And binders for your 73 Magazines are the first class way to go.

Your back issues of 73 are your very best encyclopedia of electronics and you don't want to take any chances on losing any of them. If you put them into the handsome 73 Binders, you'll have your copies when you want them... and all together with that yearly index in the December issue. Why is it that the article you need the most is always in a missing issue? Let's see... did Charlie borrow it or did it get lost when we cleaned up last year? Get a binder... only \$6.50 in red with gold lettering. Two for \$12.00.



Use the order card in the back of the magazine or itemize your order on a separate paper & mail to:

73 Magazine Binders
Peterborough NH 03458

Be sure to include check or detailed credit card information. Add \$1.00 shipping & handling charge for each order.

call us ... tell us

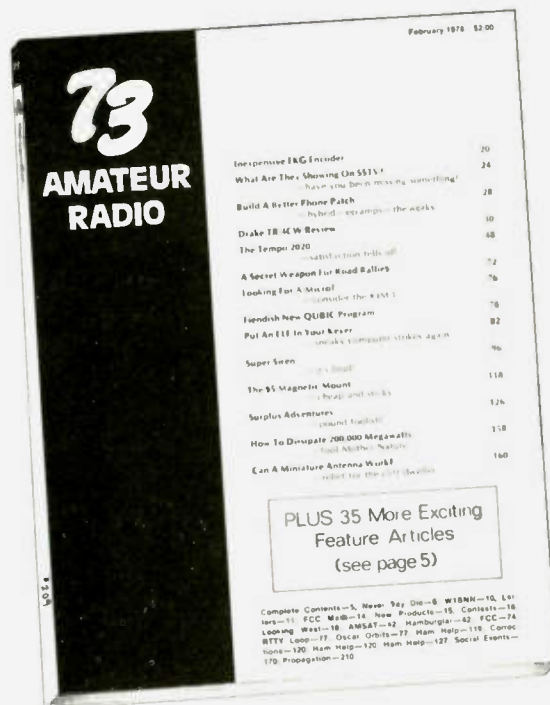

you want to SUBSCRIBE!

Also tell us your credit card number so we can enter the subscription for you. A subscription saves you a bundle of money... just figure it out. At \$2 a copy you're spending \$24 a year, yet a subscription costs a lousy \$15. Nine dollars may not be a lot today, but that's no reason to just throw it away because you don't want to bother to pick up the phone.

Three years of 73? If you figured out what the costs you'd send in a subscription instantly. Not having calculators that go out that far (allowing for the usual inflation, increases in postage, rising paper prices, and a new car for Wayne... a copy of 73 will probably be \$5 three years from now), no one at 73 has definitely been able to calculate the exact cost of three more years on the newsstand. One thing is for sure, it's going to be a lot more than the current three year \$36 subscription rate, which is an obvious rip-off. Call in your three year subscription and make us rue the day we came up with that low number.

It's toll free

800-258-5473

and someone is usually around during office hours to take your order, credit card number (Master Charge, BankAmericard or American Express). While you're calling what would it hurt to get Kilobaud too? And maybe a few books for the bathroom.

If the line is busy tear out the card bound in the back of the magazine... just inside the back cover...

While you are tearing out cards it is high time for you to mark up the reader's service part too. A good response convinces advertisers to run more ads... you get more pages of magazine. It's a good investment.

73 Peterborough NH 03458

RADIO BOOKSHOP

The ONLY Complete License Study Guides

- **NOVICE STUDY GUIDE** — Here is a completely new study guide and reference book for the potential ham. This is not a question/answer memorization course. Electronic and radio fundamentals are presented and explained in an easy-to-understand fashion, preparing the beginner for the Novice exam. Includes the latest FCC amateur regulations, as well as application forms. Easily the best path into the exciting world of ham radio! \$4.95.*
- **GENERAL CLASS STUDY GUIDE** — A complete theory course for the prospective General or Technician. This reference explains transistor, amplifier, and general radio theory, while preparing the Novice for the "big" ticket. After getting your ticket, you'll use this guide again and again as an electronic reference source. Not a question/answer guide that becomes dated when the FCC updates the amateur exams. \$5.95.*
- **ADVANCED CLASS STUDY GUIDE** — Ready to upgrade your license? To prevent retaking the FCC theory exam, you need the 73 Advanced theory guide. SSB, antenna theory, transmitters, and electronic measuring techniques are covered in detail in this easy-to-follow study guide. Special modes and techniques, such as RTTY, are also treated. An engineering degree is *not* necessary to master Advanced theory — try this book before visiting the examiner's office! \$5.95.*
- **EXTRA CLASS LICENSE STUDY GUIDE** — Before going for your 1 x 2 call, it pays to be a master of the Extra class electronic theory. This study guide is the logical extension of the 73 theory course. All the theory necessary to pass the exam is presented. Antennas, transmission lines, swr are discussed, as well as noise, propagation, and specialized communication techniques. This book is not a classroom lecture or memorization guide, but rather a logical presentation of the material that must be *understood* before attempting the Extra exam. Save yourself a return trip to the FCC and try the 73 method first! \$5.95.*



novice theory tapes

Startling Learning Breakthrough

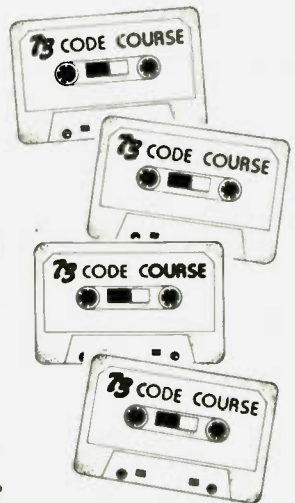

You'll be astounded at how really simple the theory is when you hear it explained on these tapes. Three tapes of theory and one of questions and answers from the latest Novice exams give you the edge you need to breeze through your exam.

73 is interested in helping get more amateurs, so we're giving you the complete set of our tapes for the incredibly low price of ONLY \$15.95.*

Scientists have proven that you learn faster by listening than by reading because you can play a cassette tape over and over in your spare time — even while you're driving! You get more and more info each time you hear it.

You can't progress without solid fundamentals. These four hour-long tapes give you all the basics you'll need to pass the Novice exam easily. You'll have an understanding of the basics which will be invaluable to you for the rest of your life! Can you afford to take your Novice exam without first listening to your tapes?

FOUR TAPES for \$15.95 \$4.95 EACH

5 WPM This is the beginning tape for people who do not know the code at all. It takes them through the 26 letters, 10 numbers and necessary punctuation, complete with practice every step of the way using the newest blitz teaching techniques. It is almost miraculous! In one hour many people — including kids of ten — are able to master the code. The ease of learning gives confidence to beginners who might otherwise drop out.

NEW CODE SYSTEM — Four Speeds Available

6+ WPM This is the practice tape for the Novice and Technician licenses. It is made up of one solid hour of code, sent at the official FCC standard (no other tape we've heard uses these standards, so many people flunk the code when they are suddenly — under pressure — faced with characters sent at 13 wpm and spaced for 5 wpm). This tape is not memorizable, unlike the zany 5 wpm tape, since the code groups are entirely random characters sent in groups of five. Practice this one during lunch, while in the car,

anywhere, and you'll be more than prepared for the easy FCC exam.

13+ WPM Code groups again, at a brisk 13 per so you will be at ease when you sit down in front of the steely eyed government inspector and he starts sending you plain language at only 13 per. You need this extra margin to overcome the panic which is universal in the test situations. When you've spent your money and time to take the test you'll thank heavens you had this back-breaking tape.

20+ WPM Code is what gets you when you go for the Extra Class license. It is so embarrassing to panic out just because you didn't prepare yourself with this tape. Though this is only one word faster, the code groups are so difficult that you'll almost fall asleep copying the FCC stuff by comparison. Users report that they can't believe how easy 20 per really is with this fantastic one hour tape. No one who can copy these tapes can possibly fail the FCC test. Remove all fear of the code forever with these tapes.

ONLY 4 for \$15.95! * 73 is in the publishing business, not tapes, so these are priced much lower than anyone else could sell them. Have you ever seen one hour cassettes for under \$6? For 1st class mail add 25¢ per tape ordered.

**RADIO AMATEURS
TALK TO THE WORLD!!**
...ask me about it!

BUMPER STICKERS:
RADIO AMATEURS TALK TO THE WORLD!!
AUTHORIZED VEHICLE
SUPPORT YOUR LOCAL POLICE
50¢ each*; any 3 for \$1.00*

BINDERS — Red Binders with gold lettering keep your 1976 & 1977 73s safe from being lost or damaged. Each binder holds 12 issues. \$6.50 ea.,* 2 for \$12.00.*

Back Issue Bundle! 73 Magazine Classics, issues containing hundreds of articles & projects. Great for nostalgia buffs. 20 copies (all different) for \$12.00.*

**LIBRARY SHELF
BOOK BOXES**
\$2.00 each*
2/\$3.00* • 8/\$10.00*

QSLs!

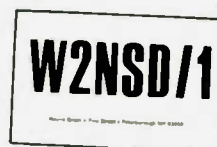

Style W — Black type, blue world

Style Y (yellow card;
black type)

Only \$8.95 for 250
\$13.95 for 500*

QSO information is standard form on back of all cards. (DOMESTIC ORDERS ONLY) Allow 6-8 weeks for delivery.

Use the order card in the back of this magazine or itemize your order on a separate piece of paper and mail to:
73 Radio Bookshop • Peterborough, NH 03458. Be sure to include check or detailed credit card information.
* Add \$1.00 shipping & handling charge for each order. Note: Price subject to change on books not published by 73 Magazine.

RADIO BOOKSHOP

RADIO BOOKSHOP

- **WEATHER SATELLITE HANDBOOK** Simple equipment and methods for getting good pictures from the weather satellite. Antennas, receivers, monitors, facsimile you can build, tracking, automatic control (you don't even have to be home). Dr. Taggart WB8DQT \$4.95.*
- **NEW REPEATER ATLAS of the ENTIRE World**, 150% as big as any list ever available — nearly 900 more repeaters listed. New improved maps that show the location by frequency of every repeater in the States. Only \$1.95.*
- **VHF ANTENNA HANDBOOK** The NEW VHF Antenna Handbook details the theory, design and construction of hundreds of different VHF and UHF antennas . . . A practical book written for the average amateur who takes joy in building, not full of complex formulas for the design engineer. Packed with fabulous antenna projects you can build. \$4.95.*
- **THE CHALLENGE OF 160** is the newest book in the 73 technical library, dedicated to 160 meter operating. Si Dunn provides all necessary information to get started on this unique band. The all-important antenna and ground systems are described in detail. The introduction contains interesting photos of Stew Perry's (the King of 160) shack. This reference is a must for new and experienced "Top Band" operators. Price: \$4.95.*
- **BEHIND THE DIAL** by Bob Grove. Get more fun out of shortwave listening with this interesting guide to receivers, antennas, frequencies and interference. \$4.95.*



- **COAX HANDBOOK** The world's only handbook devoted exclusively to coax, feedlines and connectors. Special price only \$1.50.*
- **VOL. I COMPONENT TESTERS** . . . how to build transistor testers (8), diode testers (3), IC testers (3), voltmeters and VTVMs (9), ohmmeters (8 different kinds), inductance (3), capacity (9), Q measurement, crystal checking (6), temperature (2), aural meters for the blind (3) and all sorts of miscellaneous data on meters . . . using them, making them more versatile, making standards. Invaluable book, \$4.95.*
- **VOL. II AUDIO FREQUENCY TESTERS** . . . jam packed full of all kinds of audio frequency test equipment. If you're into SSB, RTTY, SSTV, etc., this book is a must for you . . . a good book for hi-fi addicts and experimenters too! \$4.95.*
- **VOL. III RADIO FREQUENCY TESTERS** Radio frequency waves, the common denominator of Amateur Radio. Such items as SWR, antenna impedance, line impedance, rf output and field strength; detailed instructions on testing these items includes sections on signal generators, crystal calibrators, grid dip oscillators, noise generators, dummy loads and much more. \$4.95.*
- **VOL. IV IC TEST EQUIPMENT** Become a troubleshooting wizard. All you need to know about pulse, audio and sync generators, frequency counters, digital component testers, logic probes and more! Plus a cumulative index for all four volumes of the 73 Test Equipment Library. \$4.95.*
- **THE NEW RTTY HANDBOOK** is a brand new 1977 edition and the only up-to-date RTTY book available. The state of the art has been changing radically and has made all previous RTTY books obsolete. It has the latest circuits, great for the newcomer and the expert alike . . . Only \$5.95.*

- **73 VERTICAL, BEAM AND TRIANGLE ANTENNAS** by Edward M. Noll W3FQJ Describes 73 different antennas for amateurs. Each design is the result of the author's own experiments: each has actually been built and air-tested. Includes appendices covering the construction of noise bridges and antenna line tuners, as well as methods for measuring resonant frequency, velocity factor, and standing-wave ratios. 160 pages. \$5.50.*
- **IC OP-AMP COOKBOOK** by Walter G. Jung. Covers not only the basic theory of the IC op amp in great detail, but also includes over 250 practical circuit applications, liberally illustrated. 592 pages, 5 1/2 x 8 1/2, softbound \$12.95.*
- **73 DIPOLE AND LONG-WIRE ANTENNAS** by Edward M. Noll W3FQJ This is the first collection of virtually every type of wire antenna used by amateurs. Includes dimensions, configurations, and detailed construction data for 73 different antenna types. Appendices describe the construction of noise bridges, line tuners, and data on measuring resonant frequency, velocity factor, and swr. \$5.50.*
- **RF AND DIGITAL TEST EQUIPMENT YOU CAN BUILD** Rf burst, function, square wave generators, variable length pulse generators — 100 kHz marker, i-f and rf sweep generators, audio osc, af/rf signal injector, 146 MHz synthesizer, digital readouts for counters, several counters, prescaler, microwavemeter, etc. 252 pages. \$5.95.*
- **SSTV HANDBOOK** This excellent book tells all about it, from its history and basics to the present state of the art techniques. Contains chapters on circuits, monitors, cameras, color SSTV, test equipment and much more. Hardbound \$7, softbound \$5.*



Use the order card in the back of this magazine or itemize your order on a separate piece of paper and mail to:
73 Radio Bookshop • Peterborough, NH 03458. Be sure to include check or detailed credit card information.

*Add \$1.00 shipping & handling charge for each order. Note: Price subject to change on books not published by 73 Magazine.

RADIO BOOKSHOP

RADIO BOOKSHOP

- **RTL COOKBOOK** by Donald Lancaster. Explains the how and why of RTL (Resistor-Transistor Logic) and gives design information that can be put to practical use. Gives a multitude of digital applications ranging from the basic switch to the sophisticated counter. 240 pages; 5½ x 8½; softbound. \$5.50.*
- **TTL COOKBOOK** by Donald Lancaster. Explains what TTL is, how it works, and how to use it. Discusses practical applications, such as a digital counter and display system, events counter, electronic stopwatch, digital voltmeter, and a digital tachometer. 336 pages; 5½ x 8½; softbound. \$8.95.*
- **TVT COOKBOOK** by Donald Lancaster. Describes the use of a standard television receiver as a microprocessor CRT terminal. Explains and describes character generation, cursor control and interface information in typical, easy-to-understand Lancaster style. This book is a required text for both the microcomputer enthusiast and the amateur RTTY operator who desires a quiet alternative to noisy teletype machines. \$9.95.*

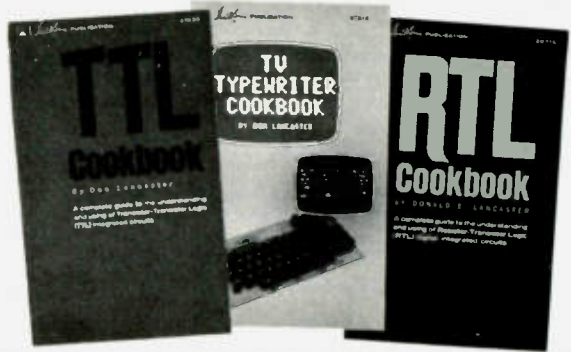

- **FASCINATING WORLD OF RADIO COMMUNICATION** Interesting stories in the history of radio pioneering and discovery. Also includes the fundamentals of broadcast band DXing. A must for every radio amateur. \$3.95.*
- **PRACTICAL TEST INSTRUMENTS YOU CAN BUILD** 37 simple test instruments you can make — covers VOMs, VTVMs, semiconductor testing units, dip meters, wattmeters, and just about anything else you might need around the test lab and ham shack. \$4.95.*
- **1001 PRACTICAL ELECTRONIC CIRCUITS** Tab's new 1001 circuits is available for only \$9.95 ppd. The next time you want a circuit for just about anything, eat your heart out that you didn't send for this book the first time you read about it. You'd better order the book right away, before they run out. \$9.95.*
- **HOW TO MAKE BETTER QSLs** Be proud of your QSL cards ... have a card which gets front space on every hamshack wall ... win prizes at hamfests. The only way to have a truly outstanding card is to make it yourself, which is easy when you have this new book. \$2.00*

- **WHAT TO DO AFTER YOU HIT RETURN** PCC's first book of computer games ... 48 different computer games you can play in BASIC ... programs, descriptions, muchly illustrated. Lunar Landing, Hammurabi, King, Civil 2, Qubic 5, Taxman, Star Trek, Crash, Market, etc. \$6.95.*
- **101 GAMES IN BASIC** 101 games for you, from very simple to real buggers. You get the games, a description of the games, the listing to put in your computer and a sample run to show you how they work. Fun. Any one game will be worth more than the price of the book for the fun you and your family will have with it. \$7.50.*
- **BASIC** by Bob Albrecht. Self-teaching guide to the computer language you will need to know for use with your microcomputer. 324 pages. This is one of the easiest ways to learn computer programming. \$4.95.*
- **THE UNDERGROUND BUYING GUIDE** Here is a handy guide for the electronics enthusiast. Over 600 sources of equipment and literature are provided; some are mail-order-only outfits that do not advertise. Sources are listed alphabetically, by service or product, and by state. The guide is cross-referenced for ease of use. Electronic publishing houses are also listed. Published by PMS Publishing Co., \$5.95.*

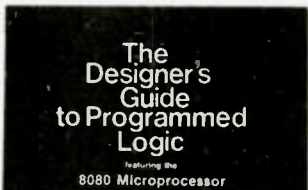

- **AN INTRODUCTION TO MICROCOMPUTERS, VOLS. 1 AND 2** by Adam Osborne Associates, are references dealing with microcomputer architecture in general and specifically with details about most of the common chips. These books are not software-oriented, but are invaluable for the hobbyist who is into building his own interfaces and processors. Volume 1 is dedicated to general hardware theory related to micros, and Volume 2 discusses the practical details of each micro chip. (Detailed review in *Kilobaud* #2) Published by Osborne Associates, Vol. I — \$7.50*; Vol. II — \$12.50.*
- **8080 PROGRAMMING FOR LOGIC DESIGN** Ideal reference for the person desiring an in-depth understanding of the 8080 processor. The work is application-oriented, and the 8080 is discussed in light of replacing conventional, hard-wired logic systems. Both hardware and software is described. Practical design considerations are provided for the implementation of an 8080-based control system. (Detailed review in *Kilobaud* #1) Published by Osborne Associates, \$7.50.*
- **6800 PROGRAMMING FOR LOGIC DESIGN** Oriented toward the industrial user, describes the process by which conventional logic can be replaced by a 6800 microprocessor. Hardware, software, and interfacing techniques are discussed. This reference provides practical information that allows an experimenter to design a complete micro control system from the "ground up." An excellent reference! Published by Osborne Associates. \$7.50.*

Use the order card in the back of this magazine or itemize your order on a separate piece of paper and mail to:
73 Radio Bookshop • Peterborough, NH 03458. Be sure to include check or detailed credit card information.

* Add \$1.00 shipping & handling charge for each order. Note: Price subject to change on books not published by 73 Magazine.

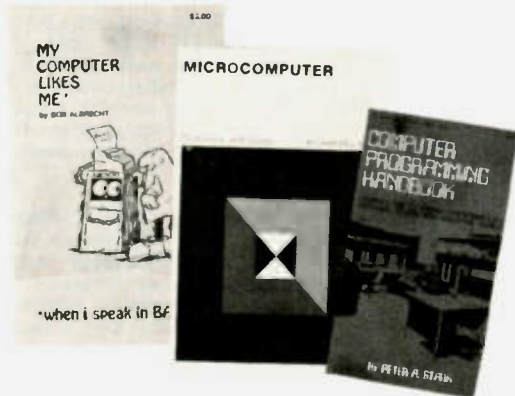

● **BRAND NEW DICTIONARY** This microcomputer dictionary fills the urgent need to become quickly acquainted with the terminology and nomenclature of the revolution in computers. Over 5000 definitions and explanations of terms and concepts (704 pages) relating to microprocessors, microcomputers and microcontrollers. There is also a comprehensive electronics/computer abbreviations and acronyms section. \$15.95.*

● **COMPUTER PROGRAMMING HANDBOOK** by Peter Stark. A complete guide to computer programming and data processing. Includes many worked out examples and history of computers. \$8.95.*

● **MY COMPUTER LIKES ME ... WHEN I SPEAK BASIC** An introduction to BASIC ... simple enough for your kids. If you want to teach BASIC to anyone quickly, this booklet is the way to go. \$2.00.*

● **SCELBI'S GALAXY GAME FOR THE "6800"** "Galaxy" pits the operator of a spaceship against alien craft, as well as such variables as speed, time, and ammunition. No two games are the same! \$14.95.*

● **6800 SOFTWARE GOURMET GUIDE & COOKBOOK** This manual describes sorting, searching, and many other routines for the 8080 user. \$9.95.*

● **8080 SOFTWARE GOURMET GUIDE AND COOKBOOK** Describes sorting, searching, and many other routines for the 8080 user. \$9.95.*

● **CMOS COOKBOOK** by Don Lancaster. Another winner from the author of the *RTL* and *TTL Cookbooks*. Details the application of CMOS, the low power logic family suitable for most applications presently dominated by TTL. Eight chapters cover all facets of CMOS logic, prefaced by 100 pages detailing the characteristics of most CMOS circuits. Required reading for every serious digital experimenter. \$9.95.*

● **HOBBY COMPUTERS ARE HERE** If you (or a friend) want to come up to speed on how computers work ... hardware and software ... this is an excellent book. It starts with the fundamentals and explains the circuits, the basics of programming, along with a couple TVT construction projects, ASCII-Baudot, etc. It has the highest recommendations as a teaching aid for newcomers. \$4.95.*

● **FUN WITH COMPUTERS AND BASIC** by Donald D. Spencer, contains an easy-to-understand explanation of the BASIC Programming Language and is intended for persons who have had no previous exposure to computer programming but want to learn BASIC quickly, easily, and interestingly. Over half the book is devoted to problems using games, puzzles, and mathematical recreations (you don't need a math background to understand most of the problems in this book). A superior book for self-teaching and learning computer programming. \$6.95.*



● **THE STORY OF COMPUTERS** by Donald D. Spencer is to computer books what *Dick and Jane* is to novels ... extremely elementary, gives the non-computerist a fair idea of what the hobbyist is talking about when he speaks computer lingo. Attempts to explain what computers are and can do. \$4.95.*

● **SCELBI'S FIRST BOOK OF COMPUTER GAMES** Need a game for your 8008 or 8080 microprocessor? Describes three popular games, "Space Capture," "Hexpawn," and "Hangman." Complete flowcharts, logic description, program listing, and instructions are provided. A must for the game freak! \$14.95.*

● **MICROCOMPUTER PRIMER** by Mitchell Waite and Michael Pardee. Describes basic computer theory, describes the world of microcomputing in "real world" terminology, explains numbering systems, and introduces the reader to the world of programming. There is probably no better way of getting involved with the exciting new hobby of microcomputing. \$7.95.*

● **INTRODUCTION TO MICROPROCESSORS** by Charles Rockwell of MICROLOG. An ideal reference for the individual desiring to understand the hardware aspects of microprocessor systems. Describes the hardware details of computer devices in terms the beginner can understand, instead of treating the micro chip as "black box." Addressing schemes, registers, control, and memory are all explained. General information about hardware systems is provided. Specific systems are not described and programming is only briefly discussed. \$17.50* US and Canada, \$20 elsewhere.

● **THE NEW HOBBY COMPUTERS!** This book takes it from where "Hobby Computers Are Here" leaves off, with chapters on Large Scale Integration, how to choose a microprocessor chip, an introduction to programming, low cost I/O for a computer, computer arithmetic, checking memory boards, a Baudot monitor/editor system, an audible logic probe for finding those tough problems, a ham's computer, a computer QSO machine ... and much, much more! \$4.95.*

● **KILOBAUD** The Small Computer Magazine written for the non-PhD computer hobbyist who wants to know what's new. \$2.00 each at the newsstand, \$15.00 for 1 year sub.

Use the order card in the back of this magazine or itemize your order on a separate piece of paper and mail to:
73 Radio Bookshop • Peterborough, NH 03458. Be sure to include check or detailed credit card information.

* Add \$1.00 shipping & handling charge for each order. Note: Price subject to change on books not published by 73 Magazine.

RADIO BOOKSHOP

● **COMPUTER DICTIONARY** by Donald D. Spencer. Defines words and acronyms used by computerists in a clear, easy to understand style. Over 2000 definitions are provided. This reference is a must for the individual getting started in the world of microcomputers. Published by Camelot Press, \$5.95.*

● **CHEMISTRY WITH A COMPUTER** by Paul A. Cauchon. Contains a collection of tutorial, simulation and problem-generation computer programs. Simulations provide models of lengthy laboratory experimentation beyond the limited classroom timeframe and enhancement of course studies by encouraging pre-laboratory research. Useable with almost any chemistry course at the high school or college level. Written in BASIC. Price \$9.95.*

● **TYCHON'S 8080 OCTAL CODE CARD** Slide rule-like aid for programming and debugging 8080 software... contains all the mnemonics and corresponding octal codes. Only 6 1/2 x 3 inches, provides neat, logical format for quick reference. Back side of card is printed with an ASCII code chart for 128 characters plus the 8080 status word and register pair codes. Also available, Tychon's **8080 Hex Code Card**, same as above only has hex codes instead of octal. Only \$3.00* each.



● **1976 PERIODICAL GUIDE FOR COMPUTERISTS** is a 20 page book which indexes over 1,000 personal computing articles for the entire year of 1976 from Byte, Creative Computing, Digital Design, Dr. Dobbs Journal, EDN, Electronic Design, Electronics, Interface Age, Microtek, Peoples Computer Company, Popular Electronics, QST, Radio Electronics, SCCS Interface and 73. Articles are indexed under more than 100 subject categories. Price \$3.00.* New January - June 1977 Edition - \$3.00.*

● **A QUICK LOOK AT BASIC** by Donald D. Spencer. A perfect reference for the beginning programmer. Assumes that the reader has no previous programming experience. A self-teaching guide for the individual desiring to learn the fundamentals of BASIC, the most common hobbyist programming language. Price: \$4.95*

● **HOME COMPUTERS: 210 Questions & Answers** by Rich Didday. Two books aimed exclusively at the novice computer hobbyist/home computer user. Written in a rather unusual style which has a beginner asking questions which are answered by a person with a substantial background in computers and personal computing. The questions are just the kind beginners come up with... and the answers are presented in easy-to-understand terms (usually with a diagram to illustrate the point). Both the hardware and software aspects of home computing are covered from A to Z. An index in both books makes them ideal as reference material for anyone. Volume 1: Hardware - \$7.95*; Volume 2: Software - \$6.95*.



● **SIXTY CHALLENGING PROBLEMS WITH BASIC SOLUTIONS** Donald Spencer. Provides the serious student of BASIC programming with interesting problems and solutions. No knowledge of math above algebra required. Includes games, programs for financial interest, conversions and numeric manipulations. Price: \$6.95*

● **SOME COMMON BASIC PROGRAMS** published by Adam Osborne & Associates, Inc. Perfect for non-technical computerists requiring ready to use programs. Business programs like depreciation formulas, loan payment solutions and loan interest rates; math routines containing statistical packages and polynomial derivations... plus miscellaneous programs. Invaluable for the user who is not an experienced programmer. All will operate in the stand-alone mode. \$7.50* paperback.

● **THE SECRET GUIDE TO COMPUTERS** Parts 1, 2, and 3 by Russ Walter. Part One describes computers in general, and after reading for ten minutes you will be writing simple BASIC programs! Employs a step-by-step teaching process, the end result being a working knowledge of BASIC. Part Two discusses computer applications. It's one thing to master the syntax of a language such as BASIC and another to solve problems using the new tool. This also provides useful techniques in problem solving. Part Three describes programming languages. Ever heard of APL and QLISP? BASIC is not the only language used to program computers, and as the hobby industry grows additional languages will become commonplace. 7th edition. Part I - \$2.75*; Part II - \$2.50*; Part III - \$3.50.*

● **FORTRAN PROGRAMMING** By Donald Spencer. If you are familiar with BASIC you will appreciate the additional capabilities of FORTRAN, a computer language with most of BASIC's features, and much more! FORTRAN was designed for complex numeric calculations; and possesses extended I/O capability. It is easily learned, as it is an English-like computer language. \$7.50.*

● **FORTRAN WORKBOOK** by Donald Spencer. Provides practical examples and problems to solve. Almost all micros support BASIC - it won't be long before FORTRAN is commonplace. Don't miss the programming boat... learn FORTRAN; and be ready for the next language boom! \$3.95.*

● **Scientific Research Instruments' BASIC SOFTWARE LIBRARY** is a complete do-it-yourself kit. Written in everybody's BASIC immediately executable in ANY computer with at least 4K, no other peripherals needed. Over 700 pages of source codes, descriptions and instructions. Vol. I contains business and recreational programs and is 300 pages. Vol. II is 260 pages and contains math, engineering, statistics and plotting programs. Vol. III contains money managing, advanced business programs such as billing, A/R, inventory, payroll, etc. Vol. IV contains general purpose programs like loans, rates, retirement, plus games: Poker, Enterprize (take charge while Capt. Kirk is away), Football and more! Vol. V is filled with experimenter's programs including games, pictures and misc. problems like "logic." Vols. I & II \$24.95,* Vol. III \$39.95,* Vol. IV & V \$9.95 each.*

PERIODICAL GUIDE FOR COMPUTERISTS
 1977
 1976

PERIODICAL GUIDE FOR COMPUTERISTS
 An Index of Magazine Articles for Computer Hobbyists
 January - June 1977
 January - December 1976

Use the order card in the back of this magazine or itemize your order on a separate piece of paper and mail to:
 73 Radio Bookshop • Peterborough, NH 03458. Be sure to include check or detailed credit card information.

*Add \$1.00 shipping & handling charge for each order. Note: Price subject to change on books not published by 73 Magazine.

RADIO BOOKSHOP

BAG-A-BUNCH OF 73 BACK ISSUES!*



**Your Choice/Our Choice Special
\$1 per Issue**

(Minimum order 5 issues, your choice)

OR 25 Issues Our Choice—\$10.00

- Vintage—1960 thru 1965**
- Mid-years—1966 thru 1971**
- Nearly New—1972 thru 1977**

*** pre-1978 issues.**

- | | | |
|----------------------------------|----------------------------------|-------------------------------------|
| <input type="checkbox"/> JUNE 63 | <input type="checkbox"/> MAY 70 | <input type="checkbox"/> NOV 73 |
| <input type="checkbox"/> AUG 63 | <input type="checkbox"/> JUNE 70 | <input type="checkbox"/> DEC 73 |
| <input type="checkbox"/> OCT 63 | <input type="checkbox"/> DEC 70 | <input type="checkbox"/> FEB 74 |
| <input type="checkbox"/> FEB 64 | <input type="checkbox"/> JAN 71 | <input type="checkbox"/> APR 74 |
| <input type="checkbox"/> MAY 67 | <input type="checkbox"/> FEB 71 | <input type="checkbox"/> MAY 74 |
| <input type="checkbox"/> JULY 67 | <input type="checkbox"/> MAR 71 | <input type="checkbox"/> JULY 74 |
| <input type="checkbox"/> OCT 67 | <input type="checkbox"/> JUNE 71 | <input type="checkbox"/> AUG 74 |
| <input type="checkbox"/> JUNE 68 | <input type="checkbox"/> JULY 71 | <input type="checkbox"/> SEPT 74 |
| <input type="checkbox"/> JULY 68 | <input type="checkbox"/> AUG 71 | <input type="checkbox"/> OCT 74 |
| <input type="checkbox"/> SEPT 68 | <input type="checkbox"/> SEPT 71 | <input type="checkbox"/> NOV 74 |
| <input type="checkbox"/> JAN 69 | <input type="checkbox"/> OCT 71 | <input type="checkbox"/> DEC 74 |
| <input type="checkbox"/> FEB 69 | <input type="checkbox"/> NOV 71 | <input type="checkbox"/> FEB 75 |
| <input type="checkbox"/> MAR 69 | <input type="checkbox"/> AUG 72 | <input type="checkbox"/> APR 75 |
| <input type="checkbox"/> APR 69 | <input type="checkbox"/> SEPT 72 | <input type="checkbox"/> AUG 75 |
| <input type="checkbox"/> MAY 69 | <input type="checkbox"/> OCT 72 | <input type="checkbox"/> SEPT 75 |
| <input type="checkbox"/> JUNE 69 | <input type="checkbox"/> NOV 72 | <input type="checkbox"/> OCT 75 |
| <input type="checkbox"/> JULY 69 | <input type="checkbox"/> DEC 72 | <input type="checkbox"/> NOV/DEC 75 |
| <input type="checkbox"/> AUG 69 | <input type="checkbox"/> JAN 73 | <input type="checkbox"/> JAN 76 |
| <input type="checkbox"/> SEPT 69 | <input type="checkbox"/> APR 73 | <input type="checkbox"/> FEB 76 |
| <input type="checkbox"/> OCT 69 | <input type="checkbox"/> JUNE 73 | <input type="checkbox"/> MAR 76 |
| <input type="checkbox"/> NOV 69 | <input type="checkbox"/> AUG 73 | <input type="checkbox"/> MAY 76 |
| <input type="checkbox"/> DEC 69 | <input type="checkbox"/> SEPT 73 | <input type="checkbox"/> JUNE 76 |
| <input type="checkbox"/> JAN 70 | <input type="checkbox"/> OCT 73 | <input type="checkbox"/> JULY 76 |
| <input type="checkbox"/> FEB 70 | | <input type="checkbox"/> AUG 76 |
| <input type="checkbox"/> MAR 70 | | <input type="checkbox"/> SEPT 76 |
| <input type="checkbox"/> APR 70 | | <input type="checkbox"/> OCT 76 |
| | | <input type="checkbox"/> NOV 76 |
| | | <input type="checkbox"/> DEC 76 |
| | | <input type="checkbox"/> HOLIDAY 76 |

73 Magazine Back Issue Classics (All 1977 issues are still available!)

\$5.00* – 5 Issues (indicate your choice at left)

\$10.00* – 25 issues – our choice

\$ _____ Enclosed. Cash Check Money order

American Express BankAmericard/VISA Master Charge

Credit Card # _____ Expiration date _____

Signature _____

Vintage Mid-years Nearly new

Name _____

Address _____

City _____ State _____ Zip _____

*Add \$1.00 shipping and handling charge.

73 magazine
Peterborough NH
03458

73/3/78

Hobby Computers Are Here

HOBBY COMPUTERS ARE HERE helps the beginner to get into the world of microcomputers. It contains the following chapters: Computers Are Here, What's A Computer?, The History of Number Systems, Is Digital All That New?, How Computers Figure, What's That in Binary?, Say, Are You A Computer?, Computers Are For Hams!, How Gates Work, TTL—The Best Logic Yet, Ins and Outs of TTL, Flip Flops Exposed, Those Memory Chips—RAMs, ROMs, PROMs, etc., Computer Languages—Simplified, The New Standard Cassette System, build This Television Typewriter, Television Typewriter Display Unit, Using Surplus Keyboards, Morse to RTTY Converter, ASCII to Baudot Via a PROM, and ASCII/Baudot Via PROMS—A Second Way. PLUS reprints of some of the 73 editorials on computers. Don't miss out any longer on the fun of hobby computing and the fantastic applications of these incredible devices! \$4.95*

The New Hobby Computers

This book takes it from where "Hobby Computers Are Here" leaves off, with chapters on: What's All This LSI Bunk?, Which Chip Dilemma, How Computer Arithmetic Works, The Death of Negative (IBM) Logic, And on the Other Side, Soft Art of Programming, Part I, Part II, Part III, A Very Cheap I/O—The Model 15, Inexpensive Paper Tape System, Baudot Monitor/Editor System, Baudot and BASIC, Getting By the Friden 8800 Communications Gap, What's All This Wire-Wrap Stuff?, How to Check Memory Boards, Eight Trace Scope Adapter, Logic Probe You Can Hear, ASCII/Baudot Converter For Your TVT, A Ham's Computer, Ham Time Sharing is Here For You, Safari RTTY Terminal, Your Computer Can Talk Morse, Sneaky Baudot with ASCII Keyboard, and Computer QSO Machine. PLUS interesting editorials on computers from 73. Everything of interest is there in one volume, ready to be enjoyed by you. Don't miss this tremendous value! Only \$4.95*

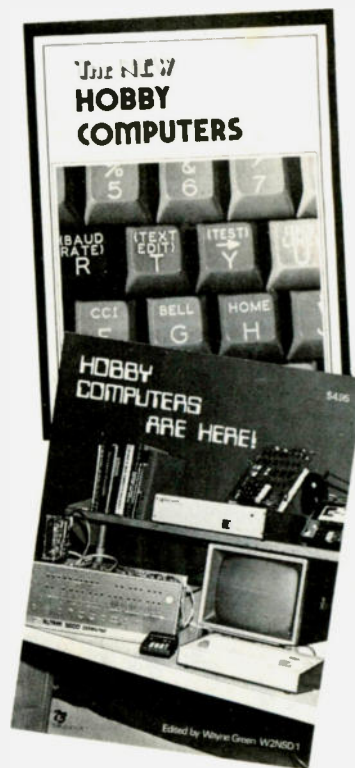

Order from: **73 Books, Dept HC, Peterborough, NH 03458**

*add \$1 handling charge per order.

Spark Forever!

That was the cry of the amateurs of the 1920's . . . none of this newfangled vacuum tube stuff for them! Then, a generation later, it was TUBES FOREVER! Amateurs of the old school fought off transistors. Now that most amateurs have come to accept solid state, large scale integration is here and reactionary amateurs are busy fighting off microcomputers.

JOIN THE REVOLUTION, DON'T FIGHT IT. Microcomputers are appearing in more and more equipment . . . scanners . . . the Edgcom 2m rig . . . and watch for a whole new generation of ham transceivers with microcomputers built in!

Read about microcomputers in Kilobaud, the magazine written for the newcomer to computers. Many of the articles are ham oriented . . . after all, a large part of the pioneers of microcomputers are hams. Don't let this revolution pass you by . . . be a part of it and join the fun. Over 20,000 hams have their own computers already and are having a ball. They're using them with their ham stations, to run repeaters, and to learn.

Never has there been such an opportunity. Microcomputers will soon be one of the larger industries in the country, so the pioneers will have a fantastic chance to get in on the ground floor . . . and that ground floor is still there. Read all about it in Kilobaud.

KILOBAUD IS GUARANTEED . . . if you are not delighted, you can return your magazines for a full refund! That's right, all you risk is the postage! Try a year's subscription to Kilobaud and see for yourself. **YOU CAN'T LOSE.**

1 year \$15. Use order card in back of this magazine or itemize order. Send to:

kilobaud

SUBSCRIBE TODAY!

PETERBOROUGH NH 03458

How would you like to make some extra money in your spare time to help you build your ham station? Wouldn't you like to be able to get the latest in ham gear? The fact is that your hobby *can* pay for itself.

At the same time that you are making money, you will also be helping amateur radio to grow by helping to interest newcomers in the hobby . . . and we need all of the new amateurs we can get, as you know.

73 Magazine is looking for Area Representatives to distribute 73 Magazine and Kilobaud to newsstands, bookstores, discount stores, supermarkets, drugstores, etc. In addition to distribution of the monthly copies of these magazines, Area Representatives would also sell magazines, books, and subscriptions at hamfests, ham auctions, and other local ham events. Radio stores, CB dealers, etc., can also be serviced by Area Representatives.

Make Extra Money! Help Amateur Radio Grow! Distribute 73s to Everyone!

Here's a way to enjoy your hobby, to be a real part of it, and to make money while you are having fun. It sure doesn't seem much like work. Area Representatives who are successful will be offered the opportunity to increase their business by taking on additional special interest magazines for newsstand distribution. The business can grow to any size you wish.

73 sells well on the newsstands. Tests in several areas show that even though every magazine rack in an area is stocked with copies of 73, at least one or two copies are sold from even the smallest of racks. 73 interests hams, SWLs, CBers, experimenters, students, computer hobbyists, electronics professionals, technicians, etc.

If you are interested in details on how you can earn from \$50 to \$500 (or even more) a month, write to Jack Shimek, Marketing Manager.

Once you sign up you'll get monthly shipments of magazines which are to be sold on consignment (the store only has to pay for the copies sold each month) and keep back issues in stock for sale at hamfests, etc.

Just think, with a few hours' work each month you might be able to have a fantastic ham station before the end of 1978. Drop Jack a line and get started . . . if you are the kind of person who gets things done and can carry things through.

73 Magazine • Peterborough, NH 03458

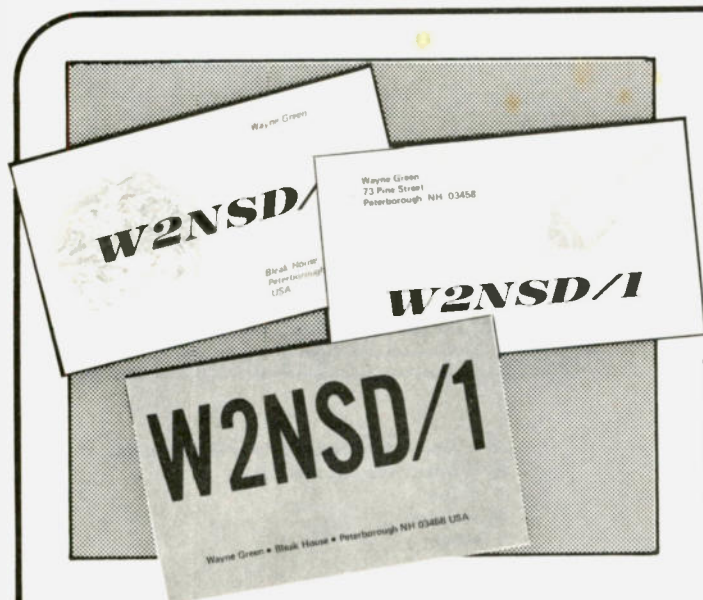

QSL CARDS

You want your QSL card to stand out on every wall, don't you? Well, here's some which no shack visitor in the world will be able to miss. It's got jet black call letters . . . great big call letters that can be read all the way across the room—black letters on a bright yellow background to make them really stand out. When pictures of DX shacks are published in the magazines you'll see your card clearly. Order style Y.

Equally impressive are styles W and X. These are white cards with black type—style W has a blue world, style X a

blue satellite. Both are top quality QSLs you'll be proud to send.

How can 73 turn out these **fantastic** QSL cards at about half the cost of having them made elsewhere? These are done as a fill-in between printing books and other items in the 73 Print Shop. That's why we don't promise anything faster than **8 weeks** delivery. We usually get them out a lot faster than that, but we could get tied up with a new edition of the Repeater Atlas or something and be slow.

The regular QSO information is printed on the back of the card . . . all you need to have the card acceptable for any awards. There's room to list your equipment on the back, if you want. A nice gift idea, too! Actual size: 5½" x 3½"

Please send me the following QSL cards:

Style: W X Y

Quantity: 250 — \$8.95 500 — \$13.95

ADD \$1.00 SHIPPING & HANDLING CHARGE.

\$ _____ Enclosed. Cash Check Money Order

American Express BankAmericard Master Charge

Credit card # _____

Exp. date _____

Signature _____

Name _____

Address _____

City _____ State _____ Zip _____

U.S.A. Orders Only

73 Magazine—QSLs
Peterborough NH 03458

73/3/78

CUSTOM TRANSFORMERS

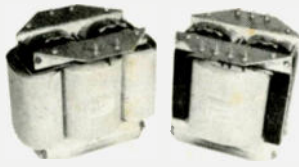

HEAVY DUTY REPLACEMENT TRANSFORMERS *

Collins 30S-1 Plate Transformer	\$165.00
Collins 516F-2 Power Transformer	95.00
Hunter 2000B Plate Transformer	125.00
ETO A-77D Plate Transformer	125.00
Henry 2K Plate Transformer	140.00
Henry 2K-2 Plate Transformer	165.00
Henry 2K-2A Plate Transformer	135.00
Henry 2K-4 Plate Transformer	165.00
Henry 3K-A Plate Transformer	165.00
Heath Marauder HX-10 Transformer	95.00
Gonset GSB-100 Transformer	95.00
National NCL-2000 Power Transformer	125.00
Gonset GSB-201 Power Transformer	135.00

SPECIALS

Plate XFMR. 4600 VAC @ 1.5A ICAS 230 VAC 60 Hz primary, Wt. 60 LB	\$195.00
Plate XFMR. 3500 VAC @ 1.0A ICAS 230 VAC 60 Hz primary, Wt. 41 LB	125.00
Plate XFMR. 3000 VAC @ 0.7A ICAS 115/230 VAC 60 Hz pri, Wt. 27 LB	95.00
Plate XFMR. 6000 VCT @ 0.8A CCS 115/230 VAC 60 Hz pri, Wt. 41 LB	135.00
FIL XFMR. 7.5 VCT @ 21A CCS 117 VAC 60 Hz primary Wt. 8 LB	29.95
FIL Choke bifilar wound 30 AMP RF Filament Choke on 1/2x7 rod	8.95
DC Filter Choke 8.0 Hy @ 1.5 ADC	150.00
DC Swinging Choke: 30 Hy @ 0.15A to 5.0 Hy @ 1.0ADC	100.00
DC Filter Capacitors 100 MFD @4000 VDC	\$75.00

*All heavy duty replacement transformers are electrically superior to original equipment(s). All transformers are manufactured to rigid commercial quality specifications and each carries a 24 month guarantee!

Write today for a free quotation on any transformer, Choke, or saturable reactor.

Peter W. Dahl Co.

4007 Fort Blvd. • El Paso, Texas 79930
Telephone (915) 566-5365 or (915) 751-4856

D6

PROPAGATION

by
J. H. Nelson

EASTERN UNITED STATES TO:

GMT:	00	02	04	06	08	10	12	14	16	18	20	22
ALASKA	14	7A	7	7	7	7	7	7	7	14	14	14
ARGENTINA	14	14	7	7	7	7	14	14A	21	21	21	14
AUSTRALIA	14A	14	7B	7B	7B	7	7	14	14	14	14	14A
CANAL ZONE	14	7A	7	7	7	7	14	14A	21	21	21	14
ENGLAND	7	7	7	7	7	7B	14	14	14A	14A	14	7B
HAWAII	14	14	7B	7	7	7	7	7B	14	14	14	14A
INDIA	7	7	7B	7B	7B	7B	14	14	14	7	7	7
JAPAN	14	7B	7B	7B	7B	7	7	7	7	7B	7B	14
MEXICO	14	7A	7	7	7	7	14	14	14	14	14A	14A
PHILIPPINES	14	7B	7B	7B	7B	7B	7B	14	14	14	7B	14B
PUERTO RICO	14	7	7	7	7	7	7A	14	14	14	14	14
SOUTH AFRICA	14	7	7	7	7B	14	14	14A	21	21	14	14
U. S. S. R.	7	7	7	7	7	7B	14	14	14	14	7B	7
WEST COAST	14	14	7	7	7	7	7	14	14	14	14A	14A

CENTRAL UNITED STATES TO:

ALASKA	14	14	7	7	7	7	7	7	7	14	14	14
ARGENTINA	14	14	7	7	7	7	7A	14	14	21	21	14A
AUSTRALIA	21	14	14	7B	7B	7	7	7	14	14	14	21
CANAL ZONE	14	14	7	7	7	7	7	14	21	21	21	21
ENGLAND	7	7	7	7	7	7B	14	14	14	14	14	7B
HAWAII	21	14	14	7	7	7	7	7	14	14	14A	14A
INDIA	7	7	7B	7B	7B	7B	7B	14	7A	7	7	7
JAPAN	14	14	7B	7B	7B	7	7	7	7	7B	7B	14
MEXICO	14	7	7	7	7	7	7	14	14	14	14	14
PHILIPPINES	14	14	7B	7B	7B	7B	7B	7	14	14	7B	14
PUERTO RICO	14	7A	7	7	7	7	7A	14	14	14A	14A	14A
SOUTH AFRICA	14	7	7	7	7B	7B	14	14	14A	14	14	14
U. S. S. R.	7	7	7	7	7	7	7B	7B	14	14	7B	7

WESTERN UNITED STATES TO:

ALASKA	14	14	7A	7	7	7	7	7	7	14	14	14
ARGENTINA	14	14	7A	7B	7	7	7B	14	14	14A	21	21
AUSTRALIA	21	21	14	14	7B	7B	7	7	14	14	14	21
CANAL ZONE	14A	14	7	7	7	7	7	14	14A	21	21	21
ENGLAND	7	7	7	7	7	7B	7B	14	14	14	14	7B
HAWAII	21A	21	14	14	7	7	7	7	14	14	21	21
INDIA	7	14	14	7B	7B	7B	7B	7B	7A	7A	7	7
JAPAN	14A	14A	14	7B	7B	7	7	7	7	7B	14	14
MEXICO	14	14	7	7	7	7	7	14	14	14	14A	14A
PHILIPPINES	14A	14	14	7B	7B	7B	7B	7	7	14	7B	14
PUERTO RICO	14	14	7	7	7	7	7	14	14A	21	21	14A
SOUTH AFRICA	14	7B	7	7	7B	7B	14	14	14A	14	14	14
U. S. S. R.	7	7	7	7	7	7	7B	7B	14	14	7B	7
EAST COAST	14	14	7	7	7	7	7	14	14	14	14A	14A

A = Next higher frequency may also be useful
B = Difficult circuit this period
F = Fair
G = Good
P = Poor

march

	sun	mon	tue	wed	thu	fri	sat
	☉	☉	☉	☉	☉	☉	☉
				1	2	3	4
				G	G	G	G
	5	6	7	8	9	10	11
	F	P	P	F	F	G	G
	12	13	14	15	16	17	18
	F	F	G	G	G	G	G
	19	20	21	22	23	24	25
	P	F	F	F	F	G	G
	26	27	28	29	30	31	
	G	P	F	F	P	F	

MOVING

Let us know 8 weeks in advance so that you won't miss a single issue of 73 Magazine. Attach old label where indicated and print new address in space provided. Also include your mailing label whenever you write concerning your subscription. It helps us serve you promptly.

Write to: **73 magazine**
Peterborough NH 03458

Address change only Payment enclosed
 Extend subscription (1 extra BONUS issue)
 Enter new subscription Bill me later
 1 year \$15.00 (I've signed below)

Signature _____

If you have no label handy, print OLD address here.

AFFIX LABEL

name _____ call _____

address _____

city _____ state _____ zip _____

name _____ call _____

address _____

city _____ state _____ zip _____

FT-901DM

COMPETITION-GRADE HF TRANSCEIVER

SPEAK TO THE WORLD IN ANY MODE



Price And Specifications Subject To
Change Without Notice Or Obligation



YAESU
The smart radio

YAESU ELECTRONICS CORP., 15954 Downey Ave., Paramount, CA 90723 (213) 633-4007
YAESU ELECTRONICS CORP., Eastern Service Ctr., 613 Redna Ter., Cincinnati, OH 45215

TR-7400A



KENWOOD'S EXCITING 2-METER TRANSCEIVER

- The TR-7400A exceeds all FCC emission requirements for amateur transceivers. RF output of the TR-7400A is factory spec'd at 25 watts... but typically over 30!
- Dual frequency readout... a large easy to read 6 digit LED display plus a functional dial readout system
 - 800 channels
 - Repeater offset over all 4 MHz (144-148 MHz)
 - Unique continuous tone coded squelch system
 - Outstanding receiver performance.

 **KENWOOD**
...pacesetter in amateur radio