

SEPTEMBER 1977
\$2.00

73

AMATEUR

RADIO



RTTY!



**Sunspot Cycle 21 takes off...
triggers exceptional
6 meter openings!**



Be there first with the ultimate...

KLM "661"

ALL MODE 6 METER TRANSCEIVER

- Complete, ready to operate. Microphone is included.
- Covers 50-54MHz. (Crystals are supplied for 50-52MHz).
- All modes: SSB with USB and LSB, CW, NBFM, AM.
- Built-in VFO covers 50-54MHz in 500 kHz increments.
- Four, crystal-controlled channels.
- Built-in low-pass harmonic filter.
- Meets F.C.C. 20777 specs.
- 10W min. power output (2.5W AM).
- Built-in power supply for 115 VAC and 13.8VDC.
- Clarifier.
- Noise blanker.
- Squelch.
- Triple conversion receiver with better than 0.25 μ V sensitivity.
- Built-in loudspeaker. Provision for external speaker.
- 100 kHz crystal calibrator and VOX options (soon available).

Soon at your favorite dealer.

Write for information.



Exceptional audio
both transmit and receive.

Outstanding AGC
and sensitivity
on receive.

***KLM* electronics, inc.**

1725 Laurel Road, Morgan Hill, CA 95037 (408) 779-7363.

they're here!

H10
16-Bit
Computer
\$1295

THE NEW HEATHKIT® PERSONAL COMPUTING SYSTEMS

The new VALUE-STANDARD in personal computing systems! You can put a system in your Shack for automatic CW operations, automatic antenna tracking for Oscar satellites and DX, complete station monitoring and logging, lots more. And play fascinating computer games, store and retrieve personal records, taxes, budgets, create and execute your own programs—literally thousands of fascinating, exciting and practical applications! The Heathkit computer systems are low-priced, versatile and reliable—they're the ones to have for REAL power and performance!

These Heathkit computer products are "total system" designs with powerful system software already included in the purchase price. They're the ones you need to get up and running fast. And they're backed by superior documentation and service support from the Heath Company, the world's largest manufacturer of electronic kits.

NEW H8 8-Bit Digital Computer. This 8-bit computer based on the famous 8080A microprocessor features a Heathkit exclusive "intelligent" front panel with octal data entry and control, 9-digit readout, a built-in bootstrap for one-button program loading, and a heavy-duty power supply with power enough for plenty of memory and interface expansion capability. It's easier and faster to use than other personal computers and it's priced low enough for any budget. With assembler, editor, BASIC and debug software.

FREE!

Heathkit Catalog

Read all about our exciting computer systems and nearly 400 other fun-to-build, money-saving electronic products in kit form.

Prices are mail-order FOB, Benton Harbor, Michigan.
Prices and specifications subject to change without notice.



H8
8-Bit
Computer
\$375

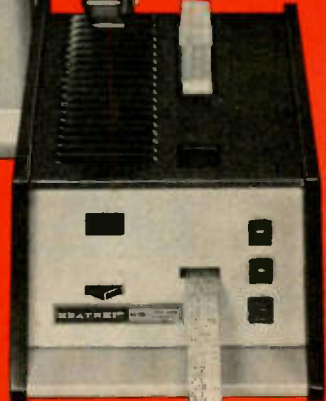

H9
Video
Terminal
\$530

H10
Paper Tape
Reader/Punch
\$350

NEW H11 16-bit Digital Computer. The most sophisticated and versatile personal computer available today—brought to you by Heath Company and Digital Equipment Corporation, the world leader in minicomputer systems. Powerful features include DEC's 16-bit LSI-11 CPU, 4096 x 16 read/write MOS memory expandable to 20K, priority interrupt, DMA operation and more. DEC PDP-11 software is included.

NEW H9 Video Terminal. A full ASCII terminal featuring a bright 12" CRT, long and short-form display, full 80-character lines, all standard serial interfacing, plus a fully wired and tested control board. Has auto-scrolling, cursor with full positioning controls, full-page or line-erase modes, a transmit page function and a pbt mode for simple curves and graphs.

NEW H10 Paper Tape Reader/Punch. Complete mass storage peripheral uses low-cost paper tape. Features solid-state reader with stepper motor drive, totally independent punch and reader modes and a copy mode for fast, easy tape duplication. Reads up to 50 characters per second, punches up to 10 characters per second.

Other Heathkit computer products include a cassette recorder/player and tape for mass storage, the LA36 DEC writer II, serial and parallel interfaces, software, memory expansion and I/O cards, and a complete library of the latest computer books—everything you need to make Heath your personal computing headquarters!

HEATH
Schlumberger
Heath Company, Dept. 011-331
Benton Harbor, Michigan 49022

Please send me my FREE Heathkit Catalog.
I am not on your mailing list.

Name _____

Address _____

City _____ State _____

CP-128 Zip _____

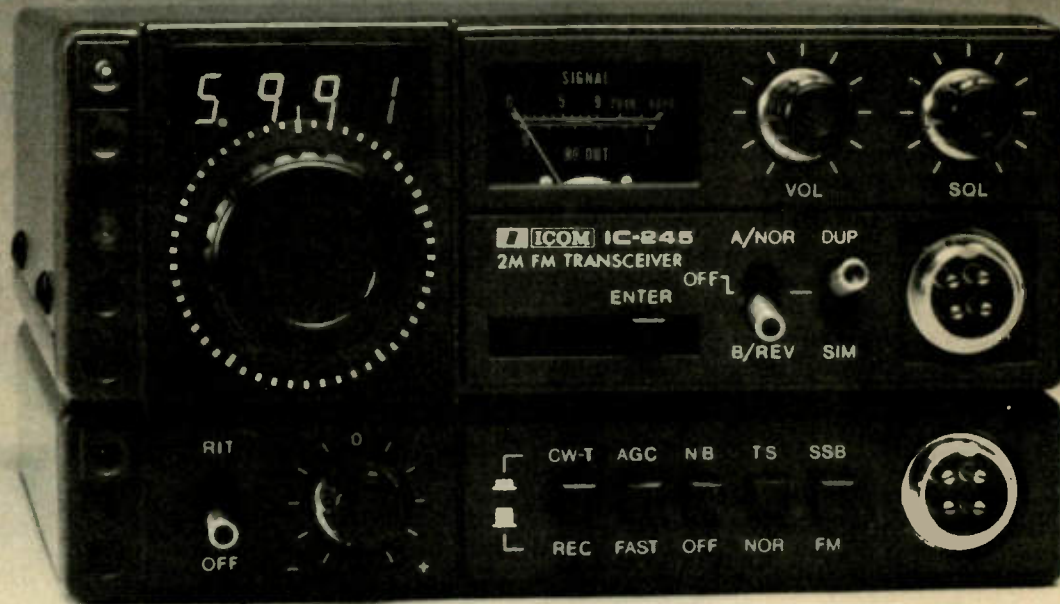

That's all, Folks!

All you need for All Mode Mobile, that is.

All Mode Mobile is now yours in a superior ICOM radio that is a generation ahead of all others. The new, fully synthesized **IC-245/SSB** puts you into FM, SSB and CW operation with a very compact dash-mounted transceiver like none you've ever seen.

- **Variable offset:** Any offset from 10 KHz through 4 MHz in multiples of 10 KHz can be programmed with the LSI Synthesizer.
- **Remote programming:** The **IC-245/SSB** LSI chip provides for the input of programming digits from a remote key pad which can be combined with Touch Tone* circuitry to provide simultaneous remote program and tone. Computer control from a PIA interface is also possible.
- **FM stability on SSB and CW:** The **IC-245/SSB** synthesis of 100 Hz steps make mobile SSB as stable as FM. This extended range of operation is attracting many FM'ers who have been operating on the direct channels and have discovered SSB.

The **IC-245/SSB** is the very best and most versatile mobile radio made: that's all. For more information and your own hands-on demonstration see your ICOM dealer. When you mount your **IC-245/SSB** you'll have all you need for All Mode Mobile.

* a registered trademark of AT&T.

SPECIFICATIONS

FREQUENCY COVERAGE MODES: 144.00 to 148.00MHz FM (F3)
 150.00 to 155.00 MHz (A1)
 DC 13.8V ± 15%
 90W ± 155W ± 2300
 2.7

TRANSMITTER TX OUTPUT: 73 10W
 133J 10W (PEP), 41 10W
 CARRIER SUPPRESSION: 40 dB OR BETTER

SPURIOUS RADIATION MAXIMUM FREQUENCY DEVIATION: 60 dB BELOW CARRIER
 MICROPHONE IMPEDANCE: 1.5KHz
 600 Ohms

RECEIVER SENSITIVITY: 1.0dB
 1.0dB
 1.0dB
 1.0dB
 1.0dB

60 dB BELOW CARRIER
 1.0dB
 1.0dB
 1.0dB
 1.0dB
 1.0dB

SQUELCH THRESHOLD SPURIOUS RESPONSE: 8 dB OR LESS (F3)
 60 dB OR BETTER

SYNTHESIZER FREQUENCY RANGE STEP SIZE: 144 MHz to 148 MHz
 5 kHz for FM
 100 Hz or 5 kHz for SSB
 PER C IN THE RANGE OF -10
 TO +60C ±0.000145%

STABILITY: 144 MHz to 148 MHz
 5 kHz for FM
 100 Hz or 5 kHz for SSB
 PER C IN THE RANGE OF -10
 TO +60C ±0.000145%

*VALID WITH SSB UNIT ONLY

VHF/UHF AMATEUR AND MARINE COMMUNICATION EQUIPMENT

Distributed by:



ICOM

ICOM WEST, INC.
 Suite 3
 13256 North-up Way
 Bellevue, Wash. 98005
 (206) 747-9020

ICOM EAST, INC.
 Suite 307
 3331 Towerwood Drive
 Dallas, Texas 75234
 (214) 620-2780

ICOM CANADA
 7087 Victoria Drive
 Vancouver B.C. V5P 3Y9
 Canada
 (604) 321-1833

73

#204 SEPT 1977

- 25 A FAAR-OUT DXpedition — airborne VHF and OSCAR!
WA6YOB
- 28 So You Want to Get Into RTTY? — "Call For Papers" winner
W9IF
- 38 Design An Active RTTY Filter — eliminate CW QRM and noise
K2OAW
- 44 Moving Display RTTY Readout — just like Times Square
WB8SWH
- 52 RTTY SWLing — new horizons!
WA2MOT/WT2AAG
- 59 RTTY Local Loop — perfect for beginners
WB5IRY
- 60 Try the RTTY Reader — computer display goes ham!
W3JJU, Cannon
- 66 Organize Your RTTY Pix — a sweet tooth is desirable
W2PSU
- 74 Build A RTTY Message Generator — it's programmable!
WB9CNE
- 78 FSK for the Drake — easy
WB8DMC
- 80 Baudot to ASCII Converter — use it for OSCAR RTTY
VE4CM
- 98 Digital Group RTTY Micro — a natural team
K2AOU
- 104 RTTY Test Station — complete pattern generator
W2FJT
- 108 The World's Cheapest Calibrator — works on 2m!
W9SS

- 110 RTTY With the KIM — features built-in display!
K4GCM
- 112 Build A Meter With Class — simple field strength device
WA4LJL
- 113 FSK for the FT-101 — a simple mod for RTTY
W6OJF
- 114 Build A Drift-free T.U. — a quality RTTY demodulator
VE7DBK
- 116 Noise Rejector — great for CW or phone receivers
WB6ZYK
- 118 RTTY CRT Tuning Indicator — still the best method
W9IF
- 122 Cassette-Aided CW and RTTY — inexpensive message storage
Staff
- 146 A Practical 2m Synthesizer — who said it can't be built?
WA3SYI
- 151 Buying Surplus — how to remain sane
W2OLU
- 152 How To Buy Surplus Parts — pick a good supplier
McClellan
- 158 RTTY RKB-1 Revisited! — auto machine functions
W9IF
- 160 Mobile Antenna Tips — for the beginner
W2FEZ
- 164 Super Wilson — several useful modifications
K4TWJ

- 4 Never Say Die
- 14 New Products
- 17 De WA3ETD
- 17 Oscar Orbits
- 17 CARF
- 18 Letters
- 20 Ham Help
- 21 RTTY Loop
- 21 Hambuglar
- 22 Contests
- 24 Corrections
- 156 Social Events
- 163 FCC
- 208 Propagation

COVER: Ken Mabie W2PSU's Model 28. Photo by John Molnar WA3ETD.

73 Magazine is published monthly by 73, Inc., Peterborough NH 03458. Subscription rates in the U.S. and Canada are \$15 for one year, \$26 for two years, and \$36 for three years. Outside the U.S. and Canada, write for rates. Second class postage paid at Peterborough NH 03458 and at additional mailing offices. Publication No. 700420. Phone: 603-924-3873. Entire contents copyright 1977 by 73, Inc. INCLUDE OLD ADDRESS AND ZIP CODE WITH ADDRESS CHANGE NOTIFICATION.

Microfilm edition — University Microfilms, Ann Arbor MI 48106.

73 STAFF

EDITOR/PUBLISHER
Wayne Green W2NSD/1

EXECUTIVE VICE PRESIDENT
Sherry Smythe

EXECUTIVE EDITOR
John Molnar WA3ETD

MANAGING EDITOR
John C. Burnett

ASSISTANT MANAGING EDITOR
Susan G. Philbrick

EDITORIAL ASSISTANT
Beth Turin

I/O EDITOR
John Craig

PUBLICATIONS EDITOR
Larry Kahner WB2NEL

PUBLICATIONS ASSISTANT
Nancy Chandler

PRODUCTION MANAGER
Lynn Panciera-Fraser

ART DEPARTMENT
Craig Brown
Gayle Cabana
Bob Drewe
Michael Murphy
Weston Parker
Noel R. Self WB1ARP
Robin M. Sloan

PRINT SHOP MANAGER
Michael Potter

PRINTING
John Bianchi
William Caring
Dwight Perry

PHOTOGRAPHY
Bill Heydolph
Tedd Cluff

TYPESETTING
Barbara J. Latti
Pauline Malvoni
Marie Walz
Sandy White

COMPTROLLER
Knud E. M. Kellier KV4GG/1
Marge Nielsen
Eleanor G. Jensen

CIRCULATION
Dorothy Gibson
Barbara Block
Fran Dillon
Jane Ames
Chris Dillon
Florence Goldman

DATA ENTRY
Judy Waterman
Mary Jo Spontanier
Judy Brumagham

MARKETING
Sherry Smythe
Laura Hanson
Lisa Joseph
Karen McDonough

INVENTORY CONTROL
Ethan Perry

TRAFFIC
Theresa Toussaint
Carol Crocker
Carol Dawdy
Lisa Hesley
Maureen Toussaint

PLANT MAINTENANCE
Bill Barry
Lorraine Pickering
Ken Cox

RECEPTIONIST
Doni Jarvis

SHIPPING
Susan Chandler
Carol Dillon
Caryn Kogos

ASSOCIATES
Robert Baker WB2GFE
E. H. Barnett WB8IJK
Shirley Cox W8BLMO
Tom DiBlase WB8KZD
Terry Fox WB4JFI
W. Sangar Green
Dave Ingram K4TWJ
Joe Kaiser G3ZCZ
Bill Pasternak WB8ITF
John Schultz W4EFA
Walter Scott K8DIZ
Peter Stark K2OAW
Bill Turner W4BABI

COMPUTER SYSTEMS MANAGER
Bob Leach WA6MCC/1

COMPUTER PROGRAMMING
Richard J. Dykema
Mitch Worrich

DRAFTING
Bill Morello
Lynn Malo

ADVERTISING
Bill Edwards WB8ED/1
Nancy Cuff WA1WSU
Gary Doherty
Tobee Philips

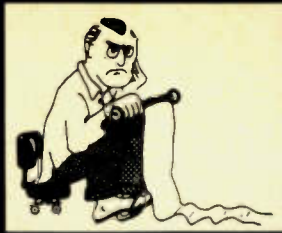

NEVER SAY DIE

...de W2NSD/1

EDITORIAL BY WAYNE GREEN

THOSE FCC DOCKETS

One of the big problems with the FCC is that they are trying to work in a vacuum, particularly now that they are having to function under the "Home Box Office" gag rule which prohibits FCC officials from discussion with anyone of rules currently under consideration.

A couple of months ago, the ham press got a panic call from the FCC — part of the staff at Gettysburg were temporary workers and the federal money for paying them was running out, with no signs that Congress would refill the money hopper. Without those workers, there was no way the hard-working crew at Gettysburg could continue to give hams and CBers that fast service on license applications.

After looking over the operation at Gettysburg, there is no question in my mind that it is indeed efficient — probably a model that a lot of other government agencies (federal and state) could review for ideas. However, the question in my mind was: Is all of this really necessary?

To my pointed questions about the need for any licensing at all of CBers, the answer seems to be that no, there is no real need. The psychology is that the need for an FCC license is supposed to impress CBers and thus perhaps encourage them to be more law-abiding. Also, in cases of illegal operation, such as out of band (called HFers) or over-power, the FCC would have jurisdiction. Without an FCC license, the FCC currently can't do a thing but ask the FBI to do something . . . and the FBI has enough of its own stuff to do, so they have kind of laughed at requests to shut up CBers. When I suggested that there was a lot to be said for *not* getting a CB license, I was met with wry smiles.

Since the FCC is almost totally unable to cope with the CB "problem," and since this problem doesn't seem to be causing anything more than TVI miseries (with which the FCC is also unable to cope), perhaps Congress would have done a lot of people a favor by letting the temporary workers at Gettysburg move out and thus give the FCC increased pressure to stop bothering with CB licensing of any kind. The staff at Gettysburg could easily handle the amateur licensing and the other services they handle once the weight of trying to issue a half to one million CB tickets a month was removed.

Not that I think we need the FCC very much for amateur licensing, either. I would prefer to see amateur radio even more self-regulating than it

is at present. One psychological concept that interferes with self-regulating and self-policing is the idea that, heck, it isn't *my* job to do anything about a problem . . . the FCC will take care of it. So when someone comes on the repeater with foul language, everyone wants to call the FCC monitors. Then they are astounded when the FCC seems disinterested . . . and they get mad at the FCC for not taking care of the band for them.

CBers also are led to believe that they have but to turn to the FCC when a problem arises. I suspect this is the bad side of licensing. CB clubs could go a long way toward cleaning up CB operation if they weren't under the screwy notion that the FCC is watching and will step in. The FCC is *not* watching and has no foot to make the step.

No, I don't think Congress should pour a bunch of money into more monitoring engineers and vans. I think both hams and CBers should be leveled with about the real situation so they can get to work themselves to provide the service they are expecting the government to provide. Most CB clubs would love to get high power amplifiers off their channels. A good high power station wipes out almost all 40 channels on nearby junk receivers . . . and most of the receivers are made as cheaply as the FCC will permit, so they don't reject much except weak signals.

Ham clubs could do a lot toward cleaning up our bands if they understood that there is no one else responsible but them. When the unknown voice appears on the repeater, reach for a direction-finder rather than a telephone line to the FCC . . . etc.

In the process of discussing all of this with the FCC people at Gettysburg, my next question was: Why are we getting all these incredibly rotten rule proposals of late? Isn't there some way that the people who are coming up with things like linear bans could get together with some knowledgeable amateurs before they go off half-cocked?

This concept struck a sympathetic cord and resulted in a "Media/FCC" meeting in mid-July. Whether that meeting was of any value or not depends mainly on whether the FCC people present were listening.

The FCC fellows spent a lot of time explaining their side of things, with charts and slides. I'm afraid I was kind of a pest, continually asking them to pinpoint the problems they were trying to solve. Time after time they would explain that they had problems

with this and with that . . . and here was the proposed solution. The solutions didn't seem tied to any specific problems that I could see.

I was reminded of the most serious disaster in amateur rule making history — a bomb called "Incentive Licensing." This all came about when the editor wrote an editorial in *QST* saying that the fellows at ARRL Headquarters had been looking over the ham bands and were very upset by what they had found. In order to cure these problems, they proposed a return to the old Class A and Class B type of licensing, thus removing all of the lower class licensees from most of the phone bands.

The actual intent of this whole exercise was to present a controversial editorial, but in short order it had escalated and the ARRL had to back up the editorial with a vote of the Board of Directors. Never at any time during the process which led up to the passing of the rules was any attempt made to say specifically what the new rules were supposed to cure. Never. This left the opponents of Incentive Licensing with little but hot air to fight, and, as usual, amateur apathy. "I don't want to be bothered with politics" won out, and the ARRL got their rules through . . . General class hams lost about half of their phone bands, and amateur licensing growth stopped cold for over ten years.

So here we are again with rule changes being proposed with no clear idea of what they are supposed to accomplish. I repeatedly tried to pin down the FCC people on this, trying to get them to make some sort of statement as to the problem they were trying to solve with the proposed rule changes on linears, type acceptance of ham gear, etc. I asked them if the main problem was television interference from CBers and I got a lot of waffling. Okay, if that isn't the main problem, then is it interference to other services from the HFers operating in the channels above 40 and below 28 MHz? No, while that irritated them, that wasn't a serious problem. Okay, maybe we were getting somewhere. Was it TVI caused by the HFers, virtually all of whom are running ham power levels rather than CB powers? Again, waffling and a general yes and no answer. Well, if the rules changes aren't aimed at curing TVI problems from CBers or HFers, and HFers are not causing interference to other services, what the hell are we talking about?

I suggested a strong need to tackle

Continued on page 16

NEW

TS-700S

WITH DIGITAL FREQUENCY DISPLAY



Kenwood has done it again! We've combined the fine, time-proven characteristics of the original TS-700A together with many of the ideas and comments for improvement from amateurs worldwide. Check out the new "built-ins": digital readout, receiver pre-amp, VOX, semi-break in, and CW sidetone! Of course, it's still all mode, 144-148 MHz and VFO controlled.

Features: Digital readout with "Kenwood Blue" digits • high gain receiver pre-amp • 1 watt low power switch • built in VOX • semi-break in on CW • CW sidetone • Operates all modes: SSB (upper & lower), FM, AM and CW • Completely solid state circuitry provides stable, long lasting, trouble-free operation • AC and DC capability (operate from your car, boat, or as a base station through its built-in power supply) • 4 MHz band coverage (144 to 148 MHz) • Automatically switches transmit frequency 600 KHz for repeater operation. Simply dial in your receive fre-

quency and the radio does the rest... simplex, repeater, reverse • Or accomplish the same by plugging a single crystal into one of the 11 crystal positions for your favorite channel • Transmit/Receive capability on 44 channels with 11 crystals.

VFO-700S

The perfect companion to the TS-700S! This handsomely styled unit provides you with extra versatility and the luxury of having a second VFO in your shack. Great for split frequency operation and for tuning off frequency to check the band.

The function switch on the VFO-700S selects the VFO in use and the appropriate frequency is displayed on the digital readout in the TS-700S. In addition, a momentary contact "frequency check" switch allows you to spot check the frequency of the VFO not in use.



TRIO-KENWOOD COMMUNICATIONS INC.
1111 WEST WALNUT/COMPTON, CA 90220

 **KENWOOD**
...pioneer in amateur radio

KENWOOD

...pacesetter in amateur radio

TS-520S

AND DG-5 DIGITAL FREQUENCY DISPLAY



FULL COVERAGE TRANSCEIVER

The TS-520S provides full coverage on all amateur bands from 1.8 to 29.7 MHz. Kenwood gives you 160 meter capability, WWV on 15,000 MHz., and an auxiliary band position for maximum flexibility. And with the addition of the TV-506 transverter, your TS-520S can cover 160 meters to 6 meters on SSB and CW.

DIGITAL DISPLAY DG-5 (option)

The Kenwood DG-5 provides easy, accurate readout of your operating frequency while transmitting and receiving.

OUTSTANDING RECEIVER SENSITIVITY AND MINIMUM CROSS MODULATION

The TS-520S incorporates a 3SK35 dual gate MOSFET for outstanding cross modulation and spurious response characteristics. The 3SK35 has a low noise figure (3.5 dB typ.) and high gain (18 dB typ.) for excellent sensitivity.

NEW IMPROVED SPEECH PROCESSOR

An audio compression amplifier gives you extra punch in the pile

ups and when the going gets rough.

VERNIER TUNING FOR FINAL PLATE CONTROL

A vernier tuning mechanism allows easy and accurate adjustment of the plate control during tune-up.

FINAL AMPLIFIER

The TS-520S is completely solid state except for the driver (12B-Y7A) and the final tubes. Rather than substitute TV sweep tubes as final amplifier tubes in a state of the art amateur transceiver,

Kenwood has employed two husky S-2001A (equivalent to 6146B) tubes. These rugged, time-proven tubes are known for their long life and superb linearity.

HIGHLY EFFECTIVE NOISE BLANKER

An effective noise blanking circuit developed by Kenwood that virtually eliminates ignition noise is built into the TS-520S

RF ATTENUATOR

The TS-520S has a built-in 20 dB attenuator that can be activated by a push button switch conveniently located on the front panel.

PROVISION FOR EXTERNAL RECEIVER

A special jack on the rear panel of the TS-520S provides receiver signals to an external receiver for increased station versatility. A switch on the rear panel determines the signal path... the receiver in the TS-820 or any external receiver.

VFO-520 — NEW REMOTE VFO

The VFO-520 remote VFO matches the styling of the TS-520S and provides maximum operating flexibility on the band selected on your TS-520S.

AC POWER SUPPLY

The TS-520S is completely self-contained with a rugged AC power supply built-in. The addition of the DS-1A DC-DC converter (optional) allows for mobile operation of the TS-520S.

EASY PHONE PATCH CONNECTION

The TS-520S has 2 convenient RCA phono jacks on the rear panel for PHONE PATCH IN and PHONE PATCH OUT.

CW-520 — CW FILTER (OPTION)

The CW-520-500 Hz filter can be easily installed and will provide improved operation on CW.

AMPLIFIED TYPE AGC CIRCUIT

The AGC circuit has 3 positions (OFF, FAST, SLOW) to enable the TS-520S to be operated in the optimum condition at all times whether operating CW or SSB.

The TS-520S retains all of the features of the original TS-520 that made it tops in its class: RIT control • 8-pole crystal filter • Built-in 25 KHz calibrator • Front panel carrier level control • Semi-break-in CW with sidetone • VOX/PTT/MOX • TUNE position for low power tune up • Built-in speaker • Built-in Cooling Fan • Provisions for 4 fixed frequency channels • Heater switch.

TS-520 Specifications

Amateur Bands: 160-10 meters plus WWV (receive only)
 Modes: USB, LSB, CW
 Antenna Impedance: 50-75 Ohms
 Frequency Stability: Within ± 1 kHz during one hour after one minute of warm-up, and within 100 Hz during any 30 minute period thereafter

Tubes & Semiconductors:
 Tubes 3 (S2001A x 2, 12BY7A)
 Transistors 52
 FETs 19
 Diodes 101

Power Requirements: 120/220 V AC, 50/60 Hz, 13.8 V DC (with optional DS-1A)

Power Consumption: Transmit: 280 Watts Receive: 26 Watts (with heater off)

Dimension: 333(13 1/4) W x 153 (6-0) H x 335(13-13/16) D mm(inch)
 Weight: 16.0 kg(35.2 lbs)

TRANSMITTER

RF Input Power: SSB: 200 Watts PEP CW: 160 Watts DC

Carrier Suppression: Better than -40 dB

Sideband Suppression: Better than -50 dB

Spurious Radiation: Better than -40 dB

Microphone Impedance: 50k Ohms
 AF Response: 400 to 2,600 Hz

RECEIVER

Sensitivity: 0.25 μ V for 10 dB (S+N)/N

Selectivity: SSB: 2.4 kHz/-6 dB, 4.4 kHz/-60 dB

Selectivity: CW: 0.5 kHz/-6 dB, 1.5 kHz/-60 dB (with optional CW-520 filter)

Image Ratio: Better than 50 dB

IF Rejection: Better than 50 dB

AF Output Power: 1.0 Watt (8 Ohm load, with less than 10% distortion)

AF Output Impedance: 4 to 16 Ohms

DG-5

SPECIFICATIONS

Measuring Range: 100 Hz to 40 MHz

Input Impedance: 5 k Ohms
 Gate Time: 0.1 Sec.

Input Sensitivity: 100 Hz to 40 MHz... 200 mV rms or over, 10 kHz to 10 MHz... 50 mV or over

Measuring Accuracy: Internal time base accuracy ± 0.1 count

Time Base: 10 MHz
 Operating Temperature: -10° to 50° C/14° to 122° F

Power Requirement: Supplied from TS-520S or 12 to 16 VDC (nominal 13.8 VDC)

Dimensions: 167(6-9/16) W x 43(1-11/16) H x 268(10-9/16) D mm(inch)

Weight: 1.3 kg(2.9 lbs)



DG-5

The luxury of digital readout is available on the TS-520S by connecting the DG-5 readout (option). More than just the average readout circuit, this counter mixes the carrier, VFO, and heterodyne frequencies to give you your exact frequency. This handsomely styled accessory can be set almost anywhere in your shack for easy to read operation... or set it on the dashboard during mobile operation for safety and convenience. Six bold digits display your operating frequency while you transmit and receive. Complete with DH (display hold) switch for frequency memory and 2 position intensity selector. The DG-5 can also be used as a normal frequency counter up to 40 MHz at the touch of a switch. (Input cable provided.)

NOTE: TS-520 owners can use the DG-5 with a DK-520 adapter kit.

KENWOOD

...pacesetter in amateur radio



TS-820S

WITH DIGITAL FREQUENCY DISPLAY

We told you that the TS-820 would be best. In little more than a year our promise has become a fact. Now, in response to hundreds of requests from amateurs, Kenwood offers the TS-820S... the same superb transceiver, but with the digital readout factory installed. As an owner of this beautiful rig, you will have at your fingertips the combination of controls and features that even under the toughest operating conditions make the TS-820S the Pacesetter that it is.

Following are a few of the TS-820S' many exciting features.

PLL • The TS-820S employs the latest phase lock loop circuitry. The single conversion receiver section performance offers superb protection against unwanted cross-modulation. And now PLL allows the frequency to remain the same when switching sidebands (USB, LSB, CW) and eliminates having to recalibrate each time.

DIGITAL READOUT • The digital counter display is employed as an integral part of the VFO readout system. Counter mixes the carrier VFO, and first heterodyne frequencies to give exact frequency. Figures the frequency down to 10 Hz and digital display

reads out to 100 Hz. Both receive and transmit frequencies are displayed in easy to read, Kenwood Blue digits.

SPEECH PROCESSOR • An RF circuit provides quick time constant compression using a true RF compressor as opposed to an AF clipper. Amount of compression is adjustable to the desired level by a convenient front panel control.

IF SHIFT • The IF SHIFT control varies the IF passband without changing the receive frequency. Enables the operator to eliminate unwanted signals by moving them out of the passband of the receiver. This feature alone makes the TS-820S a pacesetter.

*The TS-820 and DG-1 are still available separately.

TS-600



Experience the excitement of 6 meters. The TS-600 all mode transceiver lets you experience the fun of 6 meter band openings. This 10 watt, solid state rig covers 50.0-54.0 MHz. The VFO tunes the band in 1 MHz segments. It also

has provisions for fixed frequency operation on NETS or to listen for beacons. State of the art features such as an effective noise blanker and the RIT (Receiver Incremental Tuning) circuit make the TS-600 another Kenwood "Pacesetter".



TV-506

An easy way to get on the 6 meter band with your TS-520/520S, TS-820/820S and most other transceivers. Simply plug it in and you're on... full band coverage with 10 watts output on SSB and CW.



TR-8300

Experience the luxury of 450 MHz at an economical price. The TR-8300 offers high quality and superb performance as a result of many years of improving VHF/UHF design techniques. The trans-

ceiver is capable of F₃ emission on 23 crystal-controlled channels (3 supplied). The transmitter output is 10 watts.

The TR-8300 incorporates a 5 section helical resonator and a

two-pole crystal filter in the IF section of the receiver for improved intermodulation characteristics. Receiver sensitivity, spurious response, and temperature characteristics are excellent.

KENWOOD

...pacesetter in amateur radio

TS-700S

WITH DIGITAL FREQUENCY DISPLAY



Check out the new "built-ins":
digital readout, receiver pre-amp,
VOX, semi-break in, and CW sidetone!
Of course, it's still all mode, 144-148
MHz and VFO controlled.

Features: Digital readout with "Kenwood Blue" digits • High gain receiver pre-amp • 1 watt lower power switch • Built in VOX • Semi-break in on CW • CW sidetone • Operates all modes: SSB (upper & lower), FM, AM and CW • Completely solid state circuitry provides stable, long lasting, trouble-free operation • AC and DC capability (operate from your car, boat, or as a base station through its built-in power supply) • 4 MHz band coverage (144 to 148 MHz) • Automatically switches transmit frequency 600 KHz for repeater operation. Simply dial in your receive frequency and the radio does the rest... simplex, repeater, reverse • Or accomplish the same by plugging a single crystal into one of the 11 crystal positions for your favorite channel • Transmit/Receive capability on 44 channels with 11 crystals.



VFO-700S

Handsomely styled and a perfect companion to the TS-700S. This unit provides you with the extra versatility and the luxury of having a second VFO in your shack. Great for split frequency operation and for tuning off frequency to check the band. The function switch

on the VFO-700S selects the VFO in use and the appropriate frequency is displayed on the digital readout in the TS-700S. In addition a momentary contact "frequency check" switch allows you to spot check the frequency of the VFO not in use.



TR-7400A

Features Kenwood's unique Continuous Tone Coded Squelch system, 4 MHz band coverage, 25 watt output and fully synthesized 800 channel operation. This compact package gives you the kind of performance specifications you've always wanted in a 2-meter amateur rig.

Outstanding sensitivity, large-sized helical resonators with High Q to minimize undesirable out-of-band interference, and give a 2-pole 10.7 MHz monolithic crystal filter combine to give your TR-7400A outstanding receiver performance. Intermodulation characteristics (Better than 66dB), spurious (Better than -60dB), image rejection (Better than -70dB), and a versatile squelch system make the TR-7400A tops in its class.

Shown with the PS-8 power supply

(Active filters and Tone Burst Modules optional)

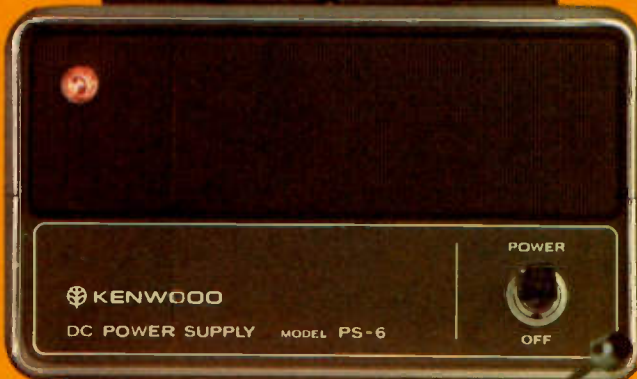

TR-7500

This 100 channel PLL synthesized 146-148 MHz transceiver comes with 88 pre-programmed channels for use on all standard repeater frequencies (as per ARRL Band Plan) and most simplex channels. For added flexibility, there are 6 diode-programmable switch positions. The 15 KHz shift function makes these 6 positions into 12 channels. 10 watt output, ± 600 KHz offset and LED digital frequency display are just a few of the many fine features of the TR-7500. The PS-6 is the handsomely styled, matching power supply for the TR-7500. Its 3.5 amp current capacity and built-in speaker make it the perfect companion for home use of the TR-7500.



TR-2200A

The high performance portable 2-meter FM transceiver. 146-148 MHz, 12 channels (6 supplied), 2 watts or 400 mW RF output. Everything you need is included: Ni-Cad battery pack, charger, carrying case and microphone.

KENWOOD

...pacesetter in amateur radio

Kenwood developed the T-599D transmitter and R-599D receiver for the most discriminating amateur.

The R-599D is the most complete receiver ever offered. It is entirely solid-state, superbly reliable and compact. It covers the full amateur band, 10 through 160 meters, CW, LSB, USB, AM and FM.

The T-599D is solid-state with the exception of only three tubes, has built-in power supply and full metering. It operates CW, LSB, USB and AM and, of course, is a perfect match to the R-599D receiver.

If you have never considered the advantages of operating a receiver/transmitter combination... maybe you should.

Because of the larger number of controls and dual VFOs the combination offers flexibility impossible to duplicate with a transceiver.

Compare the specs of the R-599D and the T-599D with any other brand. Remember, the R-599D is all solid state (and includes four filters). Your choice will obviously be the Kenwood.



R-599D

T-599D

R-300

Dependable operation, superior specifications and excellent features make the R-300 an unexcelled value for the shortwave listener. It offers full band coverage with a frequency range of 170 KHz to 30.0 MHz • Receives AM, SSB and CW • Features large, easy to read drum dials with fast smooth dial action • Band spread is calibrated for the 10 foreign broadcast bands, easily tuned with the use of a built-in 500 KHz calibrator • Automatic noise limiter • 3-way power supply system (AC/Batteries/External DC) ... take it anywhere • Automatically switches to battery power in the event of AC power failure.





Fine equipment that belongs in every well equipped station

HF LINES

820 Series

- TS-820S... TS-820 with Digital Installed
- TS-820... 10-160 M Deluxe Transceiver
- DG-1... Digital Frequency Display for TS-820
- VFO-820... Deluxe Remote VFO for TS-820/820S
- CW-820... 500 Hz CW Filter for TS-820/820S
- DS-1A... DC-DC Converter for 520/820 Series

520 Series

- TS-520S... 160-10 M Transceiver
- DG-5... Digital Frequency Display for TS-520 Series
- VFO-520... Remote VFO for TS-520 and TS-520S
- SP-520... External Speaker for 520/820 Series
- CW-520... 500 Hz CW Filter for TS-520/520S
- DK-520... Digital Adaptor Kit for TS-520

599D Series

- R-599D... 160-10 M Solid State Receiver
- T-599D... 80-10 M Matching Transmitter
- S-599... External Speaker for 599D Series

- CC-29A... 2 Meter Converter for R-599D
- CC-69... 6 Meter Converter for R-599D
- FM-599A... FM Filter for R-599D

SHORT WAVE LISTENING

- R-300 General Coverage SWL Receiver

VHF LINES

- TS-600... 6 M All Mode Transceiver
- TS-700S... 2 M All Mode Digital Transceiver
- VFO-700S... Remote VFO for TS-700S
- SP-70... Matching Speaker for TS-600/700 Series
- TR-2200A... 2 M Portable FM Transceiver
- TR-7400A... 2 M Synthesized Deluxe FM Transceiver

- TR-7500... 100 Channel Synthesized 2 M FM Transceiver
- TR-8300... 70 CM FM Transceiver (450 MHz)
- TV-506... 6 M Transverter for 520/820/599 Series

POPULAR STATION ACCESSORIES

- HS-4... Headphone Set
- MB-1A... Mounting Bracket for TR-2200A
- MC-50... Desk Microphone
- PS-5... Power Supply for TR-8300
- PS-6... Power Supply for TR-7500
- PS-8... Power Supply for TR-7400A
- VOX-3... VOX for TS-600/700A

Trio-Kenwood stocks a complete line of replacement parts, accessories, and manuals for all Kenwood models.

MORE ACCESSORIES:

Description	Model #	For use with
Rubber Helical Antenna	RA-1	TR-2200A
Telescoping Whip Antenna	T90-0082-05	TR-2200A
Ni-Cad Battery Pack (set)	PB-15	TR-2200A
4 Pin Mic. Connector	E07-0403-05	All Models
Active Filter Elements	See Service Manual	TR-7400A
Tone Burst Modules	See Service Manual	TS-700A; TR-7400A
AC Cables	Specify Model	All Models
DC Cables	Specify Model	All Models



The Kenwood HS-4 headphone set adds versatility to any Kenwood station. For extended periods of wear, the HS-4 is comfortably padded and is completely adjustable. The frequency response of the HS-4 is tailored specifically for amateur communication use. (300 to 3000 Hz, 8 ohms).



The MC-50 dynamic microphone has been designed expressly for amateur radio operation as a splendid addition to any Kenwood shack. Complete with PTT and LOCK switches, and a microphone plug for instant hook-up to any Kenwood rig. Easily converted to high or low impedance. (500 or 50k ohm).

TRIO-KENWOOD COMMUNICATIONS INC.
1111 WEST WALNUT/COMPTON, CA 90220

 **KENWOOD**
...progress in amateur radio

New Products

REVIEW OF FLESHER RTTY TERMINAL UNIT (DM-170)

The heart of any RTTY station is the demodulator, or terminal unit (TU), the device that converts frequency shift modulation into current pulses on the loop. In basic form, the TU is nothing more than two tuned filters driving a discriminator. However, on today's QRM-filled bands, there are few clean RTTY signals to copy. CW, fading, and overcrowded bands are only a few of the problems the teletype operator must face. A good terminal unit should have several stages of filtering before the discriminator to reduce QRM, some type of tuning indicator, and provision for "locking" the loop in a mark condition should conditions warrant. Several years ago, the only method of achieving the necessary front-end selectivity involved the use of LC-tuned circuits, employing bulky 88 mH toroids. The tuned discriminator also required toroids — which have become the traditional identifier of RTTY equipment. However, there are problems when designing bandpass filters with LC components. Interstage loading effects are a major problem, requiring very careful design. The size and weight of the 88 mH inductors are also considerable; thus, a miniature, high performance TU was difficult to build.

Enter the operational amplifier (op amp). The op amp allows designers to create bandpass filters at will, using only resistive and capacitive components. Filter tune-up problems are eliminated, as pots can be used to center the components of the bandpass filters. I can clearly recall building my ST-5 TU, and spending an entire evening removing turns from 88 mH coils, a turn at a time, to adjust the discriminator. At best, a junk box full of capacitors was required to tune the TUs of yesterday. Several commercial TUs have adopted the op amp as gain-producing devices, but few have utilized the device in its most natural application — as an active filter.

This month I had the pleasure of testing a new terminal unit that is definitely state-of-the-art. This device is the Flesher Corp. DM-170, a complete TU on a single 3" x 5" PC

board. The DM-170 employs six-pole active filters in the bandpass filter, and may be tuned simply by varying resistive components. The TU is designed for 170 Hz shift, with mark and space tones being 2125 Hz and 2295 Hz respectively. An input audio signal of 100 mV is required. The input impedance of the DM-170 is 1000 Ohms. (I used the output of a 600 Ohm transformer already in use with no problems.) The Flesher TU requires power supply voltages of +15 V and -15 V, at 50 mA per side. All of the connections to the device are brought out to a 12 pin edge connector, on standard .156" centers. The DM-170 also has autostart, provision for a tuning meter (1 mA movement), scope connections, and "lock on space."

Flesher Corp. was kind enough to provide the DM-170 in both kit and complete form. I built the kit first. I was impressed by the quality components used in the TU. The op amps are Motorola MC1458s. There is no compromise with quality in this unit. Building the kit only took one hour, and consisted of soldering the components into the board. Flesher provides photographs, schematic, and x-ray shots of the PC board to assist the builder. There is nothing tricky about this kit!

Tune-up was next. Since the DM-170 employs active filters, adjustment is simple. Flesher provides the necessary miniature potentiometers and resistor selection to accomplish the procedure. An audio oscillator (or existing AFSK generator) is required, as well as a VTVM or oscilloscope. The tuning operation consists of adjusting the trim control for maximum filter output, as observed on the scope connected to the mark or space outputs. Once the stage in question is aligned, the value of the trimmer must be checked with the Ohms scale on the VTVM. The nearest value fixed resistor is then inserted permanently into the circuit. This procedure is duplicated for each stage in the mark and space filter. It is not necessary to adjust the bandwidth of the active filter, as this has been done in the original design. In all cases, the resistor required was very close to the standard value of the supplied resis-

tors. The entire tune-up procedure took about an hour.

Operating the DM-170 is as easy as building the kit. The TU does not have an internal 60 mA loop supply, so this must be provided, as well as a printer. I used my Model 19. A meter can be used for a tuning indicator if a scope is not available. The meter peaks on either a correctly tuned mark or space signal; thus, when a RTTY signal is tuned in, the meter will indicate about half scale, and not fluctuate. If desired, an oscilloscope can be used for tuning, which consists of tuning for the familiar crossed ellipse pattern. I connected the 15 volt supply, loop supply, and meter, and was ready to go.

Twenty has been open in the evening lately, and there was plenty of RTTY to choose from. A couple of nice features were immediately evident. The DM-170 holds the loop in mark when no signal is present, so the printer does not run open. If a space only signal is present, the TU opens the loop for about one half second, and then returns to mark! The signal must be correctly tuned for the printer to operate — decent! I tuned across and printed several QSOs with no problem — the DM-170 worked fine. Tuning is accurate and the six-pole filter cut out most of the QRM and nearby CW signals. I have a home brew active filter module that I use to front-end my ST-5 and other home brew TUs. This filter duplicates the bandpass of the HAL ST-6 TU, which has superior QRM rejection capability.

I connected the DM-170 and my filter to the same source, and used the ST-5 with another Model 15 printer. Thus I could copy the same signal on two completely separate systems. In short, the DM-170 could copy exactly what my existing station could, under exactly similar QRM conditions. I was almost ready to clear out the ST-5 and outboard filter to free some space in my admittedly cluttered shack!

Next, I ran a bandpass check on the DM-170 filter, using a counter, VTVM, and oscillator. The DM-170 3 dB bandwidth was about 280 Hz, centered at about 2250 Hz. Not bad! (For a well-researched discussion of RTTY filters, see "Design An Active RTTY Filter," by Pete Stark, in this issue.)

All in all, I was very pleased with the performance of the Flesher DM-170. The tiny size of the unit allows it to be built into a small enclosure with power supply and loop supply with considerable size-saving over other commercially available TUs. It has enough features to please most RTTY operators. The autostart feature requires about three seconds of steady mark to activate the output line, and it holds for about fifteen seconds after mark has disappeared. These time constants are variable, requiring only resistor changes. The DM-170 should be an attractive device for the newcomer to RTTY. It eliminates most of the tedious tune-up required of other kits, and offers superior performance on either HF or VHF. Flesher Corp., Box 976, Topeka KS 66601. Kit — \$39.95, factory assembled — \$59.95.

John Molnar WA3ETD
Executive Editor

NEW DIRECTIONAL WATTMETER HAS VARIABLE RF OUTPUT

Model 4431 is a new THRULINE® rf directional wattmeter for the measurement of forward or reflected CW power with the additional feature of an adjustable rf sampling output for frequency analysis on a scope, spectrum analyzer, or frequency counter.

The wattmeter is designed for ±5% power measurement from 100 milliwatts to 5000 Watts from 2 to 30 MHz, and up to 1000 Watts from 30 to 1000 MHz, using the same standard plug-in elements in discrete bands and power levels as catalogued with the famous model 43. No plug-in elements are needed for rf analysis. The sample signal is adjustable from 15 dB to over 70 dB below the main line signal, offering all-important protection from overload for high sensitivity instrument inputs.

THRULINE model 4431 has a low insertion VSWR of 1.07 at most settings. A major feature resulting in this low VSWR value is the use of the patented QC quick-change connectors, which permit mating with male or female N, BNC, TNC, UHF, C, SC, HN, GR type 874 and 7/8" EIA lines without the need for performance-

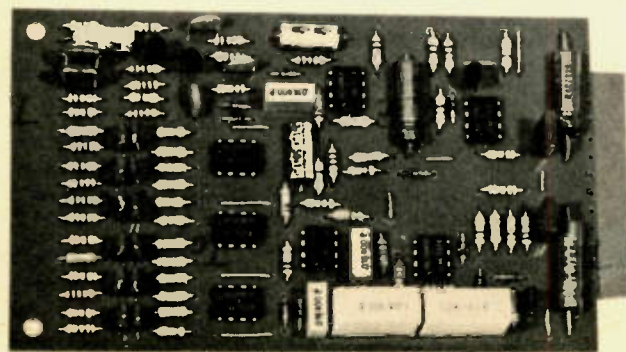

Flesher RTTY terminal unit.

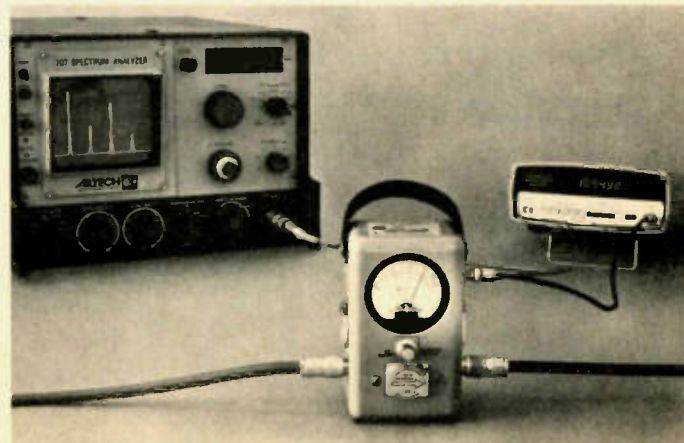

Bird's Model 4431 rf directional wattmeter.

degrading adapters.

Model 4431 price is \$175. Plug-in elements range from \$36 to \$42. Delivery is 90 days ARO. *Bird Electronic Corporation, 30303 Aurora Road, Cleveland (Solon), Ohio 44139.*

PS-170 RTTY BANDPASS PRESELECTOR

The PS-170 bandpass preselector has now joined the rapidly growing family of solid state RTTY products from Flesher Corporation. Designed with an optional bandpass for 170 Hz shift, the unit features selectable filter output or limiter output. Unwanted signals and noise are filtered out, providing the demodulator with the optimum signal to dramatically improve performance.

This preselector uses four stagger-tuned, cascaded stages to achieve a flat-topped, steep-skirted response with a rolloff of 80 dB per decade. The bandpass preselector has unity gain within the passband, with 3 dB cutoff frequencies of 2040 Hz and 2385 Hz, and 20 dB cutoff frequencies of 1925 Hz and 2560 Hz. It is available assembled and aligned or in kit form, with detailed instructions to assure easy assembly and alignment. Quality components are used throughout to insure high reliability. All components are mounted on a small 2 x 2-3/8 inch photoetched, plated, glass epoxy board. Typical power requirements are ± 15 V, mA. The power supply is not included.

The price is \$11.95 in kit form, \$18.95 assembled and aligned. Prices include first class postage. BankAmericard, Master Charge, and phone orders accepted. *Flesher Corp., PO Box 976, Topeka KS 66601.*

PALOMAR ENGINEERS VLF CONVERTER

Most amateurs are familiar with the frequency spectrum from the commercial broadcast band (540 kHz) up through the HF bands to VHF. Even though all those frequencies are not available for ham use, the owners are easily identified. Let's see, there is commercial television, FM, police, and, of course, CB. However, not many of us are familiar with the so-called VLF frequencies — the area below the bottom of the broadcast band.

I first became exposed to VLF last winter, when my friend Rich WB1ASL converted a surplus military R-23 receiver picked up at a hamfest for a buck. The old R-23 tunes from 190 to 540 kHz, and it is amazing what can be heard down there. There are weather services, beacons, and high speed CW stations all over the range of 200-500 kHz. We found a Coast Guard station transmitting clean CW at about 20 wpm — great practice for the old Extral. The only problem with the R-23 is that it is large, has tubes, and requires an external power supply for filament and plate current. Needless to say, I still purchased an R-23 from Fair Radio Sales, and tuned in on the world of VLF.

Several days ago, a small package arrived from Palomar Engineers in Escondido CA. It contained the Palomar VLF converter, measuring 4 1/4" x 2 1/4" x 1 1/4". A far cry from the R-23! This VLF converter has no real "amateur" application at the present, however; it falls into the category of a "fun" accessory. Perhaps Palomar, best known for their famous RX Noise Bridge, has predicted the outcome of WARC, as it is possible that a VLF amateur band will be created. At any rate, it is legal to communicate on some VLF frequencies without license, if power and antenna guidelines are followed.

The Palomar VLF converter is a broadband device powered by a single 9 V transistor battery. It requires no tuning, covers the range of 10-500 kHz, and uses any amateur 80m receiver as a tunable i-f. All that is required to use the VLF converter is a longwire antenna or loop, a battery, and a receiver capable of tuning the range 3.5-4 MHz. A bfo is desirable, as many VLF signals are CW.

Since it was WB1ASL that originally introduced me to VLF, I took the converter to his shack, and connected the same longwire used with our old R-23 receivers. We used the Heath 1680 receiver as the tunable i-f. It is easy to determine when the VLF receiver is on; a beat note will be heard at 3.5 MHz. Tuning up toward 4 MHz starts the VLF scan. It is recommended that a short coax connection be used between the converter and receiver, to eliminate 80 meter feedthrough.

The VLF converter is fun to use! We were able to copy the same signals we heard with the R-23, and much more. In the evening, especially on a clear cool day, it is possible to hear international broadcast stations in Europe and Africa. These stations employ high power transmitters, yet the effects of QSB are obvious. Often stations will fade completely away for no reason, only to reappear minutes later. There are beacons and CW stations, providing specific weather and shipping information. The very low frequencies contain primarily CW and beacon stations. A bfo is required to copy these outlets. Signals sounding like RTTY were also heard — I plan to demodulate and print these signals in the future. We tried to copy the WWV timebase at 60 kHz with no success. Perhaps conditions were not right, or our antenna was incorrect.

Do not attempt to copy VLF if there is a thunderstorm nearby, as the QRM is brutal. Listening is much better in the evening, as propagation is similar to that of the broadcast band — good DX at night!

The Palomar VLF converter is solid state, of course, and employs three toroids in the broadband circuit. The device is supplied with standard SO-238 UHF connectors, a battery clip and connector, and a power switch. It is foolproof and is a classic example of a "black box" — turn it on and use it! Have fun! *Palomar Engineers, Box 455, Escondido CA 92025.*

John Molnar WA3ETD
Executive Editor

NEW KITS FROM HEATH

Heath Company, the world's largest manufacturer of electronic kit products, has introduced three new frequency counter kits: The IM-4110, the IM-4120, and the IM-4130. Input frequencies of the three counters are 5

Hz to 110 MHz, 5 Hz to 250 MHz, and 5 Hz to 1 GHz, respectively.

The manufacturer says the new counters offer excellent accuracy and resolution for a wide variety of counting jobs including: CB, AM and FM, hi-fi equipment, marine and aircraft radio, military applications, land mobile, and more. Additionally, the counters can be used for events, period and period averaging.

A large, bright red eight digit LED readout indicates the frequency counted. A switchable attenuator on the 110 MHz input divides the input signal x1, x10 or x100 to facilitate measurement of large amplitude signals. The timebase switch selects the gate time and the resolution of the display. The 4120 and 4130 timebases are controlled by a TCXO (temperature-compensated crystal oscillator) with a temperature stability of ± 1 ppm and an aging rate of < 5 ppm/yr. (The 4110's crystal oscillator has temperature stability of ± 10 ppm and an aging rate of < 10 ppm/yr.)

The IM-4110 is priced at \$189.95, the IM-4120 at \$329.95, and the IM-4130 at \$529.95. The counters are also available fully assembled and tested at slightly higher prices. For complete details on these frequency counters and other Heath instruments, write for a free catalog from *Heath Company, Dept. 350-24, Benton Harbor, Michigan 49022.*

NEW SWITCHCRAFT AUDIO PLUG PERMITS EASY DISASSEMBLY OF GOOSENECK/MIKE SYSTEM

A new audio plug shown by Switchcraft, Inc., Chicago, at the 1977 CES, permits microphone gooseneck stems to be plugged directly into a receptacle on audio console, lectern, or podium.

Continued on page 67

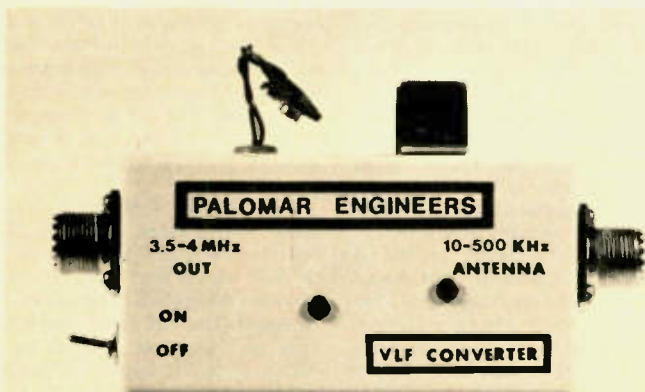

VLF converter from Palomar.



Heath's new frequency counter kits — IM-4110, IM-4120, and IM-4130.

THE SEAL OF PERFORMANCE

SEALS

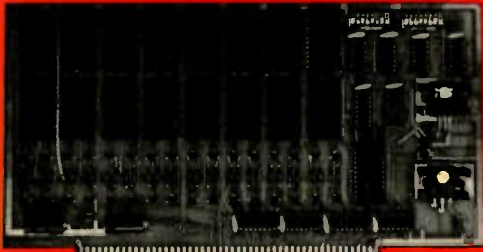

**4K
ROM**

**READ
ONLY
MEMORY**

- Will accept up to 16 ea. 1702A or 5203 EProm Providing up to 4096 Words of non-volatile memory for Boot Loads to Complete Programs.
- Programming Available at Factory for \$3.00 per EProm when accompanied by binary formatted tape.
- Each 1702-A has its own Vcc clocked for Low Power Consumption. Will work with the weakest power supply based S-100 buss computer.
- Switched Selected Address in 4K Blocks.
- Switch selected wait states so that even the slowest 1702-A can work in your system.
- Solder masked on both sides of PC Board.
- Component Screened on Component Side of PC Board.

**Kit Price:
\$119.00**

**Assembled Price:
\$179.00**

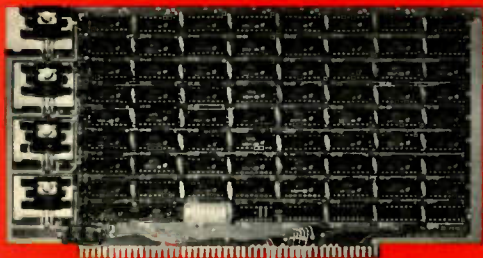

**8K
SC-Z**

**STATIC
MEMORY
CARD**

- ALTAIR IMSA1 and S-100 buss compatible.
- Access Time: 250 nsec max.
- Zilog Speed Compatible up to 4 mhz.
- Memory Chip: 2102LHPC or 2102 2
- Battery Standby >1.5 to 4 volts <
- Address Select: 8 ea. Spst. Dip Switch.
- Wait States: None.
- Current Req.: Less than 200 ma per 1K.
- All Address, Control, and Data Out lines fully buffered.
- All IC's supplied with IC Sockets.
- Solder Masked on both front and back of P.C. board.

**Kit Price:
\$295.00**

**Assembled Price:
\$395.00**

SEALS
ELECTRONICS, INC.
BOX 11651, KNOXVILLE, TN. 37919

TELEX NO. 55-7444

TELEPHONE NO. 615/693-8655



NEVER SAY DIE

...de W2NSD/I

EDITORIAL BY WAYNE GREEN

from page 4

whatever problem they were having (and I hadn't been able to get them to admit to what it was) by first stating the problem and then seeing if the mere statement of the real problem wouldn't suggest some solutions.

If the HFers are the big problem, even though the FCC doesn't want to admit it, then there are several possible ways of tackling the problem. One would be to use the historic FCC approach to solving difficult problems ... legalize the illegal activity. This worked fine with CB. Another approach would be to try and close down HFers with FCC monitoring agents, but since the FCC is outnumbered about 500 to one, and even the most determined efforts at stopping HFers haven't achieved anything significant, this doesn't seem a reasonable way to go.

If there were any justifications for closing down the HFers, I suspect that the FCC might be able to get the enthusiastic aid of amateurs and CBers. But, with the situation of their being illegal, yet not doing any great harm, it is difficult to work up much of a program. Not a few hams may take a good look at the HF band and wonder if the time might not be coming when this will be the *only* high frequency band left for using ham gear ... unless there is some major change in the prognosis of the coming disaster at Geneva. Do we really want to participate in helping to shut down a band we ourselves may desperately need someday?

Next I wanted to know if CB TVI complaints were tied in with illegal amplifiers. It seems that there is some agreement on this. Since the amplifiers have been made illegal, manufacturers have been making them as cheap and dirty as possible, with the end result that the linear ban has greatly increased TVI problems. The FCC answer to this is to make the laws even stronger banning amplifiers — a typical government approach to a problem.

Several manufacturers at the meeting testified that prohibition had rather conclusively proven that laws are not going to stop people making something that is wanted by the public. I suggested a try at getting the public not to want amplifiers ... some education which would encourage CB groups to move against any local CBers using amplifiers. After all, the chap with 4 Watts output and a lousy receiver which collapses when anything over 4 Watts comes on the band (and most of the receivers are lousy) has a vested interest in keeping amplifiers off the air ... so he can operate. Getting his own amplifier won't help his receiver.

Another approach to the linear amplifier problem on CB is to change the rules and allow 1000 Watts. If that gets out of hand, raise it to 5000 Watts. The cost of 5 kW amplifiers is such that this could be a limiting factor for a while. With the coming sunspots and the more constant opening of the CB channels for skip, a bunch of kW signals should be most interesting. Remember that the FCC has no mandate whatever to provide interference-free bands for CB.

Legalized amplifiers would make it easier for the FCC to make sure that the moonshine linears we are seeing these days would be killed off. Making something illegal doesn't stop it — it just makes it attractive and forces people to buy junk instead of goods which have withstood the test of the marketplace.

If the FCC stopped licensing CBers, they could cut the staff at Gettysburg in less than half. I realize that this is contrary to every law laid down by Parkinson and thus can't happen ... but I like to dream. Just because it is serving no useful purpose is no reason to stop it.

Let's take this even further. While I accept that we do have to have licenses and license exams for amateurs, I don't agree that the tests have to be given by the FCC. The ARRL would dearly love to take over giving the license exams, and I'm sure this would work out as it has in several countries where the national club issues the licenses ... no membership in the club, no license. And to a club whose main source of income is advertising from a magazine, government-enforced subscribing to their magazine is most attractive.

Even though the FCC found what amateurs had long known, that the Conditional class license was being cheapened by cheating, that doesn't mean that there is no possible way for hams to self-administer the exams. I'd like to see ham clubs with enough interest to run classes be permitted to give exams and issue licenses. With any exam supervised by a minimum of three licensed amateurs of an equal or higher grade than the examinee, we should have little trouble with cheating. A club's reputation would be on the line.

The FCC could require a fairly tough training course and make the clubs toe the line. It would still take far fewer people than they are using today to examine tens of thousands of applicants. The FCC could then take some of the people released from examining us and issuing us licenses and use them for monitoring, etc. I'm sure the FCC will find a way to spend the money saved.

Continued on page 64

De WA3ETD

John Molnar WA3ETD
Executive Editor

RTTY

This issue of 73 is dedicated to amateur radio teletype, or RTTY. Even if you are not a RTTY enthusiast, the special articles should be of interest to the technically inclined. The winner of the Call For Papers competition of a few months ago is in this issue. The article, "So You Want To Get Into RTTY?", by Richard Parry, contains information for beginners and experienced operators alike. A fine article, "Design An Active RTTY Filter," by Pete Stark, is also presented. This article is not only for RTTY operators, as it describes basic design techniques for active filters — also used by CW operators and audio enthusiasts. Enjoy!

There is always some trepidation about starting out on a new mode, such as SSTV, RTTY, or OSCAR. In the case of RTTY, it's not really that hard, and the advantages are many. Believe it or not, many hams have mike fright, and conversations over the air often degenerate into a tiresome routine of signal strength reports and local weather information. Typing on a teletype machine is slower paced than talking — it gives you time to organize your thoughts, just like writing a letter to a friend. And, of course, there are always those pictures (pix) to exchange. RTTY art is enjoyed by many operators; just tune in on 20 meters on Saturday morning about 14.09 MHz and see. Some of the pix are masterpieces and take over an hour to print!

I was introduced to RTTY by a friend and fellow ham, Ken W2PSU. He said that "there is always something to do" when operating teletype. Think about it; on phone, most operators just sit and listen during a QSO, having tuned up and organized before answering a call. Could get boring, unless you're locked in a pileup. There is always something to fiddle with while "printing" a QSO. You can pretype your response to questions on paper tape with most systems, prepare picture tapes, adjust your printer, or whatever! Never a dull moment — just watching the QSO type out in front of you is better than listening, in my opinion.

It really does not take a roomful of gear to gain an introduction to the world of RTTY. If you already have a transceiver (HF or VHF), it can be done for less than \$100. First you will need a page printer and keyboard. There are a multitude of these available; a common device is the Teletype Corporation Model 15. The larger Model 19 stations with paper tape equipment are based on the ubiquitous Model 15.

Printers are available for under \$50. I picked up a classic Model 15 with answerback and internal loop supply for \$35 at a flea market this summer — they can be had for less. Check flea

markets, or ask a ham who is into RTTY, as he may have a second, unused printer around.

After obtaining and converting the printer, a terminal unit, or TU, is required. The TU converts the received frequency-shift tones into dc pulses that drive the printer. TUs can be very simple. A good one is not all that expensive. This month, almost by accident, I obtained a TU kit from the Flesher Corporation in Topeka KS. Dubbed the DM-170, this S39 kit outperforms much more expensive devices. It takes an hour to build, and is on a 3" x 5" PC board! (Check my review in this issue.) So let's see, we're up to about \$80 for a TU and printer — add a loop supply to drive the printer (definitely a junk box project) and you are ready to copy RTTY signals off the air! In order to transmit, a method for keying the transmitter from the keyboard is required. The practice today is to use audio frequency shift keying, or AFSK. This technique involves generating two tones which, when shifted back and forth, provide a means of coding the keyboard characters. In most cases, the audio tones can be fed directly into the microphone input of an SSB transceiver. A suitable AFSK generator can be built with one 88 mH toroid and about \$5 of new parts. That's it! A basic RTTY station is guaranteed to produce hours of operating pleasure, and may be expanded as time and money permit. RTTY lends itself to computerization like no other aspect of hamming, and there are loads of digital operating aids that can be added. Some of these special projects are described in this issue.

NOTE TO CORRESPONDENTS

I have been receiving volumes of mail lately, requesting everything from writers' guides to conversion information on 1934 receivers. As I have said, we do our best to answer all correspondence, especially from authors. A problem exists, however. Many of the requests for information come with no return postage or SASE. Most publishing houses immediately file such correspondence in the circular out basket. In the future, I will not respond to unsolicited requests for information unless an SASE is provided. Manuscripts rejected with no return postage will be saved, but not returned unless postage is provided by the author. I don't think you would bear such expense as postal rates spiral; why ask your friendly amateur publication to do it? Thanks!

NEW TRENDS

My experiments on 10 GHz with the Gunnplexers slowed down this month for several reasons. I am refining my system with the VHF Engineering receivers, and ran into a parts bind. The mail advertisers in 73 are fast, but not that fast! The details of my experiments will be along soon, however. Who knows, RTTY on 10

GHz? I did construct a set of active filters for my RTTY station, using Pete Stark's design guidelines. Some type of filter is needed before the discriminator in a RTTY TU, and active filters are the way to go. Most older designs use 88 mH toroids, which require careful and tedious tuning. With an active filter, a variable

trim control can be used to set each stage in a matter of minutes. It was a fun project — the filter is now embedded in my terminal unit. I usually get a chance to operate on weekday evenings, especially when 20 is open. Look for me between 14.090 and 14.1. I'd like to print you!

Oscar Orbits

Oscar 6 Orbital Information				Oscar 7 Orbital Information			
Orbit	Date (Sept)	Time (GMT)	Longitude of Eq. Crossing "W"	Orbit	Date (Sept)	Time (GMT)	Longitude of Eq. Crossing "W"
N 22307	1	0132:03	86.0	12783 B	1	0122:33	74.8
NA 22319 8TN	2	0031:59	71.0	12795 A	2	0021:53	59.7
N 22332	3	0126:54	84.8	12808 B	3	0116:11	73.3
NA 22344 8TN	4	0026:50	69.8	12820 A	4	0015:31	58.1
N 22357	5	0121:46	83.5	12833 BQ	5	0109:48	71.7
NA 22369 8TN	6	0021:42	68.5	12845 A	6	0009:09	56.5
NA 22382 8TN	7	0116:37	82.3	12858 X	7	0103:26	70.1
N 22394	8	0016:33	67.3	12870 A	8	0002:47	55.0
NA 22407 8TN	9	0111:29	81.0	12883 B	9	0057:04	68.6
N 22419	10	0011:25	66.0	12896 A	10	0151:21	82.1
NA 22432 8TN	11	0106:21	79.8	12908 B	11	0050:42	67.0
N 22444	12	0006:17	64.8	12921 A	12	0144:59	80.6
NA 22457 8TN	13	0101:12	78.5	12933 B	13	0044:19	65.4
NA 22469 8TN	14	0001:08	63.5	12946 AX	14	0138:37	79.0
N 22482	15	0056:04	77.3	12958 B	15	0037:57	63.8
NA 22495 8TN	16	0105:00	91.0	12971 A	16	0132:14	77.4
N 22507	17	0050:55	76.1	12983 B	17	0031:35	62.3
NA 22520 8TN	18	0145:51	89.8	12996 A	18	0125:52	75.9
N 22532	19	0045:47	74.8	13008 BQ	19	0025:13	60.7
NA 22545 8TN	20	0140:43	88.6	13021 A	20	0119:30	74.3
NA 22557 8TN	21	0040:39	73.6	13033 BX	21	0018:50	59.1
N 22570	22	0135:34	87.3	13046 A	22	0113:08	72.7
NA 22582 8TN	23	0035:30	72.3	13058 B	23	0012:28	57.6
N 22595	24	0130:26	86.1	13071 A	24	0106:45	71.1
NA 22607 8TN	25	0030:22	71.1	13083 B	25	0006:06	56.0
N 22620	26	0125:18	84.8	13096 A	26	0100:23	69.6
NA 22632 8TN	27	0025:13	69.8	13109 B	27	0154:40	83.2
NA 22645 8TN	28	0120:09	83.6	13121 AX	28	0054:01	68.0
N 22657	29	0020:05	68.6	13134 B	29	0148:18	81.6
NA 22670 8TN	30	0115:01	82.3	13146 A	30	0047:38	66.4

The listed data tells you the time and place OSCAR crosses the equator in an ascending orbit for the first time each day. To calculate successive orbits, make a list of the first orbit number and the next twelve orbits for that day. List the time of the first orbit. Each successive orbit is 115 minutes later (two hours less five minutes). The chart gives the longitude of the first crossing. Add 29° for each succeeding orbit. When OSCAR is ascending on the other side of the world, it will descend over you. To find the equatorial descending longitude, subtract 166 degrees from the ascending longitude. To find the time it passes the north pole, add 29 minutes to the time it passes the equator. You should be able to hear OSCAR when it is within 45 degrees of you. The easiest way to do this is to take a globe and draw a circle with a radius of 2480 miles (4000 kilometers) from the home QTH. If it passes right overhead, you should be able to hear it for about 24 minutes total. OSCAR will pass an imaginary line drawn from San Francisco to Norfolk about 12 minutes after passing the equator. Add about a minute for each 200 miles that you live north of this line. If OSCAR passes 15 degrees from you, add another minute; at 30 degrees, three minutes; at 45 degrees, ten minutes.

OSCAR 6: Input 145.85-145.95 MHz; Output 145.90-146.00 MHz; Output 29.45-29.50 MHz.
Mode B: Input 145.95-146.00 MHz; Output 29.45-29.55 MHz; Telemetry beacon at 29.45 MHz.
OSCAR 7 Mode A: Input 145.925-145.975 MHz; Output 145.925-145.975 MHz.

Orbits designated "X" are closed to general use. "ED" are for educational use. "BTN" orbits contain news bulletins. "Q" orbits have a ten Watt ERP limit. "L" indicates link orbit. "N" or "S" indicates that Oscar 6 is available only on northbound or southbound passes. Satellites are not available to users on "NA" days.



Canadian Amateur Radio Federation, Inc.

CARF NEWS SERVICE BULLETIN

In reply to a CARF request for a special call sign prefix to commemorate Queen Elizabeth's Jubilee year (25th year of her reign), DOC has announced that Canadian amateurs may use the prefix "CY" for VE and

"CK" for VO station calls for the balance of this year.

DOC announced third party traffic agreement and reciprocal operating privilege agreement between Canada and Columbia, effective May 25, 1977.

ou rooms don't ever profit
lousy manuscripts from bat
burh
you
I insist that you print ev
tell Ma Bell that she shou

LETTERS

TRANSIENT SWR

I read with interest and disappointment a recent article by J.A. Murphy, "Transmission Line Primer," 73, June, 1977.

It is unfortunate that instead of enlightening your readership, the author has simply succeeded in muddying the transmission line waters even further. After reading a dreary succession of articles which attempted to explain transmission line theory, standing waves, and reflective power, I have concluded that one of the reasons that nothing definitive has appeared in the amateur literature is that a detailed understanding of the physical mechanism involved simply does not matter.

That is, most hams know that a high vswr is undesirable, and that efforts should be made to match antenna to transmission line. By following these simple rules, in most instances, a satisfactory amateur solution can be obtained without knowing much more.

Nevertheless, Mr. Murphy, apparently a professional engineer, should know better. In substance, he has simply confused the transient solution with the steady state solution. His simple analysis is correct as far as it went, but he incorrectly generalized his result.

Mr. Murphy makes use of a dc step function to describe what antenna engineers would call a pre-cursor wave front. Initially, the transmitter supplies a certain amount of extra energy to the transmission line until the first reflection makes the transit from antenna load back to transmitter. Until that time, of course, the transmitter does not "see" any change in loading due to antenna/transmission line mismatch. A first reflection does represent real power, and that real power is used to establish a standing wave. The presence of the standing wave alters the input line impedance so that the transmitter now "sees" a different load condition, and thereafter delivers less power to the line.

Standing waves, by and large, represent a steady-state condition, but standing waves do not represent a continuous back and forth reflection of real power. The phase relation between current and voltage in a standing wave pattern is indeed 90°, with a consequent zero power factor. You can see that this must be so if you consider the case of a shorted line. At the shorted end, current is at a maximum while voltage is at a minimum. If you plot current and voltage as sine waves, and superimpose

a minimum point on one curve with a maximum on the other, you will appreciate that a 90° phase shift has occurred at the load. The same reasoning, of course, applies to the case of the open line — maximum voltage with minimum current at the load. The equations derived by Mr. Murphy do not account for these conditions, resulting only in trivial solutions when the line is open or shorted.

The transient effect described in the article is rarely observed in practice by amateurs. It would take an almost lossless and relatively long transmission line to produce noticeable transient effects on transmitter loading. However, when discussing fast rise-time digital pulses in computer circuits, distortion of the leading pulse edge (caused by reflection) can be most important. But this example merely serves to confuse the issue. It is too bad indeed that the article didn't develop the steady-state solution and avoid the usual mumbo-jumbo about effects of loss, phase and group velocity, and other relatively arcane considerations which add little to an understanding of standing waves and reflected power.

I suppose what is really needed here is a definitive article by a recognized expert in the field who will, once and for all, put some of this nonsense to bed.

Martin R. Kramer K2KGF
New York NY

Comments, engineers? — J.M.

APPRECIATION

Kudos to Craig Anderton for his fine article concerning mail order in the July issue of 73. As someone in that business, I can empathize with the entire story. If everyone who shops by mail would only read Craig's story, it would save many people time and effort, not to mention money.

Al Smith WA2TAQ/WA4LDW
Merrick NY

HOW FAR WEST?

Most cases I don't like to complain too strongly, but after waiting such a long period of time, I can't hold off any longer.

I have been a subscriber to 73 for a few years now, and during that time I have been reading a column entitled "Looking West" by Bill Pasternak WA6ITF. According to my definition of the term, "West" should include many states in the western portion of the country. I don't believe the ama-

teurs in New Hampshire would consider their state as the only state in the "East." Therefore, by the same token, it seems a bit unfair to classify California as the only state in the "West." According to my qualifications, I would say all the states in the "West" would be those in the 6th and 7th call areas.

To the best of my knowledge, since I have been a 73 reader, I have yet to see any coverage of amateur activities in any area other than California in the "Looking West" column. In fact, within the past 8 to 10 months, we have sent Arizona news to Bill. Before I recently acquired my new trifocals, I sure hope I haven't missed any western ham news in "Looking West" (wherever that is) in your magazine.

Wm. Oliver Grieve W7WGW
Phoenix AZ

What say, Bill? — J.M.

SERVICE NETWORK

This is to inform you about the activities and the existence of the Guatemalan net, "TG Amigos del Mundo" (TG Friends of the World).

It was created in June 1976, on the 17th, to be precise, and this day was the first day of labors. It's already been over a year since it was initiated, and on June 17, 1977, we had a party at the American Club of Guatemala, to celebrate our first anniversary.

The net was created to thank the many friendly countries in the world that sent help and assistance to Guatemala during the past earthquake (Feb. 3, 1976), and also to correspond with other countries which have nets that have so many times helped Guatemalan ham radio operators.

Until that date of June 17, 1976, you had to try luck on the different bands to be able to catch a TG station, but now you know that on 7.085 MHz, from 02:30 to 03:30 GMT, Monday through Friday, and from 16:30 to 17:30 GMT, Saturdays and Sundays, you will be able to find TG stations.

Since the initiation of the net, we have handled about one hundred emergency traffic messages. In January 1977, there was a need for medicine in a hospital in Nicaragua, and through the net we coordinated to get the medicine. After approximately two hours, such medicine was taken on a private plane from Guatemala to Nicaragua.

There was another time, unfortunately I don't remember the date, when there were floods in Honduras. For 30 hours the Guatemalan net stayed QAP, working on different shifts of one hour each, until we were able to give the necessary help to the Honduran people.

The founders of the net are: TG9LN Mrs. Ana Maldonado, TG9VD Mr. Rafael Maldonado, TG9QV Mr. Ricardo de la Vega, TG9RL Mr. Rony E. Liang, TG9RC Mr. Rodolfo Casas, and TG9LX Mr. Luis Stolz.

TG Amigos del Mundo
Rony E. Liang TG9RL
Guatemala, C.A.

QUALITY OR QUANTITY?

Am I an old-fashioned snob? I never thought so, but apparently, according to Mr. Magness' letter (July '77, "More Tech Debate"), I must be.

I have nothing against Technicians, and certainly not Novices. I had as much, if not more, fun as a Novice as now. *But come on!*

I'm a 16 year old kid who sweated my brains out to get my General ticket. I got my Novice in Oct. of '75, and after failing the General theory in Dec. '75, I finally passed it (second try) in Jan. '76. When I failed, did I beg for an easier test? *No!* I just went home and studied a whole lot more.

At the present, I've failed the Advanced twice, but am I yelping for an easier test? *No!* I'm a DXer, and I see that the Advanced ticket is quite a point in your favor for DXing. Someday, I'll pass my Advanced, and earn new frequencies to use, *but I sure don't want them given to me!*

In explaining to my friends at school some of the differences between CB and amateur radio (besides power, frequencies, etc.), I tell them how you get a CB license by filling out an application and sending it in to the FCC. However, in order to get a ham ticket, you must pass an exam, consisting of being able to copy the International Morse Code, and then you must pass a test on electronic theory. They understand that ham tickets aren't given away, but do we?

OK. Say that the 13 wpm test is too high. Has this stopped thousands of *determined* persons from getting their General tickets yearly? And again, OK. So what if there is a high rate of Novice and Tech dropouts? If they don't want to work for their tickets, should we take it on ourselves to give them to them? Do we want quantity or quality of amateurs? If (and when) they drop out, *have we lost anything?*

I spent a lot of money on my equipment, too. Out of my own pocket (by my parents' decision). I know that since I had to shell out the cash for my rig and antennas, I'm not as likely to abuse it as someone who had it given to them (because I know what it's going to take to replace it). But do I fuss because I can't use frequencies allocated to Advanced or Extra class licensees? *No!*

When I got my Novice ticket, I knew exactly what I wanted to shoot for (General and above), so I buckled down and put out some effort. I expected nothing to be given to me, *and it wasn't!* I had to pass the 13 wpm code test like any other guy who went in for the test.

If we're going to start easing the requirements on exams to encourage CBers (and the public) to become hams, then why not just give 'em all their Extra, and be done with it (and amateur radio) in one big step.

Maybe nobody listens to kids, but after all, I'm a ham just like you, and we kids are the ones who are going to have to live with the laws you grown-ups make.

I'm sure, and I think you'll agree,

that if CBers had to pass an exam to get their licenses, there wouldn't be the problem that there is today with them. The ones who studied and passed their tests in order to *earn* their privileges would respect their right to operate, and wouldn't abuse it (or allow anyone else to).

But look at us! *We're hams!* We're really above the problems caused (and endured) by CBers. And what are we doing? We're lessening the requirements for our licenses so that more people can be hams!

I'm just as willing to welcome newcomers into ham radio as anyone, but if I had my choice, I'd rather be welcoming hams who have earned their new privileges.

Mark A. Clark WB4CSK
Fayetteville TN

WR7AFC

The idea was born over three years ago, and on Father's Day of this year, a group of fathers made this reality become true, when WR7AFC, Arizona's Finest Channel, began operating from Mingus mountain near Prescott and Cottonwood, Arizona. Operated by the Mingus Mountain Repeater Group on 147.600 input and 147.000 MHz output, coverage promises to be excellent from Phoenix to Flagstaff and almost all areas of Northern Arizona.

In fact, California repeater operators take note — many of the mountaintop (not bumps) repeaters are being operated at elevations in excess of 7000, 8000, and even 9000. Attention, Jack Anderson: Come out to Arizona and see some of our high-rise mountains, but don't look down.

Wm. Oliver Grieve W7WGW
Phoenix AZ

TRIAL SUB

Your comments about the ARRL are particularly disturbing. Apparently you do not have very good access to the facts, since many of your comments are out in left field. I realize that you are trying to sell magazines, but you would do better to stop knocking the competition and join with them to really do something for amateur radio. Split factions never do any good for the overall good. I criticize the ARRL in letters to them all the time, but I don't go around saying things bad to other folks.

Your conflicting comments regarding *CQ* in your last editorial make it readily apparent that you are using them to sell magazines. I have a number of friends that do not subscribe to *73* simply because of your lousy editorials. I think you would do much better to join a common cause to help promote amateur radio instead of trying to sell *73* through your editorials, especially when you don't know the facts. (And how about giving the new administration at ARRL a break and stop bringing up

this old stuff from years ago?) They make mistakes, but a look at the annual report shows just how much they are really doing for amateur radio.

This subscription will be a trial one for me.

D. Paul Gagnon N6MA
Camarillo CA

Thanks for the chance, Paul! — J.M.

PUBLIC FIRE

The other night while talking over beer and crackers with some amateur friends of mine, we came to a horrible prediction for amateur radio: Amateur radio may no longer be a hobby in the year 2000, due to public opinion.

One of the fellows (an Extra) mentioned the fact that amateurs take hundreds of frequencies for granted. VHF and UHF channels have very sparse activity, while only a few kilohertz away commercial channels are becoming overcrowded.

Think about this: You're watching the six o'clock news and up comes a story on the overcrowded conditions with commercial two-way radio. A telephone company rep tells how four or five megahertz of space isn't even being used by "hams" or "amateurs." He goes on to say how many hundreds of calls should be handled by their microwave links. He finishes, saying, "Amateurs are a stumbling block for the advancement of the radio art."

We may laugh now, but this could happen. Several co-workers are expressing displeasure in my hobby that used to excite them. After the Jack Anderson article, a few would say, "Is it true you hams have thousands of frequencies while CBers have a fraction of that?" One comment really hurt me: "What gives you guys the right?"

About a year ago, the ARRL made a big noise on how they would provide Public Service Announcements to broadcasters, new exciting movies, and code kits.

Where are these magical materials from the League when we need them? The radio station I work for broadcasted the PSAs five or six times, hardly enough for any listener to be convinced amateur radio is the "in" hobby. I still have not seen any PSAs on local TV.

Here's my point. Hams are coming under public fire. A few citizens have realized we do provide a public service, autopatching traffic accidents, or passing traffic. But, the general public can be turned against us, and so can legislators.

Why can't the League buy some prime time commercials during a television special? Why can't local clubs purchase commercials telling of the upcoming hamfest? Why don't hams get off their asses and show the public how exciting this space-age hobby can be?

Now is the time to get a club president of the local ham group to speak to the Chamber of Commerce. Insist on becoming a recognized

community organization. How about an OSCAR setup at the shopping mall for two days? Tell how local amateurs have put the town on the map with their contests, QSL cards, and ham-fests. Enlist the support of the mayor, the police chief, the City or Town Council.

Recently at a club meeting, the local group was having a field day on Jack Anderson. "He's a clown," "What a joker," were the comments in the meeting hall. Then I mentioned how amateurs should send letters to the Office of Telecommunications, White House, protesting comments made about our hobby. Then follow up with another letter to Congressmen and the President. The bunch of people didn't even hear me. They just went on complaining about the raw deal hams got in a newspaper article.

I know that my next-door neighbor doesn't consider Jack Anderson as a clown. I think most of the nation would agree. I respect him as a reporter. So what's the public supposed to think when this man tells us hams are getting special favors from the FCC?

I love ham radio, enough to write six letters to Washington, D.C., and one that was printed in the local paper about ham radio. I am handling more traffic for reluctant neighbors, and explaining my HT and autopatch to anyone who wants to know.

Hams have to do a "sell" job in preparation for the WARC in '79. Now is the time to become a community leader and show off your station to your neighborhood, to your kids, your kids' friends, to everyone. Once they get a glimpse at your QSLs, CB will seem like a toy.

If I have gotten the reader all fired up, great! Grab some paper and ask our President why an advisory agency that is supposed to coordinate military radio frequencies is hinting at the FCC for more CB frequencies. President Jimmy Carter or Office of Telecommunications, The White House, Washington, D.C. 20030.

You might want to send a radiogram to your Congressman, and good luck with the Chamber of Commerce. Unlike most hobbies, ours is regulated by the people, and for the people.

Dave Sweigert WB9VKO
Fort Wayne IN

You might drop Mr. Baldwin at the ARRL a note endorsing Dave's suggestions. I wonder what the effect of 100,000 letters would be? — J.M.

BELIEVER

I purchased your 13 wpm tape approximately 1 month ago and spent 1½ hours/day 7 days a week and received my General ticket 6/17/77.

I have used 3 different makes of code tapes besides yours, but they always brought me to the mental barrier of 10 wpm. I could not go beyond this until I used your tape.

You made a believer out of me. Keep plugging your method. It works!

Ed Hegyera WB9VZU
Kenosha WI



HERE SHE COMES

Please be advised that amateur radio station K2BR ("Boardwalk Radio") will be operating from the Miss America Pageant in Atlantic City, N.J., from September 1 to 10, 1977. Frequencies: CW — 3560, 7060, 14060, 21060 kHz; phone — 3960, 7260, 14290, 21390 kHz; Novice — 3720, 7120, 2112 kHz.

The station is under the sponsorship of the Southern Counties Amateur Radio Association (SCARA). Please QSL to N2NJ (ex-K2JOX).

Henry G. Rainville WB2QXX
SCARA/Miss America Pageant
Coordinator
Ventnor NJ

QRP

Hurrah for K6JQD! I just received the June issue of *73* and am very impressed with the letter from K6JQD concerning power levels. I certainly do agree with his views, but for other reasons than those stated. I have been living in Germany for several years and am aware of how high-powered American ham stations are affecting the overseas ham community, and it does not look good. I also am in about the same position as many of the European hams, in that I am not able to run high power or a very efficient antenna. I am afraid that not many American hams appreciate what is available to them at very reasonable cost. They are also giving American hams a black eye, although it may not be obvious that this is so.

Like many other hams in Europe, I am only able to run 200 Watts or so, and an inefficient antenna, and of course this limits to some extent the number of contacts I can make. This situation is not really that disturbing to me, except for the fact that when the receiver is turned on, about the only stations I can hear are lots of high-powered stateside stations with 1000 Watts and a big multi-element beam punching through with extremely strong signals which override many of the other stations I might like to work. Oddly enough, it is very difficult to work those strong stations; I suspect they only listen for loud stations and won't come back to anyone who does not have at least an S7 or S8 signal. It is very frustrating to call CQ

for hours and not receive a contact due to the stateside QRM or to hear a desirable station but not be able to work it due to the frequency being overloaded with super-powered stations. Then, of course, in the back of one's mind is the fact that you know you don't have a chance with low power (200 Watts) and a vertical antenna. For me, this is merely frustrating, but for a native European (or any other native for that matter), it must be even worse, considering that his knowledge of English is probably limited (along with his understanding of the American ham scene), and then he's limited in power and antenna and hears nothing but strong stateside stations on frequency. I speak German fluently and have had many nice eyeball QSOs and 2 meter QSOs, during which various opinions have been expressed, concerning the mess on 20 meters primarily. Many hams in my area hold a rather low opinion of the American ham and simply do not work HF anymore, or as little as possible due to this situation. One must realize that most foreign hams have had to struggle for a long time to scrape up the cash for a 200 Watt rig and have done a lot of fighting to put up any kind of antenna in the limited space most of them have available. It is then no wonder that many foreign hams are resentful when so many American hams on the air state, as if it were nothing, that they are running 1000 Watts with a multi-element beam high on a tower; such things are only wild dreams to most hams over here. I believe that the image of the American ham is tarnished enough without all of the high-powered stations rattling the ears of other hams all over the world. I would not want to introduce a blanket low power limit; however, after all, as you stated, there are cases where high power is needed, but in most cases it is not necessary.

I am afraid that many hams these

days are using high power to cover up poor operating practices or laziness. After all, it does take more effort to dig a little for the weaker stations and that is a shame, for many of those weaker stations could carry on a good QSO, too, if others would put forth a little more effort. Those weak stations out there are hams, too, although some operators seem to think they are little more than sources of QRM. I believe that most of the hams running high power could make do with less power if they would put on their headphones and sharpen up their operating skills.

I believe with WARC coming up we American hams cannot afford to give other countries a bad impression of ham radio in the US, but I am afraid that is just exactly what we are doing. We can do all the goodwill work there is to do and still come up on the short end of the stick if we do not watch our manners on the air.

In closing, I hope that others will respond on this subject and I am very pleased that you offered to open the letter forum to comment. This letter will no doubt stir up a hornets' nest, but I believe that there are many hams out there who will agree with me and K6JQD.

Richard J. Molby WB7NZG/DA 1DB
HHB 3rd BN 84th Arty
APO NY 09176

I agree, Richard! It's a shame that the kilowatt signal appears to be the norm on the HF bands, at least in the phone section. Why run 1000 Watts when 100 will do the job? Not only is this practice discourteous to our foreign neighbors, but it cuts the moderately powered stateside stations "out of the action." Most of my low frequency operating is on 20m RTTY. Very few stations run over 200 Watts, and get out just fine. I run 75 Watts out of necessity, and work everything I hear. Now, I'm sure that there are those who will point out that the RTTY

section of 20 is not as crowded as the phone areas. True, but how much more usable space would be available on phone if much of the power-induced QRM was eliminated? Think about it. — J.M.

enhance understanding in the cold, detached world of consumer economics.

Bob Grove WA4PYQ
Davie FL

ENJOY

I enjoy *73 Magazine* immensely. Pity that due to my lack of knowledge of the technical end of it, I cannot really absorb it all.

I did manage to pass the Novice exam, due in part to the excellent code tapes, and a great amount of study.

Electronics really did not interest me until the advent of CB SSB. Then I decided there had to be a choice of remaining or advancing. I will truthfully state that the knowledge does not come easily, as first I had to overcome my dislike of the electronics bit, but in the very near future, I intend to pass the Element III exam. I was extremely interested in the articles on conversion of 11 meter rigs to 10 meters, as I had a suspicion it could be done. Keep up the good work and fine articles.

Leon S. Greenwood WB3HEV
Philadelphia PA

Stay tuned for additional conversions, Leon! — J.M.

MORE MAIL

The mail-order article by Craig Arderton (73, July 77) was unusually warm to read. It was upbeat, informative, with empathy for both the seller and the buyer. I hope that enough readers paid the due that it so richly deserved, and will benefit by the insight Mr. Arderton provided to

WHO CAN LISTEN?

Have you noticed the item in the Happenings column of the July *QST* (p. 67) which states that hams in Indiana have "won" something by being exempted through legislation from the prohibition in bill SB454 against the ownership of receivers capable of copying the police bands for mobile or portable use?

I have always understood that the civil rights of American citizens included the reception of any radio transmission which is within the ability of an individual to receive it. Transmitted signals are within the public domain, and it is the obligation of the transmitting party to achieve security of information through codes, ciphers, cryptography, or whatever means are available. From this perspective, it concerns me greatly that a state agency can include legislation and criminal punishment as means of ensuring the security of its radio communications.

What have hams in Indiana won if they do not have the right of all citizens to listen to any signal which causes current to flow in their antennas? Is this a police state? What do the authorities have to hide? Can this be done at the state level?

I am writing to both the ARRL and the Governor of Indiana. I hope that the ARRL and you can come down hard on Indiana, because this activity is clearly out of the authority of state government and is clearly discriminatory if not applicable to all citizens.

Ted Edwards W1AJS
Sugarloaf PA

Ham Help

This is to request your readers to help us with our "Project Lifesaver" radio effort. We need parts and advice to enable us to adapt an ARN-6 system for finding people caught in blizzards.

We are solid stating the following tubes: 2050, 0D3, 6L6, 6V6, 6SJ7, 12SK7, 12SY7, 12SW7, 6SA7, 6SG7, 6AC7, 6J5, 26A7 — and we need a manual or at the least a schematic for ARN-6. Also, we need a 3-stack carbon pot (60k, 10k, 33k).

Ellis County Volunteer
Emergency Services
Box 522
Hays KS 67601

I have a vibroplex key with which I would like to become proficient (prior to on-the-air use). However, after scrupulously cleaning the contacts on the key and installing new batteries in the Heath transistorized code practice

oscillator, I'm still getting "dits" that are different in frequency (pitch) than the "dahs" on a straight key. Anyone have a "fix" for this?

James R. Theby WB0HZX
4912 Brockwood Drive
St. Louis MO 63128

I am in need of a tube layout or a schematic for a Jackson Model CRO 25" oscilloscope. It is manufactured by the Jackson Electrical Instrument Company of Dayton, Ohio, which is now out of business. I am missing two tubes which have 8 pin sockets — they control the intensity. Any help would be greatly appreciated.

John M. Matz
741 Schuykill Ave.
Pottsville PA 17901

Many would-be hams don't know where to turn for classes to help them obtain their Novice tickets. Therefore,

we are compiling a list of people or clubs conducting Novice classes throughout the country. We would appreciate it if these people or clubs would send us the following information about their classes: club or person sponsoring the class (if club, specific person who should be contacted); address; telephone number; whether classes are held year-round or at specific times of the year; any additional information.

Please keep us informed of any changes in your classes, so our list will be as current as possible. We ask anyone asking about information concerning classes near them to please enclose an SASE.

Bob Billson WA2TXY
837 Summit Ave.
Westfield NJ 07090

Bob Toegel WA2EGP
1775 Watchung Ave.
Plainfield NJ 07060

I would appreciate hearing from hams who might have improved the AVC in the Galaxy V Mk. II, to cure the popping on the receiver's in-

coming signals' audio, as well as the attack time of the AVC.

R.R. King
9025 N. Division
Spokane WA 99218

I am at the mercy of a U.S. Govt. OS-4B/AP oscilloscope (No. N383-46496A) whose power supply has ceased to function. I need a schematic and any operating instructions for this model. Any information will be greatly welcomed.

Carl G. Kramer WB3CYL
2525 Midpine Drive
York PA 17404

I was wondering if anyone in the Hamilton-Burlington area could help me with my code and theory. I am an avid SWL and am also very interested in amateur radio. I have been interested in amateur radio about 2 years. I am 13 years old, and I am willing to learn.

Keir Garber
75 Sharon Avenue
Hamilton, Ontario
Canada L8T 1E4

RTTY Loop

Marc I. Leavey, M.D. WA3AJR
4006 Winlee Road
Randallstown MD 21133

This month we will discuss the connections required to interface a Model 15 or 19 machine to a RTTY loop. Once this has been accomplished, the machine can be used with a terminal unit to receive and print RTTY signals.

I will assume you have acquired a Model 15 page printer or its big brother, the Model 19. This is a useful assumption for several reasons. First, it gives me a chance to talk about something I know. Second, the Models 15 and 19 constitute the foundation of ham RTTY. Setup of other machines can be based on what we cover here. Third, if you are rich enough to afford an ASR-32, you don't need my help!

The Model 15 machine consists of two major parts, a keyboard and a printer. Separate electrical circuits are provided for both devices; however, they are driven by a common motor. Some Model 15 machines have optional goodies, such as built-in loop supply, answerback, and assorted control relays. In any case, all the electrical connections are terminated on a terminal block on the right side of the machine, when viewed from the front. The terminals are available when connecting the keyboard and printer. Normally, the selector magnets in the printer are connected in series with the keyboard contacts; thus everything typed will be printed locally.

There are three connections which must be made to the Model 15 to get it running: (1) 115 V ac for the motor; (2) loop current for the selector magnets; and (3) keying circuit for the keyboard. We will cover each of these in turn.

To begin with, take a look at the motor in your RTTY machine. If there is a wheel with black and white stripes on one end, with levers protruding, you have a governor motor. The first thing you will have to do, after applying power, is set the speed of the motor. Good luck! You need a tuning fork and lots of patience. Most motors are synchronous, and remain accurate through the good graces of the electric company. To get the juice to the motor, connect the ac line to terminals 21 and 23 on the terminal strip located on the right side of the machine. See Fig. 1. You should use three-wire cable, and ground the chassis of the machine. Now, when you turn on the line switch, the motor should start, and all kinds of levers and gears should clatter. This is called "running open." Now — turn off the machine and unplug it.

Take an ohmmeter and lay it across terminals 45 and 46. There are two selector magnets, each with a resistance of 105 Ohms. If they are connected in series, total resistance is 210 Ohms and operation is for 20-30 mA of current. Parallel connection, with a resistance of 52 Ohms, is designed for 60 mA loops. If your magnets are in series, change them; see Fig. 2. A loop supply capable of delivering 150 volts at 60 mA is

needed. Fig. 3 shows a typical circuit. Notice the series resistor. If it was omitted, the current in the loop would be:

$$I = \frac{E}{R} = \frac{150}{52} = \text{about 3 Amps!}$$

Don't forget that resistor! Without it, the selector magnets will burn themselves up. By the way, required wattage for the resistor:

$$W = E \times I = 150 \times 0.06 = 9 \text{ Watts}$$

Don't skimp on size, either!

Now, take this power supply, which we will call the "loop supply," and connect it to terminals 45 and 46 (see Fig. 1 again). Plug the machine back in and turn it and the supply on. Things should run quietly now, without all that clatter. This is not running "closed"; it's just working as it should.

One more hookup and you will have yourself an electric typewriter. Connect some leads onto terminals 32 and 34 (start to wear out Fig. 1). Connect these keyboard leads in series with the loop. Fig. 4 illustrates the point. Now turn everything back on (I hope you turned it off while your fingers were in there), and everything you type on the keyboard should print on the page. Not exactly a Selectric, but still neat, right?

Next month we will discuss how to use the machine to receive signals. Familiarize yourself with the keyboard and special functions. It might be advisable to lubricate the mechanical parts, paying special attention to the oil cups on the motor and main drive shaft. Under no circumstances allow oil to contaminate the printer contacts. To do so will result in erratic transmission. See you next month!

I hope you are enjoying the RTTY Loop. As you can see, this issue of 73 features RTTY operations, so if you are into RTTY, keep reading! At this point, a little pitch for the 73 RTTY Handbook, edited by the 73 staff, is

in order. This book has information for beginners and seasoned operators alike, and is a must for all RTTY enthusiasts. This reference is up-to-date, featuring circuits based on op amps, FIFOs, and UARTs. For \$5.95 you can't pass it — order from the 73 Radio Bookshop. Another publication will be of interest to RTTY enthusiasts: The RTTY Journal, published about ten times a year, is exclusively RTTY oriented. It features a classified section loaded with teletype gear. Subscription price is \$3.50 (amazing) a year, and subscriptions may be obtained by writing RTTY Journal, P.O. Box RY, Cardiff-by-the-Sea CA 97002. (This is not a paid commercial — just a helpful tip from one RTTY aficionado to another!) — J.M.

Nice to read that you are finally going to have some RTTY coverage in your publication — it is about time. I first got hooked on that mode many years ago when Wayne Green ran his series of articles in *CQ*.

Now that the *RTTY Journal* is moving back to the West Coast, we could use some coverage for the East and Middle West.

Incidentally, I had always been informed that RATT stood for Radio Amateur Teletype. However, it is no longer used in Navy MARS, although it was ten years ago or so, when I first joined.

Herb Draeger WB5HVE
Mountain Home AR

I'm looking forward to the new column. The timing couldn't be better. I just was handed a Model 15 which is geared for 65 wpm.

I have an SB-303 receiver and an SB-401 exciter. My receiver is already set for FSK of the transmitter via shifting of the vfo in the transceive mode.

So, as you say, John, "Let's get started."

Jack Gott WA6KGI
Pleasant Hill CA

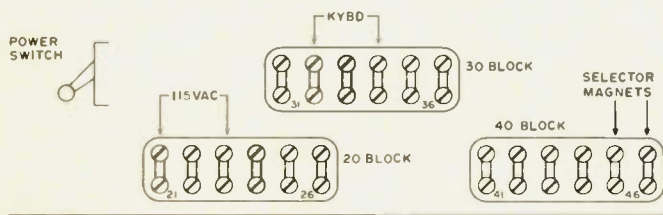

Fig. 1.

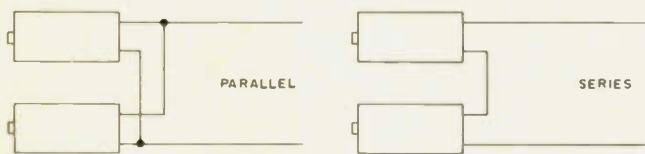

Fig. 2.

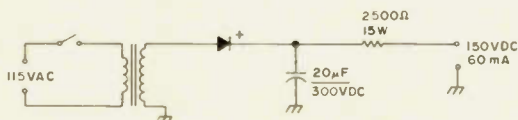

Fig. 3.

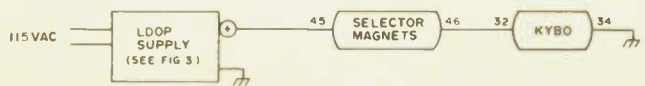

Fig. 4.

Tracking the Hamburglar

PURLOINED: Standard SRC 826M 2 meter FM transceiver, SN: 104207. Stolen on June 27, 1977 from Bill Myers WB0MCS, 942 E. Mississippi, Denver CO 80210, 303-777-3353. Has the following frequencies installed: 146.94-94, 52-52, 16-76, 34-94, 28-88, 88-88, 31-91, 148.01-01, 37-97, 19-79, 25-85, and 91-31. Has K0KGA scribed on receiver board. Receiver crystal board has been rebuilt. Channel 12 — 91-31 transmit is 450 cps. high in frequency; transmit trimmer for this channel is different from others.

RIPPED OFF: Icom IC-22A, s/n 9900 with 12 sets of crystals. Call and SS No. etched on back. Pete Jordan WA1AXK, 832 Temple Street, Whitman MA 02382.

STOLEN: Clegg Mark III, 2 meter transceiver, serial 750,187 with .52-.52 from Dick Haskin W6KEC, 149 Mauna Loa Dr., Monrovia CA 91016.

STOLEN: Drake TR-4 SSB transceiver #16491, AC-3 power supply #18572, L-4B linear amplifier #1102, L-4PS power supply #1124, Hallicrafters SX-100 receiver #151257. These items were stolen in a break-in on April 27, 1977, at a local radio store in Louisville KY, where they were held on consignment for EV Ballard WA4ACJ. Any information would be appreciated. Contact him collect at 502-451-8923 or 812-294-4819, or write 2438 Longest Av., Louisville KY. (Also: Jefferson County Police Department, 502-588-2111.)

Editor:
Robert Baker WB2GFE
15 Windsor Dr.
Atco NJ 08004

CONTESTS

FOUR LAND QSO PARTY
Starts: 1800 GMT Saturday,
September 3;
Ends: 0200 GMT Monday,
September 5

Sponsored by the Fourth Call District Amateur Radio Association of the IARS, Inc. The same station may be worked again on each band and/or mode fixed, and repeated again if operated portable or mobile and from each different county.

EXCHANGE:

RS(T), county, and state for 4th call district; state, province, or country for others.

SCORING:

4th call district stations score 1 point for W/VE QSOs and 3 points per DX contact (including KH6 and KL7). Final score is total points times states and provinces; states and provinces count only once, regardless of band/mode. All others score 2 points per QSO and multiply by the number of 4th district states and counties; count each state and county only once.

FREQUENCIES:

CW - 3575, 7060, 14070, 21090, 28090 (± 10 kHz); phone - 3940, 7260, 14340, 21360, 28600; Novices - 3710, 7110, 21110, 28110 (± 10 kHz).

ENTRIES AND AWARDS:

Certificates to top scorers in each state, province, and country. Second

and third place when scores warrant. Other awards to each 4th district county, Novices, SWLs, etc. Logs must be mailed with score within 30 days to Fourth Call District ARA, Attn: Bob Knapp W4OMW/W4NP, 105 Dupont Circle, Greenville NC 27834. Include an SASE for results.

WASHINGTON STATE QSO PARTY
Operating Periods:

0100 to 0700 GMT September 10;
1300 GMT September 10 to
0700 GMT September 11;
1300 GMT September 11 to
0100 GMT September 12

Sponsored by the Boeing Employees' ARC (BEARS), the contest is open to all amateurs. All bands and modes may be used. Stations may be worked once per band and mode, and may be worked again if they are a new multiplier.

EXCHANGE:

WA stations send QSO number, RST, and county; others send QSO number, RST, and state, province, or country.

FREQUENCIES:

CW - 1805, 3560, 7060, 21060, 28160; phone - 1815, 3935, 7260, 14310, 21380, 28660; Novice - 3735, 7125, 21150, 28160.

SCORING:

Score 2 points per QSO. WA stations multiply QSO points by total

number of states, provinces, and other countries worked. All others score 2 points per WA QSO and multiply by number of WA counties worked (39 max.). For non-WA stations only, there is an extra multiplier of one for each group of 8 contacts with the same WA county.

Washington county checkoff list for non-Washington State entries: Adams, Asotin, Benton, Chelan, Clallam, Clark, Columbia, Cowlitz, Douglas, Ferry, Franklin, Garfield, Grant, Grays Harbor, Island, Jefferson, King, Kitsap, Kittitas, Klickitat, Lewis, Lincoln, Mason, Okanogan, Pacific, Pend Oreille, Pierce, San Juan, Skagit, Skamania, Snohomish, Spokane, Stevens, Thurston, Wahkiakum, Walla Walla, Whatcom, Whitman, Yakima.

ENTRIES AND AWARDS:

Certificates to high scores in both single and multi-operator classes. Five BEARS awards are also available to anyone working 5 club members. All contest entries will be screened by the contest committee for possible Worked Five BEARS Awards. The Worked 3 BEAR Cubs Award is also available for working 3 Novice members. Logs are available from the contest committee upon request. Logs must show dates/times in GMT, stations worked, exchanges, bands and modes, and scores claimed. Include a check sheet for entries with more than 100 QSOs. Each entry must include a signed statement that the decision of the Contest Committee will be accepted as final. Logs will *not be returned*. Results of the QSO Party will be mailed to all entrants; an SASE is *not* required. Logs and scores must be postmarked no later than October 10th and sent to: Boeing Employees' ARC, c/o Contest Committee, Willis D. Propst K7RS, 18415 38th Ave. S., Seattle WA 98188.

PENNSYLVANIA QSO PARTY

Starts: 1700 GMT Saturday,
September 10;
Ends: 2359 GMT Sunday,
September 11

Sponsored by the Nittany ARC; all amateurs are invited to participate. PA stations may work both PA and non-PA stations. Each station may be worked once per band and mode.

EXCHANGE:

QSO number, RS(T), county or ARRL section.

FREQUENCIES:

CW - 1810, 3550, 7050, 14050, 21050, 28050; SSB - 1815, 3980, 7280, 14315, 21380, 28560; Novice - 3715, 7160, 21115, 28115.

SCORING:

PA stations score 3 points per out-of-state QSO and 1 point per PA QSO. Multiplier is number of ARRL sections, including EPA and WPA. One additional multiplier may be counted for DX QSO (limit: one). Out-of-state stations score 1 point per

PA QSO times the number of PA counties worked (67 max.).

ENTRIES AND AWARDS:

Logs must include dates/times in GMT, stations worked, RST sent/rcvd., band, mode, and number of new section or county as worked (multipliers). Summary sheet required, showing number of QSOs, QSO points, total multiplier, and claimed score. Also, include a check-list of counties worked. Mail logs, summary sheets, check sheets, and any comments by Oct 15th to: Douglas R. Maddox W3HDH, 1187 S. Garner Street, State College PA 16801. SASE appreciated. Certificates to section winners and outstanding PA entries with minimum of 10 QSOs required for awards.

NORTH AMERICAN SPRINT CONTEST
0200 to 0600 GMT Sunday,
September 11

Sponsored by the National Contest Journal, this contest is open to all amateurs. Entry classes include: single op (no helpers, one active xmtr, multiple rcvrs, no spotting net assistance); multi-single (multiple operators, one active xmtr, multiple active rcvrs, no spotting net assistance); multi-multi (multiple operators, multiple active xmtrs, one signal per band). All contacts must be made on CW only on any band from 160 to 20 meters. Stations may be worked once per band. North American stations are defined by the rules for CQ WW contests.

EXCHANGE:

You must make sure the entire exchange includes his call, your call, serial number (starting from 001), your nickname, state, province, or country. Example: W6OAT DE WB2GFE NR 27 BOB NJ K.

FREQUENCIES:

1800-1820, 3530-3550, 7030-7050, 14030-14050. Try 160m during the last half hour of the contest.

SPECIAL RULES FOR NA STATIONS:

If a station calling CQ NA is called by another station and makes a valid exchange with him, he cannot call CQ again on that frequency, nor can he solicit contacts by calling QRZ, etc. He must move a minimum of 5 kHz away from the frequency before calling CQ NA again, or he may answer a CQ NA on the frequency and, following a valid exchange, call CQ NA on that frequency.

CLUB COMPETITION:

Club competition is limited to a maximum of 15 operators as a single club entry unit. Clubs with more than 15 members may submit more than one entry unit. In this case, members of each unit must be drawn by lottery from the pool of members who will compete. To qualify as a club entry

CALENDAR

Sept 3-5	Four Land QSO Party
Sept 10-11	Washington State QSO Party
Sept 10-11	Pennsylvania QSO Party
Sept 10-11	ARRL VHF QSO Party
Sept 10-11*	European DX Contest - Phone
Sept 11	North American Sprint Contest
Sept 17-18	Scandinavian Phone Contest
Sept 24-25	Delta QSO Party
Sept 24-25	Scandinavian Phone Contest
Sept 25-26	Fall Classic Radio Exchange
Oct 1	Open CD Party - CW
Oct 1-2	California QSO Party
Oct 1-2	VK/ZL/Oceania - Phone
Oct 8-9	VK/ZL/Oceania - CW
Oct 15-16	Open CD Party - Phone
Oct 15-17	Manitoba QSO Party
Oct 22-23	CQWE Contest
Oct 22-23	CARTG RTTY Sweepstakes
Oct 29-30	CQ WW DX Phone Contest
Nov 5-6	ARRL Sweepstakes - CW
Nov 12-13	IPA Contest
Nov 12-13	European DX Contest - RTTY
Nov 13	OK DX Contest
Nov 19-20	ARRL Sweepstakes - Phone
Nov 19-20	WDXA International CW Contest
Nov 19-20	All Austria Contest
Nov 26-27	CQ WW DX CW Contest
Dec 3-4	ARRL 160 Meter Contest
Dec 10-11	ARRL 10 Meter Contest

*Described in last issue.

unit, the name and call of each operator in the unit must be registered with the Contest Coordinator (W6OAT) before 6:30 PDT, Sept. 10th. Changes may be made in the unit members up to that deadline. This rule limits multi-multi entries to a maximum of 15 operators if they are a club entry. Multi-multi's, multi-singles, and singles can be combined in a single unit, but the total number of operators cannot exceed 15.

SCORING:

NA stations multiply total valid contacts by the sum of states, VE multipliers, and countries to get final score. Non-NA stations multiply total valid contacts by the sum of states, VE multipliers, and NA countries. KH6 is not counted as a state and is not an NA country. VE multipliers are: maritime (VE1, VO1, VO2, etc.), and each VE call district (VE2 to VE8).

ENTRIES:

Logging is to be done on separate sheets for each band. Regardless of the number of licensed callsigns issued to a given operator entering, one and only one callsign shall be used during the contest period by that operator. Logs should include GMT time as well as complete exchange information.

Entries must be sent to Rusty Epps W6OAT, 35 Belcher Street, San Francisco CA 94114, and be received by Oct. 10th to be eligible for trophies and awards. Each entry should include a summary sheet showing valid contacts by band, total multipliers, total score, name and call of operator(s), station callsign, location, and declaration statement ("I declare, on my honor, that I operated in understanding and compliance with the NCJ Contest rules as well as all regulations for amateur radio in my country, and that my summary and log sheets are correct and true to fact."), followed by the signature(s) of the operators. Also required are a complete, legible log of all contacts (by band, with indication by numbered sequence of each multiplier claimed) and a separate check sheet for each band.

RESULTS

RESULTS OF THE 1977 FLORIDA QSO PARTY

Top 10 FLA Phone Stations

WA4LZR	94,135 points
WA4UFW	55,057
WB4PQB	34,713
WB4IIN	32,067
WB4INC	29,040
W4ZTW	20,586
W4WKQ	19,400
WA4EYR	18,069
W4KEB	15,041
N4EF	11,136

Top 10 FLA CW Stations

WA4NFF	27,900 points
K4BV	10,560
W4OO	10,098
K4KQ	9,180
K4DAS	9,030
K4IEX	7,896
W4WJ	7,524
WB4BMR	6,644
K4PB	5,740
WB4ZHU	3,600

The top FLA club score was attained by NOFARS, with 126,860 points.

Top 10 Out-of-State Phone Scores

K9DX	6,063 points
WB5STD	2,072
W7KWC	1,512
WB4HYN/9	756
K2HLC	700
WA0QIT	642
VE3RN	495
K9KKX	455
K5RPC	312
K9GTO	240

Top 10 Out-of-State CW Scores

WB4HYN/9	1,680 points
W8YL	1,550
W2RPZ	1,100
K9DX	1,058
WB0LFY	1,012
VE3EJK	940
W5KLB	798
WA2ZQB	765
W1GYV	684
W2WSS	630

DELTA QSO PARTY

Starts: 1800 GMT September 24;
Ends: 2400 GMT September 25

Sponsored by the Delta Division of the ARRL; all amateurs are invited to participate. No time or power restrictions. Amateurs outside of the Delta Division will attempt to contact as many amateurs inside the Delta Division (consisting of Ark., La., Miss., and Tenn.) as possible. Stations may be worked once per band/mode. Portables/mobiles may be reworked on the same band/mode if they change counties.

EXCHANGE:

QSO number, RST, and QTH — ARRL section for non-Delta Division; county and state for Delta Division.

FREQUENCIES:

CW — 3550, 7050, 14050, 21050, 28050; SSB — 3990, 7290, 14290, 21390, 28590; Novice — 3725, 7125, 21125, 28125.

SCORING:

Delta Divisions take number of QSOs times number of ARRL sections (75 max.). Outside the division, take number of QSOs times number of counties worked (316 max.). DX

stations may be worked, but do not count as multipliers.

ENTRIES AND AWARDS:

Logs must include date/time, call, exchange, band, emission, and multiplier. Logs must be postmarked no later than Oct 21st to be eligible for awards. The Delta Achievement Award is issued to all amateurs contacting 5 different stations in each of the 4 states in the Delta Division.

RESULTS

RESULTS OF THE 1977 BARTG RTTY CONTEST

Top 10 Single Operator Stations (107 Entries)

CT1EQ	488,160 points with 336 contacts
9H1EL	409,464 points
I5WT	281,160
I5KPK	270,560
G3YYD	258,560
K5ARH	235,056
SM6GVA	230,838
PJ3AR	229,600
W3FV	219,186
W2NZ	218,988

The top multi-operator entry was from 11PYS, with 388,448 points. W1MX finished third in the multi-op category. The top SWL entry was from Cech Luhos (OK2-5350), with 278,820 points.

RESULTS

RESULTS OF THE 1977 COUNTY HUNTERS SSB CONTEST

Mobile/Portable

WA0RJJ	336,868 points	(625 QSOs)
W6ANB	315,768	
WB0ELJ	101,376	
WB0ICP	69,300	
WB2GFE	42,688	
W5AWT	24,540	
WA7KKN	11,520	
WB9RCY	10,530	
W1EXZ	5,338	
W1DIT	4,865	

Fixed — DX

CT1UA	43,775 points
-------	---------------

Fixed — W/VE

W7KWC	3,940,942 points	(1,503 QSOs)
K1GSK	1,683,314	(1,263 QSOs)
WB4OGW	865,358	
W7SUY	365,472	
WBWT	249,678	
VE1RQ	204,200	
W7GHT	156,520	
W7KOI	103,360	
WABASV	70,713	
W1LQQ	66,783	

Other certificates and plaques for high scores. Logs will be returned if requested. Send logs to Malcolm P. Keown W5RUB, 213 Moonmist, Vicksburg MS 39180.

FALL CLASSIC RADIO EXCHANGE

Starts: 1800 GMT Sunday,
September 25;

Ends: 0100 GMT Monday,
September 26

Sponsored by the Southeast ARC (KBEMY) of Cleveland, Ohio, the contest is open to all. The object is to restore, operate, and enjoy older equipment with like-minded hams. A "classic radio" is any equipment built since 1945 but at least 10 years old — an advantage, but not required in the exchange.

EXCHANGE:

Name, RST, state, province, or country, receiver and transmitter type (if home brew, send PA tube, e.g., "6L6").

MISCELLANEOUS:

The same station may be worked with different equipment combinations, and on each mode on each band. No AM phone below 21 MHz. CW call is "CQ CX"; phone call is "CQ EXCHANGE". Non-contestants may be worked for credit.

FREQUENCIES:

CW — up 60 kHz from low end of band edges; phone — 3910, 7280, 14280, 21380, 28580; Novice/Tech — 3720, 7120, 21120, 28120.

SCORING (NOTE CHANGES FROM LAST YEAR):

Add the numbers of different transmitters and receivers, states/provinces/countries contacted for each band. Multiply by total number of QSOs. Multiply that total by class multiplier, the total years old of all transmitters and receivers (three QSOs minimum per unit). For transceivers, multiply years old by two.

ENTRIES AND AWARDS:

Awards for highest scores, longest DX, most equipment combinations, oldest equipment, and "unusual achievements." Send logs, comments, pictures, etc., to Stu Stephens K8SJ, 2386 Queenston Road, Cleveland Heights OH 44118. Include an SASE for a copy of the *Classic Radio Newsletter*.

CALIFORNIA QSO PARTY

Starts: 1800 GMT Saturday,

October 1;

Ends: 2400 GMT Sunday,
October 2

Sponsored by the Northern California Contest Club. Of the 30 hour period, the maximum operating time shall not exceed 24 hours. Times on and off must be clearly marked in the log, and each time off shall not be less than 15 minutes. All amateur bands may be used, and stations may be worked once per band and mode. Mobile or portable CA stations may be worked in each new county on each band and mode. CA stations may work other CA stations.

EXCHANGE:

CA stations send consecutive QSO

numbers and county; others send QSO number and state, province, or country.

FREQUENCIES:

CW — 1805, 3560, 7060, 14060, 21060, 28060; SSB — 1815, 3895, 7230, 14280, 21355, 28560; Novice — 3725, 7125, 21125, 28125. Try 10 meters on the hour and 15 meters on the half hour between 1800 and 2200 GMT.

SCORING:

Each QSO counts 2 points. CA stations multiply QSO points by number of states (including CA) plus Canadian districts (8 max.). DX may be worked for QSO points, but does not count for multipliers. Non-CA stations multiply QSO points by number of CA counties worked (58 max.).

ENTRIES AND AWARDS:

Log information should include date/time, band, mode, call signs worked, and exchanges sent/received. Number each new multiplier as worked. A summary sheet should be included, showing your call sign, name, address, number of QSOs per band, total number of QSOs, total multiplier, claimed score, and indication of whether single or multi-operator entry. Summary sheets are available from the NCCC. Certificates are awarded to the highest scoring station in each CA county, state, province, and country. Portable stations must make 20 QSOs minimum for county certificate. There will be second and

third place awards if justified, as well as special high score awards and a club award for highest aggregate score. All entries must be sent to the NCCC, c/o Lew Jenkins N6VV, 1750 Eucalyptus Ct., Concord CA 94521, and must be postmarked not later than Oct. 31st. Please include a large business-size SASE with each entry.

ZONE 29 AWARD

Issued by the West Australian Division of the Wireless Institute of Australia to amateurs and SWLs worldwide for contacts with 25 stations located within zone 29. Contacts may be on any amateur band or mode, but must have been made after January, 1952. The following endorsements are available when the award is issued as confirmation of following special conditions:

- (a) All 25 stations on one band only;
- (b) All 25 stations on phone (SSB, AM, FM, etc.);
- (c) All 25 stations on CW;
- (d) All 25 stations on one band and all on phone;
- (e) All 25 stations on one band and all on CW;
- (f) 25 stations heard by SWL listener, in (a) to (e) above.

Confirmation in writing of all contacts must be submitted to: The Secretary, WIA (WA Division), Box N. 1002, GPO, Perth, W.A. 6001, Australia. Include \$1 or 5 IRCs for postage and handling.

Corrections

There is an error in the article "The Morse Clock," July, 1977. The table in Fig. 7, page 57, has an incorrect value. The ROM contents for digit 1 should be "11110", not "10000" as indicated.

John Molnar WA3ETD
Executive Editor

There are several corrections to "Super DVM," starting on page 108 in the August, 1977, issue. The zener diodes in Fig. 4 are incorrectly designated. The two diodes marked "1N753" should be 6.2 V 1N753 diodes. In Fig. 3, the op amp is shown with incorrect pinouts. The 100 pF capacitor should be connected

between pins 8 and 1, not between 8 and 7 as shown. The power should be connected to pin 7. This pin is not numbered in the figure. The photographs in "Super DVM" were taken by Bert Mau.

John Molnar WA3ETD
Executive Editor

There's an error in my article, "Build A Multiplying Prescaler," in the July issue. Fig. 9(b) on p. 136 should show IC2 pins 5 and 8 grounded, as in Fig. 8.

J. H. Everhart K3JE/2
Lancaster PA

The balun transformer illustrated in Fig. 4 of "Satellite Zapper," on page 83 of our May issue, is in error. The RG-58 coax cable indicated should in reality be RG-59 or RG-11 cable. The balun transformer requires 72 Ohm cable to properly match the 300 Ohm twinlead.

John Molnar WA3ETD
Executive Editor

The article "Inside The Bird," by Robert Bloom, July, 1977, made several references to the term THRU-LINE™ on page 44. This term is a registered trademark of Bird Electronic Corporation, Solon, Ohio, and

was incorrectly used without the identifying trademark symbol.

There are also three errors in the article: The resistor in Figs. 2 and 3 has to be on opposite sides of the loop, not in the left leg. On page 45, column one, the formula for I_r is missing a minus sign, and in column two, I^2R is printed as "12R". The correct formulas are: $I_r = -E_r/Z_0$ and $I^2R = IE$.

John Molnar WA3ETD
Executive Editor

My letter to you dated 19 May concerning the conversion of certain SSB CB rigs to 10 meters contains a rather foolish statement which I wish to correct. I had said that using a 12.6685 MHz crystal in place of the X4 value given in the table would yield six additional frequencies between 28.6 and 28.8 MHz. This is obviously erroneous: The suggested change would indeed produce six frequencies different from the original crystal frequency, but no more of them would be between 28.6 and 28.8 MHz with either crystal. My apologies — this was an admittedly stupid error which I made due to trying to do the math involved in the conversion at 0230 hours.

Those who are involved in the Ten-Ten activities, and have no particular desire to operate in the DSB full carrier mode, may be interested in the following set of crystal frequencies. When substituted for the high oscillator crystals in the Cobra 138A/138, Midland 13-895, or Pace 1000 CB

transceivers, they will produce 23 operating frequencies between 28.510 and 28.800 MHz. X1 — 12.5485 MHz; X2 — 12.5585 MHz; X3 — 12.5685 MHz; X4 — 12.5885 MHz.

If you calculate the operating frequencies obtained with the above, you will note that all of them fall on frequencies which are evenly divisible by 10 kHz. Since approximately one third of the existing Ten-Ten local nets meet on frequencies which are not evenly divisible by 10 kHz, you may want to change one or more of the crystal frequencies by a few kHz to accommodate your local net.

I will repeat my earlier caution that the "delta tune" controls on most SSB CB radios swing both the transmit and receive frequencies. This is accomplished in the abovementioned radios by a varactor diode which operates in the high oscillator circuit. My experience has been that the maximum frequency swing with the original components is on the order of one kHz plus and minus. It may be possible to increase this range by using a different varactor, but I don't know of anyone who has tried it.

Finally, a brief comment on WA4MFT's 10 meter bandplan — fooye! As far as I'm concerned, we already have enough bandplans on the VHF and UHF bands without encumbering the HF bands with them. Some cooperation among 10 meter AM ops is indeed necessary, but Ray's plan is just too structured for my taste.

Stan Modjesky WB3CJ
Woodlawn MD



On Saturday, September 17, 1977, the FAAR-OUT Airborne DXpedition will take to the skies over California and Nevada. FAAR-OUT (*Five Airborne Amateurs Reaching OUT*) will provide a unique opportunity for VHF/UHF/microwave amateur operators to participate in a unique experimental DXpedition. We will fly a 1085 statute mile route over a period of nearly eight hours, operating on 4 bands and using several modes of communications. We will be seeking a maximum number of contacts on all bands and modes, and will be looking for real DX stations, as well.

We expect to make contacts with stations in high locations, with good antennas, and with other airborne stations. For pilots who would like to know our exact flight plan, here 'tis: San Jose V334 Sacramento V6N Reno V105 Las Vegas. Lunch and refuel at Las Vegas, then via V21 Hector VOR, V12 Palmdale, V137 Priest VOR, V485 San Jose. We plan to fly the San Jose to Las Vegas leg between 1600 GMT and 2000 GMT, and the Las Vegas to San Jose return leg between 2100 GMT and 0100 GMT. This timing may vary up to an hour each, or either way, and the exact times will depend on the weather and upon OSCAR orbits. The San Jose-Las Vegas leg will be flown at 11,500 feet, and the return leg will be flown at 12,500 feet.

We will be operating on the following bands and modes: 146.52 MHz FM, 145.1 MHz SSB, 223.50 MHz FM, 432.0 USB, 446.0 FM, 437.25 ATV, OSCAR Mode B, and 1296.010 USB. At present, the inclusion of ATV equipment is contingent on getting the equipment working in time, and the OSCAR shot will be made if mode, orbit, and antenna installations on the aircraft permit.

The following operators will be operating the following bands, etc.: 146.52 MHz

FM — Dave WB6KHP, 40 Watts ERP; 145.1 MHz SSB — Ray WA6VAB, 40 Watts PEP; 223.50 MHz FM — Brad WA6REE, 10 Watts ERP; 437.25 ATV (if aboard) — Ray WA6VAB, 40 Watts peak video; 432.0 USB — Paul WA6UAM, 40 Watts PEP; 446.0 FM — Alan WA6YOB, 10 Watts ERP; 1296.010 USB — Paul WA6UAM, power not specified; OSCAR Mode B — Paul WA6UAM, 40 Watts PEP.

In addition, if other airborne amateurs wish to contact us and find the QRM a bit much, call Cessna N1522Q on 122.90. We'll fit you in. Please call the operator listed above for the particular band/mode you will be using. We are not planning to use a single call for the DXpedition.

In order to provide an opportunity for as many amateurs as possible to contact us, we request that when you call us, give your callsign

and wait for an acknowledgment. Keep trying. There will be QRM and our own self-generated intermod for us to contend with, so if we seem a bit abrupt in acknowledging your contact, please be patient. Be sure to log it, too, and we will QSL 100% of verified contacts with a specially-printed photo QSL card for the expedition. We will also QSL all SWL reports that indicate that you have copied our transmissions.

If conditions permit, we are also going to try some propagation experiments within the California coastal duct. If the duct appears to be forming, or present during the latter part of our flight, we will be flying up and down inside it, in an effort to discover what atmospheric phenomena may be related to various modes of propagation within it. If we locate the duct, we will be operating primarily on 145.1 and 432.0 SSB.

Anyone wishing to schedule a contact or contacts with us can send a note requesting the desired schedule time and frequency(ies) to: Alan Christian WA6YOB, PO Box 5314, San Jose CA 95150. We will reply by mail and will make every effort to keep the schedule.

The SSB and ATV antennas will be horizontally polarized, and the FM antennas will be vertically polarized in an effort to maximize contacts.

If inclement weather on the West Coast causes postponement of the flight on the 17th, we will fly the expedition one week later on September 24.

If you have any questions about the DXpedition, please feel free to write. We would appreciate an enclosed SASE, but we will answer all queries. It seems advisable for stations near our proposed coverage limits to write and schedule their contacts in advance. ■

Alan Christian WA6YOB
PO Box 5314
San Jose CA 95150

A FAAR-OUT DXpedition

-- airborne VHF and OSCAR!

NEW! FM144-10SXRII



All Solid State-PLL digital synthesized — No Crystals to buy! 5KHz steps — 144-149 MHz-LED digital readout PLUS MARS-CAP.*

- 5MHz Band Coverage — 1000 Channels (instead of the usual 2MHz to 4MHz — 400 to 800 Channels)
- Priority Channel
- Audio Output 4 Watts • 15 Watts Output
- Unequaled Receiver Sensitivity and Selectivity — 15 POLE FILTER, MONOLITHIC CRYSTAL FILTER AND AUTOMATIC TUNED RECEIVER FRONT END — COMPARE!!
- Superb Engineering and Superior Commercial Avionics Grade Quality and Construction Second to None at ANY PRICE.

- **FREQUENCY RANGE:** Receive: 144.00 to 148.995 MHz, 5 KHz steps (1000 channels). Transmit 144.00 to 148.995 MHz, 5 KHz steps (1000 channels) + MARSCAP.*
- **FULL DIGITAL READOUT:** Six easy to read LED digits provide direct frequency readout assuring accurate and simple selection of operating frequency.
- **AIRCRAFT TYPE FREQUENCY SELECTOR:** Large and small coaxially mounted knobs select 100KHz and 10KHz steps respectively. Switches click-stopped with a home position facilitate frequency changing without need to view LED'S while driving and provides the sightless amateur with full Braille dial as standard equipment.
- **FULL AUTOMATIC TUNING OF RECEIVER FRONT END:** DC output of PLL fed to varactor diodes in all front end R-F tuned circuits provides full sensitivity and optimum intermodulation rejection over the entire band. **No other amateur unit at any price** has this feature which is found in only the most sophisticated and expensive aircraft and commercial transceivers.
- **TRUE FM:** Not phase modulation — for superb emphasized hi-fi audio quality second to none.
- **FULLY REGULATED INTEGRAL POWER SUPPLIES:** Operating voltage for all circuits, i.e., 12v, 9v and 5v have independently regulated supplies. 12v regulator effective in keeping engine alternator noises out and protects final transistor from overload.

- **MONITOR LAMPS:** 2 LED'S on front panel indicate (1) incoming signal-channel busy, and (2) un-lock condition of phase locked loop.
- **DUPLEX FREQUENCY OFFSET:** 600KHz plus or minus, 5KHz steps. Plus simplex, any frequency.
- **MODULAR COMMERCIAL GRADE CONSTRUCTION:** 6 unitized modules eliminate stray coupling and facilitate ease of maintenance.
- **ACCESSORY SOCKET:** Fully wired for touch-tone, phone patch, and other accessories.
- **RECEIVE:** .25 uv sensitivity. 15 pole filter as well as monolithic crystal filter and automatic tuned LC circuits provide superior skirt selectivity.
- **AUDIO OUTPUT:** 4 WATTS. Built in speaker.
- **HIGH/LOW POWER OUTPUT:** 15 watts and 1 watt, switch selected. Low power may be adjusted anywhere between 1 watt and 15 watts, fully protected—short or open SWR.
- **PRIORITY CHANNEL:** Instant selection by front panel switch. Diode matrix may be owner re-programmed to any frequency (146.52 provided).
- **DUAL METER:** Provides "S" reading on receive and power out on transmit.
- **OTHER FEATURES:** Dynamic microphone, mobile mount, external speaker jack, and much, much more. Size: 2 1/8 x 6 1/2 x 7 1/2. All cords, plugs, fuses, mobile mount, microphone hanger, etc., included. Weight 5 lbs.



NEW! 6 METER FM50-10SXRII

Same specifications as above except transmit/receive: 51.00-53.995 MHz. 600 channels
Introductory Price \$389.00



NEW!
TONE ENCODER/DECODER
SC 12A 12 CHANNELS DUAL TONE
Introductory Price \$119.00



Touch-Tone Pad
MODEL FMTP-1
... \$59.00

SUMMER SPECIAL
FM144-10SXRII
\$389.00
VALUE \$599.00
Regulated AC/PS
Model FMPS-4R ... \$49.00

Manufactured by one of the world's most distinguished Avionics manufacturers, Kyokuto Denshi Kaisha, Ltd.

First in the world with an all solid state 2 meter FM transceiver.

AMATEUR-WHOLESALE ELECTRONICS

8817 S.W. 129th Terrace, Miami, Florida 33176
Telephone (305) 233-3631 • Telex: 51-5628
U.S. DISTRIBUTOR

PLEASE ORDER FROM YOUR LOCAL
DEALER OR DIRECT IF UNAVAILABLE.
DEALER INQUIRIES INVITED.

Regional Sales & Service Centers:
Northeast: Buzzards Bay Electronics
Buzzards Bay, Mass.
East: Sanford Communications, Inc.
Colonia, N.J.
West: Consumer Communications, Inc.
Seattle, Wash.





NEW SIGMA XR-3000D LINEAR AMPLIFIER

INTRODUCTORY PRICE **\$789**



2 DAY AIR SHIPMENT ANYWHERE IN U.S. \$35 ALASKA AND HAWAII SLIGHTLY HIGHER

- FULL BAND COVERAGE 160-10 METERS INCLUDING MARS.
- 2000+ WATTS P.E.P. SSB INPUT. 1000 WATTS INPUT CONTINUOUS DUTY, CW, RTTY & SSTV.
- TWO EIMAC 3-500Z CONSERVATIVELY RATED FINALS
- ALL MAJOR HV AND OTHER CIRCUIT COMPONENTS MOUNTED ON SINGLE G-10 GLASS PLUG IN BOARD. HAVE A SERVICE PROBLEM? (VERY UNLIKELY) JUST UNPLUG BOARD AND SEND TO US.
- HEAVY DUTY COMMERCIAL GRADE QUALITY AND CONSTRUCTION SECOND TO NO OTHER UNIT AT ANY PRICE!
- WEIGHT: 90 lbs. SIZE: 9 1/2" (h) x 16" (w) x 15 3/4" (d).

FEATURES

CUSTOM COMPUTER GRADE COMMERCIAL COMPONENTS, CAPACITORS, AND TUBE SOCKETS MANUFACTURED ESPECIALLY FOR HIGH POWER USE—HEAVY DUTY 10KW SILVER PLATED CERAMIC BAND SWITCHES • SILVER PLATED COPPER TUBING TANK COIL • HUGH 4" EASY TO READ METERS—MEASURE PLATE CURRENT, HIGH VOLTAGE, GRID CURRENT, AND RELATIVE RF OUTPUT • CONTINUOUS DUTY POWER SUPPLY BUILT IN • STATE OF THE ART ZENER DIODE STANDBY AND OPERATING BIAS PROVIDES REDUCED IDLING CURRENT AND GREATER OUTPUT EFFICIENCY • BUILT IN HUM FREE DC HEAVY DUTY ANTENNA CHANGE-OVER RELAYS • AC INPUT 110V OR 220V AC, 50-60Hz • TUNED INPUT CIRCUITS • ALC-REAR PANEL CONNECTIONS FOR ALC OUTPUT TO EXCITER AND FOR RELAY CONTROL • DOUBLE INTERNAL SHIELDING OF ALL RF ENCLOSURES • HEAVY DUTY CHASSIS AND CABINET CONSTRUCTION AND MUCH, MUCH MORE.



SIGMA RF-2000 SWR & POWER METER
Introductory Price \$29 Cal PWR Scales 200W-2000W
Freq Range 3.5 - 150 MHz Please do not confuse the RF2000 with similar appearing lower priced units - RF2000 is an individually calibrated professional quality instrument - Unequaled at many times the price Size 7" (w) x 2 1/2" (h) x 2 1/3" (d).



NEW AM/FM ANALYZER SIGMA AF-250L

INTRODUCTORY PRICE **\$199**
Deviation/Modulation Meter - FM: 0-20 KHz, AM: 0-100%. Size: 5 1/2" (h) x 10 1/4" (w) x 7 1/4" (d)
Weight 7 lbs. Frequency: 1.8MHz-520MHz



ALSO MODEL AF-251LW WITH BUILT IN 125 WATT CALIBRATED WATT METER & DUMMY LOAD. PRICE **\$289**. PLEASE WRITE FOR COMPLETE INFORMATION.

NEW—CDR HAM ROTATORS—Reg. \$159.95 \$125.

STANDARD NEW 2 METER FM TRANSCEIVERS Model SRC 146A SPECIAL SALE



SRC 146A \$314
4 Xtlals 34/94 and 94/94 NC
USA 2 Deluxe Base Charger \$40
PT3644 Leather Case \$10
AT 19 Rubber Ant and Whip \$6
NI-Cads \$30

Reg. \$400
Our Price **\$279**

NEW!!! Touch Tone pad completely wired and ready to plug in—\$69.00



NEW! FMSC-2 SCANNER FOR KDK FM-144

14 CHANNEL PROGRAMMABLE
INTRODUCTORY PRICE \$109



NEW! 7400 SCANNER

FOR KENWOOD TR-7400A
14 CHANNEL PROGRAMMABLE
INTRODUCTORY PRICE \$109



FMSC-1 - \$169



7400 Scanner II - \$189

TWO NEW SCANNERS!

FMSC-1 Scanner for KDK FM 144 and 7400 Scanner II for Trio-Kenwood TR-7400A.
• Full scan 146 and 147 MHz consecutively or 1 MHz, or any MHz range • Scan rate: 1 MHz/2 seconds adjustable • Controls: Scan/Hold, Latch/Delay, 600 KHz offset (off, up, down), program 1 MHz • Simple installation.



ACCESSORIES FOR KDK FM 144

FMP5 4R	Regulated AC/PS	\$49
FMTF 1	Touch Tone Pad	\$59
FMTF 2	Touch Tone Pad with 10 Number Programmable Memory	\$99
FMFC 1	Microphone with Built in Touch Tone Pad	\$59
FMTD 1	Private Call Decoder for use with and Programmed by Any Touch Tone Pad	\$129
SC 12A	Audible Tone Encoder Decoder	\$119
FMSC 1	Scanner - Random Any Range	\$169
FMSC 2	Scanner - Programmable, 14 Channels	\$109
MARS CAP	Option Kit - Any Frequency Any Split	\$12
FMDF-1	Offset Option Kit - 2 Extra Positions Crystals Required	\$19
FMDF 2	±1 MHz Offset Option Kit (No Crystals To Buy)	\$19
FMTI 1	Sub Audible Tone (100 Hz - Adjustable 67 203 Hz)	\$29
FMAT 1	1/2 Wave Portable Antenna for Hotel, Motel or Apartment	\$7 95
	Extra DC Cord & Plug	\$3 50
	ACC Socket 5 Pin Din Plug	\$1 50
	Owners Manual (Extra)	\$5 00
	Service Manual	\$2 00
	Mounting Bracket (Extra)	\$6 00



NEW — TEMPO 2020

A brilliant new SSB transceiver providing advanced engineering and unique operating features. Please write for information

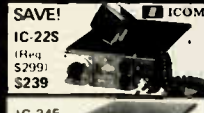

SAVE!
IC-225
(Hw) \$299
\$239



IC-245
(Hw) \$499
\$369

NEW! AMCOMM

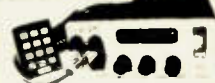

for complete information and SPECIAL INTRODUCTORY PACKAGE PRICE.

S 225 Two Meter Synthesized VHF-FM Transceiver. 25 watts output. 600 kHz and 1 MHz offsets built in. Please write

ATLAS 210X-215X and 350-XL

Please write for special bonus and package offers.



The indispensable **BIRD 43 THURLINE WATTMETER** Authorized Bird Distributor. Please write for special deal.

ATLAS, COLLINS, DEN-TRON, CUSHCRAFT, BIRD, STANDARD, KLM, HYGAIN, KENWOOD, TEMPO, MINI-PRO-DUCTS, MIDLAND, VHF MARINE, EIMAC, ICOM, AMCOMM, etc. Please write for quote.

AMATEUR-WHOLESALE ELECTRONICS

8817 S.W. 129th Terrace, Miami, Florida 33176

COURTEOUS PERSONAL SERVICE—SAME DAY SHIPMENT • Prices subject to change without notice.
TELEPHONE: (305) 233-3631 • TELEX 51-5628 • STORE HOURS: 10-5 MON.-FRI.

OUR CREW: S.I. GREGORY WA4KGU J.R. MAGGIO Mgr. W8CXL
Owner/Gen. Mgr.

S.E. GLICKMAN
WB4HFJ



A21

So You Want To Get Into RTTY?

-- "Call For Papers" winner

So you want to get into radioteletype? Congratulations, you made the right decision. Radioteletype (abbreviated RTTY) is the most interesting, fascinating and rewarding mode of communication around today.

The burgeoning of integra-

ted circuits over the last decade and the rapid decrease in the cost of these circuits have made it easier than ever before to get into RTTY at a minimum cost. It is this proliferation that has also aided the development of RTTY systems that were heretofore impossible or impractical. For

example, how would you like to be able to turn your friend's teleprinter on and leave a message for him when he gets home? You can do it; it's called a selective calling system. Or how would you like to turn on a transmitter thousands of miles away to get an idea of current propa-

gation conditions? No problem. If the other station has an answer-back system, all you need do is type the station's access code. The transmitter is then automatically turned on and a short message is broadcast. If you are of an artistic bent, exchanging RTTY pictures should fulfill your desires. If you enjoy music, composing songs to be played on the teleprinter will prove fascinating. If building is your bag, you have come to the right place. While commercial equipment is available, building your own equipment should prove rewarding, not to mention the pecuniary savings. If contests are your main interest, RTTY has many throughout the year. You say collecting award certificates is your thing? Then try working all states or all continents on RTTY for a challenge. If you like to rag chew, you have come to the right place.

RTTY is a very relaxing way to communicate. Since the conversation is printed on paper, you can go get that cup of coffee or glass of soda pop while the other fellow is talking without missing any of the conversation. It is also possible to start answering the other fellow while he is still talking by punching your message into paper tape. When the other fellow is finished transmitting, you can send your prepared message back.

If you want to keep informed on different aspects of ham radio, W1AW broadcasts RTTY bulletins daily. Information on OSCAR crossings, propagation, and general comments about ham radio are given. You say you like to keep abreast of the news and weather? No problem. Many commercial stations such as the Associated Press broadcast news bulletins throughout the day. Other commercial stations broadcast weather conditions. This type of information could be most useful during



Photo 1. The author and friends. The basic RTTY equipment includes a Model 15 teleprinter, an ST-6 demodulator, and an AFSK modulator. The amenities include an electronic keyboard; a CRT RTTY tuning indicator; a UT-4 for signal regeneration and electronic speed conversion; a digital date, time, and message generator for the Selcal and W-R-U system; and a cassette tape recorder for storing and transmitting data. (Photo by Anthony R. Donaldson.)

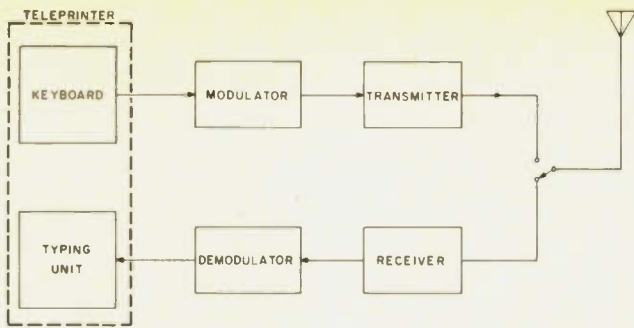

Fig. 1. Typical RTTY station block diagram.

the tornado or hurricane season.

If you are technically oriented, the flexibility of RTTY should interest you. Many amateurs are connecting microcomputers to their stations. With one of these, you are only limited by your imagination. You say you don't like the dampened roar of a teleprinter? Then an elegant video display is just what the doctor ordered. If any of these facets of RTTY intrigues you, then read on, and welcome to the wonder-

ful world of RTTY.

While the history of teleprinters goes back to as early as 1906, when the first American teletypewriter was invented, amateur use of teletypewriters is relatively new. Amateurs were involved in radioteletype as early as 1946. But it was not until 1953, when the FCC removed certain restrictions on amateur radioteletype, that the field of amateur RTTY really began to grow.

The amenities of RTTY are indeed myriad, but let's

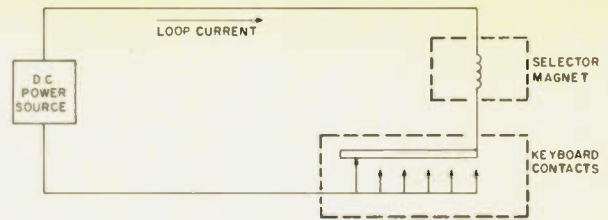

Fig. 2. The Local loop.

get down to basics. There are actually only three components necessary to get a RTTY station on the air — a teleprinter, a modulator, and a demodulator. Fig. 1 shows these three basic components and their interconnection in a typical RTTY station.

PART 1 THE BASICS

The Teleprinter

Before getting involved in the technical aspects of teleprinters, a clarification of the word teleprinter is in order. A teleprinter is often wrongly referred to as a "Teletype." Teletype is a registered trade-

mark of the Teletype Corporation. As such, it should always be capitalized and used as an adjective rather than a noun. The name Teletype has come to be used erroneously due to the popularity of the Teletype Corporation products. There are, however, other manufacturers of teleprinters including Kleinschmidt, Lorenz, Mite, and ITT Creed. Therefore, to be correct, I will use the word teleprinter to describe this family of machines.

At the heart of every amateur RTTY station is the teleprinter. The teleprinter is quite similar to a typewriter.

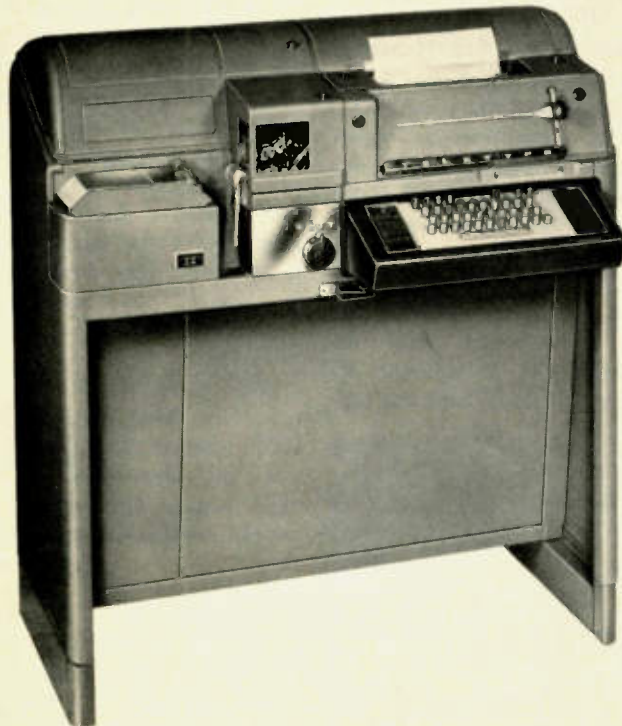

Photo 2. The Teletype Model 28 ASR shown here is a highly respected and sought-after machine. The unit includes a keyboard, a page printer, tape reader, tape punch, and a stunt box for adding special control functions. The Model 28 is built for heavy duty, 24 hour per day operation and easily operates at 100 wpm. Unlike the Model 15, the Model 28 is still manufactured by the Teletype Corporation. (Photo courtesy of the Teletype Corporation.)



Photo 3. The Model 32 ASR, shown here, is the newest model teleprinter using the Baudot code manufactured by the Teletype Corporation. The machine includes a paper tape reader and punch shown on the upper left side in the photo. (Photo courtesy of the Teletype Corporation.)

Lower Case	Upper Case	Start	Bit 1	Bit 2	Bit 3	Bit 4	Bit 5	Stop
A	—	S	M	M	S	S	S	M
B	?	S	M	S	S	M	M	M
C	:	S	S	M	M	M	S	M
D	\$	S	M	S	S	M	S	M
E	3	S	M	S	S	S	S	M
F	!	S	M	S	M	M	S	M
G	&	S	S	M	S	M	M	M
H	#	S	S	S	M	S	M	M
I	8	S	S	M	M	S	S	M
J	'	S	M	M	S	M	S	M
K	{	S	M	M	M	M	S	M
L	}	S	S	M	S	S	M	M
M	.	S	S	S	M	M	M	M
N	,	S	S	S	M	M	S	M
O	9	S	S	S	S	M	M	M
P	@	S	S	M	M	S	M	M
Q	1	S	M	M	M	S	M	M
R	4	S	S	M	S	M	S	M
S	bell	S	M	S	M	S	S	M
T	5	S	S	S	S	S	M	M
U	7	S	M	M	M	S	S	M
V	:	S	S	M	M	M	M	M
W	2	S	M	M	S	S	M	M
X	/	S	M	S	M	M	M	M
Y	6	S	M	S	M	S	M	M
Z	"	S	M	S	S	S	M	M
blank		S	S	S	S	S	S	M
car. ret.		S	S	S	S	M	S	M
line feed		S	S	M	S	S	S	M
space		S	S	S	M	S	S	M
letters		S	M	M	M	M	M	M
figures		S	M	M	S	M	M	M

Table 1. The Baudot code. M = mark, S = space.

However, in a typewriter there is a mechanical linkage between the key the typist depresses and the arm that comes up and strikes the paper. This is not the case in the teleprinter. The teleprinter consists of two virtually separate units — the typing unit, and the keyboard. When one depresses a character on the keyboard, the keyboard encodes the character as a stream of pulses. The exact coding will be discussed later in greater detail, but at this time it should be noted that

each character has a particular code much like the Morse code.

The purpose of the typing unit is to convert the stream of pulses back into a mechanical motion. Typically, the keyboard is also wired to the typing unit so that in addition to sending pulses to another machine, the pulses are received and printed locally.

Fig. 2 shows what is referred to as a local loop. With this circuit configuration, it is possible to type on the key-

board and obtain local copy. Current is flowing in the circuit until broken by the operation of the keyboard. The selector magnet senses the current pulses and prints the requested character.

The condition in which current is flowing in the loop is referred to as the "mark" state. The "space" state is characterized by the absence of current flowing in the loop. With these marks and spaces (current and no current), it is possible to make a code in which a par-

ticular combination of marks and spaces represents a particular character. We will discuss this code in greater detail later. The important concept to grasp at this point is that the keyboard and the typing unit are separate and not mechanically attached. In fact, some teleprinters do not have a keyboard at all, such as the Model 28RO. The RO indicates Receive Only. These machines are used where only one-way communication is desired, such as in a commercial newsroom.

While new teleprinters are available from the Teletype Corporation, the price is rather high for the average amateur. For this reason, most amateurs use teleprinters that have been retired from commercial use. A teleprinter may be obtained for as little as \$30. Hamfests or advertisements in the amateur radio magazines are good sources for machines.

There are several models of teleprinters that are currently used in amateur applications. However, Models 15 and 28 are the most popular. These models are called page printers. This means the message is printed on a continuous roll of paper rather than a narrow paper strip. The paper tape printer is virtually gone from amateur use.

The Code

Before we get into the two remaining basic units of the RTTY station, the modulator and the demodulator, we must discuss the code used for radioteletype communication.

The code used by the teleprinter is similar in nature to the Morse code. However, where the Morse code uses dots and dashes, the teleprinter code uses marks and spaces. One important difference between the teleprinter code and the Morse code is the length of each basic element or bit of information. For example, the length of a dot or dash is determined exclusively by the operator.

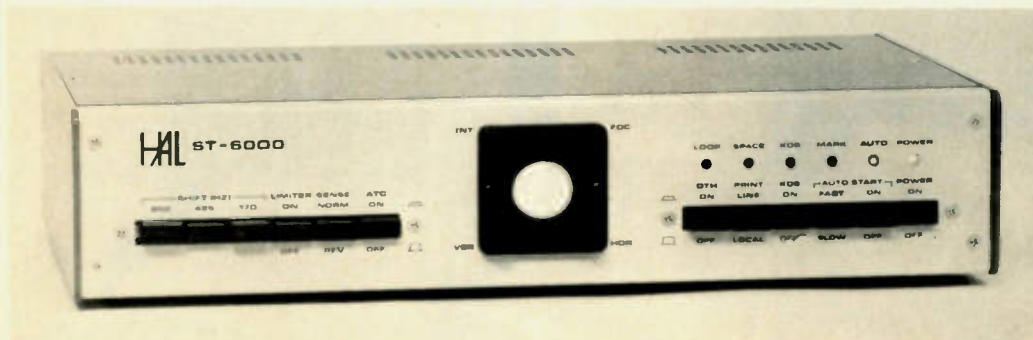

Photo 4. The Hal Communications Corporation is the most popular manufacturer of amateur RTTY equipment. Shown here is the ST-6000. Other demodulators manufactured by Hal include the ST-5000, the ST-6, and the ST-5. Of particular note is that most of the Hal products can be purchased already assembled or in kit form, or, for those with a well-stocked junk box, individual components such as printed circuit boards are available. For more information write Hal Communications Corporation, Box 365, Urbana, Illinois 61801 or call 217-367-7373. (Photo courtesy of Hal Communications Corporation.)

It would be difficult to design equipment that would have to copy correctly at all typing speeds. Therefore, a special teleprinter code, referred to as the Baudot code, is used. This code was designed so that each character contains the same number of elements or bits, and each element is of a fixed duration. One other important characteristic is required of our teleprinter code. When transmitting the code, the receiving teleprinter must be synchronized with the transmitting teleprinter, even though they may be thousands of miles apart. To accomplish this end, a start pulse is added at the beginning of the character, and a stop pulse is added at the end. These pulses are used to insure synchronization of the machines.

Table 1 shows the Baudot code that is used by teleprinters to communicate. All elements of the code are 22 ms (22/1000 seconds) except the stop pulse, which is 31 ms. Fig. 3 represents graphically a teleprinter character. The entire 7 bit word for this character may be written as SSMSMSM. Since the first and last bits are the start and stop bits respectively, the character is reduced to the following 5 bit code, SMSMS. Referring to Table 1, we see the character is the letter "R", or the number "4". Why are there two possibilities you ask? For those of a mathematical bent, you will notice with a 5 bit code that the maximum number of combinations is 32 ($2^5=2 \times 2 \times 2 \times 2 \times 2=32$). The alphabet and ten digits require 36 (26+10) combinations by themselves, and we still haven't allowed for punctuation and other special functions. To obviate this problem, the teleprinter is equipped with a lower and upper case character set. This is analogous to the upper and lower case of a modern electric typewriter. However, where the typewriter uses "shift" and "unshift" to control the case, the tele-

printer uses the "figures" and "letters" command. The upper case is attained by depressing the figures key. The teleprinter moves to the lower case when the letters key is depressed. Going back to our example, if the teleprinter is in the lower case (letters), it will print the letter "R". If a figures key has been depressed previously, the teleprinter will be in the upper case (figures) and print the number "4".

Since each character is of a finite duration, there must be an upper limit to the number of words that can be printed in one minute. Adding the duration of the 7 elements of the code, we arrive at a total time of 163 ms for each character (see Fig. 3). Since each character is 163 ms, the number of characters that can be printed in one minute is 368 (60 seconds/.163 seconds). One word is typically considered to be 5 letters plus 1 space. Thus, the number of words per minute is equal to 61.3 (368/6). This is then rounded off to 60. It would be nice to use machines that operate at higher speeds, but one should remember that teleprinters use mechanical parts that are limited to relatively slow speeds. Video display units are obviously not mechanical and hence are not limited to such low speeds. Speeds of several thousand words per minute are not uncommon. The 163 ms character length sets the upper typing limit at

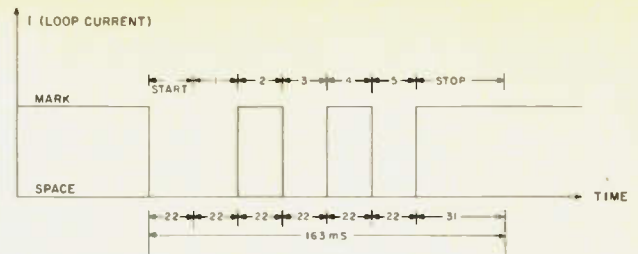

Fig. 3. Graphic representation of the letter "R" or the number "4".

60 wpm (actually 61.3). Since few amateurs are speed typists, this does not usually limit one's typing speed. While it is true that other speeds are used, such as 67, 75, and 100 wpm, amateurs use 60 wpm almost exclusively.

It is important to note that each and every character is 163 ms no matter who is typing or how fast. Contrasting this with CW, even if all operators sent CW at a specific speed, each character is of a different duration. This is a characteristic inherent in the Morse code.

We now know the code that we must use to talk to the teleprinter. Our next task is to put these marks and spaces in a form that can be transmitted over the air. This is the purpose of the modulator.

The Modulator

Modulation refers to the process of transmitting the RTTY signal. Let's return once again to our analogy between CW and RTTY. CW is transmitted by opening and closing a telegraph key. Since

a telegraph key is nothing more than a switch, and a teleprinter's keyboard is also a switch, why don't we substitute the keyboard contacts for the telegraph key? With this technique, the mark may be thought of as the transmitter's "on" condition, and the space the transmitter's "off" condition. This is called make-and-break keying and is sometimes used. However, a problem arises using this method. It occurs while the transmitter is off. Suppose a static crash occurs during the space condition (transmitter off); chances are the static crash may be misconstrued by the equipment as a mark, when it is really a space. The net outcome under this method is poor reliability, and thus a wrong character may be printed. We don't have this problem with CW because the incredible machine, the brain, can discriminate between a static crash and a signal.

So now what do we do? The answer is use frequency shift keying (FSK). With this method, the transmitter is on during both the mark and space states. If the transmitter



Photo 5. The Dovetron MPC-1000R is the Rolls Royce of terminal units. Some of the special features of the unit are electronic speed conversion, signal regeneration, a character memory up to 200 characters, error correction to erase misspelled words, Tee Dee inhibit, and variable character rate. Front panel controls permit "signal" and "loop" speed selections of 60, 67, 75, 100 wpm Baudot and 110 baud ASCII. (Photo courtesy of Dovetron.)

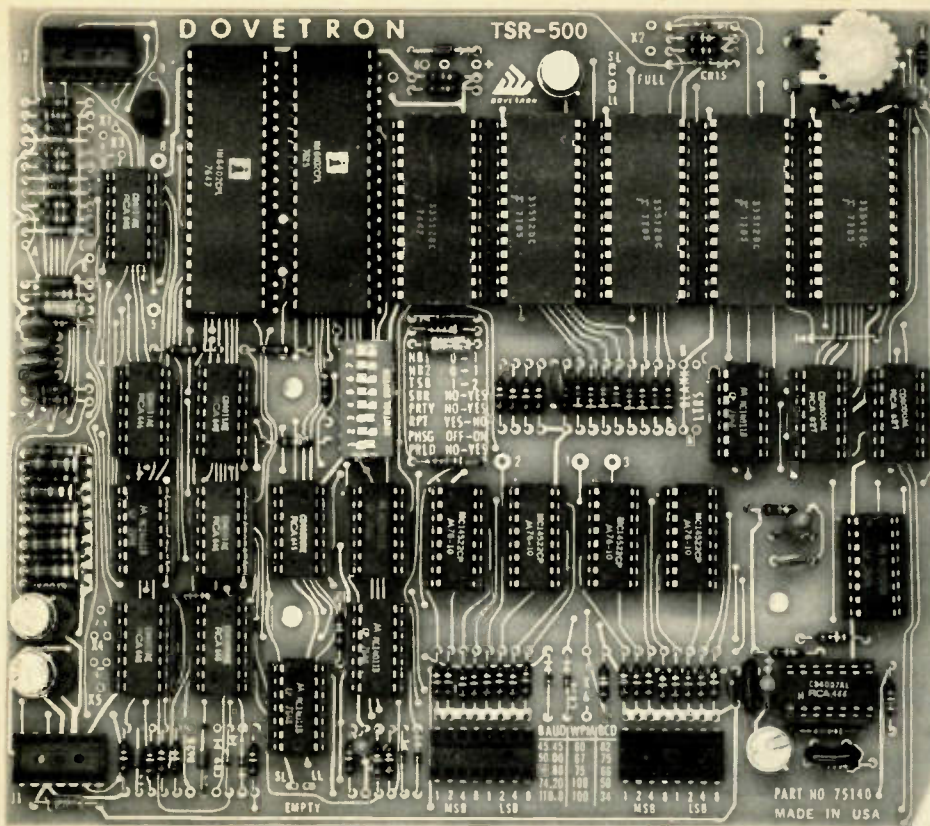

Photo 6. The TSR-500 is at the heart of all the special features of the Dovetron MPC-1000R and may be purchased separately. The error correction circuit allows one to erase the last word put in the memory by depressing a "blank" key. Information on this and other Dovetron products may be obtained from Dovetron, 627 Fremont Ave., South Pasadena, California 91030 or phone 213-682-3705. (Photo courtesy of Dovetron.)

is on during both states, how do we differentiate between the two? Simple, we let the transmitter transmit one frequency during the mark condition and transmit another frequency during the space condition. Thus, we are shifting between two frequencies, and hence the name, frequency shift keying. The difference between the two frequencies is referred to as the shift. While amateurs are allowed to transmit RTTY using any shift less than 900 Hz, the amateur fraternity has settled down to two standards, 170 and 850 Hz shifts. The 170 Hz shift is used almost exclusively on the low bands, while 850 Hz shift is typically used on the VHF bands.

Two methods are used to shift the transmitter's frequency — carrier frequency shift keying (FSK), and audio frequency shift keying

(AFSK). With the first technique, the carrier frequency is shifted by placing a capacitor across the transmitter's oscillator tank circuit. This capacitor is connected by the contacts of the keyboard. With the capacitor disconnected, the transmitter is transmitting a mark signal. When the capacitor is connected by depressing a key on the keyboard, the transmitter's frequency is lowered, and this represents the space condition. Typically, the keyboard is buffered from the tank circuit because the keyboard's contacts cannot efficiently control these radio frequency signals, but the idea of connecting a small capacitor for space and disconnecting it for mark remains unchanged.

With the second method, audio frequency shift keying, audio tones are generated and fed directly into the

microphone jack of the transmitter. For narrow shift, the AFSK unit generates 2125 and 2295 Hz signals ($2295 - 2125 = 170$ Hz shift). The 2125 Hz signal denotes the mark signal and the 2295 Hz signal represents the space signal. When the keyboard contacts are closed, a 2125 Hz signal is fed into the microphone jack. The 2295 Hz signal is generated when the contacts are open. Note that with this method, the space frequency is higher than the mark frequency. When using carrier FSK, the opposite is true; the mark frequency is higher than the space frequency. This apparent contradiction can be explained by noting that the heterodyne system of generating a lower sideband signal has the effect of flipping the frequencies over. Therefore, the final space frequency generated by the transmitter

is indeed lower than the mark frequency when using AFSK as it is when FSK is used.

The AFSK method of generating a RTTY signal requires a stable audio generator. Its main advantage lies in the ease of interfacing the keyboard with the transmitter. One need simply plug the output of the generator directly into the microphone jack of the transmitter.

The Demodulator

At the receiving end, our job is to decipher the tones and reconstruct the information in a form the teleprinter can handle. There are basically two methods that are used to differentiate between the two tones. The old technique, and still the most widely used, involves demodulation via two separate resonant LC (inductor and capacitor) circuits. In the case of 170 Hz shift, one LC resonant circuit is tuned to pass the 2125 Hz mark signal, and the other is tuned to pass the 2295 Hz space signal. These filter circuits, called discriminators, pass only their respective tones, mark or space, and drastically attenuate all other frequencies. Fig. 4 shows a simplified diagram of this type of demodulator. After the two tones have been segregated through the filtering process, they are fed to a stage called a slicer, which drives the keying transistor. When a mark signal is received, the slicer turns the transistor on, and we have a closed loop. With a space signal received, the slicer turns the keying transistor off, and we have an open loop. Thus the keying transistor acts as a switch. However, more to the point, it is simulating the keyboard switch contacts of the station transmitting.

A modernization of this method employs active filters to replace the passive LC filters. The main advantage of this technique comes from the fact that fairly large inductors (typically 88 mH) are not required. Tuning the

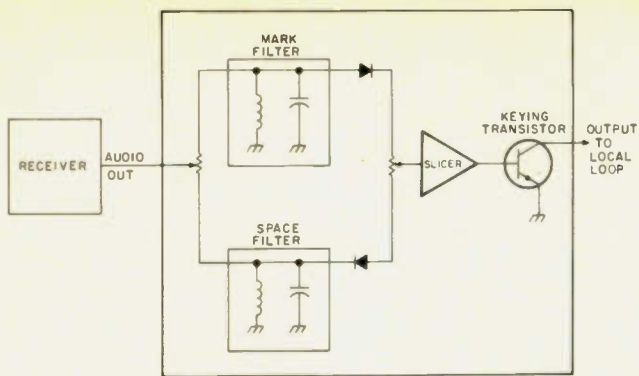

Fig. 4. Simplified circuit diagram of a RTTY demodulator using passive filters.

active filters for the exact frequency during calibration is also simpler, since it typically requires an adjustment of a resistor rather than the trial and error technique used in trimming an LC filter to the exact frequency.

The second method that is used to demodulate a RTTY signal uses a phase locked loop (PLL) integrated circuit. Despite its inferiority to the method described above, it is cheap and easy to build. As such, it makes a great demodulator to build to get on the air in a hurry.

PART 2 THE AMENITIES

As previously stated, all that one needs to get a RTTY station on the air is a teleprinter, a modulator, and a demodulator. However, several accessories may be added to a station to really increase the joy of RTTY and operating ease. Amenities available to the RTTY aficionado include an electronic keyboard, a video display, tape distributor, tape reperfector, magnetic tape recorder, a CRT RTTY tuning indicator, a Selcal, and a W-R-U answer-back system.

The Electronic Keyboard

Typing on a typical teleprinter keyboard will require some practice and patience, especially if you are accustomed to typing on a modern electric typewriter.

Referring back to Table 1, you can see that the alphabet is printed if the typing unit is in the lower case, and punc-

tuations and numbers are printed if the typing unit is in the upper case. Thus, typing a station call or an address, which contains both numbers and letters, would require extra operations to put the teleprinter into the upper or lower case as desired. An electronic keyboard, designed for the Baudot code, automatically inserts upper and lower case commands to insure the proper character is printed without the operator directly requesting the upper or lower case.

An electronic keyboard has other, more subtle, advantages. In addition to being attractive and quiet, the action of the keys is much smoother than a conventional teleprinter keyboard. These features decrease operator fatigue and increase the ease of operation.

The Video Display

For those who don't like the noise and maintenance of a teleprinter, state of the art technology has made video displays possible. An old black and white TV, coupled with a video display interface module, makes an attractive display.

Two notes of caution. Except for the Hal Corporation unit (see Photo 7), these video display units require a special code called ASCII. ASCII is the acronym for USA Standard Code for Information Interchange. Therefore a unit capable of translating the Baudot code to ASCII is required.

The second shortcoming



Photo 7. The RVD-1005 visual display unit is the modern answer to the teleprinter. The unit accepts demodulated Baudot signals at 60, 66, 75, and 100 wpm and displays the information on 25 lines with 40 characters per line. (Photo courtesy of Hal Communications Corporation.)

of a video display deals with the maximum amount of information that can be displayed on the screen. While the format of characters on the screen varies from manufacturer to manufacturer, 1000 characters is typical. This 1000 characters may seem like a lot, but it really isn't. A typical QSO consists of several thousand characters. This means that you cannot look back at the content of a previous transmission or leave the ham shack for more than a few minutes. Both are only slight disadvantages, but, nonetheless, something to consider before purchasing a video display.

The Reperfector

If one wished to record a message to be played back at some later date, he would use a reperfector. The reperfector records a message by punching holes in a narrow strip of paper tape. Messages may be recorded either locally, by typing on the local keyboard, or straight off the air. The Teletype Corporation Model 14RO is a reperfector typically used by amateurs. Of particular importance is that once the paper tape has been made, it may be transmitted at full machine speed (60 wpm), thus expediting

the transmission of information. A tape reperfector is used most often by amateurs to make and record RTTY pictures. More on this exciting facet of RTTY later.

The Tape Distributor

The tape distributor is used to read the punched paper tape made on the tape reperfector. The unit translates the holes in the tape into pulses so that they may be printed locally or sent to another station. The Teletype Corporation Model 14TD is a popular tape distributor used extensively on the ham bands.

The Magnetic Tape Recorder

Since the RTTY signals sent to the demodulator are in the audio range (2125 and 2295 Hz), why not record the information on a magnetic tape rather than on paper tape? After all, a cassette player is quieter, cheaper, and more convenient than a mechanical paper tape reperfector. The answer is that we can do just that. In fact, this technique is used extensively by computer hobbyists to record data. However, some problems can arise. For example, when using a narrow shift (170 Hz), this method becomes very sensitive to fluctuations in



Photo 8. Shown here is a small sampling of some of the RTTY pictures that are exchanged on the ham bands. The small uncomplicated pictures require approximately 10 minutes to reproduce at 60 wpm, while some of the large pictures with overlining can require an hour or more. The RTTY Journal sponsors an annual RTTY art contest for those interested in this facet of RTTY. The pictures were stored on the cassettes shown in the photo. (Photo by Anthony R. Donaldson.)

the tape speed. The mark and space tones will change frequency as the tape player changes speed. This problem can be remedied by using a high quality tape player with a low wow and flutter specification. There is still one additional complication, though. It would be difficult to find two machines that turn at exactly the same speed. Therefore, the cassettes could not be interchanged between machines. Both problems are solved by using a wider shift (850 Hz). For a mark tone of 2125 Hz to be misconstrued as a space tone of 2975 Hz, the tape player would have to be in very poor shape indeed. Photo 8 shows several RTTY pictures, all of which have been recorded on the cassette tapes shown.

The CRT Tuning Indicator

Several methods for tuning in a RTTY signal have been tried over the years. However, one of the oldest, and perhaps the best, makes use of a cathode ray tube (CRT). The mark and space signals

are depicted on the screen of a small CRT (see Photos 4 and 5). The mark is typically a line displayed horizontally, and the space signal is a line shown vertically. With such a unit, the operator tunes the receiver until the horizontal and vertical lines are of maximum length.

The Selcal

The station equipped with a selective calling (Selcal) system can be turned on and off by typing a predetermined access code. While a station may be programmed for any access code, the standard has become the use of the last three letters of the station's call. For example, if your friend's call were W9IUUV, typing the last three characters of his call, IUUV, at your station would turn on the teleprinter at the station of W9IUUV. You can now leave a message. When you are finished, typing four Ns will shut your friend's teleprinter off. The four Ns at the end of the message are a universally accepted shut-down code. Such a system is

a great way to keep in touch with friends. Of particular importance is that there is no need for a person to be on the premises. Therefore, the equipment may be left running continuously. I still get a kick out of getting home to a few notes sent by friends. The distinct advantage of this system is that only notes addressed to you are received. In an all-call system, you would receive everyone's notes.

The W-R-U

A W-R-U (who are you) answer-back system is one step beyond a Selcal system. Leaving a note for a friend can be a hit or miss affair unless you are sure his equipment is on. A W-R-U system allows one to ascertain just that. By typing a predetermined access code, one can in essence interrogate the condition of the equipment. Adding the three characters figures, blank, and H after the last three letters of the station's call has become the customary code used to gain access to the equipment. For

example, suppose you want to leave a note for W9YPS, but you are not sure if his equipment is up and running. To ascertain the condition of the equipment, you would type the six characters Y, P, S, figures, blank, H. Typically, the message sent after the W-R-U is tripped has been punched on paper tape and is played back on a tape distributor. Having tripped the W-R-U and, thus, confirmed the status of the equipment, you can now proceed as with a Selcal system and leave a note with the assurance the note has been received.

PART 3 SOME UNIQUE ASPECTS OF RTTY

For those of you who are connoisseurs of art, you should enjoy designing, making, receiving, and sending RTTY pictures. The number and kinds are truly prodigious, ranging from angels to nudes. Making a RTTY picture requires a reperforator (paper tape puncher) and a tape distributor (paper tape reader). For those wishing more information on this fascinating aspect of amateur RTTY, consult any of the RTTY handbooks listed in the annotated bibliography.

RTTY Music

I got home late one night during the Christmas season and thought I would listen to a RTTY QSO or two before retiring. Instead of hearing the customary clatter of old faithful (my Model 15), my ears were treated to a chorus of Jingle Bells followed by Noel and other Christmas favorites. This aspect of RTTY makes use of a tape distributor and tape reperforator. Instead of printing a character, the bell of the teleprinter is actuated in time to the melody.

Conclusion

It has been the purpose of this article to give the reader

an introduction to the fascinating world of RTTY and to what his appetite. For those wishing to pursue this mode of communication further, I have accumulated an annotated bibliography listing books and articles to read for further information on this subject. Good luck and

MMSMM MMMSS MSSSS. ■

ANNOTATED BIBLIOGRAPHY

Periodicals and Books Devoted to Radioteletype

American Radio Relay League. *Specialized Communications Techniques for the Radio Amateur*. Newington, Conn., The American Radio Relay League, 1975.

Only a portion of this book is devoted to radioteletype. Other topics include slow scan television, facsimile, and space communication. However, the approximately 70 pages that are devoted to radioteletype are well filled with useful information. I recommend this book highly.

RTTY Journal. *Beginners RTTY Handbook*. RTTY Journal, 1975. If you want the most for the

least, this is it. As the title indicates, the handbook is designed specifically for the beginner. I find it an excellent reference book and recommend it highly. Send \$2.50 to RTTY Journal, PO Box RY, Cardiff-by-the-Sea CA 92007.

RTTY Journal

This short but useful periodical is devoted exclusively to

GLOSSARY

AFSK	Abbreviation for audio frequency shift keying. With this method of modulation, two tones (mark = 2125 Hz, space = 2295 Hz) are fed directly into the microphone jack of the transmitter.	Mark	In RTTY applications, the mark is one of two states. The mark condition is characterized by a closed circuit. The space, the other state, is characterized by an open circuit condition.
Answer-Back (W-R-U) System	A system capable of being remotely controlled by another station. When tripped by a unique access code, a short predetermined message is broadcast.	Modem	Acronym for modulator, demodulator. A modem is typically used in a system where tones are transmitted and received over telephone lines. It may be thought of as the equivalent to a RTTY station's terminal unit.
Autostart (All-Call) System	An autostart circuit may be thought of as a squelch circuit. If an authentic RTTY signal is detected, the teleprinter motor is turned on and the message is printed. Unlike a selective calling system that turns the teleprinter on only when a particular access code is received, autostart circuits act as an all-call system and, thus, print any RTTY signal. The cessation of the RTTY signal causes the teleprinter motor to turn off.	PLL	Abbreviation for a phase locked loop. A PLL integrated circuit can be employed in a RTTY demodulator to discriminate between the mark and space tones.
ASCII	Acronym for the USA Standard Code for Information Interchange. At present, this code cannot be used on the amateur bands without special FCC permission. Unlike the 5 level Baudot code, this is a 7 level code used extensively in the electronics industry.	RTTY	Abbreviation for radioteletype. Often pronounced "ritty."
Baud	The basic unit of speed derived from the duration of the shortest code element. For 60 wpm operation, the baud rate is 45.45 (1/22 ms).	Selcal	Acronym for selective calling system. This system allows the teleprinter to be remotely controlled by a unique code.
Baudot	The code used by amateur RTTY stations to exchange information. It is a 5 level code plus one start and one stop bit.	Selector Magnet	An electromagnet that senses current flowing in the local loop and picks a character to be printed in response to the current pulses.
Oiscriminator	A discriminator, as used in RTTY circuits, consists of a filter, either passive or active, to pass one frequency and discriminate against all others.	Shift	The difference between the mark and space frequencies. For example, if the mark frequency is 2125 Hz and the space frequency is 2295 Hz, the difference of 170 Hz is referred to as the shift. The 170 and 850 Hz shifts have become two widely used standards.
FIFO	Acronym for first-in/first-out. A special integrated circuit memory device that will accept parallel data and retransmit it on a first-in, first-out basis.	Space	One of two states describing the condition of a teleprinter's loop. The space is characterized by an open loop condition. The mark state indicates a closed loop.
FSK	Abbreviation for frequency shift keying. With this method of modulation, the frequency of the transmitter's crystal or vfo is shifted.	Stunt Box	A mechanical unit that allows the operator to add control features to the teleprinter; for example, an automatic "non-overline" control which prevents printing over a message already typed. Controlling a remote device is another use for the stunt box.
KB	Abbreviation for keyboard.	Tape Distributor	A machine that reads prerecorded paper tape.
KOX	Acronym for keyboard operated transmission. A station equipped with a KOX system can turn on the transmitter and turn off the receiver simply by typing on the station's keyboard. When the operator ceases typing, the transmitter automatically turns off, and the receiver turns on after some preset delay.	Tape Reperforator	A device that records data by punching holes in a paper tape.
Local Loop	The circuit containing a power source, the selector magnets and a keyboard. This connection allows	TU	Abbreviation for terminal unit. This is the RTTY equivalent to a modem. It contains a modulator, demodulator, and loop power supply.
		UART	Acronym for universal asynchronous receiver transmitter. A sophisticated integrated circuit that accepts serial data and retransmits it as parallel data and vice versa.
		W-R-U	Abbreviation for who are you. See Answer-Back system.

amateur radioteletype. To subscribe send \$3.50 to RTTY Journal, P.O. Box RY, Cardiff-by-the-Sea CA 92007. Price differs outside the U.S., Canada, and Mexico.

73 RTTY Handbook

There are two RTTY handbooks, both of which are, or have been, distributed by 73. The old RTTY handbook, while probably a fine book several years ago, is currently outdated. Being aware of this shortcoming, 73 has recently released a new handbook called, appropriately enough, *The New RTTY Handbook*.

Teleprinters

McNatt, M.S. "A Guide to Baudot Machines: Part 1, Description of Available Devices," *Byte*, April 1977, p. 12.

An excellent, interesting, and succinct article describing many of the Teletype Corporation machines (i.e., Models 11, 12, 14, 15, 19, 20, 26, 28, 29, 31, 32, 33, 35, 37, 38, and 40). On page 158 of this article is a list of sources for Baudot equipment.

Modulators

Roos, J.C. "Universal AFSK Generator," 73, July 1974, p. 37.

This article describes a RTTY modulator using the AFSK method of modulation. The unit is somewhat advanced for the beginner, but it does a very nice job. This is the modulator I have been using for several years, and I can speak highly of its effectiveness and reliability.

Demodulators

Grossman, B., and John S. Reid. "Building the Safari RTTY Terminal," 73, August 1976, p. 122.

Unlike most demodulators that use passive filters (inductor and capacitor) to discriminate between the mark and space frequencies, this unit uses active filters. Inherent in active filters is

their ease of calibration. A resistor is used to trim the filter to the exact frequency, rather than the iterative method used in LC filters.

Hoff, I. M. "The Mainline ST-6 RTTY Demodulator," *Ham Radio*, January 1971, p. 6.

The author, Irvin Hoff, has probably done more for RTTY within the last 15 years than any other RTTY aficionado. He is responsible for many demodulators, of which this article describes the most advanced. This unit has become a standard of excellence in the RTTY community. For the amateur who is earnest about RTTY, this is the demodulator to get.

Joffe, A.S. "Ridiculously Simple RTTY System," 73, September 1976, p. 70. For those who want to get on RTTY in a hurry, this is the article you want. The demodulator, while lacking sophistication, works, and you can't argue with success.

Stinnette, N. "Phase Locked Loop RTTY Terminal Unit," *Ham Radio*, February 1975, p. 36.

This article describes a simple demodulator using the phase locked loop principle. This is probably the best demodulator for the neophyte to RTTY since it is cheap and simple.

Selcal, Answer-Back, and Related Equipment

Kelly, B. "Monitor Receiver for RTTY Autostart," *Ham Radio*, December 1972, p. 27.

This article describes a fixed frequency receiver for the RTTY aficionado interested in autostart operation. Unattended autostart operation requires more than just a receiver with good sensitivity and selectivity. It requires the receiver to be ultrastable since, as previously stated, the station is unattended. For this reason, the receiver described in this article is crystal controlled.

Lichtenwalner, B.D. "The Computer QSO Machine," 73, January 1976, p. 80.

This unit is capable of sending the time (hours and minutes), the date (year, month, and day), a pre-programmed message, and a CW ID. This unit is typically used in an answer-back system. When tripped by an access code, the time, date, message, and CW ID are broadcast, indicating the equipment is up and running.

Sanders, L.W. "RTTY Autocall — the Digital Way," 73, February 1976, p. 76.

This article describes a selective calling unit (Selcal). Of particular note is that the unit uses integrated circuits rather than a mechanical stunt box.

Advanced Projects

Guthrie, R.D. "ASCII/Baudot with a PROM," 73, June 1976, p. 114.

There are many commercial video display units on the market for those who don't like the clatter of a teleprinter. Unfortunately, these commercial units are geared for the computer hobbyist and, as such, accept only the ASCII code. This article describes a circuit that will convert the Baudot code to ASCII, so an amateur RTTY station can use one of the commercially manufactured video display units.

Hoff, I.M. "The Mainline UT-4," *RTTY Journal*, February, March, April, May 1974.

This series of articles describes the UT-4 which is a UART/FIFO combination capable of regenerating the received signal and electronic speed conversion. It's an advanced project but most worthwhile to the serious RTTY aficionado.

Hutton, L.I. "Build This Exciting New TVT," 73, March 1976, p. 76.

This article describes two projects. The first is a home brew electronic keyboard that generates the Baudot code. The second portion of the article describes a Baudot to ASCII converter and a TVT character generator.

Levy, S.P. "A Morse to RTTY

Converter," 73, June 1976, p. 106.

If you like sending CW but not receiving, this article is for you. The circuit makes use of a microprocessor to convert CW to ASCII or Baudot. It sure would be nice to have the next time you have to take a code test at the FCC. Mooring, E.E. "Phase-Shift RTTY Monitor Scope," *Ham Radio*, August 1972, p. 36.

There are many different methods that one can use to tune in a RTTY signal properly. This unit uses the phase shift method and a CRT display. This technique is superior to most other methods, since the CRT display gives a great deal of information. It is possible to tell at a glance if the other station is transmitting wide or narrow shift, if the mark and space signals are reversed, and much, much more. This is a nice amenity to add once you have a station running.

Miscellaneous

Alexander, D. "The First Computer-Controlled Ham Station," 73, August 1976, p. 82.

This very interesting article describes the amateur RTTY station of the grand prize winner at the 1976 Altair Computer Convention. If you want to get some idea of the flexibility of a computer-controlled amateur RTTY station, this article is for you.

Brehm, R.C. "RTTY Goes Modern," 73, February 1977, p. 82.

This article is a must for the beginner who wants to know the history of amateur RTTY. The author concludes with a prognosis for RTTY and its ever increasing comradeship with microprocessors.

Green, W. "Thirty Years of Ham RTTY," 73, November 1976, p. 110.

An interesting article describing the history of amateur RTTY and is by one who was around during its infancy. Also included are pictures of antique RTTY gear.

MULTI-BAND ANTENNA TRAPS

Having trouble finding air-space for an 80 meter dipole? Restricted to 40 meters? Let PACE-TRAPS provide the answer! Five-Band no-compromise coverage in 105 feet! Four bands in the same space as your 40 meter dipole! PACE-TRAPS are quality-built, use proved, resonant circuits, described in most hand-books and designed to make-up into an all-band system. Four models available. NG-series 300 watt rated . . . 4 or 5 band model . . . \$14.95 pair FG-series kw rated 4 or 5 band model . . . \$17.95 pair Stranded Copper weld equiv. to #12 . . . handles like soft drawn . . . cut to length . . . 112 feet . . . \$6.50 + \$1.00 UPS. Full installation details provided. Use with or without a transmatch. Shipped post-paid in USA. CT residents add 7% tax. Check or MO to

BOX 234 Upland Rd.
Middlebury CT 06862
(203) 758-9228 P15

COAKIT

P.O. BOX 101-A, DUMONT, N. J. 07628

RF & AUDIO CONNECTORS & ACCESSORIES

5 PL259 UHF male	\$3.50	2 M359 UHF right angle adaptor	\$3.25
5 SO239 UHF chassis female	\$3.50	1 UG224/U UHF splice	\$2.45
5 UG175/U adaptor	\$1.20	1 UG363/U UHF splice	\$2.75
5 UG176/U adaptor	\$1.20	3 UG260/U BNC male	\$2.70
2 PL259PO push-on UHF male	\$2.25	3 UG1094/U BNC chassis female	\$2.40
2 PL258 UHF splice	\$2.10	1 Lightning Arrestor in-line UHF	\$2.25
1 M358 UHF "T"	\$2.80		

ALL ITEMS POSTPAID — NO C.O.D.'s
***** SEND FOR FREE CATALOG *****

SWAN'S SS747

DRAKE'S TR4CW

KENWOOD'S TR7400A

YAESU'S FT301D

Call for competitive prices!

BankAmericard Master Charge

FRECK radio & supply co., inc.

252 Patton Ave., Asheville, N.C. 28801

PHONE: (704) 254-9551 F3

the TEMPO 2020



...an accepted and proven performer

- Phase lock-loop (PLL) oscillator circuit minimizes unwanted spurious responses.
- Hybrid Digital Frequency Presentation.
- Advanced Solid-state design...only 3 tubes.
- Built-in AC and 12 VDC power supplies.
- CW filter standard equipment...not an accessory.
- Rugged 6146-B final amplifier tubes.
- Cooling fan standard equipment...not an accessory.
- High performance noise-blanker is standard equipment...not an accessory.
- Built-in VOX and semi-break in CW keying.
- Crystal Calibrator and WWV receiving capability.
- Microphone provided.
- Dual RIT control allows both broad and narrow tuning.
- All band 80 through 10 meter coverage.
- Multi-mode USB, LSB, CW and AM operation.
- Extraordinary receiver sensitivity (.3u S/N 10 db) and oscillator stability (100 Hz 30 min. after warm-up)
- Fixed channel crystal control on two available positions.
- RF Attenuator.
- Adjustable ALC action.
- Phone patch in and out jacks.
- Separate PTT jack for foot switch.
- Built-in speaker.
- The TEMPO 2020...\$759.00.
- Model 8120 external speaker...\$29.95. Model 8010 remote VFO...\$139.00.

Send for descriptive information on this fine new transceiver, or on the time proven Tempo ONE transceiver which continues to offer reliable, low cost performance.

AVAILABLE AT SELECT DEALERS THROUGHOUT THE U.S.

Henry Radio

11240 W. Olympic Blvd., Los Angeles, Calif. 90064 213/477-6701
 931 N. Euclid, Anaheim, Calif. 92801 714/772-9200
 Butler, Missouri 64730 816/679-3127

Prices subject to change without notice. H3

Design

An Active RTTY Filter

-- eliminate CW QRM and noise

This project started several months ago when I became interested in RTTY and bought a copy of the ARRL's *Specialized Communications Techniques* to learn something about RTTY demodulators. But I couldn't quite see why, in this day and age, anyone in his right mind would want to build RTTY equipment with tubes. It seemed antediluvian.

The next thought was that perhaps the LC filters used in most current demodulators could be replaced by active filters. An active filter is

made with an operational amplifier IC such as the popular 741, plus a few resistors and capacitors. Though it has no inductor, it can be tuned just like an LC filter can. It's used in the same way and does the same job. Aside from lacking an inductance, the active filter has one big advantage — its resonant frequency and its Q can easily be adjusted with potentiometers. A conventional LC filter requires removing turns from a toroid and/or hand-picking capacitors to find one with just the right value.

In this article you will find not only several filters useful for RTTY, but also a complete description of how they were designed. Following these simple steps you could design other useful filters as well.

This description will concentrate on bandpass filters. In a good RTTY demodulator, a bandpass filter is used at the input to separate the desired RTTY tones from noise and QRM. This filter has to have fairly constant gain throughout the middle of its passband so that all needed RTTY information can pass through without distortion. But to reject the most QRM its response should drop quite fast to either side of the desired frequency range. This is a fairly tall order for a filter and usually requires the use of three 88 mH toroids and a batch of capacitors which are very carefully chosen. With active filters the three toroid filter stages are replaced instead with three op amp filter stages. Separate filters

are used for receiving 170 Hz shift and 850 Hz shift RTTY signals.

In case your knowledge of filters needs a little brushing up, the following discussion will help bring you up to date and also explain why three stages of filtering are needed.

Single-Stage Filters

The frequency response of a one stage bandpass filter is shown in Fig. 1. This particular filter is resonant at 3000 Hz and has a bandwidth of 400 Hz. This means that the peak in the response curve is at 3000 Hz. This is the frequency where the filter has a maximum gain.

The bandwidth is measured by noting those frequencies where the gain drops to 70% of its maximum value. In terms of decibels, this is equivalent to a loss of 3 dB gain from its maximum value at the top. For the sake of simplicity, the gain at the top is usually defined as 0 dB, in which case the gain at the 70% points is -3 dB. The two frequencies where this occurs (see the plot) are 2800 and 3200 Hz. Since the difference between them is 400 Hz, we say that the bandwidth is 400 Hz. Sometimes, just to be precise, we say that "the 3 dB bandwidth is 400 Hz."

The "quality" of a bandpass filter is judged by how narrow the bandpass is in relation to the center frequency. This "quality factor" is called Q, and is defined as $Q = \text{resonant frequency} / \text{bandwidth}$. In this case, the Q is $3000/400$ or 7.5, while typical Qs range from 2 or 3 up into the hundreds in some cases.

If you know the resonant frequency and the Q of a filter circuit, it is easy to draw an approximate

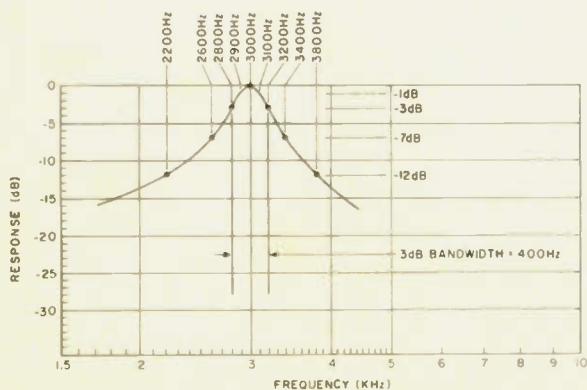

Fig. 1. Simple bandpass filter response curve.

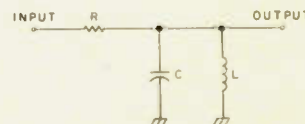

Fig. 2. Simple LC bandpass filter.

100 Hz away	(2900 and 3100)	the response is	-1 dB
200 Hz away	(2800 and 3200)	the response is	-3 dB
400 Hz away	(2600 and 3400)	the response is	-7 dB
800 Hz away	(2200 and 3800)	the response is	-12 dB

Table 1.

response curve. First, you use: bandwidth = resonant frequency/Q to solve for the bandwidth. Then you assume that the bandwidth of the filter is centered evenly around the resonant frequency. (This is usually not true, so you get a slight error when you do it.) If you divide the bandwidth by two, this tells you how far to go each side of the center frequency to find the -3 dB points. In this case the bandwidth is 400 Hz, so you go 200 Hz each side of 3000 to find the -3 dB points.

Other points on the curve can be gotten if you remember that halfway to the -3 dB point the response is at -1 dB, while twice as far away the response is at -7 dB, and four times as far as the -3 dB point the curve is at -12 dB.

In the example of Fig. 1, this works as shown in Table 1, using the center frequency of 3000 Hz as the reference.

Simple filters of this type have a curve which falls off 6 dB for every octave. What that means in this case is that each time you double the distance from the peak the response would drop by another 6 dB. Hence 1600 Hz away the response would be at -18 dB, 3200 Hz away it would be at -24 dB and so on. Most practical filters, however, completely stop dc and very low frequencies. As a result their response curve drops much faster for the low frequencies, and much slower for high frequencies than the above would make you think. Nevertheless, the above calculations are useful for high Q filters as long as we do not get too far away from the center frequency.

Bandpass responses such as Fig. 1 can be approximated by simple LC filters such as the one in Fig. 2. Because this filter has two reactive elements — one inductor and one capacitor — it is called a

two-pole filter.

Two-pole filters can also be built with op amps as shown in Fig. 3. Many different kinds of op amps can be used with just minor changes in biasing. My favorite happens to be the 741, so that is what is shown here. Because it has two reactive elements — both capacitors — such a filter is also called a two-pole filter. (In many cases there may be more capacitors used for bypassing or coupling. These are not part of the filtering action and don't count toward the number of poles. If in doubt, check whether changing a capacitor's value changes the resonant frequency or the Q. If it does, then the capacitor counts as a pole.)

The circuit of Fig. 3(a) uses only one op amp, and is usable only for Qs less than 10. The component values are easy to find from the following equations. Given the resonant frequency f , the Q, and the desired gain G, choose a convenient value of capacitance C. For typical audio filters C is often 0.01 or 0.1 uF. Then,

$$R1 = \frac{Q}{2\pi fGC}$$

$$R2 = \frac{Q}{(2Q^2 - G) 2\pi fC}$$

$$R3 = \frac{2Q}{2\pi fC}$$

$$R4 = R3$$

where $\pi = 3.14$. The value for R2 is the exact value assuming all the other components have the exact values calculated. Usually R2 is a pot about twice the calculated value, which is then used to precisely set the resonant frequency. Making R2 twice the calculated size makes the final setting come out about midway in the pot rotation.

To get higher Qs requires two op amps as shown in Fig.

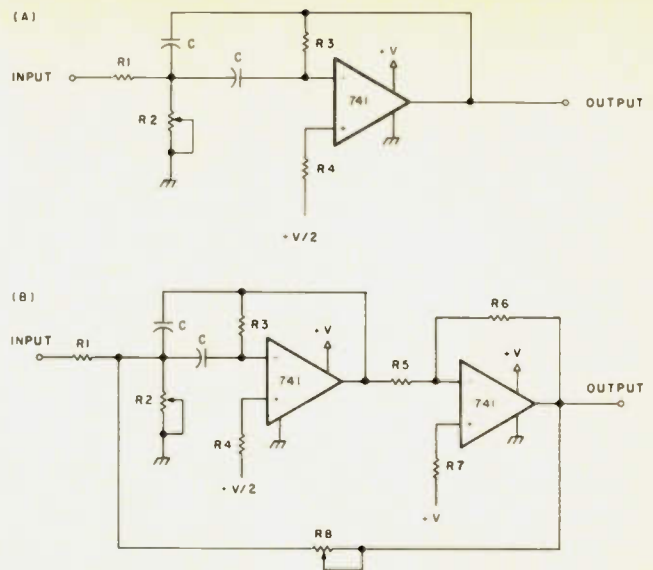

Fig. 3. Two-pole active bandpass filters. (a) Single op amp for Q less than 10. (b) Two op amps for Q between 10 and 50.

3(b). This circuit works for Qs in the range from 10 up to about 50. Component values for this circuit require a little more work to calculate.

This circuit does not work well for low gains. It is at its best when the gain is somewhat greater than the square root of Q. For instance, if the filter is designed for a Q of 16, then the gain should be greater than 4. Usually we design for a gain several times greater than that, perhaps in the range from 8 to 20.

Once you have decided on the values for the resonant frequency f , the Q, the gain G, and the capacitors C, the following equations are used to find the resistor values:

$$R1 = R3 = R4 = R5 = \frac{Q}{2\pi fC}$$

$$R2 = \frac{R1}{Q^2 \cdot 1 - \frac{2\sqrt{Q}}{G} + \frac{1}{G\sqrt{Q}}}$$

$$R6 = \frac{G R1}{\sqrt{Q}}$$

$$R7 = \frac{R5 R6}{R5 + R6}$$

$$R8 = \frac{R1 G \sqrt{Q}}{(2Q-1)}$$

While these equations look quite complex, any calculator will have them solved in a very short time.

Assuming that the values of the capacitors are exact (which is unlikely), these

equations would give exact values for all the resistors. Usually, though, the capacitors will not be exactly the values used in the calculations, and the resistors will probably be the nearest standard values rather than the exact values found from the equations. In this case the circuit has to be adjusted to give just the right center frequency and the right Q. The normal approach is to make R2 and R8 pots of about twice the calculated value. R2 is then used to adjust the center frequency while R8 is used to adjust the Q. There is a slight interaction between the two pots, so you must repeat the adjustment two or three times.

When building active filters you must use good components. Do not use disk capacitors, even for testing! Every time you breathe on them they change value with the change in temperature. Polystyrene or polycarbonate capacitors are best, followed by mylar or mica capacitors. Also use good op amps. 741-type amps (which include the 1458, 5558 and 747) provide good performance up to several kHz. High frequency op amps may be needed for higher frequencies. I have had bad luck using the LM3900. Its gain is too low for reliable operation

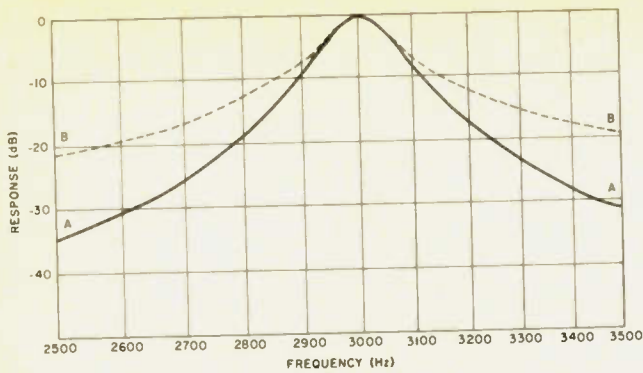

Fig. 4. Comparison of two-pole and four-pole filters.

in these circuits at the frequencies used for RTTY. Moreover, do not use dual or quad op amps such as the 1458 or 5558 in the same filter. Under some conditions the internal coupling between two amps in the same IC will produce strange results. It is best to use single 741 amplifiers.

Filters with Very Narrow Bandpass

There are different ways of building a narrow bandpass filter. You can use one stage of filtering with a high Q or use several stages cascaded (connected one after the other) with lower Q. Both approaches are often used. Cascading LC filters require

careful mathematical analysis, since connecting LC filters together causes them to load each other down. As a result often the bandwidth gets bigger rather than smaller. Active filters, on the other hand, can be connected together without loading each other because they generally have a high input impedance and a low output impedance. Connecting several low Q stages (wide bandwidth) together really does narrow down the bandwidth.

Although filters with a very narrow bandpass are not generally needed for RTTY, it's useful to examine what happens anyway. Fig. 4 shows the difference between one high Q filter and two low Q filters in cascade. Curve A is for two cascaded filters, both tuned to 3000 Hz and a bandwidth of 150 Hz, while the two together have a bandwidth of only 96 Hz. Curve B is a single filter with a Q of 31.2, which also has a 3 dB bandwidth of 96 Hz.

Although the two sets of filters have almost the same response very close to 3000 Hz, they are very different far away from 3000 Hz. The single filter (Q = 31.2) is a two-pole filter which, as we mentioned earlier, results in the response dropping 6 dB each time we double the distance away from the center frequency. For example, at 3200 Hz the response is about -12 dB, while at 3400 Hz it is about -18 dB.

Combining two filters as in

curve A makes this a four-pole filter whose response falls off twice as fast, in this case at 12 dB per octave. For example, at 3200 Hz curve A is at about -17 dB, while at 3400 Hz it is at about -29 dB. We note that 3400 Hz is twice as far from 3000 as 3200 is, and the gain is about 12 dB lower. From this example we see that a four-pole filter can be designed to have the same bandwidth as the two-pole filter, but its response falls off much more quickly to each side of the center frequency. In the same way, a six-pole or eight-pole filter would have even steeper sides to its response curve, decreasing at 18 dB per octave and 24 dB per octave, respectively. When talking about i-f amplifiers, we would say that an eight-pole filter has a better shape factor than a two-pole, meaning that it drops off faster. (You may have noticed eight-pole or ten-pole filters mentioned in ads for 2 meter FM transceivers.)

Wide Bandpass RTTY Filters

A typical RTTY demodulator — or TU for Terminal Unit — needs several filters for separating the RTTY tones from noise and also from each other. Two common sets of frequencies are used. The pair of 2125 and 2295 Hz is separated by 170 Hz and is used with 170 Hz shift, while the pair of 2125 and 2975 Hz is separated by 850 Hz and is used for 850 Hz shift. The first filter in a good TU is used to separate these tones from the rest of the audio coming from the receiver.

For use with 170 Hz shift, the filter used is centered about 2200 Hz, and usually has a bandpass of about 260 Hz, which then extends from about 2070 Hz to about 2330 Hz. This covers more than the 170 Hz difference between the tones, and is necessary to allow reception of some of the audio sidebands produced by keying as well as to allow a small amount of drift.

For use with 850 Hz shift, the filter used is centered around 2550 Hz and usually has a bandpass of about 1100 Hz, which then extends from roughly 2000 Hz to about 3100 Hz.

In either case, we need a filter which will give fairly constant amplification over the bandpass of 260 or 1100 Hz, while at the same time providing a steep rolloff for frequencies outside that range. We find that a two-pole filter could give the wide bandpass, but that its response would not fall steeply enough outside the range to reduce QRM to an acceptable level. What we need is a multiple pole filter which will have steep skirts — response whose sides fall off very fast. Most of the filters used for this purpose are six-pole designs dating back to a series of articles in *QST* and in the *RTTY Journal*, written by Irvin Hoff K8DKC/W6FFC. Each of these filters uses three parallel-tuned LC circuits which are critically coupled to each other. Each of the LC circuits provides two poles, for a total of six.

As shown in Fig. 4, cascading several bandpass filter stages gives steeper response skirts but still results in a rounded top. As it turns out, if a six-pole filter were built out of three two-pole stages all tuned to the same frequency, it would be impossible to get both steep skirts and a wide enough top to pass the entire bandpass without seriously dropping off at the edges. In order to get a good enough response curve, it is necessary to stagger-tune the three filters so that each stage emphasizes a different part of the bandpass. In this way the top of the bandpass curve is spread out and flattened, while the steep skirts are retained.

The original Irvin Hoff filters all did this by properly coupling the three LC resonant circuits. As the old-timers will remember, all the old electronics books discussed what happens when

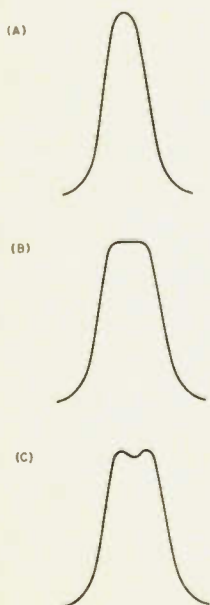

Fig. 5. Effects of coupling (or stagger tuning) on response of bandpass filter. (a) Under coupling. (b) Critical coupling (Butterworth). (c) Over coupling (Chebyshev).

the tuned primary of an i-f transformer is overcoupled to the tuned secondary. The top of the i-f response curve flattens out and in extreme cases develops a dip in the middle. (You don't read about this much in modern books because modern i-f transformers tend to have only one tuned winding.) Anyway, Irv Hoff's designs did just that — by coupling the three LC circuits he was able to broaden out the response curve so that it had a fairly flat top with steep sides. Fig. 5 shows the effect of coupling on two LC circuits. When they are under-coupled, as at (a), the response is sharp and thin with a smoothly rounded top. With critical coupling (b) the top flattens out, while with overcoupling (c) the top acquires a dip. Many old electronics textbooks had curves just like these.

With active filters, the separate filter stages in cascade are completely independent of each other so there is no such thing as overcoupling. Instead, the same effect can be achieved by stagger-tuning the stages and by carefully adjusting their Qs. When the overall filter is adjusted so that the top is as flat as possible, as in Fig. 5(b), the filter is then called a Butterworth filter. If it has one or more dips in it, as in Fig. 5(c), it is called a Chebyshev filter. While the Chebyshev generally has steeper skirts than the Butterworth, it tends to

distort pulses like those of RTTY, and so Butterworth filters are used more commonly. Hoff's filters, as well as those in the popular ST-6 demodulator, are six-pole Butterworth filters.

The correct design of a Butterworth or Chebyshev filter is very hard to do with LC filters, but amazingly easy to do with active filters — once you know how. It's just a matter of knowing how to choose the center frequency and Q of each filter stage. The whole process can be done with graph paper, a compass, and a protractor in a few minutes.

In the following example we will design an input filter for a 170 Hz shift RTTY demodulator. As mentioned earlier, we want a Butterworth filter with a center frequency of 2200 Hz and a bandwidth of 260 Hz.

Start by getting some graph paper with small squares, a compass, and a protractor. Along the bottom of the graph paper, draw a long horizontal line and label it with frequencies so that the center frequency of the filter is somewhere near the center, and the 3 dB bandwidth of the filter is centered around it. Make use of the graph paper's lines to evenly space out the frequency steps, and use graph paper with equal size squares throughout. (Don't use the log graph paper normally used for frequency response diagrams.) See Fig. 6 for an example of how to label the

line.

Now take your compass and draw half a circle centered on the center frequency of the filter, with a diameter exactly equal to the desired bandwidth. This circle should then touch the line exactly at the lower 3 dB frequency (2070 Hz in our example) and the upper 3 dB frequency (2330 Hz in our example). If you were designing a Chebyshev filter, then instead of a circle you would use an ellipse whose height would depend on how large the dips in the response should be.

Now see Fig. 7. Depending on the number of poles needed, look at the appropriate drawing in Fig. 7 to see the location of the dots. In this case we want to duplicate the performance of the Hoff filter in the ST-6 demodulator, so we will use a six-pole filter. (Usually, you would

Correction Factor (Degrees)

FF	Correction Factor (Degrees)
0 to 0.01	0
0.01 to 0.025	1
0.025 to 0.04	2
0.04 to 0.06	3
0.06 to 0.08	4
0.08 to 0.1	5
0.1 to 0.11	6
0.11 to 0.13	7
0.13 to 0.15	8
0.15 to 0.17	9
0.17 to 0.19	10

Table 2.

have to decide how many poles to use based on the desired steepness of the bandwidth curve skirts.) As shown in Fig. 7, we want one dot up at the very top of the circle, with two more exactly 30 degrees up from the line. Now go back to your drawing and use the protractor to draw in the dots. For our filter we get the dots shown in Fig. 6, and labeled A, B, and C. (In electrical engineering language, this drawing would be called the s-plane and the dots are the poles. A six-pole filter has six poles, of which only three are shown in this drawing. The other three are not used.)

If we were using an ideal filter having only the poles shown, we would use the points A, B, and C which we have drawn. There are, however, those other three poles not shown in the drawing as well as the fact that the filter

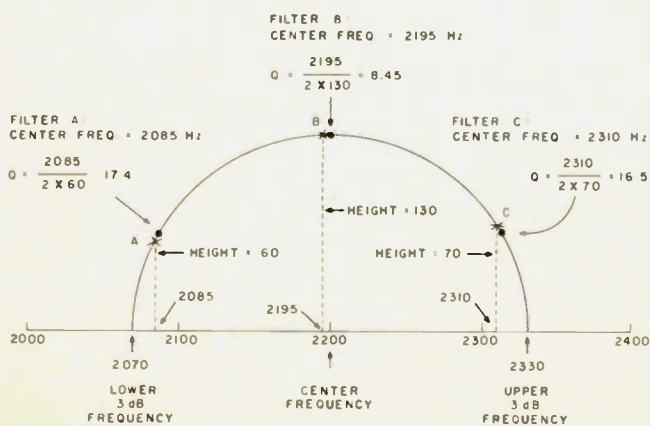

Fig. 6. Designing a Butterworth RTTY input filter for 170 Hz.

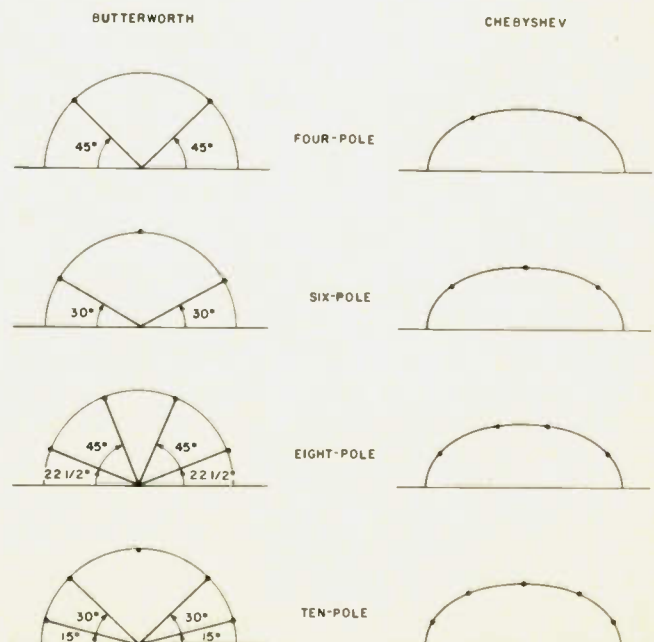

Fig. 7. Pole locations for Butterworth and Chebyshev filters.

Stage	Center Freq.	Q
A	2085 Hz	17.4
B	2195 Hz	8.45
C	2310 Hz	16.5

Table 3.

stages do not pass dc. Although their effect is not very obvious, they do cause a slight error in the final filter which we have to try to remove. And so here we apply a small "Finagle Factor."

Compute the quantity, $FF = \text{Desired filter bandwidth} / (3 \times \text{Center Frequency})$.

In our sample filter this comes out to $(260) / (3 \times 2200)$, which is equal to 0.04. Now look up this FF (Finagle Factor) in Table 2.

Now return to Fig. 6, and move all the poles left by a small angle as shown by the above table. In our example the finagle factor is .04, so we move all the poles left about 3 degrees. This puts them at the locations labeled with an X. These three poles determine the actual performance of the whole filter. (Remember, there are three more poles not shown, for a total of six.)

Each of these poles will be produced by one of the three stages of the filter, and each pole determines the center frequency and the Q of that stage. The center frequency is easily read off the graph by drawing a line from the X straight down the horizontal line and reading the frequency off the scale.

To find the Q, carefully measure the height of the X above the horizontal line. Use the frequency scale to judge

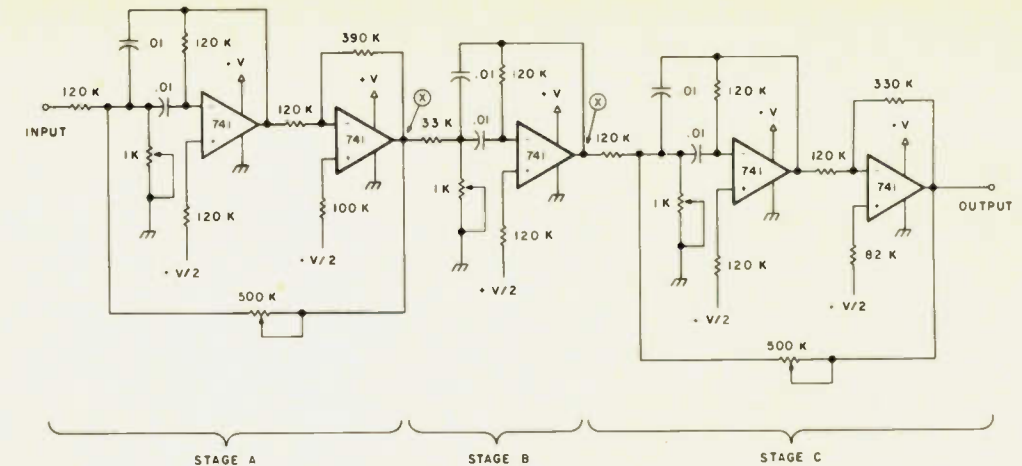

Fig. 8. 170 Hz shift bandpass input filter.

the height. In the case of the pole labeled A, its height is about 60 cycles (or is it 60 Hertz?). Calculate the Q of each stage from $Q = \text{Center frequency of filter} / 2 \times \text{Height above line}$. For pole A this works out as a center frequency of 2085 Hz and a height of 60, so the Q is $2085 / 120 = 17.4$.

To build the overall bandpass filter with a bandwidth of 260 Hz we need three staggered filter stages with the center frequencies and Qs as shown in Table 3.

Fig. 8 shows the overall circuit for the entire filter. Since filter stages A and C have Qs above 10 we use the double op amp circuit shown in Fig. 3(b). The Q of stage B is below 10 so the circuit of Fig. 3(a) is good enough. As mentioned earlier, the double amplifier circuit works best when the design gain is several times the square root of Q. For Qs around 17, the square root is slightly above 4, so I designed these circuits

for a gain about three times higher, or about 13. Stage B was arbitrarily designed for a gain of 2. There is nothing magic about these gains, and the final circuit will have different gains anyway, so there is little you can do here to obtain precise gains. The problem is that the gains would be exactly as specified if all of the components we used were exactly equal to the values calculated from the equations. But, since we have to rely on standard value resistors as well as possibly large tolerance errors, by the time we finish trimming the resonant frequency and the Q with the potentiometers, the gain will wind up considerably different from the assumed values. So the trick is to design for considerably more gain than you really need and use an external potentiometer as a level control to cut it back to the desired value.

To permit trimming the center frequency of each stage and the Q of the two end stages, five of the resistances calculated are replaced by potentiometers as shown in Fig. 8. (By the way, the three stages could have been connected together in any order.)

Alignment of the filter is easy. The three stages are disconnected from each other at the points marked X, and each stage is aligned separately. First, the 1k pot is adjusted to peak the gain at the center frequency. Then the 500k pot (for the two amplifier circuits) is adjusted to make the bandwidth correct. There is a slight interaction between the two adjustments, so the process is repeated two or three times. Once the three stages are adjusted separately, they are connected together.

Fig. 9 compares the response of this active filter



Fig. 9. Response of two LC filters and one active filter.

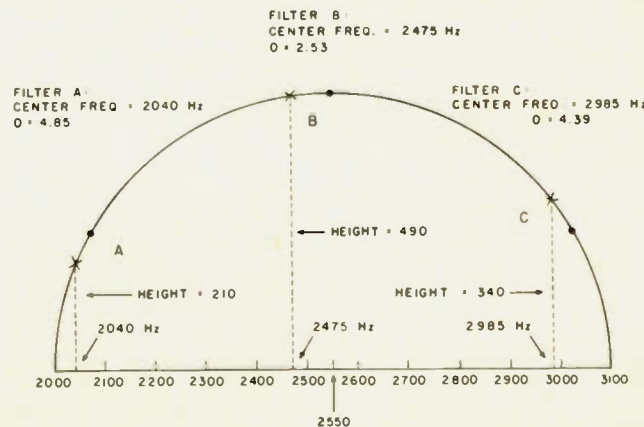

Fig. 10. Designing a Butterworth RTTY input filter for 850 Hz shift.

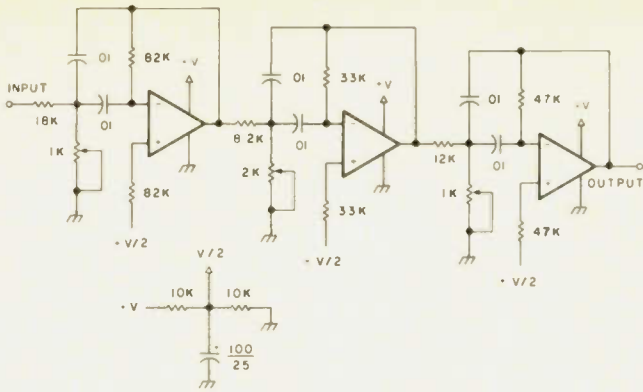

Fig. 11. 850 Hz shift bandpass input filter.

with two other filters. Curve 1 is the active filter we have just designed. Curve 2 is the curve published by Irv Hoff for his LC filter in *QST* more than ten years ago. Curve 3 is the 170 Hz shift filter in my ST-6 demodulator (built from a HAL kit). As you can see, there is remarkable similarity between the original Hoff design and the active filter we have designed. Both are Butterworth filters with 260 Hz bandwidth, so both should be very similar.

Another filter needed in a RTTY demodulator for 850 Hz shift is a bandpass filter with approximately 1000 or 1100 Hz bandwidth, which will pass the 2125 and 2975 Hz tones plus a little more to allow for modulation sidebands and drift. Though I won't go through the details of this design, it is shown in Figs. 10 and 11. Fig. 11 also shows how the 741 op amp is biased when used with a single power supply. The positive voltage, called +V, is

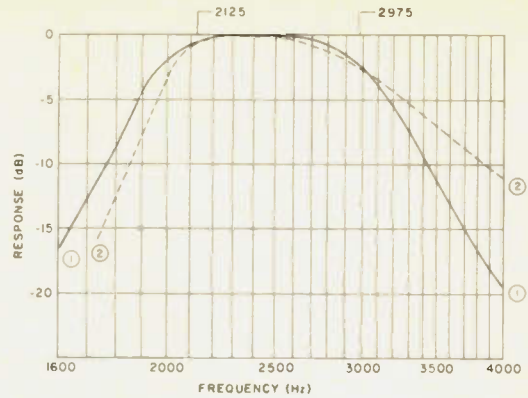

Fig. 12. Frequency response of 850 Hz input bandpass filter.

divided with two 10k resistors to give a bias voltage called +V/2, which is then connected to the + inputs on the op amps to provide bias. In this way the inputs and outputs of the op amps are biased to run at half of the supply voltage. For instance, if a 12 volt supply is used, this voltage divider provides +6 volts, so the inputs and outputs of the op amps run at +6 volts. Though not shown in Fig. 8, this voltage divider is needed there also.

Fig. 12 compares the response of this active filter (curve 1) with the similar 1100 Hz filter in my ST-6 (curve 2). (I will have to look at that ST-6 filter to see whether it is properly aligned!)

In conclusion, let me encourage you to design and build your own filters, whether it is for RTTY or other uses. It is fun and, with this graphical approach and the equations presented earlier, even relatively easy. ■

TS-1 MICROMINIATURE ENCODER-DECODER

- Available in all EIA standard tones 67.0Hz-203.5Hz
- Microminiature in size, 1.25x2.0x.65" high
- Hi-pass tone rejection filter on board
- Powered by 6-16vdc, unregulated, at 3-9ma.
- Decode sensitivity better than 10mvRMS, bandwidth, ± 2 Hz max., limited
- Low distortion adjustable sinewave output
- Frequency accuracy, ± 25 Hz, frequency stability ± 1 Hz
- Encodes continuously and simultaneously during decode, independent of mike hang-up
- Totally immune to RF

Wired and tested, complete with K-1 element

\$59.95

K-1 field replaceable, plug-in, frequency determining elements

\$3.00 each

COMMUNICATIONS SPECIALISTS

P.O. BOX 153
BREA, CALIFORNIA 92621
(714) 998-3021

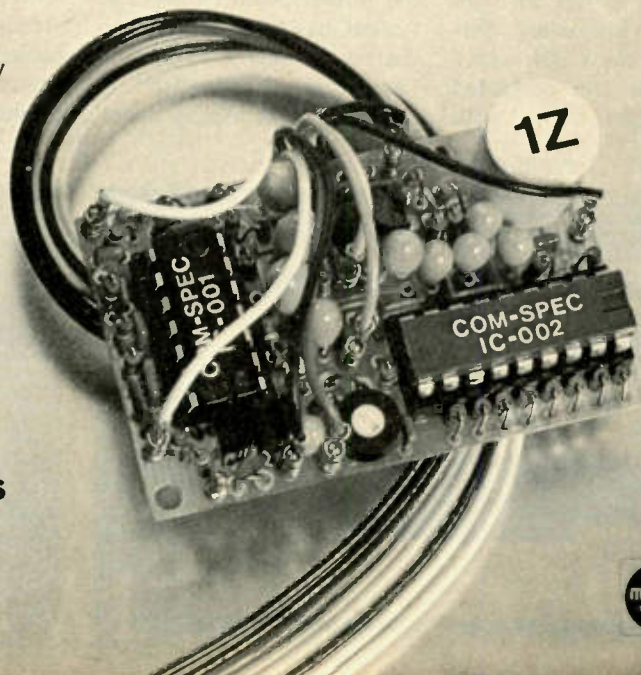

Moving Display RTTY Readout

-- just like Times Square

Francis J. Ferrara WB8SWH
PO Box 56
Enon OH 45323

The desire to build an all-electronic RTTY system without incurring the high price tag that usually accompanies video display units in this class is what prompted the construction of this terminal. The unit uses, instead of the CRT normally associated with video systems, a series of 16 alphanumeric type displays, each with the capability of reading out any one of the 64 standard ASCII characters. The readouts are clocked in such a manner that the generated words appear to "walk

across" the display screen from right to left. Provision is made for tape recording the incoming signal for playback at a later time. This provision helps offset the potential problem of there being no hard copy available. Also included is a keyboard monitor feature, which allows the operator to see his transmitted copy as it is sent out over the air. The circuit, which uses 6 level ASCII code for internal signal processing, utilizes a series of 3 read only memories (ROMs) to permit compatible operation with the 5 level Baudot code. The system has been designed so that it is only a matter of throwing one switch to realize straight ASCII opera-

tion.

Receive Circuit Description

The system starts from scratch, due to there being no RTTY equipment on hand at the onset of the project. Signal demodulation is accomplished by a phase locked loop, U2, with the receive signal first passing through limiter amp U1a. The limiter amp also drives a unity gain isolation amp, U3, and signals for a tape recorder may be taken at its output. The VCO in the NE565 PLL tracks the mark and space tones, and the VCO control voltage drives voltage comparator U1b, causing positive and negative voltages in direct proportion to the transmitted

marks and spaces.¹ Zener diode D1 makes the output TTL compatible by cutting off the negative-going portion of the signal and limiting the positive peak to 5 volts. Buffer U3 aids as a signal conditioner by shaping the rising and falling edges. The 6 uF capacitor, C1, serves as additional filtering by slowing the frequency response of the comparator amp, and is very effective in reducing short duration noise. If a suitable terminal unit with a TTL output is available, then the PLL converter can be left out. The converted output is then fed into the serial input of the UART chip, U4. The UART strips off the start and stop bits and outputs the corresponding parallel code, 5 bits for Baudot and 6 bits for ASCII. This word then addresses the two 8223 ROMs (U5 and U6) which convert the Baudot code into ASCII. Should the ASCII mode be selected, then no conversion takes place and the data is switched directly to the display section. Inverter U7 and AND gates U8 and U9 form a character recognition circuit which detects "letters" (lower case) and "figures" (upper case) commands. The output of this circuit sets flip-flop U10, which enables the appropriate ROM and disables the other. ROM outputs are "open collector" and may be tied directly in parallel. They need not be gated. Push-button switch S3 is pro-

Front view of RTTY unit.

View of rear panel.

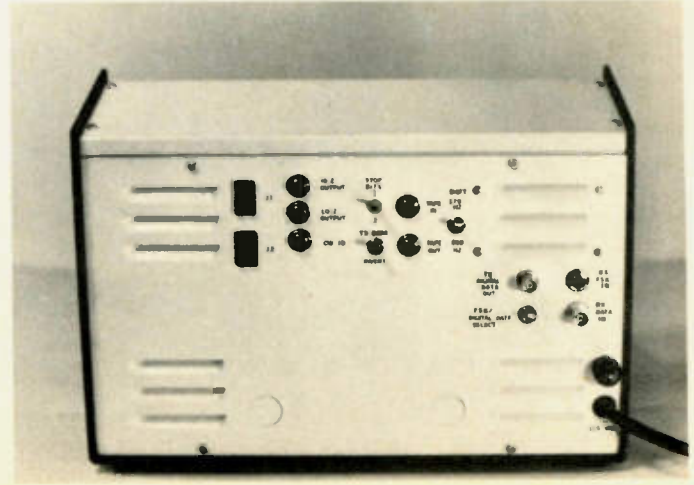

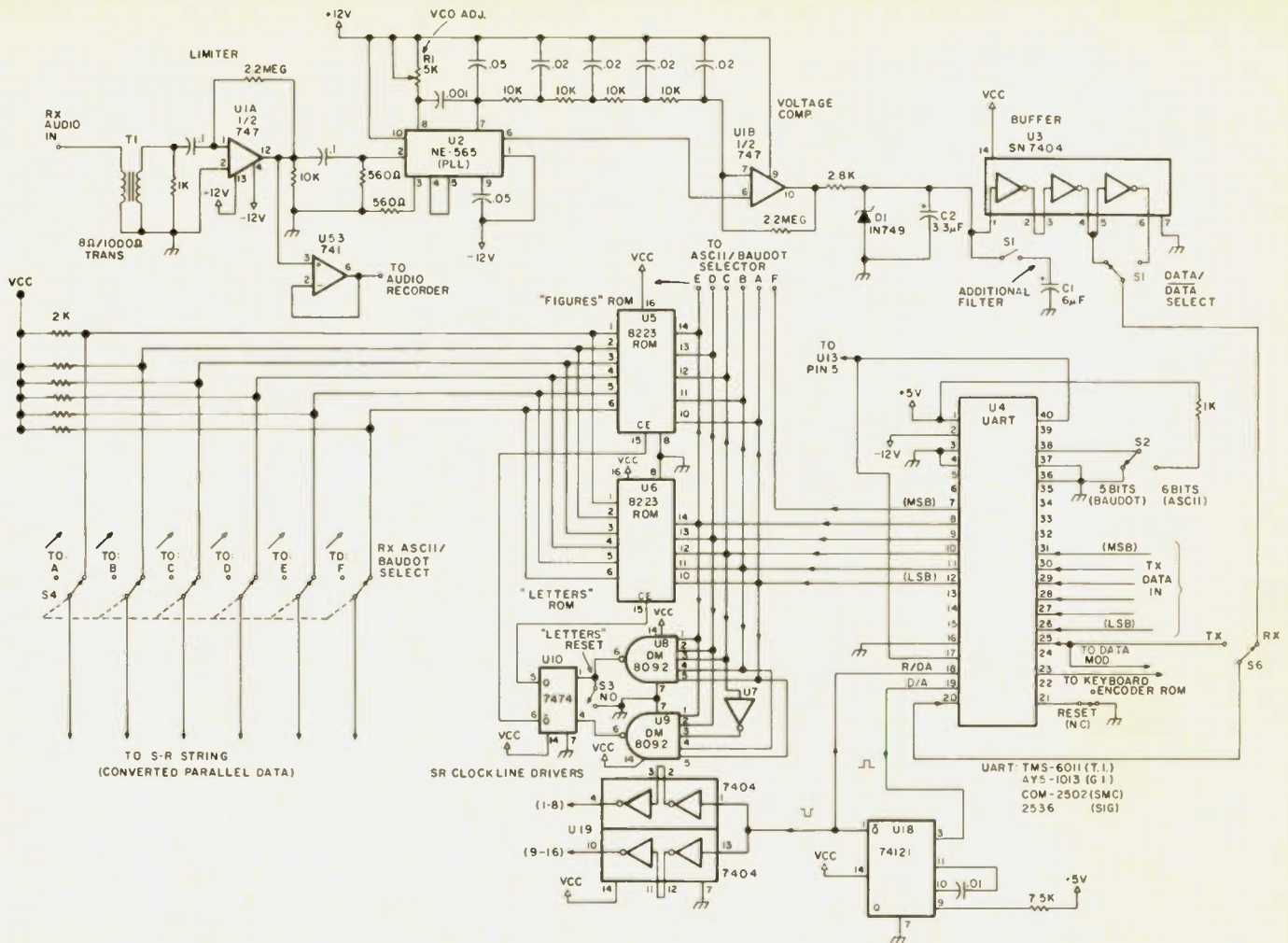

vided to manually reset the "letters" ROM should it miss the automatic command due to noise, QRM, fades, etc.

Display Section

The parallel data is then applied to the input of the shift register chain. Each shift register directly corresponds to a display, and all are clocked simultaneously from the Data Available flag on the UART, through driver U19, *The RX/driver circuit board. Driver transistor modules are on the top, with the character generator, multiplexers, and de-multiplexers on the left side. The UART is in the center with the character recognition circuit above it; the two RX code converter ROMs are to the right. The shift register string occupies the bottom two rows on the right. The +5 volt power supply is mounted on the right wall.*

to cause the characters to move along from display to display. The output of each shift register is sampled by multiplexers U37-U42, which are all clocked in parallel and, together with U11, form the horizontal scan generator circuit. A multiplex frequency of approximately 4.8 kHz was selected to provide flicker-free operation of the displays. The outputs of the

multiplexers are then inverted and fed into the 2513 character generator, U43. The six inputs from the multiplexers constitute an address and a five line dynamic parallel signal is produced at the 2513 output. The signal is again inverted and drives de-multiplexers U45-U49, which are all parallel clocked with the multiplexers. The de-multiplexers distribute the

to cause the characters to move along from display to display. The output of each shift register is sampled by multiplexers U37-U42, which are all clocked in parallel and, together with U11, form the horizontal scan generator circuit. A multiplex frequency of approximately 4.8 kHz was selected to provide flicker-free operation of the displays. The outputs of the

Rear view of RX/driver board showing density of wiring.

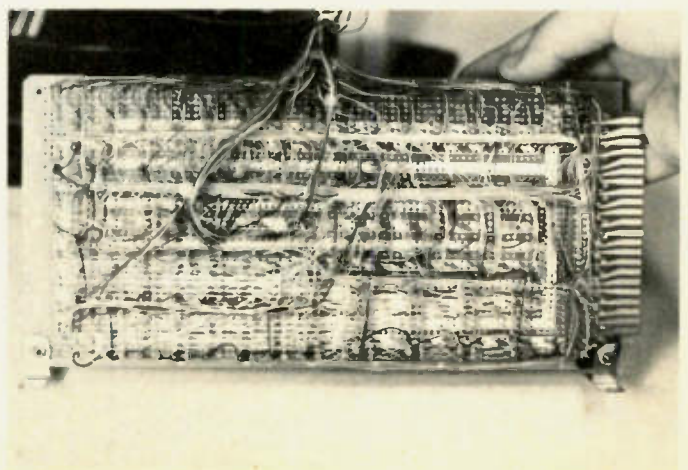
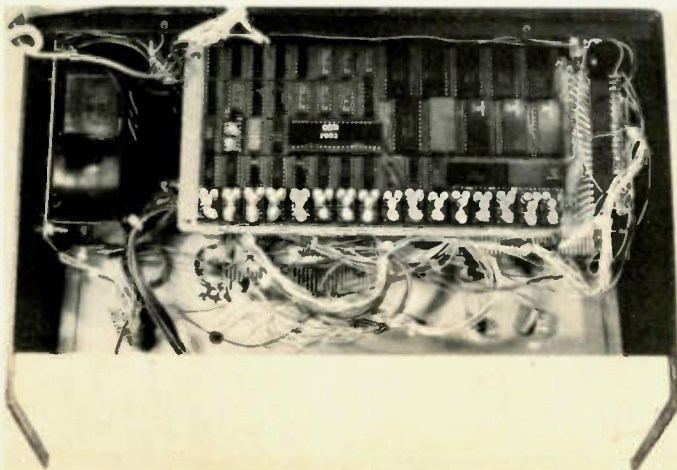

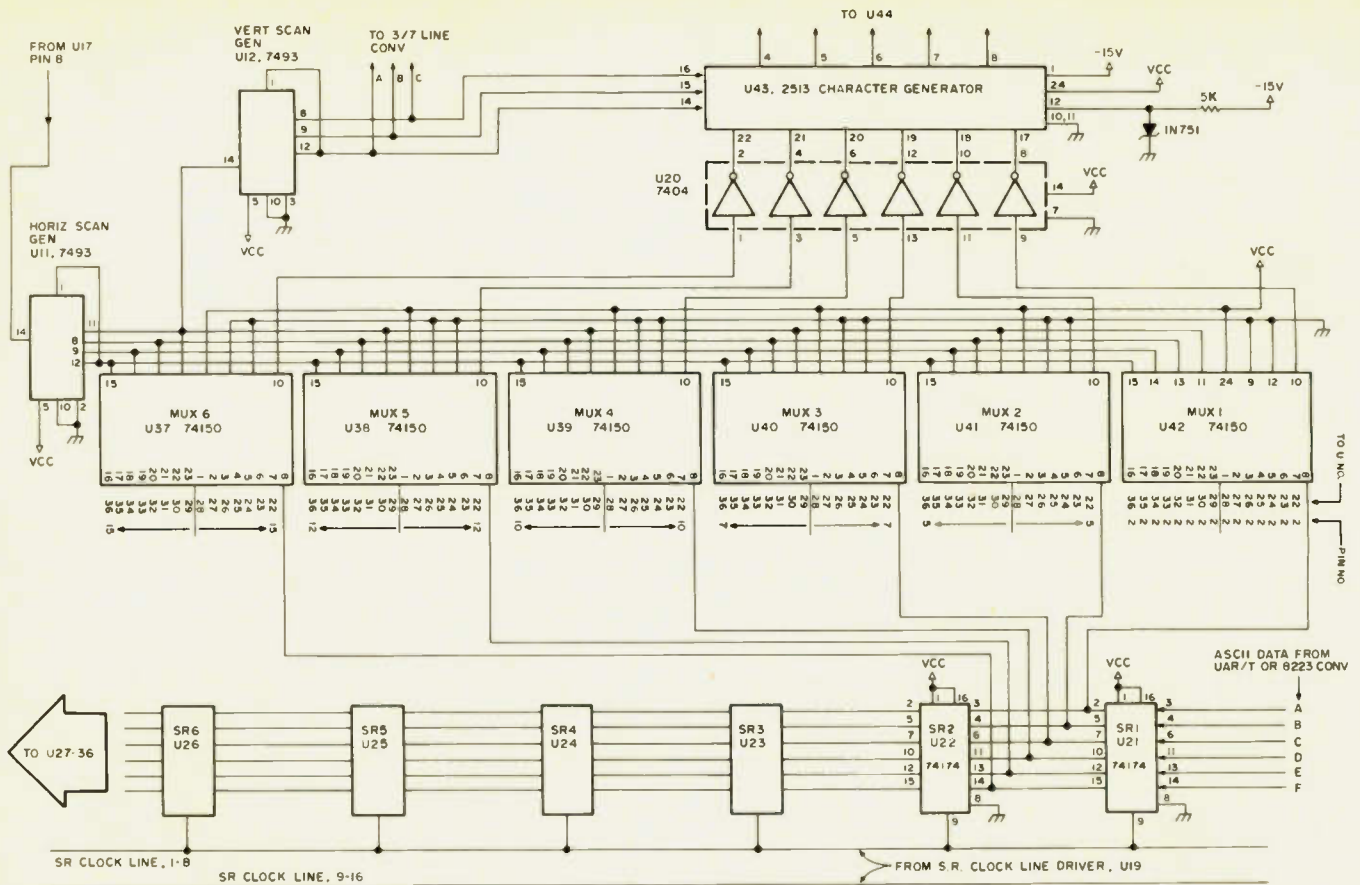

Fig. 2.

signals to their respective displays through driver transistors Q8-Q87. Multiplex clock U11 drives a second binary counter, U12, which is used to clock both the character generator and the 3-line to 7-line converter. The resulting scan is from right to left and from top to bottom, with the vertical row advancing 1 count downward for every 16 horizontal

sweeps.

Baud rate selection and the multiplexer clocks are derived from a master oscillator. 38.4 kHz was used in this model because of the availability of a stable module, but an NE555 oscillator circuit may be used in its place. The UART chip is designed to be clocked at 16 times the desired baud rate for both the transmit and

receive functions. One design goal was to make the system operable on the four commonly used speeds of 60, 66, 75, and 100 wpm (45, 50, 57 and 75 baud respectively). The four clocks are generated from the master oscillator using a divide by "N" counter chain (U14 and U15), with "N" being derived by programming a multi-deck wafer switch to produce the binary divisors required. The output of the counter chain is a very narrow pulse at twice the

desired frequency. This pulse is applied to flip-flop U13, which halves the frequency and produces a symmetrical waveform. The clock frequency does not have to be exactly 16 times the data rate, incidentally, as the UART is capable of tracking receive signals over a small range (approximately $\pm 5\%$), and in most cases this is sufficient to make up for any differences between the transmit and receive clocks. However, the correct speed range

Clock/TX/converter board showing master oscillator unit on the right, PLL converter, row drivers and LED drivers to the left. The transmit converter ROM is the 24 pin package on the bottom.

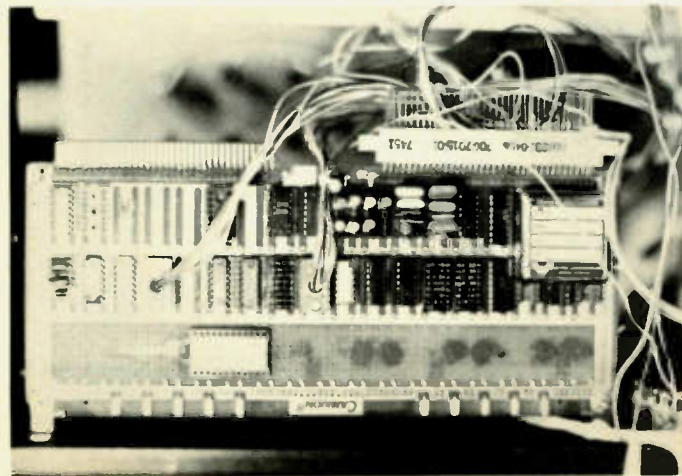

Rear view of readout board.

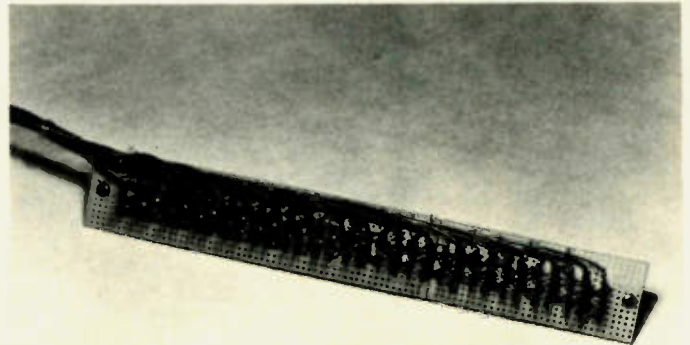

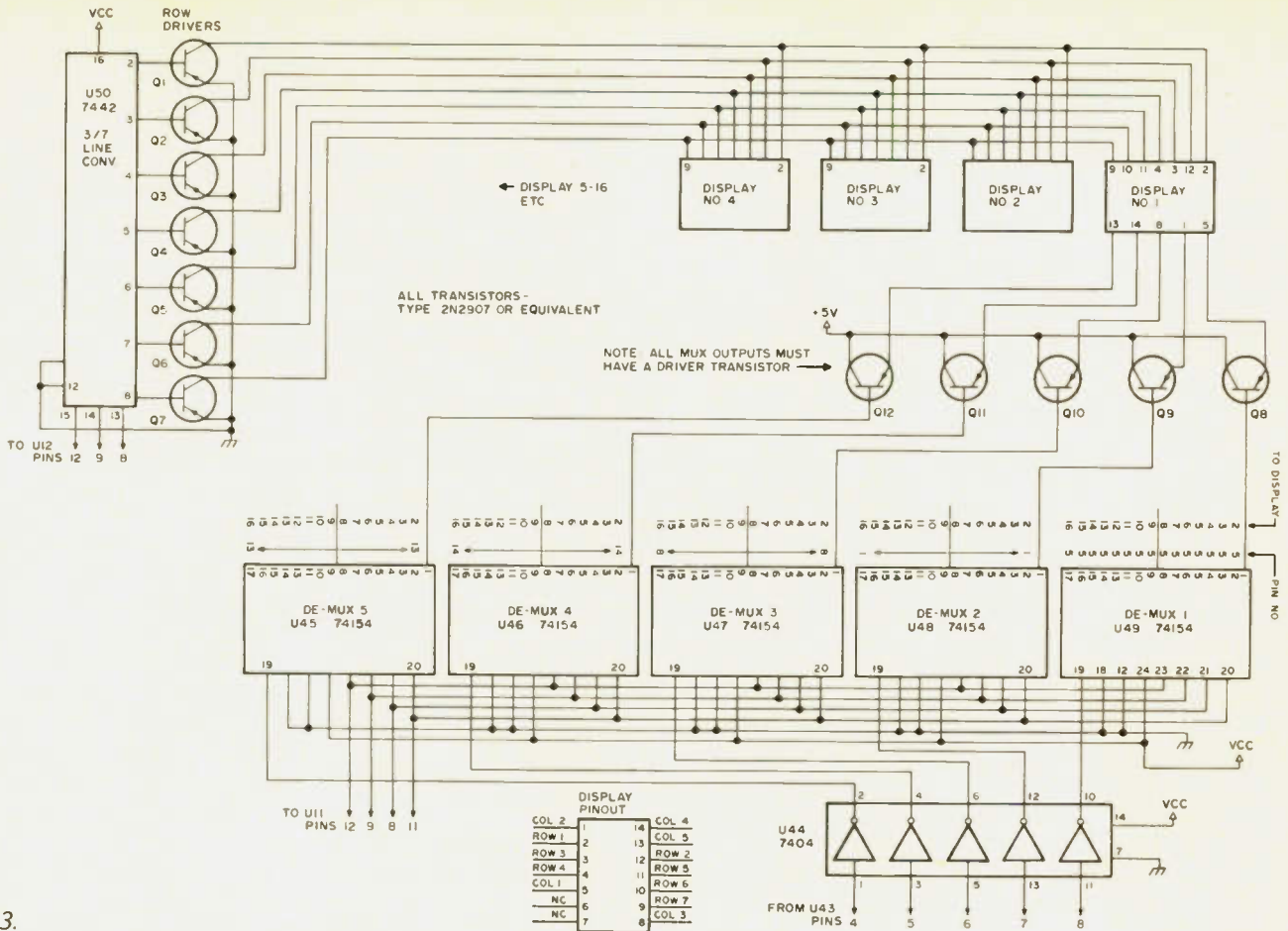

Fig. 3.

must be manually selected.

Transmit System

The transmit system is relatively straightforward. The keyboard addresses an encoder ROM which directly outputs an ASCII word and produces a transmit strobe pulse.² The output of the encoder ROM is fed into the code converter ROM which turns the ASCII data into Baudot, or passes it directly through, depending on the mode. Then the output of the converter ROM addresses the data inputs on the transmit side of the UART. The transmit strobe pulse from the encoder ROM is used to "key out" each character, and occurs whenever a key on the board is depressed. The serial digital output from the UART then branches out, with one line going back into the receive side for transmit monitoring, and the other line driving the AFSK modulator. The modulator is then outputted to the audio section of an SSB transmitter.

To facilitate construction, a commercially manufactured unit (HAL AK-1) was used as the AFSK section.

Construction

The two main circuit

digital electronics and the PLL converter, were fabricated using the wire-wrap technique. Utilization of

Baudot Address	ASCII Output	Character	11101	010001	q
00000-MSB	100000-LSB	null	11110	001011	k
00001	010100	t	11111	011111	lower case
00010	100000	carriage return			
00011	001111	o			
00100	100000	space			
00101	001000	h			
00110	001110	n			
00111	001101	m			
01000	100000	line feed			
01001	001100	l			
01010	010010	r			
01011	000111	g			
01100	001001	i			
01101	010000	p			
01110	000011	c			
01111	010110	v			
10000	000101	e			
10001	011010	z			
10010	000100	d			
10011	000010	b			
10100	010011	s			
10101	011001	y			
10110	000110	f			
10111	011000	x			
11000	000001	a			
11001	010111	w			
11010	001010	j			
11011	011111	upper case			
11100	010101	u			
			Any left over addresses should be programmed to: 100000		space

Table 1. 8223 receive converter ROM encoding programs, upper case and lower case.

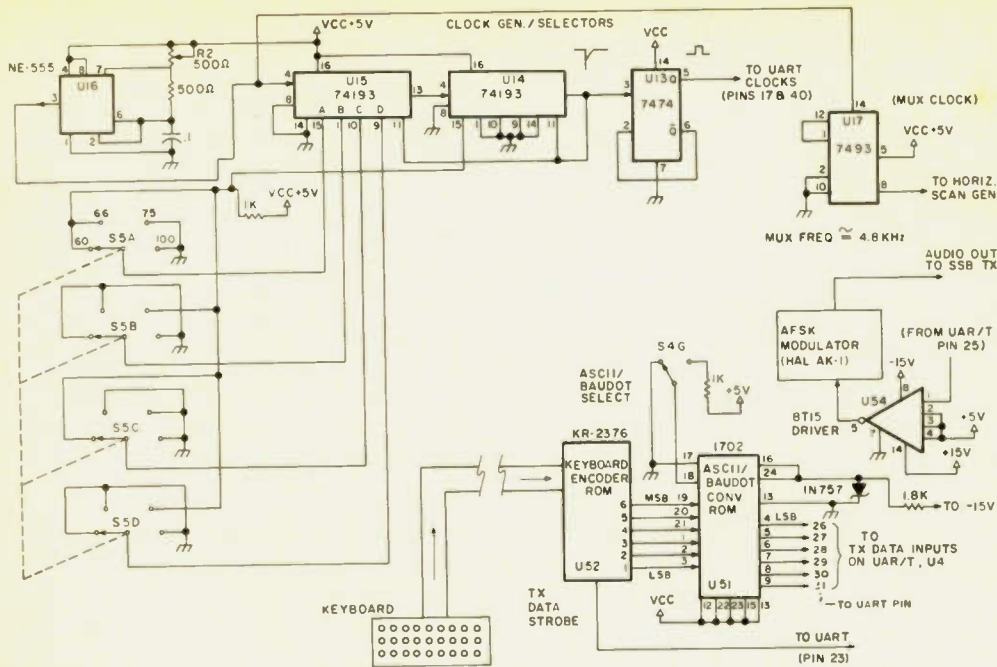

Fig. 4.

were mounted in wire-wrap sockets (which were used extensively throughout the unit) and attached to a section of vectorboard. The wiring harness between the digital and display boards was formed and carefully labeled on the digital board, bundled together, and run out to the displays. There, the wiring was custom fitted to each display. This results in a much neater package than if the lines were run out individually.

Power supply current is on the order of 1.2 Amps from the 5 volt source and 150 mA and 50 mA from the respective -15 volt and +15 volt supplies, using the type chips specified. If a larger 5 volt supply is available, then the more expensive 74LSXX series chips, which were used

other construction techniques likely result in the finished more space than the prototype. The MAN-2 displays is possible, but will most unit taking up considerably

Binary Address	5 Level Output	Baudot Character	42	not programmed	84	010100	t	
00	00100-LSB	space	43	not programmed	85	010101	u	
01	00011	a	44	01100	86	010110	v	
02	11001	b	45	00011	87	010111	w	
03	01110	c	46	11100	88	011000	x	
04	01001	d	47	11101	89	011001	y	
05	00001	e	48	10110	90	011010	z	
06	01101	f	49	10111	91	011011	[
07	11010	g	50	10011	92	011100]	
08	10100	h	51	00001	93	011101	\	
09	00110	i	52	01010	94	011110	^	
10	01011	j	53	10000	95	011111	_	
11	01111	k	54	10101-LSB	96	100000	space	
12	10010	l	55	00111	97	100001	!	
13	11100	m	56	00110	98	100010	"	
14	01100	n	57	11000	99	100011	#	
15	11000	o	58	01110	100	100100	\$	
16	10110	p	59	11110	101	100101	%	
17	10111	q	60	01101	102	100110	&	
18	01010	r	61	not programmed	103	100111	'	
19	00101	s	62	11100	104	101000	(
20	10000	t	63	11001	105	101001)	
21	00111	u			106	101010	*	
22	11110	v	Binary Address	6 Level Output	ASCII Character	107	101011-LSB	+
23	10011	w	64	000000	@	108	101100	,
24	11101	x	65	000001	a	109	101101	-
25	10101	y	66	000010	b	110	101110	.
26	10001	z	67	000011	c	111	101111	/
27	11011	upper case	68	000100	d	112	110000	0
28	not programmed		69	000101	e	113	110001	1
29	00010	line feed	70	000110	f	114	110010	2
30	01000	carriage return	71	000111	g	115	110011	3
31	11111	lower case	72	001000	h	116	110100	4
32	00100	space	73	001001	i	117	110101	5
33	01101	!	74	001010	j	118	110110	6
34	10001	"	75	001011	k	119	110111	7
35	not programmed		76	001100	l	120	111000	8
36	01001	\$	77	001101	m	122	111010	:
37	not programmed		78	001110	n	123	111011	;
38	11010	&	79	001111	o	124	111100	<
39	01011	'	80	010000	p	125	111101	=
40	01111	(81	010001	q	126	111110	>
41	10010)	82	010010	r	127	111111	?
			83	010011	s	127	111111	?

Table 2. Encoding program for 1702 transmit converter ROM.

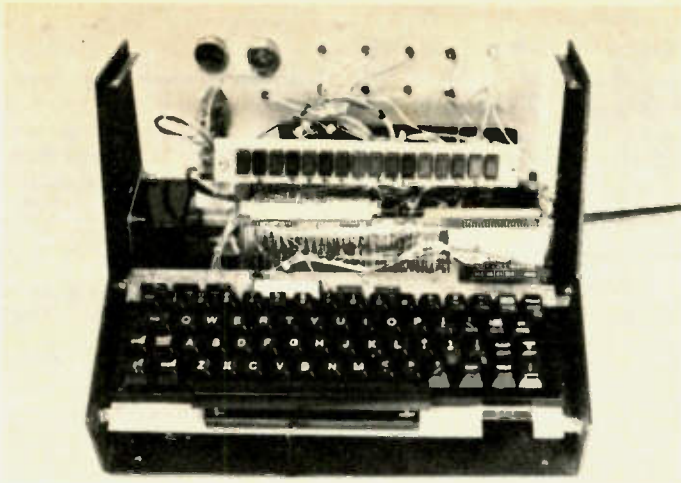

RTTY unit with top cover removed.

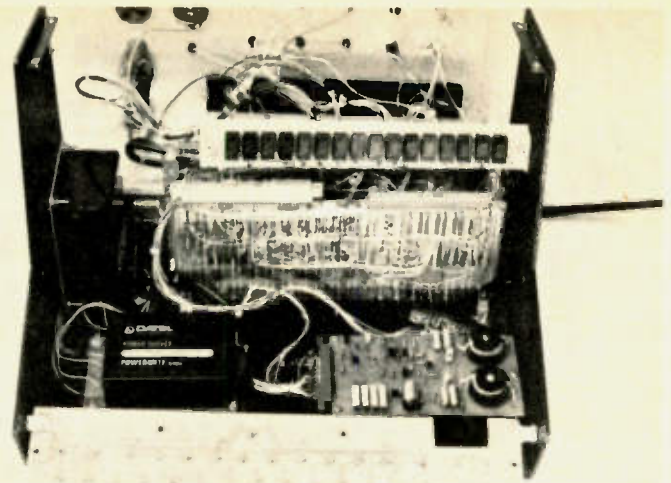

Interior front view. The keyboard has been pivoted completely forward and over, showing the ± 15 volt power supply module, and the AK-1 AFSK unit. Behind these are the clock/TX/converter board and the readout board. The +5 volt power supply module is mounted on the bottom portion of the left wall in this photo.

only to save power, need not be used. Indeed, excellent results were achieved using the standard 74XX series chips. Power supplies are of the modular type, available at reasonable cost from many discount or surplus houses. Again, for the sake of economy, units could be constructed with discrete components.

The use of a metal cabinet for housing the unit is highly recommended, as the digital circuitry (particularly the clocks and multiplexers) tends to produce a good deal of noise (which will be evidenced in your receiver if steps aren't taken to guard against it). The metal cabinet serves well in keeping this noise inside the unit and out of your speaker.

The output transistors were all mounted on 14 pin component holders for ease of installation, and for possible repairs. Should suitable integrated PNP arrays be available, they could be substituted for the 80 column and 7 row drivers.

Conclusions

At first, it was thought that the displayed words would move across the screen too fast to read, but fortunately this was not the case. Even at 100 wpm, text sent out on reperftape can easily be read. The fact that most RTTYers don't type more than 20 or 30 wpm

makes keeping up with the display that much easier.

The keyboard takes a little bit of extra thought to operate. Due to the coding of the transmit converter ROM, it is necessary in the Baudot mode to hit both the upper case and shift keys to produce the symbols for quotation marks, exclamation point, etc. However, only the upper case key need be struck to produce figures 0 through 9 and the question mark.

The ASCII/Baudot selec-

tor switch is located on the front panel, as is the adjustment for centering the VFO on the PLL. This allows for easy tuning of both 170 Hz and 850 Hz shift signals.

The only real drawback of the unit at this time is in the phase locked loop converter, which has a tendency to track and lock onto noise. How-

ever, a standard type converter of the ST-5 variety with a TTL configured output would most likely improve performance in this area.

The unit is very compact and portable. Total weight is approximately 12 pounds (substantially lighter than mechanical or even CRT type

List of Required Integrated Circuits

Quantity	Type
1	747 op amp
1	741 op amp
1	565 PLL
4	7404 inverter
1	UART, COM 2502, AY-5-1013, Signetics 2536
1	74121 one shot
2	DM8092 5 input AND gate
2	7474 flip-flop
2	8223 programmable ROM
16	74LS174 hex flip-flop (type 74174 is an acceptable substitute)
6	74150 multiplexer
1	2513 character generator
5	74150 de-multiplexer
3	7493 binary
1	NE555 timer/oscillator
2	74193 programmable counter
1	1702 256X8 programmable EROM
16	MAN-2 displays (Texas Instruments TIL-305 is an acceptable substitute)
87	2N2907 driver transistors
1	8T15 TTL/MIL-188 (± 6 volt) driver

The following IC is also required if the keyboard kit specified or a suitable substitute is not used.

1 KR-2376 keyboard encoder ROM

The following components are required if the power supply modules specified are not used and discrete units are to be constructed.

1	7806 integrated regulator
1	7815 integrated regulator
1	7915 integrated regulator
1	2N3055 power transistor
4	50 volt, 3 Amp rectifier diodes
1	2000 uF, 25 volt electrolytic capacitor
1	1000 uF, 25 volt electrolytic capacitor
5	.22 uF bypass capacitor
1	12 volt, 3 Amp filament transformer
1	12 volt, .3 Amp filament transformer

Vhf engineering

THE WORLD'S MOST COMPLETE LINE OF VHF-FM KITS AND EQUIPMENT

RX28C	28-35 MHz FM receiver with 2 pole 10.7 MHz crystal filter	\$ 59.95
RX28C W/T	same as above—wired & tested	104.95
RX50C Kit	30-60 MHz revr w/2 pole 10.7 MHz crystal filter	59.95
RX50C W/T	same as above—wired & tested	104.95
RX144C Kit	140-170 MHz revr w/2 pole 10.7 MHz crystal filter	69.95
RX144C W/T	same as above—wired & tested	114.95
RX220C Kit	210-240 MHz revr w/2 pole 10.7 MHz crystal filter	69.95
RX220C W/T	same as above—wired & tested	114.95
RX432C Kit	432 MHz revr w/2 pole 10.7 MHz crystal filter	79.95
RX432C W/T	same as above—wired & tested	124.95

RECEIVERS



RXCF	accessory filter for above receiver kits gives 70 dB adjacent channel rejection	8.50
RF28 Kit	10 mtr RF front end 10.7 MHz out	12.50
RF50 Kit	6 mtr RF front end 10.7 MHz out	12.50
RF144D Kit	2 mtr RF front end 10.7 MHz out	17.50
RF220D Kit	220 MHz RF front end 10.7 MHz out	17.50
RF432 Kit	432 MHz RF front end 10.7 MHz out	27.50
IF 10.7F Kit	10.7 MHz IF module includes 2 pole crystal filter	27.50
FM455 Kit	455 KHz IF stage plus FM detector	17.50
AS2 Kit	audio and squelch board	15.00

TX50	transmitter exciter, 1 watt, 6 mtr	39.95
TX50 W/T	same as above—wired & tested	59.95
TX144B Kit	transmitter exciter—1 watt—2 mtrs	29.95
TX144B W/T	same as above—wired & tested	49.95
TX220B Kit	transmitter exciter—1watt—220 MHz	29.95

TRANSMITTERS



TX220B W/T	same as above—wired & tested	49.95
TX432B Kit	transmitter exciter 432 MHz	39.95
TX432B W/T	same as above—wired & tested	59.95
TX150 Kit	300 milliwatt, 2 mtr transmitter	19.95
TX150 W/T	same as above—wired & tested	29.95

PA2501H Kit	2 mtr power amp—kit 1w in—25w out with solid state switching, case, connectors	59.95
PA2501H W/T	same as above—wired & tested	74.95
PA4010H Kit	2 mtr power amp—10w in—40w out—relay switching	59.95
PA4010H W/T	same as above—wired & tested	74.95
PA50/25 Kit	6 mtr power amp, 1w in, 25w out, less case, connectors & switching	49.95
PA50/25 W/T	same as above, wired & tested	69.95
PA144/15 Kit	2 mtr power amp—1w in—15w out—less case, connectors and switching	39.95
PA144/25 Kit	same as PA144/15 kit but 25w	49.95
PA220/15 Kit	similar to PA144/15 for 220 MHz	39.95
PA432/10 Kit	power amp—similar to PA144/15 except 10w and 432 MHz	49.95
PA140/10 W/T	10w in—140w out—2 mtr amp	179.95
PA140/30 W/T	30w in—140w out—2 mtr amp	159.95

POWER AMPLIFIERS



Model	BAND	Power Input	Power Output	
BLC 10/70	144 MHz	10W	70W	139.95
BLC 2/70	144 MHz	2W	70W	159.95
BLC 10/150	144 MHz	10W	150W	259.95
BLC 30/150	144 MHz	30W	150W	239.95
BLD 2/60	220 MHz	2W	60W	159.95
BLD 10/60	220 MHz	10W	60W	139.95
BLD 10/120	220 MHz	10W	120W	259.95
BLE 10/40	420 MHz	10W	40W	139.95
BLE 2/40	420 MHz	2W	40W	159.95
BLE 30/80	420 MHz	30W	80W	259.95
BLE 10/80	420 MHz	10W	80W	289.95

PS15C Kit	15 amp—12 volt regulated power supply w/case, w/fold-back current limiting and overvoltage protection	79.95
PS15C W/T	same as above—wired & tested	94.95
PS25C Kit	25 amp—12 volt regulated power supply w/case, w/fold-back current limiting and ovp	129.95
PS25C W/T	same as above—wired & tested	149.95
PS25M Kit	same as PS25C with meters	149.95
PS25M W/T	same as above—wired & tested	169.95

POWER SUPPLIES



O.V.P.	adds over voltage protection to your power supplies, 15 VDC max.	9.95
PS3A Kit	12 volt—power supply regulator card with fold-back current limiting	8.95
PS3012 W/T	new commercial duty 30 amp 12 VDC regulated power supply w/case, w/fold-back current limiting and overvoltage protection	239.95

RPT50 Kit	repeater—6 meter	465.95
RPT50	repeater—6 meter, wired & tested	695.95
RPT144 Kit	repeater—2 mtr—15w—complete (less crystals)	465.95
RPT220 Kit	repeater—220 MHz—15w—complete (less crystals)	465.95
RPT432 Kit	repeater—10 watt—432 MHz (less crystals)	515.95
RPT144 W/T	repeater—15 watt—2 mtr	695.95
RPT220 W/T	repeater—15 watt—220 MHz	695.95
RPT432 W/T	repeater—10 watt—432 MHz	749.95
DPLA50	6 mtr close spaced duplexer	575.00

REPEATERS



DPLA144	2 mtr, 600 KHz spaced duplexer, wired and tuned to frequency	379.95
DPLA220	220 MHz duplexer, wired and tuned to frequency	379.95
DPLA432	rack mount duplexer	319.95
DSC-U	double shielded duplexer cables with PL259 connectors (pr.)	25.00
DSC-N	same as above with type N connectors (pr.)	25.00

TRX50 Kit	Complete 6 mtr FM transceiver kit, 20w out, 10 channel scan with case (less mike and crystals)	229.95
TRX144 Kit	same as above, but 2 mtr & 15w out	219.95
TRX220 Kit	same as above except for 220 MHz	219.95
TRX432 Kit	same as above except 10 watt and 432MHz	254.95
TRC-1	transceiver case only	19.95
TRC-2	transceiver case and accessories	39.95

TRANSCEVERS



OTHER PRODUCTS BY VHF ENGINEERING

CD1 Kit	10 channel receive xtal deck w/diode switching	\$ 6.95
CD2 Kit	10 channel xmit deck w/switch and trimmers	14.95
CD3 Kit	UHF version of CD1 deck, needed for 432 multi-channel operation	12.95
COR2 Kit	carrier operated relay	19.95
SC3 Kit	10 channel auto-scan adapter for RX with priority	19.95
Crystals	we stock most repeater and simplex pairs from 146.0-147.0 (each)	5.00
CWID Kit	159 bit, field programmable, code identifier with built-in squelch tail and ID timers	39.95
CWID	wired and tested, not programmed	54.95
CWID	wired and tested, programmed	59.95
MIC1	2,000 ohm dynamic mike with P.T.I. and coil cord	12.95
TS1 W/T	tone squelch decoder	59.95
TS1 W/T	installed in repeater, including interface accessories	89.95
TD3 Kit	2 tone decoder	29.95
TD3 W/T	same as above—wired & tested	39.95
HL144 W/T	4 pole helical resonator, wired & tested, swept tuned to 144 MHz ban	24.95
HL220 W/T	same as above tuned to 220 MHz ban	24.95
HL432 W/T	same as above tuned to 432 MHz ban	24.95

SYN II Kit	2 mtr synthesizer, transmit offsets programmable from 100 KHz—10 MHz, (Mars offsets with optional adapters)	169.95
SYN II W/T	same as above—wired & tested	239.95
MO-1 Kit	Mars/cap offset optional	2.50
TO-1 Kit	18 MHz optional tripler	2.50

SYNTHESIZERS



HT 144B Kit	2 mtr, 2w, 4 channel, hand held transceiver with crystals for 146.52 simplex	129.95
NICAD	battery pack, 12 VDC, 1/2 amp.	29.95
BC12	battery charger for above	5.95
Rubber Duck	2 mtr, with male BNC connector	12.95

WALKIE-TALKIES



Vhf engineering

DIVISION OF BROWNIAN ELECTRONICS CORP.

BOX S / 320 WATER ST. / BINGHAMTON, N.Y. 13901 / Phone 607-723-9574

vs



RTTY SWLing

-- new horizons!

I have been an enthusiastic shortwave listener for years, with a desire to receive everything in the VLF-HF spectrum (10 kHz to 30 MHz). Recently I programmed a Data General Nova mini to give myself a glimpse into an area of SWLing that I had previously left unexplored — radioteletype, or RTTY, for short.

This article will give you a brief introduction to the technical aspects of RTTY, a

survey of many types of signals heard, and not heard, and two lists of actual off-the-air RTTY frequencies.

I first learned about the existence of RTTY years ago as a high school student attending an Armed Forces Day open house. While I was tuning around with a system on display there, I came upon a Spanish language RTTY transmission, and I was hooked. Imagine a radio typing at 60 wpm and in a

foreign language to boot!

Somewhere along the way I heard that radioteletype was sent at several different "standard" speeds and codes. Not knowing what speeds or codes were in common use was enough to delay my attacking the problem until recently, when I realized what a natural application RTTY SWLing is for a home computer.

RTTY characters are sent as binary data with a series of pulses representing each character. The classical code used for RTTY is commonly called Baudot code. A good deal of what is heard on the air today, including all present US amateur transmissions, is sent in Baudot code.

What the computer hobby-

ist calls "1" and "0" are called "mark" and "space," respectively, in RTTYese. Mark and space are transmitted by shifting the carrier a small amount to either side of an imaginary center frequency. This is called frequency shift keying, or FSK, for short.

To receive RTTY we need a way to distinguish between mark and space. The most common way is to use the receiver in either CW or SSB mode, with the bfo set above the FSK signal, to produce an audio tone of 2125 Hz for mark and a higher frequency tone for space.

What the computer hobbyist calls a demodulator, the RTTY devotee calls a TU (terminal unit), and it's into this device that the audio tones are sent. The demodulator changes the tones into what the old time RTTY man views as an on/off 60 mA loop current, to drive the selector magnets of his Model 19 machine. Modern demodulators, such as the Dovetron used in my system, provide an additional logic output which is a more welcome input to a computer.

Each character sent in Baudot code is composed of a start pulse, five data bits, and a stop pulse. See Fig. 1. The start and stop pulses are used for synchronization; the data bits define the character. A standard Baudot teleprinter has a set of 52 characters and 5 functions. This is accomplished with only 5 data bits by defining one combination of bits as a "figures shift" function and a second as "letters shift." The Baudot character set is shown in Table 1.

What Frequency Is That RTTY Signal On?

If you are interested in RTTY SWLing, you'll more than likely want to start keeping a log of stations heard. Your log would probably include frequency, shift, speed, sense (upright or inverted), times heard, and maybe a hard copy sample of

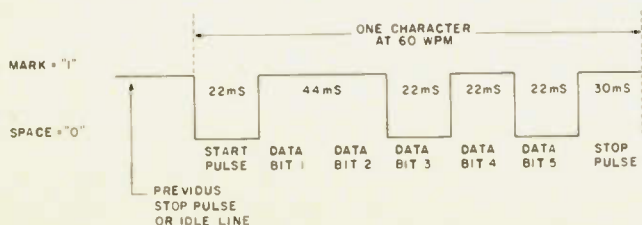

Fig. 1. Typical Baudot 60 wpm RTTY character.

SIGNAL NR	1	2	3	4	5	6	7	8	9	10	11	12	13	14	15	16	17	18	19	20	21	22	23	24	25	26	27	28	29	30	31	32	
FIGURES	—	?	:	+	3	□	▢	▣	8	BELL	()	.	,	9	0	1	4	'	5	7	=	2	/	6	+	CARRIAGE RETURN	LINE FEED	LETTERS	FIGURES	SPACE	BLANK	
LETTERS	A	B	C	D	E	F	G	H	I	J	K	L	M	N	O	P	Q	R	S	T	U	V	W	X	Y	Z							
1	1	1		1	1	1				1	1						1		1		1	1	1	1	1				1	1			
2	2		2				2		2	2	2	2				2	2	2			2	2	2					2	2	2			
FEED HOLE	0	0	0	0	0	0	0	0	0	0	0	0	0	0	0	0	0	0	0	0	0	0	0	0	0	0	0	0	0	0	0	0	
3			3				3	3		3	3		3	3		3	3		3		3	3		3	3				3		3		
4		4	4	4			4	4			4	4		4	4			4			4		4	4			4		4	4			
5		5					5	5				5	5		5	5	5			5		5	5	5	5	5			5	5			

SOME D KEYTOPS READ "WHO ARE YOU" IN U.C., OTHERS ARE BLANK. F,G,H KEYTOPS ARE BLANK IN U.C.

Table 1. Baudot 5-unit code.

some received text. You could exchange this information with other RTTY freaks, go back and listen to favorite stations with a minimum of fuss, etc. Incidentally, one thing you probably shouldn't do is ever let anyone see any of the hard copy text. Unless it's an amateur transmission or clearly of broadcast character (RTTY weather?), it would seem that its disclosure is prohibited by the Communications Act of 1934.

Having decided to start a log, your first problem is what to write down for frequency. What's the standard way of documenting the frequency of a RTTY transmission? The answer, unfortunately, is that there are several "standards" encompassing almost any reasonable method you might devise.

Dyed in the Wool RTTY Ham Method

This method, used by a number of amateurs, is to simply log the frequency of the mark signal. After all, mark is the frequency you're

Method	Frequency Logged
Mark	14800.2125 inverted
Lsb	14802.3375 inverted
Average	14800.000 inverted

Table 2. Examples of three of the methods commonly used to document RTTY frequencies. Taken from ADN, the East German News Agency, sending inverted, 66 wpm, 425 Hz shift, mark = 14799.788, space = 14800.2125.

on more often than not, especially if you aren't a hotshot typist. One of the original ways of generating an FSK signal was to shift the transmitter down from mark to space by switching capacitance into the vfo circuit. Logging the mark frequency is natural for anyone using this method. There's a complication when this method is used on foreign news transmissions or other commercial signals which frequently send "upside-down," i.e., with mark being the lower frequency rf signal. In this case, one logs the higher rf signal (the space signal) and notes that the transmission is inverted.

This method, which we'll call the mark method for short, is the one I use when logging with an R390A. All frequencies mentioned in this article are mark frequencies.

The ARRL Lsb Method

If you use a sideband receiver to receive RTTY, this method should appeal to you. Simply set the receiver to lsb, tune for a mark tone of 2125 Hz, and log the frequency indicated on the receiver's dial. The RTTY frequencies listed in QST under "Operating Events" conform to this convention. This type of signal can be generated at the transmitter simply by driving the microphone input with clean audio tones of the same frequency meant to be recovered at the receiver.

The Imaginary Method

It makes sense to average

folk to talk about RTTY being sent on the frequency halfway between the transmitted mark and space frequencies, i.e., on a frequency which is never actually sent. RTTY weather transmissions and news agencies are among the stations I've found to be using this method. With your receiver in CW mode, use the S-meter to tune for the strongest signal, then read the frequency from your dial. You'll have to set your bfo at different spots depending on the shift being used. This method can be inconvenient if the shift is unknown, if your bfo is uncalibrated, or if a sharp peak on the S-meter cannot be obtained due to a weak signal.

Examples of the three methods described are presented in Table 2. Formulas for converting from one method to another are given in Table 3.

What's To Be Printed?

Imagine that you have the ability to receive and print RTTY sent at any speed. (How this can be done with the help of a computer will be discussed.) You're ready to tune around the HF bands. What signals will you be able to print? See Table 4 for a representative list of signals heard during the last 18 months at my New Jersey QTH. Note that this list is just a sample of what's on the air. For those interested in obtaining a more comprehensive list, I strongly recommend Robert Grove's

Confidential Frequency List (Gilfer Associates, Inc., Box 239, Park Ridge NJ 0765).

Unusual FSK Signals Heard

Roughly half of the FSK signals to be heard on the HF bands cannot be printed intelligibly on a straight Baudot teleprinter, no matter how you fiddle with the adjustments for wpm, shift, upright/inverted. The characteristics of a number of these signals are described in the following paragraphs. Sample frequencies are listed in Table 5.

Cyrillic

Cyrillic alphabet traffic is transmitted using a Baudot-like code. The transmissions in Table 5 listed as "Russian telegrams" are examples of this. On a normal Baudot machine, Cyrillic transmissions print as orderly lines of numbers and punctuation with an occasional "word" or two mixed in. Unlike western Baudot machines, which have two cases (letters and figures), Cyrillic machines have three cases — Latin, Russian, and figures — which are selected by the letters, blank, and figures functions, respectively. If you can cause

$$\begin{aligned} \text{Mark} &= \text{lsb} - 2.125 \\ \text{Mark} &= \text{avg.} + \frac{1}{2} \text{ shift} \end{aligned}$$

$$\begin{aligned} \text{Lsb} &= \text{mark} + 2.125 \\ \text{Lsb} &= \text{avg.} + \frac{1}{2} \text{ shift} + 2.125 \end{aligned}$$

$$\begin{aligned} \text{Avg.} &= \text{mark} - \frac{1}{2} \text{ shift} \\ \text{Avg.} &= \text{lsb} - \frac{1}{2} \text{ shift} - 2.125 \end{aligned}$$

Table 3. Formulas for converting between the various methods of logging RTTY signals.

Freq. kHz	Time GMT	Date GMT	Speed wpm	Upright/ Inverted	Shift Hz	Notes
2429.8	0330	01-31-77	66	I	850	News in Spanish
2682	0430	01-20-76	100	I	170	USCG news relay
3344.4	0350	02-02-77	60	U	800	Station 'WAR' testing with RYs
3562.2	0130	02-01-77	67	U	360	OEJD calling OKBK
3600	OFTN	1976-77	60	U	170	Ham RTTY autostart net
3608	0100	02-06-77	60	U	170	Ham RTTY
3622.9	2230	M-F	60	U	170	ARRL bulletins
3622.9	0400	TU-SU	60	U	170	ARRL bulletins
3622.9	2200	SU	60	U	170	OSCAR schedules for week
4003.1	0145	01-16-76	60	I	425	Mexican news in Spanish
4062.4	0155	01-16-76	100	U	850	WX (weather)
4160	2033	10-11-75	67	U		German ship traffic
4232	0100	09-24-75	100	I		USCG news relay
4235.4	0100	03-05-76	67	U	850	News in Portuguese
4535.4	0255	02-17-76	67	U	425	6VU in Senegal testing
4874.4	0030	03-05-76	60	I	825	MARS traffic
5463.2	0330	02-15-77	60	U	425	News in English, strong signal
5940.4	0315	01-18-76	60	U	850	WX
7406.0	0030	01-22-76	67	I	425	Cuban telegrams
7535.3	0225	03-04-76	67	U	425	Spanish lang. news from France
7954.8	0310	01-06-77	67	I	425	News in Spanish
8140.0	0210	08-25-76	100	U	850	WX
9081.7	0020	08-25-76	67	I	425	CLN244 Havana testing
10176.5	0030		67	I		Spanish lang. telegrams
10972.2	0215	02-18-77	60	U	425	English lang. news
11016.3	2315	03-06-76	67	U	425	Spanish lang. news
11545.8	2130	01-30-77	67	U	425	WX
13479.7	1830	03-06-76	67	U	675	9HA Malta testing
13487.8	1830	03-06-76	67	U	425	News in French
13624.3	1750	01-18-76	100	U	850	WX
13843.1	1910	03-06-76	67	I	425	News in Spanish
13977.4	1945	01-01-76	100	I	170	US naval traffic
14088.0	1330	02-05-77	60	U	170	Hams
14089.6	1840	02-06-77	60	U	170	CO2FRC Havana
14530.4	1915	01-01-76	60	I	850	Telegrams in English
14901.4	1350	04-18-76	67	U	425	News in Spanish
15913.8	1815	11-30-75	67	I	445	News in English
15955.4	1540	10-31-75	67	U		News in French from Morocco
15994.0	1405	10-31-75	100	I		Canadian govt. telegrams
16372.7	1450	05-21-76	60	U	425	News in English
16440.3	1700	12-21-75	100	I	850	WX
16443.1	1500	02-28-76	67	U	425	News in Spanish
18040.8	1340	04-18-76	67	I	850	News in Turkish
18984.2	1620	01-04-76	67	U	425	News in English from Prague
19070.0	1550	10-31-76	67	U	425	News in French from Morocco
19805.5	1415	11-23-75	67	I		News in English
20078.0	1515	12-24-75	67	U	425	News in French
20907.4	1505	02-27-76	60	U	850	WX

Table 4. Normal RTTY signals copied in New Jersey.

a letters shift on receipt of a blank, the garbage lines of figures case characters will be transformed into something almost resembling Slavic language words. I say almost because occasional words will have imbedded figures characters leading to words like BO4EK and HORO&EGO. Cyrillic machines need three cases to take care of the abundance of characters in the Cyrillic alphabet. The "4" in BO4EK is the best a normal machine can do for one of these third case characters.

Baudot Crypto

Encrypted Baudot, where code characters are sub-

stituted on an essentially random basis for plaintext characters and then transmitted, prints as garbage and, as such, is difficult to identify. Unless you have a way of qualifying the speed, sense (upright/inverted), and asynchronous nature of a signal, encrypted Baudot will look like any other garbage, although it will sound better than wrong-speed garbage while being printed.

Encrypted Baudot does not lend itself to being easily decoded. The transmitted characters do not have a one-to-one correspondence to the plaintext characters they represent. Each time a particular plaintext character

is sent, it is encrypted as a different character selected on a random basis or on a pseudo-random basis derived from a complex mathematical formula known only to the receiving end. A string of test characters such as RYRYRYRY might be encrypted and sent as QANFGRM, for example.

Some signals in Table 5 are listed as Baudot crypto. They were categorized as Baudot crypto because they exhibited the following attributes: 1) The received characters are individually all valid Baudot characters; that is, each has a start pulse, five data pulses and a stop pulse. 2) Each character received in

a row exhibits these characteristics. 3) There are 32 possible individual characters in the 5-unit Baudot code.

Using the computer, a large sample of characters (e.g., 800) is received, and the occurrence of each of the possible 32 is counted. The counts are then examined. When analyzed this way, Baudot crypto exhibits an essentially flat character distribution, i.e., just about as many of any one character as of any other. Plaintext or text encoded by simple bit inversion or bit transposition (described later on) show relatively large counts on the characters corresponding to frequently sent characters (space, T, E) and low counts for infrequently sent characters.

Bit Inversion (Funny Cryptic Carrier)

A simple means of preventing the casual listener from reading one's traffic is to invert (mark becomes space and space becomes mark) one or more of the data bits in each character. When received on a normal machine, this type of transmission resembles Baudot crypto, but, upon inspection, it will not show the random character distribution of a highly encrypted code. The characters equivalent to the frequent spaces, Es, and Ts aren't hard to find, if a little elementary cryptanalysis is performed.

The result of bit inversion is the creation of a simple substitution cipher, which ought to appeal to amateur code breakers. The technically inclined code breaker need only get the five data bits of each character in parallel and experiment with inverting them in various combinations (only 32 possible) until he's printing plaintext. The bit inversion frequencies listed in Table 5 provide a 24 hour ready source which should be easy to copy anywhere in the USA. When text isn't being sent, a mark carrier is on the air. Hint: The number of bits

Freq. kHz	Time GMT	Date GMT	Speed wpm	U/I	Shift Hz	Ms/Bit	Notes
2426.4	0330	01-31-77	-	-	850	13	Synchronous
2590.4	0400	01-31-77	100	I	850	-	Baudot crypto, strong signal
2648.2	0410	01-31-77	100	I	170	-	Baudot crypto
2745.6	0330	01-31-77	100	I	850	-	Baudot crypto, strong signal
4015.6	0415	01-31-77	-	-	850	20	Synchronous, clear signal
4042.4	0255	02-08-77	67	I	850	-	Baudot crypto
4144.6	0030	03-05-76	100	U	425	-	Baudot crypto
4295.6	0425	01-31-77	-	-	850	13	Synchronous, strong signal
4348.6	0055	03-03-76	-	-	425	13	Synchronous, strong signal
4714.6	0305	01-18-76	100	I	850	-	Baudot crypto
5070.4	0350	02-15-77	-	-	850	11	Moore, duplex, both channels idle beta
5133.3	0500	03-16-76	60	U	425	-	Bit inversion privacy cipher, heard often
5158.0	0055	02-21-77	-	-	-	-	FDM, strong, buzz saw, 4 chan?
5254.1	0120	02-14-77	-	-	400	11	Moore, strong signal
5857.8	0215	02-14-77	-	-	700	11	Moore, 2 channels, strong signal
5903.6	0040	02-21-77	67	U	850	-	Baudot crypto
6252.4	0230	02-23-76	67	U	425	-	Russian telegrams
6256.4	0230	02-23-76	67	U	425	-	Russian telegrams
6284.5	0230	02-23-76	67	U	425	-	Russian telegrams
7603.8	0230	03-04-76	60	U	425	-	Bit inversion, on all the time
7617.2	0105	02-15-77	-	-	300	11	Moore, idling
7790.0	0135	03-06-76	60	U	425	-	Bit inversion, carrier with sporadic text
7900.2	0115	02-15-77	-	-	400	11	Moore twinplex, TDM/FDM
8216.4	0250	02-26-76	-	-	230	13	Synchronous, strong signal
8312.3	0216	02-07-77	67	U	425	-	Russian telegrams
8336.4	0140	02-18-77	67	U	500	-	Russian telegrams
8344.4	0300	02-26-76	67	U	425+	-	Russian service messages
10245.9	0210	02-10-77	-	-	400	11	Moore idling
11045.3	2250	05-19-76	-	-	850	13	Synchronous
11106.4	2315	05-19-76	-	-	850	16	Synchronous
11610.8	2330	03-06-76	-	-	425	16	Synchronous
12149.8	2030	02-20-77	-	-	-	-	FDM, buzz saw
12256.5	2025	02-20-77	-	-	-	-	FDM, buzz saw, strong signal
12476.3	2000	02-20-77	67	U	425	-	Russian telegrams
12850.4	0005	03-07-76	-	-	850	20	Synchronous, clean signal
12939.6	1445	02-28-76	100	I	850	-	Baudot crypto
13592.3	1245	02-22-77	-	-	850	11	Moore idling, clean signal
13830.3	1600	03-06-76	60	U	425	-	Bit inversion, always on air
13942.2	1745	03-03-76	60	U	425	-	Bit inversion
16220.4	1620	02-20-77	-	-	400	11	Moore twinplex, TDM/FDM
17397.6	1550	02-20-77	-	-	280	11	Moore idling
18045.0	1515	02-20-77	-	-	-	-	FDM, 8 channel?
18583.6	1700	02-12-77	-	-	-	11	Moore idling, strong signal

Table 5. Unusual RTTY signals heard in NJ.

inverted is always 2 or 3 (never 0, 1, 4 or 5), and the key is changed at 0000 hours GMT.

Here's an example: For the sake of discussion, let's number the data bits of the Baudot code 12345 (as in Table 1) and represent characters by binary numbers with mark represented by "1" and space by "0". The letter "E" is represented by 10000, "R" is 01010, etc. If bit inversion is being used on, let's say, bits 4 and 5, 10000 (E) becomes 10011 (B), 01010 (R) becomes 01001 (L), and 00010 (carriage return) becomes 00001 (T). Thus, if bits 4 and 5 are being inverted on a particular day, E will always print as B, R as L, carriage return as T, etc.

Synchronous Codes

We've talked about Baudot being an *asynchronous* code. By this we mean that, due to the presence of a start and stop pulse for every character, each character is self-synchronizing, and there is no other need for the transmitting and receiving ends to stay in synchronization.

There are numerous examples of signals on the air which show no evidence of start and stop pulses. In Table 5, examples of these signals are labeled as *synchronous*.

A study of various methods used for data communication between computers shows that there are many methods of synchronizing the trans-

mitting and receiving ends of a synchronous communications line. In general, these methods have in common the presence of an accurate and stable timebase reference at each end, as well as some means of achieving initial synchronization and periodic resynchronization based on the content of the received signal. A normal Baudot machine will see random false start pulses in a synchronous signal and print garbage.

Other than Moore code, which is described further on, I haven't broken, or even identified, any of the synchronous codes listed in Table 5. The characteristics by which they are classified are simply frequency, shift, and bit size in ms. Computer

analysis has shown that they do not have regularly occurring start and stop pulses for any size code, from a 6-unit code through a 14-unit code.

I would welcome information from readers having definite knowledge about any of these so-called synchronous codes.

Twinplex

Twinplex is a method of transmission in which the carrier is shifted among four discrete, closely spaced frequencies, allowing two distinct (but synchronized) RTTY channels to be simultaneously sent using one transmitter. It is designed such that reception of one of the channels is possible using a fairly standard TU.

Frequency	Notes
8899.970 kHz	Channel 1 space
8900.030 kHz	Channel 1 mark
8900.090 kHz	Channel 2 space
8900.150 kHz	Channel 2 mark
8900.210 kHz	Channel 3 space
8900.270 kHz	Channel 3 mark
8900.330 kHz	Channel 4 space
8900.390 kHz	Channel 4 mark

Table 6. Four channel FDM.

As an example, let's call the four frequencies A, B, C and D as follows:

- A 8900.000 kHz;
- B 8900.200 kHz;
- C 8900.600 kHz;
- D 8900.800 kHz.

We'd like to use these four frequencies, only one at a time, to send two synchronized TTY channels simultaneously. We design our transmitting scheme as follows:

- 1) At any point in time when channels 1 and 2 are both mark, send frequency A.
- 2) When channel 1 is mark and channel 2 is space, send frequency B.
- 3) When channel 1 is space and channel 2 is mark, send frequency C.
- 4) When channels 1 and 2 are both space, send frequency D.

This same relationship between the TTY channels and the transmitted frequency can be shown in tabular form:

Channel 1	M	M	S	S
Channel 2	M	S	M	S
Frequency				
Transmitted	A	B	C	D

If a twinplex signal is recognized as such (a good panadaptor is a help here), it should be possible to print channel 1 on a standard setup, provided the filters in the TU are not too sharp. You will have to tune so that your TU thinks it is seeing mark when either frequency A or frequency B is being transmitted, and seeing space when either frequency C or frequency D is being transmitted. Reference to the table above will show that setting up in this way will recover channel 1.

Commercial equipment,

designed to receive twinplex, separates and recovers both channels simultaneously.

Frequency Division Multiplex (FDM)

Signals exist which are comprised of 4, 8, 16 or more separate RTTY channels sent simultaneously by the same transmitter. The available literature describes both amplitude modulated (pulsed CW) and frequency modulated (FSK) subcarriers with shifts of 30, 35, 42.5, 60 and 85 Hz. The equipment used commercially to separate such a signal into its constituent channels consists of a large, impressive rack of precision narrow band filters.

An example of a 4-channel FDM system using 120 Hz channel separation and FSK with 60 Hz shift per channel is shown in Table 6.

The twinplex signals described earlier can be considered as a special example of FDM. In a twinplex system, at any one instant in time, all the power is in only one of the four subcarriers. This advantage is counterbalanced by the requirement that the two channels of information be synchronized. The channels of a more conventional FDM system need not be synchronized, but the power is shared among the subcarriers, i.e., one subcarrier per channel is transmitted at any instant in time.

It's not unusual to receive signals which sound like a buzz saw gone berserk, and it's these that are allocated to the frequency division multiplex category in Table 5. Since I haven't yet printed clean copy on most of these signals or verified them in some other way, the FDM

Frequency	Notes	Sending
8899.970	Channel AB space	} ABABABAB
8900.030	Channel AB mark	
8900.090	Channel CD space	} CDCDCDCD
8900.150	Channel CD mark	

Table 7. Four channels, TDM/FDM.

listings should not be considered 100% accurate.

Time Division Multiplex (TDM)

If two or more channels of information are separated in time by alternating the transmission of characters from each of the channels, time division multiplex results. Duplex transmission of Moore code, described further on, is an example of TDM.

For example, a 2 channel TDM system would alternate characters from each of two channels. Consider two messages punched on tapes: Channel 1, "READ KILOBAUD" and Channel 2, "ABCDEFGHIJKLM". The transmitter would alternately select a character from channel 1, then channel 2, then channel 1, resulting in a transmission of: "RAEBACDD EKFIGLHOIBJ AKULDM".

TDM/FDM

Time and frequency division multiplex techniques are sometimes combined into a single transmission. I've identified several examples of this to date — two channel FDM transmissions, each channel of which is sending duplex Moore code (TDM).

As an example, consider four TTY channels — A, B, C and D. Each, for simplicity's sake, is sending a message comprised of the channel's name repeated over and over, e.g., channel A's traffic is AAAAAA ..., channel B's traffic isBBBBBB.

This could be combined into a 2-channel (4-frequency) FDM system, the first channel of which is sending alternate characters from A and B (TDM), the second channel of which is sending characters from C and D (also TDM). See Table

7.

Moore (ARQ) Code

In 1963, the International Telecommunication Union published a unanimous recommendation that an automatic repetition on request (ARQ) code be used in situations where the use of a five-unit code would otherwise produce an intolerable error rate. The code recommended, called Moore code after its inventor, is an error-detecting synchronous code which represents each character in seven bits. For any character, three of the seven bits are always mark; the other four are space. This provides an error-detecting function, as well as the means of synchronization. The utility of the code is in full duplex (simultaneous two-way) situations. When one end detects a mutilated character, it momentarily interrupts its transmission of traffic and transmits a special character which initiates an ARQ cycle, that is, the retransmission of the last few characters from the other end.

Thirty-two of the 35 possible Moore code characters have a one-to-one correspondence to Baudot. Figures and letters case characters are paired the same in both codes. Indeed, standard 5-unit teleprinters are used in Moore systems, after appropriate code conversion, to create and print the traffic sent and received. See Tables 1 and 7 for the complete Baudot and Moore codes.

The three special Moore characters without Baudot equivalents are *idle alpha*, *idle beta*, and *signal 1*. The idle characters are used as fillers; signal 1 is the special character used to request a

FIGURES	—	?	:	+	3	□	▢	▣	8	9	()	.	,	0	1	4	'	5	7	=	2	/	6	+	CARRIAGE RETURN	LINE FEED	LETTERS	FIGURES	SPACE	BLANK	SIGNAL	IDLE	IDLE	
LETTERS	A	B	C	D	E	F	G	H	I	J	K	L	M	N	O	P	Q	R	S	T	U	V	W	X	Y	Z									
1			1				1	1	1			1	1	1	1											1	1								
2					2		2		2	2		2					2	2		2						2			2	2			2	2	2
3	3	3		3	3	3		3	3			3	3						3				3	3	3		3						3		
FEED HOLE	0	0	0	0	0	0	0	0	0	0	0	0	0	0	0	0	0	0	0	0	0	0	0	0	0	0	0	0	0	0	0	0	0	0	0
4	4	4	4	4	4						4					4	4		4							4	4		4					4	4
5			5	5										5	5		5	5		5			5	5	5			5	5				5		
6	6				6	6		6	6	6				6	6				6	6			6			6	6		6						
7		7			7	7			7	7		7				7			7	7		7	7		7	7						7		7	

Table 8. Moore 7-unit code.

retransmission when a mutilated character has been received. The Moore signals I've received are comprised of two separate channels of information. Two different Baudot signals are translated to Moore and alternately sampled to produce a single FSK transmission. This is called duplex and results in a bit length of 11.67 ms or 163.38 ms per character pair. Characters from the two channels, called the A and B channels, are sent in alternate time slots, one A character, one B character, etc. To further complicate things (actually to help synchronize and to distinguish between the A and B channels), certain character positions are sent inverted, that is, 4 bits of mark and 3 of space. The pattern of inverted and uninverted characters repeats in cycles of 8 characters, 4 from channel A, 4 from channel B. Using upper case to represent uninverted characters, the two channels are combined in the following repetitive pattern: abaBABA b. This pattern repeats over and over, providing the method of distinguishing between channels and aiding in synchronization.

RUMORED SIGNALS

This section will present the characteristics of various signals which I've never heard on the air. I almost believe they're out there just waiting for the sunspots to come back. My faith is due to the

number of people I've talked to who are convinced that they have received them, plus what I've been able to find in the literature.

Correspondence from readers who can provide actual time and frequencies of nonstandard RTTY signals, based on their personal listening or commercial experience, would be welcome.

ASCII

A popular nonsignal among hams is ASCII. Some are even convinced that most of the FSK they can't print is ASCII. I wish that were so. It's not. At least not where my antenna's been pointing. Using the computer, as will be described, I've analyzed hundreds of non-Baudot signals. I've never found any non-Baudot asynchronous code, let alone ASCII. They tell me Canadian amateurs are using it and North African news agencies, too. I'll keep looking.

Six-Unit Typesetter Code

Some South American countries are said to use a six-unit typesetter code on the air. This code is said to have a start pulse, five data bits, and that's it — no stop pulse.

High Speed Morse Code

High speed Morse code (around 300 wpm) is used in tactical situations to prevent interception and direction-finding by the enemy. Advantages are that simple equipment can be used at

both ends. An operator records a message at normal speed, it is sent at high speed, recorded at high speed at the receiving end, played back at greatly reduced speed, and reduced to writing by a trained Morse operator. Despite the current disagreements between New Jersey and New York with respect to state income taxes, no high speed Morse has been received at my QTH.

Bit Transposition Baudot Cipher

Bit transposition is said to be used in private systems, similar in application to the bit inversion system described earlier. As with bit inversion, bit transposition requires that the five data bits of the Baudot character be obtained in parallel at both ends of the circuit. At the sending end, using a switchboard type arrangement, two to five of the data bits of the character are scrambled, according to a prearranged pattern, by moving them to a different position. At the receiving end, after obtaining the data bits of the character in parallel, the bits are unscrambled, utilizing a similar switchboard, then the character is printed.

Here's an example: As in the discussion of bit inversion presented earlier, let's number the data bits of the character 12345. A simple example of bit transposition would be for the sending end to transpose bits 1 and 5. Then 10000 (E) becomes

00001 (T), 01010 (R) remains unchanged, 01001 (L) becomes 11000 (A), and 01111 (V) becomes 11110 (K).

Character frequency distribution analysis of a bit transposition cipher would indicate a simple character substitution code. To date, computer analysis of scores of strange Baudot signals has not resulted in the identification of any bit transposition transmissions.

Bit transposition and bit inversion can be combined in a single system simply by the application of both techniques simultaneously. For our example, we'll invert bits 4 and 5 of each character and then, after inversion, we'll transpose bits 1 and 5.

Plaintext:
10000 (E)
01010 (R)
10011 (B)

Bits 4 and 5 inverted:
10011 (B)
01001 (L)
10000 (E)

Bits 1 and 5 transposed:
10011 (B)
11000 (A)
00001 (T)

If the procedures are reversed, that is, transposition first, then inversion, the results are entirely different.

Plaintext:
10000 (E)
01010 (R)
10011 (B)

Bits 1 and 5 transposed:

00001 (T)
01010 (R)
10011 (B)

Bits 4 and 5 inverted:

00010 (car. ret.)
01001 (L)
10000 (E)

Note that bit inversion, bit transposition, bit inversion followed by transposition, and bit transposition followed by inversion all have one thing in common — their use results in

the creation of a simple character substitution cipher. As long as the key remains unchanged, each plaintext character will result in the same encoded character every time it is sent.

Although several sources have indicated that simultaneous bit transposition and inversion was in common use just several years ago, I haven't found any of it on the air since I've been listening.

I developed a computer

program over the last two years to help in the reception and analysis of the many hundreds of RTTY signals I have found on the air. Without this computer program, the preceding article could not have been written. The computer provided the versatility necessary to quickly identify and print a variety of normal RTTY signals, as well as to analyze and classify the unusual signals.

This combination of the

radio and computer hobbies is still in its infancy and would seem ready for growth. The number of RTTY signals on the air is increasing all the time; there are codes yet to be discovered, as well as a variety of codes already discovered, which need further analysis. Attacking this with a home computer is a computer game of sorts, a real time, real world computer game, which is at once very challenging and very satisfying. ■

THIS YEAR . . .

GET ON TOP WITH ALPHA

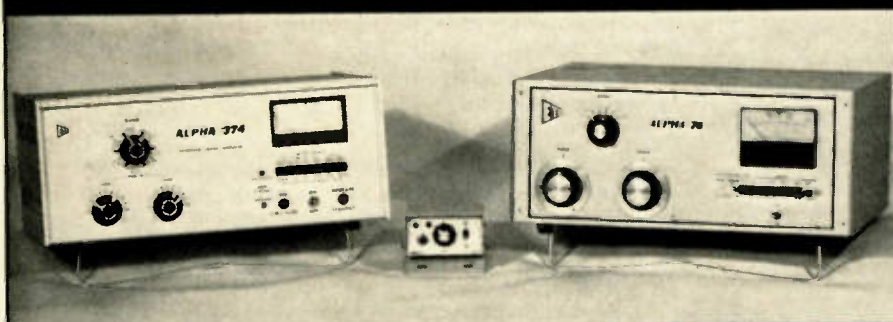

**A GREAT OPERATING YEAR IS STARTING RIGHT NOW.
SUNSPOTS ARE UP — CONDITIONS SHOULD BE THE BEST IN YEARS.
THOUSANDS OF ENTHUSIASTIC NEW AMATEURS ARE ON THE BANDS.
HAMMING WILL BE TERRIFIC —
BUT COMPETITION WILL BE ROUGH!**

**WHEN QRM RAGES AND THE PILE-UPS DEEPEN,
WOULDN'T YOU LIKE TO HAVE. . .**

- ALL THE ROCK-CRUSHING POWER YOUR LICENSE ALLOWS — on all modes — with no need to 'baby' your linear, no duty cycle or time limit at all?
- INSTANT BANDCHANGE 'NO-TUNE-UP' all the way from 10 through 80 meters, with the exclusive ALPHA 374?
- COVERAGE ALL THE WAY DOWN TO 160 METERS with the smooth-tuning, extra-rugged ALPHA 76 powerhouse?
- CRISP, PENETRATING "TALK POWER" — as much as 10 dB extra to 'punch through' when the going gets really tough, with the ALPHA/VOMAX split band speech processor? It's as effective as the best rf processor, lower in distortion, and very easy to use with any rig!
- THE PROTECTION OF A FACTORY WARRANTY THAT RUNS A FULL 18 MONTHS — six times as long as competitive units? (ETO tries to build every ALPHA to last forever . . . and we're making progress: not one single case of ALPHA 76, 77D, or 374 power transformer failure has ever been reported!)
- THE PURE PLEASURE OF OWNING ALPHA?

ALPHA: SURE YOU CAN BUY A CHEAPER LINEAR —
BUT IS THAT REALLY WHAT YOU WANT?

START ENJOYING THE ALPHA EDGE NOW. Call or visit your nearest ALPHA/ETO dealer, or ETO direct, right away, and you can have prompt delivery of your new ALPHA linear amplifier and ALPHA/VOMAX processor. While you're at it, ask for illustrated literature describing all ALPHA products in detail, as well as a copy of "Everything You Always Wanted to Know About (Comparing) Linears . . . But Didn't Know Whom to Ask."

ETO

**EHRHORN TECHNOLOGICAL OPERATIONS, INC.
BOX 708, CANON CITY, CO 81212 (303) 275-1613**

NEW!

**A \$34.95
Meter Calibrator!**

A quality volt-ohm calibrator at a breakthrough price! Why put off calibration of your VOM, VTVM, or digital multimeter?

Here's what you get:

- Check DC volts at 0.100 V, 1.000 V, and 10.000 V
 - Up to 0.02% accuracy on volts
 - Check ohms at 100Ω, 1k, 10k, 100k, and 1 meg.
 - Up to 0.1% accuracy on ohms
- Battery powered, uses 2-9 V batteries (not included)
Uses hybrid IC precision reference

Only \$34.95 each. Please add \$1.50 postage. CA residents add \$2.10 tax.

Gary McClellan and Co. Box 2085
1001 W. Imperial Hwy.
La Habra CA 90631

PRINTED CIRCUIT

**BYTESIZE CIRCUIT BOARD
BLANKS, POSITIVE ACTING PHOTO
RESIST, CARBIDE DRILL BITS, SNAP
IN CIRCUIT BOARD SPACERS AND
CARD PULLERS, DRILL/MILLS,
PROTOTYPE BOARDS, W. H. BRADY
& DATA DRAFTING ARTWORK,
MATTE FILM, PRECISION GRIDS,
BUBBLE ETCHERS, PC DESOLDER—
ING TOOLS, POSITIVE ACTING
DIAZO FILM, PRECOATED CIRCUIT
BOARDS, SILVER PLATING POWDER,
WIRE WRAP TOOLS**

SEND STAMP & ADDRESS FOR FLYER

TRUMBULL CO.

833 Balra Dr., El Cerrito, CA 94530

About two years ago I saw an amateur radio teletype (RTTY) station on the air. That one look was all it took to fix in my mind that one day I would communicate from a keyboard instead of a mike.

Finally after several months of searching, I found my machine, a Model 15. It had been used in amateur service before and was in practically new condition.

Once I was home with the 15, the big job started — convincing the XYL that there was room in the spare bedroom I call a ham shack for this thing that it took two people to carry in. Fortunately, I have an understanding XYL, and, after some moving around of furniture, the 15 was set in position next to my operating table.

I plugged it in and turned the switch on. The motor came to life, and I was ready to see if this thing would really type. It wouldn't. I didn't know much about RTTY at that point, but I took a guess that it might have something to do with the two wires that were dangling down from the machine with phono plugs on the end.

It seemed that now was the time to pull out the back issues of 73, which make up a large part of my reference library, and find out a little more about the 15 — like how do I make it type. After a few hours, I finally had it figured out. What I needed was a thing called a loop

supply. It seemed that the RTTY needed dc as well as ac to run on.

I did more reading and looking for a loop supply that I could build and finally reached a conclusion. I would design and build the supply to fit my needs. My requirements were:

1. Ability to run the page printer from the keyboard (to make sure it will work).
2. Ability to run the page printer from a paper tape reader (T.D.). I was lucky to acquire one of these with the 15.
3. Ability to run a paper tape punch and the page printer at the same time. (What good is a tape reader without a tape punch?)
4. Use as few parts as possible. (I have a small junk

box.)

5. All parts to be readily available. (Someone else might like to build one.)

6. Keep cost at a reasonable level. (My extra money is smaller than my junk box.)

A schematic diagram of the local loop supply that meets my requirements is shown in Fig. 1.

Unfortunately, the only parts I found in the parts box were the pilot lamp and the fuse holder, which is not much to start with. One of the requirements was that all parts be readily available, and a trip to the local Radio Shack found all the parts in stock. (The part numbers I used are listed in this article.)

The phono plug should not be grounded in this circuit. To overcome this problem, I first used one of the black Bakelite boxes that are so handy for small projects. This was a mistake. I found the mistake after about 10 minutes of test operation

as the box slowly started melting around the resistors.

I made a second trip to town and back for a new box, this time a metal one with vents. I had no more problem with heat buildup. I insulated the jacks from the metal cabinet by using vinyl grommets.

If you do not run a type punch and T.D., you could leave out phono jacks J-3 and J-4. R-1 is a 2.5k Ohm, 10 W resistor, which gives the 60 mA required by my 15. (Since the required resistor wasn't available, I used my vast knowledge of electronics and came up with two 1k Ohm and one 500 Ohm resistors in series.)

So, I've got my 15 typing, and it's doing a good job. Now all I have to do is find out how to get it on the air. I believe it takes something called a converter and an AFSK oscillator. I have some ideas for the oscillator, and maybe I can tell you how it turns out later. ■

Parts List

Quantity	Description	Radio Shack Part Number
1	ac power cord	278-1255
1	fuse holder	270-739
1	fuse (1 Amp)	270-1273
1	pilot lamp	272-703
1	metal cabinet 4" x 2½" x 6"	270-252
1	push/on—push/off switch	275-1551
1	full-wave bridge rectifier (4 Amp, 450 volt)	276-1172
1	electrolytic capacitor (20 uF, 450 volt)	272-103
2	10 Watt power resistors (1000 Ohm)	271-140
1	10 Watt power resistor (500 Ohm)	271-138
4	phone jacks 2 conductor (closed circuit type)	274-255

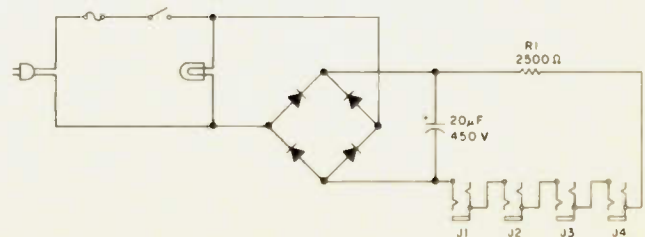

Fig. 1.

Try the RTTY Reader

-- computer display goes ham!

Only a handful of area RTTY enthusiasts could be convinced to come up to two meters from the HF bands. That was until the Central Pennsylvania Repeater Association (CPRA) established its WR3ACO RTTY machine*. Now, with autostart a must, a Model 15 printer has become a "paper hungry monster," with the machine running continuously from early afternoon until well after midnight. In the Harrisburg PA area, your only defense against a daily reading load approaching the *New York Times* is to turn the thing off, and miss all the good stuff, or record everything on cassette tape.

In my search for noiseless RTTY, I came upon a truly unique subassembly, designed

*WR3ACO RTTY rpt (ns). In: 147.975 MHz; out: 147.375 MHz.

and built by Micon Industries in Oakland CA.¹ The unit is an extra bright alphanumeric display module designated as the #932. The module is the heart of their personal computer terminal called the Pocket-term. The display consists of a single line of text with 32 alphanumeric character positions. The letters are the size of a display on a typical hand-held calculator, but the display is 6.4 inches in length. The LED module can be set up to display parallel ASCII or Baudot information simply by grounding one pin of its 16 pin minidip interface plug. Further, information may be shown in a variety of ways — typewriter mode with cursor reset, clear, and backspace, or in a walking mode similar to the Times Square news and weather display. Another mode, burst mode, may also

be used ... for the more enthusiastic builder.

Therefore, if a mother board were designed into which the display module could be plugged, providing a simple RTTY terminal unit, a UART for converting serial Baudot to parallel, power supplies and some associated interface circuitry so that the #932 module could be used without modification, a desktop RTTY reader would be the result. As an added bonus, the unit, when completed, would be hardly bigger than a carton of cigarettes.

A letter to Micon Industries brought the display to my door in less than two weeks. The associated data sheets left much to be desired, but the basic data furnished was sufficient to continue with the project. Table 1 shows the terminations for

the 16 pin male DIP plug which is furnished with the module along with about 8 inches of ribbon cable.

Circuit Interface

The scan clock and the memory clock are both driven from the same simple CMOS oscillator. The clock must run anywhere from 3 kHz to 5 kHz and is not critical. The scan clock is interrupted by the use of the clock inhibit (pin 14 for use in the walking mode, in this application). Only one 8-input NAND gate is required to decode the FIGS LTRS input. By recognizing the high condition of Baudot data bits 01, 02, 04, and 05 and pin 19 of the UART, we can then use data bit 03 to tell the display module the shift code for FIGS or LTRS.

This arrangement, when data bits and pin 19 of the UART are in the true state, allows the flip-flop to sample bit 03. Almost as an afterthought, the same logic was applied to decode uppercase "S" or bells... you just gotta have bells. One half of the CD4013 D type flip-flop is clocked similarly, but this time detecting a true condition on the 5 data lines (three inverters are required) and, once again, the high condition on pin 19 of the UART. An all conditions true for upper case "S" triggers the other half of the CD4013, which is set up as a one-shot multivibrator. Given that the single Baudot code for a bell is approximately 160 ms, the RC network on the one-shot stretches this pulse length to about 250 ms. This pulse then directly triggers pin 4 of an NE555 timer, set up in an oscillator configuration, which drives a speaker directly from pin 3 through a capacitor. This oscillator is set up to provide a fairly good volume without controls. But volume can be adjusted to suit by shunting the output more than that shown. All unused CMOS inputs must be grounded or

Pin #	Function
1	Ground
2	-12 volts dc
3	End of line (positive edge indicates start of new line)
4	Memory clock 4 kHz
5	Read/Write
6	LTRS (low); FIGS (high) ... also 6th bit in ASCII
7	05
8	04
9	03 DATA IN ... five bits for Baudot, 6 bits for ASCII
10	02 with pin 11 being the least significant bit.
11	01
12	An LED indicator which needs only +5 volts through a 470 Ohm res.
13	Scan clock ... connect to pin 4
14	Clock Inhibit "0" enable
15	Baudot (high); ASCII bring low
16	+5 volt logic supply

Table 1. Pin connections for the Micon #932 display module.

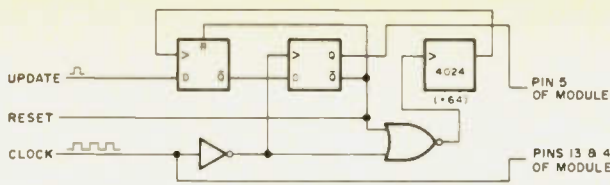

Fig. 1. Typewriter mode.

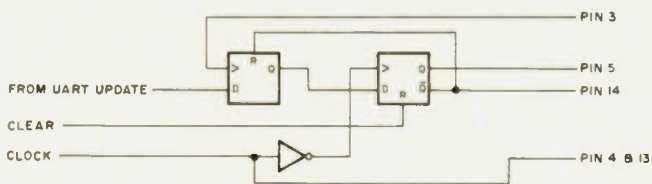

Fig. 2. Walking mode. Data bits must all be low when clear is activated.

connected to other inputs to prevent self-oscillation.

Two clocks are required to operate the display. The UART clock should be set to 727 Hz for 60 wpm operation. The clock speed control will adjust to any speed desired, however. If the fixed resistor is carbon film, then the variable control can be any cheap composition type, while still maintaining greater than 1% frequency tolerance. The capacitor should be mylar or silver mica. The display clock, on the other hand, is not critical and can have a 20% tolerance. Therefore, composition resistors and a disc capacitor may be used. No adjustment of this clock should be necessary. The CD4049 hex inverter is used for both clocks, as the outputs are buffered as necessary.

As a special note, additional information is presented for other applications for the display module. A strapping option on the board allows the use of EBCDIC. The display can accept data rates of up to 250 characters per second — too fast to read but not to photograph. Higher speed versions can be furnished by Micon that will display up to 1000 characters per second. Power requirements for the RTTY reader are +5 volt logic at about 600 mA and a scant 20 mA at -12 volts. Since the display module and the UART both require -12 volts, no other voltages are required. Each character of the multiplexed

array emits about 500 microcandles of light. It's almost too bright. Only one character position is being illuminated at any one time, and the display appears to the eye as average. Actually, each LED is being strobed 32 times brighter than its average appearance, but is run on a 1 out of 32 duty cycle. The 4 kHz clock frequency produces a scan frequency of 125 Hz. Any scan frequency below 90 Hz may cause the display to flicker.

The negative edge of the clock applied to pin 13 (see Table 1) will advance the scan logic and character position to the right. On the negative edge of the clock applied to pin 4, the memory will select the segments to be lighted for the next character. If pins 4 and 13 are tied together, as they are in this application, then the display (with no new data entered) will appear

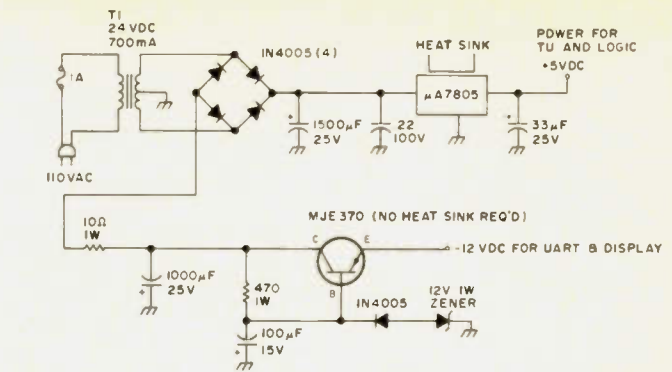

Fig. 3. RTTY reader supply. 5 — 1N4005 diodes; 1 — 1500 μ F 25 V; 1 — .22 μ F 100 V; 1 — 33 μ F 25 V; 1 — UA7805/MC7805; 1 — xfmr 24 V ac 700 mA, Stancur; 1 — MJE370; 1 — 12 volt zener; 1 — 470 Ω 1 W resistor; 1 — 10 Ω 1 W resistor; 1 — 1000 μ F 25 V; 1 — 100 μ F 15 V.

static. A positive edge is output from pin 3 every time a scan starts out from the left of the display. This pulse is used to synchronize character positioning for the updates. For example, if, in typewriter mode, you wish to place a new character in position 14 (from the left of the display), wait until you receive a positive edge from pin 3, and then count 13 negative edges of the scan and memory clock. Now the read/write line on pin 5 should be pulled low, and, during the next positive edge of the memory clock, the character on the input pins will be loaded to memory. Pin 5 should be returned high on the next negative edge.

In the project described here, the walking mode is used. Here update occurs coincident with the positive

edge of pin 3. This causes the new character to appear in the left-most position. All characters are then shifted to the left, rotating the new character to the right. In order to move characters to the left, the scan clock needs to skip one cycle in relation to the memory clock. Conversely, skipping a memory clock cycle in relation to the scan clock causes all the characters to advance in the other direction. In the walking mode, pins 4 and 13 can still be tied together, and pin 14, the scan clock inhibit, can be used to inhibit scan cycles. See Figs. 1 and 2.

Pin 12 on the module connector controls a bright spot LED on the left end of the display. This may be used as an indicator for anything. Here we use it as a tuning LED for mark (on) and space

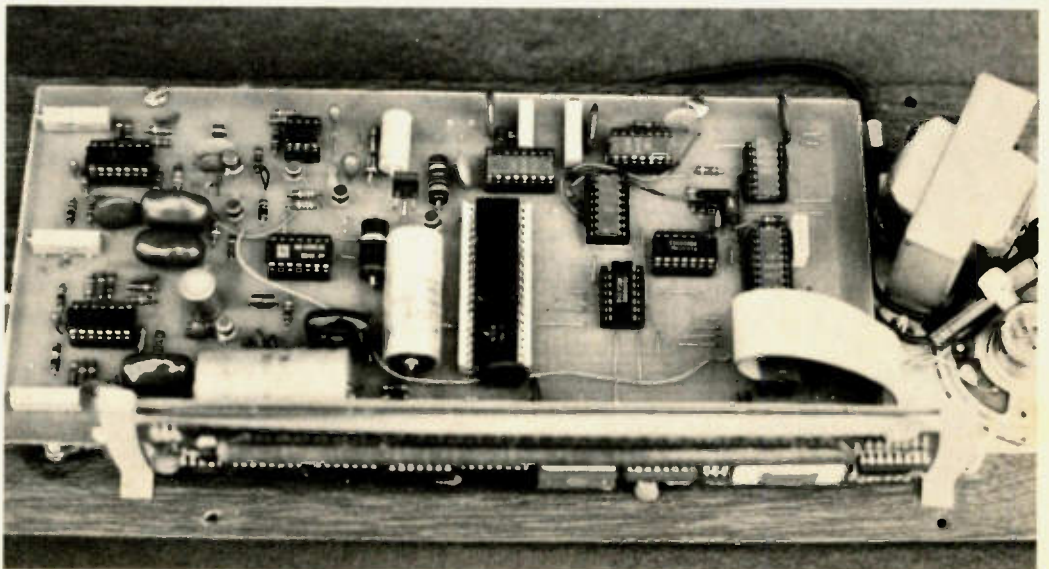

(off) for tuning in signals. In my version of the RTTY reader, there are absolutely no external controls — switches or knobs — not because we don't like them, but none were necessary. The TU to be described has such a wide dynamic range with self-limiting that no control was required. No manual reset was required, either, because of the electronic autostart control system included. The only wires coming out of the box, then, are the ac power cord and an audio input phono connector. When using the LED indicator, be sure to current limit the LED with a 470 Ohm resistor, if using a 5 volt supply.

Construction of the RTTY Reader

Construction of the RTTY reader mother board, which included TU, autostart, power supplies, and UART, is easily accomplished with a single-sided PC board included. Construction is begun with the two power supplies. A single 24 volt power trans-

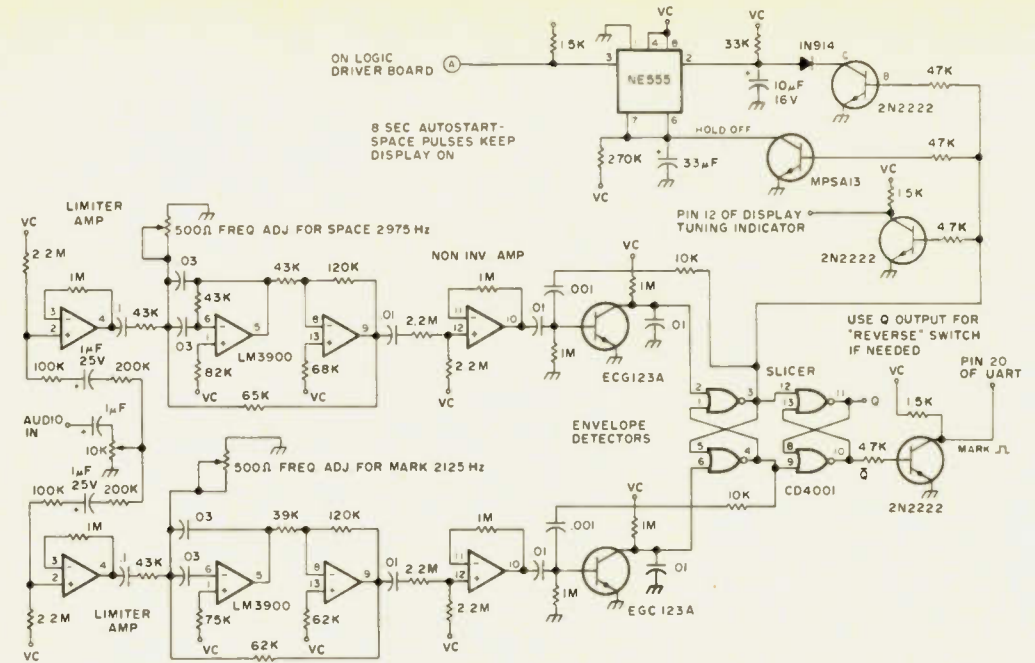

Fig. 4. RTTY reader terminal unit. Vc is +5 V dc. (Pin 14 is Vc, pin 7 is gnd.) 2 — 500 Ω type 43 trimpot, James; 1 — 10k type 43 trimpot, James; all resistors are ¼ Watt 10%/5%.

former is used with center tap to ground. The resulting plus 12 volt supply is used in the 5 volt logic regulator, and the minus 12 volt supply is regulated for both the UART and the display module. As can be seen, there are many over-board power supply

jumpers to provide power up of each individual stage or functional section of the board. This aids stage by stage testing of the unit. Complete stage by stage testing is a must to avoid errors which would destroy costly CMOS components.

The power supply is a straightforward design with an MC7805 or equivalent used for the 5 volt regulator chip. Adequate +5 volt power supply bypassing is provided throughout by the liberal use of .1 uF capacitors at the inputs of the various stages.

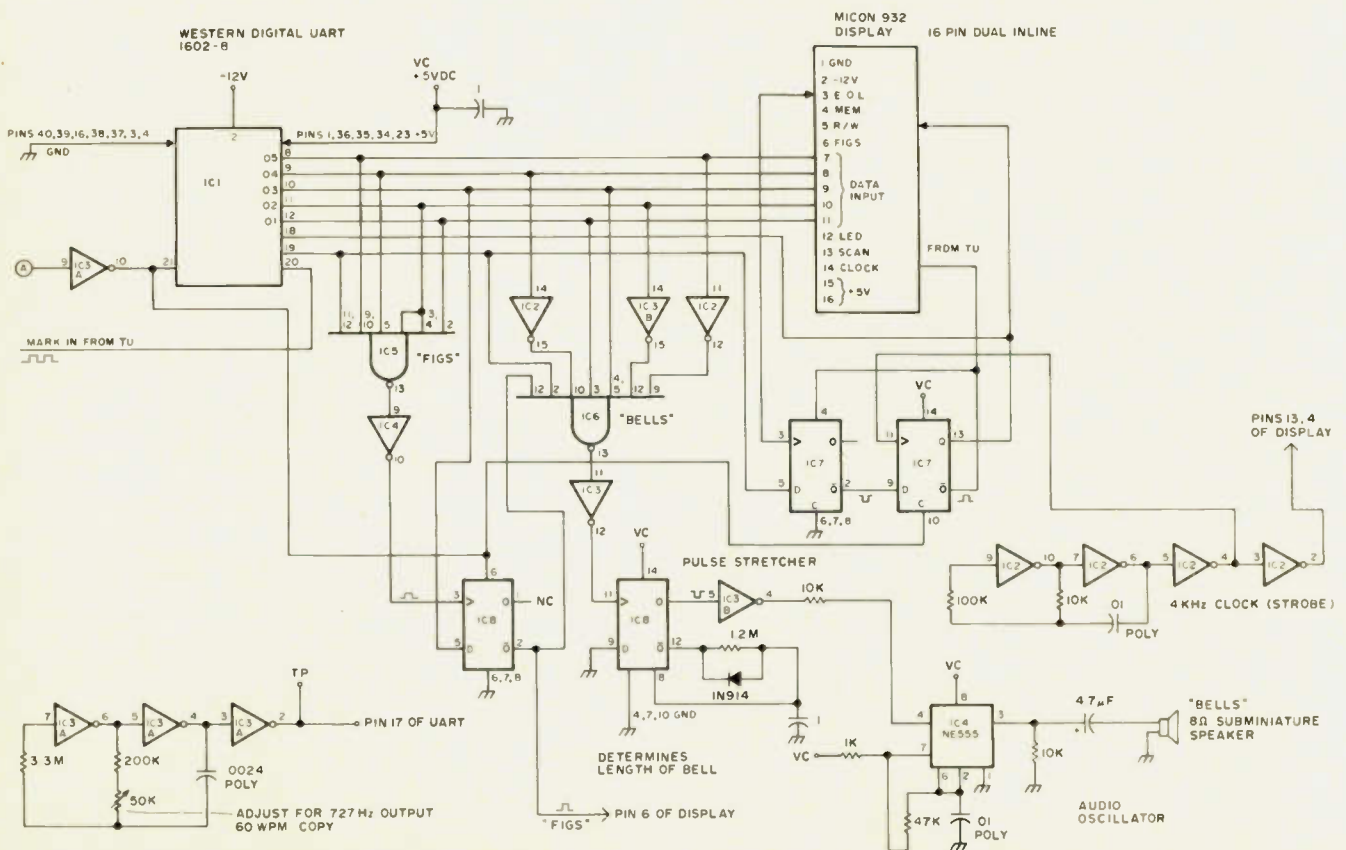

Fig. 5. Logic display driver. 1 — IC1 1602B UART, Tri-Tek; 3 — IC2, 3 CD4049; 1 — IC4 NE555; 2 — IC5, 6 CD4068B; 2 — IC7, 8 CD4013; 1 — 50k type 43 trimpot, James; all resistors ¼ Watt 5%.

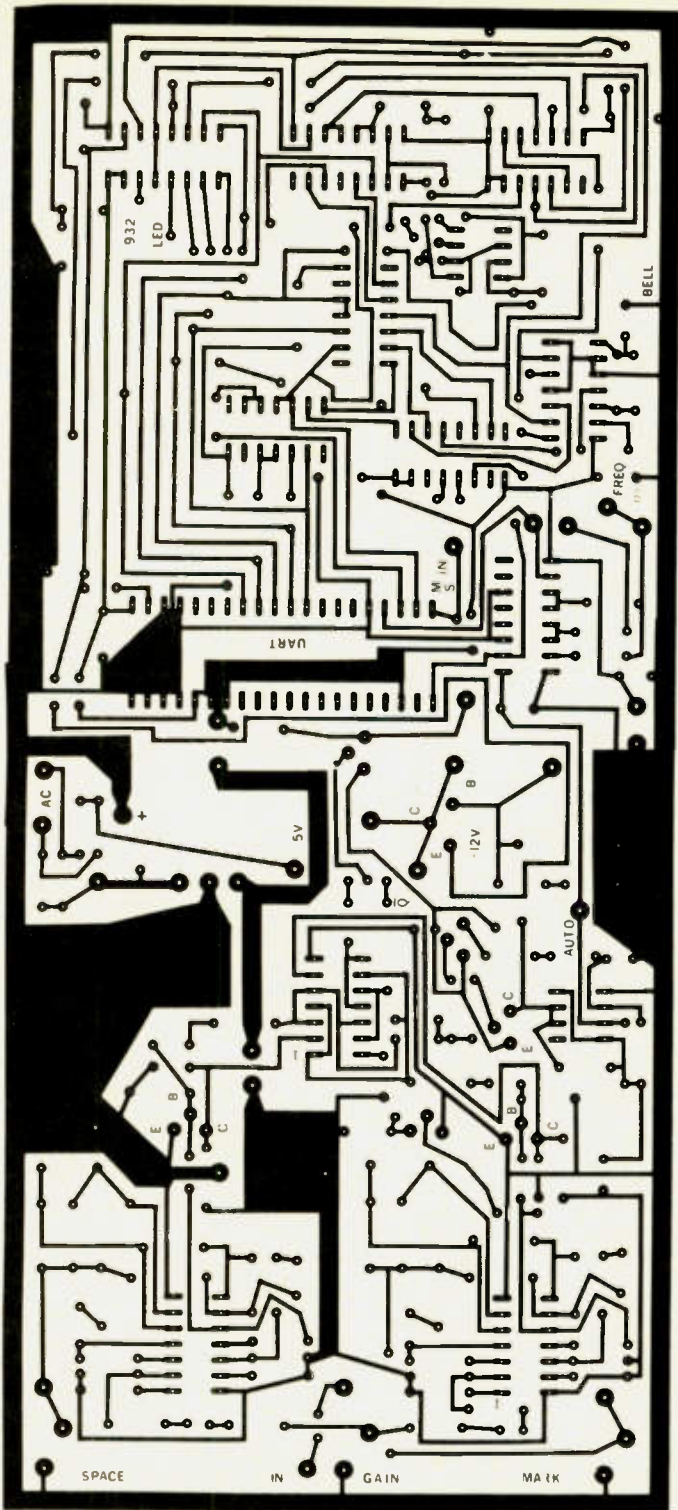

Fig. 6. PC board. Component layout shown from bottom.

The -12 volt supply requires no heat sink because the MJE370 current demand is well under 50 mA. The 5 volt supply will require heat sinking in addition to the large foil on the board for this purpose, because, with all the characters going on the screen, thermal shutdown will occur without sinking. The mother board was mounted on 1/4 inch standoff

RTTY Terminal Unit

The all-purpose mother

board also provides a simple, yet very effective, RTTY terminal unit, with many desirable features. Mark and space tones are easily adjusted with a simple pot. The terminal unit described makes use of the LM3900 quad op amp.

This unique component consists of four individual operational amplifiers in a

standard 14 pin dual in-line case. The power supplied to this component can be anything between +5 volts up to 18 volts. See Fig. 4. Audio from the receiver is brought to the board through a 1 uF capacitor and volume control. The audio path is divided and directed to two sections of the op amp, which are limiting non-inverting amplifiers. These amplifiers in turn

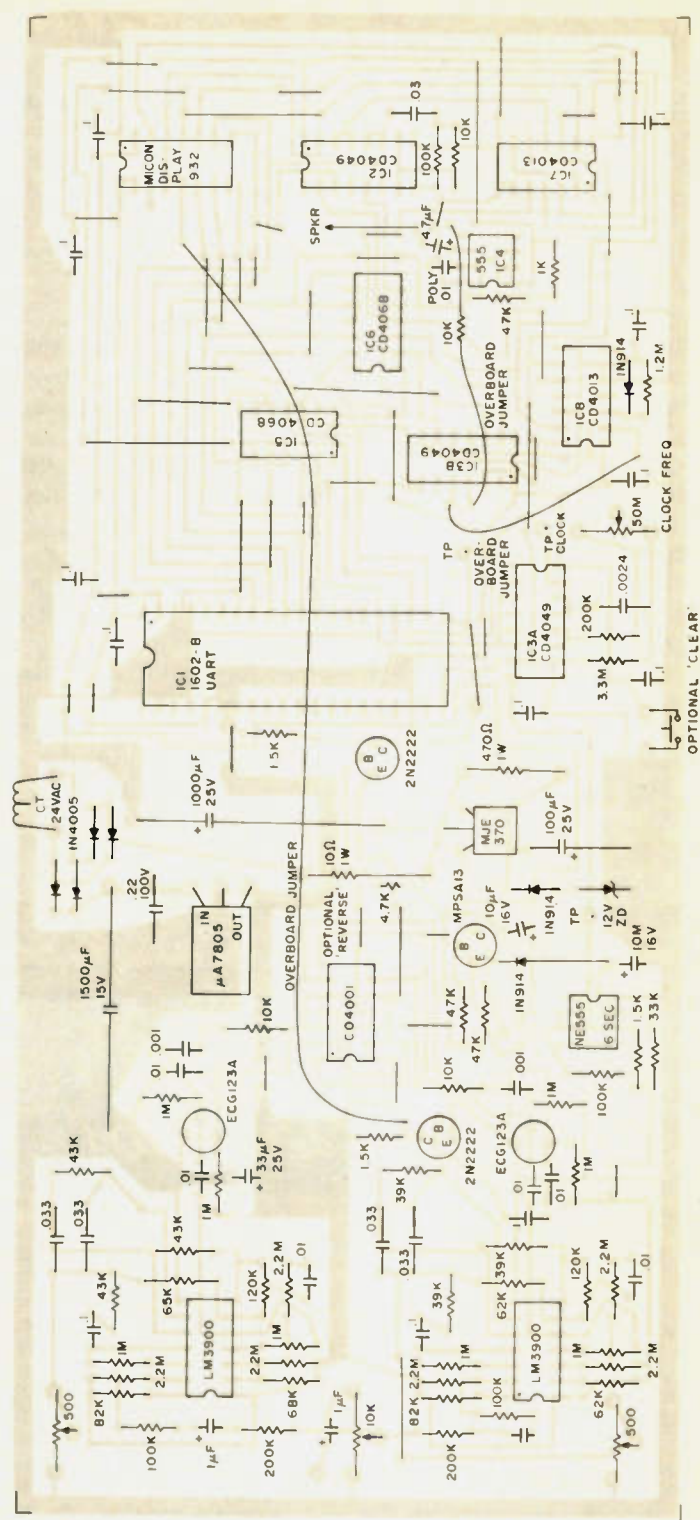

drive a two stage bandpass filter with a gain of 15 and a Q of about 25. A slight frequency variation of the bandpass is possible by using the 500 Ohm variable resistor employed in the feedback circuit of each bandpass filter. The values shown for each filter were selected for a mark tone of 2125 and a space tone of 2975 Hz, respectively. The resistors shown in the feedback path will provide for optimum gain and Q but are not that critical. Determination of these components was obtained from the *Op Amp Cookbook*². Other space tones, such as 2295, may be substituted and are within the practical range of the given component values. However, not inserting more exacting parts in the feedback circuits causes some gain and some Q loss.

The outputs of both filters are once again amplified in a non-inverting final stage of

the LM3900. Tuning the active filters consists of driving the input from an audio source of the proper frequency and turning the 500 Ohm pot on each feedback network for maximum sine wave output at pin 10 of the op amp with a simple ac scope.

The MPS 2925 (ECG 123A) transistors convert the audio peaks to CMOS driving pulses in an envelope detector configuration. The two detectors then drive alternately a basic RS flip-flop, which follows the mark-space transition. The output is buffered again, resulting in a Q and Q-bar output of IC1, which then drives a low power keying transistor used to provide RTTY serial input to the UART. A reverse switch may be installed at this point if desired.

Autostart

The autostart function utilizes a small portion of rectified audio from the out-

put of the 2125 amplifier. This audio delay starts (about 3 seconds) an NE555 timer, which is held from timing out by the use of space tones to bleed off the timing capacitor. Since the output of the NE555 at pin 3 is held high with valid RTTY only, the output is coupled to pin 21 of the UART. This supplies enable high to the UART and supplies a clear to the update flip-flop, causing the recirculate line to go low. This will fill the display with the characters present on the data lines. Since the UART has been reset, the data lines will all be "0", thereby filling the display with blanks. The NE555 also provides a clear pulse to the FIGS/LTRS FF, which always comes up in LTRS. Reset of this line occurs in three ways — autostart call-up, manual push-button (if desired), and power up.

A miniature noiseless RTTY terminal, without the rigid design specifications and

high cost of a video/CRT system, is the result of this project. Other applications could include an automatic Morse code reader display or a portable "advertising" display using prerecorded information on a tape recorder. Perhaps the more industrious ham gear manufacturers will provide a similar module in their new receiver models, which decode Morse, all speed RTTY, and ASCII at the flick of a panel switch.

We hope you will have as much fun with this project as we did in building and showing it off. Technical questions with regard to the display module should be directed to Mike, and TU interface and mother board questions to W3JJU. Good viewing. ■

References

1. Micon Industries, 252 Oak Street, Oakland CA 94607, ADM #932, \$199.00 in quantities of 7 or more.
2. *Op Amp Cookbook*, Walter Jung, Howard Sams, 1975.



EDITORIAL BY WAYNE GREEN

from page 16

FRIVOLOUS PETITIONS

The FCC says on the one hand that it doesn't hear enough from amateurs about the rules they want. On the other, they complain about the many silly petitions being sent in.

The ARRL has caused a lot of this trouble. In order to appear to be the "representative" of amateurs, the League works hard to convince amateurs that they should tell their directors about their reactions to rule changes rather than "bother" the FCC. Amateurs find that this is a sure way to not be heard at all, so they react with apathy ... what can one person do? ... etc.

The League would like it best if they were the only group entering amateur rule change petitions to the FCC ... and the only group commenting on dockets proposed by the FCC. This is the thrust of just about everything you read in *QST* and hear from directors when (and if) they visit your club.

In many cases, rule making petitions are submitted to the FCC as a

way of tackling some immediate problem. By the time the FCC has come to grips with the petition, several years later, the whole matter is often irrelevant. Unfortunately, this doesn't deter the FCC from making a big deal out of it and coming forth with some fascinating rule proposals.

Also contributing to amateur apathy in the matter of FCC dockets is the reaction of the ham magazines. *QST* generally provides a dry and boring report in very fine print. *Ham Radio*, in refusing to even mention the subject, indicates that it is of no importance. *CQ* does the same in almost all cases. I try to see that FCC dockets are as well covered and discussed as possible in *73*, but we're only one magazine out of four, so the general attitude is that someone else should worry about these things ... they are of no real significance.

Perhaps you've noticed that very few of the petitions submitted to the FCC for rule making have been published in any of the ham magazines. They are not generally published in *73* because we haven't been getting copies of them — not even the more

interesting ones. If the person submitting the petition doesn't think enough of it to send us a copy, how serious can he be about it? The FCC doesn't have the men or money to make copies of all petitions and send them to the magazines.

One possible way to keep the FCC from wasting a lot of time trying to cope with frivolous petitions would be to have a committee of interested amateurs look them over and recommend action on the valuable changes. This would act somewhat like a congressional committee. I'd be glad to help with such a committee and I'm sure we could get some other fellows to help.

The more amateurs can do for themselves, the freer amateur radio will be to encourage amateurs to do the things our "service" has been designated for: pioneering and inventing, public service, etc.

UNWELCOME VISITORS

There seems to be a lot of fretting going around that the sale of two meter transceivers by Sears, the recent promotion by Ancomm of their two meter set in CB magazines, and NRI ads for a two meter transceiver as part of their educational package might result in a lot of CBers turning up on two.

The thinking is that since little or no license is required for CB operation ... and since a lot of CBers are used to ignoring the rules ... and since there are perhaps 200,000 or so CBers operating in the "channels" above

number 40, what is to stop them from claim-jumping into two meters and showing up on our repeaters?

Maybe. If this is starting to happen, I'd like to hear about it. I don't doubt that a few CBers with more brass than others will make a try at getting on two without a ham ticket ... but I think that amateurs will figure out how to put a stop to it in short order. I'd like to hear about any experiences along this line ... and think this would be of interest to all readers.

This is something we have to come to grips with quickly ... for the most part, we are on our own. Don't think that the FCC is going to send a van out to track down a pirate for you and put him out of business. The amateur service is billed as self-policing, and this will have to be it for any practical matters. Repeater groups should plan ahead what they would do if a pirate comes aboard, and have the routine worked out ahead of time.

Most fellows who give piracy a try will probably get discouraged quickly if your group is able to respond and convince him that you are not going to put up with any non-licensed operation. I suspect that a "polite, but firm" approach may be the best. If you get abusive, then you may create a challenge for the chap to harass you with kerchunking and bad language. Explain the facts of life to him ... invite him to come to the club and take a course so he can get his ticket

Continued on page 120

The Century/21 started with a clean sheet of paper...



OBJECTIVE: To design a no-compromise HF transceiver for the beginning Ham or Old Timer and at an economical, affordable price.

CRITERIA: Cw transmit, cw and ssb receive. Full break-in. 70 watts input. Full band coverage 80-15 meters, 1 MHz on 10. All solid state. Instant,

no-tune band change. Built-in regulated power supply. Overload protection. Linear crystal mixed VFO. Direct frequency readout. Offset receiver tuning, defeatable. Built-in speaker. Sensitive receiver section. High selectivity — three position. Sidetone with adjustable level. Full line of matching accessories.

THE RESULT . . . TEN TEC *Century/21*

The Century/21 was designed and tooled from scratch for high performance cw. A unique Double Direct Conversion receiver performs as well as the conventional superhet. Broadband transmitter with instant break-in is a highly desired luxury. Accessory keyer and crystal calibrator available now, with additional accessories to follow. And . . .

THE AFFORDABLE PRICE:

Century/21, Model 570	\$289.00
Century Keyer, Model 670	29.00
Century Calibrator, Model 276	29.00

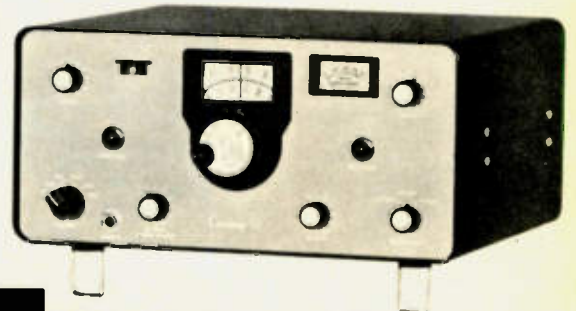

For further information, write:

TEN-TEC, INC.
SEVIERVILLE, TENNESSEE 37862
EXPORT: 5715 LINCOLN AVE., CHICAGO, ILL. 60646

Organize Your RTTY Pix

-- a sweet tooth is desirable

can usually be found exchanging pictures with other enthusiasts on Saturday morning.

Some hams may not be familiar with the technique of transmitting pictures with teletype. Let me explain, to provide insight into the associated problems. RTTY pictures are formed by typing standard characters over a "pattern," which is the picture being generated. Shading and detail is produced by using different character groups. It usually takes several attempts to make a good picture, as experimentation is required to form the correct shades. All of this "editing" is performed on the previous attempt until a perfect work of art is produced! In order to work on the previous partial picture, some method of saving it is required. The medium most commonly used is paper tape — yards of paper tape. Most RTTY machines have a paper tape punch incorporated into the keyboard system, so a tape is punched along with the character being printed. This tape can be read at a later date with a "tape distributor" (TD). Thus, the end result of the editing process is a new paper tape with the complete picture. Some detailed pix use overlining to achieve contrast, which requires many feet of tape. I

Ken Mabie W2PSU
446 Rochelle Ave.
Rochelle Park NJ 07662

There are many interesting aspects of amateur radio teletype. Some RTTY operators are into DX, others have computerized stations, and still others collect RTTY art, or "pix." I am a member of the latter category, and



Fig. 1. The author and two methods of storing paper tape pix. The choice should be obvious!

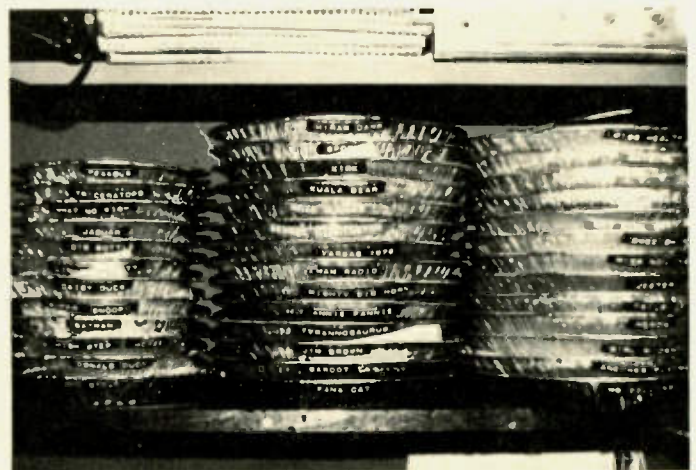

Fig. 2. Paper tape library. The titles of the pix are cemented on the outside of the plates for easy reference. The plates are stacked to conserve space.

have several pictures which are represented by several hundred feet of tape and take over an hour to print! Pictures are received off the air in similar fashion. In order to save the picture for your own collection, it is necessary to use tape or magnetic cassettes. When using paper tape, a device known as a reperforator is employed to punch the tape while the picture is being printed off the air. This tape is usually edited to correct transmission "hits," and then is saved for later use. This is where the problem develops — what does one do with mounds of paper tape as the pix library expands?

Originally, I saved my pix by winding the tapes in the classic military "figure eight," and hung them around the shack. However, this posed two problems: (1) it didn't take long until every available inch of wall space was covered with little rolls of tape, and (2) it was difficult to tell which tape was which. My initial solution involved storing the tapes in shoe boxes, with the "table of contents" on top. Soon, however, my floor began to fill up, and who can afford new shoes every week just to get the boxes? A cure to the tape storage problem was definitely required.

The ultimate cure presented itself one evening as I watched my wife discard a pile of aluminum pie plates. (Her father owns a bakery,

and pie plates are a fact of life.) It seemed obvious that a lot of tape could be stored in a flat plate, when the tape was rolled in a cylinder, like film in a 35mm cassette! Sure enough, my longest tape fit neatly in a pie plate when it was rolled up! Never again will those plates end up in the trash.

My method is simple: I simply roll the pix tape into a cylinder, and secure it with a

rubber band. The pie plate can be labeled on the outside, eliminating confusion. Another advantage to the plate method is that successive pie plates can be stacked, thus conserving additional space. See Fig. 1 for a before and after example of tape storage. Fig. 2 provides a close look at a shelf holding my pix library.

That's it! I cannot think of any easier method of storing

valuable RTTY art in limited space. The only problem with the pie plate method is obtaining a large quantity of plates. Possibly your friends can save them; if not, be prepared to join Weight Watchers, as your diet may become overloaded with cherry pie! So go after those pix, and look for me on 20 meters any Saturday — I'll be ready to copy any new works of art. ■

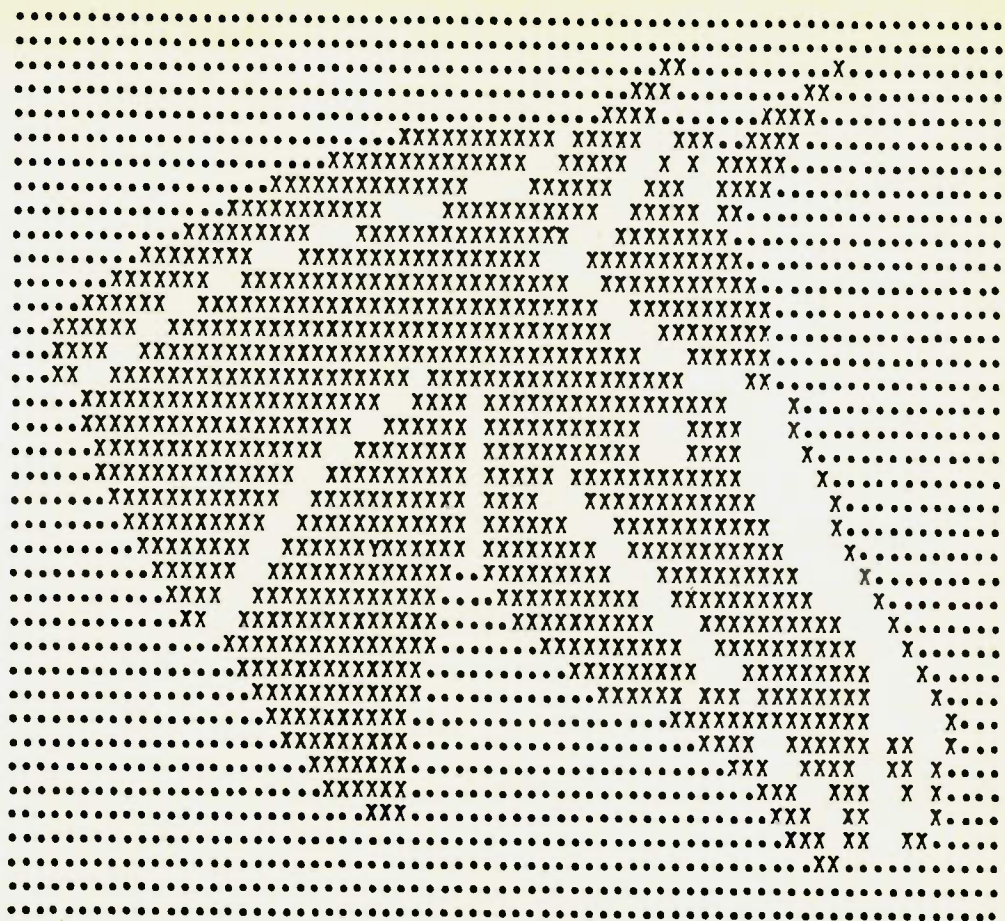

THE DERBY WINNER

Typical RTTY art.

New Products

from page 15

With the new P(*)M gooseneck plug, mike and gooseneck stem can be quickly, easily disconnected from the stationary receptacle and stored away. The potential of damage or theft of the gooseneck and microphone is eliminated.

Also, the easy connect-disconnect feature permits ready use of microphone and gooseneck in different

locations.

The new plug, available in a choice of 3, 4, and 5 pins, has heavy brass housing and satin nickel finish, 5/8-27 external thread on one end for securing plug to bottom of the gooseneck, features exclusive captive design insert screw, and "ground terminal" is electrically integral with plug housing for sure grounding.

P(*)M plugs mate with Switchcraft "Q-G" audio receptacles, new QGP (quick ground professional), and other

connectors with compatible contact configurations.

For details, write for New Product Bulletin No. 308, Sales Dept., Switchcraft, Inc., 5555 No. Elston Ave., Chicago IL 60630.

NEW ACCESSORIES FROM YAESU

Yaesu Electronics Corporation of Paramount, California, announces the availability of two accessory items to its product line: a digital LED readout for the FT-221, FT-221R two meter all mode transceiver, and high quality headphones for all communications requirements, commercial or amateur.

The YC-221 LED frequency readout simply plugs into the FT-221 series. A simple minor modification needs to be made to some of the early transceivers and full instructions are given in the YC-221 manual. The frequency readout is in seven digits, covering 144 to 148 MHz in one half inch LEDs. Amateur net price is \$119.

The YH-55 headphones are low impedance types with cushioned type earpads, and frequency response tailored for voice communications. Amateur net price is \$15. Both products are now available at all authorized Yaesu dealers. *Yaesu Electronics Corporation, 15954 Downey Ave., P.O. Box 498, Paramount CA 90723.*

*Choice of 3, 4, or 5 pin contacts.

Call 1-800-633-3410 for Kenwood*

*YAESU, DRAKE, ICOM, CDE, HYGAIN, CUSHCRAFT, NPC, TPL, TRISTAO, NEWTRONICS, DENTRON, REGENCY, ROHN, WILSON, TEN-TEC, MCM & MFJ



KENWOOD TS-520S SSB transceiver

NEW TS-520S features: • 160 thru 10 meter coverage • Optional DG-5 digital frequency display (on top of unit) • New speech processor with audio compression amplifier • Built-in AC power supply (DC-DC converter, optional) • RF attenuator, front panel activated • Provision for separate receive antenna • Provision on back for phone-patch.

649.00 list price. Call for quote.

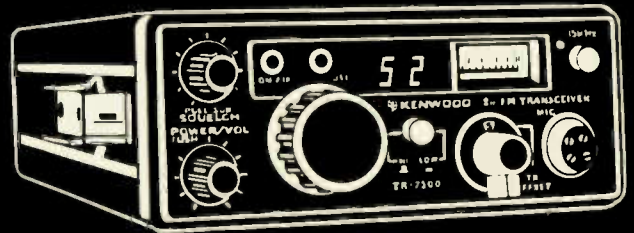

KENWOOD TR-7500 2m FM transceiver

The NEW TR-7500 has the features you need! Check these: • PLL synthesized • 100 channels (88 pre-programmed, 12 extra diode programmable) • Single knob channel selection • 2-DIGIT LED frequency display • Powered tone pad connection • Helical resonators • 10 watts HI output, 1 watt LOW output. Available very soon! Call us for quote.

Price to be announced...



KENWOOD TS-600 6m transceiver

Full 4 MHz coverage • Modes: SSB, FM, CW, AM • Repeater activation • 11 fixed channels (crystals optional) • Built-in AC/DC operation • Noise blanker • Amplified-type AGC circuit • Fully equipped RF w/dual-gate MOS FET.

649.00 list price. Call for quote.

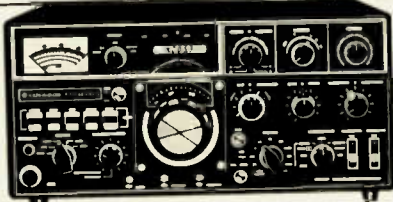

KENWOOD TS-820S transceiver

Features: • Factory installed digital readout • 160 thru 10 meters • 200 watts PEP • Integral IF shift • Noise blanker • VOX • PLL • DRS dial • IF out, RTTY, XVTR capabilities • RF speech processor.

1048.00 list price. Call for quote.



KENWOOD TR-2200A 2m FM transceiver

Features: • Solid-state construction • 2 watts HI, 0.4 watts LOW output • 12 fixed channels (6 supplied) • ¼ wave telescoping antenna • Rechargeable Ni Cad batteries • Lighted channel indicators • Hand-held microphone.

229.95 list price. Call for quote.

Remember, you can call TOLL-FREE: 1-800-633-3410 in U.S.A. or call 1-800-292-8668 in Alabama for our low price quote. Hours: 9:00 AM til 5:30 PM, Monday thru Friday.



Long's Electronics



MAIL ORDERS: P.O. BOX 11347 BIRMINGHAM, AL 35202 • STREET ADDRESS: 3521 10TH AVENUE NORTH BIRMINGHAM ALABAMA 35234

Call 1-800-633-3410 for Yaesu*

*KENWOOD, DRAKE, ICOM, CDE, HYGAIN, CUSHCRAFT, NPC, TPL, TRISTAO, NEWTRONICS, REGENCY, ROHN, WILSON, TEN-TEC, B&W, DENTRON, & MFJ.

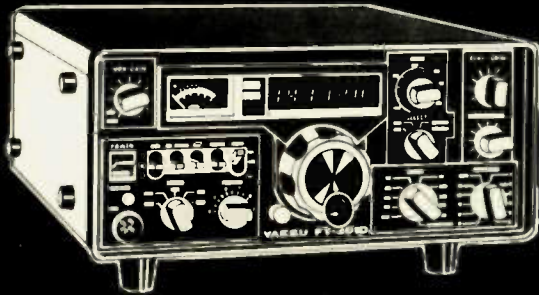

YAESU FT-301D HF transceiver

- All solid-state • LED digital readout • 160 thru 10 meters (receive only: WWV/JJY & CB) • 200 W PEP: SSB, CW and 50W for AM, FSK • Noise blanker • RF speech processor • VOX • Auto. break-in on CW w/side tone • Amplified AGC • Built-in 11-channel crystal control provision.

935.00 is list price. Call Toll-Free for quote.

YAESU FT-101E transceiver

- All solid-state • 160 thru 10 meter coverage • Built-in AC/DC power supplies • Built-in RF speech processor • 260 W PEP on SSB, 180 W on CW, 80 W on AM • Solid-state VFO • VOX • Auto. break-in on CW w/side tone • WWV/JJY reception • High-Q, permeability tuned, RF stages.

729.00 is list price. Call Toll-Free for quote.



YAESU FT-221R 2m transceiver

- 144 to 148 MHz coverage • AC/DC power supplies • Modes: SSB, CW, FM, AM • Selectable ± 600 KHz repeater offset • Noise blanker • VOX and break-in on CW • SSB output: 12 W PEP, FM/CW: 14W, AM: 2.5W • PLL.

595.00 list price. Call for quote.

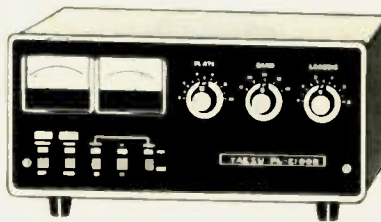

YAESU FL-2100B linear amplifier

- 1200 watts PEP • Input on 80-10 meters • Primary voltage change: 117 to 234 VAC • Dual meters for plate current and voltage • Adjustable SWR meter • Drive requirement: 30 W to 100 W • Input impedance: 50 ohm unbalanced.

399.00 list price. Call for quote.



YAESU YC-500J frequency counter

- 8-digit readout covers up to 500 MHz • Dual range system • Frequency range: Input 1: 10 to 50 MHz, Input 2: 50 to 500 MHz • Accuracy: 10 PPM • Display: 6-digit LED • Display time: 0.1 or 2 seconds.

249.00 list price. Call for quote.

Remember, you can call TOLL-FREE: 1-800-633-3410 in U.S.A. or call 1-800-292-8668 in Alabama for our low price quote. Hours: 9:00 AM til 5:30 PM, Monday thru Friday.



Long's Electronics



MAIL ORDERS: P.O. BOX 11347 BIRMINGHAM, AL 35202 • STREET ADDRESS 3521 10TH AVENUE NORTH BIRMINGHAM, ALABAMA 35234

Call 1-800-633-3410 for ICOM*

*KENWOOD, YAESU, DENTRON, CDE, HYGAIN, CUSHCRAFT, NPC, TPL, TRISTAO, NEWTRONICS, REGENCY, ROHN, WILSON, TEN-TEC, B&W, DRAKE, & MFJ.

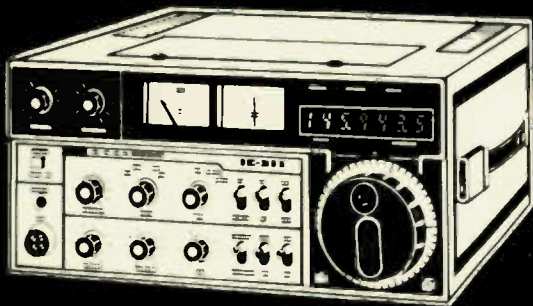

ICOM IC-211 2m transceiver

- 144 to 148 MHz coverage • Modes: SSB, CW, FM • LSI synthesizer PLL • 4-digit LED readout • Pulse-type noise blanker • VOX w/adjustable gain • SWR bridge • CW monitor • Automatic power control • AC/DC power supplies • Antenna impedance: 50 ohms unbalanced • TX output: 10W PEP.

749.00 is list price. Call Toll-Free for quote.

ICOM IC-245 2m transceiver

- LSI synthesizer PLL • 4-digit LED readout • Transmit & receive frequencies are independently programmable on any separation • Receiver front-end is a balance of low noise, high-gain MOS FET & 5 section filter • TX output: 10 W PEP • Frequency step size: 5 KHz for FM, 100 Hz (with adapter) or 5 KHz for SSB.

499.00 is list price. Call Toll-Free for quote.



ICOM IC-215 2m FM transceiver

- 2 meter FM • 3 W PEP • 15 channels, 12 by selector, 3 by function switch • Dual power level, 3 W HI for long distance, 0.5 W LOW for local • Dial illumination for night use • Power pilot lamp • Frequency range: 146 to 148 MHz.

229.00 list price. Call for quote.



ICOM IC-22S FM transceiver

- Frequency range: 146 to 148 MHz • Preset any 15 KHz channel in the frequency synthesizer by diode matrix board • Output: 10 W HI, 1 W LOW • Excellent spurious attenuation • 22 channels.

289.00 list price. Call for quote.



ICOM IC-30A FM transceiver

- 22 channels, 450 MHz • Modulation F3 • Power output: 10 W HI, 1 W LOW • TX band width: 15 KHz w 5 KHz deviation • Low intermodulation comes from a low noise MOS-FET RF amp. coupled with a 5-section filter.

399.00 list price. Call for quote.

Remember, you can call TOLL-FREE: 1-800-633-3410 in U.S.A. or call 1-800-292-8668 in Alabama for our low price quote. Hours: 9:00 AM til 5:30 PM, Monday thru Friday.



Long's Electronics



L9

MAIL ORDERS: P.O. BOX 11347 BIRMINGHAM, AL 35202 • STREET ADDRESS: 3521 10TH AVENUE NORTH BIRMINGHAM, ALABAMA 35234

Call 1-800-633-3410 for Drake*

*KENWOOD, YAESU, ICOM, CDE, HYGAIN, CUSHCRAFT, NPC, TPL, TRISTAO, NEWTRONICS, REGENCY, ROHN, WILSON, TEN-TEC, B&W, DENTRON, & MFJ.



DRAKE TR-4CW transceiver

- 80 thru 10 meters • 300 W PEP on SSB; 260 W on CW, AM • 500 Hz CW filter included • RIT • Wide range receiving AGC • Solid-state VFO • Shifted-carrier CW • VOX or PTT • Output impedance is adjustable • CW semi-break-in • Audio output: 3 watts • Transceive or separate PTO.

699.00 is list price. Call Toll-Free for quote.

DRAKE L-4B linear amplifier

- Plate input: 2000 watts PEP on SSB, 1000 watts DC input power on CW, AM, RTTY • High-efficiency class B grounded grid circuit • Transmitting AGC • Broad-band tuned input • RF negative feed back • Directional watt meter • Solid-state power supply • Two taut-band suspension meters.

895.00 is list price. Call Toll-Free for quote.



DRAKE W-4 directional RF watt meter

- Covers 2 thru 30 MHz • 2000 watts continuous duty power capability • Line impedance: 50 OHM resistive • VSWR insertion: no more than 1.05:1 • Accuracy: $\pm 5\%$ of reading • 4-position switch on front selects desired scale, forward or reflected power.

72.00 list price. Call for quote.



DRAKE 1525 EM microphone

- Auto-patch encoder and mike are a single unit, fully wired and ready to use • High accuracy IC tone generator, no frequency adjustments • Digitran® keyboard • Low output impedance, use with most transceivers.

49.95 Call for shipping.



DRAKE TR-33C 2m transceiver

- 12 channel provision (2 supplied) • All FET front-end crystal filter for superb intermod. rejection • Ni-Cad cells supplied • Built-in charger • Low power drain circuit on squelched receive • Lighted dial when using external power.

229.00 list price. Call for quote.

Remember, you can call TOLL-FREE: 1-800-633-3410 in U.S.A. or call 1-800-292-8668 in Alabama for our low price quote. Hours: 9:00 AM til 5:30 PM, Monday thru Friday.



Long's Electronics



MAIL ORDERS P.O. BOX 11347 BIRMINGHAM, AL 35202 • STREET ADDRESS: 3521 10TH AVENUE NORTH BIRMINGHAM, ALABAMA 35234

Call 1-800-633-3410 for Dentron*

*KENWOOD, YAESU, ICOM, CDE, HYGAIN, CUSHCRAFT, NPC, TPL, TRISTAO, NEWTRONICS, REGENCY, ROHN, WILSON, TEN-TEC, B&W, DRAKE, & MFJ.



DENTRON MLA-2500 linear amplifier

- Continuous duty power supply • 160 thru 10 meter coverage • 2000 + watts PEP input on SSB • 1000 watts DC input on CW, RTTY, SSTV • Two external-anode ceramic/metal triodes operating in grounded grid • Covers MARS w/o modifications • 50 ohm input/output impedance • Built-in RF watt meter.

799.50 is list price. Call Toll-Free for quote.

DENTRON MT-3000A antenna tuner

- 160 thru 10 meter coverage • Handles a full 3KW PEP • Continuous tuning 1.8 - 30 mc • Built-in dual watt meters • Built-in 50 ohm dummy load for proper exciter adjustment • Antenna selector switch enables you to by-pass the tuner direct or select the dummy load or 5 other antenna systems.

349.50 is list price. Call Toll-Free for quote.



DENTRON 160-10AT super tuner

Balanced line, coax cable, random, or long wire antennas, the 160-10AT will match it—160 thru 10 meters • Continuous tuning, 1.8-30 mc • 3 inputs • Handles 500 watts DC, 1000 watts PEP • Heavy duty, 2-core Balun (3½" dia. x 3" H) • Tapped inductor #12 ga. wire.

129.50 list price. Call for quote.

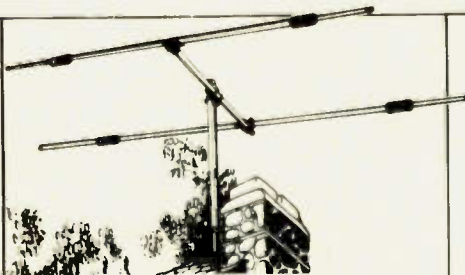

DENTRON Trim Tenna 20 meter beam

For the amateur who wants fantastic performance with good looks! • Front element: 16' driver with H-Q coils fed directly with 52 ohm coax • Reflector element: 17' with 15 dB F/B ratio • 8½' turning radius • 4 dB forward gain over dipole • Elements 7 feet apart • Weight: 14 lbs.

129.50 list price. Call for quote.

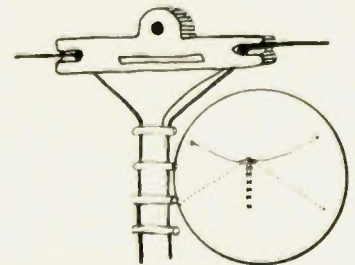

DENTRON all band doublet antenna

This all band doublet or inverted antenna covers 160 thru 10 meters. Has total length of 130 ft. of 14 ga. stranded copper wire. The doublet is tuned & center fed thru 100 ft. of 470 ohm PVC covered transmission line. Assembly is complete.

24.50 is Long's low price.

Remember, you can call TOLL-FREE: 1-800-633-3410 in U.S.A. or call 1-800-292-8668 in Alabama for our low price quote. Hours: 9:00 AM til 5:30 PM, Monday thru Friday.



Long's Electronics

L9



MAIL ORDERS: P.O. BOX 11347 BIRMINGHAM, AL 35202 • STREET ADDRESS: 3521 10TH AVENUE NORTH BIRMINGHAM, ALABAMA 35234

Call 1-800-633-3410 for Ten-Tec*

*KENWOOD, YAESU, ICOM, CDE, HYGAIN, CUSHCRAFT, NPC, TPL, TRISTAO, NEWTRONICS, REGENCY, ROHN, WILSON, DENTRON, B&W, DRAKE, & MFJ.



TEN-TEC Triton IV digital transceiver

- Solid-state • Instant bank change • Covers 3.5 to 30 MHz • 200 watts input on all bands • Receiver sensitivity: 0.3 micro V • 8-pole crystal IF filter • Large LED readout • Offset receiver tuning • WWV at 10 & 15 MHz • Separate receiving capability • Full CW break-in • S-meter and SWR bridge.

869.00 is list price. Call Toll-Free for quote.

TEN-TEC Century 21 CW transceiver

- Full break-in • 70 watts input • Solid-state • Built-in speaker • Receive CW or SSB • Instant band change • Overload protection • Offset receiver tuning • Sidetone w/adjustable level • Regulated power supply • Full band coverage: 80 thru 20 meters with crystals supplied. Other crystals available.

289.00 is list price. Call Toll-Free for quote.



TEN-TEC KR-50 electronic keyer

- Speed range: 6-50 wpm • Weighting ratio range: 50 to 150% of classical dit length • Output reed relay, contact rating 15 VA, 400 V max. • Sidetone: 500 Hz tone • Dit & dah memories with defeat switches.

67.50 list price. Call for quote.

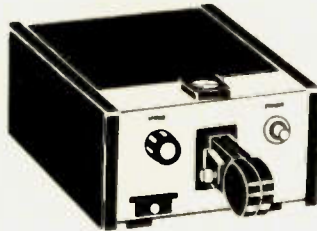

TEN-TEC KR-20A electronic keyer

- Keyed output: reed relay: 15 volt-amp. contacts, 400 volts max • Speed range: 6 to 50 wpm • Time base: keyed to start with paddle actuation • Self-completing characters • Side-tone oscillator with adjustable level.

67.50 list price. Call for quote.

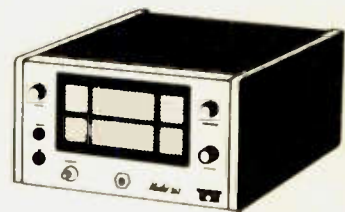

TEN-TEC 262G power supply

- Input voltage: 117 VAC, 50-60 Hz • Output voltage 13.0 VDC • Regulation: Better than 1%, NL to FL @ 117 VAC • Output current: 0 to 18 amps • Saton speaker • VOX circuits • Over current protection.

129.00 list price. Call for quote.

Remember, you can call TOLL-FREE: 1-800-633-3410 in U.S.A. or call 1-800-292-8668 in Alabama for our low price quote. Hours: 9:00 AM til 5:30 PM, Monday thru Friday.



Long's Electronics



MAIL ORDERS: P.O. BOX 11347 BIRMINGHAM, AL 35202 • STREET ADDRESS: 3521 10TH AVENUE NORTH BIRMINGHAM, ALABAMA 35234

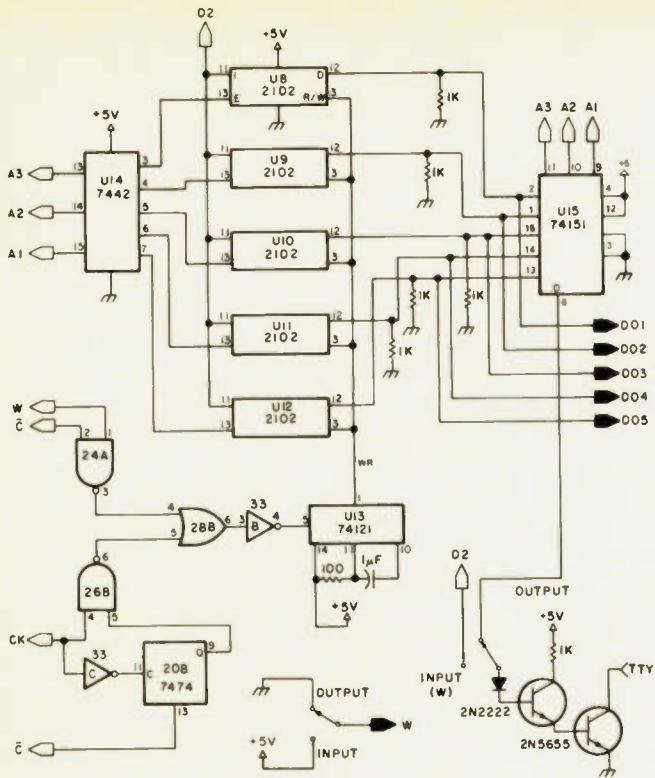

Fig. 4. Memory.

function is realized by using D2 to reset flip-flop U19B low. This allows the clock to be applied to the four bit binary counter U4 through gate U26D. After 14 clock pulses, U31B is toggled by the output of the counter through U30A, resetting flip-flop U19B and \bar{C} . When the clock then goes high, counter U4 and flip-flop U31B are reset by gate U26C. A duration of 14 clock pulses causes \bar{C} to return high during the stop pulse.

Now, the data bits are being applied to the input of five RAMs. The timing logic must sort out the times when each RAM should individually be enabled and a write pulse applied to write the first data bit into RAM one, the second data bit into RAM two, and so on.

Counter U30 is set up to count the 7 data bits of each letter. See Fig. 5(a). When in output mode, the stop pulse is split into two 22 ms pulses instead of a 31 ms pulse. They are both high, so the end result is to increase the stop pulse at the output of the system to 44 ms. This only slightly decreases the

operating speed. \emptyset is a second clock signal which has twice the period of the clock. As can be seen from the timing diagram, D2 can go low under two possibilities: when \emptyset is high (lower half of diagram) and when \emptyset is low (upper half of diagram). If it goes low when \emptyset is low, it should immediately begin clocking counter U30 with \emptyset . If it goes low when \emptyset is high, it should delay counting the first \emptyset transition and then start counting on the second. This is necessary to ensure that the address 010 lines up in time with data bit one, address 011 lines up with data bit two, and so on. Since a decision is necessary when D2 goes low, C is applied to a monostable U17 to produce a short sampling pulse. Gate U24B uses this pulse to sample \emptyset . If \emptyset was low at the time of the pulse, then the output of U24B remains high, and flip-flop U20A remains in a reset state (output pin 6 high). This allows E2 to be applied to the enable pin of U30 through U24C, U23E, and U28A to begin counting. E2 is similar to \bar{C} , except it is ANDed with a signal which is only high when the system is

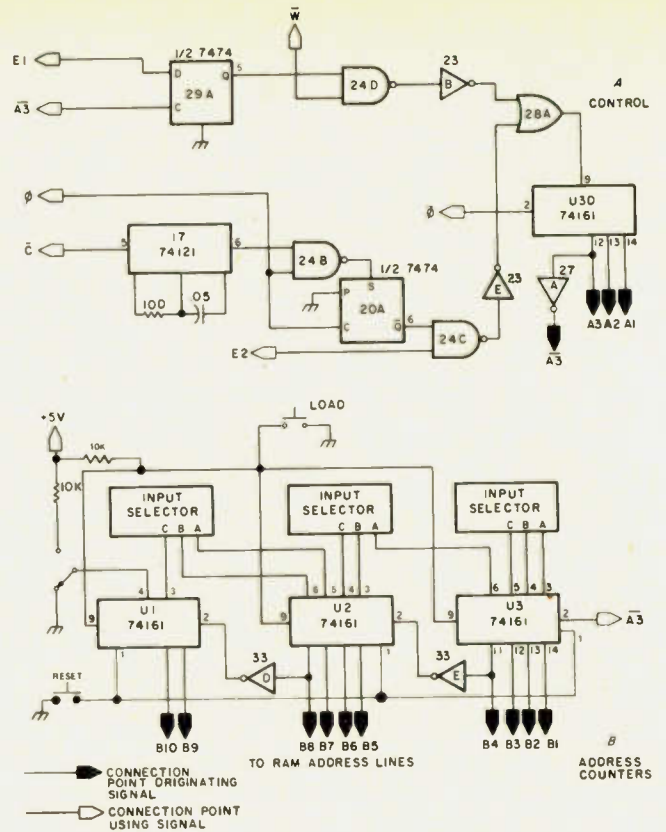

Fig. 5. a) Control. b) Address counters.

in RUN mode and not the STOP mode. Now, if \emptyset was high during that sampling pulse coming out of monostable U17, a low pulse is applied to the set input of flip-flop U20A through U24B. This sets output pin 6 low, which inhibits enabling of counter U30 until \emptyset comes along again and toggles the flip-flop back to its original reset state.

Referring to Fig. 4, the three bit output of counter U30 (A1, A2, A3) is applied to the decoder U14. This IC decodes the address and enables the proper RAM.

Now that each RAM is receiving an enable pulse at the proper time at its enable input, sometime during that enable pulse a write pulse must be applied to the read/write input of each RAM. Since no two RAMs are enabled simultaneously, a single write pulse can be applied to all RAMs simultaneously. This signal is developed by the remaining circuitry at the bottom of Fig. 4. W, which is only high when the system should be

recording information in RAM, is ANDed with \bar{C} , the clock, and a modified version of the clock. The modified clock is produced by flip-flop U20B. This is to produce a write pulse command at every other clock pulse. This combination of signals singles out the times when write pulses are desired plus one extra one. The extra one occurs during the start pulse of the incoming letter and does not do anything because at that time none of the RAMs are enabled (see timing diagram). This command is applied to monostable U13, which produces a negative pulse of the proper duration to write data into the RAM. The output is applied to the read/write terminal of all five RAMs.

The system clock consists of an NE555 timer and one flip-flop, U19A. The .08 μ F capacitor charges up through two 97k resistors. When pin 2 sees a voltage of 2/3 Vcc, pin 7 is internally grounded, discharging the capacitor through two 97 Ohm resistors (one different from charging path). When pin 2 gets down

to $1/3 V_{cc}$, the ground at pin 7 is released by the 555, and the capacitor then charges back up to $2/3 V_{cc}$ and repeats. This produces a TTL-compatible square wave at pin 3, with the frequency dependent on the capacitor and resistors used (in this design it has a period of 11 milliseconds). Flip-flop U19A divides this clock signal by two to produce ϕ .

There are several front panel controls in the unit. The RUN button grounds the set input of flip-flop 31A, which is normally held high by a resistor to V_{cc} . See Fig. 2(d). This sets output pin 9 high which is enable 1 (E1). E1 ANDed with \bar{C} in U26A and U23C produces E2 mentioned earlier. $\bar{E}1$ is also produced. The flip-flop can be reset by one of two means. A signal (stp) from the stop detector applied to U28C, or the operator depressing the stop button, will cause U23D to lower the reset pin on U31A and lower E1 and E2 immediately. The load push-button lowers the voltage on the load input on the 3 memory address counters U1-U3. This causes the memory address (B1-B10) to immediately take on the values of the output to the diode matrix (C1-C10). This is determined by the setting of the address input rotary switches. Finally, the RESET button resets the memory address to all 0s.

If the operator pushes the stop button while the machine is right in the middle of printing a letter, it would be desirable to have the machine stop after it has completed printing of that letter. If the unit stopped in the middle, the Teletype would not print the correct letter. This is taken care of by the upper circuit in Fig. 5(a). E1 goes low when the stop command is received. E1 is applied to the data input of flip-flop U29A. The stop is not transferred to pin 5 until $\bar{A}3$ toggles the flip-flop (A3-low). This happens at the end of each character during the

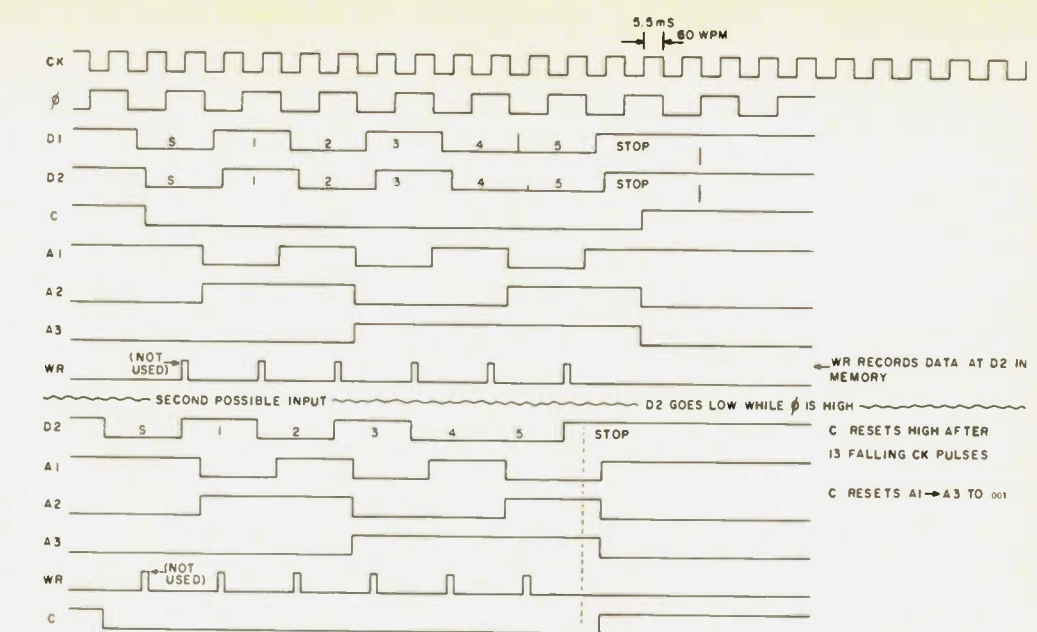

Fig. 6. Timing diagram.

stop pulse. E1 is then ANDed with \bar{W} (used only when printing out data, not when reading data in) and applied to the enable of counter U30 through OR gate U28A. The other circuit applied to U28A has already been described and is used to enable U30 when in the READ mode.

Now we are ready to follow the signal flow from RAM to Teletype machine when the unit is in the OUTPUT mode.

Referring to Fig. 4, when in the OUTPUT mode, the RAM enable selector U14 is receiving a free running count (A1, A2, A3) from U30, enabling each RAM in sequence with three counts between RAM five and RAM one, when none are enabled. These three counts last 22 ms each and are used to insert the start (one count) and stop (two counts) at the output. The data outputs from the five RAMs go to the inputs of an eight-bit data multiplexer U15. U30's count is also applied to U15's selector input. A3, A2, and A1 determine which of the eight inputs is applied to the single output. Since U30 supplies a free running count, U15 "scans" its eight inputs. It is set up so that when U14 enables RAM one, U15 transfers RAM one's data output to its output. During the start

pulse, the input to U15 is grounded, and, during the two counts of the stop pulse, the two corresponding inputs to U15 are tied to V_{cc} . So U15 is a parallel to serial converter for the five data bits from RAM and also inserts the start and stop bits necessary to operate the Teletype machine.

As seen in Fig. 1, the outputs of the RAMs are also tied to the stop detector. This circuit detects when any character has all five bits low when coming out of memory (BLANK key), and, if so, sends a signal (stp) to control the stop.

As seen in Fig. 3(a), U32 is connected to the RAM's outputs (D01-D05), so that pin 11 goes high unless all inputs are low. So, if the character being sent is anything other than a blank, at least one data bit will be high. When a data bit goes high, U32 pin 11 goes high, U27 pin 8 goes low, which resets the output (pin 9) of flip-flop U29B low. U25B, U25A, U27E, U27C decode the condition when A3, A2, and A1 are all high at the same time. This is during the first half of the stop pulse. So, when the stop pulse comes along, U25C samples the condition of flip-flop U29B. If it has been reset (any character except blank), the stp signal remains

unchanged (low). If, however, the flip-flop had not been reset during the data bits (BLANK key), U25C will sample the flip-flop and see it is high, and stp will go high, stopping the system. Flip-flop U29B is then set during each space count by $\bar{A}3$, A2, and U25D to have it ready for the next character.

The serial output signal from U15 is then applied to the output driver. A TTL signal must be used to open and close the selector magnets of the Teletype machine. They require about 60 mA of current. The output transistor must be able to handle a collector current of 60 mA, and the CE voltage must be able to handle 150 volts when not conducting. A 2N5655 was chosen for the output transistor. It is rated at 300 volts and over 100 mA. The TTL signal is applied (Fig. 4) through three diodes to ground. Thus 2.1 volts are required to turn on the driver transistor. 2.1 volts is a reasonable switching voltage for TTL logic. The remainder of the TTY loop can be seen in Fig. 7. The TU (terminal unit) converts the audio FSK signal from the receiver into a dc signal to switch the selector magnets. To receive, the generator can be in any mode except outputting. The reed relay senses

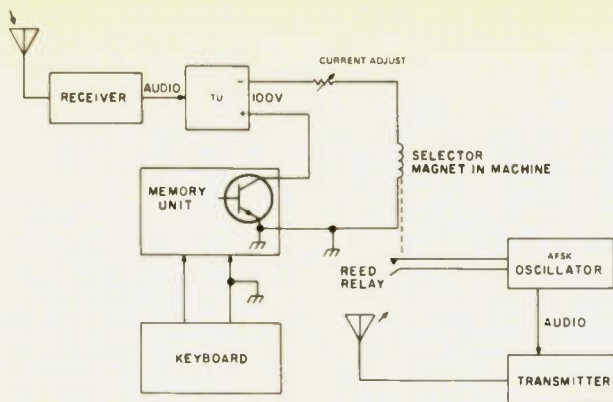

Fig. 7. This shows how the unit is connected in an amateur RTTY station.

changes in TTY loop current from memory or keyboard and drives an AFSK (audio frequency shift keyer) oscillator, which is fed into the transmitter.

The RTTY station can do any of the following functions:

1. Put received message in memory and print.
2. Put message from keyboard into memory and print.
3. Transmit from keyboard and print.
4. Transmit from memory

and print.

5. Send received message to printer only.

If it is desired to transmit at 100 wpm, the .03 uF capacitor in the clock circuit is switched out, leaving .05 uF. The speed of the generator must match the running speed of the machine, but you can type into memory as slowly as you want.

I recommend breadboarding of some type over PC boards because of the wiring complexity.

ICs

74161 - 4
2102 - 5
74121 - 3
7442 - 1
74151 - 1
7474 - 5
7404 - 3
7400 - 3
7432 - 2
7410 - 1
7447 - 3
NE555 - 1

Diodes

1N914 - 37

Resistors (all 1/4 Watt)

97k - 3
10k - 4
1k - 16
100 - 3
330 - 22

I have not included a power supply diagram because many have appeared in previous articles. Plus 5 V dc regulated is required, and an LM309 on a heat sink will do the job well. The output consists of an NPN transistor with emitter to ground, so it

Parts List

Capacitors

.05 uF - 2
.03 uF - 1
1 uF - 1

Transistors

2N2222 - 1
2N5655 - 1

Power Supply

transformer 6.3 to 8 V ac 2 A - 1
bridge rectifier 50 V 2 A - 1
filter capacitor 10,000 uF - 1
noise suppression capacitors (distributed on +5 V line) .01 uF - 10

Controls

SPST toggle - 1
SPDT toggle - 1
SPST push NO - 3

Miscellaneous

LED seven segment displays common anode - 3
LED - 1
breadboard hardware
SP8T rotary switch - 3

can be inserted directly into a 60 mA TTY loop. Also, provision is made for local copy on the printer (or video display) of data as it is typed into memory.

Good luck, and I would appreciate any comments from builders. ■

Joe Wilkowski WB8DMC
29715 Maple Grove
St. Clair Shores MI 48082

FSK for the Drake

-- easy

This circuit is actually a saturated diode keyer right out of the handbook, but instead of using an FSK driver to supply the forward bias needed for the diode, I used a 9 volt transistor battery, which is supplying .9

milliampere to the diode. Since the diode is non-linear, the current does not change in proportion to the voltage across it. At that low current, the battery will last a very long time, and even when it does start to get weak, the

current will remain the same until the battery gets very low. The 10k resistor limits the total circuit current to .9 mil.

The whole circuit can be mounted on a 3 lug terminal strip and placed near the T-4XB PTO utilizing present chassis hardware. Once the circuit is installed, you can use your own T.U. (terminal unit) to adjust the shift. Place the transmitter in spot and tune your receiver until the space is properly displayed on your scope, then simply key the shift circuit and adjust the proper shift by watching the mark display on your scope.

The reed is shown open, indicating no loop current. When the loop is on, the reed contacts are closed, completing the shift circuit.

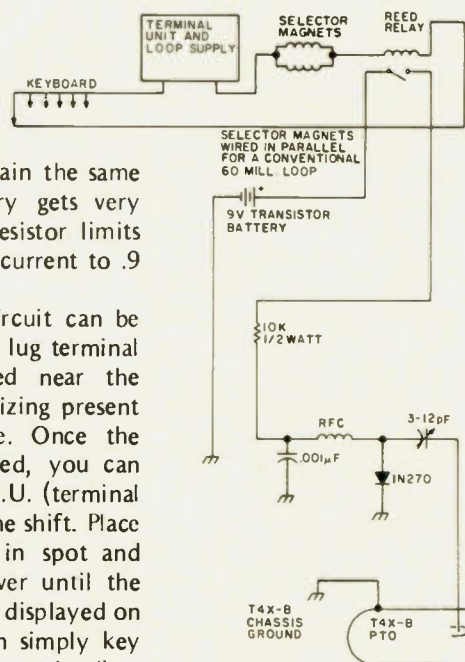

In this condition, with the keyboard closed, the vfo is downshifted 850 Hz to indicate a mark; when the keyboard is open, the vfo upshifts to indicate a space. To reverse, just wire the reed so its contacts are open when the loop is on. ■

ME-3 microminiature tone encoder

Compatible with all sub-audible tone systems such as: Private Line, Channel Guard, Quiet Channel, etc.

- Powered by 6-16vdc, unregulated
- Microminiature in size to fit inside all mobile units and most portable units
- Field replaceable, plug-in, frequency determining elements
- Excellent frequency accuracy and temperature stability
- Output level adjustment potentiometer
- Low distortion sinewave output
- Available in all EIA tone frequencies, 67.0 Hz-203.5 Hz
- Complete immunity to RF
- Reverse polarity protection built-in

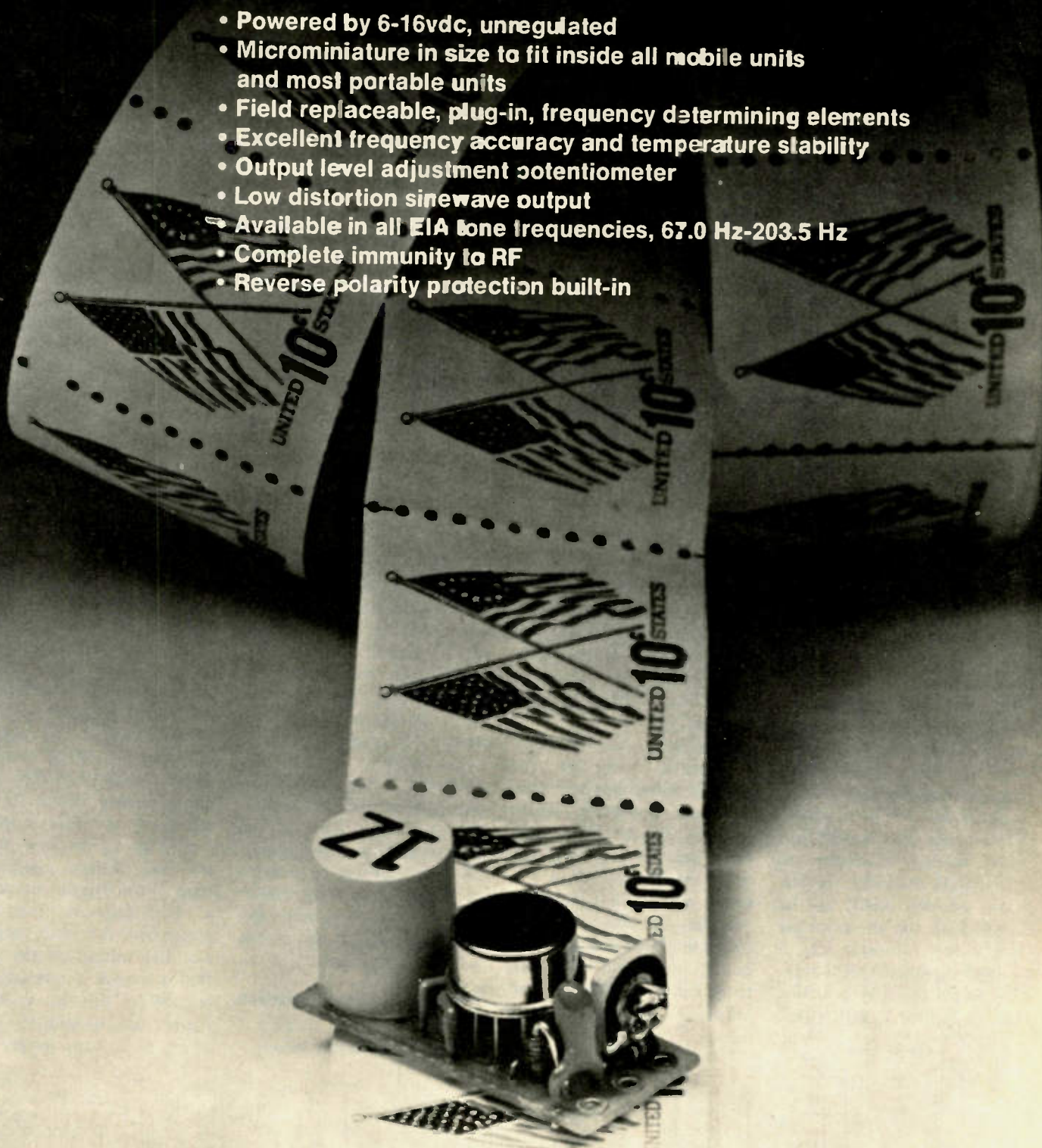

\$29.95 each

Wired and tested, complete with K-1 element



communications specialists

P. O. BOX 153
BREA, CALIFORNIA 92621

(714) 998-3021

K-1 FIELD REPLACEABLE,
PLUG-IN, FREQUENCY
DETERMINING ELEMENTS

\$3.00 each

Baudot to ASCII Converter

-- use it for OSCAR RTTY

Among the current crop of Teletype machines that are being retired from commercial service, there are quite a few ASCII machines, such as Models 33 and 35. If you are just getting into RTTY, or you are looking for more equipment, there are a number of reasons to consider building your station around an ASCII machine. First of all, the newest and most modern machines are the ASCII machines. Indications are that ASCII will be allowed on the air sometime in the near future; in fact, it is legal in Canada right now. The keyboard is very similar to a standard typewriter,

which is an advantage if you already know how to type. It is also a good place to start if you don't. Finally, if you eventually get interested in microprocessors, you can use the TTY machine as your terminal.

In order to communicate in Baudot code on the amateur bands, you will need a code converter which converts Baudot to ASCII, when you are receiving, and ASCII to Baudot, when you transmit. This article describes a two-way code converter, built on a single PC board, which will allow you to receive and transmit at all

speeds. A number of these units have been built by amateurs in the Winnipeg area and are in use on the HF and VHF bands. During the design and construction of the converter, I learned about some aspects of digital logic design that do not seem to be very widely known by amateurs. I hope that I can pass some of this information to the reader. Most of the discussion of the operation of the converter will be in terms of logical functions, rather than in terms of currents and voltages, because this is the way I visualize things.

Principles of Code Conversion

The ASCII code is comprised of seven informa-

tion bits, so there are 128 distinct combinations, or ASCII characters. An eighth bit, the parity bit, is also transmitted, but is generally ignored at the receiving end. The eight bits are framed by start and stop bits during transmission and reception.

The Baudot code has only five information bits, so there are only 32 possible combinations. In order to accommodate all the required letters, numbers, and punctuation marks, two of the Baudot characters are used to select alternate character sets in the printer. These are called the LTRS and FIGS shift characters. Thus the interpretation of Baudot code depends upon which shift character was previously transmitted. The five bits of Baudot are also framed with start and stop bits for transmission.

There is no simple relationship between the bit pattern of a Baudot character and the pattern of the corresponding character in ASCII. This means that there is no way to use a few logic gates to translate Baudot to ASCII. What is required is a translation table. If such a table is coded into a read only memory, all you have to do is to present the five Baudot bits as the address input to the ROM, and the seven ASCII bits for the corresponding character will appear at the data outputs. (See Fig. 1.) Because there are two possible interpretations of the Baudot character, a flip-flop is used to remember the shift status, and the output of the flip-flop is used as a sixth address bit. When this bit is high, figures are generated, and when it is low, letters are

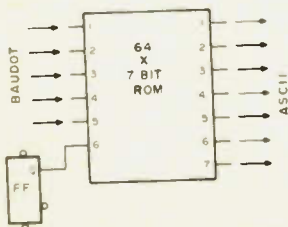

Fig. 1. Baudot to ASCII conversion.

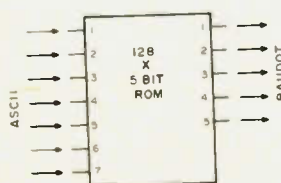

Fig. 2. ASCII to Baudot conversion.

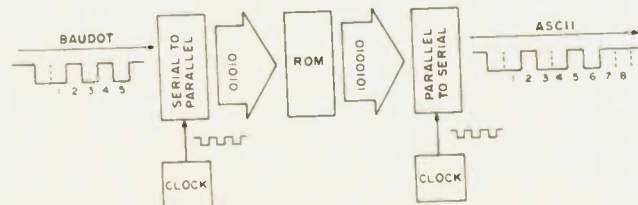

Fig. 3. Conversion of serial TTY data.

generated. The complete conversion table requires 64 seven-bit words in the memory.

Conversion from ASCII to Baudot can be done with a ROM having seven address inputs and five data outputs. (See Fig. 2.) It is also possible to use a smaller ROM and do some of the conversion with external logic, but this approach generally results in a more complex circuit. Again, a flip-flop is used to remember the current shift status. ASCII to Baudot conversion is complicated by the requirement that the FIGS or LTRS characters must be inserted into the data stream, so that the receiving station interprets the data correctly. Whenever the incoming ASCII changes from letters to figures, a FIGS character must be generated, and when the ASCII returns to letters, a LTRS character must be generated.

So far I have been discussing the conversion of parallel data from one code to another. This can be done within a few microseconds, because all the incoming data bits are present simultaneously. However, RTTY signals are transmitted in serial form with start and stop pulses. This means that a serial to parallel conversion must precede the code conversion, and a parallel to serial conversion must follow it. Fig. 3 shows the letter R in Baudot code being converted to serial ASCII. The serial input is controlled by a clock running at a fixed frequency determined by the baud rate of the incoming signal. For example, Baudot code having a maximum speed of 60 wpm has a baud rate of 45.45. Likewise, the serial output is controlled by another fixed frequency clock. In the case of ASCII with a maximum speed of 100 wpm, the baud rate is 110. Thus, a speed conversion is obtained, as well as the code conversion. In the case illustrated, if the Baudot is arriving at maximum speed,

the ASCII will be leaving the output side at about half its maximum speed. There will be pauses between the characters, and, during the pauses, the output line will remain in a marking state. This is a result of the upward conversion of speed.

When a downward speed conversion is required (for example, when converting from 100 wpm ASCII to 60

wpm Baudot), the average speed of the incoming data must be restricted to 60 wpm. Otherwise a condition known as overrun will occur, and some characters will be lost. This is no problem when I am typing on my 33ASR because I can only type at 10 wpm or so. However, in the situation when a steady stream of data is arriving at 100 wpm, there is no way on

earth to convert it and make it print on a 60 wpm machine. You might think that a memory that would store the excess characters would solve the problem, but eventually the memory would fill up, and the overrun would still occur. The only solution is to limit the speed of the incoming data to a level that the converter can handle.

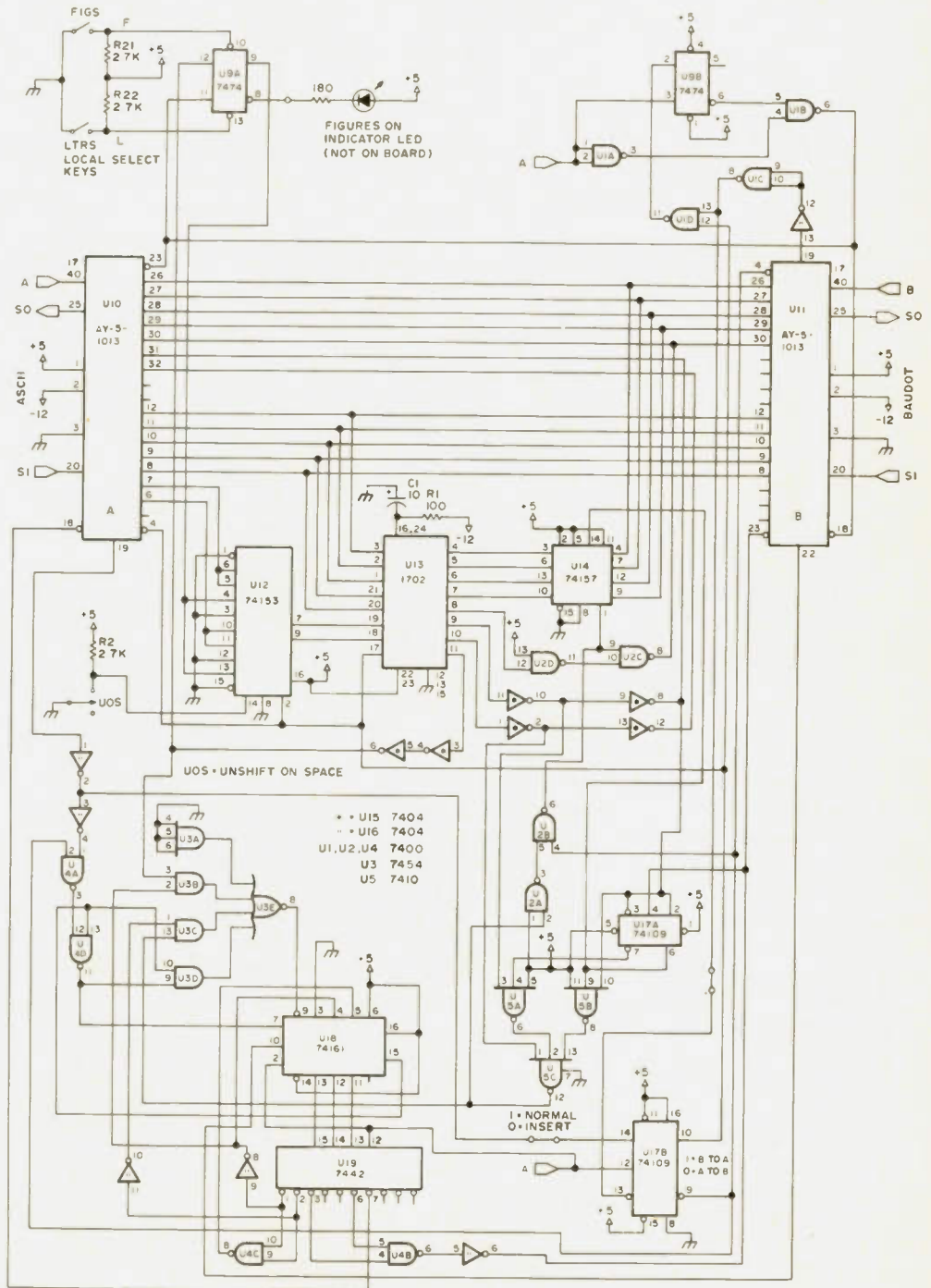

Fig. 4(a). Two-way code converter. Baudot to ASCII and ASCII to Baudot with integral Baudot speed conversion. Main circuit. Design: main circuit - Gary Mills VE4CM; interface - John Delaive VE4YD; board - Bert Franz VE4BF; design box and drawings - Fritz H. Hellmuth VE4XD.

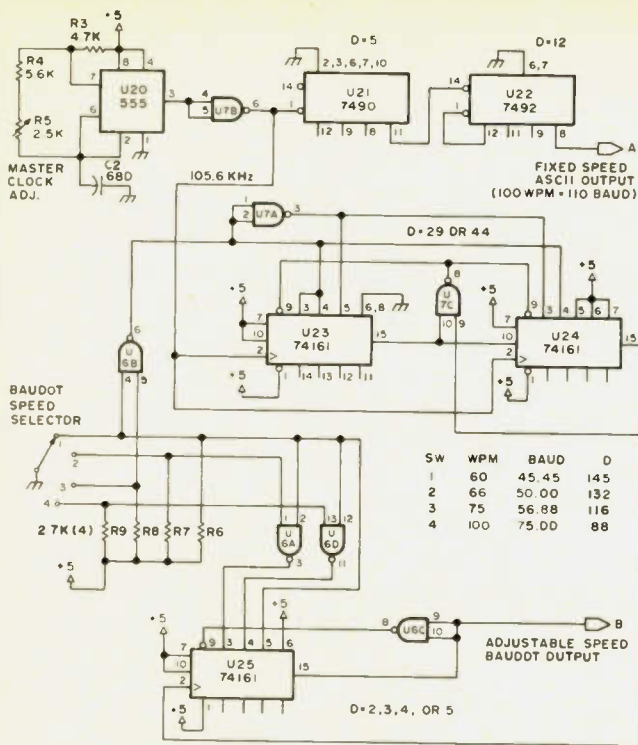

Fig. 4(b). ASCII and Baudot clock.

Circuit Description

The translation tables for both conversions are contained in a single 1702 PROM. This device has a capacity of 256 eight-bit words, giving me lots of space to play with. There are eight address inputs and eight data outputs. The way I have partitioned the memory may be seen in Table 1. The desired portion of the memory is selected by the high-order address bits.

For example, when bit 8 is high, the table to convert Baudot to ASCII is selected. The five low-order address bits are the incoming character to be translated. Bits 6 and 7 are used to select portions of the table that convert Baudot letters or figures, as well as a special portion that is designed to provide automatic unshift on space. When address bit 8 is low, the ASCII to Baudot conversion is selected. The seven low-order address bits are the incoming ASCII character. Bits 6 and 7 are changed from data to control information by a 74153 multiplexer, which behaves like a two-pole 4-position switch.

The data contained in the storage locations of the

memory consists of a character in the low-order bits and control flags in the high-order bits. In this manner, it is never necessary to decode a character to determine what to do with it. For the Baudot to ASCII conversion, seven data bits are occupied by the ASCII character. Bit 8 contains the current shift status. For the ASCII to Baudot conversion, more control flags are required, but, fortunately, the Baudot character only occupies five bits. Bit 6 is the Baudot shift required for that character. Bit 7 is a flag that, when on, says to inhibit insertion of the shift character. It is used for characters that may be transmitted in any shift. Bit 8 is another flag which causes the entire character to be ignored. It is used for ASCII codes that have no Baudot equivalent.

The insertion of LTRS and FIGS characters in a stream of Baudot is done by a five-bit multiplexer, which is constructed of a 74157 and a pair of NAND gates. A single control line is used to switch from the output of the PROM to the shift character, which is hard-wired except for the middle bit. This bit is

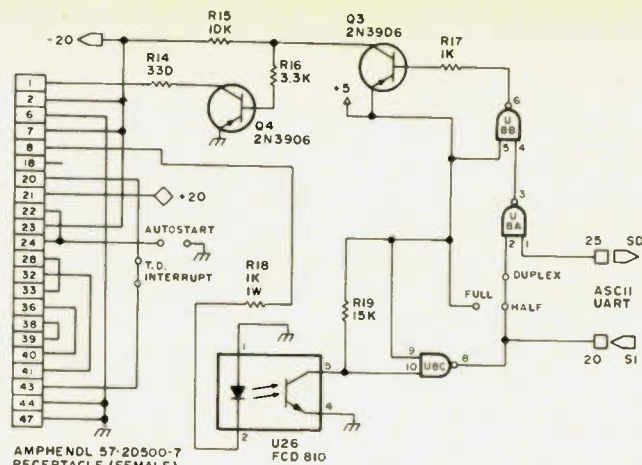

Fig. 5. Teletype Model 33 or 35 interface.

obtained from the shift status kept in the 74109 flip-flop. The decision to insert a shift character is produced by a 7410 triple NAND gate, which is connected in an exclusive OR configuration. This device compares the shift status in the flip-flop to the shift information coming from data bit 6 of the PROM.

The serial to parallel and parallel to serial conversions are performed by a pair of AY5-1013 UARTs. Each UART contains a serial receiver and a serial transmitter. The two sections are independent, except for some control information which defines the structure of the serial data. Besides the data inputs and outputs, each section has status lines that are used for communication between the UART and the control circuits. When the UART receiver has a character ready, it sets the DAV (data available) line high. The external circuit should process the character and then indicate that it is no longer needed by strobing the RDAV (reset data available) line. The transmitter section has a TBMT (transmitter buffer empty) line, which goes high when the buffer is empty. The external circuit should wait until TBMT is high and then may load a character into the transmitter by strobing the DS (data strobe) line.

The portions of the circuit I have described so far are all

concerned with operations on five- or seven-bit parallel characters. The PROM, multiplexers, and UARTs run under the control of three other portions of the circuit, which I am about to describe. First, there is the ASCII sequence generator, which consists of one flip-flop and two NAND gates. When the DAV from the Baudot UART goes high, the sequencer waits for 1/2 a clock and then puts out a negative pulse for 1/2 a clock. This pulse loads a character into the ASCII UART, clears the data available flag in the Baudot UART, and loads the shift flip-flop.

The Baudot sequence generator consists of a 74161 binary counter, a 7442 decoder, a 7454 AND-OR-INVERT gate and a few NAND gates and inverters. The sequence is initiated when the DAV from the ASCII UART goes high. Table 2 shows the steps that the circuit goes through. The output signals are negative pulses that are used to load characters into the Baudot UART, load the shift flip-flop, and clear the data available flag in the ASCII UART. The 74161 is connected as a 3-bit counter, so it has eight states. Its output is decoded by the 7442. The two count enable inputs of the counter are used to hold the counter in a given state when necessary. The AOI gate controls parallel loading of data into the counter, permitting jumps to

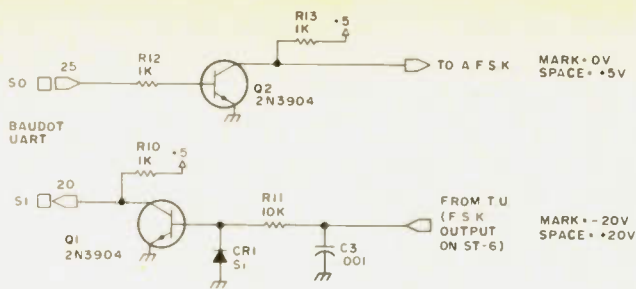

Fig. 6. Baudot interface.

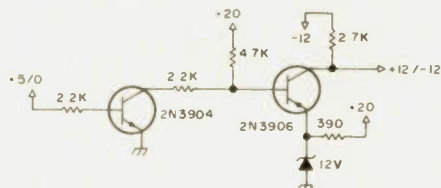

Fig. 7. Driver for FSK diode.

new states.

Finally, there is the mode switching circuit, consisting of one JK flip-flop and a couple of NAND gates. When the flip-flop is in the high state, the Baudot to ASCII conversion is selected by enabling the Baudot UART, addressing the upper half of the PROM, and gating the DAV line to the ASCII sequencer. In a similar manner, the ASCII to Baudot conversion is selected when the flip-flop is in the low state. Input to the mode switching circuit comes from the DAV lines of the two UARTs. With no inputs, the flip-flop toggles. When an input signal appears, the flip-flop holds in the required state until the conversion is completed and the DAV is cleared. It then switches to the other state if the DAV from the other UART has come on, or it just toggles if there is no input. Note that there is plenty of time to interlace the conversions this way because the control circuits are clocked at 16 times the baud rate.

The clock generator consists of a master oscillator and two divider chains. The 555 is connected as a free-running oscillator at 105.6 kHz. This frequency is divided by 60 to produce the ASCII clock. The Baudot divider chain consists of three 74161 binary counters connected as programmable dividers. The first

two divide by 29 or 44, and the third divides by 2, 3, 4 or 5 to produce the Baudot clocks for the four speeds ranging from 60 to 100 words per minute. All clock outputs are accurate to better than 0.2%, once the master clock is set. It would be possible to economize there by using separate 555 oscillators for ASCII and for Baudot, particularly if only one Baudot speed were desired.

Design Criteria

In designing the code converter, I generally followed the recommendations of the Fairchild TTL handbook.¹ You will notice that there are no monostable multivibrators or RC coupling elements in the circuit. This allows me to retain the inherent noise immunity of TTL logic. Also, I have used synchronous edge-triggered flip-flops and counters in the control circuitry. These devices are only sensitive to input conditions during the low to high transition of the clock. The use of synchronous logic makes the design very predictable and free of glitches and unexpected states. I also paid attention to the fan-out rating of the devices. Most TTL-compatible MOS devices such as the UARTs and the PROM are able to drive only one standard TTL load. Where more drive was required, I used gates or inverters as

Address		Data		Character	Purpose
Hex	Binary	Hex	Binary		
00	00000000	40	01000000	NUL	
01	00000001	FF	11111111		ASCII to Baudot
...					
1B	00011011	5B	01011011	ESC	Cntl and Figs.
...					
30	00110000	36	00110110	0	
31	00110001	37	00110111	1	
3F	00111111	39	00111001	?	
...					
40	01000000	FF	11111111		
41	01000001	03	00000011	A	ASCII to Baudot
42	01000010	19	00011001	B	Letters
...					
61	01100001	03	00000011	a	
62	01100010	19	00011001	b	
...					
7F	01111111	5F	01011111	RO	
...					
80	10000000	00	00000000	BLNK	
81	10000001	45	01000101	E	Baudot to ASCII
...					
9B	10011011	82	10000010	FIGS	Unshifted
9C	10011100	4D	01001101	M	
9D	10011101	58	01011000	X	
9E	10011110	56	01010110	V	
9F	10011111	7F	01111111	LTRS	
...					
A0	10100000	80	10000000	BLNK	
A1	10100001	B3	10110011	3	Baudot to ASCII
...					
BE	10111110	BB	10111011	,	Shifted
BF	10111111	7F	01111111	LTRS	
...					
C0	11000000	80	10000000	BLNK	
...					
DF	11011111	7F	01111111	LTRS	Auto unshift on space
...					
E0	11100000	FF	11111111		
...					
FF	11111111	FF	11111111		Unused

Table 1. Translation tables contained in the PROM. Complete listings of the tables may be obtained from the author.

buffers. Another solution would be to drive only low-power Schottky TTL from the MOS. In this case, up to four LSTTL inputs could be driven.

Interfacing

The logic levels at the serial input and output lines of the two UARTs are TTL-compatible — that is, Mark = 1 = +5 V and Space = 0 = 0 V. These lines may be connected directly to any other TTL logic, but, usually, some interfacing is required for equipment such as a

terminal unit or a TTY machine. Considering the ASCII end first, the most common requirement would be connection to a 20 mA current loop. If you are lucky enough to have a Model 33 or 35 Teletype that was formerly used for TWX service (there will be a telephone dial on the right-hand side), the circuit of Fig. 5 is for you. You will find two 50-pin micro ribbon connectors, dangling underneath the machine, that formerly connected to the modem (Bell 101C Dataset). No

State	Function
0	If bit 8 = 1, jump to 6
1	If bit 7 = 1 or shift not changed, jump to 4
2	Strobe DS
3	Wait for TBMT
4	Wait for TBMT
5	Strobe DS
6	Strobe RDAV
7	Wait for TBMT, jump to 0

Table 2. Steps of the ASCII to Baudot sequence.

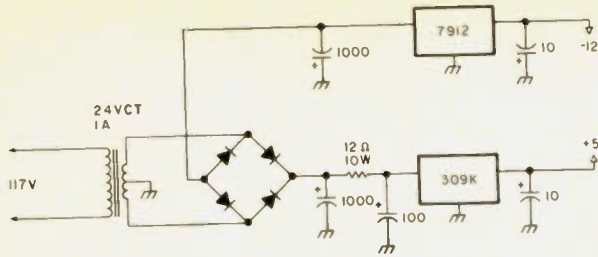

Fig. 8. Power supply.

modifications to the machine are required. Just obtain a mating female connector, wire it to the interface and plug it in. You will also require a source of plus and minus 20 volts at 30 mA or so. A Model 33 does not use the +20, so this may be omitted. The connections to pins 1 and 2 are the printer loop, and the connections to pins 7 and 8 are the keyboard loop. If you have a Model 33 without all the telephone stuff, just forget about the connector and wire these

lines directly to the machine. At the Baudot end of the converter, the usual requirements will be connections to a terminal unit (demodulator) and to an AFSK oscillator (modulator). Interfaces for the popular ST-6 and AK-1 are shown in Fig. 6. The ST-6 interface is very tolerant of input levels and may be used with many other sources of Baudot. The AK-1 interface may be modified to an open collector stage or to a higher voltage stage for use with other modulators. If you

need both positive and negative levels to drive an FSK diode, use the interface shown in Fig. 7.

Power Supply

The code converter requires a regulated +5.0 volt supply at about 600 mA and a regulated -12 volt supply at about 50 mA. In addition, voltages of -20 and +20 at about 30 mA may be required for the interfaces. Regulation is not necessary here. One design of a suitable

power supply is given in Fig. 8. Many other designs would work equally well.

Tape Controller

When I run a tape on my ASR Teletype, I get overruns in the code converter resulting in missing characters in the 60 wpm Baudot output. A simple solution to this problem is shown in Fig. 9. The 555 is connected as a free-running oscillator, with the frequency adjustable from 2 to 10 Hz. The relay

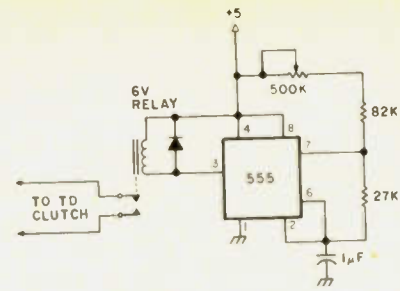
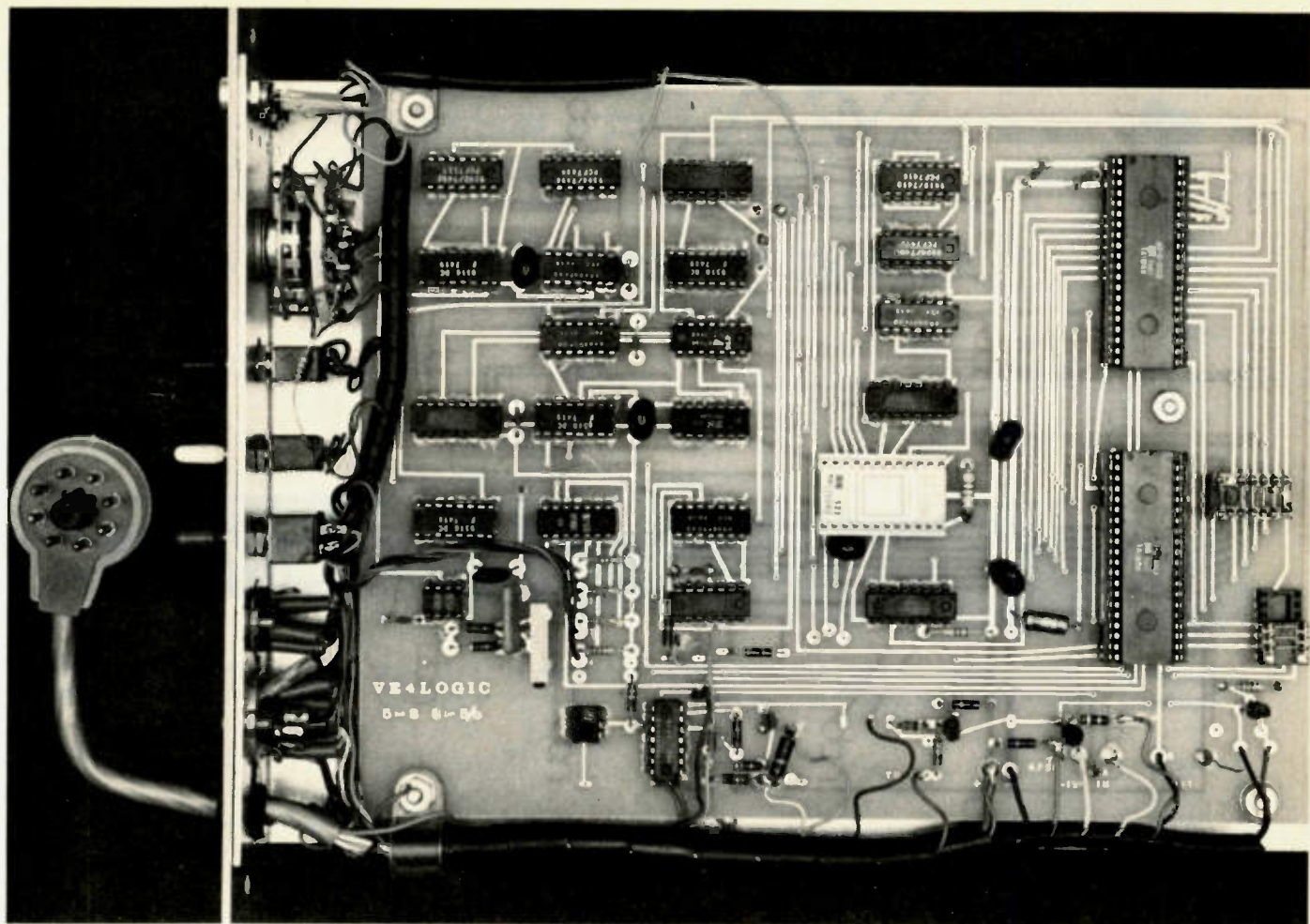

Fig. 9. Tape reader control.

Parts List

C1	10 μF, 25 V electrolytic capacitor
C2	680 pF mica
C3	.001, 50 V ceramic disc
CX1-CX11	.05-1, 25 V disc ceramic despiking capacitors
CR1	1N914 or similar silicon diode
Q1, Q2, Q3, Q4	2N3904 or similar NPN transistor 2N3906 or similar PNP transistor
R1	100 Ohm ½ Watt resistor
R2, 6, 7, 9, 21, 22	2.7k Ohm ½ W (1.5-6.8k Ohm acceptable) pullup resistors
R3	4.7k Ohm ½ W
R4	5.6k Ohm ½ W
R5	2.5k Ohm potentiometer, printed circuit style (multi-turn preferred) Master Clock Adj.
R10, 12, 13, 17	1k Ohm ½ W
R11, 15	10k Ohm ½ W
R14	330 Ohm ½ W
R16	3.3k Ohm ½ W
R18	1k Ohm 1 Watt
R19	15k Ohm ½ W
U1, 2, 4, 6, 7, 8	7400 TTL integrated circuit DIP chip
U3	7454
U5	7410
U9	7474
U10, 11	AY5-1013 General Instruments UART
U12	74153
U13	1702 UV erasable PROM
U14	74157
U15, 16	7404
U17	74109
U18, 23, 24, 25	74161
U19	7442
U20	555 timer
U21	7490
U22	7492
U26	FCD 810 optocoupler, Fairchild

A semi-kit, consisting of a double-sided PC board with plated-through holes, a 1702 EPROM programmed and tested, sockets for U10, U11, U13 and complete assembly instructions, is available at a cost of \$62.50 from: VE4 LOGIC, 76 St. Clair Blvd., Winnipeg, Manitoba, Canada R2C 0V2.



contacts close once during each oscillator cycle, causing the tape reader (TD) to transmit one character. With this circuit, you can adjust the speed of the tape to a speed that the converter can accept, and everything runs just fine with no missing characters. You can cut a tape from a received Baudot signal and transmit it later, or make a tape locally from the ASCII keyboard and transmit it in Baudot code.

One-way Conversion

The first code converter I built is shown in Fig. 10. It has two UARTs, the same PROM, one 7404 and one 7474. I used separate 555 clocks running at 727 Hz and 1760 Hz. If you want to make a gradual start into code conversion, or if you just want to listen in on amateur and commercial activity, then this circuit is ideal. If you later decide you want to transmit as well, the circuit could easily be

expanded to the two-way version.

Construction

I assembled the prototype of the code converter on an IC breadboard and had no particular problems. Everything worked just the way the circuit logic and manufacturer's data sheets predicted it would, the moment I plugged it into the breadboard. A group of local amateurs, VE4BF, VE4CM, VE4XD and VE4YD, was formed to design and produce PC boards for the converter. Because of the circuit complexity, we decided upon a double-sided board with plated-through holes. Several copies have now been built using this board.²

If you build the circuit (or part of it) yourself, using your own board or hand-wiring or wrapping, there is nothing critical about the layout. Just follow normal TTL construction practices, keep the interconnections shorter

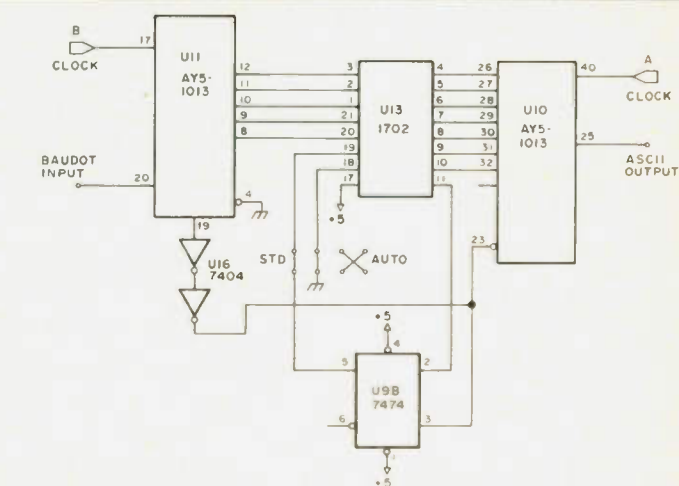

Fig. 10. Baudot to ASCII one-way conversion.

than 18 inches, and bypass the supply buses occasionally. The only adjustment required is the clock trimmer. This can be set with a counter if it is available. If not, do it on received signals by determining the range over which error-free copy is obtained and then setting the trimmer to the midpoint of the range. I can give very few suggestions on troubleshooting, other than to try to

localize the trouble to a small portion of the circuit. If you use only first quality ICs, the circuit should work the first time you try it, and no debugging will be required. ■

References

1. *The TTL Applications Handbook*, Fairchild Semiconductor, Mountain View CA.
2. Boards, programmed PROMs and some other parts are available from: VE4 LOGIC, 76 St. Claire Blvd., Winnipeg, Manitoba, Canada R2C 0V2.

WE HAVE WHAT YOU NEED AT...



YD-844
Dynamic Mike

YAESU

**ADVANCED COMMUNICATION
EQUIPMENT**



QTR-24
World Clock

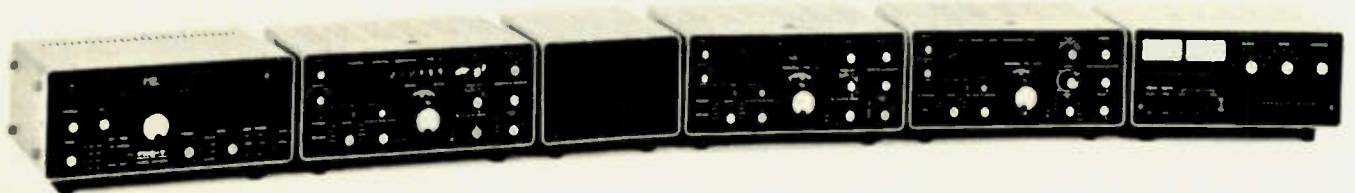

Left to right - FRG-7, Solid State Synthesized Communications Receiver • FR-101 Digital, Solid State Receiver • SP-101B, Speaker • FR-101, Digital Solid State Receiver • FL-101, 100 W Transmitter • FL-2100B, 1200 W PEP Input Linear Amplifier



Left to right - FT-620B, 6 Meter Transceiver • YP-150, Dummy Load Wattmeter • YO-100, Monitor Scope • FTV-250, 2 Meter Transverter • FTV-650, 6 Meter Transverter • FV-101B, External VFO • FT-101E 160-10 M Transceiver

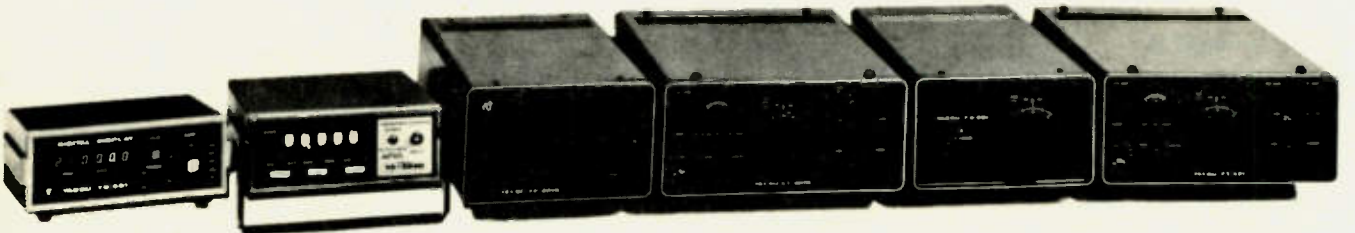

Left to right - YC-601, Digital Frequency Display • YC-355D, Frequency Counter • FP-301, AC Power Supply • FT-301S Digital, All Solid State Transceiver • FV-301, External VFO • FT-221, 144-148 All Solid State All Mode Transceiver

USED GEAR • TRADE UP • FREE UPS SHIPPING ON PREPAID ORDERS

\$2,000,000 HAM INVENTORY

HAMTRONICS - WHERE THE HAM IS KING

THE LOWEST POSSIBLE PRICES



THE PACESETTER IN AMATEUR RADIO



TS-700A \$599.00

2M ALL MODE BASE/MOBILE TRANSCEIVER. SSB (upper and lower), FM, AM and CW. AC and DC. 4 MHz band coverage (144 to 148 MHz). Dial in receiver frequency and TS-700A automatically switches xmitter freq. 600 KHz for repeater operation. Xmit, Rcv capability on 44 Ch. with 11 xtals.



TR-7400A \$399.00

2M MOBILE TRANSCEIVER. Synthesized PLL. Selectable output, 25 watts or 10 watts. 6 Digit LED freq. display. 144-148 MHz, 800 CH. in 5 KHz steps. 600 KHz repeater offset. Continuous tone-coded squelch (CTSC). Tone Burst.



TS-820 \$869.00

SSB TRANSCEIVER. PLL RF Monitor Noise Blanker. Digital hold locks counter & display at any frequency, but allows VFO to tune normally. True RF compressor adjustable speech processor. IF shift control. RF attenuator. VOX, GAIN, ANTIVOX and VOX delay controls. RF negative feedback. Optional digital readout. ORS Dial. High stability FET VFO.



TS-520S \$649.00

SSB TRANSCEIVER. Proven in the shacks of thousands of discriminating hams, field day sites, OX and contest stations and mobile installations. Superb engineering and styling.

SP-520 \$22.95

Optional external speaker for better readability.

TV-502 \$249.00

TRANSVERTER. Puts you on 2M the easy way. 144-145.7 MHz or optional 145-146 MHz.

PS-5 \$79.00

DYNAMIC MICROPHONE.

Designed especially for homes. PTT and lock switches. 600 or 50K ohm.



TR-7200A \$249.00

2M MOBILE/BASE FM TRANSCEIVER. Ignition interference control. 2 pole Xtal filter in IF rcvr. Protection for final stage transistor & reverse polarity connections. Priority Ch. switch. Quick release mount. LED CH. indicators. Switchable 10W or 1W output.



MC-50 \$39.50

Dynamic microphone designed expressly for amateur radio operation. Complete with PTT and LOCK switches, and a microphone plug. (600 or 50k ohm)



COMMUNICATIONS RECEIVER. 1.8 to 29.7 MHz, WWV and CB band. 50 MHz, 144 MHz converter optional. Stable VFO & oscillator for 5 fixed channels. 1 KHz dial readout. Xtal filters (SSB/8 pole, CW/8 pole, AM/6 pole). Squelch. S meter. Noise blanker.

S-599-\$19.94 R-599A-\$459.00 T5990-\$479.00

SSB TRANSMITTER. 3.5 to 29.7 MHz. Stable VFO. 1 KHz dial readout. 8 pole Xtal filter. AM Xmission available. Built-in AC pwr supply. Split frequency control available.



VFO-820 \$145.00

Designed exclusively for use with TS-820. RIT circuit and control switch. Fully compatible with optional digital display.

VFO-520 (Not Shown) \$116.00

Solid State Remote VFO. RIT circuit with LED indicator.

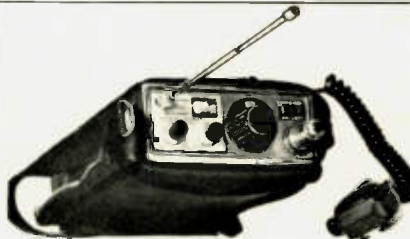

TR-2200A \$229.00

PORTABLE 2M FM TRANSCEIVER. 12 Ch. capacity. Removable telescoping antenna. External 12 VDC or internal NI-CAO batteries. 146-148 MHz. 6 CH. supplied. Switchable 2W or 400mW output.



R-300 \$239.00

ALL BAND COMMUNICATIONS RECEIVER. AC, batteries or external DC. 170 KHz to 30 MHz in 6 bands. Foreign broadcasts or ham radio in AM, SSB and CW. Dual gate MOS/FET transistors & double conversion. Band spread dial. 500 KHz marker.

THE BIG 'H' FOR ALL YOUR HAM NEEDS!

MASTERCHARGE & BANKAMERICARD ACCEPTED

HAMTRONICS

DIVISION OF TREVOSSE ELECTRONICS
4033 Brownsville Rd • Trevose, Pa. 19047
(215) 357-1400/(215) 757-5300

WE HAVE WHAT YOU NEED AT...



DRAKE®

KNOWN FOR QUALITY THROUGHOUT THE WORLD

HAMTRONICS - WHERE THE HAM IS KING

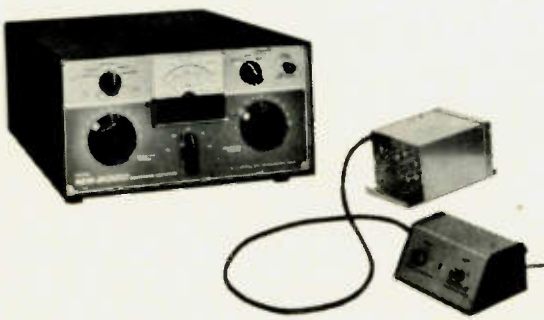

RECEIVERS

SSR-1	General Coverage, .5 to 300 MHz	\$350.00
SPR-4	Programmable, Solid State	\$629.00
DSR-2	VLF-HF Digital Synthesized SSB, AM, CW, ISB, RTTY	\$2950.00
R-4C	C-Line. HF. 160-10M	\$599.00
4NB	Noise Blanker for R-4C	\$52.00
5NB	Noise Blanker for SPR-4	\$70.00

TRANSMITTER

T-4XC	C-Line. HF. 160-10M	\$599.00
-------	---------------------	----------

TRANSCEIVERS

TR-4CW	80-10M. SSB, AM, CW	\$699.00
TR-33C	2M, FM, 12 CH. Portable	\$229.95
MMK-33	Mobile/Dash/Desk Mount for TR-33C	\$12.95
34PNB	Plug-In Noise Blanker for TR-4 Series	\$100.00
MMK-3	Mobile Mount for TR-4	\$7.00
RV-4C	Remote VFO for TR-4 CW	\$150.00
FF-1	Crystal Control for TR-4	\$46.95

SYNTHESIZER

FS-4	General Coverage for 4-Line and SPR-4	\$250.00
------	---------------------------------------	----------

LINEAR AMPLIFIER

L-4B	Linear and w/power supply & tubes	\$895.00
------	-----------------------------------	----------

MATCHING NETWORKS

MN-4	Antenna Matching Network. 200W	\$120.00
MN-2000	Antenna Matching Network. 1000W	\$240.00
RCS-4	Remote Control Antenna Switch	\$120.00

W-4	RF Wattmeter, 1.8 to 54 MHz	\$72.00
WV-4	RF Wattmeter, 20 to 200 MHz	\$84.00
7072	Hand Held Microphone	\$19.00
7075	Desk Top Microphone	\$39.00
1525EM	Pushbutton Encoding Microphone	\$49.95
HS-1	Head Phones	\$10.00
AA-10	10W, 2M Amplifier	\$49.95
TV-300-HP	300 ohm High Pass TV Set Filter	\$10.60
TV-75-HP	75 ohm High Pass TV Set Filter	\$13.25
TV-42-LP	Transmitter Low Pass Filter. 100W	\$14.60
TV-3300-LP	Transmitter Low Pass Filter. 1000W	\$26.60
TV-5200-LP	Transmitter Low Pass Filter. 1000W. 100W, 6M	\$26.60

USED GEAR • TRADE UP • FREE UPS SHIPPING ON PREPAID ORDERS

\$2,000,000 HAM INVENTORY

THE LOWEST POSSIBLE PRICES

COLLINS AMATEUR EQUIPMENT



KWM-2A TRANSCEIVER \$3533.00
 Unmatched for mobile and fixed station applications. 175W on SSB, 160W on CW. Switch select up to 14 optional Xtals. Can be used for RTTY. Filter type SSB generation. Automatic load control. Inverse RF feedback. Reimability-tuned variable oscillator.



75S-3C RECEIVER \$2504.00
 Sharp selectivity. SSB, CW and RTTY. Single control rejection tuning. Variable BFO. Optional mechanical filters for CW, RTTY and AM. 2.1 KHz mechanical filter. Zener regulated oscillators. 3-position AGC.



32S-3A TRANSMITTER \$2597.00
 Covers all ham bands between 3.4 MHz and 30 MHz. Nominal output of 100W. 175W, SSB and 160W CW. Dual conversion. Automatic load control. RF inverse feedback. CW spotting control. Collins mechanical filter.

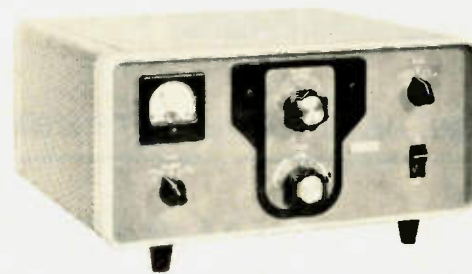

30L-1 LINEAR AMPLIFIER \$1536.00
 1000 watts PEP on SSB and 1000 Average on CW. Single control rejection tuning (50 dB). Variable BFO. 2.1 kHz Mechanical filter. Zener regulated oscillators. 3 position AGC. Exclusive comparator circuit.



312B-3 SPEAKER
\$80.00



312B-4 SPEAKER CONSOLE
\$546.00



312B-5 VFO CONSOLE
\$1212.00



516F-2 AC POWER SUPPLY
\$440.00



302C-3 DIRECTIONAL WATT METER
\$360.00



DL-1 DUMMY LOAD
\$270.00

MASTERCHARGE & BANKAMERICARD ACCEPTED

HAMTRONICS

DIVISION OF TREVOSE ELECTRONICS
 4033 Brownsville Rd • Trevose, Pa. 19047
 (215) 357-1400 / (215) 757-5300

THE BIG 'H' FOR ALL YOUR HAM NEEDS!

WE HAVE WHAT YOU NEED AT...

BIRD THRULINE® WATTMETER

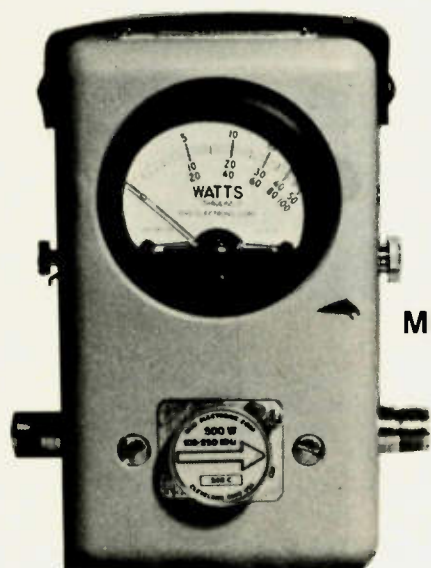

MODEL 43

- BUY ONLY THE ELEMENTS YOU NEED AND ADD EXTRA RANGES AT ANY TIME
- READ RF WATTS DIRECTLY

Table 1
STANDARD ELEMENTS

Power Range	Frequency Bands (MHz)					
	2-30	25-60	50-125	100-250	200-500	400-1000
5 watts	—	5A	5B	5C	5D	5E
10 watts	—	10A	10B	10C	10D	10E
25 watts	—	25A	25B	25C	25D	25E
50 watts	50H	50A	50B	50C	50D	50E
100 watts	100H	100A	100B	100C	100D	100E
250 watts	250H	250A	250B	250C	250D	250E
500 watts	500H	500A	500B	500C	500D	500E
1000 watts	1000H	1000A	1000B	1000C	1000D	1000E
2500 watts	2500H					
5000 watts	5000H					

Table 2
LOW-POWER ELEMENTS

1 watt	Cat. No.	2.5 watts	Cat. No.
60-80 MHz	060-1	60-80 MHz	060-2
80-95 MHz	080-1	80-95 MHz	080-2
95-125 MHz	095-1	95-150 MHz	095-2
110-160 MHz	110-1	150-250 MHz	150-2
150-250 MHz	150-1	200-300 MHz	200-2
200-300 MHz	200-1	250-450 MHz	250-2
275-450 MHz	275-1	400-850 MHz	400-2
425-850 MHz	425-1	800-950 MHz	800-2
800-950 MHz	800-1		

WE HAVE A COMPLETE STOCK OF ALL BIRD WATTMETERS AND SLUGS



NATIONAL RADIO COMPANY, INC.
NRCI

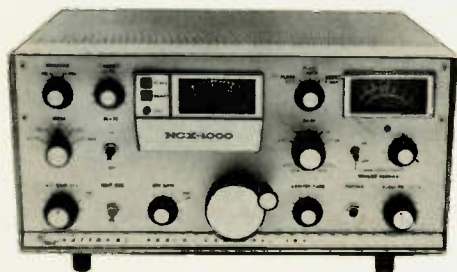

NCX-1000

The only 1000 watt, "single package" transceiver. Heavy duty design... results of 50 years of design leadership in amateur equipment. State of the art speech processing, linear amplifier, power supply, all in one package. Nothing extra to buy. Covers all amateur bands in the HF spectrum... AM, SS' CW' **\$1,600**

NCL-2000

Linear Amplifier. A full 10 dB gain, 20 watts in 2000 watts out. Can be driven with one watt. Continuous duty design utilizes two 8122 ceramic tetrode output tubes, designed for both AM and SSB operation. The industry standard for 12 years. Thousands in use all over the world.

\$1,200



HRO-500

The ultimate short wave receiver. This synthesized (phase lock loop) receiver incorporates all facilities for AM, Single Side Band (SSB), and CW reception in all frequencies from the bottom of the very low frequency band (VLF) to the top of the high frequency band (HF). National's "dead accurate" dial means no searching for transmissions. Dial up the frequency and it's there: aeronautical, marine, CB, amateur, military, etc. Continuous coverage. **\$3,000**



USED GEAR • TRADE UP • FREE UPS SHIPPING ON PREPAID ORDERS

\$2,000,000 HAM INVENTORY

HAMTRONICS-WHERE THE HAM IS KING

THE LOWEST POSSIBLE PRICES



ICOM

VHF/UHF AMATEUR & MARINE EQUIPMENT



VHF/UHF AMATEUR & MARINE EQUIPMENT

IC-245. 146 MHz FM 10W XCVR. LSI synthesizer with 4 digit LED readout. Xmit & Rcv frequencies independently programmable. 6C dB spurious attenuation.

\$499.00

IC-215. 2 METER FM PORTABLE. Three narrow filters for superb performance. 3W or 400 mW. 15 CH. capacity. MOS FET RF Amp & 5 tuned ckt. S-meter front panel.

\$229.00



\$249.00

IC-502. 6 METER SSB & CW PORTABLE XCVR. Includes antenna & battery pack. 3W PEP & stable VFO for fun & FB QSO's. Covers first 800 KHz of 6M band, where most activity is.



IC-211. 4 MEG, MULTI-MODE 2M XCVR. 144-145 MHz on SSB & CW, plus 146-147 MHz on FM. Work AMAT OSCAR six or seven. LSI synthesizer with 7 digit LED. MOS FET RF Amp, 5 helical cavities, FET mixer & 3 I.F. filters.

\$749.00



\$299.00

IC-22S. 145 MHz FM 10W XCVR. CMOS synthesizer can be set to any 15 KHz ch. between 146 & 148 MHz by diode matrix board. Spurious attenuation far better than FCC spec. 10W or 1W. IDC modulation control.



IC-21A. 146 MHz FM 10W XCVR. MOS FET RF Amp & 5 helical resonator filter, plus 3 I.F. filters. IDC modulation control. Variable output pwr: 500 MW to 10W Front panel discriminator meter. SWR bridge. 117 VAC and 13.6 VDC pwr supplies.

\$399.00

DV-21. DIGITAL VFO. Use with IC-21A to complete 2M band.

\$299.00



IC-202. 2 METER SSB PORTABLE XCVR. Puts sideband in your hand! Internal C batteries or external 12 VDC. 3W PEP. True I.F. noise blanker. 144.0, 144.2 on two other 200 KHz bands, selectable. Hamtronics stocks 145.2 and 145.8 - 146.0 MHz for calling frequency & satellite band.

\$259.00



IC-30A. 450 MHz FM LOW XCVR. 1W or 10W. Low noise MOS-FET RF Amp & 5 section helical filter. 22 CH. capacity. S-meter & relative power output meter. IDC modulation control.

\$399.00

MASTERCHARGE & BANKAMERICARD ACCEPTED

HAMTRONICS

DIVISION OF TREVISE ELECTRONICS
4033 Brownsville Rd • Trevose, Pa. 19047
(215) 357-1400 / (215) 757-5300

THE BIG 'H' FOR ALL YOUR HAM NEEDS!

WE HAVE WHAT YOU NEED AT...

TEMPO



TEMPO ONE	HF Transceiver. 80-10M. USB, CW & AM	399.00
AC/ONE	Power Supply for TEMPO ONE	99.00
VF/ONE	External VFO for TEMPO ONE	109.00
TEMPO VHF/ONE	Transceiver. 2M. 144 yo 148 MHz. PLL	399.00
TEMPO SSB/ONE	SSB Adapter for TEMPO VHF/ONE	199.00
TEMPO 2020	Transceiver. 80-10M. USB, LSB, CW and AM. PLL. Digital	759.00
FMH	2W, VHF/FM, 6 Ch. Hand Held. 144-148 MHz	199.00
RBF-1	Wattmeter & SWR Bridge	42.95
DM-20	Desk Mike. 600 or 50K ohm. PTT & Lock Switches	39.00
MS-2	4 Ch. Pocket Scanning Rcvr.	99.00

ATLAS



210X	Transceiver. 10-80M. 200W	679.00
215X	Transceiver. 15-160M. 200W	679.00
OMK	Deluxe Mtg. Kit for 210X & 215X	48.00
220CS	AC Console for 210X & 215X	149.00
350-XL	Transceiver. SSB. Solid State. 10-160M. 350W.	995.00
DD6-XL	Digital Dial Readout for 350-XL	195.00
305	Plug-In Auxiliary VFO. For 350-XL	155.00
311	Plug-In Auxiliary Crystal Oscillator for 350-XL	135.00
350-PS	AC Pwr Supply w/Spkr & Phone Jack for 350-XL	195.00
DMK-XL	Mobile Mounting Bracket for 350-XL. Easy Plug-In	65.00

SWAN



700 CX	Transceiver. 700W PEP. SSB. 80-10M. USB, LSB or CW	649.95
VX-2	Plug-In VOX for 700 CX	44.95
SS-16B	Super Selective IF Filter for 700 CX	99.95
MARK II	Linear Amplifier Full Legal Power. W/100W input. 80-10 M.	849.95
1200 X	Portable Linear Amplifier. 1200W PEP. SSB. 700W, Ch. 300W, AM. 80-10M.	349.95
FP-1	Hybrid Telephone Patch. Connect Rcvr/Xmitter to Phone lines	64.95



FC-76	Frequency Counter. 5 Digit LED	169.95
WM6200	In-Line Precision Wattmeter for 2M. 2 Scales to 200W. Reads SWR.	59.95
FS-2	SWR & Field Strength Meter	15.95
SWR-3	Pocket SWR Meter	12.95
SWR-1A	Relative Power Meter & SWR Bridge	25.95
W2000	In-Line Wattmeter. 3 Scales to 2000W. 3.5 to 30 MHz	59.95
WM-3000	Peak/RMS Wattmeter. Tells The Truth About SSB	79.95
FS-1	Pocket Field Strength Meter	10.95
WM1500	In-Line Wattmeter. 4 Scales to 1500W. 2 to 50 MHz	74.95
MARK II	Linear Amplifier. Full Legal Power. W/100W input. 80-10 M.	849.95
1200 X	Portable Linear Amplifier. 1200W PEP. SSB. 700W, CW. 300W, AM. 80-10M.	349.95

USED GEAR • TRADE UP • FREE UPS SHIPPING ON PREPAID ORDERS

\$2,000,000 HAM INVENTORY

HAMTRONICS-WHERE THE HAM IS KING

THE LOWEST POSSIBLE PRICES

NYE VIKING



No. 114-310-003 \$8.25

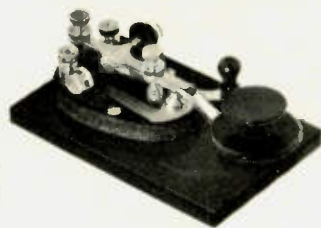

No. 114-310-004GP \$50.00

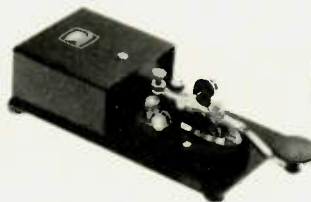

No. 114-404-002 \$18.50

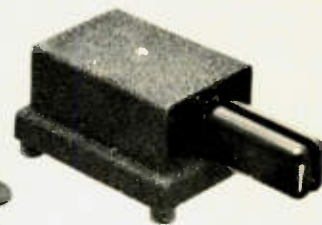

No. SSK-1 \$23.95



No. 250-46-1 \$36.50



No. 250-46-3 \$44.50



No. 250-20-1 \$19.95



No. 250-0025-003 \$212

NPC

2.5 AMP



12CB4 29.95

4 AMP



103R 39.95

6 AMP



104R 49.95

12 AMP



108 RM
99.95



25 AMP

109R 149.95

VIBROPLEX



"PRESENTATION"
66.00

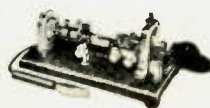

"ORIGINAL"
39.95



"LIGHTNING BUG"
39.95



"CHAMPION"
31.50



VIBRO-KEYER
33.00

MASTERCHARGE & BANKAMERICARD ACCEPTED

HAMTRONICS

DIVISION OF TREVISE ELECTRONICS
4033 Brownsville Rd • Trevose, Pa. 19047
(215) 357-1400/(215) 757-5300

THE BIG 'H' FOR ALL YOUR HAM NEEDS!

WE HAVE WHAT YOU NEED AT...

DenTron 3 Kilowatt Tuner Matches Everything From 160 to 10

160-10 MAT

Built-In
Wattmeter

Front Panel Antenna
Selector for
Coax, Balanced
Line and Random
Wire.



only \$299.50

1000 to 1200 WATTS OUTPUT TO YOUR ANTENNA

DenTron SUPER AMP



\$499.50

If the amplifier you're thinking of buying doesn't deliver at least 1000 to 1200 watts output, to the antenna, you're buying the wrong amplifier.

Our New Super Amp is sweeping the country because hams have realized that the DenTron Amplifier will deliver to the antenna, (output power), what other manufacturers rate as input power.

The Super Amp runs a full 2000 watts P.E.P. input on SSB, and 1000 watts DC on CW, RTTY or SSTV 160-10 meters, the maximum legal power.

The Super Amp is compact, low profile, has a solid one piece cabinet assuring maximum TVI shielding.

The heart of our amplifier, the power supply, is a continuous duty, self-contained supply built for contest performance.

We mounted the 4 - 811 A's, Industrial workhorse tubes, in a cooling chamber featuring the on-demand variable cooling system.

The hams at DenTron pride themselves on quality work, and we fight to keep prices down. That's why the dynamic DenTron Linear Amplifier beats them all at \$499.50.

NOW AVAILABLE WITH 572 B¹ FDR **\$574.50**



DenTron Super Tuner

160-10 Meters
Balanced Line,
Coax, Random
or Long Wire

Maximum Power Transfer, Xmitter to Antenna.

1 KW Model \$129.50

3 KW Model \$229.50

DenTron ANTENNAS

The Sky Openers

SKYMASTER

A fully developed and tested 27 foot vertical antenna covers entire 10, 15, 20, and 40 meter bands using only one cleverly applied wave trap. A full 1/4 wave antenna on 20 meters. Constructed of heavy tearless aluminum with a factory tuned end sealed HQ Trap. SKYMASTER is weatherproof and withstands winds up to 80 mph. Handles 2 KW power level and is for ground, roof or tower mounting. Radials included in our low price of

\$84.50

Also 80 m resonator for top mounting on SKYMASTER.

\$29.50

SKYCLAW

A tunable monoband high performance vertical antenna, designed for 40, 80, 160 meter operation. SKYCLAW gives you the following spectrum coverage:

BAND (Meters)	BANDWIDTH (kHz)
160	50
80	200
40	entire band

Tuning is easy and reliable. Rugged construction assures that this self-supporting unit is weatherproof and survives nicely in 100 mph winds. Handles full legal power limit.

\$79.50

EX-1

The DenTron EX-1 Vertical Antenna is designed for the performance minded antenna experimenter. The EX-1 is a full 40 meter, 1/4 wave, 33', self-supporting vertical. The EX-1 is the ideal vertical for phasing.

\$59.50



TRIM-TENNA

The antenna your neighbors will love. The new DenTron Trim-Tenna with 20 meter beam is designed for the discriminating amateur who wants fantastic performance in an environmentally appealing beam. It's really loaded! Up front there's a 13 foot 6 inch director with precision Hy-Q coils. And, 7 feet behind is a 16 foot driven element fed directly with 52 ohm coax. The Trim-Tenna mounts easily and what a difference in on-the-air performance between the Trim-Tenna and that dipole, long wire or inverted Vee you've been using. 4 & 6 Forward Gain Over Dipole.

\$129.50



ALL BAND DOUBLET

This All Band Doublet or inverted Type Antenna covers 160 thru 10 meters. Has total length of 130 feet (14 ga. stranded copper) although it may be made shorter if necessary. This tuned Doublet is center fed through 100 feet of 450 ohm PVC covered balanced transmission line. The assembly is complete. Add rope to the ends and pull up into position. Tune with the DenTron Super Tuner and you're on 10 through 160 meters with one antenna! Now just for the DenTron All Band Doublet.

\$24.50

DenTron ANTENNA TUNER

The 80-10 Skymatcher

Here's an antenna tuner for 80 through 10 meters, handles 500 w P.E.P. and matches your 52 ohm transceiver to a random wire antenna.



- Continuous tuning 3.2 - 30 mc
- "L" network
- Ceramic 12 position rotary switch
- SO-239 receptional to transmitter
- Random wire tuner
- 3000 volt capacitor spacing
- Tapped inductor
- Ceramic antenna feed thru
- 7" W, 5" H, 8" D., Weight: 5 lbs.

\$59.50

DenTron W-2 PAD INLINE WATTMASTER

Read forward
and reflected
watts at the
same time

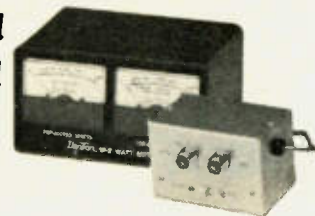

Tired of constant switching and guesswork?

Every serious ham knows he must read both forward and reverse wattage simultaneously for that perfect match. So upgrade with the DenTron W-2 Dual in line Wattmeter.

\$99.50

USED GEAR • TRADE UP • FREE UPS SHIPPING ON PREPAID ORDERS

\$2,000,000 HAM INVENTORY

HAMTRONICS-WHERE THE HAM IS KING

THE LOWEST POSSIBLE PRICES

TEN-TEC INC.

TRITON IV EQUIPMENT



TRANSCEIVERS

MODEL 540-200W, SSB/CW
3.5 - 30 MHz \$699.00

MODEL 544- DIGITAL, 200W
SSB/CW, 3.5 - 30 MHz \$869.00

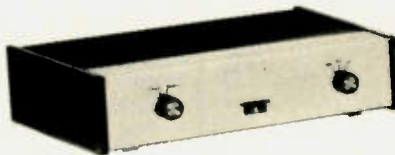

MODEL 240 \$97.00
ONE - SIXTY CONVERTER



MODEL 242 \$169.00
REMOTE VFO

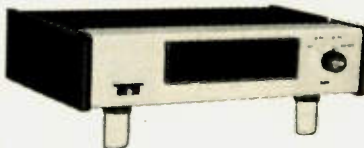

MODEL 244 \$197.00
DIGITAL READ OUT/COUNTER



MODEL 262-G \$139.00
DELUXE POWER SUPPLY



ARGONAUT

MODEL 509 \$359.00
SW, SSB/CW, 3.5-30 MHz

LINEAR AMPLIFIER

MODEL 405 \$159.00
100W, 3.5 - 30 MHz

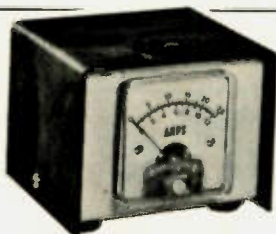
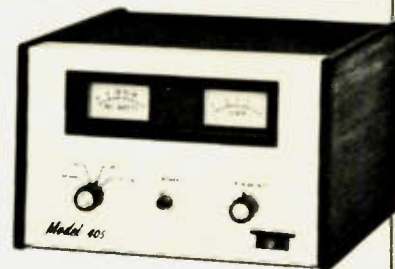

AMMETER
207 \$14.00

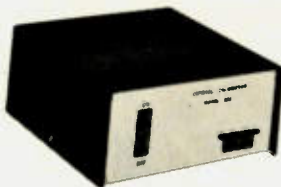

XTAL CALIBRATOR
206 \$29.00



ELECTRONIC KR-50
\$110.00

KEYERS



ELECTRONIC KR20-A
\$69.50



ELECTRONIC KR-5A
\$39.50

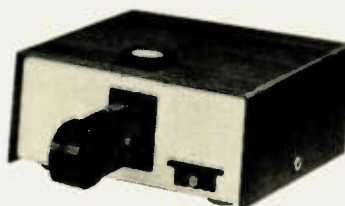

KR-2A \$17.00



KR1-A \$35.00

MASTERCHARGE & BANKAMERICARD ACCEPTED

HAMTRONICS

DIVISION OF TREVISE ELECTRONICS
4033 Brownsville Rd • Trevose, Pa. 19047
(215) 357-1400 / (215) 757-5300

THE BIG 'H' FOR ALL YOUR HAM NEEDS!

SPECIALS FROM MHz electronics

Fairchild VHF Prescaler Chips

11C01FC	High Speed Dual 5-4 Input no/nor	15.40
11C05DC	1 GHz Counter Divide by 4	74.35
11C05DM	1 GHz Counter Divide by 4	110.50
11C06DC	UHF Prescaler 750 MHz D Type flip/flop	12.30
11C24DC	Dual TTL VCM same as MC4024P	2.60
11C44DC	Phase Freq. Detector same as MC4044P	2.60
11C58DC	ECL VCM	4.53
11C70DC	600 MHz flip/flop with reset	12.30
11C83DC	1 GHz 248/256 Prescaler	29.20
11C90DC	650 MHz Prescaler Divide by 10/11	16.00
11C90DM	same as above except Mil. version	24.00
11C91DC	605 MHz Prescaler Divide by 5/6	16.00
11C91DM	same as above except Mil. version	24.00
95H90DC	350 MHz Prescaler Divide by 10/11	9.50
95H90DM	same as above except Mil. version	16.50
95H91DC	350 MHz Prescaler Divide by 5/6	9.50
95H91DM	same as above except Mil. version	16.50
T.I. TMS4060/C2107, 4K RAM		19.01

Batteries

Gel-Cell 12 volts at 1.5 Amp Hr. #GC-1215 \$19.95

Crystals

1.000000 MHz	4.95	JUST ARRIVED! These radios have just been pulled out of service. Set up for approx. 150 MHz.
5.000000 MHz	4.95	Clean. All tubes included. No accessories. Prices
10.000000 MHz	4.95	F08 Phoenix.
3579.545 KC	2.95	Motorola U43 GGT \$49.95
		GE TPL \$99.95
		GE MT-33 \$39.95
		6EMT42N \$79.95

10.7 MHz Narrow band Crystal Filters type 2194F \$7.95

10.7 MHz Ceramic Filter

MuRata SFW10.7MA \$3.95

Johanson and Johnson

Trimmer Capacitors

1 to 14 pf.	\$1.95
1 to 20 pf.	\$1.95

Ferrite Beads

12 for .99 or
120 for 9.99

FET's

2N3070	1.50	2N5460	.90	MFE3002	3.35
2N3436	2.25	2N5465	1.35	MPF102	.45
2N3458	1.30	2N5565	5.45	MPF121	1.50
2N3821	1.60	3N126	3.00	MPF4391	.80
2N3822	1.50	MFE2000	.90	U1282	2.50
2N4351	2.85	MFE2001	1.00	MMF5	5.00
2N4416	1.05	MFE2008	4.20	40673	1.39
2N4875	1.75	MFE2009	4.80	40674	1.49

TUBES

2E26	5.00	811	6.95	7984	4.95
3828	4.00	811A	9.95	8072	32.00
4X150A	15.00	931A	11.95	8156	3.95
4X150G	18.00	5849	32.00	8908	9.95
4CX2508	24.00	6146A	5.25	8950	5.50
4CX350A/8321	35.00	6146B/8298A	6.25	4-400A	29.95
4CX15000	\$150.00	6360	7.95	4-250A	24.95
DX415	25.00	6907	35.00	4-125A	20.95
5728/T160L	25.00	7377	40.00	4-65A	15.95

RF TRANSISTORS

2N1561	15.00			2N5590	6.30
2N1562	15.00	2N3866 JAN TX	4.85	2N5591	10.35
2N1692	15.00	2N3925	6.00	2N5635	4.95
2N1693	15.00	2N3927	11.50	2N5636	11.95
2N2631	4.20	2N3948	2.00	2N5637	20.70
2N2857	1.80	2N3950	26.25	2N5643	20.70
2N2876	12.35	2N3961	6.60	2N5641	4.90
2N2880	25.00	2N4072	1.70	2N5643	20.70
2N2927	7.00	2N4073	2.00	2N5764	27.00
2N2947	17.25	2N4135	2.00	2N5841	11.00
2N2948	15.50	2N4427	1.24	2N5842/MM1607	19.50
2N2949	3.90	2N4470	20.00	2N5849/MM1622	19.50
2N2950	5.00	2N4440	8.60	2N5852	50.00
2N3287	4.30	2N4957	6.30	2N5942	49.50
2N3300	1.05	2N5070	13.80	2N5922	10.00
2N3302	1.05	2N5090	6.90	2N6080	5.45
2N3307	10.50	2N5108	3.90	2N6081	8.60
2N3309	3.90	2N5109	1.55	2N6082	11.25
2N3375/MM3375	7.00	2N5179	.68	2N6083	12.95
2N3553	1.80	2N5184		2N6084	14.95
2N3571	4.10	2N5216	47.50	2N6094	5.75
2N3818	6.00	2N5583	5.60	2N6095	10.35
2N3824	3.20	2N5589	4.60	2N6096	19.35
2N3866	1.09			2N6097	28.00
2N3866 JAN	4.14				

H.P. TS510 A/U / H.P. 608D UHF Signal Gen. 10 MHz to 420 MHz \$500.00
 H.P. HO3-624C / KS16647 Microwave Signal Gen. 10.7 GHz to 11.7 GHz \$900.00
 Motorola MR510 Diodes 1000 piv @ 3 amp. 9.90 / 20 pcs

HP 623B Microwave test set 6565 MHz to 7175 MHz \$900.00

Beckman Model 6127 Eput meter with Model 607 Heterodyne plug in D.C. to 1 GHz \$900.00

New Motorola Carbon Microphone Model P-7255A. This unit is a "noise cancelling" palm type microphone. These mikes come with or without cables. Price without cables \$19.95; with cables \$29.95.

H.P. 624B Microwave test set 6565 MHz to 7175 MHz \$900.00

Beckman Meter and Heterodyne Plug-in/Freq meter D.C. to 1 GHz \$900.00

Motorola MC14410CP CMOS tone generator uses 1 MHz crystal to produce standard dual frequency telephone dialing signal. Directly compatible with our 12 key Chomeric pads. Kit includes the following.

1 MC14410CP	
1 1 MHz Crystal	
1 Printed Circuit Board (From Ham Radio Sept. 1975)	
And all other parts for assembly.	\$15.70

Fairchild 95H90DC Prescaler divide by 10 to 350 MHz. Will take any 35 MHz Counter to 350 MHz. Kit includes the following.

1 95H90DC	
1 2N5179	
2 UG-88/u BNC's	
1 Printed Circuit Board	
And all other parts for assembly.	\$29.95

Fairchild 11C90DC Prescaler divide by 10 to 650 MHz. Will take any 65 MHz Counter to 650 MHz or with a 82590 it will divide by 10/100 to 650 MHz. This will take a 6.5 MHz counter to 650 MHz. Kit includes the following.

1 11C90DC		
1 2N5179		
2 UG-88/U		
1 MC7805CP	1 Printed Circuit Board and all other parts for assembly.	
1 Bridge	82590 add \$5.70 to total.	\$59.95

TRANSFORMERS

F-18X	6.3vct at 6 amps	3.56
F-93X	6.5v to 40v at 750 ma.	3.53
F-92A	6.5v to 40v at 1 amp	4.59
N-51X	Isolation 115vac at 35va.	2.80
Model D-2	6.5v at 3.3 amps	4.95
	6.5v at 3.3 amps	
BE-12433-001	30v at 15 ma.	.49
BGH-9	6.3vct at 10 amps	
	115 vac at 100va Isolation	6.95
F-107Z	12V @ 4A or 24 V @ 2A	7.80

P6377 12v at 4 amps or 24v at 2 amps. \$6.30

P6378 12v at 8 amps or 12v at 4 amps. \$10.31

P8196 80vct at 1.2 amps \$6.28

DIODES

1N270 Germanium Diodes \$7.95/c

Semtech SFMS 20K, 20KV, 10 ma, fast recovery \$1.26 ea.

FANS

Pamotor Fans, Model 4500C 117 VAC, 60 Hz, 19 w. \$7.95

RF TRANSISTORS

MRF207	2.00	Amperex 8LY90	22.50	MM3002	1.65
MRF208	10.20	Amperex A209	8.60	MM3009	1.80
MRF209	12.35	MSC 2001	20.00	MM3375	7.00
MRF237	1.85	MSC 3000	20.00	MM3904	1.50
MRF238	8.55	MSC 3001	20.00	MM3906	1.43
MRF450	16.55	MSC 3005	20.00	MM4000	1.24
MRF453	19.55	MSC 80205	20.00	MM4001	1.39
MRF504	6.75	MSC 80206	20.00	MM4003	1.85
MRF509	5.50	MSC 80255	20.00	MM4036	1.60
MRF511	8.60	Fairchild SE7056	3.00	MM4044	3.00
MRF620	27.00	MM1051	2.00	MM4545	3.00
MRF8004	1.90	MM1500	32.20	MM8006	2.15
HEPS3013/75	2.95	MM1550	10.00	MM1552	50.00
HEPS3014/76	4.95	MM1601	5.50	MM1553	56.50
HEPS3002	11.03	MM1602	7.50	HEPS5026	2.48
HEPS3003	29.88	MM1607/2N5842	8.65	MSC 80256	20.00
HEPS3005	9.55	MM1614	2.75	CTC D1-28	20.00
HEPS3006	19.90	MM1620	17.50	CTC D10-28	20.00
HEPS3007	24.95	MM1622/2N5849	19.50	CTC E1-28	20.00
HEPS3008	2.18	MM1661	15.00		
HEPS3010	11.34	MM1669	17.50		
RCA TA7994	50.00	MM1943	3.00		
RCA 40290	2.48	MM2605	3.00		
Kertron K2126	5.50	MM2608	5.00		
Kertron K86008	5.50				

MHz electronics

2543 N. 32nd STREET
 PHOENIX, ARIZONA 85008
 PH. 602-957-0786



NO C.O.D. MB

THE PAIA 8700 COMPUTER/CONTROLLER

An exceptional price on an applications oriented 6503 based micro-processor system featuring:

- 1K bytes RAM locations (512 bytes supplied)
- 1K bytes ROM locations (256 byte monitor included)
- 2 - 8 bit input ports
- 2 - 8 bit output ports (1 latched, 1 buffered)
- 24 key touch operated keypad (used by the monitor to allow entry and execution of user programs - also user definable.)
- 2 - latched seven segment displays (used by monitor to display memory location and contents - easily user programmed)
- Optional cassette interface (\$22.50) fits entirely on the processor board.

THE IDEAL, LOW COST SOLUTION TO IMPLEMENTING ALL THOSE WILD COMPUTER BASED CONTROL SYSTEMS YOU'VE BEEN DREAMING OF!

PAIA software currently available or under development includes:

- Electronic music synthesizer interface.
- Home applications package including: Multi-zone fire & burglar alarm, real time clock, energy saving heat/air conditioning control, computer generated "door-bell".
- Model railroad controller
- More.....

8700 COMPUTER/CONTROLLER KIT \$149.95
(requires 5v. @ 1.2A. ; 12v. @ 150 ma.)

Shipped direct to you by PAIA (add \$3.00 postage & handling)

DETAILS ON PAIA KITS IN OUR FREE CATALOG WRITE FOR IT TODAY!

.. OR PHONE OUR 24HR DEMO/ORDER LINE (405) 843-7396 BAC & MC ORDERS ALSO ACCEPTED.

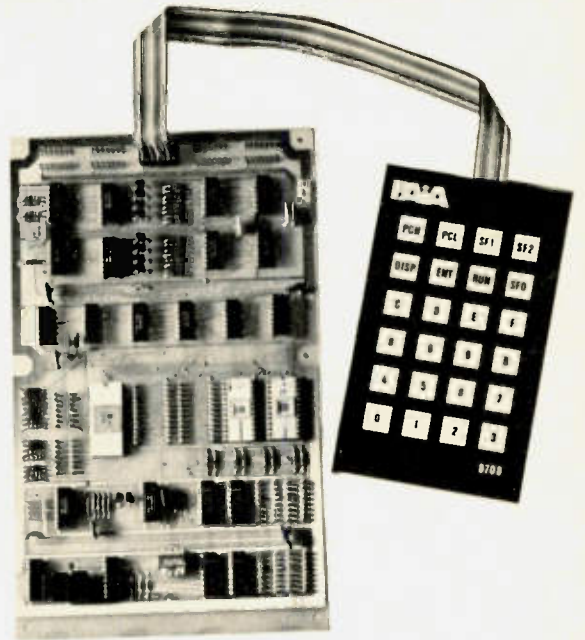

Also available at FULL-LINE Computer stores.

PAIA
P9 ELECTRONICS, INC.

Dept. 7-H 1020 W. Wilshire Blvd.
Oklahoma City, OK 73116

ok wire wrapping center ok

NEW HOBBY WRAP
MODEL BW 630



Battery
wire
wrapping
tool

\$34.95

COMPLETE WITH BIT
AND SLEEVES

STRIP/WRAP/UNWRAP
TOOL MODEL WSU-30



\$5.95*

RIBBON CABLE
ASSEMBLY

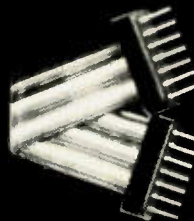

DIP SOCKETS

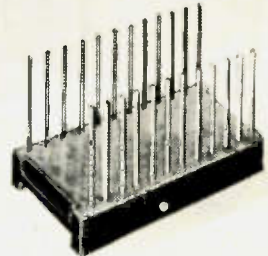

DIP IC INSERTION
TOOL WITH PIN
STRAIGHTENER



MODEL
INS-1416

\$3.49*

WIRE DISPENSER
MODEL
WD-30-B



\$3.45*

PRE-CUT
PRE-STRIPPED WIRE

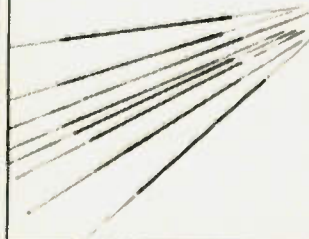

WIRE WRAPPING KIT

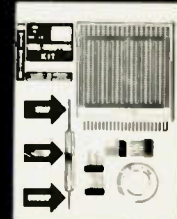

\$15.45*

*MINIMUM ORDER \$25.00, SHIPPING CHARGE \$1.00, N.Y. CITY AND STATE RESIDENTS ADD TAX

05

OK MACHINE AND TOOL CORPORATION

3455 CONNER STREET, BRONX, NEW YORK, N.Y. 10475 U.S.A.

PHONE (212) 994-6600 TELEX NO. 125091

Digital Group RTTY Micro

-- a natural team

Because I was interested in electronics, including amateur radio, I decided to get in on this new thing called microprocessing. I have

worked with digital electronics before and have put together some successful hardware projects. I quickly found that there were a few

small computer systems available, so some wise decision-making was necessary.

I sent away for literature and paid close attention to

magazine advertising. Then, things were pretty well summed up for me at the Spring, 1976, Rochester, N.Y. Hamfest, where they had a computer seminar. Prior to that I seemed to have a choice between MITS, IMSAI, and HAL. But now there was a new one on the scene — the Digital Group. I was planning to get the HAL 8080, but, when I found out that the Digital Group System could actually do something, and that software was only \$5 per cassette, I was sold. Further discussion with the fellows at the seminar confirmed that the Digital Group was for me. I knew nothing about software or programming, so the best bet had to be a company that would get me started without overcharging.

I took delivery of my system on the July 4th weekend of 1976. I managed to complete the unit inside 3 days — it didn't work. After searching under a magnifying glass and bright light, I found and removed the solder bridge that could have done me in. Sure enough, there it was, telling me via my TV monitor to "Read 8080 Initialize Cassette." I was off in another world, making it play the Star Spangled Banner while printing the flag on the TV. It would also play a number guessing game, send Morse code from the keyboard, and receive RTTY on the TV.

Since I had also ordered an additional 8K of memory with the system, I quickly began construction of the extra memory board. This board, along with the 2K of memory on the processor board, is what makes it a 10K system. Well, this time things didn't go so well. Nothing really seemed to work, including the Tiny BASIC tape and the Ham-1 tape. After some phone conversation with Digital Group and a check of my tapes by the software people (Dianne Howerton is very patient and

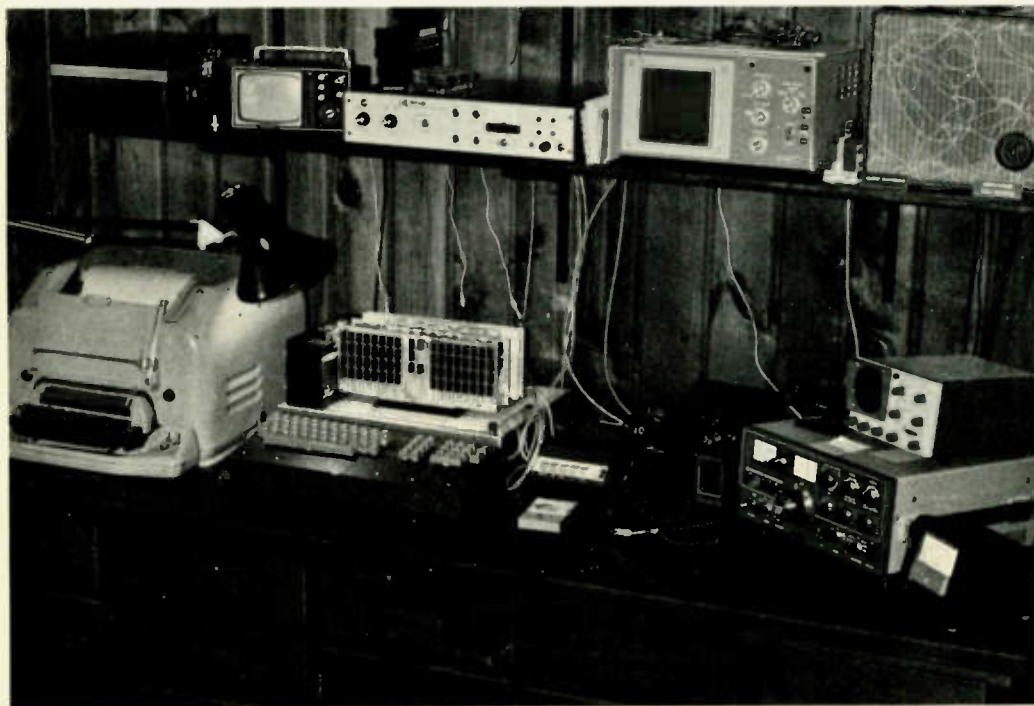

The author's shack, showing his Digital Group 8080A-4BD system with 10K RAM memory, 4 input/output ports x 8 bits, and 16 line x 32 letter character generator; surplus keyboard; Kleinschmidt 60 wpm Baudot machine; Ampex Micro 9A cassette recorder; Icom IC-22; and Kenwood TS-520.

understanding), I finally paid attention to the construction instructions. Back *again* to the bright light and the magnifying glass. Sure enough, just as written in the instructions. I had forgotten to solder two socket pins. Two in over a thousand isn't bad, is it? Anyway, the BASIC worked, and the Ham-1 tape worked.

Being inquisitive, I began to "dump storage" and look at what was going on in there. After reading and more reading, I finally was able to start some programs of my own. First I ran a few simple things, and then I began block moving data, studying sub-routines, and learning how to change memory addresses. Little by little I worked on making modifications. Before long I was surprised at how many octal instructions I could remember — load, jump, call, return, compare and jump based on flag sets, and so on, throughout the Intel 8080 program card. I found that I could remember octal more easily than hex, and, since the Digital Group 8080 operating system was in octal, I adopted it.

I found that the Digital Group Ham-1 RTTY transmit was not really doing as much as I wanted it to do, and, in fact, the Digital Group instructions encourage making modifications and improvements. One of the more aggravating problems was missing letters when typing too fast, especially during automatic figures-letters shifting, and another problem was no carriage return or line feed. The read

switch ASCII keyboard would barrel right along when 60 wpm was the limit. Of course, a mechanical machine like my Klienschmidt would mechanically prevent typing too fast. For a while I was using Tiny BASIC Baudot for amateur RTTY, but it kept giving out automatic error messages. It was for BASIC, not ham use.

At any rate, I wanted to have a RTTY transmit program which would have automatic carriage return after 70 letters, and, after accomplishing that, I went further to add an additional carriage return after 64 letters and a space. I then made a program to act just like punching paper tape, where letters entered at the keyboard were shuffled off to a blank memory area and stored. Executing the read program would then go back to the start and read the memory whenever called and as many times as I wanted.

Next, I put in a program modification to back step (decrement) the pointer, and back spacing for error correction was born. I even made a quick little program to send K2AOU in Morse code on the output and "Here is K2AOU" in RTTY — all at the punch of a number at the keyboard. I have future plans for it to turn the transmitter on and off. You had better not let it control your frequency, though; I heard of one fellow working WWV that way!

My ultimate goal was to build a buffer system. I had a discussion with an associate who had done some FORTRAN and general programming, and I learned about rotary pointers and fullness registers. I also dismantled the CW transmit part of the Ham-1, which works great as is but is scattered throughout memory. From it I learned more about pointers and timing loops, and I cleaned up the CW program's structuring within memory. Mind you, I did all this *before*

Digital Group came out with their Dissassembler.

I felt that the operator with only 2K of memory needed a fair deal, so I began work on a 2K FIFO (first in first out) buffer, as outlined here. It is a program which can be useful to any RTTY enthusiast, essentially a side-kick to the amateur RTTY station. Actually it takes only 500 bytes of instruction space and 256 bytes of scratchpad memory. The machine language is for the Intel 8080A. Those of you who have 8080 systems from other manufacturers can probably adapt the program. Be careful to observe Digital Group subroutines for TV output, delay loops, and keyboard input. If you have more memory, of course, you can add RTTY receive, additional buffers, CW ID, here is key, etc.

The Digital Group Operating System is based on the following routines:

1. READ in a new program from audio cassette to memory.
2. WRITE out a program from memory to the audio cassette record input.
3. OCTAL STORAGE DUMP of sequential memory locations.
4. KEYBOARD PROGRAM memory by entering each

byte in octal numbers.

5.6.7.8.9.0. User assigned "go to" or "execute" at specified addresses.

How It Works

It takes time to output Baudot RTTY, time for the start pulse, time for the five bits and time for the stop pulse. During this time the computer is kept busy, continuously sampling the keyboard input for action. If a key is pressed, it holds the letter, waits for the keyboard strobe to go low again (one letter per keystroke please), and then sweeps the letter off to the proper storage point in the buffer. Write storage point, read storage point, and storage fullness are all kept track of by special pointer bytes, including the location of the last carriage return, whether manual or automatic. This software is set up for 60 wpm output. If you wish to experiment with other speeds, there are three memory locations to work with — 007 304 is 015 for 60 wpm, 010 for 100 wpm. 007 154 is 064 for bit length, and 007 172 is 112 for the stop pulse. This can also be worked on if you have other than a 2 MHz clock speed.

Output Connections

The system output for the

Memory Blocks:

000 000 TO 000 377
 001 000 TO 001 277
 001 300 TO 001 316
 001 317 TO 005 055
 005 056 TO 005 075
 005 076 TO 005 123
 005 124 TO 005 136
 005 140 TO 005 247
 005 250 TO 005 274
 005 277 TO 005 377
 006 000 TO 006 377
 007 000 TO 007 277
 007 300 TO 007 362
 007 363 TO 007 377

Digital Group PROM
 Digital Group Operation System
 Start #5 Buffer Preload
 Digital Group Operating System
 Part of Buffer Preload
 Operating System
 Part of Buffer Preload
 Keyboard Subroutine
 Delay Loop Subroutine
 Operation Monitor Title Page
 Buffer Scratchpad (initialize full of 240s)
 Baudot Output Subroutine
 Start #6 Buffer load and read
 Start #7 Buffer Read Only

Table 1. ASCII to Baudot buffer system (FIFO). As you can see, no space is wasted to put this in 2K of memory. For more simplicity, one could eliminate the buffer preload and the buffer read only routines, but these are quite handy. An address is specified by page number and byte number, i.e., 007 000 in octal. When giving the address to the computer, always give it low first and then the high.

303

100 Means jump to page 7, byte 100.

007

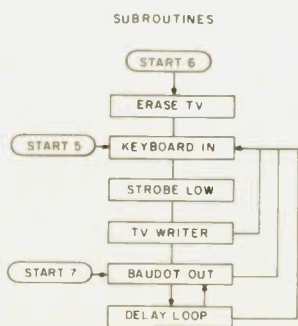
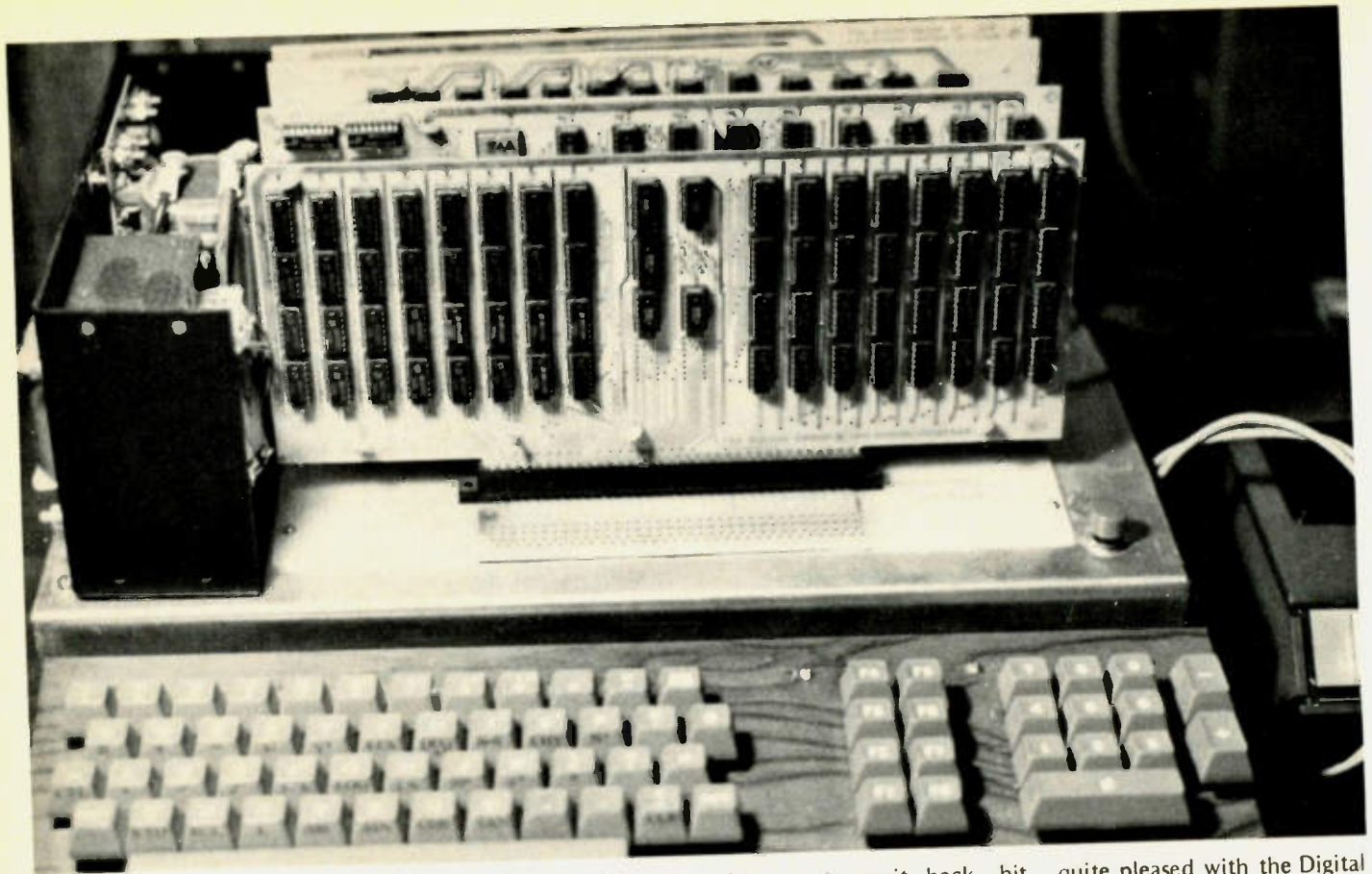

Fig. 1.



serial Baudot is port 002 lsb. I connect from this output through a 1000 Ohm safety resistor to a HAL ST-6 terminal unit. Inside the HAL there is an extra switch position for the optional 425 Hz discriminator. You can add a connector on the cabinet or make use of an extra pin on the back. Position 1 is then 850 shift, position 2 is computer output and position 3 is 170 shift. Because I wanted to be able to output either shift, I removed the AK-1 from this switch and installed a separate one. I also placed a jumper from the autostart bus to an open section of the input switch to turn on the page printer when in the computer position. Other connections to the RTTY loop can be made, but, by all means, use caution! TTL and loop voltages do not survive together. Refer to the article "How to Use Those Old Teletypes," 73, February, 1977, p. 88. Simpler yet would be to output to port 001, the built-in RTTY oscillator.

Instructions For Use

After reading in your tape

to the operations monitor, hit number 6 to use the buffer in real time. The processor will go to 007 300 and loop and wait for your message. You will have to be a good typist to get into the buffer to any depth, but it is very handy during figures to letters shifts and carriage return line feeds. When you hit the keys too fast for the output speed, the buffer remembers everything and puts it out in order. It does automatic carriage returns at the end of 70 letters or after 64 letters at the next space. Figures-letters are automatic in the ASCII conversion, and, whenever you hit a carriage return, it is automatically carriage return, line feed, letters. Hitting a control alpha will exit back to the operations monitor. ASCII % is Baudot bell, and ASCII # is Baudot H (STOP). Hitting a 5 from the operations monitor will cause the processor to go to 001 300, loop, and wait for you to preload the buffer with your next message of up to 250 letters, while the other station is sending to you on your page printer. When it is

time to transmit back, hit control L and continue to type into the buffer. The processor will output your message in Baudot while you continue to feed into it with ASCII. If you are slow, it will soon catch up to you. The whole idea here is that you get a 250 letter head start, just as if you were using punched tape. Also, during the preload mode, if a mistake is made, just key in an ASCII delete and the buffer will step back one space at a time. Hitting a 7 from the operations monitor will execute at 007 363 and read the buffer contents from the start at any time.

What Kind of Hardware?

If you only want this one item of software, you could get a single board system going with an 8085, 1K PROM, and 256 bytes of RAM. The board could be mounted underneath your ASCII keyboard and remain dedicated to this one job. If you are the innovative and inquisitive type (and bore easily), then you will want a more flexible system. I am

quite pleased with the Digital Group System, as it offers a lot of flexibility. CPU boards can be changed at any time, drawing from 8080A, Z-80, 6800 6502, and others, as they become available. The system comes with 2K of RAM memory on the CPU board 4 parallel input output ports, a TV character generator, and 1100 baud cassette interface. I'm using port 000 in for the ASCII keyboard. Port 000 out drives the TV generator's 512 byte memory, port 001 lsb in and out is for the cassette tape system, and port 002 lsb out is the Baudot serial RTTY output. My total memory at this time is 18K.

Locally, I am working on the air with Bob Hanson WB2DHL, and Ed McNeely K2RQB. We are trying to convince WA2BTG to join us, but, we've had no luck yet. We monitor two meter FM on 147.15 MHz RTTY and carry on at times on 146.25-85 (Oswego Repeater). Shhhh... we've even sent programming at 1100 baud on the air with super results. Hurry up with ASCII, FCC! ■

KEY BOARD IN SUBROUTINE

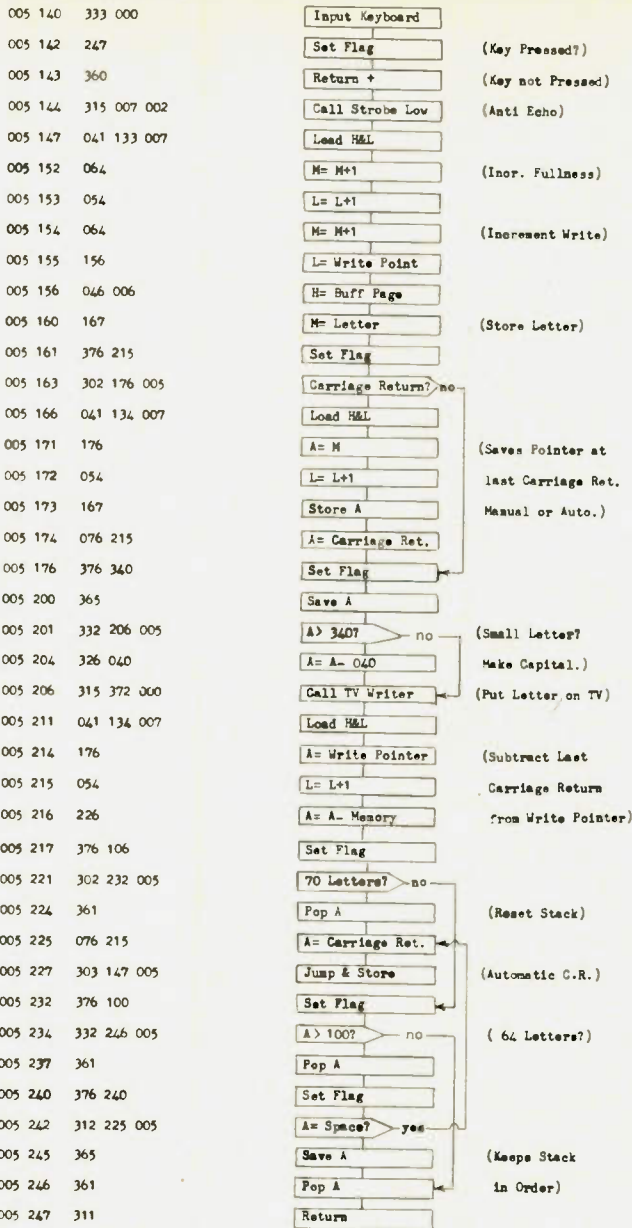

This keyboard routine is called by the Delay Loop routine, which is called by the Baudot Output routine. Even this keyboard routine calls for one more step of nesting for a Keystroke Low routine and the TV Writer routine, both of which are within the Digital Group operating system.

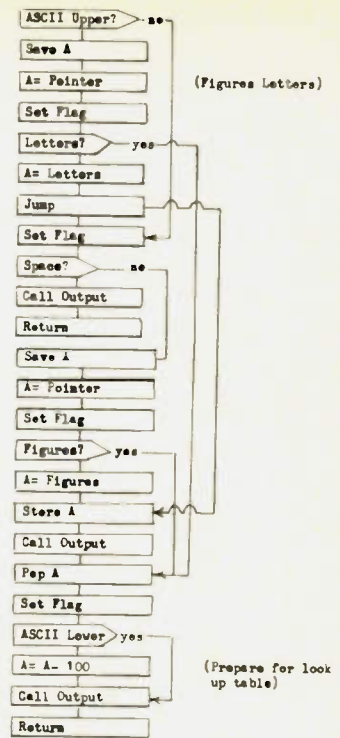
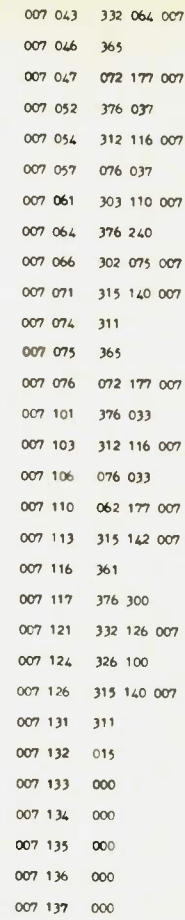

BAUDOT OUTPUT SUBROUTINE CONTINUED (OUTPUT PORTION)

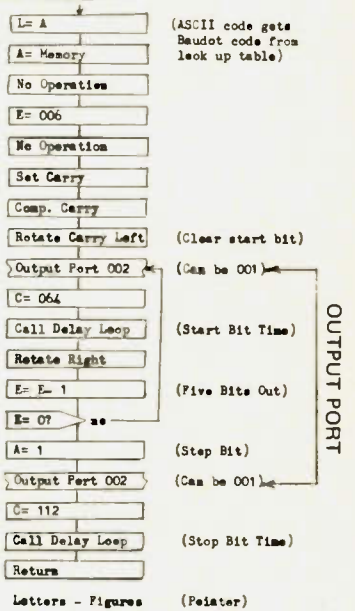

BAUDOT OUTPUT SUBROUTINE*

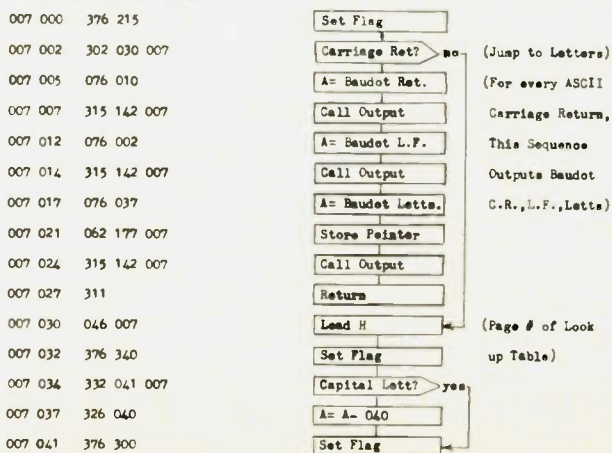

BAUDOT OUTPUT SUBROUTINE LOOK UP TABLE

007 200	000	#	007 220	026	P	007 240	004	Space	007 260	026	0
007 201	003	A	007 221	027	Q	007 241	015	!	007 261	027	1
007 202	031	B	007 222	012	R	007 242	021	"	007 262	023	2
007 203	016	C	007 223	005	S	007 243	024	# OFF	007 263	001	3
007 204	011	D	007 224	020	T	007 244	011	\$	007 264	012	4
007 205	001	E	007 225	007	U	007 245	005	% BELL	007 265	020	5
007 206	015	F	007 226	036	V	007 246	032	&	007 266	025	6
007 207	032	G	007 227	023	W	007 247	013	'	007 267	007	7
007 210	024	H	007 230	035	X	007 250	017	(007 270	006	8
007 211	006	I	007 231	025	Y	007 251	022)	007 271	030	9
007 212	013	J	007 232	021	Z	007 252	035	*	007 272	016	:
007 213	017	K	007 233	000		007 253	032	+ &	007 273	036	;
007 214	022	L	007 234	000		007 254	014	,	007 274	017	{ <
007 215	034	M	007 235	000		007 255	003	-	007 275	016	=
007 216	014	N	007 236	000		007 256	034	.	007 276	022	>
007 217	030	O	007 237	000		007 257	035	/	007 277	031	?

*Adopted from Digital Group Tiny BASIC and modified for efficiency.

References

1. 73 Magazine, Dec., 1976, "A Ham's Computer," Page 78, K7YZZ.
 2. 73 Magazine, Feb., 1977, "How to Use Those Old Teletypes," Page 88, K7YZZ.

3. 73 Magazine, Apr., 1977, "An Intelligent RTTY Station," Page 72, K7YZZ.

DELAY LOOP SUBROUTINE

```
005 250 365
005 251 041 132 007
005 254 106
005 255 005
005 256 312 267 005
005 261 315 140 005
005 264 303 255 005
005 267 015
005 270 302 251 005
005 273 361
005 274 311
```

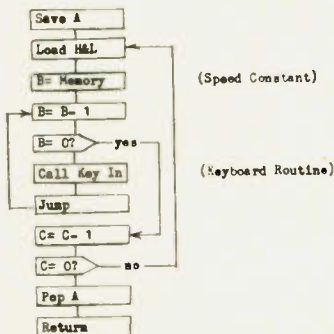

At 60 words per minute output, the keyboard is checked for a key pressed 5018 times for each Baudot letter printed out (or 30,108 times per second).

BUFFER PRELOAD (OPTIONAL)

```
001 300 041 132 007
001 303 257
001 304 006 004
001 306 054
001 307 167
001 310 005
001 311 302 306 001
001 314 303 124 005
005 124 315 140 005
005 127 376 214
005 131 302 056 005
005 134 303 322 007
005 056 376 377
005 060 302 124 005
005 063 041 133 007
005 066 065
005 067 065
005 070 054
005 071 065
005 072 065
005 073 303 124 005
```

NOTICE: ADDRESSES

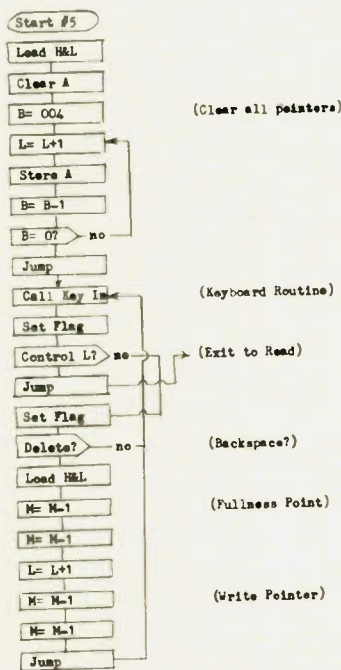

BUFFER READ ONLY (OPTIONAL)

```
007 363 076 377
007 365 041 133 007
007 370 167
007 371 257
007 372 056 136
007 374 167
007 375 303 322 007
```

Start #7

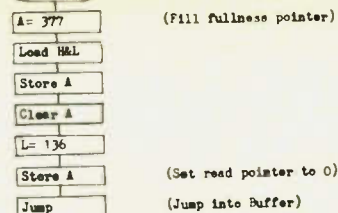

Using Start #5, preload with RYRY, The Quick Brown Fox, CQ DE K2AOU, etc. Then, hit Start #7 as many times as you want the message! Program your Digital Group "GO TO" or "Execute" (Start) locations as follows:

```
005 112 300 #5 GO
005 113 001
005 114 300 #6 GO
005 115 007
005 116 363 #7 GO
005 117 007
```

KEYBOARD STROBE LOW ROUTINE (Digital Group Op. Sys.)

```
002 007 365
002 010 333 000
002 012 376 200
002 014 362 010 002
002 017 361
002 020 311
```

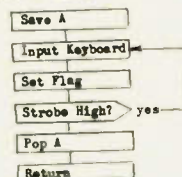

Note that the TV Erase and TV Writer routines are also part of the Digital Group operating system. The Operations Monitor title page was also moved and condensed to make room for this program. Change the following bytes to move the title page TV editor location:

005 004	041 300 005	Load H&L (With new ASCII message location)
005 300	377 Erase	005 327 033
005 301	011 9 Spaces	005 330 263 3
005 302	310 H	005 331 240
005 303	301 A	005 332 323 S
005 304	315 M	005 333 364 t
005 305	240	005 334 304 D
005 306	322 R	005 335 360 p
005 307	324 T	005 336 032
005 310	324 T	005 337 264 4
005 311	331 Y	005 340 240
005 312	057	005 341 320 P
005 313	261 1	005 342 347 g
005 314	240	005 343 355 m
005 315	322 R	005 344 073
005 316	345 e	005 345 265 5
005 317	341 a	005 346 240
005 320	344 d	005 347 320 P
005 321	032	005 350 362 r
005 322	262 2	005 351 345 e
005 323	240	005 352 314 L
005 324	327 W	005 353 357 o
005 325	362 r	005 354 341 e
005 326	364 t	005 355 344 d
		005 356 027
005 357	266 6	
005 360	240	
005 361	302 B	
005 362	365 u	
005 363	346 f	
005 364	346 f	
005 365	345 e	
005 366	362 r	
005 367	030	
005 370	267 7	
005 371	240	
005 372	322 R	
005 373	345 e	
005 374	344 d	
005 375	344 d	
005 377	000	

ATTENTION: HAM OPERATOR/COMPUTER OWNERS

At last the missing components for implementing a true automated ham shack are available and they are all products of International Data Systems, Inc. The following boards plug into any ALTAIR, IMSAI, or other S100 bus compatible computer and provide the needed hardware capability for maintaining time of day in a form the computer can easily manipulate, measure (and/or compute) the frequency of your transmitter and receiver up to 600MHz, decode Morse Code or RTTY, and key your transmitter for CW and RTTY operation. Extensive software is included with all modules and software is provided in MITS BK BASIC, PTCC BASIC 5, and Assembler source and object listings.

S100 BUS COMPATIBLE BOARDS (ALTAIR 8800/IMSAI 8080, etc.)	USES	KIT PRICE
88-SPM Clock Module	Your computer constantly knows the time of day and can use it in applications such as tracking OSCAR automatically, time stamping log data for contests, or more trivial applications such as performing 10 minute station time or time of day clock display functions.	\$ 96.00
88-UFC Universal Frequency Counter	Use it to select from 4 software selectable signal inputs and compute signal frequency, event periods or count total number of events. Use it to monitor and display transmit and receive frequency, automatic frequency logging for contests and contests, and even measure inside and outside temperature when used in conjunction with the TSM peripheral module listed below. Measures frequency to 800 MHz. Includes program to use 88-UFC to decode RTTY.	\$179.00
PERIPHERAL DEVICES FOR USE WITH ANY COMPUTER:		
MCTK Morse Code Trainer/Keyer	This hardware/software package is the best thing to happen to ham radio since OSCAR. Use it to teach Morse Code or to key your transmitter. Provides double isolation between your computer and your transmitter. Generates audio sidetone for headphones or speaker. All software included. User's NEW CODE METHOD in trainer mode.	\$ 29.00
TSM Temperature Sensing Module	Use it with the 88-UFC to measure temperature inside or outside. Is temperature monitor and control applications or just to be able to report current conditions during your QSO. Resolution is 1 degree.	\$ 24.00

Terms: Payment with order or C.O.D. Delivery: Stock to 30 days. Assembled units available at higher prices. Telephone (703) 536-7373.
 Product descriptions available for all items listed above plus many more ham related items.

IDS

INTERNATIONAL DATA SYSTEMS, INC.
 400 North Washington Street, Suite 200, Falls Church, Virginia 22046, U.S.A.

IDS

110

CANADIANS!

Eliminate the Customs Hassles.
Save Money and get Canadian
Warranties on IMSAI and S-100
compatible products.

IMSAI 8080 KIT \$ 838.00
ASS. \$1163.00

(Can. Duty & Fed. Tax Included).
AUTHORIZED DEALER

Send \$1.00 for complete IMSAI
Catalog.

We will develop complete applica-
tion systems.

Contact us for further information.

**Rotundra
Cybernetics**



Box 1448, Calgary, Alta. T2P 2H9
Phone (403) 283-8076

R13

\$699 builds Equinox 100™

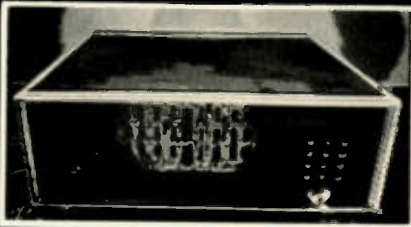

THE FRONTRUNNER

Equinox 100™ is the 8080 CPU / S-100 Bus
computer kit that's years in front of Altair®
and IMSAI in design, function and front-
panel programming capability. At \$699,
it's clearly **The Frontrunner**. Write for
free specs to Parasitic Engineering,
P.O. Box 6314, Albany, CA 94706.

EQUINOX 100

The Frontrunner from Parasitic Engineering

® A trademark of MITS Inc.

Armchair Copy



Barlow XCR-30

Shortwave Listening

Our ONLY occupation is
supplying everything you
need to tune the mediumwave
and shortwave bands—and
identify what you hear. Our
NEW mini-catalog details
Barlow Wadley, Drake and
Yaesu receivers, WORLD
RADIO TV HANDBOOK, logs,
receiving antennas & tuners,
calibrators, FM or TV guides,
AM pattern maps, QSL
albums, ITU publications,
RTTY displays, CONFIDEN-
TIAL FREQUENCY LIST,
clocks and all SWL books.

GILFER ASSOCIATES, INC

P.O. Box 239, Park Ridge, NJ 07656

IN WIRE-WRAPPING  HAS THE LINE.....

MODEL WD-30



PATENT PENDING

WIRE DISPENSER

- 50 FT. ROLL OF 30 AWG.
KYNAR® WIRE-WRAPPING WIRE
- CUTS THE WIRE TO LENGTH
- STRIPS 1 INCH OF INSULATION

AVAILABLE IN FOUR COLORS

WD-30-B BLUE WIRE
WD-30-Y YELLOW WIRE
WD-30-W WHITE WIRE
WD-30-R RED WIRE

**\$345
EACH**

MINIMUM BILLING \$25.00
ADD SHIPPING CHARGE \$1.00
NEW YORK STATE RESIDENTS
ADD APPLICABLE TAX

®KYNAR PENNWALT

OK MACHINE & TOOL CORPORATION

3455 Conner St., Bronx, N.Y. 10475 (212) 994-6600 / Telex 125091

RTTY Test Station

-- complete pattern generator

E. H. Sommerfield W2FJT
49 Spring Road
Poughkeepsie NY 12601

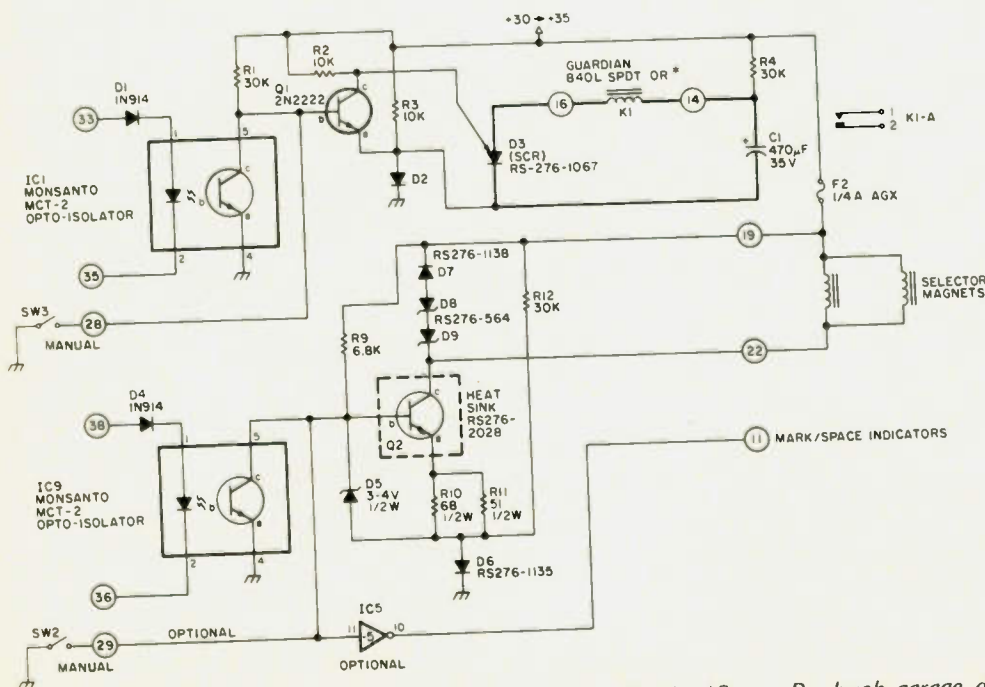

Fig. 1. Motor control and selector drive. RS = Radio Shack. *Sears, Roebuck garage door opener, model 139.65400, replacement part #160B27.

This article describes a solid state Teletype control/test system that satisfies the following needs:

For the RTTY amateur:

- A solid state selector magnet driver;
- A low power motor control for standby operation;
- RY test generator for stand alone operation and maintenance.

For the microprocessor enthusiast:

- A solid state selector magnet driver with TTL interface;
- A low power motor control with TTL interface.

The design is modular in that any function can be implemented independently of the others.

Functional Specifications

The "box" satisfies the following needs:

1. Complete electrical isolation between the Teletype and the microprocessor.
2. Computer-controlled on/off motor control.

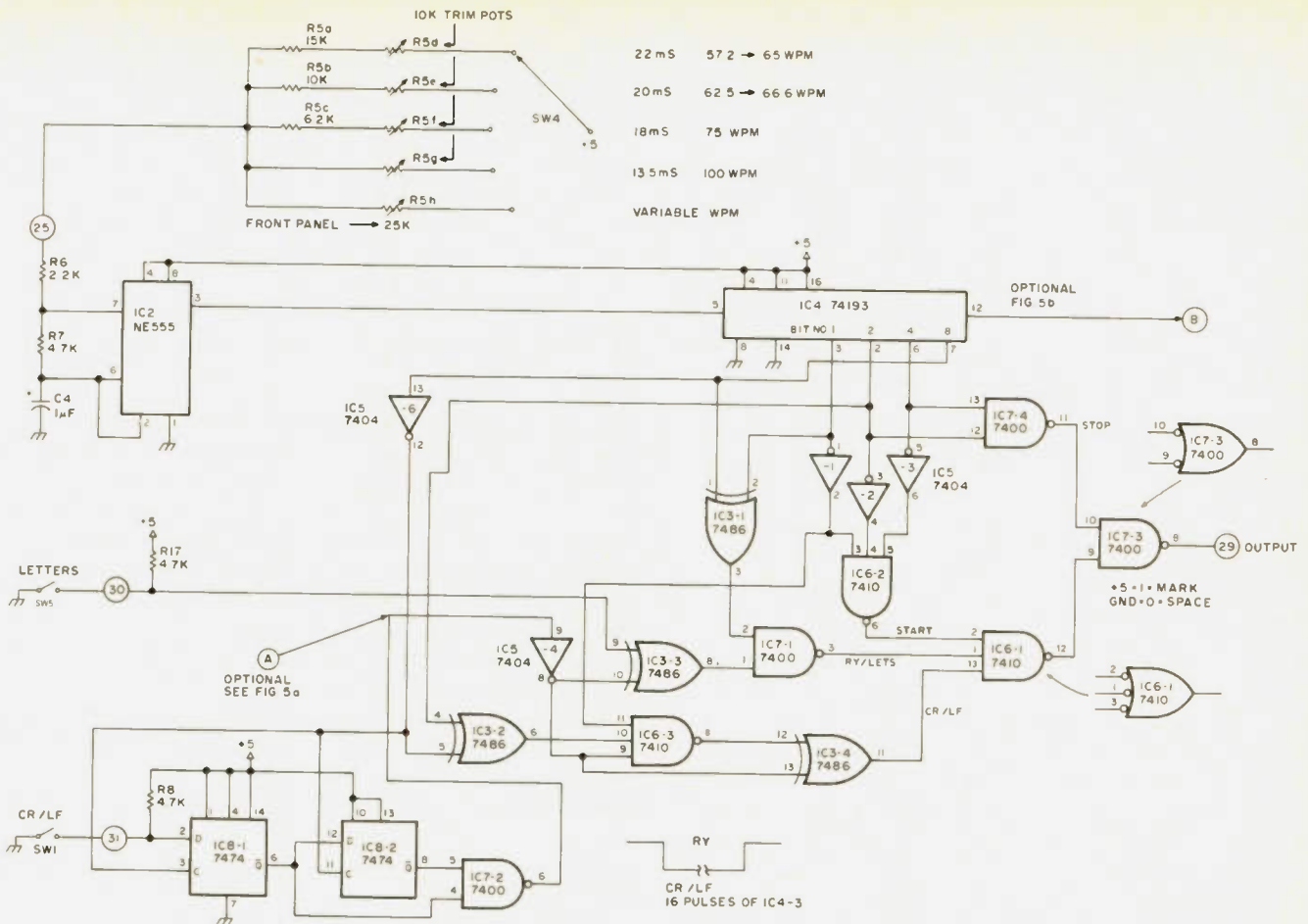

Fig. 2. Test pattern generation.

3. Solid state selector magnet control.
4. Self-contained RY test generator.
5. TTY interface.

Motor Control – Fig. 1

IC1, an optoisolator, is normally in the off state. Q1, normally in the on state, holds D3 (the SCR) in off state. C1, the power storage capacitor, has charged to +30 V via R4; this takes about 15 seconds. The steady state current is about 8 mA.

When 10 mA is applied to IC1 pins 1 and 2, IC1 turns on, driving Q1 off. This per-

mits 3 mA of gate current to flow into D3 via R2. D3 turns on, discharging C1 through the motor control relay K1. K1 is a mechanically latching relay. Each successive pulse changes its state; if it is on, it is turned off; if it is off, it is turned on. The stored charge in C1 is sufficient to energize K1. When the charge on C1 is dissipated in K1, K1 de-energizes and the anode current on D3 drops to 1 mA (via R4), which is insufficient to maintain conduction in D3 and D3 turns off. There is no inductive kick on K1 since no current exists in K1 at the

time of turnoff. This condition will last until the 10 mA is removed from IC1.

A waiting period of 15 or more seconds must be observed before another action can be initiated in order to recharge C1 at a power supply voltage of 35 volts, 25 to 30 seconds at 30 volts.

Note the connection of C1 to D3 must be direct and as short as possible since there are 3 Amperes of pulsed current flow in this loop.

D2 is used to bias Q1 high enough to insure that IC1 turns off Q1. Manual control is achieved by turning off Q1 via SW1.

D2 is used to bias Q1 high enough to insure that IC1 turns off Q1. Manual control is achieved by turning off Q1 via SW1.

Test Pattern Generator – Fig. 2

A test pattern that generates letters R and Y (or numbers 4 or 6) is stimulated by IC2, a free running oscil-

lator. IC2 generates positive transitions at a rate determined by R5a-R5h and SW4. These rates range from one each 22.0 ms (60 wpm) to one each 13.5 ms (100 wpm), or at a variable rate determined by R5h.

The function generation logic is divided into five functional areas: START, STOP, R(4)/Y(6), CR/LF, LETTERS. The START logic IC6-2 provides a down level at the output when the timing generator, IC4, is at 000x (outputs 1, 2, 4, and 8, respectively) START time. Note "x" is a don't-care condition. The STOP logic IC7-4 provides a low pulse at the output when the timing generator, IC4, is at 011x or 111x STOP time. The following explanations are only concerned with the 1-5 Baudot bits; the start and stop bits are common to all test patterns.

Letters

The LETTERS feature

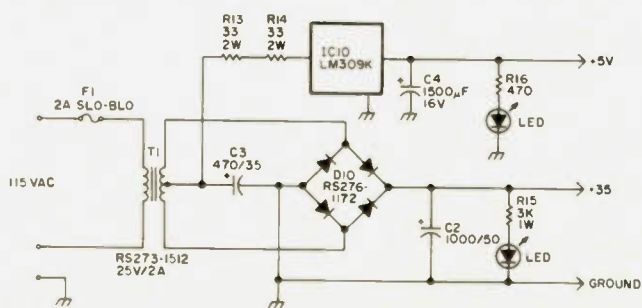

Fig. 3. Power supply. RS = Radio Shack.

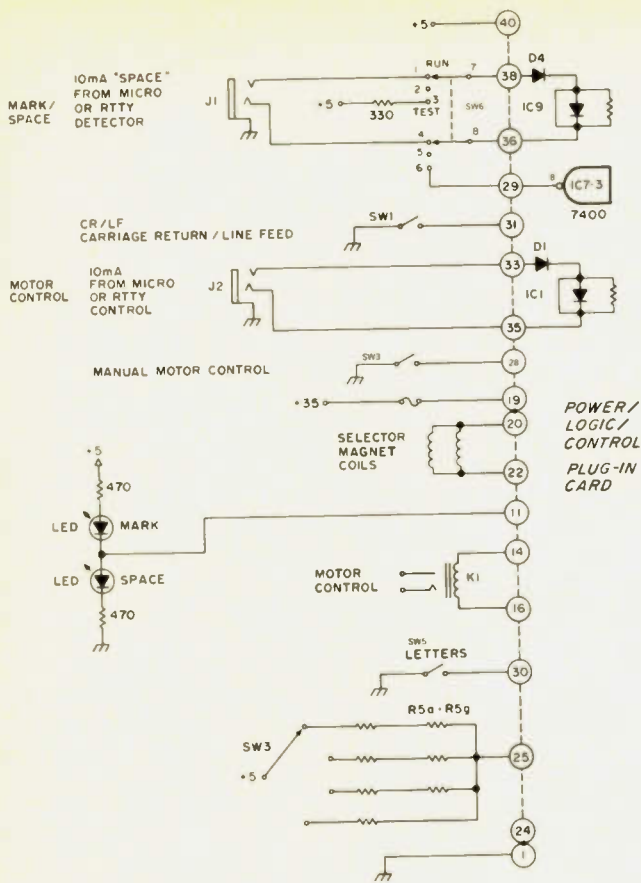

Fig. 4. Interconnections.



Solid state Teletype control/test system.

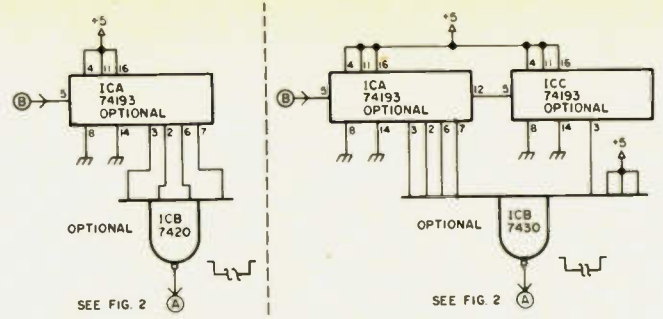

Fig. 5. Optional automatic CR/LF. (a) 30 character line. (b) 62 character line.

came essentially free. Since one section of IC3 was still unused, it was wired in using only an additional push-button and a 4.7k pull up resistor. Unfortunately, the FIGURES function would have required more than the simple implementation of that required for LETTERS, and since both LETTERS and FIGURES are "wants" versus "needs," I decided to get along without the FIGURES function.

RY(46)

RY(46) is generated continuously, but is only applied to the output when IC7-1 is high (no CR/LF). "R" is derived from bit 1 being high, and "Y" is derived from bit 1 being low. This is accomplished by exclusive OR logic IC3-1, controlled by bit 8.

CR/LF

Carriage return is executed before line feed to allow the

maximum amount of time for the carriage to return before RY printing resumes. CR/LF is generated when IC6-pin 9 is high (CR/LF). As in the RY generation, timing pulses are combined in IC3-4 to provide CR/LF.

Timing bit 8 controls whether CR or LF is generated by inverting timing bit 2 via IC3-2. IC3-4 is required to provide the proper polarity of signals at IC6-pin 3 when generating CR/LF vs RY.

Character/Line Control

IC4 generates 16 timing pulses — 8 for sequence 1 (8 bit low) and 8 for sequence 2 (8 bit high). There are three alternatives that can be used to control the number of characters/line. The manual control is shown in Fig. 2. Two optional automatic controls of 30 and 62 characters/line are shown in Fig. 5.

The common requirement is that the negative CR/LF

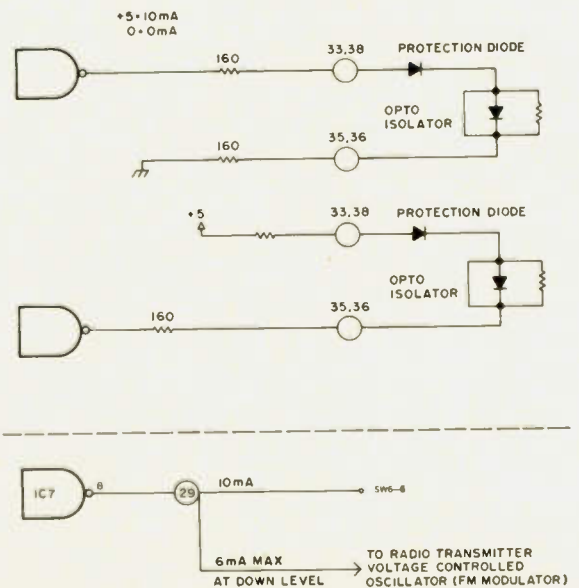
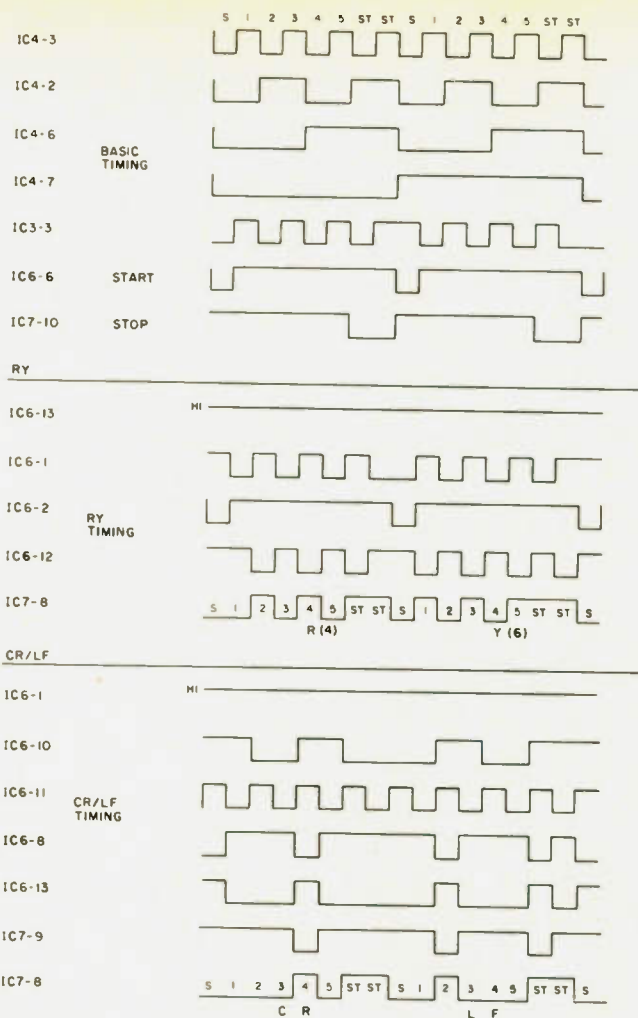

Fig. 6. Example of TTL drive (input and output).



gating signal start at the beginning of CR and end at the end of LF. This is accomplished in the manual configuration by clocking the pulse generator IC8-3,11 with bit 8 low. It is implied in the automatic generator ICA and ICB (Fig. 5) since ICA is controlled and synchronized by IC4. Since ICA increments one for each 16 bits of IC4, each ICA count equals two printing characters. ICA and ICB provide a count of 16; this results in 30 characters plus CR/LF for a total of 32 characters. ICA, ICB, and ICC provide a count of 32; this results in 62 characters plus CR/LF for a total of 64 characters.

The automatic CR/LF circuits in Fig. 5 can be used by disconnecting at points "A" and "B" in Fig. 2 and connecting in one of the circuits shown in Fig. 5.

The selection of the mode and number of characters/line is strictly an economic and

space choice.

Selector Magnet Driver — Fig. 3

IC9, an optoisolator, is normally in the off state. This permits 4.7 mA to flow into D5 and the base of Q2 via R9. The voltage across R10 and R11 is clamped via D5, minus the base to emitter drop of Q2, to about 3 volts. This fixes the voltage across R10 and R11, and thereby the current through Q2, independent of the collector voltage variations of Q2. This value should be trimmed via either R10 or R11 to 60 mA.

The "Pick" current level of the selector magnet coils in the 60 mA configuration is about 35 mA (the "drop level" is about 25 mA). The measured time to reach this value, in this circuit, is about 2.3 ms. This compares favorably to the calculated time of 2 ms in the original high voltage circuit. The driver has operated at a 100 wpm rate

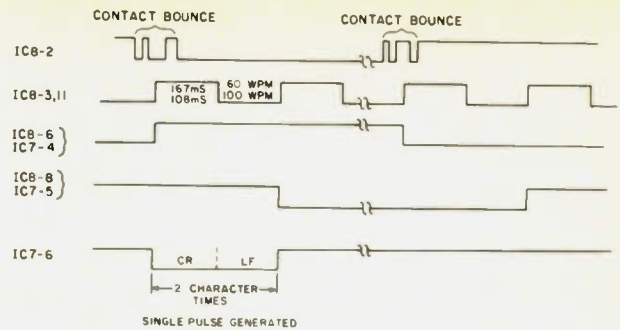

Fig. 7. System timing diagrams.

with a power supply voltage as low as 20 V.

D4 is used to prevent damage to the optoisolator in case the wrong polarity is applied to pins 1 and 2 of IC9. Note that the selector magnet coils are connected in the 60 mA loop configuration (Fig. 1).

Power Supply

The power supply is a dual voltage configuration supply, +35 volts at up to 1 Ampere and +5 volts regulated at up to 500 milliamperes.

The approximate current loading is about 160 mA at +5 volts and about 80 mA at +35 V. R13 and R14 are used to reduce the power dissipation on IC10.

Adjustment Procedure

1. Preliminary 60 mA Mark Adjustment

Remove F2 and place a milliammeter across the F2 contacts.

Adjust the MARK current to 60 mA by trimming R10 or R11.

Replace F2.

2. Frequency Adjustment Scientific Method:

Set the range selector to 50.

Place a scope probe on the collector of Q3.

Adjust R5d-R5g until the voltage glitch, caused by the movement of the selector magnet, appears at the trailing edge of each MARK voltage waveform.

Brute Force:

Set the range selector to 50.

Adjust R5d-R5g until Rs (or Ys) are being printed.

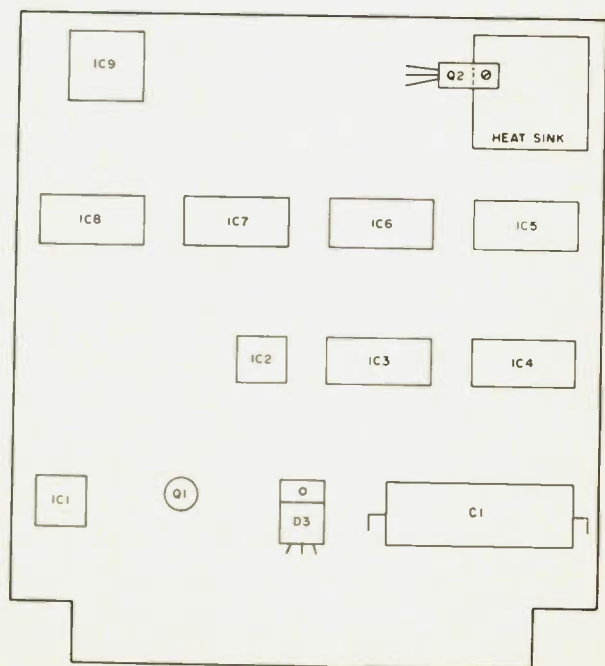

Fig. 8. Board layout used at W2FJT.

Rock R5d-R5g until they are in the center of the range.

Operation

1. Test

Place mode switch in TEST position.

Press SW3 to start motor.

If manual CR/LF is implemented, press SW1 and hold for at least 1/2 second to ensure a CR/LF.

2. Automatic

Plug mark/space signal line into J1.

Plug motor control line into J2.

Provide a current pulse, with at least 10 mA to control each of the functions (Fig. 6).

Construction

I implemented the manual CR/LF configuration, since my Model 28 had automatic CR/LF, together with the selector magnet driver and power control relay driver, on a single card. If I had to construct the whole thing

again, I would build the power circuits on one card and the logic on a second card. This would leave sufficient room for the automatic CR/LF circuitry if desired.

The physical layout is arbitrary except to keep the high current motor control relay (K1) loop direct and short.

Both Q2, the selector magnet driver, and IC10, the +5 V regulator, must be heat sinked. Note that the heat

sink tab on Q2 is not electrically isolated from the collector and, therefore, the heat sink must be insulated from the chassis.

Conclusion

The low power drain, electrical isolation, reliability, and testing versatility offered by this control/test system makes it a valuable addition to either a computer or a radio-controlled Teletype installation. It has been at W2FJT. ■

Dennis G. Eksten W9SS
5006 N. Second St.
Loves Park IL 61111

Having trouble netting your transmit crystals on your 2 meter handie-talkie or transceiver? Can't buy or conveniently borrow a frequency counter to do the job? Then read on about a \$10 solution...

With today's proliferation of sensitive, narrow band repeaters, it is increasingly important to be right on frequency to obtain maximum range and good audio quality from your own gear when "making the system." Even when operating simplex the tolerant wide band receivers are rapidly disappearing. Most would agree equipment should be within about ± 1 kHz of the nominal channel frequency for optimum results.

I got tired of borrowing a frequency counter every time I put new rocks in my equipment or changed the channel locations of some of them. Couldn't see putting out \$100 or more for a frequency counter. One day while tuning my low band receiver with its stable 1 kHz calibration, the idea hit me. Add a 2 meter converter to it! So what if the low band receiver is for SSB-CW and my 2 meter gear is FM? The frequency of the unmodulated FM carrier would be just as recognizable as a continuous CW signal.

In looking around for a 2 meter converter for my Heathkit SB-301 low band receiver, I discovered Heath Company no longer made the Model SBA-300-4 2 meter

converter. However, I picked up a used one in the flea market for only \$10! The Heath Model SBA-300-4 2 meter converter output is a 28-30 MHz signal that is inputted into the four SB-301 half megahertz 10 meter band increments. With the proper crystal in the converter, any 2 MHz segment of 2 meters is tunable with 1 kHz resolution on the SB-301. Other 2 meter converters are available or you can build one yourself from the literature.

Netting 2 meter crystals is a snap now. First, check the calibration of your receiver and converter. You can verify it by comparing it to the output frequency of one or more of the accurately calibrated repeater stations when keyed by an unmodulated

FM carrier with the receiver in the CW position. Use a minimal antenna or back off the rf gain if necessary, so your receiver is not overloaded and the S-meter reaches a maximum without pinning the needle. Reset your receiver dial hairline if required for accurate calibration.

The actual netting of your 2 meter crystals is simple. Feed your transceiver, preferably into a dummy load. Turn your low band receiver audio gain down to minimum to prevent audio feedback. Use little or no receiver antenna or reduce rf gain if necessary to avoid overloading. With the low band converted receiver set to the desired 2 meter frequency,

adjust the netting capacitor for maximum S-meter reading by alternately keying and adjusting the 2 meter gear. Double check your work by varying the receiver frequency slightly while keying your unmodulated 2 meter transceiver. The S-meter reading should peak sharply at the desired frequency, especially with the receiver in the CW mode.

I've found I can get to within about ± 1 kHz using the above ... and for \$10 that's a good bargain! As a bonus, a low band receiver-converter can be used to receive FM (somewhat poorly though) in an emergency by detecting it off the bandpass slope in the low band receiver. ■

The World's Cheapest Calibrator

-- works on 2m!



CHOOSE ONE OF THESE TWO GREAT 2-METER FM TRANSCEIVERS. BOTH SYNTHESIZED FOR STANDARD AND "ODD-BALL" REPEATER SPLITS!

Model FM-28 Check these outstanding features: Fully-synthesized from 144 to 148 MHz in 5 KHz steps. Bright six-digit frequency display. Supplied with simplex, plus 600 and minus 600 KHz offsets. Up to two additional "non-standard" offsets available. Clean 25 watt transmitter. 0.25 UV receiver with helical front end. Modular construction. All solid state. Complete with base station and mobile mounts, hardware, DC cable, microphone and manual.
Introductory priced at only \$359.95.

Model FM-DX Compare the specifications of this unchallenged performer: 40 watt transmitter output. Extended frequency coverage from 143.5 to 148.5 MHz to facilitate MARS and CAP. Supplied with simplex, plus 600 and minus 600 KHz offsets. Up to three additional "non-standard" offsets available. LED frequency display. Selective, single conversion receiver. Rugged extruded chassis and modular construction will withstand the most severe environment. Engineered and built in USA. Shipped with mobile mounting hardware, power cables, microphone and manual. **Limited time pricing only \$499.00.**

Optional accessories: Include base station, power supplies, tone encoders, antennas and solid state power amplifiers. Write or telephone today for detailed specifications.

Count on Clegg superior service. Clegg's well staffed well equipped organization is always available to you. Whether you need free product literature, replacement parts, service or just information, make a free Watts-line call from anywhere in the USA (except Pennsylvania) at no cost. Just dial 1-800-233-0250. In Pennsylvania, call (717) 299-7221 collect.

Should your Clegg product ever require service, you can expect the fastest turn-around time in the industry—typically 48 hours—almost always less than one week.

Direct to you. Because Clegg considers licensed amateurs a professional group, you can purchase directly from Clegg and save dealer and middleman markup. And you're protected.

All Clegg products are sold with a 10-day money-back guarantee.

To place your order, send check (Visa or Master Charge accepted) to Clegg Communications Corporation, 208 Centerville Road, Lancaster, Pennsylvania 17603. Better yet—phone us on our TOLL-FREE line and we'll ship today.

Clegg

Advanced technology in action!

RTTY

With the KIM

-- features built-in display!

Wilfred J. Gregson II K4GCM
4104 Wadsworth Ct., Apt 202
Annandale VA 22003

0300 40	ltrs	0320 40	ltrs
0301 FO	K	0321 89	(
0302 E7	Q	0322 86	1
0303 9C	U	0323 87	7
0304 20	figs	0324 20	figs
0305 9E	J	0325 82	.
0306 BE	W	0326 D8	2
0307 F7	A	0327 CO	-
0308 94	X	0328 D2	/
0309 F1	F	0329 8A	
030A EE	Y	032A FD	6
030B ED	S	032B 00	bell
030C FC	B	032C D3	?
030D DE	D	032D B6	\$
030E C9	Z	032E A2	"
030F F9	E	032F CF	3
0310 EA	V	0330 C5	:
0311 D8	C	0331 C1	:
0312 F3	P	0332 BF	0
0313 84	l	0333 FF	8
0314 BD	G	0334 C6	&
0315 DO	R	0335 E6	4
0316 B8	L	0336 8F)
0317 40	line feed(ltrs)	0337 40	.
0318 B7	M	0338 98	.
0319 D4	N	0339 8C	.
031A F6	H	033A B8	.
031B 80	space	033B 80	space
031C DC	O	033C EF	9
031D 80	car ret (space)	033D 80	car ret (space)
031E F8	T	033E ED	5
031F 88	blank	033F 88	blank

Fig. 1. Character set.

The classic RTTY receiving setup consists of a terminal unit to change RTTY tones to dc pulses and a teleprinter which mechan-

```
020F 2C 00 17
0212 30 08
0231 2C 00 17
0234 30 06
0264 2C 00 17
0267 10 06
```

Fig. 2. These changes, when inserted in the program, will make the KIM-1 a teleprinter only. The input is PA7 (pin 8 of the applications connector).

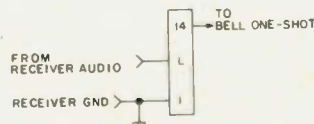

Fig. 3. KIM-1 applications connector hookup for full RTTY system. If you wish for the bell function to operate, have pin 14 key a one-shot driving a Sonalert.

ically decodes the pulses and displays the resulting message. The KIM-1, which many hams are using today, has those elements. All that you need is the proper program and one simple connection between the station receiver and the KIM-1, and you will be displaying RTTY on the seven segment readouts. The displayed character set may take a bit of getting used to, but can be read with surprising ease. For instance, there is no way to get a perfect "Z" into a seven segment readout, but the displayed character "≡" becomes recognizable easily enough when read in context. The idea for this sort of readout is not all mine, but was developed simultaneously by several KIM-1 users. I have tried to put together a fairly uniform and sensible character set, however. This character set is shown in the program listing starting at address 0300.

At this point, you might ask how much can be read using only 6 displays. Surprisingly, most words longer than 6 characters can be easily read with almost no practice, proving, I suppose, that you really don't need all those letters anyhow.

As the terminal unit, I use the KIM-1's own tape interface circuit. This is a 565 phase locked loop and op amp buffer connected to an

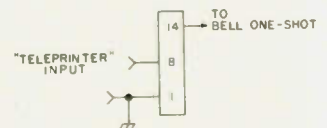

Fig. 4(a). Connections for teleprinter display operation only (no KIM-1 TU).

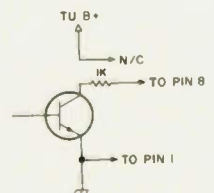

Fig. 4(b). Method of connecting TU slicer transistor to KIM-1 I/O port without using TU B+.

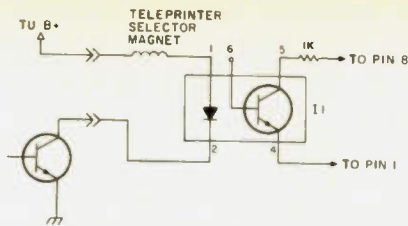

Fig. 4(c). Method of connecting RTTY 60 mA loop with KIM-1. I1 is Monsanto MCT-2, Texas Instruments TIL 111, Motorola MOC1000, Fairchild FCD 820, GE H11A1 or Clairex CL1-3.

I/O port. While it is no Mainline ST-6, it will give adequate performance on strong wide shift signals.

The first part of the program (see Fig. 6) is an adjustment loop to aid in setting the TU properly. A low tone should light all segments of

the left data digit (displays an 8); a high tone will light the right digit. On some receivers (like mine) that are response limited because of sideband filters, it may be necessary to adjust the KIM-1's pot (VR-1) to get the TU to operate. Adjust this pot so

that the not on digit is completely off. If both digits are lit, it indicates that the PLL is "hunting," and no readable display will result. Ideally the display should appear to be moving from one digit to the other. When you have this display, simply move to the decoder portion of the program by pressing the F button. The characters should start to display themselves on the seven segment readouts

moving from right to left. The microprocessor is doing the same thing as a mechanical decoder. First it waits for the start bit. Then, when it has detected this bit, it delays a set time until the middle of the Baudot start bit. The timer is then set to a different time that will not let the TU look at the data until enough time has elapsed and the middle of the first Baudot data bit is available

Data pulse (ms.)	Baud	Address		
		023D	0255	02C0
22	45.5	0F	14	15
20	50	0C	12	13
18	56.9	08	11	12
13.33	75	06	0C	0D
10	100	04	09	0A

Fig. 5. Timing bit table for different RTTY speeds.

0200	20 6A 1F	KEY	JSR 1F6A	Get key subroutine.	027F	85 E3	STA 00E3	
0203	C9 0F		CMP \$0F		0281	B9 00 03	LDA 0300, Y	
0205	F0 1D		BEQ START		0284	85 E7	STA 00E7	
0207	A9 7F		LDA \$7F	Change segments to output.	0286	24 E7	BIT 00E7	Check for command.
0209	8D 41 17		STA 1741	Turn them all on.	0288	10 17	BPL FUNC	
020C	8D 40 17		STA 1740		028A	A2 EC	LDX SEC	Move all characters 1 space to the left and insert the new character in the right display location.
020F	2C 42 17		BIT 1742	Look at the PLL.	028C	B5 00	MOVE LDA 0000, X	
0212	10 08		BPL HI	If a high tone go to HI.	028E	E8	INX	
0214	A9 11		LDA \$11	Select the left data bit.	028F	95 00	STA 0000, X	
0216	8D 42 17		STA 1742		0291	CA	DEX	
0219	4C 00 02		JMP KEY		0292	CA	DEX	
021C	A9 13	HI	LDA \$13	Select the right data bit.	0293	E0 E6	CPX SE6	
021E	8D 42 17		STA 1742		0295	F0 03	BEQ SETX	
0221	4C 00 02		JMP KEY		0297	4C BC 02	JMP MOVE	
0224	A9 7F	Start	LDA \$7F	Initialize for display.	029A	A2 09	SETX LDX \$09	Prepare the X and Y registers for use in DISP.
0226	8D 41 17		STA 1741		029C	A0 06	LDY \$06	
0229	A0 06		LDY \$06		029E	4C BF 02	JMP FINSH	
022B	A2 09		LDX \$09		02A1	06 E7	FUNC ASL 00E7	Decode and execute ltrs command.
022D	A9 00		LDA \$00	Put ltrs in the ltrs, figs byte.	02A3	24 E7	BIT 00E7	
022F	85 E4		STA 00E4		02A5	10 07	BPL FIGS	
0231	2C 42 17	INTL	BIT 1742	Look for a start bit.	02A7	A9 00	LDA \$00	
0234	10 06		BPL SET		02A9	85 E4	STA 00E4	
0236	20 D9 02		JSR DISP	Call the display subroutine.	02AB	4C BF 02	JMP FINSH	
0239	4C 31 02		JMP INTL		02AE	50 07	FIGS BVC BELL	Decode and execute figs command.
023C	A9 0F	SET	LDA \$0F	Set the timer for the first delay.	02B0	A9 20	LDA \$20	
023E	8D 07 17		STA 1707		02B2	85 E4	STA 00E4	
0241	A9 00		LDA \$00	Clear the new character register.	02B4	4C BF 02	JMP FINSH	
0243	85 E7		STA 00E7		02B7	A9 01	BELL LDA \$01	Execute bell command.
0245	A9 10		LDA \$10	Set up the bit position register.	02B9	8D 01 17	STA 1701	
0247	85 E5		STA 00E5		02BC	8D 00 17	STA 1700	
0249	20 D9 02	DECO	JSR DISP	Display and check for time out.	02BF	A9 15	FINISH LDA \$15	Set for third delay.
024C	2C 07 17		BIT 1707		02C1	8D 07 17	STA 1707	
024F	30 03		BMI BITE		02C4	20 D9 02	LOOK JSR DISP	Display and check timer.
0251	4C 49 02		JMP DECO		02C7	2C 07 17	BIT 1707	
0254	A9 14	BITE	LDA \$14	Set timer for second delay.	02CA	30 03	BMI BACK	
0256	8D 07 17		STA 1707		02CC	4C C4 02	JMP LOOK	
0259	20 D9 02	WAIT	JSR DISP	Wait for the timer to time out.	02CF	A9 00	BACK LDA \$00	Turn off bell.
025C	2C 07 17		BIT 1707		02D1	8D 00 17	STA 1700	
025F	30 03		BMI RDBT		02D4	4C 31 02	JMP INTL	
0261	4C 59 02		JMP WAIT		02D7	EA	NOP	
0264	2C 42 17	RDBT	BIT 1742	Read the bit.	02D8	EA	NOP	
0267	30 06		BMI SHIFT	If 0 do not load.	02D9	C0 00	DISP CPY \$00	Display subroutine.
0269	A5 E7		LDA 00E7	Load the bit.	02DB	D0 04	BNE STILL	
026B	05 E5		ORA 00E5		02DD	A0 06	LDY \$06	
026D	85 E7		STA 00E7		02DF	A2 09	LDX \$09	
026E	46 E5	SHIFT	LSR 00E5	Shift the bit position register.	02E1	B9 E7 00	STILL LDA 00E7, Y	
0271	A5 E5		LDA 00E5	Check for all 5 Baudot data bits.	02E4	84 FC	STY 00FC	
0273	C9 00		CMP \$00		02E6	20 4E 1F	JSR 1F4E	
0275	F0 03		BEQ MKB1		02E9	88	DEY	
0277	4C 54 02		JMP BITE		02EA	60	RTS	
027A	A5 E7	MKB1	LDA 00E7	Complete the byte with ltrs/figs prefix.				
027C	05 E4		ORA 00E4					
027E	A8		TAY	Look up the byte.				

Fig. 6. When tuning is satisfactory, as described in text, press button F to start display.

from the TU. When all 5 data bits have been decoded and stored in a memory byte, another memory byte is looked at to see if the upper case/lower case bits are set. With this information, the alphanumeric character may be looked up in the character table and tested to see if it is a character or a command. If it is a character, the data byte is loaded into a display location, and the display is shifted one space to the left.

If it is a command (bit 7 set to 0), the command is decoded, and the appropriate action taken. The timer is then loaded with a timeout time which gets the microprocessor out of the last Baudot data bit. When this time expires, it is again time to look for a start bit. The display is run continuously whenever the microprocessor is not busy doing anything else.

For those of you who al-

ready have a TU and would like to use only the display portion of the KIM-1, I have included (Fig. 2) the necessary changes to the program to use one of the regular input ports (pin 8) as your input connection.

Since the KIM-1 timer is variable, you can also decode baud rates other than the standard amateur 45.5 baud (60 wpm) that the program is set for. Fig. 5 shows the necessary changes to the

timing bits to decode other RTTY speeds. To decide which baud rate applies, measure the length of a data pulse with a scope, then consult the table for the data pulse length which fits and insert the timing bits accordingly. Do not, by the way, expect to decode everything you hear. All that frequency shifts is not necessarily Baudot. Many commercial stations are using ASCII these days and others encrypt. ■

Greg Richter WA4LJL
1812 Briarwood Circle
Milledgeville GA 31061

Build A Meter With Class

-- simple field strength device

The manual for my rig suggests that a "better procedure" for loading it up is to use an swr bridge on forward or a field strength meter to peak plate and loading controls for maximum output power. The field strength meter seemed the easy way out, since a bridge costs fifteen dollars. The meter would cost me next to nothing to build considering the present status of my junk box. Therefore, I decided on the junk box approach to measure output power.

While building the field strength meter, I consulted an article in the July, 1976, issue of 73. The article dealt with building the world's smallest field strength meter. The design given was standard and allowed wide margins for parts substitution. Recently, another ham wrote 73 about an rf choke that cost four dollars, adding that amount to the cost of his otherwise free field strength meter. I just thought I'd mention that all parts in my field strength meter came from junked PC boards, with the exception of the meter movement.

When you go scrounging parts for this project, remember about the choke. Anything that will choke rf works. So, substitute freely,

but don't change from a diode to a resistor.

As I said, the design is standard, but the antenna is quite unconventional. Instead of using a piece of twelve gauge bare copper or coat hanger wire, I used twenty-two gauge tinned copper wire bent into the form of my initials.

Construction

Select the amount of wire you feel necessary to complete your initials or whatever. Straighten the wire with a vise and a pair of pliers. Starting at the top of the left initial, make a bend to form the beginning of the antenna. Try to use one continuous piece of wire to make the antenna. To insure this, draw

your idea on a piece of paper first. If you use one piece of wire the antenna will look a lot better, and you will eliminate having to solder on extra pieces of wire. The joints make bulges in the antenna which just don't look as nice on the finished meter. Solder a few spots to hold this thing together. While the iron was still hot, I also attached a banana plug.

With the antenna done, I built the guts of the meter. The easiest way to go is to mount the pot and use its terminals as tie points. The wiring is the easiest you'll ever do and is almost impossible to screw up. My only problem was mounting the banana jack, which I solved by using two shouldered washers.

Conclusion

Taking a lead from modern art, you can make just about anything for an antenna on your FSM. You've got to admit, now that we have an alternative, that bare copper does look a bit uncouth! This meter may not be the best or the smallest, but it does have class! ■

Parts List

- 1 diode, 1N914 or just about anything else
- 1 50 uA meter
- 1 rf choke
- 1 pot, 1k or thereabouts (I have a 500 Ohm)
- 1 .001 uF capacitor
- 1 mini box
- 1 banana plug
- 1 banana jack
- 2 shouldered washers
- Plenty of twenty-two gauge wire

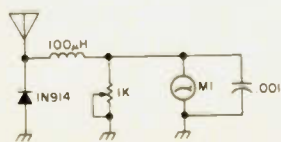

Fig. 1.

FSK

for the FT-101

-- a simple mod for RTTY

The Yaesu FT-101 series transmitters (FT-101B, E, EE, and EX models) have now passed the 200,000 mark in production and are in use all over the world. Therefore this article is to show you how to easily convert these transceivers for teletype service.

The schematic in Fig. 1 is set up for "dry keying" and supplies 7.5 volts to the keyboard or tape reader. One word of warning: Do not apply voltage from a keyer or you will fry the components. You might mount all of the

parts involved in a minibox. Put a jack in one side to plug in the keyboard. The potentiometer can be mounted in the minibox and is used to set the shift which is adjustable from 850 Hertz to less than 170. The latter shift is generally used on the HF bands while 850 Hertz is still heard on VHF, at least in the Los Angeles area.

The connections from the FSK device to your FT-101 are just three in number, with one going to the above ground side of the 3179.3 kHz crystal on PCB 1184A.

Another lead goes to PCB 1314A, pin 14, which leads directly to the IC, Q4MFC6034A. The third lead is strictly a ground connection between the minibox chassis and the transceiver chassis. One side of the keyboard jack goes to this ground in the minibox as well. I would suggest that for this purpose a two wire shielded cable be used, between the minibox and the transceiver.

You will find that if you flip from one band to another you may have to readjust the "pot" to maintain your shift. Once done on each band by checking with the receive station, you can apply decals or scribe the box, however you choose, for resetting to each band. Obviously you want a pointer knob on the pot shaft for this purpose. If you are a purist, you could measure the pot resistance required for the shift used on each band adjustment of the pot and use fixed resistors of the correct accuracies instead. This would then require a switch in place of the pot and, by rotating the switch, you would then be able to

move from one band to the other. The switch, of course, would have to have the correct number of positions for whatever number of bands you will be doing your RTTYing on.

All the components used in the FSK circuitry are garden variety parts found in any ham supply house or electronics store. Assembly time may take as long as an hour or two, depending upon your experience and whether or not you accidentally pick up the soldering iron by the wrong end while working.

Tune-up of the transceiver would be under AM loading conditions, as teleprinter operation is the same as CW (keydown), and the surest way to cause your transceiver to self-destruct would be to ignore this fact.

There seems to be quite an upsurge in teleprinter communications among radio amateurs these days. One of the reasons, perhaps, is that your friendly surplus store makes them available for as little as \$25. This would be for the RTTY workhorse, the good old Model 15, which is a page printer, send and receive. Prices vary in the various stores as might be expected. "Big Daddy," the Model 19, generally can be located for under \$100, and this provides for punching and transmitting tape while waiting for the other guy to stand by or for calling CQ, and thereby impressing people with your keyboard finesse until the tape runs out and you resume "hunt and peck."

These machines normally are found with synchronous motors and 60 word per minute gears; however, sometimes they are equipped with governed motors and 75 word per minute gears. Stay away from this type of machine, as these governed motors are noise generators and ham communications are at the 60 wpm speed (even though you don't type that fast).

Be seeing you on the green keys! ■

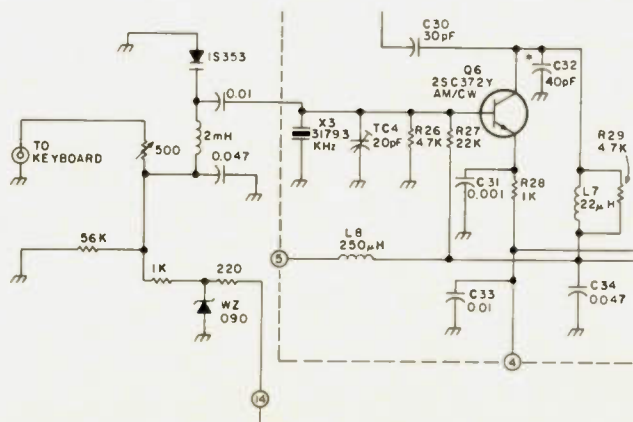

Fig. 1.

Build A Drift-free T.U.

-- a quality RTTY demodulator

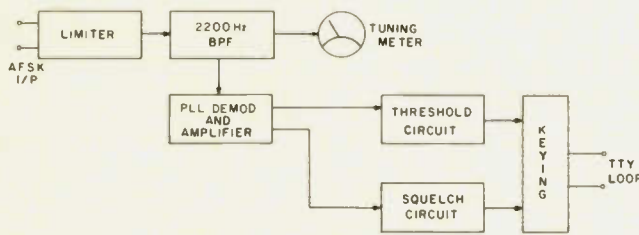

Fig. 1. Block diagram of RTTY demodulator.

Since I have an old SHRO-60 receiver which has a lot of drift, and since I wanted to copy RTTY with it, I had to find a circuit which would be easy to tune and compensate for the drift. I also required the facility to reverse the mark-space sense when coupled to a transceiver.

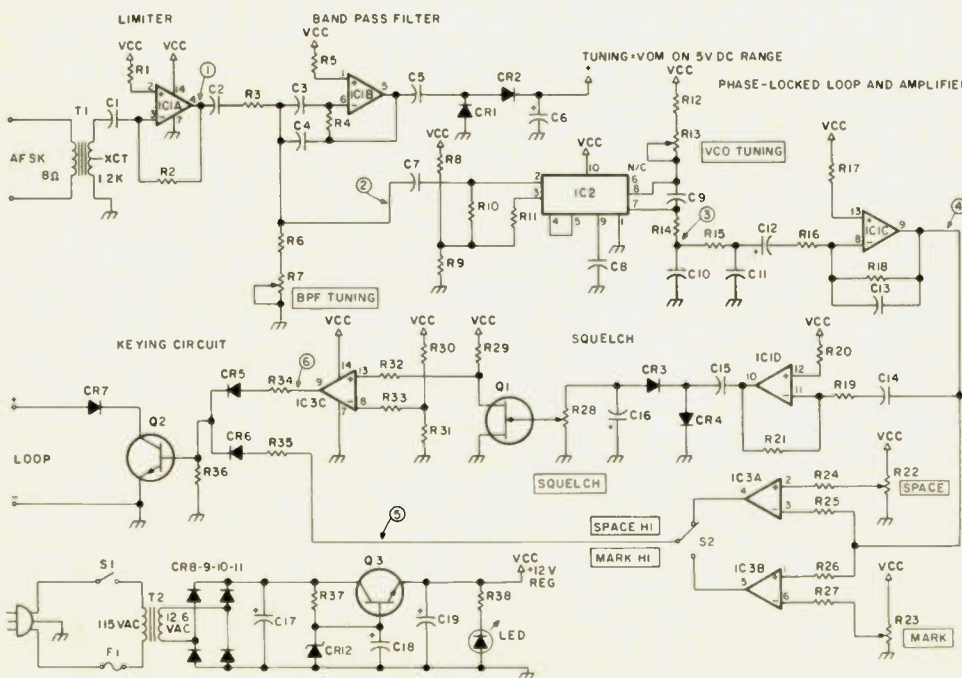

Fig. 2. Schematic.

The following circuit which was developed has the following characteristics:

1. Narrow shift detection;
2. Easy to tune;
3. Reversible sense;
4. Good signal to noise characteristics;
5. Auto mark-hold;
6. Easy to obtain parts;
7. Easy to adjust.

Block Diagram Operation (see Fig. 1)

Limiter: The audio from the receiver is hard limited to compensate for fading signals. The limiter will operate at approximately 1 volt peak-to-peak input and applies an 11 volt peak-to-peak square wave to bandpass filter.

Bandpass Filter: This has a center frequency of 2210 Hz and a "Q" of 10. The purpose of the filter is to improve the signal to noise ratio and to discriminate between close signals. There are two outputs: the high level output is used for the tuning indicator and the low level output is applied to the phase locked loop demodulator.

Phase Locked Loop: An LM565 is used to convert the AFSK tone to a varying dc level. The dc level is approximately +10.5 volts and changes by 50 mV in step with the mark-space shift. An amplifier stage is required to increase the shifted level to approximately 11 volts peak-to-peak. This is applied to two circuits, the threshold circuit and the squelch circuit.

Threshold Circuit: Consists of two comparators which determine if the shift meets predetermined limits. The outputs of the comparators are connected to an SPDT switch to enable sense selection. The comparator circuits are used to differentiate the amount of shift on a noisy signal and a good signal.

Squelch Circuit: Noise for the squelch circuit is derived through a differentiator from the phase locked loop amplifier. The noise is rectified,

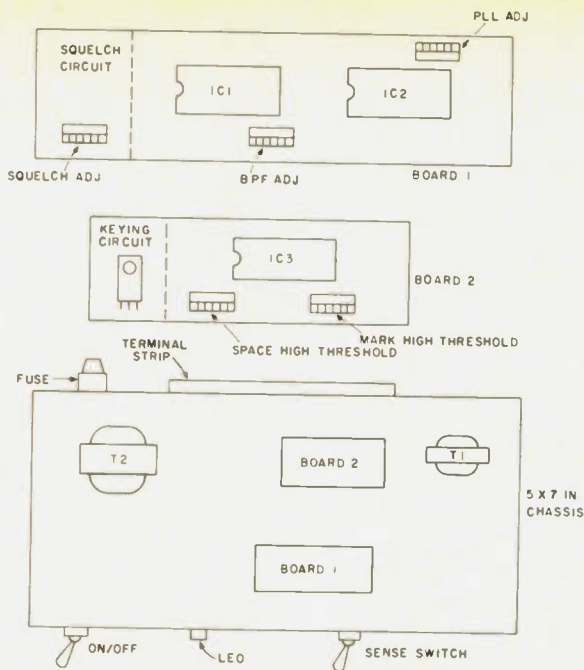

Fig. 3. Layout.

and controls an FET which produces a dc level which is +12 volts on noise. This is to prevent the teleprinter running "open" on noise or static crashes.

Keying Circuit: The output of the threshold circuit is applied via an OR gate to the keying transistor. The output of the squelch circuit is applied to a comparator which is used as a switch to disable the keying signal from operating the keying transistor. If the noise is greater than the signal, the keying transistor will continue to conduct, causing a mark-hold configuration. If the signal is greater than the noise, the squelch output goes LOW, enabling the keying transistor to follow the mark and space levels from the threshold circuit.

The schematic diagram is seen as Fig. 2.

Construction

The complete demodulator was built on two IC type Vero boards with a layout similar to Fig. 3.

The sense switch, +12 volt regulated power supply, and the input transformer were mounted on a 5 x 7 aluminum chassis with a terminal strip on the back. The two circuit boards were mounted

on the top of the chassis to enable easy adjustments.

Adjustments

The following test instruments are required:

- VOM or VTVM;
- Dc coupled oscilloscope;
- A tape recorder with a good recording of AFSK tones. (This can be a recording of the output of an AFSK keyer, which can be obtained from your local RTTYer.)

Bandpass Filter Tuning: With the AFSK signal fed into the demodulator, adjust the bandpass filter tuning until maximum smooth deflection is seen on the tuning meter.

Phase Locked Loop: If you have a counter, set the VCO frequency for 2210 Hz at the junction of pins 4 and 5 of the LMS65. If you do not have a counter, do the following: Connect a dc scope to the junction of the 1k Ohm resistor and the .47 uF capacitor at the output of the LMS65. Adjust the scope so that there is maximum vertical gain and the dc level can still be seen. Use the vertical position control. (*Note: Do not use ac coupling.*) Adjust the VCO frequency until the dc level remains constant

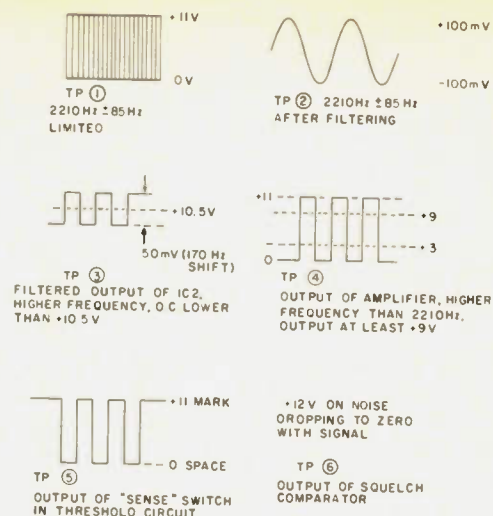

Fig. 4. Test points.

RTTY Demodulator Parts List

C1, C7, C9, C14	.001 disc ceramic
C2	.005 disc ceramic
C3, C4	500 pF 5% polycarbonate or mylar*
C5	.01 disc ceramic
C6, C16	2 uF 25 V dc electrolytic
C8	.01 uF 5% polycarbonate or mylar*
C10	.47 uF mylar
C11, C15	.1 uF disc ceramic
C12	6.8 uF 25 V dc electrolytic
C13	680 pF disc ceramic
C17	500 uF 25 V dc electrolytic
C18, C19	100 uF 25 V dc electrolytic
*to limit the amount of drift due to heat.	
All resistors ¼ Watt 10% except as noted.	
R1, R5, R17, R20	4.7 megohm
R2, R18, R21	2.2 megohm
R3	1.0 megohm ¼ Watt 5%
R4	2.2 megohm ¼ Watt 5%
R6	7.5k Ohm ¼ Watt 5%
R7, R13, R22, R23	10k Ohm potentiometer, printed circuit type
R8, R9, R15, R30	
R31	10k Ohm
R10, R11	4.7k Ohm
R12	12k Ohm ¼ Watt 5%
R14, R37, R38	1k Ohm
R16	3.3k Ohm
R19	150k Ohm
R24, R25, R26, R27	
R32, R33	1 megohm
R28	100k Ohm potentiometer, printed circuit type
R29	15k Ohm
R34, R35	3.9k Ohm
R36	10k Ohm ½ Watt 10%
CR1, CR2, CR3, CR4	1N34A germanium diode
CR5, CR6	1N914 silicon diode
CR7, CR8, CR9, CR10	
CR11	1N4007 rectifier
CR12	12 volt 1 Watt zener diode
LED	light emitting diode
IC1, IC3	LM3900 CN (National)
IC2	LM565 CN (National)
Q1	MPF 102 or equivalent N-channel FET
Q2	High voltage silicon NPN transistor (Sylvania ECG 228 or equivalent)
T1	1.2k Ohm center-tapped to 8 Ohm transistor type output transformer used backwards.
T2	115 V ac to 12.6 V ac ½ Amp filament transformer
F1	½ Amp fast blow fuse and holder
S1	SPST on-off switch
S2	SPDT sense switch
Miscellaneous	
5 x 7 chassis, terminal strip, #6-32 nuts and bolts, insulated spacers for #6-32 to mount boards on chassis, holder for LED	

with and without the AFSK input signal. You should also see the 50 mV shift in time with the mark-space frequencies.

Threshold Detector: The SPACE threshold potentiometer wiper should have +9 volts dc to ground, and the MARK threshold potentiometer wiper should have +3 volts to ground. These can be readjusted from on-the-air signals for minimum distortion and glitching of the copy.

Squelch Circuit: Connect the demodulator to the receiver and the teleprinter loop circuit. With the receiver picking up noise, adjust the SQUELCH level potentiometer until the machine just stops printing the noise. Different atmospheric and domestic noise may require more or less squelching action.

Operation

Very simply tune the

receiver onto a RTTY signal until the tuning meter indicates a maximum. The teleprinter should start printing. If the copy is garbled, switch to the opposite sense. Fine adjustments may be required to the threshold circuit to produce glitch-free copy, but I found the +9 volt and +3 volt levels to be good enough.

Conclusion

This demodulator has been in operation at my location for over 4 months. It has

copied very well through the local line interference and fading of the 20 meter band. With the Swan 350, on 20 meters I use MARK HIGH, and on 80 meters I use SPACE HIGH. The waveforms in Fig. 4 can be seen at the points indicated during normal operation of the demodulator. ■

Reference

National Semiconductor Linear Applications, 1973 copy, LM3900 and LM565 sections.

Noise Rejector

- - great for CW
or phone receivers

S. T. Rappold WB6ZYK
PO Box 4678
Redway CA 95560

Here is another version of the outboard noise and interference-rejecting circuit for both phone and CW. It is an accessory aid to even the most modern of receivers. The unit is widely variable and flexible, doing a real job under difficult on-the-air conditions for which the unit was designed.

Throughout my more than forty years of hamming, I have tried many types and combinations of both simple and complex filter circuits, to find that indeed they all do some specialized job. But this circuit has proven to be simple, most effective, and a pleasure to build and use, providing much-needed QRN-QRM rejection and

cutting background noise to almost nothing. Of equal importance — it is cheap and dirty. No doubt every ham has the components in the junk box, or can get them at the local electronics surplus store. This simple and straightforward circuit produces surprisingly effective results. The unit has only three controls: a 4-position rotary switch to select desired combinations of the noise-

limiting diodes, an af filter notch control, and a tone control.

The unit is to be plugged into the receiver's headphone jack; the unit's output jack can take either phones or speaker. The circuit input begins by cutting sharp and heavy noise pulses in three steps with the 4-position rotary switch. The three diode combinations handle progressively more severe

noise pulses.

This is followed by the af filter, which is simply an af T-notch circuit, a smoothly adjusting type, being quite effective in limiting the af passband over a sufficient range for both phone and CW uses. This filter is without any of the ringing of some filter types. The inductor is an 88 mH toroid, a common item. This part of the unit is also noise-limiting.

The filter is followed by an audio peaker circuit in order to overcome insertion losses of previous circuitry. The peaker restores the audio level back up to desirable level.

The output of the unit incorporates an old-fashioned and long-employed circuit to cut still other types of noise and adjust and clear up received signal problems: an ordinary tone control circuit. It is remarkable how much this simple circuit modifies signals and atmospheric conditions.

Try this simple unit on the workbench some evening, and see if it isn't a delightfully cheap and dirty way to enhance receiver performance and utility. Its noise control makes possible 160 meter operation all through the QRN season of the year, and I have been able to stay on the air on 160 in particular when others QRT because of atmospheric and Loran QRN and heavy QRM.

The unit is housed in a 6" x 3" x 2½" utility box. ■

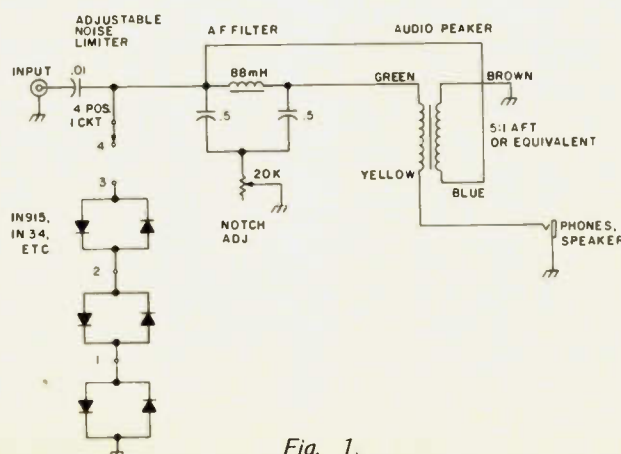

Fig. 1.

JAN
CRYSTALS

"Right on"
with
Jan
Crystals



for

- General Communication & Industry
- Citizen's Band (Standard & Synthesized)
- Two-Meter - Monitor - Scanners
- Marine VHF • Amateur Bands

Depend on Jan Crystals
made in U. S. A. for

- Frequency Control • Frequency Stability
- High Performance

Send 10* for our latest catalog
Write or phone for more details



2400 Crystal Drive
Ft. Myers, Florida 33901
all phones (813) 936-2397

J2

PRE-AMP



HIGH GAIN • LOW NOISE

35dB power gain, 2.5-3.0 dB N.F. at 150 MHz 2 stage, R.F. protected, dual-gate MOSFETS. Manual gain control and provision for AGC. 4 3/8" x 1 7/8" x 1 3/8" aluminum case with power switch and choice of BNC or RCA phono connectors (be sure to specify). Available factory tuned to the frequency of your choice from 5 MHz to 250 MHz with approximately 3% bandwidth. Up to 10% B.W. available on special order.

N. Y. State residents add sales tax.

Model 201 price: 5-250 MHz \$29.95

Vanguard Labs

196-23 JAMAICA AVE.
HOLLIS, N. Y. 11423

V1

6th ANNUAL
HAMBURG INTERNATIONAL HAMFEST
PRESENTS

HAM-O-RAMA "77"

SEPTEMBER 17th — 8 A.M.-5 P.M.

ERIE COUNTY FAIRGROUNDS

BUFFALO, N.Y.

Speakers — Big Prizes — Ladies' Programs — Major Manufacturers — R.V. Hookups — Indoor/Outdoor Flea Markets — Talk In On 52 & 31/91 — Off N.Y.S. 1-90 at Exit 57

Details: H.I.H. Committee, P.O. Box 308, Hamburg, N.Y. 14075 — Phone 716-873-3984

Bearcat[®] 210 Scanner

\$289.



The Bearcat 210 super synthesized receiver scans and searches 32-50, 146-174 & 416-512 MHz without expensive crystals. Order now on our 24 hour toll-free credit card order line 800-521-4414. In Michigan and outside the U.S. call 313-994-4441. Add \$5.00 for shipping in U.S. or \$8.00 for air UPS to west coast. Charge cards or money orders only. Foreign orders invited. For additional information, write: Communications Electronics, P.O. Box 1002 Dept. 21, Ann Arbor, Michigan 48106



COMMUNICATIONS ELECTRONICS
P.O. BOX 1002 DEPT. 2 D
ANN ARBOR, MICHIGAN 48106



C5

...at last - your shack organized!

\$12995 S-F RADIO DESK

Deluxe - Ready to Assemble

Designed with angled rear shelf for your viewing comfort and ease of operation.

FINISHES: Walnut or Teak Stain.
Also available in Unfinished Birch, \$114.95.

Additional Information on Request.

Checks, Money Orders, BankAmericard and Master Charge Accepted.

25% Down Required with C.O.D. Orders.

F.O.B. Culver City. (In Calif. Add 6% Sales Tax.)

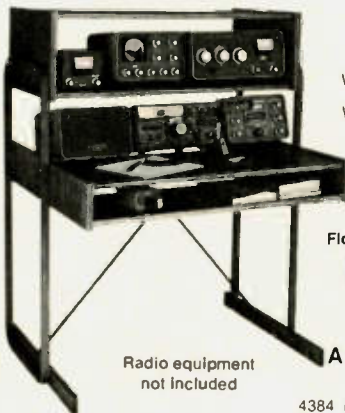

WA6BRR
WB6OYO

Floor Space:
37" Wide
30" Deep

Radio equipment
not included

A beautiful piece of furniture — your XYL will love it!

S-F AMATEUR RADIO SERVICES

4384 KEYSTONE AVENUE

S7

CULVER CITY, CALIF. 90230

RTTY CRT Tuning Indicator

-- still the best method

Tuning your receiver until the teleprinter stops printing Greek and starts printing English is one way to tune in a RTTY signal, but it obviously leaves much to be desired. The ST-6, with its "plus-plus" tuning meter, is a step in the right direction, but valuable information is lost using this method. One of the oldest, and still one of the best, methods makes use of a CRT display.

With the aid of the CRT display, one can tell at a glance if the station is narrow or wide and, with a little practice, can estimate how wide or narrow the station might be. In addition, the display depicts possible trouble with the discriminators in the demodulator. For example, if either the mark or space LC tuned circuits have changed, believe me, you'll be the first to

know. If the other station is transmitting upside down signals (mark and space frequencies reversed), the CRT display will show this condition vividly. The phenomenon of selective fading, in which one signal, mark, or space is attenuated more than the other, is also readily seen. In addition, the CRT display is an excellent coarse tuning indicator. It enables one to tune in a station rapidly and then to fine adjust the signal using the ST-6 tuning meter. In general, the ST-6 tuning meter and the CRT display are not redundant — they actually complement each other.

Theory

Before we go into a description of the circuit, it would be wise to give some background information.

Photos by Anthony R. Donaldson

By convention, the mark signal is displayed horizontally, and the space signal is displayed vertically. There is, of course, no particular reason why the mark signal could not be displayed vertically and the space signal displayed horizontally.

A theoretically perfect display would show the mark signal as a perfectly horizontal straight line. The space signal would be shown as a perfectly vertical straight line. In the real world this is hardly the case. Because the bandwidth of the mark and space tuned circuits is rather broad, at least in the case of the ST-6, some of the mark signal gets into the space tuned circuit. The result is two ellipses rather than two straight lines. For this reason, when tuning in a station, one should ignore the minor axis or width of the ellipse and

tune the receiver for maximum amplitude of the major axis.

Theoretically, these ellipses would be perpendicular to each other. Returning to the real world once again, we find this is not the case. Because there is a phase difference between the mark signal induced in the mark tuned circuit in the demodulator and the same mark signal induced in the space tuned circuit, the major axis of the mark ellipse is not horizontal. For the same reason, the major axis of the space ellipse is not vertical. In my case, I have found the major axis of the mark ellipse to be approximately -30 degrees off the horizontal axis and the major axis of the space ellipse to be approximately 20 degrees off the vertical axis. It is possible to add additional filtering to both the mark and space signals to approach the "perfect" condition of two perpendicular straight lines; however, this detracts from the display because one loses information in the process. For example, if the tuned circuits in the demodulator should shift slightly, chances are the display will not see the shift because of the extra filtering.

When constructing this project, you should be aware of one possibly critical point. Stray magnetic fields may deflect the spot, making it impossible to focus the spot to a fine point. For this reason, care should be exercised to keep the CRT as far as possible from transformers, especially the filament transformer. If you should be unable to focus the spot to a fine point, wrapping the CRT in iron or steel of high permeability should alleviate the problem. Tube type demodulators, such as the TT/1, will not require additional amplification to drive the CRT. However, more and more amateurs are building solid state demodulators such as the ST-6. The nominal mark and space

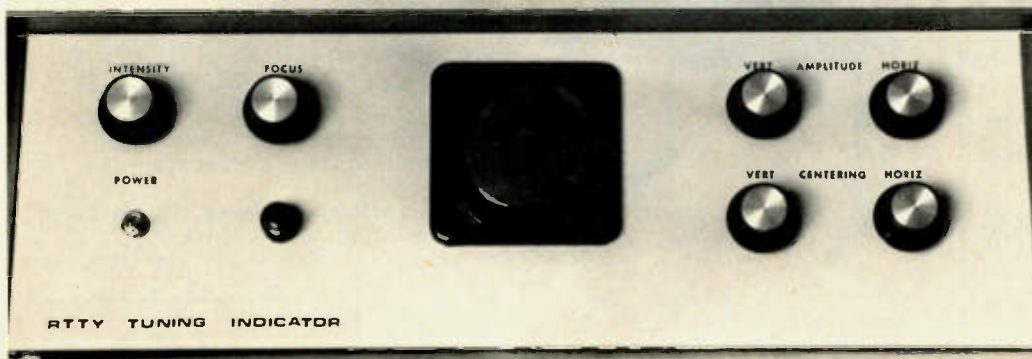

CRT RTTY tuning indicator.

signal from one of these units is 1.5 volts, hardly enough to drive the deflection plates of the CRT, which typically require a 30 volt signal for full face deflection. The objective, then, is to provide enough amplification to drive the CRT. There is, however, one other requirement of the design; it must have an extremely high input impedance. The reason for this is simply to prevent the loading of the mark and space discriminators in the demodulator. Fig. 2 shows the 741 operational amplifier connected as a noninverting buffer amplifier. In this configuration it will provide a modest voltage gain of 2 and have an input impedance well above 100 megohms. If the output from the demodulator is much less than 1.5 volts, additional amplification may be required. This is easily accomplished by changing the 47k feedback resistor connected between pins 2 and 6 of each 741 amplifier to 100k to obtain a gain of 3, or to 150k to obtain a gain of 4. The output of the 741 is capacitively coupled to a high voltage amplifier used to drive the CRT. This stage makes use of a high voltage transistor and, installed in the circuit, exhibits a voltage gain of 10. From there, the signal is applied to the electrostatic deflection plates of the 2AP1-A CRT. The 2BP1 is another CRT that works well in this application; however, it is not pin for pin compatible with the 2AP1-A.

High Voltage Power Supply

The high voltage power supply schematic shown in Fig. 3 provides the necessary voltage (270) for the deflection plates of the CRT, as well as the voltage (130) for the high voltage amplifier. The voltages are not critical, but it is important that the ripple voltage be low. The supply is connected as a simple half wave rectifier with a goodly amount of capacitance on the output to reduce ripple.

Low Voltage Power Supply

If you have an ST-6, you can use the plus and minus 12 volt power from it like I do. Should this not be the case, Fig. 4 shows a power supply that may be used.

Adjustments

Turn the power on and, assuming there is no smoke, ascertain that the focus, intensity, and centering controls are working properly. Since there is no signal at this time, only a simple spot should appear on the CRT face. As previously mentioned, inability to focus the spot to a fine point may be indicative of stray magnetic fields.

Connect a voltmeter to test point 1 (T.P.1). If the voltage is not 65 volts (one half of 130), try different values of RV until the T.P.1 voltage is 65 volts. The purpose of this step is to center the signal so that it will be able to swing equal amounts on either side of this reference. If the bias were not set in this way, one side of the sine wave would be clipped, causing distortion. An identical procedure should be used for T.P.2. Different values of RH are used, until the voltage at T.P.2 is 65 volts. I found RV to be 150k,

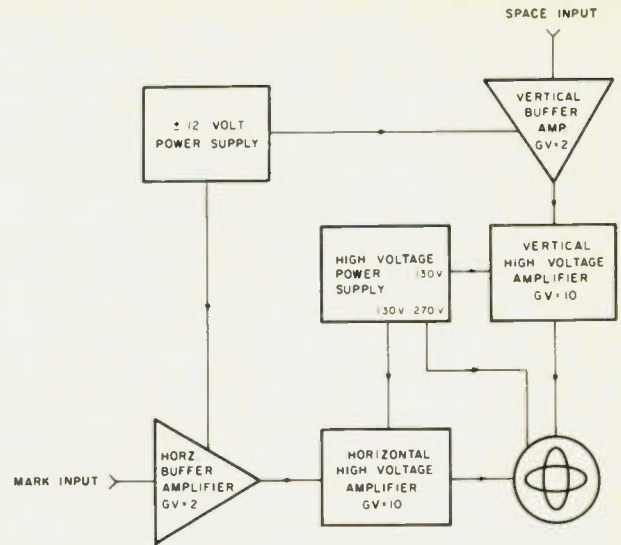

Fig. 1. Block diagram.

and RH to be 180k in my unit.

In case you have gotten used to working on circuits with the power on, because they were low voltage circuits (e.g., TTL circuits), I wish to remind you that the voltages in this unit are lethal. Turn the power off, and make sure the energy stored in the capacitors has dropped to zero before trying new values for RV and RH.

The next step is to position the CRT properly. This is accomplished by supplying a one volt audio signal (approximately 2 kHz) to one input and then the other. One should find a straight line is produced in

each of these tests and that they are perpendicular to each other. The purpose of this step is to identify the position of the vertical and horizontal deflection plates. With the power off, rotate the CRT so that when the signal is applied to the mark input, the straight line on the CRT face is horizontal.

Tuning with a Scope

Tuning with a scope is a quick and simple process. The vertical and horizontal amplitude controls may be set by the individual to produce a display that nearly fills the face of the CRT screen; however, the two controls should be set to

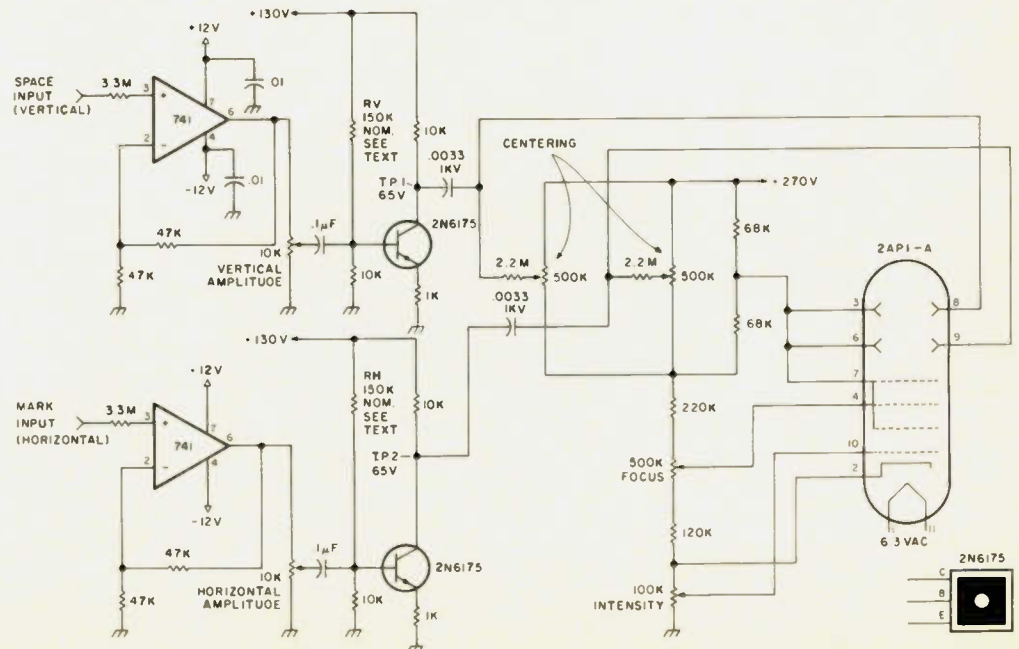
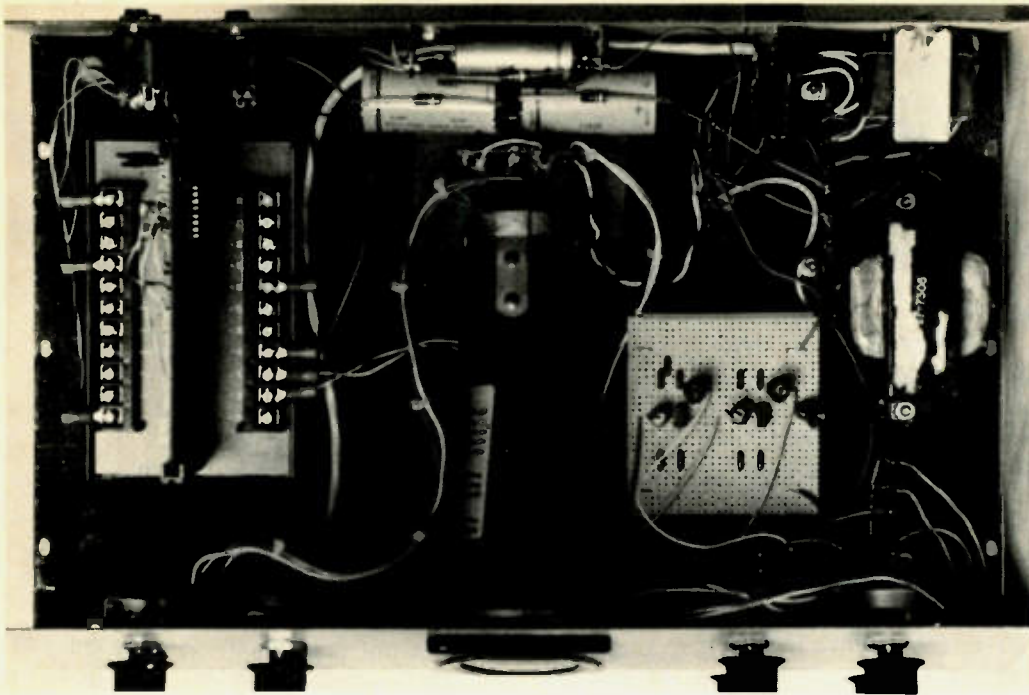

Fig. 2. CRT RTTY tuning indicator circuit.



The high voltage amplifier is located on the perforated board. The low level buffer amplifier is constructed on a PC board and is shown in the card holder. The low voltage power supply is not shown in this photo.

identical positions to give an accurate display. As previously stated, one should tune for the maximum

amplitude of the major axis of each ellipse. If the shift of the station and the discriminators are identical, both

amplitudes will peak at the same time. If the station is wide of narrow, one should tune for equal amplitudes even though they are not maximized. This method, called straddle-tuning, is

perhaps one place where the ST-6 "plus-plus" tuning meter is superior. A typical application of this technique is found in tuning in commercial 425 Hz shift stations with 850 Hz discriminators.

One last note: When you tune in a station, it is best to have the limiter on (FM); once the station is tuned in properly, the limiter may be turned off (AM) if desired.

Conclusion

The CRT RTTY tuning indicator described in this article has been in use for over a year with no problems. The display provides a quick and accurate method to tune in a RTTY station. In addition, this method gives a great deal of information, much more than any simple meter could. ■

References

1. "Improved Scope Display," Irv Hoff, *RTTY Journal*, October, 1974.
2. *Specialized Communications Technique for the Radio Amateur*, American Radio Relay League, First Edition, 1975.

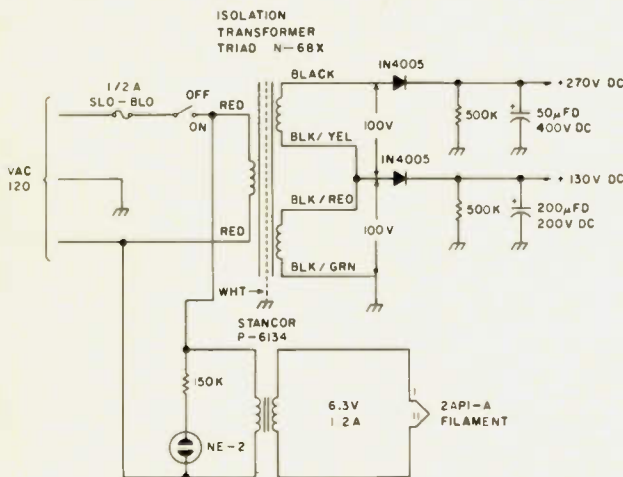

Fig. 3. High voltage power supply.

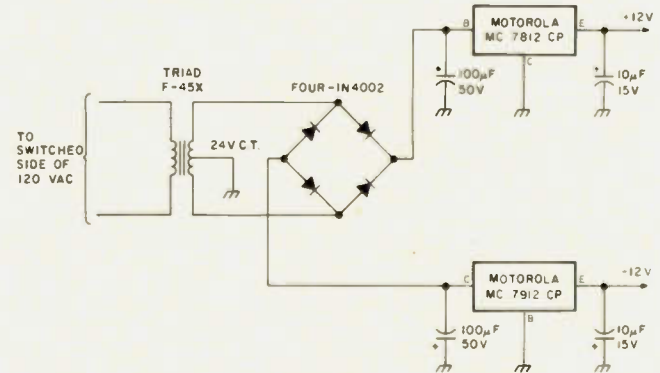

Fig. 4. Low voltage power supply.



from page 64

... and then, after that, never acknowledge that his audio is being heard ... etc.

With a little experience, you can write the book ... and please do write to 73 and tell all of us what works and what doesn't work.

In case you get some hard ones ...

EDITORIAL BY WAYNE GREEN
and you may ... it doesn't hurt to have a fox hunting team with some practice. Get those Sunday morning fox hunts going. We're looking for articles on fox hunting equipment and techniques, by the way.

INSTRUCTOR'S GUIDE

It is a little scary at first to accept the responsibility for teaching a class

of prospective Novices. It does get easier as you get into it ... but there is nothing like a guide to the forest before you enter it.

We have such a guide available.

One amateur has been responsible for more other amateurs getting their licenses than anyone else ... a chap named Bill Welsh W6DDB out in beautiful (?) Burbank. He's been at it for over twenty years, and has turned out thousands of hams from his classes. Bill has written a great guide for the instructor, and it is invaluable for anyone getting into this field.

Bill discusses the equipment and materials needed ... the classroom requirements ... the library that will help ... the code ... preparing the course ... certificates ... and fi-

nances.

This *Instructor's Guide* is free if you drop by the 73 HQ ... and costs you \$1 for handling and mailing if we send it to you. You won't run into a much better bargain if you're involved in teaching. Send \$1 for *Instructor's Guide*, 73 Magazine, Peterborough NH 03458.

HAMFESTS - DAYTON ...

The Dayton Hamvention was well attended this year - probably a little better than last year, though it was difficult to tell from inside at the exhibit booths because it seemed a little less crowded there. It's possible that the expanded flea market drew

Continued on page 175

TELETYPE® MODEL 33 ASR

COMPUTER I/O COMPLETE WITH:

\$840⁰⁰

INCLUDING PACKING
F.O.B. - N.J. FACTORY

- Tape Punch
- Ready to Go
- Tape Reader
- Line/Local Wired
- Guaranteed 30 Days

LOOK! Hard to Get Parts & Supplies for 33 ASR/KSR's

- PAPER SPINDLE (181043) \$1.25
- TAPE SPINDLE (182918) \$1.25
- PLATEN KNOB (180039) \$1.00
- PAPER TAPE**
- 28 ROLLS 1 CARTON \$32.00
- 7 ROLLS 1 BOX \$10.00
- MYLAR 1 ROLL \$23.00
- REPERF COVERS (182109) \$3.50*
- Replacement UPE-800 PUNCH \$75.00
- CHAD BOX (182965) \$3.50
- Replacement UX800 READER \$50.00
- REPAINTED STAND WITH FEET (183246) \$30.00
- FEET ALONE (183243) \$12.00/Pr.
- LINE CORD (182510) \$3.25

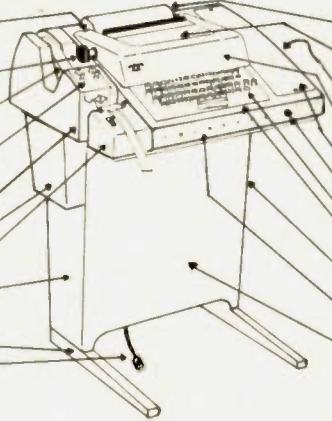

- PAPER - WHITE or CANARY \$22.00 / 12 - 5" diam. rolls.
- BLACK NYLON RIBBONS
- SINGLE SPOOL \$11/Doz.
- DOUBLE SPOOL \$15/Doz.
- ANSWER BACK DRUM (180827) \$7.00
- CODED (SPECIFY CODE) \$10.00
- DOME LID (181137) \$5.75*
- BLANK PLATE (181910) \$7.00*
- KNOB (181824) \$1.00
- KEYTOPS (YOUR CHOICE) 60c ea.
- ONE PIECE COVER (187300) \$22.00*
- UCC-6 LINE/LOCAL \$150.00
- UCC-3 FOR TWX \$150.00
- FRONT PLATE (181812) \$2.50
- DATA SETS 101C FOR TWX \$450.00
- NEW 105A FOR TWX \$300.00

- COMPLETE COVER READY TO INSTALL
- INCLUDING ALL *'s \$ 35.00
 - COPY HOLDER (182036) \$ 14.00
 - TAPE UNWINDER (12") \$ 32.00
 - WIND UP PAPER TAPE WINDER \$ 22.00
 - ELECTRIC TAPE WINDER \$ 55.00
 - ELECTRIC PAPER WINDER (LPW-300) ... \$ 50.00
 - DEC TYPE READER RUNCARD \$ 45.00
 - ACOUSTIC COUPLER
 - OMNITEK 701A \$160.00
 - READER POWER PACK (182134) \$ 35.00
 - STANDARD EIA INTERFACE \$ 55.00
 - ACOUSTIC COVERS with FAN \$258.00

If you don't see what you need, CALL or WRITE! ○ If its for TELETYPE® We Have It.



TELETYPEWRITER COMMUNICATIONS SPECIALISTS

550 Springfield Avenue • Berkeley Heights, N. J. 07922
(201) 464-5310 • TWX: 710-986-3016 • TELEX: 13-6479
Deaf Line TTY: 201-464-5314

SUBSIDIARY OF VAN'T SLOT ENTERPRISES, INC.



PLEASE NOTE

Due to increased costs of processing orders minimum orders: \$10.00 cash or check, \$25.00 charge. All orders shipped UPS. Please include sufficient postage.

T13

MAKE YOUR REMOTE VFO AN SFO* * SYNTHESIZED FREQUENCY OSCILLATOR



- 100 Hz steps.
- No more guessing what frequency you are on.
- Accuracy and stability better than 10 Hz. [1 Hz Optional].
- For use with any Transceiver, Receiver, or Transmitter with a 5.0 to 5.5 MHz VFO input. Such as HW-100 series, SB-100 series and TS-520/820.
- Less cost and more stability than remote VFO and counter.
- Price - \$225.00.
- Dimensions: 9 inches wide, 5 1/4 inches high, and 12 inches deep.



INTERAD LTD.
7808 Cessna Ave.
Montgomery County Airpark
Gaithersburg, Maryland U.S.A. 20760



Please Rush my SFO-2020 - Price \$225.00

Check Box For:

Check Money Order Master Charge Bank Americard

Credit Card No.: _____ Interbank No.: _____

Expiration Date: _____ Signature: _____

Name: _____

Address: _____

City: _____ State: _____ Zip Code: _____

Maryland Residents add 4% sales tax.

Cassette-Aided CW and RTTY

- - inexpensive message storage

The "in" thing today is to use IC memories for functions such as routine CQs or special calls on CW, ID functions, RTTY test messages, etc. But, for individual station use, there is still a lot to be said for the use, for these functions, of a compact cassette recorder once it is equipped with the proper interface and signal conditioning circuits to handle digital data. Such recorders are inexpensive, reasonably reliable and can be used for both digital type signals and voice signal recording/playback. Unlike some IC memories where the data in memory is lost when the power is removed, there is no need to reprogram the memory (the cassette) of such a recorder every time it is used. A situation that particularly enhances the use of such recorders is the recent availability of endless loop cassettes at a reasonable

price. Although such cassettes were available before from Phillips, they were relatively expensive. But now the Japanese have done it again, and such endless loop cassettes in a variety of loop times ranging from 20 seconds to 12 minutes long are available for \$4-\$5 from outlets such as Lafayette Radio. The shorter duration tapes (not the 12 minute one!) allow for a CQ call to be made on CW, a pause of

10-15 seconds to check for replies and then more repeats of the call. With a station wired for semi-break in, the operator only has to listen for replies at the right time. The tapes can be used in the same way for a phone station equipped with VOX.

Recording and playing back speech transmission is no problem with a cassette unit, although it is better to use the station microphone rather than a cheap cassette

type. Also, it is worthwhile to pay a bit of attention to room acoustics and make the recording as good as possible. After all, the recording need not be made at the station location, but where conditions favor the recording process.

Recording and playing back CW or RTTY transmissions requires conditioning circuits. Poor results will usually be obtained if one just audio records the output of a CW sidetone monitor, for instance, and uses the audio playback to activate a relay. A very good conditioning circuit for CW or RTTY recording and playback appeared some time ago (*Electronics*, April, 1974) and with some slight modifications is shown in Figs. 1 and 2. It has been used with several cassette units with good results. The circuitry has the advantage of using inexpensive components; it may be built inside most recorders and powered from the recorder's internal power supply.

Fig. 1 shows the record mode input circuit. The keyed signal is filtered to remove contact bounce and then it is used to turn on the 2N3906 stage which in turn gates the 2N2646 sawtooth oscillator. The 200 pF between the base and emitter of the 2N3906 is rf bypassing in case a transmitter is also keyed as a recording is made. The 2N2646 operates at about 5 kHz. If this frequency is too high for some inexpensive recorders, the .005 mF capacitor in the gate of the 2N2646 may be raised to .01 mF. The output is fed to a high impedance input or, if the recorder does not have such an input, to a low impedance input via a 470k resistor. In the latter case, it can be permanently left connected since it will not affect voice recordings.

The playback conditioning circuit is shown in Fig. 2. The recorded tone is rectified by the 1N4148 and applied to an

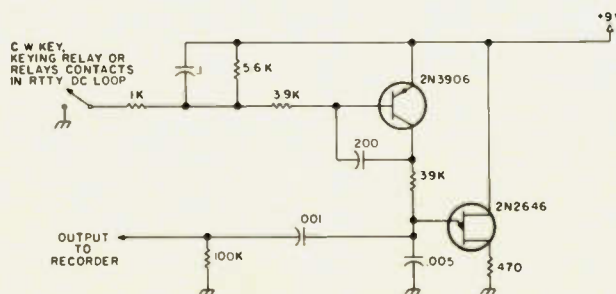

Fig. 1. Signal conditioning circuit for recording produces a keyed sawtooth signal at approximately 5 kHz.

RC timing circuit. The decay voltage developed across this network, when the tone is removed, is used to turn on the 2N3904 and 2N3906 stages. Both transistor base-emitter junctions have 200 pF bypass capacitors across them for rf protection. Keep these leads as short as possible. The output of the 2N3906 stage may be used to drive a reed relay, as shown, or the relay may be replaced by a resistor. The positive voltage across the resistor

which is developed during key down periods can then be used to drive the appropriate IC or transistor stages in an electronic keyer. The RC timing combination of .01 mF and 39k should be right for most CW keying and RTTY speeds. However, if clean output keying is not obtained at the speed desired, try varying the RC values slightly.

The total cost for the circuitry described should be on the order of \$5. A few

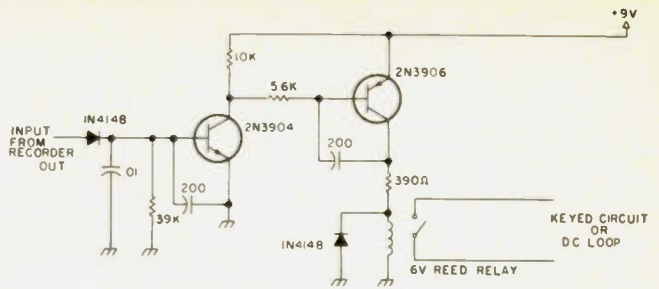

Fig. 2. Playback signal conditioning circuit.

endless loop cassettes, if that type is used, will bring the cost up to \$20 or so. But, it still represents a lot of opera-

tional convenience, economy, flexibility and data storage room as compared to IC memories. ■

77/78 AMATEUR RADIO EQUIPMENT DIRECTORY



A one stop buying and reference guide to all your amateur needs. The new 77/78 supplement (32 pages) updates the 1977 Edition and brings the total number of pages to 168 (2 volumes). Almost 100 manufacturers/distributors are included.

\$3.50 plus 25¢ postage and handling—U.S. only
Canadian orders \$4.00. Foreign orders \$5.00 (air)

KENGORE CORP — Dept. C K11
9 James Ave. Kendall Park, NJ 08824

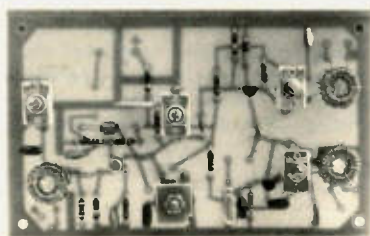

160M Receiving Converter Kit

ADD THIS BAND TO YOUR STATION!
Crystal-controlled converter has 7 MHz. if. Includes high gain rf amp. and operates from 9 to 15 V dc with low current drain.

160M Receiving Converter Kit \$29.95ppd
160M Vackar VFO Kit \$29.95ppd

 Direct Conversion Technique
3132 North Lowell Avenue
Chicago, Illinois 60641 D21

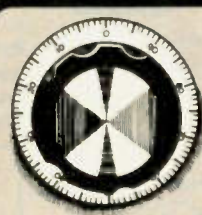

Adirondack has it!

Amateur Headquarters for the Northeast

ADIRONDACK Radio Supply

185-191 West Main Street • P.O. Box 88
Amsterdam, N.Y. 12010 Tel. (518) 842-8350
Just 5 minutes from N.Y. Thruway — Exit 27

HERBACH & RADEMAN, INC.

ELECTRONICS FOR SCIENCE AND INDUSTRY



POLISHER & GRINDER

A two speed compact unit operating from four AA size cells (supplied). Ideal for a variety of applications in electronics, metallurgy, optics and lab. Useful for circuit board work, small parts and components where larger files and polishing tools do not fit.

H5-233A \$9⁹⁵

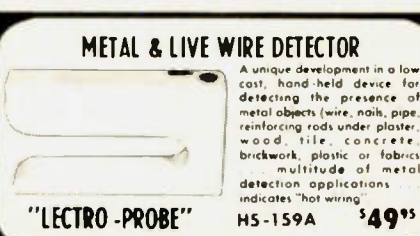

METAL & LIVE WIRE DETECTOR

A unique development in a low cost, hand-held device for detecting the presence of metal objects (wire, nails, pipe, reinforcing rods under plaster, wood, tile, concrete, brickwork, plastic or fabrics) ... multitude of metal detection applications ... indicates "hot wiring"

"LECTRO-PROBE" H5-159A \$49⁹⁵

SPECIAL PURCHASE

Enables us to offer VIZ test equipment instrument (formerly RCA Instruments) at a fraction of its normal cost. This versatile, bench type VOM can be employed in service shops, schools, industrial shops, etc. Many outstanding features with high-impact, low-silhouette case.



V5-136A \$34⁹⁵

HIGH TORQUE REVERSIBLE 6 OR 12 V. PM FIELD MOTOR

This beautiful, chrome finished, high efficiency field motor was originally designed as a "pedal assist" drive motor for bicycles. It will find many applications in mechanical drives where high starting torque is needed. Can also serve as a low power DC generator.



TM21K139A \$9⁹⁵ 6/54⁰⁰ 12/96⁰⁰

OVER 43 YEARS ... SUPPLYING INDUSTRIAL ELECTRONIC, SCIENTIFIC AND ELECTRO-MECHANICAL PRODUCTS TO ENGINEERS, SCIENTISTS, HOBBYISTS AND GADGETEERS

HERBACH & RADEMAN 401 E. ERIE AVE., PHILADELPHIA, PA. 19134 H21

ORDERING INSTRUCTIONS

SEND CHECK OR MONEY ORDER. SPECIFY QUANTITY, CATALOG NUMBER AND SHIPPING ADDRESS. ALL ITEMS ARE FULLY GUARANTEED. PLEASE PRINT CLEARLY.

ADD \$2.00 POSTAGE AND HANDLING

PLEASE PLACE ME ON REGULAR CATALOG MAILING LIST

HUNDREDS OF UNIQUE, HARD-TO-FIND SPECIAL BUYS IN COMPLETELY ILLUSTRATED AND DESCRIBED CATALOG PREPARED 7 TIMES YEARLY.

NO PURCHASE NECESSARY TO RECEIVE CATALOG.

NAME _____

ADDRESS _____

CITY, STATE, ZIP _____

HOME BUSINESS

GENERAL MULTI-PURPOSE V-O-Ms • DROP RESISTANT • HAND SIZE • MODEL 310 V-O-M • TYPE 3

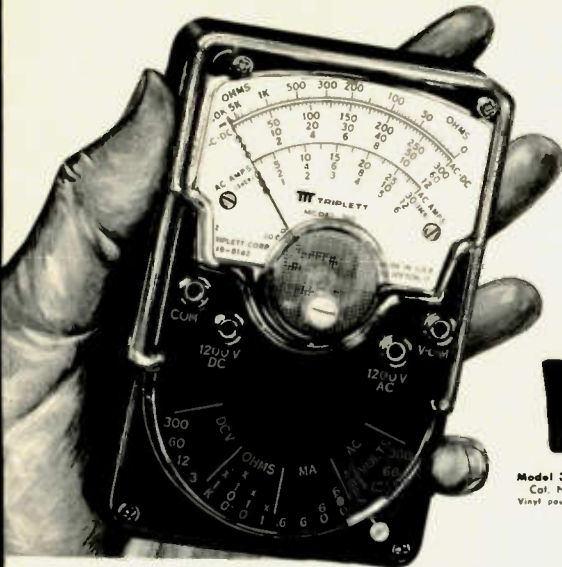

Model 310
Cat. No. 10-2856 \$2.10
Vinyl push case

1. Drop-resistant, hand-size V-O-M with high-impact thermoplastic case.
2. 20,000 Ohms per volt DC and 5,000 Ohms per volt AC; diode overload protection with fused Rx1 Ohms range.
3. Single range switch; direct reading AC Amp range to facilitate clamp-on AC Ammeter usage.

RANGES

DC Volts: 0-3-12-60-300,1,200 (20,000 Ohms per Volt).
AC Volts: 0-3-12-60-300,1,200 (5,000 Ohms per Volt).
Ohms: 0-20k-200k-2M Ω -20M Ω (200 Ohm center scale on low range).

DC Microamperes: 0-600 at 250 mV.
DC Milliampere: 0-6-60-600 at 250 mV.
Accuracy: $\pm 3\%$ DC; $\pm 4\%$ AC; (full scale).
Scale Length: 2-1/8".

Meter: Self-shielded; diode overload protected; spring backed jewels.
Case: Molded, black, high impact thermoplastic with slide latch cover for access to batteries and fuse, 2-3/4" w x 1-5/16" d x 4-1/4" h.

Batteries: NEDA 15V 220 (1), 1 1/2V 910F (1): Complete with 42" leads, alligator clips, batteries and instruction manual. Shpg. Wt. 2 lbs.

Model 310 Cat. No. 3018 \$53.00

BOMAR Crystal Company
Novice Crystals (Specify Band Only)
Two Meters
CRYSTALS IN STOCK
Motorola HT 220 Crystals
In Stock!

Standard • Icom • Heathkit • Ken • Clegg • Regency • Wilson • VHF
Eng • Drake • And Others! \$4.50 @ Lifetime Guarantee

Make/Model	Xmit Freq.	Rec. Freq.



ALL BAND PREAMPLIFIERS



- 6 THRU 160 METERS
- TWO MODELS AVAILABLE
- RECOMMENDED FOR RECEIVER USE ONLY
- INCLUDES POWER SUPPLY

MODEL PLF employs a dual gate FET providing noise figures of 1.5 to 3.4 db., depending upon the band. The weak signal performance of most receivers as well as image and spurious rejection are greatly improved. Overall gain is in excess of 20 db. Panel contains switching that transfers the antenna directly to the receiver or to the Preamp.

Model PLF 117V AC, 60 Hz. Wired & Tested \$44.00

NYE VIKING CODE PRACTICE SET



No. 114-404-002 \$18.50

Get the RIGHT START!

With a NYE VIKING Code Practice Set you get a sure, smooth, Speed-X model 310-001 transmitting key, a linear circuit oscillator and amplifier, with a built-in 2" speaker, all mounted on a heavy duty aluminum base with non-skid feet. Operates on standard 9V transistor type battery (not included). Units can be connected in parallel so that two or more operators can practice sending and receiving to each other. List price, \$18.50.

MOR-GAIN

Fully Air Tested - Thousands Already in Use

• 916 40% Copper Weld wire annealed to fit handles like soft Copper wire - Rated for better than full legal power AM/CW or SSB-Coaxial or Balanced 50 to 75 ohm feedline - VSWR under 1.5 to 1 at most heights - Stainless Steel hardware - Drop Proof Insulators - Terrific Performance - No coils or traps to break down or change under weather conditions - Completely Assembled ready to put up - Guaranteed 1 year - ONE DESIGN DOES IT ALL.

EXCLUSIVE 66 FOOT, 75 THRU 10 METER DIPOLES

NOTES

1. Models prefaced ' ** ' will be available 1/77.
2. All models above are furnished with crimp/solder lugs.
3. All models can be furnished with a SO-239 female coaxial connector at additional cost. The SO-239 mates with the standard PL-259 male coaxial cable connector. To order this factory installed option, add the letter 'A' after the model number. Example: 40-20 HD/A.
4. 75 meter models are factory tuned to resonate at 3950 kHz. (SP) models are factory tuned to resonate at 3800 kHz. 80 meter models are factory tuned to resonate at 3650 kHz. See VSWR curves for other resonance data.

MODEL	BANDS (Meters)	PRICE	WEIGHT (Oz/Kg)	LENGTH (Ft/Mtrs)
40-20 HD	40/20	\$49.50	26/7.3	36/10.9
**40-10 HD	40/20/15/10	59.50	36/1.01	36/10.9
80-40 HD	80/40 + 15	57.50	41/1.15	69/21.0
75-40 HD	75/40	55.00	40/1.12	66/20.1
75-40 HD (SP)	75/40	57.50	40/1.12	66/20.1
75-20 HD	75/40/20	66.50	44/1.23	66/20.1
75-20 HD (SP)	75/40/20	66.50	44/1.23	66/20.1
75-10 HD	75/40/20/15/10	74.50	48/1.34	66/20.1
75-10 HD (SP)	75/40/20/15/10	74.50	48/1.34	66/20.1
**80-10 HD	80/40/20/15/10	76.50	50/1.40	69/21.0

NO TRAPS—NO COILS—NO STUBS—NO CAPACITORS

MOR-GAIN HD DIPOLES . . . • One half the length of conventional half-wave dipoles. • Multi-band, Multi-frequency. • Maximum efficiency - no traps, loading coils, or stubs. • Fully assembled and pre-tuned - no measuring, no cutting. • All weather rated - 1 KW AM, 2.5 KW CW or PEP SSB. • Proven performance - more than 15,000 have been delivered. • Permit use of the full capabilities of today's 5-band xcvrs. • One feedline for operation on all bands. • Lowest cost/benefit antenna on the market today. • Fast QSV - no feedline switching • Highest performance for the Novice as well as the Extra-Class Op.

SST T-1 RANDOM WIRE ANTENNA TUNER



All band operation (160-10 meters) with most any random length wire. 200 Watt power capability. Ideal for portable or home operation. A must for Field Day. Size: 2 x 4-1/4 x 2-3/8. Built-in neon tune-up indicator. Guaranteed for 90 days. Compact - easy to use. Only \$29.95.



ASTATIC MICROPHONES

SILVER EAGLE - \$69.95

- T-UG8-D104, transistorized \$48.60
- T-UG9-D104, "Golden Eagle," transistorized \$95.40
- T-UG9-D104, "Silver Eagle," transistorized . \$69.95
- UG-D104, ceramic or crystal \$42.60



Model 200 V



Model 210



Model 220

CES Touch Tone Pads

- Model 200V - acoustic coupling. \$59.95
- Model 210 - for mounting on walkies or hand-helds. \$54.95
- Model 220 - CES can now offer you a TOUCH TONE back for Standard Communications hand-held radios. This is the complete back assembly with the TOUCH TONE encoder mounted and ready to plug into the private channel connector. Also included is a LED tone generator indicator and an external tone deviation adjustment. \$74.95.

talk power by **TPL**
TPL for an Economy Price?
 THAT'S RIGHT!
 introducing the ECONO-LINE

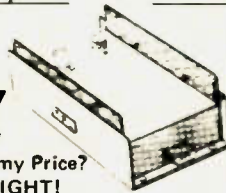

Model	Input	Output	Typical	Frequency	Price
702	5-20W	50-90W	10 in/70 out	143-149 MHz	\$139.00
702B	1-4W	60-80W	1 in/70 out	143-149 MHz	\$169.00

Now get TPL COMMUNICATIONS quality and reliability at an economy price. The new Econo-Line gives you everything that you've come to expect from TPL at a real cost reduction. The latest mechanical and electronic construction techniques combine to make the Econo-Line your best amplifier value. Unique broad-band circuitry requires no tuning throughout the entire 2-meter band and adjacent MARS channels. See these great new additions to the TPL COMMUNICATIONS product line at your favorite amateur radio dealer. For prices and specifications please write for our Amateur Products Summary! FCC type accepted power amplifiers also available. Please call or write for a copy of TPL's Commercial Products Summary.

SLINKY! \$43.95 Kit

A LOT of antenna in a LITTLE space
 New Slinky® dipole* with helical loading radiates a good signal at 1/10 wavelength long!

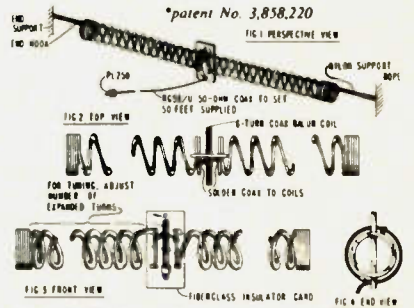

* This electrically small 80/75, 40, & 20 meter antenna operates at any length from 24 to 70 feet • no extra balun or transmatch needed • portable—erects & stores in minutes • small enough to fit in attic or apartment • full legal power • low SWR over complete 80/75, 40, & 20 meter bands • much lower atmospheric noise pickup than a vertical and needs no radials • kit includes a pair of specially-made 4-inch dia. by 4-inch long coils, containing 335 feet of radiating conductor, balun, 50 ft. RG58/U coax, PL-259 connector, nylon rope & instruction manual • now in use by US Dept. of State, US Army, radio schools, plus thousands of hams the world over

YAESU



FT-301D



FT-101E TRANSCEIVER

FT 301	160M-10M Transceiver - 200 WPEP	\$769
FP 301 DIG	160M-10M Transceiver - 200 WPEP	935
FP 301	AC Power Supply	125
FP 301 CID	AC P.S. w/Clock and CW ID	209
FRG-7	General Cov. Synthesized Receiver	299
QTR-24	Yaesu World Clock	30
FT-101-E		
160-10M	XCVR W/Processor	729
FT-101EE		
160-10M	XCVR W/O Processor	649
FT-101EX		
160-10M	XCVR W/O Processor	589
FL-2100B	AC Only, Less Mike	399
FTV-650B	Linear Amplifier	199
FTV-250	6M Transverter	199
FV-101B	2M Transverter	199
SP-101B	External VFO	109
SP-101PB	Speaker	22
YO-100	Speaker/Patch	59
YD-844	Monitor Scope	199
FA-9	Dynamic Base Mike	29
MMB-1	Cooling Fan	15
RFP-102	Mobile Mount	19
XF-30C	RF Speech Processor	79
FR-101S	600 Hz CW Filter	40
SOLID STATE	160-2M/SW RCVR	489
FR 101 DIG		
SOLID STATE	160-2M/SW RCVR	599
FT 301S	160-10M 40WPEP	559
FT 301S	160-10M 40WPEP Digital	765

Accessories:		
FC-6	6M Converter	24
FC-2	2M Converter	25
FM-1	FM Detector	20
	Aux/SW Crystals	5
	AM-Wide Filter	40
	600 Hz CW Filter	40
	FM Filter	49
	Speaker	22
XF-30B		
XF-30C		
XF-30D		
SP-101B		
FL-101		
SOLID STATE	160-10M	525
TRANSMITTER		
Accessories:		
RFP-101	RF Speech Processor	79
MONITOR/TEST EQUIPMENT		
YC 500 J	500 MHz (10 PPM) Counter	249
YC 500 S	500 MHz (1 PPM) Counter	399
YC 500 E	500 MHz (0.02 PPM) Counter	537
YO-100	Monitor Scope	199
YP-150	Dummy Load/Watt Meter	69
YC-601	Digital Readout (101/401 series)	169
VHF FM & SSB TRANSCEIVERS		
FT-620B	6M AM/CW/SSB	365
FT-221	2M AM/FM/CW/SSB	629
Accessories:		
MMB-4	Mobile Mount (FT-620B, FT-221)	19

TUFTS

Name _____ Call _____
 Address _____
 City _____ State _____ Zip _____
 Order: _____

MasterCharge
 American Express
 BankAmericard
 accepted on
 MOST items!

Radio Electronics

209 Mystic Avenue
 Medford MA 02155
 (617) 395-8280

FREE Gift With Every Order!

Check enclosed
 BankAmericard MasterCharge American Express
 Credit card # _____ Interbank # _____
 Signature _____ Card expiration date _____

Cash orders over \$1200 deduct 5%. No other discounts offered. All sales final.

TUFTS RADIO CATALOG TUFTS RADIO

HAM RADIO / MOBILE COMMUNICATIONS



MODEL	NET PRICE	103R	\$39.95
12V4	\$19.95	*13 HM 4	\$41.95
600	\$20.50	104R	\$49.95
102	\$24.95	12/115	\$69.95
612	\$27.95	108RA	\$79.95
107	\$28.95	108RM	\$99.95
12 HM 4	\$29.95	109R	\$149.95



MODEL 108RM

NPC 12 Amp Regulated Power Supply.
Solid State.
3-Way Protected.
Current Meter.



This heavy duty unit quietly converts 115 volts AC to 13.6 volts DC ± 200 millivolts. 8 amps continuous, 12 amps max. All solid state. Features dual current overload and overvoltage protection. Ideally suited for operating mobile Ham radio 2 meter AM-FM-SSB transceivers in your home or office. Can also be used to trickle-charge 12 volt car batteries.

	TYPICAL	MAXIMUM
Output Voltage	13.6 \pm 2VDC	13.6 \pm 3VDC
Line/Load Regulation	20 mV	50 mV
Ripple/Noise	2 mV RMS	5 mV RMS
Transient Response	20 μ Sec	
Current Continuous	8 Amp	
Current Limit	12 Amp	
Current Foldback	2.5 Amp	
Overvoltage Protection	14.5 V	15 V

Case: 4 1/4" (H) x 7 1/2" (W) x 5 1/2" (D). Shipping Weight: 9.5 lbs.

ALSO AVAILABLE AS MODEL 108RA WITHOUT METER AND OVERVOLTAGE PROTECTION.

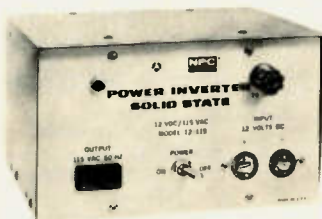

Output Voltage (No Load)	12 VDC 1N	14 VDC 1N
Output Voltage (Full Load)	115 V RMS	130 V RMS
Frequency (No Load)	100 V RMS	115 V RMS
Power Continuous	58 Hz	66 Hz
Power Peak	54 Hz	62 Hz
Parallel Connection	200W	240W
		350W

All Values Are Typical

MODEL 12HM4

NPC 2.5 Amp Regulated Power Supply.
Solid State. Short Circuit Protected.



ALSO! Available as 13 HM 4 with built-in loudspeaker.

	TYPICAL	MAXIMUM
Output Voltage	13.5 \pm 5VDC	14VDC
Continuous Current	1.5 Amp	
Regulation	2.5 Amp	
Ripple/Noise	5 mV RMS	10 mV RMS

Case: 3" (H) x 4" (W) x 5 1/4" (D). Shipping Weight: 3 lbs.

MODEL 107

NPC 4 Amp Power Supply, 6 Amp Max. Solid State. Overload Protected



Functions silently in converting 115 volts AC to 12 volts DC. 4 amps continuous, 6 amps max. Enables anyone to enjoy CB radio, car 8-track cartridge, cassette player or car radio in a home or office.

Continuous Current (Full Load)	4 Amp
Output Voltage (No Load)	16 V max
Output Voltage (Full Load)	12 V min
Filtering Capacitor	10,000 μ F
Ripple (Full Load)	5 V RMS
Short Circuit Protection	Thermal Breaker

Case: 3" (H) x 4 1/4" (W) x 5 1/4" (D). Shipping Weight: 5 lbs.

MODEL 109R

NPC 25 Amp Regulated Power Supply. 4-Way Protected. Output Voltage and Current Meters.

Extra heavy-duty unit quietly converts 115 volts AC to 13.6 volts DC ± 200 millivolts. 10 amps continuous, 25 amps max. All solid state. Features dual current overload, overvoltage and thermal protection. Ideally suited for operating mobile Ham radio and linear amplifier in your home or office. Excellent bench power supply for testing and servicing of mobile communications equipment.

	TYPICAL	MAXIMUM
Output Voltage	13.6 \pm 2VDC	13.6 \pm 3VDC
Line/Load Regulation	50 mV	100 mV
Ripple Noise	5 mV RMS	10 mV RMS
Transient Response	20 μ Sec	
Current Continuous	10 Amp	
Current Limit	26 Amp	
Overvoltage Protection	14.5 V	15 V
Thermal Overload	180 $^{\circ}$ F	

Case: 4 1/4" (H) x 9" (W) x 8 1/2" (D). Shipping Weight: 15 lbs.



MODEL 104R

NPC 6 Amp Power Supply Regulated. Solid State. Dual Overload Protection.

Converts 115 volts AC to 13.6 volts DC ± 200 millivolts. Handles 4 amps continuous and 6 amps max. Ideally suited for applications where excellent DC stability is important, such as CB transmission, small Ham radio transmitter, and high quality eight-track car stereos. Can be used to trickle-charge 12 volt car batteries.

	MAXIMUM	TYPICAL
Output Voltage	13.6 \pm 2 VDC	13.6 \pm 3 VDC
Line/Load Regulation	20 mV	50 mV
Ripple/Noise	2 mV RMS	5 mV RMS
Transient Response	20 μ Sec	
Current Continuous	4 Amp	
Current Limit	6 Amp	
Current Foldback	2 Amp	

Case: 3 1/2" (H) x 5 1/2" (W) x 6 1/2" (D). Shipping Weight: 6 lbs.

MARINE & RV

MODEL 12-115

NPC 12-115 Solid State Inverter. 200 W. Parallel Connection for Higher Power up to 350 W.

Converts 12 volts DC to 115 volts AC @ 60 Hz output. 200 watts continuous operation with peak power up to 240 watts. All silicon semiconductors assure high reliability at excessive ambient temperatures. The output voltage is a square wave. The inverter is not recommended where high transients are not tolerable.

The 12-115 allows you to have AC house current in your boat, car, truck, camper, house trailer, or houseboat. Will operate small household appliances, T.V., hand tools, electric shaver, AC radios, and lights within power rating. Built-in overload protection.

Case: 4 1/2" (H) x 7 1/2" (W) x 5 1/2" (D). Shipping Weight: 7 lbs.



MODEL 103R

NPC 4 Amp Regulated Power Supply. Solid State. Dual Overload Protection.



Converts 115 volts AC to 13.6 volts DC ± 200 millivolts. Handles 2.5 amps continuous and 4 amps max. Ideally suited for applications where no hum and DC stability are important such as CB transmission, small Ham radio transmitter, and high quality eight-track car stereos. Can also be used to trickle-charge 12 volt car batteries.

	TYPICAL	MAXIMUM
Output Voltage	13.6 \pm 2 VDC	13.6 \pm 3 VDC
Line/Load Regulation	20 mV	50 mV
Ripple/Noise	2 mV RMS	5 mV RMS
Transient Response	20 μ Sec	
Current Continuous	2.5 Amp	
Current Limit	4 Amp	
Current Foldback	1 Amp	

Case: 3" (H) x 4 1/4" (W) x 5 1/4" (D). Shipping Weight: 4 lbs.

MODEL 12V4

NPC 1.75 Amp Power Supply. 3 Amp Max.



Functions silently in converting 115 volts AC to 12 volts DC. Ideally suited for most applications including 8-track stereo, burglar alarm, car radio and cassette tape player within power rating.

Continuous Current (Full Load)	1.75 Amp
Output Voltage (No Load)	16 V max
Output Voltage (Full Load)	12 V min
Filtering Capacitor	5,000 μ F
Ripple (Full Load)	4 V RMS
Short Circuit Protection	Thermal Breaker

Case: 3" (H) x 4" (W) x 5 1/4" (D). Shipping Weight: 3 lbs.



MODEL 102

NPC 2.5 Amp Power Supply. 4 Amp Max. Solid State. Overload Protected.

Functions silently in converting 115 volts AC to 12 volts DC. 2.5 amps continuous, 4 amps max. Enables anyone to enjoy CB radio, car 8-track cartridge, cassette tape player or car radio in a home or office.

Continuous Current (Full Load)	2.5 Amp
Output Voltage (No Load)	16 V max
Output Voltage (Full Load)	12 V min
Filtering Capacitor	5,000 μ F
Ripple (Full Load)	6 V RMS
Short Circuit Protection	Thermal Breaker

Case: 3" (H) x 4 1/4" (W) x 5 1/4" (D). Shipping Weight: 4 lbs.

MODEL 612

Model 612 Power Converter

NPC 612 converts 6 volt negative ground or 12 volt positive ground electrical systems to 12 volt negative ground operation. Provides full 3 amp continuous power. The inexpensive solution for installing car radios, stereo and cassette tape players, in vehicles with 6 volt negative ground or 12 volt positive ground systems. Case 2 1/2" (H) x 3" (W) x 5" (D). Shipping Weight: 1 lb.





ARGONAUT
#509

AMPLIFIER
#405

TEN-TEC

ARGONAUT, MODEL 509

Covers all Amateur bands 10-80 meters. 9 MHz crystal filter. 2.5 kHz bandwidth. 1.7 shape factor @ 6/50 dB points. Power required 12-15 VDC @ 150 mA receive, 800 mA transmit at rated output. Construction: aluminum chassis, top and front panel, molded plastic end panels. Cream front panel, walnut vinyl top and end trim. Size: HWD 4 1/2" x 13" x 7". Weight 6 lbs.

LINEAR AMPLIFIER, MODEL 405

Covers all Amateur bands 10-80 meters. 50 watts output power, continuous sine

wave. RF wattmeter. SWR meter. Power required 12-15 VDC @ 8 A, max. Construction: aluminum chassis, top and front panel, molded plastic side panels. Cream front panel, walnut vinyl top and end trim. Size: HWD 4 1/2" x 7" x 8". Weight 2 1/2 lbs.

Argonaut, Model 509 \$359.00

Linear Amplifier, Model 405 . 159.00

Power Supply, Model 251

(Will power both units) 85.00

Power Supply, Model 210

(Will power Argonaut only) . . 30.00

The new ultra-modern fully solid-state TRITON makes operating easier and a lot more fun, without the limitations of vacuum tubes.

For one thing, you can change bands with the flick of a switch and no danger of off-resonance damage. And no deterioration of performance with age.

But that's not all. A superlative 8-pole i-f filter and less than 2% audio distortion, transmitting and receiving, makes it the smoothest and cleanest signal on the air.

The TRITON IV specifications are impeccable. For selectivity, stability and receiver sensitivity. And it has features such as full CW break-in, pre-selectable ALC, off-set tuning, separate AC power supply, 12 VDC operation, perfectly shaped CW wave form, built-in SWR bridge and on and on.

For new standards of SSB and CW communication, write for full details or talk it over with your TEN-TEC dealer. We'd like to tell you why "They

Don't Make 'Em Like They Used To" makes Ham Radio even more fun.

TRITON IV \$699.00

ACCESSORIES:

Model 240 One-Sixty Converter...\$ 97.00
Model 244 Digital Readout 197.00

Model 245 CW Filter \$25.00
Model 249 Noise Blanker 29.00
Model 252G Power Supply 109.00
Model 262G Power Supply/VOX . . 139.00



TEN-TEC

TRITON IV
Digital Model 544
\$869.00

KR20-A ELECTRONIC KEYS

A fine instrument for all-around high performance electronic keying. Paddle actuation force is factory adjusted for rhythmic smooth keying. Contact adjustments on front. Weighting factor factory set for optimum smoothness and articulation. Over-ride "straight key" conveniently located for emphasis, QRS sending or tune-up. Reed relay output. Side-tone generator with adjustable level. Self-completing characters. Plug-in circuit board. For 117 VAC, 50-60 Hz or 6-14 VDC. Finished in cream and walnut vinyl. Price \$69.50

KR5-A ELECTRONIC KEYS

Similar to KR20-A but without side-tone oscillator or AC power supply. Ideal for portable, mobile or fixed station. A great value that will give years of troublefree service. Housed in an attractive case with cream front, walnut vinyl top. For 6-14 VDC operation. Price \$39.50

KR1-A DELUXE DUAL PADDLE

Paddle assembly is that used in the KR50, housed in an attractive formed aluminum case. Price \$35.00

KR2-A SINGLE LEVER PADDLE

For keying conventional "TO" or discrete

character keys, as used in the KR20-A. Price \$17.00

KR50 ELECTRONIC KEYS

A completely automatic electronic keyer fully adjustable to your operating style and preference, speed, touch and weighting, the ratio of the length of dits and dahs to the space between them. Self-controlled keyer to transmit your thoughts clearly, articulately and almost effortlessly. The jambie (squeeze) feature allows the insertion of dits and dahs with perfect timing.

An automatic weighting system provides increased character to space ratio at slower speeds, decreasing as the speed is increased, keeping the balance between smoothness at low speeds and easy to copy higher speed. High intelligibility and rhythmic transmission is maintained at all speeds, automatically.

Memories provided for both dits and dahs but either may be defeated by switches on the rear panel. Thus, the KR50 may be operated as a full iambic (squeeze) keyer, with a single memory or as a conventional type keyer. All characters are self-completing. Price \$110.00

SPECIFICATIONS

Speed Range: 6-50 w.p.m.
Weighting Ratio Range: 50% to 150% of classical dit length.

Memories: Dit and dah. Individual defeat switches.

Paddle Actuation Force: 5-50 gms.
Power Source: 117VAC, 50-60 Hz, 6-14 VDC.

Finish: Cream front, walnut vinyl top and side panel trim.

Output: Reed relay. Contact rating 15 VA, 400 V, max.

Paddles: Torque drive with ball bearing pivot.

Side-tone: 500 Hz tone.
Adjustable output to 1 volt.
Size HWD: 2 1/2" x 5 1/2" x 8 1/4"
Weight: 1 1/4 lbs.

TEN-TEC

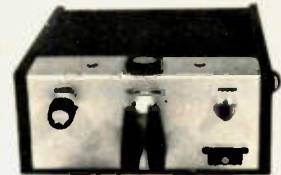

KR50

NORTH SHORE RF TECHNOLOGY

DUPLEXER & CAVITY KITS...



NOW AVAILABLE FOR YOU FULLY ASSEMBLED & TUNED!

- UPGRADE YOUR REPEATER WITH AN RF TECHNOLOGY DUPLEXER.
- ALL DUPLEXERS AND CAVITIES ARE TEMPERATURE COMPENSATED WITH INVAR® AND MEET ALL COMMERCIAL STANDARDS
- ONLY TOP QUALITY MATERIALS GO INTO OUR PRODUCTS.
- BOTH KITS & ASSEMBLED DUPLEXERS AND CAVITIES ARE AVAILABLE TO YOU AT A SAVINGS TO YOU.

Mod. 62-3 . . . 6 cav., 2 mtr., insertion loss 0.6 db with isolation 100 db typical;

pwr. 350 w. Kit \$399 ea. — Assembled \$499.

Mod. 4220-3 . . . 4 cav. 220 MHz insertion loss 0.6 db with 80 db isolation typical; pwr. 350 w. Kit \$279 ea. — Assembled \$349.

Mod. 4440-3 . . . 4 cav. 440 MHz, insertion loss 0.6 db with 80 db isolation loss 0.6 db with 80 db isolation typical; pwr. 350 w. Kits \$249 ea. — Assembled \$329.

Mod. 30 Cavity Kits: 2 mtr. \$75 ea. 220 MHz \$65 ea., 440 MHz \$65 ea.; 6 mtr. \$115 ea. Add \$15 for Assembled Kit.

Also available: 6 mtr., 4 cav. Kit \$399 — Assembled \$499, 2 mtr. 4 cav. Kit \$299 — Assembled \$399, 440 MHz TV Repeater Duplexer.

Now You Can Receive The Weak Signals With The ALL NEW AMECO PREAMPLIFIER

Model PT-2 is a continuous tuning 6-160 meter Pre-Amp specifically designed for use with a transceiver. The PT-2 combines the features of the well-known PT with new sophisticated control circuitry that permits it to be added to virtually any transceiver with No modification. No serious ham can be without one.

- Improves sensitivity and signal-to-noise ratio.
- Boosts signals up to 26 db.
- For AM or SSB.
- Bypasses itself automatically when the transceiver is transmitting.
- FET amplifier gives superior cross modulation protection.
- Advanced solid-state circuitry.
- Simple to install.
- Improves immunity to transceiver front-end overload by use of its built-in attenuator.
- Provides master power control for station equipment.

MODEL PT-2

\$69.95



BIRD

The indispensable
BIRD model 43
THRULINE®
Wattmeter



Read RF Watts Directly.

0.45-2300 MHz, 1-10,000 watts ±5%, Low Insertion VSWR—1.05.

Unequaled economy and flexibility: Buy only the element(s) covering your present frequency and power needs, add extra ranges later if your requirements expand.

Table 1
STANDARD
ELEMENTS
(CATALOG
NUMBERS)

Power Range	Frequency Bands (MHz)				
	2-30	25-60	100-250	200-500	400-1000
5 watts	—	5A	5C	5D	5E
10 watts	—	10A	10C	10D	10E
25 watts	—	25A	25C	25D	25E
50 watts	50H	50A	50C	50D	50E
100 watts	100H	100A	100C	100D	100E
250 watts	250H	250A	250C	250D	250E
500 watts	500H	500A	500C	500D	500E
1000 watts	1000H	1000A	1000C	1000D	1000E
2500 watts	2500H	—	—	—	—
5000 watts	5000H	—	—	—	—

MODEL

PRICE

43		\$120
	Elements (Table 1) 2-30 MHz	42
	Elements (Table 1) 25-1000 MHz	36
	Carrying case for Model 43 & 6 elements	26
	Carrying case for 12 elements	16

(Specify Type N or SO239 connectors)

Novice Crystals (Specify Band Only)

BOMAR Crystal Company

TWO METERS
CRYSTALS IN STOCK

Motorola HT 220 Crystals
In Stock!

Standard • Icom • Heathkit • Ken • Clegg • Regency • Wilson • VHF
Eng • Drake • And Others! \$4.50 @ Lifetime Guarantee

Make/Model	Xmit Freq.	Rec. Freq.

THE BIG SIGNAL \$12.95

"W2AU" BALUN

THE APPROVED LEADING HAM AND COMMERCIAL BALUN IN THE WORLD TODAY.

THE PROVEN BALUN

- HANDLES FULL 2 KW PEP AND THEN SOME. Broad Banded 3 to 40 Mc.
- HELPS TV PROBLEMS By Reducing Coax Line Radiation.
- NOW ALL STAINLESS STEEL HARDWARE. SO239 Double Silver Plated
- IMPROVES F/B RATIO By Reducing Coax Line Pick Up
- REPLACES CENTER INSULATOR Withstands Antenna Pull of Over 500 Lbs
- BUILT-IN LIGHTNING ARRESTER. Helps Protect Balun — Could Also Save Your Valuable Gear

3. BUILT-IN HANG-UP HOOK. Ideal For Inverted Vees, Multi-Band Antennas, Dipoles, Beam and Quads

NOW BEING USED BY ALL BRANCHES OF THE U.S. ARMED FORCES, FAA, RCA, CIE, CANADIAN DEFENSE DEPT. PLUS THOUSANDS OF HAMS THE WORLD OVER

THEY'RE BUILT TO LAST...

BIG SIGNALS DON'T JUST HAPPEN — GIVE YOUR ANTENNA A BREAK

Comes in 2 models. 1: matches 50 or 75 ohm unbalanced coax with 50 or 75 ohm balanced load. 2: matches 50 or 75 ohm unbalanced coax with 70 or 300 ohm balanced load

AVAILABLE AT ALL LEADING DEALERS IF NOT, ORDER DIRECT

The Big Signal W2AU Balun reflects the type of quality that has kept our product out front and number 1 in Baluns the world over for the past 10 years.

The originator of the Balun with a built-in lightning arrester and hang up hook

IF'S WHAT'S INSIDE THAT COUNTS!

W-2 GUARANTEE no other balun, of any price, has all these features

SERIES 31 — BNC CONNECTORS

Amphenol's BNC connectors are small, lightweight, weatherproof connectors with bayonet action for quick disconnect applications.

Shells, coupling rings and male contacts are accurately machined from brass. Springs are made of beryllium copper. All parts in turn are ASTROplated® to give you connectors that can take constant handling, high temperatures and resist abrasion.

BNC BULKHEAD RECEPTACLE 31-221-385 UG-1094
Mates with any BNC plug. Receptacle can be mounted into panels up to 104" thick. \$1.25

BNC (M) TO UHF (F) ADAPTER 309-2900-385 UG 255
Adapts any BNC jack to any UHF plug. \$3.63

DOUBLE MATE ADAPTER 83-877-385 Both coupling rings are free turning. Connects 2 female components. \$2.72

JACK ADAPTER 1.95
575-102-385 Adapts 83-1SP-385 to Motorola type auto antenna jack or pin jack.

PANEL RECEPTACLE 83-1R-385 SO239 Mounts with 4 fasteners in 21/32" diameter hole. \$1.17

PANEL RECEPTACLE 83-878-385 SO239SH Mounts in single 21/32" diameter hole. Knurled lock nuts prevent turning. \$1.59

BNC ANGLE ADAPTER 31-009-385 UG-306 Adapts any BNC plug for right angle use. \$4.23

BNC TEE ADAPTER 31-008-385 UG-274 Adapts 2 BNC plugs to 31-003-385 or other female BNC type receptacle. \$4.56

UG-273

UG-1094

575-102-385

BNC(F) TO UHF (M) ADAPTER 31-028-385 UG-273
Adapts any BNC plug to any UHF jack. \$2.39

PUSH-ON 83-1SP-385
83-5SP-385 Features an unthreaded, springy shell to push fit on female connectors. \$2.27

LIGHTNING ARRESTOR 575-105-385 Eliminates static build-up from antenna. Protects your valuable equipment against lightning damage. \$4.80

BNC PLUG 31-002-385 UG-88 Commonly used for communications antenna lead cables. For RG 55/U & RG 58/U cables. \$1.59

BNC STRAIGHT ADAPTER 31-219-385 UG-914 1 9/32" long, allows length of cables to be joined. Mates with BNC plugs. \$2.12

BNC PANEL RECEPTACLE 31-003-385 UG-290 Mounts with 4 fasteners in 29/64" diameter hole. \$1.74

SERIES 581 — PACKAGED CABLE ASSEMBLIES

All popular lengths are now available in your choice of RG 8/U or RG 58/U type low loss polyfoam dielectric cable. Installed PL-259 connectors are ASTROplated — Amphenol's new non-tarnishing finish — which has all the advantages of precious metal plus more heat, corrosion and abrasion resistors that silver ever had! These cable assemblies are ideal for CB, ham radio and other communications antenna installations and they are ready for immediate use.

PL-259 ... 90¢
UG-175 (Adapter for RG 58U)
... 25¢

SO239

UG-290

UG-274

SO239SH

83-5SP-385

575-105-385

UG-306

UG-255

UG-88

UG-914

RG 8/U TYPE POLYFOAM COAXIAL CABLE ASSEMBLIES 581-803 3-ft. with ASTROplated PL-259's on both ends. \$93.71

581-820 20-ft. with ASTROplated PL-259's on both ends. \$7.95

581-850 50-ft. with ASTROplated PL-259's on both ends. \$15.39

581-875 75-ft. with Astroplated PL-259's on both ends. \$21.10

581-8100 100-ft. with ASTROplated PL-259's on both ends. \$26.49

RG 58/U TYPE POLYFOAM COAXIAL CABLE ASSEMBLIES 581-5812 12-ft. with ASTROplated PL-259's on both ends. \$4.19

581-5820 20-ft. with ASTROplated PL-259's on one end and SPADE LUGS ON OTHER END. \$4.15

518-5820-2 20-ft. with ASTROplated PL-259's on both ends. \$4.89

581-5850 50-ft. with ASTROplated PL-259's on both ends. \$7.44

581-5875 75-ft. with ASTROplated PL-259's on both ends. \$9.28

581-58100 100-ft. with ASTROplated PL-259's on both ends. \$10.76



Now It's Crystal Clear

Yes, now ICOM helps you steer clear of all the hassles of channel crystals. The new **IC-225** is the same surprising radio you've come to know and love as the **IC-22A**, except that it is totally crystal independent. **Zero crystals.** Solid state engineering enables you to program 23 channels of your choice without waiting. Now the ICOM performance you've demanded comes with the convenience you've wanted, with your new **IC-225**. Price: \$299.00



IC-245 Transceiver

The VFO Revolution goes mobile with the unique, ICOM developed LSI synthesizer with 4 digit LED readout. The IC-245 offers the most for mobile on the market. The easy to use tuning knob moves accurately over 50 detent steps and assures excellent control as easily as steering the vehicle. With its optional adapter, the IC-245 puts you into all mode operation on 12V DC power with a compact dash-mounted transceiver. In FM, the synthesizer command frequency is displayed in 5 kHz steps from 146 to 148 MHz, and with the side band adapter the step rate drops to 100 Hz from 144 to 146 MHz. For maximum repeater flexibility, the transmit and receive frequencies are independently programmable on any separation. The IC-245 even comes equipped with a multiple pin Molex connector for remote control. The IC-245 is a product of the revolution in VFO design, from its new style front panel, to its excellent mechanical rigidity and Large Scale Integrated Circuitry. Your IC-245 will give you the most for mobile. \$499.00



THE NEW ICOM 4 MEG, MULTI-MODE, 2 METER RADIO — IC 211

ICOM introduces the first of a great new wave of amateur radios, with new styling, new versatility, new integration of functions. You've never before laid eyes on a radio like the IC-211, but you'll recognize what you've got when you first turn the single-knob frequency control on this compact new model. The IC-211 is fully synthesized in 100 Hz or 5 kHz steps, with dual tracking, optically coupled VFOs displayed by seven-segment LED readouts, providing any split. The IC-211 rolls through 4 megahertz as easily as a breaker through the surf. With its unique ICOM developed LSI synthesizer, the IC-211 is now the best "do everything" radio for 2 meters, with FM, USB, LSB and CW operation. \$749.00



Hold it!

Take hold of SSB with these two low cost twins. ICOM'S new portable **IC-202** and **IC-502** put it within your reach wherever you are. You can take it with you to the hill top, the highways, or the beach. Three portable watts PEP on two meters or six!

Hello, DX! The ICOM quality and excellent receiver characteristics of this pair make bulky converters and low band rigs unnecessary for getting started in SSB-VHF. You just add your linear amp, if you wish, connect to the antenna, and DX! With the **202** you may talk through **OSCAR VI** and **VII!** Even transceive with an "up" receiving converter! The **IC-502**, similarly, makes use of six meters in ways that you would have always liked but could never have before. In fact, there are so many things to try, it's like opening a new band.

Take hold of Single Side Band. Take hold of some excitement. Take two.

IC-202
2 Meter SSB - 3 Watts PEP - True IF Noise Blanker
Switched Dial Lights - Internal Batteries - 200KHz
VFO Tuning - 1.44.0 - 1.44.2 - 2 Meters - RTT
Price: \$269.00

IC-502
6 Meter SSB - 3 Watts PEP - True IF Noise Blanker
Switched Dial Lights - Internal Batteries - 800KHz
VFO - RTT
Price: \$249.00

Now ICOM Introduces 15 Channels of FM to Go! The New IC-215: the FM Grabber

This is ICOM's first FM portable, and it puts good times on the go. Change vehicles, walk through the park, climb a hill, and ICOM quality FM communications go right along with you. Long lasting internal batteries make portable FM really portable, while accessible features make conversion to external power and antenna fast and easy.

Grab for flexibility with the new **IC-215** FM portable.

- Front mounted controls and top mounted antenna
- Narrow filter (15KHz — compatible spacing)
- 15 channels (12 on dial / 3 priority)
- Fully collapsible antenna
- Compatible mount feature for flexible antenna
- Dual power (3 watts high / 400 mw. low, nominal)
- External power and antenna easily accessible
- Lighted dial and meter

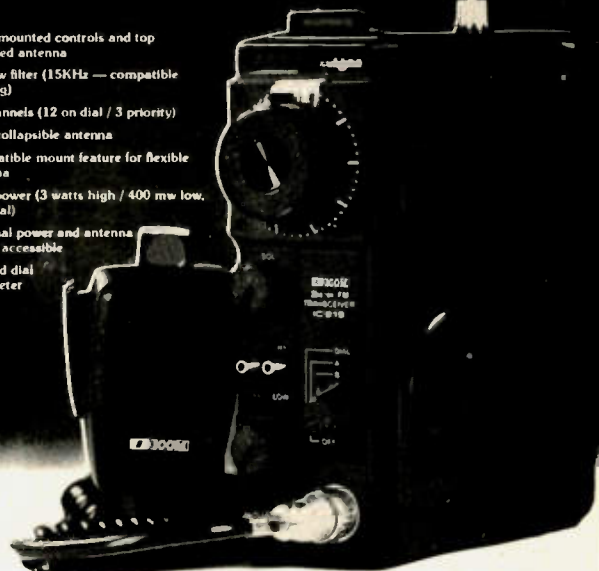

Price: \$229.00

Your new **IC-215** comes supplied with: 5 popular channels; handheld mic, with protective case; shoulder strap; connectors for external power and speaker; 9 long-life C batteries.



ICOM

TUFTS RADIO CATALOG TUFTS RADIO



**model 333
dummy load
wattmeter**

**Favorite Lightweight Portable—250 WATT RATING—
Air Cooled**

Ideal field service unit for mobile 2-way radio—CB, marine, business band. Best for ORP amateur use, CB, with zero to 5 watts full scale low power range.

■ specifications	
Frequency Range	DC to 300 MHz
VSWR	Less than 1.3:1 to 230 MHz
Power Range	250 watts intermittent
Wattmeter Ranges	0-5, 0-50, 0-125, 0-250
Connector	SO-239
Size	4" x 7" x 8"
Shipping Weight	2 lbs.
Price	\$98.50

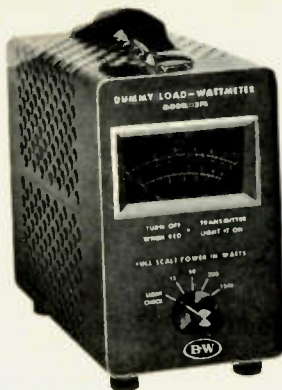

model 374 dummy load wattmeter

Top of the Line—1500 WATT RATING—Oil Cooled
Our highest power combination unit. Rated to 1500 watts input (intermittent). Meter ranges are individually calibrated for highest accuracy.

■ specifications	
Frequency Range	DC to 300 MHz
VSWR	Less than 1.3:1 to 230 MHz
Power Range	1500 watts DC Intermittent. Warning light* signals maximum heat limit.
Wattmeter Ranges	0-15, 0-50, 0-300, 0-1500
Input Connector	SO-239 (hermetically sealed)
Size	4-3/4" x 9" x 10-1/4"
Shipping Weight	12 lbs.
Price	\$215.00

LITTLE DIPPER

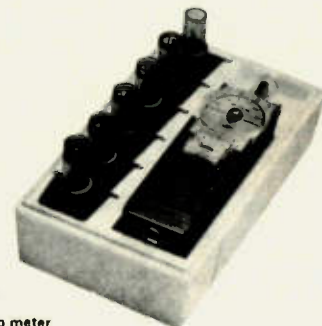

**model 331A
transistor dip meter**

Portable RF single generator, signal monitor, or absorption wavemeter. Lightweight (1 pound, 6 ounces with all coils), battery-powered unit is ideal for field use in testing transceivers, tuning antennas, etc. Can also be used to measure capacity, inductance, circuit Q, and other factors. Indispensable for experimenters, it is easily the most versatile instrument in the shop. Continuous coverage from 2 MHz to 230 MHz in seven ranges.

Unit consists of a transistorized RF dip oscillator and 100-microampere meter circuit. Meter circuit uses a single-transistor DC amplifier with a potentiometer in the emitter circuit to control meter sensitivity. A 3-position slide switch connects the meter circuit to the oscillator for dip measurements, to a diode for absorption wavemeter peak measurements, or provides audio modulation of the RF signal.

Frequency dial has a calibrated reference point for Q and bandwidth measurements. Each coil has its own frequency dial there's no confusion with multiple markings or small, hard-to-read scales near the center of the dial.

■ specifications

Frequency Coverage	2 MHz to 230 MHz in 7 overlapping ranges by plug-in coil assemblies: 2 MHz-4 MHz, 4 MHz-8 MHz, 8 MHz-16 MHz, 16 MHz-32 MHz, 32 MHz-64 MHz, 50 MHz-110 MHz, 110 MHz-230 MHz
Accuracy	±3%
Modulation	1000 Hz, 25% to 40%
Power	9-volt transistor battery, Burgess 2U6 or equivalent
Size	7" x 2-1/4" x 2-1/2"
Shipping Weight	1 lb., 6 oz.
Price	\$120.00



BARKER & WILLIAMSON, INC.



**Economy High Power Load—1500 WATT RATING—
Oil Cooled
model 384 dummy load**

For high power when all you need is the load.

■ specifications	
Frequency Range	DC to 300 MHz
VSWR	Less than 1.3:1 to 230 MHz
Power Range	1500 watts Intermittent. Warning light* signals maximum heat limit.
Connector	SO-239 (hermetically sealed)
Size	4-3/4" x 9" x 10-1/2"
Shipping Weight	12 lbs.
Price	\$94.50



**High Power—1000 WATT RATING—Oil Cooled
model 334A dummy load wattmeter**

Our most popular combination unit. Handles full amateur power. Meter ranges individually calibrated. Can be panel mounted.

■ specifications	
Frequency Range	DC to 300 MHz
VSWR	Less than 1.3:1 to 230 MHz
Power Range	1000 watts CW intermittent. Warning light* signals maximum heat limit.
Wattmeter Ranges	0-10, 0-100, 0-300, 0-1000
Input Connector	SO-239 (hermetically sealed)
Size	4-3/4" x 9" x 10-1/4"
Shipping Weight	12 lbs.
Price	\$174.00

WIDE RANGE ATTENUATOR



Model 371-1

Protect your receiver or converter from overload, or provide step attenuation of low-level RF signals from signal generators, preamplifiers, or converters. Seven rocker switches provide attenuation from 1 dB to 61 dB in 1-dB steps. Switches are marked in dB, 1-2-3-5-10-20-20. Sum of actuated switches (IN position) gives attenuation. With all switches in OUT position, there is NO insertion loss. Attenuator installs in coaxial line using UHF connectors.

■ specifications

Power Capacity	1/4 watt
VSWR	1.3:1 maximum, DC to 225 MHz
Impedance	50 ohms
Accuracy	1 dB/dB, DC to 60 MHz 0.1 dB/dB -0.5 dB, DC to 160 MHz 0.1 dB/dB -1.0 dB, DC to 225 MHz
Size	8-1/2" x 2-1/2" x 2-1/4"
Shipping Weight	1-1/2 lbs.
Price	\$49.50

• Handle full 200 watts • low-low V.S.W.R. • Deliver 3 dB gain and more! • Pick the one that best fits your needs:

Larsen Kūlrod® Antennas

MAGNETIC MOUNT
stays put even at 100 mph!

MM-JM-150 for 144 MHz use } Only
MM-JM-220 for 220 MHz use } **\$38.50**
MM-JM-440 for 440 MHz use } complete

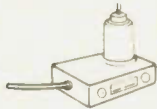

TRUNK LID MOUNT

No holes and low silhouette too!
TLM-JM-150 for 144 MHz use }
TLM-JM-220 for 220 MHz use } **\$38.50**
TLM-JM-440 for 440 MHz use } complete

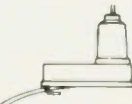

And 1/4 wave antenna for trunk and magnetic mount — **\$18.50**

ROOF or FENDER MOUNT

Goes on quick and easy in 3/8" or 3/4" with fewest parts.

JM-150-K for 144 MHz use } Only
JM-220-K for 220 MHz use } **\$31.50**
JM-440-K for 440 MHz use } complete



Above antennas all complete with mounting hardware, coax, connector plug, allen wrench and complete instructions.

model 372 CLIPREAMP



Model 372 — \$27.50

Get maximum legal modulation without danger of splatter. Solid state speech preamplifier and clipper for transmitters, public address systems, and tape recorders needs no external power.

specifications
Input Impedance 100,000 ohms
Input Levels 5 millivolts to 20 millivolts
Voltage Gain 10 dB
Output Level 60 millivolts
Output Impedance 50,000 ohms
Power 9-watt transistor battery, Burgess 2U6 or equivalent
Size 2 3/4" x 3" x 4-1/2"
Shipping Weight 7 oz.
Connectors Terminal strip

COAXIAL ANTENNA CHANGEOVER RELAY

model 377



Model 377 — \$17.95

Economical and reliable. Can be operated from VOX circuit for completely automatic operation or from PTT or manual T/R switch. Receiver input is automatically grounded when the relay is in the Transmit position. Wide AC operating voltage range and low operating current.

specifications
Power Rating 1000 watts CW (2000 watts SSB)
VSWR Less than 1.15:1, DC to 150 MHz
Power Requirements 0.815 Ampere, 48 to 130 volts AC
Connectors UHF Type SO 239
Dimensions 3-1/2" x 1-1/2"
Shipping Weight 1 lb.

UNIVERSAL HYBRID COUPLER II PHONE PATCH

model 3002W and model 3001W



Model 300 2W with *Compreamp*
— \$125.00

Connect your station to the telephone lines. Five switch-selectable modes give complete flexibility for patching the station to the line and for tape recording and playback to or from the line or the station. The hybrid circuit provides for effortless VOX operation of the phone patch. A built-in *Compreamp* speech preamplifier/limiter (in Model 3002W) increases the level of weak phone signals and also prevents overmodulation when the local telephone is used as the station microphone. (The *Compreamp* also functions as a preamplifier/limiter with the station microphone, if desired.)

specifications
Inputs from:
Line 600 ohms
Receiver 4 ohms
Microphone High impedance (50,000 ohm) crystal or dynamic
Tape Recorder 4 ohms
Outputs to:
Transmitter 50,000 ohms
Receiver Speaker 4 ohms
Tape Recorder 0.5 megohm
Size 8-1/2" x 7-1/2" x 3"
Shipping Weight 3-1/2 lbs.
Power 9-watt battery, Burgess 2U6 or equivalent
Connectors Phone

Model 300 1W without *Compreamp*
— \$85.00

BARKER & WILLIAMSON, INC.

Model 359 — \$37.50

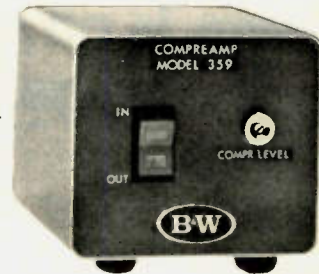

Increase your transmitter's effective speech power up to four times. Or use it with your tape recorder or public address system for improved performance. This two-stage, transistorized Audio Preamplifier/Limiter can be used with all types of transmitters. Powered by a long-lasting dry cell battery—no external power needed. Installs without any wiring changes in your transmitter. Just connect the *Compreamp* between your microphone (50,000 ohm dynamic or high impedance ceramic) and your transmitter's microphone input connector. Front-panel rocker switch lets you bypass the *Compreamp* when you want to. Compression level is adjustable, too.

specifications
Input Impedance 100,000 ohms
Input Level 5 millivolts to 20 millivolts
Voltage Gain 10 dB
Output Level 60 millivolts
Output Impedance 50,000 ohms
Power 9-watt transistor battery, Burgess 2U6 or equivalent
Size 2 3/4" x 3" x 4-1/2"
Shipping Weight 8-1/2 oz.
Connectors Terminal strip

COAXIAL SWITCHES AND ACCESSORIES

for antenna selection and RF switching

These high-quality switches have set the standard for the industry for years. Ceramic switches with silver alloy contacts and silver-plated conductors give unmatched performance and reliability from audio frequencies to 150 MHz.

B&W coaxial switches are designed for use with 50 to 75 ohm non-reactive loads, and are power rated at 1000 watts AM, 2000 watts SSB. Connectors are UHF type. Insertion loss is negligible, and VSWR is less than 1.2:1 up to 150 MHz.

Crosstalk (measured at 30 MHz) is 45 dB between adjacent outlets and 60 dB between alternate outlets.

Models are available for desk, wall, or panel mounting, and with or without protective grounding of inactive outputs. Radial (side-mounted) connector models can be either wall or panel mounted, axial (backplate-mounted) connector models are for panel mounting only, save panel space.

Use the selector chart below to choose the models you need.



COAXIAL SWITCH SELECTOR CHART

Model	PRICE	Outputs	Connector Placement	Mounting			Automatic Grounding	Dial Plate	Remarks
				Panel	Wall	Desk			
375	18.95	6	Axial	x			x	Supplied	PROTAX switch. Grounds all except selected output circuit.
376	18.95	5	Radial	x	x		x	Supplied	PROTAX switch. Grounds all except selected output circuit. Sixth switch position grounds all outputs.
550A	14.00	5	Radial	x	x			DP 5	
550A-2	12.50	2	Radial	x	x			DP 2	
551A	17.50	2	Radial	x	x			DP 2	Special 2 pole, 2-position switch used to switch any RF device in or out of series connection in a coaxial line. See figure (over).
556	.95	-	-		x			-	Bracket only, for wall mounting of radial connector switches.
590	17.95	5	Axial	x				DP 5	
590G	17.95	5	Axial	x			x	Supplied	Grounds all except selected output circuit.
592	16.50	2	Axial	x				DP 2	
595	18.50	6	In-line		x	x	x		Grounds all except selected output circuit.

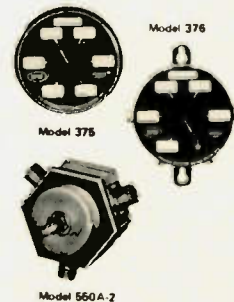

TUFTS RADIO CATALOG TUFTS RADIO

There is no substitute for quality, performance, or the satisfaction of owning the very best.

Hence, the incomparable Hy-Gain 3750 Amateur transceiver. The 3750 covers all amateur bands 1.8-30 MHz (160-10 meters). It utilizes advanced Phase-Lock-Loop circuitry with dual gate MOS FET's at all critical RF amplifier and mixer stages. There's a rotating dial for easy band-scanning and an electronic frequency counter with digital readout and a memory display that remembers frequencies at the flip of a switch. And that's just the beginning.

Matching speaker unit (3854) and complete external VFO (3855) also available.

See the incomparable Hy-Gain 3750 at your radio dealer or write Department MM. There is no substitute.



3854 - \$59.95

3750 - \$1895.00

3855 - \$495.00

There is no substitute.

hy-gain
Amateur Radio Systems.



Super 3-Element Thunderbird for 10, 15 and 20 Meters Model TH3Mk3 - \$199.95

Hy-Gain's Super 3-element Thunderbird delivers outstanding performance on 10, 15 and 20 meters. The TH3Mk3 features separate and matched Hy-Q traps for each band, and feeds with 52 ohm coax. Hy-Gain Beta Match presents tapered impedance for most efficient 3 band matching, and provides DC ground to eliminate precipitation static. The TH3Mk3 delivers maximum F/B ratio, and SWR less than 1.5:1 at resonance on all bands. Its mechanically superior construction features taper swaged slotted tubing for easy adjustment and larger diameter. Comes equipped with heavy tiltable boom-to-mast clamp. Hy-Gain ferrite balun BN-86 is recommended for use with the TH3Mk3.

Electrical	TH6DXX	TH3Mk3
Gain—average	8.7dB	8dB
Front-to-back ratio	25dB	25dB
SWR (at resonance)	Less than 1.5:1	Less than 1.5:1
Impedance	50 ohms	50 ohms
Power rating	Max legal	Max legal

Mechanical	TH6DXX	TH3Mk3
Longest element	31.1'	27'
Boom length	24'	14'
Turning radius	20'	15.7'
Wind load at 80 MPH	156 lbs	103.2 lbs.
Maximum wind survival	100 MPH	100 MPH
Net weight	57 lbs.	36 lbs.
Mast diameter accepted	1 1/4" to 2 1/2"	1 1/4" to 2 1/2"
Surface area	6.1 sq. ft.	4.03 sq. ft.

6-Element Super Thunderbird DX for 10, 15 and 20 Meters Model TH6 DXX \$249.95 Separate HY-Q traps, featuring large diameter coils that develop an exceptionally favorable L/C ratio and very high Q, provide peak performance on each band whether working phone or CW. Exclusive Hy-Gain beta match, factory pretuned, insures maximum gain and F/B ratio without compromise. The TH6DXX feeds with 52 ohm coaxial cable and delivers less than 1.5:1 SWR on all bands. Mechanically superior construction features taper swaged, slotted tubing for easy adjustment and re-adjustment, and for larger diameter and less wind loading. Full circumference compression clamps replace self-tapping sheet metal screws. Includes large diameter, heavy gauge aluminum boom, heavy cast aluminum boom-to-mast clamp, and heavy gauge machine formed element-to-boom brackets. Hy-Gain's ferrite balun BN-86 is recommended for use with the TH6DXX.

HY-GAIN'S INCOMPARABLE HY-TOWER FOR 80 THRU 10 METERS

- Model 18HT**
- Outstanding Omni-Directional Performance
 - Automatic Band Switching
 - Installs on 4 sq. ft. of real estate
 - Completely Self-Supporting

By any standard of measurement, the Hy-Tower is unquestionably the finest multi-band vertical antenna system on the market today. Virtually indestructible, the Model 18HT features automatic band selection on 80 thru 10 meters through the use of a unique stub decoupling system which effectively isolates various sections of the antenna so that an electrical 1/4 wavelength (or odd multiple of a 1/4 wavelength) exists on all bands. Fed with 52 ohm coax, it takes maximum legal power ... delivers outstanding performance on all bands. With the addition of a base loading coil, it also delivers outstanding performance on 160 meters. Structurally, the Model 18HT is built to last a lifetime. Rugged hot-dipped galvanized 24 ft. tower requires no guyed supports. Top mast, which extends to a height of 50 Ft., is 6061ST6 tapers aluminum. All hardware is iridite treated to MIL specs. If you're looking for the epitome in vertical antenna systems, you'll want Hy-Tower, Shpg. Wt., 96.7 lbs. Order No. 182, Price: \$279.95

NEW Special hinged base assembly on Model 18HT allows complete assembly of antenna at ground level ... permits easy raising and lowering of the antenna.

BROAD BAND DOUBLET BALUN for 10 thru 80 meters Model BN-86 \$15.95



The model BN-86 balun provides optimum balance of power to both sides of any doublet and vastly improves the transfer of energy from feedline to antenna. Power capacity is 1 KW DC. Features weatherproof construction and built-in mounting brackets. \$15.95 Shpg. Wt. 1 lb. Order No. 242



MULTI-BAND HY-Q TRAP DOUBLET'S Hy-Q Traps

- Install Horizontally or as Inverted V
- Super-Strength Aluminum Clad Wire
- Weatherproof Center and End Insulators

Installed horizontally or as an inverted V, Hy-Gain doublets with Hy-Q traps deliver true half wavelength performance on every design frequency. Matched traps, individually pretuned for each band feature large diameter coils that develop an exceptionally favorable L/C ratio and very high Q performance. Mechanically superior solid aluminum trap housings provide maximum protection and support to the loading coil. Fed with 52 ohm coax, Hy-Gain doublets employ super-strength aluminum clad single strand steel wire elements that defy deterioration from salt water and smoke ... will not stretch ... withstand hurricane-like winds. SWR less than 1.5:1 on all bands. Strong, lightweight, weatherproof center insulators are molded from high impact cycolac. Hardware is iridite treated to MIL specs. Heavily serrated 7-inch end insulators molded from high impact cycolac increase leakage path to approximately 12 inches.

MODEL 2BDQ for 40 and 80 meters. 100' 10 1/2" overall. Takes maximum legal power. Shpg. Wt., 7.5 lbs \$49.95 Order No. 380

MODEL 5BDQ for 10, 15, 20, 40 and 80 meters. 94' overall. Takes maximum power. Shpg. Wt., 12.2 lbs. \$79.95 Order No. 383



CENTER INSULATOR for Multi-Band Doublets Model CI

Strong lightweight, weatherproof Model CI is molded from high impact cycolac. Hardware is iridite treated to MIL specs. Accepts 1/4" or 3/4" coaxial. Shpg. Wt., 0.6 lbs. \$5.95 Order No. 155

MULTI-BAND ANTENNA Dipole Antenna - Model DIV-80 \$13.95

For 10 thru 80 meters - choice of one band

A dipole antenna for the individuals who prefer the "do-it-yourself" flexibility of custom-designing an antenna for your specific needs. (Work the frequencies you wish in the 10 through 80 meters bands).

The DIV-80 features: Durable Copperweld wire for greater strength, Mosley Dipole Connector (DPC-1) for RG-8/U or RG-58/U coax and all the technical information you will need to construct your custom-designed antenna.



END INSULATORS for Doublets Model EI

Rugged 7-inch end insulators are molded from high impact cycolac that is heavily serrated to increase leakage path to approximately 12 inches. Available in pairs only. Shpg. Wt., 0.4 lbs. \$3.95 Order No. 156



For 10, 15, and 20 Meters
New Hy-Gain Model 12 AVQ

Completely self-supporting, the Model 12AVQ features Hy-Q traps...12" double-grip mast bracket...taper swaged seamless aluminum construction with full circumference compression clamps at tubing joints. It delivers outstanding low angle radiation. SWR is 2:1 or less on all bands. Overall height is 13'6". Shipping weight 7.2 lbs. Price: \$47.00
Order No. 384

New, improved successor to the world's most popular vertical!
Hy-Gain Model 14 AVQ/WB for 40-10 Meters.

- Wide band performance with one setting (optimum settings for top performance furnished)
- New Hy-Q Traps • New 12" Double-Grip Mast Bracket • Taper Swaged Seamless Aluminum Construction

The Model 14AVQ/WB, new improved successor to the world famous Model 14AVQ, is a self-supporting, automatic band switching vertical that delivers omni-directional performance on 40 through 10 meters. Three separate Hy-Q traps featuring large diameter coils that develop an exceptionally favorable L/C ratio and a very high Q, provide peak performance by effectively isolating sections of the antenna so that a true 1/4 wave resonance exists on all bands. Outstandingly low angle radiation pattern makes DX and other long haul contacts easy. Superior mechanical features include solid aluminum housing for traps using air dielectric capacitor...heavy gauge taper swaged seamless aluminum radiator...full circumference compression clamps at tubing joints that are resistant to corrosion and wear...and a 12" double-grip mast bracket that insures maximum rigidity whether roof-top or ground mounted. The Model 14AVQ/WB also delivers excellent performance on 80 meters using Hy-Gain Model LC-80Q Loading Coil. Overall height is 18 feet. Shipping weight 9.2 lbs. Unsurpassed portability...outstanding for permanent installations. Price: \$67.00
Order No. 385

TYPICAL 14AVQ/WB VSWR CURVES

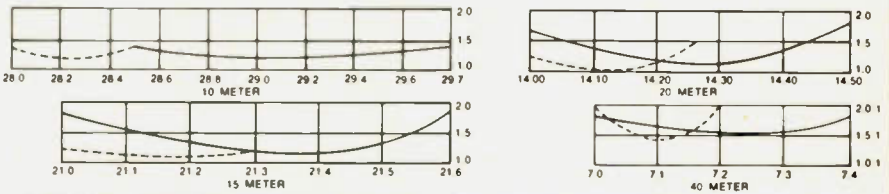

ROOF MOUNTING KIT—Model 14RMQ provides rugged support for Model 14AVQ/WB.
Order No. 184 Price: \$24.95

Hy-Gain REEL TAPE PORTABLE DIPOLE for 10 thru 80 Meters Model 18TD

The most portable high performance dipole ever...

The Model 18TD is unquestionably the most foolproof high performance portable doublet antenna system ever developed. It has proven invaluable in providing reliable communications in vital military and commercial-applications throughout the world. Two stainless steel tapes, calibrated in meters, extend from either side of the main housing up to a total distance of 132 feet for 3.5 mc operation. 25 ft. lengths of polypropylene rope attached to each tape permits installation to poles, trees, buildings... whatever is available for forming a doublet antenna system. Integrated in the high impact housing is a frequency to length conversion chart calibrated to meter measurements on the tapes...makes installation foolproof. Feeds with 52 ohm coax. Delivers outstanding performance as a portable or permanent installation. Measures 10x5 1/2 x 2 inches retracted. WL, 4.1 lbs.
Order No. 228 Price: \$94.95

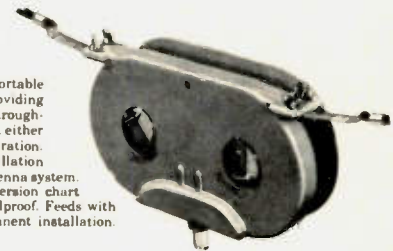

DenTron MLA-2500 \$799.50

DenTron Radio has packed all the features a linear amplifier should have into their new MLA-2500. Any Ham who works it can tell you the MLA-2500 really was built to make amateur radio more fun.

- ALC circuit to prevent overloading
- 160 thru 10 meters
- 1000 watts DC input on CW, RTTY or SSTV Continuous Duty
- Variable forced air cooling system
- Self-contained continuous duty power supply
- Two EIMAC 8875 external anode ceramic/metal triodes operating in grounded grid
- Covers MARS frequencies without modifications
- 50 ohm input and output impedance
- Built-in RF wattmeter
- 117V or 234V AC 50-60 hz
- Third order distortion down at least 30 db
- Frequency range:
 - 1.8MHz (1.8-2.5) 3.5MHz (3.4-4.6)
 - 7MHz (6.0-9.0) 14MHz (11.0-16.0)
 - 21MHz (16.0-22.0) 28MHz (28.0-30.0)
- 40 watts drive for 1 KW DC input
- Rack mounting kit available (19" rack)
- Size: 5 1/2" H x 14" W x 14" D Wt. 47 lbs.

Pipo Communications TROUBLE FREE TOUCH-TONE ENCODER



POSITIVE TOUCH (KEYS DEPRESS) • MOBILE • HANDHELD
DESK MOUNT • NO POTTED PARTS (SERVICEABLE)
MIL. SPEC. COMPONENTS • NO RFI • SELF CONTAINED
XTAL CONTROLLED • LEVEL ADJUSTABLE FROM FRONT
Pat. Pend.

M series is for mounting to surfaces inaccessible from the rear: mobiles, systems interface panels, test equipment, etc.
K series is self contained with a relay inside the encoder. When keys are present contact closer occurs with a 2 sec. delay, (adjustable). Contacts are rated at 110ma @ 28 Volts switched, 500ma carry. PP-2K contains delay excitation for the fourth column. However, by jumpering D-5, 4th column delay is restored.

Pipo Communications has developed a trouble free reliable instrument to be free of any defects for years. Unit is constructed with the best components available without compromise in quality. Unit is operable from 4.5 - 50 Volts at temperatures from below 0° to +140°F. Output level will drive any transmitter or system. Adjustable output level is controlled with an extremely stable millium trimpot, with access from the front of the encoder (not behind), saving time for level setting, which amounts to hours when involved with a system.

PP-1 555 12 Keys PP-2 558 16 Keys PP-1A 568 For Standard Comm
PP-1m 555 Comm Modifiable PP-2m 558 Comm Modifiable Hand Held
PP-1K 566 Am 9:00 PP-2K 569 Am 9:00

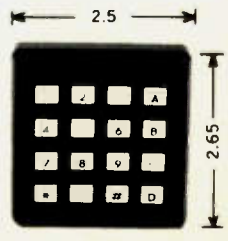

ALL NEW 3-BAND, 2 ELEMENT HY-QUAD

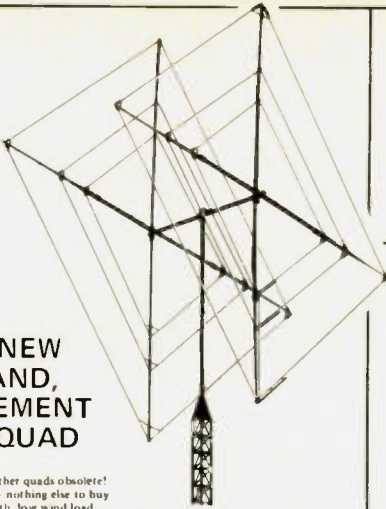

- Makes all other quads obsolete!
 - Complete - nothing else to buy
 - High strength, low wind load
- The Hy-Quad from Hy-Gain makes all other quads obsolete! Here's why. First, it's the only quad that is complete. There is nothing more to shop for or buy. Secondly, it is uniquely designed so that it overcomes all of the previously undesirable features inherent in quads. The all aluminum structure stays up. The single feed line and diamond shape simplifies feed line routing.

Order No. 244 Price: \$219.95

SPECIFICATIONS

Overall length of spreaders	25'5"	Forward gain	8.5 db
Turning radius	13'6"	Input impedance	52 ohms
Weight	42 lbs.	VSWR	1.2:1 or better
Boom diameter	2"		better at resonance on all bands
Boom length	8'	Power	Maximum
Mast diameter	1 1/4" to 2 1/2"		legal
Wind survival	100 mph	Front-to-back ratio	25:35 db
Surface area	64 sq ft		depending upon electrical height
Wind load at 100 mph	256.0 lbs.	Polarization	Horizontal

The Versatile Model 18V for 80 thru 10 Meters

The Model 18V is a low cost, highly efficient vertical antenna that can be tuned to any band 80 thru 10 meters by a simple adjustment of the feed point on the matching base inductor. Fed with 52 ohm coax, this 18 ft. radiator is amazingly efficient for DX or local contact. Constructed of heavy gauge aluminum tubing, the Model 18V may be installed on a short 1 1/2 inch mast driven into the ground. It is also adaptable to roof or tower mounting. Highly portable, the Model 18V can be quickly knocked down to an overall length of 5 ft. and easily re-assembled for field days and camping trips. Ship. Wt. 5 lbs.
Order No. 193 Price: \$33.00

WIDE BAND VERTICAL for 80 - 10 Meters Hy-Gain's 18 AVT/WB

Take the wide band, omni-directional performance of Hy-Gain's famous 14AVQ/WB, add 80 meter capability plus extra-heavy duty construction—and you have the unrivalled new 18AVT/WB. In other words, you have quite an antenna.

- Automatic switching, five band capability is accomplished through the use of three beefed-up Hy-Q traps (featuring large diameter coils that develop an exceptionally favorable L/C ratio).
- Top loading coil.
- Across-the-band performance with just one furnished setting for each band (10 through 40).
- True 1/4 wave resonance on all bands.
- SWR of 2:1 or less at band edges.
- Radiation pattern has an outstandingly low angle whether roof top or ground mounted.

CONSTRUCTION... of extra-heavy duty tapered swaged seamless aluminum tubing with full circumference, corrosion resistant compression clamps at slotted tubing joints... is so rugged and rigid that, although the antenna is 25' in height, it can be mounted without guy wires, using a 12" double grip mast bracket, with recessed coax connector.

Order No. 386 Price: \$97.00

TUFTS RADIO CATALOG TUFTS RADIO

— C — LINE AMATEUR EQUIPMENT



— COMMUNICATIONS RECEIVERS —



Drake R-4C

Solid State Linear permeability-tuned VFO with 1 kHz dial divisions. Gear driven dual circular dials. High mechanical, electrical and temperature stability.

Covers ham bands with crystals furnished. Covers all of 80, 40, 20 and 15 meters, and 28.5-29.0 MHz of 10 meters.

Covers 160 meters with accessory crystal. In addition to the ham bands, tunes any fifteen 500 kHz ranges between 1.5 and 30 MHz, 5.0 to 6.0 MHz not recommended. Can be used for MARS, WWV, CB, Marine and Shortwave broadcasts.

Superior selectivity: 2.4 kHz 8-pole filter provided in ssb positions. 8.0 kHz, 6 pole selectivity for a-m. Optional 8-pole filters of .25, .5, 1.5 and 6.0 kHz bandwidths available.

Tunable notch filter attenuates carriers within passband.

Smooth and precise passband tuning.

Transceive capability; may be used to transceive with the T-4X, T-4XB or T-4XC Transmitters. Illuminated dial shows which PTO is in use.

Usb, lsb, a-m and cw on all bands.

Agc with fast attack and two release times for ssb and a-m or fast release for break-in cw. Agc also may be switched off.

New high efficiency accessory noise blanker that operates in all modes.

Crystal lattice filter in first i-f prevents cross-modulation and desensitization due to strong adjacent channel signals.

Excellent overload and intermodulation characteristics.

25 kHz Calibrator permits working closer to band edges and segments.

Scratch resistant epoxy paint finish.

Price: \$599.00



Drake T-4XC

Solid State Linear permeability-tuned VFO with 1 kHz dial divisions. Gear driven dual circular dials. High mechanical, electrical and temperature stability.

Covers ham bands with crystals furnished. Covers all of 80, 40, 20 and 15 meters, and 28.5-29.0 MHz of 10 meters.

Covers 160 meters with accessory crystal. Four 500 kHz ranges in addition to the ham bands plus one fixed-frequency range can be switch-selected from the front panel.

Two 8-pole crystal lattice filters for sideband selection.

Transceives with the R-4, R-4A, R-4B, R-4C and SPR-4 Receivers. Switch on the T-4XC selects frequency control by receiver or transmitter PTO or independently. Illuminated dial shows which PTO is in use.

Usb, lsb, a-m and cw on all bands.

Controlled-carrier modulation for a-m is compatible with ssb linear amplifiers.

Automatic transmit-receive switching. Separate VOX time-delay adjustments for phone and cw. VOX gain is independent of microphone gain.

Choice of VOX or PTT. VOX can be disabled by front panel switch.

Adjustable pi network output.

Transmitting agc prevents flat-topping.

Meter reads relative output or plate current with switch on load control.

Built-in cw sidetone.

Spotting function for easy zero-beating.

Easily adaptable to RTTY, either fsk or afsk.

Compact size; rugged construction. Scratch resistant epoxy paint finish.

Price: \$599.00



Drake SPR-4 — \$629.00

- Programmable to meet specific requirements: SWL, Amateur, Laboratory, Broadcast, Marine Radio, etc.
- Direct frequency dialing: 150-500 kHz plus any 23 500 kHz ranges, 0.5 to 30 MHz
- FET circuitry, all solid state
- Linear dial, 1 kHz readout
- Band-widths for cw, ssb, a-m with built-in LC filter
- Crystals supplied for LW, seven SW, and bc bands
- Notch filter
- Built-in speaker



Drake DSR-2 — \$2950.00

- Continuous Coverage 10 kHz to 30 MHz
- Digital Synthesizer Frequency Control
- Frequency Displayed to 100 Hz
- All Solid State
- A-m, Ssb, Cw, RTTY, lsb
- Series Balanced Gate Noise Blanker
- Front End Protection
- Optional Features Available on Special Order

Power Supplies

Power Supplies for T-4, T-4X, T-4XB or T-4XC (The AC-4 can be housed in an MS-4 speaker cabinet).

Model No. 1501 Drake AC-4 \$120.00

Model No. 1505 Drake DC-4 \$135.00



Drake MS-4

Drake MS-4 Matching Speaker for use with R-4, R-4A, R-4B and R-4C Receivers. (Has space to house AC-3 and AC-4 Power Supplies)

Price: \$30.00

Accessories

DRAKE MICROPHONES

Wired for use with Drake transmitters and transceivers, for either push-to-talk or VOX. Type of operation is determined by the VOX control setting of the transmitter.



Desk Type Model No. 7075

• Type: Heavy Duty Ceramic Desk Top • Cable: Four Foot, 3-Conductor, One Shield • Output Level: Minus 54 dB (0 dB = 1 volt/microbar) • Frequency Response: 80-7000 Hz • Switching: Adapts to either push-to-talk or VOX. Price: \$39.00



Hand-Held Type Model No. 7072

• Type: Ceramic, hand held • Cable: 11" Retracted, 5' extended, PVC 3 Cord, 1 shielded, Coil Cord • Case: Cyclac • Finish: Grey • Output Level: Minus 65 dB (0 dB = 1 volt/microbar) • Frequency Response: 300-3000 Hz • Switching: Adapts to either push-to-talk or VOX. Price: \$19.00



Drake FS-4 Digital Synthesizer — \$250.00

The new solid state Drake FS-4 Synthesizer opens the door to a new world of continuous-tuning short wave! Combines synthesized general coverage flexibility with the selectivity, stability, frequency readout and reliability of the Drake R-4C or SPR-4 Receivers.

- Interfaces with all R-4 series receivers and T-4X series transmitters: (R-4, R-4A, R-4B, R-4C, SPR-4, T-4, T-4X, T-4XB and T-4XC), without modification. • MHz range is set on FS-4, with kHz readout taken from receiver dial. • Complete general coverage—no range crystals to buy. • T-4/T-4X series transmitters transceive on any FS-4 frequency, when used with R-4 series receivers. • Readout 1 kHz with Drake PTO. Price: \$250.00

- Remote
- Motor Controlled



RCS-4

COAX ANTENNA SWITCH



- Control unit works on 110/220 VAC, 50/60 Hz, and supplies necessary DC to motor.
- Excellent for single coax feed to multiband quads or arrays of monobanders. The five positions allow a single coax feed to three beams and two dipoles, or other similar combinations.
- Control cable (not supplied) same as for HAM-M rotator.
- Selects antennas remotely, grounds all unused antennas. GND position grounds all antennas when leaving station. "Rain-Hat" construction shields motor and switches.
- Motor: 24 VAC, 2 amp. Lubrication good to -40°F.
- Switch RF Capability: Maximum legal limit. Price: \$120.00

MATCHING NETWORKS



MN-4
200 watts

Price: \$120.00



MN-2000
2000 watts PEP

Price: \$240.00

General: • Integral Wattmeter reads forward power in watts and VSWR directly, can be calibrated to read reflected power • Matches 50 ohm transmitter output to coax antenna feedline with VSWR of at least 5:1 • Covers ham bands 80 thru 10 meters • Switches in or out with front panel switch • Size: 5 1/2" H, 10 1/2" W, 8" D (14.0 x 27.3 x 20.3 cm), MN-2000, 14 1/2" D (36.5 cm).

• Continuous Duty Output: MN-4, 200 watts; MN-2000, 1000 watts (2000 watts PEP) • MN-2000 only: Up to 3 antenna connectors selected by front panel switch.



RF WATTMETERS

W-4 1.8-54 MHz Price: \$ 72.00
WV-4 20-200 MHz Price: \$ 84.00

Reads forward and reflected power directly in watts (VSWR from nomogram). Two scales in each direction. Size: 5 1/2" H, 3 1/2" W, 4" D (14.0 x 9.5 x 10.2 cm).

Model	Full Scale	Calibration Accuracy
W-4	200 watts	±(5% of reading + 2 watts)
	2000 watts	±(5% of reading + 20 watts)
WV-4	100 watts	±(5% of reading + 1 watt)
	1000 watts	±(5% of reading + 10 watts)



SSR-1 COMMUNICATIONS RECEIVER

- Synthesized • General Coverage
- Low Cost • All Solid State • Built-in AC Power Supply • Selectable Sidebands
- Excellent Performance

PRELIMINARY SPECIFICATIONS: • Coverage: 500 kHz to 30 MHz • Frequency can be read accurately to better than 5 kHz • Sensitivity typically 5 microvolts for 10 dB S+N/N SSB and better than 2 microvolts for 10 dB S+N/N AM • Selectable sidebands • Built-in power supply: 117/234 VAC ± 20% • If the AC power source fails the unit switches automatically to an internal battery pack which uses eight D-cells (not supplied) • For reduced current drain on DC operation the dials do not light up unless a red pushbutton on the front panel is depressed.

The performance, versatility, size and low cost of the SSR-1 make it ideal for use as a stand-by amateur or novice-amateur receiver, short wave receiver, CB monitor receiver, or general purpose laboratory receiver.

Price: \$350.00

GENERAL: • All amateur bands 10 thru 80 meters in seven 600 kHz ranges • Solid State VFO with 1 kHz dial divisions • Modes SSB Upper and Lower, CW and AM • Built-in Sidetone and automatic T/R switching on CW • 30 tubes and semi-conductors • Dimensions: 5 1/2" H, 10 1/2" W, 14 1/2" D (14.0 x 27.3 x 36.5 cm), Wt.: 16 lbs. (7.3 kg).

TRANSMIT: • VOX or PTT on SSB or AM • Input Power: SSB, 300 watts P.E.P.; AM, 260 watts P.E.P. controlled carrier compatible with SSB linears; CW, 260 watts • Adjustable pi-network.

RECEIVE: • Sensitivity better than 1/2 µV for 10 dB S/N • I.F. Selectivity 2.1 kHz @ 6 dB, 3.6 kHz @ 60 dB. • AGC full on receive modes, variable with RF gain control, fast attack and slow release with noise pulse suppression • Diode Detector for AM reception.

Price: \$699.00

34-PNB Plug-in Noise Blanker	100.00
FF-1 Crystal Control Unit	46.95
MMK-3 Mobile Mount	7.00
RV-4C Remote VFO	\$150.00



TR-4CW SIDEBAND TRANSCEIVER

POWER SUPPLIES	
AC-4 Power Supply	\$120.00
DC-4 Power Supply	135.00

2 METER FM PORTABLE TRANSCEIVER Model TR-33C

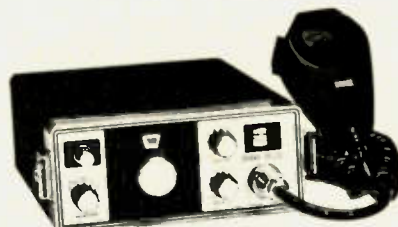

Amateur Net \$229.95

- SCPC* Frequency Control
- 12 Channels with Selectable Xmtr Offsets.
- All FET Front-end and Crystal Filter for Superb Receiver Intermod Rejection.
- Expanded Antenna Choice.
- Low Receiver Battery Drain.
- Traditional R. L. Drake Service Backup.
- Single Crystal Per Channel.

LINEAR AMPLIFIER Model L-4B



L-4B Linear Amplifier 895.00
• 2000 Watts PEP-SSB • Class B Grounded-Grid — two 3-500Z Tubes • Broad Band Tuned-Input • RF Negative Feedback • Transmitting AGC • Directional Wattmeter • Two Tautband Suspension Meters • L-4B 13-15/16" W, 7-7/8" H, 14-5/16" D. Wt.: 32 lbs. • Power Supply 6-3/4" W, 7-7/8" H, 11" D, Wt.: 43 lbs.

POWER SUPPLIES	
AC 4 Power Supply	\$120.00
DC 4 Power Supply	135.00

Touch-n-go with DRAKE 1525EM Push Button Encoding Mike



Drake 1525EM, microphone with tone encoder and connector for TR-33C, TR-22, TR-22C, ML-2 \$49.95

- Microphone and auto-patch encoder in single convenient package with coil cord and connector. Fully wired and ready for use.
- High accuracy IC tone generator, no frequency adjustments.
- High reliability Digitran® keyboard.
- Power for tone encoder obtained from transceiver through microphone cable. No battery required. Low current drain.
- Low output impedance allows use with almost all transceivers.
- Four pin microphone plug: directly connects to Drake TR-33C without any modification in transceiver. Compatible with all previous Drake and other 2 meter units with minor modifications.
- Tone level adjustable.
- Hang-up hook supplied.

why waste watts?

(SWR-1A \$25.95)



SWR-1 guards against power loss

If you're not pumping out all the power you're paying for, our little SWR-1 combination power meter and SWR bridge will tell you so. You read forward and reflected power simultaneously, up to 1000 watts RF and 1:1 to infinity VSWR at 3.5 to 150 MHz.

Got it all tuned up? Keep it that way with SWR-1. You can leave it right in your antenna circuit.



DELUXE 742 TRI-BAND MOBILE ANTENNA

- Automatically adjusts to proper resonance for 20, 40 and 75 meters.
- Power rated at 500 Watts P.E.P.

- Includes base section, auto-maticoil and whip top section. 742 Antenna

Price: \$109.95

EXCLUSIVE DELUXE 5-BAND MOBILE 45 ANTENNA

- All band manual switching antenna for 10, 15, 20, 40 and 75 meters.
- Power rated at 1000 Watts P.E.P.

- Includes base section with mobilecoil and six foot whip top section. 45 Antenna

Price: \$119.95



JMR MOBIL-EAR™

Two-way-radio headset with superior fidelity Electret-Capacitor boom microphone and palm-held talk switch.

\$69.95



MODEL 1015-A

FOR BROADCAST-QUALITY TRANSMISSION AND RECEPTION FOR BOTH MOBILE UNITS AND BASE STATIONS.

- Boom-mounted electret-capacitor microphone delivers studio-quality, undistorted voice reproduction. Variable gain control lets you adjust for optimum modulation.
- Cushioned earcup lets you monitor in privacy - no speaker blare to disturb others. Blocks out environmental noises, too. Made of unbreakable ABS plastic.
- Headband self-adjusts for comfortable wear over long hours. Spring-flex hinge lets you slip headset on and off with just one hand. Reversible for right or left ear.
- Headset can be hung on standard microphone clip.
- Compact palm-held talk switch lets you keep both hands on the wheel for safer driving. Made of unbreakable ABS plastic.
- Built-in FET transistor amplifier adapts microphone output to any transceiver impedance.
- Compatible with most two-way radios including 40-channel CB units.
- Built-in Velcro pad for easy mounting of the talk switch.
- Made in U.S.A.

SWAN METERS HELP YOU GET IT ALL TOGETHER

These wattmeters tell you what's going on.

With one of these in-line wattmeters you'll know if you're getting it all together all the time. Need high accuracy? High power handling? Peak

power readings? For whatever purpose we've got the wattmeter for you. Use your Swan credit card. Applications at your dealer or write to us.



WM2000 In-Line Wattmeter With Muscle Scales to 2000 watts. New flat-response directional coupler for maximum accuracy. \$59.95



WM3000 Peak-reading Wattmeter Reads RMS power then with the flick of a switch, true peak power of your single-sideband signal. That's what counts on SSB. \$79.95



WM1500 High-Accuracy In-Line Wattmeter 10% full scale accuracy on 5, 50, 500 and 1500 watt scales, 2 to 30 MHz. Forward and reflected power. Use it for trouble-shooting, too. \$74.95



SWAN LINEAR AMPLIFIERS A Mark II 2000 watt P.E.P. full legal input power unit or the 1200X matching Cygnet 1200 watt P.E.P. input powerhouse with built-in power supply. The choice is yours. \$849.95



NEW Swan MMBX Impedance Matcher

It keeps your transmitter and your antenna on speaking terms for a song. Price: \$23.95

CYGNET 1200X PORTABLE LINEAR AMPLIFIER

To quadruple the output of the 300B Cygnet *de novo*, simply add this matching unit for more than a kilowatt of power. Complete with self-contained power supply and provision for external ALC, this Cygnet offers exceptionally high efficiency and linearity. \$349.95

Additional Swan products include: fixed and mobile antennas, VFO's telephone patch, VOX, wattmeter, microphones and mounting kits. As another extra service, only Swan Electronics offers factory-backed financing to the amateur radio community. Visit an authorized Swan Electronics dealer for complete details



SPECIFICATIONS

- Earphone impedance and type: 8 ohms, dynamic
- Microphone type: Electret capacitor
- Microphone frequency response: 200-6000 Hz
- Amplifier type: FET transistor, variable gain
- Amplifier battery: 7-volt Mallory power: TR-175
- Switching: Relay or electronic

IDEAL FOR EVERY TWO-WAY RADIO COMMUNICATIONS NEED . . .

- CB operators • Amateur radio operators • Police and fire vehicles • Ambulances and emergency vehicles • Taxis and trucks • Marine pleasure and work boats • Construction and demolition crews • Industrial communications • Security patrols • Airport tower and ground crews • Remote broadcast and TV-camera crews • Foresters and fire-watch units •

A new precision clock which tells time anywhere in the world at a glance, has been announced by Yaesu Electronics Corporation. The time in any principal city or time zone can be simultaneously coordinated with local time on a 24 hour basis. After the initial setting, as the clock runs, a Time Zone Hour Disc advances automatically, showing correct time all over the world without further adjustment. The clock is especially designed to withstand shock and may be hung on a wall or placed on its desk mount. The clock will run an entire year on a single 1.5 volt flashlight battery and the mechanism starts as soon as the battery is inserted. It measures six inches in diameter by two and one half inches deep. An excellent item for the business office, ham radio operator, short wave listener, boat owner, and others who want an accurate dependable clock. Price: \$30.00 Amateur net.



Educator II & Power Supply Kits



EDUCATOR II KIT



EDUCATOR II POWER SUPPLY KIT

KEY FEATURES

- On-board clock
- 128 x 8 RAM
- On-board provision for second 128 x 8 RAM
- Resident executive provides for front panel control
- Built-in cassette interface for program load and record
- Search feature for program load from cassette provided
- Edge connectors provide full interface to peripheral interface adapter (PIA) and all address, data and control bus signals for system expansion
- Test-As-You-Build for accurate, error-free construction
- Easy, quick construction — one evening
- Support documentation aimed at teaching MPU theory and programming
- Completely self-contained. All parts included as well as complete construction manual
- Separate power supply required 5V @ 1.0 amps

KEY FEATURES

- Designed specifically for the Educator II
- Regulated 5.0 ± 5% volts d.c. output @ 1.0 amps
- 60Hz real time clock available (approximately 5.1V peak-to-peak)
- Complete kit — all parts, cabinet and construction manual
- Easy, one evening construction

CUSTOMER INFORMATION

- **EDUCATOR II KIT PRICING INFORMATION:** Suggested Resale: \$169.95
- **ACCESSORIES:** POWER SUPPLY (SEE PHOTO ABOVE): Suggested Resale: \$29.95. ADDITIONAL 128 x 8 RAM (C4811): Suggested Resale: \$19.04
- **ACCESSORIES TO COME IN NEAR FUTURE:** VIDEO DISPLAY, KEYBOARD, MODULE CARD RACK AND POWER SUPPLY, MEMORY MODULES, APPLICATIONS PROGRAMS ON CASSETTES

WHEN SYSTEM 3000 BYTES you will never let go!



- **TEN FRONT-PANEL-PROGRAMMABLE PRIORITY CHANNELS** for storage of frequency, transmitter offset, and tone encoder/decoder mode/frequency.
- **BUILT-IN SCANNER** for automatic tuning in user-selected one or four MHz bands. Scan speed 2.5 sec/MHz, adjustable pause.
- **PRIORITY CHANNEL SILENT MONITOR** so you can operate on one frequency while monitoring another.
- **TWO FREQUENCY TONE ENCODER/DECODER** provides two selectable, fully adjustable, sub-audible tones for transmit and/or tone-coded squelch.
- **ANY TRANSMITTER OFFSET** without additional crystals.
- **AUDIO/VISUAL ALARM** to let you know when the monitored priority channel is occupied or when tone-coded squelch is activated.
- **ADVANCED PLL SYNTHESIZER** covers 144,000 — 147,995 MHz with full push-button tuning.
- **SUPERIOR RECEIVER** with sensitivity, selectivity and intermodulation characteristics that are more like military than amateur.
- **POWER OUTPUT ADJUSTABLE TO 25 WATTS.**
- **EXTRAORDINARY WARRANTY.** Every SYSTEM 3000 is warranted to be free from defects for two full years, and it is American made so servicing is no problem.
- **SMALL SIZE.** Designed for mobile and fixed operation, SYSTEM 3000 is only 5.3 inches wide, 2.6 inches high and 11 inches deep.
- **VERY COMPETITIVELY PRICED.** Introductory price is only \$499.



- No. 114-320-003 — \$9.90
- No. 114-322-003 — Brass — \$10.30
- No. 114-320-001 — \$8.30
- No. 114-322-001 — Brass — \$8.65
- No. 114-310-003 — \$8.25
- No. 114-312-003 — Brass — \$8.65

NYE VIKING SPEED-X KEYS

NYE VIKING Standard Speed-X keys feature smooth, adjustable bearings, heavy-duty silver contacts, and are mounted on a heavy oval die cast base with black wrinkle finish. Available with standard, or Navy knob, with, or without switch, and with nickel or brass plated key arm and hardware.

Pamper yourself with a Gold-Plated NYE VIKING KEY!

Model No. 114-31C-004GP has all the smooth action features of NYE Speed-X keys in a special "presentation" model. All hardware is heavily gold plated and it is mounted on onyx-like jet black plastic sub-base. List price is \$50.00.



- No. SSK-1 \$23.95
- No. SSK-1CP-Chrome — \$29.95

NYE VIKING SQUEEZE KEY

Extra-long, finger-fitting molded paddles with adjustable spring tension, adjustable contact spacing. Knife-edge bearings and extra large, gold plated silver contacts! Nickel plated brass hardware and heavy, die cast base with non-skid feet. Base and dust cover black crackle finished. SSK-1 — \$23.45. SSK-1CP has heavily chrome-plated base and dust cover. List price, \$29.95.

CODE PRACTICE SET

You get a sure, smooth, Speed-X model 310-001 transmitting key, linear circuit oscillator and amplifier, with a built-in 2" speaker, all mounted on a heavy duty aluminum base with non-skid feet. Operates on standard 9V transistor type battery (not included). List price, \$18.50. PHONE PATCH Model No. 250-46-1 measures 6-1/2" wide, 2-1/4" high and 2-7/8" deep. List price, \$36.50. Model 250-46-3, designed for use with transceivers having a built-in speaker, has its own built-in 2" x 6" 2 watt speaker. Measures 6-1/2" wide, 2-1/4" high and 2-7/8" deep. List price, \$44.50.

Mosley

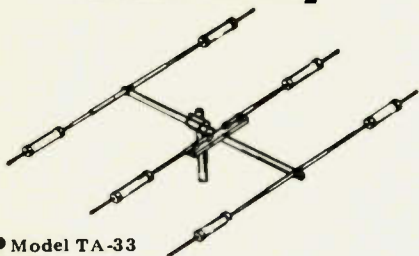

- Model TA-33
- 3 Elements
- 10.1 db Forward Gain (over isotropic source)
- 20 db Front-to-Back Ratio

The Mosley TA-33, 3-element beam provides outstanding 10, 15 and 20 meter performance. Exceptionally broadband — gives excellent results over full Ham bandwidth. Incorporating Mosley Famous Trap-Master traps. Power Rating — 2KW P.E.P. SSB. The TA-33 may also be used on 40 meters with TA-40KR conversion. Complete with hardware. \$206.50

MULTI-BAND BEAMS TRAP MASTER 33 . . . 10, 15 & 20 Meters

- Model TA-33Jr.
- 3 Elements
- 10.1 db Forward Gain (over isotropic source)
- 20 db Front-to-Back Ratio

The TA-33Jr . . . incorporates Mosley Trap-Master Junior traps. This is the low power brother of the TA-33. Power Rating — 1 KW P.E.P. SSB. \$151.85

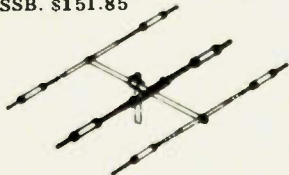

TA-33JR. POWER CONVERSION KIT MODEL MPK-3

Owners of the Mosley Trap-Master TA-33Jr. may obtain higher power without buying an entirely new antenna. The addition of the MPK-3 (power conversion kit) converts the TA-33Jr. into essentially a new antenna with 750 watts AM/CW and 2000 watts P.E.P. SSB. \$52.25

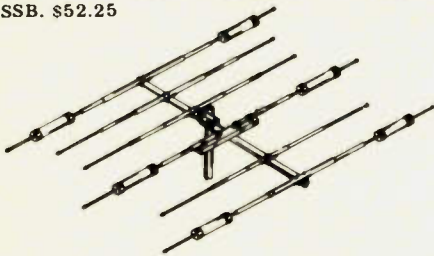

TRAP MASTER 36 . . . 10, 15 & 20 Meters

- Model TA-36
- 6 Elements
- Forward Gain (over isotropic source) - 10.1 db on 15 & 20 meters, 11.1 db on 10 meters.

Front-to-Back Ratio on all bands. 20 db. This wide-spaced, six element configuration employs 4 operating elements on 10 meters, 3 operating elements on 15 meters, and 3 operating elements on 20 meters. Automatic bandswitching is accomplished through Mosley exclusively designed high impedance parallel resonant "Trap Circuit." The TA-36 is designed for 1000 watts AM/CW or 2000 watts P.E.P. SSB. Traps are weather and dirt proof, offering frequency stability under all weather conditions. \$335.25



MOSLEY AK-60 MAST PLATE ADAPTER
Mast Plate Adapter for adapting your Mosley 1 1/2" mounted beam to fit 2" OD mast. Complete with angle and hardware. \$11.15



A brilliant new 2 meter transceiver with every in-demand operating feature and convenience

KLM MULTI - 2700 - \$ 795.95

- ★ Synthesizer and VFO.
- ★ All modes: NBFM, WBFM, AM, SSB w/USB/LSB and CW.
 - Frequency synthesizer (PLL)
 - 3 Knob, 600 channels, 10 kHz steps.
 - VXO, plus or minus 7 kHz.
- ★ LED readout on synthesizer.
 - Standard 600 kHz splits plus . . .
 - Two "oddball" splits.
- ★ OSCAR transceive 2 to 10 meter operation.
 - OSCAR receiver built-in.
 - Connectors on rear for separate 2

- meter and 10 meter antennas.
- Built-in VFO (continuous coverage, 144-148 MHz in 1.3 MHz segments. 1 kHz readout).
- 8 pole SSB filter plus two FM filters.
- 100 kHz crystal calibrator.
- Voice operated relay (VOX) or p-t-t.

- ★ Audio speech compression.
 - Noise blanker.
 - RIT, plus or minus 5 kHz.
 - Power out/"S" meter.
 - FM center deviation meter.
 - 10W minimum output power. NO TUNING!
 - Hi-Lo power provision.
 - Built-in AC/DC power supply.
 - Double conversion receiver. 16.9 MHz and 455 kHz I-Fs.
 - Receiver sensitivity:
 - FM: 0.5µV for 28 dB S/N.
 - SSB/CW: 0.25µV for 14 dB S/N.
 - AM: 2µV for 10 dB S/N.
 - Size: Inches: 5H, 14.88W, 12D.
 - MM: 128H, 378W, 305D.
 - Weight: 28 lbs. (13 KG).

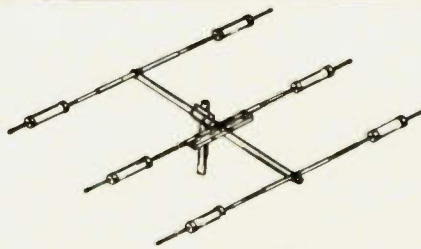

CLASSIC-33 . . . 10, 15 & 20 Meters

Model CL-33

- 3 Elements
- 10.1 db Forward Gain (over isotropic source) on all bands.
- 20 db Front-to-Back Ratio on 15 & 20 meters, 15 db on 10 meters.

BRIDGING THE GAP . . . The Classic 33, combines the best of two Mosley systems. Incorporating Mosley Classic Feed System for a "Balanced Capacitive Matching" system with a feed point Impedance of 52 ohms at resonance, and the Famous Mosley Trap-Master Traps for "weather-proof" traps with resonant frequency stability. This extra sturdy multi-band beam, Model CL-33, for operation on 10, 15 & 20 meters features improved boom to element clamping, stainless steel hardware, balanced radiation and a longer boom for even wider element spacing. Power Rating — 2 KW P.E.P. SSB. Recommended mast size — 2" OD. Wind Load — 120 lbs. at 80 MPH. Approx. shipping weight — 45 lbs. \$232.50

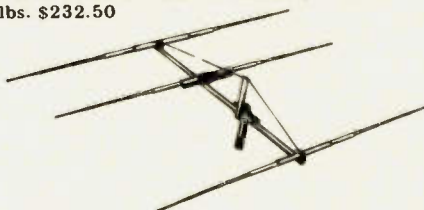

CLASSIC-203 . . . 20 Meters

Model CL-203

- 3 Elements
- 10.1 db Forward Gain (over isotropic source)
- 20 db Front-to-Back Ratio

Incorporating the Mosley patented Classic Feed System, this full size 20 meter single-band beam has 1 1/2" to 3/8" dia. "swaged" elements wide spaced on a 2" dia. 24' boom. Maximum element length—37' 8 1/2". The high standards in quality construction established by Mosley in over a quarter-century of manufacturing is reflected in this mono-band . . . Model CL-203. Boom-to-mast clamping assures stability with a time-tested arrangement of mast plate, cast aluminum clamping blocks and stainless steel U-bolts. The exclusive "Balanced Capacitive Matching" System has a nominal feed point Impedance of 52 Ohms at 2 KW P.E.P. SSB. Recommended mast size—2" O.D. Approx. shipping wt: 42 lbs. via truck. \$227.65

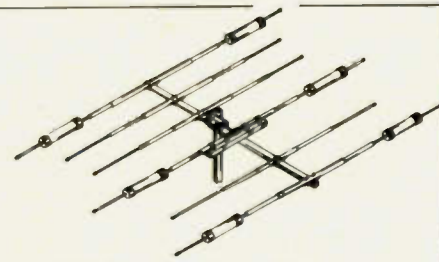

CLASSIC-36 . . . 10, 15 & 20 Meters

Model CL-36

- 6 Elements
- 10.1 db Forward Gain (over isotropic source) on 15 & 20 meters, 11.1 db on 10 meters.
- 20 db Front-to-Back Ratio on all bands.

The Classic 36, like the smaller Classic 33, incorporates both the Mosley World-Famous Trap-Master Traps and the Mosley Classic Feed-System. Designed to operate on 10, 15 & 20 meters, this multi-band beam Model CL-36, employs the high standards of quality construction found in all Mosley products. The boom-to-mast clamping assures stability with a time-tested arrangement of mast plate, cast aluminum clamping blocks and stainless steel U-bolts. The exclusive "Balanced Capacitive Matching" system has a feed point impedance of 52 ohms at resonance. Wind Load — 210.1 lbs. at 80 MPH. Power Rating — 2 KW P.E.P. SSB. Recommended mast size — 2" OD. Approx. shipping weight — 71 lbs. via truck. \$310.65

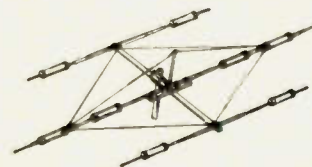

40 METER CONVERSION KIT MODEL TA-40KR

Work 40 meters in addition to 10, 15 & 20 meters by using a TA-40KR conversion kit on the radiator element of the TA-33 and TA-36. (Beams with broad band capacitive matching may not be converted!) Convert the TA-33Jr. with the MPK-3 (power conversion kit) before adding the TA-40KR kit. \$92.25

SIGNAL-MASTER ANTENNA
Beam Antenna . . . Model S-402 for 40 meters
For a top signal needed to push through forty meter QRM, the Mosley Signal Master S-402 will do the trick! This 100% rust-proof 2-element beauty constructed of rugged heavy-wall aluminum is designed and engineered to provide the performance you need for both DX hunting and relaxing in a QRM free rag-chewing session. Beam is fed through link coupling, resulting in an excellent match over the entire bandwidth. \$267.50

6 METER BEAMS

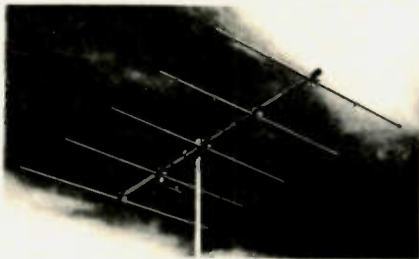

3-5-6-10 ELEMENTS

Proven performance from rugged, full size, 6 meter beams. Element spacings and lengths have been carefully engineered to give best pattern, high forward gain, good front to back ratio and broad frequency response.

Booms are .058 wall and elements are 3/4" - 5/8" .049 wall seamless chrome finish aluminum tubing. The 3 and 5 element beams have 1 3/8" - 1 1/4" booms. The 6 and 10 element beams have 1 5/8" - 1 1/2" booms. All brackets are heavy gauge formed aluminum. Bright finish cad plated bolts are adjustable for up to 1 5/8" mast on 3 and 5 element and 2" on 6 and 10 element beams. All models may be mounted for horizontal or vertical polarization.

New features include adjustable length elements, kilowatt Reddi Match and built-in coax fitting for direct 52 ohm feed. These beams are factory marked and supplied with instructions for quick assembly.

Description	3 element	5 element	6 element	10 element
Model No.	A50 3	A50 5	A50 6	A50 10
Boom Length	6"	12"	20"	24"
Longest El.	117"	117"	117"	117"
Turn Radius	6"	7 6/8"	11"	13"
Fwd. Gain	7.5 dB	9.5 dB	11.5 dB	13 dB
F/B Ratio	20 dB	24 dB	26 dB	28 dB
Weight	7 lbs.	11 lbs.	18 lbs.	25 lbs.



4.5 dB* - 6 dB**
Omnidirectional
GAIN
BASE STATION
ANTENNAS
FOR
MAXIMUM
PERFORMANCE
AND
VALUE

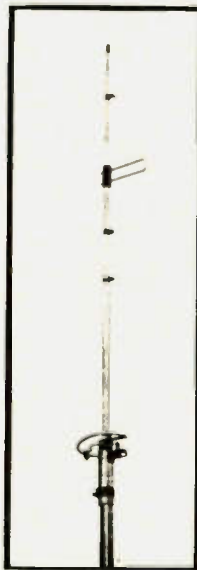

Cush Craft has created another first by making the world's most popular 2 meter antenna twice as good. The new Ringo Ranger is developed from the basic AR-2 with three half waves in phase and a one eighth wave matching stub. Ringo Ranger gives an extremely low angle of radiation for better signal coverage. It is tunable over a broad frequency range and perfectly matched to 52 ohm coax.

ARX-2, 137-160 MHz, 4 lbs., 112"

ARX-220, 220-225 MHz, 3 lbs., 75"

ARX-450, 435-450 MHz, 3 lbs., 39"

* Reference 1/2 wave dipole.
** Reference 1/4 wave whip used as gain standard by many manufacturers.

Work full quieting into more repeaters and extend the radius of your direct contacts with the new Ringo Ranger.

You can up date your present AR-2 Ringo with the simple addition of this extend. kit. The kit includes the phasing network and necessary element extensions. The only modifications required are easy to make saw slits in the top section of your antenna.

ARX-2K CONVERSION KIT

2 METER FM ANTENNAS

A.F.M. RINGO 375 dB Gain (reference 1/4 wave whip). Half wave length antennas with direct dc ground, 52 ohm feed takes PL-259, low angle of radiation with 1-1 SWR. Factory preassembled and ready to install. 6 meter partly preassembled, all but 450 MHz take 1 1/4" mast. There are more Ringos in use than all other FM antennas combined.

Model Number	AR-2	AR-25	AR-6	AR-220	AR-450
Frequency MHz	135-175	135-175	50-54	220-225	440-460
Power-Hdly. Watts	100	500	100	100	250
Wind area sq. ft.	.21'	.21'	.37'	.20'	.30'

B-4 POLE Up to 9 dB Gain over a 1/4 wave dipole. Overall antenna length 147 MHz - 22 220 MHz - 15' 435 MHz - 6', pattern 360° = 6 dB gain. 180° = 9 dB gain. 52 ohm feed takes PL-259 connector. Package includes 4 complete dipole assemblies on mounting booms, harness and all hardware. Vertical support mast not supplied.

AFM-ID 144 - 150 MHz, 1000 watts, wind area 2.58 sq. ft.
AFM-24D 220 - 225 MHz, 1000 watts, wind area 1.85 sq. ft.
AFM-44D 435 - 450 MHz, 1000 watts, wind area 1.13 sq. ft.

D-POWER PACK The big signal (22 element array) for 2 meter FM, uses two A147-11 yagis with a horizontal mounting boom, coaxial harness and all hardware. Forward gain 16 dB, F/B ratio 24 dB, 1/2 power beamwidth 42°, dimensions 144" x 80" x 40", turn radius 60", weight 15 lbs., 52 ohm feed takes PL-259 fitting.

A147-22 146 - 148 MHz, 1000 Watts, wind area 2.42 sq. ft.

O-YAGI STACKING KITS VPK includes horizontal mounting boom, harness, hardware and instructions for two vertically polarized yagis gives 3 dB gain over the single antenna.

A14-VPK, complete 4 element stacking kit
A14-SK, 4 element coax harness only
A147-VPK, complete 11 element stacking kit
A147-SK, 11 element coax harness only
A149-SK, 6 + 11 element coax harness only

E-4-6-11 ELEMENT YAGIS The standard of comparison in VHF-UHF communications, now cut for FM and vertical polarization. The four and six element models can be tower side mounted. All are rated at 1000 watts with direct 52 ohm feed and PL-259 connectors.

Model Number	A147-11	A-147-4	A449-11	A449-6	A220-11
Boom/Longest ele.	144"/40"	44"/40"	80"/13"	35"/26"	102"/26"
Wght./Turn radius	6 lbs./22"	3 lbs./44"	4 lbs./60"	3 lbs./18"	5 lbs./51"
Gain/F/B ratio dB	13.2/28	9/20	13.2/28	11/25	13.2/28
1/2 Power beam	48°	66°	48°	60°	48°
Wind area sq. ft.	1.21	.43	.39	.30	.50
Frequency MHz	146-148	146-148	440-450	440-450	220-225

F-FM TWIST 12.4 dB Gain. Ten elements horizontal polarization for low end coverage and ten elements vertical polarization for FM coverage. Forward gain 12.4 dB, F/B ratio 22 dB, boom length 130", weight 10 lbs., longest element 40", 52 ohm Reddi Match driven elements take PL-259 connectors, uses two separate feed lines.

A147-20T 145 - 147 MHz, 1000 watts, wind area 1.42 sq. ft.

HIGH PERFORMANCE VHF YAGIS



3/4, 1-1/4, 2 METER BEAMS

The standard of comparison in amateur VHF/UHF communications. Cush Craft yagis combine all out performance and reliability with optimum size for ease of assembly and mounting at your site.

Lightweight yet rugged, the antennas have 3/16" O. D. solid aluminum elements with 5/16" center sections mounted on heavy duty formed brackets. Booms are 1" and 7/8" O. D. aluminum tubing. Mast mounts of 1/8" formed aluminum have adjustable u-bolts for up to 1-1/2" O. D. masts. They can be mounted for horizontal or vertical polarization. Complete instructions include data on 2 meter FM repeater operation.

New features include a kilowatt Reddi Match for direct 52 ohm coaxial feed with a standard PL-259 fitting. All elements are spaced at .2 wavelength and tapered for improved bandwidth.

Model No.	A144 7	A144 11	A220 11	A430 11
Description	2m	2m	1 1/2m	1 1/2m
Elements	7	11	11	11
Boom Length	98"	144"	102"	57"
Weight	4	6	4	3
Fwd. Gain	11 dB	13 dB	13 dB	13 dB
F/B Ratio	26 dB	28 dB	28 dB	28 dB
Fwd. Lobe @				
1/2 pwr. pt.	46	42	42	42
SWR @ Freq.	1 to 1	1 to 1	1 to 1	1 to 1

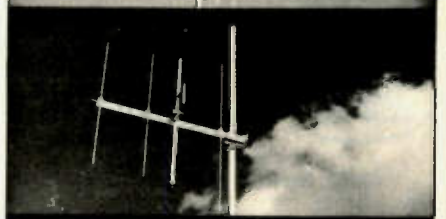
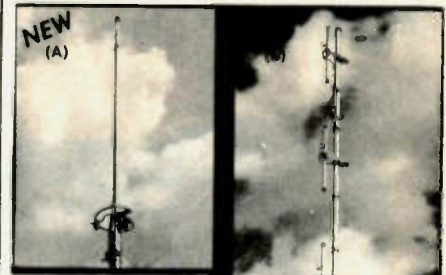

VHF/UHF BEAMS

A50-3	\$ 32.95	A144-7	21.95
A50-5	49.95	A144-11	32.95
A50-6	69.95	A430-11	24.95
A50-10	99.95		

AMATEUR FM ANTENNAS

A147-4	\$ 19.95	AFM-44D	54.95
A147-11	29.95	AR-2	21.95
A147-20T	54.95	AR-6	32.95
A147-22	84.95	AR-25	29.95
A220-7	21.95	AR-220	21.95
A220-11	27.95	AR-450	21.95
A449-6	21.95	ARX-2	32.95
A449-11	27.95	ARX-2K	13.95
AFM-4D	59.95	ARX-220	32.95
AFM-24D	57.95	ARX-450	32.95

Description	144 MHz.		220 MHz.		432 MHz.	
	Model	Price	Model	Price	Model	Price
20 Element DX-Array	DX-120	42.95	DX-220	37.95	DX-420	32.95
Frame & Harness (40 E.)	DXK-140	59.95	DXK-240	54.95	DXK-440	39.95
Frame & Harness (80 E.)	DXK-180	109.95	DXK-280	89.95	DXK-480	79.95
1-1/2 52 ohm balun Vert. Pol. Bracket (20 E.)	DX-VPB	9.95	DX-VPB	9.95	DX-VPB	9.95

TUFTS RADIO CATALOG TUFTS RAD



For all you hams with little cars ...

We've got the perfect mobile rig for you.



The Atlas 210x or 215x measures only 9 1/2" wide x 9 1/4" deep x only 3 1/2" high, yet the above photograph shows how easily the Atlas transceiver fits into a compact car. And there's plenty of room to spare for VHF gear and other accessory equipment. With the exclusive Atlas plug-in design, you can slip your Atlas in and out of your car in a matter of seconds. All connections are made automatically.

BUT DON'T LET THE SMALL SIZE FOOL YOU! Even though the Atlas 210x and 215x transceivers are less than half the size and weight of other HF transceivers, the Atlas is truly a giant in performance.

200 WATTS POWER RATING! This power level in a seven pound transceiver is incredible but true. Atlas transceivers give you all the talk power you need to work the world barefoot. Signal reports

constantly reflect great surprise at the signal strength in relation to the power rating.

FULL 5 BAND COVERAGE
The 210x covers 10-80 meters, while the 215x covers 15-160 meters. Adding the Atlas Model 10x Crystal Oscillator provides greatly increased frequency coverage for MARS and network operation.

NO TRANSMITTER TUNING OR LOADING CONTROLS
With Atlas' total broadbanding. With your Atlas you get instant QSY and band change.

MOST ADVANCED STATE OF THE ART SOLID STATE DESIGN
Not only accounts for its light weight, but assures you years of top performance and trouble free operating pleasure.

PLUG-IN CIRCUIT BOARDS
and modular design provides for ease of servicing.

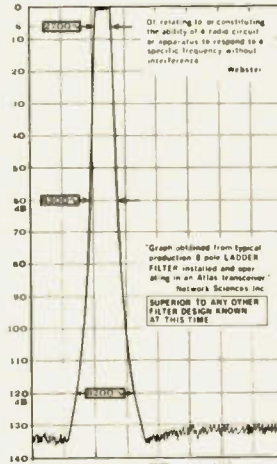

PHENOMENAL SELECTIVITY
The exclusive 8 pole crystal ladder filter used in Atlas transceivers represents a major breakthrough in filter design, with unprecedented sharp selectivity and ultimate rejection. As the above graph shows, this filter provides a 6 db bandwidth of 2700 Hertz, 60 db down of only 4300 Hertz, and a bandwidth of only 9200 Hertz at 120 db down! Ultimate rejection is in excess of 130 db; greater than the measuring limits of most test equipment.

EXCEPTIONAL IMMUNITY TO STRONG SIGNAL OVERLOAD AND CROSS MODULATION. The exclusive front end design in the receiver allows you to operate closer in frequency to strong neighboring signals than you have ever experienced before. If you have not yet operated an Atlas transceiver in a crowded band and compared it with any other receiver or transceiver, you have a real thrill coming.



A WORLD WIDE DEALER NETWORK TO SERVE YOU.
Whether you're driving a Honda in Kansas City or a Mercedes Benz in West Germany, there's an Atlas dealer near you.

Atlas 210x or 215x	\$675.00
W/Noise Blanker	719.00
ACCESSORIES:		
AC Console 110/220 V	\$147.00
Portable AC supply 110/220 V	100.00
Plug-in Mobile Kit	48.00
10x Osc. Less crystals	59.00
Digital Dial DD-6B	229.00

For complete details see your Atlas dealer, or drop us a card and we'll mail you a brochure with dealer list.



HUSTLER

"the home of originals"

AMATEUR ANTENNAS

STANDARD GAIN MOBILES

- 5/8 wavelength — 34 db gain over 1/4 wave mobile
- Frequency coverage—143 to 149 MHz
- SWR at resonance—1.1:1 typical
- Power rating—200 watts FM

MODEL BBLT-144

47" antenna complete with easy to install, no holes to drill, trunk lip mount, impact spring and 17 MIL SPEC RG-58 U and PL-259. Antenna removable from mount. Price: \$33.75

MODEL BBL-144

47" antenna mounts on any flat surface, roof, deck or fender, in 3/8" hole. Includes impact spring, 17 MIL SPEC RG-58 U and PL-259. Antenna removable from mount. Price: \$31.65

HUSTLER "BUCK-BUSTER"

MODEL SF-2
5 1/2" two meter, 5/8 wavelength, 34 db gain over 1/4 wave mobile. Designed with 3/8" 24 base to fit your mount or a wide selection of Hustler mobile mounts (Mount or cable not included). Price: \$9.00

DELUXE MOBILE MOUNTS

For medium length, light weight antennas with 3/8" 24 base

MODEL TLM

Trunk lip mount for no holes installation on side or edge of trunk lid. Includes 17 RG-58 U connectors attached. Price: \$14.85

MODEL MLM

Deluxe trunk lip mount with 180 degree swivel ball for positioning antenna to vertical. Easy — no holes — installation. Includes 17 RG-58 U cable and connectors attached. Price: \$17.20

MODEL GCM-1

Rain gutter mount fits all shapes, angles even latest trim line gutters. Includes 180° swivel ball. Price: \$9.00

MODEL MM-1

Cowl mount installs in 1" hole. Includes 180° swivel ball and SO-239 connectors. Price: \$7.50

MODEL TGM-1

Trunk groove mount installs in hidden area of groove under trunk lid. Mounting hardware included. Price: \$8.00

SUPER GAIN MOBILES

Two Meters

- 52 db gain over 1/4 wave mobile antenna
- Frequency coverage—143-149 MHz
- SWR at resonance—1.1:1 typical
- Power rating—200 watts FM

TWO AND SIX METERS—TRUNK LIP MOUNT

MODEL WFT
Four section telescopic antenna permits separate adjustment for simultaneous resonance on two and six meters. Operational height, 40". Complete with trunk lip mount, 17 MIL SPEC RG-58 U and factory attached PL-259. Price: \$22.55

VHF/UHF ANTENNA—ROOF MOUNT

MODEL UHT-1
Field trimmable radiator for 1/4 wave operation on any frequency from 140 to 500 MHz. Cutting chart included. Mounts on any flat surface, roof, deck, fender in 3/8" hole. Includes 15 RG-58 U and PL-259. Price: \$9.95

RESONATOR SPRING—STAINLESS STEEL

MODEL RSS-2
Installs between Hustler mast and resonator. Absorbs shock when antenna strikes overhanging obstruction. Supplied ready for easy installation. Price: \$16.95

MODEL RSS-2

Installs between Hustler mast and resonator. Absorbs shock when antenna strikes overhanging obstruction. Supplied ready for easy installation. Price: \$16.95

MODEL C-32

Ball mount complete with mounting hardware. Price: \$8.20

MODEL CGT-144

Get big signal performance, superior receiving capability with this 85" colinear antenna. Easy installation on side or edge of trunk lip without drilling—complete with 17 MIL SPEC RG-58 U and PL-259. Price: \$41.30

MODEL CG-144

Same characteristics as CGT-144 supplied with 3/8" 24 base to fit all mobile ball mounts—Length is 85" Mount and cable not included. Price: \$25.50

VHF/UHF ANTENNA—TRUNK LIP MOUNT

MODEL THF
Field trimmable radiator permits quarter wave operation on any frequency from 140 to 500 MHz. Cutting chart included. Complete with trunk lip mount, 17 RG-58 U and PL-259. Price: \$16.55

MODEL SSM-2

Stainless steel ball mount for deck, fender or any flat surface. Price: \$19.20

MODEL SSM-2

Heavy 2" reinforced stainless steel 180° adjustable ball mount easily supports any sized antenna. Includes stainless steel 3/8" 24 threads—female end and male the other. Price: \$16.95

QUICK DISCONNECT—100% STAINLESS STEEL

MODEL QD-1
Removes antenna from mount with easy press and twist release. Complete with stainless steel ball mount. Price: \$16.95

FEED LINE

MODEL L-14-240
Get strong performance, maximum shielding for minimum noise pickup in this MIL SPEC 20 length of RG-58 U cable. Supplied with connectors attached for use with ball or bumper mount and transceiver. Price: \$6.55

MODEL G6-144A

Deluxe Two Meter Colinear for Repeater or any fixed station operation. 6 db gain over a 1/4 wave dipole. Maximum radiation at the horizon. Shunt fed with D.C. grounding. Radiator 3/4 wave lower section. 1/4 wave phasing 3/4 wave upper section. Weight: 11 1/2 lbs. Power rating: 1000 Watts FM. Wind survival: 100 MPH. Installs on vertical pipe up to 1 1/2" O.D. SO-239 car connector. Price: \$67.55

All resonators are precision wound with optimized design for each band. Assembly includes 17-7 PH stainless steel adjustable tip rod for lowest SWR and band edge marker. Choose for medium or high power operation.

STANDARD HUSTLER RESONATORS

Power Rating: 400 Watts SSB

Model	Band	Price
RM-10	10 meters	\$ 6.50
RM-15	15 meters	6.95
RM-20	20 meters	7.30
RM-40	40 meters	13.20
RM-75	75 meters	15.50
RM-80	80 meters	15.95

SUPER HUSTLER RESONATORS

Power Rating: Legal Limit SSB
Supers have widest bandwidth

Model	Band	Price
RM-10S	10 meters	\$11.30
RM-15S	15 meters	12.65
RM-20S	20 meters	13.00
RM-40S	40 meters	15.50
RM-75S	75 meters	30.00
RM-80S	80 meters	30.40

For 6-10-15-20-40-75-80 Meters

Fold over mast for quick and easy interchange of resonators or entering a garage. When operating, mast is held vertical with shakeproof sleeve clutch. S6 mast also serves as 1/4 wavelength 6 meter antenna. Stainless steel base has 3/8" 24 threads to fit mobile ball mount or bumper mount.

MODEL M0-2

For bumper mounting—Fold is at roof level 27" above base. Price: \$22.00

MODEL M0-1

For deck or fender mounting—Fold is at roof level 15" above base. Price: \$22.00

Covers 10 - 15 - 20 - 40 Meters

Only Hustler Gives One Setting for Whole Band Coverage

MODEL 4BTV

- Lowest SWR—PLUS
- Bandwidth at its broadest! SWR 1.6 to 1 or better at band edges.
- Hustler exclusive trap covers — Spritz attached to otherwise unattainable close tolerances assuring accurate and permanent trap resonance.
- Solid one inch fiberglass trap forms for optimum electrical and mechanical stability.
- Extra heavy duty aluminum mounting bracket with low loss — high strength insulators. Mounting hardware included.
- All sections 1 1/4" heavy wall, high strength aluminum.
- Stainless steel clamps permitting adjustment without damage to the aluminum tubing.
- Guaranteed to be easiest assembly of any multi-band vertical.
- Antenna has 3/8" 24 stud at top to accept RM-75 or RM-75-S Hustler resonator for 75 meter operation when desired.
- Top loading on 75 meters for broad band-width and higher radiation efficiency!
- Feed with any length 50 ohm coax.
- Power capability—full legal limit on SSB or CW.
- Mounting Ground mount with or without radials, or roof mount with radials.

Weight: 15 lbs
Length: 21' 5"
MODEL 4BTV
Price: \$99.95

SUPER AMP from DenTron



If the amplifier you're thinking of buying doesn't deliver at least 1000 to 1200 watts output, to the antenna, you're buying the wrong amplifier.

Our New Super Amp is sweeping the country because hams have realized that the DenTron Amplifier will deliver to the antenna, (output power), what other manufacturers rate as Input power.

The Super Amp runs a full 2000 watts P.E.P. input on SSB, and 1000 watts DC on CW, RTTY or SSTV 160-10 meters, the maximum legal power.

The Super Amp is compact, low profile, has a solid one piece cabinet assuring maximum TVI shielding.

The heart of our amplifier, the power supply, is a continuous duty, self-contained supply built for contest performance.

We mounted the 4-572B's, industrial workhorse tubes, in a cooling chamber featuring the on-demand variable cooling system.

The hams at DenTron pride themselves on quality work, and we fight to keep prices down. That's why the dynamic DenTron Linear Amplifier beats them all

\$574.50

The 80-10 Skymatcher

Here's an antenna tuner for 80 through 10 meters, handles 500 w P.E.P. and matches your 52 ohm transceiver to a random wire antenna.



- Continuous tuning 3.2 - 30 mc
- "L" network
- Ceramic 12 position rotary switch
- SO-239 receptional to transmitter
- Random wire tuner
- 3000 volt capacitor spacing
- Tapped inductor
- Ceramic antenna feed thru
- 7" W. 5" H. 8" D., Weight: 5 lbs.

\$59.50

**Read forward
and reflected
watts at the
same time**



Tired of constant switching and guesswork?

Every serious ham knows he must read both forward and reverse wattage simultaneously for that perfect match. So upgrade with the DenTron W-2 Dual in line Wattmeter.

\$99.50

Match everything from 160 to 10 with the new 160-10 MAT

NEW: The Monitor Tuner was designed because of overwhelming demand. Hams told us they wanted a 3 kilowatt tuner with a built-in wattmeter, a front panel antenna selector for coax, balanced line and random wire. So we engineered the 160-10m Monitor Tuner. It's a lifetime investment at \$299.50.

\$299.50



Meet the SuperTuner

The DenTron Super Tuner tunes everything from 160 to 10 meters. Whether you have balanced line, coax cable, random or long wire, the Super Tuner will match the antenna impedance to your transmitter. All DenTron tuners give you maximum power transfer from your transmitter to your antenna, and isn't that where it really counts?

1 KW MODEL **\$129.50**

3 KW MODEL **\$229.50**

The Sky Openers

SKYMASTER

A fully developed and tested 27 foot vertical antenna covers entire 10, 15, 20, and 40 meter bands using only one cleverly applied wave trap. A full 1/4 wave antenna on 20 meters. Constructed of heavy seamless aluminum with a factory tuned and sealed HQ Trap. SKYMASTER is weather-proof and withstands winds up to 80 mph. Handles 2 KW power level and is for ground, roof or tower mounting. Radials included in our low price of

\$84.50

Also 80 m resonator for top mounting on SKYMASTER.

\$29.50

SKYCLAW

A tuneable monoband high performance vertical antenna, designed for 40, 80, 160 meter operation. SKYCLAW gives you the following spectrum coverage:

BAND (Meters)	BANDWIDTH (kHz)
160	50
80	200
40	entire band

Tuning is easy and reliable. Rugged construction assures that this self-supporting unit is weatherproof and survives nicely in 100 mph winds. Handles full legal power limit.

\$79.50

EX-1

The DenTron EX-1 Vertical Antenna is designed for the performance minded antenna experimenter. The EX-1 is a full 40 meter, 1/4 wave, 33', self-supporting vertical. The EX-1 is the ideal vertical for phasing.

\$59.50

TRIM-TENNA

The antenna your neighbors will love. The new DenTron Trim-Tenna with 20 meter beam is designed for the discriminating amateur who wants fantastic performance in an environmentally appealing beam. It's really loaded! Up front there's a 13 foot 6 inch director with precision My-O coils. And, 7 feet behind is a 16 foot driven element fed directly with 52 ohm coax. The Trim-Tenna mounts easily and what a difference in on-air performance between the Trim-Tenna and that dipole, long wire or inverted Vee you've been using. 4 & 6 Forward Gain Over Dipole.

\$129.50

ALL BAND DOUBLET

This All Band Doublet or inverted Type Antenna covers 160 thru 10 meters. Has total length of 130 feet (14 ga. stranded copper) although it may be made shorter if necessary. This tuned Doublet is center fed through 100 feet of 450 ohm PVC covered balanced transmission line. The assembly is complete. Add rope to the ends and pull up into position. Tune with the DenTron Super Tuner and you're on 10 through 160 meters with one antenna! Now just for the DenTron All Band Doublet.

\$24.50

DenTron

DRAKE TVI FILTERS High Pass Filters for TV Sets provide more than 40 dB attenuation at 52 MHz and lower. Protect the TV set from amateur transmitters 6-160 meters.



Drake TV-300-HP
Model No. 1603
For 300 ohm twin lead
Price: \$10.60



DRAKE TV-3300-LP
1000 watts max. below 30 MHz. Attenuation better than 80 dB above 41 MHz. Helps TV i-f interference, as well as TV front-end problems. Price: \$26.60 Model No. 1608



DRAKE TV-5200-LP
200 watts to 52 MHz. Ideal for six meters. For operation below six meters, use TV-3300-LP or TV-42-LP. Model No. 1609 Price: \$26.60

Drake TV-75-HP
Model No. 1610
For 75 ohm TV coaxial cable; TV type connectors installed
Price: \$13.25



DRAKE TV-42-LP Model No. 1605 is a four section filter designed with 43.2 MHz cut-off and extremely high attenuation in all TV channels for transmitters operating at 30 MHz and lower. Rated 100 watts input. Price: \$14.60

TUFTS RADIO CATALOG TUFTS RADIO

WORK ALL REPEATERS WITH OUR NEW SYNTHESIZER II



The Synthesizer II is a two meter frequency synthesizer. Frequency is adjustable in 5 kHz steps from 140.00 MHz to 149.995 MHz with its digital readout thumb wheel switching. Transmit offsets are digitally programmed on a diode matrix, and can range from 10 kHz to 10 MHz. No additional components are necessary!
 Kit \$169.95 Wired and tested \$239.95

- RX28C 28-35 MHz FM receiver with 2 pole 10.7 MHz crystal filter \$ 59.95
- RX28C W/T same as above—wired & tested 104.95
- RX50C Kit 30-60 MHz rcvr w/2 pole 10.7 MHz crystal filter 59.95
- RX50C W/T same as above—wired & tested 104.95
- RX144C Kit 140-170 MHz rcvr w/2 pole 10.7 MHz crystal filter 69.95
- RX144C W/T same as above—wired & tested 114.95
- RX220C Kit 210-240 MHz rcvr w/2 pole 10.7 MHz crystal filter 69.95
- RX220C W/T same as above—wired & tested 114.95
- RX432C Kit 432 MHz rcvr w/2 pole 10.7 MHz crystal filter 79.95
- RX432C W/T same as above—wired & tested 124.95
- TX50 transmitter exciter, 1 watt, 6 mtr. same as above—wired & tested 59.95
- TX50 W/T same as above—wired & tested 29.95
- TX144B Kit transmitter exciter—1 watt—2 mtrs same as above—wired & tested 49.95
- TX144B W/T transmitter exciter—1 watt—220 MHz 29.95

- PA2501H Kit 2 mtr power amp—kit 1w in—25w out with solid state switching, case, connectors 59.95
- PA2501H W/T same as above—wired & tested 74.95
- PA4010H Kit 2 mtr power amp—10w in—40w out—relay switching 59.95
- PA4010H W/T same as above—wired & tested 74.95
- PA50/25 Kit 6 mtr power amp, 1w in, 25w out, less case, connectors & switching 49.95
- PA50/25 W/T same as above, wired & tested 69.95
- PA144/15 Kit 2 mtr power amp—1w in—15w out—less case, connectors and switching 39.95
- PA144/25 Kit same as PA144/15 kit but 25w 49.95
- PA220/15 Kit similar to PA144/15 for 220 MHz 39.95
- PA432/10 Kit power amp—similar to PA144/15 except 10w and 432 MHz 49.95
- PA140/10 W/T 10w in—140w out—2 mtr amp 179.95
- PA140/30 W/T 30w in—140w out—2 mtr amp 159.95

- PS15C Kit 15 amp—12 volt regulated power supply w/case, w/fold-back current limiting and overvoltage protection 79.95
- PS15C W/T same as above—wired & tested 94.95
- PS25C Kit 25 amp—12 volt regulated power supply w/case, w/fold-back current limiting and ovp 129.95
- PS25C W/T same as above—wired & tested 149.95
- PS25M Kit same as PS25C with meters 149.95
- PS25M W/T same as above—wired & tested 169.95

- RPT50 Kit repeater—6 meter 465.95
- RPT50 W/T repeater—6 meter, wired & tested 695.95
- RPT144 Kit repeater—2 mtr—15w—complete (less crystals) 465.95
- RPT220 Kit repeater—220 MHz—15w—complete (less crystals) 465.95
- RPT432 Kit repeater—10 watt—432 MHz (less crystals) 515.95
- RPT144 W/T repeater—15 watt—2 mtr 695.95
- RPT220 W/T repeater—15 watt—220 MHz 695.95
- RPT432 W/T repeater—10 watt—432 MHz 749.95
- DPLA50 6 mtr close spaced duplexer 575.00

- TRX50 Kit Complete 6 mtr FM transceiver kit, 20w out, 10 channel scan with case (less mike and crystals) 249.95
- TRX144 Kit same as above, but 2 mtr & 15w out 219.95
- TRX220 Kit same as above except for 220 MHz 219.95
- TRX432 Kit same as above except 10 watt and 432MHz 254.95
- TRC-1 transceiver case only 19.95
- TRC-2 transceiver case and accessories 39.95

- SYN II Kit 2 mtr synthesizer, transmit offsets programmable from 100 KHz—10 MHz, (Mars offsets with optional adapters) 169.95
- SYN II W/T same as above—wired & tested 239.95
- MO-1 Kit Mars/cap offset optional 2.50
- TO-1 Kit 18 MHz optional tripler 2.50

- HT 144B Kit 2 mtr, 2w, 4 channel, hand held receiver with crystals for 146.52 simplex 129.95
- NICAD battery pack, 12 VDC, 1/2 amp 29.95
- BC12 battery charger for above 5.95
- Rubber Duck 2 mtr, with male BNC connector 8.95

RECEIVERS

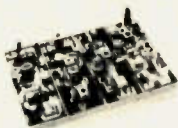

- RXCF accessory filter for above receiver kits gives 70 dB adjacent channel rejection 8.50
- RF28 Kit 10 mtr RF front end 10.7 MHz out 12.50
- RF50 Kit 6 mtr RF front end 10.7 MHz out 12.50
- RF144D Kit 2 mtr RF front end 10.7 MHz out 17.50
- RF220D Kit 220 MHz RF front end 10.7 MHz out 17.50
- RF432 Kit 432 MHz RF front end 10.7 MHz out 27.50
- IF 10.7F Kit 10.7 MHz IF module includes 2 pole crystal filter 27.50
- FM455 Kit 455 KHz IF stage plus FM detector 17.50
- AS2 Kit audio and squelch board 15.00
- TX220B W/T same as above—wired & tested 49.95
- TX432B Kit transmitter exciter 432 MHz 39.95
- TX432B W/T same as above—wired & tested 59.95
- TX150 Kit 300 milliwatt, 2 mtr transmitter 19.95
- TX150 W/T same as above—wired & tested 29.95

TRANSMITTERS



POWER AMPLIFIERS



Model	Frequency	Power Input	Power Output	
BLB 3/150	45-55MHz	3W	150W	TBA
BLC 10/70	140-160MHz	10W	70W	139.95
BLC 2/70	140-160MHz	2W	70W	159.95
BLC 10/150	140-160MHz	10W	150W	259.95
BLC 30/150	140-160MHz	30W	150W	239.95
BLD 2/60	220-230MHz	2W	60W	159.95
BLD 10/60	220-230MHz	10W	60W	139.95
BLD 10/120	220-230MHz	10W	120W	259.95
BLE 10/40	420-470MHz	10W	40W	139.95
BLE 2/40	420-470MHz	2W	40W	159.95
BLE 30/80	420-470MHz	30W	80W	259.95
BLE 10/80	420-470MHz	10W	80W	289.95

POWER SUPPLIES

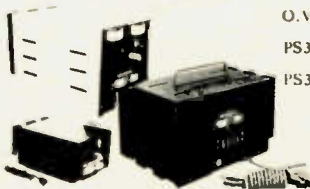

- O.V.P. adds over voltage protection to your power supplies, 15 VDC max 9.95
- PS3A Kit 12 volt—power supply regulator card with fold-back current limiting 8.95
- PS3012 W/T new commercial duty 30 amp 12 VDC regulated power supply w/case, w/fold-back current limiting and overvoltage protection 239.95

REPEATERS



- DPLA144 2 mtr, 600 KHz spaced duplexer, wired and tuned to frequency 379.95
- DPLA220 220 MHz duplexer, wired and tuned to frequency 379.95
- DPLA432 rack mount duplexer 319.95
- DSC-U double shielded duplexer cables with PL259 connectors (pr.) 25.00
- DSC-N same as above with type N connectors (pr.) 25.00

TRANSCIVERS



SYNTHESIZERS



WALKIE-TALKIES



OTHER PRODUCTS BY VHF ENGINEERING

- CD1 Kit 10 channel receive xtal deck w/diode switching \$ 6.95
- CD2 Kit 10 channel xmit deck w/switch and trimmers 14.95
- CD3 Kit UHF version of CD1 deck, needed for 432 multi-channel operation carrier operated relay 19.95
- COR2 Kit 10 channel auto-scan adapter for RX with priority 19.95
- Crystals sw stock must repeater and simplex pairs from 146.0-147.0 (each) 5.60
- CWID Kit 159 bit, field programmable, code identifier with built-in squelch tail and 10 timers 39.95
- CWID wired and tested, not programmed 54.95
- CWID wired and tested, programmed 59.95
- MIC-1 2,000 ohm dynamic mike with P.T.L. and coil cord 12.95
- TS1 W/T tone squelch decoder 59.95
- TS1 W/T installed in repeater, including interface accessories 89.95
- TD3 Kit 2 tone decoder 29.95
- TD3 W/T same as above—wired & tested 39.95
- HL144 W/T 4 pole helical resonator, wired & tested, swept tuned to 144 MHz ban 24.95
- HL220 W/T same as above tuned to 220 MHz ban 24.95
- HL432 W/T same as above tuned to 432 MHz ban 24.95



THE WORLD'S MOST COMPLETE LINE OF VHF-FM KITS AND EQUIPMENT

KLM RF Power Amplifiers



- A simple, add-on-immediately RF amplifier.
 - Merely coax-connect amplifier between antenna and transceiver.
 - No tuning! Efficient strip-line broad band design.
 - Automatic! Internal RF-sensor-controlled relay connects amplifier whenever transmitter is switched on.
- Highest quality, American-made "brand" transistors are fully protected for VSWR, short and overload, reverse polarity. Highly effective heat sinking assures long
- Manual, remote-position switching is optional.
- Models for 6, 2, 1¼ meters, 70CM amateur bands plus MARS coverage.
 - Two types: **Class C** for FM/CW. **Linear** for SSB/AM/FM/CW.
 - Negligible insertion loss on receive.
 - American made by KLM.
- life, reliable performance. Black anodized containers...exclusive KLM extrusions, have seven, full length fins on both sides!

FREQ. (MHz)	MODEL NUMBER	PWR INP (watts)	NOM. PWR OUT (watts)	NOM. CUR. (amps) †	SIZE	PRICE
50-54	PA4-80AL	4	30	10A	C	164 95
144-148	PA2-12B	1-4	12	2	A	59 95
	PA2-70B	1-4	70	10	C	159 95
	PA2-70BL	1-4	70	10	C	169 95
	PA2-140B	1-4	140	20	D	229 95
	PA10-40B	5-15	40	5	B	83 95
	PA10-40BL	5-15	40	5	B	94 95
	PA10-70B	5-15	70	8	C	139 95
	PA10-70BL	5-15	70	8	C	149 95

FREQ. (MHz)	MODEL NUMBER	PWR INP (watts)	NOM. PWR OUT (watts)	NOM. CUR. (amps) †	SIZE	PRICE
144-148	PA10-80BL	5-15	80	10	C	159 95
	PA10-140B	5-15	140	18	D	199 95
	PA10-140BL	5-15	140	18	D	215 95
	PA10-160BL	5-15	160	22	D	229 95
	PA30-140B	15-45	140	15	D	179 95
	PA30-140BL	15-45	140	15	D	189 95
219-226	PA2-70BC	1-4	70	10	C	169 95
	PA10-60BC	5-15	60	8	C	149 95
	PA30-120BC	15-45	120	15	D	189 95

FREQ. (MHz)	MODEL NUMBER	PWR INP (watts)	NOM. PWR OUT (watts)	NOM. CUR. (amps) †	SIZE	PRICE
400-470	PA2-40C	1-4	40	7	C	149 95
	PA10-35C	5-15	35	6	B	119 95
	PA10-35CL	5-15	35	6	B	139 95
	PA10-70C	5-15	70	13	D	229 95
	PA10-70CL	5-15	70	18	D	249 95

SIZES: inches: *A: 2.25 x 5.2 *B: 6.5 x 5.2 *C: 6.5 x 7.5 x 2 *D: 6.5 x 10 x 2
 MM: 57 x 127 x 50.8 165 x 127 x 50.8 165 x 190 x 50.8 165 x 254 x 50.8
 † LINEAR AMPLIFIER † AI 13 SVDC.

TEMPO



THE TEMPO 2020

- Phase lock-loop (PLL) oscillator circuit minimizes unwanted spurious responses.
- Hybrid Digital Frequency Presentation.
- Advanced Solid-state design... only 3 tubes.
- Built-in AC and 12 VDC power supplies.
- CW filter standard equipment... not an accessory.
- Rugged 6146-B final amplifier tubes.
- Cooling fan standard equipment... not an accessory.
- High performance noise-blanker is standard equipment... not an accessory.
- Built-in VOX and semi-break in CW keying.
- Crystal Calibrator and WWV receiving capability.
- Microphone provided.
- Dual RIT control allows both broad and narrow tuning.
- All band 80 through 10 meter coverage.
- Multi-mode USB, LSB, CW and AM operation.
- Extraordinary receiver sensitivity (3u S/N 10 db) and oscillator stability (100 Hz 30 min. after warm-up).
- Fixed channel crystal control on two available positions.
- RF Attenuator.
- Adjustable ALC action.
- Phone patch in and out jacks.
- Separate PTT jack for foot switch.
- Built-in speaker.
- The TEMPO 2020... \$759.00
- Model 8120 external speaker... \$29.95. Model 8010 remote VFO... \$139.00.

ATLAS 350-XL



- ALL SOLID STATE
- 350 WATTS P.E.P. OR CW INPUT
- SSB TRANSCEIVER
- 10 THROUGH 160 METER COVERAGE



Illustrated with optional AC supply, Auxiliary VFO, and Digital Dial.

The all new Atlas 350-XL has all the exciting new features you want, plus superior performance and selectivity control never before possible. Price: \$995.00

- 10-160 METERS
- Full coverage of all six amateur bands in 500 kHz segments. Primary frequency control provides highly stable operation. Also included is provision for adding up to 10 additional 500 kHz segments between 2 to 22 MHz by plugging in auxiliary crystals.
- 350 WATTS P.E.P. and CW input. Enough power to work the world barefoot!
- IDEAL FOR DESKTOP OR MOBILE OPERATION
- Measuring just 5 in. high x 12 in. wide x 12½ in. deep, and weighing only 13 pounds, the Atlas 350-XL offers more features, performance and value than any other transceiver, regardless of size, on the market today!

- 350-PS matching AC supply — \$195.00
- DD-6XL plug-in digital dial readout \$195.00
- 305 plug-in auxiliary VFO — \$155.00
- 311 plug-in crystal oscillator — \$135.00
- DMK-XL plug-in mobile mounting kit — \$65.00

TEMPO VHF/ ONE PLUS



The Tempo/ONE PLUS offers full 25 watt output or a selectable 3 to 15 watt low power output, remote tuning on the microphone, sideband operation with the SSB/ONE adapter, MARS operation capability, 5 KHz numerical LED, and all at a lower price than its time tested predecessor... the Tempo VHF ONE.

The Tempo VHF/One Plus is a VHF/FM transceiver for dependable communication on the 2 meter amateur band • Full 2 meter coverage, 144 to 148 MHz for both transmit and receive • Full phase lock synthesized (PLL) • Automatic repeater split — selectable up or down • Two built-in programmable channels • All solid state • 800 selectable receive frequencies with simplex and +600 kHz transmit frequencies for each receive channel. Price: \$399.00



TEMPO ONE AC/ONE VF/ONE HF Transceiver. 80-10M. USB, CW & AM — \$399.00
 Power supply for TEMPO ONE — \$99.00
 External VFO for TEMPO ONE — \$199.00

TEMPO SSB/ONE SSB adapter for the Tempo VHF/One
 Selectable upper or lower sideband. • Plugs directly into the VHF/One with no modification. • Noise blanker built-in. • RIT and VXO for full frequency coverage. • \$225.00

TUFTS RADIO CATALOG TUFTS RADIO



SAVE YOUR RADIO!

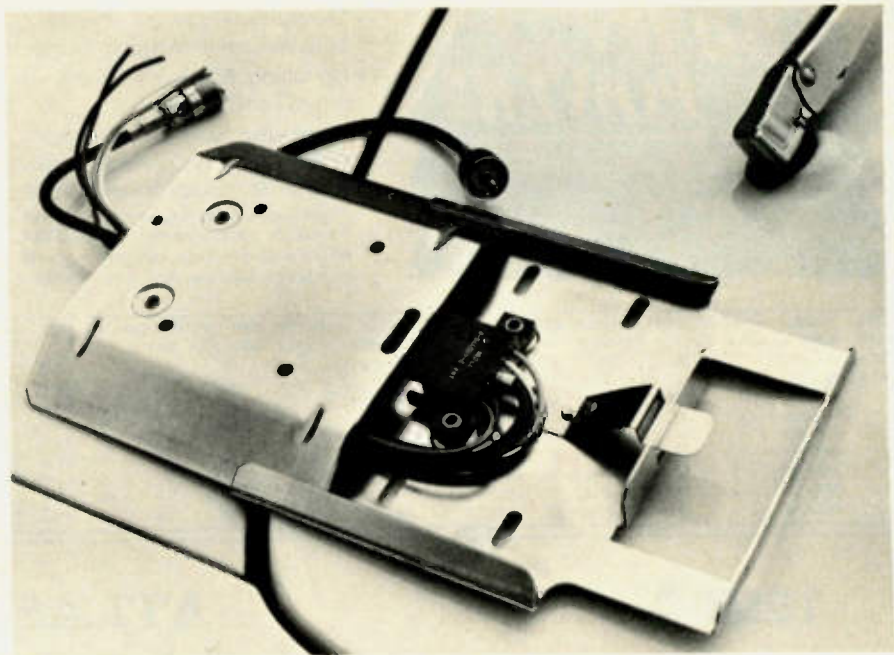

DESIGNED FOR COMMERCIAL USE UP TO 1000 MHZ.

The TUFTS SAVE-YOUR-RADIO bracket can save you a bundle ... and a lot of hassle. Why worry about rig ripoff? The TUFTS SYR bracket mounts quickly and easily in your car and makes it possible to snap your rig out of its bracket when you park and put it out of sight.

The connector system has a special coaxial cable connector which will provide you with a lossless connection right up to 1000 MHz! No loss! In addition to the quick coax connector there are also four power and accessory connections which are made automatically when the rig is slid into its bracket ... just what you

need for feeding power and loudspeaker connections to the set.

This is a rugged bracket and connector system ... it'll take a beating. There is a hole on each side of the 16 gauge steel plate for a padlock in case you want to leave the rig for short periods in its bracket. They'll have to rip out the dash to get it ... and it won't be the first time for that.

With two of these brackets you can bring the mobile rig into the house and use it in seconds. On trips you can take an AC supply for the rig and use it in your hotel room. Price: \$29.95

**400% MORE RF POWER
PLUGS BETWEEN YOUR MICROPHONE AND TRANSMITTER**



\$ 49.95

LSP-520BX. 30 db dynamic range IC log amp and 3 active filters give clean audio. RF protected 9 V battery. 3 conductor, 1/4" phone jacks for input and output. 2-3/16 x 3-1/4 x 4 inches



\$ 59.95

LSP-520BX II. Same as LSP-520BX but in a beautiful 2-1/8 x 3-5/8 x 5-9/16 inch Ten-Tec enclosure with uncommitted 4 pin Mic jack, output cable, rotary function switch.



\$ 27.95

CWF-2BX Super CW Filter

By far the leader. Over 5000 in use. Razor sharp selectivity. 80 Hz bandwidth, extremely steep skirts. No ringing. Plugs between receiver and phone or connect between audio stage for speaker operation.

- Selectable BW: 80, 110, 180 Hz • 60 dB down one octave from center freq. of 750 Hz for 80 Hz BW • Reduces noise 15 dB • 9 V battery • 2-3/16 x 3-1/4 x 4 in. • CWF-2PC, wired PC board, \$18.95 • CWF-2PCK, kit PC board \$15.95



\$ 49.95

CMOS-8043 Electronic Keyer

State of the art design uses CURTIS-8043 Keyer-on-a-chip.

- Built-in Key • Dot memory • Iambic operation with external squeeze key • 8 to 50 WPM • Sidetone and speaker • Speed, volume, tone, weight controls • Ultra reliable solid state keying • 300 volts max • 4 position switch for TUNE, OFF, ON, SIDETONE OFF • Uses 4 penlight cells • 2-3/16 x 3-1/4 x 4 inches



\$ 39.95

NEW

MFJ-16010 Antenna Tuner

Now you can operate all band — 160 thru 10 Meters — with a single random wire and run your full transmitter power output — up to 200 watts RF power OUTPUT.

- Small enough to carry in your hip pocket, 2-3/16 x 3-1/4 x 4 inches • Matches low and high impedances by interchanging input and output • SO-239 coaxial connectors • Unique wide range, high performance, 12 position tapped inductor. Uses two stacked toroid cores



\$ 15.95

NEW

CPO-555 Code Oscillator

For the Newcomer to learn the Morse code. For the Old Timer to polish his list. For the Code Instructor to teach his classes.

- Send crisp clear code with plenty of volume for classroom use • Self contained speaker, volume, tone controls, aluminum cabinet • 9 V battery • Top quality U.S. construction • Uses 555 IC timer • 2-3/16 x 3-1/4 x 4 inches

TK-555, Optional Telegraph Key \$1.95



\$ 29.95

SBF-2BX SSB Filter

Dramatically improves readability.

- Optimizes your audio to reduce sideband splatter, remove low and high pitched QRM, hiss, static crashes, background noise, 60 and 120 Hz hum • Reduces fatigue during contest, DX, and ragchewing • Plugs between phones and receiver or connect between audio stage for speaker operation • Selectable bandwidth IC active audio filter • Uses 9 volt battery • 2-3/16 x 3-1/4 x 4 inches



\$ 27.95

MFJ-200BX Frequency Standard

Provides strong, precise markers every 100, 50, or 25 KHz well into VHF region.

- Exclusive circuitry suppresses all unwanted markers • Markers are gated for positive identification CMOS IC's with transistor output. • No direct connection necessary • Uses 9 volt battery • Adjustable trimmer for zero beating to WWV • Switch selects 100, 50, 25 KHz or OFF • 2-3/16 x 3-1/4 x 4 inches



\$ 49.95

MFJ-1030BX Receiver Preselector

Clearly copy weak unreadable signals (increases signal 3 to 5 "S" units).

- More than 20 dB low noise gain • Separate input and output tuning controls give maximum gain and RF selectivity to significantly reject out-of-band signals and reduce image responses • Dual gate MOS FET for low noise, strong signal handling abilities • Completely stable • Optimized for 10 thru 30 MHz • 9 V battery • 2-1/8 x 3-5/8 x 5-9/16 inches



\$ 27.95

MFJ-40T QRP Transmitter

Work the world with 5 watts on 40 Meter CW.

- No tuning • Matches 50 ohm load • Clean output with low harmonic content • Power amplifier transistor protected against burnout • Switch selects 3 crystals or VFO input • 12 VDC • 2-3/16 x 3-1/4 x 4 inches

\$27.95

MFJ-40V, Companion VFO \$27.95
MFJ-120C, IC Regulated Power Supply, 1 amp, 12 VDC \$27.95

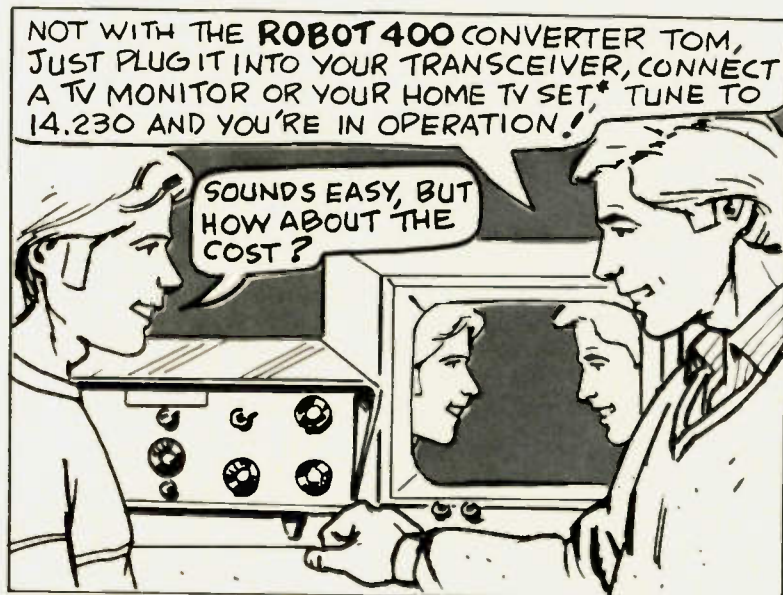
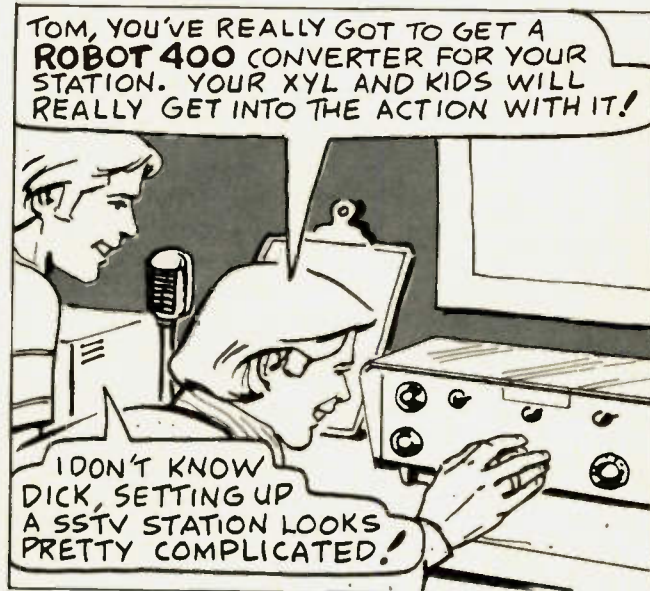
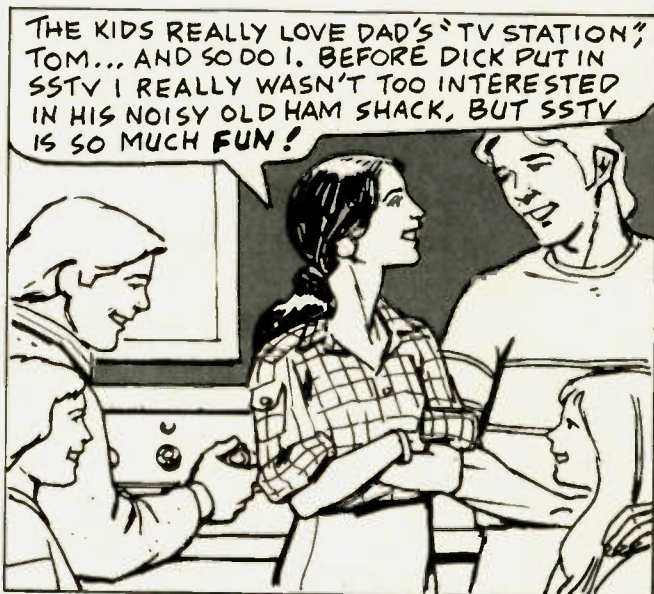
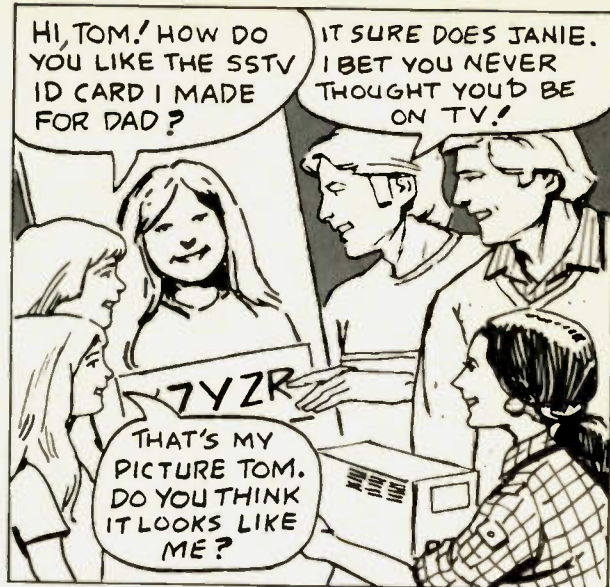
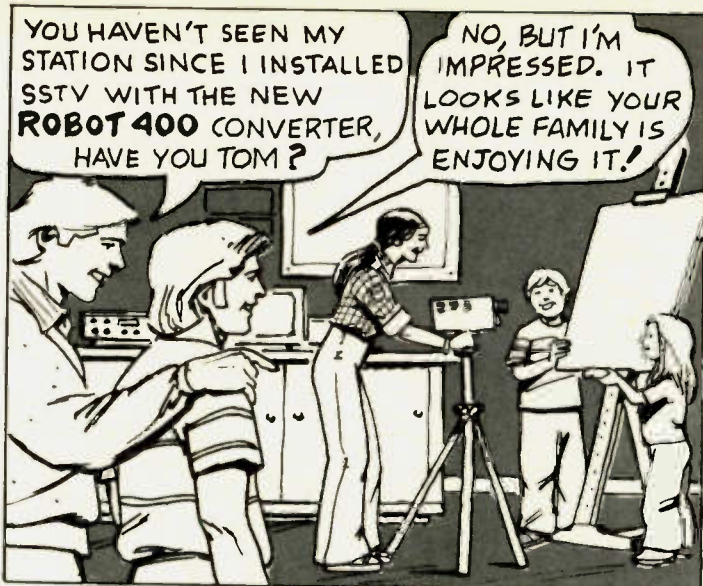

ROBOT ROBOT RESEARCH INC.
7591 CONVOY CT.
SAN DIEGO, CA 92111

R9

* The Robot 400 Converter can be connected to the antenna terminal of a home TV set by means of the Robot RF Adapter Kit option for \$25.

A Practical 2m Synthesizer

-- who said it can't be built?

Michael I. Cohen WA3SYI
210 Indian Creek Apts.
Wynnewood PA 19096

A simple frequency synthesizer for use with amateur 2m radios is described below. It features portability, using state of the art CMOS construction, and it draws only 18 mA. A phase locked loop (PLL) is employed to achieve precise high purity output. The entire PLL circuitry includes only five transistors and four integrated circuits for low cost

and small size. Most of the required parts are readily available from Radio Shack, including much of the CMOS logic and the circuit board. Coverage of the synthesizer is 140-150 MHz in 5 kHz steps. Frequency input may be obtained directly by thumbwheel or lever switches or indirectly by miniature keyboard and encoder. The keyboard encoder may be built from CMOS chips and includes an LCD readout and scanner. This circuit operates on only 0.4 mA total current draw. The synthesizer de-

scribed here was built on a single board with favorable results. It draws a total of 20 mA and measures 4.5" x 5.0" x 2.4" overall. This synthesizer will interface directly to the Drake TR33C and to the Heathkit HT with minor modification.

The one I built fits right on the top of my TR33C with Velcro holding it in place. It is connected to the rig by a single length of RG-174/U cable, using the auxiliary jack on the back of the radio. The unit goes on and off with the TR33C, so

there is no need for a separate ON/OFF switch on the synthesizer.

Schematics

Fig. 1 shows a block diagram of the PLL synthesizer. This diagram shows the frequencies for 144-148 MHz, although these are not the limits of coverage. The diagram in Fig. 1 illustrates that the input frequency to the system is the reference signal. It is one input to the phase comparator. The other input to the phase comparator is the i-f $\div N$, which varies directly with the VCO since the LO and N are constant. The phase comparator outputs a correction signal that is applied to the VCO through a low pass filter. The digital edge triggered-phase comparator used here will maintain inputs of both frequency and phase coherence at lock. Thus, the lock range is the capture range, and locking on harmonics is not possible.

Fig. 2 is a complete schematic of the PLL frequency synthesizer. Also shown are TR33C and Heathkit HT interface modifications. Synthesizer power must be regulated. The power supply is a 723 precision regulator. The 723 is wired with no external components. Consequently, the chip reference voltage of about 7.15 volts becomes the output voltage for the synthesizer. The 723 offers high ripple and noise rejection. Three terminal regulator substitutes are not recommended if any mobile operation is planned where alternator whine may become a problem.

The VCO is a grounded base Colpitts oscillator. It offers high stability and separate outputs for the rig and mixer buffers. L1, C1, and the varactor diode comprise the tuned circuit. C1 may be made variable to adjust the VCO center frequency and L1 fixed. Both L1 and C1 can be made variable so that both the spread

Photos by Michael A. Gray



The completed synthesizer with Drake TR33C transceiver.

(L1) and center frequency (C1) of the VCO are adjustable. However, such control is not necessary. The rig buffer is a broadband amplifier. The load inductance is taped to match the cable going to the radio.

The VCO-to-mixer buffer is a single CMOS quad NAND gate chip. Each gate is wired as an inverter and is biased up for linear operation. This buffer configuration offers the following advantages: excellent reverse isolation from the mixer, four stages, low current draw, high input impedance, and few parts count. The mixer is a dual gate MOSFET with a resistive load. The dual gate MOSFET offers good isolation between the VCO and LO signals. However, drive to this stage should be the minimum required at each input to reduce crosstalk as much as possible. Following the mixer is an i-f amplifier. A grounded emitter circuit is used to achieve the high gain required

to produce a CMOS compatible square wave i-f output. The reference oscillator and divider are obtained using a single CD4060 RCA CMOS chip. This reduces component count and simplifies wiring, although it may increase the cost a little.

The local oscillator employs a JFET for high sta-

bility and low current operation. As can be seen, the LO has a switchable capacitor to shift its frequency slightly. This is how the 5 kHz steps are implemented.

The divide-by-N and phase comparator are combined on one Hughes CMOS chip. The phase comparator is of the digital edge triggered type, so

the duty cycles of the incoming signals are not important. The divide-by-N portion accepts three BCD and one 7 bit binary number, which are added together to form the final division integer. The binary inputs may be used to generate offset splits between transmit and receive, but only the BCD

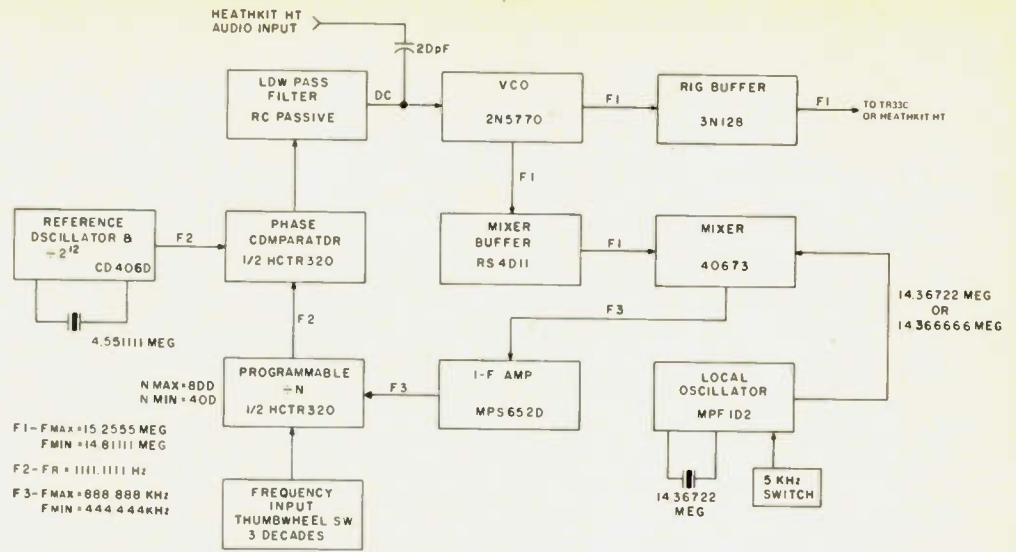

Fig. 1. Block diagram of the PLL 2m synthesizer showing the frequencies for 144-148 MHz coverage with TR33C.

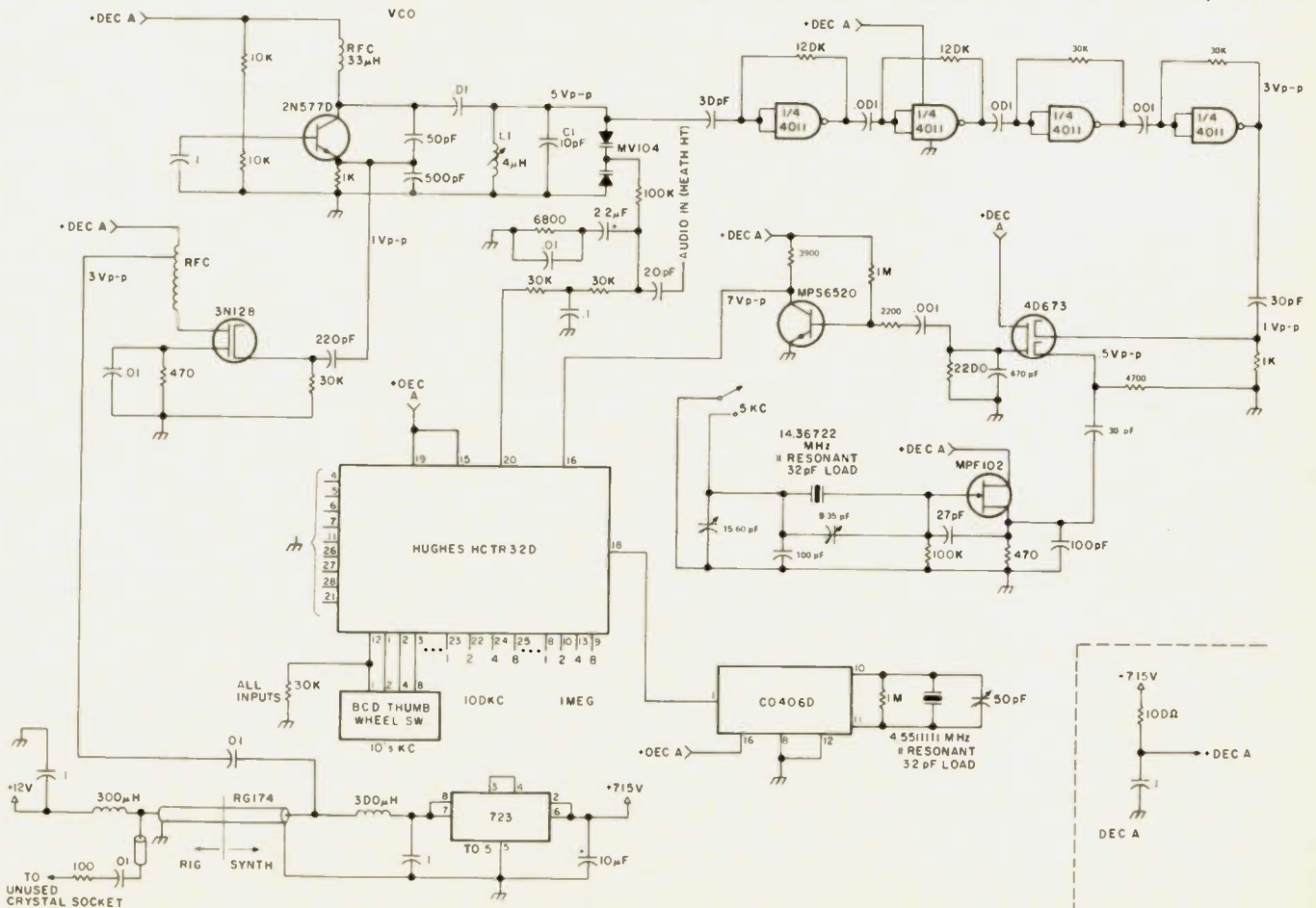
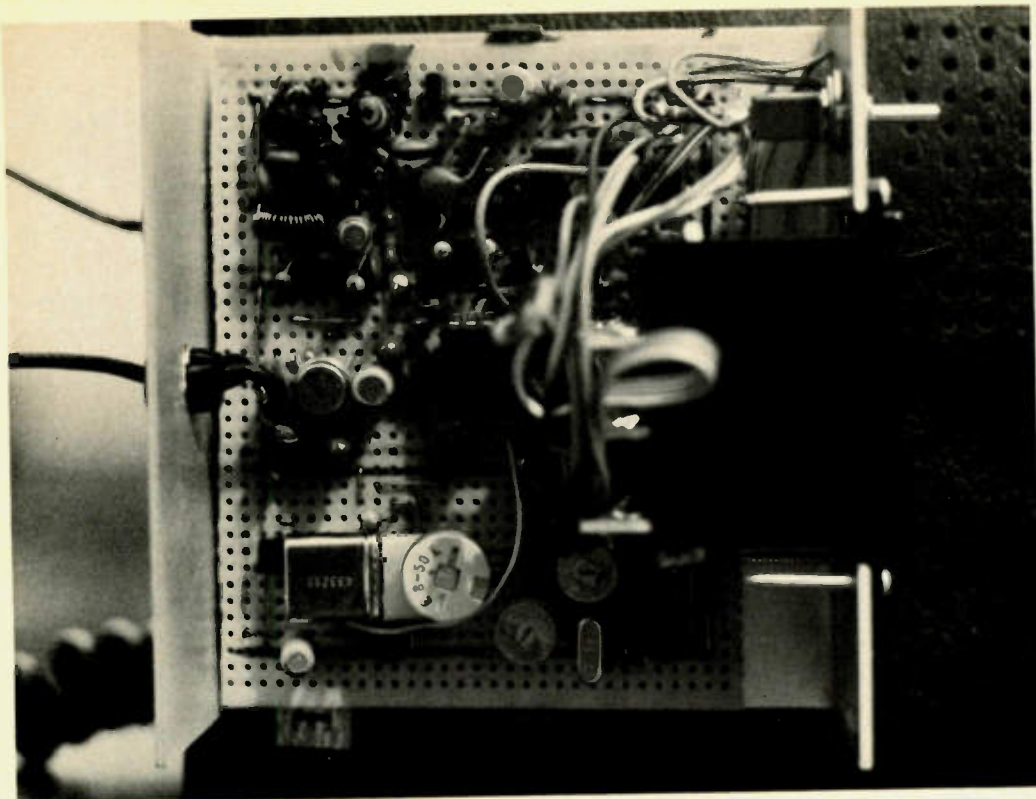

Fig. 2. PLL 2m synthesizer.



Top view of the synthesizer. Reference oscillator is located in the lower left portion of the perfboard.

inputs are used here and the binary inputs are all tied to ground. Also employed on the chip is a Schmitt trigger input for the i-f. The output of the phase comparator is filtered by the passive low pass filter and applied as input to the VCO in order to maintain lock.

Construction Tips

Either single or multiple board construction of the PLL synthesizer is possible. I used a single board approach employing the IC breadboard available from Radio Shack (#276-154). If a single board is used, then the component layout must be carefully planned. I put the VCO and LO on opposite corners of

the board to help isolate them from one another. Fig. 3 illustrates the stage layout used. Before soldering the components in place, I arranged them for shortest lead length and fewest required jumpers. All stages must be either RC or LC decoupled from the supply line. RC decoupling is effective and less expensive than LC decoupling. The importance of having a sufficient ground plane cannot be overstated. If the Radio Shack breadboard is used, the ground plane must be provided after the PLL is operational. This is accomplished by cutting a piece of single-sided, copperclad, prepunched board to the same dimensions as the bread-

board. Then ground leads are soldered at every stage on the breadboard to protrude from the copper foil side. These bare wires are then aligned with their corresponding holes on the copperclad perfboard. The two boards are sandwiched together and the numerous ground leads soldered to the perfboard ground plane as shown in Fig. 4. Also, hobby store "solderable tin" may be used to make stand-up shields between the rf stages.

If a multiple board arrangement is used, then the LO and reference oscillator should share their own circuit board as proposed in Fig. 6. The VCO and its buffers also comprise a sensible board. A preferable method would be to install the VCO and its

buffers in a shielded box if space permits. In any configuration, the VCO components should be glued in place and its circuit board acoustically decoupled to minimize microphonics. Double-sided foam tape works well for this purpose. Braided strap should be used to make interboard ground connections. This strap is called slot car pickup cable in hobby stores.

Toroids are preferable to tubular inductors, and their use is encouraged if possible. This will help make the circuit less susceptible to nearby rf fields.

Alternative Stages

Every stage has a suitable alternative. The rf section works quite well, so I won't recommend any changes there. However, you may wish to substitute different transistors for the VCO, i-f amp, LO, or rig buffer. For the VCO you want a transistor with a low output capacitance and medium gain. The i-f amp should have a garden variety high gain device with low leakage current. Almost any JFET will work for the LO with the appropriate biasing. A JFET may also be substituted directly for the MOSFET shown as the rig buffer with little difficulty.

The Hughes HCTR320 synthesizer chip was selected to conserve board space, to reduce component count, and to simplify wiring. However, if board space is not a problem for you, or if you have difficulty obtaining this chip, it may be replaced by two readily available chips as shown in Fig. 5. The

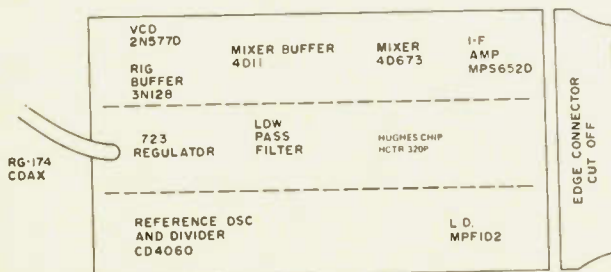

Fig. 3. Single board synthesizer layout using Radio Shack breadboard and Hughes synthesizer chip.

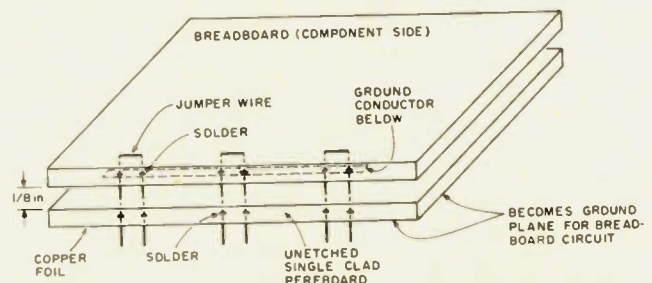
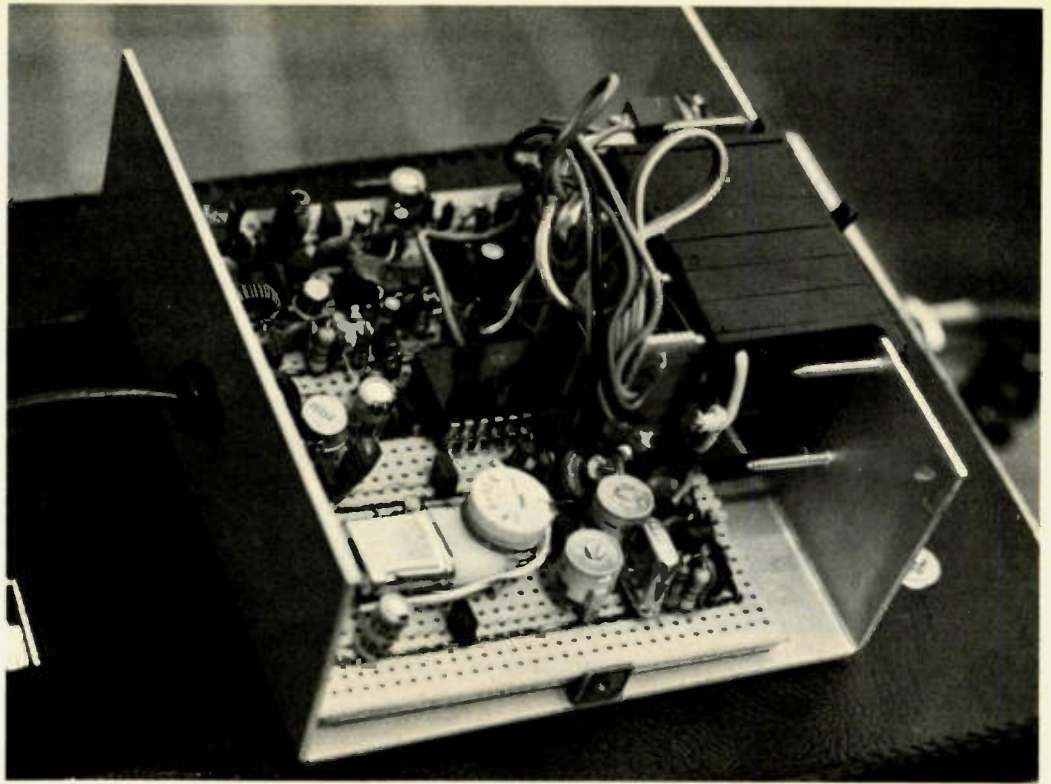

Fig. 4. Method for supplying a ground to breadboard circuits.

divide-by-N function is now handled by the RCA CD4059 programmable divider, and the phase comparator is obtained using two type D CMOS flip-flops. Alternatively, the phase comparator number two on the CD4046 phase locked loop chip may also be substituted for the digital edge triggered type called for above. It should be noted that, if the Hughes chip is eliminated, an additional stage of i-f amp may be required to properly condition the i-f signal for the CD4059 counter.

Troubleshooting

Not much difficulty is anticipated in getting the PLL operational. If something is amiss, start with the VCO. Verify the output amplitude and frequency as well as range of the VCO. Make sure that you have not forgotten the 100k Ohm resistor between the loop filter and the VCO. Check the signal levels at the mixer inputs. Verify that the local oscillator is working properly. Once the mixer is operational, check the i-f amp for a high amplitude clean output. Check the output of the divide-by-N chip to see if the chip is responding to the i-f signal. If it is not, then adjust the i-f amp components until an acceptable signal is presented to the divide-by-N chip. On the Hughes chip, pin 14 is the divide-by-N output. Once the appropriate signal is appearing at the output of the divide-by-N logic, check to make sure the reference



Another view of the 2m synthesizer. The complete circuit is assembled using point-to-point breadboard techniques.

oscillator is working and the divider is generating the required reference frequency. Verify the inputs to the divide-by-N chip and make sure none of the CMOS inputs are floating. Look at the output of the phase comparator with a dc coupled oscilloscope. If the output is saturated, go back to the rf section and start with the VCO to look for the problem. If the output is oscillatory, then you probably just need an adjustment of the low pass filter. Try changing the damping resistor and/or integrating capacitor in an effort to stop the loop from oscillating. If this fails, seek references on

phase locked loop low pass filters in the library. The Signetics analog manual has a thorough discussion of the loop filter used here.

Interfacing

The synthesizer will work without modification for the TR33C. This ham uses the Drake Mike Encoder to achieve touchtone capability, which frees the mini jack on the rear panel for synthesizer application. As shown in Fig. 2, the dc supply to the synthesizer goes through the center conductor of a length of RG-174/U coax. In return, the synthesizer sends its rf output back down the same wire and connectors. Thus, there is no inconvenience associated with this synthesizer.

The dc supply and rf are isolated by rf chokes at each end, and the rf is coupled by capacitors at both ends. The rf goes to an unused crystal socket in the rig. The dc supply comes from the 12 volt switched line in the radio, so there is no need for an ON/OFF switch on the synthesizer.

The same system used with the TR33C may also be used for the Heathkit HT. However, the TR33C applies the audio modulation to the 10.7 MHz transmit mix-up oscillator so the synthesizer need not be interfaced with audio signals. In the case of the Heathkit HT, audio will have to be applied to the VCO in order to accomplish frequency modulation. This

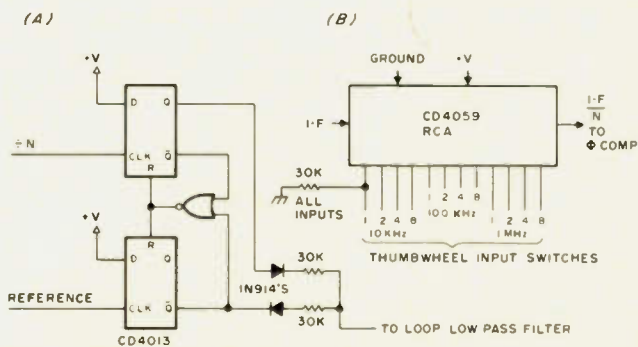

Fig. 5. Alternative digital logic for the PLL synthesizer. a) Phase comparator (CMOS); b) $\div N$ (CMOS).

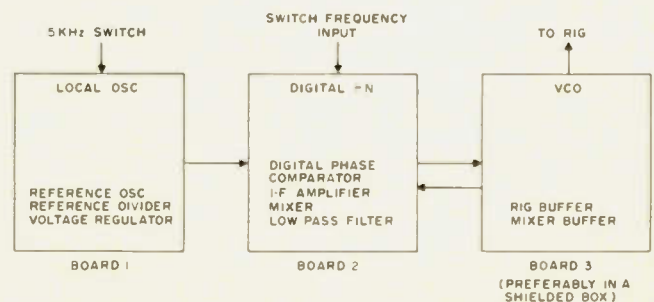
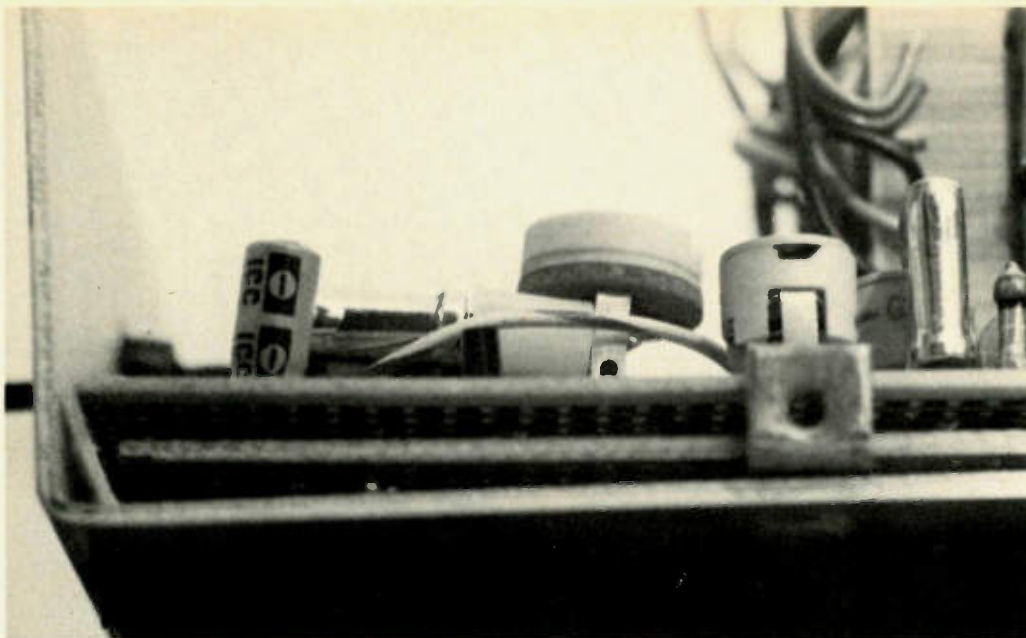

Fig. 6. Suggested multiple board synthesizer.



Close-up of the mounting bracket employed to secure the two perboards. Oscillator components are visible above the bracket.

connection is shown in Fig. 2. Of course, the basic synthesizer will work with any radio if the appropriate changes are made. Primarily, these changes involve the mathematics of the phase

locked loop relative to the desired application. Tutorial information regarding the design of phase locked loops is available from RCA and Motorola upon request. Some sources are listed as re-

ferences below. It should be pointed out that spurious responses in the synthesizer may result due to undesired interstage coupling or ground loops. The synthesizer described above offers inherent

immunity to this problem. However, extreme layout or ground plane deficiencies can promote spurious interactions in any multifrequency system. It is your responsibility, as a ham, to check for and eliminate any spurious responses in your home brew synthesizer. Therefore, multiple board construction is recommended but is not necessary for the experienced rf home brewer.

A Keyboard Entry System For Your PLL Synthesizer

Here is a CMOS circuit that enables you to have keyboard frequency entry for your 2m synthesizer. It draws only 0.4 mA, has 4.5 digit LCD readout, and a built-in scanner capability. This is a viable alternative to thumb-wheel or lever switch frequency input.

The circuit is shown in Fig. 7. It uses a Hamlin 3909 reflective LCD readout available through most Resco stores on order. RCA

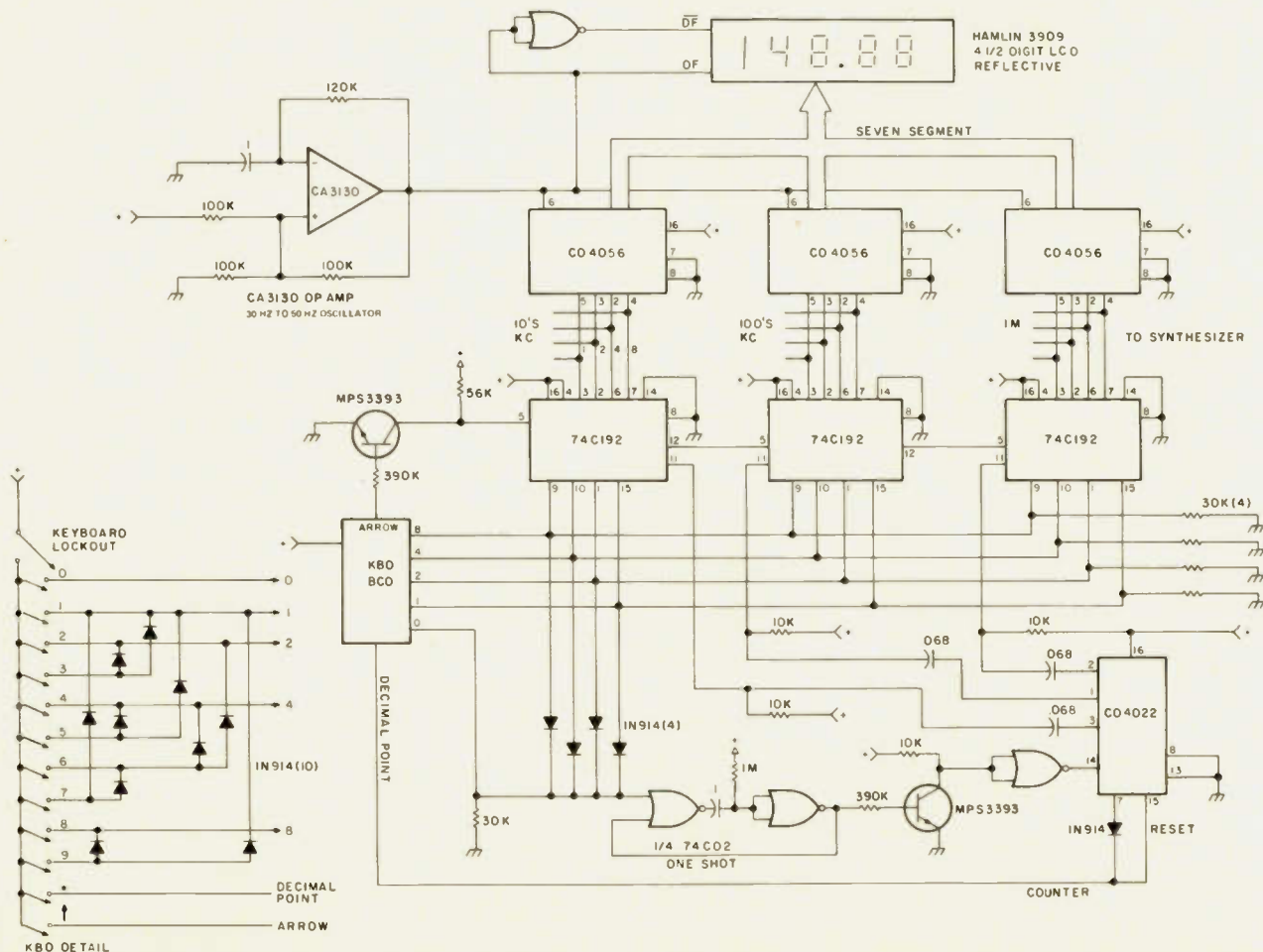

Fig. 7. Keyboard entry system.

CD4056 LCD drivers are also employed. The drivers and display may be replaced by a conventional LED arrangement in the interest of reduced overall cost, if current draw and portability are not important to you. The LCD readout is quite attractive, though, and is of the latest — black on white — FET LCD variety. The numerals are large and clearly visible in bright sunlight.

When a key is depressed, the one shot fires, causing the

CD4022 counter to increment. Meanwhile the key-switch places the appropriate BCD data on the input lines of the 74C192 presettable decade counters. By now, the falling edge of the previous output of the CD4022 causes the load line of one of the 74C192s to become active, thus loading the data into that counter. The load line is restored to an inactive high state before the data is removed from the input lines. The data is then removed

after releasing the keyboard switch. The one shot cycles for the next entry. Inadvertent double entries are almost impossible due to the one shot. The cheapest noisiest keyboard switches may be used due to the adjustable duration of the flash picture the 74C192s take of the data lines.

Output from the presettable counters goes to the synthesizer input and to the display decoder-driver. Note that pull down resistors at the

inputs of the programmable divide-by-N chip are not required if this encoder is employed, but are required if thumbwheel or lever switches are used. A keyboard lockout switch may be included if the keyboard is located where it is susceptible to accidental entries. ■

References

1. RCA, ICAN 6101, ICAN 6267, ICAN 6498, ICAN 6716.
2. Motorola, AN 564, AN 535, AN 553.
3. *Signetics Analog Manual*, 1976.

Neil Johnson W2OLU
74 Pine St. Lane
Tappan NY 10983

Is inflation getting you down? Tired of fighting the high cost of living? Prices are rising everywhere — in the metropolitan area the inflation factor hovers between 10 and 15 percent. Maybe you are thinking of taking up stamp collecting or some less expensive hobby? Don't give up. Help is on the way!

If you are a builder of ham gear, or even if you do a little experimenting, you may be pleasantly surprised to learn that many of your supplies and electronic components can be purchased at discount prices. How? Simply by buying at surplus. Some of these prices taken from a recent catalog may seem high to you: type 1625 tube, \$11.25; dc meters, from \$15 to \$20; relays, \$5 to \$6. But did you know that these same components can be purchased as new merchandise from surplus sources at prices of \$1.25, \$3 to \$4, and \$1 to \$2, respectively?

Let me point out that the situation is not all peaches and cream. There are certain factors in the surplus market which should be understood in order to reap the greatest benefit. The most prominent difference in the surplus market lies in the fact that it is not a substitute for the regular electronics dealer who generally offers for sale whatever you may wish to purchase. The surplus dealer is a seller of what he has to offer. Once you have grasped this fundamental difference,

you've bridged the gap. If you can utilize some of the merchandise offered by the surplus dealer, tremendous savings are possible.

This proposition suggests a certain flexibility of mind. If a certain component is needed, the chances are good that it can be bought at surplus, but if you insist upon a part made to certain specification, perhaps made only by one manufacturer, then the odds are that you will not see it offered for sale in the surplus market. Also, one should try to put himself in the surplus dealer's shoes, so to speak. To my way of thinking, the surplus shops are roughly akin to the thrift stores presently being patronized by knowledgeable women ... if you can use what's available, substantial economies are possible.

How do you pick a good surplus dealer? If you are

located near a large city, why not drop in and see for yourself? If this is not convenient, you can ask for the various catalogs that are available. I have noticed that many of the better surplus houses generally have a supply of such catalogs. In some cases, you may be asked to pay for the cost of mailing the catalog.

With the catalog in hand, you are in a much better position to see for yourself the size, shape and style of what is being offered for sale. Often this helps to clear up any doubtful points that might exist. If you can't find what you need in catalog A, there are others that may carry the wanted item. Sometimes a catalog may offer merchandise in groups of several pieces, all at bargain prices. This economy allows you to buy at the lowest possible cost and still have something left over for

the spare parts box. Over the years, I have amassed a fair sized collection of catalogs from various surplus dealers. While I do not believe in favorites, a few outfits have served me without headache or heartache for more years than I care to recall, among them Meshna and Fair Radio. Naturally, there are many other respectable firms dealing in surplus.

Finally, if you should experience any trouble, real or otherwise, in your business dealing with any surplus firm, my advice is quite simple: Holler, loud and clear. Amazingly simple and effective, that formula!

When you order from any mail-order house, it is always wise to state in big, bold letters: No substitutes/no back orders/no credit slips/refund any overage in check or stamps.

Good surplus-ing! ■

Buying Surplus

-- how to remain sane

How To Buy Surplus Parts

-- pick a good supplier

Sooner or later even the most dedicated parts scrounger must buy parts for his projects. Some people build equipment using the latest, state-of-the-art semiconductors and parts. They have no choice; they must buy all of their parts, and usually from an industrial supplier at that! But if you are like most people, you fit somewhere in between these extremes. Most projects send you to both the junk box and the local electronics store.

The problem is that you may not be able to get what you want, or you pay too much or too little and don't realize it. Purchasing electronic parts (or anything else for that matter) is an art unto itself. If you pride yourself on quality projects at lowest prices, you'll want to learn more about electronic purchasing. To my knowledge

(dating over 10 years), no one has published a good general article on electronic parts buying. Hopefully, this article will be the first!

Actually, this article was prompted by one thing. Readers interested in building some of the construction projects I have published have written to ask how to get certain parts. After reading some of the letters, it dawned on me that not everyone has good sources of supply and that I should write about how to go about getting parts. I might add, at this point, that the techniques I write about were developed during about 10 years at the school of hard knocks. So my methods are based on experience. If there are any professional buyers reading this, I apologize for some of my rather unusual methods!

Before getting into

specifics, there are a few things you should do to make your purchasing easier. It is important that you have good suppliers. If you don't, you can waste both time and money running around for your parts. By good I mean suppliers who usually carry the items you need and can be trusted to help when your purchases aren't what you want or are defective. When you find you have a good electronic supplier, be nice to him. And dump the bad ones in a hurry. Here's how to go about choosing your suppliers.

Picking out a good electronic supplier is a job like selecting a reputable car dealer. You first locate him, size him up, and then perhaps buy a car from him. Later you may have some after-sale servicing done, and so on. So it is with the electronics dealer. You want to find him

first. Get out the phone book for your area and look under "Electronics." Jot down on a piece of paper the names and addresses of any listings. You are only concerned with *retail* distributors at this point, if you are an individual. Wholesale distributors and some manufacturers may show you the door if you don't have a resale number. (A resale number is a number issued to you by the State Franchise Tax Board. It allows you to buy goods without paying state sales tax. However, you must resell the goods and have the customer pay the tax, or keep the goods and you must pay.) While collecting the names and addresses of distributors, check the phone book of any large city you happen to live by for more prospects. If you happen to live in a rural area, like I once did, give the phone book a glance and then refer to the various mail-order ads in this (and other) magazines.

The next step is to find out what sort of people the dealers you found are and what kind of parts they carry. You may be tempted to skip this part, but don't! You want to know more about your suppliers in order to make better buys. Suppose one dealer had some 7490 ICs for \$1.69 each, and another had the same thing for 5 for a dollar. Chances are that if you want that IC, you would walk into the \$1.69 place first (revised Murphy's Law). If you were aware of the second dealer, you could have gotten not only that 7490, but 4 others for future projects and paid only a dollar at that! And that is the way it often is in electronics.

In your spare time, pay the dealers nearest to your home a visit. You don't have to be building anything to call on them. While you are there, take mental notes on the stock available and how useful it is to you. For example, you like to work with ICs. Does the distributor have

many different kinds of ICs? How about resistors, caps, cabinets, etc? You might want to jot down next to the dealer's name on your list some of the things he has in quantity or has low prices on. You might also note whether he has surplus or new stock — surplus electronics can be real money-savers! When you have either the time or the opportunity, drop by the distributors farther from your home. There's no sense in ignoring anyone simply because they are a distance from your house. And with the larger outfits, a telephone call will bring your order to your door COD. But check with your distributor before you try a COD; not all firms are set up for it.

After you have made up your list of dealers with addresses, phone numbers, and hopefully any comments about their stock, keep it in a safe place until needed.

When you are ready to start a project, locate as many parts as you can from your junk box or from generous friends. Then dig out that list of dealers and scan it for prospects. Either visit or call those dealers who might have your parts. Check to see how much they are and if they are readily available. If you are in a hurry (say you are putting up a tower and need extra coax), you will have to buy from the distributor who has the parts in stock. But if you were foresighted enough to plan ahead and have more time to shop, you can save by trying at least one other store for your parts (preferably two others). Be careful of the dealer who says he can have it for you in a week. If you know he keeps his promises, fine; if not, try somewhere else if your time is limited. Electronic parts are notoriously hard to get on schedule, even for the best of dealers.

Here are some tips for buying parts: Concentrate on the most expensive parts when you shop. Then worry about the cheaper ones. It's

easy to sweat over a few resistors and then blow dollars on a cabinet without a second thought. Note that some parts tend to have the same prices all over your area. Nationally known brands of tubes and semiconductor universal replacements are good examples, and it doesn't matter too much where you buy them. Availability will probably mean more to you at this point.

Don't be afraid to use several distributors for all your purchases; this is normal more often than not. Recently I built a synthesized commercial AM/FM tuner. It cost \$100 in parts, which I ordered from 2 local stores, 4 mail-order houses, and one industrial supplier. And, in addition, I received a part sample from a major IC house, free. So this is what a big order can come to! I ordered this way, because the mail-order houses had the ICs cheaper, the industrial distributor had the state-of-the-art type parts unavailable elsewhere, and the locals happened to have the various odds and ends. I saved about \$35.00.

So you build your project, confident you bought good parts and saved money. If it works, congratulations! If not, and you trace the problem to a bad part, you really get to check out your dealer! Actually, this tests you as well as the dealer, because your attitude can influence whether you get your part exchanged or not. That's just human nature. I have seen too many people vent their spleen on a salesman, who then gets mad and gives the customer the most shopworn part in stock. If you are reasonable, you are far more likely to get a replacement part and perhaps a cup of coffee and a little advice. Try it! Then too, you get to see how a dealer performs. If he replaces it, fine. If not, or if he sends you to another place of business, or tries to sell you a replacement at a discount price, look out! I am

rather wary of outfits like these, personally. I also don't care for those who have signs all over proclaiming, "No return or refund." Why? The manufacturers of electronic parts (especially semiconductors and tubes) will replace bad parts from a distributor free.

Now that I have discussed the basics of buying from the local dealer/distributor, let's go on to some special cases. Take the mail-order house, for instance. I believe that mail-order suppliers are popular because they offer parts at low prices that are often hard to get. Here's how to deal with them.

Dealing with most mail-order houses is easy. But there are a few things you can do to get better service. The first thing you do is make up a parts shopping list. Then look in the back of 73 for names and prices. Also, it would be wise to pick up copies of *Popular Electronics*

and *Radio Electronics* magazines for other names. Not all mail-order houses advertise in more than one magazine. And sometimes you can get better prices from another mail-order house. Be careful of very low prices on certain parts. This usually means either the supplier made a large purchase (which he would shout about) or is selling junk. Junk is just what the name implies, and you often get what you pay for. You should be aware that junk ICs, for instance, are parts rejected by the IC manufacturer for various reasons, and then barreled and sold to the highest bidder. The buyer (dealer/mail-order house, etc.) tests them, puts a part number on them, and sells them dirt cheap. You can tell because these parts don't have the manufacturer's name on them — just the part number written on in pencil or stamped on. I strongly advise you not to use them;

PURCHASE ORDER				
No. 0317	Req. No. _____	Date 4-22 1977		
To _____	PAULA, Sales Desk			
Address _____	Liberty Electronics GARY McCLELLAN AND CO. P. O. BOX 2085			
Ship To _____	1061 W. IMPERIAL HIGHWAY LA HABRA, CALIF. 91731			
Address _____				
FOR _____	DATE REQUIRED ASAP	HOW SHIP UPS	TERMS CK 114	
QUANTITY	PLEASE SUPPLY ITEMS LISTED BELOW		PRICE	UNIT
1 ea	Synetics N8X08N Synthesized Chip		22 75	
2 10ea	RCA CD4511P IC		10 26	
3 1ea	RCA CD4059P IC		6 00	
4 2ea	INTERSIL ICM7202AIPD IC		16 30	
5				
6				
7	TOTAL		55 31	
8	6% TAXABLE		3 32	
9	GRAND TOTAL		58 63	
10				
11				
12				
IMPORTANT OUR ORDER NUMBER MUST APPEAR ON ALL INVOICES - PACKAGES, ETC. PLEASE NOTIFY US IMMEDIATELY IF YOU ARE UNABLE TO SHIP COMPLETE ORDER BY DATE SPECIFIED.		Please Send / Copies Of Your Invoice <i>Gary McClellan</i> Purchasing Agent		
Redifprm 1H 140		ORIGINAL		

Fig. 1.

the money you save will be made up in lost time troubleshooting later. Compare ads and look for the best prices. Then order.

A good way to deal with a mail-order house is to write a purchase order. See Fig. 1. You can get these forms from your local stationery store. Just ask for Rediform 1H140. Fill out the form with the parts you want and then the total prices. Make sure that you specify what package you want your ICs to come in ("14 pin DIP" or "TO-5 can" are OK) and that you include shipping costs. Note that some outfits ship small items postpaid. Also, some have handling charges. Total up the cost, and enter it at the bottom of the page. Then make out a check or money order for the amount. Never send cash; it may not reach its destination. Then write in your address and the company you are buying from. For best results, print in large numbers and letters. If you bought the Rediform I suggested, you will have a duplicate of the PO you just wrote. Keep it until your parts arrive, and then check them off the list as they are unpacked. You might also hang on to the PO and the canceled checks for tax purposes if you are in business. Why write a PO? Many businesses in mail-order do not send an invoice telling what you bought. This way you have a record that will serve as a reminder, ending the "Did I get what I ordered?" blues.

The best way to see how good a mail-order house is to send them a small order (say \$10 or so). This is the way I evaluate a new firm. I get to see how fast they handle it, the quality of their parts, and how they react to returns if I don't like their merchandise. I might add that I have dealt with essentially all of the people advertising in this magazine over the years, and I have found only one house that was suspicious in its dealings. They aren't

around anymore. You will find houses that have excellent service but lousy parts, and vice versa. A few offer excellent parts and service, and if you do much buying by mail-order, you'll quickly find out who they are.

The next and last step up the ladder is the industrial electronics distributor. In the old days you would think Allied and Newark, but today you call on other firms. Dealing with an industrial distributor involves a certain ritual, and you must be able to meet their minimum order requirements. In the Los Angeles area, for example, Hamilton Electro Sales has a minimum order of \$5.00 or more. Cramer Electronics has a \$25.00 minimum. It would be wise for you to either pool orders for several projects or get several interested friends together for one order to make the minimum order and get better service.

The first step is to locate those outfits near your home. If you did your homework with the phone book, you may have some good leads. Generally, these outfits are located in major cities like New York, Chicago, Los Angeles, etc., so look there.

Once you have found some candidates, call them up and ask for the sales desk. Then ask the person who answers for either a catalog (Cramer has a good one) or a *line card*, and have it sent to you. Caution: If you are an individual, you may not get one. In fact, the salesperson may put you on hold for a half hour or hang up! If so, drop them fast and try another supplier. This treatment usually suggests what you'll get on your first order: the famous cold shoulder.

The ritual for ordering from an industrial distributor goes something like this: You call to get the current prices on your parts and find out whether they are in stock. With most outfits, you are talking to a person sitting at a computer terminal, and that means you must give him the

exact part number and the manufacturer of the part. The manufacturer must be one on the industrial distributor's line card, a notebook-size piece of paper listing the manufacturers the distributor represents. If you can't cross-reference your parts over to a manufacturer he carries, you are out of luck. You must be able to tell him exactly what you want, or the salesman may not be able to help you. Ask for a "741", and he'll be puzzled. But ask for an "MC-1741P by Motorola" and you'll get results.

After you give the salesman the part and manufacturer, he'll ask for the quantity you need. Tell him. He'll check the terminal and give you the price of each and whether they are in stock.

At this point, there are three things you can do. Have the parts sent COD, have them sent and billed on your account, or mail an order and pay cash. Also, some outfits will accept your order and put it on "will call" for you. The first method is preferred for dealing with large parts houses. If you have the order sent COD, you get it sooner, and the extra cost is small. Also, there is less chance that a foul-up in the distributor's credit department will reach you. This approach is highly recommended if you are ordering as an individual. The second method is for business people only — you hold an account with the industrial distributor, and you are billed monthly. This method can work well if the credit bureaucracy is well organized. But, in my area, this isn't always the case. Recently I had to scream at the president of a large outfit and knock heads in the credit department over a simple computer error. Yes, I am well acquainted with credit problems. The third method works if you do it a certain way — call and casually inquire if your parts are available. If so, fine. Do not let the salesman talk you into placing an order! Instead, write

up a purchase order and send it to that salesman. Enclose your check for the parts and any sales tax. You do not have to allow for postage; most outfits include it in their parts cost. If you send extra money for postage, they will pocket it. Keep your money. If they want postage, let them bill you. This method works well for cash customers, and it keeps the credit department out of the act. If you like, try "will call" service if offered. This is the quickest way of getting your parts if you are located close to the distributor.

There is a chance that you will get the wrong parts or get defective units. Industrial distributors usually require that you call their customer service department and get a Return Material Authorization (RMA) number before returning the parts. You *must* return your parts with this number! Otherwise, your return will be (ulp!) ... returned! Without any action. Don't forget the RMA number. Also, be sure to enclose a note with your name/address, the sales order number (or your PO number), and the nature of the problem.

That's the gist of dealing with a commercial distributor. This may sound like a lot of bother to you for just a few parts, but you must go to a distributor like this if you are using either hard-to-get parts or state-of-the-art components.

Now that you know a little more about buying electronic parts, which places are the best for buying your parts? That's pretty simple. Are you in a hurry for your stuff? Buy from your local dealer/distributor or industrial distributor. Use "will call," and pick them up yourself. Want to save some money? Use a local surplus dealer or mail-order houses. Need state-of-the-art or hard-to-get parts? Use an industrial distributor. If you are like me, you will probably end up using all three sources for a project. Good luck! ■



Crescomm CM 200

Low Cost 5 Function Digital Multimeter

- 3-1/2 Digits Full Overrange
- Automatic Polarity
- 8 Hour Rechargeable Battery Operation
- Five Functions
- 1 mV Resolution
- Fused Inputs For Protection
- Easy To Use

Send check or money order to:
Crescomm Inc., Building 13, Euclid Avenue
Newark, New Jersey 07105

NAME _____

ADDRESS _____

CITY _____ STATE _____ ZIP _____

Bank Americard and Master Charge accepted. Please
include account number & expiration date with order.

NOW! SAVE OVER 20% Special Offer \$115.95 (Reg. \$149.95) Order Today "NOT" A KIT

The new CRESCOMM CM 200 is a major breakthrough in LSI electronic instrumentation. Compact in size, this battery-operated digital multimeter will measure AC and DC volts, AC and DC current, and resistance in 21 ranges. With polarity indicators, the convenient LED display will read up to 1999. Overload indicators are also provided. The CM 200 can be powered by either an internal battery or external AC-DC converter which can also charge the battery. A battery, fully charged, will power the instrument for more than 8 HOURS and can be charged overnight. The handle serves a dual-function carrying or bench stand.

1 YEAR WARRANTY

\$15 optional rechargeable battery

\$115.95 includes two test leads and DC converter

SPECIFICATIONS

Power: Internal battery 6V or AC-DC converter. (Converter can also be used to charge battery.)

Input Terminals: As indicated on front panel.

Function: The CM 200 will measure AC and DC volts, AC and DC current and resistance.

Range: The four range multipliers 1, 10, 100 and 1000 are selected by pressing the appropriate button—the decimal point will be automatically positioned.

Reading Rate: 2-1/2 per sec on DC and K ohm range.

Readout Height: 0.3"

Temperature Coefficient: DC Ranges 0.03% Per °C

AC Ranges 0.05% per °C

Resistance Ranges 0.05% per °C

Operating Temperature Ranges: 0°C to +50°C

Current Consumption: 100mA approximately

Crescomm WIRE DIVISION • COMMUNICATION DIVISION • ELECTRONIC DIVISION
Incorporated

Bldg. 13 Euclid Avenue, Newark New Jersey 07105 (201) 589-4647

C25

Social Events

BOSTON MA AUG 25-27

Computermania, an exhibition of the new hobby computers, will be held on August 25, 26, and 27, 1977, at the Boston Commonwealth Pier. On exhibit will be hundreds of computers, memory boards, printers, floppy disks, new calculators, new TV games, demonstrations, forums, talks, and prizes. Over 250 exhibits. For info, write Computermania, Peterborough NH 03458, or call Toll Free (800) 258-5473.

ROLLAG MN SEPT 2-5

The Western Minnesota Steam Threshers reunion will be held in Rollag, Minnesota, Sept. 2-5, 1977. Featured will be amateur special events station WM0STR. Plans are being made for operation of CW and SSB on 80 through 10 meters, and possibly on 6 meters. QSL certificate will be sent upon verification of the log and receipt of an SASE. Send to: WB0LRK, PO Box 596, Fertile MN 56540.

SAINT ANDREWS-BY-THE-SEA NEW BRUNSWICK SEPT 3-5

The All Saints Amateur Group will hold their Family-Holiday Hamfest on September 3rd, 4th, 5th, 1977, at the Algonquin Hotel in Saint Andrews-by-the-Sea, New Brunswick. The program includes: a technical forum, flea market, antique radio show, outstanding speakers, exhibit of leading ham equipment, prizes and awards, transmitter hunt, and much more. A full range of accommodations is available. For more information write: Hamfest 77, R.R. 325-8, Rothesay, New Brunswick, Canada E0G 2W0.

DANVILLE IL SEPT 4

The Danville Hamfest will be held on Labor Day weekend, Sunday, September 4, 1977, at beautiful Douglas Park, one block from I-74 Bowman Ave. exit in Danville, Illinois. The Danville Hamfest is cosponsored by the Illiana Repeater System and the Vermilion County Amateur Radio Association. For more information write Don Russell, R5, Danville IL 61832.

CLEVELAND OH SEPT 10

The Cleveland Hamfest Association presents the 1977 Cleveland Hamfest to be held on Saturday, September 10, 1977, from 6 am to 5 pm at the German Central Farms, 7863 York Road, Parma. Hamfest includes family picnic area, YL activities for the whole family, commercial displays of the very latest in ham gear. Door prizes throughout the day with final

grand prize drawing at 1600. WBQV for mobile check-ins for number on 146.52 from 0600 to 1200 with mobile prize drawing at 1400. Early ticket donations are \$1.50 before August 27th, \$2.00 at gate for all over 12 years of age. Flea market parking \$1.50 additional per space at 0600. For more information write Cleveland Hamfest Association, Box 43413, Cleveland OH 44143.

MELBOURNE FL SEPT 10-11

The 12th Annual Melbourne Hamfest will be held Saturday and Sunday, September 10 and 11, 1977, from 9 am to 5 pm each day in the air conditioned Melbourne Civic Auditorium located on Hibiscus Boulevard. Donation is \$2.50 per person. Full program includes forums, meetings, auction, swap tables, commercial exhibits, awards, prizes, etc. Contact K4HPT, 2749 Herford Road, Melbourne FL 32935 for swap table reservations. FCC exams on Saturday; donation not needed for exams. Form 610 must be filed with FCC, Room 919, 51 S.W. First Avenue, Miami FL 33130, not later than August 31, 1977. Hamfest talk-in on 25/85 and 52/52. Sponsored by Platinum Coast Amateur Radio Society. For more info write PO Box 1004, Melbourne FL 32901.

MENA AR SEPT 10-11

The Queen Wilhelmina Hamfest will be held atop Rich Mountain on September 10 and 11, 1977. There will be door prizes, games, and exhibits for everyone. Talk-in on 3995 kHz, .52-.52, .19-.79. For more information contact Steven W. Myers WB5MFI, Rt. 1 Box 204, Hatfield AR 71945, (501) 389-6791.

FINDLAY OH SEPT 11

The 35th Annual Findlay Hamfest will be held September 11 at the Riverside Park, Findlay, Ohio. Advance tickets are \$1.50 and \$2 at the gate. For tickets and additional information send an SASE to Clark Foltz WBUN, 122 W. Hobart, Findlay OH 45840.

FLINT MI SEPT 11

The Greater Genesee Valley A.R.C. will hold a swap & shop on Sunday, September 11, 1977, from 8 am to 4 pm at the Southwestern High School in Flint, Michigan. Take I-69 to the Hammerberg Road exit located near downtown Flint. Tickets are \$1.00 in advance, \$1.50 at the door. Door prizes will be given away, and food sales available. Large tables will be available at reasonable price for sellers. No trunk sales. Talk-in on 31/91 and 52 simplex. For advance

tickets, table reservation, and additional information contact Jack Walters WA8UXN, 1315 Butcher Road, Fenton MI 48430.

SOUTH DARTMOUTH MA SEPT 11

The Semara Annual Picnic and Flea Market will be held on September 11 at the Stackhouse Street Fairgrounds, South Dartmouth, Massachusetts. Talk-in on 147.60-147.00.

HAMBURG NY SEPT 17

The 6th Annual Hamburg International Hamfest 77 will be held September 17, 1977, at the Erie County Fairgrounds. Electronic flea market, amateur computer displays, manufacturers' displays, technical forums, women's programs, door prizes, etc. For additional information contact Fran Wilson 833-9631 or Bert Jones 873-3984.

HUDSONVILLE MI SEPT 17

The Grand Rapids Amateur Radio Club will hold its annual Swap-N-Shop Saturday, September 17 from 8 am to 4 pm at the Hudsonville Fairgrounds in Hudsonville, Michigan, 12 miles southwest of Grand Rapids on M-21. Talk-in on 146.52 and 16/76. \$2 donation at the gate with plenty of refreshments and free tables available.

GRAYSLAKE IL SEPT 17-18

Radio Expo '77 will be held September 17 and 18, 1977, at the Lake County Illinois Fairgrounds, Rts. 45 and 120, Grayslake, Illinois (halfway between Chicago and Milwaukee). Displays of the latest in electronic communications technical forums, gigantic flea market, thousands of dollars in door prizes, ladies' program, etc. Tickets \$3 for both days, \$2 in advance. Radio Expo Tickets, Box 1014, Arlington Heights IL 60006.

ROSS OH SEPT 18

The Cincinnati Hamfest will be held at the improved Stricker's Grove, State Route No. 128, Ross (Venice), Ohio, on Sunday, September 18, 1977. Exhibits, contests, prizes, swaps, trades, thrilling and spectacular air show, group and net meetings, hidden transmitter hunt. Advance ticket \$7.50 - at gate \$8.00. Mail check or money order prior to September 11 to: Greater Cincinnati Amateur Radio Assn., c/o John P. Haungs WA8STX, Treasurer, 10615 Thornview Drive, Evendale OH 45241.

OAKWOOD GA SEPT 18

Lanierland ARC will hold its fourth annual "Hamnic" at the Lanier Islands Dogwood Pavilion on September 18, 1977. Two large covered pavilions and large parking area for swap shop and exhibits. Food available. No entry

fee for Hamnic; however, Lanier Islands charges \$2.00 entry fee per car. Picnic, hiking, and swimming for the kids. First prize IC-22S. Many other prizes. Talk-in on W4IKR/4 on 3975 and .07/.67. For further information, write Terry Jones WB4FMJ, Route 1, Box 298, Oakwood, Georgia 30566.

MT. CLEMENS MI SEPT 18

L'anse Creuse A.R.C. presents its 5th Annual Swap and Shop to be held on September 18, 1977, at L'anse Creuse High School, Mt. Clemens, Michigan, 0900-1500. Prizes, plenty of food and parking. Directions: I-94 eastbound, exit Metro Pkwy, Metro Pkwy to Crocker, left on Crocker to Reimold, right on Reimold to last school - L'anse Creuse High School. Admission: \$1.50 at door, \$1 in advance. SASE to WB8QFR, 32111 Harper Ave., St. Clair Shores MI 48082.

HARRISBURG PA SEPT 18

The 4th Annual Electronic Swap Fest of the Central Pennsylvania Repeater Association will be held Sunday, September 18, 1977, at the Park and Shop Garage, 200 Block of Walnut Street, Center City, Harrisburg. Indoor parking for 1100 cars, so come rain or shine. Starts at 8 am. Registration \$3.00. No charge for tailgating, wives or children. Talk-in on WA3KXG, 146.16/76, 146.52/52. For more information contact Roger Urban W3HUP, phone: (717) 761-7178.

PEORIA IL SEPT 18

The Peoria Area Amateur Radio Club's 20th Annual Hamfest will be held Sunday, September 18, 1977 at the Exposition Gardens located on Northmoor Road just west of North University Avenue. Free coffee and donuts 8:30 to 9:00 am, free swapfest and free parking. Prizes will be given away. Advance tickets \$1.50, door tickets \$2.00. Talk-in on 146.94 simplex - call W9UVI. For hamfest tickets write Bruce Funston K9PWO, 304 Indian Circle, East Peoria, IL 61611.

KENNER LA SEPT 24-25

The Jefferson Amateur Radio Club and the Crescent City Computer Club would like to announce the New Orleans Hamfest/Computerfest which will be held at the Hilton Inn in Kenner LA (directly across from the New Orleans International Airport) on September 24 and 25. This is the ARRL Delta Division Convention for 1977 and is the largest ham outing in the deep south. This year's event will feature a banquet Saturday night with entertainment, two days of commercial exhibits, flea markets, forums, hospitality room, ladies' events, FCC examinations and more. Grand prize is a complete Drake "C-Line" ham

station. For more information contact the New Orleans Hamfest/Computerfest, PO Box 10111, Jefferson LA 70181.

**MADISON WI
SEPT 25**

The 5th Annual Madison Swapfest will be held Sunday, September 25 at Dane Co. Expo Center Youth Building, Madison WI. Rain or shine — inside facilities — doors open at 8 am. 12,000 sq. ft. of electronic equipment and components for hams, computer hobbyists and experimenters. Bring the whole family for delicious food and entertainment. Excellent overnite camping accommodations. Tickets — advanced \$1.50; at door \$2.00. Tables — advanced \$2.00; at door \$3.00. Make check or money order payable to M.A.R.A. — mail to M.A.R.A., Box 3403, Madison WI 53704. Reservations must be in by Sept. 10, 1977.

**ERIE PA
SEPT 25**

The 2nd Annual Erie HamJam will be held Sunday, September 25, 1977 at Rainbow Gardens, Waldameer Park. Door prizes, flea market, forums, large indoor facilities. For more information write Radio Association of Erie, Inc., PO Box 844, Erie PA 16512.

**LOUISVILLE KY
SEPT 25**

The Seventh Annual Greater Louisville Hamfest will be held on Sunday, September 25, 1977 at the Kentucky Fair and Exposition Center with marked exits off either I-65 or I-264. Indoor exhibitors area plus indoor or outdoor flea market areas. There will be meetings and forums, ladies' free bingo, also food and drinks available. Admission is \$2 adults — 12 and under free. Flea market vendors pay admission price plus \$2.00 per space indoor or \$1.00 per space outdoor. For info contact Denny Schnurr K4GOU, 2415 Concord Dr., Louisville KY 40217, phone (502) 634-0619.

**ADRIAN MI
SEPT 25**

The Annual Adrian Hamfest will be held on Sunday, September 25, 1977 at the Lenawee County Fairgrounds, Adrian, Michigan. Prizes every hour! Grand prize drawing — 3 pm. Flea market and trunk sales. Tickets \$1.50 advance, \$2.00 at gate. Tables \$2.50 half, \$4.00 full. Talk-in on 31/91 and 52. For more information contact Adrian Amateur Radio Club, Box 26, Adrian, Michigan 49221, (517) 265-8016.

**NEW BERLIN IL
SEPT 25**

The Sangamon Valley Radio Club will hold its Second Annual Hamfest on Sunday, September 25, 1977 at the Sangamon County Fairgrounds, New Berlin, Illinois, 16 miles west of Springfield. Indoor display area and a covered pavilion. Food, refreshments,

exhibits and ladies' activities. Overnite camping on grounds. Tickets \$1 advance; \$1.50 at gate. First prize — Wilson HT. Talk-in 146.28/.88 and .52. Info: Carole Churchill WB9QWR, 622 Magnolia, Rochester IL 62563.

**WILLOW GROVE PA
OCT 1**

The Mid-Atlantic States VHF Conference will be held on Saturday, October 1, 1977 at the Treadway Inn on Easton Road (Route 611, Exit 27 of the Pennsylvania Turnpike) in Willow Grove, Pennsylvania on the day before Hamarama 77 (at nearby Warrington, Pennsylvania). The conference will be an all day VHF program moderated by prominent VHFers. Advance registration is \$2.50 (includes admission to Hamarama 77 on Sunday). Cocktail hour (cash bar) and get-together at 6:30 pm. Buffet dinner at 7:30 pm is \$8.00. Special rates for rooms overnight. For advance registration contact Ron Whitsel WA3AXV, Chairman, PO Box 353, Southampton PA 18966, phone (215) 355-5730. Advance registration must be received by September 28, 1977. Indicate motel registration forms required.

**MEMPHIS TN
OCT 1-2**

The Memphis Hamfest, bigger and better than the 4,500 who attended last year, will be held at State Technical Institute, I-40 at Macon Road, on Saturday and Sunday, October 1 and 2. Demonstrations, displays, MARS meetings, flea market, ladies' flea market, too! Hospitality Room, informal dinners, XYL entertainment, many outstanding prizes. Dealers and distributors welcome. For further information contact Harry Simpson W4SCF, PO Box 27015, Memphis, Tennessee 38127.

**WARRINGTON PA
OCT 2**

The Mt. Airy VHF Radio Club (the Packrats) are holding "Hamarama 77" at the Bucks County Drive-In Theater, Route 611 (Easton Road), Warrington, Pennsylvania on Sunday, October 2, 1977, 8 am to 4 pm rain or shine. Registration \$1.50, tailgating \$2.00/space (bring your own table). Talk-in via W3CCX/3 on 52.525 and 146.52, WR3ACD on 222.98/224.58, WR3ADS on 147.63/147.03, and WR3AHC on 147.60/147.00. Advance registration to the Mid-Atlantic States VHF Conference includes admission to Hamarama. For information contact Ron Whitsel WA3AXV, Chairman, PO Box 353, Southampton PA 18966, phone (215) 355-5730.

**CEDAR RAPIDS IA
OCT 2**

The Cedar Valley Amateur Radio Club annual Hamfest will be held Sunday, October 2, 1977. Top prizes are Atlas 210X Xcvr, Wilson 1402 SM H/T, Heathkit HW-8 QRP CW Xcvr, Clegg FM-76 Xcvr, plus much more. Technical talks featuring Doug

DeMaw W1FB. Manufacturers and dealers welcome. Talk-in on 146.16/.76, 146.52, 3.970, and 223.5 MHz. Advance tickets \$1.50, \$2.00 at the door. Write CVARC Hamfest, Box 994, Cedar Rapids IA 52406.

**NEWPORT NH
OCT 2**

Autumnfest, the first annual hamfest of the Connecticut Valley FM Association, will be held on October 2, 1977, at the Community Center, Belknap Ave., off Rt. 10, north end of the Common. Flea market opens at 9 am — auction at 2 pm. Program includes antenna gain contest, fox hunt on 52 simplex, frequency and modulation checks by W1RNZ, and talks and demonstrations throughout the day. Donation: \$1.50 in advance — \$2.00 at the door. Talk-in on 16/76 or on 52 simplex.

**EAST RUTHERFORD NJ
OCT 8**

The Knight Raiders VHF Club, K2DEL, presents its world famous Auction & Flea Market to be held at St. Joseph's Church of East Rutherford, New Jersey, Saturday, October 8, 1977 beginning at 10 am. Free admission — free parking. Flea market tables (in advance) \$5 full table, \$3 half table; (at door) \$6 full table, \$3.50 half table. Directions: take Rt. 17 north from Rt. 3 to East Rutherford, exit onto Paterson Plank Road, follow to traffic light with Diner on the corner, make sharp right, follow for one block, at light you will see St. Joseph's Church on your right, make right turn at corner and enter parking lot. For further information call: Bob Kovaleski (210) 473-7113, evenings only. Talk-in on 146.52. Send reservations and make checks payable to: Knight Raiders VHF Club Inc., PO Box 1054, Passaic NJ 07055 (reservations close October 1).

**SHREWSBURY MA
OCT 8-9**

The Heart Fund Hamboree (all proceeds to be given to the Heart Fund) will be held on October 8 and 9, 1977, at Simeon's Park on Route 9 in Shrewsbury MA. Program includes door prizes, trophies, special prizes and entertainment. For advance tickets send \$1.50 donation (orders must be received by Sept. 15) — \$2 donation at gate. Senior citizens and children 12 years or under free. For dealer space and ticket information write: Central Mass. 2-Way Radio Assoc., P.O. Box 154, Northboro MA 01532.

**SYRACUSE NY
OCT 8**

The Radio Amateurs of Greater Syracuse presents the Syracuse Hamfest, October 8, 1977 from 9 am to 5 pm at the Syracuse Auto Auction, Route 11, Nedrow, New York. Easy access from Route 81, 5 miles south of Syracuse. Food available all day at reasonable prices. Large exhibitor area and flea market under cover. Exhibitors: \$13.00 (includes one 8-foot

space, 8-foot table, two chairs and admission to hamfest). For further information: General info — RAGS Hamfest, Box 88, Liverpool NY 13088; exhibitors — Dale Mecomber WB2FJC, Box 87, Skaneateles Falls NY 13153.

**YONKERS NY
OCT 9**

The Yonkers Amateur Radio Club is holding "Super Hamfest 77" on October 9, 1977 (rain date Oct 16) from 9 am to 5 pm at Redmond Field, Cooke Avenue in Yonkers. Manufacturers displays, door prizes, raffles, refreshments and a general auction are all in store. Buyers \$1, sellers \$3 — bring your own table. Talk-in 146.265, 146.865, 146.52 simplex. For further information contact Doug McArtin WA2AUJ, 411 Bellevue Ave., Yonkers NY 10703, (914) 423-0515.

**WINDSOR LOCKS CT
OCT 14-16**

The Region 1 Air Force MARS Convention will be held on October 14, 15, 16, 1977 at the Howard Johnson's Conference Center, Center Street Exit I-91, Windsor Locks, Connecticut. 73 publisher Wayne Green will be guest speaker.

**SAN MATEO CA
OCT 15-16**

The Greater Bay Area Hamfest and ARRL Pacific Division Convention will be a combined event this year held on Saturday and Sunday, October 15 and 16 at the Royal Coach Inn, centrally located on the San Francisco Peninsula just off the intersection of U.S. 101 and Route 92 in San Mateo. For more information contact the Greater Bay Area Hamfest, Box 751, San Mateo CA 94401.

**TAYLOR MI
OCT 16**

The Repeater Association of Downriver Amateur Radio (R.A.D.A.R.) Hamfest will be held on October 16, 1977, at the Kennedy High School located in Taylor, Michigan, on Northline Road, east of Telegraph (U.S. 24). Door prizes and food. Admission \$2.00/YLs free. Reserved tables \$1. Open 9 am until 3 pm. Talk-in will be on 52-52, 34-94, 93-33. For further info write: R.A.D.A.R. Inc., PO Box 1023, Southgate, Michigan 48195.

**PLYMOUTH IN
OCT 30**

The Radio and Electronics Swap and Shop, sponsored by the Marshall County Amateur Radio Club, will be held on Sunday, October 30, 1977, at the Plymouth, Indiana National Guard Armory, located at 1220 West Madison Street, from 8 am to 5 pm. Free tables, no charge for setup. Tickets \$2 at door. Food, drink and door prizes. Talk-in on 146.07-67 and 146.52 simplex. For further information contact Wayne Zehner WA9INM, Rt. 3, Box 526, Plymouth IN 46563.

RTTY RKB-1 Revisited!

-- auto machine functions

About 15 ms after I started typing on my Model 15 teleprinter, I realized that this was not at all like typing on a modern electric typewriter. There simply had to be a better way. HAL's RKB-1 electronic keyboard was a step in the right direction. However, it still required the time-consuming and monotonous

carriage return, carriage return, line feed, letters (CR, CR, LF, LTRS) procedure at the end of each line. This operation is used by all good RTTY aficionados to help ensure that the machine is set up properly to print the next line. This article describes a circuit that will, when actuated, cause the RKB-1 to perform the CR, CR, LF,

LTRS operation automatically.

Encoding the LTRS Character

The first modification requires the addition of a LTRS character. Encoding characters in the keyboard is performed by a toroid matrix. This matrix is composed of seven toroidal trans-

formers labeled T0 through T6. The photo shows the T0 toroid located above the number 9 key. Toroid T6 is located above and between the number 2 and 3 keys. The remaining toroids are numbered consecutively in between. Toroids T0 through T4 are used to encode the standard five bit Baudot code. Toroids T5 and T6 are connected to a case-sense circuit. The purpose of this circuit is to send a LTRS or FIGS character automatically before the actual character depressed is sent, if necessary.

Fig. 1 shows how a LTRS character, represented by MMMM in the Baudot code, can be encoded in the RKB-1. The character is encoded by connecting a thin enamel coated wire (approximately #30 AWG) to pin 20 of the keyswitch printed circuit board. This point is located directly above the number 0 key. It is a common tie point for about 30 other wires. The wire is then passed through the center of toroid T5. If you wish to actuate the LTRS character externally, the wire must be connected to an unused key. I found the key to the left of the A key to be convenient. Should you not wish to access the LTRS character, the wire is connected directly to pin 9 of the 7445 shown in Fig. 3. This single wire acts as the primary of each toroidal transformer. T0 through T4 are not used, since the Baudot code for the LTRS character does not contain any spaces. Only those characters requiring a space are fed through these toroids.

To further illustrate the technique, should you wish to add other characters, Fig. 2 shows another example. It indicates the proper connections to encode the FIGS character, MMSMM.

You should be aware of, but not necessarily concerned with, an anomaly in the keyboard. Since the toroid primary of each character passes through either the

Photos by Anthony R. Donaldson

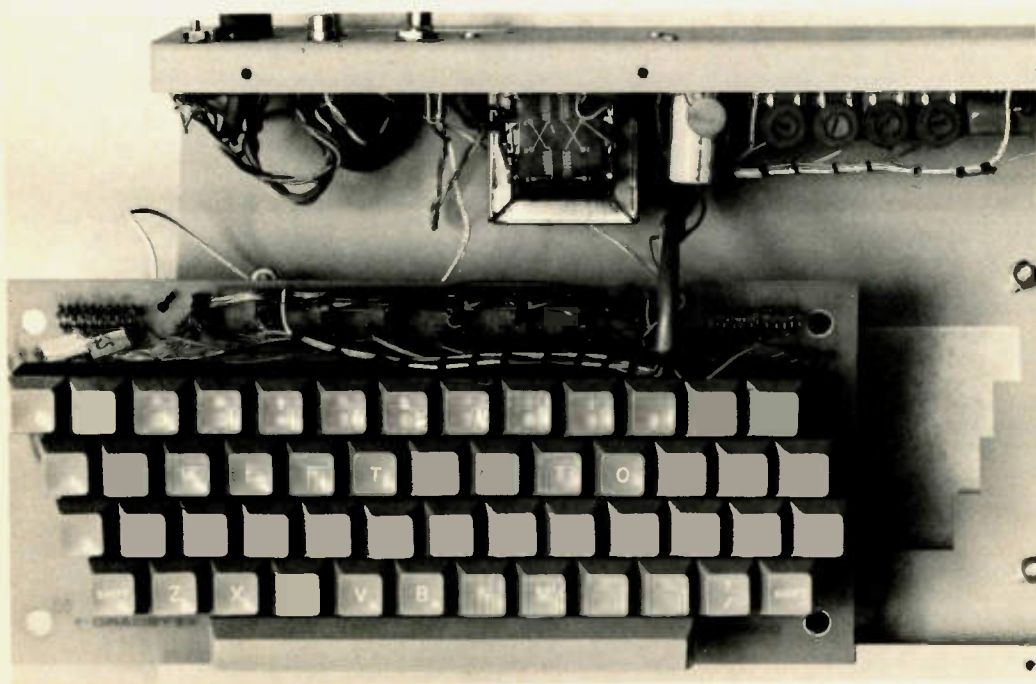

Toroids T0 through T6 can be seen above top row of keys.

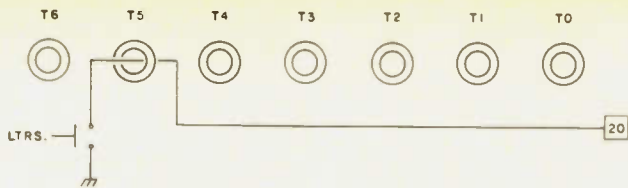

Fig. 1. LTRS encoding schematic.

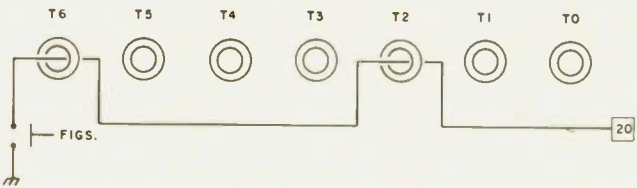

Fig. 2. FIGS encoding schematic.

LTRS or FIGS toroid, T5 and T6 respectively, it is possible when depressing either the LTRS or FIGS keys to get two LTRS characters or two FIGS characters. For example, if you are in the figures case and then depress the LTRS key, the keyboard will produce a LTRS character generated by the case-sense circuit, toroid T5, and then an additional LTRS character will be generated due to the encoding of toroids T0 through T4.

Return Circuit

Now that we have the LTRS character, we must design a circuit that will in essence simulate magic fingers depressing the carriage return key twice, followed by the line feed key and, lastly, the LTRS key. The circuit in Fig. 3 will do just that. The 555 timer runs continuously. However, the 7493 binary counter will not count these pulses until the Q output of the 7473 J-K flip-flop is low. This occurs when the return key is depressed. It stays in this state until the automatic return process is over. With pins 2 and 3 of the 7493 low, binary coded digits will be sent to the 7445 decoder. This will in turn cause the 7445 to act as a distributor. Since the 7445 uses open collector outputs, they may be placed in parallel with the CR, LF, and LTRS keys to simulate the actuation of these keys. The last output of the 7445, pin 11, is used to reset the 7473. A convenient unused key that may be used

for the return function is located in the extreme upper right hand corner of the key-switch board.

Power for this circuit is derived from the keyboard's main power supply. The foil on the printed circuit board separating T4 and T5 is 5 volts with respect to ground. This is an easy and convenient point to pick off the power for the circuit.

Adjustments

The 555 timer should be adjusted via R1 so that the CR, CR, LF, LTRS process is fast, but not so fast as to cause the characters to run into each other. The actual speed that you set the timer for will be function of the baud rate you usually operate at. For a baud rate of 45.45

(60 wpm), the timer frequency will be about 12 Hz.

The values of R1 and C1, as shown in Fig. 3, are primarily for 60 wpm operation. If you operate the keyboard at several speeds, you will want to externally vary the value of R1 as you change speeds. The main speed switch that comes with the keyboard is a 3P4T switch. While I have not tried this method, since I operate at only one speed, it seems like making use of this switch to change fixed resistors would be ideal for those wishing this feature.

Construction

The photo of the foil side of the keyswitch board shows the construction method that I used. The circuit was built on a perforated board and installed on the keyswitch board by using standoffs. The board was dipped in a coating compound, which accounts for its appearance in the photo.

The circuit has been in operation for about a year now, and I can't see how I ever got along without it. May you also have many happy returns. ■

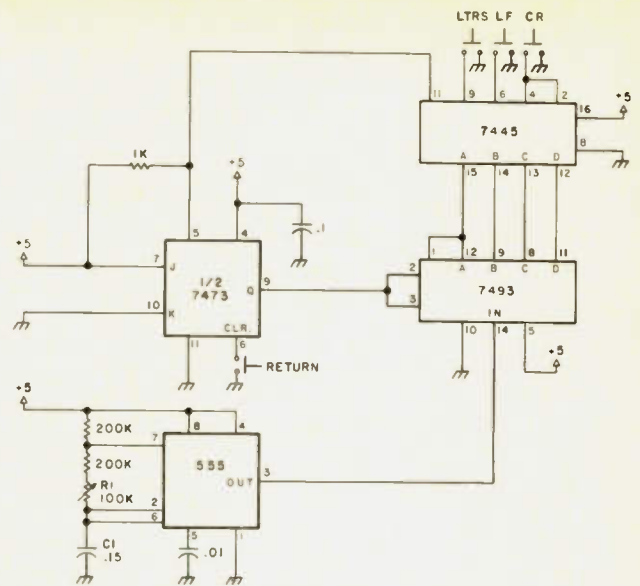
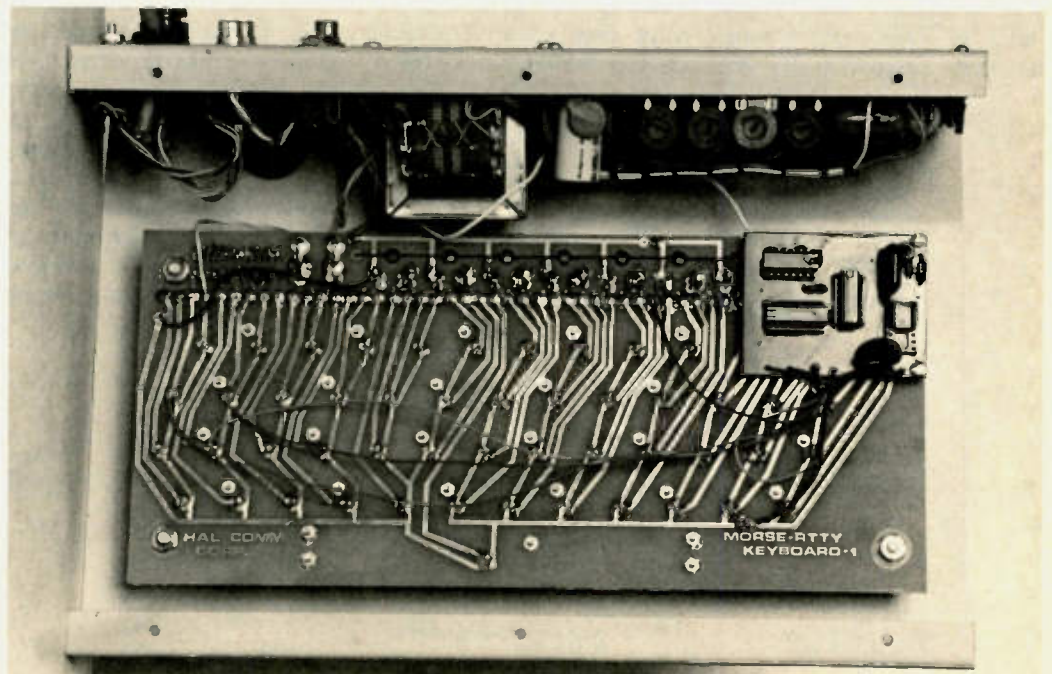

Fig. 3. Return circuit.



Return circuit is mounted to keyswitch board on standoffs.

Mobile Antenna Tips

-- for the beginner

This article is directed primarily to the novice — the experienced amateur won't find very much here that is new. Amateurs have been on wheels longer than CB has even existed. The techniques have changed somewhat since the advent of solid state inverters, so far as mobile power supplies are concerned, but antenna systems remain much the same as always, except for a few gimmicks to facilitate tuning.

The mushrooming popularity of VHF mobile transceivers augmented by

repeaters has largely diverted attention from what this writer believes to be a fascinating, far more challenging phase of mobile operation — high power at low frequency.

It is one thing to power a ten or fifteen Watt transceiver from a twelve volt car battery and quite another to supply a 100 or 200 Watt unit. It is one thing to clamp a 19-inch whip to the gutter or mount it on the roof for 2 meter work, but something else to mount an eight foot whip and make it act like a thirty or sixty foot tower! Operating on two meters poses little in

the way of noise problems: Tune up on 75 in a car and you pick up every spark plug, power line, and neon sign for miles around . . . unless you know what to do about it.

Let us, then, examine the various problems one at a time, beginning with what most mobile enthusiasts find to be the touchiest part of a mobile rig — the antenna. Amateurs have long been operating mobile on every band from 160 meters on up. We do, however, need to have an antenna that is resonant, and a resonant antenna is usually a quarter wavelength or multiple thereof. How, then, can we fit, say, a 75 meter antenna on a car? Somehow I can't imagine a Volkswagen going down the road with a 65-foot whip on the rear bumper. In fact, few mobile antennas are much

more than eight feet long.

The secret lies in the fact that an eight foot whip, being less than a quarter wavelength, presents a capacitive load to the transmitter. But wait. A capacitor has at least two elements. Where is the other one?

The other side of the capacitor is the ground. In our case, it's the car body, which, incidentally, is the worst possible ground plane you can have at these frequencies. Still, it's the only ground available, so we have to make the most of it.

In Fig. 1 we see the way the capacity is distributed. While a formula exists to calculate the capacity, it is a monster, and, for eight foot whips, it has long since been calculated. See Table 1 for the values as they work out for various diameter whips.

OK, then, we have it established that a whip of known dimensions presents a definite value of capacity at the feedpoint. Now, if we add an inductance of the proper amount to resonate the whip to the operating frequency, the antenna is resonant and satisfies the prime requirement of an efficient radiator.

This inductor is added, either at the base where it utilizes the full amount of capacity and is therefore a lower value of inductance, or at the center where more inductance is required, but it distributes the antenna current more evenly. (See Fig. 2.)

The novice who has graduated from CB will recognize this as what many CBers call

	1/8"	1/4"	1/2"
6 feet	17	19	22
7 feet	19	22	25
8 feet	22	24	27
9 feet	24	27	30
10 feet	26	30	33

Table 1. Values expressed in picofarads.

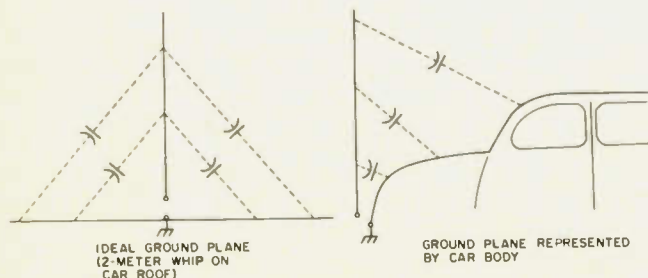

Fig. 1.

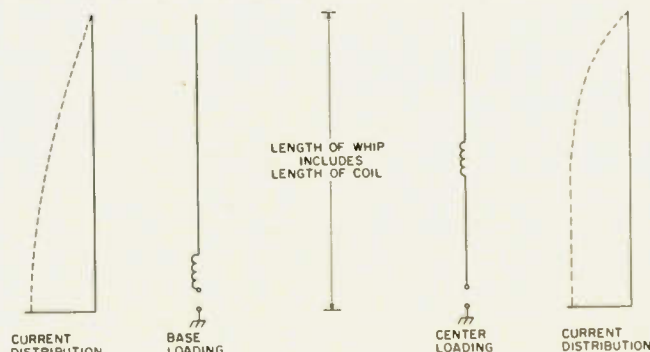

Fig. 2.

a booster coil. Whatever name it is called, it simply resonates the antenna to make it an electrical quarter wavelength. On the lower frequency bands, base-loaded antennas are preferred when the antenna is mounted on the trunk lid, and center loading is generally preferred with fender or bumper mounting. Of course, there are exceptions, mostly depending on an individual's personal tastes.

With the problem of resonating the antenna solved, there is yet another hurdle to jump. At these frequencies, an eight foot whip, even if it is resonant, presents a very low radiation resistance. Consequently, the greater part of the impedance it presents to the transmitter is resistive, and even then the impedance can be considerably lower than the 50 Ohm output of the transmitter. While some manufacturers offer lower than normal impedance cable, there is a better way to solve the problem.

An inductor or a capacitor can be connected directly across the feedpoint to increase the impedance to 50 Ohms. Now I know this goes across the grain of the average novice's knowledge of ac theory. However, it does work. Don't ask me why. I'll confess that I can't fully explain it even though I've written a book on antennas. The reasoning behind it is contained in a fiendish device called a Smith Chart, a round chart of reactance and impedance values which, after 25 years in ham radio, I still don't fully understand. In that respect, I belong to a

very large club which excludes only engineers specializing in antennas. However, I've found to my satisfaction that it does work, and you will too, if you try it. (See Fig. 3.)

Approximate values are given for the lower amateur bands, using either base or center loading. These values do have considerable tolerance, unless you're fussy over swr. Even then, they're not extremely critical. Heathkit, for example, recommended a .001 capacitor on 75 meters, which is quite easy to get. The optimum value, however, is in the neighborhood of .00095. The .001 works quite well, however. (See Fig. 4.)

Once everything's connected, there remains the job of tuning up. I don't want to frighten you away, but, unless you have the right equipment, the initial tune-up of a low band mobile antenna can be a stinker. Don't even consider it unless you have an swr meter and a grid dipper or equivalent.

Tuning Up a Mobile Antenna

Position the vehicle where it will be clear of substantial objects (houses, trees, etc.) for a radius of at least 1/8 wavelength. Couple the dip oscillator into the base of the antenna, either by coupling into the matching inductor, or by adding a small loop of wire between the base of the antenna and the matching capacitor as shown. Adjust the telescoping top section of the antenna until the dip oscillator indicates resonance. (See Fig. 5.) It may be necessary to add or remove a turn or two on the loading

inductor.

At this point I may add that in 25 years of amateur radio, I've yet to find a dip oscillator whose calibrations can be trusted. It is best to tune in the signal of the dip oscillator on a calibrated receiver so you will know where you are in the frequency spectrum.

Once the antenna is set into the right ball park with the dip oscillator, the next thing to do is to key the transmitter at low drive and measure the swr. Then adjust the telescoping section of the antenna, a quarter inch at a time, measuring the swr after each change, until you reach the point where the swr is minimum. This done, you can, if you really insist on a very low swr, juggle the matching capacitor or inductor in 5 or 10% steps to the point where swr is immeasurably low.

Sounds simple, doesn't it? The steps are very basic, yet the process is so extremely critical that it can be a frustrating experience. A quarter inch difference in antenna length at the operating frequency can push the swr up to 2 with 75 meter

operation. On 160 meters, the total bandwidth with a given antenna length is scarcely enough to accommodate two SSB voice channels. If you're transmitting while in motion and a truck passes, you can see the swr momentarily go way up.

Now I've discussed the tune-up process on 75 and 160 meters where the most difficulty is experienced. As you go into higher bands, the tuning becomes less critical. Generally speaking, 40 is the more popular band for low band mobile operation. It is high enough in frequency to minimize noise problems, and low enough for impressive DX operation.

The mention of noise brings in the second biggest bugaboo of mobile operation — the biggest one after you conquer the antenna. For some reason, most natural and man-made static is vertically polarized. Since you have a vertical antenna, it is like having a noise magnet. On 75, the noise can be murder, especially when you are driving along a rural road where the power company is too tight to properly maintain their insulators and

Band	Matching Element (Base-loaded)	Matching Element (Center-loaded)
160	2000 pF, 3.7 uH	1100 pF, 5.73 uH
80	1000 pF, 1.4 uH	920 pF, 1.8 uH
40	660 pF, 0.72 uH	560 pF, 0.85 uH
20	390 pF, 0.31 uH	290 pF, 0.44 uH
15	220 pF, 0.25 uH	130 pF, 0.43 uH
CB and Up	CB — none needed. 8-foot whip naturally resonant; above CB — ¼ wave whip less than 8 feet	

Fig. 4. For a base-loaded whip, the loading coil inductance can be determined by calculating a series tuned circuit consisting of the whip capacity, the matching capacity or inductance, and the loading inductance. Use the formula:

$$L = \frac{1}{(2\pi F)^2 C}$$

For a center-loaded whip, the loading coil inductance can be determined by calculating a series tuned circuit consisting of half the whip capacity, all the matching inductance or capacity, and the loading inductance. Use the same formula.

When the antenna is inductively matched, L in the formula is the sum of the loading coil inductance and the matching inductance.

When the antenna is capacitively matched, C in the formula is the series result of the whip capacity and the matching capacity.

$$C = \frac{C_1 C_2}{C_1 + C_2}$$

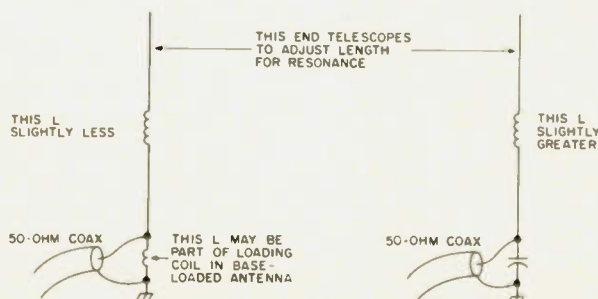

Fig. 3.

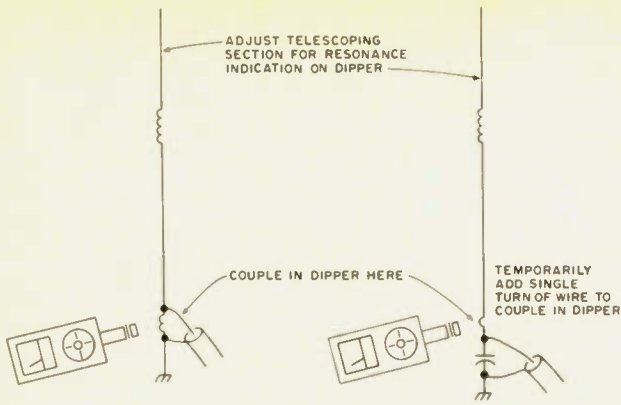

Fig. 5.

transformers. Here in western New York State, for example, a certain rural road between the villages of Mount Morris and Nunda is known among mobile hams for the 20 over S9 roar it produces in their receivers. The power company tightwads must be wasting a tremendous amount of energy there.

If power lines were the only noise worry, mobile hams would have it made. Unfortunately, however, there are numerous other sources of noise. Mother Nature is one of them. I've seen the S-meter climb to over 40 above 9 when there were thunderstorms in the area. On one occasion, as I was hearing the results of a storm in the area of Buffalo 50 miles from where I was, I noticed a steady, whining roar, not too unlike the sound of rain on a tin roof. My rider said it was caused by a tornado, and I pooh-poohed the idea. The next day the papers said that a small funnel had been spotted in Erie county. It hadn't touched the ground, but my receiver had picked it up 50 miles away.

Even Mother Nature can, at times, quiet down.

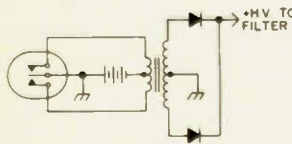

Fig. 7(a). Typical vibrator power supply. The vibrator coil and interrupter contact have been omitted for simplification.

However, the mobile ham is carrying, in addition to his own transmitter, 4, 6, or 8 miniature spark transmitters, and he can't drive away from them. Now, you can't very easily fight the power company or Mother Nature, but you at least have a fighting chance against the noise generated by your car.

Noise can be produced, not only by the spark plugs, but also by the alternator, regulator, distributor, signal lights, horn, and even by the tires. Here is one place where the extreme popularity of CB has helped us. With all those CB radios around trying to pick 5 Watts out of the air, ignition interference suddenly gained high priority on the consumer market. Consequently, ignition suppressor kits are available almost anywhere.

Before you install ignition suppressors in your car, it might be wise to look under the hood. Some spark plugs have suppressors already built in. Some ignition wiring has suppression built in. If you add suppressors to a system that already has suppressor plugs and suppressor wiring, you might end up suppressing the spark that makes your engine go. (See Fig. 6.)

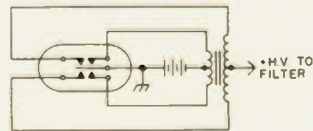

Fig. 7(b). Synchronous vibrator power supply in which an extra pair of contacts provided reactification.

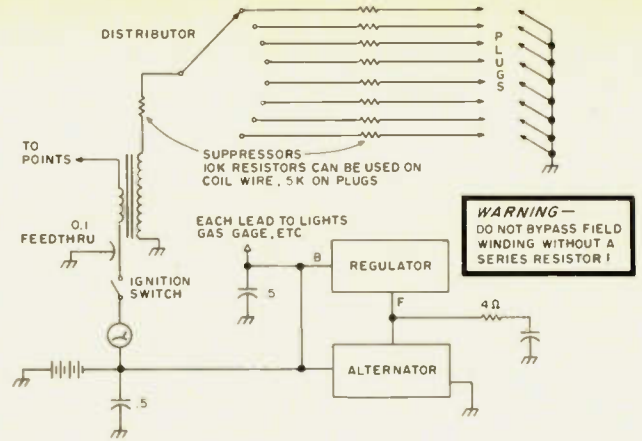

Fig. 6. For additional suppression, coil, distributor, and ignition wiring can be shielded.

Shielded ignition kits are available. I've seen some advertised in *73 Magazine*. If this, together with all the steps recommended in Fig. 6, isn't satisfactory, there is still more you can do. Bond the hood and the car body together with lengths of heavy copper braid on either side near the hinges. Also ground the trunk lid in the same way. Connect the engine block to the car body with another length of braid, and ground the rig in the same way. Grounding the axles to the car body can suppress wheel static. Few amateurs have to take all these steps, but, on the other hand, no two amateurs have the same problems.

Finally, we come to the power supply, and it is here that the state of the art has seen the most dramatic changes in the last couple of decades. Right after World War II, solid state inverters were yet to be invented, so

amateurs had to use other means of providing the needed high voltages for their rigs. Two types of supplies were used: vibrators and dynamotors, and they still provide the answer for the high-power men.

The vibrator supply used a vibrating set of contacts to chop the dc current, which was then fed into a transformer. At one time there were more different types of vibrators than there were circuits to use them in. Some even featured an extra set of contacts to rectify the high voltage. See Fig. 7(a). They had one main disadvantage in the large current demand which could quickly drain a battery.

A dynamotor is a motor operating at the battery voltage which then drives a generator to produce the high voltage. Some produce 115 volts ac, from which any rig could easily be operated. These have the disadvantage of

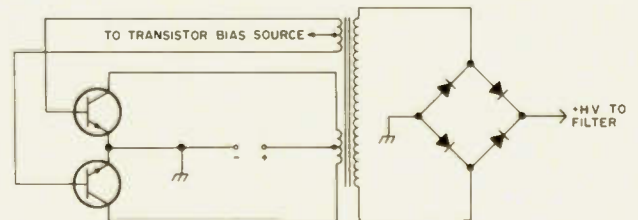

Fig. 8. Simplification of a dc to dc converter. The transistors form an oscillator circuit with the transformer providing feedback and transforming the voltage of the ac thus generated. Except for filter capacitor values, which are smaller due to the higher ripple frequency, the filter and regulation circuits are the same as in a conventional supply. Commercial manufacturers often use a more sophisticated oscillator circuit, employing a starter circuit to ensure that the oscillator always starts oscillating when the unit is turned on.

high current drain as well as the arcing commutator. I've heard of a fellow in Buffalo who once tried to mount a dynamotor in his trunk. He very carefully drilled mounting holes in the trunk floor — right through the top of the gas tank. He did a neat job of installation and drove about for a while, unknowingly filling his trunk with fumes. Then he keyed the rig and blew his trunk lid clean off.

Nowadays most mobile

power supplies utilize solid state inverters. An inverter is simply an oscillator, usually a particular variety of astable multivibrator circuit employing the primary of the power transformer, coupled into a feedback secondary winding. Alternating current is produced in the transformer primary by the flip-flop action of the transistors and transformed to the desired voltages, after which it is rectified and filtered in the conventional manner.

Filter capacitors are usually smaller than those in ac supplies, since the oscillator operates at a much higher frequency than 60 Hz. The multivibrator circuit is preferred over a sine wave producing circuit, since the transistors in a square wave circuit waste much less power. However, the square wave requires a slightly different transformer, and the supply must be well shielded to prevent radiation of rf interference. (See Fig. 8.)

As a general rule, most hams prefer to buy their power supply and antenna. While there is nothing that exotic about these devices, the requirement of rugged construction discourages many home brew enthusiasts who don't have access to a machine shop. As for power supplies, in all too many circumstances, the transformer is designed specially for the manufacturer of a supply and is unavailable to the general public. ■

FCC

Before the
FEDERAL COMMUNICATIONS
COMMISSION
Washington DC 20554

DOCKET NO. 21116

In the Matter of

Amendment of Part 2 of the
Commission's Rules to prohibit
the marketing of external radio
frequency amplifiers capable of
operation in any frequency from
24 to 35 MHz

To: The Commission

OPPOSITION TO PROPOSED RULE MAKING

The American Radio Relay League, Incorporated, the nationwide nonprofit organization of almost 140,000 amateur radio operators and enthusiasts in the United States, submits its opposition to the Notice of Proposed Rule Making released February 28, 1977 (42 F.R. 12203), and requests said proposal not be adopted.

In support whereof, the following is respectfully submitted:

Summary of Comments

The proposal to prohibit the marketing of external radio frequency amplifiers capable of operation on any frequency from 24 to 35 MHz, including the 28-29.7 MHz amateur band, is ill-conceived and impractical and, if adopted, not only will not reduce the unlawful use of such devices by the undisciplined Citizens Band (CB) Radio Service, but also will have a most severe impact upon and unfairly penalize the innocent, law-abiding and self-regulating Amateur Radio Service. The time has come — indeed, it is long past — for the Commissioners and the Commission's staff to concede that rules without effective enforcement are not worth the paper upon which they are written.

The state of the art is such that, unless such devices, including the components, are manufactured in strict conformance to a design either developed or specified by the Commission, any circuitry designed to prevent operation on frequencies from 24 to 35 MHz may be easily circumvented by persons with only minimal technical knowledge and experience. The Commission never has engaged in the development and design of equipment, and does not now propose to do so. In fact, the Commission may lack statu-

tory authority to engage in such activities.

The League, as the only responsible spokesman for a substantial number of the nearly 300,000 licensed amateur radio operators in the United States, for years has been and continues to be extremely concerned about the undisciplined nature of the 27 MHz CB service, the inability of the Commission to enforce its rules, and the lack of Administration and Congressional support of the Commission's efforts. Most unfortunately, efforts of local jurisdictions to eliminate interference to television reception (TVI) from the 27 MHz CB service have had the practical effect of most severely penalizing the amateur radio operators in those jurisdictions. Numerous constructive suggestions and proposals made by the League over the years have been ignored. The League implores the Commission not to give similar treatment to the comments in opposition to the instant proposal.

The Commission is required to act in the public interest. A mere assertion that the public interest will be served by the adoption of rules such as proposed will not suffice; the Commission must demonstrate a reasonable possibility that any new rules are practical and stand a reasonable chance of producing the desired result. The League seriously doubts that any such showing can be made.

II

Circuits Intended To Prevent 24-35 MHz Operation Can Be Easily Circumvented

At the time the Commission adopted the present Section 2.815 of its Rules in 1975,¹

¹ § 2.815 External radio frequency power amplifiers.

(a) As used in this Part, an external radio frequency power amplifier is any device which, (1) when used in conjunction with a radio transmitter as a signal source is capable of amplification of that signal, and (2) is not an integral part of a radio transmitter as manufactured.

(b) After January 23, 1975, no person shall sell or lease, or offer for sale or lease (including advertising for sale or lease), or import, ship or distribute for the purpose of selling or leasing or offering for sale or lease, any external radio frequency power amplifier capable of use with a transmitter operated on any frequency or frequencies between 24.00 MHz and 35.00 MHz. Type accepted external radio frequency power amplifiers as defined herein may not be marketed after August 12, 1975.

(c) The proscription in paragraph (b) of this section shall not apply in the case of any external radio frequency power amplifier capable of use with a transmitter in the amateur frequency bands 28.00-29.70 MHz if the amplifier is an integral part of a unit or device having incorporated there power amplification capability in the bands 7000-7300 kHz, 14,000-14,350 kHz and 21.00-21.45 MHz.

(d) The proscription in paragraph (b) of this section shall not apply in the marketing to another licensed amateur radio operator of any single band external radio frequency power amplifier fabri-

external radio frequency amplifiers almost without exception employed an output circuit tuned to the operating frequency. Operation on several frequency bands, e.g., the 3.5, 7, 14, 21, and 28 MHz amateur bands, usually was accomplished by switching into or out of the tuned circuit inductance, capacitance, or both.

About that time, amplifiers, both internal and external, employing broadband radio frequency transformers and capable of operation on any frequency between 3.5 and 29.7 MHz without any tuning adjustments appeared on the market. Thus, these amplifiers met the exemption of Section 2.815 and hundreds are manufactured and sold each day to CB operators.^{2,3}

After explaining that the "24 MHz and 35 MHz limits were chosen so that practical circuitry could be used to achieve adequate suppression of radio frequency energy appearing on the CB frequencies" with only "a minimum effect upon the licensees of other services" (Notice, para. 8), the Commission states as follows:

9. Comments are also solicited concerning the practicality of such a prohibition and possible techniques which would be used to produce such an amplifier. Such comments should also address the problems associated with preventing the few unscrupulous manufacturers from including such features as accessible wiring which can be cut to provide operation on the prohibited frequencies, controls both external and internal which could provide for operation on these frequencies, or any other concepts which could be used to circumvent this prohibition.

Most unfortunately, there are not readily available at this time circuitry and techniques which cannot be easily circumvented by an unscrupulous dealer, service technician, or user, unless the Commission has the legal authority to specify certain manufac-

cated in not more than one unit of the same model by any licensed amateur radio operator, whose license affords him the privilege of operating on amateur frequencies between 1.80 and 29.00 MHz, for his own personal use at his licensed amateur radio station.

² The Notice of Proposed Rule Making in this proceeding states, in pertinent part, as follows:

2. To illustrate the manner in which the new rules were circumvented, almost immediately after the Report and Order [Docket No. 20118, 40 F.R. 12431] was released, there appeared on the market a device commonly called a "broadband linear." These devices may be considered to meet the strict letter of our Rules, inasmuch as they claim to provide for operation on the frequency bands specified under our exemption. However, these devices have an even greater potential for interference due to the higher levels of spurious emissions.

4. The advertisements for external radio frequency amplifiers generally carry a specific disclaimer to the effect that "Use of this equipment is not permitted in the Citizens Band (CB) Radio Service in the United States." However, the suppliers of such equipment consistently place their advertisements in publications which cater to the CB operator and seldom, if ever, advertise in publications that cater to amateur operators who could use such power amplifiers legally. Thus,

turing techniques such as, perhaps, encapsulated tuned circuits or transformers which not only are inaccessible but also cannot be substituted or bypassed. The League knows of no provision of the Communications Act of 1934, as amended, which gives the Commission authority over manufacturing design and techniques except for home television receivers which must be capable of reception of all VHF and UHF television channels.⁴

The frequency of an amplifier designed for operation on frequencies immediately below 24 MHz and employing at least one tuned circuit can easily be increased to 27 MHz by reducing either the inductance or capacitance, or both, of the tuned circuit. Reductions in inductance can be accomplished by any of several simple techniques such as increasing the spacing between turns, changing a tap, or shorting a turn. Reductions in capacitance can be accomplished by inserting another capacitor in series with the tuning capacitor, by removing a plate from a variable air capacitor, or by decreasing the meshing of plates of a variable air capacitor. The frequency of an amplifier designed for operation on frequencies immediately above 35 MHz and employing at least one tuned circuit can easily be decreased to 27 MHz by increasing either the inductance or capacitance, or both, of the tuned circuit. Increases in inductance can be accomplished by inserting magnetic material, such as a powdered iron core, in the field. Increases in capacitance can be accomplished merely by adding another capacitor in parallel with the capacitor of the tuned circuit.

The frequency response of the recently developed broadband transformer type amplifiers can best be limited by employing a low pass filter in amplifiers designed for operation on frequencies below 24 MHz, and

Continued on page 168

some equipment suppliers see fit to comply only with the strict letter of the law, and at the same time disregard the spirit of the law, encouraging subversion of the Commission's regulations and efforts at improving the quality of the Citizens Band for all licensees. This is our next step in increasing the level of regulation applicable to the marketing of external RF power amplifiers.

³ A recent report in a reputable electronic industry publication stated that a single manufacturer is producing 6,000 amplifiers each week. Another publication recently estimated that at least 4,000,000 stations are operating with power far in excess of the 4 Watts output permitted by the Rules.

⁴ Section 303(s) of the Communications Act of 1934, as amended, provides as follows:

§ 303. Except as otherwise provided in this chapter, the Commission from time to time, as public convenience, interest, or necessity requires, shall —

(s) Have authority to require that apparatus designed to receive television pictures broadcast simultaneously with sound be capable of adequately receiving all frequencies allocated by the Commission to television broadcasting when such apparatus is shipped in interstate commerce, or is imported from any foreign country into the United States, for sale or resale to the public.

Super Wilson

-- several useful modifications

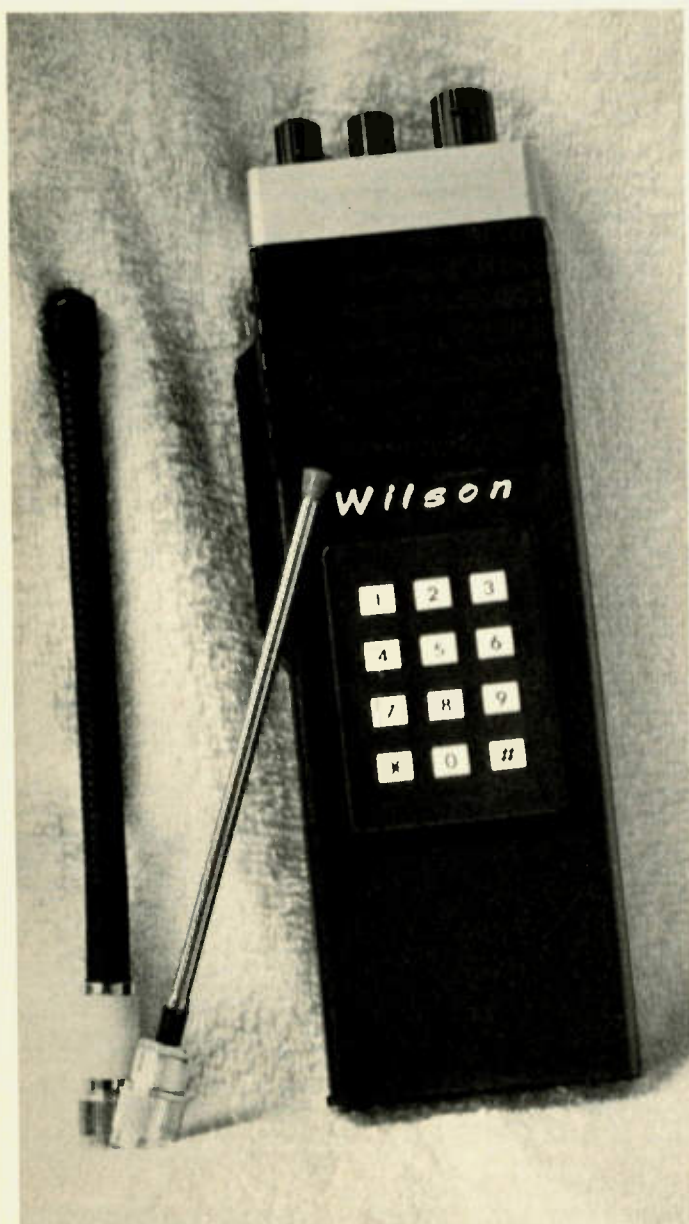

Super Wilson, with the modifications described in the text, is compact and original in appearance. The Digitran pad and full length antenna are shown.

One of the most flexible means of enjoying ham radio today is with the use of a small two meter handie-talkie. The capability of these rigs appears to be limited only by one's imagination. You can carry them anywhere and experience interference-free operation on a moment's notice. Likewise, the enjoyment of HT operation can be substantially increased if you add a few personal touches to your unit.

The following information describes such expansions that I added to my Wilson 1405 SM. These modifications are equally applicable to other handie-talkies which are presently available. You can mix and match these modifications as desired.

As I previously owned an elaborate, but low power, HT (Motorola HT 100 modified for 1 Watt on 4 frequencies as described in November, 1973, *73 Magazine*, page 77), I decided that my next HT should run the highest power reasonably available. Wilson's 5 Watt unit was the logical choice. After hassling with some minor purchase problems for a couple of months, I finally found time to modify the Wilson. Modifications included: 1) a special touchtone encoder, 2) carrier/"on" indicator, 3) extendable full length whip, 4) external antenna adaptor, 5)

remote mike, 6) alternate blinker, and several other additions which will be discussed briefly at the end of this article.

Touchtone Encoder

The touchtone™ encoder consists of two parts: a small "SME" encoder manufactured by Data Signal, Inc., 2403 Commerce Lane, Albany GA 31707, and a Digitran touch pad obtained from Pipo Communications, Box 3435, Hollywood CA 90028. The "SME" was chosen because it perfectly filled the Wilson's only available free space, because the two tone levels could be independently adjusted (a necessity with the 1405 SM), and because of its previous outstanding performance.*

The newly-announced Digitran pad caught my eye because of its positive snap action, small size, and rugged construction. Mating these two units and mounting them in the Wilson can be a time-consuming project unless you follow a specific guideline similar to that described here.

Remove the HT's front cover and battery pack, and then ream a shallow trench inside the cover's back from the pad's connecting area to the cover's top. Mark the exact location for touchpad mounting/connection holes

*"The Shirt Pocket Touchtone," *73 Magazine*, Nov. 1976, pg. 58.

and carefully drill the holes. I did this by dipping the pad's bottom in the XYL's sewing chalk, and then sitting it on the HT. The white chalk left marks where each hole should be drilled. (I must have been too exacting on this because she doused me in leftover chalk shortly thereafter.)

Now secure a short length of small, flat 8 conductor cable (alpha wire makes a suitable cable), and ascertain that it fits flush in the reamed groove. Solder cable connections to the "SME", route the cable around the SME's bottom side, and tape it as shown in Fig. 1. Set the encoder and cable exactly in place as shown in Fig. 2; then trim leads and solder touch-tone pad connections as shown in Fig. 1. This is also an ideal time to adjust high/low tone amplitudes for compatibility with the Wilson's frequency response. As the Wilson attenuated low frequency tones ≈ 3 dB (identifiable by its ability to dial all numbers except 1, 2 and 3), I paralleled the "low frequency 4.7k" resistor (R3 on Data's board) with another 4.7k resistor. This solved the problem perfectly. (Data Signal supplies complete instructions with each unit on adjusting tone levels to match rigs.) Wrap a layer of tape around the 1 MHz crystal and tape the encoder above the speaker's magnet (see Fig. 2).

Next, series connect a 500k pot and non-polarized 1 μ F capacitor from the encoder output to the microphone's connection pad beside the mike. (Later the pot will be replaced with a fixed value 1/4 Watt resistor.) Surprisingly, my unit works only when this wire connects to the mike cable shield rather than the center conductor, so remember to swap connections if your unit doesn't tone. You are now ready to power up the opened HT and set tone level with the 500k pot. (I did this by actually dialing a number with the opened HT.) Now remove the pot, measure its resistance, and substitute a 1/4 Watt resistor for it. Wrap the resistor and capacitor in tape and fit them into available space. Finally, shift the encoder's position as required to avoid hitting the volume control, and reassemble the HT. Have patience and be careful not to force the case together. (Remember the tilt angle shown in Fig. 2?)

Carrier/On Indicator

Another useful modification for the Wilson HT is an incoming carrier indicator. This circuit activates a light emitting diode when a signal is on frequency, regardless of the HT's volume setting. An activating signal for this circuit is obtained from the junction of R066 and R067 in the Wilson. The best way

to locate this point is with the use of a volt ohmmeter. Turn on the opened HT and switch it to an unoccupied channel. Make sure the rig is squelched. Set the VOM on a low voltage range and connect the negative lead to ground. Then, carefully touch the positive prod to the top of each resistor near Q118 and IC101. When you touch the proper resistor, the volt ohmmeter will deflect to approximately +2 volts. Unsquelching the HT will decrease this voltage to approximately zero. After locating this point, use a small soldering iron and carefully solder a small wire from that point to the input of Fig. 3.

Referring to Fig. 3, when the HT is squelched, +2 volts are applied to the base of Q1 through isolation resistor R1. This forward biases Q1, which conducts and shorts out the LED. The base voltage of Q1 rises from +2 to $\approx +6$ volts during transmit; however, Q1 merely stays on. Base voltage on Q1 drops to zero when a signal is received, thus "opening" Q1 and allowing the LED to light. Current drain of this circuit is limited to $\approx .5$ mA by R2. If this circuit is assembled as shown in Fig. 3(b), Q1 and R1 can be placed in the open area near Q118 and a small wire routed to an unused pin on the external mike connector. The LED and R2 are then mounted in the top of this connector, securing voltage from the appropriate pins (pins 4 and 5). A jumper is placed

between the previously mentioned R1/Q1 pin and the junction of R2 and the LED. This provides incoming carrier indication. Removing this jumper allows the LED to function as a simple on/off indicator for the HT. A small cover/mount for the indicator may then be fabricated from cardboard and electrical tape.

Collapsible Antenna

A full length whip (which will substantially increase HT performance from fringe areas) is fabricated from the top part of a portable TV whip and a TNC rf connector. The whip is cut at 19 inches and crimped to hold the center connecting pin of this plug. Then the whip and pin are soldered for rigidity. A short piece of heat shrinkable tubing is affixed to the whip's bottom to prevent shorts, and the TNC's RG-58 reducer is slipped over the whip. A dimple is then added to prevent slippage, and the whip assembly (reducer, etc.) is screwed into the TNC plug. The collapsible antenna is now smaller than Wilson's rubber ducky and easier to carry.

External Mike and Antenna Connector

One of the main disadvantages of 2 meter mobile rigs is their high theft rate. Their only true means of protection is removing them every time you leave the car — no exceptions. My solution to this dilemma is to use the HT mobile and carry it with me when leaving the car. Thus,

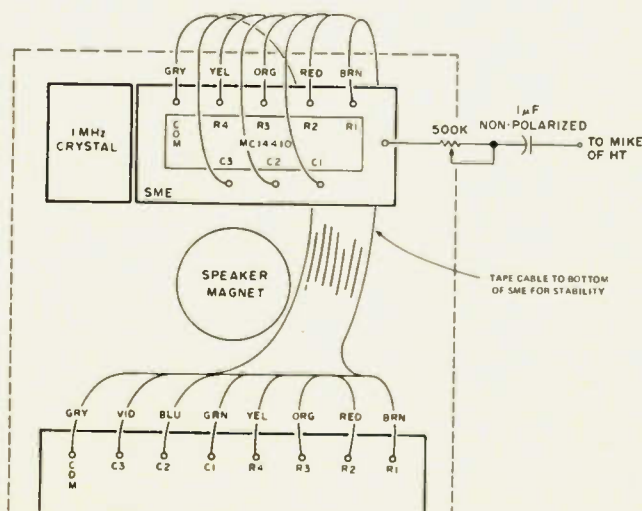

Fig. 1. Touchtone layout for inside of the HT's front cover.

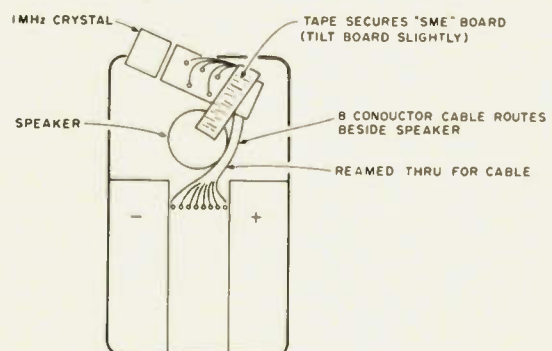

Fig. 2. A mounting suggestion for "SME" in the HT's front cover.

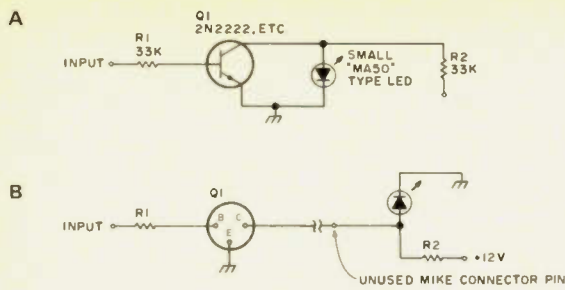

Fig. 3. a) Carrier indicator for the Wilson. b) Parts layout for the carrier indicator.

interesting QSOs are never missed due to chore stops. I merely grab the rig and continue the conversation. For mobile use, an extension rf cable is made from a 2 foot length of RG-184, a PL259 and a TNC connector. This cable and a magnetic mount 5/8 wave antenna provide very reliable mobile communications. An under-the-seat rf amplifier may be added here if desired.

Although I merely hold the complete HT during brief mobile excursions, I also fabricated a mobile mike for extended hands-free mobile use. This mike is constructed by placing a small Motorola HT mike at the end of a lightweight tube and cementing an alligator clip to the other end of this tube. Mike wires are routed through the tube and to the HT. This boom mike is clipped to my glasses during use. Transmit/receive switching is accomplished by mounting a stomp-to-talk switch near the auto's light dimmer switch. The rig can be used portable within seconds by disconnecting the external mike/PTT plug and antenna connector.

Alternate Flasher

As a special nonsense feature, I placed an LED on each side of the HT and connected them to a small 555 flasher circuit, which I mounted in the open (PL) area near the rig's bottom. The circuit for this blinker is shown in Fig. 4. This item doesn't do anything for the HT except make it look impressive. Build it small so you'll have room for more

important modifications later. Component values are not critical, so feel free to use whatever junk box parts you have available. My circuit was assembled on a one inch piece of vectorboard as shown in Fig. 4. Power for the flasher is derived from the HT's battery pack. This may be accomplished by locating S202 (A and B) and moving the 1 Watt connections to the off position, and then securing flasher voltage from the 1 Watt position. The HT's hot wire is then connected through the unused squelch control switch for rig on/off functions. These flasher circuits were so enjoyable to build and use that I constructed several of them. Then I purchased some small paper mache animals with hollow insides from a local gift store and mounted the circuits in them. LEDs were placed in the drilled out eyes. A 9 volt transistor battery was placed in each unit for powering the flasher. Exclude the 2k resistor on pin 8 to +V if you use a 9 volt battery.

Latest Modifications

As mentioned earlier, I continue to modify the Wilson at every opportunity. Some of my latest ideas will now be described briefly.

Call Indicator — I often monitor one of our repeaters for calls at specific times, so I fashioned a simple set-reset circuit to indicate when this repeater was keyed "on". In the event I miss a call (or the HT's volume is low while I'm doing something else), an LED will be illuminated until it's extinguished by a reset button. As this circuit

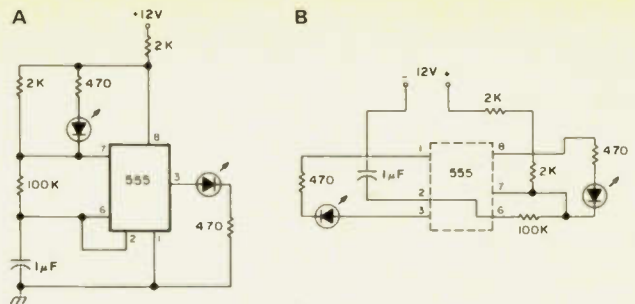

Fig. 4. a) The alternate flasher for the HT LEDs can be hamfest or Radio Shack specials. Resistor values are not critical. b) Parts layout for the flasher.

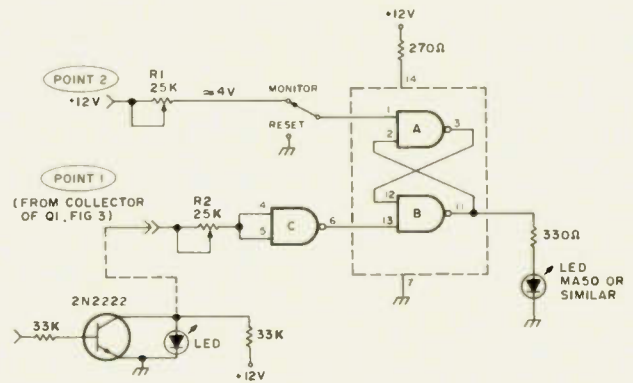

Fig. 5. Set-reset call indicator used on Super Wilson.

connects to the squelch-operated carrier indicator of Fig. 3, it can monitor any frequency to which the HT is switched. The "call LED" will illuminate when any carrier on frequency breaks squelch on the HT, but this is quite acceptable for my use.

Referring to Fig. 5, point 1 connects to the collector of Q1 in Fig. 3, and point 2 connects to the rig's +12 volts. R1 and R2 may be replaced by fixed resistors whose values are determined by the following procedure.

Set R1 and R2 to maximum before energizing the circuit, and then apply power and adjust R2 for proper "call LED" tracking (approximately 4 volts at pin 13 of IC1). Next, adjust R1 until the flip-flop resets properly (approximately 4 volts at pin 1 of IC1). Now measure R1 and R2 and replace them with the appropriate resistors. Don't forget to include the 270 Ohm resistor to pin 14 of the IC. Mount the complete circuit on a small piece of vectorboard and put it in one corner of the previously

mentioned PL area.

Carry Strap/Holster — Like many of the popular HT's, my unit has two features which don't impress me — it's uncomfortable when carried on my belt, and it doesn't have an internally contained antenna. As an alternative to this inconvenience, I am having a local leather craft shop fabricate a shoulder carry strap/holster with a sewn-in 19 inch length of wire. One end of this wire will go to a connector which plugs into the HT's antenna jack. This antenna will primarily be used for receiving, rather than transmitting.

I'm also working on a mobile battery charger for the HT, and contemplating adding my Sinclair Black Watch to the unit. There's enough room available in the PL area for the watch's circuitry, and the readout can be placed above the touch-tone pad on the case front.

I see that Tec Kan has recently introduced a 6 channel scanner for the Wilson, so forthcoming modifications may be perpetual. ■

'ROUND THE WORLD CRUISE'

Meet adventure head on!

Rapa, Tahiti, Moorea, Galapagos,
Zanzibar, Devil's Island, Madagascar,
Martinique, Samoa, Tutuila, Danger Island
aboard the world famous motor sailer Yankee
Trader.

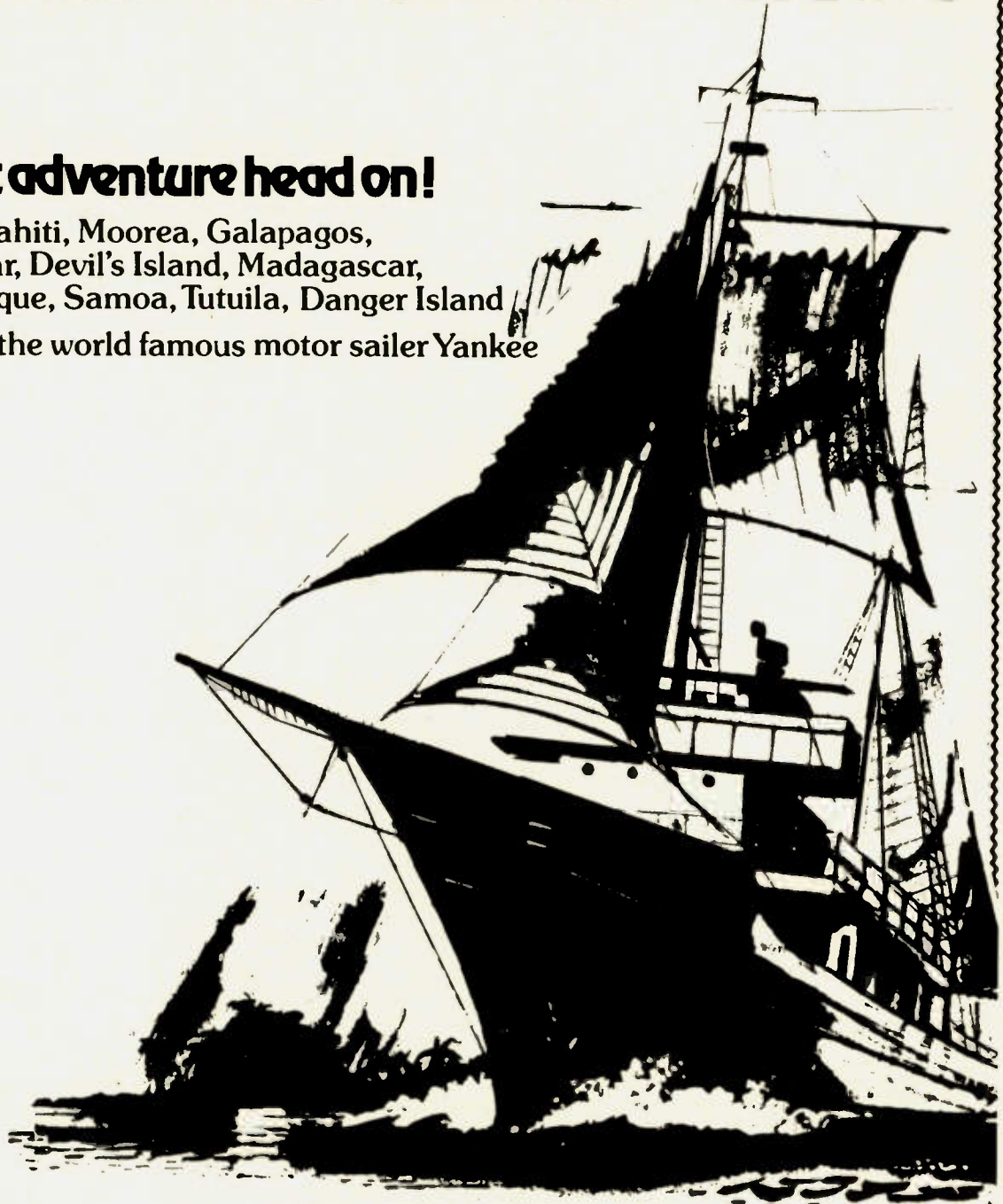

SPECIAL HAM DISCOUNT

Send me your color brochure on 10 day 'barefoot' vacations from \$250.

Name _____

Address _____

City _____ State _____ Zip _____

 **Windjammer Cruises.**

Post Office Box 120, Dept. 00, Miami Beach, Florida 33139.

from page 163

by employing a high pass filter in amplifiers designed for operation on frequencies immediately above 35 MHz. In either case, the filter can easily be rendered ineffective by a single bypass wire. By their very nature, broadband transformers do not have sharp frequency cutoff characteristics.

There may be circuits or techniques of a proprietary nature not known to the League. If there are, it seems unreasonable to believe that they will be used voluntarily by a manufacturer not favoring the instant proposal.

A rule such as proposed may appear to a person without technical knowledge to be practical and desirable. However, as illustrated above, there are many ways in which an unscrupulous dealer, service technician, or user can circumvent the rule.

III

Restriction On Dissemination Of Information As To How The Rule Can Be Circumvented Would Be Unrealistic And Impractical And May Violate The First Amendment To The Constitution

The notice appears to invite comments as to whether the Commission can prohibit an unscrupulous manufacturer from including in the operation, instruction, or service manual information as to how the prohibition against operation between 24 and 35 MHz can be circumvented. Even if the Commission has the authority to dictate or restrict the content of such manuals, and the League knows of no provision of the Communications Act granting such authority, the information most certainly will be widely disseminated by other means, such as magazine articles, mailing pieces, telephone, and word of mouth. Violation of First Amendment constitutional rights undoubtedly would be raised should the Commission undertake any such restrictions.

IV

Small Scale Garage and Basement Manufacturing Would Occur Even If Circuits And Techniques Are Available To Achieve The Commission's Objectives

The components necessary to build an amplifier for use on the 27 MHz CB band are readily available and relatively inexpensive. Design and construction articles already are contained in numerous publications. Is it not reasonable to expect that many qualified persons will want to earn extra money by building amplifiers on a small scale basis? The League thinks so. Instead of having only a limited number of relatively large un-

scrupulous manufacturers, the Commission will be confronted by a very large number of small unscrupulous manufacturers as well as by countless thousands of home constructors. Once again, the rule would not achieve the intended result.

V

Prohibiting The Marketing Of External Power Amplifiers Capable Of Operation Between 24 and 35 MHz Would Not Prevent Illegal High Power Operation At 27 MHz

The maximum output of 27 MHz transmitters is 4 Watts average power for the amplitude modulation (AM) mode and 12 Watts peak envelope power (pep) for the single sideband suppressed carrier (SSB) mode. If the primary objective of the instant proposal is to prevent operation with higher powers, that objective cannot be achieved by limiting the frequency range of external radio frequency amplifiers as proposed in the Notice.

Many manufacturers, both domestic and foreign, now produce HF transceivers for operation on all amateur frequencies between 3.5 and 29.7 MHz with output powers from 50 to 500 Watts. The ready availability of such transceivers led the Commission in 1976 to increase the maximum input power to the final stage of transmitters operated by Novice Class operators from 75 to 250 Watts [Section 97.67(d), Docket 20282]. Within the last few months, transceivers with single sideband (SSB) output powers in excess of 1,000 Watts pep have appeared on the market and have been widely advertised in magazines catering to CB operators. Almost all of the HF transmitters can be operated in the 27 MHz CB band and on the frequencies between that band and the 28 MHz amateur band merely by substituting a quartz crystal, which can be purchased for \$3.95 to \$7.95, or by re-adjusting one tuned circuit. Tens of thousands of transceivers now are operated in violation of the Commission's rules on frequencies within and immediately above the 27 MHz CB band. If the primary purpose of the proposal of this proceeding is to limit or prevent 27 MHz CB operations with powers in excess of that authorized by the rules, it cannot be achieved by adoption of the amplifier proposal of this proceeding.

VI

Type Approval, Type Acceptance or Certification Would be Impractical

In companion Notice of Proposed Rule Making in Docket 21117 (42 F.R. 12204), released concurrently with the Notice in the instant proceeding, the Commission has proposed amendment of Section 2.983 of its

rules to require type acceptance of equipment marketed for use in the Amateur Radio Service. Although the League is submitting separate comments in response to that Notice, a few observations at this time are appropriate.

The purpose of type approval, type acceptance or certification is to assure that certain equipments meet minimum specifications and standards set forth in the Commission's rules. For example, in the Amateur Service, spurious radiations from transmitters and oscillator circuits and receivers are legitimate concerns of the Commission. However, there is a substantial question as to whether the Commission's statutory authority extends beyond the electrical and safety characteristics to mechanical design. To illustrate, if an external amplifier which employs a low pass filter to prevent radio frequency output on frequencies above 24 MHz meets the specifications and standards for fundamental frequency and spurious radiations, can the Commission nevertheless refuse to grant type approval, type acceptance, or certification because the design permits the filter to be easily bypassed, thereby making possible operation at 27 MHz? The answer appears to be that the Commission has no such authority and must grant type approval, type acceptance or certification. This subject is discussed in greater depth in the League's comments in response to the Notice in Docket No. 21117.

VII

Construction Of Single Amplifiers Should Not Be Limited To Operators With General Or Higher Class Licenses

The Commission recognizes that many amateurs construct their own equipment and proposes that "to lessen the impact of this proposal upon the amateur operator who wishes to use the 10 meter [28 MHz] band, . . . a licensed amateur operator may construct one unit of a particular model amplifier for use at his own station" which he may also sell to another licensed amateur operator. Comments are invited to the proposal that "construction of these amplifiers will be restricted to those operators with a General or higher class license" (Notice, para. 10).

If the proposal to prohibit the marketing of amplifiers capable of operation between 24 and 35 MHz should be adopted, the League supports adoption of the exemption for amplifiers constructed by a licensed amateur for his own use. However, the League objects to the proposal that the amateur hold a General or higher class license.

The Commission's proposal is not limited to external radio frequency amplifiers having certain characteristics such as the radio frequency input and output powers. An ever increasing number of amateurs are specializing in low power (QRP) operation with transmitter powers up to 5 Watts. At least one QRP manufactured transceiver and

at least one QRP transmitter kit are available, and QRP contests are conducted on a regular basis.

The limitation of amplifier construction to those holding a General or a higher class license would work a severe and unfair hardship upon Novice class operators. For example, many Novices operate QRP transmitters in the CW subbands of the 3.5, 7, 21 and 28 MHz amateur bands. Should the Commission's proposal be adopted, the Novice no longer would be permitted to construct an external amplifier capable of increasing his station's power from one or three Watts to fifty or one hundred Watts in the 28 MHz band, even though he may operate with an input power of 250 Watts in that band.

The Commission observes that consideration was given to "the higher degree of technical competence and experience which must be demonstrated to obtain such a (General class) license" (Notice, para. 10). A radio frequency amplifier, particularly one with relatively low power to cover two adjacent amateur bands, such as the 21 and 28 MHz bands, is a simple device which requires little technical competence or experience to construct.

Limiting construction of amplifiers to certain classes of operators would be unreasonable and unfair.

VIII

The Feasibility Of Prohibiting Sale Of Amplifiers To Other Than Licensed Amateurs Should Be Explored

Chairman Richard E. Wiley concurred with considerable reluctance to the issuance of the Notice in this proceeding, and expressed the hope "that the comments we receive will suggest other and better alternatives to the Commission's proposals" and, at the same time, "recognize the tremendous task facing the FCC in regulating CB radio which, in the space of only 2 years, has grown from 50,000 license applications a month to over one million applications in January, 1977, alone."

From time to time in recent years, individual amateurs have suggested that dealers in amateur equipment be prohibited from selling amateur and amateur type equipment to persons not holding valid amateur licenses. A few dealers have adopted such a policy and practice. Most unfortunately, it appears that voluntary compliance with such a policy on a large scale cannot be achieved.

Two petitions for rule making proposing rules to permit the sale of amateur type equipment only to licensed amateurs now are before the Commission awaiting action: RM-2839, filed by the San Antonio Repeater Association on February 9, 1977, and RM-2866, filed by Frank W. Napurano, licensee of Amateur Radio Station K20KA, on March 24, 1977. The R. L. Drake Co. has filed comments in response to RM-2839 which set forth a comprehensive and detailed plan to provide such controls. Numerous comments in response to the Notice in this proceeding suggest similar controls. Some of the respondents also have suggested that all amplifiers and transceivers bear permanently affixed serial numbers and a central registration office be established to aid in enforcement activities.

Although the League has considered the feasibility of prohibiting the sale of external radio frequency amplifiers, transmitters and transceivers to persons not holding a valid amateur license, it has serious doubts as to the statutory authority of the Commission to adopt such rules and practices.

The League strongly recommends that the Commission proceed with high priority the two petitions, RM-2839 and RM-2866, and either issue a notice of inquiry and notice of proposed rule making or deny the petitions with a statement of the reasons for the action. Should a denial of the petitions be based upon lack of statutory authority to adopt and enforce any such rules, requests for appropriate legislation then can be presented to the Congress.

NOT FOR EVERYONE . . .

The Antenna For The Purist

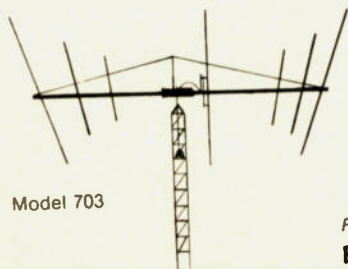

Model 703

- No Traps
- Seven Elements
- Three Bands (10-15-20)
- Single Feed Line
- Flexible Tuning
- Close To Mono-Bander Specs With Optimum Spacing For: High Forward Gain High F:B & F:S Ratios

For Specifications Write To:

BROOKFIELD MANUFACTURING CO.
50 Whipoorwill Road
Bethel, CT 06801
(203) 792-8944

B13

IX
Effective Enforcement Of The
Present Rules
Is The Only Solution To
The Problem Of Illegal
Operations

The Commission has been aware of the widespread misuse of the 27 MHz CB and adjacent channels by unlicensed stations and by stations operating with powers in excess of that permitted by its rules since shortly after the Class D Citizens Radio Service was established in 1958. The Commission's requests to Congress for legislation granting it authority over unlicensed stations and equipments have gone unanswered for several years. Requests for funds to mount an effective or wide or nationwide enforcement program have been unproductive. The Commission is the laughingstock of millions of licensed as well as unlicensed 27 MHz CB operators. The chances of a CBER being apprehended for unlawful operation are far less than a motorist being apprehended for violation of the national 55 mile per hour speed limit in a state where only token enforcement is practiced.

Amateur radio operators have expressed their concern over the ever increasing unlawful operations in and close to the 27 MHz CB band over the years, and have been expecting the CBERs to overrun the amateur bands like swarms of locusts and grasshoppers. Advance intruders already have appeared in the amateur bands, some using amateur call signs either assigned to others or unassigned, and some operating only with pseudonyms or "handles" or phony call signs.

Effective enforcement is the only solution. Millions of CB operators are losing respect for law and order by the excesses on the CB band. The Commission must find some way to impress upon Congress the need for funds to mount an effective enforcement program, not so much against the individual operator who may violate relatively minor rules, but against the flagrant individual violators, manufacturers, and sellers of the high power equipment used for such unlawful purposes. Perhaps legislation granting the Commission additional enforcement powers also is necessary. But one thing is certain: Adoption of unenforceable rules such as those proposed here will simply make matters worse and make even more difficult, if not impossible, the adoption of corrective measures in the future.

X

Conclusions

There must be some reasonable expectation that a rule will be effective before it can be adopted (Home Box Office, Inc., v. FCC, 1977). It is respectfully submitted that no useful purpose will be served by adopting a rule prohibiting the manufacture or sale of external radio frequency amplifiers capable of use between 24 and 35 MHz as proposed in this proceeding. Termination of this proceeding is respectfully requested.

Respectfully submitted,
**THE AMERICAN RADIO
RELAY LEAGUE,
INCORPORATED**
Robert M. Booth, Jr.
General Counsel

COMMENTS ON DOCKET 2117

Assuming Docket 2117 is adopted by the FCC in some form or another, manufacturers of amateur radio equipment will be faced with a number of difficult, and hard to answer problems.

For Example:

1. Will conformance of a product to federal standards at the time of manufacture provide an inherent defense against product liability suits?
2. Is there any statute of limitations to define how long after manufacture (or original purchase) that a manufacturer remains liable for the performance specs?
3. Will modification or alteration of the equipment relieve the manufacturer of further liability?
4. Does misuse of the equipment provide

a defense?

5. Must defects be present at the time of manufacture in order to justify claims, or will manufacturers remain liable for developed defects?

These questions, and their answers, should point up a serious oversight in the FCC's thinking. Other commercial services do not "encourage experimentation" by owners or operators. By placing the responsibility for transmitter adjustments in the hands of licensed commercial radiotelephone/radiotelegraph operators, the responsibility for spurious, or incorrect, transmitter adjustments is limited to that known, tested, and (presumably) qualified group.

Contrast this with the typical amateur, as we know him, and it readily is apparent that equipment manufacturers are headed into stormy waters. Modification is the norm in the amateur service, misuse is common, and twenty-year-old equipment can be found in almost any ham shack.

Let me ask you (with what we now have from the FCC) if the manufacturer of a twenty-year-old antenna tuner is liable for a corroded screw terminal that causes excessive harmonic/interference, resulting in the ham being fined \$500.00.

Grandfathering? That is no defense in 1987 for what we are producing in 1977. Nor will it be a proven defense until one or more of us is sued and successfully defends himself. From some ham whom the FCC fined 500 (or 5,000) bucks, and he blames the equipment.

To protect themselves from future legal hassles, manufacturers will be forced to increase their product liability insurance, and build a fund to provide legal defenses against future lawsuits by amateurs and various agencies of the government in addition to the FCC. With Docket 2117, OSHA, consumer groups, Customs, and God knows who else will have an interest in ham radio that they never saw before.

The net result of Docket 2117 will be to increase the cost to the purchaser, by enough to cover the extra QC recording, outside engineering lab work, UL approvals, product insurance premiums, legal defense fund, and the engineering freeze that is sure to occur in amateur equipment (as it has in commercial equipment).

These things frequently have a domino effect. By making it necessary to precisely identify the break-in point where a capacitor made by AEROVOX is substituted for an identical (or better) one made by TOSHIBA, the manufacturing engineer resists the substitution, and will only do it if the original is unavailable. Production is stopped totally at times in military work for this precise reason.

As a manufacturer, you must prepare your defense in advance by having absolute configuration control, with supporting documentation to prove that each change was necessary and justified. Do you now have a configuration control system? If not, then expect to add on that cost, too. How long should you retain the records? As long as you are liable, and right now there is no answer.

What are your chances of being nailed? Ask General Motors. They substituted equal or better Chevy engines for Pontiac and Olds engines. Their bill (so far) is over a million dollars.

Now, Docket 2117 is serious, and the amateur service was exempted from type acceptance requirements for very valid reasons. Amateurs are encouraged to experiment, develop new approaches, and modify their gear; commercial users are not.

QST runs "Hints & Kinks," and so does Ham Radio, CO, 73 and many, many non-ham publications such as *Popular Electronics*. Indeed, Yaesu is "blessed" with a group called the "FOX-TANGO CLUB," which monthly issues quantities of modifications, some of which even work. Will Yaesu be liable if some "FOX-TANGO" mod results in out-of-spec operation? Or a 73 mod? Or a QST kink?

These are the questions that we must press upon the FCC, hopefully to encourage them into some other, less harmful, course of action to solve their interference problem.

It is important to realize that the domestic issues presented so far pale into insignificance when viewed in terms of WARC '79. With amateur radio interests going unrepresented to any significant degree, the very real possibility is present that ham radio could go to a new philosophy entirely.

If, as one country suggests, HF operations were chopped to 20 kHz limits below 30 MHz, manufacturers can look forward to new designs and a shift away from traffic handling, DX hunting, and probably phone operation, because who would assign 3 kHz SSB slots into a 20 kHz band? CW would be the only practical mode — probably coherent CW, of the nature described recently in one of the amateur magazines. Lucky you!

Above 220 MHz? Fine, but with the loss of our wide choice of satellite frequencies, not much DX with countries who cannot come up with good UHF-SHF gear.

Lots of changes are coming, and soon. What can you as a manufacturer do? You can band together in organizations like ARMA, to give you a means of doing things like lobbying and passing favorable rulings.

You can set up formal QC organizations and initiate a configuration control system that will withstand a legal assault.

You can begin examination of your advertising, to be sure that no legal grounds exist on which the FTC or consumer groups could bring suit. Have your lawyer and your chief engineer approve every ad before it is released.

Place your ads where the publisher is not hostile to manufacturers. Does that sound silly? It's not, because (as strange as it seems) some magazines are just bleeding us to finance other operations. You can sense the contempt in which they hold "store bought" equipment.

As far as I know, only one magazine has begun to actively support ARMA, and they even help the smaller advertisers make up ads. This is not to imply that the rest are hostile — just derelict, indifferent, or not comprehending the importance of what the ham radio manufacturing industry is undergoing.

Our company is not the smallest in the business, but we will look long and hard at our 1978 advertising budget, and we advise you to do the same. If the amateur population increases at 30,000 per year, this figure (when converted to dollar purchases and divided up among all companies from our size to the Ma and Pa outfits, plus sales of used equipment to new hams) simply does not represent significant, or even noticeable, growth. Unless everyone who struggles to make a dollar in the ham market presents a united front, the harassment that amateur radio is undergoing, and will be undergoing in the next few years, could spell its demise as an industry.

This united front must include not only the few manufacturers that exist within the U.S. and in foreign countries, but amateur radio dealers, the electronics publications (with spearheading by the ham publications), and gear roots hams. And, we cannot get hopeful about what the general amateur population might do to help, as it consists of a rather inarticulate group, largely young people or retirees — by tradition, they expect that someone else will come to their salvation. Doubtless the military will preserve their own out-of-ham-band frequencies for MARS use, but there are now only several thousand hams involved with this special service, and their pool of operators will diminish in proportion to the total ham population.

I want to emphasize as strongly as possible that we must press forward as soon as practicable with our ham ambassador program, or risk not having an industry at all! Without amateur frequencies, FCC actions affecting the amateur manufacturer become moot.

We must elicit answers from the FCC regarding precisely what the basis will be for acceptance/rejection of new designs of amateur gear, and what the requirements are for records (and how long must they be kept?). How detailed must a configuration control

system be, with respect to prints, manuals, and engineering change orders?

The liability question must be studied, and limits put into the rules to avoid those problems now being experienced in other industries.

In short, we have two major projects, and possibly a third.

It has been put forward for discussion that amateur radio is totally represented to the world by the ARRL, and that a second organization, providing an alternative for individual amateurs, should be brought about in the near future.

Naturally, the ARRL is opposed to this idea, on the basis that it would provide a divisive picture to the FCC and the world, and result in damage to the ARS as a whole.

Several other arguments against a second organization have been put forth, but the possibility of damaging the amateur service by polarizing individual hams into two hostile camps is the only serious consideration we find valid.

Currently, the ARRL claims about 120,000 paid members, or roughly 40% of the 300,000 licensed amateur population.

The "sole and only" approach has been successful in the past, and anyone who thinks the ARRL has not made solid contributions in the amateur radio service simply has had his head in the sand.

Without the ARRL, DX awards, satellites, conventions, and a yard-long list of services would not have occurred at all, so it is small cheese indeed to cry that the ARRL is bad for ham radio. It is no exaggeration to say that none of us would even be in this business today if it were not for the League developing a market for us.

But the monolithic structuring of the ARRL has led to occasional blunders, and like most organizations (including my own), we (and they) have no desire to parade our failures, screw-ups, and outright bums out to public view.

Burying one's past mistakes is only human. Indeed, doctors do it all the time. But doctors are trained to learn from their errors, and occasionally even account legally for the malpractice.

Lacking checks and balances, the ARRL has shown increasing tendencies to turn a deaf ear to any voice west of the Allegheny Mountains, and for years has been laughingly pointed to as "living behind the codfish curtain."

So perhaps in the fullness of time, the ARRL has reached a "critical mass."

If the ARRL represents 40%, who represents the other 60% of the amateur population?

Would a new amateur radio group attract its membership from the ARRL's 40%, the uncommitted 60%, or both? Or neither? One of the first things to do would be to survey the amateur population and see if hams themselves want to join any new group.

The form of a "second ARRL" would probably determine its success or failure, so a great deal of thought should be given to where the ARRL must compete head to head, and to what areas the new organization would find itself exclusively owner of.

For example, the ARRL cannot lobby, so that would become an exclusive feature of the second group. Both would purport to represent amateurs, so a head to head contest for bodies would be natural. However, the ARRL would remain the sole purveyor of such invaluable technical aids as they now produce, along with their panoply of awards, certificates and so forth.

The ARRL has made it quite inviting for a new organization to gestate. They increased their dues again, as well as advertising rates, travel expenses, and salaries.

In a word, they are "fat." Enough of the mechanics involved; what positive good would occur that would make ham radio prosper and grow?

I cannot answer that question to my own satisfaction, and admit that until more information is available, a second organization would be hard to endorse.

Nevertheless, it is essential that we in ARMA take up this question and give it the careful study it deserves. We, as a group, could make it happen, if we choose to do so,

and if it appears to be good for amateur radio to do so, we should grasp the nettle firmly and move with firmness and dispatch to start the ball rolling. If on balance it appears harmful to get a second organization into the act, then the matter should be dropped.

So the third major question is here: Should ARMA open up a second amateur radio organization, or not?

Thank you for your patience, your attention, and the privilege of sharing these thoughts with you.

Bernie Towers
Yaesu Radio Corp.

Before the
FEDERAL COMMUNICATIONS
COMMISSION
Washington DC 20554
DOCKET NO. 21117

In the Matter of

Amendment of Parts 2 and 97 of the
Commission's Rules to require type
acceptance of equipment marketed
for use in the Amateur Radio Service

To: The Commission

OPPOSITION TO PROPOSED
RULE MAKING

The American Radio Relay League, Incorporated, the nationwide nonprofit organization of almost 140,000 amateur radio operators and enthusiasts in the United States, submits its opposition to the Notice of Proposed Rule Making released February 28, 1977 (42 F.R. 12204), and requests said proposal not be adopted.

In support whereof, the following is respectfully submitted:

I
Summary Of Comments

The reasons given by the Commission for proposing type acceptance of equipment marketed for use in the Amateur Radio Service are (1) to control the design of transmitters, transceivers, and external radio frequency amplifiers to prevent their unlawful use with or without modification in the 27 MHz Citizens Band Radio Service, and (2) to "protect" the amateur bands from "store bought" equipment that does not at least meet minimum technical standards.

The League opposes adoption of the proposals for the following reasons: (1) the desired result, i.e., control of the design and marketing of transmitters, transceivers, and external radio frequency amplifiers to prevent their use in the 27 MHz CB band, would not be achieved; (2) no significant need for type acceptance of amateur equipment has been shown and none is known to the League; and (3) the statutory authority of the Commission to control the design and related characteristics of amateur equipment without specific legislation by the Congress is questionable.

II
Amateur Equipment Usually
Is Designed To Cover
Frequencies Outside The
Amateur Bands

Most HF equipment now manufactured for sale to and used by amateurs is designed to cover frequencies outside the present amateur bands for one or more of the

following reasons: (1) to facilitate design and construction; (2) to make possible operation of the amateur station as a Military Affiliate Radio System (MARS) station on government frequencies usually adjacent to the amateur bands¹; (3) to provide for changes in amateur bands by World Administrative Radio Conferences²; (4) to permit operation on amateur bands available for use in some countries but not in the United States³; and (5) to permit use of equipment by other services with but minor modifications.^{4,5}

The many variations in design and the flexibility of operation of HF amateur equipment makes impossible effective measures to prevent operation of such equipment with but minor modification or adjustment in the 27 MHz CB band. Restrictions on the design of HF amateur transmitters and transceivers, and perhaps of external radio frequency amplifiers, even if possible and practical, would eliminate the flexibility necessary to (1) accommodate future changes in the amateur bands, (2) participate in MARS, and (3) participate in Alaskan emergency communications on 4,383.8 kHz. Restrictions also would seriously inhibit the design and development of amateur equipment and the usefulness of such equipment to other services and, in time of national emergency, to the government.

III
The Commission's Objectives,
To Prevent Use Of Amateur
Equipment On 27 MHz CB
Frequencies, Would Not Be
Achieved

The primary purpose of the proposal to require type acceptance of amateur equipment is to prevent use of such equipment for illegal operation in the 27 MHz CB band and adjacent frequencies. In its Notice, the Commission states:

2. . . . The vast majority of amateurs now utilize commercially produced equipment, although the individual amateur operator often modifies this equipment to alter or improve its capabilities. This trend has resulted in a proliferation of equipment makes and models, and among them are now several types not only operable on amateur frequencies, but also, with no or only minor modifications, capable of operation on the 27 MHz CB frequencies. This quasi-CB equipment, as well as all other amateur equipment, does not now fall under the Commission's regulations on type acceptance and marketing, and we believe that the time has now come to amend our rules accordingly.

4. *We visualize the type acceptance requirement as a method to bring to our attention the quasi-CB equipment of the type mentioned above.* At that time, we can determine the suitability of permitting the marketing of the equipment. Under our type acceptance requirements, before a grant is made, we must determine not only that the equipment meets the applicable technical standards, but also that a grant of type acceptance would be in the public interest. Conditions which we would look for in deciding if a type acceptance grant should be made include, but are not limited to: any accessible wiring which, when cut, would allow operation on a frequency where use of the equipment is not permitted; the providing of circuit boards or similar circuitry to facilitate the addition of components, the purpose of which would be to change the equipment's operating characteristics in a manner not permitted under our rules; or, any internal or

external adjustments or controls which are provided to facilitate operation in a manner not permitted under our Rules. Therefore, if a device met the technical requirements of the ARS (Part 97) but was presumably intended for illegal use in another service, type acceptance could be denied and the manufacturer would be denied the right to market that device. The manufacturer of devices intended for legitimate use would not be affected by this proposal. Comment is requested concerning specific details which should be placed in our rules concerning the conditions under which type acceptance could be denied. (Emphasis supplied.)

As shown in the discussion in the preceding section, almost all HF amateur transmitters and transceivers fall within the Commission's definition of "quasi-CB equipment." Just because the equipment may be easily adjusted or modified to operate on frequencies outside the present amateur bands, even including the 27 MHz CB band, does not and cannot create a presumption that the manufacturer intended that the equipment would be used illegally in the 27 MHz CB band.

It is apparent that the Commission contends that it may refuse to grant type acceptance to equipment which fully "meets the applicable technical standards" if there are some features of the design and construction it does not like. The League respectfully disagrees and submits that any other characteristics which might possibly bring about a refusal to grant type acceptance must be clearly and concisely stated in the rules. In the absence of such rules, how would a manufacturer know what standards he must meet to obtain type acceptance, how could the Commission defend itself against charges that refusal to grant type acceptance was arbitrary and capricious, and how could a court review upon appeal?

In the last sentence of paragraph 4, the Commission asks for "specific details which should be placed in our rules concerning the conditions under which type acceptance could be denied."

The League can offer no such suggestions, for the following reasons: *First*, present day design and construction practices provide the frequency flexibility necessary for full and complete amateur operation now and in the future. *Second*, as discussed later in these comments, there is serious question that the Commission has statutory authority to adopt and apply restrictions on the design and construction of amateur equipment.

The inescapable fact is that the Commission's objectives, to prevent use of amateur equipment of 27 MHz CB frequencies, cannot be achieved through the guise of type acceptance.

IV
Statutory Authority To Use
Type Acceptance To Regulate
Electrical and Mechanical Design
Is Doubtful

It is apparent from paragraph 4 of the Notice, particularly the third and fourth sentences, that the Commission believes it has the statutory authority to withhold grant of type acceptance even though the equipment fully "meets the applicable technical standards."

The League knows of no provision of the Communications Act of 1934, as amended, or other statutes, which gives the Commission authority to regulate the electrical and mechanical design and manufacturing techniques of equipment, with but two exceptions. The first exception is where safety of life or property may be endangered. The

second is Section 303(s) of the Communications Act which granted the Commission the authority to adopt and enforce rules requiring that all television receivers be capable of adequately receiving all VHF and UHF television broadcast channels — the all-channel receiver bill.

It appears from the third sentence of paragraph 4 that the Commission believes it has authority to determine that equipment not only "meets the applicable technical standards, but also that a grant of type acceptance would be in the public interest." "The public interest" is a nebulous standard. Under the guise of the "public interest" and nothing more, an agency could act in a most arbitrary manner. It is respectfully submitted that equipment which meets all "applicable technical standards" and presents no safety hazards must be granted type acceptance without a supplemental "public interest" conclusion.

The public interest required that television receivers be capable of receiving all VHF and UHF channels. Without such receivers, the demise of early UHF stations was imminent, and growth of an effective UHF television service was doubtful. The Commission concluded in 1961 that it lacked authority under its "public interest" power to adopt and enforce regulations requiring all-channel receivers. If the Commission found it necessary to seek statutory authority to adopt rules for all-channel television receivers, it would appear that statutory authority must be obtained from the Congress to adopt and enforce rules to prevent amateur equipment, particularly transceivers and external amplifiers, from being capable of operation in the 27 MHz CB band.

The League respectfully suggests that this matter be carefully considered before any rules such as proposed here are finalized. The size of the amateur market is sufficiently large that the possibility of an appeal is great should the proposals of this proceeding be adopted.

V
Need For Type Acceptance
Has Not Been Shown

Some need for adoption of a rule must be shown or be apparent. Except for the desire to prevent use of amateur equipment for unlawful 27 MHz CB operation discussed in paragraphs 2 and 4 of the Notice (which are quoted earlier in these comments), the only need or justification appears in general language in paragraph 5 of the Notice:

5. Although the rules will continue to place the responsibility for meeting high technical standards upon the individual amateur, and we will continue to encourage experimentation and testing of equipment, we believe that those marketing amateur equipment must share in the responsibility to provide equipment capable of meeting these standards. Moreover, type acceptance of commercially marketed equipment does offer certain benefits to the amateur community. In addition to closing the amateur "loop-hole" that allows illegal CB "linears" to be openly advertised and sold, these requirements will also assist in preventing the marketing of inferior equipment to amateurs. The amateur band will be protected from "store bought" equipment that does not at least meet minimum technical standards.⁶ This should result in fewer occurrences of interference to television receivers, other home electronic equipment, and other radio services including the amateur service itself.

It has been the League's experience, particularly in recent years, that amateur

¹ Some MARS frequencies and bands are adjacent to the HF amateur bands, and others are scattered throughout much of the HF portion of the spectrum.

² The League has urged the Commission to support a proposal that the United States propose new amateur bands in the vicinity of 10, 18 and 24 MHz at the WARC to be held in 1979. Tentative proposals prepared by the Commission contemplate the following changes in the present HF amateur bands: from 7.0-7.3 MHz to 6.95-7.25 MHz; from 14.0-14.35 MHz to 13.95-14.4 MHz;

from 21.00-21.45 MHz to 20.95-21.45 MHz; and a new band, 25.76-26.86 MHz (Fifth Notice of Inquiry, Docket 20271, released May 23, 1977).

³ The band 26.96-27.23 MHz was withdrawn from amateur use in the United States in 1958 and made available for the Class D Citizens Radio Service.

⁴ Amateur equipment of at least one manufacturer was purchased by the Department of Defense during the Viet Nam action and is widely used at the present time. The amateur equipment of another manufacturer is used in the Maritime Mobile Radio Service with only minor modifica-

tions. Sources of equipment are readily available in times of national emergency.

⁵ Amateur stations in Alaska may operate on 4,383.8 kHz with a maximum power of 150 Watts for emergency communications with other authorized stations in and within 50 nautical miles of Alaska.

⁶ Recently, a case of commercially marketed amateur radio equipment operating in the 2 meter band caused harmful interference to a radio navigation system used by aircraft. It was found that the

equipment was generating spurious emissions which were disrupting operations of this source of interference required investigation by the Commission, in addition to assistance from the amateur operators. The operators involved cooperated by ceasing operation until the equipment problem was corrected. It is anticipated that such situations will be minimized by requiring the equipment suppliers to demonstrate to the Commission the capability of their equipment to comply with the appropriate technical standards before they are permitted to market it to the amateur community.

equipment is designed and built to very high standards. Equipments of many manufacturers have undergone extensive testing in the League's well-equipped laboratory before advertising has been accepted for QST or before descriptions of equipments have been reported in QST. As far as the League has been able to ascertain, every manufacturer of receivers, transmitters, transceivers, and external amplifiers either owns modern up-to-date test equipment including spectrum analyzers, or has access to such equipment through contract with a qualified laboratory. Spurious radiations, if they do occur, are more likely to result from malfunctioning of some component than from any deficiency in design. The single example in footnote 6 of interference from spurious emissions from an amateur station illustrates the effectiveness of amateur cooperation in eliminating interference conditions. Have not the manufacturers learned a lesson from that incident? Are dozens of manufacturers to be ensnared in government red tape because of a single incident involving a single manufacturer? How could the higher prices which would be required be of benefit to the individual amateurs? The answer is obvious. One instance of unsatisfactory equipment does not establish a need for type acceptance of all equipment.

The League is not opposed to type acceptance if there is a real need for it. It does oppose the instant proposal, however, both because it knows of no substantial need and because the real purpose is to achieve control over the design of equipment in an effort to prevent its use in the 27 MHz CB band. There is no way even to estimate at this time the effect type acceptance and the modifications required to prevent a "change in the equipment's operating characteristics" (Notice, para. 4) which the Commission may impose, would have on the basic design and construction, the adaptability for operation on other frequencies such as those of MARS and those which may be added by the 1979 WARC, ease of servicing, and cost to the amateur.

Unless and until a more persuasive showing is made that type acceptance, as proposed in this proceeding, would not have an adverse impact upon the Amateur Radio Service and its equipment, the League must oppose the proposal.

VI The Proposed Limits On Spurious Emissions And Radiations Are Unnecessarily Severe

As recently as March 2, 1977, the Commission amended Section 97.73 of its Rules to establish the following limits on spurious emissions:

§97.73 Purity of emissions.

(a) The mean power of any spurious emission or radiation from any amateur transmitter or external radio frequency power amplifier being operated with a carrier frequency below 30 MHz shall be at least 40 decibels below the mean power of the fundamental without exceeding the power of 50 milliwatts. For equipment of mean power less than 5 Watts, the attenuation shall be at least 30 decibels.

(b) The mean power of any spurious emission or radiation from any amateur transmitter or external radio frequency power amplifier being operated with a carrier frequency above 50 MHz but below 235 MHz shall be at least 60 decibels below the mean power of the fundamental. For transmitters having mean power of 25 Watts or less, the mean power of any spurious radiation supplied to the antenna transmission line shall be at least 40 decibels below the mean power of the fundamental without exceeding the power of 25 microwatts, but, in any event, need not be reduced below the power of 10 microwatts.

(c) Spurious emission or radiation from an amateur transmitter or external radio frequency power amplifier being operated with a carrier frequency above 235 MHz shall be reduced or eliminated in accordance

with good engineering practice.

The Commission now proposes even stricter limits for type acceptance. After stating in paragraph 6 that, while the limits of Section 97.73

may be adequate for equipment used by the individual amateur, we propose to require a 43 + 10 log (mean power in Watts) decibel suppression for type acceptance purposes, inasmuch as such equipment may be available in large quantities and thus, in the aggregate, will have a greater potential for interference. This degree of attenuation was chosen to correspond to the requirements for the land mobile and broadcast services.

It is respectfully submitted that there is no sound basis for suppressing spurious emissions of amateur equipment beyond those set forth in Section 97.73. Unlike transmitters in the land mobile and broadcast services which are designed to operate on one or a limited number of discrete frequencies, most amateur HF transmitters, transceivers, and amplifiers are designed to operate on any frequency within five amateur bands between 3.5 and 29.7 MHz, and some equipments are designed to operate in the MF 1.8 MHz band as well as four or five HF bands. The design of equipment operating over such a wide range of frequencies is much more difficult than for equipment operating on fixed frequencies. In addition, should spurious emissions occur, they probably would fall within the amateur band and not cause interference to any other service. Any potentially objectional spurious emission probably would be a harmonic and, because of the harmonic relationship of the amateur bands, might very well fall within an amateur band. Finally, when complaints of interference are received, whether because of spurious emissions, overloading of the complainant's receiver, or other causes, the amateur invariably installs a low pass filter in the output of his transmitter which attenuates all harmonic emissions above the designed cutoff frequency by at least 60 dB and often more than 80 dB. The end result is that there is only a very slight possibility of spurious emissions from an amateur station even without the limits of Section 97.73.

One other concern must be expressed. The building of amateur equipment from kits supplied by several manufacturers is an extremely important aspect of amateur radio. Not only does the kit builder often obtain high quality equipment at a price lower than that of manufactured equipment, but also he improves his technical knowledge and learns to service his equipment should malfunctioning occur.

Under the circumstances, it is respectfully submitted that no need has been shown and none exists for increasing the spurious emission limits for type acceptance beyond those specified in Section 97.73.

VII Interference From Operation In The Amateur 10 Meter Band Has Not Been A Problem

In a further effort to justify its type acceptance proposal, the Commission states as follows:

7. Traditionally, the amateur operators have been in the forefront in developing techniques for solving interference problems, both through the use of external filtering and through actual modification of the transmitting equipment. This, in addition to the lesser degree of proliferation of equipment as compared to transmitters in the Citizens Band Radio Service, is our reason for not requiring the attenuation level of these transmitters to be as great as for the CB band. However, it may be necessary in a future rule making proceeding to readdress this matter if frequent problems from interference occur. Of immediate concern is operation in the 10 meter band. A Notice of Inquiry and Proposed Rule Making in Docket 21000 released November 30, 1976, addressed the matter of requiring 100 decibels of attenuation for spurious and harmonic emissions generated from transmitters in the

Citizens Band Radio Service. Any actions taken in Docket 21000 may be reflected in our actions in this proceeding. Therefore, the attenuation level of spurious and harmonic emissions for transmitters operating in the 10 meter band may be made equivalent to any attenuation levels which may be adopted in Docket 21000. Presumably, the Commission is referring to television interference.

The number of complaints of television interference from amateur operations in the 28.0-29.7 MHz band has been commensurate with complaints from operation in lower frequency amateur bands. The techniques referred to in paragraph 7 of the notice consist of installation of low pass filters between the output of the transmitters and the input to the antennas, and, at times, a high pass filter between the television receiving antenna and the input to the tuner of the receiver. Occasionally, additional shielding and/or grounding has been necessary.

To equate amateur 10 meter operation with the 27 MHz CB service is unfair in the extreme. A CB operator is not required to have any knowledge whatsoever of radio theory. All that is required is enough money to buy a transceiver, an antenna, and a transmission line, and file a simple application for license with this Commission. As noted by Chairman Richard E. Wiley when he reluctantly concurred in the issuance of the instant Notice of Proposed Rule Making:

My concern is that, in attempting to deal with the rapidly proliferating and sometimes troublesome CB service, we may appear to be penalizing the amateur community which, in my judgment, is one of the most "professional" and self-regulated services within the Commission's jurisdiction.

I look forward to a healthy and vigorous discussion on the proceedings which the Commission has opened today. Whatever their ultimate outcome, I wish to take this opportunity to express my respect and admiration for the amateur community. I hope and trust my colleagues will give these dockets, and the comments filed by the amateur community (as well as others), careful attention prior to reaching any final conclusion.

Should the Commission find it desirable or necessary to apply even more rigid standards on equipment capable of operation in the amateur 28 MHz (10 meter) band, a further notice of proposed rule making would be appropriate and is requested.

VIII It Is Not Clear If Existing Manufactured Equipment Would Be "Grandfathered"

It is not clear from the Notice if manufactured equipment now in the possession of amateurs would be granted "grandfather rights" to permit the continued use and unrestricted sale of such equipment. The following appears in the Notice:

8. We wish to stress that although we propose to require the use of type accepted equipment at stations in the ARS, we have made specific exemptions for equipment constructed or modified by individual amateurs for use at a licensed station in the ARS. While manufacturers would be prohibited from marketing equipment prior to the receipt of a grant of type acceptance, the individual amateur would be permitted to construct his own equipment or to modify his equipment, whether home built or commercially procured, provided the modified equipment was for use at a licensed amateur station. In addition, the amateur would be permitted to sell his home built or modified equipment to another amateur. However, the amateur operator who decides to build or modify equipment in quantity for sale to other amateurs will be considered a manufacturer and will be subject to the type acceptance requirement. We feel that this will place the minimum burden upon the individual amateur radio licensee and will still encourage the experimentation and

testing of equipment which, in the past, has been a major characteristic of the amateur community. (Emphasis supplied.)

Any changes in the rules obsoleting equipment would impose a very heavy financial burden upon amateurs. Unlike commercial users of radio, amateurs cannot amortize for tax purposes the cost of their equipment.

The Notice leaves unanswered several important questions. Must an amateur modify his manufactured equipment in some manner to continue to use it or to sell it? A similar ambiguity in the Notice of Proposed Rule Making and in the First Report and Order in Docket 20777 led to the filing of several petitions for reconsideration and brought about clarifying amendments to the rules adopted by the First Report.

Should the substance of the rules proposed in this proceeding be adopted, the League urges that the lessons learned in Docket 20777 be applied here, and that the report and order as well as the rules specifically provide that all equipment now owned by amateurs be exempt. The League also recommends that ample lead time be provided before any new or amended rules become effective to enable manufacturers to set up new production lines and distributors and dealers to sell equipment now in the distribution system.

IX What Has Happened To The Commission's Program Of Deregulation?

Under the leadership of Chairman Wiley, the Commission embarked upon a program of deregulation four years ago. Insofar as the amateur service is concerned, a few deregulation actions were taken, followed shortly thereafter by more restrictions under the guise of deregulation. Now, in a number of proposals including Dockets 21000, 21116, and 21117, all pretense of deregulation has been abandoned.

The League is constrained to ask, "What has happened to the Commission's program of deregulation of the Amateur Radio Service which almost every Commissioner for the last 40 years has praised for its self-regulation?"

X Amateurs Are Cognizant Of And Deeply Concerned About The Illegal High Power Operations In And Adjacent To The 27 MHz CB Band

In the almost 20 years since the Class D 27 MHz CB service was established, literally thousands of amateurs have expressed to the Commission and to members of Congress their concern about the excesses in 27 MHz operations by both licensed and unlicensed stations. Particularly since the growth of the 27 MHz CB service exploded two years ago, amateurs have been unjustly blamed for television and other interference actually caused by high power operation of 27 MHz CB equipment in violation of the rules, with the result that countless municipalities have adopted ordinances severely restricting the use of outdoor antennas by amateurs.

The League's objection to the proposals of this proceeding and to those of Dockets 20282, 20777, and 21116 should not be construed as a lack of awareness of the extremely serious problem of illegal CB type operations facing the Commission.⁷ The League is most desirous of assisting the Commission in finding a solution to the dilemma, but it cannot sit idly by while the Commission proposes regulation after regulation which will have the cumulative effect of emasculating the amateur service.

XI The Feasibility Of Prohibiting Sale Of Amateur Equipment To

⁷It is respectfully submitted that the critical comments in paragraph 3 of the Notice are not warranted. The method to be used for determining power of an amateur transmitter is unrelated to the instant proposal.

**Other Than Licensed Amateurs
Should Be Explored**

Chairman Wiley concurred with considerable reluctance to the issuance of the Notice in this proceeding, and expressed the hope "that the comments we receive will suggest other and better alternatives to the Commission's proposals" and, at the same time, "recognize the tremendous task facing the FCC in regulating CB radio which, in the space of only 2 years, has grown from 50,000 license applications a month to over one million applications in January, 1977, alone."

As long ago as 1971, the League suggested in comments filed in opposition to RM-1747 and in opposition to the proposal for a Class E CB service in the 220 MHz amateur band (Docket 19759) that the Commission consider prohibiting sale of amateur equipment to other than licensed amateur operators and requiring the registration of serially numbered equipment. Similar suggestions have been received from other amateurs over the years. A few dealers in amateur equipment have adopted a policy and practice of refusing to sell to non-amateurs. Most unfortunately, it appears that voluntary compliance with such a policy on a large scale cannot be achieved.

Two petitions for rule making proposing rules to permit the sale of amateur type equipment only to licensed amateurs now are before the Commission awaiting action: RM-2839, filed by the San Antonio Repeater Association on February 9, 1977, and RM-2866, filed by Frank W. Napurano, licensee of Amateur Radio Station K2OKA, on March 24, 1977. The R. L. Drake Co. has filed comments in response to RM-2839 which set forth a comprehensive and detailed plan to provide such controls. Numerous comments in response to the Notice in this proceeding suggest similar controls. Some of the respondents also have suggested that all amplifiers and transceivers bear permanently affixed serial numbers and a

central registration office be established to aid in enforcement activities.

Although the League has considered the feasibility of prohibiting the sale of external radio frequency amplifiers, transmitters, and transceivers to persons not holding a valid amateur license, it has serious doubts as to the statutory authority of the Commission to adopt such rules and practices.

The League strongly recommends that the Commission process with high priority the two petitions, RM-2839 and RM-2866, and either issue a notice of inquiry and notice of proposed rule making or deny the petitions with a statement of the reasons for the action. Should a denial of the petitions be based upon lack of statutory authority to adopt and enforce any such rules, requests for appropriate legislation then can be presented to the Congress.

**XII
Effective Enforcement Of The
Present Rules
Is The Only Solution To
The Problem Of Illegal
Operations**

The Commission has been aware of the widespread misuse of the 27 MHz CB and adjacent channels by unlicensed stations and by stations operating with powers in excess of that permitted by its rules since shortly after the Class D Citizens Radio Service was established in 1958. The Commission's requests to Congress for legislation granting it authority over unlicensed stations and equipments have gone unanswered for several years. Requests for funds to mount an effective arwide or nationwide enforcement program have been unproductive. The Commission is the laughingstock of millions of licensed as well as unlicensed 27 MHz CB operators. The chances of a CB'er being apprehended for unlawful operation are far less than a motorist being apprehended for violation of the national 55 mpe per hour speed limit in a state where only token

enforcement is practiced.

Amateur radio operators have expressed their concern over the ever increasing unlawful operations in and close to the 27 MHz band over the years, and their fear that CB'ers may overrun the amateur bands. "Intruders" already have appeared in the amateur bands, some using amateur call signs either assigned to others or unassigned, and some operating only with pseudonyms or "handles" or phony call signs.

Effective enforcement is the only solution. Millions of CB operators are losing respect for law and order because of the lack of enforcement of the rules and the excesses on the CB band. *The Commission must find some way to impress upon the Office of Management and Budget and upon Congress the need for funds to mount an effective enforcement program.* Any such program should be directed not so much against the individual operator who may violate relatively minor rules, but against the flagrant individual violators, manufacturers, and sellers of the high power equipment, both transceivers and external amplifiers, used for such unlawful purposes. Perhaps legislation granting the Commission additional enforcement powers also is necessary. *But one thing is certain: Adoption of unnecessary and unenforceable rules such as those proposed here will simply make matters worse and make even more difficult, if not impossible, the adoption of corrective measures in the future.*

**XIII
Conclusions**

The League well understands the demands of constituents to their representatives in Congress "to do something to clean up the CB mess" which interferes with their television reception, the urgings by members of Congress that the Commission take some affirmative action, and the pressures upon the Commission's staff to come forward with some solutions. The League and the

entire Amateur Radio Service are just as desirous of finding a solution to the CB mess as is the Commission.

Amateurs, because of their technical training and practical experience acquired under the Commission's comprehensive and effective programs and policies, are uniquely qualified to evaluate the effectiveness of proposals intended to find at least a partial solution to the troublesome CB problems. The comments of the League and numerous individual amateurs opposing the proposals in this proceeding and the companion proceeding in Docket 21116 should be considered as being constructive. The Commission's hope that adoption of the proposals in these two proceedings will be effective has been misplaced.

If even one lesson has been learned from this proceeding and from the basic 27 MHz CB problem, it is that a personal radio service such as the 27 MHz CB service must never again be placed on frequencies in close proximity to amateur frequencies. The other lesson has been that the relationship to television broadcast channels must be considered when assignments are made in the future.

The Commission must recognize that, even should a type acceptance program for amateur equipment be successful, there are other techniques available which will permit continued operation with high power in and close to the 27 MHz CB band.

In conclusion, the Commission is urged to not adopt the proposals of this proceeding but, in cooperation with other interested parties, develop a more realistic program which will have some chance of success.

Respectfully submitted,
**THE AMERICAN RADIO
RELAY LEAGUE,
INCORPORATED**
Robert M. Booth, Jr.
General Counsel

VERTICALS - DIPOLES - TRAPS - BALUNS

TRAP VERTICAL ANTENNAS

No antenna tuner needed — Full legal power limit — Fully assembled and ready for operation — No radials required — 1:1 VSWR to 50 OHM coax

MODEL	BANDS	HT	PRICE
TV-215	20 15	13'	\$34.95
TV-4215	40 20 15	22'	\$44.95
TV-84215	80 40 20 15	30'	\$69.95

**HIGH PERFORMANCE
COMPACT VERTICAL ANTENNAS**

Uses "top loading" for reduced size and maximum efficiency — Use 2 or more to form a phased array — No antenna tuner needed — Folds to 5' package

MODEL	BANDS	HT	PRICE
CV-160	160	23'	\$44.95
CV-80	80	20'	\$39.95
CV-40	40,15	15'	\$34.95
CTV-8040	80/40/15	20'	\$59.95

AO-1 — 10 Meter Conversion Kit — add 10 meter coverage to any Antenna Sup. vertical . . . \$9.95

All verticals include ground post plus all mounting hardware

TO ORDER — Write or Phone —
Include Shipping — Dipoles \$2.50 —
Verticals \$3.00 — Florida residents,
please add 4% sales tax

— Phone Orders Welcome —
9:30 to 5:00 — Monday thru Saturday
813 / 585-9688

Include Interbank No. and expiration date on credit card orders — 24 hour shipment, 30 day guarantee — For more info: SASE or 1st class stamp

APARTMENT - PORTABLE - TRAILER

AV-1 ALLTENNA

Use this portable antenna anywhere — Mounts on window sill or patio railing — Solves landlord problems — 80-10 meters — Change bands by switching preset inductance — Adjustable to 1:1 VSWR at any frequency — 13' maximum extended height — Light weight — Under 10 lbs. — Use on travel campers and vans — Mounts easily on ground post (included) or on side of camper or van — No antenna tuner needed — Full legal power limit — Fully assembled & ready for operation — No radials required — Folds to 5' package for easy storage — Export version folds to 3'

MODEL	BANDS	HT	PRICE
AV-1	80-10	13' (max)	\$49.95

FULL SIZE VERTICAL ANTENNA

Full quarter wave which can be configured for 10, 15 or 10' — No coils or traps — No tuner needed — VSWR less than 1.2:1 over each entire band — Folds to 5' package

MODEL	BANDS	HT	PRICE
FV-201510	20,15,10	16'	\$29.95

Z-1 BALUN \$9.95 postpaid
1:1 ratio, takes place of center insulator, helps eliminate TVI coax fitting, full legal power

Coaxial cable & connector —		
RG58AU	50'	\$9.95
	100'	\$9.95

Aluminum radial wire —		
No. 8 heavy duty	100'	\$3.99
Nylon guy rope	100'	\$3.49

FULL SIZE DIPOLES

Model	Bands	Length	Price
D-80	80/75	130'	\$31.95
D-40	40,15	66'	\$28.95
D-20	20	33'	\$26.95
D-15	15	22'	\$25.95
D-10	10	16'	\$24.95

FULL SIZE PARALLEL DIPOLES — ONE FEED LINE

PD8040	80/75,40,15	130'	\$36.95
PD4020	40,20,15	66'	\$30.95
PD8010	80/75,40,20,15,10	130'	\$41.95
PD4010	40,20,15,10	66'	\$35.95

LIMITED SPACE DIPOLES

SP-160	160	130'	\$36.95
SP-80	80/75	63'	\$31.95
SP-40	40,15	33'	\$28.95

MSP-1 SHORT POLE COMPACT SYSTEM

MSP-1	80/75,40,15	70'	\$41.95
-------	-------------	-----	---------

ANTENNA SHORTENER KITS —

Same coils as the SP & MSP series — use with your own antenna

S-160	160	130'	\$12.95
S-80	80/75	63'	\$11.95
S-40	40,15	33'	\$10.95

TRAP DIPOLES — Adjusted — ready to go — Rated legal limit

TD-8040	80/75,40	78'	\$41.95
TD-4020	40,20	40'	\$36.95

TRAPS ALONE

T-8040	80/75,40	78'	\$12.95
T-4020	40,20	40'	\$ 9.95

(All above are complete with balun, No. 14 antenna wire, ceramic, insulators, 100' nylon support rope, rated for full legal limit. Can be used as Inverted V, MARS, SWL.)

ANTENNA SUPERMARKET P.O. Box 1682 Largo, Fl. 33540 813/585-9688

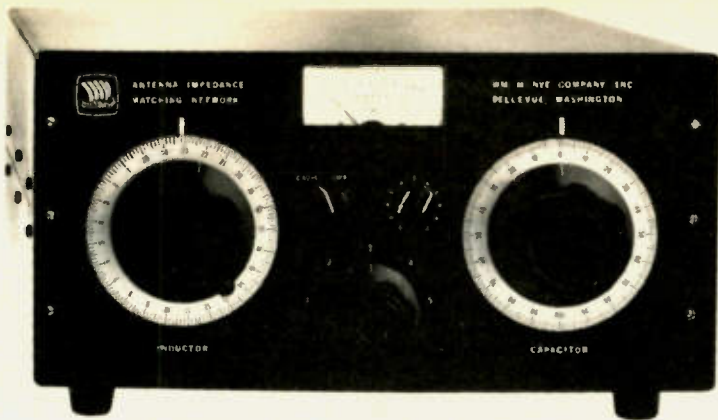

**Model MB II \$285
(with Balun) \$315**

**The NEW NYE
"Matchmaker!"
VIKING MB II**

**Antenna Impedance-matching Network
assures maximum perfectly matched
power to your antenna!**

MB II provides:

- ★ Constant SWR monitoring. ★ Precision tuning of final amp. ★ Harmonic suppression.
- ★ Receiver input impedance-matching. ★ Maximum power transfer to antenna. ★ Continuous frequency coverage 1.6 to 30 MHz. ★ Precision tuning of any wire 1/4 wavelength or longer, with SWR of 1:1.

MB II features:

- ★ Finest quality, made-in-USA components. ★ Large, precision, easy-to-read dials with 360° readout. ★ Optional 3000 watt Balun for twin lead antennas.



Available at leading dealers throughout the U.S.A.

WM. M. NYE COMPANY, INC.
1614 - 130th Avenue N.E., Bellevue, WA 98005 * (206) 454-4524

N4

WE WANT TO MAKE YOU A STAR

— a STAR amateur radio antenna. COM*STAR antennas are used by industry, schools, the U. S. government, and hams around the world. STAR antennas are modified magnetic loops, a unique design which greatly reduces ground losses, resulting in a physically small antenna without the usual performance compromises of compact antennas. And now COM*STAR introduces the STAR 10 for 10 meter or CB use, with a diameter under 2 feet.

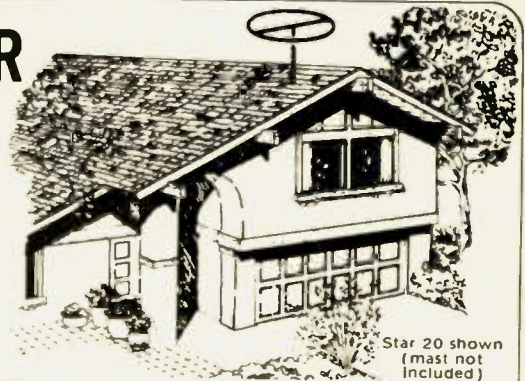

Features of STAR antennas:

- Wide bandwidth. Low VSWR over entire band with no antenna tuning required after assembly
- Low angle of radiation with directivity and gain over a vertical or dipole. Antennas can be stacked or phased for increased gain
- Low noise pickup and reduced TVI radiation
- No radials or ground plane required
- 52 ohm input impedance
- Handles legal power
- Small size and weight permit flexible installations with choice of horizontal or vertical polarization

Comments received from STAR Owners (letters on file):

- You have a really "dynamite" antenna in the STAR 40. I've been really impressed with the gain, low noise, and magnificent performance. (It) beats my previous ground plane and inverted V's by a mile. W2---
- Very satisfied. Worked 1000 miles to Toronto (40 meter SSB) with heavy QRM. Very definitely would recommend that a fellow ham purchase one. WB3---
- My SWR ranges from 1:1 to 1:1.6 over the entire 40 meter band. W7---
- Been inactive for 4 years due to apartment antenna restrictions. The STAR 20 let me get back on the air. Works great! W6---

ANTENNA	BAND	LOOP DIAMETER	PRICE
STAR 10	10 meters/CB	23 inches	\$34.95
STAR 15	15 meters	35 inches	\$42.95
STAR 20	20 meters	46 inches	\$49.95
STAR 40	40 meters	90 inches	\$59.95

If unavailable at your local dealer, STAR antennas can be purchased from COM*STAR at the address below. Send check, money order, VISA, B/A, or Mastercharge (include card # and expiration date). Phone orders accepted with above credit cards. State antenna(s) desired. California residents add 6% sales tax. Antennas, with assembly/tuning instructions, shipped by UPS. Dealer inquiries invited.

The COM ★ STAR Corporation

138 Ardmore Ave., Hermosa Beach, CA 90254
Phone: (213) 379-8822 C19

Join the Gunnplexer™ Generation

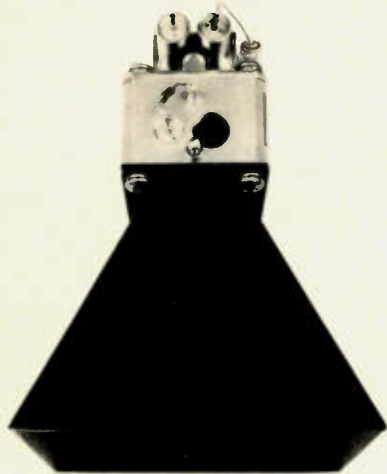

If your urges tend toward linking remote receivers to VHF repeaters, transmitting video (the real thing — living color — not slow scan), linking home-made computers, full duplex mountain top or over water duct dxing, the Microwave Associates' 10.0 — 10.5 GHz Gunnplexer™ Transceiver front end is a must.

Over 400 units are in the field in 16 countries. The Gunnplexer is available off-the-shelf in Burlington and our main European offices. Send for all the info on the latest cigarette lighter compatible modulator/power supply/AFC/receiver circuits/propagation and antennae. Send in your own circuit ideas now. We will pay \$100 for all new circuits we incorporate in our sales bulletins. Send your check or C.O.D. order now!

MA-87140-1 Gunnplexer \$108
MA-87141-1 Pair of
Gunnplexers \$180

See you on 10.3 GHz.

Microwave Associates, Inc.
Building # 4
South Avenue
Burlington, MA 01803
Tel. (617) 272-3000

M26



**MICROWAVE
ASSOCIATES**

More Economical RTTY

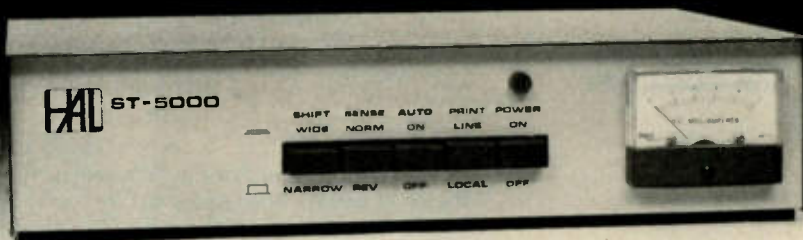

The ST-5000 from HAL

The HAL ST-5000 sets the pace for an economical demodulator/keyer for radio-teletype (RTTY). All the features you need for reception and transmission of HF and VHF RTTY are here.

The demodulator features a hard-limiting front end, active filter discriminator, and active detector circuitry for wide dynamic range. Autostart and motor control circuitry make for easy VHF and HF autostart operation.

Convenient front panel switches are provided for 850 and 170 Hz shift, normal or reverse sense, autostart on/off, print - line or local, and power on/off. 425 Hz press transmissions may also be copied with the ST-5000. High voltage 60 ma. loop output as well as low level RS-232 compatible output are provided by the demodulator.

The audio keyer section of the ST-5000 generates stable, phase-coherent audio tones. Transmission is a simple matter of applying these tones to your HF SSB or VHF FM transmitter.

The ST-5000 is housed in an attractive blue and beige cabinet and is backed by the HAL Communications one year warranty.

For complete specs on the HAL ST-5000, write or call HAL today.

\$275.00



HAL Communications Corp., Box 365, 807 E. Green St.
Urbana, Illinois 61801 • Telephone (217) 367-7373



...de W2NSD/I

EDITORIAL BY WAYNE GREEN

from page 120

off the crowds.

The inexpensive booths encouraged ham dealers to come in from all over the country, and it seemed as if about half of the booths were filled with growingly desperate dealers trying not to have to carry tons of ham gear back home ... almost at any loss. Too many dealers ... too many.

ROCHESTER

This was a big disappointment for me this year — nowhere near the crowds I expected. Dayton spoils us, I suppose. I think there may be a need for a hamfest like this to specialize. Although it's fairly close to Dayton,

the Ohio hamfest takes care of the need many hams have to get to a hamfest — with the result that they make it to Dayton and then don't bother with Rochester. Rochester is out of the way from just about everything, and I suppose the crowds they are pulling are remarkable, considering the location.

ATLANTA

They had the biggest crowd I've ever seen at a hamfest on a Sunday. Saturday was okay, but not outstanding ... Sunday was incredible. If this keeps growing, it could outdo Dayton as the biggest in the country. It's a lot of work organizing something like this, and Chaz Cone has come up with a masterpiece.



Chuck Martin drives his Suburban and a trailer filled with small goodies to as many hamfests as he can reach. The supporting team flies out. Here we see Eric and Bill of the supporting team selling at Rochester. Chuck says that despite the poor crowds, he did just fine. Chuck doesn't like to sell big equipment unless he is going to back it up 100% with service, and that means there is just no room for discounts ... so he seldom brings much to hamfests in expensive equipment, letting other dealers kill each other off with discounting.



The Rochester exhibits are in a huge domed building. The air conditioning broke down for a while and it was murder ... but they finally got it going again.



Al Smith WA2TAQ of Aldelco rests for a moment at Rochester. Al sells all kinds of small parts for hams and computer addicts. His place out on Long Island is a browsing mecca for local hams.



WB2OSZ got all carried away by the latest Kilobaud and overprinted his Byte tee shirt with the Kilobaud logo. Smart kid.



Here's the Aldelco booth ... digital clocks sell very well at hamfests and computerfests ... crystals ... tools ... and a supply of chips you wouldn't believe.



Hufco flew in from Provo, Utah, with their new counter kit.



Spectronics (the FM people) drove over from Chicago to Rochester — quite a drive with all that equipment ... most of it a two-way trip.

WESTCOM POWER

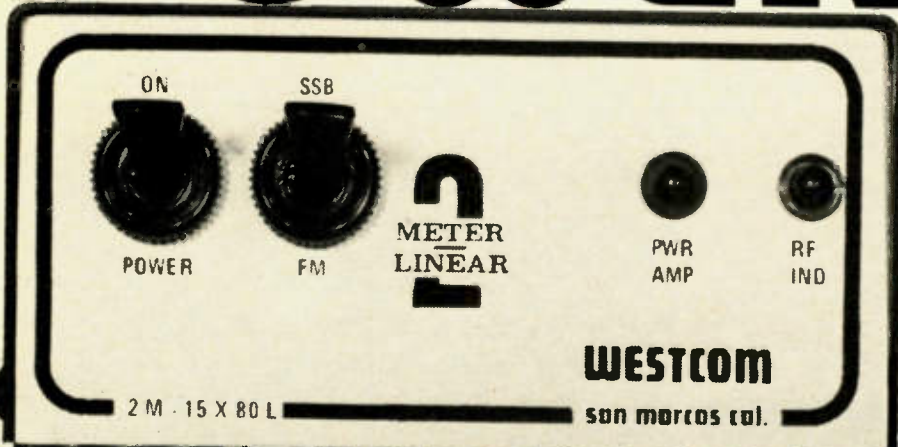

the new 2 meter VHF amplifier from Westcom.

• An add-on unit, no internal connections or adjustments required to associated equipment • Standard Amplifier Models operate FM, Linear Models operate all modes: SSB, FM, AM, RTTY, CW, etc. • "Microstrip" design provides high stability and optimum performance over wide bandwidth • Factory adjusted, no tuning required. • Mobile mounting bracket included • RF sensing T/R switching, adjustable dropout delay • Remote keying capability • Thermally coupled biasing • Reverse Voltage protected and fused • Conservatively rated with oversized heat sink • Red LED indicators for monitoring DC and RF • VSWR protected • Ninety day material and workmanship warranty

MODEL NO.	INPUT POWER (watts)	NOM OUTPUT (watts)	NOM CURRENT 13.8 VDC	PRICE
2M 3X30	1-4	30	4	\$72.95
2M 3X30L*	1-4	30	4	\$82.95
2M 10X40	2-12	40	5	\$77.95
2M 15X50L*	5-15	50	6	\$94.95
2M 15X80	5-15	80	11	\$129.95
2M 15X80L*	5-15	80	11	\$139.95

*Linear; AM, CW, FM, SSB, RTTY; Size: 4 1/8 x 5 1/2 x 2 5/8
technical specifications and data subject to change without notice

Call your local dealer, or write direct:

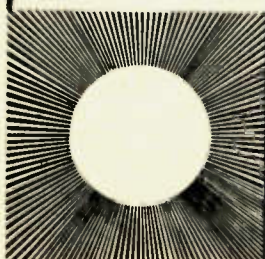

WESTCOM

ENGINEERING

1320 Grand Avenue San Marcos,
California 92069 (714) 744-0700

ELECTRONIC TECHNICAL WRITER

- Sprague Electric Company has immediate opening for an Electronic Technical Writer at our headquarters in the Berkshire hills of Massachusetts. Qualified applicant will prepare engineering bulletins, technical papers and catalogues on electronic components. Should have good familiarity with semiconductor components.
 - Requires AS Engineering Technology / Electronics or equivalent.
 - Familiarity with MIL Specs helpful.
 - Send resume with salary requirements to:
Norma M. Hays, Coordinator
Corporate Recruiting Office
Sprague Electric Company
87 Marshall Street
North Adams MA 01247 **S36**
- SPRAGUE ELECTRIC COMPANY**
An Equal Opportunity Employer M/F

SCAN 20 CHANNELS WITH YOUR HW-2036 AND OUR NX-1 SCANNER KIT

- *Scan 20 channels including 1 channel selected by HW-2036
- *Instant lockout of any number of channels
- *Programmed for your choice of 19 frequencies and modes on custom ROM
- *Monitor active channels for 5 seconds or lock on active channel
- *3 second scan delay controlled by Squelch or PTT
- *Bypass mode for normal operation of HW-2036
- *Easy assembly and installation, only 1.5" x 5" x 5"

To order, specify frequency and mode for up to 19 channels \$59.50 plus postage
Fla residents add 4% tax Additional ROM - \$12.50

EQUINOX CORPORATION
P.O. Box 13292, St. Petersburg, Fla. 33733

MICROSWITCH TELEPHONE FORMAT KEY BOARD "BRAND NEW" NW SERIES

16 NW7-25 Numeric Keyboard
16 NW7-21 Alphanumeric Keyboard

SPECIAL PRICE \$9.50 each

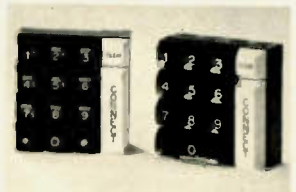

Quality Guaranteed. PA residents include 6% sales tax. Add \$.75 for Shipping and Handling. Quantity Discounts Available.

STANDARD ELECTRONICS
1 BROWN STREET
PHILADELPHIA PA 19123
215/925-5711 **S35**

SCR 1000

State of the Art in

VHF FM Repeaters

NEW!
Spec Comm
Repeater/Duplexer
Pkgs. Fully Factory
Checked-out! Inquire.

Some
Plain
Talk
About
Repeaters -



SEND
FOR
BROCHURE

Let's face it - your repeater group's success or failure hinges on the Quality and Reliability of your "Machine"! That's why the engineers at Spec Comm dedicated themselves to the production of the finest repeater available on the amateur market. The SCR1000 has been conservatively designed for years of trouble-free operation, and every consideration has been given to operator convenience and accessory interfacing. Features like full metering, lighted status indicators, full front panel control of every important repeater operating parameter, and accessory jacks for autopatch, xmtr. remote control, etc. And audio so good and so full, your 30 watts will sound like 100! Think about it, and think about your users. The purchase of a Spec Comm Repeater is a sound investment in your group's future, and they'll be thanking you for years to come. Sold Factory Direct only. \$899.95.

Don't make a mistake - your group deserves the finest!

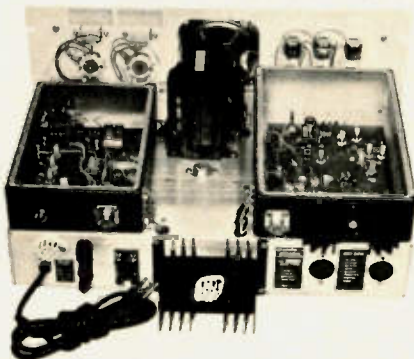

Custom 'Mods' Available: 'PL', 8 Pole Rcvr. Filter, Hi/Lo Power, Multi-Freq., etc. - Inquire.

Specifications

RF Output 30 Watts
Infinite VSWR proof
Sensitivity 0.3uV/20dB Qt.
Selectivity -6dB @ ±6.5 kHz;
-58dB @ ±15 kHz;
-90dB @ ±30 kHz.
(Sharper 8 Pole Fltr. Available)
Desense/Overload . . . W/1uV de-
sired signal, desense just begins @
approx. 50,000uV @ ±600kHz.
Spurious Response . . . -70dB min.

FEATURES

- Full Metering of critical levels.
- Front Panel Controls for timers & AF levels.
- Lighted push-buttons for control/test functions & status indicators
- State of the Art CMOS control logic & timers - No Relays!
- Built-in IDer - field programmable. Fully adjustable speed, pitch, time, etc.
- Exclusive Spec Comm MOSFET/Hot Carrier Diode rcvr. front end - greatly reduces 'desense' & IM problems!
- Built-in AC Supply w/instant btry. switchover for emergency pwr.
- Supplied with .0005% Sentry xtals and a Turner local mic.
- Jacks Provided for Remote Control, Auto-Patch, DC out, AF in/out, COR Switch, etc.
- True FM - For Rpt. Audio so good, it "sounds like direct"!

SPEC COMM REPEATER BOARDS

Inquire about complete shielded RCVR. & XMTR. Assemblies!

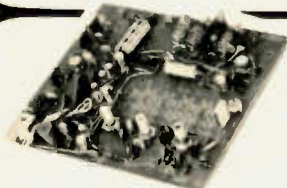

SCR100 Receiver Board

- Ext. wide dynamic range! Greatly reduces overload, 'desense', and IM.
- Sens. 0.3uV/20dB Qt.
- Sel. -6dB @ ±6.5KHz; -90dB @ ±30KHz, (-110dB w/opt. 8 Pole Fltr.)
- Exc. audio quality! Fast squelch! \$115.00 w/xtal, Asmbld. & Tested

Call or write today and get the details!



SCT 100 Xmtr/Exciter Board

- 5-6 Wts. Output
- Infinite VSWR proof
- True FM for exc. audio quality
- Spurious -60dB
- With .0005% xtal. \$115.00 Asmbld. & Tested.
- BA-10 30 Wt. Amp Board & Heat Sink. 3 sec. LPF & rel. pwr. sensor. \$51.95 Asmbld. & Tested

(Ship./Handl. - \$3.00. PA residents add 6% tax)



CTC100 COR/Timer/Control Board

- Complete COR circuitry
- Carrier 'Hang' & T.O. Timers
- Remote xmtr. control
- 100% Solid State
- Many other features \$32.95 Asmbld. & Tested



ID100 ID & Audio Mixer Board

- 100 bit diode programmable memory
 - Adjustable ID tone, speed, level, time
 - 4 Input AF Mixer & Local Mic amp
 - COR input & xmtr. hold
 - All CMOS logic
 - Many other features \$59.95 Asmbld./Tested/Programmed
- Send for Data Sheets!



SPECTRUM COMMUNICATIONS

1055 W. Germantown Pk., Norristown PA 19401 (215) 631-1710

Formerly of Worcester PA

S8

GET YOUR NEW RADIO AMATEUR CALLBOOKS

1977

The **U.S. Callbook** has over 300,000 W & K listings. It lists calls, license classes, names and addresses plus the many valuable back-up charts and references you come to expect from the **Callbook**.

\$14.95
PLUS SHIPPING

Specialize in DX? Then you're looking for the **Foreign Callbook** with over 250,000 calls, names and addresses of radio amateurs outside the USA plus many valuable, additional features of interest to the DX'r.

\$13.95
PLUS SHIPPING



ALL OF THESE EXTRA FEATURES INCLUDE!

- International Radio Amateur Prefixes!
- Radio Amateur Prefixes by Countries!
- A.R.R.L. Phonetic Alphabet!
- Great Circle Bearings and Charts!
- International "Q" and "Z" Signals!
- World Standard Time Charts!
- International Postal Information!
- World Prefix Map!
- F.C.C. Examination Points!
- Where to Buy!
- Telegraphers' Abbreviations!
- DX Operating Code!
- A.R.R.L. Countries List!
- At Your Service — Amateur Radio Dealers!
- QSL Managers Around the World!
- World Wide QSL Bureaus!
- Census of Radio Amateurs of the World!
- Telegraph Codes!
- AMSAT — Oscar Users Directory!
- Slow Scan Television Directory!
- Reciprocal Licenses!
- Hawaii Included!
- Many Other Features!

*Respected worldwide as
the only complete authority
for radio amateur
QSL and QTH information.*

ORDER FORM

Item	Price Each	Shipping	Total Price
U. S. CALLBOOK	\$14.95	\$1.25	\$ 16.20
FOREIGN CALLBOOK	\$13.95	\$1.25	\$ 15.20

See your favorite electronics dealer or write direct for free catalog to the publisher.

Illinois residents only add 5% sales tax _____

Name _____ Total _____
 Address _____
 City _____
 State _____ Zip _____ Total Enclosed _____
 Master Charge No. _____ Interbank # _____
 Bank _____ Expiration Date _____

RADIO AMATEUR
callbook INC.
 Dept. B 925 Sherwood Drive
 Lake Bluff, Ill. 60044

**LIQUID CRYSTAL DIGITAL
CLOCK-CALENDAR**



- For Auto, Home, Office
- Small in size (2x2 1/2 x 1 1/2)
- Push button for seconds release for date.
- Clocks mount anywhere with either 3M double-sided tape or VELCRO, included.
- 2 MODELS AVAILABLE:
LCD-101, portable model runs on self-contained batteries for better than a year.
LCD-102, runs on 12 Volt system and is back-lighted.
- LCD-101 or LCD-102 your choice. **\$34.95 ea.**
- Clear desk stand for **\$2.00**

ACE • All-Circuit Evaluator
for fast, solderless, plug-in circuit building and testing

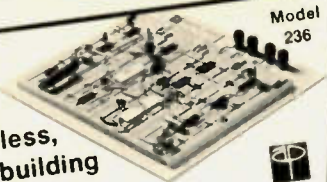

Just plug in any components with leads to .032" dia. Interconnect with solid wire up to 20 ga. Assembled models tool

ACE Model No.	Tie Points	DIP Capacity	No. Buses	No. Posts	Board Size (inches)	Price Each
200-K (kit)	728	8 (16's)	2	2	4-9/16 x 5-9/16	\$18.95
208 (assem.)	872	8 (16's)	8	2	4-9/16 x 5-9/16	28.95
201-K (kit)	1032	12 (14's)	2	2	16 x 7	24.95
212 (assem.)	1224	12 (14's)	8	2	4-9/16 x 7	34.95
218 (assem.)	1760	18 (14's)	10	2	6-1/2 x 7-1/8	46.95
227 (assem.)	2712	27 (14's)	28	4	8 x 9-1/4	59.95
236 (assem.)	3648	36 (14's)	36	4	10-1/4 x 9-1/4	79.95

Gold-anodized aluminum base, ground, non-corrosive nickel-silver terminals, 4 rubber feet

Vector Plugboards 8800V

Universal Microcomputer/Processor plugboard, use with S100 bus complete with heat sink & hardware 5.3 x 10 x 1/16"

- 1-4 **\$19.95**
- 5-9 **\$17.96**
- 10-24 **\$15.96**



MS-75 RECHARGEABLE BATTERIES & CHARGER UNIT
\$289

- 15 megahertz bandwidth.
- External and internal trigger settings ± 3%.
- Automatic or line sync modes.
- Power consumption < 15 watts.
- Viewing area 1.1" x 1.35".
- Case size 2.7" H x 6.4" W x 7.5" D, 3 pounds.
- 10 to 1, 10 meg guaranteed 1 year.
- Leather carrying case.



100 K Joypots

\$4.95

ELIT WRAP
Wraps insulated wire on .025" square posts
FOUR TIMES FASTER
than regular manual wrap-post tools



With two 100' spools of 28 ga. wire **\$24.95**

NO PRE-STRIPPING*
NO PRE-CUTTING*
SPOOL-FED WIRE*
*The spooled wire passes through the tool past a slitting edge next to the wrap post. A narrow longitudinal cut is made in the insulation where it presses the square post corner, the bared copper is indented by the sharp edge. (7 turns = 28 contacts)
Insulation is slit where wrapped but not between terminal posts when led straight) out of the tool.

"Daisy-Chain" runs
Reliable and easy to use
Manual or power operation

P160-4T
Includes charger, wire **\$75.00**

IC TEST CLIPS
TC-14 3 in. **\$4.50**
TC-16 3 in. **\$4.75**
TC-16 fits 14 & 16 Pin Dips

LEDU SPECIAL Model XL-334A Econo-Lamp List
23.00



Popular low-priced lamp tubular steel, spring balanced arms, vented shade, tension control knobs; 33" reach UL listed 60 watt. Colors: Red, Yellow, Blue, Black, White, 2 choices pls.

SPECIAL
14CS2 100 for \$14.00
16CS2 100 for \$16.00
14 pin CS2 10 for \$2.00
16 pin CS2 8 for \$2.00

These low cost DIP sockets will accept both standard width plugs and chips. For use with chips, the sockets offer a low profile height of only .125" above the board. These sockets are end stackable.

3662
P pattern for IC's plugboard 6.5 x 4.5 x Epoxy Glass .44 pin con. spaced 1/16" .156" **\$6.95**

3 LEVEL GOLD WIRE WRAP SOCKETS

	1-24	25-49	50-99
8 pin	.47	.42	.37
10 pin	.45	.41	.37
14 pin	.39	.38	.37
16 pin	.43	.42	.37
18 pin	.75	.68	.40
22 pin	1.00	.97	.62
24 pin	1.00	.94	.65
26 pin	1.09	.98	.75
36 pin	1.59	1.45	.84
40 pin	1.49	1.39	1.30
			1.29

1/16 VECTOR BOARD

Phenolic	PART NO	SIZE	PRICE
	64P44-062XXP	4.5 x 6.5"	\$ 1.49
	169P44-062XXP	4.5 x 17"	\$ 3.51
Epoxy Glass	PART NO	SIZE	PRICE
	64P44-062	4.5 x 6.5"	\$ 1.97
	84P44-062	4.5 x 8.5"	\$ 2.44
	169P44-062	4.5 x 17"	\$ 4.50
	169P44-062	8.5 x 17"	\$ 6.39



LMA 3 dig 1% DC
LMA 5A 3 1/2 dig .5% DC
LMA 4 dig .03% DC
LMA 4 dig .03% DC
Rechargeable batteries and charger included
Measures DC Volts, AC Volts, Ohms and Current
Automatic polarity, decimal and overload indication
Rechargeable batteries, AC Volts, Ohms and Current
Measures DC Volts, AC Volts, Ohms and Current
Automatic polarity, decimal and overload indication
No zero adjustment and no full-scale ohms adjust
Battery-operated — NiCad batteries, also AC line operation
Large LED display for easy reading without indicator
Size: 1.9" H x 2.7" W x 1.0" D
Introductory price on 1000's
Ships in leather carrying case



LEDU MG 10A
List \$72.00



Perfectly balanced, fluorescent lighting with precision magnifier lens. For prof'l, techn'l & hobbyist. Has die cast protective shade, inst. start 3 diopter lens. 42" reach. **\$49.95**

with T-9 fluorescent lamp (required) **\$49.95**
colors: Gray or Black

PRIORITY ONE ELECTRONICS

10031 Woodley Ave. Sepulveda CA. 91343

Terms: BAC, MC, Check, Money Order, C.O.D. CA. residents add 6% sales tax. Orders less than \$75.00 include 10% shipping & handling; excess refunded. Just in case... please include your phone no. Good thru October, 1977

Send for our latest brochure.

phone orders welcome (213) 893-8202
PRIORITY 1 ELECTRONICS a div. of theHEATH Group.

P21
OEM and Institutional inquiries invited.

TELEPHONE ORDERS WELCOME! CREDIT CARDS ACCEPTED. MASTER CHARGE, BANK AMERICARD AND AMERICAN EXPRESS CARDS WELCOME! CALL US (617) 531-5774 / 532-2323

DESK TOP DISPLAY STATION



At one time these data terminals were used by stock brokers for keeping track of stock quotations. They tied in to a central system which has now been updated, leaving these surplus units behind. Use this unit as a basis for building your own computer input/output station or to build a compact scope... or simply take it apart for the components within. Sold complete or in parts, prices and descriptions listed below:

- † 3" CRT, with Hi-volt. supply (+3315 vdc; -1730 vdc), and low-volt. supply +440V; +225V; +125V; +28V; +1.2V; +0.6V; 6.3VDC; 6.3VAC. Also ramp generator card & some drive circuits (15 Lbs.) \$17.50
- † 50 key Block keyboard, with diode matrix on 2 cards (5 Lbs.) \$12.50
- † Handsome desk-top, slope front case, suitable for up to an 11" CRT, overall 10 1/2" w x 16" d x 9 1/2" h. (10 Lbs.) \$7.50
- † Plus: 3 wire line cord, brown, 7'lg for \$1.00; 14 wire connector cable for \$2.50.

† **COMPLETE UNIT** Sh. Wt. 35 Lbs. **6NB60336** \$29.95
 Also available is a complete tech. manual covering operating procedure, theory disassembly (& reassembly), trouble shooting techniques and schematics. With complete unit - \$1.00 or sold separately for \$3.50 each. Sh. Wt. 8 oz.
WHEN ORDERING:
 Specify part, use order no. 6NB60336

TOUCH-TONE GENERATOR CHIP



New, 2 of 8 encoder chip ME8900, (similar to the MC14410). Sold with data sheet on uses of MC14410 chip. No crystals required. Sh. Wt. 8 oz. **7V170160** \$6.95 ea. \$60.00 for 10



1. **HOCKEY & SOCKER** game, 2 skill levels, LED scoring, joystick controls. New and guaranteed. Sh. Wt. 8 Lbs. **7HU70284** \$22.50 5 for \$100.00
2. **TV TENNIS**, New & guaranteed. 5 Lb. **7HU70285** \$13.88 3 for \$38.88
3. **TV TENNIS**, Kit form, AS IS. 5 Lbs. **7HU70250** \$8.88 4 for \$28.88



JOYSTICKS Two 10K POT'S

Super for X-Y functions: audio, computer, remote control, graphics, etc. Sh. Wt. 8 oz. **7J70163** \$4.95

LOGIC AND OP AMP POWER SUPPLY



This regulated power supply has outputs of ±15 volts at 0.25 amps and ±5 volts at 2.5 amps, with an input of 115 VAC. Manufactured by a computer company as part of a phone data terminal. Three (3) 723's (IC's) are used for voltage regulation. Units have barrier strip outputs, and are open frame. Size 5" x 9" x 2". New surplus Qty Ltd. Sh. Wt. 5 Lbs. **6M160215** \$17.50
 3 for \$45.00 **6M160215** \$45.00/3

COLOR "TV" CHASSIS & PARTS



New solid state color TV chassis and parts for use with In-Line black matrix picture tubes. Features include one button color tuning AFC and low power consumption.

We have two chassis types, the TS951 (for 13" & 15") and the TS953 (for 19"). To build a complete 19" TV these parts must be added: UHF & VHF tuners, picture tube, tube shield, yoke, purity magnets, antenna, yoke, speaker, on-off switch, 4 10K pots, binding posts & case. To build a 13" or 15" TV you'll have to add: picture tube, tube shield, yoke, purity magnets, antenna, 2nd stage hi-voltage boost, binding posts & case (chassis has tuners).

We do not offer a complete parts package, but we do include full tech. training manual, and we have some parts available.

These chassis are new & guaranteed. Price List Sh. Wt. 12 Lbs. each.

- 13" TV Chassis (w/tuners & controls) **6Z60175** \$49.50
- 15" TV Chassis (w/tuners & controls) **6Z60174** \$49.50
- 19" TV Chassis (no tuners, no controls), **6Z60172** \$29.50
- VHF Tuner (for 19") **6Z60303** \$8.50
- UHF Tuner (for 19") **6Z60304** \$2.50
- Antenna Telescope **5MI00419** \$1.50
- Binding Post Ass'y. **4MI00422** \$1.50

ALSO

We have found some of the same model "TV" chassis that have been damaged, most with bent frames or cracked P.C. boards. They are sold "AS IS", at low, low prices. Parts are worth 5X as much. All sales final. Sh. Wt. 12 Lbs. each.

- 13" Chassis **7DZ70059** \$22.50
- 15" Chassis **7DZ70060** \$22.50
- 17" Chassis **7DZ70061** \$14.88
- 19" Chassis **7DZ70062** \$14.88

TV TO MONITOR INTERFACE KIT

TV game board allows interface of any TV as a video monitor for computer use. With power supply & data for 300/75 ohm. Home brew money-saver! 3 Lbs. **7ZU70213** \$5.00 ea. \$27.88 for 5

B&L HELIUM-NEON GAS LASER POWER SUPPLY



Complete laser power supply, including case, coil, and enough room to mount a laser tube. We have tried it with a Hughes laser tube and it fits easily. This supply should power any 1mW helium-neon gas laser, like those manufactured by B&L, Metrologics, etc. Brand new, boxed. Sh. Wt. 12 Lbs. **5Z00178** \$15.00
 8 for \$100.00 **5Z00178** \$100.00/8

FERRIC CHLORIDE P.C. BOARD ETCHANT

New, packaged ferric chloride crystals in 1 Lb. bags. Use to make 64 oz. of P.C. board etching solution by simply adding water. Our competition sells 6 oz. of this for \$3.95 at our low price you get over 10 times as much for \$3.00! Quantity is limited. Sh. Wt. 1 1/2 Lbs. **7H70258** \$3.00/bag
 4 bags for \$10.00 \$10.00/4 bags

POSTAGE: Please add sufficient funds for postage and insurance. Shipping weight for merchandise is listed at the end of each product description. All shipping is from Peabody, Ma. 01960. Mass. Residents Add 5% Sales Tax.

SEND FOR OUR FREE CATALOG!
 Or, receive our catalog in an order and insure yourself of a place on our mailing list

BOOKSHELF OR FLOOR SPEAKER CABINETS

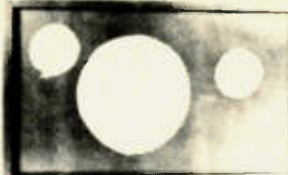

Large computer-designed cabinet made for an 8" woofer, 4" tweeter or midrange and a 3 1/2" tweeter or ducted port (speakers not included). Compact cabinet measures 21" high x 12" wide x 8" deep. Good for floor, wall or bookshelf, just add 2 or 3 speakers, acoustic padding and crossover network. Grill cloth included. A fine pair of cabinets. Sh. Wt. 30 Lb./pr. **70B70197** \$25.00/pair
 4 pair for \$80.00 \$80.00/4 pair

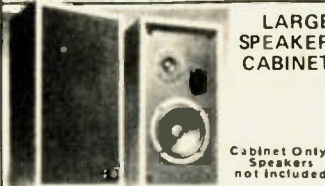

LARGE SPEAKER CABINET

Cabinet Only, Speakers not included

This enclosure was intended to go into a system that is renowned to be the most accurate medium priced speaker on the market. Size: 25 1/4" high x 15 1/4" wide x 9 1/2" deep. Cabinet will accommodate a 10" woofer, a 4 or 5" midrange and a 4" tweeter. Walnut grained vinyl exterior, black vinyl front face. Qty. Ltd., With data & grill cloth. Sh. Wt. 18 Lbs. ea. **70B70189** \$19.88 each
 Pair for \$34.88 \$34.88/pair

DIGITAL CLOCK / ALARM



New surplus clock alarm movement by General Time (Tally). This lighted digital movement was part of a clock/radio alarm, and has a 15 amp SPST switch to turn on radio (or whatever) at the time that you set. Numeral Height is 3.3". Overall dimensions are 5" wide x 3 1/8" deep x 2 1/4" high. Runs on 115V, 60 Hz. Sh. Wt. 6 oz. **7D70235** \$4.00

"THE NAMER CALLER" AUTOMATIC PHONE DIALER



Here's a neat item, brand new and packaged surplus. Great for business, home, baby sitters, people confined to beds, emergencies... or just as a convenience. Keep all your most-often-called numbers in memory at all times. Two models available: Home 2001 and Business 3001. (Business 3001 has 40 pin connector for multi-line phones). Sh. Wt. 12 Lbs. Home 2001 **7ZU70265** \$28.88
 Business 3001 **7ZU70266** \$38.88

PHONE ORDERS WELCOME!

Bank Americard, Master Charge and American Express Accepted
 Phone: (617) 531-5774 / 532-2323
 \$10.00 Minimum on Charge Orders

B&F ENTERPRISES Dept. "S"

119 FOSTER STREET PEABODY, MASS. 01960 (617) 531-5774/532-2323

FANTASTIC SPEAKER CABINETS

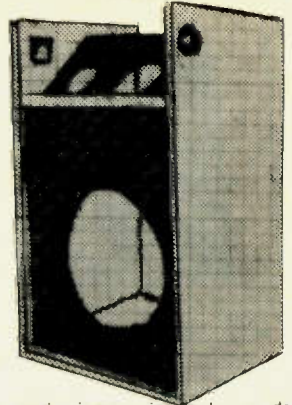

Fantastic air-suspension enclosures, designed for direct dispersion of the hi-frequency driver and wide dispersion of the woofer. By adding the proper speakers you can obtain a frequency response of 30 to 20,000 Hz. Sold in matching left and right-hand pairs, with grill cloth and instructions. Size: 17" x 10 1/2 x 9 1/2 deep. Takes 8" woofer and 4" tweeter. Sh. Wt. 25 Lbs. **70B70200** \$25.00/pair
 4 pair for \$80.00. **70B70200** \$80.00/4

MM5240 CHARACTER GENERATOR chip, 64-8x5 char's, 2560-bit, w/data, like 2513. **7IC70231** \$6.00 or 20/\$100.00
PROM - MMI 6301, 1024-bit, 256x4, TTL = Fairchild 93427C/M, **7IC70173** \$2.00
PROM - MMI 6306, 2048-bit, 512x4, TTL = Fairchild 93446C/M, **7IC70174** \$2.00
PROM - Signetics 82S126, 1024 bit, 256x4, TTL, = Fairchild 93417C/M, **7IC70175** (all chip: Sh. Wt. 1/2 Lb.) \$2.00

POWER SUPPLY KITS



1. **C.B. POWER SUPPLY KIT**
 A complete kit which puts out 10 to 24 VDC at 2 amps, regulated, 115 VAC in. Can be wired for constant 13.8VDC, ideal & compact for C.B. Kit includes PC card, components and instructions... just add your own case. Super as a bench supply! Sh. Wt. 6 Lbs. **6C60498** \$14.88
2. **5A, 10 to 24VDC Reg. P.S. KIT**
 A simple, adjustable regulated power supply. Kit includes all components, vector board and complete schematics. All you add is the case. A powerful supply! Sh. Wt. 15 Lbs. **6M160301** \$14.88
3. **0 to 30V AC/DC P.S. KIT**
 This high amp adjustable supply is an easy kit to build. It includes a 0 to 40 volt autotransformer (Variac®), 24V 5A transformer and all other components. Useful as a battery charger, bench supply or any use requiring high current. Sh. Wt. 9 Lbs. **6C60462** \$14.50

TOUCH-TONE CALLING KEYBOARD



New surplus boxed "ITT" keyboard, just the thing to make your own touch-tone phone or repeater. You can use these with our dialer chips ME 8900, MC 14410 or our Auto Dialer kit No. 6M160189. Supplied with typical applications circuit diagrams. Sh. Wt. 8 oz. **7M170162** \$5.88
 3 for \$17.00 **7M170162** \$17.00/3
GTE (AE) Used Touch-Tone Keyboard Sh. Wt. 1 Lb. **6M160182** \$5.00
Chor erics Touch-Tone Keyboard - New Sh. Wt. 8 oz. **5MI00349** \$4.50

B&F

CALIFORNIA INDUSTRIAL

Post Office Box 3097 A • Torrance, California 90503

CALCULATOR WRIST WATCH



Designed for the on the go executive, that individual who has to make those on the spot decisions.

Handsome gold tone stainless steel watch features space age micro-circuitry. The MOS integrated circuit contains the equivalent of more than 10,000 transistors.

This LED wrist watch displays date, time, elapse seconds and also functions as an eight digit calculator with memory. Information stored in memory can be recalled at any later date, even weeks or months. Use this memory feature to store phone numbers, parking stall location or flight departure time.

Manufactured by one of California's leading aerospace contractors. Because of the discount price we have agreed not to publish the manufacturer's name.

Includes batteries, jewelry case and 18-month factory warranty.

\$149.50

ELECTRONIC ENTERTAINMENT CENTER

Tennis-Handball Hockey-5mash

Action-packed color entertainment for the whole family. Adjustable skill level controls allow players of all ages to compete in tennis, hockey and handball! This four game entertainment center turns your television into a video play ground.

On screen scoring, live action sound and true component color makes this video center an excellent buy at only \$24.88. Complete with antenna box and AC adapter.

Color \$24.88

TELETYPE MODEL 43

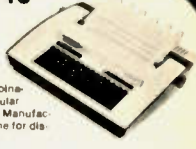

New from Teletype, the Model 43 is capable of printing 132 ASCII characters per line. Send and receive data at 10 or 30 words per second. Keyboard generates all 128 ASCII code combinations. RS-232 interface, same as the popular Model 33. Data sheet sent upon request. Manufacturer suggested price \$1377.00, telephone for discount and availability.

We also have for sale a limited quantity of used Model 35's. Priced at only \$449.50

HEXADECIMAL KEYBOARD

Maxi-Switch hexadecimal keyboards are designed for microcomputer systems that require 4-bit output in standard hex code.

Each assembly consists of 16 hermetically sealed reed switches and TTL "on shot" debounce circuitry.

Reliable low friction acetal resin plungers are credited for the smooth operation and long life of this premium keyboard.

Requires single +5 volt supply.

\$29.95

DIGITAL ALARM CLOCK

Completely Assembled

\$19.95



Walnut-grained decorator clock features large 7" LED display which is driven by the new National MM536 alarm clock chip. Preset 24-hour alarm function allows you to awaken at the same time each morning without resetting. Upon reaching the wake-up time, the clock's loudspeaker emits a gentle tone. Touch the snooze button and dose off for an additional 9 minutes of sleep. Clock also functions as a ten-minute elapse timer. "Alarm Set" indicator. AM/PM display.

CONNECTORS

RS-232

DB25P male plug & hood

\$3.95

DB25S female

\$3.95

\$4.98

100 PIN IMSAI/ALTAIR Edge Connector

Altair, Imsai compatible gold plated, dual 50 (125 centers) three tier wire wrap edge connector. 3 for \$13.50.

SPERRY UNIVAC KEYBOARD

The famous Sperry Univac 1710 Holter keyboard assembly is now available from California Industrial for only \$24.88. The ideal computer input device for accountants and mathematicians. The numeric keys are placed on the lower three rows to resemble a ten key adding machine. This format allows one handed numeric data entry. Original cost was \$385. Used but guaranteed in excellent condition. Complete with documentation.

\$24.88

JOYSTICK \$5.50

This joystick feature four 100K potentiometers, that vary resistance proportional to the angle of the stick. Perfect for television games, quad stereo and radio controlled aircraft.

FREE MANUAL GRAPHITE DISPLAY GENERATOR

Modern technology has pioneered the development of this unique character printer. Our Manual Graphite Display Generator has the capability of producing the full upper and lower case ASCII set. Self-contained cursor assembly allows the operator to eliminate erroneous entered information. Each unit is manufactured to strict tolerances as prescribed by standards set forth by California Industrial. One free with every order.

Scotch DISKETTES

10 for \$45.

3M IBM 3740 series and compatible drives

\$4.98

CALCULATOR KEYBOARD

Ideal for keyless entry systems, burglar alarms, Touch Tone or hexadecimal computer input code.

\$2.98

Digital Clock

Manufactured for the Panasonic clock radio. The clock mechanism trips a microswitch upon reaching your preset wake-up time.

\$3.98

2708

\$24.95

8K UV Erasable MEMORY

BRIDGE RECTIFIER

MOTOROLA 12 Amp. 50v.

\$1.95

BNC CABLE

15 feet of RG-58U connector at ends

\$3.50

intel 2102AL 1k RAM 450ns

Lowest Price Anywhere

\$1.19

7400	13	7476	39
7401	19	7479	39
7402	19	7483	79
7403	19	7487	99
7404	19	7483	99
7405	19	7486	49
7406	19	7488	3.40
7407	25	7489	2.79
7408	25	7490	49
7409	25	7491	99
7410	19	7492	99
7411	25	7493	49
7412	35	7494	79
7413	49	7495	79
7414	79	7496	79
7415	39	7497	3.99
7416	39	74100	1.19
7417	19	74107	39
7420	49	74109	99
7423	39	74110	1.79
7425	39	74116	1.99
7426	39	74120	1.99
7427	39	74121	39
7428	49	74122	39
7429	39	74123	69
7430	25	74125	99
7433	39	74126	99
7438	39	74128	49
7439	39	74133	99
7440	39	74136	99
7442	39	74141	99
7443	89	74142	1.29
7444	89	74147	2.49
7445	79	74148	99
7446	89	74150	2.99
7447	99	74151	99
7448	99	74153	89
7449	99	74154	99
7450	25	74156	99
7451	25	74157	1.29
7453	25	74159	2.99
7454	25	74160	1.19
7455	39	74161	99
7470	39	74162	1.49
7472	39	74163	99
7473	39	74163	99
7474	39		
7475	49		

MEMORY

4044	79	4049	79
4045	79	4050	79
4051	1.99	4051	1.99
4052	1.49	4052	1.49
4053	2.19	4053	2.19
4060	3.19	4060	3.19
4071	1.19	4071	1.19
4069	49	4069	49
4071	49	4071	49
4077	79	4077	79
4081	49	4081	49
4181	2.49	4181	2.49
74282	99	74282	99
74194	1.99	74194	1.99
74195	1.99	74195	1.99
74196	4.99	74196	4.99
74197	1.19	74197	1.19
74198	1.19	74198	1.19
74199	1.99	74199	1.99
74200	99	74200	99
74201	1.49	74201	1.49
74199	1.99	74199	1.99
74273	1.99	74273	1.99
74290	99	74290	99
74366	99	74366	99
74390	1.79	74390	1.79
74399	1.79	74399	1.79
74490	1.99	74490	1.99

CPU'S

8000A	24.95	5314	3.95
8000B	24.95	5316	4.95
280	69.95	5375	3.95

CLOCK'S

NE555	48	NE555	48
NE126	1.29	NE126	1.29
NE555H	1.49	NE555H	1.49
NE555N	1.29	NE555N	1.29
NE566N	1.25	NE566N	1.25
709H	99	709H	99
709N	39	709N	39
710N	79	710N	79
711H	79	711H	79
711N	39	711N	39
722H	55	722H	55
723H	39	723H	39
725H	3.49	725H	3.49
733H	1.49	733H	1.49
739N	99	739N	99
739N	1.19	739N	1.19
741N	0.99	741N	0.99
747H	79	747H	79
748H	39	748H	39
748H	1.75	748H	1.75
1458	69	1458	69
1496N	99	1496N	99
211H	1.95	211H	1.95
2901H	2.95	2901H	2.95
3805N	69	3805N	69
3805N	49	3805N	49
3809N	1.19	3809N	1.19

LM741 \$1.09*

commodore Personal Electronic Transactor

Finally a complete small system computer that anyone can afford. New from Commodore International, the Personal Electronic Transactor. The system includes input keyboard, tape cassette transport, MOS6502 CPU and 4k of user memory in addition to the 14K of operating resident software. Also included is a "ten-key" numeric entry pad and a 9" video display screen. Manufacturer suggested price is \$995.00. Telephone for discount and availability.

\$95.00

COMPUTOR Power Adapter

shipping \$75

output 7vdc 1.4A

\$4.98

Transistors

ea.	10	50	100	
2N2222A	.20	.18	.16	.15
2N3055	.89	.84	.77	.65
MJ3055	.99	.94	.87	.75
2N3772	2.19	1.95	1.75	1.59
2N3904	.15	.11	.09	.07
2N3906	.15	.11	.09	.07

SOLID-STATE MICRO BUZZER

1.5 TO 3 VDC

\$1.98

TRIMMER POTENTIOMETERS

2K	10K	50K
5 for	\$98	
20	50	100
16¢	14¢	12¢

COMBINATION LENS MOUNTING DEVICE

5 Red Amber Green 20 50 100 1k

\$98

CLIP LITE

9 foot

\$1.49

SOLAR CELLS

Output: 12v. 175ma TRANSFORMER

\$1.19

Thumbwheel switch

Ten position BCD

\$1.39 ea.

10	50	100
\$1.19	\$9	\$8.89

CAPACITORS

ELECTROLYTICS

ea.	10	50
4500/50v.	\$1.99	1.35 1.19
1000/15v.	\$.55	.49 .45

DISCOUNT Wire Wrap Center

IC SOCKETS

pin	wire wrap	solder	
	ea.	25 50 ea.	25 50
8		17¢	16 15
14	37¢	36 35	20 19 18
16	38 37	36 35	21 20 19
24	99 93	85 84	36 35 34
40	199 155	139	63 60 58

50ft. **\$98**

KYNAR WIRE WRAP

500	1000	11000
\$9.	\$15.	\$105.

SPDT MINIATURE TOGGLE SWITCH

\$98. ea.

10	50	100	1k
\$8.8	\$8.	\$7.3	\$6.66

DPDT ROCKER SWITCH

\$98. ea.

DIP Switch

10 100 1k

\$1.95 ea.

\$1.74 1.52 1.29

Diodes

10	25	100
1N4002	100v.	.08 .06 .05
1N4005	600v.	10 .08 .07
1N4148	signal	.07 .05 .04

Jumbo red LED'S

ea.	10	25	100
\$15.	\$13.	\$11.	\$9.

125mA. At 43V. Ideal for powering radio receivers or charging batteries.

NEW

Frequency Counter

\$79⁹⁵ kit

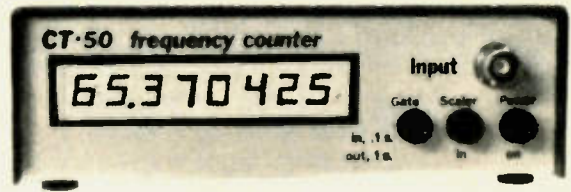

UTILIZES NEW MOS-LSI CIRCUITRY

You've requested it, and now it's here! The CT-50 frequency counter kit has more features than counters selling for twice the price. Measuring frequency is now as easy as pushing a button, the CT-50 will automatically place the decimal point in all modes, giving you quick, reliable readings. Want to use the CT-50 mobile? No problem, it runs equally as well on 12 V dc as it does on 110 V ac. Want super accuracy? The CT-50 uses the popular TV color burst freq. of 3.579545 MHz for time base. Tap off a color TV with our adapter and get ultra accuracy — .001 ppm! The CT-50 offers professional quality at the unheard of price of \$79.95. Order yours today!

- CT-50, 60 MHz counter kit \$79.95
- CT-50 WT, 60 MHz counter, wired and tested 159.95
- CT-600, 600 MHz prescaler option for CT-50, add 29.95

SPECIFICATIONS

- Sensitivity: less than 25 mv.
- Frequency range: 5 Hz to 60 MHz, typically 65 MHz
- Gate time: 1 second, 1/10 second, with automatic decimal point positioning on both direct and prescale
- Display: 8 digit red LED .4" height
- Accuracy: 10 ppm, .001 ppm with TV time base!
- Input: BNC, 1 megohm direct, 50 Ohm with prescale option
- Power: 110 V ac 5 Watts or 12 V dc @ 1 Amp
- Size: Approx. 6" x 4" x 2", high quality aluminum case
- Color burst adapter for .001 ppm accuracy available in 6 weeks.
- CB-1, kit \$14.95

MINI-KITS

TONE DECODER KIT

A complete tone decoder on a single PC Board. Features 400-5000 Hz adjustable frequency range, voltage regulation, 567 IC. Useful for touch tone decoding, tone burst detection, FSK demod, signaling, and many other uses. Use 7 for 12 button touchtone decoding. Runs on 5 to 12 volts.
Complete Kit, TD-1 \$4.95

SUPER-SNOOP AMPLIFIER

A super-sensitive amplifier which will pick up a pin drop at 15 feet! Great for monitoring baby's room or as a general purpose test amplifier. Full 2 watts of output, runs on 6 to 12 volts, uses any type of mike. Requires 8-45 ohm speaker.
Complete Kit, BN-9 \$4.95

FM WIRELESS MIKE KIT

Transmit up to 300' to any FM broadcast radio, uses any type of mike. Runs on 3 to 9 V. Type FM-2 has added super sensitive mike preamp.
FM-1 \$2.95 FM-2 \$4.95

COLOR ORGAN/MUSIC LIGHTS

See music come alive! 3 different lights flicker with music or voice. One light for lows, one for the mid-range and one for the highs. Each channel individually adjustable, and drives up to 300 watts. Great for parties, band music, nite clubs and more.
Complete Kit, ML-1 \$7.95

LED BLINKY KIT

A great attention getter which alternately flashes 2 Jumbo LEDs. Use for name badges, buttons, or warning type panel lights. Runs on 3 to 9 volts.
Complete Kit \$2.95

POWER SUPPLY KIT

Complete triple regulated power supply provides variable +15 volts at 200 mA and +5 volts at 1 Amp. 50 mV load regulation good filtering and small size. Kit less transformers. Requires 6.8 V at 1 Amp and 18 to 30 VCT.
Complete Kit, PS-3LT \$6.95

SIREN KIT

Produces upward and downward wail characteristic of police siren. 5 watts audio output, runs on 3-9 volts, uses 8-45 ohm speaker.
Complete Kit, SM-3 \$2.95

DECADE COUNTER PARTS

Includes: 7490A, 7475, 7447, LED readout, current limit resistors, and instructions on an easy to build low cost frequency counter.
Kit of parts, DCU-1 \$3.50

CLOCK KIT 6 digit 12/24 hour



Want a clock that looks good enough for your living room? Forget the competitor's kludges and try one of ours! Features: jumbo .4" digits, Polaroid lens filter, extruded aluminum case available in 5 colors, quality PC boards and super instructions. All parts are included, no extras to buy. Fully guaranteed. One to two hour assembly time. Colors: silver, gold, black, bronze, blue (specify).
Clock kit, DC-5 \$22.95
Alarm clock, DC-8, 12 hr only 24.95
Mobile clock, DC-7 25.95
Clock kit with 10 min ID timer, DC-10 25.95
Assembled and tested clocks available, add \$10.00

VIDEO TERMINAL KIT \$149.95

A compact 5 x 10-inch PC card that requires only an ASCII keyboard unit & TV set to become a complete interactive terminal for connection to your microprocessor asynchronous interface. Its many features are single 5 volt supply, crystal controlled sync and baud rate (up to 3600 baud), 2 pages of 32 characters by 16 lines, read to and from memory, computer and keyboard queried cursor and page control, parity error display and control, power on initialization, full 68 character ASCII display, block type see thru cursor. Keyboard/computer control back spaces, forward spaces, line feeds, raw line feeds, home, returns cursor. Also clears page, clears to end of line, selects page 1 or 2, reads from or to memory. The card requires 5 volts at approx. 900 ma and outputs standard 75 ohm composite video.

- TM3210 Kit \$149.95
- TM3210, Assembled and Tested 239.95
- VD-1, Video to RF Modulator Kit 6.95

CAR CLOCK KIT \$27.95



- 12/24 Hour 12 Volt AC or DC
- High Accuracy (1 minute/month)
- 10 jumbo .4" LED readouts
- Easy, no polarity hook-up
- On/off blanks with ignition
- Case, mounting bracket included
- Super instructions
- Complete Kit, DC-11 \$27.95

AUTO DIMMER \$2.50

Automatically adjusts display brightness according to ambient light level. For DC-11 Car Clock.

CHEAP CLOCK KIT \$8.95

- DC-4 Features: Does not include board or transformer
- 6 digit 4" LED
- 12 or 24 format
- PC Board \$2.95
- Transformer \$1.49

600 MHz PRESCALER



Extend the range of your counter to 600 MHz. Works with all counters. Less than 150 mv sensitivity. Specify 10 or 100. Wired, tested, PS-1B \$59.95
Kit, PS-1B \$44.95

30 watt 2 meter Power Amp

The famous RE class C power amp now available mail order! Four Watts in for 30 Watts out, 2 in for 15 out, 1 in for 8 out. Incredible value, complete with all parts, instructions and details on T-R relay. Case not included.
Complete Kit, PA-1 \$22.95

CALENDAR ALARM CLOCK

Has every feature one could ever ask for. Kit includes everything except case, build it into wall, station or even car!

- 8 Outputs, 5" High LED
- Calendar shows mo/day
- True 24 Hour Alarm
- Battery back up with built in on chip time base
- 12/24 Hour Format
- Snooze button
- 7001 chip does all!
- Complete Kit, less case, DC-9 \$34.95

LINEAR		REGULATOR		TRANSISTORS	
5314 Clock	\$2.95	555	\$.50	78MG	\$1.49
74S00	.35	556	.75	89 NPN 2N3904 type	10/\$1.00
74S112	.75	566	1.49	PNP 2N3906 type	10/\$1.00
7447	.79	567	1.49	NPN Power Tab 40W	3/\$1.00
7473	.35	1458	.50	PNP Power Tab 40W	3/\$1.00
7475	.50	LED DRIVER	7812	FET MPF 102 type	3/\$2.00
7490A	.55	75491	.50	UJT 2N2646 type	3/\$2.00
74143	3.50	75492	.50	2N3055 NPN Power	.75

DIODES: 1KV.25A 5/\$1.00 100V.1A 10/\$1.00 1N914A type 50/\$2.00

LED DISPLAYS



- FND 35975
- FND 510 1.25
- DL 707 1.25
- HP 7730 1.25

Red Polaroid Filter .425" X 1.125"59

741 OP-AMP SPECIAL

Factory prime mini dip with both Xerox and 741 part numbers
10 for \$2.00

SOCKETS

- 14 PIN 5/\$1.00
- 16 PIN 5/\$1.00
- 24 PIN 2/\$1.00
- 40 PIN 3/\$2.00

FERRITE BEADS

- with info and specs
- 15/\$1.00
- 6 hole Balun Beads
- 5/\$1.00

ramsey electronics

P.O. Box 4072 Rochester NY 14610

(716) 271-6487

TELEPHONE ORDERS
WELCOME



Satisfaction guaranteed or money refunded. C.O.D. add \$1.00. Orders under \$10.00 add \$.75. NY residents add 7% tax.

ADVA

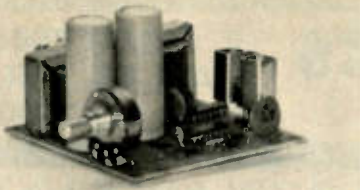

KIT \$11⁹⁵

ASSEMBLED \$17.95
ADD \$1.25 FOR
POSTAGE/HANDLING

VARIABLE POWER SUPPLY

- Continuously Variable from 2V to over 15V
- Short-Circuit Proof
- Typical Regulation of 0.1%
- Electronic Current Limiting at 300mA
- Very Low Output Ripple
- Fiberglass PC Board Mounts All Components
- Assemble in about One Hour
- Makes a Great Bench or Lab Power Supply
- Includes All Components except Case and Meters

OTHER ADVA KITS:

LOGIC PROBE KIT - Use with CMOS, TTL, DTL, RTL, MTL, MNIL and most MOS IC's. Built in protection against polarity reversal and overvoltage. Draws only a few mA from circuit under test. Dual LED readout. Complete kit includes case and clip leads. **ONLY \$3.85**

FIXED REGULATED POWER SUPPLY KITS - Short-circuit proof, with thermal current limiting. Compact size and typical regulation of 0.5% make these ideal for most electronic projects. Available for 5V @ 500mA, 6V @ 500mA, 9V @ 500mA, 12V @ 400mA, 15V @ 300mA. Specify voltage when ordering. **\$8.95 ea**

These easy-to-assemble kits include all components, complete detailed instructions and plated fiberglass PC boards. Power supply kits do not include case or meters. Add \$1.25 per kit for postage and handling.

EMAIL NOW! FREE DATA SHEETS supplied with many items from this ad. FREE ON REQUEST - 741 Op Amp with every order of \$5 or more - 749 Dual Op Amp or two \$1.00 FET's with every order of \$10 or more, postmarked prior to 3/31/77. One free item per order.

ORDER TODAY! All items subject to prior sale and prices subject to change without notice. All items are new surplus parts - 100% functionally tested.

WRITE FOR FREE CATALOG #76 offering over 350 semiconductor carried in stock. Send 13¢ stamp.

TERMS: Send check or money order (U.S. funds) with order. We pay 1st class postage to U.S. Canada and Mexico (except on kits) \$1.00 handling charge on orders under \$10. Call for rates add 8% sales tax. Foreign orders add postage. C.O.D. orders add \$1.00 service charge.

MORE SPECIALS:

RC4195DN - 15V @ 50mA VOLTAGE REGULATOR IC. Very easy to use. Makes a neat Highly Regulated - 15V Supply for OP AMP's, etc. Requires only unregulated DC (18-30V) and 2 bypass capacitors. With Data Sheet and Schematics. 8 pin mDIP **\$1.25**

LM741 FREQ COMPENSATED OP AMP, μ A741, MC1741, etc. mDIP 5/S1 3/S1

MC1458 DUAL 741 OP AMP mDIP 3/S1

RC4558 DUAL 741 OP AMP mDIP 3/S1

2N3904 NPN TRANSISTOR AMPLIFIER/SWITCH to 50 mA μ 100 6/S1

ZENERS - Specify Voltage 3.3, 3.9, 4.3, 5.1, 6.8, 8.2 400mW 4/S1 0.0 9.1, 10, 12, 15, 16, 18, 20, 22, 24, 27, or 33V (+10%) 1 Watt 3/S1 0.0

- MONEY-BACK GUARANTEE
- ALL TESTED AND GUARANTEED

ADVA

ELECTRONICS
BOX 4181 K, WOODSIDE, CA 94062
Tel. (415) 851-0455

FREE

IC or FET'S WITH
\$5 & \$10 ORDERS. 1
DATA SHEETS
WITH MANY ITEMS.

DIODES	TRANSISTORS	TRANSISTORS	TRANSISTORS	LINEAR IC's
ZENERS & RECTIFIERS	2N706 50.24 2N4091 3/S1 2N5638 2/S1	2N4091 3/S1 2N5638 2/S1	2N4091 3/S1 2N5638 2/S1	LM300K 5 \$1.75
1N455 10 2N710 24 2N4092 50.75 2N5640 2/S1	2N710 24 2N4092 50.75 2N5640 2/S1	2N710 24 2N4092 50.75 2N5640 2/S1	2N710 24 2N4092 50.75 2N5640 2/S1	LM3005 1 1.75
1N458 6/S1 2N720 40 2N4121 3/S1 CP643 54.00	2N720 40 2N4121 3/S1 CP643 54.00	2N720 40 2N4121 3/S1 CP643 54.00	2N720 40 2N4121 3/S1 CP643 54.00	LM3008 1 1.75
1N483 3 to 6/S1 2N918 3/S1 CP950 55.00	2N918 3/S1 CP950 55.00	2N918 3/S1 CP950 55.00	2N918 3/S1 CP950 55.00	LM3012 1 1.75
1N485 6/S1 2N1613 50.20 2N4124 5/S1 CP561 54.00	2N1613 50.20 2N4124 5/S1 CP561 54.00	2N1613 50.20 2N4124 5/S1 CP561 54.00	2N1613 50.20 2N4124 5/S1 CP561 54.00	LM3015 1 1.75
1N746 10 2N1711 29 2N4248 5/S1 E100 4/S1	2N1711 29 2N4248 5/S1 E100 4/S1	2N1711 29 2N4248 5/S1 E100 4/S1	2N1711 29 2N4248 5/S1 E100 4/S1	LM3017 2 1.50
1N750 4/S1 2N1800 38 2N4249 5/S1 E101 3/S1	2N1800 38 2N4249 5/S1 E101 3/S1	2N1800 38 2N4249 5/S1 E101 3/S1	2N1800 38 2N4249 5/S1 E101 3/S1	LM3020 1 1.75
1N914 15/S1 2N2219 24 2N4274 5/S1 E175 3/S1	2N2219 24 2N4274 5/S1 E175 3/S1	2N2219 24 2N4274 5/S1 E175 3/S1	2N2219 24 2N4274 5/S1 E175 3/S1	LM3080N 1.20
1N921 6 4/S1 2N2222 0/S1 2N4302 50.20	2N2222 0/S1 2N4302 50.20	2N2222 0/S1 2N4302 50.20	2N2222 0/S1 2N4302 50.20	NE555V 2/S1
1N974 4/S1 2N2222A 5/S1 2N4303 20	2N2222A 5/S1 2N4303 20	2N2222A 5/S1 2N4303 20	2N2222A 5/S1 2N4303 20	NE556A 50.90
1N3064 6/S1 2N2369 5/S1 2N4338 51	2N2369 5/S1 2N4338 51	2N2369 5/S1 2N4338 51	2N2369 5/S1 2N4338 51	LM109CN 20
1N3000 6/S1 2N2906 10 82 2N4360M 2/S1	2N2906 10 82 2N4360M 2/S1	2N2906 10 82 2N4360M 2/S1	2N2906 10 82 2N4360M 2/S1	LM109CN 28
1N4001 12/S1 2N2909 5/S1 2N4361 51	2N2909 5/S1 2N4361 51	2N2909 5/S1 2N4361 51	2N2909 5/S1 2N4361 51	LM1023M 2/S1
1N4002 12/S1 2N2905 50.24 2N4362 50.90	2N2905 50.24 2N4362 50.90	2N2905 50.24 2N4362 50.90	2N2905 50.24 2N4362 50.90	LM123M 51.00
1N4003 12/S1 2N2906A 24 2N4416 2/S1	2N2906A 24 2N4416 2/S1	2N2906A 24 2N4416 2/S1	2N2906A 24 2N4416 2/S1	LM739N 51.00
1N4004 12/S1 2N2907 5/S1 2N4416A 50.80	2N2907 5/S1 2N4416A 50.80	2N2907 5/S1 2N4416A 50.80	2N2907 5/S1 2N4416A 50.80	LM741CN 3/S1
1N4005 10/S1 2N2952 51.50 2N4506 10 51	2N2952 51.50 2N4506 10 51	2N2952 51.50 2N4506 10 51	2N2952 51.50 2N4506 10 51	LM741CN 48/S1
1N4006 10/S1 2N3563 0/S1 2N4661 51	2N3563 0/S1 2N4661 51	2N3563 0/S1 2N4661 51	2N3563 0/S1 2N4661 51	LM741CN14 36
1N4007 10/S1 2N3564 4/S1 2N4887E 2/S1	2N3564 4/S1 2N4887E 2/S1	2N3564 4/S1 2N4887E 2/S1	2N3564 4/S1 2N4887E 2/S1	LM742CN 65
1N4148 15/S1 2N3565 10 6/S1 2N4888E 2/S1	2N3565 10 6/S1 2N4888E 2/S1	2N3565 10 6/S1 2N4888E 2/S1	2N3565 10 6/S1 2N4888E 2/S1	7402C DIP 35
1N4164 25/S1 2N3568 6/S1 2N4881 52.50	2N3568 6/S1 2N4881 52.50	2N3568 6/S1 2N4881 52.50	2N3568 6/S1 2N4881 52.50	7402C DIP 1.00
1N4370 10 2/S1 2N3638 6/S1 2N4888 51	2N3638 6/S1 2N4888 51	2N3638 6/S1 2N4888 51	2N3638 6/S1 2N4888 51	884CP mDIP 80
1N4372 10 2/S1 2N3638A 5/S1 2N4965 3/S1	2N3638A 5/S1 2N4965 3/S1	2N3638A 5/S1 2N4965 3/S1	2N3638A 5/S1 2N4965 3/S1	LM1304N 1.10
1N4454 15/S1 2N3640 5/S1 2N5037 2/S1	2N3640 5/S1 2N5037 2/S1	2N3640 5/S1 2N5037 2/S1	2N3640 5/S1 2N5037 2/S1	LM1585N 3/S1
1N4728 10 3/S1 2N3642 5/S1 2N5058 4/S1	2N3642 5/S1 2N5058 4/S1	2N3642 5/S1 2N5058 4/S1	2N3642 5/S1 2N5058 4/S1	LM2111N 51.00
1N4753 3/S1 2N3643 5/S1 2N5126 10 6/S1	2N3643 5/S1 2N5126 10 6/S1	2N3643 5/S1 2N5126 10 6/S1	2N3643 5/S1 2N5126 10 6/S1	XR2556CP 1.55
1N5231 10 4/S1 2N3644 4/S1 2N5135 5/S1	2N3644 4/S1 2N5135 5/S1	2N3644 4/S1 2N5135 5/S1	2N3644 4/S1 2N5135 5/S1	27400E 1.85
1N5236 6/S1 2N3646 4/S1 2N5139 5/S1	2N3646 4/S1 2N5139 5/S1	2N3646 4/S1 2N5139 5/S1	2N3646 4/S1 2N5139 5/S1	CA3028A 1.75
1N5370 10 2/S1 2N3648 3/S1 2N5139 5/S1	2N3648 3/S1 2N5139 5/S1	2N3648 3/S1 2N5139 5/S1	2N3648 3/S1 2N5139 5/S1	CA3046 84
1N5144 52 2N3821 50.60 2N8210 3/S1	2N3821 50.60 2N8210 3/S1	2N3821 50.60 2N8210 3/S1	2N3821 50.60 2N8210 3/S1	LM3075N1 1.45
DS 144MHz 51 2N3822 .70 2N5308 2/S1	2N3822 .70 2N5308 2/S1	2N3822 .70 2N5308 2/S1	2N3822 .70 2N5308 2/S1	CA3088 35
FF 432MHz 51 2N3823 .40 2N5307 51.50	2N3823 .40 2N5307 51.50	2N3823 .40 2N5307 51.50	2N3823 .40 2N5307 51.50	LM3300N 66
MV820 10 2N3866 .75 2N5432 1.00	2N3866 .75 2N5432 1.00	2N3866 .75 2N5432 1.00	2N3866 .75 2N5432 1.00	RC4194D 1.50
MV832 51 2N3903 10 6/S1 2N5457 3/S1	2N3903 10 6/S1 2N5457 3/S1	2N3903 10 6/S1 2N5457 3/S1	2N3903 10 6/S1 2N5457 3/S1	RC4194D 1.50
MV1620 10 2N3906 50.38 2N5459 50.38	2N3906 50.38 2N5459 50.38	2N3906 50.38 2N5459 50.38	2N3906 50.38 2N5459 50.38	LM3075N 2.00
MV1834 51 2N3919 55.00 2N5484 3/S1	2N3919 55.00 2N5484 3/S1	2N3919 55.00 2N5484 3/S1	2N3919 55.00 2N5484 3/S1	LM3075N 2.00
MV1856 10 2N3922 5.00 2N5486 2/S1	2N3922 5.00 2N5486 2/S1	2N3922 5.00 2N5486 2/S1	2N3922 5.00 2N5486 2/S1	NE555V 95
MV1872 52 2N3954 3.70 2N5482 53.00	2N3954 3.70 2N5482 53.00	2N3954 3.70 2N5482 53.00	2N3954 3.70 2N5482 53.00	NE556V 90
MV2201 10 2N3958 1.18 2N5564 2.80	2N3958 1.18 2N5564 2.80	2N3958 1.18 2N5564 2.80	2N3958 1.18 2N5564 2.80	LM3075N 1.25
MV2205 51 2N3970 1.00 1N5561 12.00	2N3970 1.00 1N5561 12.00	2N3970 1.00 1N5561 12.00	2N3970 1.00 1N5561 12.00	RC4195DN 1.25

*SUPER SPECIALS:

1N914 100V/10mA Diode	20/S1	MPF102 200MHz RF Amp	3/\$1
1N4001 100V/1A Rect.	15/S1	40673 MOSFET RF Amp	\$1.75
1N4154 30V 1N914	25/S1	LM324 Quad 741 Op Amp	.94
BR1 50V 1/4 Bridge Rec	4/S1	LM376 Pos Volt Reg mDIP	.55
2N2222A NPN Transistor	6/S1	NE555 Timer mDIP	2/S1
2N2907 PNP Transistor	6/S1	LM723 2.37V Reg DIP	3/S1
2N3055 Power Xistor 10A	.69	LM741 Comp Op Amp mDIP	4/S1
2N3904 NPN Amp/Sw μ 100	6/S1	LM1458 Dual 741 mDIP	3/S1
2N3906 PNP Amp/Sw μ 100	6/S1	CA3086 5 Trans Array DIP	.55
CP650 Power FET 1/2Amp	55	RC4195DN - 15V/50mA mDIP	1.25
RF391 RF Power Amp Transistor 10-25W @ 3-30MHz TO 3			\$5.00
555X Trimer 1us-1hr Different pinout from 555 (w/data)			3/S1
RC4194TK Dual Tracking Regulator - 0.2 to 30V @ 200mA TO 66			\$2.50
RC4195TK Dual Tracking Regulator - 15V @ 100mA (TO 66)			\$2.25
8038 Waveform Generator 1/1A Wave With Circuits & Data			\$3.75

SPECIALS - THIS MONTH ONLY

1N34	Germanium Diode 60V 10mA	10/\$1
1N6263	Hot Carrier Diode (HP2800, etc.)	\$1.00
2N918	UHF Transistor - Osc/Amp up to 1 GHz	4/\$1
2N3866	UHF Transistor - 1 Watt at 432 MHz	\$0.75
RCA29	NPN Power Amp/Switch 30W TO-220	.70
LM741	Compensated Op Amp mDIP or DIP	6/\$1
LM1304	FM Multiplex Stereo Demodulator	\$0.99
LM2111	FM IF Amp/Limiter/Detector	.99
CA3028A	RF/IF Amplifier DC to 120 MHz	1.45
RC4136	Quad 741 Op Amp - Low-Noise	.95
LP-10	LOGIC PROBE Kit - TTL, CMOS, etc.	\$7.85
	(See Above - "OTHER ADVA KITS")	

ADVA

ELECTRONICS

BOX 4181 K
WOODSIDE, CA 94062
Tel. (415) 851-0455

A24

BULLET ELECTRONICS

P. O. BOX 19442E
DALLAS, TEXAS 75219
(214) 823-3240

B8

PHONE ORDERS ON MASTERCARD OR VISA CARDS

New! PS-14 HIGH CURRENT REGULATED POWER SUPPLY KIT

A low cost, no frills, heavy duty power supply. Designed for use and abuse!

12V @ 15A

Less Case, meters & jacks

- * Better than 200mV load and line regulation
- * Foldback Current Limiting
- * Short Circuit Protected
- * Thermal Shutdown
- * Adjustable Current Limiting
- * Less than 1% ripple.
- * 15 amps 11.5 to 14.5V
- * All parts supplied including heavy duty transformer.
- * Quality plated fiberglass PC board.

\$35.00

UPS SHIPPING PAID!

PS-12 DUAL RANGE 3 to 30V VARIABLE HIGH CURRENT POWER SUPPLY KIT

ALL THE FEATURES OF THE PS-14 PLUS:
Continuously variable from 3-15 and 14-30 volts, (2 ranges)

Less case, meters & jacks.

Note the PS-12 DOES NOT have thermal shutdown. Canadian orders include \$10.00 for shipping and insurance

\$49.95

UPS Shipping Paid!

OVERVOLTAGE PROTECTION KIT

Provides cheap insurance for your expensive equipment. Trip voltage is adjustable from 3 to 30 volts. Overvoltage instantly fires a 25A SCR and shorts the output to protect equipment. Should be used on units that are fused. Directly compatible with the PS-12 and PS-14. All electronics supplied. Drilled and plated PC board. (Order OVP-1)

\$6.95

A COMPLETE CAPACITOR DISCHARGE IGNITION KIT for **\$9.95**

You get all the electronics less the case and heat-sinks.

SPECIAL SALE! The response to our anniversary sale on CDI's was fantastic so here goes again...WHILE THEY LAST...Buy two CDI kits for \$9.95 each, get the third CDI kit for \$1.00!

2N6283 MOTOROLA HOUSE # DEVICE

\$1.00

20amp NPN Darlington with Hfe of over 5,000! VCE of 80V. Outperforms MJ3001 and MJ1000 devices. TO-3. Limited Qty.!

MK-05 MINI MOBILE CLOCK

The smallest and best priced mobile clock kit on the market. Designed to be a mobile clock from the ground up. There has been no compromise on quality.

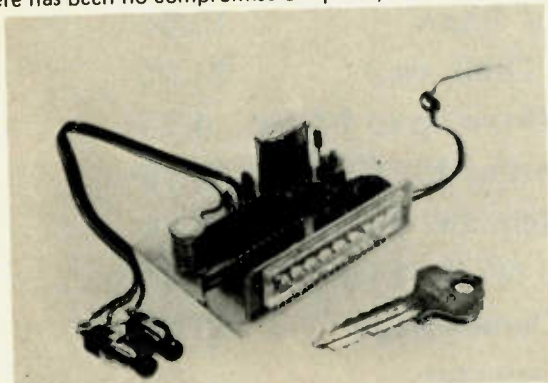

FEATURES:

- * Quartz crystal timebase
 - * Toroid & zener noise & overvoltage protection.
 - * Magnified .15", 6 digit LED readout.
 - * Complete with presettable 24 hr. alarm.
 - * 9-14 VDC @ 40 to 50 ma.
 - * Readouts can be suppressed
 - * EASY, QUICK ASSEMBLY
 - * All components required included (you supply the speaker).
 - * Top quality drilled and plated PC boards.
- Clock board: 2.6" x 2"
Readout board: 2 3/8" x .75"

\$12.95

Small enough to mount in the instrument panel

LM340-12 HOUSE # DEVICE

1 amp voltage regulator WITH SPECS. Built-in thermal and overvoltage protection.

TO-3

89¢

CA3011 RCA'S HIGH GAIN WIDE BAND IC IF AMP.

75 DB gain. 100 KHZ to over 20MHZ 10 lead TO-5 can. With Specs.

5 for \$2.00

MC1351P FM IF, LIMITER, DISCRIMINATOR

AND AF PREDRIVER IC IN A STAGGERED LEAD DIP PAK.

5 for \$3.00

MINI ELECTRONIC GRANDFATHER CLOCK KIT

Complete Electronics!

- * Chimes the hour (ie: 3 times for 3 O'clock)
- * Unique "swinging" LED pendulum
- * Tick tock sound matches pendulum swing.
- * Large 4 digit .5" LED readout
- * All CMOS construction
- * Complete electronics including transformer & speaker; drilled and plated PC boards measure 4.5" x 6.5"

\$39.95

BEAUTIFUL SOLID WALNUT

Custom case for above kit. Over 9 3/4" tall.

\$19.95

- No COD'S.
- Send check or MO
- MasterCard or VISA accepted.
- Texas Residents add 5% sales tax.

- Foreign orders add 10% (20% airmail)
- Catalog included with each order
- Orders over \$50. take 10% discount.

SPECIAL

All Phone Orders over \$10. from this ad will receive a FREE Warble Alarm Kit (\$2.50 value), during September.

Synthacoder

New!



★ ALL NEW SYNTHESIZER/ENCODER FROM ENGINEERING SPECIALTIES
THE ULTIMATE IN FREQUENCY CONTROL FOR IC-22S OWNERS!

No more soldering diodes every time you want to try a new repeater. Just plug the Synthacoder into the back of your radio, select channel 22, and the Synthacoder takes command of your radio — Giving you fingertip control of ALL frequencies.

- Front Panel Thumbwheel Control of All Channels
- Fully Automatic Invalid Code Control
- Small Size: 3 3/8" x 1 1/2" x 6"
- Factory Wired and Tested
- Easy To Install

SPECIAL
only \$87.95
postpaid
CA Residents add 6% sales tax

Engineering Specialties

P.O. BOX 2233
1247 COMMERCIAL AVENUE
OXNARD CA 93030
(805) 486-0817

YES, I would like to purchase a Synthacoder for my IC-22S. Enclosed please find my \$87.95 (Price includes postage and handling). California residents add 6% sales tax.

\$_____ enclosed. Cash Check Money Order
Please charge my Master Charge BankAmericard
Credit card # _____

Interbank # _____
Expiration date _____
Signature _____

- I'LL BITE! Please send more info.
 I'M HOOKED! Please RUSH my Synthacoder.

Name _____ Call _____
Address _____
City _____ State _____ Zip _____





WE PAY POSTAGE!

ELECTRONICS

P. O. Box 401247, Garland, Texas 75040 (214) 271-2461

16K E-PROM CARD

\$69.95 (KIT)

S-100 (1MSA1/ALTAIR) BUSS COMPATIBLE

IMAGINE HAVING 16K

OF SOFTWARE ON LINE AT ALL TIME!

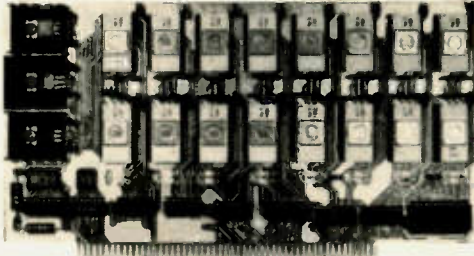

KIT FEATURES:

1. Double sided PC Board with solder mask and silk screen and Gold plated contact fingers.
2. Selectable wait states.
3. All address lines and data lines buffered!
4. All sockets included.
5. On card regulators.

USES
2708's!

DEALER INQUIRES INVITED

KIT INCLUDES ALL PARTS AND SOCKETS! (EXCEPT 2708's)

SPECIAL OFFER: Our 2708's (650 NS) are \$12.95 when purchased with above kit.

2708 1KX8 2708 EPROMS

Prime new units from a major U.S. mfg. 650 N. S. access time. Equivalent to four 1702A's in one package!

GOING INTO
BUSINESS
SALE!

\$15.75 each

8K LOW POWER RAM KIT

(S-100 BUSS COMPATIBLE)

\$149.00

(Kit of All
Parts and
Sockets)

The last word in RAM Kits. Uses 21L02-1 RAM's. All address and data lines fully buffered. PC Board is solder masked and silk screened and has gold plated contacts. Four regulators with heatsinks included.

OPCOA LED READOUT

SLA-1 Common Anode. .33 In. character size. The original high efficiency LED display.

\$.75 each
4 FOR \$2.50

741C OP AMPS

MINI DIP. Prime New Units. Has computer MFG's house number.

12 FOR \$2
100 FOR \$15

CAR CLOCK MODULE — \$19.95

MA 1003. By National. Same as sold by others at \$24.95. Self contained, NOT a Kit. Same as used by Detroit in new cars. With Data.

Mating Edge Connector: **\$1.50**

DISC CAPACITORS

.1 MFD 16 V.P.C. Leads. Most Popular Value! P.C. Leads. By Sprague.
20 FOR \$1

TANTALUM CAPACITOR

1 MFD. 35 V. Kemet. Axial Lead. Best Value.
10 FOR \$1

ROTARY SWITCH

Instrument grade. 6 Pole. 3 Postion. Centralab.
\$.99 each

POWER RESISTORS

.5 OHM 50 WATT. Adjustable 5%
2 FOR \$1

3 OHM 15 WATT. 5%
3 FOR \$1

.25 OHM 3 WATT. 1% IRC
4 FOR \$1

16 PIN IC SOCKETS

Low profile. Solder Tail.
5 FOR \$1

CALCULATOR DISPLAYS

Brand New Units By BOWMAR. Common Cathode.

.11 INCH CHARACTER.
9 DIGIT - \$.99 6 DIGIT - \$.69

2N3616 Motorola TO - 3 Power PNP Germanium. 85 W. 75 V.

7 AMP.
2 FOR \$1

2N3566 - TO - 5 plastic. NPN. VCEO-40 HFE 150 TO 600

10 FOR \$1

1 AMP RECTIFIERS

House Numbered. Factory marked units. All meet 200 PIV minimum. Many up to 1,000 PIV!

30 FOR \$1 Full Leads

MPS-6566 - TO - 92 plastic. NPN.

VCEO-45 HFE 100 TO 400
10 FOR \$1

TRW POWER DARLINGTON

15 AMP 500V NPN. **\$2 Each**

HIGHSPEED SCR

TO-66 5 AMP 250 PIV. By Hutson.
\$.69 Each

TERMS: ORDERS UNDER \$15 ADD \$.75. NO C.O.D. WE ACCEPT VISA AND MASTER CHARGE CARDS. MONEY BACK GUARANTEE ON ALL ITEMS. TEXAS RESIDENTS ADD 5% SALES TAX.



ELECTRONICS P. O. BOX 401247 • GARLAND, TEXAS 75040 • (214) 271-2461

D20

HELLO OUT THERE...

ARE YOU A HOBBYIST, A TINKERER, SOMEONE WHO LOVES TO PLAY WITH PARTS, BUILD THINGS, AND EXPERIMENT? WELL, WE'RE HOBBYISTS TOO, AND WE NEED A LOT OF STUFF AROUND OUR LAB SO THAT WHENEVER WE WANT TO PLAY, IT'S ALL RIGHT THERE SO WE CAN START RIGHT IN. WE HAVE IT EASY... BUT THAT DOESN'T LEAVE YOU OUT: YOU CAN HAVE IT ALMOST AS EASY AS WE DO. DON'T WASTE YOUR TIME AND ENERGY TRYING TO TRACK DOWN YOUR FAVORITE PARTS AT ALL THOSE LITTLE STORES ACROSS TOWN; DON'T SUBJECT YOURSELF TO THE FRUSTRATION OF TRYING TO SUBSTITUTE PARTS THAT WERE NEVER MEANT TO BE SUBSTITUTED: YOU ARE AS CLOSE TO OUR RESERVES OF PARTS AND KITS AS YOUR MAILBOX OR OUR 24 HOUR ORDER DESK. AND WHILE YOU'RE ORDERING... WHY NOT STOCK UP ON RESISTORS, CAPACITORS, ENCLOSURES, AND OTHER COMPONENTS. OUR PRICES ARE LOW ENOUGH SO YOU CAN AFFORD TO STOCK YOUR LAB AND BE READY FOR IDEAS WHEN THEY COME TO YOU. WHO KNOWS, YOU MAY EVEN SAVE ENOUGH TIME TO BUILD MORE PROJECTS OR AT LEAST SAY HELLO TO YOUR FAMILY. SEND FOR OUR FLYER AND SEE WHAT WE HAVE; IN THE MEANTIME, HERE ARE SOME SAMPLES...

lower prices ...more choice 74LS TTL

74LS00	\$0.30	74LS139	1.15
74LS01	0.30	74LS151	0.95
74LS02	0.30	74LS155	1.38
74LS04	0.33	74LS157	0.95
74LS08	0.36	74LS160	1.40
74LS10	0.36	74LS161	1.40
74LS11	0.36	74LS162	1.40
74LS12	0.33	74LS163	1.40
74LS14	1.38	74LS168	1.87
74LS15	0.30	74LS169	1.87
74LS20	0.30	74LS173	1.65
74LS21	0.33	74LS174	1.25
74LS22	0.33	74LS175	1.15
74LS26	0.43	74LS240	1.88
74LS27	0.36	74LS257	1.25
74LS30	0.30	74LS258	1.25
74LS32	0.38	74LS266	0.53
74LS37	0.45	74LS283	1.20
74LS38	0.45	74LS365/	
74LS42	0.98	80LS95	0.75
74LS47	1.00	74LS366/	
74LS48	0.98	80LS96	0.75
74LS74	0.50	74LS367/	
74LS75	0.68	80LS97	0.75
74LS76	0.50	74LS368/	
74LS86	0.50	80LS98	0.75
74LS109	0.50	74LS386	0.55
74LS125	0.63	81LS95	1.13
74LS126	0.63	81LS96	1.13
74LS132	1.25	81LS97	1.13
74LS138	1.10	81LS98	1.13

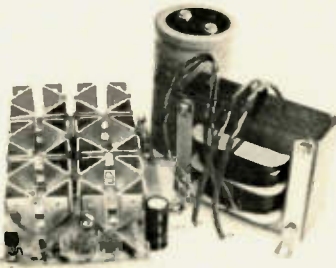

Photo of assembled supply. Case and hardware not included with kit.

what a supply!

That 8A figure, by the way, is for continuous operation. We believe that RMS ratings are the most honest and conservative way to go... but this supply has enough reserve so that you can draw TWELVE AMPS with a 50% duty cycle. Our custom wound transformer, generous heat sinking, and conservative design make this possible. What else will you like about this supply? How about crowbar overvoltage protection... .05 Volt regulation... variable out 11-14V... RF bypassing... and simple construction. All parts (except transformer, bridge, filters) mount on a single circuit board, and that includes the heat sinks and pass devices! Whether for ham, CB, or bench, here's the ideal supply. PLEASE ADD POSTAGE

12V 8A \$39.95

8K Econoram II T.M.

Sure, anybody can throw together an 8K RAM... or there wouldn't be so many available! But those who know memory recognize the Godbout board as not just an exceptional value (it's no secret we know how to keep costs down), but as an example of how to pack extra options into a basic memory board. Extras like a vector interrupt provision if you try to write into protected memory. An ALL STATIC design, eliminating the timing and refresh requirements of dynamic types. It zips along at 450 ns, with a 1 wait state option for those of you with 4 MHz Z-80 machines... yet power is 1250 mA typ, and guaranteed to be less than 1.5 A. Selectable write strobe means you can use this board with or without a front panel. Each 4K block may be addressed independently for extra flexibility. And of course, there are sockets for all ICs, prime 2102-11s, a super circuit board... 1 year warranty on all parts... this isn't just another board, this is a board you can depend on.

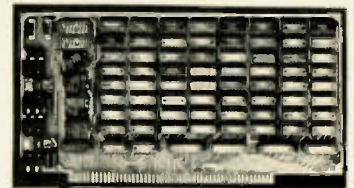

1 kit \$163.84
3 kits \$450
24K of MEMORY!

RF POWER TRANSISTORS

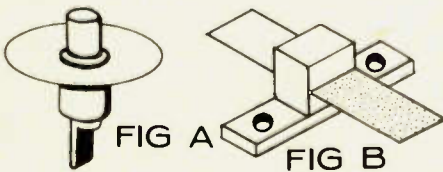

For operation at lower frequencies gain and efficiency are higher, giving higher output power.

\$4.95	A	3.5W	1.0W	310mW	30%	sim	RCA 2N5470
\$5.95	B	8.7W	2.5W	300mW	33%	sim	RCA TAB407
\$6.95	B	21W	5.5W	1.25W	33%	sim	RCA 2N6269
\$7.95	B	29W	7.5W	1.5W	33%	factory select	part--2N6269

PRICE	FIG.	Pd MAX @ 250C	POUT MIN @ 2 GHz	EFFICIENCY @ 2.0 GHz	PIN
-------	------	---------------	------------------	----------------------	-----



★ **\$10.95** ★
PLEASE INCLUDE POSTAGE



MULTI-METER

Everyone needs at least one VOM, but how many people can afford two? Now you can, and measure voltage and current at the same time, bipolar supplies, etc. Compact, and includes meter damping position for safe transportation. 6 DC V ranges; 3 DC current; 5 ACV RMS ranges; 2 ohms ranges; -20 to +22 dB; 50 uA meter; includes 34" test leads. Requires 1 "AA" cell (not included).

THIS SPECIAL GOOD THROUGH 9 / 30 / 77; SUBJECT TO STOCK ON HAND.

MORE COMPUTER KITS

CPU Power Supply \$ 45

Gives 5V @ 4A with crowbar overvoltage protection, +12V @ 1/2A, -12V @ 1/2A, and an adjustable 5-10V bias supply. Although intended for small computer systems, this is also a dandy little bench supply for digital experiments.

10 Slot Motherboard \$ 89

Includes 10 edge connectors; use as IMSAI add-on or for stand alone system. Active, regulated terminations minimize crosstalk, overshoot, and other bus problems. Epoxy glass board, quality parts, S-100 compatible, heavy power traces.

18 Slot Motherboard \$ 124

Same features as above, but with 18 slots + edge connectors.

Terminator Board \$ 29.50

Add active terminations to your bus, and clean up the noise, crosstalk, ringing, and overshoot that can foul up data and crash programs. Plug into 1 slot of an S-100 compatible motherboard, and you are ready to go.

TERMS: Add 50¢ to orders under \$10. Please add 5% to cover shipping--more in the case of power supplies--excess refunded. We accept COD order if street address is included for UPS. To place BankAmericard®/VISA®/Mastercharge® orders (\$15 minimum) call our 24 hour order desk at (415) 562-0636.

GODBOUT

BILL GODBOUT ELECTRONICS
BOX 2355, OAKLAND AIRPORT, CA 94614

FREE FLYER: If you haven't see one of our flyers lately, you are in for a surprise. See, we keep finding all these neat parts to carry... and we keep generating new kits... now we have books, more music kits, esoteric ICs, more Vector products... in short, stuff that delights the heart of the electronics hobbyist. All you have to do to get your own copy is to send us your name and address. We'll take care of the rest.

7400N TTL

SN7400N	16	SN7495A	25	SN74154N	1.00
SN7400N	16	SN7495A	22	SN74154N	99
SN7400N	16	SN7495A	45	SN74154N	99
SN7400N	16	SN7495A	39	SN74154N	99
SN7400N	16	SN7495A	37	SN74154N	99
SN7400N	16	SN7495A	32	SN74154N	99
SN7400N	20	SN7495A	36	SN74154N	99
SN7400N	24	SN7495A	32	SN74154N	99
SN7400N	20	SN7495A	36	SN74154N	99
SN7400N	25	SN7495A	5.00	SN74154N	1.10
SN7400N	25	SN7495A	50	SN74154N	1.10
SN7400N	25	SN7495A	50	SN74154N	1.10
SN7400N	18	SN7495A	90	SN74154N	1.25
SN7400N	30	SN7495A	90	SN74154N	1.25
SN7400N	33	SN7495A	89	SN74154N	2.10
SN7400N	45	SN7495A	39	SN74154N	8.50
SN7400N	70	SN7495A	2.49	SN74154N	8.50
SN7400N	49	SN7495A	49	SN74154N	1.25
SN7400N	35	SN7495A	49	SN74154N	1.25
SN7400N	21	SN7495A	75	SN74154N	99
SN7400N	33	SN7495A	49	SN74154N	99
SN7400N	37	SN7495A	79	SN74154N	2.49
SN7400N	29	SN7495A	79	SN74154N	2.49
SN7400N	29	SN7495A	89	SN74154N	1.95
SN7400N	37	SN7495A	40	SN74154N	2.00
SN7400N	42	SN7495A	1.00	SN74154N	2.00
SN7400N	36	SN7495A	39	SN74154N	2.00
SN7400N	31	SN7495A	39	SN74154N	3.19
SN7400N	27	SN7495A	39	SN74154N	1.95
SN7400N	27	SN7495A	51	SN74154N	1.25
SN7400N	25	SN7495A	60	SN74154N	89
SN7400N	15	SN7495A	60	SN74154N	89
SN7400N	89	SN7495A	1.09	SN74154N	1.25
SN7400N	59	SN7495A	1.15	SN74154N	1.25
SN7400N	74	SN7495A	1.15	SN74154N	1.25
SN7400N	75	SN7495A	4.00	SN74154N	1.75
SN7400N	75	SN7495A	4.50	SN74154N	1.75
SN7400N	81	SN7495A	4.50	SN74154N	1.75
SN7400N	69	SN7495A	2.50	SN74154N	1.25
SN7400N	74	SN7495A	1.15	SN74154N	1.25
SN7400N	74	SN7495A	2.35	SN74154N	99
SN7400N	26	SN7495A	2.00	SN74154N	1.79
SN7400N	27	SN7495A	1.00	SN74154N	6.00
SN7400N	27	SN7495A	1.51	SN74154N	6.00
SN7400N	20	SN7495A	89	SN74154N	7.00

MANY OTHERS AVAILABLE ON REQUEST
20% Discount for 100 Combined 7400's

CMOS

CD4000	25	CD4030	85	74C04N	75
CD4001	25	CD4030	85	74C04N	65
CD4002	25	CD4030	85	74C04N	65
CD4006	2.50	CD4040	2.45	74C03N	65
CD4007	2.50	CD4042	1.90	74C24N	2.15
CD4009	5.9	CD4044	1.50	74C73N	1.50
CD4010	5.9	CD4046	1.51	74C74	1.15
CD4011	25	CD4047	2.75	74C030N	3.00
CD4012	25	CD4049	79	74C95N	2.00
CD4013	47	CD4050	79	74C107N	1.25
CD4016	26	CD4051	2.95	74C151	2.90
CD4017	1.35	CD4053	2.95	74C154	4.00
CD4019	55	CD4060	3.25	74C157	2.15
CD4020	1.49	CD4066	1.75	74C160	3.25
CD4022	1.25	CD4069	45	74C161	3.25
CD4023	25	CD4071	45	74C163	3.00
CD4024	1.50	CD4081	45	74C164	3.25
CD4025	25	CD4511	2.50	74C173	2.60
CD4026	53.95	CD4518	2.50	74C193	2.75
CD4027	69	CD4519	2.95	74C200N	2.75
CD4028	1.65	74C08N	39	MC044A	4.50
CD4029	2.90	74C02N	55	MC14016	56

LINEAR

LM309H	80	LM351N	1.65
LM301H	35	LM349C	1.75
LM302H	35	LM350H	1.15
LM303H	1.00	LM307N	3.25
LM304H	95	LM377N	4.00
LM305H	35	LM380N	1.95
LM306H	1.00	LM380N	1.05
LM307H	1.00	LM380N	1.05
LM308H	1.10	LM382N	1.79
LM309H	1.10	LM382N	1.79
LM309H	99	LM382N	1.79
LM309H	99	LM382N	1.79
LM310H	1.15	LM310A	8.00
LM311H	1.15	LM311A	8.00
LM312H	1.15	LM312A	8.00
LM313H	1.15	LM313A	8.00
LM314H	1.15	LM314A	8.00
LM315H	1.15	LM315A	8.00
LM316H	1.15	LM316A	8.00
LM317H	1.15	LM317A	8.00
LM318H	1.15	LM318A	8.00
LM319H	1.15	LM319A	8.00
LM320H	1.15	LM320A	8.00
LM321H	1.15	LM321A	8.00
LM322H	1.15	LM322A	8.00
LM323H	1.15	LM323A	8.00
LM324H	1.15	LM324A	8.00
LM325H	1.15	LM325A	8.00
LM326H	1.15	LM326A	8.00
LM327H	1.15	LM327A	8.00
LM328H	1.15	LM328A	8.00
LM329H	1.15	LM329A	8.00
LM330H	1.15	LM330A	8.00
LM331H	1.15	LM331A	8.00
LM332H	1.15	LM332A	8.00
LM333H	1.15	LM333A	8.00
LM334H	1.15	LM334A	8.00
LM335H	1.15	LM335A	8.00
LM336H	1.15	LM336A	8.00
LM337H	1.15	LM337A	8.00
LM338H	1.15	LM338A	8.00
LM339H	1.15	LM339A	8.00
LM340H	1.15	LM340A	8.00
LM341H	1.15	LM341A	8.00
LM342H	1.15	LM342A	8.00
LM343H	1.15	LM343A	8.00
LM344H	1.15	LM344A	8.00
LM345H	1.15	LM345A	8.00
LM346H	1.15	LM346A	8.00
LM347H	1.15	LM347A	8.00
LM348H	1.15	LM348A	8.00
LM349H	1.15	LM349A	8.00
LM350H	1.15	LM350A	8.00
LM351H	1.15	LM351A	8.00
LM352H	1.15	LM352A	8.00
LM353H	1.15	LM353A	8.00
LM354H	1.15	LM354A	8.00
LM355H	1.15	LM355A	8.00
LM356H	1.15	LM356A	8.00
LM357H	1.15	LM357A	8.00
LM358H	1.15	LM358A	8.00
LM359H	1.15	LM359A	8.00
LM360H	1.15	LM360A	8.00

Timeband by FAIRCHILD

— Watches —
Men's & Ladies

- Solid State
- Displays hour, minute, second, month & day
- Free set of replacement batteries
- Choose LED or LCD styles
- One year factory warranty

T249 White w/bracelet \$19.95
T248 Yellow w/bracelet \$22.95
LED

T245 White w/strap \$29.95
T244 Yellow w/strap \$34.95
LED

T237 White w/bracelet \$22.95
T236 Yellow w/bracelet \$26.95
LED

T235 White w/strap \$24.95
T234 Yellow w/strap \$27.95
LED

T243 White w/bracelet \$20.95
T242 Yellow w/bracelet \$24.95
LED

CHANNEL F

Freeze Action • Speed Option
Automatic time and scorekeeping
Battery-free AC operation
Dual controls with 8-way action
Built-in Pro Hockey and Tennis games
Easy hook-up on any B/W or Color TV
Factory warranty

Channel F — additional cartridges — \$17.95 ea.

0811 — Tic-Tac-Toe/Shooting Gallery
0812 — Desert Fox/Shooting Gallery
0813 — Spacewar (2 players)
0814 — Spillies (1 or 2 players)
0815 — Spacemar (2 players)
0816 — Drag strip (1 or 2 players)
0817 — Maze (2 players)
0818 — Baseball (2 players)

DISCRETE LEDES

KC209	Red	10S1	KC211	Red	10S1
KC209	Green	4S1	KC211	Green	4S1
KC209	Orange	4S1	KC211	Yellow	4S1
KC209	Yellow	4S1	KC211	Orange	4S1

125' dia .185' dia .200' dia .085' dia

KC222 Red 10S1 KC526 Red 5/S1 KC556 Red 10S1 MV50 Drag 6/S1
KC222 Green 4S1 KC526 Green 4/S1 KC556 Green 4/S1
KC222 Yellow 4S1 KC526 Yellow 4/S1 KC556 Yellow 4/S1
KC222 Orange 4S1 KC526 Orange 4/S1 KC556 Orange 4/S1
SSL 22 RI 4/S1 KC526 Clear 4/S1 KC556 Clear 7/S1

DISPLAY LEDES

TYPE	POLARITY	MT	TYPE	POLARITY	MT
MAN 1	Common Anode	270 2.95	MAN 3640	Common Cathode-orange	300 1.75
MAN 2	5 x 7 Dot Matrix	300 4.95	MAN 4710	Common Anode-red	400 1.95
MAN 3	Common Cathode	125 3.11 0.00	DL701	Common Anode-red	300 99
MAN 4	Common Cathode	167 1.95	DL704	Common Cathode	300 99
MAN 5	Common Anode	300 1.25	DL707	Common Cathode	300 99
MAN 6	Common Anode	300 1.95	MAN 4740	Common Anode-red	400 99
MAN 7	Common Anode-yellow	300 1.95	DL741	Common Anode	600 1.50
MAN 54	Common Anode-green	400 99	DL 747	Common Anode	600 2.25
MAN 57	Common Anode-green	300 99	DL 750	Common Cathode	600 2.49
MAN 58	Common Anode-red	400 99	DL 758	Common Cathode	110 50
MAN 74	Common Cathode	300 1.50	DL 759	Common Cathode	250 75
MAN 82	Common Anode-yellow	300 99	FN070	Common Cathode	500 1.00
MAN 84	Common Cathode-yellow	300 99	FN0503	Common Cathode	500 1.00
MAN 3620	Common Anode-orange	300 1.75	FN0507	Common Cathode	500 1.00

FCS 8000A - 3 1/2 Digit - 8" Display

NEW! 25 Pin Version with color & amp/cm indicator

Connects almost one for one with 3817, 3817A or D (3817 available at \$5.00 each)

Typical segment current 8mA except 10n, 10ns B & C and 10mA, A & D which are 16mA

Forward voltage drop 1.5 volts

MAXIMUM FORWARD CURRENT - 25 mA

SPECIAL \$4.95 EA.

HP 5082-7300 Series - Multi-Digit

1/2" Ht. • Common Cathode • Dip Package
3 to 5 volts @ 5 mls per segment
7 segment Monolithic • Red Display

2 Digit \$.79
3 Digit \$.99
4 Digit \$ 1.19
5 Digit \$ 1.19

IC SOLDEXTAL - LOW PROFILE (TIN) SOCKETS

8 pin	\$17	16	15	24 pin	\$38	37	36
14 pin	20	19	18	28 pin	45	44	43
16 pin	22	21	20	36 pin	60	59	58
18 pin	29	28	27	40 pin	63	62	61
22 pin	37	36	35	48 pin	76	75	74
14 pin	52	25	24	28 pin	99	90	81
16 pin	50	27	26	36 pin	139	126	115
18 pin	35	32	30	40 pin	159	145	130
24 pin	49	45	42				

SOLOERTAL STANDARD (TIN)
SOLOERTAL STANDOARD (GOLD)
WIRE WRAP SOCKETS (GOLD) LEVEL #3

50 PCS. RESISTOR ASSORTMENTS \$1.25 PER ASS.

ASST. 1	5 ea.	10 OHM	12 OHM	15 OHM	18 OHM	22 OHM	27 OHM	33 OHM	39 OHM	47 OHM	56 OHM	1/4 WATT 5% - 50 PCS.
ASST. 2	5 ea.	180 OHM	220 OHM	270 OHM	330 OHM	390 OHM	470 OHM	560 OHM	680 OHM	820 OHM	1K	1/4 WATT 5% - 50 PCS.
ASST. 3	5 ea.	1.2K	1.5K	1.8K	2.2K	2.7K	3.3K	3.9K	4.7K	5.6K	6.8K	1/4 WATT 5% - 50 PCS.
ASST. 4	5 ea.	8.2K	10K	12K	15K	18K	22K	27K	33K	39K	47K	1/4 WATT 5% - 50 PCS.
ASST. 5	5 ea.	22K	27K	33K	39K	47K	56K	68K	82K	100K	120K	1/4 WATT 5% - 50 PCS.
ASST. 6	5 ea.	300K	470K	560K	680K	820K	1M	1.2M	1.5M	1.8M	2.2M	1/4 WATT 5% - 50 PCS.
ASST. 7	5 ea.	2.7M	3.3M	3.9M	4.7M	5.6M	6.8M	8.2M	9.8M	11.5M	13.3M	1/4 WATT 5% - 50 PCS.

ASST. 8R Includes Resistor Assortments 1-7 (350 PCS.) \$7.49 ea.

\$5.00 Minimum Order - U.S. Funds Only
California Residents - Add 6% Sales Tax
Spec Sheets - 25c - Send 35c Stamp for 1977A Catalog
Dealer Information Available

James ELECTRONICS

1021-A HOWARD AVE., SAN CARLOS, CA. 94070
PHONE ORDERS WELCOME - (415) 592-8097
All Advertised Prices Good Thru September

WIRE WRAP CENTER

HOBBY-WRAP TOOL-BW-630

- Battery Operated (Size C)
- Weights ONLY 11 Ounces
- Wraps 30 AWG Wire onto Standard DIP Sockets (.025 inch)
- Complete with built-in bit and sleeve

\$34.95 (batteries not included)

WIRE-WRAP KIT - WK-2-W
WRAP • STRIP • UNWRAP

- Tool for 30 AWG Wire
- Roll of 50 Ft. White or Blue 30 AWG Wire
- 50 pcs. each 1", 2", 3" & 4" lengths - pre-stripped wire.

\$11.95

WIRE WRAP TOOL WSU-30
WRAP • STRIP • UNWRAP - \$5.95

WIRE WRAP WIRE - 30 AWG
25 ft. min. \$1.25 50 ft. \$1.95 100 ft. \$2.95 1000 ft. \$15.00
SPECIFY COLOR - White - Yellow - Red - Green - Blue - Black

WIRE DISPENSER - WD-30
50 ft. roll 30 AWG KYNAR wire wrap wire \$3.45 ea.
Cuts wire to desired length
Strips 1" of insulation Specify - Blue-Yellow-White-Red

HEAT SINKS

205-CB	680: 75A
208-CB	Beryllium Copper w/Black finish for TO-5 \$ 2.50
291-36H	Aluminum for TO-220 Transistors & Regulators \$ 2.60
580-75A	Black Anodized Aluminum for TO-3 \$1.60
401-A	Black Anodized Aluminum - predrilled mounting

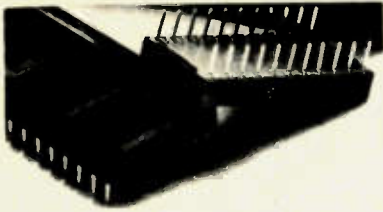

High quality sockets for IC's and PC interconnections. Check our price and quality and you will see why TRI-TEK is fast becoming the leader in IC sockets.

Low Profile DIP Solder Tail (Tin)

	1-9	10-24	25-100
SKT-0802 8 pin	.15	.15	.14
1402 14pin	.18	.17	.16
1602 16pin	.20	.19	.18
1802 18pin	.27	.26	.25
2002 20pin	.29	.28	.27
2202 22pin	.35	.34	.33
2402 24pin	.36	.35	.34
2802 28pin	.42	.41	.40
4002 40pin	.60	.57	.53



3 Level Wire Wrap Gold

	1-9	10-24	25-100
SKT-1400	.38	.37	.36
1600	.42	.41	.40
1800	.73	.65	.59
2400	1.00	.91	.83
4000	1.69	1.51	1.37



PRESTRIPPED WIRE WRAP WIRE

Highest quality 30 ga. Kynar insulated silver plated wire for wrapping. Stripped 1" on both ends. Indicated lengths are lengths of insulated portion. Packed 100 per sturdy plastic vial or 1000 per poly bag. Compare our prices!!! Available in Black, Red, Yellow and Green. State color desired.

Length	Price per tube of 100	Price per bag of 1000
1"	\$1.48 (WW30VC-1)	\$11.84 (#WW30BK-1)
2"	\$1.60 (WW30VC-2)	\$12.80 (#WW30BK-2)
4"	\$1.85 (WW30VC-4)	\$14.80 (#WW30BK-4)
6"	\$2.20 (WW30VC-6)	\$17.60 (#WW30BK-6)

ROLLS OF WIRE SAME AS ABOVE (30 ga. KYNAR)
100 ft...\$2.95 500ft...\$8.95 1000ft...\$14.95

WRAP WIRE SPECIAL FOR AUGUST

Special purchase of quality KYNAR insulated 30 ga. wire brings you a real bargain in pre-stripped wrapping wires. Available in blue color only. 1" and 2" insulation only.
1" insulation, blue, bag of 100 pieces.....\$5.99
2" insulation, blue, bag of 100 pieces.....\$1.19

RIBBON CABLE IC INTERCONNECTS

No Of Pins	SINGLE END				
	6"	12"	18"	24"	36"
14P	1.51	1.62	1.72	1.83	2.05
16P	1.64	1.76	1.87	1.99	2.21
24P	2.49	2.69	2.88	3.08	3.48

No Of Pins	DOUBLE END				
	6"	12"	18"	24"	36"
14P	2.76	2.87	2.97	3.08	3.30
16P	3.01	3.13	3.24	3.36	3.58
24P	4.55	4.75	4.94	5.14	5.54

AMPLANNY Says

GET THE DROP ON THOSE WIRE WRAPPING PROBLEMS WITH WIRE AND TOOLS FROM TRI-TEK!!!!



OK WIRE WRAP TOOLS
BW-630 GUN.....\$34.95
HW-30 Tool.....\$5.95
HW-30M Tool.....\$6.95
FREE. 50 roll of wire wrap with purchase of tool!

NEW BOOK

1977 IC MASTER. Latest edition of this classic reference work has 1263 pages of technical data, cross-references, second source listings, index of available application notes from the guys who make the parts! A free up-date service card to help keep your copy current is included. Beautifully bound in hard cover leather grained jacket. Want IC info? Here 'tis.....
1977 IC MASTER..(includes shipping in USA).....\$38.88



PROFESSIONAL TEMPLATES-LOGIC SYMBOLS-Standard MIL806-B
3/4 Size.....\$3.50
1/2 Size....(Handy shirt pocket size).....\$3.25
Computer Flow Chart Symbols.....\$3.50

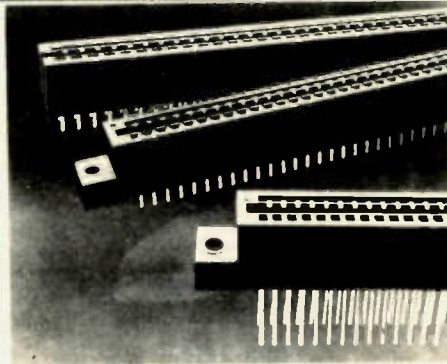

100 PIN MINICOMPUTER PC CONNECTORS

2X50 with .125" spacing. Solder tail or wrap terminals. By TI.
PCC-100ST (solder)....\$4.99 PCC-100WW....\$4.99 4/\$17.75

SIGNETICS 8000 SERIES TTL LOGIC

These quality units are faster and have greater fan-out capability than standard TTL. From a giant factory change-over you get real bargain prices. All are house numbered, but we provide a reference and pin-out sheet.

N8880A...Quad-2 Input NAND gate.....	8/\$1.00
N8822A...Dual J-K master/slave F/F.....	4/\$1.00
N8885A...Quad 2-Input NOR gate.....	8/\$1.00
N8890A...Hex Inverter.....	6/\$1.00
N8202A...10 bit "D" type register.....	\$1.25

The following items are available in large quantities Dealer or manufacturer inquiry is invited.

2N314... NPN switch on reels.....	10/\$1
1N753A... 6.2V, 5%, 1/4 Zener.....	5/\$1
CI106F2... 50V, 4A SCR w/socket.....	3/\$1
1N967B... 18V, 5%, 1/4 Zener.....	5/\$1
42501-1 Quad Ht speed NPN transistor in 14 pin DIP package. Similar to Motorola MPQ3303.....	5/\$1

MCM6571A is an 8192-Bit Horizontal-Scan (Row select) character generator with shifted characters. It contains 128 characters in a 7x9 matrix, and has the capability of shifting certain characters that normally extend below the baseline, such as j,y,g,p and q. A 7-bit address code is used to select one of the characters.

Features:

- .Static operation
- .TTL compatibility
- .CMOS compatibility (5V)
- .Shifted character compatibility
- .Includes Greek alphabet
- .Maximum access time =500ns

(See article in March '77 issue of 73 Magazine for applications including TV-Computer interface)

MCM6571A.....	\$9.95
Specs.....	\$1.00

MM5320 TV SYNC GENERATOR I.C.

Generate all the sync pulses necessary for camera or video terminals. Use with MCM6571A in the TV-Computer interface. MM5320N.....\$18.80
Specs.....60c

7 SEGMENT TO BCD DECODER, OR IS IT ENCODER?

Think about it-- how many times have you seen an application for device with 7 segment readout if only you had the output in BCD? Calculators, clocks, timers and the like can now be read into your mini'puter with minimum conversion hassel. CMOS for low power drain. Latched.
MM74C915N...18 pin DIP.....\$2.99

78HGKC 5A VARIABLE REGULATOR

Now- at last, a high current adjustable regulator. Some simple circuitry as the popular 78KC. Needs only two external resistors to program to any voltage between +5 and 30V @ 5A output.
78HGKC.....\$13.95
Specs.....30c

1N5393 200V, 1.5A Diode. Sturdy replacement for 1N4003 at a good savings.....15/\$1

HEX INVERTER DTL IC. Useful and economical replacement for 7404 where you don't need the speed. House marked. #0027 (DM936N).....SPECIAL...6/\$1.00

Japanese Transistor. Special buy on Hitachi 2SB367 brings you a bargain on this popular part. 2SB367.....\$1.29

Germanium Power Transistor. Delco house numbered replacement for ECG105. Removed from new assemblies at real bargain price. #251M-1. (ECG-105).....\$1.00

500V, 3 A BRIDGE RECTIFIER

1/2" hexagonal metal jacket stud mount with 2" stab-on wire terminals. #KB506. (Mfd. by G.I.).....89c

MC14412VP Universal Modem Chip.....\$16.95

"COOK BOOKS"

The famous Howard Sams "Cook Book" series tells you what and how in a broad range of subjects. Probably the most widely referenced works in their fields.

Prices quoted include shipping (U.S. only)	
TTL Cookbook.....	328 pages.....\$9.95
Active Filter Cookbook.....	223 pages.....\$15.95
CMOS Cookbook.....	402 pages.....\$10.95
IC OP AMP Cookbook.....	579 pages.....\$14.25
TV Typewriter Cookbook.....	250 pages.....\$10.95

MC14411 BIT RATE GENERATOR.

Single chip for generating selectable frequencies for equipment in data communications such as TTY, printers, CRT's or microprocessors. Generates 14 different standard bit rates which are multiplied under external control to 1X, 8X, 16X or 64X initial value. Operates from single +5 volt supply. MC14411.....\$11.98
4 pages of data.....40c
Crystal for the above.....\$4.95

- Accuracy -0.05% of Reading -1 Count
- Two Voltage Ranges 1.999 V and 199.9 mV
- Up to 25 Conversions
- $Z_{in} = 1000 M \Omega$
- Auto Polarity and Auto Zero
- Single Positive Voltage Reference
- Standard B Series CMOS Outputs Drives One Low Power Schottky Load
- Uses On-Chip System Clock or External Clock
- Low Power Consumption 8.0 mW typical @ +5.0 V
- Wide Supply Range @ -4.5 V to +8.0 V

MC14433 SINGLE CHIP 3 1/2 DIGIT A/D

Single chip combines linear and CMOS digital to bring you the simplest yet DVM approach. Requiring only 4 external passive parts, this subsystem gives you: Auto polarity, auto zero, single voltage reference, 8 mW operation, overrange, underrange signals, 25 conversions per second and .05% ± 1 count accuracy! 100 uV resolution. 24 Pin DIP.
MC14433P.....with specs.....\$19.55



TRI-tek, inc.

6522 NORTH 43RD AVENUE,
GLENDALE, ARIZONA 85301
PHONE 602 - 931-6949

We pay surface shipping on all orders over \$10 US, \$15 foreign in US funds. Please add extra for first class or air mail. Excess will be refunded. Orders under \$10, add \$1 handling. Please add 50c insurance. Master charge and Bank America cards welcome, (\$20 minimum). Telephone orders may be placed 10AM to 5:30PM daily, Mon thru Fri. Call 602-931-4528. Check reader service card or send stamp for our latest flyers packed with new and surplus electronic components.

ALDELCO ELECTRONIC CENTER NOW OPEN!

Kits, Books, Boards, Magazines. Special 2102LI 8 for \$17.50. 8080A CPU Chip \$19.95. We stock OK Battery Operated Wire Tool \$34.95, OK Hand Wire Wrapped Tool \$5.95. 7400 ICs CMOS, Timers PLL's IC Sockets. All kinds of transistors, rectifiers and diodes. Plus other electronic parts.

Add 5% for shipping. Minimum order \$10.00 Out of USA send certified check or money order, include shipping costs.

BUILD THE W7BBX PROGRAMMABLE KEYS. SOLID STATE PARTS WITH IC SOCKETS \$42.00. WE CAN SUPPLY THE FOUR PC BOARDS AND COMPREHENSIVE CONSTRUCTION MANUAL - ALL FOR ONLY \$29.95.

AL and PHIL say:

If you're in our neighborhood DROP IN and say Hello. If you're too far away to visit, give us a phone call at 516 378-4555, and we'll be glad to take your order over the phone. We have Master Charge and BankAmericard. Orders can also be sent COD, either UPS or U.S. Mail. Store hours are 9:30 AM to 5:00 PM, Monday to Saturday. Wednesday evenings till 9:00 PM. Give us a try. You'll like our friendly service but more than that you'll enjoy Aldelco Quality in everything we sell. Want our catalog quickly? Send a first class stamp. If you're not in a rush, circle the reader service card in the back of the magazine.

- #22 PVC Stranded hook up wire 50' roll \$1.00
- OK Wire Hand Tool
- WSU 30 5.95
- WSU30M (modified wrap) . 6.95
- Battery operated wire-wrap tool BW 630 Wraps #30 wire 34.95
- New! Model BW 2628. Wraps #26 + #28 wire \$39.95
- Batteries not included.

RECTIFIERS

- 2 amp 1000 volt 10 for \$1.00
- 2 amp 1500 volt .5 for 1.00
- 10 amp stud 50 volt . . . 1.50
- 10 amp stud 600 volt . . 4.50
- 40 amp stud 50 volt . . . 1.20
- 40 amp stud 750 volt . . 2.05

BRIDGES

- 2 amp to 5. 50 volt 35
- 2 amp to 5. 200 volt 50
- 2 amp to 5. 600 volt . . . 1.25
- 3 amp. 50 volt 50
- 3 amp. 400 volt 1.10
- 25 amp. 200 volt 1.50
- 25 amp. 600 volt 5.50
- 25 amp. 1000 volt 8.50

- 2N6103 to 220 plastic power transistor 75 watts 16 amps only 89¢

ALDELCO BOOKSHELF

- Howard W. Sams Books
- TTL Cookbook \$8.95
- CMOS Cookbook 9.95
- IC Timer Cookbook 9.95
- TV Typewriter Cookbook 9.95
- Microcomputer Primer 7.95
- How to Buy & Use Microcomputers 9.95

add \$1.00 per book order for shipping

FETS

- 40673 1.55
- MPF 10255
- 2N381935
- 2N545750
- 2N545850
- 2N545955
- 2N548550

DARLINGTON

- MPSA 1380
- MPSA 1440
- 2W530650

SCR

- C 106A55
- C 106B65
- C 122B85

- ALD 14 T03 power transistor 15 amps replaces GE 14 ECG 130 • HEP S 7004 only \$2.49

- ALD 20 general purpose transistor NPN to 18 replaces GE 20 • ECG 123A • HEP S 3001 only 49¢

- ALD 48 general purpose transistor to 92 replaces GE 48 ECG 159 • HEP S 0019 only 59¢

RECTIFIERS Special

- 2 AMP 50 volts 20 for \$1.00

- NOW AVAILABLE 6 AMP 100 VOLT RECTIFIER 69



#26 RIBBON CABLE

- Solid colors
- 14 Strand 25 ft
- 20 Strand 45 ft
- 26 Strand 50 ft
- 40 Strand 90 ft
- 50 Strand 1.00 ft

NEW IMPROVED ALARM CLOCK

- Digital alarm clock • Six big .5 display LEDs
- New on board AC Transformer • 12 Hour format with 24 hour Alarm • Snooze Feature • Elapsed time indicator.

A natural for cars, campers and mobile homes. Use on 12 volt dc with optional crystal time base (not including cabinet) \$19.95

CRYSTAL TIME BASE KIT \$4.95

- Optional cabinet - in simulated walnut grain or black leather \$4.95
- Plastic cabinets - blue, black, white or smoke \$3.95

- Red clock filters \$6.00

- 12 or 24 hour DIGITAL CLOCK KIT uses .5 display LED. 5314 clock chip fits our standard cabinet. Freeze feature \$18.95

VARIABLE POWER SUPPLIES

- PS-5 5-15 volt dc 600 mA \$6.95
- PS-12 12-28 volt dc 600 mA \$6.95

Add \$1.00 per kit shipping

ZENERS

- 1N746 to 1N759 400 Mw ea. 25
- 1N4728 to 1N4764 1 watt 28
- 1N5333 to 1N5378 5 watt 2 10
- 1N2970 to 1N3005 10 watt 2 40
- 1N3305 to 1N3340 50 watt 4 75

- AL 215 (GE 215) \$4.50
- AL 216 (GE 216) 7.95
- 2N3055 99
- 2N3904 or 2N3906 25
- 2N5496 or 2N6108 70
- MJE340 (2N5655) 1 10
- 741 or 709 14 Pin DIP 25
- 555 Timer 1.60
- 556 Dual 555 1.50
- 1N914 1N4148 15 for 99
- 1N34 1N60 1N64 10 for 99
- CA 3028 Dif. Amp 1.50
- 4060 CMOS 2.00
- LM309K Volt Reg 1.10
- MJ3055 2.20
- 5313 Clock Chip 3.95
- 5314 Clock Chip 4.50
- 82S23 3.95
- 2N6103 89
- LM709 or 741 Min DIP Dp Amp 45
- LM741CE T05 Dp Amp 45
- 14 or 16 Pin IC Sockets 30

RF DEVICES

- 2N3375 3W 400 MHz \$5.50
- 2N3866 1W 400 MHz 1 15
- 2N5589 3W 175 MHz 4 75
- 2N5590 10W 175 MHz 7 80
- 2N5591 25W 175 MHz 10 95
- 2SC517 3 95
- 2SC1226 1 25
- 2N6080 4W 175 MHz 5 40
- 2N6081 15W 175 MHz 8 45
- 2N6082 25W 175 MHz 10 95
- 2N6083 30W 175 MHz 12 30
- 2N6084 40W 175 MHz 16 30
- 2SC1306 4 30
- 2SC1307 5 25
- 2N2876 special 10 95

ALDELCO KITS

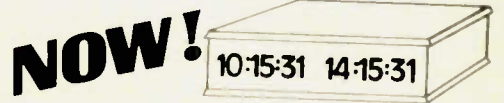

NOW! 2 Dual Digital 12-24 hour clock kits

MOEEL ALD5: Six big .5 display LEDs in an attractive black plastic cabinet with a red front filter. Great for a ham or broadcast station. Set one clock to GMT the other to local time. Or have a 24 hour format on one clock and 12 hour on the other. Freeze feature lets the clock be set to the second. Each clock is controlled separately. Cabinet measures 2 1/2" x 4 1/2" x 9 1/2". Complete Kit \$44.95.

MOEEL ALO7: Four bright .3 nixie tube display. Cabinet is an attractive deep blue including front filter. Will display seconds at the push of a button. An asset to any station. Cabinet size is 2 1/2" x 3" x 9 1/2". Complete Kit \$34.95.

7400 SERIES

- | | | | |
|-----------------|------------------|--------------------|--------------------|
| 7400 18 | 7476 50 | 74177 1.35 | 74LS153 1.89 |
| 7401 18 | 7480 50 | 7418095 | 74LS155 1.55 |
| 7402 20 | 7482 1.75 | 74181 3.75 | 74LS160 2.25 |
| 7403 20 | 7485 1.15 | 7418275 | 74LS161 2.25 |
| 7404 25 | 7486 45 | 74191 1.50 | 74LS163 2.25 |
| 7405 25 | 7489 2.49 | 74192 1.50 | 74LS169 2.25 |
| 7406 45 | 7490 60 | 74193 1.45 | 74LS173 1.95 |
| 7407 45 | 7492 80 | 74194 1.45 | 74LS175 1.85 |
| 7408 25 | 7493 80 | 74196 1.25 | 74LS190 2.60 |
| 7410 20 | 7494 95 | 74199 2.25 | 74LS191 2.85 |
| 7411 30 | 7495 90 | 74283 2.25 | 74LS192 2.85 |
| 7413 85 | 7496 85 | | 74LS195 2.00 |
| 7414 70 | 74100 1.25 | | 74LS196 2.00 |
| 7416 45 | 74104 45 | 74LS0039 | 74LS197 1.75 |
| 7417 45 | 74105 45 | 74LS0239 | 74LS257 1.75 |
| 7420 25 | 74107 50 | 74LS04 45 | 74LS365 1.75 |
| 7421 40 | 74121 55 | 74LS0839 | 74LS366 1.75 |
| 7425 45 | 74122 60 | 74LS1039 | 74LS368 1.75 |
| 7427 40 | 74123 1.05 | 74LS1139 | 74LS390 3.75 |
| 7430 20 | 74125 65 | 74LS2039 | |
| 7432 32 | 74141 1.25 | 74LS2139 | 74H SERIES |
| 7437 50 | 74145 1.25 | 74LS2239 | 74H0033 |
| 7438 1.05 | 74148 2.25 | 74LS3039 | 74H0135 |
| 7444 1.10 | 74150 1.10 | 74LS37 45 | 74H0431 |
| 7445 1.10 | 74151 1.00 | 74LS38 45 | 74H1033 |
| 7446 1.45 | 74153 1.35 | 74LS74 65 | 74H2133 |
| 7447 90 | 74154 1.70 | 74LS90 95 | 74H3033 |
| 7448 1.15 | 74155 1.35 | 74LS93 95 | 74H4033 |
| 7450 50 | 74156 1.35 | 74LS113 79 | 74S SERIES |
| 7451 20 | 74157 1.35 | 74LS114 65 | 74S04 45 |
| 7453 20 | 74160 1.35 | 74LS132 1.55 | 74S40 30 |
| 7454 20 | 74161 1.45 | 74LS138 45 | 74S153 2.25 |
| 7460 20 | 74162 1.50 | 74LS139 45 | 74S158 2.00 |
| 7470 45 | 74164 1.70 | 74LS151 1.55 | 74S175 2.25 |

Aldelco presents a



Frequency Counter and digital clock kit in one cabinet

- 12 or 24 hour digital clock
- Six .3 display LEDs
- Frequency counter typical 100 Hz to 40 MHz accuracy .0001%



Switchable from counter to clock. Clock maintains time while frequency counter is in use. Can be wired for either 4 or 6 digit clock. Small size makes attractive unit for auto or boat. Operates on 12 volt DC. Plug in power supply is available for 110 volt AC use. Comes complete with instructions. Cabinet and all parts assembled unit \$139.95. Optional 110 volt AC supply \$5.95 Kit only \$99.95

Frequency counter kit with memory similar to above but without digital clock \$99.95

Assembled unit \$139.95
110 V ac power supply \$5.95



2281A BABYLON TURNPIKE, MERRICK NY 11566
516-378-4555

S.D. SALES CO. P.O. BOX 28810 -A DALLAS, TEXAS 75228

★ Imsai - Altair "A" Compatible Kits ★

Z-80 CPU KIT COMPLETE - \$149. kit

Z-80 Chip & Manual \$49.95

Z-80 Manual - \$7.50 Separately

From the same people who brought you the \$89.95 4K RAM KIT. We were not the first to introduce an Imsai/Altair compatible Z-80 Card, but we do feel that ours has the best design and quality for the lowest price!
The advance features of the Z-80 such as an expanded set of 158 instructions, 8080A software compatibility, and operation from a single 5VDC supply, are all well known. What makes our card different is the extra care we took in the hardware design. The CPU card will always stop on an M1 state. We also generate TRUE SYNC on card, to insure that the rest of your system functions properly. Dynamic memory refresh and NMI are brought out for your use. Believe it or not, not all of our competitors have gone to the extra trouble of doing this.
As always this kit includes all parts, all sockets, and complete instructions for ease of assembly. Because of our past experience with our 4K kit we suggest that you order early. All orders will be shipped on a strict first come first served basis. Dealers inquiries welcome on this item. KIT includes Zilog Manual and all parts. KIT shipped with 2 MHz crystals.

**THE WHOLE WORKS
\$89.95**

4K LOW POWER RAM BOARD KIT

Imsai and Altair 8080 plug in compatible. Uses low power static 21L02-1 500 ns. RAM'S. Fully buffered, drastically reduced power consumption, on board regulated, all sockets and parts included. Premium quality plated through PC Board. *For 250 ns RAM's add \$10.00*

NEW! DESIGN CONSOLETTA KIT - \$89.95

S.D. Sales announces the inexpensive way to beat the wire wrap jungle. Our latest kit gives you 124 solderless quick connect terminals, enough for eight 16 pin IC's and provides 50 x 8 common buss matrix. Has regulated +5VDC and +/- 15VDC, all at 1 AMP. Voltage regulation at 100%. Also includes a pulse generator variable from 10hz to 50mhz and .01 sec. to 100 nano seconds. Generator output is +5V. In kit form only and includes all parts. sockets: front panel measures 7/8"x8/8", and hardware. case not available.

CAR/BOAT KIT *New Item!*
\$34.95

Music to your Ears!

MUSICAL HORN

Musical Horn Kit for car, boat, or home. Plays any tune from Mozart to Led Zeppelin. Change tunes in seconds; complete solid state electronics. Standard or custom tunes available at \$6.95 each (you supply us with the sheet music - we supply electronics for your favorite tune.) One song supplied with original order. Standard tunes available: DIXIE - EYES OF TEXAS - ON WISCONSIN - YANKEE DOODLE DANDY - NOTRE DAME FIGHT SONG - PINK PANTHER - AGGIE WAR SONG - ANCHORS AWAY - NEVER ON SUNDAY - BRIDGE OVER RIVER QUI - CANDY MAN.

**HOME KIT
\$26.90**

Home kit includes speaker which operates from your door bell. When door bell is pushed your favorite tune is played. Car/boat kit DOES NOT include speaker. Uses standard Bohm PM speaker. Allow 4 weeks delivery on both kits.

Limited Quantity!
\$9.95 kit

6 DIGIT ALARM CLOCK KIT

We made a fantastic kit even better. Redesigned to take advantage of the latest advances in IC technology. Features: Litronix Dual 1/2" displays, Mostek 50250 super clock chip, single I.C. segment driver, SCR digit drivers. Greatly simplified construction. More reliable and easier to build. Kit includes all necessary parts (except case). For P.C. board add \$3.00; AC XFMR add \$1.50. Do not confuse with Non-Alarm kits sold by our competitors! Eliminate the hassle - avoid the 5314! **NEW! WITH JUMBO LED READOUTS!**

1000 MFD Filter Caps Rated 35 WVDC Up-right style with PC leads. Most popular value for hobbyists. 4/\$1.00	SLIDE SWITCH Assortment Our best seller. Includes miniature and standard sizes, single and multi-position units. All new. 12/\$1.00	POWER RESISTOR 15 OHM 25W BY CLAROSTAT 75¢ ea.	RESISTOR ASSORTMENT 1/4W 5% & 10% PC leads. A good mix of values! Special! 200/\$2.	P.C. LEAD DIODES 1N4148/1N914 100/\$2. 1N4002 - 1A 100 PIV 40/\$1.	Just received a good mixed lot of National TO-92 plastic transistors. PNP & NPN, even a few FET's. 40-50% yield. Untested Asst. 500/\$3.	DISC CAP ASSORTMENT P.C. Leads. At least 10 different values. Includes .001, .01, .05 plus other standard values. 60/\$1.00
---	---	--	---	---	--	---

AMD-1702A
Huge Factory Purchase
FACTORY PRIME UNITS! BRAND NEW!
1.5 Micro-Seconds Access Time.
10/\$40. \$4.95 ea.

★ *Special!* ★

3.579545 MHz Time Base Crystal \$1.25	11,000 MFD 50WVDC Computer Grade Cap \$3.00 each
28 PIN SOCKETS 3 for \$1.00	39 MFD 16 V Mallory Electrolytic 15 for \$1.00

**FACTORY PRIME!
21L02-1**

Not only are our RAM'S faster than a speeding bullet but they are now very low power. We are pleased to offer prime new 21L02-1 Low Power and Super Fast RAM'S. Allows you to STRETCH your power supply farther and at the same time keep the wait light off!

**500ns 8/\$12.95
250ns 8/\$15.95**

IC'S REMOVED FROM PC BOARDS ALL TESTED; FULL SPEC.

IC's from XEROX

1402 A Shift Regulator - 50c
MH0025CN - 55c

Great Buy!

7400 - 9c	7430 - 9c	7493 - 26c
7402 - 9c	7440 - 9c	74121 - 22c
7404 - 9c	7437 - 10c	74123 - 32c
7406 - 11c	7438 - 10c	74151 - 9c
7407 - 11c	7451 - 9c	74155 - 22c
7410 - 9c	7474 - 16c	74193 - 35c
7416 - 13c	7475 - 24c	8233 - 35c
7420 - 9c	7486 - 16c	Intel - 1302 - 45c

MOS 6 DIGIT UP/DOWN COUNTER

40 PIN DIP. Everything you ever wanted in a counter chip. Features: Direct LED segment drive, single power supply (12 VOC TYPE), six decades up/down, pre-loadable counter, separate pre-loadable compare register with compare out-put. BCD and seven segment outputs, internal scan oscillator, CMOS compatible, leading zero blanking. 1MHZ. count input frequency.

\$12.95 Exclusive! \$12.95

CALL IN YOUR BANK-AMERICARD OR MASTER CHARGE ORDER IN ON OUR CONTINENTAL UNITED STATES TOLL FREE WATTS LINE:

1-800-527-3460

Texas Residents Call Collect:

214/271-0022

**TERMS:
Money Back Guarantee!**

NO COD'S. TEXAS RESIDENTS ADD 5% SALES TAX. ADD 5% OF ORDER FOR POSTAGE & HANDLING. ORDERS UNDER \$10.00 ADD 75c. FOREIGN ORDERS - U.S. FUNDS ONLY!

Orders over \$15. - Choose \$1. FREE MERCHANDISE!

Calling
All Hams...



...All Hams
Call Us!

It's Toll Free... So Dial Away!

1-800-325-3636

for the famous
HAM KEYS



Model HK-1

- Dual-lever squeeze paddle
- Use with HK-5 or any electronic keyer
- Heavy base with non-slip rubber feet
- Paddles reversible for wide- or close-finger spacing

\$29⁹⁵



Model HK-4

- Combination of HK-1 and HK-3 on same base

\$44⁹⁵

Terminals red or black. \$ 75 each

- Base only with rubber feet \$12.00



Model HK-2

- Same as HK-1 less base for incorporation in own keyer

\$19⁹⁵



**Model HK-5
Electronic Keyer**

- Iambic Circuit for squeeze keying
- Self-completing dots and dashes
- Dot memory

- Battery operated with provision for external power

\$69⁹⁵



Model HK-3

- Deluxe straight key
- Heavy base no need to attach to desk
- Velvet smooth action

\$16⁹⁵

Model HK-3A

- Same as above less base \$9.95

- Built-in side-tone monitor
- Speed, volume, tone and weight controls
- Grid block or direct keying
- For use with external paddle, such as HK-1

Navy type knot only \$2.75

**FOR NEW OR USED
AMATEUR RADIO
GEAR**

... we're specialists and carry *in stock* most of the famous-brand lines. Or, we will talk trade.

**FOR FAST, DOOR-
STEP DELIVERY**

... give us a call. You'll be amazed; for we guarantee we'll ship your equipment the same day. Plus, most shipments are **PRE-PAID**.

TO SAVE MONEY

... join thousands of our satisfied customers who buy from us as easily as from their local supplier. So, remember your call is *Toll Free*.



We welcome your Master Charge or Bank Americard

HAM RADIO CENTER, INC.



8340-42 Olive Blvd. P.O. Box 28271 St. Louis, MO 63132

DIODES/ZENERS

1N914	100v	10mA	.05
1N4004	400v	1A	.08
1N4005	600v	1A	.08
1N4007	1000v	1A	.15
1N4148	75v	10mA	.03
1N753A	6.2v	z	.25
1N758A	10v	z	.25
1N759A	12v	z	.25
1N4733	5.1v	z	.25
1N5243	13v	z	.25
1N5244B	14v	z	.25
1N5245B	15v	z	.25

SOCKETS/BRIDGES

8-pin	pcb	.25	ww	.45
14-pin	pcb	.25	ww	.40
16-pin	pcb	.25	ww	.40
18-pin	pcb	.25	ww	.75
22-pin	pcb	.45	ww	1.25
24-pin	pcb	.35	ww	1.25
28-pin	pcb	.35	ww	1.45
40-pin	pcb	.50	ww	1.95
Molex pins	.01	To-3 Sockets		.25
2 Amp Bridge		100-prv		1.20
25 Amp Bridge		200-prv		1.95

TRANSISTORS, LEDS, etc.

2N2222	NPN		.15
2N2907	PNP		.15
2N3740	PNP	1A 60v	.25
2N3906	PNP		.10
2N3054	NPN		.35
2N3055	NPN	15A 60v	.50
T1P125	PNP	Darlington	.35
LED Green, Red, Clear			.15
D.L.747	7 seg 5/8" high com-anode		1.95
XAN72	7 seg com-anode		1.50
FND 359	Red 7 seg com-cathode		1.25

C MOS

4000	.15
4001	.20
4002	.20
4004	3.95
4006	1.20
4007	.35
4008	1.20
4009	.30
4010	.45
4011	.20
4012	.20
4013	.40
4014	1.10
4015	.95
4016	.35
4017	1.10
4018	1.10
4019	.70
4020	.85
4021	1.35
4022	.95
4023	.25
4024	.75
4025	.35
4026	1.95
4027	.50
4028	.95
4030	.35
4033	1.95
4034	2.45
4035	1.25
4040	1.35
4041	.69
4042	.95
4043	1.25
4044	.95
4046	1.50
4049	.80
4050	.60
4066	1.35
4069	.40
4071	.35
4082	.45

7400	.15
7401	.15
7402	.20
7403	.20
7404	.15
7405	.25
7406	.35
7407	.55
7408	.25
7409	.15
7410	.10
7411	.25
7412	.30
7413	.45
7414	1.10
7416	.25
7417	.40
7420	.15
7426	.30
7427	.45
7430	.15
7432	.30
7437	.35
7438	.35
7440	.25
7441	1.15
7442	.55
7443	.85
7444	.45
7445	.80
7446	.95
7447	.95
7448	.95
7450	.25
7451	.25
7453	.20
7454	.25
7460	.40
7470	.45
7472	.45

7473	.25
7474	.35
7475	.35
7476	.30
7480	.55
7481	.75
7483	.95
7485	.95
7486	.30
7489	1.35
7490	.55
7491	.95
7492	.95
7493	.40
7494	1.25
7495	.60
7496	.80
74100	1.85
74107	.35
74121	.35
74122	.55
74123	.55
74125	.45
74126	.35
74132	1.35
74141	1.00
74150	1.00
74151	.75
74153	.95
74154	1.05
74156	1.15
74157	.65
74161	.85
74163	.95
74164	.60
74165	1.50
74166	1.35
74175	.80

74176	1.25
74180	.85
74181	2.75
74182	.95
74190	1.75
74191	1.35
74192	1.65
74193	.85
74194	1.25
74195	.95
74196	1.25
74197	1.25
74198	2.35
74221	1.00
74367	.85
75108A	.35
75110	.35
75491	.50
75492	.50
74H00	.25
74H01	.25
74H04	.25
74H05	.25
74H08	.35
74H10	.35
74H11	.25
74H15	.30
74H20	.30
74H21	.25
74H22	.40
74H30	.25
74H40	.25
74H50	.25
74H51	.25
74H52	.15
74H53J	.25
74H55	.25

74H72	.55
74H101	.75
74H103	.75
74H106	.95
74L00	.35
74L02	.35
74L03	.30
74L04	.35
74L10	.35
74L20	.35
74L30	.45
74L47	1.95
74L51	.45
74L55	.65
74L72	.45
74L73	.40
74L74	.45
74L75	.55
74L93	.55
74L123	.55
74S00	.55
74S02	.55
74S03	.40
74S04	.35
74S05	.35
74S08	.35
74S10	.35
74S11	.35
74S20	.35
74S40	.25
74S50	.25
74S51	.45
74S64	.25
74S74	.40
74S112	.90
74S114	1.30

74S133	.45
74S140	.75
74S151	.35
74S153	.35
74S157	.80
74S158	.35
74S194	1.05
74S257(8123)	.25
74LS00	.45
74LS01	.45
74LS02	.45
74LS04	.45
74LS05	.55
74LS08	.45
74LS09	.45
74LS10	.45
74LS11	.45
74LS20	.40
74LS21	.25
74LS22	.25
74LS32	.40
74LS37	.40
74LS40	.55
74LS42	1.75
74LS51	.65
74LS74	.75
74LS86	.75
74LS90	1.30
74LS93	1.00
74LS107	.95
74LS123	1.00
74LS151	.75
74LS153	1.20
74LS157	.85
74LS164	1.90
74LS367	.85
74LS368	.70

9000 SERIES

9301	.85
9309	.35
9322	.85
95H03	.55
9601	.75
9602	.50

LINEARS, REGULATORS, etc.

8266	.35
8836	.95
MCT2	.95
8038	3.95
LM201	.75
LM301	.25
LM308 (Mini)	.75
LM309H	.65
LM309K(340K-5)	.85
LM310	1.15
LM311D(Mini)	.75
LM318 (Mini)	.65

LM320K5 (7905)	1.65
LM320K12	1.65
LM320T12	1.25
LM320T15	1.65
LM339	.95
7805 (340T-5)	.95
LM340T-12	1.00
LM340T-15	1.00
LM340T-18	1.00

LM340T-24	.95
LM340K-12	2.15
LM340K-15	1.25
LM340K-18	1.25
LM340K-24	.95
LM373	2.95
LM380	.95
LM709(8,14 PIN)	.25
LM711	.45

LM723	.50
LM725	1.75
LM739	1.50
LM741 8-14	.20
LM747	1.10
LM1307	1.25
LM1458	.95
LM3900	.50
LM75451	.65
NE555	.50
NE556	.95
NE565	.95
NE566	1.25
NE567	1.35
SN72720	1.35
SN72820	1.35

MEMORY CLOCKS

74S188 (8223)	3.00
1702A	7.95
MM5314	3.00
MM5316	3.50
2102-1	1.75
2102L-1	1.95
TMS6011NC	6.95
8080AD	15.00
8T13	1.50
8T23	1.50
8T24	2.00
2107B-4	4.95

INTEGRATED CIRCUITS UNLIMITED

7889 Clairemont Mesa Blvd. San Diego, CA 92111 (714) 278-4394

All orders shipped prepaid No minimum
Open accounts invited COD orders accepted

Discounts available at OEM Quantities
California Residents add 6% Sales Tax

24 Hour Phone (714) 278-4394

MasterCharge / BankAmericard

Watch for our supermarket bargains each month!

any way you look at it

POLY PAKS® IS THE WORLD'S LARGEST ELECTRONIC DISCOUNT SUPERMARKET

SEPT 1977 73 MAGAZINE SPECIALS

— FEATURING THE BARGAINS OF THE MONTH!!! —

\$5.50 TV GAME JOY STICK

Includes four 100K pots
For TV & computer games, and quadrophonic balance. Incl 1 1/2 x 1 1/2 x 1". With 1/2" handle. Wt. 6 ozs. Cat. No. 9A3808



RCA High quality "POCKET" VOM

• 1000 ohms per volt
Model WV-539A. Features 1% precision, movement, diode protected against burnout. Measures DC volts 0-15-150-1000; AC volts 0-15-150-1000; DC current 0-150ma; resistance X1000. Sensitivity 1000 ohms/volt AC-IM. Case penins. cell, not included. Size 2 3/4 x 3 1/2 x 1 3/4". Wt. 5 ozs. Cat. No. 9A3921



SPECIAL THIS AD G-E "BLUE" FLUORESCENT READOUTS

Bright blue 7-segment characters, 0.57" high 1.5V filament. 2.1V characters. Common cathode. Fits standard 9 pin tube socket. Driven directly by MM5316. Incl. Cat. No. 9A3846
• MM5316 Clock Chip — \$2.95
Cat. No. 9A1759



6-DIGIT CAR CLOCK KIT

For auto, plane, boat, vans, etc. Top quality & accuracy at the lowest price! Displays hours, minutes & seconds in 12 hour format. Controls for fast & slow set. Attractive grey cabinet with chrome trimmed red lens. Only 4 x 4 1/2 x 1 3/4". Complete "Clock Kit", 12 VDC. Wt. 14 ozs.
• Crystal controlled time base!
• Easy to assemble and install!
• Bright RED 0.35" LED digits!

\$2200 KIT
REG. \$26.88

Cat. No. 9A3852



J.C. PENNEY'S 8-Track TAPE TRANSPORT

Excellent replacement or design your own quality tape system! Automatic or manual track selection with program indicator lights. Player shuts off automatically when tape is removed. Built-in low-distortion preamp and wow-free motor. With input & output cables. Requires external power supply. With instructions. Size 8 1/2 x 6 1/2 x 1 1/2". Wt. 4 lbs. Cat. No. 9A3010

• 115 VAC fan-cooled motor
• Slides easily into modular cabinet
• Shielded preamp

\$1295

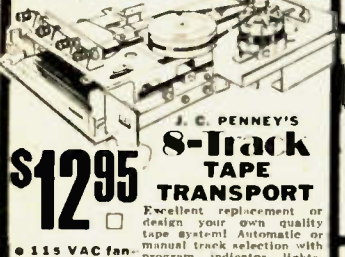

SPECTROL "SKINNY-TRIMS" 3/8" Sq. POTENTIOMETERS

Choose ANY 3 FOR \$1.19

- 9A3863 25 Turn upright, type 64
- 9A3864 20 Turn flat, type 62
- 9A3866 Single turn flat, type 63

CODE: • Available in all types • Available in Cat. No. 9A3863 only

OHMS ••
20 ••
50 ••
100 ••
200 ••
500 ••
1000 ••
1K ••
2K ••
5K ••
10K ••
20K ••
50K ••
100K ••
200K ••
500K ••
1000K ••
1 Mega ••



15% OFF BUY 10

25% OFF BUY 100

Order by Cat. No. 9A1981

We know we have the lowest prices!

Type	Sale	Reg.
SN7400	\$0.14	0.14
SN7401	0.14	0.14
SN7403	0.14	0.14
SN7404	0.14	0.14
SN7405	0.14	0.14
SN7406	0.14	0.14
SN7407	0.14	0.14
SN7410	0.14	0.14
SN7411	0.14	0.14
SN7412	0.14	0.14
SN7413	0.14	0.14
SN7414	0.14	0.14
SN7415	0.14	0.14
SN7416	0.14	0.14
SN7417	0.14	0.14
SN7418	0.14	0.14
SN7419	0.14	0.14
SN7420	0.14	0.14
SN7421	0.14	0.14
SN7422	0.14	0.14
SN7423	0.14	0.14
SN7424	0.14	0.14
SN7425	0.14	0.14
SN7426	0.14	0.14
SN7427	0.14	0.14
SN7428	0.14	0.14
SN7429	0.14	0.14
SN7430	0.14	0.14
SN7431	0.14	0.14
SN7432	0.14	0.14
SN7433	0.14	0.14
SN7434	0.14	0.14
SN7435	0.14	0.14
SN7436	0.14	0.14
SN7437	0.14	0.14
SN7438	0.14	0.14
SN7439	0.14	0.14
SN7440	0.14	0.14
SN7441	0.14	0.14
SN7442	0.14	0.14
SN7443	0.14	0.14
SN7444	0.14	0.14
SN7445	0.14	0.14
SN7446	0.14	0.14
SN7447	0.14	0.14
SN7448	0.14	0.14
SN7449	0.14	0.14
SN7450	0.14	0.14
SN7451	0.14	0.14
SN7452	0.14	0.14
SN7453	0.14	0.14
SN7454	0.14	0.14
SN7455	0.14	0.14
SN7456	0.14	0.14
SN7457	0.14	0.14
SN7458	0.14	0.14
SN7459	0.14	0.14
SN7460	0.14	0.14
SN7461	0.14	0.14
SN7462	0.14	0.14
SN7463	0.14	0.14
SN7464	0.14	0.14
SN7465	0.14	0.14
SN7466	0.14	0.14
SN7467	0.14	0.14
SN7468	0.14	0.14
SN7469	0.14	0.14
SN7470	0.14	0.14
SN7471	0.14	0.14
SN7472	0.14	0.14
SN7473	0.14	0.14
SN7474	0.14	0.14
SN7475	0.14	0.14
SN7476	0.14	0.14
SN7477	0.14	0.14
SN7478	0.14	0.14
SN7479	0.14	0.14
SN7480	0.14	0.14
SN7481	0.14	0.14
SN7482	0.14	0.14
SN7483	0.14	0.14
SN7484	0.14	0.14
SN7485	0.14	0.14
SN7486	0.14	0.14
SN7487	0.14	0.14
SN7488	0.14	0.14
SN7489	0.14	0.14
SN7490	0.14	0.14
SN7491	0.14	0.14
SN7492	0.14	0.14
SN7493	0.14	0.14
SN7494	0.14	0.14
SN7495	0.14	0.14
SN7496	0.14	0.14
SN7497	0.14	0.14
SN7498	0.14	0.14
SN7499	0.14	0.14
SN7500	0.14	0.14

POLY PAKS "RAMS" 2102-1 PRICES

8 FOR \$9.95

Reg. \$1.69 ea.

Switches Your Choice

Cat. No. Switches \$1.00

- 9A3669 2 1/2" solid em. 14-pin DIP
- 9A3021 4 \$2.98 each. You can mix them when you buy. All sockets. Wt. 1-oz.
- 9A3670 5
- 9A3671 6
- 9A2677 7



"POCKET" VOM

1% precision resistors. Impedance 20,000 ohms/volt AC. Measures DC volts 0-25-50-250-500-2000; AC volts 0-10-50-100-500-1000; DC current 0-50ua-2.5ma-250ma; Ohms x10, x1000. Measures db x10 x 20". Thumbwheel ohms adj. at Unbreakable "H" test probes. Uses AA battery cell, not included. Wt. 10 ozs. Cat. No. 9A3860

SAVE \$2.00 REG. \$15.88

• Mirrored 3" scale!
• 20,000 ohms per volt!
• Overload protection!



"CB" POWER SUPPLY

Ideal for CB's, Ham rigs, tape decks & more! Modern cabinet. 6 x 4 1/2 x 2 1/4". With on/off switch, LED lamp, built-in circuit breaker. 115 VAC 60 Hz. Wt. 5 lbs. Cat. No. 9A3452

• 12 VDC @ 3 Amps output
• Regulated, continuous duty

\$19.95

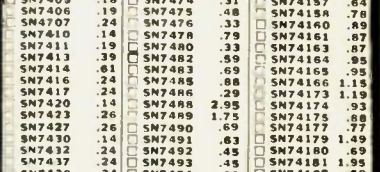

DIP Switches Your Choice

Reg. \$1.69 ea.

Cat. No. Switches \$1.00

- 9A3669 2 1/2" solid em. 14-pin DIP
- 9A3021 4 \$2.98 each. You can mix them when you buy. All sockets. Wt. 1-oz.
- 9A3670 5
- 9A3671 6
- 9A2677 7



"CB" POWER SUPPLY

Ideal for CB's, Ham rigs, tape decks & more! Modern cabinet. 6 x 4 1/2 x 2 1/4". With on/off switch, LED lamp, built-in circuit breaker. 115 VAC 60 Hz. Wt. 5 lbs. Cat. No. 9A3452

• 12 VDC @ 3 Amps output
• Regulated, continuous duty

\$19.95



15% OFF BUY 10

25% OFF BUY 100

Order by Cat. No. 9A1981

We know we have the lowest prices!

Type	Sale	Reg.
SN7460	0.20	0.20
SN7461	0.20	0.20
SN7462	0.20	0.20
SN7463	0.20	0.20
SN7464	0.20	0.20
SN7465	0.20	0.20
SN7466	0.20	0.20
SN7467	0.20	0.20
SN7468	0.20	0.20
SN7469	0.20	0.20
SN7470	0.20	0.20
SN7471	0.20	0.20
SN7472	0.20	0.20
SN7473	0.20	0.20
SN7474	0.20	0.20
SN7475	0.20	0.20
SN7476	0.20	0.20
SN7477	0.20	0.20
SN7478	0.20	0.20
SN7479	0.20	0.20
SN7480	0.20	0.20
SN7481	0.20	0.20
SN7482	0.20	0.20
SN7483	0.20	0.20
SN7484	0.20	0.20
SN7485	0.20	0.20
SN7486	0.20	0.20
SN7487	0.20	0.20
SN7488	0.20	0.20
SN7489	0.20	0.20
SN7490	0.20	0.20
SN7491	0.20	0.20
SN7492	0.20	0.20
SN7493	0.20	0.20
SN7494	0.20	0.20
SN7495	0.20	0.20
SN7496	0.20	0.20
SN7497	0.20	0.20
SN7498	0.20	0.20
SN7499	0.20	0.20
SN7500	0.20	0.20

BARREL KITS

Every kit carries money back guarantee.

EXCLUSIVE

TEST 'EM YOURSELF 'N SAVE

Buy 10 BARREL KITS AND RECEIVE THE 11TH KIT FREE

BARREL KIT #203 CALCULATOR KEYBOARDS

10 for \$1.98

It's true! 20-key, 4 function keyboards at ridiculous give-away. Wt. 12 ozs. Cat. No. 9A322



BARREL KIT #201 6V INDICATORS w/leads

15 for \$1.98

Test lamp manufacturer dumps inventory! Worth 69¢ ea. Like grain-o-wheat. Cat. No. 9A3526 hobby



BARREL KIT #200 6V DIGIT READOUT MODULES

5 for \$1.98

Barrels and barrels and no time to test. Calculator and driver chips. Cement epoxy on back. Wt. 6 ozs. 9A3515



BARREL KIT #188 400 PARTS \$1.98

Includes resistors, capacitors, IC's, for PC work, some on PC boards. Dumped into barrels by factories. 100% material. Wt. 12 ozs. Cat. No. 9A3401



BARREL KIT #127 AXIAL ELECTROS

40 for \$1.98

Ass't. capacities and voltages. Cat. No. 9A3227



BARREL KIT #126 UPRIGHT ELECTROS

40 for \$1.98

1mf to 300mf in mixture of voltages. 100% marked in good. 9A3226



BARREL KIT #238 HALF INCH READOUTS

15 for \$1.98

From factory to you. Includes Fairchild FND-500 series. Hobby. Wt. 4 ozs. Cat. No. 9A3629



BARREL KIT #163 MINI TRIM POTS

30 for \$1.98

Ass't. values 100 to 1 meg. What a buy. Single turn. 1/2" W. Wt. 6 ozs. 9A3348



BARREL KIT #160 500V VOLTAGE REGULATORS

10 for \$1.98

LM-309K TO-3 barreled, bot by the pound, bot who wants to check 'em? Your gain. Wt. 20 ozs. 9A3330



BARREL KIT #154 CLOCK CHIPS

20 for \$1.98

We gathered an assortment of clock chips, alarm, calendar, beepers, who knows, all mixed! Cat. No. 9A3308



BARREL KIT #127 AXIAL ELECTROS

40 for \$1.98

Ass't. capacities and voltages. Cat. No. 9A3227



BARREL KIT #126 UPRIGHT ELECTROS

40 for \$1.98

1mf to 300mf in mixture of voltages. 100% marked in good. 9A3226



BARREL KIT #215 MOLEX 100% GOOD SOCKETS

200 for \$1.98

Calculator maker dump! We sent a million of 'em. Cat. No. 9A3141

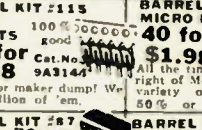

BARREL KIT #112 MICRO MINI LEADS

40 for \$1.98

Hobby

All the tiny leads, axial, upright of Monsanto, Litronix, variety of colors. Yield 50% or better. 9A3138



BARREL KIT #109 TERMINAL STRIPS

100 for \$1.98

Wide asst. of terminal strip connectors. From 1 contact up. Strip manufacturer barrel dump in your gain. Wt. 1 lb. Cat. No. 9A3138



BARREL KIT #104 SLIDE VOLUME CONTROLS

10 for \$1.98

Cal. No. 9A1057



BARREL KIT #101 RESISTOR SPECIAL

200 for \$1.98

Includes: 1/4, 1/2, 1, 2-watt, carbon, 8 oz. 100% good. 9A3054



BARREL KIT #99 PHOTO ELECTRIC CELLS

10 for \$1.98

Ass't. GE types, CDS types. Mixed by factory. Big job for us to separate. 100% good. Cat. No. 9A1052



BARREL KIT #93 HALF WATTERS

200 for \$1.98

Resistor factory tried to fool us by mixing 100% color-coded resistors in barrel. But value is there. 4 oz. 9A3046 Untested



BARREL KIT #87 NAT. IC BONAZAI

100 for \$1.98

Hobby and untested, factory mixed in barrels. Lines of 400's, ROMS, DTL's, registers, clock and calculator chips in more. Wt. 12 ozs. Cat. No. 9A2660

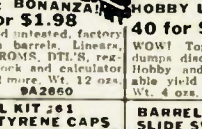

BARREL KIT #86 HOBBY LEADS

40W for \$1.98

WOW! Top U.S.A. maker dumps discretes in barrels. Hobby and untested. Usable yield 50% or better! Wt. 4 ozs. Cat. No. 9A2859



BARREL KIT #83 LM-340T VOLTAGE REGULATORS

15 for \$1.98

Factory rejects, hobby, cosmetic rejects. May include 8, 10, 12, 15, 18 or 24 volts. TO-220 power tab. Wt. 4 ozs. Cat. No. 9A2635

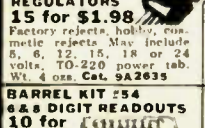

BARREL KIT #76 1-WATT ZENERS

100 for \$1.98

Factory sums as 400-mw's. Never-to-see-again offer. 8, 10, 12, 15V, under glass double plug. Cat. No. 9A2741 Untested



BARREL KIT #71 CAPACITOR SPECIAL

100 pcs. \$1.98

Includes: 1/4, 1/2, 1, 2-watt, carbon, 8 oz. 100% good. Cat. No. 9A2738



BARREL KIT #68 2 WATTERS

100 for \$1.98

Suppliers throw 'em in the barrel. It's a 1/2" cold mine. All marked. Cat. No. 9A2735



BARREL KIT #65 MIXED READOUTS

10 for \$1.98

Factory returns, 300 numbers as MAN 4's, MAN 7's, MAN-3's 11 barrels & 100 times to separate. Hobby All marked. Cat. No. 9A2733 Untested

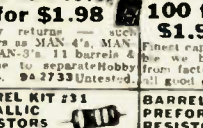

BARREL KIT #61 POLYSTYRENE CAPS

100 for \$1.98

Finest caps made. As a gambler we bought 10 barrels from factory, mixed values; all good. Cat. No. 9A2729



BARREL KIT #58 SLIDE SWITCHES

30 for \$1.98

All changes, nice, slip-on, momentaries, etc. Tremendous shop pak for 100's of switching projects. Cat. No. 9A2726 100% good



BARREL KIT #54 6 & 8 DIGIT READOUTS

10 for \$1.98

Bargain of a lifetime. We got a barrel of 'em, but no time to test. Untested and hobby. Multiplexed, blinder type. Wt. 8 ozs. Cat. No. 9A2722

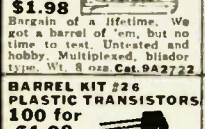

BARREL KIT #40 HOBBY PNP POWER TRANSISTORS

15 for \$1.98

Popular germanium and silicon TO-3's, factory "off-spec" and fallout. 100% hobby, no opens, no shorts! Wt. 18 ozs. Cat. No. 9A2618



BARREL KIT #39 HOBBY NPN POWER TRANSISTORS

15 for \$1.98

Factory fallout and "off-spec" TO-3 powers. 100% hobby, no opens, no shorts! Wt. 1 lb. Cat. No. 9A2617



BARREL KIT #35 NEON LAMPS

30 for \$1.98

100% good. Factory made millions and barreled 'em. Your advantage. Cat. No. 9A2613



BARREL KIT #31 METALLIC RESISTORS

100 for \$1.98

Made mostly by Corning. The finest resistor made. Mostly 1/2 watters. 5% tol. & a barrel of value. Cat. No. 9

NEW!

\$32.50

plus \$1.50 s/h
NY res. add tax



Features: CMOS Electronic Keyer

- State-of-the-art CMOS circuitry
- Self completing dots and dashes
- Dot and dash memory
- Lambic keying with any squeeze paddle
- 5-50 WPM
- Speed, volume, tone controls, side tone and speaker
- Low current drain CMOS-battery operation
- Deluxe quarter-inch jacks for keying and output
- Handsome eggshell white base - woodgrain top
- Compact and portable - 1-7/8 x 4-1/4 x 6-1/4
- Grid block keying
- Wired and tested - fully guaranteed - less battery

TRAC

Electronics, Inc.
1106 Rand Bldg. T18
Buffalo NY 14203

Programmable Contest Keyer

Build it yourself and Save!



Among the features of the W7BBX Programmable Memory Keyer 4 x 512 bit memories, paddle programming, protected ps, lambic operation with dot and dash memories, STO, paddle override of message readout, remote operating control, and much more. See April '76 HAM RADIO MAGAZINE. The 50+ p. manual includes step-by-step assembly, testing, and operating instructions, pictorials, schematics, and templates.

Send \$30 for all circuit boards plus manual to

HFB ENTERPRISES

P.O. Box 667, Herndon, Virginia 22070

"DEALER INQUIRIES INVITED" H18



Germantown Amateur Supply, Inc.

MEMPHIS, TENNESSEE

NO MONKEY BUSINESS!

- (A) Complete Service Facilities
- (B) Good Deals on most Brands
- (C) Shipping within 24 Hours
- (D) All inquiries handled by Active Hams with over 20 years experience in ham radio

CALL TOLL FREE 1-800-238-6168
MONDAY - SATURDAY 8:30-5:30
FOR YOUR SPECIAL.

G-12

Write: 3202 Summer Ave., Memphis, Tennessee 38112

HATRY electronics

500 Ledyard St., Hartford CT 06114
203-527-1881

(1 block east of Wethersfield Ave. off Airport Rd. Rte. 6)

See Ward W1WRQ - John W1JJR
or
Dave WA1HFE

HEADQUARTERS for 2M FM

Tempo VHF/ONE, SSB/ONE adaptor, Tempo VHF amplifiers, FMH-2, FMH-5; Drake TR 33C, AA 10, AC 10; Regency HR 2B, HR 312, AR 2, P 110 & crystals for all lines listed above.

FM GAIN ANTENNAS

For mobile, fixed or portable operation by Cush-Craft, Hy-Gain, Antenna Specialists & New-Tronics.

ANTENNA STUFF

Open wire feedline - #18, #14, #12 ga. bare copperweld wire - #14, #12 enamel copper - insulators - W2AU baluns 1-1 or 4-1 - lowloss coax cable - Rohn 25G towers & accessories - Blitzbug lightning arrestors - glassline guy - B&W antenna switches - Belden 72 & 300 ohm KW twinlead - Amphenol UHF & BNC connectors.

AMATEUR GEAR

Drake, Swan, Tempo, Ten-Tec, Dentron, Regency, Mosley, Hy-Gain, CushCraft.

(Canadian Amateurs Send U.S. Funds Only)

F.O.B. Hartford

Please include postage

CONNECTICUT'S OLDEST HAM STORE

H15

ALL BAND TRAP ANTENNA !



5 BAND OPERATION - ONLY ONE NEAT SMALL ANTENNA. FOR CONGESTED HOUSING AND APARTMENT DWELLERS! FOR ALL AMATEUR HF TRANSMITTERS GUARANTEED FOR 1,000 WATTS POWER. LIGHT, NEAT WEATHERPROOF.

Complete as shown total length 102 ft. with 90ft. of 52 ohm RG58U coax and PL259 connector. HI-impact molded resonant traps. (wt. 3 oz. 1" x 5" long) You just tune to desired band for excellent reports! EXCELLENT FOR ALL WORLD - WIDE RECEIVERS AND AMATEUR TRANSMITTERS.

For NOVICE AND ALL CLASS AMATEURS! NO EXTRA TUNERS OR GADGETS NEEDED! ELIMINATES 5 SEPARATE ANTENNAS WITH EXCELLENT PERFORMANCE GUARANTEED. CAN BE USED IN ATTICS, TOPS OF BUILDINGS OR AS V.I.S. IN MINIMUM SPACE, ETC. NO HAYWIRE HOUSE APPEARANCE! EASY INSTALLATION! FULL DETAILS FURNISHED.

80-40-20-15-10 meter bands. Complete \$39.95
40-20-15-10 meter bands. 54-ft. ant. \$38.95
20-15-10 meter bands. 24-ft. ant. \$37.95

SEND ONLY \$3.00 (cash, ck., mo.) and pay postman balance COD plus postage on arrival or send full price for pp. del. BANK AMERICARD - - MASTER CHARGE - - by mail or Ph 308-236-5333 Free info. available only from.

WESTERN ELECTRONICS Dept. A7-9
Kearney, Nebraska, 68847

New From Davis Electronics

7200 SERIES MINI COUNTER



60 MHz
600 MHz
(with optional prescaler)

*General Purpose Low Cost Counter
Without The Sacrifice Of Basic Performance*

- Small & Lightweight
- 8 Digit LED Display
- Digit Size - .4"
- All Metal Cabinet
- Selectable Gate Times (1 sec. & .1 sec.)
- State of the Art Circuitry
- Sensitivity - 10 mv
- Crystal Time Base

Model 7208 60 MHz Kit \$119.95
Model 7208A 600 MHz Kit \$149.95

DAVIS ELECTRONICS 636 Sheridan Dr., Tonawanda, NY 14150
(716) 874-5848 Call TOLL FREE 1-800-828-7422

D10

Govt. SURPLUS ELECTRONIC EQUIPMENT CATALOG

New ITEMS . . . New BARGAINS!

FREE UPON REQUEST!

If you haven't received our new Catalog, write for free copy today. Address: Dept. 73

FAIR RADIO SALES
1016 E. EUREKA • Box 1105 • LIMA, OHIO • 45802

* You asked for it!

A \$65.00 Digital Multimeter kit.

Now there's just no excuse for not having a digital multimeter at our low price. Our unit is based on the famous \$29.95 DVM kit you have heard about and has the following features:

DC volts: Better than 0.1% accuracy. Reads 0 to 1200 volts in 4 ranges

AC volts: Better than 0.3% accuracy. Reads 0 to 750 volts RMS/4 ranges

Ohms: Better than 0.2% accuracy. Reads from 0 ohms to 20 megs

* You get the two modules and the range switches for your money. Case and few remaining parts optional for \$15.95. CA residents add tax. Add \$3.95 for postage and handling.

As always we have calibration and repair service

Gary McClellan and Co. Box 2085
G11 1001 W. Imperial Hwy.
La Habra CA 90631

TEE/AX PRESENTS; THE FIRST

Coax Toggle Switch \$39.95 Coax Relay Version \$45.95

Patent Pending

TEE/AX, INC.

5701 N.W. 31st AVENUE
FT. LAUDERDALE,
FLORIDA 33309



Model SW-5000

- 52 ohms
- SPDT, DPDT
- Power 1 KW
- All Brass Construction
- Teflon Insulated
- Captivated Internal Contacts
- Available in UHF, BNC, N, F, all series

*Distributor Inquiries
Invited*

Mail Orders Accepted — Add 75¢ for Postage

T19

NEW

for '77
Only

\$145

less batteries
and crystals

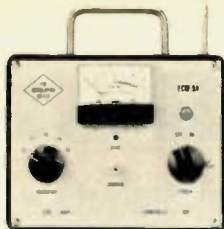

ECM-5B MK-II fm modulation meter

- 0-6KHz peak reading linear scale, meets commercial standards
- Operates 25MHz to 500MHz
- Crystal controlled for easy operation
- Audio/scope output with earphone
- Options: NICAD power PAK \$34.95

Charger \$29.95

Write or call for complete information. Send check or money order for \$145 plus \$1.75 for shipping. Indiana residents add 4% sales tax. Crystals for 146.94MHz: \$4.95. All other freq: \$7.95.

ECM

ECM Corporation
412 N. Weinbach Ave.
Evansville IN 47711
812-476-2121 E1

SST T-I RANDOM WIRE ANTENNA TUNER



Allband operation (160-10 meters) with any random length of wire. 200 watt output power capability - will work with virtually any transceiver. Ideal for portable or home operation. Great for apartments and hotel rooms - simply run a wire inside, out a window, or anywhere available. Toroid inductor for small size: 3X4-1/4X2-3/8. Built-in neon tube-up indicator. SO-239 connector. Guaranteed for 1 yr., 10 day trial. IF NOT SATISFIED RETURN FOR A FULL REFUND! COD OK BY PHONE

THE ORIGINAL RANDOM WIRE ANTENNA TUNER - in use by amateurs for 5 years.

COMPACT
EASY TO USE

... only \$29.95
POSTPAID (ADD SALES TAX IN CALIF.)

SST Electronics, (213) 376-5887
P.O. Box 1, Lawndale CA 90260

S10

SUB-AUDIBLE GENERATOR for FM

THE CUBE

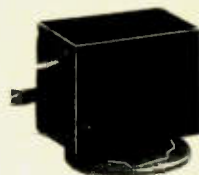

- Inexpensive multi tone encoder
- Compatible with PL-CG-QC
- Low distortion sinewave
- Input 8-18 VDC unregulated
- Rugged, plastic encased with leads
- Adjustable frequency (98-250 Hz), Lower available
- Excellent stability

.5 x .6 x .8 in.

Price \$19.95

Freq. set at factory \$5.00 extra

Calif. res. add 6%

Send for more info

yle Products

Dept. 73 P.O. Box 2083 Santa Clara, CA. 95051

Are YOU a computer hobbyist



— yet?

If you are like the rest of us you've been reading about microcomputers ... you're excited about them ... but there is so much to understand and it all seems so complicated that there is no way to understand it. Hogwash.

A brand new magazine is being published for computer hobbyists ... for people who are beginners ... neophytes ... novices ... people who have no idea what a vectored interrupt is, but just the same want to learn about computers and have fun.

A home computer system can cost you a bundle if you don't know what you are doing. Kilobaud could save you a lot of money ... others have learned the hard way. Kilobaud is a sort of giant club newsletter for computer hobbyists ... a place to tell each other about the problems they've had ... and the solutions. It's a magazine filled with great articles ... all written so you'll be able to understand them (for a change).

You want to know about hardware? Read about the new MITS Z-80 CPU in Kilobaud, simply explained by the chap who designed the circuit. Or how about the best-selling TDL Z-80 CPU ... the designer has written about it in Kilobaud too. You're wondering about what cassette system to use? You can go crazy on this one ... but before flipping out, read the Hal Walker article in Kilobaud and find out what the problems are ... and the solutions.

What do you do with the confounded things after you've gotten them working? The programs are in Kilobaud ... lot's of them.

MAKE MONEY

Perhaps you've been thinking of the computer hobby as a way to get into a small business. Why not? This is going to be an enormous field in a couple of years and you can bet that those on the ground floor will have the best chance at the gold ring. Kilobaud will help you learn how to get into manufacturing ... to become a dealer ... a manufacturer's representative ... a service bureau ... a writer. Never before has there been an opportunity like this ... so don't miff it ... grab hold and start getting your feet wet. It'll not only pay off well in the long run, you'll have a ball every minute of the way.

KILOBAUD IS BRAND NEW

The first issue was January 1977 ... and the magazine is the fastest growing and best accepted magazine in the hobby computer field already. You doubt that? Just stop in at any hobby computer store and ask anyone you see. Kilobaud is outselling all other magazines combined ... which says something considering the cover price of \$2. It's full of good articles and has a sense of humor. There are more articles in Kilobaud than you can read in a day ... most readers comment that Kilobaud just has to be read from cover to cover and this takes several days. It's packed.

CONTROVERSIAL?

You bet! Kilobaud calls a spade a spade, with no pulled punches.

DO YOU WANT TO LEARN COMPUTERS?

Some magazines emphasize OEM systems ... some are written more for computer scientists ... Kilobaud is written for and by its readers ... the hobbyists. You'll find great articles in there by well known hobbyists such as Don Lancaster ... Don Alexander ... Pete Stark ... Dennis Brown ... Hal Walker ... Art Childs ... Sheila Clark ... and many more. The emphasis is fun.

TRY A SUBSCRIPTION

The cover price is \$2 (that's \$24 a year), but the subscription rate is only \$15 for the year ... a saving of \$9.00. You can pay for it with your credit card (BankAmericard, Master Charge, American Express) or you can even be billed directly. Send in the below coupon ... or call TOLL FREE 800-258-5473 (during office hours). Please have your credit card handy.

Your subscription will start with the next published issue, so allow about six weeks for any apparent action. If you would like to be filled in with the back issues they are \$3 each and at last count some were still available.

YES! Start my one year Kilobaud subscription for \$15 with the next published issue.

Name _____ Call _____
Address _____
City _____ State _____ Zip _____

\$15.00 enclosed. Cash Check Money Order
Bill: Master Charge BankAmericard American Express

Card # _____ Interbank # _____
Signature _____ Exp. date _____

Bill me direct.

*Subscription will start with next published issue. Allow six weeks for processing.

Toll Free Subscription Number (800) 258-5473



PETERBOROUGH NH 03458

73/9/77

DUPLEXERS

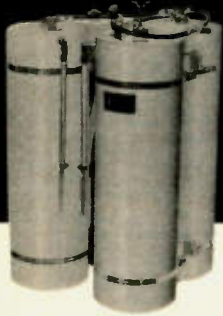

*Patent Pending

OUR NEW BANDPASS-REJECT DUPLEXERS WITH OUR EXCLUSIVE

BpBr CIRCUIT*

... provides superior performance, especially at close frequency spacing.

Models available for all Ham bands. Special price for Amateur Repeater Clubs

CALL OR WRITE FOR DETAILS:

WACOM PRODUCTS, INC.



Box 7307
Waco, Texas 76710
817/776-4444

2 METER CRYSTALS IN STOCK

FOR THESE RADIOS ON STANDARD ARRL REPEATER FREQUENCIES

Clegg HT-146	Regency HR-212
Drake TR-22	Regency HR-2B
Drake TR-33 (rec only)	Regency HR-312
Drake TR-72	Regency HR-2MS
Genave	S.B.E.
Heathkit HW-2021 (rec only)	Sonar 1802-3-4, 3601
Heathkit HW-202	Standard 146/826
Icom/VHF Eng	Standard Horizon
Ken/Wilson	Swan FM 2X
Lafayette HA-146	Tempo FMH
Midland 13-505	Trio/Kenwood
Regency HR-2	Trio/Kenwood TR2200
	Trio/Kenwood TR7200

\$3.50 each — in quantities of 10 or more, \$3.25 each

Certified check or money order only — NO CODs

ROLIN DISTRIBUTORS
P.O. Box 436
Dunellen NJ 08846

-- LIMITED OFFER --

R15

PROUD OF YOUR CALL? . . . WORRIED ABOUT THEFT?

Identify your FM transceiver with automatic code on each transmission.

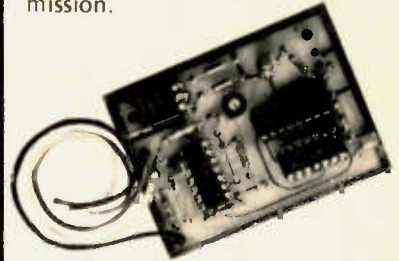

SMALL: 2" x 2 5/8" x 5/16"
Installation: Only THREE wires

WARRANTY

Returnable for full refund within ten day trial period. One year for repair or replacement.

PRICE \$39.95 Ppd + \$2.40
CA. SALES TAX

Your call sign programmed at factory, please be sure to state call sign when ordering.

AUTOCODE

8116 Glider Ave, Dept S
Los Angeles, Ca. 90045
(213) 645-1892

A36

THE CHALLENGE OF 160

ARE YOU IN A RUT? Tired of talking to the same characters on 75 every evening? If so, perhaps it's time to try a new band — something different and exciting. Consider 160 meters. The "Top Band" is different from any other amateur allocation. Its propagation characteristics are unique, resembling the standard AM broadcast band. Amateur radio's roots can be traced to 160, as it was there (actually, 200 meters) that amateur radio began.

If you are remotely interested in 160 meter operation, 73's newest book, *The Challenge of 160*, is for you. Sid Dunn, the author, has compiled a complete reference for the new and experienced 160 operator. Eleven chapters cover everything from receiving and transmitting equipment to antenna and ground systems. Weather effects upon propagation are discussed, as well as operating tips. An interesting introduction provides an insight into the origins of amateur radio — complete with pictures and comments about Stew Perry W1BB, the "King of 160."

This reference is heavily illustrated . . . and complete schematics are provided for construction projects. An additional reading index of related articles and publications is provided — as you are sure to become excited with 160 operating after reading *The Challenge of 160*. Price: \$4.95.

Use the order card in the back of the magazine or itemize your order on a separate paper & mail to: 73 Radio Bookshop/Peterborough NH 03458. Be sure to include check or detailed credit card information. Prices subject to change on books not published by 73 Magazine.



WHAT HAVE YOU MISSED?

The back issues of 73 are a gold mine of interesting articles . . . just take a look at what's been covered . . . every possible interest. This is the most important library you can have for hamming.

The supply of these back issues is very limited . . . and when these are gone, that will be it. Don't miss out by procrastinating.

Single issues . . . \$1.50 each (before 1976)
Ten back issues (your choice) . . . \$12 postpaid in US.
Twenty-five back issues (your choice) \$20 postpaid in US.
Twenty-five back issues (our choice) \$10 postpaid in US.

JUNE 63. Surplus issue: DMQ-2 Beacon Tx on 220. Increasing ARC-2 transceiver selectivity, PE-97A pwr supply conversion, BC 348 band spread, inductance tester, converting BC-230 tx, beginner's rx using BC-453, rev. motor-tuning, transistor wv monitor, BC-442 ant relay conversion, mobile loading coils, increasing Two-er selectivity, TV with the ART-26 tx, TRC-8 rx on 220, ARC-5 hf rx & tx, ARC-3 tx on 2M.

AUG 63. Battery-op 6M str. diode noise gen, video modulation, magic T-R switch, ant gain, halo mods, cw breakin, VEE beam design, coax losses, RF wattmeter, TX Tube Guide, diode pwr supply, "Lunchbox" squelch, SWR explanation, vertical ant info, Info on Windom ant.

OCT 63. WBFM transceiver ideas, HF propagation, cheap fone patch, remote-tuned Yagi, construction hints, ant coupler, S5 Vertical, filament xformer construction, 2M navistor converter, Lafayette HE-35 mods, Buyer's Guide to Rx & Tx, product detector, novel H-C VFO, radio astronomy, panadaptor, "H" converter, compact mike amp.

FEB 64. 2M multichannel exciter, rx design ideas, majic tr switch, loudspeaker enclosures, 40M 2L tx, look at test equipment, radio grounds, 40M 2L Special ant, neutralization.

MAY 64. Quad issue: 432 Quadquad quad, expanded HF quad, Two el quad, miniquad, 40M quad, quad experiments, half quad, three el quad, 20M quad, tiltover quad, easy to erect quad, Quad Conversion, FET extender, tube troubleshooting, HF dummy load, understanding "dB", HF SSB/cw rx, geometric circuit design, GSB-201 transceiver, FET converter for 10 20M, hi-pass rx filters.

JULY 67. VE ham radio, VEO hams, dsb adaptor, home brew tower, transistor design, '39 World's Fair, god plane ant, G4ZU beam, SSTV monitor, UHF FET preamps, IC "H" strip, vertical ant, VHF/UHF dipper, tower hints, scope monitoring, operating dsb, S-Line crossband, hi-school ham club, Heath HR-10 mods.

OCT 67. HF solid state rx, rugged rotator, designing slung-tuned coils, FET converter, SSTV pix gen, VHF log-periodics, rotatable dipole, gamma-match cap, old-time dxing, modern dxing.

JUNE 68. Surplus issue: Transformer tricks, BC-1206 rx, APS-13 ATV tx, low voltage dc supply, surplus scopes, FM rig commercial tx types, Wilcox F-3 rx, restoring old equipment, 75A1 rx mods, TRA-19 on 432, freq counter uses, transceiver pwr supply, uses for cheap tape recorders, Surplus Conversion Bibliography, RT-209 walkie on 2M, ARC-1 guard rx, RTTY tx TU.

JULY 68. Wooden tower construction, tiltover towers, erecting a telephone pole, IC AF osc, "dB" explained, ham club tips (Part 1).

SEPT 68. Mobile vhf, 432 FET preamps, converting TV Tuners, xtal osc stability, parallel Te design, moonbounce rhombic, 6M xciter (corrections Jan 69), 6M transceiver (corrections Jan 69), 2M dsb amp, ham club tips (Part 3).

NOV 68. SSB xtal filters, solid state troubleshooting, IC freq counter (many errors & omissions), "cv" transformers, space comm odyssey, Pulsar info, thin-wire ants, 40M transistor cw tx/rx, BC-38M double conversion, multifunction tester, copper wire specs, thermistor applications, hi-voltage transistor list, ham club tips (Part 5).

JAN 69. Suppressor compressor, HW-12 on 160, beam tuning, AC voltage control, 2M transistor tx, LC power reducer, spectrum analysis info, 6M transistor rx, operating console, RTTY autostart, calculating osc stability, lo-pwr 40 cw tx, sequential relay switching, sightless operator's bridge, ham club tips (Part 7).

FEB 69. SSTV camera mod for fast-scan, tri-band linear, selective af filter, unijunction transistor info, Nikola Tesla biography, mobile installation hints, extra-class license study (Part 1).

MAR 69. Surplus issue: TCS tx mods, cheap compressor/amp, RXZ calculations, transistor keyer, better balanced modulator, transistor oscillators, using surplus, half-wave feedline info, Surplus Conversion Bibliography, extra license study (Part 2).

APR 69. 2 channel scope amp, rx preamp, Two-er PTT, variable DC load, SWR bridge, 100 kHz marker gen, mobile transceiver specs, SB 610 monitorscope mods, portable 6M AM tx, 2M converter, extra license study (Part 3).

MAY 69. 2M Turnstile, 2M Slot, rx attenuator, generator filter, short VEE, quad tuning, using antennascope, measuring ant gain, phone patch reg, SWR indicator, 160M short verticals, 15M antenna, HF propagation alerts, FSK exciter, KW summy load, hi-power linear, extra license study (part 4), all-band curtain array.

JUNE 69. Microwave pwr generation, 6M sbs tx, 432-er tx/rx, 6M converter, 2M 5/8 wave whip, UHF tv tuners, ATV video modulator, UHF FET preamps, RTTY monitorscope, extra license study (part 5), building uhf cavities, mini-VEE for 10 20M, vhf vfo.

JULY 69. AM modulator, SSTV sig gen, 6M kw linear, 432 kw amp, 432-er tx/rx, 6M IC converter, radio controlled models, RTTY IC

TU, audio notch filter, VRC-19 conversion, tube substitution, 2M transistor xciter, extra license study (part 6), hf FET vfo.

AUG 69. FET regen for 3.5 MHz up, FM crystal switching, 5/8 wave vertical, introducing to ICs, RTTY tone gen, good/bad transistor checker, 2M AM tx, measure transistor Ft, 160M propagation, triac applications, simple IF sweep gen, transistor keyer, SB-100 on 6M, xtal freq measurement, extra license study (part 7), FM deviation meter, qrp 6M tx, circular quads, FM noise figure, transistor parameter tracer.

SEPT 69. Tunnel diode theory, majic tee, soldering techniques, wave travel theory, cable shielding, transistor theory, AM noise limiter, AFSK gen, transistor amp debugging, measure meter resistance, diode-stack pwr supply, transistor testing, 2 1/2 W 6M tx, HX-10 neutralizing, capacitor usage, radio propagation, AM mod percentage, extra class license study (part 8), 3-400Z linear, ATV vidicon camera, 2 transistor testers, FET compressor, rf plate choke.

OCT 69. Super gain 40M ant, FET chirper, telephone info, scope calibrator, thyristor surge protector, lower tuning rates, identify calibrator harmonics, FM adaptor for AM tx, CB sets on 6M, proportional control xtal oven, xtal filter installation, Q-multiplier, transceiver pwr supply, extra class study (part 9).

NOV 69. NCX 3 on 6M, IF notch filters, dial calibration, HW32A external VFD, 6M converter, feedline info, rf z-bridge, fm mobile hints, umbrella ant, 432-er tx (part 1), pwr supply tricks with xtal, transistor keyer, transistor bias design, xtal vhf sign gen, electronic varac, SB33 mods, extra class study (part 10), SB34 linear improvements.

DEC 69. Transistor-diode checker, dummy load/attenuator, tuned filter chokes, band switching Swan 5D & TV-2, 88MHz selectivity, match exercises, rf xtal vibrator, transistor rx design, hv mobile p.s., 1-10 GHz freemeter, CB rig on 6M, extra license study (part 11), 1970 buyer's guide.

JAN 70. Transceiver accessory unit, bench power supply, SSTV color method, base-tuned center-loaded ant, 6M bandpass filter, extra license study (part 12), rectifier diode usage, facsimile info.

FEB 70. 18 inch 15M dipole, 6M converter, high-density pc board, camper-mobile hints, 2M freq synthesizer, encoding/decoding for repeaters, DX-35 mods, panoramic vhf rx, variable-Z HF mobile mount, extra license study (part 13), linear IC info, qrp 40M tx, IC Q-multiplier.

MAR 70. Gdo applications, charger for drycells, FM freq meter, pc board construction, ham fm standards, cheap rf wattmeter, multifreq fm osc, "IF" system modules (part 1), Six-er mods, gdo dip lite, Motorola 41V conversion, cw monitor, buying surplus logic, SSO-23A sonobuoy conversion, GRC-9 rx/tx conversion, extra class study (part 14), Intro to vhf fm.

APR 70. Noise blanker, 2M hotcarrier diode converter, repeater controller, understanding COR repeater, 7/8 wave 2M ant, extra class study (part 15), inexpensive semiconductors, removing surplus meters, linear amp bias regulator, hi performance amp & age system, SSB bfo for shortwave radio, vacuum tube load box, general fm dope & repeater guide, meggering your ant.

MAY 70. Comments on "fm docket" = 18803, future of cw, fm/am rx aligner, 5/8 wave verticals, using 2M intelligently, auto burglar alarms, pwr supplies from surplus components, "IF" system modules (part 2), vhf FET preamps, educated "idiot" lites, postage stamp 6M tx, extra class study (part 16), 81shop IFLN, low-band police monitor, mobile cw tx, Wichita ant patch.

JUNE 70. DRRR ant, vfo circuit, remote SWR indicator, intro, hf vertical, two rx on one antenna, environment & coax loss, 2 el trap verticals, buying surplus, two 40M qrp tx, 21 dB 2M beam, extra class study (part 17).

DEC 70. Solidstate vhf exciter, delta freq control for SSB, 2M transistor FM tx, HW-10 offset tuning, "idiot" radio, vacuum, 3 500Z hf linear, general class study (part 5), "trans test"

(no good - errors), transistor p.s. current limiter.

JAN 71. Split tones for dxing, Heath Ten-er mods, cw duty cycle, repeater zero beater, HEP IC projects, 10 15-20M parabolic ideas, light ning protection, IC rx accessory, attic ants, double balanced mixers, permanent marker tool, ham license study questions.

FEB 71. Metal locator, varactor theory, AFSK unit, SSTV patch box, ATV hints, RTTY tuning indicator, tone encoder/decoder, 220 MHz converter, SSTV magnetic deflection, IC code osc, 6M tx beeper, general class study (part 6), RTTY intro, perf-board terminal, lowohmmeter.

MAR 71. IC audio filter, IC 6M converter, trap vertical ideas, digi counter info, surplus equipment identification, hf linear, simple fone patch, repeater audio mixer, digi RTTY accessories, coathanger gndplane, general class study (part 7).

APR 71. Intro to fm, noise limiter, repeater problems, Motorola HX-100, microwave water linking, diode, 2M fm rx/tx, rep, 2M fm marketplace, meter evb, motor modulator, simple sig gen, touz, low hookup, hf preselector, 10M 12W tx.

MAY 71. 75M mobile whip, 2M preamp, transistor amp design, 10M dsb tx, portable fm transceiver directory, audio compressor clipper, transistor LM freemeter, 450 MHz link tx, simple af filter, 1-2M 2M transceiver, surplus 2M power amp, general class study (part 8).

JUNE 71. 2M beam experiments, 3 el 2M quad, multi-band dipole patterns, weather balloon vertical, pocket-pager squelch, two-er vfo, tuning mobile whips, transistor pwr supply, capacity decade box, 40M gain ant, general class study (part 9).

JULY 71. IC audio processor, audio sig gen, cw filter, 2M fm osc, 2M collinear vertical, FM supplier directory, Motorola G-strip conversion, transistor beta tester, general class study (part 10).

AUG 71. Ham facsimile (part 1), 500 Watt linear, dimensions for July collinear, 4-tube 80/40 station, vfo digi readout, Jupiter on 15M, general class study (part 11), pink ticket wave meter.

SEPT 71. Transformerless power supplies, solid state tv camera, IC substitution, two rf wattmeters, IC compressor-agc, multichannel HT-200, ham facsimile (part 2), causes of manmade noise, vfo with tracking mixer, general class study (part 12), transistor heat sinking, IC pulse gen, fone-patch isolation, hcd wattmeters.

OCT 71. Emergency repeater cor, transceiver power supply, predicting meteor showers, digi switching, reverse-current battery charger, passive repeaters, earth grounds, audio "tailor" filters, Swan 503 mods.

NOV 71. 3-el 75M beam, motor-tuned gndplane, 2M gain vertical, transistor biased split-side repeater, fox-hunting, audio filter, transistor-diode tester, xtal tester, 6M kw amp, 10 15-20M quad, transistor pi-net final, ant feedline, communications dbs, 2300 MHz xciter.

AUG 72. SSTV intro, speech processor, fm repeater info, test probe construction, GE progline ac supply, 432 rf testing, preamp compressor, Six-er mods, fone patch, Two-er info, solar info, SCR regulator for HVPs, "ideal" xtal osc, fm rx adaptor, auto theft alarm.

SEPT 72. Plumbicon tv camera, WWVB 60 kHz rx, clearable sig gen, cw active filter, rf testing at 1296-3500 GHz, balun ant feed, transistor power supply, IC 6M rx, IC fm/am detector (part 2), active filter design (part 3), K20AW freq counter (part 3), 2M freq synthesizer (part 1).

OCT 72. Corrections for Aug. fm rx adaptor, 2M freq synthesizer (part 2), 6M transistor vfo, nano-ampere meter, time-freq measurement (part 1), active filter design (part 4), repeater trim, extra-class Q&A (part 3), balloon vertical, ID gen, time delay relay, 432 filter ideas, DC-AC inverter, hcd diode converter, tri decade and nixie driver, plus-minus supply for ICs.

NOV 72. HF transistor power amp, RTTY selcal, IC trf rx, transistor keyer, emergency power, 220 MHz preamp, double delta ant, simple converter using modules, hf RF tester, "lumped line" osc, 2M freq synthesizer (part 3), K20AW counter errata, 2M preamp, extra class Q&A (part 4), hi-Z voltmeter, Nikola Tesla story, vhf swr meter, transistor regen rx, 432 SSB transverter, AC arc welder, intro to computers, hybrid am modulator, HR10 tx mods, 10M transistor am tx, 40M gndplane, IC logic demonstrator, overload protection, hf rf sweep generator, digi freq counter, aural tx tuning.

DEC 72. SSTV scope analyzer, 2M fm rx, tone burst encoder and decoder, universal hf amp, autopatch hookup, LM380N info, voltage variable cap info, 2M 18 watt amp, SSB modulation monitor, xtal freq/activity meter, 10A var. dc supply, transmission line uses, radio astronomy, inductance meter, 75 to 20M transverter, LED info, 40M preamp, transistor vfo, 1972 Index, 2M preamp.

JAN 73. HT 220M touchtone, 3-el 20M yagi, 50 MHz freq counter, speech processor, 2-tone gen, fm test set, tilt-over tower, 6M converter using modules, tuneable af filter, six band linear, 10M fm tuner, diode noise limiter, cw/usb agc, HW22A transceiver 40M mod, HAL ID-1 mod.

FEB 73. CW id gen, tone operated relay, toroidal quadrature ant, active filter, time freq measurement (part 2), repeater timing control, SSTV circuits (part 1), 2M converter using modules, multifunction metering, FET blasing, freq counter preamp, TR22 hi-power mod, transistor rf power amps (part 1), light bulb rf power indicators, 75A4 filters, capacitance measurement, Gonset 201 mod, world time info.

APR 73. FM deviation meter, 2M FET preamp, two 2M power amps, repeater control (part 1), repeater licensing, European 2M fm, fm scanner adaptor, RCA CMU15 mods, lightning detector, cb alignment gadget, transistor rf power amps (part 2), repeater economics.

JUNE 73. 220 MHz sig gen, uhf power meter, repeater licensing info, RTTY autopatch, 40M hybrid vfo tx, ant polar mount, 10 15-20M quad, K20AW counter mods, double coax ant, ham summer job, tone decoder, field strength meter, nicad battery pack, ohm meter, FCC regs (part 1).

AUG 73. Log-periodics (part 1), tone burst gen, rf power amp design, transistor radio intercom, 160M ant, SSTV monitor, low cost freq counter, VOM design, qrp 40M tx, 432 MHz exciter, fm audio processing, FCC regs (part 3).

SEPT 73. Repeater control system, log-periodics (part 2), 2M tx calibrator, PLL IC applications, TT pad hookup, Heath HWL "s" meter, Dscar-6 doppler, 2M coaxial ant, 2M converter, IC keyer, measure ant 2, FCC regs (part 4).

OCT 73. GE Pocketmate mods, microwave freq measurement, CA3102E 2M frontend, 2 kw hf linear, rf wattmeter, meter repair, 60/40 dipole, IC "hi" gen, vhf freq multiplier, FCC regs (part 5).

NOV 73. 450 MHz exciter, Intro to ATV circuits, nicad voltage monitor, autopatch connections, IC meter amplifier, TR22 ac supply, indoor vertical, IC af filter, momentary power failure protection, 160M ant coupler, Motorola HX-10, SSTV-ISB, Class-B af amp, FCC regs (part 6).

DEC 73. Code speed display, 2M kw amp, IC keyer, 8038 waveform gen, helical resonator design, sensitive rf voltmeter, proximity control switch, IC tester, sequential tone decoder, 2M portable beam, electronic calculator math, cw filter design, FCC regs (part 7).

FEB 74. SSTV monitor info, IC audio amps, scope sweep gen, 15/20M vertical, telephone line control system, pc board construction, var Q af filter, blown-fuse indicator, 40m cw str with Ten-Tec modules, simple preamp compressor, single IC rx, "432-er" final assembly, transistor keying circuit, 7 segment readout with nixie driver.

APR 74. Vox for repeaters, tone operated relay, hf transverter, 10 to 2m tx converter, remote control panel for scanner, RCA fm tx tuning, subaudible tone gen, FCC regs (part 9), Repeater Atlas.

MAY 74. Cd car ignition, audio compressor info, interference suppression for boats, auto burglar alarms, 2m ic preamp, 10m ft converter.

JULY 74. 4 1000A linear, universal freq gen, universal afsk gen, 555 IC timer, 80M phased array, 135 kHz-432 MHz preamps, 10M qrp am tx, 3000 vdc supply, how to read diagrams.

AUG 74. Toroidal directional wattmeters, 450 MHz FET preamp, use gdo to find "c", Trimline It pad hookup, R390 & R392 rx mods, tracking cw filter, aural voltmeter, uni-versal regulated supply, sstv scan converter, itl logic problems, ID timer.

SEPT 74. MOSKEY electronic keyer (part 1), exp warning system, Heath 10 103 scope mods, qrp 6M am tx, rf speech clipper, audio noise limiter, wx satellite on SSTV monitor, universal IC tester, miniature rig construction, tower construction, infinite rf attenuator, electronic

(More)

photo flash ideas, IC select object

OCT 74. Microtransistor circuits, synthesized HT 220 (part 1), repeater government, regulated 5 vdc supply, fm select, removable mobile ant, Motorola metering, 2M coaxial coilant, Motorola model code, 2M coaxial dipole, 1.6 MHz if strip, MOSKEY electronic keyer (part 2), carbon mike circuit, hp power to pass filter, 6M preamp, 3 wire dipole, ATV sync gen, NGK 5 mods, mobile whip for apartment dwellers, stv auto vertical trig

NOV 74. K20AW counter update, regulated 5 vdc supply, wind direction indicator, synthesized HT 220 (part 2), 20M 3-el beam, auto patch pad hookups, double stub ant march, novice class instruction, digi swr meter (part 1), 6M converter (1.6 MHz if), "C bridge," MOSKEY electronic keyer (part 3), Aug stv scan converter errata, repeater off freq indicator.

DEC 74. Care of nicads, wind speed/direction indicator, wx satellite video converter, electronic keyer, hints for noices, unknown meter scales, SSTV tape ideas TTL logic probe, public service band converter, tuned diode test receivers, digi swr meter (part 2), telephone pole beam support, rhombic antennas, 1974 index

FEB 75. Heath HQ 10 scope mod for SSTV, electronic keyer, digital satellite orbital timer, Oscar 7 operation, satellite orbital prediction, Heath SB 102 mods, comparing FM & AM, repeater engineering, Robot 80A stv camera mod, neutralizing Heath SB 110A, "Bounce less" IC switch, tape keyer for cw tx.

APR 75. 550 walky for 2M, 2M scanning synthesizer, 88 mH toroid info, 8 function repeater controller, nicad battery precautions, TR22C preamp, telephone attachment reqs, Guide to 2M Hand-held Transceivers, 2M 7-el beam, basic telephone systems (part 1), 10 min ID timer, modified hf Hustler mobile ant for 2M, 15M quad modified for 20M, 2M collinear beam, R 11A surplus vs conversion, 5/16 wave 2M ant, Hallicrafters SK 111 rx mods, 160M cw tx.

AUG 75. 146/432 MHz Helical ants (part 2), 10 min ID timer, digi swr computer (part 1), debugging rf feedback, DVM byer's guide, wx satellite monitor, cmos "accu keyer," pc board method, sweep-tube final precautions, compact multiband dipoles, small digital clock, accessory vfo for hf transceiver, modern non Morse codes, multi-function gen, 2M scanning synthesizer errata, KP 202 walky charger, 10M multi-element beam.

SEPT 75. Calculating freq counter, wx satellite FAX system (part 1), IC millivoltmeter, three button TT decoder, troubleshooting stv pix, 40M de ants, 146/432 MHz helical ants (conclusion), digi swr computer (conclusion), reed relay for cw bk in, NES55 preset timer, power failure alarm, portable qrp rig power unit, precision 10 vdc reference standard, 135 khz if strip, telephone handsets with fm transceivers,

Since there's little to get stale in back issues of 73 (our magazine is not padded ... like others ... with reams of activity reports), you'll have a fantastic time reading them. Most of the articles are still exciting to read ... and old editorials are even more fun for most of the dire predictions by Green have now come to pass. Incentive licensing was every bit the debacle he predicted ... and more. You'll really get a kick out of the back issues.

Motorola T 44 tx mod for ATV, 0.60 MHz synthesizer (part 10, ham radio PR)

OCT 75. A deluxe TTY keyboard (part 1), Op Amps: a basic primer, an introduction to microprocessors, 2m Synthesizer (conclusion), Satellite Fax System (conclusion), regulated supplies (dispelling the mystery), Digital Logic made simple, FCC interview, contest up system, digital clock time bases, the operating desk, QRP 432, ham PR.

NOV-DEC 75. Blockbuster double issue! Flip-flops exposed, breakthrough in fast scan ATV, strobing displays is cool, the tuned lunch box (antenna tuner for HF transceivers), a deluxe TTY keyboard (part 2), the 127' rotating mast, less than \$100 multi-purpose scope for your shack (part 1), predicting third order intermod, feedline primer, GRMing the Third Reich, why tubes haven't died, instant circuits - build your own IC test rig, the K20AW synthesizer PROM-oted, a ham's intro to microprocessing, Ground Fault Interrupter (a keep alive circuit for yourself), a \$1 strip chart recorder, an even simpler clock osc., the Fun City surplus scene, updating the Heath 1B-1101 counter, 256 pages!

JAN 76. Clocks - Really Simplified, De-Strain your Ham-M, An Automatic Dialer for the Deluxe Mobile, Zapping Dead Reads to Life, The Computer OSO Machine, \$50 Self-Powered Counter, Save Money on Coax, How to Pass Exams, Using a Bargain Surplus Keyboard, Improve Your SSTV with the FRAMER, and more. The best 73 in new large format! (Includes 1975 Index to 73).

FEB 76. Build a Starburst Communicator - Trackset Special, Synthesized IC Frequency Standard, You Can Hear Photo PC Boards, How's Your Speech Quality?, ASCII to Baudot Converter, RTTY Autocall - The Digital Way, Improving the FT 101, Night DXing on 10 and 15m, Really Soap Up Your 2m Receiver, Put Your SB-100 to Sleep.

MAR 76. Special Surplus Issue - Tune-Up FM Receiver, Strip, Surplus Circuit Boards - A Gold Mine of Parts, Space Age Juniper, A PC Based Bonanza, Government Surplus: Is It All Gone?, Stereo - A New Type of CW Filter, Build This Exciting New VTY, The

Smart Power Supply, How to Use Surplus Pots.

APR 76. Special FM Issue - A Program Amplifier, Put That AM Rig on FM, A COR for your Receiver, Amplifier, Build 220 MHz Repeater - A New Frequency, Long Distance CW, Low TT Decoder, One IC Tone Burst, The ... er, A Versatile TTY Generator, The PLL - Exp ... HT-22 Taps, Computers Are Ridiculously Simple.

MAY 76. Special Antenna Issue - The Magnificent Seven Microhorns, An Allband Inverted V, Load Loss Antenna Tuning, The 75 Ohm Broadbander, The Magic of a Matchmaker, How to Coax Your Antenna, 40m DXing in City Style, The Secret 2m Mobile Antenna, An Inverted Vee for 160/80m, The Dipole Dangler, Amateur Weather Satellite Reception, Scan Your MH 212, A Very Cheap 10 - the M0del, 15, Code Converter, Living PROMs, A Nifty Cassette Computer System, The Ins and Outs of TTL, Build a CW Memory, 5/8 Wave Power for Your HT, 555 Timer Sweep Circuit for SSTV, AM is Not Dead - It Never Existed at All, Computer Languages - Simplified.

JUN 76. VHF Special - Super COR - Digital of Course!, Touchtone Decoder - Using a Calculator Readout, Simple Amateur TV Transmitter, Amateur TV Receiving System, Mobile Autodials, Autocall '76 - Using a Touchtone Decoder, Build This Lab Type Bridge - and Measure Transformer Impedances, How Those Triangle Things Work - a Sort of Op Amp Handbook, Those Exciting Memory Chips - RAMs, ROMs, PROMs, etc., ASCII Baudot with a PROM - for Ridiculous RTTY on Computers, Am Your Beam Right - with a Programmable Calculator.

JUL 76. Perfect CW - Drive 'em Crazy with the Keyzader I, The Mini-Mite Allband QRP Rig - A Mighty 7 Watts, A Fun Counter Project - Under \$50, Build a FAX from Scratch - Then Get Satellite Pictures and Other Things, Our Repeatermaster - Repeat Control with ID, The Quartz Heart Clock, Creative SSTV Programming, CW Regenerator/Processor, What's Up on 156 MHz?, TT Pad for the Wilson HT, Power Supply Testing - To Save Your Digital Circuits, A RTTY/Computer Display Unit, Your Computer Can Talk Morse, Gain for Your HT - a Half Wave Whip, The Super Transmatch, Simple VHF Monitor.

AUG 76. How Do You Use ICs? - Fundamentalists, Surprising Miniature Low Band Antenna - the DRRR (Part II), MINIMOS - the Best Keyer Yet!, The Skafitnik's Delight Breadboard - Cheap Imitation of a Commercial IC DIP Board, More PLL Magic, The Logic Grabber - Selected Internal Logic Tracer, Global Calculators for the DXer - Using a Hand Calculator, Instant Counter Calibration - Using Your TV Set, Simple 450 MHz Rig - Go ATV With a \$42.50 Module, The First Computer Controlled Ham Station - Grand Prize Winner, The Which One Dilemma - 4, 8, 12, or 16 bits: pros and cons, Meaningful Conversations with your Computer - What All Those Mysterious Languages Are All About, A Baudot Monitor/Editor System, A Logic Probe You Can Hear, Satellite Orbit Prediction - Using a Pocket Calculator, F5E with the SB-401, Build the Safari RTTY Terminal, El Cheapo Signal Tracer - Test Gear for the Cheapoake.

SEP 76. The Surprising DRRR Low Noise Antenna (part III), Ultra-simple Regulation with New IC - Power Supply Design Greatly Simplified, Can an Indoor Antenna Work - Making the Best Out of a Bad Bargain, Inexpensive 12 Volts for Your Base Station, A Test Lab Bonanza - Using a Transistor Radio, Protect Your VHF Converter - Novel Antenna Healy, Ridiculously Simple RTTY System, How to Catch a CBR, A 450 MHz Transceiver for Under \$100, Space Age Juniper II, PROM Memory Revisited, Eight Trace Scope Adapter, The PROM Zapper, Slinky Baudot, Whip an ASCII Keyboard, Simple Graphics Terminal - Using surplus, Counters are Not Magic - They're Simple.

OCT 76. Build a Weird 2 Band Mobile Antenna, Build a Counter for Your Receiver, How do You Use ICs? (part II), ORP Fun on 40 and 80 - Have a Real Ball with Just 5 Watts, The Hybrid Quad - Low Windload, Expense, Heist!, Frequency Detector for Your Counter, Programmable CW ID Unit - for RTTY, Repeaters, Mobile, etc., New ICs for the Counter Culture - Simple Counters with Less Used Power, Is My Rig Working or Not? - Build an Effective Related Field Meter and Know, Quickie Collimators for 15 and 10 - a Satisfaction Guaranteed, Build a Super Standard - Great Right Down to 1 Hz, The Incredible Lambda Dode, Mechanical RTTY Buffer, How You Used a Trace Yet?, How to Interface a Clock Chip - Baudot, BCD, or ASCII Converter, A TTL Tester - Great for Unlearned Bargain IQs, The New Ham Programmer - Making Those Confounded up's Work, BASIC? What's That? - the Basics of BASIC, The Soft Art of Programming (part I).

NOV 76. Blockbuster 288 pg usual Cordless Iron Tips, Bicycle Mobile, Build a Simple Lab Scope - Open Line Scope Get on Site with Surplus - The El Cheapo RT-70 is a Natural, The Beam Saver - Rotor Memory System, Updated Universal Display Generator, The Short Pocket Touchtone, Liquid Crystal Display, Self Powered Mike Preamp, The Wind Control, The S3B is Not Dead!, The Amazing Inverted L - Antenna for 20, 40, and 80m, Battery Chargers Explored, How Do You Use ICs (part III), Thirty Years of Ham RTTY, Big Nose Burger Alarm, Dandy Digital Dial Decoder, Weather Satellite Display Control, Ham Tone Sharing is Here for You!, The Soft Art of Programming (part II), OSCAR Orbits on Your Antair, ASCII/Baudot Converter for Your TVT, The Smoke Tester - Power Supply Tester, The Man Who Invented CAT - Tests, the Greatest Power of Them All, Baudot to ASCII - You Want to Learn Programming?, Baudot and BASIC - an Interpreter for a Baudot Computer, Toward a More Perfect Touchtone Decoder - Using a Wireless Broadcaster, The Quiet Spy - Amateur Uncovers Spy Ring in the US!, The Benefits of Sideline Monitoring - And How to Do It.

DEC 76. Go Tone for Ten - Simple Subaudible Encoder, World's Simplest Five Band Receiver?, How Do You Use ICs? (part IV), A Super Cheap CW Dial, The 2F Special Antenna, CT 7001 Clock Buster, Saving a CBR, A Ham's Computer, What's All This LSI Bunk? - an Outsider's Eye View of the Microcomputer, The Soft Art of Programming (part III), Put Snap into Your SSTV Pictures - Using a \$20 Frequency Standard, What's all This Wee Wrap Stuff? - Talk About Cold Solder Joints, Exploding the Power Myth, Exploding the SWR Myth, The IC-22 Walkie - Portabilization with Nicads, Watch DX with a Spectrum Analyzer, DXing with a Weather Map.

HOLIDAY 76. 55 article issue! An Inexpensive 400 Watt HF amplifier, How Do You Use ICs? (part V), Mobile Smokey Detector - 10.8 GHz: Use It or Lose It!, Add RTTY to Your Transceiver, DXpedition: Memories for a Lifetime - Reflections of HK1TL, Design Your Own QRP Dummy Load, Fritsle Super Charger - Multirate Load, The Amazing 18' Antenna for 160m, Replacing the Knife Switch - Simple T6 System for the Novice, How Can Synthesizer - the VHF Engineering Approach to 2m Happiness, Hutchingson's Remedy - the Christie CW Machine, The Mod Squad Does the Packet Scanner - Radio Shack Pro-6 Update, TR-22 Mod Squad, What Computer Can and Can't Do, A Ham Shack File Handler - Program in BASIC for OSs, Repeaters, etc., Print Your Own Logbook - On Your Nearest Computer, Shooing Your HT, Cash In on the CB - Installation for Fun and Profit, Tuning Those Big Antennas, The 2m Mod Squad Tackles the Weather Radio - and Wins!, Hamming by Laser, A 60 Foot Antenna on a 20 Foot Lot - Solving a 40m Noise problem, Dual Voltage Power Supply, An Autopatch Busy Signal, Inside the GLE - a Gummy Look at a Synthesizer, How to Bug an Automatic Keyer, A 450 Duplexer that Fits in Your Car, Will Silver-Zinc Replace the Nicad?

BACK ISSUES

73 MAGAZINE CLASSICS

- JUNE 63
- AUG 63
- OCT 63
- FEB 64
- MAY 67
- JULY 67
- OCT 67
- JUNE 68
- JULY 68
- SEPT 68
- NOV 68
- JAN 69
- FEB 69
- MAR 69
- APR 69
- MAY 69
- JUNE 69
- JULY 69
- AUG 69
- SEPT 69
- OCT 69
- NOV 69
- DEC 69
- JAN 70
- FEB 70
- MAR 70
- APR 70
- MAY 70
- JUN 70
- JULY 70
- AUG 70
- SEPT 70
- OCT 70
- NOV 70
- DEC 70
- JAN 71
- FEB 71
- MAR 71
- APR 71
- MAY 71
- JUN 71
- JULY 71
- AUG 71
- SEPT 71
- OCT 71
- NOV 71
- DEC 71
- JAN 72
- FEB 72
- MAR 72
- APR 72
- MAY 72
- JUN 72
- JULY 72
- AUG 72
- SEPT 72
- OCT 72
- NOV 72
- DEC 72
- JAN 73
- FEB 73
- APR 73
- JUNE 73
- AUG 73
- SEPT 73
- OCT 73

- NOV 73
- DEC 73
- FEB 74
- APR 74
- MAY 74
- JULY 74
- AUG 74
- SEPT 74
- OCT 74
- NOV 74
- DEC 74
- FEB 75
- APR 75
- AUG 75
- SEPT 75
- OCT 75
- NOV/DEC 75
- JAN 76
- FEB 76
- MAR 76
- MAY 76
- JUNE 76
- JULY 76
- AUG 76
- SEPT 76
- OCT 76
- NOV 76
- DEC 76
- HOLIDAY 76

- \$1.50 - single issues (indicate your choice at left) issues @ \$1.50
- \$12 - ten issues (indicate your choice at left)
- \$20 - 25 issues (indicate your choice at left)
- \$10 - 25 issues, our choice '66-'70 '71-'75 '76
- Cash, check, money order enclosed.

Name _____
 Call _____
 Address _____
 City _____
 State _____ Zip _____
 Charge: American Express BankAmericard Master Charge
 Credit card # _____ Interbank # _____
 Expiration date _____
 Signature _____

(Add \$1.00 handling charge for orders less than \$4.00)

SEND TO: 73 BACK ISSUES PETERBOROUGH NH 03458

9/77

RADIO BOOKSHOP

The ONLY Complete License Study Guides

- **NOVICE STUDY GUIDE** — Here is a completely new study guide and reference book for the potential ham. This is not a question/answer memorization course. Electronic and radio fundamentals are presented and explained in an easy-to-understand fashion, preparing the beginner for the Novice exam. Includes the latest FCC amateur regulations, as well as application forms. Easily the best path into the exciting world of ham radio! \$4.95.
- **GENERAL CLASS STUDY GUIDE** — A complete theory course for the prospective General or Technician. This reference explains transistor, amplifier, and general radio theory, while preparing the Novice for the "big" ticket. After getting your ticket, you'll use this guide again and again as an electronic reference source. Not a question/answer guide that becomes dated when the FCC updates the amateur exams. \$5.95.
- **ADVANCED CLASS STUDY GUIDE** — Ready to upgrade your license? To prevent retaking the FCC theory exam, you need the 73 Advanced theory guide. SSB, antenna theory, transmitters, and electronic measuring techniques are covered in detail in this easy-to-follow study guide. Special modes and techniques, such as RTTY, are also treated. An engineering degree is *not* necessary to master Advanced theory — try this book before visiting the examiner's office! \$3.95.
- **EXTRA CLASS LICENSE STUDY GUIDE** — Before going for your 1 x 2 call, it pays to be a master of the Extra class electronic theory. This study guide is the logical extension of the 73 theory course. All the theory necessary to pass the exam is presented. Antennas, transmission lines, swr are discussed, as well as noise, propagation, and specialized communication techniques. This book is not a classroom lecture or memorization guide, but rather a logical presentation of the material that must be *understood* before attempting the Extra exam. Save yourself a return trip to the FCC and try the 73 method first! \$5.95.

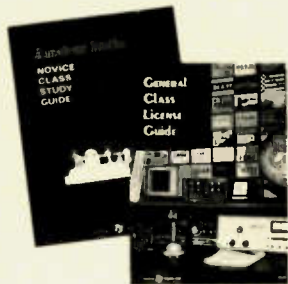
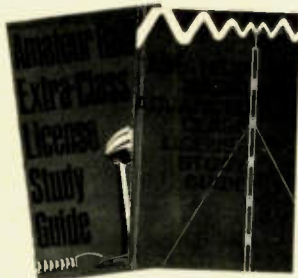

novice theory tapes

Startling Learning Breakthrough

You'll be astounded at how really simple the theory is when you hear it explained on these tapes. Three tapes of theory and one of questions and answers from the latest Novice exams give you the edge you need to breeze through your exam.

73 is interested in helping get more amateurs, so we're giving you the complete set of our tapes for the incredibly low price of ONLY \$15.95.

Scientists have proven that you learn faster by listening than by reading because you can play a cassette tape over and over in your spare time — even while you're driving! You get more and more info each time you hear it.

You can't progress without solid fundamentals. These four hour-long tapes give you all the basics you'll need to pass the Novice exam easily. You'll have an understanding of the basics which will be invaluable to you for the rest of your life! Can you afford to take your Novice exam without first listening to your tapes?

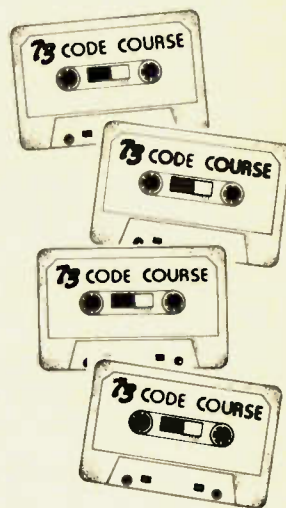

FOUR TAPES for \$15.95 \$4.95 EACH

5 WPM This is the beginning tape for people who do not know the code at all. It takes them through the 26 letters, 10 numbers and necessary punctuation, complete with practice every step of the way using the newest blitz teaching techniques. It is almost miraculous! In one hour many people — including kids of ten — are able to master the code. The ease of learning gives confidence to beginners who might otherwise drop out.

NEW CODE SYSTEM — Four Speeds Available

6 WPM This is the practice tape for the Novice and Technician licenses. It is made up of one solid hour of code, sent at the official FCC standard (no other tape we've heard uses these standards, so many people flunk the code when they are suddenly — under pressure — faced with characters sent at 13 wpm and spaced for 5 wpm). This tape is not memorizable, unlike the zany 5 wpm tape, since the code groups are entirely random characters sent in groups of five. Practice this one during lunch, while in the car,

anywhere, and you'll be more than prepared for the easy FCC exam.

13 WPM Code groups again, at a brisk 13 per so you will be at ease when you sit down in front of the steely eyed government inspector and he starts sending you plain language at only 13 per. You need this extra margin to overcome the panic which is universal in the test situations. When you've spent your money and time to take the test you'll thank heavens you had this back-breaking tape.

20 WPM Code is what gets you when you go for the Extra Class license. It is so embarrassing to panic out just because you didn't prepare yourself with this tape. Though this is only one word faster, the code groups are so difficult that you'll almost fall asleep copying the FCC stuff by comparison. Users report that they can't believe how easy 20 per really is with this fantastic one hour tape. No one who can copy these tapes can possibly fail the FCC test. Remove all fear of the code forever with these tapes.

ONLY 4 for \$15.95! 73 is in the publishing business, not tapes, so these are priced much lower than anyone else could sell them. Have you ever seen one hour cassettes for under \$6? For 1st class mail add 25¢ per tape ordered.

**RADIO AMATEURS
TALK TO THE WORLD!!**
...ask me about it!

BUMPER STICKERS:
RADIO AMATEURS TALK TO THE WORLD!!
AUTHORIZED VEHICLE
SUPPORT YOUR LOCAL POLICE
50¢ each; any 3 for \$1.00

BINDERS — Red Binders with gold lettering keep your 1976 & 1977 73s safe from being lost or damaged. Each binder holds 12 issues. \$6.00 ea., 2 for \$11.00.

BACK ISSUE BUNDLE! 73 Magazine Classics, issues containing hundreds of articles & projects. Great for nostalgia buffs. 20 copies (all different) for \$8.00.

**LIBRARY SHELF
BOOK BOXES**
\$2.00 each
2/\$3.00 • 8/\$10.00

QSLs!

ONLY \$7.50
for 250,
\$12.50 for 500,
\$20.00 for 1000!

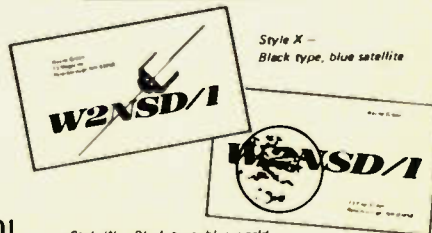

How can 73 make such beautiful cards, printed on the best coated stock, available for about half the regular cost?

The world and satellite are printed in blue, your name, address and call are in black. The QSO information is a standard form on the back. **DOMESTIC ORDERS ONLY
ALLOW 6-8 WEEKS FOR DELIVERY.**

Use the order card or itemize your order on a separate piece of paper and mail to:
73 Radio Bookshop • Peterborough NH 03458 Be sure to include check or detailed credit card information.
Note: Prices subject to change without notice on books not published by 73 Magazine.

RADIO BOOKSHOP

RADIO BOOKSHOP

● **REPEATER ATLAS** Hundreds of new listings . . . by both location and frequency . . . dual listing, invaluable for your car . . . find those repeaters as you travel. This is the **ONLY** complete list of repeaters being published. Almost 3000 repeaters listed in this issue . . . repeaters from all over the entire world. Only \$1.95.

● **VHF ANTENNA HANDBOOK** The **NEW** VHF Antenna Handbook details the theory, design and construction of hundreds of different VHF and UHF antennas . . . A practical book written for the average amateur who takes joy in building, not full of complex formulas for the design engineer. Packed with fabulous antenna projects you can build. \$4.95.

● **WEATHER SATELLITE HANDBOOK** Simple equipment and methods for getting good pictures from the weather satellite. Antennas, receivers, monitors, facsimile you can build, tracking, automatic control (you don't even have to be home). Dr. Taggart WB8DQT \$4.95.

● **COAX HANDBOOK** The world's only handbook devoted exclusively to coax, feedlines and connectors. Special price only \$1.50.



● **VOL. I COMPONENT TESTERS** . . . how to build transistor testers (8), diode testers (3), IC testers (3), voltmeters and VTVMs (9), ohmmeters (8 different kinds), inductance (3), capacity (9), Q measurement, crystal checking (6), temperature (2), aural meters for the blind (3) and all sorts of miscellaneous data on meters . . . using them, making them more versatile, making standards. Invaluable book, \$4.95.

● **VOL. II AUDIO FREQUENCY TESTERS** . . . jam packed full of all kinds of audio frequency test equipment. If you're into SSB, RTTY, SSTV, etc., this book is a must for you . . . a good book for hi-fi addicts and experimenters tool \$4.95.

● **VOL. III RADIO FREQUENCY TESTERS** Radio frequency waves, the common denominator of Amateur Radio. Such items as SWR, antenna impedance, line impedance, rf output and field strength; detailed instructions on testing these items includes sections on signal generators, crystal calibrators, grid dip oscillators, noise generators, dummy loads and much more. \$4.95.

● **THE NEW RTTY HANDBOOK** is a brand new 1977 edition and the only up-to-date RTTY book available. The state of the art has been changing radically and has made all previous RTTY books obsolete. It has the latest circuits, great for the newcomer and the expert alike . . . Only \$5.95.

● **73 VERTICAL, BEAM AND TRIANGLE ANTENNAS** by Edward M. Noll W3FQJ Describes 73 different antennas for amateurs. Each design is the result of the author's own experiments: each has actually been built and air-tested. Includes appendices covering the construction of noise bridges and antenna line tuners, as well as methods for measuring resonant frequency, velocity factor, and standing-wave ratios. 160 pages. \$5.50.

● **IC OP-AMP COOKBOOK** by Walter G. Jung. Covers not only the basic theory of the IC op amp in great detail, but also includes over 250 practical circuit applications, liberally illustrated. 592 pages, 5½ x 8½, softbound \$12.95.

● **73 DIPOLE AND LONG-WIRE ANTENNAS** by Edward M. Noll W3FQJ This is the first collection of virtually every type of wire antenna used by amateurs. Includes dimensions, configurations, and detailed construction data for 73 different antenna types. Appendices describe the construction of noise bridges, line tuners, and data on measuring resonant frequency, velocity factor, and swr. 160 pages. \$5.50.

● **RF AND DIGITAL TEST EQUIPMENT YOU CAN BUILD** Rf burst, function, square wave generators, variable length pulse generators — 100 kHz marker, i-f and rf sweep generators, audio osc, af/rf signal injector, 146 MHz synthesizer, digital readouts for counters, several counters, prescaler, microwavemeter, etc. 252 pages. \$5.95.

● **SSTV HANDBOOK** This excellent book tells all about it, from its history and basics to the present state of the art techniques. Contains chapters on circuits, monitors, cameras, color SSTV, test equipment and much more. Hardbound \$7, softbound \$5.



Use the order card or itemize your order on a separate piece of paper and mail to:
73 Radio Bookshop • Peterborough NH 03458 Be sure to include check or detailed credit card information.
Note: Prices subject to change without notice on books not published by 73 Magazine.

RADIO BOOKSHOP

RADIO BOOKSHOP

● **RTL COOKBOOK** by Donald Lancaster. Explains the how and why of RTL (Resistor-Transistor Logic) and gives design information that can be put to practical use. Gives a multitude of digital applications ranging from the basic switch to the sophisticated counter. 240 pages; 5½ x 8½; softbound. \$5.50.

● **TTL COOKBOOK** by Donald Lancaster. Explains what TTL is, how it works, and how to use it. Discusses practical applications, such as a digital counter and display system, events counter, electronic stopwatch, digital voltmeter, and a digital tachometer. 336 pages; 5½ x 8½; softbound. \$8.95.

● **TVT COOKBOOK** by Donald Lancaster. Describes the use of a standard television receiver as a microprocessor CRT terminal. Explains and describes character generation, cursor control and interface information in typical, easy-to-understand Lancaster style. This book is a required text for both the microcomputer enthusiast and the amateur RTTY operator who desires a quiet alternative to noisy teletype machines. \$9.95.



● **FASCINATING WORLD OF RADIO COMMUNICATION** Interesting stories in the history of radio pioneering and discovery. Also includes the fundamentals of broadcast band DXing. A must for every radio amateur. \$3.95.

● **PRACTICAL TEST INSTRUMENTS YOU CAN BUILD** 37 simple test instruments you can make — covers VOMs, VTVMs, semiconductor testing units, dip meters, wattmeters, and just about anything else you might need around the test lab and ham shack. \$4.95.

● **1001 PRACTICAL ELECTRONIC CIRCUITS** Tab's new 1001 circuits is available for only \$9.95 ppd. The next time you want a circuit for just about anything, eat your heart out that you didn't send for this book the first time you read about it. You'd better order the book right away, before they run out. \$9.95.

● **HOW TO MAKE BETTER QSLs** Be proud of your QSL cards ... have a card which gets front space on every ham shack wall ... win prizes at hamfests. The only way to have a truly outstanding card is to make it yourself ... which is easy when you have this new book. \$2.00.



● **WHAT TO DO AFTER YOU HIT RETURN** PCC's first book of computer games ... 48 different computer games you can play in BASIC ... programs, descriptions, muchly illustrated. Lunar Landing, Hammurabi, King, Civil 2, Qubic 5, Taxman, Star Trek, Crash, Market, etc. \$6.95.

● **101 GAMES IN BASIC** Okay, so once you get your computer up and running in BASIC, then what? Then you need some programs in BASIC, that's what. This book has 101 games for you, from very simple to real buggers. You get the games, a description of the games, the listing to put in your computer and a sample run to show you how they work. Fun. Any one game will be worth more than the price of the book for the fun you and your family will have with it. \$7.50.

● **BASIC** by Bob Albrecht, etc. Self-teaching guide to the computer language you will need to know for use with your microcomputer. 324 pages. This is one of the easiest ways to learn computer programming. \$4.95.

● **THE UNDERGROUND BUYING GUIDE** Here is a handy guide for the electronics enthusiast. Over 600 sources of equipment and literature are provided; some are mail-order-only outfits that do not advertise. Sources are listed alphabetically, by service or product, and by state. The guide is cross-referenced for ease of use. Electronic publishing houses are also listed. Published by PMS Publishing Co., \$5.95 each.

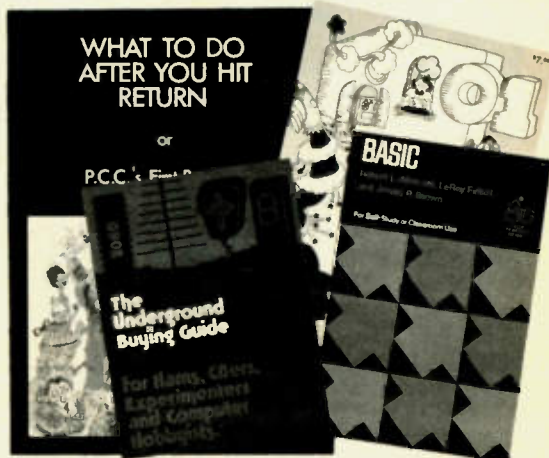

● **AN INTRODUCTION TO MICROCOMPUTERS, VOLS. 1 AND 2** At last! Someone has finally written a book containing hardware details about most of the popular micro chips available to computerists. *An Introduction to Microcomputers*, Volumes 1 and 2, by Adam Osborne Associates, are references dealing with microcomputer architecture in general and specifically with details about most of the common chips. These books are not software-oriented, but are invaluable for the hobbyist who is into building his own interfaces and processors. Volume 1 is dedicated to general hardware theory related to micros, and Volume 2 discusses the practical details of each micro chip. (Detailed review in *Kilobaud* #2) Published by Osborne Associates, Vol. I — \$7.50; Vol. II — \$12.50.

● **8080 PROGRAMMING FOR LOGIC DESIGN** Here is an ideal reference for the person desiring an in-depth understanding of the 8080 processor. The work is application-oriented, and the 8080 is discussed in light of replacing conventional, hard-wired logic systems. Both hardware and software is described. Practical design considerations are provided for the individual wishing to implement an 8080-based control system. (Detailed review in *Kilobaud* #1) Published by Osborne Associates, \$7.50.

● **6800 PROGRAMMING FOR LOGIC DESIGN** Oriented toward the industrial user, this book describes the process by which conventional logic can be replaced by a 6800 microprocessor. Both hardware and software techniques are discussed, as well as interface information. This reference, and its companion dedicated to 8080 users, provide practical information that allows an experimenter to design a complete micro control system from the "ground up." An excellent reference! Published by Osborne Associates, \$7.50.



Use the order card or itemize your order on a separate piece of paper and mail to:
73 Radio Bookshop • Peterborough NH 03458 Be sure to include check or detailed credit card information.
Note: Prices subject to change without notice on books not published by 73 Magazine.

RADIO BOOKSHOP

● **BRAND NEW DICTIONARY** This new microcomputer dictionary fills the urgent need for all computer people, engineers, scientists, industrialists, communications people — as professionals, amateurs, teachers, or students — to become quickly acquainted with the terminology and nomenclature of a new revolution in computer control capabilities in areas that pervade most of man's daily activities.

Over 5000 definitions and explanations of terms and concepts (704 pages) relating to microprocessors, microcomputers and microcontrollers. There are also separate appendices on: programmable calculators; math and statistics definitions; flowchart symbols and techniques; binary number systems and switching theory; symbol charts and tables; summaries of BASIC, FORTRAN and APL. In addition there is a comprehensive electronics/computer abbreviations and acronyms section. \$15.95.

● **COMPUTER PROGRAMMING HANDBOOK** by Peter Stark. A complete guide to computer programming and data processing. Includes many worked out examples and history of computers. \$8.95.

● **MY COMPUTER LIKES ME ... WHEN I SPEAK BASIC** An introduction to BASIC ... simple enough for your kids. If you want to teach BASIC to anyone quickly, this booklet is the way to go. \$2.00.

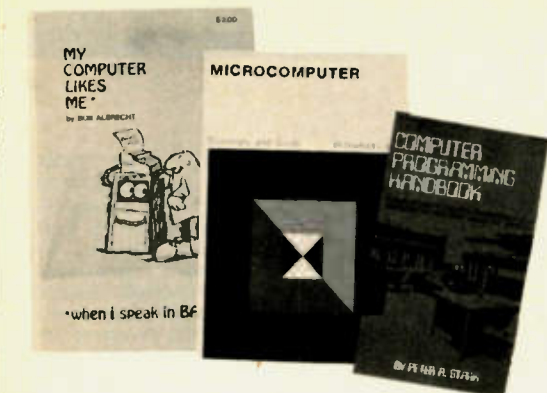

● **SCELBI'S GALAXY GAME FOR THE "6800"** Here's a new twist in computer games by Scelbi Computer Consulting and Robert Findley/Raymond Edwards. The game, "Galaxy," pits the operator of a spaceship against alien craft, as well as such variables as speed, time, and ammunition. No two games are the same! This game is described in *Galaxy Game for the 6800*, published by Scelbi Computer Consulting, Inc. \$14.95.

● **6800 SOFTWARE GOURMET GUIDE & COOKBOOK** If you have been spending too much time developing routines for your 6800 microprocessor, try the new book by Scelbi Computing and Robert Findley. This manual, *6800 Software Gourmet Guide and Cookbook*, describes sorting, searching, and many other routines for the 8080 user. \$9.95.

● **8080 SOFTWARE GOURMET GUIDE AND COOKBOOK** If you have been spending too much time developing simple routines for your 8080, try this new book by Scelbi Computing and Robert Findley. This manual, *8080 Software Gourmet Guide and Cookbook*, describes sorting, searching, and many other routines for the 8080 user. \$9.95.

● **CMOS COOKBOOK** by Don Lancaster, pub. Howard W. Sams Company. Another winner from Don Lancaster, author of the famous *RTL* and *TTL Cookbooks*. The *CMOS Cookbook* details the application of CMOS, the low power logic family suitable for most applications presently dominated by TTL. The book follows the style of the original Cookbooks. Eight chapters cover all facets of CMOS logic, and the work is prefaced by 100 pages detailing the characteristics of most CMOS circuits. The *CMOS Cookbook* is required reading for every serious digital experimenter. \$9.95.

● **HOBBY COMPUTERS ARE HERE** If you (or a friend) want to come up to speed on how computers work ... hardware and software ... this is an excellent book. It starts with the fundamentals and explains the circuits, the basics of programming, along with a couple TVT construction projects, ASCII-Baudot, etc. This book has the highest recommendations as a teaching aid for newcomers. \$4.95.



● **THE STORY OF COMPUTERS** by Donald D. Spencer is to computer books what *Dick and Jane* is to novels ... extremely elementary, gives the non-computerist a fair idea of what the hobbyist is talking about when he speaks computer lingo. Attempts to explain what computers are and can do to a spouse, child or any un-electronics-minded friend. \$4.95.

● **MICROCOMPUTER PRIMER** by Mitchell Waite and Michael Pardee, pub. by Howard W. Sams Company. If you are afraid to get involved with microcomputers for fear of not understanding them, worry no longer! The *Microcomputer Primer* describes basic computer theory, explains numbering systems, and introduces the reader to the world of programming. This book does not elaborate on specific systems or chips, but describes the world of microcomputing in "real world" terminology. There is probably no better way of getting involved with the exciting new hobby of microcomputing. \$7.95.



● **INTRODUCTION TO MICROPROCESSORS** by Charles Rockwell of MICROLOG. Here is an ideal reference for the individual desiring to understand the hardware aspects of microprocessor systems. This book describes the hardware details of computer devices in terms the beginner can understand, instead of treating the micro chip as a "black box." Addressing schemes, registers, control, and memory are all explained, and general information about hardware systems is provided. Specific systems are not described and programming is only briefly discussed. *Introduction To Microprocessors* is a hardware introduction ... and a good one. \$17.50 US and Canada, \$20 elsewhere.



● **THE NEW HOBBY COMPUTERS!** This book takes it from where "Hobby Computers Are Here" leaves off, with chapters on Large Scale Integration, how to choose a microprocessor chip, an introduction to programming, low cost I/O for a computer, computer arithmetic, checking memory boards, a Baudot monitor/editor system, an audible logic probe for finding those tough problems, a ham's computer, a computer QSO machine ... and much, much more! Everything of interest is there in one volume, ready to be enjoyed by you. \$4.95.

● **KILOBAUD** The Small Computer Magazine Software & Hardware exposed to the core. Written for the non-PhD computer hobbyist who wants to know what's new. \$2.00 each at the newsstand, \$15.00 for 1 year subscription. Back issues \$3.00 per copy.

Use the order card or itemize your order on a separate piece of paper and mail to:
73 Radio Bookshop • Peterborough NH 03458 Be sure to include check or detailed credit card information.
Note: Prices subject to change without notice on books not published by 73 Magazine.

RADIO BOOKSHOP

● **COMPUTER DICTIONARY** by Donald D. Spencer. A compendium of computer terms for beginners and professionals alike. The *Computer Dictionary* by Donald D. Spencer defines words and acronyms used by computerists in a clear, easy to understand style. Over 2000 definitions are provided. This reference is a must for the individual getting started in the world of microcomputers. The *Computer Dictionary* by Donald D. Spencer; published by Camelot Press, \$5.95.

● **CHEMISTRY WITH A COMPUTER** by Paul A. Cauchon. An exciting new chemistry book which contains a collection of tutorial, simulation and problem-generation computer programs. Tutorials provide individualization of assignment, immediate evaluation of responses and a new set of problems with each run. Simulations provide models of lengthy laboratory experimentation beyond the limited classroom timeframe and enhancement of course studies by encouraging pre-laboratory research. Problem-generating programs provide individualized sets of questions on a given topic. Can be used with almost any chemistry course at the high school or college level. All programs are written in BASIC, the most popular and easy to learn educational programming language. \$9.95.

● **TYCHON'S 8080 OCTAL CODE CARD** Slide rule-like aid for programming and debugging 8080 software . . . contains all the mnemonics and corresponding octal codes. Instructions are color coded to indicate which flags are affected during execution. Pocket sized card only 6½x3 inches provides neat, logical format for quick reference. Back side of card is printed with an ASCII code chart for 128 characters plus the 8080 status word and register pair codes. Also available, Tychon's *8080 Hex Code Card*, same as above only has hex codes instead of octal. Only \$3.00 each.

● **FUZZBUSTER Radar Detector** judged most dependable, fastest and overall BEST by Wayne Green in a side by side three month study of all the other radar detectors on the market. Specially priced at \$95.00.

● **LIGHTED TRAVEL DESK** Handy little gadget, looks like a clipboard with a light and plugs into the cigarette lighter of your car. Read books or maps easily in the car, great for note taking if you come up with ideas while driving . . . helps make riding in the car a little more enjoyable for kids who can use it for puzzles or playing games at night. Only \$7.50.

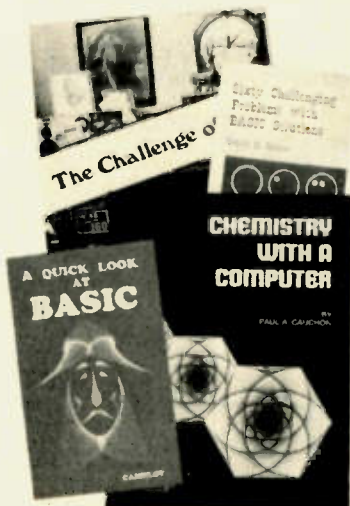
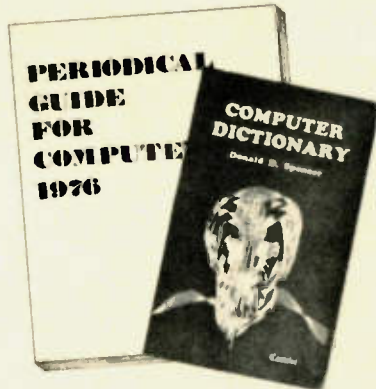

● **PERIODICAL GUIDE FOR COMPUTERISTS** This is a 20 page book which indexes over 1,000 personal computing articles for the entire year of 1976 from Byte, Creative Computing, Digital Design, Dr. Dobbs Journal, EDN, Electronic Design, Electronics, Interface Age, Microtek, Peoples Computer Company, Popular Electronics, QST, Radio Electronics, SCCS Interface and 73 Amateur Radio. Articles are indexed under more than 100 subject categories. Price \$2.50.

**NEW ADDITIONS
to
the BOOKSHOP**

● **A QUICK LOOK AT BASIC** by Donald D. Spencer. Here is a perfect reference for the beginning programmer. *A Quick Look at BASIC* assumes that the reader has no previous programming experience. This book is a self-teaching guide for the individual desiring to learn the fundamentals of BASIC, the most common hobbyist programming language. Price: \$4.95.

● **SIXTY CHALLENGING PROBLEMS WITH BASIC SOLUTIONS** Donald Spencer. This book provides the serious student of BASIC programming with sixty interesting problems and their solutions. None of the problems require a knowledge of math above algebra and should interest the casual user of BASIC on hobby machines. A number of game programs are also provided, as well as programs for financial interest, conversions, and numeric manipulations. Price: \$6.95.

● **THE CHALLENGE OF 160** The newest book in the 73 technical library is *The Challenge of 160*, dedicated to 160 meter operating. Si Dunn provides all necessary information to get started on this unique band. The all-important antenna and ground systems are described in detail. The introduction contains interesting photos of Stew Perry's (the King of 160) shack. This reference is a must for new and experienced "Top Band" operators. Price: \$4.95.

Use the order card or itemize your order on a separate piece of paper and mail to:
73 Radio Bookshop • Peterborough NH 03458. Be sure to include check or detailed credit card information.
Note: Prices subject to change without notice on books not published by 73 Magazine.

RADIO BOOKSHOP

**what do you
give the man
who has
everything?**

**a box
to put it in.**



73 Magazine, as thick as it is, is more like a floppy when it comes to standing on the bookshelf. Enter the new 73 Magazine Library Shelf Boxes, sturdy corrugated cardboard boxes which will hold your magazines on the shelf and keep them from flopping around.

Yes, we know all about binders . . . we have them too . . . and we sell them, but binders are a drag when you want one copy of a magazine. And they cost like sin (which costs plenty).

Just to be rotten (a talent we are trying to develop, but which comes hard), we have self-sticking labels for the boxes, not only for 73 Magazine, but also for Kilobaud . . . and for Personal Computing, Radio Electronics, Popular Electronics, Interface Age, and . . . yep . . . Byte. Heh, heh! Just ask for whatever stickers you want and we'll throw 'em in with your box order. Hams may want our labels for CQ, QST or Ham Radio, if they get any of those magazines. This is a way you can buy one set of matching boxes and line 'em up on your shelf . . . looks very nice that way.

The boxes are a white color and are particularly resistant to dirt, a real plus for white boxes. There's some kind of funny plastic finish on 'em.

You'll probably do like most people who have tried these so far and order one or two for starters . . . then get a couple dozen. The postage on these is the killer . . . so one box costs \$2.00 postpaid and \$1.50 for each additional box, 7 for \$10.

Unless the magazine gets whole lot fatter than it is right now these boxes should hold a full year of 73 . . . or Kilobaud.

One side is cut low to permit you to see the binding of the magazine . . . and note that we are now printing the information on the top part of the binding so it will show in these boxes. You can put the boxes on your shelves with the bindings showing or with just the white board showing, there are little marks to help you center your labels on either side.

Your magazine library is your prime reference, so keep it handy and keep it neat with these strong library shelf boxes.

Send me _____ boxes for 73 Magazine Shelf Storage at \$2.00 for the first box and \$1.50 for each additional box, or 7 for \$10. Include the following labels: _____

\$ _____ Enclosed Cash Check M.O.

Bill: American Express BankAmericard

Master Charge - Interbank # _____

Card # _____ Expiration date _____

Signature _____

Name _____

Address _____

City _____ State _____ Zip _____

73 MAGAZINE LIBRARY SHELF BOXES

Peterborough NH 03458

or call Toll Free (800) 258-5473

NH & Evenings (800) 251-6771 9/77

call us



...tell us you love us

Also tell us your credit card number so we can enter a subscription for you. A subscription saves you a bundle of money . . . just figure it out. At \$2 a copy you're spending \$24 a year, yet a subscription costs a lousy \$15. Nine dollars may not be a lot today, but that's no reason to just throw it away because you don't want to bother to pick up the phone.

Three years of 73 . . . if you figured out what that costs you'd send in a subscription instantly. Not having calculators that go out that far (allowing for the usual inflation, increases in postage, rising paper prices, and a new car for Wayne . . . a copy of 73 will probably be \$5 three years from now), no one at 73 has definitely been able to calculate the exact cost of three more years on the newsstand. One thing is for sure, it's going to be a lot more than the current three year \$36 subscription rate, which is an obvious rip-off. Call in your three year subscription and make us rue the day we came up with that low number.

It's toll free:

800-258-5473

(NH & nights 800-251-6771)

and someone

is usually around during office hours to take your order, credit card number (Master Charge, BankAmericard or American Express). While you're calling what would it hurt to get Kilobaud too? And maybe a few books for the bathroom.

If the line is busy tear out the card bound in the back of the magazine . . . just inside the back cover . . .

While you are tearing out cards it is high time for you to mark up the reader's service card and send that in too. A good response convinces advertisers to run more ads . . . you get more pages of magazine. It's a good investment.

73-peterborough nh 03458

CUSTOM TRANSFORMERS



HEAVY DUTY REPLACEMENT TRANSFORMERS*

Collins 30S-1 Plate Transformer	\$165.00
Collins 516F-2 Power Transformer	95.00
Hunter 2000B Plate Transformer	125.00
ETO A-77D Plate Transformer	125.00
Henry 2K Plate Transformer	140.00
Henry 2K-2 Plate Transformer	165.00
Henry 2K-2A Plate Transformer	135.00
Henry 2K-4 Plate Transformer	165.00
Henry 3K-A Plate Transformer	165.00
Heath Marauder HX-10 Transformer	95.00
Gonset GSB-100 Transformer	95.00
National NCL-2000 Power Transformer	125.00
Gonset GSB-201 Power Transformer	135.00

SPECIALS

Plate XFMR. 4600 VAC @ 1.5A ICAS 230 VAC 60 Hz primary, Wt. 60 LB	\$195.00
Plate XFMR. 3500 VAC @ 1.0A ICAS 230 VAC 60 Hz primary, Wt. 41 LB	125.00
Plate XFMR. 3000 VAC @ 0.7A ICAS 115/230 VAC 60 Hz pri, Wt. 27 LB	95.00
Plate XFMR. 6000 VCT @ 0.8A CCS 115/230 VAC 60 Hz pri, Wt. 41 LB	135.00
FIL XFMR. 7.5 VCT @ 21A CCS 117 VAC 60 Hz primary Wt. 8 LB	29.95
FIL Choke bifilar wound 30 AMP RF Filament Choke on 1/2x7 rod	8.95
DC Filter Choke 8.0 Hy @ 1.5 ADC	150.00
DC Swinging Choke: 30 Hy @ 0.15A to 5.0 Hy @ 1.0ADC	100.00

*All heavy duty replacement transformers are electrically superior to original equipment(s). All transformers are manufactured to rigid commercial quality specifications and each carries a 24 month guarantee!

Write today for a free quotation on any transformer, Choke, or saturable reactor.

Peter W. Dahl Co.

4007 Fort Blvd. • El Paso, Texas 79930
Telephone (915) 566-5365 or (915) 751-4856

D6

propagation

by
J. H. Nelson

EASTERN UNITED STATES TO:

	GMT:	00	02	04	06	08	10	12	14	16	18	20	22
ALASKA	14	7A	7	7	3A	3A	3A	7	7	7A	14	14	
ARGENTINA	14	7A	7B	7	7	7	14	14	14	14	14A	14A	
AUSTRALIA	14	7A	7B	7B	7	7	7	7	7	7B	14	14	
CANAL ZONE	14	7A	7	7	7	7	14	14	14	14	14A	14A	
ENGLAND	7	7	7	7	7	7B	14	14	14	14	14	7B	
HAWAII	14	7A	7B	7	7	7	7	7B	14	14	14	14	
INDIA	7	7	7B	7B	7B	7B	14	14	14	7	7	7	
JAPAN	14	7B	7B	7B	7B	7B	7	7	7	7	7	7	14
MEXICO	14	7	7	7	7	7	7	7	14	14	14	14A	14
PHILIPPINES	14	7B	7B	7B	7B	7B	7	7	7A	7A	7B	14	
PUERTO RICO	7	7	7	7	7	7	14	14	14	14	14	14	
SOUTH AFRICA	7	7	7	7	7B	14	14	14	14A	14A	14	14	
U. S. S. R.	7	7	7	7	7	7B	7A	14	14	14	14	7B	7B
WEST COAST	14	7A	7	7	7	7	7	14	14	14	14	14	

CENTRAL UNITED STATES TO:

ALASKA	14	14	7	7	3A	3A	3A	7	7	7A	14	14	
ARGENTINA	14	14	7B	7	7	7	7A	14	14	14	14A	14A	
AUSTRALIA	14	14	7B	7B	7	7	7	7	7	7B	14	14	
CANAL ZONE	14	14	7	7	7	7	7A	14	14	14	21	21	
ENGLAND	7	7	7	7	7	7	7B	14	14	14	14	7B	
HAWAII	14	14	7B	7	7	7	7	7	14	14	14	14	
INDIA	7	7	7B	7B	7B	7B	7B	7B	14	14	7	7	
JAPAN	14	14	7B	7B	7B	7B	7	7	7	7	7A	14	
MEXICO	14	7	7	7	7	7	7	7A	14	14	14	14	
PHILIPPINES	14	14	7B	7B	7B	7B	7B	7	7	7	7B	14	
PUERTO RICO	14	7	7	7	7	7	14	14	14	14	14	14A	14A
SOUTH AFRICA	7	7	7	7	7B	7B	14	14	14	14	14	14	
U. S. S. R.	7	7	7	7	7	7B	7B	7A	14	14	14	7B	7B

WESTERN UNITED STATES TO:

ALASKA	14	14	7	7	3A	3	3	7	7	7	7A	14	
ARGENTINA	14	14	7B	7	7	7	7B	14	14A	14A	14A	14A	
AUSTRALIA	21	21	14	7B	7	7	7	7	7	7B	14	14	
CANAL ZONE	14A	14	7	7	7	7	7	14	14	14	14A	21	
ENGLAND	7	7	7	7	7	7	7B	7B	14	14	14B	7B	
HAWAII	14A	14A	14	7A	7	7	7	7	14	14	14	14	
INDIA	7A	14	7A	7B	7B	7B	7B	7B	7	7	7	7	
JAPAN	14	14	14	7B	7	7	7	7	7	7	7A	14	
MEXICO	14	14	7	7	7	7	7	7A	14	14	14	14	
PHILIPPINES	14	14	14	7B	7B	7B	7	7	7	7	7B	14	
PUERTO RICO	14	7	7	7	7	7	7	14	14	14	14	14A	14A
SOUTH AFRICA	7	7	7	7	7B	7B	7B	14	14	14	14	14	
U. S. S. R.	7B	7B	7	7	7B	7B	7	7	14	14	14	7B	7B
EAST COAST	14	7A	7	7	7	7	7	7	14	14	14	14	

- A = Next higher frequency may also be useful
- B = Difficult circuit this period
- F = Fair
- G = Good
- P = Poor

Let us know 8 weeks in advance so that you won't miss a single issue of *73 Magazine*. Attach old label where indicated and print new address in space provided. Also include your mailing label whenever you write concerning your subscription. It helps us serve you promptly.

Write to: **73 magazine**
Peterborough NH 03458

Address change only Payment enclosed
 Extend subscription (1 extra BONUS issue)
 Enter new subscription Bill me later
 1 year \$15.00

name _____ call _____

address _____

city _____ state _____ zip _____

If you have no label handy, print OLD address here.

name _____ call _____

address _____

city _____ state _____ zip _____

1977		SEPTEMBER					1977
SUN	MON	TUE	WED	THU	FRI	SAT	
☾	☉	☾	☉	1	2	3	
				G	F	G	
4	5	6	7	8	9	10	
G	F	F	P	F	G	G	
11	12	13	14	15	16	17	
G	F	G	G	G	P	G	
18	19	20	21	22	23	24	
G	G	F	P	P	F	G	
25	26	27	28	29	30		
G	G	F	G	G	G		

73 magazine

ADVERTISER INDEX

- A1 Adirondack 123
- A24 Adva 183
- A2 Aldelco 191
- A21 Amateur Wholesale 26-27
- A14 Antenna Supermarket 172
- A36 Auto Code 199
- B4 B & F Enterprises 180
- B13 Brookfield Mfg. 168
- B8 Bullet 184
- C50 California Industrial 181
- C3 Clegg 109
- C21 Coakit 36
- C5 Communications Electronics 117
- C6 Communications Specialists 43, 79
- C19 Com * Star 173
- C25 Crescomm 155
- D6 Peter W. Dahl Co. 208
- D10 Davis Electronics 197
- D21 Direct Conversion Tech. 123
- D20 DRC 187
- E1 ECM Corp. 198
- E17 Ehrhorn Tech. Operations 58
- E12 Engineering Specialties 186
- E23 Equinox Corp. 176
- F1 Fair Radio 197
- F5 Flesher Corp. 50
- F3 Freck Radio 36
- G10 Gary McClellan & Co. 58, 197
- G12 Germantown Amateur Supply 196
- G6 Gilfer 103
- G4 Godbout 188
- * Hal Communications 174
- H22 Ham-O-Rama 117
- H2 Ham Radio Center 193
- H8 Hamtronics - PA 86-95
- H15 Hatry 196
- H5 Heath Company 1
- H3 Henry Radio 37
- H21 Herbach & Rademan 123
- H18 HFB Enterprises 196
- I1 ICDM 2
- I9 Integrated Circuits Unltd. 194
- I14 Interad Ltd. 121
- I10 International Data 102
- J1 James 189
- J2 Jan Crystals 117
- K6 Kaufman Industries 50
- K11 Kengore 123
- * Kenwood CIV. 5-13
- K4 KLM CII
- L9 Long's Electronics 68-73
- L4 Lyle Products 198
- M8 MHz Electronics 96
- M26 Microwave Assoc. 174
- N4 Nye Co. 173
- O5 DK Machine & Tool 97, 103
- D3 Optoelectronics 185
- P15 Pace Traps 36
- P9 Paia Electronics 97
- P17 Parasitic Engineering 103
- P2 Poly Paks 195
- P21 Priority One 179
- O3 Quest 50
- R1 Radio Amateur Callbook 178
- R8 Ramsey 182
- R9 Robot 145
- R15 Rolin Distributors 199
- R13 Rotundra Cybernetics 103
- S2 S. D. Sales 192
- S22 Seals Electronics 16
- S33 S-F Amateur Radio Services 117
- S8 Spectrum Communications 177
- S36 Sprague 176
- S10 SST 198
- S35 Standard Electronics 176
- T19 TEE/AX 197
- T13 Teletypewriter Comm. 121
- * Ten-Tec 65
- T18 TRAC Electronics 196
- T1 Tri-Tek 190
- T2 Trumbull 58
- T3 Tufts Radio 124-144
- V1 Vanguard Labs 117
- V5 VHF Engineering 51
- W15 Wacom 199
- W17 Westcom Engineering 176
- W18 Western Electronics 197
- W10 Windjammer 167
- Y1 Yaesu Musem CIII

From 73 ...
198-208

* Reader Service inquiries not honored.

73 READER SERVICE

Circle appropriate Reader Service # for desired company brochures, data sheets or catalogs and mail to **73** Include your zip code, please. Send money directly to advertisers. LIMIT: 25 requests.

- A1 C21 E12 H8 J2 P15 S2 T2
- A24 C5 E23 H15 K6 P9 S22 T3
- A2 C6 F1 H5 K11 P17 S33 V1
- A21 C19 F5 H3 K4 P2 S8 V5
- A14 C25 F3 H21 L9 P21 S36 W15
- A36 D6 G10 H18 L4 Q3 S10 W17
- B4 D10 G12 I1 M8 R1 S35 W18
- B13 D21 G6 I9 M26 R8 T19 W10
- B8 D20 G4 I14 N4 R9 T13 Y1
- C50 E1 H22 I10 O5 R15 T18 **73**
- C3 E17 H2 J1 O3 R13 T1

Subscriber please print or type Newsstand Buyer

Name _____ Call _____

Address _____

City _____ State _____ Zip _____

Coupon Expires in 60 Days

9/77

PLACE
STAMP
HERE

73 magazine

peterborough, n.h.
03458

Att: Mail Order

I WANT TO subscribe!

Send me **73** for:

1 year - \$15.00*

3 years - \$36.00**

Life Subscription - \$150.00 **

Renewal

New Sub.

Enclosed \$ _____ Cash Check Money order

American Express BankAmericard Master Charge

Credit Card # _____ Interbank # _____

Expiration date _____ Signature _____

Bill me Signature _____

Name _____ Call _____

Address _____

City _____ State _____ Zip _____

* U.S. & Canada ONLY! Others write for foreign rates.

** U.S. & Canada ONLY.

Coupon Expires in 60 Days

9/77

73 magazine

Peterborough NH 03458

FIRST CLASS
Permit No. 73
Peterborough NH

BUSINESS REPLY MAIL
NO POSTAGE NECESSARY IF MAILED IN UNITED STATES

POSTAGE WILL BE PAID BY

73 magazine

peterborough, n.h.
03458

Att: Reader Service

PLEASE SEND ME THE FOLLOWING 73 PRODUCTS

Quantity	Description	Unit Price	Total

Total _____

Shipping & Handling Charge \$1.00

Order Total _____

Enclosed \$ _____ Cash Check Money order
Bill: American Express BankAmericard Master Charge
Credit Card # _____ Interbank # _____
Expiration date _____ Signature _____

Name _____ Call _____

Address _____

City _____ State _____ Zip _____

please print or type 9/77

PLACE
STAMP
HERE

73 magazine

peterborough, n.h.
03458

Att: Subscriptions

FROM 73

- Coax Handbook \$1.50
- Fascinating World of Radio Communication \$3.95
- How to Make Better QSLs \$2.00
- IC OP Amp Cookbook \$12.95
- New RTTY Handbook \$5.95
- 1001 Practical Electronic Circuits \$9.95
- Practical Test Instruments You Can Build \$4.95
- 1977 Repeater Atlas of the World \$1.95
- RF & Digital Test Equipment You Can Build \$5.95
- RTL Cookbook \$5.50
- 73 Dipole and Long-wire Antennas \$5.50
- 73 Vertical Beam and Triangle Antennas \$5.50
- SSTV Handbook - Hard \$7; Soft \$5
- Study Guides
 - Novice \$4.95 Advanced \$3.95
 - General \$5.95 Extra Class \$5.95
- Test Equipment Library
 - Vol I - Component Testers \$4.95
 - Vol II - Audio Frequency Testers \$4.95
 - Vol III - Radio Frequency Testers \$4.95
- Novice Theory Tapes \$15.95 (set)
- Code Tapes \$4.95 ea., 4/\$15.95
 - 5 WPM 13 WPM
 - 6 WPM 20 WPM
- VHF Antenna Handbook \$4.95
- Weather Satellite Handbook \$4.95
- BASIC \$4.95
- Brand New Microcomputer Dictionary \$15.95
- CMOS Cookbook \$9.95
- Chemistry with a Computer \$9.95
- Spencer's Computer Dictionary \$5.95
- Tychon's 8080 Octal Code Card \$3.00
- Tychon's 8080 Hex Code Card \$3.00

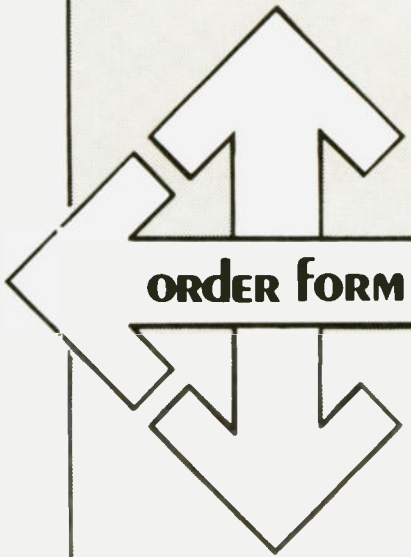

- Computer Programming Handbook \$8.95
- 101 Games in BASIC \$7.50
- Hobby Computers Are Here! \$4.95
- Introduction to Microprocessors
 - \$17.50 USA & Canada; \$20 elsewhere
- Kilobaud - 1 yr Subscription \$15.00
- Microcomputer Primer \$7.95
- My Computer Likes Me \$2
- New Hobby Computers \$4.95
- Periodical Guide for Computerists 1976 \$2.50
- Scalbi's Galaxy Games for "6800" \$14.95
- 6800 Software Gourmet Guide & Cookbook \$9.95
- 8008 Software Gourmet Guide & Cookbook \$9.95
- Story of Computers \$4.95
- TTL Cookbook \$8.95
- TVT Cookbook \$9.95
- What To Do After You Hit Return \$6.95
- An Introduction to Microcomputers
 - Vol I - \$7.50; Vol. II - \$12.50
- 8080 Programming for Logic Design \$7.50
- 6800 Programming for Logic Design \$7.50
- The Underground Buying Guide \$5.95
- Bumper Stickers 50¢ ea., any 3 for \$1
- Fuzzbuster \$95
- Lighted Travel Desk \$7.50
- QSLs - Style W or Style X
 - 250 - \$7.50; 500 - \$12.50; 1000 - \$20.00
- 73 Binders \$6.00 ea., 2 for \$11.00
- Back Issue Bundles \$8.00
- Library Shelf Boxes \$2 ea.; \$1.50 ea. additional box

NOTE: Prices subject to change without notice on books not published by 73 Magazine.

73 magazine
Peterborough NH 03458

AN **ENERGY** CONSERVATION SUGGESTION FROM **YAESU**



FT-301S
Analog Dial-20 Watts PEP

OR



FT-301SD
Digital Dial-20 Watts PEP



FL-110 Broadbanded Solid State Linear
200 Watts Output-Power When You Need It

CUT YOUR ELECTRICITY BILL!

Do your part in Uncle Sam's energy conservation program. Obey FCC rules that tell you not to run more power than is needed. But when the going gets tough, switch in the linear!

Yaesu's Deluxe Accessories Complete Your Station



Shown above: Deluxe Power Supply/Speaker/Digital Clock and Programmable CW Identifier
• FT-301SD Transceiver • External VFO • Monitor Scope

For a copy of our latest catalog, send your name, address, zip code and ham call sign.

YAESU
The radio.



888

YAESU ELECTRONICS CORP., 15954 Downey Ave., Paramount, CA 90723 (213) 633-4007
YAESU ELECTRONICS CORP., Eastern Service Ctr., 613 Redna Ter., Cincinnati, OH 45215

TS-820S



In little more than one year, the TS-820 has become the most sought after transceiver in the world. And as a result of hundreds of customer requests, it is now available with the digital readout factory installed as the TS-820S. Also, in response to its unprecedented acceptance, production has been increased, so the long wait is over. The same quality standards, superb performance, dependability and innovative engineering are still built into every TS-820S. ***** Now it's time to treat yourself to the best.