

# 73

## BOOK SUPPLEMENT: LOG PERIODICS

*Antenna Radiation  
Mystery?*

*40m Inverted Vee*

*Invisible Antennas*

*18" Allband Antenna*

*Double Inverted  
Vee*

MARCH 1975 ONE DOLLAR

amateur radio

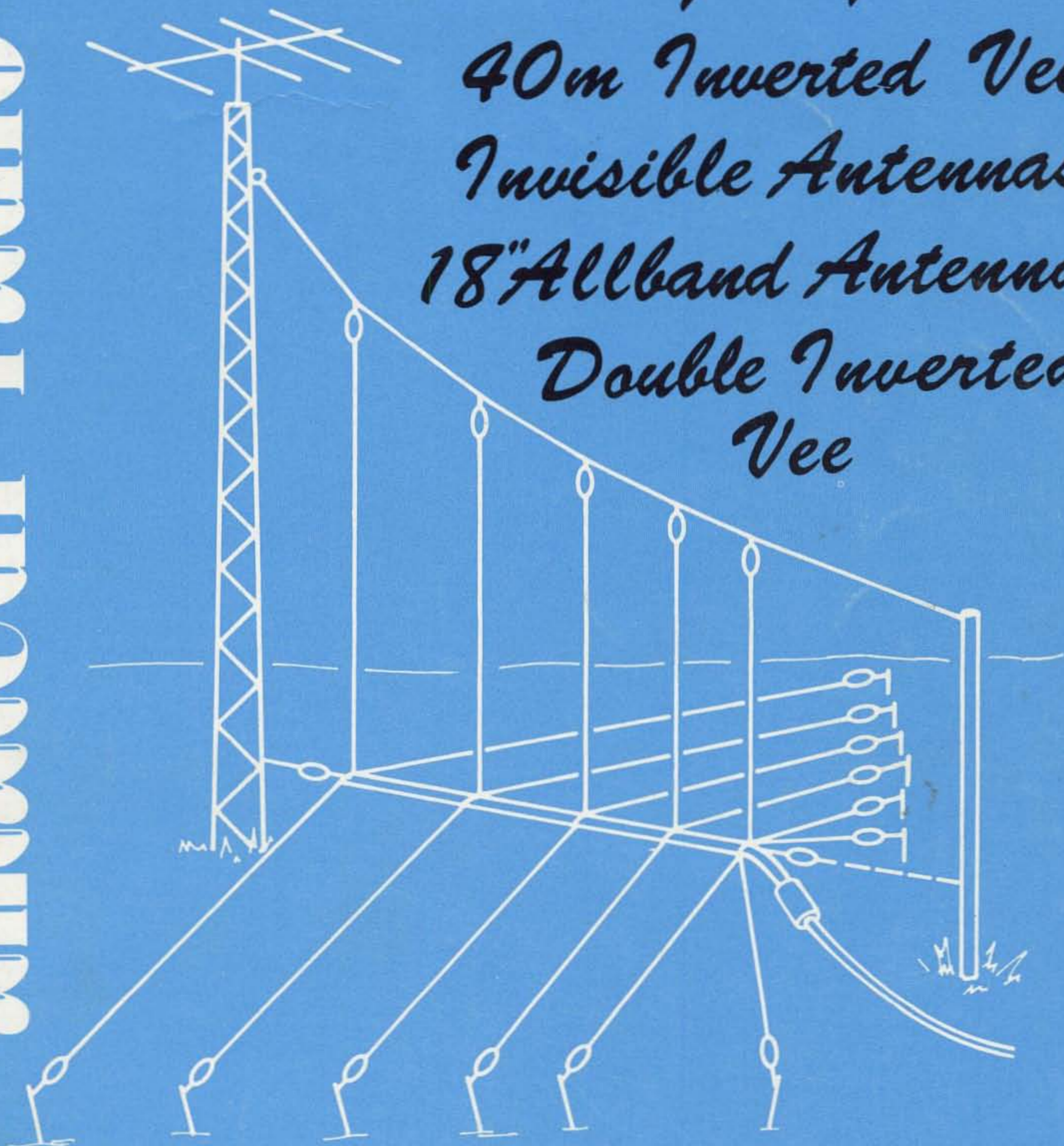

*32 Antennas You Can Build!*

# GIANT SPECIAL ANTENNA ISSUE



**in any class  
from novice to extra  
go first class with **HUSTLER!****

**the **HUSTLER** 4-BTV  
has  
everything**

**FIXED STATION  
TRAP VERTICAL  
40 THRU 10 METERS**

**one setting for  
total band  
coverage**

- **Lowest SWR—PLUS!**
- Bandwidth at its **broadest!** SWR 1.6 to 1 or better at band edges.
- Hustler exclusive trap covers "Spritz" extruded to otherwise unattainable close tolerances assuring accurate and permanent trap resonance.
- Solid one inch fiberglass trap forms for optimum electrical and mechanical stability.
- Extra heavy duty aluminum mounting bracket with low loss—high strength insulators.
- All sections 1 1/4" heavy wall, high strength aluminum. Length 21'5".
- **Stainless steel clamps** permitting adjustment without damage to the aluminum tubing.
- Guaranteed to be **easiest assembly** of any multi-band vertical.
- Antenna has 3/8"-24 stud at top to accept RM-75 or RM-75S Hustler resonator for 75 meter operation when desired.
- Top loading on 75 meters for broader bandwidth and **higher radiation efficiency!**
- Feed with any length 50 ohm coax.
- Power capability—**full legal limit** on SSB and CW.
- Ground mount with or without radials; roof mount with radials.



**MODEL 4-BTV  
Wgt. 15 lbs.**

**choice of  
the majority**

**HUSTLER MOBILE  
ANTENNA FOR 6-10-  
15-20-40-75 METERS**



Only Hustler gives you exceptional reports, lowest SWR, broadest bandwidth and optimized performance on each band. Choose from either medium or high power resonators for your favorite bands. Get quick band change or easy garaging with the Hustler fold over mast. Matching devices not required; use any convenient length 50 ohm cable. Choose Hustler, the majority favorite!

**Two meter "ACTION"  
antennas—5.2 db gain**

For mobile, the Hustler 85" colinear super gain antenna is your answer to outstanding and unequalled performance! Get the dual advantage of gain transmitting—gain receiving.

**Model CGT-144** (illustrated)—Easy installation, no holes to drill, with the Hustler heavy duty trunk lip mount. Supplied complete with 17' RG-58/U ready for installation and use.

**Model CG-144**—colinear antenna supplied with 3/8"-24 base to fit all standard mobile ball mounts (mount or cable not supplied).

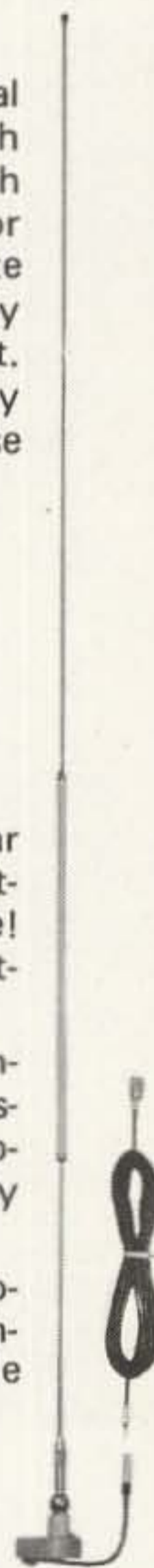

**MODEL CGT-144**

For HF, VHF and UHF mobile and fixed station antennas, see the complete Hustler line.

*Available from all distributors  
who recognize the best!*

**new-  
tronics  
corporation**

15800 commerce park drive,  
brook park, ohio 44142

WØPJG	33	Can a 7 foot 40m Antenna Work? <i>The small loop.</i>
K2OAW	39	The Secret of Antenna Gain <i>(Shhh - it's capture area!)</i>
WB2NQT	47	Twinlead Phased Array <i>Two elements on 40m - or any other band.</i>
WØKGI	49	The Incredible Capacitive Antenna <i>Now: an 18" allband antenna.</i>
W2OZH	52	An 80m Phased Array <i>Switchable directivity.</i>
W5GDQ	58	A Coax Amplifier for 450 MHz <i>6 dB stacked collinear.</i>
WA8BHR/5	61	Invisible Antennas <i>Why ask for trouble?</i>
WB6PDN	66	Another Look at the Swan Beam Antenna <i>Testing . . . again.</i>
W4ATE	69	City Dweller's Multiband Antenna <i>An inverted Windom?</i>
WA7OET	72	40m Inverted Vee Beam <i>Satisfying.</i>
W7IDF	74	The Unofficial Standard Standard <i>Quack, Rot, Vice?</i>
VE3DDS	81	The Mystery of Antenna Radiation <i>Is it still a mystery?</i>
VK6IZ	91	The Double Inverted Vee <i>A remarkable wire beam.</i>
W2NYU/WA1JJV	93	A Short and Sweet 160m Antenna <i>Build this simple portable topbander.</i>
WA4NWM	95	Pete's Dipole <i>A better method of feeding.</i>
W4AEO	97	The Magic of the Log Periodic <i>SPECIAL BOOK SUPPLEMENT.</i>
STAFF	126	Avoiding Traps with Antennas <i>Three great multiband designs.</i>
VE3VCA	129	A New National Amateur Radio Society for Canada <i>Introducing CARF.</i>
W2NSD/1	139	Mobile SSTV Breakthrough <i>73 discovers the cassette recorder.</i>
ANDERTON	143	Yet Another Etching Technique <i>Something fishy here.</i>



#174 MARCH 1975

COVER: Drawing  
by Bill Morello.  
Article, page 97.

# 73 amateur radio

2	Never Say Die	21	Surplus
3	Hotline Headlines	22	Hamburglar
4	News	23	Letters
6	Be My Guest	28	Social Events
8	Ancient Aviator	29	Upcoming
9	AMSAT	30	Contests
10	FCC	30	QSL Contest
13	Novice	30	Ham Help
14	Looking West	31	Caveat Emptor
16	50 MHz Band	64	Voxpoop
17	Traveling Ham	136	Circuits
17	Solid State	160	Advertiser Index
20	SSTV	160	Propagation

73 Magazine is published monthly by 73, Inc., Peterborough, New Hampshire 03458. Subscription rates are \$8 for one year in North American and U.S. Zip Code areas overseas, \$9 per year elsewhere. Three years, \$16 and \$17 overseas. Second class postage paid at Peterborough, New Hampshire 03458 and at additional mailing offices. Phone: 603-924-3873. Microfilm edition of 73 available from University Microfilms, Ann Arbor MI 48106. Magnetic tapes available from Science for the Blind, 332 Rock Hill Rd., Bala Cynwyd PA 19904. Entire contents copyright 1975 by 73 Inc. Peterborough, NH 03458.





# 73 staff

**EDITOR/PUBLISHER**  
Wayne Green W2NSD/1

**BUSINESS MANAGER**  
Virginia Londner Green

**EDITORS**  
Alex Barvicks WB4RVH  
John Burnett

**PRODUCTION MANAGER**  
Lynn Panciera-Fraser

**PRODUCTION**  
Bob Drew  
Nancy Estle  
Cathy Greenwood  
Bill Heydolph  
Neal Kandel  
Bob Sawyer  
Rod Tulonen  
Barbara Walker

**PRINTER**  
Biff Mahoney

**ADVERTISING**  
Bill Edwards WB6BED/1  
Katherine Pilewicz

**COMPROLLER**  
Knud E.M. Keller KV4GG/1

**MARKETING**  
David A. Behnke

**CIRCULATION**  
Barbara Block  
Dorothy Gibson  
Cheryl Hurd

**TRANSPORTATION**  
Bill Barry  
Marshall Raymond

**ASSOCIATES**  
Schley Cox WN9LHO  
Tom DiBiase WB8KZD  
Terry Fox WB4JFI  
W. Sanger Green  
Dave Ingram K4TWJ  
Joe Kasser G3ZCZ  
Bill Pasternak WA6ITF  
John Schultz W2EY  
Waller Scott K8DIZ  
Peter A. Stark K2OAW  
Bill Turner WA0ABI

**DRAFTING**  
Bill Morello  
Lynn Malo



NEVER SAY DIE

...de W2NSD/1

EDITORIAL BY WAYNE GREEN

It is terribly unfair to point a finger at a group of amateurs and demand they feel guilty for not being pioneers . . .

## KEYNOTE: GUILT

One benefit to me of publishing Hotline is the daily flow of club bulletins I receive in exchange for Hotline subscriptions. There are, I believe, well over a thousand coming in each month, and they make very interesting reading.

One of the bigger and better of these bulletins is Squelch Tales, put out by the San Diego Repeater Association. Beautiful job. In the December issue they reprinted the keynote speech of Armond Noble, the publisher of a West Coast ham newspaper, made at the San Diego ARRL Convention. (I seem to recall that someone else was supposed to be the speaker, but didn't make it, so Armond was pressed into service.)

The talk was too long to reprint here — it ran to over ten pages — but in essence it was an indictment of amateur radio. Armond went on at length, making his listeners feel guilty for being DXers, for working contests, for collecting certificates, for operating service nets, for not being builders, and so on. It was kind of a replay of an old Prose Walker talk, but without the part about how we should pity the poor CBers.

While there is some truth in what he said, Armond did not present the situation in perspective. He is right that few amateurs have done as much as they can toward coming up with new inventions and pioneering new techniques — though he does overlook many tremendously important things amateurs have done in this field. He gives us credit for opening short waves and stops there, ignoring the ham pioneering of FM, NBFM, SSB, SSTV, RTTY, etc., where ham work has been more than substantial.

It is true that not every amateur is an inventor or pioneer and it is unrealistic to expect it. It is terribly unfair to point a finger at a group of amateurs and demand they feel guilty for not being pioneers. Amateurs have done their share in this and, rather

than feel guilty, every one of us should be damned proud to belong to a group that has done so much for our country and the world. Can you name any other group of hobbyists which has given the world as much?

Armond next points to DXers. Sure, a great many DX contacts are only seconds long and do absolutely nothing to enhance international good will. It may be that this aspect of amateur radio would be more productive if the QST Honor Roll were abandoned — though I am reasonably sure that the Honor Roll fills a gap and would be quickly replaced by some other group if it were cut — and instant DX contacts would continue to proliferate. Oddly enough, despite the pressure for short contacts, many meaningful conversations actually do take place on our bands and the cause of international good will is being taken care of.

The prospect of 100,000 American DXers lurking in wait for foreign amateurs to turn up on the bands so good will can be spread is not confidence inspiring. Never mind that a lot of the DX brethren don't spikka da Eengleesh too good and don't want anything more than a signal report and a QSL card. Never mind that the bands aren't big enough for more than a few long winded contacts at any one time and that one of the biggest blessings to band usage is that monster the pileup. A nice pileup can clean out a good part of the band.

The very nature of ham contacts makes it difficult to develop serious conversations. We spend years learning how to talk with people on a give and take (duplex) basis — with little if any practice on how to talk when you can't see or hear the other person while you are talking — and then, with no background, we get on the air and flounder around. The fact is that little work has been done on this problem — little has ever been published — little thought has gone into solving this difficulty.

When VOX came into use with the development of sideband, it looked as if we might be on the verge of solving this long standing misery. But no, amateur ingenuity quickly overcame the benefits of the VOX circuit and habit prevailed. At first we used errs to fill in the gaps to keep that VOX relay from kicking out — then we just turned it off. When is the last time you heard a VOX contact? So there we were, back to long winded (and often boring) pontifications or else hello-goodbye contacts.

Even if we were able to work out a duplex system of contacts, we would still have problems developing ways to

---

**The prospect of 100,000 American DXers lurking in wait for foreign amateurs to turn up on the bands so good will can be spread is not confidence inspiring...**

---

get into meaningful conversations with strangers. If you've ever done the cocktail party circuit you know what I mean. The odds against getting into anything interesting in a conversation with a stranger are frightening. It is difficult to do.

There are probably many things that you know about or have done that I would enjoy hearing about during a contact. But how do I discover them and get out of the usual boring rut? Even after some 37 years on the bands I know as little about this as this year's Novice. Now and then a contact clicks and we both have a great time. Usually I get through talking with a few people and wonder why I wasted my time. This holds for all bands and all countries. I don't have much more luck in finding interesting contacts on two meters than I do on 20, DX or local. Note that I did not say anything about interesting people. I am sure that most of the people I contact are interesting, if only I knew how to get them primed.

When conditions are such that the best you can do is a signal report, then why not enjoy that — without guilt? It may be poor skip, interference from other stations, language incompatibility, a DXpedition situation where time is important, or pressure from others who "need" a QSL from the chap you are working — things like this are part of amateur radio and you make your short contact and move on. When you have a good solid contact and are able to get into something of interest to the two of you, have it and enjoy.

Is there any reason for self-flagellation if we are guilty of not personally inventing SSB? Must we mope if we ourselves have not fostered international good will? Should we cringe if we have not handled traffic during a big disaster? Armond taps every reservoir of guilt in his keynote speech, going on to make us uncomfortable if we are only interested in one aspect of the hobby.

Amateur radio *is* a hobby. Those of us who are "serious" about it spend as much time as we can working with it. Some are into DXing, some into repeaters, some into moonbounce, Oscar contacts, DXpeditioning, SSTV, traffic handling, CD, rag chewing, certificate hunting, VHF contests, DX contests, club work, ARRL work, hamfests and conventions, putting out club bulletins, mobile DXing, mobile SSTV, and so it goes. There are dozens of fascinating hobbies all wrapped up in ham radio. Some even build (actually, an awful lot are building), and some invent. Obviously no one can do everything — at least not until there is a certificate out for it.

There is no way to work up a list of ham activities and assign priorities to them. Is international good will more important than Oscar contacts... than phone patches for Antarctic servicemen? It all depends on what your own bag happens to be at the time.

Armond puts down DXpeditions as pointless pursuits. Having been to Bat Guano Island twice for the purpose of giving out 5/9 reports, perhaps my own ox is being gored, but I can still remember the excitement we created

---

**A nice pileup can clean out a good part of the band...**

---

on the bands as we worked through the pileups. We helped bring fun to thousands of amateurs all over the world. And *fun* is an integral part of amateur radio and living. Is something pointless because it does nothing more than create fun for thousands of people? If so, where does that leave television, radio broadcasting, theater, novels, etc. Fun is an important part of life and we pay a lot to those who help us enjoy living, even to the extent of donating money to hams foolish enough to go to Bat Guano Island and operate for a few days.

One other thing: I doubt if any of the thousands of amateurs who con-

## HOTLINE HEADLINES

*Summarized late-breakers  
for the active radio amateur.*

**ITU Crisis.** FCC Commissioner Lee threatens possible U.S. walkout.

**K7GCO Convicted.** CQ Magazine antenna expert gets wrong number in fraud case brought by phone company.

**Inverted Splits.** Southern California has agreed to standardize on inverted pairs for splinter repeater channels.

**Prose Goes.** Reports that Walker will leave Amateur Division for BC post seem likely — are denied by FCC.

**Huntoon "retires."** Replaced by Baldwin as General Manager ARRL and Editor QST.

**Australia Doubles Fee.** Up from \$8 to about \$16 now (U.S. dollars).

**Fees Lowered in U.S.** Down from \$9 to \$4. CB fees dropped, too.

**CB Linears Banned.** FCC action will ban single band amplifiers — should not affect amateurs.

**A5 Magazine Renews.** WB8HEE announces takeover of A5 ATV newsletter.

**Crooks Caught.** Detroit repeater used to zero in on holdup pair followed by 2m amateur.

**CB Licenses High.** Now coming in at rate of about 75,000 per month up 10,000 over last year — FCC fears impact of lowering license fee from \$20 to \$4.

**Telemetry Problem.** Amateurs must get special authority for telemetry of any kind.

**Amsat Seeks Funds.** \$15,000 needed to fund Oscar 8.

**Bicentennial Calls?** FCC asks for suggestions for special prefixes for us.

**FCC Okays Calculators.** Now you can bring a calculator to the FCC exams.

**Mexican Repeater.** The Southern California Repeater Association managed to find a channel for a new Baja repeater.

**CB Service Disrupted.** Little old madam found soliciting Interstate biz by CB in Nebraska.

**220 CB Hot Again.** EIA, React and E. F. Johnson Co. just won't quit.

**Fresno DX Meet.** April 19-20 — Fred Laun — Darleen — others.

**PA7 Prefix.** Amsterdammers celebrate 700th anniversary with PA7 prefixes.

*Continued on page 137*

# Amateur Radio

MCMLXXV

Monthly Ham

## THE "SURPRISE" STORY

*Voila a thumbnail sketch of a harrowing expedition by I2NSF/MM. 73 Magazine will be interested in getting further reports on this ambitious attempt to sail around the world single handed.*

I2NSF/MM Ambrogio Fogar, in his yacht SURPRISE, left Italy November 5th, 1973. His aim was to sail around the world from East-West solo. He is probably the first Italian to attempt this voyage.

### December 26th:

Arrived in Rio de Janeiro after an uneventful journey across the Atlantic Ocean.

### January 2nd, 1974:

Left Rio for Cape Horn.

### January 27th:

Rounded Cape Horn.

### February 3rd:

Caught in a 90 mph storm 900 miles west of Chile, "Surprise" flipped upside down. All equipment ruined, daily contact with all amateurs ceased. ZL1BAK requested to give radio watch assistance and search and rescue alerted.

### March 1st:

"Surprise" holed by playful whale. Emergency repairs to keep afloat.

### April 9th:

Arrived in Auckland.

### May 11th:

Left Auckland to travel south of Australia. New Swan SS200 transceiver and hustler antenna installed by ZL1AQE Des, and ZL1BAK. Ship repaired and restocked.

### May 25th:

"Surprise" hit by worst storm around Australia, Ambrogio swept overboard on lifeline, "Surprise" capsized and Ambrogio able to reboard the "Surprise". All the equipment ruined again.

### May 26th:

Ambrogio failed to keep daily schedule. ZL1BAK, VK4LZ, VK3OL, VK3UX, YJ8EE, VK3BH/aero mobile, maintained continuous watch, marine operations centre, Canberra, notified.

### May 27th:

"Surprise" sighted heading for Sydney in good order.

### June 5th:

Left Sydney heading south. Radio and antenna repaired by courtesy of Sydney VK's and A.W.A. Caught in storm, decided to sail north.

From then on, reasonable sailing conditions until the hazards of the

Great Barrier Reef were encountered. From Torres Strait across the north of Australia, good weather gave the "Surprise" a good speed. July 21st, 2100 miles west of Australia. Assistance given by amateurs in New Zealand and Australia has been invaluable and contributed to the success of the voyage around Australia.

Reprinted from *Amateur Radio*, Journal of the Wireless Institute of Australia.

## ORIENTAL FM

Repeaters are not permitted in Japan. The main calling channel is 144.48 MHz.

After the contact is established, the operator moves to another working channel, although some operators QSO on the main channel, and cause a lot of grief to everyone.

The Japanese 2 metre band extends from 144 to 146 MHz.

A1 and F1 — 144.00-145.48

A2, A3, SSB — 144.10-145.48

F2, F3 — 144.32-145.48

JARL 2m beacon on 145.48

All modes 145.48 and above

All Japanese simplex FM channels are planned with a 40 kHz separation up to 145.44.

Australia — 50 kHz channeling

USA — 30 kHz channeling

Europe — 25 kHz channeling

Some clubs have so-called "private channels" between 145.48 and 146 MHz. These clubs have regularly scheduled Roll Calls; On Air Meetings; or "Gab Fests" on these channels. The Toyota Motor Club for instance meets on 145.62 MHz.

### 2m Japanese FM Channels

CH	1	144.36 MHz	*
	2	144.40	*
	3	144.44	*
	4	144.48 National Calling	
	5	144.52	
	6	144.56	
	7	144.60	*
	8	144.64	
	9	144.68	



Bill Welsh W6DDB dressed up as Santa — a most apt costume for the chap who has helped over 20,000 amateurs get their tickets. Here Bill is working on 6-land DX QSL bureau records during time off between stints as Santa at a Lockheed Christmas party for kids.

# News Pages

News of the World

73 MAGAZINE

10	144.72	*
11	144.76	
12	144.80	*
13	144.84	
14	144.88	
15	144.92	
16	144.96	
17	145.00	*
18	145.04	
19	145.08	
20	145.12	
21	145.16	
22	145.20	
23	145.24	
24	145.28	
25	145.32	
26	145.36	
27	145.40	
28	145.44	

F2 & F3 144.32 145.48 MHz

\*Main Channels fitted.

JARL plan

## FM IN HONG KONG

Japanese 2m FM simplex channels are used, mainly

Channel A 144.480 MHz

Channel B 144.600 MHz

Hong Kong has one repeater going.

144.480 MHz in

145.640 MHz out.

... George Francis VK3ASV

Reprinted from *Amateur Radio*, Journal of the Wireless Institute of Australia.



## OSCAR 7

Interested in hearing the new AMSAT-OSCAR 7 satellite? Tune your receiver between 29.40 and 29.50 MHz (most any antenna will do), and listen for a "band opening" of 20 to 50 CW and SSB signals at any of the following times:

Friday, Mar. 7, 1975 from 8:45-9:05 pm EST and from 10:40-11:00 pm EST.

Sunday, Mar. 9, 1975 from 8:40-9:00 pm EST and from 10:35-10:55 pm EST.

(The second pass given for each date is good for the West Coast as well as the East Coast of the USA.)

Be sure to report your reception to AMSAT, P.O. Box 27, Washington, D.C. 20044, and you will receive one of the attractive new AMSAT-OSCAR 7 QSL cards.

## Eye Emergency Network

# HAM WHO HELPS HUMANITY

When Dick Colwell of Lubbock, Texas, positions himself before his amateur radio operator's console precisely at 6:45 A.M., it is not just to pass the day sending messages to other hams. Rather, he hopes to help a blind person see again.

As a member of the Eye Emergency Network, Mr. Colwell tunes into the network's frequency and jots down how many eyes are needed. After signing off, he calls the eye banks in his area. If the required eyes are available, he radios the network back.

"The time I spend working the eye network is rewarding and exciting," Mr. Colwell says. "The network is made up of people from all vocations. Some are retired like myself, others still work."

Mr. Colwell's work isn't limited to

the search for eyes. Any large-scale disaster glues him to his radio for long, exhausting hours. During Hurricane Hilda in 1964, he relayed hundreds of messages from the devastated area to distraught relatives who had spent anxious hours awaiting world of loved ones.

For his efforts during that catastrophic event, Mr. Colwell was awarded the American Relay League Public Service Award "in recognition of meritorious service in connection with Hurricane Hilda." The honor was just another feather in the cap of a man who thoroughly enjoys serving others.

... Mickia Mitchel

Reprinted from *Modern Maturity*, October-November, 1974. Submitted by William Barry.



Attending the SIRA new board of directors party at the Bacardi Bar in Miami, Florida we have left to right: Larry Lytle YN1LL, SIRA's Secretary; Ted Wayne WB4CBP, Vice-Director of the ARRL SE Division and President of the South Florida FM Association; Francisco Salar LU9AME, Honorable Consul of Argentina in Miami; Rafael M. Estevez WA4ZZG, SIRA's President & Coordinator; and Diego Lopez TI2DLM, Honorable Consul of Costa Rica in Miami.



# BE MY GUEST

*Visiting views from around the globe.*

## *The Name of the Game*

I had checked into the Maritime Mobile Service Net this past Sunday, October 14, as I often do. At 2145 GMT EL8C and I moved off the net frequency about 14.325 MHz and I ran a phone patch for him. We closed the patch at 2215 GMT and I was about to return to the net frequency when I heard TU2DP, Al, call me from somewhere in the Ivory Coast.

Al told me that his wife was quite sick and wanted to know if I could get a doctor that he could talk to. My XYL, Robin, was in the shack with me and she went to the telephone to call our doctor. Al's signal was 4-5 and I was worried that it was not going to be patch quality. But someone broke in (I didn't get his call) and told us that there were a couple of doctors in a net a few kHzs down the band. I asked him to get one of them to come up on our frequency.

Within two or three minutes we were joined by WB0DKK, Gordon, located near St. Louis MO. He and Al could not copy each other so I remained on frequency to act as relay, copying Gordon off the back of the beam.

Al's wife had been suffering from severe abdominal pains for the past week. Her pains were due to a gynecological problem. Al wanted to know whether he should transport a considerable distance to an American hospital or whether his wife's problem would subside of its own accord.

Gordon informed us that he was a gynecologist (some luck!) and started asking questions about history and symptoms. I relayed the questions to Al; relayed the answers to Gordon, which elicited more questions and more replies. This went on for about 40 minutes at which time Gordon advised Al to get his wife to the hospital as soon as possible — from what he had heard he felt that an operation would be necessary and should not be delayed any longer. About this time, we were joined by WA7RPR, Eldon, in Portland OR who is also a doctor and had listened throughout the QSO. He concurred

with Gordon's opinion. At one point, I lost copy on Gordon, so his comments were relayed to me by Eldon and then relayed by me to Al.

After everyone was satisfied that all pertinent information had been exchanged, we ended our contact at 2258 GMT. I continued to monitor the frequency for awhile and heard EL3DN call TU2DP to tell Al that he had heard the whole thing and had patched the QSO to a doctor at a nearby hospital who also agreed with Gordon's diagnosis and recommendations.

The next time someone asks you what hams do and don't they get tired of talking about their rigs, tell them that the name of the game is service, both to fellow hams and to the public. The story just related is certainly not an unusual one in the annals of amateur radio, but it is really a moment of human drama in the lives of those who participate in it and perhaps makes one small addition to the outstanding tradition of amateur radio.

... Norm Kushnick WA3BPC

## **Anatomy of a Public Service Event**

Local civic agency wants communications for fund-raising event (bike-athon, walk-a-thon, etc.). They ask for ham radio.

"Great," you exclaim... what with most everyone having two meters and the availability of a repeater, we'll give them a dazzling performance.

Someone assumes chairmanship (or delegated to club VP, etc.) and starts to call people to help. X-amount of souls will be vacationing... Y-amount will have to work... Z-amount will call you back and let you know. (If there's nothing better to do,

they will grudgingly say yes.) You already have a list of definites (the few that you can always count on to drop whatever they're doing and help).

D-Day minus 1: Two or three of committed group call to say they can't make it. (Work, etc.) Borrow their rig, you ask? (It's part of the planned coverage.) They'd rather not...

D-Day arrives. You are not sure everyone is going to make it because of the constant changing of plans. Somehow communications come off surprisingly well, but with some flaws. (It's never perfect.) You look good to the civic group because you "snow" them in areas of lack. In any case, radio works well enough to let the civic group know that their planning did not meet their own criteria. All ends well! Radio gets good publicity...

Let's examine a few of the areas in which some light should be shed.

First of all, you are not doing the chairman a big favor by agreeing to help. You are doing ham radio and yourself a big favor.

Second, the chairman doesn't have 24 hours a day to devote to the planning and execution of an event for which he gets nothing in the way of recompense. He only has part of his spare time to devote to it, and if he is half as busy as you say you are, do you understand why he may get impatient sometimes?

Some remedies: When you call at the last minute to say you can't make it, please tell the chairman that you have recruited so-and-so to take your place. This is the least you can do, since the chairman had you scheduled for checkpoint duty and has no one to substitute.

If you can recruit no one to take your place, don't say "nothing doing" when asked to donate your rig for a few hours. (Remember, it was already figured in the plans.) Could be he can find a newcomer or non-2-meter type to take your place.

Public service events may seem like trivia to you, but they are important



to their sponsors (Mental Health, Cancer, etc.). Certainly the SET, Field Day and other drills are important, but in a public service event, you are helping people DIRECTLY, and in a REAL situation. They appreciate it... they cannot thank you enough... they give you much local publicity. This is what the public remembers. After all, isn't that what it's all about... people helping people?

Please remember, then, whenever you are next called upon... BE A SOLUTION TO THE PROBLEM, not part of it.

P.S. If the shoe fits, wear it.

... Anonymous

Reprinted from the Central Ohio AREC Bulletin.

## Stuck on Two Meters?

I recently had the somewhat interesting experience of being indirectly called a "greenhorn" by an enthusiastic, but relatively new amateur. The explanation for this seems to be the fact that I frequent two meters, and of course, everyone knows, don't they, that only Technicians hang out there. Well, I must confess, that I don't hold the Extra Class license yet. However, I hope to someday. I do hold the Advanced Class ticket and I've been a licensed amateur for over 15 years. Additionally, I hold a 2nd Class Radio-Telephone Commercial license. I certainly do not claim to be an expert in any sense of the word, but I'm hardly a newcomer to the hobby either. I'm no stranger to the low bands and quite regularly fire up the Yaesu on 20 and 10 SSB and, yes, believe it or not, manage to work a fair amount of DX in spite of my obvious inferiority due to the fact I am a VHF enthusiast as well.

The point I am trying to convey is that many of us on VHF, actually a fairly large percentage, are General Class amateurs or higher and enjoy other facets of the hobby as well as VHF. Most of us work two meters because we enjoy it, not because we are stuck there! I still believe that two meter FM and repeaters are the greatest things to hit amateur radio

### Guest Editorial: Footnote

# Tie A HEMAC Around the Old Magnolia Tree

The January 1975 issue of 73 carried a guest editorial about U.S. Army experiments in the use of live trees and live persons as "antennas". We subsequently received calls here at 73 (from Al Wolff WB2NTL and others) expressing concern over possible ill effects radiation hazard-wise or otherwise to the subjects, vegetable or animal, as they might happen to be.

We telephoned Dr. Kurt Ikrath, director of the HEMAC experiments at Fort Monmouth, and received some enlightening comments on the matter.

Dr. Ikrath said that most of the Army work has been done at high frequencies with power levels in the neighborhood of 10 to 20 watts, and at times even up to 100 watts, with never an observed "burn" or other ill effect to any tree. Of course, he said, their operations have been intermittent and not on a continuous duty basis.

As for use of a live human being as the antenna subject, again at high frequencies, the hazard potential was deemed to be negligible, if power levels were not in excess of one watt.

Dr. Ikrath observed that the toroidal loop in this HEMAC procedure is inductively rather than "galvanically" coupled to the living

body, and that the living tissue is actually subjected only to an inductive field. He noted that human beings at a large airport, where much rf radiation is occurring, are subjected to considerably more stress from inductive fields than would be a person participating as a "person" antenna in HEMAC experiments.

One caution: The hazard goes up as the frequency goes up, so let that be a word to the wise if you are a VHF or higher nut.

So we are moved to comment finally that, if you have ever been tempted to put a little life into your wife's favorite magnolia tree by firing it up on 20 meters, you may feel perfectly free to go ahead, being assured that there will follow no ill or fatal effects to the tree, nor subsequently to you.

As our January commentary on the use of antenna persons had indicated, coupling to the belly is not recommended. We neglected to ask Dr. Ikrath about this, so the reason for the precaution is not clear. It is possible that it may be simply a division of labor among the military services, with the Army working in certain restricted anatomical areas, while leaving navel operations to the Navy.

... Alex Barvicks WB4RVH  
Technical Editor

since the Marconi Coherer! Much more technical ability has been displayed by two meter enthusiasts in building up some of the most complicated and sophisticated communications systems around. The vast majority of appliance operators who frequent the low bands would be hard pressed to equal these accomplishments. Amateur radio is a lot more than going out and buying a radio and an antenna and then calling yourself a communications expert as many of

our eleven meter friends seem to do.

It seems to me that many of the dyed-in-the-wool dc boys would do well to take a second look at what is happening on two meters FM and VHF in general and possible re-assess their judgment of those who are "stuck" on two meters.

... K9UBF

Reprinted from *WRGABN*, Allen Co. Amateur Radio Tech. Society, Ft. Wayne, Indiana.

# Autobiography of an Ancient Aviator

W. Sanger Green  
1379 E. 15 Street  
Brooklyn NY 11230

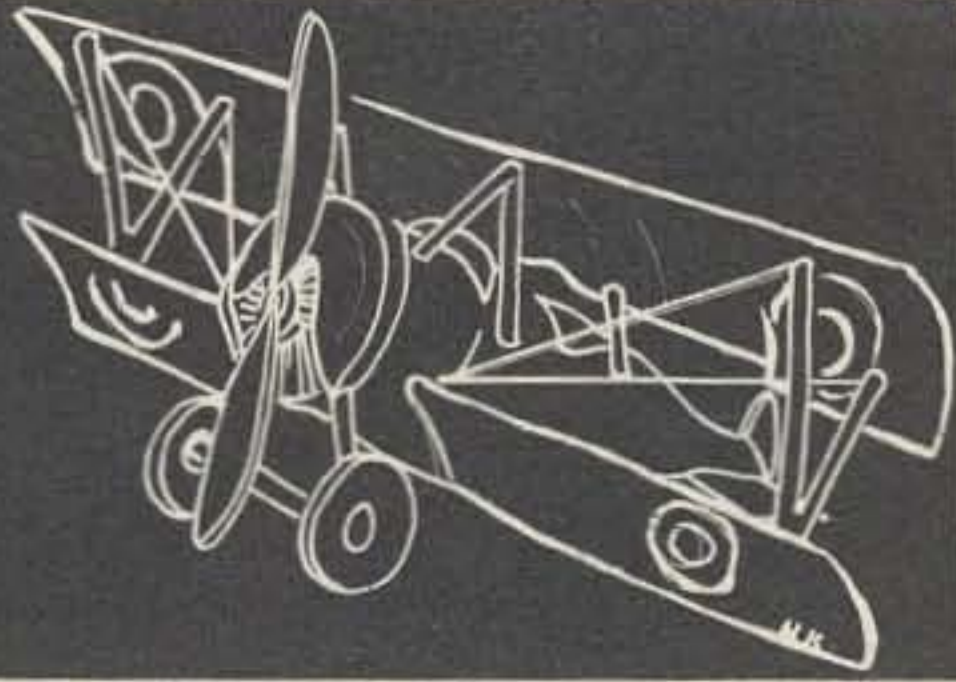

## MARKING TIME

In last month's column I told about my good fortune in passing the Air Service Cadet Selection Board and the physical examination for flying. That was late in March 1920. The class for which my name was entered didn't start until September 1921 — almost a year and a half wait. I filled this time with various jobs from selling kitchen gas ranges to working as an inspector for the Lawrence Aircraft Engine Co. in New York. During this time I also met my wife-to-be, Cleo Willson.

When August 1921 rolled around, having had no word from the Air Service, I went to Washington to make sure all was well with my appointment to their flying school. I got an old friend of mine who was then director of the U.S. Coast and Geodetic Survey to make an appointment for me with Brig. General Billy Mitchell who was Assistant Chief of the Air Service. I had an interesting half hour with the general during which he had one of his aides check the status of my appointment. I asked him about the types of planes then being used for training. He said that, since no funds had been made available for newer types, they had upgraded the old WWI OX5 Jennies by installing 180 HP Wright Hispano-Suiza engines in them. These were used for primary training and WWI DeHaviland DH 4B planes with 400 HP Liberty engines for advanced bombardment and observation training and also for most routine flying. WWI SW5s and Spads were used for pursuit training. The general complained that the army seemed to think that flying was a passing fad, that it was not worth spending money on, while he considered flying of major importance, an attitude which got him into considerable trouble later on.

The general's aide returned and reported that I was indeed assigned to the Flying Cadet class scheduled to start September 15th at Carlstrom Field, Arcadia, Florida. The general mentioned that I would have a good *flying* commanding officer at Carlstrom in the person of Major

Ralph Royce. Since I was going back to Littleton, N.H., I was advised to enlist as a Flying Cadet at Fort Ethan Allen, Vermont (near Burlington) and a letter authorizing this enlistment was sent to the commanding officer at that post.

Back in Littleton I got my things in order and, since I expected the class to take more than a year, I asked Cleo to marry me and come along to Florida. So we were married August 25, 1921 and had about a week honeymoon at Patridge Lake (near Littleton). Then I went over to Fort Ethan Allen and enlisted and got my travel orders to Arcadia, Florida. Since orders from Washington to the C.O. Fort Ethan Allen said nothing about transportation for any family, I had to pay Cleo's fare to Arcadia.

We arrived at Arcadia the afternoon of September 12th and checked in at the only hotel. It was a hot afternoon and we were pretty dirty after our long train trip so, without question, a nice bath was top priority. There was no shower so I turned on the water in our bath tub. In a few minutes the sickening rotten egg odor of sulphur water filled the room. How could washing in such water get you clean? You'd just be trading one bad odor for another.

Next morning I rode the six miles to Carlstrom Field on the railroad the town of Arcadia built on the level "Big Prairie" in a few days early in 1918. The military business of reporting to the post commanding officer, assignment to the Cadet Detachment and reporting to the Detachment C.O. took most of the morning. In the afternoon I passed a very thorough 64 examination (for flying) without difficulty. The fact that I was married caused a bit of a flurry. There were no married quarters on the post so we would have to live in Arcadia and I would commute on the "Florida Special" (train) leaving Arcadia at 6:30 am and returning after retreat (end of day's work). Since I would be having only the noon meal at the Detachment mess I arranged to have two thirds of my mess allowance (\$1

per day) issued to me in kind (canned and fresh food). I also tried to get a Commutation of Quarters to help out on my rent in Arcadia. However, since the rank of Flying Cadet seemed to float somewhere between enlisted men and officers, they could find nothing in the regulations that would permit such a payment. Flying Cadet pay at that time was \$75 per month.

Since my morning arrival at Carlstrom was at about 6:50 am I missed the reveille health class (calisthenics) as well as first mess. The cook, however, always had a cup of coffee and a bun or so for me. While I was having my coffee the rest of the class was in barracks cleaning, making up bunks and standing the daily inspection by the detachment C.O. Then, during the early part of the training, they all had to turn out for military drill. Because of my wartime experience as an Infantry officer I was detailed to perfect the class in close order drill and the manual of arms. Of course no one could see the importance of or reason for this drill. I explained to them that, since the Air Service was part of the Army its units had to be trained to at least not fall all over themselves when executing "squads right" in case of an inspection by high brass and that the sooner they got the hang of it the sooner they could go back to their bunks. In two weeks they were proficient enough for a 2 star general's inspection. The manual of arms drill proficiency was so low that I got the C.O. to forget about it and send the rifles back to the warehouse.

Primary Ground School started September 25th. It consisted of 24 subjects and took some 460 instruction hours plus examination time. The usual Army subjects such as Infantry drill, Army Regulations, property accounting, military law, paper work and interior guard duty were covered first (stuff every Army commissioned officer should know). Then aeronautical subjects such as aerodynamics, engines, propellers, rigging, meteorology, instruments, aeronautical navigation, radio and code were covered in some detail. Then the various machine guns and synchronizing gears (to shoot through propeller blades) followed. These were morning and afternoon classes until flight instruction began on November 15th. Then flying in the morning and school in the afternoon.

The ground school courses were quite thorough and the instructors well qualified. It was no tea party.

They had a board of officers nicknamed the "benzine board" that checked the record of each student after each examination and if any failed the examination or gave any other cause for disqualification he was immediately "BENZINED" (discharged). As a matter of fact our class started with 72 cadets and only 21 graduated (29%) from the advanced flying school. Two cadets from my class and a cadet from the class following ours "Went West" in a DH crash near Brooks Field, Texas on June 28, 1922. It seems that Cadets Farrell and McCoy, two of the best

rated pilots of our class, had flown from Kelly Field over to nearby Brooks Field early in the afternoon of June 28th. When they were ready to return to Kelly Field, Cadet Thompson, who had just arrived from Carlstrom Field a few hours earlier and was on his way to report for advanced training at Kelly Field, asked them to give him a lift to Kelly. Farrell and McCoy agreed so all three climbed into the DH, Farrell in the front cockpit piloting and McCoy and Thompson in the rear cockpit (made for one passenger) for the ten minute hop to Kelly. They took off at about

5 pm and had only gained about 200 feet altitude when the ship suddenly spun in and burned. All three died. The consensus of barracks guesses was that, since most of Farrell's recent flying had been in single seater SE5s, he may not have been as familiar with the eccentricities of DHs as he would have been if he had had a lot of recent time in them. It was quite evident that he tried to pull up too fast after take-off with an extra heavy load in the rear cockpit — and the DH had said "NO".

Next month I will tell you about keeping Jenny seat cushions warm.



Two spacecraft are up and working. AMSAT-OSCAR 6 continues on its normal schedule, being available on Sunday mornings for descending node passes, and on Monday, Thursday and Saturday for ascending node passes. AMSAT-OSCAR 7 is available for use every day except for Wednesday. Note that all these times are CUT, which means that an ascending node pass on Monday really takes place on Sunday evening Eastern Standard Time.

Now that AMSAT-OSCAR 7 is up every one has a spacecraft to use on a regular basis, so stations that found AMSAT-OSCAR 6 too unreliable for them, due to the unavailability of Command stations, can and are dusting off their equipment and working through the new satellite. AMSAT-OSCAR 7 carries two repeaters, the 2/10 (as in AMSAT-OSCAR 6) is on for use on ODD days of the year, where Day 1 is January the first and so on, while the 70/2 repeater is available for use on EVEN days. Note that Wednesdays (CUT) are reserved for bulletins and experiments.

It seems to be the general impression that AO-7 is less sensitive on the 2/10 than AO-6. The cause of this phenomenon has not yet been defined but may be due to one or more of the following: Receiver (on the spacecraft) sensitivity; spacecraft tumbling; or just that the agc is doing its job,

being affected by the high power boys and shutting the weaker ones out. Larry VE3QB has worked through both satellites using an IC-22 and a dipole, keying the rig by means of the push-to-talk button on the mike. He says that the mike is just the right shape for use as a key, but cautions silence when using that set up. "A sneeze does wonderful things to your carrier."

As for who is on the satellites, G3IOR writes about the following contacts in Oscar News: The best DX seems to be the contact between G8AWS and W6ZVV. Other stations heard in Europe are K1PXE, W0PHD, W0LER, K2LGJ, UG6AD, UR2EQ, K2KNV, LX1DB, HG5AIR, HG5KEB, WA1NGR, OE1WW, FC6ABP, LZ1FO, WA2RDE, W5HN, EA4AO, JA8RS, I1TEX, I5TDJ, ON4DY, DK2ZF and KL7MF. In fact G3IOR has worked 50 countries through the OSCARs. Although recommended modes of operation are SSB and CW a lot of work has been done on other modes. SSTV, RTTY and Fax have been sent through the spacecraft with good copy at the receiving end.

G3COJ writes in to tell about his first month's operation on mode B. He writes . . . "The main impression is of a vast number of DL and F stations, a few G, PA, I and OK and one station from each of the remaining countries. Good signals from USA and Canada, especially passes between 2300 and 2330 GMT which are out of range for continental Europe — cuts down the QRM tremendously. . . .The repeater seems to work well and I have fair signals back at times with NINE Watts erp, though I have not had QSOs with less than 45 Watts. Other times 100 Watts output has

given a very weak return, especially with K2UYH, DL3YBA, EA4AO, F9FT or F6CJL on." Even so COJ has worked 24 countries including VE2, VE4, W1, W2, W3, W4, W8 and W0.

From another part of the world KL7MF writes, "When it goes out over Siberia I get a beautiful signal (back), but nobody to work out that way. Hi! Do work an occasional USSR station out that way like RA9MBN."

RTTY telemetry is being transmitted by OSCAR 7 on two meters using space only keying. This is not the afsk signal that has been previously publicized but is another normal but previously unpublicized mode of operation. A modification to the ST-5 was described in the AMSAT Newsletter, December 1974, to enable it to copy the RTTY telemetry. There will be no need for most people to go to the lengths that G3JZK did to copy it. He played his receiver into an electrocardiograph recorder and then proceeded to decipher it manually. He sent in a sample and the readout, and his method does work.

Some frequencies to listen out on are:

29.510/475 SSB YV1AQE  
29.495 SSB LX1SI  
29.475 KP4DPN  
29.475 ZE1DX

Coming up are ZD8PL, TU2VF, HV3SJ, and M1C. These may very well be on the air by the time that you read this. Sorry to say that VP9YC was a pirate as that call has not been issued by the Bermuda authorities. Either that, or someone's CW needs refreshing!

. . .G3ZCZ



## FCC NEWS

The following is an excerpt from the Chairman's Report in the SCRA Bulletin.

### Covert Rule Changes By The FCC?

One of the primary justifications the Commission has used in some of their more repressive interpretations has been the logical separation of the "control" and "operate" functions as they relate to an amateur radio station. They have said that to control is not to operate and, most importantly, to operate is not to control. This has been their rationale for requiring that a licensed Control Station do nothing more than effect the control of its associated remotely controlled station and that to operate, i.e., communicate, through it a separate Auxiliary Link station must be used. This is in spite of the fact that Section 97.108(a) stated "An amateur radio station may be *operated* by remote control . . . from an authorized *control* point . . ." (emphasis supplied). Since this section appears to directly refute their interpretations, it was probably considered to be a source of possible future embarrassment to them. In what appeared to be an attempt to preclude this from happening, on Tuesday, 11 June 1974, under the guise of a ". . . minor editorial revision . . .", this section, 97.108(a) was changed to read "An amateur radio station may be *remotely controlled* . . . from an authorized *control* point . . ." (emphasis supplied). In other words, where before we could *operate* a station from its control point, now we may do nothing more than *control* it; where before this section contained a very reasonable and logical restriction, its level of restrictedness has been increased to an excessive and unjustified degree. This change, this "minor editorial revision," has effected the removal of a significant amateur privilege.

What this change means to you is that if you have ever used your systems control channel/station to

override the input channel and to communicate directly via the output channel, you can no longer do this. No more control station overrides to make announcements; no more control station break-ins to explain system procedures to a newcomer; no more control station communications, *PERIOD!* I used the term "covert" previously because the FCC made this rule change without a formal Notice of Proposed Rulemaking or Docket procedure, but rather under the heading of a *minor* editorial revision. In so doing, they prevented us from making any comments or arguments against it and were able to effect the change with almost zero publicity.

I am currently working directly with ARRL General Counsel Booth to see if we have any recourse to this change since it appears to be contrary to the Administrative Procedure and Judicial Review provision of 5 U.S.C. 553. Be advised, however, that getting it changed back could get a bit hairy; the FCC can't very well require a formal petition to reverse a change they made without the benefit of formal rule change procedures, but then how do you go about convincing them to change back something which they must publicly defend as being the same in content as the original?

### A "Ringer" In The Crossbanding Docket

FCC Docket 20113, the "Crossbanding Docket", proposes the addition of a new Section 97.126 and describes it in Paragraph 7 of that Docket. This new section, as it is being proposed, is as follows:

"97.126 Retransmitting radio signals. No amateur radio station, except a properly licensed repeater station, auxiliary link station, or a remotely controlled station in a system with an auxiliary link station, may automatically retransmit the radio signals of other amateur radio stations."

In my opinion, there are three major items of concern embodied within this proposed section:

1. **Complete lack of justification.** The only thing resembling an attempt at justification is within Paragraph Seven where the statement is made that ". . . New Sec. 97.126 . . . would incorporate the *current policy* on other types of retransmissions." (emphasis supplied). Apparently the FCC feels that whatever policies are generated internally within the Commission are sufficient, in and of them-

selves, to justify a formal change in the Rules and Regulations. I don't know just how accurately I am able to read between the lines, but I get the impression that what they are trying to say is that they have been engaging in practices that, if they are not contrary to the Rules, are at least not mandated by them. This proposed new Section would not only legitimize these past practices, but justify their future use. Like most people, I am not concerned with the justification they use to effect de-regulation, but I am concerned with allowing them to set the precedent of "Regulate now, put it in the rules later." I respect the FCC, but not that much!

2. **Unnecessarily restrictive.** Even though the proposed section refers to the practice of ". . . *automatically* retransmit(ing) . . .", the narrative within Paragraph Seven states ". . . An example of a prohibited practice would be the *retransmission* on the 14.0-14.35 MHz amateur band of another amateur station transmitting on the 144-148 MHz band, *or vice versa*." (emphasis supplied). Note that within their example, no mention is made of the prohibited retransmission being "automatic". In fact, their own definition of "automatic retransmit" is ". . . (the) retransmitting (of) other signals in real time or very near real time." In other words, it is the very fact that the retransmission is in ". . . real time or very near real time . . .", and not the fact that it was effected by automatic means, that places the practice within the domain of this proposed new section. This would then place the received transmissions of other amateur radio stations in the same category as music; their appearance within the content of an amateur transmission would render that transmission in violation of the Rules and Regulations. Personally, I fail to see the necessity, nor even the desirability, of adding these new restrictions to an already overly-restrictive Part 97.

3. **Detrimental to remote base interests.** A very large number of SCRA members are also heavily involved in Remote Base operation and this proposed new section is aimed directly at them. As most of us know, probably the biggest single stumbling block to the proper licensing of most Remote Bases is the FCC's interpretation that the communications audio, both to and from a remote, must be transmitted via an Auxiliary Link station. Most remotely controlled

Continued on page 12

# Reliability.



That's what you get from Sentry.  
The most reliable crystals you'll find anywhere.  
Because Sentry crystals are made of the finest quartz to the latest state-of-the-art specifications. And our manufacturing methods are the most precise available.

Since Sentry has the largest semi-processed crystal bank in the world, we can custom-make crystals for any rig. Any frequency. Faster than anyone else in the business.

And talk about frequency stability. You've got it with Sentry.

So place your next order with us. It's easy. Our processing is quick, accurate, efficient. Our guarantees are solid. And we'll send you our complete 1975 Catalog. Absolutely free.

Sentry. You can depend on us.  
Sentry Manufacturing Company.  
Crystal Park, Chickasha, Oklahoma 73018.  
Phone: (405) 224-6780,  
TWX-910-830-6425.

## Sentry

Manufacturing Company

**Tuned-In to Quality.**

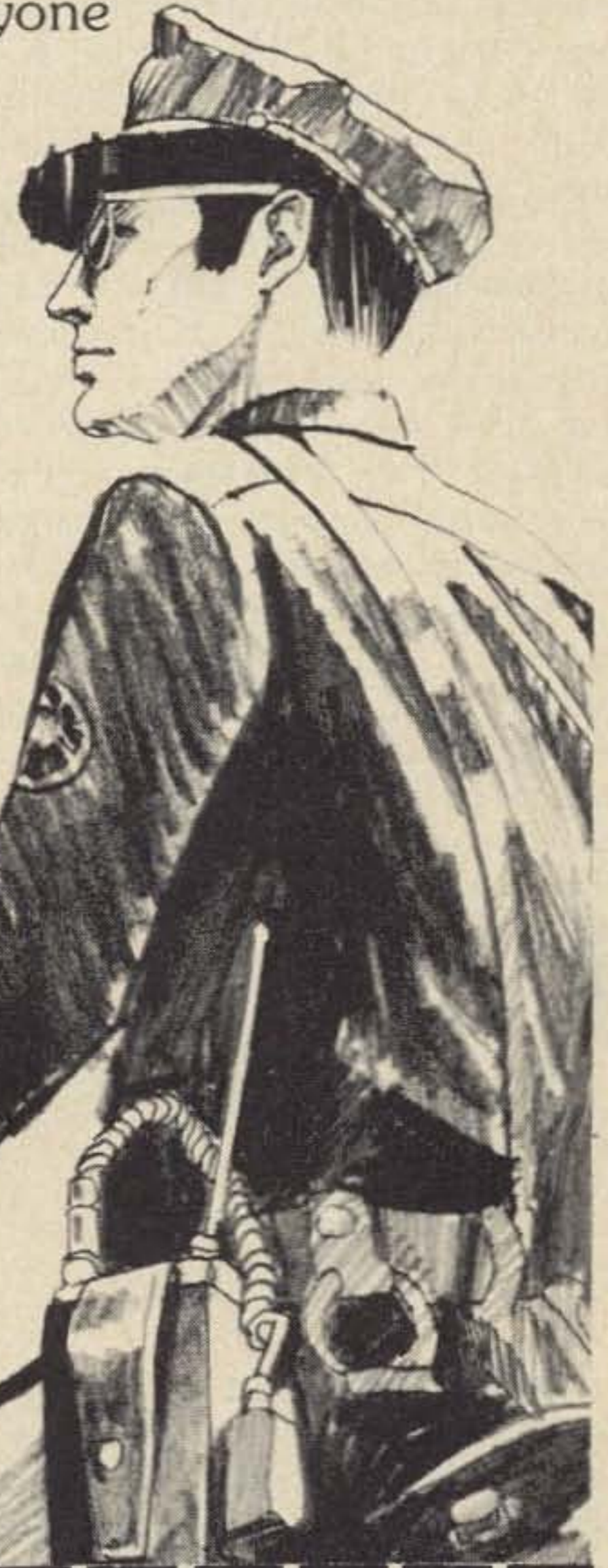

73:1

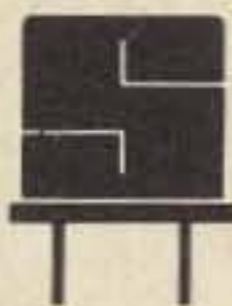

Sentry Manufacturing Co.  
Crystal Park  
Chickasha, Okla. 73018

**Please send me your Free 1975 Sentry Catalog.  
RIGHT AWAY!**

Name \_\_\_\_\_

Street \_\_\_\_\_

City \_\_\_\_\_ State \_\_\_\_\_ Zip \_\_\_\_\_

**Send for  
Sentry's  
FREE 1975  
Catalog!**

repeaters are also hamstrung by this same interpretation. Of interest here is the fact that the FCC has not stated exactly which section of the Rules and Regulations they were interpreting. It is the belief of many that there is no such section; that they have established a baseless interpretation for the purpose of making illegal that which Section 97.109(b) specifically permits. (97.109(b) states that a remotely controlled station may be operated from its authorized control station(s), be those stations fixed, portable or mobile.) The point that I am trying to make here is that, as far as I know, there is no current basis within the Rules and Regulations for their prohibitive interpretations. One of my primary fears is that this proposed Section 97.126, if allowed to become a part of the Rules and Regulations, will become their basis for these interpretations. Notice the wording of the proposed section. For a remotely controlled non-repeater station to be "legal," it must be "... in a system with an auxiliary link station..." Now here would be a section that nobody could question the interpretation of; this would create an almost unbreakable bond between Remote Bases and auxiliary links, making the former virtually unlicensable without the latter.

Reprinted from *Squelch Tales*, San Diego Rptr. Assn., P.O. Box 5815, San Diego CA 92105.

Paul Schuett WA6CPP/WA7PEI  
Box 10  
Wallace CA 95254

**FCC REGULATION**

While cleaning out the garage I came across some old FCC rules in effect in 1956. Rather than consign them to the trash, I keep these in a special binder — it's sort of fun to look through them and remember "the good old days" when life was a bit simpler and taxes were lower. (We are now in the "good old days" that we will be talking about in the future.) Many things were simpler than they are now, according to the old rules, but many things are better now than they were then, with the possibility of getting better.

In the amateur rules, we have more use on 160, and expanded phone privileges. The broadcast rules no longer require repetitious announcements that music is recorded (mechanically reproduced). Holders of radio-

Part	1956		1975	
	Pages	Price	Pages	Price
Frequency Allocations and Treaty Matters	33	\$ .25	139	\$8.00
Radio Broadcast Services	96	*	466	18.50
Amateur Radio Service	20	.15	72	3.50
Commercial Radio Operators	7	.15	?	8.00

\*The price is not stated.

telephone third-class permits can operate more complex stations now than before.

The most striking change is noted in the size, along with the associated price of the documents. Admittedly, the print is a bit larger and subscribers to the rules receive convenient supplements consisting of corrected and additional pages (usually issued quite late — the amateur rules regarding log changes have yet to arrive).

Each of these parts now comes with several other parts — the government combined the individual parts into groups some time ago in an effort to save money(!). The amateur service also contains rules for the disaster

communications service and the citizens' radio service. (Whooppee! The subscriber can peruse the citizen band rules at his leisure to see that there are in fact rules for this service which apparently are not enforced by the commission — perhaps they don't know about them.) The radio broadcast service also contains auxiliary broadcast rules, involving remote pickup, experimental, developmental, CATV rules, and the like.

In 19 years, the allocation information has increased in price 32 times; the amateur rules have increased 23.33 times. It would appear that the government, while talking a lot about fighting inflation, does little about it.

...WA6CPP/WA7PEI

**The Australian Exam**

Amateurs working to pass the FCC exams may be interested in how it is for their compatriots down under. How would you do on these?

**SECTION M (Theory)**  
(Time allowed — 2½ hours)

Note: SEVEN questions only to be attempted. Credit will not be given for more than SEVEN answers. All questions carry equal marks.

1(a) With the aid of a block diagram describe the operation of each stage of a single-sideband suppressed-carrier transmitter.

(b) Explain how the transmitted sideband may be changed from upper to lower sideband.

2(a) Assisted by a circuit diagram describe a variable-frequency oscillator (V.F.O.) suitable for use in the 7 MHz amateur band.

(b) With reference to a V.F.O., discuss the factors upon which the stability of the generated frequency depends.

3 The antenna coupling network of an amateur transmitter is designed to match an antenna whose impedance lies between 50 and 80 ohms. Assisted

by a diagram, describe an antenna which will meet this requirement on at least two amateur bands. Show dimensions and state the frequencies involved.

4(a) With reference to a radio-frequency amplifier stage, explain under what circumstances neutralisation is necessary.

(b) Aided by a circuit diagram, explain the theory of one method of neutralising a single-ended output stage.

(c) Explain why it is necessary to neutralise a frequency multiplying stage of a transmitter.

5(a) Describe the manner by which high-frequency radio waves may be propagated over long distances. Explain why communication between countries such as America and Australia is restricted to certain times in the H.F. bands.

(b) Explain why communication over long distances as described in (a) is not possible using the V.H.F. and U.H.F. amateur bands.

6(a) Discuss features you consider desirable in a microphone which is to be used in a mobile capacity.

(b) With the aid of a sketch describe the construction and theory

of operation of a microphone which you consider meets these requirements.

7(a) With the aid of a sketch show the construction of a cathode-ray-tube and explain the theory of operation.

(b) Show a method of connecting a cathode-ray-oscilloscope to a telephony transmitter to indicate its depth of modulation.

(c) Sketch the pattern obtained when using the connections shown in (b) if the carrier is modulated to a depth of 100%.

8 In relation to a communications receiver explain what is meant by the following terms: (i) signal-to-noise ratio, (ii) selectivity; (iii) image rejection; (iv) cross modulation; and (v) automatic gain control.

9(a) Find the total capacity when three capacitors of 3, 6 and 9 microfarads respectively are connected: (i) in parallel; and (ii) in series.

(b) Calculate the capacitive-reactance of the series combination in (a) when connected across a 50 Hertz supply.

#### SECTION K (Regulations)

Time allowed — 30 minutes)

**NOTE: THREE questions only to be attempted. Credit will not be given for more than THREE answers. All questions carry equal marks.**

1 What action should be taken by an amateur station licensee when informed that transmissions from his station are causing interference to the reception of television or broadcast programmes?

2 State the regulatory requirements concerning the recording and re-transmission of another amateur station's transmissions.

3(a) State the maximum power which may be used in an amateur radio station using: (i) amplitude-modulated double-sideband emission (A3); (ii) single-sideband suppressed-carrier emission (A3J).

(b) Briefly describe the method for determining the peak envelope power of a single-sideband suppressed-carrier transmitter.

4 Give the "Q" code abbreviations for the following: (i) Shall I send faster? (ii) The name of my station is . . . (iii) Your signals are fading. (iv) I have nothing for you. (v) When will you call me again?

Reprinted from *Amateur Radio*, Journal of the Wireless Institute of Australia.



Schley Cox WB9LHO  
1613 Culbertson Avenue  
New Albany IN 47150

## Who's In Charge Here?

Questions about the "control operator" can show up on either the Novice or the General license exam.

The control operator is the licensed amateur who is actually operating a ham station whether the station belongs to him or someone else.

Let's say you have your Novice ticket and your call is WN9LHO. When you're operating your station you are known as the control operator and the licensee of WN9LHO (since it's your license). You are in charge of the station and you are responsible for its proper operation.

A friend of yours, WN9LJW, comes over and wants to operate your station for a while. You say sure and retire to the corner pub for a few tall ones while your friend uses your station. You are still the licensee of your station, but you are no longer the control operator. WN9LJW is the control operator.

Both of you are now responsible for the proper operation of your station. You are because you are the licensee; WN9LJW is because he is the control operator.

Let's say that instead of WN9LJW that your friend happens to be WB9LJW, who has his Advanced class license.

WB9LJW can operate your station and sign your call as long as he stays in the Novice band and uses 75 Watts or less. But here's the interesting part. WB9LJW can also operate your Novice station in the General and Advanced bands (including phone) if he signs both your and his call like this, ' ' K 4 E M X d e WN9LHO/WB9LJW', or on phone,

"K4EMX from WN9LHO with WB9LJW as control."

It doesn't work the other way around though. You can't go to WB9LJW's station and operate in the General and Advanced bands as the control operator. A control operator may not assume operating privileges greater than those granted by his license. You have to stay in the Novice bands and use 75 Watts or less, if you are a Novice licensee and the control operator at WB9LJW.

However, you could go to WB9LJW and operate his station as a "third party." So can anyone else, whether they have a license or not. This means that while you are operating WB9LJW, he or another control operator has to be present and able to

continuously monitor and supervise your operation to make sure you don't violate the rules. If you want to operate sideband in the General bands the control operator has to have at least a General class ticket. If you want to operate CW down in the Extra band segment then the control operator has to have an Amateur Extra license.

Let's say WN9LHO has a friend who knows the code pretty well visiting the station. The friend doesn't have an amateur license. That friend can operate CW at WN9LHO's station as long as the licensee or another control operator is present to supervise the third party operator.

Maybe WN9LHO's XYL learns the code. She can operate his station as long as LHO or another control operator is present to see that she observes all the rules and regulations.

You may have a friend whose license has expired. It's perfectly legal for him to operate your station as long as you or another control operator is present.

Just remember that if you are a control operator at another station you are responsible along with the station licensee for the proper operation of the station.

If you knowingly and flagrantly violate the FCC rules while you are the control operator, both you and the licensee can get into big trouble fast. You can't say as an excuse, "Yeah, but it's his station!" and he can't say as an excuse, "Yeah, but he was control operator!" Both of you can be blamed and held accountable.

...WB9LHO



Bill Pasternak WA6ITF  
14725 Titus St. #4  
Panorama City CA 91402

Shows you how you can never be sure of anything these days. In part II of my coverage of the November '74 SCRA meeting I went and gave all that lovely information about how the problem of solving a frequency allocation need for amateurs in Mexico had been concluded so successfully at that meeting. Well, everyone thought it had, so I reported it that way. Turns out that I was a bit ahead of myself, as the updated information that appeared in Hotline will attest. (Another case that proves the utility of Hotline.)

True, a tentative agreement had been reached at that meeting. However, this fell through when one of the systems that had been requested to move to an alternate channel pair decided to stay put where they were. So, after many months of work, the SCRA found itself right back at the starting point with the amateurs in Baja becoming impatient for some affirmative action on their behalf.

A final settlement of this problem was brought about by the generosity of one Doug Andrews K6VGH. Doug is the owner of a West L.A. based system under the call of WR6ACK. You might remember my writing about 'ACK some months back, when they tried to put up the first open autopatch system in Los Angeles. Unfortunately, the attempt was a failure and the autopatch function was taken out of service. Since that time 'ACK has been one of those nice quiet local coverage machines that abound in Southern California. After approaching many other repeater owners in an attempt to secure a set of standard 30 kHz split channels to assign to Baja, the SCRA approached Doug and explained the problem. In turn, Doug generously agreed to move WR6ACK to 146.805 - .205, doing so *in the interest of true international amateur radio cooperation.*

Let's face it: No one can blame the owners of the other systems asked to move for declining to do so. Changing

channel allocation for a repeater can be an expensive proposition, especially for the system users. For an average system of 50 users, that's 100 crystals at \$7 each plus two for the repeater itself. Aside from the economics, you still have no idea of what other electronic problems you will face on the new channel: Intermod, mixes, etc. That is why our hat is off to Doug. He is taking 'ACK to a split-split channel from 147.93 - .33 so that the new Baja California repeater can come to pass. I'll tell you, if there was a "Good-Guy" award in amateur radio, I would personally nominate Doug Andrews K6VGH for it!

And I ended the article in the January newspapers "P.A.R.C. does and SAROC is next. Hm m m m m WR7FM?". I was talking about the portable repeater that the Palisades Amateur Radio Club had taken to San Diego under the callsign WR6FM. Well, to be honest, I did know something at that time, but since the license for WR7FM had not arrived at Fred Deeg K6AEH's house yet, we could not be sure. So, we only hinted. The license did arrive in plenty of time, so that within hours of the time the convention started, the voice of Bella WA2CZU could be heard on 146.61 announcing: "Hi; welcome to SAROC. This is WR7FM Las Vegas. A special events repeater station sponsored by the Palisades Amateur Radio Club of Culver City, California." Having the P.A.R.C. portable repeater was a real benefit to those of us with .01 - .61 in our radios since it was all but impossible to get a word in on either WR7AEH (.34 - .94) or on .94 simplex. I have heard unofficially that this year the turnout was better than ever probably due to the excellent weather and the decision to move the show back to the Hotel Sahara.

There has been a lot said and written, pro and con, about this particular event and I have heard both sides of the story many times over. For me however, this was my first SAROC and I decided to go there and report on it as objectively as possible. For better or worse, here goes.

First, if you go to SAROC looking to find an amateur convention like San Diego or Dayton you will be very disappointed. By far it is the most disorganized event of its type I have ever attended, though I will admit I have not attended many such functions. This, though, is not to the discredit of the convention, but rather it is due to the "Fun-Fun" atmos-

phere that *is* Las Vegas. I think that it is the aforementioned atmosphere that accounts for the lack in number of formal symposia that abound at many other conventions. At SAROC this year there were but two major sessions: A 2½ day on-going FM Forum led by Dick Flanagan W6OLD, Chairman of the SCRA, and the ARRL Forum led primarily by ARRL President Harry Dannels W2TUK. In both cases, the discussions mainly revolved around Docket 20282 and its effect on the amateur populace. Having "wagon-trained" up to Vegas with Dick Flanagan on .52, I had a fair understanding of what was to be covered at the FM Forum and therefore I did not attend same. I did get in on the tail end of the ARRL forum and basically I received the impression that whatever you as an individual felt in relation to 20282, it was your responsibility to read it and comment back to the FCC as they have requested.

As for the displays, from my observations the two that drew the most attention were Icom and Yaesu. Icom had their new DV-21 Phase Locked Digital Programmable VFO hooked to an IC-21A, and you just couldn't keep your fingers off this little gem. The DV-21 lets you operate any channel and any split you want, scan the entire band from 146 to 148 and tells you where you are to the last 5 kHz. You simply have to see it operate to believe what it will do and how easily it will do it. Yaesu's 200R Sigmasizer and FR-101 Digital receiver also drew a respectable on-going crowd.

Back to the convention as a whole, it is obvious that the aura of Las Vegas is what brings people to SAROC each year. If, like me, you enjoy the night life that this city has to offer and do not mind fattening the coffers of the various casinos, then you will enjoy going to a "SAROC". (OK, we only lost \$15 on the slots, so there is nothing to complain about. The shows are my cup of tea, and the ones Sharon and I attended were the most lavish put on anywhere.) In my view, SAROC is a good excuse to go to Las Vegas and enjoy myself and have the pleasure of again seeing such friends as Art Householder of Spectronics, Dave Flynn W2CFP (who, among other interests, puts out a fine Newsletter each month as the Hilltopper) and Mitch Wolfson WA6GSN, who not only treated us to a fine dinner but acted as our guide at

*Continued on page 16*



# EBC 144JR



HEY! This is like two transceivers in one! Fully synthesized covering 143.5 to 148.5 MHz in 5 kHz increments. Standard 600 kHz offsets up or down automatically. Reverse simplex and frequency split allow totally independent receive and xmit frequencies, and a priority channel guard that switches you back to it as soon as a signal is detected.

**\$599.00**

- Sensitivity – .35uV for 12 dB sinad, .30uV for 20 dB quieting
- 20 Watts output
- Intermodulation, spurious and image 60 dB minimum
- 10 pole xtal filter
- Frequency stability .001%
- S-meter speaker built in
- Independent selectable priority channel

***now shipping daily!***



**emergency  
beacon corp.**



15-B6 River Street  
New Rochelle NY 10801

the beginning of the convention as well. In closing, if I had to describe what SAROC is in one sentence, I would have to say that it is a fun gathering held for those who happen to share an interest in amateur radio, but not an amateur radio convention devoted solely to amateur radio as an entity unto itself. If you are like us and enjoy a fun time that does not necessarily revolve around amateur radio 24 hours a day, then a gathering such as SAROC is for you. On the other hand, if you are of the school that believes an amateur radio convention should be that and nothing more (an extension of the QSO, the coffee house technical seminar, the fully structured radio club meeting that follows traditional rules of order) — well, SAROC is none of this and you are going to have a lousy time. Sharon and I had a good time in Las Vegas as always, but it was the fact that SAROC was being held now that induced us to visit there again at this time. I suspect that it will influence us again the same way next year.

Finally, as those of you again who

read Hotline already know, the Technical Committee of the Southern California Repeater Association has decided to adopt the Mt. Wilson Repeater Assn. Tertiary Split band plan, rather than the ARRL band plan. The MWRA plan inverts the split-split channels so that the repeater user's receiver always sees a clear 30 kHz slot, since the channel either side is a repeater input. What this means is that unless your next door neighbor is operating on an adjacent channel 15 kHz away, there should be little or no interference either to or from adjacent systems. It is nice to see a coordinating group made up of repeater owners that is responsive to the needs of users. The SCRA is such a group, one willing to put technological development of the VHF spectrum ahead of tradition. If you are interested in learning more about the SCRA, or if your coordinating group wishes to exchange ideas with them, they can be contacted at P.O. Box 2606, Culver City, CA 90230. They have accomplished a lot because they are willing to lead and willing to listen.

...WA6ITF

# 50 MHz BAND



Bill Turner WA0ABI  
Five Chestnut Court  
St. Peters MO 63376

## Around and About

Larry WB5CWB proudly announces confirmation of Nebraska in the person of John W0EKB to complete the continental 48. The contact took place on Friday the 13th last December. "I attribute the Nebraska contact to my new 8 element KLM 6 Meter beam. Sure is great. Also, John hanging in there with me. Thanks to John and KLM."

Perry WA5IKU says "Not much to report other than an Es opening 12-26, worked several 0-4-8-9 between 1545 and 1705 CST ... I might men-

tion that I worked several of the new North Carolina 6 Meter Association members, I understand if you work five stations (and send) \$1 to Ken WB4MXC you can receive a nice piece of wallpaper. I worked 4, looking for the 5th."

Received a long and detailed letter from Ted WA9FEE outlining activity to and from northern Illinois during November and December ... Ted seems to have had better than average conditions from the number of contacts made and the areas covered. Unfortunately space limitations won't allow a blow by blow description. There was one note of sadness included, that being the information that Leo WA4MHS had passed away the first week of December. "Leo was very active on 6 Meters from New Port Richey, Florida and made many good friends on 6 — he is going to be missed. Leo was a member of SPESM. At the time I am writing this the club is setting up a memorial fund in Leo's name, probably through ARRL ... to be used for either a task force or committee on 6, or to further the advancement of 6 Meters ... the fund will be carried on whenever another avid 6 Meter operator passes away — I will let you know when I can get the

information on the address and fund name." On other subjects Ted says, "Four groups in the 6 Meter Council, SMIRK, 6-6, SPESM and the newest, NCSMA, the North Carolina Six Meter Association. I for one can't understand why other groups have not joined, the only cost is stamps, exchanging newsletters, views and coordinating our efforts to create a better band on 6. If anyone is interested in joining SPESM, the only requirement is \$2.00, which entitles them to a nice certificate and a monthly newsletter ... contact us through P.O. Box 768, South Elgin, Illinois."

Band conditions in the Midwest have been very poor this last Fall. November brought a few unexpected openings but the usual December activity was almost entirely lacking. This is not to say that there were no openings. There were some, but these were not of the intensity or duration or, for that matter, the frequency that we have come to expect at that time of year. With very few exceptions the letters received and contacts made indicate this to be a general trend all over the country, not just a local problem. WA1EXN and WA1OJB (Art and Bob) in an extended but sometimes marginal contact a few evenings ago made about the same comments about conditions from their Maine location. There was mention of a good opening December 14th but through most of the month and into early January conditions were nothing to brag about.

I ran across Joe WB4OSN on 15 Meters one afternoon last week and naturally the conversation revolved around our favorite band. Joe said essentially the same things repeated above ... the big deal for the month was hearing the TI2NA beacon one time. Joe has been talking up 6 Meters on 10 Meters of late and has gotten some interest started in several South American countries. In particular, HC8GI is beginning to express the desire. The push is on to use 29.530 as a 10 Meter meeting place.

One last bit of news ... Joe says Bob '4PKW has applied for a VP7 call (prefix soon to be changed) in hopes of lining up a trip to the Bahamas sometime in the Spring ... hopefully during June contest week. This will be something new for the many who have gotten on the band since the days of Scotty VP7DD.

...WA0ABI



*Joe Kasser G3ZCZ*  
 1701 East West Highway, Apt. 205  
 Silver Spring MD 20910

Delays in processing license applications are not unique to the USA. A notice published in the Journal of the Wireless Institute of Australia, August 1974 reads . . .

"Licensing Delay in VK3.

If you have passed the examinations and have made application in Victoria for a license (or if you want a change in call sign or wish to reserve a call sign) you must expect to face a normal delay of about three weeks before getting your license." Three weeks — that's just due to the post office in this country.

The New Zealand Association of Radio Transmitters Inc. 1974 Callbook contains an item that advises overseas radio amateurs that holders of certificates issued by Australia, Canada, the United Kingdom, Eire and the Cook and Nive Islands can be granted reciprocal licenses on payment of the ubiquitous fee. The class of license is as follows:

Grade 3. VHF only for those with less than 12 wpm Morse.  
 Grade 2. 160, 80, 6 and up, for those with 12 wpm Morse but no evidence of operating experience.  
 Grade 1. Full privileges on all bands, for those with 12 wpm Morse and proven experience.

Now to Europe. The focus this month is Spain. The Spanish radio club is called La Union de Radioaficionados Españoles, and they publish a monthly magazine called U.R.E.

The magazine contains a number of advertisements for locally made VHF equipment as well as the ubiquitous Kenwood and Sommerkamp ones. If you plan to visit Spain you might find this list handy. It is a list of local representatives of the URE, so with this list and a call book you might make a useful contact.

Madrid	EA4JF
Baleares	EA6BC
Granada	EA7IE
Sevilla	EA7NJ
Valencia	EA5GO
Barcelona	EA3BD
Cadiz	EA7AR
Las Palmas	EA8CI
Tenerife	EA8AH

Since the Spanish hams are very active both on HF and on VHF, it would be nice if you took as gifts the usual hard to find (over there) components such as rf power transistors

for the home brewers, mint (commemorative) U.S. postage stamps for the DXers to get QSLs direct from stateside QSL managers, and integrated circuits of any kind. If you are not going for some time, it would be a good idea to write ahead and let them know that you will be visiting, that you would like to meet some of the locals. Give some details of your proposed itinerary and ask if there is anything you could bring along that they might find useful. Suggest one or two things so that they have some idea of the type of things you mean. The language in Spain is slightly different from the language of South and central America, even though they are both called Spanish. There are pronunciation differences and the use of idioms is different. It is somewhat like the difference between English as it is spoken in England and English as it is spoken in the USA. In fact after four years of marriage to my American wife I still find that we are talking different languages.

To finish off, on a recent trip out of town I forgot my charging cord for the TR-22. On hearing of my plight someone, and I can't remember who, suggested that a TV cheater cord would make a good substitute. Do you know that he was right? It works fine — just remember to take the rig to the store with you to ensure a perfect fit.

...G3ZCZ

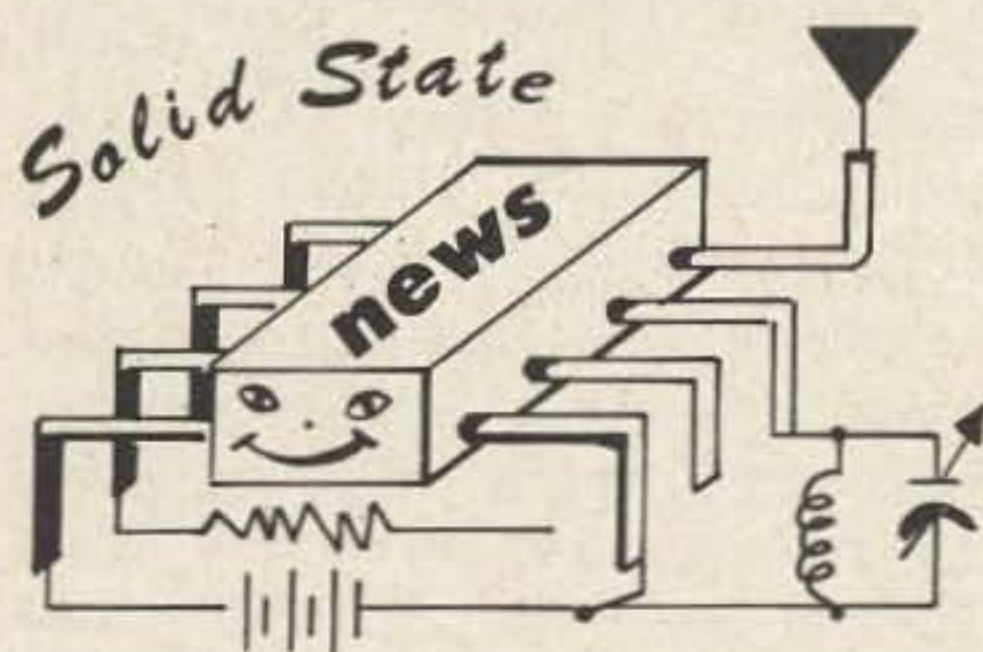

*Waller Scott K8DIZ*  
 7318 Hollywood Drive  
 West Chester OH 45069

A new digital voltmeter IC has appeared on the scene. It is the Analogic Corporation MN2301 one-chip DVM. Unlike other voltmeter ICs, the 2301 contains both digital and analog portions of the circuit on the same chip thus reducing interconnections and the need for as many outboard components.

This IC has been under development for three years and it was not an easy task to obtain the integration of both digital and analog circuits on the

same chip while striving for the required accuracy, power requirements, and other features. The chip design was first implemented for Analogic by a European company and then transferred to the U.S. for production by another semiconductor manufacturer.

The 2301 is a 3½ digit DVM of the dual slope integrating type. With the addition of dc reference voltages, power, a clock oscillator, a display strobing IC and a few resistors and capacitors it becomes a fully operational DVM capable of driving a LED display.

Specifications for the IC are an accuracy of 0.1%, temperature coefficient of 100 ppm/°C, an input impedance of 1000 megohms, and input current of 0.1 nanoamps.

The circuitry included on the 125 mil square chip includes an input amplifier, integrator, comparator, control logic, digital display outputs, zero level hysteresis control, polarity indication, under and over range indica-

tion, and an automatic zeroing circuit. The device is fabricated using P-channel MOS techniques. The 2301 can also take a triggered reading.

Analogic claims that by lowering the number of parts required to make a DVM, lower overall prices will result in more widespread use of DVM's and create new applications. They plan to use the MN2301 in a digital panel meter called the 2538, which will contain 20 to 30 additional parts and a ½ in. LED display. This panel meter measures dc volts only, but could be the basic part of a complete DMM with added range and function control circuitry. The 2538 DPM requires only 1.5 W of power and costs \$89.00. The MN2301 IC is \$39.00 in single quantities (Analogic Corporation, Audubon Road, Wakefield, Massachusetts).

Dual gate FETs have been around for a spell but new devices appear occasionally that should be of particular interest to hams. Two of these are

*Continued on page 18*

the 3N209 and 3N210. These dual gate transistors are designed and characterized for UHF communications applications. Both are rated at a common source power gain of 10 dB min. (13 dB typical) at 500 MHz. Features include zener diode protected gates, silicon nitride passivation for excellent long term stability, and excellent intermod distortion performance. Maximum drain-source voltage is 25 V and optimum drain currents are 5-10 mA. A typical noise figure of 4.5 dB can be obtained at 500 MHz with even better performance in the next two lower ham bands.

The 3N209 comes in a hermetically sealed TO-72 metal can and the 3N210 in a "MICRO-H" plastic package that looks like a very miniature IC with 4 leads (2 on each side). The 3N210 will solder nicely directly to stripline circuits. Reverse feedback capacitance is an extremely low 0.023 pF!

These devices are currently available from Motorola but will likely be sold by others in the near future. Prices: 3N209 @ \$1.35, 3N210 - \$1.10.

432 MHz has attracted DXers for many years, but recent interest in the rest of the 420-450 MHz for FM and repeater operations promises to increase the population of this, our widest "low frequency" band - low

frequency compared to microwave, that is! The field of VHF and UHF power transistors has seen some tremendous accomplishments in the last few years. The latest additions to the UHF field of high power transistors are the Motorola MRF621 and RCA 40971 45 Watt devices. These transistors are designed specifically for 12.5 V dc operation.

The MRF621 is the latest in the state-of-the-art series 450 MHz "CONTROLLED Q" power devices from Motorola. This device is spec'd at a minimum power gain of 4.8 dB at 12.5 V dc and a frequency of 470 MHz. The minimum collector efficiency is 55%. When operated in the 420-450 MHz band typical gains of 6.5 dB can be obtained. All units are tested to withstand a load mismatch at all phase angles of 20:1 VSWR and at rated input power. An internal MOS capacitor chip is utilized to form a "T" type matching network inside the transistor. This technique of internal matching networks Motorola calls "CONTROLLED Q."

At high frequencies, the transfer of rf from a signal source into the base of a transistor has presented one of the most difficult problems in the efficient design of solid state power amplifiers. Ideas have been borrowed from IC fabrication technology to help solve the problem. The insertion of a matching network into an rf power transistor package gives the

transistor a consistent and highly controlled Q. This controlled Q means that these devices are easier to match into the surrounding circuit networks and offer better consistency of other high frequency parameters than the standard rf power devices. At 450 MHz this can mean an increase from the previously available gain of 4 dB to 6 dB. For an input of 10 Watts, this can make the difference between only 25 Watts of output and 40 Watts.

With the new controlled Q devices, location of some of the impedance matching elements inside the package brings the network closer to the active transistor die. Not only does this eliminate some of the required external components, but it also means that a small amount of capacitance can minimize the imaginary part of the input impedance for maximum bandwidth. This keeps the input impedance virtually constant over the 420-450 MHz band in the MRF621. In addition, the internal construction techniques help establish a better signal ground by removing most parasitic reactance. Fig. 1 shows a schematic of the elements actually contained within the transistor case.

Controlled Q transistors use both monolithic and hybrid assembly techniques in their construction. The transistor die is fabricated using monolithic IC methods. A small MOS chip capacitor is wire bonded to the transistor die using hybrid technology. You can think of the resulting assembly as an active transmission line element for UHF amplifier design. The photo shows a closeup of the die and capacitor used in the MRF621.

Because of the high power handling requirements of this type of transistor, it is specially constructed with each of its many emitter sites having its own series ballast resistor. These resistors are made of nichrome and have different resistances in order to

Continued on page 20

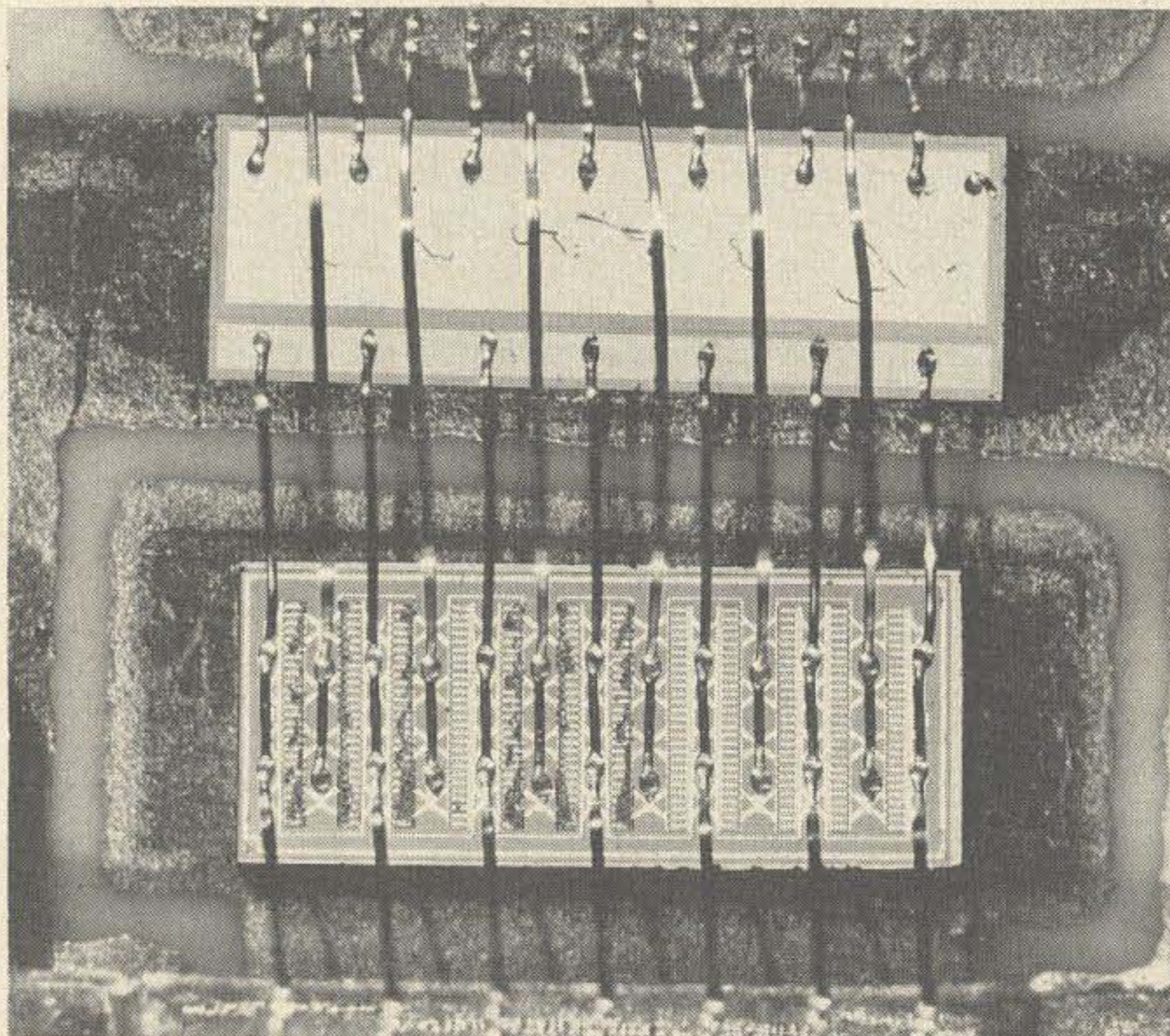

Inside a CQ Transistor.

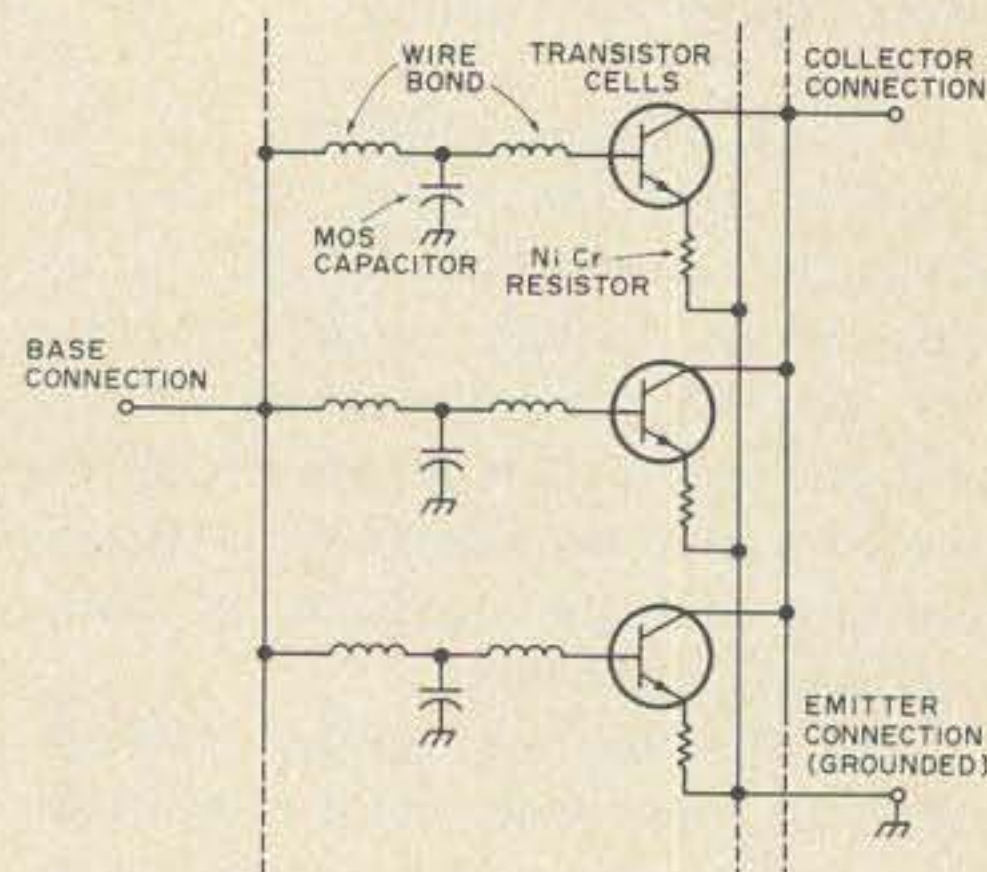

Fig. 1.

# " THE ULTIMATE IN SSTV EQUIPMENT "

ALL AMERICAN MADE — HAND CRAFTED CHASSIS & PC BOARDS



## THE SEEC HCV-3KB SLOW SCAN TV KEYBOARD

Announcing another first from the company and the designer of the world famous HCV-1B SSTV Camera and the HCV-2A SSTV Monitor, now the HCV-3KB Slow Scan TV Keyboard. This is the first commercially made SSTV Keyboard and it is built with the same quality as all SEEC/THOMAS equipment. We will not attempt to list all the features of the HCV-3KB here and we suggest that you write for full specifications. For those that are not familiar with SSTV Keyboards, the HCV-3KB eliminates the need for a menu board or other number/letter set-up arrangements which is very time consuming to set-up a meaningful text by arranging letters one at a time, by hand on a board or other surface. It also "frees up" the SSTV camera for other uses, such as live shots of the operator or other subject matter. Simply type out the message you wish to send. #DD-033469 on file in U.S. Patent Office.

### BASIC SPECIFICATIONS

\*30 characters per SSTV frame. Six characters horizontally and 5 characters vertically. Special 35 characters per frame available.

\*Meets all standard accepted SSTV specifications.

\*Positive-Negative color (video) reversal.

\* $\frac{1}{4}$  and  $\frac{1}{2}$  frame rates.

\*4 shade gray scale generator.

\*Dual Fast and Slow Scan rf and video outputs (special-optional).

\*Plug-in printed circuit board-gold flashed edge connector.

\*ICs, op amps, transistors in plug-in sockets.

\*Built-in 115/230 V 60 Hz power supply.

\*Special 16 $\frac{1}{2}$ " x 8 $\frac{1}{2}$ " x 3 $\frac{3}{4}$ " aluminum cabinet — black and white or optional 2 tone gray — specify. B&W Standard.

\*Special introductory cash with order price: \$455.00. Regular price \$495.00. Five ways to purchase: Cash, C.O.D. (20% deposit), Mastercharge, BankAmericard, SEEC Financing plan (up to 36 months). Note: All credit cards pay regular price of \$495.00. All prices F.O.B. Hendersonville TN. Standard 1 year warranty.

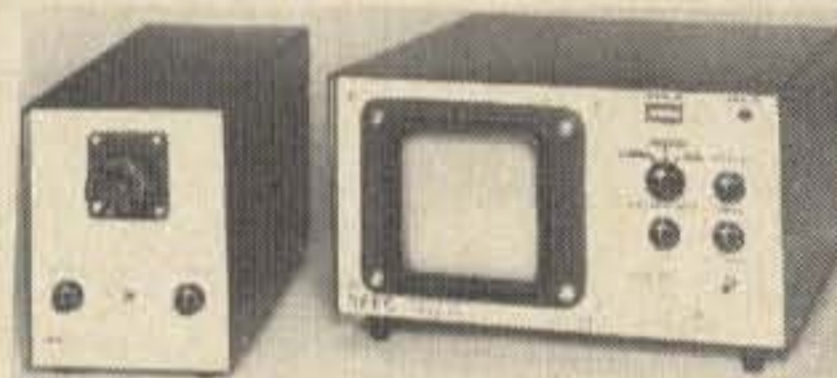

HCV-1B SSTV Camera \$452.00. (Reg. \$475.00) with lens & power supply.

HCV-1B SSTV Camera with ALC \$492.00 (Reg. \$515.00) with lens & power supply.

HCV-2A SSTV Monitor with 2 CRT filters \$398.00 (reg \$425.00).

HCV-2B SSTV Monitor with built-in Fast Scan viewfinder \$493.00 (reg. \$520.00).

HCV-70FSVFK Fast Scan viewfinder modification kit for 70 and 70A. Monitors \$69.95. Factory installation \$37.50 additional.

Sony TC110A Cassette Recorder \$134.95.

Heavy Duty Camera tripod \$34.95.

A complete line of camera and monitor accessories are available — please write for current prices and delivery. Five ways to purchase: Cash With Order, C.O.D. (20% deposit), Mastercharge, BankAmericard, SEEC Financing Plan (up to 36 months). Note: All credit cards pay regular price shown. All prices are F.O.B. Hendersonville TN. Call or write us for complete specifications on any of our equipment or to be put on our mailing list. We have a 24 hour telephone answering service to better serve you, plus on the air technical assistance from the designer, WB4HCV (Jim). Two locations to better serve you. Our main plant at 138-B Nauta-Line Drive, and our lab at 218 Tyne Bay Drive, Hendersonville. Complete 80-2 meter operation from either location. Drop in to see us if you are ever near Nashville, Tennessee.

## Sumner Electronics & Eng. Co. inc.

P.O. BOX 572  
HENDERSONVILLE, TENNESSEE 37075  
TELEPHONE: 615-824-3235

compensate for the thermal differences at various portions of the transistor chip. This prevents overloading of some of the emitters due to temperature differences. This technique of emitter ballasting assures balanced current distribution throughout the transistor for more consistent operation at various power levels. Many rf power transistors available today make use of this type of emitter ballasting construction. Careful examination of the photo will show the many emitter contact "fingers"

(metalization). The nichrome resistors are attached to each of these "fingers." CQ transistors have bonding wires extending from the base regions to the capacitor chip and then on to the package base lead. These bonding wires and the MOS capacitor form the matching network shown in Fig. 1. So much for the intricacies of rf power transistors. The MRF621 is available from Motorola for \$39.00 in quantities of from 1-24. At less than a dollar per Watt, the MRF621 is a pretty good deal!

The RCA 40971 is almost identical

in all specifications to the MRF621 and is mounted in the same type package, which is designed specially for efficient heat sinking of power devices. The package consists of a flange base requiring 2 bolts for mounting to a heat sink. The flange is electrically isolated. Four wide leads protrude from the encapsulated transistor die mounting area, 2 emitter leads, collector, and base. The 40971 is not quite as good a deal at \$60.00 (1-99).

Why not start building your UHF mobile rig right now? 73!

...K8DIZ

## SSTV SCENE

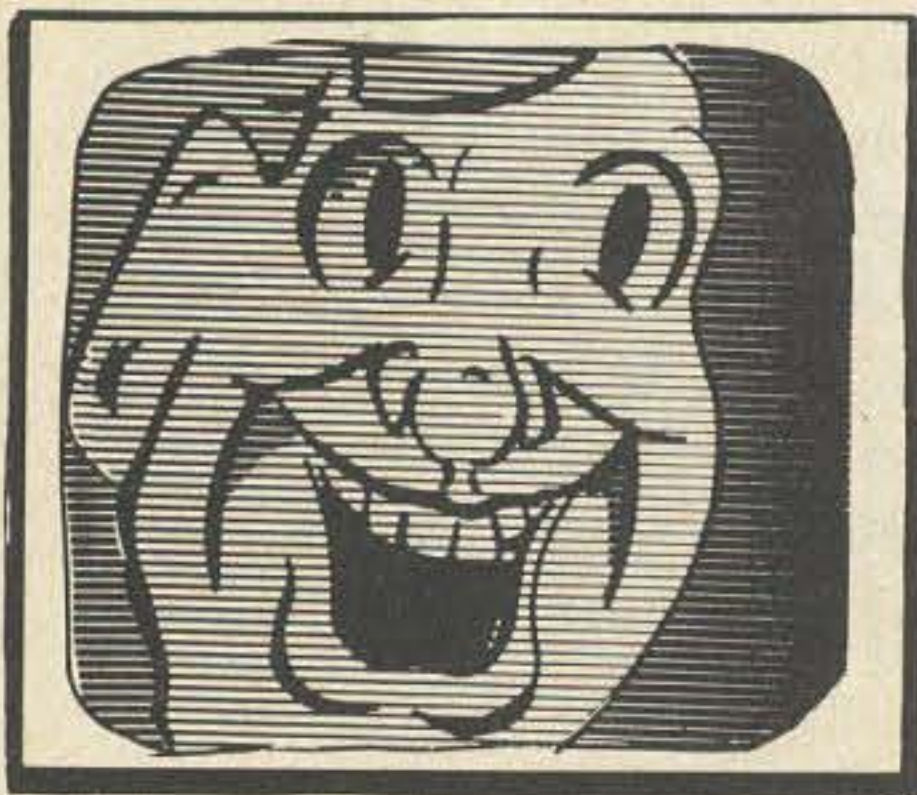

Dave Ingram K4TWJ  
Rte 11, Box 499 Eastwood Vil. 604 N.  
Birmingham AL 35210

### Save the P-7 Monitor

During the last few months I've been talking quite a bit about Slow to Fast Scan conversion. However, I don't want to give you the impression that regular P-7 type SSTV monitors are becoming extinct. Indeed, they still have several outstanding advantages. Sure, this era of poor propagation is a fine time to build gear and the advantages of scan conversion are obvious — bright pictures that can be viewed indefinitely on your regular (Fast Scan) television. But memory chip cost, coupled with our present economic status, still place the P-7 monitor as the easiest and most economical approach to SSTV. It will be a fair time yet before commercial manufacturers can build Slow to Fast Scan converters that everyone can afford. Several of the Fellows with scan converters say that ordinary P-7 SSTV pictures appear more natural and life-like than scan converted pictures. Possibly this is due to the extremely high definition capabilities and the minute instability in most scan converters. I think the situation could best be summed in saying that old time SSTVers would enjoy the

scan converter while newcomers would prefer a regular P-7 monitor.

### Spooky Subject

Several of the fellows have asked how multipath propagation creates "ghosts" on received pictures, so here's a brief explanation. Let's say there is a station in Germany transmitting to the United States. While the signal travels directly across the Atlantic Ocean, another wave of this signal also travels long path and across the Pacific to the United States. The long path signal travels much further than the direct signal. Thus, when received, there is an initial signal followed in one or two milliseconds by the long path "echo." Now, a SSTV Monitor sweeps each scanning line in 66 milliseconds, so the one or two milliseconds delayed picture produces a shadow or ghost to the right of the initial image. The brightness of this ghost depends on strength of the long path signal. Savvy?

### DXCC on SSTV

Our long time DX leader, Gene W8YEK, finally hit the 100 country mark during November.\* A Slow Scan first! As Gene is retired, his trump card was the availability of time necessary for such an endeavor. No doubt W4MS, W6KZL and some others are close on his heels. The world of SSTV is looking brighter!

### New Robot Gear

Robot Research is on the move again. This time the result is a model 70 B Monitor and 80 B Camera. Their new monitor boasts a built-in viewfinder function plus a built-in demod-

\*Our apologies to Gene W8YEK (and bread and water to our proofreaders) for misprinting his call on our February cover. An update from Gene: "I worked KZ5LG, 2XSSTV, and EI7D — total countries worked is 102. I have 96 confirmed as I received a card from EP2FB, HC1BV and EI7D." — Ed.

ulated SSTV waveform display. The 80 B Camera now features ALC (Automatic Light Control) and two axis sweep reversal controls. Owners of "A" model gear may obtain modification kits for these features directly from Robot.

### Newsy Notes

G3AID appears to be leading the European DX Pact with 73 Countries worked on SSTV. Richard G3WW is right behind him with 63 SSTV Countries. Richard is also the first British station to work SSTV mobile. G3OXY and G3WW report seeing I5SBF's good quality SSTV pictures through Oscar. Any stateside viewers of European SSTV via satellite? The United Kingdom SSTV Net is reported meeting on 3735 kHz Sundays around 1000 GMT. Any of you "early birds" catching this one? G3WW relates that the English Secretary of State for Home Affairs (formerly the Ministry of Postal and Telecommunications) reports issuing at least 125 "permits to transmit SSTV."

The most well known U.S. SSTVers in Europe are W4MS, W0LMD and W6MXV. Their circuits are popular overseas although transistors replace some of the IC functions. This situation makes sense when you consider their integrated circuits are expensive but transistors are extremely plentiful.

Australian SSTV activity is being promoted by the Eastern and Mountain District Radio Club, P.O. Box 87, Mitcham, Victoria. Their members are producing PC Boards for a SSTV monitor (Model X51) and camera (X52) which can be built for a very reasonable outlay of funds. One of the club's outstanding achievements is the development of an E-26 phosphor. This E-26 phosphor can be sprayed into a regular TV picture tube during the rebuilding process. The result is a

reddish-orange picture minus the bright initial trace which is common with P-7 tubes. Typical high voltage utilized is 15kV and it is reported the pictures can be viewed in relatively bright lighting conditions. The SSTV Club now has a TV picture tube rebuilder manufacturing re-phosphored and re-gunned SSTV tubes. Approximate off-the-shelf cost of an eleven inch SSTV tube is twenty-seven dollars.

Gervie W7FEN has been quite busy lately with several SSTV projects. His latest development is an external Independent Sideband adapter for the Drake TR-4C Transceiver. The outstanding feature of this unit lies in the fact it can be unplugged from a jack mounted on the TR-4 when normal operation, like mobile or portable, is desired. This converter could be a tremendous boost for ISB. I will have more information on this as it's available. There's also talk "in the wind" that Swan Electronics is working on an ISB Adapter for one of their transceivers. Gosh — the West Coast is hot on Independent Sideband!

There is a fair amount of Slow Scan

activity beginning to appear on 3845 kHz each Wednesday night around 8:00 pm Central Standard Time. A wide array of SSTV subjects are discussed and the format is relatively informal. Possibly this switch to 75 Meters is due to the poor propagation on 20 Meters.

Overseas Broadcasts are crunching our 40 Meter SSTV frequencies of 7171 and 7220 kHz. If any of you are operating on 40 Meters, how about dropping me a card describing your success.

W8OZA is now producing PC boards of the W9LUO MK II SSTV Monitor I mentioned a few months ago. This straightforward, inexpensive monitor is an ideal way for the neophyte to get started in SSTV.

#### Words or Pictures

I am still concerned about the large amount of printed material being exchanged over the air. One can verbally tell a contact anything that can be written on a monitor screen, but pictures actually show that rig or special project. Slow Scan differs from RTTY in that it is a *visual* means and

it doesn't make sense to use this means exclusively for facsimile type communication. Many (if not all!) SSTVers have some very interesting items around their shack, but instead of televising these, they transmit sketches or ID's. A certain amount of printed material is fine (and I'm not bucking that) but don't neglect using SSTV as a communications window also. Several fellows have enjoyed seeing my antique transmitters and receivers, my home brew linear in a TR-4 cabinet, the way my station is arranged and my "trick" 2 foot integrated circuit. The point I am making is this — Use the SSTV Camera as a *communications aid* and strive for more meaningful QSOs. Try to give your contact the impression of an actual visit. The results will be immensely gratifying.

In future columns, I will go into detail on camera operations — picture make-up, lighting and taping. Meanwhile, why not try your hand at transmitting some live pictures off the camera. Until then, 73.

...K4TWJ

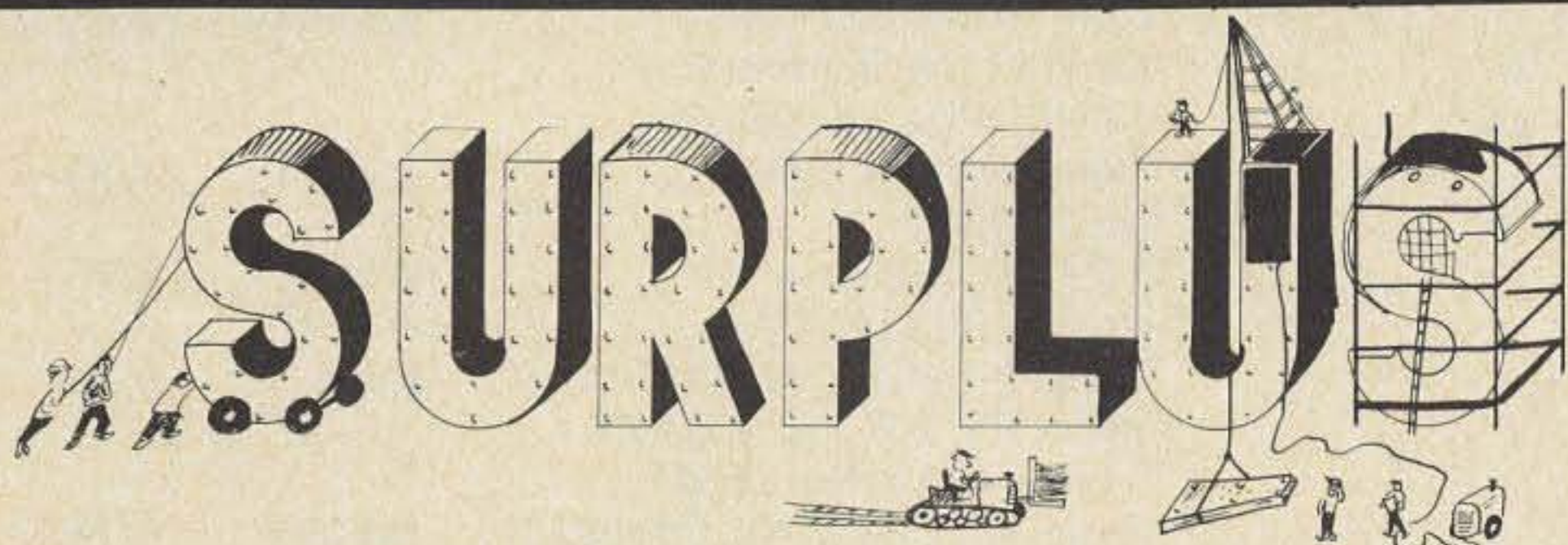

Bill Turner WA0ABI  
Associate 73

The first item on the agenda this month is crystals. Quaker Electronics, P.O. Box 215, Hunlock Creek, PA 18621 is the supplier of all the following at the most reasonable price of \$1.10 each postpaid. For the 6 Meter AM buff there are HC-6/U types at 50.3, .4, .5, .7 and .9. For the clock builder there are 360 kHz and 3.6 MHz for simple time-bases using only a 7400 gate for the oscillator and four or five 7490's for dividers. For the HF nut there is a 2.5 MHz crystal which would make an excellent calibrator with outputs at 500, 250, 50, 25, 5 and 2.5 kHz and requiring only the 7400 and three 7490s. For the 2 Meter FM fan a 3 MHz crystal is available which will when divided by 100, produce markers every 30 kHz, which pinpoints every repeater and

simplex channel. In this case it would be best to use a 74H or 74S gate as an output buffer in order to increase the harmonic output. Last but not least, there is a 5.000000 HC-6/U manufactured by McCoy which would be excellent for a counter time-base. In the counter which comes to mind, the K2OAW published in 73 during 1972, the crystal specified was 10 MHz. Modifications required to use this crystal are minimal. It is only necessary to jumper out a divide by two section of a 7490 somewhere in the time-base divider chain.

For the FMer or the owner of one of the new low power SSB rigs, Olson Electronics lists a 6 Volt, 6 Amp/Hr wet cell (dry charged... supply your own acid) for \$2.88. You would of course require two for most rigs. Also

of interest is a UHF TV tuner marked down to \$1.99 through the 24th of February. This is the same item mentioned several columns back as a possible converter for 420 MHz. For the FM receiver builder Olson has a 10.7 MHz FM i-f strip for \$1.59 (#XM-355X) or a similar unit with a multiplex detector (#XM-354X) for \$1.79. With the addition of a converter and an audio IC this should make a reasonably good monitor receiver for the ham bands or public service frequencies. One final item... a 12 Volt charger for the previously mentioned batteries, rated at 2.3A for only \$2.49. For the repeater crowd there is a TV remote control chassis including a stepper relay, power relay, switching relays, transistors, etc., etc., for \$7.98. Olson is located at 260 S. Forge, Akron, Ohio 44327 and has a handling charge of 50¢ for orders under \$5.

CPO Surplus, P.O. Box 189, Braintree MA 02184, has a number of smaller items of the types so often needed by the builder. Plastic and mica filled, 3 and 4 pin transistor sockets — assorted — 20/\$1.00 or 100/\$2.50. Disc ceramics; 2.2, 2.7, 8.0, 15, 100 and 500 pF, your choice 20/\$1.00. 470 or 500 pF button mica's, your choice 10¢ each, 500 Ohm or 500k PC mount 1/4 Watt

Continued on page 22

pots, your choice (may be mixed) 20/\$1.00, 1N34 equiv Germanium diodes, leads formed for PC mounting . . . 100/\$1.00. Augat Nylon ( H C - 6 / U ) c r y s t a l sockets . . . 10/\$1.00, and mica/ceramic padder capacitors, PC mount, 3-60 pF also 10/\$1.00. There is 50¢ handling charge for orders under \$3.00.

Through February 28th Burstein-Applebee, 3199 Mercier St., Kansas City MO 64111, is featuring the Midland model 13-902 weather radio at \$9.95, reduced from the regular \$15.95. This model is easily converted to repeater or public service monitor duty by merely padding the oscillator. For linear builders B-A has 1 Amp/4000 piv diodes at 2/\$2.95. These are 3/4 x 3/4 x 3 inches (18 x 18 x 75 mm) with 2 1/2 inch mounting centers (62mm) and solder terminal connections. For the low voltage/high current applications around the shack there are 12 Amp/100 piv diodes (Motorola MR

1121) at 3/\$1.00. B-A charges \$1.00 handling on orders under \$10.00.

Another good source of disc ceramic capacitors is Brigar Electronics . . . if you like to buy in quantity or split a batch among several people. Brigar currently lists 8.2, 11, 15, 100, 220, 390, 620 and 820 pF discs at \$3.00 per hundred or \$15.00 per thousand. All are 500 Volt rated and are of various tolerances and characteristics. In silver mica Brigar has Cornell Dubilier DM19 types in 270, 300 and 430 pF, 5%, 500 Volt at 7, 7 and 9¢ each. They also have the DM15 in 300 pF, 5% at 7¢. In 1/4 Watt resistors the 5% type manufactured by Spear are 3¢ each in 100,2700 and 51k values. For the ham who has everything— new, boxed, Eastern Microwave model 10-1259 high power dummy load, dc to 4 GHz, 50 Ohms, 1 KW and requiring point 218 gal/min water flow for each 100 Watts dissipated. The price is a mere \$29.95. Minimum order is \$5.00, the address is 10 Alice Street, Binghamton, New York 13904.

B & F Enterprises, 119 Foster St., Peabody, MA 01960, has some excellent filter capacitors for the linear builder. These are 25 OUF at 330 Volts and priced at \$1.25 each or 12 for \$12. Your \$12 buys (in round numbers) 2 OUF at 4 KV or twice the capacitance at half the voltage. Not a bad deal at all . . . For the military surplus nut/MARS member with a mad desire to run a selsyn or similar piece of 400 Hz gear, B & F has the answer if the requirement is for 70 Watts or less. For \$3.00 plus shipping they will send you an inverter transformer and schematic to make such a supply. Not much else is needed — a pair of transistors, a couple of resistors and capacitors — and you are in business running the equipment as it was intended.

Your comments are solicited as to what kinds of surplus you would like mentioned. If you need something in particular . . . drop me a note (SASE appreciated) and I will try to come up with the item you need . . .

. . .WA0ABI



**The Hamburglar STRIKES AGAIN!**

Mfr., Model, Ser. No.	Owner	Issue
SBE Model SB-144 No. 46316 \$25 reward \$25 for information for arrest and conviction of thief.	K4KVF/5	7/74
Clegg 27B No. 27103-2891	WA1ECF	7/74
Clegg 27B No. 27104-3498	W9VHD	11/74
Drake TR3 No. 12746A	W9VHD	11/74
Collins 30L1 No. 29625	W9VHD	11/74
Drake TR22 No. 620272	K3NCL	11/74
VHF Eng. 1501 amp	K3NCL	11/74
Std. 826M No. 203085	WA9VNW	11/74
Motorola Motran VHF Trans Serial No. DG153W	Contact 73	11/74
SBE SB-144 2m FM Trans Serial No. 720087	WA3IID	11/74
Varitronics HT-2, 146.97MHz Serial No. 640256	K3ZPH	11/74
Unimetrics Ultracom-25 Serial No. 090561	VE7AZG	11/74

2 mtr transc SBE-144 No. 620615, 2 mtr cry. & 148.29 155.655 159.21	Broulette	3/75
Standard SR-C 826M No. 110082	K2LSX	3/75
1 FT101 160 mtrs No. 82L129340/CWF	W1FX	3/75
Yaesu FT 401B No. 316104, Yaesu FV 401, No. 679927, Collins 75A4, No. 5564	Kragh	3/75
Regency HR-212 No. 2400829	K8COT	3/75
Yaesu FT401 A serial #316104 Yaesu FV401 serial #679927 Collins 75A4 serial #5564	K2UPD	3/75
Johnson Valient 2916		
Std. Handie Talkie Model 146A No. 310377 w/mini-mike	WB2HYW	3/75
Varitronics HT-2, 146.97 MHz receive crystal; TR22 s/n 640256	K3ZPH	3/75
Regency HR2B 49-01726. (Engraved C FH-6 & W2EKB)		3/75
Yaesu FT401 A No. 316104 Yaesu FV401 No. 679927 Collins 75A4 No. 5564 Johnson Valient 2916	K2UPD	3/75
TR-22 12 channels - channel 6 wired together plus GLB - homemade synthesizer	WB4JFI	3/75
5 Collins Model KWM-2A transceivers, Nos. 11359, 10731, 10095, 11218, & 16066	MARS Radio Station	3/75
2 Collins Model 30LI ampli, Nos. 10620 & 11012		
3 Collins Model 312B-5 Control radio, Nos. 10016, 10394 & 59502		
1 Collins 516F2 power sup. No. 18607		
3 power sup. Nos. 12046, 12045 12015		
2 Radio Rec. Nos. 2918 & 1168		
1 Multimeter No. 11065		



ou goons don't ever proofr  
easy manuscripts from tab  
bunch of trocks are long on  
you ignored my comments in  
I insist that you print ev

---

#### NICAD BEHAVIOR

---

Re: K2OAW article on Nicads: Under no circumstances should "alkaline-rechargeable" cells be discharged in excess of about 25% of capacity, since they have an irreversible chemical situation which makes them only about 25% of capacity truly rechargeable.

His statement of never "completely" discharge is much too optimistic. Any discharge in excess of 25% may be very hard to recover. This is not a widely published fact I realize, matter of fact it is kept quite quiet.

I would qualify his "don't solder to a cell", to exclude "tab" cells, which sure had best be soldered.

On the matter of "salvaging" Nicads, I have found connecting a reversed cell to a *very well* filtered dc source will quite often get a Nicad going the right way which refuses to charge on a normal charger.

A nice article, the kind I like.

... Jack Bayha W8BPY/7

---

#### MORE STARK COMMENTS

---

I was gratified to read, in your December issue, Peter Stark's information-packed and excellently-written article on Nicad care, undoubtedly the most complete presentation I've seen in an amateur journal on this most timely topic.

I would, however, like to take issue with one thing author Stark says regarding the use of filament transformers for chargers. I believe we're missing a chance to save a few bucks if we overlook all the 12.6 V ac filament transformers now lying unused in junk boxes.

Although Stark is correct in noting that the average voltage of a half-wave-rectified 12.6 V (rms) sine wave is only 6 volts, his argument against using a 12.6 V transformer in his 5 V Nicad charger does not apply if we replace his half-wave rectifier with a

full-wave bridge. Under this new arrangement, the average voltage of our full-wave-rectified 12.6 V (rms) sine wave is twice the half-wave value, or 12 volts. Since this is more than twice the Nicad voltage, we can conclude that the 12.6 V transformer is okay, after all.

The apparent contradiction stems from the fact that the battery charger *peak* voltage, not the average voltage, must be at least twice the Nicad voltage in order to obtain the desired constant-current Nicad charger characteristic. Naturally, with a peak voltage of 12.6 times root two, or 17.8 V, our 12.6 V (rms) transformer easily satisfies this requirement. To obtain an average charging current of 120 mA through the 5 V battery, use the 12.6 V transformer and a total series resistance of about 28 Ohms with the half-wave rectifier, or about 56 Ohms with the full-wave. Incidentally, another good transformer bet is the safe, el cheapo, doorbell transformer. Used in huge quantities, it rarely costs more than a couple bucks or so, and it comes with built-in series resistance.

Finally, a question for author Stark: I've heard that Nicads can be reconditioned automatically during charging by using a current made up of dc superimposed on ac. Is this true, and if so, what are the recommended charging characteristics?

Again, thanks for the great article, and I hope to hear from you.

... Ping S. Chun  
WA2SGF (KH6ALN/2)

---

#### AUTHOR K2OAW REPLIES

*Although WA2SGF is theoretically quite correct, practically he is cutting things too close for comfort.*

*What is clearly needed is a constant-current charger. In the interests of simplicity, most charging circuits approximate this constant-current condition by using a relatively large power supply voltage and then dropping a large portion of it in a relatively large series resistor. But if all of these circuits only approximate the ideal condition, how good an approximation do we need? This point is open to*

*discussion, but it is my feeling that reader Chun's 12.6 volt transformer is marginal for charging a 5 volt battery. For example, if the battery voltage drops by 2%, from 5 volts to 4.9 volts, the charging current will go up by about 1.2%. If line voltage goes up 10%, charging current will go up by 16%. This is not exactly a good approximation to a constant current, and I believe that a larger transformer voltage would be safer. The 24 volt transformer referred to in the article would definitely be a more conservative value.*

*The suggestion of using a doorbell transformer is a good one, though I would be careful when using it anywhere near its rated current. These transformers are designed for an occasional burst of current, not for continuous loads. I suspect that they would badly overheat if you kept your finger on your bell button for an hour or two.*

*Finally, charging Nicads with a combination of dc and ac current is a technique I have heard of, but never actually tried, so I cannot report on its usefulness. The idea is that the battery be charged in spurts, separated by short, heavy discharge currents. Honeywell used this idea in one of their electronic flashes a number of years ago but, to the best of my knowledge, gave it up shortly thereafter. It was written up in a Popular Science article about three or four years ago in connection with a storage battery charger. Another reader (Lloyd W. Root, K7AS) brought to my attention an article in the March 1970 issue of 73 Magazine which described a similar idea, but mentions that he has not noticed much difference between this technique and straight dc charging. I would appreciate hearing from anyone who has had experience with the Honeywell flash circuit.*

---

#### ALIVE AND WELL

---

Will you please let the ham fraternity know that the real K9OMA is alive and well, and does not travel about the USA repairing CB sets at truck stops from south Ohio to Kansas. As a matter of fact, I haven't left the State of Indiana in the past six months.

It seems that there is an individual using my call very freely about the country. I have notified the Chicago field office, the Kansas City field

Continued on page 24

office, and the Washington, DC office. They don't care. A fellow ham in Salina, Kansas has sent me a tape of my bootleg friend using my call, name, QTH and even my peculiar phonetics. The bootlegger has even had the gall to use my call in Indianapolis about 100 miles from my QTH.

... James Pliett K9OMA

---

TRY THAT, FCC!

---

I'd like to add a comment or two to your little article in Voxpop on p. 138 in Nov. 1974 concerning reciprocal licenses in the UK. I had not written ahead to anyone here when I arrived. I contacted the RSGB and was introduced to a Mr. Bostock, a G3???, who furnished me with a sheet showing me what was needed. This was a Monday. Later that day I went to the home office at Waterloo house with my WA2TLQ license, a photo stat of same, and my passport. A lady there helped me fill out a 3 page application. Note: Important on the application is a frequency standard of some kind — you must have one — a xtal calibration is ok. The application completed, she disappeared upstairs, then returned 20 minutes later to tell me the application was approved! Try that, FCC! Two days later I received G5BIU in the mail. I was impressed. The license was 3 pounds — about seven bucks — for six months. It's renewable so there you go. I am also permitted to operate as GM5, GA5 GC5 or GD5 and as portable with a /p appended to my call or from approved alternate premises with /A added. Bands are 160M, 3500-3800, 7000-7100, 14000-14350, 21000-21450, 28-29.7, 4 meters, 144-146, and some up. Been having a great time with an HW-7 and a GP.

... David Earl-Clark WA2TLQ/G5BIU

---

BILLINGS, HERE I COME

---

After reading your magazine for quite some time, I finally thought I should write to give my two cents.

I read with ever increasing fear the address from Commissioner Lee. Then your article about Japan and the state of American "Hamdom." After coming home from a six year hitch in the Navy, I was greeted with a sad state of affairs. I live in an area with a population total of about 15,000. Out

of that I know of only a dozen hams. There are no regular meetings and two meters is a disaster. I had purchased an ICOM IC-230 for use in the San Diego area where I was stationed. I got plenty of use out of it down there but am about ready to trade it off up here.

One local amateur (ex-California) had a 450 remote base and headed up the local repeater (16-76) both sited on a five thousand foot mountain with a one hundred and fifty mile radius of range. During the testing period of the repeater we found the local hams would rather use simplex because they could not understand repeater usage. So now that our license is on the way, the machine sits in the local two-way shop due to lack of interest.

One day while talking to one of the few active locals (another ex-California) in the area, while parked in a store parking lot, I had someone knock on my window. When I rolled it down I was greeted with "What channel are you on, I work 19." After talking for a while, I found out the gentleman was a ham who "let his license just expire" due to knowing there was no one to talk to on two. He had sold all his ham gear and bought a CB outfit, co-phased whips and a "black box" for getting over the bootleggers. I tried to tell him that we needed more people on two and to get his license back and get active. But he said "Why should I, all the guys I used to talk to have gone CB also."

Due to the fact that I have an Antenna Specialists 3 dB gain antenna on my car, everyone thinks I've got a CB set. Out of self defense I am going to pay the extra money this year for call letter plates! I can see that if the hams don't use it, we'll lose it!

I am a Tech class and really do not ever wish to change. I feel code is out-dated and useless. While in the Navy I was an electronics technician. Due to close work with the radio men I found out that code is used as a last resort only, and of the thirty that I know, only two could send and receive over five words per minute.

Once, while in San Francisco, I went to the local Navy ham club. Although nice, I was told that I could not even use the two meter base because I was a Tech not a General. Since we take the same theory test the only difference is the code. Needless to say I never went back. What kind of esprit de corps is that? The few people who have become interested in the ham radio that I know lose

interest quickly when told they have to learn code. The usual reply is "What for, I want to talk to people."

I soon will be working for Montana Power Co., and will be located in Billings, Montana. It's the biggest city in the state so there should be many active hams. Hopefully my enthusiasm for ham radio will not be drowned in a sea of apathy. Keep up the good work with your magazine.

... Ric Helvey WA7QZT  
Columbia Falls, Montana

---

HAM'S HUMP HELPED

---

Just a few words about your Ham Help column. I sent my name for the column back in early 1974. You ran my name in the column at that time. I received two calls from local hams, WB9DVY and WN9JMJ, so we got together to study theory and code. At this time all three of us have our Advanced tickets. Thought you would like to know. Thanks again. 73.

P.S. I can truly say your Ham Help column helped me over the hump.

... Don Cook WB9LOV  
Centerville IN 47330

---

THOUGHTFUL CB COMMENTS

---

I have just completed reading the December issue of 73 Magazine. I have been licensed in the class D, citizens radio service for slightly more than a year. My station affords communications between three mobile units and the base.

Since coming into the ranks of the CB population, I have probably saved several thousand miles worth of wear and tear on the mobiles, as they now do not have to come back to the base for new assignments. Of course, at various times the 27 MHz band displays propagation characteristics which are detrimental to good two-way radio communications. However, this problem stems from the continued use of rf amplifiers far above the allowable four watt CB output. I do not know the answer to stopping this, I believe the FCC is doing what it can. A recent article in a monthly magazine devoted to CB related items, showed the licensed CB population to be approaching the one million mark; of the unlicensed population who knows how many exist. Fines and

court orders evidently do not have their desired effect. Perhaps on the spot dismantling of the offending equipment would more likely get the point across. Much like the "revenueurs" would dismantle a still producing corn liquor, with an axe.

The area in which I live is located only a scant ten miles or less from a main FCC office, in Norfolk, Va. There are constantly rumors floating that the FCC is in town and listening, but the chit chat, though subdued, still goes on. Most of the handle talkers hang somewhere around 27.195 MHz. For the most part they keep their chatting to a minimum, though some can be a little long winded. While using a handle and talking on a channel set aside for mobile/base communications is presently a violation of Part 95, so long as they keep their QSO short and their power in the QRP range, they do not interfere with anyone. It is the CBer who must fly with all the QRO he can get, who dominates not only the channel he is on but for 60 kHz either side, that brings down the wrath of the FCC on everyone's head.

I recently read an article stating that the Canadian DOC, our equivalent to the FCC, was considering throwing in the towel, that in so many words, they were unable to control the situation. Perhaps that is a solution in itself. Maybe by the time the log jams of QRM become so deafening people will start to wise up. Perhaps FM equipment would put a halt to it. From what I understand propagation of LD in FM is very rare. Of course this would tend to make many millions of dollars worth of AM equipment obsolete. But then again why not an FM converter much like the converters that can be attached to regular car AM radios?

I understand that proposed modifications to Part 95 would make it illegal to manufacture or sell an rf amplifier capable of operation in the 25 to 30 MHz area. Also that upon inspection of a CB radio station that if such an amplifier is even found on the premises it will be assumed that it is in use.

The proposed class E is being met with stiff opposition from amateurs. From what I have read, the 220 MHz band was in little use until this proposal was put forth; now activity by amateurs is gaining. The adage of either use it or lose it seems to have struck home. However, one fact

remains; the amateur population is dwindling (I believe your figures in Dec. 74 issue of 73 Magazine states at the rate of 350 per month) while the CB population is gaining at near 4000 per month. The present licensed CB population being nearly 875,000. While the decision to allocate this portion of the amateur band may be political in nature, the sheer fact of weight of numbers will also make itself felt.

Let the hobbyist CBer go to this class E proposal, let him just have his head. However, if after the class E is allocated, should the hobbyist QRO CBer persist on 11 meters, burn him good, fine him, confiscate the equipment, and let him wear the gray uniform of the federal penal system for a while.

Well, in CB jargon, I've shot my nickel's worth. Let me say in closing that these are opinions, not of someone experienced in electronics, or anything like that, but just someone who would like his equipment to do the job for which it was intended. I've talked with the handle talkers and with the call letter operators, for the most part I am unable to separate them into good and bad guy categories. In closing I would like to thank you for taking the time to read this.

... James Johnson  
Light Hauling Ltd.  
KGK2528

---

#### THANKS ( YOU'RE WELCOME )

---

Just a short note to say thank you for your study courses and cassette tapes. Without them, my passing of the general exam last September (received license early in November) would have been much more difficult.

... Robert W. Gardner WA2OVT

---

#### OLDIES ARE GOODIES

---

I just received my January issue of 73 Magazine about an hour ago, and after browsing through it lightly, I do my heavy reading after supper, two things prompted me to drop you this note.

The first one was regarding the letter from the priest who was unable to understand all the solid state items in the wind-direction indicator. Then your editorial when you mentioned Virginia had been talking to an old timer who had commented about not reading any of the articles on tube type circuits anymore.

I happen to be one of those old timers too, received my license in June of 1938, but my worst downfall was only getting a ninth grade education.

I realize that the majority of the new hams are at least high school graduates and many college graduates so they have had the necessary math education to work with the modern day solid state articles that all the ham magazines are putting in their magazines these days.

Many of the old time hams here in this city have let their subscriptions expire for this very reason. I and a lot of the old timers here have been tired of all the 2 meter FM that has been put in your magazine recently. I, for one don't give a damn for 2 meter FM. It gripes me to see all the guys setting on one or two frequencies in the middle of a big band like 2 meters with very little activity on each end from CW, AM and SSB. Remember, we lost the 11 meter band years ago the same way because we didn't use it, we hams only have ourselves to blame when we lose our frequencies. I do work 2 meter AM right now, had a 2 meter SSB, CW rig some years ago but sold it when I heard no one on CW or SSB here in the city.

I work all bands from 2 meters up to 160 at the present time, and work all three modes, CW, AM and SSB. I have always observed the so-called gentlemen's agreement and worked the proper mode in that portion of the band.

I have, in my library, my prize collection of magazines that you published when you were with CQ, many years ago. I would not part with them at any price.

I only wish that you would publish your present magazine with the variety of articles like you did then. Let's have an occasional tube article, more antenna articles, something on 160 more often and an occasional RTTY as I am getting set up on RTTY rather than 2 meter FM.

I still think you have the best magazine of the 4 and I get them all, so keep up the good work and remember us old timers with an article at times and include a solid state directory for the benefit of myself and the priest who don't know the difference between a TTL and a DTL or a CMOS.

I'll be retiring in a few months, so will have more time to experiment and build, providing I know what I am doing. I have faith in the future of

*Continued on page 26*

your magazine, as you will note with the enclosed mailing label. I think my subscription is paid till January 1978 if I can figure your code right. In closing, my best regards to you and your family and staff at 73 for the coming year.

... William H. Toben W7JGL

All right. Let's have some articles of the type Bill suggests and we'll try to publish one or two a month... Wayne

REFORM OR DIE!

Today I received the December issue of 73 and, as usual, dropped everything else to read it. Totally irresponsible but absolutely pleasurable! I am one of those readers who tends to read the magazine from the back to the front and therefore read Commissioner Robert E. Lee's remarks last. Were it never true before, I can honestly say that this was one time when I read the best of 73 last.

While in college at Purdue University I got interested for the hundredth time in Amateur Radio (Commissioner Lee is right: Capitalize it as a measure of respect!) and through the Purdue club got my Technician's ticket (WB 9 EUV). To celebrate this accomplishment I subscribed forthwith to a lifetime subscription of 73 (boy, that's got to be the absolute best financial investment I've ever made - if I could apply that kind of wisdom to the stock market, I'd rule Wall Street!). However, since graduation in January, 1972 I set aside Amateur Radio to pursue my career. Several times I've started to renew my love affair but the thought of the Morse Code requirement for the General ticket repulsed me. Thus the text of Commissioner Lee's speech hit a nerve. Your own comments on page 124 also drove right to the quick.

The Amateur Radio Service in the United States, while serving without equal, is slowly dying. For years the established clique of ARRL, FCC, et al has prevented removal of a code requirement or a stipulation of a 5 wpm requirement for the General Class. Comes now the "new breed" in the personage of yourself, Commissioner Lee, and others who wish to rejuvenate the ranks. In the pages of your magazine we find such radical talk as needing to recognize CBers, etc. God, has this been a long time in coming!

There are those amongst us who will, with brazen stupidity, unmitigated gall, and unthinking selfishness, condemn these fine proposals, insisting instead upon the "purity of the past." These advocates stand a very strong chance of being the pall bearers of the Amateur Radio Service if their protests go without counter and defeat. This is 1974 and if Amateur Radio is to succeed it must streamline itself and redirect its path. Yes, take a lesson from the Japanese. Innovate, create, perpetuate! If, failing this, our leadership continues along the channel of antiquity, then surely the wings of the U.S. Amateur Radio Service will beat no more! If we must remove or modify the code requirement to attract new members to the ranks, do it! If we must join hands with CBers in the interests of the common good, do it! If re-allocation of frequencies is necessary, do it! Do these things and thousands of others. Let the readers of 73, CQ, QST, etc. join together and DEMAND that their editors aggressively act to bring these changes. Let the readers DEMAND that said editors JOIN TOGETHER (God, would that be refreshing instead of the incessant bitching) with men such as Commissioner Lee and those principals in the Citizen's Band community to enact immediate changes! Give our ranks 500,000 youth and then damn the torpedoes - full speed ahead.

Let us be as adamant about this, our greatest problem, as we are about the IRS, gasoline prices, and the cost of decent housing. We are a MINORITY. Take a lesson from other minority groups. Find strength and action through unity. Find despair and hopelessness through the plaintive cries for reform of the solitary and the foolish regressions of the "leaders" who have assisted us in reaching the point at which we find ourselves now. Change the rules, change the face of Amateur Radio, do whatever is necessary, but do NOT let this lovely mistress die! For she wears the face now of the great ships of the Cunard line who, like us, have no more places to go. True tragedy!

Can we, in closing, say "good luck"? Hell, no. Let instead the scream "Reform or die!" echo through the hallowed halls. Stop the infighting. Write your bloody Congressman and insist upon reform. If you don't think that 50,000 letters to the men in the Sam Rayburn building, etc. won't get some action, then there is no hope. Don't buy that new rig until you've spent 10¢ on a postage

stamp and sent your feelings to Washington. Amateur Radio could change completely in 6 months. Or never. R.I.P.

... Richard M. Bash

Thanks for the nice letter Dick. There's no doubt that the ham magazines could help amateur radio enormously if they could cooperate. Someday, I suppose, the inside story of the schisms within the ham publishing industry can be written - but for the present it would be an understatement to say that they seem insurmountable. 73 Magazine is ready, at any time, to cooperate to the fullest with the other publishers for the betterment of amateur radio.

... Wayne

AND FURTHERMORE...

In reference to my article on the R-392 in the August, 1974 issue, here are some corrections:

R2 is 4700 Ohms one Watt.

C2 is across ZD1.

Q1 is mounted on the chassis with a mica washer.

Q2 is mounted on the HEP 500 heat sink with a mica washer.

I apologize if I have caused your readers any inconvenience.

... W7UGV

UTICA 650A?

I am in need of some critical info. I am the owner of a "Utica" model "650A" 6 mtr am xcvr. This is now a defunct company. I need a schematic for this rig and I cannot find one locally. Could you, or one of your readers furnish me a copy of this item. If absolutely necessary, I will pay postage for the mailed drawing. Thank you from a loyal subscriber.

... John T. Carrigan, Jr.

WB4PES

WE'RE GLAD TO HELP

The novice course seems quite good (the parts I've had a chance to listen to) and the approach of explaining the ideas behind the questions instead of just dwelling on the questions themselves is very constructive.

Thank you for making these useful things available at a very fair price. I am positive that many people will be able to get into amateur radio that would not be able to do it the misdirected ways available in the past. I remember how hard it was for me to get even basic information on what to do when I did it 15 years ago.

... Ron Gunn WA6KLL

# MEET THE STATE OF THE ART ON 2 METERS... THE ITC MULTI-2000 CW/SSB/FM TRANSCEIVER



Whether your interest is simplex, repeater, DX or OSCAR the new ITC MULTI-2000 lets you get into all the action on all of the

band. Fully solid-state and employing modular construction, the MULTI-2000 enjoys features found in no other 2m transceiver.

## FEATURES

- PLL synthesizer covers 144-148 MHz in 10 kHz steps
- Separate VXO and RIT for full between-channel tuning
- Simplex or  $\pm$  600 kHz offset for repeater operation
- Three selectable priority channels
- Multi-mode operation (CW/SSB/NBFM/WBFM)
- Built-in AC and DC power supplies, noise-blanker squelch and rf gain control
- Selectable 1W or 10W output
- Separate S-/power and frequency deviation meters
- Built-in test (call) tone and touch-tone provision
- Excellent sensitivity (.3  $\mu$ V for 12 dB SINAD)
- Superior immunity to crossmodulation and intermodulation
- Introductory price: \$695.

**THE ITC MULTI-2000 TRANSCEIVER...  
PERFORMANCE THAT CHALLENGES YOUR IMAGINATION**

**INTERNATIONAL TELECOMMUNICATIONS CORP.**  
P.O. BOX 4235, TORRANCE, CALIF. 90510 • (213) 375-9879



**SAYREVILLE NJ  
MAR 2**

First annual electronic flea market of the Raritan Bay Radio Amateurs will be Sunday, March 2, 11 am at the Sayreville Community Center (Old VFW Hall) Dolan Street, behind Sayreville Municipal Bldg. 50¢ at the gate, \$5 per table. For information contact WA2SAJ (Rick) or WB2OVI (Alan). Talk-in on 146.52, .76, .94.

**ON-THE-AIR  
MAR 8-9**

We hams like to think of ourselves as communicators, but just what is it that we communicate? If we're honest, we'll admit that all too often it's trivia. During the weekend of March 8-9 there will be some communications of substance. These are messages which concern the future of our planet from some well known people into economics, ecology, energy and other fields; and some little known people involved with home brew approaches to designing a better future. Ron Wilbur K6ZEZ came up with this idea of a "Futures Hamfest" where we could listen to and talk with these folks via ham radio from our own shacks. Most of the action will take place on 7175 mornings, 14234 afternoons, and 3849 kHz both evenings. Generals will be able to call in on frequencies exactly 100 kHz higher, with comments and/or questions. Illustrations, when used, will be transmitted via SSTV. Come join us.

Cop Macdonald WØRX

**ROCK FALLS, ILL MAR 9**

Sterling-Rock Falls Hamfest will be held March 9th. For info write Donald Van Sant, 1001 9th Ave., Rock Falls, Illinois 61071.

**PARMA, OHIO  
MAR 14**

Spring ham gear auction sponsored by the Radio Club of Parma. Inspection 7:30 to 8:00 pm, auction 8:00 until at least 11:PM. Located in the basement of the Cardinal Savings and Loan Bldg., 5839 Ridge Rd., Parma,

Ohio. Bring gear to sell, find some goodies you need. 10% commission charged on items over \$2.50, 25¢ flat rate on anything under.

**BERRIEN SPRINGS, MI  
MAR 15**

Blossomland ARA Hamfest will be held at the Berrien Co. Youth Fairgrounds. Advance registration \$1.50, \$2.00 at the gate. Indoor tables \$1.00. For info write BARA Hamfest, P.O. Box 175, St. Joseph, MI 49085.

**HANCOCK MI  
MAR 15**

The Copper Country Radio Amateur Association will be having their annual Ham Radio Auction on Saturday, March 15, 1975 in Hancock MI. Everyone is welcomed. Talk-in on 3.922 MHz and 146.94 MHz. 2-meter repeater will be 146.28 MHz-IN; 146.88-OUT.

**STUART, FLORIDA  
MAR 15**

The Martin County Amateur Radio Assn. will sponsor a hamfest Mar. 15th from 9 am to 5 pm at the Tri-County Rehabilitation Center, 4461 S. Federal Hwy, Stuart, Fla. Prizes every hour, refreshments, exhibits, swap shop, etc. Talk-in 3.950, 146.94/94. For info write E. K. Shinn, 2089 N W Pinetree Way, Stuart, Florida 33494 or call 283-5210 or 334-4455.

**WHITEWATER, WIS. MAR 16**

The Tri-County ARC Midwinter Swapfest is March 16th, 9 AM to 5 PM at the National Guard Armory, Whitewater. \$1.50 advance, \$2 at the door (additional \$1.50 reserves one displaceable). Advance tickets eligible for special prize. Talk-in on 94. Refreshments, free parking, everything indoors. For tickets and details, Dan Servais, WA9AJW, Rt 4 Box 309AA, Elkhorn, Wis 53121. Tel 414-723-2227.

**SILVER SPRING MD  
MAR 16**

Sunday, 9-4 indoor electronic swapfest, rain/snow/shine, Whiteoak Armory, East Randolph Rd, 1/4 mile East of US29, Silver Spring MD. Door prizes, refreshments, For info and adv. table reser. contact Mike Cox K3GEG. (301) 262-9640. Talk-in 16/76 - 94 - 52 and channel 10.

**MIDLAND TX  
MAR 23**

St. Patrick's Day Swapfest beginning at 8:00 am in the Midland

County Exhibit building 2 miles East of Midland on highway U.S. 90. Bring all your goodies, it will be bigger and better than ever.

**CHARLOTTE NC  
MAR 23**

Metrolina Hamfest, Carolina Trade Mart, Corner of Stonewall and College Streets, 8 am til about 6 pm. Prizes and flea market. Sponsored by Mecklenburg ARS, Inc.

**PATERSON NJ  
MAR 23**

The Knight Raiders VHF Club will hold their auction and flea market Sunday, March 23, 1975 at the YWCA, of Paterson, 185 Carol Street, Paterson, New Jersey. Free admission, free parking, refreshments available. Talk-in frequency 146.94 MHz. Flea market tables: \$5 for full table, \$3 for 1/2 table. Reserve your tables in advance by writing to: Knight Raiders VHF Club, Inc., K2DEL, P.O. Box 1054, Passaic, New Jersey 07055.

**MALDEN, MASS  
MARCH 29**

The Malden Repeater Association will hold its auction on Saturday March 29 at 1 PM. It will be held in the rear room of A & W Electronics, 491 Riverside Ave., Medford, Mass. Talk-in on 19-79 & 52.

**BROOKLYN NY  
MAR 29-APRIL 6**

The Radio Society of Greater Brooklyn will hold its first annual Worked All States Week Contest March 29 0001G to 2359G April 6. Winner will be the one to work all states in the shortest period of time. Anyone who works all states within the period will receive a certificate. Special certificate to the Novice who works the most states and operator working most states under most unusual conditions. Number of states only counts, not number of QSOs. Logs must include description of your station and the time, date, call and state of all stations worked. Any legal band, mode or power. Send logs to F. Grossman WB2BXO, 9519 Ave. M, Brooklyn, NY 11236.

**TOWSON MD  
APRIL 6, 1975**

The Greater Baltimore Hamboree will be held at Calvert Hall College, Putty Hill and Goucher Boulevard, Towson, Maryland (one mile south of Exit 28 of Beltway-Interstate 695), on

Sunday, April 6, 1975 at 9 am. Food Service, Flea Market, Contests, Prizes. Registration: \$2.00. Complete table set-ups indoors. INFO: Joe Lochte, 5400 Roland Avenue, Baltimore MD 21210 or Brother Gerald Malseed, 8102 La Salle Road, Towson MD 21204. (301) 825-4266.

**JOHNSON CITY NY  
APRIL 19, 1975**

The Sixteenth Annual Hamfest, sponsored by the Southern Tier Amateur Radio Clubs, is scheduled for 10 am, April 19, 1975, at St. John's Ukrainian Hall, Johnson City, New York. Admission to lectures and flea market only, \$1.00 for adults. Total admission, including awards and excellent dinner, \$6.50. For tickets or further information, write to: STARC, P.O. Box 11, Endicott NY 13760.

**COLUMBUS GEORGIA  
APRIL 19-20**

The Columbus Georgia Hamfest sponsored by the Columbus Amateur Radio Club will be held April 19-20, 1975.

Activities will begin with the flea market at 1 pm Eastern time. on Saturday and finishing with the main prize drawing at 2 pm Sunday.

For information and reservations contact Gary L. Kindred, 293 Nightingale Drive, Columbus, Georgia 31906. Phone 404 689-4494.

**RALEIGH NC  
APRIL 20, 1975**

Third Annual Raleigh Amateur Radio Society Hamfest will take place all day Sunday, April 20, 1975, at Crabtree Valley Mall, Hwy 70-W, just west of the city. A covered flea market, bigger than ever; many great prizes; group meetings will be featured. General admission \$2.50 ea. Food at reasonable cost. For flea market reservation and other info write: George Richards WA4EKJ, Chairman, RARS Hamfest, P.O. Box 17124, Raleigh NC 27609.

**GRAND RAPIDS MI  
APRIL 24-26**

Grand Rapids Annual Communication Show and Swap 'n Shop. On the Mall exhibits April 24-26, 1975. Ham and Electronic Swap 'n Shop April 26, 1975. At Eastbrook Mall on East 28th Street (N.E. corner of M11 and M44). Contact Bob WN8PTM, P.O. Box 2402, Grand Rapids, Michigan.

**AMBOY IL  
APRIL 27, 1975**

Rock River Radio Club Hamfest, Sunday, April 27, 1975. Same location as in past year's at the Lee County 4-H Club Center, Amboy, Illinois. 1 mile East of Junction Rt52 & Rt 30, South of Dixon, Illinois. Advanced Tickets \$1.50. Gate \$2.00. Special to April 1, 1975 4 tickets for \$5.00. Rain or shine, indoor facilities, etc. Camping area. Limit 1 table free per party. Additional tables \$5 each or bring your own. Talk-in frequency will be 146.94 mc.

**DURHAM NC  
MAY 17-18, 1975**

Durham F.M. Association proudly presents its annual Hamfest, flea-market and F.M. Convention, Saturday and Sunday, May 17-18, 1975. Downtown Ramada Inn, Durham NC. Advanced registration \$2.00 - \$3.00 at door. Children free. Saturday night banquet - res. \$11.00. For info write: Durham F.M. Association, Inc., P.O. Box 8651, Durham NC 27707.

**CONNECTICUT  
QSO PARTY  
MAY 3 to MAY 5**

Contest period 2100 GMT May 3 to 0200 GMT May 5. Certificates to highest scorer in each ARRL section or Province and each Connecticut county. Special - Worked All Connecticut Counties certificate. Trophy to highest scoring club entry. For info write Candlewood Amateur Radio Assn., c/o Donald Crosby W1EJM, 10 Royal Rd., Danbury, Conn. 06810.

**KNOXVILLE TENN  
MAY 24-25**

The Radio Amateur Club of Knoxville is pleased to announce that its annual Greater Knoxville Hamfest will be held again on May 24th and 25th, 1975. As always, the activities will be located in the Jacobs Building at Chilhowee Park, Knoxville. All activities, including the large flea-market, will be held indoors, so inclement weather will be no problem. In addition to the fleamarket and various exhibits, we have an excellent zoo, amusement park, and overnight camp hookups right in the Park. No hamfest admission or registration charge. Table rental for fleamarket. Ticket donations for prize drawing on Sunday. Picnic Saturday afternoon. Talk-in on 34/94 and 3980. More info from WA4BTK, John Gwin, 1316 Kirby Road, Knoxville, Tennessee 37919.

**73 april**

**FM  
FM  
FM**

**Mini-Repeater  
Yaesu Sigmasizer  
Tunable FM Receiver Strips  
Kit Repeater -  
Another View  
HW-202 AC Power  
The Perfect SSTV Picture!  
IC-230 Versatility  
Hefty 12V Supply  
2m Linear Amplifier  
Can Ether Cause Gravity?**

**Plus:  
TELEPHONE CIRCUITS  
Frighteningly  
Comprehensive  
BOOK SUPPLEMENT!**

**UP  
COMING**



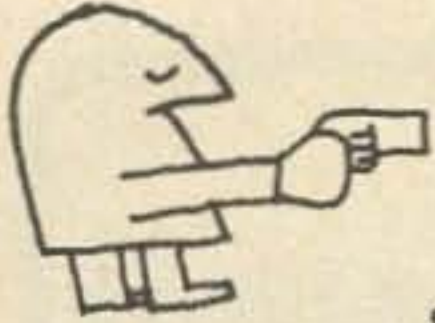

**APRIL 5-6  
SP-DX CONTEST**

From 1500Z April 5 to 2400Z April 6. 80 thru 10 meters CW. Work as many Polish stations (SP, SQ, 3Z) as possible, once per band. Call "CQ SP." Send RST and serial QSO nr. (E.g. 599001, etc.) SP/SQ/3Z stations will send RST and POWIAT abbreviation (e.g. 559AB, 379ZG, 549KC, etc.). Score 3 pts per SP QSO per band and multiply by each POWIAT denoted by two-letter abbreviation, but only *once* independently of band. Categories are single-op multi-band,

**CONTESTS**

Tom DiBiase WB8KZD  
708 6th Avenue  
Steubenville OH 43952

multi-op multi-band, single-op single band (separately each band), and single-op listeners (SWL). Logs must show dates/times GMT, complete exchanges, summary sheet with all scoring info, category of competition, name and address, multiplier check list and usual declaration. Appropriate awards. Postmark deadline is April 30. Send to: SP-DX Contest Committee, P.O. Box 320, 00-950 WARSZAWA, POLAND.

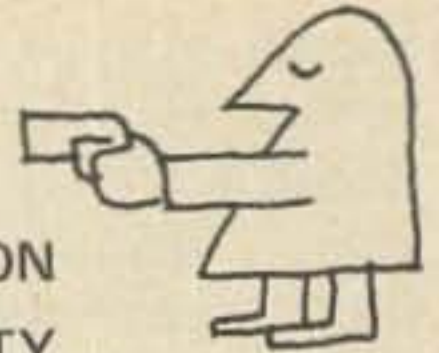

**RESULTS  
1974 WASHINGTON  
STATE QSO PARTY**

Top five Wash. — WA7SLO, WA7UQG, K7RSB, W7YTN, K7KGP. Top five non-Wash. — WB4YPT, W7RIR, K4ZGB, W4UPJ, K6WT. Sponsor — Boeing Employees' ARS.

REMINDER: Send all info on contests to the above Steubenville address 3 months prior to the date of the contest. Thanks.

...WB8KZD

**QSL CONTEST: GEORGIA PEACHES**

**W4HWN**

ROBERT L. (LARRY) YOUNG 422 UNIVERSITY DR. ATHENS, GA. 30601

**'HAM AIDS' SEA RESCUE**

Amateur radio enthusiast Larry Young sat in an airplane and manna mended a long-distance sea rescue of a young couple floundering in a sinking 50-foot sailing schooner in the Pacific early Sunday and Monday.

The 18-hour ordeal ended at 7:20 p.m. Monday through a network of ham radio cooperation.

Young was driving to his home at 1 a.m. Sunday when his superpowered car radio picked up a faint message from another ham, Jack White of New Zealand.

White's message was that Dorothy West and his wife were frantically hauling sea water out of their schooner Yamao — at trouble somewhere in the west Gulf of Mexico.

When Young reached home, he switched on his 1,000 watt amateur station, and was able to contact West, who told him, "When we pump, the caulking in the leak breaks. When we work, the water stops in. We are pulling 35 degrees and the winds are big and the sea is rough. We are very tired."

Fixing the Yamao's position, Young contacted another ham, Murray Gilbo, who was aboard the freighter S. S. Horace Lokenbach. Gilbo's ship was about 400 miles south of the sinking schooner, but would head full steam for the distressed craft.

Another ham, Carol DeLeon Zambrana Jr., in Mexico City, happened to listen in on the action, and he raced to Naval Headquarters to enlist the aid of the Mexican patrol boat S. S. California in the rescue. Fernando at Vallarta, a ham in Cincinnati, Mexico, made radio contact with the S. S. California, and Naval Headquarters gave the okay through him, which was re-



**HAM HELPS SAVE LIVES**

Ham radio operator Larry Young has been commended by Minnesota Secretary of State Joseph I. Dowd for saving victims in a boisterous storm from heading to death.

"Your action was a great help," said Dowd in making the commendation in letter.

"It was not luck on my part," commented Young today.

Young referred a plea for help from a Minnesota boat back to authorities there in time to send ambulances speeding to the scene. Latest word is that all of the accident victims will live.

"I was just looking to help hands — as usual when I hear a distress who is a ham in Minnesota calling for help. The doctor — he's a PhD, not a medical doctor — was riding in his automobile when he came upon the scene of a very serious accident on Highway 104 near Lake Mille Lacs."

"He said it was a pretty bad wreck and that several people were hurt and needed help immediately," recalled Young.

A peculiarity in ham reception makes it impossible for other operators in the area to hear the ham who's transmitting, so Dr. Fellow S. Jenkins was unable to get response to his plea for help from amateur radio men in the Minnesota area.

But the message was audible to fellow hams, and Young happened to be on the receiving end. Young immediately sent out the distress call, and three hams in the Minnesota area phoned the Minnesota State Patrol — giving the exact location furnished by Young through Dr. Jenkins.

"Some of my friends asked me why I didn't put in a long distance call to

arrived by Fernando Diaz, aboard the boat.

Two ships were then speeding toward the stricken Yamao — the Oregon Lokenbach and the S. S. California.

If the Lokenbach arrived first, the 300-foot ship planned to "tow" the boom and take the whole ship (Yamao) aboard. But the California was first to reach the schooner, and the Mexican patrol boat towed the Yamao to port in Manzanillo, Mexico.

**RADIO HAMS PERFORM SERVICE TO COMMUNITY**

Doing it the ham way, we had the

**K4COR**

Confirming QSO with \_\_\_\_\_ on \_\_\_\_\_ at \_\_\_\_\_ GMT on \_\_\_\_\_ MHz RST \_\_\_\_\_



689 ROLLINGWOOD DR.  
STONE MOUNTAIN  
GEORGIA U.S.A. 30083

**HAM HELP**

Helpers: Times are tough all over, but remember when you were just starting out? Brighten one of the following's ham day by getting in touch and lending a hand. Preserve the race!

Helpes: Don't be bashful. Drop a postcard to 73, Ham Help, Peterborough, NH 03458.

Sid Blumner  
9425 Ramona Avenue  
Montclair CA 91763  
714-626-6447

Candace M. Vorpahl  
1508 S 92nd St. Apt 16  
West Allis WI 53214  
414-476-8755

J. E. Stewart Jr. WN2UTF  
Mileses NY 12761

Kevin derKinderen  
38 Great Republic Avenue  
South Weymouth MA 02190  
617-335-5259

Ed Wilkening  
900 E. Manitoba  
Ellensburg WN 98926  
Tel No. (509) 925-2407

Bill Fletcher  
1230 Hiawatha Drive  
Beaver Dam, Wisconsin 53916

LeRoy Davis Jr.  
1117 Clagett Drive  
Rockville, Maryland 20851  
301-762-3425

Preston E. Koelling  
P.O. Box 428  
Webb City MO 64870



# Caveat Emptor?

Price — \$2 per 25 words for non-commercial ads; \$10 per 25 words for business ventures. No display ads or agency discount. Include your check with order.

Deadline for ads is the 1st of the month two months prior to publication. For example: January 1st is the deadline for the March issue which will be mailed on the 10th of February.

Type copy. Phrase and punctuate exactly as you wish it to appear. No all-capital ads.

We will be the judge of suitability of ads. Our responsibility for errors extends only to printing a correct ad in a later issue.

For \$1 extra we can maintain a reply box for you.

We cannot check into each advertiser, so Caveat Emptor . . .

**SALE:** Heathkit HW 202 FM transceiver with tone burst and ac supply. Factory serviced. \$185. Alton Dwight Sunday 708 Langrick St., Sturgis MI 49091.

**COLLECTOR** is interested in books, autographs and other information on early radiotelephone pioneers. Ronald Phillips, 1925 Baltimore, Kansas City, Missouri 64108, (816) 842-9009.

**COLORADO HAM** directory. Over 4,000 listings by call, name and zip. Also lists Colorado repeaters and nets. \$2.50 ppd. from the Colorado Council of Amateur Radio Clubs, Box 242-A, Longmont, CO 80501.

**CMOS INTEGRATED** Circuits. While they last. Guaranteed, tested. 1103 \$2.89, 4011 39¢, 4049 89¢, 4116 99¢, Dual NPN like 2N4880 47¢, many more types. Postage free with \$5 order. Electronic Product Associates, Inc., Box 80341, San Diego CA 92138.

**TRADE HANDI-TALKIE** Regency HRT-2, new, never opened, for any interesting solid state gear. WØKGI (303) 447-8692 (Colorado).

**AMSAT/OSCAR** 6-7 slides — set of 5, \$1.25 lift-off and equipment. Proceeds AMSAT. K6PGX, P.O. Box 463, Pasadena CA 91102.

**TALLY SYSTEM** 1020A Digital mag. tape deck. Perfect for mini-micro computer systems. 2 manuals — full spare parts included 140,000 8 bit or 5 bit word capability complete with control panel and power supply, fully operational — new condition. First \$350.00 takes it. R. McCulla K7HBG, 20333-15 NE #28, Seattle WA 98155.

**FM RECEIVER**, preamp, scanner, UHF converter kits. Hamtronics, Inc., 182 Belmont, Rochester, NY 14612.

**R-390A/URR** — like new, recent overhaul, with books and connectors. \$550, pick-up only. WA1TEJ, 31 Kern Drive, Nashua NH 03060.

**AN/URA-8B** — like new, complete dual-diversity RTTY audio-type TU set (2 each CV-89A/URA-8A converters, CM-22A/URA-8A comparator, MT-719/URA-8A cabinet, connectors and book). \$350, pick-up only. WA1TEJ, 31 Kern Drive, Nashua NH 03060.

**TT-63A/FGC** — Excellent RTTY regenerative repeater with book. \$25, pick-up only. WA1TEJ, 31 Kern Drive, Nashua NH 03060.

**AN/FGC-20** — Kleinschmidt TT-100/FG teleprinter, like new, with table, copywinder, 60, 67, 75 and 100 gears, book. \$150, pick-up only. 31 Kern Drive, Nashua NH 03060. WA1TEJ.

**AN/FGC-25** — Kleinschmidt ASR, like new, complete with table, printer and printing reperf, 3 books. \$200, pick-up only. WA1TEJ, 31 Kern Drive, Nashua NH 03060.

**COMPLETE RTTY** receiving set-up as listed individually above, plus 170 HZ AFSK board, 19" relay rack, RTTY manuals, cables, etc. \$1,000, pick-up only. WA1TEJ, 31 Kern Drive, Nashua NH 03060.

**AN/APX-6** and late **AN/APX-6B** 1296 transceivers, unmodified, one less tubes, with mobile omnidirectional antenna. \$50, pick-up only. WA1TEJ, 31 Kern Drive, Nashua NH 03060.

**DIODES**, Mallory 2½A, 1000V. 10/\$2.00, 50/\$8.00, 100/\$15.00, 1000/\$120.00 BECO, Inc., Box 686H, Salem, VA. 24153.

**SELL:** Motorola 60W desk top 3 channel on 2M. GE pocketmate on 94 manual. Best offers. Vernon Fitzpatrick, WA8OIK McLain Park, M 203 Hancock MI 49930.

**COMPLETE 5-Band SSB** Station. Central 20A XMTR w/VFO; Heath HR-10B RCVR; Antenna Tuner w/SWR, Mic, Key, Phones; \$150/offer; Carey Witkov 9110 LaCrosse Skokie, Ill. 60076.

**PC Boards**, from magazine page; original; magic marker; art, 1/2:1-1:1-2:1 Scale size. \$3.30 up. BECO, Inc., Box 686H, Salem, VA. 24153.

**AUTOMOTIVE** Voltage Regulator Kit, IC Construction, (PE April 1971) RFI Free, \$16.95 — \$19.95. BECO, Inc., Box 686H, Salem, VA. 24153.

**FOR SALE:** R-390 receiver \$100.00; 30 watt 6 meter Motorola transceiver \$25.00. WA1QKQ, 18 Clearview Ave., Lynn MA 01904.

**WANTED:** Hallicrafters T-54, early 7-inch TV receiver in metal cabinet with push-button tuning. Any condition, including parts only. Also manufacturer's service manual (not Photo-fact). Please write the description to: C. H. Sarver, 6011 N. River Rd, Waterville, Ohio 43566.

**VERMONT HAM** Paradise for rent May-October. New six bedroom chalet S. Londonderry, Vt, Windham County, complete with Drake kilowatt station 80-10, Tower and Tribander, near lakes, theater, shopping, antique auctions, tennis, elevation 1200 feet available by week, month or season. Peter Sherry K2AUO. (212) 532-5047 or Box 194 S. Londonderry VT 05155.

**MOULTRIC AMATEUR** Radio Klub 14th annual hamfest, April 27, Wyman Park, Sullivan. Indoor, outdoor market. Tickets \$1. Advanced \$1.50 at gate. Write Mark, P.O. Box 327, Mattoon IL 61938.

**HEATHKIT** HD-15 phone patch, mint, \$30; Westinghouse 3" reel tape recorder & 4 tapes, needs some work, \$20. Richard Morofsky, Box 11, Nemacolin, Pennsylvania 15351.

**DECORATE YOUR SHACK.** 2X3 ft. Vinyl backed washable polyester mat with "AMATEUR RADIO" and your call. In red, green, gold, or blue with black letters. Enclose \$15.95 plus \$2 shipping and handling. Georgia residents add 3% tax. BankAmericard or Master Charge accepted. Ringo Sales Co., Box 577A, Ringgold, GA 30736.

**CLEGG, SWAN**, CushCraft at prices I dare not publish. Call or write WØNGS, Bob Smith Electronics, 1226 9th Ave., North, Fort Dodge, Iowa 50501. (515) 576-3886.

**VACATION LAND HAMFEST** Sunday May 18, 1975; Erie County Fairgrounds near Cedar Point. Huge flea market area. First prize — Regency HR-2B. Tickets \$1.00 advance, \$1.50 at gate. Information: Hamfest, P.O. Box 2037, Sandusky, Ohio 44870.

**DRAKE** TR-4, MS-4, AC-4, DC-4 Mint condition. \$450.00 or best offer. Knud E. M. Keller, RT 12 A, Surry, NH 03431.

*Continued on page 32*

CAVEAT EMPTOR from page 31

ATTENTION DXers! Ham sentences written in 54 languages get DX QSLs. Use K3CHP's DX QSL GUIDE. \$3.95. Joe Mikuckis, 6913 Furman Pkway., Riverdale, MD 20840.

FREE: 12 extra crystals of your choice with the purchase of a new Regency HR-2B at \$229. Send cashier's check or money order for same-day shipment. For equally good deals on Drake, Collins, Ten-Tec, Kenwood, Swan, Atlas, Standard, Tempo, Clegg, Icom, Genave, Midland, Alpha, Hy-Gain, Mosley, CushCraft, and Hustler, write to Hoosier Electronics, your ham headquarters in the heart of the Midwest. Become one of our many happy and satisfied customers. Write or call today for our low quote and try our individual, personal service. Hoosier Electronics, R.R. #25, Box 403, Terre Haute, Indiana 47802. (812) 894-2397.

MIDLAND 30 Watt 13-505 w/.94, .34, .76, .88, .85, .82, .52 and 5/8 wave ant - \$250, HWIZA, new HP13B, Hustler Ant & chain mount, good mike - \$165 - W9DSV, 21 Britton Dr., Hudson FL 33568. (813) 868-3991.

CLEANING OUT shack for fun and profit! All types of equipment for sale at hamfest prices including CW, SSB, ATV, SSTV, RTTY, FM, HF/VHF/UHF and even radar as well as station accessories, antennas, and test equipment. A huge assortment of tubes, vacuum variables, meters, capacitors, transformers, blowers, resistors, relays, high power components, and other rare goodies too numerous to mention. Send large S.A.S.E. for list to: WA8ONQ, 311 N. Marshall Road, Middletown, Ohio 45042.

WANT SIGNAL ONE CX-7 working or not, will trade my new TS-520 up or down. Need 3-400z or 3-500z. Pohorence, 2334 Regal Court, Lawrenceville GA 30245.

FOR SALE: Swan 250, 117XC. Excellent \$300.00. HT-37, P.T.T. VOX like new, manual \$165.00. HA-2, P26, manual \$175.00. Want LSB, CW, filter for TR-6. Call or write Jim W1VYB (617) 922-3850.

TECH MANUALS - \$6.50 each: R-220/URR, URM-25D, USM-159, USM-16, PRC-10. Thousands more available. Send 50¢ (coin) for large list. W3IHD, 7218 Roanne Drive, Washington DC 20021.

AUCTION

Canton Amateur Radio Club, Friday, March 14, 1974 at 6:00 pm, check-in on 52 or 19 79. Imperial House at I-77 and Easton St., Canton, Ohio.

TWO-METER FM ANTENNAS, 1/4; 5/8 W "Cartop"; and Fixed Station. Unique designs. Send for literature. Marsh Devices, P.O. Box 154, Old Greenwich, Connecticut 06870.

SELL J&R SSTV, Yaesu 400 S.D. rcvr, 400 xmtr, F.T.V. 650. Other priced to sell. (304) 478-2270 evenings. SASE - List. Box 326, Parsons WV 26287.

RADIO EXPO 75: September 6&7, Fairgrounds, Grays Lake Ill. Seminars, fleamarket, manufacturers' exhibits, camping. Information: Write EXPO, Box 1014, Arlington Hts., IL 60006.

COLLECTOR is interested in books, autographs and other information on early radiotelephone pioneers. Ronald Phillips, 1925 Baltimore, Kansas City, Missouri 64108. (816) 842-9009.

WANTED old radios and radio items. Also old toy trains of all kinds. Want viking KW Desk Amplifier - mint. W2GHF, 45 Allen Dr., Woodstock NY 12498.



NOW YOU CAN BUILD UP YOUR HAM LIBRARY FOR NEXT TO NOTHING!

SPECIAL BACK ISSUE OFFERINGS

PACKAGE A

25 different issues (of our choice) for ONLY \$5.00. That's just 20¢ an issue - it costs us more than that to print them! Choose from three different categories:

- Vintage: 1962-1965
Recent: 1966-1969
Very Recent: 1970-1973

PACKAGE B

A complete set of 12 issues for a particular year for only \$3.95. At only 33¢ an issue, you're still saving a bundle. Choose any year(s) from 1971-1973. Should we run out of a particular issue, you will receive a 50¢ credit.

HURRY WHILE OUR SUPPLY LASTS. ALL ORDERS ON A FIRST COME, FIRST SERVED BASIS.

BACK ISSUE OFFERS

\*Please enclose \$1.50 postage for each package ordered. (domestic)

Total Enclosed \$ \_\_\_\_\_

PACKAGE A (\$5.00 EACH)
[ ] Vintage: 1962 - 1965
[ ] Recent: 1966 - 1969
[ ] Very Recent 1970 - 1973

PACKAGE B (\$3.95/year)
[ ] year(s) \_\_\_\_\_

Name \_\_\_\_\_ Call \_\_\_\_\_
Address \_\_\_\_\_
City \_\_\_\_\_ State \_\_\_\_\_ Zip \_\_\_\_\_

## Can A 7 foot 40m Antenna Work?

### ... the Small Loop

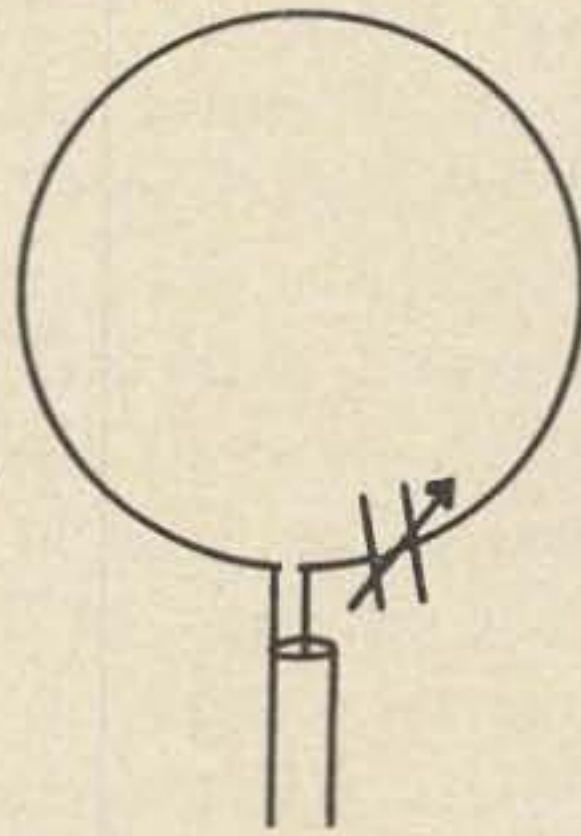

In attempting to operate an amateur radio station while living in an apartment on the top floor of a three story frame house, it was desirable to use the smallest antenna possible. Since in the interests of social harmony it was virtually mandatory that the antenna be concealed from the landlady who lived one floor below, the antenna had to be restricted indoors to the confines of the apartment. In the course of trying to match a number of different shapes of wire to a coaxial transmission line it was noticed that when the loop forming the gamma match in the center of an 'S' shaped antenna was made large enough, a close match to the transmission line could be obtained. While the first surprise was that the loop forming the gamma match was as large as it was, the second was that the match to the line was little affected when the arms of the 'S' were shortened and even removed. That the loop that remained was of a useful size for an antenna was evident since at 7.15 MHz the length of wire in the loop was about 6.7 meters (22 feet) and the total height when erected vertically was about 2.1 meters (7 feet). An antenna this size was easily manageable while there was simply not enough room to put up a half wavelength antenna 20 meters long.

At first it seemed to be a bit strange that a loop antenna this small would have as high a radiation resistance as it did. In a number of books the radiation resistance of a loop

antenna with a uniform current distribution is calculated (as in ref. 1) and a loop with a circumference of about .7 wavelength is needed to obtain a radiation resistance of 50 ohms. Since this would mean the calculated loop circumference would be some 4.5 times the actually measured size a qualitative check was made of the current distribution in the loop. As can be seen in Fig. 1, the current distribution was certainly not uniform. Indeed it was not even symmetric about the two points where the antenna was fed; a much greater current flowed in the side connected to the capacitor. This held true with the connections to the coax braid and center conductor switched. Once it is established the current is not uniform it is to be expected that the radiation resistance will be higher than the uniform current model would predict. Thus it appears that a more accurate physical model would have to be used to explain why the current flow assumes the form it does. (These measurements are not precise but are probably accurate enough to ascertain the antenna current. They were made with a loop of wire a couple inches in diameter held several inches from the antenna. This test loop and a four germanium diode bridge were mounted on the end of a four foot piece of plastic pipe and the dc output was fed through a coax line to a galvanometer.)

It needs to be said that the above mentioned and all the following measure-

ments were made with the antenna indoors on the ground floor of a two story frame apartment building in San Diego, California. The concrete floor, which is essentially at ground level, was covered with at least two layers of regular aluminum foil. This gave a solid ground plane roughly 6.7 by 4 meters and .0032 cm thick (which is about the skin depth of a 7 MHz rf current in aluminum). The antenna was made of 19 strands of aluminum wire in a loose bundle. Each strand was slightly less than 1/16 inch in diameter. The antenna was erected in a vertical plane and fed with RG-58/U at its lowest point which was 20 cm (8 inches) above the ground plane. The ground plane was not directly connected to the antenna, feed line or signal source. A Galaxy V transceiver was used as the rf source and the swr readings were taken on the swr meter in a Galaxy Deluxe Accessory Console which gave a 1.0 to 1.0 reading for a 51 ohm load. The antenna was about 3.5 meters from the transceiver.

The small loop antenna, as might be expected, is inductive and from Fig. 3 it can be seen that the inductive reactance increases as the length increases. This can be

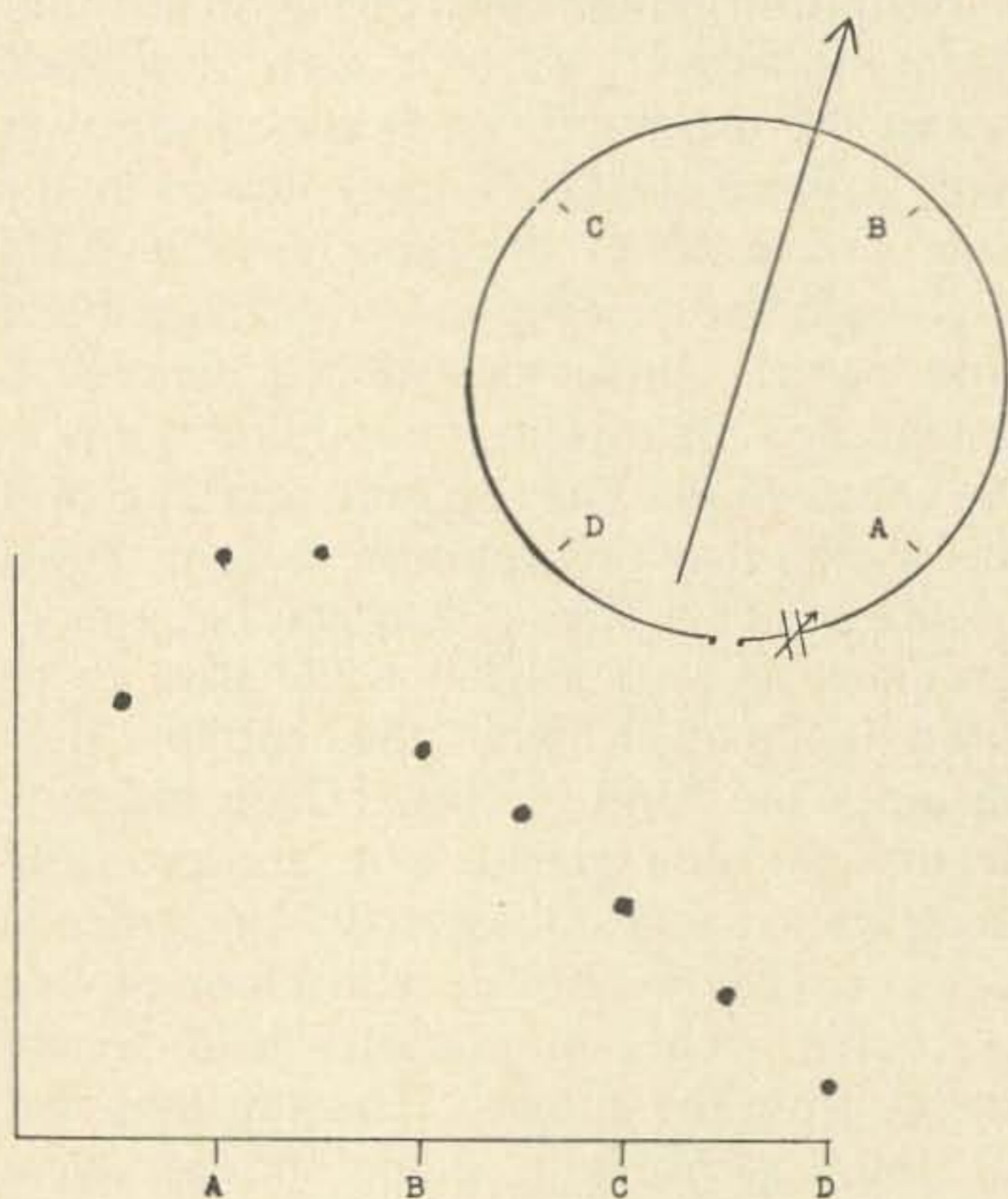

Fig. 1. A plot of the approximate current flowing in the antenna. Current is plotted on the vertical axis in arbitrary units. The slanted arrow indicates the general radiation polarization of the antenna positioned as shown.

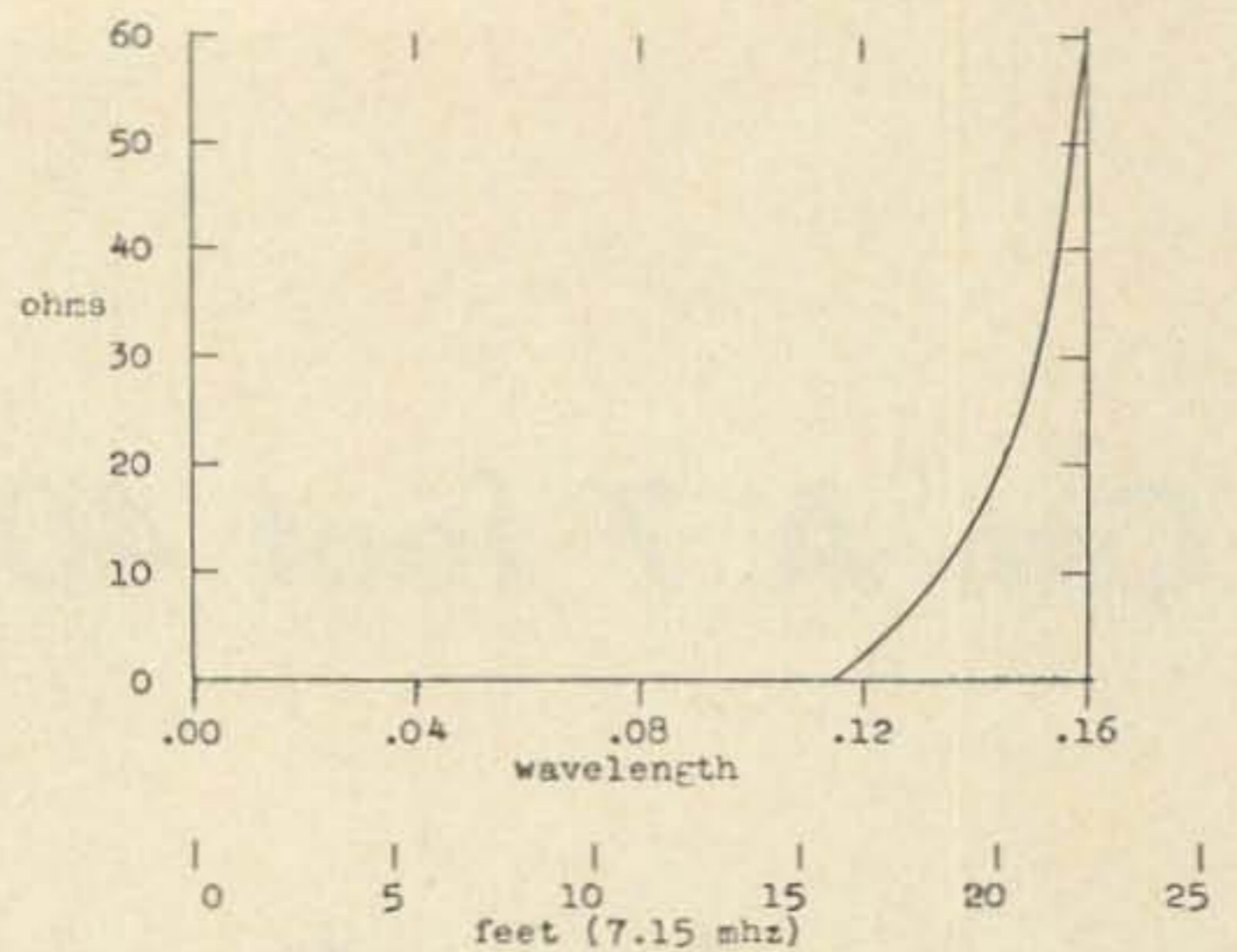

Fig. 2. The radiation resistance of the loop antenna versus the length of the circumference measured in fractions of a wavelength. The bottom scale gives the circumference in feet for a signal frequency of 7.15 MHz.

contrasted with the short linear dipole which looks capacitive and whose reactance goes to and crosses through zero as its length is increased. The radiation resistance of the loop as a function of its length is given in Fig. 2. Comparing the points on the graphs where the radiation resistance equals 51 ohms it can be seen that the reactance is almost eight times as large as the resistance which indicates that the setting of the capacitor in series with the antenna will in practice be critical. Adding to this problem is the very rapid change in resistance as the length increases, which indicates that the length of the antenna will also be a critical factor. Experience confirms that only small variations in the length and in the capacitance can be tolerated if a close match to a transmission line is sought. These readings were taken at low power with a calibrated 100 ohm carbon potentiometer inserted in series between the coax inner conductor and the variable capacitor.

The swr of the loop antenna across the entire 40 meter band is shown in Fig. 4. Here the length of the antenna and the setting of the capacitor were chosen to give the best match at 7.15 MHz. As can be seen the swr is less than 1.6 to 1 even at the band edges. In Fig. 5 the length of the antenna was not changed but the capacitor was adjusted to give the lowest swr at each frequency. One can see that for a fixed length the antenna can be tuned to keep the swr below about 1.2 to 1 even at the band

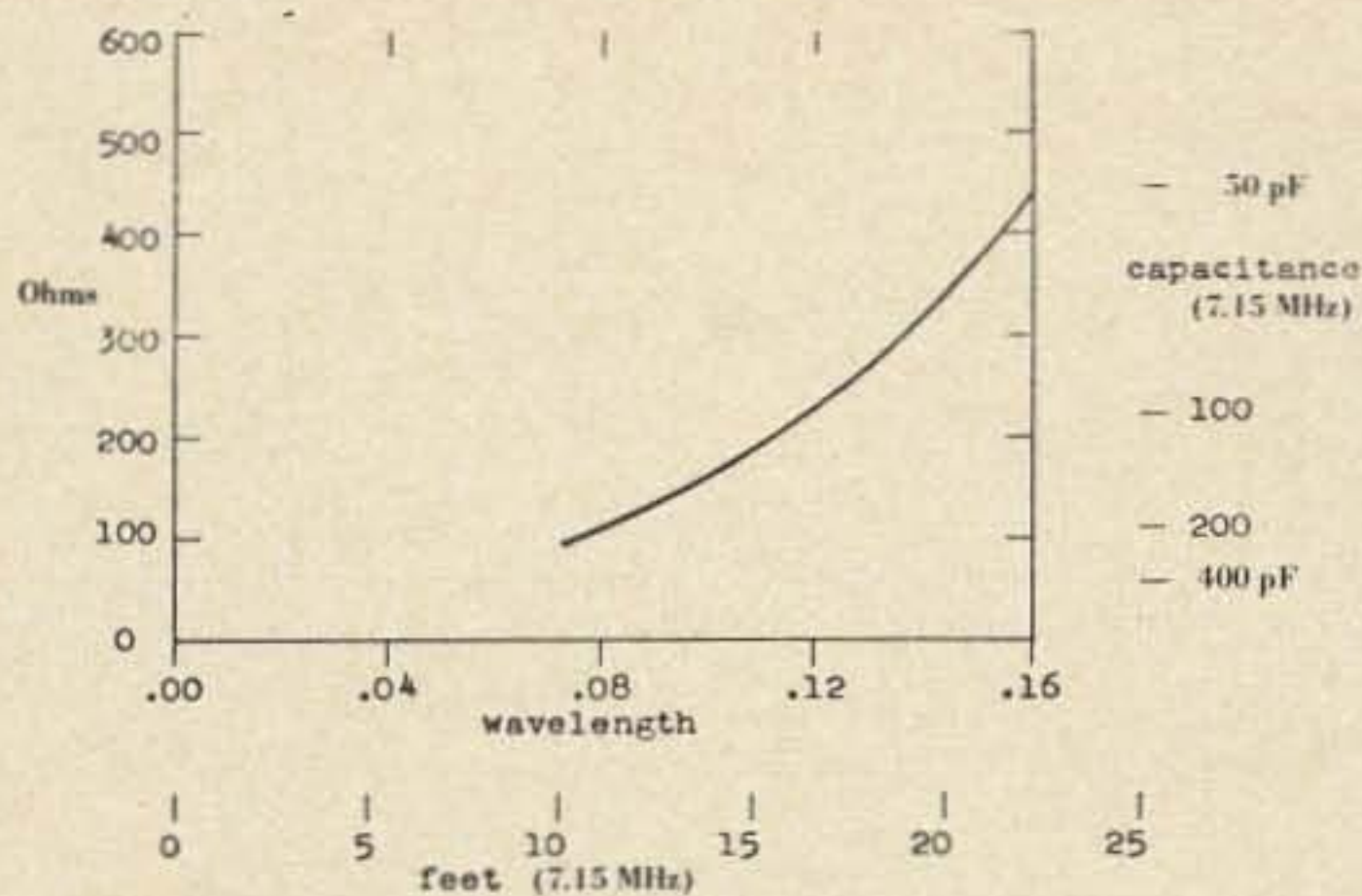

Fig. 3. The inductive reactance of the loop antenna versus the length of the circumference. The scale on the right indicates the value of the series capacitor needed to tune out the antenna's reactance for a signal frequency of 7.15 MHz.

edges. In Fig. 6 swr plots are given for several different capacitor settings.

### Some Important Practical Aspects of Small Antennas

While a loop antenna that is .05 wavelength high can radiate as well as any simple dipole antenna, there are a number of very important practical considerations that have to be kept in mind. Indeed, these considerations apply to any short antenna whether it is a dipole, loop or whatever, even though the discussion here will focus on the loop. The first concern is with tuning out the reactance and obtaining the proper radiation resistance while the second involves minimizing nonradiative energy losses.

1. Tuning out the reactance and obtaining the proper radiation resistance.

Most short antennas will be reactive and the loop is especially so. For maximum operating efficiency in most situations, it is desirable to have the feedline see a purely resistive load. It is also usually desirable that this resistive load be of a particular value. Since in most short antennas a small change in the length will have a profound effect on both the resistance and the reactance, the length has to be determined rather accurately. One difficulty here is that the "right" length is going to depend on such things as the proximity of conducting bodies, antennas, feedlines, towers, etc., as well as the height above ground and the nature of the ground itself. The reactance needed to tune the antenna will be similarly affected.

What this means in practice is that the length of the antenna and the value of the tuning reactance will have to be adjusted in each situation to make sure a reasonable match is being obtained. Thus it is essential that an swr meter, antenna bridge or other accurate device be used to determine that the antenna does indeed provide a close match to the feedline being used.

In connection with tuning the antenna there is another detail to consider. Since the loop antenna has much inductive reactance, the capacitor used to tune it will also have a high reactance which means that the voltage appearing across the capacitor will be large. For the loop antenna under consideration here it means that 100W of rf fed into a 50 ohm loop will produce about 800V peak across the capacitor, which indicates that even at this power level there are few capacitors other than air or vacuum dielectric ones which can be used that will not arc through or burn out. For an rf power level of 2 kw PEP into the loop it means that something like 3600V appears across the plates, which indicates that the capacitor will have to be chosen with some care.

2. Minimizing nonradiative energy losses.

In principle the ability of an antenna to radiate does not change as the antenna is made smaller since the current goes up as the length is reduced. The problem is that as the current rises the energy lost to heating the antenna wire increases as the current squared so that what may have been built to be a

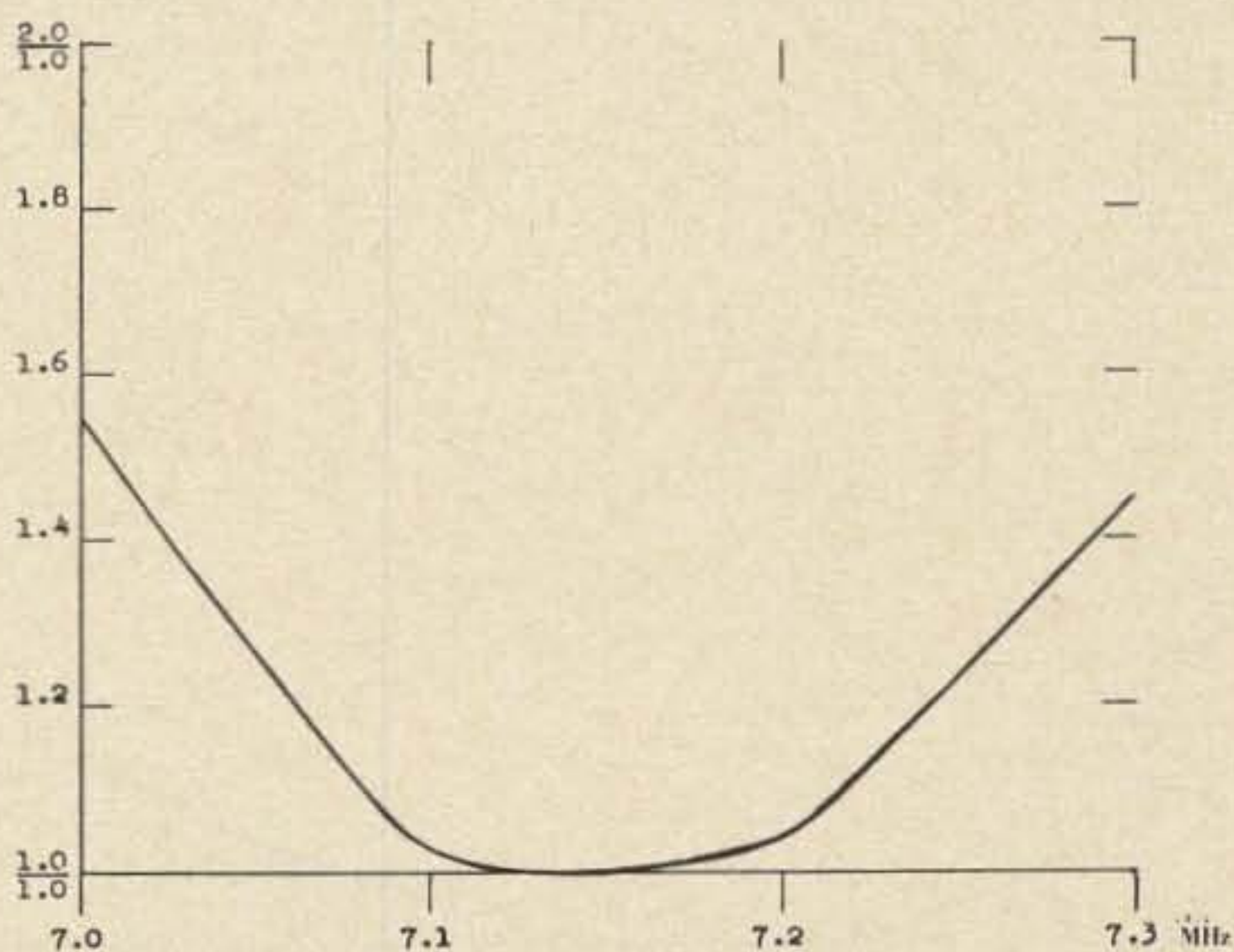

Fig. 4. The swr of the small loop antenna across the 40 meter band. The antenna was matched to a 51 ohm coaxial transmission line at the band center.

small antenna may in fact be a big resistor that generates a lot of heat and radiates little rf. If the probably not unreasonable assumption is made that the loop antenna electrically looks like an antenna that is .05 wavelength high with a nonuniform current distribution then the antenna has an intrinsic radiation resistance of about  $\frac{1}{2}$  ohm. This low value should not be confused with the much higher resistance presented to the feedline. In order that at least 90% of the energy be radiated this means the antenna wire has to have a circumference of about 4cm or, for a single conductor, a diameter of about 1.3cm ( $\frac{1}{2}$ "') at 7MHz. All that is important is the effective 'surface area' of the conductor. The thickness can be quite small since a flat strip of aluminum foil that is four layers thick and 2cm ( $\frac{3}{4}$ "') wide is sufficient. If a small antenna is constructed by joining sections of tubing or wire or whatever together then care must be taken to insure that the joints do not constrict the diameter enough to create points of high resistance and accompanying high heat losses.

The second source of nonradiative energy loss that affects every antenna, regardless of its size or type and in almost all locations, is the heating of the ground near the antenna. This subject is somewhat involved and will be mentioned only briefly here even though ground losses are probably the major limiting factor on the lower ham bands in most amateur radio stations. The less the height of an antenna the greater the ground losses are. Indeed, for antennas close to the

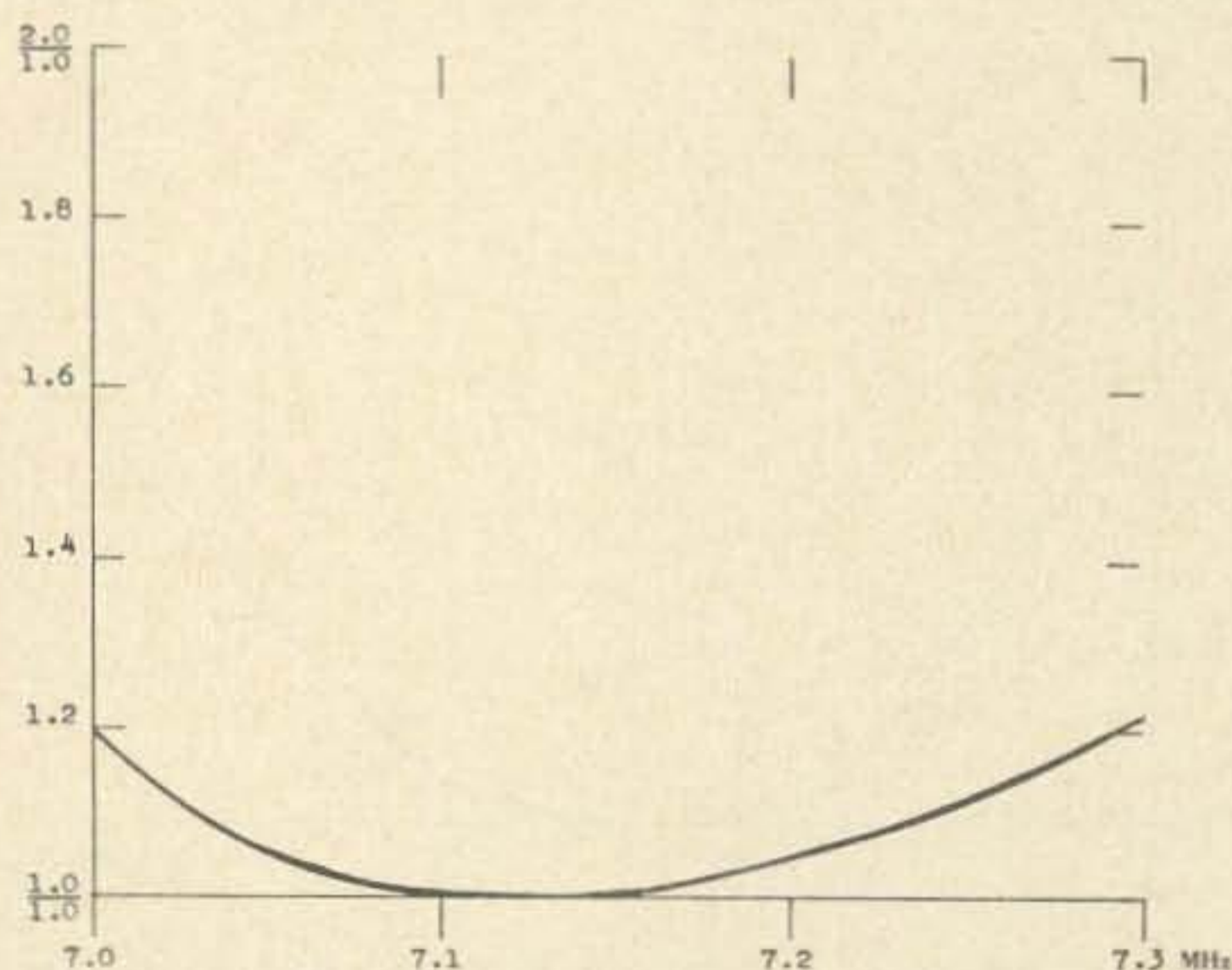

Fig. 5. This is the same plot as Fig. 4, except that the series capacitor was adjusted to give the lowest swr at each frequency.

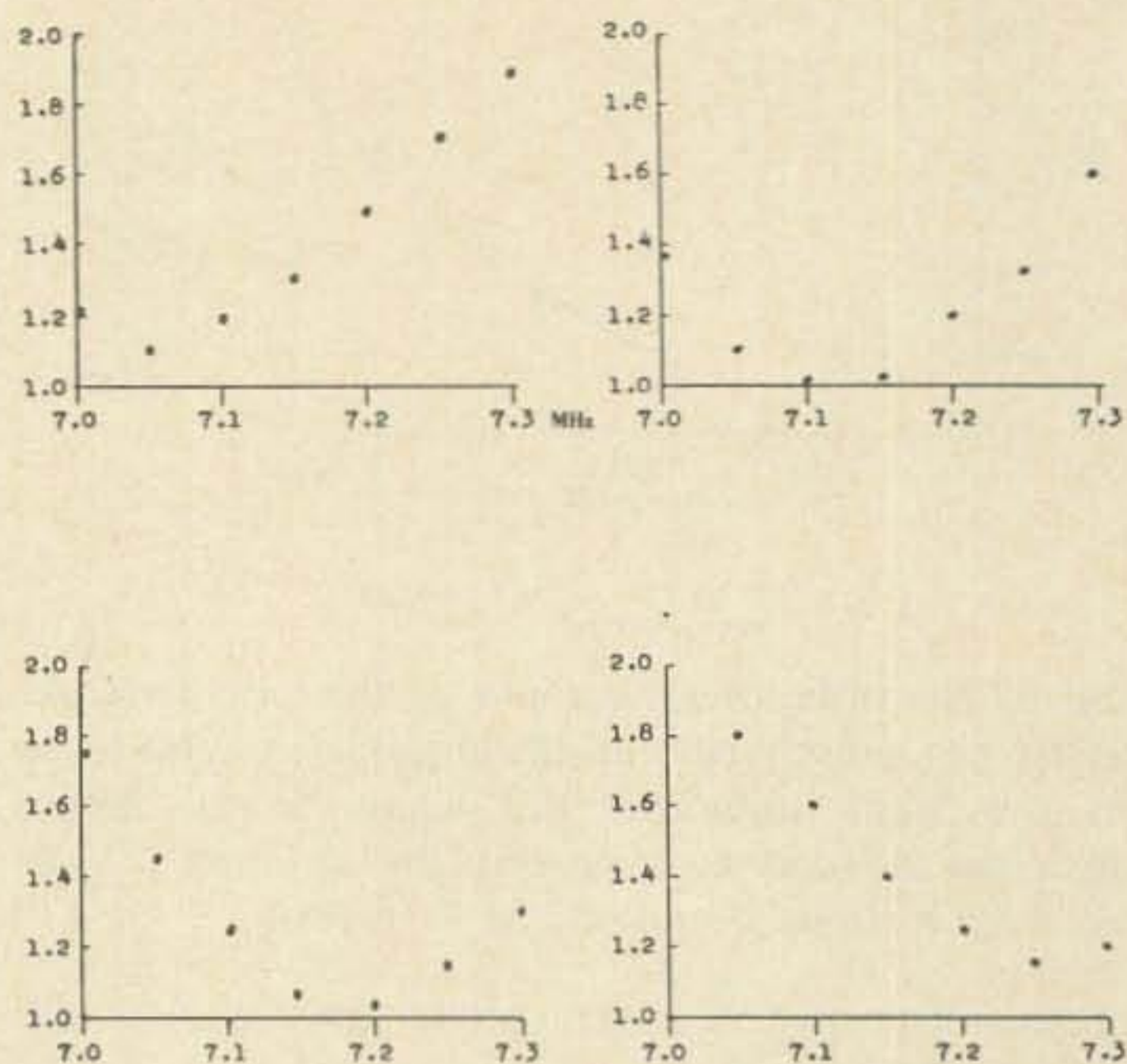

Fig. 6. These plots are the same as Fig. 4, with the exception that each one was made with a different setting of the series capacitor. The antenna length remained fixed.

ground surface, the ground loss is horrendous and only a small fraction of the rf fed to the antenna is radiated. Ground losses can, however, be greatly reduced and such low antennas can be highly efficient radiators if an adequate ground system is used. While the size of the ground system needed will depend on such factors as the ground conductivity, the height and size of the antenna and the frequency, a minimal system might consist of 100 wires each a quarter wavelength long shallowly buried in a radial pattern. An indication of what can be achieved when ground losses have been reduced to a low level is given in ref. 2.

The aluminum ground plane used here with the 7 MHz loop antenna should be about as efficient as an extensive wire ground system of the same dimensions (6.7 by 4 meters). Assuming a local ground conductivity of 15 millimhos per meter (ref. 3), a rough calculation adapted from ref. 4 indicates that, neglecting wire losses, the efficiency of the antenna system is reduced by ground losses to about 35%. Thus about two thirds of the rf energy fed to the antenna merely heats up the ground near the antenna and is wasted; 35% is radiated to the atmosphere. Wire losses in the loop antenna itself may reduce this to near 30%. To

compound the losses a bit further, if the final amplifier in the transceiver used here is assumed to be about two thirds efficient, then a dc input power of 200W to the final amplifier finally results in all of about 40W of rf being radiated to the atmosphere — this is an overall efficiency of about 20%. Without the ground plane the losses would be expected to be much greater than they already are.

### Some Results

That the loop antenna works even with a not overly efficient ground plane can briefly be indicated with the operating results obtained on the 40 meter CW band the first couple of nights the antenna was used in San Diego. In addition to a number of closer contacts, QSOs were readily started with east coast, midwest, Canadian and Hawaiian stations. That QSOs resulted from a healthy proportion of the CQs that I responded to was personally satisfying considering that 200W of input to the final was feeding an antenna seven feet high whose base was virtually sitting on the floor of my living room. In addition, the building is located in a shallow canyon which raises the lowest possible radiation angle a number of degrees above true horizontal.

### Some Possible Uses of a Short Antenna

As discussed above, the small loop has two disadvantages relative to a conventional full size dipole. First it has to be constructed of a much larger wire size to minimize resistive wire losses. Second it has to be tuned fairly accurately — both the length and the series capacitance have to be within narrow tolerance limits. In addition, the capacitor has to have a hefty voltage rating which for many hams means using a suitable air or vacuum capacitor or a section of coax trimmed to the proper length. In practice, once they have been recognized, the disadvantages can be readily overcome, giving the user a small antenna that can be expected to work much the same as a regular dipole with the same orientation at the same height.

Since the 7 MHz loop is about 7 feet in diameter it is possible to construct it of a self supporting conductor such as copper or

aluminum tubing or fairly stiff 3/4" diameter coax and to suspend it from a single support. It could, for example, be mounted instead of a center supported horizontal dipole or inverted V. The loop has the advantages that no end supports are needed and that it will usually be possible to orient it as desired instead of orienting it to fit space limitations. The loop also possesses the unique advantage that in such an installation it can be orientated to radiate vertically; it should work much as would a vertical dipole whose center was as high as the center of the loop.

Table I

Amateur Band	Loop Circumference	Series Capacitance	Conductor Diameter
160 meters	88 feet	200 pf	1.0 inches
80	44	100	.7
40	22	50	.5
20	11	25	.4
15	7.3	12	.4
10	5.5	6	.3

Approximate loop circumferences, tuning capacitances and minimum conductor diameters (if a single round conductor is used) for the lower ham bands.

In choosing a particular orientation it should be noted that in Fig. 1, with the antenna fed at the bottom, the orientation of the radiated rf will be mostly vertical with a sizeable horizontal component; it looks like a tilted vertical. For true vertical radiation it will be necessary to rotate the loop, capacitor and feedline counterclockwise. A suitable clockwise rotation will make it radiate like a horizontal dipole. It will also radiate horizontally if the plane of the loop is parallel to the ground. In many installations it will be possible to erect two or even three loops so the operator has a choice of polarization.

In addition to being usable where space limitations rule out a full size dipole, the small loop antenna lends itself to emergency and portable operations. If erected close to the ground without an extensive ground system, it can be expected to work as badly as any other antenna at the same height, although there are many situations in which such performance is adequate. The loop is a lot smaller than a full size dipole and it can be oriented to radiate vertically or horizon-

tally. As indicated in Fig. 4, it can be constructed to cover a fairly wide range of frequencies and still maintain an acceptable swr. It might be noted that while the effect depends on the conductivity of the ground, the radiation resistance of an antenna that is not above an extensive ground system will be affected by the height above ground. As a rough figure, the effect can become important below a quarter wavelength and drastic below an eighth wavelength.

Table 1 gives rough length, capacitance and minimum single conductor diameter (for aluminum) for the lower ham bands. With aluminum conductors, either solid or hollow of the diameters given, the wire losses should be less than 10%. Losses in a copper wire of a given size should be about .8 times the aluminum losses. To obtain a suitable conductor it is possible to use two conductors with half the diameter, four conductors with a quarter the diameter, twenty conductors with a twentieth the diameter, etc., provided the wires are well separated from each other and not tightly bundled together. These numbers were obtained by scaling the 7 MHz

results. If  $f$  is the frequency, the length and the capacitance are proportional to  $1/f$ , while the conductor "surface area per unit length" is proportional to  $1 \div f^{1/2}$ . The exact length and capacitance values required may well vary with different installations and it is urged that, as with beams, quads, and many other antennas, the length of the loop and the series capacitance be adjusted for an optimum match to the feedline with the antenna at the intended height and orientation.

#### References

1. J.D. Krauss, *Antennas*, McGraw-Hill, New York, 1950, p. 167.
2. J. Sevick, "The constant-impedance trap vertical," *QST*, March, 1974, p. 30; "A high performance 20- 40- and 80-meter vertical system." *QST*, December, 1973, p. 30; and earlier articles by the author.
3. P. H. Lee, "Vertical antennas — part I," *CQ*, June, 1968, p. 24.
4. J. R. Wait and W. A. Pope, "Input resistance of 1.f. unipole aerials," *Wireless Engineer*, May, 1955, p. 131.

...WØPJG

## FAST SCAN AMATEUR TELEVISION

NOW you can enjoy FSTV at reasonable cost.

NOW available — a COMPLETE FSTV equipment line.\*

\* U.S. made with parts available from your local electronic parts distributor.

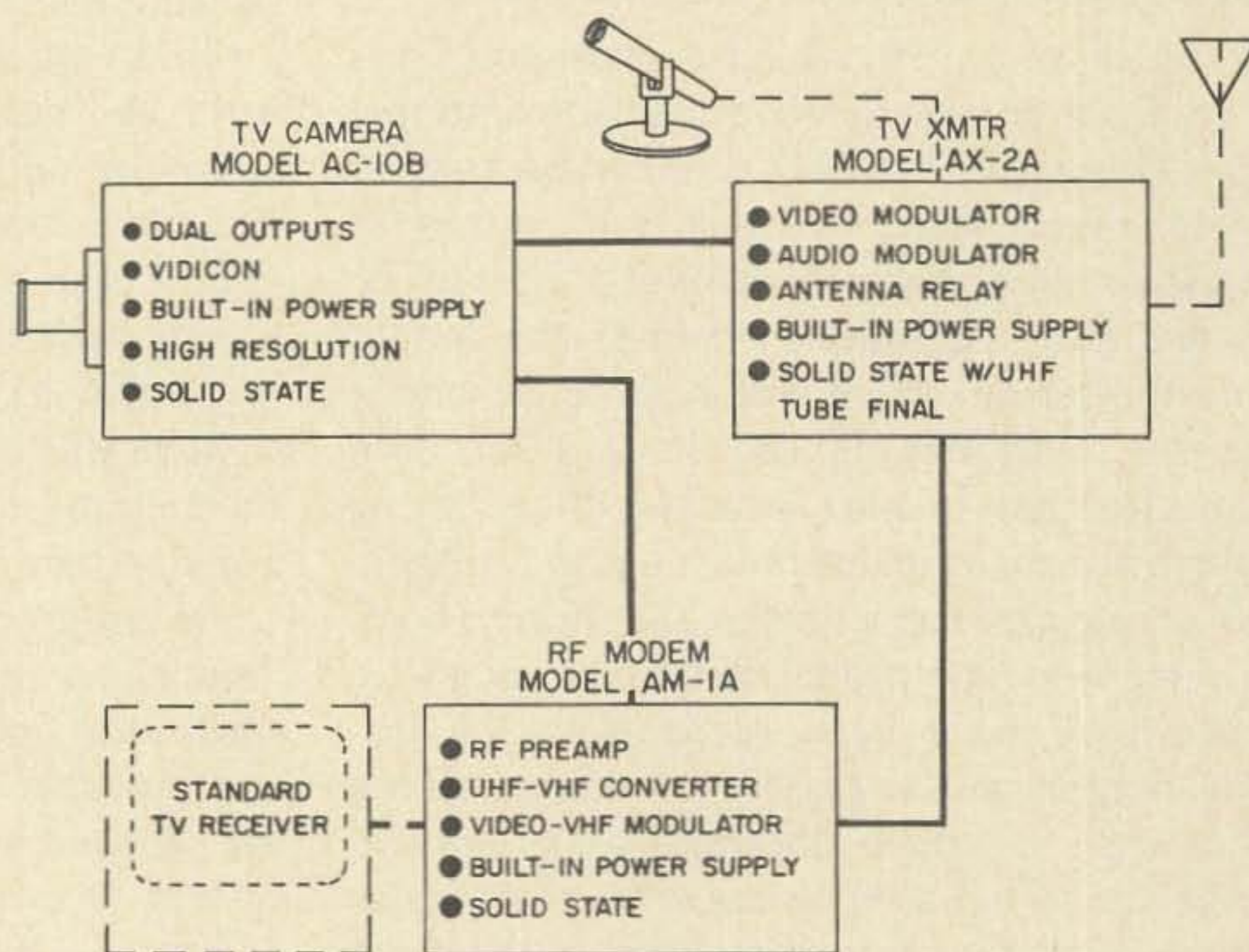

For detailed technical information and pricing—write to:

**APTRON**

Dept AMTV  
P.O. Box 112A, R.R. 2  
Bloomington, Indiana, 47401



# The Secret of Antenna Gain

## (shhh - it's capture area!)

Aside from the mystery of words like *capture area*, *gain*, and *isotropic radiator*, the antenna theory they deal with is both interesting and useful to the amateur. This article describes some of the more useful aspects and shows how they apply to HF and VHF transmission of radio signals.

As a starter, let us assume that you have an antenna connected to a transmitter through a short length of 52 Ohm coax transmission line. Let us also assume that the antenna is perfectly matched to the transmission line, and the transmitter is also perfectly matched. Although we say that the coax cable has a "52 Ohm impedance", in the perfectly matched case it is actually a "resistive impedance", meaning that it acts like a resistance — the current and voltage at any point in the line are in phase with each other. This then means that the antenna looks like a resistive load to the coax — all the power leaving the transmitter arrives at the antenna (since we have assumed that the coaxial line is short so that it has no loss itself).

So what happens to all the power once it enters the antenna? Part of that power is radiated into space, while the rest is lost in the antenna as heat. In an efficient antenna, such as a half-wave dipole, most of the power can be radiated with relatively little power lost in heat. On the other hand, a shortened inductively-loaded vertical antenna such as a 20 meter mobile antenna is fairly inefficient, and so a large portion of the transmitter power is used to heat the

loading coil, and therefore less power is left over to be radiated.

### The Isotropic Radiator

The isotropic radiator is an imaginary antenna which satisfies two impossible conditions:

- 1) It is perfectly efficient — all the power entering it from the feedline is radiated, with none lost in the antenna itself.
- 2) All the power radiated is sent out into space equally in *all directions*.

The first condition can be approximated fairly closely in real life by using good conductors and an antenna design, such as a half-wave dipole, which does not have or need any external components such as loading coils or fancy coupling networks. But of course we cannot build an antenna which has no losses whatsoever.

It's the second condition, however, which makes the isotropic radiator impossible — all practical antennas have at least one direction in which there is no radiation whatsoever. This is caused by radio waves radiated from different parts of the antenna cancelling themselves out. In the case of the dipole, there is no signal (at least theoretically) coming off the ends of the dipole. And so there is no such thing as an antenna which radiates equally well in all directions; you simply cannot build an isotropic radiator.

Nevertheless, the isotropic radiator is a useful theoretical tool, since it provides a yardstick with which we can measure the performance of other antennas. To see how this is done, let us take a specific example

and juggle the numbers to see what we get.

Suppose we could get an isotropic antenna, connect it to a transmitter, and feed 100 watts of power into it. Call the transmitted power  $P_t$ , so that

$$P_t = 100 \text{ watts.}$$

Since an isotropic radiator is supposedly 100% efficient, all of this power is assumed to be radiated out into space. Assuming that the air around the antenna is clean and dry, so that no power is absorbed by moisture around the antenna, we could then build a large ball around the antenna, in the shape of a large sphere, and collect the transmitted power to get the whole 100 watts back. Practically, of course, this is silly, but theoretically it is useful.

As an example, suppose the ball has a radius of 1000 meters (to make the results come out in common units of measurement, it is necessary to use meters in these calculations). Since the equation for the area of a sphere is

$$\text{Area} = 4 \pi r^2$$

where  $r$  is the radius and  $\pi$  (the Greek letter pi) is 3.14159, we can calculate the area of our 1000-meter-radius sphere as

$$\begin{aligned} \text{Area} &= 4 \times 3.14159 \times (1000)^2 \\ \text{Area} &= 12,566,360 \text{ square meters} \end{aligned}$$

(where "square meters" is often abbreviated as  $\text{meters}^2$  or just plain  $\text{m}^2$ ).

Since the isotropic radiator is assumed to radiate equally well in all directions, this means that each part of this sphere is getting the same portion of the total transmitted power. In other words, the 100 watts of transmitted power is spread out over the surface of the entire sphere, with each square meter of the sphere getting its share. We can calculate that share simply by dividing the total transmitted power by the total area of the sphere; this result is then called the "power density" which we shall indicate with the letter  $p$ . Therefore

$$p = \frac{P_t}{\text{Area}} = \frac{P_t}{4\pi r^2}$$

which is measured in watts per square meter, which can be abbreviated as  $\text{watts/meter}^2$ .

In our example, the power density is

$$p = \frac{100 \text{ watts}}{12,566,360 \text{ m}^2} = .000007958 \text{ watts/meter}^2$$

which is equivalent to 7.958 microwatts per square meter. You can clearly see that, by the time the signal is spread out over even a fairly small sphere like this one, it represents a small power density indeed.

### Antenna Gain

Since an isotropic antenna is already 100% efficient, radiating all the power it gets from the transmitter, we cannot improve on the total power radiated simply by changing to a different antenna. In other words, we cannot increase the power density in the above example uniformly over the entire sphere just by changing the antenna. However, we can use a *directional* antenna which concentrates the power in some preferred direction, always at the expense of the power going in some other direction. In other words, a directional antenna diverts some of the power which would normally go off in some undesired direction, and concentrates it in some other direction. From the standpoint of a receiver standing in the right direction, which is now getting more signal than it would have with an isotropic antenna, this looks like the antenna has *gain over an isotropic antenna*.

For example, a half-wave dipole has little or no radiation off its ends. Instead, it takes the power which would normally be radiated off the ends, and sends it out broadside to the dipole. Doing some high-powered calculations tells us that a half-wave dipole (assuming that it does not lose power in heat) sends out 1.64 as much power in a direction broadside to the dipole as an isotropic radiator would have. A power gain of 1.64 translates into a gain of 2.14 dB, and so we would say that a half-wave dipole has a gain of 2.14 dB over an isotropic antenna.

Obviously, then, an antenna with high gain has to be very directional, since all this apparent gain is achieved merely by aiming the radiated power in some preferred direction. (The opposite of this statement is not

necessarily true, though, since an antenna might be directional and lossy. Such an inefficient antenna might then lose a large portion of the power before it is radiated, resulting in a very directional but weak signal.)

To continue with our example, suppose our 100 watt signal were radiated with an antenna having a gain of 3 dB over a dipole. This basically means that there is some direction in which the particular antenna transmits 3 dB more power than a dipole would. Since antenna gain is usually measured by the manufacturer in the most favorable direction, called the *major lobe*, such an antenna would have to be aimed reasonably well to get the full benefit of this 3 dB gain over the dipole.

We might then ask — what would be the power density 1000 meters away in the direction of the major lobe? In order to do the calculation, we have to convert the gain, specified as 3 dB over a dipole, into a gain over an isotropic radiator. Since the dipole itself has a gain of 2.14 dB over the isotropic antenna, the total gain of our given antenna is 5.14 dB over the isotropic antenna. Using the standard formula for converting power gain into dB, we work it backwards to get a power gain of about 3.27; in other words, the power density in the desired direction (major lobe) of the antenna will be 3.27 times that produced by an isotropic radiator. In our example, the power density would then be

$$3.27 \times 7.958 \text{ microwatts/meter}^2 \\ = 26.02 \text{ microwatts/meter}^2.$$

### Signal Strength

The above calculation shows us what the power density a certain distance from the transmitting antenna is. However, signal strength is usually given in units such as volts per meter, and it would be useful to be able to convert from one to the other.

In ordinary circuits we can relate the voltage and power in a circuit by the relation

$$\text{Power} = E^2/R$$

Given the power and resistance, for example, we could solve for the voltage. Interestingly, free space (vacuum, but air is very similar in its propagation characteristics to a vacuum)

also has something called a "characteristic wave impedance" which for all intents and purposes is like the resistance R in the above equation. Using the same equation, and using the characteristic wave impedance of free space, which is 377 Ohms, allows us to relate the power density and the field intensity (signal strength) in free space (or air, which is for all intents and purposes the same). In this case,

$$\text{Power density} = \frac{(\text{field strength})^2}{377 \text{ Ohms}}$$

Even the units of this work out nicely; since the field strength is measured in volts per meter, the right hand side of the equation is

$$\frac{(\text{volts/meter})^2}{\text{Ohms}} = \frac{\text{volts}^2/\text{meter}^2}{\text{Ohms}} = \\ \left(\frac{\text{volts}^2}{\text{Ohms}}\right)/\text{meter}^2 = \text{watts/meter}^2$$

which is the perfect unit for a power density.

To go from a power density to field strength, we have to juggle the equation a bit:

$$\text{Power density} \times 377 \text{ Ohms} = (\text{field strength})^2$$

$$\text{Field strength} =$$

$$\sqrt{\text{power density} \times 377 \text{ Ohms}}$$

Going back to our example above, we found that the power density 1000 meters away from the transmitting gain antenna was 26.02 microwatts per meter<sup>2</sup>. To use the above equation properly, we have to convert that back into watts/meter<sup>2</sup>, and then we get the field strength as

$$\text{Field strength} =$$

$$\sqrt{.00002602 \text{ watts/m}^2 \times 377 \text{ Ohms}} \\ = \sqrt{0.0098 \text{ volts/meter}} \\ = \sqrt{0.0990 \text{ volts/meter}}$$

This type of calculation can be useful if you ever get your hands on a calibrated field strength meter, but in most applications we do not have to calculate the field strength to arrive at our next result.

## Capture Area

Let's therefore return to the power density in free space. As you remember, the power density is used to describe the amount of power which may be received over an area of one square meter located on a sphere surrounding the transmitting antenna. In the case of a gain antenna, such as the one in our previous example which had 3 dB gain over an isotropic antenna, we have to measure this power density in a direction where the transmitted power is a maximum — the major lobe. In the previous example, this power density was 26.02 microwatts/meter<sup>2</sup>.

Suppose we now put a receiving antenna into this field. This receiving antenna will now absorb some of this power from the transmitted signal, and convert this power into a voltage (and current) along a transmission line leading to the receiver. The bigger and more effective this antenna, the more power it will capture out of the air and deliver to the receiver. Suppose that the antenna, when placed into the field at a place where the power density is 26.02 microwatts/meter<sup>2</sup> just happens to deliver 26.02 microwatts of power to the receiver. Then we say that it captures the power hitting one square meter of our imaginary sphere's area — in other words, we say that this antenna has a *capture area* of one square meter. Put into an equation, we can write the relation between power density  $\underline{p}$ , the capture area  $A_{\text{capture}}$ , and the power actually received and sent to the transmission line  $P_{\text{rec}}$  this way:

$$P_{\text{rec}} = \underline{p} \times A_{\text{capture}}$$

In plain words, this simply means that the power actually intercepted by the antenna is equal to the power density (in watts per square meter) times the capture area (in square meters). The greater the capture area of a receiving antenna, the greater the amount of power it picks up out of the air and sends to a receiver.

As you might suspect, there should be some connection between the capture area of an antenna and its actual physical size. For certain antennas, such as parabolic dishes of high gain (which, by the way, are also very directive) the capture area is almost

equal to the area of the dish as seen by the arriving signal. In such a case it becomes quite easy to estimate the capture area of a dish and, from the area, calculate the gain.

With most other antennas, however, the capture area is larger than the actual physical area of the antenna as seen by the arriving signal. Certainly the cross-sectional area of a wire antenna as seen by the arriving signal is very small, whereas the amount of signal picked up by a wire antenna can be substantial. In such a case the capture area of such an antenna can be quite a bit larger than the actual cross-sectional area of the antenna. It's almost as if the antenna can reach out into the space around it to "capture" the signal.

As with many other antenna concepts, the idea of a capture area is purely theoretical. For instance, if it really did what it sounds like it does, namely capture *all* the power existing in a certain area of space, then a second antenna placed behind the first antenna would pick up no signal at all, and we know that is not true. Similarly, putting a reflector behind a dipole would do nothing because there would be no signal there to reflect, whereas we know that reflectors are commonly used in beam antennas. Still, the idea of a capture area is useful because it allows us to calculate other antenna parameters. Specifically, it lets us know how much rf signal a given antenna will pick up and deliver to the receiver.

Just a few paragraphs ago we mentioned that the capture area of a high gain dish is easy to estimate; for most amateur antennas this is not the case, and so we have to go backwards. Instead of estimating capture area and using it to calculate the gain, we measure the gain and use it to calculate the capture area.

The gain of an antenna is reasonably easy to measure by comparing it with that of a half-wave dipole. Once we have that, we calculate the capture area from the following equation:

$$A_{\text{capture}} = \frac{\text{Gain} \times (\text{wavelength})^2}{4\pi}$$

The wavelength in the equation is simply the wavelength of the signal which the antenna is trying to pick up.

# top quality... top value... fm by tempo

Tempo's VHF transceivers offer commercial performance at amateur prices. Compare these transceivers with any other available. Compare their performance, their quality of construction, their ease of maintenance, and then compare prices. Your choice will have to be Tempo.



## TEMPO/CL 146

The CL-146 offers operation on the 146 MHz amateur band. The price includes a microphone power cord, mounting bracket and one pair of crystals. A full line of accessories is also available.

- 12 channel capability • 13 watts or a power savings 3 watts
- All solid state, 12 VDC • 144 to 148 MHz (any two MHz without retuning) • Supplied with one pair of crystals • RF output meter, S-meter, receiver detector meter • Provisions for external oscillator • Monitor feature • Audio output at front panel
- Internal speaker • The Price: \$299.00

## TEMPO/CL 220



As new as tomorrow! The superb CL-220 embodies the same general specifications as the CL-146, but operates in the frequency range of 220-225 MHz (any two MHz without retuning). At \$299.00 it is undoubtedly the best value available today.



FMH-MC for Marine & Commercial service also available.

## TEMPO/fmh

So much for so little! 2 watt VHF/FM hand held. 6 Channel capability, solid state, 12 VDC, 144-148 MHz (any two MHz), includes 1 pair of crystals, built-in charging terminals for ni-cad cells, S-meter, battery level meter, telescoping whip antenna, internal speaker & microphone. \$199.00



## TEMPO

### VHF/UHF Power Amplifiers

Solid state power amplifiers for use in most land mobile applications. Increase the range, clarity, reliability and speed of two-way communications.

#### VHF (135 to 175 MHz)

Drive Power	Output	Model No.	Price
2W	130W	130A02	\$199
10W	130W	130A10	\$179
30W	130W	130A30	\$189
2W	80W	80A02	\$169
10W	80W	80A10	\$149
30W	80W	80A30	\$159

#### UHF (400 to 512 MHz)

2W	70W	70D02	\$270
10W	70W	70D10	\$250
30W	70W	70D30	\$210
2W	40W	40D02	\$180
10W	40W	40D10	\$145
2W	10W	10D02	\$125

FCC Type accepted models also available. Please write.

# Henry Radio

11240 W. Olympic Blvd., Los Angeles, Calif. 90064 213/477-6701  
931 N. Euclid, Anaheim, Calif. 92801 714/772-9200  
Butler, Missouri 64730 816/679-3127

AVAILABLE AT SELECT DEALERS THROUGHOUT THE U.S.

Prices subject to change without notice.

You may wonder what this equation means. It's easy to see why the Gain term is in it — if you double the gain of an antenna, that means it picks up twice the signal. But that means that it has twice the capture area.

Now, why the (wavelength)<sup>2</sup> term? Let's take an example for this explanation. Suppose you have an antenna which is 3 by 10 feet in size, and which has a gain of 3 dB at some particular frequency. If we now want to build an identical type of antenna but for a frequency half as large (twice the wavelength), we will have to make a new

$$P_{rec} = p \times A_{capture}$$

$$= p \times \frac{Gain \times (\text{wavelength})^2}{4\pi}$$

Finally, knowing the received power, we can use the equation  $Power = E^2/R$  to calculate the voltage in the transmission line if we know its impedance.

#### Practical Example

Fig. 1 shows a typical problem. In an auxiliary link on a repeater, we have a 0.1 watt transmitter on 449 MHz, feeding a 9 dB gain beam through a coax which has 4 dB loss. At the receiving site, which is ½ mile

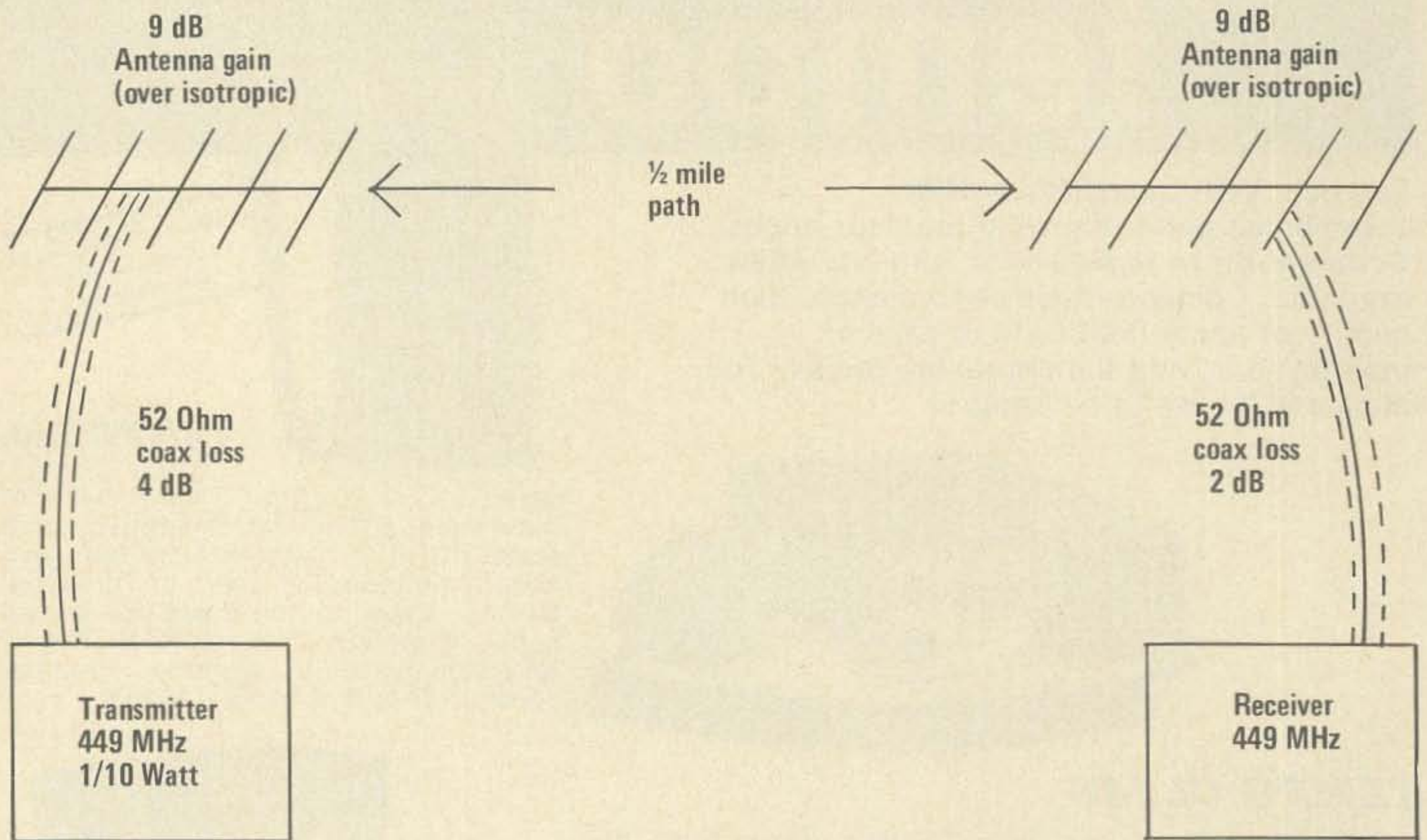

Fig. 1. Practical example of a 449 MHz repeater link.

antenna twice as large, so our new antenna will be 6 by 20 feet. Since the area of the antenna is four times as large now, we would now expect that the capture area would also be four times as large (though the capture area is not the same as the physical area of an antenna, it makes sense to expect the capture area to go up at the same time as the physical area goes up if the type of antenna — and its gain — stay constant).

Since the capture area is only a stepping stone to calculating how much power a given receiving antenna picks up, let's combine the two previous equations. We substitute the equation for the capture area into the equation which tells the received power:

away, a similar antenna feeds a receiver through a 52 Ohm coax having a loss of 2 dB. Under these conditions, how much signal will the receiver get? Moreover, what transmitter power do we need to get a signal of 100 microvolts at the receiver?

Our calculations go like this:

- 1) Transmitter power is 100 milliwatts into the coax.
- 2) 9 dB antenna gain, less 4 dB coax loss, gives a total power gain of 5 dB in the desired direction. A 5 dB power gain is a power ratio of 3.16, so the power actually radiated toward the receiver is the same as an isotropic antenna would radiate if it was fed with

3.16 x 100 milliwatts = 316 milliwatts.

3) A half mile is 1609/2 meters, or 805 meters. The power density at the receive antenna is therefore

$$p = \frac{P_t}{4\pi r^2} = \frac{316 \text{ milliwatts}}{4 \times 3.14159 \times (805)^2} \\ = 0.0388 \text{ microwatts per meter}^2$$

4) 9 dB antenna gain on the receiver is actually a power ratio of 8, since each 3 dB power gain doubles the power. The wavelength at 449 MHz is  $300/449 = 0.668$  meter, and so the received power at the receive antenna is found from

$$P_{\text{rec}} = \frac{p \times \text{Gain} \times (\text{wavelength})^2}{4 \times 3.14159} \\ = \frac{(0.0388 \text{ microw/m}^2) \times (8) \times (0.668)^2}{4 \times 3.14159} \\ = 0.011 \text{ microwatts.}$$

5) Another 2 dB is lost in the receive coax line, so the power actually at the receiver is only

$$\frac{0.011 \text{ microwatts}}{1.59} = 0.0069 \text{ microwatts}$$

6) We use  $P = E^2/R$  to calculate the actual voltage at the 52 Ohm receiver input:

$$E^2 = P \times R \\ E = \sqrt{P \times R} \\ = 600 \text{ microvolts}$$

7) If we see that we only need 100 microvolts at the receiver for perfect copy, then the above signal has 6 times the voltage. Since  $\text{Power} = E^2/R$ , we see that the power is proportional to the voltage-squared; in other words, we have  $6^2$  or 36 times the power we need. Hence we could drop the transmitter power by a factor of 36 down to 2.77 milliwatts, and still get 100 microvolts of signal at the receiver.

This example shows the theoretical features of this approach, but it has a number of practical disadvantages. It assumes the perfect case — perfect line of sight, no absorption of the signal in the air or in any other objects, no reflections from nearby objects which might cancel out part of the signal, and perfectly good coax,

fittings, antenna, and all other parts. It also assumes that the manufacturer of your antenna is telling the truth when he specifies 9 dB gain over an isotropic antenna. In any practical case, it might be a good idea to include a safety factor of 1000% — or more — to compensate for aging, wear and tear. Still, an analysis such as this does give you a rough idea of the *minimum* reasonable power that might do the job.

### Path Loss

In the above example, we started with a transmitter output of 100 milliwatts and wound up with only 0.0069 microwatts at the receiver. This is a total loss of

$$10 \log \frac{100 \text{ milliwatts}}{0.0069 \text{ microwatts}} \\ = 10 \log (1.45 \times 10^7) \\ = 71.6 \text{ dB}$$

Part of this signal loss was loss in the actual transmission, while part was due to the antennas and coax lines. In the above example, the antennas actually contributed an 18 dB *gain* (9 dB for each antenna), while the cable loss added up to 6 dB (4 dB at the transmitter, 2 dB at the receiver). This adds up to a total *gain* of  $18 - 6 = 12$  dB. In other words, we had an effective gain of 12 dB and still lost 71.6 dB in the transmission; this means that the loss in the 1/2-mile path was actually  $71.6 + 12 = 83.6$  dB. This is called the *path loss*.

The path loss is actually dependent only on the distance and the frequency. It is calculated by assuming that isotropic antennas are used at both ends and no coax cable losses exist, and then using the foregoing equations; alternatively, we can combine all of them into one big equation which gives the path loss directly in dB:

$$\text{Path loss (in dB)} = 10 \log \frac{157.91 \times (\text{dist})^2}{(\text{wavelength})^2}$$

where both the distance between transmitter and receiver and the wavelength must be given in meters.

The path loss is useful not only in cases where we *want* to get a signal from one place to another, but also in cases where we don't. For example, suppose a two-meter repeater is located at two sites 1/5 mile (322 meters)

apart; how much interference will the transmitter cause the receiver? The path loss is a guide to how much the transmitted signal will be attenuated in the 1/5-mile path:

$$10 \log \frac{(157.91) \times (322)^2}{(2 \text{ meters})^2} = 66.1 \text{ dB}$$

In an actual case, this path loss would have to be modified by the two antenna gains and coax losses, and might easily be only on the order of 55 or 60 dB once these are taken into account.

As further references, in addition to the many amateur radio books on antennas, you may be interested in two textbooks on antennas used in schools. The "Bible" of antenna design engineers is *Antennas* by J.D. Kraus (McGraw-Hill, New York, 1950). A more readable and shorter book for technicians is *Antennas* by L. V. Blake (John Wiley & Sons, New York, 1966). An interesting article about measuring antenna gain is "Antenna Performance Measurements," by Dick Turrin W2IMU (*QST*, Nov. 1974, p. 35).

... K2OAW

# K-ENTERPRISES



## PRESCALER MODEL PD-301

**\$55.50 plus \$1.50 postage**

Model PD 301 is a 300 MHz prescaler designed to extend the range of your counter ten times. This prescaler has a built-in preamp with a sensitivity of 50 mV at 150 MHz, 100 mV at 260 MHz, 175 mV at 300 MHz. The 95H90 scaler is rated at 320 MHz. To insure enough drive for all counters, a post amp. was built-in. The preamp has a self contained power supply regulated at 5.2V + .08%. (Input 50 Ohms, Output Hi Z)

All prescalers are shipped in a 4" by 4" by 1 1/2" cabinet. All are wired and calibrated.

## K-ENTERPRISES

1401 NORTH TUCKER  
SHAWNEE, OK 74801  
405-273-1598

**new!**

THE "EXPANDABLE" 2M FM  
5WATT TRANSCEIVER

**SPEC**

**COMM**

**KNOCKS THE WIND  
OUT OF INFLATION!**  
WITH LOW FACTORY DIRECT PRICES!

SPEC COMM 560

**\$149.95**



**SC560 SHOWN WITH ACCESSORIES**  
FULLY WIRED AND TESTED-NOT A KIT  
(MADE IN USA - 90 DAY WARRENTY)

- 5 Watts RF Output
- 6 Channels
- Excellent Quality Modulation
- Electronic T/R Switching
- Compact "Clip On" Modules provide Versatile, expandable performance

### OPTIONAL ACCESSORIES

- "Clip-On" rechargeable 1.2 AH battery module, w/ carrying strap, 18" antenna, & charger. BP-1 \$55.95
  - "Clip-On" 25 Watt Amp./ lo noise receiver preamp module. BA-1 \$79.95
  - "Clip-On" AC Power Supply module, AC-1 \$44.95
  - Mobile Mounting Bracket, MB-1 \$7.95
  - Modification Kit to expand SC560 to 12 channels
- COMING SOON**
- Unique compact companion synthesizer
  - External mobile/fixed speaker

### JOIN THE FUN ON 2! USE THE SC560 MOBILE, FIXED OR OVER THE SHOULDER

- 0.6 uV for 20 dB Qt. Sens. (typ.)
- 14 kHz B.W., 6 pole xtal filter
- Bal. Mxr. for superior I.M. performance
- Built in 3" Speaker
- 146.52 xtals included
- Size: 2 1/4 x 6 x 8"

See Nov 73 Mag  
for more details -  
Write for club offer

Include Shipping  
& Handling \$2.50

(PA residents add 6% tax)

ORDER TODAY - DIRECT FROM THE FACTORY  
**SPECTRUM COMMUNICATIONS**

BOX 140, WORCESTER PA 19490

215-584-6469

Send for Spec Sheet



# Twinlead Phased Array

The ideal answer to many a ham's antenna problems would be directive, rotatable, have some front to back ratio, and probably most important, would be inexpensive.

The phased array to be described in this article is both simple and effective. The use of commonly available materials and "electric rotation" beats the high cost of rotors and the unavailability of some antenna components. While the antenna used by me was designed for use on forty and fifteen meters, there is no reason why this general design cannot be used on any of the other bands.

## Theory

The array consists of a pair of folded dipoles fed  $90^\circ$  out of phase to provide end-fire directivity. This phase-shift is caused by an electrical quarter wavelength of  $300\Omega$  twinlead. By using a DPDT relay to switch the phasing line, bi-directional operation can be obtained. Each folded dipole has a characteristic impedance of  $300\Omega$ . Ideally, the two elements are fed at the center with electrical half-wavelength lines of twinlead. This brings the  $300\Omega$  resistive load present to the switching relay without inducing any reactive components. Of course, if the length specified is too long for your particular installation, don't be afraid to try whatever length is needed as long as both feedlines are of equal length. If a longer length is needed, use any integral multiple of the lengths given. At the relay the two  $300\Omega$  impedances are presented in parallel, trans-

forming the impedance to  $150\Omega$ . This is fed through a 4 to 1 balun to bring the final impedance down to  $35\Omega$ . When fed with  $50\Omega$  coax (RG-8, RG-58) it will present an excellent standing wave ratio (SWR) across the entire band. This broadness is due to the inherent wide bandwidth of the folded dipole itself, plus the use of the 4 to 1 balun, which, besides bringing down the impedance, also reduces the change in impedance as the frequency is varied.

## Construction

The elements, feedlines, and phasing line are all made of  $300\Omega$  twinlead. It is best to weatherproof the relay by mounting it in a plastic refrigerator box and then mounting

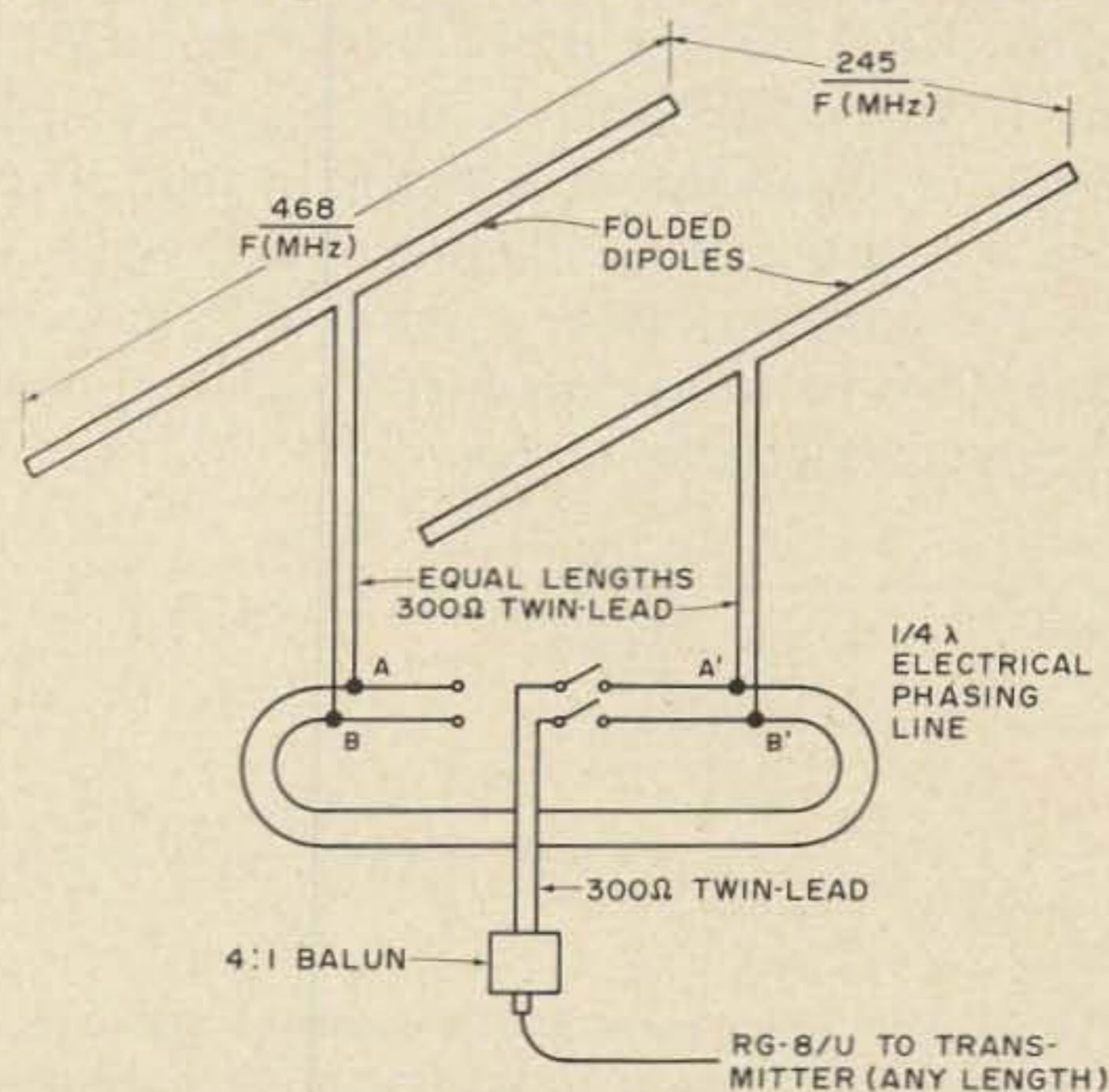

Fig. 1. Two element phased array. If SWR is unacceptable, interchange lead A with B or A' with B'. With the relay in this position directivity is to the left.

Frequency (kHz)	Element Length		Spacing		Phasing Line		Elec. 1/2 Wavelength		
	Ft	In.	Ft	In.	Ft	In.	Ft	In.	
<b>80 Meter Band</b>									
3550	131.	9.97	69.	0.17	56.	9.87	113.	7.74	
3650	128.	2.63	67.	1.48	55.	3.19	110.	6.38	
3850	121.	6.70	63.	7.64	52.	4.74	104.	9.47	
3950	118.	5.77	62.	0.30	51.	0.82	102.	1.64	
<b>40 Meter Band</b>									
7100	65.	10.99	34.	6.08	28.	4.94	56.	9.87	
7250	64.	6.62	33.	9.52	27.	9.88	55.	7.76	
<b>20 Meter Band</b>									
14100	33.	2.30	17.	4.51	14.	3.68	28.	7.35	
14275	32.	9.41	17.	1.95	14.	1.57		3.14	
<b>15 Meter Band</b>									
21100	22.	2.16	11.	7.34	9.	6.72	19.	1.44	
21350	21.	11.0	11.	5.70	9.	5.38	18.	10.76	
<b>10 Meter Band</b>									
18050	16.	8.21	8.	8.81	7.	2.30	14.	4.59	
18600	16.	4.36	8.	6.80	7.	0.64	14.	1.28	

Table I  
A Simple Directive Phased Array  
Chart

the box on a tree or building. From the relay, zipcord can be run to a control console in the shack. It will be best to wire the relay so that in its unenergized position the directivity will be in the most often used direction. This will cut down wear and tear on the relay. If the SWR of the finished array is unacceptable, possible remedies include transposing the A and B leads (see Fig. 1) of the feedline, or changing the length of the line from the relay to the balun. The fact that changing the line length varies the SWR shows that the line is not "flat," but this is really inconsequential as the loss from high SWR in the twinlead is less than that of an equal length of perfectly matched RG-58.

The antenna can be supported by towers, buildings or four conveniently placed trees can be pressed into service.

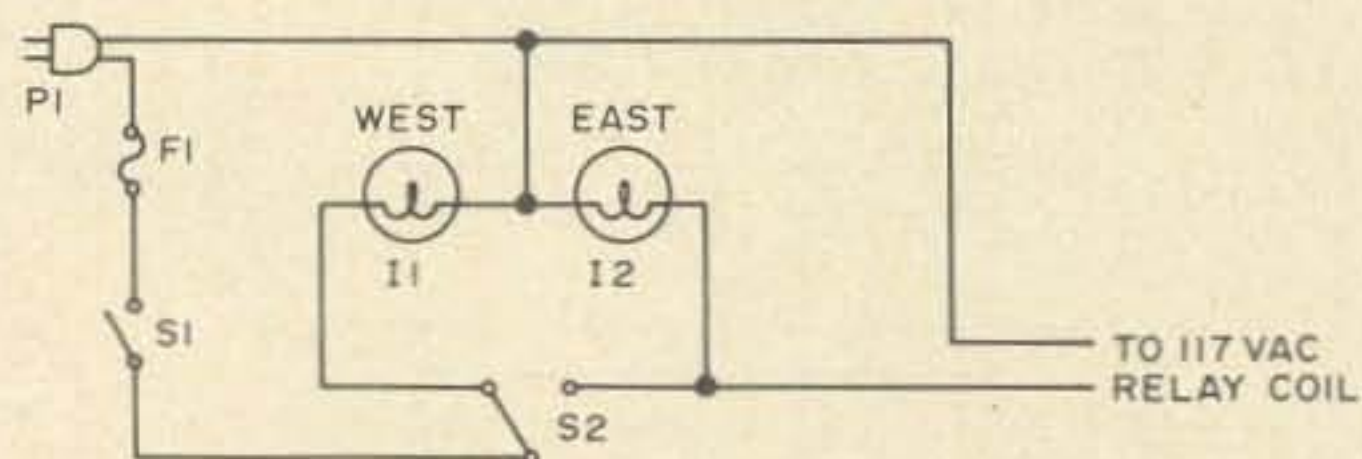

Fig. 2. This is a schematic of a control console that should be used where the most used direction is to the west. To use a lower voltage relay just put a transformer on the 117V ac output. F1 - 2 amp fuse; I1, I2 - 117V ac light; P1 - standard power plug; S1 - SPST switch (turns unit on or off); S2 - SPDT switch (selects direction).

### Performance

This type of antenna cannot be expected to beat out a full size mono-band beam in terms of gain, but it can be very effective, especially on the lower bands where yagis are prohibitively large for most installations. On 40 meters Europeans could be worked nightly when using a popular 180W transceiver. This is with the antenna 37 ft in the air and broadside east and west. On the third harmonic, 15 meters, the antenna was equally effective, with some change in directivity apparent when switching the phasing line. The change in direction was not the same as that on 40 meters. The antenna was cut for 7.1 MHz and the SWR remained below 1.5 over the entire band. Similar results were found on 15 meters. On 40 the front-to-back ratio is sufficient to cut down broadcast interference on phone and stateside QRM while working CW into Europe. It varies from about 20 dB on 7.1 MHz to about 7 dB on 7.3 MHz. The gain appears to be 3 to 5 dB with respect to a dipole. By cutting the antenna for any particular frequency, performance will be optimized for that frequency.

From the performance of the 40 meter array, similar results can be expected on the other bands. All in all, this is a very effective antenna system, in both performance and cost.

. . . WB2NQT

# The Incredible 18" All-band Antenna

I'd like to tell you about a new type of antenna which was the subject of a paper at a recent International Communications Conference. It was designed to work on very low frequencies, but since the time of the conference, I have never heard another word about it!

It seemed to me that this was an antenna which could be adapted to other frequencies with slight modification and could fill in my need for a very small, all-band antenna to work with my 3 to 30 MHz receiver. Thus I went to work on a design and came up with a rather remarkable device.

A simplistic explanation of the antenna is that it is not an antenna in the common meaning at all. Rather it might be thought of as a capacitor coupled to all the rest of the universe. In this universe are quite a few other antennas connected to transmitters — transmitters I'd like to receive, also a few I'd rather not hear (i.e. power line noise, etc.).

The size of this capacitance must be very, very small as its elements are very far apart. Any capacitance existing must represent an extremely high impedance. Thus it is necessary to build a transformer which will

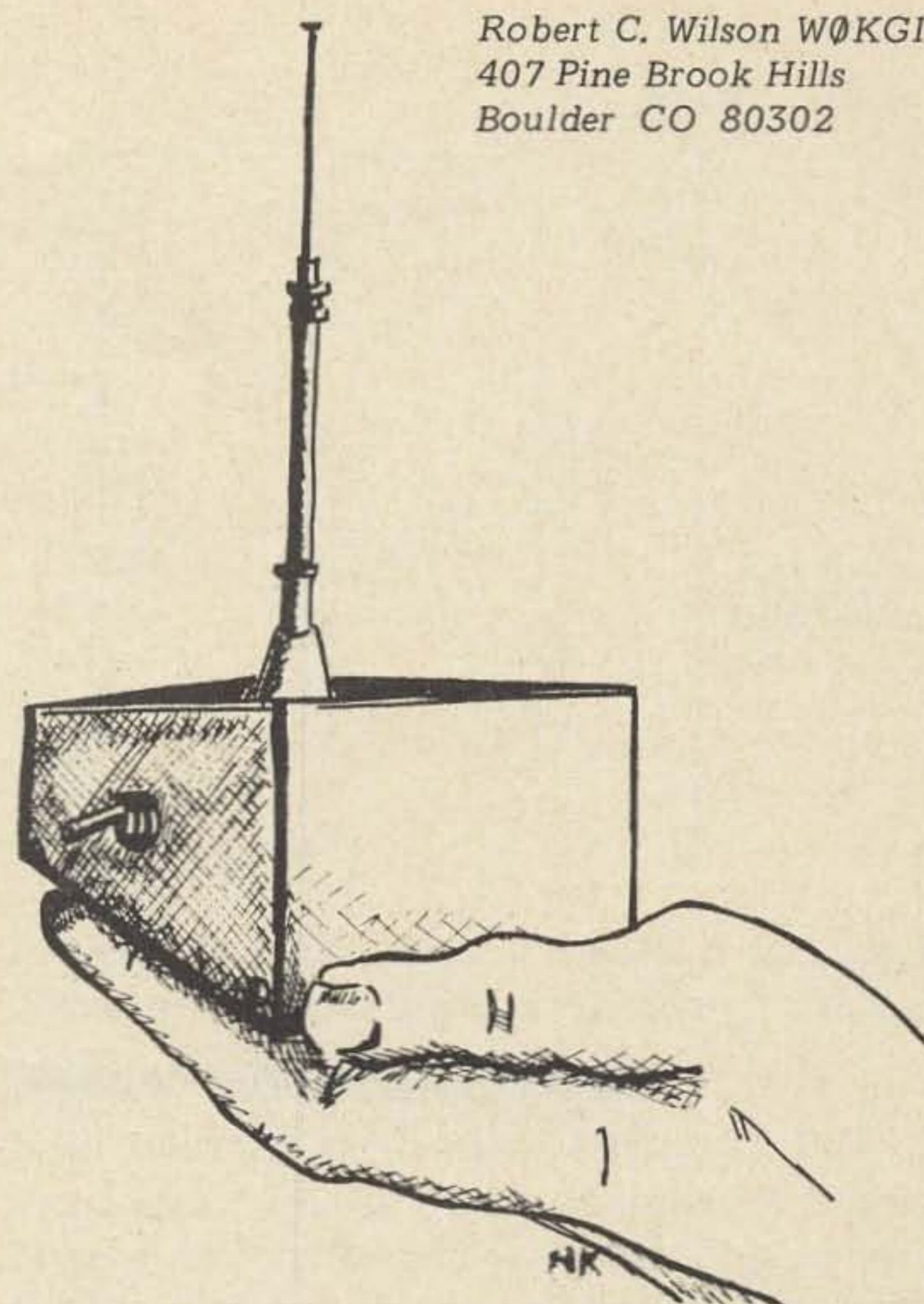

convert this high impedance down to something manageable, like 52 Ohms.

Today we can manage this enterprise with real components by the use of a FET source follower, as shown in the diagram. An input capacitor is used to prevent inadvertent dc coupling to the FET gate and its subsequent destruction. At the input of the FET is also the only special component, a high quality low noise metal or carbon film resistor of about one megohm resistance.

This is required to reduce resistor noise at the input which will soon develop if carbon composition resistors are used. Of course, a choke would solve all the problems if only one could find one with a high enough impedance and no strange characteristics like resonances at undesired frequencies or low Q figures to eat up the signal.

The "antenna" portion of the unit also was a bit critical in that the capacitance to the rest of the world often needed to be adjusted to fit a particular location in the real world. For example, a nearby broadcast station or a bad fluorescent light would cause cross modulation. Thus the "antenna" used was a replacement receiver whip which could extend from about 8 inches to about 4 feet.

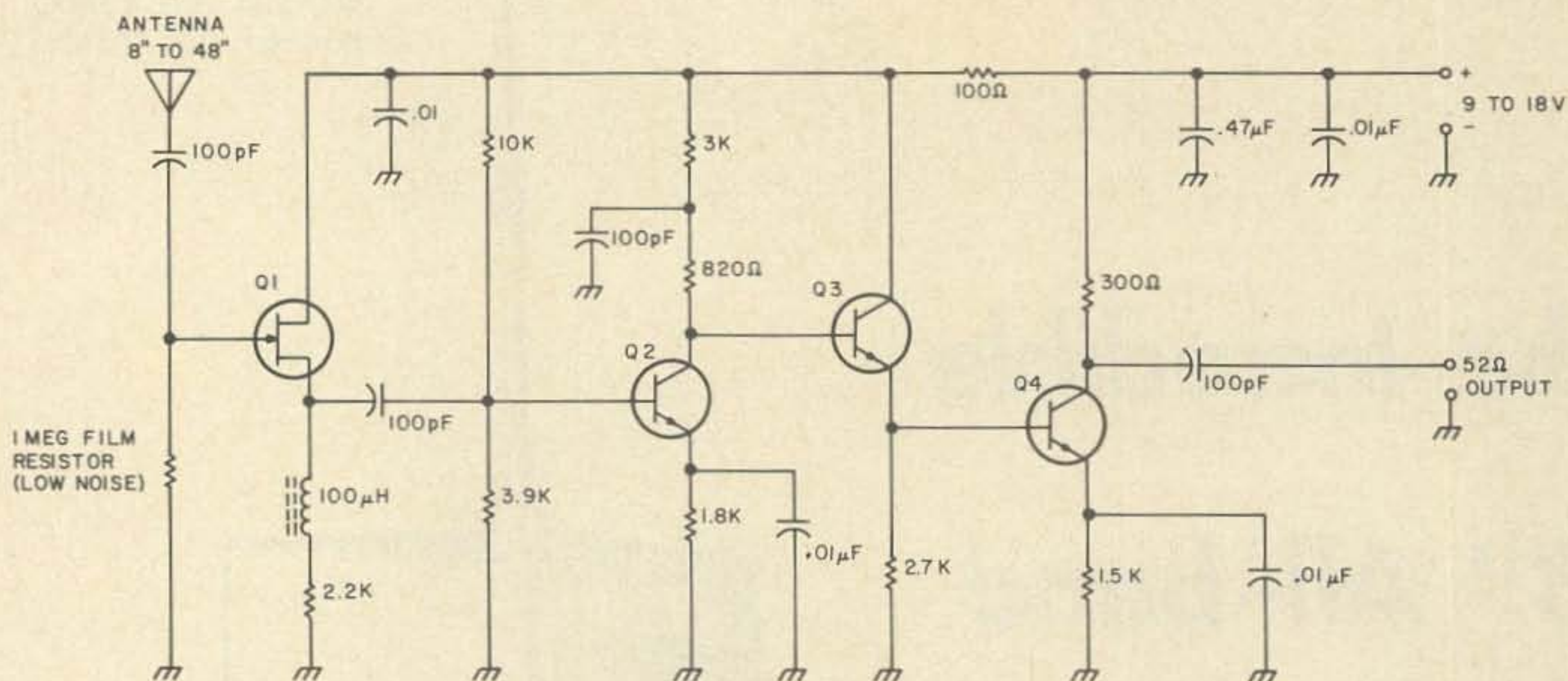

Fig. 1. Q1 = 2N3819 or equal. Q2, 3, 4 = any 200 MHz, 20V, NPN transistor, i.e., 2N918, 2N6008, etc. R = Carbon composition, except where noted, all ¼ watt.

But 18 inches seems best for most locations. Remember again this is a capacitive device, and any stray capacitance to ground from the antenna or circuitry leading to the gate of the FET causes the signal to be divided into an unwanted capacitive branch. So use a big insulator at the base of the whip and a short lead to the FET base. The units I have built are "free form" electronics with all components soldered together in space and the grounds soldered to a piece of brass .010 shim stock or printed circuit board. Looks funny but it works!

All of the circuit following the source follower is simply a 30 dB gain broad-band amplifier. The roll-off is about at 3 MHz on the low end and at about 35 MHz at the high end. By using this amplifier, the result is a lot more gain at the receiver input (and

possibly some cross modulation if the antenna is extended too far). The extra gain makes the receiver think it has a quarter wave whip connected to it at any frequency from 3 to 35 MHz.

I should note that this particular broad-band amplifier has been designed to be fairly foolproof. Just don't bring the input and output close together, and do apply anywhere from 9 V to 18 V. Hard core cases of local cross modulation may require a filter between the FET source follower and amplifier to remove the offending station. Or it has been suggested that a FET broad-band amplifier be used to handle the large signal levels of a local station without cross modulation. So far the capacitor-FET antenna has worked so well that neither has been necessary.

In use the capacitive antenna has been remarkable. It draws only about 6 mA from a 9V battery. I can tune to any frequency in the working range and receive good strong signals, the kind that often have my PRO 310 "S" meter needle on the peg. It doesn't seem to be frequency selective at any place within its range and once the whip has been adjusted for the location, you can tune 10 meters, WWV, all major shortwave bands, etc., with nothing but a small box sitting on top of the receiver and a twist of the dial.

Try it, you'll like it!

... WØKGI

# CATALOG

## GOVERNMENT SURPLUS ELECTRONIC EQUIPMENT

# For 1975

**FREE** UPON REQUEST! Write for  
Copy of Catalog WS-75 Now!  
Address: Attention Dept. 73

**FAIR RADIO SALES**

1016 E. EUREKA • Box 1105 • LIMA, OHIO • 45802

# Heathkit IG-1271 – a high-performance function generator for every ham shack...only \$99.95\*

This versatile generator provides sine, square & triangle waveforms from 0.1 Hz to 1 MHz, 10-volt output, and up to 70 dB attenuation ...at a price you can afford.

That old sine-square or audio generator you've been using has served you well over the years. But it just doesn't have the versatility you need for today's high-speed circuitry. Now, Heath has the generator you need at a price every ham will appreciate. The Heathkit IG-1271 is a compact, easy-to-operate function generator that will be the most-used piece of test gear on your bench. Output is 10 volts p-p into a 50-ohm load. The calibrated attenuator provides 0 to 50 dB attenuation in 10 dB steps with up to 20 dB additional variable attenuation for each step, for a total of 70 dB. Triangle waveform non-linearity is 5% max., with waveform symmetry within 10%. Sine wave harmonic distortion is 3% max. from 5 Hz to 100 kHz. Square wave rise & fall times are 100 ns max. Dial range is 100:1.



Price of the kit-form IG-1271 is only \$99.95\*—a triggered scope is all that's needed for alignment. For \$140.00\*, you can have the factory assembled & calibrated SG-1271. Either way, it's probably the best generator buy on the market. Just compare it to believe it.



## INSTRUMENTS ROUNDTABLE

Tom Yeager  
Chief Engineer  
Lab Instruments  
W8JAN

### Why You Should Choose A Function Generator As A Low-Frequency Signal Source For Your Bench

If you are more than an "appliance operator", like to get involved in circuitry, and occasionally "roll your own", then you find yourself choosing test equipment. In the past when it came to low frequency sources, the choice was rather simple...you bought an audio generator. Later the choice expanded to include sine-square generators. Now there is a third way to go...function generators. Here are some reasons why the hams at Heath believe a function generator belongs on your bench.

- 1. Wider frequency coverage.** In addition to covering the audio spectrum where, besides the obvious, it's handy for checking tone encoders and repeaters, a function generator gets you down into the sub-Hertz area so you can test electro-mechanical devices such as relays and servos and it's great for slowing down a circuit for easy observation and measurement. It also gets you up into the mega-Hertz region so you can work with operational amplifiers, do IF alignment and trap tuning. And a 100:1 dial range gives you an easy way to check bandwidth and filter roll-off characteristics.
- 2. Three waveforms.** A function generator gives you a sine wave for audio work, a square wave for use with today's complex IC logic families, and a triangle wave to checking amplifier clipping, distortion, and linearity.
- 3. High output voltage, low output impedance.** A function generator will give you 10 volts peak-to-peak at its 50 ohm output which will drive a variety of circuits regardless of sensitivity. And being able to drive a 50 ohm test cable without loading the generator and without causing "ringing" (high VSWR) is a marked advantage over conventional generators.
- 4. More for your money.** If you are like most hams, you spend your test equipment dollars carefully, comparing your needs with what's available, narrowing the choice to a few, and finally selecting the one or more pieces of test gear that give you the most of what you need for the dollars invested. We believe that's what you get in a function generator...more frequency coverage, more waveforms, more usable output, more versatility, more for your money...all in one single instrument.



## Send for your free Heath catalogs

Our latest catalogs contain complete description & specs for the 1271 and many other high-performance, low-cost instrument values from Heath. Send for your free copies and see how you can get more value for your instrument dollar.

Heath Company, Dept. 11-03  
Benton Harbor, Michigan 49022

HEATH  
Schlumberger

- Please send the 1975 Heathkit Catalog.  
 Please send the latest Assembled Instruments Catalog.

Name \_\_\_\_\_

Address \_\_\_\_\_

City \_\_\_\_\_

State \_\_\_\_\_

Zip \_\_\_\_\_

\*MAIL ORDER PRICES; F.O.B. FACTORY.

PRICES & SPECIFICATIONS SUBJECT TO CHANGE WITHOUT NOTICE. TE-322

# An 80m Phased Array

**A**s a confirmed 80 meter type I have always resisted the urge to put up a truly superior antenna system for that band. Finally, last summer I decided to respond to the creative urge by constructing a system which would offer advantages over a simple dipole and which would also include sufficient flexibility to permit direct experimental comparison of a number of antenna configurations which are of interest. This article reviews the approach, the results and the current status of those experiments.

## Approach

Consideration of space limitations (2/3 acre) and other practical constraints, led to the choice of two parallel dipoles as the basic elements of the array. Since it was desired to switch to a unidirectional pattern and also to control the angle of maximum radiation, direct feed, rather than a parasitic array, was chosen.

Reference to the radiation patterns in the handbooks shows that a uni-directional cardioid (heart-shaped) pattern can be obtained in an end-fire array of two parallel elements, with a spacing of  $\lambda/4$  and fed with a  $90^\circ$  phase difference. The radiation pattern in this case is a reversible cardioidal pattern with maximum gain in the direction of the lagging dipole element. This cardioidal arrangement was chosen as the basic horizon-

tal directional array with other related options available by switching.

It is of interest to provide, in addition to the reversible cardioid, a  $45^\circ$  lag (higher radiation angle), a  $0^\circ$  lag (highest radiation angle -  $90^\circ$ ), and  $180^\circ$  lag (8 JK configuration - low angle, bi-directional) and, for comparison purposes, each of the two dipoles separately. This is a total of eight different pattern options!

Still in the experimental stage is an attempt to achieve the same options using quarter wave vertical radiators. Thus far, with the ground system available, the performance of the vertical system is uniformly inferior by about ten decibels.

## Circuitry

The entire circuitry for the horizontal and vertical phased arrays is shown in the schematic diagram, Fig. 1. Instantaneous switching from one pattern to another is achieved by only three switches: a main selector switch S; the reversing switch X, which permits  $180^\circ$  phase reversal; and the 4PDT switch for changing between the horizontal and the vertical arrays.

For purposes of description, the system will be treated under the following headings: The Horizontal Dipoles; the Verticals; Impedance Matching; and the Switching Manifold.

## Horizontal Dipoles

The original installation utilized two dipoles as described previously in my article "Construction of a Balanced Dipole Antenna" in 73 Magazine. The centers were 46 feet above the ground with a horizontal spacing of 61 feet. The RG-8/U feedlines, one wavelength long, were inside the masts with the balun action and lightning protection as previously described. This original arrangement gave very good operation.

However, since it was desirable to have the lowest possible angle of radiation the centers of the two dipoles were raised to 61 feet ( $\lambda/4$ ). This was accomplished by lengthening each steel mast by the addition of a thirty foot length of three inch diameter aluminum irrigation pipe at the bottom end of the mast. The steel mast is inside this pipe and the overlapping portion is bolted securely by use of 1/4 inch plated bolts through the pipe and mast in perpendicular pairs. (No. 8 self-tapping screws in the steel mast served to space the mast within the pipe radially before the bolts were put in place.)

No data could be taken for comparison of these two heights but it is assumed that the 61 foot height yields a somewhat lower angle of radiation for each pattern option.

## Verticals

The sixty-one foot masts are fed as top-loaded verticals. The horizontal dipoles are connected to the top of each mast and the two halves of each dipole are connected together by shorting the opposite end of the  $1\lambda$  feedline.

Referring to the diagram, all of these connections are switched by means of the 4 PDT switch. This permits the selection of all of the vertical phasing options by the selector switch S just as for the horizontal system.

The resonating and impedance matching of the verticals is accomplished by the capacitors C and the inductors L. A noise bridge was used to insure adjustment to  $52\Omega$  resistive input at 3.955 MHz.

The 220 pF fixed mylar capacitor connected across the feedlines of the verticals, during use of the horizontals, serve to tune

out residual reactances for optimum swr to the horizontals.

When full lightning protection is desired the bottoms of the masts are connected directly to ground by means of copper jumper cables. With this connection the horizontal array can be used with dc paths to ground from both sides of each dipole, giving full protection against build-up of static charge.

## Impedance Matching

The feedline input impedances are  $52\Omega$  resistive at the resonant frequency (3.955 MHz). It is necessary to switch-in phase lag by inserting a length of  $52\Omega$  line in either of these feed lines, as desired, and to feed equal currents to both dipoles while maintaining a  $52\Omega$  match at the transmitter output.

This is accomplished by use of two quarter wave transformer sections of RG-11/U ( $75\Omega$ ) coax. These serve to transform the  $52\Omega$  antenna input impedance up to  $108\Omega$  by the relation:

$$Z_{\text{input}} = Z^2 \text{Line} / Z_{\text{output}}$$

When these two  $108\Omega$  inputs are connected in parallel the resulting  $54\Omega$  value is well matched to the transmitter output.

## Switching Manifold

The heart of the switching manifold is the 5-section 12-position switch, S. The current rating of this switch is sufficient to handle the full power as long as the transmitter power is removed before the switch position is changed. As the diagram shows, the system can be switched from the west antenna alone, at the 9 o'clock position, through the various angles of radiation to the east antenna alone, at the 3 o'clock position.

The reversing switch permits instantaneous switching of patterns, for example, from east to west, without having to turn the selector through the intermediate positions.

Only four of the twelve switch positions are not used: 4, 5, 7 and 8 o'clock. The six o'clock position is used for a dummy load

The switches are mounted in the 3 x 4 x 7 inch aluminum chassis box with the sixteen coax sockets as shown. The box is

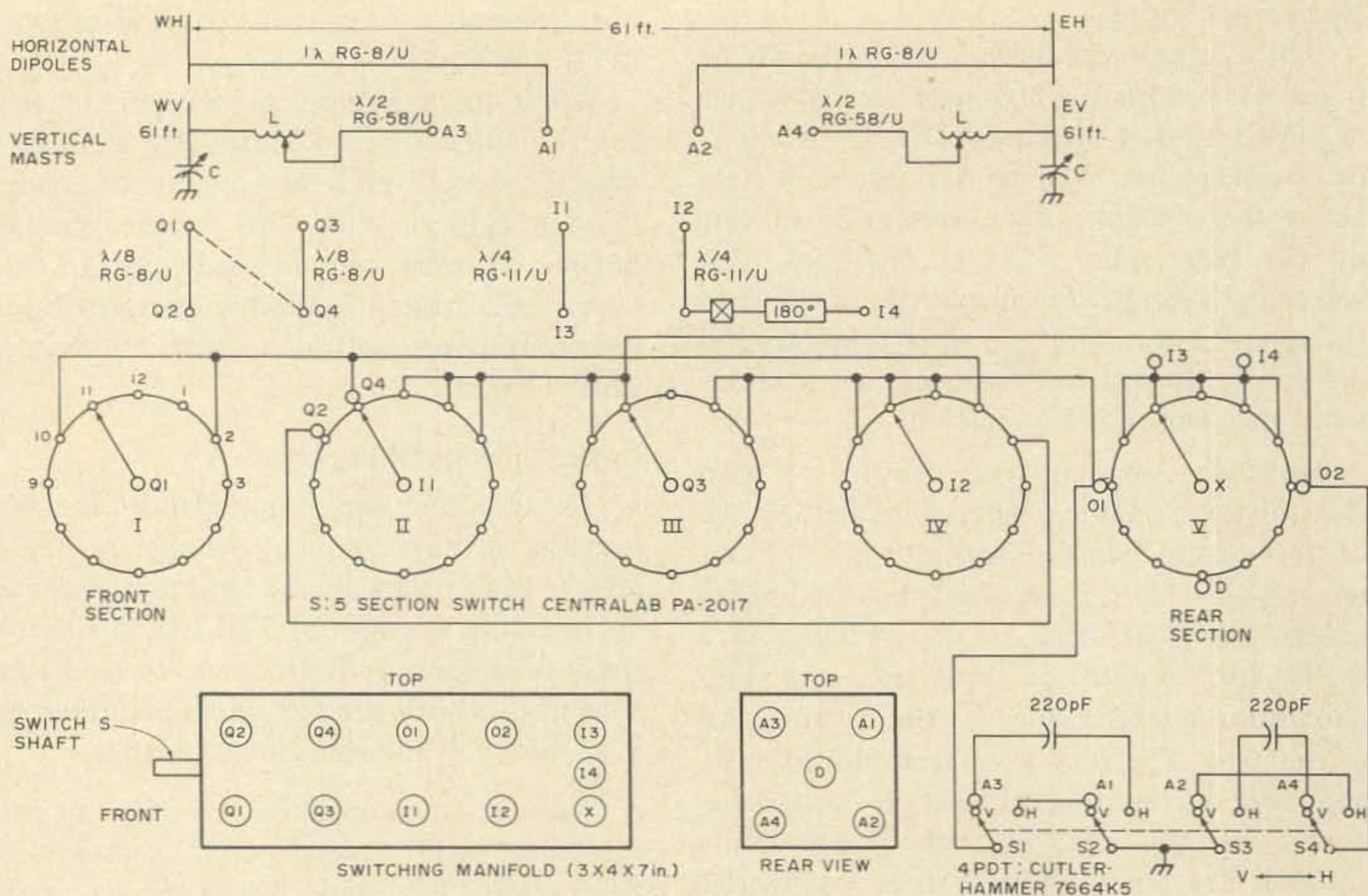

#### Notes

$180^\circ$ : Transposed coax 6" long

X: Reverse switch 4 PDT Cutler Hammer 7664K5

O<sub>1</sub>, O<sub>2</sub>: 'Scope

O, o: Chassis coax

X: Transmitter output

L: Master mobile 40m coil, tapped

C: Receiving variable 200 pF

D: Dummy load

9: West antenna

10: Directive west ( $\lambda/4$  wave lag)

11: Directive west ( $\lambda/8$  wave lag)

12: Out of phase (8 JK)/ In phase

1: Directive east ( $\lambda/8$  wave lag)

2: Directive east ( $\lambda/4$  wave lag)

3: East antenna

Fig. 1. Schematic diagram — 80 meter phased array.

mounted under a projecting top of the operating desk. The four lengths of coax used for matching and delay lines are wound on a wooden reel and placed inconspicuously behind the desk.

The connectors O<sub>1</sub> and O<sub>2</sub> provide inputs to the vertical and horizontal plates of an oscilloscope for a Lissajous display of the inputs to the two antennas. (The integral scope in the CE 100V transmitter is used at W2OZH). Thus, the phasing and the amplitude of the rf voltages can be continuously monitored, allowing any change in either antenna to be immediately noticed.

The scope shows a circle for the cardioidal patterns, diagonal lines for in-phase or out-of-phase, and a flattened ellipse for either antenna alone. (This pattern is elliptical rather than a straight line due to the rf energy picked up by the non-energized antenna.)

#### Performance

The performance of the array has been all that was hoped for, both for transmission and for reception.

The swr is consistently low (under 1½:1) for all configurations. The array shows a broadband behavior typical of coupled resonant circuits. The swr remains low throughout a bandwidth of some 400 kHz — only the phasing varies.

The measured front-to-back ratio is of the order of 15 dB and the gain is about 4 dB, for both transmission and reception. The improved operation for low angles of radiation is sometimes spectacular — a net of California stations on 3952 kHz could be repeatedly heard and worked during the winter at 9:30 pm EST!

One of the most pronounced characteristics noted has been the great reduction of QRM for reception. The combination of



# Wilson Electronics

**DIRECT**

## **SPECIAL MARCH SALE!!!**

### **WILSON 1402SM HAND HELD 2.5 WATT FM TRANSCEIVER**

- \* Rubber Flex Antenna
- \* Complete Set NiCad Batteries
- \* Leather Case
- \* Three Sets of Crystals, Your Choice  
Of Common Frequencies,  
Extra Crystals, \$8.00 pr., Common Frequency.

**ALL FOR JUST \$199<sup>95</sup>**

- 6 Channel Operation, Individual Trimmers  
On All TX and RX Xtals. All Xtals Plug In.
- S Meter Battery Indicator.
- 10.7 IF and 455 KC IF. 12 KHz Ceramic Filter.
- .3 Microvolt Sensitivity For 20dB QT.
- 2.5 Watts. Nominal Output 12 VDC.
- Microswitch Mike Button.
- Size 8-7/8 x 1-7/8 x 2-7/8 Inches.
- Weight 1 lb. 4 ounces. Less Battery.
- Current Drain RX 14MA TX 380 MA.

**ACCESSORIES:**

- SMI Speaker Mike \$24.00
- BCI Battery Charger \$29.95
- 1410A Amplifier Mobile Mount \$99.00



To: Wilson Electronics  
P.O. Box 794  
Henderson, Nevada 89015  
(702) 451-5791

Ship me 1402 SM Special March Package  
Plus  SM1  1410A  BC1

Enclosed is \$ \_\_\_\_\_  Check  Money Order

Master Charge  Bank Americard  
# \_\_\_\_\_ M/C Interbank # \_\_\_\_\_

Card Expiration Date \_\_\_\_\_

Xtals \_\_\_\_\_

Name \_\_\_\_\_

Address \_\_\_\_\_

City and State \_\_\_\_\_ Zip \_\_\_\_\_

Signature \_\_\_\_\_

All orders will be shipped Air Mail within 24 hours after receipt of order (excluding weekends). Enclose additional \$3.50 for prepaid shipping. Nevada residents add sales tax.

Sale ends March 31, 1975

the high front-to-back ratio and the low angle of radiation serves to reduce the level of some signal strengths while increasing the level of others. Thus, there is often at night-time a sort of single-signal performance which is very gratifying. (It should be gratifying to the stations off the back of the pattern too!) This single-signal selectivity of the antenna system is particularly impressive when the station being worked also has a low-angle directive antenna system. In this case the directivities complement each other with spectacularly strong signals at either end.

For the type of operation prevalent at W2OZH the two cardioid patterns are used more than 90% of the time. Frequently the out-of-phase (W8JK) bi-directional configuration is used for calling CQ and the proper cardioid pattern is used for the ensuing contact. Under normal conditions there is little need for a linear amplifier, once contact has been established. The principal directivities are in the east and west directions so stations to the north or south are seldom worked. The 0° or 45° phase shifts

and the single dipole patterns seldom show consistent superiority over the cardioids. It is interesting to listen to two stations on the same frequency which have about equal signal strengths, when one is to the east and the other to the west. Either signal can be selected at will by switching the cardioid patterns and the unwanted signal is barely audible in the background!

Such an array would be a great boon to stations located on the coasts as the 3 dB of power wasted out over the water could be largely utilized.

The only disappointment thus far has been the consistent weakness of signals from the vertical antennas. The separate vertical antennas are typically down about 10 dB compared with the horizontals and this inferiority carries over to the vertical array, regardless of direction or distance. The poor performance of the verticals is attributed to ground losses, with attendant high radiation angles, in spite of the fact that a parallel grid of about 3500 feet of ground wire is used. Perhaps this explains why so many writers describe their eighty meter vertical constructional features at great length with hardly any space devoted to results. Maybe the results were unprintable!

Weather and motivation permitting, I plan to experiment further with improved radial grounding and I hope to get some meaningful quantitative comparisons. Meanwhile I will be skeptical when I hear of a "superior" 80 meter vertical with only a modest ground system.

#### Conclusions

A two-element horizontal phased array for 80 meters has been constructed with a total of eight pattern options available by direct switching. Operating results have confirmed the expected gains and front-to-back ratios. The performance of the unidirectional cardioidal patterns has been particularly effective, especially when the station being worked also has a directive antenna system.

Preliminary results using a vertical array with similar pattern options have not been encouraging, apparently due to high ground losses. Further experimentation on this system is planned.

... W2OZH

## YOUR HAM TUBE HEADQUARTERS!

TUBES BOUGHT, SOLD AND TRADED  
SAVE \$\$\$ - HIGH \$\$\$ FOR YOUR TUBES

### MONTHLY SPECIALS

3-500Z	\$42.00	6146B	\$ 4.25
3-1000A	120.00	6883B	4.50
4-65A	28.00	6939	9.00
4-125A	42.00	7289/2C39WB	12.00
4-400A	45.00	807	2.50
4CX250B	24.00	811A	5.00
4X150A	19.00	813	18.00
572B	18.00	8236	22.00

BRAND NEW\*\*\*\*FACTORY GUARANTEED

TOP BRAND Popular Receiving Tube Types.  
BRAND NEW 75%+ Off List\*Factory Boxed.  
FREE LIST Available - Minimum Order \$25.



COMMUNICATIONS, Inc.  
2115 Avenue X  
Brooklyn, NY 11235  
Phone (212) 646-6300

SERVING THE INDUSTRY SINCE 1922

# GET TO THE FAST TOP!

NOW YOU CAN CHANGE, ADJUST OR JUST PLAIN WORK ON YOUR ANTENNA AND NEVER LEAVE THE GROUND!

ROHN manufacturers towers that are designed and engineered to do specific jobs and that is why we have the FOLD-OVER TOWER . . . designed for the amateur. When you need to "get at" your antenna just turn the handle and there it is. Like other ROHN big communication towers, they're hot dip galvanized **after** fabrication to provide a maintenance free, long lived and attractive installation. ROHN towers are known and used throughout the world . . . for almost a quarter century . . . in most every type of operation. You'll be in good company. Why not check with your distributor today?



**ROHN** MANUFACTURING

®

DIVISION OF



P.O. Box 2000 / Peoria, Ill. 61601

# An Honest 6 db on 450 MHz

*... the stacked collinear*

**T**his antenna can be called a stacked collinear, but whatever it is called, it does a beautiful job in the 450 MHz band. Inspired by a similar design in another magazine for 2 meters, and in dire need of a good antenna for 450, I recalculated the dimensions and built it. There are 3 of us on 449.1 in the Dallas area; myself (W5GDQ), WA5QFO and W5GQE.

I had been trying my 6 Watt RCA Carfone base station on my 2 meter antennas, which work pretty well, but I am tired of wearing my rotator out on VHF and wanted a little more gain. I took this antenna, hung it from the light bulb in the garage and noted considerable gain over the 43 foot 4 element 2 meter beam with W5GQE some 20 miles away. (His antenna was about 50 ft. high.) With this antenna about 51 ft. above the ground, I am now hearing a Ft. Worth 3 Watt transmitter about 26  $\mu$ A at this limiter.

## Construction

Start by cutting 5 pieces of RG-8 10 inches long. These will be the 1/2 wave sections. Strip the braid back until the braid is 8-11/16 inches long. The braid should be centered in each section leaving about 3/8" gap between the sections as in the drawing.

cut another section of RG-8 about one foot long; strip the rubber insulation back about 6". This will be the bottom section. Strip some of the braid back and overlap center-conductor to braid as before placing this section below the already assembled 5 sections. Solder this piece on. On this bottom section, from the top edge of the braid, measure down 4-5/16 inches. Mark this spot. Tin it with solder and mark it again. This is where the 4 radials will leave the braid for their drooping 30 degree 5 inch run. Needless to say, start your radials with about 6 1/2" lengths then bend them, measure 5" and cut them off. Then solder securely, binding them with copper wire first. I found it much easier to put one radial on, bind it, solder it, cut off the rest of the unused copper wire for binding, then go to the next radial. For the radial material, brazing rod is ideal. It bends with no difficulty but won't accidentally bend and solders very well. Put your coax connector on the bottom of this section.

For the top section, cut a 12 inch length of RG-8. Prepare one end as before. Remove the rubber insulation. From the upper end, pull the braid back to where you can see the point 4-5/16" from the bottom edge of the braid. Mark this point. About 1/4" further

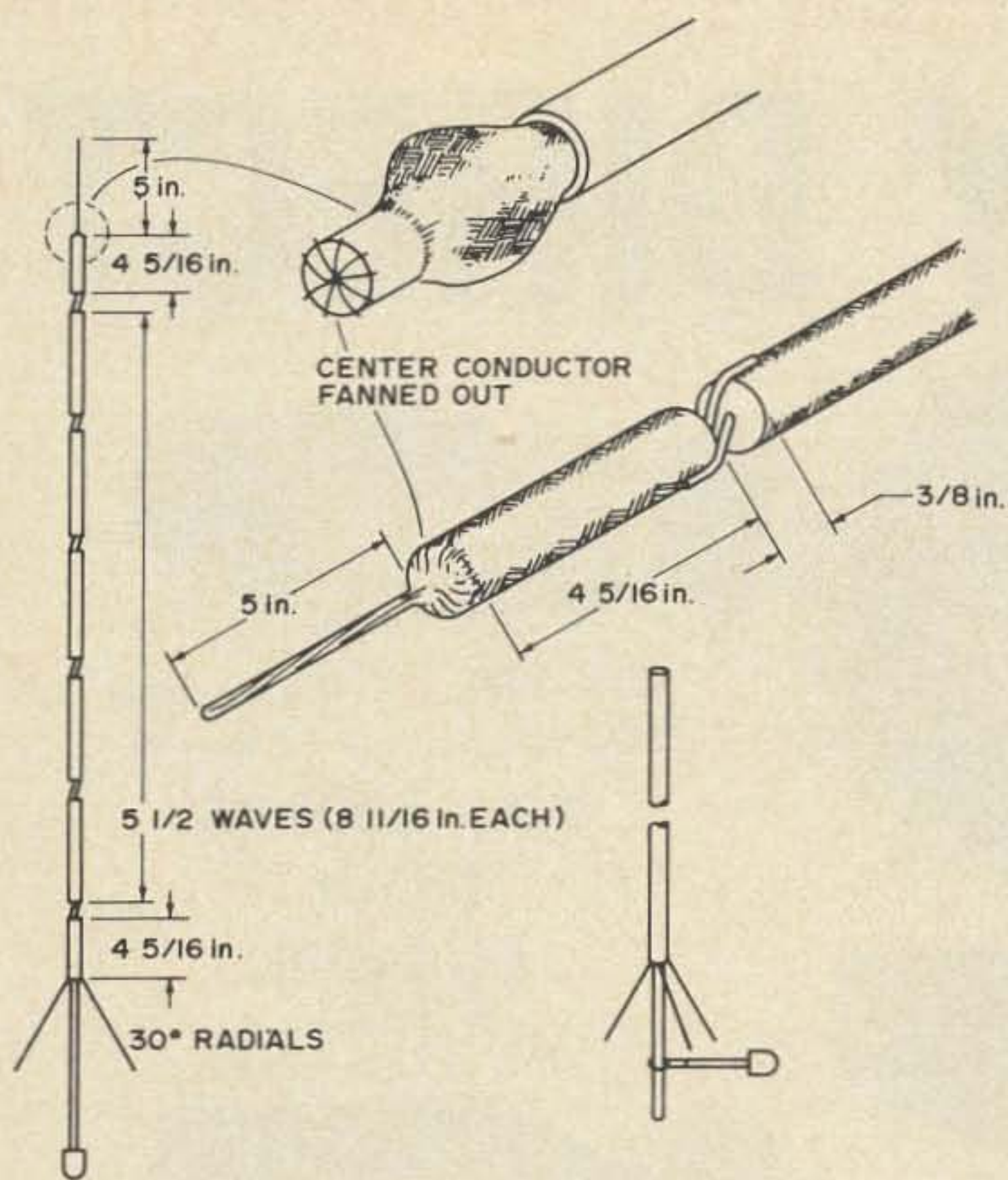

towards the top, cut the insulator and center conductor off. At the point where you made the mark 4-5/16" from the bottom edge of the braid, carefully cut the polyethylene off leaving the exposed center conductor and the still pulled back braid. Cut the center conductor off leaving about 1/16" exposed. Fan each strand out to the edge as shown in the figure. Pull the loose braid up over the cut off center conductor and pull down tight as shown. Solder the braid to the fanned out edges of the center conductor, then solder the braid making it solid up for about another 5 1/2." Measure up from the fanned out center conductor and cut the braid off at 5 inches. This 5 inches will not compute with your formulas but for some reason works best.

This completes the construction of the antenna itself. I recommend you buy a 10 foot length of PVC rigid plastic pipe 3/4" diameter. You will find it measures about 1 inch but that's OK. Lay your newborn antenna down on the floor. Place the PVC pipe beside it with the bottom edge of the pipe at the top of the radials. Cut the pipe off about 4 inches longer than the antenna from the radials up. At the top section of the antenna where you have the top two sections soldered together, drill a small hole through the pipe. Place the antenna inside the pipe and thread a piece of nylon fishing

line through the pipe, through the gap in the antenna and out the other side of the pipe. Tie securely. This will keep the antenna straight and taut in the pipe. Seal the upper end of the pipe with either the cap, plastic wood, fiberglass, epoxy, etc. I cut another 4 inch piece of pipe and put it up under the radials and epoxied that in solid.

Take the remaining PVC pipe, cut off 12 inches, and take the rest and place below the antenna overlapping 12 inches. Take PVC cement and cement the two pipes together. After they are dry, take the remaining 12 inches of pipe, and rip it lengthwise into 4 pieces. Throw 2 of them away. Take the other two and place along the 12 inch overlap in a concave fashion. Cement them onto the assembled antenna. At your local TV shop, for about \$2.50 you can buy a package of 2 (you need only 1) 6" wall mounts. They may have an extra chimney mount you can buy cheaper. The only difference is the chimney mount is at a 90 degree angle instead of 180 degrees. (You can straighten it out.) In the provided hole on the bracket, your antenna will fit. Take the other end, drill holes for a "U" bolt then cut off the excess. It is now ready to mount below an existing beam and go up through it with no ill effects.

Note: More 1/2 wavelength sections can be added to this antenna as long as the number of sections is an odd number. However, going from 5 sections to 11 sections will only give you about 3 dB more gain, but a lot of construction headaches. I am using about 100 ft. of RG-213 (RG-8). This is about 5 dB loss but think what I would have if I didn't have this 6 dB antenna!

... W5GDQ

## INTERESTING MORSELS

What frequency did Heinrich Hertz use during his experiments of 1888-1889? HF? VHF? UHF? The answer is: Approximately 500 MHz! (60 cm)

Who took out the first patent on a tuned circuit for radio receivers or transmitters? It was Oliver Joseph Lodge, and the date was 1898. It was several years before the use of tuned circuits became common, though.

... W5JJ

# NOW! BUY DIRECT



**GTX-600 6-Meter FM**  
100 channels, 35 watts

**WAS \$309.95**

**NOW**

**\$219<sup>95</sup>**

(Incl. 52.525 MHz)



**GTX-100 1 1/4-Meter FM**  
100 channels, 12 watts

**WAS \$309.95**

**NOW**

**\$219<sup>95</sup>**

(Incl. 223.5 MHz)



**GTX-2 2-Meter FM**  
10 channels, 30 watts

**WAS \$299.95**

**NOW**

**\$189<sup>95</sup>**

(Incl. 146.94 MHz)

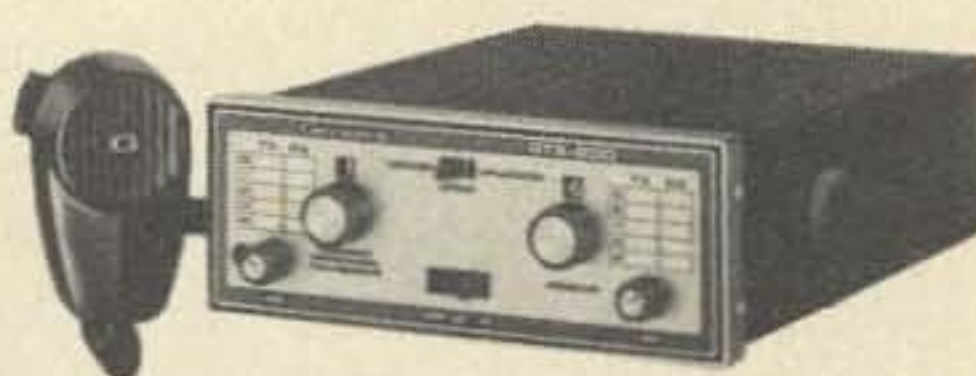

**GTX-200 2-Meter FM**  
100 channels, 30 watts

**WAS \$299.95**

**NOW**

**\$199<sup>95</sup>**

(Incl. 146.94 MHz)



**GTX-10 2-Meter FM**  
10 channels, 10 watts

**WAS \$239.95**

**NOW**

**\$169<sup>95</sup>**

(Incl. 146.94 MHz)

CLIP OUT AND ORDER NOW!



**GENAVE**, 4141 Kingman Dr., Indianapolis, IN 46226

73

**HEY, GENAVE!** Thanks for the nice prices! Please send me:

- |   |   |
|---|---|
| <input type="checkbox"/> GTX-600 @ \$219.95 \$_____ | <input type="checkbox"/> Lambda/30 2-M Base Antenna @ \$39.95 \$_____ |
| <input type="checkbox"/> GTX-200 @ \$199.95 \$_____ | <input type="checkbox"/> Lambda/4 2-M Trunk Antenna @ \$29.95 \$_____ |
| <input type="checkbox"/> GTX-100 @ \$219.95 \$_____ | <input type="checkbox"/> TE-1 Tone Encoder Pad @ \$59.95 \$_____      |
| <input type="checkbox"/> GTX-2 @ \$189.95 \$_____   | <input type="checkbox"/> PSI-9 Port. Power Package @ \$29.95 \$_____  |
| <input type="checkbox"/> GTX-10 @ \$169.95 \$_____  | <input type="checkbox"/> PS-1 AC Power Supply @ \$49.95 \$_____       |

and the following **standard** crystals @ \$4.25 each: \_\_\_\_\_ \$\_\_\_\_\_

**Non-standard** crystals @ \$5.75 each — allow 8 weeks delivery.

*For factory crystal installation add \$8.50 per transceiver.*

**Sub-Total:** \$ \_\_\_\_\_

IN residents add 4% sales tax:

CA residents add 6% sales tax:

**TOTAL:** \$ \_\_\_\_\_

For C.O.D.. Include 20% Down.

*All orders shipped post-paid within continental US.*

NAME \_\_\_\_\_

AMATEUR CALL \_\_\_\_\_

ADDRESS \_\_\_\_\_ CITY \_\_\_\_\_ STATE & ZIP \_\_\_\_\_

Payment by:  Certified Check/Money Order  Personal Check  C.O.D.

Note: Orders accompanied by personal checks will require about two weeks to process.

20% Down Payment Enclosed. Charge Balance To:

BankAmericard # \_\_\_\_\_ Expires \_\_\_\_\_

Master Charge # \_\_\_\_\_ Expires \_\_\_\_\_ Interbank # \_\_\_\_\_

Prices and specifications subject to change without notice.

Mike Naruta WA8BHR/5  
International Linguistic Center  
7500 West Camp Wisdom Road  
Dallas TX 75211

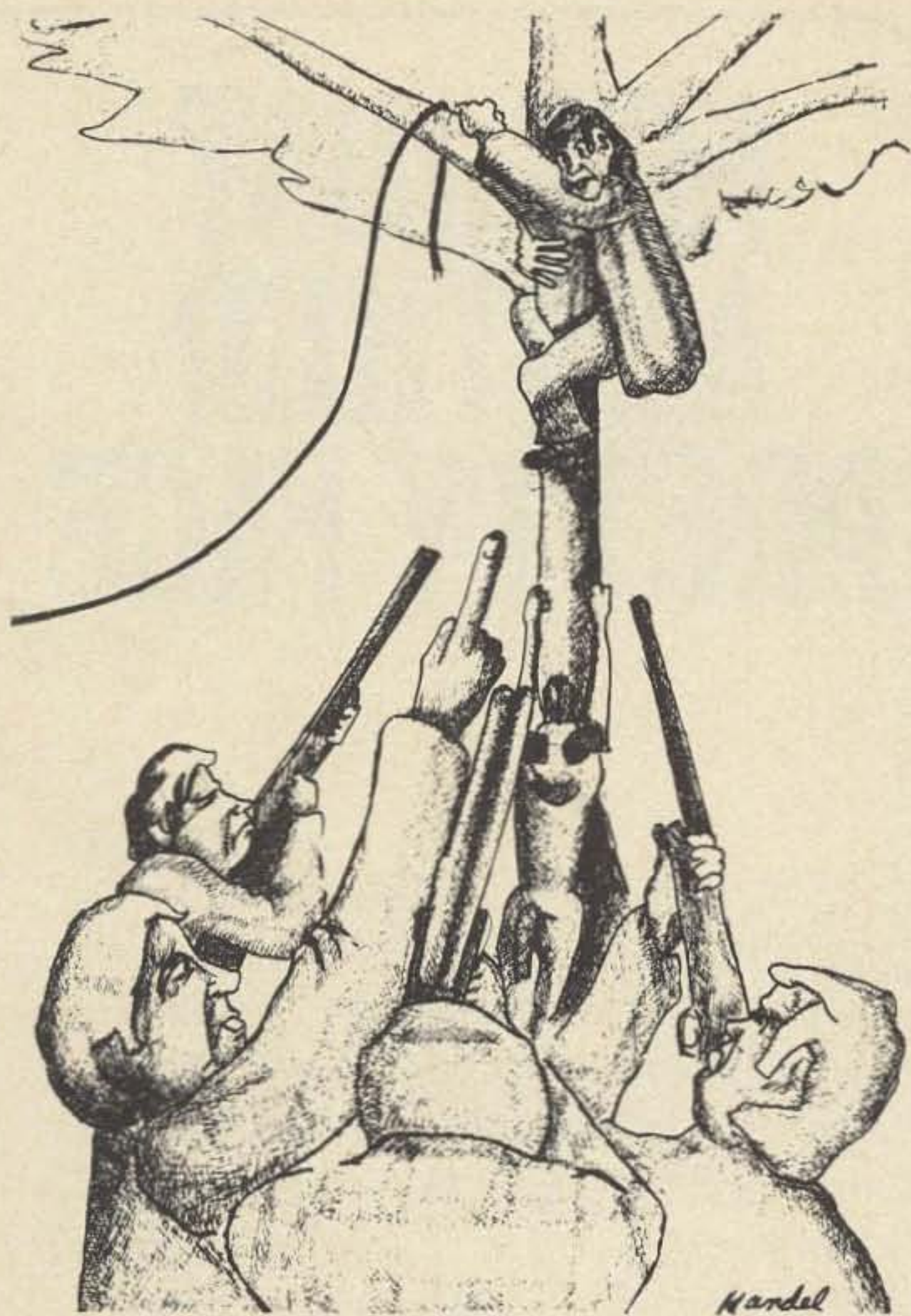

## Invisible Antennas

### Why ask for trouble?

If you are a little leary of putting up a really identifiable antenna like a dipole in a neighborhood that has been plagued by TVI from those who call themselves the Purple Knight, Cotton Picker, or whatever, than an invisible antenna is for you.

Well, not actually invisible, but very difficult to see from your neighbor's property line. The secret is to use very thin wire. My present 80 meter inverted vee is made from #30 magnet wire and even when you are looking for it, it's very difficult to see. The strength is not as great as with thicker wire, but this 80 meter job held up to everything but a freak Texas ice storm. Then again, a lot of the trees didn't do so well either.

The easiest configuration seems to be an inverted vee with the feedpoint at or near your shack. A long wire is also good, but difficult to install and maintain. Other variations stick the feedline out in the air. Coax is very heavy, difficult to disguise, and it's best to keep it short anyway. Do not use those big ceramic insulators. They weigh more than the rest of the antenna and are very obvious. If you must have insulators, use a small chunk of transparent plastic. I've

found that fishing line is beautiful stuff. It's an insulator, is very strong, and doesn't seem to soak up rain. At the far ends of the antenna, use one of those knob insulators with the screw in the ceramic, or just wrap the fishing line around a tree branch or whatever you're using for support. If you are after a little height, heave the insulator over a tree, haul down the other side and tie it off. Lightweight antennas work very well this way. You should not use utility poles, although they make very nice supports and tend to make your antenna appear to be just another power line.

Just as important as what to put up is when to put it up. The idea of invisible antennas is to prevent you from being the target of every noisy ignition or static crash that appears on junior's cartoons, mother's soap operas, or father's football. Therefore, it makes sense not to put up your antenna when everyone is staring at you. So choose a time when people are occupied, like prime time around 8 pm. But watch out for the half hour commercial breaks. Pick a day when the weather is not good for being out of doors. (It has been proven that antennas function best when they are erected in the

worst weather.) But watch that you don't leave suspicious footprints in the mud or snow.

There are several drawbacks to invisible antennas. The wire is difficult to see when you are installing the antenna. Make sure that you have all the kinks out of the wire as this weakens it. You must keep the wire at least 8 feet high or people will run into it and think it's a spider web, or kids will try to knock it down.

Watch out for dogs. I had a rough time in a suburb of Detroit because of one. I mean, hams are noted for being a little strange, but I had a difficult time explaining to my neighbor what I was doing in a tree in his yard in the dark! A friend of mine had a much rougher time in a heavily forested rural part of Michigan. Bob had prepared quite well. He scouted the area first, and waited for a cold, dark night when everyone was occupied with their one eyed pacifier. He wore an old fur coat because it was cold and he didn't want to tear his clothes on tree branches. As Bob neared the top of the tree, a huge German shepard noticed the unusual sight and promptly made his best attempt to let the neighborhood know about it. A young boy came out to see what the dog was barking about. Bob remained motionless in the tree, hoping that he wouldn't be noticed. The boy returned to his house and Bob breathed a sigh and returned to fastening the antenna. Suddenly, the boy and his father returned and Bob froze again. He overheard the father saying, "You're right, Kenny. That *is* a bear in that tree. I'd better get my GUN." Before Bob could get down that tree, he was surrounded by the entire neighborhood, including barking dogs, kids yelling "shoot, shoot," trigger happy fathers, and lots of artillery. Bob spent a long time trying to explain, but the people just shook their heads and walked away.

Invisible antennas are not substitutes for large arrays, but are for the ham who wants to put out a signal strong enough to get out of his state and doesn't want to attract attention to himself. I've used these antennas with peak powers up to 300 watts, but I see no reason why you couldn't run more power if you are careful. Good luck and have fun. . . .WA8BHR/5

# NOT JUST ANOTHER PRETTY FACE

*From time to time Standard introduces new transceivers for Land Mobile-Business and Public Safety users that are also of general interest to Amateurs. This is just such an occasion. We are pleased to introduce you to Standard's new 15 or 35 watt, 1 to 12 channel VHF Transceiver — the new model 809/859.*

*Although this is not an Amateur 2 meter radio, we thought you or perhaps your business associates would be interested in this new, relatively low cost commercial radio. The specifications are outstanding — as you can see.*

*If you would like further details and pricing information, please let us know.*

Jim Hervey  
V.P. Marketing



**Standard  
Communications**

639 North Marine Avenue  
Wilmington, California 90744  
Phone 213/835-3134



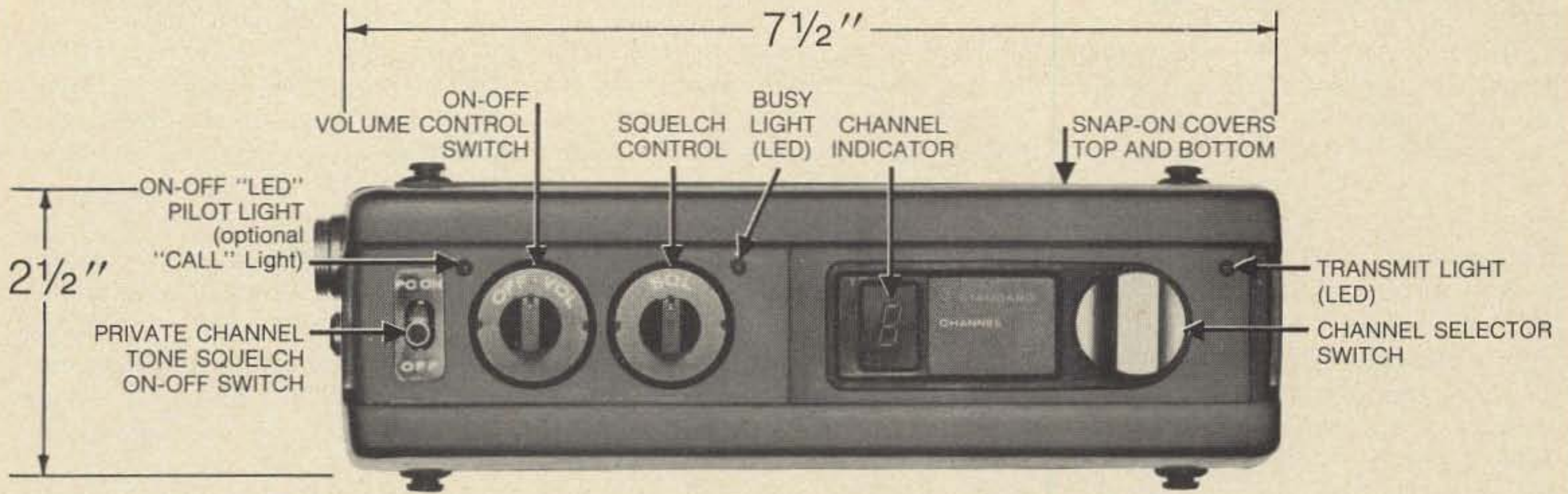

# The 809/859 Base Mobile Transceiver

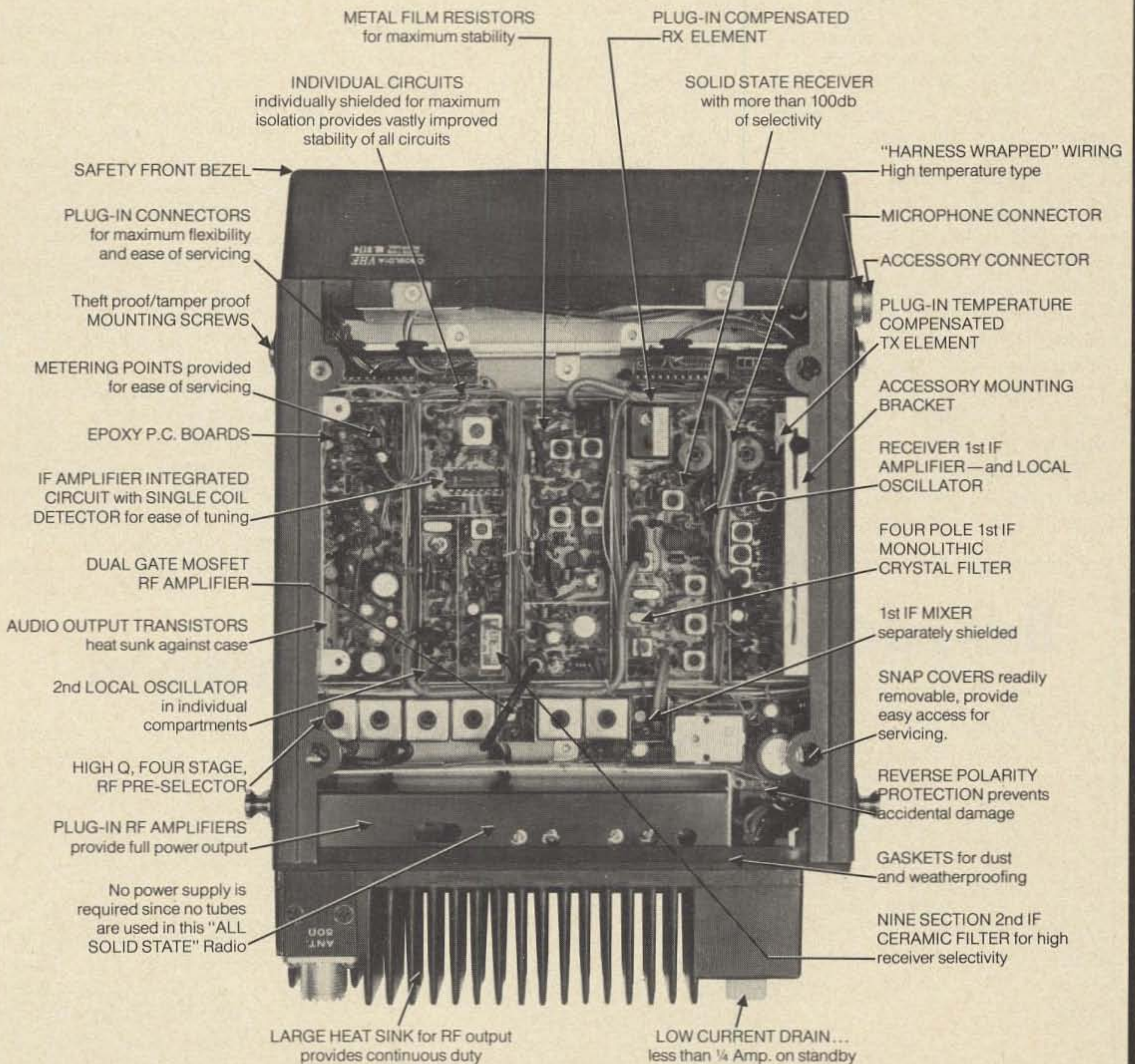

## Voxpoop

Here are some more reader comments and requests received recently. Wonderful magazine. Wish you would run an article on digital computers in the future — Pemberton, Evansville IN. (*I'm sure many readers would be interested in such an article; any authors for this?* — Wayne.) Cut some of the endless babble about 2m FM... glorified CB — WN8KYO. (*Sorry to hear 2m is that bad in West Virginia — it's nothing like CB at all here in the East — or have you ever heard 2m?* — Wayne.) I would like more state of the art solid state projects, UHF construction projects, product reports on some of the newer ham rigs such as the Ten Tec Triton and Kenwood TS-520. Great magazine, keep it up — WNØMBY. (*Anybody use a Triton out there? We'll have a 520 report before long — I think — getting one is a real bear these days* — Wayne.) Enclose a readers service card in the magazine which does not have to be cut off another page — K4ACH. (*Love to, but the printer wants about three cents each to do this, and that is a bundle. Perhaps we can find a printer to do it for less as it should cost a fraction of that* — Wayne.) Since there are more and more repeaters now in use, some readers like myself may be interested in a construction article on a frequency synthesizer for 2m — WA8AUD. (*We beat you to it in Nov.* — Wayne.) Really enjoy your solid state news — WA4RJD. I'd like to see a few articles on phase lock,

## Voxpoop

TTL and op amp basics so readers like me can know more about them — Sanford, Nanuet NY. (*A reader has spoken, authors* — Wayne.) I thought the article on the ID timer was terrific. I'm half done on its construction and can't wait until it's completed — WA3VRR. Please expand SSTV coverage — Schmidt (lifer). (*Glad to* — Wayne.) When I first got into the hobby, about 12 years ago, I devoured every copy of 73. I have a complete set up to 1972, but now buy only occasionally since I feel the magazine has become specialized. I have nothing against FM or state of the art lab equipment, but I really miss those basic communications articles and simply written technical articles — WA7ZTO. (*So do I, John, and we'll have 'em back — you wait and see. Note that many readers are asking for simple theory articles. Authors, man your typewriters* — Wayne.) Solid State Column is a great idea! — Linder, Rantoul IL. Hello Wayne! Remember me from Brooklyn, Mensa, etc? Perhaps not, but now I'm back in hamming. I'll prod your memory sometime — WA1TYH. (*No, I don't remember* — Wayne.) I always buy two copies of 73 and then keep one handy to give away to a needy op who may not be working or to a prospective op who has never read 73 before. Let's have more travel articles in the States and foreign — like Jordan — K6OPG. IRS strikes: A friend, a rancher, was advised he owed \$2000

## Voxpoop

and was given ten days to pay. He called them and told them he had paid and had cancelled check.. They said they didn't make errors and gave him two days to pay — K7100. (*Figures* — Wayne.) I dropped QST because it turned into a 150 page gossip column — WØZG. Just keep up the good job — your magazine is great — WB6PGN. I'm always interested in articles on theory — W1MKF. How about a SWL column? Also like to see some articles on available obsolete surplus gear — and more 2m FM — WB4JUN. (*Cripes! An SWL column? Good grief!* — Wayne.) More SSTV and ATV — VE3FAH. How about less FM which is nice, but not for Novices — WN3WOM. I think complete circuits of receivers and transmitters would be helpful — Zabriskie, Weston MA. Schematic of the Month deeply appreciated, wonderful idea, please continue. How about more articles from J. K. Bach WB2PAP? Like his free and easy style of writing. "Diagrams" should be most helpful for beginners and old timers alike — VE1AMF. (*OK, more Schematics of the Month coming up. I ran out of pages last month and had to leave it out. We've a couple more good Bach articles in the works and we'll try to get him back to his typewriter for more — he is superb. Maybe we can get Bob Manning to turn out some more too?...* Wayne) Diagrams is the best article in the book. We need more articles like this. Anything to help us become better amateurs such as how to put out a clean signal — WB4SNK.

## Voxpoop

While we are to some extent a prisoner of the authors of the articles — if they don't write them we can't print them — still we do like to know your reaction to what we do publish so we can keep trying to bring you what you enjoy the most. In the interests of science then, please let us know which articles you enjoyed the most and which you disliked most. The author of the article with the most votes will get a check for \$50 extra to encourage him to get busy and write more.

WOW!

UGH!!

VOXPOOP, 73, Peterborough NH 03458

### VOXPOOP WINNER

## Stark vs. Dunteman

Obviously there has been some sort of conspiracy under foot to produce an exact tie in the vote for our December-January Voxpoop winner. As this is being written, the results of the race for U.S. Senator from New Hampshire are being pondered in Washington, because the contest was virtually a dead heat. This is no reason, however, for our readers to have taken it upon themselves to produce another deadlock.

That they did, though, as after sorting through the ballots we found that we had a tie between Peter Stark K2OAW ("Making Nicads Behave",

Dec.) and Jeff Duntemann WB9MQY ("How to Get Zillions of Parts for Nothing", Dec.). Each of these gentlemen thus receives half of our \$50 award for March, as well as hundreds of hearty thanks from our readers.

Don't forget to put your Voxpoop vote in the mail today — it helps us to keep producing the kind of magazine you want and it helps your favorite author pay the bills. The address is 73, Voxpoop Winner, Peterborough NH 03458 — and by the way, all tie contests in New Hampshire are not sent to Washington for review.

*high accuracy*

# CRYSTALS

for over 30 years



**ONE or A MILLION...**

Commercial or Amateur Use



Write for Free Catalog

**SAVOY ELECTRONICS, INC.**

P.O. Box 5727 Fort Lauderdale, Florida 33310

Tel: 305-563-1333 or 305-947-9925

Norman C. Milne WB6PDN  
7800 Brentwood Drive  
Stockton CA 95207

# Another Look at the Swan Beam Antenna

**A** 73 Magazine article on evaluation of the Swan beam antenna some time ago was not comprehensive of the work that has been done in evaluating Oliver Swan's work. His multiple driven element system is one of the greatest advances in beam antenna design since the work of Dr. Yagi.<sup>1</sup> Swan's interest started with ham radio and branched into the TV antenna area about 25 years ago. His well-worn copy of Jasik's *Antenna Handbook* is an indication of his study into every conceivable type of antenna, and the finalized product is the result of many thousands of hours of range testing and changing.

Because of my interest in the 2 meter DX area he requested that I test his 9-element antenna on a 10 ft boom. With installation of a Rohn tilt-over tower in early 1968, it was possible to make easy installation and changes. A 9-element Swan was installed on a 10 ft stub above the rotor and because of the wide acceptance in Europe of the J-Slot, a commercial version, 8 over 8, was used as a yardstick. This particular antenna had been used for DX skeds into the Los Angeles area on both CW and SSB with 40W output.

The manufacturer's specs quote a gain figure of 14.8 dB measured on a test range. They do not give the reference antenna for this but state elsewhere in their literature that the gain figures for the 4 over 4 model are over a dipole in free space. This antenna was used as a reference because of its known quality and approximate gain figure, and is in no way to be misconstrued as a criticism of this particular design or manufacturer. A transco relay was mounted on the stub between the two antennas, which were in excess of 6 ft apart, so that either could be

used for transmit or receive. Station equipment at this time consisted of a 32S1 Collins exciter, 75S1 receiver and 62S1 transverter, with a 2N4416 preamp in the receive section.

Using a weak signal source with the system in receive it appeared that the Swan was between 3 to 5 dB better on receive than the J-Slot. At this point I felt there was something wrong in the system and the tower was cranked over. A thorough inspec-

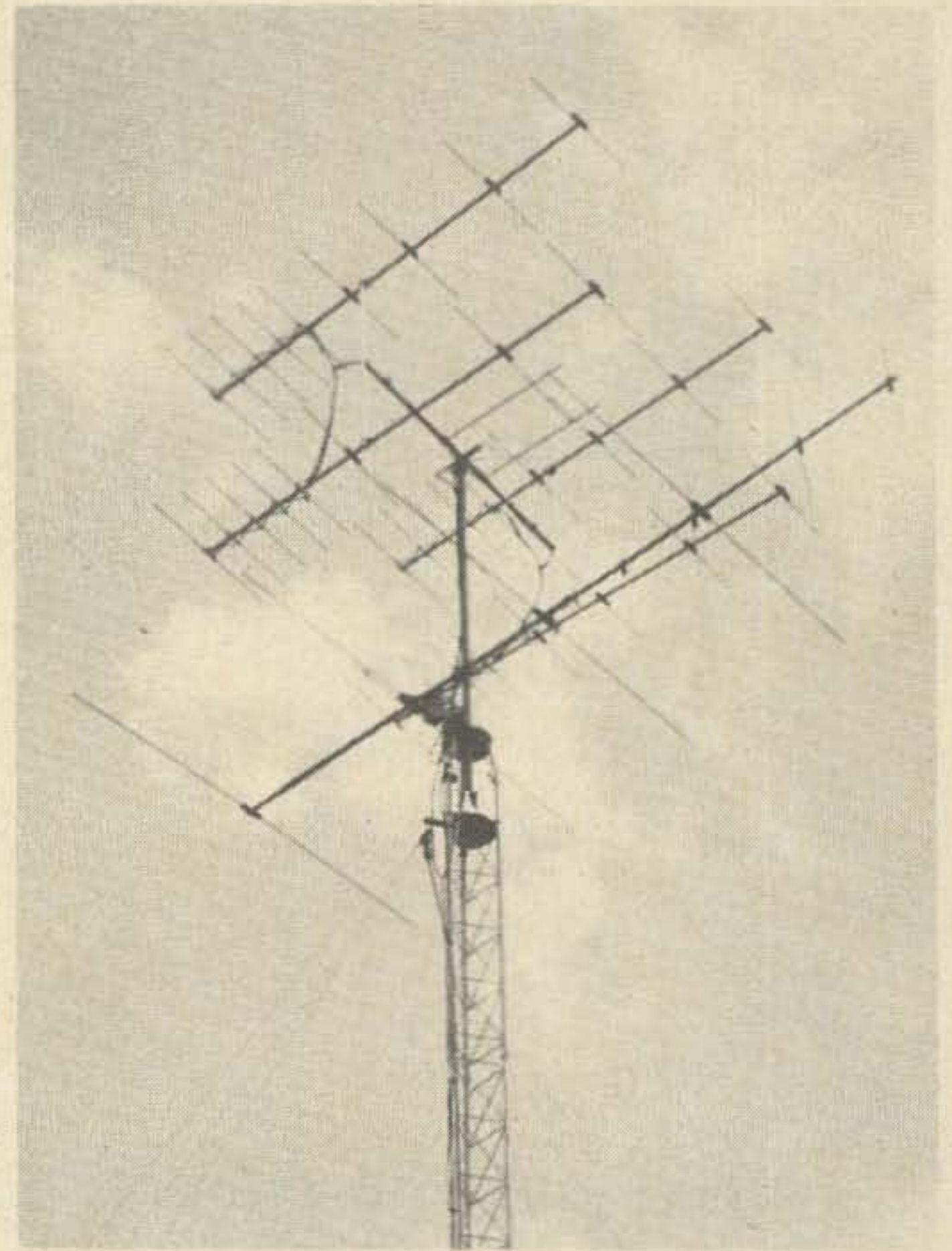

*The original quad array of nines. A four element six meter beam also carries a vertically polarized Swan nine on the front portion of the boom since we have both senses out here. There is a homebrew 7 over 7 J-Slot on the cross-arm also. Low ban inverted vees have apex at rotor base for liaison on 40 and 80 during meteor showers and DX skeds.*

tion was made on the J-Slot and a new balun constructed for it. There was still no change; testing continued for the next week. Del Crowell, then K6RIL, who later evaluated the Swan 6 meter version, helped by listening on his end over a 60 mile path. He confirmed a minimum of 3 dB on receive at his end. Pat Peterson WA6UAP, listening at the same time, did likewise. Del later tested the 6 meter beam and with Bill Orr W6SAI, published similar findings.<sup>2</sup> Pat got into the act with a weekend mountain top station, and with a large group of northern California VHF enthusiasts listening, came up with nearly twice the gain of a commercial beam of the same boom length.

Still having reservations, I sent a 9-element 10 ft boom model to Ron Hensley WB6RNH, at a research and development center near San Francisco at which there was an antenna range for government work. They made a polar plot for each 1 MHz of the 2 meter band and came up with a gain figure over a reference dipole of 15.5 dB. This figure was essentially flat over the entire band with a drop to just below 14 dB at 148 MHz. Front to back ran as high as 24 dB; there were virtually no side lobes. VHF-UHF people are extremely conservative in gain ratings on antennas and I was particularly critical of Ron's plot. He discussed it further with his antenna engineers and their feelings were that if their range was good enough for the military it should be good enough for the hams.

Oliver then made up a quad array of four of the nines for me and I continued skeds into Los Angeles and San Diego. Lanny Holt K6HAA, was very frustrated as he could hear me nearly all the time, but due to noise at my end, I managed only one CW contact. I further discussed the situation with Mike Staal K6MYC, who was quite sophisticated on 2 meter moonbounce with an array of 16 reworked collinears. He did extensive testing of the 9-element Swan, and with a quad array of 4 similar to mine, was able to hear moonbounce signals from KØMQS. Mike and Ken Holladay K6HCP, worked together on a moonbounce array using 8 of the 9-element Swans. They found this setup to be 3 to 4 dB below Mike's big array. Ken has published his findings in detail (any work on a

*Regency* brings you the best  
in 220 MHz transceivers

## MODEL HR-220



*American Made Quality at Import Price*

### Full 12 Channels with 10 Watts Power Out

Compactly designed for dash mount, this little transceiver gives you big signal power on the go . . . at low current drain. 3 watts audio equipped with a noise operated squelch system provides clear reception and excellent sensitivity of 0.4  $\mu$ v. High-Low power switch. American Made and Regency reliable, the HR-220's solid state design brings you tough, top quality circuitry at the low price of only

**\$239<sup>00</sup>**

Amateur Net

*Regency* **ELECTRONICS, INC.**

7707 RECORDS STREET  
INDIANAPOLIS, INDIANA 46226

**An FM Model For Every Purpose . . .  
Every Purse**



**HRT-2**

5 Channel Hand-Held  
2 Meter FM Transceiver



**HR-2MS**

8 Channel Transcan  
2 Meter FM Transceiver



**AR-2**

2 Meter FM  
Power Amplifier

large array for moonbounce is extensive) and he also covers his moonbounce contacts.<sup>3</sup>

It had been my opinion that here was a compact antenna that would lend itself to the gain needed for good DX or moonbounce without scaring the natives by its size. Ken's article moves this into the area of practicality. Most of us would have too many problems with an array the size of Mike's without even considering the neighbor problem. With this potential of compactness I felt obligated to make an effort to have the information available to as many as could be reached by an article. This was sent to Ed Tilton for publishing in *QST*. The article did appear but only after further testing of a beam that was shipped to support the claims that were made. Our correspondence alone would make a small book.<sup>4</sup>

At this point I must separate fact from opinion. Most of the people I have mentioned are extremely knowledgeable in the VHF-UHF area and I am sure they will bear me out. It is possible to build good high-gain beam antennas and get them to work well. It is also possible to build them and get them to work not so well. This holds equally true with purchased beams. On the other hand there are a considerable number of both kinds around that are fooling their owners. This also holds true with feedline that is used. My opinion after much observation is that most VHF stations have poor line and poor antennas because the exhaustive testing needed to get the best performance is beyond the average ham's capabilities. This is particularly true with antenna construction and the repeatability of antennas, say, for a quad array. The baluns alone can cause many problems unless you have access to a sweep generator and scope to watch the results. Oliver Swan's biggest problems have been in the area of balun design. Finalization has meant changes in antenna design to fit the baluns. In fact the only criticism that I have been able to make has been in this area, and even this is no fault of his. Most of his work has been in the TV area, and its needs are vastly different from the ham area. However, he caught up very fast and has spent most of his recent time working in

this area. He has readily supplied dimensions, insulator kits, and a tremendous amount of his time helping the ham fraternity in recent years, and will continue to do so in the future. Since each situation may require special information, I suggest he be contacted either directly or through me. I recommend the articles below, and especially the *VHF Antenna Handbook* by Jim Kyle K5JKX, a 73 publication still in print. It is very meaty.

Additional development must be mentioned. Swan has gone on to both an eleven and a fourteen element beam for two meters. I have tested both and currently have a pair of fourteens on two meters and a pair of 20-element beams on 432 MHz. I found the 11 an extremely fine antenna with a boom that is 148 in. long, and if I could have only one antenna, and if boom length were a factor, this would be the one I would choose. However, I do have fantastic results with the two 14-element units, and Bill Jungwirth WA6NRV, is ecstatic about his quad array of fourteens. Some extreme tests have been conducted with Bob Jensen WB6QDH, over what might be considered impossible paths. Most outstanding was a contact made from Reno using a Gonset Sidewinder putting out 7W and a 7-element Swan about 20 ft high. CW was used initially, with SSB employed after making contact. Bob was putting out about 40W to a pair of 11-element Swans up about 25 ft. While the distance is not extreme (only 150 miles), it was over the Sierras, a range of mountains between 9 and 10,000 ft and 4000 ft altitude at Reno. This type of path relies on what is known as knife edge refraction (bending over sharp peaks) and experienced operators on each end. Similar interesting operations are not beyond the average ham and the results are quite rewarding.

... WB6PDN

#### Recommended Reading

1. *VHF Antenna Handbook* – Jim Kyle – 73 Publications.
2. "Log Periodic Yagi Antenna" – Dell Crowell & Bill Orr – Ham Radio Magazine, July 1969.
3. *Practical 144 MHz Moonbounce Array* – Ken Holladay K6HCP.
4. "The Swan Multi-Drive Two Meter Antenna" – Ed Tilton – QST Oct. 1969.

# City Dweller's Multiband Antenna

*And now - an inverted Windom?*

**T**he antenna, being the most important single component of the radio station, poses an especially critical problem for the city-bound amateur, whose space may be limited.

One satisfactory solution is described. The characteristics of several simple antenna forms are reviewed briefly, the goal being to incorporate as many desirable features as possible from each, into one efficient, compact multiband system.

## The Horizontal Linear Dipole

The center one-half of a half-wave dipole contributes most to the radiation process. It is more directional normal to the radiator. Increasing amounts of the radiated energy, which proceed directly upward, are wasted as the operating frequency is raised, never returning to receivers on earth. This energy may be channeled to lower, useful angles by forming the radiator into the popular inverted dipole. A more desirable omnidirectional radiation pattern then results, becoming slightly more directional off the radiator ends in some cases. This arrangement reduces the amount of ground space required and elevates the important center one-half of the radiator by the use of only one tall support. Efficient multiband operation requires open-line feeder and match box arrangements.

## The Folded Dipole

Broadband characteristics and simplicity

of construction are represented by the folded dipole. However, operation is limited to fundamental and third harmonic frequencies, such as 7 and 21 MHz. This antenna also may be installed as an inverted dipole to enhance low angle radiation.

## The Trap Antenna

For fast band changing, the trap antenna is probably the ultimate choice. However, this convenience is accomplished at the expense of some losses in the isolation and matching networks. Also, in many designs, only a small portion of the structure is actively radiating on the higher frequency bands. The extensive guying necessary to some vertical trap antennas has been known to elevate eyebrows, both within and outside the household.

## The Windom Antenna

In the true Windom the single wire feeder offers the lowest loss feed line system, because no insulation is used except air. Multiband operation is available on the even harmonically related 160, 80, 40, 20 and 10-meter bands, using a simpler tuner. The entire radiator actively contributes to its operation on every band.

## Application

All of these simple antenna forms have been tested in the above order, mounted in the same position, over the past 5 years. The inverted Windom surpassed all others in

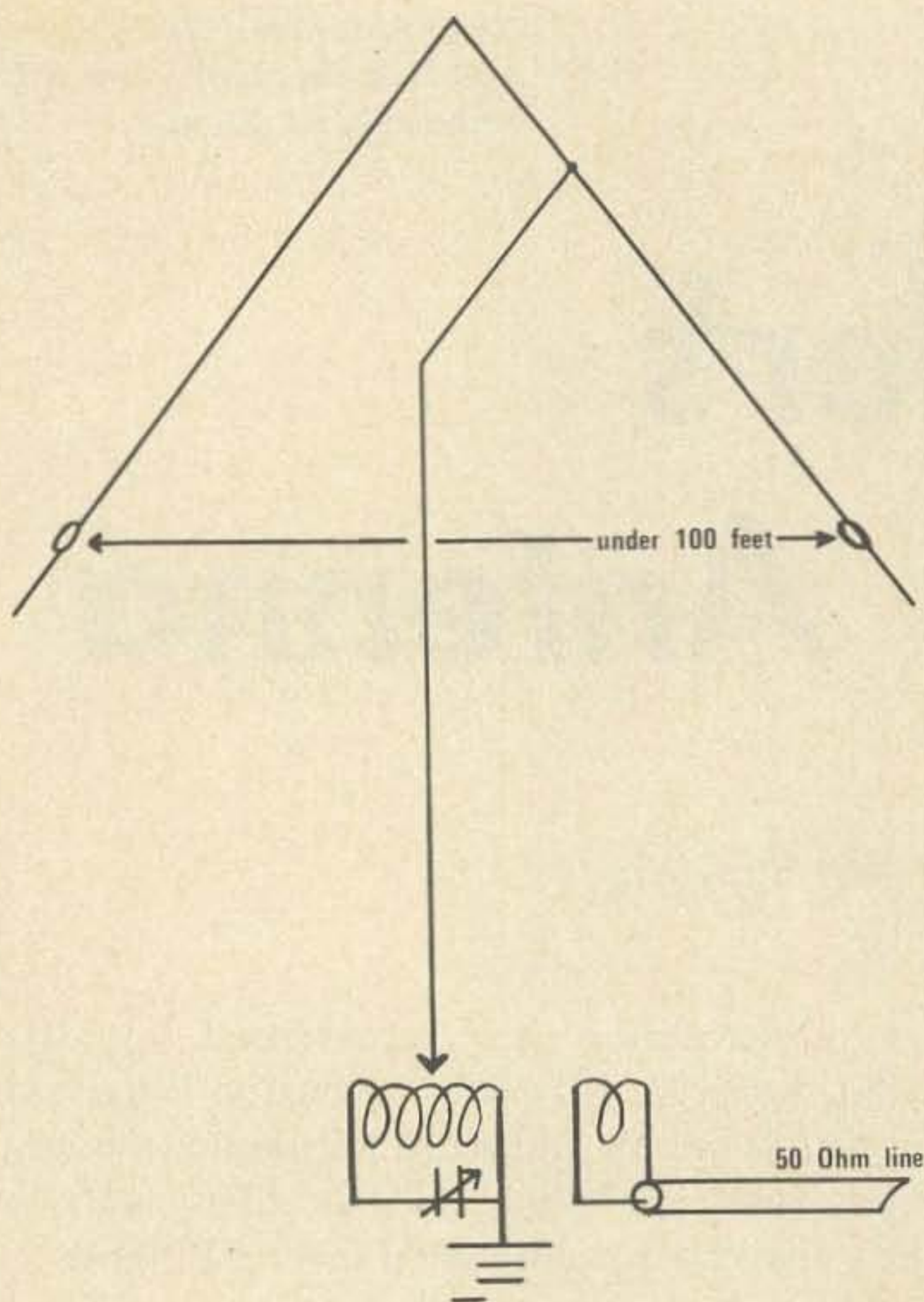

Fig. 1. Inverted Windom. The tank component ratings are the same as in the transmitter final.

signal reports, simplicity and space requirements.

The length, 140 feet, remains un-pruned for extra-class CW use on 80 through 10 meters. The single feeder is tapped at 20 feet off-center. The inverted configuration was borrowed from the inverted dipole antenna design, and for the same reasons. The radiator is supported by the family TV mast, and appears to be an unobtrusive pair of guy wires. The simple tuner in Fig. 1 was mounted at a window to avoid dielectric losses which would result if the feeder were routed inside the building. Tuneup is conventional, tapping the coil for the best transfer of energy, while maintaining resonance of the tank.

### Results

Signal reports and received signal strengths favor the multiband antenna described, over the above systems, including careful comparisons with a 1,000 foot long wire pointing to Europe. Some ominous pileups have been assaulted using a single 6146 final, with rewarding results.

... W4ATE

### WANNA WORK MORE DX ?

Subscribe to THE WORLDS ONLY weekly DX Magazine. Strictly DX news in depth. I give you upcoming events, dates, times, freqs, DX QSL info, contest info, DX articles, etc. **SUBSCRIBE NOW and WORK EM ALL ! DX NEWS GALORE !** \$ 6.00 for 6 mo. or \$ 12. per yr to W/K, VE, XE, First Class mail. **THE DXERS MAGAZINE, (W4BPD), Drawer "DX", CORDOVA, S.C. 29039. DXING IS GREAT USING OUR INFO !**

*Rush \$1 for exciting Surplus and Factory Closeouts Catalog. Save Big Money.*

## ETCO Electronics

Dept 73 Box 741  
Montreal, Quebec H3C 2V2 Canada

### POWER SUPPLIES FOR THE HOMEBREWER

1.2kVA power transformer — input 115V 60Hz output 1000V 900mA, 600V 250mA and 6.3V 10.4A — \$69.50. Miniature transformer with built-in wave rectifier — input 115V 60Hz, output 10V(DC) 100mA — ideal for NiCad charging — \$5.65. Universal AC/DC power supply kit — supplies plate and filament power from 12.6V DC or 115V 60Hz AC by changing leads — output 750V 200mA and 12.6V 6A from 115V AC or 750V 200mA from 12.6V DC input — all parts except chassis, terminals and wire — \$39.50. Michigan residents include sales tax. All items postpaid — no C.O.D.'s — for fast service use M.O. or cashier's check. S.A.S.E. for specs.

MOHAWK ELECTRONICS SALES DIVISION  
P.O. BOX 611  
MADISON HEIGHTS, MICH. 48071

## FM YOUR GONSET

(or your Clegg 22'er, Poly Comm 2, PC 62, Johnson 6N2, Aerofron 500, Ameco TX 62 or VHF 1)

- New! Plug-in modulator puts the Communicator transmitter on FM.
- No modification or rewiring on your Communicator. Just plug into mike jack and crystal socket.
- Compact self-contained modulator measures 4" x 3" x 1 1/2".



- Works with Communicator I, II, III, IV and GC-105, and other rigs listed.
- FM at a tenth the cost of a new rig.
- Frequency adjust for netting built in.
- \$37.50 postpaid USA & Canada. Specify transmitter model. Calif. residents add sales tax. (HC-6/U crystal and 9 volt transistor battery not supplied.)
- Send for free descriptive brochure.

## PALOMAR ENGINEERS

BOX 455, ESCONDIDO, CA 92025



# DIGITAL!



## DV-21

The perfect companion for your IC-21A, the DV-21 is an all new unique digital VFO to complete your ICOM 2 meter station. The DV-21 will operate in 5 or 10 KHz steps over the entire 2 meter band. It can also scan either empty frequencies, or the frequencies being used, whichever you select. Complete, separate selection of the transmit and receive frequencies, is as simple as touching the keys. When you transmit, bright easy to read LEDs display your frequency. Release the mic switch, and the receive frequency is displayed. There are also two programmable memories for your favorite frequencies.

You won't believe the features and versatility of the DV-21 until you've tried it. It's new, and it's from ICOM.



Distributed by:



# ICOM

ICOM WEST, INC.  
Suite 232—Bldg. II  
300-120th Ave. N. E.  
Bellevue, Wash. 98005  
(206)454-2470

ICOM EAST Div. ACS Inc.  
Suite 509  
13777 N Central Expwy  
Dallas, Texas, 75231  
(214)235-0479

William Hansen WA7OET  
20919 Elberta Road  
Lynnwood WA 98036

# 40m Inverted Vee Beam

## Satisfying

**B**een looking for an antenna with gain and directivity for 40 meters? Read on. I will describe the antenna that I built quite cheaply.

The antenna consists of two inverted

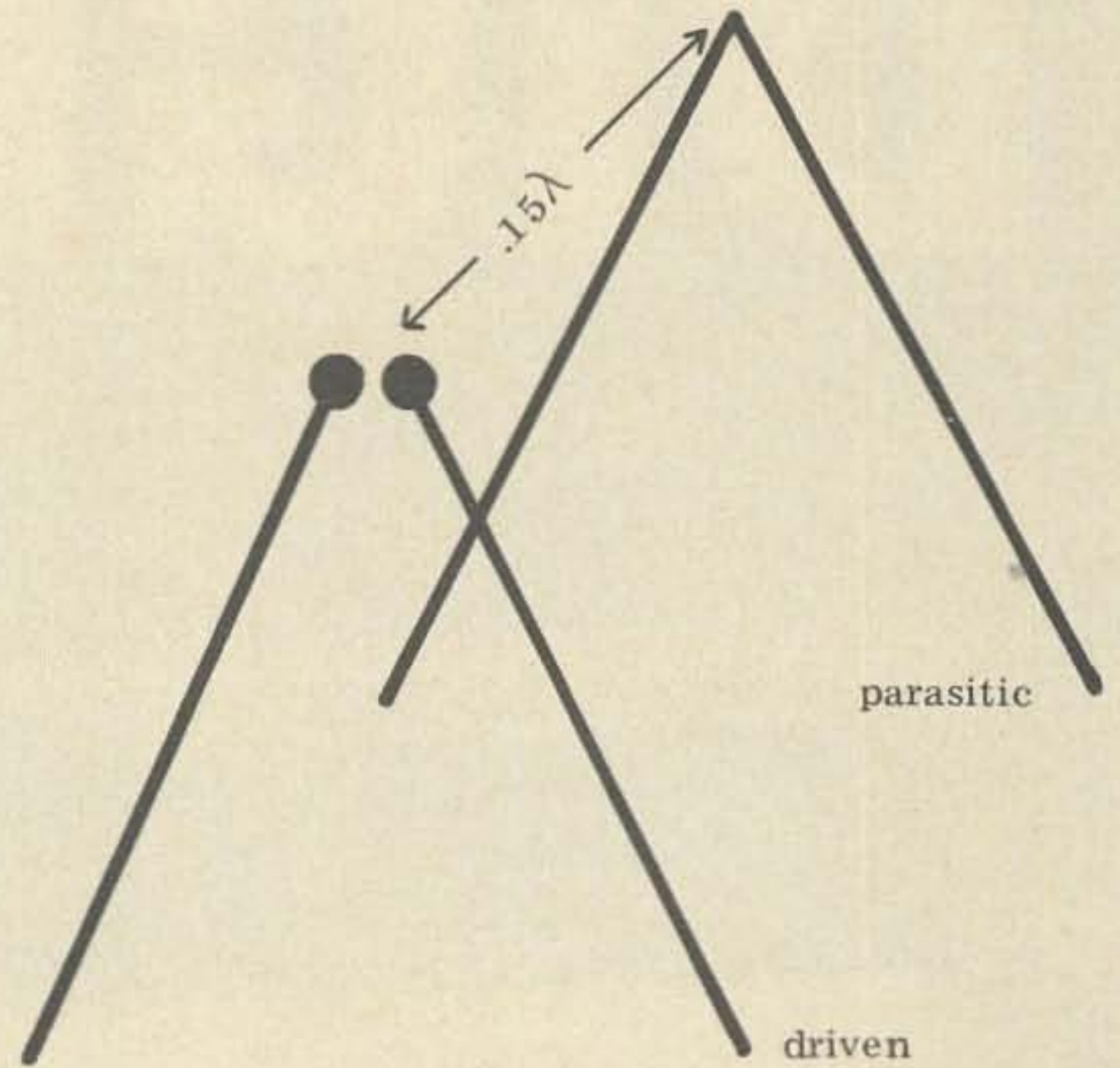

vees, one driven and the other operating as a parasitic. The spacing depends on whether you are using the parasitic as a reflector or director. I made my parasitic element a reflector/director with clip leads to change the direction of the beam.

When building the antenna, you find the length of the driven element by the formula  $492/FMC = \text{Length}$ . For making a reflector, add 5 percent of the length. A director would be 4 percent shorter. I spaced my elements at  $.15 \lambda$ , or about 18 feet. One important thing to remember when putting up the antenna is to keep the apexes of the inverted vees at the same height. You can do this by using a boom, or as in my case, using two equal length poles. I live on a large piece of property, but after cruising in the city of Seattle, I think this antenna can be put up in most city lots.

My results were very satisfying. I pointed my antenna to the east and worked several east coast stations with average signal reports of S89. I then repositioned the inverted vees and pointed them at South America. I heard more DX from there than I have ever heard on 40 meters before. I hope other hams will construct this type of beam to enjoy hearing good DX on 40 meters. This type of antenna could also be constructed for 80 meters.

...WA7OET

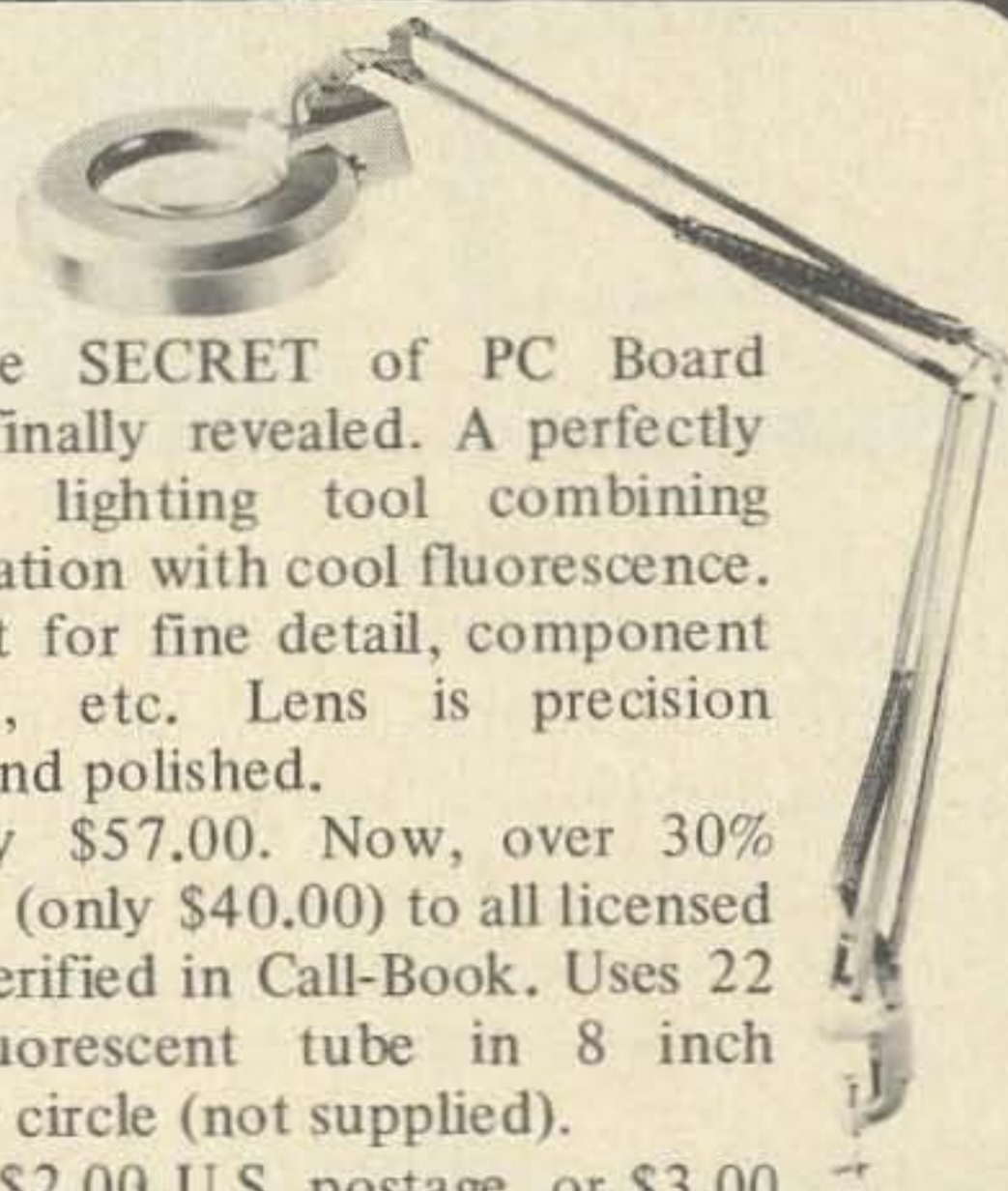

Aha, the SECRET of PC Board success finally revealed. A perfectly balanced lighting tool combining magnification with cool fluorescence. Excellent for fine detail, component assembly, etc. Lens is precision ground and polished.

Regularly \$57.00. Now, over 30% discount (only \$40.00) to all licensed Hams, verified in Call-Book. Uses 22 watt fluorescent tube in 8 inch diameter circle (not supplied).

Include \$2.00 U.S. postage, or \$3.00 in Canada, \$4.00 elsewhere. California residents include 6% sales tax.

Or send stamped envelope for free brochure of other incandescent or fluorescent lamps suitable for all engineers, architects, students, etc.

\$40.00 price assured until July 1, 1975.

### D-D ENTERPRISES

Dept. B, P.O. Box 7776  
San Francisco CA 94119

**NOW  
available  
for the first time  
in North America**



**the all NEW synthesized  
VHF FM TRANSCEIVER  
the KDK-144**

Compare the features:

SYNTHESIZED — no more crystals

L.E.D. READOUT — for quick, easy readability

10KHZ FREQUENCY DIAL UP CAPABILITY 146-148 MHZ — Perfect for the 2nd generation of repeaters and simplex channels

600 KHZ UP AND DOWN REPEATER CAPABILITY

POWERFUL 2W AUDIO OUTPUT

10W.R.F. OUTPUT

Compare the sizes:

KDK-144 2" x 6 3/8" x 7 3/4" Deep

ICOM AC-230 2 9/32" x 6 1/8" x 8 1/2" Deep

CLEGG FM 27B 3 1/2" x 7 3/8" x 9 1/4" Deep

ONLY  
**\$399**  
F.O.B. Blaine Wash.

HAM IMPORT SALES

73-1-2

P.O. Box 1009 Blaine Wash. 98230

(Washington State Residents add 5% Sales Tax)

Please Rush me a KDK-144. Enclosed is a  cheque

money order for \$399. (plus sales tax if applicable)

NAME: .....

ADDRESS: .....

ZIP: .....

# The Unofficial Standard Standard

Communication by radiotelephone, compared with communication by manual wireless telegraphy, possesses certain advantages and disadvantages. It is, in a sense, easier and swifter for most of us to communicate by voice, and nuances of meaning or emotional context which are impossible to convey by telegraphy can be transmitted adequately through the microphone. Conversely, when factors connected with propagation create difficult conditions, then the transmission of intelligence by radiotelephony experiences serious degradation, while at the same time it may be quite feasible to carry on, albeit more slowly, by radiotelegraphy.

At times, when static waxes severe and, alas, is combined with spectacularly infuriating interference from undesired signals, attempts to communicate by voice can end in depression and/or hysteria. It may be pertinent at this point to mention that a misunderstood message can have worse consequences than one that comes through totally unintelligible. Scientists, as is their wont, have attacked this problem with fervor, often getting their gaiters caught in the cables they are always laying about and forgetting. Sooner or later, however, they come up with an answer to anything, that being their job. Indeed, they frequently come up with several answers, as they did in this case.

If you can't make a word understood, they reason, perhaps you had better try spelling it out. And to do this you had better use words to represent the letters you are to use to spell out the original words you couldn't make understood. It is also suggested that you turn for help to special code-words (which are unpronounceable), substitute these for the words which you once had in mind (such as QRM for "interference"), and then spell these code-words by using other words to represent their letters. Well, that's science, you see. Now, then, what words to use to stand for the letters spelling out the words we wish to have understood (or the code-words representing those words)?

Standardization is clearly the key here, and to do the job properly we have been provided with several word lists, all equally standard. At hand I have three of these, which I will be happy to share with you. And a fourth which is explained below.

The first list of preferred words is from the 1928 edition of the Radio Handbook, the second is a 1968 ARRL list, and the third — reportedly even more standard than all the others put together — carries the imprimatur of the International Civil Aviation Organization. The fact that only one word is found in the same position on these three lists invited close and objective scrutiny of the selections. This task, carried

out in a coolly scientific manner, resulted in the compilation of a fourth list which I call the Unofficial Standard Standard.

In the following paragraphs of review, analysis and appraisal, quintessential brevity was the goal. Much detail was left out, including the mysterious disappearance of a consultant from Newington, whose hat was found floating in a New Hampshire bathtub. Finally, in each paragraph the italicized list-words appear in order of seniority — like the 1928 word comes first. Got it? Occasionally, in the interest of clarity, examples of typical usage are provided in the scientific manner. There are a few humorous asides.

*ABLE*. At least it sounds like "A."  
*ADAM*. Biblical, but otherwise no points.  
*ALFA*. Like in Romeo. At this point in time, as they used to say, let's not plug Italian cars.  
*ALE*. Sounds nice. One syllable and tastes good.

*BOY*. Doesn't sound like "B" and it fires off Women's Lib.  
*BAKER*. Nothing.  
*BRAVO*. I like you, too. Ambiguous if not confusing. Expletives are for deleting.  
*BEE*. Short, and sweet as honey. A real stinger.

easy way out. *EDWARD*. Probably the wry wit of a sly Scot: the second Edward blew it at Bannockburn when he was run over by Robert the Bruce; the fifth was murdered by the third and the eighth resigned.  
*ECHO*. Substantively confusing. "Echo? Maybe it's auroral, or you're getting me long path — try swinging your beam."  
*EASE*. Simple and short. Like with "C" it's just the plural of the letter. Why didn't Huntoon think of this?

*FOX*. Sounds too much like "VOX" and may be misinterpreted as technically critical, ending the QSO. Or, if you hesitate, you have "Fox pause" and an imbroglio.  
*FRANK*. More invitation to confusion: "Frank? Well, frankly, your signal is sorta crummy, considering the power you're running. I've had better luck with ESP. And that's 'E' like in 'Eelgrass', old buddy."  
*FOXTROT*. Can you imagine those international slickers going back that far for their words?  
*EFFLUVIUM*. Not one you would use around the house every day, but a genuine "F" word and any good dictionary will tell you it means Citizen Band; look it

---

**EFFLUVIUM: A genuine "F" word, and any good dictionary will tell you it means Citizen Band; look it up and think about getting on 220 . . .**

---

"Bee, man, just bee! Like in summertime with roses! Buzz, buzz and lay it on you! Don't you know what a bee is?"

*CAST*. No fun here, just a dumb old word.  
*CHARLIE*. Names lead you up dead ends: "Charlie who? Is he on frequency now?"  
*CHARLIE*. This guy has friends all over town.  
*CEASE*. Perfect — the plural of "C."

*DOG*. A zero. I thought Zero was Orphan Annie's best friend but my wife, who went to college, says I'm thinking of Sandy. Orphan Annie was the little creep with the blunk out eyes, wasn't she? Anyway, you will notice they didn't use "cat" for "C." Prejudice has no place in amateur radio.  
*DEED*. Neat. Sounds the same at both ends and spels the same backwards. "Whaddya mean, 'D' like in 'D' OM?" "Deed I do, deed I do!" That should do it.

*EASY*. Queasy, greasy, sleazy. Sneezy — which one was he? Some lazybones took the

up and think about getting on 220.

*GEORGE*. A TV rassler around the turn of the century. Successfully restated the male need to be lovely.  
*GORGEOUS*. Let's call this second one a congenital error.  
*GOLF*. To be chosen by the ICAO means it's a world-word. Everybody plays golf, right? Well, almost everybody. Yuk.  
*GEE*. It's right because it means "right." Right? If you just keep saying "gee" sooner or later some clown will break in with "haw" and make the meaning perfectly clear.

*HAVE*. Possession used to be nine points of the law, but now sugar is fifty cents a pound (as this is written) and what you have is not nearly so important — unless you've got it all.  
*HENRY*. It would have been a good name, thanks to Laurence Olivier, but most people think of Henry the Eighth and bad vibes for the XYL's. There was a friendly Henry in the funny papers but he went bald when he was about five.  
*HOTEL*.

To be fair, a word that means something to everyone. The hotel with the best French cooking in the world was Cuqui de Carbajal's Safari in Zihuatanejo, Mexico — except it was a motel. Alas for the good hotels of the world — who remembers Henry (H) Busse sinking into his trumpet in the Palace Rose Room? *H* is just *H*, and what the "HE double toothpicks."

---

**Otto the First was king of Germany around 970, and ordered his name lettered in gold on the first VW; thereafter he was known as Otto the Mobile . . .**

---

*ITEM.* Dullsville. Pardonable from a bureaucrat months this side of a pension, searching for a harmless word. Success and failure. *IDA.* Remember Ida? She was the one who sat in front of you in the ninth grade and gave the teacher fits. *INDIA.* Not bad. A word of intricate imagery — too bad it doesn't have the sound of the letter. *ISLE.* If you live on a small island, as we do, and the taxes are too high, you can call it an isle. But it does carry through the sound of the letter. Monosyllabically.

*JIG.* If you dance one with anybody but your wife it's up. The implications are frivolous and inappropriate. *JOHN.* I wouldn't touch this with a forty meter pole. *JULIETT.* There are five male names in the ICAO list and this single entry from the distaff side won't appease Gloria Steinem. And why two T's? *JAY.* It's the sound of the letter and it doesn't sound like anything else. To anyone outside of New York you can usefully amplify this to "jaywalk" but in Fun City the term is meaningless.

*KING.* Obsolete as of 1776. *KING.* Monarchists do persevere, don't they? *KILO.* 2.2 pounds — about five bucks in our money for a foreign word when many of our own are unemployed. *KAY.* A gift of love — the name of a girl I knew a hundred years ago and it's still one of the nicest words I know. Ah, youth.

*LOVE.* A lovely word but out of place here for its fugitive charm will not endure the abrasion of currency. Heigh ho, put it on hold with regrets. *LEWIS.* Just another solid, middle-of-the-road male label. If they really wanted an "L" name why not Llewellyn? *LIMA.* The capital of Peru, which is in Ohio.

Poor planning here. *ELLEN.* Mellifluous name of Kay's mother and the last favor I will ask. Notice that the "L" sound is dominant.

*MIKE.* More than meets the eye to this choice, which was switched to *MARY* and quickly back to *MIKE.* Fascinating possibilities entertain the ruminative mind. *My lists* indicate only that the ARRL dumped Mike

in favor of Mary, and that the ICAO picked up Mike who, his head turned by international recognition, no longer speaks to Mary. Was it really that simple? Watch for the exciting outcome in Jack Anderson's column. *MSG.* Accent on the "M." No, it's not "message" like on dah-dit-dah-dit dit-dah-dah. *MONOSODIATEGLUTIMOUS.* It's what Chinese restaurants use to make their half-cooked vegetables taste better than anybody else's, and gives everything on the menu a half-life of thirty minutes in the stomach. Now you know why Chinese restaurants are a short walk apart. Very clever.

*NAN.* Sounds like baby talk, depressingly suggestive of nannies and nappies. Sober thought prevailed eventually and a change was made to *NANCY.* *NOVEMBER.* A fresh start here which stumbled over the desk calendar. Three lengthy syllables rooted in three vowels, and the "n" sound is inferior to that of June — a much nicer month. *ENTER.* The hard "t" effectively terminates the accented "n" sound and the hospitable connotation is added value.

*OBOE.* Not a word of wide appeal. Detailed information about this instrument is not generally available to the public, and may in fact be termed arcane. Only one tenth of the world population play the oboe, and they all live in Boston. *OTTO.* Another curious choice. Otto the First was king of Germany around 970 and ordered his name be lettered in gold on the first Volkswagen; thereafter he was known as Otto the Mobile. By the way, "VW" really stands for "VorWärts!" An Afrika Korps joke. *OSCAR.* After you write it you can see an "o" is

# THE ALL NEW *Clegg* FM-DX

## 2 METER FM TRANSCEIVER

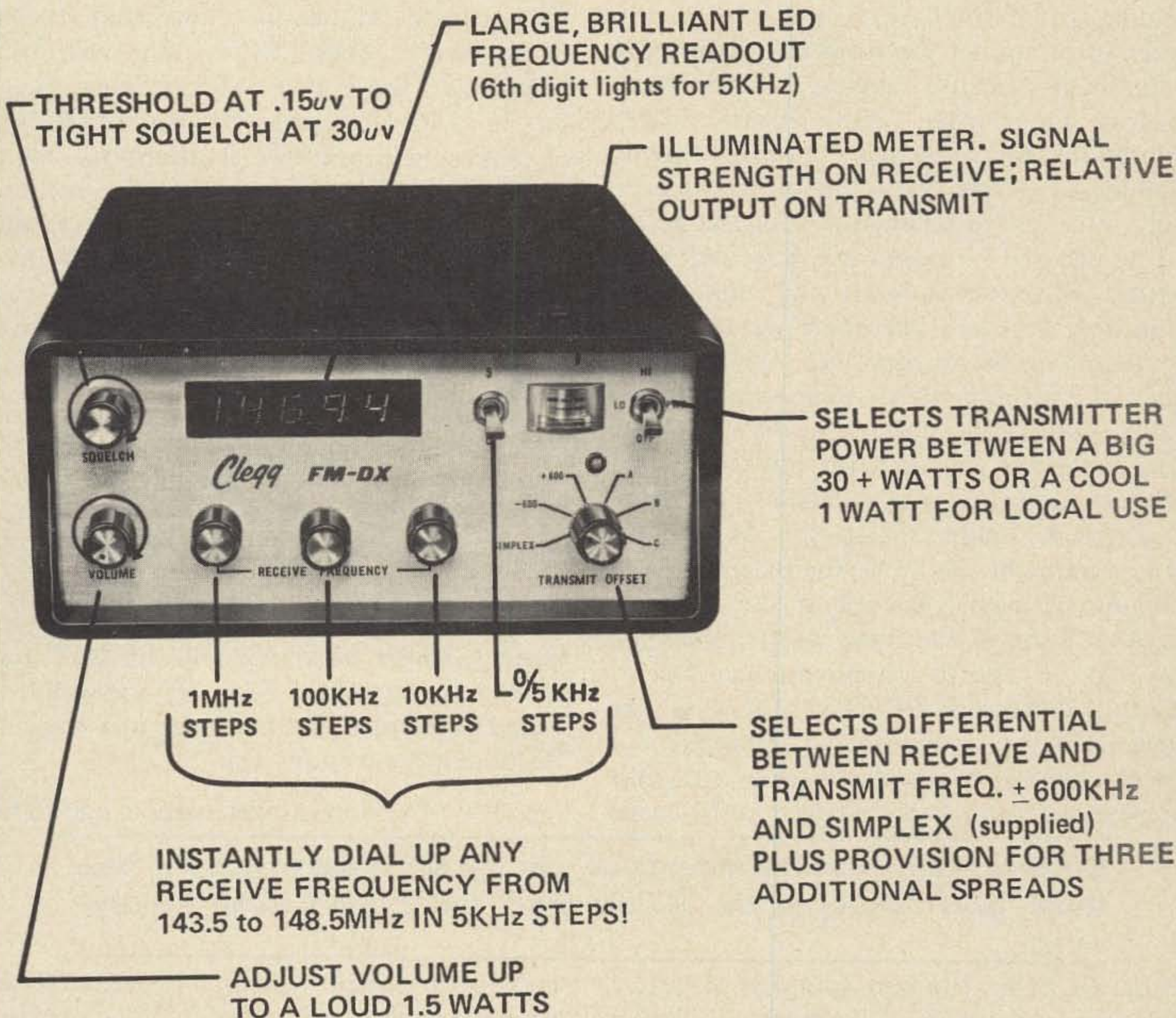

**WANT MORE INFO ?  
WRITE (a QSL will do) OR  
PHONE TODAY !**

*Clegg* DIVISION

3050 Hempland Rd. • Lancaster, Pa. 17601

Tel: (717) 299-3671 • Telex 84-8438

A Division of International Signal & Control Corp.

involved. Big deal. "Auscar" sounds almost the same. (That's a VW fast going backwards, according to my German humorist.) *OKAY*. If you disqualify profanity, this is probably the word that gets the prize for international success. A natural.

*PUP*. Unless you are addressing a small dog this is not a word, it's just a funny noise. Lots of English words have two "p's" in the middle, and if you have to repeat "pup pup" in an effort to get the word across the reply will likely include laughter and/or complaints about your *VOX*. *PETER*. Given conditions bad enough to require phonetic spelling of words your contact may reasonably infer you're talking to Peter. Names are to be avoided — except for Kay and Ellen which will excite interest and close attention. *PAPA*. Fair's fair; there was no mama so there will be no papa. *PIE*. Which stands for "pi" without which there would be no radio. Granted it doesn't sound the letter like the word we can't use, but what other one can be spelled with numbers?

*QUACK*. I didn't believe this. More about it in a moment. *QUEEN*. The Bicentennial is coming up next year and if we cool this royalty thing in the name of the Republic we may be able to extend the ban later to Festival Princesses. *QUEBEC*. This would be nice if they pronounced it "kewbeck" but there's another problem; the Separatists may achieve partition and change it to Nouvelle

*SAIL*. Has as much of the sound of the letter as "ceramic" or "cent" but I like another one better. *SUSAN*. Never knew a girl named Susan so I won't make another exception here. *SIERRA*. A painful reminder of the W6's I hear working all the DX they filter out with sierras and soak up with smog. Do they really tune the mountains? On the worst days I can still hear those guys talking to the Middle East, and I don't mean Pennsylvania. *SOB*. Often this will win compassion and a little extra patience. Spelling it in the old fashioned way, S.O.B., no phonetics, will get special attention. Your contact will instantly try a little harder. When conditions improve, perhaps as a result of his renewed efforts, you can explain that the letters stand for Son of Beowulf, the Superman series on the British telly. Don't forget to explain.

*TARE*. A weighted choice. It only tells you how heavy a container is and cannot be converted into "S" units. Doesn't even sound like the letter. *THOMAS*. Okay, Thomas, go look for Frank, George, Henry, John and the rest of the gang. *TANGO*. Another mad entry from the foxtrot people. Besides, I saw the movie and this isn't that kind of magazine. *TEA*. Phonetically a sound substitute for the ones just bagged. Never mind, the end is near.

*UNIT*. The Puprotquack people had to be

---

**Do they really tune the mountains? On the worst days I can still hear those guys talking to the Middle East, and I don't mean Pennsylvania . . .**

---

Paris. *QUEUE*. The pure sound of the letter, and the suggestion of sequence is fitting. When conditions get rough what do the British do? No, they don't make another pot of tea, they queue up and behave with civility. You don't have to spell it, you know.

*ROT*. Another gem from the Handbook list, and a third will be along later, but now let's go back to the preceding one. "I said I'm running *low power* here, OM. Quack, Rot, Pup! Quack, Rot, Pup!" *ROBERT*. Once again, no names, please. *ROMEO*. Not even the cute ones. *ARE*. It seems that *word* is the name of the game, so this is the sound of the letter and it's a word, but not rot.

right once out of twenty six tries. *UNION*. Here we have "unit" and "onion" combined just to make a different word. A cheap trick. *UNIFORM*. Too long and sounds like "unicorn" which is a protected species. *UNIT*.

*VICE*. Gamy implications, otherwise ludicrous. "Ready for your message, old buddy. QRV. Quack, Rot, Vice!" *VICTOR*. Another name, and offensively presumptive. *VICTOR*. Or, everybody loves a winner? *VEE*. Satisfies both the shortness rule and the ban on unnecessary length. Helpfully apt for this community of antenna-oriented souls. Clarification option for extraordinary circumstances is the addition of "inverted" or "beam" — but not both.



*WATCH.* Many Anglo-Saxon words fail to trip lightly across the auditory nerves. Squat, mash, drag. The hairy ancestor who first picked up a bone to use as a weapon probably growled, "Watch me fix this clock!" A rude-sounding word and one often used as a signal by applause-starved children poised proudly on the brink of disaster. "Watch, daddy, watch me slide down the bannister and land on the table!" And watch

**ZEBRA: Breakfast of Champions on the Serengeti Plains . . .**

the bowl of gravy land in daddy's lap. Research soon proved the word could be replaced by *WILLIAM*. Then more intense research, about which we may speculate, resulted in the selection of *WHISKEY*. Unfortunately, unless my information is incorrect, "dry" counties persist in some of our states and of course this word would be meaningless there. No matter, "double-you" is perfectly adequate, just the sound of the letter, *W*.

*X-RAY.* For once all three agree. *X-RAY* and *X-RAY*. But it's a perfect opportunity to make points, so let's use *XYL*.

*YOKE.* Who can afford to feed oxen? That leaves the epicenter of an egg, or a humorous anecdote from Oslo. *YOUNG.* Years ago this would have appealed to me. *YANKEE.* Let's not open up old wounds. Since we've already used "XYL" and thereby disarmed the domestic militia, how about "YL?" Something to think about.

*ZED.* Licensed only in the United Kingdom and the Dominions. *ZEBRA.* A horse of two other colors, and on the Serengeti Plains the Breakfast of Champions. Depressing connotations, unless you're on the side of the lions. *ZULU.* The flower of the Bantu nation. Chaka, meet Geronimo. *Sick transit gloria mundi.* *ZEKE.* A succinct word for the end of the alphabet. "Zeke! Like old Zeke makes it and young Zeke wheels it down from the mountains on weekends! Zeke! The ballerina of the Japanese Air Force, the Zero with the long, round-tip wings! No, the Hamp had the short wings. Zeke, like your sister's name. Okay, same to you, fella."

... W7IDF

# DATA SIGNAL

the latest in station accessories

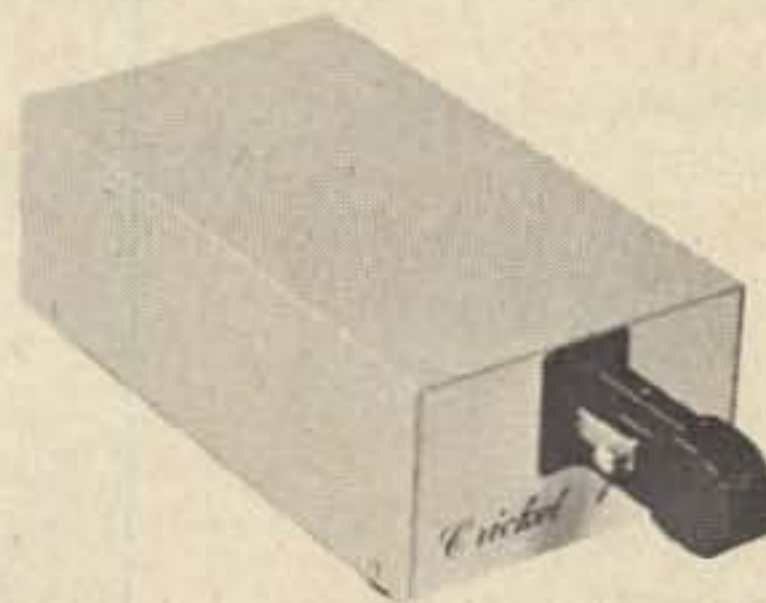

## CRICKET 1 ELECTRONIC KEYER

A popularly-priced IC keyer with more features for your dollar. Cricket 1 is small in size and designed for the beginner as well as the most advanced operator. It provides fatigue-free sending. Easy to copy at all speeds. Turn on its side and use as a straight key for manual keying. AC/DC.

Shipping Weight 3 lbs. \$49.95



## SPACE-MATIC 21-B

The Switchable Keyer. It's up to eight-keyers-in-one. Use the switches to make this your very own personal keyer, both today and tomorrow. Add such features as dot dash memory or adjust spacing with the turn of a switch. Completely perfect.

Sh. wt. 4 lbs. \$119.50

## TOUCH-TONE DECODER

A highly reliable twelve digit decoder with input protection, and PLL circuitry for extremely stable operation. Heavy duty output relays, small size, plug-in circuit board. All these major features at an UNBEATABLE price.

Sh. wt. 1 lb.

TTD-12K Kit \$114.50  
TTD-12 Touch-Tone Decoder \$129.50

Write today for complete details

## Data Signal, Inc.

Successor to Data Engineering, Inc.

2212 Palmyra Road

Albany, Ga. 31701

912-435-1764

# BRAND NEW QSLs



- two styles
- QSO info back
- two colors
- LOW PRICES

**X**

Style X — Black type, blue satellite

While the cost of everything continues to skyrocket, 73 has *STILL* kept the price of these beautiful QSLs at absolute rock bottom. When we started selling our top quality QSLs two years ago at a *PENNY-A-PIECE* it was a great deal (postpaid no less!). When we held that price firm last year against all obstacles, it became a fantastic opportunity. Now, this year we're *STILL HOLDING DOWN THE PRICES* and it's the next best thing to having your very own oil well! And with two brand new designs too!

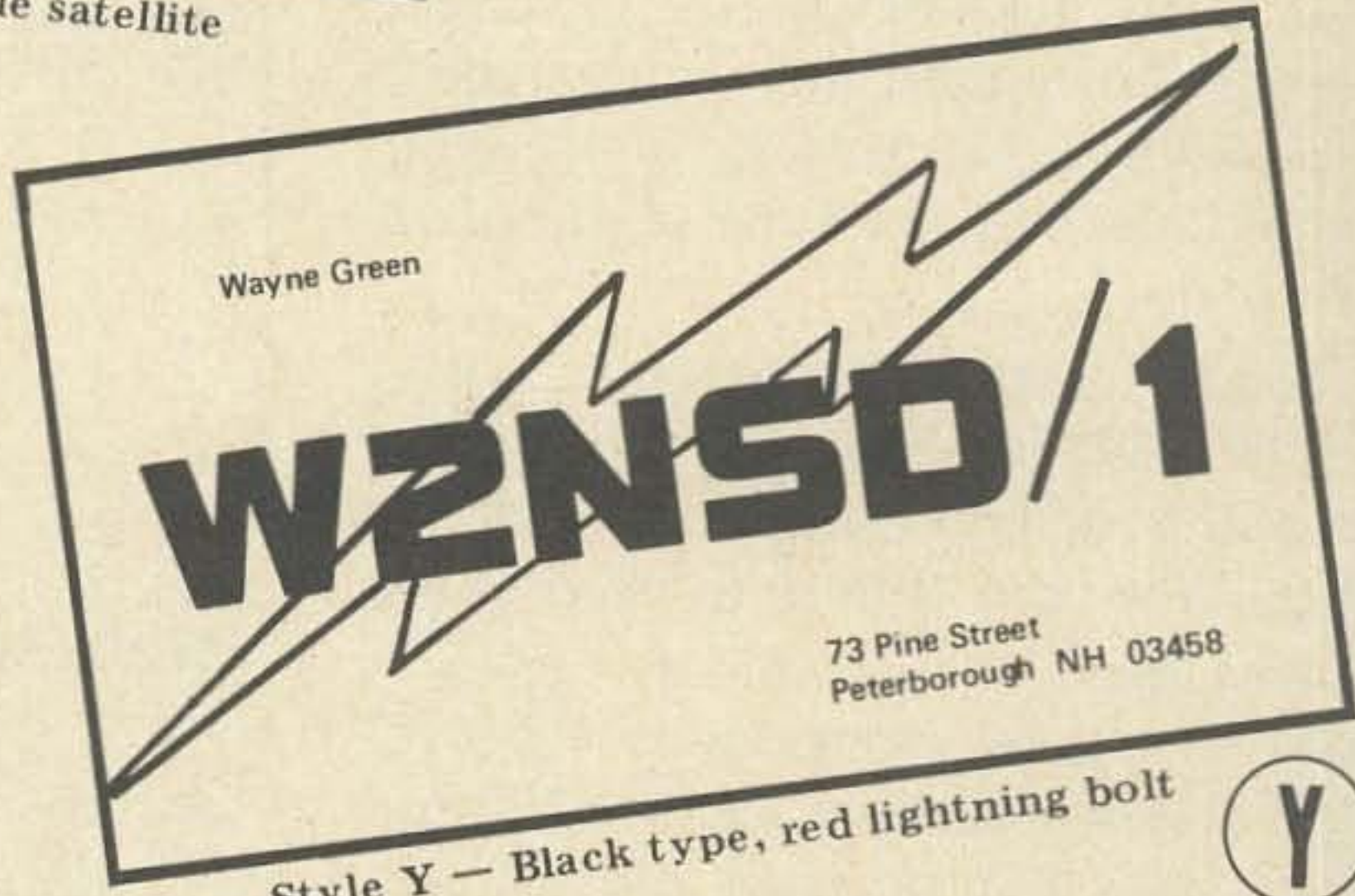

**Y**

Style Y — Black type, red lightning bolt

ORDER — AND PAY	
250 . . . . .	\$6 (2.5¢ ea)
500 . . . . .	\$10 (2¢ ea)
1000 . . . . .	\$15 (1.5¢ ea)
2000 . . . . .	\$20 (1¢ ea)

These QSLs are printed on *Fine Quality Glossy Card Stock* and are as good or better than cards sold elsewhere for several times the price. We can offer this fantastic low price, because we "gang print" orders between other jobs in our own print shop which keeps the costs way down and we pass the savings on to you. If you haven't been QSLing as much as you'd like to because of the cost of cards, do you really have an excuse anymore? Get some cards and help improve the image of U.S. Amateurs.

Name \_\_\_\_\_ Call \_\_\_\_\_  
 (First and last name is most friendly)

Address \_\_\_\_\_  
 (as brief as possible and still get through the mail)

City \_\_\_\_\_ State \_\_\_\_\_ ZIP \_\_\_\_\_ County \_\_\_\_\_  
 (a must) (if desired on the card)

Style	
X	<input type="radio"/>
Y	<input type="radio"/>

250 — \$6     500 — \$10    Awards to be \_\_\_\_\_  
 1000 — \$15     2000 — \$20    listed on card \_\_\_\_\_

Foreign Orders: Add following amounts for shipping and handling. (Parcel Post)      Amount enclosed \$ \_\_\_\_\_

250 — \$1.75	1000 — \$4.00
500 — \$2.25	2000 — \$6.25

Check local Post Office for air rates . . .

A product of 73 Magazine, Peterborough NH

# The Mystery of Antenna Radiation

**T**his is a subject that has been discussed, argued and has stimulated more interest than any other phase of ham radio.

The current theory of radiation depends on the electromagnetic wave theory. Briefly, it states that when an alternating current of a specific frequency is placed on an antenna of a predetermined length, calculated by the formulas very familiar to all amateurs, an electrostatic field and a magnetic field are formed, one being geometrically at right angles to the other. Both of these fields are components of the thing we call the electromagnetic wave, or more commonly, the radio wave.

These radio waves display certain characteristics, such as the speed at which they travel being equal to the speed of light; critical angles — the angle at which they approach; the direction — horizontal or vertical — in which they peel off the antenna.

All of these things have been studied, tested, tried and proven to some degree. Predictions can be made and results that have been achieved by this popular concept of wave formation have been for the most part quite satisfactory.

The only thing is, I don't believe a word of it! Many years ago, the Earth was considered to be the center of the solar system, or even further, the center of the universe. It certainly appeared to be, for it was obvious that all things in the heavens revolved about it. Mathematical formulae, predictions of eclipses, tides, moon quarters,

etc., were all done with remarkable accuracy. Then Galileo looked through his telescope and realized that the sun is the center of our solar system, and we are revolving around it! A whole new system had to be devised, and of course, it was.

So it is with the electromagnetic wave. I will attempt to show you why.

If you were to hold a pebble above a still pond and let the small stone drop, a series of small concentric waves would spread out from the point of impact in all directions; as the wave distance from the point of impact increases, the size of the wave decreases. The energy of the falling stone has been transformed into a wave upon the water.

The important thing here is that the transformation of energy from the falling stone to the wave required a medium for this to happen. The medium in this case is the water, for without the water, there would be no wave of energy to move upon.

Another example is the energy of my vibrating vocal cords pushing against the air, setting up an air wave that would vibrate your ear drum, allowing you to hear my voice. Take away the medium (air) and I would be voiceless, for there would be no means of transporting the energy from my throat to your ear.

Back in the days when the electromagnetic wave theory came into its own, a small problem arose. If light (an electromagnetic wave, in theory) were to reach the earth from the sun sitting in outer space,

how would it get here? If space were a vacuum, there would be no medium and hence no sun light. Obviously, there must be a medium present. Classical physics was so sure of this that the invisible medium was called the "ether". The explanation of why we can't see it or detect it was that we were like fish immersed in water: it's all around us, thus not readily apparent.

It bothered some people that the ether was there but was yet to be detected and confirmed. Two scientists decided to do something about this situation.

#### The Famous Michelson-Morely Experiment

Michelson conceived the brilliant idea of splitting a single ray of light into two parts and by means of optical instruments would cause one portion of the ray to hit an optical screen; the other half would be deflected by a series of mirrors. The spin of the earth would cause an ether current (like wind on your face as you run forward).

The apparatus was set so that one half of the ray went downstream in the ether; the other half deflected upstream and then downstream. The two portions of the wave were now joined to form one again. Since one fraction had to travel further than the other, and to buck upstream ether flow, it seemed logical that one fraction of the ray would be out of phase with the other. This would mean heterodyning or beating of the waves to form new waves. The logic of this thought was sound and the experiment was carried out carefully.

Unfortunately for Michelson, when the rays were rejoined, they were *in* phase. This was a very disturbing result. Fortunately, Michelson was an honest man and reported his results as he found them. He did not believe that there was no ether, but that his instruments were too crude to detect the difference in phase.

Undaunted, he tried again. This time he improved the optics and had Morely move farther away to get more distance between source and screen. This he hoped would show the rays to be out of phase.

To his dismay, along with that of the rest of the scientific world, the rays came back *in* phase. Over and over again, the experiment was carried out. Each time the optical instruments were perfected, but alas, the

results were the same. To his dying day, Michelson believed in the presence of the ether, but simply could not prove its existence.

The experiment had a very disturbing effect in the scientific world. To some, it was almost easier to believe that the earth stood still rather than scrap the wave-ether theory.

A few years later, a scientific "bomb" was dropped, followed by a whole salvo of "bombs" by two giants in the world of physics.

Among those who scratched their heads over the experiment mentioned was Max Planck who took the bold view that light was not a wave, but a "packet of energy" — a quantum. The quantum of energy that referred to light became known as a "photon".

Now, this was a very different situation. If light from the sun came to the earth through empty space as a particle, no medium is necessary as in the case of a wave; a new step in the understanding of the mechanics of the universe evolved.

The other giant in the scientific world was Albert Einstein. He grasped a hitherto unknown phenomenon from the Michelson-Morely experiment. The fact that the two light beams arrived at the same spot at the same time, even though one of them had to travel twice as far, brought forth the remarkable conclusion that the speed of light is *constant*, and if that is so, then distances must shrink and time must change to accommodate light!

This is not an easy thing to swallow and in the beginning I am sure there were very few people who could digest the concept. More likely the man was stark raving mad. Imagine rulers shrinking and clocks slowing down as they move fast enough to approach the speed of light! If you were never exposed to Einstein's theories before, you are probably having a difficult time trying to follow these weird statements. One might ask, "Do you really mean that my watch would slow down and that my twelve inch ruler would shrink if I were on a rocket ship that went fast enough to approach the speed of light?" That is exactly what I mean!

Other predictions were made. If light

were a particle, then it would be affected by gravitation. Einstein predicted that a light ray would bend if it passed near a large enough mass. He then proposed that the heavens be photographed before an eclipse and the locations of various stars be charted. Then the heavens would be photographed during a solar eclipse, when day is turned to night. The stars nearest the sun should appear to shift because the rays would be bent as they passed near the sun.

On May 29, 1919, men of science from various countries of the world, even those countries that were at war with each other, gathered in the equatorial regions in Africa to confirm Einstein's predictions. The stars in the photograph taken during the eclipse did shift, to the amount of Einstein's calculations.

Still more was to come. One step led to another until the realization that energy and mass are one and the same, that is to say that mass is coalesced energy and that one can transform mass into energy and energy into mass. The most famous equation in history was brought forth by Einstein:

$$E = MC^2$$

C = Speed of light.

The dramatic proof of the validity of this equation was given on a dark night on July 14, 1945, in the Los Alamos desert in New Mexico. The United States exploded the first atomic bomb.

The world stepped into the Atomic Age.

What does all this history of quantum mechanics have to do with a radiating antenna? To answer this, we have to walk a few steps further along the path of discovery of Einstein and Planck.

Max Planck found a relationship between energy content and wavelength ( $\lambda$ ) of a quantum that is linked with the second fundamental constant of the universe (now known as Planck's constant). He formed the basic equation of the quantum theory:

$E = hV$  where  $V$  = frequency,  $h$  = Planck's constant, and  $E$  = energy.

With this equation before him, Einstein made another prediction, that of the photoelectric effect. Certain metals contain outer electrons in their atoms, which are loosely attached to their nuclei due to the relatively great distances they are from their nuclei.

## HAS THE THOUGHT OF 220 FM TEMPTED YOU?

IF SO . . . YOU JUST  
FOUND YOUR EXCUSE:



### MIDLAND 220 MHz FM \$197

**ONCE AGAIN, DISCOUNT ELECTRONIC SUPPLY OFFERS YOU MORE FOR YOUR MONEY WITH THIS OUTSTANDING MIDLAND 220 MHz FM RADIO. COMPARE THIS MODEL WITH ANY OTHER 220 RADIO ON THE MARKET—YOU'LL AGREE YOU CAN'T FIND A BETTER VALUE ANYWHERE! LOOK AT THESE FEATURES:**

- Full 10 watt output—low power switch for 1 watt output
- High performance dual conversion superheterodyne receiver with FET's, cavity resonator, and ceramic filter
- Large, back lighted S/RFO meter, easy glow yellow channel dial
- 12 Channel capability—crystals supplied for 223.50 simplex
- Includes microphone, mobile mounting bracket, and hardware

**IF YOU'VE WANTED TO MOVE UP TO 220 FM, DON'T DELAY ANY LONGER! THE SUPPLY AT THIS UNBEATABLE PRICE IS LIMITED. ORDER TODAY—**

**FOR EACH RADIO DESIRED, SEND \$197 PLUS \$2.50 POSTAGE AND INSURANCE TO:**

**DISCOUNT ELECTRONIC SUPPLY, INC.  
999 ASYLUM AVENUE, DEPT. M-2  
HARTFORD, CONNECTICUT 06105**

Save Even More! Postage and Insurance will be paid on all orders accompanied by Certified Check or Money Order—Another DES bonus!

Conn. Residents please add 6% Sales Tax

Einstein reasoned that if an electron were struck by a photon of light, it would be possible to knock it out of its orbit, provided the photon had enough energy to overcome the attractive forces binding the electron to the nucleus. Once the electron was ejected from the atom, the metal atom now became charged positively.

As you can see from the equation, the higher the frequency, the greater the energy content of the photon. Therefore, he predicted that it is not the *amount* of light striking the metal that causes the photo-electric effect, but the *frequency* of the ray involved.

If the frequency of a ray of light is increased to the point that the photo-electric effect occurs, it is this frequency or any *higher* frequency that will produce this result, even though the *amount* of light is cut down to a feeble quantity.

To illustrate why it takes a certain amount of energy to knock out the electron, even though all light hits the metal at the same speed, let us imagine that you are sitting on a small dock, dangling your feet in the water. If a small canoe came toward the dock at 5 mph, you could stick out your foot and easily stop the canoe; however, if a 100,000 ton ocean liner came gliding up to the dock at 5 mph, you had better get your leg out of the way or it would be crushed, and for that matter, the dock would be smashed and a hole dug out before the big ship came to a halt.

This effect of energy content of the quantum can be related directly with radiation of an antenna and the reflection off the ionosphere.

The QST Handbook describes the critical angle of radiation by stating that, as the frequency of an electromagnetic wave is increased, there is less bending back from the ionosphere; as the wavelength is decreased, the bending is less and less, the skip distance increases until finally the angle is too great for any bending or reflecting from the ionosphere. The wave then strikes the ionosphere at an angle that allows it to pass through and not be reflected.

The quantum theory explains this from another point of view. If the particle of energy does not have a high energy level, it

strikes the lower portion of the ionosphere and bounces off like a ball against a wall. The higher the frequency, the greater the energy content of the particle, hence it goes deeper into the ionosphere layer before it is reflected. The lower frequency particle may bounce off the ionosphere at 60 miles up, whereas the higher energy particle may bounce off the 150 mile level. (As the particle passes through the ionosphere, constant impacts with electrons drain enough energy until eventually the particle smacks into an electron of equal energy level and then rebounds back to earth.)

By increasing the frequency (and energy) the radio beam finally reaches a point where the energy level is too high for the ionosphere to stop or reflect particles, and it passes on through into outer space. It is for this reason that the higher frequencies are normally useful only for distances tangent to the earth's surface.

A word or two about the ionosphere might be useful here. In the outer reaches of the earth's atmosphere, the rarefied air is subjected to radiation from the sun. The ultra violet or *higher* energy photons strike the air molecules and cause the ejection of electrons from the outer shells. The loss of an electron ionizes (or charges) the gases positively and causes free electrons to float around up there. These free electrons eventually find their way back to a positive ion and restore a neutral state to the gas.

However, as long as the radiation continues, the sea of electrons remain, since new electrons are continually being knocked out of their orbits. Any increase in solar activity such as solar storms (sun spots) causes the sea of electrons to deepen.

In quiet times, the sea depth shrinks and at night, the ionosphere normally is less thick than in daytime.

#### **How is a Photon or Quantum Formed?**

To best understand this, we must picture an atom (of any substance) to be a miniature solar system, the nucleus acting as the sun with the orbiting electrons as its planets. These electrons orbit the nucleus in definite levels or orbits. Each level has a maximum number of electrons that it can hold. For example, the first orbit will hold two electrons. Any more electrons have to go into

the next orbit up, that can hold up to a total of eight electrons. The next orbit has a definite limit of electrons it can hold, and so on.

It is in the nature of things that atoms tend to be in a state of balance, or neutral. That is, each atom tries to be electrically neutral, with the number of electrons in orbit equal to the number of protons in the nucleus. Each electron furthermore tends to stay in an orbit at its *normal* distance from the nucleus. Any movement out of this orbit creates an unstable situation. If energy, one form or another, is applied to an atom and forces an electron to move out of its normal shell or orbit level, it (the energy) is converted to a photon by the following means: the displaced electron tends to resume its normal orbital level. In bouncing back to its regular orbit, it has to give up the energy that forced it out of the orbit. The energy thus liberated is a quantum or photon. In the case of light frequencies or higher (X-ray, etc.) the electrons closest to the nucleus emit the photons. The outer electrons do not require as much energy to be knocked out of orbit and I suspect these may be responsible for the lower frequency radiations such as radio frequencies.

From this point on, the waters muddy a bit. Some of the following statements represent the latest scientific thought and some pure conjecture on my part. However, let us plunge a little deeper into the wonders of the Universe.

The wave theory of light is not an easy theory to bury, for some of the characteristics of light can be explained by particles, but others seemed to be answerable only by a picture of wave mechanics. The phenomenon of diffraction gave the wave theory its greatest support.

If a beam of light were passed through a small hole in a plate and allowed to project on a white screen, it would show up as a white spot. If the hole is reduced in size to a minute opening, the spot on the screen has a different appearance. It no longer looks like a bright spot, but rather like a conventional target, with progressive concentric dark rings, going away from the center. Placing two small holes very close to each other has the effect of heterodyning the two sets of

## LOOKING FOR REAL VALUE?

TRY THIS MONTH'S  
INFLATION FIGHTING  
SPECIAL:



### MIDLAND 2-METER FM \$217

IN OUR CONTINUING EFFORT TO BRING YOU THE MOST RADIO FOR YOUR DOLLAR, DISCOUNT ELECTRONIC SUPPLY OFFERS YOU THIS OUTSTANDING VALUE MIDLAND RADIO AT A ONE-TIME, SPECIAL PRICE OF \$217. THIS NEW (NOT DISCONTINUED) RADIO IS JAM-PACKED WITH THESE FEATURES:

- Full 15 watts output power
- Complete multiple FET front end coupled with high Q resonator filter and ceramic filters
- Large back-lighted S/RFO meter, easy glow channel selector
- Instantaneous final protection circuit
- With dynamic microphone and mounting bracket
- 12 channel capability—crystals supplied at no extra charge for: .16/.76, .34/.94, and .94/.94!

IF YOU'RE SERIOUS ABOUT BEATING INFLATION, COMPARE THIS SPECIAL WITH ALL THE OTHERS—WE THINK YOU'LL FIND US A WELCOME CHANGE FROM HIGHER AND HIGHER PRICES! HURRY, OUR SUPPLY AT THIS PRICE IS LIMITED, SO SEND YOUR ORDER IN TODAY!

FOR EACH RADIO DESIRED, SEND \$217 PLUS \$2.50 POSTAGE AND INSURANCE TO:

**DISCOUNT ELECTRONIC SUPPLY, INC.**  
999 ASYLUM AVENUE, DEPT. M-2  
HARTFORD, CONNECTICUT 06105

Save Even More! Postage and Insurance will be paid on all orders accompanied by Certified Check or Money Order—Another DES bonus!

Conn. Residents please add 6% Sales Tax

waves so that alternating dark and bright lines now show on the screen. This can be easily shown with waves of water meeting with each other causing alternative cancellation and addition of the joining waves.

To further complicate matters, the famous French physicist, Louis de Broglie, in 1925 threw a body blow to the quantum theory by stating that electrons (which are particles) were not hard spheres as previously thought, but also showed wave characteristics. Put to the diffraction test, lo and behold, they too showed concentric rings!

Extension of this thought led to the amazing discovery that whole atoms and even small molecules showed wave characteristics! Is anything solid?

The interference patterns (heterodyning lines) of the diffraction of light are now looked upon in a different manner. It is now thought that the photon does not travel in a straight line, but moves in a wiggling or spiral motion. That is to say, if a photon were a bullet fired from a smooth bore gun into a pipe or long tube, it would travel straight down the center of the tube. However, if the gun bore were rifled, the bullet would travel off in a spiraling motion limited by the diameter of the pipe.

I suspect the higher the frequency, the narrower the pipe is, so that the spiral motion is "tighter".

Exactly where the photon is in relation to the center of the imaginary tube at any given moment is a matter of probability.

Evidently, the photons that follow each other through the small aperture display themselves on the screen in a wave-like pattern.

"We might say then, that photons are the components of a light beam, whereas, the wave is a description of it." (Scientific American, September 1968)

What makes some antennas good radiators and others mediocre or poor?

The "magic" formula for calculating antenna length as found in the QST handbook works very well, but does not give us insight as to why an antenna radiates.

Any conductor will radiate, but how well it radiates depends on several factors.

First, it is a matter of matching impedances from transmitter to radiator to allow

a maximum transfer of energy from one to the other. Unless the capacitive and inductive reactances are properly balanced, this cannot occur.

An interesting incident occurred one evening last year to prove this point. Myself and a few other fellows were in QSO with VE3DMU in Ottawa, about 190 miles from Toronto. Band conditions that night were very good, and the further contacts were bouncing the S meter needle to 5 x 20/9.

We decided to try a few experiments with each other to see what would happen. In one experiment we reduced the audio modulation lower and lower, until it barely showed on the oscilloscope. The Ottawa station could still copy the signal, but reported a drop in audio. The same result occurred the other way — then VE3DMU in Ottawa did something else. He restored the audio to 100% modulation and reduced the rf to a bare minimum on his scope. Several of us tried the same thing and the results were the same — we were able to copy each other remarkably well on such low power.

Then the Ottawa station tried something that has had us talking ever since.

He disconnected his antenna and loaded into a light bulb as a dummy load. Restoring the output to full power, he then modulated the signal. With each modulation the intensity of the light increased and decreased in brilliance.

He then asked in a joking manner, "Do you copy me now, Doc?" "Yes, I do, Gordy" was my response, and the S-meter showed 5x7! Everyone else in Toronto heard him too, and we held quite a QSO that night on a light bulb!

I will refer to this incident in a few moments, but let us carry on as to what else a conductor must have in order to radiate efficiently.

It must have "surface area" — that is "skin" surface of conductor exposed for radiation. If you remember the method of quantum or photon production, and apply it to a conductor, it is only the outermost layer of atoms that do the actual radiating.

In the case of the light bulb experiment it is interesting to note that the light bulb gave a fairly good impedance match to the transmitter, allowing a transfer of energy to



the filament of the light bulb. It is obvious that the filament of the bulb is not 132 feet long, so that the surface area of the conductor is not as large as the conventional antenna. Hence the amount of rf leaving the bulb is not as great.

Nevertheless, there was some, enough to transmit almost 200 miles. If the rf from the filament is limited, what happens to the rest of the energy poured into the filament?

The energy backed up in the filament has placed enough force on the deeper electrons (closed orbits) in the atoms of the conductor to form higher energy photons. The filament of a light bulb does have a resistance to ac so that it will glow (radiate light), but the impedance is a good match for the transmitter.

The quanta or photons thus formed are larger (higher energy content) so that a host of new and various energy photons are formed. Now we have rf, light and all frequencies in between being formed. If the filament had more surface area, more rf and less of the higher energy photons would be radiated.

This brings to mind a few new ideas in antenna design that I would like to try some day.

On the receiver end, the photons (rf) striking the antenna set up a displacement of electrons in the surface atoms, causing an electrical potential to be set up in the conductor.

The longer the antenna, the greater the "capture" area; the more quanta striking the antenna, the greater the voltage. It is as simple as that.

No doubt many will not agree with this line of thinking, and I am sure that they have strong reasons and evidence against it. However, I believe this to be basically correct.

#### Bibliography:

*A Star Called The Sun* — G. Gamow  
*The Universe and Dr. Einstein* — Lincoln Barnett  
*One Two Three...Infinity* — G. Gamow  
*Scientific American*, September 1968

...VE3DDS

# instant repairs

on all Ham Equipment

## WE SELL HAM GEAR TOO!

New — used — 2m — lowband  
 450—220 etc. Largest stock in  
 Boston FM xtals in stock \$3.95  
 Chuck WA1KPS Bob W1YVT

Tufts Radio Electronics  
 386 Main Street  
 Medford Mass 02155  
 617-395-8280

SPREAD  
 the  
 WORD!

RADIO AMATEURS!  
 TALK TO THE WORLD!!  
 ...ask me about it!

ONLY .50¢

Ham radio is too great a hobby for us to keep it to ourselves. Let's tell the whole world about it! And what better way than by sporting this attractive lime-green bumper sticker on your car! It's only 50¢ — and it's phosphorescent so you can see it even at night. Go ahead... SPREAD THE WORD! Order yours TODAY!

Spread the Word Bumper Sticker  
 73 Inc., Peterborough NH 03458

Name \_\_\_\_\_

Address \_\_\_\_\_

City \_\_\_\_\_ State \_\_\_\_\_

Call \_\_\_\_\_ Zip \_\_\_\_\_

# TECO

Teco is a subsidiary of Tucker Electronics. Tucker is the world's largest supplier of reconditioned test equipment, the original test instrument DISTRIBUTOR (with 18 lines of new test equipment), and the Southwest's leading repair and calibration facility.

## 5 Good Reasons Why YOU Should Buy Your Ham Equipment From TECO

- 1. Wats Communication:** You can shop by either mail or by telephone, toll free. You merely dial 800-527-4642 and ask for Teco. Your questions will be promptly answered.
- 2. Trade-ins:** We will allow top dollar for your excess test equipment in trade for new ham equipment. Typical trade-in allowances: HP 200 CD (\$100.00), HP 608D (\$600.00), HP 410B (\$90.00), Bird 611 (\$100.00). We will also take Ham and CB equipment and calculator trade-ins.
- 3. Financing:** You can finance your purchase through BankAmericard, Master Charge or American Express, with up to 24 months to pay.
- 4. Shipping Facilities:** Complete facilities for both domestic and export shipments.
- 5. Service:** Teco is service oriented. Complete service facilities in-house. A complete comprehensive technical manual library is available to assist you with equipment problems.



**TECO**

a subsidiary of Tucker Electronics Co.

**SURPLUS TEST EQUIPMENT FOR BARGAIN HUNTERS**

P.O. BOX 1050 1717 S. Jupiter Rd. GARLAND, TX. 75040

214—348-1560



# ICOM

## At ICOM the benchmark is quality.

ALL ICOM RADIOS HAVE . . . .

- 5 Helical Resonators
- 0.4UV Sensitivity
- High and Low I.F. Filters
- Extremely Low Spurious TX
- Transmit and Receive Trimmers
- ESP
- 5KHz Freq. Deviation
- "S" Meter

### INOUE'S NEW PLL SYNTHESIZED IC-230



- 67 + Channels (Direct or  $\pm 600$  KHz)
- 30 KHz Steps (Optional 15 KHz)
- 146-148 MHz PLL Synthesized
- Modular Construction
- Socket For Tones or Dial
- Digital Readout (No Tuning)
- P.L.L. Lock Indicator
- \$489.00

- 5 Channels Included
- 22 Channels Total
- No Relays
- Large Speaker
- Carrier Operated Light



\$249.00

IC-22



IC-21A

- 24 Channels
- Discriminator Meter
- Wide Range - 144 - 148 MHz + MARS
- SWR Bridge
- AC Supply Built In
- DC Supply
- Modular Construction
- \$449.00



## TECO

a subsidiary of Tucker Electronics Co.

P.O. BOX 1050 1717 S. Jupiter Rd. GARLAND, TX. 75040

214-348-1560

**TEN-TEC**

TEN-TEC, INC. FROM

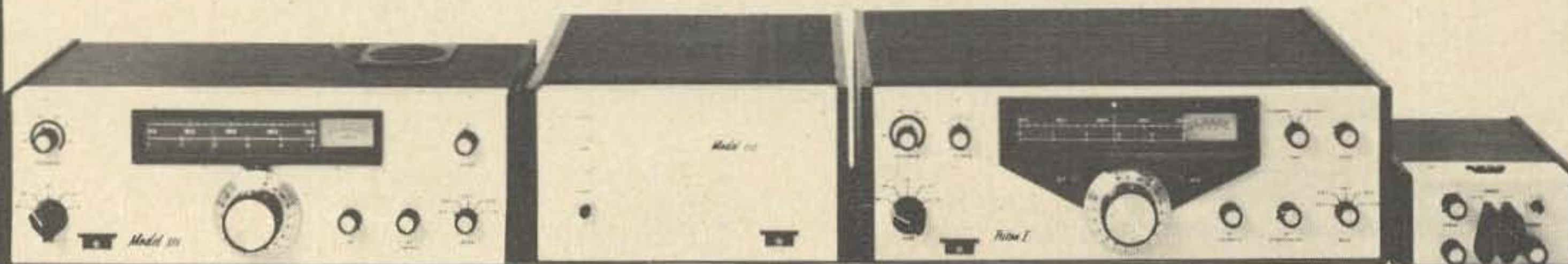
**TECO**

The **TRITON** is a One-of-a-Kind HF transceiver, totally solid state including the final amplifier. The new generation that does more things better than ever before.

**One**, you can change bands instantly. Just turn the bank switch — and go!

**Two**, there is less internal heat to prematurely age components and no high voltage to break down insulation or cause accidental shock.

**Three**, it has ample reserve power to run at full rating even for RTTY or SSTV without limit. Great for contests or emergency service.

**Four**, it is light and compact with a detachable AC power supply to work directly from 12 VDC — For mobile operation without tedious installation.

**Five**, the **TRITON** is a delight to operate. SSB is clean, crisp and articulate. Amplified ALC puts all available speech power into the antenna without splatter. CW is wave-shaped to cut through QRM and pile ups. Instant break-in (not "semi" which really isn't break-in) lets you monitor the frequency while transmitting.

**And six**, a lot more goodies such as excellent dial illumination, plug-in circuit boards, offset tuning, built-in SWR bridge, speaker, crystal calibrator, boards, offset tuning, built-in SWR bridge, speaker, crystal calibrator, snap-up anti-parallelax front feet, light indicators for offset and ALC, direct frequency readout, WWV, entire 10 meter band coverage — and a lot more.

The **TRITON** brings together all that is new and exciting in Solid State for your greater enjoyment of Amateur Radio.

TRITON I — 100 Watt Input \$579<sup>00</sup>  
MODEL 251 — Power Supply \$79<sup>00</sup>

TRITON II — 200 Watt Input \$669<sup>00</sup>  
MODEL 252 — Power Supply \$119<sup>00</sup>

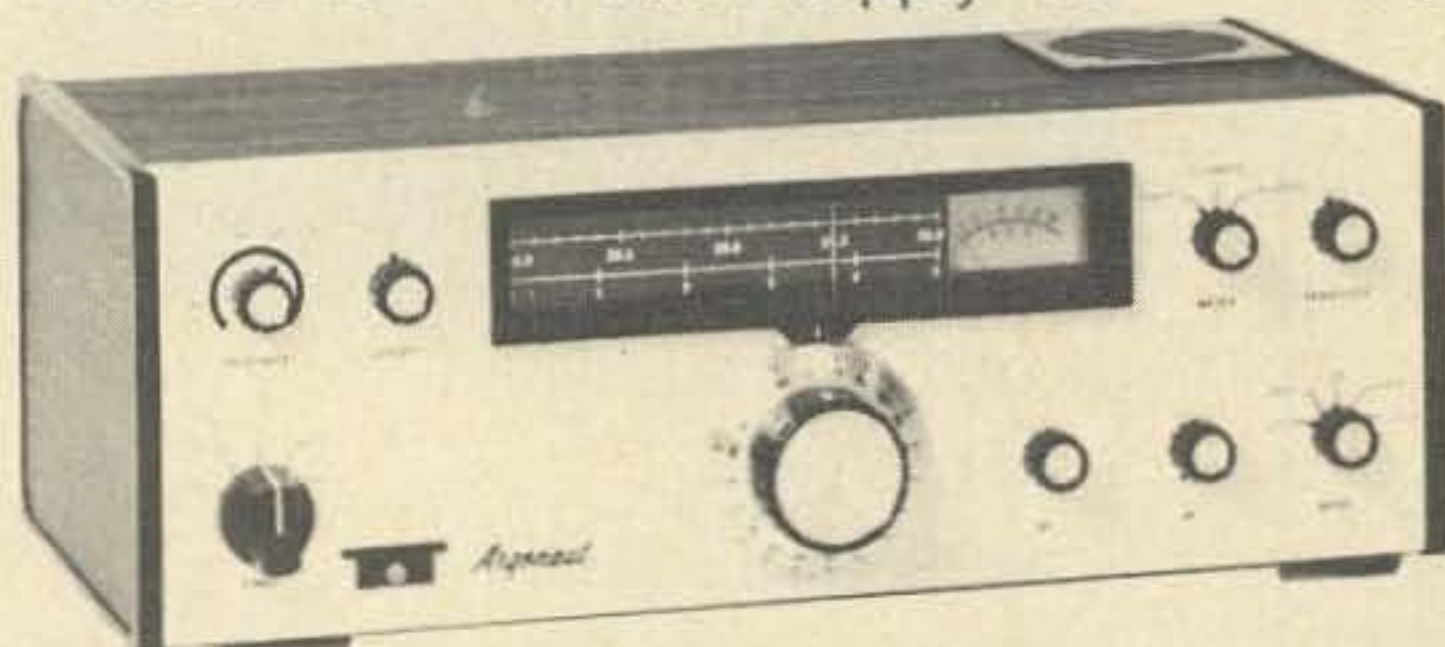
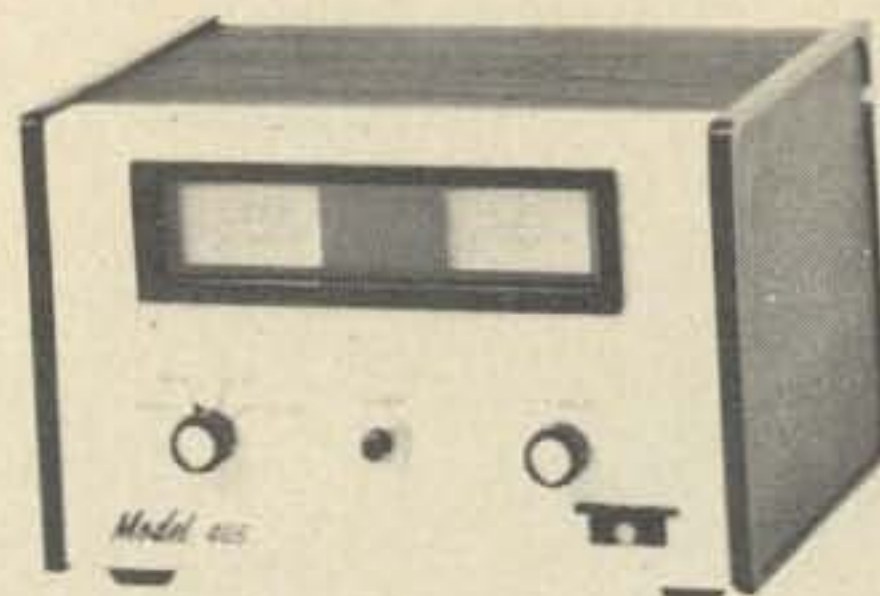
**Argonaut****Model 405 Linear**

The sustained demand and the enthusiastic comments from happy Argonaut owners are music to our ears. We designed this portable pair to be fun, and your response tells us that it's just what you've been looking for. The Argonaut and it's companion, the 405 Linear, are here to stay — thanks to you.

Argonaut, Model 505 .....\$319<sup>00</sup>  
Linear, 100 Watt, Model 405 .....\$149<sup>00</sup>

Power Supply for 505 only, Model 210 .....\$24<sup>95</sup>  
Power Supply for 505 and 405, Model 251 ..\$69<sup>00</sup>

**TECO**

a subsidiary of Tucker Electronics Co.

P.O. BOX 1050 1717 S. Jupiter Rd. GARLAND, TX. 75040

214—348-1560

# The Double Inverted Vee

*If one is good, two is better*

**A** beam costs about \$200 and a quad over \$100. Then there is the problem of what to hold it in the air with. A tower is the most popular device, ranging in price from perhaps \$50 for a used tower up to

depending on how it is constructed. The antenna will give a much lower angle of radiation and thus a better signal to DX areas not normally workable with simple antennas such as a dipole.

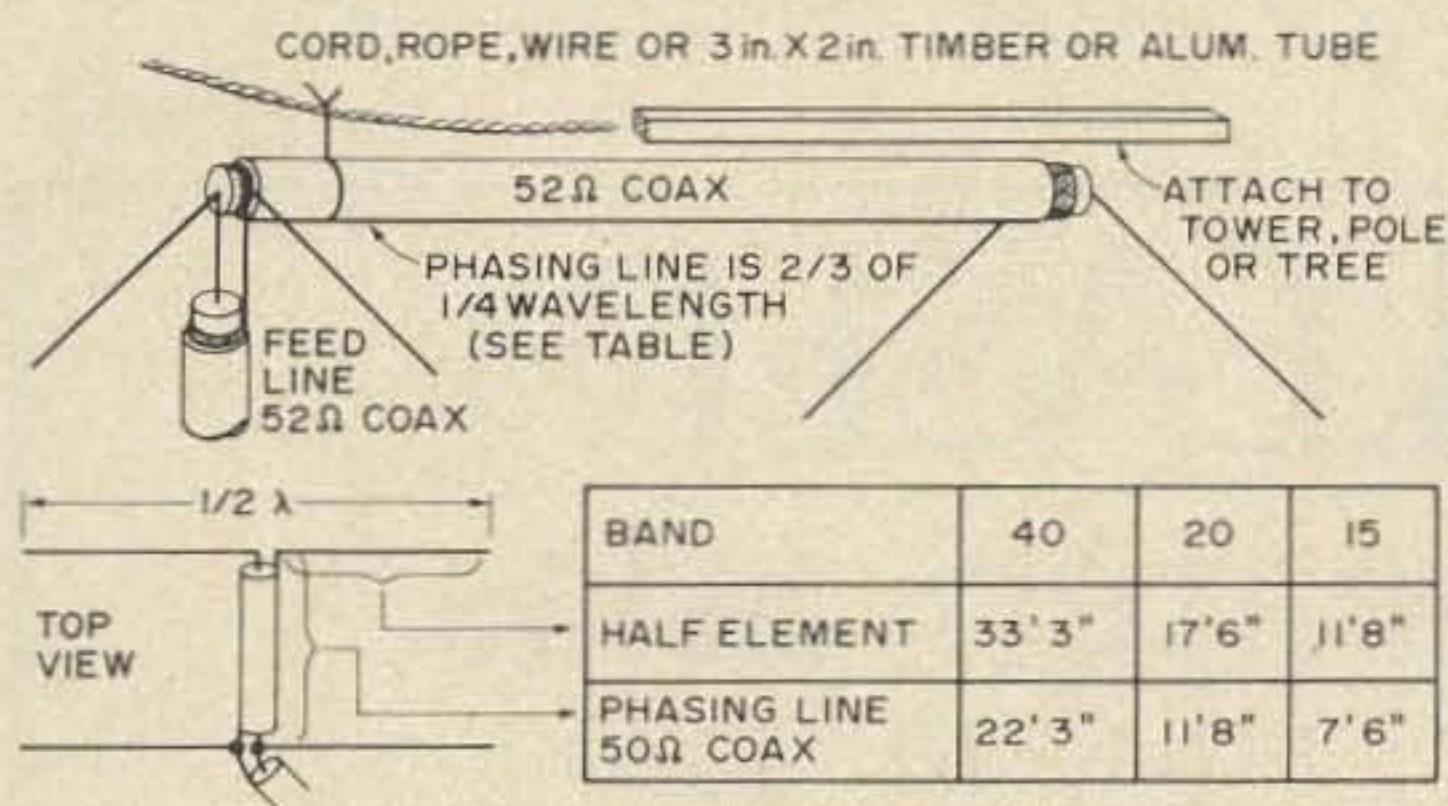

Fig. 1.

many hundreds of dollars, depending on the type desired. The more expensive types might be crank-up, non-guyed (with tilt over action). Of course a heavy duty rotator such as a Ham M costs around \$130 plus cable, freight, etc., and the cost never seems to end.

This antenna, which may also be built for other bands if desired, is known as a *double inverted vee*, gives good directivity and power gain in the direction chosen, but also allows signals to be heard and worked from the sides and back. Construction is relatively simple and cost can be held to a minimum

Reprinted from *Amateur Radio*, Journal of the Wireless Institute of Australia, June, 1974.

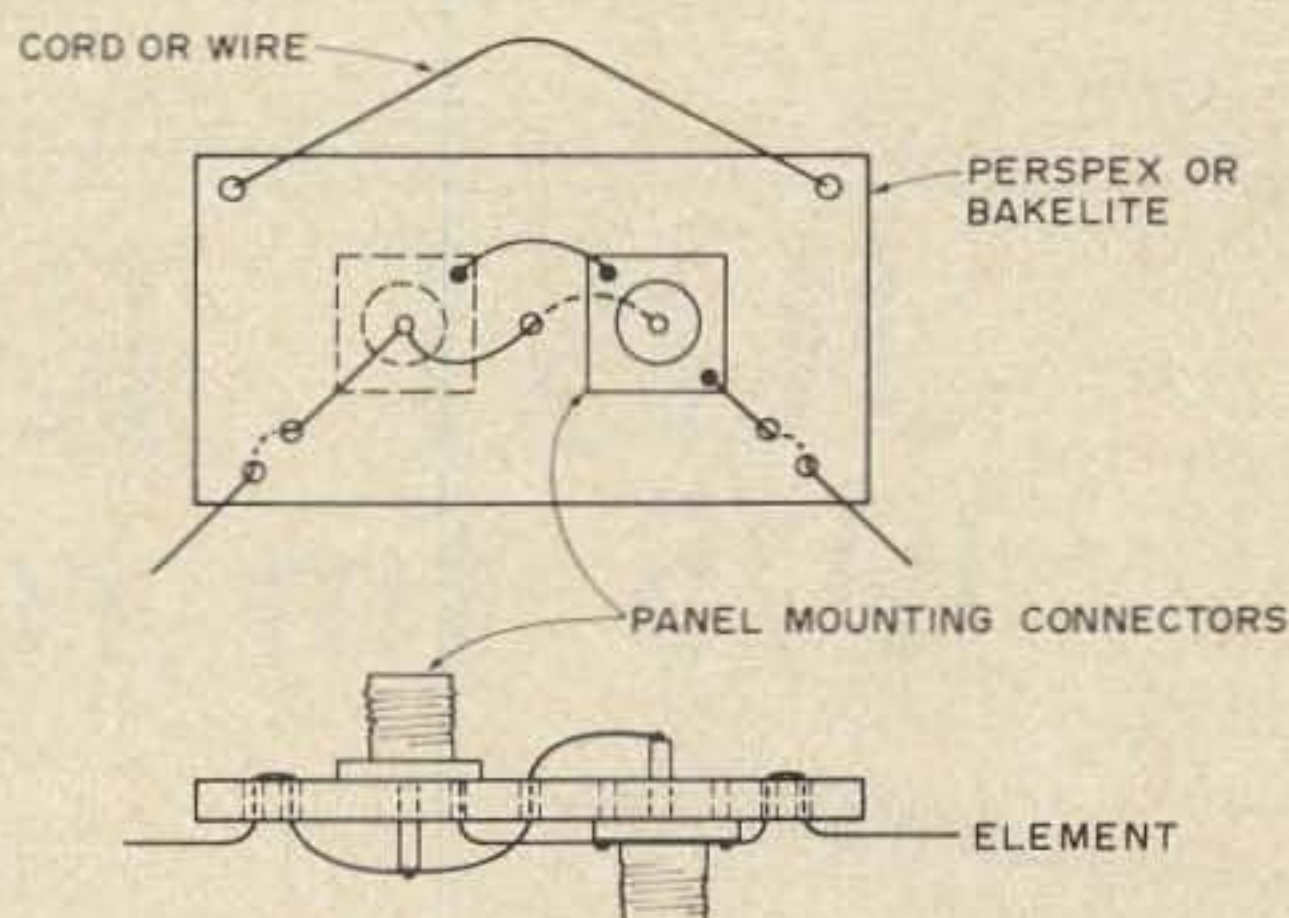

Fig. 2.

When finished the antenna looks like the outline of a tent, Fig. 1. The lower this antenna is placed to the ground the shorter the elements become due to ground effects. This can be determined by experiment with an SWR meter and cut and try, the easiest method being to allow a foot or two of the element to hang down beyond the end insulator, where it may easily be trimmed. This saves unfastening insulators each time. Fig. 2 shows how the connections may be made at the feedpoint. Alternatively the elements and co-ax may be soldered together at the appropriate points using egg insulators or similar supports. Theoretically a 1.1 balun

**GLADE VALLEY  
SCHOOL RADIO  
SESSION — 16<sup>th</sup> Year**  
July 26 — August 8, 1975



**Courses Taught:**  
General Theory and Code, Advanced Theory  
and Code, Amateur Extra Theory and Code

**UPGRADE YOUR HAM TICKET  
BE READY FOR ANY FCC RESTRUCTURING**

The Glade Valley Radio School is the only place in the country where you can get two solid weeks of concentrated radio theory and code — all taught by instructors with Extra Class licenses and years of experience in teaching.

You meet fine people of all ages and backgrounds. All with a sincere interest in ham radio. During the 15 years of this school's operation, over 900 have attended, and many long lasting friendships have developed.

Instruction is given at the General, Advanced and Extra Class levels, with small groups for personal attention.

Excellent rooms and meals are provided, and the schedule is planned for a healthy mixture of learning and recreation, all in the beautiful mountains of cool North Carolina. Facilities are available for single people as well as for married couples.

*Have a Vacation with a Purpose.*

**C.L. Peters K4DNJ DIRECTOR**  
Box 458 Glade Valley NC 28627

Please send me the booklet and application blank for the Glade Valley School Radio Session.

Name \_\_\_\_\_ Call \_\_\_\_\_

Address \_\_\_\_\_

City/State/Zip \_\_\_\_\_

should be used at the feed-point, but it does not appear to make such difference.

The antenna will work well with 75 ohm co-ax but the SWR will be slightly higher, although not excessive (less than 1.5 to 1). With 52 ohm co-ax SWR should be near unity, depending somewhat on height and surrounding objects.

If no co-ax is available a twisted pair of wires will serve the same purpose as 72 ohm co-ax and should substitute quite nicely. Another possibility is 75 ohm twin lead, which will make the whole structure lighter.

For the adventurous, more elements (up to 6 or so) can be added for higher directivity and gain. Element ends are insulated and tied off on bushes, trees or stakes in the ground. The beautiful thing about this antenna is that it is highly transportable, fitting into a box when traveling to a Field Day site and easily erected in a matter of minutes in emergency conditions. Note when more than 2 elements are used the element length, co-ax length, and spacing are exactly the same. Just add them on.

... VK6IZ

# JUST RELEASED!

## 1975 fm repeater atlas

**STILL ONLY \$1.50**



**LISTINGS BY STATE  
ORDER TODAY!**

73's all new REPEATER ATLAS is a must for every ham on 2 meters. There are 2,500 repeaters around the world (2,000 of them in the U.S.), and this atlas lists them all! Just off the presses, the 1975 edition is the most up-to-date listing you can buy. And monthly repeater updates in the 73 newspapers makes sure that it stays that way! You can still purchase this invaluable tool for JUST \$1.50. Isn't it nice to know that there are a few places left where your dollar is still worth something?

1975 FM Repeater Atlas

Please send \_\_\_\_\_ copy(ies) at 1.50 \_\_\_\_\_ Total enclosed.

Name \_\_\_\_\_ Call \_\_\_\_\_

Address \_\_\_\_\_

City \_\_\_\_\_ State \_\_\_\_\_ Zip \_\_\_\_\_

**73 MAGAZINE Peterborough, N.H. 03458**

# A Simple, Short 160m Antenna

## *Great for portable use*

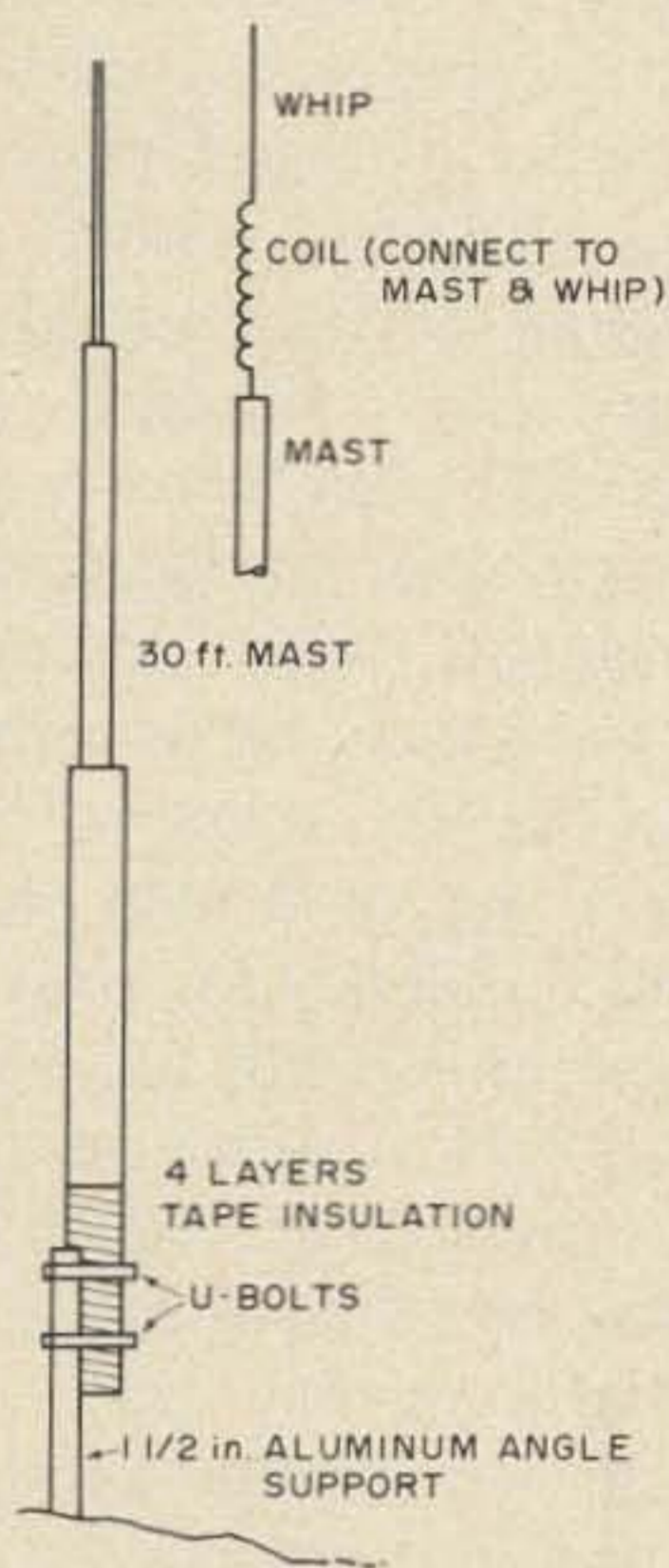

**A** thirty-foot vertical, top-loaded and using as good a ground as possible, can produce good results on 160. The antenna described here was designed for field day and portable operation, but may be made a permanent installation. It makes use of readily available materials and is inexpensive to build and easy to tune up.

Most anything can be used for a mast, as long as it is capable of supporting the loading coil, and provided that it can be made a solid low-resistance structure. The mast I used was made of telescoping 8-foot sections of aluminum tubing, using self-tapping screws at the joints for good bonding. Other possibilities might be copper water pipe, thin-wall tubing such as conduit, or even a wooden mast with a few heavy aluminum wires stapled to it to form a low-resistance conductor. I used 90 lb nylon

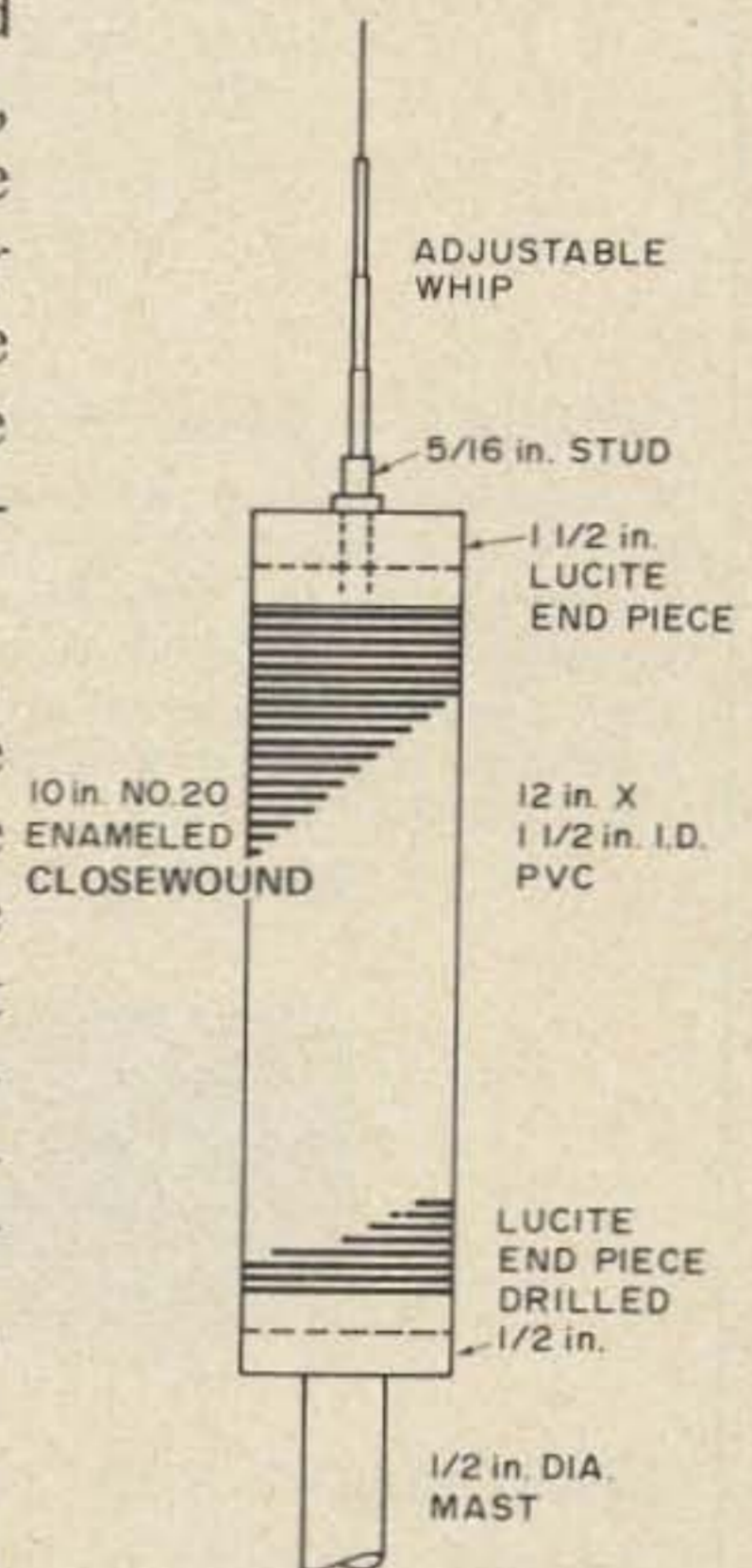

string for guys, but if a permanent installation is to be made, wire guys and suitable insulators should be used. Four layers of scotch electrical tape are wound over the bottom of the mast as an insulator, although a better insulator might be made by using a section of old bicycle innertube slipped over the end of the mast.

The adjustable end-section above the loading coil is a broadcast-band replacement automobile whip of the telescoping type, designed to fit over the broken-off stub of the old antenna, and is available at most auto supply stores and electronics stores. This whip is used as a tuning device. Varying its length will allow you to achieve resonance at the portion of the band desired, in the same manner that the commercial mobile whips are resonated.

The loading coil form is a piece of PVC water pipe, 1 1/2 inches i.d., with a 1 7/8 o.d., and makes a light, strong coil form of

excellent Q. It is readily available at plumbing supply, hardware or home handyman centers. The coil itself consists of 10 in. of #20 closewound, the ends secured with a drop of epoxy cement after passing through a hole in the form, and lugs soldered to the ends for connections as shown in the sketch.

The end pieces, which are held in place with a screw passing through the coil form and end piece, are made of 1-inch thick lucite, 1 1/2 inches in diameter to fit inside the coil form. Mine were made for me by a friend who used a lathe, but they can easily be fashioned using a coping saw and a hand drill. The bottom end piece was drilled to fit over the end of the mast, in my case 1/2 inch, but if you are using different mast, change the dimensions to suit. The top stud is a 2 inch 5/16 bolt, passing through the center of the top end piece, and allows the whip to be clamped solidly over this stud, using the screws provided by the whip manufacturer.

# DATA SIGNAL

the latest in station accessories

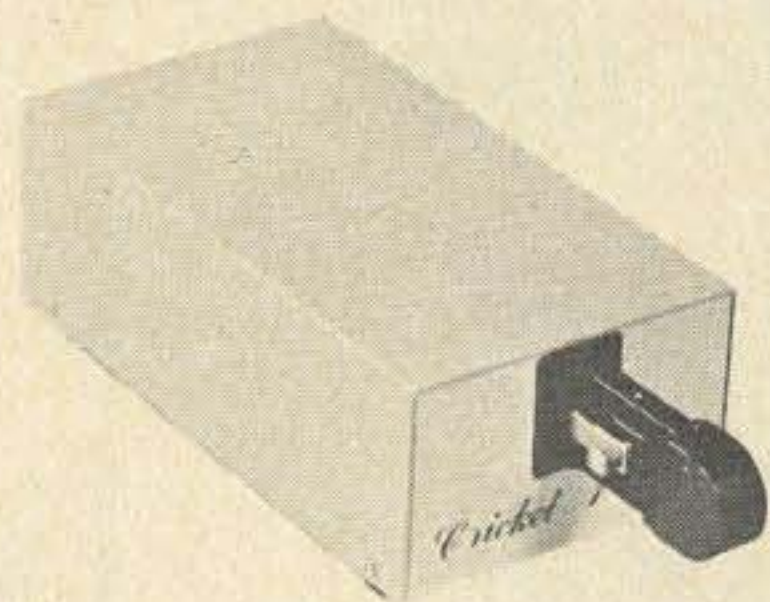

## CRICKET 1 ELECTRONIC KEYER

A popularly-priced IC keyer with more features for your dollar. Cricket 1 is small in size and designed for the beginner as well as the most advanced operator. It provides fatigue-free sending. Easy to copy at all speeds. Turn on its side and use as a straight key for manual keying. AC/DC.

Shipping Weight 3 lbs. \$49.95



## SPACE-MATIC 21-B

The Switchable Keyer. It's up to eight-keyers-in-one. Use the switches to make this your very own personal keyer, both today and tomorrow. Add such features as dot dash memory or adjust spacing with the turn of a switch. Completely perfect.

Sh. wt. 4 lbs. \$119.50

## TOUCH-TONE DECODER

A highly reliable twelve digit decoder with input protection, and PLL circuitry for extremely stable operation. Heavy duty output relays, small size, plug-in circuit board. All these major features at an UNBEATABLE price.

Sh. wt. 1 lb.

TTD-12K Kit \$114.50

TTD-12 Touch-Tone Decoder \$129.50

Write today for complete details

## Data Signal, Inc.

Successor to Data Engineering, Inc.

2212 Palmyra Road

Albany, Ga. 31701

912-435-1764

After the entire loading coil assembly is completed, place a piece of shrink-tube over the coil and apply heat. This will form a good weather seal and offer protection to the coil windings.

Tuneup of the antenna is simplified by placing the coil on the top section of mast, supporting it temporarily, and adjusting the whip for resonance as indicated by lowest swr. Adjust for resonance 25 kHz HIGHER than you wish to operate, then when the rest of the mast is added, the frequency will be where you wish to operate. If a grid dipper lowered to where you wish to operate. If a grid dipper and impedance bridge are available, they will simplify the procedure. A direct connection to 50 Ohm coax was found to be satisfactory, and no elaborate matching system needed. My antenna showed 1.2 to 1 at resonance. In use, the antenna will show a VERY narrow frequency range, on the order of 8 kHz plus and minus the selected frequency for an swr below 2 to 1. However, this is not too bad on 160, since the band is most active on the bottom 1.800-1.825. Any segment which is active in your area may be selected and the loading adjusted for that frequency. (1)

The best available ground should be used. A rod driven a few feet into the ground is useless except for lightning protection. Use a connection to a cold water pipe, and at least two 130 foot wire radials, zig-zagged if necessary, to fit the space available. DON'T shorten the wires, even if the space is tiny. If you possibly can, run the radials straight out, and don't bury them unless you must, and then only a scant inch deep. (2) (3) (4).

This antenna works well for local contacts, and does well on DX if the band is quiet. See you on top-band next field day!

(1) See ARRL 160 meter allocations chart available from headquarters free.

(2) 73 Magazine, June 1974, "A Practical Ground System for 160," pg. 51.

(3) Ham Radio, April, 1973, pg. 16. "The Vertical Radiator."

(4) My own footnote; DON'T mount the antenna anywhere but on the ground. Most hams seem to think "if it's higher it's better." Look at the commercial antennas in the Jersey marshes. If it's a vertical it should be on the ground and well grounded, or more accurately, well ground planed.

... W2NYU/WA1JJV



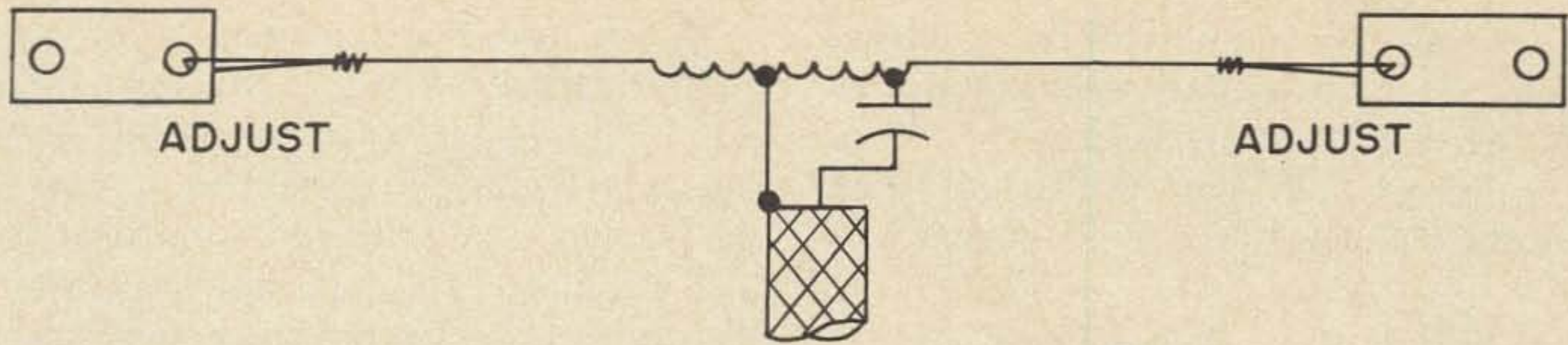

Fig. 1.

J. A. Peterson WA4NWM  
 1311 Greenway Avenue  
 Tavares FL 32778

# Pete's Dipole

*... balun schmalun*

Dipole antennas and the method of feeding them are well known among amateur radio operators.

Nothing new under the sun? Well, here is another method of feeding dipole antennas that results in a balanced antenna with a low swr, and it is fed directly with RG-8/U coax. A balun is not necessary to produce a 1-1 match.

Present day transceivers and transmitters are designed for 52 Ohm output-input impedance. With this fact in mind, this antenna was designed to a circuit with a feed point of 52 Ohms.

Construction is very simple and can be checked out easily and quickly. A great many circuit changes and tests have been made to arrive at the design shown in Fig. 1.

The coil in the circuit is not used as a loading coil but is used in the antenna circuit to determine the 52 Ohm feed point.

Coils for low and medium power are made from 1/8" copper tubing or No. 9 copper wire. Coils for high power are made from 1/4" copper tubing. All coils are spaced the diameter of the tubing and all the coils are self-supporting.

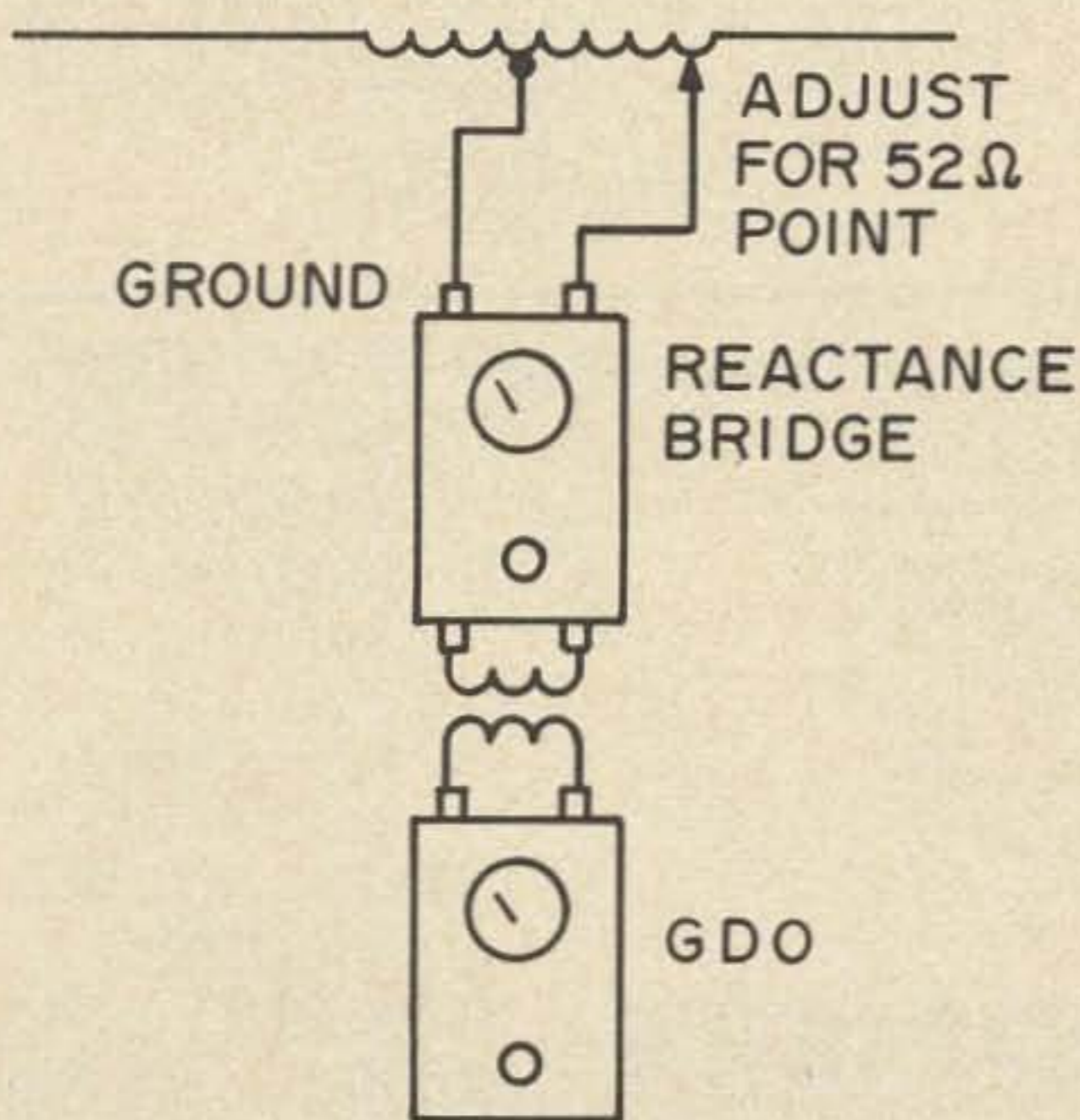

Fig. 2.

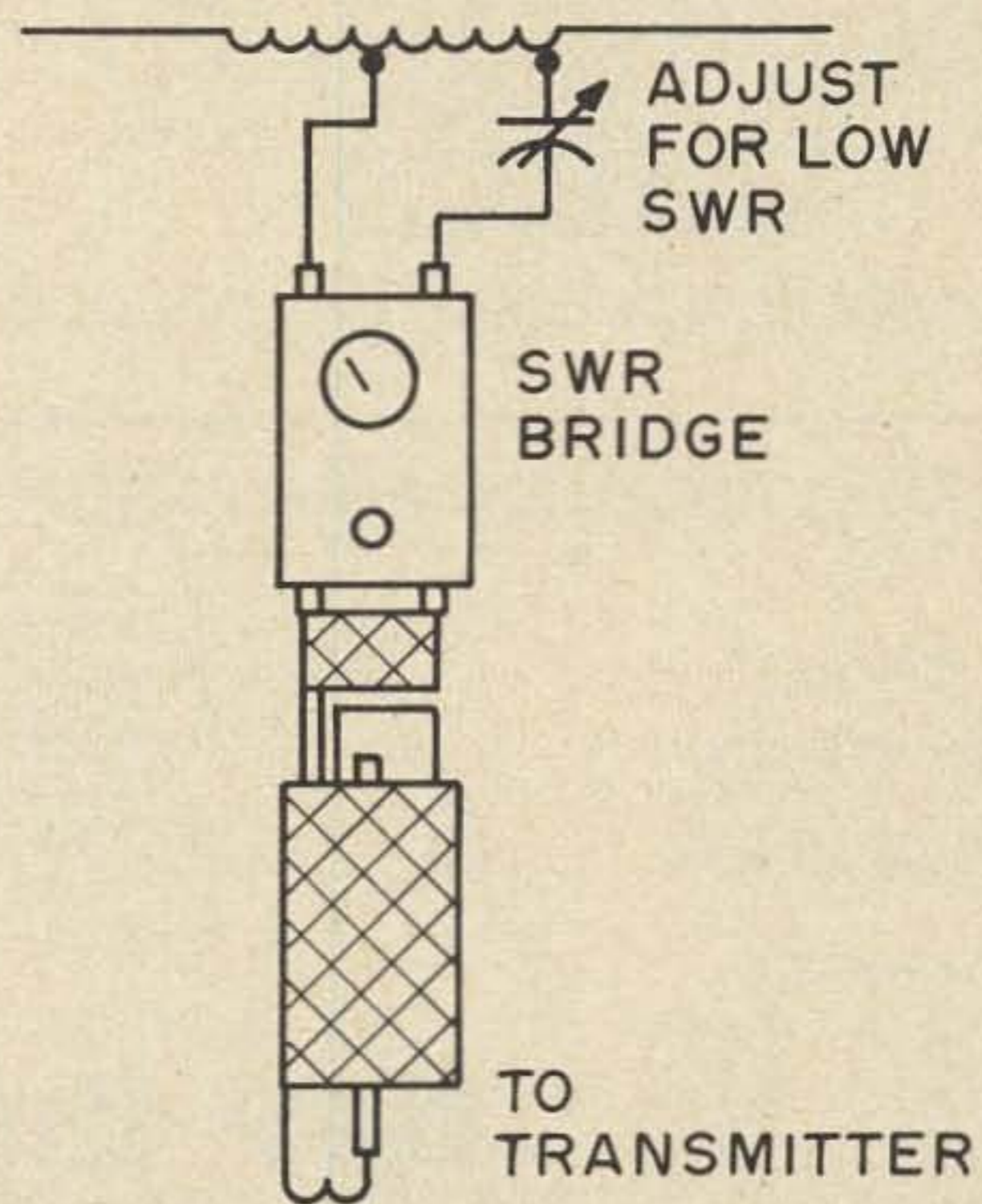

Fig. 3.

The coils are supported by a center insulator or to an insulator that is fabricated from a durable insulating material.

The length of wire needed for each half of the dipole is found by the formula

$$\frac{238}{F_{\text{MHz}}} = \text{Length (ft.)}$$

No. 12 solid or stranded copper wire may be used.

A convenient method to determine the antenna frequency is to suspend the antenna about six feet above the ground, supporting the antenna coil on a wooden platform on top of a six foot step ladder. Using the platform for a work table, set a gdo to the desired frequency, bringing it into inductive relationship with the antenna coil. Adjust the length of each element until resonance is obtained, keeping each end the same length.

Locate the center of the coil and solder on a tab there. Connect the reactance bridge and gdo as shown in Fig. 2. With the reactance set at 52 Ohms and the gdo set at the desired frequency, slide the terminal from the reactance bridge along the coil until 52 Ohms is indicated on the bridge meter. At this point solder on a tab.

Before any checks are made of the swr, a variable capacitor is placed in series with one side of the circuit as shown in Fig. 3. This capacitor is used in the circuit to tune out the reactance, and should have a capacity of 7 pF per meter. This capacitor may be left in the circuit or replaced with a fixed capacitor of the same value.

Attach feed line and swr meter as shown in Fig. 3 and adjust the capacitor to the lowest reading swr. Use low power for this operation. You are now ready to connect the transmitter to the antenna and go to work.

#### PRECAUTIONS

- Be certain that your test instruments are calibrated correctly.
- Do not allow the leads from the coil to droop down along the coil, let them come straight out for an inch or two.
- In construction of the coils be sure the spacing of wire or tubing does not change.
- If you fail to get a low swr do not start to cut the feedline, but check your work and adjustments.
- Seal the ends of the coax so moisture cannot enter.

... WA4NWM

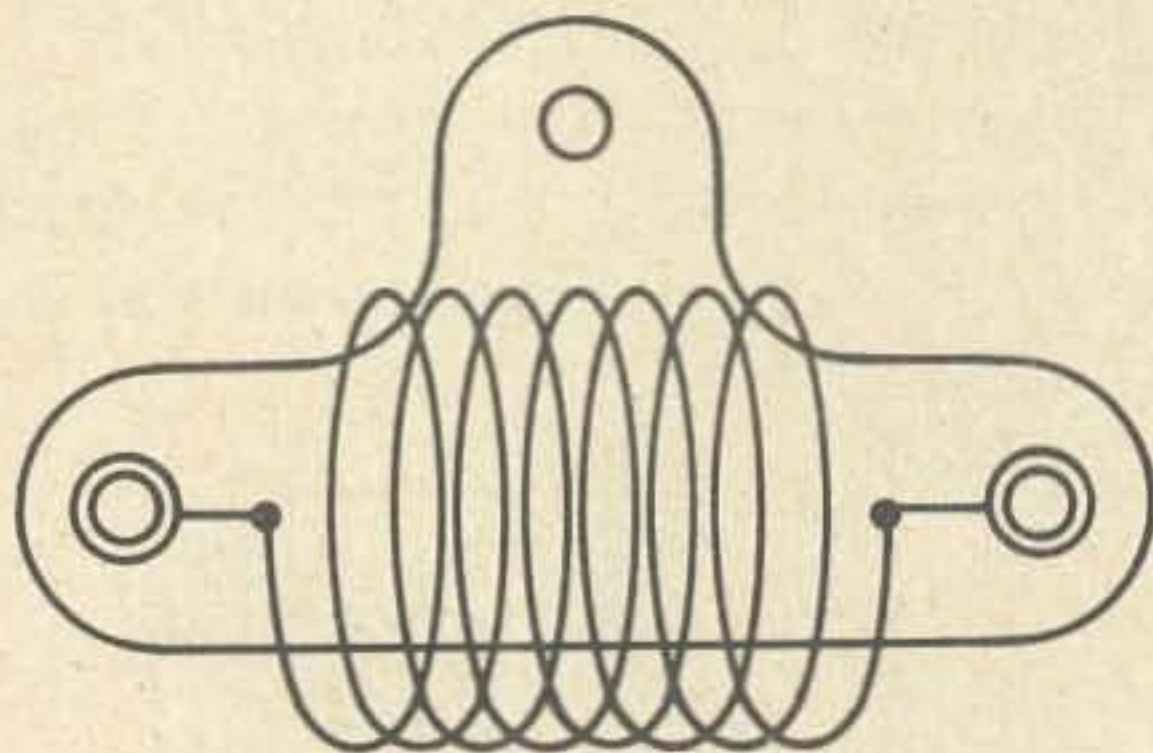

PORCELAIN CENTER INSULATOR

Fig. 4.

BAND	DIA.	TURNS
80	2.5"	13
40	2"	9
20	2"	5
15	2"	4
10	1.25"	5

COIL TABLE

LOW COST  
7  
STYLES  
MIX/MATCH  
SOLDERLESS

T0-5 MODEL  
1000-6 6 PIN  
1000-8 8 PIN  
1000-10 10 PIN  
1000-12 12 PIN

EXPERIMENTER'S IC CIRCUITMASTER

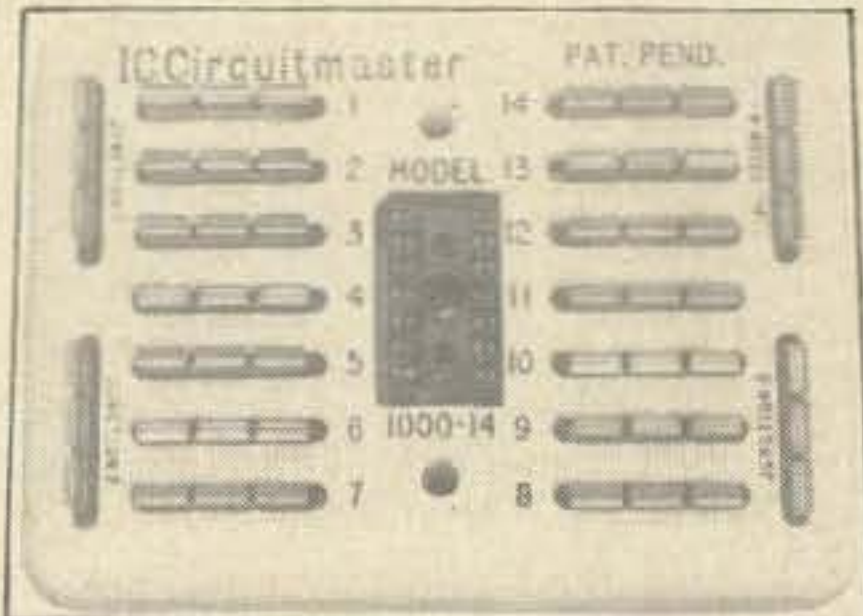

FOR MORE INFO

SEND 10¢ STAMP

BUY NOW  
SAVE \$ .50  
HANDLING  
\$7.00 EA.  
PPD U.S.A.  
2-5 -5%  
PA residents  
add 6% tax  
DUAL INLINE  
MODEL  
1000-8DI 8 PIN  
1000-14 14 PIN  
1000-16 16 PIN

## Key Enterprises

DEPT 73A 1624 MAPLE AVE, HATFIELD, PA 19440

# Yes, I've Built Sixteen Log Periodic Antennas!

The broad-band, uni-directional HF Log Periodic beam antenna was originally developed about 1957 (see references at the end of article). Although these very excellent beams are used extensively by Commercial, Military and Government agencies for both medium and long haul circuits, their use has been rather neglected by amateurs.

I have assembled, erected and tested a number of fixed Log Periodic Wire Beams since 1970 with excellent results and would like to pass along some information on these very efficient beams.

It is believed the amateur fraternity may have overlooked or shied away from these antennas due to:

1) Very little information has been published on HF Log-Periodics in ham publications although there have been several articles covering these for VHF and UHF. (Listed in a previous LP article — September 73 issue of 73 Magazine, p. 42.)

2) These antennas are quite complex and are highly mathematical. Several pages of formulas, reference to log tables and four or five graphs or monographs are required for optimum design. This information was best presented to the hams in the May, 1965 issue of 73. Although this covered the design of VHF L-Ps, the formulas also apply to HF.

The antenna manufacturers producing L-Ps for Commercial and Military use, program this data on a computer. By supplying the frequency range desired, gain required, etc., the computer prints out the element lengths, optimum element spacing,

boom length, etc., to provide for maximum forward gain, front-to-back ratio, minimum beam width etc.

Although these formulas can be computed manually, several days may be required to design (on paper) an L-P having optimum performance in a given space.

3) Most amateurs feel that Log-Periodics are extremely expensive, which they are if purchased. The least expensive rotatable types by one commercial manufacturer are in the \$1500 to \$3000 range for a rotary covering 6 to 30 MHz, capable of 40, 20, 15 and 10m operation. Some of these are used by MARS stations. Rotatable L-P ham antennas have recently been announced in the \$300 to \$1000 class.

The larger fixed types for the 2–30MHz range having higher gain are generally in the 10–30 “kilo-buck” range. However, by assembling smaller, less complicated wire L-Ps for the 14–30MHz range on a “do-it-yourself” basis, one having an 8–10dB forward gain (over a doublet at the same height) can be assembled for a material cost of \$15 to \$25, not including masts or coax which will vary depending on the particular site. The largest 17-element 14–30MHz L-P being used here, having a 12-13dB measured gain, should cost about \$19.50.

4) Many amateurs believe a fixed L-P requires a great deal of “acreage.” This is true of the large commercial types having a 10:1 band width or a single beam covering 3 to 30 MHz. These are 63.5 — 127 meters (250' — 500') in length, some even 203 meters (800'). However a 14–30 MHz L-P for 20–15 and 10m having an 8dB gain can

be erected in a space 10.16m (40') wide by 12.7m (50') long. If the length can be extended to 17.78m (70') the gain can be increased to 10dB compared with a doublet at the same height. By extending to 25.4m (100'), 12-13dB can be realized.

### Log-Periodic Types

Log Periodic Antennas can be classified under three general types:

1) The doublet Log-Periodic (DLP) Configuration. Fig. 1 illustrates this type covering a 2:1 (plus) bandwidth suited for a ham beam for 7-14.35 or 14-28MHz.

2) The vertical monopole Log Periodic working against ground or a ground plane counterpoise. Fig. 2 illustrates this type, also covering a 2:1 band width.

3) The trapezoidal zig-zag or saw tooth configuration, Fig. 3. This type being more complicated and not too suited for HF ham applications, will not be covered by this article which will deal only with the first two types.

Before outlining the construction of the doublet and the monopole types, a brief report will be presented covering the tests conducted here over the past four years.

### W4AEO Test Results on Log Periodic Antennas

During 1970 the first Log Periodic was put up experimentally here for 20m and 15m only, to be compared with doublets and also a well known "store bought" trap vertical for 40-20-15 and 10m (using separate radials for each band). The vertical had given fair results for DX, evidently due to its low angle of radiation and its 8.9m (35') height (at the base) above ground.

The first L-P was quite simple, using only 7-elements for 20 and 15m and only 9.7m (38') in length. It is supported at the rear end by the peak of the roof, 10.2m (40') above ground, and the forward end by two cedar trees about 11.4m (45') high. It is beamed South as I had been working friends in South and Central America also interested in improving beam antennas. They were capable of making good comparisons with the non-gain antennas previously used.

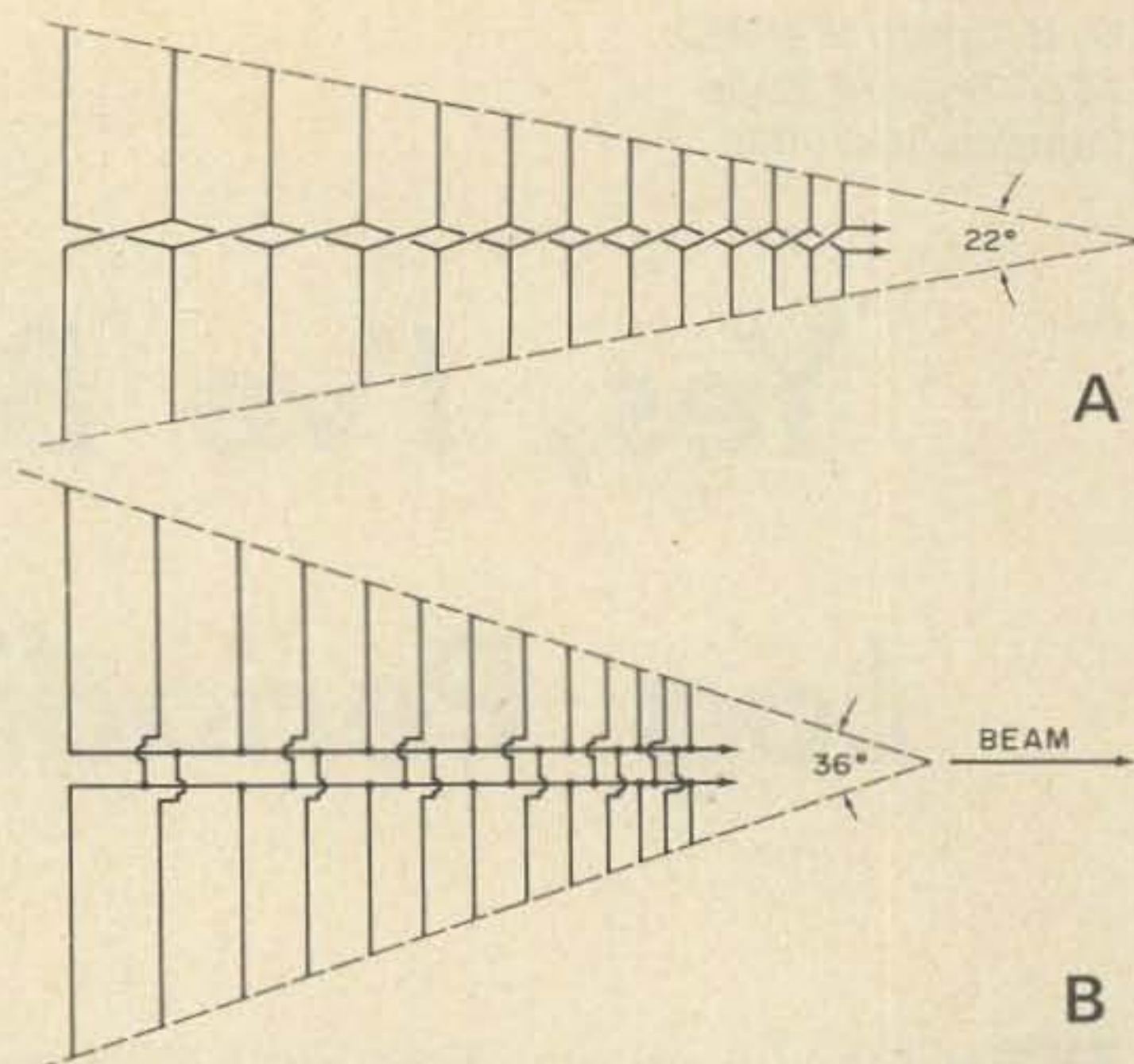

Fig. 1. Doublet log periodic configuration. This will cover a 2:1 bandwidth, say 7-14 MHz or 14-28 MHz. (a) has a 22° aperture angle and gives about 10 dB gain. Note the criss-cross method of transposition of the feeder. (b) is shorter, with a 36° aperture and about 8 dB gain. Note alternate method of transposition of the feeder.

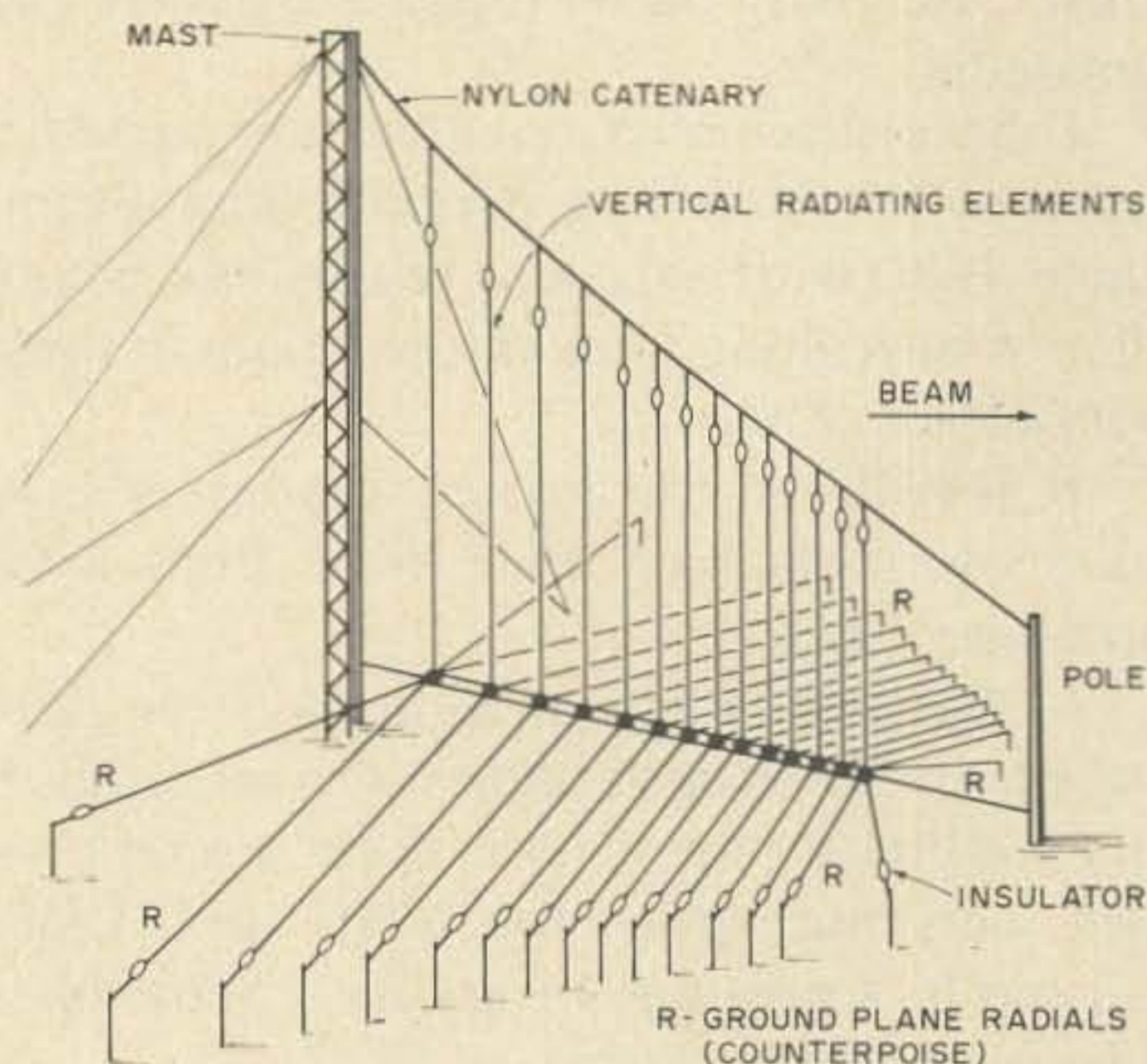

Fig. 2. Vertical monopole log periodic - 2:1 bandwidth.

The results of these first tests amazed me and also the stations being worked. Reports on the non-gain antennas (at the same height as the L-P) normally gave reports of S8-9 on 20m from these stations. I used a popular transceiver operated "bare foot." Switching to the L-P, these stations would generally report an increase of two S-units, or at least a 10 dB increase over the doublet. Usually, when the doublet was giving S-9, they would give "20 over" on the L-P. Although a 20dB gain would seem exaggerated, the "S" meter at this end

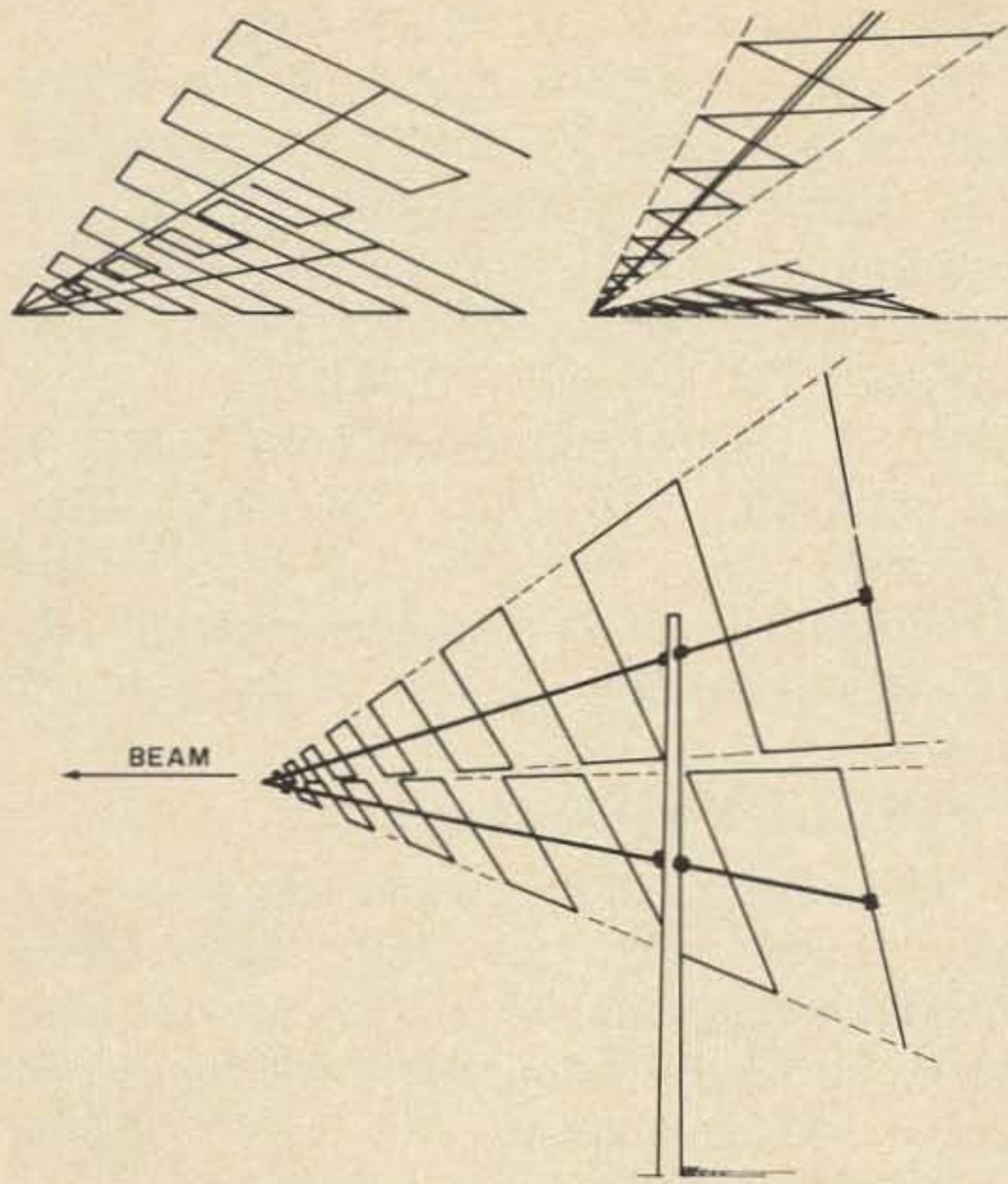

Fig. 3. Trapezoidal log periodics.

would generally confirm this increase on their signal when switching to the L-P.

It is realized that many "S" meters exaggerate but most are fairly linear and can be used for *relative* comparisons at the lower levels. Further the "S" meter here correlated very closely with the gain figures reported when switching to the experimental L-P.

Although the original L-P, Fig. 4, would only have a theoretical gain of 8-10dB, L-P gain figures are often based on VHF or UHF models tested over a line-of-sight path. It is noted that one of the large manufacturers of Commercial and Military HF Log Periodics (see reference B), rate their 10-12dB gains "over average soil conditions." It is therefore believed that this first experimental L-P gives an honest 8-10dB gain by averaging the many reports received from various stations to the South over the past 4 years. The "S" meter on the receiver here is quite "Scotch." Generally, if a station reports a two S-unit or 12dB increase when switching from the doublet to the L-P, the "S" meter here normally shows the same increase in his signal.

Since the original simple 7-element (L-P #1) for 20 and 15m was put up in 1970 it has continued to give excellent results and is still being used as of this writing. Several others having more elements and greater

length, providing greater gain, have been put up and thoroughly tested. Briefly, these are (in the order tested):

L-P #2. 12-element, 17.8m (70') in length for 20-15-10m. Now being used for the NE beam for W1s, W2s and Europe.

L-P #3. 12-element 6.35m (25') length for 15-10-6m.

L-P #4. 12-element, 10.16m (40') length for 20-15-10m.

L-P #5. (#2 tested on edge in the vertical plane or vertically polarized for about two weeks).

L-P #6. 13-element, 22.86m (90') length for 40-20-15m. This was a "skip band" type with a portion between the the 40 and 20m bands omitted. Two of these are now being assembled for permanent North and South beams.

L-P #7. 5-element, 12.7m (50') length for 40m only. (See reference 18).

L-P #8. Two 5-element (same as #7) for 40 only; back-to-back in an inverted V configuration suspended by a single center support line. One beamed North, one South — exactly 180° difference. Put up to obtain additional and more accurate forward gain and better front-to-back data on 40m.

L-P #9. Improved 5-element, 40m only at increased height for additional forward gain data. Aimed South. Gave consistent 10dB gain over doublet "standard" at same height.

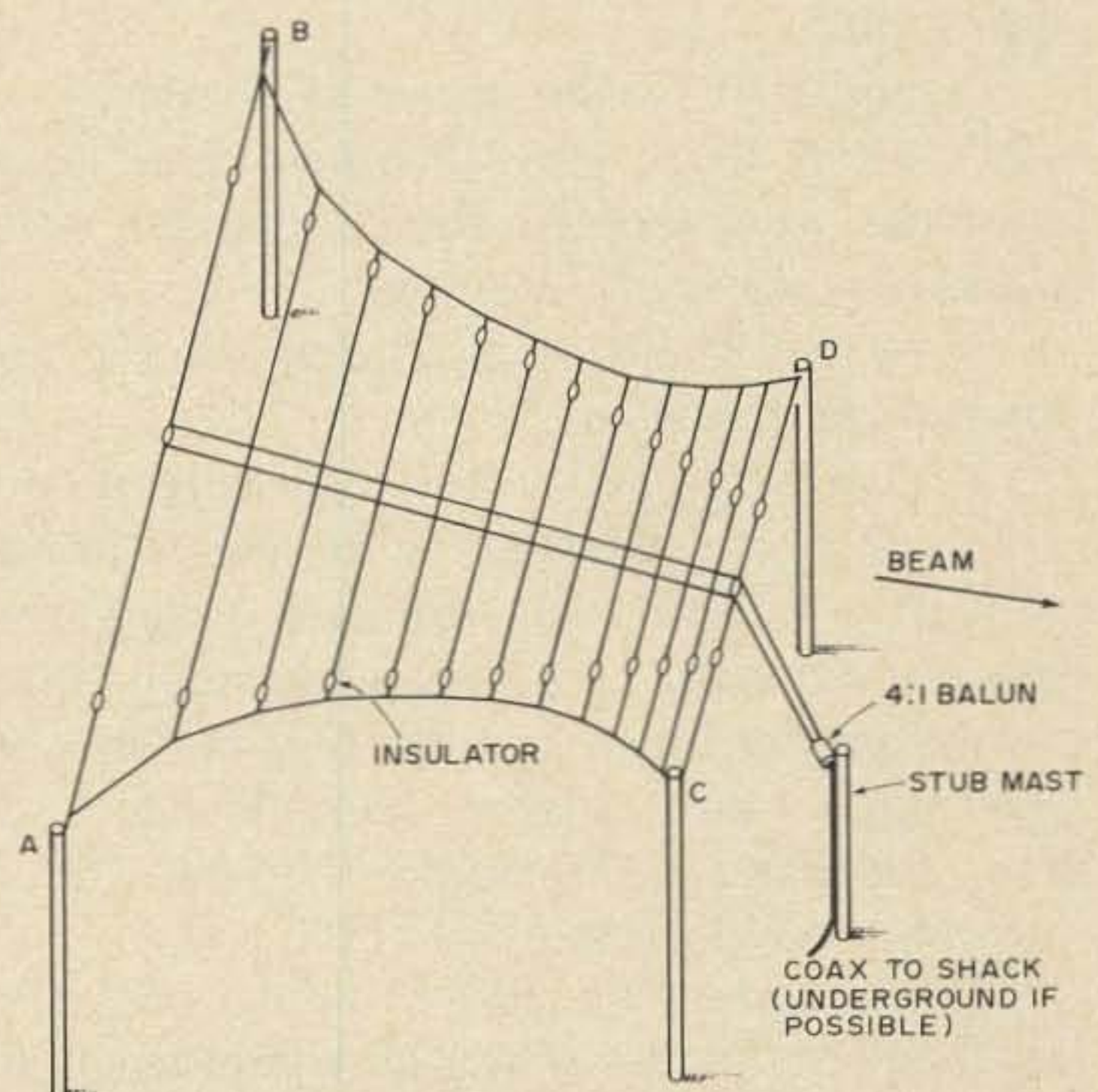

Fig. 4. For method of transposing the center feeder see Fig. 1b and Fig. 6. Illustrates the four masts used to support the antennas.

L-P #10. 5-element 10m monoband L-P. (See reference 18.)

L-P #11. 17-element, 25.4m (100') length for 20-15-10, 15.24m (60') above ground. This is the permanent West beam which has a measured 12-13dB forward gain to the West. By far the best and highest gain L-P installed here to date. Side attenuation is down 25-30dB.

L-P #12. 6-element, 12.7m (50') length. Experimental for 20m only. 10dB gain. Four additional forward parasitic directors (non-driven) were added later but little if any increase in gain could be noted.

L-P #13. 5-element vertical monopole Log-P for 40m only, using ground plane radials or counterpoise. Although this L-P gave a 10dB gain, it had an extremely low angle of radiation. Was good for DX but horizontal doublet type. L-P #7 or #9 was better for normal operation.

L-P #14. Same as #13 except inverted as an "up-side-down" inverted ground plane. Strictly an experimental antenna to try for an even lower angle of radiation.

L-P #15. 5-element vertical monopole Log-P for 80m only. Results similar to 40m monopole, L-P #13. Good for DX but poor for close by stations. Gave 10dB gain (over 80m doublet at 11.43m, 45') from stations greater than 1500 miles.

L-P #16. Trapezoidal L-P for 20 and 15m only, both the zig-zag and the saw-tooth types tested.

In addition to the above L-Ps designed and tested here, several other directional antennas were erected for comparison with the L-Ps. Some of these were:

- 1) A 6-element 15m "Long John" yagi mentioned below.

- 2) A 20m phased beam consisting of two  $1/2\lambda$ 's in phase, collinear with two collinear reflectors and two collinear directors beamed toward Europe. Although this showed approximately a 10dB gain, the lobe was much more narrow than the NE L-P and the band width quite narrow. At  $\pm 50$ kHz, the SWR exceeded 1.5:1.

- 3) A 5-element Bruce array on 20m beamed for Caracas. The gain was lower than any of the L-Ps tested in that direction or possibly, being vertical, the angle of radiation may have been too low for this dis-

tance. It was only tested a few weeks.

In addition to the ham L-Ps assembled here, several other L-Ps have been designed "on paper" for friends and others, one covering 12-24MHz for several MARS frequencies as well as 20 and 15m. Several commercial L-Ps for 3-30MHz, 2-4, 4-8, 6-12, 8-16MHz and several VHF and UHF for 30-50, 140-145, 150-470 MHz, including two for TV: 174-215 and 475-750MHz. Several have been completely assembled for others on "custom built" orders.

#### YV5DLT - W4AEO Tests

The most accurate 20 and 15m tests have been made with my long time friend YV5DLT (ex-W5DLT) of Caracas. We have been constantly testing the L-Ps for several years. He is able to give very accurate readings on any changes made here.

During the original testing of the first three L-Ps, schedules were kept daily between 1200 and 1400 local time here as these hours gave the worst case conditions on 20m. Other schedules were kept on 15m.

It was during this period that the 17.78m (70') L-P #2 and the 15 and 10m L-P #3 were put up for comparison with the original L-P #1 which had performed so well on both 20 and 15m. L-P #3 was especially good during the 15m tests, generally showing 5 dB over L-P #1 and even slightly better than L-P #2; however #3 was aimed at approximately  $165^\circ$ . Caracas is  $149^\circ$  true, 1854 miles Statute. The other two L-Ps were approximately  $180^\circ$ . All three were about the same height above ground.

After several months of 15m tests on #3, we wished to make a direct comparison with a good yagi aimed in the same direction. I assembled a 6-element "Long John" Yagi per (see reference 20, p. 104). This was erected to the side of L-P #3, exactly parallel and aimed in the same direction; both 11.43m (45'), or about a full wave above ground.

Several weeks were spent comparing these two beams. Invariably YV5DLT would report L-P #3, 3-5dB better than the yagi. The "S" meter readings here confirmed this.

#### 40m L-P Tests

Most of the 40m tests were conducted

over a period of several months with old friends, W4QS and K4FBU in Florida at the same time daily. During this period four different 40m L-Ps were beamed South for Florida at various times for comparison with a good 40m horizontal doublet at 11.43m (45'). One 40m L-P #8 was also beamed North for comparisons in that direction. All of these L-Ps produced 8-10dB gain in these directions over the dipole; however, many of the tests indicated as much as a 20dB improvement which was confirmed by the "S" meter at this end and a number of other stations in various parts of Florida.

Since the usual 2-element 40m yagi or two extended  $1/2\lambda$ 's in phase collinear do not normally exceed 3-4.8dB gain, the 10dB average gain of the L-Ps tested is worth considering; especially because of their low cost and ease of construction.

#### 75 or 80m Vertical Monopole L-P Tests

A 5-element vertical monopole L-P, #15, was assembled for 75m. Since the mast height limited the longest rear element (the reflector) to 16.51m (65',  $1/4\lambda + 5\%$ ) this L-P was limited to 3.8 - 4.0MHz, and all tests were within this range.

It was soon evident that this vertical beam was strictly for longer range communications, due to its lower angle of radiation. The  $1/2\lambda$  80m dipole up  $45^\circ$  (not an inverted V) used as the "standard" was better for distances from 400-500 miles. Beyond this range the vertical L-P was better in the forward direction. At night the doublet was better to about 1000 miles; beyond, the monopole L-P would show its increase, giving a good gain over its beam width.

For ranges greater than 1000 to 1500 miles, the 75m monopole, L-P #15, showed at least a 10dB gain over the dipole. However, for the normal working range on 80m or 75m, the doublet was better for the shorter distances.

A similar test using a 5-element 40m vertical monopole, L-P #13, was conducted with similar results as the 75m test. The horizontal doublet type 5-element 40m L-Ps #7, 8 or 9, being better for normal operations and the vertical monopole for DX. This beam was aimed NW.

During a pre-dawn 40m test with L-P#13, a W7 (working a VK on phone) in the NW about, 2000 miles from here, was monitored. On repeated "S" meter readings taken, the monopole was consistently 2 "S" units or 12dB better than on the 40m dipole when receiving the W7 in line with the monopole beam.

#### Receiving Advantages of the Log-Periodic

In addition to the excellent forward gain of the L-P which is quite apparent to those being worked, the received gain is also quite noticeable. Another plus factor of the L-P is its excellent diversity or "capture" effect during reception.

When QSB is bad on the dipole used as the "standard," switching to the L-P reduces fading considerably, since the "readability" on the L-P is much better.

Evidently the number of elements and its "boom length" produces the diversity effect due to its size and length compared with the doublet or even a smaller 3 or 4 element beam. The greater the number of elements and the greater its length, the better it performs for reception in addition to the increased gain apparent on both transmission and reception.

For those more acquainted with the yagi, the L-P can be considered as a multi-element, uni-directional end-fire array having a driven (rear) reflector, a  $1/2\lambda$  driven "active" radiator and a number of forward driven directors.

L-P theory implies that for a given discrete frequency within its bandwidth, 5-elements are generally excited or driven as an "active cell." However, while testing the 17.78m (70'), 12-element, L-P #2, it was excited with low power on 20m. Rf voltage could be detected (using a neon bulb) on *all* elements except the long rear (reflector) element. The second or  $1/2\lambda$  driven element (on 20m) was quite "hot" at the ends as would be expected. The rf voltage on the following driven director elements 3, 4 - 11 and 12, decreased gradually toward the forward end. Some rf could still be detected on the short forward element #12.

Evidently these multi-element, driven directors add gain and also possibly help lower the angle of radiation in the E plane

# SAVE \$50



## SWAN FM2XA

Reg. \$299—Now only \$249

SWAN FM2XA 2m FM transceiver, 10 watt, 12 channels w/crystals for 146.34T/.94, .34/.76R and .94 simplex. 12vdc WITH detachable 110vac supply. Extra crystals \$5 each (special order). Add \$5 for shipping in the "48 states".

Use Your SWAN CREDIT CARD!

# YAESU

## Special Offer!

SAVE \$40 on YAESU's FRdx-400SD Receiver (with 2 & 6 meters).  
Reg. \$399 — Now Only \$359.

A limited quantity of FLdx-400 Xmtrs. are available for \$319 (Reg. \$339).

# SAVE \$120



SBE SB-450, UHF FM Xcvr, 5 watt, 12vdc, 12 channels w/xtals for 449.5T/444.5R & 446 MHz simplex. Reg. \$399 — Now \$279

# SAVE \$130



## Clegg FM-27B

LATEST MODEL!  
reg. \$479 — Now \$349

# SAVE \$50

Purchase a Regency HR-2B for the reg. price of \$229 (Without Trade) and we'll give you 10 Free Crystals (reg. \$5 ea.).

# Standard

## SAVE \$60



Purchase a Standard CI46A Hand-Held for the regular price with No-Trade, and you may take a \$60.00 Credit toward the purchase of any other new merchandise.

SR-CI46A 2w hand-held, 5 ch. w/xtals for 146.34T/.94R & 146.94. . . . . \$298.00

### ACCESSORIES FOR SR-CI46A

SR-CMP08 Miniature microphone	\$ 22.00
SR-CSA Desk-top charger	43.00
HM-4 6" Flexible antenna	6.59
SR-CPT-3644 Leather case	8.50
SR-CLCC-1 Deluxe case	19.50
Crystals for Certificates	6.50
SR-CMA Mobile Charger	13.00
SR-CI2/120-6 AC Charger	16.00
SR-CAD Antenna adaptor	8.00
#2GCI Pair of Ni-Cad batteries	3.10
(5 pair required for C-146A)	

### E-Z Ways to Purchase

- 1- CASH
- 2- C.O.D. (20% deposit)
- 3- Master Charge
- 4- BankAmericard
- 5- American Express



# AMATEUR ELECTRONIC SUPPLY

4828 West Fond du Lac Ave. Milwaukee, Wis. 53216

Phone (414) 442-4200

STORE HOURS: Mon & Fri 9-9. Tues. Wed & Thurs 9-5:30. Sat 9-3



# AMATEUR ELECTRONIC SUPPLY USED GEAR

★ 10 Day Free Trial (Lose only Shipping Charges) ★ 30 Day Guarantee ★ Full Credit Within 6 Months on Higher

Priced New Equipment ★ We Welcome your Master Charge or BankAmericard ★ Order Direct from this Ad!

<b>ALLIED</b> AX-190 Receiver \$159 SP-190 Speaker 9	<b>DYCOM</b> 10-0 2m Amplifier \$129	<b>HEATHKIT</b> GR-78 Receiver \$ 99 SB-300 Receiver 209 SB-301 Receiver 229 HS-24 speaker 9 XC-2 2m converter 25 XC-6 6m converter 25 SBA-300-4 2m conv. 19 DX-60 Transmitter 59 DX-60B Transmitter 69 DX-100B Xmtr 99 TX-1 Transmitter 99 HX-10 Transmitter 189 HX-20 Transmitter 125 VHF-1 6-2m Xmtr 79 SB-400 Transmitter 225 SB-401 Transmitter 249 HW-7 QRP Xcvr 59 HWA-7-1 AC supply 9 HW-12 75m Xcvr 75 HW-12A 75m Xcvr 85 HW-22A 40m Xcvr 85 HW-100 Xcvr 249 SB-100 Xcvr 325 SB-101 Xcvr 349 SB-102 Xcvr 369 SB-630 stn. console 69 SB-650 Digital frequency display 169 HW-18 Xcvr 99 HW-30 (Two'er) 29 HW-17 2m Xcvr 75 HP-13 DC supply 49 HP-13A DC supply 54 HP-23 AC supply 45 HP-23A AC supply 49 HO-10 monitor 69	<b>AC-500 AC supply 75</b> <b>NCL-2000 Linear 349</b>	<b>P &amp; H</b> AFC-2 compressor \$ 39 LA-400C Linear 69	<b>PEARCE-SIMPSON</b> Gladding 25 w/AC \$169	<b>POLYTRONICS</b> PC-2 2m Xcvr \$ 99 PC-62B 6-2m Xcvr 149	<b>REGENCY</b> HR-25 2m FM Xcvr \$239 HR-212 2m FM 189 AR-2 2m Amplifier 89 HR-6 6m FM Xcvr 169 HR-220 220mHz FM 189 HR-2B 2m FM 169	<b>SBE</b> SB-34 Transceiver \$249 SB2-LA Linear 175 SB2-VOX 15 SB2-CW codaptor 25	<b>SB2-MIC mike 9</b> <b>SB-450 UHF FM 229</b> <b>SB-144 2m FM Xcvr 179</b>	<b>SWAN</b> SW-240 Xcvr \$169 400 Xcvr/420 VFO 299 406B VFO 49 410 VFO 69 22B VFO adaptor 19 117B AC supply 59 160 external VFO 75 260 Cygnet Xcvr 289 14A DC converter 29 350 Xcvr (late) 259 350C Xcvr 299 500 Xcvr 309 500CX w/SS-16B 449 700CX w/SS-16B 499 117C AC supply 65 117XC AC supply 85 14C DC module 49 512 DC supply 69 14-117 DC supply 99 600T Transmitter 399	<b>FM-2XA 2m FM 199</b> <b>FM-1210A w/AC 249</b>	<b>TEMPO</b> Tempo One Xcvr \$289 AC/One AC supply 75 2000 Linear 295	<b>TEN TEC</b> RX-10 Receiver \$ 49 200 VFO 49 315 Receiver 169 TX-100 Transmitter 59 AC-5 antenna tuner 6 210 AC supply 19 PM-3 Transceiver 49	<b>YAESU</b> FL-200B Xmtr \$169 FT-101 Xcvr 499 FT-101B Xcvr 549 FTDX-401 Xcvr 449 FV-401 rem. VFO 75 FL-2100B Linear 249							
<b>AMECO</b> R-5 Receiver \$ 39 CB-6 (7-11) 29 CB-6 (14-18) 29 CN-50 (14-18) 29 CN-144 (30-34) 29 CN-144 (14-18) 29 PS-1 AC supply 9 TX-62 VHF Xmtr 75 621 VFO 39	<b>EICO</b> 723 Transmitter \$ 39 730 Modulator 39 717 Keyer 49	<b>ELMAC</b> AF-67 Transmitter \$ 49 PS-2V AC supply 29 M-1070 AC/DC sup. 39	<b>GENAVE</b> PSI/10 AC supply \$ 49 GTX-200 2m FM 159 Ham-Pak 25	<b>GLOBE/GALAXY/WRL</b> Galaxy III Xcvr \$169 Galaxy V Xcvr 199 Galaxy V Mk II 239 Galaxy V Mk III 269 GT-550 Xcvr 279 GT-550A Xcvr 329 AC-35 AC supply 69 AC-400 AC supply 79 DC-35 DC supply 65 G-300 DC supply 39 G-500 DC supply 75 CAL-35 calibrator 9 SC-35 speaker 9 DAC-35 dlx. console 69 2000 Linear/supply 275 Economy AC supply 39 FM-210 2m FM 99 R-530 Receiver 599	<b>B &amp; W/WATERS</b> 3001 Hybrid coupler \$34	<b>CENTRAL ELECT.</b> 20A Exciter (table) \$ 89	<b>CLEGG/SQUIRES-SANDERS</b> 66'er 6m Xcvr \$109 Thor 6 (RF only) 75 417 AC sup./mod. 65 418 DC sup./mod. 25 Zeus VHF Xmtr 249 Interceptor Receiver 219 Interceptor B 289 Venus 6m SSB Xmtr 175 Apollo Linear 175 FM-27A 2m FM 269 FM-27B 2m FM 299 011 AC supply 49 22'er FM (ser. 25) 199 22'er Mk II (AM) 199	<b>COLLINS</b> 75A-1 Receiver \$139 75A-2 Receiver 199 75A-3 Receiver 269 75A-4 (ser. #1452) 349 75A-4 (ser. #1669) 349 75A-4 (ser. #5113) 449 75S-1 Receiver 325 75S-3 Receiver 495 75S-3B Receiver 695 32S-1 Transmitter 349 312B-3 Speaker 19 312B-4 stn. control 169 KWM-1 Xcvr 225 351D-1 mount 35 KWM-2A Xcvr 695 351D-2 mount 75 516F-2 AC supply 125 516E-1 DC supply 75 PM-2 AC supply 95 CC-2 carrying case 49	<b>GONSET</b> Comm II 2m \$ 79 Comm II 6m 69 Comm IIB 6m 79 Comm III 2m 99 GC-105 2m 119 Comm IV 2m 149 Comm IV 6m 119 G-28 Xcvr 149 910A 6m Xcvr 199 911A AC supply 39 Thin-Pak 19 G-76 DC supply 39 GSB-100 Xmtr 169	<b>HALLICRAFTERS</b> SX-100 Receiver \$139 SX-101A Receiver 159 S-106 Receiver 39 S-108 Receiver 79 SX-122 Receiver 225 SX-146 Receiver 175 HT-32A Transmitter 219 HT-37 Transmitter 159 HT-40 Transmitter 49 HT-44 Transmitter 159 SR-150 Xcvr 249 SR-160 Xcvr 149 PS-150-120 AC sup. 75 PS-150-12 DC sup. 49 MR-150 rack 19 SR-400 Xcvr 495 P-500AC AC supply 85 SR-2000 Xcvr/AC 849 SR-34 (AC) Xcvr 175 SR-42A 2m Xcvr 89 HA-1 keyer 49	<b>ICOM</b> IC-21 2m FM Xcvr \$299	<b>JOHNSON</b> Challenger \$ 49 Viking I 49 Ranger I 89 Ranger II 139 Valiant I 139 Invader 200 199 Invader 2000 449 275w M'box/SWR 129 6N2 VHF xmtr 89 6N2 conv. (250-43) 39	<b>K-W</b> KW-204 Xcvr \$329	<b>KENWOOD</b> PS-511S AC supply \$ 79 VFO-55S rem. VFO 79	<b>KNIGHT</b> R-100A Receiver \$ 69 TR-108 2m Xcvr 89	<b>LAFAYETTE</b> HA-250 Linear \$ 59 HA-260 2m Amp. 59 HA-800 Receiver 89	<b>LETTINE</b> 242 6m Xmtr \$ 39	<b>MASTER MOBILE</b> MPS-800 DC sup. \$ 39	<b>MOTOROLA</b> Metrum II (25w) w/9 xtals & offset \$339	<b>NATIONAL</b> NC-155 Receiver \$ 99 NC-190 Receiver 139 NC-270 Receiver 119 NC-300 Receiver 129 NCX-3 Transceiver 169 NCX-5 Transceiver 279 NCX-5 Mk II 299 NCXA AC supply 69 NCXD DC supply 75 500 Transceiver 199 200 Transceiver 199	<b>R. L. DRAKE</b> 1A Receiver \$119 2A Receiver 149 2B Receiver 189 2C Receiver 189 2AC calibrator 9 R-4 Receiver 269 R-4A Receiver 289 R-4B Receiver 339 R-4C Receiver 399 4NB noise blanker 49 FL-500 filter 39 FL-6000 filter 39 CPS-1 conv. supply 12 CC-1 conv. console 39 TR-3 Xcvr 299 TR-4 Xcvr 389 TR-4/NB Xcvr 459 RV-4 remote VFO 69 TR-4C Xcvr 449 RV-6 remote VFO 89 2NT Transmitter 99 AC-4 AC supply 85 DC-3 DC supply 75 DC-4 DC supply 95 MN-4 matcher 69 ML-2 2m FM Xcvr 199 TR-22 2m FM Xcvr 149 TR-22C FM Xcvr 179

12/31/74

All items subject to prior sale. Amateur Electronic Supply reserves the right to sell such items as power supplies with their matching equipment only, and not separately - depending upon our stock situation. To insure quality, our used gear is sent through our repair shops after we receive your order - so please allow for a possible slight delay (approximately 5 to 10 working days).

SAVE on	Model	Reg.	Factory	NOW	★ New ★ Clegg FM-27B Reg. \$479. NOW \$349.
<b>Genave</b>	GTX-10	\$209	\$169	\$159	
	GTX-2	259	189	179	
	GTX-200	269	199	189	
	PS-1	79	49	48	

\*While our supply lasts!  
Factory Warranty

## Factory Authorized Sale!



If you purchase a Metrum II on Sale as shown below - We will also sell you a PK-736 Tone Encoder kit for just \$1 (reg. \$45) and, or a T-1670A AC Power Supply for just \$99

	reg.	Now
10 watt Metrum II	\$399	\$279
25 watt Metrum II	499	349
Crystals (one per channel)	9.00	
Repeater Offset Crystal	13.50	
T-1670A AC Power Supply	150.00	
PK-735 Multiple Repeater		
Offset Modification Kit		39.00
PK-736 Tone Encoder Kit		45.00

## SAVE \$50 ICOM



Purchase a ICOM IC-230 for \$489, with No-Trade, and you may take a \$50 Credit towards the purchase of other merchandise.

## AMATEUR ELECTRONIC SUPPLY

4828 West Fond du Lac Ave. Milwaukee, Wis. 53216

Phone (414) 442-4200

HOURS: Mon & Fri 9-9; Tues, Wed & Thurs 9-5:30; Sat 9-3

**IMPORTANT!** - Please Be Sure to send all Mail Orders and Inquiries to our Milwaukee store, whose address is shown above. The following Branch stores are set up to handle Walk-in business only.

17929 Euclid Avenue; Cleveland Ohio Phone (216) 486-7330

621 Commonwealth Ave.; Orlando, Florida Phone (305) 894-3238

and concentrate the forward lobe in the H plane. This may be the reason the apparent gain generally exceeded the theoretical during tests.

### Front-to-Back Ratio

The front-to-back of the L-P is generally less than a well designed mono-band yagi. The L-P seems to be 14-15dB maximum with 10 to 13dB as typical. From the tests made here, the front-to-back improves as the L-P is raised to at least a  $\frac{1}{2}\lambda$  above ground (at its lowest cut-off frequency).

The front-to-back of the 40m dipole L-Ps (DLP) tested appeared to be better for the horizontal than the inverted V configuration, as would be expected and the forward gain also better.

### The Forward Lobe

The forward lobe of the L-P is generally wider (about 90-100° beam width) than that of a well designed yagi; however, for a large fixed beam this is good as it can be aimed to cover a certain part of the country or a particular DX continent. For example the NE (L-P #2) covers Europe quite well and the 30.48m long, 17-element West beam (L-P #11) seems to cover all of Australia. The side attenuation of this long L-P is down 25-30dB.

A W1, -2 or -3 could use one or two L-Ps to cover most of the states. A W6 with an L-P beamed East would cover most of the East Coast. At this QTH 4 L-Ps will cover most continents of interest: NE, Europe; East, Africa (and Australia long path); SE or South, South America; West, Australia; and NW — Alaska, Japan, etc. One for SW may be tried later for long path to Europe.

### Fixed Beam Antennas vs Rotaries

An advantage in using several fixed beams over a single rotary is that they can be switched instantly from one to the other (and to the doublet used as a "standard"), whereas, it takes some time for the rotary to swing, making quantitative readings difficult, especially when QSB is bad.

Another item noted during the first year these L-P tests were started: about half the stations worked during the winter of '70-'71, using rotaries, would come back

"Sorry OM I can't swing my beam, it is frozen up for the winter." I noted less of this problem the second winter. Evidently better rotators are being used.

The following comments are comparisons of the L-P with several other beams.

### Compared with the Yagi

As more hams no doubt use yagis than other beams, these will be compared first. A well designed and properly adjusted 3 or 4-element mono-band yagi should give about the same gain as a moderate size 20-15-10m L-P when both are at the same height above ground. The L-P will, of course, cover all frequencies 14 and 28MHz and can be operated with a comparatively flat SWR any place in the three bands. The band width of a high Q yagi may be limited to a portion of a band as the band width at resonance may be only 2.5%.

Compared with a tri-band yagi for 20-15-10m, which is generally a compromise antenna, the L-P should give the greater gain.

Of all the contacts made while testing these L-Ps during the past four years, not a single station worked (most using yagis for 20, 15 and 10) had a doublet for use as a "standard" or test antenna for comparison with his beam. Many have been most cooperative in rotating their yagis the full 360° to demonstrate the front-to-back, but none were able to demonstrate its forward gain. The front-to-back on some of the mono-band yagis was quite good, while others were very poor.

One MARS station worked had both a rotatable L-P and a yagi. He obliged by rotating the L-P 360° which gave a good demonstration of its pattern. When both antennas were beamed in this direction, the L-P showed greater gain; however, he did not have specifications on the yagi.

An advantage of having several fixed beams for various directions is that they can be selected instantly by a coax switch or relay. This allows for more accurate data in comparing antennas. Even under fading conditions a fair comparison can be made by switching rapidly and averaging the readings.

### Compared with a Rhombic

Anyone having room for a rhombic cer-

tainly has room for several L-Ps for various directions and is then not limited to one direction as is the rhombic.

The TCI engineers (Technology for Communications International of Mountain View CA) advertise their "Extended Aperture" L-P which is only 60.98m (200') in length and has a gain of 17 dBi. A rhombic to produce this gain requires a length of 518.29m x 228.66m (1700' x 750') width according to the TCI ads.

Further, the gain of a rhombic generally decreases at its low frequency end (less wavelengths per leg), whereas, the gain of the L-P is approximately the same over its bandwidth. If anything, at least from the tests here, the L-P seems to give slightly better gain at the low frequency cutoff end. The forward lobe of the L-P is generally wider than the rhombic, requiring less accurate aiming than the latter.

#### Compared with Phased Arrays

To date I have only made comparisons with two phased arrays on 20; a 5-element Bruce and a 6-element collinear array mentioned above, both strictly single band an-

tennas. Neither gave the performance of the L-Ps. I do plan to test the L-P vs a multi-element Sterba curtain or similar stacked arrays later.

#### The SWR of Log-Periodics

As a general rule the SWR of a L-P does not exceed 2:1 over the band width for which it is designed, i.e., 14 - 28MHz. From the tests here, the SWR over an entire band, 7.0-7.3; 14.0-14.35 or 21.0-21.45 does not exceed 1.5:1. Table 1 gives some of the readings taken from several of the L-Ps tested. (Also see reference 18 for SWR readings taken on the mono-band L-Ps.)

#### Log-Periodic Site Selection

The first step is to determine if space is available for the L-P when beamed in the desired direction. The second step is to decide the desired band width or the bands it must cover and the gain desired. These will, of course, determine the size (length) of the L-P and if it will "fit" the space available.

The long rear element (reflector) must be at least 5% longer than the lowest cutoff

Table 1

SWR Readings						
kHz	LP #1 7-element 20 & 15	LP #2 12-element 20-15-10	#11 17-element 20-15-10	kHz	#9 5-element 40 only	LP #15 5-element monopole For 80m only
14.0	1.1:1	1.4:1	1.4:1	3.5	NA	1.2:1
14.1	1.1:1	1.5:1	1.4:1	3.6		1.2:1
14.2	1.02:1	1.6:1	1.3:1	3.7		1.1:1
14.3	1.02:1	1.7:1	1.2:1	3.8		1.2:1
14.35	1.01:1	1.7:1	1.1:1	3.9		1.4:1
				4.0		1.25:1
21.0	1.01:1	1.1:1	1.3:1	7.0	1.05:1	
21.1	1.01	1.2:1	1.15:1	7.1	1.05:1	
21.2	1.05:1	1.3:1	1.05:1	7.2	1.01:1	
21.3	1.15:1	1.4:1	1.01:1	7.3	1.1:1	
21.4	1.25:1	1.4:1	1.02:1			
21.45	1.3:1	1.5:1	1.1:1			
28.0	NA	2.0:1	1.5:1	Also see SWR readings for mono-band L-Ps, Aug 1973 issue of 73 Magazine, p. 23 and 24.		
28.2		1.5:1	2.0:1			
28.4		1.6:1	2.25:1			
28.6		1.6:1	2.0:1			
28.8		1.8:1	1.3:1			
29.0		2.0:1	1.01:1			
29.2		1.6:1	1.5:1			
29.4		1.6:1	2.0:1			
29.6		1.4	2.0:1			
29.7		1.3	2.7:1			

frequency. The short forward element should be 50% shorter than the high frequency cutoff. The pages of math required for their complete design will not be presented here. (See reference 2, 3, 4, 5, 8, 11 and 13.)

To simplify the design and eliminate the formulas entirely, Table 2 presents in tabular form some of the doublet type L-Ps (DLP) assembled and tested here for the ham bands as mentioned above. (Dimensions for single band L-Ps were given by reference 18.)

This tabulation gives frequency band width, element lengths and element spacings, overall (boom) length, apex angle, etc. of each.

Similar information on the vertical mono-pole L-Ps for 40m and 80m is supplied by Fig. 10.

If space is available for a L-P at your QTH, at least one of these can be tried.

Fig. 4, is sketch illustrating four masts used to support a typical DLP for 20-15-10m. These masts can be inexpensive 12.20m (40') collapsible guyed TV masts, power poles, towers, trees (as used here) or other supports if available.

Fig. 5, illustrates two high and four stub masts for an inverted V-Log-P which I call my "Λ-Log-P" configuration.

Fig. 6, illustrates a simple 5-element mono-band L-P which requires the least space. This is especially adapted for 40m. (See reference 18 for complete information.)

Fig. 7, illustrates an "acreage saver," using a DLP on edge in the vertical plane. This only requires one high and one lower mast and little width.

This one is only suited for the higher bands due to the rear mast height. The vertical DLP will usually have a lower angle of radiation than an equivalent horizontal DLP. It will generally not be too good for

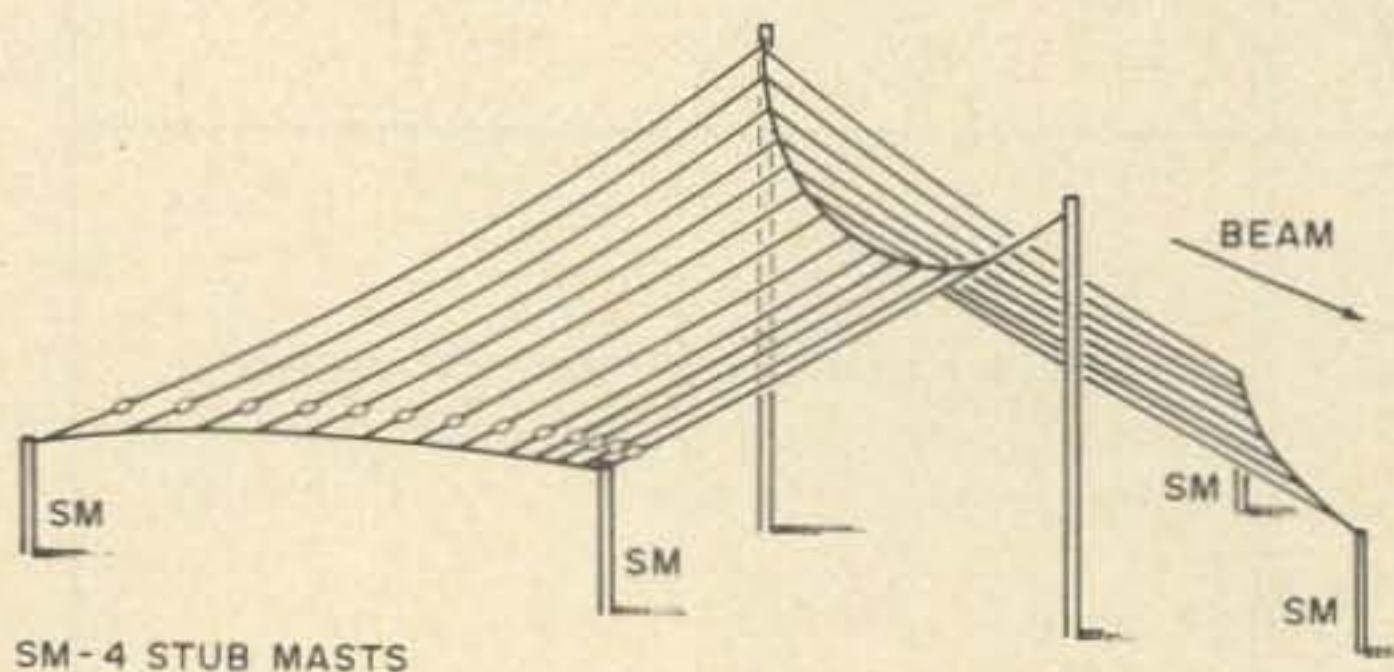

Fig. 5. W4AEO inverted Vee log periodic.

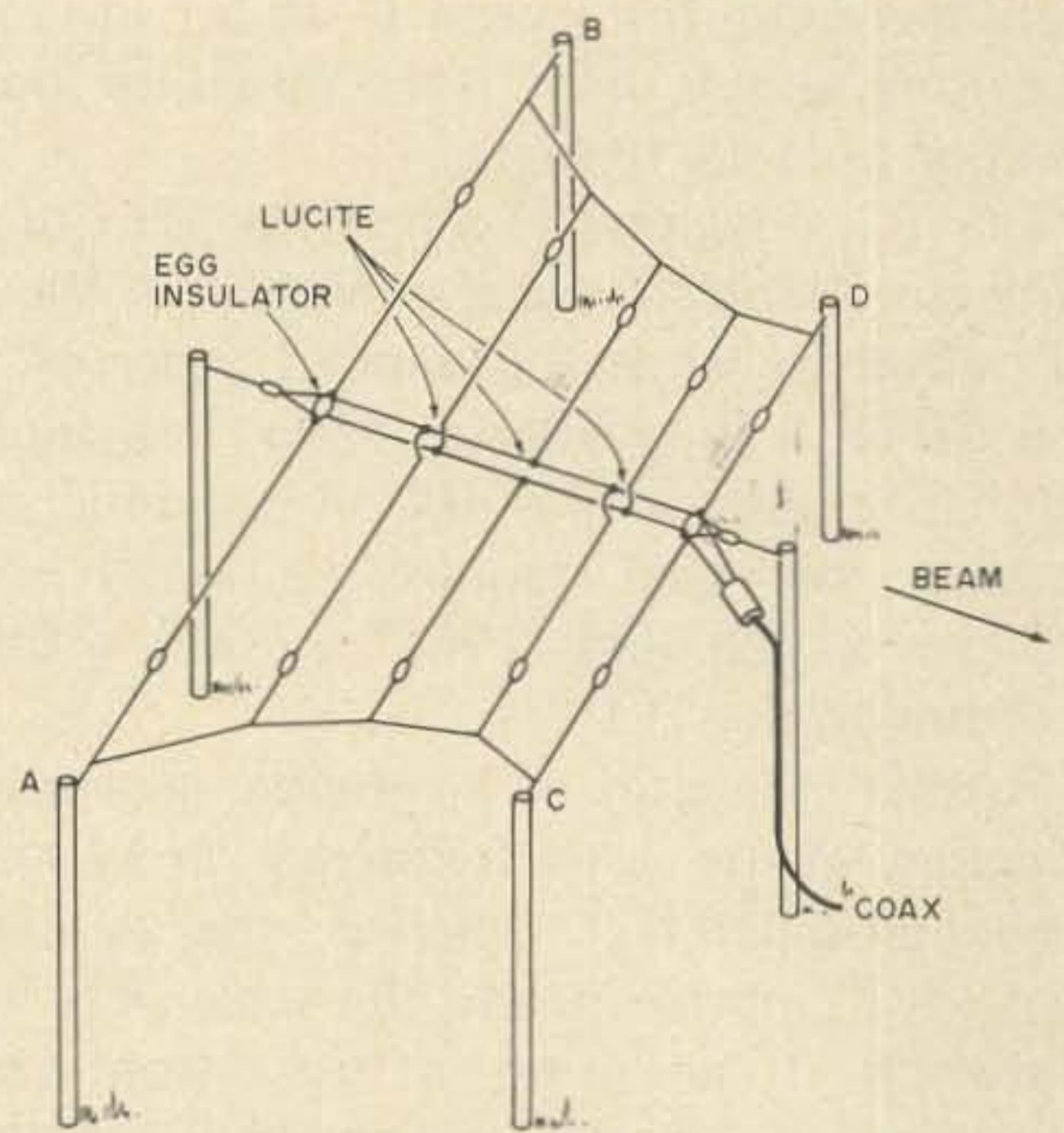

Fig. 6. Five element monoband log periodic — fine for any band 10 thru 80m — see the Aug. and Sept. 1973 issues of 73 Magazine for details.

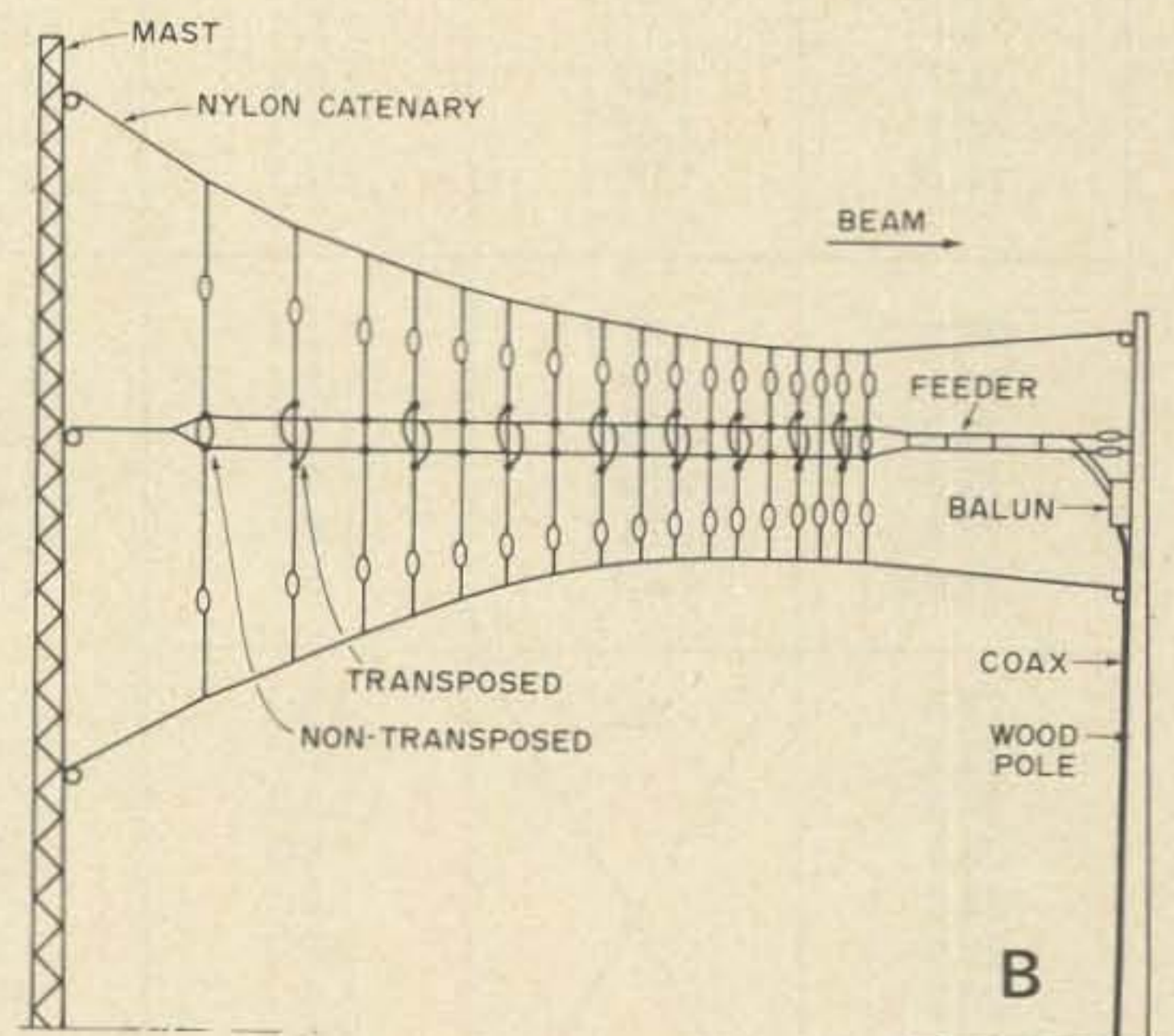
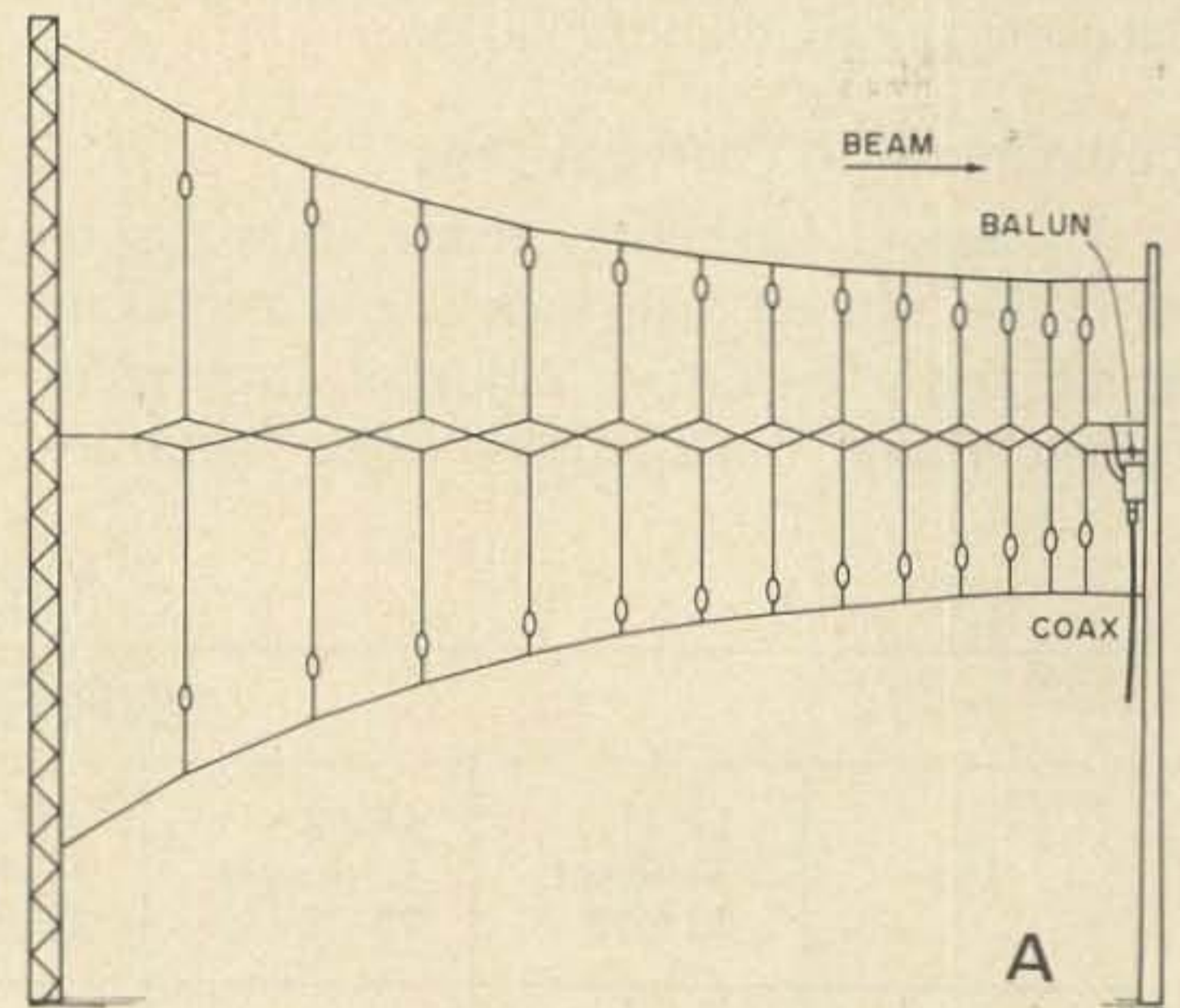

Fig. 7. Vertical dipole log periodic — acreage saver model.

# HOW TO SAVE \$20 in one easy lesson

*Wouldn't you like to save yourself \$20.00? Of course you would!  
Want to know how to do it? Here's the plan.*

*Step #1: Send in your sub to 73 for \$16.*

*Step #2: Have 73 delivered to your door for 36 months.*

*Step #3: Deposit the \$20 you've just saved in the bank.*

*Now isn't that simple? You're reading 73 Magazine right now, so  
we don't have to tell you what a great magazine it is. You have the  
proof right in your hand. You can see for yourself that 73 has:*

*TWICE as many feature articles  
TWICE as many construction projects  
50% MORE ads  
50% MORE shopper's bargains  
The MOST concise news reports available  
The ONLY circuits circuitry pages*

*73 gives you MORE of everything you buy a ham magazine for.  
And by subscribing, you save \$20 — and that's a whopping 56%  
SAVINGS over the newsstand cost!*

*Go ahead — make the easiest twenty bucks of your life —  
subscribe to 73 TODAY!*

Name \_\_\_\_\_ Call \_\_\_\_\_

3 years \$16

1 year \$8

Address \_\_\_\_\_

City \_\_\_\_\_ State \_\_\_\_\_ Zip \_\_\_\_\_

check enclosed

bill me

Mail today to 73 Magazine, Peterborough NH 03458.

# 2 meter FM HEADQUARTERS

FEATURING: Drake, Regency, Icom  
 TRADE: Big on trades. Write for a quote.

ALPHA  
 AMPEREX  
 AMPERITE  
 AMPHENOL  
 AMPROBE  
 ANACONDA  
 ARCO-ELMENCO  
 ASTATIC

B & W  
 BELDEN  
 BLACKBURN  
 BOGEN  
 BRYANT  
 BUCHANAN  
 BUD  
 BUSSMANN

CAROL  
 C-D-E  
 CENTRALAB  
 CINCH-JONES  
 CIRCLE F  
 CLAROSTAT  
 CLAUSS  
 COLLINS  
 C-R-L  
 CUTLER-HAMMER

DOW-KEY

EICO  
 EIMAC  
 ELECTRONICS  
 ELECTRO-VOICE  
 ELLIOTT McKINSTRY  
 EQUIPTO  
 ERSIN MULTI-CORE  
 ESICO  
 EVEREADY

FANON  
 FARADAY

GC ELECTRONICS  
 GENERAL CEMENT  
 GENERAL ELECTRIC  
 GENERAL TIME  
 GREENLEE

HALLICRAFTERS  
 HAMMARLUND  
 HEXACON  
 HOLUB (H-I)  
 HOYT

ITT

E. F. JOHNSON

## KEY LINES

KEDMAN  
 KELLEMS  
 KLEIN  
 KRYLON  
 LINEMASTER  
 LITTLEFUSE  
 LUXO

MILLEN  
 MILLER  
 MINNESOTA (MMM)  
 MOE  
 MOSLEY  
 MUELLER  
 NARRAGANSETT  
 NATIONAL  
 NUTONE

OAKTRON  
 OHMITE (A-B)

PETERSEN  
 POTTER-BRUMFIELD  
 P-W-C

QUAM

RACO  
 RCA  
 RED-DOT  
 REPUBLIC  
 ROBINS  
 ROHN  
 ROYAL

SAMS  
 SARKES-TARZIAN  
 SIMPSON  
 HH SMITH  
 SPRAGUE  
 SUPERIOR ELECTRIC  
 SUPERIOR-POWERSTAT  
 SWITCHCRAFT  
 SYMPHONIC

THOMAS & BETTS  
 TRIAD  
 TRIMM  
 TRIPLETT

UNGAR  
 UNIMAX  
 UNIVERSAL

V-M  
 VERNITRON

WESTINGHOUSE  
 WELLER  
 WIREMOLD  
 WRIGHT  
 XCELITE

OTHER LINES: Hy-Gain, Mosley, Newtronics, C-D-E Rotors, Ten-Tec, Antenna Specialists, Collins, Hallicrafters, Cushcraft, B & W, Rohn Towers and Vibroplex.

SERVICE BACKED UP BY OUR OWN ENGINEERING DEPARTMENT

Carl	W1BFT	Tiny	K1OKX
Dot	W1FTJ	Henry	W1DKG
Frank W.	W1ZJC	Frank R.	K1PCY
Brad	W1DHL	Clarence	W1AJE
Ira	K1OJA	John	W1IUKA
Forest	W1FN	Vern	W1YXA
Dave	W1TON		



"WE SERVICE WHAT WE SELL"

**EVANS** RADIO, INC.  
 ELECTRICAL SUPPLY CO.

BOX 893, CONCORD, NEW HAMPSHIRE 03301 (ROUTES 3A, 89, 93, BOW JUNCTION)

Name \_\_\_\_\_ Call \_\_\_\_\_

Address \_\_\_\_\_

City \_\_\_\_\_ State \_\_\_\_\_ Zip \_\_\_\_\_

Table 2

Element Lengths and Element Spacing Distances						
LP # & Length Bandwidth	LP #1-38' 7-element 14-22 MHz	#2-70' 12-element 14-30 MHz	#4-40' 12-element 14-30 MHz	#7-50' 5-element 40 only	#11-102 17-element 14-30 MHz	Exp 25' 5-element 20 only
Element #1 (Overall Length)	36'	36'	36'	70'	36'	35'
2	32	32	32	64	34	33
3	28	29	28	56	31	28
4	24	26	25	49	29	24.5
5	21	22.5	22	40	26.5	20.5
6	18	20.0	20		24.0	
7	16	18.0	17.5		22.0	
8		16.0	15.5		21.0	
9		14.0	13.5		18.5	
10		12.0	12.0		17.0	
11		11.0	10.5		16.0	
12		10.0	9.5		14.5	
13					13.0	
14					12.0	
15					11.0	
16					10.0	
17					9.5	
Total Wire For Elements	175'	246.5'	231.5'	279'	345'	141'
Spacing #1 Distance	8'	10'	6'	14'	14'	7'
2	7.25	9	5.4	13	10	6.5
3	6.25	8.25	4.5	12	9	6.0
4	6.0	7.2	4.25	9	8.5	5.0
5	5.5	6.9	3.6		7.5	
6	4.25	5.7	3.5		7.0	
7		5.35	3.2		6.5	
8		4.8	2.8		6.0	
9		4.3	2.5		5.5	
10		4.0	2.0		5.0	
11		3.4	1.8		4.7	
12					4.2	
13					3.8	
14					3.5	
15					3.3	
16					3.0	
Boom Length	37.25'	68.9'	39.55'	48'	101.5'	24.5'
X2 Feeder Wire Required	74.5	137.8	79.1	96	203.0	49.0
+ Element Wire	175.0	246.5	231.5	279	345.0	141.0
Total Wire	249.5	384.3	310.6	375	548.0	190.0
Apex Angle	29° ( $\alpha = 14.5$ )	22° ( $\alpha = 11^\circ$ )	36° ( $\alpha = 18^\circ$ )	32° ( $\alpha = 18^\circ$ )	16° ( $\alpha = 8^\circ$ )	32° ( $\alpha = 8^\circ$ )
Approx. Gain	8-10 dB	10 dB	8 dB	10 dB	12-13 dB	10 dB
For Bands	20 + 15	20-15-10	20-15-10	40 only	20-15-10	20 only

*Also see mono-band L-Ps for 10, 15, 20, 40 and 80 Aug 1973 issue of 73 Magazine, p. 25.*

NEW  
(A)

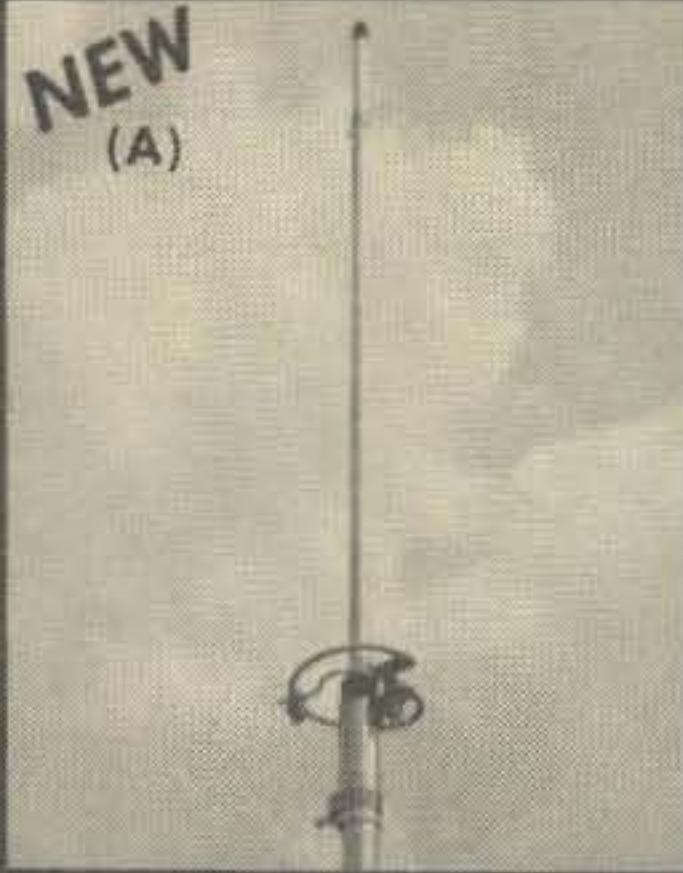

NEW  
(B)

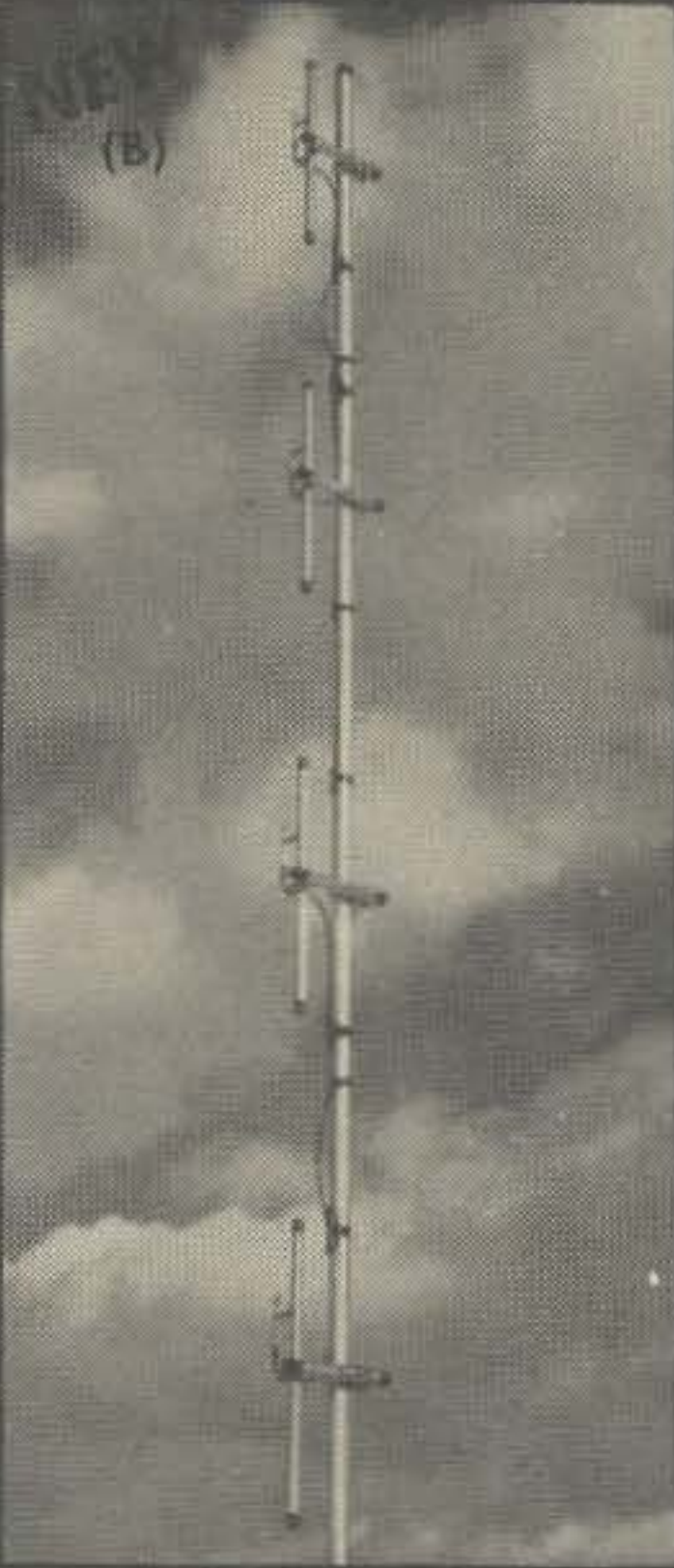

NEW  
(C)



NEW  
(D)

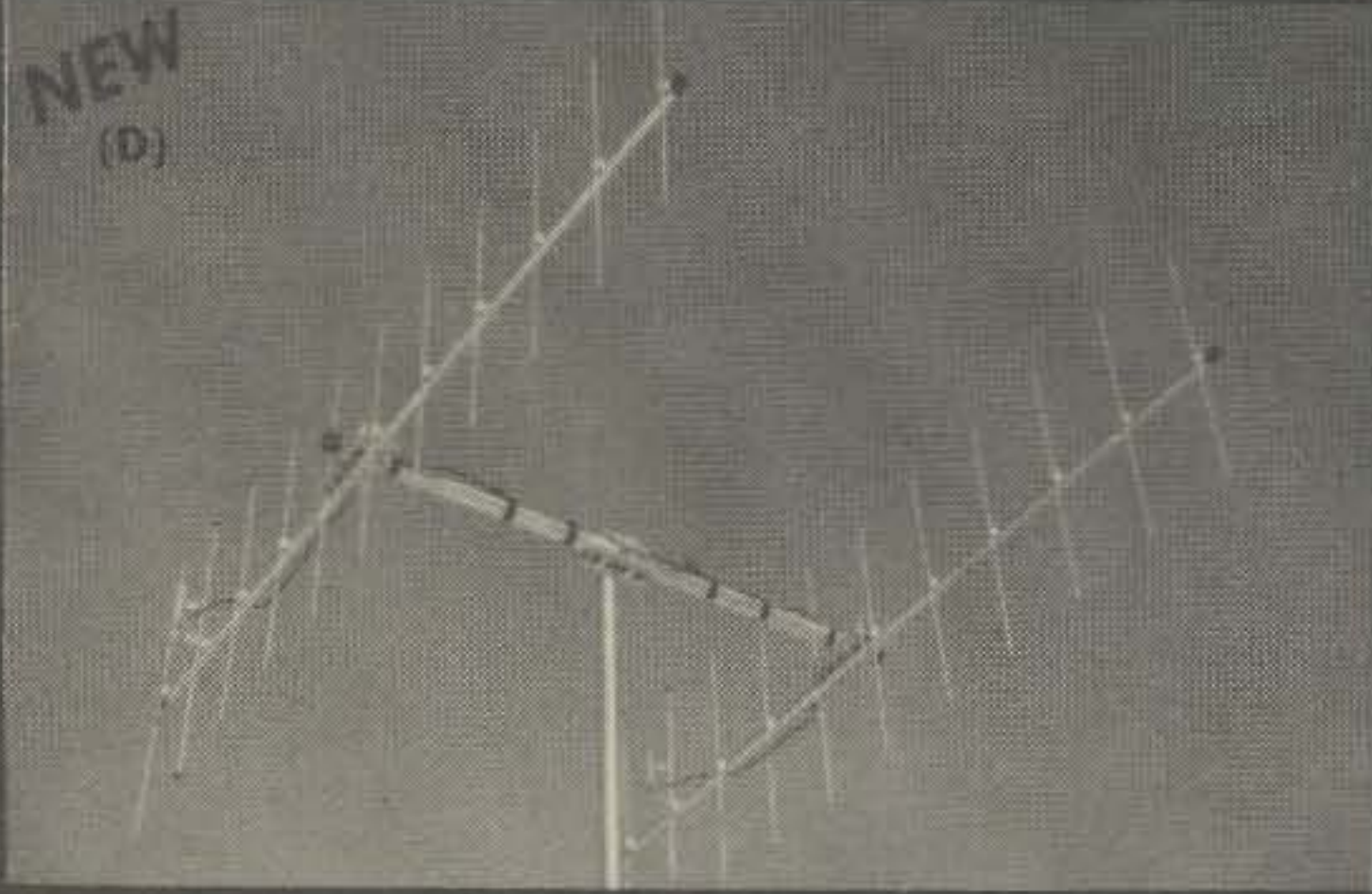

NEW  
(E)

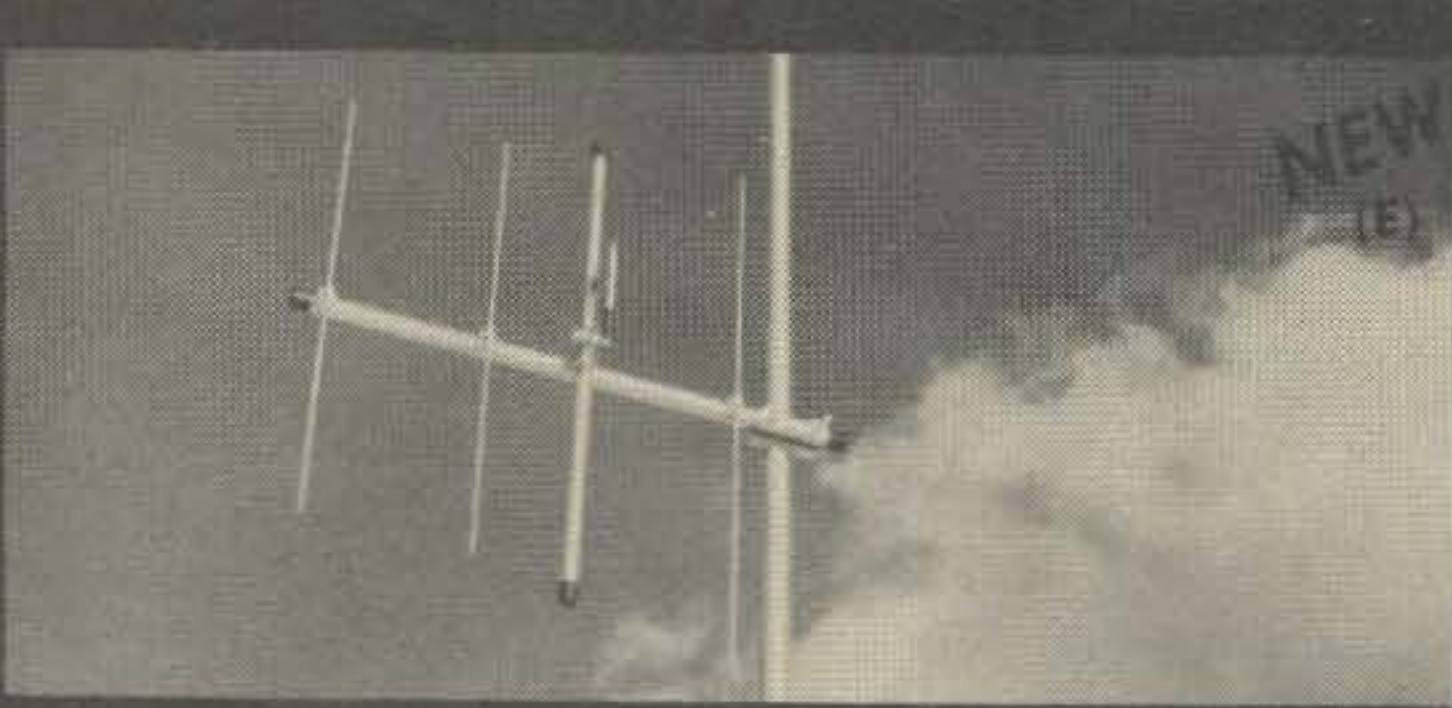

NEW  
(F)



# Cush Craft

## 2 METER FM ANTENNAS

**NEW** FROM THE WORLD'S LEADING MANUFACTURER OF VHF/UHF COMMUNICATION ANTENNAS

(A) **FM GAIN RINGO:** The most popular — high performance, half-wave FM antennas. Give peak gain, and efficiency, instant assembly and installation.

AR-2	100 watts	135-175 MHz	\$16.50
AR-25	500 watts	135-175 MHz	\$19.50
AR-220	100 watts	220-225 MHz	\$16.50
AR-450	100 watts	420-470 MHz	\$16.50
AR-6	100 watts	50-54 MHz	\$23.50

(B) **4 POLE:** A four dipole gain array with mounting booms and coax harness 52 ohm feed, 360° or 180° pattern.

AFM-4D	1000 watts	146-148 MHz	\$52.50
AFM-24D	1000 watts	220-225 MHz	\$48.50
AFM-44D	1000 watts	435-450 MHz	\$46.50

(C) **FM MOBILE: IMPROVED** Fiberglass 3/8 wave mobile antenna with new molded base and quick grip trunk mount. Superior strength, power handling and performance.

AM-147T	146-175 MHz mobile	\$29.50
---------	--------------------	---------

(D) **POWER PACK:** A 22 element, high performance, vertically polarized FM array, complete with all hardware, mounting boom, harness and 2 antennas.

A147-22	1000 watts	146-148 MHz	\$68.50
---------	------------	-------------	---------

(E) **4-6-11 ELEMENT YAGIS:** The standard of comparison in VHF/UHF communications, now cut for 2 meter FM and vertical polarization. 4 & 6 Element models can be tower side mounted.

A147-4	1000 watts	146-148 MHz	\$14.50
A147-11	1000 watts	146-148 MHz	\$23.95
A220-11	1000 watts	220-225 MHz	\$21.95
A449-6	1000 watts	440-450 MHz	\$14.95
A449-11	1000 watts	440-450 MHz	\$19.95

(F) **FM TWIST:** A Cush Craft exclusive — it's two antennas in one. Horizontal elements cut at 144.5 MHz, vertical elements cut at 147 MHz, two feed lines.

A147-20T	1000 watts	145 & 147 MHz	\$46.50
----------	------------	---------------	---------

IN STOCK WITH YOUR LOCAL DISTRIBUTOR



### TECO

a subsidiary of Tucker Electronics Co.

P.O. BOX 1050 1717 S. Jupiter Rd. GARLAND, TX. 75040

214-348-1560



You know you can count on

**hy-gain**

for the finest in Ham  
Radio Antennas!

The voice of



is heard around the world

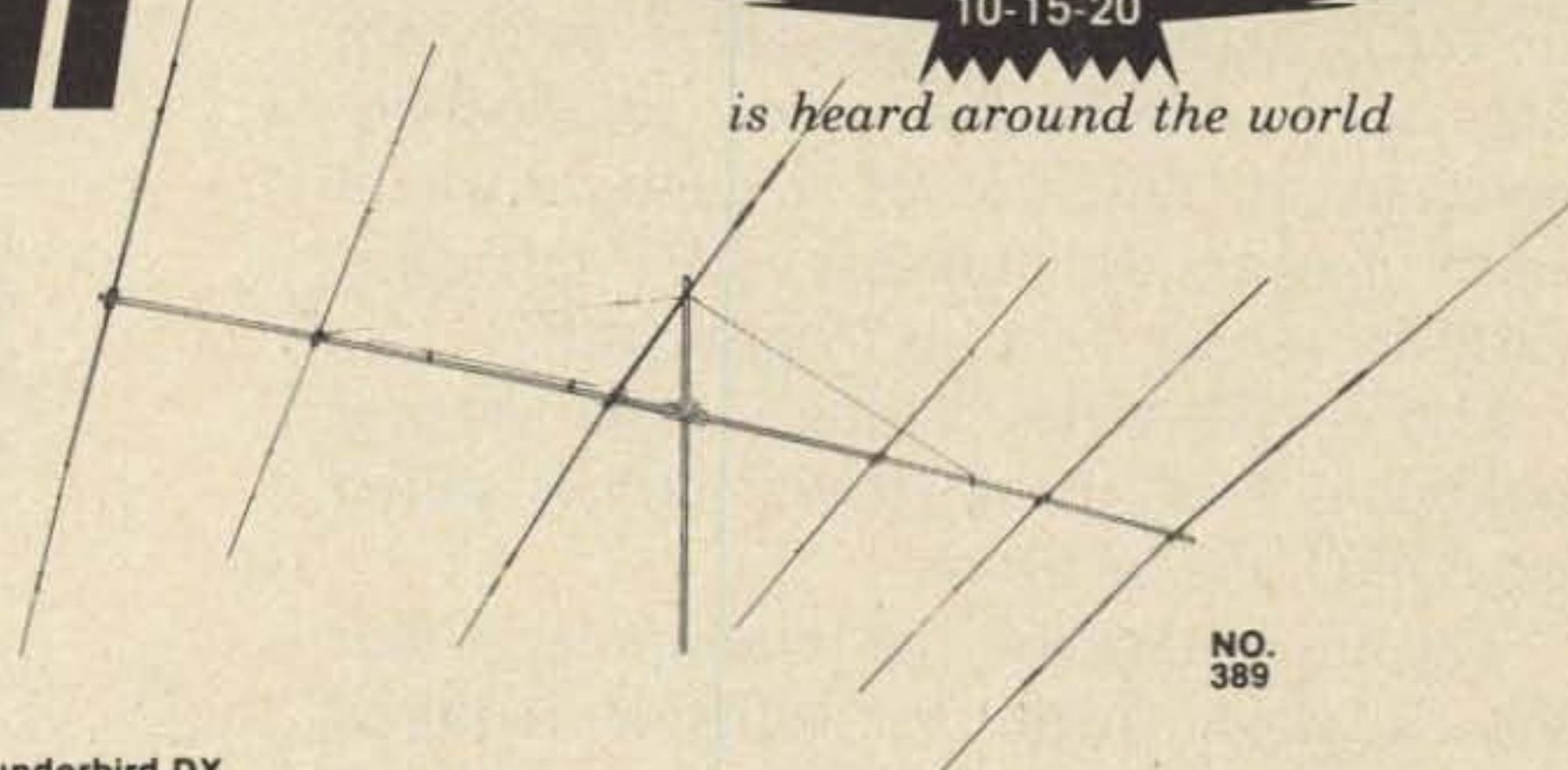

**TH6DXX**  
6-Element Super Thunderbird DX  
Superior Performance TriBander.

Impressive coverage 10-15-20 meters. Separate, improved Hy-Q traps for each band... SWR less than 1.5:1 on all bands. Takes maximum legal power, up to 1 kw AM, 2 kw PEP. Exclusive Beta Match. Factory pre-tuned. Feeds with 52 ohm coax.

ORDER NO. 389

\$189.95

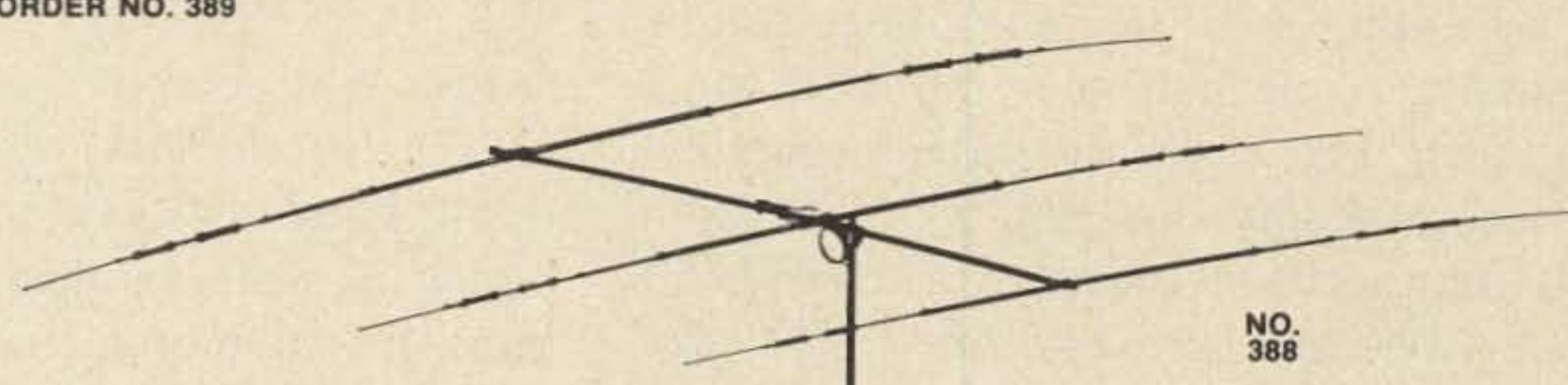

**TH3Mk3** 3-Element Super Thunderbird  
Popular TriBand Beam Improved!

Outstanding performance 10-15-20 meters at reasonable cost. Separate, matched Hy-Q traps for each band. Exclusive Beta Match for tapered impedance, DC ground. SWR less than 2:1 at resonance. Accepts maximum legal power and feeds with 52 ohm coax.

ORDER NO. 388

\$154.95

**TH3JR**

3-Element Thunderbird TriBand Junior. Ideal for top performance in limited space. Beta Match. SWR 2:1 or less.

ORDER NO. 221

\$109.95

**18AVT/WB** The Great Wide Band Vertical  
Super Performer 80 thru 10 Meters!

Superb omnidirectional capabilities. Automatic band switching. Beefed-up Hy-Q traps. Top loading coil. True 1/4 wave resonance on all bands. SWR 2:1 or less at band edges. Outstanding low radiation pattern. Entirely self-supporting.

ORDER NO. 386

\$79.95

**14AVQ/WB**

Wide band performance 40 thru 10 meters with one setting. Hy-Q traps. True 1/4 wave resonance on all bands.

ORDER NO. 385

\$55.00

**12AVQ**

For 10-15-20 meters. Hy-Q traps. Low angle of radiation. Self-supporting.

ORDER NO. 384

\$35.00

**18V**

Low cost, high efficiency vertical. Can be easily tuned to any band 80 thru 10 meters. Highly portable.

ORDER NO. 193

\$24.95

**TH2Mk3**

2-Element Super Thunderbird. Compact TriBander delivers excellent performance. Beta Match. Hy-Q traps.

ORDER NO. 390

\$99.95

**18 HT**

Incomparable Hy-Tower  
Finest Multiband on the Market!

Automatic band selection 80 thru 10 meters. Unique stub decoupling system isolates electrical 1/4 wavelengths for each band. Takes maximum legal power. Feeds with 52 ohm coax. 24' tower is entirely self-supporting, virtually indestructible. Requires only 4 sq. ft. for installation.

ORDER NO. 182

\$219.95

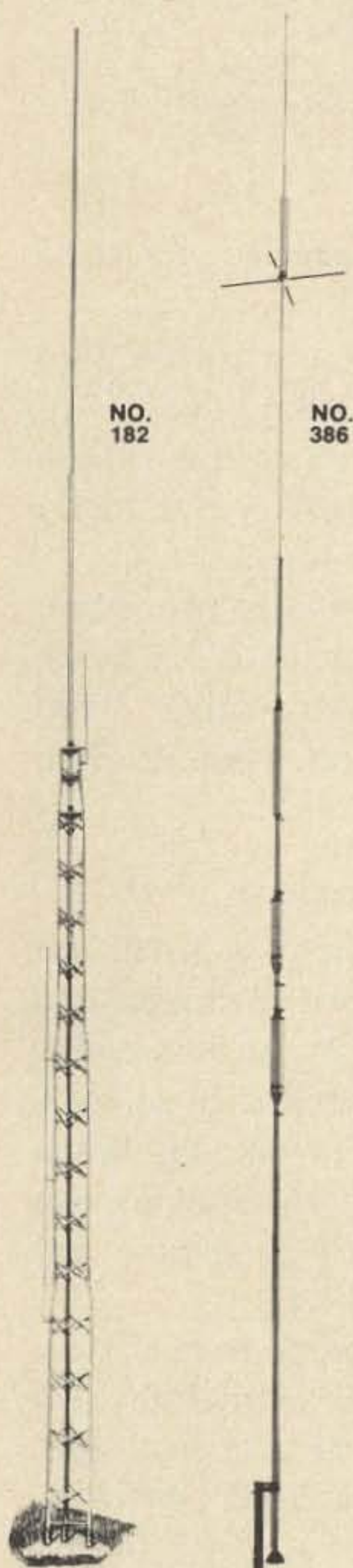

NO. 182

NO. 386



**TECO**

a subsidiary of Tucker Electronics Co.

P.O. BOX 1050 1717 S. Jupiter Rd. GARLAND, TX. 75040

214-348-1560

short-haul on 20m or 15m but might be better on longer, multi-hop circuits. The one tested here worked extremely well on 10m.

Being vertically polarized, it is more subject to man-made QRM. This type is only suggested as a space saver or possibly mounted on the roof of a building where length may be available but with insufficient width for a four mast horizontal DLP.

Fig. 8, illustrates a single band vertical monopole L-P using ground radials suited for a 40m or 80m beam.

The advantage of the monopole is that only a single high rear mast is required (which might be the tower for a rotary beam) and a shorter wood pole for the forward mast. As the vertical radiating elements are only  $\frac{1}{4}\lambda$ , the rear mast can be approximately one half that required for a vertical DLP, Fig. 7, for the same frequency. A rear mast height (for Fig. 8) of 15.24m (50') is required for 40m and 22.87m (75') for 3.8-4.0MHz or 24.39m (80') for 3.5-4.0MHz.

The disadvantage is that at least 30% more antenna wire is required for the monopole L-P using ground radials compared with a DLP.

A vertical beam of this type should have an open area in the direction of the beam. Aiming toward a hill, heavy wooded area, etc., should be avoided due to its low angle of radiation. From the tests made here, a two or three story dwelling in the beam's path seems to give about 5dB attenuation. No doubt the plumbing, electrical wiring or air conditioning ducts either resonate or give sufficient screening to cause this attenuation. It is, therefore, suggested that vertical beams be used only on open terrain, having good ground conductivity. Avoid trees or other obstacles in the path of the beam.

The ideal location for a vertical beam of this type would be at a coastal area as near the shore line as possible with the beam aimed seaward toward a DX continent. Those lucky enough to have such a location would no doubt have excellent results with a monopole L-P having a 10dB gain on 40m or 80m. One aimed across a lake might also be good.

A vertical monopole for both 40m and 80m of the "skip band" type is not out of

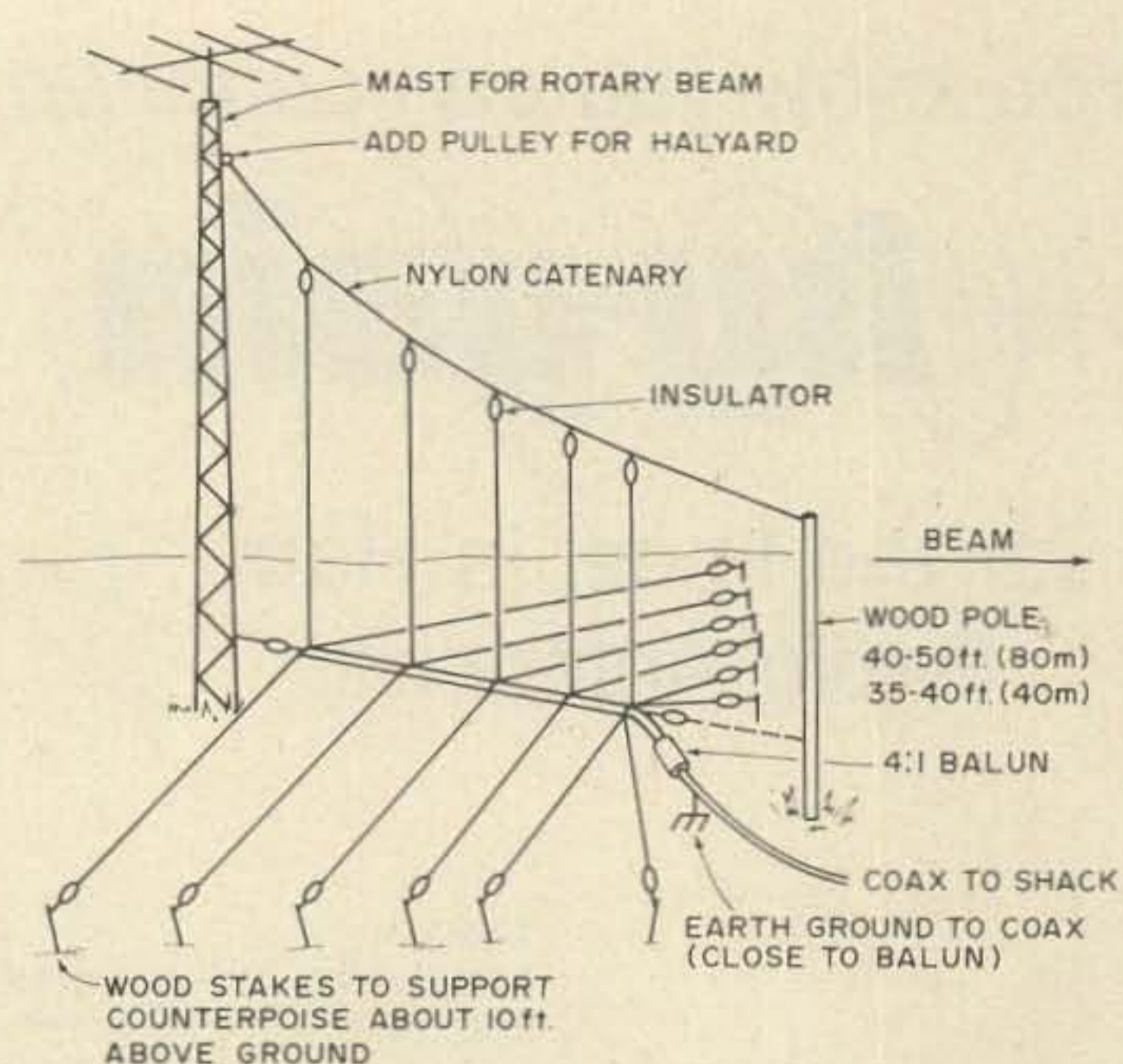

Fig. 8. Single band vertical monopole — for 40 or 80m. About 10 dB gain.

reason but would require at least 45.73m (150') in length by 42.68m (140') or 6,042.44m<sup>2</sup> (21,000 sq. feet) of open space which is quite an area except for one lucky enough to live on a ranch or farm.

The following is a step-by-step procedure for assembling simple, inexpensive 2:1 bandwidth DLPs for 20-15-10m, single band L-Ps for 40m or 20m and 40m or 80m vertical monopoles.

### Log-Periodic Assembly Procedure

After determining if there is sufficient area for the L-P when aimed in the desired direction, it is suggested that a scale drawing be made showing the proposed mast locations for the L-P as it will be when suspended from the masts. By drawing this to scale, it is quite easy to determine any needed or unknown dimensions.

Next procure the necessary material for the L-P selected. Fig. 9 illustrates the construction or assembly of a typical DLP and Fig. 10, the monopole L-P configuration.

Note that for the long rear element (#1) and the short forward element of a horizontal DLP, small ceramic egg type compression insulators are used as these two end elements carry most of the load or strain of the center 2-wire open feed line and its center insulators or spacers. The latter are home made from .64m ( $\frac{1}{4}$ " ) thick Lucite or Plexiglass. This can usually be purchased at hardware, building supply or radio stores.

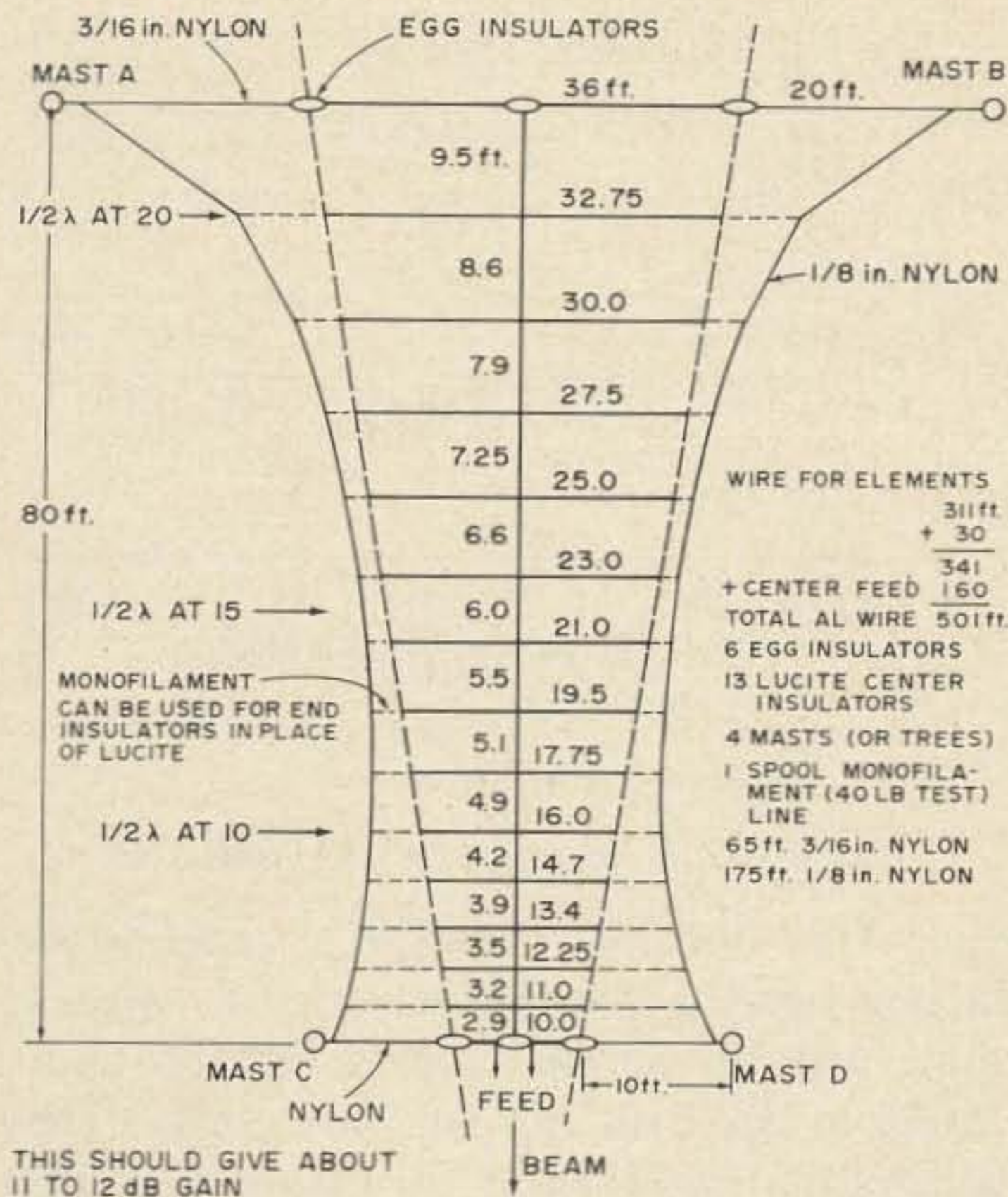

Fig. 9. 15 element 20/15/10m periodic.

The Lucite is cut into strips 1.59cm wide x 15.24cm long (5/8" x 6"). These are then drilled to make three type insulators for the L-Ps, which are:

- 1) End insulators for all elements (except the front and rear as mentioned above). Two holes are drilled in this type.
- 2) Center insulators for the DLP center feeder which serves as the center insulator for all elements (except front and rear), also supporting and spacing 10.16cm (4") the 2-wire center feeder. 4-holes drilled.
- 3) Center insulator for the monopole L-P. Same as the DLP type except these have an extra center hole for securing to the 1/4λ vertical elements. For this type the two outside holes are for securing the 1/4λ ground radials or counter-poise.

The hole spacings for above are illustrated in Fig. 11. These are all the same size to simplify production.

Lucite is used for these as it is difficult to locate a ceramic insulator of this type. The Lucite is light in weight, easy to cut and drill, low loss and less expensive than commercial insulators. They average 10 to 20¢ each. Hundreds of these have been used on the L-Ps here. Only one has broken after four years of use.

The importance of transposing between elements can not be stressed enough. This is

accomplished either by criss-crossing the feeder as illustrated in Fig. 1a or by transposing the feed to the elements as illustrated in Fig. 1b. Both work equally well in providing phase reversal to alternate elements. The latter method is better suited for wire beams from a construction standpoint as shown in Figures 6 and 10. This method has been used here for all but one L-P. It is the method generally used for the large commercial L-Ps.

An L-P is in effect a multi-element end-fire array and *must have a phase reversal between adjacent elements* as with any end-fire array (example, the "ZL Special" or the "W8JK.") If there is no phase reversal between elements, you do not have an L-P.

Briefly, an L-P is similar to a yagi except all elements are driven. The "active" section of an L-P consists of a rear driven reflector, a driven or "active" 1/2λ radiator, and a number of driven forward directors. It must, therefore, function as an end-fire array. If the adjacent elements are not approximately 180° out of phase, there will be no forward lobe or gain.

Several have written that their L-Ps were non-directional and gave no gain. After

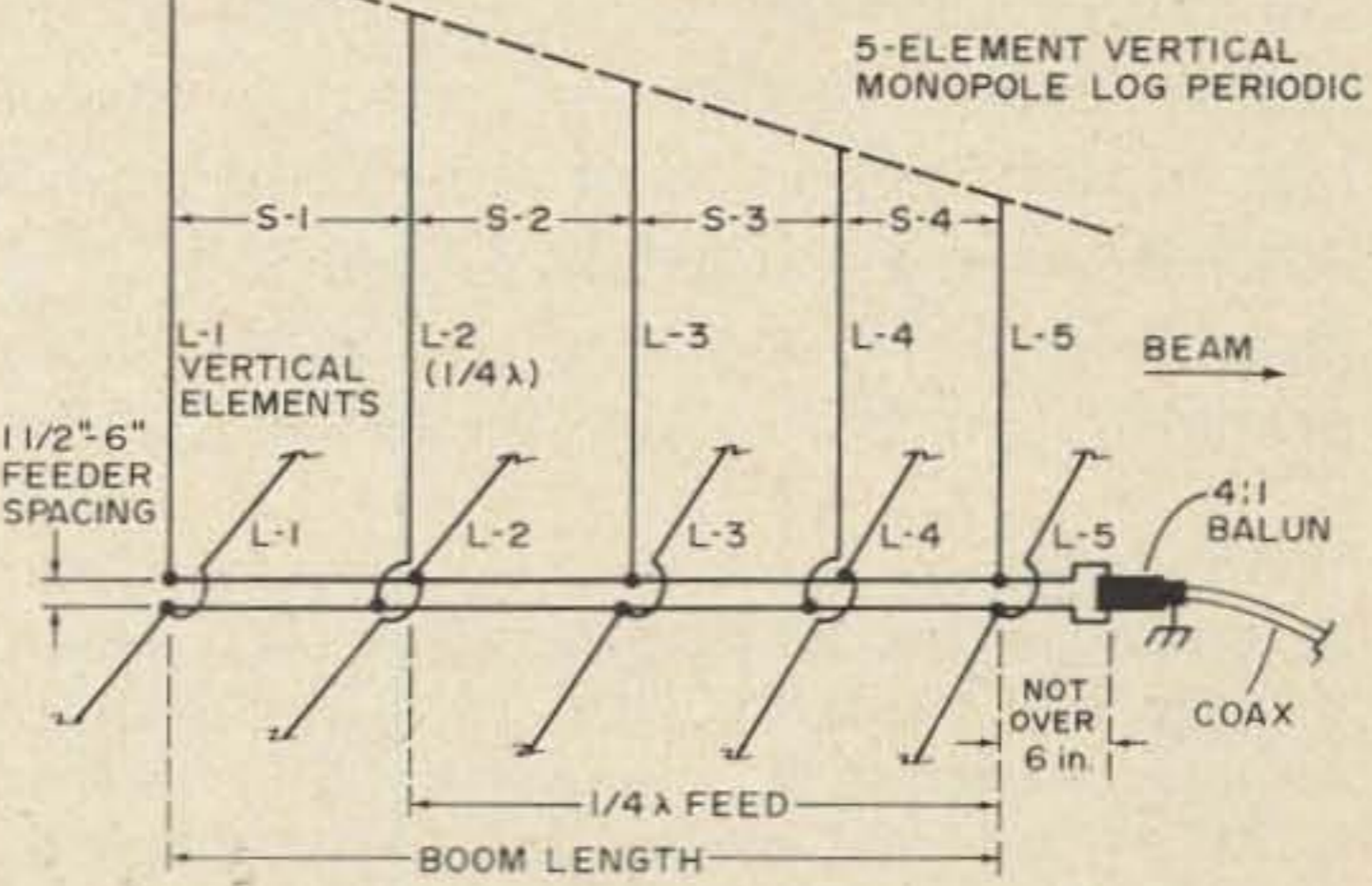
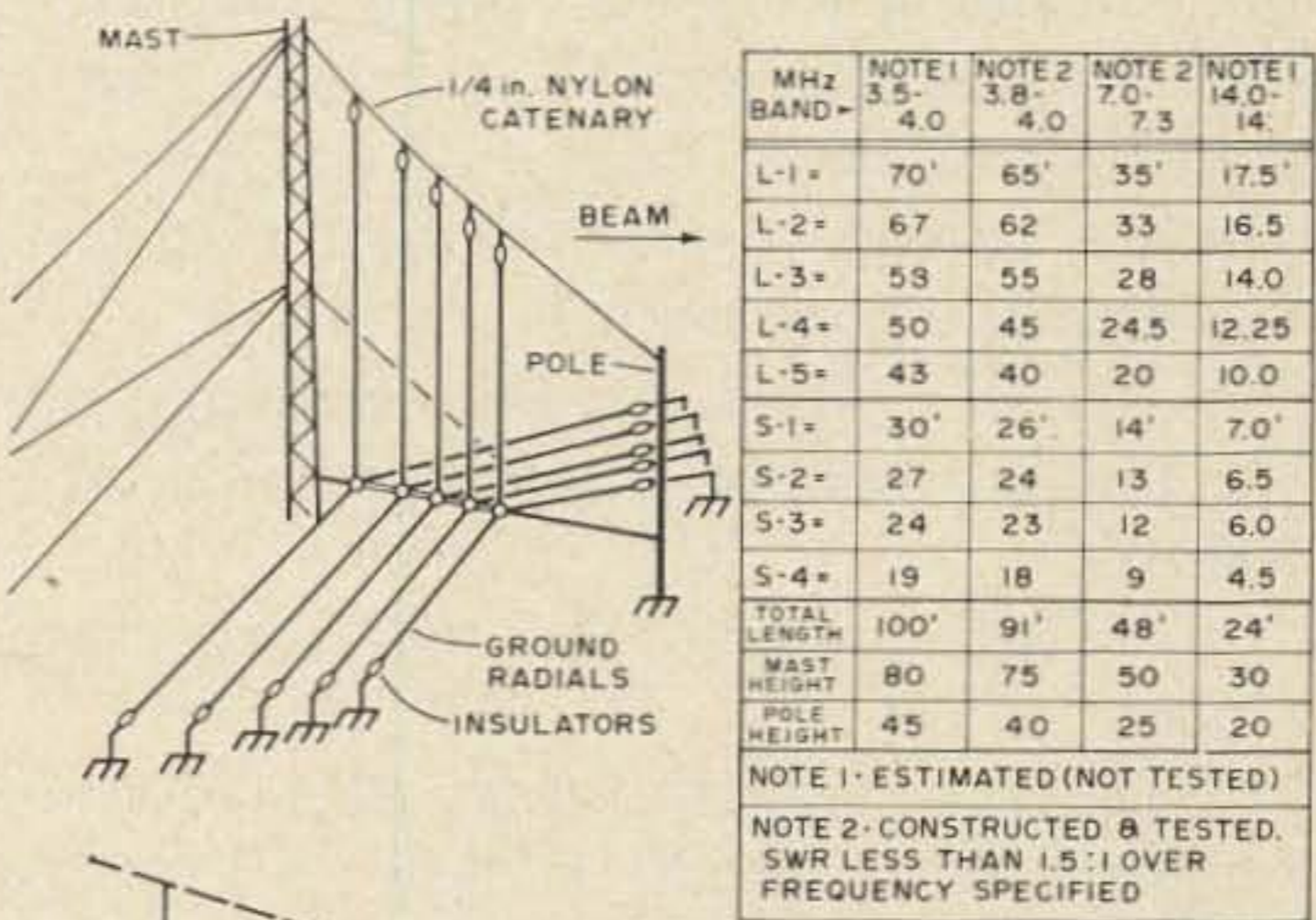

Fig. 10. 5 element vertical monopole log periodic.

checking, it was found they failed to transpose.

### Antenna Wire

Because the forward and rear elements and the 2-wire center feed line are the only portions requiring a strain type wire, these should be #7/22, #7/24 or #14 copper or copper clad.

All of the other elements can be #16 soft drawn bare copper, enameled or tinned (hook up) wire. This can be purchased economically in 304.88m (1000') spools. Even #18 has been used here which seems entirely satisfactory; at least to 500W. This saves weight and cost.\*

Since an L-P has a lower Q than a yagi, there is not the high rf current in the elements. The yagi generally requires tubing whereas wire is entirely satisfactory for an L-P. Wire is used for the large commercial or military fixed L-P antennas (reference A, B and C). Further, since there are several "active" elements per band, the rf current is no doubt distributed over several elements, therefore, wire is entirely satisfactory.

Soft drawn wire is suggested for all elements except #1 and the short forward element since there is practically no pull on the remaining elements. Being soft drawn, the wire will not tend to coil up or kink as does hard drawn or some of the copper clad. There is enough tension on the forward and rear elements to prevent this problem.

After all material has been collected, and the Lucite insulators fabricated, proceed as follows:

1) First assemble the two wire center feeder.

Select two sturdy posts, trees or other supports with about 1.53cm (5') greater separation than the required length of the center feeder for the L-P selected. Secure one end of the pair to or around the post at a height of approximately 1.83m (6') above ground level. Now thread the center Lucite insulators on the 2-wire feeder at the free

\* A number of the L-Ps here have been constructed entirely of aluminum wire (#15 electric fence wire, Sears Cat. No. 13K22065). This is quite inexpensive compared with copper; 402.44cm (1320') roll at \$8.70. The aluminum is also used here to reduce weight since trees are used as the "masts."

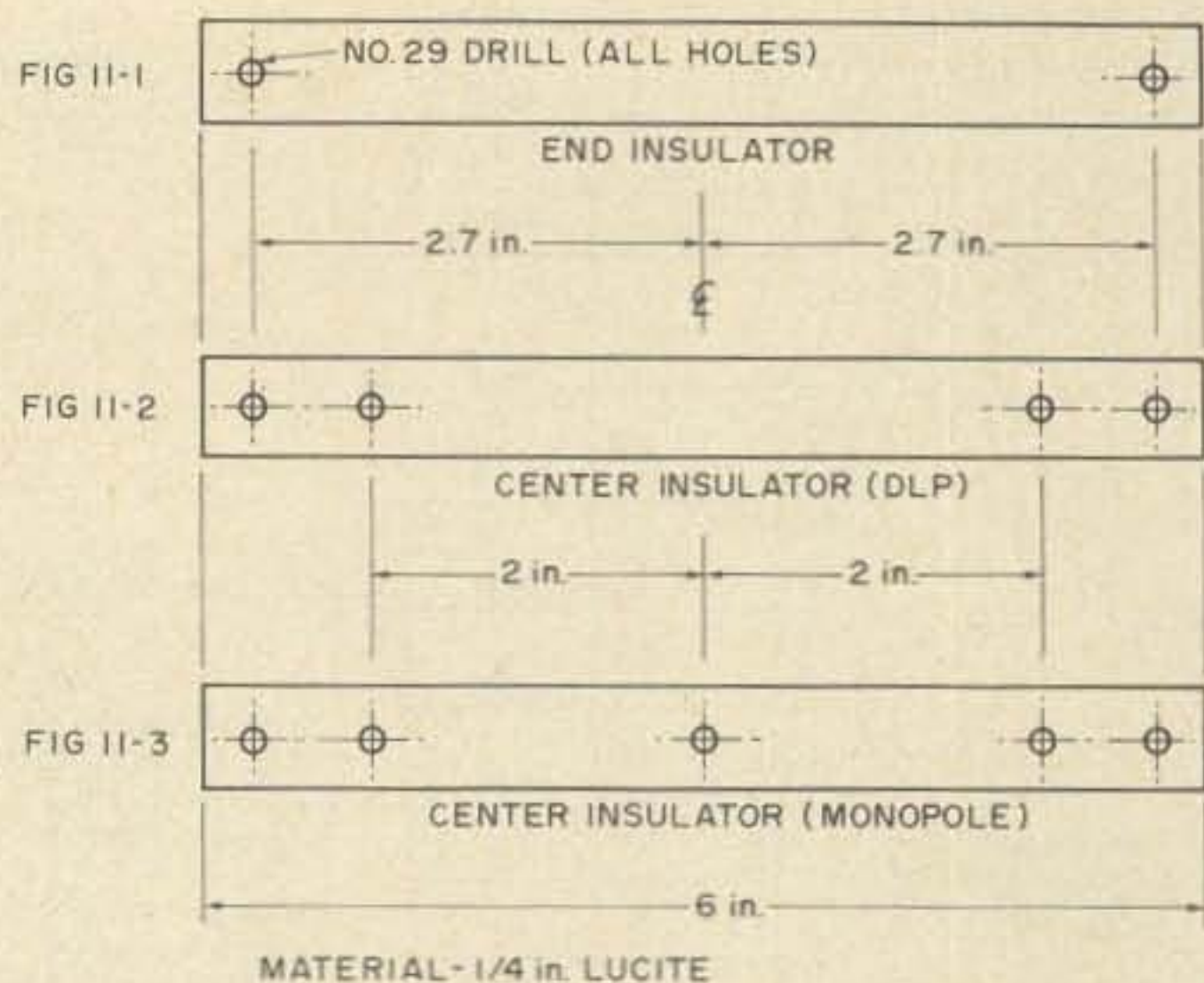

Fig. 11. Hole spacings for the insulators.

end. This end may now be secured to the second post or tree. Stretch the two wires so they will be parallel and separated about 20.32cm (8") at the support ends. They will tighten to 10.16cm (4") separation after the center insulators/separators are spaced. They should be at about shoulder height to make for easy assembly. If necessary, two turnbuckles can be used temporarily at one end to tighten the two parallel wires and to adjust them for equal tension.

Now slide the center insulators (spacers) and distribute along the feeder in their approximate locations as given in Table 2. Starting at one end mark or indicate the location where the 2-wire open feeder will be attached to the center of the long rear element #1. A piece of 2cm (3/4") masking tape can be used on each of the two wires to indicate this starting point, which should be about 30.48cm (12") from one of the end supports. The #1 element will be located at this starting point.

Now measure from this point with a steel tape the first spacing distance, S1 which will separate Elements #1 and #2. The first Lucite center insulator will be located at this point (location of the second element, #E2). This insulator is held in place between the 2-wire feeder by means of a few turns of 2cm (3/4") masking tape served on either side of the Lucite insulator on both wires. Allow a slight distance or "play" on each side of the insulator so the tape will not be snug against the insulator. The wires should be able to turn free in the insulator holes. This helps keep the 2-wire line from twisting after the antenna is completed. The masking

# SWAN HQ'S



## 700 CX

An explosion of power. Less cost per watt than any other rig. 80 thru 10 Meters. 700 Watts PEP. Receiver sensitivity 0.5 MV for 10 dB signal plus noise to noise ratio.



## CYGNET de NOVO:

This is the one - 300 Watts built in AC Supply. Completely portable 10 thru 80 Meters SSB, CW, AM.



## 600T

600 Watts PEP 80 thru 10 Meters. Many Mars frequencies included Hot.

## 600SP

Deluxe speaker with built in phone patch.

## 600RC

Less than 0.25 MV sensitivity. Continuous coverage 3 to 30 MHz

## ANTENNAS

TB4HA	189.95
3HA	159.95
2A	119.95
40H	179.95

Four working elements on each band in 10, 15 and 20 meters. 24 foot boom permits optimum spacing for maximum forward gain and front-to-back ratio.

Two working elements on each band in 10, 15 and 20 meters. 6.5 foot aluminum boom.

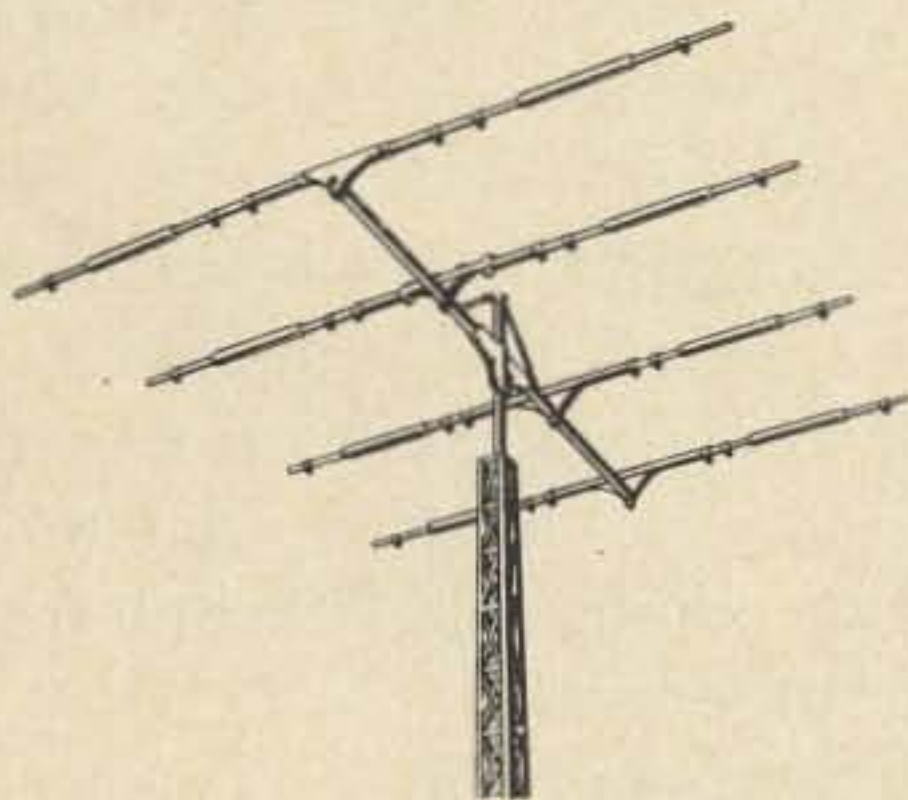

Heavy duty 4-element tri-band beam.  
Economical 2-element tri-band beam.  
High-Q fixed antennas.



## WM-1500 IN-LINE WATTMETER

Ideal for trouble-shooting as well as accurate measurement of output power. Four easy to read scales of 0 to 5, 50, 500 and 1500 watts.

**CONTACT THE MOUNTAIN BOYS FOR ALL YOUR HAM NEEDS.**

MASTER CHARGE - BANK OF AMERICA - IMMEDIATE DELIVERY FROM STOCK

# FRECK

## radio & supply co., inc.

38-40 Biltmore Avenue, P.O. Box 7287, Asheville NC 28801

Phone: (704) 254-9551

tape hardens after a few days in the weather and prevents the center insulators from sliding on the wires, which would alter the correct spacing of the elements.

Next measure the spacing distance, S2 and secure the next center insulator. Continue measuring and securing the insulators until all are in position. Then measure the last spacing distance and mark with tape as was done for the starting, #1 element. This last marking will be the location of the shortest end element (egg insulator) and will also be the feed point to the L-P.

The distance from the back side marking to the last forward marking will be the overall length (boom length) of the L-P and will total the spacing distances, S1 + S2 + S3...etc. It is suggested that this total length of the center feeder be measured to make certain no errors have been made in any of the spacing distances. This total length is given in Table 2.

2) The next step will be cutting the various elements (or doublets) to length; L1, L2 etc. It is suggested that the rear element #1 and the short forward element be cut last as these will not be connected to the feeder until all of the other elements are cut and secured to the center insulators; thus leaving the feeder attached to the supports for convenience until all except the forward and aft elements are in place, connected and soldered to the feeder.

In addition to the actual element lengths, allow several centimeters for connecting to the end insulators and about 25.4cm (10") extra for the center connections from the element center ends to the 2-wire feeder, as *every other element is transposed* as illustrated in Fig. 1b and 9. By using a continuation of the element centers, it eliminates an extra splice.

An odd number of elements is recommended since this allows the 2-wire feeder to be connected directly (non-transposed) across the center (egg) insulators of the end elements. (Reference 18.)

Also note that the rear of the center feeder is "fanned" or separated at the rear element (reference 18). This helps in keeping the two feeder wires separated on the longest rear (S1) span, especially important for lower frequency L-Ps. This precaution

helps prevent the two feeder wires from becoming twisted or from touching during a high wind. Additional Lucite spacers between S1+S2 and possibly S2+S3 may be necessary for 40m, or even 20m L-Ps. This can usually be determined after the L-P is finally assembled at the 1.83m (6') level.

3) After the elements are cut to the various lengths, they can be attached to the center Lucite insulators, starting with element 2. The connections from the elements to the feeders can be made after all elements (except the rear and forward elements) are secured to the center insulators. *Note that every other element is transposed, i.e., Element 1, non-transposed; #2, transposed; #3, non-transposed...etc.; or all even number elements transposed and uneven numbers non-transposed.*

Fig. 11 illustrates the Lucite center insulator, the transposed and non-transposed method of connecting the element center ends to the feedline and the method of connecting the feeder to the short forward element and the long rear elements which use the egg strain insulators.

4) After the elements (except forward and rear) are attached to the center insulators and in turn connected to the feeder, all joints can be soldered while the center feeder is still elevated 1.83m (6').

The ends of the center feeder can now be removed from the 1.83m (6') supports and lowered to the ground. The feeder can now be attached to the rear and forward elements and soldered. Spread the complete L-P on the ground at its approximate location (when aimed in the desired direction) between the four masts (DLP type) from which it will be suspended.\*

#### Nylon Catenary Support Lines

The DLPs used here are supported by two catenary side lines shown in Figures 4 and 6. These are stretched between masts A-C and B-D and the L-P suspended between these. Nylon line, .32cm (1/8") is used. .48cm (3/16") nylon is used for supporting the

\* For some of the L-Ps, I have used monofilament fish line (40 or 50 lb. test) in place of the Lucite end-insulators to reduce weight, cost and fabrication time for the Lucite insulators. The line used was Sears Cat. No. 6KV32232 (40 lb. test).

long rear element, #1 and the short forward element as shown in Fig. 4, 6 and 9. Nylon does not shrink when wet or stretch when dry as does most rope. Further nylon will not rot and should last several years. After four years in constant use here none of the nylon line has broken.

The next step is to suspend the L-P between the two catenary side lines.

At this point the L-P has been assembled and is spread out on the ground between the four masts or other supports, aimed in the beam direction. It should now be raised 1.83 – 3.05m (6 – 10') above ground level and suspended at this height between the masts to be used in its final full height position. By using these masts, all angles and distances will be the same as when the L-P is hoisted to its maximum height.

The long rear element, #1, and the short forward element are attached to the .48cm (3/16") nylon line which supports the rear element between supports A & B. The short element is stretched between C & D.

The .32cm (1/8") side catenary lines or bridles are now stretched between A & C and B & D. Actually these are supported A-B and C-D, however, these splices will be near the masts; the .48cm (3/16") lines carry all the load and will be tied to the mast halyards.

Next, add the Lucite end-insulators to all elements except #1 and the short forward element. These use the egg strain insulators.

Now, starting with element #2, tie short lengths of #18 (165 lb test) nylon cord to the end insulators. These will in turn be tied to the side catenary lines, A-C and B-D. Element #2 will then be suspended between the side bridles.

When first tying these element support cords to the catenaries, make a knot which can be easily untied. It may be necessary to adjust the tension on the various elements several times before they are correct and the catenary lines start taking their proper "suspension bridge" shape as shown by Fig. 4, 6 or 9.

Elements #1 and #2 should be parallel, by making certain that their end spacings are equal to the center spacing, S1. After element #2 has been attached and adjusted parallel with #1, proceed to suspending and

adjust element #3 and the following elements, #4, #5, etc., until all are suspended between the side bridles. As these are attached, the catenaries will start taking on the shape of a commercial L-P.

Adjusting the tension of the elements between the side lines is the only "cut-and-try" procedure required for the L-P assembly. When constructing your first L-P it may require several tries but it will soon assume the correct shape illustrated by Figures #4, #6 or #9.

Note: All elements other than the rear #1 and the short forward element will have some sag. This does not seem to affect the operation. If the elements are pulled too tight between the side support lines (to try and level the elements), too much strain will be placed on the side lines, possibly requiring larger line and even sturdier masts.

There will also be some sag of the center feed line sagging toward the center. This shows no ill effect in the L-P's operation. Some sag or "give" in all elements (except the long #1 and the short forward element) is desirable. If all lines are too tight, they might break during heavy icing conditions.

None of the L-Ps here have come down over the past four years. During this time there have been three heavy ice storms. The L-Ps sagged almost to the ground from the ice build-up. As soon as it melted they returned to their normal height. They have also withstood several high winds without damage.

After all element support cords (#18 nylon) have been adjusted (and readjusted) several times so the sag of these are approximately the same, all elements parallel, and the side lines appear identical and have a similar catenary "curve" as in Fig. 4, the cords can be secured permanently to the side lines.

I suggest that a few turns of 2cm (3/4") masking tape be served on the .32cm (1/8") side lines on either side of the #18 nylon support cords. This will prevent the latter from sliding out of place along the side lines after the antenna has been raised.

Before raising the L-P to normal height on the masts, an SWR should be run while the antenna is still 6 to 10 ft above ground. Proceed as follows.

## Feeding the Log-Periodic

The simplest method of feeding the L-P is to connect the high impedance balance winding of a 4:1 broad band balun at the feed point (short element end). The coax is then connected to the balun. Two other feed methods will be presented later but the 4:1 balun method is the easiest for running the initial SWR before raising the L-P to full height.

A low powered transmitter or transceiver should be placed on a box or table directly under or a short distance in front of the short element feed end. Connect a short length of coax from the 4:1 balun to the SWR meter and another short length to the transmitter or transceiver.

An SWR run should be made over each of the bands for which the L-P has been designed to cover. Readings should be taken at least every 100kHz over each band. Record these for comparison with a second SWR run to be made after the L-P has been hoisted to full height and the final length coax used between the antenna and the shack is positioned.

While the L-P is still at a workable height it is interesting to check the element ends for rf voltage on each of the bands. Either a small  $\frac{1}{4}$  watt neon or a "sniffer" can be used. This test will give one a better idea as to the operation of the L-P.

If the SWR readings are 2:1 or better, the L-P should be O.K. after it is raised to full height. Generally the SWR readings will improve after being raised higher above ground. They should then be similar to the SWR examples given by Table 1 (and reference 18).

## Other Feed Methods

The feed method mentioned above using a 4:1 balun directly to coax is the simplest and is recommended; however, two other feed systems can be used:

1) Tuned open line from shack directly to the L-P feed point. This, of course, requires a tuner at the shack which must be returned when changing bands. The tuner with open line is O.K. for a mono-band L-P but is a nuisance when more than one band is used.

2) 300 $\Omega$  TV flat line can be used from

the L-P feed point to the shack, then the 4:1 balun and coax to the set. This is the method used here. Since trees are used as "masts," RG-8/GU or RG-11/U coax is too heavy, causing the L-Ps to sag. The 300 $\Omega$  TV line seems entirely satisfactory for low power "bare foot" operation. Further the TV line has extremely low loss if properly terminated and is quite inexpensive for long runs. Some of my L-Ps use over 107m (350') of TV line between the L-P feed point and the 4:1 balun.

After the final method of feed is selected, it can be connected permanently to the L-P feed point.

The beam is now ready to be hauled up to maximum height by the mast halyards. After the L-P is in place, another SWR should be run over each band and compared with those run at the lower level. They should not exceed 1.5:1 over any band (or any frequency within its band width, if necessary test equipment is available to make measurements outside the ham bands).

A doublet at the same height and broad-side to the L-Ps beam should be used as a "standard" or test antenna for comparing gain in the forward direction.

## Monopole Log Periodic Assembly

The assembly and erection of the monopole L-P configuration is similar to the DLP. Fig. 8 illustrates the general construction for either a 7.0-7.3 or 3.5-4.0MHz monoband monopole L-P. Fig. 10 gives element lengths and spacing distances for 40m and 80m.

A single catenary line is run from the high rear mast to the shorter forward mast, .64cm ( $\frac{1}{4}$ " ) nylon line is suggested. The 5 vertical elements are suspended from the support line. Note the "suspension bridge" shape of the catenary illustrated by Figures 2 and 8.

The short forward mast should be a wood pole or any other non-metallic support since it is directly in the line of fire of the vertical beam.

Note that the ground radials decrease in length from the rear end (below the longest rear vertical reflector, element #1.) to the #5 forward element, the radials being the same length or slightly longer than their  $\frac{1}{4}\Omega$  vertical elements.



The radials should be about 3.05m (10') above ground to allow access under them. Although the radials can slant down from the center feeder, the ends should be high enough to prevent contact as some are quite "hot" with rf.

The 2-wire feed line is identical to the DLP type; however, the elements connected to and supported by the Lucite center insulators (Fig. 11) are arranged differently in that the two outside holes are for the two  $\frac{1}{4}\lambda$  side radials and the center hole is for the  $\frac{1}{4}\lambda$  vertical element. Actually the center insulator and the 2-wire feeder are suspended by the 5 vertical radiating elements and they in turn by the single catenary line. Fig. 10 illustrates these elements, showing the jumper connection between the two side radials. Transposition or the "criss-cross" feed is accomplished as illustrated in Fig. 10.

The suggested method of feed is by the 4:1 balun, then to coax. Be sure the coax shield is grounded to an earthground as near the balun as possible.

For these mono-band monopole L-Ps, the #2 or  $\frac{1}{4}\lambda$  "active" radiator is approximately  $\frac{1}{4}\lambda$  from the balun feed point. This  $\frac{1}{4}\lambda$  line provides a matching stub between the low impedance feed point of the #2 element and high impedance at the feed point which is probably in the order of 200-300 $\Omega$ , making a good match to the input of the 4:1 balun.

### Summary

I believe anyone having observed the gain of the L-Ps used here will agree as to their effectiveness. When using the 17 element 20-15-10m West beam, (L-P #11) on 20m, W6's often report "strongest W4 on the band at this time." Considering that many of the other W4's are using the legal limit with rotary beams, a report of this type is encouraging.

I wish to thank the many hams who have assisted by reporting the readings taken on the various L-Ps tested here over the past four years and hope these tests will be beneficial to others. I especially wish to thank YV5DLT for his many reports on the 20m and 15m L-Ps; also, W4QS and K4FBU for their observations during the

40m tests for the past year.

I would appreciate hearing from any others trying these beams. . . .W4AEO

### Log-Periodic Antenna Mfgs. — References

Granger Associates — Palo Alto CA — See Model 747V-4/30 — R/T. Nov. 1962.

Hy-Gain Electronics Corp., Lincoln NB — Commercial Catalogue E-1969. Excellent design ideas for fixed L-Ps.

TCI — Technology for Communications International — Mountain View CA — See Technical Notes — "The Extended Aperture Class of Log-Periodic Antenna."

KLM Electronics — San Martin — C A Rotatable L-Ps for Amateurs.

Prodelin — Heightstown NJ — VHF and UHF L-Ps.

### HF — Log-Periodic Formulas and References

1. Basic Principle — Du Hamel and Isbell — 1957 & Du Hamel's U.S. Patent 2985878.
2. Log-Periodic Design by Deschamps & Du Hamel. Antenna Engineering Handbook, Jasik — 1961.
3. Dr. Carel's Report — IEE 1961 National Convention Record. "Analysis and Design of the Log-Periodic Dipole Antenna."
4. Defense Communications Agency — Engineering Installation Standards Manual — DCAC 330 — 175 — Add. No. 1 "MF/HF Communications Antennas."
5. Log-Periodic Antenna Design Handbook — by Carl E. Smith.
6. A Uni-directional 11.5 — 120 MC Logarithmically Periodic Antenna by Vito P. Minerva — 15 July 1958 — Collins Radio Company. Good design data for Trapezoidal Rotary Beam.
7. Logarithmically Periodic Antenna Arrays by R. H. Du Hamel and D. G. Berry — 22 Sept. 1958 Collins Radio Co. — Formulas and Design Data for Trapezoidal Tooth Structure L-Ps and Multi-L-P Arrays.
8. International Radio Consultative Committee — C.C.I.R. "Handbook on High-Frequency Directional Antennae" — L-P Section, pp 26-38. Published by International Telecommunication Union — Geneva, 1966.
9. "Frequency Independent Antennae," pp. 71-81. Rumsey.
10. Arrays of Unequal and Unequally Spaced Dipoles. Cheong-1967.
11. "MF/HF Communication Antennas," Defense Communication Agency Engineering, Installation Standards Manual, DCAC 330-175-1, Addendum I, 1967.
12. NAVELEX 0101, 104 — Naval Shore Electronics Criteria — HF Radio Antenna Systems -pp 4-7 to 4-19. Naval Electronic Systems Command — June 1970.

13. "The Design of Log Periodic Antennas - by A.E. Blick - VE3AHU - 73 Magazine, May 1965. Good summary of above formulas with design examples for VHF - L-Ps.
14. "Three-band HF Log-Periodic Antennas," G.E. Smith - W4AEO - Ham Radio - September 1972.
15. "40-meter Log-Periodic Antennas," G.E. Smith - W4AEO - Ham Radio - May 1973.
16. "High-Gain Log-Periodic Antenna for 10, 15 and 20." - G.E. Smith - W4AEO - Ham Radio - Aug. 1973.
17. Vertical Monopole Log-Periodic Antennas for 40 and 80 meters." - G.E. Smith - W4AEO - Ham Radio - Sept. 1973.
18. "Mono-Band Log-Periodic Antennas" - G.E. Smith - W4AEO - 73 Magazine - Part 1 - Aug. 1973. Part 2 - Sept. 1973.
19. "The Log-Periodic Dipole Array" - Peter Rhodes - K4EWG - QST Nov. 1973.
20. Beam Antenna Handbook - Bill Orr - W6SAI, p. 104.
21. "Fixed Log-Periodic Beam for 15 and 20 Meters," G. E. Smith - W4AEO - Ham Radio - May 1974.
22. "Designing Log-Periodic Beam Antennas by the Graphic Method," G. E. Smith - W4AEO - Communications News - June 1974, pp. 82-87.
23. "Feed Systems for Log-Periodic Antennas," G. E. Smith - W4AEO - Ham Radio - October 1974.

# Startling Learning Breakthrough!

You'll be astounded at how really simple the theory is when you hear it explained on these tapes. Nine year old children have used our cassette course to breeze through their novice exam! Three tapes of theory and one of questions and answers from the latest novice exams give you the edge you need to do likewise.

Most cassettes these days sell for \$6 and up. But 73 is interested in helping get more amateurs, not being in the tape business. So we're giving you the complete set of four tapes for the incredibly low price of ONLY \$13.95. And they'll play on any cassette player on the market!



**SET OF 4 TAPES  
ONLY \$13.95  
Order  
Today!**

Scientists have proven that you learn faster by listening than by reading because you can play a cassette tape over and over in your spare time - even while you're driving! You get more and more info each time you hear it.

You can't progress without solid fundamentals. These four hour-long tapes give you all the basics you'll need to pass the Novice exam easily. These days, the exam changes so fast that you can't memorize for it any more. Besides, this way you'll have an understanding of the basics which will be invaluable to you for the rest of your life! Can you afford to take your Novice exam without first listening to your tapes?

NOVICE THEORY TAPES 73 MAGAZINE, PETERBOROUGH NH 03458

Name \_\_\_\_\_

Address \_\_\_\_\_

City \_\_\_\_\_

State \_\_\_\_\_

Zip \_\_\_\_\_



Signature \_\_\_\_\_



Card No. \_\_\_\_\_

Expiration Date \_\_\_\_\_

Amt. Encl. \_\_\_\_\_

# 73 gift gallery



**DIGITAL CONTROL OF REPEATERS**  
softbound \$5 hardbound \$7  
Here's a book for the FMer who wants to design and build a digital repeater control system. Contains sections on repeaters, basic logic functions, logic circuit design, control systems, support circuits, mobile installations, touch-tone, plus a special section on a "mini" repeater control system.



**4 STUDY GUIDES**  
NOVICE — \$4      GENERAL — \$6  
ADVANCED — \$4      EXTRA — \$5

FCC exams got you scared? Frustrated by theory fundamentals? There's no need to worry. 73's four License Study Guides will help you breeze through any of the four tough exams! They are the ONLY guides which cover ALL the material you will have to know. Many amateurs find that one quick reading through our guides is enough to get them through with no sweat.

## INTRODUCTION TO RTTY

\$1

In this book the world of radio-teletype is explained in an easily understood manner for the beginner.

The last part of this book contains a bibliography of everything published about RTTY since 1952.

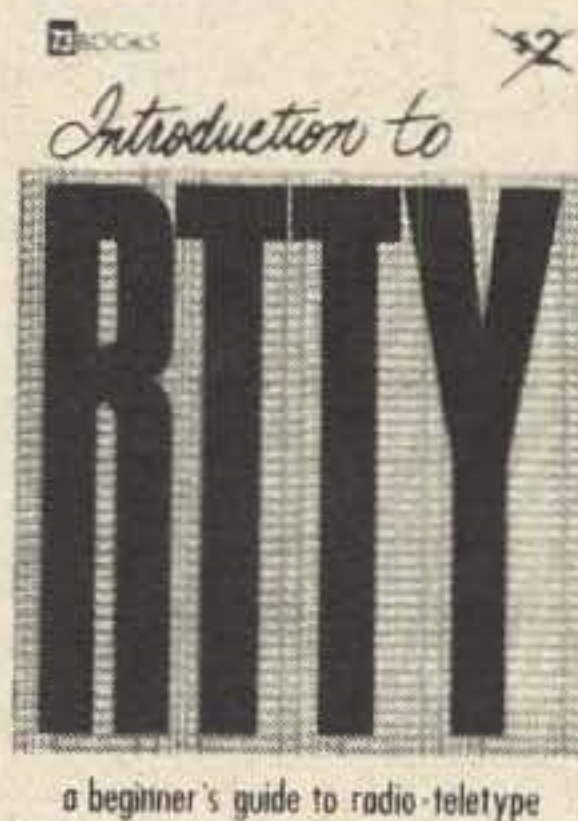

## FM REPEATER CIRCUITS MANUAL

hardbound \$7  
softbound \$5

Contains almost every conceivable circuit that might be needed for use with a repeater. All circuits explained in detail. All aspects covered, from the operator to the antenna.

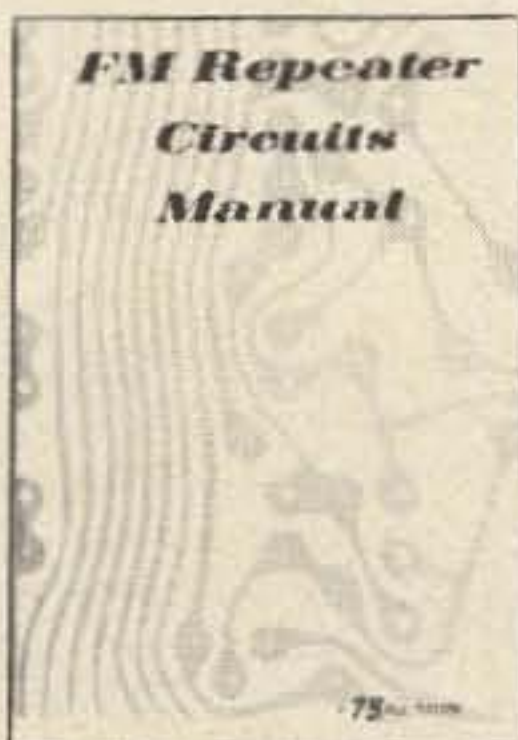

## 73 USEFUL TRANSISTOR CIRCUITS



## TRANSISTOR CIRCUITS

\$1

Useful transistor circuits for audio, receivers, transmitters and test equipment. 47 chapters with circuit diagrams for each, complete with component values, etc. A must for the solid state home brewer. Easy to read and to understand.

## DIODE CIRCUITS HANDBOOK

\$1

115 diode circuits including power supply application, regulators, ac meter applications, receiver detectors for AM-FM-SSB, noise limiters, squelch, AGC, varicap tuning.



**VHF PROJECTS FOR AMATEUR AND EXPERIMENTER**

**\$5**

A must for the VHF op. Opening chapters on operating practices and getting started in VHF, both AM and FM, followed by 58 chapters on building useful test equipment, modifying existing and surplus gear.

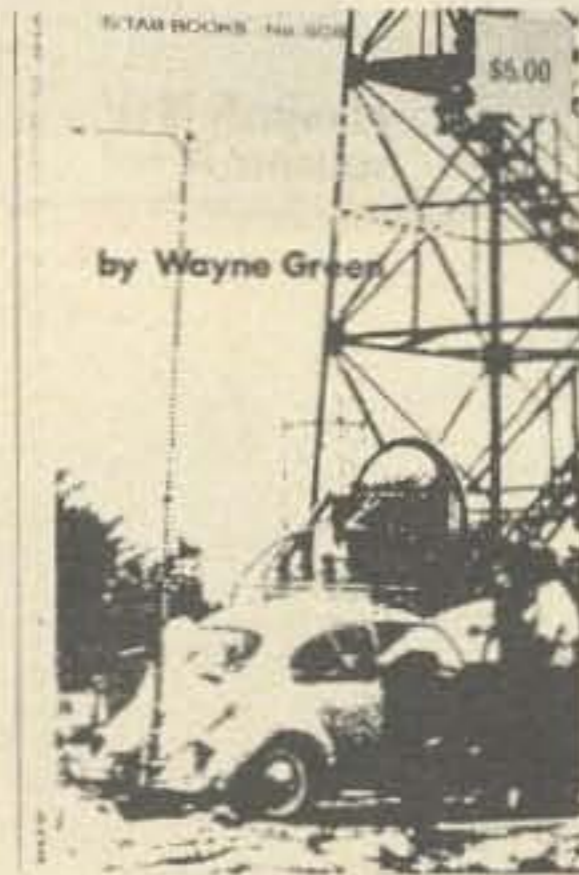

**SOLID STATE PROJECTS**

**\$4**

More than 60 projects of interest to anyone in electronics. The devices range from a simple transistor tester to a ham TV receiver. This collection will help you become more intimately acquainted with zeners, ICs and varactors, etc.

**TRANSISTOR PROJECTS \$3**

Crammed full of home construction projects, from receivers to transmitters and all in between. Chapters include such articles as zener diodes, how they work, how to use, test and buy them; integrated circuits; how to design transistor amplifiers; and many more.



**DX HANDBOOK with MAP**

**\$3**

How to work DX, how to get QSLs, country lists, award lists, QSL bureaus, maps of the world, great circle maps centered on major US cities. Wall size DX map of the world included.

**108 QUESTIONS AND ANSWERS**

**\$2**

Discussions of transmitting, receiving, antennas, power and audio measurement devices, etc. Circuits, gadgets, small construction projects, with complete diagrams. A wealth of interesting information.

**QUESTIONS & ANSWERS**

**\$2**

- Transmitting
- Receiving
- Antennas
- Power & Audio Measurement Devices

**SLOW SCAN TELEVISION HANDBOOK**  
hardbound \$7  
softbound \$5

This excellent book tells all about it, from its history and basics to the present state-of-the-art techniques. Contains chapters on circuits, monitors, cameras, color SSTV, test equipment and much more.



**The Fascinating World of RADIO COMMUNICATIONS**

BY WAYNE GREEN



**FASCINATING WORLD OF RADIO COMMUNICATIONS**

**\$4**

All about broadcast band DXing, tuning the tropical DX bands, DXing radio amateurs, antennas for short-wave, radio licenses, pioneers in electricity and radio, commercial broadcast stations, WWV, etc.



**COAX HANDBOOK**

**\$3**

All about coaxial cables, connectors and applications. It's all here — pictures, part numbers and specifications for all types. Includes lengths for different types for quarter, half and full wave feed-lines.



**HOW TO USE FM**

**\$1.50**

This book presents the basics of two meter FM operation and repeaters in short form with the end in mind of getting you on FM quickly and easily.

# LATEST RELEASES from 73 publications

## RF and DIGITAL TEST EQUIPMENT YOU CAN BUILD



RF burst, function, square wave generators, variable length pulse generators — 100 kHz marker, i-f and rf sweep generators, audio osc, af/rf signal injector, 146 MHz synthesizer, digital readouts for counters, several counters, prescaler, microwavemeter, etc. 252 pages. **\$5.95**

## PRACTICAL TEST INSTRUMENTS YOU CAN BUILD



37 simple test instruments you can make — covers VOMs, VTVMs, semiconductor testing units, dip meters, watt meters, and just about anything else you might need around the test lab and ham shack. **\$4.95**

## 73 CERTIFICATES

### WAAS \$1

Worked Almost All States — Proof of your having worked 49 of the 50 states.

### ALL MODE DXDC \$1

An award for 2-way communications with 10 countries using CW-SSB-RTTY-SSTV modes.

### DXDC \$1

Available for those who present proof of contact (copy of log) with 10 different countries.

### SSTV DXDC \$1

For 2-way Slow Scan Television communications with 10 countries.

### RTTY-DXDC \$1

All operating award for those who have submitted proof of 2-way teletype communications with 10 countries.

## LAPEL BADGES

\$1

Name and call identifies you at club meetings, ham-fests, busted pot parties. Hand engraved by skilled New Hampshire craftsman with loving care.

## CUSTOMIZED DX BEARING CHART

\$4

An amateur who works for a big computer company has a program which permits him to plug in your location and have it print out the bearings of all the countries of the world from your shack.

## 73 BINDERS

\$5

These binders are a gorgeous red and come with the nicest set of year stickers you've ever seen. The perfect thing for storing your issues of 73 so that they won't get lost or spilt on, or into the hands of the Jr. Op. Dress up your shack with these binders.

## WORLD DX MAP

\$2

This is the same wall-sized DX map that is included with the DX Handbook except it comes to you rolled up instead of folded. This is so you can put it on the wall or have it framed.

## CALL LETTER DESK PLATE

\$2

How about dressing up your operating table with a desk plate showing your first name and call? These embossed desk plates are nice — and inexpensive. No zero available, sorry. There is room for twenty letters and spaces total.

## U.S. MAPS

\$1

These wall sized maps show the states and call area. They are specially designed for coloring to show your progress toward the Worked All States award of ARRL. They come in groups of four.

<input type="checkbox"/> Practical Test Instruments	\$4.95	<input type="checkbox"/> VHF Projects	\$5.00
<input type="checkbox"/> RF & Digital Test Equipment	\$5.95	<input type="checkbox"/> Solid State Projects	\$4.00
<input type="checkbox"/> Digital Control of Repeaters	\$5.00	<input type="checkbox"/> Transistor Projects	\$3.00
<input type="checkbox"/> Digital Control (hardbound)	\$7.00	<input type="checkbox"/> DX Handbook/Map	\$3.00
<input type="checkbox"/> Novice Study Guide	\$4.00	<input type="checkbox"/> Slow Scan Television	\$5.00
<input type="checkbox"/> General Study Guide	\$6.00	<input type="checkbox"/> Slow Scan (hardbound)	\$7.00
<input type="checkbox"/> Advanced Study Guide	\$4.00	<input type="checkbox"/> Coax Handbook	\$3.00
<input type="checkbox"/> Advanced Study Guide (hard)	\$6.00	<input type="checkbox"/> Fascinating World of Radio	\$4.00
<input type="checkbox"/> Extra Study Guide	\$5.00	<input type="checkbox"/> How to Use FM	\$1.50
<input type="checkbox"/> Extra Study Guide (hard)	\$7.00	<input type="checkbox"/> 108 Questions & Answers	\$2.00
<input type="checkbox"/> Intro to RTTY	\$1.00	<input type="checkbox"/> Simplified Math	\$ .50
<input type="checkbox"/> FM Repeater Circuits	\$5.00	<input type="checkbox"/> CW Manual	\$ .50
<input type="checkbox"/> FM Repeater Circuits (hard)	\$7.00	<input type="checkbox"/> FM Repeater Atlas	\$1.50
<input type="checkbox"/> Diode Circuits Handbook	\$1.00	<input type="checkbox"/> 73 Useful Transistor Circuits	\$1.00

<input type="checkbox"/> WAAS Certificate	\$1.00	<input type="checkbox"/> Call Letter Desk Plate	\$2.00
<input type="checkbox"/> All Mode DXDC Certificate	\$1.00	<input type="checkbox"/> US Maps (4)	\$1.00
<input type="checkbox"/> DXDC Certificate	\$1.00	<input type="checkbox"/> 5 WPM Morse Code Tape	\$3.95
<input type="checkbox"/> SSTV-DXDC Certificate	\$1.00	<input type="checkbox"/> 6 WPM Morse Code Tape	\$3.95
<input type="checkbox"/> RTTY-DXDC Certificate	\$1.00	<input type="checkbox"/> 13 WPM Morse Code Tape	\$3.95
<input type="checkbox"/> Lapel Badge	\$1.00	<input type="checkbox"/> 21 WPM Morse Code Tape	\$3.95
<input type="checkbox"/> Customized DX Bearing Chart	\$4.00	<input type="checkbox"/> Complete Set Morse Tapes	\$13.95
<input type="checkbox"/> 73 Binder	\$5.00	<input type="checkbox"/> Novice Tapes (set of 4)	\$13.95
<input type="checkbox"/> World DX Map	\$2.00	<input type="checkbox"/> FCC Rules & Regulations	\$ .50

Check desired items from



## 73 Gift Gallery list above and

mail **TODAY** to: 73 MAGAZINE, Peterborough NH 03458

Name \_\_\_\_\_ Call \_\_\_\_\_

Address \_\_\_\_\_

City \_\_\_\_\_ State \_\_\_\_\_ Zip \_\_\_\_\_

 
 Check
  Bill Me

Signature \_\_\_\_\_

Card No. \_\_\_\_\_

Expiration Date \_\_\_\_\_ Total Enclosed \_\_\_\_\_

# ***ANNOUNCING***

## **BELTEK**

## **W 5570**



THE NEWEST TWO METER RIG SPECS ABOVE AVERAGE  
USES TR 22 XTALS XMIT AND RECEIVE

---

*AUDIO LAND has a complete ICOM line in stock for  
**immediate delivery***

---

*WE NEED GOOD USED LOW BAND GEAR!! High trade ins on ICOM – BELTEK 5570 – ITC – MULTI 2000 – SBE 50. We have memory scans in stock. IMMEDIATE DELIVERY. Write for high trade quote. Amateur Dept, AUDIOLAND.*

*For more information write*

## **Audioland**

36633 S. Gratiot  
Mt. Clemens Michigan 48043  
313-791-1400  
Attention: Amateur Sales Dept.

# Multiband Antennas - How not to be trapped

The harmonic relationship of the high-frequency amateur bands has over the years generated a multitude of multi-band dipole designs. That is, a dipole form which can be fed with a single feedline (preferably coax) and operated on several or preferably all bands 80–10 meters without any tuning adjustments. “Trap” type dipoles have been most popular over the past several years and any number of variations of trap antenna designs are available. In general, trap type dipoles when constructed of high quality components give a good account of themselves. Their disadvantages are usually fairly sharp resonance within each band so that it is difficult or impossible to obtain optimum performance in both the CW and phone portion of each band and the physical loading of the antenna structure due to the trap components. A number of amateurs have been trying to get away from the use of traps by finding the right combination of dipole element lengths so one can construct an efficient multiband antenna from solely wire elements. The following is a description of some of these designs which have proved popular and interesting. One can duplicate these antennas directly, if desired, but they also provide some very useful ideas for individual experimentation with antenna designs.

## G5RV Multibander

The antenna design of Fig. 1 is often called the G5RV antenna. By a proper

combination of choice for the antenna's flat-top element lengths as well as for the length of the 300Ω feedline, resonance can be achieved on all of the amateur bands from 80 to 10 meters. The impedance present at the end of the 300Ω line is about 50–60Ω and a regular coaxial cable of any desired length can be used after this point. Although not absolutely necessary, it would be a good idea to use a 1:1 balun for connection between the coax and the 300Ω line (note again that a 1:1 balun should be used and not a 1:4 balun). The antenna is slightly “short” on 80 meters and the 300Ω line section serves as a form of matching stub on this band and a combination of stub and/or impedance transformer on the other bands. An SWR maximum of 2:1 can be achieved across most bands with a minimum of about 1.3:1 at the best frequency within a band. One should take a bit of time to properly trim the 300 line section for the best SWR, particularly on the 20 and 15

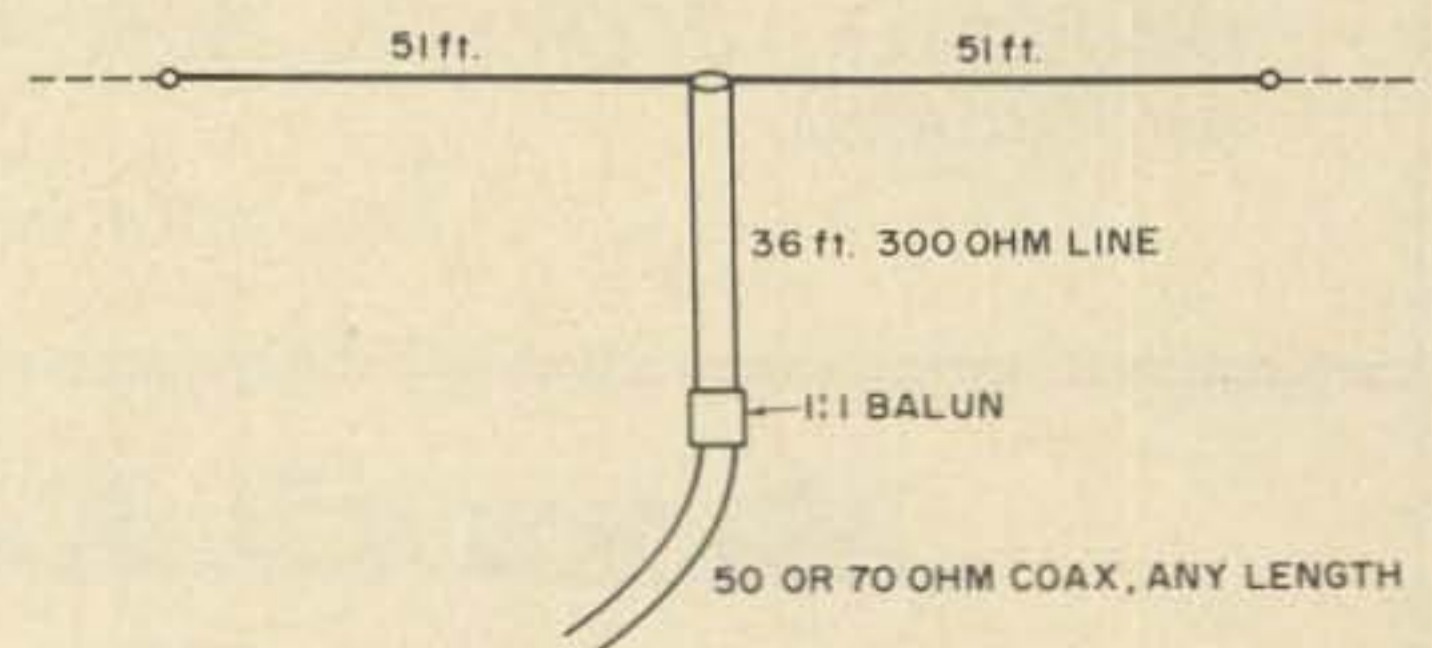

Fig. 1. The G5RV multiband 80–10 meter antenna.



meter bands. A few feet, plus or minus, depending upon the installation environment, can make a considerable difference in the SWR on 20 and 15 meters. Generally, as far as the cost of construction goes as related to performance, the G5RV design is about the best design one can find.

### DJ4BQ Double-Dipole

An only slightly more complicated design is the DJ4BQ multi-band double-dipole as shown in Fig. 2. This antenna operates on every band from 80 through 10 meters. One dipole (the longer one) operates on 80, 20 and 15 meters while the other dipole (the shorter one) operates on 40 and 10 meters. So, on every band only one dipole at a time is operative and, in fact, if one were only interested in the bands on which the indi-

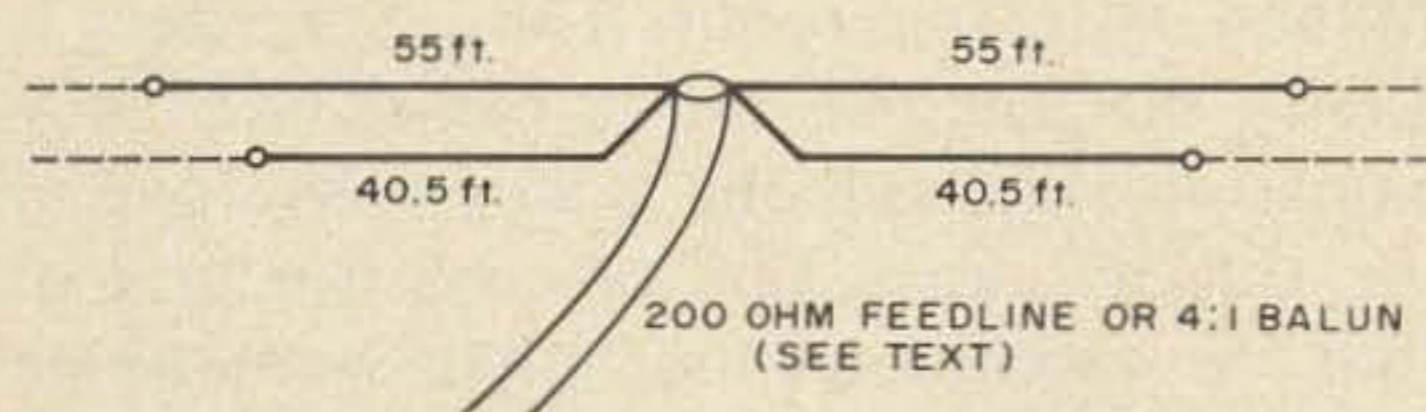

Fig. 2. The DJ4BQ double dipole for 80-10 meters.

vidual dipoles operate, one could put up just a single dipole. The theory behind the operation of the antenna is to choose the dipole element lengths just to be slightly short on each band such that about a 200Ω feed point impedance results on each band. This is accomplished by the dimensions shown for the dipole. If the feedpoint impedance is matched correctly, an SWR of no greater than 1.5 to 1 should be achieved over most of each amateur band. The dipole which is operative on each band can, of course, be fine trimmed for almost a perfect 1:1 SWR in any specific portion of a band. The matching of the 200Ω feed point impedance can be done easily with a 1:4 toroid balun working from a 50Ω coaxial line. The 1:4 balun can be connected directly at the feed point of the antenna and coax used to the transmitter or 200Ω open wire line constructed for a light-weight and more economical approach and used as a feedline with a 1:4 balun at the transmitter. The developer of the antenna recommends spacing the dipole wires at least 6 in. apart to prevent interaction of the elements. One

could probably construct the flat-top from 300Ω twinlead with each wire in the twinlead forming one of the dipole elements. Heavy duty twinlead with copperweld wires should be used (Belden 8230) and one will have to do some experimenting with the elements lengths because of the close spacing of the dipole elements.

### A Modern Windom

Some old timers may still remember the classical Windom antenna shown in Fig. 3 and named after the amateur who developed it in the 1930's. It is simply a half wave antenna feed 14% off of the center point with a single wire feeder of any length. It operates only on the evenly harmonically related bands (80, 40, 20 and 10 meters for the basic 80 meter antenna; 40, 20 and 10 for a 40 meter flat-top, etc.). It enjoyed great popularity in its day as a simple but very efficient multi-band antenna and a theoretical analysis of its construction proved the soundness of its design. That is, if one studies the current and voltage relationships which exist along the flat-top on each band, the feed point chosen 14% off center does indeed provide the correct matching point on even bands for a single wire feeder. [The characteristic impedance is 500Ω at the feedpoint - Ed.] The era of TVI pretty well killed the Windom because of the rf that the feedline brought into the shack which in turn made efficient transmitter shielding and filtering almost impossible. For a short while in the mid-1950's a variation of the Windom became popular where the flat-top portion of the antenna was broken and fed by a 300Ω line at approximately the same point as the original single linefeed was connected in the original Windom. The 300Ω line could be any desired length but at some point a 4:1 balun had to be used to bring the feedline impedance down to 75Ω for a coaxial cable feed. The requirement for

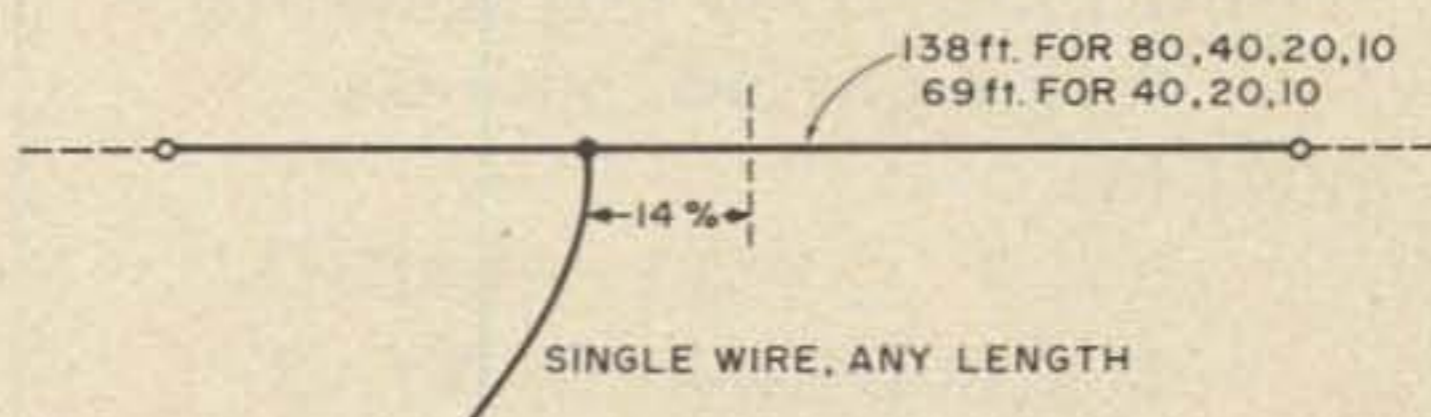

Fig. 3. The Windom antenna of the 1930's.

this multiband balun which was not a simple thing to construct before the event of toroids caused the antenna to fall into oblivion.

Recently, DJ2XH has come up with a modification of the preceding antenna idea. Instead of using  $300\Omega$  twinlead, however, he goes directly from a coaxial cable through a 1:6 balun transformer connected in the antenna flat-top as shown in Fig. 4. A 1:6 balun can be wired using one of the toroid balun kits in much the same manner as the common 1:1 or 1:4 baluns. The balun serves the purpose of impedance stepup from the coaxial line as well as the unbalanced coax to balanced antenna transformation. An SWR of under 2 to 1 can be easily achieved with this antenna over the entire amateur

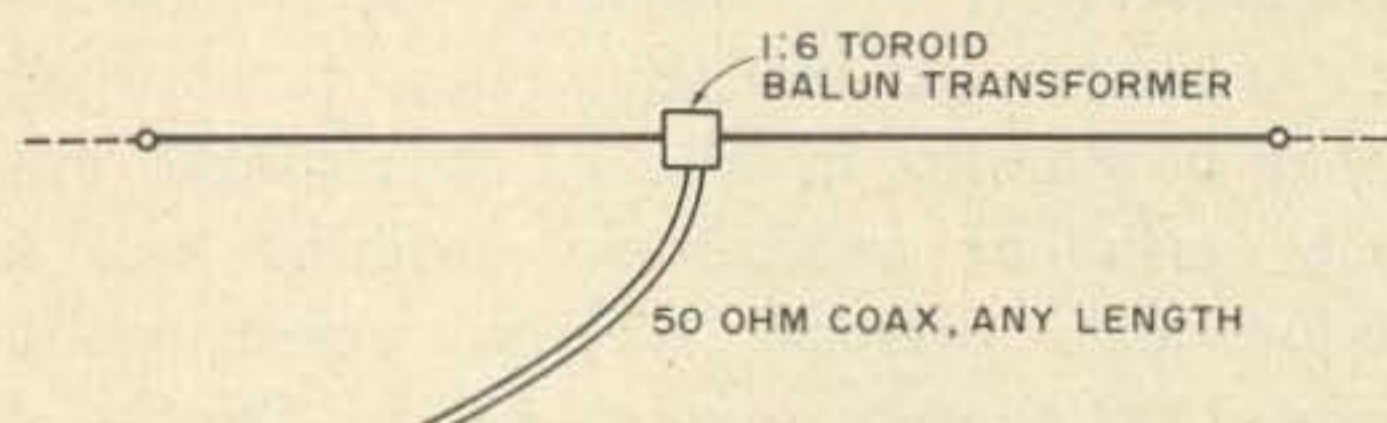

Fig. 4. The modernized Windom. Same dimensions apply as shown in Fig. 3. Balun is made using toroid kit.

## WORLD QSL BUREAU

5200 Panama Ave., Richmond CA USA 94804

THE ONLY QSL BUREAU to handle all of your QSLs to anywhere; next door, the next state, the next county, the whole world. Just bundle them up (please arrange alphabetically) and send them to us with payment of 6¢ each.

### Temtron Electronics

"We carry the largest stock of all types of ELECTRON TUBES, SEMICONDUCTORS, ICs. Special prices on 4CX1000As; 3-400Zs, 829Bs, 811As — and many other industrial and receiving types. Prices and catalog on request.

138-69 FRANCIS LEWIS BLVD. ROSEDALE NY 11422 (212)978-5896

Clegg

## Bargains

New FM27B-HT146 & Extras

At a low low price tag.

WRITE

AL'S 2-WAY RADIO

J. AL DEWALD RT. 3

DANVILLE, PA. 17821

CALL 717-437-2622.

bands on which it operates. Note, however, that this method of feeding the antenna does not change the basic nature of the antenna. It will operate only on even harmonic bands and 15 meters is not covered by a basic 80 or 40 meter antenna. One simple way to include 15 meters would be to erect parallel to the Windom a regular half wave 15 meter dipole which is connected in parallel to the coaxial feedline on the low impedance side of the balun transformer.

### Performance and Construction

The trapless types of antennas described here once properly adjusted and checked for SWR will generally perform as well on the low frequency bands as a trap antenna and usually better than a trap antenna on the 20, 15 and 10 meter bands. The latter effect is due to the fact that on the higher frequency bands, the full antenna is still used while in the trap antennas, the traps are arranged so that the antenna remains a half-wave dipole on each band. Trapless antennas on 20, 15 and 10 start to exhibit some gain and hence directivity.

Naturally, the performance of any antenna depends upon its height above ground. However, height above ground also effects the impedance developed at the terminals of an antenna and this is true for trap or trapless antennas. Since the electrical height above ground changes as the antenna is used on different bands, the feed point impedance is also changing on various bands. A bit of patience is required to carefully check the SWR on each band before rushing to put the antenna into operation. Some time spent in trimming the flat-top element lengths, or the feedline in case of the G5RV antenna, will pay dividends over the long run with far better SWR performance on each band.

Many amateurs will undoubtedly think of using these multi-band antennas as V types from a tower support. Basically, the antennas should work fine in this manner as long as the SWR is properly controlled. The Windom antenna has also been reportedly used with the shorter leg vertical and the longer leg arranged at a right angle to it.

. . . Staff

# Introducing CARF

The Canadian Amateur  
Radio Federation, Inc.  
Box 356, Kingston, Ont.  
Canada K7L 4W2

## A New National Amateur Radio Society For Canada

**T**he 13,500 amateurs in the largest country in the western hemisphere now have a healthy and active national organization of their own. Started in the centennial year of Canada's nationhood, 1967, the Canadian Amateur Federation now serves the growing ranks of Canadian amateurs.

In 1967 the Amateur Radio League of Alberta invited the other provincial societies to meet at the Winnipeg hamfest to discuss the organization of a Canadian national amateur society. Although for various reasons a number of provincial societies could not or did not attend, there was still interest and support for the idea from a number of them, and officials of the ARRL's Canadian Division lent their experience and advice.

The need for an independent national body for the amateurs of Canada having been recognized, a decision was taken to form an association of provincial societies under the name of the Canadian Amateur Radio Federation.

Although during the next two years several other provincial societies gained membership in the Federation, progress was slow. The membership, however, eventually increased to nine of the ten provincial societies, activity increased and finances were put on a solid footing.

Since then the national Federation has steadily forged ahead. In 1972 it was incorporated under a Federal Charter with the stated objective of becoming the national voice of amateur radio in Canada.

Each member society pays annual dues based on its own membership and appoints a delegate to the annual meeting where the

Federation's officers and directors are elected. Affiliate membership is available to other amateur radio societies which are national or international in scope. Associate membership is available to amateurs who wish to support the Federation directly.

The main function of the Federation is to represent the membership on the national level to the federal regulatory agency, the Department of Communications, known to Canadian amateurs as "the DOC".

In representing the amateurs of Canada many submissions and proposals concerning regulations have been made to the DOC, after due consultation with the provincial societies. Minor problems are quickly and satisfactorily solved due to the excellent day-to-day personal contact of the Federation's officials with the department's headquarters in Ottawa, the nation's capital.

There are seven directors on the board, elected by the provincial delegates. The usual corporate officers and the heads of the various committees deal with the management of day-to-day affairs. To keep Canadian amateurs informed of what goes on in Canada in the amateur world, especially in regulatory matters, the Federation publishes "The Canadian Amateur".

This monthly tabloid, with its topical news and comment on amateur radio events on the provincial, national and international scene, has met with approval by the fraternity and has filled a long felt need which publications from other countries could not fulfill. Essentially news oriented, rather than technical, it was started originally by an experienced newspaper man, Gil Stevens VE3BBQ, who died in 1973. The appear-

ance, format and content of the two-year-old publication is steadily improving under the hand of a professional journalist, Steve Campbell, in Trenton, Ontario.

Another Federation publication which is uniquely Canadian and is now in its third printing is "The Canadian Amateur Radio Regulations Handbook". This has been edited by a former DOC official, Art Stark VE3ZS, who heads the Federation Regulations Committee. It gives Canadian amateurs interpretations of the regulations and all the information needed to operate stations in accordance with the rules. These do not yet exist in Canada in the nearly codified form which the U.S. amateur finds in the FCC Part 97, but the Federation, at the request of the DOC, is now drafting a codified form of regulations for Canadian amateurs.

At present, the rules for amateurs are scattered throughout the Radio Act and the Part 1 and Part 2 of the related regulations. After inputs from Federation members as to changes which should be made, the draft "code" will be submitted to the DOC. If the DOC approves, the draft will go through a process similar to the FCC notices of proposed rule making. The codified regulations will be published in the "Canada Gazette" and comments invited from all interested parties.

To meet the demand for the rapid supply of information on important developments, the national Federation started the CARF News Service in early 1973. This supplies news of immediate interest directly to the editors of provincial and major club bulletins across Canada. Really "hot" items are immediately put on all major nets and broadcast from VE3VCA, "the Voice of the Canadian Amateur". Formation of a Trans-Canada RTTY net is now under way to ensure rapid distribution of important bulletins.

At the request of foreign national societies, a central clearing house for incoming QSL cards was formed in early 1973. The CARF National QSL Bureau, utilizing the Toronto-based Wheel Chair Round-up Amateurs under the capable leadership of Len Sumner VE3DOR, now handles thousands of cards, speeding their despatch to the provincial bureaus and in some cases directly to the amateurs of Canada. The

Bureau provides an interesting work outlet for a number of handicapped persons.

The regulations for the Canadian Amateur Experimental Services differ in many ways from those of the United States. Two classes of life time Certificates of Proficiency in Radio can be obtained — amateur and advanced amateur. The first enables the holder to license an amateur station restricted to CW operation on the HF bands with phone etc., privileges above 30 MHz; the latter gives full operating privileges on all amateur frequencies. Both classes may obtain a station license which includes their mobile, portable and base stations. In addition to the theory requirements the amateur certificate requires 10 wpm and the advanced "ticket" requires 15 wpm.

Special suffixes to the normal VE— and VO calls can be readily obtained for use by clubs, organizations, auto repeaters, etc. For example the prefix "C" in combination with certain other letters is often used for such calls in Canada.

Last year the Federation proposed the formation of the Canadian Repeater Advisory Group (CRAG) jointly sponsored by it and the ARRL Canadian Division. A national two meter channel plan, compatible with the ARRL plan, was recommended and the formation of repeater councils in all areas has been encouraged. The support of CRAG is reflected in the fact that most amateur repeaters are now using the recommended channels and 600 kHz spacing. The objective of the Canadian channel plan is to enable a mobile station to travel from coast to coast in Canada using a minimum number of crystals. So far the plan has five channels, with three or four more being recommended for congested areas.

As much of Canadian VHF mobile activity is close to the U.S. Border a number of the repeater councils are international and are working efficiently in channel allocations and preserving good relations that have always existed between the Canadian and U.S. amateurs. CRAG bulletins to provincial councils and FM associations provide a clearing house for repeater information on frequencies and DOC rulings. There are no repeater regulations in Canada but rather a minimum of "guidelines" which are easily

met by owners or operators. This follows the DOC policy of minimum regulation and letting the amateurs do their own policing.

Canadian amateurs are well aware of the contributions made by the ARRL in Canada since the League assumed a trusteeship of amateur affairs in Canada in 1923 at the request of a delegation of Canadian amateurs. This trusteeship developed into the formation of a Canadian division of the League with the full, voting status of any ARRL division. There are unique advantages in having a Canadian amateur on the ARRL Board, not the least of which is the facility to put the position of the Canadian members of the League before the ARRL Board.

Two Canadian division directors have been elevated to the post of vice-president ARRL over the years, the last being Noel Eaton VE3CJ, who recently assumed the office of president of the International Amateur Radio Union.

At present the ARRL Canadian division director sits on the IARU for League members in Canada but the Federation has requested that this representation be relinquished to it as the federally chartered national organization, as befits a sovereign nation. There is growing support for this action in Canada but the IARU has to date not recognized the Federation's legitimate aspirations in this direction although the national Federation is ready and willing to undertake this responsibility.

On the domestic scene the Federation is studying a probable change to full voting membership by individual amateurs as well as by provincial societies, enlarging its administrative and organizational structure and an increasing its now sound financial base. Its future lies with the amateurs of Canada. Their participation and support are needed.

For interested amateurs, the mailing address for information about the Canadian Amateur Federation Inc. is P.O. Box 356, Kingston, Ontario K7L 4W2. Annual dues for individual associate members are \$5.00 which includes a subscription to the Canadian Amateur. A new and up to date Canadian Regulations Handbook, just published in its 2nd edition, is now available for \$4.00 from the same address. . . . VE3VCA

# GATEWAY ELECTRONICS

8123-25 PAGE BOULEVARD  
ST. LOUIS, MISSOURI 63130  
(314) 427-6116

## THUMBWHEEL SWITCHES

STANDARD SIZE - 0.5 x 2.125 x 1.78  
10 position decimal **\$3.00**  
10 position BCD & compl. **\$4.00**  
End Plates (per pair) **\$1.45**

MINIATURE SIZE - 0.312 x 1.3 x 1.3  
10 position decimal **\$3.00**  
10 pos. BCD & comp. **\$4.00**  
10 pos. BCD only **\$2.75**  
End Plates (per pair) **\$1.00**  
Divider Plates **\$1.25**  
Blank Body **\$ .30**

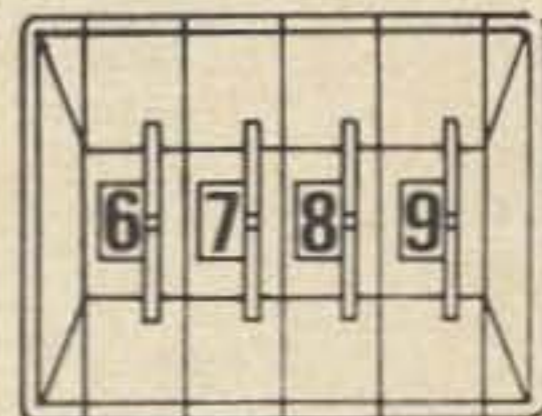

*All switches are black with white figures and snap-in front mounting.*

**11 MFD** - 10kV dc capacitor - 19 x 13 x 5. Ship wt. 90 lbs. **\$25.00**

**4 MFD** - 10kV dc capacitor - 9 x 8 x 4. Ship wt. 30 lbs. **\$15.00**

**7.5 MFD** - 7.5kV dc capacitor - 12 x 8 x 5. Ship wt. 25 lbs. **\$10.00**

**Sub-Miniature Toggle Switches** - Silver contacts, self-wiping, 6 amp contacts, American made, new - **\$1.00 ea.**

*Types available - SPDT, SPDT(center off), DPDT, DPDT(center off), DPDT(center off, spring return).*

## MARCH SPECIALS

DL-62 LED, giant 6 inch, seven segment **\$2.50**

1 Ohm, 1%, 25-watt dale-Ohm resistor, single hole mount **\$ .50**

1 Ohm, 50 Watt slider resistor **\$ .50**

## GATEWAY ELECTRONICS of COLORADO

Announcing the opening of our new Denver Colorado store on or about March 1st. Location is 2839 W. 44th Avenue. Come in and see us for store opening specials and prizes.

*\$5.00 minimum order. Visit us when in St. Louis. Please include sufficient postage.*

# NEW CODE SYSTEM

*Now you can learn the code in a fraction of the time it used to take!*



## four speeds available

Plays on any cassette player so you can practice anywhere anytime!

**5 WPM** This is the beginning tape for people who do not know the code at all. It takes them through the 26 letters, 10 numbers and necessary punctuation, complete with practice every step of the way using the newest blitz teaching techniques. It is almost miraculous! In one hour many people — including kids of ten — are able to master the code. The ease of learning gives confidence to beginners who might otherwise drop out.

**14 WPM** Code groups again, at a brisk 14 per so you will be at ease when you sit down in front of the steely eyed government inspector and he starts sending you plain language at only 13 per. You need this extra margin to overcome the panic which is universal in the test situations. When you've spent your money and time to take the test you'll thank heavens you had this back breaking tape.

**6 WPM** This is the practice tape for the Novice and Technician licenses. It is made up of one solid hour of code, sent at the official FCC standard (no other tape we've heard uses these standards, so many people flunk the code when they are suddenly — under pressure — faced with characters sent at 13 wpm and spaced for 5 wpm). This tape is not memorizable, unlike the zany 5 wpm tape, since the code groups are entirely random characters sent in groups of five. Practice this one during lunch, while in the car, anywhere and you'll be more than prepared for the easy FCC exam.

**21 WPM** Code is what gets you when you go for the Extra Class license. It is so embarrassing to panic out just because you didn't prepare yourself with this tape. Though this is only one word faster, the code groups are so difficult that you'll almost fall asleep copying the FCC stuff by comparison. Users report that they can't believe how easy 20 per really is with this fantastic one hour tape. No one who can copy these tapes can possibly fail the FCC test. Remove all fear of the code forever with these tapes.

**ONLY \$3.95!** 73 is in the publishing business, not tapes, so these are priced much lower than anyone else could sell them. Have you ever seen one hour cassettes for under \$6?

ORDER NOW!

Name \_\_\_\_\_ Call \_\_\_\_\_

Address \_\_\_\_\_

City \_\_\_\_\_ State \_\_\_\_\_ Zip \_\_\_\_\_

- 5 WPM 1 hr cassette \$3.95       14 WPM 1 hr cassette \$3.95  
 6 WPM 1 hr cassette \$3.95       21 WPM 1 hr cassette \$3.95  
 all four cassettes \$13.95

**73 Magazine — Peterborough NH — 03458**

# JUGE



## MOTOROLA 2m FM

- 25 or 10 watt models with 1-watt low power switch
- Installation of receive frequency crystal provides receive, simplex transmit and repeater transmit (-600 kHz)
- Best intermod and adjacent channel rejection available
- 12-channel capability
- Optional tone burst encoder - mounts internally
- Optional secondary transmit offset frequency kit
- Snap-in mounting tray
- Typical Motorola quality and performance

**SPECIAL**

**25 watt model  
\$349.95**

*FOR A LIMITED TIME...  
(financing available)*

**xtals \$9 ea.**

**ED JUGE ELECTRONICS, INC.**

3850 S. FREEWAY  
FT. WORTH TX 76110

11181 HARRY HINES BLVD.  
DALLAS TX 75229



**hotline**

# NEWS AS IT HAPPENS

ONLY \$8.00

That's just what HOTLINE gives you. Late breaking news is in your hand while it's still happening! Every other Friday, HOTLINE rushes you all the up-to-the-minute info that's so vital to the active ham. At only 30¢ an issue, it's one of the few real bargains still left! And a third of that's for postage! Just what does HOTLINE offer you?

- LATEST breaking FCC news
- NEW petitions filed
- IMMEDIATE job openings
- HOT classified ads
- BRAND NEW product reports
- CURRENT DXpeditions
- contest NEWS
- hamfest EVENTS
- government ACTIONS
- propagation FLASHES
- everything UPCOMING
- convention HAPPENINGS

Get the news while it's still news.

SUBSCRIBE TO HOTLINE TODAY!

Mail today to 73 Magazine, Peterborough NH  
Bill me after I receive my first issue. 03458.

Yes! RUSH ME HOTLINE TODAY.

Name \_\_\_\_\_ Call \_\_\_\_\_

Address \_\_\_\_\_

City \_\_\_\_\_ State \_\_\_\_\_ Zip \_\_\_\_\_

**YOU WOULDN'T  
START A LOG  
IN MARCH**



*RIGHT NOW*

is the time to order your

# 75 callbook

Don't wait until 1975 is half over. Get your new Callbooks now and have a full year of the most up-to-date QSL information available anywhere.

The new 1975 U. S. Callbook will have over 300,000 W & K listings. It will have calls, license classes, names and addresses plus the many valuable back-up charts and references you have come to expect from the Callbook.

Specialize in DX? Then you're looking for the new, larger than ever 1975 Foreign Callbook with over 225,000 calls, names and addresses of amateurs outside of the USA.

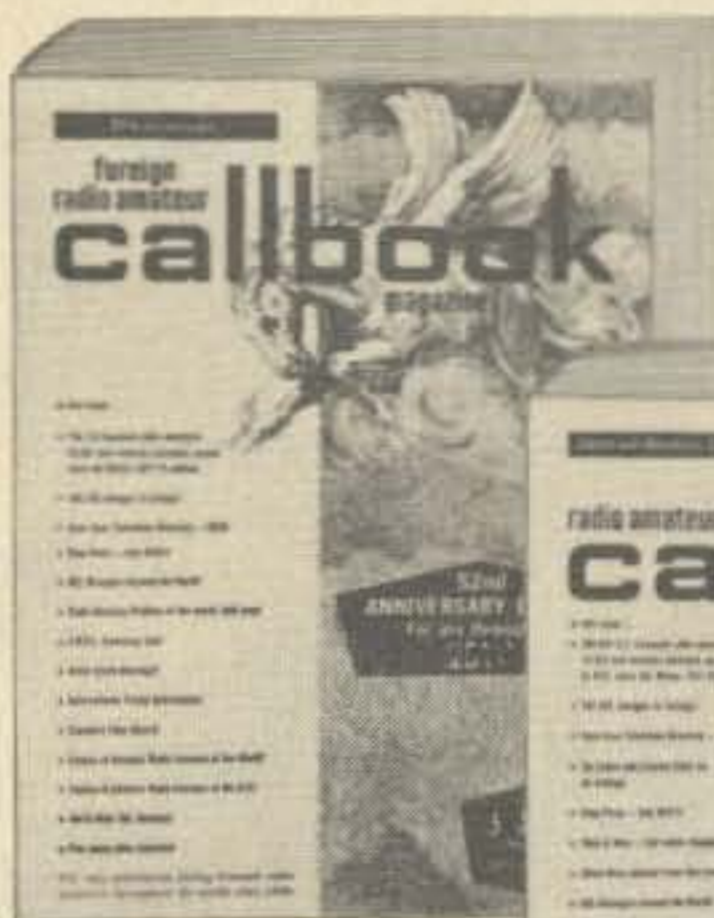

**Foreign Radio Amateur Callbook  
DX Listings  
\$11.95**

**United States  
Callbook  
All W & K Listings  
\$12.95**



Order from your favorite electronics dealer or direct from the publisher. All direct orders add 75¢ shipping and handling per Callbook.

**WRITE FOR FREE BROCHURE** RADIO AMATEUR **callbook** INC.  
Dept. B 925 Sherwood Drive  
Lake Bluff, Ill. 60044



# 1975 CATALOG

We would like to express our sincere thanks to the readers of 73's for the overwhelming response to our previous advertising. As an answer to the many requests we are now offering the items below. Please refer to the January issue for general information on products and shipping.

## FILAMENT TRANSFORMER

115W-60Hz primary 6.3V 6.6 amp secondary (Catalog \$7.50).

#FT66 \$3.75  
#FT66 3 for \$10.00

## POWER TRANSFORMERS

Brand new, boxed, industrial grade units. Dual primary (460, 230 v.), sec. (115 v.) Can be used as 2 or 4 to 1 stepup or stepdown. (Example; 115 v. in, 30, 60, 230, or 460 v. out. Or can be paralleled for + and - supplies for amplifiers etc. Two power ratings available.

#PT50 50 watt- (worth \$10) . . . \$5.00  
#PT100 100 watt- (worth \$13) . . . \$6.50

Copper Clad  
plug in boards

3 for \$1.00  
10 for \$3.00  
100 for \$25.00

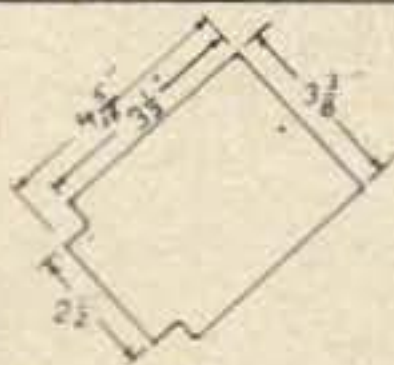

## New Unetched Blank Plug In Boards

Single sided copper clad boards (3-3/8" x 4-5/16" x 1/16"). Now you can design your circuits on convenient plug in boards and eliminate the hard wiring that is so frustrating in frequently changed or experimental circuits. Fits standard 15 pin .056" connector.

Order Number C PIB3 3 for \$1.00  
C PIB10 10 for \$3.00  
C PIB100 100 for \$25.00

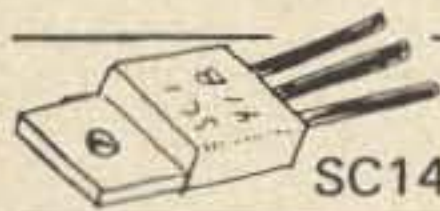

## PLASTIC TRIAC

SC141B 200 prv., 8 amp . . . \$1.10 ea.

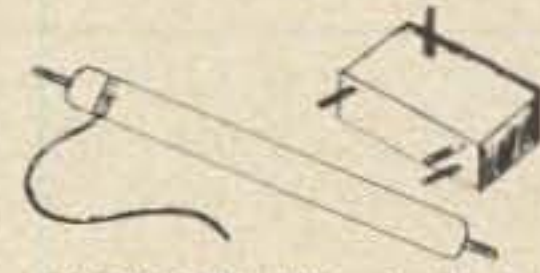

## XENON Flash Tube

This XENON flash tube is sold with hard to find matching pulse transformer, industrial design, not the cheaper version used in most hobby kits. Exceedingly bright flash. Supplied with complete specs and flasher circuit diagrams. The tube is 2 1/4 inches long. Order Number SXFTWT \$4.50

## SEMICONDUCTORS

Brand New--Tested--Guaranteed

### R.F. Transistors

2n384 PNP sil. TO-5, 40 V  
10 ma., 100 mhz, \$1.00 ea.  
ECG123A NPN sil. TO-18, 40 V,  
600 ma., 200 mhz, . . . .85¢ ea.

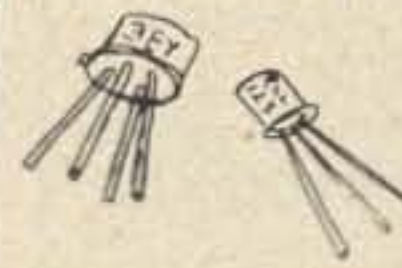

### Plastic Power Output Transistors

30 watt, 3 amp., 60 volt Complimentary Pair. PNP- 2SA496  
NPN- 2SC496. \$1.50 ea. Pair \$2.50.

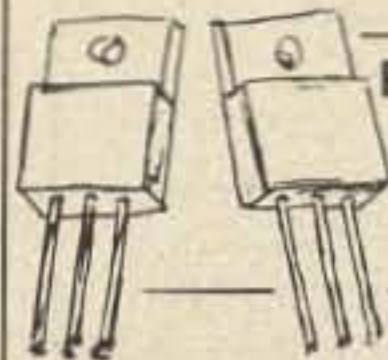

### UNIUNCTION TRANSISTOR

2N2646 N-type, TO-18, standoff ratio .56-.75, RBB 4.7-9.1, IP 25 . . . \$1.20 ea.



Miniature SCRs, TO-92, 500 ma., 1,2 volt gate

2N5060 30 volt . . . \$ .40 ea.  
2N5061 60 volt . . . \$ .45 ea.  
2N5062 100 volt . . . \$ .50 ea.  
2N5063 150 volt . . . \$ .55 ea.  
2N5064 200 volt . . . \$ .60 ea.



## NEWLY RECEIVED TEST EQUIPMENT

FXR Model B812A Standing Wave Amplifier, use as VSRW meter, square law detector, etc . . . . .	\$35.00
B&K Model 850 Color TV Analyzer with manual and accessories . . .	\$75.00
Fluke Model 801 Differential Null Voltmeter, bench model, working condition . . . . .	\$50.00
Empire Devices Model MM120 Amplitude Modulation Meter with Model T2/MM120 tuning unit (50-1000 MHz) . . . . .	\$55.00
Superior Model TW11 Tube Tester (emission type) . . . . .	\$15.00
Heathkit Intermodulation Analyzer . . . . .	\$15.00
General Radio Model 1539A Stroboslave, slave unit for G.R. Strobotac .	\$12.00
Beckman Model 7361R Digital Counter . . . . .	\$38.00
Hewlett Packard Model 205AG 20-20kHz metered audio generator . .	\$90.00
Millivac Model MV73B Multimeter VTVM, AC, DC, RF, Ohms, Current from 1 uamp to 10 amp . . . . .	\$27
Action Labs Model 800A VTVM . . . . .	\$24.00
Baird Atomic Model KT-1 General Purpose Transistor Tester . . . . .	\$18.00
Hewlett Packard Model 200C Oscillator 20-200kHz . . . . .	\$30.00
Signal Corps ME22/PCM Decibel Meter . . . . .	\$34.00
IBM Block Tube Tester . . . . .	\$25.00
Tektronix Model RM31 Oscilloscope, working condition with three plug-in units (1A), (N), (S), and original manual . . . . .	\$575.00

**Special Tube Tester Offer. . . Two Hickok Model 123A Cardmatic Dynamic Mutual Conductance Testers (one carries the Montgomery Ward name) with a huge assortment of plug-in cards. These are fully automatic testers, no dials to adjust, just push in a pre-punched card and the unit does the rest. . . . . \$150 each, \$250 for both.**

Browning Laboratories Model TAA-16B swr Amplifier . . . . .	\$45.00
Browning Laboratories Model TVN-11 Klystron Power Supply . . . . .	\$34.00
Metered high power adjustable load bank for generators, power supplies, etc. Meters monitor voltage in four ranges (1, 10, 20, 50) and current in four ranges (10, 50, 100, 500). Complete with test cables, shunt etc. . . . .	\$47.00

Minimum Order - \$2.00  
On orders of \$25.00 or more we ship FREE except test equipment  
P.O. Box 438  
Lowell MA 01852  
617-458-3077

SOUND SYSTEMS  
**VERADA 214**  
SURPLUS ELECTRONICS

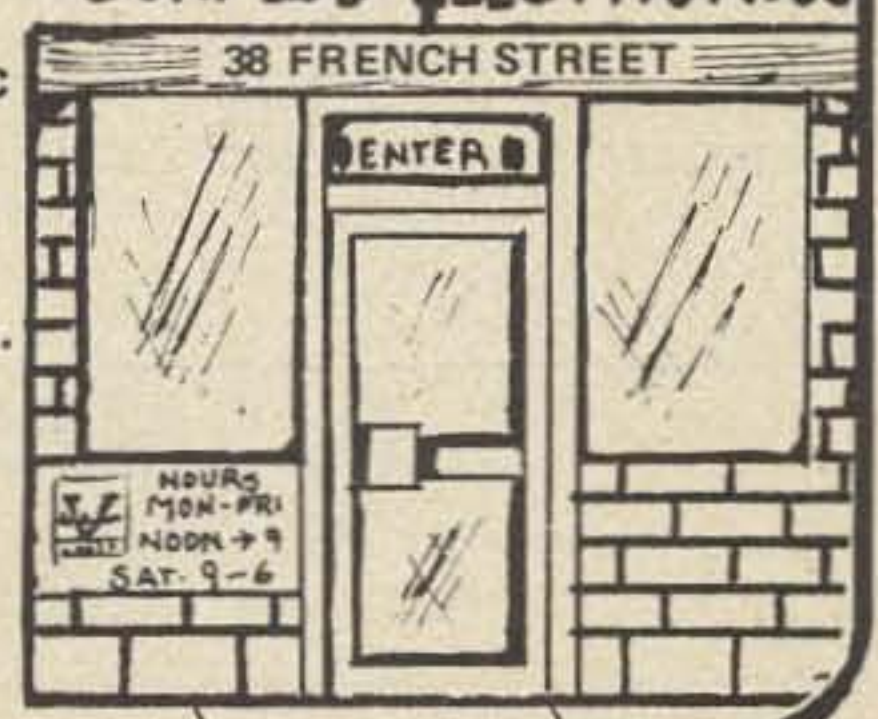

# ELECTRONIC PARTS BARGAINS

## DIGITAL CLOCK CHIPS BY NATIONAL FACTORY NEW UNITS!

MM5314 — 4 or 6 digits. 24 pin DIP. Use with LED Readouts. With Specs. — \$3.95  
MM5316 — Alarm chip. 40 pin DIP. \$4.95

**TEXAS INSTRUMENTS 8 DIGIT CALCULATOR CHIP**  
TMS0103NC. Four function. Same style as used in TI pocket calculators. Factory new units, with specs. \$2.95 each

## LED READOUT KIT

You get: 1 — OPCOA SLA-1 Readout 1-7490, 1-7475, 1-7447.

Complete Kit — \$2.95

## DL747 JUMBO LED READOUTS

By Litronix. .65 inch character. Common anode. Outperforms SLA-3. Perfect for giant digital clocks. Only 20 MA. per segment. Special — \$2.50 each.

## HEWLETT-PACKARD LED READOUT

.30 inch character. Common cathode. One of the brightest readouts around. Factory prime units, not retested seconds as sold by others. #5082-7740 99¢ ea.

## 1AMP 1000 PIV Silicon Rectifiers

IN4007. Factory prime devices. 10 for \$1.00.

## RCA HIGH VOLTAGE POWER TRANSISTOR

100 Watts. 5 Amps. 300 VCEO. TO-3 case. Silicon NPN. Mfg. house numbered 2N5240. Regular catalog is \$6. Perfect for H.V. supplies or vertical and horizontal circuits. SPECIAL — 99¢

## POWER TRANSISTOR HEATSINKS

Double finned, black anodized aluminum. Drilled for 2 TO-3 transistors.

59¢ each.

## 12VDC RELAY

DPDT. Heavy gold plated 5 amp contacts. 300 OHM coil. Limited Qty. 99¢

## SWITCHES FOR DIGITAL CLOCKS, ETC.

Rocker style. SPDT. miniature size. 4 for \$1.  
Push Button. SPST N.O. Enclosed, mini. 3 for \$1.

## HEAVY DUTY TRANSFORMER

36 VAC, 3.5 AMPS. 115VAC 60HZ. PRI. For power supplies or audio power amps. Best quality, fully enclosed. \$4.95.

## SUBMINIATURE TRIMMER CAPS

Ultra stable. Range: 3.5 to 18 PF. 2 for \$1

## FILTER CAPS

5000 MFD 20 WVDC. Twist lock. 99¢ ea.

## NATIONAL VOLTAGE REGULATOR

Like 7805. 5VDC — 1AMP output. Has TO-220 plastic power tab — 99¢

## IN4148 COMPUTER DIODES

Same as IN914. Factory prime. 20 for \$1.

## 48 HOUR SERVICE

You deserve, and will get prompt shipment. On orders not shipped in 48 HRS., a 20% cash refund will be sent. We do not sell junk. Money back guarantee on every item. WE PAY POSTAGE. Orders under \$10 add 75¢ Handling. No C.O.D. Texas Res. add 5% tax.

## S. D. SALES CO.

P.O. BOX 28810  
DALLAS, TEXAS 75228

# CIRCUITS...

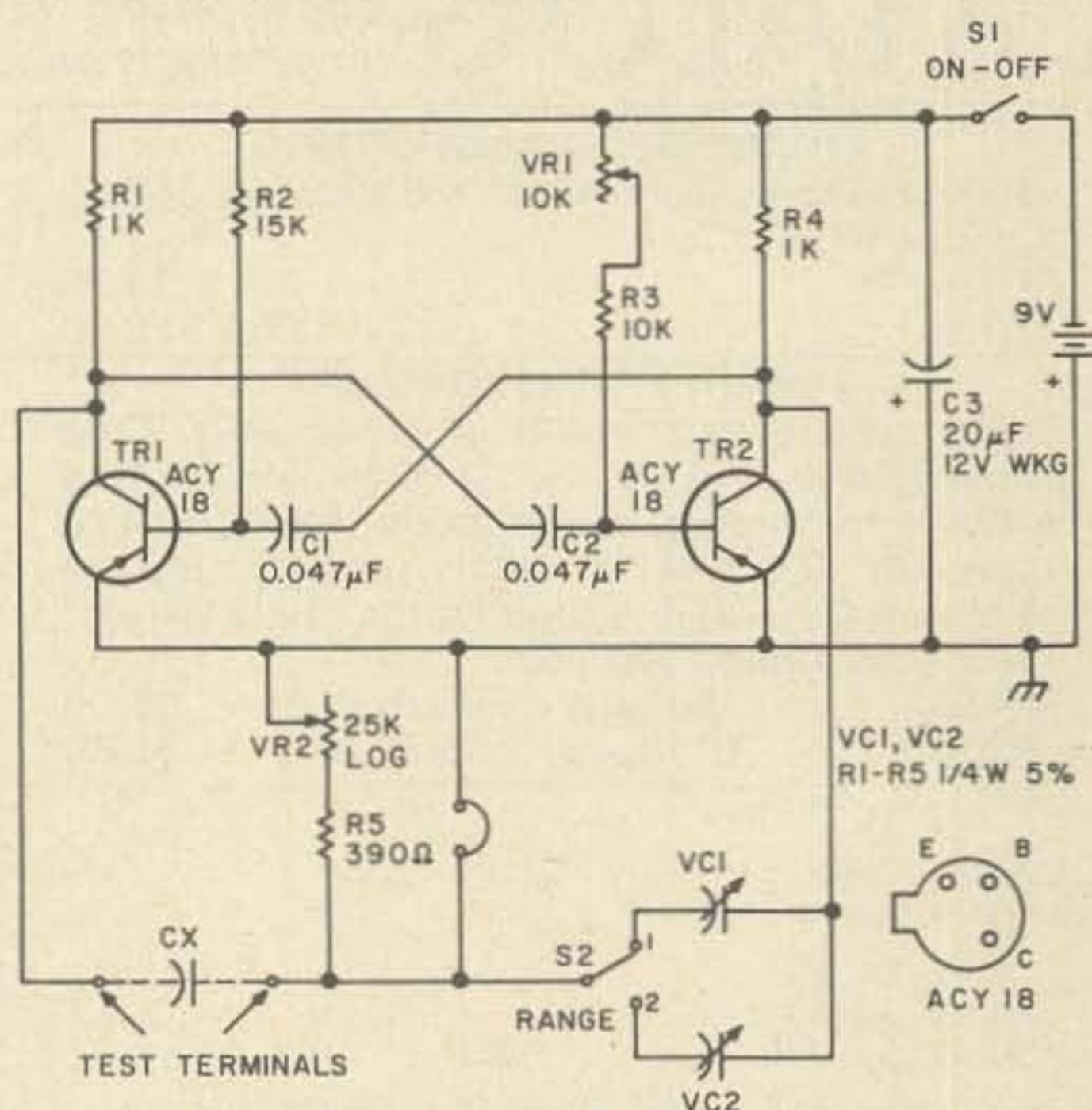

Precision rectifier for ac Volts to 1V for your lab. Used with an attenuator you have a precision millivoltmeter. To set up short A and B to ground and adjust P2 for zero output. Unshort A and B and adjust P1 for zero output. Complete details can be found in *Radio & Electronics Constructor*, Aug. 74 page 25.

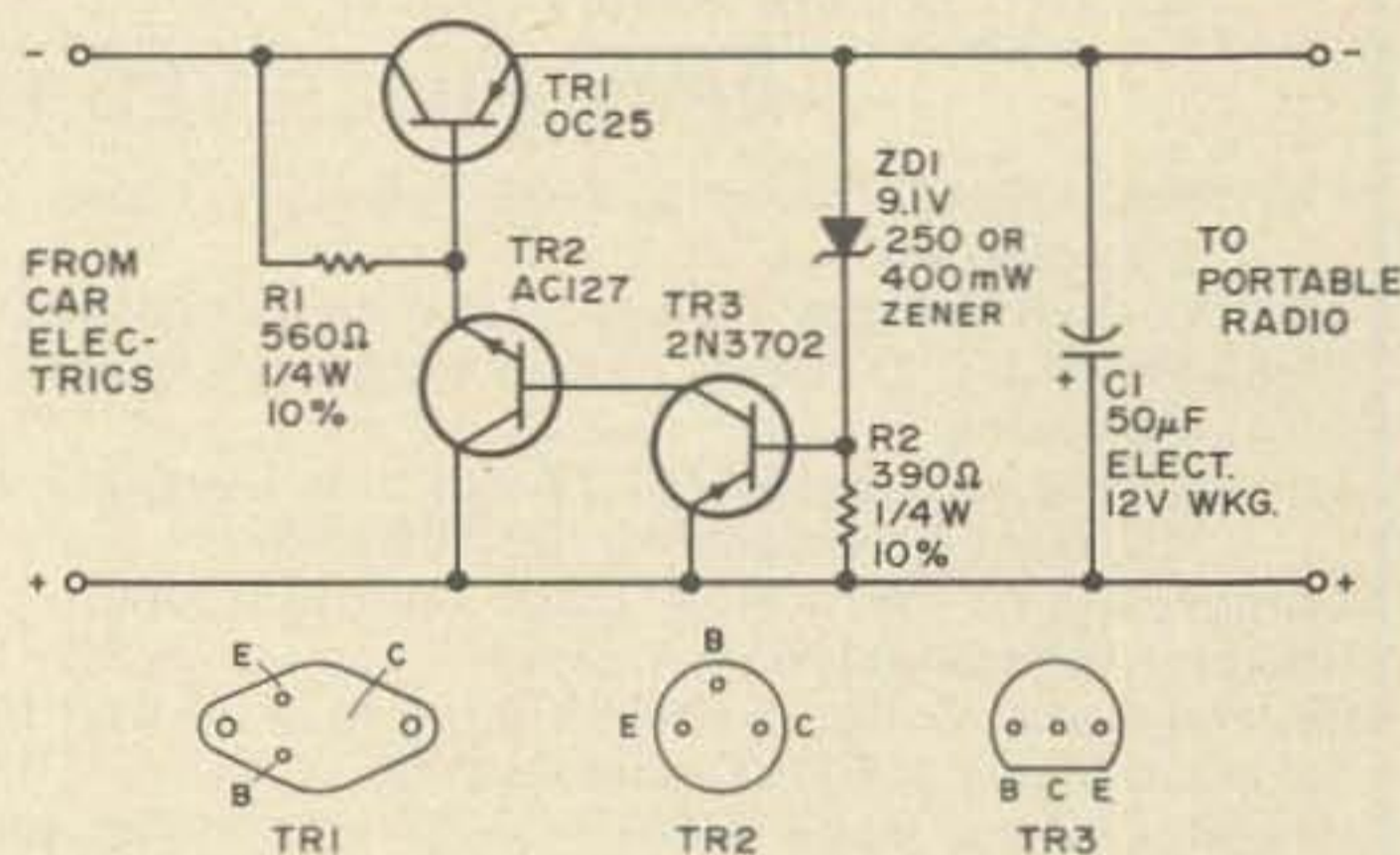

9 volt supply from 12V battery. Project from Aug. 74 *Radio & Electronics Constructor*, 57 Maiden Vale, London W91SN, England. Sub: \$7/yr.

## DIPOLE ANTENNA CONNECTOR

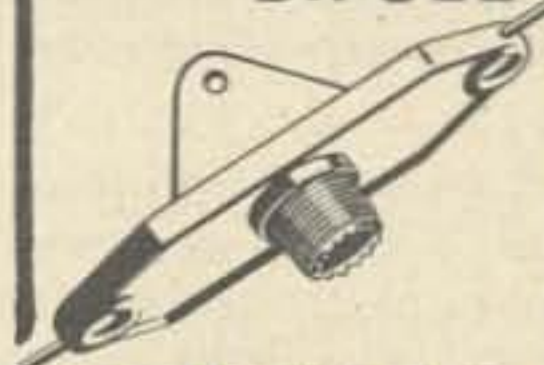

**HYE-QUE (HQ-1)** dipole connector has coax SO-239 socket molded into glass filled plastic body to accept coax PL-259 plug on feedline. Drip-cap keeps coax fittings dry. Instructions included. Guaranteed. At your dealers or **\$3.95 postpaid**. Companion insulators 2/\$.99.

**BUDWIG MFG. Co.** PO Box 97B, Ramona CA 92065

tacted us on BGI had as much fun as those of us who made the trip — that is something none of us will ever forget for the rest of our lives — it was true adventure.

Armond tells a story of an aircraft in trouble whose MAYDAY call on 20m was answered by two W6s with a

**Amateur ingenuity quickly overcame the benefits of the VOX circuit . . .**

request to QSY since they were busy working Europe long path. True story. From this Armond decided that the W6s didn't care whether the plane crew died or not and again the finger of guilt was pointed. Baloney! Five will get you ten that the 6s heard someone opening up in the next channel and asked them to move. I'll bet that as soon as they found out it was an emergency they broke their guts to do everything possible to help. Hams don't ignore cries for help — if anything they over-react and go to incredible lengths to help. They get medicine for people in remote places against all sorts of odds. They get word of illness through to relatives. And they do this regularly.

Sure, we have a few nuts among us. The FCC has not yet started giving sanity tests along with the code test — or even intelligence tests. Not that intelligence counts for much, by the way. The head of Mensa recently observed that "intelligence is no impediment to stupidity." I think that is worth making into a plaque or a bumper sticker. The 6s in question did something stupid.

While it probably isn't fair to pick on Armond for saying these things, since many others have said them before, the fact that a publisher and editor of a ham newspaper sees hams in this way is significant — and it is indicative that a great many other amateurs may be thinking of ham radio in the same terms. Should we feel guilty because we don't "build any more?" Should we feel guilty because we don't feel that we personally are really contributing? I think we should all feel proud that we are a part of a group that has contributed so much.

The fact is that few of us are perfect creatures. There is more than a little bit of laziness in the best of us — some larceny — prejudices — arrogance — and all of the other characteristics that we really wish we didn't have, but are stuck with. Sure, darned few of us can look Armond in the eye

and tell him that, dammit, we have nothing to feel guilty about. Not honestly, anyway.

There is no requirement in this world for anyone to be perfect. It is not expected and I think if someone perfect were to show up we would get rid of him as fast as we could. We have a pretty good record along that line, right? People who are too good step on toes and have to be taken care of.

Once we understand that we really don't have to be perfect — to try and be Super-ham — we can start coming to terms with our hobby. It is difficult to work when you are all wound up with guilt — it's a big turnoff. Just ask club presidents and club bulletin editors who try to use guilt to get members to meetings or to write for the club paper — it doesn't work. Guilt has been used for years to try and get us to use our unused bands. No amount of shame will populate 220 MHz — we'll see activity there when there is a good logical reason for using the band — when it is *fun*.

The FCC regulations give us a list of the reasons for amateur radio to exist in this country. It is worth reading over. It starts out with our providing communications in times of emergency. We do that. Few of us have not participated in some sort of emergency communications and every one of us is ready and trained to be of help when the time is right. Fate may not have selected *you* quite yet, but it probably will.

The regs ask that amateurs contribute to the radio art. We do that. We may do it by working on some fool invention that can't possibly pan out . . . but does . . . something no laboratory could waste time and

**Is there any reason for self-flagellation if we are guilty of not personally inventing SSB? . . .**

money on. We may do it by helping another ham prove a new system or technique is workable as thousands of amateurs did when FM was first invented — when narrow band FM was pioneered — when sideband was pioneered — when SSTV was pioneered — when new RTTY circuits were developed and tested on the bands — etc. Did you know that circular antenna polarization (which is now used for much of the satellite work) was invented by a ham and pioneered on the ham bands? . . . that the parametric amplifier was developed on six meters by a ham? . . . , etc.

The regs ask us to become skilled in communicating and in technical work. Contests and certificates encourage us in learning communications . . . building helps us develop our technical abilities. More hams are building today than ever before in the history of the hobby, as you probably know. True, not many of us build stuff that we can buy — it isn't very practical to build a receiver or transmitter today — but that doesn't stop us from knocking together counters, synthesizers, and all of the other goodies described in the articles in 73 Magazine. One look at the pages of ads for parts tells the real story about hams building — I count 39 pages of parts and test gear advertised in the January issue of 73 — just compare

**Obviously no one can do everything — at least not until there is a certificate out for it . . .**

that with any past year of QST back during the golden age of building in the 20's and 30's.

The regs ask that we have a reservoir of trained operators, technicians and technical experts. That includes every one of us one way or another. There is nothing there about any of us having to be all three — to be super-ham.

Lastly, the FCC mentions international good will. Even the most dedicated DXer does get into long winded contacts with fellows in other countries now and then when things are slow . . . and many contribute to international good will. Oh, a few work up some pretty bad will, but not many.

Hopefully I have done much to expiate any latent guilt feelings you may have had about amateur radio. With that out of the way, let's take another look at our hobby and see what we can do to improve it. I hope that we agree that hamming is fun. No matter what your present bag is, I hope you'll agree that all aspects of the hobby are fun for those involved. Building is fun — DXing is fun — contests are fun — moonbounce is fun — Oscar is fun — inventing is fun — repeaters are fun — rag chewing is fun — clubs are fun — club newsletters are fun — traffic handling is fun — phone patching is fun — and so on. The other side of that coin is the understanding that no one aspect of amateur radio shines golden with good as compared to the others. There isn't time for anyone to do everything in amateur

Continued on page 138

radio — and there is thus no logical reason for any feelings of guilt over omitting some of these aspects of the hobby — and there is no reason to be bigoted about your particular current enthusiasm and talk down other interests.

---

The FCC has not yet started giving sanity tests along with the code test . . .

---

One of the purposes of 73 Magazine is to try to communicate the fun of the different aspects of the hobby. We try to encourage you to try new things — to learn more about what is going on. When two meter FM came along we saw it as big fun so we did everything we could to get you to try it. At first it was a lonely go, with readers writing in telling us not to bother them with all this FM stuff, and with little help from the other ham magazines. But gradually, after a couple of years, after about 20,000 of the 73 readers had been convinced to give FM a try, and the couple of hundred repeaters had grown to a thousand, the other magazines discovered FM and then it was okay.

#### DOCKET 20282

The basic reason cited for the "restructuring" of amateur radio is the steady drop in the number of amateurs. Frankly, I don't think that setting up a Communicator Class of ticket is the only possible solution to the problem . . . but it may indeed work.

Even if this does go through, which I suspect it will, perhaps it is time for us to sit back and think a bit about amateur radio and our personal involvement with it. We don't have to wait for 20282 to go through and unleash a million CBers on our VHF bands (well, some people are predicting that . . . I don't believe it), we can get started right away with programs to get more hams licensed.

A few hams have discovered that it is fun to teach people to get their tickets. Bill Welsh W6DDB has helped over 20,000 to get licenses so far and is still at it hot and heavy. He is doing that because he enjoys it, not because he is a saint or a super-ham. Bill's classes take up so much of his time that he doesn't get much else done in hamming — a fact that I hope does not make him feel guilty.

Code classes are simple to set up — all you need today is a cassette player and you are in business. Theory

classes aren't much more difficult. If you aren't sure about the theory then ask around and you'll find volunteers who do know what they are talking about and who will help. High schools are brimming with prospective hams — as are the CB channels — not to mention the retired people and the handicapped in your neighborhood. Deaf people find amateur radio a fantastic blessing — they use CW and RTTY — as do the blind. I've even met deaf-blind hams. And you think you have problems!

How do you get people to the classes? Advertise. You use the local bulletin boards — demonstrations in shopping plazas — signs at the high schools — articles in the local papers on ham activities and the benefits of amateur radio — there are any number of ways to attract newcomers.

Be proud that you are an amateur — a ham — a HAM! Let your neighborhood know what it means to be a ham and how much fun it is. Let them know what the benefits are to them — how older people and shut-ins are no longer lonely — how you provide telephone calls home for service men

---

If you have some TVI, look upon this as an opportunity to convert a neighbor to an appreciator of amateur radio, not as a curse thrown on your door . . .

---

in isolated parts of the world — how your help in times of disaster — how you make friends all over the world. If you have some TVI, look upon this as an opportunity to convert a neighbor to an appreciator of amateur radio, not as a curse thrown on your door. Get in a couple of other hams and invite the neighbor over to see and talk — and air his complaints — be sympathetic and work with him to solve the problem. You may end up, as many have, with TVI of your own when the neighbor gets on the air.

Hams often wish that they had political clout. It isn't that difficult to get, with just a little planning and work. A club can arrange things so their Senator or Representative gets a good view of amateur radio in his home area. All of these gentlemen do get back home now and then to campaign and they are very interested in meeting constituents. If your club arranges a meeting at the shack of a member the chances are that the congressman will come. You'll be able to tell him about amateur radio and show it in action to him, complete with an interesting (and perhaps pre-

planned) DX contact. How many CBers do you think will be able to pull something like that off? And you know that such a demo, besides being invaluable to the hobby, would be a lot of fun.

It really is about time for all of us to feel a tremendous sense of pride in our hobby. It is one of the most valuable hobbies there is. Youngsters that we get involved in it will probably benefit from the association for the rest of their lives. A high percentage of high school age hams go into electronics or communications for their life's work — providing both our country and the world with the technicians and engineers to keep things developing.

When an amateur provides emergency communications we should all be proud to be a part of this — that one of our brothers was lucky enough to be in the right place at the right time.

Sure, there is a lot we can do to improve the image of amateur radio. We can pitch in to help when there are services to be performed for our communities. We can keep our imaginations active for ways to use amateur radio for public service — and we should do all we can to make sure that our services do not go unnoticed — for these things are news and will help us attract more prospective amateurs.

And the next time someone gets up and starts making you feel guilty about your lack of participation in amateur radio — don't let him get away with it. Stand up and give him hell.

#### DX INFO WANTED

Readers in foreign countries or amateurs visiting other countries are asked to get all the information they can about the classes of licenses available — the privileges of each class — and some idea of the exams involved in getting the various classes of license, including a brief of the exam material if available. Please send this information to 73 Magazine, Peterborough NH 03458.

This info is needed to help with a booklet on the subject — it may also be of considerable help to the FCC in its reciprocal licensing program and to the amateur licensing authorities of countries planning changes in licenses. It could be most helpful too in approaching third world countries — the countries which now hold the whip hand at the ITU.

. . . W2NSD/1



Wayne Green W2NSD/1  
c/o 73 Magazine  
Peterborough NH 03458

## Mobile Slow Scan Television ? ... yes - and other trivia

**N**ot a few of the slow scanners are working their countries mobile these days. Well, if they can work 'em on the low bands, why not two meters too? No reason against it, obviously.

The next step was to give it a try with a small cassette portable recorder. This was put up to the 2m FM mike and the system worked, amazingly enough. That slow scan is rugged stuff when it will manage to survive a trip through a cheap recorder — out a tiny speaker, into a ultra-low fidelity hand mike, on through a 2m rig, then a repeater, another 2m receiver and finally into a slow scan monitor. Formidable.

The fact emerged from the tests that it is difficult to drive evasively enough to ward off wild Massachusetts drivers while running a tape recorder on the passenger seat and holding the mike to its speaker. The quick change on receive to the recorder mike into the 2m speaker so the received slow scan signals could be recorded and looked at later on the home monitor was too much.

Obviously a more permanent installation would have to be made.

Toshiba had a good looking mobile cassette recorder — stereo — so that was bought and installed behind the passenger seat. There is a little problem in the Datsun 240Z car that not everyone faces — a drastic lack of room for installing more than one or two of those small boxes our rigs and other toys come in. I'd already used up the most choice spot for the IC-230, which was screwed to the drive shaft tunnel at my right knee, facing up at me. Just forward of that was the Heath Siren/P.A. system. And there was no room at all under the dash, so the only spot I could easily reach was behind the passenger seat, screwed to the tunnel wall. This turned out to be just fine and simple to use.

Any stereo system is no better than the loudspeakers used — and, in general, this means the larger the speaker and speaker enclosure, the better the sound. That is, of

course, an oversimplification, but not far off base for smaller speakers. In the interest of economy and the best sound I could manage to fit in the car, I decided to get a pair of the Heath bookshelf "hi-fi" speakers.

The pair of Heath AS-16's went together easily and didn't take up too much room in the back of the car. The sound may not be hi-fi, but it is spectacular compared to just about any other mobile stereo system.

Having been a designer and manufacturer of speaker enclosures in past years, I have a fair idea of what can or cannot be done within the confines of an automobile — and I must say that the sound coming from the Heath speakers was not disappointing. Though small, the speakers filled the inside of the car with a surprisingly rich bass. I made cassettes of some of my more demanding demonstration records and found that the performance was quite credible. Perhaps some day I'll have the time to put together an enclosure of my own design to match one of those super compliant four inch speakers. I'll bet that I can get the response down to below 40 cycles with that — and that's all you can really expect in a car.

The interwiring took a while — connecting one output of the cassette recorder to the IC-230 for slow scan transmission — the output of the 230 to the recorder — as well as to the public address system and a separate speaker which is in place of the car's ash tray (I don't smoke) and cigarette lighter on top of the transmission hump. I installed a small switch in the moulded plastic hump cover to switch the speakers from the cassette recorder to the stereo car radio, and another switch to permit the Heath P.A. system to be fed from the stereo line or the IC-230 audio. That's enough switches to keep anyone happy.

To send slow scan it is only necessary to plug in the SSTV cassette. To receive, just turn on the cassette recorder.

Stereo FM signals take a lot more rf signal strength than mono, so I found that I was having trouble with many of the signals fading as I drove around through the mountains and hills of New Hampshire trying to listen to those Boston stations about seventy miles away. I needed more antenna. I checked the Lafayette and Radio Shack

catalogs, but could find nothing listed that looked like a gain antenna for 100MHz mobile. One day, while talking with Andy at Gam, I mentioned this problem and within minutes I had a nice Gam gain antenna in hand for the broadcast FM band! Durn thing worked, too. I could even get good stereo copy from inside my garage, right through the local mountain which shields us from all those nice Boston stations on FM and TV. If you need a little more poop in your car stereo receiver you could do worse than check into the Gam SS-FM gain antenna.

The IC-230 has a plug on the side to feed in audio such as the output of a tape recorder. The Standard, which I used previously, had one on the back panel for the same thing. Many of the FM rigs are set up for that — not that it is so difficult to match into the mike circuit if your rig doesn't have that facility.

Even though you might not be all that interested in going slow scan mobile, you still might like to have the ability to make tapes from your 2m FM rig — or from the car radio. Now and then there is either something so interesting or so awful on 2m that I am glad I have the recorder set up for quick use in the car. I get some fantastic recordings now and then when I'm passing through Connecticut on the way to New York. One of the ARRL HQ chaps is on 2m down there and he has fascinating things to say about me... on the air!

Not that there is anything to stop you from getting on the low bands with slow scan mobile and joining the country hunt on 20m — several fellows are doing it and having a ball. It may be telling tales out of school, but the fact is that it is perfectly possible to work hundreds of slow scan ops without even having a monitor of your own, much less a camera. You do need a friend with one so you can play your tapes and see your contacts — and make up your own transmission tapes.

All of my slow scan two way contacts from Jordan (other than when I was operating JY1) were done completely via a little Toshiba KT-270 hand held tape recorder. The two way slow scan contacts from Navassa at KC4DX in 1972 were all done with an under \$20 cassette recorder! In both

cases I had to wait until I got back to New Hampshire to see the pictures I received.

Before you rush out to buy an El Cheapo cassette recorder, perhaps I should explain that while these will send and receive usable pictures, the fact is that there are a lot of jiggles in them which wouldn't be there with a better recorder. Many of the SSTV crew use fairly good quality reel to reel recorders and you can tell it when you see their pictures — they're clean and sharp. Some of the newer cassette decks will do the same job, but they all run well over \$100, with many in the \$300 and up range.

Right now we're having superb results with a Toshiba PT-490 — that's the new Dolby deck which has automatic reverse built in — and I see it listed in the latest Radio Shack flier with their brand name on it for \$320, with the only difference noticeable being circular pots instead of sliding pots and an "edit" button...called the Realistic SCT-7. We're also using it for making the Morse Code tapes.

Another good deck we've been using lately is the Concord Mark IX, which has the advantage of a built in mixer for microphone and separate line input. This was used for making the Novice tapes and the Morse Code tapes which have voice and code mixed.

There are so many applications for a good Dolby cassette deck that it is one of those things that you turn out to use just about every day once you have one — much like a

frequency counter. I went for years without a counter — I dunno how — and now that we have one handy, it gets used just about daily. It may be for crystallizing up an HT for a visit to a hamfest or to Boston — testing the stability of a vfo — checking out a receiver calibration or a calibrator — finding out which FM transceiver a crystal was made for (each crystal is easily identifiable by how much higher or lower than the marked channel it is — for instance the crystals for the Wilson HT and the Henry FMH units are 17 kHz lower than marked on the average — Standard receive crystals run about 12 kHz high — ICOM receive run 66 kHz low — when used in a broad band oscillator).

The cassette decks are great for taping talks at clubs — making up talks for clubs where it is too far for me to travel — duplicating music from the radio — things like that. Along that line, if any readers have a chance to tape any League officials who are making speeches or FCC officials doing ditto, I would appreciate getting a chance to run off a copy — I'll get your tape back to you pronto. The Toshiba KT-270 does a nice job of picking up a speaker at a considerable distance, but it does sound better if you can get the recorder or at least the mike up there within a foot or two of the speaker. Few speakers have any objection.

We're in the process of getting a couple of new cassette recorders for this type of application, a Sony TC-55 for low profile



# WE'RE FIGHTING INFLATION NO PRICE RISE IN '75



## FOR FREQUENCY STABILITY

Depend on JAN Crystals. Our large stock of quartz crystal materials and components assures Fast Delivery from us!

### CRYSTAL SPECIALS

Frequency Standards	
100 KHz (HC 13/U).....	\$4.50
1000 KHz (HC 6/U).....	4.50
Almost all CB sets, TR or Rec.....	\$2.50
(CB Synthesizer Crystal on request)	
Amateur Band in FT-243.....	ea. \$1.50
	4/\$5.00
80-Meter.....	\$3.00 (160-meter not avail.)
<b>Crystals for 2-Meter, Marine, Scanners, etc. Send for Catalog.</b>	

For 1st class mail, add 20¢ per crystal. For Airmail, add 25¢. Send check or money order. No dealers, please.



Div. of Bob Whan & Son Electronics, Inc.  
2400 Crystal Dr., Ft. Myers, Fla. 33901  
All Phones: (813) 936-2397

Send 10¢ for new catalog with 12 oscillator circuits and lists of frequencies in stock.

recording and a Sony TC-152SD for really top notch work where hi-fi will be helpful. I'll let you know more about these after we have a chance to use them a bit. I am sure that both will be superb for slow scan.

There are several types of tape available to confuse the newcomer to cassettes. You can use just about any at all for slow scan and they will work, but if you are going to the expense and trouble of making your slow scan tapes with a good recorder, it makes sense to use a fairly good tape. High fidelity addicts will probably go for the most esoteric tapes, such as the chromium dioxide, but this added expense (and they are not cheap) is a waste for slow scan. Since most of your slow scan programs will be relatively short (hopefully), you won't be getting into the thinner tapes that are used for the 90 minute cassettes or the ultra-thin tapes in the 120 minute cassettes. Don't ask for trouble. Any of the 60 minute or shorter cassettes use the thicker tape, and that will last a lot longer with rough handling and use in inexpensive recorders.

... W2NSD/1

# PHOTO ETCH PRINTED CIRCUIT KIT

## MAKES PRINTED CIRCUITS THREE WAYS!

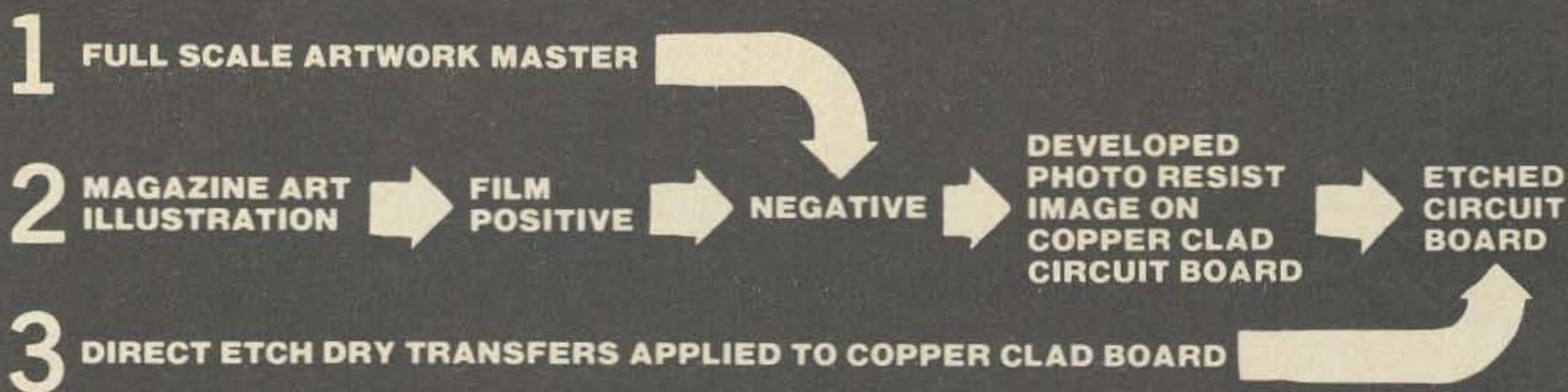

**NO** CAMERA DARKROOM FILM CUTTING TRACING

**USES DATAK'S POS-NEG PROCESS**  
The revolutionary photographic way that makes **PERFECT** printed circuits from original art or a printed page.

KIT CONTAINS: 5" x 6" steel printing frame, 4 sheets 5" x 6" photocopy film, yellow filter, chemicals for 1 pint film developer and 1 pint film fixer, 5" x 6" copper clad board, 3" x 4½" copper clad board, spray can of photo etch resist, 1 pint resist developer, 2 sheets 8½" x 11" layout film, 1 roll 1/16" printed circuit tape, 1 roll 1/32" printed circuit tape, 8 sheets dry transfer direct etch PC patterns including pads, transistors, round can and flat pack ICs, DIP ICs, edge card connectors, lines, circles, jogs, etc., ¼ lb anhydrous ferric chloride to make 1 pint etchant, instructions.

**ER-4 COMPLETE PHOTO ETCH SET . . . . . postpaid \$24.95**  
**AT YOUR DISTRIBUTOR OR DIRECT (N. J. residents add sales tax)**

**The DATAK corp. • 65 71st St. • Guttenberg, N. J. 07093**



# Yet Another Etching Technique

*Something fishy here.*

Let's face it, etching pc boards is not exactly the best part of working in electronics. This method, however, does seem to give a minimum of hassles and a cleanly etched board.

The key to successful etching is agitation. Usually this is accomplished by putting the pc board in a shallow, photography-type plastic tray, and rocking it back and forth until the board is etched. This is fine until you get tired of rocking it back and forth, at which point some mechanical rocking system is usually improvised.

A simpler way to agitate is to purchase a small aquarium aerator, available at under \$10 at pet supply houses. They work by pumping air through a plastic tube, which then ends in an aerating stone; the stone is highly porous, and converts the steady

stream of air into lots of little bubbles (see Fig. 1). These little bubbles not only aerate the ferric chloride, keeping it fresher longer, but also scrub the copper-clad pc board surface in a gentle yet effective way. The constant agitation also etches the board very evenly.

One thing you'll notice is that the force of the air will tend to make the stone bob up to the surface of the ferric, where it does no good. Chances are you'll have to weight the stone down; try a rubber band around the plastic hose, connected to a rock so the whole thing will stay put in the bottom of the tray.

You can simply put the aerator in your etching tray; but if you etch a lot of boards, you might try the following. After you've used up the ferric in the etching tray, don't throw it away but rather buy a small plastic garbage can and pour the spent ferric in. Anytime you have some excess or old ferric, throw it in the garbage can.

Now that you've got a can full of ferric, place a dowel, rod, coathanger, etc. across the top, hang the printed circuit boards by some nylon thread or equivalent, and put the aerator stone in the bottom of the can (Fig. 2). The bubbles will come up through

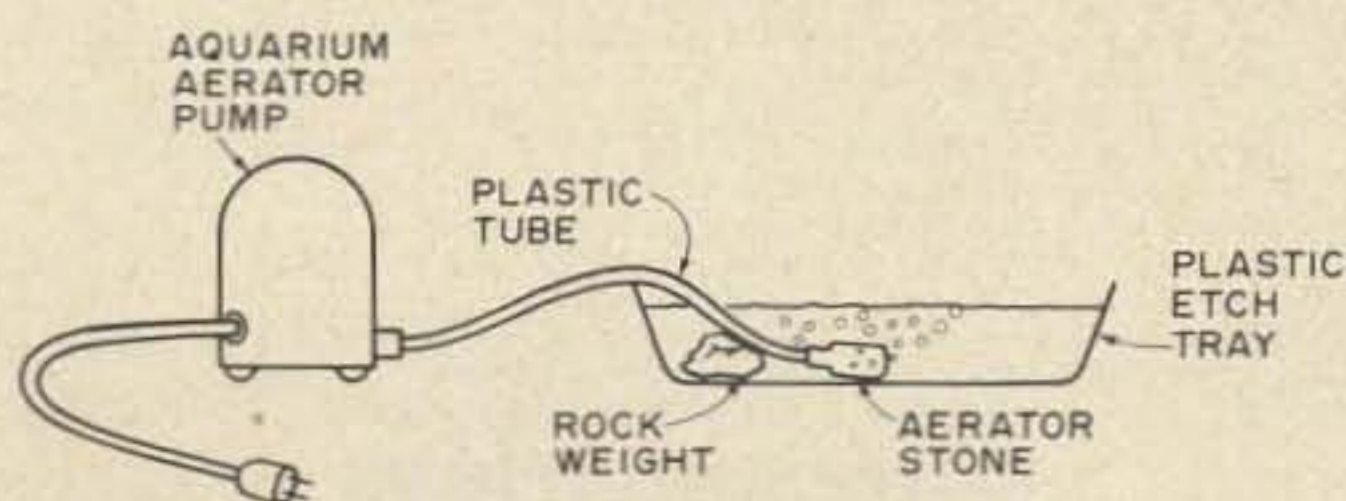

Fig. 1.

**PARTS! CORNELL TUBES!**  
 FREE Send For FREE  
**CORNELL'S**  
 New Color  
 Catalog  
 48 Pgs. New Items  
**33¢** per tube  
**36¢** per tube  
 ORDER FREE  
 IF NOT SHIPPED  
 IN 24 HOURS!  
 IN LOTS OF 100  
 4215 S University Ave. San Diego, Calif. 92105

**PL-259** Either Plugs OR Sockets  
**SO-239** 5 for \$3.50  
 POST-PAID  
 N.J. residents add 18c Sales Tax  
 Send SASE for other Connectors.  
**COAKIT** P.O. Box 101-A, Dumont, N. J. 07628

want some?  
 quality - value  
 integrity - variety  
 fast ppd delivery  
 try  
**TRI-tek, inc.**  
 10d Stamp for Latest Flyers Full of New  
 and Surplus Elec-  
 tronics Bargains  
 P. O. Box 14206 • Phoenix, Arizona 85063

**PRINTED CIRCUIT**  
**TECHNIQUES FOR THE HOBBYIST**  
 BOOKLET: \$2.00  
 ARTWORK, PC DRILL BITS:  
 SEND SASE FOR FLYER.  
 TRUMBULL, 833 BALRA DR.,  
 EL CERRITO, CA. 94530

**Star-kits** G.P.O., Box 545  
 Staten Island, N.Y. 10314  
 We carry etched circuit boards for all the  
 K2QAW projects - Counter... CW ID'er...  
 Synthesizer... Repeater Control... Scaler...  
 and now, the Brand New  
**DIGITAL SWR COMPUTER**  
 Automatically computes and displays your SWR  
 at all times - ideal for antenna adjustments or  
 constant monitoring. Circuit board and full  
 instructions only \$16 postpaid (N.Y. orders  
 add sales tax.)  
 Designed & Engineered **by K2QAW**

**YOU ASKED FOR IT! ECM-5B**  
**FM Modulation Meter**  
**Only \$99.95** less batteries  
 and crystals  
 • 0-7.5 kHz deviation peak reading  
 Meets commercial requirements  
 • Operates 30-500 MHz  
 • Crystal controlled for easy operation  
 • Telescopic antenna  
 NEW OPTIONS  
 • NICAD power pak \$20.46  
 • Charger \$29.95  
 • Audio/scope output  
 with earphone \$12.95  
 Write or call for complete info  
 Send check or money order for \$99.95 plus \$1.50 for  
 shipping. Indiana residents add 4% sales tax. Crystals  
 for 146.94 MHz \$3.95. All other freq: \$7.10.  
**ECM** ECM Corporation  
 412 North Weinbach Ave.  
 Evansville, Indiana 47711  
 812-476-2121

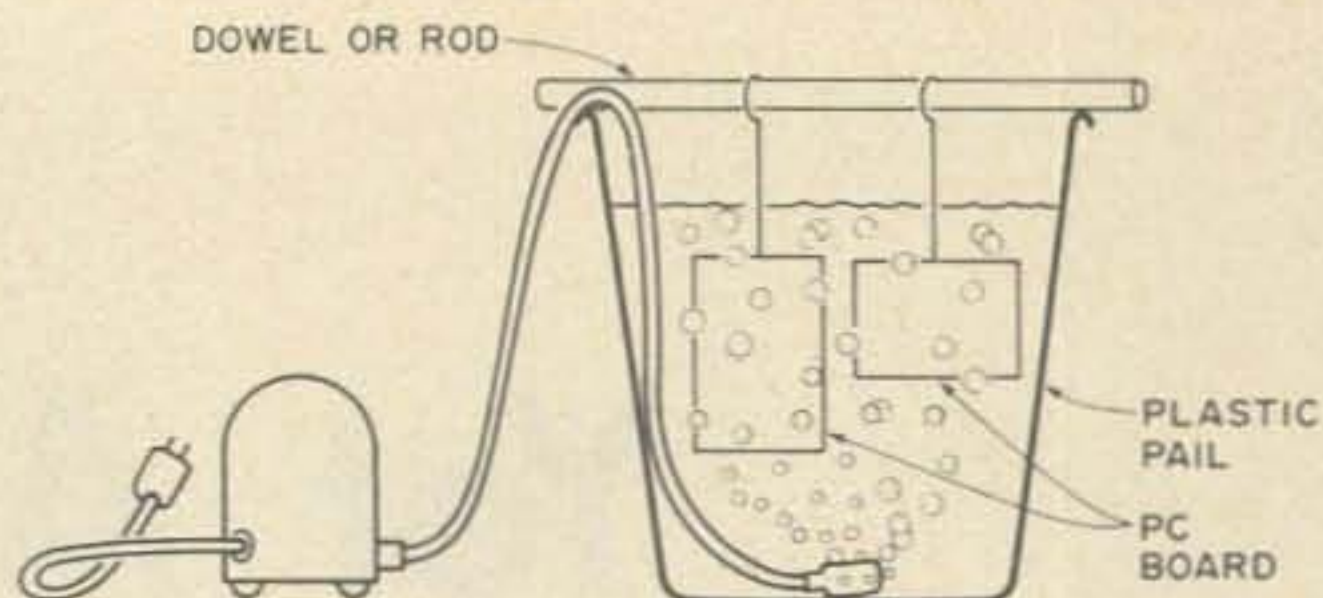

Fig. 2.

the pc boards and etch them just fine.

One final tip: after the ferric chloride appears totally gone, you can extend the life even further by throwing in a little bleach. However, stand back when you add it - no explosions or anything, but the smell can be pretty potent. For some reason this seems to re-activate the ferric a bit and extend its useful life.

So there you have it, another way to etch boards. The principal advantage is that you can do a fair amount of boards with a minimum investment in ferric chloride, and you get to recycle old ferric by throwing it in the garbage can, aerating it, and extending its life. Check it out. . . . ANDERTON

Cash for any Collins military or commercial equipment or parts, especially 618 T Tranceivers, 490 T antenna couplers, AN/ARC-102, AN/ARC-94,

**CASH**

AN/MRC-95. SPACE ELECTRONICS CO.,  
 76 Brookside Drive, Upper Saddle River, N.J. 07458  
 (201) 327-7640

**LOOKING FOR A NEW CHALLENGE?**  
**... then build a TV camera!**  
 ONLY SOLID-STATE CAMERA AVAILABLE IN KIT FORM OR FACTORY ASSEMBLED COMPLETE KIT WITH VIDICON TUBE ONLY \$166.00. POSTPAID DELIVERY ANYWHERE IN USA, CANADA and MEXICO. OPTIONAL AUDIO SUBCARRIER \$18.95. WRITE or PHONE NOW FOR COMPLETE CATALOG OF KITS, PARTS and PLANS. DIAL 402-987-3771.  
 1301 N. BROADWAY **ATV Research** DAKOTA CITY, NEBR. 68731

**MINIATURE SUB-AUDIBLE TONE ENCODER**  
 • Compatible with all sub-audible tone systems such as Private Line, Channel Guard, Quiet Channel, etc.  
 • Glass Epoxy PCB, silicon transistors, and tantalum electrolytics used throughout  
 • Any miniature dual coil contactless reed may be used (Motorola TLN6824A, TLN6709B - Bramco RF-20)  
 • Powered by 12vdc @3ma  
 • Use on any tone frequency 67Hz to 250Hz  
 • Miniature in size 2.5x.75x1.5" high  
 • Wired and tested . . . . . \$14.95  
 • Complete less reed (Available in 33 freqs. for \$17.50 ea)  
 • Output 3v RMS sinewave, low distortion  
 • Postpaid - Calif. residents add 5% sales tax  
**COMMUNICATIONS SPECIALISTS**  
 P.O. Box 153, Brea CA 92621

## C-MOS

	1-9	10 up
4000AE	\$ .50	.48
4001AE	.49	.48
4002AE	.49	.48
4004AE	5.85	5.85
4006AE	3.85	3.75
4007AE	.60	.55
4008AE	3.55	3.25
4009AE	.90	.89
4010AE	.90	.89
4011AE	.49	.48
4012AE	.49	.48
4013AE	1.10	1.00
4014AE	3.65	3.20
4015AE	3.75	3.65
4016AE	1.10	1.00
4017AE	2.85	2.65
4018AE	3.15	3.00
4019AE	1.25	1.15
4020AE	3.85	3.25
4021AE	3.75	3.55
4022AE	2.70	2.50
4023AE	.49	.48
4024AE	2.25	1.95
4025AE	.49	.45
4026AE	9.75	7.05
4027AE	1.30	1.17
4028AE	2.90	2.70
4029AE	5.35	4.55
4030AE	1.20	1.00
4035AE	2.80	2.75
4040AE	4.55	4.35
4041AE	3.25	3.15
4042AE	2.98	2.80
4043AE	2.90	2.80
4044AE	2.90	2.80
4047AE	3.65	3.55
4048AE	1.45	1.35
4049AE	1.30	1.00
4050AE	1.30	1.00
4056AE	3.45	3.41
4060AE	5.15	4.85
4066AE	3.15	2.91
4069AE	.80	.70

## Schottky TTL

SN74S00N	\$ .80
SN74S02N	.80
SN74S03N	.80
SN74S04N	.80
SN74S08N	.80
SN74S10N	.80
SN74S11N	.80
SN74S20N	.80
SN74S30N	.80
SN74S32N	.80
SN74S40N	.80
SN74S64N	.80
SN74S74N	1.50
SN74S85N	6.10
SN74S86N	2.90
SN74S112N	2.50
SN74S113N	1.50
SN74S133N	1.00
SN74S138N	4.50
SN74S139N	3.90
SN74S140N	1.00
SN74S151N	3.30
SN74S153N	3.30
SN74S154N	3.40
SN74S157N	2.70
SN74S158N	3.00
SN74S160N	6.60
SN74S161N	6.60
SN74S174N	4.75
SN74S175N	4.00
SN74S181N	11.50
SN74S189N	5.10
SN74S194N	3.30
SN74S195N	4.40
SN74S251N	4.20
SN74S253N	4.20
SN74S275N	3.20
SN74S258N	3.70
SN74S260N	.90
SN74S280N	5.70
SN74289N	5.00
93S10	6.80
93S16	6.80
93S21	3.50
93S22	3.20
93S48	3.70

## HIGH SPEED TTL

74H00N	.34
74H01N	.49
74H04N	.36
74H05N	.38
74H08N	.44
74H10N	.44
74H11N	.44
74H15N	.38
74H20N	.39
74H40N	.36
74H74N	.69

## I-Amp Rectifiers

	10	100	1000
1N4001	\$ 1.00	7.00	60.00
1N4002	1.10	8.00	70.00
1N4003	1.20	9.00	80.00
1N4004	1.30	10.00	90.00
1N4005	1.40	11.00	100.00
1N4006	1.50	12.00	110.00
1N4007	1.60	13.00	120.00

SPECIFICATION SHEETS: \$.25 ea.

## Waveform Generator Kit



XR205K Only \$28.00

Here's a highly versatile lab instrument at a fraction of the cost of conventional unit. Kit includes two XR205 IC's, data & applications, PC board (etched & drilled, ready for assembly) and detailed instructions.

## FM Stereo Demodulator

XR1310 \$3.90

## Audio Amps

LM352: 6-15V, 1.15W, 8Ω	1.60
LM354A: 6-27V, 2.80W, 8Ω	2.50
TAA611B12: 6-15V, 1.15W, 8Ω	1.60
TAA621A12: 6-27V, 1.40W, 8Ω	2.00
TBA641B11: 6-18V, 2.20W, 4Ω	3.00
TBA800: 5-30V, 4.70W, 8Ω	2.20
TBA810AS: 4-20V, 2.50W, 4Ω	3.00
TBA820: 3-16V, 0.75W, 4Ω	1.70
TCA830: 5-20V, 2.00W, 4Ω	2.20
TCA940: 6-24V, 6.50W, 8Ω	4.40

## Power Transistors

BU204 3A 1300V	\$4.14
BU205 3A 1500V	4.95
BU206 3A 1700V	5.94
BU207 6A 1300V	5.85
BU208 6A 1500V	6.93
BU209 6A 1700V	8.64

2N512B	\$3.00
2N1136	1.50
2N1483	1.20
2N1534	1.00
2N1540	1.10
2N1544	.90
2N3053	.35
2N3055	.95
2N3375	5.50
2N3442	2.20
2N3730	1.70
2N3731	2.00
2N3732	1.50
2N3771	2.20
2N3772	2.30
2N3773	3.40
2N3789	3.00
2N3866	.95
2N4347	1.60
2N4348	2.00
2N4395	1.30
2N4427	1.10
2N5109	2.10
2N5322	.92
2N5323	.70
2N6099	.80
2N6101	.80
2N6103	.90

## 7400N TTL

7400N	\$ .16
7401N	.23
7402N	.22
7403N	.22
7404N	.25
7405N	.29
7406N	.38
7407N	.48
7408N	.24
7409N	.54
7410N	.24
7411N	.29
7412N	.51
7413N	.78
7414N	2.81
7416N	.46
7417N	.64
7420N	.19
7421N	.51
7423N	.49
7425N	.39
7426N	.29
7427N	.35
7428N	.51
7430N	.22
7432N	.28
7433N	.61
7437N	.44
7438N	.44
7439N	1.01
7440N	.19
7441AN	1.16
7442N	.98
7445N	.98
7447N	1.50
7448N	1.29
7450N	.23
7451N	.28
7453N	.25
7454N	.26
7460N	.24
7470N	.30
7472N	.39
7473N	.46

## DUAL LOW NOISE OP AMP

LM331N:  
V<sub>io</sub> = 6mV  
I<sub>ie</sub> = 1000nA  
I<sub>b</sub> = 2000nA  
Noise = 1.5dB  
\$2.20

## HYBRID POWER AMPLIFIERS

SI-1010G	10W	\$ 6.90
SI-1020G	20W	9.90
SI-1030G	30W	18.70
SI-1050G	50W	25.90

## Decoded Read/Write RAM

P1103 \$6.20

## PREMIUM QUALITY COMPONENTS

We've been buying and selling top quality components for nearly ten years. Our annual volume exceeds \$3 million. We handle only original parts, from the world's leading manufacturers and our customers include some of the largest and most quality-conscious companies.

Now you can take advantage of our component buying skills and power and select from a broad range of advanced circuits.



## IC sockets

Solder	Teflon	Wire Wrap
8 pin DIL .22	3 pin TO-5 .55	14 pin DIL .40
14 pin DIL .26	4 pin TO-5 .65	16 pin DIL .45
16 pin DIL .29	6 pin TO-5 .90	
24 pin DIL .75	8 pin TO-5 1.10	
28 pin DIL 1.10	10 pin TO-5 1.40	
36 pin DIL 1.70		
40 pin DIL 1.90		

## 1024 Bit N-Channel RAM

2602B	\$21.00
2602-1B	25.00
7552CPE	21.00
7552-ICPE	25.00

## LOW POWER TTL

74L00N	\$ .34
74L02N	.34
74L03N	.39
74L04N	.39
74L10N	.34
74L20N	.39
74L42N	1.62
74L51N	.34
74L73N	.74
74L74N	.89
74L90N	1.62
74L93N	1.74
74L95N	1.62

## Model 4440

A PORTABLE 4 1/2 DIGIT MULTIMETER FOR \$299. A 10 MHZ COUNTER OPTION FOR \$50.

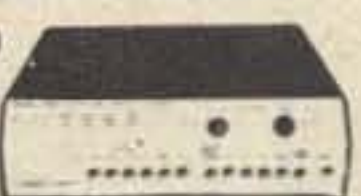

## Interface Modules

CY1010	Instr. Amp., Bipolar Input	\$ 29.00
CY1011A	Instr. Amp., Bipolar Input	49.00
CY1020	Instr. Amp., FET Input	34.00
CY1021	Instr. Amp., FET Input	49.00
CY1021A	Instr. Amp., FET Input	59.00
CY2018	DAC, 8 Bit, 2 Quad Multiplying	99.00
CY2137	DAC, 10 Bit, Low Drift	39.00
CY2218	DAC, 12 Bit, 2 Quad Multiplying	149.00
CY2236	DAC, 12 Bit, Fast Settling, Low Drift	89.00
CY2237	DAC, 12 Bit, Low Drift	69.00
CY2735	DAC, 4 Digit BCD, Low Cost	79.00
CY2737	DAC, 4 Digit BCD, Low Drift	139.00
CY3035	ADC, 8 Bit, Sect. Counting, Low Cost	89.00
CY3635	ADC, 3 Digit BCD, Sect. Count, Low Cost	119.00

## LED's

.125" dia.

209	Red	\$ .25
209	Yellow	.35
209	Green	.35

.160" dia.

216	Red	.25
216	Yellow	.30
216	Green	.30

.200" dia.

220	Red	.25
220	Yellow	.30
220	Green	.30

## LOW PROFILE

226	Red	\$ .25
226	Yellow	.30
226	Green	.30
226	Orange	.30

5053	Red	\$ .35
5053	Yellow	.40
5053	Green	.40
5053	Orange	.40

216 = MV5024  
5053 = MV5053

## Linear IC's

LM114H	TO-5	\$ 3.00
LM301A	TO-5	.90
LM301AM	Mini-dip	.75
LM301AN	Dip	1.10
LM302H	TO-5	.95
LM302N	Dip	1.40
LM306H	TO-5	2.80
LM307H	TO-5	.90
LM307M	Mini-dip	.90
LM308H	TO-5	1.20
LM308AH	TO-5	5.00
LM310H	TO-5	1.40
LM311H	TO-5	1.70
LM318H	TO-5	2.50
LM555CM	Mini-dip	.90
LM709CH	TO-5	.45
LM709CN	Dip	.45
LM710CH	TO-5	.60
LM710CN	Dip	.75
LM715CH	TO-5	4.30
LM725CH	TO-5	5.00
LM733CH	TO-5	1.50
LM733CN	Dip	1.50
LM741CH	TO-5	.45
LM741CM	Mini-dip	.44
LM747CH	TO-5	1.90
LM747CN	Dip	.90
LM748CN	Dip	.40
LM3046CN	Dip	.95
LM3054CN	Dip	1.50

## Phase Locked Loops

LM567CM	Mini-dip	2.10
---------	----------	------

## IC Power Regulators

LM335K: 5V, 600mA	2.40

# Slep Electronics

**NOW SHIPPING!**

# has Antennas

CUSHCRAFT

A-147-4	146-148 MHz 4EL BEAM	\$14 50
A-147-11	146-148 MHz 11EL BEAM	23.95
A-147-22	146-148 MHz 22EL BEAM	68.50
AFM-4D	144-148 MHz J POLE	52.50
ARX-2	135-170 MHz RINGO RANGER	26.50
ARX-2K	CONVERTS AR-2 RINGO TO ARX-2 RANGER	10.95
ARX-220	220-225 MHz RINGO RANGER	26.50
ARX-450	435-450 MHz RINGO RANGER	26.50
DGPA	30-50 MHz GROUND PLANE	21.95
DGPB	108-170 MHz GROUND PLANE	19.95
LAC-1	COAX LIGHTNING ARRESTOR PL-259, SO239 EACH END	4.50

## ANTENNA SPECIALISTS

ASP-558	MOBILE ANTENNA MAGNETIC MOUNT, POSITIVE MOUNT ON ROOF OR DECK. DRILL NO HOLES, 5/8 WAVELENGTH, 3 DB GAIN 51" WITH COIL AND SPRING 17' RG-58/U SUPPLIED 130-170 MHZ	35.00
HM-181	6 METER TRUNK MOUNT MOBILE ANTENNA 3DB, 49" LONG, 17' RG-58/U, SPRING AND LOADING COIL	30.00
HM-182	6 METER SNAP-IN MOUNT MOBILE ANTENNA 3DB, 49" LONG, 17' RG-58/U, SPRING AND MOUNT	26.00
HMR-173	11EL YAGI 2 METER FM RATED 500 WATTS, F/G 130B, F/B 16DB, BANDWIDTH 4MHZ BEAMWIDTH 36 DEGREES LENGTH 17', ADJUSTABLE GAMMA MATCH	46.00

## MINI-PRODUCTS

HQ-1	HYBRID QUAD, EL LENGTH 11 FT., BOOM 4½ FT., TUNING RADIUS 6'2', WT. 15 LBS., COVERS 6, 10, 15, & 20 METERS 1200W PEP, F/B RATIO 12/17DB	94.50
B-24	2EL MINIATURE BEAM 6, 10, 15 AND 20 METERS WT. 13 LB., F/B 6/8DB, EL LENGTH 11 FT., BOOM 5 FT.	69.95
RK-3	THIRD ELEMENT ADD ON FOR B-24, GIVES EXTRA 3DB GAIN	42.50
C-4	VERTICAL HEIGHT 11½ FT., 1200 W PEP COVERS 6, 10, 15, AND 20 METERS, FULL HALF WAVE ON ALL BANDS CAN BE MOUNTED TO ROOM OR CHIMNEY	42.50

## MOSLEY

Classic 33	3 ELEMENT CLASSIC BEAM 10, 15, 20 MTR. 2KW PEP	220.00
TA-31	ROTARY DIPOLE 10, 15, 20, SINGLE ELEMENT TRAP DIPOLE BOOM LENGTH 23' 11" 2KW PEP	48.00

## HY-GAIN

14AVQ/WB	40 THRU 10 METERS NEW MODEL WITH LATEST HY-Q TRAPS, HEIGHT 18 FT.	65.00
18AVT/WB	80 THRU 10 METERS SAME AS 14AVQ/WB WITH 80 METER COIL MOUNTED ON TOP	95.00
Model 18HT	HY-TOWER 80 THRU 10 METERS, SELF SUPPORTING VERTICAL, 2KW PEP WITH HEAVY DUTY 24' TOWER, TOP MAST EXTENDS TO 50 FEET HINGED BASE ASSEMBLY, REQUIRES NO GUYS. CAN GO ON 160 METERS WITH ADDITION OF A BASE LOADING COIL.	235.00

## NEW-TRONICS HUSTLER

4-BTV	VERTICAL 10, 15, 20, 40 METERS HEIGHT 21'5", 2KW PEP	79.95
RM-75S	SUPER RESONATOR, ADDS 75 METER OPERATION TO 4 BTV OR MOBILE USE	28.95
G6-144A	6DB COLINEAR 140-150 MHZ 1KW FM, VERTICAL ELEMENT 117" LONG. USE TV MAST TO ERECT	52.95
CGT-144	MOBILE 2 METER COLINEAR 5.2 DB GAIN 200 WATT FM, 85" TRUNK LIP MOUNT	39.95

WE PAY SHIPPING TO 50 STATES, APO, FPO, SATISFACTION GUARANTEED OR MONEY BACK, IMMEDIATE SHIPMENT, WRITE OR PHONE BILL SLEP (704) 524-7519.

# Slep Electronics

P.O. BOX 100 DEPT 73  
OTTO, NORTH CAROLINA 28763

# IF YOU CAN SOLDER, YOU CAN BUILD YOUR OWN Clock/Calendar

**SOLID STATE SYSTEMS, INC.** has available a **CLOCK/CALENDAR** kit containing over 120 separate electrical components.

The clear, simplified instructions include step by step construction procedures and ample illustrations which will quickly take you through construction of this versatile Clock/Calendar.

## THE KIT FEATURES:

- ★ **DISPLAY OF DATE WITH MONTH AND DAY** - displays month and day automatically, through year, except for February 29.
- ★ **DISPLAY OF TIME ON 12 HOUR CYCLE** - hours and minutes displayed with A.M. and P.M. indicators.
- ★ **A 24 HOUR ALARM OPTION** - this also includes a snooze button which delays alarm an additional 10 minutes.
- ★ **A 9 HOUR 59 MINUTE TIMING OPTION** - this allows operation of any pluggable 600 watt, 120 volt, 5 amp, 60 Hz electrical device such as a radio, room light, stereo or coffee pot.
- ★ **EASILY VISIBLE SPERRY® DISPLAY** - this display is highly visible in a well lighted room.

An attractive case may be fabricated of wood, plexiglas, metal or whatever you feel would make an appropriate show-case for your finished kit.

## TO ORDER:

Order Number **01-12241** - **BASIC CLOCK** - This kit does not include the 24 hour alarm option or the 9 hour 59 minute appliance timer option. Price .....\$49.95.

Order Number **02-12241** - **COMPLETE CLOCK** - This kit includes all available options. Price .....\$65.00.

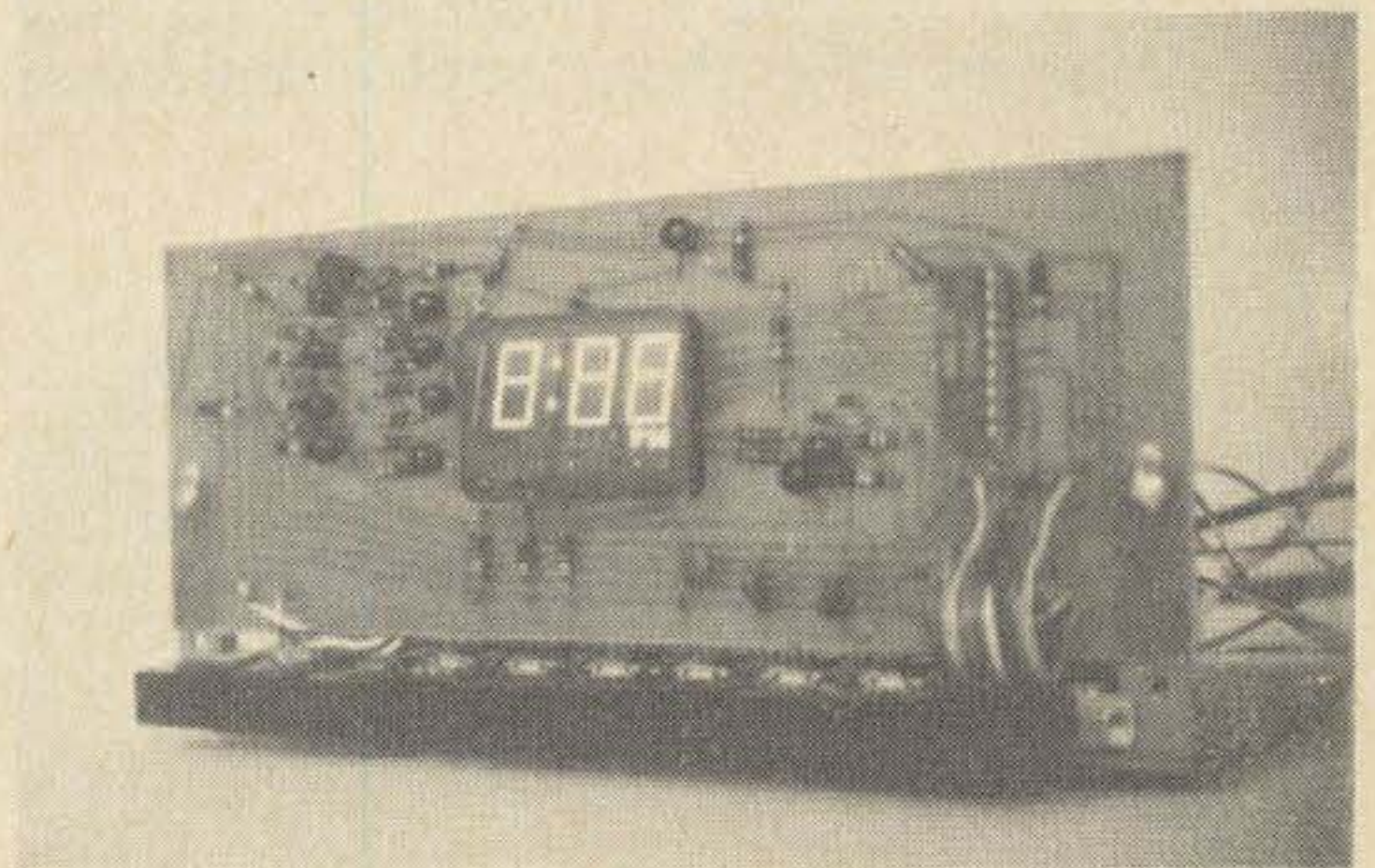

**PLEASE NOTE:** These kits do not include cases.

This kit when completed is a sophisticated device which offers many additional features due to its flexibility, here are two examples of what can be done with this device:

1. You may set the timer to play your radio for 15 minutes at bedtime, then the alarm allows you the option of waking up to the radio in the morning all automatically.
2. You may set the alarm to later start an appliance which will operate for the duration of the setting on the timer.

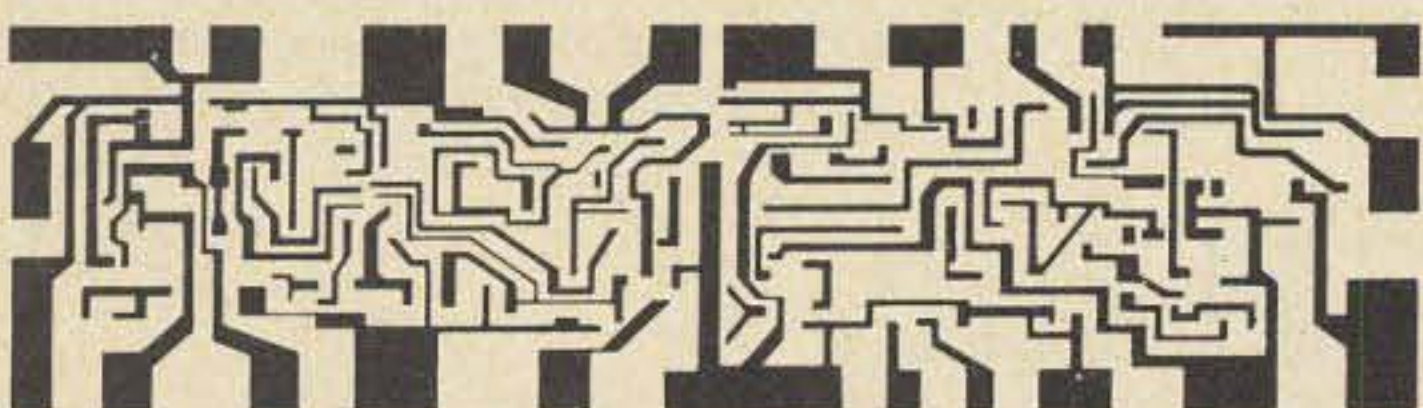

**SOLID STATE SYSTEMS, INC.**

SEND YOUR ORDERS TO:

**SOLID STATE SYSTEMS, INC.**

P. O. BOX 617

COLUMBIA, MISSOURI 65201

OR PHONE (TOLL FREE)

800-325-2981 - 800-325-2983



# DU PAGE FM

**WILL NOT BE UNDERSOLD!**  
*moving day specials*

## HELP US MOVE

We are moving to larger quarters next month so in order to save much backbreaking labor we offer these "such a deal" specials.

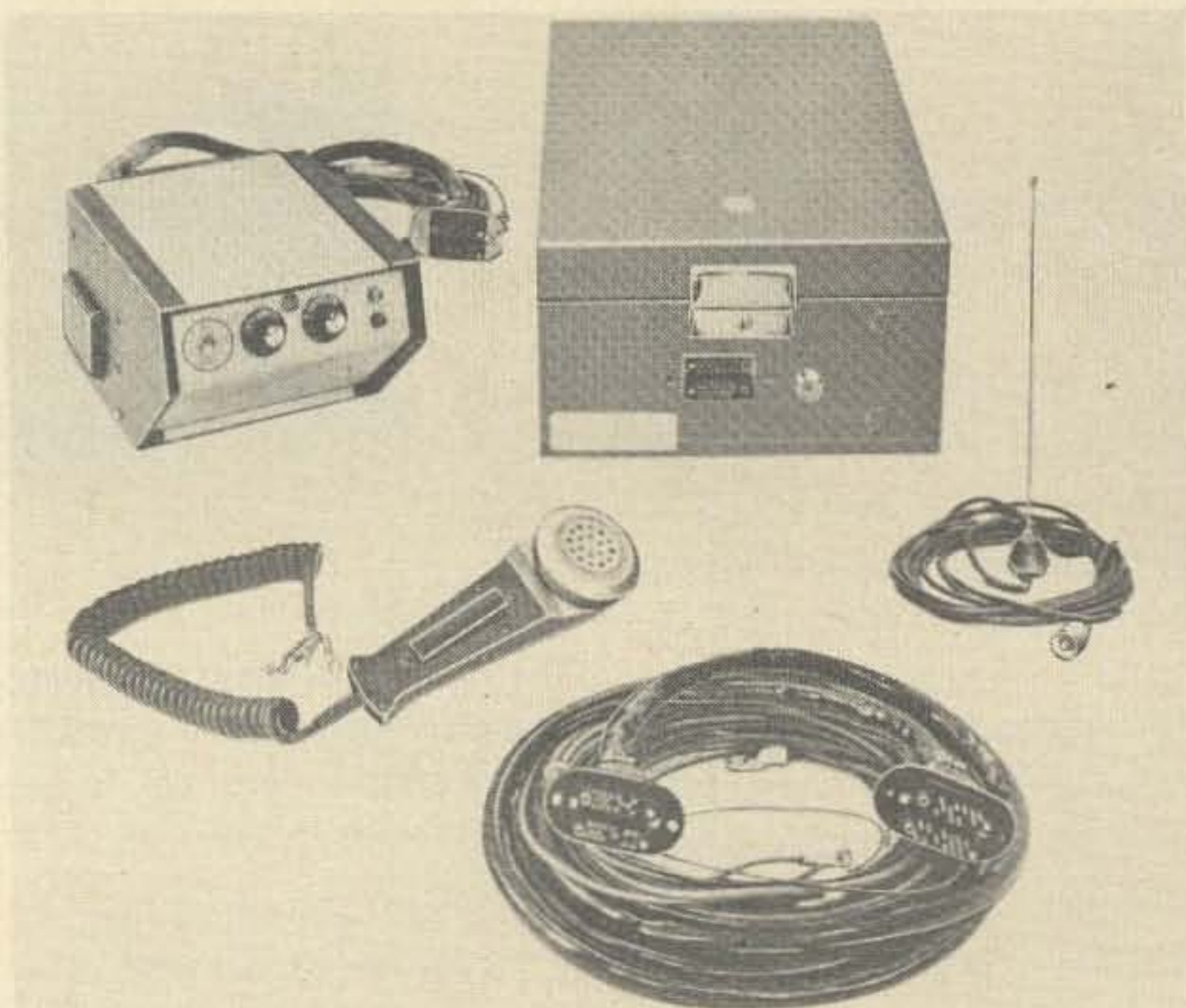

RCA "E" Line model CMCE-30 Thirty watts output on the two meter band. Transistor power supply. Normal price is \$75.00, but in order to move we offer "Such a Deal" for only \$60.00 each

RCA "E" Line model CMUE-15 Fifteen watts output on the 450 mc band. Transistor power supply, normally \$70.00 each, but this is "Such a Deal" at \$50.00 each

General Electric Progress Line Model MT-42. Fifteen watts output on the 450 mc band. Transistor power supply, with accessories, normally \$60.00 each, but this is "Such a Deal" at \$50.00 each.

MOTRAC SPECIAL: Motorola model U43HHT 3100- 152 to 172 mc, Thirty watts output. Transistorized receiver and power supply. With "Private Line" and standard squelch. With accessories, regularly \$285.00, for March only \$225.00 each.

## DU PAGE FM Inc.

P. O. Box 1, Lombard IL 60148, (312) 627-3540

TERMS: All items sold as is. If not as represented return for exchange or refund (our option) shipping charged prepaid within 5 days of receipt. Illinois residents must add 5% sales tax. Personal checks must clear before shipment. All items sent shipping charges collect unless otherwise agreed. Accessories do not include crystals, relay or antennas.

# RGS ELECTRONICS

## 008A MICROCOMPUTER KIT

8008 CPU, 1024 x 8 memory; memory is expandable. Kit includes manual with schematic, programming instructions and suggestions; all ICs and parts supplied except cabinet, fuses & hardware. Includes p.c. board. \$375.00

MANUAL ONLY, \$25.00

**"THE CUBE"** Fully assembled subaudible tone generator for small handheld or portable FM radios. 9-16 volts; no moving parts; set anywhere between 98 & 240 Hz with a trim resistor.

.5" x .6" x .7" \$19.95

Set on frequency by the factory, \$5.00 extra

## 008A-K ASCII KEYBOARD INPUT KIT

Includes keys, p.c. board, all ICs, power supply, instructions, schematic. Intended to interface ONLY with the RGS Electronics 008A Microcomputer.

\$75.00

**PS 5-1** 5v 1a regulated power supply kit with p.c. board & instructions. Board measures 2" x 5", completed kit is 2" high. Transformer has internal r.f. shield. \$8.00

TTL			
7400	\$ .20	7485	\$1.40
7401	.20	7486	.50
7402	.20	7489	2.90
7403	.20	7490	.80
7404	.25	7492	.80
7405	.25	7493	.80
7406	.45	7495	.90
7407	.45	7496	.85
7408	.25	74107	.50
7409	.25	74121	.60
7410	.20	74122	.60
7411	.30	74123	1.10
7413	.85	74125	.65
7416	.45	74126	.65
7417	.45	74141	1.25
7420	.20	74150	1.70
7430	.20	74151	1.00
7432	.30	74153	1.40
7437	.50	74154	1.70
7438	.50	74157	1.40
7440	.20	74161	1.50
7442	1.10	74163	1.70
7446	1.45	74164	2.00
7447	1.45	74165	2.00
7448	1.45	74166	1.75
7450	.20	74174	2.20
7451	.20	74175	2.20
7453	.20	74176	1.60
7454	.20	74177	1.35
7473	.45	74181	3.90
7474	.45	74192	1.50
7475	.80	74193	1.45
7476	.50	74195	1.00
7483	1.10	74200	8.00

**PS 25-1** 0 to 25v 1a lab type power supply with adjustable current limiting; remote sensing & remote programming for voltage & current. Instructions included. All parts except chassis, meter(s), p.c. board. Kit of parts with schematics \$14.95

P.C. boards available, No. 007 \$3.00 ea

✱ We have brand new 8038 function generators ✱ \$5.25 ea

## BRAND NEW ALUM. ELECTROLYTIC CAPS, RADIAL LEAD

	10wv	35wv	50wv
1mfd	\$ .10	\$ .12	\$ .15
2mfd	.10	.12	
5mfd	.10	.12	
10mfd	.11	.13	.16
30mfd	.12	.20	.28
50mfd	.13		
100mfd	.15	.30	.45
200mfd	.20		.70
500mfd	.28	.75	
1000mfd	.50		

## TRANSISTORS

	1-9	10+
2N2222 (NPN) TO-18	\$ .25	\$ .20
2N2907 (PNP) TO-18	.25	.20
TO-92 general purpose NPN & PNP transistors, beta > 100, breakdown > 40v	\$ .08 each	\$5.95/100

## JUNCTION FETs, TO-18

### N-CHANNEL:

NJF10  
NJF11  
NJF12  
NJF13  
NJF14

### SIMILAR TO:

2N4416, MPF102 3/\$1.00  
2N4091-93 4/\$1.00  
2N4338-41 4/\$1.00  
2N3089 3/\$1.00  
2N4221-22 4/\$1.00

### P-CHANNEL

PJF11  
PJF14

2N3382-86 4/\$1.00  
2N2608 4/\$1.00

All FETs come with data sheets.

## RGS ELECTRONICS

3650 Charles St., Suite K ■ Santa Clara, CA 95050 ■ (408 247-0158)

*We sell many ICs and components not listed in this ad. Send a stamp for our free flyer. TERMS OF SALE: All orders prepaid; we pay postage. \$1.00 handling charge on orders under \$10.00. California residents please include sales tax. Please include name, address and zip code on all orders and flyer requests. Prices subject to change without notice.*

**DISCOUNTS:** 10% OFF ORDERS OVER \$25.00; 20% OFF ORDERS OVER \$250.00.

# COMMUNICATIONS UNLIMITED

9519 MAIN STREET  
P.O. BOX 463  
WHITMORE LAKE, MICHIGAN 48189  
(313) 449-4367

## DC-TO-LIGHT COMMUNICATIONS EQUIPMENT

HAM, CB, TV ANTENNAS • HAM, BUSINESS, CB RADIOS • MONITOR  
SCANNER RADIOS • PARTS, VIDEO TAPE RECORDERS, RECORDING  
TAPE • HI-FI EQUIPMENT • POWER SUPPLIES • TEST EQUIP-  
MENT • VHF – UHF REPEATERS • RADIOS • HANDI-TALKIES

IN STOCK: Standard, Regency, Clegg, ITC, ICOM, Motorola, SBE, CushCraft, Larsen, Antenna Specialists, M-Tech, Hy-Gain, Hustler, RP, GLB and many other fine brands of amateur radio equipment.

PL Boards and Reeds. Thousands of special micro and mini parts for builders, repair or experimentation...including thousands of imported parts for repair of imported radio and TV equipment.

CITIZENS BAND RADIOS IN STOCK INCLUDE... Johnson, Royce, Robyn, Browning, SBE, Regency, Sonar.

SCANNING MONITORS... Regency, Robyn, Sonar.

POLICE RADAR UNITS... Police radar detectors!... Mobile tele-  
phones... Amplifiers.

BUSINESS RADIO EQUIPMENT INCLUDING... Sonar, Regency, Standard, Phelps Dodge, Sinclair, Antenna Specialists, Heights Tower, Larsen, TPL.

TEST EQUIPMENT... Bird, Singer, Lampkin, Girsch, Vega, Radio Specialty, Eldorado, Secode Spectrolab.

TV CAMERA KITS... Custom Designed. Home/Office Burglar – Hold Up – Security Alarms Video Surveillance Equipment.

Service of COMMERCIAL/HAM/CB Radio Equipment, Video Cameras, Recorders, Monitors and related equipment.

Stamp-it etch-it printed circuit kits. Circuit board. Mobile antennas, base station antennas, walkie-talkies, color and black/white video recorders. TV cameras, speakers, earphones, transformers, motors, tape heads, if transformers, capacitors; fixed and variable, transistors, resistors, pots, chassies, meters, switches, coils, ferrite rods, telescoping antennas, relays, plugs and jacks, diodes, ICs, trimmer caps, crystals and crystal sockets, recording tape, phono and tape belts and wheels, power cords, MIC cords, microphones, yokes, tubes, CRTs, battery chargers and eliminators, lights, fuses, hardware, batteries, dial cord and springs, car lighter plugs, TV monitors, TV lenses, CCTV connectors, coax cable, noise filters, books, magazines, freebies, phasing harnesses, repeaters, used radio equipment, special parts not available anywhere else for imported equipment. Micro resistors and capacitors for Motorola HTs and other equipment. Rubber ducky antennas, knobs, equipment handles, tape player parts, auto radio parts, PA speakers and much more.

## SPECIALTY & NEW ITEMS DAILY

VISIT OUR STORE VISIT OUR STORE VISIT OUR STORE VISIT OUR STORE



# GODBOUT

BILL GODBOUT ELECTRONICS  
BOX 2673, OAKLAND AIRPORT, CA 94614

## kits

electronic components  
+ circuit board  
+ schematic

### CLOCK CLOSEOUT - \$23.73

brings you ppd. (1) 6 - 1/8" digits  
(2) black anodized case (3) 50/60  
Hz operation and 12/24 hr oper.  
Look for our new model in mid-  
75 with internal time base and  
AC or DC operation.

### CMOS XTAL TIME BASE

For \$13.95 + shipping you get  
a portable, ultra-low power  
time base with a 60 Hz square  
wave output. Makes your line  
time base equipment (clocks,  
freq counters, etc.) independ-  
ent of power line timing.

### 12 VOLT 8A RETROFIT KIT

Updates the 1974 12V 8A kit.  
Adds current limiting, short cir-  
cuit protection, and adjustable output from 11-14 VDC. Includes  
new regulator circuitry w/ p.c. board and Darlington series  
pass element for \$7.50 ppd.

## WE-NEED-A-NEW-TYPEWRITER SPECIALS(LIM. TIME)

95H90 hi-speed prescaler \$7.50

4140 dual 709 op amp 10/\$1

"What this country needs is a good  
5¢ op amp" - and we got it. With  
application notes. Save more! 60/\$5

## FROM OUR FLYER

8008 8 bit CPU.....\$50.00

G5203 2048 bit EROM...\$19.95

SPECIAL = 1-8008 1-G5203 EROM

+ 8 - G2102/2602 STATIC RAMS \$130.00

1595 4 QUAD MULT.....\$1.10

1596 BALANCED MOD.....\$1.25

8 pc. trimpot kit 1 ea. 500Ω -

1K - 2.5K - 3K - 5K - 10K - 50K - 100K

8 trimpots for \$1.00 (or 20¢ each)

**MICROSWITCH KEYBOARD** type

53RW4-1 53 key full alpha-

numeric, brand new.....\$19.95

## FLYER NOW AVAILABLE! SEND FOR IT.

If you include (1) a self-stick label (and it better be self-  
sticking, too) and (2) a 10¢ stamp, we'll send you a flyer  
and a free 4140 to play with. **TERMS:** Include 50¢  
for orders under \$10. Include postage on items where indicated;  
all other items shipped **POSTPAID** (on orders over \$10). California  
residents add sales tax. Sorry, no COD orders. Our flyer  
lists TTL, CMOS, linears, passive components, optoelectronics, and more...



artwork:  
CAVE  
grafix

# mitScope

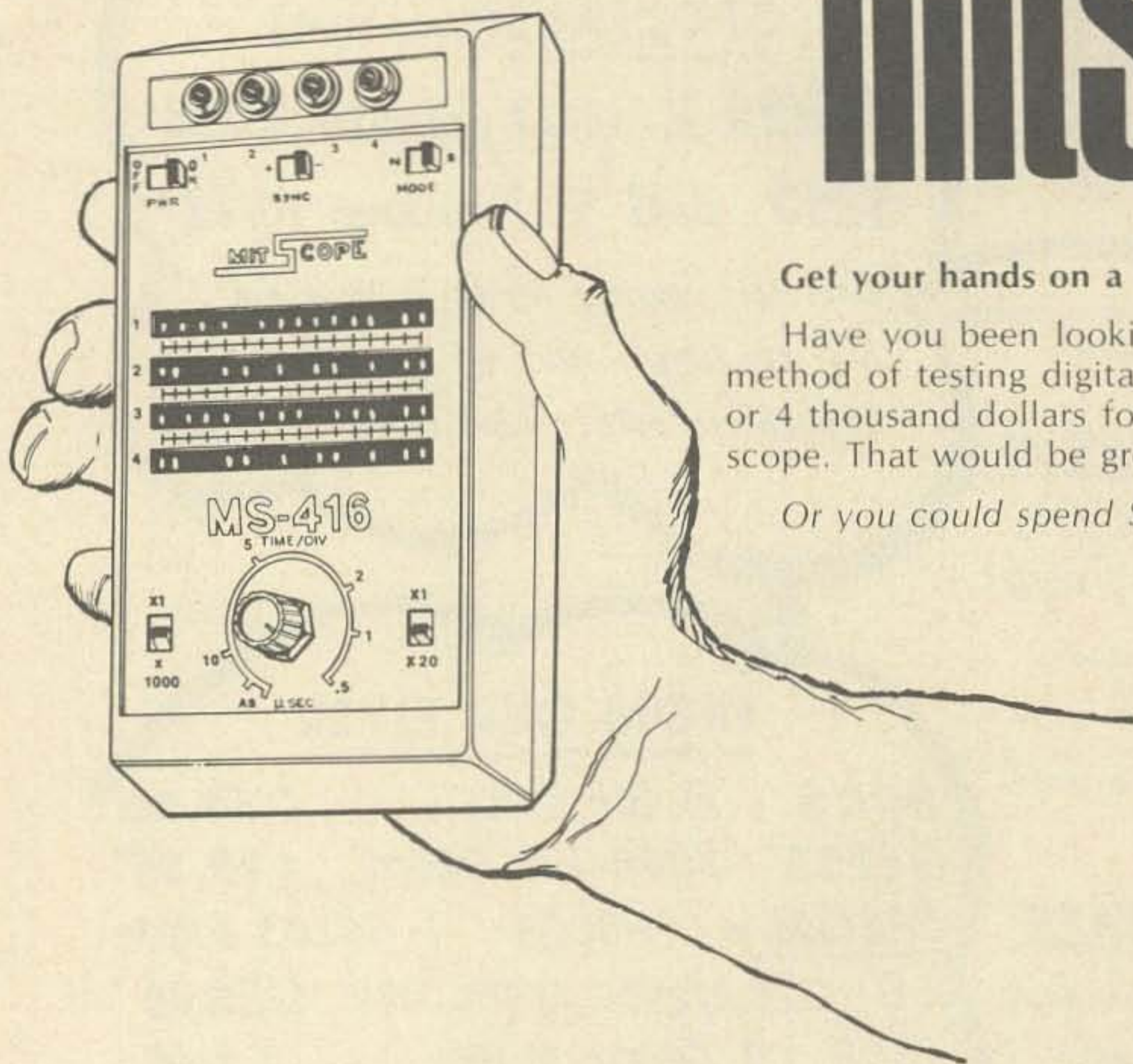

## Get your hands on a MitScope!

Have you been looking for a convenient, inexpensive method of testing digital circuitry? You could shell out 3 or 4 thousand dollars for a four channel, storage oscilloscope. That would be great—if you can afford it.

*Or you could spend \$189.50 for a MitScope.*

### What's a MitScope?

A MitScope is a four channel, digital logic (DTL, TTL) oriented scope with full memory capability. Its time-base range (.5 microseconds to 200 milliseconds) will cover most digital circuit needs. Its four channels allow observation of extensive timing relationships.

In addition to the normal mode of operation, the MitScope can be switched into storage operation at any time during testing. This mode serves as an excellent pulse catcher for those elusive, one-time occurring pulses.

### How does it work?

The MitScope signal is displayed on a four-line, sixteen-row LED matrix; one line for each channel. The information on the display is interpreted in much the same manner as that of an ordinary oscilloscope.

### 30 Day Trial Offer

To help convince you, MITS is making this special offer. Buy an assembled MitScope. If you aren't satisfied, return it within 30 days and we will refund your money (excluding postage and handling charge).

**PRICE:** \$189.50 assembled. \$127.50 kit.

Price includes nicad battery and charger, 4 probes and case.

**MITS** INC.

"Creative Electronics"

Warranty: 90 days on parts and labor for assembled units.

90 days on parts for kits.

Prices and specifications subject to change without notice.

Enclosed is a Check for \$ \_\_\_\_\_

or  BankAmericard # \_\_\_\_\_

or  Master Charge # \_\_\_\_\_

Credit Card Expiration Date \_\_\_\_\_

Include \$5.00 for Postage and Handling

MS-416    Assembled    Kit

Please send information on Entire MITS Line.

NAME \_\_\_\_\_

ADDRESS \_\_\_\_\_

CITY \_\_\_\_\_

STATE & ZIP \_\_\_\_\_

MITS / 6328 Linn, N.E., Albuquerque, New Mexico 87108 505/265-7553

3-75-73

**T T L**

**CMOS**

7400*	6/\$1.00	7488	4.00	CD4001	\$ .55
7401	.23	7489*	2.25	CD4002	.55
7402	.23	7490*	.69	CD4007	1.25
7403	6/1.00	7491*	1.00	CD4009	1.40
7404	.25	7492	.95	CD4010	.60
7405	.24	7493	.95	CD4011	.55
7406	.50	7494	.97	CD4012	.55
7407	.50	7495	.95	CD4013	1.50
7408	.25	7496	.95	CD4016	1.40
7409	.25	74100	1.50	CD4017	2.75
7410*	6/1.00	74107	.47	CD4019	1.25
7411	.30	74121	.55	CD4020	1.50
7412	.40	74122	.47	CD4022	2.50
7413*	.75	74123	1.05	CD4023	.55
7416	.45	74125	.60	CD4025	.55
7417	.45	74126	.80	CD4027	1.25
7418	.25	74141	1.15	CD4030	.60
7420	.23	74145	1.15	CD4035	2.75
7421	.27	74150	.95	CD4049	1.25
7423	.32	75151	1.20	CD4050	1.25
7425	.27	74153	1.50	74C00	.45
7426	.31	74154	1.25	74C02	.45
7427	.32	74155	1.30	74C04	.70
7429	.40	74156	1.30	74C20	.65
7430	.33	74157	1.55	74C74	1.15
7432	.26	74160	1.65	74C160	3.25
7437	.45	74161	1.65	74C161	3.25
7438	.50	74163	2.50	74C107	1.50
7439	.50	74164	2.50	74C151	2.90
7440	.23	74165	2.50	74C154	3.50
7441	1.10	74166	1.75	74C163	3.25
7442	1.05	74170	3.00	74C164	3.50
7443	1.10	74173	1.75	74C173	2.90
7444	1.15	74174	1.85	74C195	3.00
7445	1.10	74175	1.85		
7446	1.25	74176	.85		
7447*	.89	74177	.85		
7448	1.25	74180*	1.00	(Zener) DIODES (Rectifier)	
7450	.25	74181	3.75	IN456	6/\$1
7451	.27	74182	1.00	IN458	6/\$1
7453	.27	74184	2.30	IN485A	5/\$1
7454	.40	74185	2.30	IN746	4/\$1
7459	.25	74187	7.00	IN752	4/\$1
7460	.25	74190	1.50	IN1183	1.60
7470	.45	74191	1.50	IN1184	1.70
7472	.41	74192*	1.25	IN1186	1.80
7473*	.39	74193*	1.25	IN3600	6/\$1
7474	.47	74194	1.50	IN4001	.09
7475*	.75	74195	1.05	IN4002	.10
7476*	.40	74196	1.25	IN4004	.10
7480	.50	74197	1.05	IN4148	15/\$1
7482	1.75	74198	2.25	IN4154	12/\$1
7483	1.15	74199	2.75	IN4734	.28c
7485*	1.10	74200	7.00	IN4735	.28c
7486	.47	84250	5.00	IN5232	.28c
				IN5234	.28c
				IN5243	.28c
				IN5282	5/\$1

20% Discount for 100 pcs.  
Combined 7400's  
(except Specials)

**\* MARCH SPECIALS**

1101	256 Bit Ram Mos	\$ 2.95
2102	1024 Bit Ram	8.00 ea.
8008	8 Bit Processor	60.00

**Miniature Aluminum Electrolytic Capacitors**

MFD-VOLTS			MFD-VOLTS		
1-	9-	100	1-	9-	100
1 UFD/50V	14c	12c	11c	100 UFD/16V	19c 15c 14c
2.2 UFD/50V	14c	12c	11c	100 UFD/25V	24c 18c 17c
3.3 UFD/25V	14c	12c	11c	220 UFD/16V	24c 18c 17c
4.7 UFD/25V	14c	12c	11c	220 UFD/25V	35c 25c 24c
10 UFD/16V	14c	12c	11c	330 UFD/16V	35c 25c 24c
10 UFD/25V	14c	12c	11c	330 UFD/25V	44c 35c 32c
22 UFD/16V	14c	12c	11c	470 UFD/16V	37c 30c 27c
22 UFD/25V	15c	13c	12c	470 UFD/25V	49c 39c 35c
33 UFD/16V	15c	12c	11c	1000 UFD/16V	49c 39c 35c
33 UFD/25V	17c	13c	12c	1000 UFD/25V	75c 60c 55c
47 UFD/16V	17c	14c	13c	2200 UFD/16V	75c 60c 55c
47 UFD/25V	19c	15c	14c		

**Axial or Radial Lead Type**

**50 VOLT CERAMIC DISC CAPACITORS**

.001 mf.	5c	3.5c	3c	.033 mf.	6c	4c	3.5c
.0047 mf.	6c	4c	3.5c	.047 mf.	6c	4c	3.5c
.01 mf.	5c	3.5c	3c	.1 mf.	12c		7.5c
.022 mf.	6c	4c	3.5c	100 pf	6c	4c	3.5c

MPS-A05 5/\$1 TRANSISTORS			
2N918	.25	2N2906A	4/\$1
2N2219A	3/\$1	2N2907A	5/\$1
2N2221A	4/\$1	2N3053	2/\$1
2N2222A	5/\$1	2N3724A	2/\$1
2N2369	5/\$1	2N3725A	2/\$1
2N2369A	4/\$1	2N3903	5/\$1
2N2484	4/\$1	2N3904	4/\$1

**CALCULATOR & CLOCK CHIPS w/data**

5001 LSI	40 pin DIP	4 funct	\$3.95
5005 LSI	28 pin DIP	4 funct w/mem	6.95
5030	28 pin	one Chip Calculator	7.95
MM5311	28 pin bcd	6 dig Mux	5.95
MM5312	24 pin	1 pps BCD 4 dig mux	5.95
MM5313	28 pin	1 pps BCD 6 dig mux	5.95
MM5314	24 pin	6 dig mux	5.95
MM5316	40 pin	alarm 6 dig	6.95

Satisfaction Guaranteed. All Items 100% Tested  
\$5.00 Min. Order - 1st Class Mail - No Charge  
California Residents - Add 6% Sales Tax  
Wholesale Outlets - Write for Special Discounts  
Write for FREE 1975 Catalog - Data Sheets .25¢ each

**JAMES**  
P.O. BOX 822, BELMONT, CA. 94002  
PHONE ORDERS - (415) 592-8097

**LINEAR**

LM300		\$ .79
LM301H/N*		3/1.00
LM302H	Voltage Follower	.79
LM304H	Negative Volt Reg	.89
LM305H	Positive Volt Reg	1.00
LM307H/N	Op Amp (Super 741)	.35
LM308H/N	Micro Power Op Amp	1.15
LM309K*	5 Volt Regulator/Amp	1.25
LM310H	Imprd Volt Follower	1.19
LM311H/N	Hi-perform Volt Comp.	1.00
LM318N	Hi-Speed Op Amp	2.00
LM320K	-5V 5.2V 12V 15V-24 Neg. Reg.	1.75
LM324N	Quad 741 Op Amp	1.90
LM339N	Quad Comparator	2.35
LM340K	+5V 12V 15V 24V Pos. Reg.	1.89
LM340T	+5V 12V 15V 24V Pos. Reg.	1.75
LM370N	A 6 C - Squelch Amp	1.15
LM373N	AM/FM \$\$ B Strip	3.15
LM380N*	2 Watt Audio Power Amp	1.25
LM380-8N*	.6 Watt Audio Amp	1.00
NE531T	OP Amp	3.00
NE550N	Volt. Reg.	.79
LM555V*	Timer	.75
NE565H*	Phase Lock Loop (TO5)	1.75
LM565N*	Phase Lock Loop (DIL)	2.00
LM566CN*	Function Generator	2.00
LM567H*	Tone Generator (TO5)	1.75
LM567CN	Tone Generator (MINI)	2.00
LM703H	RF/IF Amp	.45
LM723H/N*	Voltage Regulator	.55
LM741H/N*	Comp. Op Amp	3/1.00
LM747H/N	Dual Compen. Op Amp	.90
LM1310P	Stereo Demodulator	4.10
LM1458N	Dual Comp. Op Amp	.65
LM1556N*	5 Times Faster 741	1.85
LM2307P	Current Controlled	3.15
LM3065N	T.V.-FM Sound System	.75
LM3900N*	Quad Amp	.50
LM3905N*	Precision Timer	.65

PROJECTS	LEDS	8000 Series
8263 \$ 7.00	MV 10 5/1	8090-98 .55
8267 4.00	MV 50 6/1	8123 1.50
2513* 11.00	MV 5024 5/1	8223* 3.00
2518 7.00	MAN-1 1.95	8263 7.00
2519 4.00	MAN-3 .95	8267 4.00
2524* 5.00	MAN-4 1.95	8280 .75
2525 7.00	MAN-7 1.50	8281 .85
2529* 4.00	DL 33 1.95	8288 1.15
4024P* 2.25	DL747 2.50	8880 1.35

CHARGE IT  
ON



CHARGE IT  
ON

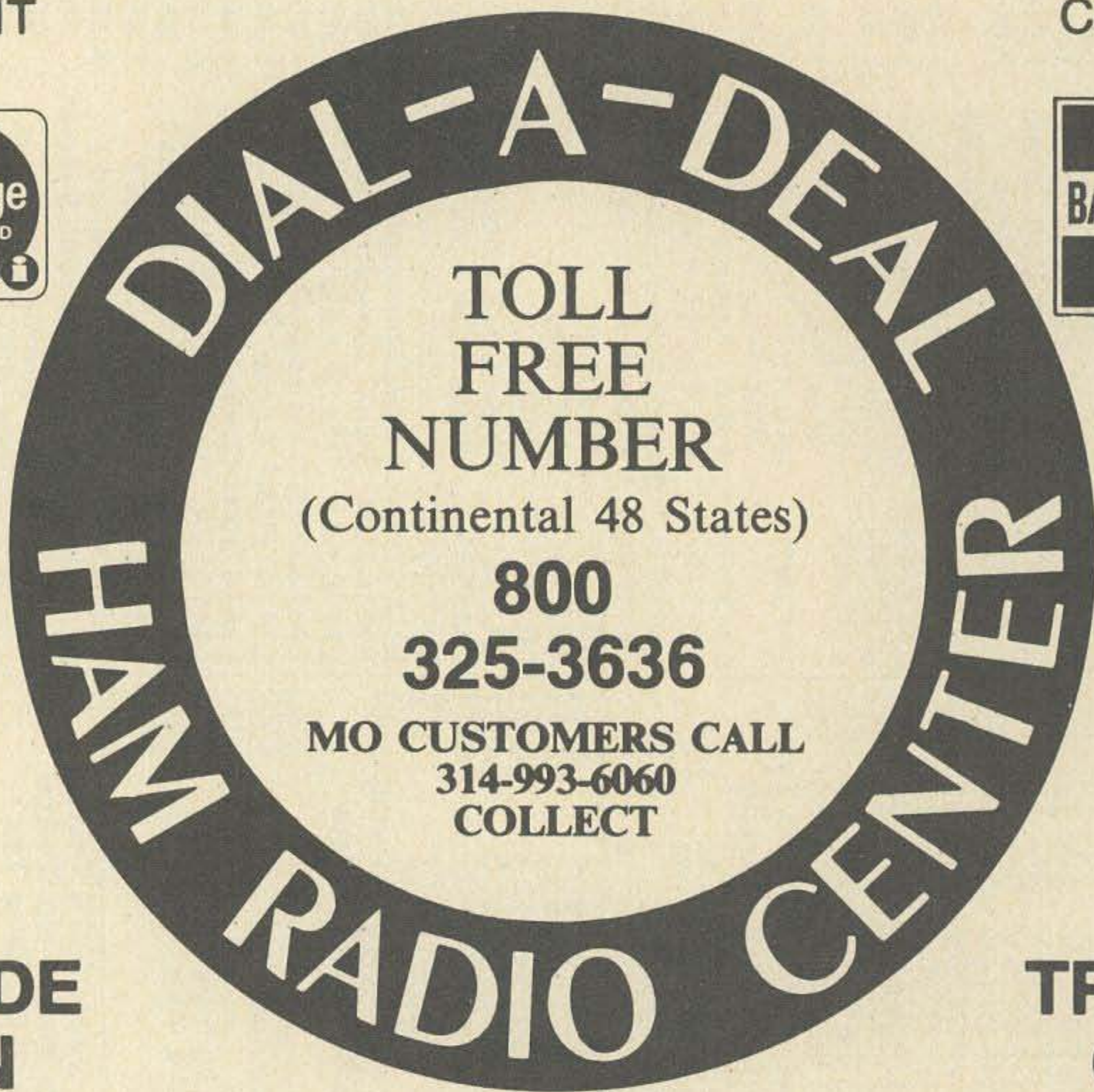

**CALL  
FREE**

**CALL  
FREE**

**TOLL  
FREE  
NUMBER**

(Continental 48 States)

**800  
325-3636**

**MO CUSTOMERS CALL  
314-993-6060  
COLLECT**

**TRADE  
ON  
NEW**

**TRADE  
ON  
USED**

**CALL**

**HAM RADIO CENTER**

*(9 A.M. – 5 P.M. Central, Closed Sunday and Monday)*

**FOR  
A SQUARE DEAL  
ON**

- **DRAKE**
- **TEMPO/ONE**
- **TEN/TEC**
- **CLEGG**
- **STANDARD**

- **YAESU**
- **SWAN**
- **COLLINS**
- **KENWOOD**
- **REGENCY**

*We carry all major brands and a large stock of used reconditioned equipment*

**HAM RADIO CENTER INC.**

**8342 OLIVE BL.**

**P.O. BOX 28271**

**ST. LOUIS MO 63132**

# INTERNATIONAL ELECTRONICS UNLIMITED

## MARCH SPECIALS

5001	12 DIG 4 funct fix dec	\$2.95	1103	256 bit RAM MOS	\$2.95
5002	Same as 5001 exc btry pwr	4.95	5260	1024 bit RAM	2.95
5005	12 DIG 4 funct w/mem	6.95	5261	1024 bit RAM	2.95
5725	8 DIG 4 funct chain & dec	2.25	5262	2048 bit RAM	7.95
5736	18 pin 6 DIG 4 funct	4.45	2102	1024 bit static RAM	6.95
5738	8 DIG 5 funct K & Mem	4.95	5203	UV Eras.	19.85
5739	9 DIG 4 funct (btry sur)	4.95	HP50827414	4 digit common cathode	
5311	28 pin BCD 6 dig mux	4.95		Fits 14 pin DIP - .11 bubble lens	2.75
5312	24 pin 1 pps BCD 4 dig mux	4.95	MAN 7	Red 7 seg .270"	.99
5313	28 pin 1 pps BCD 6 dig mux	4.95	MAN 66	Red .6" spaced seg	3.50
5314	24 pin 6 dig mux	4.95	MAN 6	Red .6" solid seg	4.25
5316	40 pin alarm 4 dig	5.95	8008	8 bit CPU prime quality	64.50

### TTL

7400	\$ .19	7485	\$ 1.39
7401	.19	7486	.44
7402	.19	7489	2.75
7403	.19	7490	.76
7404	.22	7491	1.29
7405	.22	7492	.79
7406	.39	7493	.79
7407	.39	7494	.89
7408	.25	7495	.89
7409	.25	7496	.89
7410	.19	74105	.49
7411	.29	74107	.49
7413	.79	74121	.57
7415	.39	74122	.53
7416	.39	74123	.99
7417	.39	74125	.69
7420	.19	74126	.79
7422	.29	74141	1.23
7423	.35	74145	1.15
7425	.39	74150	1.09
7426	.29	74151	.89
7427	.35	74153	1.29
7430	.22	74154	1.59
7432	.29	74155	1.19
7437	.45	74156	1.29
7438	.39	74157	1.29
7440	.19	74161	1.39
7441	1.09	74163	1.59
7442	.99	74164	1.89
7443	.99	74165	1.89
7444	1.10	74166	1.65
7445	1.10	74173	1.65
7446	1.15	74175	1.89
7447	1.15	74176	1.65
7448	1.15	74177	.99
7450	.24	74180	1.09
7453	.27	74181	3.65
7454	.39	74182	.89
7460	.19	74190	1.59
7464	.39	74192	1.49
7465	.39	74193	1.39
7472	.36	74194	1.39
7473	.43	74195	.99
7474	.43	74196	1.85
7475	.75	74197	1.15
7476	.47	74198	2.19
7483	1.11	74199	2.19

Data sheets supplied on request  
Add \$.50 for items less than \$1.00

### CMOS

74C00	\$ .39	74C154	3.50
74C02	.55	74C157	2.19
74C04	.75	74C160	3.25
74C08	.75	74C161	3.25
74C10	.65	74C163	3.25
74C20	.65	74C164	3.50
74C42	2.15	74C173	2.90
74C73	1.55	74C195	3.00
74C74	1.15	80C95	1.50
74C76	1.70	80C97	1.50

### 4000 SERIES RCA-EQUIV.

CD4001	\$ .55	CD4017	2.95
CD4009	.85	CD4019	1.35
CD4010	.85	CD4022	2.75
CD4011	.55	CD4023	.55
CD4012	.55	CD4025	.55
CD4013	1.20	CD4027	1.35
CD4016	1.25	CD4035	2.85

### LINEAR CIRCUITS

301	Hi perf. op amp	mDIP	\$ .32
307	Op amp	mDIP	.35
308	Micro-pwr op amp	mDIP	1.10
309K	5V reg 1A	TO-3	1.65
310	V follr. Op Amp	mDIP	1.19
311	Hi perf. V comp	mDIP	1.05
319	Hi-speed dual comp	DIP	1.29
320	Neg. regulator (5V, 5.2V, 12V, 15V)	TO3	1.35
322	Prec. timer	DIP	1.59
324	Quad op amp	DIP	1.95
339	Quad comp	DIP	1.69
340T	Pos V reg (5V, 6V, 8V, 12V, 15V, 18V, 24V)	TO-220	1.95
372	AG-IF strip det	DIP	.79
376	Pos V reg	mDIP	.59
377	2 w stereo amp	DIP	2.69
380	2w audio amp	DIP	1.49
380-8	.6w audio amp	mDIP	.89
381	Lo noise dual preamp	DIP	1.79
550	Prec. V reg	DIP	.79
555	Timer	mDIP	.99
560	Phase locked loop	DIP	2.75
562	Phase locked loop	DIP	2.65
565	Phase locked loop	DIP	2.65
566	Function gen	mDIP	2.75
567	Tone decoder	mDIP	2.95
709	Op amp	DIP	.29
710	Hi speed V comp	DIP	.39
723	Volt reg.	DIP	.69
739	Dual hi perf amp	DIP	1.19
741	Comp. op amp	mDIP	.35
747	Dual 741	DIP	.79
748	Freq adj 741	mDIP	.39
1304	FM mux st demod	DIP	1.19
1307	FM mux st demod	DIP	.82
1458	Dual Comp op amp	mDIP	.69
3900	Quad amp	DIP	.65
7524	Core mem sense amp	DIP	1.89
7525	Core mem sense amp	DIP	.95
7535	Core mem sense amp	DIP	1.25
75451	Dual prl. driver	mDIP	.39
75452	Dual prl. driver	mDIP	.39
75453	Dual prl. driver	mDIP	.39
75491	Quad seq driver	DIP	.79
75492	Hex dig. driver	DIP	.89

Data sheets supplied on request  
Add \$.50 for items less than \$1.00

### CALCULATOR & CLOCK CHIPS w/data

5001	12 DIG 4 funct fix dec	3.95
5002	Same as 5001 exc btry pwr	7.95
5005	12 DIG 4 funct w/mem	8.45
MM5725	8 DIG 4 funct chain & dec	2.79
MM5736	18 pin 6 DIG 4 funct	4.95
MM5738	8 DIG 5 funct K & Mem	7.95
MM5739	9 DIG 4 funct (btry sur)	6.95
MM 5311	28 pin BCD 6 dig mux	6.95
MM 5312	24 pin 1 pps BCD 4 dig mux	6.95
MM 5313	28 pin 1 pps BCD 6 dig mux	7.95
MM 5314	24 pin 6 dig mux	8.95
MM 5316	40 pin alarm 4 dig	8.95

### MICROPROCESSOR KIT

Basic kit provides a very versatile 16 bit microprocessor. Optional memory boards are available allowing possible expansion of the basic system to microcomputer or minicomputer proportions.

#### Basic Kit Includes:

- A printed circuit boards (compatible with 22 pin edge connectors - not supplied)
- B microprocessor chip sets
- C gates, interface elements, clock drivers, etc.
- D transistors, diodes, capacitors
- E 75 page data package which includes an introduction to microprocessors, all necessary data sheets and extensive data on the workings and applications of microprocessor chips.

PRICE (basic kit) \$349.50

#### Available Options

- Power supply component pkg (P.P. or UPS) \$11.95
- Memory board B4 8-1101 26.95
- Memory board B5 4-1101 4-5203 98.00
- Memory board B6 space for 16 memories 11.95
- DATA PACKAGE REFUNDABLE WITH PURCHASE OF BASIC KIT 7.50

### MEMORIES

1101	256 bit RAM MOS	\$1.75
1103	1024 bit RAM MOS	4.95
5203	2048 bit eras. PROM	24.95
5260	1024 bit RAM low power	3.95
7489	64 bit RAM TTL	2.75
8223	Programmable ROM	4.95
74200	256 bit Ram-tri-state	7.95

### LED'S AND OPTO ISOLATORS

MV10B	Red TO 18	\$ .25 ea.
MV50	Axial leads	.20
MV5020	Jumbo visible red	.33
ME4	Infra red diff. dome	.60
MAN1	Red 7 seg. .270"	2.50
MAN2	Red alpha num .32"	4.95
MAN3A	Red 7 seg. .127"	.79
MAN3M	Red 7 seg. .127" claw	1.15
MAN4	Red 7 seg. .190"	2.15
MAN5	Green 7 seg. .270"	2.95
MAN7	Red 7 seg. .270"	1.35
MAN8	Yellow 7 seg. .270"	3.95
MAN66	60" high dir. view	4.65
DL707	Red 7 seg. .3"	2.15
MCT2	Opto-iso transistor	.69

### ON ORDERS OVER \$25.00 DEDUCT 10%

All items are new, unused surplus parts - tested functional. Satisfaction is guaranteed. Shipment will be made via first class mail - postage paid - in U.S., Canada and Mexico within three days from receipt of order. Minimum order - \$5.00. California residents add sales tax.



(408) 659-3171

INTERNATIONAL ELECTRONICS UNLIMITED  
P.O. BOX 1708 MONTEREY, CALIF. 93940 USA

**Numeric Readout Tubes from Burroughs**  
Pixies #9012. Character Height 1/8" with socket.  
Price: 3/\$3.00 Sold only in lots of three.

**NIXIES**  
5031 Character Height 5/8" without sockets.  
Price: \$1.00 ea.

**LARGE NIXIES**  
7971 Character Heights 2" without sockets.  
Price: \$1.00 ea.

**POWER SUPPLIES**  
SCHAUER CO. metered rack mount. 220V. 3 ph. 60 cy. input. adjustable 55-65 v.d.c. @ 15 amps. output. Cont. Duty. Like New.  
Price: \$150.00 F.O.B. shpt wt 200#.

**MODULE TYPE POWER SUPPLY**  
4 V. @ 6 amp. Regulated. 115V 60 cy. input 6" x 7" x 5". Limited Supply.  
Price: \$15.00 ea. shpt. wt. 10 #

**INVERTER TRANSFORMERS 2 TYPES**  
Dual transistor input 6-12 VDC input. 300-500 V output.  
Price: \$2.00 ea. or 3/\$5.00.  
Single transistor input 6-12 d.c. 300-500 V.  
Price: \$2.00 ea. or 3/5.00. Shpt. wt. 1#  
Good for C.D. Ignition, Flour. Lite or portable Strobe lt.

**TRANSFORMERS**  
115 V. input 60 cy. 36 VCT @ 4 amps. Open frame 4 x 4 x 3 1/2.  
Price: \$4.95 ea. Shpt. wt 8#

**FLASH TUBE TRIGGER COILS**  
Price: \$1.00 ea. or 6/\$5.00

**HAZARD WARNING LITES**  
7" round yellow lenses. High intensity xenon strobe. Operates on 12 VDC in orange plastic case.  
Price: \$10.00 ea. or 3/\$25.00 Shpt. wt. 6#

**HIGH INTENSITY STROBE LITES**  
Without case or reflector. 40 watt second flash @ 60 FPM. Good for market beacon, photography. Psychedelic lite, operates from 12VDC or 110V. 60 cy. Size: 8 x 10 x 10.  
Price: \$15.00 ea. or 2/\$25.00. Shpt wt. 10#

**UNBREAKABLE PLASTIC MIRRORS**  
5" dia. 1 1/4" thick. one side flat, one side concave.  
Price: 4/\$1.00

**High Impact Plastic Case, Orange Color**  
Water tight. Will accept 6 V. lantern type battery. Good for use as battery case or emergency lite.  
Price: \$1.00 or 6/\$5.00.

We have a few of the R 392/URR receivers that need minor repairs, good shape as is. Physically complete.  
Price: \$125.00.

**DIAL CODE LAMP CARTRIDGES**  
6 V. 40 ma. #39. Spec color - red, yellow, white.  
Price: 25¢ or 5/\$1.00.

**VHF RECEIVER**  
118-148 MHz, part of ARC-60 aircraft radio set. Front panel tuning 118-148 MHz, lightweight, compact 5" x 6" x 12". 28 VDC input, 250V, 50mA, dynamotor.  
Price: \$14.95

Miniature lever switch-model 2900 5/16" hole mounting 1 9/32" behind panel 2 amp silver contacts 3 P.S.T. 2 P.S.T. 2 P.D.T. Specify type 35¢ 3/\$1.00.

**ANOTHER TOROID INVERTER**  
Input 27.5 V at 23 amps. Output 1000V at 500 mA. 4" round x 8 1/2" long. 8 lbs. Both inverters operate on 12 VDC one half voltage output.  
\$14.95

**DIGITAL READOUTS SETS**  
Make your own counter, frequency meter, digital voltmeter, readouts, etc. Includes 6-B 5031 mixes w/sockets (.6" character height), 1 transformer, 1 p/s board with socket.  
Price: \$12.95, 2/\$20.00

**ANOTHER SPECIAL**  
**LARGE ALPHA NUMERIC READOUTS**  
Two B7971 tubes in sockets, driver transistors and components all on one board - can be used for clocks, counters, numerous other uses...  
Price: \$2.00 a board, 3/\$5.00

**TOROID INVERTER \$9.95**  
P/S high efficiency, equipped with cooling and for continuous duty. Input 27.5V at 5.5 amps, output 250 VDC at 300 mA, 45 VDC at 10 mA, 115 VAC 400 cycle at 30 VA. 3" round by 8 3/4" long. 6 lbs.

**Modern Aluminum Bench Rack Cabinet**  
11 1/2" H x 18" D x 19" W. 8" panel openings w/rubber feet and disappearing handle.  
Lt Blue Price: \$7.95 ea.

**ADJUSTABLE PRINTED CARD BOX**  
For Rack Mount Price \$9.95  
5" to 7 1/4" - 16 slides and sockets - includes 30 double contact position edge connector type.

**METERS - 1 3/4 square, 1 1/2 hole mount - 1" behind panel. 0-25 mA FS.** \$2.50

**VU Volume Level .20 to + 3 \$4.95**

**SOCKETS**  
Sockets for 4 x 150's - 2 sockets with chimney, mounted on aluminum chassis \$7.00

**FIBRE OPTIC LIGHT GUIDE**  
1/8" diameter 9" long with 1/4 diameter brass ends  
\$1.00 each 6/\$5.00

Module type P/S. 115 V. 60 cy. input. Output +12 -12 -6 VDC. Regulated, adj. 10%  
Price: \$14.95 Shipt wt 8#

All prices are F.O.B. our warehouse, Philadelphia, PA. All merchandise described accurately to the best of our knowledge. Your purchase money refunded if not satisfied. Terms are cash. Minimum order \$5.00. All merchandise subject to prior sale. RFE - Removed from equipment.

**SELECTRONICS**

1206 South Napa Street  
Philadelphia, PA 19146  
215-468-7891 215-468-4645



## 7-Segment Readout 12-PIN DIP

Three digits with right-hand decimal  
Plugs into DIP sockets  
Similar to (LITRONIX) DL337  
Magnified digit approximately .1"  
Cathode for each digit  
Segments are parallel for multiple  
operation  
5-10 MA per segment  
EACH \$3.00 4 (12 Digits) \$11.00

## RCA Numitron

EACH.....\$ 5.00

SPECIAL: 5 FOR \$20.00

### DR2010



## MOS MEMORY INTEL #2102-2

1024 BIT FULLY DECODED STATIC  
MOS RANDOM ACCESS MEMORY, . . .  
\* fast access 650ns.....  
\* full TTL compatible  
\* N channel silicon gate  
\* single 5 volt supply...  
\* tri-state output.....  
\* 1024 by 1 bit  
\* chip enable input.....  
\* no clocks or refreshing  
required.....

BRAND NEW FACTORY PARTS

16 PIN DIP - - - - - EACH \$6.95  
EIGHT FOR \$49.95

## Power Supply SPECIAL!

723 DIP variable regulator chip 1-40V,  
+ or - output @ 150 MA 10A with external  
pass transistor--with diagrams for  
many applications.  
EACH \$1.00 10 FOR \$8.95

## 5001 Calculator

40-Pin calculator chip will add, sub-  
tract, multiply, and divide. 12-digit  
display and calculate. Chain calcula-  
tions. True credit balance sign out-  
put. Automatic over-flow indication.  
Fixed decimal point at 1, 2, 3, or 4.  
Leading zero suppression. Complete  
data supplied with chip.

CHIP AND DATA.....ONLY \$6.95  
DATA ONLY (Refundable)... \$1.00  
5002 LOW POWER CHIP AND DATA \$12.95

## High Quality PCB Mounting IC Sockets

8-PIN, 14-Pin, 16-Pin and 24-Pin PCB  
mounting ONLY--no wire wrap sockets.

8-Pin.....\$ .22

14-Pin.....\$ .26

16-Pin.....\$ .30

24-Pin.....\$ .75

40-Pin.....\$1.25



All IC's are new and fully-tested.  
Leads are plated with gold or solder.  
Orders for \$5 or more will be shipped  
prepaid. Add 55¢ for handling and  
postage for smaller orders; residents  
of California add sales tax. IC orders  
are shipped within 2 workdays--kits  
are shipped within 10 days of receipt  
of order. \$10 minimum on C.O.D.'s  
(phone in). (916) 334-2161

MAIL ORDERS:  
P. O. Box 41727 4811 Myrtle Ave.  
Sacramento, CA Sacramento, CA  
95841 95841

MONEY BACK GUARANTEE ON ALL GOODS!  
SEND FOR FREE FLYER LISTING 100's OF  
MONEY-SAVING BARGAINS!

## CTUL SPECIAL

Complementary Transistor Logic.  
This logic family is unique in that  
both NPN and PNP transistors are  
combined in the same package. Un-  
like TTL & DTL, the outputs are  
current sources (in the high state)  
as well as sinking current in the  
low state. These are brand new  
units, some of which are mismarked  
with DTL numbers.



CTL 9956 dual 2-input  
AND buffer  
CTL 9953 2-2-3-input  
AND/OR gate  
CTL 9952 dual 2-input  
NOR gate

Data supplied; all parts are dual-  
in-line. MIX OR MATCH. 5 FOR \$1.00

## LED's

MV50 Red Emitting \$ .20  
10-4 MA @ 2V 10 FOR \$1.25



MV5024 Red T0-18 \$ .35  
High Dome 10 FOR \$2.95



MV10B Visible Red \$ .30  
5-7 MA @ 2V 10 FOR \$2.50

## CMOS

CD4001	\$ .75	CD4023	\$ .75
CD4002	.75	74C20	.75
CD4011	.75	74C160	3.25
CD4012	.75		

## 3-Amp Power Silicon Rectifiers

MARKED EPOXY AXIAL PACKAGE

PRV	PRICE	PRV	PRICE
100.....	\$.10	800.....	\$.30
200.....	.15	1000.....	.40
400.....	.18	1200.....	.50
600.....	.23	1500.....	.65

DIODE ARRAY 10-1N914 silicon  
signal diodes in one package. 20  
leads spaced .1"; no common connec-  
tions.

EACH.....\$.29  
10 FOR \$2.50



## BABYLON ELECTRONICS

7400	.20	74H51	.25
74H00	.25	7453	.20
7401	.20	7454	.20
74H01	.25	74L54	.25
7402	.25	74L55	.25
7403	.25	7460	.16
7404	.25	74L71	.25
74H04	.30	7472	.40
7405	.30	74L72	.60
7406	.40	7473	.35
7408	.30	74L73	.75
74H08	.30	7474	.45
7410	.20	74H74	.75
7413	.75	7475	.80
7417	.40	7476	.55
7420	.20	74L78	.70
74L20	.30	7480	.50
74H20	.30	7483	.70
74H22	.30	7489	3.00
7430	.20	7490	1.00
74H30	.30	7492	.65
74L30	.30	7493	1.00
7440	.20	7495	.65
74H40	.30	74L95	1.00
7442	1.00	74107	.50
7447	1.50	74145	1.25
7450	.20	74180	1.00
74H50	.30	74193	1.50
7451	.20	74195	.80

## 7400 Series DIP

## 25K Trimmer

PRINTED CIRCUIT BOARD TYPE  
EACH \$.20 10 FOR \$1.50

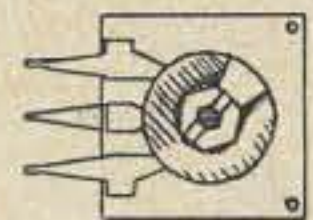

## Rectifiers



VARO FULL-WAVE BRIDGES  
V5447 2A 400V \$ .90  
V5647 2A 600V \$1.10  
MR810 Rectifier 50V 1A \$ .10

## Special 811: Hex Inverter

TTL DIP Hex Inverter; pin interchangeable with SN  
7404. Parts are brand new and branded Signetics  
and marked "811."

EACH.....\$ .30  
DATA 10 FOR..... 2.50  
SHEET 100 FOR.... 23.00  
SUPPLIED 1000 FOR...\$220.00



## 0-9 plus MAN 3

Right-hand decimal point.  
Flat-pack type case. Long  
operating life. IC vol-  
tage requirements. Ideal  
for pocket calculators!



EACH \$1.25  
10 OR MORE \$1.00 EA

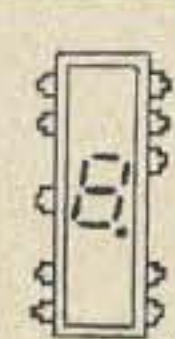

MAN 4 7-Segment, 0-9 plus letters.  
Right-hand decimal point. Snaps in 14-  
pin DIP socket or Molex. IC voltage re-  
quirements. Ideal for desk or pocket  
calculators!

EACH \$2.75 10 OR MORE \$2.50 EACH

## CD-2 Counter Kit

This kit provides a highly sophisticated display  
section module for clocks, counters, or other nu-  
merical display needs. The unit is .8" wide and  
4 3/8" long. A single 5-volt power source powers  
both the ICs and the display tube. It can attain  
typical count rates of up to 30 MHz and also has  
a lamp test, causing all 7 segments to light. Kit  
includes a 2-sided (with plated thru holes) fiber-  
glass printed circuit board, a 7490, a 7475, a  
7447, a DR2010 RCA Numitron display tube, complete  
instructions, and enough MOLEX pins for the ICs...  
NOTE: boards can be supplied in a single panel of  
up to 10 digits (with all interconnects); there-  
fore, when ordering, please specify whether you  
want them in single panels or in one multiple  
digit board. Not specifying will result in ship-  
ping delay.

COMPLETE KIT ONLY \$11.95  
FULLY-ASSEMBLED  
UNIT \$15.00



Boards supplied separately @ \$2.50 per digit.

## LINEARS

NE555	Precision timer.....	1.50
NE560	Phase lock loop DIP.....	3.25
NE561	Phase lock loop DIP.....	3.25
NE565	Phase lock loop.....	3.25
NE566	Function generator T0-5.....	4.00
NE567	Tone decoder T0-5.....	3.00
709	Popular Op Amp DIP.....	.45
710	Voltage comparator DIP.....	.75
711	Dual comparator DIP.....	.40
723	Precision voltage regulator DIP.....	1.00
741	Op amp T0-5/MINI DIP.....	.55
748	Op Amp T0-5.....	1.00
CA3018	2 Isolated transistors and a Darling- ton-connected transistor pair.....	1.00
CA3045	5 NPN transistor array.....	1.00
LM100	Positive DC regulator T0-5.....	1.00
LM105	Voltage regulator.....	1.25
LM302	Op Amp voltage follower T0-5.....	1.25
LM308	Op Amp T0-5.....	2.00
LM309H	5V 200 MA power supply T0-5.....	1.00
LM309K	5V 1A power supply module T0-3.....	2.00
LM311	Comparator T0-5.....	1.75
LM370	AGC amplifier.....	2.00
LM380	2-Watt Audio Amp.....	1.75
LM1595	4-Quadrant multiplier.....	2.00
MC1536T	Op Amp.....	2.00

### RC OSCILLATORS

16 pin IC chip contains 4 RC osc. Ideal for touch tone encoder. TCA 430. . \$5.00

### COLUMBIA 4 CHANNEL SQ

Solid state SQ 4 channel adapter, 2 amps built in. Decodes 4 channel or synthesizes 4 channel. \$25.00

### 8 CHAN MULTIPLEX SWITCH

Solid state 16 pin IC MOS. 8 channel w/output enable control & one-of-eight decoder in chip. With data. Fairchild 3705. . \$5.00

### LED READOUTS 5/\$1.00!

The price is not a mistake. We have some hobby variety with some segments out. Ukinbuyem for as low as 5 for \$1.00

### LOGIC SUPPLY

New, made by Computer Products, Fla. High voltage 170V and 5V logic output. Solid state, highly regulated & filtered. #PM 728. . \$20.00

### DUAL 16 BIT MEMORY

Dual 16 bit memory, serial MOS by Philco TO-5 case, brand new with 2 page specs. #PLR 532 \$1.00 each \$10/12

### MEMORY SYSTEM \$125.00

1024 core memory system, 1024 words memory, 8, 9 or 10 bits/word. Random access, with all logic, register, timing, control, core select and sense functions in one package. New, with 60 page booklet includes schematics. Measures only 9x4x1 inches. Good start for mini-computer.

### AM-FM RADIO

For console installation, w/face plate, no knobs. Stereo amplifiers for tape or turnable playback. \$15.00  
Pair of matching speakers w/xfmrs for above \$5.00

### TONE GEN. BOARD

3 Octave tone gen. board from Magnus Organ. Untested, with instructions. \$9.95, 2 for \$18.00

### CALCULATOR CHASSIS

Fully assembled pocket calculator chassis with calculator chip. Uses LED readouts, not included. \$5.00

### PIANO KEYBOARD \$9.95

For use with above organ or synthesizer, etc.

### ELECTRIC SIREN \$10.00

Brand new, operate 6 or 12 volts dc. Just the thing to protect car or boat. Used also as burglar or fire alarm in house & camp. Kinda scarce, but we found some. While they last \$12 each, 2/\$20.00

### MULTI-USE XFMR \$8.95

Output 18 V @ 6 amp; 17V @ 6 amps; 10V @ 10 amp. Brand new. \$8.95 ea, 2 for \$15; 10 for \$50

### SOLAR ENERGY

Electricity for free from the sun. An exciting experimental device. Instructions included show how to make a solar energy bank for higher voltages and/or current, also how to make a solar operated radio receiver.

### PHOTO-STROBE

Made for Instamatic but useful on any camera with instructions provided. Info also on trick uses, automotive strobe, slave strobe, automotive strobe, Psychadelic repetitive strobe, etc. Complete with charger & Nickel Cadmium batteries. \$9.00, 3 for \$25.00

Giant cell 2" diameter - \$1.50

Large cell 1 3/4" - \$1.25

Medium cell 1" diameter - \$1.00

Rectangular 3/4 x 1 1/2" - \$.75

Any six for the price of 5 . . .

### BOOKSHELF SPEAKERS

Completely finished, 9 x 12 x 5 inches. 16 ohm, with extension cord. \$15 a pair.

FREE catalog.

MESHNA PO Bx 62 E. Lynn Mass. 01904

Please add shipping cost on above.



# MICROPROCESSORS by Poly Paks!

**8008**  
"THE COMPUTER ON THE CHIP"



**\$79.95**

**16-BIT MICRO PROCESSOR BASIC SYSTEM**

**\$149.**

The lowest-priced 16-bit system! Outperforms the 8008. The CPU (Central Processing Unit) includes 4-MM5750's, called RALU's, and one MM5751 CROM. RALU — called Register and Arithmetic Logic Unit — is a 4-bit control bus, and the CROM is a Control-and-Read-Only Memory. The four RALU's in parallel form a 16-bit unit. The RALU's are controlled by micro-instructions, stored in the CROM. With spec sheets.

Usually called "Microprocessor" — it is a p Channel Si gate MOS 8-bit Parallel Central Processor. A CPU Central Processing Unit on a chip. Features complete instruction decoding and control. Capability to address 16K x 8 bits of memory (RAM, ROM, SR). Build a micro-computer system when interfacing with other chips, such as 1101, 1103, 2102 (RAMS), etc. With spec sheets. 16-pin dip package. . . . . \$79.95  
 2102 1000-bit "static" Ram for above. . . . . \$9.95



## 10% INFLATION - FIGHTING DIVIDEND 10%

CHOOSE any item or group of items FREE that add up to 10% of your order  
 Minimum order \$15.00  
**Poly Paks—1st with Lowest Prices!**  
**1st with Quantity Discounts!**  
**1st WITH DIVIDENDS!**

### 'ALL LED' MONSANTO READOUTS

MAN-1	MAN-3	MAN-6	MAN-64
<b>MONSANTO CHAR. TYPE</b>	<b>HT.</b>	<b>SALE EACH</b>	<b>Quantity Discounts</b>
<input type="checkbox"/> MAN-1	.27	\$3.50	3 for \$ 9.
<input type="checkbox"/> MAN-2	.32*	4.95	3 for \$14.
<input type="checkbox"/> MAN-3	.12	1.00	3 for \$2.50
<input type="checkbox"/> MAN-6	.60	4.50	3 for \$12.
<input type="checkbox"/> MAN-64	.4	3.50	3 for \$ 9.
<input type="checkbox"/> MAN-7	.27	1.50	3 for \$ 3.

MAN-64 \*35 LED matrix

### 1N4000 "BLASTAWAY" ON RECTIFIER PRICES

Type	PIV	Sale
<input type="checkbox"/> 1N4001	50	10 for 35c
<input type="checkbox"/> 1N4002	100	10 for 45c
<input type="checkbox"/> 1N4003	200	10 for 55c
<input type="checkbox"/> 1N4004	400	10 for 65c
<input type="checkbox"/> 1N4005	600	10 for 75c
<input type="checkbox"/> 1N4006	800	10 for 85c
<input type="checkbox"/> 1N4007	1000	10 for 99c

### 6 DIGIT KRONOS CLOCK

Using MAN-3 S  
 Complete KIT  
**\$29.95**

Monsanto, in original individual packages. Clear lens, color red. Narrow band of light. Size: .110 H x .110 dia. T 3/4" size.

### 7-segment OPCOA SLA-1 REFLECTIVE LED READOUT

**\$2.50**  
 3 for \$ 6.  
 Red  
 Yellow  
 Green  
**"C" THRU S METER**  
**\$1.50**  
 Indicates: 0 to 1.5  
 Plastic case.  
 1 1/2 x 1 1/2 x 1".

Imagine a chip (MK50250) "Beepin" and audible alarm! All others are external. It also features internal brightness control. The CT7001 requires external triggering of alarm, date of the month and direct drive to LED readouts. Both require minimum current drain and voltages, for either 4 to 6 LED readouts, 12 or 24 hours, AM and PM.

### 'BEEPER' AND 'DATER' CLOCK ON THE CHIPS

- MK50250 BEEPER ONLY \$ 8.50
- CT7001 Alarm and Date \$12.50



### SCRS! TRIACS! QUADRACS! SAME PRICE SALE!

10-Amp Power Tab Plastic Units

PRV	Sale
<input type="checkbox"/> 50	\$ .75
<input type="checkbox"/> 100	.95
<input type="checkbox"/> 200	1.25
<input type="checkbox"/> 300	1.50
<input type="checkbox"/> 400	1.98
<input type="checkbox"/> 500	2.25
<input type="checkbox"/> 600	2.50

### CLOCK CHIPS ON A "DIP" as Low as \$4.95

WITH DATA SHEETS

<input type="checkbox"/> MM5311	6-digit 28-Pin	6.95
<input type="checkbox"/> MM5312	4-digit 24-Pin	6.95
<input type="checkbox"/> MM5313	6-digit 28-Pin	6.95
<input type="checkbox"/> MM5314	6-digit 24-Pin	6.95
<input type="checkbox"/> MM5316	4-digit 40-Pin, Alarm	8.88
<input type="checkbox"/> MM5316-A	no alarm	4.95

### FULL EPOXY SILICON BRIDGE RECTIFIERS

WAVE	PIV	2 Amp	6 Amp	10 AMP
<input type="checkbox"/>	50	\$ .69	\$ .88	\$1.49
<input type="checkbox"/>	100	.79	.99	1.69
<input type="checkbox"/>	200	.95	1.25	1.89
<input type="checkbox"/>	400	1.19	1.50	2.09
<input type="checkbox"/>	600	1.35	1.75	
<input type="checkbox"/>	800	1.59	1.95	
<input type="checkbox"/>	1000	1.79	2.25	

Code: 2 amp TO-5 case  
 6 Amp 1/2 x 1/2 x 3/16 sq.

## Inflation-Fighting IC PRICES

Buy 10 or more **15% discount**  
 Buy 100 — Take 25%  
 Order by type number! Spec sheets on request "ONLY" \* Factory Marked

<input type="checkbox"/> SN7400	.17	<input type="checkbox"/> SN7441	.95	<input type="checkbox"/> SN7489	2.50	<input type="checkbox"/> SN74154	1.49
<input type="checkbox"/> SN7401	.17	<input type="checkbox"/> SN7442	.95	<input type="checkbox"/> SN7490	.71	<input type="checkbox"/> SN74155	1.09
<input type="checkbox"/> SN7402	.17	<input type="checkbox"/> SN7443	.95	<input type="checkbox"/> SN7491	1.15	<input type="checkbox"/> SN74156	1.19
<input type="checkbox"/> SN7403	.17	<input type="checkbox"/> SN7444	1.05	<input type="checkbox"/> SN7493	.71	<input type="checkbox"/> SN74157	1.19
<input type="checkbox"/> SN7404	.21	<input type="checkbox"/> SN7445	1.05	<input type="checkbox"/> SN7495	.85	<input type="checkbox"/> SN74158	1.45
<input type="checkbox"/> SN7405	.21	<input type="checkbox"/> SN7446	1.10	<input type="checkbox"/> SN7496	.85	<input type="checkbox"/> SN74161	1.29
<input type="checkbox"/> SN7406	.37	<input type="checkbox"/> SN7447	1.10	<input type="checkbox"/> SN7496	.85	<input type="checkbox"/> SN74163	1.49
<input type="checkbox"/> SN7408	.23	<input type="checkbox"/> SN7448	1.10	<input type="checkbox"/> SN74100	1.55	<input type="checkbox"/> SN74164	1.79
<input type="checkbox"/> SN7409	.23	<input type="checkbox"/> SN7450	.17	<input type="checkbox"/> SN74104	1.25	<input type="checkbox"/> SN74165	1.79
<input type="checkbox"/> SN7410	.18	<input type="checkbox"/> SN7451	.23	<input type="checkbox"/> SN74105	.45	<input type="checkbox"/> SN74166	1.55
<input type="checkbox"/> SN7411	.27	<input type="checkbox"/> SN7453	.23	<input type="checkbox"/> SN74106	.45	<input type="checkbox"/> SN74173	1.55
<input type="checkbox"/> SN7413	.73	<input type="checkbox"/> SN7455	.37	<input type="checkbox"/> SN74107	.45	<input type="checkbox"/> SN74174	1.49
<input type="checkbox"/> SN7414	2.25	<input type="checkbox"/> SN7462	.37	<input type="checkbox"/> SN74108	.89	<input type="checkbox"/> SN74175	1.81
<input type="checkbox"/> SN7415	.37	<input type="checkbox"/> SN7464	.37	<input type="checkbox"/> SN74112	.91	<input type="checkbox"/> SN74176	1.55
<input type="checkbox"/> SN7416	.37	<input type="checkbox"/> SN7465	.37	<input type="checkbox"/> SN74113	.91	<input type="checkbox"/> SN74177	1.55
<input type="checkbox"/> SN7417	.37	<input type="checkbox"/> SN7471	.49	<input type="checkbox"/> SN74114	.89	<input type="checkbox"/> SN74180	1.05
<input type="checkbox"/> SN7420	.18	<input type="checkbox"/> SN7472	.33	<input type="checkbox"/> SN74121	.55	<input type="checkbox"/> SN74181	3.50
<input type="checkbox"/> SN7422	.27	<input type="checkbox"/> SN7473	.41	<input type="checkbox"/> SN74122	.51	<input type="checkbox"/> SN74182	.79
<input type="checkbox"/> SN7423	.33	<input type="checkbox"/> SN7474	.41	<input type="checkbox"/> SN74125	.65	<input type="checkbox"/> SN74189	1.49
<input type="checkbox"/> SN7425	.37	<input type="checkbox"/> SN7475	.71	<input type="checkbox"/> SN74126	.73	<input type="checkbox"/> SN74190	1.49
<input type="checkbox"/> SN7426	.27	<input type="checkbox"/> SN7476	.45	<input type="checkbox"/> SN74140	2.50	<input type="checkbox"/> SN74191	1.49
<input type="checkbox"/> SN7427	.31	<input type="checkbox"/> SN7478	.55	<input type="checkbox"/> SN74141	1.19	<input type="checkbox"/> SN74192	1.45
<input type="checkbox"/> SN7430	.17	<input type="checkbox"/> SN7480	.61	<input type="checkbox"/> SN74145	1.12	<input type="checkbox"/> SN74193	1.29
<input type="checkbox"/> SN7432	.27	<input type="checkbox"/> SN7481	1.19	<input type="checkbox"/> SN74148	2.50	<input type="checkbox"/> SN74195	.89
<input type="checkbox"/> SN7437	.41	<input type="checkbox"/> SN7482	.99	<input type="checkbox"/> SN74150	.99	<input type="checkbox"/> SN74197	.89
<input type="checkbox"/> SN7438	.35	<input type="checkbox"/> SN7483	.99	<input type="checkbox"/> SN74151	.85	<input type="checkbox"/> SN74198	2.10
<input type="checkbox"/> SN7440	.17	<input type="checkbox"/> SN7486	.41	<input type="checkbox"/> SN74153	1.05	<input type="checkbox"/> SN74199	2.10
						<input type="checkbox"/> SN74200	4.95

### BIGGEST MAN-7 SALE \$1



THAT'S RIGHT! MAN-7's at the readout sale of the century! The MAN-7 is a 7-segment "reflective bar" version of the famous MAN-1. The optimum in light efficiency and construction. Looks like, acts like, the MAN-1. Pin connections same. Wide angle viewing. 0.27" character height, color red.

Terms: add postage Rated: net 30  
 Phone Orders: Wakefield, Mass. (617) 245-3829  
 Retail: 16-18 Del Carmine St., Wakefield, Mass.  
 (off Water Street) C.O.D.'S MAY BE PHONED

20c CATALOG Fiber Optics, 'IC's, Semi's, Parts  
 MINIMUM ORDER — \$4.00

## POLY PAKS

P.O. BOX 942A LYNNFIELD, MASS. 01940

# 73 reader service

Check appropriate boxes for desired company brochures, data sheets or catalogs and mail in to 73. Include your zip code, please. Send money directly to advertisers. **LIMIT: 25 requests.**

## ADVERTISER INDEX

- |  |   |
|--|---|
| <input type="checkbox"/> Al's Two Way 128      | <input type="checkbox"/> Int. Telecomm 27       |
| <input type="checkbox"/> Amateur Elect.        | <input type="checkbox"/> James Elec. 153        |
| <input type="checkbox"/> Supply 102, 103       | <input type="checkbox"/> Jan 142                |
| <input type="checkbox"/> Ancrona 145           | <input type="checkbox"/> Juge 133               |
| <input type="checkbox"/> Apron 38              | <input type="checkbox"/> K-Enterprises 46       |
| <input type="checkbox"/> *ATV 144              | <input type="checkbox"/> Key Enterprises 96     |
| <input type="checkbox"/> Audioland 125         | <input type="checkbox"/> Meshna 158             |
| <input type="checkbox"/> Babylon 157           | <input type="checkbox"/> MITS 152               |
| <input type="checkbox"/> Budwig 136            | <input type="checkbox"/> Mohawk 70              |
| <input type="checkbox"/> CeCo 56               | <input type="checkbox"/> Newtronics C 11        |
| <input type="checkbox"/> Clegg 77              | <input type="checkbox"/> Palomar 70             |
| <input type="checkbox"/> Coakit 144            | <input type="checkbox"/> Poly Paks 159          |
| <input type="checkbox"/> Comm Spec. 144        | <input type="checkbox"/> Radio Am. Callbook 134 |
| <input type="checkbox"/> Comm Unltd. 150       | <input type="checkbox"/> Regency 67             |
| <input type="checkbox"/> Cornell 144           | <input type="checkbox"/> RGS 149                |
| <input type="checkbox"/> Datak 142             | <input type="checkbox"/> Rohn 57                |
| <input type="checkbox"/> Data Signal 79, 94    | <input type="checkbox"/> Savoy 65               |
| <input type="checkbox"/> D-D Enterprises 72    | <input type="checkbox"/> S&D 136                |
| <input type="checkbox"/> Discount Elec. 83, 85 | <input type="checkbox"/> Selectronics 156       |
| <input type="checkbox"/> DuPage 148            | <input type="checkbox"/> Sentry 11              |
| <input type="checkbox"/> DXers Mag 70          | <input type="checkbox"/> Slep 146               |
| <input type="checkbox"/> ECM 144               | <input type="checkbox"/> Solid State 147        |
| <input type="checkbox"/> Emergency Beacon 15   | <input type="checkbox"/> Space Elec. 144        |
| <input type="checkbox"/> ETCO 70               | <input type="checkbox"/> Spec Comm. 46          |
| <input type="checkbox"/> Evans 108             | <input type="checkbox"/> Standard 62, 63        |
| <input type="checkbox"/> Fair 50               | <input type="checkbox"/> Starkits 144           |
| <input type="checkbox"/> Freck 115             | <input type="checkbox"/> Sumner 19              |
| <input type="checkbox"/> Gateway 131           | <input type="checkbox"/> Temtron 128            |
| <input type="checkbox"/> GENAVE 60             | <input type="checkbox"/> Tri Tek 144            |
| <input type="checkbox"/> Glade Valley 92       | <input type="checkbox"/> Trumbull 144           |
| <input type="checkbox"/> Godbout 151           | <input type="checkbox"/> Tucker 88-90, 110, 111 |
| <input type="checkbox"/> Ham Import Sales 73   | <input type="checkbox"/> Tufts 87               |
| <input type="checkbox"/> Ham Radio Center 154  | <input type="checkbox"/> Verada 135             |
| <input type="checkbox"/> Heath 51              | <input type="checkbox"/> VHF Eng. C 1V          |
| <input type="checkbox"/> Henry 43              | <input type="checkbox"/> Wilson 55              |
| <input type="checkbox"/> ICOM 71               | <input type="checkbox"/> World QSL 128          |
| <input type="checkbox"/> Int. Elec Unltd. 155  | <input type="checkbox"/> Yaesu C 111            |

### 73 Stuff

- |                    |                   |
|--------------------|-------------------|
| Back issues 32     | Novice Tapes 120  |
| QSLs 80            | Books 121-124     |
| Bumper Stickers 87 | Cassette Code 132 |
| Repeater Atlas 92  | Hotline 134       |
| Subscriptions 107  |                   |

NEWSSTAND  SUBSCRIPTION

\*Reader service inquiries not solicited. Correspond directly to company.

Reader's Service MARCH 1975  
**73 Inc., Peterborough NH 03458**  
 Please print or type.

Name \_\_\_\_\_ Call \_\_\_\_\_  
 Address \_\_\_\_\_  
 City \_\_\_\_\_  
 State \_\_\_\_\_ Zip \_\_\_\_\_

Coupon expires in 60 days . . .

## PROPAGATION CHART

J.H. Nelson

Good (open) Fair (□) Poor (O)

March - 1975

Sun	Mon	Tue	Wed	Thu	Fri	Sat
						I
2	3	4	5	6	7	8
9	10	11	12	13	14	15
16	17	18	19	20	21	22
23	24	25	26	27	28	29
30	31					

### EASTERN UNITED STATES TO:

	GMT:	00	02	04	06	08	10	12	14	16	18	20	22
ALASKA	7A	7	7	7	7	7	7	7	7	7A	14	14	
ARGENTINA	14	7A	7	7	7	7	14	14A	21	21	21	14	
AUSTRALIA	14A	14	7B	7B	7B	7	7	14	14	14B	14	14A	
CANAL ZONE	14	7	7	7	7	7	7A	14A	21	21	21	21	
ENGLAND	7	7	7	7	7	7	14	14	14	14A	14	7	
HAWAII	14A	14	7B	7	7	7	7	7	7A	14	14	14A	
INDIA	7	7	7B	7B	7B	7B	7A	14	14	7	7	7	
JAPAN	14	7B	7B	7	7	7	7	7	7	7	7	14	
MEXICO	14	7	7	7	7	7	7	7A	14	14	14A	14	
PHILIPPINES	14	7B	7B	7B	7B	7B	7	7	14	14	7B	7A	
PUERTO RICO	7A	7	7	7	7	3A	7	14	14	14	14	14	
SOUTH AFRICA	14	7	7	7	7B	7B	14	14	21	21	14	14	
U. S. S. R.	7	7	7	7	7	7B	7B	14	14	14	7B	7	
WEST COAST	14	7	7	7	7	7	7	7A	14	14	14A	14A	

### CENTRAL UNITED STATES TO:

ALASKA	14	7A	7	7	7	7	7	7	7	7A	14	14	
ARGENTINA	14	14	7	7	7	7	7	14	14A	21	21	21	
AUSTRALIA	21	14	14	7B	7B	7	7	7	14	14B	14	21	
CANAL ZONE	14	7A	7	7	7	7	7	14	21	21	21	21	
ENGLAND	7	7	7	7	7	7	7	14	14	14	14	7	
HAWAII	14A	14	7A	7	7	7	7	7	7A	14	14A	21	
INDIA	7	7A	7B	7B	7B	7B	7B	7	14	7	7	7	
JAPAN	14	14	7B	7B	7	7	7	7	7	7	7	14	
MEXICO	14	7	7	7	7	7	7	7A	14	14	14	14	
PHILIPPINES	14	7A	7B	7B	7B	7B	7	7	7	7	7B	14	
PUERTO RICO	14	7	7	7	7	7	7	14	14	14A	14A	14	
SOUTH AFRICA	14	7	7	7	7B	7B	7A	14	14	14A	14	14	
U. S. S. R.	7	7	7	7	7	7B	7B	7B	14	14	7B	7	

### WESTERN UNITED STATES TO:

ALASKA	14	14	7	7	7	7	7	7	7	7A	14	14	
ARGENTINA	14	14	7	7	7	7	7B	14	14	14	21	21	
AUSTRALIA	21	21	14	14	7B	7	7	7	7	7A	14	21	
CANAL ZONE	14A	14	7	7	7	7	7	14	21	21	21	21	
ENGLAND	7	7	7	7	7	7	7B	7B	7A	14	14	7B	
HAWAII	21	21	14	7A	7	7	7	7	7A	14	21	21	
INDIA	7	14	14	7B	7B	7B	7B	7B	7	7A	7	7	
JAPAN	14A	14	14	7B	7	7	7	7	7	7	14	14	
MEXICO	14	14	7	7	7	7	7	14	14	14	14	14A	
PHILIPPINES	14	14	14	7B	7B	7B	7	7	7	7	7B	14	
PUERTO RICO	14	7	7	7	7	7	7	14	14	14A	14A	14	
SOUTH AFRICA	14	7	7	7	7B	7B	7B	7A	14	14	14	14	
U. S. S. R.	7	7	7	7	7	7B	7B	7B	7A	7A	7B	7	
EAST COAST	14	7	7	7	7	7	7	7A	14	14	14A	14A	

A = Next higher frequency may be useful also.  
 B = Difficult circuit this period.

A = Next higher frequency may be useful also.  
 B = Difficult circuit this period.

# simply a great transceiver



## • YO-100 MONITOR SCOPE      • FT-101B 160-10 METER\* TRANSCEIVER

The FT-101B transceiver features advanced, solid-state, plug-in modular circuitry-with a complete line of versatile accessories including the NEW YO-100 Monitor Scope. Add this ideal companion for complete signal monitoring.

### FT-101B FEATURES:

- 240 watts PEP input (180 watts CW)
- AC & DC power supply
- Noise blanker
- VOX with break-in CW
- 25 & 100 KHz calibrators
- WWV reception
- Internal speaker

### YO-100 FEATURES:

- 1500/1900Hz tone generator
- Wide range inputs for all mode monitoring-even RTTY

### ACCESSORIES AVAILABLE:

- FL-2100B 1200 watt linear
- FV-101B External VFO
- YO-100 Monitor scope
- SP-101B External speaker
- SP-101PB Speaker/Phone Patch
- MMB-1 Mobile mount
- FA-9 Cooling fan
- XF-30C 600Hz CW filter
- YD-844 Desk microphone
- 160 meter crystal

Compare the features, versatility, and performance. Ask the amateur who owns one and your choice will be Yaesu-the world's leader in amateur communications equipment.

\*160 meter crystal optional

Specifications subject to change without notice.



**YAESU**  
MUSEN USA INC.



Visit your dealer for details or write for our new catalog.

All Yaesu products warranted by the selling dealer. Complete after-warranty service available in Paramount, Calif.

# REPEATERS



144 MHz

220 MHz

Why make do with a converted Mark II Gizwachi when you can get a complete repeater designed for Hams by Hams, AT A PRICE YOU CAN AFFORD. The RPT 144 and RPT 220 are self-contained—all solid state machines. Conservatively rated, high quality, components deliver EXCELLENT RELIABILITY. Careful consideration has been given to both interfacing and control flexibility.

**Factory wired and tested      \$595.95**

**Kits available      Write for details**



## Vhf engineering

— DIV. of BROWNIAN ELECTRONICS CORP. —

320 WATER ST. P.O. BOX 1921 BINGHAMTON, NY 13902 607-723-9574



March 1975