

AMATEUR
RADIO

73

Issue No. 117

A
CE
\$1.00

ANTENNAS
EMPHASIS:
ANTENNAS

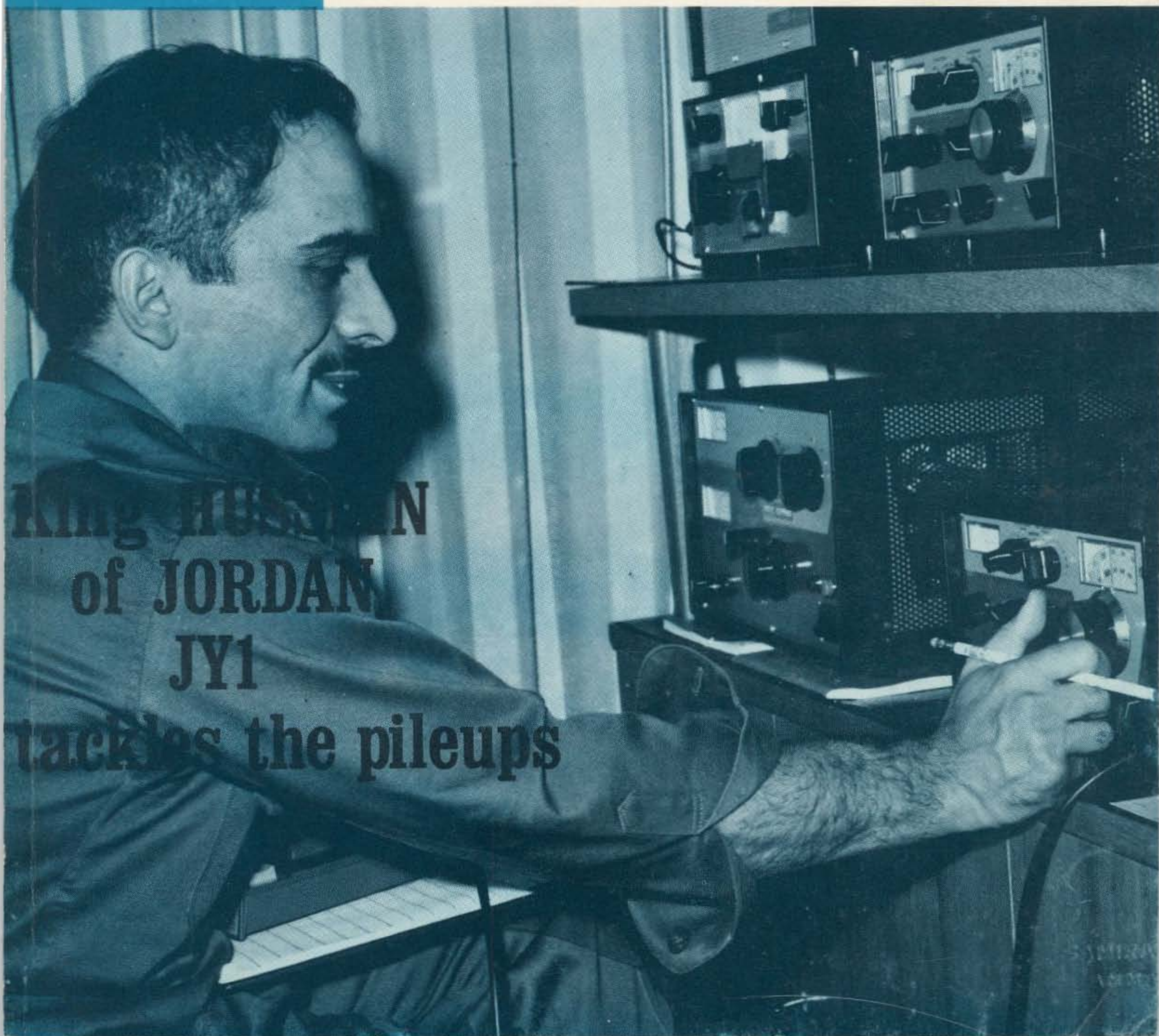

**King Hussein
of JORDAN
JY1
tackles the pileups**

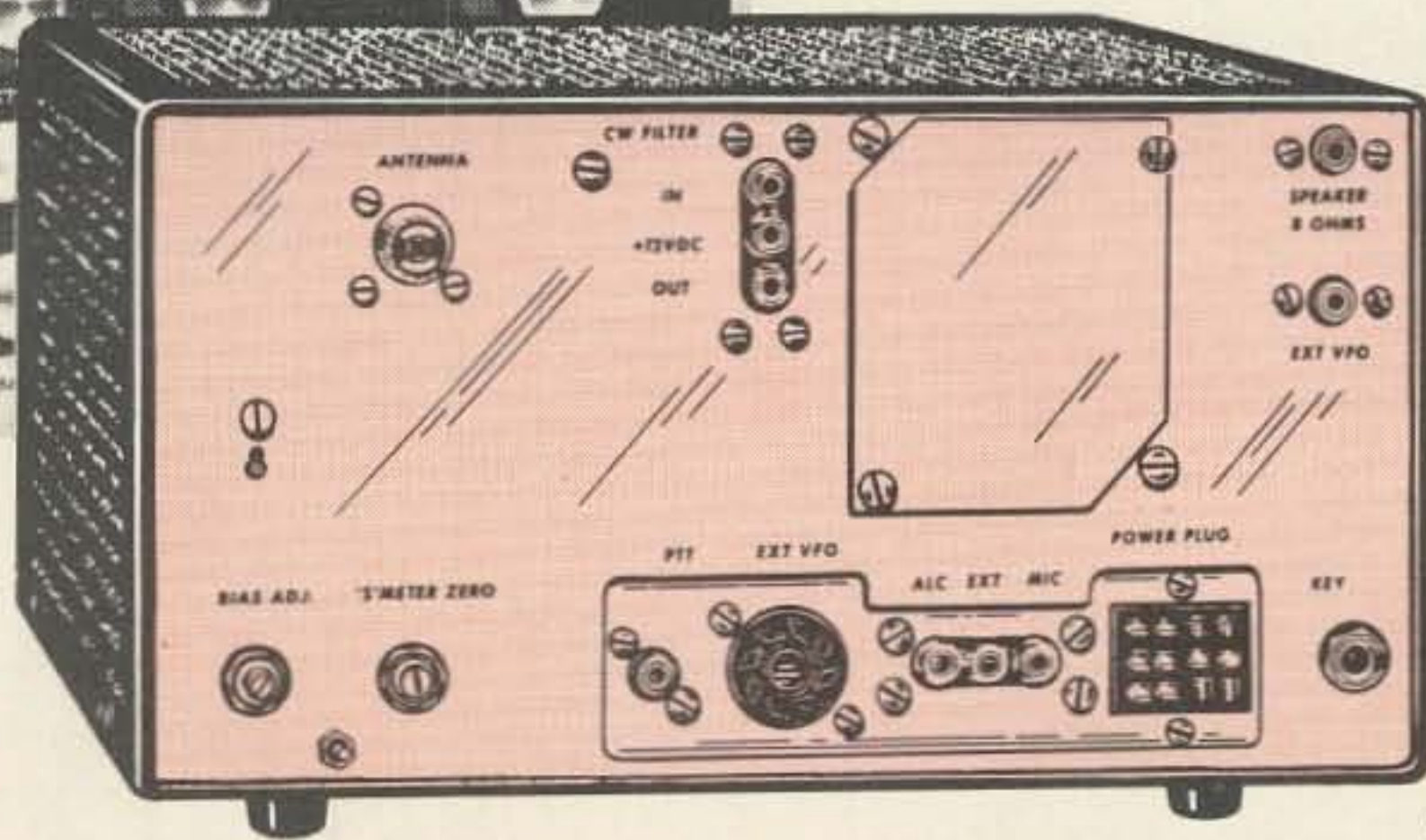
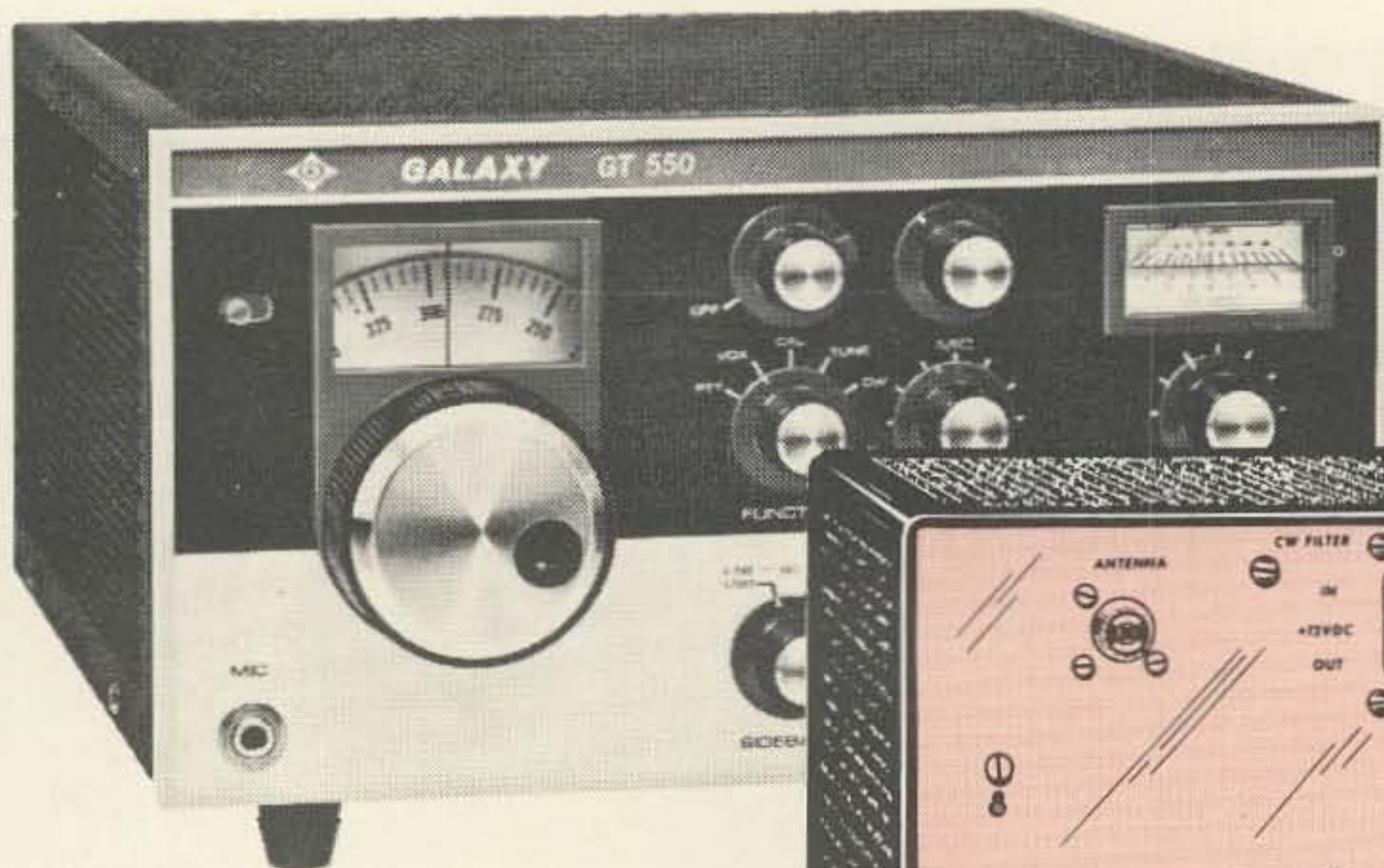

The GT-550's "business" end... Plug-in Versatility!

The Superb Transceiver with Total System Capability



Plug in the RV-550 Remote VFO!

With its function switch you can select the remote unit to Control, Receive, Transceive or Transmit frequency independently. Gives you about the same flexibility as a separate transmitter and a receiver!

Plug in the PR-550 Phone Patch!

Record your own station, playback a recording to the transmitter, record or playback to your phone...or record a complete two-way conversation while making a phone patch with the use of a tape recorder!

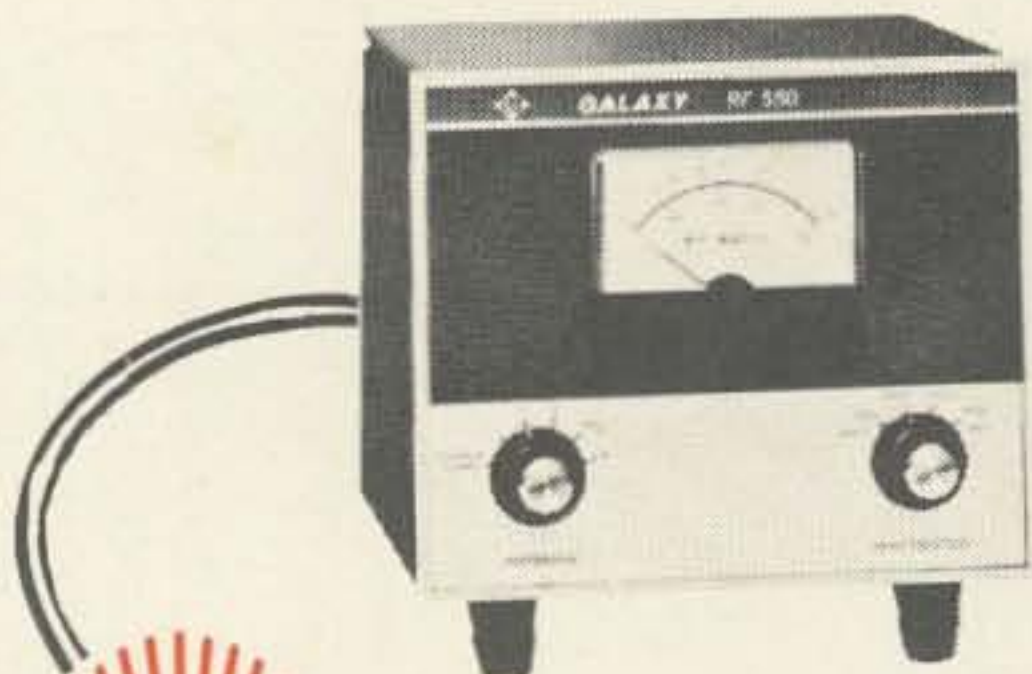
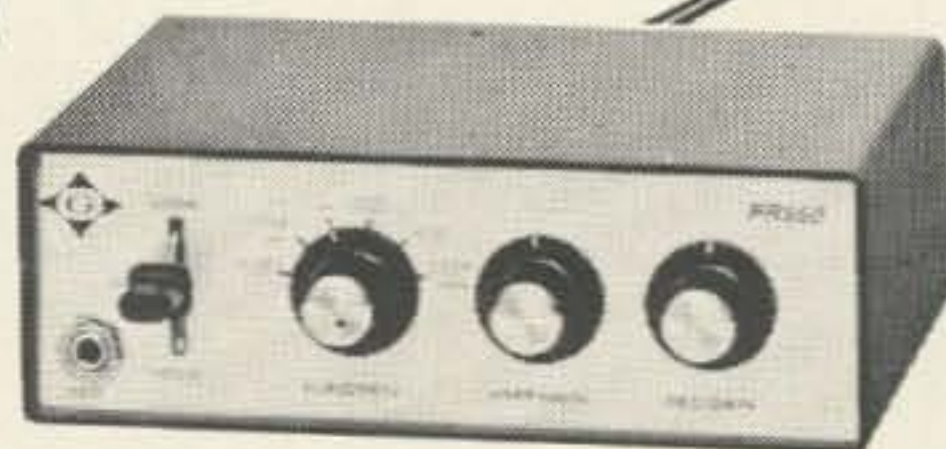

Plug in the RF-550 Console!

Precision wattmeter 3.5 - 30.0 mHz with 400 and 4,000 watt scales, forward and reflected power. *Built-in Antenna Selector Switch* for six positions with unused outputs grounded.

Write for free brochure on the GT-550 line -



galaxy electronics

"Pacesetter in Amateur/Commercial Equipment Design"

10 South 34th Street • Dept. 73-JJ54 • Council Bluffs, Iowa 51501

#117 June, 1970

Features

- 2 Radio Amateur News Page
Caveat Emptor
- 10 Never Say Die
- 14 Mr. Virgo Himself
- 18 DX Desk
- 96 Propagation Chart
- 100 New Products
- 135 Letters
- 144 Advertiser's Index
Reader's Double Bonus

STAFF

Editor-Publisher
Wayne Green W2NSD/1

Managing Editor
Ken Sessions K6MVH/1

Advertising Manager
Diane Shaw

Art Director
Roger Block

Graphic Arts
Jeanne Caskie
Nancy Estle

Composition
Jane Tracey
Joan Bernier

Drafting
Wayne Peeler K4MVW
Bill Morello
Gary Audiss WA6EPN

Production
Phil Price
Judy Marcus
Lloyd Carren

Subscriptions
Dorothy Gibson

Circulation
Jon Fisher

Comptroller
Joe LaVigne

Propagation
John Nelson

WTW Editor
Dave Mann K2AGZ

FCC Liaison
Bob Nelson WA5MAM/4

Contents

- 20 A Practical DRRR Antenna W6WYQ
Expensive, difficult-to-build mediocre antenna.
- 36 VFO Circuit KØHVK
In case you are tired of crystal control.
- 39 The Low-Noise Antenna WB6JNI
High noise you're looking for?
- 41 Experimental Remote SWR Indicator W2EEY
Experimental means we think it might work.
- 46 The Little Wonder: Mark II W5ZBC
Proving again that almost anything will radiate.
- 48 CW Can Be Fun (With the Ord DK-1) Staff
...if you know the code.
- 49 Two Receivers From One Antenna WA6UFW
Without suckout. (tsk)
- 50 Factors in Coaxial Cable Loss W9KXJ
Like temperature and frequency.
- 52 Improving Trap-Type Vertical Antennas W2EEY
By adding an element.
- 56 Measuring Incident and Reflected RF VE7BS
It's the difference that counts.
- 58 Government Surplus Straight from the Horse's Mouth . WA9ANW
Hay, hay!
- 62 QRP WA3JBN
40m with 40 mW.
- 64 Ground Support for the Powder Puff Derby W7ZC
Public service and politics.
- 73 Coax Adapter VHF to BNC W9MEV
For 75¢.
- 74 The Sly Beam ZL4TAH
32 elements on 2 meters.
- 80 Three Unrelated Articles: WA6CPP
Installing the Swan 250-C Noise Silencer
Measuring Rf Output
Useful Cable Clamps
- 83 ¼-Wave Top-Loaded Mobile Antenna W5AZE
For 20 meters.
- 86 11 Element 2 Meter Circular Quad W4KAE
9 dB forward gain.
- 92 The 633 ZL2ASJ
For 10, 15, & 20 meters.
- 97 73 Tests the Grundig Satellite Receiver Staff
Tunes in CW, SSB, FM, and everything!
- 104 De-RF Your VTVM WAØFFJ
Works better.
- 105 Getting Your Extra Class License
Part XVII: Conclusion Staff
Now go!
- 117 Special Antenna Catalog Section
For your reference pleasure.
- 142 More Accuracy on Microwaves S. Goldstein
Improvement on December wavemeter.

73 Magazine is published monthly by 73, Inc., Pine St., Peterborough, New Hampshire 03458. Subscription rate: \$12.00 for three years, \$6.00 for one year. Second Class Postage paid at Peterborough, New Hampshire, and at additional mailing offices. Printed at Pontiac, Illinois, U.S.A. Entire contents copyright 1970 by 73, Inc., Peterborough, New Hampshire 03458.

Amateur Radio News Page

June XIXLXX

Monthly Ham News of the World

73 Magazine

GOLDWATER PRESENTS HAM AWARD

Winner Flown to K7UGA Residence by Helicopter

by Bob Drete K7VOR

Over the past seven or eight years, John Buchanan, a Tucson ham VHF-FM radio operator, has helped other amateurs repair their sets, taught them the tricks of the trade. He recently set up an amateur repeating station for FM at the top of Mt. Lemmon.

So when, for the first time, a state VHF-FM "Amateur of the Year Award" was given this year, it wasn't too surprising that Buchanan was the recipient.

He was flown by helicopter Thursday to the home of Sen. Barry Goldwater, in Phoenix, where he was presented a plaque for his research and activities in the VHF-FM ham frequencies.

More important, he was also given a solid state Varitronics IC2F, one of the newest instruments on the ham radio market.

The radio is symbolic, in a way, since Buchanan's latest project involved designing a new concept of a repeater station which would be all "solid state."

The concept itself is not new, Buchanan said, because it has been used for some time by commercial FM



Arizona's amateur of the year, John Buchanan K7CRO, arrives at the Goldwater residence in a helicopter, where he is greeted by the senator himself, K7UGA.

SPRING BRINGS RASH OF HAM TRAGEDIES

by W6KGN

In Costa Mesa, California, 20-year-old Laurence Bandiera (call not known) was electrocuted when the antenna he was erecting fell against a high-power line. Policemen who were called to the scene said that Bandiera's neighbor, Merrit Girgis, was helping with the antenna when it began to topple. Bandiera, Girgis told police, tried to hold the antenna as it fell against the wires. Attempts to revive Bandiera were futile.

Word-of-mouth reports from sales personnel at Radio Products Sales Co. in Los Angeles indicate that two other hams were killed in a Southern California plane crash. According to the source, the two were overflying hilly terrain in the vicinity of Los Angeles to look for a 2 meter FM repeater site. The two FM'ers were Carl Sundstrom K6IYI and Clarence Emerson K6QIP. Unconfirmed reports indicated the two were operating on 2 meters FM at the time of the crash.

Amateur Radio Station Operates
At International Standards Meeting

stations, but ham radio operators are just beginning to get into the field of FM.

Up until now, he said, FM equipment was too complicated for the amateur to build. Recently, however, FM equipment has come on the market, either as obsolete or surplus goods, and the noncommercial radio operators are able to obtain what they need.

Buchanan has been in ham radio for about 12 years, but it is still just a side hobby. His business, logically, is machines, and he owns the Buchanan Machine Co., 2550 N. 14th Ave. in Tucson.



The honored FM'er displays bronze plaque and Varitronics newly released IC2F 2 meter FM unit. FM'ers will recognize Bill Adams K7OED president of Varitronics, Inc. on the right; ALL hams should recognize Barry Goldwater, who presented the award.

HAM RADIO in U.S.S.R.

by WB2CGE

The Soviet Union has some of the world's most skilled amateur radio operators and builders. Credit for this goes partly to the Soviet government, which sets high licensing standards and offers surplus equipment, technical knowledge, and attractive rewards as incentives. Possibly no other government does as much for its hams.

Despite these encouragements, almost no mass-produced equipment designed especially for Soviet amateurs is available. Today the Soviet Union's amateurs number over 15,000, second only to the United States' 300,000. About 10% of Soviet hams are women.

In order to become a licensed amateur, Russians usually follow this procedure:

1. Complete a basic electronics course.
2. Join a club and take a test which licenses them to listen on the ham bands. They must be able to send and receive code at 10 wpm.
3. After at least six months of experience as an SWL, the Russian applicant is then able to take the third class test.

4. The third class test consists of a more difficult exam and 12 wpm code test. The schematic of a 10-watt rig must be drawn, and they must explain how it would be integrated, how frequency stability would be achieved, what kind of antenna would be used, and how it would be tuned. The third class certificate permits them to use 10 watts on 3.5-3.65 and 7-7.1 MHz, CW, and 28-29.7 MHz phone. Licenses are renewed only when the operator moves to another class.
5. The second class license is more difficult. When passed, Russian hams are permitted to run a maximum of 40 watts. They can operate CW on 3.5-3.65, 7-7.1, 14-14.35, 21-21.45, 28-29.7, 144-146, and 420-435 MHz. They can use phone on 10 meter frequencies. 160 meters is not open to Soviet hams, nor is 6 meters (which is taken by TV).
6. The difficult first class exam is similar to the extra class in the U.S. They must be able to send

RADIO SHACK AND ALLIED JOIN

Form Multimillion

Dollar Retail Merchandising Firm

Allied Radio, one of the most popular sources of ham gear in years past, has just been acquired by Tandy Corporation, parent firm of the multi-outlet "Radio Shack." The result is a total chain of more than 700 electronics department stores in 48 states.

To kick off the new association, all Radio Shack stores will display Allied catalogs. In time, the individual stores are expected to stock a large percentage of Allied's 30,000-item line.

For the time being, all Allied stores will continue to operate under the Allied name, though such stores will begin stocking Radio Shack's exclusive lines, such as *Realistic*, *Archer*, and others.

On the surface at least, this appears to add up to a pretty good deal for the amateur radio operator, who has never had much trouble finding a Radio Shack store, but who frequently finds it difficult to find the ham gear items he needs. With Allied's ham gear line, and Radio Shack's merchandising centers, getting parts and supplies should be simplified considerably in the future.

and receive code at 18 wpm, design transmitter and receiver circuits, and build and troubleshoot advanced transmitters and receivers. They can run 200 watts CW or phone on all bands available to second class operators.

A special amateur radio station will be operating from the Washington Hilton Hotel in Washington, D.C. from May 17 to 30 while more than 1400 delegates from 41 countries are assembled there for the 35th General Meeting of the International Electrotechnical Commission.

Special temporary authority has been granted by the Federal Communications Commission to operate the amateur radio station which will have the callsign WF3IEC.

The station will be installed in Suite 9101 of the hotel. It will be under the supervision of amateur operator Ed Redington whose callsign is W4ZM. Mr. Redington will be assisted by members of the Foundation for Amateur Radio.

The station is planning to be on a round-the-clock basis. Single sideband radio-telephony and radio-telegraphy will be used on all bands except 160 meters.

A special acknowledgment (QSL) card will be sent to all who contact WF3IEC. Confirmation cards may be sent to W3ZA, L.M. Rundlett, Engineering Dept., Electronic Industries Assoc., 2001 Eye St., N.W. Washington, D.C.

The International Electrotechnical Commission is the oldest international standards organization in the world. The Commission is meeting in the United States for the first time since 1954.

FIELD DAY-CONTESTS

The German Amateur Radio Club invites amateurs from all over the world to participate in the German Fieldday-Contests 1970.

These contests are mainly for portable operating outside the home, independent of the mains using only batteries or petrol-electric generating sets for power supplies. For complete details contact Norbert Meyer DJ7JC, DARC Fieldday-Manager, POB 1752, D-463 Bochum, Germany.

Auction/Hamfest in Pennsylvania

"Second Sunday in June," Third Annual Hamfest of the Foothills Radio Club, Inc., of Greensburg, Pa., will be held in Wendel Park, Wendel, Pa., 3½ miles South of U.S. Route 30, Irwin, Pa. All activities under an enclosed pavilion, rain or shine. Snack Bar for lunch, registration only required for prizes and parking is free. Drawings, displays and the traditional "trunk-line" merchants. New this year — public ham hear auction and a Club Display Contest."

QSO Party

The White Sands Amateur Radio Station, K5WSP, will hold a QSO party on July 9, 1970. The QSO party will be held in conjunction with an "Armed Forces Day" open house at White Sands. K5WSP will send a special commemorative QSL card to all stations contacted during the QSO party. The proofs of the QSL card are completed and the final, full color, model will be going to the printers soon. The card depicts 25 years of progress in aerospace and nuclear research and development at White Sands Missile Range. There will be several rigs operating simultaneously in the General class phone bands and possibly one Novice class band.

HAMFEST

Six Meter Club of Chicago Inc.

The Six Meter Club of Chicago, Inc., will hold its 13th annual hamfest in Frankfort, Illinois, on Route 45, one mile north of Route 30, on August 2, 1970. We anticipate that at least 1200 licensed amateurs, members of their families, and others who share an interest in amateur radio will be present. Contributions such as electronic parts, kits, components, books, QSL cards, antennas, magazines, instruments, gift certificates, etc., will be gratefully appreciated. All contributors

Pittsburgh, Pa.

The 16th annual Breeze Shooters Hamfest will be held at White Swan Park near Pittsburgh PA on May 17, 1970. This event attracts over 1200 amateurs annually. For more information contact J.L. Burnett K3IXB, 608 Charlotte Drive, Pittsburgh PA 15236.

ROME HAMFEST

The Rome Radio Club is holding its annual Ham Family Day on June 7, 1970 at Beck's Grove, Blossvale, New York. There will be three programs running simultaneously; one for hams . . . one for the ladies. . . and one for the children. The Hamfest starts at 1300 and at 1700 a steak and chicken dinner will be served.

WASHINGTON HAMFEST

Two-Day Program

by W7BUN

The Washington State Hamfest will be July 11 and 12 this year. This event will be sponsored by the Radio Club of Tacoma and will be held at the Sportsmen's Chateau, 164th and Canyon Road, south of Tacoma. Activities include CW awards program, QLF and QAS contests, mobile judging and mobile efficiency contests, technical meetings, technical displays, QCWA display, manufacturers' displays, 75 and 10 meter mobile hunts, swap shop, hole-in-one contest, women's and childrens' activities, after-dinner program, many fine prizes, etc. Camping space available on the grounds, \$1.00 per night with free electrical hookup; 3970 kHz, 50.5 MHz, and 146.76 MHz FM will be monitored for arriving mobiles. The fee of \$5 includes Saturday evening dinner and registration

ZL SSTV OK!

The Wireless Institute of Australia reports that slow scan or narrowband TV has been approved by the Postmaster General for use on all amateur bands as presently authorized in Australia.

Standards to be used are entirely at the discretion of the amateur, although bandwidth of emissions shall not exceed that of an A3 single sideband or double sideband signal.

Where A3 and A5 emissions are used simultaneously on the same carrier frequency, the total bandwidth is restricted to no more than that of an A3 double sideband emission.

Identification is required to be by call sign in visual form on televised picture and by telegraphy on telephony sound channel.

EBRC Spring Picnic

Saturday, May 2 at NAPA Valley Ranch Club, is the date and place for the spring picnic. The activities will include operating, archery, hiking, possibly swimming, ball games, etc., Guaranteed sunshine! There will be a nominal charge per person. Bring your own food.

ATLANTA HAMFEST

The Atlanta Radio Club will hold its 44th annual hamfest June 13th and 14th at the North DeKalb Shopping Center. The main prize is a Swan 500C transceiver with ac supply, along with many others. There will be many contests for the amateurs as well as games and other activities for the ladies. Further information may be obtained from John Fearon, 3384 Peachtree Rd., N.E., Suite 705, Atlanta, Ga., Tel. 261-4924.

News, Reviews, Announcements

Hawaii SCM to QSL for Kure

Notes 1969 Log Entries
Not Valid

Lee R. Wical KH6BZF has announced that he is managing the QSL end of the DX business for KH6EDY, Kure Island, and that he holds that operating logs dating all the way back to January 1961.

In his report, Wical noted that some of the 1969 operations appeared to be invalid. The logs, he said were not, in all cases, properly signed in accordance with Section 97 of the FCC Rules and Regulations. He held hope for nonconfirmed contacts, however, by adding that QSLs for these occasions would be "handled on a case-by-case basis."

Wical listed the criteria to be met for stations expecting DX credit for Kure: U.S. amateurs must include SASEs; bureau cards will not be accepted. Do not send cards direct to Kure, as loss will be an inevitable result. DX stations must include SAE plus two IRCs for surface mail (or four IRCs for airmail).

Attachment Adds New Band to 4-Band Vertical

Mosley Electronics is marketing a conversion kit that includes a coil used to expand the Mosley 4-band vertical antenna to 5 bands. The added band,



will be publicized during the hamfest drawing, and in our Club's monthly newspaper "The Halo." Please contact Jack Hellwig K9ZWU, Prize Chairman, Six Meter Club of Chicago, Inc., 3420 S. 60th Court, Cicero IL 60650.

FERMANAGH FESTIVAL

Activates GB3

by Sean MacMahon G18AWF

For the second year running an amateur radio station will be established for the duration and in conjunction with the 1970 Fermanagh Festival.

The station, GB3FRE, will be in action at the Townhall Enniskillen, from Friday, June 19 to Sunday, June 28. At least two fully equipped operating positions will be set up. Operating time, which will be mainly in the evenings, will be spent most of the time on 160, 20, and 15 meters, sideband and CW.

The principal objects of GB3FRE, are:

- (1) To enable hams throughout the world to have a contact with this rare county.
- (11) To publicize Fermanagh.
- (111) To interest members of the public in Fermanagh and elsewhere in amateur radio.

A special QSL card will be issued to all stations from whom a QSL is received.

Last year GB3FRE was in great demand and worked approximately 800 stations in all continents.

20 Meters

All stations having traffic for the L.A. area are invited to check into the Southern California Amateur Network, 14.325 MHz, 0500-0600 GMT, Monday thru Friday.

(Children under 12, \$1.50 for dinner only). Logger's breakfast served by the club Sunday for only \$1.25. Snack bar open both days. All dinner reservations must be made in advance. Contact John Austin K7CZF, 8478 Eastside Drive N.E., Tacoma, Washington 98422, for information, motel reservations, or hamfest tickets.

Champlain Valley Hamfest

The annual hamfest of the Champlain Valley Amateur Radio Club will be held July 19 starting at 10:30 a.m. at the club shack on Akey Road, Cadyville, N.Y. (7.2 miles west of Plattsburgh on Route 3.) Food and beverages available on the grounds, talk-in on 146.34-146.94 FM (WIKOO) and 3925 Kc. SSB. Send advance registrations (\$1.50) to CVARC, Box 241, Cadyville, N.Y. 12918.

ERIE, PA. BANQUET

On Saturday, October 10, 1970, the Radio Association of Erie will be holding its annual dinner banquet. This is our 25th year of serving the ham and community, having been founded in 1945. A part of our program features the giving away of door prizes which are donated by local stores, as well as various gear from manufacturers and distributors. The Radio Association of Erie would be honored to have companies represented at our dinner and W3GV would be happy to distribute the literature and will provide advertisement in our monthly paper, the *QUA-RAE* in return for any donation. Please send any donated material to: The Radio Association of Erie, c/o John Gebler, PO 844, Erie PA 16512.



Charles Ercolino Named
Telrex President

C. Charles Ercolino has been elected president of Telrex Communication Engineering Laboratories, Asbury Park, New Jersey, manufacturers of TV and communications antennas. He succeeds his father "Mike" Ercolino who will continue as chairman of the board and chief engineer.

Charles Ercolino is a graduate of Youngstown University with a BS in business management. He started with Telrex as a salesman traveling the country extensively.

In discussing this change in leadership, Mike Ercolino said, "The time has come for Telrex to expand both its TV antenna line and its communication antenna systems. To do this, we need the vitality and modern marketing methods which stem from younger people. I look forward to being able to devote my time to research and development as well as supervising the construction and installation of our 'Big Berthas' and other highly sophisticated arrays for which Telrex is noted. I have enjoyed every minute since we established Telrex nearly fifty years ago. Now it's Chuck's turn and I know he'll do a good job."

75/80 meters, is incorporated with a special coil rated at 2000 watts PEP that attaches to a condenser tube fitted over the vertical element of the original vertical (RV4C). Tuning is accomplished by sliding a U-shaped matching rod along the vertical element until the desired frequency is attained. According to Mosley spokesmen, the resultant vswr is 1.5:1 or better.

VHF'ers PICNIC

The Mt. Pleasant Amateur Radio Club cordially invites you to attend the southeastern Iowa VHF'ers picnic to be held at McMillen Park, Mt. Pleasant, Sunday, July 12, 1970 from 9 a.m. Pot Luck lunch, free coffee, trunk sales. All hams welcome, no charge. Rain or shine, shelter provided. Talk-in on 50.480 and 3.950 MHz.

Lancaster and Fairfield County Hamfest

The Lancaster and Fairfield County Amateur Radio Club is pleased to announce their annual hamfest to be held this year at the Lancaster Fair Grounds in Lancaster, Ohio, Sunday May 31, 1970. The club will be happy to accept any prize contributions, large or small, for use as door prizes. If further information is required, please write for reply to Howard Schaefer, President, The Lancaster and Fairfield County Amateur Radio Club, P.O. Box 3, Lancaster OH.

Massachusetts Amateur Radio Week

Worked all Massachusetts cities & towns

These two contests under the auspices of the Massachusetts Chapter of the National Awards Hunters Club will take place the week of June 14-20 from 0001 GMT June 14 to 2400 GMT June 20. These will run simultaneously during this week which has been proclaimed by the Governor as Massachusetts Amateur Radio Week.

*Dayton Hamvention
A Real Blockbuster*

by K6MVH

The Dayton Hamvention was the biggest smash success of any ham convention I've ever seen. Records showed that more than 4000 hams passed through the halls at Hara arena in Dayton to see the wares being exhibited by the manufacturers. The flea market area, where hams from all over the country displayed their goods for sale and trade, covered a seemingly endless territory from the arena proper to a dirt area a jillion miles from the buildings. Money changed hands faster and more furiously than in a Las Vegas casino, and many hams bought and sold to such an extent that they were able to run up a modest purchase into an impressive shackful of equipment.

The convention area was several miles from the nearest hotel, which might have presented a problem for many out-of-staters who flew in for the occasion. Anticipating such logistical dilemmas, the Hamvention planners hired buses that ran regular schedules during the convention. The distributors themselves, however, with their heavy displays and other exhibit material, found themselves in a veritable "transportation bind."

The 73 booth was so active that all the magazines and books I had taken were gone the first night of the Hamvention. If I couldn't get more from Peterborough I would have been out of business. A quick long distance call got more books loaded onto an airplane, but there was still the problem of getting the merchandise from the Dayton airport to the arena.

Thanks to the traditional ham spirit, as exemplified by Steve Holden

FREE SPEECH for HAMS ?

by K2AGZ

If you read the May issue of 73, and I hope you did...and if you happened to see the lead story in the recently inaugurated Radio News Page, and I would be disappointed if you hadn't...you are aware that we may witness, eventually, some sort of court test of FCC Rule 95.83(a) (3). This rule spells out prohibitions of "... obscene, indecent or profane language, words or meaning." Commissioner Nicholas Johnson, in a detailed statement, which the Commission published as an appendix to Docket 18804, expresses serious reservations as to the constitutionality of 95.83(a) (3), due to an apparent abridgment of the guarantee of free speech, as explicitly cited in the First Amendment, part of the Bill of Rights.

This matter is of particular significance to amateurs because of the dialog which followed a specific editorial in QST, in which it was stated by inference that the FCC did indeed have the right to suspend or revoke ham licenses on these specific grounds, and in which the editorial took the position that free speech, while it may be guaranteed in all other respects in our society, may be undesirable on the ham bands. 73 disagreed with QST's position, as expressed in Leaky Lines. And the correspondence which was subsequently published in QST showed that there was disagreement among rank and file ARRL members also. In its editorial, QST also sanctioned the activities of a group of self-appointed monitors and vigilantes, who constantly roam the bands, gratuitously offering opinions and advice in the form of unsolicited and unwelcome anonymous comment as to the appropriateness or acceptability of other people's conversation. They were sanctioned thus,

entire text of Johnson's statement. We urge you to refer to page 2 of the May issue of 73, for the text. Although it is merely an opinion, it is certain that it reflects the views of a growing body of persons with profound misgivings with respect to an apparent drift of public confidence away from the Bill of Rights. A growth of willingness among the public to repeal such guarantees, all of which are fundamental to our system, makes it particularly important to focus attention upon the dangers of a too equanimous approach.

This is a deadly serious matter, and merits the undivided attention of every American who values our way of life, for if ever we allow these time-tested cornerstones of our Constitution to be eliminated, we would be opening the door to the most heinous form of totalitarian tyranny...that of mob rule!

At this juncture, I can almost fancy that I hear the voices of some of my best friends, even, saying that I'm going crazy, for how could anything so unimportant as this possibly result in any type of totalitarian takeover.

So that there may be no ambiguity about this point, let me enlarge upon it and examine it. The Bill of Rights, basic threads in the fabric of our democracy, came about as a result of the experiences of other nations where no guarantees existed. Indeed, they were unique because they had never been embodied in any *corpus juris* prior to their adoption here, in our Constitution. This was a new experiment; untried and unheard of. There was but one purpose in them; to guarantee the rights of all citizens who might hold minority views at variance with the views of the majority. If you study them, you will find this implicit

proved ability to tolerate all sorts of differences of opinion. We do not require the sort of conformity which would guarantee our leaders a type of authority minus checks, balances, or criticism. Our country is the best on earth because of this apparent contradiction; not in spite of it! And when we forsake this fundamental principle, that is the day we will begin to deteriorate into something less than the best.

The drive toward conformity of ideas, ethics, morals, dress, manners, standards, and goals, is fraught with the most fearful consequences. The most alarming result of all this is the seeming docility with which many persons are accepting the idea. We are growing so used to having the government rule every facet of our lives these days, we are beginning to lose our ability to think like free men. If we do not put a stop to it, we may be getting close to the adoption of the "Big Brother" system. (Ed. note: 1984 is less than 14 years away!) That would be the end of our free society.

Commissioner Johnson recognizes this. When we go on the air and voice opinions, no matter how distasteful they may seem to some, we are guaranteed the right to express them, as spelled out in the Amendment. Until there is devised a meaningful set of standards which will clearly delineate the limits in unmistakable and unequivocal terms, then no one has the right to muzzle us...not the FCC, the Vice President, the attorney general, or even some self-righteous hams, who appoint themselves the sentinels of public morality.

The Constitution was never meant to provide anyone with a guarantee against somebody else's freedoms to

K8RZL, the problem wasn't one after all. Steve, the trustee of Toledo's FM repeater, not only made the trips to and from the Dayton airport, but he made his services available to 73 on a no-strings basis throughout the whole convention.

It is sometimes difficult to determine what makes one show such a phenomenal success and others no more than adequate. Looking back and analyzing the convention objectively, I can see several factors that might be key contributors to Dayton's popularity. Other convention planners take notice:

Plenty of active on-the-air exposure, with continuously manned talk-in frequencies.

Carefully planned and well executed advance advertising and coordination, including interesting publicity releases.

Saturated publicity around Dayton. Motels carried special "welcome" signs, a Foster & Kleiser billboard screamed out the Hamvention message, and special buses sported huge banners giving the essentials.

An atmosphere of friendliness pervaded the arena. This is extremely important, and was handled professionally and proficiently by the Dayton Hamvention people. In many conventions, you get the feeling everyone is after your money — but not at Dayton. The local amateurs, for example, set up a coffee and donut area the first night, right on the convention floor; a large sign told the world the goodies were free. And there was plenty of refreshments to go around.

Local amateurs participated in the convention, giving the impression that they really cared about how the attendees felt. K8RZL's support to 73 was but one example among many.

despite the fact that they, the vigilantes, are in clear violation of a totally unambiguous rule pertaining to station identification.

It now appears that there are serious doubts, not only with respect to the previously condemned use of prohibited styles of language, but also concerning the very rule which spells out such prohibition. We have always contended that since there are no precise standards for permissible speech over the air, and that those standards which do exist merely reflect an arbitrary individual point of view, depending upon the criteria of the party in judgment, then it is clearly an abridgment of individual liberty when speech is limited, so long as such limits are not in conflict with what is clearly against the Constitution, as in cases of sedition or treason, as spelled out in the Smith Act, for example.

We cannot, of course, reprint the

The ham booths were taken seriously, carefully prepared, continuously manned, and were not "junky" in appearance. The FM booth, in particular, was a winner. The clever local FM group which operates on the local repeater output frequency of "seven-six," managed to get some advertising gimmicks from Union Oil Co.'s "76" gasoline promotion campaign. They were able to display a huge orange ball with a boldly imprinted "76" in the booth, and distributed smaller versions of the balls to local FM'ers, who fixed them to the tops of their handie-talkie antennas.

The safest way to assure a successful ham convention, it would seem, is to plan all activities, promotions, meetings, and logistics well in advance, and to treat all attendees with as much respect as you'd show your own relatives. And after all, aren't we all related anyway?

in each and every one of the Amendments of the Bill of Rights. The First assures freedom of speech, press, and the right to petition for redress of grievances. It also guarantees against laws respecting an establishment of religion, or prohibiting the free exercise thereof. This is clearly designed to protect the rights of minority opinion. And the others are similarly designed, whether the Fifth, which protects against self-incrimination; the Seventh, which guarantees trial by jury; the Fourth, which prevents unreasonable search and seizure, or any of the others. They were created explicitly to protect those who might hold minority views, and to protect their right to express those views.

There happens to be, however, a very strong current running just now, encouraged by powerful persons, including the Vice President, which opposes the spirit of these Amendments. Mr. Agnew keeps talking about the will of the "silent majority," and about the "liberal press which thwarts that will," and about "intellectual punks." He has been extremely vocal in his attempt to stir up public outrage against those persons and groups representing views which differ from the norm. A recent poll by CBS-TV disclosed that many people are now expressing willingness to repeal all or part of the Bill of Rights, and one cannot separate this growing willingness from the context of the Agnew statements and others. Consequently, the end result would be a stifling of all but majority opinion and majority will...clearly an example of the precise condition which the Bill of Rights was designed to avoid.

It must be stated here that I do not presume to tell the Vice President of the United States that he is wrong and I am right. I do not disrespect Mr. Agnew; I regard him as an articulate, capable spokesman for a point of view with which I happen to disagree, that is all. One thing I know...the strength of this nation is based largely upon our

speech or think. Your freedom depends upon mine. And when I lose my freedom of speech, you begin to lose yours.

So where does all this leave us? It simply means that we come down to the same old standards we've always observed; common sense, good taste and tact. Speech cannot be legislated. Neither can feelings, instincts, ideas, thoughts, or tastes. Just as you cannot regulate prejudice by statute, you cannot impose a state of verbal unanimity. Goodwill can be found not in a law book, but in the human heart.

The point is, though, that when someone doesn't quite measure up to your idea and mine of what constitutes proper behavior, it may not be within the Constitutional rights of the FCC to deprive him of his license. This is the tenor of Commissioner Johnson's statement. If this view should be upheld in a court of law, it is likely to cause a great deal of change in ham radio.

But once again, we can recognize the deep need for a rewriting of the FCC regulations. This one ambiguity, resulting from the confusing language of the regulations, is like the proverbial one-eighth of the iceberg which is visible.

INDIANA HAMFEST

The Madison County (Indiana) Amateur Radio Club will hold its annual "Hamboree" on Sunday, July 12, 1970. Doors will open at 11 a.m. at the county Civil Defense Control Center located 4 miles north of Anderson at Linwood. Activities include a general get-together and flea market. Door prizes will be awarded thru the afternoon, and refreshments will be available. Talk-in freqs. 50.4, 145.35, 146.940.

Classified

Caveat Emptor?

Price — \$2 per 25 words for non-commercial ads; \$10 per 25 words for business ventures. No display ads or agency discount. Include your check with order.

Deadline for ads is the 1st of the month two months prior to publication. For example: January 1st is the deadline for the March issue which will be mailed on the 10th of February.

Type copy. Phrase and punctuate exactly as you wish it to appear. No all-capital ads.

We will be the judge of suitability of ads. Our responsibility for errors extends only to printing a correct ad in a later issue.

For \$1 extra we can maintain a reply box for you.

We cannot check into each advertiser, so Caveat Emptor. . .

GET YOUR "FIRST!" Memorize, study—"1970 Tests-Answers" for FCC First Class License. Plus "Self-Study Ability Test." Proven. \$5.00. Command, Box 26348-S, San Francisco CA 94126.

HAMFESTERS 36th ANNUAL HAMFEST and picnic. Sunday, August 9, 1970, Santa Fe Park, 91st and Wolf Road, Willow Springs, Illinois, southwest of Chicago. Exhibits for OM's, XYL's. Famous Swappers Row. Information and tickets—Tom Ondriska WA9YZW, 6609 South Kedvale, Chicago IL 60629.

TONE CONTROL SYSTEMS — Decoders, encoders, logic, power supplies, COR, autopatch. Compact, plug-in modules, from \$7.50. For complete

NEW EQUIPMENT: FACTORY WARRANTY: BTI LK-2000 Heavy Duty Linear, Reg. (\$895.00), Cash price \$649.00: New Early Model Swan 260 Cygnet with microphone, Reg. (\$435.00), Cash price \$329.00: Gonset GSB 201 MkIV Linear, 2000 Watts, Reg. (\$495.00), Cash price \$339.00. Ed Moory Wholesale Radio Co., Box 506, Dewitt AR 72042. Tel. 501-946-2820.

"TOWER HEADQUARTERS!" 12 brands! Heights aluminum 35% off! Antennas—20% off! Galaxy, Hammarlund, Gonset, SBE at discount. Catalog—20¢. Brownville Sales Co., Stanley WI 54768.

40th ARRL WEST GULF DIVISION CONVENTION July 17, 18—19, Orange, Texas. Come by car, plane, or boat, but come to the fun, fellowship and entertainment. A bargain you can't afford to miss. Registration, \$8.50. Orange Amateur Radio Club, Box 232, Orange TX 77630.

TOP SECRET! Classified frequencies: spies, NASA, military, emergency networks, many more! \$1.00. **TRANSISTOR PROJECTS:** send for free list. EDI, 1918 49th St. E, Palmetto FL 33561.

TRANSISTOR PROJECTS: send for free list. EDI, 1918A 49th St. E. Palmetto FL 33561.

73 IS AVAILABLE to the blind and physically handicapped on magnetic tape from: **SCIENCE FOR THE BLIND**, 221 Rock Hill Road, Bala Cynwyd PA 19004.

NOVICE CRYSTALS: 40-15M \$1.33, 80M \$1.83. Free flyer. Nat Stinnette Electronics. Umatilla FL 32784.

RTTY GEAR FOR SALE. List issued monthly, 88 or 44 MHy torroids 5 for \$2.50 postpaid. Elliott Buchanan & Associates, Inc., 1067 Mandana Blvd., Oakland CA 94610.

END CARD PROBLEMS. Frame, protect, store or display 200 QSL's in 20 card plastic holders for \$3.00, prepaid and guaranteed. TEPABCO, Box 198, Gallatin TN 37066.

FM MOBILE/PORTABLE TRANSCEIVER, 2 meters. Varitronics FDFM2. Perfect for repeaters. Six crystal-controlled channels included: .34—.94, .94—.94, .34—.76, .31—.88, .22—.94, .28—.76. Crystals are International. Includes 12V battery pack, mobile battery cable w/connector, \$200. Ken Sessions K6MVH, RFD 2, Peterborough NH 03458.

HEATHKIT DX60-B, \$70. Johnson electronic T-R switch, \$25. Both for \$90. College forces sale, good condition. Chuck Logan WA0URY, P.O. Box 694, Merville IA 51039.

BECKMAN Freq Cntr & conv. (7370—7570) 0-1 GHZ, Mint, \$450. SP-600-J, \$195. EICO 753, \$95. B.N. Adams, 125 Cordova, Alhambra CA. Tel. 576-1025.

BEFORE YOU BUY any balun, see page 79 for the new higher power balun, all stainless steel hardware. Unadilla Products, Dept. I, Unadilla NY 13849.

1970 S.E. WISCONSIN SWAPFEST July 18. Sponsored by South Milwaukee Amateur Radio Club. Write Larry Kieck K9ZBX, 2801-9th Ave., So. Milwaukee WI 53172.

DTL INTEGRATED CIRCUITS: Guaranteed new-gates 70¢, buffers 80¢, F/F 90¢, dual F/F \$1.15. Add 20¢ postage. Also other inexpensive parts. Lists and prices from Mitch-Lan Electronics Co., Dept. 770, P.O. Box 4822, Panorama City CA 91402.

HQ 110-C Hammerlund Recvr with clock and 100 KC calibrator and manual. Model B Central Electronics sideband-slicer complete with AP-1 (IF amplifier stage) Q multiplier and manuals. Audio filter used with above items. ALL for \$110. W2KKA, P.O. Box 85, Nicholville NY.

HAS ANY ONE built a transistorized single band 80 meter SSB transmitter using switchable modules of Davco DR30 receiver? Please state your price for diagram. S. Renaamo, 4318 Sixth Avenue, Tacoma WA 98406.

LZ1KSZ desperately needs an i-f filter, any frequency, for his homemade SSB rig. 5 MHz ideal. If you have one to spare please send it to 73 Magazine or direct to LZ1KSZ, Box 73, Stara Zagora, Bulgaria marked as a "free gift, used radio part, no commercial value."

COLLINS MINT KWS1: \$500, BC221, P/S \$50. New RBU 2 Panadapter \$50. RCA 7 inch Scope \$35. Send SASE for list. Need Collins Mechanical Filters. Write 73 Magazine (Box 60) Peterborough NH 03458.

MINT CONDITION! HQ 160 General coverage receiver, matching speaker and owner's manual. First \$125 takes. W6VDA, 4850 Jessie Ave., La Mesa CA 92041 (714) 466-3129.

2 PORTABLE TRANSCEIVERS, Wabco 14H82C, 148—174 MHz., FM, 2 Channels, Input 10—18 VDC, 3W RF output, 0.5 W audio output, 14 diodes, 30 transistors, triple conversion receiver, like new with manual, \$225.00 each. B. Dickerson, 1200 Johnston St., Phila PA 19148.

TONE DECODERS: Touchtone-Digital-Burst. Solid-state, modular, plug-in unit, 2 x 2 x 3 in., \$22.50 postpaid. ITT 12-button tone dial, \$27.50. Write Digitone, Box 116, Portsmouth OH 45662.

HOSS TRADER ED MOORY says he will not be undersold on Cash Deals! Shop around for your best cash price and then call or write the HOSS before you buy! Ed Moory Wholesale Radio Co., Box 506, Dewitt AR 72042. Tel. 501-946-2820.

WISCONSIN HAM PICNIC

The Wisconsin amateur radio picnic, sponsored by the Wisconsin Nets Association will be held in Oschner Park in Baraboo, Wisconsin on July 12, 1970. Activities will include code receiving contest, softball game, ladies' activities & eyeball QSOs. Refreshments are included with registration but bring your own lunch. Registration begins at 10 a.m. Registration is \$1.50 single, or \$2.50 for family.

information, write DIGITONE, Box 116-S, Portsmouth OH 45662.

FOR SALE: Heath SB200 linear w/manual. Only 10 hours use. Excellent condition. \$190.00. W1MCO, 130 Main St., Marlborough NH 03455.

STROBE LIGHT PARTS: Flashtube (FT-151) 125 watt-seconds, matching triggering coil, reflector, suggested schematics. \$15.95 ppd. CLAUDE'S Surplus Electronics, 621 18th Ave., Belmar NJ 07719.

WANTED: Hammarlund Model HX-50 with 160 mtrs, in good condition. Peter Turbide K1VGR, 42 Washington St., Newburyport MA 01950.

WORLD RADIO'S used gear has trial-guarantee-terms! 22er—\$129.95; 66'er—\$99.95; 99'er—\$69.95; KWM2A—\$749.95; 350 late—\$289.95; 400 & 420 VFO—\$279.95; NCX3—\$159.95; Galaxy V—\$229.95; HT40—\$49.95; 75A1—\$149.95; 2A—\$159.95; R4—\$299.95. Free "Blue-Book" list for more. 3415 W Broadway, Council Bluffs IA 51501.

COLOR ORGAN KIT, three 200 watt channels, \$7.50. Cabinet, \$8.50. Power supplies, \$2.75 to \$8.50. Ceramic capacitors, \$.10. Dual flasher 1000 watt, \$3.98. Computer grade electrolytic capacitors, \$.35. TV cheater cords, \$.25. Catalog. Murphy, 204 Roslyn Ave., Carle Place NY 11514.

FM RECEIVER. Portable, Heathkit, tunable, model GR-88. Tunes from 145 to 167 MHz. Battery-operated. Exc. sensitivity and selectivity for monitoring local repeater outputs. Like new, \$50. Ken Sessions K6MVH, RFD 2, Peterborough NH 03458.

FM MOBILE TRANSCEIVER, 450 MHz, 2-channel trunk mount RCA rig in perfect condition. Fully duplexed and operating as a mobile telephone. Includes transmit crystals for 442.12 and 442.05; receive crystals for 448.82 and 448.85. Crystals are from Sentry and all enclosed in ovens. Complete less control head and cables: \$100. Will throw in two 4 dB Com Prod mobile gain antennas. Ken Sessions K6MVH, RFD 2, Peterborough NH 03458.

GREENE... center dipole insulator with...or...without balun. See 73, November '69, page 107.

FOR SALE: HW 32A mint condition, \$75.00. Heathkit IM-17 VOM, \$12.00. Max Holland, W4MEA, Hiwassee College, Madisonville TN 37354.

SELL: HT-37, mint condition \$200 (can deliver St. Louis). EZ Way crank up tower with H.B. rotator, house mount \$90. William M. Hurni, 1204 Inverlieth Rd., Lake Forest IL 60045.

AM PARALYZED bedridden, multiple sclerosis. Cannot afford correspondence course, TV repair. Please lend me yours. Technician Tom WB4CBV, 504 Victoria Blvd., Auburndale FL 33823.

TRADE: 28KSR, 19, Typing reperforator, TT/L-3, for 28ASR, 60 cycle supply or motor for mite. David G. Flinn, 10 Graham Road West, Ithaca NY 14850.

LINEAR BUILDERS: Send SASE for amplifier and power supply parts. Low price list. "Fox" 2006 West Gonzalez St., Pensacola FL 32501.

WANTED: Up-to-date roll chart for "Precision" Tube Master, series 10-12 tube tester. WA5QFV, Route 2, Box 82, Bowie TX.

NEW ROHN 50 ft. Foldover tower prepaid, \$199.95: New Mosley Classic 33 and Demo Ham-M Rotor, \$198.00. Ed Moory Wholesale Radio Co., Box 506, Dewitt AR 72042. Tel. 501-946-2820.

USED EQUIPMENT: R4, \$269.00, HT-37, \$179.00, 75A-4, \$299.00, 2B, \$169.00, Galaxy 5, \$229.00. Ed Moory Wholesale Radio Co., Box 506, Dewitt AR 72042. Tel. 501-946-2820.

FOR SALE: COD HW32, EICO753, HQ100, SX100, DX100, \$100. BC348, BC221, TBS50 \$75. DX40, DX60, HT40, \$60. Globe 90 \$30. F. Shain, Box 8352, Savannah GA 31402.

HW-12, factory overhauled, HP-23, PTT mike. \$105. WA4LBO, U-2255, Columbia SC 29208.

radio amateur callbook

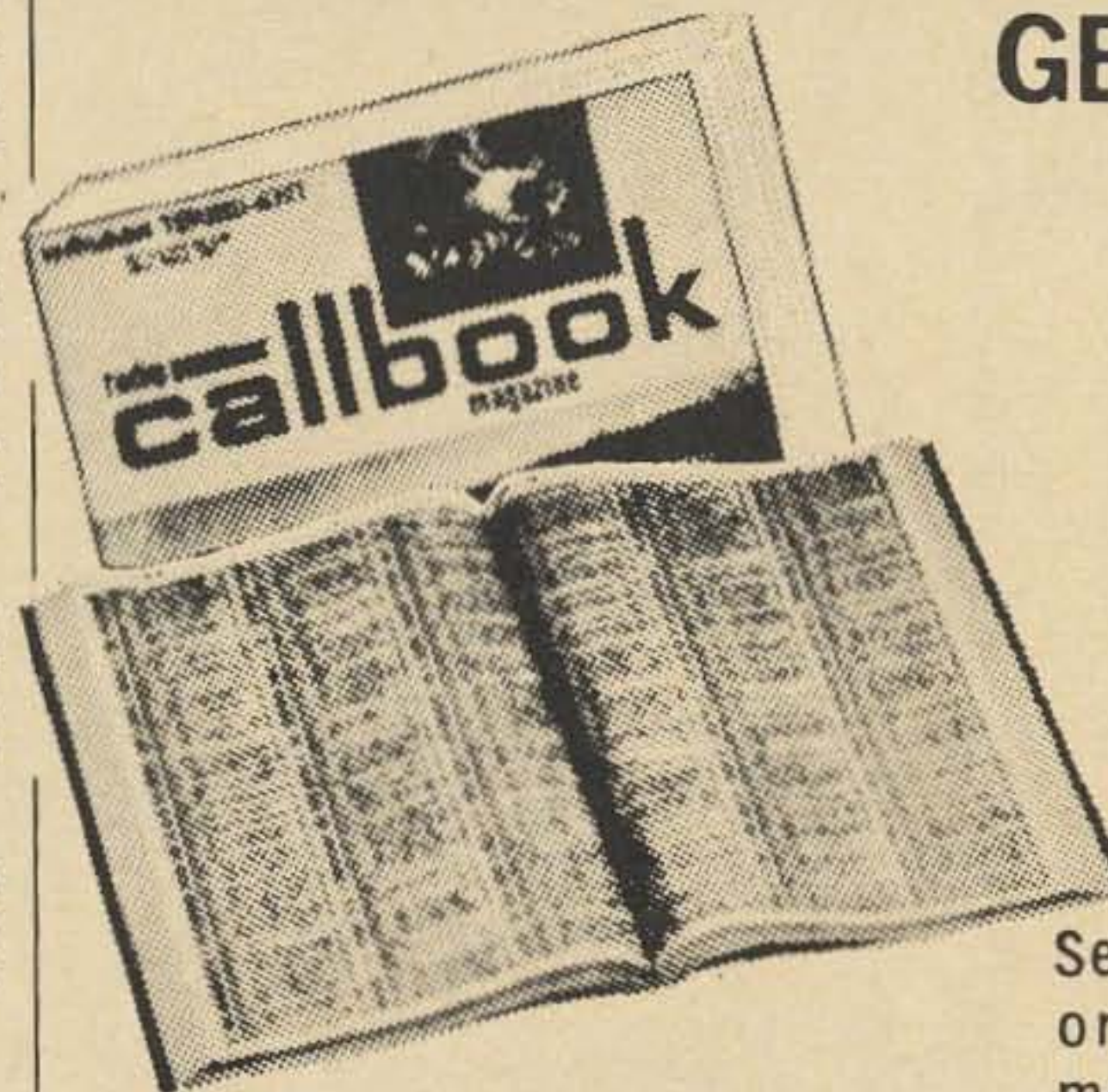

GET YOUR NEW ISSUE NOW!

Over 283,000 QTHs
in the U.S. edition
\$7.95

Over 135,000 QTHs
in the DX edition
\$5.95

See your favorite dealer or order direct (add 25¢ for mailing in U.S., Possessions & Canada. Elsewhere add 50¢).

These valuable EXTRA features included in both editions!

- QSL Managers Around the World!
- Census of Radio Amateurs throughout the world!
- Radio Amateurs' License Class!
- World Prefix Map!
- International Radio Amateur Prefixes
- Radio Amateurs' Prefixes by Countries!
- A.R.R.L. Phonetic Alphabet!
- Where To Buy!
- Great Circle Bearings!
- International Postal Information!
- Plus much more!

**WRITE FOR
FREE
BROCHURE!**

RADIO AMATEUR

callbook INC.



Dept. B. 925 Sherwood Drive
Lake Bluff, Ill. 60044



NEVER SAY DIE

...de W2NSD/I

EDITORIAL BY WAYNE GREEN

A Visit to Jordan

With nothing more to go on than a note in Gus' DX bulletin to the effect that King Hussein of Jordan had been heard on the bands fighting off tremendous piles of QRM, I sent a cable to him asking if he could use some help for a few days to beat down the multitudes. With Radio Today just being started and the tight U.S. economy making its pinch felt all too clearly on 73, I wasn't really too enthusiastic about my proposal.

On the other hand, the insurmountable problems at 73 have continued without any real letup for a long time, with me there or away, so perhaps a few days off wouldn't be too serious. And uppermost in my mind was the opportunity to possibly make a good friend for amateur radio, one who could have a strong long-range impact on the hobby. If amateur radio could be developed in the Arab countries this would not only benefit them tremendously by encouraging the growth of engineers and technicians, but would help amateur radio by giving it a few more votes at the ITU conferences in the future.

Much to my surprise an answering cable arrived from His Majesty asking me to come. Within a few days I was off to Jordan and whatever lay ahead. Where would the station be? At an army base? Perhaps in the palace? Would I be able to operate much? Would I get to do more than just meet His Majesty? Those of you who have been reading my editorials know that all sorts of ingenious plans for solving the mid-East crisis started coming to my mind.

When I checked in at the airport in Boston they suggested that I hand carry all films with me since all checked baggage is xrayed at London before going on to the mid-East. This called for a complete repacking of my bags in the black of the parking lot, and I ended up by carrying on two bulky bags full of cameras and film.

Lin didn't think I should go in my dungarees, so I hope the IRS will agree that the business suit I bought for the trip was a necessary business expense. You don't need business suits very much in New Hampshire.

The plane left Boston in the evening and arrived in London the next morning. As usual on these trips I managed zero sleep. They had some fool movie that I had seen so I saved the \$3 for

the earphones, but still couldn't keep my eyes off it.

After a couple of hours wait at London in the passenger lounge I was off again to Beirut. I'd written Bob ODSBZ there, hoping he would have time for dinner between my planes. Late that afternoon I arrived at Beirut, but no Bob. I found out later that he was out of the country on business. I put away a great Arabian meal at the airport restaurant and continued on to Amman on a Royal Jordanian Airline plane, landing there about 9:30, wide awake on my second wind, beyond being tired.

There was a big commotion outside of the plane, with newsreel photographers and all . . . the man beside me said, "Look out there and see our King." Sure enough! I could end that there, leaving you with the notion that he had come to see me, but actually he was greeting his sister. I was met by a man from the palace who expedited my passport and bags through, told the King that I had arrived, and drove me in a beautiful Mercedes to the Jordan Intercontinental Hotel where I was to be the guest of His Majesty!

I slept.

The Hotel Jordan, as it is called, is an American style hotel . . . showers, wall-to-wall carpeting, the whole bit. It has a serviceable coffee shop and a first rate restaurant on the roof. The "maids" are men, but they know all the ropes such as opening your door at 6 a.m. to see if the room is occupied. Just like America. They try the door again at 7 to make sure they were right at 6.

The next morning a phone call explained that a Mrs. Salti would be picking me up shortly. Mrs. Salti turned out to be the private secretary to His Majesty and a very nice looking English girl. She explained that there was some sort of big do on shortly if I would like to come . . . I grabbed my camera case and we were Mercedes'd to the gigantic sports arena . . . jammed with people. We sat up in the grandstand, not far from the King's box and awaited developments.

The "do" consisted of a couple hours of speeches, His Majesty presenting flags to a number of artillery groups, inspection, parades, and some really beautiful precision marching by both military and bagpipe bands. There were some-

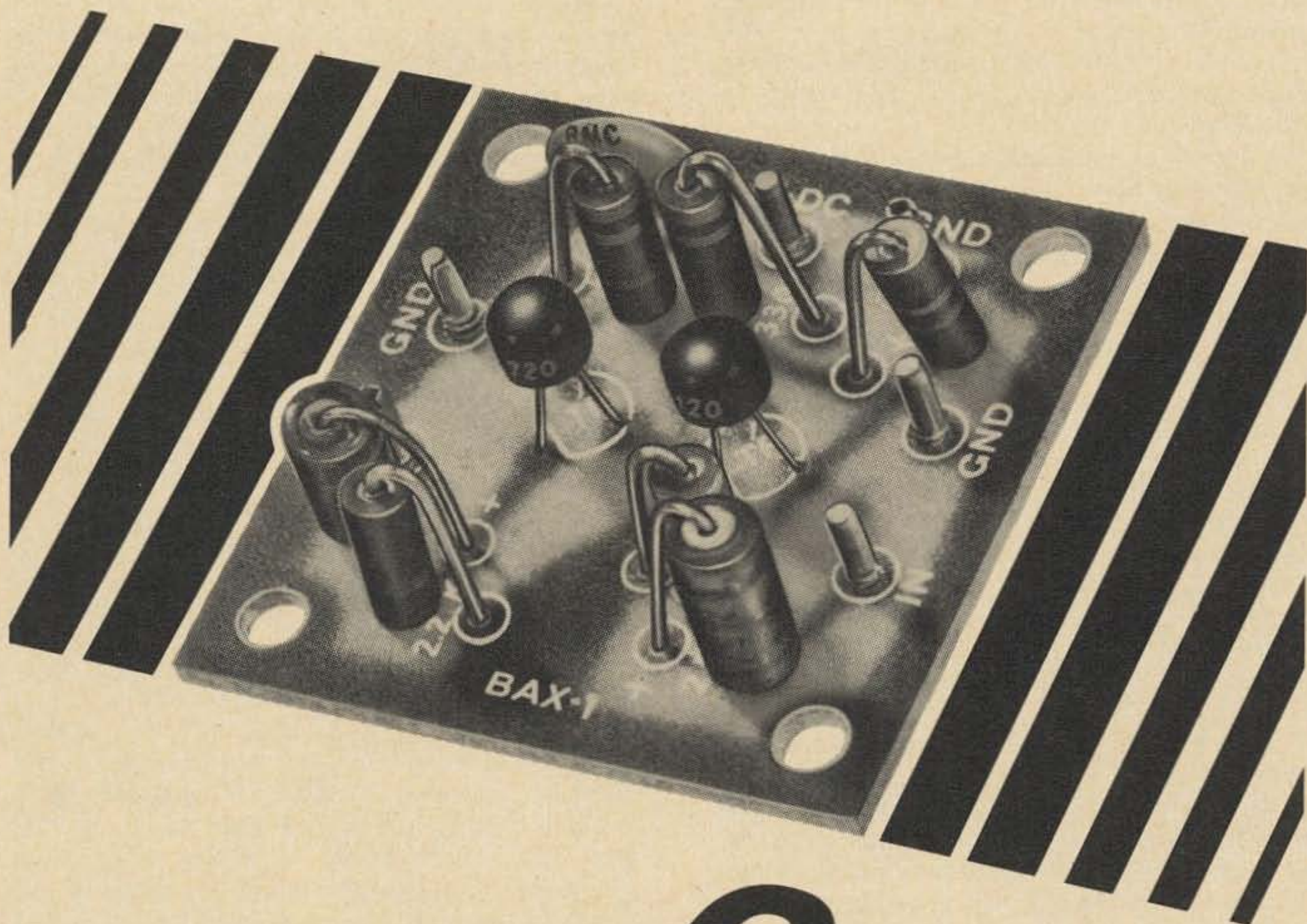

International BAX-1 Broadband Amplifier is a general purpose unit which may be used as a tuned or untuned amplifier in RF and audio application. For example: when used as untuned RF pre-amplifier connect between antenna and receiver antenna posts. Ideal for SWL, Experimenter or Amateur applications. Easy to build. Complete Kit.....\$3.75

SPECIFICATIONS:

1. Power9 to 15 volts dc @ 10 ma
2. Frequency Range.....20 Hz to 150 MHz
3. Gain at 1 MHz.....30 db
Gain at 150 MHz.....6 db
4. Response ref 1 mhz.....down 6 db at 50 hz ,
±3 db 100 hz to 10 mhz
down 15 db at 100 mhz
down 24 db at 150 mhz
5. Operational Impedance.....50 to 500 ohms
6. Noiseless than 10 microvolts rf
across 50 ohms; audio
less than .0005 volts
7. Maximum Input Level......01 volts ac
8. Output at Maximum Input...50 ohms — .1 volt
(at 1 mhz).....500 ohms — .5 volt
- Size inches.....1½" x 1½" x 1"
- Mounting4 holes with spacers

Write for complete catalog.

6 to 30 DB GAIN!

WITH **ICM** LOW COST
**BAX-1 BROADBAND
AMPLIFIER** (20 Hz to 150 MHz)



CRYSTAL MFG. CO., INC.
10 NO. LEE • OKLA. CITY, OKLA. 73102

what over 15,000 people in the stands for the big show.

Mrs. Salti delivered me back to the hotel and promised to pick me up later to meet His Majesty. She surprised me by arriving in her little Renault instead of a Mercedes and we were off to see the King.

We drove for some ten miles or more out of town, stopping at several checkpoints and gates along the way, ending at a beautiful two-story modern home atop a hill with a little vertical antenna on top. We were met at the door by His Majesty and shown into the study where he has his ham station. He has a Drake R4B, T4XB, L4, and MN2000 tuner. A nice setup.

During the next two weeks I operated the station using the call JY1 on a daily basis, usually operating from about 3 p.m. until 8 or 9 p.m. Since the station was installed in the King's home (palace) I appreciated that he and his family were not too anxious to have me sitting there around the clock. We did arrange for one all-night session in order to make JY1 available to the eastern U.S. stations who missed the 1300 GMT openings.

I had the opportunity to talk with His Majesty on many occasions, sometimes for an hour or so. I found him to be interesting, well informed, warm, friendly, and reasonable in every way. I in no way found an emotional and intransigent Arab leader. He is modest, rather shy, and gracious almost to a fault. The list of problems he has to face would fill a book . . . a lack of resources . . . shortage of water . . . lack of power facilities . . . extremist groups galore . . . little industrial capacity . . . undeveloped agriculture . . . recent loss of a large part of his people and the most productive and advanced territory (Palestine) . . . a loss of brainpower to more developed countries . . . a loss of money from the wealthy to safer banks in Switzerland. . .

Bleak as the picture might seem to be – and I should hasten to say that His Majesty offered no complaint, only optimism – the list above is one I gleaned from talking with others. He has accomplished miracles already, considering what he has to work with. The State Department paper on Jordan is most enthusiastic about the rapid strides that Jordan has made in the last few years since King Hussein came to power at 17 years of age in 1953.

One evening I was invited to dinner by His Majesty. Along about 10 I joined the family in the living room watching television. The children were off to bed much earlier (twin girls, two years old, and two boys about five and six). With His Majesty was his English wife and her parents, his sister and her husband, etc. Dinner was served and we went to the dining room. There was an oval glass-topped table about 12 ft long, just loaded with dishes of food in the center. We sat down and helped ourselves family-style to roast lamb, hamburger patties on rice, salad, cheese

omelette, ad infinitum. For dessert, sweet fresh strawberries and whipped cream.

After dinner we all got in the cars and were off to the downtown palace for a movie in the King's private movie theater. The feature this night was billed as a comedy, but it was "If," and the imagination has to be stretched a lot to call that grim exercise a comedy. Mrs. Salti dropped me at the hotel at 2 a.m.

Well, so much for the royal life . . . now, what about the ham radio end of things? I did manage to get quite a few stations contacted, even with the time restrictions. I doubt if there are any stations in Europe with any serious interest in DX that have not contacted JY1. For that matter, there really should not be many stations around the world that missed working JY1, if they set their minds to it.

For the most part I found everyone most cooperative and helpful on the air. There were exceptions, of course, but they were exceptions. One of the biggest problems in this area is the wonderful propagation just about around the clock into Italy . . . or should I say from Italy into Jordan? Couple this with the absolute fact that somewhat over 90% of the Italian operators do not understand one single word of English and have no intention whatever of not making a contact exactly when they want to, no matter who else is involved or what they want. I am afraid that I am guilty of taking advantage of this once or twice, being quite insulting because I knew darned well that the offending station would not understand. For instance, only once during the entire two weeks at JY1 was I able to get through to my home station and actually hear them. All through this contact IIVEL continued to call almost continuously, ignoring the most pitiful pleas to wait. You might think that the best answer to this is to just sigh and go ahead and let him make his contact. This is probably so, but it is discouraging to know absolutely certainly that this chap is going to have a very long name which he will spell phonetically twice for you, followed by an even longer city name which he will also spell twice phonetically. Then he will demand to know my name and where to send the QSL card and will not be placated in any way until he gets this information spelled out phonetically twice. Since I had to go through this routine well over a hundred times I am absolutely certain that one of the worst enemies of our hobby yet to turn up has been licensing Italians and giving them a card with their contacts all spelled out for them. All they have to do is read from the card to make contacts and there is no need whatever to understand any English.

There are other devils to slay. While I found most of the USSR amateurs quite polite and cooperative, I must say that the bulk of the really rotten signals also came from their direction. They have a virtual monopoly on bad signals.

Most of the time I was quite successful in using the transceive system of operating. About

(continued on page 140)



HENRY RADIO PRESENTS THE BEST ANTENNA PACKAGES YET!

For three years Henry Radio has been providing a beam antenna-tower program for amateurs who wanted an efficient, but economical package. A package pre-engineered, pre-matched and pre-packaged to his requirements and pocketbook. Thousands have benefited from this offer in the past. And now Henry Radio has researched the field and up-dated the program . . . including the unique new tubular design Mini Mast for less expensive installations and the great new Magna Mast for the more deluxe installations. Now you can get the latest components at the same great savings.

Magna Mast illustrated

EASY FINANCING • 10% DOWN OR TRADE-IN DOWN • NO FINANCE CHARGE IF PAID IN 90 DAYS • GOOD RECONDITIONED EQUIPMENT • Nearly all makes and models. Our reconditioned equipment carries a 15 day trial, 90 day warranty and may be traded back within 90 days for full credit toward the purchase of NEW equipment. Write for bulletin. Export inquiries invited.

TED HENRY (W6UOU)

BOB HENRY (WØARA)

WALT HENRY (W6ZN)

Henry Radio

"World's Largest Distributor of Amateur Radio Equipment"

HR-"Mini" Antenna Package

Tristao MM-35 "Mini-Mast"*

tubular tower — crank-up

CDR AR-22R Rotator**

100 ft. RG-58A/U Coax

100 ft. 4 Cond. rotor cable

Complete with one of the following antennas:

Hy-Gain TH2MK3 \$240.00

Hy-Gain TH3JR \$240.00

Hy-Gain Hy-Quad \$255.00

Hy-Gain 203BA \$270.00

Hy-Gain TH3MK3 \$280.00

*MB-10 Free standing base, add \$36.95

**TR-44 Rotator and cable, add \$35.00

HR-"Standard" Antenna Package

Tristao CZ-454 crank-up tower w/mast*

CDR TR-44 rotator**

100 ft. RG-58A/U Coax

100 ft. Control cable

Complete with one of the following antennas:

Hy-Gain DB10-15A \$555.00

Hy-Gain Hy-Quad \$565.00

Hy-Gain 204BA \$590.00

Hy-Gain TH3MK3 \$590.00

Hy-Gain TH6DXX \$615.00

*Free-standing base, add \$10.00

**Ham-M rotator, RG-8/U Coax, add \$50.00

HR-"Magna" Antenna Package

MA-490 "Magna-Mast"

MARB-40 Rotor base

CDR Ham-M Rotator

100 ft. RG-8/U Coax

100 ft. Control cable

Complete with one of the following antennas:

Hy-Gain TH3MK3 \$735.00

Hy-Gain 204A \$735.00

Hy-Gain TH6DXX \$760.00

The Magna Mast is ideal for stacked arrays. Write for a quotation on the antenna of your choice.

Freight prepaid to your door in the Continental U.S.A. west of the Rockies. For shipment east of the Rockies add \$10.00. Substitutions may be made . . . write for prices.

11240 W. Olympic Blvd., Los Angeles, Calif. 90064

213/477-6701

931 N. Euclid, Anaheim, Calif. 92801 714/772-9200

Butler, Missouri 64730

816/679-3127



I've been dying to talk about New England, and now that the boss is gone, there's no one to stop me. Wayne got an invitation to spend a few days with Jordan's King Hussein, and like a lightning flash he was gone. Now if I can get this editorial into print before he gets back, I'm home free.

The reason I wanted to talk about New England is because I am an impressed Californian. I was born in California and I lived there all my life. Like most other out-of-staters, I had heard a lot about New England, but nothing that would warrant making me want to go there for any length of time. But now I'm here and I'm hooked on the place. (Imagine – four different seasons every year!)

Now, I'm a ham and this is a ham magazine, so I don't suppose I'll be readily forgiven if I deviate from the track for any elaborate travelogs. But I feel like Wayne must have when he got his International Crystal Co. microwave oven – it's so great I *have* to talk about it. There's a whole new realness to American history when you live in New England. It's so easy to get all the behind-the-scenes facts.

Take Paul Revere, for instance. Now, it could be that California schools are a trifle uninformed when it comes to historical events that took place before the state was even a territory. And I might be basing my judgment on Longfellow's misleading "Midnight Ride" epic. But since I came to New England I have learned that old Paul was only one of several who spread the word about those consarned Redcoats. And he failed his main objective – to get word to the citizens of Concord that the King's "Regulars" were high-tailing it from Boston to confiscate or destroy supplies that the Provincials had stored in and around Concord.

Paul took off from Boston all right. He split as soon as he and his companion learned how the Regulars would be traveling. Just a jump and a half ahead of General Gage's troupes, Revere and his companion, Dawes, went riding toward Concord. They stopped in Lexington with a message for upstarts Hancock and Adams (the Hoffmans and Seales of the day). Part of the British troops' assignment, they said, was to arrest these rebel leaders. So when John Hancock and Adams were safely salted away, a Dr. Sam Prescott suggested they head on up to Concord to warn the unsuspecting colonists who were storing arms.

Concord wasn't too far away, so the three of them – Dawes, Revere, and Prescott – set out. At about the halfway point, they were met by a British patrol. Dawes fled back toward Lexington. Revere was captured. But the real hero, Dr. Prescott, was the only one of the three who made it to Concord, and he passed the word.

A few hours later, when the troops did march into Concord, they met the first resistance of the war. And at the outskirts of Concord that same day, the famous shot, described by Emerson as being "heard round the world" rang out, and several soldiers – on both sides – fell dead at the old north bridge. Not 200 yards away, from his bedroom, William Emerson, the father of Ralph Waldo, watched the entire incident, a fact which doubtless helped to inspire the younger Emerson when he phrased those immortal words about this initial action.

Is that the way you learned it in school? Well, it wasn't the way I learned it either, but that's the way it really happened.

Someday, when I really feel brave, I'd like to tell you about my experiences in homebrewing maple syrup: what happens when you confuse the sap from a diseased elm with the good stuff from a sugar maple, and the curious effects on wallpaper when the kitchen stove is used for the boildown process. Later, though – I've taken enough chances for one issue.

A Word to Authors

A very large percentage of you readers are part-time authors. Sometimes you write articles for 73; sometimes for Ham Radio; and sometimes for CQ. Rumblings have been finding their way recently from more and more of you fellows that payment for your services is not always easy to come by. One of our top authors even offered to write an exposé for us on the pay-avoidance policies of one of the other ham journals.

Specifically, the complaint seems to be that when an author submits a manuscript to one of the journals, an acceptance or rejection is received within a reasonable period – several weeks to two months. But when the article is accepted, the authors tell us, there is an inordinately long period of waiting before the publisher makes out a check.

As a parenthetical "aside," it is perhaps time for me to interject a word or two about 73's policy with respect to manuscripts: When articles come into my office, I evaluate them as fast as I can, usually within a few days. I place the rejects in a special basket for return to the authors. The accepted articles are graded for amount of editing required, interest value of material, eye appeal of photos, etc., and a dollar value is assigned. The article is placed in a folder and given to the bookkeeper for payment. Nobody in the production department can touch that article until it has been paid for and returned to me, the editor. There is practically no way for an article to sneak into print without being paid for first. That's our system and it was established by Wayne because

We'll pay you ten bucks to join the fun on the 2 meter FM repeater this month!

This page is worth \$10.00* in cash on the sensational Varitronics HT-2 two meter FM Amateur Walkie Talkie . . . super hot receiver, two watts out, ni-cad powered with charger, completely portable or mobile.

See it at your dealer's today.

**Simply mail this page with your HT-2 warranty card during this month only, and we will refund \$10.00 in cash on your purchase price of the HT-2. Now's the time to move to the exciting 2 meter FM band . . . and get paid \$10.00 for doing it!*



VARITRONICS INCORPORATED

Arizona Interstate Industrial Park
2321 East University Drive
Phoenix, Arizona 85034

of some bad experiences he had with a former employer who let a number of authors down. Wayne has religiously upheld his emphatic resolution that it won't happen at 73.

All this notwithstanding, there are increasing numbers of reports that authors are being short-changed by some of the publications within the amateur fraternity. Perhaps some of the authors are afraid to say anything for fear of being blackballed. But it is the journals who should do the fearing – suppose all top authors blackballed one ham publication; who then would bother to read that journal?

Maybe 73 can help. You readers who are part-time authors let me know the problems you've had trying to collect money for your material after it has been published. I will compile a record of your experiences for publication in 73. If you'd rather your name not be mentioned, you can just tell us the essentials along with a request for anonymity, and we'll have the facts that, once published, will help future authors.

To be quite frank, I am not totally naive in this issue. Before I came to 73 I submitted articles to other publications from time to time. In one instance I had to wait for five months after an article was in print before I got paid for it, and even then I was only paid after writing several unfriendly letters to the publisher. I suspect that prospective authors will begin to get better treatment if the guilty publisher reads this editorial and realizes that he'll be getting some undesirable publicity.

Be fair when you write and tell us your experiences. If you've contributed articles to the other journals and have received immediate payment, we'd like to know about that, too. There's no point in printing only the bad if there's even a grain of good in there somewhere.

Magic Ears

People sometimes get curious expressions when I refer to Wayne Green as "Magic Ears." But I have good reason; old Magic Ears hears everything. His office is on the third floor, in what we laughingly (and realistically) refer to as The Garret. Now, The Garret is a long way from just about everywhere; even those CB walkie-talkies barely hack it from Wayne's office to mine. Boistrous activity can be in full blossom in The Garret while the rest of the place is as placid as a churchyard at dawn. All kinds of things happen up there; radios go in and radios come out – desks are moved hither and thither – test equipment gets stacked up one day and vanishes the next – bookshelves come and go. But there's never so much as a stir as far as the rest of the inhabitants of 73 can hear.

It seems only logical that if what happens in The Garret can't be heard downstairs, the converse must also be true. And maybe it would be true except for that special ability of old Magic Ears. Three floors down and a hundred yards away a printing press will stop running. Seconds

later, there's Magic Ears, wondering what the holdup is.

Two flights down and on the other side of the mansion from The Garret, an interesting but quiet discussion will develop. At about the high point, in will walk Magic Ears, completely prepped on all facets of the discussion that have taken place before his entry.

But the most fascinating aspect of Wayne's phenomenal ability is when he's operating the station. He hears calls, locations, facts and figures, names, and other vital statistics when I would swear there's nothing but noise coming from the speaker. The last time it happened, I sat down beside him at the operating table with my ear glued to the speaker; I was convinced he was putting me on.

Right after he put out a short CQ he pressed the transmit switch and called UV3FD in Moscow, seemingly returning a call. There were several short exchanges, and each time I strained my ear at the receiver trying to hear the drummer Magic Ears was marching to. I watched him fill in his log: 0420Z, UV3FD, A1, Moscow. If I were to tell you that I was skeptical I would be grossly understating the facts.

But believe this or not – and I can still hardly believe it myself – some semblance of a signal began to work its way up through the mire there on 14.205. And suddenly, amid the din and garbage that characterizes 20 meters, there was A1. He had been asked about his occupation and was making his retreat after "an enjoyable discussion." Calling Wayne by name, he then signed off, giving both his call letters and Wayne's.

I don't know how he does it. But don't feel bad if you enter a contest and get beat out by Magic Ears. That's the breaks – some of us have it, some don't. . . . K6MVH ■

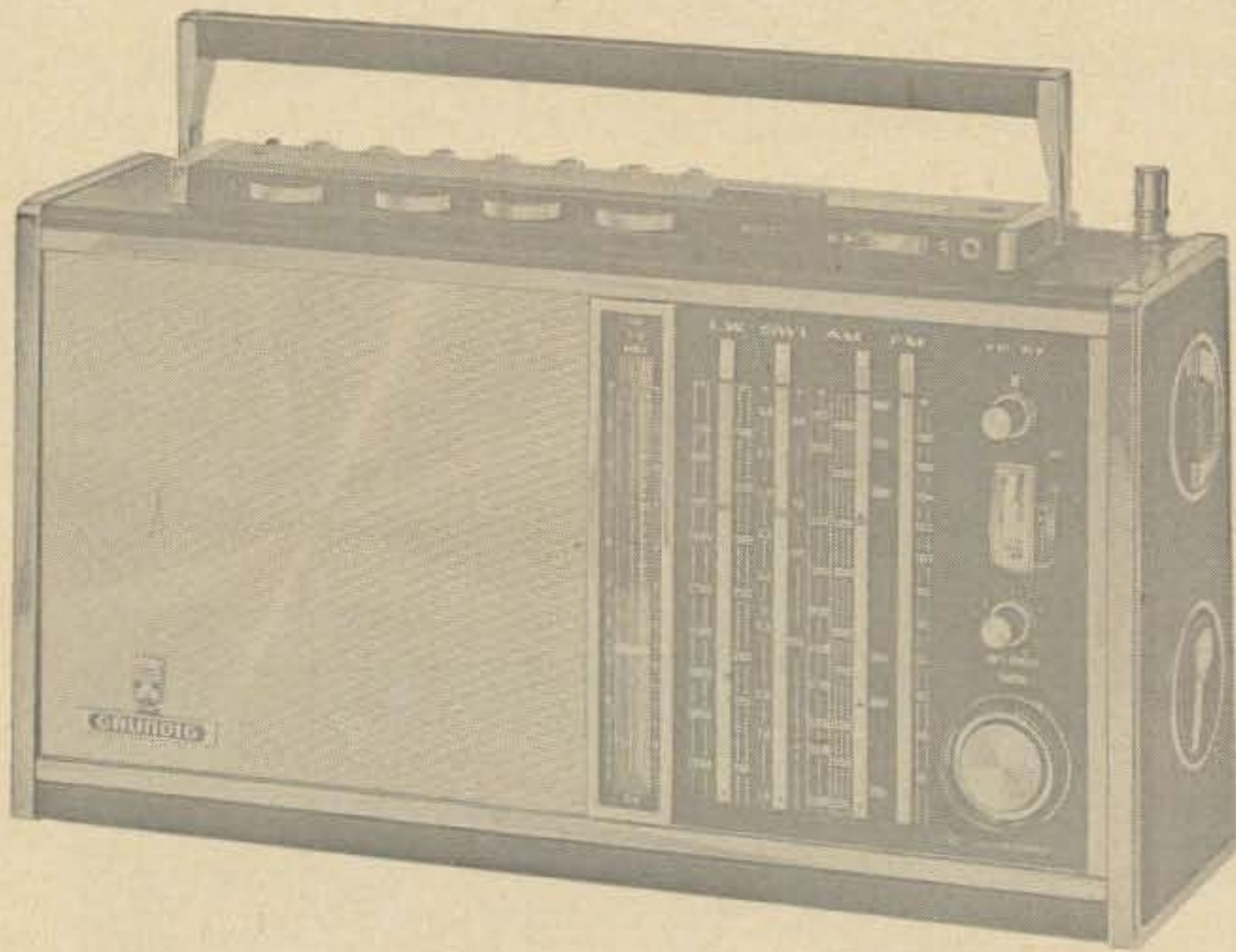

"Not Yiddish, you lid! British!! Bravo, Romeo, India..."

GRUNDIG**SATELLIT-AMATEUR 210**

**Yes, it copies Sideband
and CW too!**

FOR SHORTWAVE A highly sensitive receiver whose selectivity can be switched to wide or narrow for optimum results on sideband or AM. And for serious DXing, just plug in an external antenna.

FOR FM Hi-fi quality through broad bandwidth, high-power audio, and multiple speaker arrangement.

FOR SWL Easy tuning on a number of selectable bands. This receiver is sensitive enough to pull in even the weak stations without an external antenna.

FUNCTION	BAND (MHz)	
BANDSPREAD TUNING (INCLUDES CB)	28.3-29.8	LONGWAVE
	26.9-28.3	150- 450 kHz
(INCLUDES CHU) (SW BROADCAST)	20.9-21.7	BROADCAST BAND 510-1650 kHz
	13.8-14.5	
	7.0-7.35	
(INCLUDES 75m)	5.95-6.25	HIFI FM (WIDEBAND) 88- 108 MHz (AFC)
	3.5-3.8	
	1.7-2.0	
	1.6-5.0	

AC OR BATTERY - S-METER - BUILT-IN ANTENNA

*Operated by Hams
... for Hams*

Dymond
ELECTRONICS

\$225.00 PREPAID

Anywhere in the Continental USA
Certified Check or Money Order

501-515 Blackstone - Fresno, Calif. 93701

209 - 266-9644

If the attitude of some amateurs is to be credited with any validity, there would seem to be a grossly misunderstood provision of the regulations, or at least of the FCC interpretations and administration of those regulations. I refer to the rules governing third party traffic.

There are cases in which it would be normally assumed that violation notices would inevitably ensue. But there are other instances which pose some doubt. There is an area of ambiguity in the minds of many, although the rules are spelled out with clarity. I find the following passage in the ARRL License Manual, page 65 in my issue: "Amateurs may handle, in emergencies, traffic relating directly to safety of life or property."

In a recent instance during the passage of priority emergency medical traffic, some overzealous, self-appointed vigilantes were heard to make snide comments, causing unwarranted interference, and making pests of themselves. A physician-ham, WA2RAU, was attempting with difficulty to ascertain the exact particulars of a life and death case in an African locality, in order to determine the proper drug shipment to the patient's doctor. The traffic was finally passed, but it took four times as long as it would have taken if it had not been for the interference from persons who took it upon themselves to intrude. It could be that in their determination to horn in, they themselves might run afoul of a few regulations and run the risk of violation notices. And in this particular instance this would have been poetic justice, in my view.

In order to clarify this situation concerning the rules for third party emergency traffic, the FCC District of Columbia Bureau was called. A man named Mr. Sam Ferraro gave the caller permission to quote him directly. This is what Mr. Ferraro said:

"Under any circumstances, emergency, that is, life and death traffic, is permissible by the FCC with any country."

He stated further that the Commission will not prosecute any ham for handling any emergency traffic with any country. In

other words, not only is such traffic permissible, but the FCC policy is that it does not wish to discourage it by implying any threat of prosecution or other punishment.

Unfortunately, there are some who insist upon complicating the simplest matters. Certain net control stations, in spite of Mr. Ferraro's assurance, have stated that they would still insist upon *written permission for each such emergency*. This rigid

AN
EDITORIAL
by
DAVE MANN K2AGZ

The DX Desk

1 DANIEL LANE, KINNELON NJ 07405

approach, sadly, does not fit in with the nature of emergencies! While an operator is chasing around in order to satisfy these requirements, cutting all the red tape strung by these petty, picayune martinets with their own homebrew regulations, a seriously ill human being, waiting for a life-saving drug, might be expiring in his final agony!

Let's get it straight, once and for all. If there is a medical emergency, and if an amateur decides on the basis of the information that it is indeed a matter of life and death, therefore serious enough to fall within the limits of the regulations, don't let's all jump in to advise him of the third

party rules. . . he knows them as well as we do. And he is mature enough to determine for himself the consequences of his own actions, without reminders from the rest of us. All we succeed in accomplishing with our unsolicited advice is to cause confusion and interference.

If the stations require relaying, translation, or other assistance, they will request it. But there is nothing worse than the bedlam caused by a mob, all talking at once, making nuisances of themselves, when a life may be hanging in the balance.

And while on this subject, I would like to toss a few orchids to those intrepid doctors among us, who have been doing this mercy work, to the everlasting credit of ham radio. The aforementioned WA2RAU, Sam Rosen, has been involved in so many such jobs that it would be impossible to calculate the numbers of lives which have been affected. Of my own knowledge I can recall a few of these. Doc sent over \$300,000 worth of drugs to a certain country. The certificate which was issued to him by this grateful nation states that the drugs were responsible for the saving of 38,000 lives. He spent 72 hours running continuously, working patches during the Alaskan earthquake a few years ago. He has pestered the large pharmaceutical houses, promoting these shipments of drugs, and arranging for the airlifts by which to transport them. The drug companies may regard him as a pest, but he always succeeds in getting them to send the drugs. And for that, he's more than willing to be called any name they can think of.

I've selected Sam at random. I can assure you that there are dozens of these dedicated men, fulfilling one of the finest functions a ham can possibly find. In my opinion, for what it's worth, I regard such drug shipments to be at least as valuable as the Peace Corps, in terms of enhancing the image of the United States of America.

* * *

DX has not provided us with too many exciting events in recent months. True, we have had a new country, Market Reef, OJØMR, a rather surprising one which came out of the blue. AC3PT was activated

for a short while by Dr. Fred Lieberman, a music professor from Brown University, who was in Sikkim to tape the songs of the hill people. That station is owned and operated by the Maharaja, P.T. Namgyal. He does not get on the air very frequently, and when he does, he becomes confused by pileups, and leaves as soon as the confusion begins.

There is current activity at Qatar, with a fine operation, MP4QBK, on both phone and CW on 15 and 20, with special permission from the Sultan. ZS2MI, Marion Island, has been coming through with booming signals. And W9FIU/KS4 has been 5/9 from Serrana Bank.

There are a few items due to come up this year which will make it a memorable one for the DX fancy.

One of the most exciting was Wayne Green's operation from JY1. This was one of the most intriguing prospects in a good long time, since JY is one of the most wanted prefixes on everybody's list. The JY episode, however, is Wayne's own story, and he's included it this month under "Never Say Die."

We hear all sorts of rumors concerning a French operator, testing on FO8, Clipper-ton Island. It is said that the chap is there on some sort of installation in connection with a satellite tracking station. It is further rumored that a regular amateur operation will be activated. This is another of the most wanted ones.

The projected Spratley expedition, which was due to begin shortly, has had to be tabled, due to a leaky schooner hull. Jens has slowly been making his way toward Hong Kong for the repairs, and then he is supposed to resume the trip. This one will take about two years, according to the best information, and should afford us a number of interesting possibilities.

Our old pal Gus is planning another DXpedition for the Spring, also. Let's hope that all the details are ironed out on this, and that Gus will be successful with all the preparations. It's just what is needed to give DX a shot of adrenalin and put some life back into the game. We've had some

(continued on page 143)

A PRACTICAL

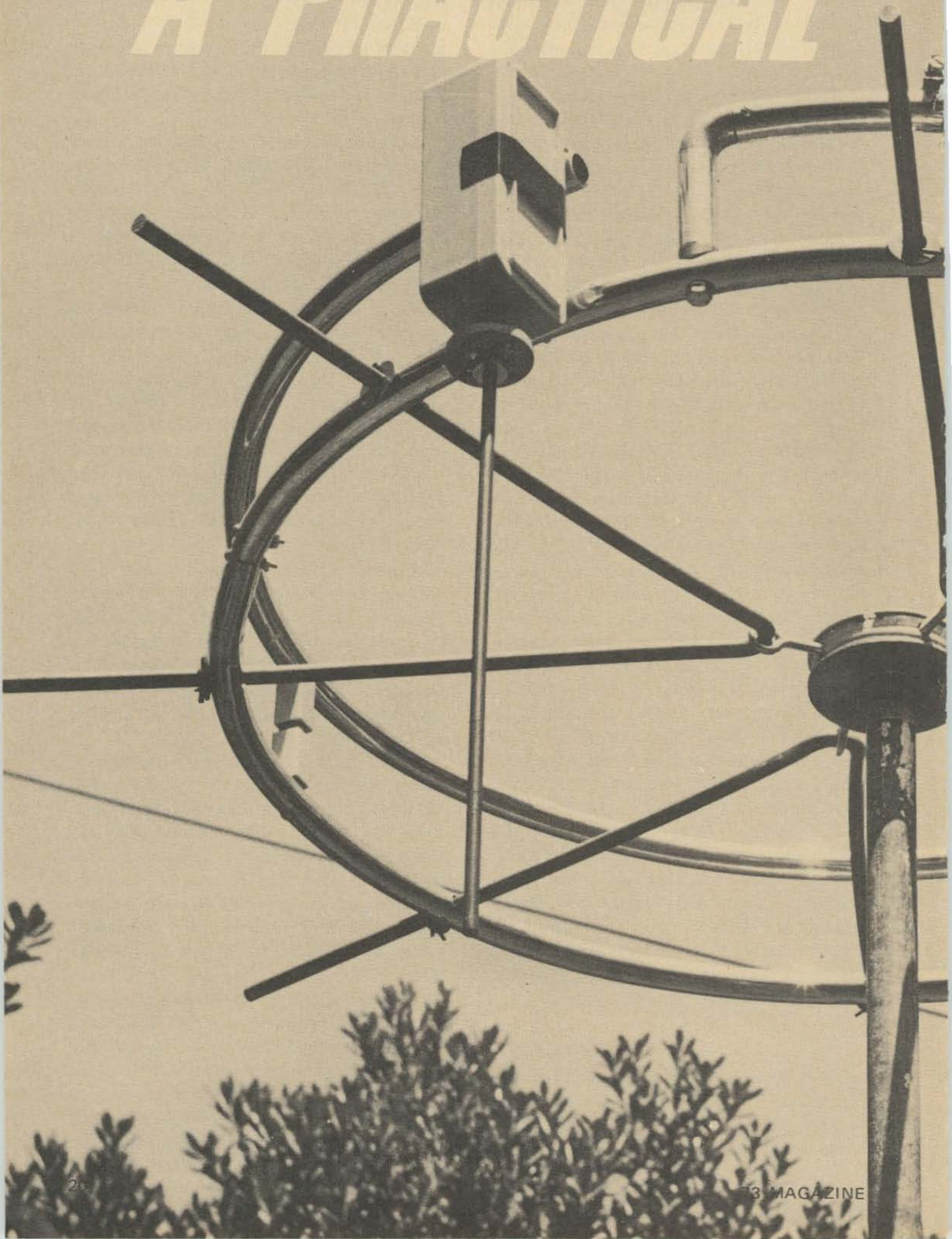

DDRR ANTENNA



Since the DDRR (Directional Discontinuity Ring Radiator) was first announced by its inventor, J. M. Boyer; and the article by Clifford E. Hicks appeared introducing this new antenna to the ham fraternity, very little serious work has been done in this area. Yet this lightweight, compact antenna has many features which recommend it for use by hams. I, for one, have found it a most interesting antenna to work with. In spite of its many advantages the DDRR has some drawbacks which might discourage the otherwise interested amateur.

The two major problems are: construction difficulties which stem from the unorthodox (to the average antenna builder) fabrication of the DDRR, and the extremely high voltage which develops at the termination of the fed ring. The former tends to discourage experimentation because of the difficulty of bending tubing with reasonable accuracy and in arriving at a configuration with the mechanical stability that the sensitive nature of this antenna demands. The latter challenges the average junkbox to produce a tuning capacitor which will withstand the voltage and not

W. E. English W6WYQ
1841 Pinecove Drive
San Luis Obispo CA 93401

exceed the dimensions of the antenna itself. Indeed, it is difficult to locate a suitable capacitor for this service among the standard units available from the manufacturers. Another discouraging factor is the fairly large ground plane employed, which makes the antenna difficult to mount and gives it the appearance of a hovering flying saucer.

After working with antennas of this nature since 1965, I have evolved a design which overcomes, or at least minimizes, these problems. This design is such that any amateur, reasonably proficient with common hand tools, should be able to construct a DDRR antenna which will not only work well, but which is also easy to mount and easily equivalent to a quarter-wave vertical in performance.

For those who may not be familiar with this extremely interesting radiator, a brief description is in order. Essentially the DDRR consists of a quarter-wavelength element bent to form a ring, open for a small percentage of its circumference, mounted, horizontally, a few inches above a ground plane surface. The feedline is connected between one end of the circular element and the ground plane. It is usually tuned at the end farthest from the feed-point by means of a low-capacitance variable condenser between the ring and the ground plane. (See Fig. 1.)

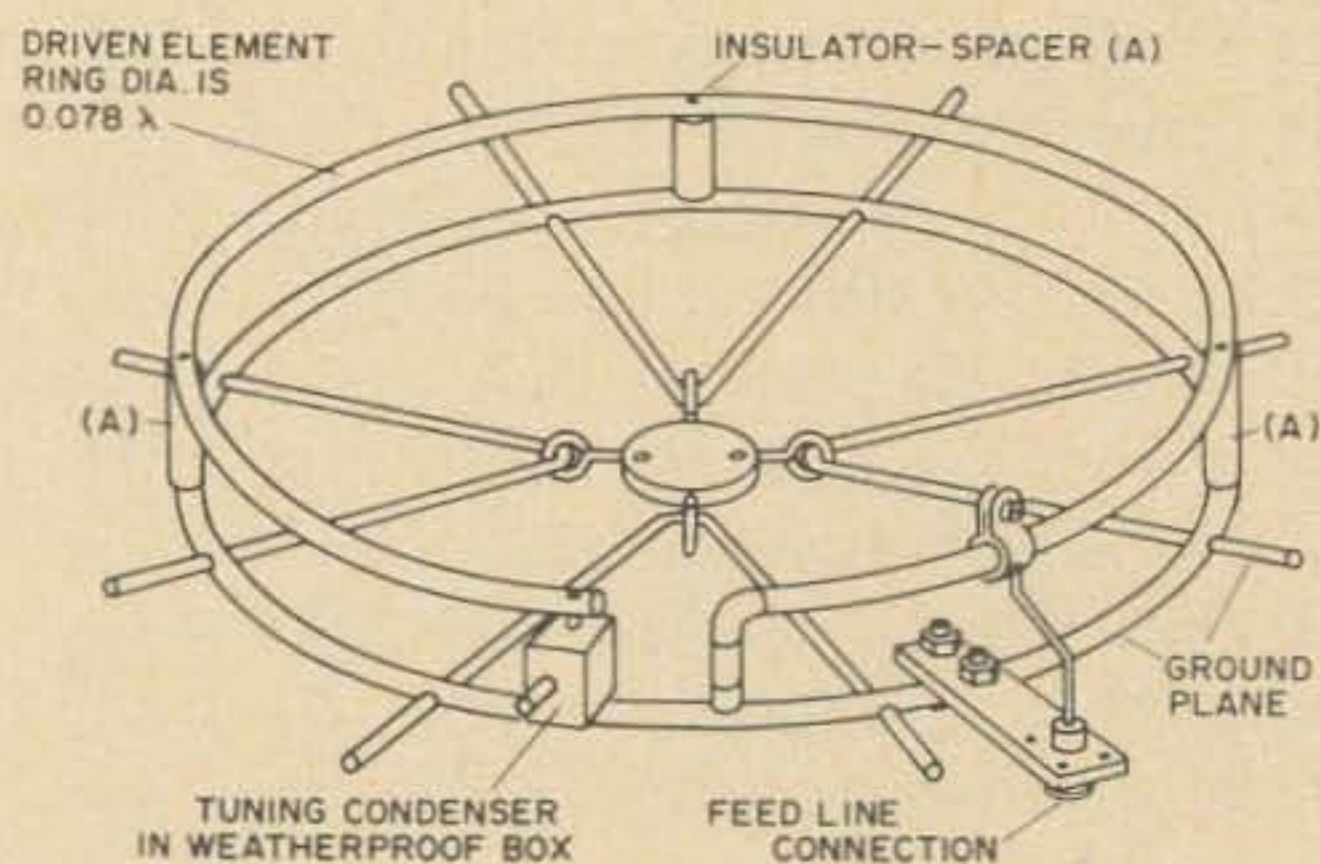

Fig. 1. Basic DDRR.

In contrast to its appearance, this antenna, like a $\frac{1}{4}$ -wavelength vertical, develops a vertically polarized radiation signal. It is also interesting to note that this antenna displays exceptionally high Q and

is sharp enough in tuning to be considered an additional tuned circuit in the communications loop. If the fed end of the discontinuous loop is grounded to the ground plane surface, the antenna can be shunt fed with coaxial cable (I used 50Ω RG-8/U and easily achieved an swr of 1.1:1). The physical size of the antenna is one of its most significant advantages. Since the ring is only .078 wavelength in diameter and the ground plane but 25% greater than that, with overall height for any frequency a matter of inches, it is easy to see that the DDRR is an amazingly compact antenna. The 10 meter antenna has a maximum diameter of 36 in. and an overall height of 4 in. The 2 meter version is almost pocket-size, 8 to 10 in. in diameter and 2 in. high.

The following construction details pertain to the 10 meter version of the DDRR. Tabular data in Table 1 provide dimensions

Table 1. Dimensions for antennas for other bands.

		10	15	20	40
Ground Plane Diameter	GPD	36"	50"	78"	135"
Feed Point	FP	1"	1.5"	2"	3"
Gap	G	2"	2.5"	3"	5"
Capacitor	C	15 pf	15 pf	35 pf	70 pf
Spacing	S	3"	4-3/4"	6"	12"
Tubing Diameter	TD	3/4"	3/4"	1"	1-1/4"
Radial Diameter	RD	3/8"	3/8"	3/4"	1-1/4"
Ring Radius	RR	28"	40"	54"	108"
	NR	8"	8"	12-16	12-16

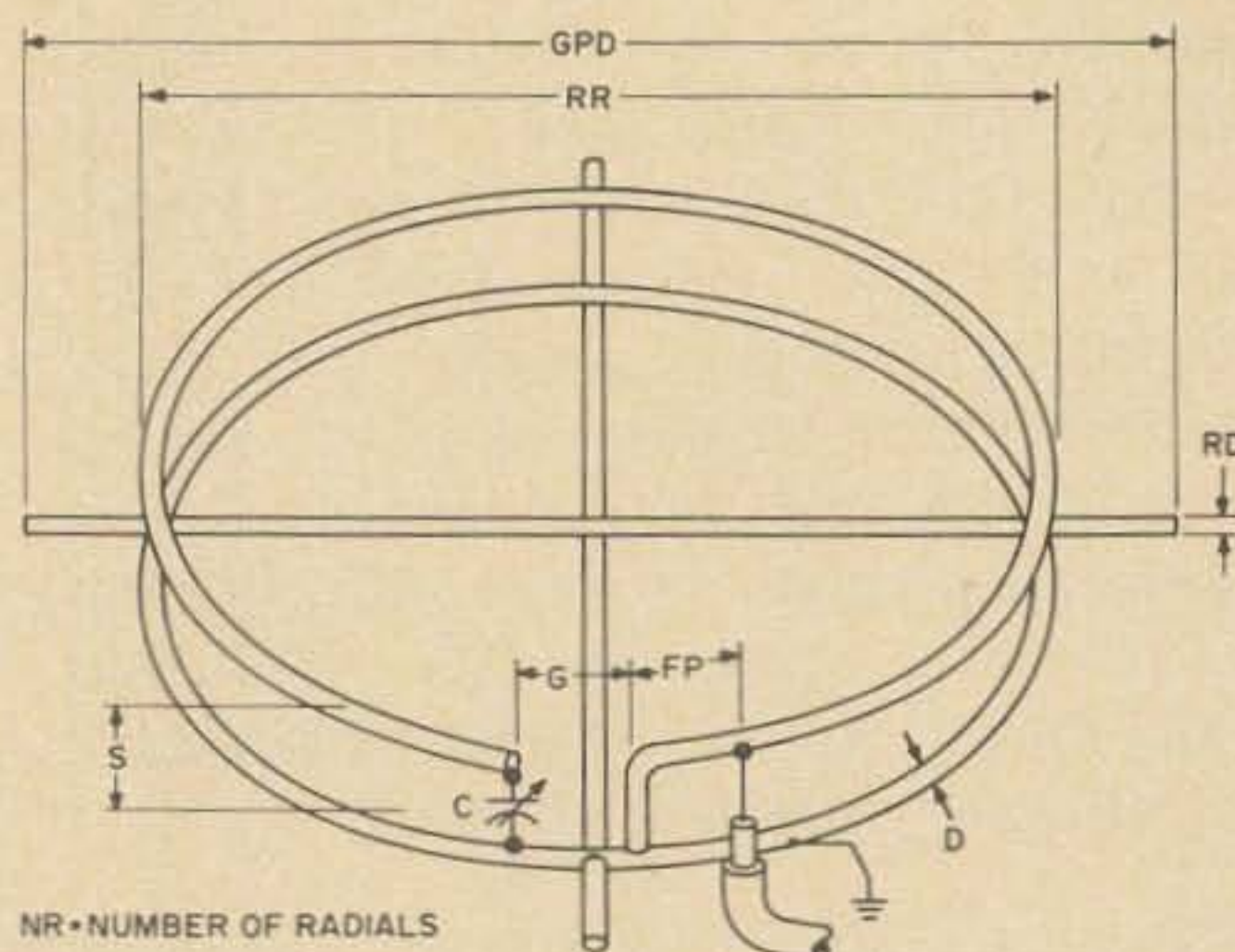

Fig. 2. Dimension key for DDRR.

for antennas for other bands. General construction details are suitable for all frequencies with sizes of assembly hardware being modified accordingly. Signifi-

cant variations, when they occur, such as with radials for low frequency units, will be described in detail.

Constructing the 10m DDRR

The solution to the construction difficulties mentioned earlier stems from use of standard hardware items commonly available in hardware stores throughout the country. If all of the recommended materials are procured before construction begins, assembling the DDRR should be little more difficult than assembling a kit antenna from the commercial supplier. (See Parts List, Table 2.)

Table II. Parts list.

Part	Source	Part No.	Quantity Required For			
			10	15	20	40
3/4" A1 Tubing	Reynolds	4222 ⁴	2	3	11	11
1" A1 Tubing	Reynolds	4242	0	0	5	0
1-1/4" A1 Tubing	Reynolds	4262	0	0	0	7
3/8" A1 Rod	Reynolds	1806	2	2	0	0
3/4" T-Butt Connector	Reynolds	7824	1	1	12	12
1" T-Butt Connector	Reynolds	7825	0	0	1	0
1-1/4" T-Butt Connector	Reynolds	7826	0	0	0	1
3/4" 90° Elbow	Reynolds	7832	1	1	0	0
1" 90° Elbow	Reynolds	7833	0	0	1	0
1-1/4" 90° Elbow	Reynolds	7834	0	0	0	1
3/4" Splicer	Reynolds	7840	1	3	0	0
1" Splicer	Reynolds	7841	0	0	4	0
1-1/4" Splicer	Reynolds	7842	0	0	0	7
1x1/4 A-1 Bar 3/8" x 2"	Reynolds	1821	1	1	1	1
Eye Bolt			4	4	0	0
1/4-20 Bolt 3"	(Use 4" for 20 & 40)		1	1	1	1
3/4 x 2-1/2 Ceramic Insulator	H. H. Smith	2649 ³	3	0	0	0
1/4-20 Screws 1"			6		0	0
1/8 x 3/4 Washer 1/4" hole			6	For Insulators— See Table I		
3/4" U Bolt Turnbuckles Inc.	T-308		1	1	0	0
Coax Receptacle SO-239	Allied	47C-0352	1	1	1	1
Variable Cap 0-15 pf Fixture Box	Cardwell	ET-30-AD	1	1	See Table I	
Fixture Box	Universal	56111 ¹	1	1	0	0
Fixture Box Cover	Universal	54-C-1	1	1	0	0
1-3/8 x 1-7/8 x 5-1/8 (ID) Plastic Box	Loma Products	401 ²	1	1	0	0
Pipe Flange			1	1	0	0
6" Turn Buckle			0	0	12	12
1/4-20 Threaded Rod (6" Length)			0	0	12	12
1" U Bolt			0	0	1	0
1-1/4" U Bolt			0	0	0	1
Tuning Capacitor (See Text)			-	-	1	1
Insulators (See Text)			-	-	5	5
Misc. Hardware — Lockwashers, washers, cotter pins, pipe clamps, etc. (See Text)						

¹This is an electrical light fixture box known in the trade as a "Pancake Box"—other numbers are Bowers 410, Appleton 4-CL, Raco 293.

²This is a Butter Dish, the Loma Classic Flair, manufactured by Loma Products, Fort Worth, Texas, available in department stores, hardware stores, etc.

³The larger DDRR antennas require greater spacing between elements. We found it best to make insulators for the larger units from plastic stock. The selection of these items is left to the ingenuity of the builder.

⁴Standard 1/2 inch EMT (Thin wall Conduit) can be substituted wherever Reynolds 4222 is specified. The Reynolds fittings can be filed to adapt them to the slightly smaller inside diameter. The prototype antenna seen in many of the photographs was made with EMT. If you wish to make this substitution, you can save money, but there will be about a 30% increase in weight.

Forming the Rings

In my experience, the most difficult operation is bending the tubing to form a 28 in. diameter circle. In the pilot model the tubing was bent by hand (with a little assistance from the foot) and satisfactory results were achieved; however, a more esthetic appearance will result if a jig is used. A 26 or 27 in. bicycle wheel with the tire removed is satisfactory for this purpose. There is sufficient spring-back in the tubing to allow for the slight difference in diameter. With the wheel locked so that it will not rotate, position one end of the tubing in the groove of the rim and secure it. This can be done with a C-clamp, a vice, or simply by wrapping a few turns of wire around the rim and tubing. The free end of the tubing may be pulled around with even pressure until the complete circle is formed. If you do not achieve a perfect circle, no serious electrical problems will result; moreover, minor deviations can be corrected by tightening the radials later. The principal objective is to make two rings as close to circular and as similar as possible, with a center-to-center diameter of 28 in. When this task is completed, your DDRR is practically finished because the remaining construction is very simple.

Assembling the Ground Plane

Join the ends of one of the rings using the coupler (Reynolds 7840). Be sure to allow for "makeup" for inserting this part. To do this, the total circumference of the ring should be cut 1/4 in. shorter than required.

Measuring around the outermost perimeter of the assembled ring, divide the entire ring into 8 equal parts. This spacing, measured around the perimeter, is approximately 11 1/4 in. Mark each division on the centerline of the tubing with a center punch. Drill completely through the tubing from the center punch mark toward the center of the ring with a 7/16 in. drill. These drilled holes are for the radials.

Cut the 3/8 in. rod (Reynolds 1806), into 36 in. lengths. Bend each length of the center to an angle of 45°. Drill a 1/8 in. hole in each leg of the vee 6 in. from the ends.

Thread a 3/8 x 2 in. eyebolt onto each of the four vees and let it hang at the mid-point.

Mark the fixture box (Universal 56111) around its perimeter at the mid-point between top and bottom. Mark the 90° points around this line with a center punch and drill each point with a 5/16 in. drill. Make sure that the eyebolts remain on the inside of the assembly. Push the vees out far enough to leave about a 6 in. diameter at the center with all of the vees installed. You may find it difficult to get radials started in the holes, but they will go and fit easily when in the final position.

With the ring and radials resting on a flat surface, place the fixture box in the center. Pass the threaded end of the eyebolts through the holes drilled in the sides of the fixture box and run a nut onto each of the eyebolts until one or two threads are visible past the nuts.

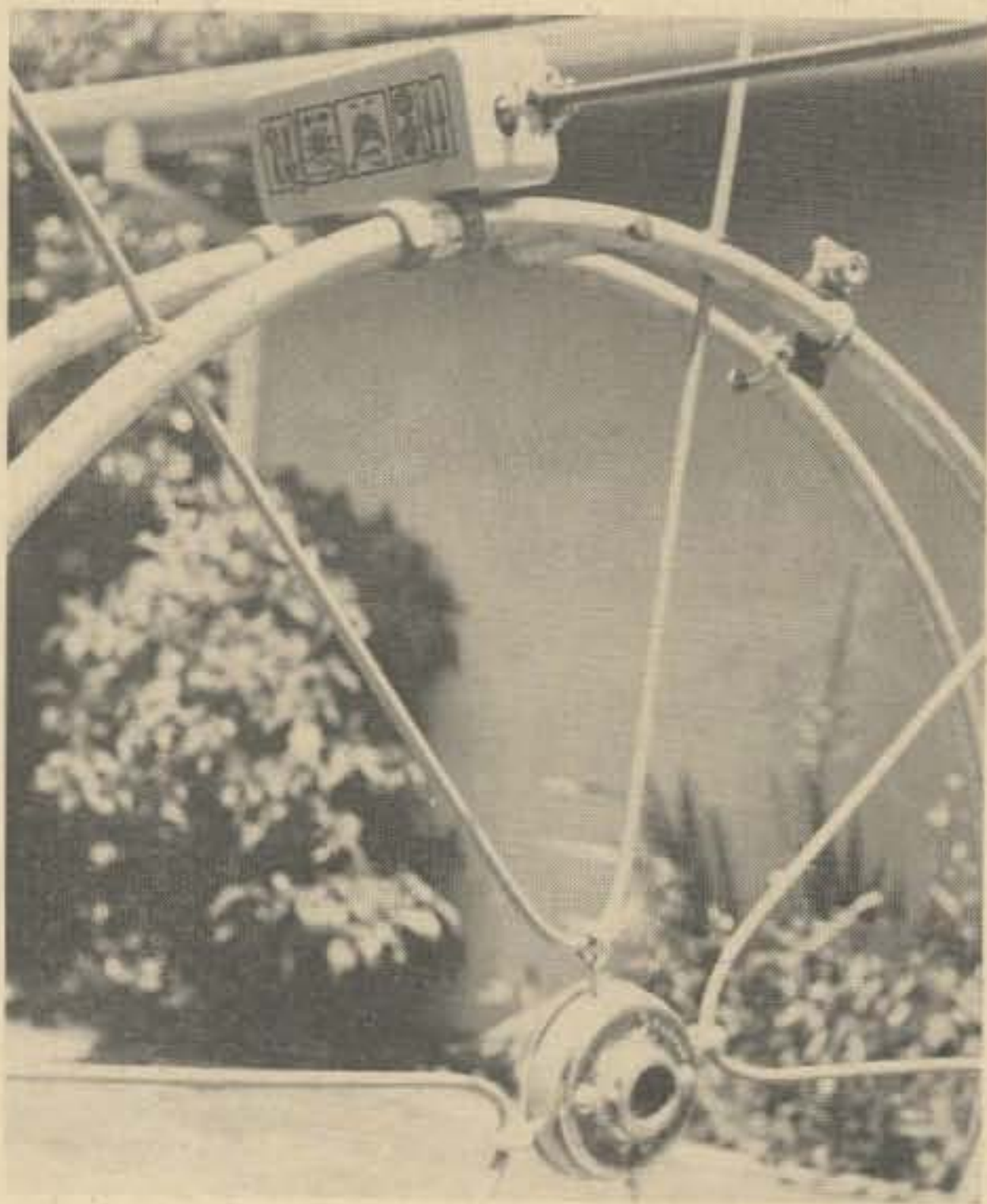

The prototype DDRR, a view from the bottom showing details of the hub, mounting flange, feed connection, and tuning condenser.

Slip a washer over each rod tip and push it past the drilled hole toward the ring and install a 1/8 x 3/4 in. cotter pin in each hole. As the work progresses it may be necessary to loosen the nuts at the hub slightly in order to fit the cotter pins and washers.

Once all cotter pins and washers are installed, tighten the nuts at the hub until all radials have equal tension and the circle is not distorted. As a check, the visible portion of the threads inside the hub should be nearly equal for all four eyebolts.

If the outer dimensions are critical for your installation, measure 18 in. from the center of the hub along the radials and cut off the excess length. If outer dimensions are not critical, just make sure that all radials are of equal length. The minimum is 18 in. from center. Any greater length, within reason, will provide a slight improvement in operation.

Turn the assembly over and install the pipe flange on the bottom of the fixture box with two 1/4 in. bolts and nuts. You will find that two holes in the fixture box align almost exactly with the two holes in the pipe flange when the flange is centered on the box. When these mounting bolts have been securely tightened, install the cover plate (Universal 54-C-1) on the top of the box using the two 10-32 screws which come with the box. This cover will help to keep water from collecting inside the box and thereby reduce corrosion problems. It also adds a professional finish to the job.

The ground plane for your antenna is now complete. It should be rigid enough to be supported on a pipe, threaded into the pipe flange, without sagging.

Attaching the Driven Element

Place the second ring of 3/4 in. tubing on top of the ground plane assembly and make any last-minute adjustments necessary to cause the two rings to coincide.

With a tubing cutter or a hacksaw, cut the end of the tubing so that a gap of 3-1/8 in. is left in the upper ring.

If you intend to use the base loading feed system, omit installation of the 90° elbow and its associated parts. Cut the gap in the upper ring to 6 in. and proceed with the installation of insulators. You will have to install a fourth insulator an inch or so in from the gap on the fed end of the ring.

Install the 90° elbow (Reynolds 7832) in one end of the tubing and position it so

that it points downward toward the ground plane ring. The elbow comes with an expandable spring clip which is screwed onto the end of the elbow. This attaching system may be used, but it is preferable to omit it and attach the elbow to the ring by drilling a hole horizontally, through the

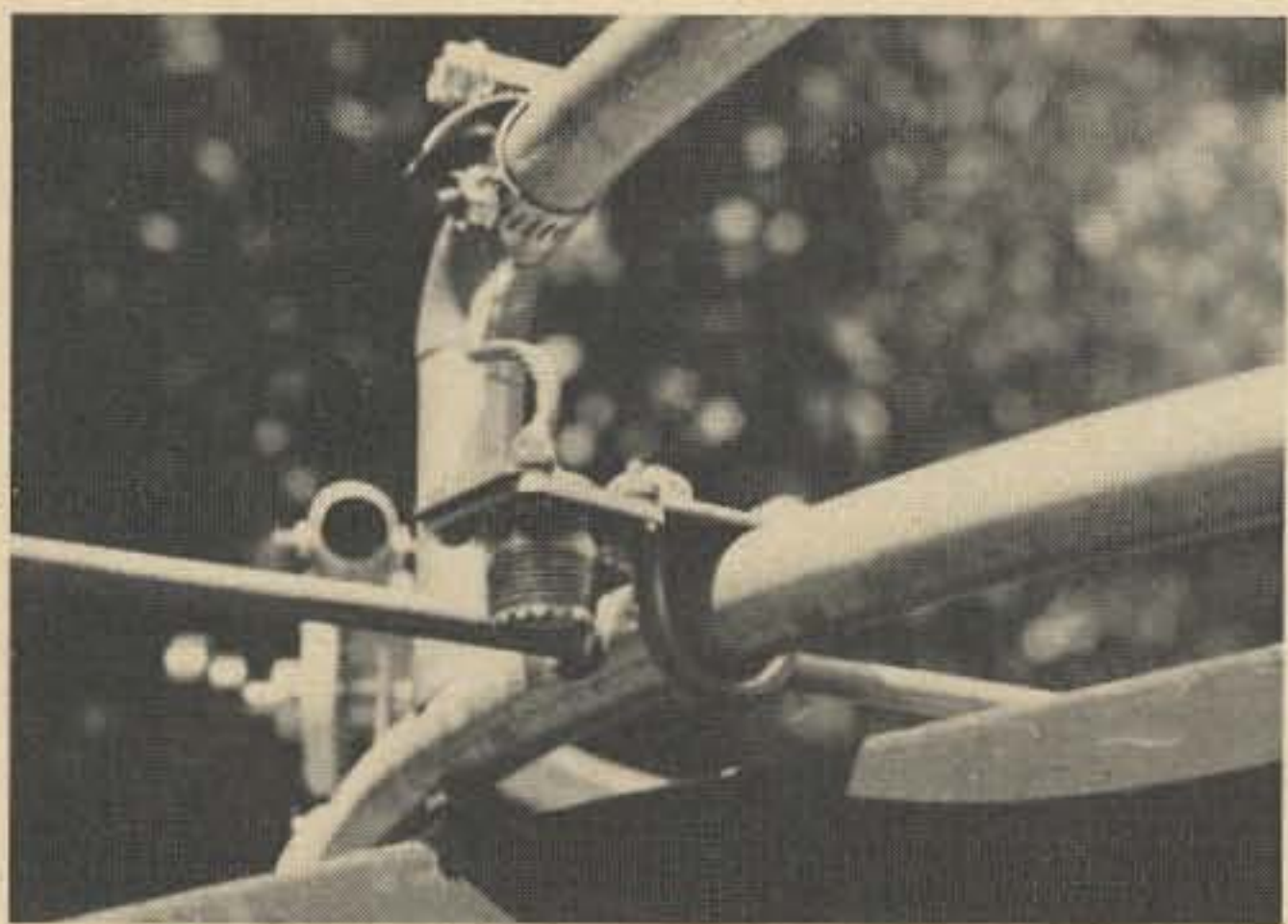

A view of the feedline connector attached to the prototype DDRR.

tubing and the elbow to take a 8-32 x 1 in. screw. The latter system insures a good electrical connection at this junction and is a stronger mechanical assembly, less likely to fail after the antenna is erected. This precaution was not necessary on the closed ground plane ring at the joiner, because the tension of the radials serves to hold the joint in solid contact.

Cut a 2-1/8 in. length of tubing from the scrap left over from the rings and slip it

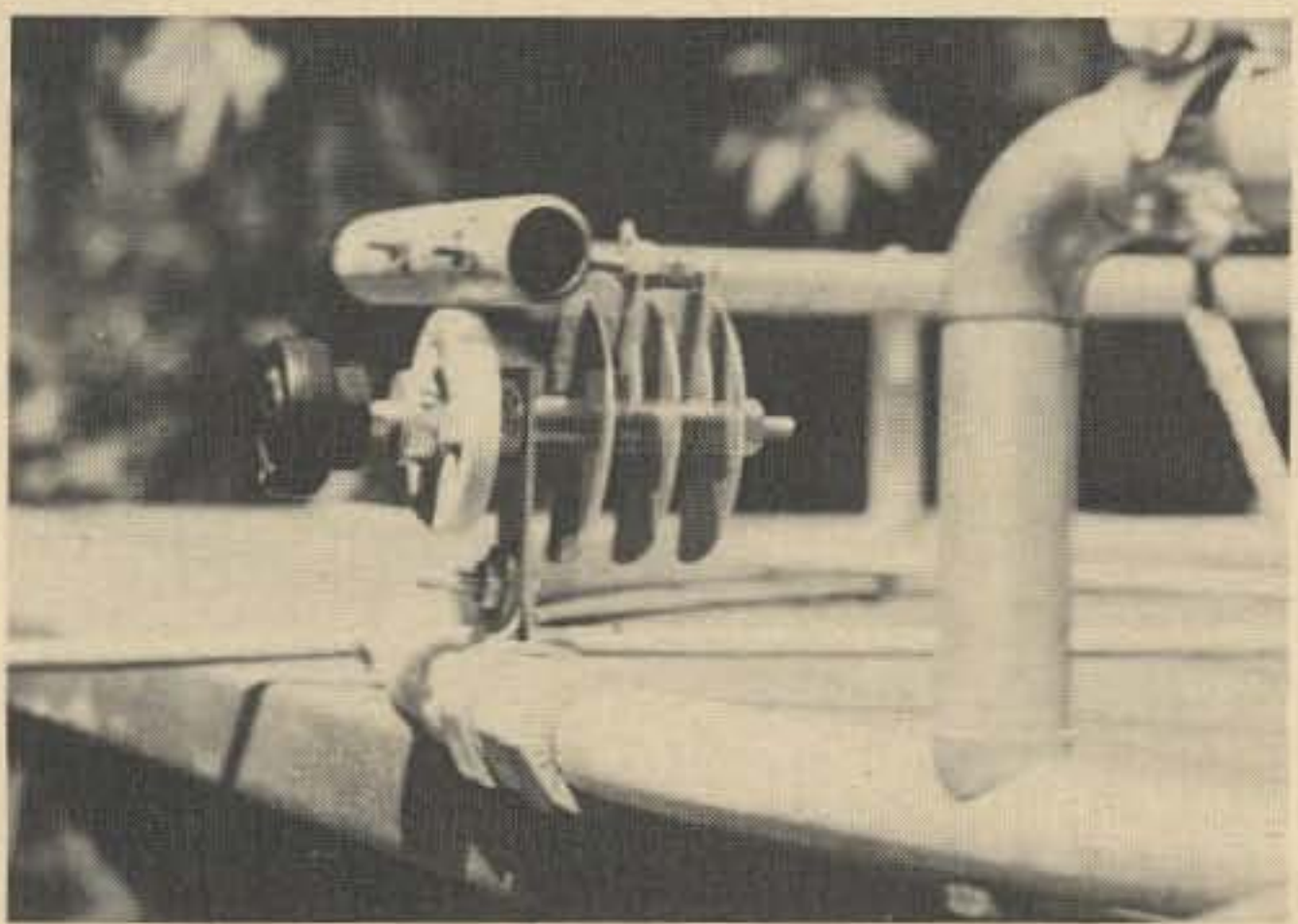

The home-made tuning condenser mounted on the prototype DDRR.

over the remaining end of the 90° elbow. Insert the T-butt connector (Reynolds 7824) in the opening at the lower end of the short piece of tubing.

Position the upper ring over the ground plane ring so that the T-butt connector on the lower end of the elbow assembly is midway between two of the radials. Make sure that the joiner in the ground plane ring is not in a position to interfere with installation at the tuning capacitor, T-butt connector, coaxial connector bracket, or any of the insulators. (See Fig. 1.) Drill a 1/4 in. hole straight down through the ground plane ring at the selected point. It is important that this hole be as close to vertical as possible. The T-butt connector may be used as a drilling guide.

Discard the bolt supplied with the T-butt connector and replace it with the 3 in. 1/4-20 bolt. This bolt passes upward through the hole in the ground plane ring, through the T-butt connector and the short length of tubing, and engages the threads in the 90° elbow. Tighten this bolt just enough to take all of the slack out.

Carefully measure the distance between the centerline of the upper ring and the top of the lower ring close to the 90° elbow, to insure a 3 in. dimension. If this dimension has not been achieved, remove the short length of tubing and adjust its length accordingly. A good electrical connection at this point is crucial.

Installing the Insulators

Mark a point directly opposite the center of the gap on the upper ring and drill a 1/4 in. hole directly downward for the first insulator. Measure around the circumference of the upper ring, a distance of 24 in. each side of the hole for the first insulator. At each of these two points drill a 1/4 in. hole directly downward for two more insulators. Mark the corresponding points on the ground plane ring and drill each of these points with a 1/4 in. drill.

Install the insulators (Smith 2649; Allied 47-C-4357), between the two rings at the drilled points. These insulators are 2 1/2 in. in length, and a 1/16 in. washer must be installed at top and bottom of each insulator to provide the 2-5/8 in.

separation required. Fiber washers sold in plumbing supply houses are ideal here. Once again, a lockwasher under the heads of the 1 in. $\frac{1}{4}$ -20 screws will serve to keep the mechanical structure solid even with vibration caused by wind.

The mechanical construction of your DDRR is now complete. The next operation is to provide for feedline connection and to install the loading condenser.

Installing the Feedline Connector

Cut a length of the 1 in. by $\frac{3}{16}$ in. aluminum bar (Reynolds 1821) $2\frac{3}{4}$ in. long. Drill two $\frac{1}{4}$ in. holes, $\frac{1}{2}$ in. and $1\frac{1}{2}$ in. from one end and on the centerline. At the opposite end, drill the holes to accept the coaxial fitting (SO-239). (See Fig. 3.)

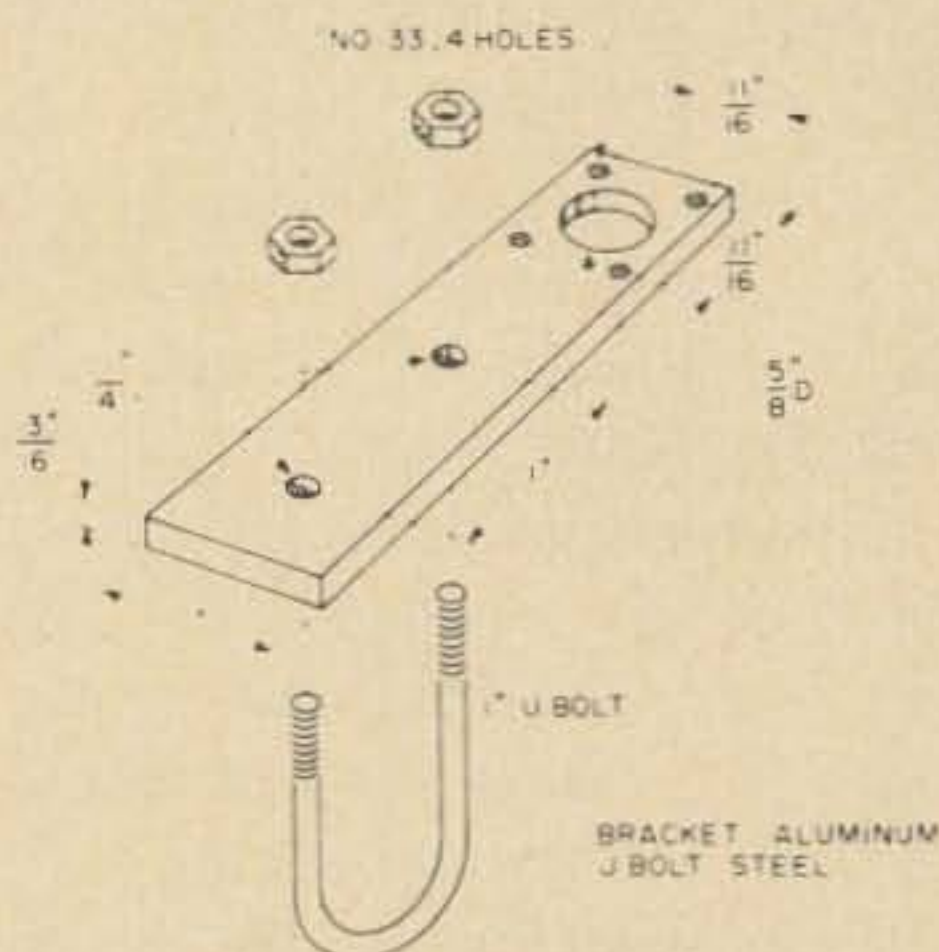

Fig. 3. Dimension details for feed line connector.

Install the coaxial fitting in the bracket and attach the bracket to the ground plane ring about 4 in. from the junction of the 90° elbow and the ground plane ring. (See photo.) The bracket should be on top of the ground plane straddling the ring and passing through the holes provided in the bracket. When the bracket has been clamped in place, any excess of the threaded ends of the U-bolt should be cut off flush with the top of the nuts. If you are planning to use the base-loading feed system, follow these same instructions, but position the bracket at about the mid-point of the 6 in. gap.

Installing the Tuning Condenser

There are a number of variables affecting condenser installation. These have been discussed in the section on condenser considerations. If you do not intend to use the recommended part, it would be advisable to review that section before proceeding. If you are planning to use the base-

loading feed system, you will not need to install a tuning condenser at the top end of the ring. (See the section on alternate feed system.)

The Cardwell ET-30-AD dual-section condenser was chosen as the best component for this application, because it has the low minimum capacitance required; and, with the two sections connected in series, it withstands the high voltage encountered.

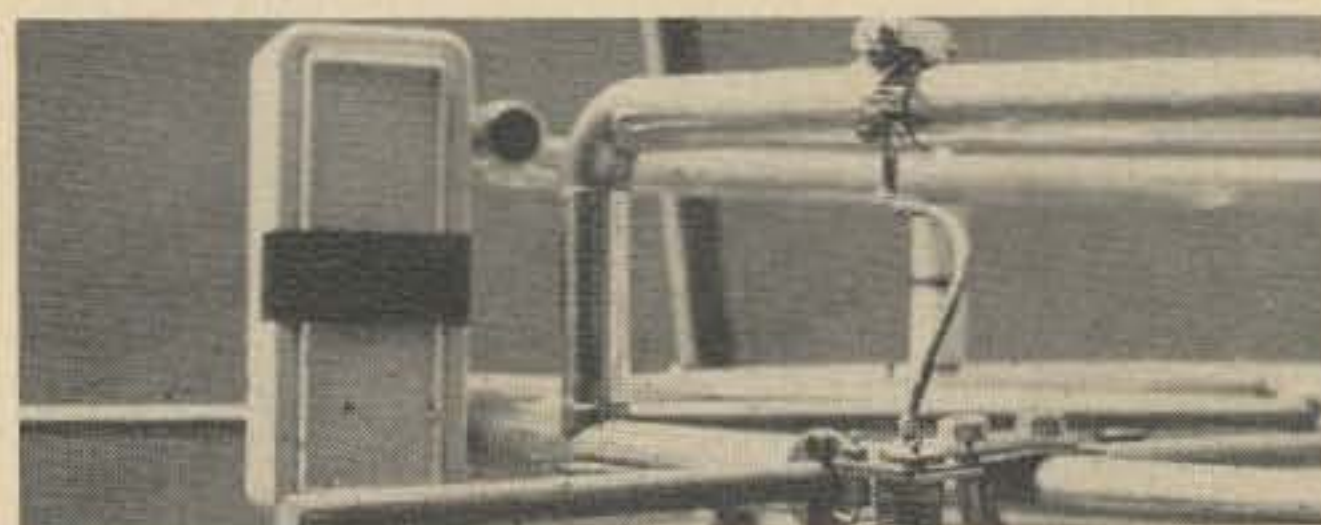

Details of the DDRR built in accordance with the instructions in the article. Note the methods of attaching the radials, the feed connections and the box containing the tuning condenser.

Since most antenna installations using the DDRR will involve manual tuning, the condenser has been oriented with the shaft extending downward. This position allows easy access for portable, mobile, or emergency installations. Horizontal positioning may be used and is advisable if motor-driven tuning is contemplated.

To mount the ET-30-AD in a vertical position with a plastic box for protection, proceed as follows:

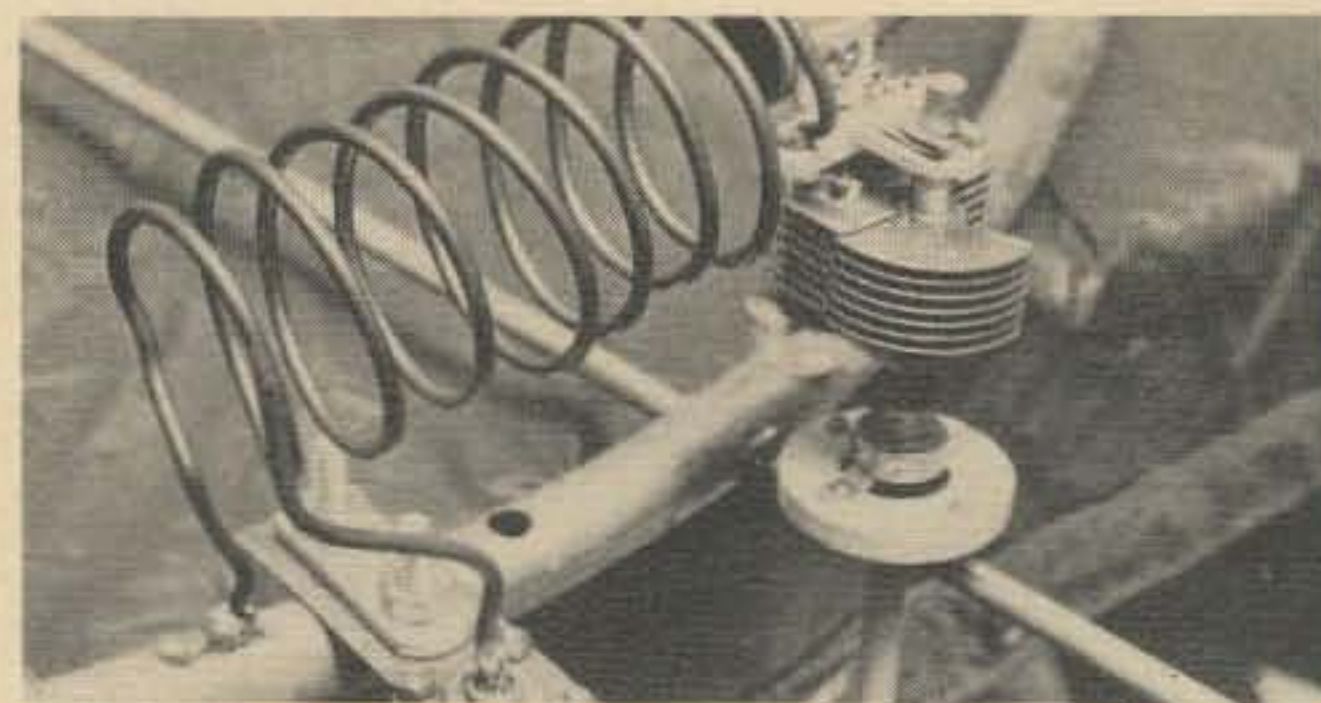

Closeup of the "base loaded" feed system assembled on the prototype DDRR.

In one end of the box (Loma 401) drill a $\frac{7}{16}$ in. hole on the centerline and $1\frac{1}{16}$ in. from the inside bottom. Drill four holes $\frac{5}{32}$ in. diameter in the bottom of the box to accept the mounting screws which come with the capacitor. These holes must be symmetrical about the centerline, in pairs and on $1\frac{1}{8}$ in. centers. The first pair must be $\frac{13}{16}$ in. from the end with large

NEW Heathkit® SB-102...



the world's best rig
(the SB-101)
is now even better

• New all solid-state Linear Master Oscillator gives shorter warm-up, greater stability, increased dial linearity • New receiver circuitry delivers 0.35 uV sensitivity • 180 watt PEP SSB input — 170 watt CW input • 80-10 M coverage • USB, LSB or CW modes • Built-in CW sidetone • Built-in 100 kHz crystal calibrator • Triple Action Level Control® reduces clipping & distortion • Front panel selection of built-in 2.1 kHz SSB or optional 400 Hz CW crystal filters • Operate with built-in VOX or PTT • Fast, easy circuit board-wiring harness construction • Run fixed or mobile with appropriate low cost power supplies

The New Heathkit SB-102 . . . proud descendant of the famous "100" & "101". With a heritage like this, you expect top performance and value . . . and you get it.

We improved the already excellent frequency stability and dial linearity of the "101" with an all solid-state LMO . . . the result is a rig that stabilizes in half the time and tracks more accurately.

The "102" receiver is even hotter than the famed "101" . . . sensitivity is now less than 0.35 uV for 10 dB S+N/N . . . an increase that gives you solid copy longer when the band is on the way out.

The new "102" . . . the famous flexibility & performance of the "101" plus important new features. Put the hot new SB-102 in your shack now. From the Hams At Heath, of course.

- SB-102, 23 lbs. \$380.00*
- SB-600, Communications Speaker, 6 lbs. \$19.95*
- HP-23A, AC Power Supply, 19 lbs. \$51.95*
- HP-13A, DC Power Supply, 7 lbs. \$69.95*
- SBA-100-1, Mobile Mtg. Bracket, 6 lbs. \$14.95*
- SBA-301-2, 400 Hz CW Crystal Filter, 1 lb. \$21.95*

SB-102 SPECIFICATIONS — RECEIVER SECTION — Sensitivity: Better than 0.35 microvolt for 10 dB signal-plus noise to noise ratio for SSB operation. **SSB selectivity:** 2.1 kHz minimum at 6 dB down, 5 kHz maximum at 60 dB down — 2:1 nominal shape factor — 6:60 dB. **CW Selectivity:** (With optional CW filter SBA-301-2 installed) 400 Hz minimum at 6 dB down, 2.0 kHz maximum at 60 dB down. **Input impedance:** Low impedance for unbalanced coaxial input. **Output impedance:** Unbalanced 8 and 600 ohm speaker, and high impedance headphone. **Power output:** 2 watts with less than 10% distortion. **Spurious response:** Image and IF rejection better than 50 dB. Internal spurious signals below equivalent antenna input of 1 microvolt. **TRANSMITTER SECTION: DC power input: SSB:** 180 watts P.E.P. continuous voice. **CW:** 170 watts — 50% duty cycle. **RF power output:** 100 watts on 80 through 15 meters; 80 watts on 10 meters (50 ohm nonreactive load). **Output impedance:** 50 ohms to 75 ohms with less than 2:1 SWR. **Oscillator feedthrough or mixer products:** 55 dB below rated output. **Harmonic radiation:** 45 dB below rated output. **Transmit-receive operation: SSB:** Push-to-talk or VOX. **CW:** Provided by operating VOX from a keyed tone, using grid-block keying. **CW side-tone:** Internally switched to speaker in CW mode. Approx. 1000 Hz tone. **Microphone input impedance:** High impedance. **Carrier suppression:** 50 dB down from single-tone output. **Unwanted sideband suppression:** 55 dB down from single-tone output at 1000 Hz reference. **Third order distortion:** 30 dB down from two-tone output. **Noise level:** At least 40 dB below single-tone carrier. **RF compression (TALC):** 10 dB or greater at .1 ma final grid current. **GENERAL: Frequency coverage:** 3.5 to 4.0; 7.0 to 7.3; 14.0 to 14.5; 21.0 to 21.5; 28.0 to 28.5; 28.5 to 29.0; 29.0 to 29.5; 29.5 to 30.0 (megahertz). **Frequency stability:** Less than 100 Hz per hour after 10 minutes warm-up from normal ambient conditions. Less than 100 Hz for ±10% line voltage variations. **Modes of operation:** Selectable upper or lower sideband (suppressed carrier) and CW. **Visual dial accuracy — "re-settability":** Within 200 Hz on all bands. **Electrical dial accuracy:** Within 400 Hz after calibration at nearest 100 kHz point. **Dial mechanism backlash:** Less than 50 Hz. **Calibration:** 100 kHz crystal. **Audio frequency response:** 350 to 2450 Hz ±3 dB. **Phone patch impedance:** 8 ohm receiver output to phone patch; high impedance phone patch input to transmitter. **Power requirements:** 700 to 800 volts at 250 ma; 300 volts at 150 ma; —115 volts at 10 ma; 12 volts at 4.76 amps. **Cabinet dimensions:** 14⁷/₈" W x 6⁵/₈" H x 13³/₈" D.



NEW FREE 1970 CATALOG!
Now with more kits, more color. Fully describes these along with over 300 kits for stereo/hi-fi, color TV, electronic organs, guitar amplifiers, amateur radio, marine, educational, CB, home & hobby. Mail coupon or write Heath Company, Benton Harbor, Michigan 49022.

HEATH COMPANY, Dept. 11-6
Benton Harbor, Michigan 49022

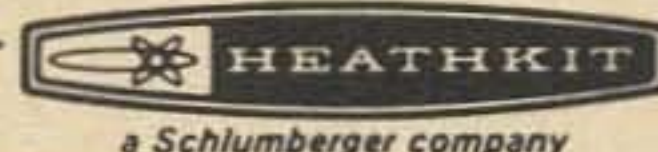

Enclosed is \$ _____, plus shipping.

Please send model (s) _____

Please send FREE Heathkit Catalog. Please send Credit Application.

Name _____

Address _____

City _____ State _____ Zip _____

*Mail order prices; F.O.B. factory. Prices & specifications subject to change without notice. AM-233

holes drilled previously. The next pair must be 3-3/8 in. from the first pair and in line with them. On the centerline of one side of the box, drill two holes for 10-32 screws 1 in. from each end. In this last pair of holes, install two 10-32 x 1 in. screws with solder lugs under the head of each screw on the inside of the box. Run nuts onto these screws and tighten them securely. Install the capacitor in the box by slipping the shaft through the large hole in one end and with the mounting bars toward the bottom. Install the four capacitor mounting screws and tighten them securely. Connect a short length of wire from the solder lug under one of the 10-32 screws to the solder lug on the nearest set of stator plates. Connect the other set of stator plates to the other 10-32 screw in a similar manner. The solder lugs for the rotor, at each end of the shaft, must be cut off flush with the ceramic end plates to provide clearance for the cover.

Measure 1 1/4 in. in from the gap end of the driven ring, that is the end farthest from the feed point. Drill a hole horizontally and on the centerline through the tubing with a #10 drill. Directly below this hole drill a similar hole in the ground plane ring.

Slip the two 10-32 screws protruding from the side of the plastic box through the two holes in the rings. Be sure that the shaft is pointing down. Using lockwashers and nuts, securely fasten these two points.

Install an insulated shaft coupler on the shaft of the condenser.

There is a base attached to the cover of the plastic box which may be removed. This is the olive green portion cemented to what was originally the bottom of the box and which now serves as a cover. This unnecessary portion can be removed by carefully cutting around the edge with a knife to separate the glued area. The friction fit of the cover should be adequate to hold it in place; but for mobile service, and if the antenna is to be mounted at considerable height, it is advisable to provide some means of locking the cover securely in place. The simplest approach is to wrap the joined edge of box and cover with plastic electrician's tape, which will

also provide a degree of weatherproofing.

Connect a 6 or 7 in. length of 1/8 in. flexible braided lead to the coaxial connector in the bracket. Slip the free end of the lead through a 3/4 in. pipe clamp installed on the upper ring about 1 in. from the end of the elbow. Tighten the clamp only enough to provide a good sliding connection.

Your DDRR is now ready for tuning.

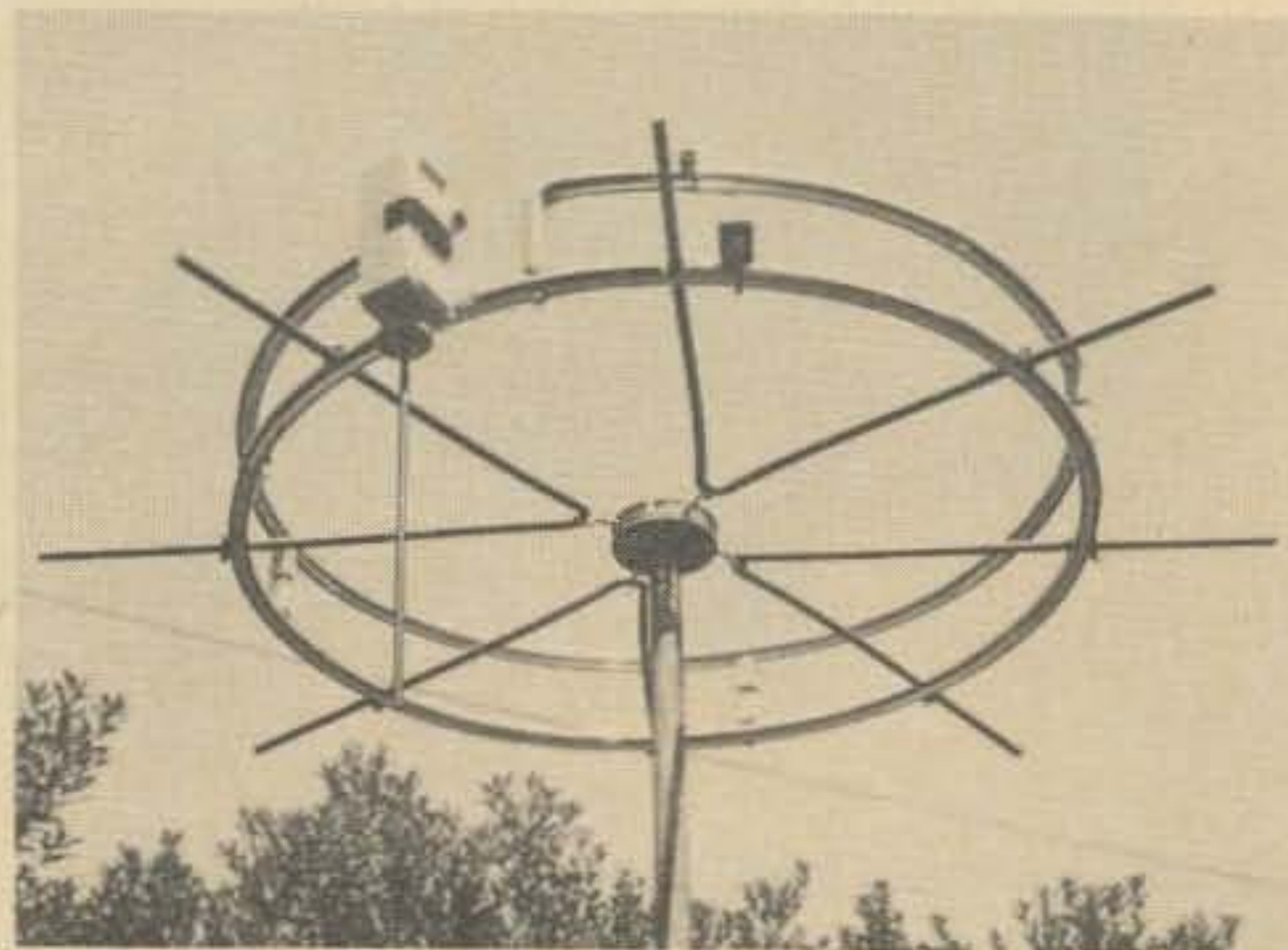

The final version of the DDRR atop the pipe mast.

Tuning The Antenna

Tuning the DDRR is a relatively simple operation, when done with an swr bridge in the line – and very nearly impossible without one. If you do not own one of these valuable devices, it would be wise to borrow, build, or buy one before attempting the tuning procedure.

With the DDRR supported at least two or three feet above the ground, connect a coaxial cable to the connector on the bracket. Install an insulated shaft on the coupler at the bottom of the tuning con-

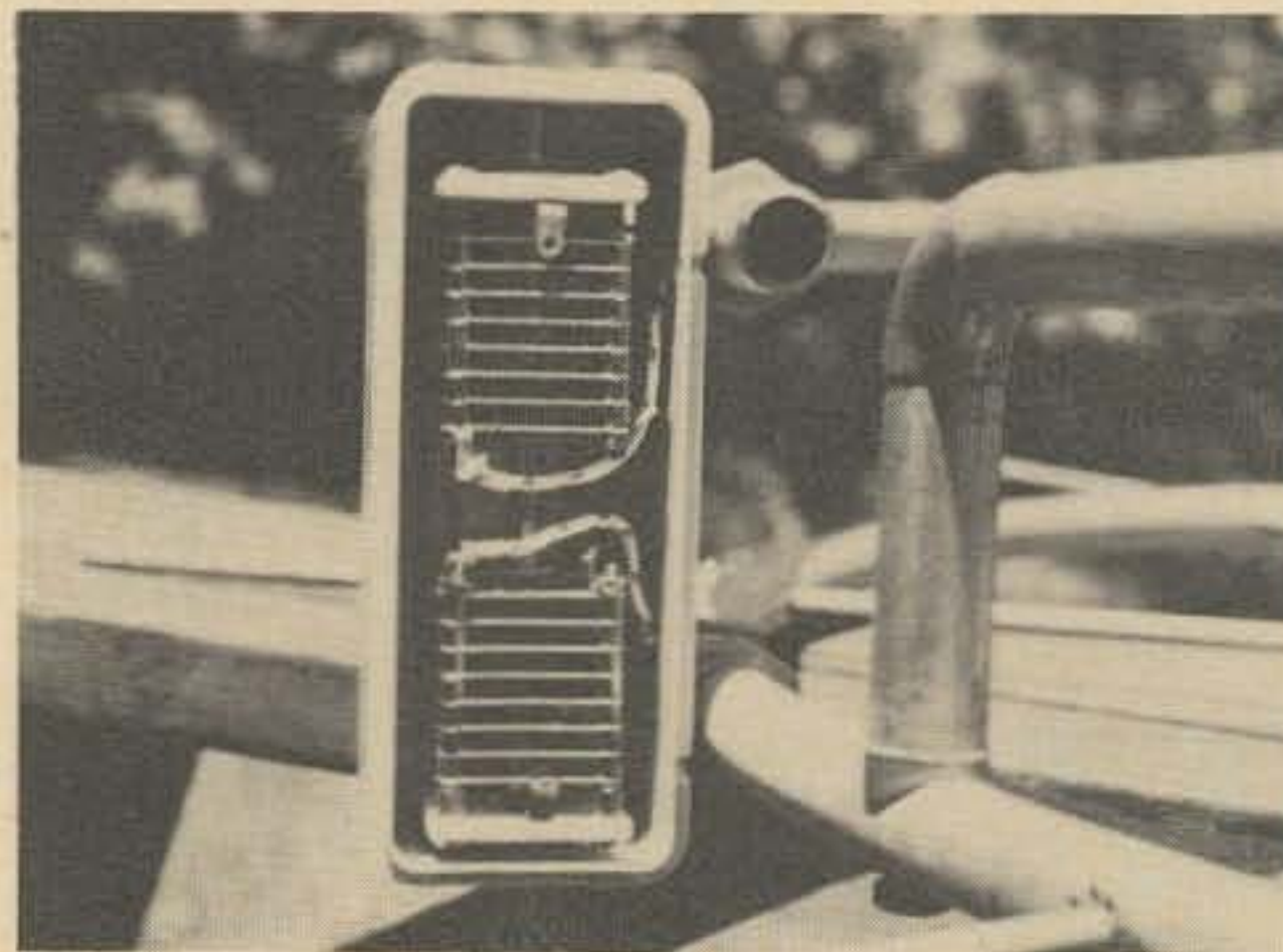

A view of the dual section condenser installed in the "butter box" and mounted on the prototype antenna.

denser. Connect the other end of the coaxial cable through the swr bridge to a low-power rf source on the desired frequency. (I used a Globe DSB 100.) The low power is a safety precaution to hold the high voltage hazard to a minimum. With power on, *slowly* adjust the tuning capacitor for minimum indicated swr. With an insulated screwdriver or plastic rod, push the sliding connection at the feed point back and forth until the minimum swr is indicated.

There appears to be a transformer action which occurs between the different diameters of the tubing and the lead from the coaxial fitting by moving the bracket on the lower ring. You should be able to achieve a match with the bracket nearly directly under the contact point on the upper ring. Slight deviation one way or the other from this position will have no significant effect on the efficiency, so any pair of points which provide a satisfactory swr should do. Whatever the end point of the lead is, it should be direct and fairly taut so that it will not shift position later.

There will be interaction between the setting of the condenser and the position of the feed point, so it will be necessary to adjust each one alternately during the tuning procedures. Once a satisfactory swr has been achieved by adjusting the condenser and the feed point, tighten the feedline to the transmitter to be used or increase power to normal operating level and recheck the swr. If the low-power source had the same output impedance as the operating rig, no further adjustment should be necessary. If an unacceptably high swr is encountered, retune the condenser for minimum swr. You should be able to achieve an indicated swr of 1.2:1 with ease. If not, the feed tap must be reset to match the transmitter. This must be done by moving the tap slightly with transmitter power off and checking the resultant swr with power on. It is a bit tedious, but usually a satisfactory setting located in this manner will be good for any antenna location. Once the preliminary adjustments have been made, you should be able to vary the transmitter frequency over a range of ± 250 kHz and maintain an

swr below 2:1 without resetting the capacitor. By resetting the capacitor, you should be able to maintain an swr close to 1:1 over the entire band.

Erecting the Antenna

The 10m or 15m DDRR antenna constructed as described can be mounted atop a pipe threaded into the pipe flange bolted to the fixture box used as a hub. A length of pipe may be used as a mast or clamped to any existing tower or pole. After the antenna has been raised to the desired height, it will be necessary to readjust the capacitor setting to center the minimum swr on the desired frequency. Once this has been done, the condenser shaft should be locked in place to avoid undesirable movement from vibration. After all adjustments have been made and all mechanical connections secured, it is a good idea to give the entire assembly a protective coating of acrylic to reduce corrosion.

When choosing the permanent location for your DDRR, consider the following factors: Extreme height does not appear to be a significant consideration with this antenna. As with other antennas, it should be located clear of metal objects which might alter its characteristics. Sometimes height is the best way to accomplish this. As height increases so, necessarily, does the length of the coaxial cable. As the length of coaxial cable is increased, the capacitor setting needs to be adjusted to compensate. Therefore the final adjustment of the tuning condenser must be made with the antenna at, or near, the final operating position. This is fairly easy if the antenna is to be relatively close to the ground as in portable or mobile installations. It may become more difficult if the antenna is to be mounted atop a high tower or pole. In this latter case, if it is impossible to do the final tuning in place, one approach is to tune the antenna at the highest possible height and with the full length of feedline connected. If this is done at least one half-wavelength above the ground, satisfactory final tuning adjustment should result.

An Alternate Method of Feeding the DDRR

If the conventional tuning method proves to be too troublesome, or if you

wish to avoid the high-voltage problem, an alternate method of feed is possible.

If we consider the ring radiator as a quarter-wave vertical which is resonant just above the desired frequency, we can feed it as though it were a short vertical whip. In this case base loading lends itself to the mechanical configuration. (See Fig. 4.)

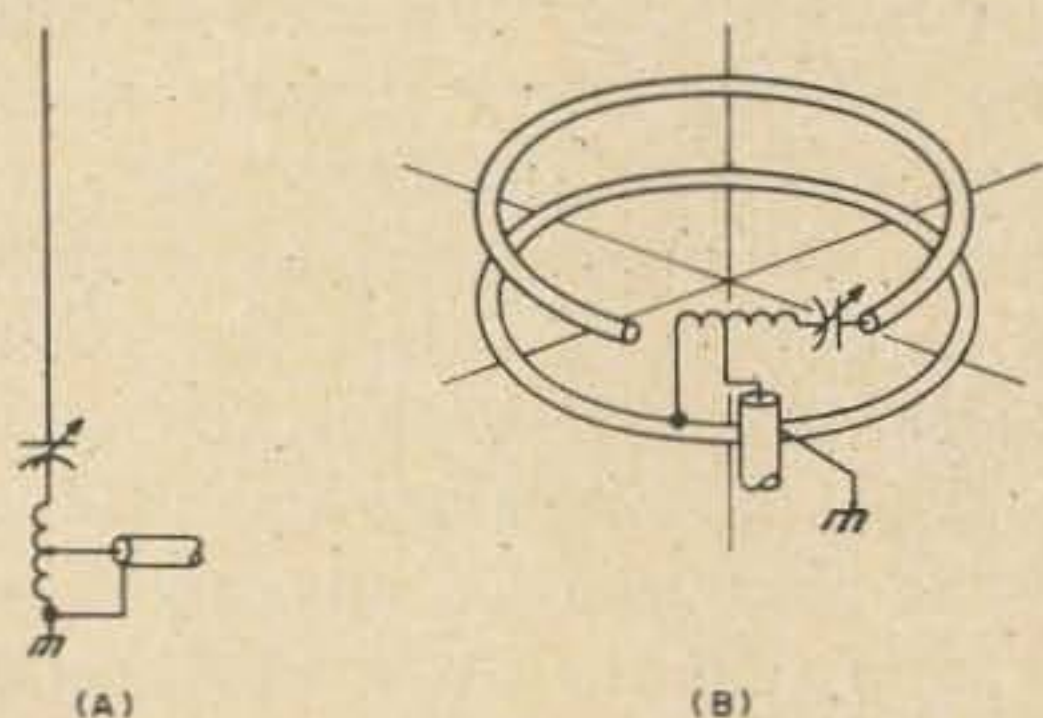

Fig. 4. Comparison between base loaded whip antenna (A) and "base loaded" DDRR (B).

Technical considerations concerning feeding quarter-wave vertical antennas in the manner described can be found in the ARRL handbook in the antenna section. The application of this method of feed to the DDRR is consistent with the electrical principles contained in the reference.

Some modification of mechanical construction is required to incorporate this method of feed for the DDRR antenna described herein. Essentially this amounts to omitting the 90° elbow and its associated hardware and replacing that part of the structure with tuned circuit elements. Mounting of these components must provide for sufficient mechanical strength and also yield the electrical characteristics necessary for proper operation.

The method devised and tested in experiments of W6WYQ is as follows:

Drill a hole horizontally through the upper ring 3/8 in. in from the end. Bolt the rear foot of a 100 pF capacitor (Johnson, Type R, 149-5), with an 8-32 screw through this hole. The capacitor shaft should point downward. Wind a coil of 1/8 in. copper tubing; 7 3/4 turns, 1-5/16 in. inside diameter, evenly spaced over the 4 in. length. Leave sufficient length at one end of the coil to provide a 1 1/2 in. upright support. Solder a lug to the end of this

length and bend it at right angles, in line with the axis of the coil.

Drill a hole downward through the lower ring at a point 2 in. into the gap space measured from the upper end of the fed ring. Bolt the upright support of the coil to the lower ring with an 8-32 screw through this hole. The other end of the coil should terminate at a point very close to the stator connection of the capacitor. A good solder connection should be made between these two points. Attach a length of 1/8 in. copper tubing, or similar size wire, from the coaxial connector to a point 1/2 to 3/4 turns in from the grounded end of the coil. Some experimentation will be necessary to find the exact point for your setup. I matched a 52Ω feedline to this antenna 5/8 turn in on the coil. When mechanical mounting is complete, the gap end of the coil should be bent to re-establish the 2 in. gap prescribed for the 10m DDRR. I found that I could tune the entire 10m band with less than half of the 100 pF capacitor. The standard Type R, with .024 air gap easily handled all that the Galaxy had to offer. If you run higher power, you might need wider spacing. The Type R is available with: .036, .050, .071, and .095 in. air gap. If you must go to wider spacing to handle your power, space might be saved by going to a 50 pF maximum capacitance. Whatever capacitor is used, it should be protected with a weatherproof cover. Since minimum capacitance is not a limiting factor with this type of feed, a minibox should do nicely for the purpose.

Tuning the Base-Loaded DDRR

Tuning procedures are the same as for the shunt-fed system except that the lead from the coaxial connector is moved along the coil until a minimum swr is obtained. We found this point to be 5/8 turn from the bottom end of the coil for RG-8/U.

The advantages of this method of feed are: A narrow spaced capacitor is quite adequate, extremely high voltages are not encountered in the tuning circuit, the system is not highly sensitive to stray capacitance, and the problems of minimum capacitance associated with the shunt-fed system do not apply.

Important E & E Amateur Books from SAMS

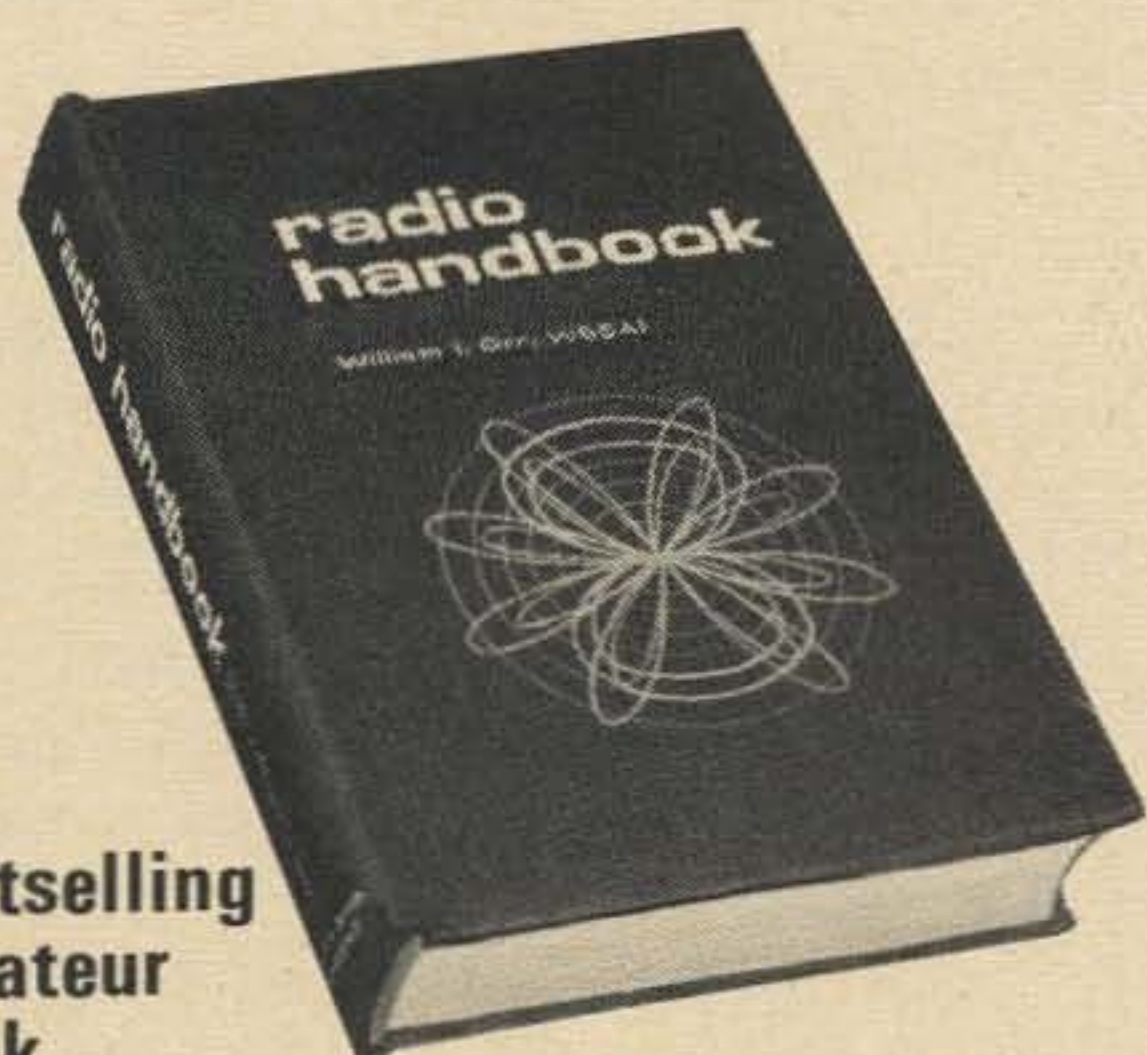

the
bestselling
Amateur
book

New 18th Edition of the famous E & E RADIO HANDBOOK

by WILLIAM I. ORR, W6SAI

Completely updated edition of the famous communications handbook which is the electronics industry standard for engineers, technicians and advanced amateurs. Explains in authoritative detail how to design and build all types of radiocommunications equipment. Includes SSB design and equipment, RTTY circuits, latest semiconductor circuits and IC's, as well as special-purpose and computer circuitry. 896 pages; hardbound. Order **24020**, only... **\$13.50**

latest E & E title

The Radio Amateur's F-M Repeater Handbook

by KEN SESSIONS, JR., K6MVH

This is the definitive work on the momentous and challenging subject of amateur f-m repeaters, a vital new development which has been virtually undocumented. Chapters

include: Preparing and Obtaining Sites for Repeaters; How to Build a Repeater; Repeater Applications. Includes an F-M Repeater Directory. There is no other comparable book available. 228 pages; hardbound. Order **24008**, only... **\$6.95**



Single Sideband: Theory and Practice

by HARRY D. HOOTON, W6TYH

This one-source guide emphasizes basic principles and circuitry of ssb. Covers the origin of ssb, the derivation of ssb signals, carrier-suppression techniques, sideband selection, and a complete analysis of all types of ssb equipment. Order **24014**, only... **\$6.95**



73 Dipole and Long-Wire Antennas

by EDWARD M. NOLL, W3FQJ

This is the first compendium of virtually every type of wire antenna used by amateurs. Includes dimensions, configurations, and detailed construction data for 73 different antenna types. Appendices describe the construction of noise bridges, line tuners, and data on measuring resonant frequency, velocity factor, and SWR. 160 pages. Order **24006**, only... **\$4.50**



73 Vertical, Beam, and Triangle Antennas

by EDWARD M. NOLL, W3FQJ

Describes the design and construction of 73 different antennas used by amateurs. Each design is the result of the author's own experiments with various antenna configurations; each has actually been built and air-tested by the author. Includes appendices covering the construction of noise bridges and antenna line tuners, as well as methods for measuring resonant frequency, velocity factor, and standing-wave ratios. 160 pages.

Order **24021**, only... **\$4.95**



Order from your electronic parts distributor or send coupon at right.



EDITORS and ENGINEERS

Howard W. Sams & Co., Inc. Dept. 73-6
4300 W. 62nd St., Indianapolis, Ind. 46268

Send the following books: Nos. _____

_____ \$ _____ enclosed

Send FREE 1970 Sams Book Catalog

Name _____
PLEASE PRINT

Address _____

City _____ State _____ Zip _____

Theoretically, this method of feed should be less efficient than the shunt-fed method. This may be true for the long haul, poor conditions, DX work; however, no significant difference could be detected between the two antennas under normal operating conditions.

Expanding Band Coverage

One of the advantages of the DDDR is its high-Q characteristics, which greatly reduce noise and help to minimize interference. Unfortunately, these characteristics limit the band coverage of a fixed-tuned DDDR. This shortcoming can be circumvented by providing some means of remotely adjusting the capacitor. This consideration applies to both the shunt-fed and base-loaded feed systems. If the antenna is to be mounted close to the operating position an extension shaft is all that is required. In some installations, chain drives, pulley and cord, or other mechanical linkage can be applied. By far the most satisfactory arrangement is a low-speed reversible motor geared to the capacitor's shaft. There are numerous reversible motors available on the surplus market which would be suitable for this purpose. Since no specific unit is identifiable, no detailed installation instructions are included here. However, certain general precautions must be observed when installing any motor. To begin with, if the motor is to be installed close to the capacitor, which is the most logical location for it, the motor windings are in a strong rf field. To minimize the effects of this environment, the motor should be mounted directly to the ground plane ring and bypass condensers installed on the leads to the motor as close as possible to the grounded case. Leads to the capacitors should be as short as possible. The power lead for the motor should come away from the antenna as nearly as possible to a right angle with the ground plane for a distance of one-half wavelength. A well grounded shielded cable would be an advantage, but is by no means mandatory. There is no requirement to incorporate a selsyn indicator in the system as the minimum swr indication is all that is required.

Capacitor Considerations

It is anticipated that many who read this article will wish to make modifications to the design to incorporate their own ideas or introduce improvements. Some will also wish to press into service some of the junkbox components they have on hand but which do not conform to the specifications in this article. Most aspects of the mechanical construction allow for fairly wide deviation; however, there are some restrictions on the type of capacitor which is suitable for the DDDR which limit the selection severely. I discovered these by the age-old method of trial and error, with the latter leading all the way. To save the adventuresome experimenter from frustration, these considerations are included here. Most of the limitations mentioned pertain to antennas for 20 MHz and above. The lower frequency antennas require more capacitance for tuning and a little stray capacity has less effect on the overall circuit. The high voltage problem, however, seems to be more aggravated on the lower frequencies.

In my experiments I first used a single-bearing capacitor similar to the E. F. Johnson Type M with .017 in. spacing. While the capacitor was completely satisfactory in terms of minimum capacitance, it arced at rf power levels above about 300W. I tried substituting a glass-insulated piston trimmer with about 1/32 in. glass walls, which arced at 400W. Next, I went to a wide-spaced unit (Bud 1543), with a .175 in. spacing. This capacitor withstood the voltage easily, but even in the fully open position, the antenna system would not resonate above 26 MHz. (It was at 29 MHz with the other components installed.) The cause of this was determined to be the high minimum capacitance caused by the large metal end bearing plates which were a little over 2 in. apart and with an area of about 4 sq in. I had on hand a Cardwell NG-35-DS which was of similar construction to the Bud unit but with end plates spaced 4 in. apart. This, too, proved to have too much capacitance, even at the minimum setting. I then found that the Cardwell ET-30-AD, specified here for the 10m unit, was entirely

AMATEUR ELECTRONIC SUPPLY

Make those "S" meters bounce!

You will with
the exciting
new...
Galaxy GT-550



- 550 Watts PEP-SSB, 360 Watts CW
- Highest Powered 80-10 Meter Transceiver in its Class!
- Sharp 2.1KHz filter for minimum QRM and concentrated "Talk Power"
- ALC prevents "Flat Topping" and keeps those S-meters reading High

**FULL
GALAXY LINE
IN STOCK!**

GT-550 80-10m Transceiver	\$550.00
AC-400 110/230v AC Supply	99.95
G-1000 DC Supply	129.95
SC-550 Speaker Console	29.95
RV-550 Remote VFO	95.00
RF-550 RF Console	75.00
PR-550 Phone Patch	49.00
VX-35C VOX Accessory	29.95
CAL-25 25KHz Calibrator	25.00
F-3 300Hz CW Filter	37.50
GTM Mobile Mount	8.95
ZZM Floor Adaptor	6.00
R-530 .5-30MHz Receiver	795.00
SC-530 Speaker Console	45.00
FL-5305 500Hz Filter	45.00
FL-53015 1.5KHz Filter	45.00
FL-5306 6Hz Filter	45.00
FM-210 2m FM Transceiver	200.00
AC-210 AC/DC "Booster"	39.95

**AMATEUR
ELECTRONIC
SUPPLY**

4828 West Fond du Lac Avenue
MILWAUKEE, WISCONSIN 53216
PHONE (414) 442-4200

STORE HOURS Mon & Fri 9 to 9; Tues, Wed, Thurs 9 to 5:30; Sat 9 to 3

SAVE \$100

Purchase a GT-550 or R-530 for the regular price, with no trade and you may take a \$100.00 Bonus Credit toward other merchandise. (\$20.00 Bonus on FM-210)

To: **AMATEUR ELECTRONIC SUPPLY**
4828 West Fond du Lac Avenue
Milwaukee, Wisconsin 53216

I am interested in the following new equipment:

I have the following to trade: (what's your deal?)

Ship me the following New Equipment.

I enclose \$_____ ; I will pay balance (if any)

COD (20% deposit) Revolving Charge Plan

Name _____

Address _____

City _____

State _____ Zip _____

Send Reconditioned Equipment Bulletin

AMATEUR ELECTRONIC SUPPLY

AMATEUR ELECTRONIC SUPPLY

AMATEUR ELECTRONIC SUPPLY

satisfactory. This condenser has ceramic end plates and the minimum capacitance is well within bounds. Plate-to-plate spacing is 1/16 in. and connecting the two sections in parallel gives an effective plate spacing at 1/8 in., which is adequate for the 500W maximum power used. Wider spacing might be necessary if higher power is applied. Although the ET-30-AD was satisfactory in electrical operation, it is a little long for the installation. I hoped to find a capacitor which would fit between the two rings. Finding no suitable unit listed in the manufacturer's catalog, I manufactured one. The plates were removed from a National capacitor of similar construction to the Bud and Cardwell units which were rejected. The National capacitor was tried and rejected also, but the stator and rotor plates were mounted on shafts with a bolt and spacer arrangement which made it ideal as a source of parts. With the parts from this capacitor, a capacitor was assembled directly onto the antenna. The stator plates were bolted to the driven ring and the rotor mounted to a bearing attached to the ground plane ring by a bracket. The plates, two stators, and three rotors were spaced to about 1/4 in. This arrangement seems to be the most satisfactory all around, since it not only withstands the voltage, but also fits within the limited space. This method has not been prescribed in this article because of the additional mechanical construction involved and because of the difficulties in providing a weatherproof housing for it. It is described here because it may well be that those running full legal power may have to resort to this approach in order to make the antenna work at those power levels. Of course it is not necessary to dismantle an old capacitor for parts. Suitable plates may be cut from stock. Those I used had an area of about 2 sq in.

If you have an old disc-type neutralizing capacitor (Millen 15011) this can be made to work. It is particularly well suited to fixed-tuned applications but can be used as a variable with proper linkage.

If you are only interested in fixed-tuned systems, by far the easiest solution to the capacitor problem is to install a length of

coaxial cable between the two rings with the shield connected to the ground plane and the center conductor to the driven element. I found that 2-5/8 in. of RG-8/U tuned the 10m antenna to 29 MHz.

DDRR Antennas For Other Frequencies

Details for construction of the 10m DDRR described herein are suitable for frequencies down to 21 MHz. Above 30 MHz, sheet metal or screen ground plane surfaces are more easily fabricated. Smaller tubing sizes recommend copper, and soldering techniques replace pipe clamps and U-bolts. Those who wish to use this antenna on 6 or 2m would do well to review the article by G. W. Horn 11MK, in the September 1967 issue of CQ.

The general construction details described above for the 10m DDRR are applicable to lower frequency units, but below 21 MHz. The method of making and attaching the radials requires some modification. The V-shaped radials of 1/4 or 3/8 inch aluminum rod do not provide adequate mechanical strength, and there is some doubt as to their electrical efficiency when used in conjunction with the larger size tubing. Moreover, a larger number of radials should be used to improve both electrical efficiency and mechanical strength. Obviously the small utility box used as a hub would not be adequate on these large antennas.

We tried several methods of making radials for the 20m antenna and finally adopted the following system as most suitable. (See Fig. 5.)

The hub on this larger antenna is a disc of aluminum 1/4 in. thick and 12 in.

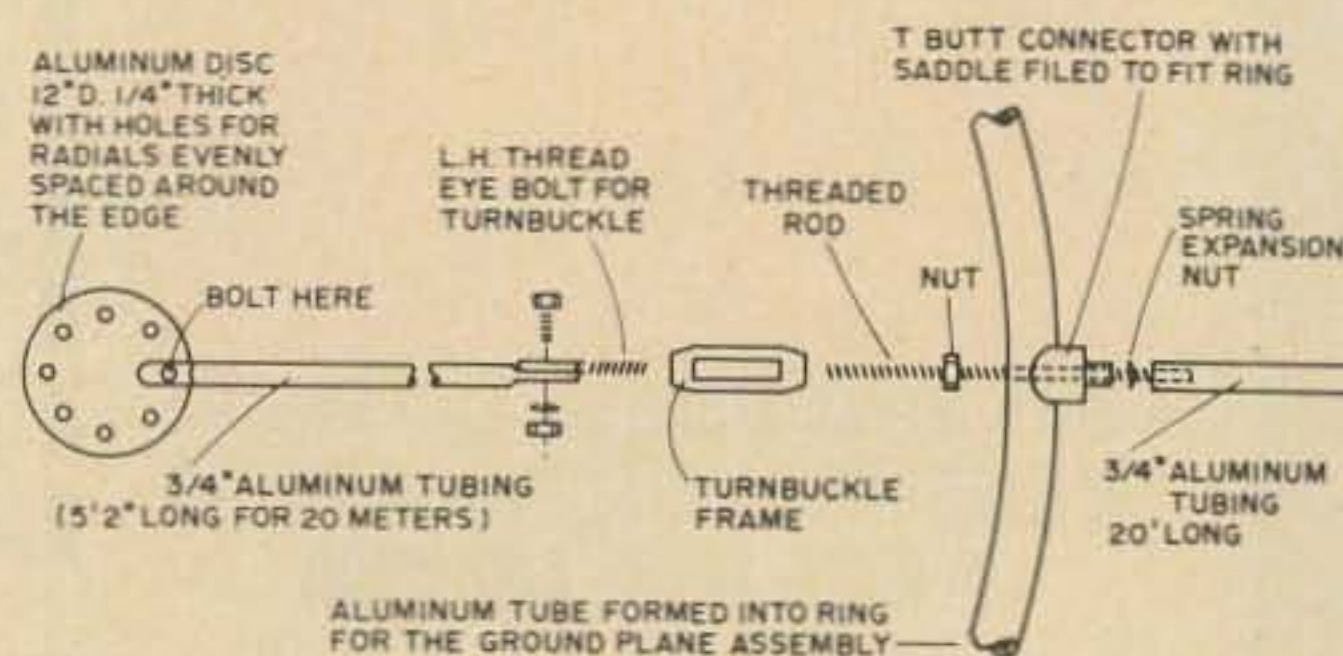

Fig. 5. Assembly technique for DDRR ground plane radials for 20 and 40 meter antennas.

diameter. The radials are $\frac{3}{4}$ in. aluminum tubing. The inner portion of each radial is 5 ft 2 in. long. A $1\frac{1}{4}$ in. section on each end of these radials is flattened and a $\frac{1}{2}$ in. hole drilled through the flat part one inch from the ends. Radials are bolted to the edge of the aluminum disc, at about 3 in. intervals. The left-hand-thread end of a 6 in. turnbuckle is bolted to the opposite end of each radial; 20 in. lengths of $\frac{3}{4}$ in. tubing are mounted around the outer perimeter of the ring. These stubs are attached using T-butt connectors with the bolt replaced with a length of $\frac{1}{4}$ -20 threaded rod with a nut run on it to cinch it up against the ring. The right-hand-thread-end of the turnbuckle is run onto the rod; then, by turning the turnbuckle, tension can be applied to each rod in turn. The whole assembly presents a neat appearance and is quite strong enough for pole mounting, although we added 3 legs from the midpoint of 3 radials down to the mast to provide more stability.

Performance

The 10m DDRR as described in this article has been in use at W6WYQ for about 4 months. On-the-air checks show its performance to be equal to that of a standard isotropic radiator mounted on the roof. The DDRR has been handicapped by being located variously: on a box in the middle of the garage, in the rafters of the garage, on the roof, on top of the car, and even resting on the ground. In spite of this, solid contacts have been made with W1s, W4s, VE7s, and many stations in between. The DDRR doesn't compete with the multielement beams, but it seems to be right in there with the verticals. It has shown itself to be superior to the multi-band trap-type verticals. Most of the best contacts have been made with stations using verticals or quads, which is, no doubt, the vertical polarization of the DDRR antenna being demonstrated. The sharp tuning characteristic markedly reduces QRM and noise, and that aspect has been quite enjoyable.

The 20m DDRR is presently undergoing evaluation at another station. Initial tests indicate that its performance is very similar to that of the 10m version. . . . W6WYQ ■

FREE!

112 pages of the best in electronic equipment. Special package buys and many exclusive items you can't get anywhere else!

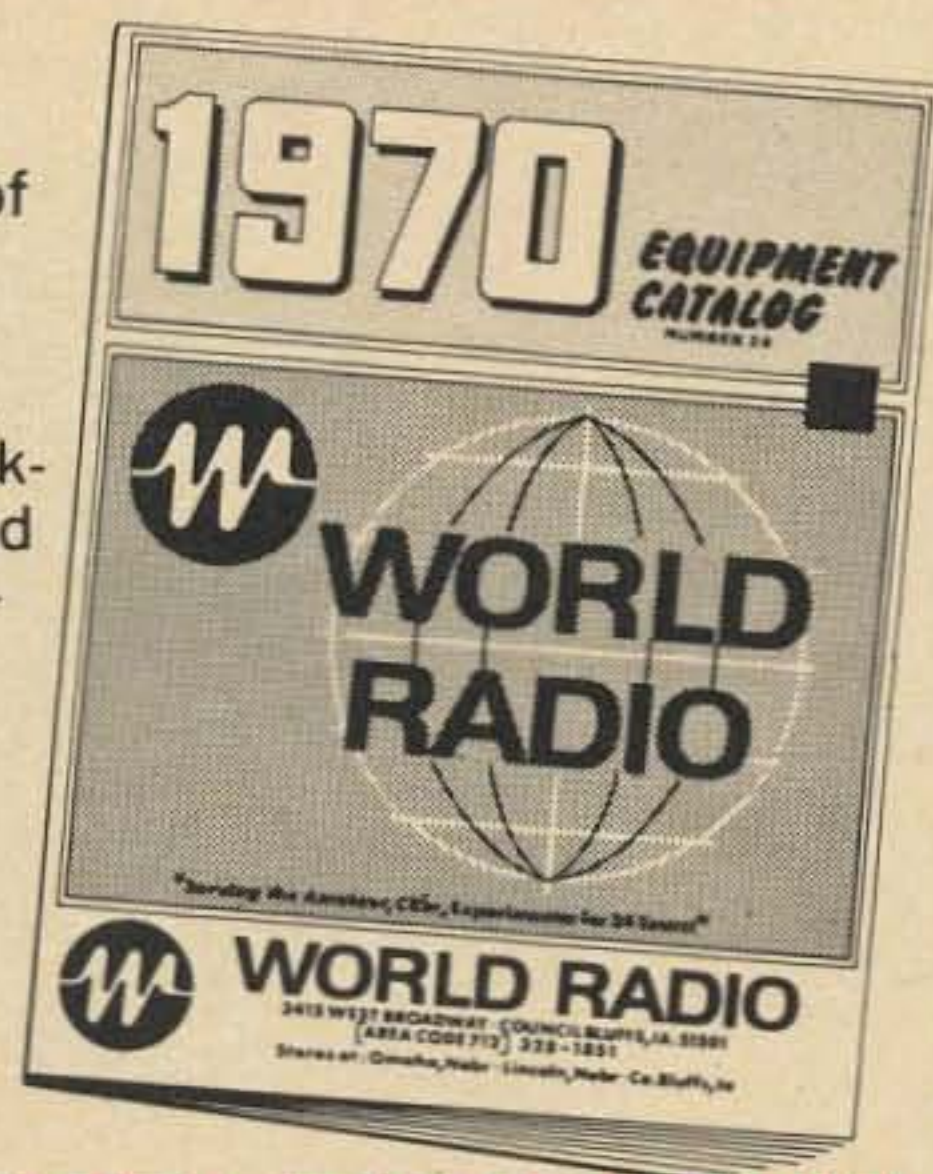

1970 EDITION WORLD RADIO Electronic Equipment CATALOG

OUR BIGGEST EVER!

SHOP BY MAIL AND SAVE ON Hi-Fi, Radios, Recorders, CB Equipment, Ham Gear, Parts and Tools—everything in electronics at real money-saving prices. Use our easy credit terms, BankAmericard or Master Charge. *Get your copy now!*

JUST MAIL IN THIS COUPON—



WORLD RADIO

3415 West Broadway
Council Bluffs, Iowa 51501

Dept. EE-54

Gentlemen:
Please send me your Free 1970 Catalog.

Name _____

Address _____

City _____ State _____ Zip _____

VFO CIRCUIT

Horton Presley KØHVK
1126 S. Hickory
Ottawa KS

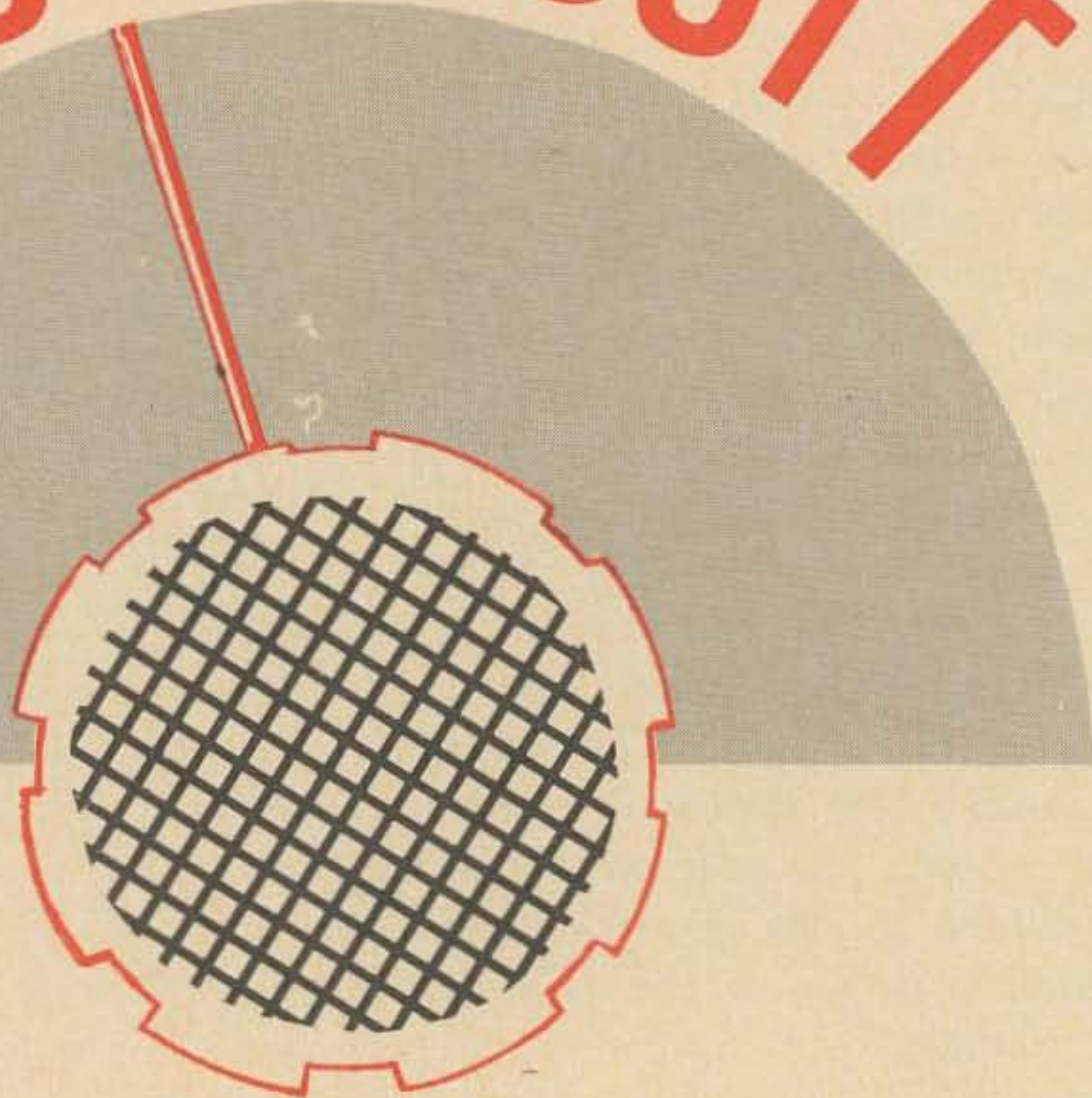

If you want a stable, simple vfo for 80 and 40 with full bandsread on both bands and possible 20 meter usage with bandsread on about 2/3 of the dial, read on. This is basically the rig from *GE Ham Tips* of March-April 1959 without the complicated inductance and capacitance switching which is used there to get full bandsread on all bands.

This unit starts at 160 then doubles in the plate circuit to come out on 80. Switch S1 (Fig. 1) cuts out C2a and inserts C3 in order to give full bandsread when doubling in your transmitter to 40. Depending on the slug-tuned form you used and the BC capacitor, you may have to juggle the turns of L1 and possibly C1 to get full 1.75-2.0 coverage, and C3 may be somewhat different

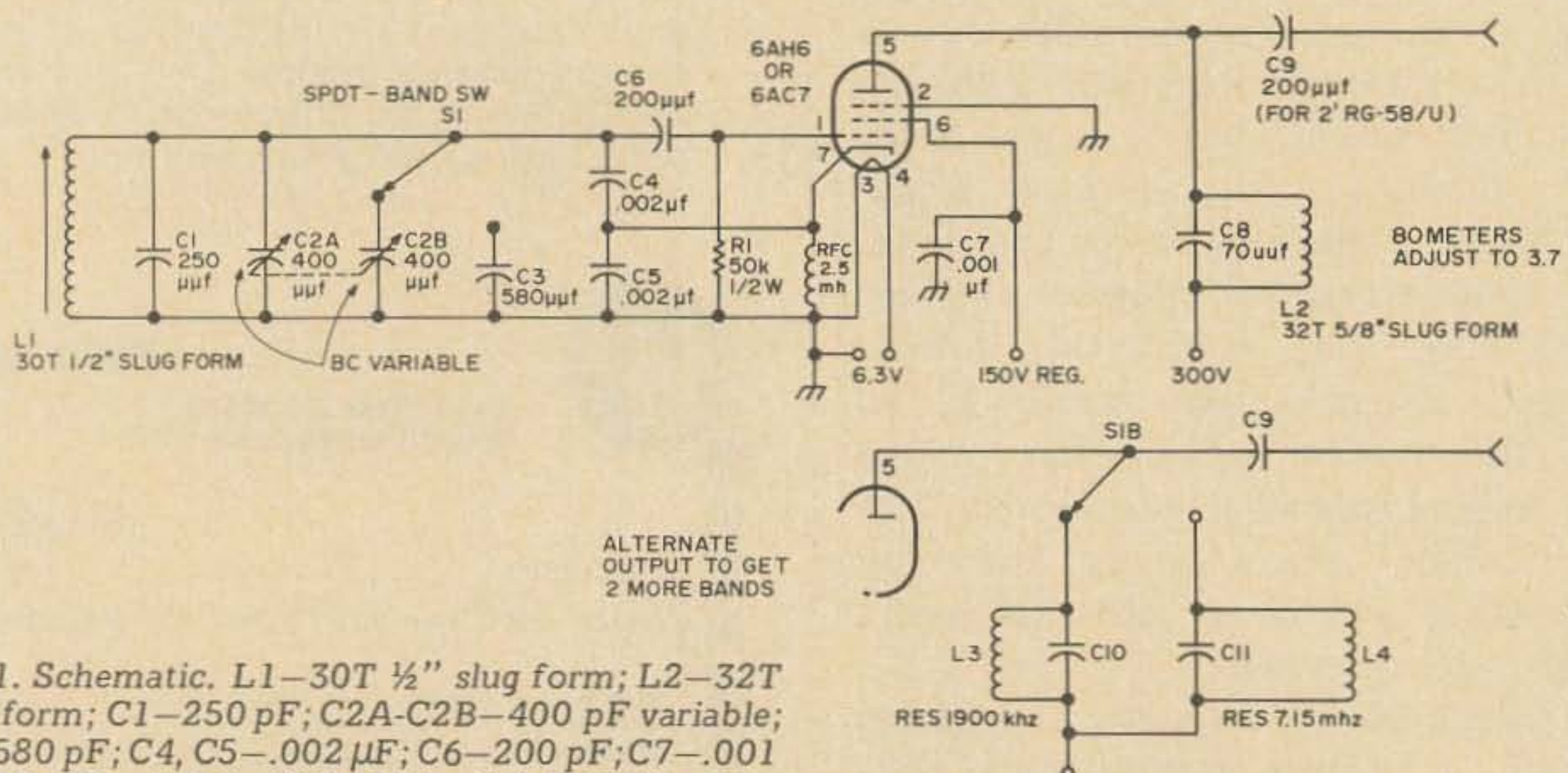
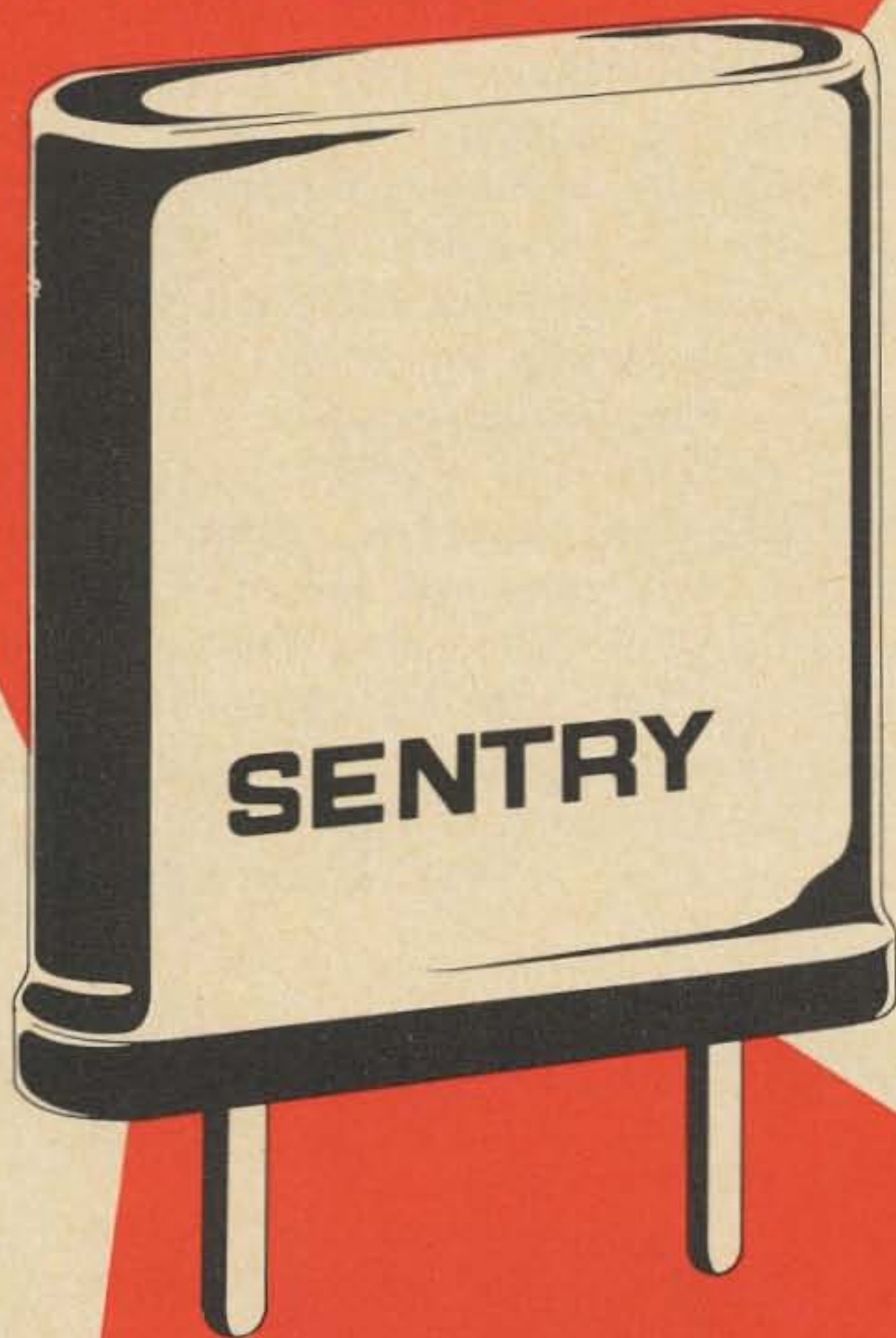

Fig. 1. Schematic. L1—30T 1/2" slug form; L2—32T 5/8" form; C1—250 pF; C2A-C2B—400 pF variable; C3—580 pF; C4, C5—.002 μ F; C6—200 pF; C7—.001 μ F; C8—70 pF; C9—200 pF for 2 ft RG580; R1—50K 1/2W; RFC—2.5 mH; S1—SPDT toggle sw—band sw.

**IF YOU'VE
EVER
USED
A
REPEATER,**



**YOU'VE USED A
SENTRY CRYSTAL**

If you haven't
already received
a copy of our **NEW**
1970 Catalog of Precision
Quartz Crystals & Electronics
for the Communications Industry,
SEND FOR YOUR COPY TODAY!

Somewhere along the line, in virtually every ham repeater in the world, you'll find a couple of Sentry crystals.

Repeater owners and FM "old-timers" don't take chances with frequency—they can't afford to. A lot of repeater users depend on a receiver to be on frequency, rock stable...in the dead of winter or the middle of July. The repeater crowd took a tip from the commercial "pros" a long time ago—and went the Sentry Route.

That's one of the reasons you can depend on your local repeater to be there (precisely there) when you're ready to use it. FM'ers use the repeater output as a frequency standard. And for accuracy, crystals by Sentry are THE standard.

**IF YOU WANT THE BEST,
SPECIFY SENTRY CRYSTALS.**

*"Ask the Hams and Pros
Who Build Repeaters!"*

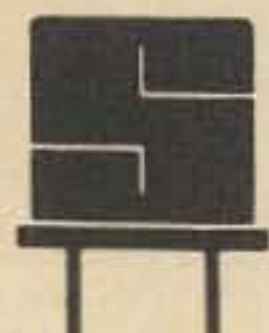

SENTRY MANUFACTURING COMPANY
Crystal Park, Chickasha, Oklahoma 73018

PHONE: (405) 224-6780

TWX-910-830-6425

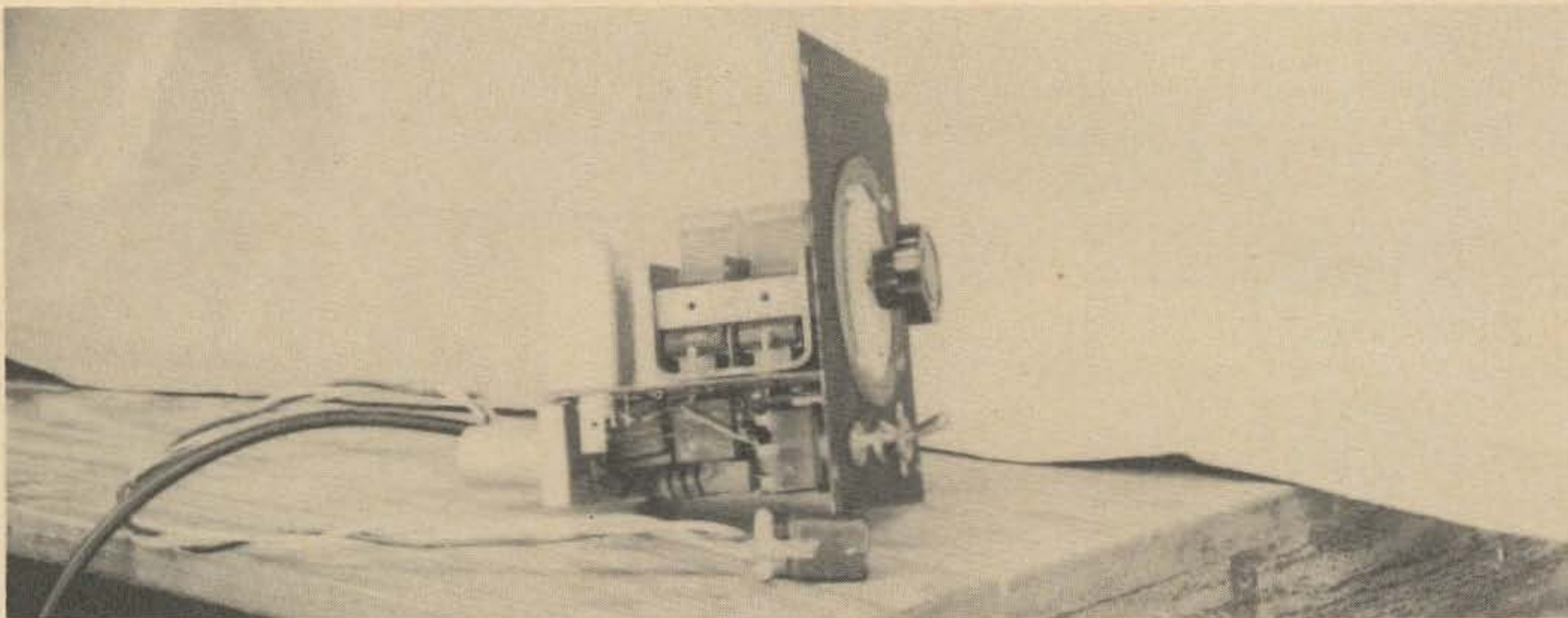

As this view of the unit with its cover removed shows, the vfo can be attractively packaged within a very small volume. Power is furnished to the unit from the transmitter. If no "external power" connector is provided on the transmitter chassis, it can normally be installed with little effort.

from mine in order to get full bandspread on 40.

The fixed condensers I used were ordinary micas from the junkbox. Probably as a consequence, the vfo takes about 15 or 20 minutes to settle down where it will stay zero beat with a BC221. I know that I should spend a couple of bucks for zero or negative-temperature-coefficient ceramics so that it will not drift more than a hertz or two from a cold start, but my old much-chopped-up National 100X takes that long or longer to settle down, so what good is it to have a vfo that stabilizes faster? Obviously though, the better the fixed condensers you use, the better the stability.

This is my first vfo project and if the

same is true for you, take heed! *Don't* put a pilot lamp right under the confounded main tuning capacitor! It sure makes a nice looking, symmetrical front panel, but does it ever play hob with drift! Also, keep all tube heat away from L1. I put the tube on the back, outside the case.

One further suggestion you may want to try: Make S1 a DPDT unit and follow the suggested alternate output circuit. Make L3-C10 tune 160 meters and L4-C11 tune 40. This will give a 160 meter output in addition to the former 80 and 40, and better 20 meter usage than is the case with the simpler circuit (since you will be only doubling to get to 20 instead of quadrupling).

... KØHVK ■

What's wrong with this picture? The pilot lamp has been installed immediately below the tuning capacitor. The glowing lamp looks great when the vfo is in use, but the heat of the lamp does interesting things to the frequency of operation.

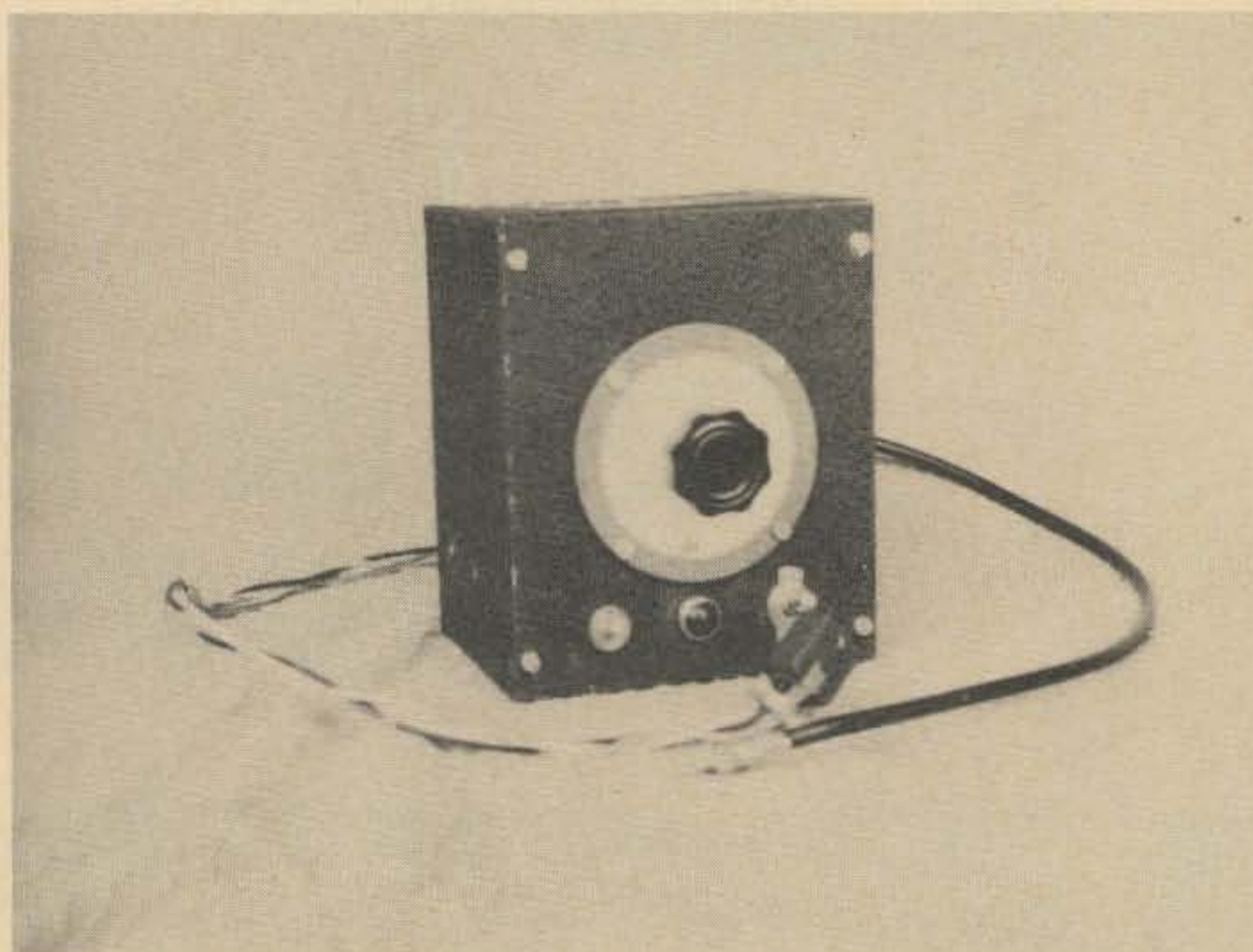

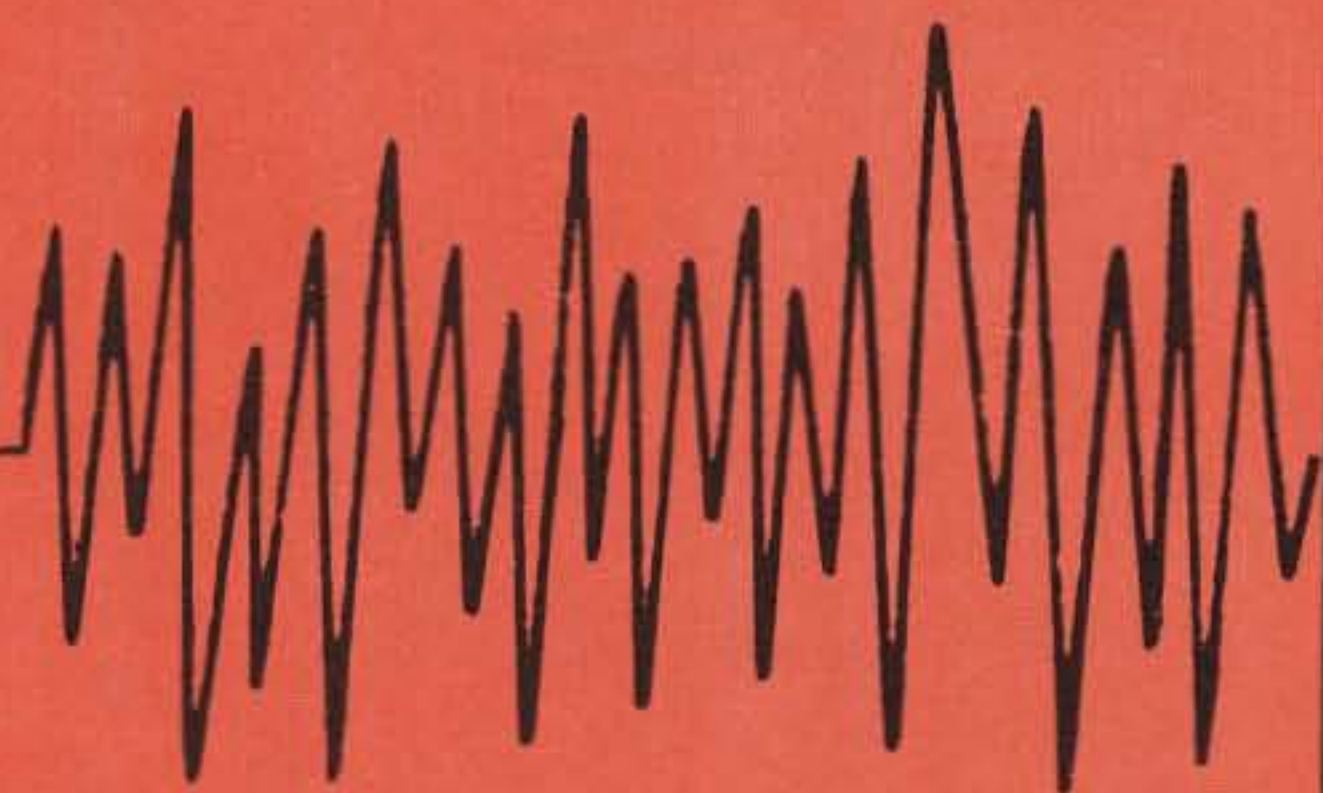

*Del C. Winger WB6JNI
7400 Tiptoe Lane
San Jose CA 95129*

The hypothesis of antenna reciprocity—that is, a good transmitting antenna is a good receiving antenna—is only conditionally true. A tuned antenna will give you a signal that is twice as loud as an untuned antenna, but it may have four times the noise. The controlling factor in the noise transfer is the impedance match. For efficient transmission of power, the reflected antenna impedance must match the transmitter output impedance. But, “. . .the best receiving noise figure is usually obtained with some degree of mismatch between the receiver and the antenna.” The quote is from S.N. Van Voorhis, MIT Radiation Series Volume 23.

I found this out experimentally while looking for a better signal. I have two antennas, a 13 ft vertical for the receiver, and a balun-fed three-band inverted vee for the transmitter. The transmitting antenna is trimmed to an swr of 1.5:1 in the middle

the low noise antenna

of the CW section of each band and pushes 40W very nicely.

Bearing in mind the adage that says you can't work 'em if you can't hear 'em, I put the transmitting antenna on the receiver. Although the signal was twice as loud, the noise was almost impossible to work through—I heard it, but I didn't believe it! Then I did a little research.

The signal-to-noise figure is dependent upon a poor match for the noise and a better match for the signal. This can be obtained at the expense of signal gain, but most receivers have plenty of gain to spare.

There are a large number of variables in any working system and one cannot say that any specific fix will lower your signal-to-noise ratio; but at least now you know that it is possible to improve the situation by experimenting. Just remember that the loudest signal will not necessarily be the most readable. . . . WB6JNI ■

Direct from 73

TWO GREAT E&E HANDBOOKS

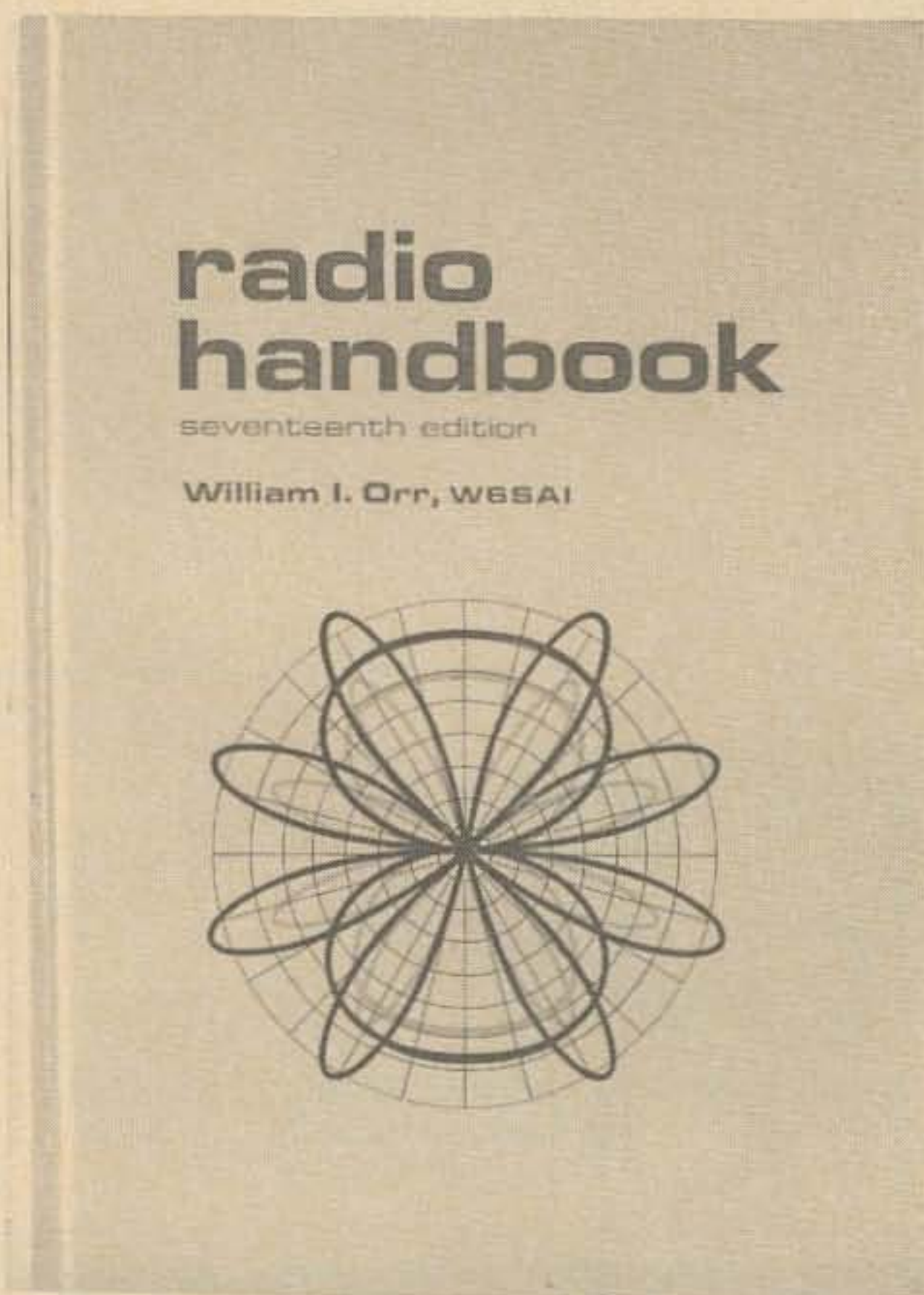

Regularly...\$ 12.95 / **A STEAL at \$ 10.**

The Radio Handbook is by far the biggest and the best handbook in print. Here is your chance to get this great book at a substantial discount, if you act fast. We have a limited quantity on hand and when they are sold that will be the end of the bargain.

The Radio Handbook is the *only* handbook that has all original material rather than just reprints of magazine articles. The hundreds of construction projects were built specially for this handbook by top amateur radio builders. Hardbound, with some 850 pages of theory, construction projects, and reference data covering every aspect of amateur radio.

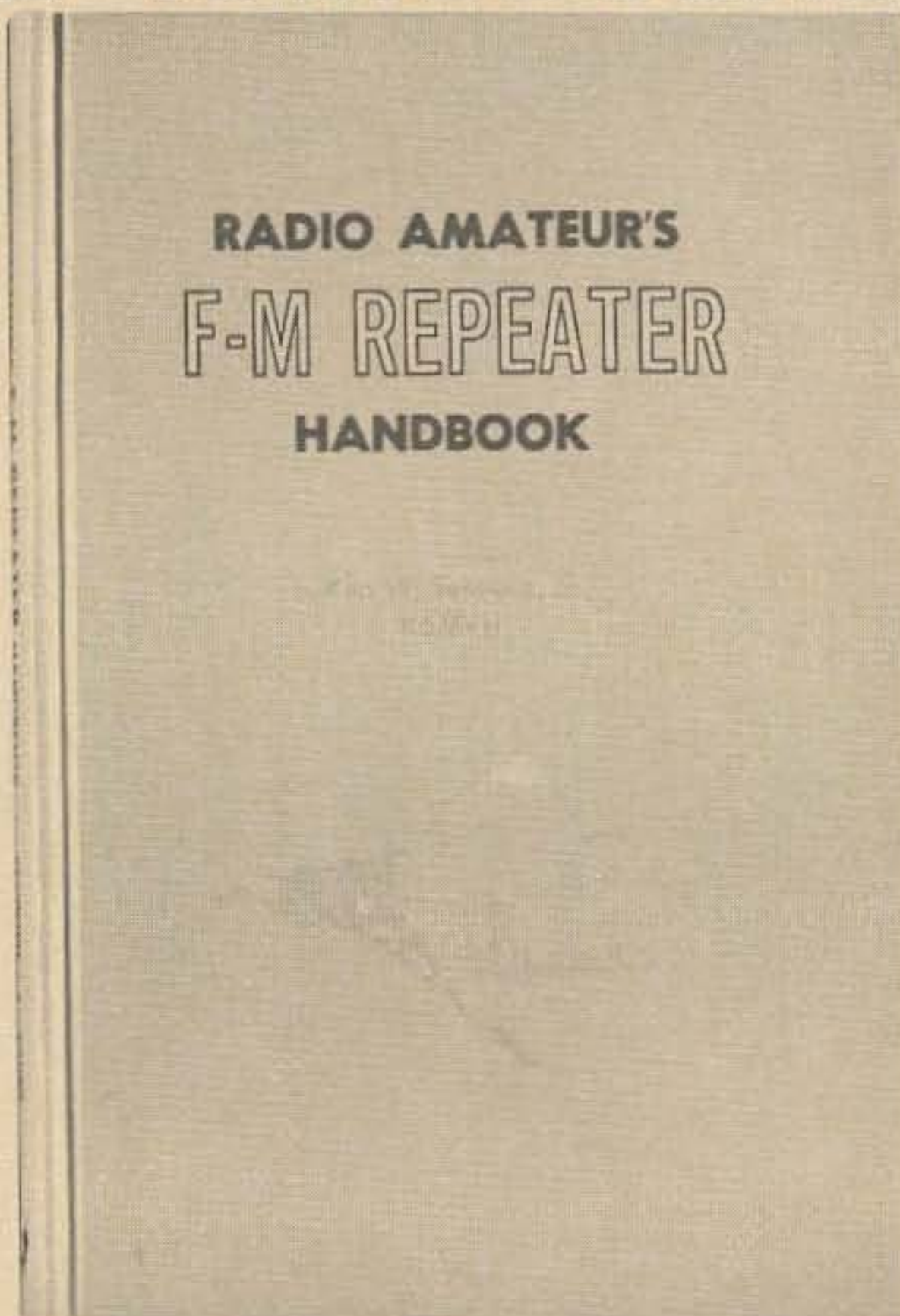

... a sellout

at radio stores from coast to coast!

Want to build a repeater?

Or improve your existing site?

Whether you're a newcomer or an oldtimer, you'll find "The Radio Amateur's FM Repeater Handbook" to be the most valuable repeater aid you can get.

The Repeater Handbook contains 208 pages of useful, hard-to-come-by information, and it's written in an interesting, personal vein.

A wealth of information.

GET BOTH OF THESE GREAT HANDBOOKS — WHILE THEY LAST-FOR THE LOW LOW PRICE OF ONLY \$15.00

Use the coupon to order the Radio Handbook, the FM Repeater Handbook, or the special two-book package.

MAIL TO 73 HANDBOOKS, PETERBOROUGH NH 03458

NAME _____ CALL _____

ADDRESS _____

CITY/STATE _____ ZIP _____

Radio Hndbk
I enclose \$10

FM Repeater Hndbk
I enclose \$6.95

Both Hndbks
I enclose \$15

REMOTE SWR INDICATOR

Conventionally placed swr meters often do not indicate the true swr at the transmission line/antenna junction. Remote location of the reflected power sensing portion of an swr unit is the key to true swr value indication.

Rather than using a combined swr indicator and sensing unit in the transmission line by the transmitter, there is a great advantage to placing the swr sensing unit at the junction of the transmission line and the antenna. For one thing, the true swr would then be shown on an indicator placed by the transmitter rather than an swr reading which depends upon transmission line attenuation characteristics. Also, one would have a means of checking the condition of the transmission line continuously, all the way to the antenna termination.

The constructional problems in placing the sensing portion of an swr unit at the far end of the transmission line have prevented most amateurs from building a remote-type swr meter. A separate enclosure must be used for the sensing unit which adds additional weight at the antenna. Generally, this would be no problem with a beam antenna where the boom can be used to

support the necessary enclosure. However, such an enclosure could cause quite a droop in the center of a thin wire antenna. Another problem is transferring the output from the sensing unit to the indicator unit at the transmitter, unless a separate wire pair is used for this purpose.

Most of these problems have been overcome in the simple experimental swr unit described in this article. The unit described was constructed for use in a 300-ohm twinlead transmission line, but the techniques used are applicable to other impedance transmission line systems. Some minor problems that are noted later arose because of the particular antenna system in which the unit was tried, but the basic validity of the construction and circuitry used was established.

Basic Units

Figure 1 shows the arrangement of the swr sensing and indicator units in the transmission line. The sensing unit is a

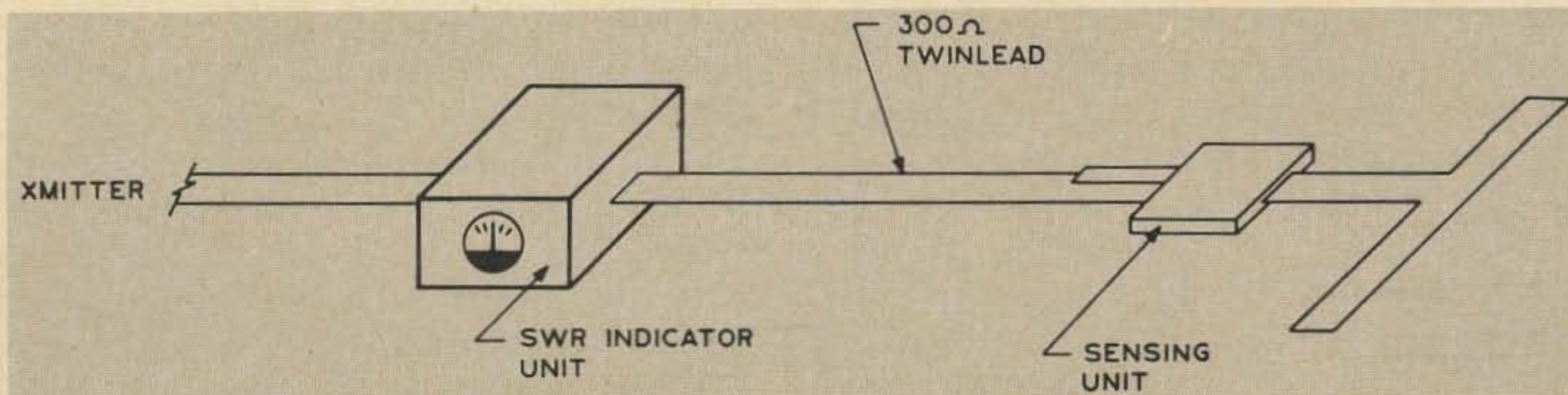

Fig. 1. Basic setup of components used in the remote swr monitoring unit.

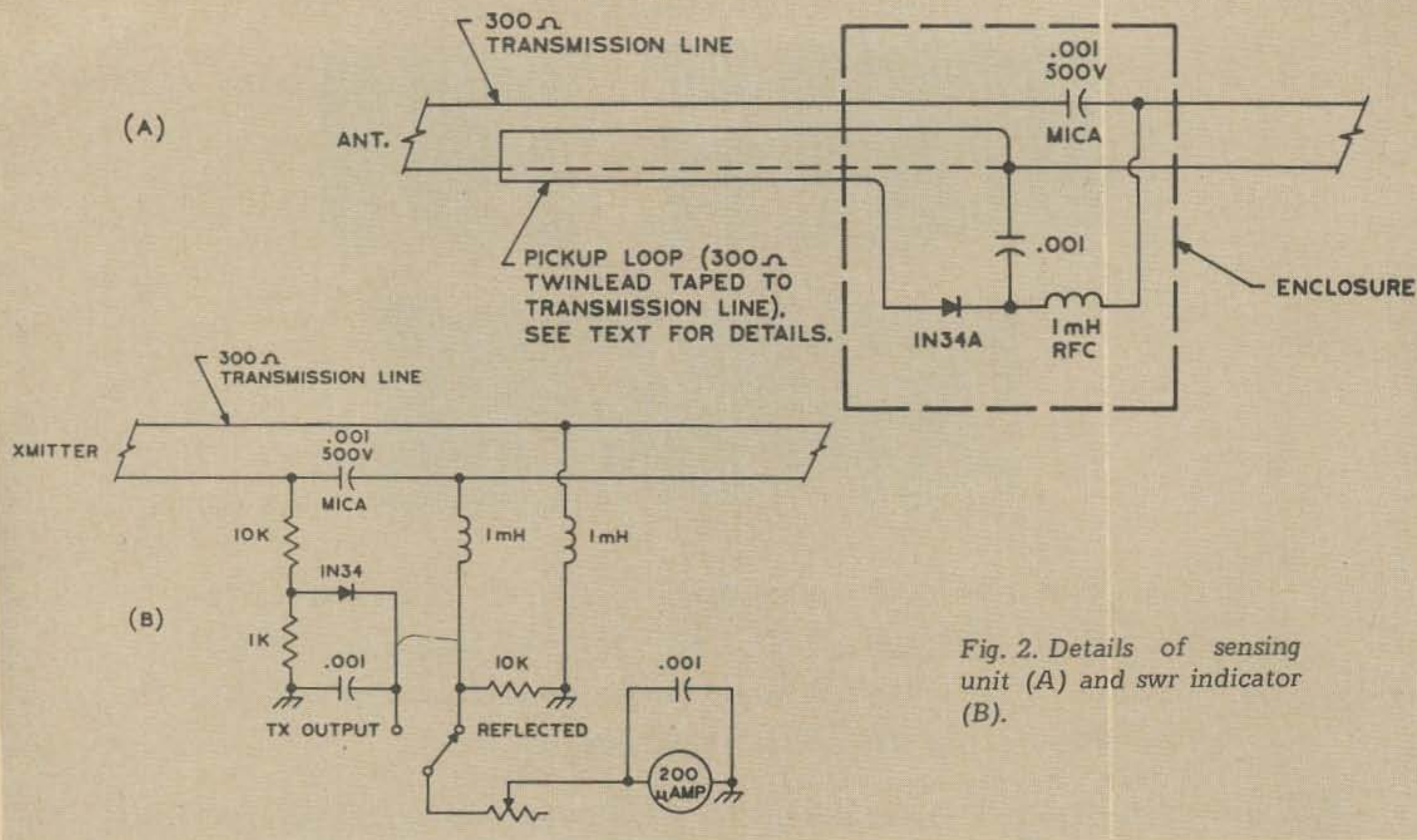

Fig. 2. Details of sensing unit (A) and swr indicator (B).

modified form of the old twin-lamp swr indicator for twinlead transmission line but arranged to only respond to reflected power pickup. The indicator unit functions as a combination rf voltmeter to indicate the relative power output of the transmitter and as an indicating dc voltmeter for the reading of a dc voltage generated by the sensing unit which is proportional to the swr. The connection between the two units is via the same transmission line between the transmitter and antenna. The same line can be used simultaneously for both purposes since the rf power flow and the dc voltage generated by the sensing unit can flow on the same line but then be separated by appropriate capacitor and rf choke combinations. This feature is indicated more clearly in Fig.2(A) and 2(B) which show the details of the sensing and indicator units.

The sensing unit consists of a length of 300-ohm twinlead identical to that used for the transmission line. The assembly is taped onto the transmission line. One end is terminated in a short. A small rectifier/capacitor unit is placed at the other end where a pilot lamp would normally have been placed in the old "twin-lamp" swr indicator. The dc voltage generated is placed on one side of the transmission line via the rf choke. The dc blocking capacitor

prevents a dc short circuit path from existing via the antenna (a folded dipole, for instance). The dc voltage, then, which is proportional to the reflected power level at the transmission line/antenna junction is transferred along the transmission line to the transmitter as a dc voltage difference between the two transmission line conductors.

At the indicator unit, a dc ground reference is established via an rf choke to ground for the side of the transmission line directly connected to the sensing unit pickup loop. The rf choke and blocking capacitor in the other side of the transmission line perform the same general function as in the sensing unit, only this time the capacitor is used to prevent a dc short between the transmission line conductor via the transmitter output circuit. A resistor voltage divider network and rectifier circuit on the transmitter side of the blocking capacitor provide a dc voltage proportional to the transmitter output level. The meter is switched between reading this voltage and that transferred along the transmission line from the sensing unit. The variable resistor in series with the meter allows the meter to be adjusted to a "set" value before being switched to read swr. However, the operation and meaning of the "set" reading is

HEY! HOW ABOUT THAT

S.W.R. BRIDGE

- MODEL SWB-2
- READS FORWARD AND REFLECTED POWER SIMULTANEOUSLY
- "EASY READ" METERS
- USE FOR REFERENCE POWER METER
- DUAL 100-MICROAMP METER MOVEMENTS
- LOW INSERTION LOSS
- SIZE-5"X2"X2"

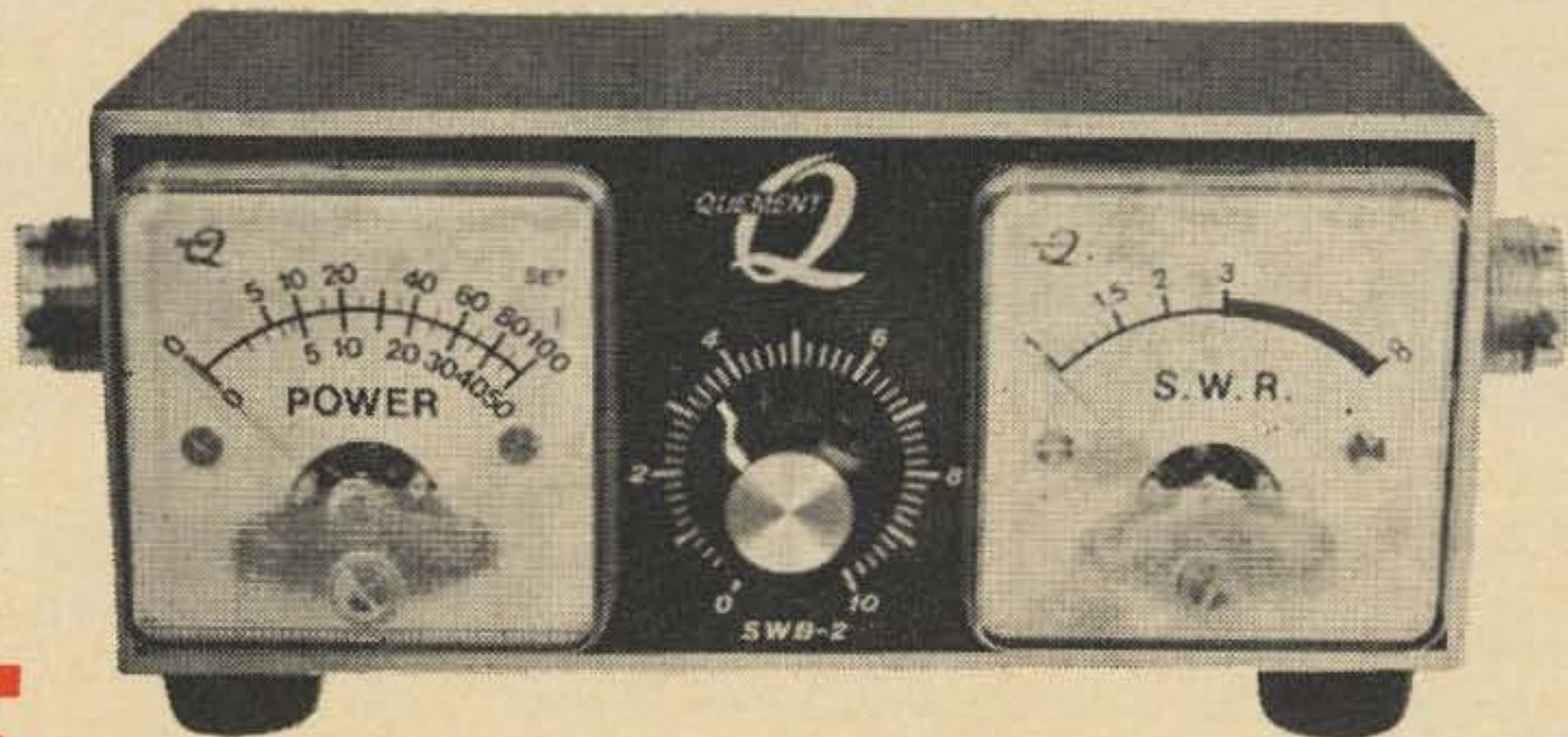

\$15.95

ALLOW \$1.00 FOR
PACKING & SHIPPING.
CALIFORNIA RESIDENTS
INCLUDE SALES TAX.

THE BEST
VALUE WE
HAVE
EVER
OFFERED!

MAY BE LEFT
IN LINE, UP
TO 2000 WATTS.

GOOD THROUGH
2 METERS

SINCE 1933

FAST SERVICE

Phone 408-294-0464

QUEMENT ELECTRONICS

1000 SOUTH BASCOM AVENUE

SAN JOSE, CALIFORNIA

"Northern California's Most Complete Ham Store"

95128

quite different from that of the usual swr meter. The differences, which are explained later, should be well appreciated.

Construction and Adjustment

The use of the swr indicator was mainly checked on 40 and 20 meters. The length of twinlead used as the pickup loop was taped to the transmission line. The components shown in Fig.2(A) were compactly assembled in a plastic snap-open box measuring about 2 x 1 x 1 in., which was acquired as the result of some now unknown purchase. However, almost any similar lightweight enclosure would suffice. Particularly when dealing with coaxial transmission lines, it would be advisable to also use a shielded enclosure instead of a plastic unit in order to preserve the continuity of the outer shield. With some care in construction, it would seem to be perfectly feasible to use the smallest minibox available for this purpose (Bud CU3000A).

The indicator unit, as shown in the photograph, was assembled in a Bud CU-2103A enclosure. Most of the components were mounted on a 6-lug terminal strip to

which sections of twinlead going to the transmitter and antenna were also connected. Before soldering to the terminal strip, the twinlead sections were passed through access holes drilled in the mating part of the minibox enclosure. The toggle switch and potentiometer used were special miniature types and, therefore, appear quite small in relation to the other components. Regular size components can, of course, be used and there is more than ample space for them in the enclosure specified.

After connection of the sensing and indicator units in a 50 ft transmission line, the far end of the line was terminated in a 300-ohm dummy load and the line swr checked using a conventional swr meter. This was done to verify that the rf chokes used in the sensing and indicator units did not upset the line conditions. Although the chokes should present a reactance of some 40 k Ω on 40 meters, it is possible that some odd resonant condition might affect their performance on a specific band. The swr was found to be essentially 1:1. Next,

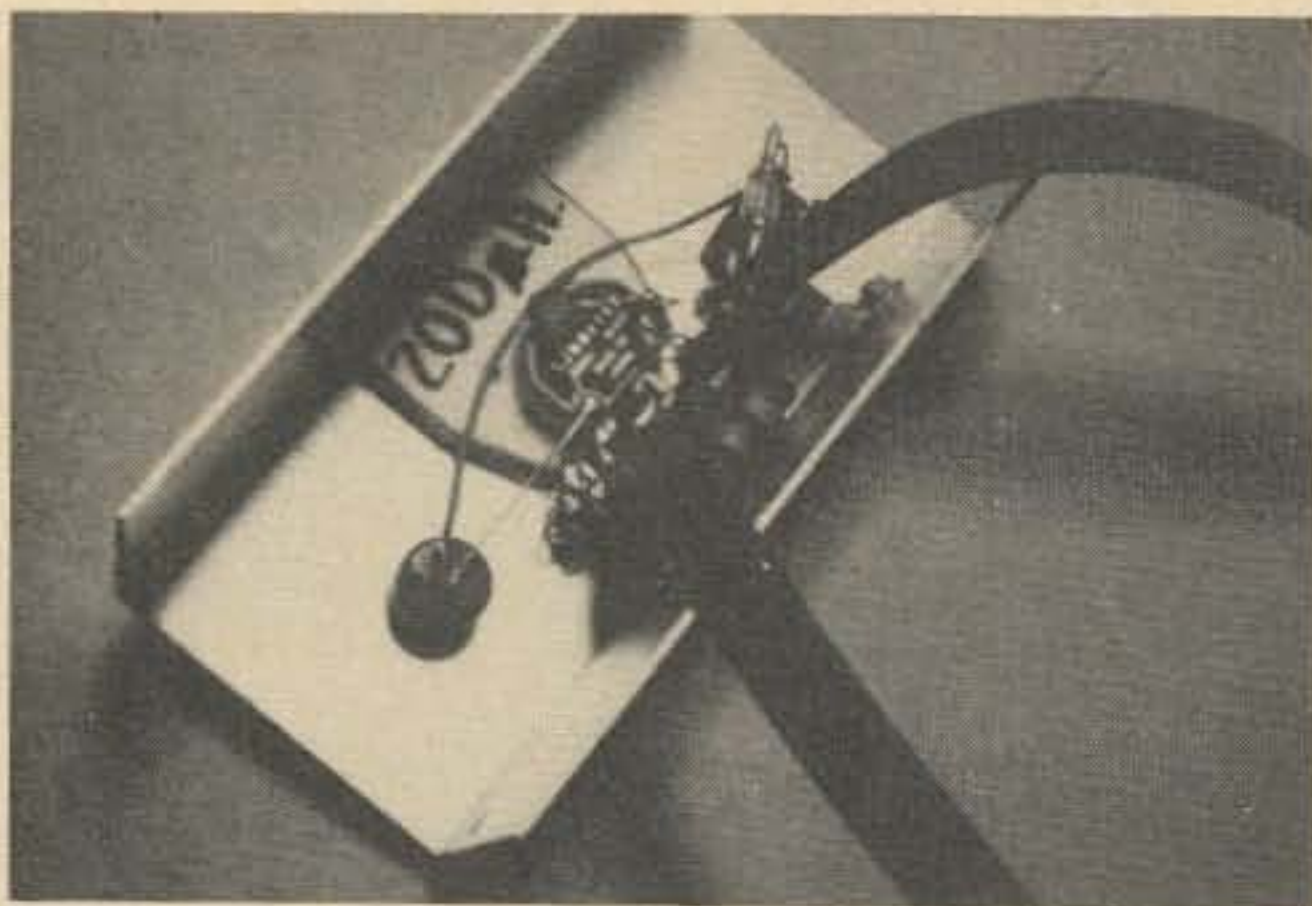

All components are assembled on a terminal strip or wired between it and the panel components in the swr indicator unit. IN34 diode is shown connected between terminal strip and switch on right side. Panel unit on left is miniature potentiometer.

while using a transmitter with about 50 watts output, the "set" potentiometer in the indicator unit was used to obtain a full-scale meter reading with the switch set to measure the relative transmitter output. A deliberate swr of 2:1 was then introduced by substituting a 150-ohm resistor for the 300-ohm dummy load. The switch in the indicator unit was set to measure the reflected power and the pickup piece of twinlead connected to the sensing unit — extended as necessary to produce about a .2 reading on the meter's 0–10 relative scale. About 2½ ft of twinlead was required. The same procedure was followed using other resistors, as available, to simulate different swr indications. Of course, the length of the twinlead pickup piece cannot be changed once established. One has to accept the relative reading that results on the meter scale for various swr measurements (or make a new meter scale). Also, during the calibration of the scale for swr, the potentiometer setting should never be changed.

The above procedure calibrates the indicator unit for a particular set of conditions — transmitter output, frequency, and transmission line length. Once calibrated, the swr unit can only be used under different conditions with some reservations. The calibration will remain correct for a range of transmitter powers, the same as a conventional swr meter. The potentiometer in the indicator unit is used in the

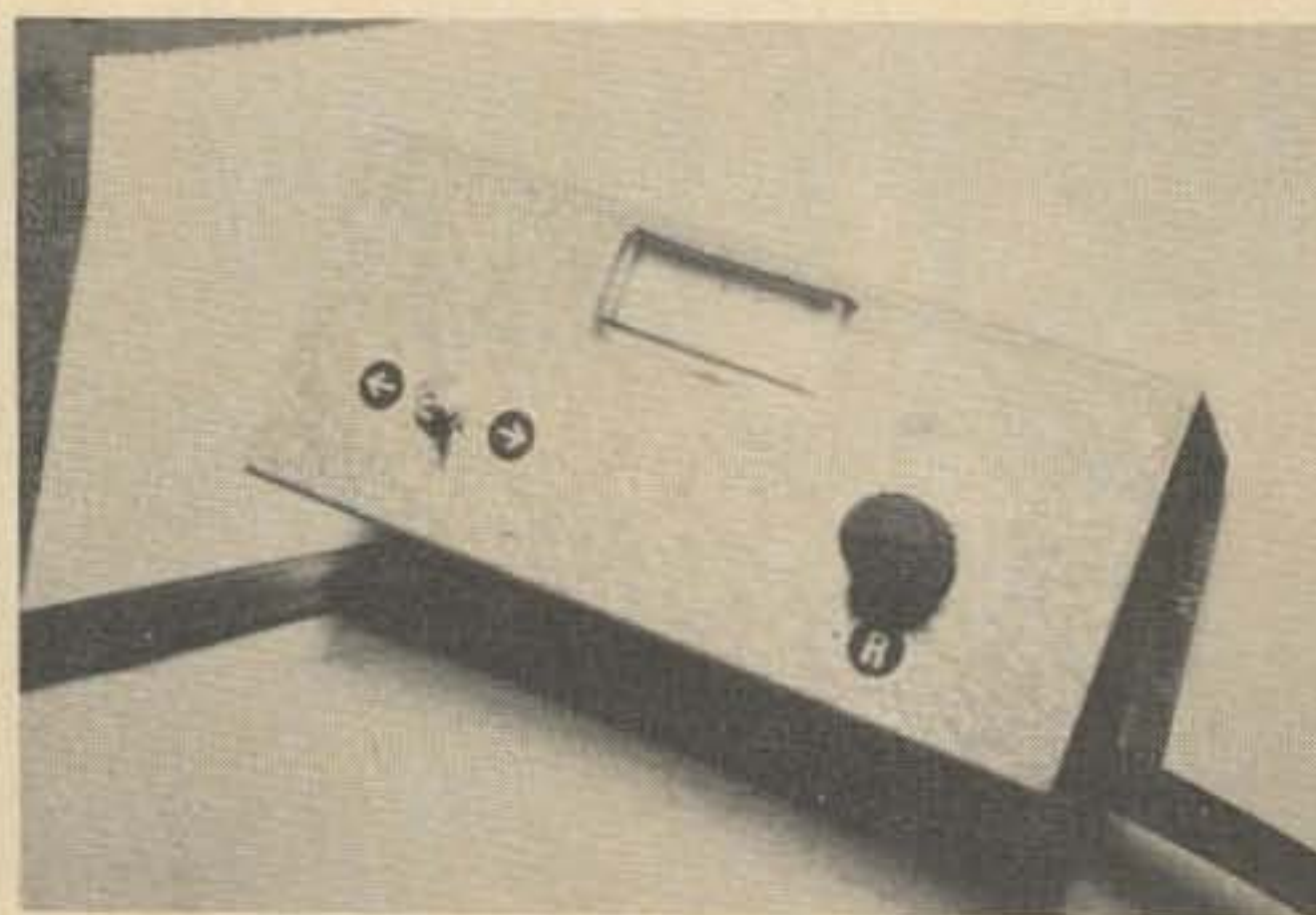

Front view shows simple controls arrangement. Meter scale must be calibrated for various swr readings as described in text.

same manner to "set" the meter while reading the relative transmitter output. The calibration will not remain correct over a very wide frequency range since the pickup proportional to reflected power will not vary in the same manner as that used to measure the relative transmitter output — unlike the action in a conventional swr meter. The calibration will generally remain correct over two bands and the scale can, of course, be specifically calibrated on any band. The calibration will also be affected by any major change in the transmission line length due simply to change in ohmic resistance affecting the transfer dc flow from the sensing unit.

Practical Results

The swr unit described in this article was developed as an experimental idea and it was not expected that it would work in practice the first time without some flaws. Actually, the test results with an antenna were surprisingly good. Used with an antenna that had previously exhibited essentially a 1:1 swr with a 50 ft twinlead transmission line, the indicated swr using the remote swr system was about 1.5:1. This difference in swr reading probably was due to "antenna current," since the transmission line could not be run away exactly at right angles from the center of the antenna. Also, using a shielded enclosure for the sensing unit might have helped. As best as it could be done, various discontinuities resembling transmission line faults

VHF FM MONITOR RECEIVER



100% MADE
IN U.S.A.



Only
\$79.95
Postpaid
in the U.S.A.

The new **VANGUARD FMR-150** is not just another frequency converter but a complete FM receiver with outstanding performance.

Check the following features and see why it's the best. Collins IF filter for separating those closely spaced stations you hear together on other sets● Double conversion to eliminate interference from image frequencies● Dual Gate MOSFET RF stage for low noise. .2 uv. sensitivity, and minimum cross modulation● Automatic squelch for eliminating noise● Self-contained speaker● Operates on 12v. D.C. negative ground● Heavy gauge anodized aluminum case 6" x 7" x 1-3/8"● Provision for 4 crystal controlled channels at the push of a button● One channel of your choice supplied with receiver. Additional channels available just by plugging in another crystal at \$4.95 ea. No need to buy another RF unit as in some other sets● Factory tuned to cover any 6MHz segment from 135 to 175 MHz.

HOW TO ORDER: The **VANGUARD FMR-150** is available only direct from our factory. Include remittance in full plus sales tax if you reside in N. Y. Be sure to state the 6MHz segment you will want to cover and the exact push button frequencies to be included.

VANGUARD LABS

Dept. H, 196-23 Jamaica Ave.,
Hollis, N.Y. 11423

were created. The faults were reflected in the readings observed on the indicator unit — a situation which would not occur with a fairly long transmission line. Some of the faults created were observed on the indicator unit as even a slight improvement in swr — as when metal foil was wrapped around portions of the transmission line or antenna to simulate dielectric condition change. But, the foil probably acted in some manner to improve matching conditions, such as a stub would. The important thing is that changes in the transmission line or antenna condition were indicated. Drastic faults such as an open conductor were clearly indicated by a high rise in the swr on the indicator unit.

Summary

There are many refinements that could be incorporated into the swr unit as described. Nonetheless, the type of swr monitoring scheme demonstrated is a definite advance over conventional ones.

Ideally, it should be possible to place a sensing unit at the far end of the transmission line which would transfer back

near the sensing unit and antenna faults *over the transmission line* voltages proportional *both* to the forward and reflected powers at the sensing unit. Then, one should be able to monitor independently the transmission line condition and the swr existing at the very termination of the transmission line. One could build a suitable sensing unit if two independent dc paths from the sensing to the indicating units were available. The only simple solution to this problem would seem to be the use of a shielded balanced transmission line, either 70 or 300 ohms impedance. More sophisticated, time-sharing current flow schemes over a two-conductor transmission line are certainly possible, but their reliability and economy might not make the total effort worthwhile. The incorporation of a dc amplifier in the sensing unit, which could be of the Monimatch type, would also allow the construction of an extremely compact sensing unit. It could easily be rf powered directly from the transmission line current flow.

... W2EEY/1 ■

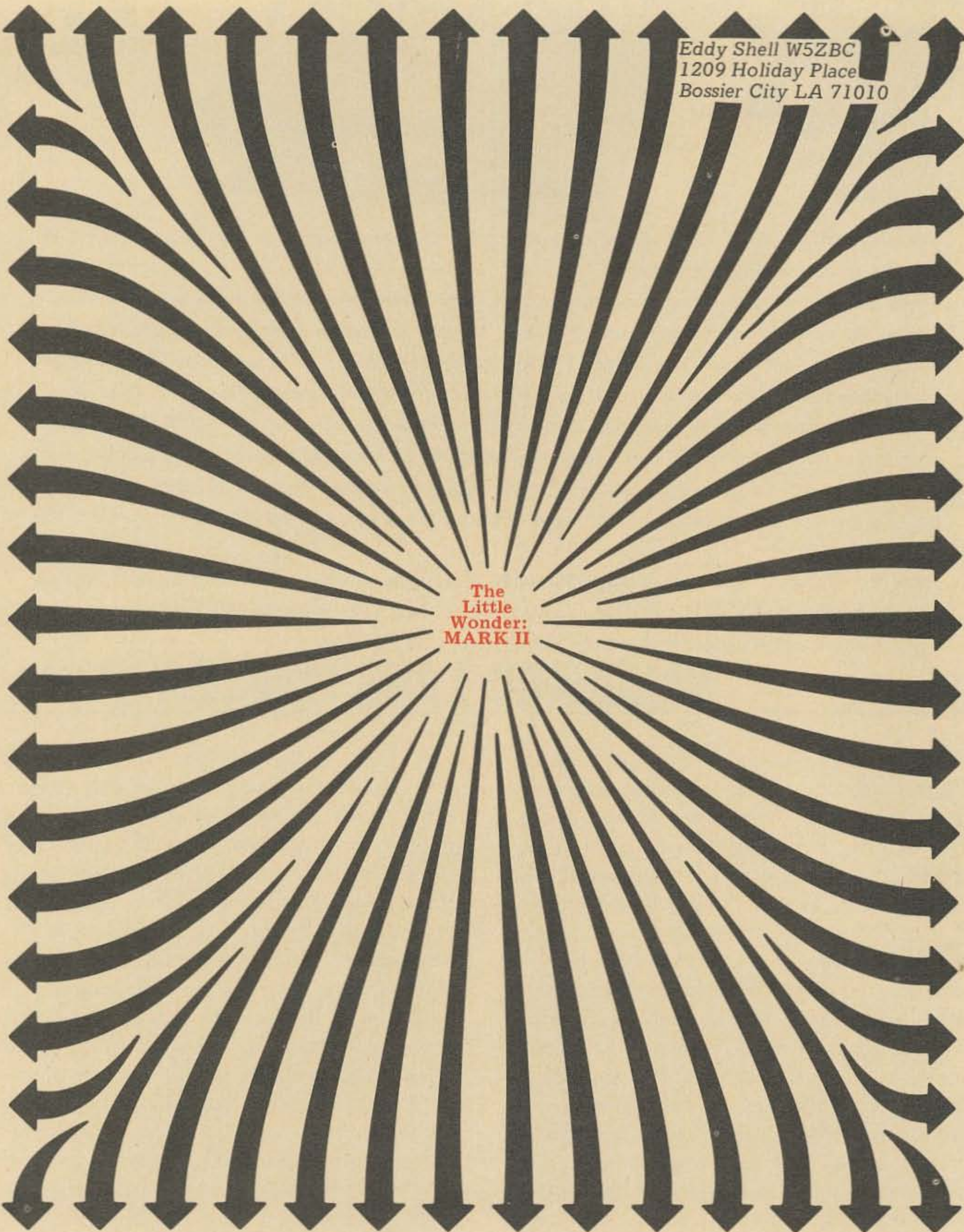

Eddy Shell W5ZBC
1209 Holiday Place
Bossier City LA 71010

The
Little
Wonder:
MARK II

While in college this past school year we designed the "Little Wonder" antenna described in 73 Magazine of May 1969. This article brought a flood of mail from amateurs all over the world. Moving from the college dorm back to my permanent home the "Little Wonder" for the most part was discarded in favor of the "Skeleton Cone Antenna" which appeared

in 73 Magazine, August 1969. The reader will quickly note the simplicity of the "Little Wonder." The "Little Wonder: Mark II" has the same simplicity, but two added charms: (1) its appearance is more attractive with its scant 7 ft stature; and (2) more important, it has a strong radiation characteristic which is a benefit to any ham on today's crowded bands.

For those who missed the original article of 73, May 1969, a bit of a review is in order. Two pieces of hard-drawn $\frac{3}{4}$ in. copper tubing $43\frac{3}{4}$ and $31\frac{1}{2}$ in., were connected via a coil which was 197 turns of 12 AWG Nyclad close wound on a wooden dowel. The unit was end-fed with a single feeder to an L network or Viking Matchbox and tuned for 1:1 swr.

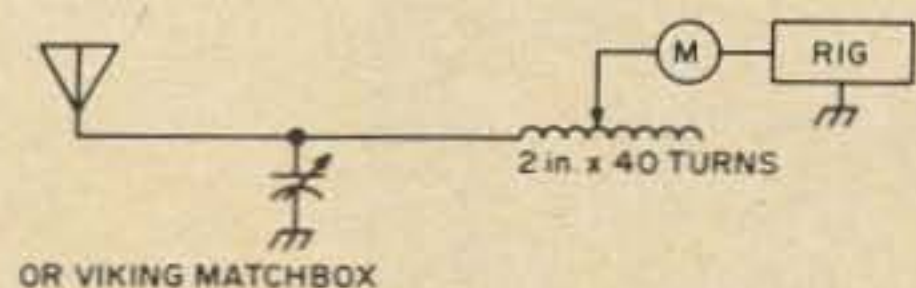

The *Mark II* uses the basic concept of the original "Little Wonder" antenna with four exceptions: (1) the hard-drawn copper tubing is now two sections from a discarded polelamp stand; (2) the low-Q 197 turns of Nyclad wire is now a high-Q BW 3034 coil stock, $2\frac{1}{2}$ in. diameter (8 turns per inch and 135 mH); (3) the *Mark II* is tapped for the band being used; and (4) the antenna can stand anywhere in the room due to the polelamp construction concept.

Construction is simple and all parts can be purchased or scrounged:

- 1 used polelamp or spring-type stand
- 2 "bar stool" rubber feet
- 1 BW 3034 coil stock or equivalent ($2\frac{1}{2}$ in. dia, 8 turns per inch)
- 3 $6/32 \times 1\frac{1}{4}$ bolts and nuts
- 1 3 ft dowel rod or an old broomstick
- 1 alligator clip
- 1 8 ft single-wire feedline to run from the *Mark II* to the antenna tuner.

How to construct. The pole stand is cut in two pieces, one $43\frac{3}{4}$ in. and the second $31\frac{1}{2}$ in. Before cutting the $31\frac{1}{2}$ in. section, press the spring section until the tension is

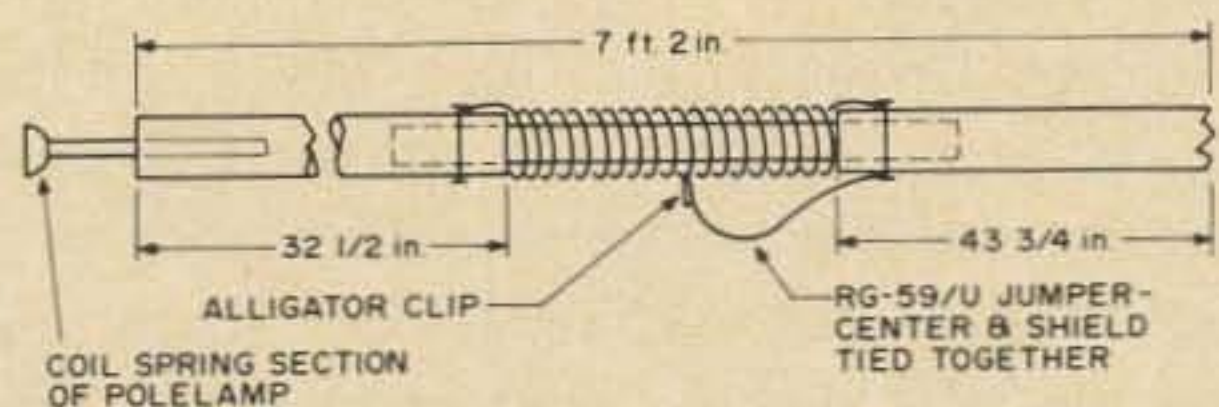

tight. When the spring section is depressed then measure for $31\frac{1}{2}$ in. The two sections of the pole stand are connected together via a 1 in. wooden dowel rod or broom-

stick. The two metal poles are spaced 10 in. apart to accommodate the coil stock. A small hole is drilled in each pipe and dowel so the poles will not slip together and provide for a mechanical and electrical connection for the coil. A second dowel rod is placed in the opposite end of the pole from the spring coil section. The length of the dowel will be determined by

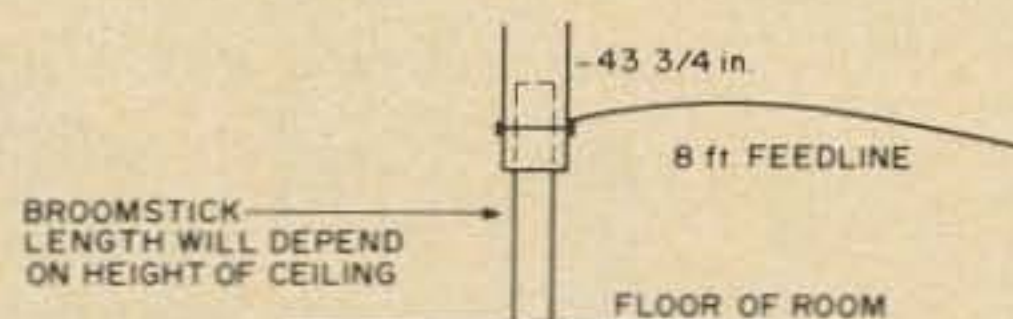

the height of your ceiling. A standard 8 ft ceiling will require a 14 in. dowel. The 8 ft single feedline is connected to the *Mark II* at the same point in which the 14 in. dowel is attached to the pole stand. A jumper wire with an alligator clip attached to the bottom of the coil end is used to short out part of the coil, depending on what frequency you are operating. For 75 meters, the coil is tapped 10 turns from the bottom; 40 meters is tapped 32 turns from the top; and 10 meters are all $3\frac{1}{2}$ turns from the top. The use of an swr bridge and a field strength meter will determine the specific tap for each for each location. Both the east and west coast have been worked on 75 and 40 meters on both a barefoot KWM-2 and the KWM-2 with the SB200.

The *Mark II* is tuned in the same manner as the original *Little Wonder*. The equipment is first tuned into a 50Ω load and then connected to the antenna tuner. (Do not tune the rig.) The antenna tuner is tuned for 1:1 swr utilizing 275W Viking Matchbox or L network.

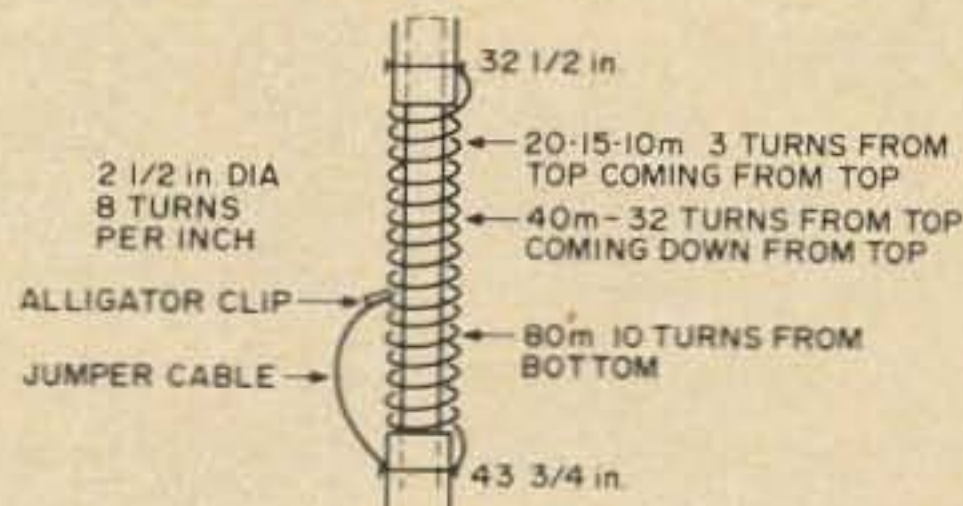

I trust the apartment dwellers will try the *Mark II* and find hamming is still the best hobby of them all.

... W5ZBC ■

WITH THE ORD DK-1

CW CAN BE FUN

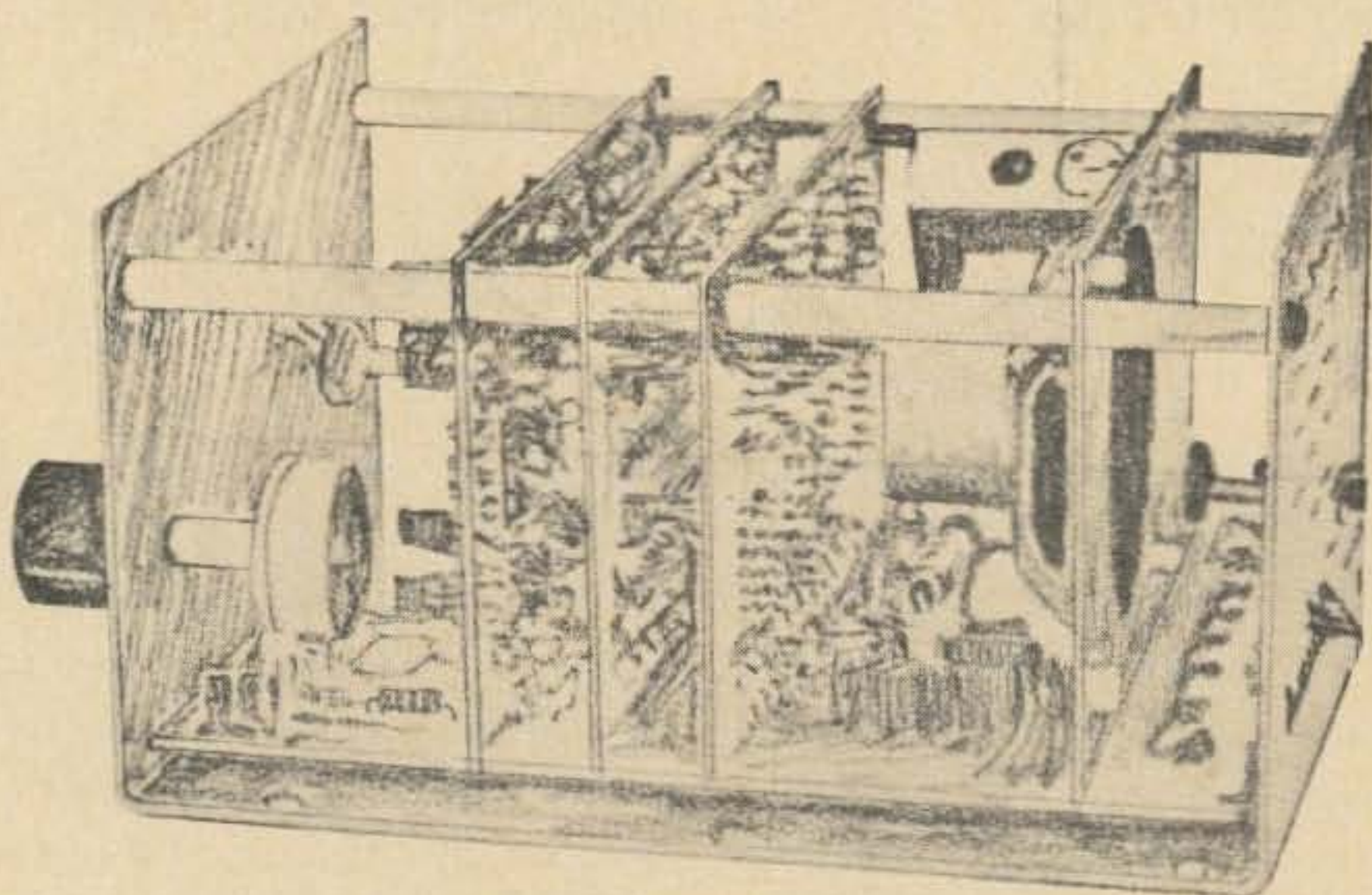

Disenchanting with CW? Is the code too old a mode for you? If so, you might be an ideal candidate for ORD's DK-1 digital keyer, a fantastic little package with a brain inside. Believe it or not, the ORD actually makes it fun to send CW.

If you're already sold on CW but haven't yet tried the DK-1, by all means stop in at your nearest radio store and give it a go. This unit is nothing short of fantastic!

With a built-in memory and "interchange" circuitry, the DK-1 "remembers" which paddle was pushed last, even when both the dot and dash keys are activated at the same time. This feature minimizes errors that might otherwise be caused by an operator's inadvertent keying of the wrong paddle.

It shouldn't take long to achieve proficiency on CW with the DK-1, though you may never be able to utilize the full capability of the keyer: a breathtaking 60 wpm. A panel knob allows smooth and continuous adjustment of sending speed all the way down to 7 wpm.

Regardless of code speed, the spacing of and between digital pulses remains at a constant ratio, with the dashes always exactly three times the duration of the dots.

An engineer looking at the guts of the DK-1 might well mistake it for a modern missileborne package. That same high-density, modular-construction approach used in the aerospace industry is employed in the assembly of the ORD keyer. With cover removed, the unit resembles a "card rack"; three circuit cards and the monitor speaker frame are stacked vertically over a "mother board," which contains a transistor-regulated power supply.

The paddle assembly is not included in the purchase price (\$130) of the DK-1. To be compatible with the electronics, the mechanical portion must be a dual-contact paddle set. A conventional keying mechanism would also be a handy "extra" for the paddle assembly, since the DK-1 can be keyed on a "manual" as well as "automatic" basis.

The Brown Bros. key set is an ideal choice for the DK-1. It contains precision-machined, adjustable speed paddles as well as an adjacent standard key, all mounted on an extra-heavy cast metal base. Terminal boards on the rear underside of the mechanism make interconnection to the DK-1 a snap.

All in all, CW's a ball, 'cause the DK-1 makes "sending" fun!

two receivers from one ANTENNA

The classic method of using two receivers on the same antenna is to tie them in parallel directly or use decoupling resistors. But for my money, both methods result in unacceptable compromises in performance. Being a purist, and more importantly, a DXer, a 1 or 2 dB drop in signal can mean the difference between hearing a rare one or not.

As an alternative, I purchased (from Permag Pacific Corp., 5441 West 104th St., Los Angeles, California 90045) a ferrite core, Indiana General CF 108-Q2 (\$1.25). This core is good to 50 MHz.

Three trifilar windings of 26 AWG wire were wound on the core, care being taken to space the turns around the core. I then used coil dope to hold them in place. The primary (antenna input) is 10 turns and the two secondaries (for the receivers) are 7 turns each. All three are used for 50Ω antenna and receiver input impedances.

In my case I use two Collins receivers, a

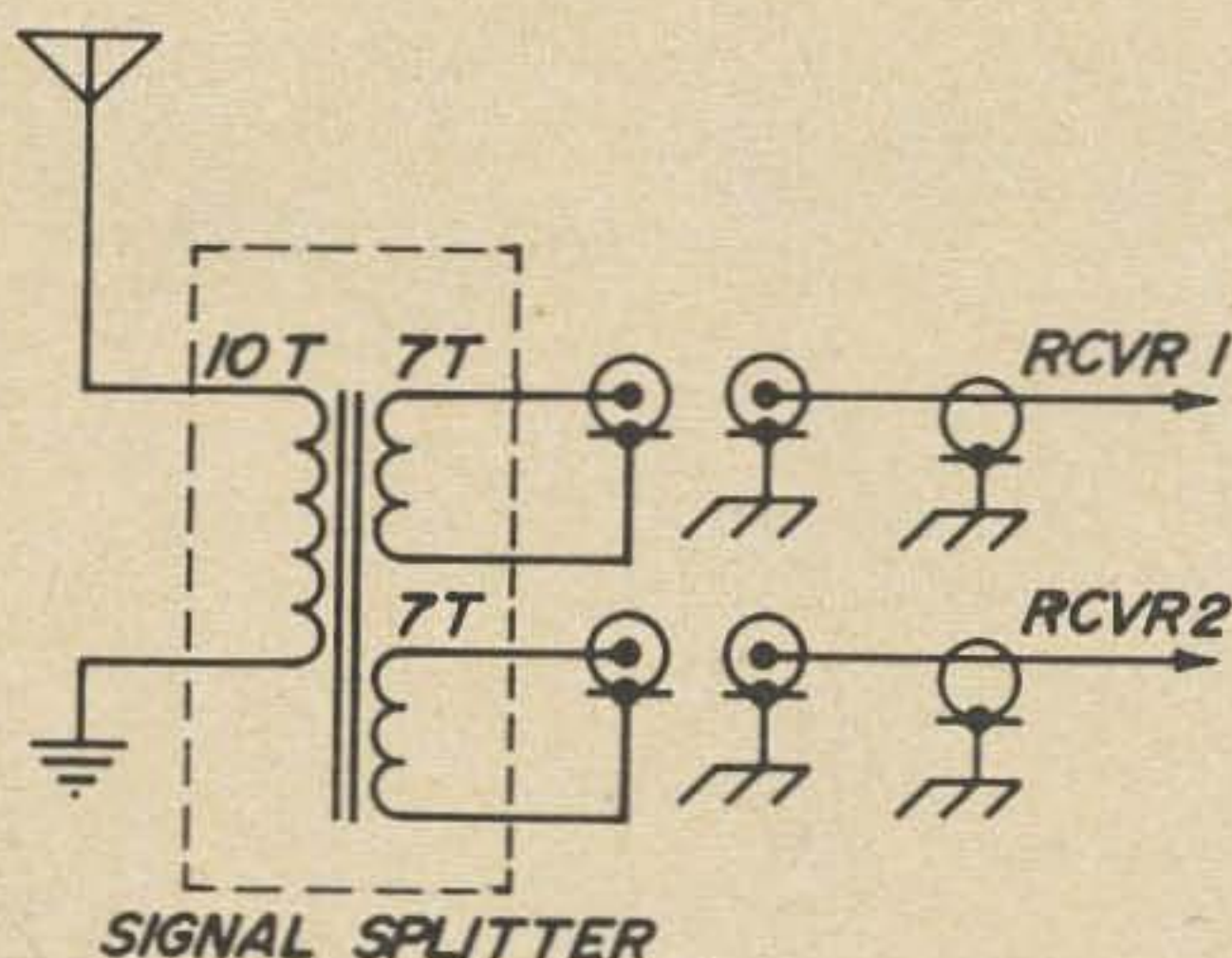

75S3B and a 75S3. No "suckout" or loss is noted on either receiver, regardless of what band either receiver may be tuned to. In fact, no difference in S-meter reading or audio level can be detected from the antenna straight into the receiver or through the toroid.

One caution: If two different makes of receivers are tied together, some loss may be noted. This occurs because of the differences between the two input circuits of the receivers, and it can be corrected by varying the turns ratio of the two secondaries.

In my case, the toroid was mounted in a small Minibox with three RCA jacks on it. It could just as easily mount in the transmitter or one of the receivers. If used with a transceiver and a separate receiver, the toroid must be put in the transceiver receiver side at the input of the receiver. It cannot handle transmitter directly!

... WA6UFW ■

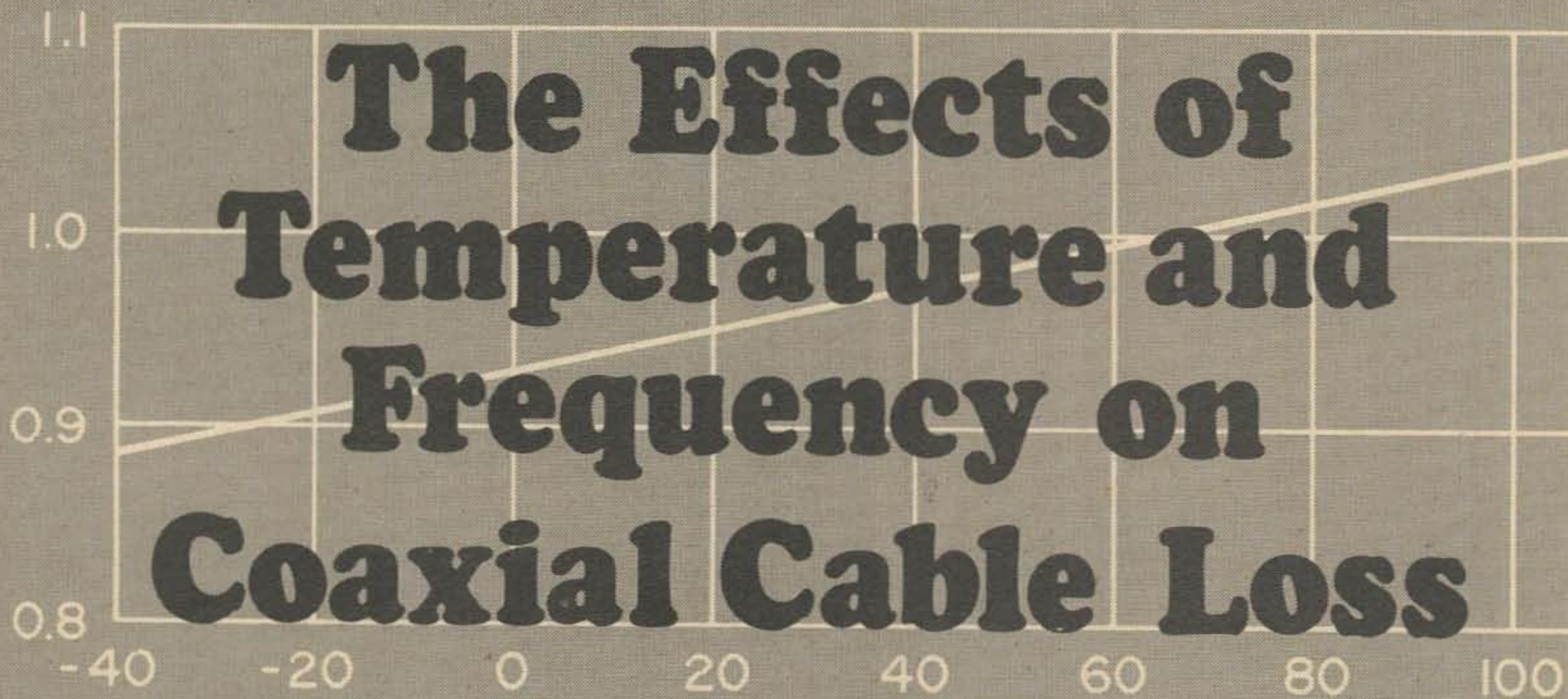

As transmission line temperature increases, so also does loss — and vice versa. Complicating matters, the losses get worse as the operating frequency is raised...

Elliott S. Kanter W9KXJ
3242 W. Hollywood
Chicago IL 60645

Perhaps the most common concern of the amateur radio operator is to get the most signal to his antenna with the least possible loss. This has been true since the first spark-gap was heard, and is equally valid today. This fact of maximum power and minimum loss is a prime consideration in both UHF and VHF communications.

There are many factors which will determine the loss or attenuation we might experience in a coaxial cable run. Some are constants but two specific factors are variable and frequently overlooked. These factors are temperature and frequency. Most of us have seen cable charts where the

loss or attenuation in dB/ft is given, but the figures do not reflect the two very important parameters of frequency and temperature.

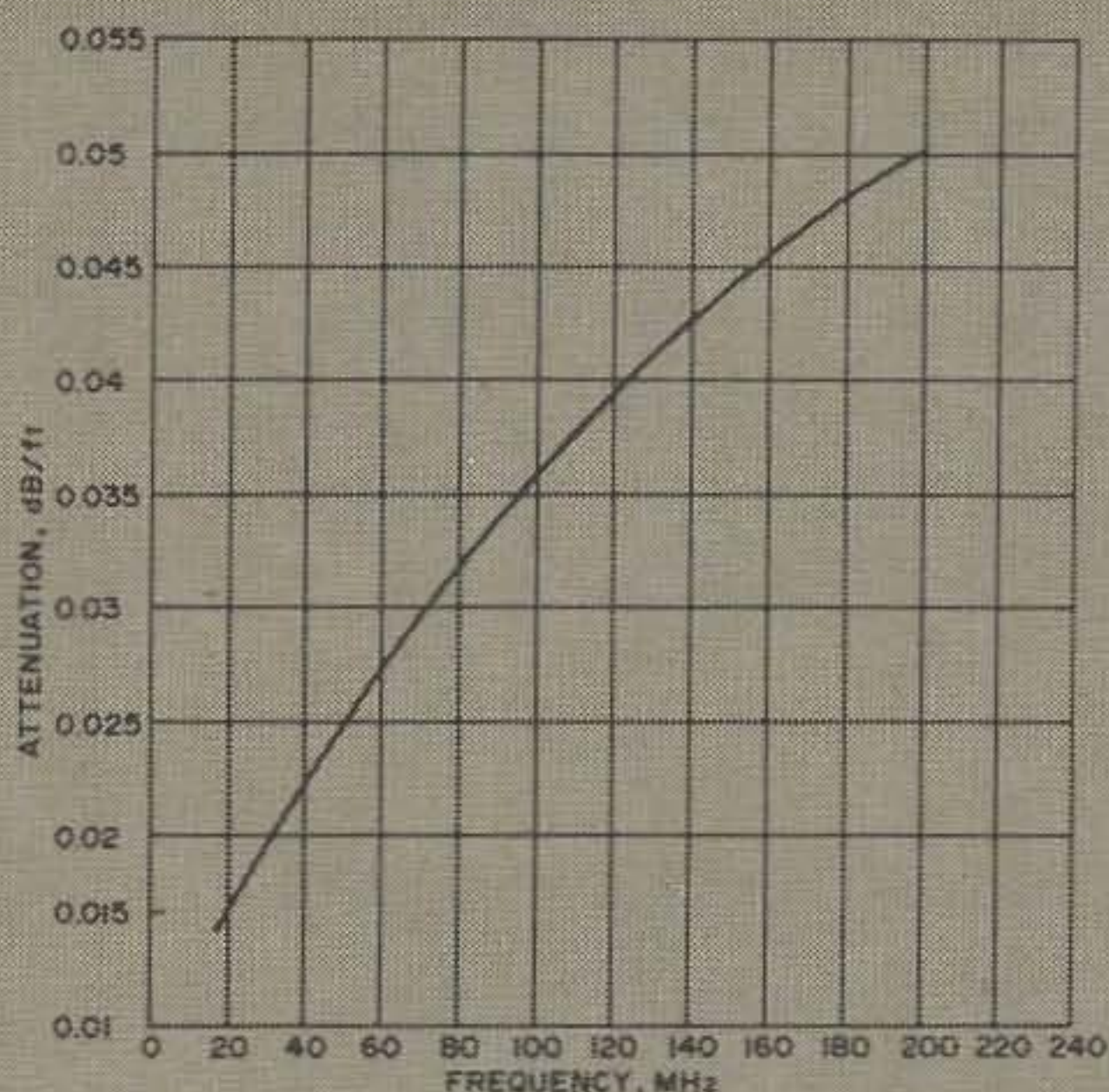

Fig. 1. Signal loss of RG-59/U cable at a temperature of 68°F. Note that loss increases with frequency. The effects of temperature are shown in Fig. 2.

For the purpose of explaining these two parameters more completely, Figs. 1 and 2 were prepared. Figure 1 is a graph showing the attenuation in dB/ft of RG-59/U coaxial cable. If you note the lower scale of this graph, you will find that this graph shows the effects of frequency change on the attenuation. For example, at 20 MHz we can expect a 1.5 dB loss per hundred feet of cable; at 50 MHz a 2.5 dB loss per hundred feet; and at 200 MHz, we note a loss of 5.0 dB/100 ft.

These facts are interesting, but the most important factor is usually ignored. This graph was prepared to show the attenuation of RG-59/U cable at 68°F. Few of us are blessed by living in an area where the temperature is a constant 68° year-round. The midwesterner could expect temperatures of from -40° to +100° in a given year's time. Hams living in the southern states can experience changes of from 40° to 100° in a single day. Our graph at 68° is useful, because some basis for measurement must be made, but this does not reflect the various extremes the coaxial cable will be subjected to.

If you dispute the effects of temperature on attenuation, remember the last hot afternoon you operated. Your receiver just wasn't as hot as it was later that night — a

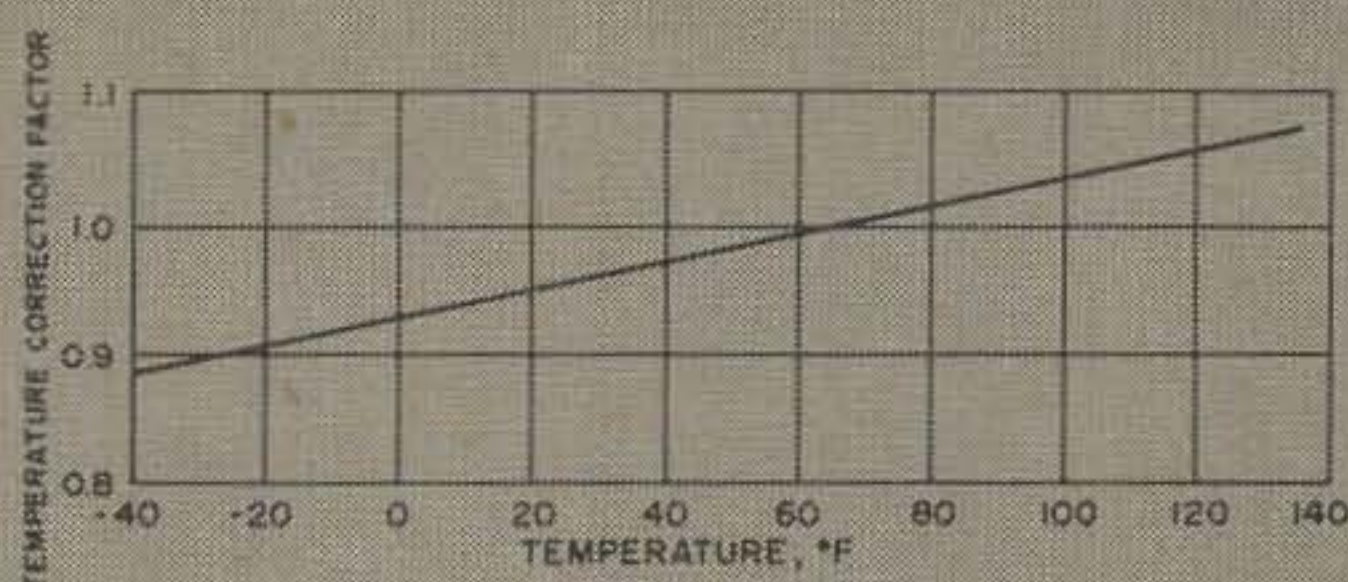

Fig. 2. As the chart shows, coaxial cable exhibits less loss at lower temperatures. To calculate attenuation, the correction factor, determined by ambient temperature, must be multiplied by characteristic loss of cable (Fig. 1).

lot of those weaker stations were lost in the noise. During that day your antenna cable probably underwent temperature extremes from 50° to possibly as high as 120° at mid-day and then back down again.

Figure 2 is a temperature correction graph which will permit you to arrive at the necessary factor by which you can calculate the accurate attenuation loss in dB/ft at any temperature. For example, by consulting Fig. 1 you see that at 20 MHz a 0.015 dB/ft loss exists at 68°F. However, you want to know what attenuation you can expect when the sun is up and the temperature is 100°. By referring to Fig. 2, note that the correction factor at 100° is approximately 1.03. The formula thus tells you that attenuation at 100° is equal to:

$$1.5 \text{ dB} \times 1.03 = 1.545 \text{ dB/100 ft}$$

Similar calculations can be made to arrive at attenuation for lower temperatures as well. Although Fig. 1 was prepared for RG-59/U cable, the correction factor derived from Fig. 2 will apply to any type of coaxial cable you might choose. To make the best use of Fig. 2, you must know what temperature and at what frequency the information in your cable chart was made from. A letter to the manufacturer will usually get this information so that you may make the necessary calculations.

... W9KXJ ■

John J. Schultz W2EEY
1829 Cornelia Street
Brooklyn NY 11227

IMPROVING THE PERFORMANCE OF TRAP - TYPE VERTICAL ANTENNAS

The addition of another element can considerably improve the performance of multiband vertical antennas such as the Hy-Gain 12AVQ or 14AVQ models. The added element can be automatically bandswitched and a transmission line system used which allows simple changeover from an omnidirectional to a directive radiation pattern.

Multiband trap-type verticals such as the Hy-Gain 12AVQ or 14AVQ (or homebrew types) provide many amateurs with a multiband antenna system in a limited space. Provided that a good ground system is used, such antennas can prove to be very effective for DX work. The disadvantage to such antennas is that their radiation pattern in the horizontal plane is omnidirectional. If one is interested in DX in any specific area, it is discouraging to realize that only a fraction of the total radiated power available radiates in any specific direction. One solution to this problem is to use another element with the basic antenna. Such an element should be economical, provide an effective directional radiation pattern, automatically bandswitchable on desired bands, and not require any major change to the transmission line system used with a multiband vertical antenna.

This article describes such an add-on antenna element which will provide auto-

matic bandswitching from 20 to 10 meters, develop a directive pattern with at least 3 dB gain, and not require any change to the transmission line system to the trap antenna. Basically, it is a stub bandswitched element properly spaced from the main antenna and fed in such a manner that the current distribution between the main and secondary antenna is such as to effect a directional pattern on the desired bands. Since the scheme used employs direct feed of the secondary antenna or element, rather than a parasitic-type excited element, it is really applicable to a wide range of multiband antennas including horizontal multiband trap dipoles. Of course, when considering a horizontally oriented antenna, the secondary or add-on element would also have to be horizontally oriented.

Basic Scheme

Figure 1 shows the basic antenna arrangement. Either antenna 1 or 2 can be considered to be the trap antenna and the

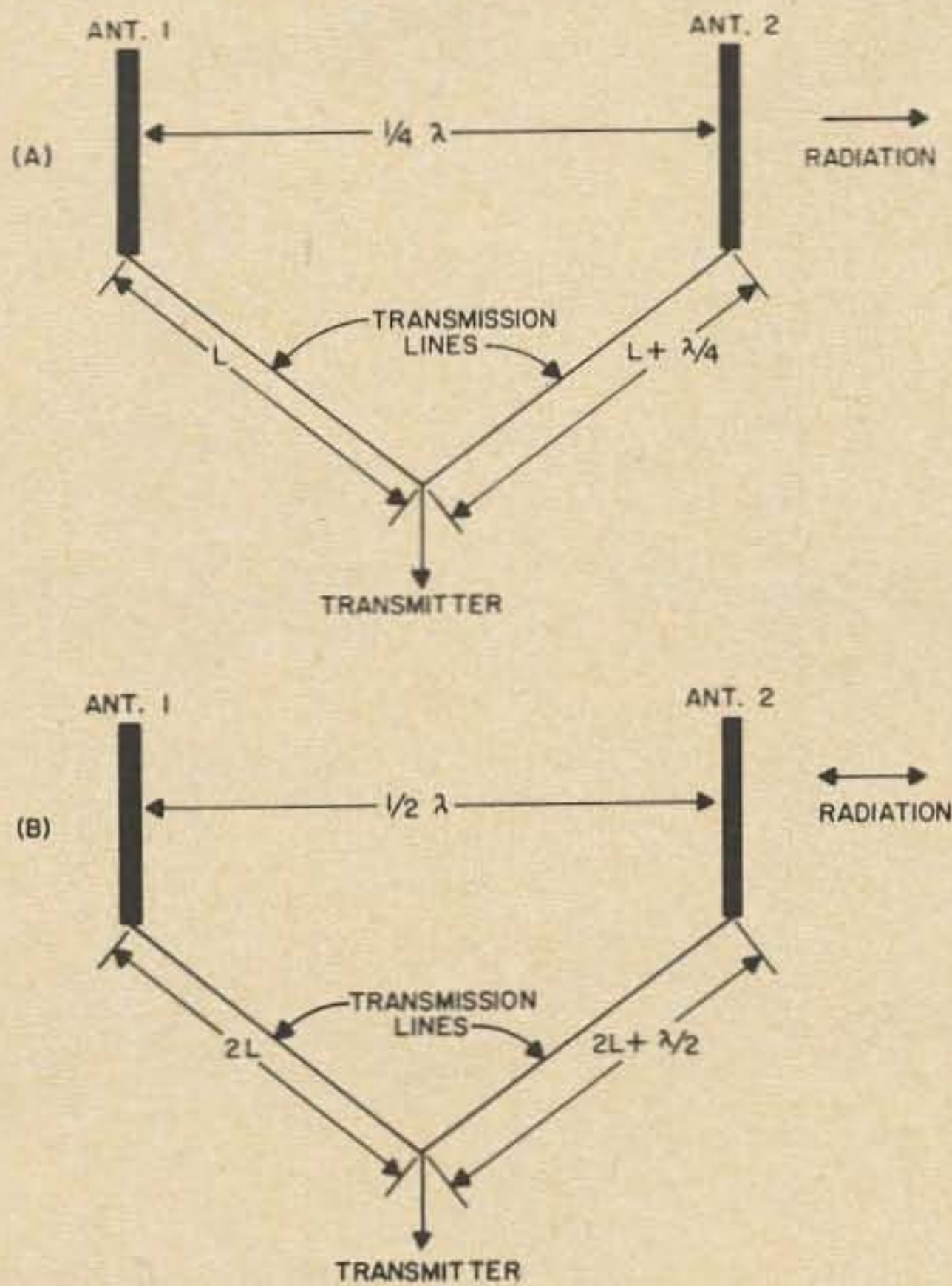

Fig. 1. Two-element antenna spaced $\frac{1}{4}\lambda$ and fed 90° out of phase (A) automatically becomes $\frac{1}{2}\lambda$ spaced 180° out-of-phase array (B) on second harmonic frequency without changing feedline lengths.

other antenna the secondary antenna. Figure 1(A) shows the antennas separated by $\frac{1}{4}\lambda$. The transmission line to the secondary antenna is chosen so that it is $\frac{1}{4}\lambda$ longer or shorter than that going to the main trap antenna, depending on the direction in which the main radiation is desired. Fed in this manner (90° or $\frac{1}{4}\lambda$ out of phase) and spaced $\frac{1}{4}\lambda$, a cardioid directivity pattern results in the horizontal plane with the direction of radiation as indicated in Figure 1(A). Assuming that each antenna still properly matches its transmission line on the 2nd harmonic frequency, Figure 1(B) shows the spacing and phasing relationships. The antennas are now electrically spaced by $\frac{1}{2}\lambda$ and the one transmission line is $\frac{1}{2}\lambda$ (180°) longer than the other. Under these conditions, the antennas will develop a bidirectional radiation pattern in the horizontal plane as shown by the arrows in Figure 1(B).

The transmission lines are simply paralleled together at the transmitter. This results in a resultant impedance of about 25–26 ohms which the transmitter has to load into, but such an impedance is well within the loading range of almost any transmitter with a *pi* network and variable

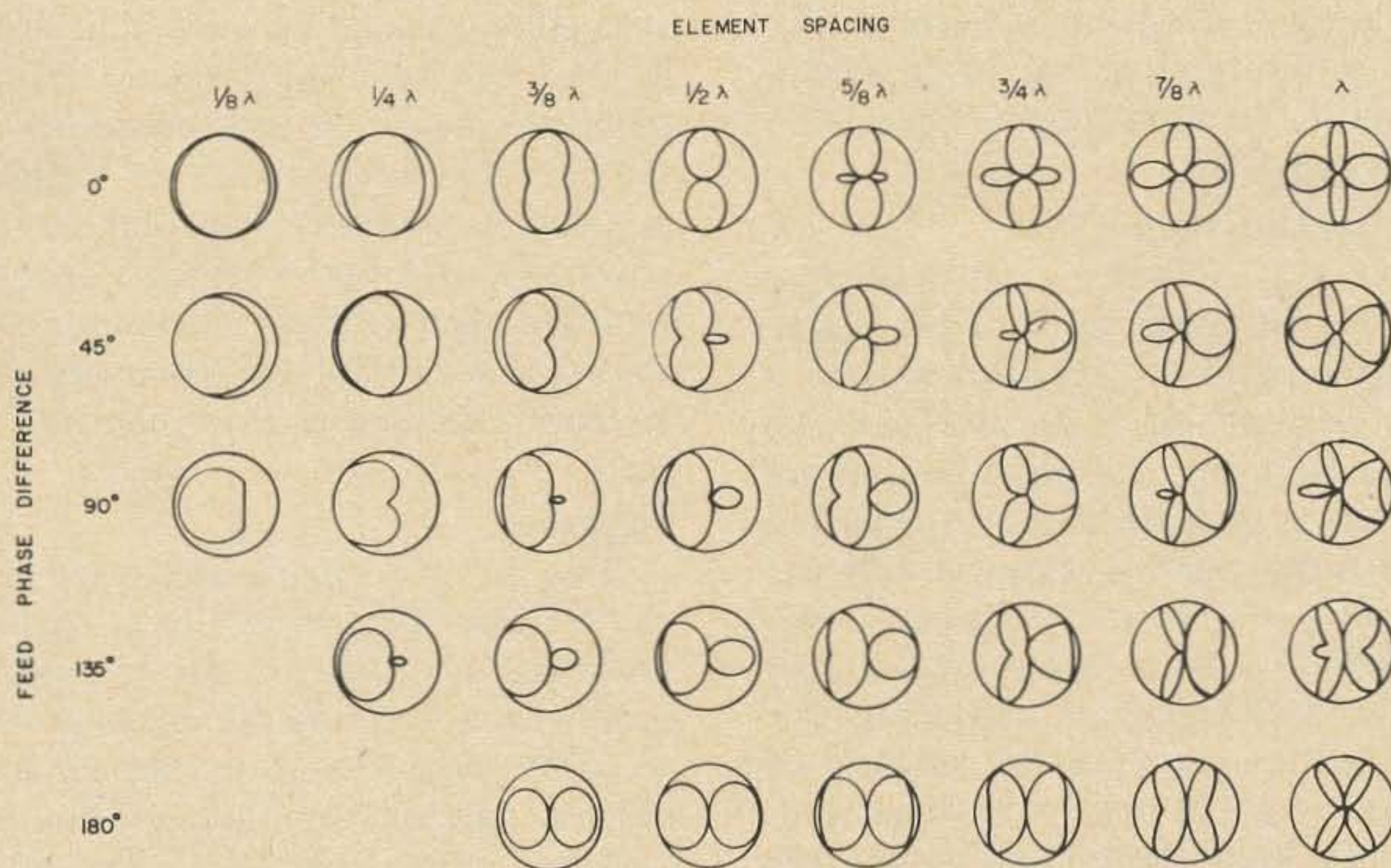

Fig. 2. Besides the usual in-phase (0°) or out-of-phase (180°) current feed systems that appear in antenna designs, a very wide selection of radiation patterns can be obtained by different phasings of two antennas. The patterns shown are the horizontal radiation patterns. In all cases, the amplitude of the currents to both antennas is equal.



output loading. This is especially true on the higher frequency bands. In order to revert back to omnidirectional operation, the secondary antenna is disconnected at the transmitter and the transmitter reloaded.

The spacings and phasings shown in Figure 1 are conventional ones well known by any amateur acquainted with driven, phased antenna arrays. Many amateurs, however, falsely think that there are only a small number of spacing and phasing combinations that provide useful directional patterns for a driven array with two antenna elements (e.g., $\frac{1}{4}\lambda$ or $\frac{1}{2}\lambda$ spacing, in-phase (0°) or out-of-phase (180°) feed, etc.). Actually, there are a great many more combinations that can be used, as illustrated in Fig. 2.

From all the combinations shown, it should certainly be possible to develop a useful directive pattern no matter how restricted one may be in the physical placement of the antennas. If the spacing and feedline lengths are chosen correctly, as illustrated in one case by Fig. 1, an effective directional pattern will be obtained without changing transmission line lengths or one or more bands harmonically related to the band for which the antenna array is designed. If there is any difficulty in interpreting Fig. 2, one should first locate the combinations illustrated by Figs. 1(A) and 1(B).

Practical Construction

Figure 3 shows how a secondary antenna was installed with a basic multi-band trap vertical in order to provide a directive pattern on both 10 and 20 meters. The spacing and phasing used are those shown in portion of the antenna and the lower approximate 8 ft section acts as a $\frac{1}{4}\lambda$ vertical on 10 meters. The antenna used was constructed from telescoping aluminum tubing with $1\frac{1}{4}$ in. o.d. tubing used for the base section. Any similar method of construction can be used but some provision should be made to allow adjustment of the length of the antenna and the stub. The secondary antenna should first be used alone and the transmission line to it checked for low swr (of at least 1.5:1 or less on both bands).

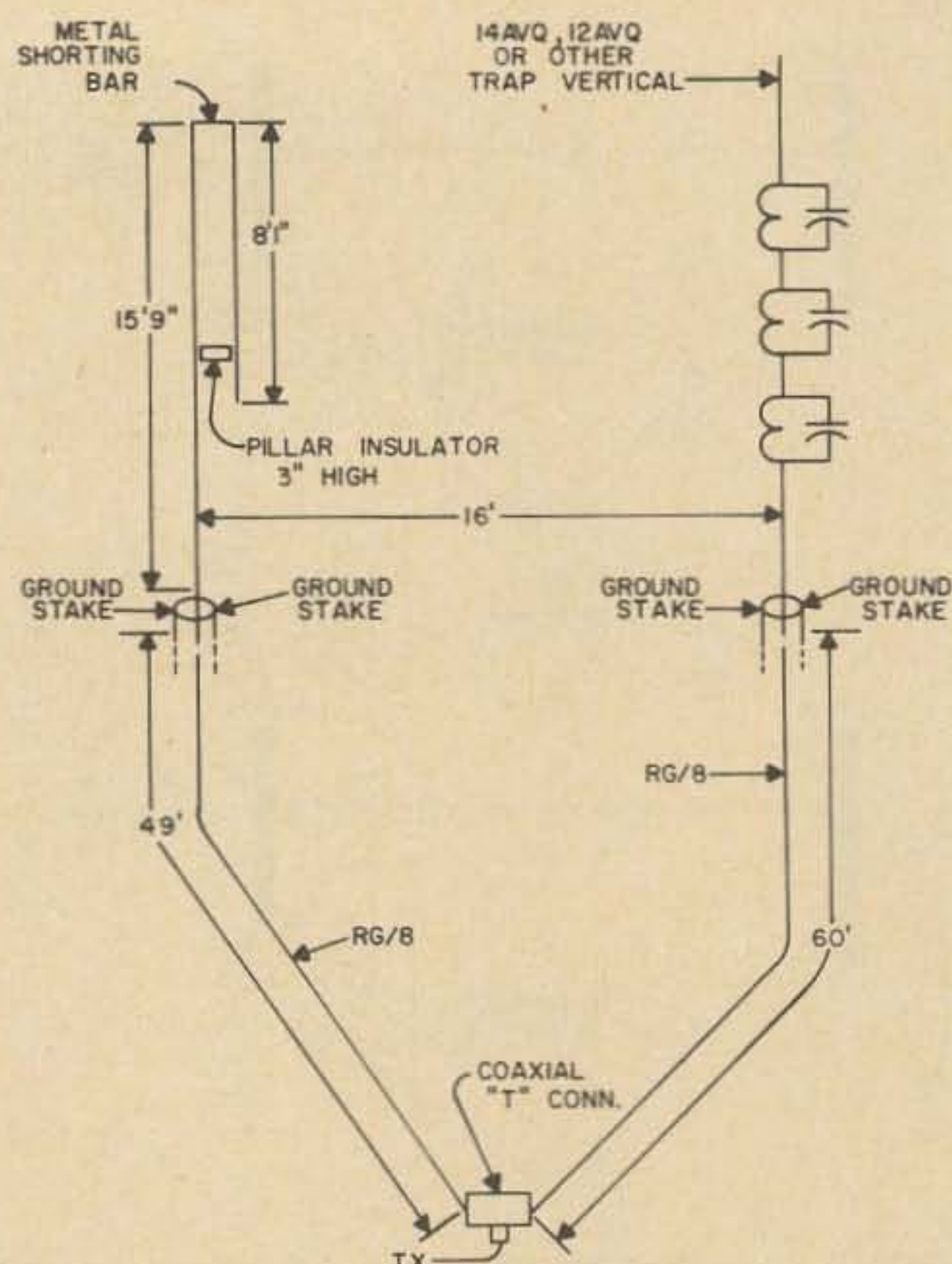
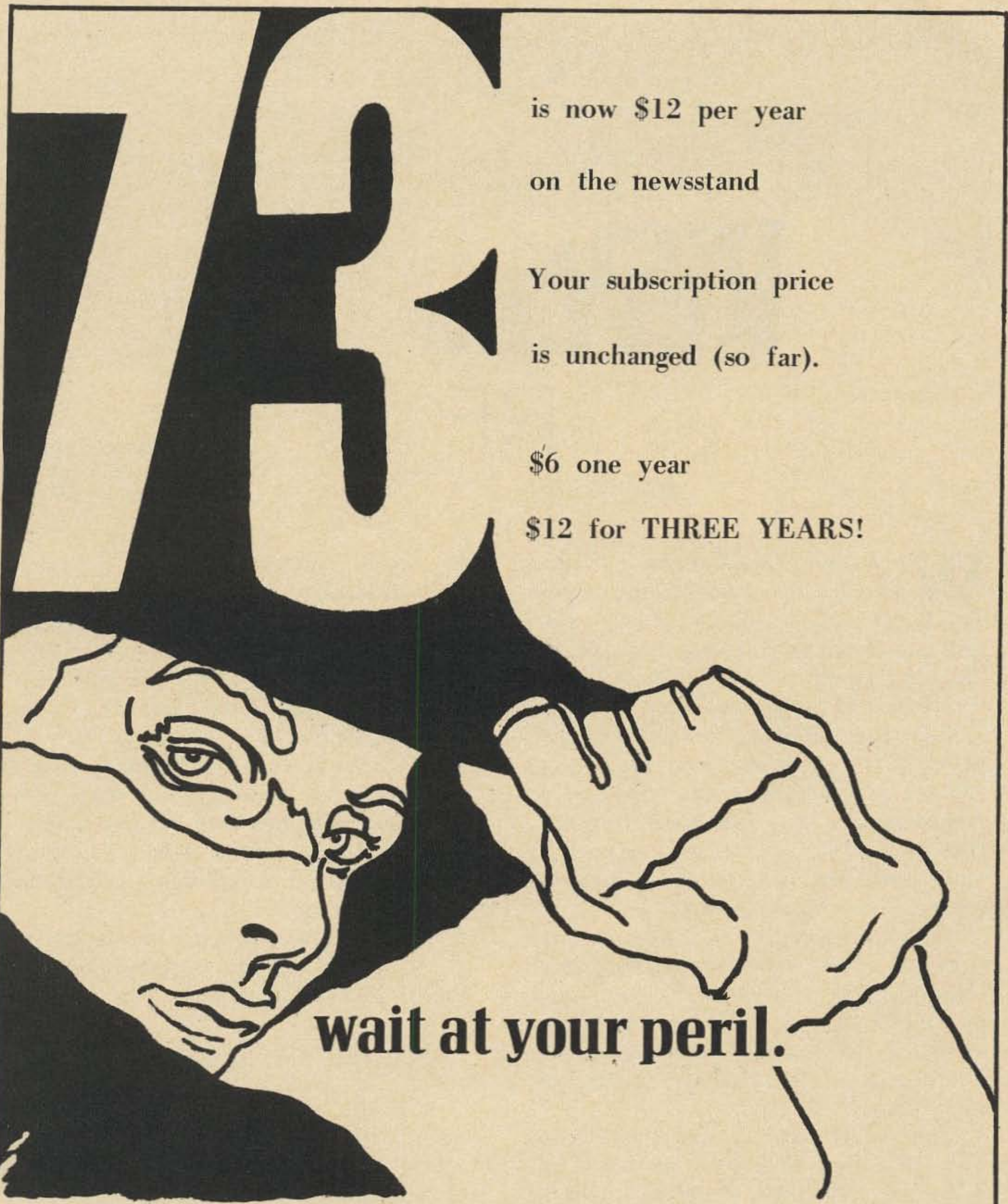

Fig. 3. Secondary stub-bandswitched antenna used with 14AVQ antenna on 10 and 20 meters to form directive array. Feedline system is based on Fig. 1.

The transmission line to the secondary antenna is cut to be $\frac{1}{4}\lambda$ shorter on 20 meters than the line going to the trap antenna. Note that the velocity factor for coaxial transmission line (.66) must be used when calculating the $\frac{1}{4}\lambda$ difference in length. The two coaxial lines are joined together via a coaxial tee connector which mounts directly on the coax output jack on the transmitter. For omnidirectional coverage or for operation on a band where the secondary antenna does not resonate, the coaxial plug for the secondary antenna is simply unscrewed from one side of the tee.

Summary

The use of a simple secondary antenna can increase the gain in almost any desired direction by usually 3 dB or more when used with a trap vertical. There is no need to limit oneself to conventional antenna element spacings or phasings. One should carefully study Fig. 2 to decide which spacing and phasing suits a given situation. Then, one can proceed with usage of the secondary antenna in the manner shown for the specific construction example shown in this article. . . . W2EEY/1 ■



is now \$12 per year
on the newsstand

Your subscription price
is unchanged (so far).

\$6 one year

\$12 for **THREE YEARS!**

wait at your peril.

Name _____ Call _____

Address _____

City _____ State _____ Zip _____

- | | | |
|------------------------------------|-----------------|-----------------|
| <input type="checkbox"/> I enclose | 1 yr. . . \$6 | 3 yrs. . . \$12 |
| <input type="checkbox"/> Bill me | 10 yr. . . \$25 | LIFE. . . \$50 |

73 MAGAZINE PETERBOROUGH, NEW HAMPSHIRE 03458

Measuring the Difference Between

INCIDENT & REFLECTED

RF

Bob Eldridge VE7BS
805 East 20th Avenue
Vancouver 10, BC

When there is some standing wave on a feeder, the actual reading on your directional coupler doesn't really mean very much unless you keep adjusting the "forward power" for full-scale deflection before reading the scale on vswr.

Generally speaking, you won't go far wrong if you concentrate on tuning your antenna or transmatch for minimum reflected power, but sometimes you may find the "forward power" has suffered by more than the amount by which the reflected power has improved.

On some meters you can watch the forward and reflected scales simultaneously; this is fine if you have the knack of reading two things at once and separating the two facts in your brain, or in effect reading the *difference* between the two readings.

This is the kernel of the whole affair. The only thing that really matters is the difference. True forward power, that is the power transferred to the load, is the difference between *incident power* (power registered on the meter as going forward) and *reflected power* (that registered as coming back). Don't forget that you are really reading *voltage* across the line, so halving the reading represents a 6 dB reduction.

If you want to be fussy, you don't really transfer that much, because some of the incident power is lost on the way up

the feeder, and some of the reflected power is lost on the way down. This makes the picture look brighter than it really is.

At HF there isn't much loss in feeders, but at VHF and UHF it is quite a different story. If you have 6 dB loss in the feeder your vswr meter will read a reasonable vswr even if the antenna is quite seriously mismatched at the top of the cable. For example, an antenna with a radiation resistance of 250Ω (vswr of 5 to a 50Ω coax cable) will cause an apparent vswr at the transmitter of only 1.4:1.

Here is a graph which relates apparent to true vswr for various feeder losses. I hope it doesn't depress you.

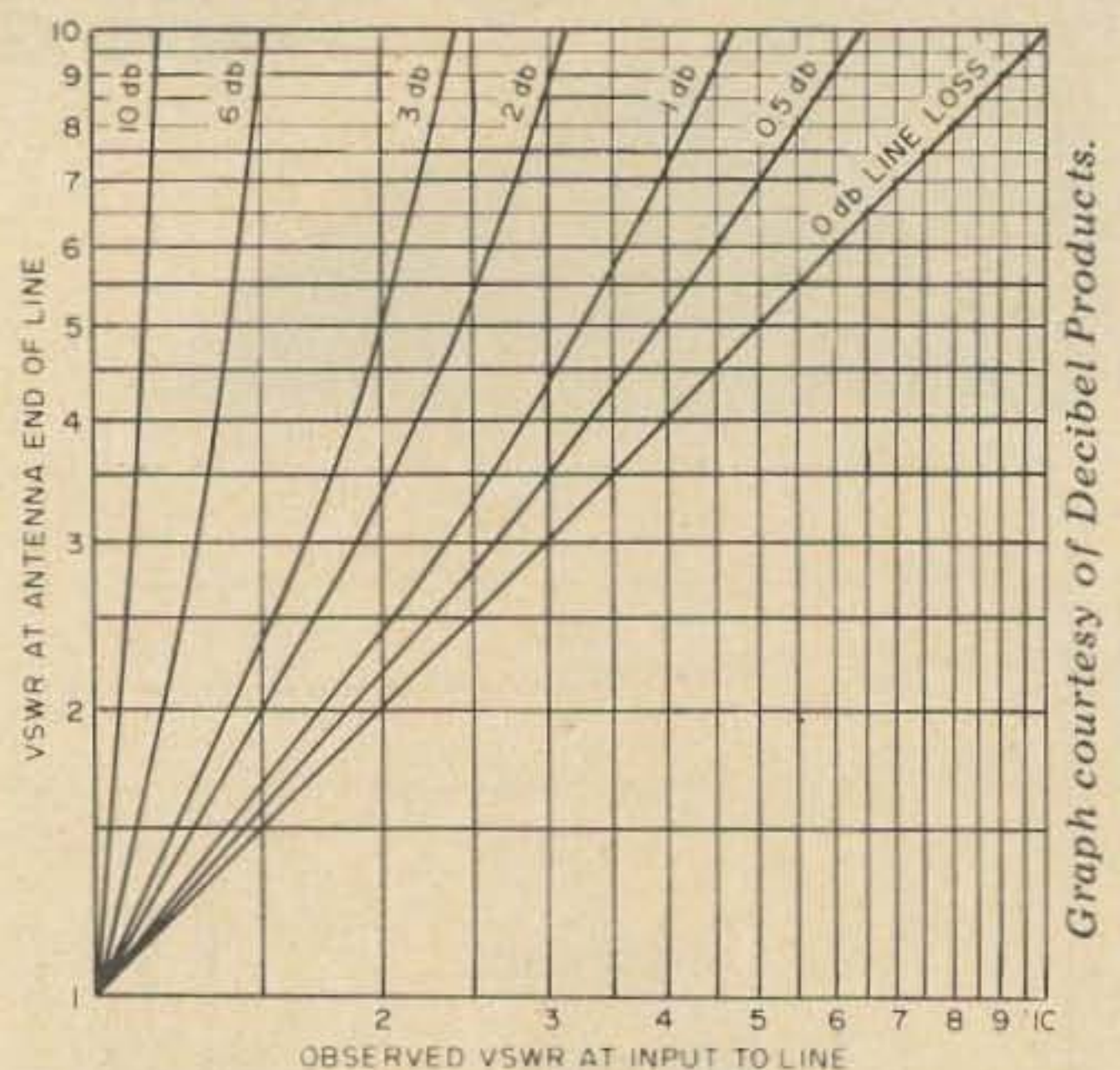

Fig. 1. Curves showing actual versus observed vswr for various line losses.

Tuning Indicator

There is a useful trick in wiring directional couplers (Mickeymatches, Monimatches, Micromatches are all directional couplers):

Close S1 and read incident power.

Close S2 and read reflected power.

Close both and read the *difference*, which is all you need most of the time.

Close them both and the TVI disappears.

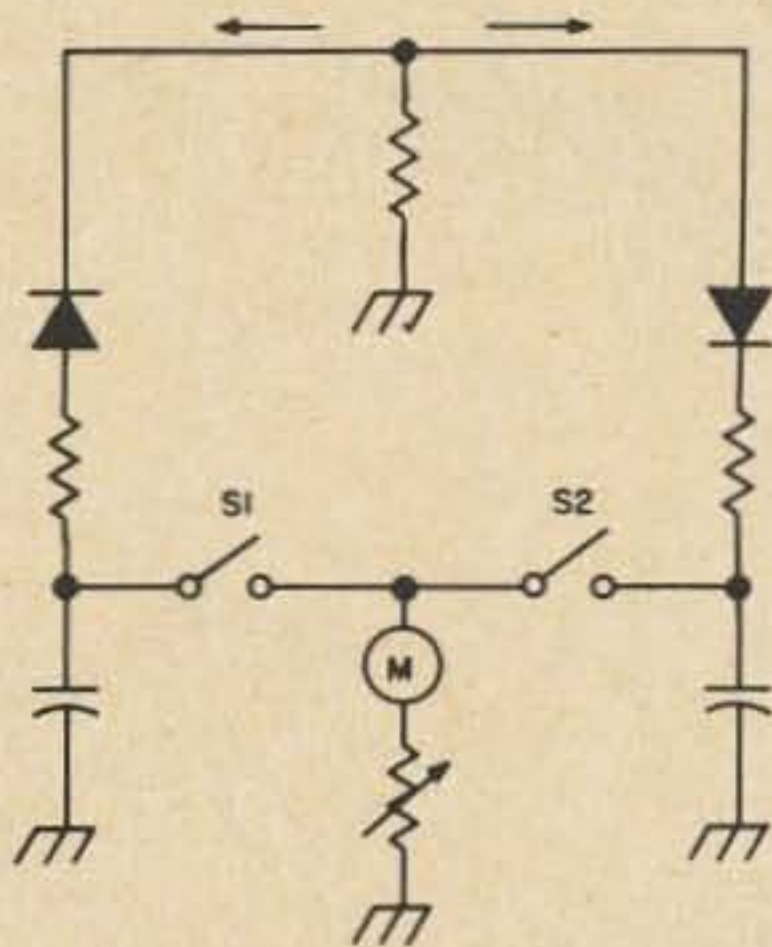

Fig. 2. Reversed diodes can be switched in the circuit to indicate incident, reflected, or "difference."

Note that the diodes are in opposite polarity. Each presents the opposite sign of dc voltage to the meter, and the meter reads the amount by which one exceeds the other. Incident power always wins out over reflected power; it had better, because there is something screwy if more comes back than originally got to the load!

The better the match the greater will be the true forward power into the transmatch.

If you have a short length of coax between the transmitter and the transmatch, and no 50Ω "black boxes" in the line (lowpass filters and the like), it doesn't do much harm if the transmatch cannot transform the feeder impedance down to 50Ω . If the best you can do is tune the transmatch to look like 100Ω , that is fine as long as the transmitter is adjusted to load into 100Ω . Be careful, though, if there are filters in the line, or you may hear your modulation talking out of the black box, and that spells trouble!

... VE7BS ■

GUARANTEED CUBICAL QUADS

PRE-TUNED — COMPLETE
PRE-CUT — PRE-DRILLED

- **QUADS ARE BETTER BECAUSE:** They have more gain than flat tops, element for element—Are quieter—less static and ignition noise—Possess lower vertical radiation angle—Require less space—($\frac{1}{2}$ width of flat tops)—Greater capture area, so better on weak signals—Negligible corona losses—
- Excellent SWR/Freq. characteristic—Light weight (30 lbs for 2 el, 60 lbs for 4 el) Detuning less from nearby objects. Your choice, bamboo or fiberglass—no aluminum spreaders. Bamboo exceptional quality and half the cost of fiberglass.
- **SPECIAL DEAL** on purchase of an E Z WAY Tower/quad combination. Free literature.

CB Quads from \$59.95
SKYLANE PRODUCTS

406 Bon Air Ave.,
Temple Terrace, Fla. 33617

KW BALUN KIT STILL ONLY \$5!

The AMIDON Toroid Balun Kit makes a modern, compact antenna transformer that can be wired for either 4:1 or 1:1 impedance ratio. The balun is ideal for use between a coaxial feedline and a balanced antenna. It reduces coax radiation and properly balances the energy for application to the antenna's feedpoint. The balun also acts as an isolation device and removes the capacity of the coax from the antenna which extends the low SWR frequency range of the array. Baluns made from this kit can be used to advantage on these antenna types: Dipole, Quad, Beam, Inverted Vee, Windom and Folded Dipole.

SEND FOR
FREE FLYER!

AMIDON
Associates



12033 OTSEGO STREET · NORTH HOLLYWOOD CALIF 91607

BACK ISSUE GUNSMOKE!

30, count 'em 30, stupendous tremendous (more handbooks than magazines) fascinating enormous devastating incredibly energizing back issues of 73.....

ONLY \$6.00
postpaid worldwide

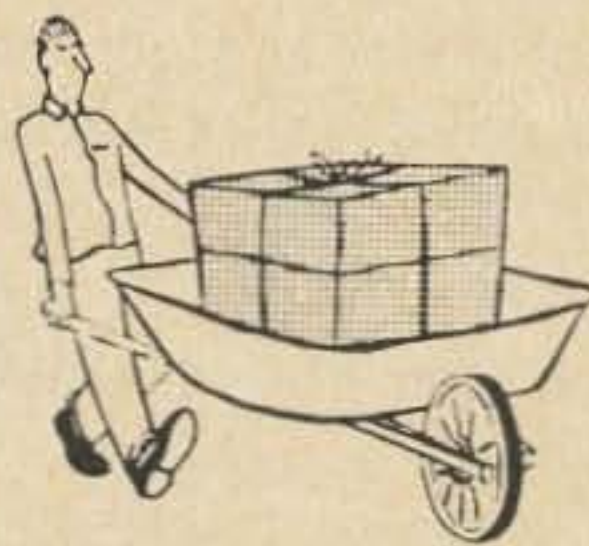

Yes...yes...yes...here is a golden opportunity to blow your mind on 30 back issues of 73. You send us \$6 in negotiable securities, cash or check and we will send you an unbelievable miscellany of thirty different (all different) back issues, all from the 1960-1966 era. These are all rare collectors items. Every one could likely be worth a fortune to you. Who knows, you might even find a rare January 1961 in this pile! We don't even know what is in these packages. To keep costs down we have had these magazines packed into sloppy bundles by the Chimps from Benson's Wild Animal Farm (nearby). Watch out for banana skins. —If you want specific issues of 73 they are available at the low low (high) price of \$1 each. Unless we don't have them, in which case the price is higher. —How about sending a bundle to a DX friend? Back issues of 73 are worth their weight in unicorn dung in most countries. —Money received without a shipping address will be used for beer.

73 Magazine Peterborough NH 03458

H. F. Smith WA9ANW
4N180 Ridgewood
Bensenville IL 60106

GOVERNMENT SURPLUS



STRAIGHT FROM THE HORSE'S MOUTH

For many years Uncle Sam's surplus electronics have been a gift horse to many hams and electronic experimenters alike. However, in the last few years, good surplus has become increasingly more difficult to locate. Yet, there is one open door to the bargain store. Buy government surplus straight from the horse's mouth!

There isn't anything difficult or mysterious about buying direct from the government. It's simply a matter of knowing who to contact and what procedures to follow in order to buy. Although the government sells as surplus almost any item imaginable, our discussion will be limited to the sale of electronic equipment. All government surplus is sold through two agencies. The Department of Defense sells property belonging to the armed forces and therefore has the most property for sale. Pro-

perty from all other departments and agencies is sold through the General Services Administration. In the last couple of years, very little electronic equipment has been offered for sale by the GSA. Most of what has been available was airport navigation equipment, although some communications items and some test sets were sold.

Government sales are of the auction, spot bid, or sealed bid variety. The latter is the only one that will be discussed here. A sealed bid sale will begin with the receipt of a catalog listing the items for sale. Each item will be described as completely as possible by the office issuing the catalog. But sometimes this is nothing more than the equipment "type designator" number or a federal stock number. Each listing will also contain the quantity offered for sale, whether it is new or used, its condition,

Letter	First Digit	Second Digit	Third Digit
A	Airborne (installed & operated in aircraft).	Invisible light, heat radiation.	Auxiliary assemblies (not complete operating sets).
B	Underwater mobile, submarine.	Pigeon.	Bombing.
C	Air transportable (inactivated).	Carrier.	Communications (receiving and transmitting).
D	Pilotless carrier.	Radiac.	Direction finder and/or reconnaissance.
E		Nupac (nuclear protection & control).	Ejection and/or release.
F	Fixed.	Photographic.	
G	Ground, general ground use.	Telegraph or teletype.	Fire control or searchlight directign.
H			Recording and/or reproducing (graphic, meteorological, and sound).
I		Interphone and public address.	
J		Electro-mechanical (not otherwise covered).	
K	Amphibious.	Telemetry.	
L		Countermeasures.	Searchlight control (inactivated; use G).
M	Ground, mobile (installed as operating unit in a vehicle which has no function other than transporting the equipment).	Meteorological.	Maintenance and test assemblies (including tools).
N		Sound in air.	Navigational aids (including altimeters, beacons, compasses, racons, depth sounding, approach and landing).
P	Pack or portable (animal or man).	Radar.	Reproducing (inactivated).
Q		Sonar & underwater sound.	Special, or combination of purposes.
R		Radio.	Receiving, passive detecting.
S	Water surface craft.	Special types, magnetic, etc., or combinations of types.	Detecting and/or range and bearing.
T	Ground, transportable.	Telephone (wire).	Transmitting.
U	General utility (includes 2 or more general installation classes, airborne, shipboard, and ground).		
V	Ground, vehicular (installed in vehicle designed for functions other than carrying electronic equipment, etc., such as tanks).	Visual and visible light.	
W	Water surface & underwater.	Armament (peculiar to armament, not otherwise covered).	Control.
X		Facsimile or television.	Identification and recognition.

Table I. Equipment Indicator Letters, "AN" Nomenclature System.

(good, fair, poor, or scrap) whether it is packed or unpacked, the total acquisition cost, estimated total weight, and the location of the property.

After you've found an item that looks interesting, it's time to determine the amount of your bid and make an offer to buy it. Several important things figure into this process. First, all items offered for sale are "where is - as is." This means the government does not guarantee that the description covering the item under consideration is 100% correct. (The descriptions I've seen have *usually* been accurate, but they are not guaranteed.) With this in mind, I strongly recommend that you take advantage of the inspection period that precedes each sale. During this inspection

period, all items are on display for prospective bidders to make their own determination of type and condition. Dates and times of the inspection period for a particular sale are found in each individual sale catalog.

Most bidders are unable to view the offerings first hand due to the travel requirements and must use the written description and their knowledge of military electronic nomenclature to determine the amount of their bid. I use a list of AN nomenclature (Table I) plus a card file as an aid to bid determination. Another important consideration is the location of the property. The bidder that is awarded the sale is responsible for removal of the property within a specified time, usually

30 days. Unless you can pick up the property yourself, the expense of having a commercial firm pack and ship it will be incurred. This cost should be taken into consideration when determining the amount of your bid. A list of packers and shippers serving the activity where the property is located is available from the office issuing the sale catalog. An item containing but one kind of property is offered for sale on a unit basis with the bidder being required to buy the total quantity listed. An item containing two or more kinds of property will be offered for sale as a *lot*. Property in a lot cannot be separated for bidding purposes. Everything listed must be considered as one unit. In bidding on a lot, a unit price bid is not required. Only total price.

After considering what it is, where it is, and how many there are, you enter your bid on the form enclosed with the catalog. Instructions for completing and mailing the bid form are contained in the catalog and on the form itself, and will not be covered here. The only point worthy of mention is the bid deposit. A deposit of at least 20% of the total amount bid is required to accompany the bid form. In this respect, I have found postal money orders are superior to personal checks. Awards are processed faster when money orders are used and they don't foul up your checkbook when returned from an unsuccessful bid.

They are good for five years and can be used as deposits over and over again.

After submitting a bid, three things can happen. You can be outbid, in which case your deposit will be returned. You can be the high bidder and receive the award for the sale. In this case, you pay the balance of the amount you bid and start making arrangements for removal of the property. Or you might be the high bidder and have the government reject your bid as giving them insufficient return. You get the deposit back, but it's very disappointing to be the high bidder and lose. All the bidders participating in a sale receive an award sheet which lists all successful bidders and the amount paid for each item. The sheet also shows which items didn't receive any bids at all and which items were withheld for insufficient return.

Government property is being offered for sale in locations all over the country. The General Services Administration sells through 10 regional offices scattered throughout the country. Each of these offices maintains a mailing list for persons interested in bidding on property located within the region controlled by that office. For a list of regional offices and their addresses, see Table II. Write any office, requesting that you be put on the bidders mailing list. This request will bring a form on which you select the type of property you wish to bid on. Mailing this form back

Geographical Area	Address
Maine, New Hampshire, Vermont, Rhode Island, Massachusetts, Connecticut	620 Post Office and Courthouse Boston 9, Mass.
New York, Delaware, New Jersey, Pennsylvania, Puerto Rico, Virgin Islands	30 Church Street New York 7, N.Y.
District of Columbia, Maryland, Virginia, West Virginia	7th and D Streets, SW Washington 25, D.C.
Alabama, Florida, Georgia, North Carolina, Mississippi, South Carolina, Tennessee	1776 Peachtree Street, NW Atlanta 9, Georgia
Illinois, Indiana, Kentucky, Ohio, Michigan, Wisconsin	219 South Clark Street Chicago 4, Illinois
Iowa, Kansas, Minnesota, Missouri, Nebraska, North Dakota, South Dakota	2306 E. Bannister Road Kansas City 31, Missouri
Arkansas, Louisiana, Oklahoma, Texas	1114 Commerce Street Dallas 2, Texas
Arizona, Colorado, New Mexico, Utah, Wyoming	Denver Federal Center Bldg. 41 Denver 25, Colorado
Nevada, California	49 Fourth Street San Francisco 3, California
Hawaii	Post Office, Courthouse and Customhouse Building 335 South King Street Honolulu, Hawaii
Idaho, Montana, Oregon, Washington	909 First Avenue Seattle 4, Washington
Alaska	Post Office and Courthouse Bldg. 4th and F Streets Anchorage, Alaska

Table II. General Services Administration Regional Offices.



A bargain receiver purchased from the government and the card file the author used to identify it.

to the regional office places you on their bidders list. To be placed on the list for Department of Defense sales, write the Defense Logistics Services Center, Federal Center Building, Battle Creek, Michigan, 49016. This request brings a booklet listing the classes of property sold by the department and a bidder's application form. Fill out the form indicating the classes of property you wish to bid on and the geographical areas in which you wish to bid. When this form is returned to the logistics center, they will place you on the bidders list for the property and areas you have specified. They will also issue you an identification card containing a bidder identification number. Save this card. Your bidder identification number must be placed on all bids you submit.

That covers the highlights on how to bid and how to get placed on the lists. Now you're ready to try your luck. At the start of the article I said that this is one avenue to a bargain. That it is. But not all the time. It's hard to get a bargain when packing and shipping charges are added to the sale price. The closer you are to the location of the property, the better your chances. Another asset is a good knowledge of military equipment nomenclature. If you can identify a good piece of equipment from no description other than the AN nomenclature or type number, your chances of getting a bargain are materially increased. Don't be too upset about repeatedly being outbid. The ones you win will be worth waiting for.

...WA9ANW ■

New Personalized Station Calendar

Dress up your ham shack with this exclusive appointment calendar wall plaque. Full color Apollo glossy photo, 1970 calendar, your name or call personalized on metal plate, all attractively mounted on walnut plaque. Nets, Skeds and Contests can be

noted one month at a time. Size 11½" x 22". Mounting hardware included. 1971 replacement calendar available this fall. Only \$4.75 ea. plus 75¢ for prepaid postage and handling.

Send for FREE catalog "Ham Shack Specialties"

GLOBAL RESEARCH & SUPPLIES

P.O. Box 271A, Lombard, Illinois 60148



THIS YEAR'S BIG ONE

**A.R.R.L. NATIONAL
CONVENTION at BOSTON
SEPTEMBER 25-26-27**

Free Descriptive Brochure

28 Forest Ave., Swampscott, Mass. 01907

QRP

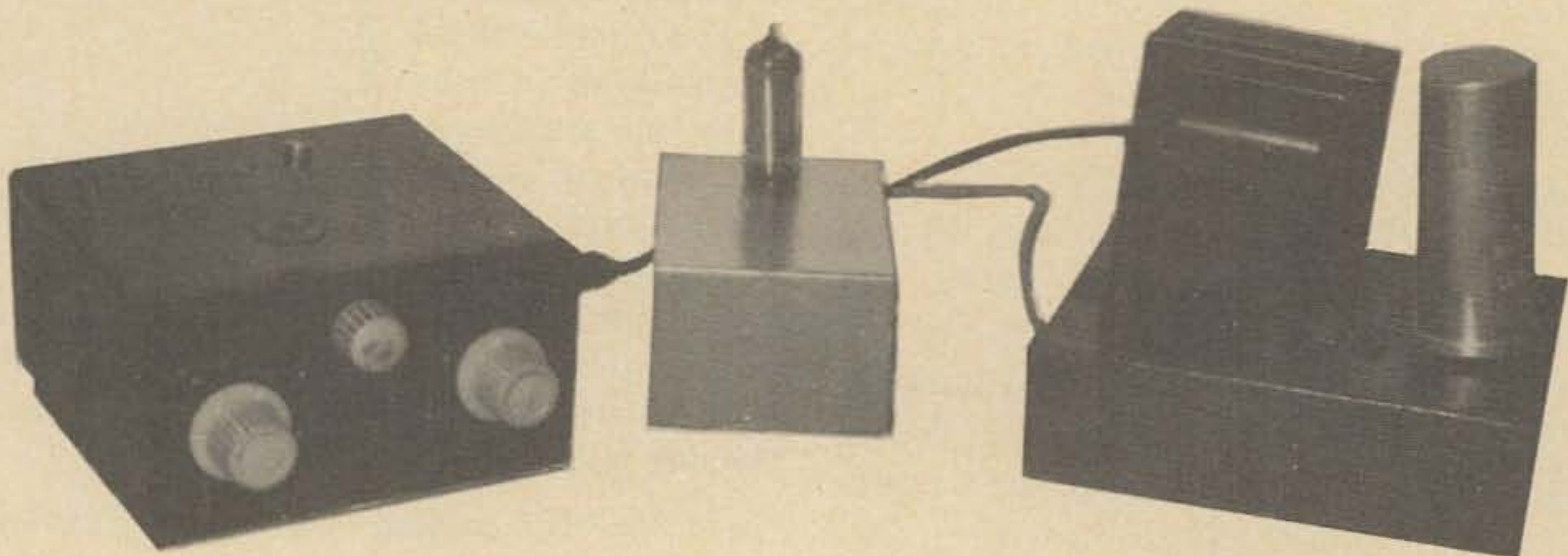

Whether you like low power or superlow power, you'll appreciate the simplicity of these two rigs for CW operation on 40 meters.

Ever want to try a hand at QRP operation? Here are two rigs that run low power on 40 meters at low cost.

The first rig (Fig. 1) uses a highly efficient 5763 tube and runs about 13W with a 350V supply. The B+ voltage may be dropped down for lower power operation. Almost any power supply delivering about 350V for B+ and 6.3 for the filaments can be used in place of the one shown. Adjust C3 and the position of L2 for maximum output and best keying.

The second rig (Fig. 2) runs about 40 mW with a 9V battery supply. Transistor

Q1 can be a GE-1, 2N247, 2SA268, 2N416, or 2N394. Adjust R1, C1, and C2 for maximum output and best keying.

With the 5763 Rig running 13W, I've worked as far as Athens, Georgia (475 mi.) with a 5 x 9 report. Cutting down the power to 5W with a Variac, I worked as far as Syracuse, N.Y. (200 mi.) with similar results. With the transistor rig, I ran some tests with WA3EYL about 2 mi. away. Copy was solid, even when the output power was reduced from 40 mW to only 2 mW.

Doug Pongrance WA3JBN ■

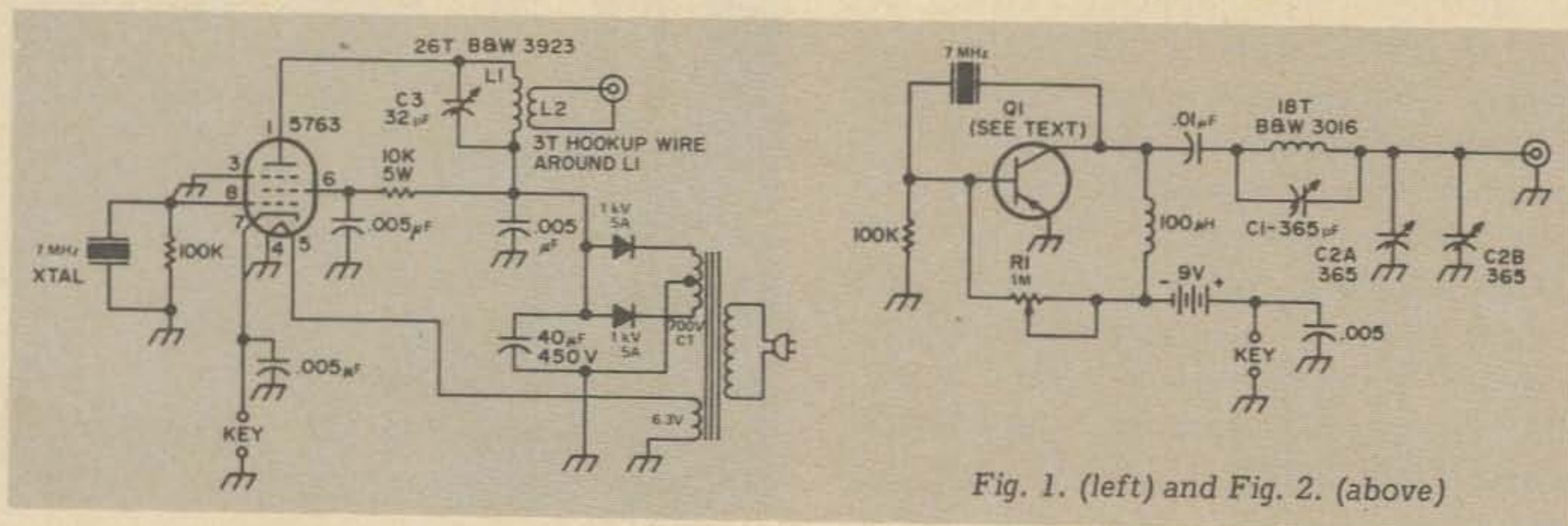

Fig. 1. (left) and Fig. 2. (above)

When it comes to antenna systems...

is yours

a space problem? an installation problem?
 a budget problem? an applications problem?
 or simply a problem of where to buy?

Your one-stop solution is **ANTENNAS, INC.**

Exclusively specialists in radiating systems, complete systems or any component part. Arrays—complete or in kit form, quads, yagis, dipole assemblies, verticals—fixed or mobile, towers, masts rotors, guy and control cable, transmission line, coax relays and switches, connectors and adaptors, test gear, technical publications, corrosion resistant hardware, corrosion proofing chemicals, insulators, installation and wiring hardware, aluminum tubing and plate, wire, and much, much more.

If your requirements are for a complete system, major components, or the smallest yet important piece of hardware—

ANTENNAS, INC. has:

Amphenol
 Antenna Specialists
 Belden
 Bilada
 CDE Rotors
 Cubex
 Cushcraft
 DGP
 DPZ
 Dow-Key

E Z Way
 R. L. Drake
 Ham-Kits
 Heights
 Hy-Gain
 General Cement
 General Electric
 Gentec
 Goldline
 Gotham

Intl. Wire
 E. F. Johnson
 Kirk Electronics
 Millen
 Mini-Products
 Mor-Gain
 Mosley
 Newtronics
 Omega-T
 Phasar
 Polygon Plastics
 Productos Joga

Rohn
 Saxton Wire
 Skylane
 Swan
 Telrex
 Times Wire
 Tri-Ex
 Tristao
 Unadilla
 Vesto
 Waters
 Whitaker Cable

Our prices and deliveries are hard to beat . . . anywhere.

ANTENNAS, INC.

Dept. B, 512 McDonald Road
 Leavenworth, Kansas 66048.

ANTENNAS, INC. can be your one-stop, single-source. Write for our catalog today, \$2.00 refundable on first order.



\$585.00



Norelco
 EL401A/54
 VIDEO
 RECORDER

EXTRA SPECIAL COMBINATION

Complete VTR Recording System
 ALL BRAND NEW

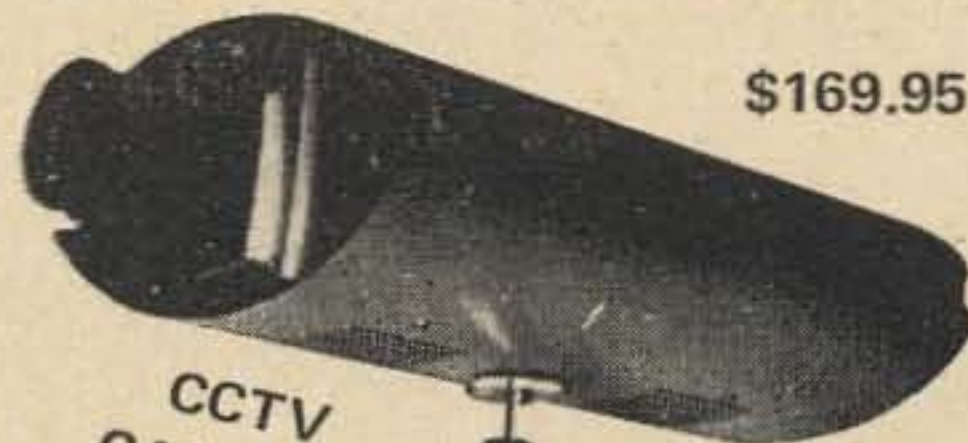

\$169.95

CCTV
 CAMERA

1 – Norelco VTR EL3401A/54 \$585.00; 1 – TV Camera TK-204 VD-4 \$169.95 and
 1 – Canon TV-16 1" F1.4 Lens \$39.95. Value \$794.90 – **Special Package Price \$749.95**

Stock #5000-WG. Shipped via REA or truck, chgs. collect. Details flyer 970J2.

DENSON ELECTRONIC CORP.

PO Box 85, Longview St.

(203) 875-5198

Rockville, Conn. 06066

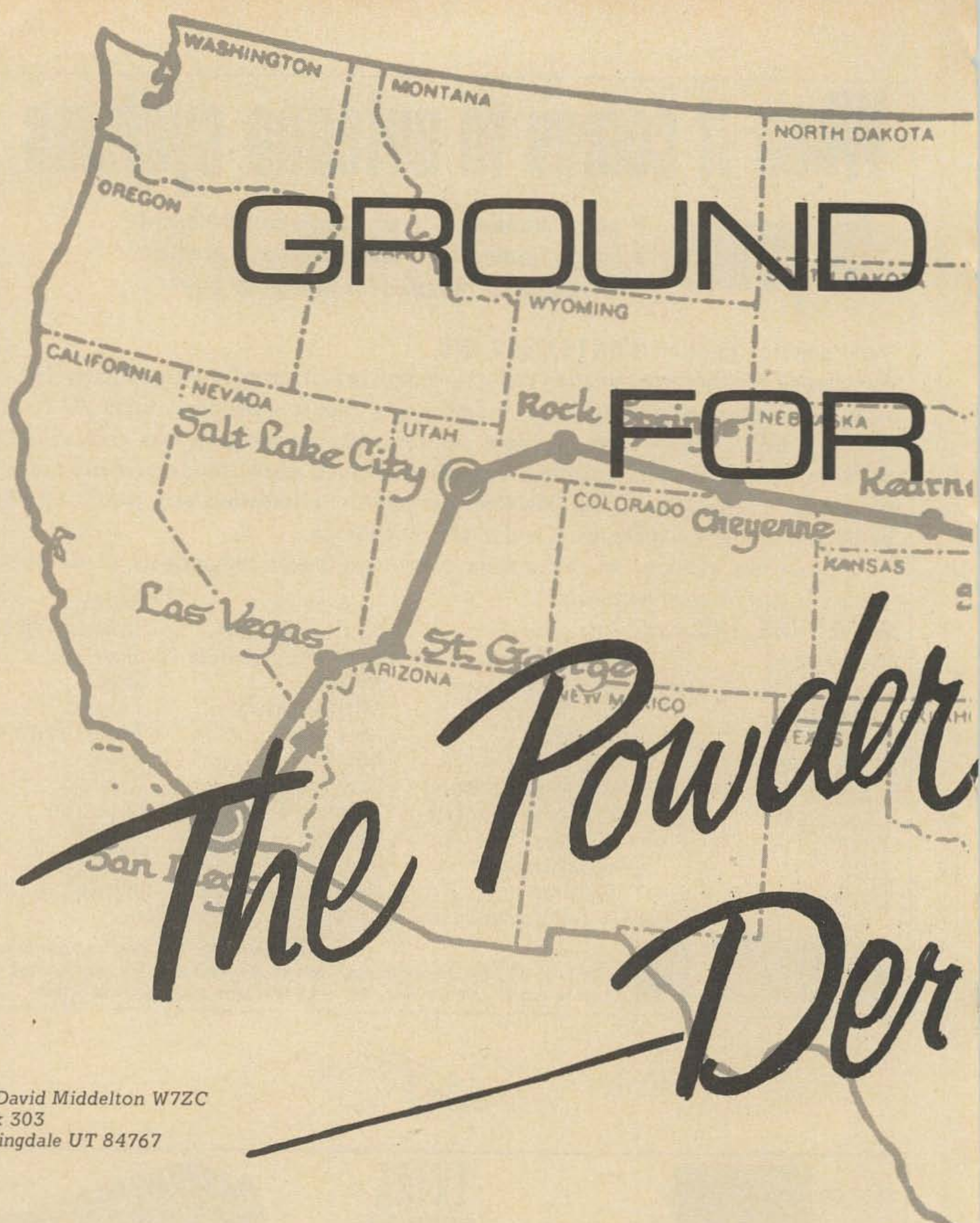

A. David Middleton W7ZC
Box 303
Springdale UT 84767

It is the morning of Independence Day, and Lindbergh Field is socked in — closed. Poised on the San Diego runways are 92 planes all with lady pilots ready to take to the air for the 23rd Annual Powder Puff Derby!

The destination is Dulles Airport, Washington, D.C., over a prescribed 2500-mile route with designated checkpoints and stopovers.

Amateur radio's problem: Relay to race officials, on both coasts, arrivals and departures of all 92 planes at every one of the nine checkpoints along the official route from San Diego to Washington.

Here is a true account of four days of genuinely worthwhile *communications* by a handful of dedicated ham operators. They sweated, cursed, (as off-the-air "asides"), and battled propagation that ranged from fantastically good to impos-

SUPPORT

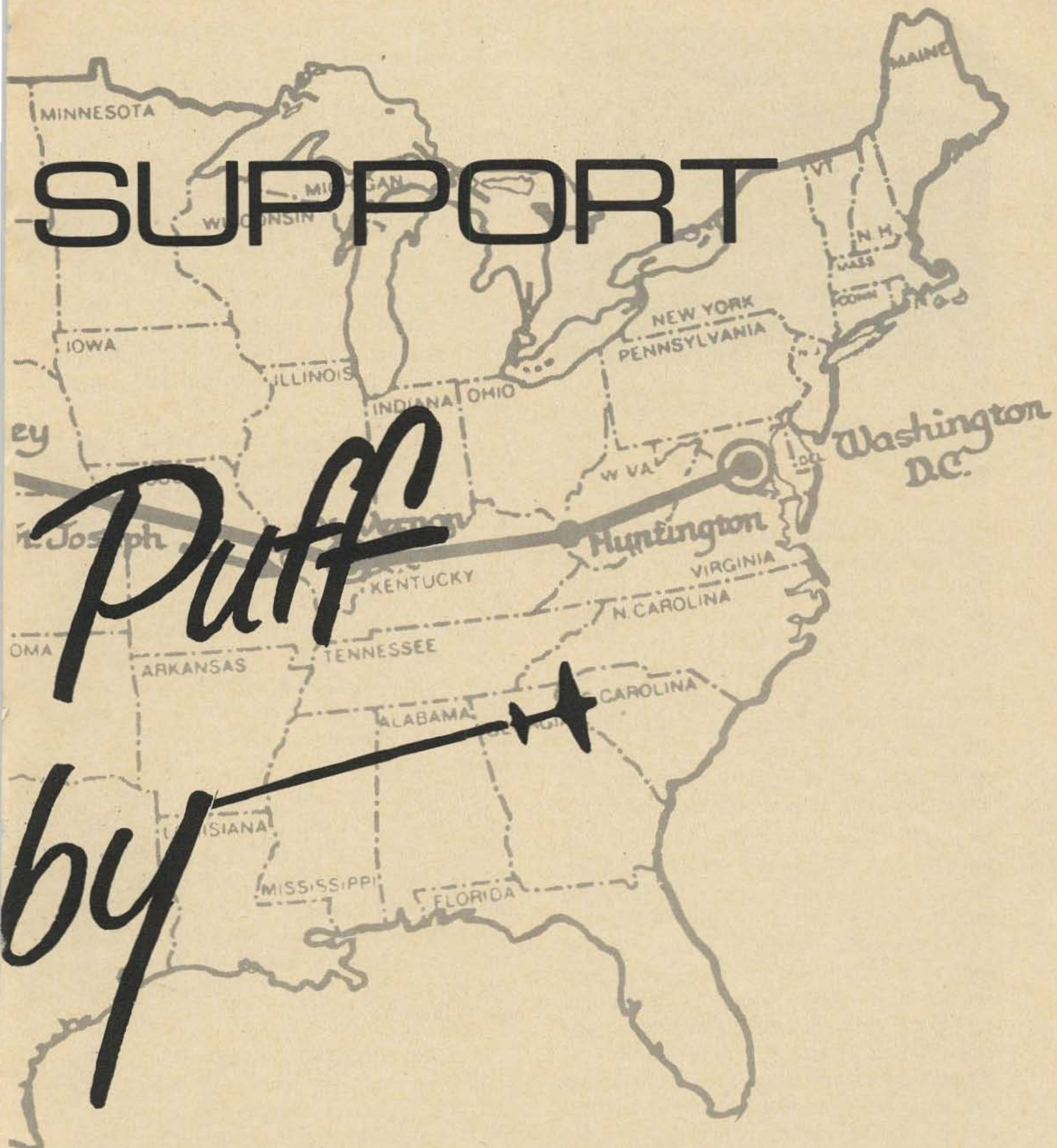

sible. And they provided a reliable and almost continuous flow of *intelligence* in a 12-station relay back and forth across the U.S.

Time was when the word "relay" was synonymous with amateur radio. Today, there is little or no relaying being done except on established traffic nets. Another facet of old-time ham radio has all but vanished: the requirement for total *accuracy* in the passing of information

from one station to another. All thinking people know what happens to word-of-mouth messages: they usually come out well garbled.

The Powder Puff Derby relay network requires total accuracy, without delay, and full cooperation between operators who have no previous experience in working each other. Many are participating for the very first time, though the Derby is an annual event.

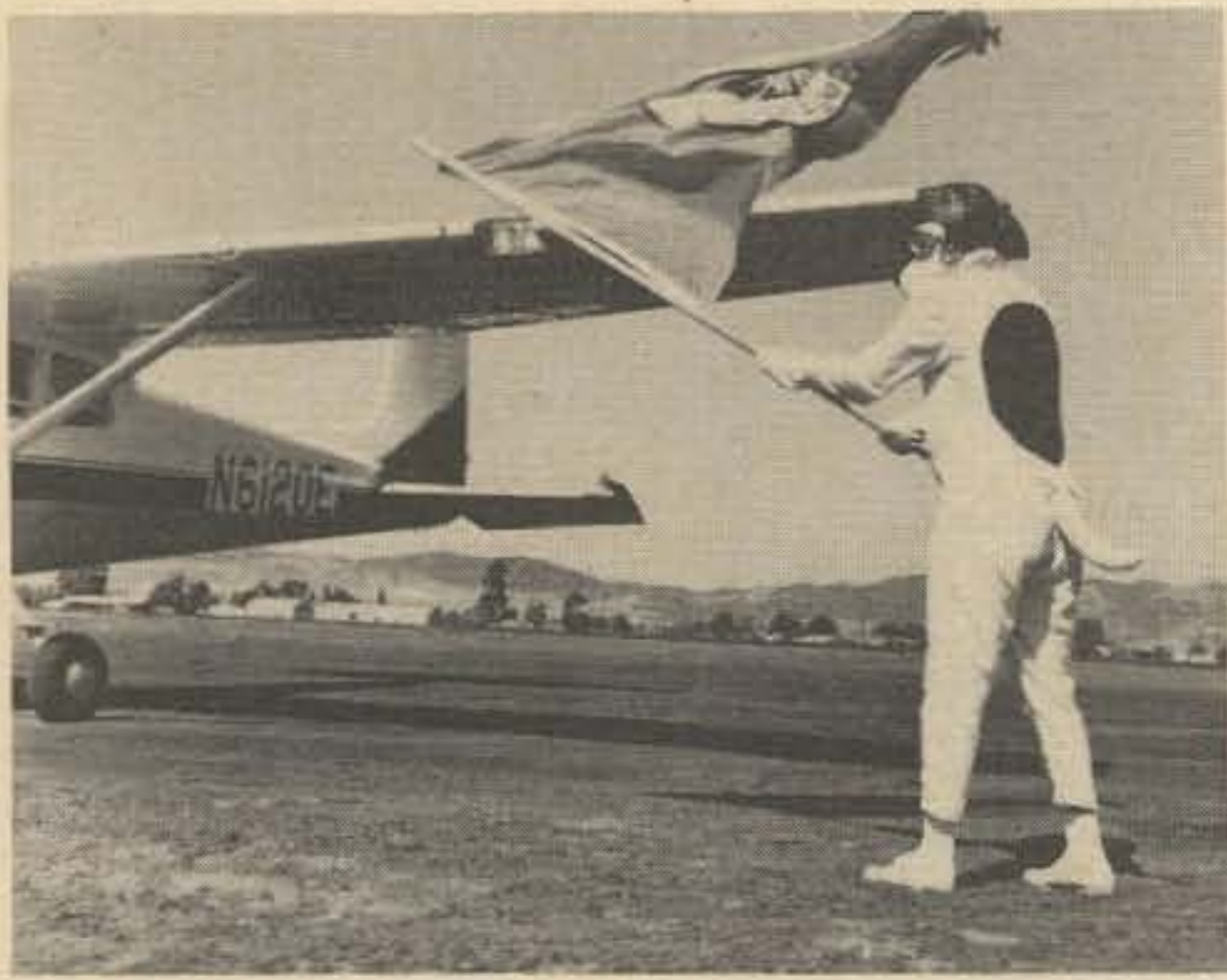

Honorary Starter "Snoopy" waves off first of the 92 planes in the '69 Powder Puff Derby, with the flag bearing official San Diego bicentennial emblem. (Who's Snoopy? — Ruth Ebey of San Diego.)

By the time the fog lifted at San Diego and the planes were cleared for takeoff, three of the entries had been scratched. But the 92 did get under way, and the radio operation swung into action.

At first, things were confused and hectic, as is often the case with such ambitious undertakings. An FAA official called, via ham radio, to ask how many planes had bypassed St. George. Such a question might be perfectly normal, but it had been asked before the race had even started. Once the gals were airborne, though, radio traffic began to fall into something of a routine.

Nervousness settled over race officials as well as members of the communications net when, 12 hours after the planes had departed, one of the contestants was unaccounted for. A concentration of cooperative effort within the framework of the nationwide network managed to turn up the elusive missing plane, and the net secured for the night. The first leg of the race had ended with no casualties and no critical problems. But that was just the first day.

The second day was no more than a few hours old when, from W7LYV, came the report: "Plane down and burning near Jacobs Lake, near the north rim of the Grand Canyon."

Quickly, the net control station passed the word that the downed plane was *not*

one of the Powder Puff Derby contestants, although it was in the general path of flight. The ham who originated the call, W7LYV, alerted the Federal Aviation Agency and the Arizona highway patrol, but the net control station kept the message from being relayed east of Salt Lake City. No need to pass traffic that was not pertinent to the race, the reasoning was; and besides, like any message, news of an accident, even though unrelated to the Derby, could be misunderstood or misinterpreted at subsequent checkpoints, resulting in needless confusion and concern.

When the emergency traffic had cleared, the network bustled with routine messages going both ways along the route; thousands of bits of information were passed from one point to another. The planes began together, but now they were strewn in the air over the entire flight route; and the communications had to cover the complete range — from the area of the first femme pilot to that of the last. The network was alive with traffic all right; but it was organized, tersely worded, efficiently passed.

All afternoon and evening of July 6, radio and TV weather reports indicated rapidly deteriorating flying conditions in the midwest, with a bad front moving into the central and eastern portion of the U.S. The racing ladies were heading directly into very bad weather! Many set down and stayed put in various locations to avoid flying into the storm!

As the net ended its second day, all planes but one were once more accounted for. The FAA was alerted, and an official follow-up would provide data on that last elusive straggler.

The results of the first two full days of the Derby Relay Net indicated a splendid spirit of cooperation, a high order of discipline, and an intense interest on the part of not only the relay members but by nonparticipating amateurs as well, many of whom called in to briefly express an interest in the race and in the net. W6OII at Carmel, Calif. performed yeoman service policing the 40 meter frequency of oper-



Boy, were we impressed!

The Brute stopped in the other day and showed us Raytrack's Red Line Series. Now we know why these amps are called the "Brutes".



HORIZON VI L Six Meter

- 2000 watts PEP SSB
- 1000 watts PEP AM, CW, RTTY
- Two EIMAC 3-500Z Zero Bias Triodes
- Precision Taut Band Meters
- Adjustable "ALC" Network
- Designed for Continuous Duty



DX 2000L 80-10 Meter

- 2000 watts PEP SSB
- 1000 watts PEP AM, CW, RTTY
- Two EIMAC 3-500Z Zero Bias Triodes
- Hybrid Tank Circuit — Raytrack's own unique Toroid and Air Inductor Combination
- Rugged, Separate, Heavy-Duty Solid-State Power Supply

Oh yes, the Brute also dropped off a fresh stock of Raytrack's world-famous AutoLevel, the Ultimate in Speech Compressors.

AMRAD SUPPLY

Central California's Most Complete Amateur Radio Shop.
See Amrad for the Finest in Service, Equipment, and Supplies.

1025 Harrison St.
Oakland, California 94607
Phone 415/451-7755

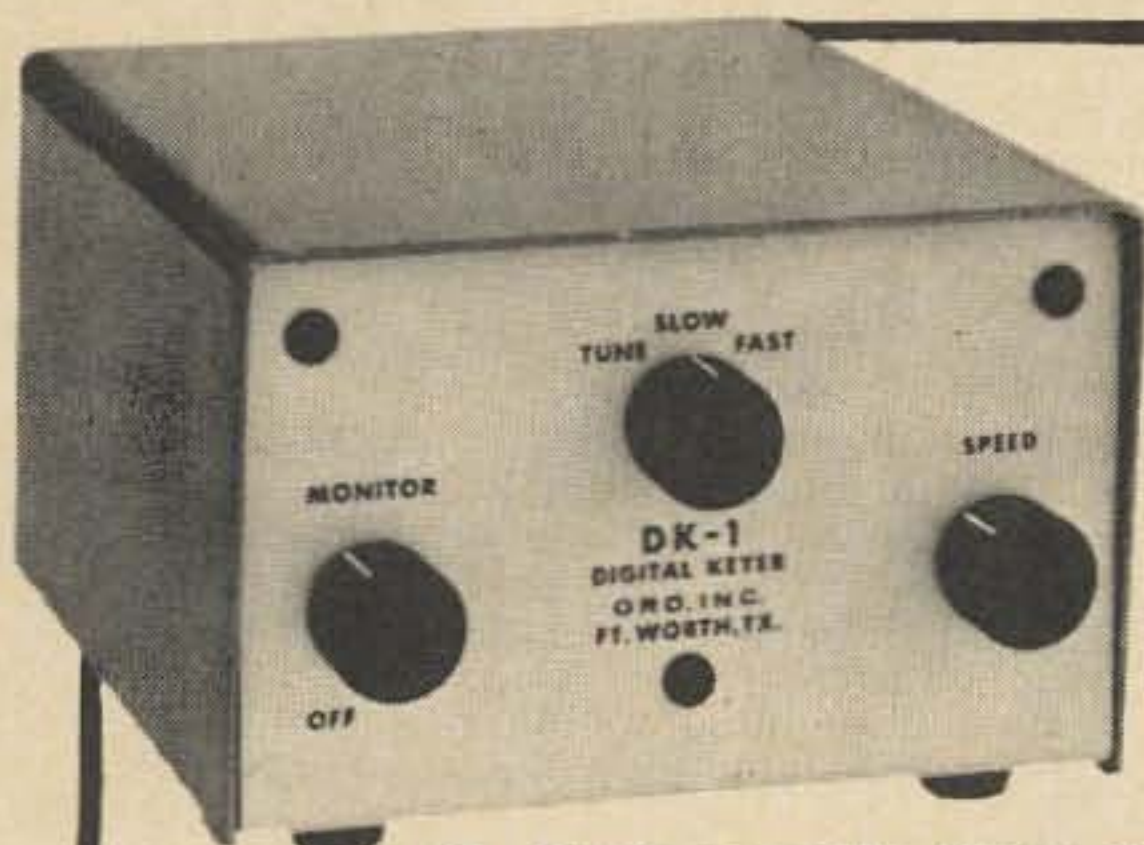

THE DK-1 DIGITAL KEYER

is designed to allow the CW operator to transmit morse code with a MINIMUM of hand motion. No other keyer exceeds the DK-1 in this respect.

- Code speeds from 7 to 60 WPM with correct inter-letter and inter-word spacings
- Mercury reed relay for transmitter keying and receiver muting
- Input for manual key
- Keying monitor with built-in speaker
- 18 integrated circuits, 12 transistors, 5 diodes

These examples illustrate the minimum hand motion required. The dot and dash keys may be closed or released in the order indicated within microseconds of each other.

"A"—Close dot-dash key. During the dot or dash, release dot-dash key.

"R"—Close dot-dash key. During the dash or second dot, release dash-dot key.

"P"—Close dot-dash key. During the second dash or dot, release dash-dot key.

"L"—Close dot key. During the first dot, flick the dash key. Release dot key during the last dot.

"B"—Close dash-dot key. Release dash key at any time during the three dots and dot key during the last dot; or, release dash-dot key during the last dot.

"Double Dash"—close dash-dot key. Release dot-dash key during the last dot or dash.

Note that in the above examples, only one depress-release cycle of the dot and dash keys is required. All letters, numbers and punctuation marks may be generated using variations of this technique.

\$124.50

PPD. CONT. U.S.A.
From Distributor or
Direct from Factory

WRITE FOR
FREE
BROCHURE

ORD, Inc.

3201 HANDLEY EDERVILLE RD.
FORT WORTH, TEXAS 76118
817 / 268-1611

ation during these first two long days of this hectic communication problem.

Problems

The weather was bad in the midwest and east as the third day began. Severe storms raged over all the route east of St. Joseph, Mo. At 1920 GMT, WØQOQ reported from Kearny that all planes were still on the ground. Not one of those sensible gals chanced a takeoff in the face of that storm!

Then that seemingly inevitable result of all huge nets happened. The messages became increasingly contradictory. Here is the log for the afternoon of the third day.

- 1423Z – WØNH reports via relay that 13 planes have departed but 9 still left at St. Joseph.
- 1432Z – W9JLL tells W8VA that planes 24, 14, and 21 departed Mt. Vernon. The ladies are moving east again!
- 1438Z – K7FCN says his two birds still on ground at SLC. No one knows why the delay.
- 1445Z – K7FCN breaks in to say that one plane is in the air and one on takeoff strip. This clears SLC of all his planes.
- 1447Z – Plane 21 had been scratched prior to the start of the race; yet it kept showing up in checklists. A critical look is taken at information sources and word goes out to correct and prevent such errors.
- 1529Z – WØQOQ says that NO planes have departed Kearny.
- 1543Z – WØQOQ reports that No. 8 departed Kearny on a “special V F R” after much deliberation between Kearny and San Diego regarding race rules.
- 1546Z – W7ZC reads W8VA, Huntington, directly (W8DUV, YL Kay, operating).
- 1640Z – WA7DUG, Fran, Las Vegas, checks into net. (She was to be active and a great help in checking racers’ locations during the remainder of the race.)
- 1701Z – Plane 40 arrives at Dulles



Marilyn Copeland and Pat McEwen, both of Wichita, Kan., ready to board Pat's snazzy checkered racing Beechcraft Bonanza V-35A.

Field, the terminal point.

1720Z to 1817Z – Scores of arrival and departure times relayed by stations east and west of Kearny as the racers move eastward.

1817Z – The RONS (required overnight stays) for the third night begin. And planes are scattered!

1956Z – WØQOQ sends W9JLL a request to determine accurate list of *arrivals* at Dulles, but no information was received in reply to this formal request.

The conflicting reports and incompleting message loops raised questions among the responsables of the communications networks. And at 2013 GMT (or Z), W6KBT, the western net control station, suggested that all stations furnish “modus operandi” of relay station setups along with lists of participating personnel. It stood to reason that if the net operation was to be smoothed in future efforts, the place to begin was in the organization. Mailed questionnaires would be put into circulation after the Derby.

Meanwhile the gaps in the relay net were widening and difficulty was mounting in handling data from the midwest across to the west coast. And still no word on arrivals. At 2050, a message from W6KBT to destination stations K4EAM, W8VA, and W9JLL: “Imperative expedite arrival times your station”. Still no reply. The net control kept pressing W7ZC to obtain



"Granny" Maybelle Fletcher, pilot, and Jackie Kelly (copilot not shown) made a fetching pair in their red dotted tops and tattered minis.

information from the east regarding arrivals. For some reason, information seemed to be flowing to the east but little data flowed from the east to the west.

Eventually, the long list of arrivals at Dulles was received in the west directly from W0QOQ by W7ZC. The Kearny station was the sole remaining link between east and west. Relay possibilities east of Kearny were scant; clearly, a communications breakdown had developed along the last leg of the route.

The snafu continued the following day. Western station W7ZC made repeated all-out attempts to establish contact directly with *any* Washington, D.C. station, irrespective of its net participation. Dozens of calls made on all modes and frequencies yielded no response from the Washington area!

Finally, at 1830, W7ZC raised W3NY, near Washington, and explained the situation. W3NY, unable to raise K4EAM, managed to make contact with a Huntington station. Thus, the net stepped out of the net to maintain a flow of communications. Through a series of schedules, W3NY passed additional data updating the location of racers.

There was no explanation of the failure of all other Washington area stations to reply to W7ZC's repeated directional calls, particularly in view of the fact that W3NY reported the western station's signal was consistently loud and clear.

Even though not a smashing success, the Derby relay net worked! The team had

successfully moved traffic efficiently and accurately across the U.S.

There were a few unsatisfactory conclusions. Information is still unavailable as to why Dulles did not originate and forward more data to the western race officials, via the relay. Information from Dulles was frustratingly sparse, and especially on the last day.

In spite of the communications blackout in the east (or boycott), the event spoke well for the amateur fraternity. Had it not been for the fine cooperation of non-net W3NY, and the continued activity at W8VA, W6KBT (who was being queried by race officials) would have been left without any news.

Word reached W6KBT after the relay that K4EAM operated under a severe handicap due to station location and a poor antenna. And, of course, the complete lack of any transcontinental circuit severely hampered net operation.

On July 3, 1970, the 24th annual Powder Puff Derby will begin from Monterey Peninsula Airport in Northern California. As the damsels make their 2760-mile trip to Bristol, Pennsylvania, the ground-based observers will again be looking to the amateurs for their communications support. Will they get it?

Possibly! Here's some insurance measures:

1. Establish a *trunk* system, with relay terminal stations *not* located at the Race airports, but with these stations serviced by "drops" from the airport. These "drop" circuits should be on a different frequency from the net itself, preferably on VHF FM. This method was very successfully used at several stations along the relay.

Placing stations *away* from airports would permit *better* installations and antennas due to restrictions enforced by airport communications managers.

2. Establish adequately equipped and manned stations (with CW and SSB facilities) plus suitable antennas and operations space, for totally reliable communication along the net system. Redundant or at least multiband equipment is desirable. Each relay station must have *total* communication with the stations in both directions.

Though it is not necessary for a relay point to be able to communicate with stations beyond the next one, it is highly desirable — as proved in 1969 when communications was maintained across wide gaps because of poor conditions or other reasons.

Emergency power may well be a requisite, especially at key points! Mobile units might provide such links if the system chain is broken.

All stations should be capable of operating at their maximum potential, as this is badly needed when QRM, QRN, or propagation causes difficulty.

Station planning must be done *in advance*. Jury-rigged antennas and facilities prove a handicap to the system.

3. Alternate frequencies should be predetermined, preferably in the lower ends of the bands (less QRM) by providing upgraded licensees and equipment. At many points difficulty was had in finding *any* reliable operators. A few upgraded licensees *did* take time and have sufficient interest to be valuable to the net's operation.

4. Establish better liaison between race officials (having data) and operators at relay points. This is a matter for race officials working with net personnel.

At each western station, operators were ready, able, and willing to do their job without delay. In some locations it



Safe and sound all the way from San Diego to Washington, D.C. Crew #55 from San Jose, Calif. are greeted by pilot/author and president of National Aviation Trades Association, Frank Kingston Smith. (At controls) Layne Hackett, "Cumulus" held by Betty Hicks, world famous golfer. (No dog-sitter could be found so Cumulus had to race, and loved it.)

appeared that race officials were indifferent or were uninformed as to the net's purpose and availability, resulting in a delay in passing information.

It is clear that the prime consideration is the safety of the pilots and crews — that the transmission and reception of arrivals and departures is secondary. However, this "flying safety" may require accurate updated information in the event of a mishap.

The amateur operators were aware of this and did expeditiously handle all information given them. But it was not charged to the net.

The Powder Puff Derby relay net is a *service* operation and all who participate should take cognizance of this fact. Net responsibilities include the establishment of suitable equipment and operational facilities to maintain solid communication back and forth across the country in order to handle data supplied by race officials.

It follows, therefore, that race officials should extend the same full spirit of cooperation to the amateur radio operators so that the fullest utilization may be made of far-flung net talent.

Now. What about that Powder Puff Derby coming up? Where and how do the misses and Mrs. fly?

On July 3, the 24th annual Derby will take off from Monterey Peninsula Airport in Monterey, Calif.



It's Fess Parker's Piper Comanche PA-24; this team flew in the coast-to-coast dash, "Daniel Boone" himself capped the pilots of #32 just before takeoff. L. (Copilot) Billie Herrin.; R. (Pilot) Margaret Mead, winner of the Derby in 1968.

see the *Mann* for the best in USED communications equipment

Here are some of the great buys at Mann...

Motorola Models

T53GAD 50Watt Mobile 150-160MHz 6/12V with accessories	\$5.00
U43GGT 30Watt Mobile 150-160MHz Transistor Powered 12Volt less accessories	150.00
U44BBT 15Watt Mobile T-Power 450MHz 12V less acc	125.00
U51GGT 50Watt Mobile T-Power 40-50MHz 12V less acc	150.00
T41G 30Watt Mobile (Vibrator Powered) 40-50MHz 6/12V with acc	75.00
T44A5A 15Watt Mobile (Vibrator Powered) 450 MHz 6/12V with acc	29.00
H23A Series Portable 1 Watt 150MHz Dry Cell Pack less Batteries	39.00
F33A Series Portable 5 Watt 150MHz Dry Cell Pack less Batteries	49.00
L03F 117Volt AC Monitor Receiver in Desk Top Housing 150MHz	49.00

WRITE FOR FREE CATALOG

Mann COMMUNICATIONS

P.O. Box 138, 18669 Ventura Blvd., Tarzana, Calif. 91356 Phone: (213) 342-8297

The COMPLETE Code Practice System

MOST CODE PRACTICE SYSTEMS WILL HELP YOU IMPROVE YOUR RECEIVING
BUT HOW MANY OF THEM WILL REALLY HELP YOUR SENDING? ...

THIS ONE WILL

AND IT INCLUDES A PANASONIC
PORTABLE CASSETTE RECORDER !

- Practice receiving with pre-recorded cassettes
- Practice sending with the built in code practice oscillator
- By recording your own sending, you will be able to spot flaws and errors that would ordinarily be overlooked
- When it is not being used for code practice, the recorder may still be used around the shack and for general entertainment purposes
- The system comes complete with a 1 hour pre-recorded cassette (specify speed), a 1 hour blank cassette, microphone, earphone, and batteries.

PLEASE ALLOW \$3.00 FOR SHIPPING - EXCESS REFUNDED



WOODSIDE CS-1\$48.00

- Extra pre-recorded cassettes (1 hr)
specify 8, 16, or 25 wpm .. \$5.50
- Johnson heavy duty key ... \$6.50
- 110 vac adaptor \$7.00

WOODSIDE RESEARCH CO.

BOX 276, YARDLEY, PA. 19067

PHONE: 215-493-5850



"Snoopy" on Louise White's Mooney Super 21 might have had a rough ride, but pilot Louise looks cool and relaxed after arrival at Dulles, although thunderstorms plagued the last half of the race route.

The race is open to all qualified women pilots flying stock model, fixed-wing, single or multiengine aircraft. As always, only daylight flying in VFR (contact) weather, as defined by the Federal Aviation Administration, is permitted. Winners are determined on a handicap basis, "par speeds" having been established based on figures available from manufacturers' data for each make and model of aircraft. Since takeoffs are in order of entry, winners cannot be known until all planes have crossed the finish line.

Climbout will soon take them over the fruited farms of Fresno, first of the 10 *en route* stops officially designated for refueling and remaining overnight. Stop towers will be equipped with Simplex time stamps so that after the flyby of the timing lines, time will not be counted in the final scoring until the wheels start their takeoff roll on the runway.

Racers will point their noses into the blue to clear Mt. Whitney's 14,000 foot peak. They will overfly the blinding gleam of Death Valley before letting down into star-studded Las Vegas. Eastward, they'll flash over the desolate beauty of a last

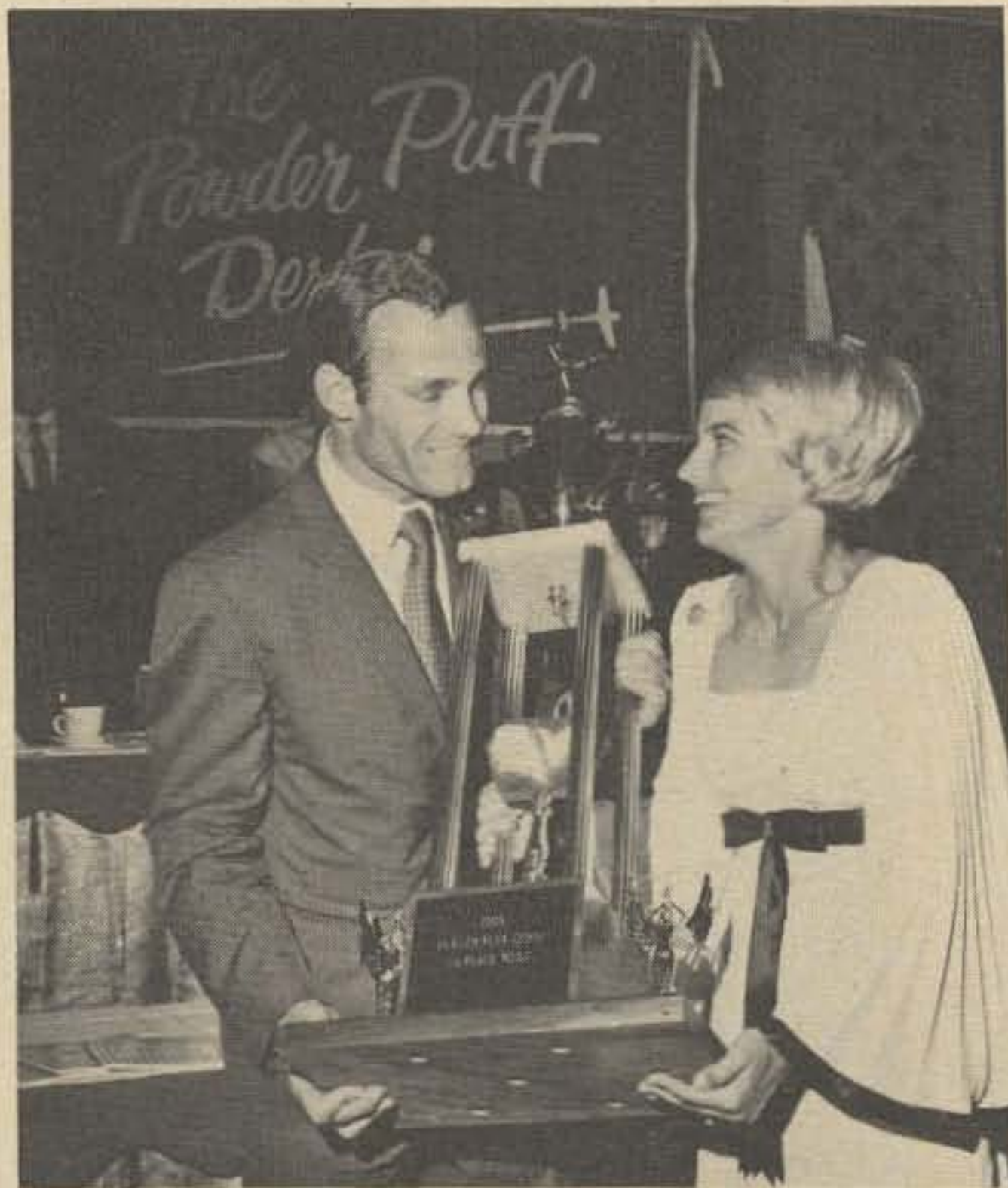

K7UGA Harmonic. — All hail the happy winner of the 1969 Powder Puff Derby, as Congressman Barry Goldwater, Jr. hands her the trophy at the awards banquet held at Marriott Twin Bridges Hotel, Virginia.

frontier with its intricate spires and serrated ridges, the brilliant red sandstone of the Valley of Fire, and the goosenecks of the river canyons, to arrive at the foot of the penetrating blue, serpentine Lake Powell at Glen Canyon Dam and Page, Arizona.

Continuing along the north rim of the mighty Grand Canyon, contestants will enjoy unlimited visibility encompassing Zion National Park with deep purple gorges, sculptured Bryce Canyon, Rainbow Bridge — "one of the seven natural wonders of the world," Monument Valley with its red cliffs, and volcanic Shiprock before arriving at booming Farmington, New Mexico, "Energy Capital of the World."

From here it's still high country with a let-down over the Navajo Trail for a *must* flyby at Johnson Field in Walsenburg, Colorado, before heading for a *must* stop at Peterson Field, Colorado Springs in the shadow of 14,000 ft Pikes Peak. Desire to linger in the Garden of the Gods, red monoliths scattered among green fields, and at the architecturally beautiful Air Force Academy, must be denied with the longest leg still ahead: 375 miles into Hutchinson, Kansas. From this prosperous

city, contestants may press onward without oxygen if lower winds are favorable, to revisit Springfield, Mo., then into the business hub of northwestern Tennessee, Dyersburg. A high welcome awaits the racers at this mandatory stop.

Then it's a takeoff on a northeast heading for historic Louisville, Ky., which combines midwestern vigor with southern charm.

Off and upward the racers will press to Morgantown's splendid airport set atop one of the verdant hills of West Virginia.

The final lap is a hurdle over the sprawling Allegheny Mountains into the 3 M Airport, Bristol, where the Pennsylvania Turnpike Bridge over the Delaware River connects Lower Bucks County with New Jersey. Here, atop their tower, the timers will click off the final seconds for each plane as its crew flashes past the glorious orange finish line, salute to a challenge accomplished.

Contestants will be vieing for the \$5,250 purse to be divided among the top five winners. Trophies will be given, as well as several thousand dollars more in additional prize monies for the best scores between stops, best in each horsepower class of aircraft, and in other specialized categories.

The racers will help Monterey celebrate its bicentennial. Sponsoring the start is the Monterey Bay Chapter of the Ninety-Nines. The terminus is being sponsored by the Eastern Pennsylvania Chapter of the Ninety-Nines.

And for the 18th consecutive year, the radio net will be furnished by ham radio.

Considering the checkpoints between the two terminal points, the total ground distance covered, and the very large number of people participating, it is truly no wonder that two-way coverage gets to be a problem at times. But improved procedures and a determination by conscientious amateurs will combine to make the next Derby the most successful of all.

The author wishes to acknowledge the contributions of Kay A. Brick, Chairman of the board, All-Woman Transcontinental Air Race, Inc., Teterboro, N.J. . .

. . . W7ZC ■

COAX ADAPTER VHF to BNC

Many new converters, SWR meters, and other accessories are now coming out with the newer BNC coax connectors on them. Most hams have been using coax equipped with the PL-259 plug or similar larger size connector. A simple, easily-constructed adapter can be assembled as follows, at a cost of approximately 75 cents according to current "bargain-counter" prices. All that is needed is one PL-259 plug and one UG-1094/U. The latter is the BNC type also known as UG-625, and is the single-hole chassis-mount version.

Drill and tap the neck of the PL-259 3/16 inch from the end with a 6-32 thread, and fit this threaded hole with a flat-head screw. Solder a piece of 16 or 18 AWG wire to the center pin of the BNC fitting, cutting it long enough to extend through the center pin of the PL-259 when the BNC fitting is inserted into the neck of the PL-259. The BNC fitting has a flat on its threaded surface; tighten the setscrew against this flat, and solder the wire to the center pin of the PL-259.

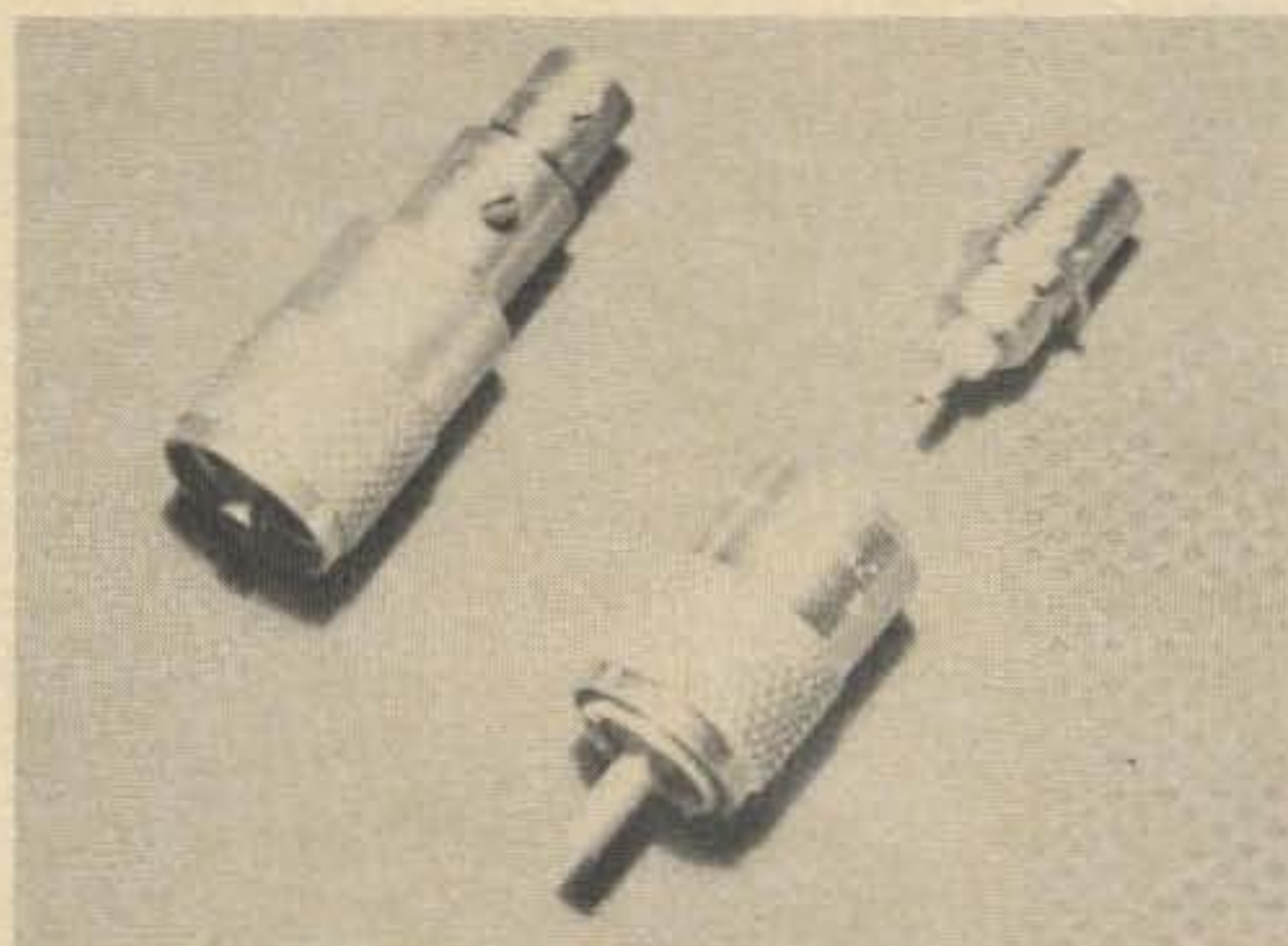

The photograph shows the "before and after" views of the assembly. This makes a sturdy, short, convenient adapter, and takes ten minutes to assemble, preventing loose, haywire lash-ups.

Herbert Sandstrom, Jr. W9MEV ■



21 dB of gain on 2 meters with a new approach to the construction of VHF beams

*by A.H.C. Smirk, B.E. ZL4TAH
(Reprinted from Break-In)*

Introduction

Of all the components making up a VHF installation the antenna offers the most potential for improving a station's capability. For those who may have doubts it is pointed out that with the low-noise transistors available today, such as the MPF107 of the field-effect type, it is relatively easy to obtain a good noise figure; however, the overall noise figure of a VHF receiving installation is affected by the gain of the antenna. The improvement that can be obtained by increased antenna gain depends only upon the size of array that it is practical and economical to construct.

In recent months I have developed a suspension system for VHF antennas where the rigid booms and structural framework of the conventional high-gain antenna are replaced by ropes under tension. With this

system it is easy to construct very long yagi antennas which individually have the same gain as stacked arrays of conventional design.

The 32-element yagi described in this article has a length of 73 ft, a theoretical gain of 21 dB, and can be constructed from all new materials for less than \$10. Photo 1 shows a completed 32-element beam before it was raised onto its masts. Antennas of this form could properly be described as suspended long yagis and I suggest that they should be called "sly" beams, using initial letters to form the acronym.

Electrically the sly beam is identical to a rigid boom yagi of equivalent length except that the elements are slightly shortened to compensate for the removal of the usual metal boom.

Suspension Cords

Ordinary cotton or hemp rope is not satisfactory for the suspension cords as these materials absorb water into their fibers resulting in swelling and shrinking. Furthermore, the length of such ropes depends upon the period for which they have been subject to load, a phenomenon known as "creep." For any VHF antenna it is a fundamental requirement that elements must have the correct spacing at all times when the antenna is in use. Nylon cords generally do not absorb water into the fiber, but some types will hold water by capillary absorption between the fibers. A 120 lb breaking strain fishing line made of "Ulstron" fiber has been found to have adequate mechanical properties. (It is New Zealand made, so may not be readily available in all areas. But parachute cords, deep-sea-fishing lines, and other high-strength nonporous cords should be equally suitable.)

Elements

With yagi antennas the directors may be all of the same length or of decreasing length with distance from the driven element. In the former case the optimum length for all director elements depends upon their total number. When there are more than 12 in number, the length of directors becomes less than 36 in. for a design frequency of 144.2 MHz. Aluminum welding rod of 1/8 in. diameter is supplied in 36 in. lengths and is a ready source of elements. The low-cost, lightweight and high-conductivity characteristics of aluminum make it an ideal material. For the driven element and reflector which are necessarily greater than 36 in. long at 2 meters, solid brass rod of 1/8 in. diameter has been used. It is available in long lengths from suppliers of nonferrous metals. The lengths and spacings of all elements for the 32-element sly beam are given in Table I.

Matching

Most of the usual forms of impedance matching should be satisfactory with the sly beam. I used a 300Ω delta match at the driven element and a length of 300Ω

All directors - cut from 1/8 in. diameter aluminum welding rod.

Driven Element and Reflector - cut from 1/8 in. diameter brass rod.

Spacing of Fiber Cords - 14 in.

Design Frequency - 144.2 MHz

Element Director	Length, in.	Spacing from Preceding Element	Spacing from Driven Element (in.)
1	35.2	6.6	6.6
2	35.2	7.4	14.0
3	35.2	7.4	21.4
4	35.2	16.4	37.8
5	35.2	31.9	69.7
6	35.2	31.9	101.6
7	35.2	31.9	133.5
8	35.2	31.9	165.4
9	35.2	31.9	197.3
10	35.2	31.9	229.2
11	35.2	31.9	261.1
12	35.2	31.9	293.0
13	35.2	31.9	324.9
14	35.2	31.9	356.8
15	35.2	31.9	388.7
16	35.2	31.9	420.6
17	35.2	31.9	452.5
18	35.2	31.9	484.4
19	35.2	31.9	516.3
20	35.2	31.9	548.2
21	35.2	31.9	580.1
22	35.2	31.9	612.0
23	35.2	31.9	643.9
24	35.2	31.9	675.8
25	35.2	31.9	707.7
26	35.2	31.9	739.6
27	35.2	31.9	771.5
28	35.2	31.9	803.4
29	35.2	31.9	835.3
30	35.2	31.9	867.2
Driven Element	38.4		
Reflector	43.0	12.3 20.5	

Note: The reflector spacing has a slight effect on the radiation resistance of the driven element.

If maximum front-to-back ratio is required the length of the reflector should be adjusted while making actual measurement.

Table I. Dimensions and spacing for 32-element sly beam.

slotted, balanced TV feeder to a fully adjustable balun at the transceiver. To some, this system may seem a bit crude but it does contribute to the overall simplicity of the antenna. Results using the delta match are very satisfactory and checks made with an impedance bridge confirm that a good match is obtained at the driven element. When using balanced line it is necessary to keep the line taut, otherwise some fluctuations in forward and reflected power may occur with movements of the feeder. Details of the delta match are given in Diagram 1.

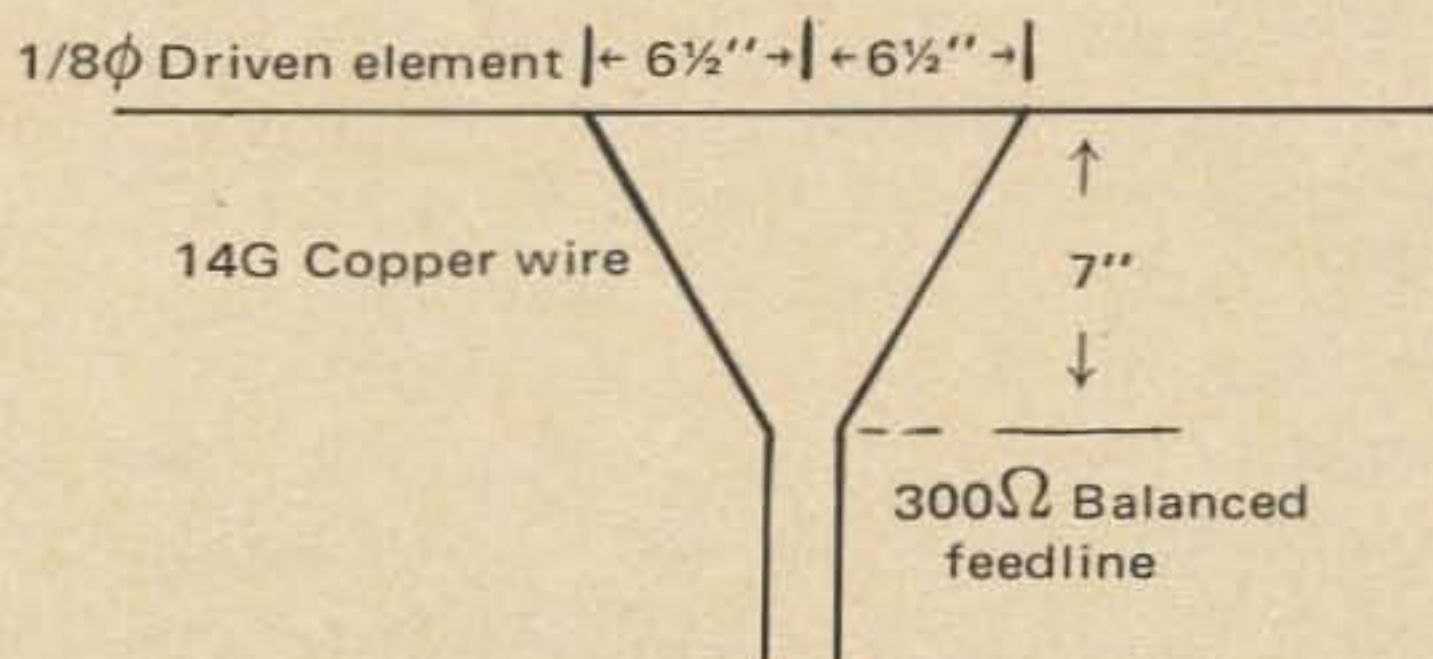

Diagram 1. Details of delta matching for 300Ω balanced feedline.

Fabrication

Even with the best artificial fiber cords available a small amount of creep inevitably occurs. A standard technique to minimize this is to prestretch the cords for 24 hours at about 90% of the breaking load. This is well worthwhile as about 80% of the ultimate creep will occur within the first few hours of loading, leaving only a small percentage to occur while the material is in service. The prestretching is conveniently done by placing two of the cords in parallel ready for the elements to be fixed and then tensioning between anchors as prescribed.

As an additional safeguard against creep it is recommended that when the sly beam is not in use the tension on its supporting cords be reduced to less than 50% of the working load. In practice, this is easy to do and only requires that the supporting cords pass through a pulley at the mast head and down to some convenient point from which adjustments can be made.

Two light wooden spacers about 15 in. long are used to maintain the cords at the correct spacing. These can be fixed to the fiber cords by passing the cords through small holes drilled near the ends of the spacers and then knotting the cords about the spacers.

It should be noted that the supporting cords are slightly elastic so that the spacing of the elements depends upon the tension applied. Also the sag of the array and susceptibility to lateral displacement in high winds is affected by the tension in the cords. It has been found that a total of 80–100 lb of tension in the antenna is satisfactory for a system employing two cords each of 120 lb breaking strain.

The elements should be cut to size and fitted to the supporting cords while they are subject to the intended working tension. Many methods of attaching the elements to the supporting cords are possible. However, wire ties should be avoided because of the risk of producing noise in the receiver due to the interaction of the unbonded metals. The simplest approach is to tie the elements firmly in

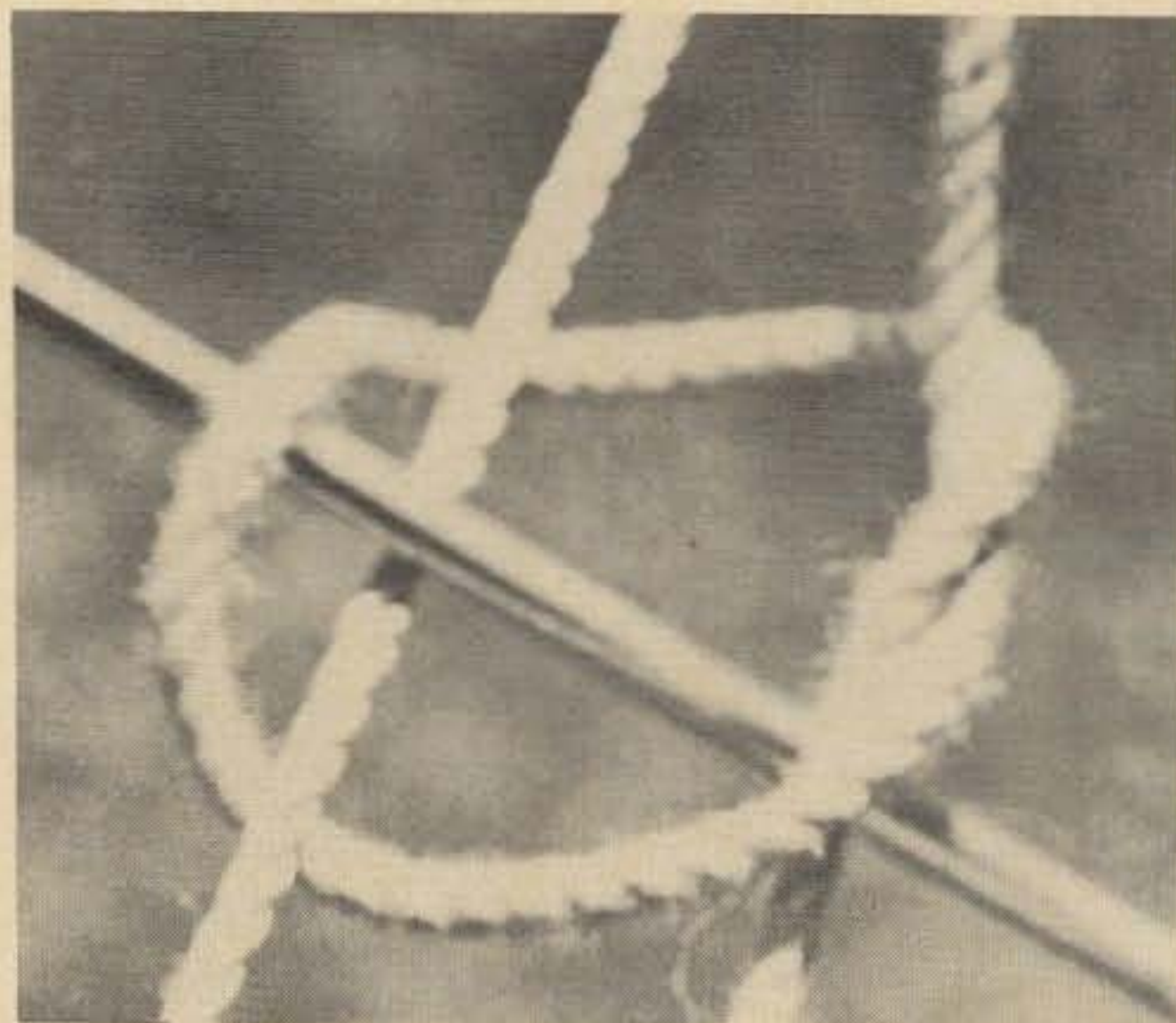

Fig. 2. Knot used to fix elements to suspension cords.

place with a piece of cotton fishing line as shown in Fig. 2.

It is useful to arrange the knots so that they can be slid along the fiber supporting cords. The first step then is to tie all the elements in place and then working from one end slide each element into its exact position. A measuring stick with the leading dimensions marked on it simplifies this procedure. Knots are then trimmed and a drop of glue or varnish applied to hold them.

Masts

Two supporting points are required, one at each end of the array, and each of these must be capable of taking up to 100 lb of sideways loading. This sounds difficult but in practice is not really so. Use can be made of trees, chimneys and other natural objects although care is necessary to insure that the antenna's performance is not affected by objects within its effective aperture. If a tree is employed some arrangement is necessary to compensate for sway; otherwise the element spacing will vary. One solution is to use a pulley at the treetop and a counterweight which may rise and fall in a setup similar to that used for low-frequency longwire antennas. Even if two masts are required the cost need not be excessive. I used masts of 1½ in. galvanized pipe with three guy wires at every 10 ft of height. The guys used are

Improve your CW sending!

NEW AMECO CW MONITOR & CODE PRACTICE OSCILLATOR

- Monitors Transmitter's CW
- Transistorized
- Kit or Wired
- Built-in Speaker
- Low Cost

The Model OCM is a combination Code Practice Oscillator and CW Monitor. It monitors your CW sending with a simple (no modification) connection to the keying terminals transmitter. It may be used with any transmitter or transceiver employing negative bias keying. A tone control, as well as volume control, and head phone jack are included on the front panel. Built-in back-to-back diode switching makes it unnecessary to turn the unit on and off, even when switching from CW to Phone. Current drain only takes place when the key is actually depressed. The model OCM contains one transistor and two diodes. Size: 6" x 3" x 2"



Model OCMW (Wired & Tested) (less batteries)

Model OCMK (Kit form) (less batteries)



Leader in Compact, Quality Ham Gear

P.O. BOX 6527, RALEIGH, NORTH CAROLINA 27608

A Division of Aerotron, Inc.

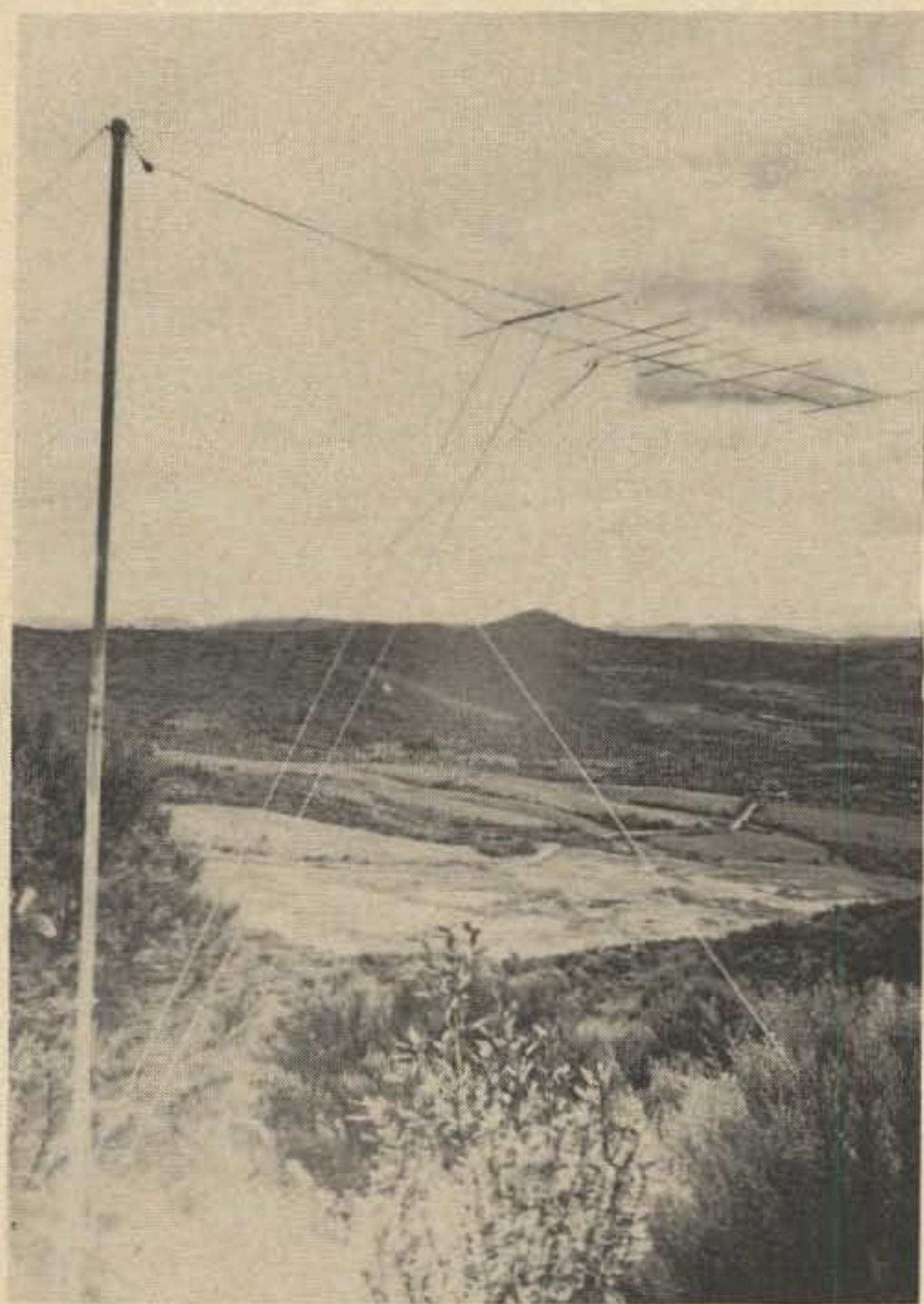

Fig. 3. The launching end of the "sly" beam.

10-gage fence wire, each fitted with a wire strainer for easy tensioning. With this arrangement there is no difficulty in obtaining the necessary 100 lb lateral load ability at 40 ft above ground, provided the guy anchors are firmly set.

Polarization

With the arrangement shown in Fig. 1 the two fiber cords are brought together to form a single cord at each end of the antenna. Generally the weight of the feeder is sufficient to keep the elements horizontal but in windy conditions the antenna may rotate, thus altering the plane of polarization. A simple solution is shown in Fig. 3. Two light cords are attached to the wooden spacer at the reflector element to maintain the desired plane of polarization of the array. A change from horizontal to vertical polarization or vice versa can be effected in a few moments by altering the relative positions of the two stabilizing cords thus rotating the array about its long axis.

Bandwidth

Generally speaking, the bandwidth of a yagi antenna is inversely proportional to the gain; for a 21 dB yagi, peak performance can only be expected over a narrow portion of the band. As normally defined, the bandwidth of the 32-element sly beam is probably about 0.5 MHz at 2 meters. Outside this range a noticeable drop in performance is expected. However, the sly beam has an unusual feature not found in conventional antennas: The supporting cords are quite elastic and by altering the tension on the beam it is possible to alter the spacing between adjacent elements. This *en masse* altering of element spacing tunes the array and has the effect of increasing the useful bandwidth of the antenna. It should be pointed out that to achieve maximum gain at a particular frequency the spacing between every element and the length of every element must be optimum.

Gain

Some authorities do not state performance figures for antenna arrays because of the uncertainties involved. However, I consider that an indication of the potential performance should be given so that different arrays may be tentatively compared. Provided the readers realize that many factors such as antenna height and multipath reflectors can markedly affect antenna performance, no serious disputes should arise.

The theoretical gain of the 32-element sly beam is close to 21 dB when compared with a dipole. Many weeks have been spent in attempting to verify this gain figure experimentally but a reliable and accurate figure has not been obtained. On-the-air comparative tests using a dipole and a 5-element yagi generally support the theoretical gain figure. The antennas used for comparisons were carefully checked for impedance matching and resonant frequency. Measurements were made with the aid of a reliable stepped alternator fitted between the converter and tunable i-f system. Tests were conducted from two sites under a variety of conditions with

stations up to 180 miles distant. The improvement obtained with the sly beam over the 5-element yagi on receiving tests was typically 2.5-units, or 12 dB.

On the long path between Dunedin and Wellington (370 miles) the sly beam has shown its superiority. On December 14 when Bill (ZL2CD) was in contact with Peter (ZL4LV) and ZL4TAH (me), Bill's signals were barely perceptible on a 5-element yagi at my Pigeon Flat DX site. On the 32-element yagi Bill's signals were easily readable.

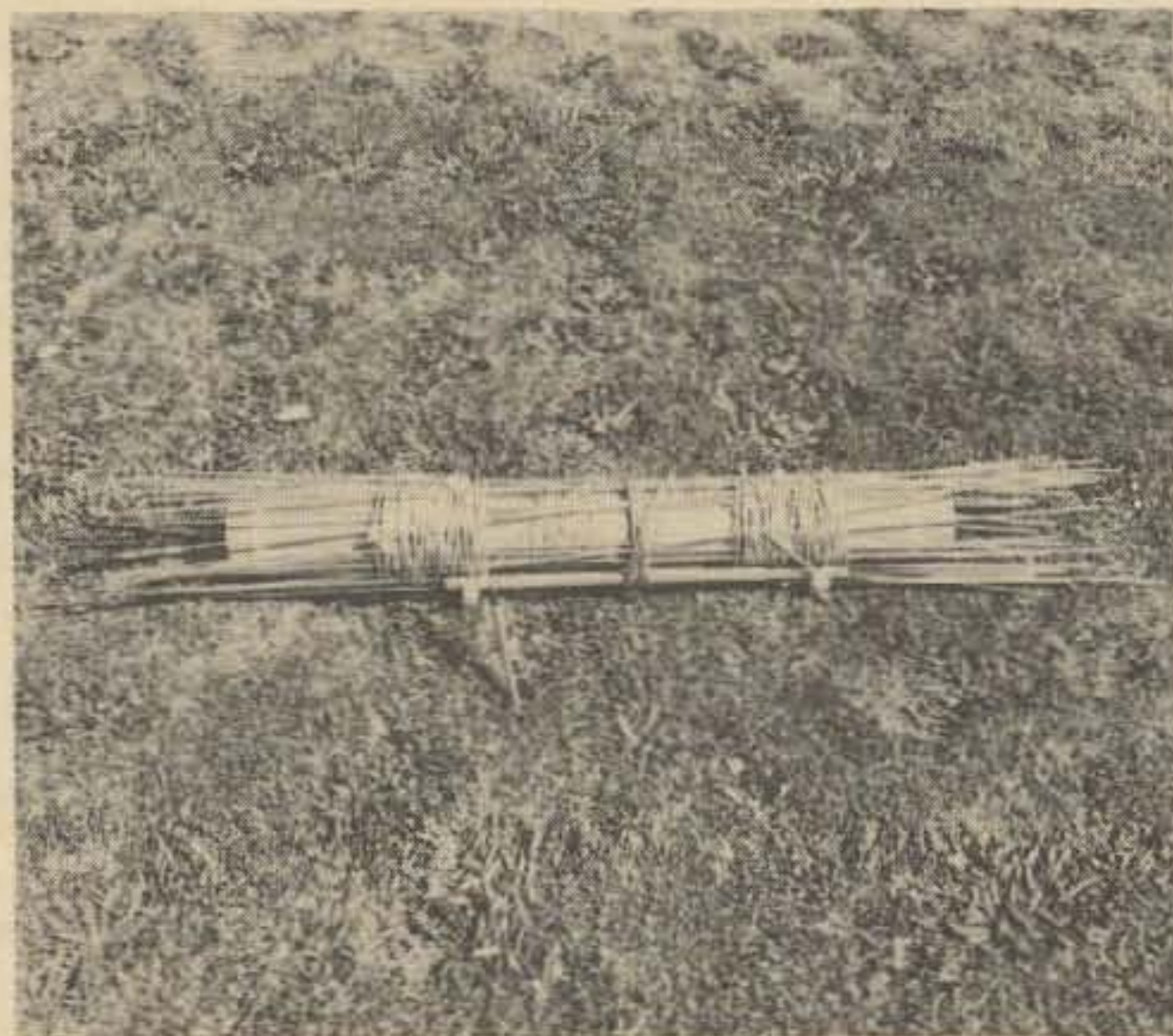

Fig. 4. A "sly" beam can be rolled on to a cardboard tube for transport.

Portable

Because the sly beam has no rigid boom, it can readily be rolled into a cardboard tube for transport to field day or DX sites. The total packed weight of the 32-element beam, excluding feedline, is about 2½ lb.

Usefulness

Obviously the sly beam is not intended for across-town contacts. With a simple antenna, such as a 5-element yagi, it should be possible to consistently work stations out to 100 miles or more, given average conditions and moderate transmitter power. If you cannot do this, fix your gear first or find yourself a good portable operating site, then think about building a sly beam.

For most DX purposes the fact that the array is fixed in direction may be of little importance. The 32-element beam described here has a beamwidth in the "E"



THE BIG SIGNAL

"W2AU" BALUN = \$12.95

**BIG SIGNALS DON'T JUST HAPPEN—
GIVE YOUR ANTENNA A BREAK**

Comes in 2 models. 1:1 matches 50 or 75 ohm unbalanced (coax line) to 50 or 75 ohm balanced load. 4:1 model matches 50 or 75 ohm unbalanced (coax line) to 200 or 300 ohm balanced load.

IT'S WHAT'S
INSIDE
THAT COUNTS!

AVAILABLE AT ALL LEADING DEALERS. IF NOT, ORDER DIRECT

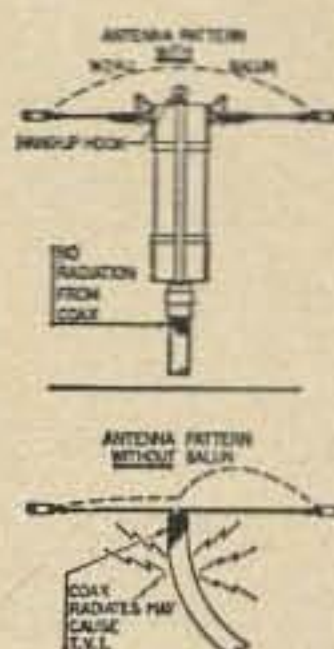

\$ FOR \$
YOUR BEST
BALUN BUY

1. **HANDLES FULL KW INPUT—THEN SOME** Broad Banded 3 to 40 Mc. 2. **HELPS TVI PROBLEMS** By Reducing Coax Line Radiation. 3. **NOW ALL STAINLESS STEEL HARDWARE.** SO239 Double Silver Plated. 4. **IMPROVES F/B RATIO** By Reducing Coax Line Pick Up. 5. **REPLACES CENTER INSULATOR.** Withstands Antenna Pull of Over 600 Lbs. 6. **BUILT-IN LIGHTNING ARRESTER.** Protects Balun—Could Also Save Your Valuable Gear. 7. **BUILT-IN HANG-UP HOOK.** Ideal For Inverted Vees, Multi-Band Antennas, Dipoles, Beam and Quads. 8. **SPECIAL SELECTED FERRITE.** Permits High Power Operation Without Breakdowns. 9. **FACTORY ADJUSTED LIGHTNING ARRESTER.** Bleeds Off Heavy Static Charges. Makes For Quieter Listening. **QUALITY WITHOUT COMPROMISE!**

UNADILLA RADIATION PRODUCTS MFRS. OF BALUNS & QUADS Dept. I **UNADILLA, N.Y. 13849**
Tel: 607-369-2985

plane of about 10° (at the half-power points). Thus at 200 miles the width of the main lobe is about 34 miles. My long yagi at Pigeon Flat near Dunedin has been carefully aligned so that the centerline of the main lobe passes close to Wanganui in the North Island. In the region of Wellington the main lobe (when it gets that far) would be 75 miles wide. Thus Christchurch, Wellington, and Auckland all lie close to the 10° solid angle enclosing the main lobe of the antenna on its present heading. In addition to the dispersion of a signal with distance, resulting from the diverging antenna beam, there is scatter due to topography and atmosphere. All this means that beyond 200 miles the area over which the transmitted signal will be heard and from which signals will be received is quite broad.

Future Development

Although the suspension system appears best suited to the yagi, it could readily be adapted for collinear or other types of array. Even with the yagi there is much scope for experimentation and development. An accurate measure of the gain of the sly beam and an assessment of the broadening of the bandwidth achieved by altering the tension of the suspension cords would be worthwhile projects.

A quick glance at Table I, which gives the length and spacing of elements, shows that apart from the reflector, the driven element, and the first four directors, the element length and spacing is constant. If a reflector, driven element, and set of launching directors were fitted to each end of the array, a switchable bidirectional antenna might result. This could prove handy for ZL2s who could then beam north or south simply by feeding the array at one end or the other.

Conclusion

The sly beam is an exceptionally high performance antenna which can be constructed in a single afternoon from all new materials for less than \$10 (excluding feeder and masts). No special tools or fabrication techniques are required and anyone who can tie a knot could construct one. Unusual features of the suspended beam are its ability to be tuned by varying the tension on the supporting cords, its high gain resulting from its length, and its portable nature. It is best suited to fixed-direction communication beyond 100 miles and should make possible some rare DX communication on 2 meters and perhaps even a record-breaking contact between a first and fourth district station.

... ZL4TAH ■

THREE UNRELATED ARTICLES, EACH WITH A NEW IDEA FOR GETTING MORE SERVICE AND PLEASURE FROM YOUR RIG.

Installing the Swan 250-C Noise Silencer

Measuring RF Output

Useful Cable Clamps

by Paul Schuett WA6CPP
14472 Davis Road
Lodi CA 95240

Installing the Swan 250-C Noise Silencer

Installing the noise silencer in the Swan 250-C can be a problem if it is done according to the factory directions. Their way requires the noise silencer to be disassembled every time the transceiver's top is removed. They're probably hoping that the purchaser will never have to open the top — except every couple of years or so to change a tube — however, this is not necessarily the case.



Inside view of 250-C showing the two bolts to mount the noise silencer (the other one is just right of the electrolytic).

I installed the silencer on the back of the unit. There was already one hole drilled there; careful planning will enable you to place another hole at a critical spot for two-point mounting.

Be careful not to mount the silencer snugly against the transceiver or the top won't fit on. An extra nut on each screw will act as a spacer providing the necessary clearance.

There is all sorts of wire left over which could probably be cut off. I just wound it up in a circle so as not to be bothered soldering connectors. Be sure to remove the jumper wire inside the transceiver between the IN and OUT jacks.

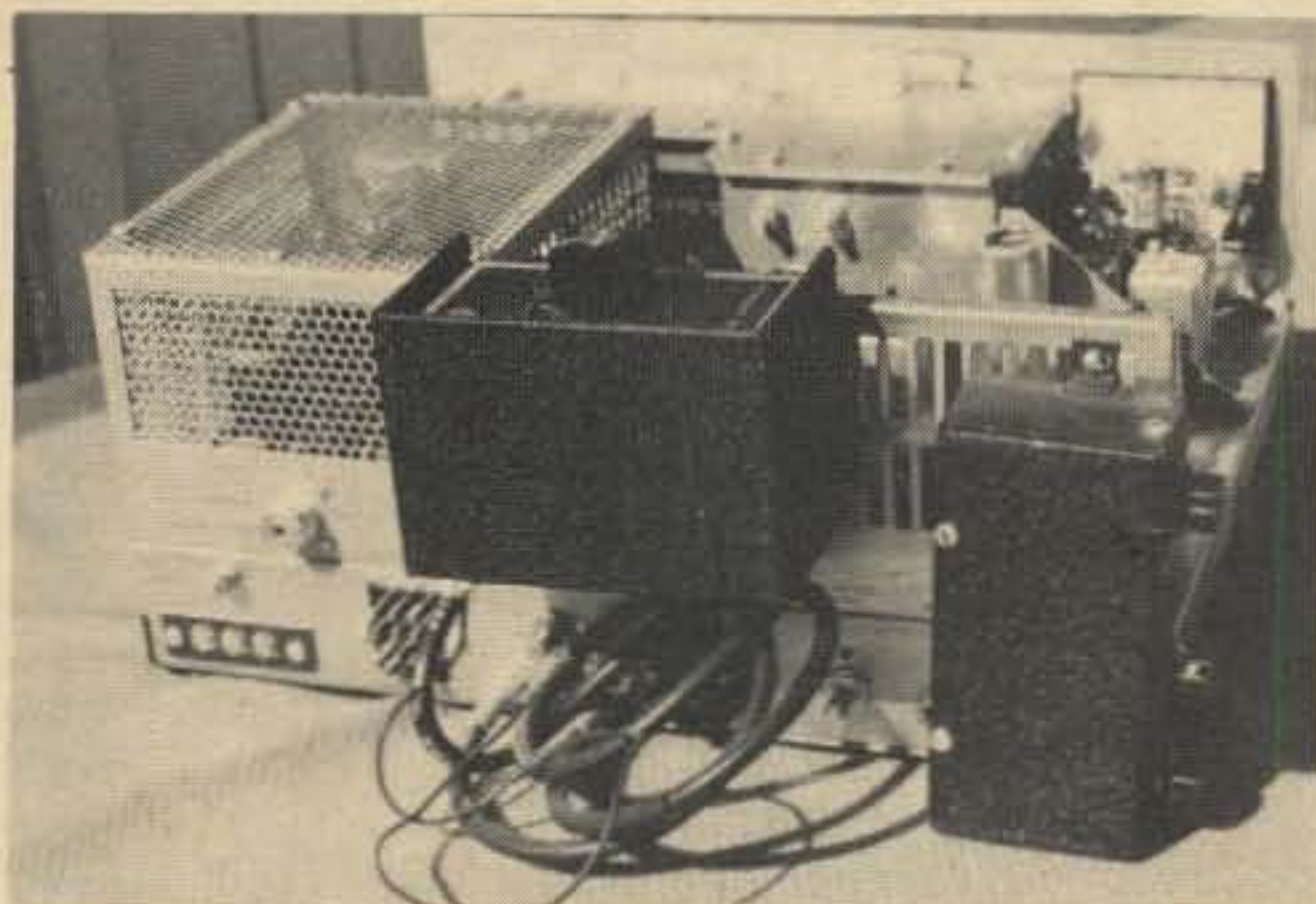

Back of unit after mounting silencer.

This silencer works quite well on silencing ignition-type interference that seems to be the curse of all 6 meter operation, but is ineffective against the "solar noise" that comes and goes.

Installing the noise silencer on the back of the unit makes it convenient to remove the top for service, does not distract from the appearance of the equipment; and it is no great problem to reach back there to turn on and off if you remember to keep the knob up.



Front view of completed project. Be sure to line top of silencer with top of transceiver.

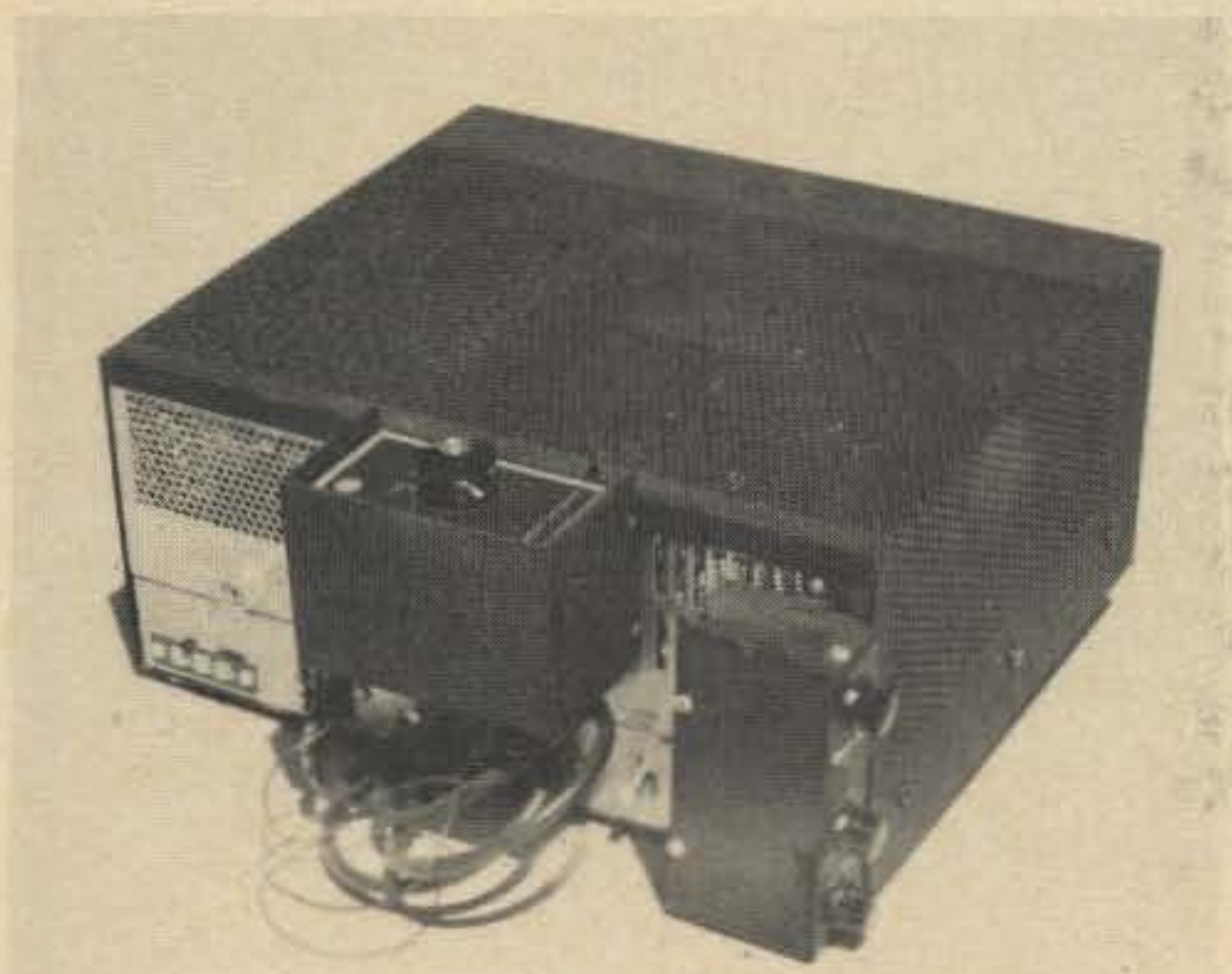

Back of unit after completing work. Wires probably could be shortened.

This silencer is also sensitive to any stray rf that the antenna picks up. There are three other 6 meter men within six miles of my home — this device will detect the rf and send it to the speaker whenever they operate, even if (especially if) I'm not tuned to the same frequency. The other day a police car drove by with the radio in operation, somewhere between 40 and 50 MHz, and it picked that up. The Swan factory advised me there was no way to eliminate that problem — inherent in the FETs.

So your new Bandjammer 5000-Q is rated at 752W peak power. Big deal. How much of this is getting out where it counts?

It's easy to find out by inserting an rf ammeter in series with the line. A more exact reading would be to have the rf ammeter at the antenna input terminals, but that might be impractical when it comes to reading the meter (although you could put a diode there and a remote-reading meter in the shack).

Recently I found an rf ammeter at one of the mail-order surplus houses for \$2.95. I installed this in a little cabinet, put two coax connectors on the back (in and out) and now can read rf current in the line, into the dummy antenna, or wherever it is going.

Measuring RF Output



Inside wiring is extremely simple. Note ground wire installed to insure continuity of the shield circuit.

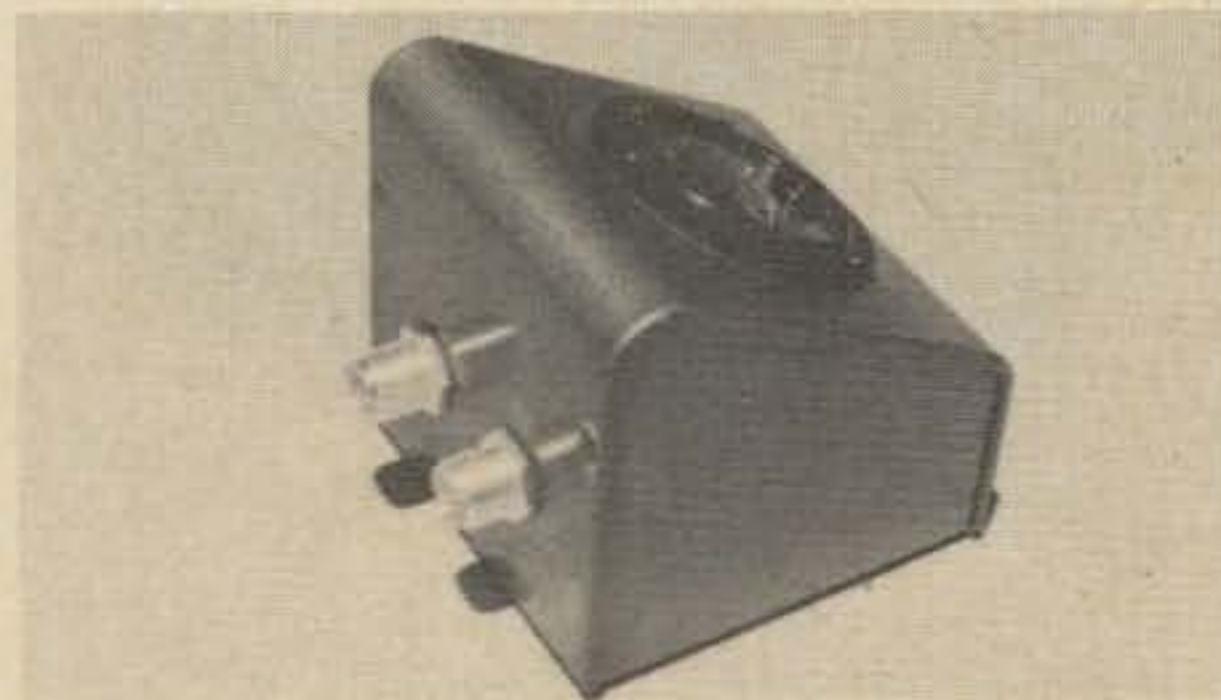

The completed instrument showing the coax connectors on the rear.

Remember the formula $P=I^2 R$? Square the reading on the meter, multiply by the impedance of the line you're using, and you have the power past that point. At the antenna, you could determine the antenna resistance and take the current reading at that point.

When tuning up the rig, place the ammeter on the antenna side of any tuning or matching devices and tune for maximum current.

It's amazing to learn how much (or how little) current these rigs produce. For instance, my Swan 250-C puts 1.35A into a 50Ω line. My friend's SB101 from Heathkit put out 0.7A until we worked on the antenna — then it put out about 1.25A. My Heathkit SB401 puts anywhere from 2 to 0.6A into a 50Ω Antenna, depending on what band it's on.

Commercial stations determine their power by the antenna current. Knowing the antenna resistance at the operating frequency, they multiply that by the current squared. If the antenna resistance is $62\frac{1}{2}\Omega$, 4A rf would be 1 kW into the antenna. 126.48A would be 1 MW.

Remember the ammeter does insert a little reactance in the line (I never leave it in all the time), and the calibration changes with frequency, although you can tell what side of the ballpark you are on. An rf ammeter in the shack makes a nice piece of test equipment.

Useful Cable Clamps

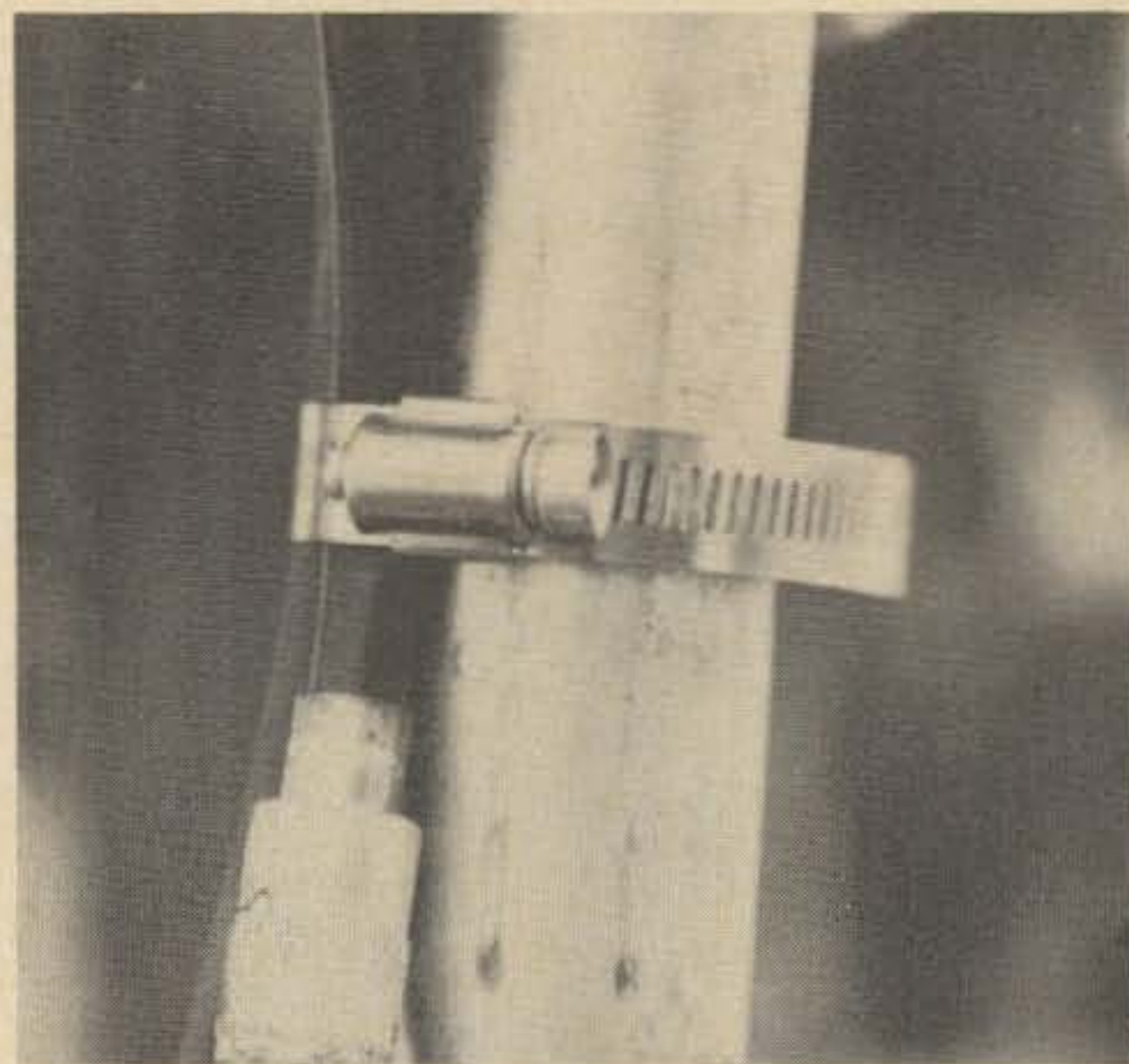

Radiator hose clamp used for coax-to-mast application at WA6CPP.

After using plastic tape to hold coax to mast, and after having a big mess trying to undo the tape, I came up with the idea of using automotive radiator hose clamps to hold the coax to the mast.

These clamps are available at almost any automotive supply outlet or discount store, come in a number of sizes, and are relatively inexpensive.

Several coax lines can be held with one clamp.

The worm gear does not loosen in time and holds the coax securely. Be careful not to tighten down too far, however, as it could cause a problem in the future. Just "ease down" until the cable is snug.

WA6CPP ■

1/4 TOP-LOADED MOBILE ANTENNA

...an efficient short 1/4 wave twenty meter dipole

Henry W. Strege W5AZE

Increasing the efficiency of a mobile antenna has always been a worthwhile project to me, especially so, after reading the first paragraph of the article, *The W8 High-RF Short Beam*, by David L. Walsh W8HRF, in the Feb. 1969 QST. This paragraph shows how a short dipole can be made more efficient by end-loading with a coil and capacitive hat: The radiation resistance is increased while the coil losses are decreased. An illustration on page 496 of the 1969 ARRL Radio Amateur's Handbook shows why more power is radiated with this type of antenna. Note the ground-loss resistance is given as 10Ω or more in the above reference. The W8HRF article applies to a $\frac{1}{2}\lambda$ dipole. I decided to try this idea with a $\frac{1}{4}\lambda$ 20 meter mobile antenna, which is 7 ft 4 in. (including the antenna mount on the car).

Comparison

My commercial antenna has a continuously variable coil, adjustable from 3.8 MHz to 29.0 MHz. Both antennas were adjusted for resonance at 14.235 MHz. Reports from different parts of the country, including one from the Hawaiian islands, indicated that the top-loaded antenna is one S-unit better than my commercial antenna. This difference was

obtained by checking each mobile antenna with the trap vertical on the house, switching quickly from one to the other, to avoid fading effects. The two mobile antennas were interchanged on the car near the house, fed through 75 ft of coax cable from the base station. The commercial antenna was down two S-units while the top-loaded antenna was down only one S-unit from that of the house antenna. The transmitter PA current changed only 7% when switching antennas, which would not significantly affect the results. This 6 dB gain should be equivalent to increasing the transmitter output by a factor of about 4. This is a cheap and easy way to increase power output as well as receiving ability.

The top-loaded antenna is a little top-heavy and needs guy cords or light ropes to keep it from leaning back or swaying out from the car. I used two nylon cords, anchored at the coat hooks above each rear window, passing through the top of each window to the bottom of the coil. At speeds of over 60 mph a low howl can be heard; however, a person usually slows down when using the mobile rig.

Input Impedance

To find out how much the radiation resistance was increased, an rf bridge was

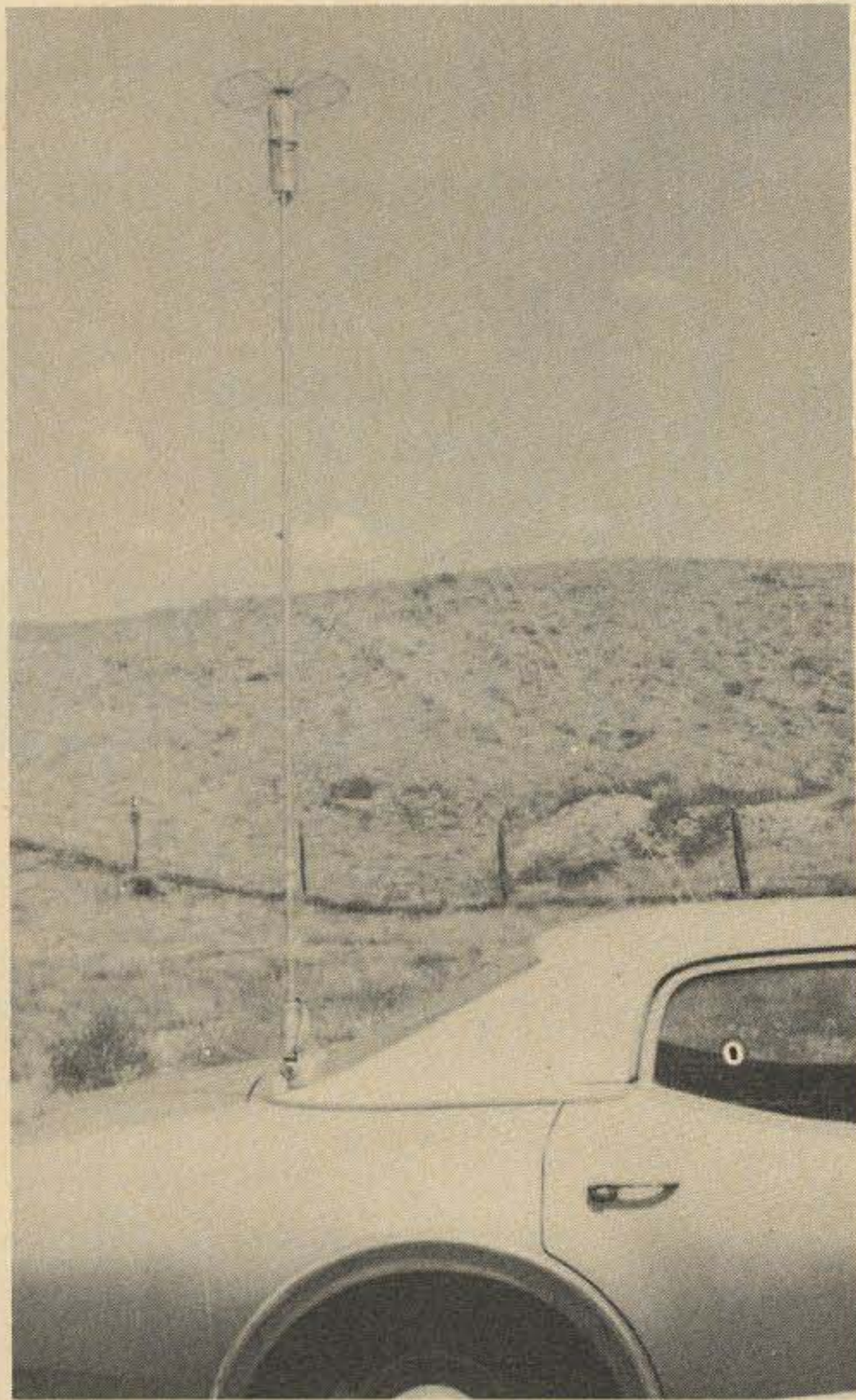

constructed similar to the one described in the article, *How to Hang a Dipole*, by James Ashe W2DXH, in 73, May 1968. The input impedance of the commercial antenna was measured as 30Ω and that of the top-loaded was 42Ω ; both antennas resonated at 14.3 MHz. This would indicate a 12Ω increase in radiation resistance, as the ground-loss resistance would not change appreciably for the two measurements. The coax feedline was disconnected from the antenna, and the rf bridge connections were made as short as possible — in my case, 3 in.

Construction

The construction of this antenna is similar to that used in the W8HRF article except I used only half the driven element. I used a 12 in. capacitive hat from a previous project, with 16 spokes made of 12-gage hard-drawn enameled wire. With the total length of the $\frac{1}{4}\lambda$ dipole, the required coil was made with 25 turns of 9-gage aluminum clothesline wire (2½ in. outside diameter and 8 in. long). I made this dipole in two sections so that it could

be dismantled and carried in the trunk of the car. I used ½ in. aluminum tubing for the bottom half and a slightly smaller tubing that would slide inside for the top half.

One of the two sections was made 3 in. longer to allow for telescoping. For the insulating section I used a 5/8 in. wood dowel trimmed at the ends so it would make a tight fit 1 in. into the top half of the dipole and into a 1 in. piece of ½ in. long tubing. Two opposing sections were cut off and the other two sections were bent in at right angles, one over the other. In the center of this bent-over section, a hole was drilled and tapped for a 10-32 bolt. A 1 in. long bolt was inserted and threaded through from the open end of the tubing before being fitted over the wood dowel.

It is advisable to secure the dowel inserts in the tubing with small bolts or screws.

Before mounting the coil the wooden insulating section should be given one or two coats of shellac and after thoroughly drying, one coat of marine spar varnish should be applied. This should keep the moisture out for a long time. One end of the coil was formed into a small loop to take the 10-32 bolt; the other end was straightened out to lie parallel to the aluminum tubing.

The loop end of the coil and the capacitive hat were put on the 10-32 bolt at the end of the insulating section and fastened with lockwasher and nut. The insulating section should be centered in the coil. The other end of the coil was fastened to the aluminum tubing with a small stainless steel automotive hose clamp, available at most car repair or filling stations.

Four equally spaced slits, about 2 in. long, were cut at one end of the bottom tubing section, the one with the largest diameter. The two sections of tubing were then telescoped together for about 3 in. and clamped with another stainless steel hose clamp. The junction was marked so that it can be assembled again to the same length.

This type of construction allows the antenna to be taken apart and carried in

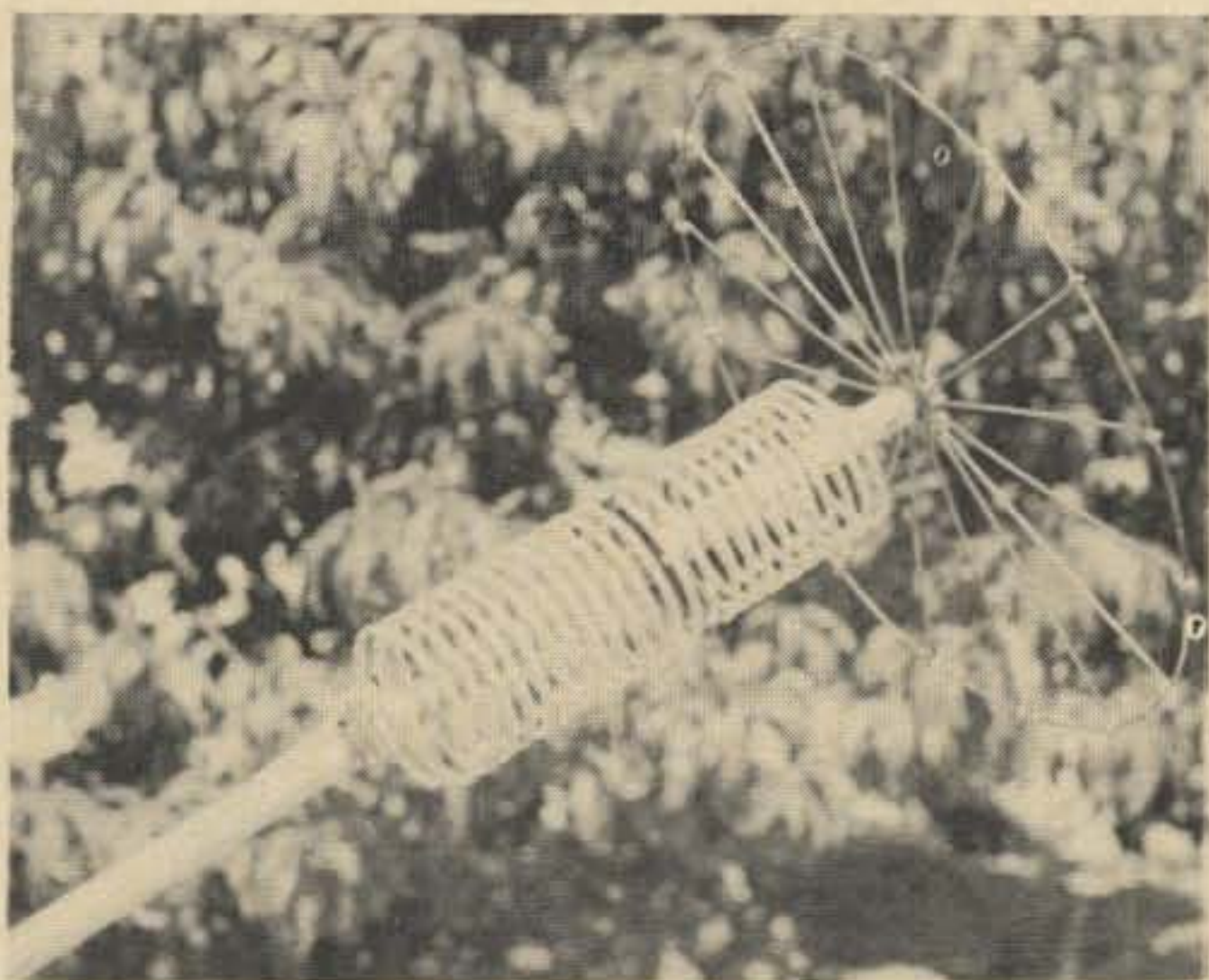

the trunk of the car when not in use. The bottom of the antenna was fitted with a bolt which would fasten onto the antenna mount on the car. The center of the coil should be supported as suggested in the W8HRF article. I used two small Bakelite strips fastened with small wood screws to the center insulating section. I tied the coil wire to the Bakelite strips with fishing line through small holes drilled near the ends of the strips and covered them with coil dope.

Adjustment

With the antenna fastened to the antenna mount on the car and the feedline disconnected, a small half-turn link was connected between the bottom of the antenna and one of the mounting bolts on the car body. A grid-dip meter was used to check antenna resonance. The coil was adjusted by moving the hose clamp, at the bottom of the coil to spread or compress the coil until the grid-dip meter showed resonance at the chosen frequency. With the meter left in the dip position, the frequency should be checked on the station receiver for a more accurate reading.

I found a small change in the position of the hose clamp gave a large frequency change. I bent the end turns a little for the fine adjustment after making the coarse adjustment with the hose clamp. Other adjustment procedures using an SWR bridge or a field strength meter can be used to tune the antenna to resonance. The SWR reading changed very little when the frequency was changed from 14.2 to 14.3 MHz.

... W5AZE ■

DUAL GATE MOSFET PRE-AMPS



to 175 MHz. \$21.95 ppd.
to 300 MHz. \$25.95 ppd.

NEW FOR 1970!

The above models now have rf gain control.

For 300 to 470 MHz

See Model 202 in our catalog.

- Available from 5 MHz. to 450 MHz. Bandwidth is approximately 3% of frequency.
- Voltage gain 30 to 40 DB depending on frequency.
- Two Dual Gate MOSFET amplifier stages with each having a tuned input and tuned output. Each Dual Gate MOSFET is actually an integrated cascode circuit thus giving you 2 cascode circuits equivalent to 4 triodes.
- Exceptionally low noise (2.5 DB at 175MHz.), greatly reduced cross modulation and 10 times the dynamic range (signal handling capability) of the best bi-polar transistors. Also superior to preamps using junction FETs and Single Gate MOSFETs.
- Internal connections for high impedance AGC or manual gain control if needed.
- Type BNC input and output receptacles for minimum loss at UHF. Standard impedance is 50-75 ohms.
- Carefully tuned at our laboratory with sweep generator and oscilloscope for the best bandpass characteristic.
- Full wave UHF diodes protect input transistor.
- Operates on 6 to 16 volts DC, 5 to 15 Ma.

New York City and State residents add local sales tax.

VANGUARD LABS

Dept. H

196-23 Jamaica Ave., Hollis, NY 11423

... for the Ham

GREAT "MINI MAST" NEW

Self Supporting Crank-up Masts

High strength tubing — 6 square feet of antenna with adequate margin of safety in 50 mph winds — easy 2 step installation.

Available with the
Exclusive new Rotor Base Accessory

Installation details, other models
and accessories available

TRISTAO TOWER CO.

Box 115 Hanford CA 93230

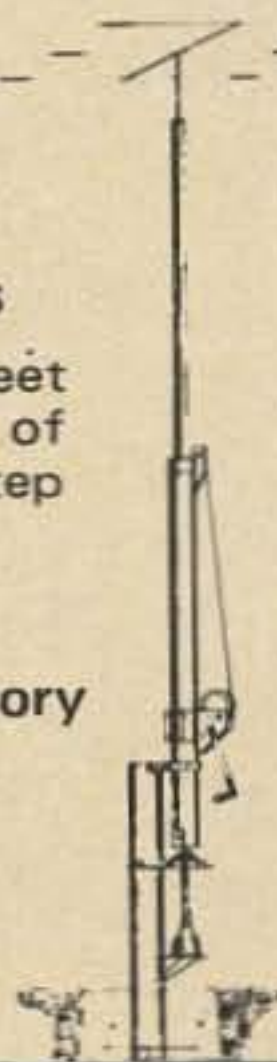



11 ELEMENT 2 METER CIRCULAR QUAD

Ralph W. Campbell W4KAE
216 Mariemont Drive
Lexington KY 40505

The 11-element version of the long circular quad is designed for operation on 144 MHz up to about 146 MHz. Measured horizontal forward gain showed 15 dB gain over a dipole. Front-to-back was 21 dB for the horizontal pattern ratio (and not the vertical directivity of that pattern); and I measured 9 dB over a dipole for the vertical forward gain, and 12 dB vertical front-to-back. Measurements were made on the linear scale of the SX-122 S-meter that was modified for elimination of contact-potential bias effects, and with increased control of i-f amplifier cathode current (meter electrical zero). By using a Parks Electronics' Lab Converter plus a JFET preamplifier, linearizing of the S-meter scale on the low end was obtained. These measurements are repeatable. An International Crystal secondary frequency standard provided the transmitting signal source on exactly 144.00 MHz, from a seventh-overtone crystal. The transmitting antenna was a simple $\frac{1}{4}\lambda$ groundplane that could be turned vertical or allowed to radiate horizontally, depending on the relative position of its case. The 11-element long circular quad was operated as a

receiving array for these tests. Antenna height was 70 ft above flat ground, thereby eliminating ground reflections.

Theory of the 11-Element Circular Quad

Initial measurements — made by an organization having ties with Project Oscar — showed 18 dB gain over isotropic (not over a dipole), since the pattern was obtained while my antenna was *transmitting* on 1000 MHz to a reference antenna receiving the signal. I am very grateful to those who made the tests possible; however, there is one point that should be cleared up: There is vertical polarization in the major lobe, which means some circular is generated. Repeatable tests have shown — on this 2 meter model — that with 11 circular group-phased elements there's 9 dB/dipole forward gain on 2 meters; and 12 dB/dipole front-to-back for the vertical pattern! According to W0HTH, some circular polarization is always present in most common antennas. If you try to test your own antenna, remember that the structure under test cannot be operated in the transmit mode for reliable readings. Grouping the elements as shown in the photographs boosted horizontal receiving-mode gain by as much as 5 "real" dB on the 18-element structure. At present, the gain of an 11-element circular quad is 15 dB/dipole, with an estimation of 18 dB/dipole possible with 18 properly phased (*not* like a yagi) elements.

Screen size is also a factor in reconciling gain expected with actual measurements. As you increase forward gain, front-to-back tends to decrease, with any major improvement in the forward lobe. This doesn't hold for yagi arrays, for example, since adding extra elements to make it "long" reduces the overall efficiency to such an extent that a slight increase in forward gain is the only effect. And, by adding even more elements, considerable power is dissipated as element "heat" if we could measure it! This is where I stopped further research and developed "driven" parasitic director groups. Getting back to screen size, you can expect an increase of 2 dB by increasing screen size from 4 to 8 ft



Fig. 1. This photo shows the completed 11-element 2 meter circular quad. Screen size is only 4 ft, and found to be inadequate, unless it could be increased to 200 inches. An 8 ft diameter screen reflector would have cost \$48 for materials alone! Forget about "chicken wire" and you'd need a "cherry picker" for hardware cloth, because of the weight.



Fig. 2. Carl Day made 2½ round trips before final ground readings were taken as being acceptable.

diameter; however, I would expect front-to-back ratio to increase to only 24 dB. Hopefully, the horizontal forward gain would be 17 dB/dipole!

Construction

Figure 1 shows the completed 11-element 2 meter quad. The boom is made of thin-wall aluminum TV mast and is quite strong. The screen is a braced, two-part structure covered with half-inch Macklanburg-Duncan "expanded aluminum" mesh (chicken wire won't do!). The top set of guys is attached at the 60 ft level.

Figure 2 shows the antenna man's position at the 40 ft level; and the tower is back-lighted nicely against a darkened sky. This photo shows most clearly the connecting tower bolts and the aluminum *Foamflex* transmission line taped to it. Note especially the slipknot of rope around the first director in the first (common) group. You can see the element wiring if you look closely



Fig. 3. Seen here is one of those crucial moments when "you don't know if he can make it but you don't dare ask!" Since this was a success with a 4 ft screen, a later modification to include a driven, reverse-phased aluminum element certainly made the job easier.

Figure 3 shows perhaps the most hazardous or in-between position of the tower and 11-element quad. He made it!

(But I had some doubts because of guy wire breakage the day before.) The top of the gin pole is at 80 ft. I was on the ground pulling up on the line streaking down to the left. This shot is included in the article to show how a steeplejack or tower construction man can safely erect this antenna. Incidentally, boom length is 21 ft and screen diameter is 4 ft.



Fig. 4. The array is in position, with ropes gleaming in the sunlight. Use of a rugged gin pole is an essential.

Figure 4 is a dramatic one. With erection lines streaming in the wind Carl Day is tightening down the mast bolts prior to connecting the RG-8/U to the aluminum *Foamflex*. We used a Dill Tower TV tower for a rugged \$10-per-section mast. Rohn 1½ in. heavy galvanized mast is used to rotate and support the 11-element quad.

Figure 5, a closeup of the driven-element connections, reveals the screen-mesh structure. The round 9 in. flat plate is connected to the aluminum A-frame struts. The plate is made from M-D yellow brass. Plate-to-boom attachment is accomplished using right-angle shelf brackets which are thoroughly bolted to the boom with 3/16 galvanized roundhead machine screws. Rivets are used to hold the screen to the A-frame. From this position we can also see where the boom was electrically broken



BE SET FOR LIFE

and have 73 delivered to your door for as long as you live

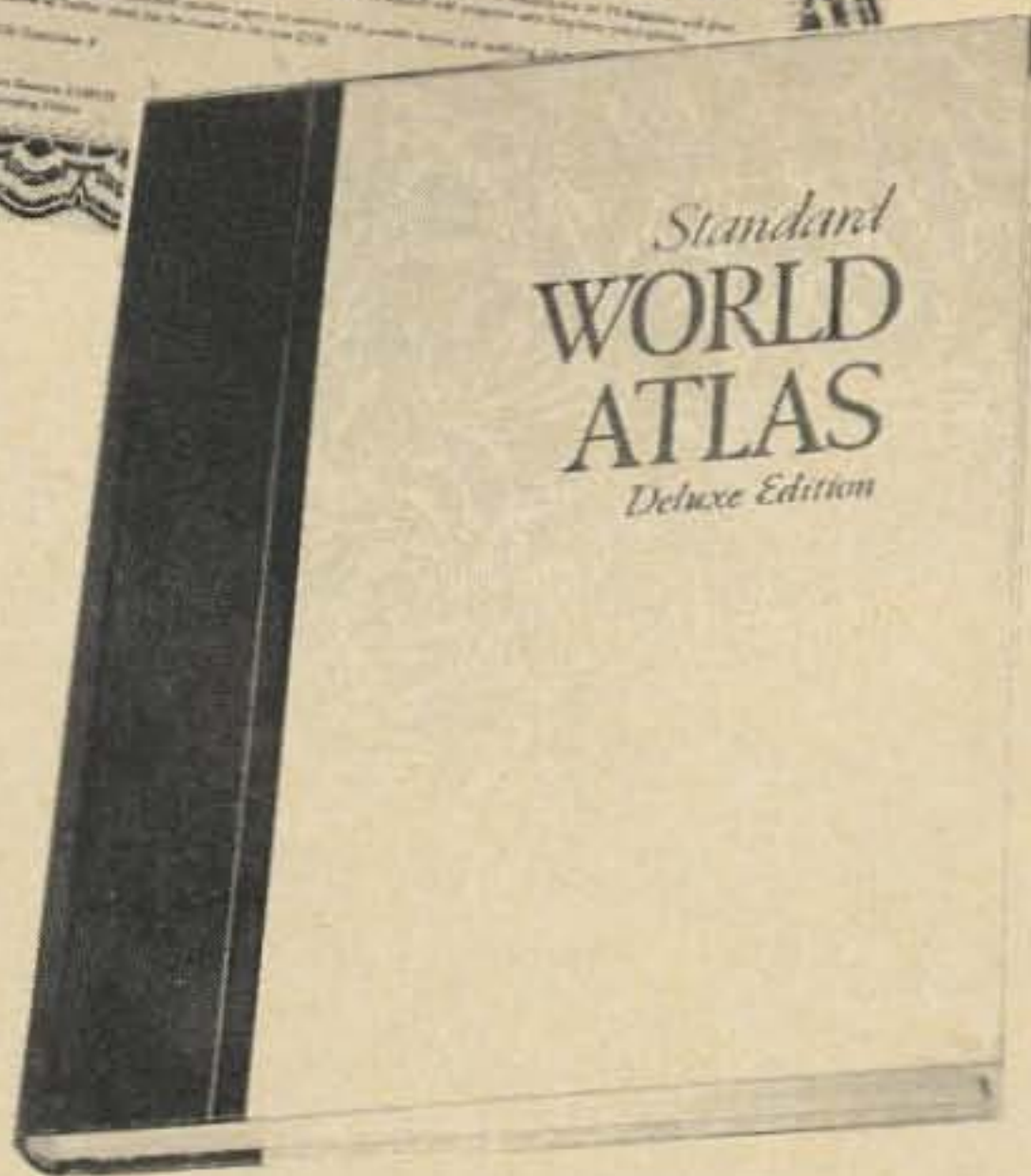

SPECIAL LIFER DEAL: \$10 down and \$8.80 per month for five months.

In addition to getting 73 for the rest of your life you will get a great big beautiful LIFE SUBSCRIBER Certificate for the shack wall.

The cover price has gone from 37¢ to \$1.00.

The yearly subscription rate went from \$3 to \$4 to \$5 to \$6.

The life rate is ONLY \$50 and will obviously have to go to \$75 soon.

If you send the full amount with your order, you will receive this beautiful Deluxe edition of the Hammond Standard World Atlas. (U.S. residents only, please.)

Yes! I want to be a 73 LIFER. Put my name in your "eternal" file and send me the LIFER certificate.

- I enclose \$10 and agree to pay \$8.80 each month for the next 5 months.
 I enclose \$50 cash. Don't forget to send my free Deluxe atlas (U.S. only).

Name _____ Call _____

Address _____

City/State _____ Zip _____

___ I am a stuntman

___ I am a test pilot

___ I am a bomb disposal man

___ Other

___ I already subscribe, and hereby extend till death us do part.

___ I am not already a subscriber

___ Other

Send to 73 Magazine, Peterborough, N. H. 03458

with an external nylon sleeve; this was to prevent irregularities in the antenna's pattern; however, it was not found to be completely necessary. Figure 5 also shows a *Cushcraft CL-116* collinear element block. These circular elements were bent in a local sheet-metal shop. Sufficient care must be used to prevent breaking the mounting block (especially when straightening an already mounted loop). Connections to the block are made with 200Ω *Federal Wire and Cable* transmitting twinlead. The other end of the twinlead goes to a *Sound & TV Systems* 4-to-1 ferrite-core VHF balun. The balun is wound on an IRN-9 core, available from *Permacor* Division of Radio Cores. I used 14-gage wire for the windings, insulated with shrinktubing on the inside. The wound core is next encapsulated with GE silicone rubber. The encapsulated balun is then housed in a large rubber *Muellar* boot and taped thoroughly. The vswr is unity at 144 MHz; it rises to about 1.5 to 1.0 at 146 MHz. The *Cushcraft* collinear elements need to be shortened 2 in. off each

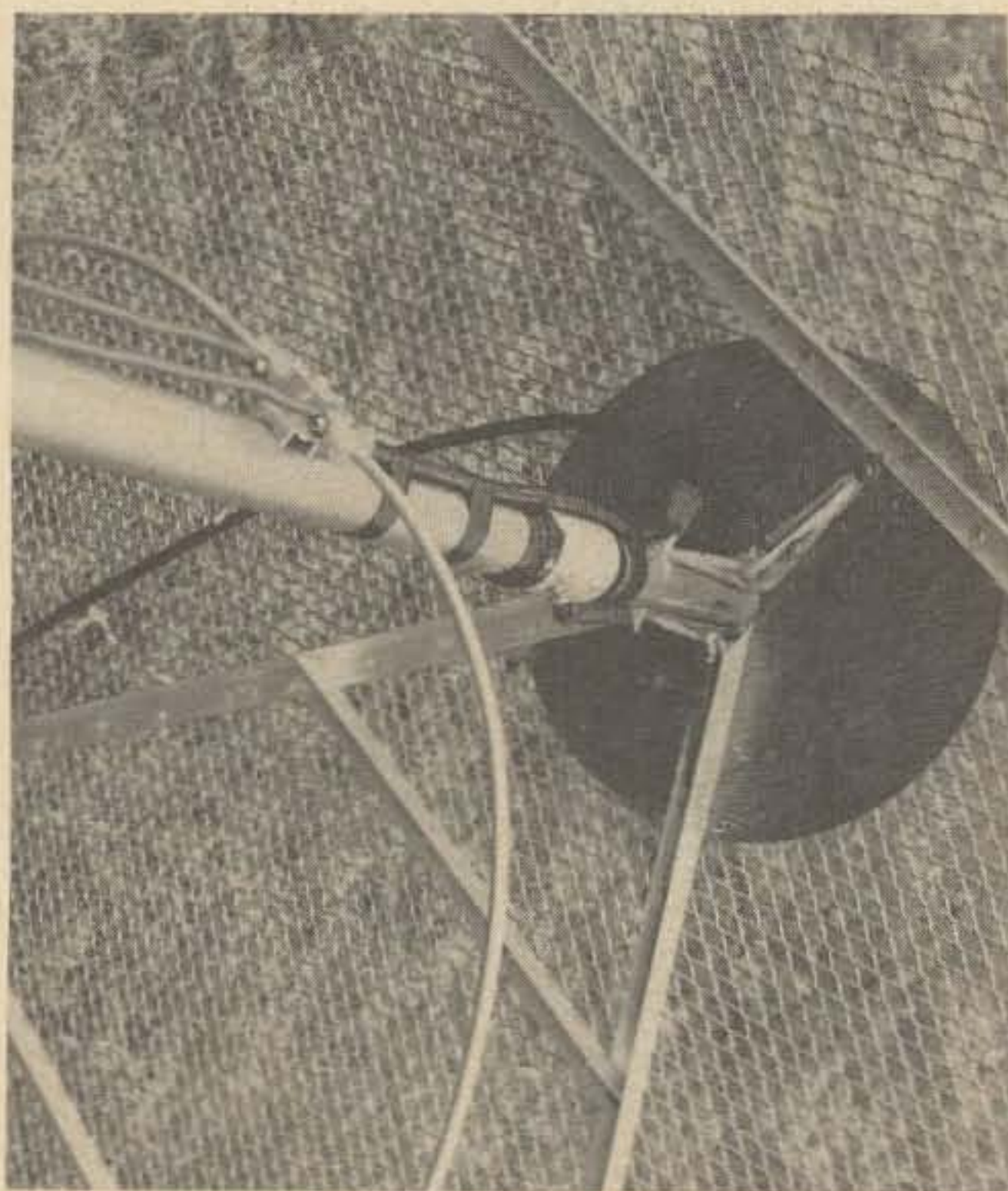

Fig. 5. In a later version of the same 11-element 2 meter circular quad, the screen reflector was cut off the hind portion of the boom, and an extension of the boom was made to allow the new reflector to have proper 19 in. spacing from the first driven element.

reflector half-loop plus an additional length for the distance from block terminal to block terminal. An inch off each *Cushcraft driven element* is all that is required for the 38 in. elements.

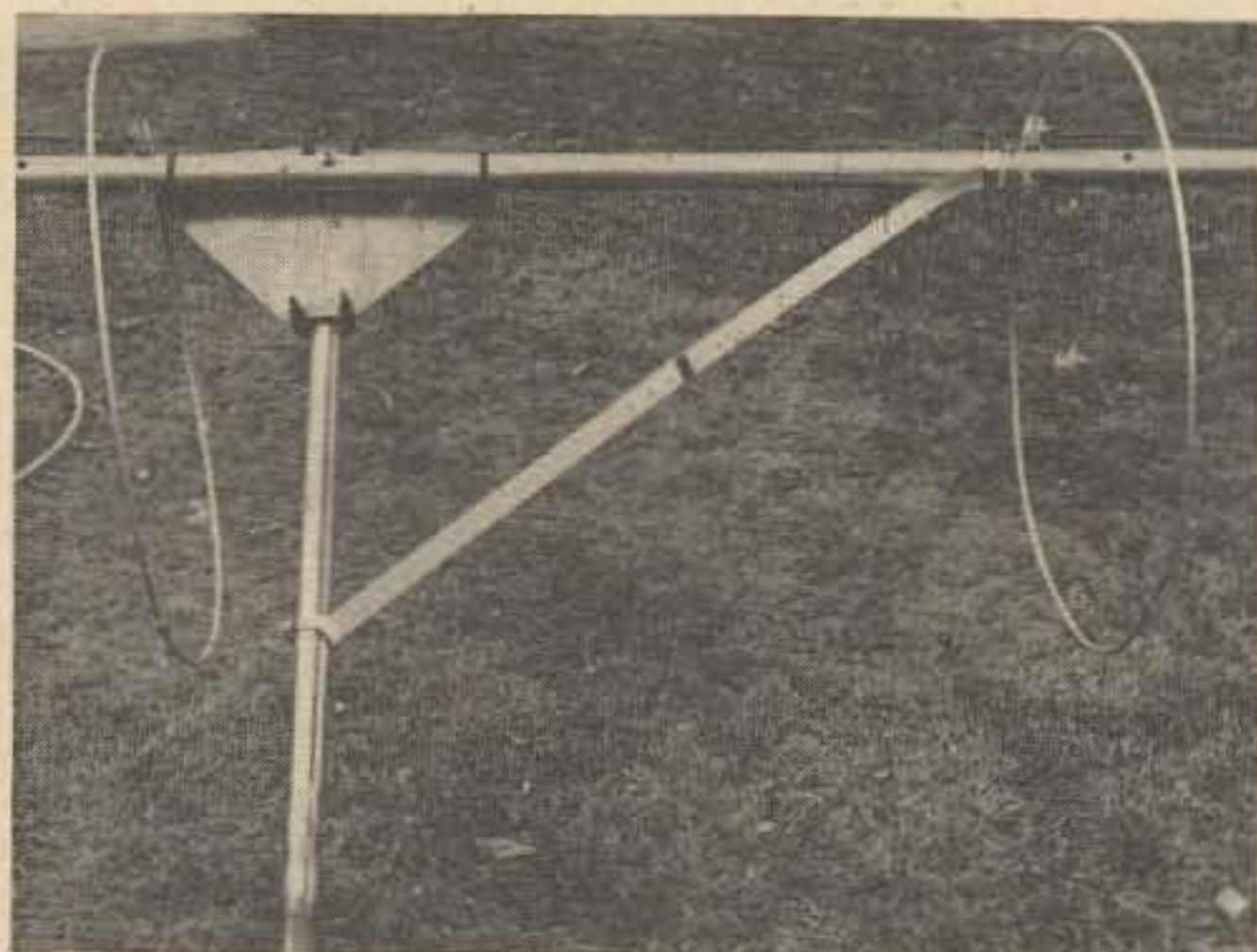

Fig. 6. Detail of the insulated strut from mast to boom. Notice the element ends. Mounting and physical connections with these elements are critical! (Loc-Tite nut and stud lock is mandatory for holding screws in place, unless you have stainless-steel lockwashers.)

Figure 6 shows closeup of the elements, brass gusset plate, and the electrically broken boom-to-mast brace. The gusset plate is patterned after another design except that it is made of brass and not $\frac{1}{4}$ aluminum. Another improvement is that there's a bolt all the way through both the masting and the boom! Muffler clamps are also used, instead of the usual clamp. Since our mast is smaller than the boom, a piece of scrap rubber garden hose serves to bind these surfaces. The broken boom brace is a piece of scrap aluminum $\frac{1}{16}$ in. angle, riveted to a solid PVC block.

Each end of the *Cushcraft* circularly bent elements is butted against each other inside a steel $\frac{1}{4}$ in. shaft coupling previously drilled through with a $\frac{1}{8}$ in. bit. After drilling, element half-loops are inserted about midway, drilled in place, and riveted. This is the only way I could find to rigidly connect elements without breakage.

The driven elements are 76 in. diameter, with allowance made for block-to-block spacing. The first group of directors are all

cut to have an overall circumference of 72 in. The second group of directors all have an overall circumference of 68 in. For a given constant in inches we can arrive at a formula which we divide by frequency in MHz to get the correct lengths. (Slide rule accuracy is all that's necessary.)

Driven Elements	1st Directors	2nd Directors
$\frac{11,050}{F_{\text{MHz}}} = \text{ans. (in.)}$	$\frac{10,375}{F_{\text{MHz}}} = (\text{in.})$	$\frac{9,800}{F_{\text{MHz}}} = (\text{in.})$



Fig. 7. The aluminum Foamflex transmission line (shown here above-ground) has been buried in a shallow trough; now I have a good crop of Kentucky bluegrass over it.

Figure 7 shows erection equipment, rope line for the gin pole, and a closeup of the bottom section as it attaches to the Dill Tower "Pickle" base. I like to call it the "mud base" because all you do is dig a 4 ft hole in decent soil, then slide the base into it and refill with mud; all the while mixing in water from a garden hose. Let the mixture set for several hours and periodically check the vertical angle with a carpenter's level. If you let the mixture become completely hardened, it is possible to erect up to 4 tower sections, without guys! Always guy at least the 20 ft section before going further. Another advantage of the Pickle base is that it may be left in the earth, should you decide to move, and the other tower sections can be saved for a new site.

Amateur Use

Successful use of the 11-element circular quad dates from the first evening it

was compared with my 28 ft L-matched yagi. Both the quad (boom length just over 20 ft) and yagi had the same forward gain. However, the yagi canceled out vertical 2 meter signals just as effectively as if the coaxial cable was disconnected from the receiver! Not so for the round quad. (I will be glad to demonstrate this test to any 2 meter mobileers.)

Here in Lexington, Ky., we have had no recent stratobending band opening to fully evaluate the array's performance with DX. However, it receives the usual 75 mile groundwave signals better than the 28 ft yagi. Scatter pickup is at least 3 dB better (by the ear). Curiously enough, "coaxial cable noise" was first noticed with yagi in comparison to the circular quad. After repeated checks as to carrier strength at 75 miles, with antennas at the same height, it was obvious to reporting stations that the horizontal forward gain was equal. The important difference between arrays is that my RG-9/U silver-plated coax was much noisier than twice as much aluminum *Foamflex* cable, fed to the equal forward-gain antennas! Receiving signal strengths favored the quad. Perhaps the most overlooked point in antenna design is reduction of fading. With a circularly polarized antenna fading is less — but never eliminated without a complicated VHF diversity feed. But the 11-element round quad is a step in the right direction.

Conclusion

Although I do have a patent pending on the long circular quad, I feel that since it is a breakthrough in antenna design, it should be passed on to the amateur fraternity. The only yagi characteristics this array has is in shortening each group of parasitic directors. There are many new variations which I see possible, like group-phased half-wave parasitic elements, a driven reflector within the first group, and "squaring" the round elements to make a "top-vertex-fed" conventional quad. Top vertex feed on each full-wave element would probably eliminate the vertical pattern and boost the gain!

... W4KAE ■

THE "663" BEAM

...for 10, 15, and 20 meters

The varying degrees of success I have attained with beams using loaded elements, trapped elements, compromised matching networks, and tuned lines led me to a project which resulted in the design and construction of the "663" beam—an efficient three-band yagi for 10, 15, and 20 meters.

One of the primary design goals was a beam that would give performance comparable to three individual yagis; the result was a 3-element antenna on 20m and a switched 6-element collinear array on 15 and 10m. The 6-element beams show higher gain figures, of course.

Necessary prerequisites were:

- A single coax feedline with low SWR
- All elements in use on all bands
- No high-Q traps or stubs
- Manual band-switching by remote control
- Must be full size on the lowest band

The completed beam is no bigger than a full size 20m 3-element yagi on a slightly shortened boom (this is the only compromise and does not affect the bandwidth on 20m). Viewed from ground level it appears to be a mono-bander. The "663" title is derived from 6 elements on 10, 6 elements on 15, and 3 elements on 20m.

Mechanical

The mechanical construction is quite straight forward. Two lengths of wood forming the boom are 2 x 1½ in. x 16 ft long; the cross spars for mounting the elements are 1½ x 1½ in. x 9 ft long. Try to obtain straight-grained wood with no knotholes or splits, and apply many coats of the necessary weatherproofing agents. The woodwork is bolted together with ¼ in. galvanized coach bolts. As each of the elements is split in the center, 4 insulators are required on each spar. The insulators are those used for mounting bus bars in switchboards; they are attached to the spars with heavy brass wood screws.

All metal parts should be galvanized steel, brass, or aluminum; and remember that you can put galvanized steel with aluminum but NOT brass or copper, due to corrosion. The elements are Dura tubing, tapered in three steps commencing at 1 in. diameter and reducing to 7/8 in. and then to ¾ in. for the end tips.

Where the elements telescope together they are slotted and hose-clamped. Similar clamps are used for mounting the elements to the insulators.

The boom is braced with 4 struts back to the main support pipe or mast made from ¾ in. galvanized conduit 6 ft long. Top guying of the boom could be employed instead of the struts. The remainder of the mechanical construction is obvious from the photographs and it can all be assembled from readily available parts.

Mounting of the beam to the tower or mast is left to the builder. Mine is a two-point mount thus enabling the boom to be tilted over one way or the other for adjustment or maintenance.

Electrical

The heart of the whole triband feature is the various switched networks inside the weatherproof boxes in the center of each element. These boxes are plastic containers with airtight lids as used for storing food in refrigerators and are available from most stores for about 60¢ each. Each box has a ¾ in. diameter vent in the bottom covered with plastic gauze.

All capacitors are isolated from ground by mounting straight to the plastic case for

the radiator tuning unit or on strips of polystyrene for the parasitic elements as evidenced in the photographs. All the capacitors are adjusted at full height so an 8 ft length of 1 in. dowel is used as a long trimming tool to reach the capacitors on the director and reflector. The capacitor shafts have a flat filed on them to match an adapter on the end of the 8 ft dowel. On 20m the 3 large ZC1 type relays (RL1) are energized, thus sorting out the parallel networks in all elements, and in the case of the driven element, connects the coax feedline to series capacitor C3 on the 20m omega match. (Although this setup looks like the conventional gamma match, it is actually an omega match due to the stray capacity in the tuning box.)

The tuning of the beam on 20m is determined entirely by element length and these were taken straight from Bill Orr's Beam Handbook with slight reductions to allow for length of the ZC1 relays and connecting braids. The element lengths are as follows:

Director — 30 ft, 9 in.

Radiator — 32 ft, 10 in.

Reflector — 34 ft, 8 in.

Matching rod — 36 in., 3/8 in. diameter, spaced 5 in. center to center from radiator.

Series capacitor C3 is a 150 pF transmitting type. All elements have a gap of 4 in. at the center. Referring to the diagram, note that RL1 (b) contacts seem to be unnecessary, but utilizing the coil center-tap for the earth return to the coax gave odd reactive effects, so the coil was shorted out in all directions possible with the available relay contacts.

For operation on 10m, all the relays are left open, leaving a parallel-tuned circuit across the center of each element. The coax feedline is then tapped across one turn of the radiator coil by the changeover action of RL1 (a).

The position of the tapping point can be varied to suit the impedance of the coax and no series reactance capacitor was found necessary. The tapping point was found to be the same for 10 and 15m, one turn being the case for 50Ω heavy duty coax. Operation on 15m is achieved by

oscillator/monitor^{mark 2}

- makes an audible tone to monitor the RF of any CW transmitter from 10Mw to 1 Kw & 100Kc to 1000Mc, using only an 8" pickup antenna.
- can be self-triggered for code practice or the testing of solid state components and circuits.
- aids in tuning up & testing RF oscillator and power circuits.
- 4 transistor, 2 diode circuit, speaker, tone adjust, AA pcell, test tips, 8" ant., & magnetic base.
- cabinet is 16 gauge black & clear anodised aluminum, 3.4 x 2.3 x 1.2" US made & guaranteed for 1 year.

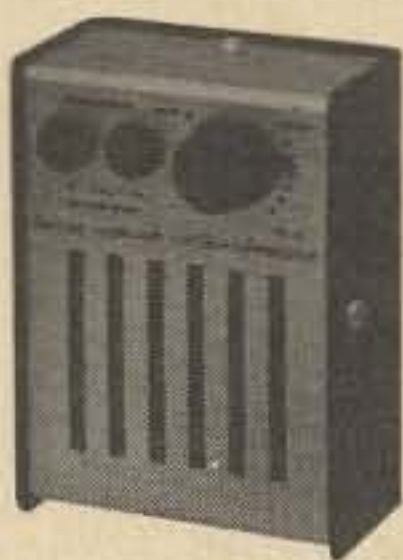

14.95 complete,
ppd usa & can.
send a check or m.o.
sold by mail only

James Research company, dep't: AR-M
20 willits road, glen cove n.y. 11542

energizing the three relays (RL12), connecting capacitors C2 across the existing 10m LC network.

The coils are wound with 3/16 in. diameter copper tubing, 2 in. internal diameter, spaced 3/16 in. between turns. The director coil is 7 turns, radiator coil 5 turns, and the reflector coil 8 turns. The radiator coil is smaller than the other two due to the longer connecting leads.

The parallel capacitors C1 and C2 (6 altogether) should have a capacitance of 30–40 pF.

The coils of the three ZO1 type relays (RL1) are wired in parallel requiring 12V dc at 600 mA. Likewise, the RL12 relays are parallel connected, requiring 24V at 300 mA. The two voltages are furnished by the one simple supply using a TV vertical output transformer and bridge rectifier. A 100 μ F, 25V electrolytic capacitor is necessary across the output of the supply to eliminate relay chatter.

The relays used are war surplus items and can be replaced with more modern types. Five of the relays are spst. The RL1 relay in the radiator requires a 1-pole changeover and dpst contacts.

The switching sequence is as follows:

- 10m – all relays de-energized.
- 15m – RL2 relays only energized.
- 20m – RL1 relays only energized.

Tuning Up

The initial tuneup is at about 6 ft above ground just to ascertain that the various LC

networks will cover the correct frequencies. The final tuning must be done as near as possible to full height – and takes up most of an afternoon! The setup was as follows: an swr bridge was in the feedline at all times; a remote dipole with the voltmeter extended back to the shack was used; a telephone from the shack to the top of the tower was most useful. All adjustments were done for maximum gain (front-to-back ratio was best at these settings) as measured on the dipole voltmeter; this naturally coincided with the lowest swr readings.

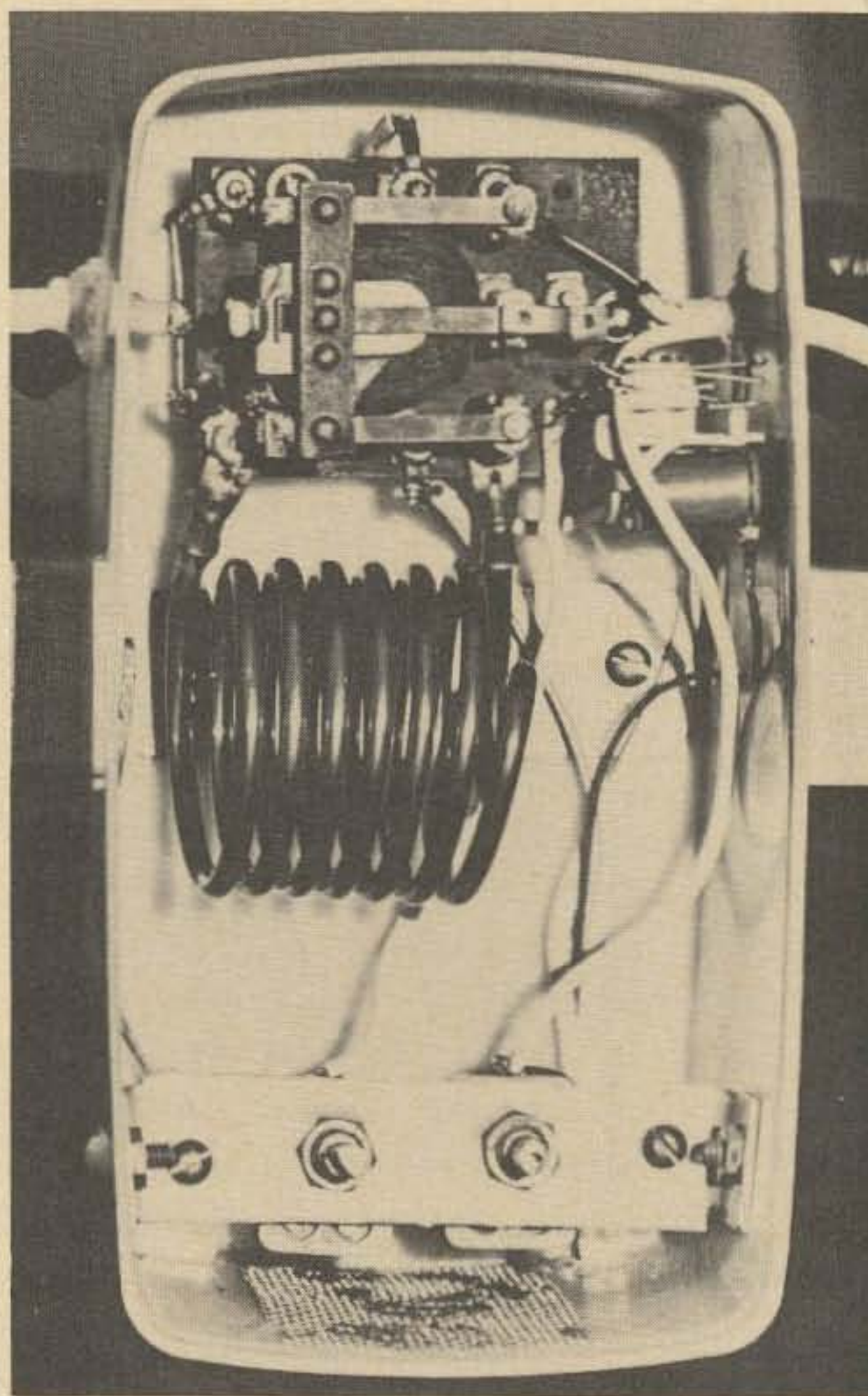

Director and reflector tuning unit.

Tuning is started at 20m by closing RL1 relays only. Check that the radiator is resonant on 14.2 MHz with a grid dipper, and if possible check the frequencies of the director and reflector to ascertain that they

are just above and below the 20m band. An rf carrier on 14.2 MHz is applied to the beam, then the matching rod length and series capacitor C3 adjusted until the swr reading is nil. Front-to-back ratio can be checked and will be found to be about 25 dB. This completes the 20m tuning.

The next step is to deenergize all relays and apply an rf carrier on 28.6 MHz. Adjust the C1 capacitor starting with the radiator, then director, and then reflector for maximum gain on the dipole voltmeter. It pays to go over these adjustments at least twice to get best gain. Front-to-back

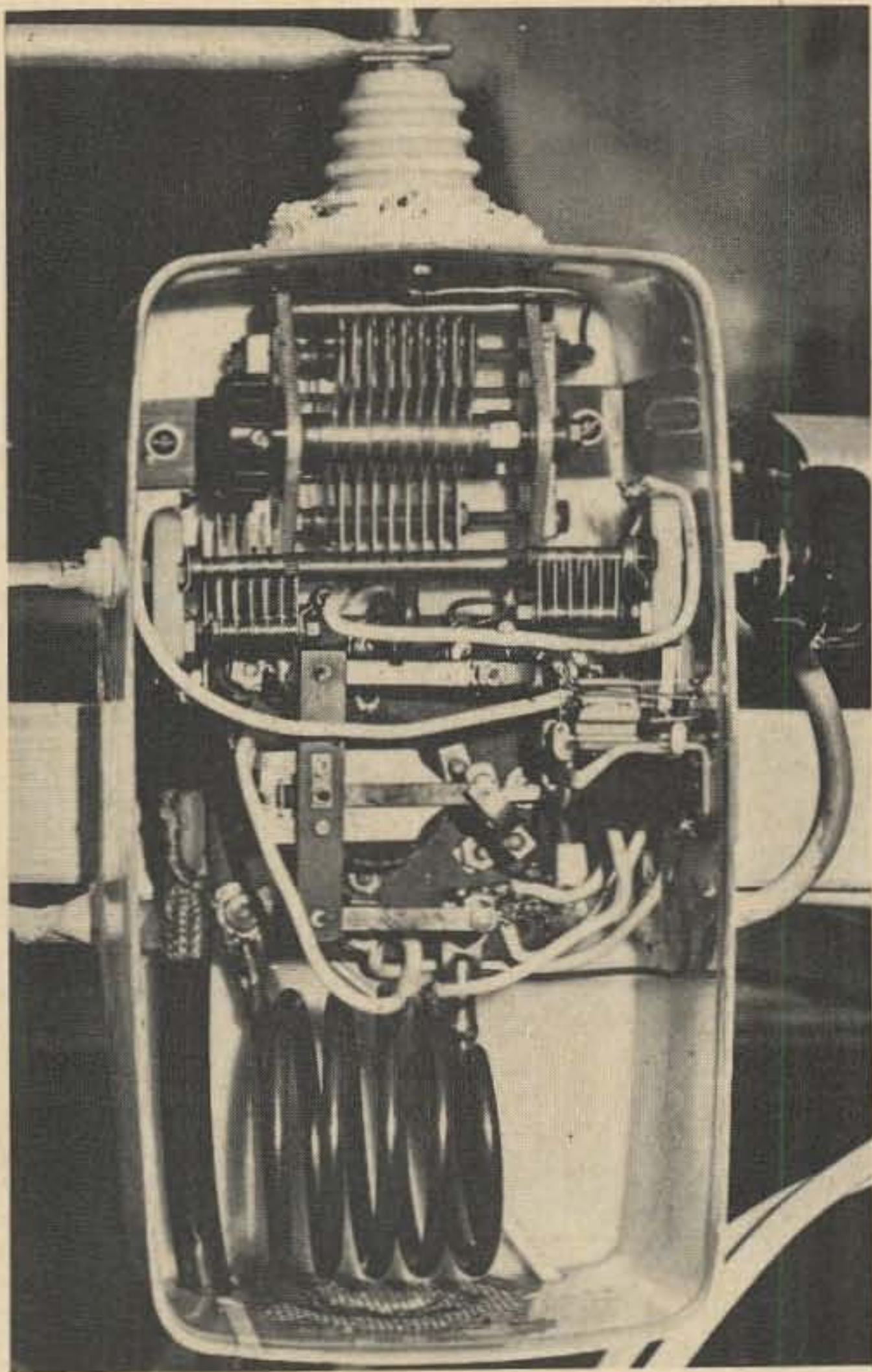

Driven element tuning unit.

ratio on this band is about 35 dB. Maximum gain will coincide with minimum swr, but if a complete null is not evident, move the radiator coil tap slightly one way or the other.

the permaflex key

- both a twin lever & straight hand key in a pivotless 2 paddle design.
- gives instant choice of automatic semi-automatic & straight hand keying when used through an electronic keyer.
- use directly with any transmitter
- 8 amp. gold diffused silver contacts adjust from 0-.060" & 5-50 grams.
- distinctive blue paddles are of rugged G-10 fiberglass epoxy.
- cabinet is 16 gauge polished chrome steel: 1.95" sq. x 3.75", paddles extend 1.25", weight 10 oz.
- silicone rubber feet for stability.
- 100% US made & guaranteed for 1 yr.

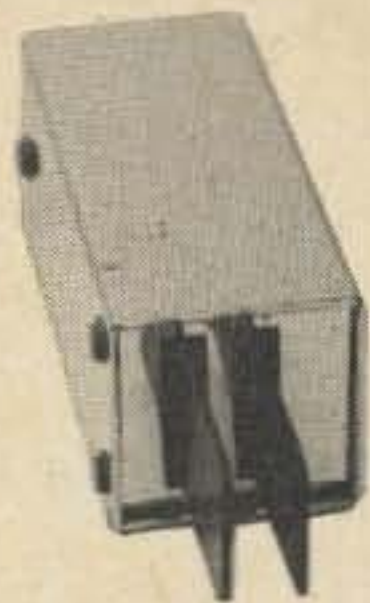

1995 complete,
ppd usa & can.
send a check or m.o.
sold by mail only

James Research company, dep't: AR-K
20 willits road, glen cove n.y. 11542

Tuning on 15m is the last step and the RL2 relays only are energized with 21.175 MHz rf. Tuning on this band is the same as that on 10m except that the adjustment is made to the C2 capacitor.

The coil tapping point once set for 10m is correct for this band. Front-to-back ratio is about 30 dB.

Antenna Performance

Conservative gain figures for the 3 bands are as follows:

- 20m - 8 dB
- 15m - 10 dB
- 10m - 11.5 dB

The swr will be unity at the resonant point on all bands and will rise up to no higher than 2:1 at the band edges on 20 and 15m. On 10m, an swr of no more than 2:1 was experienced at 28.2 MHz, dropping to unity and then rising to 2:1 at 29.1 MHz. This may appear to be a wide bandwidth for the swr stated, but I feel it attributed to the elements being a full wavelength on 10m.

This antenna has been in use here for 2½ years and the results obtained on all bands are most gratifying when compared to the automatic trapped beams and inter-laced cubical quads.

... ZL2ASJ ■

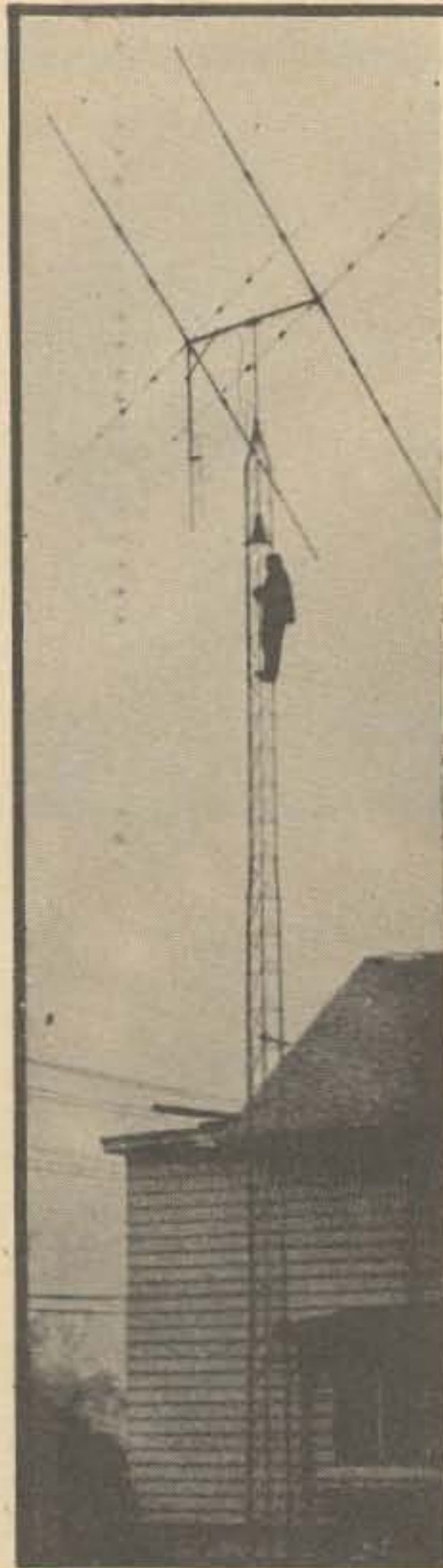

**UNIVERSAL
Self Supporting
T.V. Ham & Radio
ALUMINUM
TOWERS**

No Climbing Necessary
With Hinged Base

Minimum configuration
is tested for 80 m.p.h.
winds with the maximum
free standing rating of
140 m.p.h.

**50 FOOT TOWER
11 SQ. FT.
ANTENNA WINDLOAD**

\$208.26

freight prepaid

Contact
your local distributor.

Write for Information on
other tower sizes up to
90 ft.

**UNIVERSAL
MANUFACTURING
COMPANY**
6017 E. McNichols
Detroit, Michigan 48234
Tel: 313-368-0730

**THE BEST
2 METER
CONVERTER**

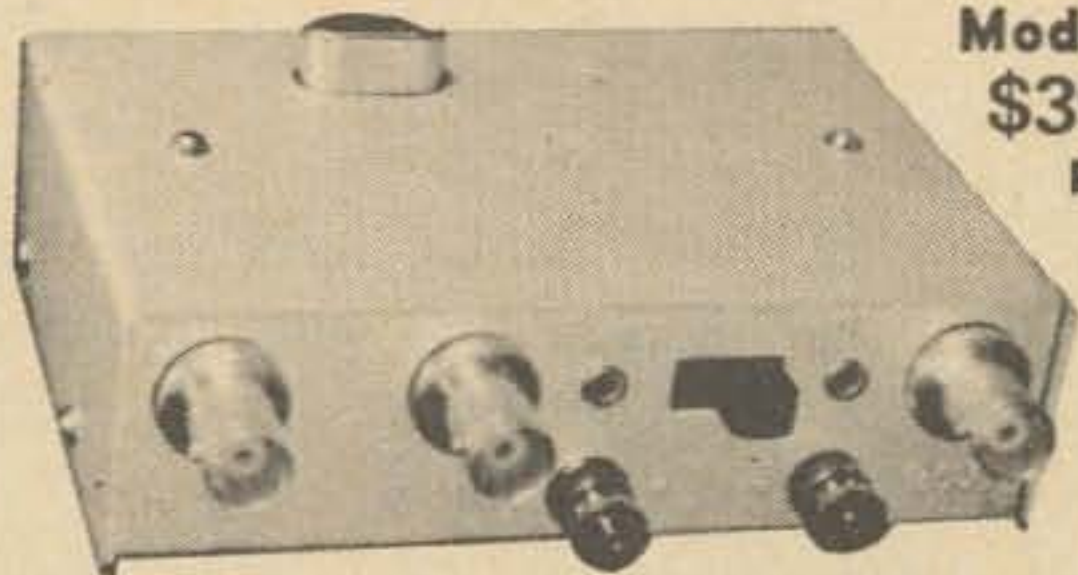

**Model 407
\$39.95
ppd.**

144-146 MHz in. 28-30 MHz out
or 146-148 MHz with a second crystal
Available at \$4.95 each.

A full description of this fantastic converter
would fill this page, but you can take our word
for it (or those of thousands of satisfied users)
that it's the best. The reason is simple—we use
three RCA dual gate MOSFETs, one bipolar,
and 3 diodes in the best circuit ever. Still not
convinced? Then send for our free catalog and
get the full description, plus photos and even
the schematic.

Can't wait? Then send us a postal money order
for \$39.95 and we'll rush the 407 out to you.
NOTE: The Model 407 is also available in any
frequency combination up to 450 MHz (some
at higher prices) as listed in our catalog.

*New York City and State residents add local sales tax.

VANGUARD LABS

Dept. H, 196-23 Jamaica Ave., Hollis, N.Y. 11423

PROPAGATION CHART

J. H. Nelson

Good O Fair (open) Poor □

June 1970

SUN	MON	TUES	WED	THUR	FRI	SAT
	①	②	③	④	⑤	⑥
⑦	⑧	⑨	⑩	⑪	⑫	⑬
⑭	⑮	⑯	⑰	⑱	20	20
⑳	㉑	㉒	㉓	㉔	25	27
28	29	30				

EASTERN UNITED STATES TO:

	GMT: 00	02	04	06	08	10	12	14	16	18	20	22
ALASKA	14	14	14	7A	7	7	7	14	14	14	14	14
ARGENTINA	21	21	14	14	14	7	14	21	21	21	21A	21
AUSTRALIA	21	21	14	14	7B	7B	7A	14	14	7B	14	14
CANAL ZONE	21	14	14	14	7	7	14	14	14	21	21	21
ENGLAND	14	14	7A	7A	7	14	14	14	14A	14A	14A	14
HAWAII	21	14	14	7A	7	7	7	14	14	14	14	14
INDIA	14	14	7A	7B	7B	7B	14	14	14	14	14	14
JAPAN	14	14	14	7A	7B	7B	7A	14	14	14	14	14
MEXICO	21	14	14	7	7	7	14	14	14	14	21	21
PHILIPPINES	14	14	14	7A	7B	7B	7B	14	14	14	14	14
PUERTO RICO	14	14	14	7	7	7	14	14	14	14	14	14A
SOUTH AFRICA	14	7B	7	14	14	14	21	21	21A	21	21	14
U. S. S. R.	14	14	7A	7A	7	14	14	14	14A	14A	14A	14
WEST COAST	14A	14A	14	14	7	7	7	14	14	14	14	14

CENTRAL UNITED STATES TO:

	GMT: 00	02	04	06	08	10	12	14	16	18	20	22
ALASKA	14	14	14	14	7A	7	7	14	14	14	14	14
ARGENTINA	21	21	14	14	14	7	14	21	21	21	21	21A
AUSTRALIA	21	21*	14	14	14	14	7A	14	7B	14A	14A	
CANAL ZONE	21	21	14	14	7A	7A	14	14	21	21	21	21
ENGLAND	14	7A	7A	7A	7	7	14	14	14	14	14	14
HAWAII	21	21	14	14	14	14	7	14	14	14	21	21
INDIA	14	14	14	7A	7B	7B	7B	14	14	14	14	14
JAPAN	14	14	14	14	7B	7B	7	14	14	14	14	14
MEXICO	14	14	14	7	7	7	7	14	14	14	14	14
PHILIPPINES	14	14	14	14	7B	7B	7B	14	14	14	14	14
PUERTO RICO	21	14	14	7	7	7	14	14	14	14	21	21
SOUTH AFRICA	14	7B	7	7B	7B	7B	14	14	14	14	14	14
U. S. S. R.	14	14	7A	7A	7	7B	7B	14	14	14	14	14

WESTERN UNITED STATES TO:

	GMT: 00	02	04	06	08	10	12	14	16	18	20	22
ALASKA	14	14	14	14	7	7	7	7A	7A	14	14	14
ARGENTINA	21A	21	14	14	14	7	14	14	21	21	21	21
AUSTRALIA	21	21A	21A	21	14	14	14	14	7A	7	14A	21
CANAL ZONE	21	21	14	14	7A	7A	7A	14	14	21	21	21
ENGLAND	14	7A	7A	7A	7	7	7	14	14	14	14	14
HAWAII	21A	21A	21	21	14	14	14	14	14	14A	21	21
INDIA	14	14	14	14	7A	7B	7B	14	14	14	14	14
JAPAN	14	14	14	14	14	7A	7	14	14	14	14	14
MEXICO	21	14	14	7A	7	7	7	14	14	14	14	14A
PHILIPPINES	14	14	14	14	14	14	7B	14	14	14	14	14
PUERTO RICO	21	21	14	14	7	7	14	14	14	14	14A	21
SOUTH AFRICA	14	7B	7B	7B	7B	7B	7B	14	14	14	14	14
U. S. S. R.	14	14	14	14	7	7B	7B	14	14	14	14	14
EAST COAST	14A	14A	14	14	7	7	7	14	14	14	14	14

A — Next higher frequency may be useful.
B — Difficult circuit this period.

73 tests the
Grundig
SATELLITE
Ham Radio Receiver

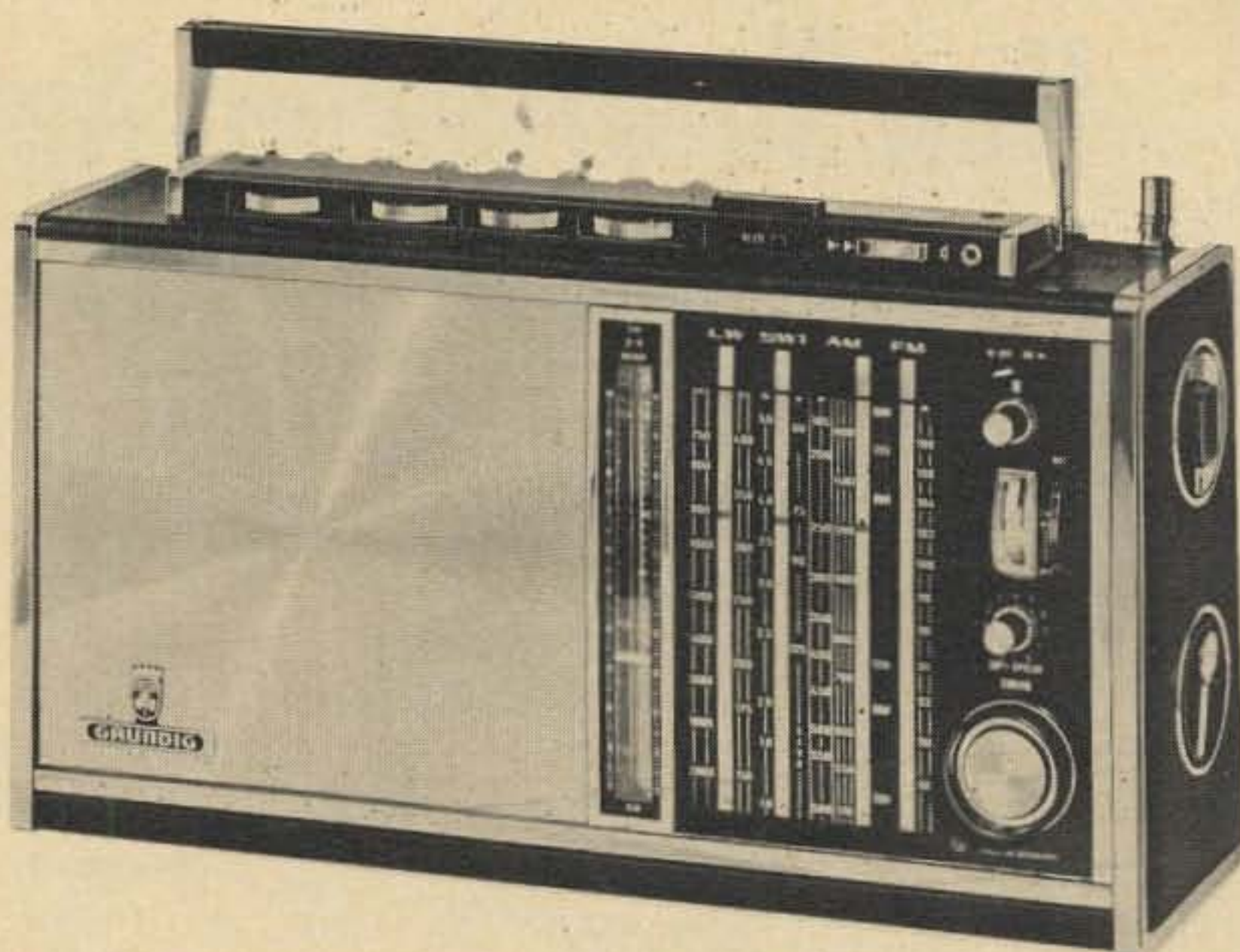

...and is impressed!

Those crafty Germans have come up with a remarkable portable receiver, one that seems to have just about everything imaginable. Here is a receiver with separate bandspread dials for each of the amateur radio bands, a receiver that has a product detector so you can copy sideband and CW! It even covers 160m, tuning from 1700–2000 kHz. The 80m bandspread dial covers 3500 to 3800 kHz, with the remainder of the band being adequately covered by the regular shortwave band which covers 1600 to 5000 kHz. The 40m band covers 6900 to 7350 kHz, including CHU, naturally. There is also a 49m band for SWLs, tuning from 5950 to 6250 kHz. The 20m band covers from 13.9 to 14.5 MHz. 15m covers 20.5 to 21.75 MHz. 10m is in two bands, one from 26.9 to 28.4 MHz, which includes the citizens band, and one from 28.3 to 29.8 MHz.

There is also a band for low-frequency listening from 150 to 450 kHz, plus the broadcast band and the FM 88–108 MHz band.

It has so many features that it is hard to list them all. The i-f response can be switched from broad to narrow, giving optimum response for FM music and crowded ham-band reception. The speaker is huge and has a remarkable richness of

tone for a portable radio. The receiver operates on built-in batteries or ac, and has a meter to show the battery voltage. The sideband unit has a narrowband filter (to cut down noise pulses) as well as a manual avc function. There are separate tone controls, an S-meter, a 13-section antenna, provisions for using your car antenna, an outside FM antenna, and a shortwave or ham-band antenna. There are inputs and outputs for a tape unit or phonograph player and a plug for external loudspeakers.

When we removed the Grundig from the carton here at 73 to test it just about everyone on the staff blew their minds over it. Everyone had an immediate case of wants. There was a tussle between the rock fans to listen to FM and the hams to listen to 20 meters. The receiver is stable enough to allow excellent sideband reception and there are enough controls to give you good flexibility in tuning in signals. This certainly could be used for communications for it does a lot better job than some ham receivers that are not all that much lower in price. The major advantage of this receiver is that it is portable and that it covers just about anything you would normally want – AM, FM, SSB, or CW. With a little converter it would be excellent for tuning in FM repeaters!

How To Order An Antenna Tower

There are many kinds of towers on the market today. You may choose the kind that requires guying or the type that is self-supporting. You may select a foldover, a crankup, or the kind that hinge at the base and then either fold over or crank up. Then there are the rigid types that rise section by section after the base has been securely planted. Towers are made of steel or aluminum. They can be of telescopic masting or braced triangular or of square-framed design.

Confusing? You can say that again!

So how do you sort out the facts? How do you know what *you* want?

First you must know what you can legally or permissively put up. This depends upon either the landlord or the zoning restrictions in your town. Then there is the esthetic consideration meaning mainly your good wife, and, of course, your neighbors' opinions too. For you to put up a stark ugly structure on the front lawn on a street of fine homes, you had best at least be prepared for some tongue wagging, or worse, a letter from the neighborhood improvement association. But assuming that such considerations as to where this structure will be placed have been settled, then you must decide what the tower will be used for specifically!

The tower selected must reflect the maximum windload in a horizontal direction which is imposed by your antenna, or combination of antennas, assuming a velocity of 80 mph (which is the minimum recommended standard). Depending upon historical weather statistics for your area, you must be conservative in choosing a tower design—a skimpy choice usually results in a total loss within a year or two. Go ahead then in adding up windload. With the small TV or VHF beams, 2–5 sq. ft. of load should be expected. Larger VHF beams in small 10 meter arrays require 5–8 sq. ft.; 2 element tri-band quads also fall in this category. Typical tri-band 3 element beams require 8–11 sq. ft. A typical small VHF antenna stacked on top of a 3 element tri-band beam requires a total of 11–14 sq. ft. Two small HF 10 or 15 meter 3 element beams would call for 14–18 sq. ft., while even a single large 20 meter array requires 18–22 sq. ft. Even the light 40 meter beam needs 26 sq. ft. By the way, the sq. ft. of windload times 20 equals the lateral pressure in pounds at 80 mph. At 90 mph you multiply by 25, at 100 mph you multiply by 30, at 115 mph—40, at 130 mph, factor is 50, and at 160 mph you will use a multiplier factor of 60. And when you do all these calculations be conservative. In still another direction, that of your future ham operations, allow for the fact that you may want to expand your activities and thus your antennas.

Bear in mind that the height of your antenna and the top of your tower must be at least 5–10 ft higher than the average foliage in your backyard, and preferably should be halfwave or higher for the lowest frequency that you are going to operate on. In general, quads will provide satisfactory operation in lower heights than yagis.

Secondly, your bankbook must be consulted. While it is true that a ham's station performance is more directly related to good antenna performance, it is also true that your first obligation must be to the family and their needs. Some idea of cost can be gleaned from the following:

- Minimum cost of steel in 10 ft sections with guys, rotor plate, masting, anchors, etc. will be about \$2.50 per lineal ft of erected height.
- Minimum cost of aluminum — 8 ft sections with rotor plate and masting (no guys) will approximate \$3.20 per lineal ft of erected height.
- The minimum cost of a crankup or foldover design in a guyed steel tower will be about \$5 per lineal ft of erected height.
- Minimum cost of self-supporting crankup or foldover steel tower will be \$8 on the same basis per ft.
- Minimum cost for a hinged base, aluminum construction, crankup or foldover self-supporting type will be \$9 per ft of erected height.

By referring to the above and knowing how high you wish your antennas to be, you can quickly compute minimum values for basic types of tower design. But please remember, these are minimum values, and our nation is in a depression/recession, with inflated or deflated prices, and we surely know prices go up, not down!

Remember, too, that there are other considerations. You wouldn't put a guyed tower in your backyard where your kids were playing ball. First thing you would hear would be a hysterical wife on the telephone. Then, too, how frequently are you apt to move? How easy is the tower to erect? Do you need two or three cases of suds and the whole club for a rooting section?

Maintenance is annoying, especially antenna repairs after a winter storm and you're 55 years old with four extra inches of spare tire to hinder your climbing. Another consideration is whether or not you have provided for the possibility that for some reason your tower and antenna may come crashing down on the neighbors home next door. Because of all these things and many others that you can think of to fit your individual circumstance, towers do take a lot of study

We sell them all, and literally have dozens in stock, but over many years of selling ham gear, we have reached the conclusion that one brand is especially appealing to the ham. I now refer to HEIGHTS Aluminum Towers, appealing because their design provides a great flexibility for your particular needs with respect to strength and height. Further, should your circumstances change, their design best lends itself to easy dismantling and reerection — to expansion — to freedom from the maintenance problems.

Detailed literature is available for the asking on any tower. Furthermore we'd be glad to quote on a package deal for any rotor, antenna, or tower combination or to render advice on your problem. We have helped others, maybe we can help you.

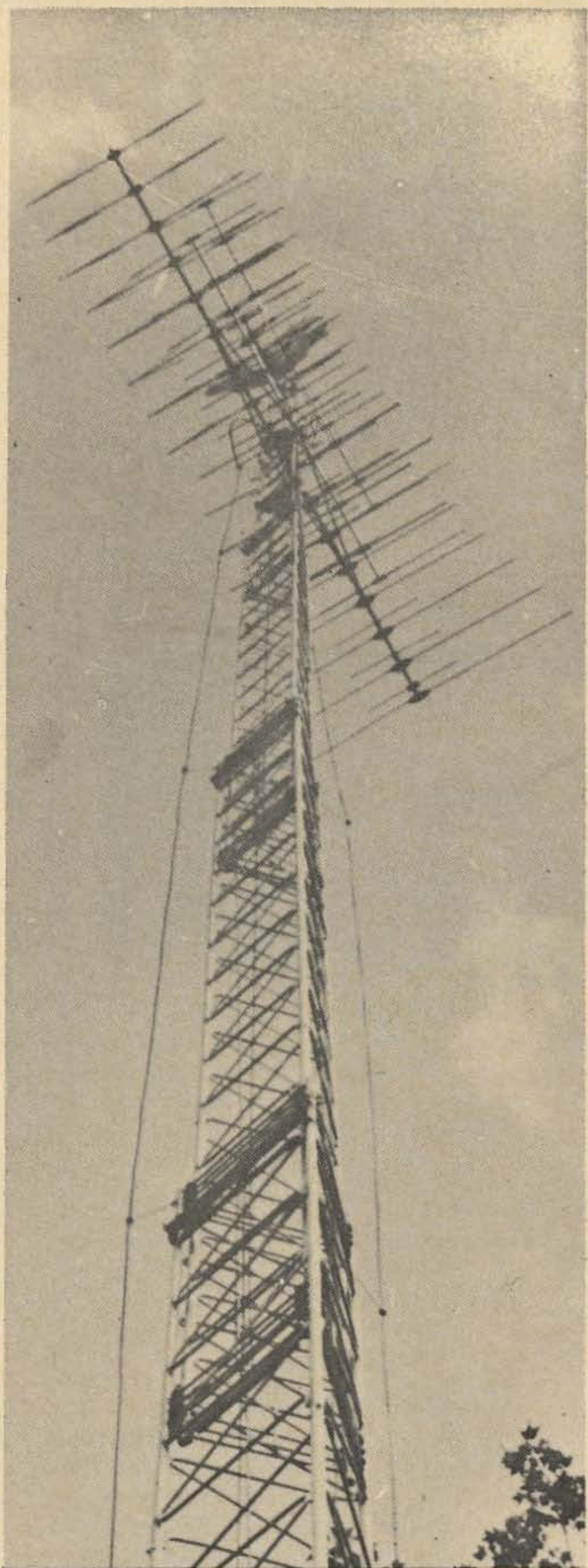

HERBERT W. GORDON COMPANY

HELPING HAMS TO HELP THEMSELVES

Woodchuck Hill Road



PHONE: 617-456-3548

Harvard, Mass. 01451



NEW PRODUCTS

In-Circuit Resistance Checker

The model FE20 "Hi-Lo multimeter checks conductivity of transistors, diodes, and rectifiers; with a flip of the function switch the ohms section is powered with a lower voltage (below the conductivity point of solid-state devices). Resistances can then be measured in-circuit for true values without solid state device conducting and causing erroneous results. Both Hi and Lo



ohms are read on the same scale to avoid confusion. Other features include a tenth of a volt full scale for more accurate measurements of transistor biases. A high voltage probe is also shipped with each multimeter to extend the voltage range to 30,000 volts. A low voltage probe with isolation resistor is also provided. The new meter has 9 dc ranges, 3 high voltage ranges, 9 ac ranges, and 7 resistance ranges. The FE20 is priced at \$129.50. *Sencore, Inc., Addison IL 60101.*

Semiconductor Data Book

The Motorola Semiconductor Data Book (Fourth Edition) is the largest yet - 2160 pages - and includes specifications for all discrete semiconductors registered by the EIA at publication time. The book also features a new arrangement of data that makes it easier than ever to find information on semiconductors; other sections of the book include case outlines for semiconductors, selector guides to digital and linear integrated circuits, and application notes that explain how to use the transistors, diodes, and other devices described in the Data Book. *Motorola Semiconductor Products Inc., Box 20912, Phoenix AZ 85036.*

3 Amp Epoxy Rectifiers

The ER2000-ER2006 series of plastic encapsulated, low cost, hi rel 3 amp rectifiers offers design engineers increased packaged density excellent hermeticity, low power dissipation and

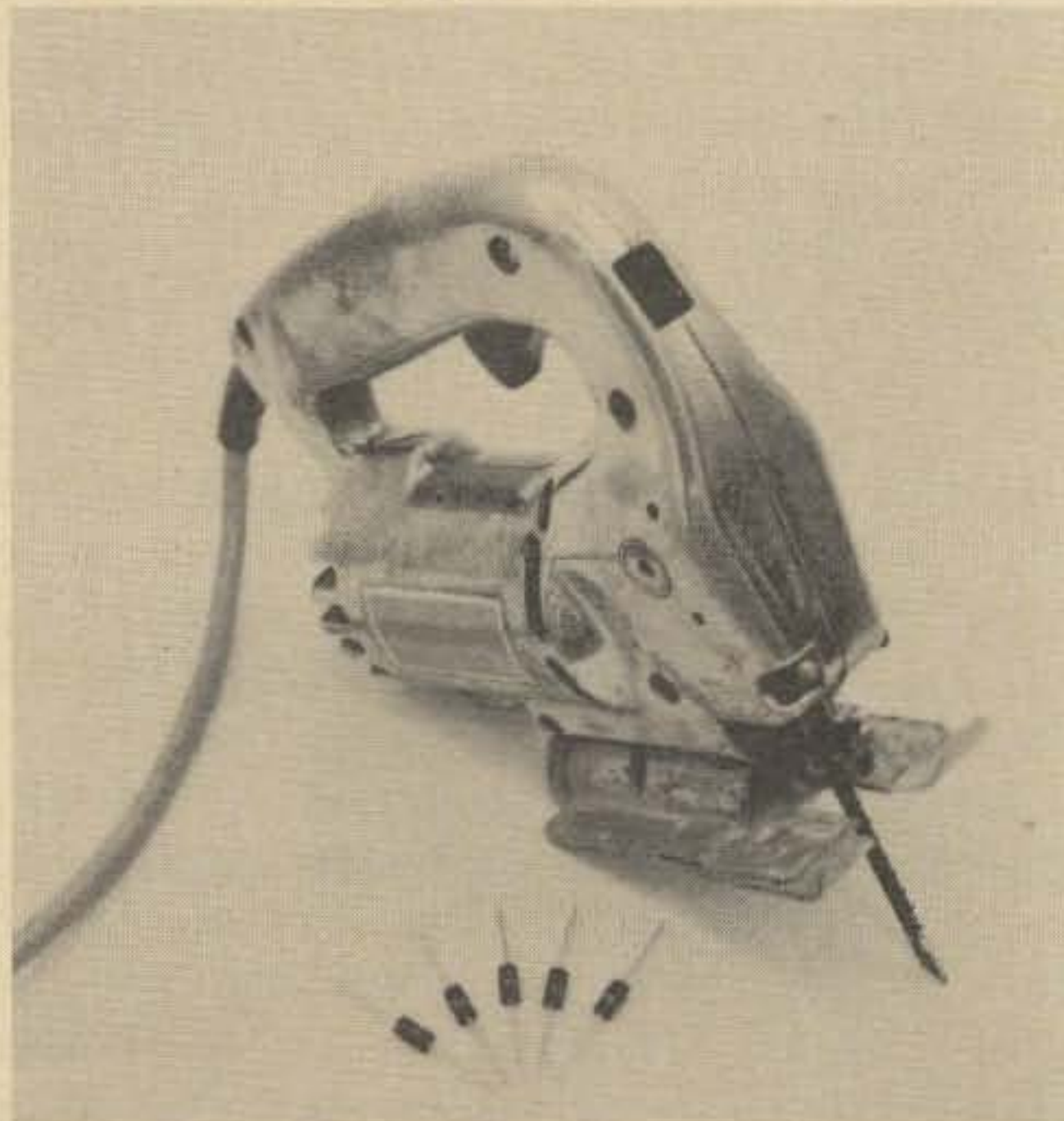

high surge limit in high temperature applications. Voltage range is 50 to 1000V with mass surge limit of 200 amps. Average forward current is 3 amps. *Transitron Electronic Corp., 168 Albion St., Wakefield MA 01880.*

3 kW Vacuum Coaxial Relay

A vacuum coaxial crossover/transfer relay utilizing both a vacuum dielectric and the latest in coaxial switch technology is now available. The Series 313 will handle up to 3 kW of power at 30 MHz. It utilizes switch contacts enclosed in a vacuum dielectric in a copper and ceramic



envelope to ensure permanently low and stable contact resistance, long life, low loss and inherently low noise level with no distortion. The Series 313 is supplied in a variety of alternate versions with various electrical and mechanical

characteristics. *Dow-Key Company, 2260 Industrial Way, Broomfield CO 80020.*

Monolithic, N-Channel, Dual FETs

The FM3954 series are monolithic dual JFETs manufactured with special processing and a radical new departure in geometry. The geometries of both FETs are intertwined to obtain a perfect match. The series completely removes the prob-

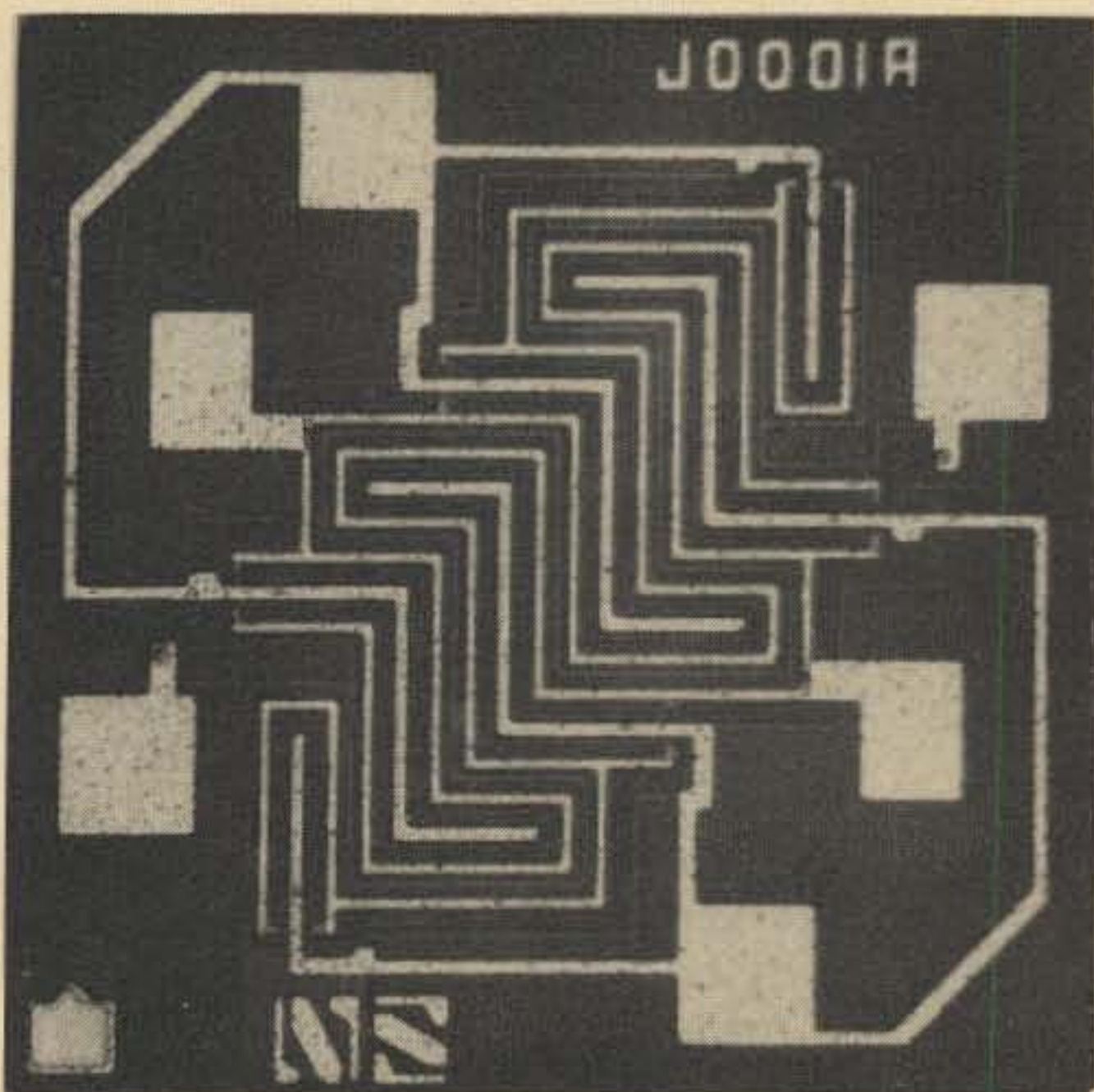

lem of complicated testing because each dual die is a perfect match. Features of the series include very close tracking regardless of bias point, from $50 \mu\text{A}$ to $500 \mu\text{A}$, low leakage of 100 pA and high gain of $1000 \mu\text{mhos}$. *National Semiconductor Corp., 2975 San Ysidro Way, Santa Clara CA 95051.*

Solid State FM Signal Generator

Electronic vernier tuning provides a more precise setting of frequency with or without

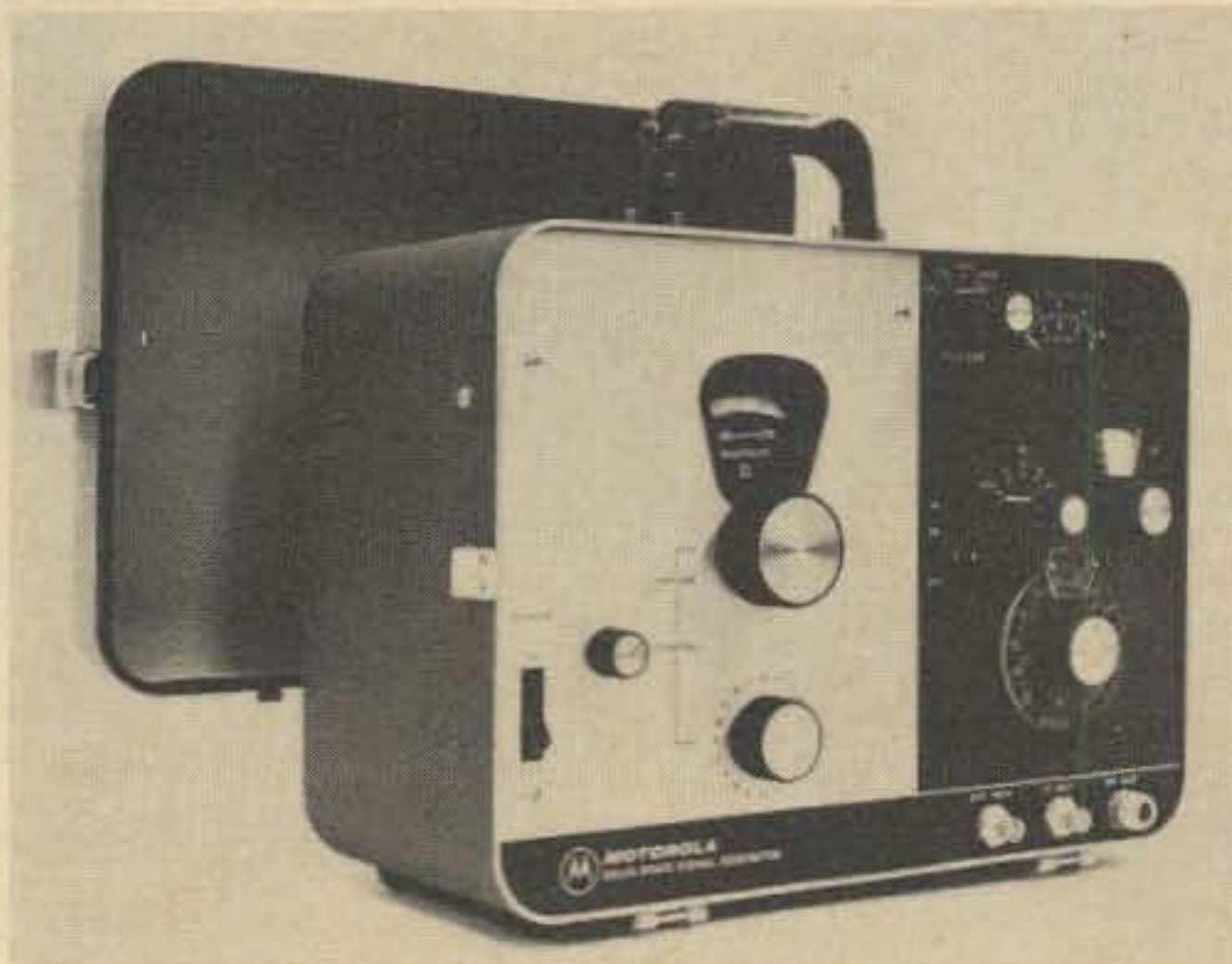

modulation for the solid state nuvistor oscillator, FM signal generator. Incremental electronic tuning allows the frequency to be adjusted 16 kHz either side of zero center. The unit's automatic level set now sets a "red line" reference automatically. External modulation and deviation sensitivity of only one volt input

provides a full 16 kHz deviation eliminating the need for high powered external signal sources. *Precision Instruments Department, Motorola Communications & Electronics, Inc., 1875 Greenleaf Ave., Elk Grove Village IL 60007.*

Low Cost General Purpose FET Amplifiers

This group of low cost general purpose FET amplifiers offers outstanding performance in all types of amplifier applications due to their low noise (2.5 dB max), low leakage (100 pA max)

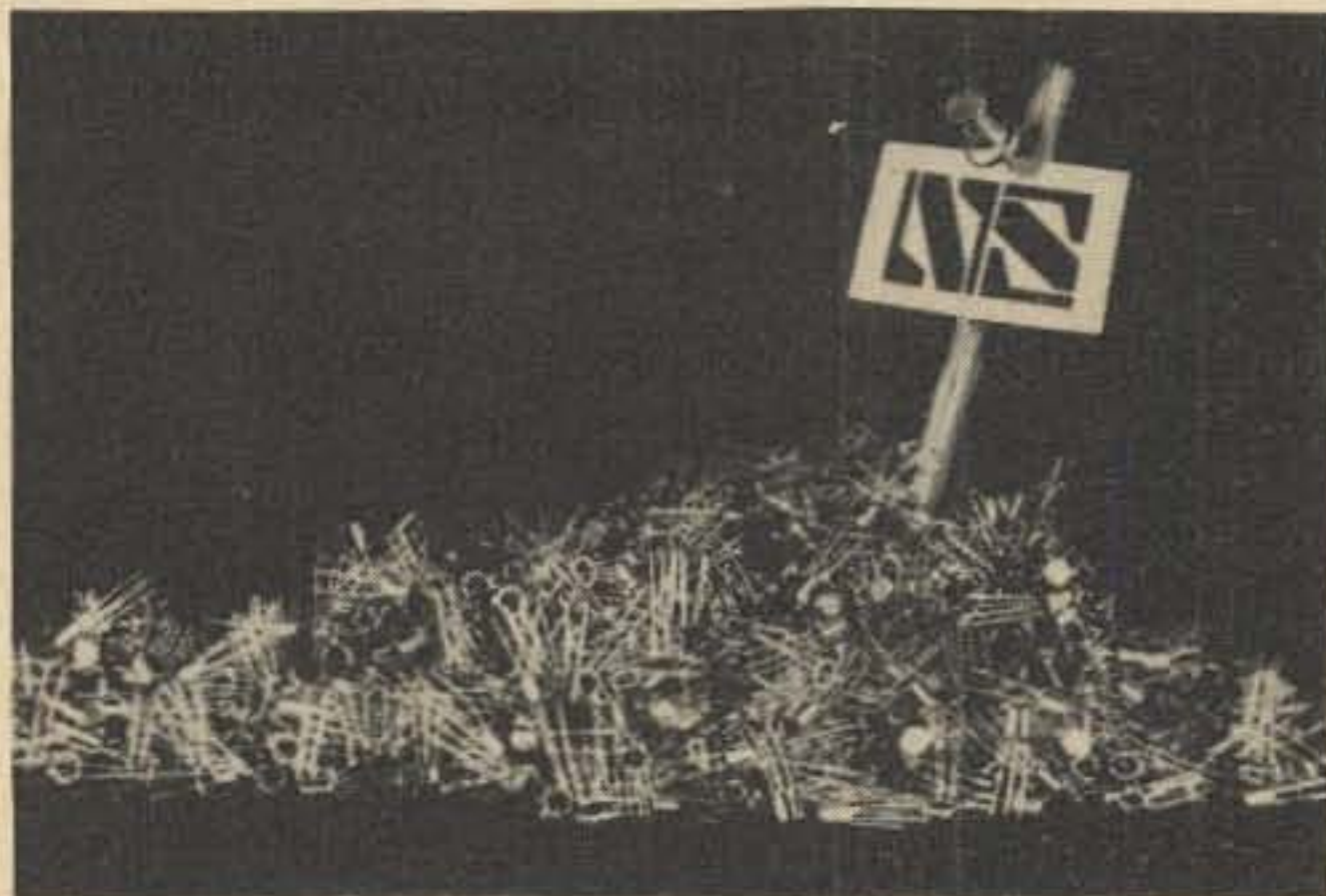

and low capacitance (2.0 pF max). They also offer low on-resistance. *National Semiconductor Corp., 2975 San Ysidro Way, Santa Clara CA 95051.*

Neon Tube Repeatability In Timing Circuits

The close tolerance in breakdown voltage characteristic and the high leakage resistance of the A039A neon tube provides a high degree of repeatability when it is used in RC timing circuits. Breakdown voltage of the tube is $66-72 \text{ volts}$ in the dark. Maintaining voltage is $50-60 \text{ volts}$ at $.3 \text{ mA}$. Leakage resistance of the A039A

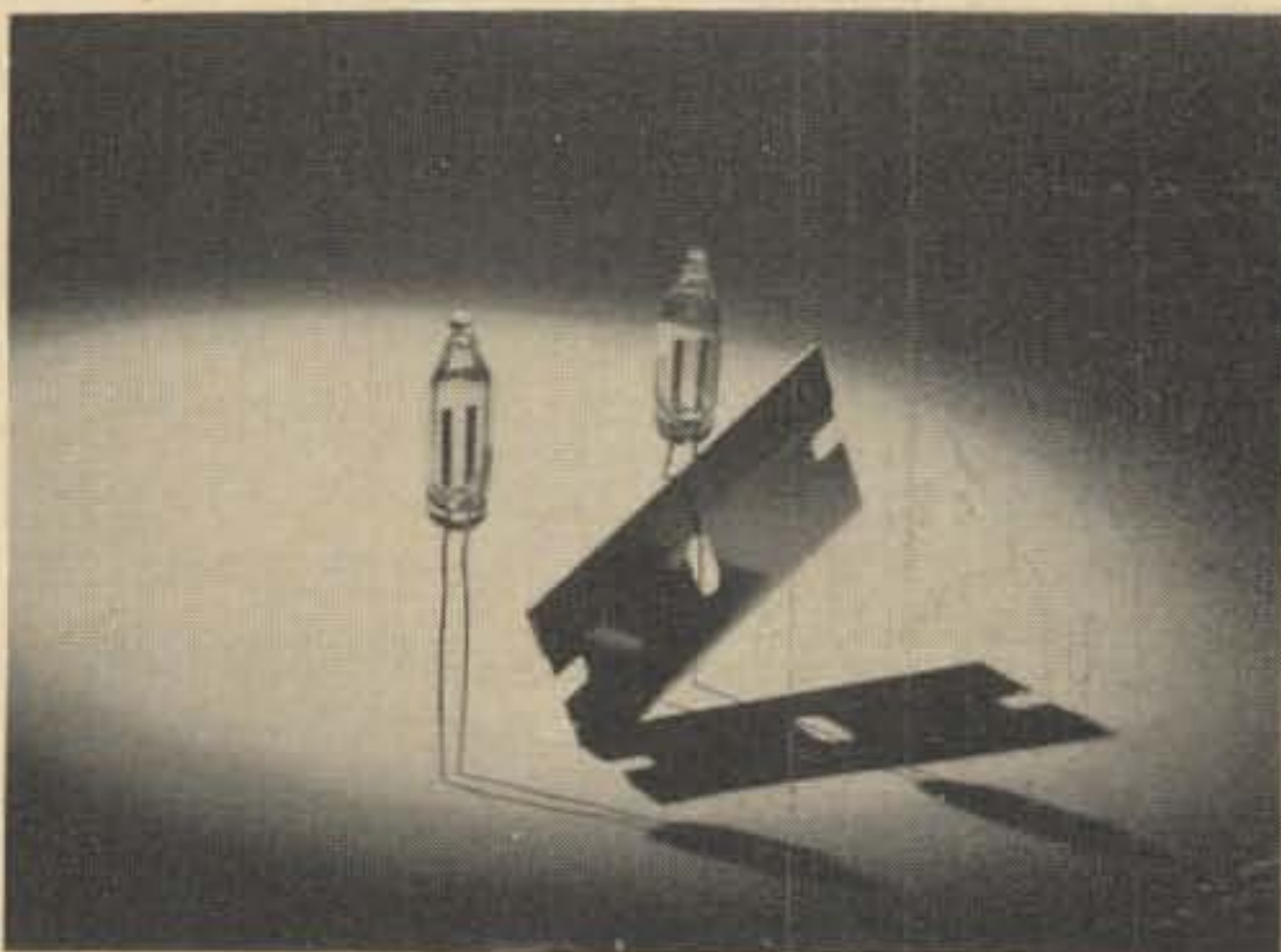

is greater than $20,000 \text{ megohms}$. The A039A is $27/32''$ in length and $.244''$ diameter. It is provided with $1''$ tinned leads. Where electrical characteristics are slightly different the A243 neon tube has a breakdown voltage rating of $68-76 \text{ volts}$ and a leakage resistance of $10,000 \text{ megohms minimum}$. *Signalite Inc., 1933 Heck Ave., Neptune NJ 07753.*



TAPE DECK

This unit cost \$69 to produce! We now offer a limited quantity of these new original packed tested units for only \$29.95 plus shipping and handling.

On cash with order, shipment is made the same day of receipt of order for only \$4.55 shipped P.P. Ins. anywhere in the USA. COD orders accepted, same prices plus COD fee.

LOOK AT THESE UNPARALLELED FEATURES NOT FOUND ON ANY OTHER DECK OF U.S. MANUFACTURE AT MUCH HIGHER PRICES.

STOP-START: Full speed attained in less than 0.5 sec.

DRIVE CONTROL: Single rotary control for all functions. Interlock prevents tape breakage, stretching and spilling when changing mode of operation.

MOTOR: 4 pole shaded, 50/60 Hz.

BRAKES: Mechanical braking eliminates need for adjustments.

TAPE SPEEDS: 3¾ and 7½ ips.

WOW AND FLUTTER: Less than; .25% at 7.5 ips; .3% at 3.75 ips.

POWER: 26 WATTS, 120V 60 Hz.

DIMENSIONS AND WEIGHT: 10 5/16" x 14¼" x 5½" Below panel, 1½" above panel. 14 pounds.

REEL AND TAPE SIZE: 7" max. reel, ¼" tape.

HEADS: Record/playback staggered two track stereo, dual erase. (¼ track stereo erase, and R/P head available, \$9.95 for complete kit).

COUNTER: Resettable 4 digit index counter.

R/P FREQUENCY RESPONSE: 40 to 15,000 cps ± 3 dB.

TAPE DECK ONLY

Electronics listed separately

WARREN Electronic Systems

BOX 73, CHICKASHA OK 73018

Subminiature LED Indicator Line

LEDs (light emitting diodes) are used as the light source for subminiature indicators and switch indicator devices. The "SS" series are resistant to shock, vibration and other environmental extremes. The body diameter is .360" and

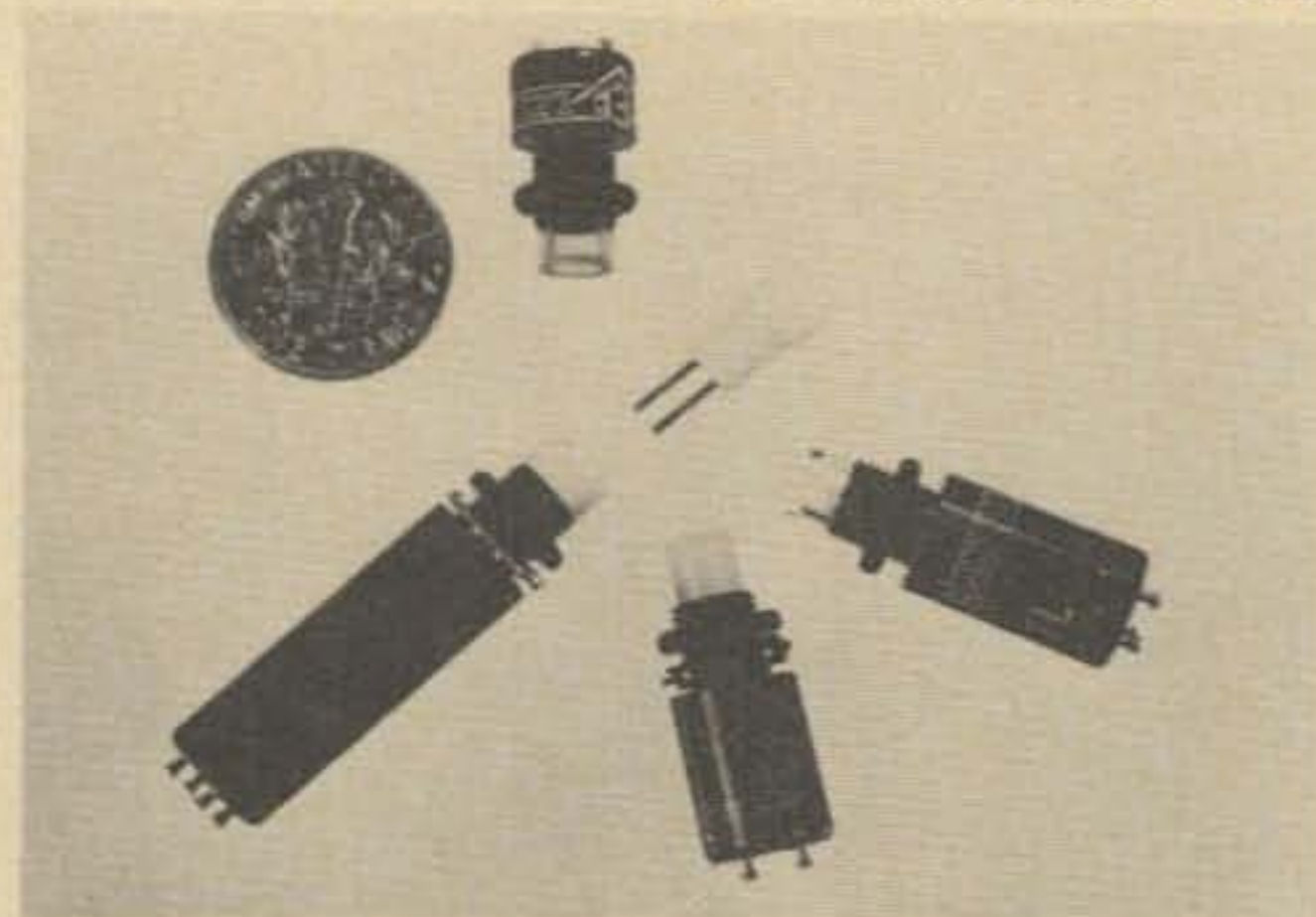

3/8" mounting centers in a ¼" panel hole. Units mount from the rear and are secured by lock-washer and knurled nut. Turret lug terminals are provided. TEC, Inc., 6700 South Washington Ave., Eden Prairie MN 55343.

Inexpensive Integrated Circuits

Two devices, Types MFC4000 and MFC4010, are the first units in a line of inexpensive consumer integrated circuits. Type MFC4000 is a low-power audio amplifier featuring 250 mW of audio output power and low total harmonic



distortion. Type MFC4010 is a wide-band amplifier featuring high gain and low typical output noise. Both devices are housed in a four-lead plastic package. Motorola Semiconductor Products Inc., P.O. Box 20912, Phoenix AZ 85036.

Germanium Power Transistors

Types 2N5692 through 2N5696, 40-ampere pnp germanium power transistors feature significantly improved safe operating area. Minimum collector-emitter sustaining voltages range from 50 to 140V at 10A, and from 45 to 65V at 40A. The series is ideal for use in voltage/current

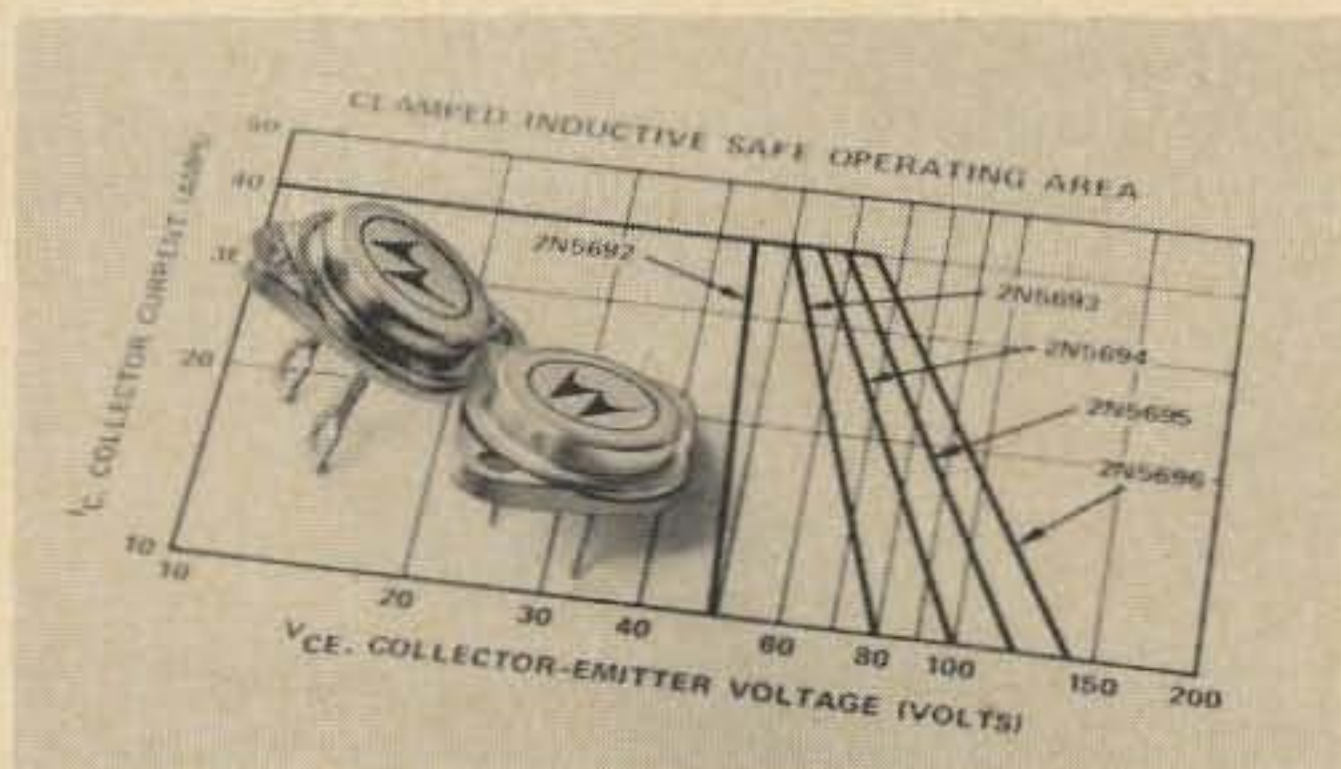

regulators, motor controls, inverters, converters, and servoamplifiers. *Motorola Semiconductor Products Inc., Box 20912, Phoenix AZ 85036.*

Chip Resistors Feature Beam Leads

A series of unencapsulated resistors featuring small size (50 mil square) and gold beam leads, with resistance values ranging from 5 to 5000Ω, is offered by Motorola. The miniature resistors

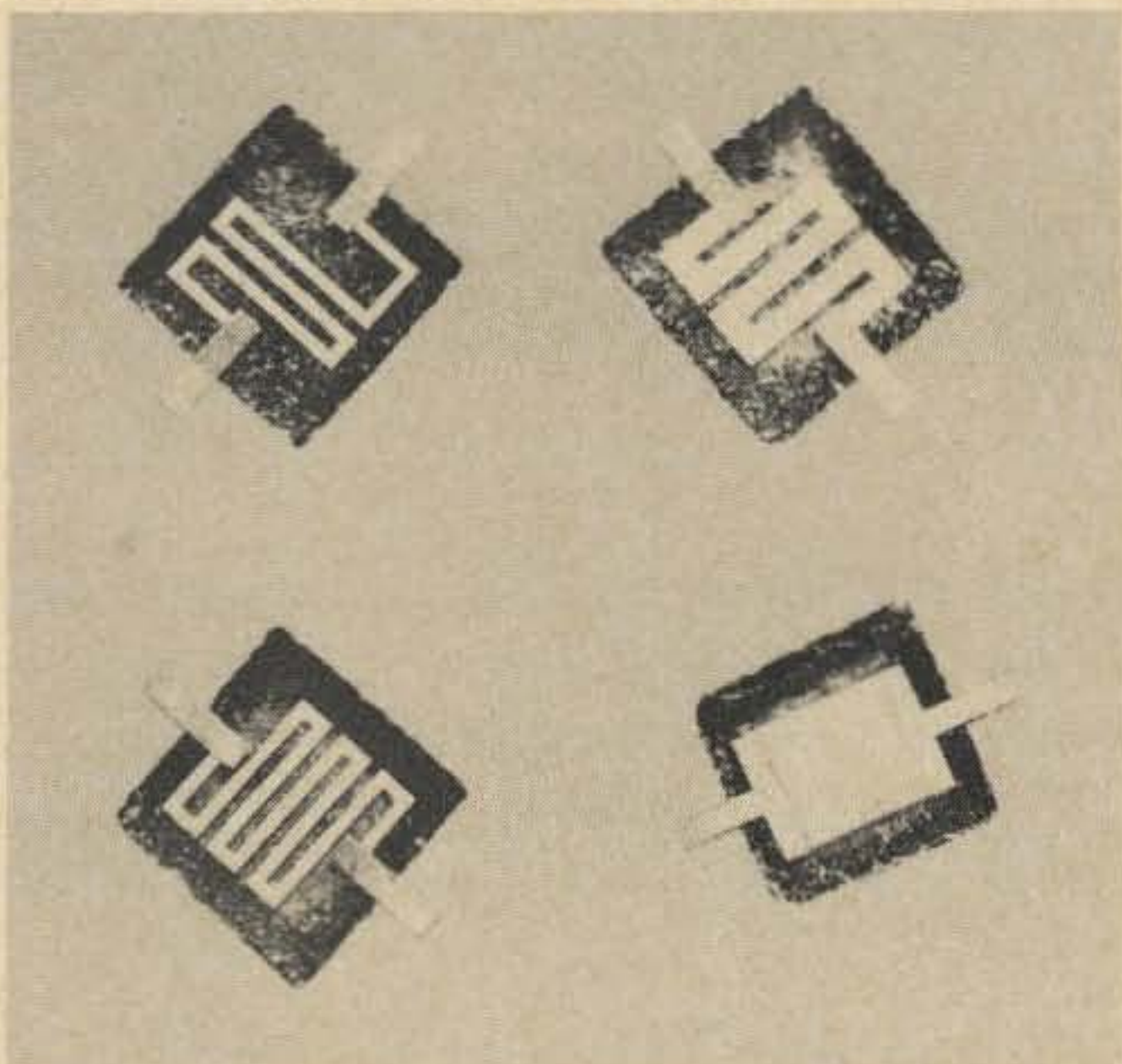

feature a temperature coefficient of 50 ppm/°C and maximum power dissipation of 125 mW. *Motorola Semiconductor Products Inc., P.O. Box 20912, Phoenix AZ 85036.*

Fast Photodiode has High Radiation Sensitivity & Low Dark Current

Featuring ultrafast response, high radiation sensitivity, low dark-current level, and low cost are two p-i-n photodiodes, MRD500 and MRD510. Both devices are sensitive over a

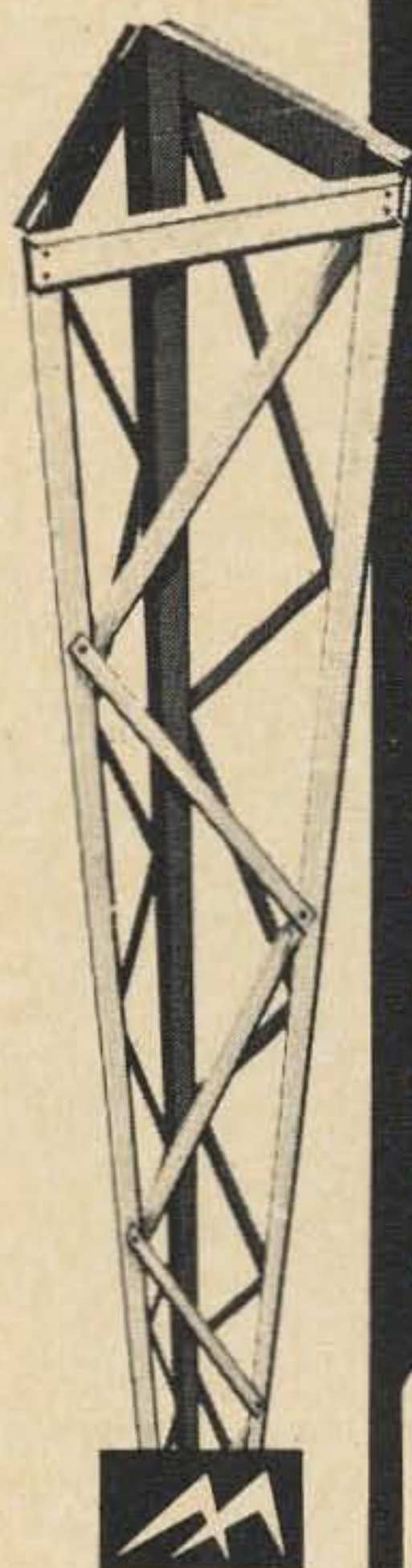
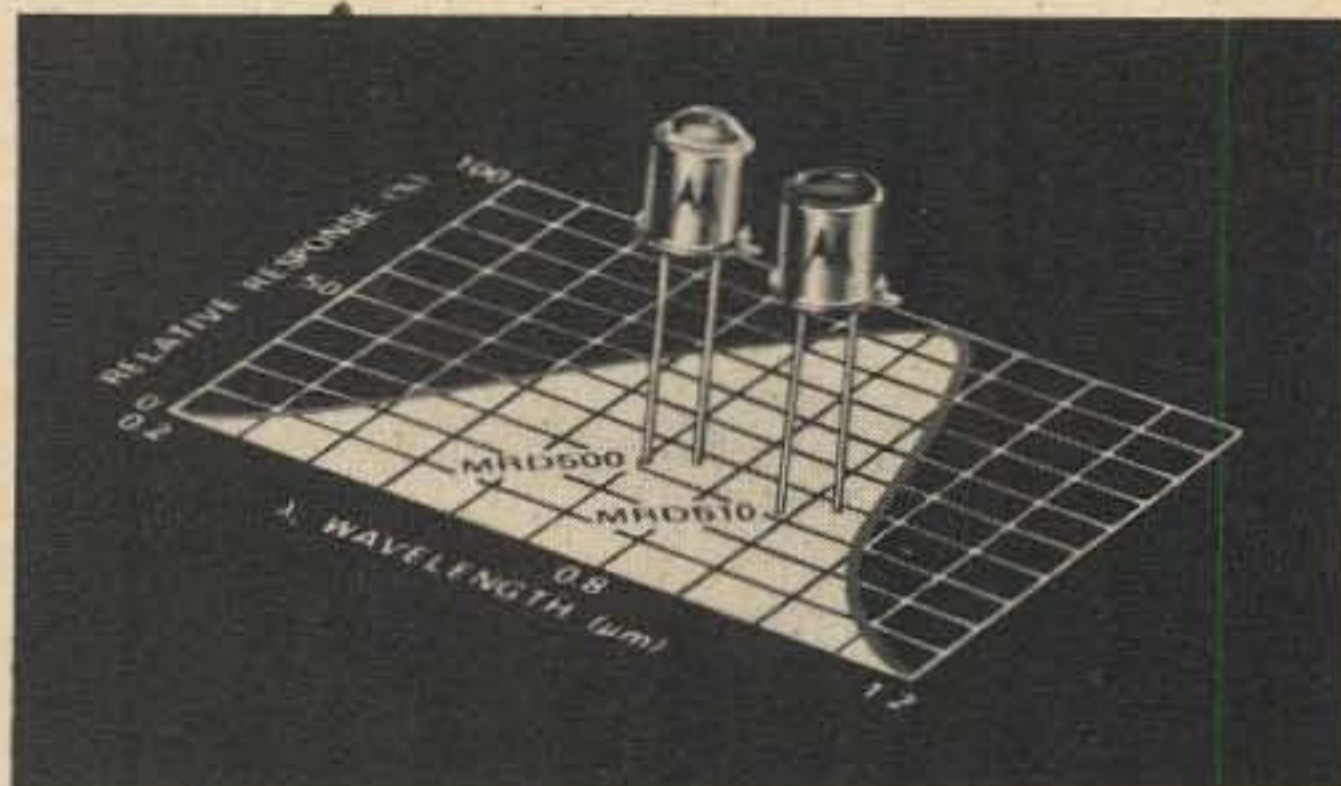

AL SERIES ALUMINUM TOWERS for uhf - vhf

Ideal for mounting industrial, commercial, citizens band, amateur, or television receiving antennas. Exceptional strength in proportion to weight qualities. Easy access to equipment mounted on the Microflex top mast extension. Other features are:

- 10 to 120 feet high in easy to erect 10 foot sections.
- Available factory assembled or in kit form.
- Lightweight all aluminum 10 foot sections weigh only 12½ lbs.
- Low maintenance, will never rust or require painting.
- Staggered ladder treads for easy climbing.
- Can be used for direct radiator at HF.
- Wide variety of mounting brackets and accessories available

DISTRIBUTOR INQUIRIES INVITED

MICROFLECT

3575 25th STREET
SALEM, OREGON 97302
AC 503-363-9267 TWX 510-599-0107

— RF TOROID CORES —

Red "E" Cores — 500 kHz to 30 MHz, $\mu = 10$

#	OD	ID	H	EACH
T-200-2	2.00"	1.25"	.55"	\$3.00
T-130-2	1.30	.78	.44	2.00
T-94-2	.94	.56	.31	.75
T-80-2	.80	.50	.25	.60
T-68-2	.68	.37	.19	.50
T-50-2	.50	.30	.19	.45
T-37-2	.37	.21	.12	.40
T-25-2	.25	.12	.09	.30
T-12-2	.125	.06	.05	.25

Yellow "SF" Cores — 10 MHz to 90 MHz, $\mu = 8$

T-94-6	.94	.56	.31	.95
T-80-6	.80	.50	.25	.80
T-68-6	.68	.37	.19	.65
T-50-6	.50	.30	.19	.50
T-25-6	.25	.12	.09	.35
T-12-6	.125	.06	.05	.25

Black "W" Cores — 30 MHz to 200 MHz, $\mu = 7$

T-50-10	.50	.30	.19	.60
T-37-10	.37	.21	.12	.45
T-25-10	.25	.12	.09	.40
T-12-10	.125	.06	.05	.25

FERRITE BEADS: THE LITTLE GIANTS. $\mu = 900$, Spec Sheet and Application Notes. Pkg. of 12: \$2.00

KILOWATT BROADBAND TOROID BALUN KIT: \$5.00

EXPERIMENTER'S 2 CORE TOROID KIT: Thousands Sold. Has cores, wire and charts & construction suggestions. Make your own High Q inductors for hundreds of modern uses: \$1.50
MINIMUM ORDER: \$3.00

Please add 25¢ per order for Packing & Shipping
FREE ILLUSTRATED FLYER

AMIDON ASSOCIATES
12033 Otsego Street
North Hollywood, Calif. 91607

wavelength of 0.4 to 1.1μ , with peak sensitivity at 0.8μ . They also have a low series resistance of 10Ω max and a maximum total capacitance of 4 pF. *Technical Information Center, Motorola Semiconductor Products Inc., Box 20924, Phoenix AZ 85036.*

Data Selector Highlights High Speed

The dual four-channel data selector, Type MC4000, features high speed characterized by a typical propagation delay of 11 ns from data input to output. The selector consists of inter-

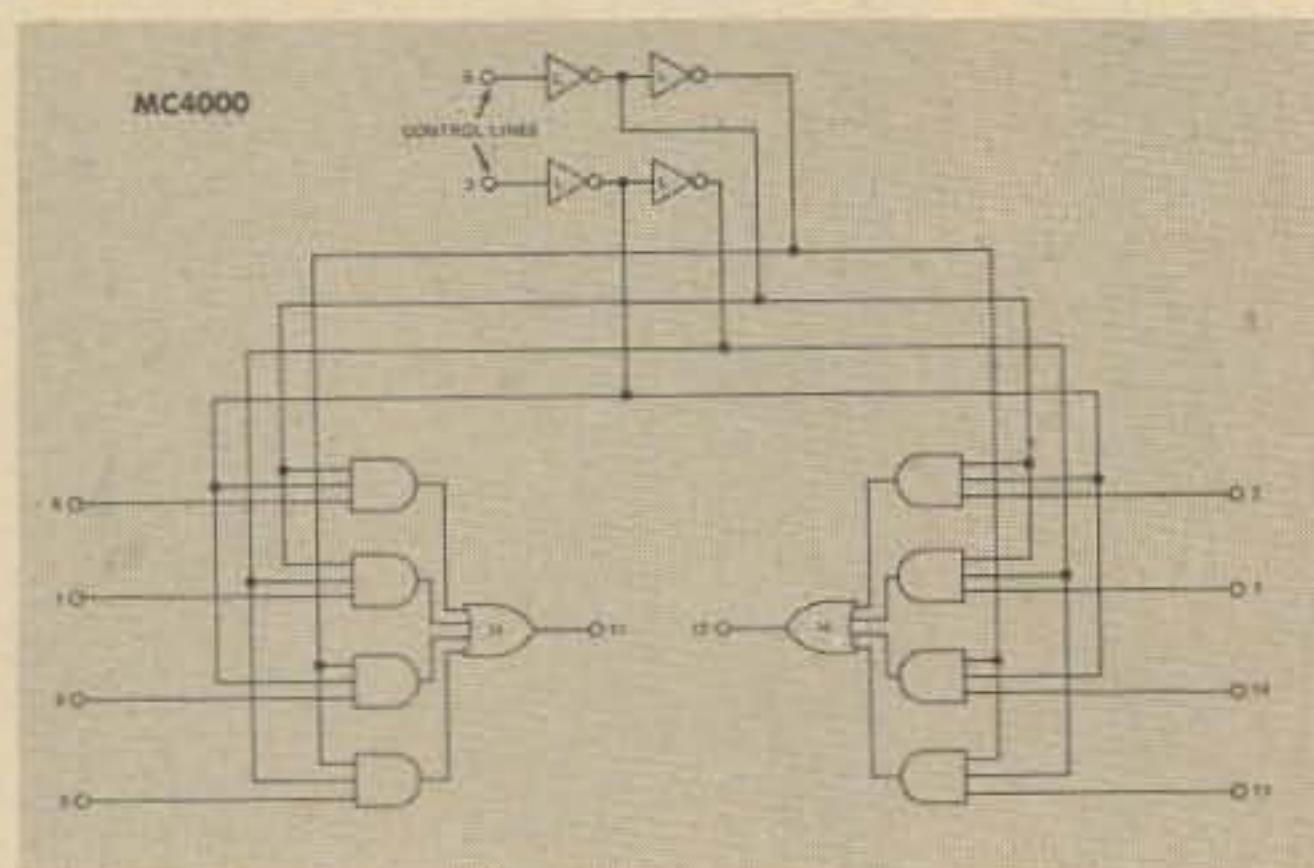

nally connected low-level inverters and high-level and-or gates. Data on any one of the four inputs

is selected according to the binary code on the control lines and is routed to the output. *Motorola Semiconductor Products Inc., P.O. Box 20912, Phoenix AZ 85036.*

TV Video I-F Amplifier

Type MC1352 TV video i-f amplifier has an integral keyed agc amplifier circuit in addition to the i-f amplifier circuit of the Type MC1350

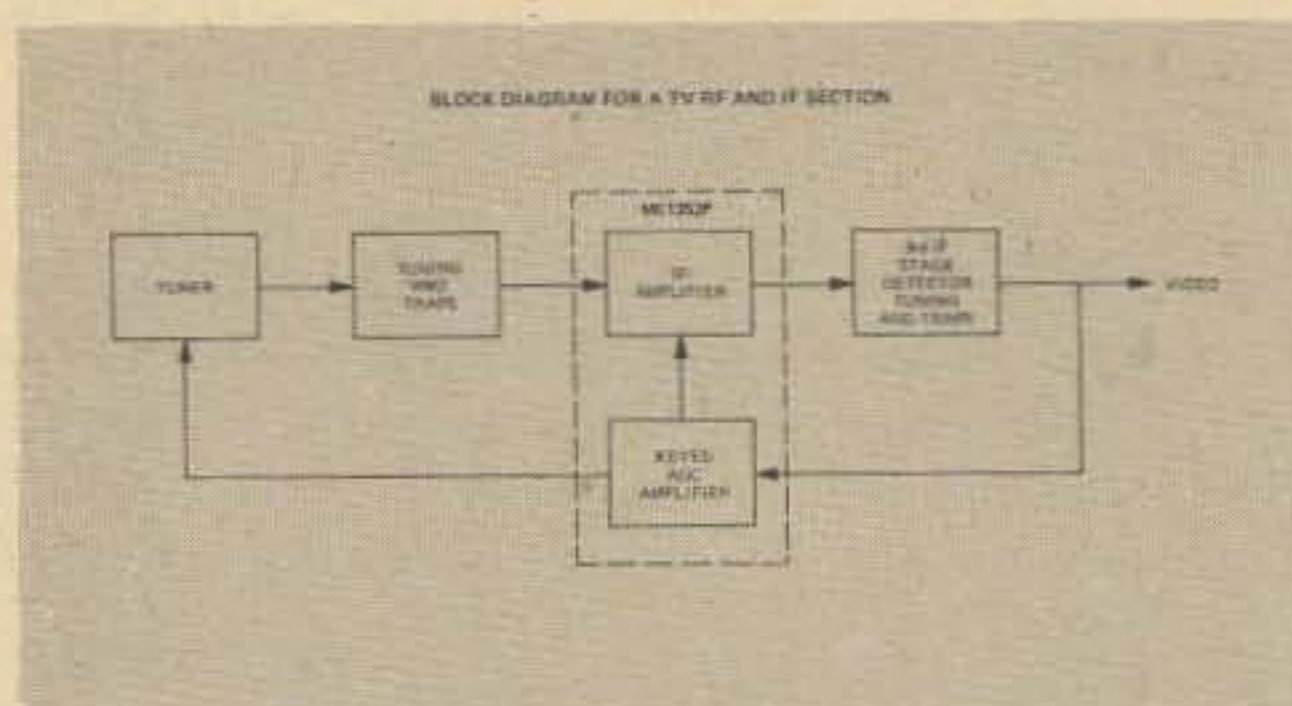

device. It constitutes a complex TV i-f strip, resulting in cost reduction compared with discrete circuits. *Motorola Semiconductor Products Inc., P.O. Box 20912, Phoenix AZ 85036.*

De-RF Your VTVM

A partial schematic for a common vtvm is shown in Fig. 1. The modifications shown in the bold lines of the schematic allow the vtvm to be used near a strong rf field and can be added to almost any vtvm without affecting the accuracy of the meter.

This modification bypasses the rf to the bridge tube (12AU7), keeping the rf from driving this tube into grid rectification.

The capacitors used can be anything from $.001$ to $.01$ disc ceramic. They should

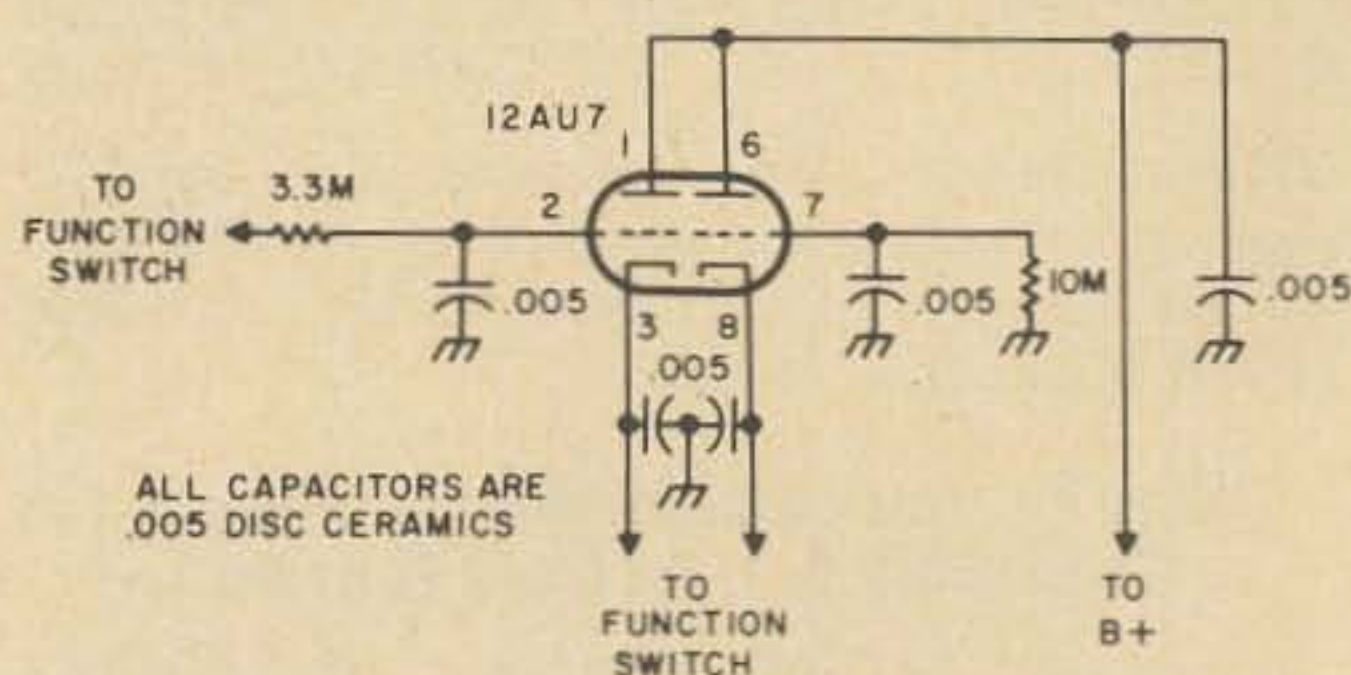

Fig. 1. A partial schematic for a common VTVM.

be mounted with short leads and returned to the same ground point. The capacitors which are already in the circuit need not be bypassed.

This modification was added to the Heathkit Model V5A vtvm and it is no longer affected by rf.

These modifications *do not* apply to an ac meter.

Jan Wilstrup, WA0FFJ ■

432 MHZ CONVERTER
MODEL 432CA

ONLY \$64.95 pp.



Low Noise Silicon Circuitry • Attractive Metallic Green Styling • Built-in ac Power Supply • Silver Plated Cavities • Write for detailed literature or order direct, specifying i-f frequency.

JANEL
LABORATORIES

P.O. Box 112, Succasunna, NJ 07876
Telephone 201-584-6521

Getting Your Extra Class License

STAFF

Part XVII: Conclusion

All things end, the philosophers tell us, and this installment brings our study course for the Extra Class exam to its close. All we have left from the 90 questions on the official FCC study list are a half-dozen "miscellaneous" items covering a number of relatively minor but nevertheless important points.

The official questions which remain for us to examine are:

47. What useful functions does a balanced modulator perform in a radio transmitter?

69. What is a third party agreement? What countries have agreements with the United States?

83. Describe briefly how an ac power supply produces a dc output voltage. Discuss the merits of using choke-input versus capacitor-input filters in power supplies. How does the leakage resistance of the capacitors affect the output voltage? Also, what is voltage regulation as related to power supplies?

85. What is push-pull amplifier operation?

86. What is a Q-multiplier and how is it used in amateur equipment?

89. What visual observation within an operating vacuum tube's envelope would indicate that the tube is gaseous?

90. Be familiar with Part 97 of the Commission's rules.

Since these questions cover such a broad range of subject matter, we'll abandon our usual technique of rephrasing the FCC questions this time, and simply extend our looks a bit past the specific points asked. Keep in mind that the actual Extra Class exam may contain questions of similar nature on other parts of radio theory—but the official study questions are intended to provide adequate preparation for the "real thing" and any questions in radically different areas will probably be few and far between. All set?

What Does A Balanced Modulator Do?

The balanced modulator is generally considered to be a part of SSB or DSB equipment, although it doesn't necessarily have to be. The function of a balanced modulator is to mix (or heterodyne) two input signals into a group of output signals; so far, that's the same as the function of any other kind of modulator or even a receiver mixer stage.

But the balanced modulator differs from a conventional modulator in one essential particular. Where a conventional modulator or mixer produces *four* signals in its output—

the original "carrier," the modulating signal, and the sum and difference of these two inputs (generally called the upper and the lower sideband)—the balanced modulator has only three parts to its output. The "carrier" is suppressed by being "balanced" out, and the output contains only the modulating signal and the two sidebands.

In a radio transmitter, the modulating signal is usually at audio frequency while the carrier and the sidebands are at rf. The af is not coupled out from the mixer stage, so that a conventional modulator's output (after the coupling) contains only the carrier and the two sidebands.

A balanced modulator's modulating-signal output is similarly disposed of in the output coupling circuit, and the carrier signal is balanced out in the modulator circuit, so that the effective output of a balanced modulator in a radio transmitter consists of *only* the two sidebands. In a phrase, the balanced modulator produces a DSB signal.

Because the carrier disposal is accomplished by built-in circuit action, rather than by filters, a high degree of carrier suppression can be achieved. It's limited primarily by the care taken in adjusting the circuit, and by the shielding which prevents stray carrier-frequency signal from leaking around the circuit; the balanced modulator stage itself is capable of "perfect" rejection of the carrier in theory at least, and in practice 30 to 40 dB of suppression is normal.

For this reason, almost all SSB transmitters use some balanced modulator circuit to generate the original SSB signal. "Phasing" designs use a pair of balanced modulators, in which the phase relationships between carrier and modulating signal differ, so that the individual outputs of the two balanced modulators will add together for one sideband and cancel out for the other. "Filter" designs depend upon filter selectivity to reject the unwanted sideband, but the balanced modulator's rejection of the carrier together with frequency shaping in the audio channel before modulation provides a region near the carrier in which little or no signal is present, and thus eases the task of the filter designer.

The balanced modulator has another feature which comes along automatically at

no extra charge. Since carrier suppression depends upon the fact that the modulator is balanced, all that's necessary to put some carrier in is to deliberately unbalance the modulator. This permits carrier insertion, which is sometimes handy to have.

Balanced modulators aren't restricted to SSB and DSB transmitters, either. The Armstrong technique for producing FM (it actually produces a mixture of phase and frequency modulation, but it's the system normally used by FM broadcasting stations) also makes use of balanced modulators. If the carrier is removed from an AM signal, shifted in phase by exactly 90 degrees, and then reinserted into the signal, the result is PM. If audio frequency response is properly shaped, the PM which results cannot be distinguished from FM by any method. The Armstrong technique uses a balanced modulator to simultaneously produce the AM signal and remove its carrier, and a separate phase-shift network to shift carrier phase by the necessary 90 degrees. The carrier is then reinserted, and the result is FM—but crystal-controlled. This technique is seldom used by hams because we have no need for a wide frequency swing in our FM signals, but it's the mainstay of commercial FM broadcasting.

A number of balanced-modulator circuits exist. They range from simple diode-ring switches, in which the carrier signal acts as a switch to steer the modulating signal through coupling networks (or vice versa, with the modulating signal switching the carrier), up to push-push amplifiers. A typical amplifying balanced modulator using tetrode tubes is shown in Fig. 1. In this circuit, the carrier is applied to both control grids in push-pull while the output is taken from both plates in parallel. With no modulating signal present, any increase in current through one tube (caused by the carrier waveform's going positive) is balanced out by a corresponding decrease in current through the other tube, because the waveform at its control grid goes negative by the same degree. Therefore the carrier is balanced out of the output circuit, and nothing emerges from the plate tank.

When a modulating signal is applied to the screen grids in push-pull, though, the

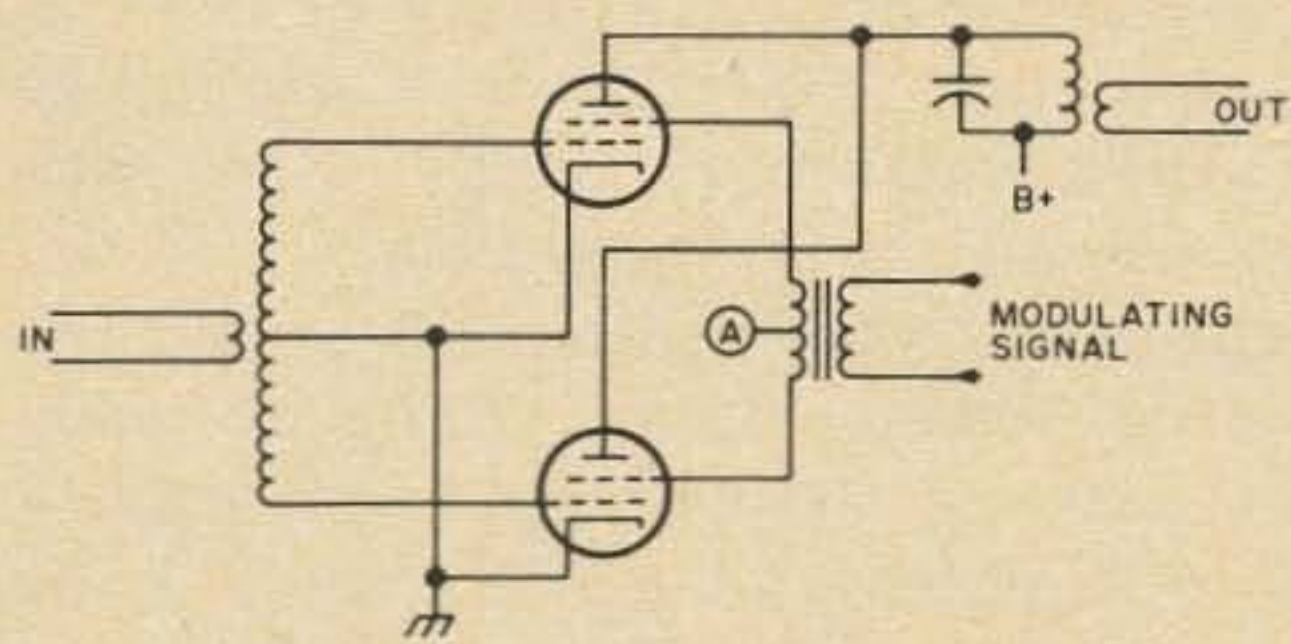

Fig. 1. This oversimplified schematic of a tetrode balanced modulator is intended to show only the operating principle. All arrangements for tuning the grid circuit, supplying grid bias, and bypassing the screens have been omitted. Carrier input applied to the terminals labeled "IN" goes to the two control grids in push-pull, and balances itself out so that none emerges in the parallel-connected plate circuit. When modulating signal is applied to the screens, also in push-pull, the circuit's balance is upset and sidebands are not canceled out. Point "A" may be returned to ground, to a slightly negative voltage, or to a slightly positive voltage, depending upon the tubes used. It should not connect to a normal screen-voltage level, since full screen voltage in this circuit would cause excessive power dissipation in the tubes.

two tubes no longer operate under identical conditions if any modulating signal is present. If a modulating signal drives one screen slightly more positive, it will at the same time drive the other screen slightly more negative. The carrier signal is no longer balanced out as a result. When the tube with the positive screen gets positive control grid voltage as well, it draws correspondingly more current than the other tube; the net change at the plate tank circuit is a slight increase in current.

As both modulating and carrier signals vary in polarity and strength, the power in the plate tank circuit will vary. The net result is that no power gets out at carrier frequency, but the signal components at both the sum and the difference frequencies (or in the upper and the lower sidebands) do appear and can be coupled out.

This circuit was popular as an "instant" DSB transmitter when double sideband was first pushed some 10 years ago; it still has its uses.

A similar circuit using only one tube, called a "beam deflection tube," has been used as a receiver mixer and as a product detector, as well as for color demodulation in TV receivers. The stereo multiplex circuits

in quality FM receivers also make use of balanced modulators to recover the stereo signal and route it to the appropriate channel. But these uses are outside the range of the FCC question, which deals only with "useful functions" in a radio transmitter.

What Are Third Parties? The phrase "third-party traffic" is frequently encountered both on the air and in the ham literature, not to mention its occurrences in the FCC rules and international regulations. What is it all about?

The "third party" does not refer to political innovations. It's a legal phrase similar to "the party of the first part" and "the party of the second part," and it has a most specific meaning in regard to ham radio.

In any QSO, only two parties are involved; they are the ham who is talking (or transmitting), and the one who is listening (or receiving). A "third party" is anyone else other than one of these two.

It might appear that a roundtable or net operation would have more than two parties, but in any properly operating net or roundtable only one person transmits at any given time. He is the first party, and all the other participants (collectively) are the second party. Again, a "third party" is anybody on the outside.

The international rules governing radio communication include a specific prohibition forbidding amateur stations from handling any kind of traffic or messages on behalf of "third parties." This means that, so far as this rule is concerned, you can't tell the guy on the other end to give your regards to his family—for his family is a third party to the conversation. You might argue that the message is on your behalf, not theirs—and you *might* get by with this argument. But you certainly would not be safe in sending *your* family's regards to *his* family.

This rule came into being because, in most countries, the radio communications facilities are government-owned, and the governments which created the rules feared that ham stations might compete with the government monopolies on traffic handling. In this country, of course, the commercial radio communications services are privately

owned rather than being parts of the government, and so this nation has not been an enthusiastic supporter of the "no ham traffic" movement.

In fact, that same rule which generally forbids third-party messages through ham stations includes a loophole, to the effect that the rule may be suspended by mutual agreement between two nations, so far as the hams of those nations are concerned. This part of the rule was written to satisfy U.S. requests, in part at least.

A "third-party agreement" is such an agreement between two nations that their hams may handle third-party traffic. This country has third-party agreements with about 30 other nations, and message traffic can be handled to and from those countries. Messages within this country can, of course, be handled without third-party restriction because this government has chosen to permit them. The exact list of nations with which third-party traffic may be handled varies from time to time, as new names are added (and occasionally, old ones taken off when agreements are canceled for one reason or another). Check a current list just before going for the exam to be sure.

Power Supplies. Every item of electronic equipment requires a power supply of some sort. The pocket transistor receiver is probably the simplest in this respect, because its power supply consists of a single dry-cell battery (usually the 9V size). Most of our ham equipment, however, is not so simple nor so portable. Producing 1 kW of dc input to a transmitter requires several kilowatts of power, and the supply which does this job is a bit bulky.

Power supplies in general can be grouped into three main classes. The first, typified by the transistor set, gets power directly from expendable batteries. It's dc to begin with, and it's also at the proper voltage. This type of power supply is simply one or more batteries, and we can ignore it from here on.

The second class also operates from a battery, but gets all its various output voltages from a single rechargeable battery which is normally of comparatively low voltage. The mobile rig's vibrator or transistorized supply is an example of this type. It's fairly complex, but once the low-voltage

dc from the battery is changed to either ac or a pulsating dc (either of which will go through a transformer nicely), it becomes much the same as the third class.

The third type, which we'll examine in some detail here, operates from ac input. The normal ac input voltage is either 117V from a wall plug, or 220V from a 3-wire connection. The output voltages may range from a few volts (to replace the battery in a transistor set) up to several thousand volts. The ultimate output is dc, but its "purity" may range from being almost completely free of hum, ripple, and noise, just like a good battery, to being almost ac and qualifying for the "dc" label only because current flow never reverses.

The ac power supply consists of three major sections: the transformer (which changes the input voltage to the appropriate voltages for the desired outputs), the rectifiers (which convert the ac to pulsating dc), and the filter (which removes the pulsations from the dc and smooths it into something approximating "pure dc").

The transformer in the power supply establishes the maximum output voltage and current available. While it's possible to cut down the output voltage by resistors, it's wasteful of power and components to do so, and as a result the transformer is normally chosen to produce the proper output voltage rather than merely letting it set the maximum. The relationship between rms ac voltage at the transformer secondary, and dc output voltage, depends on both the rectifiers employed and the type of filter circuits used. In general, the dc output will almost never (with conventional rectifier circuits) be more than 1.5 times the rms ac voltage at the secondary, and will seldom be less than the rms ac value.

The ac from the transformer secondary is applied to the rectifier circuit. Most transformer-type supplies use full-wave rectification; most of these, in turn, use the center-tap circuit which requires two rectifiers. Each rectifier anode connects to one end of the transformer secondary. The center-tap of the secondary is the negative terminal for the dc output, and the cathodes of the rectifiers (which are connected together) provide the positive terminal.

Some full-wave rectifier circuits use the bridge circuit, which takes four rectifiers but needs no center-tap on the transformer secondary. If a bridge circuit is used with a transformer which was designed and rated for center-tap circuits, the secondary voltage to figure on is that from end to end of the winding, rather than from one end to center tap. This means that a secondary rated (as so many TV transformers are) at 350-0-350V would give 700V end-to-end, and with a bridge circuit could be expected to produce a dc output voltage around 900 to 1100 volts.

Sometimes a half-wave rectifier circuit is used. This takes only one rectifier, but is neither as efficient in its use of the ac nor as desirable in terms of simplicity of filtering as a full-wave circuit. The half-wave circuit simply blocks off half of the ac waveform and lets the other half pass through; the result is dc output which pulsates at input ac frequency. All it really is is a string of half-cycles of the input ac. A full-wave circuit, whether center-tap or bridge, passes both halves of the ac waveform, but steers them around so that they emerge always going in the same direction. This produces twice as much power with less strain on the rectifiers, and also makes the ripple frequency be twice the input frequency—which means it's easier to get rid of the ripple.

The filter circuits make use of capacitors to store the pulsating dc and smooth out the ripple. Sometimes, the capacitors are the only elements in a filter, but by themselves capacitors don't do much filtering. If inductors or resistors are placed in series with the load while capacitors are in parallel with it, the inductors will oppose any changes in current while the capacitors tend to smooth things out, and almost pure dc can be obtained.

The two most commonly used filter circuits are shown in Fig. 2. The only difference is that in one, the input element is a capacitor, and in the other, an inductor or choke.

This single difference provides the names for the circuits: "capacitor input" and "choke input." While the circuits are extremely close to each other in appearance, they have some notable differences.

A capacitor, when discharged, is almost a short circuit even to dc. It's only after the capacitor reaches nearly full charge that the current flow into it comes down to small levels. A capacitor-input filter, then, represents almost a dead short to the transformer and rectifiers when power is first turned on. The larger the capacitor, the worse the short—yet it takes a large capacitor to do much smoothing. One of the major characteristics of a capacitor-input filter is the enormous power surge into the input capacitor when power is applied the first time.

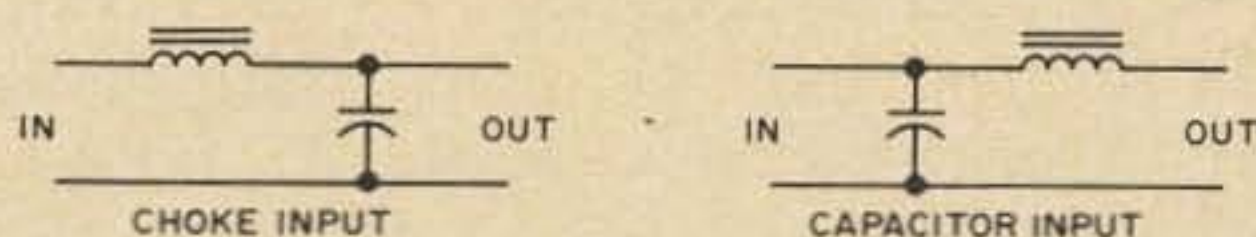

Fig. 2. The two basic types of filter sections used in power supplies are shown here. Note that both are lowpass filters, and could be designed by normal lowpass techniques if one desired. However, the frequency-cutoff requirements in a power supply filter are most uncritical, and so the complexity of audio filter design is unnecessary. The only requirements are that the choke's inductance, and the capacitor's capacitance, both be large enough to reduce ripple to acceptable terms. A single section of filtering usually reduces ripple by about 95%; two sections will reduce ripple by 0.95 times 0.95, or 99.75%. More than two sections are seldom used.

As power is taken from the supply, it tends to discharge the filter capacitors, and so with each cycle of rectified ac there's still quite a charging-current flow into the capacitor. A capacitor input filter will, then, draw more current from the transformer (for a given dc load) than would some other type.

This is generally considered to be a disadvantage, but it has a compensating advantage. Under light current load, the input capacitor will charge up to nearly the peak voltage of the rectified ac, which is 1.4 times the rms voltage. With light current loads, the voltage will remain near this peak. Thus a capacitor input filter produces a higher output voltage—provided that load current is low. As load current increases, the capacitor voltage drops, and the advantage is lost.

A choke opposes any change in current flow, and so the choke-input filter tends to retard the high current flow into the filter

capacitor. This reduction of charging-current surges means that less current is taken from the transformer to keep the capacitor charged, and so more is available to the load. For the same transformer, a choke-input filter can deliver more current.

Offsetting this advantage, in some applications, is the fact that the choke (by slowing down the charging) prevents the capacitor from ever charging up to the peak voltage value if any load current is coming out. Thus a choke-input filter delivers more current, but at lower voltage.

Complicating the action of the choke-input filter is the fact that a certain minimum current *must* be drawn through the filter to make the choke behave as intended. The bleeder resistor value is chosen so that this minimum load is always taken; this power is "wasted" insofar as producing any useful work is concerned.

Most power supplies use at least two filter capacitors separated by a series choke. If choke input is employed, two chokes are used. Because of the additional reactance of the second choke, ripple is usually lower from the choke-input design; if a corresponding reactance were added to the capacitor-input filter, its ripple would be reduced equally.

The output element of all filters is a capacitor. It performs little filtering action in most cases; its purpose is to serve as a storage reservoir to satisfy sudden surges of load current and keep output voltage from falling when this happens. That is, it helps determine the "voltage regulation" of the supply. The larger the value of output capacitor, the better the regulation, in general.

"Voltage regulation" in a power supply is the change in output voltage with changes in load. Any supply will produce higher output voltage when it is unloaded than it will under heavy load. The change in voltage from maximum to minimum is called the "regulation" of the supply and is often expressed as a percentage. Just what this percentage refers to differs from one engineer to the next. Some obtain the percentage by taking the *change* in voltage as a fraction of the minimum voltage, some get it by taking the change as a fraction of the

maximum voltage, and some get it by taking the ratio of minimum to maximum.

This can lead to most conflicting descriptions of the same power supply. Let's assume we have a supply which produces 200V without load, and under maximum load the output drops to 150V. This is pretty poor regulation by anybody's standards, but let's see how the three ways of figuring it would differ. The first method would take the change, 50V, as a fraction of minimum, or 150V, and report a regulation of 33-1/3%. The second method would take 50 as a fraction of maximum, 200V, and report 25%. The final way would take the ratio of minimum to maximum, 150/200, and come up with 75%.

If minimum output was 20V (yes, that is an extreme case), the first way would call the regulation 180/20V or 900%, the second way would call it 180/200 or 90%, and the third way would call it 20/200 or 10%. You can see that the phrase "voltage regulation" expressed as a percentage means very little, unless the quantities composing the percentage are specified. The second method is the one most widely used, but the first and third are encountered frequently enough to make one treat them all with caution.

Since capacitors are a vital part of all power-supply filters, and all capacitors have leakage resistance, it's important to know what effects this leakage resistance may have upon the operation of the filter.

If the leakage resistance is high, there is almost no detectable effect. However, many power-supply filters use electrolytic capacitors, which tend to have much lower values of leakage resistance than do paper or oil types.

If leakage resistance is low, it will produce extra load on the power supply, drawing additional current through the transformer and the rectifiers. This added load will tend to reduce the output voltage, and may cause overheating of all power-supply components. In addition to these effects, the leakage resistance acts as a shunt across the capacitor, thus reducing the effective value of its capacitance and making its filtering action less effective. You might say that an extremely leaky filter capacitor is something

like a sieve; neither of them are very useful as storage devices.

The leakage resistance of electrolytic capacitors varies with the capacitor's age. As an electrolytic ages, its leakage resistance usually goes down, making it less useful.

Fortunately (in a roundabout way), the effects of excessive leakage tend to be self-destructive. As abnormal leakage currents overheat the capacitor, it becomes even more leaky. Finally, the point is reached at which the capacitor literally explodes from internal heat. This removes the capacitor from the circuit, and in most power-supply designs nothing else in the supply is damaged (although the inside of the chassis becomes somewhat messy). The violent action is desirable, since it prevents the capacitor's turning into a dead short which might destroy transformer and rectifiers as well, and it leaves no doubt as to the identity of the failed component.

What Is Push-Pull Amplifier Operation?

A push-pull amplifier is actually two amplifiers working together, with input and output signals arranged so that plate (or collector) current in one of the two increases at the same time that of the other decreases. In industrial electronics, this same circuit is often called a "differential amplifier" or "diffamp" for short.

The input and output arrangements which are the heart of push-pull operation involve driving half of the stage with a signal which is exactly 180 degrees out of phase with the signal applied to the other half, and reversing the phase of one of the output signals by 180 degrees before combining them.

The most conventional method of obtaining the out-of-phase input signals, and of reversing phase of one output signal with respect to the other, is by using center-tapped transformers at input and output. The phase reversal is inherent when the signals are taken from opposite ends of a single center-tapped winding, with the center-tap used as a common reference point.

Transformer coupling is actually not necessary for push-pull circuits to operate. Especially in audio frequency amplifiers,

don't miss this!!

Fibre optic lens from formally
SECRET
Starlight Scope.

UNUSUAL .. UNIQUE .. MYSTIFYING

(GOV. COST \$80.00) only \$3.00

ADJUSTABLE IC VOLTAGE REGULATOR

TO-5, 8.5-30 volt, load current 0-50 ma and 5
amps using ext. pass transistor.
Choice NEG or POS stock #32 \$1.75 ea.

PHOTO DIODE ARRAY

Sensitive to light & IR
Bank of 8 diodes 1.75
Single diode75

LAMP DRIVER, QUAD-RESETTABLE

IC flat pak, 12 volt 200 mil
Stock #F26 \$1.00 each

EPITAXIAL PLANAR RF POWER TOWER

12 volt 50 watts 72 mc #M83 . \$1.50
12 volt 10 watt 174 mc #M87 . 1.50



ARC-5 TRANSMITTER SPECIAL

Like brand new, easily convert to 40 or 80
meter band by turning slugs, w/directions.
4-4-5.3 mc T-20 5.3-7 mc T-21
\$9.00 each or 2 for \$17.00

TRANSISTOR AUTO RADIOS

Brand new factory packed automobile radios,
vintage around 1961. 12 volt neg. ground. No
choice of models. The exceptional sensitivity
of an auto radio makes it superior for use in
car, boat, truck, camper, etc., where you are
quite a distance from xmtr location. This is
also the best kind of radio to use with short
wave converters. Each with large original
equipment hi-fi speaker. Some with noise
suppressor kit. High quality, most made to sell
in the \$100 range. A real "find." \$15.00
Hybrid-less speaker 8.50

2 METER ARC-3

Just uncovered a batch of the famous ARC-3
rcvrs & xmtrs with all tubes. Range 100-156
mc, 8 xtl channels. Cheap way to get on 2
meters, CD nets, MARS nets, etc. With con-
version details. Rcvr \$15, Xmtr \$15;

Above equipment on hand, ready to ship. Terms net
cash, f.o.b. Lynn, Mass. Many other unusual pieces of
military surplus electronic equipment are described in
our catalog.

Send 25¢ for Catalog #70

JOHN MESHNA JR.

19 ALLERTON ST., LYNN, MASS. 01904
P. O. BOX 62, E. LYNN, MASS. 01904

where a wide frequency response may be needed, a special "phase inverter" circuit may be used to generate two signals of equal amplitude but opposite phase. These signals may then be fed individually to the two halves of a push-pull amplifier, and the two outputs from that push-pull stage used to drive another push-pull stage. The cascading of push-pull stages may continue indefinitely. At the output, another phase-inverter circuit could restore the signals from each half to the same phase. In practice, however, a transformer is usually used at the output if vacuum tubes are being used, because phase inverters capable of handling appreciable power levels with vacuum tubes are not common.

Push-pull transistor amplifiers may be similar to their vacuum-tube cousins, but when transistors are involved, it is no longer necessary to use either transformers or phase inverters. This comes about because transistors come in two flavors of opposite polarity: PNP and NPN. A signal which would increase current in a PNP transistor would decrease current in an NPN. To build a push-pull transistor amplifier, then, no phase inverter at the input is necessary. Just parallel two stages, using a PNP transistor in one and an NPN in the other, and the outputs will automatically be push-pull if the transistors' characteristics are matched.

This quality (and design trick) carries the polysyllabic name of "complementary symmetry," and several sets of PNP-NPN paired types have been designed for just such applications.

At the output, a similar trick can be employed, using what someone several years ago dubbed the "totem pole" configuration with two transistors in series, and output taken from the midpoint. The circuit for such an output stage is shown in Fig. 3. This circuit is adapted from one which has appeared in several editions of the GE Transistor Manual, and hardly anything in it is particularly critical. With conventional 150 mW transistors, it can produce up to 2W of audio, which is surprisingly loud and clear.

Push-pull amplifiers have a number of advantages for audio and whenever linear amplification is necessary (as for SSB). The

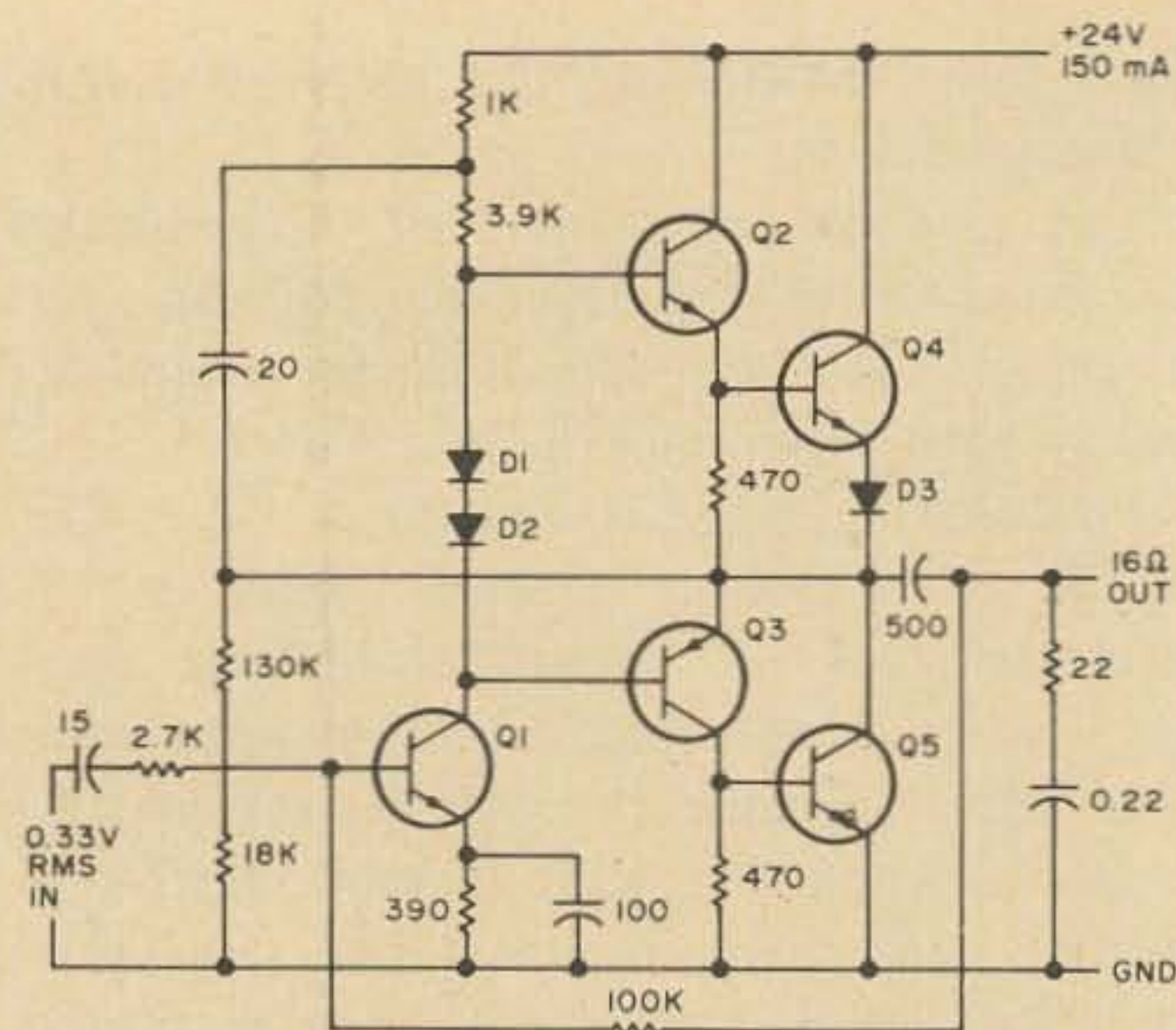

Fig. 3. This circuit for a 2.5W af power amplifier illustrates complementary-symmetry phase inverters (Q2 and Q3) as well as totem-pole output circuit (Q4 and Q5). Transistor Q1 is simply a preamp to provide drive to the phase inverter stage. A 100 k Ω resistor at bottom provides negative feedback. Diodes compensate for base-emitter voltage drops of transistors, making dc coupling safe to use. Transistors Q4 and Q5 must handle 800 mW dissipation; type 2N3402 transistors are simply 2N3414's with built-in heatsinks to raise power rating and are recommended for Q4 and Q5.

advantages are less pronounced when simple rf power amplification is needed, but some are still present.

One of the major advantages of the push-pull amplifier arrangement is the fact that it is a "balanced" amplifier. Any signals which are *in* phase with each other in both halves of the circuit, such as hum in the dc power supply, tend to be balanced out and are not passed on to the output. The same is true of second-harmonic distortion, and for that matter of all even-order distortion products.

The reduction of second-harmonic distortion because of its being balanced out permits us to choose between having less distortion for the same power output (the path taken by hi-fi designers) and having more power output from the same tubes without passing an objectionable distortion figure (the route taken by most hams).

The push-pull arrangement also permits us to operate the tubes or transistors over a wider range of conditions than would be possible with a "single-ended" stage. The class B amplifier is the extreme example of push-pull operation; a class B audio amplifier *must* employ the push-pull circuit to pro-

duce a recognizable output signal, since each half of the circuit works on only half the waveform. The popular class AB amplifiers are based on the same principles, only not to such an extreme degree.

With class C operation, these advantages disappear. The balancing out of second-harmonic distortion is still present, though, and permits us to emit a cleaner signal than we could from a comparable single-ended stage. Neutralization of a push-pull stage is also usually simpler than for a single-ended one, since the required out-of-phase neutralizing voltages are already present in the "other half" of the amplifier.

The Q-Multiplier

Although the Q-multiplier has been with us, under that name, since about 1950 or so (and under other names since the first vacuum-tube receivers were used in ham radio!) its operating principles remain a mystery to many of us.

This isn't too surprising, because it seems almost unbelievable that any device can be connected to a receiver by a single wire which serves as both input and output connection, and produce either a dramatic boost to one signal without affecting others, or an equally dramatic decrease in level of one signal (again without affecting the others).

And this bit of black magic is just what a Q-multiplier circuit does. It connects into the i-f amplifier strip of a receiver by a single connection, and you then have the choice of boosting one signal above the rest, notching out one signal, or having the device do nothing. The secret of this capability is an old friend to constant readers of this series—feedback. While uncontrolled feedback is normally a rather horrible and all-devouring monster, controlled feedback is, like fire, one of our most versatile tools. The Q-multiplier circuit is a device for generating and inserting a feedback signal, with complete control.

The name of Q-multiplier comes from the apparent effects of the circuit: When it is connected across any tuned circuit, the Q of that tuned circuit appears to be multiplied enormously (if the Q-multiplier is set to "peak" a frequency).

What the circuit actually amounts to is a way of picking out a sample of the signals present, and feeding them back over the same wire with controlled amplitude and phase. If the "peak" function is in use, the phase of the signal sent back to the i-f strip is such as to produce positive feedback, or regeneration. If the "null" function is selected, the phase is reversed to provide negative feedback, or degeneration.

The Q-multiplier contains, within itself, a tuned circuit of high Q to which the regeneration is also applied. This tuned circuit inside the Q-multiplier effectively substitutes for the original tuned circuit in the receiver, when the "peak" function is selected. The signals to which the Q-multiplier's internal tank circuit are tuned are not affected by the Q-multiplier at all, but any signals at adjacent frequencies (which would have been passed by the original receiver tuned circuits) are shunted out by the much higher selectivity of the internal tank.

When the "null" function is selected, the operation is a little bit different. The signals to be notched out are amplified by the internal tank just as in the "peak" operation, but they then pass through a phase inverter inside the Q-multiplier before returning to the i-f strip. The signal which was peaked up by the internal tank is, of course, the only one which goes through the phase inverter because the tank's selectivity has eliminated all the others from consideration, so it is the only one which is reversed in phase. When this signal in reversed phase is returned to the i-f strip, it cancels out the original signal. The other signals in the i-f passband are not affected, though. The result is to notch out the signal to which the Q-multiplier is tuned, without effect on the remaining signals.

The confusing part about operation of such a circuit, in either mode, is the fact that input and output travel over the same wire. How, then, if phase has been reversed for the "null" function, can the signal be present as an "input" to produce the action?

To explain this, we'll have to digress slightly into general servomechanism theory. While most persons think of "servos" as mechanical items in airplanes, or something equally far from ham radio, in truth any

circuit using controlled feedback is a servomechanism. A "servomechanism" is defined as "an object controlled, either in whole or in part, by the effects of its own operation"—and since feedback produces at least partial control of a circuit's operation by the effects of the output, it qualifies.

In a servo, the normal situation is to establish a "reference" signal. The servo's output is then compared to the reference, and an "error" signal results which tells how far the actual output is from the desired reference output, and whether it is greater or smaller. The error signal is then applied to the control portions of the servo, which are set up so as to attempt to drive the error signal to zero. If this occurs, it means that the actual output and the desired output are identical.

But, unfortunately, if the error signal ever does actually get down to zero, the servo is no longer controlled. The only thing holding it under control is the error signal's existence, and when it does succeed in forcing the error to nothing at all, the control disappears at the same time. Such a situation is known as "dither," "jitter," or "hunting." With no control, the servo circuit may do anything. As soon as it does, of course, the error signal reappears, and control is restored, but if the error signal is allowed to reach zero very often, the output will fluctuate whenever it does so. The "hunting" or "dither" describes the action which results.

The standard way to prevent the problem is to introduce just enough delay into the servo's feedback loop so that no matter what happens, the error signal can never completely disappear. This assures that hunting cannot occur, but the feedback will still make the error signal as small as it possibly can. In most cases, this is too small for us to measure directly. If we tried to do so, we would conclude that the error signal had indeed vanished—but the fact that hunting is absent indicates that enough error signal remains to keep the circuit controlled.

The Q-multiplier is a servo, of course, and when we set it up for the "null" function, we are in effect setting up the input signal-to-be-notched-out as the error signal. The circuit picks this specific signal out of its many possible input signals, and reverses its

phase to cancel it out. If it should succeed in complete cancellation, there would be no input left to reverse in phase, and action would fail. As soon as this occurred, though, the reappearance of the signal would put the circuit back into play. The net result is that the notched-out signal is *effectively* canceled, but just enough of it remains to permit the circuit to operate. The process is aided by the fact that the voltage and current waveforms of ac signals are not necessarily in phase with each other, and so the voltage waveform can be canceled while leaving some of the current waveform untouched. The necessary error signal can then be obtained, inside the Q-multiplier, by converting this current back to a voltage.

A somewhat similar circuit operating at audio frequency and using RC phase-shift networks rather than a tuned circuit is known as the "Select-O-Ject." It operates in essentially the same way, to produce the same result but at audio frequency rather than at i-f.

Since the width of the peak, or of the rejection notch, is proportional to the frequency at which the circuit operates, both types of circuits serve useful purposes. The Q-multiplier can select one desired phone signal out of several in the passband, or can reject one which may be causing interference. The Select-O-Ject can peak up the desired beat note for CW reception, or can reject a heterodyne caused by a carrier just off the signal you want.

Either is often used to substitute for a crystal filter in a communications receiver. The circuits, being based on active devices, can be produced at less expense than can crystal filters, and in addition they are capable of some operations which crystals cannot do (such as notching out interference which is almost exactly on top of the desired signal). One feature of these circuits which has not been emphasized much is the fact that any number of them can be connected to a receiver with little if any interaction. This permits several different functions to be in use at the same time, such as peaking up one desired signal, notching out another which is still causing interference, and (with the audio version) slicing out several remaining traces of carrier whistle. However, oper-

ation of several at the same time might require the services of several trained octopi. . .

What Indicates A Gassy Tube?

From time to time we are impressed by the "gobbledegook" turned out in Washington, and the question in the FCC study list on which this discussion is based is one of the more notable gems: "What visual observation within an operating vacuum tube's envelope would indicate that the tube is gaseous?"

Apparently the anonymous government employee who worded this question was so fearful of using "jargon" in the list that he avoided the normal technical phrase "gassy" to describe a tube containing unwanted gases rather than the normal high vacuum—but the word he chose to replace it, unfortunately, does not mean the same thing. Since the three states of matter are solid, liquid, and gaseous, we would have to assume on the face of things that the tube under consideration is neither solid nor liquid. In that case, the most likely visual indication would be an inability to see the tube, wouldn't it?

However, we don't think that is what they really meant. It appears much more likely to us that they really want to know how you can tell a tube has gone gassy by looking at it—and Washington is not alone in sometimes using two dozen ten-pound words where a half-dozen everyday ones would do better.

Tubes go gassy for a number of reasons. The most normal is for some of the chemicals in the coating of the cathode to eventually break down under the high temperatures at which the cathode operates, and release gases. At least as frequent, though, in ham operation, is for the tube to be overloaded to such a degree that one or more of the tube's elements is actually vaporized, thus releasing gas. Screen grids of beam-power transmitter output tubes are particularly prone to this occurrence.

When a tube goes gassy, it no longer operates as it was intended to. The grid cannot control current flow when the gases ionize. This characteristic is made use of deliberately in the thyatron tube, and in a

GATEWAY ELECTRONICS

6150 DELMAR BLVD., ST. LOUIS, MO 63112
314-726-6116

- 6.3 Volt at 1 Amp small FILAMENT TRANSFORMER — 115 volt pri.
Shipping wt. 1 lb. \$ 1.75
 - 75 METER SSB TRANSCEIVER — Heath HW 12.
Shipping wt. 25 lb. \$ 75.00
 - Transistorized 12 volt DC POWER SUPPLY — Heath HP-13
Shipping wt. 10 lb. \$ 45.00
 - Hewlett Packard 130BR Oscilloscope
Shipping wt. 50 lb. \$250.00
 - GONSET G-76 TRANSCEIVER with G-76 AC & G-76 DC Power Supplies. 75 meters thru — 6 meters.
Shipping wt. 75 lb. \$150.00
 - 52 OHM CO-AX CABLE — Amphrenol double shielded low loss — similar to RG-58A/U
Shipping wt. 7 lb. per 100 ft. per ft. \$.04
 - TELEPHONE OPERATORS HEADSET
Shipping wt. 2 lb. \$ 14.50
 - 4 Mfd. @ 2000 VOLT CAPACITORS
Shipping wt. 3 lb. \$ 3.95
 - 24 Volt DC CO-AXIAL RELAY — with type N conn.
Shipping wt. 1 lb. \$ 4.25
 - 0-10 PIXIE TUBES — Burroughs #B9012—1 inch diameter.
Shipping wt. 1 lb. \$ 3.50
- Minimum order \$5.00. Sorry, no catalog at this time. Write for specific items. Watch for our ads in 73. Stop in and see us when you're in St. Louis.



CAMP ALBERT BUTLER INVITES HAM RADIO ENTHUSIASTS OF ALL AGES TO TRY FOR YOUR GENERAL CLASS TICKET

THIS SUMMER! OUR 11TH SEASON
STUDY INSTRUCTION LEADING TO GENERAL ADVANCE
and AMATEUR EXTRA LICENSE

This co-ed Amateur Radio Camp, Y.M.C.A. owned and operated, can accommodate 60 campers. There is no age limit. We have had campers from 7 through 74 years of age. It is very helpful if you can copy 5 wpm or have a Novice or Technician ticket, but it is not necessary. Time is divided between radio classes in code and theory and the usual camp activities, such as swimming, archery, riflery, hiking, etc. Golf privileges are included at the beautiful New River Country Club course. Entire staff consists of licensed hams who are instructors in electrical engineering in some of our finest colleges and universities. Camp opens August 1 and closes August 15th. Tuition of \$200 includes all camp expenses: room, meals, notebooks, textbooks, and insurance. Send for our brochure.

C. L. Peters, K4DNJ
General Secretary
Gilvin Roth Y.M.C.A., Elkin, North Carolina

Please send me the Booklet and Application Blank for the Camp Albert Butler Radio Session.

Name
Call
Address
City/State/Zip

different way in the controlled rectifier. In general, though, a gassy tube must be replaced.

When a tube does go gassy, it usually lets you know immediately by glowing bright blue. This blue glow is produced by the gas ionizing under the impact of the electron stream, and is the most obvious visual indication of gassiness.

However, not all tubes which show a blue glow are gassy. If the glow is only at the inside of the glass envelope, it's more likely to be a fluorescence of the glass itself under electron bombardment. Many modern tubes show this effect, but it does not indicate gassiness.

Some tubes, also, exhibit a faint blue glow in the space between the cathode and the plate, even when operating normally. This is, again, fluorescence, but this time it's from the tube elements themselves.

The glow of a gassy tube, on the other hand, fills the space from cathode to plate, and is much brighter than any glow in a normally operating tube.

Some high power transmitter power supplies use mercury vapor rectifiers. These rectifiers are built with gas in them, and use it as a part of their normal operation. They also serve as perfect examples of what a gassy tube looks like. If any tube which is *not* a mercury-vapor rectifier begins to look like one, it has probably gone gassy. Or, if you prefer, it "is gaseous."

Rules and Regulations

The final question on the study list isn't a question at all, but an admonition: "Be familiar with Part 97 of the Commission's rules."

In this study course, we have taken great care to sidestep the details of the rules wherever possible, for one major reason. While the details of radio theory remain relatively constant, and are just as true today as they were five years ago or will be five years hence (although new discoveries may alter a few of the fine points, or provide additional understanding), this is not true of rules and regulations.

Rules and regulations are constantly subject to change. Right now we are in a period of transition which sees the permissible

operating band limits changing every year—and a number of petitions before the FCC to make other changes.

Our intent in publishing this study course was to provide reference material. To do this, we felt it necessary to concentrate on that part of the examinations which would not be subject to change at the will of a regulating agency.

But it *is* important that you know the rules and regulations, as they exist at the time you take the test, if you want to succeed in obtaining your Extra Class ticket. While most of the emphasis is on theory, the fact remains that the top grade license requires a top grade of knowledge in every facet of ham radio.

So, before taking the exam, get a copy of at least the pertinent parts of Part 97 of the FCC rules and regulations, and brush up. You can order Part 97 complete from the Government Printing Office, or you can buy an up-to-date edition of the ARRL license manual. If you don't like spending money, you may be able to find a copy of Part 97 in a large library or in the files of some friendly commercial radio installation (FCC rules are bound in volumes, and normally you can buy only a complete volume; many commercial installations have copies of Part 97, as a result, in the volumes which they bought to get the rules applicable to their own service).

Key things to know are the effective band limits for each class of license and for each type of emission (and don't forget the UHF and EHF bands while you're at it), the restrictions which may be applied to ham operation and why, and the prescribed procedures for identification of all kinds of ham signals. Also important are the restrictions on types of messages which may be transmitted and received, and under what conditions these restrictions may not apply. Notification of portable and mobile operation, operation by aliens, and operation away from the U.S. jurisdiction may also be items worth being up to date on.

So there you have it. Good luck, and congratulations to you for your determination to obtain the top grade of all ham licenses.

... Staff ■

73 *presents*

the
1970

Buyer's Guide
of

ANTENNAS & TOWERS

*A complete listing of manufacturers
of top quality, nationally advertised
brands of antennas and towers for
the amateur.*

CUSHCRAFT 131

HEIGHTS 129

HY-GAIN 122-123

MOSLEY 124-125

NEWTRONICS 134

ROHN 133

STRUCTURAL GLASS 132

SWAN ANTENNA 128

SWAN ELECTRONICS 118-121

TELREX 126-127

TRI-EX 130

single band performance with

SWAN BEAM

FOR 10, 15,

EXCLUSIVE FEATURES:

Swan Triband Beams feature a patented* trap design which permits precision factory adjustment. This results in maximum forward gain and front-to-back ratio from each and every Swan antenna. Their outstanding performance is comparable to single band antennas having the same number of elements.

The electrical principals employed in a trap type multi-band antenna are quite simple. The "trap" is a parallel resonant circuit consisting of a high Q inductance with a coaxial sleeve capacitor connected in parallel. At resonance the impedance across the trap is very high, and its effect is the same as inserting an insulator at that point. Thus, the electrical length of the antenna element can be altered by insertion of a parallel tuned trap. Each element in a Swan Triband Beam has two traps for 10 meters, and two traps for 15 meters. (None are required for 20 meters since the elements are full length on this band). It is vitally important that the traps are tuned to exact frequency, or antenna performance will not be optimum. Normal manufacturing tolerances in the coil and capacitor assembly create considerable variation in resonant frequency. Unless the trap has some means for precise adjustment, its resonant frequency will be pretty much a hit or miss affair. The exclusive precision tuned traps in Swan antennas* explain why they give consistently superior performance.

2000 watts P.E.P. power rating: All models of the Swan Triband Beams are rated at the full legal power limit.

Low SWR. Swan Triband Beams are designed for a near perfect match on each band with 52 ohm coaxial cable. Standing wave ratio will be down as low as 1.2 at band center, resulting in extremely low transmission line loss. There are no gimmicks or gadgets in the feed system. It's very simple, and works very well. In fact, we offer no magic whatsoever in our antennas, except that they are designed to provide maximum performance on each band, and mechanically built to withstand severe weather conditions for a long long time. Ask any ham who owns one. The Swan antenna is an improved Hornet design, manufactured formerly by Hornet Antenna Products. Compare the Swan Tribander feature for feature with other brands. Ask your dealer to open up the shipping carton and let you inspect the Swan antenna. We think you'll like what you see, and like its performance even more.

*Patent No. 3064257



SWAN
ELECTRONICS

305 Airport Road
Oceanside, California 92054
A Subsidiary of Cubic Corporation

*For better ideas
in amateur radio.*

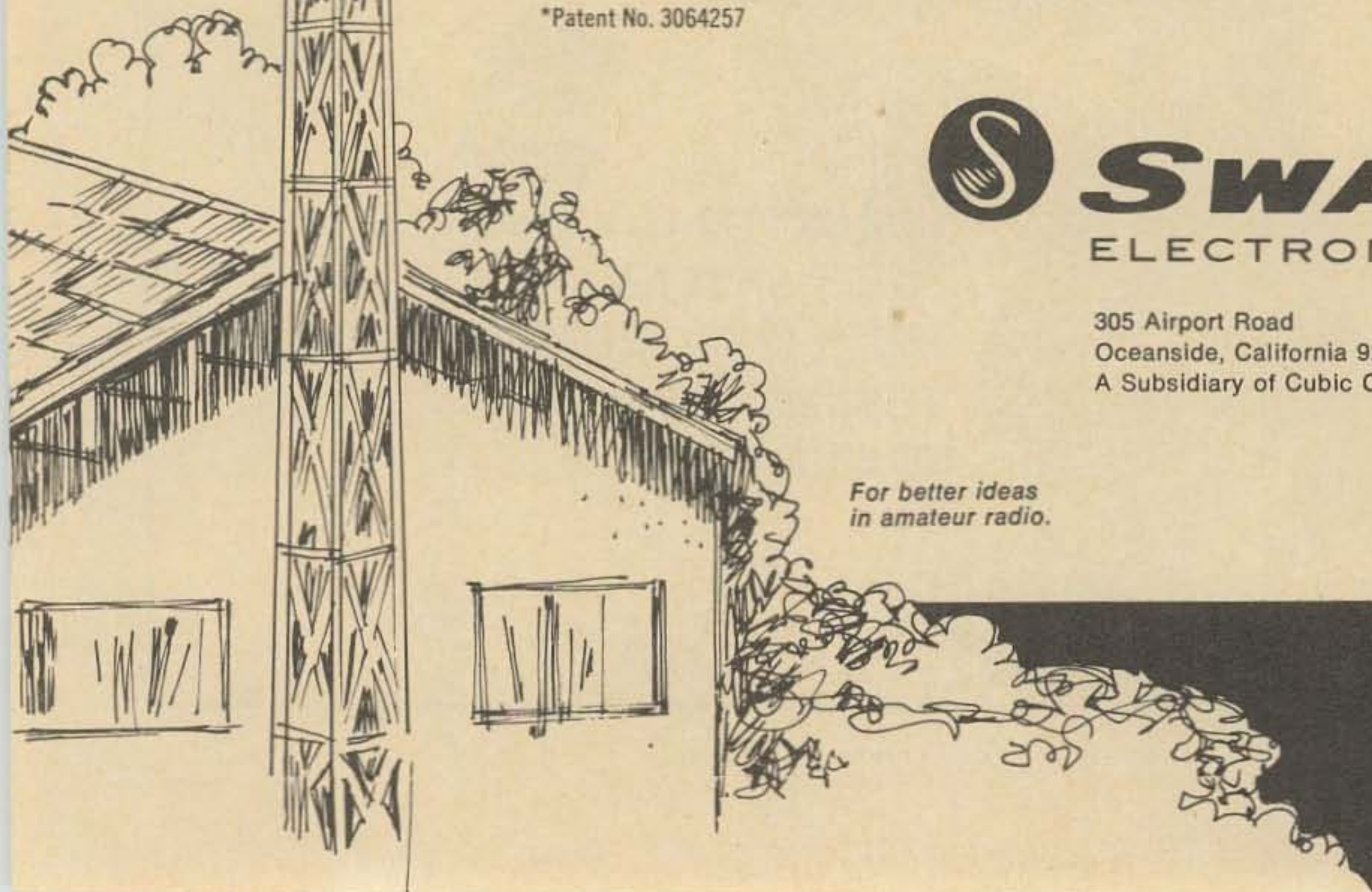
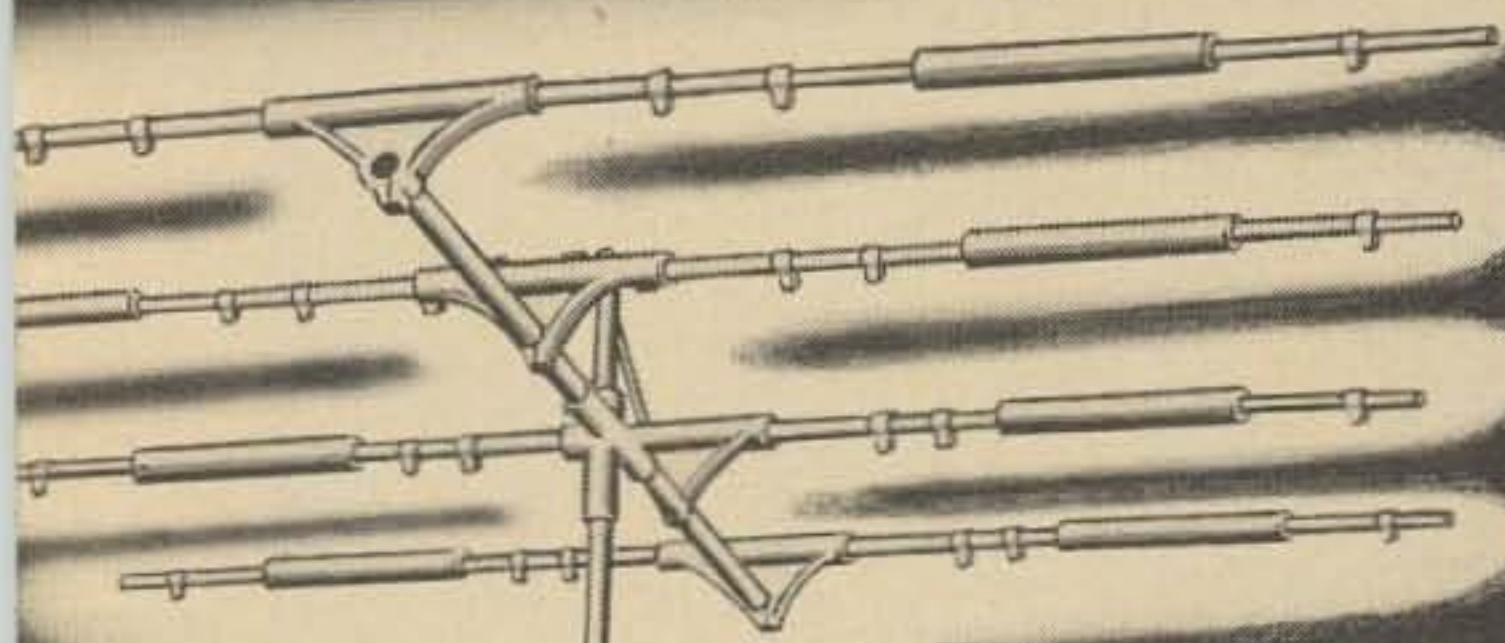

patented * tuneable traps

TRIBAND ANTENNAS

AND 20 METERS

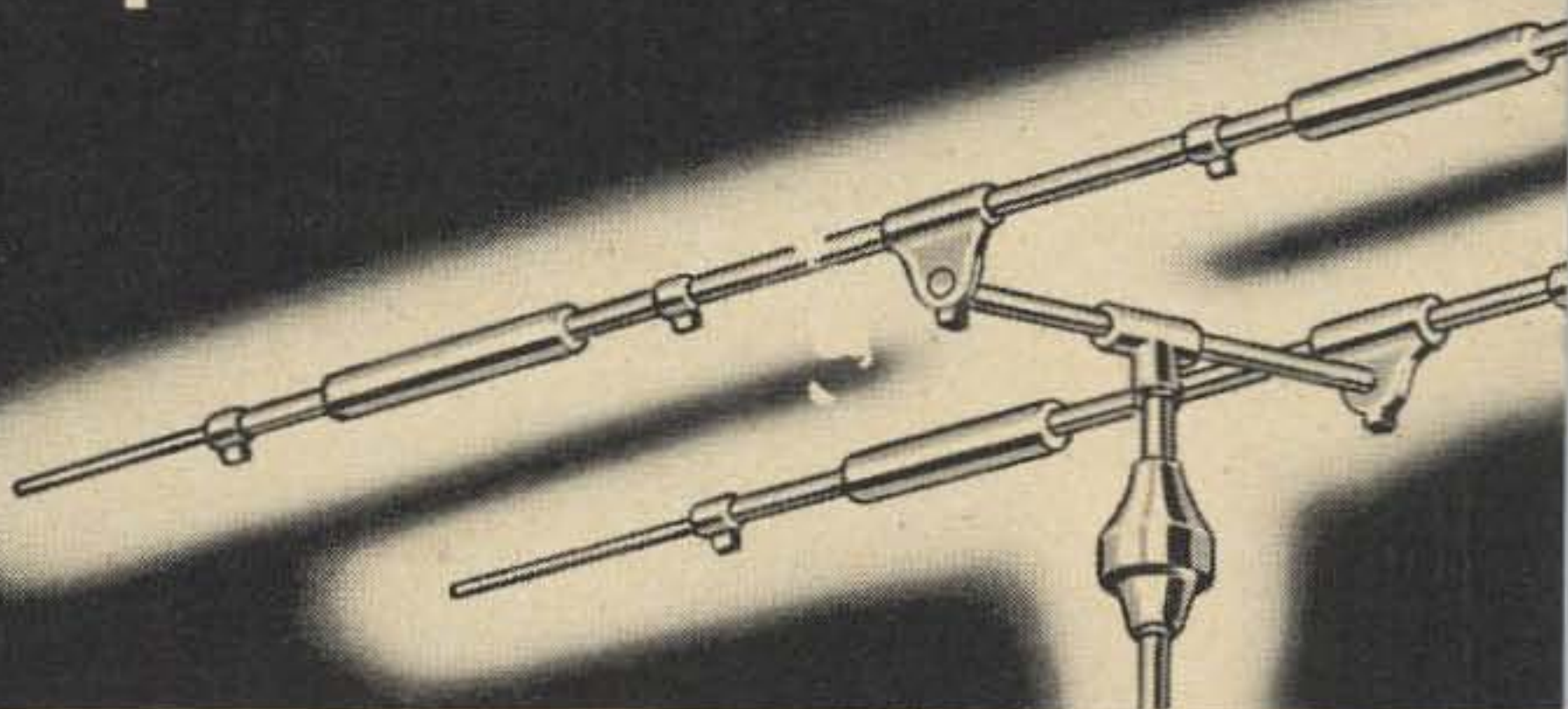

4 ELEMENT MODEL TB-4H

The Swan 4 Element Heavy Duty Triband Beam gives you 4 working elements on each band: 10, 15, and 20 meters. A 24-foot boom permits optimum spacing for maximum forward gain and front-to-back ratio. All traps have been precision tuned and weather proofed. The Heavy Duty mechanical design of the TB-4H means that it will easily take winds up to 100 mph, and provide years of reliable service in any kind of climate from the arctic to the tropics.

- Forward Gain: 9 db average
- Front-to-Back Ratio: 24-26 db
- Power Rating: 2000 watts P.E.P.
- Weight: 64 lbs.
- Wind Load at 80 mph: 148 lbs.

Price: \$169

3 ELEMENT MODEL TB-3H

Same Heavy Duty design as the TB-4H, but with 3 elements on a 16-foot boom.

- Forward Gain: 8 db Average
- Front-to-Back Ratio: 20-22 db
- Power Rating: 2000 watts P.E.P.
- Weight: 44 lbs.
- Wind Load at 80 mph: 110 lbs.

Price: \$139

3 ELEMENT MODEL TB-3

Of somewhat lighter construction and shorter boom length, the TB-3 is adequate for many installations. Wind survival rating is 80 mph compared to the 100 mph rating of the TB-3H. Its lighter weight permits easier erection, a lighter weight tower, and lighter duty rotator, all resulting in lower overall cost. The same precision tuned, weather proofed traps are used, so power rating and reliability are the same as in heavier duty models. Boom length is 14 feet.

- Forward Gain: 7.5 db average.
- Front-to-Back Ratio: 18-20 db
- Power Rating: 2000 watts P.E.P.
- Weight: 37 lbs.
- Wind Load at 80 mph: 92 lbs.

Price: \$119

2 ELEMENT MODEL TB-2

Same design as the TB-3 but with 2 elements on a 6½-foot aluminum boom. Weighing in at only 15 pounds, this model can be a real surprise. An inexpensive telescoping mast and TV rotator will easily get it 60 feet or higher off the ground, and at that height it will out perform a 3 or 4 element beam at lesser height. If your choice is putting up a TB-4H at a 30 to 40 foot height, or this 2 element model at 60 feet, by all means put up the TB-2. We won't make as much money, but you'll put out a terrific signal, and maybe we'll sell more TB-2's. Of course, if you can put the 3 or 4 element model up 60 feet, or more, there's no argument. Just don't under estimate the TB-2. It's a little bomb.

- Forward Gain: 5 db Average.
- Front-to-Back Ratio: 16-18 db
- Power Rating: 2000 watts P.E.P.
- Weight: 15 lbs.
- Wind Load at 80 mph: 60 lbs.
- Shipping Carton: Just 6 ft. long.

Price: \$99

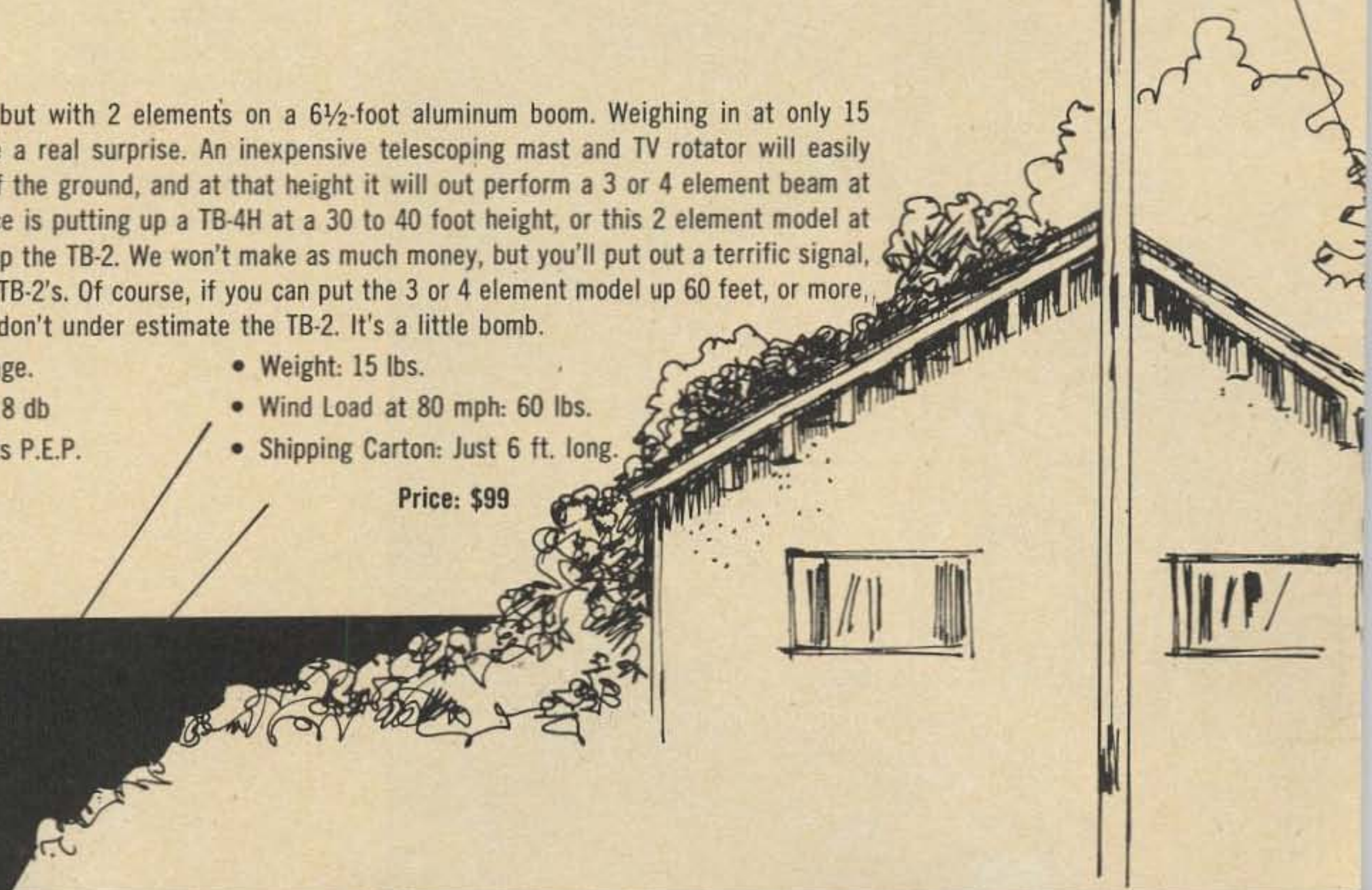

new high performance trap vertical

10, 15, 20, and 40 meter operation, with provision
for 75 meter add-on kit.

The Swan model 1040-V Trap Vertical has a low angle, nondirectional radiation pattern, making it the ideal antenna when a larger array is not practical. It can be installed at ground level, or on a rooftop.

The high Q patented* traps have the same adjustable design as the Swan tri-band beams. Precision factory tuning results in maximum radiation efficiency on each band, with low SWR across the entire band.

- Power Rating: 2000 watts P.E.P.
- Heavy duty mechanical design.
- Wind survival rating: 100 mph.
- Weight: 16 pounds.

Includes all necessary ground radials, brackets, and hardware.

PRICE: \$59.50

*Patent No. 3064257

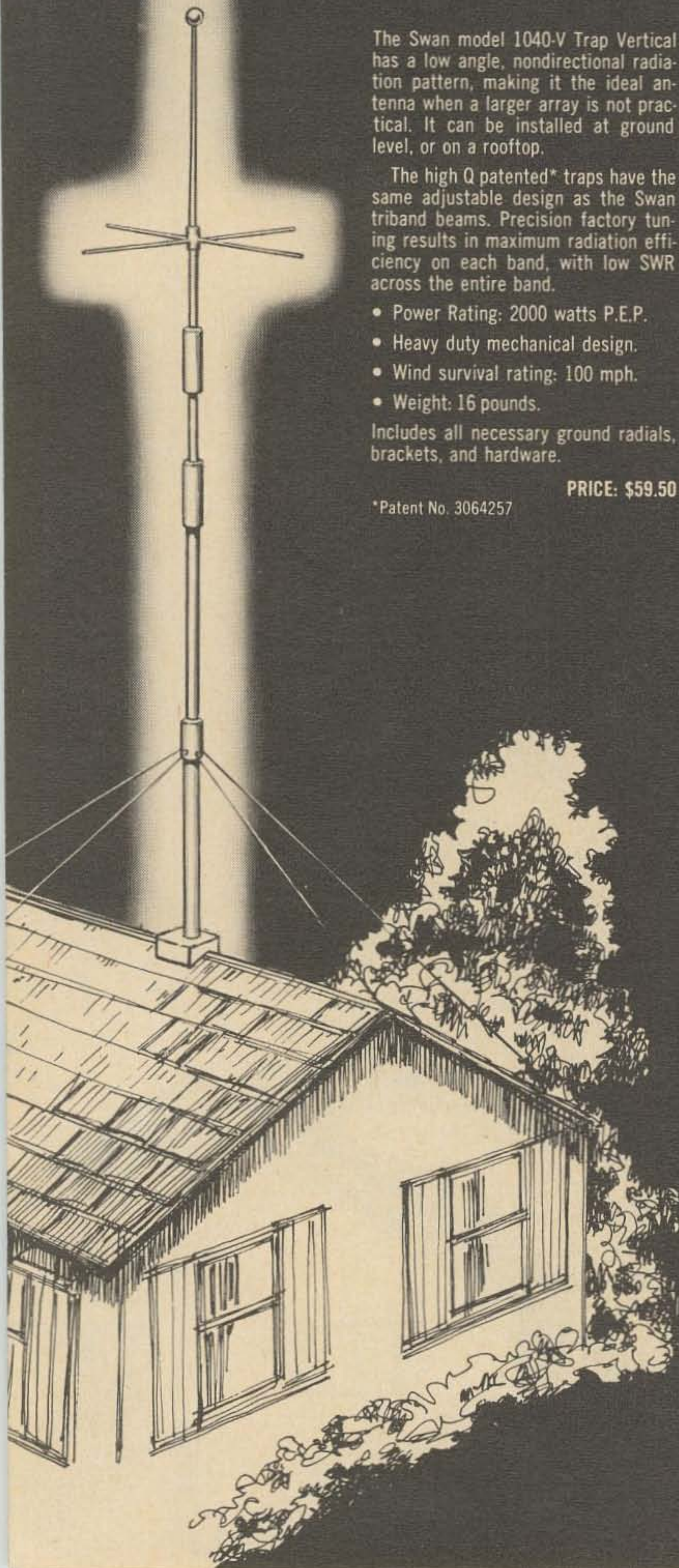

 **SWAN**

high Q— high efficiency

WILL YOUR MOBILE ANTENNA PASS THE TAPE MEASURE TEST?

Try measuring the wire size, coil diameter and coil length of your loading coil. If the figures are not as large as the Swan loading coil, then radiation efficiency cannot and will not be as high. It's as simple as that.

A mobile antenna is, of necessity, a compromise. It takes a loading coil to make it look like a quarter wave vertical. Radiation efficiency is related directly to the Q of the loading coil. Q is a figure of merit which is the reciprocal of equivalent series resistance in the coil. It is this resistance which dissipates power. Obviously, the smaller this equivalent series resistance is, the smaller coil losses will be.

Theoretically, with infinite Q the coil would have no loss, and the antenna would be as efficient as a full size vertical. This isn't possible, so we have to settle for something less. But, how much of your transceiver power are you willing to lose in heating up the coil? It takes a lot of amps from your battery to generate that 300 watts of RF power. We build transceivers too, (in case you hadn't noticed), and we hate to see them warming up those inefficient loading coils. That power should be radiated instead, to help break through QRM. This is why you'll find the Swan mobile antenna line with really high Q coils.

The coils are so handsome, we think you'll want to show them off, so the weather shield is transparent. Notice that other brands are covered up. Is this to make them prettier? Or is it to hide the small, close wound wire. Don't let anyone kid you. The smaller coils are not nearly as efficient. A laboratory Q meter will prove this quickly. But, if you don't have access to a Q meter, try the tape measure test.

MOBILE ANTENNAS

single band and multi-band models

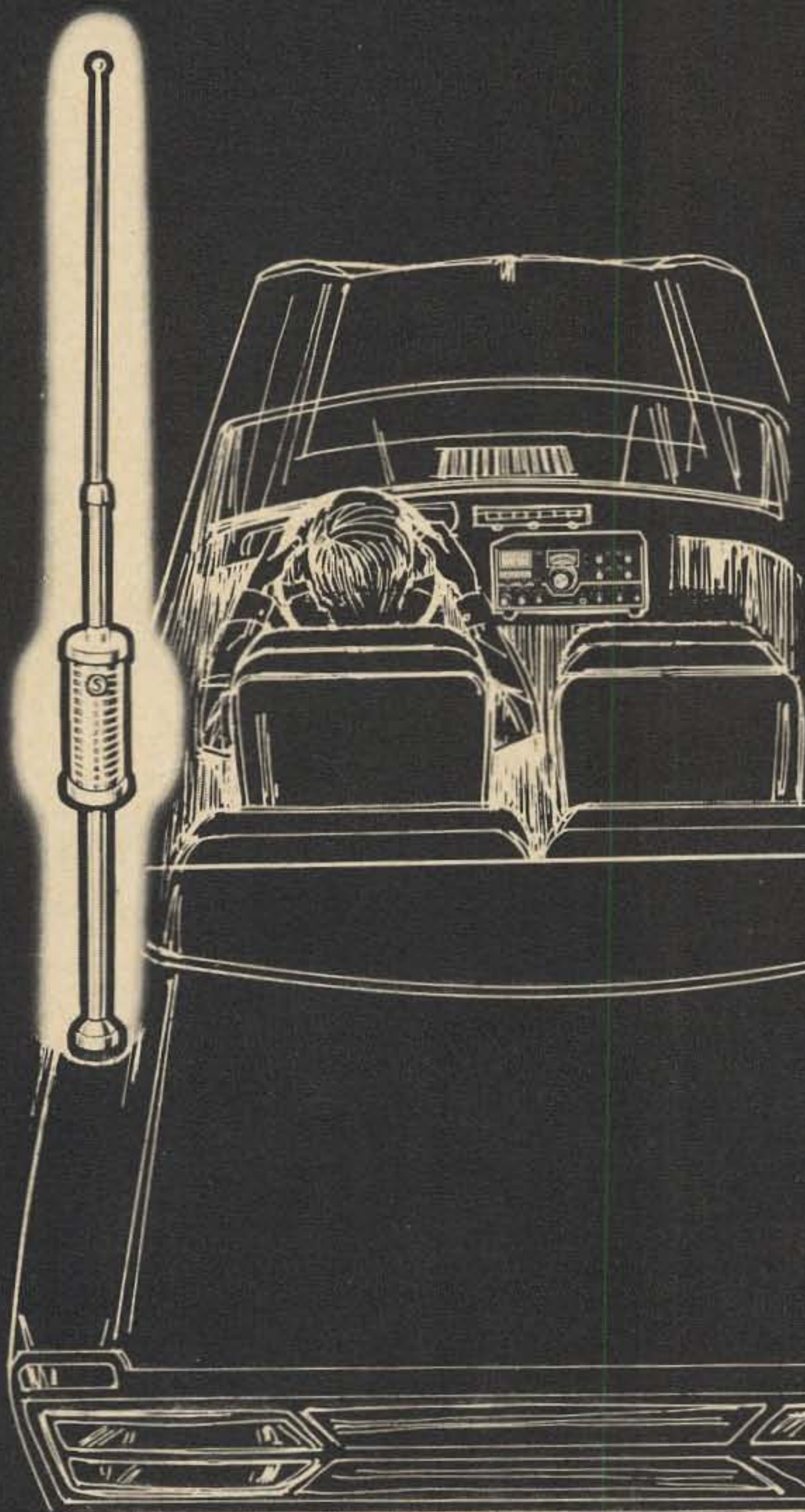

5-BAND MANUAL SWITCHING MODEL 45

No coil changing with this model, it covers 10, 15, 20, 40, and 75 meters. Gold plated contacts on the patented* vertical switch provide 5 stops for full coverage of the 75 meter phone band. High radiation efficiency is provided by the high Q coil, (same size as the single band coils). 1000 watt P.E.P. power rating, 5 foot whip comes with Kwik-On connector. Top quality throughout.

PRICE: \$79.50

5-BAND REMOTE CONTROL MODEL 55

This is our most deluxe model, for the band hopping operator. A control box under the dash permits instant band changing while driving. Covers 10, 15, 20, 40, and 75 with the same patented* electrical and mechanical design as the manual model 45, but with motor drive and remote control. Finest quality construction, nothing has been spared to make this model the very best, and most efficient you can buy. Power rating is 1000 watts P.E.P. 5 foot whip comes with Kwik-On connector.

PRICE: \$129.50

Extra KWIK-ON Connectors, for quick removal of model 45 or 55.
All stainless steel construction \$5.95

Deluxe Bumper Mount \$24.95

SINGLE BAND MODEL 35

For maximum radiation efficiency, our single band design is the best. If you're a one band operator, or don't change bands very often, this is the model for you. Heavy duty construction is of the highest possible quality. Stainless steel whip has Kwik-on connector for easy removal. Each coil has a similar Kwik-on connector, also for easy removal and stowage. Power rating is 2000 watts P.E.P.! Heavy duty base sections of various lengths permit choice of deck or bumper mounting.

- Top section, 5 ft. Whip \$11.95
- 15 Meter Coil \$21.95
- 20 Meter Coil \$23.95
- 40 Meter Coil \$25.95
- 75 Meter Coil \$27.95
- 18 inch Base Section \$ 8.50
- 36 inch Base Section \$ 8.95
- 48 inch Base Section \$ 9.50

*Patent No. 2961657

SWAN
ELECTRONICS

305 Airport Road
Oceanside, California 92054
A Subsidiary of Cubic Corporation

The voice of



is heard around the world

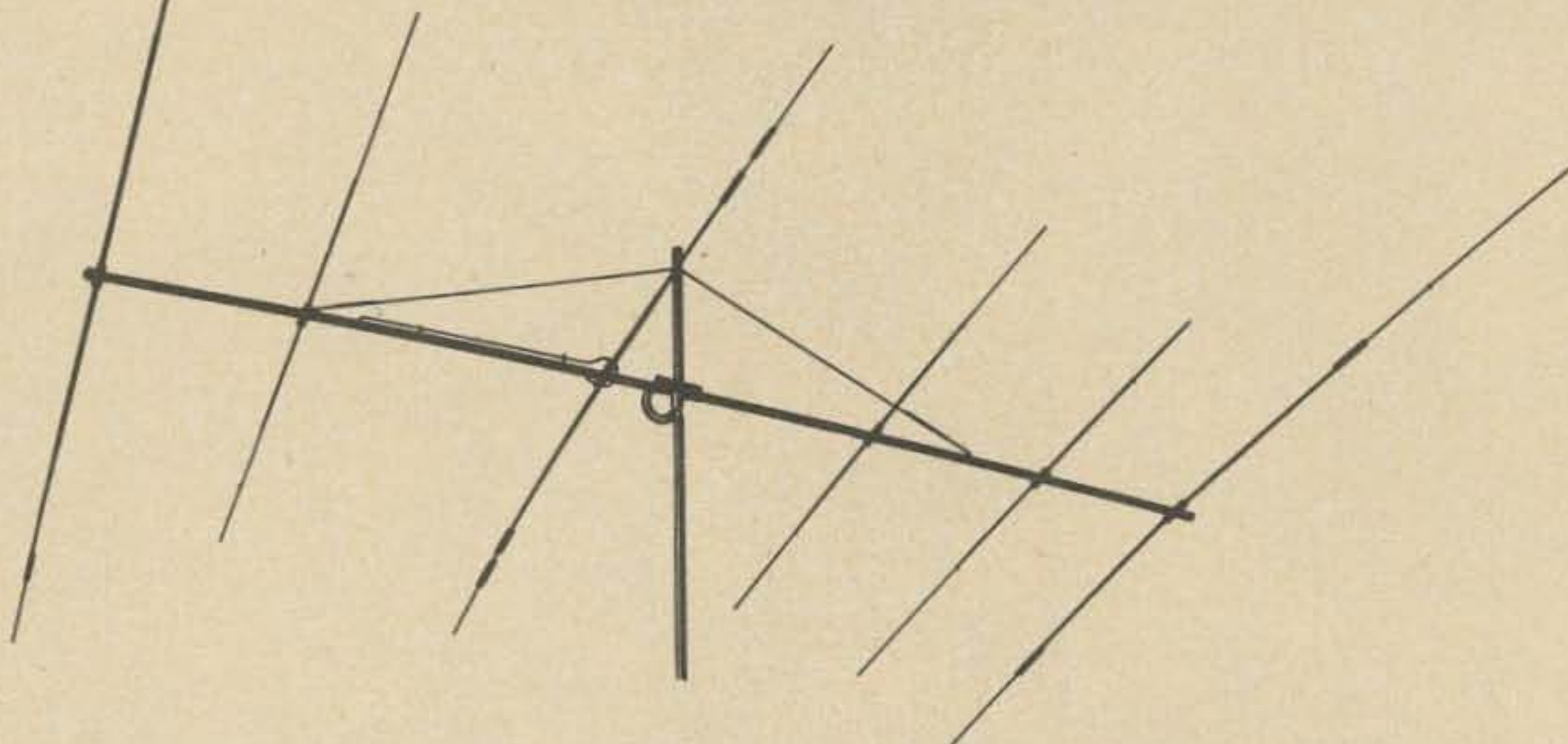

Here's why Thunderbirds outperform all other tri-banders:

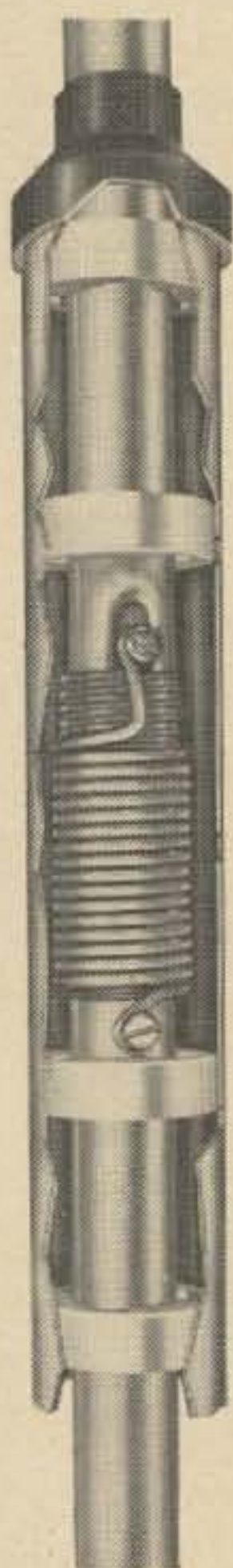

Thunderbird's "Hy-Q" traps provide separate traps for each band. "Hy-Q" traps are electronically tuned at the factory to perform better at any frequency in the band—either phone or CW. **And** you can tune "Hy-Q" traps, using charts supplied in the manual, to **substantially** outperform any other traps made.

Thunderbird's superior construction includes a new, cast aluminum, tilt-head universal boom-to-mast bracket that accommodates masts from 1 1/4" X 2 1/2". Allows easy tilting for installation, maintenance and tuning and provides mast feed-thru for beam stacking.

Taper swaged, slotted tubing on all elements allows easy adjustment and readjustment. Taper swaged to permit larger diameter tubing where it counts! And less wind loading. Full circumference compression clamps are mechanically and electrically superior to self-tapping metal screws.

Thunderbird's exclusive Beta Match achieves balanced input, optimum matching on all 3 bands and provides DC ground to eliminate precipitation static.

Up to 9.5 db forward gain.

25 db front-to-back ratio.

SWR less than 1.5 to 1 on all bands.

24-foot boom...none longer in the industry.

High-performance element spacing.

Extra heavy gauge, machine formed, element to boom brackets, with plastic sleeves used only for insulation. Bracket design allows full mechanical support.

New 6-Element Super Thunderbird
Model 389

Suggested retail price, \$169.95

Improved 3-Element Thunderbird
Model 388

Suggested retail price, \$139.95

Fabulous 3-Element Thunderbird Jr.
Model 221

Suggested retail price, \$92.50

Popular 2-Element Thunderbird
Model 390

Suggested retail price, \$91.50

Buy one today at your favorite Hy-Gain distributor!

HY-GAIN ELECTRONICS CORPORATION

P.O. Box 5407-GF, Lincoln, Nebraska 68505

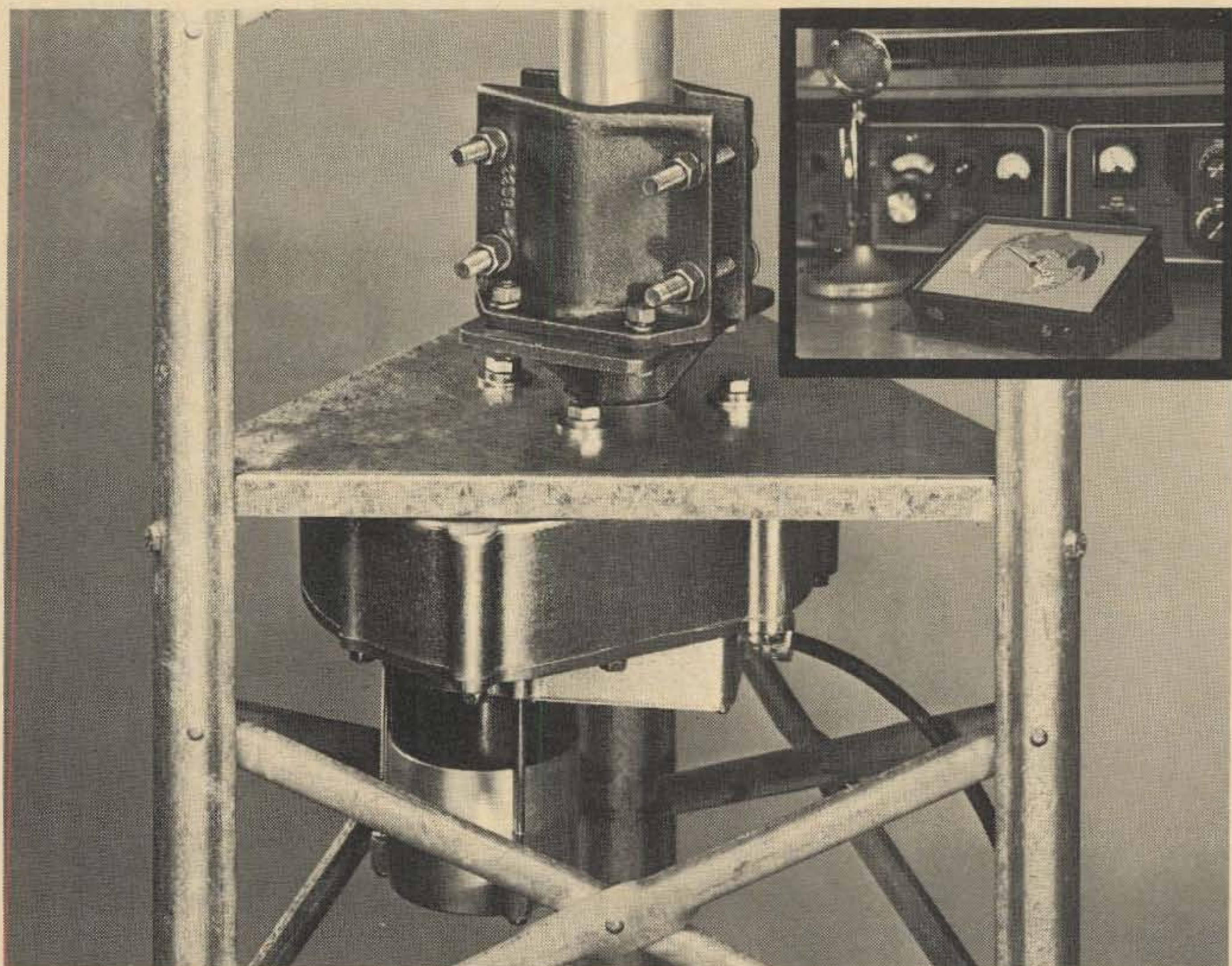

HY-GAIN'S NEW 400 ROTO-BRAKE

Handles Large Beams And Stacked Arrays With Ease!

Up to 10 times the mechanical and braking capability of any rotator on the market!

The ROTO-BRAKE delivers over 4,000 IN/LBS of starting and rotating torque. Brake slips at 5,000 IN/LBS to prevent damage to parts. Motor and gear train are protected by husky cast aluminum housing.

Handsome control unit features sweep pointer over choice of great circle map or compass rose. Select desired position and capacitor-start rotator (operating off 110VAC 60 cycle power source through five-conductor cable) moves until null seeking circuit brings into position. No blind spots. As a matter of fact, rotator will move 380°, giving you a generous overlap. And, if antenna should move during severe environmental conditions, it will automatically return to original position when control is activated. All circuitry is highly reliable—no troublesome selsyns used.

Heavy duty mast clamp takes up to 3" O.D. mast. Mounts to standard tower plate with minimum of 10" tower leg spacing. Mounting kits available for poles and small towers; universal tower mount available for towers without a plate.

There's just nothing like the ROTO-BRAKE for performance. Buy one from the best distributor under the sun—the one who stocks Hy-Gain.

Model No. 400 Suggested Retail Price \$189.95.

HY-GAIN ELECTRONICS CORPORATION

P.O. Box 5407-GF, Lincoln, Nebraska 68505

A REVOLUTIONARY NEW

Mosley Electronics Inc. Classic

Classic SINGLE BAND BEAMS

FORWARD GAIN:
8 db compared to reference dipole;
10.1 over isotropic source

FRONT-TO-BACK RATIO:
20 to 25 db

SWR: 1.5/1
or better

MATCHING SYSTEM:
Balanced
Capacitive

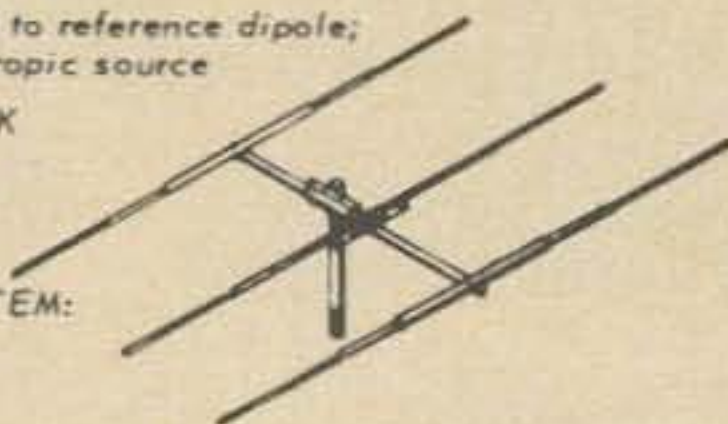

FEED POINT
IMPEDANCE: 52 ohms
RECOMMENDED TRANSMISSION LINE: RG-8/U

NUMBER OF ELEMENTS: 3
MAXIMUM ELEMENT LENGTH: 24' 1"
BOOM LENGTH: 14'
RECOMMENDED MAST SIZE: 1 1/2" OD
TURNING RADIUS: 14'
WIND SURFACE: 5.43
WIND LOAD (EIA Std. 80 MPH): 110.44 lbs.
ASSEMBLED WEIGHT: 30 lbs.
APPROX. SHIPPING WEIGHT: 36 lbs. via truck

CL-15 for 15 meters

1 KW

The Classic 10 and Classic 15 antennas have been developed by Mosley Electronics, Inc. in order to give hams a new choice in beam matching systems, featuring the new Classic Feed System plus optimum spacing, with maximum gain, increased bandwidth, and more efficient performance provided by the better electrical balance "Balanced Capacitive Matching," the Classic Feed (Pat. No. 3419872). The models, CL-10 and CL-15, incorporating the same rugged, lightweight construction typical of all Mosley beams, combine high-impact insulators and clamping blocks, aluminum element support, aluminum tubing and all stainless steel hardware.

CL-20 for 20 meters

1 KW

Mosley Electronics Inc. has developed the Classic 20 to give amateurs a 20 meter single-band beam featuring the Classic Feed System (Pat. No. 3419872). The improved electrical balance, "Balanced Capacitive Matching," combines with optimum spacing to provide maximum gain, increased bandwidth and more efficient performance. The rugged construction typical of all Mosley Beams is incorporated into the Classic 20: high-impact insulators and clamping blocks, aluminum tubing and stainless steel hardware.

FORWARD GAIN: 9.8db compared to reference dipole;
11.9db over isotropic source.

FRONT-TO-BACK RATIO: 20db

SWR: 1.5/1 or better

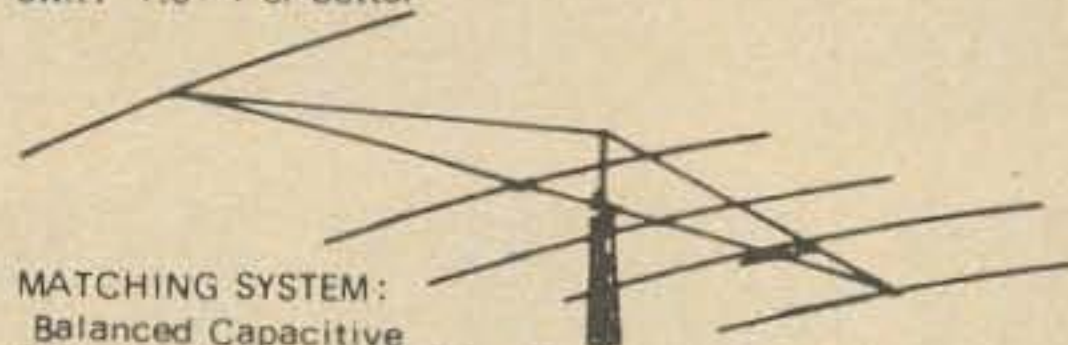

MATCHING SYSTEM:
Balanced Capacitive
FEED POINT IMPEDANCE: 52 ohms
RECOMMENDED TRANSMISSION LINE: RG-8/U

NUMBER OF ELEMENTS: 5
MAXIMUM ELEMENT LENGTH: 38' 1 1/2"
BOOM LENGTH: 46'
RECOMMENDED MAST SIZE: 3" OD
TURNING RADIUS: 28'
WIND SURFACE: 18.7 sq. ft.
WIND LOAD (EIA Std. 80 MPH): 364.45 lbs.
ASSEMBLED WEIGHT: Approx 139 lbs.
APPROX. SHIPPING WEIGHT: 145 lbs. via truck

FORWARD GAIN:
8 db compared to reference dipole;
10.1 over isotropic source

FRONT-TO-BACK RATIO:
20 to 25 db

SWR: 1.5/1
or better

MATCHING SYSTEM:
Balanced
Capacitive

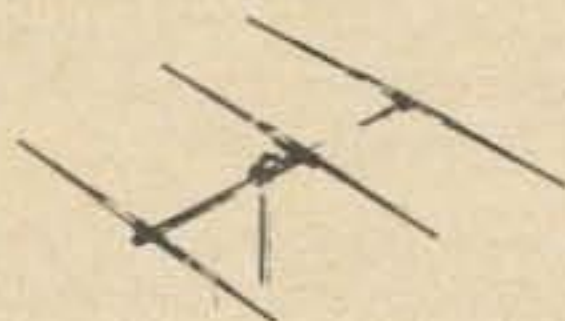

FEED POINT
IMPEDANCE: 52 ohms
RECOMMENDED TRANSMISSION LINE: RG-8/U

NUMBER OF ELEMENTS: 3
MAXIMUM ELEMENT LENGTH: 18' 4"
BOOM LENGTH: 12'
RECOMMENDED MAST SIZE: 1 1/2" OD
TURNING RADIUS: 11' 2"
WIND SURFACE: 4.36 sq. ft.
WIND LOAD (EIA Std. 80 MPH): 88.4 lbs.
ASSEMBLED WEIGHT: 21 1/2 lbs.
APPROX. SHIPPING WEIGHT: 27 1/2 lbs. via truck

CL-10 for 10 meters

1 KW

Now Classic Feed plus Optimum Spacing: the Classic Feed System, famed for its phenomenal success in multi-band beams, has been incorporated into two single-band three-element beams for 10 and 15 meters; Models CL-10 and CL-15. In addition to the optimum spacing possible, these new Mosley beams offer the maximum gain, increased bandwidth and more efficient performance provided by the better electrical balance "Balanced Capacitive Matching," the Classic Feed (Pat. No. 3419872).

BEAM MATCHING DEVICE

Feed System

Mosley's Classic Feed System is a revolutionary new beam matching device, "Balanced Capacitive Matching," featuring a coax-fed balanced element. Design avoids the possibility of corrosive action in matching system. Type N connectors supplied.

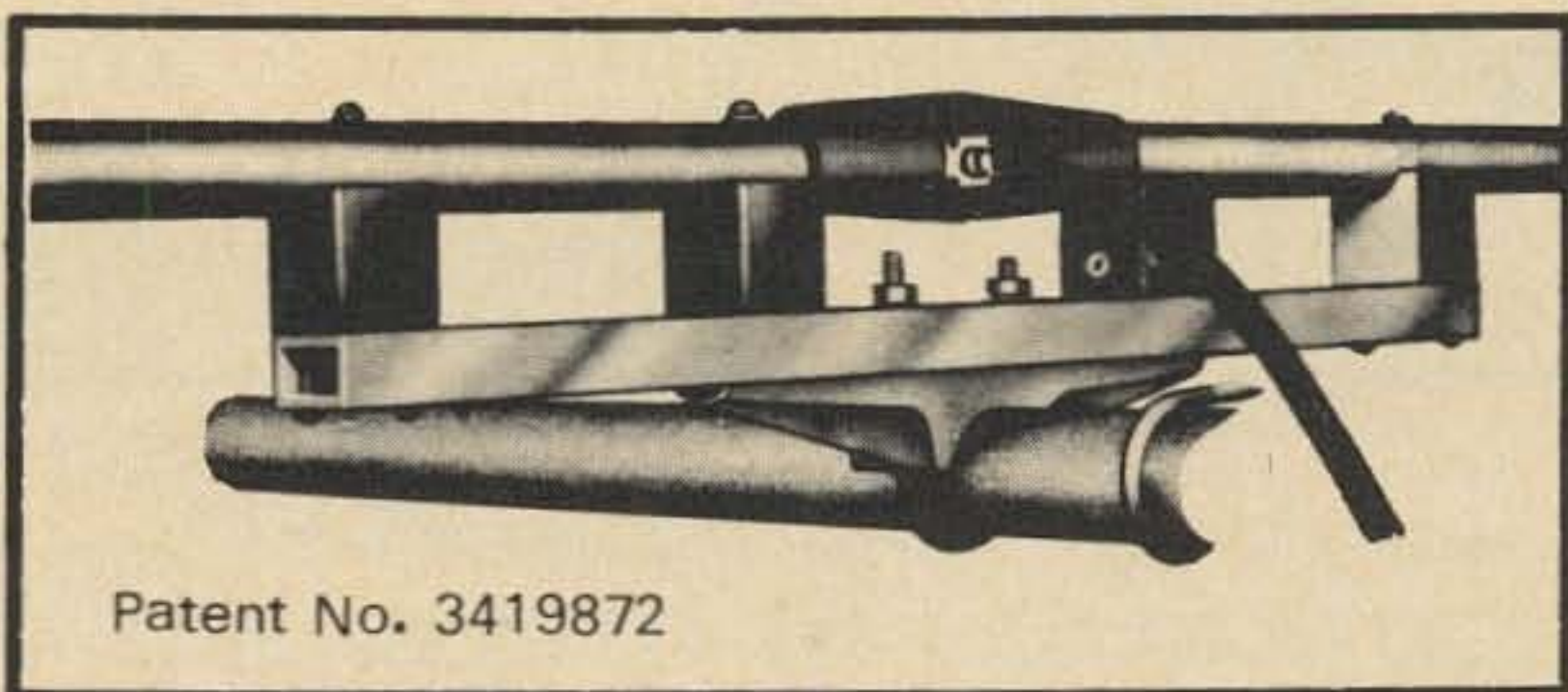

Classic MULTI-BAND BEAMS

FORWARD GAIN: Compared to reference dipole: on 10 meters--9.0db; on 15 and 20 meters--8.0db. Over isotropic source: on 10 meters--11.1 db; on 15 and 20 meters--10.1 db.

FRONT-TO-BACK RATIO: 20 db or better

SWR: 1.5/1 or better

MATCHING SYSTEM: Balanced Capacitive

FEED POINT IMPEDANCE: 52 ohms

RECOMMENDED TRANSMISSION LINE: RG-8/U

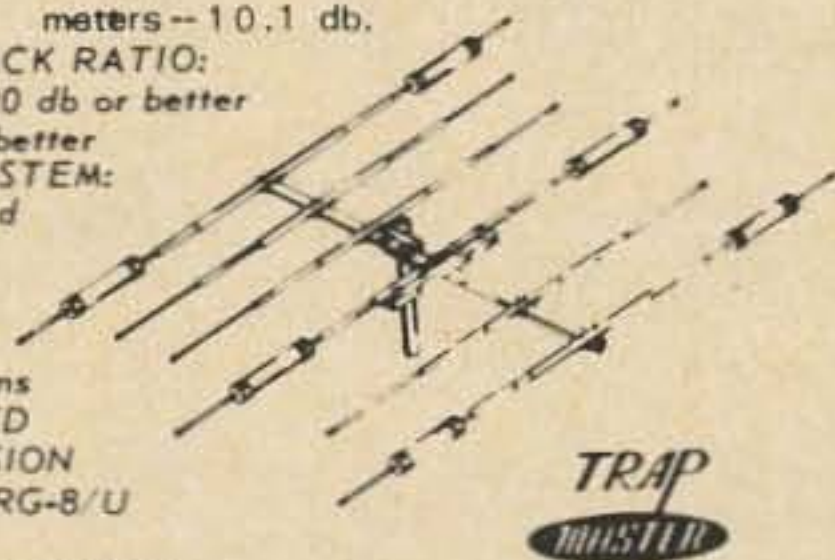

NUMBER OF ELEMENTS: 6
MAXIMUM ELEMENT LENGTH: 29' 9"
BOOM LENGTH: 24'
RECOMMENDED MAST SIZE: 2" OD
TURNING RADIUS: 19' 3"
WIND SURFACE: 10.7 sq. ft.
WIND LOAD (EIA Std. 80 MPH): 210.1 lbs.
ASSEMBLED WEIGHT: 69 lbs.
APPROX. SHIPPING WEIGHT: 71 lbs. via truck

CL-36 for 10, 15, and 20 meters 1 KW

Mosley Electronics, Inc., announces the latest addition to the Trap-Master line of amateur radio antennas, the Classic 36, a six-element tri-band beam incorporating the famous Classic Feed System, "Balanced Capacitive Matching" (U.S. Patent No. 3419872). Classic 36, rated for maximum legal power on 10, 15 and 20 meters, features the Classic coax-fed balanced element for more efficient beam performance, increased bandwidth, and maximum gain. As a Mosley Trap-Master, CL-36 offers Trap-Master Traps and weather-proven construction, as well as automatic bandswitching by means of high-impedance parallel resonant Trap Circuits.

CL-33 for 10, 15, and 20 meters

A new addition to the Trap-Master family of quality beams is the Classic 33 for 10, 15, and 20 meters with a power rating of 1 kW AM/CW and 2 kW PEP SSB. This new Mosley beam which incorporates the same durable, long-lasting Mosley traps made famous by the TA-33 and other Mosley Trap-Master beams, features a new type of matching system developed by Mosely engineers - 'Broad Band Capacitive Matching' with coax fed balanced element. This new type of matching system not only brings the ham an antenna of greater efficiency, but a beam with a FULL 8 dB of gain over reference dipole on all three bands or 10.1 dB compared to isotropic source. Front-to-back is the maximum possible on all three bands. SWR is 1.5/1 or better.

FORWARD GAIN: 8 db compared to reference dipole; 10.1 db over isotropic source
FRONT-TO-BACK RATIO: on 15 and 20 meters; 20 db or better; on 10 meters: 15 db

SWR: 1.5/1 or better

MATCHING SYSTEM: Balanced Capacitive

FEED POINT IMPEDANCE: 52 ohms

RECOMMENDED TRANSMISSION LINE: RG-8/U

NUMBER OF ELEMENTS: 3
MAXIMUM ELEMENT LENGTH: 21'
BOOM LENGTH: 18'
RECOMMENDED MAST SIZE: 2" OD
TURNING RADIUS: 16'
WIND SURFACE: 6 sq. ft.
WIND LOAD (EIA Std. 80 MPH): 120 lbs.
ASSEMBLED WEIGHT: 42 lbs.
APPROX. SHIPPING WEIGHT: 45 lbs. via truck

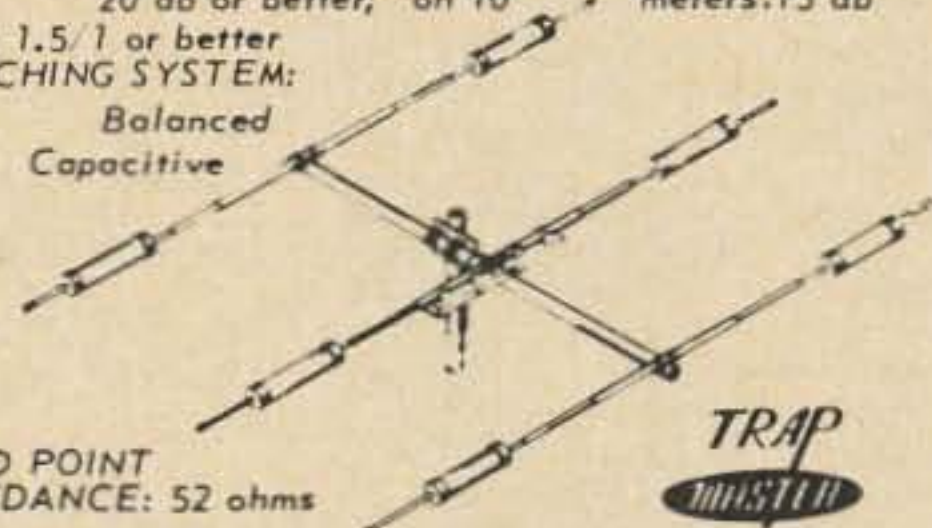

Mosley Electronics Inc. 4610 N. LINDBERGH BLVD.
 BRIDGETON MO. 63042

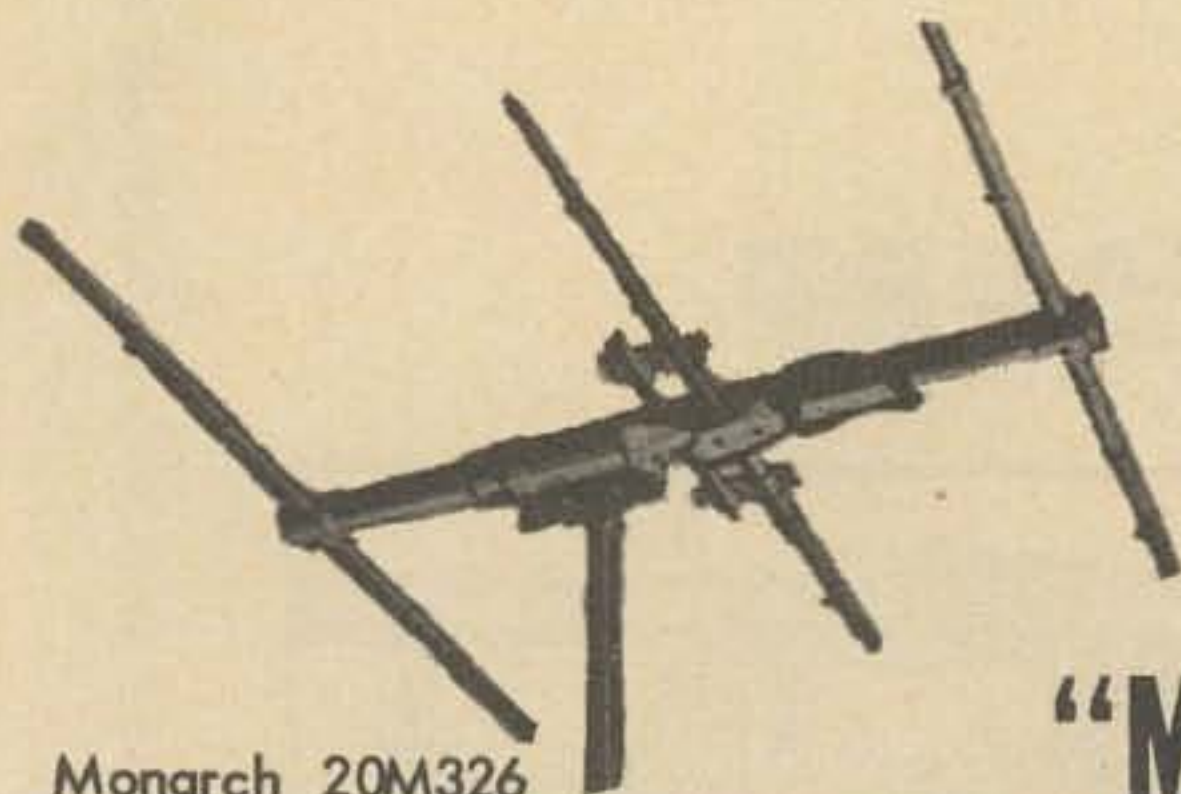

Monarch 20M326

**UP TO
STEP**

"MONARCH" SERIES

EXTRA RUGGED TO LAST A LIFETIME!

2 METER MONARCH CUSTOM MONO-BAND ARRAYS			GAIN	F/B	B/W	PEAK Pwr. Rating	Boom O.D. Length	Weight	Longest El. Length	Turning Radius	Wind Load	Wind Area	Wind Rating
\$85.00	2M1528M	15 ELEMENT ROTARY	17.2 DB	23 DB	27°	4.0 KWP	2.0" x 28'	30 Lbs.	3'6"	14'-0"	65 Lbs.	2.23 Sq. Ft.	110 MPH
\$85.00	2MSR2020M	20 EL. SPIRALRAY (Circ. Pol.)	16.5 DB	23 DB	28°	4.0 KWP	2.0" x 20'	28 Lbs.	3'6"	12'-6"	80 Lbs.	2.69 Sq. Ft.	110 MPH
6 METER MONARCH CUSTOM MONO-BAND ARRAYS													
\$99.00	6M624M	6 ELEMENT ROTARY	15.0 DB	24 DB	42°	2.0 KWP	2.50 x 2"x24'	30 Lbs.	10'-0"	12'-6"	67 Lbs.	2.3 Sq. Ft.	110 MPH
\$165.00	6M1136	11 ELEMENT ROTARY	17.8 DB	24 DB	33°	3.0 KWP	2.50 x 2"x36'	42 Lbs.	10'-0"	19'-6"	134 Lbs.	4.4 Sq. Ft.	110 MPH
\$245.00	6M1147	11 ELEMENT ROTARY	19.0 DB	24 DB	31°	4.0 KWP	3.50 x 3"x47'	82 Lbs.	10'-0"	24'-6"	263 Lbs.	8.4 Sq. Ft.	110 MPH
\$295.00	6MSR1147	11 EL. SPIRALRAY (Circ. Pol.)	18.7 DB	24 DB	32°	4.0 KWP	3.50 x 3"x47'	82 Lbs.	10'-0"	24'-6"	308 Lbs.	9.7 Sq. Ft.	110 MPH
10 METER MONARCH CUSTOM MONO-BAND ARRAYS													
\$135.00	10M313	3 ELEMENT ROTARY	10.0 DB	28 DB	58°	4.0 KWP	2.25 x 2"x14'	22 Lbs.	18'-0"	12'	82 Lbs.	2.8 Sq. Ft.	120 MPH
\$285.00	10M523	5 ELEMENT ROTARY	13.5 DB	28 DB	48°	5.0 KWP	3.50 x 3"x24'	65 Lbs.	18'-0"	17'	138 Lbs.	4.5 Sq. Ft.	120 MPH
\$445.00	10M636	6 ELEMENT ROTARY	15.0 DB	28 DB	44°	8.0 KWP	3.50 x 3"x36'	85 Lbs.	18'-0"	20'	170 Lbs.	5.5 Sq. Ft.	120 MPH
\$725.00	10M1044	10 ELEMENT ROTARY	17.5 DB	28 DB	40°	8.0 KWP	3.50 x 3"x44'	140 Lbs.	18'-0"	29'	380 Lbs.	12 Sq. Ft.	120 MPH
15 METER MONARCH CUSTOM MONO-BAND ARRAYS													
\$165.00	15M317	3 ELEMENT ROTARY	10.0 DB	28 DB	58°	4.0 KWP	2.50 x 2"x17'	37 Lbs.	24'-0"	14'-6"	107 Lbs.	3.6 Sq. Ft.	130 MPH
\$435.00	15M532	5 ELEMENT ROTARY	13.0 DB	28 DB	53°	8.0 KWP	3.50 x 3"x32'	95 Lbs.	24'-0"	19'	310 Lbs.	10 Sq. Ft.	130 MPH
\$725.00	15M845	8 ELEMENT ROTARY	15.0 DB	28 DB	46°	8.0 KWP	3.50 x 3"x45'	140 Lbs.	24'-0"	29'	450 Lbs.	14 Sq. Ft.	130 MPH
20 METER MONARCH CUSTOM MONO-BAND ARRAYS													
\$355.00	20M326	3 ELEMENT ROTARY	10.0 DB	30 DB	58°	8.0 KWP	3.50 x 3"x26'	71 Lbs.	36'-0"	24'	266 Lbs.	8.5 Sq. Ft.	130 MPH
\$465.00	20M436	4 ELEMENT ROTARY	11.0 DB	28 DB	53°	8.0 KWP	3.50 x 3"x36'	108 Lbs.	36'-0"	26'	380 Lbs.	12.52 Sq. Ft.	130 MPH
\$525.00	20M536	5 ELEMENT ROTARY	12.0 DB	30 DB	50°	8.0 KWP	3.50 x 3"x36'	113 Lbs.	36'-0"	26'	430 Lbs.	13.6 Sq. Ft.	130 MPH
\$695.00	20M546	5 ELEMENT ROTARY	13.0 DB	30 DB	48°	8.0 KWP	3.50 x 3"x46'	150 Lbs.	36'-0"	29'	450 Lbs.	14.0 Sq. Ft.	130 MPH
\$795.00	20M646	6 ELEMENT ROTARY	14.0 DB	30 DB	46°	8.0 KWP	3.50 x 3"x46'	176 Lbs.	36'-0"	29'	530 Lbs.	17.0 Sq. Ft.	130 MPH
\$ 85.00	RVD-20M	"Rocket" Vertical Dipole	1.5 DB	Omni-Dir.		4.0 KWP	36' long	26 Lbs.	36'-0"		96 Lbs.	3.0 Sq. Ft.	120 MPH
40 METER MONARCH CUSTOM MONO-BAND ARRAYS													
\$365.00	40M214	2 ELEMENT ROTARY	5.6 DB	14 DB	66°	5.0 KWP	3.50 x 3" x 14'	60 Lbs.	64'-0"	34'-0"	252 Lbs.	8.0 Sq. Ft.	130 MPH
\$465.00	40M329	3 ELEMENT ROTARY	8.3 DB	32 DB	59°	8.0 KWP	3.50 x 3" x 29'	110 Lbs.	64'-0"	35'-0"	405 Lbs.	12.0 Sq. Ft.	130 MPH
\$745.00	40M 335	3 ELEMENT ROTARY	8.7 DB	30 DB	58°	8.0 KWP	3.50 x 3" x 35'	150 Lbs.	64'-0"	36'-0"	480 Lbs.	12.5 Sq. Ft.	130 MPH
\$1110.00	40M346	3 ELEMENT ROTARY	9.0 DB	30 DB	57°	8.0 KWP	3.50 x 3" x 46'	177 Lbs.	64'-0"	40'-0"	490 Lbs.	13.5 Sq. Ft.	130 MPH
TRI-BAND® MONARCH CUSTOM HI-Q, HI-VOLTAGE "TRAPPED" SINGLE TRANSMISSION LINE ARRAYS			GAIN	F/B	B/W	Pwr. Rating	Boom Lgth.	Weight	EL. Length	Turning Radius	Wind Load	Wind Area	Wind Rating
\$298.00	TB5EM	10-15-20 Meter TRI-BAND - 4 KWP -	8.5 DB	28 DB	60°	4 KWP	2.50x2"x18'	49 Lbs.	36'-0"	20'-0"	210 Lbs.	6.6 Sq. Ft.	110 MPH
\$448.00	TB6EM	10-15-20 Meter TRI-BAND - 5 KWP -	10.0 DB	30 DB	59°	5 KWP	3.50x3"x26'	85 Lbs.	36'-0"	28'-0"	300 Lbs.	9.5 Sq. Ft.	130 MPH
DUO-BAND MONARCH CUSTOM HI-Q, HI-VOLTAGE "TRAPPED" SINGLE TRANSMISSION LINE ARRAYS													
\$185.00	DBM1015	10-15 METER DUO-BAND 4 ELEMENT ROTARY	8.5 DB	28 DB	60°	3.0 KWP	2.50x2"x12'	41 Lbs.	23'-0"	15'-0"	125 Lbs.	4.1 Sq. Ft.	110 MPH
\$298.00	DBM99D	15-20 METER DUO-BAND 4 ELEMENT ROTARY	8.5 DB	28 DB	60°	4.0 KWP	2.50x2"x18'	49 Lbs.	36'-0"	20'-0"	184 Lbs.	5.9 Sq. Ft.	110 MPH
\$448.00	SDBM30D	15-20 METER DUO-BAND 4 ELEMENT ROTARY	10.0 DB	28 DB	59°	5.0 KWP	3.50x3"x26'	85 Lbs.	36'-0"	28'-0"	300 Lbs.	9.5 Sq. Ft.	130 MPH
4-BAND MONARCH CUSTOM HI-Q, HI-VOLTAGE "TRAPPED" SINGLE TRANSMISSION LINE ARRAY													
\$1250.00	ST4BM/3	10-15-20-40 METER 7 ELEMENT ROTARY	8.0 DB	23 DB	62°	5.0 KWP	3.50x3"x31'	176 Lbs.	58'-0"	35'-0"	420 Lbs.	12.0 Sq. Ft.	120 MPH
EMPIRICAL-LOG® MONARCH CUSTOM Broad-Band Continuous Coverage Array													
\$750.00	TEL1330	13 THRU 30 Mhz.	8.0 DB	21 DB	63°	5.0 KWP	3.50x3"x33'	210 Lbs.	38'-0"	26'-0"	364 Lbs.	11.5 Sq. Ft.	120 MPH
80 METER MONARCH CUSTOM MONO-BAND ARRAYS													
	80M2	2 ELEMENT ROTARY	5.0 DB	16 DB	71°	6.0 KWP	4.50" x 47'	275 Lbs.	74'-0"				

"BALUN" FED TELREX ARRAYS ARE "BALUN" SUPPLIED

The Mfg. Resrves The Right To Change Design, Materials, Specs. & Prices Without Notice.

Telrex

Professionally Engineered Systems
YOU'LL BE GLAD YOU DID I

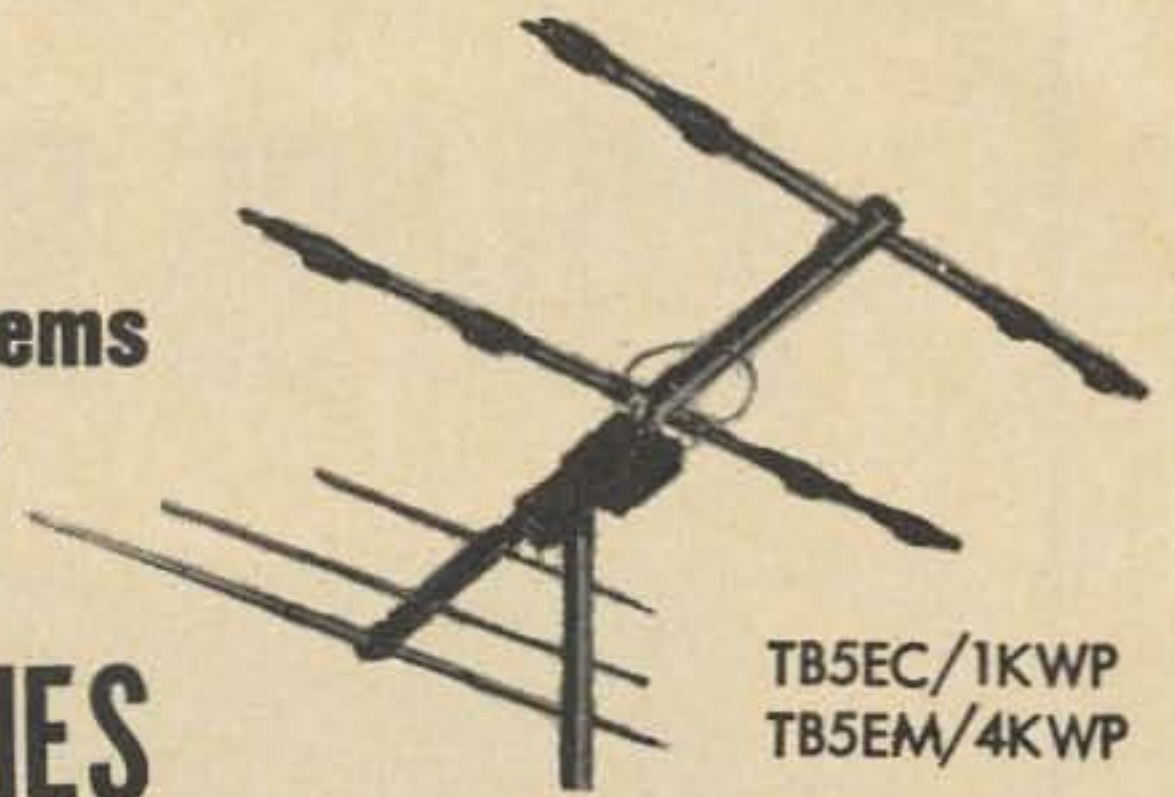

TB5EC/1KWP
TB5EM/4KWP

CHALLENGER SERIES

YOU COULDN'T EXPECT A MORE INEXPENSIVE SERIES FOR SUCH HI-PERFORMANCE

3/4 METER CHALLENGER SERIES	GAIN	F/B	B/W	Pwr. Rating	Boom O.D. Length	Weight	Longest EL. Length	Turning Radius	Wind Load	Wind Area	Wind Rating
\$41.50 430M15C 15 ELEMENT ARRAY	16 DB	24 DB	27°	200 W	1" x 9'	3 Lbs.	13"	5'-0"	26 Lbs.	1 Sq. Ft.	100 MPH
1-1/4 METER CHALLENGER SERIES											
\$18.00 220M5C 5 ELEMENT ARRAY	12 DB	24 DB	51°	250 W	1" x 4'	1 Lb.	28"	26"	15 Lbs.	.50 Sq. Ft.	100 MPH
\$41.50 220M15C 15 ELEMENT ARRAY	16 DB	24 DB	27°	250 W	1.5"x20'	10 Lbs.	28"	11'-6"	50 Lbs.	1.72 Sq. Ft.	100 MPH
2 METER CHALLENGER SERIES											
\$ 9.95 2M3C 3 ELEMENT ARRAY	10 DB	18 DB	55°	250 W	1" x 3'	1.0 Lb.	3'-6"	3'-0"	9 Lbs.	0.29 Sq. Ft.	100 MPH
\$15.95 2M6C 6 ELEMENT ARRAY	14 DB	23 DB	42°	300 W	1" x 9'	3 Lbs.	3'-6"	5'-6"	21 Lbs.	.73 Sq. Ft.	100 MPH
\$22.50 2M814C 8 ELEMENT ARRAY	16.5 DB	23 DB	35°	300 W	1.375x14'	5 Lbs.	3'-6"	7'-0"	35 Lbs.	1.23 Sq. Ft.	100 MPH
\$46.50 2M1528C 15 ELEMENT ARRAY	17.2 DB	23 DB	27°	300 W	1.5" x 28'	15 Lbs.	3'-6"	14'-0"	55 Lbs.	2.23 Sq. Ft.	100 MPH
\$10.75 OD-2M "Rocket" Vertical Dipole	1.5DB	360°	Omni Dir.	1KWP							
6 METER CHALLENGER SERIES											
\$19.95 6M3C 3 ELEMENT ARRAY	10 DB	23 DB	58°	400 W	1.5"x 8'	5 Lbs.	10'	6'-0"	28 Lbs.	.95 Sq. Ft.	100 MPH
\$26.50 6M4C 4 ELEMENT ARRAY	12 DB	28 DB	54°	400 W	1.5"x12'	8 Lbs.	10'	8'-8"	35 Lbs.	1.20 Sq. Ft.	100 MPH
\$31.50 6M5C 5 ELEMENT ARRAY	13 DB	24 DB	51°	400 W	1.5"x16'	11 Lbs.	10'	9'-6"	47 Lbs.	1.70 Sq. Ft.	100 MPH
\$41.50 6M6C 6 ELEMENT ARRAY	15 DB	24 DB	42°	400 W	1.5"x24'	17 Lbs.	10'	14'-0"	67 Lbs.	2.29 Sq. Ft.	100 MPH
\$15.95 OD-6M "Rocket" Vertical Dipole	1.5 DB	360°	Omni-Dir.	1KWP							
10 METER CHALLENGER SERIES											
\$49.95 10M309C 3 ELEMENT ARRAY	9 DB	24 DB	60°	1.0 KWP	1.5" x 9'	12 Lbs.	18'	11'-0"	62 Lbs.	2.03 Sq. Ft.	100 MPH
\$95.00 10M512C 5 ELEMENT ARRAY	12.5 DB	25 DB	48°	4 KWP	2.50 x 2"x28'	75 Lbs.	37'-0"	24'	110 Lbs.		
\$19.95 OD-10M "Rocket" Vertical Dipole	1.5 DB	360°	Omni-Dir.	2KWP							
15 METER CHALLENGER SERIES											
\$64.95 15M312C 3 ELEMENT ARRAY	8.9 DB	24 DB	60°	1.0 KWP	2" x 12'	32 Lbs.	23'-6"	14'-6"	171 Lbs.	5.52 Sq. Ft.	110 MPH
\$25.95 OD-15M "Rocket" Vertical Dipole	1.5 DB	360°	Omni-Dir.	3KWP							
20 METER CHALLENGER SERIES											
\$139.95 20M316C 3 ELEMENT ROTARY	8 DB	28DB	58°	4 KWP	2.50, x2"x16'	32 Lbs.	36'	22'-0"	188 Lbs.	6.02 Sq. Ft.	110 MPH
\$194.00 20M428C 4 ELEMENT ROTARY	10 DB	28DB	58°	5 KWP	2.50, x2"x28'	70 Lbs.	36'				
\$33.95 OD-20M "Rocket" Vertical Dipole	1.5 DB	360°	Omni-Dir.	4KWP							
"TRAPPED" TRI-BAND® 10-15-20 M CHALLENGER SERIES - Single Transmission Line Arrays -											
\$145.00 TB4EC 4 ELEMENT ROTARY	5.5 DB	14 DB	60°	2KWP	2", 2-1/2"x8'	30 Lbs.	30'	17'-0"	116 Lbs.	4.0 Sq. Ft.	110 MPH
\$198.00 TB5EC 5 ELEMENT ROTARY	8.5 DB	28 DB	60°	1KWP	2", 2-1/2"x18'	49 Lbs.	36'	20'-0"	210 Lbs.	6.6 Sq. Ft.	110 MPH

"BALUN" FED TELREX ARRAYS ARE "BALUN" SUPPLIED



Model Number	A 1312RIS
Price	\$375.00
Rotating Torque (in lbs.)	1,300
Output Shaft Travel	380°
Output Shaft RPM	1.5 Approx.
Drive Motor (110 vac-60 cps)	1/12 HP
Operating Current (amps)	2.0
Over-All Dimensions (inches)	9-1/2 x 9 x 19
Net Weight (approx. lbs.)	52
Shipping Weight (approx. lbs.)	74

STANDARD CONTROL CONSOLE
(WITH 6" TRICOLOR DIRECT AND
RECIPROCAL READING AZIMUTH
ROSE)



OTHER EXTRA-HEAVY-DUTY ROTATOR-SELSYN-INDICATOR SYSTEMS AVAILABLE.

Patented Balun Fed Inverted-Vee®

2KWP and 4KWP Antenna Kits

Simple to set up, hi-performance antenna systems.
Kits include—patented encapsulated broad-band balun, 200 ft. antenna wire, insulators and complete instructions for erecting as either Mono 40 or 80M Inverted-Vee or Fan-Dipole 40/80 Meter Inverted-Vee.
2KW Peak Model CIV2KWP ----- \$18.95
4KW Peak Model CIV4KWP ----- \$25.95

ROTATABLE "BALUN" FED
"INVERTED-VEE"® DIPOLES

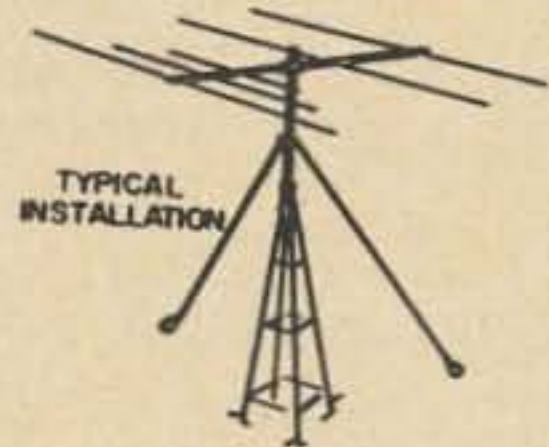

40M-BFIVM - \$98.00
20M-BFIVC - \$68.95
15M-BFIVC - \$55.00
10M-BFIVC - \$45.00
6M - BFIVC - \$25.00

PRICES F.O.B. **Telrex** ANTENNA LABS. ASBURY PARK, N.J. 07712 - 201 - 775-7252

RECENTLY ADAPTED FOR 2 AND 6 METER AMATEUR BANDS

220-225 BAND PASS ANTENNA

from SWAN ANTENNA CO.

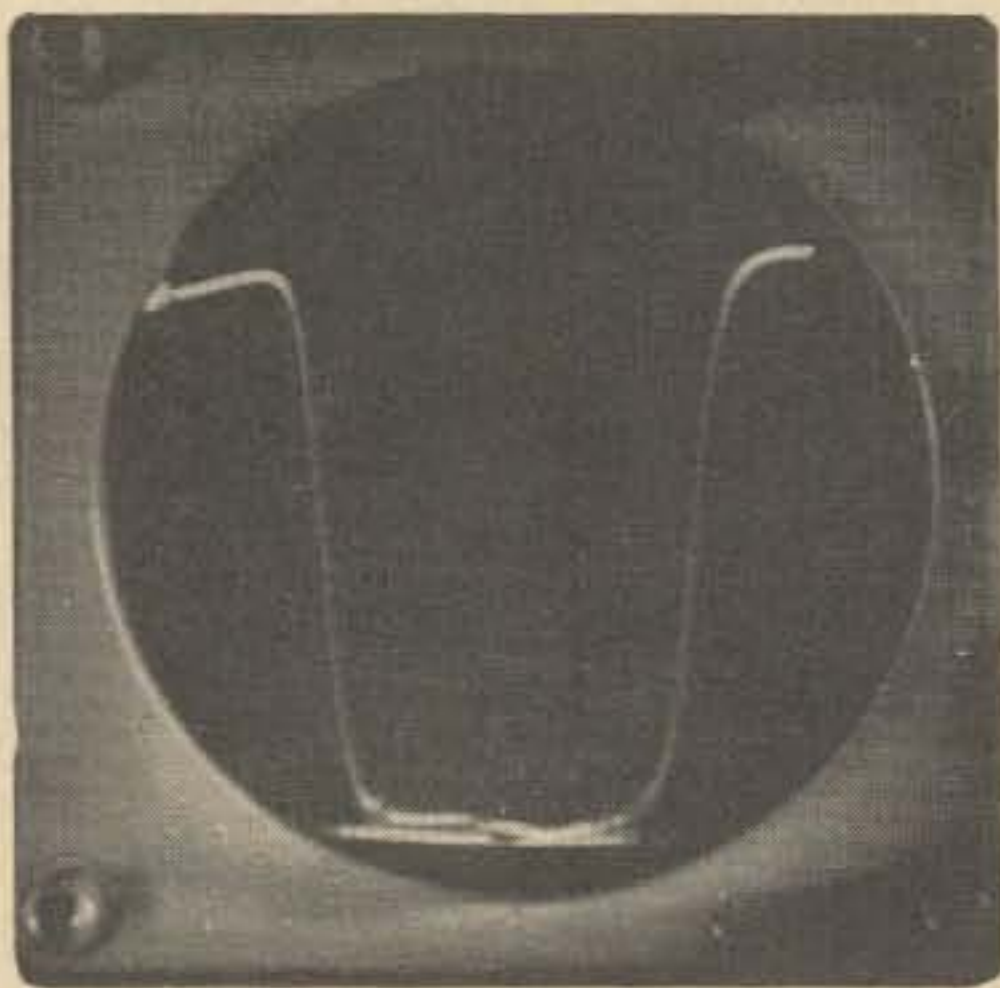

RETURN LOSS RESPONSE

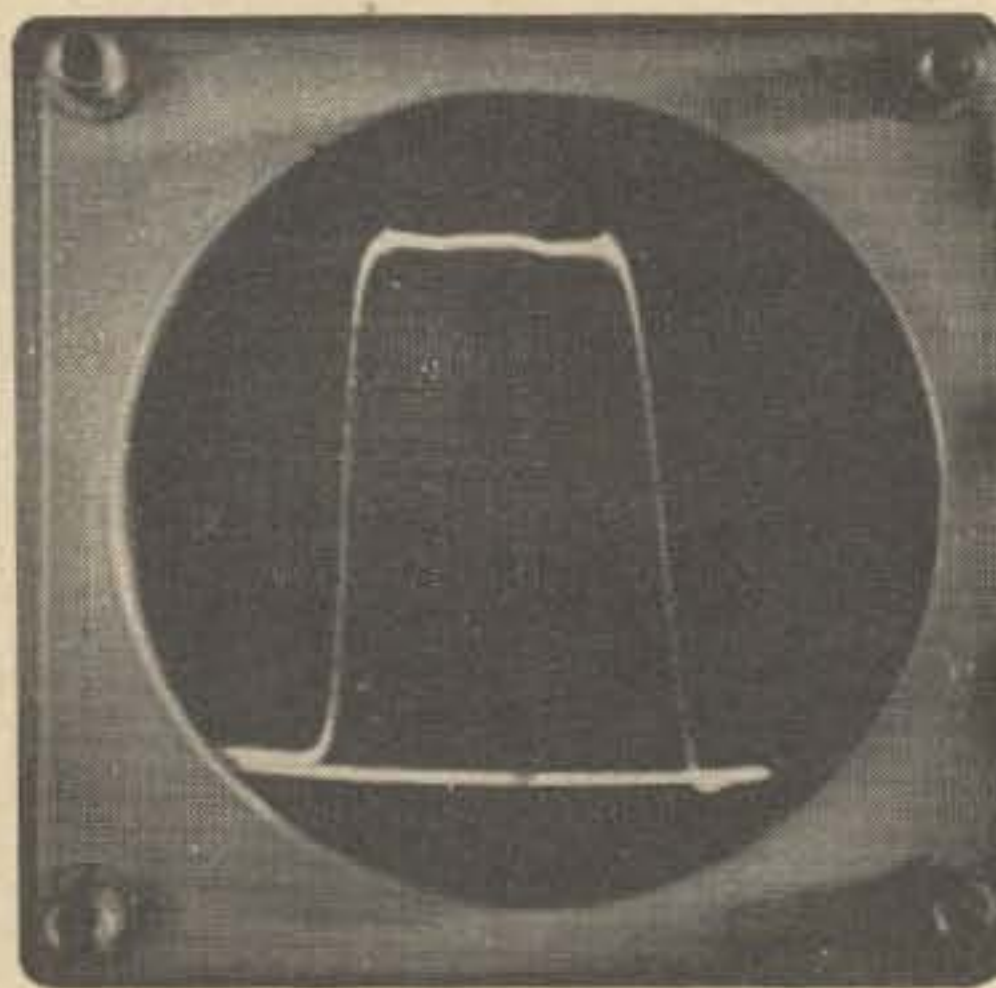

BAND PASS RESPONSE

- CONTROLLED BANDWIDTH RESPONSE
- CONTROLLED BANDWIDTH IMPEDANCE
- UNIDIRECTIONAL RESPONSE
- IMPROVED SIGNAL-TO-NOISE RATIO
- GREATER GAIN THAN THE YAGI ARRAY FOR THE SIZE
- REJECTION OF UNDESIRED FREQUENCIES AND NOISE ABOVE AND BELOW
- DESIRED BANDPASS RESPONSE

The Swan bandpass antenna, developed for use in home television reception, has recently been adapted for the 2 and 6 meter amateur bands. Swan's bandpass antenna has the combined properties of constant impedance match across the entire passband of response, with gain superior to that of an equivalent-sized yagi. The antenna features a very high front-to-back ratio as well as front-to-side in both the X and Z planes. With four driven elements, the first director is saturated with virtually all of the power radiated from those active elements. Since the first director sees four driven elements at four different distances, it responds to the designed bandwidth, giving gain at four different frequencies, hence the bandpass response. Similarly, each dipole is matched to four separate frequencies, giving a constant impedance match across the design bandpass.

12 Element	gain 15 dB	120 in. long	\$19.95
14 Element	gain 17 dB	157 in. long	\$24.95

See the 2 Meter 11 & 14 Element Array for directivity ratings.

DO-IT-YOURSELF KITS AT 50¢ PER ELEMENT; INCLUDES INSULATORS, WIRE & CLIPS, AND INSTRUCTIONS.

WE DESIGN ANTENNAS FOR C.A.T.V. SYSTEMS
AND FOR SPECIAL FREQUENCIES, 6 METERS AND ABOVE, TO 2000 MHZ

SWAN ANTENNA CO.

646 N. UNION ST. P.O. BOX 1122 STOCKTON, CA 95201 464-9897

WE ARE OPEN FOR DEALERS
IN EVERY STATE AND FOREIGN COUNTRY.

DO IT THE EASY WAY

WITH A **110 VOLT GEARMOTOR**

from HEIGHTS

COMPLETE WITH MOUNTING HARNESS



REMOTE REVERSING SWITCH



ATTACHED OR REMOVED IN MINUTES



FITS PREVIOUSLY INSTALLED

STANDARD

SCREW OPERATED HINGED BASES

OR

FOLD OVER KITS

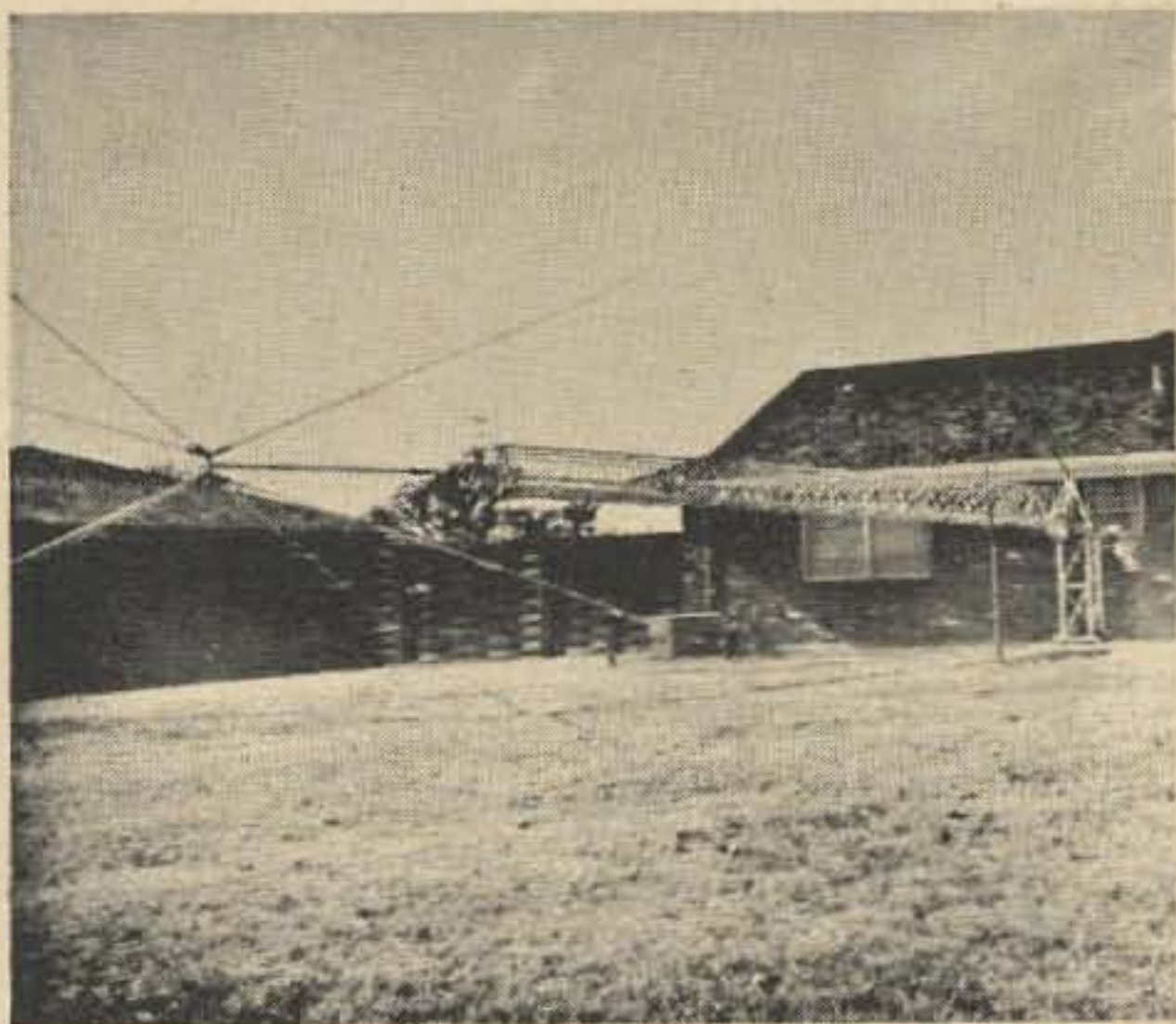

Laid over for antenna work

Two units are available, both at a List Price of \$250.00. The 8 minute unit for light to medium loaded towers; the 18 minute unit for heavily loaded towers (generally those where the SOHB mounts to 26" section or where the FOK folding point is between 26" sections).

In operation, the gearmotor and harness simply pivot along the same axis as the Jack screw as it declines from the vertical to approximately 45° and back to vertical (the folding segment of the tower can be declined as far as 30° below horizontal.)

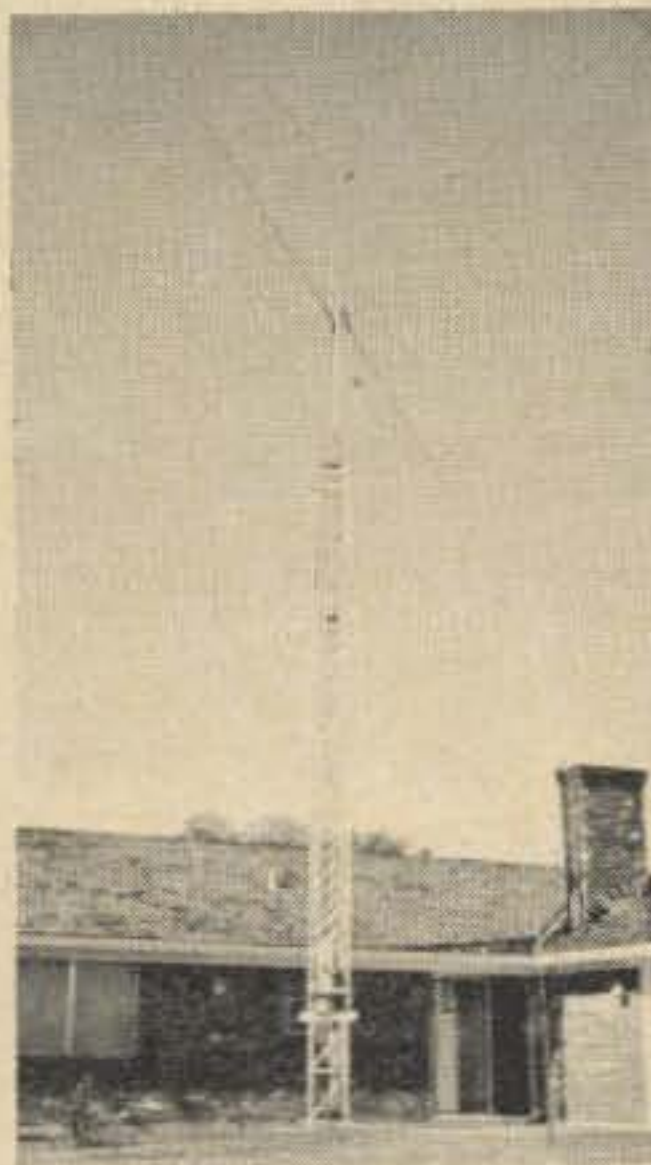

Erect but not extended



Fully extended
Total tower height 69 ft.

The tower pictured in this sequence is the CUA64 (6 sq. ft) mounted on the SOHB-22 (in this case with optional gearmotor accessory). The gearmotor requires about 20" of clearance behind the SOHB.

SEE YOUR LOCAL DISTRIBUTOR
OR WRITE
FOR COMPLETE INFORMATION

The "STANDARD" TAPERED ALUMINUM TV, HAM and RADIO TOWERS

A PRODUCT OF **HEIGHTS MANUFACTURING CO.**

4226 MAYBURY GRAND, DETROIT, MI 48208 Area Code 313-894-6700

Rugged Giants

Tri-Ex Sky Needle Towers Give your antennas a big lift!

Regular and
heavy duty
towers

This advanced state-of-the-art "Sky Needle" is fast earning its own special place of honor in the ham-communications field. Tri-Ex takes great pride in being the developer and first to build this crank-up, freestanding tubular tower for the amateur. Uniquely eye-pleasing, the slim and graceful "Sky Needle" is a symbol of pride to its owner as well as proof positive that he has the very best in towers. Tri-Ex offers immediate

delivery. Act now! Write for your free brochure, today.

- *Three Hi-Gain 10, 15, 20M long Johns.
- **Log-periodic antenna for MARS use 13 to 30 MHz.

MODEL	HEIGHT	
	EXTENDED	NESTED
TM-240	40'	22'
TM-358	58'	22½'
TM-370/370HD	70'	27'
TM-490	90'	28'
TM-5100R	100'	29'



Tri-Ex TOWER CORPORATION

7182 RASMUSSEN AVE. VISALIA, CALIF. 93277

Cush Craft

ANTENNAS WITH A "PATTERN OF FIRSTS" IN COMMUNICATIONS

VHF YAGIS

A144-4	2 meter FM	\$ 9.95
A144-7	2 meter, 7 element	12.95
A144-11	2 meter, 11 element	16.95
A220-11	1 1/4 meter, 11 element	14.95
A430-11	3/4 meter, 11 element	12.95
A26-ZP	6 & 2 meter portable	16.95
A50-3	6 meter, 3 element	18.50
A50-5	6 meter, 5 element	29.50
A50-6	6 meter, 6 element	39.50
A50-10	6 meter, 10 element	59.50

SQUALO

ASQ-2	2 meter, 10" square	\$11.95
ASQ-22	2 meter stacked	24.95
ASQ-6	6 meter, 30" square	15.95

BIG WHEEL

ABW-144	2 meter, gain	\$13.95
---------	---------------	---------

DX-ARRAY

DX-120	2 meter, 20 element	\$29.50
DX-220	1 1/4 meter, 20 element	22.50
DX-420	3/4 meter, 20 element	17.50

RINGO

AR-2	2 meter, gain	\$12.50
AR-6	6 meter, gain	18.50

BLITZ BUG

LAC-1	Lightning Arrester	\$ 3.95
LAC-2	Lightning Arrester	4.45

MONOBEAMS

A14-2	20 meter, 2 element	\$69.95
A14-3	20 meter, 3 element	99.95
A21-3	15 meter, 3 element	59.95
A21-4	15 meter, 4 element	79.95
A28-3	10 meter, 3 element	39.95
A28-4	10 meter, 4 element	49.95

Make yours a real signal with a Cush Craft antenna.

See your local distributor or write for a free copy of our new catalog.

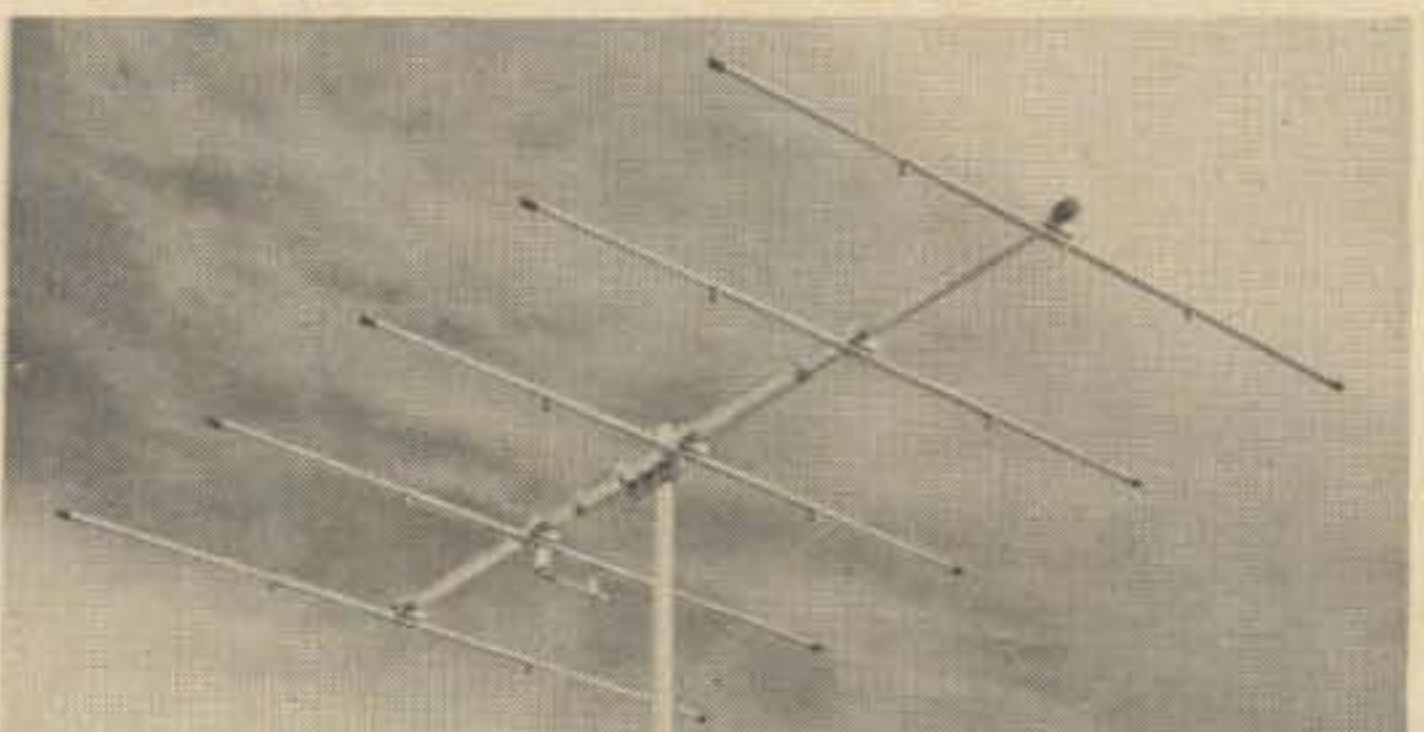
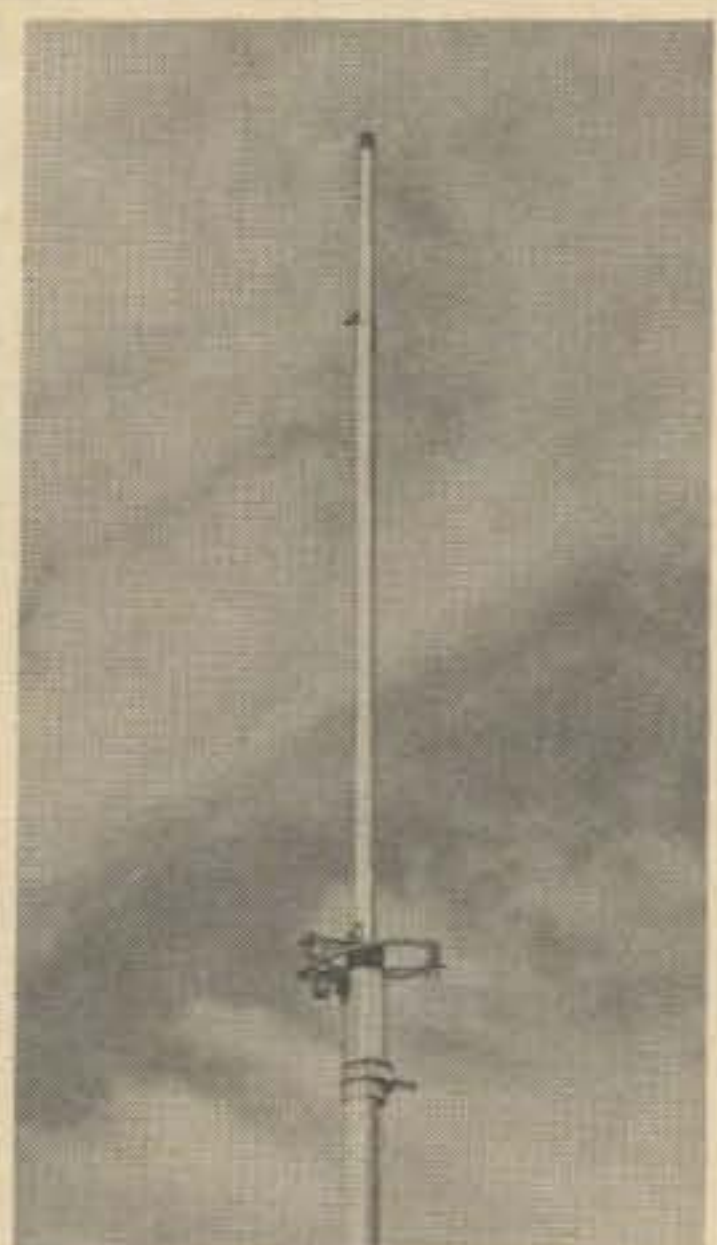
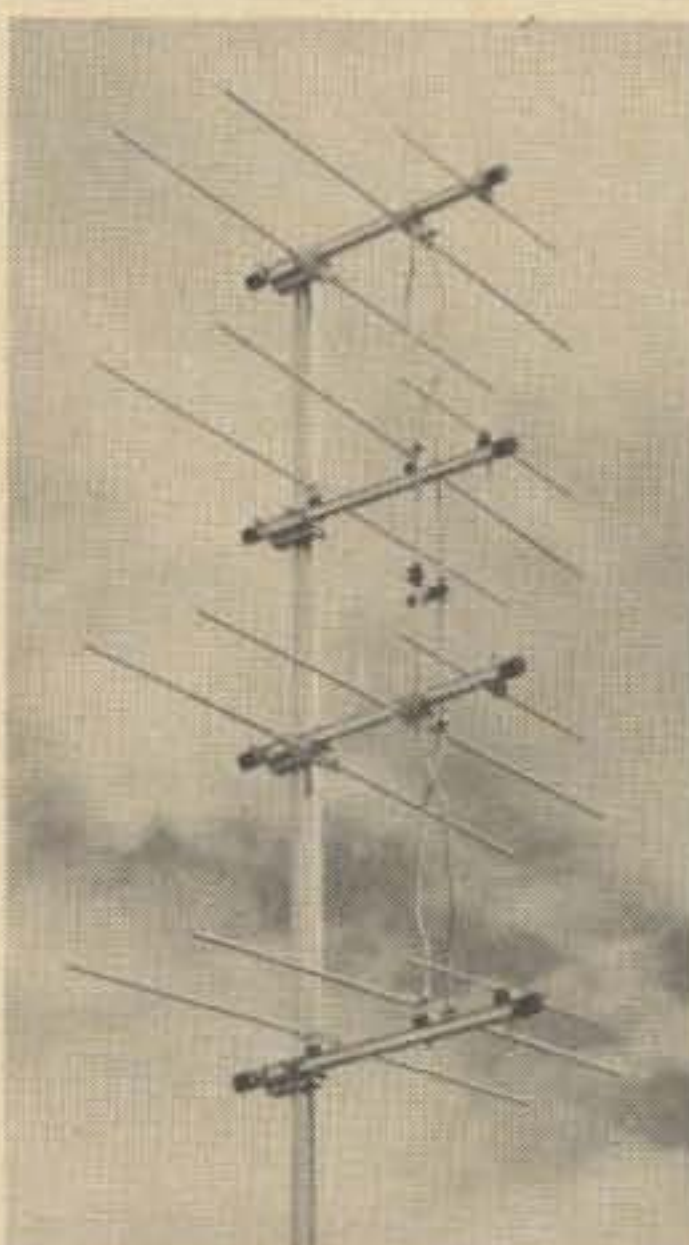
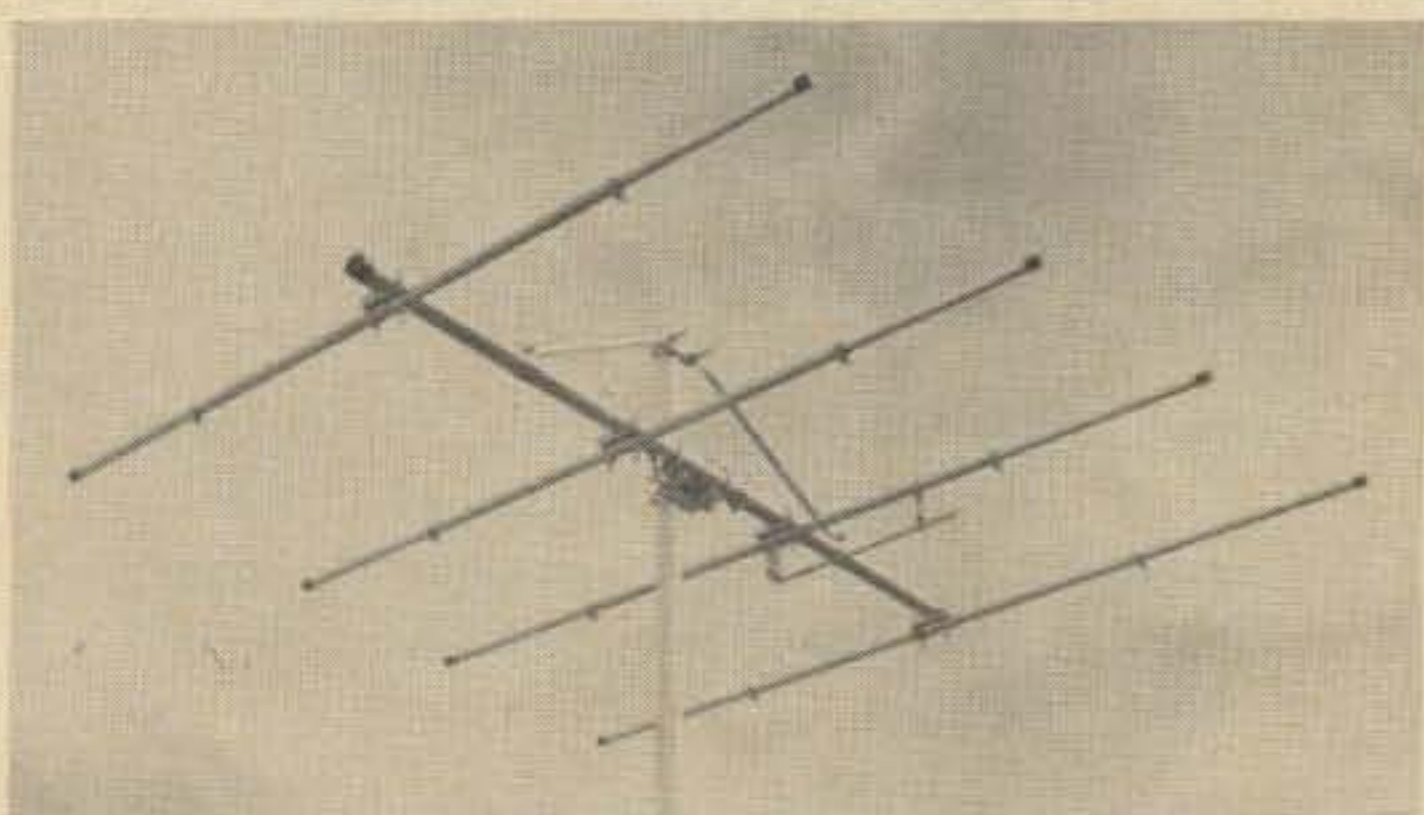
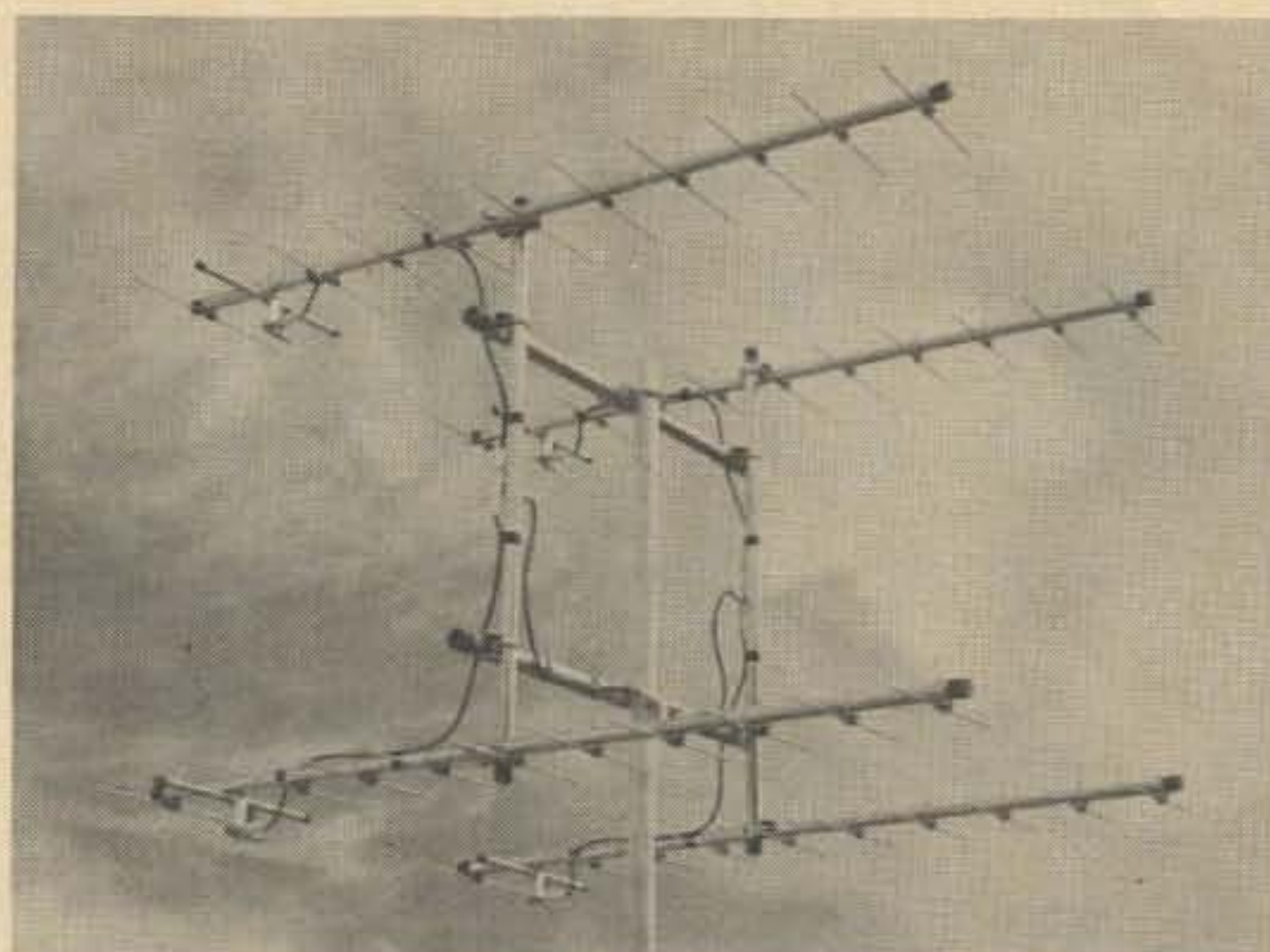

Cush Craft

621 HAYWARD STREET
MANCHESTER, N. H. 03103

FIBRE-GLASS
GEM-QUAD

FOR 10, 15, AND 20 METERS

Never before has one antenna offered so much

- The GEM QUAD is a two, three, or four element antenna designed to operate on ten, fifteen, and twenty meters.
- Forward gain for two element GEM QUAD gives maximum gain on DX, "where it counts."
- Optional third element (easily installed) has given optimum forward gain with a narrow forward cone of effectiveness, resulting in excellent rejection of unwanted signals.
- Front to back ratio designed for maximum signal discrimination.
- Toroid balun kit supplied for single feed line matching.
- Mounting spider of durable heavy duty aluminum alloy. 1½ inch o.d. stub facilitates easy mast mounting.
- Hollow spider allows insertion of boom for additional element.
- Fibreglass arms withstand 100 m.p.h. winds with minimum loading on tower (2.5 sq. ft. wind load area).
- Tridetic arm design (air passes through the arm). Low wind resistance eliminates need for excessive guy wires.

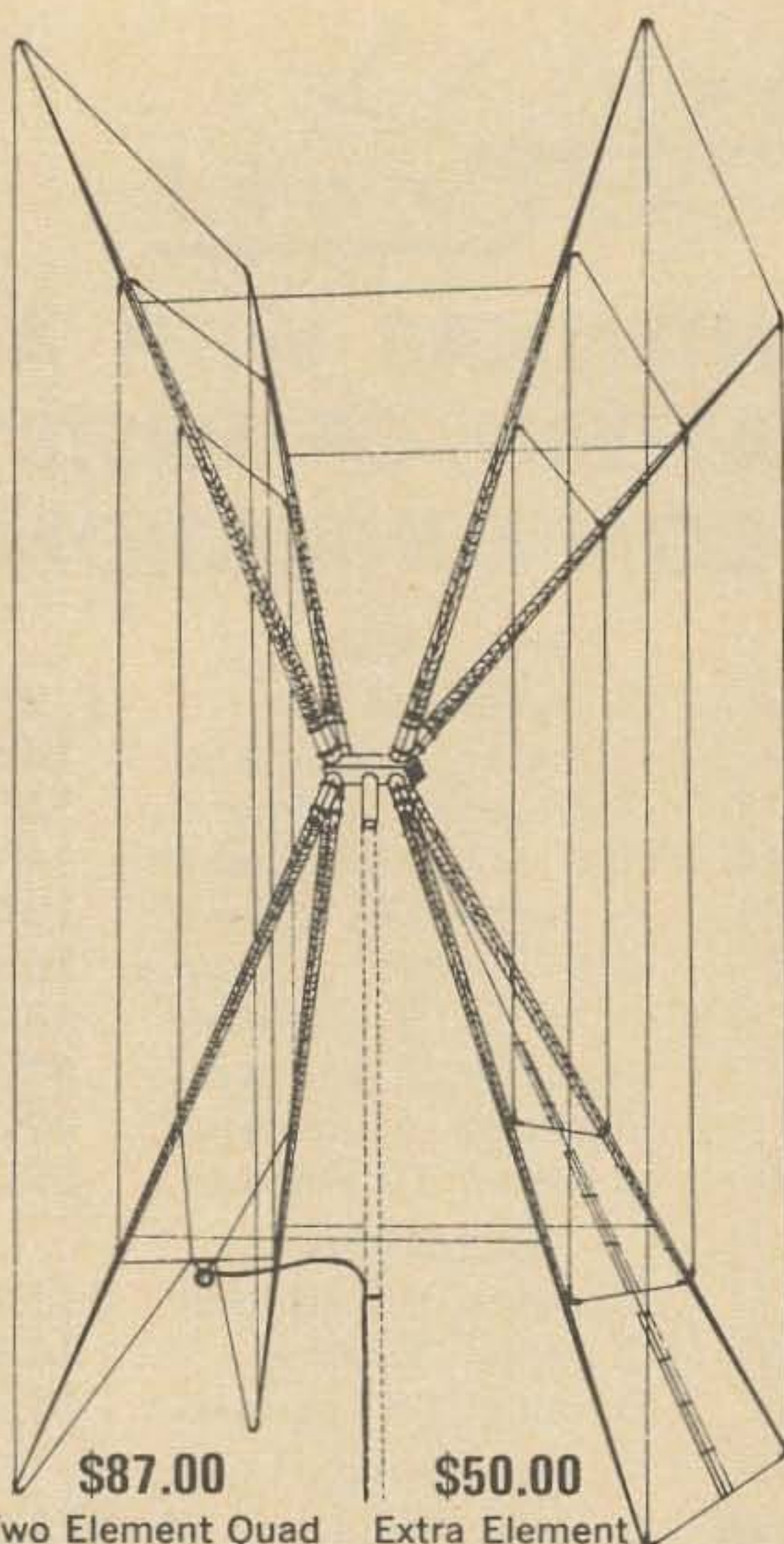

\$87.00 **\$50.00**
 Two Element Quad Extra Element
 Includes U.S. Customs Import Duty and
 Can. Federal Sales Tax — Shipped Collect

- Simple assembly and tuning instructions are supplied with every kit, showing measurements and assembly procedure. When assembled as instructed, tuning only takes a matter of minutes.
- Maintains rigid form continuously. Double "Cone-shaped" design maintains critical measurements under severe weather conditions. Completely weather resistant — will not freeze or crack.
- Light weight (complete antenna weighs 20 lbs., 3rd element 10 lbs.). Simple TV rotator will rotate antenna.
- Single 52 ohm feed-line for all bands. SWR of 1 to 1 easily obtained using ferrite Toroid Balun provided, (produces minimum harmonic radiation). Will handle maximum power input.



Can. Patent
 794506
 U.S. Patent
 Pending



Structural Glass
 LIMITED

20 Burnett Ave., Winnipeg, Manitoba, Canada



ROHN, as the largest tower manufacturer in the United States, provides outstanding commercial quality equipment for amateurs. We're best known

in this field for our crank-up, fold-over and #25G towers. Like all our big commercial towers, they're hot-dipped galvanized after fabrication according to EIA specifications. We also make commercial hardware and accessories amateurs use, too, and it's all designed with an understanding of your needs, particularly in the area of quality. And don't overlook our constant search for new ideas, processes and products — just for you. Keep an eye out for the ROHN name. It's well worth your while.

ROHN® THE QUALITY PEOPLE

Home Office — Factory
PO Box 2000, Peoria, Ill., USA 61601
Phone 309-697-4400 TWX 309-697-1488

ROHN®

Western Office
310 Quincy Street, Reno, Nevada 89502
Phone 702-322-9300

Eastern Office
PO Box 681, Turnersville, N. J. 08012
Phone 609-589-8032

Southern Office
PO Box 6537, Birmingham, Ala. 35217
Phone 205-841-1789

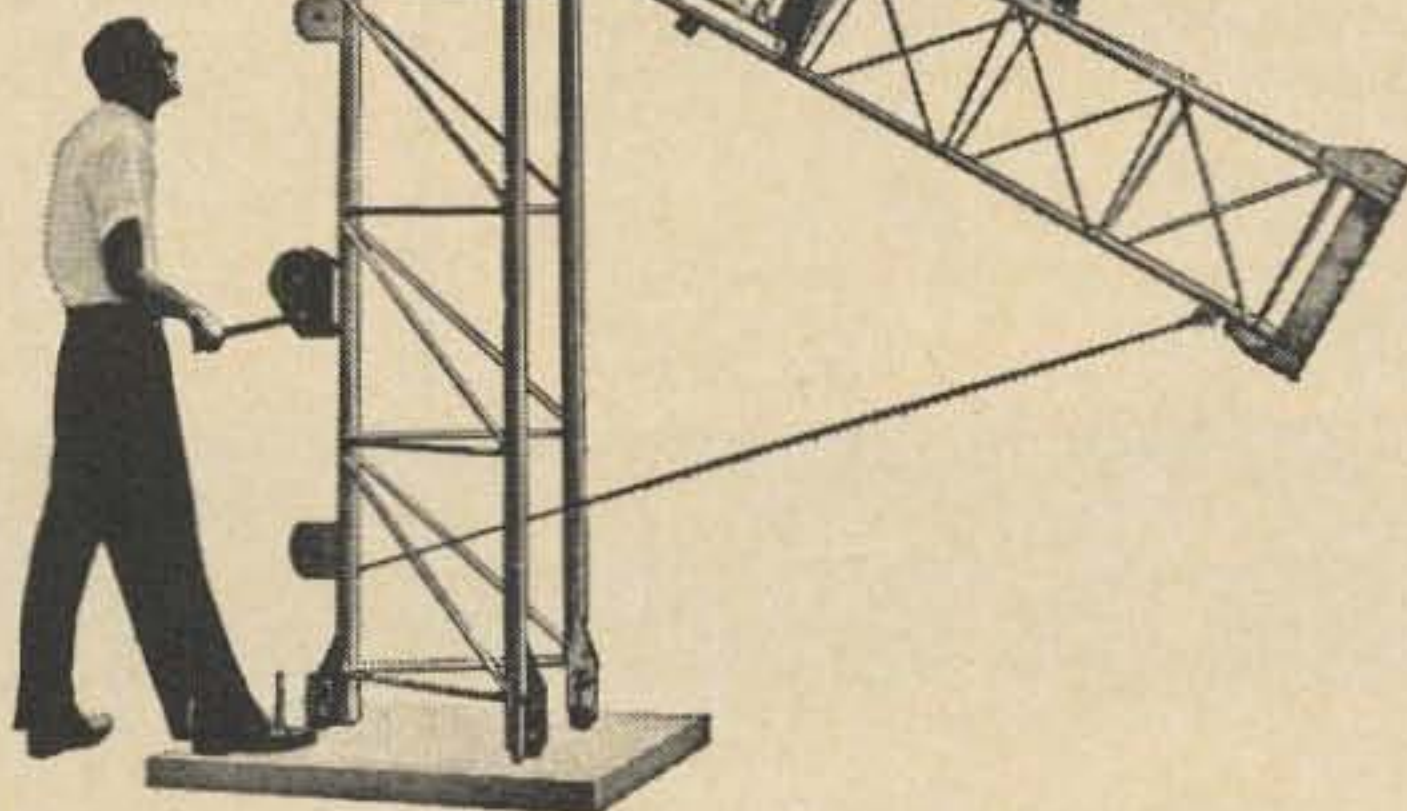



More Amateurs Use
HUSTLER *Than All Other*
Mobile Antennas Combined!

NOW... More Consistent Commun-
ications, Greater Signal,
More Uniform Pattern..

**STANDARD
MODEL
RESONATORS**

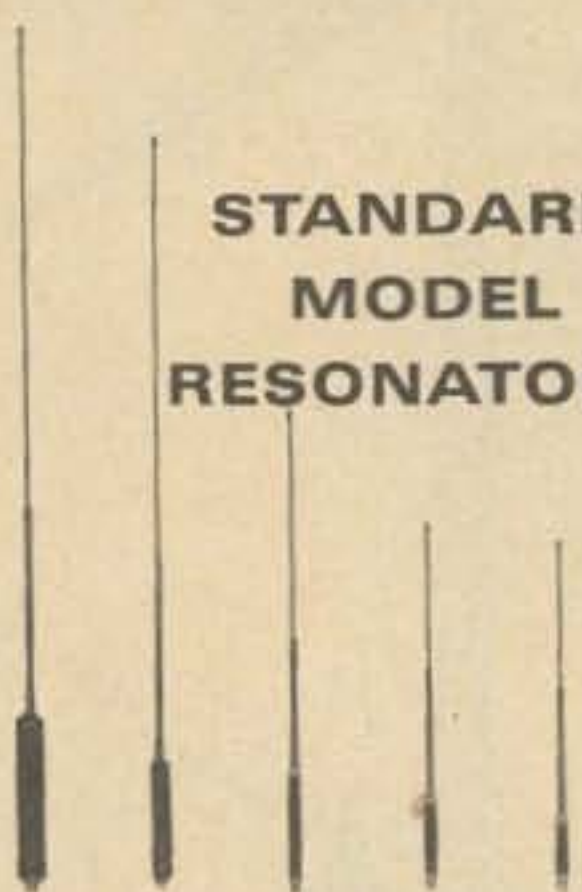

- RM-10 10 METER RES.
 - RM-15 15 METER RES.
 - RM-20 20 METER RES.
 - RM-40 40 METER RES.
 - RM-75 75 METER RES.
- 400 WATTS PEP.

**SUPER
MODEL
RESONATORS**

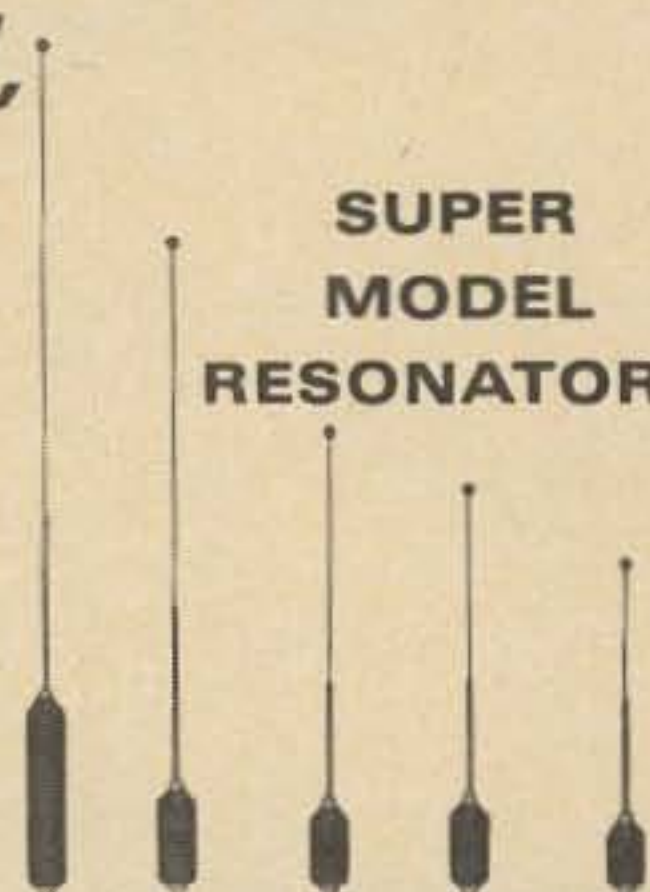

- RM-10S 10 METER RES.
 - RM-15S 15 METER RES.
 - RM-20S 20 METER RES.
 - RM-40S 40 METER RES.
 - RM-75S 75 METER RES.
- 2 KW PEP.

TWO Hustlers phased
with DOUBLE TALK harness!

DOUBLE-TALK

**JOIN THE FRATERNITY...
 HAVE THE BEST SIGNAL—
 USE A HUSTLER—OR TWO!**

You get top signal reports—consistent contacts. That's why Hustler is the number one choice! And only Hustler has 50 ohm nominal base impedance, quick band change, broad band width, adjustable tip rod resonators, and exclusive 90° vertical plane and 360° horizontal swivel tip over mast with years of proven performance.

Model HF-62 for cowl or fender mount

Tunable for 6 and 2 meters with low SWR across band. Stainless steel adjustable tuning rod. Antenna opens to 44", collapses to 22". Base has 30° vertical adjust and mounts in 1" hole. Supplied with 5' coax and PL-259 connector.

Model HF-2
Same as HF-62 but with 3/8"-24 stud to fit standard mobile mount.



Roof top Antennas—140 to 500 MHz
New—lowest of all—low profile base offers easiest installation. Solid stainless steel radiator. Model UHT-1 mounts in 3/4" hole. No soldering. Complete with 15 foot coax. Supplied with cutting chart.

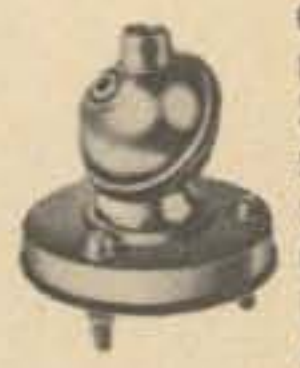

Model SSM-2 Ball Mount
Mount your Hustler on the finest, commercial duty, Model SSM-2, stainless steel ball with 180° swivel available only from Hustler. Gray cycolac insulator, cork gasket, and steel back up plate.



Bumper Mount—Model BM-1
Hustler's stainless steel strap fits any shape bumper inconspicuously. Assembly is held rigid by two "J" bolts. Antenna base is standard Hustler base, Model C-32. Hardware is cadmium plated.



MASTS FOR DECK OR BUMPER MOUNT

Model MO-1
54" Mast, folds at 15" above base, swivels 360° for deck or fender mount.

Model MO-2
54" mast, folds at 27" above base, swivels 360° for bumper mount.

The foldover, heat treated, 1/2" aluminum mast permits quick and easy interchange of resonators. The mast can be folded over for entering garages or carports. Mast has a 3/8"-24 base thread to fit any standard mobile mount.

NEW-TRONICS CORP. 15800 COMMERCE PARK DRIVE,
 BROOK PARK, OHIO 44142

advised by my lawyers that
ou goons don't ever proofr
loasy man... from tab
bunch of rocks... on
you ignored my comments in
I insist that you print ev
should be boiled in oil ov

LETTERS

Crystal Plea

I am a prospective Grade II (5 wpm) ham (expecting my license). Maximum power allowed is 25 watts in the 14000 to 14350 kHz amateur band. In our country, ham equipment is not available for sale. However, I have managed to procure one junk Hallicrafters SX-28 which is in working condition. I hope I shall be able to rig up a 25 watt transmitter using two EL84s (6V6) as final amplifiers. But, a stable vfo will be prohibitively expensive for me to assemble, and crystals are just not available. I understand that war surplus crystals are available at a nominal price in the U.S. Kindly help me to locate a ham who is willing to send me a few war surplus crystals. It will be convenient if the crystals are of the type that can be plugged into standard octal sockets and the frequencies are in the range of 7000 to 7100 kHz so that I shall be able to operate in other bands (14000 to 14350, 21000 to 21450, and 28000 to 28700) by frequency multiplication when I am qualified for Grade I (12 wpm).

Mathews Pulican
13-E. Govt. Quarters
Santa Ines, Panaji P.O.
Goa. (India)

Decision

Please enter my subscription to 73 for 3 years at \$12. After comparing your publication to three other amateur radio magazines the choice was an easy one to make.

Richard H. Smith WQ0IAQ
Lot 403
2130 Miller Trunk Highway
Duluth MN 55811

Maltese Directory

I am a Maltese ham living in Canada for the last 20 years, I still have an active 9H1AW call, also a G3WJL active call. During the last few months a number of Maltese hams from England, Canada, U.S.A. and Australia have asked me to create a book of as many Maltese hams as I can find; therefore I wish to say "Any Maltese emigrant to any country in the world who holds an amateur license) please write to; George N. Muscat.

G. N. Muscat VE3GNM
3913 Casgrain Drive
Windsor 22, Ontario, Canada

CB vs Hams

As a county Civil Defense director, I work with both groups and from where I sit there is no conflict involved. I have been involved with a number of emergency situations using both services and have found both groups, in a pinch, willing to do anything they possibly can to help.

First, there are just not enough hams, particularly those with mobile equipment to make much of a dent in the crying need in an emergency. As an example, in this county of roughly 25,000 souls, we have about a dozen licensed hams, most of whom are inactive. Back in the late 50s and early 60s we bought a dozen Gonset Communicators and issued them to the members of local clubs. This was about the same time that CB made its debut. Since that time interest in ham radio has lagged, and CB use has increased. At the present time there are a half a dozen 6m Communicators stacked in my office available to any local hams who will keep them operable. Most of those who presently have them do not have mobile antennas on their cars and probably would have to look around for anything more than a piece of loose wire to cut to length (after digging up an outdated handbook for the proper dimensions).

On the other hand, we have something in the neighborhood of a hundred CB operators, many of these with mobile units. I might add that I'm referring to solid citizen type of CB users rather than the irresponsible type commonly equated with CB.

On a number of occasions, I have found CB an answer to a highway accident I have been involved with personally or in obtaining aid for someone else. Ham radio would have been out of the question because the coverage just was not there. In one case, a life was saved because there was someone on the air to take a call. Ham radio facilities were nonexistent and CB was the only available answer.

After the close of WWII, ham radio made some great steps and enthusiasm was at an all-time high. Now, with incentive licensing and other factors that contrast with CB, ham radio does not have the glamor it formerly had and the interest is lagging.

My personal feeling is that an updating of the ham radio licensing structure in line with the state of the art and the civil rights laws just to mention a few of the many.

Bob Forman W9RJH/K9TNX
P.O. Box 68
Monmouth IL 61462

April

Just received issue #115 (April) and all I can say is WOW. A very fine job indeed. I see works like this and become even prouder of being a part of it all.

Jack Forbing K9LSB
1416 Lakewood Drive
Fort Wayne IN 46809

April Cover

It was quite a surprise to see our building and television towers on the cover of my April 73. The Sandia Television Corporation operates this building. We arranged to allow WA5JDZ to install a repeater in the building and operate there free - including power.

Television stations KOB and KGGM-TV share this facility, as you might guess by the two TV antennas shown. The two domes are microwave dishes for a cable feed down south to Roswell. The little white house in the middle is a weather station which the personnel maintain for the weather bureau - the highest weather station

RG 196 AU 50 ohm teflon coaxial cable. Outside diameter .080" RF loss .29 db per foot at 400 Mhz. Silver plated shielding and conductor. Used for internal chassis wiring, antenna coupling, RF coupling between stages, etc. Random lengths from 35 foot to 150 foot. Colors: black, red, brown, blue, grey, orange. Regular price- 23¢ per foot. Our price 5¢ per foot \$3.00 per 100 ft.

455 KHz ceramic filters type BF-455-A. These filters will help to sharpen the selectivity of most sets using 455 KHz IF's. Use across cathode bias resistor in place of a capacitor, or in transistorized sets, across the emitter bias resistor. Impedance is 20 ohms at 455KHz., DC resistance is infinite. Impedance increases rapidly as you leave 455 KHz. Plan your own LC filter circuits at very low cost.
10 for \$1.00 25 for \$2.00

TOROID POWER TRANSFORMERS

T-2 This toroid was designed for use in a hybrid F.M. mobile unit, using a single 8647 tube in the RF amp. for 30 watts output. Schematic included. 12 VDC pri. using 2N1554's or equivalent. Sec. #1 500 volts DC out at 70 watts. Sec. #2 .65 volts DC bias. Sec. #3 1.2 volts AC for filament of 8647 tube. Sec. #4 C/T feed back winding for 2N1554's. 1 1/4" thick. 2 1/4" dia. \$2.95 ea. -2 for \$5.00
T-3 Has a powdered iron core and is built like a TV fly back transformer. Operates at about 800 CPS. 12V DC Pri. using 2N442's or equivalent. DC output of V/DBLR 475 watts 90 watts. C/T feed back winding for 2N442's. \$2.95 ea. -2 for \$5.00

TRANSFORMERS

P-7 117 VAC Pri. Sec. #1 185 VAC @ 120 ma. Sec. #2 6.3 VAC @ 4A. Double Half Shell Mail Box Type. SX 146 type. \$2.75 ea. -2 for \$5.00
P-9 117 VAC Pri. Sec. # 900 VAC @ 300 ma. Sec. # 2 100 VAC @ 10 ma. Bias. Sec. #3 12.6 VAC @ AMP. Wt. 16 1/2 lbs. Double Half Shell \$4.50
P-10 117 VAC Pri. Sec. #1 960 VAC C.T. @ 160 ma. Sec. #2 425 VAC C.T. and tap at 100 VAC 10 ma Bias. Sec. #3 12.6 VAC @ 4.5A Double Shell Mail Box type. Wt. 8 1/4 lbs. \$3.75
Output transformers, all types 59 cents or 3 for \$1.50
OT-1 Transistor TO-3 Power Diamond. Imp. 15 ohms to 3.2 ohms DC Res. Pri. .6ohm. Sec. .3 ohm.
OT-2 Pri. imp. 7000 ohm. Sec. 3-2 and 500 ohm for Phones or 70 volt line 3 watts. Full shielded Double Half Shell.
OT-3 Pri. imp. 5500 ohms. Sec. 3.2 ohms. SC122 type.

All prices F.O.B. All weights listed are net. Please allow for packaging. Please allow enough for postage. We will return any extra.

TOWER COMMUNICATIONS

1220-22 Villa St., Racine, WI 53403

LINEAR AMPLIFIERS
\$6.60 PER POUND

SOUND RIDICULOUS?

Not at all! That is about what you will pay whether you buy a box of parts or a fully assembled, rugged, heavy duty BTI LK-2000. Extra weight means extra dependability, plus: Adequate back-up power • Good harmonic suppression • Operating convenience • Eimac 3-1000Z • ALC • Fast acting overload protection • 80 through 10 meters • Prestige styling • Adequate cooling, even on a continuous use basis.



BTI LK-2000 ... For maximum legal amateur input ... SSB, CW, RTTY.
Price \$79500

BTI LK-2000HD ... For heavy duty applications such as MARS, high power RTTY and SSB.
Price \$89500

Write for free brochure or send \$1.00 for technical instruction manual.



BTI AMATEUR DIVISION

Hafstrom Technical Products

4616 Santa Fe, San Diego, Ca. 92109

with daily reports in the U.S. The Public Service Company has a meter-reading microwave link, too. It's quite an elaborate electronic installation.

I use 73 for ideas adaptable to our business. Currently, we are very interested in 900 MHz equipment adaptable to UHF television transmitters.

George S. Johnson
Sandia Television Corporation (NSL)
P.O. Box 1351
Albuquerque NM

Burn Baby Burn

Suppressing a great desire to "keep my mouth shut," I would like to express my viewpoint about a few remarks made in the February and April issue of "73," concerning the Technician class licensee by Dave Mann and Wayne Green. I take no particular personal exception to the remarks of "73" as I am not a Technician and because I believe that such articles are in keeping with the basic philosophy of "73," i.e. that everything printed in "73" may not be "gospel," but that if enough readers' minds are stimulated and challenged, some solutions and "truths" may emerge.

Basically, I agree with Misters Green and Mann that some change is necessary. I do, however, feel that Dave Mann and Wayne Green may have gotten a little carried away in trying to show cause. The examples given to prove the Technician class licensee as unworthy of the distinction of amateur, apply to every class of license. To lack character and integrity is not only a weakness found in SOME Technicians, but in SOME General, Advanced, and Extra class licensees. To imply that a Technician gets his license by cheating is not only irresponsible journalism but is lacking in good sense.

It would be well to note that those Technicians, Novices, and Conditional class licensees who gained their ticket by cheating did so with the knowledge and consent of some higher (?) class licensee. And, oh yes, the higher class licensee, in the spirit of our fraternity, took nothing (much) for this service. Perhaps, we who saw practices like this and did nothing are just as guilty as those involved.

I certainly hope that the Technician or Novice that tunes in on the General, Advanced, or Extra bands, doesn't judge all of us by the occasional "lid" or loudmouth that gets on. If a problem exists and that problem deals with infractions of the law, then enforce the law. If a program is a failure or not relevant any longer, then replace it with a better program. Don't spend time running down a fellow because he doesn't have as high a grade license as you or because he took advantage of a program authorized by the government even though it may not be your "bag." The same, I might add, applies to the CB'er.

This "higher than thou" attitude reminds me of a club 18 years ago that no longer exists. The club's attitude was if a fellow wasn't at least a General, he wasn't anything. And, of course, we had that asinine philosophy of "well, if I did it, he can do it" to put up with. I need not go into detail to describe why the club died.

As for Technicians operating on 10 meters, the only time 90% of us "high" class amateurs get on is when the band is open. I, for one, would certainly like to see some regular activity on this band, CW or phone.

As for the "before the examiner" jitters, I can recall when I got my General ticket the FCC examiner refused to allow a blind fellow to use a typewriter for the exam. He made him "write" it. The examiner then "flunked" him because he couldn't read the writing. I also recall a friend of mine who had gone with me to take that test. He was so nervous that he could hardly hold on to his pencil. In both cases, both were qualified but for different reasons unable to perform before Big Brother. Fortunately for the Technician license, they were part of the amateur fraternity until each made the General. This was reason enough for the Technician license.

Attitudes as expressed by 73 concerning this particular topic do not in my mind reflect the best interests of amateur radio if we are to believe what we read elsewhere in 73. We have more than enough groups to go around. We are divided enough. We need to be pulling ourselves together if we have any hope of preserving amateur radio.

73 makes with a lot of noise while ARRL has its head in the sand and CQ wanders aimlessly denying everything. Well, pass the fiddle around and "burn, baby, burn."

Rev. Peter Gonos K6GZN
1803 Second Street
Concord CA 94520

There is one big difference: At 73, we really care. The big noise is because we're concerned. A head in the sand is protection for the head, of course (which is almost useless without a body); and we don't need to tell you that aimless wandering doth not bring forth fruit. Ah, but a big noise...that's something else again. You, good Reverend, have written a letter; is that not a start?

... Ken

Anti-ARRL Editorials

Ken stated in his editorial, "It doesn't take a genius to figure out that if every dissatisfied ham dropped his membership, the ARRL would either change or drop out itself. Your most powerful voice is not your ARRL membership; rather it is the absence of it." Following this reasoning it follows that if you don't like the way the country is run, the thing to do is denounce everything it does and disregard what it says. If you agree with this reasoning there is nothing wrong with the League, rather there is something wrong with K6MVH/1.

Concerning hams who don't believe (belong to?) in the League. The FCC welcomes comments from the hams (no discrimination against non-Leaguers) before it takes action on its dockets or rulings. Thus, all amateurs have a voice on issues that affect all amateurs; all they have to do is use it.

Rather than denounce the League while offering no real solution why don't you have a proposal printed in your magazine which could be sent to you to give basis to your editorials and then forwarded to the League for their consideration. Or doesn't due process appeal to you? I think 73 would have more constructive influence if it presented all the facts on specific issues with which you disagree and then urge your readers to write to ARRL expressing their ideas on the subject. I think that the ARRL reads all the mail

LEARN RADIO CODE



\$9.95

Album contains three 12" LP's 2 1/2 hr. Instruction Available on magnetic tape, \$9.95 Cassette, \$10.95

THE EASY WAY!

- No Books To Read
- No Visual Gimmicks To Distract You
- Just Listen And Learn

Based on modern psychological techniques—This course will take you beyond 13 w.p.m. in LESS THAN HALF THE TIME!

EPSILON [E] RECORDS

508 East Washington St., Arcola, Illinois 61910

DXERS, I CAN HELP YOU—

A MAGAZINE STRICTLY FOR DXERS!
FROM 16 TO 24 PAGES EACH WEEK.

Up to the minute DX news — current events, coming events, and DX info in depth. Pictures and stories of interest to only DXers. I TELL YOU WHEN AND WHERE TO LISTEN FOR THAT RARE ONE.

First Class mail rates
U.S.A., Canada & Mexico \$11.00
Air mail to above \$13.00
Overseas rates upon request.

THE DXERS MAGAZINE

(Gus M. Browning, W4BPD)

Rt: 1, Box 161-A, Cordova, S.C. 29039

WE PAY CASH FOR TUBES

Lewispaull Electronics, Inc.
303 West Crescent Avenue
Allandale, New Jersey 07401

BUILD YOUR OWN TV CAMERA!!

Imagine transmitting amateur TV pictures over the air...or watching the kids on the living room TV...or monitoring some remote area, such as a driveway, swimming pool, nursery, etc! Select from a variety of starter or complete kits. Also, plans available separately
DETAILED CATALOG FREE.

ATV RESEARCH

13th & Broadway N. Dakota City NB 68731

WORLD QSL BUREAU

5200 Panama Ave., Richmond CA USA 94804

PLAN 1. We forward your QSLs (please arrange alphabetically) to or within USA, Canada and Mexico for 3¢ each and to all other places in world for 4¢ each.

PLAN 2. You use our special log form and send us a copy. We supply QSL-make out QSL-deliver QSL, all for 8¢ each.

\$2538 ACQ.-COST METER FOR \$75!
AN/URM-79 (FR-4/U in Transit Case): 100 khz to 20 mhz, 7 bands, each 50,000 dial div. .001% accur., .0001% stabil. Measures & Emits. Built-in AC sply, scope for zero-beating, speaker for monitoring. Serial-matched calib. book includes instruct. Exc. cond., money-back grty OK. Shipping wt. 146 lbs. **75.00**

**HIGH-SENSITIVITY
 WIDE-BAND AM/FM RECEIVER**

38-1000 MHZ: AN/ALR-5 consists of a brand-new Tuner/Converter **CV-253/ALR** in original factory pack and an exc. used, checked OK & grtd. main rcvr **R-444** modified for 120 v, 50/60 hz. Packed with each tuner is the factory checkout sheet. The one we opened showed **SENSITIVITY: 1:1 μ v** at 38.3 mhz, 0.9 at 133 mhz, 5 at 538 mhz, 4½ at 778 mhz, 7 at 1 ghz. We furnish Handbook & pwr-input plug, all for. . **\$275.00**

SP-600-JX(*) Rcvr: 0.54 to 54 mhz, popular late Hammarlund Super-Pro, aligned, grtd exc. physical condition, with book **325.00**

R-390/URR Rcvr: Collins xtl-calibrated driftless receiver, grtd 100% perfect **795.00**

\$2000 MASTER OSCIL., XMTR OR RCVR TMC VOX-2 (0-330/FR) 2-64 MHz VFO, read out to 7 places. Resettability & stability better than 20 ppm. Xtal in double-controlled oven, calib. each 50 kHz, plus 6 xtal-controlled freq. P_0 to 75 ohms 2W 2-4 MHz (fund.), 0.5W 4 4-64 MHz. Replaces xtal osc in xmtr or use as local osc in rcvr. Exc. cond. w/all tech data **179.50**

REGUL. PWR SPLY FOR COMMAND, LM, ETC.
PP-106/U: Metered. Knob-adjustable 90-270 v up to 80 ma dc; also select an AC of 6.3 v 5A, or 12.6 v 2½ A or 28 v 2½ A. With mating output plug & all tech. data. Shpg wt 50# **19.50**

**BARGAINS
 WHICH THE ABOVE WILL POWER:**

LM-(*) Freq. Meter: .125-20 MHz, .01%, CW or AM, with serial-matched calib. book, tech. data, mating plug. Shipping wt. 16 lbs.
 Checked & grtd. **57.50**
 Same, less calib. book **27.50**
TS-323 Freq. Meter: Similar to above but 20-480 mhz, .001%. With data **169.50**
A.R.C. R11A: Modern Q-5'er 190-550 khz. **12.95**
A.R.C. R22: 540-1600 khz w/tuning graph. **17.95**

IF YOU DON'T SEE IT HERE, ASK FOR IT! But don't ask for a general catalog. . . we believe that is nonsense in surplus. . . we get new things in almost every day! **WE ALSO BUY!** So tell us what you have, condition, and your asking price!

R. E. GOODHEART CO., INC.
 Box 1220-GC, Beverly Hills, Calif. 90213
 Phones: Area Code 213, Office 272-5707

ARNOLD'S ENGRAVING
Personalized

**ELECTRIC
 ON-THE-AIR
 SIGN
 WITH CALL**



Works on
 110 VAC
\$12.95



Metallex Lapel Bar - \$1.50 Metallex Tie Clip - \$2.25

ARNOLD'S ENGRAVING

2041 Linden St. Ridgewood, N.Y. 11227

it receives without concern to whether or not it was sent by a member. Doesn't that seem reasonable.

James M. Szot WB2VVZ
 423 Lord Street
 Dunkirk NY 14048

It certainly does seem reasonable. But have you any particular reason for believing the ARRL reads all the mail it receives without concern to whether or not it was sent by a member? I have proof positive, in case after case, that this is simply not the way it really is.

And why do you equate the League with the Country. I am a citizen of the Country, as is every individual born here. But I am not a member of the League, and to become one, I must pay the money. Would it not seem more reasonable to equate the League with a church? The League is but one denomination of a possible number of denominations. Yet, the League has the power to influence rulemaking for all people, be they members of that denomination or not. To me, it is like the Catholics having power to impose laws about not eating meat on Friday.

. . . Ken.

Newsbeat

I like the "Amateur Radio News Page" at the front of your magazine - very clever - keep it up.

Kelly W2ICE

Sour Grapes

At the risk of offending my successor as editor of this illustrious magazine, I am appalled at the lack of checking in the lead article in the April issue. It does not have the quality of an April Fool article, but it sure fools me.

The text refers to D1, D2, and D3. There are indeed three diodes on the schematic, but they are not marked.

The first i-f transformer is not identified. What is it?

The text says it is absolutely necessary to retain the exact value of resistors and capacitors, but the values are not given.

The text, under adjustment and operation, refers to adjusting voltage at point A. Where is this point ("A")?

I could go on and on. . .but I'll let you reread the article and check the schematic. When there was only one name on the masthead other than the publisher, we had a few complaints about errors. Now the masthead is full, and there should be someone about the premises who could compare the text with the diagram and make some sense of an article.

The title of the article, "A Noise Blanker that Works," is only true if you can give the reader the important details to make it work.

Kayla Hale W1EMV
 Box 548
 Port Salerno FL 33492

Let's face it. . . I'm incompittant.

. . . Ken.

Kickback

I am compelled to voice my sincere appreciation for Bob Manning KIYSD and his writings

in opposition to the critical letter from Jim Wagner in your April issue.

In today's world of canned media, Bob's original talent and sharp cracks at amateur radio's nuttier characters remains as one of the few sources of a really good laugh. I have just reread "Vidiots That Have Known Me," and have received just as much pleasure from it as upon the first reading. I hate to think that anyone would wish to have all humor removed from the pages of 73.

Manning's style of language is not vulgar, but reflective of true life and effectively hilarious. His "caliber of thought" is the highest kind of satire and wit, on a level that perhaps eludes some of his critics. No doubt Mr. Wagner was so shocked and repulsed by Bob's article that he felt compelled to read every word.

I know that the editor will not succumb to the "one in every crowd," and I only hope that Bob Manning will continue his contributions to this magazine that is enjoyed by so many.

Jerry "Ron" Johnson WA5RON
224 Roberts Hall
Austin TX 78705

Reference the "Letters" column in the April 1970 issue. Specifically a letter titled "Ban the Book" by Jim Wagner, taking issue with an article by Robert Manning K1YSD.

Mr. Wagner feels that K1YSD's articles are out of place in your magazine. I disagree. K1YSD's articles fit your magazine to a tee.

Let's not have fewer articles by K1YSD, but rather, more of these interesting and highly educational (?) pieces. He's the best thing you've got going for you - except perhaps Mr. Green's comments on the condition of the universe, et al. Both writers are highly amusing, though I must admit I do laugh more at Manning's stuff than I do at Green's - still they're both good.

Stan Poland WB0ABE
307 N. Logan
Olathe KS.

Ban the book? Ban the book? Ban the book?
How about "Can the Crank"?

Let's have more "vulgar" and "low thought."

Let's run K1YSD for President of folly, fantasy, and fun down with Jim Wagner.

Cal Emerson
16 Greene St.
Salem MA

73 on the March

I would like to commend someone for the most imaginative magazine cover I can recall for some time, if not all time. i.e. March 70. I enjoyed that almost as much as the contents, and that is a broad statement.

Dan Wilhite
Argenta Lumber Company
North Little Rock AR

Just got and read the March Surplus issue. Wonderful. Best value for the money is your magazine. Kyle's article on surplus logic is priceless. I've been looking for down-to-earth info like this for a long time. Now - if someone will just tell me how I can tell if an unmarked diode is or is not a Zener!

John G. Pere WA8YIM
2143 Pressler Road Akron OH 44312

NEW G&G CATALOG! MILITARY ELECTRONICS

24 PAGES, crammed with Gov't Surplus Electronic Gear - the Biggest Bargain Buys in America! It will pay you to SEND 25c for your copy - Refunded with your first order.

BC-645 TRANSCEIVER 15 tubes, 435 to 500 Mc. Easily adapted for 2 way voice or code on Ham, Mobile, Television Experimental, and Citizens Bands. With tubes, less power supply in factory carton, BRAND NEW..... **\$16.95**

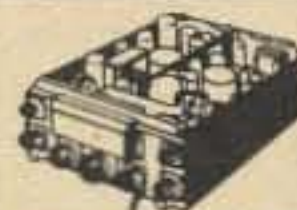

SPECIAL PACKAGE OFFER: BC-645 Transceiver, Dynamotor and all accessories, including mounting, UHF Antenna Assemblies, control box, complete set of connectors and plugs. Brand New **\$26.95**

AN/APR - 4Y FM & AM RECEIVER "FB" for Satellite Tracking!

High precision lab instrument, for monitoring and measuring frequency and relative signal strength, 38 to 4000 Mc. in 5 tuning ranges. For 110 v 60 cycle AC. Built-in power supply. Original circuit diagram included. Checked out, Perfect. LIKE NEW..... **\$88.50**



DUAL AMPLIFIER



Has two input circuits, each feeding a single 6SN7GT twin triode amplifier. 115 V 60 cy. power supply. Finest components. Size: 5 3/4" x 2 1/4" x 4 3/4". Weight 11 lbs. Brand new, SPECIAL..... **\$7.95**

WILLARD 2-VOLT STORAGE BATTERY

Rated at 20 Amp.-Hours. Model 20-2. Rechargeable. Compact nonspill construction. Lightweight polystyrene container, 3x4x5 1/2". Shipped dry, uses standard electrolyte. Shipping Weight 3 lbs. NEW, each . . . **\$2.79**



BC-605 INTERPHONE AMPLIFIER

Easily converted to home or office intercom system! Uses pair of 1619 tubes, delivering 10 watts of audio power. Massive construction, suitable for shops, factories. Finest parts used. Conv. diagram and instr. included. BRAND NEW..... **\$2.45**



HEADSET

Low impedance. With large chamois ear cushions. 4-ft. cord and plug. Reg. \$12.50. OUR SPECIAL PRICE..... **\$2.95**



SCR-274-N, ARC-5 COMMAND SET HQ!

Freq. Range	Type	Exc. Used	Like New	BRAND NEW
RECEIVERS.	Complete with Tubes			
190-550 Kc.	BC-453	\$16.95	\$23.50	\$27.50
3-6 Mc.	BC-454	\$16.50	\$19.50	\$22.50
6-9.1 Mc.	BC-455	\$14.95	\$17.95	\$21.50
1.5-3 Mc.	R-25		\$19.50	\$21.50

TERMS: 25% Deposit with order, balance C.O.D. -or- Remittance in full. Minimum order \$5.00 F.O.B. NYC. Subject to prior sale and price change

G&G RADIO ELECTRONICS COMPANY

47 Warren St., (2nd Fl.) New York, N.Y. 10007 Ph. 212-267-4605

LARGEST ASSORTMENT of BRAND NAMES

You can save enormous amounts of money while choosing from a complete line of transceivers, receivers, transmitters, etc.

**WE HAVE EVERYTHING IN HAM GEAR
SAVE MONEY ORDER BY MAIL**

CB Radio Co., Inc.
Swampscott, Mass. 01901

89 Aspen Rd.
617-598-9700

VIBROPLEX

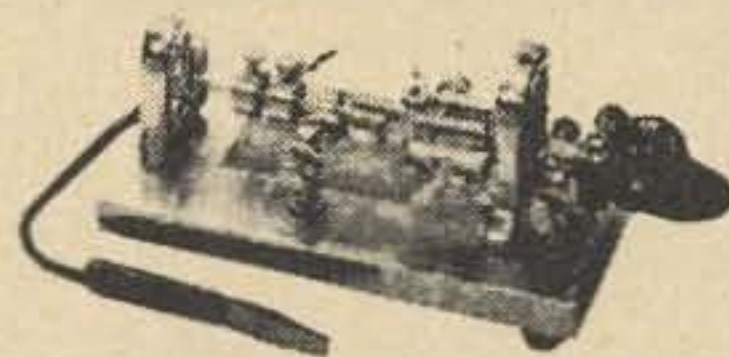

**ENJOY EASY,
RESTFUL KEYING**
\$21.95 to \$43.95
**THE VIBROPLEX
CO., INC.**
833 Broadway,
N. Y. 3, N.Y.

How to Build and Tune Antennas

Work more DX with the right antenna for your location. New book gives step-by-step instructions (176 pages, 200 illustrations) for building every type of antenna: long wires, dipoles, yagis, trap, etc. Plus many others not described elsewhere: low cost miniature beams from converted TV antennas; indoor beams; "invisible" antennas; window sill antennas; 40 meter beams; vertical beams; Novice Band DX; many, many others. Secrets of tune-up of both manufactured and homemade antennas for greater DX. How to use antenna test gear. Buy book "Ham Antenna Construction Projects" at your "H.W. Sams" distributor. Only \$3.95. Or for autographed copy, send \$1.00 (cash, ck, or m.o.) direct to author, J.A. Stanley, 855 South Fillmore Street, Denver, Colorado 80209. Pay postman balance COD plus postage. Or send full amount for post-paid delivery. Money-back guarantee.



AMECO TX-62 (2 in stk) . . . 109.00	SX-110 (3 in stk) . . . 99.00	KNIGHT TR 108 VFO 2m . . . 149.00
B & W 5100 . . . 99.50	SX-111 . . . 119.00	T 150 . . . 59.00
CENTRAL ELECTRONICS 458 . . . 49.00	SX-117 . . . 225.00	R 100A . . . 79.00
108 . . . 85.00	SX-140 (2 in stk) . . . 59.00	R 55A . . . 49.00
CLEGG Thor 6 . . . 80.00	SX-146 (2 in stk) . . . 195.00	T-50 . . . 40.00
417 ac mod . . . 60.00	HAMMARLUND HQ-100 (2 in stk) . . . 99.00	LAFAYETTE HA-410 Transceiver . . . 89.00
99'er . . . 69.00	HQ-105 TR . . . 139.00	HE-458 (2 in stk) . . . 50.00
COLLINS KWM2 (used) . . . 795.00	HQ-105 w/8 crystal bank . . . 169.00	HE-50 (2 in stk) . . . 39.00
516 F2 ac Power . . . 125.00	HQ-110C . . . 125.00	HA-600 Rcvr SS . . . 79.00
32V3 . . . 150.00	HQ-110 . . . 99.00	MOSLEY CM-1 Good Ham Rcvr . . . 95.00
75A2 . . . 219.00	HQ-160 . . . 189.00	NATIONAL HRO 50 w/four coils . . . 100.00
75A3 (2 in stk) . . . 275.00	HQ-170A . . . 239.00	NC-109 . . . 50.00
75S-1 . . . 295.00	HQ-170 . . . 169.00	NC-125 . . . 79.00
75S-3B rcvr . . . 595.00	HX-50 . . . 189.00	NC-155 . . . 99.00
75S-1 (4 in stk) . . . 325.00	HX-50A . . . 225.00	NC-173 . . . 60.00
32S-1 (3 in stk) . . . 395.00	HEATH DX-20 . . . 29.00	NC-188 . . . 69.00
DRAKE T4 reciter . . . 299.00	DX-35 . . . 35.00	NC-270 . . . 99.50
TR3 . . . 375.00	DX-40 (2 in stk) . . . 39.00	NC-8B . . . 39.00
EICO 717 . . . 69.95	DX-100 . . . 99.00	NCL-2000 w/2 new 8122 tubes . . . 395.00
753 . . . 99.50	GB-64 . . . 39.00	NCXA Pwr Sply ac Power . . . 79.00
722 . . . 39.50	HA-14 . . . 110.00	NCX 500 (new) . . . 299.00
ELMAC PMB7 . . . 35.00	HA-20 . . . 75.00	Speakers . . . 10.00
AF-54 . . . 25.00	HP-20 . . . 29.00	POLY-COMM PC2 . . . 199.00
AF-68 (3 in stk) . . . 50.00	HR-10 . . . 59.00	PC62 . . . 175.00
GALAXY AC35 . . . 59.00	HW-22A . . . 99.00	RME RME DB22A . . . 29.00
DAC 35 . . . 79.00	HW-32 . . . 99.00	RME 45 . . . 40.00
384 ac Pwr Sply . . . 69.50	HX-20 (2 in stk) . . . 79.00	RME 4300 . . . 60.00
Galaxy III Trans. . . 179.00	HX-30 (2 in stk) . . . 175.00	VHF 152A . . . 29.00
Galaxy V, Mark II . . . 259.00	MI-1 . . . 39.00	REGENCY ATC-1 . . . 24.95
2000 B Linear amp (used) . . . 325.00	OF-1 . . . 10.00	SWAN ELECTRONICS 117ac . . . 59.00
GONSET G-43 . . . 50.00	SB-10 (2 in stk) . . . 79.50	117X . . . 75.00
G-63 . . . 75.00	SB-200 (2 in stk) . . . 200.00	TCU VFO for 240 . . . 75.00
G-76 . . . 99.00	SB-300 . . . 225.00	SW-175 . . . 79.00
HALLCRAFTERS HT-32 (2 in stk) . . . 225.00	SB-600 . . . 19.00	Swan 500 (new) . . . 395.00
HT-37 (2 in stk) . . . 199.00	VF-1 . . . 9.50	SECO ELECTRONICS 88 Tube Tester . . . 79.95
HT-40 (5 in stk) . . . 50.00	TX-1 . . . 115.00	WRL 680 Globe Scout . . . 29.00
R-46 . . . 15.00	Mohawk RX-1 . . . 149.00	680A Globe Scout (4 in stk) . . . 35.00
S-85 . . . 79.00	Seneca VHF-1 (2 in stk) . . . 99.50	Globe Champion 300A . . . 50.00
S-108 . . . 89.00	SB-630 Control Box . . . 75.00	Globe King (3 in stk) . . . 100.00
S-120 . . . 39.50	HENRY 2KD-2 Linear 2000 Pep . . . 495.00	Globe Scout Deluxe . . . 49.00
SR-46 . . . 69.00	JOHNSON Viking II . . . 50.00	RACK TRANSMITTER (1 kW Rig) Collins VFO, Globe King, power supply modulator, Ex- citer antenna relays . . . 195.00
SR-46A . . . 125.00	500 (2 in stk) . . . 249.00	6 meter VFO . . . 10.00
SR-150 . . . 250.00	Pacemaker (2 in stk) . . . 100.00	Surplus FT 243 type 6-7 kc., 6 mc . . . ea.50
SR-2000 & ac (used 8 hours) . . . 1,095.00	Valiant (4 in stk) . . . 95.00	
SX-96 . . . 95.00	250-33 audio amp . . . 35.00	
SX-100 (3 in stk) . . . 125.00	122 VFO . . . 19.00	
SX-101 . . . 119.00	Challenger (2 in stk) . . . 40.00	
SX-101A . . . 189.00	Viking trans. No. 240-141 (new) . . . 69.00	
	Dynamotor #289-104 (used) . . . 35.00	
	Viking VFO 6N2 . . . 29.00	
	TR Switch . . . 19.00	

30 DAY GUARANTEE on USED EQUIPMENT
FRECK RADIO SUPPLY CO.
 38-40 BILTMORE AVE.
 ASHEVILLE, NC 28807 Phone: 254-9551

FT 243 CRYSTALS
 3000 to 8500 Khz.
 ± 2 Khz. \$1.25
 ± .01 % 2.50
 Surface mail 6c, Air Mail 10c extra
DENVER CRYSTALS
 Rt. 1, Box 357 Parker, Colorado 80134

PROFESSIONAL REPAIR AND CALIBRATION SERVICE
 Specialist in the maintenance and calibration of school's electronic laboratory equipment, test equipment and amateur equipment. Prompt service by holders of amateur and commercial FCC licenses. Write for shipping instructions.
PANTRONICS OF VIRGINIA, INC.
 6608 Edsall Rd.
 Alexandria, Virginia 22312

HAL DEVICES
 Hot Carrier Diodes: HP2800 . . . 90¢, 12/\$10.00 Matched by HAL . . . 4/\$4.25
 IC's: f μ L 900, 914 . . . 60¢ f μ L 923 . . . 90¢
 MRTL MC790P, MC890P . . . \$2.00, 10/\$19.50
 MC724P, MC789P, MC792P, MC725P . . . \$1.05, 10/\$9.50
 Also Available: MC788P, MC880P, MC767P, MC9760P.
 OP AMP: SN72709N (DIP) . . . \$1.75, 7/\$10.00
 TOROIDS: Indiana General CF102-06, CF102-Q1, CF101-Q2, . . . 50¢
 CINCH IC sockets, 14-DIP, 8-ICS . . . 60¢ **HAL DEVICES**
 Add Postage, send for complete list. Box 365L, Urbana, Illinois 61801

ALL BAND TRAP ANTENNA!

 Reduces Interference and Noise on All Makes Short Wave Receivers. Makes World-Wide Reception Stronger. Complete with 96 ft. 72 ohm feedline. Sealed resonant traps. For novice and all class radio amateurs! Eliminates 5 separate antennas with better performance guaranteed 80-40-20-15-10 meter bands. Complete 102 ft. \$19.95. 40-20-15-10 meter bands, 54 ft. (best for world-wide short wave reception) \$18.95. Send only \$3.00 (cash, ck, mo) and pay postman balance COD plus postage on arrival or send full price for post-paid delivery. Complete instructions included.
WESTERN ELECTRONICS Dept. A Kearney, Nebraska 68847

the only time I came to grief on this was with those Italians and the U.S. stations. I knew the U.S. operators understood English, so the only explanation for their behavior was that they just didn't care one bit what I or anyone else thought of them. I made only a small fraction of the U.S. contacts that I might have otherwise. Oh, I tried splitting frequencies, and this worked at some times. The best results to the U.S. were when conditions were marginal and only a few stations were coming through. When the band was wide open with hundreds of stations wanting to get through they were not about to work with any system whatever - prefixes, lists, or anything else.

You know it only takes about two persistent stations to absolutely ruin a good band opening like that. One station in Brooklyn flatly refused to permit me to work from a list and he called in constantly every time I tried to stand by for anyone. I was so busy trying to hear through him that I neglected to write down his call . . . too bad . . . I sure would like to let that louse know what I think of him and how many dozens of stations he prevented from working JY1.

Even so, I contacted hundreds upon hundreds of U.S. stations, and as I said earlier, I doubt if anyone that seriously needed JY1 missed it.

I even had the surprising experience of being snubbed. I heard VQ9CD calling CQ U.S. from Chagos so I broke in and called him . . . he absolutely refused to answer me!

Though I didn't stop to count, I am sure that JY1 is well over the 100-country mark. Every now and then a rare one would call in through the pileups.

The original aim of getting JY1 well worked so His Majesty could sit back and enjoy hamming was achieved, I think. Although I am not so sure that this is of as great importance now as it was when I arrived. His Majesty sat for hours watching me operate, and spelled me when a particularly obdurate Italian would wear me down a bit. During the all-night stint His Majesty sat there right up until we closed down at 7 a.m.! And he enjoyed every minute of it. As my time for departing came closer I noticed that he was getting to be able to handle pileups very well . . . and enjoying them!

After two weeks of almost daily contact with His Majesty it is hard to think of him as a King . . . he is a friend. When you run into him on the air please be considerate so we can keep him a friend of our hobby. You just might go out of your way a little when you hear him operating to watch over him and protect him from the inconsiderate.

At the request of His Majesty I outlined a set of amateur radio regulations that are custom-made for Jordan. The Royal Jordanian Amateur Radio Society is in the process of being established with His Majesty as honorary president and Mrs. Salti as the secretary. My proposal calls for

CIRCUIT BOARD SPECIAL

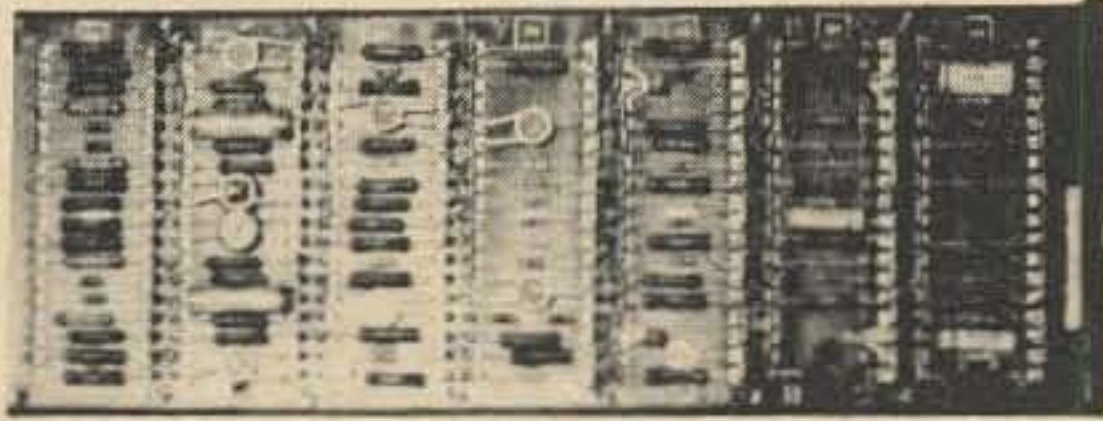

HONEYWELL COMPUTER BOARDS 4½" x 11"; loaded with transistors, zeners, diodes, precision res.
A9098 (all different) 3/1.00

Transistors		
A4000	2N277	Motorola PNP Germanium Power 55 Watts 75 3/2.00
A4001	2N1183B	RCA PNP Germanium Power 7.5 Watts 75 3/2.00
A4002	2N1204	Motorola PNP Germanium General Purpose 5/1.00
A4003	2N231	PNP Germanium General Purpose 5/1.00
A4018	2N1907	Texas Inst. PNP Germanium Power 150 Watts 1.75
A4022	2N1546	Motorola MP1546 High Reliability 90 Watts 1.00
A4023	#108	Motorola or Delco Similar to 2N1100 40 Watts 3/2.00
A4024	2N3567	Fairchild NPN Silicon General Purpose 5/1.00
A4025	MADT	Sprague 4/1.00
A4027	2N706A	Sylvania NPN Silicon VHF 1 Watt 5/1.00
A4028	2N1011	Motorola PNP Germanium Power 35 Watts 3/2.00

A4016	FET Field Effect Transistor To-18 25 Volt Source to Gate N Channel	.50 5/2.00
A4017	Tunnel Diode Similar to 1N3717	.50 5/2.00

Miscellaneous Items

A8010	2000 Ohm Multiturn trimmer	75
A9004	TO-3 Power Transistor Sockets	8/1.00
A9040	Fan Motor 110 AC	1.00
A9001	Sub-miniature slide switches	3/1.00
A9003	Fuse Holders (Panel type)	6/1.00
A9032	Dialco 28 Volt pilot light bulb and Assembly	3/1.00
A9076	Mercury Wetted Relay Clare HGP 1059	1.00
A9067	Isolation Transformer Triad N-51X	2.00
A9062	D.C. Servo Motor, 24V, 4.2 Amps	9.95
A9063	Nickel-Cadmium Batt., 1.25V, 4AH	1.25
A9075	Reed Switch & 24V Coil SPDT (Removed from equipment) .75.	3/2.00
A8013	Delay Line, 10-40 usec, Imp. 20000 Ohms	2.00
A2031	Miniature var. Capacitor 3-75 pF	3/1.00

Zener Diodes

A4010	1N751A	5.1 Volts, 400 mw	5/1.00
A4011	1N3039A	62 Volts, 1 Watt	3/1.00
A4012	1N3822	3.6 Volts, 1 Watt	5/1.00
A4013	1N3000B	62 Volts, 10 Watts	2/1.00
A4014	1N3048B	150 Volts, 1 Watt	3/1.00
A4015	1M3.0	3 Volts, ½ Watt	4/1.00
A4029	1N429	5.6 Volts, 1 Watt	4/1.00
A4038	1N961B	150 Volts, 1.7 ma (Matched pair)75
A4040	1N3048		

Integrated Circuits

Stk. No	Type	Case	Function	Price
A3000	907	TO-5	Four input gate75
A3001	914	TO-5	Dual 2 input gate	1.00
A3008	914	FP	Dual 2 input gate	1.00
A3002	915	TO-5	Dual 3 input gate	1.00
A3003	923	TO-5	JK Flip Flop	1.00
A3007	3M4 923	FP	JK Flip Flop	1.00
A3005	1M4 925	FP	Dual 2 input gate exp.	1.00
A3004	926	TO-5	Buffered JK Flip Flop	1.00
A3006	926	FP	Buffered JK Flip Flop	1.00

(FP - Flat Pack)

SPECIAL With every order of ten dollars or more, choose two more dollars FREE.

Lots of other items — send for free flier; All merchandise fully guaranteed. Please include postage; excess will be refunded.



DELTA ELECTRONICS CO.

BOX 1, LYNN, MASSACHUSETTS 01903

LIBERTY PAYS MORE!

WILL BUY FOR CASH ALL TYPES

- ELECTRON TUBES
- SEMICONDUCTORS
- Military Electronic Equipment
- Test Equipment

WIRE, WRITE, PHONE COLLECT! WE PAY FREIGHT ON ALL PURCHASES WE MAKE

LIBERTY OFFERS MORE!

PRESTEL FIELD STRENGTH..METER
(Model 6T4G)

★ *Never Anything Like It!*

★ *1 Man Can Do a Better Job than 3 in the Same Time!*

★ *A Gold-Mine for Antenna Installers!*

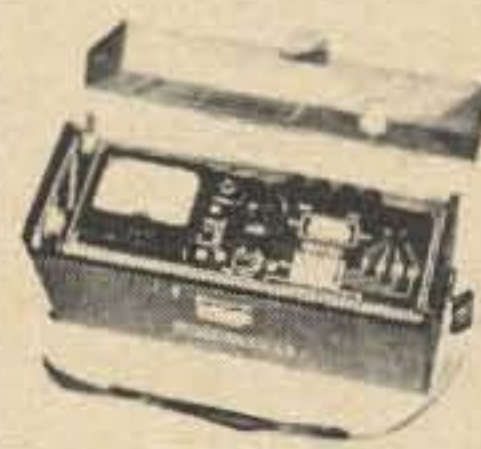

Frequency Range: 40 to 230 and 470 to 860 Megahertz. Calibrated outward from 10 to 50,000 Microvolts. Nothing makes it easier to properly and speedily find the correct place to install TV, FM and Communication Antennas. You can measure and hear the signals

with this 4½ volt battery economically powered unit. There is nothing else like it!

Only \$120.00 FOB N. Y.

Liberty Electronics, Inc.

548 Broadway, New York, New York 10012, Phone 212-925-6000

TWO-WAY COMMUNICATION CRYSTALS

AMERICAN CRYSTAL CO.
PO BOX 2366 KANSAS CITY, MO.

WE PAY HIGHEST CASH PRICE
for Electron Tubes & Semiconductors
Immediate Payment on Unused Tubes
H & L ASSOCIATES
Elizabethport Industrial Park
Elizabeth, New Jersey 07206
(201) 351-4200

CUSTOM TRANSFORMER DESIGN & MANUFACTURE

Write today for a free quotation on any transformer, choke, or saturable-reactor. Each unit will be designed and manufactured to your exact specifications. Standard E-I and tape wound "C" cores are available. Quantities from single units to production runs may be accommodated.

PETER W. DAHL CO.
5325 Annette Ave., El Paso, Texas 79924
Tele: 915-751-4856

Thousands of Parts

Good Business for sale
DOW TRADING CO., INC.
ELECTRONIC PARTS & EQUIPMENT
1829 E. HUNTINGTON DRIVE
DUARTE, CALIFORNIA 91010 357-3763

radio amateur callbook



GET YOUR NEW ISSUE NOW!

Over 283,000 QTHs
in the U.S. edition
\$7.95

Over 135,000 QTHs
in the DX edition
\$5.95

See your favorite dealer or
order direct (add 25¢ for
mailing in U.S., Possessions
& Canada. Elsewhere add
50¢).

These valuable EXTRA features
included in both editions!

- QSL Managers Around the World!
- Census of Radio Amateurs throughout the world!
- Radio Amateurs' License Class!
- World Prefix Map!
- International Radio Amateur Prefixes
- Radio Amateurs' Prefixes by Countries!
- A.R.R.L. Phonetic Alphabet!
- Where To Buy!
- Great Circle Bearings!
- International Postal Information!
- Plus much more!

**WRITE FOR
FREE
BROCHURE!**

RADIO AMATEUR



callbook INC.

Dept. B. 925 Sherwood Drive
Lake Bluff, Ill. 60044

two classes of license for Jordanians, a Class B and a Class A. Both would require five words per minute code speed, with the Class B permitting restricted power operating in the CW bands on 80-40-15-10, plus phone on the VHF's. The B license would be similar to our Novice in difficulty and the A would be more like our General.

I also proposed a special visitors license good for ten days and a license for aliens resident in Jordan, both requiring valid home amateur licenses.

There seems to be good reason to believe that these beginnings will bear fruit. I outlined the plan to an assembly of the General of the Army, the General of the Air Force, the head of the Royal Auto Club (I also wrote in permission for mobile operation), the Minister of Communications and other dignitaries. One or two shuffled their feet and wanted time to study the matter and think about it, but His Majesty urged speed, and His Majesty is His Majesty and what he wants happens.

For those of you who have the opportunity to contact Hussein (as he calls himself), you might keep in mind that he is an ardent flyer, has quite a bunch of cups for racing and hill climbing in his Porsches, enjoys skin diving, skiing, water skiing, and you name it. If you have nothing to talk about with him it is your lack of interests, not his. Let me also clue you that a person with a wide range of interests like that will be interested in your field of expertise, whatever it is.

... W2NSD ■

More Accuracy on Microwaves

There are undoubtedly a few readers who would like to construct the microwavemeter that appeared in the December issue of 73. With a slight amount of exterior modification greater accuracy can be obtained, as well as some protection against bent plunger fingers.

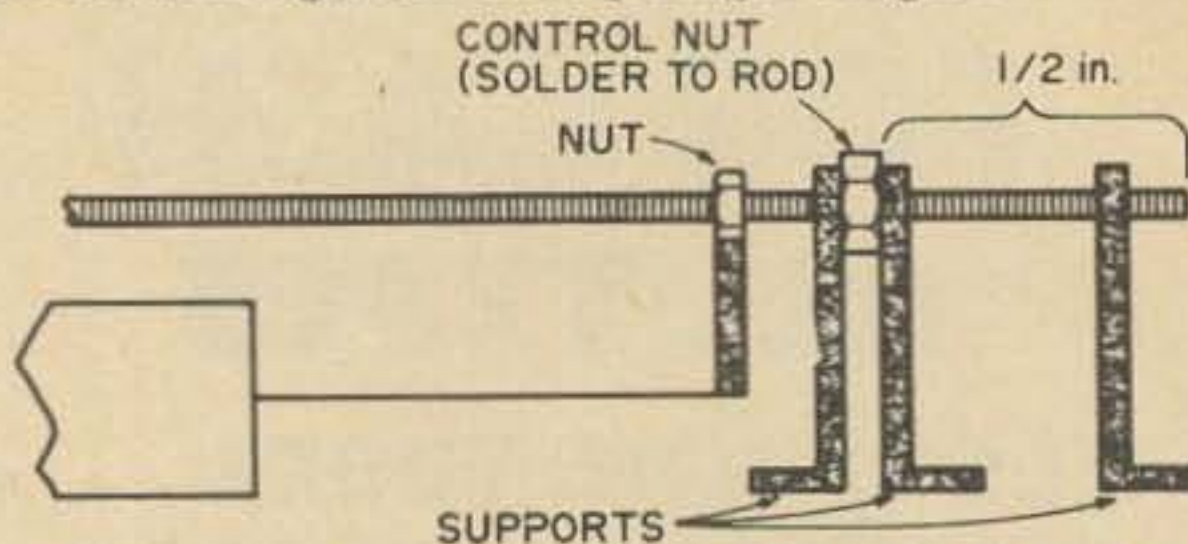

The modification consists of adding a thumb-screw drive for slower, smoother tuning. First, solder the plunger rods to a brass plate. To this solder a vertical support topped off with a hex nut; 4-40 or 6-32 is all right. Fashion three supports with holes high enough to pass a threaded rod parallel to the base. Solder a hex nut to a 4 in. threaded rod as shown. Thread it through the plunger nut, then align the supports and fasten them to the base. Attach the pointer as per the article. Pull the plunger out as far as possible before attaching the threaded rod. Be sure that the two supports near the control nut are as close together as possible to prevent any horizontal movement of the control rod.

... Stephen Goldstein
146 Eighth Street
Providence RI 02906

SALE ON FAIRCHILD "ICs"

*Brand New! *Lowest Prices

- RTL-908 Full Adder
- RTL-909 Buffer
- RTL-912 Half Adder
- RTL-913 Shift Register
- RTL-914 Dual 2 Input Gate
- RTL-915 Dual 3 Input Gate
- RTL-923 JK Flip Flop
- RTL-960 Dual Buffer



99¢
Each
3 for \$2.75

Guaranteed! W/Spec Sheets

400 mc **2⁹⁹** ea.
NPN HIGH POWER
UHF TRANSISTORS
2N3632 23W, 3A.



- Fairchild 958 Decade Counter
 - Fairchild 959 Quad Latch
 - Fairchild 9601 Mono Vibrator
- \$3.98** each

TEXAS! NATIONAL! COUNTING "IC's"

Guaranteed! W/Spec Sheets



- SN7475 Quad Latch
 - SN7490 Decade Counter
 - SN7493 4 Bit Binary Counter
 - SN7441 BCD Decoder
- 4.50
5.50
4.95
6.50

GE PA-237 2-WATT AUDIO AMPLIFIER

*Lowest Prices *Brand New!



\$2.95

2 watts continuous 9 to 27 volt supply, 8 mV sensitivity, includes 11 circuits, for phono, tape recorders, dictating, TV, FM, movie.

WESTINGHOUSE AUDIO AMPLIFIER

- ★ 8 Transistors
 - ★ 6 Diodes
 - ★ Dime Size
- \$1.98**

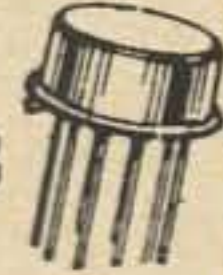

for phono, tape,

HIGH VOLTAGE

1 AMP EPOXY

PIV	SALE
<input type="checkbox"/> 2000*	1.00
<input type="checkbox"/> 3000	1.35
<input type="checkbox"/> 4000	1.65
<input type="checkbox"/> 5000	2.25
<input type="checkbox"/> 6000	2.96
<input type="checkbox"/> 8000	3.50
<input type="checkbox"/> 10000	3.95

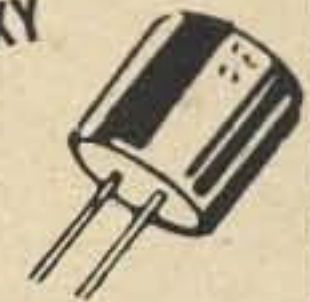

**SILICON
RECTIFIERS**

LINEAR AMPLIFIERS

\$1.69 each, 3 for \$4.75

- 702C DC Amplifier
- 709C Operational Amp
- 710C Differential Comp.
- 711C Sense Amplifier



Fairchild 741 OP. Amplifier*
*frequency compensated 709\$2.98

How's "MEMORIES" for 1970?

- Fairchild 1128 8 bit\$2.49
- Fairchild 9033 16 bit\$3.98
- Philco PL5R100 Dual 50 bit \$12.50
- 4000 Bit Core Planes\$8.50

★ Handles 2 Amps
1 AMP
800 PIV **5 for \$1**



POLY PAKS

P.O. BOX 942 A
Lynnfield, Mass.
01940

Terms: add. postage. Rated: net 30, cod's 25%
Phone Orders: Wakefield, Mass. (617) 245-3829
Retail: 211 Albion, St., Wakefield, Mass.

CATALOG
10¢

(continued from page 19)

rough going since all the problems of a couple of years ago, and there's nothing like a Gus Browning outing to reawaken the too-long dormant DX bug.

One of the problems which has resulted from the division of our bands into segments is the apparent ignorance of some foreign DX operators with respect to the allocations. Many of these stations have been heard working W/K contacts in the Extra Class/Advanced frequency segments, and the General Class DX'ers have been forced to wait endlessly with their tongues hanging out. I actually heard a DXpedition recently, calling CQ for contacts, and he announced that he was listening 14.210 to 14.225. He had virtually no takers, yet there were dozens of fellows calling above 14.275, whom he didn't even know were calling him.

If the available DX is to be the sole province of the higher class licensees, and if the Generals are not going to be considered by expeditions as worthy of contacts, then the restructuring is even more diabolical than it first appeared to be.

It is one thing to establish restrictions under the principle that incentives will tend to provide impetus for individual achievement. But it is quite another thing to fail, after this restructuring, to advise all foreign hams, through their official organizations, whether affiliated in some confederation or not, that the change has been made. It is only in this way that these operations will be split up so as to afford an even break to those who can no longer operate on the low ends of the bands.

If this situation is permitted to deteriorate any further it is likely that those Generals who do not upgrade to Advanced will be forced out of the hobby altogether. It is no fun to be isolated from all others, and to be ostracized in this fashion... it is reminiscent of a sort of solitary confinement. And it does have the end effect of a kind of punitive punishment as the price of failure to upgrade. I'm sure that the FCC had no such intention when it imposed the new allocations. But, as the old saying goes, "...the road to Hell is paved with good intentions."

... K2AGZ ■

73 Readers' DOUBLE BONUS

Want info quick? Just check the box next to the name of the advertiser of your choice in the index below. We'll rush your name to the firm so you can get all the dope direct from the source. (Don't forget to include your name and address at the bottom.)

ADVERTISER INDEX

- | | |
|---|--|
| <input type="checkbox"/> Amateur Elect. Supply 33 | <input type="checkbox"/> Johnson, Stan 139 |
| <input type="checkbox"/> Ameco 77 | <input type="checkbox"/> Lewispaul 137 |
| <input type="checkbox"/> American Crystal 142 | <input type="checkbox"/> Liberty 141 |
| <input type="checkbox"/> Amidon 103, 57 | <input type="checkbox"/> Mann Communications 71 |
| <input type="checkbox"/> Amrad 67 | <input type="checkbox"/> Meshna 111 |
| <input type="checkbox"/> Antennas, Inc. 63 | <input type="checkbox"/> Microfect 103 |
| <input type="checkbox"/> Arnolds Engraving 138 | <input type="checkbox"/> Mosley 124, 125 |
| <input type="checkbox"/> ARRL National 61 | <input type="checkbox"/> National Radio III |
| <input type="checkbox"/> ATV 137 | <input type="checkbox"/> New-Tronics 134 |
| <input type="checkbox"/> Callbook 9, 142 | <input type="checkbox"/> Ord 67 |
| <input type="checkbox"/> Camp Albert Butler 115 | <input type="checkbox"/> Pantronics 140 |
| <input type="checkbox"/> CB Radio 139 | <input type="checkbox"/> Poly Paks 143 |
| <input type="checkbox"/> Cushcraft 131 | <input type="checkbox"/> Quement 43 |
| <input type="checkbox"/> Dahl 142 | <input type="checkbox"/> Ray-Track 67 |
| <input type="checkbox"/> Delta 141 | <input type="checkbox"/> Rohn 133 |
| <input type="checkbox"/> Denson 63 | <input type="checkbox"/> Sams 31 |
| <input type="checkbox"/> Denver Xtal 140 | <input type="checkbox"/> Sentry 37 |
| <input type="checkbox"/> Dow Trading 142 | <input type="checkbox"/> Skylane 57 |
| <input type="checkbox"/> Drake, RL IV | <input type="checkbox"/> Stanley 139 |
| <input type="checkbox"/> DX'ers Magazine 137 | <input type="checkbox"/> Structural Glass 132 |
| <input type="checkbox"/> Dymond 17 | <input type="checkbox"/> Swan Antenna 128 |
| <input type="checkbox"/> Epsilon 137 | <input type="checkbox"/> Swan Electronics 118, 119, 120, 121 |
| <input type="checkbox"/> Freck 140 | <input type="checkbox"/> Telrex 126, 127 |
| <input type="checkbox"/> Galaxy II | <input type="checkbox"/> Tower 136 |
| <input type="checkbox"/> Gateway 115 | <input type="checkbox"/> Tri-Ex 130 |
| <input type="checkbox"/> Global Research 61 | <input type="checkbox"/> Tristao 85 |
| <input type="checkbox"/> Goodheart 138 | <input type="checkbox"/> Unadilla 79 |
| <input type="checkbox"/> Gordon, H 98, 99 | <input type="checkbox"/> Universal 96 |
| <input type="checkbox"/> G&G 139 | <input type="checkbox"/> Vanguard 45, 85, 96 |
| <input type="checkbox"/> Hafstrom 136 | <input type="checkbox"/> Varitronics 15 |
| <input type="checkbox"/> HAL Devices 140 | <input type="checkbox"/> Vibroplex 139 |
| <input type="checkbox"/> Hatry 144 | <input type="checkbox"/> Warren 102 |
| <input type="checkbox"/> Heath 27 | <input type="checkbox"/> Western 140 |
| <input type="checkbox"/> Heights 129 | <input type="checkbox"/> Woodside Research 71 |
| <input type="checkbox"/> Henry 13 | <input type="checkbox"/> WRL 35 |
| <input type="checkbox"/> H&L 142 | <input type="checkbox"/> World QSL 137 |
| <input type="checkbox"/> Hy-Gain 122, 123 | <input type="checkbox"/> 73 Magazine |
| <input type="checkbox"/> International Crystal 11 | <input type="checkbox"/> Gunsmoke 57 |
| <input type="checkbox"/> James Research 94, 95 | <input type="checkbox"/> Handbooks 40 |
| <input type="checkbox"/> Jan Crystal 144 | <input type="checkbox"/> Lifers 89 |
| <input type="checkbox"/> Janel 142 | <input type="checkbox"/> Subscriptions 55 |

Haven't got time to browse through the ads? Just put an X by the subject that makes you flip.

- | | |
|--|---|
| <input type="checkbox"/> Antennas | <input type="checkbox"/> PC supplies |
| <input type="checkbox"/> Coaxial Relays | <input type="checkbox"/> Preamps |
| <input type="checkbox"/> Code Practice | <input type="checkbox"/> Receivers |
| <input type="checkbox"/> Components | <input type="checkbox"/> Receivers (FM) |
| <input type="checkbox"/> Converters | <input type="checkbox"/> Surplus Elec. |
| <input type="checkbox"/> Crystals | <input type="checkbox"/> Towers |
| <input type="checkbox"/> Equipment Dist. | <input type="checkbox"/> Transceivers (FM) |
| <input type="checkbox"/> Integrated circuits | <input type="checkbox"/> Transceivers (VHF) |
| <input type="checkbox"/> Keys, Keyers | <input type="checkbox"/> Transceivers (SSB) |
| <input type="checkbox"/> Linears | <input type="checkbox"/> TV/Fax |
| <input type="checkbox"/> Oscillators (code) | <input type="checkbox"/> Video Tape Recorders |
| <input type="checkbox"/> Oscillators (rf) | |

MAIL TO 73 Inc., Peterborough NH 03458

Name _____

Call _____

Address _____

Zip _____

NEED CRYSTALS?

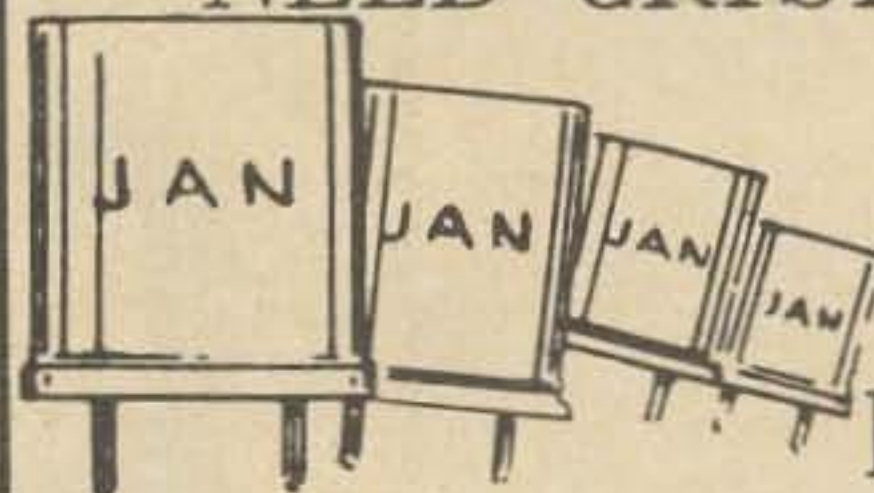

48 hr.
DELIVERY

SPECIALS

Color TV crystal (3579, 545KHz) wire leads	\$1.60 4 for 5.00
100 KHz frequency standard crystal (HC 13/U)	4.50
1000 KHz frequency standard (HC6/U)	3.50
Any CB crystal, trans. or rec. (except synthesizer crystals)	2.25
Any amateur band crystal in FT-243 holders (except 80-160 meters)	1.50 4 for 5.00
Any marine frequency (HC6/U)	2.85
80 meter crystals in FT-243 holders	2.50

We have in stock over six million crystals which include types CR1A/AR, FT243, FT241, MC7, FT249, HC6/U, HC13/U, etc. Send 10¢ for our 1970 catalog with oscillator circuits, listing thousands of frequencies in stock for immediate delivery. (Add 10¢ per crystal to above prices for shipment 1st class mail; 15¢ each for air mail.)



ORDER DIRECT
with check or money order to
Special Quantity Prices
to Jobbers and Dealers

2400B Crystal Dr., Ft. Myers, Fla. 33901

HATRY ELECTRONICS

500 Ledyard St., Hartford, Conn. 06114
203-527-1881

(1 Block East of Wethersfield Ave. off
Airport Rd., Rte 6)

Telephone: 203-527-1881

See CORKY, WIKXM or WARD, W1WRQ

ANTENNA STUFF

In 100 foot rolls only

450 ohm open wire. Per 100 feet	\$ 4.95
300 ohm open wire. Per 100 feet	4.65
Standoff-Mast or Screw-In	.19

In 100 ft. interconnected coils

18 Copperweld. Per 100 feet	\$ 1.19
14 Copperweld. Per 100 feet	2.95
12 Copperweld. Per 100 feet	3.99
14 Copper-Solid. Per 100 feet	4.29
12 Copper-Solid. Per 100 feet	5.79
Times T4-50 L/Loss 8U. Per foot	.18
Times T5-50 L/Loss 58U. Per foot	.10
Times Solid Sheath Alumafilm in stock	
Kits with connectors 50/100 ft	
Glass Line-guy wire. Per 100 feet 500 lbs Test	3.79
Glass Line-guy wire. Per 100 feet 1000 lbs Test	5.85
Hy-Gain Balun. Each	14.95
W2AU Balun. Each	12.95
Blitz Bugs. Each	4.95

All major lines of Amateur gear • Rohn #25 towers and accessories • Waters Protax switches • Dow Key relays • Greene Baluns • New-Tronics Hustler Mobile • All antenna insulators in stock.

(Canadian Amateurs Send U.S. Funds Only)

F.o.b. Hartford

Please Include Postage

CONNECTICUT'S OLDEST HAM STORE

NCX



1 kw Solid State
TRANSCEIVER
(80-10 Meters)

1000

Here's a transceiver designed for the amateur who would rather spend his hard-earned radio dollar on performance than frills. The NCX-1000 is built to meet the demands of the operator who needs and desires a high performance SSB-AM-CW-FSK rig with solid-state dependability and plenty of power. Add to this the convenience of having your transmitter (including linear amplifier), receiver, power supply, and monitor speaker in a single, compact, smartly styled 59 pound package.

So let's look at the NCX-1000, starting with the double-conversion, solid state receiver. After the received signal is processed by a double-tuned preselector, a stage of RF amplification, and another preselector, it is applied to the first mixer for conversion to the first IF frequency. The first IF contains passband filters and a stage of amplification. A second mixer then converts the signal to the second IF frequency for additional processing by a 6-pole crystal-lattice filter and four IF stages. Finally, the signal is detected and amplified by four audio stages. The unparalleled high dynamic range lets you tune in weak stations surrounded

by strong interfering signals. The result? High performance for SSB, AM, CW, and FSK. Sensitivity of 0.5 EMF microvolt (for a 1Q db S-N/N ratio).

In the transmitter you'll find three stages of speech amplification followed by a balanced modulator, a crystal-lattice filter, a filter amplifier, and an IF speech processor (clipper). A mixer converts the signal to a first IF frequency for processing by two crystal passband filters, and two IF amplifiers. A second mixer converts the signal to the transmitting frequency where it is amplified in five RF stages before it gets to the grid of the 6BM6 driver. Final power amplification takes place in a forced-air-cooled 8122 ceramic tetrode which feeds the antenna through a pi network. Other features? You bet! Grid block keying for CW. Complete metering. Amplified automatic level control (AALC).

So here's a package that can give you 1000 watts PEP input on 80 through 10 meters, 1000 watts on CW, and 500 watts for AM and FSK. The speech processor lets you double your SSB average power output with minimum distortion. No frills with the NCX-1000. Just top performance.

For complete (and impressive) specifications and details, write:



NATIONAL RADIO COMPANY, INC.

NRCI

37 Washington St., Melrose, Mass. 02176

Separately they're great!

R. L. Drake quality-built R-4B Receiver is versatile, accurate, dependable, as is the Drake T-4XB Transmitter. They stand on their own merits used independently, but . . .

TOGETHER they're incomparable!

Ideal for transceiving, 160 and MARS



DRAKE



4
LINE

T-4XB TRANSMITTER

R-4B RECEIVER

- Covers ham bands 80, 40, 20, 15 meters completely and 28.5 to 29.0 Mc of 10 meters with crystals furnished; MARS and other frequencies with accessory crystals, except 2.3-3, 5-6, 10.5-12 Mc.
- Upper and Lower Sideband on all frequencies
- Automatic Transmit Receive Switching on CW (semi break-in)
- Controlled Carrier Modulation for AM is completely compatible with SSB linear amplifiers
- VOX or PTT on SSB and AM built-in
- Adjustable Pi-Network Output
- Two 8-pole Crystal-Lattice Filters for sideband selection, 2.4 kc bandwidth
- Transmitting AGC prevents flat topping
- Shaped Grid Block Keying with side tone output
- 200 Watts PEP Input on SSB— 200 watts input CW
- Meter indicates plate current and relative output
- Compact size; rugged construction
- Solid State Permeability Tuned VFO with 1 kc divisions
- Solid State HF Crystal Oscillator
- 11 Tubes, 3 Transistors and 12 diodes
- Dimensions: 5½"H, 10¾"W, 12¼"D. Wt.: 14 lbs. \$495.00 Amateur Net.

- Linear permeability tuned VFO with 1 kc dial divisions. VFO and crystal frequencies pre-mixed for all-band stability
- Covers ham bands 80, 40, 20, 15 meters completely and 28.5 to 29.0 Mc of 10 meters with crystals furnished
- Any ten 500 kc ranges between 1.5 and 30 Mc can be covered with accessory crystals for 160 meters, MARS, etc. (5.0-6.0 Mc not recommended)
- Four bandwidths of selectivity, 0.4 kc, 1.2 kc, 2.4 kc and 4.8 kc
- Passband tuning gives sideband selection, without retuning
- Noise blanker that works on CW, SSB, and AM is built-in
- Notch filter and 25 Kc crystal calibrator are built-in
- Product detector for SSB/CW, diode detector for AM
- Crystal Lattice Filter gives superior cross modulation and overload characteristics
- Solid State Permeability Tuned VFO
- 10 tubes, 10 transistors, 17 diodes and 2 integrated circuits
- AVC for SSB or high-speed break-in CW
- Excellent Overload and Cross Modulation characteristics
- Dimensions: 5½"H, 10¾"W, 12¼"D. Wt.: 16 lbs. \$475.00 Amateur Net.

\$495⁰⁰ + \$475⁰⁰ = \$970⁰⁰

Togetherness...it's wonderful!

Get together with your distributor,
or write for free brochure . . .

R. L. DRAKE COMPANY 540 Richard Street, Miamisburg, Ohio 45342