

# TM-73

NOT-TOO-TECHNICAL MANUAL

---

## RADIO SURPLUS

### A LA 73

CONVERSIONS ET CETERA

**RESTRICTED.** This annual catalog issue contains hobbytype projects developed expressly for radio amateurs; any other use constitutes a flagrant show of interest in 73, THE WORLD'S LARGEST INDEPENDENT HAM MAGAZINE.

---

NOT AFFILIATED WITH THE

**WAR DEPARTMENT**

**MARCH 1970**

# WORLD RADIO HAS THEM



## The New Galaxy FM-210 Transceivers!

• The one the Amateurs have been waiting for! A 2-Meter FM Transceiver with Galaxy's well-known fine quality and performance! This American-made, solid state, FET front end transceiver offers no compromise performance for direct or repeater communications. A full 5 watts of Power (or 10 watts with the optional AC-DC Power Booster!) Check these specs and you'll agree – it's a lot of Transceiver for only \$199.95!

### SPECIFICATIONS

**General:** Frequency Range: 143-149 MHz. • Antenna Impedance: 50 Ohms Nominal  
Power Req'mts: 12-14 VDC (or optional power booster) • TRANS/REC. Crystals:  
146.94 MHz included.

**Transmitter:** Power Input: 5 watts (10 W. with pow. booster) • Freq. Control: 3 Chan.  
crystal controlled • Microphone: High Impedance (PTT) required • Deviation:  
Adj. narrow or wideband with clipper filter also adjustable for optimum clipping  
level.

**Receiver:** Sensitivity: SINAD .5uv for 12db, 1uv provides 20db quieting. • Adjustable  
squelch • Modulation Acceptance: FM wideband (narrow band available) • Type:  
Dual Conversion, FET front end for minimum cross modulation and overload  
• IF Frequencies: 10.7 MHz and 455 KHz • Frq. Control: 3 chan. crystal controlled  
• Audio Output: 3 watts (internal 3.2 speaker)

**Power Booster:** Provides high power operation from either 12-14VDC or 117 VAC.  
Makes an ideal fixed station accessory. (\$39.95)

— WHEN ORDERING, SPECIFY: —

66MA013 — GALAXY FM-210 .....\$199.95  
66MA015 — GALAXY AC-210 Power Booster.....\$ 39.95



## WORLD RADIO

"THE HOUSE THE HAMS BUILT"

3415 WEST BROADWAY  
COUNCIL BLUFFS, IOWA 51501

WE ACCEPT



#114, March 1970

## Contents

### Features

- 2 Radio Amateur News Page
- 4 Never Say Die
- 8 Modulated Vibrator Hash
- 12 Leaky Lines
- 14 Letters
- 78 Propagation Chart
- 172 Caveat Emptor
- 176 Advertisers' Index  
Reader's Double Bonus

### STAFF

#### Editor-Publisher

Wayne Green W2NSD/1

#### Managing Editor

Ken Sessions K6MVH/1

#### Asst. Publisher

Mike Van Den Branden WA8UTB

#### Advertising

Diane Shaw

#### Production

Roger Block  
Jane Tracey  
Jeanne Caskie  
June Trasky  
Whitney Tobias  
Bruce Marshall  
Nancy Estle

#### Art

Bill Morello  
Wayne Peeler K4MVW

#### Circulation

Phil Price

#### Subscription

Dorothy Gibson

#### Comptroller

Joe LaVigne

#### Propagation

John Nelson

#### WTW Editor

Dave Mann K2AGZ

#### Books

Lloyd Carren

- 18 **Extra Services From Your Grid Dip Oscillator** ..... WA4UZM  
Like checking crystals, tuning FM receivers and such.
- 20 **Reverse-Current Charging** ..... K8YUC  
Turns out you really can recharge flashlight batteries!
- 24 **A Poor Man's Frequency Meter** ..... W6YAN  
Combines surplus from two services.
- 29 **Professional PCs From Roll-Your-Own Negs** ..... K6MVH  
Eliminates drafting, camera work, and darkroom entirely.
- 36 **How I Read The R. O.'s Handbook & Found Happiness** .... Johnson  
Instant profundity.
- 38 **A Look At Amateur FM Standards** ..... WB6DJT  
Or...how do we get out of this mess?
- 43 **An Inexpensive RF Wattmeter** ..... WB4MYL  
Surplus meter for those too cheap to buy a regular wattmeter.
- 44 **A Remote Multifrequency Oscillator For Surplus FM Units.** .. W2ACM  
Drive people crazy on lots more FM channels with this.
- 49 **Add Spotting to Your VFO** ..... K8BYO  
If your VFO is unspotted.
- 50 **Towards an Ideal Solid-State I-F For Amateurs** ..... K1CLL  
Closing in on the state of the art with Bill Hoisington.
- 58 **Ham Exchange** ..... WA2ELA  
Visiting foreign amateurs makes trips more enjoyable.
- 60 **Super Sixer** ..... WA3AQS  
Heath wouldn't recognize it.
- 62 **Bob, Bob, Bobbin' Along** ..... K1YSD  
Special April feature article. Well, it's almost April.
- 68 **The Dip Light** ..... VE3ECU  
A grid-dip meter with no grid and no meter.
- 70 **73 Checks Out The Kris Scanning Receiver** ..... Staff  
Snazzy.
- 72 **Two Conversions For The Motorola 41 V**  
**Part 1: AC Power Supply** ..... K9PKQ  
**Part 2: 6 to 12V Filament Conversion** ..... W6YAN  
Here's the surplus, if you want to make an issue out of it.
- 76 **A CW Monitor** ..... WB2GQY  
Using a 98¢ audio module, you cheapskates.
- 80 **The Logical Approach To Surplus Buying** ..... Jim Kyle  
Here's your key to fun with those surplus logic circuits.
- 96 **Converting The Sonobuoy to a 2W FM Rig** ..... W1BYX  
Two meters. Why not have some fun with this one?
- 97 **Easy Diode Testing** ..... K4JK  
Checking out those bargain diodes.
- 98 **Turning The AN/GRC-9 Into a Novice Rig** ..... W6JTT  
2-12 MHz transmitter-receiver.
- 104 **Extra Class Study Course, Part XIV** ..... Staff  
Measurements.
- 118 **VHF-FM And You** ..... K9STH  
Part of our Encyclopedia of FM; a good part.

*73 Magazine is published by 73, Inc., Peterborough, New Hampshire 03458. Subscription rate: \$12.00 for three years, \$6.00 for one year. Second Class Postage paid at Peterborough, New Hampshire, and at additional mailing offices. Printed at Pontiac, Illinois, U.S.A. Entire contents copyright 1970 by 73, Inc., Peterborough, New Hampshire 03458. A bunch of people (listed at the left) worked far beyond the call of the almighty dollar to make this the biggest, best, most attractive issue of 73 yet published. They hope you notice. They are working on the Big April Special FM Repeater Issue which will carry the most complete and up-to-date listing of the over 300 amateur FM repeaters in the U.S. They solicit your help in getting interesting items for the Amateur News Page, the first ham newspaper of its kind. You're not on FM yet? You will be.*

# Amateur Radio News Page

March XIXLXX

Monthly Ham News of the World

73 Magazine

## Subbands Reallocated in FCC Action

### Amendment of FCC Rules Adopted To Shift Frequencies and Emissions In the Amateur Radio Service

Amendment of Section 97.61 (a) of the Rules shifting frequencies and emissions in the Amateur Radio Service to the subband where A-1 emission is exclusively permitted from the 147.9-148 MHz band to the 144.0-144.1 MHz band; and shifting the subband where F-1 emission is permitted from the 29.0-29.7 MHz band to the 28.0-28.5 MHz band, has been adopted by the Commission, effective March 2, 1970 (Docket 18508, RM-886, RM-950).

The amendments were originally requested by the American Radio Relay League (ARRL). A Notice of Proposed Rule Making in the matter was released on April 3, 1969, (FCC 69-313), inviting interested persons to file comments on or before June 11, 1969, and reply comments on or before June 23, 1969.

Comments in support of the changes were filed by the ARRL, the Electronic Industries Association (EIA), Central States VHF Society (Central), and Forrest A. Bartlett (W6OWP). A comment filed by Donald R. Nelsch (K8EIW) supported adoption of the proposal in RM-886, but requested F-4 emission to be included in the 144.1 to 148.0 MHz frequency band. A comment filed by Howard McCall (W8TNF) was the only one which opposed adoption of the proposal in RM-950. No reply comments were filed.

### SNOWMOBILE "MOBILE"... a first?



Bill Loeffler W1PFA Salem N.H. combines ham radio with the new popular sport snowmobiling. With a Galaxy FM 210 and Antenna Specialists 2 meter gain

### CD Group Goes 2 Meters - FM

Bill Loeffler, W1PFA radio officer for the town of Salem, N.H. recently announced the RACES section of Civil Defense has planned to purchase 10 Galaxy FM 210 units of local communications. Recent tests made with the units proved the town to be neatly covered with mobile operation to base station with no blackout area whatever. Don Alexander W1UFK and Tony Coco K1ILB, communications officers for the town, feel that channelized operation on the 2 meter FM band, will greatly advance the local operation. Salem is expected to be the first RACES operation in New Hampshire to go FM.

### YA Club Formed, Award Offered

#### Group standardizes prefixes

Since there is no licensing authority in Afghanistan, amateur operation in that country has been somewhat confused in the past. Amateurs have mere-

In its comments, ARRL pointed out that the 144.0-146 MHz band was assigned to the Amateur Radio Service on a world-wide basis, and that the 146.0-148.0 MHz band is authorized to the Amateur Radio Service in Regions Two (Western Hemisphere) and Three (Southern Asia and Oceania), and to the fixed and mobile services in Region One (Europe, Africa, and Northern Asia); that while the 144.0-146.0 MHz band is specifically authorized for amateur satellite operation, the present 147.9-148.0 MHz, reserved for A-1 emission, cannot be used in Region One. The proposed 144.0-144.1 MHz band may, however, be used world-wide. Canada also has set aside 144.0-144.1 MHz for A-1 only operation.

The Commission said it believes that "clearing a portion of the 144-146 MHz band is desirable for continued experimentation in space techniques by amateurs."

Central commented that, although it supported the proposal, the Commission was not going far enough. It stated that "the assignment of the first 100 kHz of the 144 MHz Amateur band to A-1 emission is at best a stop gap measure . . ." and that additional protection of experimentation may be required in the future. The Commission said, however, that the evidence submitted by Central is "insufficient to persuade us that a larger subband is needed and should be authorized at this time."



FUCHU AS, Japan — Members of the Far East Auxiliary Radio League in Japan receive a demonstration of manufacturer's performance specifications versus actual performance in electronic equipment by Mark Radke (seated) of the U.S. Army Depot Command, Japan. Watching the demonstration are (from Left) Skip Brady, KA2SB/WB6RBI, Ed Frazier, KA2ZD/WA0ZZD, and Bill Ross, KA2DK/K5LLK, league president. The league is composed of U.S. military personnel in Japan with an interest in amateur radio. The group promotes activities of KA stations in Japan and fosters goodwill in the Far East and throughout the world through the medium of amateur radio.

antenna mounted on front of Ski Doo, Bill works into the W1ALE repeater at Concord, N.H. Power for the rig is taken from the cigarette lighter socket on Ski Doo. The snowmobile is a Bombardier Ski Doo Nordic 640E. Bill is also a member of the Salem, N.H. S-Ki-Mos snowmobile club. The 73 on front of the 'mobile is Bill's registration number in the Salem S-Ki-Mos club; there are 85 members.

In reference to the suggestion made by Mr. Nelsch that F-4 emission be included in the 144.1-148.0 MHz amateur band because of the availability of facsimile equipment of commercial quality, the Commission said that this request is beyond the scope of this proceeding. It added, however, that the matter is the subject of a separate petition for rule making (RM-1429) filed by James L. Turrin (WA8DCE) and would be considered when that petition comes before it.

Howard McCall told the Commission that he disagreed with the proposal in RM-950 to relocate F-1 emission in the 28.0-28 MHz frequency band because it would result in a loss of 200 kHz for this type of transmission. Although the proposed relocation would result in a reduction of 20 kHz of bandwidth available for F-1 emission, the Commission said it believes this loss is "not extensive and is outweighed by the advantage of moving radioteletype emission (F-1) into the CW portion of the 28 MHz band."

Finally, the Commission stated that it believed that the shift in frequencies would not affect the operation of its users significantly.

## Allied has free classes

Allied Radio Corporation will begin its annual Novice amateur radio license course on January 19, at the main Allied store, 100 N. Western Ave., Chicago.

The free 14-week code and theory course will meet each Monday evening to help prepare would-be hams to take the Novice FCC license examination. The course will be taught by one of Allied's staff of licensed radio amateurs, with the major emphasis placed on learning the code.

W1TNO (Ted) in Concord, N.H. reported that he worked W1PFA/snowmobile in Salem, N.H. in late January. Bill was out with the local snowmobile club, with some 90 snowmobiles, running a test to check on the emergency use of FM via the repeater. The test worked perfectly, easily turning on the W1ALE repeater in Concord, some 40 miles away. Is this the first repeater FM operation from a snowmobile?

## FCC Nails Ham for "Fraud"

In a public notice issued on January 16, 1970, the FCC revoked the license of Herbert L. Rippe W8DE. According to the report, Rippe had obtained his two-letter call by "fraudulent" means, in violation of Section 97.129 of Amateur Rules and Regulations, Part 97. His revocation was made effective as of February 16.

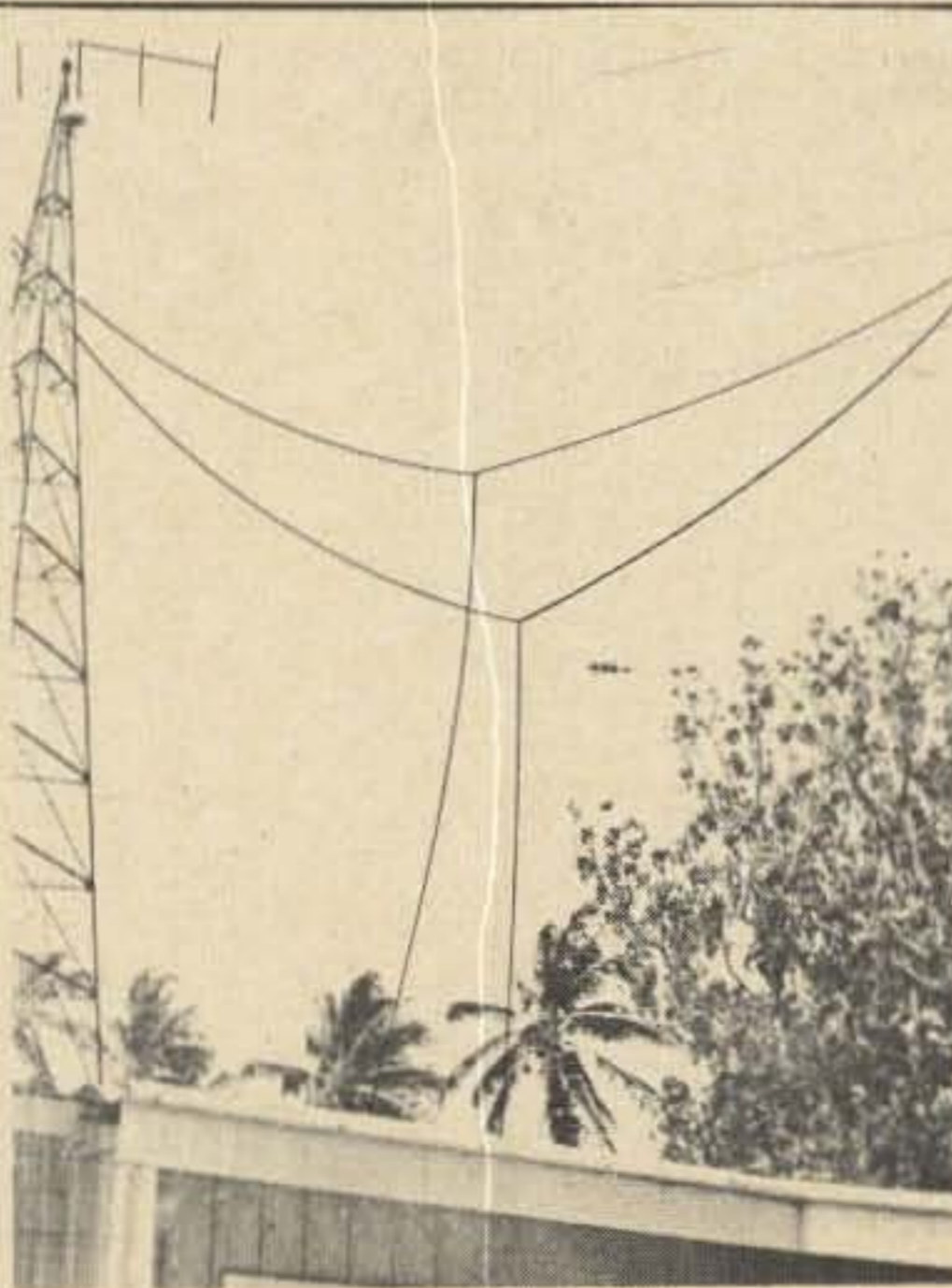

ly brought in their equipment, set it up, picked out a call they liked, and gone on the air, hoping that no one would get upset in the government.

A little order is appearing out of the chaos now with the formal organization of the Camel Drivers Radio Club, organized by YA5RG. The country has been broken up into nine prefix districts, and the club will endeavor to get all ops to abide by them. This may be helpful and will certainly go a long way toward preventing one op from coming to Kabul and using ten different number prefixes in order to generate more DX activity, giving the impression that he is actually moving around the country.

The club is offering the *Afghanistan Radio Award* to all amateurs and SWLs of the world. Contacts must be confirmed on at least two amateur bands and six contacts are required for YA amateurs, four for Asian amateurs (except YA), three for Europeans, and two for the rest of the world. Send QSLs and 10 IRCs (or one dollar), contacts from 1966 on count, to CDRC, Box 279, Kabul, Afghanistan. Send an extra dollar for airmail return.

## VK9KY ACTIVE FROM COCOS KEELING ISLE

One of the more remote spots in the world is Cocos Keeling Island, off the coast of Australia and south of Sumatra. The only active station on this island is VK9KY, operated by Ken Young, who is living on Cocos running the Ionospheric Prediction Service station. The tower is used for the vertical sounding of the ionosphere and the fixed beam on top of the tower is pointed at Sydney for the weekly reports to the home office.

The dipoles are used for contacts on 15 and 20 meters and are broadside to Europe, thus holding the signal down a bit toward the States. Ken is planning on putting up a groundplane, and may even be able to swing a wire beam in a stateside direction. There are, of course, no materials available on the island for building even a simple regular beam.

If you might be able to help Ken out with antenna materials, his address is Box 31, Cocos (Keeling), Indian Ocean via Perth, Australia. QSL to his manager VK2SG. He often can be worked on 20 meters around 1200Z, sideband. Stamp collectors will treasure the beautiful bird stamps from Cocos.



NEVER SAY DIE

...de W2NSD/I

### EDITORIAL BY WAYNE GREEN

Since I am sure that many readers must be pretty sick of reading about the ARRL in my editorials, I will ignore them completely this month except for a short answer to a letter.

The letter (from Paul Crilly WA1IND, 15 Rosewood Drive, Simsbury, CT) is quite critical of me for having bad things to say about the ARRL, which he considers a fine organization which has helped hams in countless ways. He feels that the amateurs are enthusiastic about incentive licensing and that I am afraid of progress and improvement of the quality of amateurs.

You might think, from some of my mail, that I have written editorials saying that the ARRL is run by a bunch of crooks, headed by Captain Klutz, a chap whose morals would make the Mafia blush and whose intelligence would hardly qualify him for admission to the Crochted Mountain Home for the Mentally Retarded. No matter what I may personally think, I have not written anything like that.

The ARRL was started by Hiram Percy Maxim, a genius, the son of a genius, and the grandson of a genius. It took genius to get something like the ARRL going. When Maxim died there was the usual fight for control by those of less than genius talent. Some day someone will write an honest history of the ups and downs of the ARRL, but so far all we have seen are self-congratulatory rewrites of history.

Though the League has fallen into the hands of those of less than genius calibre, the organization continues to provide many very valuable services to the amateurs it was founded to serve. Few of them, unfortunately, are completely above criticism. We have not historically seen much improvement in ARRL programs until the tide of public opinion has forced changes. In connection with this you might note that the voice of 73 is the only one not stilled by fearful publishers. I won't list the manufacturers who withhold their advertising from 73 in an effort to force us to run bland editorials, but they are large and well known, and conspicuous in their absence from the magazine.

Perhaps I am deluding myself, but I can't recall running into a fervently anti-Wayne Green amateur that has read many of my editorials. When I talk with them I find that they are mad at

me for things they have heard that I have written, not for what I have actually written.

Though I think of myself as a conservative, many readers seem to feel that I am a liberal. My reaction to incentive licensing is, I think, conservative. I feel that the ARRL management should have consulted the membership before petitioning the FCC for the rules change and I also feel that the whole idea would have been infinitely better if additional privileges had been offered for advancement rather than the punitive taking away of privileges from those who chose not to advance. It is basically the concept of using the stick or the carrot, with me favoring the carrot and ARRL the stick. You get more flies with honey than with vinegar.

A recent poll asked 73 readers if they thought amateur radio should have a lobby in Washington. The response was almost 100% in favor, yet the probability of anything like this happening seems remote. Why? The ARRL management certainly recognizes that such a lobby is not only needed, but is of critical importance to our future, yet they continue to do everything in their power to keep the directors from bringing it up at Board meetings. How come? As one of the HQ small fry explained it to me, the management feels that if a lobby is started in Washington there will be no way to keep the headquarters from eventually being moved to Washington, since HQ would have to follow the action. They don't want to move. They have nice houses, friends, and are comfortable in Newington where they are. As long as they can keep the Washington lobby cooled they can live on undisturbed.

But what of amateur radio, you ask? Since few of the ARRL management have been active amateurs in many years it is not really surprising at their seeming lack of emotional involvement with the hobby. I get a strong feeling that this is strictly a business matter with them and nothing more. They try and have business interfere with their personal lives as little as possible.

You might contrast that with the involvement at 73. Mike, Ken and I spend a good part of our waking hours working at 73 (or hamming), seven days a week. You will seldom not find at least one of us on tap by 6 a.m., and the work goes on into the night when deadlines demand.

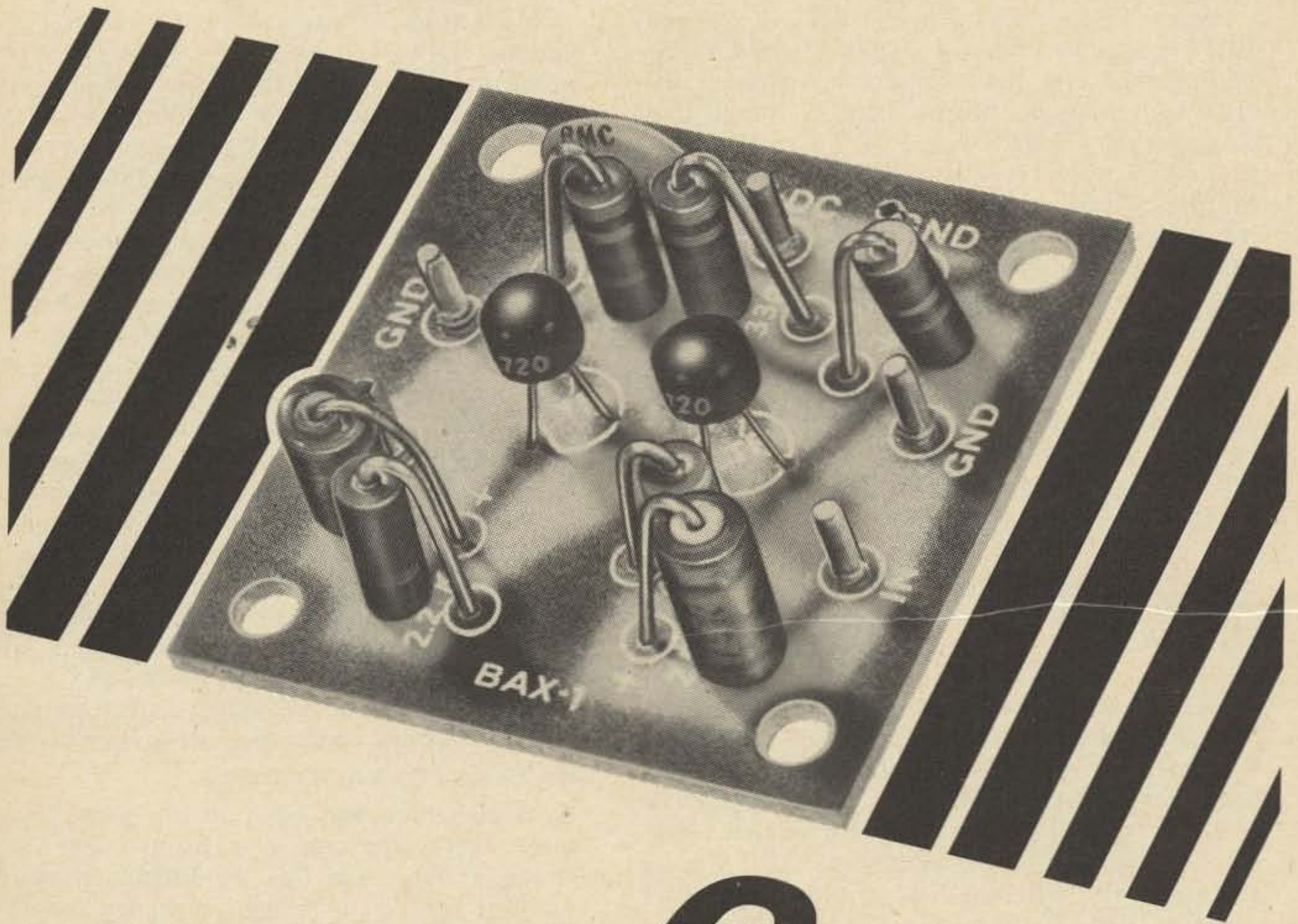

International BAX-1 Broadband Amplifier is a general purpose unit which may be used as a tuned or untuned amplifier in RF and audio application. For example: when used as untuned RF pre-amplifier connect between antenna and receiver antenna posts. Ideal for SWL, Experimenter or Amateur applications. Easy to build. Complete Kit.....\$3.75

**SPECIFICATIONS:**

1. Power ..... 9 to 15 volts dc @ 10 ma
2. Frequency Range..... 20 Hz to 150 MHz
3. Gain at 1 MHz..... 30 db  
Gain at 150 MHz..... 6 db
4. Response ref 1 mhz..... down 6 db at 50 hz ,  
±3 db 100 hz to 10 mhz  
down 15 db at 100 mhz  
down 24 db at 150 mhz
5. Operational Impedance..... 50 to 500 ohms
6. Noise ..... less than 10 microvolts rf  
across 50 ohms; audio  
less than .0005 volts
7. Maximum Input Level..... .01 volts ac
8. Output at Maximum Input... 50 ohms — .1 volt  
(at 1 mhz)..... 500 ohms — .5 volt
- Size inches..... 1½" x 1½" x 1"
- Mounting ..... 4 holes with spacers

Write for complete catalog.

# 6 to 30 DB GAIN!

WITH **ICM** LOW COST  
**BAX-1 BROADBAND  
AMPLIFIER** (20 Hz to 150 MHz)



**CRYSTAL MFG. CO., INC.**  
10 NO. LEE • OKLA. CITY, OKLA. 73102

No matter how much good the ARRL does, there are bound to be some bad things and if these are not discussed and exposed, how can they be improved? Bad flourishes in secrecy and dies in the open.

When I write about the ARRL I try and differentiate *between* the 75,000 members (including me) and the management running the show at Newington. Most of the bad things that are going on are attributable to this small group, not the members. Now, do you feel that there is anything wrong about discussing the problems we are having with what can best be described as amateur radio's unelected "government?" Am I being picayune when I criticize this group?

Down through the years I have spoken out many times in my editorials in support of many of the programs run by the League. It seems to me that it would be redundant to do this in every editorial. For the most part readers of this editorial are the same readers that have endured dozens or even hundreds of my past editorials, so I try not to repeat myself too often.

When I first started in amateur radio I, too, used WIAW for code practice. Of course there were not nearly as many alternatives in those days. Few amateurs sent at less than 13 per on the air, there were no Novices yet, and about the only choice was an Instructograph tape machine or expensive 78 rpm records. Now, with inexpensive tapes and LP records available, plus thousands of Novices on the air, the need for WIAW code practice is probably not as dramatic as it was 35 years ago, but thousands of would-be amateurs still tune in WIAW every year for the service.

There has been considerable criticism recently of the WIAW practice of just coming on and sending code or bulletins with no regard for those already on the frequency, but I suspect this may be due to one tactless operator rather than headquarters policy.

The short-haul limitations of amateur radio were responsible for the beginnings of the American Radio Relay League, since relaying was the only way to cover longer distances before the short waves were discovered. This still lives on in the dozens of traffic nets spread out around the country, an activity that is basic to the ARRL. Since I have never been an enthusiastic CW operator, my own experiences with traffic handling have all been on phone or RTTY, but I certainly never put down the fellows that love traffic handling.

#### **Are We Afraid of Progress?**

Since 73 is normally months or years ahead of the other amateur magazines in bringing new technical developments to the amateurs, our marks in "progress" should be okay. The high density of technical and construction articles in 73 should acquit me on "improvement of quality of amateurs."

Might I point out, too, that only 73 has run a technical study course to help you upgrade your license. Are we doing more to help improve the

quality of amateurs than the ARRL? Speaking of which, whether we like incentive licensing or not, it doesn't seem about to go away, so perhaps it is time to sit down and start plugging through our Extra Class series.

You know, I suspect that if Maxim were running ARRL we would be good friends and working together instead of the present system whereby HQ seems to be doing everything in its power to undercut 73 and ignoring as long as possible the needs and wishes of the members.

#### **ARRL November Board Meeting**

Several letters have been received complaining about the directors meeting, pointing out that they spent thousands of dollars getting together, only to discuss trivia and to ignore the major problems facing amateur radio. Since I have decided not to be critical of the ARRL in any way in this editorial, I shall say nothing about the Board meeting except that those of you who have access to the January QST will find it fascinating to read the detailed minutes of this historic Board meeting starting on page 75.

#### **Improvement?**

Now, didn't you like that editorial much better than those rotten ones where I am critical of the League? If this turns out to be popular I may write an editorial avoiding critical comments on our esteemed competitors down in New York.

#### **New Year's Present for Wayne**

A daughter was born to my wife Lin just hours before the new year. Name: Sage Anetta Green. Your wives may be interested that we used the bubble all through pregnancy and during labor. The long term results are to be seen, but labor was quite easy and the birth was quick. The bubble, if you are not familiar with it, was invented in South Africa recently and provides a way for extra oxygen to get to the baby's brain during pregnancy, theoretically helping the brain to develop better and faster than without the oxygen. It also helps greatly during birth, providing the extra oxygen at this critical time, and easing delivery markedly.

#### **Million Dollar TVI Suit Dies**

We checked with Grid W4GJO and found that the TVI suit against him has been dropped. I am sure that the impressive backing Grid got from interested amateurs who sent donations to help with the fight had a lot to do with the dropping of this suit. If you have any illusions about what a great fight ARRL puts up for amateurs that get into serious legal difficulties such as this one, difficulties that could well turn into a nightmare for all amateurs if not fought to the bitter end, then just drop in at the Ham Shack in Sarasota and talk with Grid. You will find that not one penny of the thousands of dollars Grid spent on his fight came from the League.

Legal battles like this one might never get started if the complainant knew that the amateur he was suing would be supported financially all the way to the Supreme Court by the ARRL. The Institute of Amateur Radio did furnish cash for



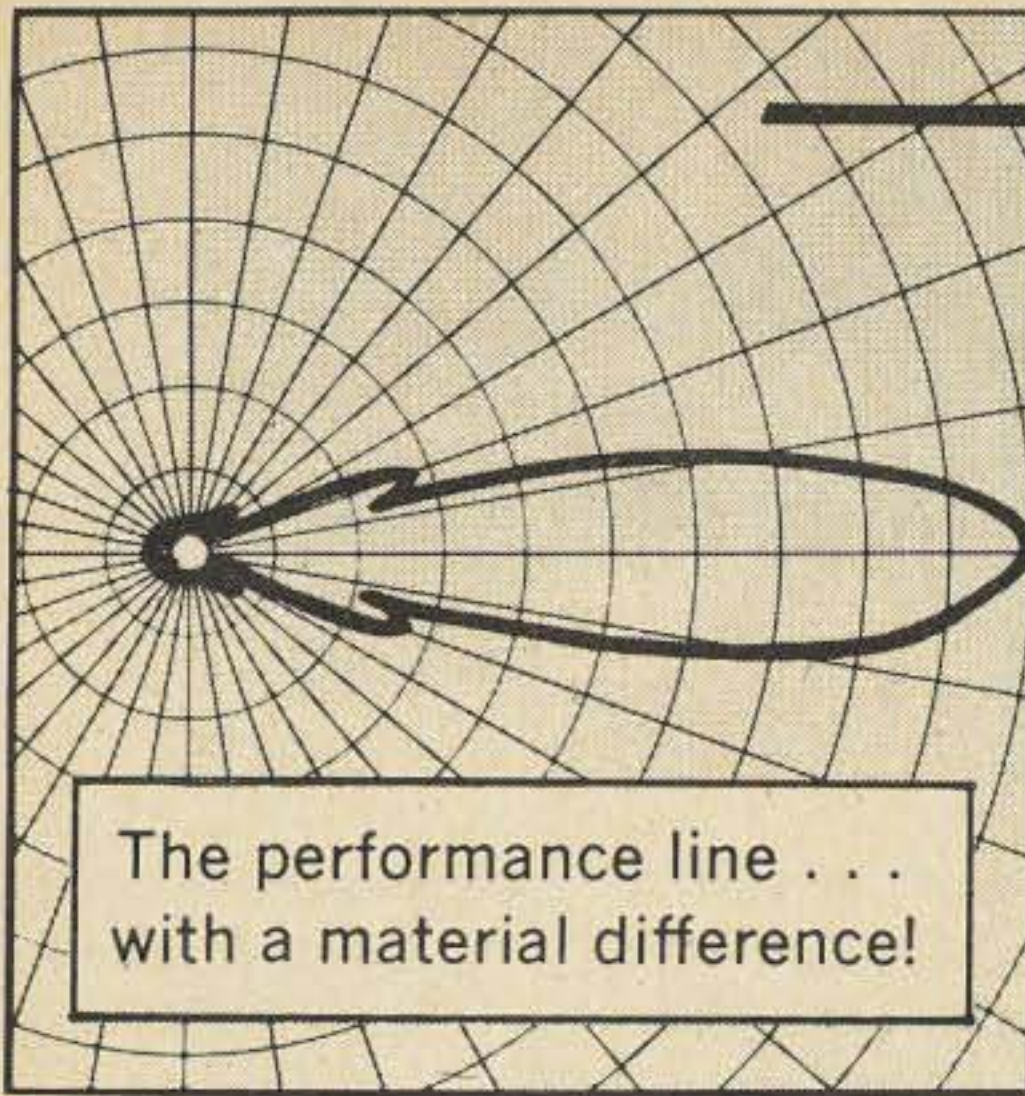

The performance line . . .  
with a material difference!

# telrex

**PREFERRED AND SPECIFIED WORLD-WIDE BY  
COMMUNICATION ENGINEERS AND ADVANCED AMATEURS**

Don't settle for anything less than the very best! Use Telrex Communication products — for long lasting optimum performance and value!

**FREE . . .** Tech data and pricing catalogs describing off-the-shelf and custom-built antennas, systems, "Inverted-vee kits"®, towers, mono-poles and rotatable "Berthas".

For commercial and military applications write for CM69 . . . for amateur applications write for PL69.

COMMUNICATION SYSTEMS SINCE 1921  
**telrex** Laboratories  
 Communication Engineering

ASBURY PARK,  
NEW JERSEY 07712, U.S.A.

helping amateurs in legal difficulties, because one of its tenets was the belief that one ham's fight is amateur radio's fight. If the Institute could do this, so can the ARRL. The next time an ARRL director talks to your club, ask him about this . . . or write to him and ask. Get that ball rolling. Could you personally stand the \$5000 to \$50,000 that a suit like this can cost?

### Band Occupancy

A recent study of the occupancy of our major bands during high density hours showed that the Extra Class segments are getting a lot more use than many of the underprivileged think. The survey, run by ARRL, and using about 100 amateurs as observers, might be more meaningful if it also covered medium and low density hours when the level of interference does not keep as many operators inactive that might otherwise be on the air. I suspect that the General bands fill up first, then the Advanced, and lastly the Extra. Full is full, and when all are full, then all are being equally used . . . right?

### Free Advertising

Although we realized that 73 is very popular in colleges all around the country, we are flabbergasted at the strength of the student devotion. You may note, as we have, that pictures of college students with the "73" emblem on them are appearing in papers everywhere!

. . . Wayne ■

## VOX POP

### Monthly Report of Activities on our Bands

There are a lot of interesting things going on in our bands that are all too poorly reported. Starting in April we would like to devote some space in 73 to reports of doings on the bands, with a separate section devoted to each amateur band and mode. Reports should be in our hands by the tenth of the month.

What's interesting? That depends upon the band, of course. Our 160m readers

would like to know about DX tests, activities in rarer spots, nets, new counties activated, and any other organized activities on that band. Heretofore, there has been no good place to report something like this or any way to organize special interest nets, etc.

On 80m we have lots doing with the traffic nets, plenty of interesting activities in the Novice band, plus DX. I don't have in mind anything like the QST Station Activities column which lists who bought what new equipment and who passed along how many messages. But if TR8MC shows up on 3565 now and then, I think a lot of fellows would like to know about it. Up in the phone band there are a number of interesting nets that could well use some publicity now and then. When the Eyebank Net gets an eyeball to the right spot at the right time, that's news. When KR6AJ comes through regularly on 3808, that's news. When DX-minded ops manage to get the DX stations to tune up into the band for them, that's news. When a DXpedition is going to give the 75m gang a workout, everyone would like to know about it. I'm sure that the RTTY group on 80 has some news now and then that they would like to pass along...etc.

DX chasers will want to know the frequency, GMT, and QSL manager of rarer DX. We will pass it along, complete with the call of the fellow reporting the news.

On the higher bands I am sure that many of us want to know what is happening around the country on FM, TV, SSTV, moonbounce, satellites, meteor scatter, and other specialized branches of the hobby.

. . . W2NSD/1 ■

## Modulated Vibrator Hash

AN  
EDITORIAL  
BY K6MVH  
KEN SESSIONS, JR.

**I**n the past several weeks I have been doing a great deal of soul searching. My position as editor of 73 requires that I give full and adequate coverage – nonpreferentially – to all facets of amateur radio. Yet my personal involvement has been almost entirely with VHF FM and repeaters. As somewhat of a prominent figure in FM circles, I feel that I am under a special obligation to make 73 take up where FM Magazine left off. On the other hand, 73 has always represented the DX'er, the sidebander, the CW enthusiast.

So you see the embryo of a dilemma that has cost me more than just a few hours of sleep. The problem became even more dramatic when Mike Van Den Branden, former publisher of FM, joined 73. With the entire staff of the now-defunct FM journal at 73, a commitment to heavy FM/repeater coverage seemed even more necessary.

Good ol' Father Green gave me the answer. He came into my office, closed the door; and said something like, "Okay, it can't be all that serious . . . We've got Blue Cross, your rent's paid up, and we all love you. So what's on your mind?"

I told him that I felt a special obligation – and need – to publish circuits, stories, features and news about the fast-moving and ever-changing field of FM and repeaters, but I couldn't justify slighting the other amateur modes in the process.

There would be no need to slight the other aspects of radio, he told me. And he solved my whole problem without so much as a wrinkled eyebrow. All we have to do, he said, is include more FM articles each month than the Journal did – and do it without sacrificing any of our regular content.

Simple solution . . . just make 73 a little bit thicker. So that's what we did! Is that any way to run a magazine? You bet it is!

RM-1542

One year ago last January, FM Magazine published a tentative petition with regard to repeater rulemaking, and repeater owners were invited to submit comments and recommendations for changes. The purpose was to present a comprehensive rulemaking proposal to the FCC that reflected the combined ideas of all active FM people.

Shortly after the petition was published, suggestions began pouring into the editorial office. Then the League decided to take a hand, too. With the FM'ers going all out on the one side to get a meaningful set of repeater rules, the

ARRL went off in another direction by appointing a staff of seven men to study the requirements of repeaters so that the League itself could make a recommendation to the FCC.

The League ignored the efforts already under way, and chose instead to make up its committee of staunch League members, *nearly half of whom have not participated at all* in the actions of the rulemaking group. Because of the apathy of part of the League's committee, some of the more conscientious members have become quite piqued, and are looking for a reorganization. Several members of the committee have not participated in any of the group functions, a fact that has stirred considerable controversy among the members.

One member of the League's advisory group has taken a more than passing interest in the problems, and is trying to pull the group out of its slump by actively campaigning for a set of proposed rules drafted as a result of recommendations based on comments from repeater organizations (particularly the California Amateur Relay Council) and, presumably, the original set of recommendations published in FM Magazine. That man is John J. O'Brien W6GDO, who is serving the dual role of ARRL repeater advisory committeeman and FM editor of Ham Radio. (I didn't think it was legal, since League President Denniston told me personally a year ago that I was ineligible for the committee because of my former association with FM Magazine.)

At any rate, O'Brien's rules have been reviewed by a number of active repeater groups, but they have not been adopted by the advisory committee. His recommendations are sketchy, but they appear sound and workable. The unfortunate thing is that his proposal is a long, long way from home. The advisory group must agree to accept it, following which it must be sold to League officials in Newington.

Meanwhile, hundreds of active FM'ers responded to the call for suggestions published originally in FM. These recommendations have been sifted and integrated, reworked and redrafted. Finally, one full year after the first draft was published, the final non-ARRL petition was submitted to the FCC. I personally submitted the petition, which bears identification number RM-1542, and will attest to the fact that it contains the ideas, recommendations, and constraints recommended by the collective body of active FM'ers.

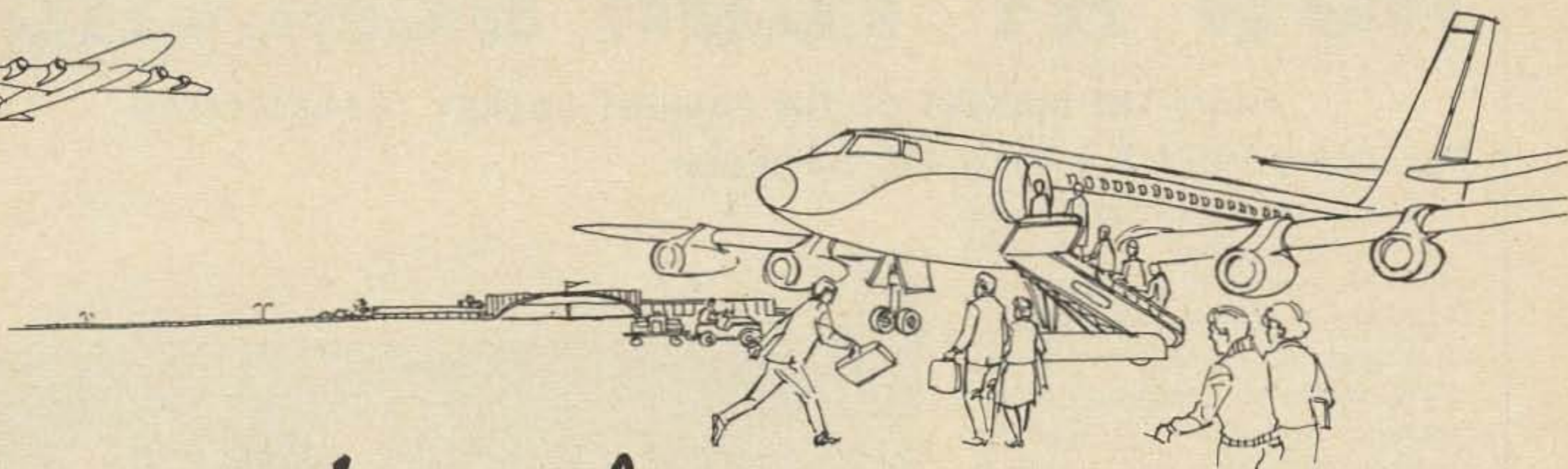
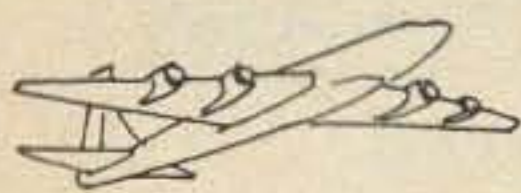

# Traveling companion

**DELUXE**

**SWAN** *Cygnnet*

**MODEL 270**

**A 5 BAND 260 WATT SSB  
TRANSCEIVER WITH BUILT-IN  
AC AND DC SUPPLY, AND  
LOUDSPEAKER, IN ONE  
PORTABLE PACKAGE.**

The Swan Cygnnet is the most versatile and portable transceiver on the market, and certainly the best possible value. The lightweight compact design of the Cygnnet makes it an ideal traveling companion. You can take it with you on vacation or business trip, and operate from your motel room, summer cabin, boat or car. All you do is connect to a power source, antenna, and you're on the air.

AMATEUR NET PRICE

**\$525**



**SWAN**

**ELECTRONICS**

*For Better Ideas  
in Amateur Radio*

OCEANSIDE, CALIFORNIA—A Subsidiary of Cubic Corporation

# NOW AT YOUR DEALERS!

FROM THE MAKERS OF THE FAMOUS GALAXY TRANSCEIVERS

## The Galaxy FM-210 2 Meter FM Transceiver

• Now every Amateur can buy Galaxy's well-known quality and performance in a 2-Meter FM Transceiver! This American-made, solid-state, FET front end transceiver offers no compromise performance for direct or repeater communications...a full 5 watts of Power (or 10 watts with the optional AC-DC Power Booster!) Check these specs and you'll agree it's a lot of Transceiver for only \$199.95!

See one...try one!

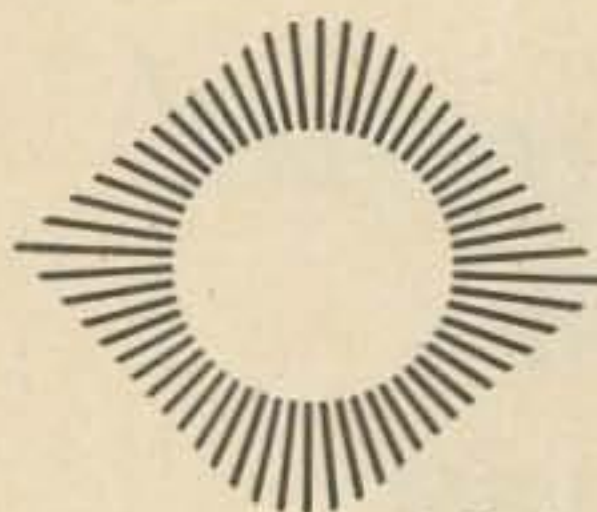

## galaxy electronics

"Pacesetter in Amateur/Commercial Equipment Design"

10 South 34th Street • Dept. 73-FF46 • Council Bluffs, Iowa 51501

In case you're wondering what was in RM-1542, the essentials are listed in last month's "Modulated Vibrator Hash." If you're an FM'er and you care about recognition, licensing, and modifying the restrictions of repeaters, write the FCC now, and recommend quick action on RM-1542.

### VIRGO

Probably every ham goes through the "cute phonetics" stage at some point early in his career. I started looking around frantically for something clever back in 1956 when I had a column in *Western Radio Amateur*, a west coast publication published by Don Williamson W6JRE. I wanted something snappy, like "Never Say Die," but my call, unfortunately, didn't end with "NSD." Quite coincidentally, during a late night QSO with my half converted military surplus transceiver, someone—I don't even remember who—commented that my signal was so raunchy it sounded as if I were modulating vibrator hash. The column title was born for me. It was something I was never crazy about, but it seemed reasonably apropos, so it stuck ... through several amateur publications.

It wasn't until after I got to 73 and Wayne introduced me to someone as "Mr. Virgo himself," that I became totally disenchanted with the vibrator hash bit. After overcoming my initial depression resulting from the fact that I hadn't thought of the Zodiac tie-in myself, I elected to retire the tired "Hash" for good. From now on, I'll be Mr. Virgo Himself.

### SPECIAL PEOPLE

Sometimes I think somebody ought to do something special for the "special people" in the ham radio business. The special people are those who manufacture and sell the gear we use. I've been around long enough to know that no one gets rich doing business with hams. Yet, as hams, we demand more of these fine folks than we'd expect of Sears or Montgomery Ward—and we get it!

I've lost track of the times I've pestered poor old Ted W6UOU at Henry Radio in Los Angeles. This rig didn't work right, or a part was missing from that antenna kit. Never a complaint or question. Always, the Henry people would make sure I was satisfied before I left the store.

My dad (Ken Sr., K6MQB) really puts them through their paces. He's an active ham with interests that change with the seasons. And he lives no more than a few blocks from Henry's L.A. store. He goes from 6 meters to 75...then he gets a yen for 15 and 20 sideband...it's beams and towers and quads...something for the shack, then something for the mobile. And each change means a trip to Henry, to check in the old gear and check out the new. I'm sure half the stuff he carts out of Henry's never even gets turned on. Everybody there pretty much knows him by name, and I suspect they don't even bother to write up the paper on half his purchases, knowing he'll be back in a week or two to trade it all in.

But they're good sports at Henry's—like they are at a lot of other stores where you and I and my dad buy gear. They may flinch when they see us walk in the door, but they don't show it, bless 'em.

...K6MVH 

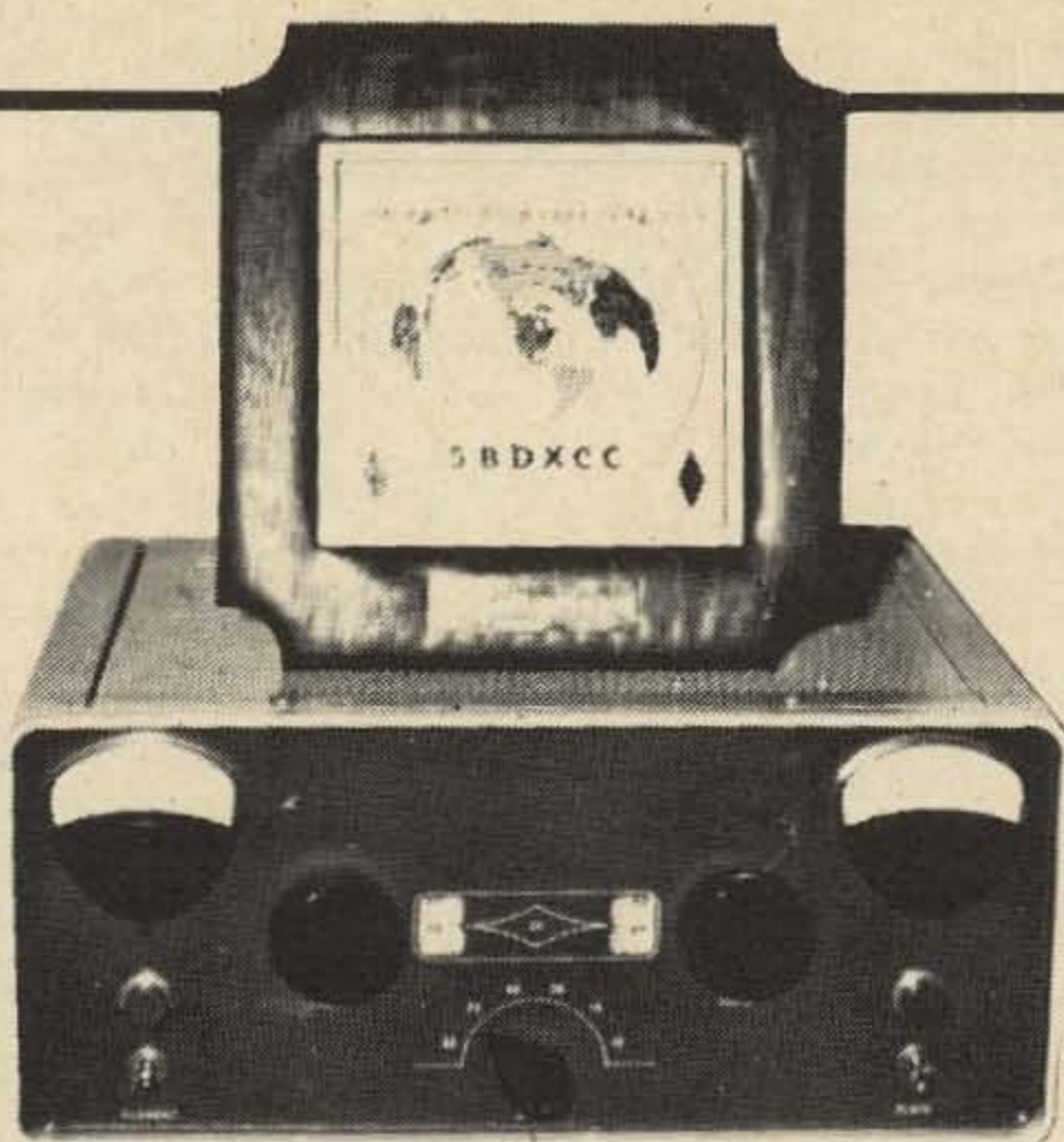

**Bob Eshleman, W4QCW,  
earns top Five Band DXCC Award and his  
“trusty” 2-K amplifier was with him all the way!**

Most amateurs dream of being number ONE. Few have the opportunity. W4QCW was ready. Bob had the skill, the patience and he had the fine equipment he needed. At Henry Radio we are proud the 2-K helped W4QCW win this unique honor.

Like Bob Eshleman you can own a big 2-K signal. Three thousand discerning amateurs throughout the world are solving their communications problems with 2-K's---the “clean signal” amplifier. For maximum power, maximum linearity and maximum value the answer is obviously the 2K-3.

\$745.00 Floor console or Desk model.

EASY FINANCING • 10% DOWN OR TRADE-IN DOWN • NO FINANCE CHARGE IF PAID IN 90 DAYS • GOOD RECONDITIONED EQUIPMENT • Nearly all makes and models. Our reconditioned equipment carries a 15 day trial, 90 day warranty and may be traded back within 90 days for full credit toward the purchase of NEW equipment. Write for bulletin. Export inquiries invited.

TED HENRY (W6UOU)

BOB HENRY (WØARA)

WALT HENRY (W6ZN)

# Henry Radio

11240 W. Olympic Blvd., Los Angeles, Calif. 90064

213/477-6701

931 N. Euclid, Anaheim, Calif. 92801 714/772-9200

Butler, Missouri 64730

816/679-3127

Henry Radio has representatives in different areas of the U.S. to simplify ordering for those living near one. Or you can order direct and we will ship . . . across the street or around the world. Call or write for specifications and terms.

Texas area: Stewart E. Fason, W5RER

New York area: John Richardt, W2WIY

Chicago area: Bill Reynolds, K9ZXD

*Attention: Military and commercial users.*

The new 3K amplifier is now available for continuous duty high power RTTY and extra power SSB operation. \$895.00 F.O.B. Los Angeles, Calif.

I spent this evening on the air, working old friends whom I haven't contacted in months. Now my antenna situation is cleared up I've been making up for all the time I've been struggling with limited means . . . dipoles mainly. After three or four contacts I got a call from a fellow in a nearby town. He has one of those shiny new two-letter calls, but he used to be an ordinary, garden variety K2 like the rest of us plain peasants.

"I've been reading your stuff in 73," he began. His tone was a little patronizing, as though he were at least the book reviewer of the Sunday Times. "It's pretty good," he says, "but I'd sure like to talk to you about one rock you pulled. I disagree with you completely on that one, Kid. I'm sure you didn't mean it the way it sounded, Dave."

This sounded serious and it piqued my curiosity. I asked him what part of the article he meant, but he demurred, saying he'd rather not discuss it on the air. He indicated that he would call me on the telephone, but did not wish to talk about it at present. I told him that I didn't mind his taking issue with what I had written...after all, the objective of a column like mine is to provoke thought and discussion. I never intended to write the sort of mealy-mouthed ambiguity with which everyone would automatically agree. I did not set out writing for 73 merely in order to put down on paper all those things which would justify widely held opinions, merely to bolster them. I added that sometimes an opposite opinion could serve to strengthen a reader's precepts and ideas, thus could serve two opposing viewpoints.

This particular column did not carry anything too terribly controversial, for I was merely trying to show how some topics might be handled innocuously. To be honest, the piece was written more or less jocularly, with no really serious objective in mind other than to illustrate the folly of outlawing particular subjects on the ground that they are in and of themselves unsavory and unwholesome. I thought to myself, "Perhaps he has taken exception to the part about religion. Many persons have rather thin skins on this subject, and consider it improper to discuss at all." When I asked him about this he said that it was not the part about religion.

By this time I was puzzled, and started pumping him. But he would not say anything

more than he had already said. He simply changed the subject and would not "drop the other shoe."

Then I began to feel the pangs of annoyance. Why should I have to listen to what he had to say in the first place? He's not particularly qualified to do more than express an opinion, not being any sort of an expert, so far as I know. I'd gone over the column mentally in order to puzzle out what could have bugged him, but couldn't imagine what it was...unless it was the part about the pig farmer in Secaucus who ran for the

Presidency so often. In my article I alleged that he could not have done worse than some of our recent Presidents, governors, and mayors. Maybe it was that apparent irreverence that annoyed him.

Now that I think of it, I tend to agree with him. I too am annoyed. I'm annoyed at myself for not saying that the pig farmer would have done better than some of our recent leaders!

The other afternoon the educational TV station programmed the new film pro-

duced and directed by Dave Bell W6BVN, entitled *The Ham's Wide World*. I was very much impressed with it, and must confess that it turned out a darned sight better than I thought it would. I don't wish to sound patronizing about it, for it needs no qualifying preface or apologetic foreword to prepare the way for some amateurish or unprofessional home-movie type stuff . . . it is a finished product in every sense of the term.

I was a little irked about its limiting the activities shown to those which are ARRL connected, thus making nonpersons of hams who don't belong to the League. While it is perfectly reasonable for ARRL to depict League activities in any film which it sponsors, it should not be forgotten or overlooked that there are thousands of amateurs, engaged in helpful spheres of hamming, thoroughly in keeping with the spirit of dedication to the public good. This is only a minor point, however, and can be dismissed in view of the overall value of the film.

The best thing about it, to me, is that there are entertainment values in it, which have been all too lacking in its predecessors. Most of the earlier efforts were marred by a certain quality of dreariness. The voice of K4LIB, Arthur Godfrey, is so familiar that any audience can identify with it readily, and he was probably the best possible

AN  
EDITORIAL  
by  
DAVE MANN K2AGZ

## Leaky Lines

1 DANIEL LANE, KINNELON NJ 07405

# HERE'S THE ALL NEW *Clegg 22'er MK II*

2 METER TRANSCEIVER

## WITH THESE EXCLUSIVE FEATURES

- SELF CONTAINED VFO
- SUPER SENSITIVE SOLID STATE RECEIVER
- 40 WATT TRANSMITTER
- HIGH LEVEL MODULATION
- SPEECH CLIPPER
- BUILT-IN AC AND MOBILE POWER SUPPLY
- AMPLIFIED AGC ADJUSTABLE SQUELCH
- COVERS MARS AND CAP



see it at your local dealer's —  
Amateur Net Price \$349.95  
complete with PTT microphone

*e.t. Clegg associates, inc.*

LITTELL RD., EAST HANOVER, N. J. 07936

choice as narrator.

You will probably have an opportunity to see the film since it has been accepted by National Educational Television for showing on all educational channels for the next couple of years. I recommend that you take the time to view it, for it is surely an excellent piece of material which should help to promote good relations between amateur radio and the public.

I've got to level with you about something that's been bothering me since I started writing LEAKY LINES. There have been letters and phone calls . . . even visits, all expressing satisfaction and enthusiasm with my position concerning ARRL's extraordinary lack of responsiveness on certain issues recently.

When this sort of response occurs, it is natural to assume that it will be followed by some sort of action. Such a response signifies a readiness to roll up the sleeves and do a job. It denotes agreement that the League's only chance to become, in fact, what it claims to be, lies in the direction of increased membership activity.

But what have they done? Precisely nothing! That is, all excepting the members of the Atlantic Division, who elected W3EPC, who may just turn out to be the best director in years.

How are the rest of us supposed to match the Atlantic Division? If the only action a member can take is to vote in an election, a lot of people are going to be cooling their heels for a long time. If a member has to suffer the leadership to do anything it wishes, pending the only date on which he can register disapproval, election day, it seems unlikely that anything will be accomplished to effect any improvements. What are we supposed to do until then?

I think the time has come to think realistically about some structural changes in the

League machinery. Is it possible, I wonder, to restructure the League, so as to be able to recall or dismiss persons who are not doing, or show no signs of willingness to be doing, the job they were elected to do? In Britain, whenever there is any sort of disagreement in which the opposing forces are unalterably unwilling to come to a position of compromise, they hold a "vote of confidence," in which the popular support and rectitude of the "ins" is tested in a general election. If the Prime Minister cannot muster support for his program, the other party takes over the reins of government, and names a new cabinet. In this way, although the parties may face periodic crises, the body politic is constantly able to renew and refresh itself, secure in the knowledge that the will of the constituency is being served and gratified.

Perhaps we could establish some similar organizational arrangement in the American Radio Relay League. It would certainly be a distinct novelty to know that the democratic (small d) institution of a two-party system, which works so well for our nation, would guarantee a more equitable situation in the ARRL.

Doubtless, this type of change would result in one thing, at least. It would compel every functionary desirous of retaining his post to pay some heed to the membership, lest he get "dumped." If they did not like what he was doing, they would simply hold an election, and the guy would either shape up or ship out.

I've always admired the British. The main reason, I think, is because of this extraordinary tremendous concept of government, geared and gaited for the benefit of the governed, rather than those who govern. Good system, that.

Till next time, 73  
... K2AGZ

advised by my lawyers that  
ou goons don't ever proofr  
leasy manuscripts from bob  
bench of rocks  
you ignored my comments in  
f insist that you print ev  
should be boiled in oil ov

## LETTERS

### Leaky Lines Feedback

In regard to the Leaky Lines editorial, I found it one of the most fascinating ham radio articles that I have ever read. I saw thru that bunch of ARRL clowns way back in the 50's. I sure go along with your ideas that the commission believes the ARRL is a spokesman for all of us hams, and I fully intend to tell them that I for one am not a fond member of the ARRL; further, I know hundreds of others who feel the same way.

**Kenneth Mahoney K6OPG**  
455 41st Ave.  
San Francisco CA 94121

I think that Dave Mann's ideas are very close to the truth...but I sometimes wonder if the mass of your readers are as fully committed to amateur radio. What I'm trying to say is that I feel that your articles and critiques are causing people to think, and most people don't like to think! If I'm wrong, please correct me.

**Neil Johnson W2OLU**

With reference to Dave Mann's "editorial" (73, February 1970) about QRM from WIAW, I would like to point out to your readers one example of the faulty reasoning found so often in your magazine. It is true that WIAW is just an amateur station, but unlike any other club station, it represents nearly 100,000 amateurs, worldwide. As such, it has special permission to operate transmitters on seven bands concurrently. As it would be impossible to check all frequencies just before transmitting—and we know that such checks are not always accurate, anyway—I would suggest that Mr. Mann's two friends should step aside graciously in the interests of the thousands.

**Al Taylor WB4CTY**  
5722 1st St. S  
Arlington VA

I have just received and read most of February 1970 issue. As I have received and read the first issue and all issues since, I must agree the Feb 1970 issue is one of the greaters. There are numerous articles in this issue and I am glad to see that not only both sides, but most sides are represented.

I must take issue with your Leaky Lines editorial by Dave Mann. It is such articles that have brought much of the things we are not proud of in ham radio today. He says that most all technicians got their licenses by fraud. Who is responsible for this, if true? Certainly not the Tech. Why not call all of the Generals or higher in that give these tests and ask them if the Tech. has a valid license, that they signed their names under oath.

It is a sorry thing that many advanced persons today hate to see anyone less gifted get anything or anywhere. I know of many hams that would rather see a piece of Novice equipment that had gathered dust for years remain so than to help some poor kid trying to get on the Novice band and give him something that will otherwise never be used.

**Harold D. Mohr K8ZHZ**  
5670 Taylor Road  
Gahanna OH

I find that Leaky Lines stuff on said-to-be-taboo topics not very interesting in a ham magazine. I am interested in the subjects all right, but not in a magazine that I regard as a technical gold mine. Speaking for myself, I have never hesitated to discuss anything over the air, and have found plenty of other hams ready to take part.

**Bob Eldridge VE7BS**  
8386 McGregor Avenue  
Burnaby 1, B. C.

### Drumodulation?

Enjoyed the January 1970 issue immensely, especially the article on SSB, AM-FM Modulator by Bill Hayes. Seems though that this article should have been in the April issue. Would like to suggest another method to obtain the same results without using an oil drum. First, the trunk lid should be properly grounded to the car body. Silver-plated finger stock should be fine for this job. Next mount a 10 in. piece of heating duct to the bottom of the trunk. The cavity could then be tuned by banging on the trunk lid with a sledgehammer.

**Wallace WA8OXR**  
5696 Williamson Ave.  
Dearborn MI

You have got to be kidding! In the "SSB AM-FM Modulation System" article, Jan 70, F9 is not kosher for ham use.

What he has got there is most probably F9—depending on how he modulates the subcarrier, either AM-FM or FM-FM as in telemetry and all those Muzak-type SCA systems on broadcast FM. Minimum bandwidth of the signal must be in the subcarrier frequencies; in this case 35 kHz deviation, plus bandwidth of the Subcarrier modulation. Not such a good idea except for the wide-open spaces of two or up. Howsomever, the article rates a nod for the idea on cavities. The idea of trying a 55 gal drum hadn't struck me—trying for a low cost Magic Tee for a one-antenna 2 meter FM repeater. A drum might work!

**Fritz Hervey WB4MSJ**  
Rt. 1 Indian Trail NC

### Comparison

I received my issue of 73 which was excellent as always. I also picked up a copy of CQ at the newstand and this is what I noticed.  
*Number of articles in 73:* 28 technical articles not counting the excellent editorials.  
*Number of articles in CQ:* 9 and these were not all technical articles. Strange thing too about these 9 articles: 5 were by the same two authors, giving me the impression that CQ is hard up for suitable articles and good authors. This is bad enough but the editorials in CQ are all noncommittal and don't state a positive point. CQ is just



# LEARN CODE THE NEW EASY WAY

BEGINNER

NOVICE

GENERAL

Draw Stylus Downward Across  
The Printed Circuit Board Paths

## CODE BOARD

E T I S A H D R M U F B L P O C Q W K N V G J Y X Z

1 2 3 4 5 6 7 8 9 0 . , ? e e e d w k

STUHLMAN ENG. CO.  
Route 126  
PLAINFIELD ILL.  
60544

Produce True Code Sounds  
At Any Desired Speed

**\$9.95**  
post paid

**COMPLETE BOARD · STYLUS · BUZZER · BATTERY**  
Actual size 6 X 10 inches

**\$9.95**  
post paid

send check or money order (no COD's)

## STUHLMAN ENGINEERING CO.

ROUTE 126 EAST

P.O. 236-A

PLAINFIELD, ILLINOIS 60544

wishy-washy in its content and will not take a stand where there might be a chance of getting caught in a corner.

Keep up the good work at 73—you put to shame all the other ham publications put together. Even though I am thousands of miles away, you have my support in any way possible.

Richard J. Molby  
579th Ordnance Co.  
APO New York

### Ham Lobby

You undoubtedly saw the article (on spectrum grabbing) in the December 5th Wall Street Journal. This publicity certainly points up dramatically the need for a PR bureau and lobby for radio amateurs.

Everett T. Plumer Wb6VVT  
1244 Sixth Street  
Santa Monica CA

*The article, "Spectrum Scramble — Airwave Jam Worsens As More Radio Users Demand Frequencies" backed up the editorials that I have been writing about the vital importance of our having a lobby in Washington, yet the ear in Newington seems to be as deaf as ever, and nothing else much seems to be taking shape.*

... Wayne

1984

Being relatively a newcomer to the ranks of radio amateur hamdom, having obtained my license only a year ago, I have carefully studied the situation which exists in the amateur world before plunging in with both feet. Years ago

while yet in high-school, I had sensed something in regards to the ARRL which at that time I could not quite ascertain the nature of. In your battle against the undemocratic nature and scope of this organization, I believe I have been able to pinpoint the factor which gave rise to a "queasy" feeling earlier and remains with me to this day whenever confronted with this organization. In its manner of operation it resembles some of the radio societies in the Red fascist countries. It seems to serve the interests of "Big Brother" far more actively than the rights of the ham. But the, why shouldn't it if it was set up by Big Brother for the sole purpose of keeping control of radio enthusiasts? Instead of trying to instill democratic concepts into an organization which because of its nature can only reject them, would it not be far wiser to organize a new ham organization along the lines of the NRA, AOPA etc? Any new movement though, established while a prior despotic group is still in power, must have as a focusing point a published medium which breathes life and spirit into the soul of the new organization.

Jesse G. Korchmaros WB8CDP  
331 Jackson Drive  
Campbell OH

### Tailored Callsign

When I write to you, it is primarily to announce the event of the year! I've got my call sign, at last.

I got it on my birthday, and it reads LA8PM. Since my name is Per Marienborg, I thought it pretty nice of Televerket (Norwegian FCC).

After having spent my two months summer holiday working, I bought a Sommerkamp FT250 transceiver for about \$350. And a Mosley H-band vertical. In addition, I have a W3Dzz multi-dipole for 80 and 40.

Now, I am QRU on 10 meters almost every day. I may be identified by overmodulation, and the fact that I say Ah..., each third word and Well...about every seventh. I suffer from mike fright.

Per Marienborg LA8PM  
Stovneren. 17  
Hoybraten Norway

#### Helping Hand

The STI Amateur Radio Club (WB9ADF) has undertaken a "Helping Hand" project to assist hams or would-be hams in solving their technical problems. We wish to extend this service to hams in all parts of the world, and particularly to those who are just getting started in ham radio or who are isolated from help. As a technical pool from which to draw solutions, the members are students working toward the Associate Degree in Electronic Engineering Technology, and are hams themselves for the most part, with a highly trained staff of instructors to back them up.

If you feel this project is of a worthy nature, we would appreciate it if you would mention it in a future issue. Inquiries and problems should be addressed to: STI Amateur Radio Club, Sams Technical Institute, Interstate Industrial Park, Fort Wayne, IN 46808.

Jeffrey Stineburg WA9TOJ  
Trustee, STI Amateur Radio Club  
WB9ADF

#### Why?

Why is it that...the only audible station on the entire 20 meter band has an operator who speaks only Esperanto and I have no way in God's world of making contact...the only 9M6 I ever heard was when the XYL gave me the supper ultimatum on the double...the one maritime mobile I really wanted came back to me when my swr bridge took a turn for the worse...the most important phone patch I ever tried was lost in band transition...the one opportunity to impress a VIP resulted in a "no propagation" day...the one last country I have looked for to make 200 was heard by the XYL while I was at work and I have been listening for 2 years while she has just learned how to tune the rig...the one piece of gear I ever bought through advertising was damaged before I got it...the QSLs were sent with an apology for being the wrong color...the YL with the most pleasing voice turned out to be an XYL...the day I was about to trade in my rig was the day I had the best contacts...my neighbor who complained about my interference admitted that his hi-fi broke down and then, when he had it repaired, he complained that he could not hear me: I have had no interruptions from my neighbors ever since I explained that my large antenna (beam) was for color TV...that the pink slips were an attempt to work WAFCC stations...I had failed to achieve this very simple goal.

Ian M. MacDonald DL4MI  
KARLSRUHE  
W. Germany

#### Author Talkback

This letter is in reference to my article (published in the July '69 issue) "A Simple

Effective RTTY Terminal Unit." In this article it was not made clear as to the counting of the pins of the integrated circuits involved. Since I have received so many letters and phone calls from readers who can't make the unit work, and the problem, with only one exception, has been the integrated circuits in the circuit wrong, I would like to point out the correct basing diagrams.

On the  $\mu$ A 710C, the tab is over pin 8 and looking at the bottom view, the pins are counted clockwise in ascending order. On the MC1429G, the pins are counted in the same manner, except that the tab is over pin 1.

As I mentioned, I have heard from quite a few readers who have had minor problems, now I would like to hear from a few who are using the circuit.

C. Warren Andreassen WA6JMM  
3737 King St.  
Lemon Grove CA

#### RG-8 Dummy Load

"Lossy Transmission Lines" by KH6IJ/1 (Feb 70) rang a bell with me: somewhere in the pile of junk I moved down here to the land of warm (?) winters, white likker, and some of the best looking women in the wide world is a hunk of RG-8/U labeled "Federal" which has a grey-ish looking dielectric rather than the usual translucent sort. About 60 feet long, this has long been my "Don't buy surplus line" convincer. Terminated w/50 ohms, fed by any 2 mtr xmtr thru a Bird ThruLine will show, say 10 watts in, NO refl pwr. Move the Bird down to t'other end, feed in same 10 watts, *NOTHING OUT!!!* Repeat Experiment with two Birds, same results. Lossy? You bet! Loss showed up above about 20 MHz, negligible, lower. Experienced same thing with new 7/8" foam line, solid OD: 42 MHz loss 100% Found water in the foam!

Fritz Hervey WB4MSJ  
Box 25006  
Charlotte NC

#### New Church

Now that the impact of this incentive license business is being felt by the majority of radio amateurs, many of us are becoming dismayed by conditions on the portion of the bands we are forced to use. Even some of the old timers have given up amateur radio as a hobby.

I can't see any hope that The Organization will ever do anything for us. Yet they have so many advantages ever over any of the other three amateur publications: They alone have the amateur's bible and sunday school pamphlets; they are the umpires of all the games (contests); they set up the rules on how the games are played. There are no other referees.

As I see it, we need a new church, a new ritual, and above all a new bunch of deacons. Perhaps then we can get back that which was taken from us.

John McFarland  
Port Richey FLA

#### Candid Suggestion

As editor/publisher, you will of course be responsible for everything in your mag, and quite probably a lot not in it. Perhaps you could perforate the page with your comments and the people not liking same can detach and file, while enjoying the rest?

Michael R. Hanna K8UO

# The New Heathkit® 2-KW Linear Is Here (at last)



**New SB-220 . . . \$349.95\***

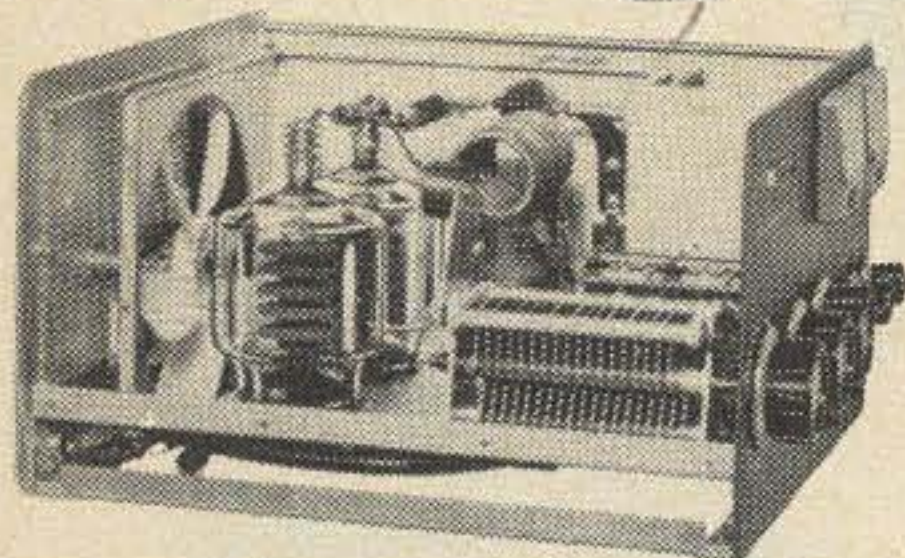

Two rugged, dependable Eimac 3-500Z finals for top performance. Zener regulated operating bias reduces idling Ip for cool running.

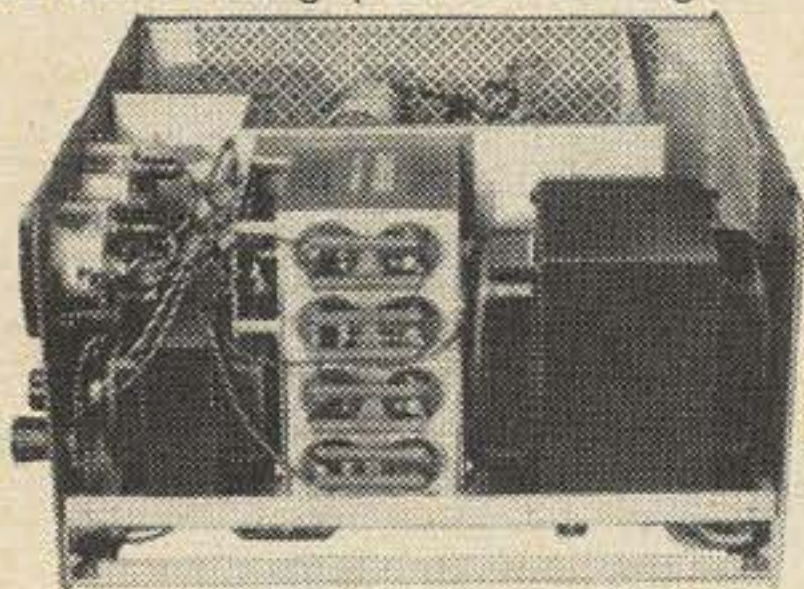

Reliable power supply . . . plate transformer on right, capacitor bank in center for excellent regulation, filament & bias circuitry on left.

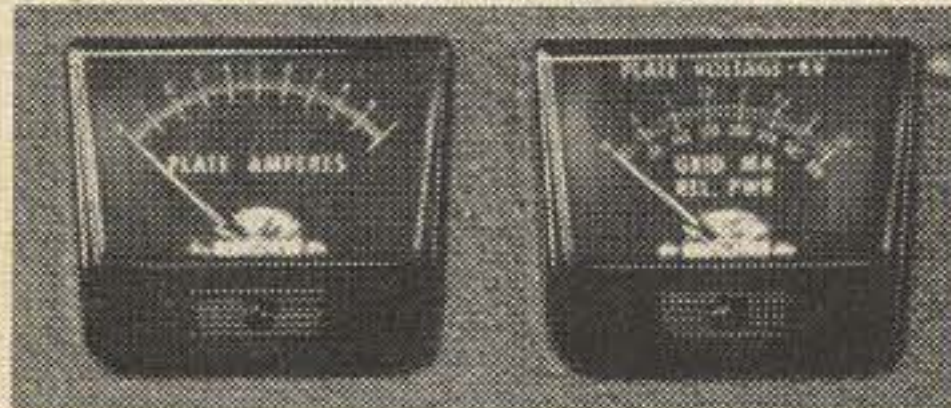

Continuous monitoring of Ip plus switch selected monitoring of Rel Pwr., Ep & Ig.

It's not just a rumor anymore . . . the SB-220 is here, with a price and performance worth the wait.

The New Heathkit SB-220 uses a pair of conservatively rated Eimac 3-500Z's to provide up to 2000 watts PEP input on SSB, and 1000 watts on CW and RTTY. Requires only 100 watts PEP drive. Pretuned broad band pi input coils are used for maximum efficiency and low distortion on the 80-10 meter amateur bands.

**Built-In Solid State Power Supply** can be wired for operation from 120 or 240 VAC. Circuit breakers provide added protection and eliminate having to keep a supply of fuses on hand. Operating bias is Zener diode regulated to reduce idling plate current for cooler operation and longer life.

**Double Shielding For Maximum TVI Protection.** The new "220" is the only final on the market that's double shielded to reduce stray radiation. The heavy gauge chassis is partitioned for extra strength and isolation of components. When you put this kind of power on the air, you'd better be sure. With the SB-220, you are.

**Really Cool Running.** The layout of the SB-220 is designed for fast, high volume air flow, and a quiet fan in the PA compartment does the job. The "220" actually runs cooler than most exciters.

**Other Features** include ALC output for prevention of overdriving . . . safety interlock on the cover . . . easy 15 hour assembly and sharp Heathkit SB-Series styling.

**Tired Of Stumbling Barefoot Through The QRM?** Put on big shoes . . . the new Heathkit SB-220. Another hot one from the Hams At Heath.

**Kit SB-220, 55 lbs. . . . . \$349.95\***

**SB-220 SPECIFICATIONS** — **Band coverage:** 80, 40, 20, 15 and 10 meter amateur bands. **Driving power required:** 100 watts. **Maximum power input:** SSB: 2000 watts P.E.P. CW: 1000 watts. RTTY: 1000 watts. **Duty cycle:** SSB: Continuous voice modulation. CW: Continuous (maximum key-down 10 minutes). RTTY: 50% (maximum transmit time 10 minutes). **Third order distortion:** —30 dB or better. **Input impedance:** 52 ohm unbalanced. **Output impedance:** 50 ohm to 75 ohm unbalanced; SWR 2:1 or less. **Front panel controls:** Tune, Load, Band, Sensitivity, Meter switch, Power CW/Tune — SSB, Plate meter, Multi-meter (Grid mA, Relative Power, and High Voltage). **Rear Panel:** Line cord, Circuit breakers (two 10 A). Antenna Relay (phono), ALC (phono), RF Input (SO-239). Ground post. RF output (SO-239). **Tubes:** Two Eimac 3-500Z. **Power required:** 120 VAC, 50/60 cycles, at 20 amperes maximum. 240 VAC, 50/60 cycles at 10 amperes. **Cabinet size:** 14<sup>7</sup>/<sub>8</sub>" W x 8<sup>1</sup>/<sub>4</sub>" H x 14<sup>1</sup>/<sub>2</sub>" D. **Net weight:** 48 lbs.



## FREE '70 CATALOG

Describes these and over 300 other Heathkits. Save up to 50% by building them yourself. Use coupon and send for your FREE copy!

**HEATH COMPANY, Dept. 11-3**  
Benton Harbor, Michigan 49022

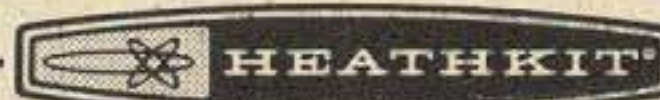

a Schlumberger company

Enclosed is \$ \_\_\_\_\_, plus shipping.

Please send model (s) \_\_\_\_\_

Please send FREE Heathkit Catalog.

Name \_\_\_\_\_

Address \_\_\_\_\_

City \_\_\_\_\_

State \_\_\_\_\_

Zip \_\_\_\_\_

Prices & specifications subject to change without notice.  
\*Mail order prices; F.O.B. factory.

AM-230

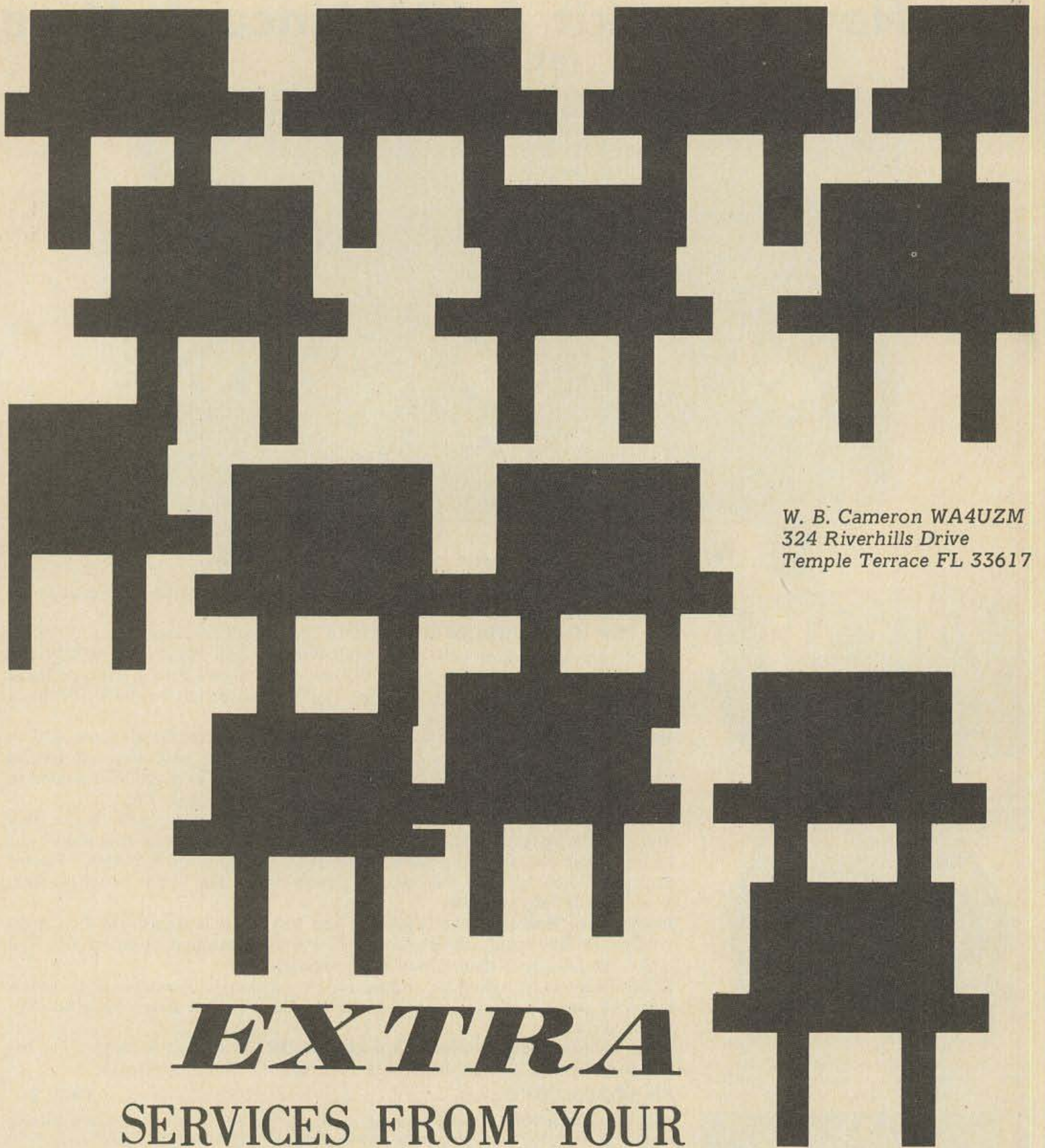

W. B. Cameron WA4UZM  
324 Riverhills Drive  
Temple Terrace FL 33617

## ***EXTRA*** SERVICES FROM YOUR GRID DIP OSCILLATOR

A plug-in adapter turns the oscillator  
into an A1 crystal calibrator . . .

One of the handiest instruments around the average ham shack is the grid dip oscillator, but many hams do not get all of the advantages this little instrument can offer. Most people know that it is useful for finding the resonant frequency of an LC

circuit, or for generating a signal someplace in the range, although it is not quite a substitute for a well calibrated signal generator in this respect.

Many people do not realize that the grid dip oscillator makes an excellent crystal

calibrator as well. The typical grid dip oscillator uses a two-terminal coil and a two-section variable capacitor, connected in the form of a Colpitts oscillator circuit, with the variable capacitor providing the voltage division for proper feedback. This same circuit, with a quartz crystal replacing the coil, becomes a very satisfactory crystal oscillator. In this case, the variable capacitor becomes a trimming capacitor capable of putting the crystal on the proper frequency with considerable accuracy and also allowing a fairly wide latitude higher or lower for checking bandpass.

The meter reading gives an index of crystal activity. What is required is an adapter to match the pins of the crystal holders to the coil socket of the grid dip oscillator. I have made up such an adapter for my particular unit which consists of a 1½

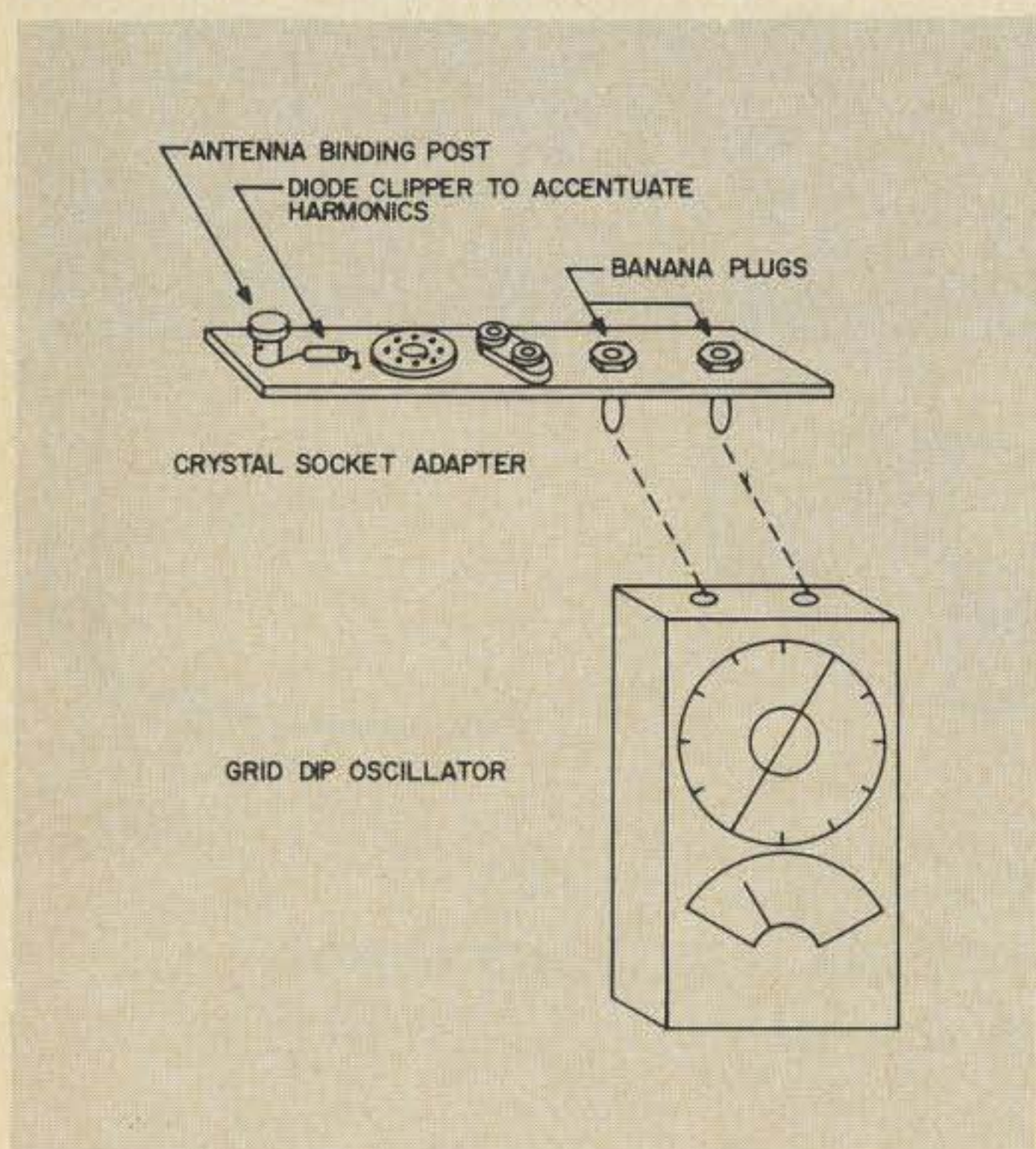

*Crystal socket adapter for grid dip oscillator extends the unit's capability by enabling it to read crystal activity.*

inch by 4½ inch piece of masonite which carries two banana plugs to insert into the oscillator socket, and several different sizes of crystal holders, all connected in parallel, to accommodate any crystals I happen to have around the shack. I carry in my tool kit

various assorted crystals. These give me spot frequencies for band edges and other reference points on all of the amateur bands.

In checking the higher frequency bands, I find it useful to add a diode clipper and have one permanently wired on the same adapter board. This is a 1N69 which simply goes from one side of the crystal to a terminal point at which I can attach an antenna or a lead to the input jack of the receiver. By simply attaching a short length of wire approximating a quarter wavelength at this frequency, I can provide a strong enough signal from the shack to enable me to check out my direction finding loop in the automobile fifty feet away.

In tuning up my 2 meter FM gear, I plug in a 3061.25 crystal (which is the transmitter oscillator crystal for my Link 2m FM unit) and then couple from the 1N69 to the input of the receiver. This provides a signal stronger than most of the local signals on the band, and adequate for initial tune-up. For finer adjustment of the i-f strip, I clip the lead from the 1N69 to the chassis close to the antenna input jack and the leakage provides a signal of the order of .2  $\mu$ V, which is useful for final adjustment of the critical tuned circuits, the squelch control, and others. For best results, I leave the oscillator and the receiver on for a half hour or so to warm up, and then with the variable capacitor in the grid dip oscillator, I zero-beat the incoming signal of a station generally considered to be on frequency. Once this is done, I have a signal source on the bench with which to check the receiver for passband balance as indicated on the microammeter connected to the discriminator output.

One thing which could be added to increase the utility of the instrument is some form of modulation. It would not be too hard to add an outboard modulator connected to the oscillator through pin jacks or some other means. I have not done so simply because I happen to have a modulated signal generator in the shack.

... WA4UZM ■

Michael Windolph K8YUC  
3649 East 65th Street  
Cleveland OH 44105

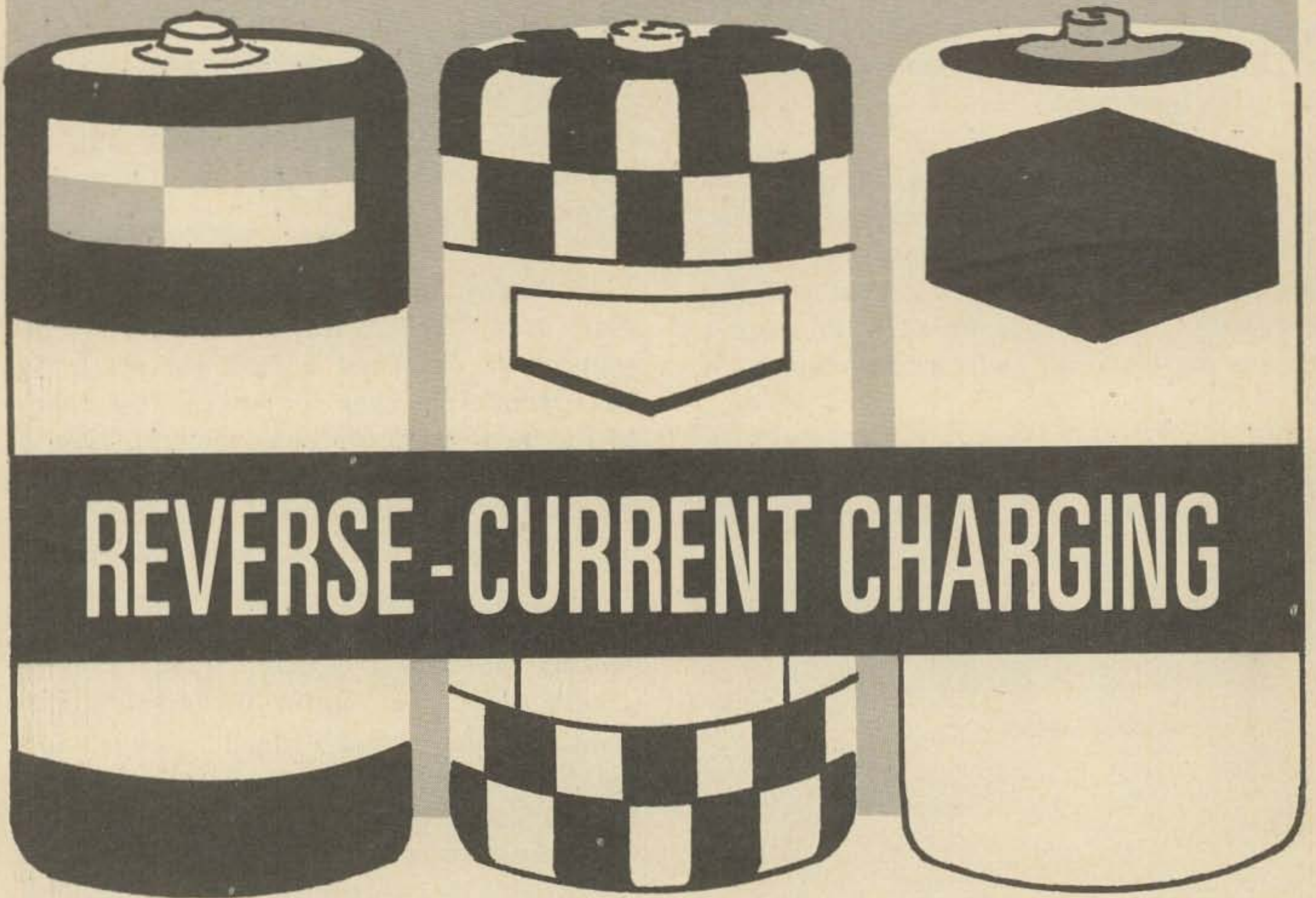

## REVERSE-CURRENT CHARGING

With an almost foolishly simple technique you can successfully recharge ordinary dry cells — and make them hold the charge — again and again!

Do your kids continually pester you with their battery-operated toys that don't work any more because the batteries are dead? Or do you use a flashlight or other battery-operated gadget often enough yourself that you wish you could afford rechargeable cells? Maybe this article can provide the necessary relief without any extra strain on your pocketbook.

Would you believe you could make a better battery charger? How about one that can charge at twice the usual rate or more, without damage to the battery? Or one that can charge, *really* charge the ordinary flashlight battery even higher than its bought-new charge?

It can be done! The process was invented in 1954 by Ernst Beer of the Netherlands

and bears patent number 2,752,550. Recently tested by Donald J. Vargo of Lewis Research Center in Cleveland, the process resulted in a better mousetrap — it really did the job better!

Although normal flashlight batteries will give, in a lifetime, about 2 or 3 A-hr of current (at 250 mA drain), with this new technique of recharging, some have given 30 to 40 A-hr and are still going strong!

Such claims sound fantastic — but try it before you decide it's impossible. It is quite a simple discovery and one that is not yet fully explained. But it works. Chemists are not really certain of all the chemical changes taking place in the normal battery. Theoretically, the chemical changes taking place when a cell is discharged should be reversed when the cell is charged. But this theory does not take into account an effect called "polarization," which tends to restrain the reaction. Besides, it has been found that with the ordinary dc charging technique the zinc of the regular LeClanche (flashlight) battery does not just migrate back to its proper place. It tends to clump up and form crystals or spikes of zinc on the negative electrode. Then further discharging thins out even more the zinc between clumps and you soon have holes in the zinc. Your cell dries out and you have a dead battery.

The discovery of Mr. Beer was a way to get the zinc to return to the negative electrode in an even layer instead of in clumps. This he accomplished by putting a small reverse current through the cell at the same time he was charging it. No one as yet has figured out just why this works but tests indicate that the reverse current seems to serve as a depolarizer. At any rate, it improves the efficiency of the charge many times.

In electroplating, this technique is used and results in much smoother, hard and even plating. Another effect of this higher efficiency in charging is that one can charge a cell at a much faster or higher rate without the cell heating up. With flashlight cells the only condition is that the cell not be already dead. Nickel-cadmium cells, of course, can

be completely discharged and will still accept a charge.

It is best to recharge a carbon-zinc (flashlight) cell before it has dropped below 1.3V. After this point, the cell soon develops holes in the zinc with consequent drying out and deterioration. However, it was found that even a cell with some very small holes could be rejuvenated because the zinc is recoated so as to actually seal up the small holes! A lead-acid cell which would accept no more than a 50% charge by the ordinary technique was built up to a complete charge by alternately charging and discharging with this new circuit until it was up to full capacity.

The circuit is simplicity itself. All that is necessary beyond the diode rectifier and the resistor (or capacitor used as a reactance-type resistor) found in the cheapest recharger, is another resistor across the rectifier. This second resistor allows some ac to flow through the cell and so the technique is called asymmetrical alternating-current charging. It has been found to work best when about 10% of the forward current is allowed to flow backward in the circuit. You can easily calculate the necessary resistance.

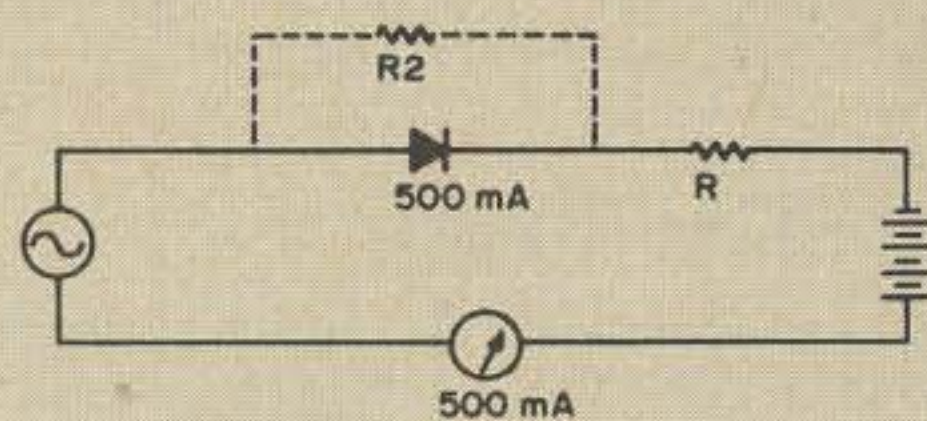

Fig. 1.

First set up your circuit as in Fig. 1. By trial and error figure out the resistance of R. Do this by deciding how much charging current you want; e.g., for a typical nickel-cadmium cell, you might choose the 100 mA they are usually rated for — or about the same or more for an ordinary flashlight cell. Begin by using a high resistance at R. This depends

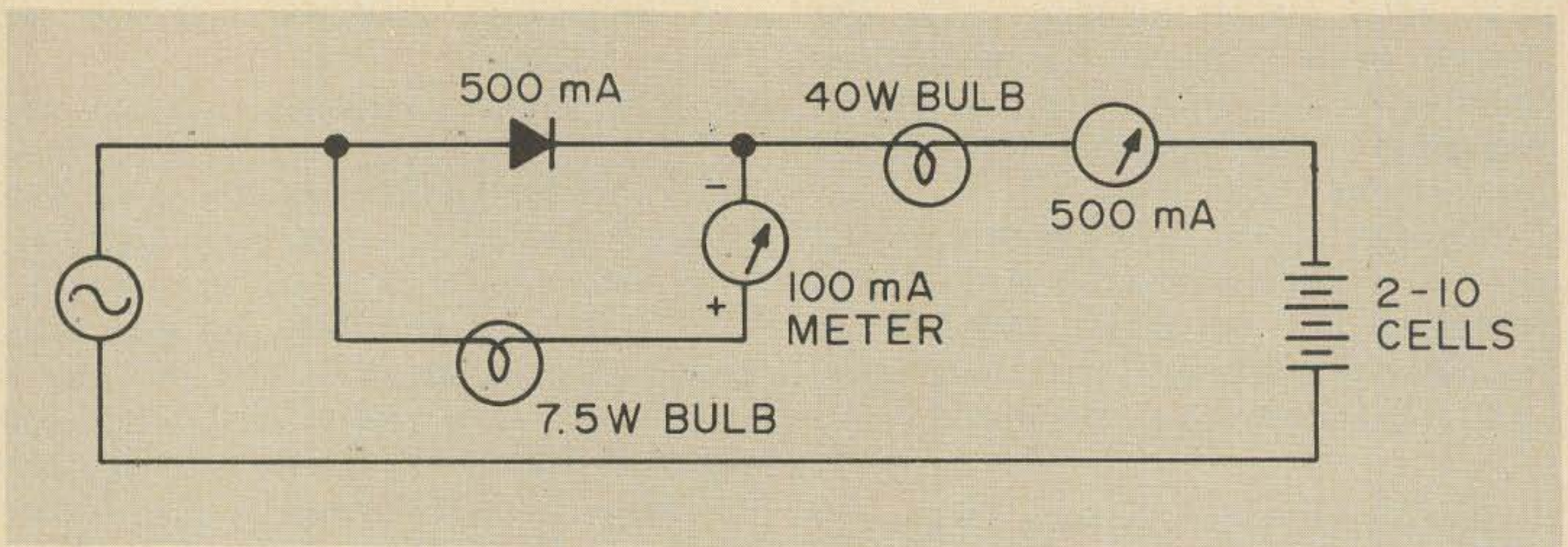

Fig. 2

on your ac source; if you use 117V you could try a 10W light bulb in series, but with only 25V or so from a transformer you could get by with a few thousand ohms to begin with. Then gradually reduce the resistance (or use a higher wattage light bulb) till the meter shows about 100 mA. Remember, the resistance has to be able to carry 100 mA, so use one of adequate rating.

Next, multiply R by 10 and place the corresponding resistor across the rectifier and you're finished. Make it big enough to carry the 10 mA of current it will be drawing in reverse. Or if you like to use trial and error, you can try different resistors at R2 also, starting with one at least 10 times greater than R and reducing it till you get the 10 mA reverse current. Remember, this is *reverse* current, so connect your meter leads accordingly.

As previously stated, this system allows recharging at a much higher rate than ordinary chargers, and without overheating a cell, I recharge my 100 mA nickel-cadmium cells at 275 mA with about 30 mA reverse current flowing. Figure 2 shows the circuit of my complete battery charger using this new technique, along with an added refinement. Due to the 117V source current and the current-dropping light bulbs, this circuit enables one to charge anywhere from 2 to 8 or more cells in series at one time without changing the circuit at all for each cell I add to the circuit. This is because the line voltage with only the bulbs in series produces an essentially constant-current source for the rectifier and any number of cells. Actually, by bulb ratings one should use a 4W bulb to

go with the 40W bulb, but according to actual current drawn, the 7.5W bulb proved a better match to draw 10% of the forward current.

The meters are not necessary, of course. Once you measure and obtain the current you want, or just use this circuit as is, the meters are no longer needed unless you want to be sure current is being drawn. With this circuit you will draw about 275 mA through from 2 to 8 nickel-cadmium cells. If you use ordinary flashlight cells there will be less current as carbon-zinc cells have more internal resistance than nickel-cadmium cells.

The best way to determine length of charge is to figure the normal capacity of the cell and charge accordingly; a 1 A-hr cell, for example, could be charged at 250 mA for about four or five hours. Cells have been left for days in this charging setup without any apparent damage, so don't be too concerned over a few extra hours.

Another way to check charge is to measure the voltage across the cells. Towards the end of a full charge the voltage will rise. Ordinary flashlight cells, if new, can be charged to almost 2V each. They lose the extra voltage soon afterwards but it is an increase of energy that no common charger will give.

So, dig out all your dying batteries and see which ones are capable of a lot more life.

... K8YUC ■

Source: "Brief Investigation of an Asymmetrical Alternating-Current Battery-Charging Technique" by Donald J. Vargo — Technology Utilization Office Lewis Research Center, Cleveland, Ohio.



# NEW NCX-500 only \$249.<sup>95</sup>



- All factory fresh material
- Full six months' warranty offered
- No trades considered
- Bank Americard, Master Charge and American Express accepted; Financing available through GECC
- Special overseas prices available

#### PRICE SCHEDULE

NCX-500 w/AC500 . . . . .	\$299.95
NCX-500 w/NCXB (spkr & cab inc) . . .	319.95
NCX-500 w/Linear Systems 400-12 . . .	359.95
NCX-500 without supply . . . . .	249.95
XC-28 plug-in solid state crystal calibrator (available 1 March) . . . . .	19.95

#### SPECIFICATIONS:

**Frequency Coverage:** 3500-4000 kHz, 7000-7300 kHz, 14000-14500 kHz, 21000-21500 kHz, 28500-29100 kHz (2 additional crystals available at \$7 each to provide expanded coverage of entire 10 meter band).

**Power Input:** 500 watts PEP on sideband, 360 watts on CW, 125 watts on AM, D rated 20% for mobile operation.

**Emission:** SSB upper on 10, 15 and 20 meters; lower on 40 and 80 meters.

**Output Impedance:** 40-60 ohms minimum pi network.

**Receiver Offset Tune:** By means of a varactor controlled oscillator you obtain plus or minus 3 kHz.

**SSB Generation:** Crystal lattice filter 6-50 db shape factor 2.2-1, gate 2.8 kHz on 6 db, center frequency 5.202 mHz; uses stable solid state ring modulator.

**Dial Calibration:** 5 kHz on all bands.

**Tuning Ratio:** Excellent mechanical resolution with 45-1 rate.

**Electrical Stability:** Nominally 1500 cycles in first 30 minutes thereafter plus or minus 400 cycles for room ambient.

**Suppression:** Carrier minus db, rejected sideband minus 40 db, third order products minus 30 db at full output.

**Sensitivity:** .5 microvolt for 10 db s/n in ss mode.

**Audio Output:** Better than 2 watts into 3.2 ohms.

**Metering:** PA cathode current on transmitter. 5 units on receive.

**Special Features:** Includes side tone monitoring plus built-in code practice oscillator for Novices; incrementation toning, provision for crystal calibrator.

**Dimensions:** 6<sup>3</sup>/<sub>16</sub>" high x 13<sup>3</sup>/<sub>16</sub>" wide x 11" deep. Weighs but 15 lbs.

**Accessories Available:** AC-500 supply, 21 lbs.; NCX-A deluxe supply, 25 lbs.; 400-12 mobile DC supply, 13 lbs.; AC supply operates on either 117 or 234 VAC 50-60 cycles; suitable for export. Mobile bracket furnished at no extra charge.

**Shipments:** Prefer via United Parcel Service, Railway Express or Parcel Post. Specify and include provisions for same otherwise charges will go COD.

# NEW CLEGG 66'er \$175.<sup>00</sup>



**RECEIVER:** Dual conversion with 10.7 MHz 1st IF and 456 kHz 2nd IF; sensitivity better than .35  $\mu$ V for 10 dB S+N/N; selectivity 8 kHz; frequency coverage 49.9 to 52.1 MHz; drift less than 3 kHz per hour after 20 minute warmup; spurious responses down more than 60 dB; AGC provides more than 10 dB compression for 40 dB signal increase; squelch threshold adjustable; switchable ANL; audio output greater than 2 watts; speaker built in.

**TRANSMITTER:** 22 watts input, output 52 ohm; high talk power performance; harmonic outputs down more than 50 dB; spurious outputs excluding harmonics down more than 66 dB; exciter stages are broadband and multituned for quick OSY; ptt operation; audio response 300 to 3000 Hz  $\pm$ 3 dB; operated with 8.3, 12.5 or 25 MHz crystals or external VFO; spotting switch for transmitter frequency checks; built-in solid state power supply for both 115 volt AC and 12 volt DC operation; compact: 12"W x 12"D x 6<sup>1</sup>/<sub>2</sub>"H; 19 lbs.

\*ALL PRICES FOB HARVARD, MASS.  
**HERBERT W. GORDON CO.**

Woodchuck Hill Rd., Harvard, Mass. 01451 (617-456-3548)

Donald L. Milbury W6YAN  
Box 463  
West Covina CA

# A Poor Man's Frequency Meter

How to turn a few cheap surplus sows' ears into a satin handbag.

While the FM'ers may be the only hams around who make a religion out of being precisely on frequency, virtually *all* active amateurs have a need for a frequency meter periodically. Well, this may come as something of a shock to some, but there *is* a way to measure frequency accurately without the use of expensive equipment. With a handful of parts and a few items found commonly around the radio shop, you can build the *poor man's frequency meter*, which is capable of tolerances that should amaze you.

This is *not* a substitute for a good frequency meter for commercial use, but if you have a limited number of frequencies that you want to be "dead on," this may be the answer. And it ought to be a must for the group of fellows who maintain the local FM repeater.

A nice feature of the *poor man's frequency meter* is the fact that it puts to use that old surplus military communications receiver which has undoubtedly been sitting around in a dark corner of your basement under piles of old magazines and discarded dynamotors. It also uses any old commonly available surplus wideband FM receiver, such as the types advertised in this issue of 73.

The idea is not new; hams in the two-way business will recognize it as the system that has been used for many years for the

Motorola station monitor and various other common applications. Basically, it is composed of four major units:

- Receiver converter with calibration oscillator constructed on a high-band front-end deck from an old Motorola Sensicon A receiver chassis.
- Monitor receiver (any 150 MHz wideband receiver); a low i-f of 455 kHz is best.
- WWV receiver (here is where the surplus communications receiver comes in).
- Accessory items (hang a modulation meter on it).

The block diagram of Fig. 1 shows how the individual items of equipment are interconnected to form the frequency meter. Note that although a narrowband receiver can be used, a more dependable "off frequency" indication is obtainable with a wideband i-f receiver. Periodic calibration (before use) to WWV is recommended for high accuracy measurements; however, the unit will maintain its operating frequency to within 1 kHz (an error of 0.0006%) for an ambient temperature within the range of  $-20^{\circ}\text{C}$  to  $+60^{\circ}\text{C}$ .

## Principle of Operation

The frequency converter operates on the heterodyne principle. A station frequency is

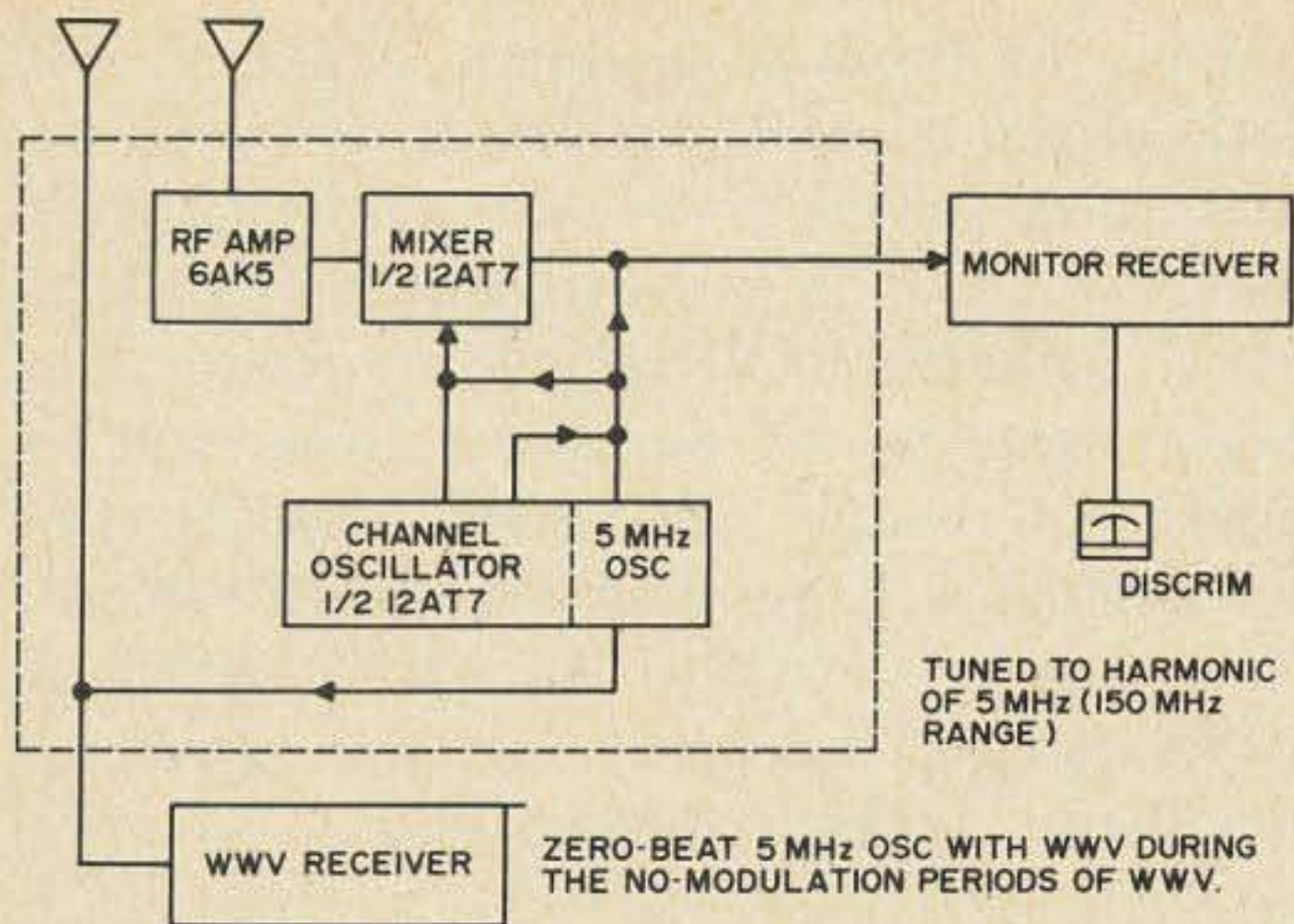

Fig. 1. This system block diagram shows how equipment should be interconnected to make the frequency meter setup.

monitored by heterodyning its carrier with the output frequency of the crystal oscillator and then feeding the resultant frequency of these two signals into the calibrated monitor receiver. If the beat frequency between the crystal oscillator signal and the monitored carrier is exactly equal to the frequency to which the receiver is aligned, the discriminator meter will indicate zero. If the beat frequency is lower or higher in frequency than the one to which the receiver is aligned, a direct indication of carrier frequency error in the monitored transmitter will be given on the meter.

The monitor receiver is aligned to a predetermined frequency. The specific frequency used will depend upon the spurious harmonics emitted by the channel crystals

which will be required to monitor the specific carrier channels in consideration, plus the operating frequency to be measured.

The beat frequency fed to the control receiver may be either the sum or difference frequency of the channel crystal frequency and the monitored carrier frequency. Channel crystals for operation in the range from approximately 1.6 to 12.5 MHz may be used.

#### Calibration Oscillator

The calibrating oscillator consists basically of an rf amplifier stage, a mixer, and an oscillator. The calibrating crystal, shunted by a trimmer capacitor for any minor adjustment of oscillator frequency, is used for calibrating the monitor receiver.

Although the crystal is temperature controlled, a *greater degree of accuracy is obtainable without the use of the heater*. The trimmer capacitor provides *exact* calibration of the crystal frequency at any temperature by zero-beating the oscillator against the WWV signal.

The crystal heater should be used *only* when a quick check is necessary; such as, where it is desired to quickly bring the crystal to a temperature that would eventually be reached due to the heat dissipation of the equipment.

The control receiver may operate in the 145-160 MHz range; therefore, when using a 5 MHz calibration crystal, the 29th, 30th, 31st, or 32nd harmonic of the 5 MHz crystal

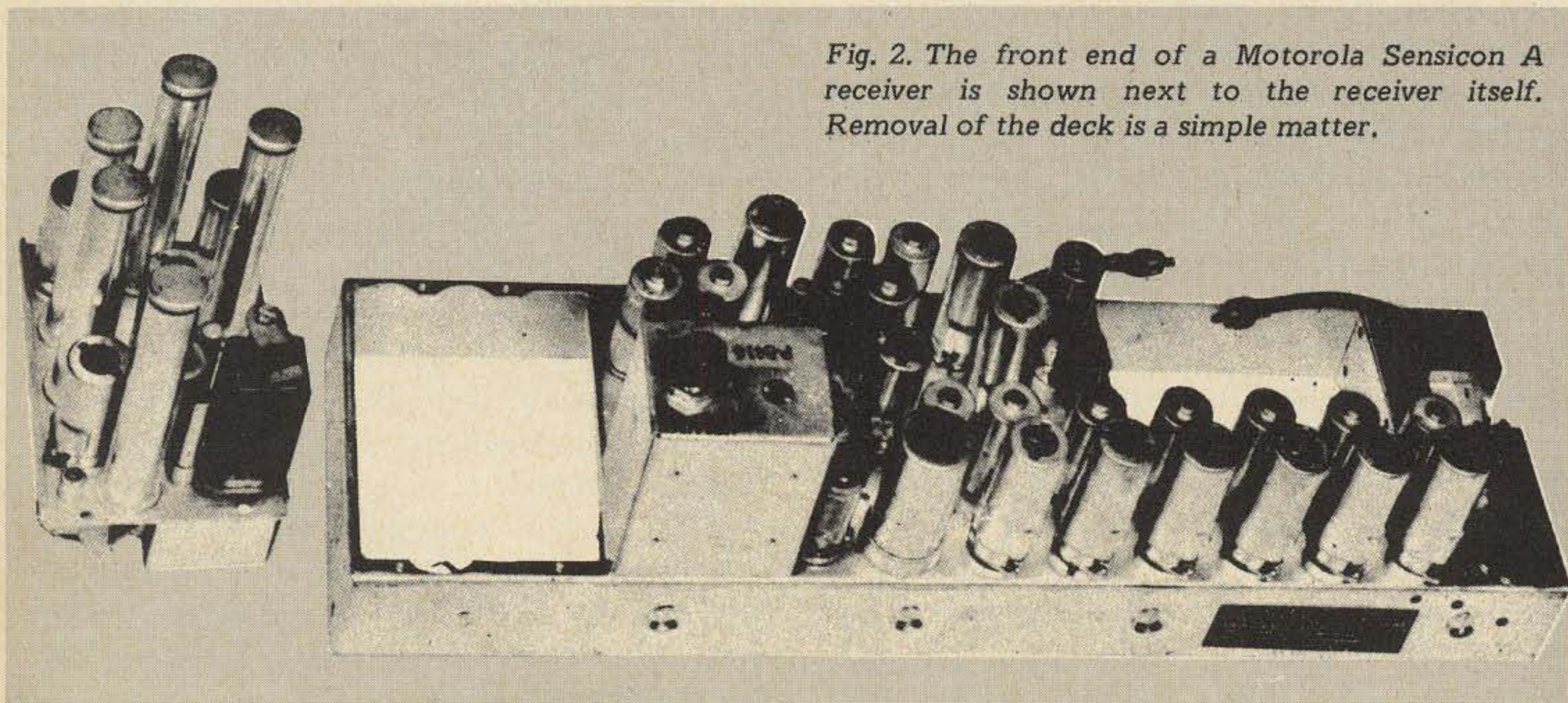

Fig. 2. The front end of a Motorola Sensicon A receiver is shown next to the receiver itself. Removal of the deck is a simple matter.

frequency is used to calibrate the receiver to 145, 150, 155, or 160 MHz.

The selector switch operates in conjunction with the calibrating oscillator. This switch may be used to select any one of several crystals as the frequency controlling element of the oscillator. These crystals include the 5 MHz calibration crystal and the five channel crystals.

One half of a 12AT7 tube is used as the oscillator while the other half of the tube

frequency to produce an input signal of 150 MHz at the control receiver. In this case, no indication will be given by the discriminator meter. If the monitored transmitter carrier is above or below its designated frequency, the input signal to the monitor receiver will be above or below 150 MHz, causing the discriminator to produce an output voltage. This voltage is fed to the meter, which is calibrated in kilohertz to give a direct reading of carrier frequency error.

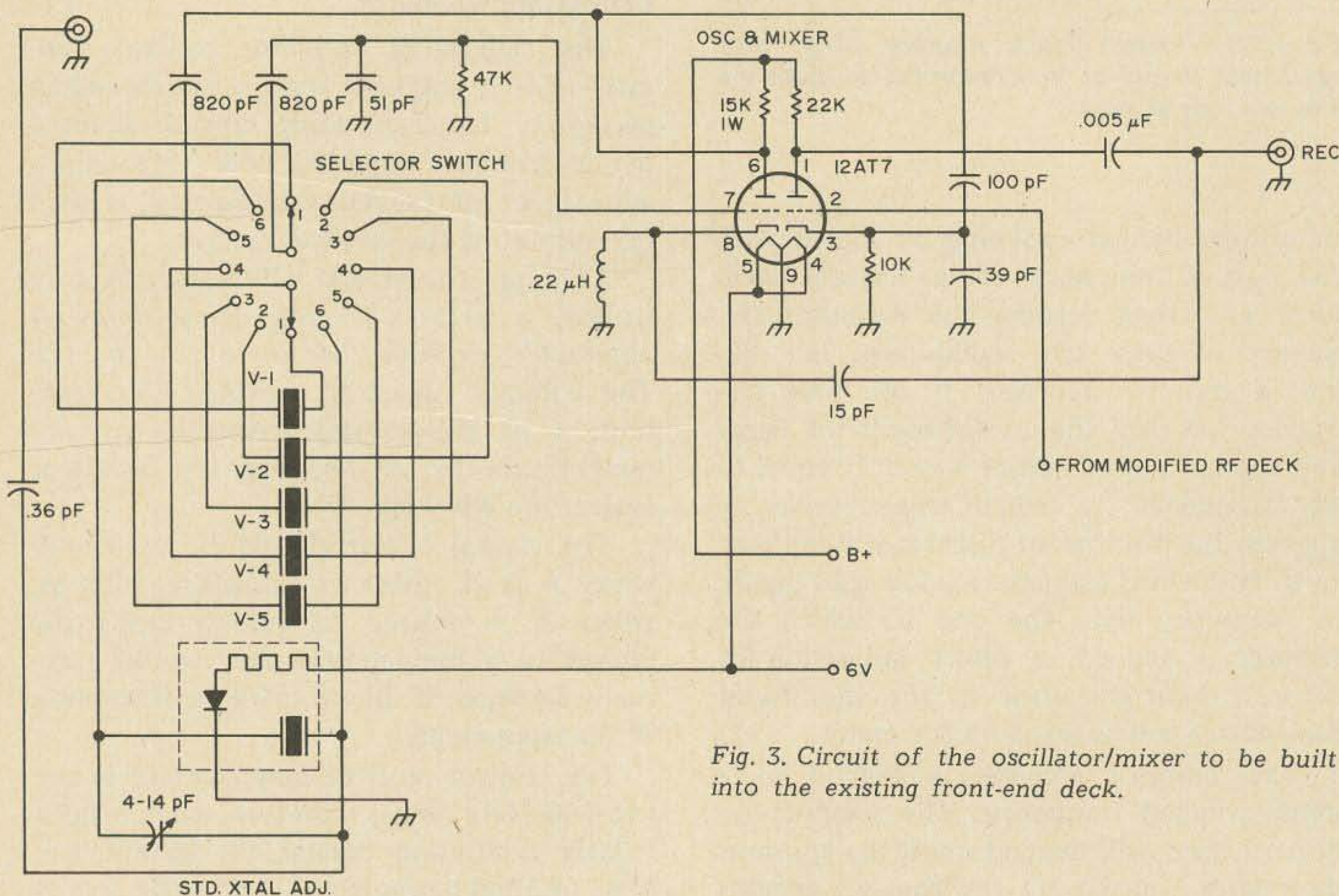

Fig. 3. Circuit of the oscillator/mixer to be built into the existing front-end deck.

functions as the mixer. The carrier frequency to be monitored is picked up by the VHF antenna, amplified by the 6AK5 amplifier, and then mixed with the selected channel crystal frequency. The output of the mixer is fed to the calibrated monitor receiver where it is determined if the transmitted carrier is on frequency.

Assume that it is desired to monitor the output of the transmitter which is operating on 146.94 MHz and that the control receiver has been calibrated at 150 MHz. The necessary channel crystal frequency will be the difference between 146.94 MHz and 150 MHz, or 3.06 MHz. If the transmitter is on frequency, the 146.94 MHz signal will mix with the 3.06 MHz channel crystal fre-

When monitoring transmitters which operate in the 420-450 MHz band, the monitor must be placed so that the monitor antenna is within a few feet of the transmitter. For this application, the frequency of the stage preceding the final tripler is monitored. This is done by selecting a difference frequency crystal for the monitor which, when beat against the frequency of the transmitter stage preceding the tripler, produces the frequency at which the control receiver is tuned.

Say that it is desired to monitor the output of a transmitter operating on 443.75 and that the monitor receiver is calibrated at 150 MHz. The channel crystal frequency is determined as follows:

$443.70 \div 3$  (tripler) = 147.90  
(frequency actually monitored)  
 $150 - 147.90 = 2.1$  MHz  
(channel frequency crystal)

If the transmitter is on frequency, the frequency of the stage preceding the final tripler will mix with the 2.1 MHz channel crystal frequency to produce an input signal of 150 MHz at the monitor receiver. In this case, no indication will be given by the discriminator meter. If the monitored transmitter carrier is above or below its designated frequency, the input signal to the monitor receiver will be above or below 150 MHz, causing the discriminator to produce a positive or negative output voltage. This voltage is fed to the discriminator meter *which can be calibrated to give a direct reading of carrier frequency error.*

Any error in carrier frequency indicated on the discriminator meter is an error in the frequency of the stage preceding the tripler; therefore, the error in the transmitter signal from the final amplifier will be three times as great. When using this method of monitoring, check the output (420–450) of the transmitter with a reliable wavemeter to ascertain that proper frequency multiplication is made.

#### Channel Crystal Accuracy

Since the fundamental frequency of the channel crystals is used, any error in crystal frequency is not multiplied. Therefore, the error in monitoring a frequency by this method is very small. Crystals are held to within 0.002% of the specified frequency over the ambient temperature range of  $-30^{\circ}\text{C}$  to  $+60^{\circ}\text{C}$ . Therefore, with the previous 2 meter example, the maximum frequency error of the 3.06 MHz crystal would be  $3.06 \times 0.0020\%$ . At the frequency being monitored, the percentage error would not be discernible on the meter.

The "improvement factor" of possible percentage accuracy at the channel crystal frequency over the percentage accuracy at the carrier frequency is approximately the same ratio as the monitored carrier frequency over the channel crystal frequency, or  $146.94/3.06$  equals 48. This is another way of stating that the channel crystal is more than 48 times as good percentage-wise

at the monitored frequency than at its fundamental frequency.

The improvement factor may be checked on any channel by the above method. It will always remain reasonably high; therefore, the possible error of the channel crystal frequency is negligible.

The front end deck of a Motorola Sensicon A receiver provides an ideal converter for the *poor man's frequency meter*. Figure 2 shows this assembly as a separate unit as well as in its original form installed in a Motorola Sensicon A receiver. The part numbers referred to in the modification procedures described here are those part numbers called out in the Motorola manual for the Sensicon A 150 MHz receiver. The procedure is quite simple, too. Here is all you do:

1. Replace R102 ( $2.2\text{M}\Omega$ ) with  $3.3\text{M}\Omega$  and ground low side.
2. Remove C104.
3. Replace R103 ( $33\text{ k}\Omega$ ) with ( $470\text{ k}\Omega$ ).
4. Replace L101 with a  $100\text{ k}\Omega$  resistor.
5. Remove R112 ( $3.9\text{ k}\Omega$ ), complete B+ circuit.
6. Replace X102 with 9-pin socket (with shield).
7. Remove wire from pin 1 and connect to pin 2.
8. Connect  $1\text{ M}\Omega$  resistor from pin 2 to ground.
9. Wire 12AT7 socket for 6V filaments. (Connect 6V to pins 4 and 5, and ground pin 9.)

This completes the modification of the rf amplifier. To construct the oscillator/mixer, remove the balance of the circuitry on the deck with the exception of the crystal socket. Then build the circuit as shown in Fig. 3 around the new X102. Be sure to use silver mica capacitors in the crystal circuits. The crystals themselves are Motorola SFMT-2 (R11, 5 MHz), and they may be obtained from Sentry or International.

The Sensicon A receiver is found in a number of the older, less expensive Motorola FM units, such as the 40V, the early 41V, and all Model series bearing the AAV and AAD suffix. These are available from New-some (Detroit), Mann (Tarzana, Calif.), C & H (Long Beach, Calif.), and Gregory (Saddlebrook, N.J.).

... W6YAN ■

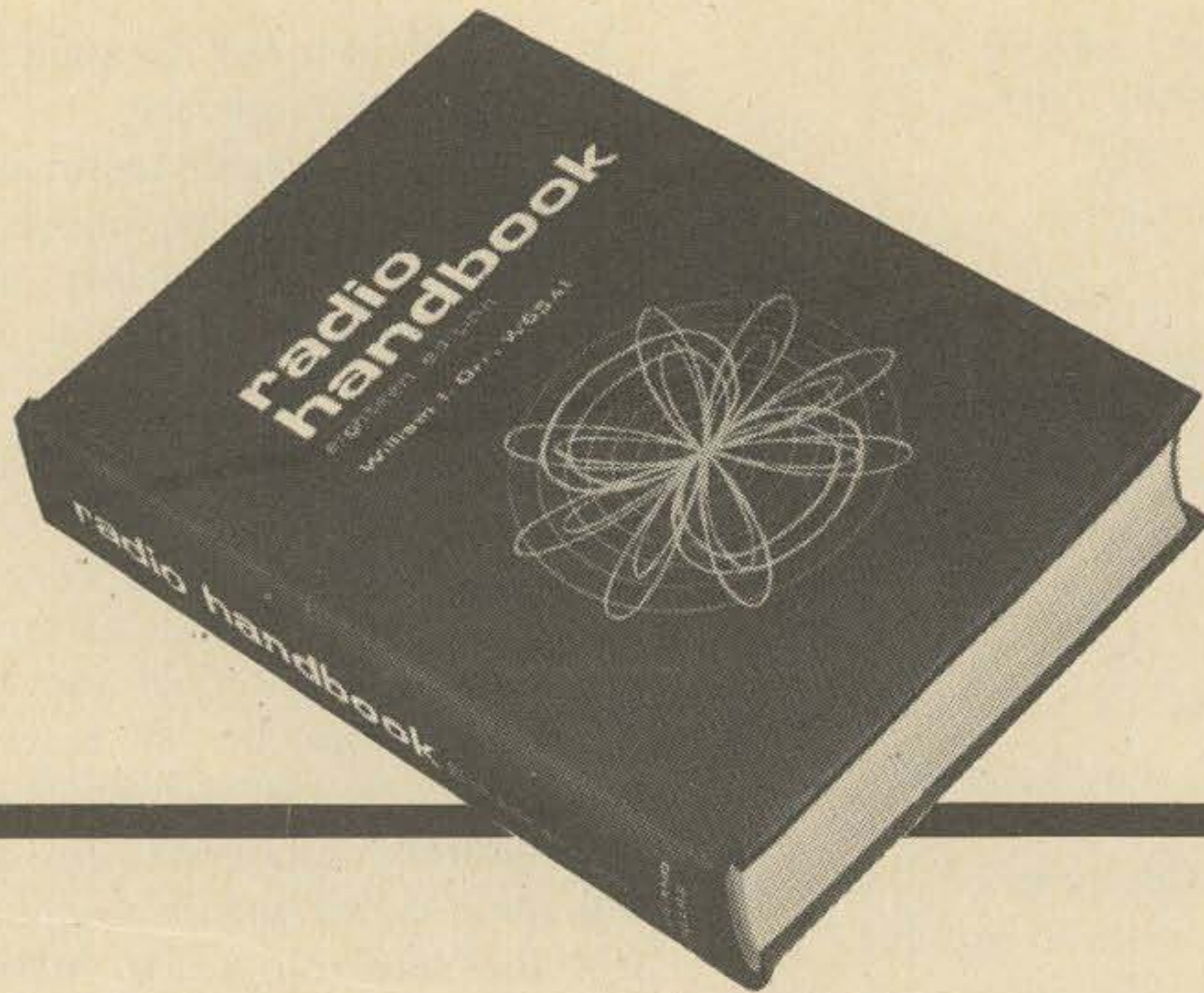

# NEW 18TH EDITION OF THE FAMOUS E&E Radio Handbook

by WILLIAM I. ORR, W6SAI

*biggest selling book for the amateur*

Completely revised and updated. This is the comprehensive communications manual which is the industry standard for radio amateurs, electronics engineers, and technicians. Explains in authoritative detail how to design, build, and operate all types of radio-communications equipment.

## LATEST HOW-TO-BUILD DATA

The new 18th Edition of the famous Editors & Engineers RADIO HANDBOOK presents complete design data on the latest transmitters, receivers, transceivers, amplifiers, and test equipment. Covers SSB design and equipment, RTTY circuits, and latest semiconductor circuits, as well as IC's. Also includes coverage of r-f feedback amplifiers and special-purpose and computer circuitry. All equipment described is of modern design, free of TVI problems.

Order from your electronic parts distributor or bookstore, or send coupon.

## COMPLETELY UPDATED—INVALUABLE

Provides a complete understanding of the theory and construction of all modern circuitry, semiconductors, antennas, power supplies; full data on workshop practice, test equipment, radio math and calculations. Includes aspects of the industrial and military electronics fields of special interest to the engineer and advanced amateur. The 18th Edition of the RADIO HANDBOOK provides the broadest coverage in the field—complete information on building and operating a comprehensive variety of high-performance equipment. All data is clearly indexed. 896 pages; 6½ x 9¼"; hardbound.

No. 24020. RADIO HANDBOOK 18th Ed., only \$13.50



**EDITORS and ENGINEERS, Ltd.**

Howard W. Sams & Co., Inc., Dept. 73-3  
4300 W. 62nd St., Indianapolis, Ind. 46268

Send me \_\_\_\_\_ copy (ies) of the new 18th Edition  
RADIO HANDBOOK.

\$.....enclosed.  Check  Money Order

Name \_\_\_\_\_

Address \_\_\_\_\_

City \_\_\_\_\_

State \_\_\_\_\_

Zip \_\_\_\_\_

Ken Sessions K6MVH/1  
RFD 2  
Peterborough NH 03458

# *Professional* PCs *from roll-your-own* *"negs"*

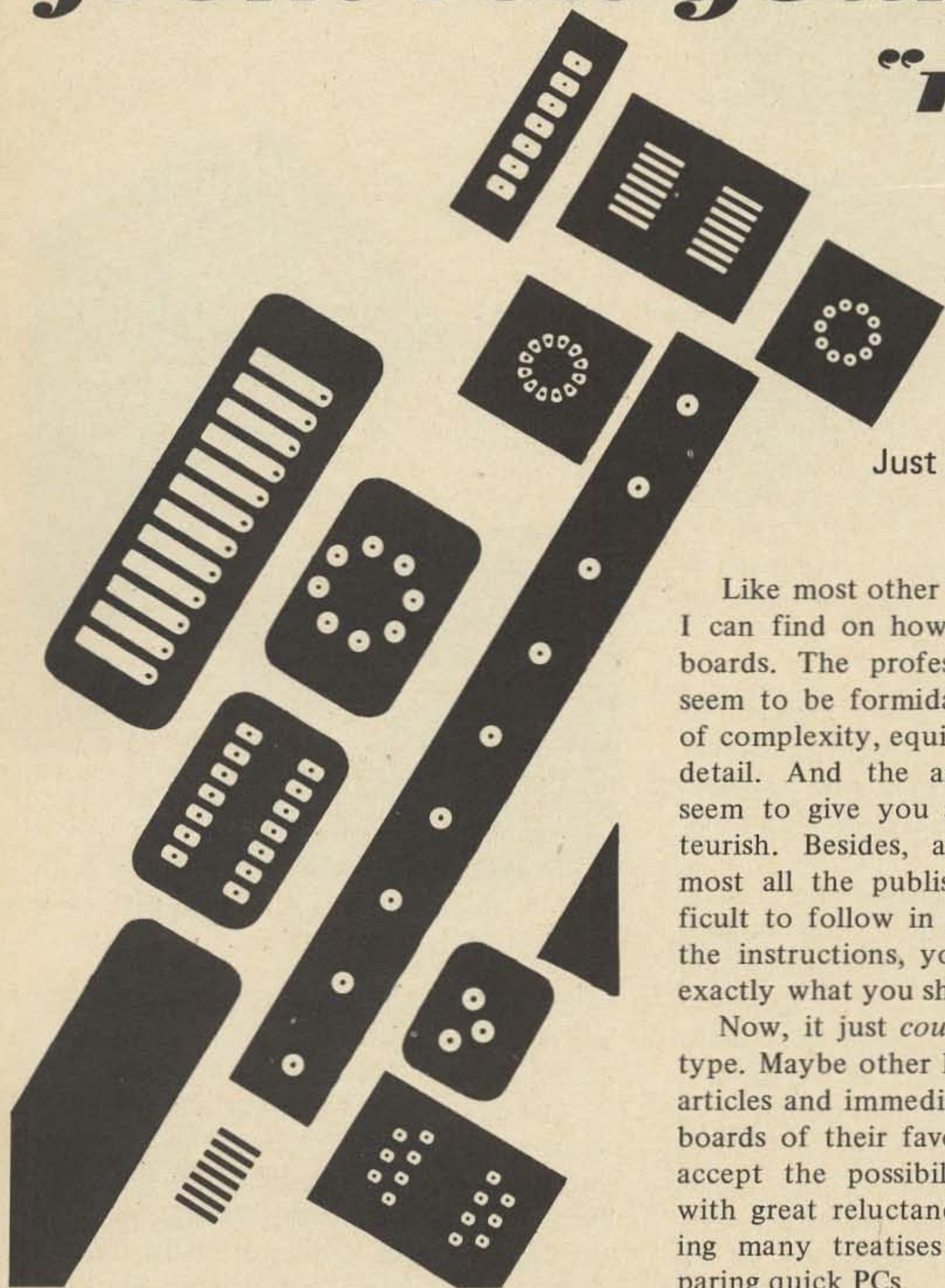

Just the thing for the  
next club project!

Like most other hams, I read every article I can find on how to make printed-circuit boards. The professional processes always seem to be formidable from the standpoint of complexity, equipment requirements, and detail. And the amateur methods always seem to give you a board that *looks* amateurish. Besides, amateur or professional, most all the published procedures are difficult to follow in your mind; as you read the instructions, you find it hard to know exactly what you should be doing and when.

Now, it just *could* be that I'm the dense type. Maybe other hams breeze through the articles and immediately whip up five or six boards of their favorite circuits. I began to accept the possibility of my "numbness" with great reluctance and only after digesting many treatises on the subject of preparing quick PCs.

Then one day, while I was preparing a batch of "new product" announcements for a trade magazine in Chicago, I happened across a news release from Sol Shein Advertising Agency that extolled the virtues of a simplified PC production process developed by Bishop Graphics, Inc., a California firm. The text supplied rapidly lost me as had all the previous articles I'd read, but the cagy



*Step 1. Negative (B-Neg) version of a typical dual in-line IC package is laid down just the way positive configurations are handled.*

people at Shein were clever enough to foresee possible confusion, so they included a raft of photos that showed the complete preparation process, from layout to finished board.

I made a mental note at the time to write an article for 73 Magazine at my earliest opportunity; 73 readers, I reasoned, would appreciate as much as I do a truly easy way to make their own professional PC boards. The "mental notes" proved to be ill-filed, however, because I lost them as well as all of the photos when I moved from the Chicago area to Peterborough. But — as luck would have it — the Shein agency was on the ball; their press releases were also sent to 73, photos and all.

### The Bishop Process

The Bishop Graphics company produces a photoresist solution that can be used to sensitize a copper-clad board for photo exposure. The product line also includes developer, etchant, and stripper; but the big thing is the technique they have for eliminating any drafting, camera work, or the necessity for darkroom processing.

The Bishop method involves the use of preprinted "negatives" which can be placed in any configuration to suit the needs of the individual. The negative patterns — including transistor layouts, dual in-line IC patterns, and a thousand and one other variations — come already printed on pressure-sensitive "B-Neg" acetate. The company also

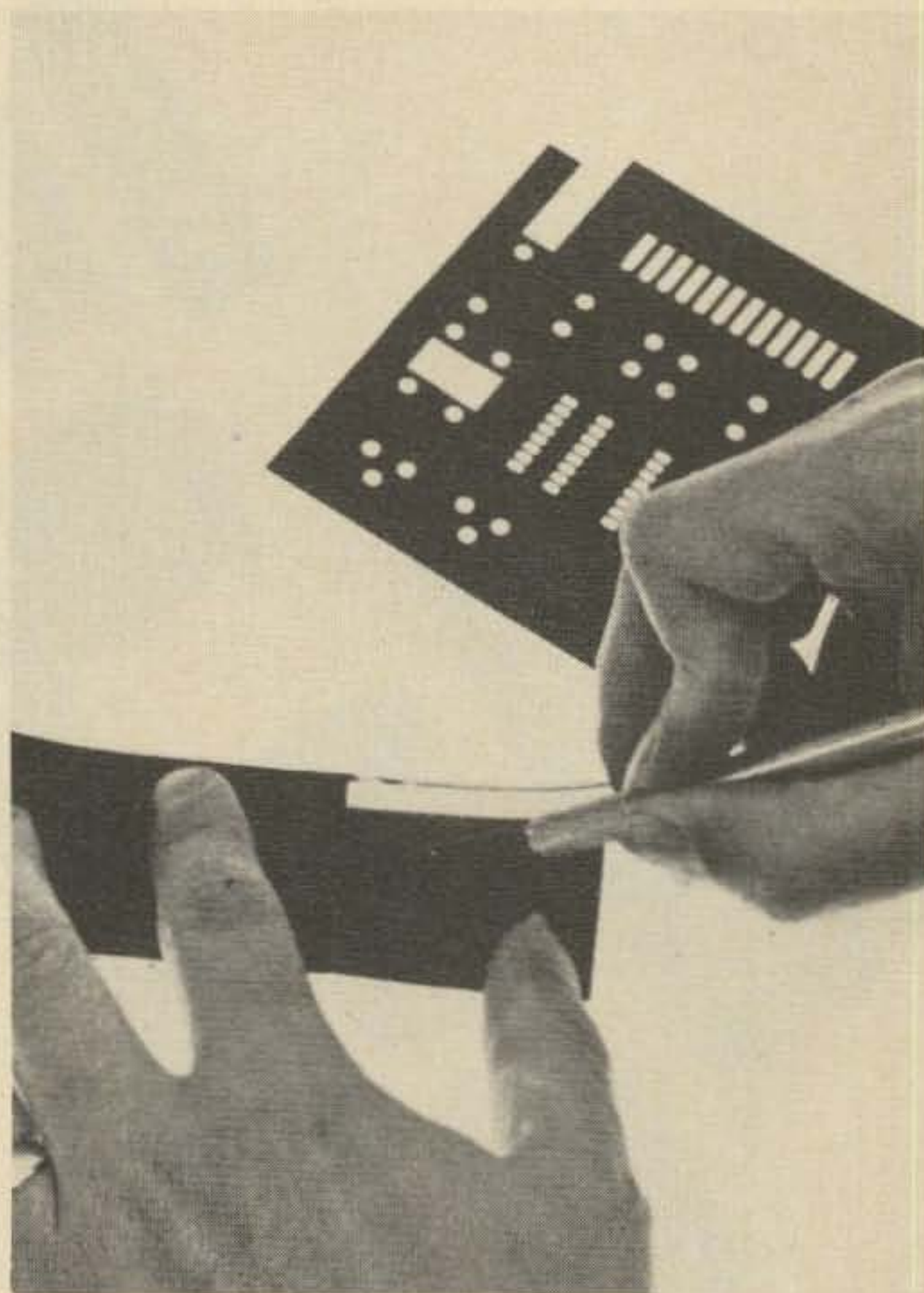

*Step 2. Opaque black B-Neg "background" film fills in spaces between terminals.*

supplies pure black pressure-sensitive B-Neg material so that anyone can form his own completely custom-designed negatives.

The completed B-Neg pattern can be used to produce a positive pattern on the presensitized (photoresist) copper-clad laminate or film. And the laminate, quickly etched on the spot, becomes a circuit board ready for drilling and component wiring. The whole



process takes an hour or two —and the result is a *professional* job.

The steps are simple. After the B-Neg pattern is laid down on a thin transparent Mylar, acetate, or film base, the clear areas are overlaid with a mask of B-Neg opaque film. Then, with a sharpened piece of white chalk or any light marker, interconnecting circuit lines are drawn on the B-Neg mask to establish conductor paths. Corrections of

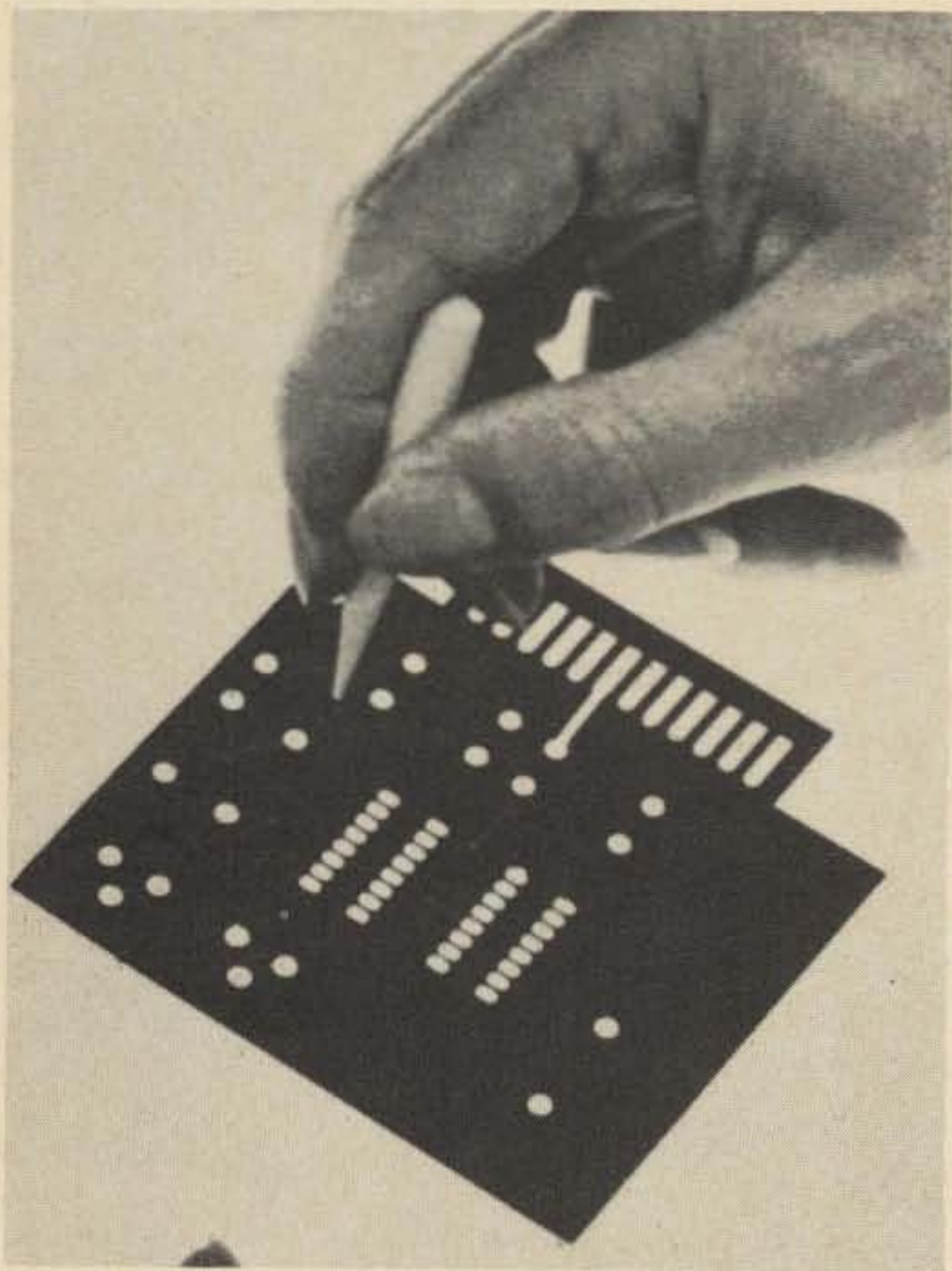

*Step 3. Circuit lines are traced in white chalk or marking pencil.*

mistakes or changes are easy. Simply rub away the chalk and redraw the conductors.

The final conductor paths are established by cutting along the established chalk lines and peeling away the B-Neg material. Fine conductors may be scribed. Conductor paths can just as easily be eliminated by covering with the black B-Neg mask material.

The completed B-Neg and copper-clad laminate (which has been coated with Bishop photoresist) are placed in a contact frame or in a plate glass "sandwich." Exposure under an ultraviolet light source (or a noontime summer sun) takes no more than a few minutes, and the subsequent developing, etching and strip/rinse cycles can be completed in approximately an hour. The

board is then ready for drilling and assembly.

If you are accustomed to producing your negatives with a regular process camera, you should know that existing negatives can also be changed quickly with B-Neg. Entire patterns can be relocated or conductor traces changed without retaping and reshooting original artwork.

All B-Neg pads and patterns are available in 1:1 scale. Other necessary materials are available from Bishop dealers: Mylar matte base material and grids, knife, tweezers, erasing shields (for cutting accurate conductor paths), and white charcoal pencils. If you don't know where to get Bishop's B-Neg stuff, write to the main office at 7300

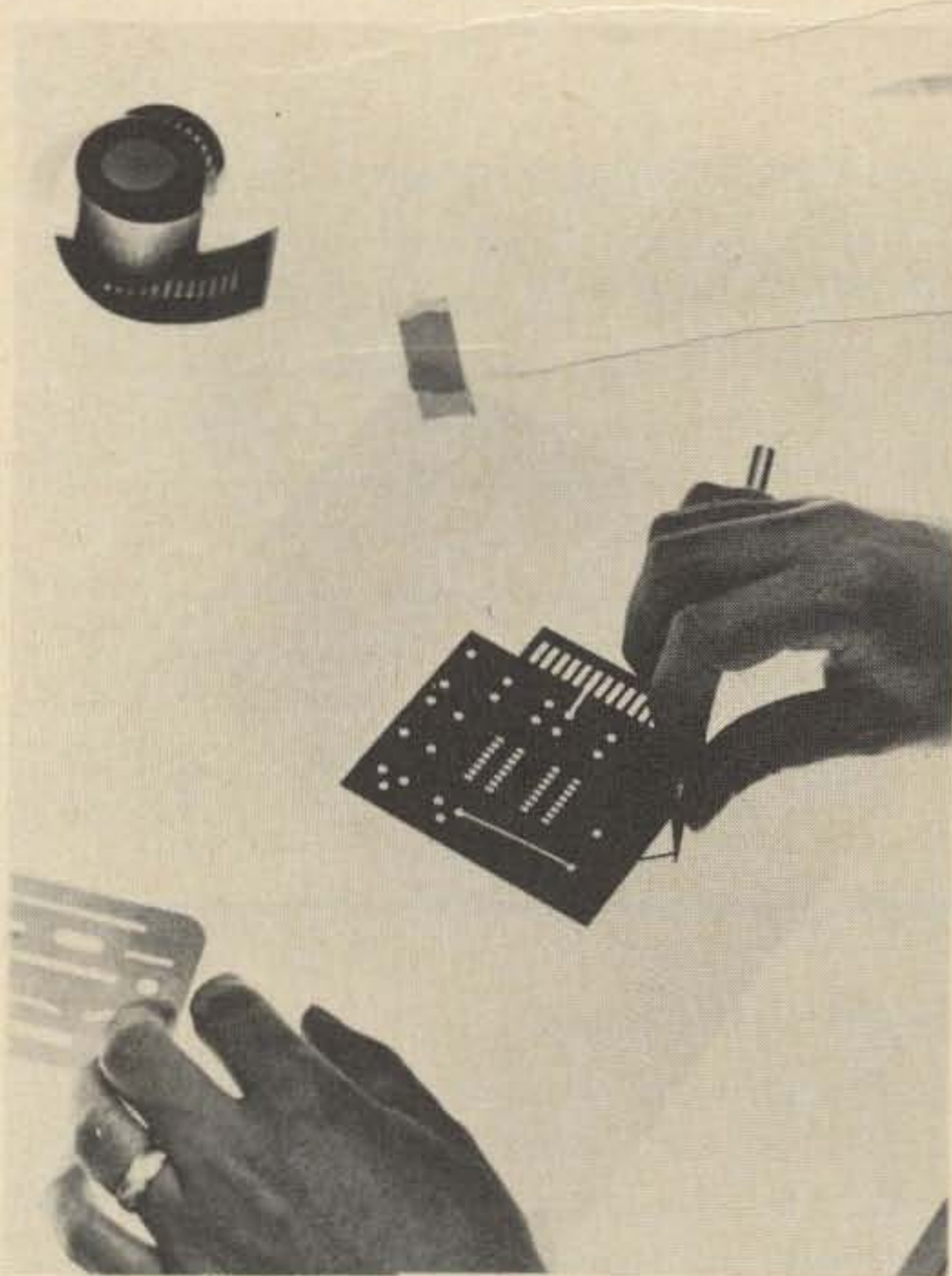

*Step 4. Using common eraser shield for a guide, neat circuit paths are cut and peeled.*

Radford Ave., No. Hollywood, Calif. 91605. Chances are you'll even get a free sample.

#### **Getting the Material Together**

There are several ways you can go when you get on a PC production kick. You can do it the easy way by sending \$28.50 to Bishop Graphics, which gets you a complete PC production kit, including an exposure frame and a couple of processing trays. Or you can scrounge and cumshaw and do

everything kind of slipshod the way I do. My system differs a bit from Bishop's recommended procedure, because I am inherently cheap; as a consequence, I don't employ the trays and contact frames and other trinkets and niceties the Bishop brochures rave about. But my method is just about as effective, even if a bit more cumbersome . . . and after all, it *is* my story.

The table presented here shows the material recommended by Bishop alongside the material I recommend for the cheapskate scroungers. With care, you should get excellent results regardless of which bill of materials you use.



Step 5. Finished B-Neg and photoresist-coated copper-clad laminate are placed in contact frame.

### Bill of Materials

#### Bishop Catalog number, description, and price.

B-Neg material and patterns as necessary	
7902 Photoresist, 7 oz. aerosol spray	\$6.85
7904 Developer _____	1.50
7905 Stripper _____	1.25
7906 Tray set _____	1.25
7908 Etchant _____	5.80
7909 Contact pressure frame _____	7.55
7952 4 x 6" boards (1 side copper)	4.50
Ultraviolet fluorescent lamp	29.95
	\$56.65

#### Scroungers list and price

	Same as at left
6.85	Same as at left
1.50	Same as at left
1.25	Same as at left
	2 shallow pans—one metal, one ceramic, plastic, or paper.
5.80	Same as at left
2.98	8 x 10" picture frame w/glass and backing
4.50	Same as at left
Free	Sunlight
21.88	

### Preparing the Board

Prepare the copper-clad laminate *carefully*. All soil, stains, and foreign matter must be completely removed. Scrub it with ordinary household cleanser and a stiff brush. Rinse. Repeat the scrubbing. Rinse again. Wipe off thoroughly with a clean towel. Rinse *again*. Now air-dry (or oven-dry at 110° to 120°F), always handling with care and never touching the surface with bare hands or fingers. (Residual oils in the skin will reduce the quality of the end result.)

If you don't have a darkroom, wait until after dark before you prepare the board. In the dimmest light possible, place the clean, copper-clad laminate on a protective background (several paper towels) and spray on a full, even coat of Bishop photoresist, fol-

lowing the directions on the can. Immediately pick up the board and slant one edge toward the floor. As the 'resist runs to the lower edge and forms a bead, soak the bead off with a paper towel. Turn the board 90° and repeat (the equivalent of a slow spinning action) so that excess 'resist is removed and no longer forms droplets at the lower edge. Then place the board flat for air-drying (or in an oven at 110° to 120°F). The 'resist will flow out, leaving a very even layer. For further processing, the board must be completely dry . . . no tackiness, no solvent smell.

With the B-Neg protomaster and a contact frame close at hand, half-fill a shallow metal or ceramic dish or tray. (Don't use plastic or you'll find yourself with no dish and a big mess.)

# AMATEUR ELECTRONIC SUPPLY

## Make those "S" meters bounce!

You will with  
the exciting  
new...  
**Galaxy GT-550**

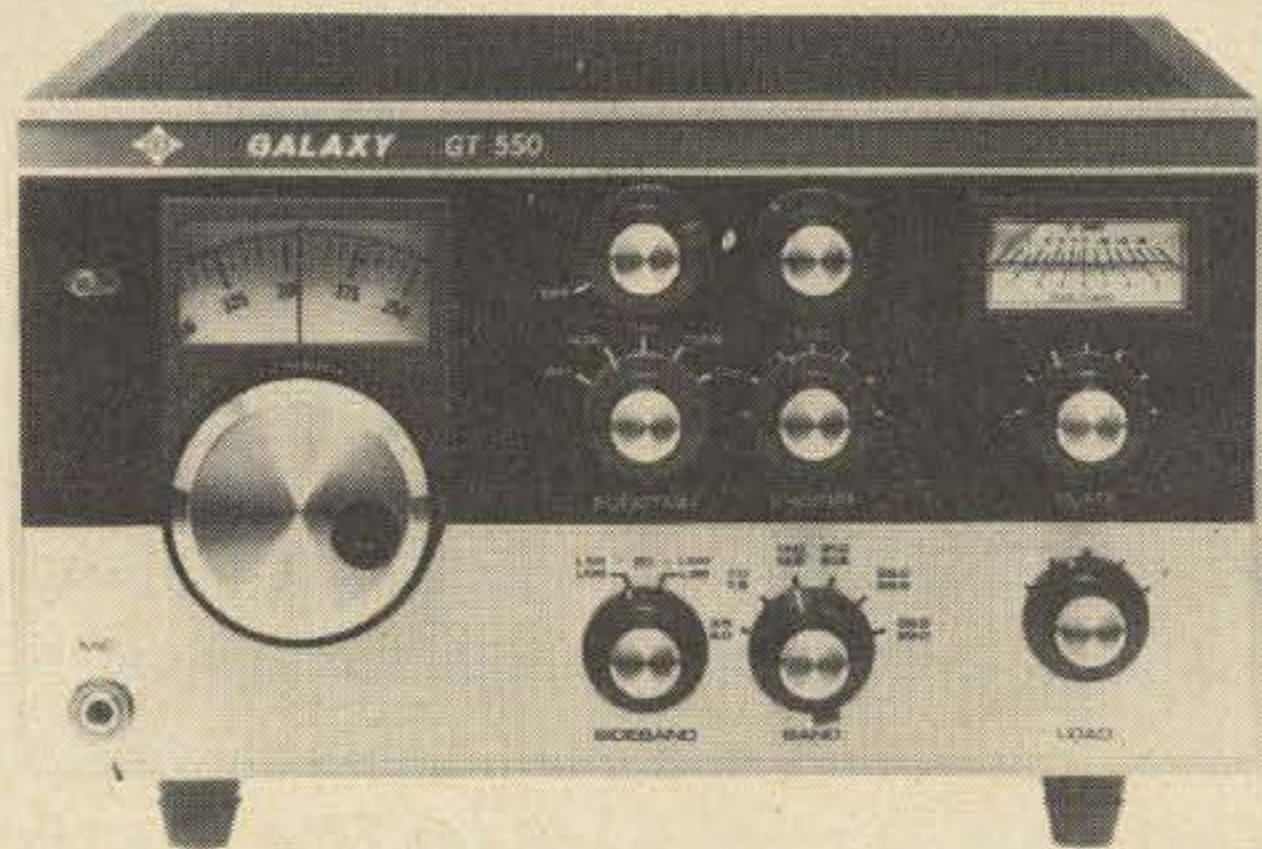

- 550 Watts PEP-SSB, 360 Watts CW
- Highest Powered 80-10 Meter Transceiver in its Class!
- Sharp 2.1KHz filter for minimum QRM and concentrated "Talk Power"
- ALC prevents "Flat Topping" and keeps those S-meters reading High

**FULL  
GALAXY LINE  
IN STOCK!**

GT-550 80-10m Transceiver	\$550.00
AC-400 110/230v AC Supply	99.95
G-1000 DC Supply	129.95
SC-550 Speaker Console	29.95
RV-550 Remote VFO	95.00
RF-550 RF Console	75.00
PR-550 Phone Patch	49.00
VX-35C VOX Accessory	29.95
CAL-25 25KHz Calibrator	25.00
F-3 300Hz CW Filter	37.50
GTM Mobile Mount	8.95
ZZM Floor Adaptor	6.00
R-530 .5-30MHz Receiver	795.00
SC-530 Speaker Console	45.00
FL-5305 500Hz Filter	45.00
FL-53015 1.5KHz Filter	45.00
FL-5306 6Hz Filter	45.00
FM-210 2m FM Transceiver	200.00
AC-210 AC/DC "Booster"	39.95

**AMATEUR  
ELECTRONIC  
SUPPLY**

4828 West Fond du Lac Avenue  
MILWAUKEE, WISCONSIN 53216  
PHONE (414) 442-4200

STORE HOURS Mon & Fri 9 to 9; Tues, Wed, Thurs 9 to 5:30; Sat 9 to 3

## SAVE \$50

Purchase a GT-550 or R-530 for the regular price, with no trade, and you may take a \$50.00 Bonus Credit toward other merchandise. (\$10.00 Bonus on FM-210)

To: **AMATEUR ELECTRONIC SUPPLY**  
4828 West Fond du Lac Avenue  
Milwaukee, Wisconsin 53216

I am interested in the following new equipment:

I have the following to trade: (what's your deal?)

Ship me the following New Equipment.

I enclose \$ \_\_\_\_\_; I will pay balance (if any)

COD (20% deposit)  Revolving Charge Plan

Name \_\_\_\_\_

Address \_\_\_\_\_

City \_\_\_\_\_

State \_\_\_\_\_ Zip \_\_\_\_\_

Send Reconditioned Equipment Bulletin

# AMATEUR ELECTRONIC SUPPLY

AMATEUR ELECTRONIC SUPPLY

AMATEUR ELECTRONIC SUPPLY

# VHF FM MONITOR RECEIVER



100% MADE  
IN U.S.A.



Only  
\$79.95  
Postpaid  
in the U.S.A.

The new VANGUARD FMR-150 is not just another frequency converter but a complete FM receiver with outstanding performance.

Check the following features and see why it's the best. Collins IF filter for separating those closely spaced stations you hear together on other sets● Double conversion to eliminate interference from image frequencies● Dual Gate MOSFET RF stage for low noise. .2 uv. sensitivity, and minimum cross modulation● Automatic squelch for eliminating noise● Self-contained speaker● Operates on 12v. D.C. negative ground● Heavy gauge anodized aluminum case 6" x 7" x 1-3/8"● Provision for 4 crystal controlled channels at the push of a button● One channel of your choice supplied with receiver. Additional channels available just by plugging in another crystal at \$4.95 ea. No need to buy another RF unit as in some other sets● Factory tuned to cover any 6MHz segment from 135 to 175 MHz.

**HOW TO ORDER:** The VANGUARD FMR-150 is available only direct from our factory. Include remittance in full plus sales tax if you reside in N. Y. Be sure to state the 6MHz segment you will want to cover and the exact push button frequencies to be included.

## VANGUARD LABS

Dept. H, 196-23 Jamaica Ave.,  
Hollis, N.Y. 11423

Open the contact frame (or substitute therefor), placing the B-Neg face down on the glass. Make sure the sprayed board is completely dry and place the 'resist side

against the B-Neg. Close and lock the frame, and place it under the blacklight source about 3 in. from the lamps. Expose for two to four minutes (a test or two will give you a

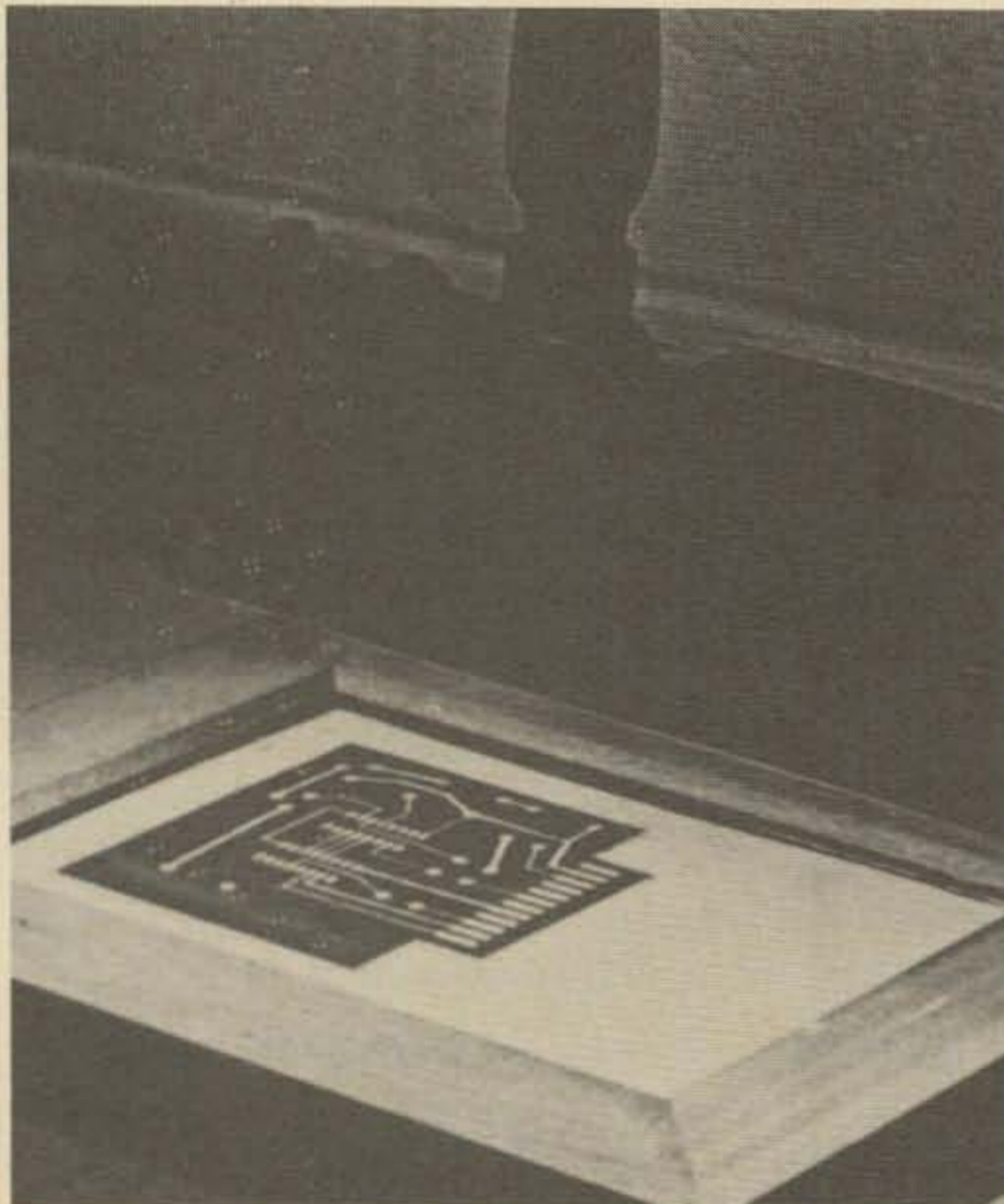

Step 6. Exposure to ordinary black-light fluorescent lamps takes less than four minutes.



Step 7. It takes only a few seconds for a crisp pattern to show in the developer tray.

reliable guide). If you use bright sunlight, allow 10–15 minutes around noon.

Immediately after exposure, immerse the board in the developer. Agitate gently; 30 sec to 1 minute should produce a bright, sharp image. Now rinse in running water at the sink, where etching and stripping will soon complete the process.

To etch the board, dissolve one packet of Bishop etchant powder in a pint of hot water in a *plastic* tray. Immerse the exposed

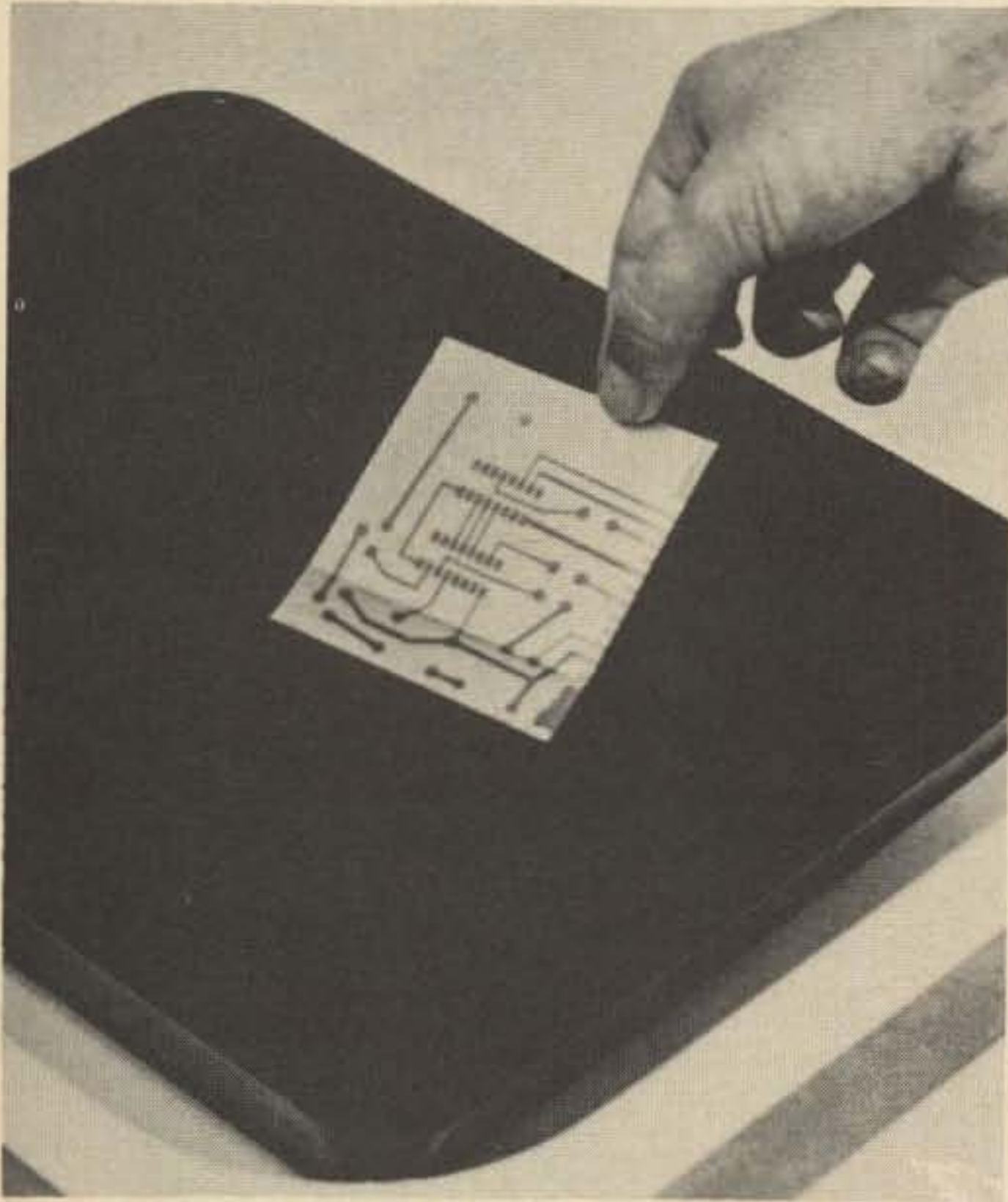

Step 8. The developed board is immersed in a solution of Bishop etchant and left for an hour.

and developed board. In about an hour, the board will be fully etched. Gentle agitation from time to time will speed the process. Hot water around the plastic tray will keep the etching solution warmer, speeding the process.

As soon as the etching process is complete, pour some Bishop stripper over the board, and, with water running over it, rub the stripper over the pattern until the copper is glossy . . . and all the dye is removed. Then dry the board and it is ready for drilling and assembly.

When you add the prices shown in the table, you may feel that the overall cost of producing your own boards is prohibitive. And of course it *would* be for a single board. But the amounts of chemicals you get are sufficient to turn out quite a few printed

## DAYTON HAMVENTION

Saturday, April 25, 1970

Dayton Hara Arena and  
Exhibition Center

- Technical Sessions • Women's Activities
- Exhibits • Flea Market • Awards • Banquet

Dayton Amateur Radio Association  
Dept. S : Box 44 Dayton, Ohio 45401

## LEARN RADIO CODE



\$9.95

Album contains three 12" LP's 2½ hr. Instruction

### THE EASY WAY!

- No Books To Read
- No Visual Gimmicks To Distract You
- Just Listen And Learn

Based on modern psychological techniques—This course will take you beyond 13 w.p.m. in LESS THAN HALF THE TIME!

Available on magnetic tape, \$9.95 - Cassette, \$10.95

## EPSILON [E] RECORDS

206 East Front Street, Florence, Colorado

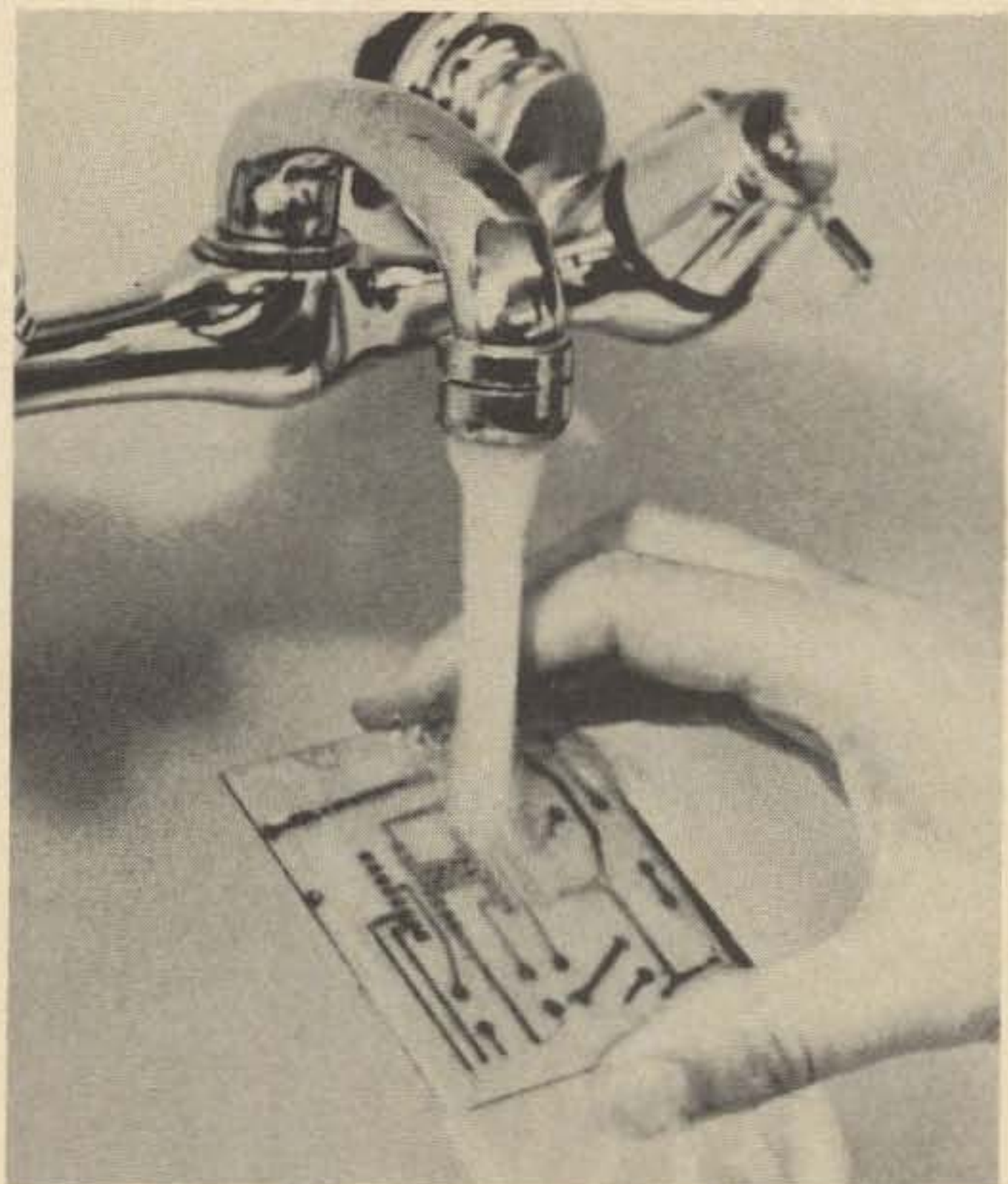

Step 9. While rinsing in water, Bishop stripper is rubbed on the pattern, removing all dye and leaving a finished board, ready for drilling and assembly.

circuits. For a club project, there just *can't* be a cheaper way to get a lot of professional boards. . . . K6MVH ■

# Feature This



KHZ

## SIGNAL/ONE'S CX7 GIVES YOU ELECTRONIC COUNTER FREQUENCY READOUT

Electronic counters belong in the laboratory . . . because they're big, expensive, precision instruments . . . right? So what's one doing in the CX7? Well, it gives you . . . . .

- **CALIBRATION ACCURACY OF 100 HZ** at every point in every band
- **READOUT DIRECT TO 100 HZ** . . . without interpolation
- **LIFETIME PRECISION . . .** free of error due to aging or environment
- **BIG, BRIGHT DISPLAY . . .** virtually impossible to mis-read

SIGNAL/ONE engineers did it by putting **state-of-the-art** technology to work in a precision counter no larger than a small book. This remarkable unit actually counts **each individual cycle** of VFO output during a precise (crystal-controlled) 1/100 second time interval . . . and displays the last four digits of the total on an electronic readout. (For example, a VFO frequency of 3521.7 kHz (**3,521,700 cycles/second**) yields a 1/100 second count of 35,217 . . . and the display shows **521.7 kHz**). The readout is as accurate as the 1/100 second timing. Timing is derived digitally from the 100 kHz reference standard. So, by simply zero-beating the 100 kHz oscillator to WWV (or a BC station) you automatically calibrate the VFO to 100 Hz accuracy . . . everywhere.



A Division of ECI (An NCR Subsidiary)  
2200 Anvil Street No.  
St. Petersburg, Fla. 33710

how  
I read  
the  
Radio  
Operators  
Handbook  
and  
found  
happiness



. . . and he thought a logarithm  
was the beat of a jungle drum

R. W. Johnson  
31 Maclarnon Road  
Salem NH

There are one hundred fifty-four million ham operators living on my street. Some of them sleep six to a room. Together with the thirty-two thousand at the office that I work with and socialize with every day, you can probably well imagine that for some length of time, I have felt somewhat alone if not downright black-sheepish, considering the fact that up until last Saturday evening, I didn't know the difference between a waveform and a potentiometer. For years,

whether at parties or the water cooler, I felt left out.

Don't get me wrong! I'm not insinuating that the ham population has grown to unhealthy proportions or anything. All I'm saying is that when the time comes that a milkman or grocer or any other normal type of unassuming personage such as myself develops serious psychological traumas because of an inability to discuss capacitive reactance with every Tom, Dick, and Alfred, then one must do something. What one must do is largely up to oneself. I — having a very agile and analytical mind — chose to acquire an education in electronics.

So last Saturday I read the amateur radio operator's handbook —from cover to cover (minus the ads). Granted, this doesn't make me an engineer. But you wouldn't believe how it has changed my life. Things are different now. I not only feel confidence in my relationships with my contemporaries, but —and get this— I actually feel *a little cocky*. Don't laugh! I know what you're thinking. *Here's a guy who reads something and comes on like the guy who wrote the book*. Right? Isn't that what you're thinking? For my defense, I submit that all things are relative (I didn't make that up; I read it somewhere). What I mean is simply this: My knowledge on Saturday night compared to my knowledge on Friday night makes me something of a Marconi—Faraday—David Niven conglomerate. It's unbelievable how my life has changed. My confidence is not unlike that of a Karate black-belt.

Like yesterday, for instance, I went into the local Radio Shack. I didn't need a thing. It was just a place where I could feel at home —*wanted*, if you will. I asked the electronics guy if he had any microfarads, and you could tell he was really impressed because he didn't say anything for a while. He just sort of looked around and blinked a couple of times. He asked me if I was putting him on. I assured him I wasn't and he muttered something that I couldn't quite catch, and called a couple of other guys over to meet me. Their names were Chuck and Lennie, if my memory serves me right. Anyway, the four of us stood around smoking for a while and talking about this

and that. Chuck and Lennie were a couple of pretty good guys. Lennie kept giving me cigarettes and lighting them for me. You could tell he wanted to keep me around for a while. Then, the first guy I had spoken to asked me how many microfarads I wanted. I told him I could use about a handful (I knew



they had to be cheaper in quantity orders). "Wouldn't use anything else," I said with a sly, knowing smile. You could tell they got a big kick out of this because Lennie kept nudging Chuck.

Now don't get me wrong. I'm not bragging or anything. That's not the point of me telling you all this. This is just to illustrate what a little erudition can do.

When I left, Lennie, Chuck, and the other guy were all hee-hawing their heads off and slapping each other's shoulders and everything. Chuck looked like he was ready to roll on the floor. Boy! You could tell that they really enjoyed electronics.

Like I say, though, life is different for me now. I can *talk* to people. I really can! New worlds have opened up to me. I feel comfortable — contented — relaxed — IN!

A few days ago, I put a dipole on my roof. It's beautiful. The ole sun reflects off that thing like there was no tomorrow. And the gleam is enough to knock your eye out (what kind of wax do you use on those things anyway?)

Hank, my next door neighbor, says I ought to get a "rig" for it. But I figure it can wait a while. First things first, you know. I'm in no hurry. I figure: today a dipole—tomorrow an ohm.

... WOW ■

# Incentive Licensing Is Here!



**Brush up - Tone up - Shape up  
with AMECO Technical Books  
and code practice records.**

## EASY TO UNDERSTAND BOOKS

- # 16-01 Advanced class license guide ..... .50
- # 17-01 Extra class license guide ..... .75
- Radio amateur theory course. Latest edition  
is ideal for brushing up.
- #102-01 (over 300 pages) .....3.95

## THE FASTEST AND SIMPLEST WAY TO INCREASE CODE SPEED... AMECO CODE PRACTICE RECORDS (33 $\frac{1}{3}$ RPM)

- #104-33 Contains material to increase  
code speed from 13 wpm to 22 wpm .....3.95
- # 106-33 19 to 24 wpm supplement  
to above .....3.95

## AND FOR THOSE OF YOU WHO ARE A BIT RUSTY

- #103-33 Contains material for 8 to 18 wpm ....3.95
- #105-33 supplement to above .....3.95

AT LEADING  
HAM DISTRIBUTORS



DIVISION OF AEROTRON, INC.  
P. O. BOX 6527 • RALEIGH N. C. 27608

Robert Kelty WB6DJT 2661 Carol Drive San Jose CA

A LOOK AT  
AMATEUR FM  
STANDARDS

A general survey of the VHF  
revolution with respect to  
repeaters over the past few years,  
and some suggestions for  
planning ahead.



*The first eight years of amateur FM repeater operation in the United States has been a period of growth and stabilization. Today, because of the unprecedented popularity of repeaters and channelized operation on the VHF amateur bands, we are faced with such problems as:*

- *Frequencies for new systems*
- *Channelizing*
- *Logical frequency pairing*
- *Deviation and bandwidth*
- *Tone frequency standards*
- *Guard channels*
- *Command methods*
- *Selective calling standards*

Many systems have grown in their present shapes because of availability of equipment, bulk availability of crystals, long-term usage on certain channels, patterning from a successful scheme, or because it seemed the thing to do at the time. In most cases, changes were made before cost prevented modification and systems developed so that members were served as necessary. But now it is 1970, we are thinking nationally—and for good reason. Travelers report that directories are inaccurate and that they have found activity not quite as reported or that the local repeaters are tone-protected. Frequencies in one area are not used in another. Interconnection presents problems in selective calling and command. Multichannel users compromise equipment performance. One area is narrowband, the other wide. So-called national frequencies are used with a variety of input frequencies, depending on area. UHF users find a wild variety of pairings and come to the conclusion that this band is haphazardly planned with frequencies confidential.

But all is not so bleak. With a little forethought, users can plan together, applying techniques known as spectrum engineering, frequency administration and conservation, or whatever name suits. It has been done with great success for the past two years in the west and I'll wager that with a little intentional planning that even in Los Angeles — that great super

hodge-podge of "secret channels" and RF overlay — a measure of order will result in the next five years. Let's take a look, then, at what we can achieve and how to go about it with minimum outlay.

First there must be some form of mutual planning, whether on an agreed basis, by meetings of the repeater groups in a state or area, or by the principal repeater group taking the initiative. Acceptable standards can be determined and, though planned changeovers would meet with little acceptance, any changes could conform to agreements. Most amateur relay systems have changed enough in five years to prove they are fluid. In some concentrated areas of relay activity, coordinators, gentlemen's agreements, or adherence to accepted plans have been very successful. To my knowledge, very few systems have gone into service haphazardly and without thought. Those that ran into technical or operational problems soon changed because of opposition or impracticality.

#### **NEW RELAYS**

Where is there room for additional groups, especially in areas of intense usage? By being careful with the spectrum — that is, by channelizing and establishing standards of bandwidth — the greatest number of channels can be rendered with full compatibility. A generally accepted plan for 2-meter FM operation, for example, is each 60 kHz up from 146.04, leaving the lower portion to AM and DX'ers. Greatest activity still seems to be the upper portion of 146 MHz. A significant amount of narrowband FM equipment is available and the 30 kHz channel standard on 2-meters could within five years fit in very nicely, rendering 32 discrete channels. I see no problem in using this plan, then selecting a suitable deviation standard for one's own purposes. The equipment is made for either 5 or 15 kHz; anything else is a compromise in performance.

Six meters is less intensely used and 52.525 MHz seems to be the most popular for wideband operation. Narrowband operation does exist in some areas, from

51.0 to 52.0 MHz, on a 25 kHz channelizing plan. TV high-pass filters, though limited in effectiveness above 52.0, will help prove to TVI complainants that they often eliminate problems. AM operation stays low on 6 for reasons of self-preservation.

The 450 band is a world apart. Only the coordinators and trustees seem to know what really is in service and all admit there is more than meets the eye up there where channel frequencies are semiprivate. In Los Angeles as well as other places, for example, 50 kHz channelizing is the rule except that in L.A. ALL channels have been used above 440 and a coordinator tries vainly to keep accurate records. Those who prefer to go it alone find someone is sharing the space. Pairing is not in vogue just yet but efforts have been made to standardize, and several nets have adopted 5 MHz separation utilizing 440-444 outputs with 445-449 inputs. TV repeater experimenters have been a potential hazard, but recent concessions, after realization that FM'ers are serious, agreed to TV in the 435-440 portion of the spectrum. 450 is looking better each month as those who use this band for mobile operation see the value of planned pairing and reconfigure frequencies for better usage.

#### PAIRING

Armchair planning is always subject to criticism and rationalizing why it won't work. Moreover, existing nets complicate the matter. But let's look at what is being done in some areas and consider it for future planning in others.

	RELAY OUTPUT	INPUT
6 METERS	51.000	51.600
NARROWBAND	51.025	51.625
15 CHANNELS	51.050	51.650
	51.075	51.675
	51.100	51.700
	51.125	51.725
	51.150	51.750
	51.175	51.775
	51.200	51.800
	51.225	51.825
	51.250	51.850

		UNPAIRED
2 METERS	146.610	146.010
NARROWBAND	146.640	146.040
13 CHANNELS	146.670	146.070
	146.700	146.100
	146.730	146.130
	146.760	146.160
	146.790	146.190
	146.820	146.220
	146.850	146.250
	146.880	146.280
	146.910	146.310
	146.940	146.340
	146.970	146.370
	146.400-146.580	
		UNPAIRED
	146.940	(GUARD
	51.275	51.875
	51.300	(GUARD
		CHANNEL)
	51.325	51.925
	51.350	51.950
	51.375	51.975
	51.400 - 51.575	
		CHANNEL)
450 MHz	440.050	445.050
100 CHANNELS	444.950	449.950

This arrangement aims at compatibility with other amateur operation, best utilization of the spectrum, and extension of existing FM relay systems. It is placed in nomination as a national plan.

#### TONE

Overlapping repeater coverage on the same channels as well as the desirability of multichannel compatibility brings us to the realization that pulse tone must be standardized where used. If pulse tone entry is planned, choose standards and hold to this plan.

Touchtone is gaining popular acceptance for control and signaling in some areas and probably will dominate as ability to produce good decoders becomes more widespread. This is an excellent approach for the more talented groups.

#### GUARD CHANNELS

Faced with the problem of where to establish a common meeting ground for members of various groups, each operating on its own discrete frequencies, the

THERE ARE MORE THAN

**300** **FM REPEATERS**  
FROM COAST TO COAST...

**Get IN on the action**

with a

**GALAXY**  
**FM-210**  
**2 meter FM**  
**TRANSCEIVER**

from  
**STELLAR**



Power  
Booster \$39<sup>95</sup>

**\$199<sup>95</sup>**

As a "barefoot" mobile unit, the American-made Galaxy FM-210 runs a full five watts of power. Just connect it to your antenna and clamp it under the dash—then plug in a high-impedance mike and you're off and running . . . on three crystal-controlled channels! The receiver section's FET front end gives you unmatched selectivity and sensitivity. And the transmitter's husky signal gets you through even in those "dead spots."

If the nearest repeater is in the next county—or if the activity in your area is all "direct," you'll want the Galaxy AC-210 power booster. It doubles the output power of your FM-210 transceiver and allows operation from either 12 VDC or 115 VAC.

**SPECIFICATIONS**

**Frequency:** 143–149 MHz  
**Channels:** Three; transmit and receive are independently controllable, giving 9 possible frequency combinations.  
**Transmitter:** 5W in (10W with optional power booster)  
**Deviation:** ±15 kHz max (wideband) or ±5 kHz (narrowband), with adjustable speech limiting for optimum matching to local standards.  
**Receiver Sensitivity:** 0.5 SINAD  
**Power Req:** 12 VDC (power booster accessory allows operation from either 12 VDC or 115 VAC)

**STELLAR**

10 GRAHAM ROAD WEST • ITHACA, N. Y. 14850  
TELEPHONE AREA CODE 607 257-2424

# HEY! HOW ABOUT THAT

## S.W.R. BRIDGE

- MODEL SWB-2
- READS FORWARD AND REFLECTED POWER SIMULTANEOUSLY
- "EASY READ" METERS
- USE FOR REFERENCE POWER METER
- DUAL 100-MICROAMP METER MOVEMENTS
- LOW INSERTION LOSS
- SIZE-5"X2"X2"

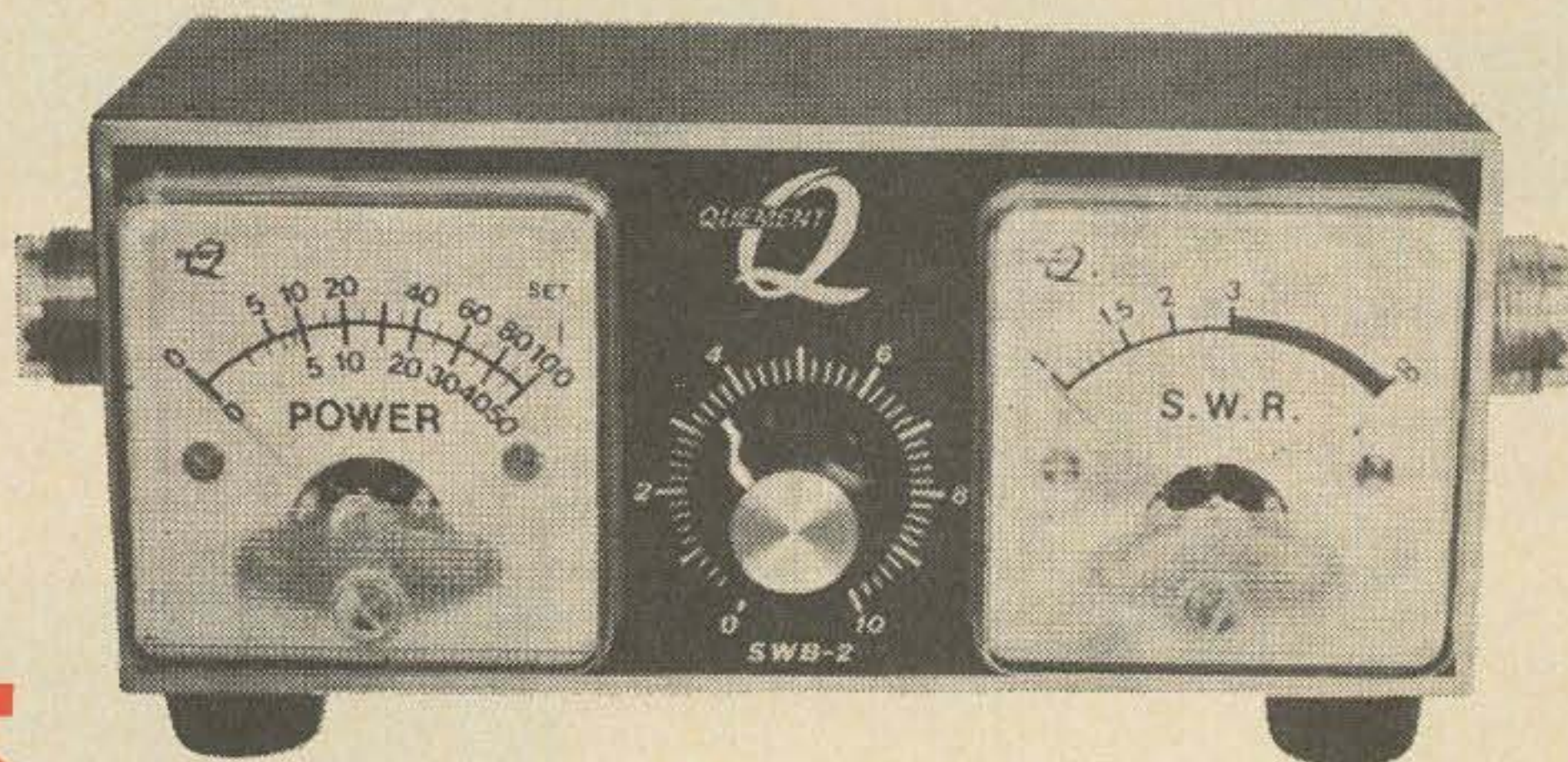

# \$15.95

ALLOW \$1.00 FOR  
PACKING & SHIPPING.  
CALIFORNIA RESIDENTS  
INCLUDE SALES TAX.

THE BEST  
VALUE WE  
HAVE  
EVER  
OFFERED!

MAY BE LEFT  
IN LINE, UP  
TO 2000 WATTS.

GOOD THROUGH  
2 METERS

SINCE 1933

FAST SERVICE

Phone 408-294-0464

# QUEMENT ELECTRONICS

1000 SOUTH BASCOM AVENUE

SAN JOSE, CALIFORNIA  
95128

"Northern California's Most Complete Ham Store"

## THE BEST 2 METER CONVERTER

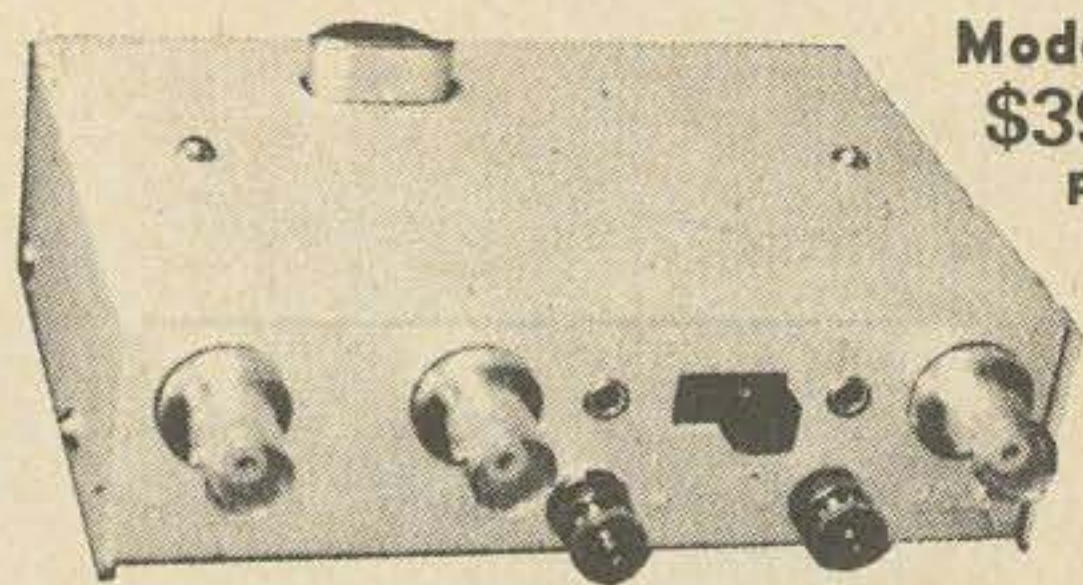

Model 407  
\$39.95  
ppd.

144-146 MHz in. 28-30 MHz out  
or 146-148 MHz with a second crystal  
Available at \$4.95 each.

A full description of this fantastic converter would fill this page, but you can take our word for it (or those of thousands of satisfied users) that it's the best. The reason is simple—we use three RCA dual gate MOSFETs, one bipolar, and 3 diodes in the best circuit ever. Still not convinced? Then send for our free catalog and get the full description, plus photos and even the schematic.

Can't wait? Then send us a postal money order for \$39.95 and we'll rush the 407 out to you. NOTE: The Model 407 is also available in any frequency combination up to 450 MHz (some at higher prices) as listed in our catalog.

\*New York City and State residents add local sales tax.

## VANGUARD LABS

Dept. H, 196-23 Jamaica Ave., Hollis, N.Y. 11423

idea of guard channels has become an acceptable solution and has proved successful where implemented. 51.3 and 146.94 are logical choices here, having been sanctioned by the California Amateur Relay Council as a regional solution. By guarding these channels or using a receiver scanner which samples more than one channel, a surprising flexibility is possible. By guarding one's regularly used channels plus the common calling and working frequency, we can provide ourselves with even better systems, both at home and while traveling.

The first eight years of repeaters has taken us through a period of organizing and building. Let's let the next eight be devoted to sophistication and joint planning. With good nonrestrictive repeater regulations a good possibility within a year a fine magazine to spread the word and cement us together, and the enthusiasm we all possess, the future looks promising indeed.

... WB6DJT ■

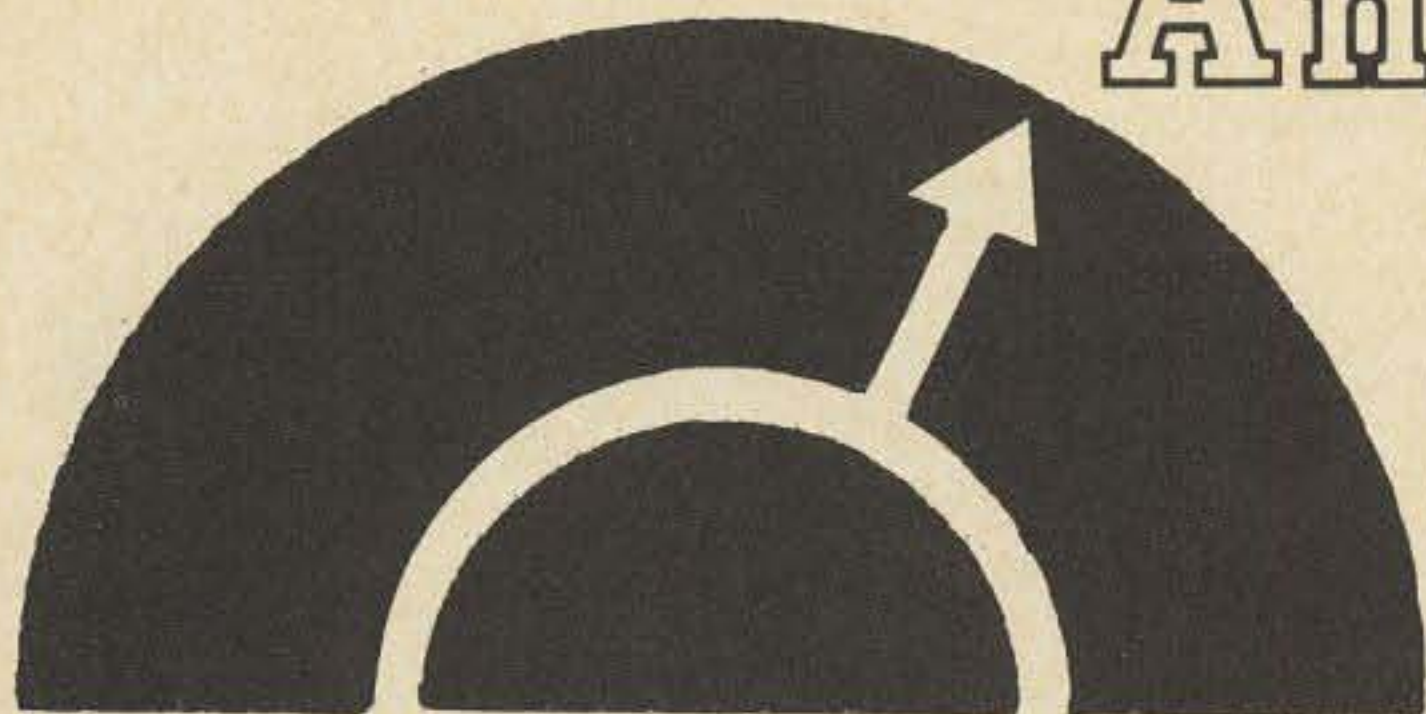

# An Inexpensive RF Wattmeter

Walt Pinner WB4MYL  
7304 Lorenzo Lane  
Louisville KY 40228

While on vacation recently, I was rummaging through the various surplus outlets in the Detroit area. Among the goodies purchased was a small surplus "Antenna Current Indicator." It has a 2½ in. meter movement, three spring-loaded feedthrough connectors, and a power plug for connection to an internal antenna relay. It also includes the pickup unit and shunt necessary to operate the meter. The unit is a thermocouple-type antenna current indicator. Its nameplate states it was manufactured for the Army Signal Corps under the name of "Antenna Current Relay Unit BC442-AM."

The unit has a fitted bottom cover and ample room to install two SO-239 connectors in place of the feedthrough connectors already there. The antenna change-over relay is mounted to a plate and secured to the box with four screws. It may be removed as an assembly for use elsewhere. The rf contacts appear to be more than adequate for amateur use up to the legal limit of power. The rf contacts have an additional single-pole contact which may be

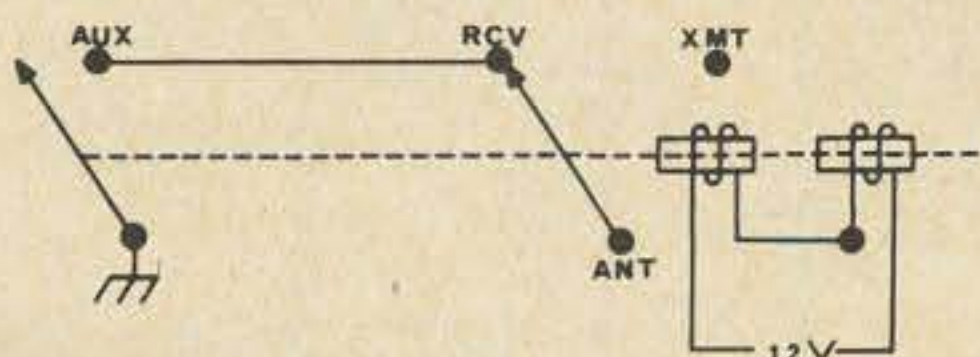

used for B+ control or grounding of the receive antenna lead during transmit, as shown in the diagram.

The relay is operated by two series-connected coils and requires +12V at 80 mA. If the coils are parallel-connected, a 6V source may be used. A single diode with a small filter on the rig's filament supply works nicely.

The meter scale reads from 1 to 10. Comparison readings of this unit, with no change other than substituting standard coax fittings, were made against a Drake W-4 wattmeter into a 50Ω dummy load. The results are tabulated below:

BC442 reading	Power (watts)
1	100
2	200
3	300
4	400
4.9	500
5.5	600
6.2	700
6.9	800

These readings remained constant over a range of frequencies from 3.5 to 30 MHz. Power levels of 25, 50, and 75 watts may be read with reasonable accuracy if the mechanical zero meter setting is adjusted with the meter in the vertical position and the power readings taken with the meter in the same position. The best part of this unit is its price. It was purchased from Bauer Industrial Supply, Redford Ave., Detroit, Michigan for \$3.00, less his 15% discount (to anyone) which lowers the already ridiculous price to \$2.55 plus tax. A terrific buy for your surplus buck.

... WB4MYL ■

# A REMOTE MULTIFREQUENCY

A simple method for modernizing your surplus

FM unit by adding those extra channels.

If your VHF FM gear is a single-channel type and you have been wondering how to add multifrequency capability, here is your answer. This article describes a remote crystal oscillator with switch selection of up to four crystals.

Since the original unit was intended for the transmitter of a GE pre-Progress Line ES-1B 2 meter FM unit, 3 MHz crystals were used. The circuit should work equally well with crystals of other frequencies (up to 15 MHz or so), and it can be applied to receiver local oscillators as well as transmitters. It is not designed to work with overtone crystals, however.

The circuit, Fig. 1, consists of a transistorized Pierce oscillator coupled to an emit-

ter follower for isolation and low output impedance.

The oscillator unit may be mounted in any convenient location and coupled to the transmitter by a length of ordinary shielded cable. Neither the type of cable nor its length appears to be critical. In the original installation, a four-conductor shielded cable having a length of about 6 ft was used. The output impedance of the circuit is low enough to tolerate the shunt capacitance of 15 ft of shielded cable or coax without any drastic reduction in output voltage. Impedance matching is not necessary, since optimum power is not a requirement.

The rf output from the remote oscillator is fed directly into the grid of the former

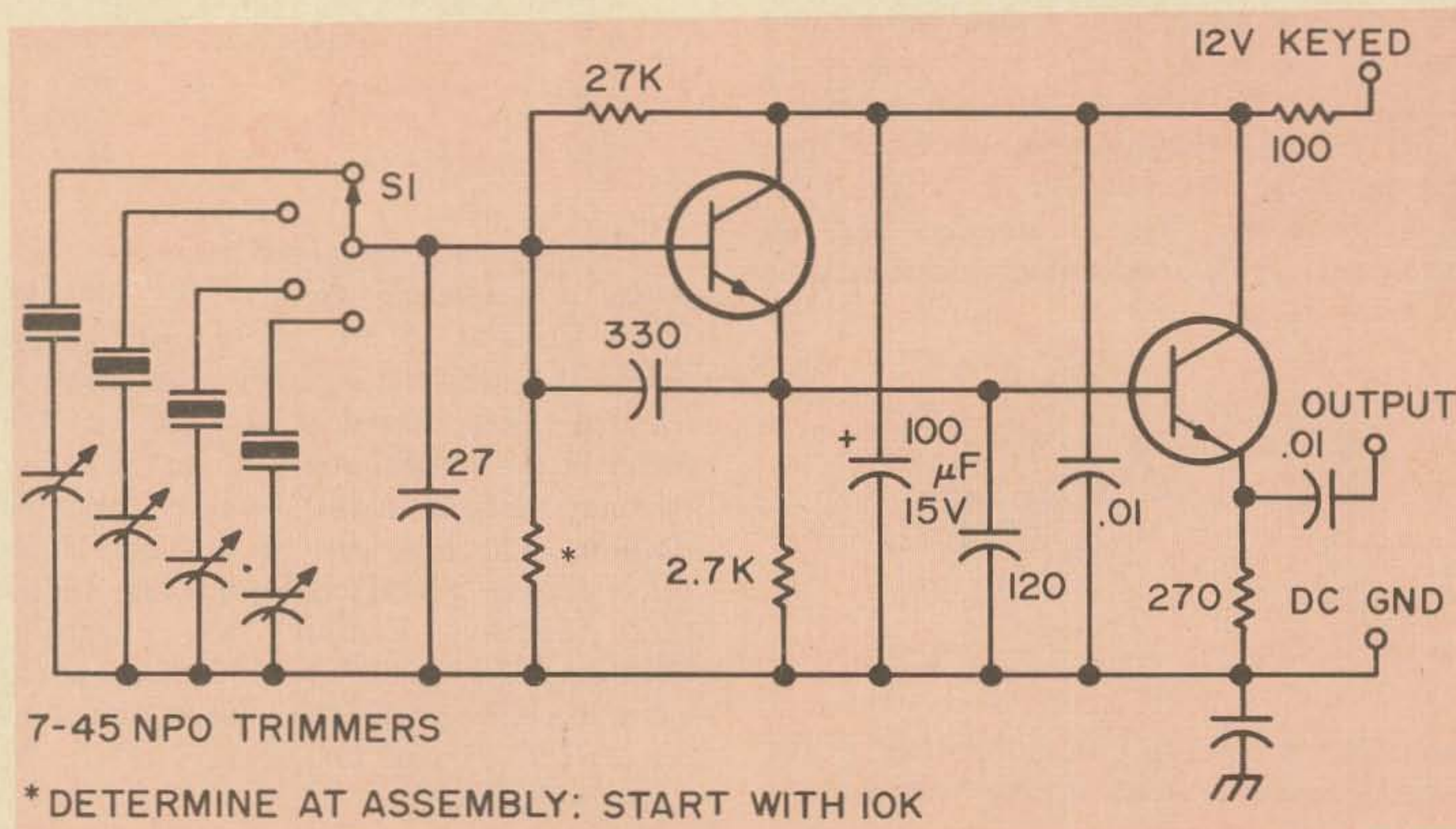

Fig. 1. Remote multifrequency oscillator schematic.

# OSCILLATOR FOR SURPLUS FM UNITS

oscillator tube in the transmitter, so that this stage now becomes a buffer. The cathode of this tube (and screen, if a pentode) should be bypassed to ground for rf if not already done in the existing circuit. In my installation, the grid current in this stage was not as high with the remote oscillator as it was originally, but the drive level in the subsequent stages was unaffected.

The output frequency is not affected by the load, and changes only a few hertz when the supply is varied between 5 and 15V. Although the output voltage increases as the supply voltage is increased, the use of more than 15V is not recommended.

The oscillator consists of a two-board "sandwich" and a third board, which mounts perpendicularly to the other two, as shown in the plan view of Fig. 2. The actual size layouts of circuit paths for all three boards are shown in Fig. 3.

Once the etched circuit boards are made, assembly of the unit is quite simple. After soldering the components to the main circuit board (see Fig. 4), attach the output, power, and ground leads and mount the board in the Minibox. Be sure that leads and solder do not protrude more than 1/16 in. on the foil side of the board. Then attach and wire the connector (J1). Next, the rotary switch (S1) should be put in place and connected to the main board. The remaining two circuit boards with the crystal sockets and trimmers are fastened together and mounted last in the box. The front of this assembly is supported by the leads from the boards to the switch, so no size smaller than 20 AWG solid wires should be used for mechanical

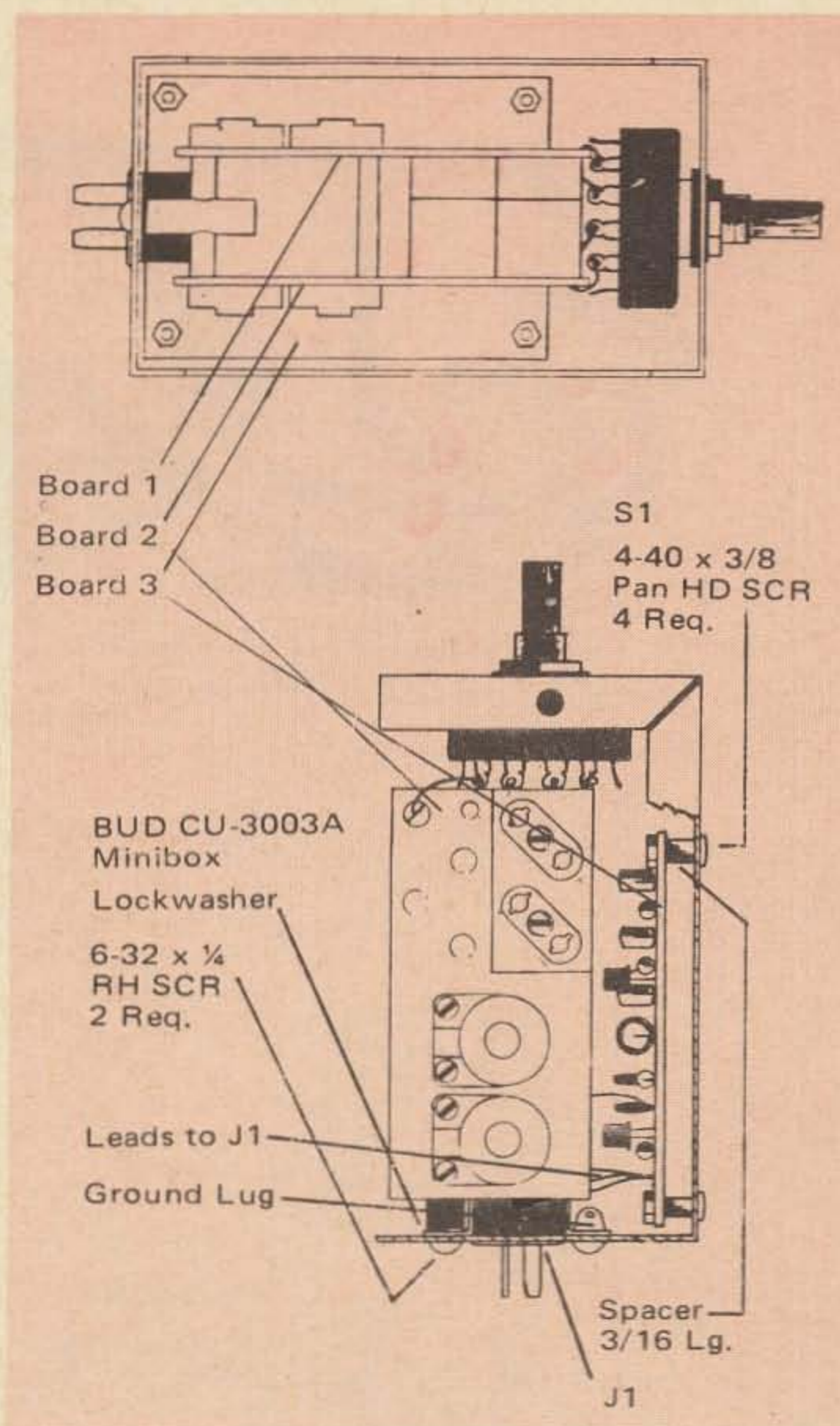

Fig. 2. Layout of oscillator.

stability. Use care when inserting or removing the crystals so as not to crack the circuit boards. Glass-epoxy board material is worth using, if available, because of its greater strength. Figure 5 shows the construction and layout detail for the two-board sandwich. When adjusting the trimmers for

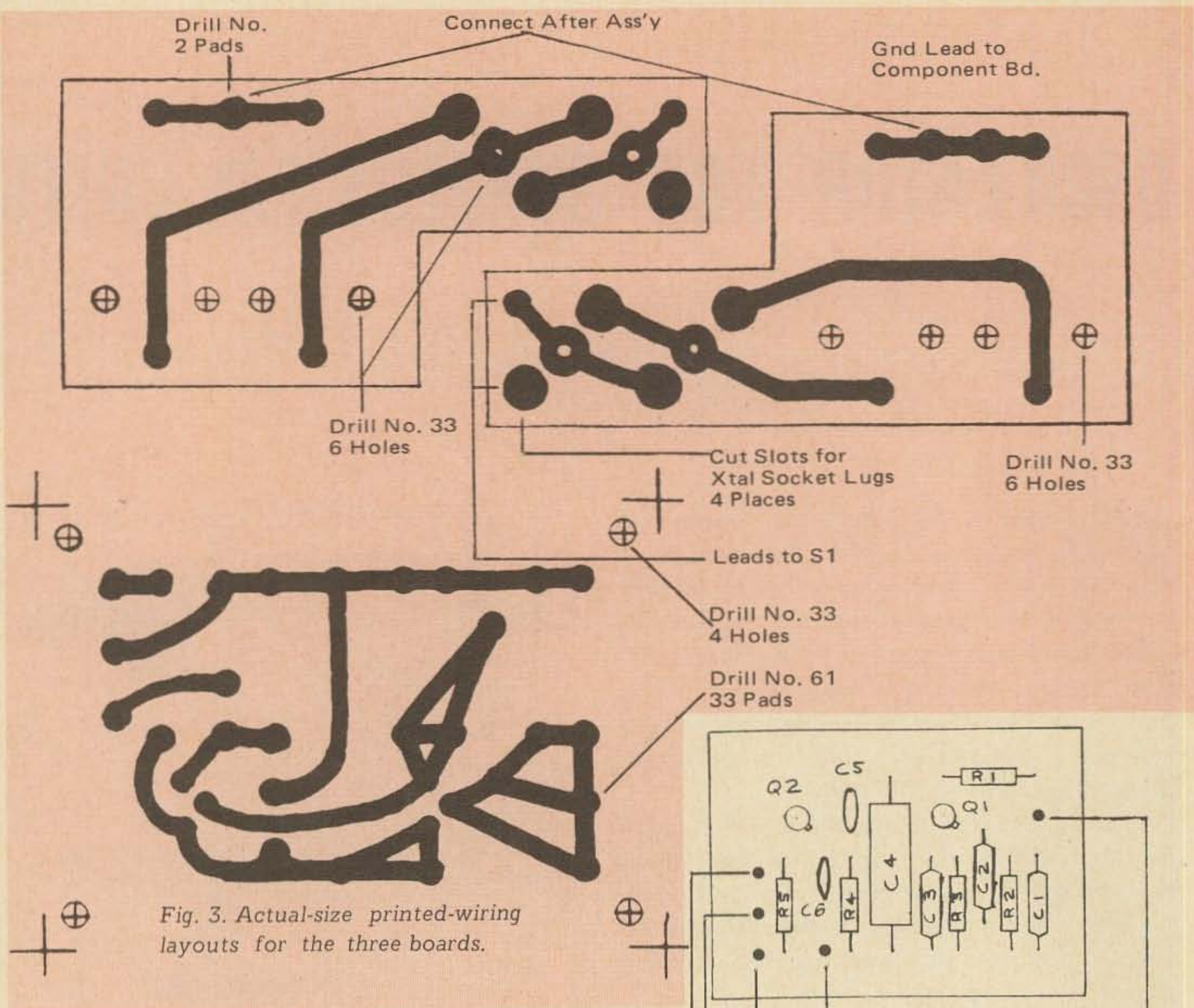

Fig. 3. Actual-size printed-wiring layouts for the three boards.

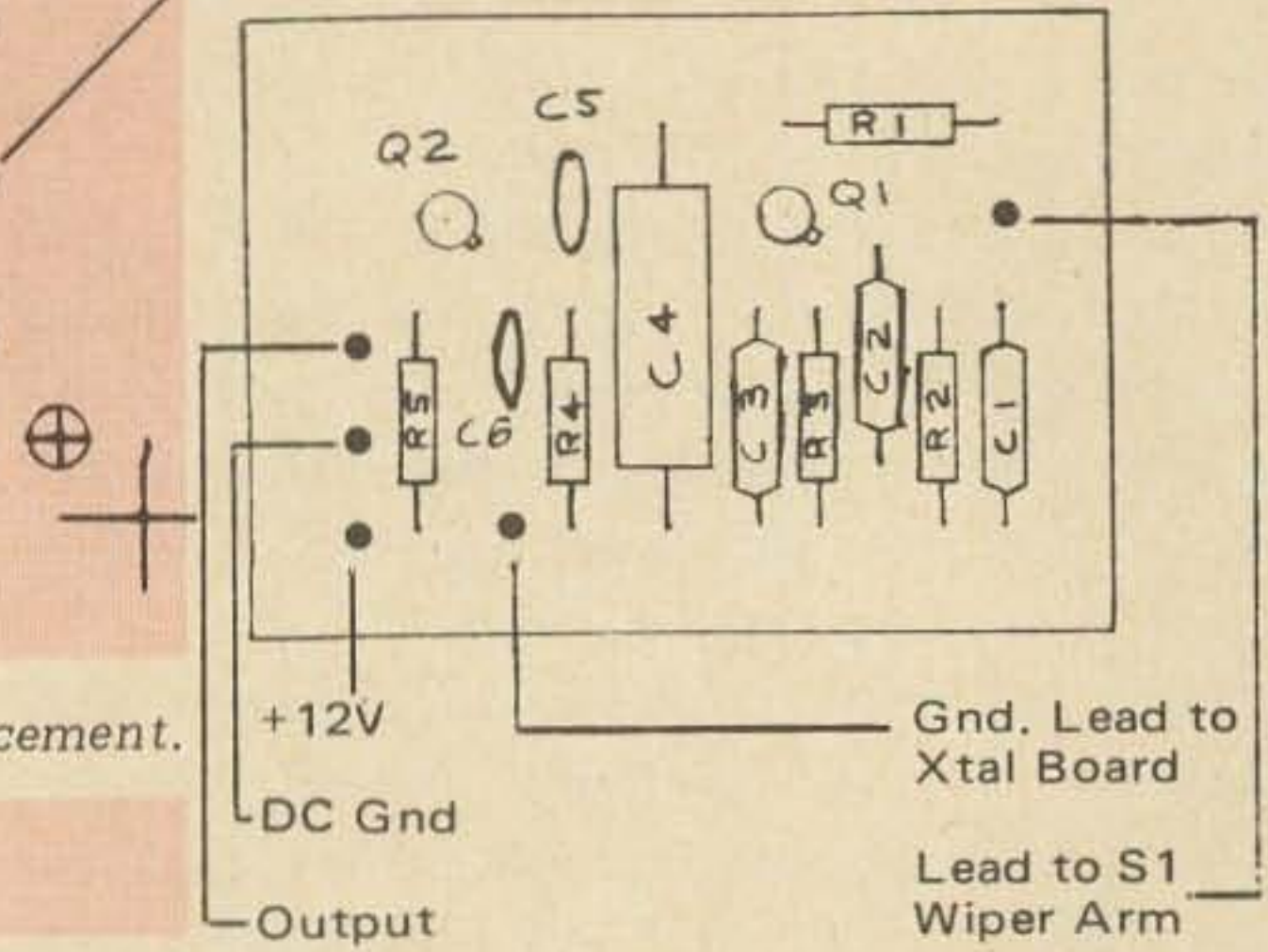

Fig. 4. Main circuit board component placement.

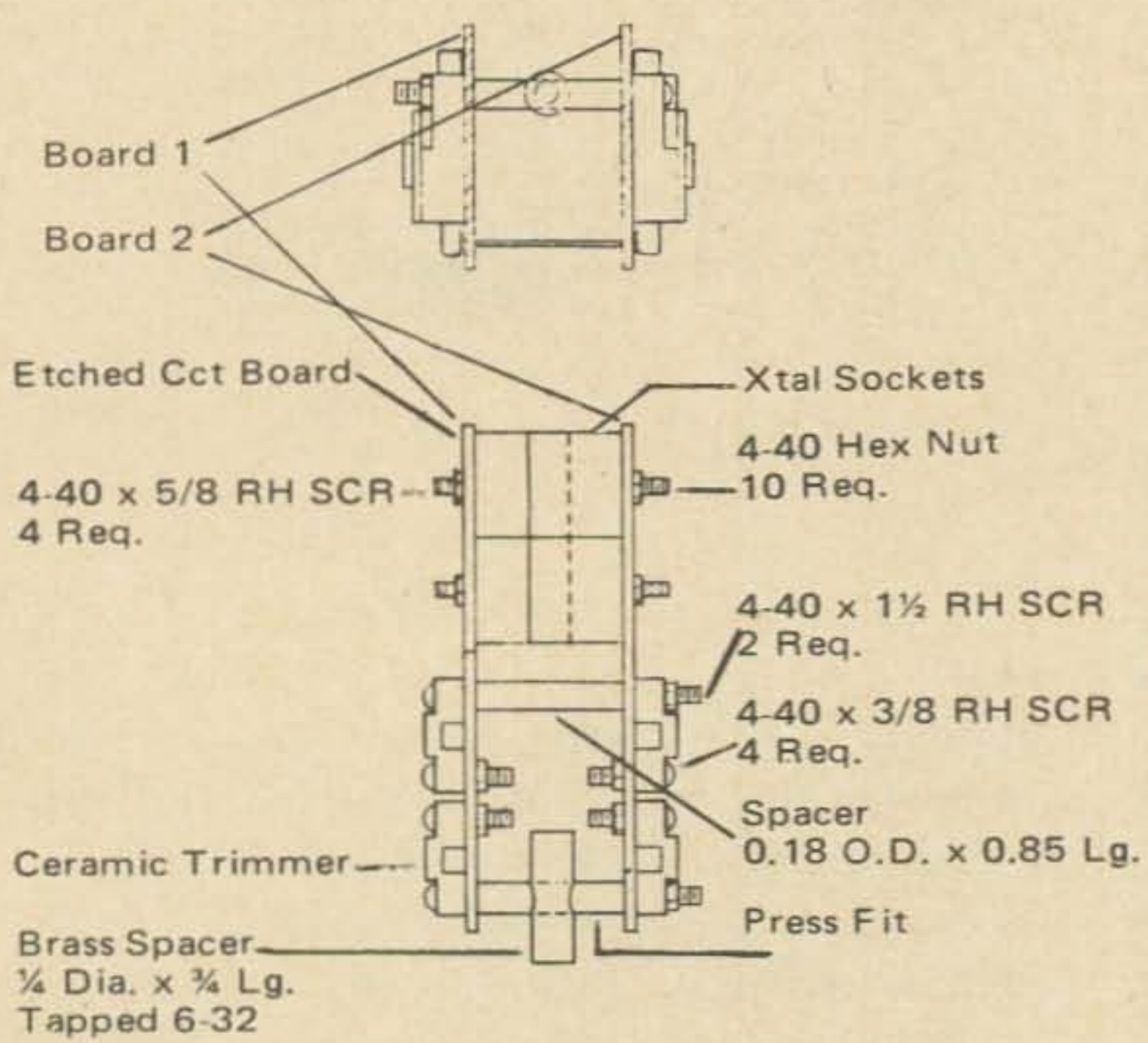

Fig. 5. Vital statistics for the two-board "sandwich."

exact frequency, remember that placing the cover on the box will lower the frequency slightly (10 to 20 Hz with 3 MHz crystals) due to the added capacitance. To avoid this problem, holes can be drilled in the cover for access to the trimmers. Because of its small size, the oscillator can easily be taken to a counter or other measuring equipment for accurate frequency adjustment.

Measurements of thermal stability have not been taken yet, but experience has shown that in the usual mobile environment the frequency does not change enough to be evident at the receiving end.

I am indebted to N. V. Friend, who furnished the idea for this device.

... W2ACM ■



# SO YOU WANT CRYSTALS FASTER!

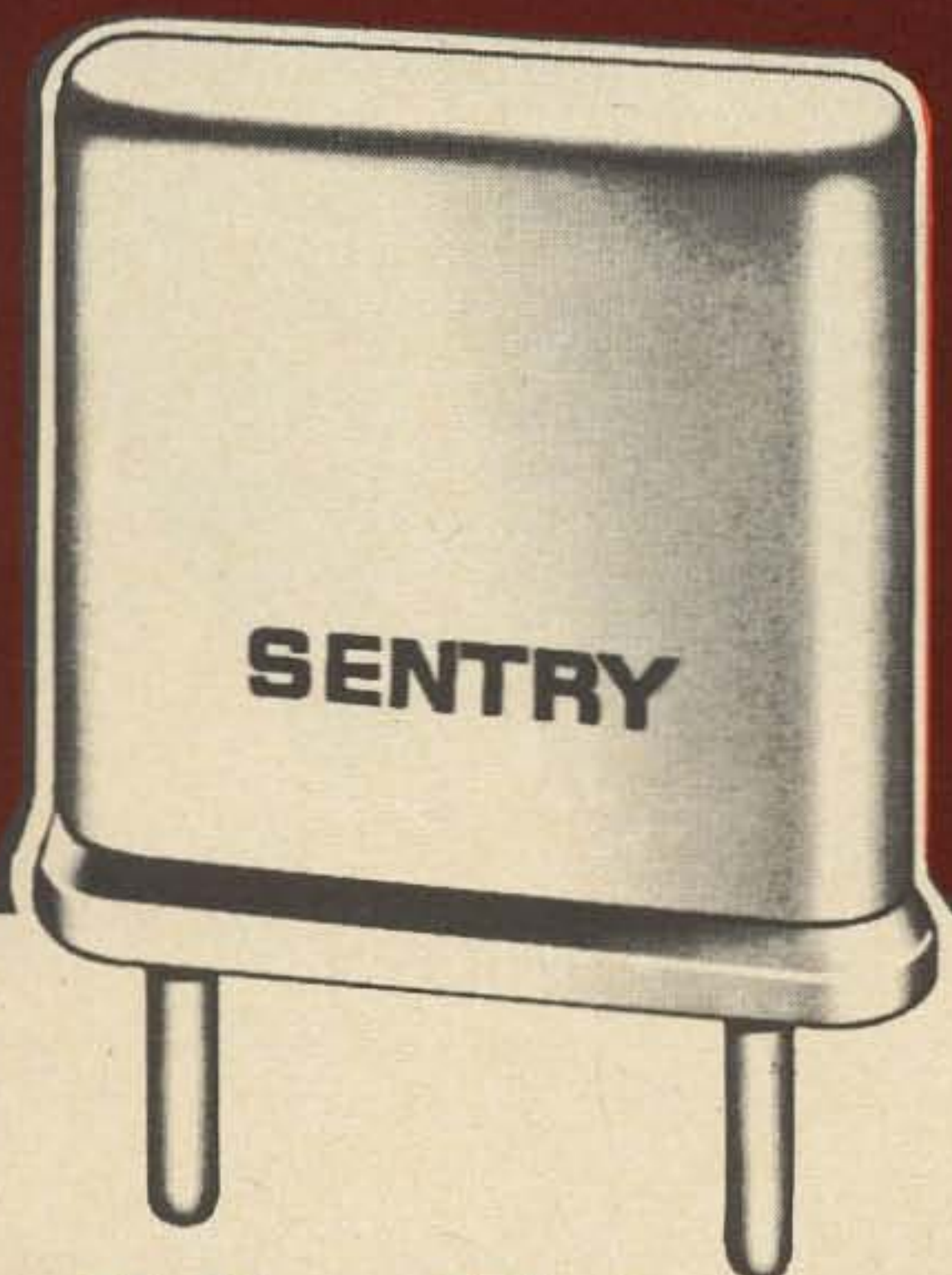

# 24

HOUR DELIVERY ON  
ALL ORDERS OF TEN  
CRYSTALS OR LESS

...well it will take someone  
with manufacturing  
"know how" to do it

But of more importance the crystal must be manufactured to Strict Specifications, have good activity and operate "on frequency" in the circuit for which it was ordered.

**SENTRY** can manufacture crystals for all two-way radio equipment: Commercial, Amateur, Aircraft, Military and Citizen Band. You need only to specify the model of set and channel frequency.

You don't believe it, when we say - "Buy the Best"?

You are satisfied with your present supplier?

You are satisfied with high prices?

You are satisfied with "second best"?

Until you try **SENTRY** you will never know!

Try Us! Make Us Prove It! "Buy the Best"



SEND FOR OUR CATALOG OF PRECISION  
QUARTZ CRYSTALS AND ELECTRONICS  
FOR THE COMMUNICATIONS INDUSTRY.  
IT WILL COST YOU NOTHING



**SENTRY MANUFACTURING COMPANY**  
Crystal Park, Chickasha, Oklahoma 73018

PHONE: (405) 224-6780

INTRODUCING THE  
**DELUXE SWAN Cygnet**



● AC and DC SUPPLIES  
 BUILT IN!

- 5 BANDS
- 260 WATTS
- \$525.00

\* RECONDITIONED \* LIKE NEW \*  
 \* TRADE IN EQUIPMENT \* 30 DAYS \*  
 \* PARTS & LABOR GUARANTEE \*

BTI		GALAXY		HQ150	\$ 125.00	LAFAYETTE	
LK 2000	\$ 499.00	Galaxy V Mark II	\$ 249.00	HQ170C	129.00	HE 144	\$ 59.00
CLEGG		GONSET		HQ180C w/spkr	199.00	HE 35A	39.00
Thor 6 w/AC sply	\$ 119.00	77A w/AC DC sply	\$ 69.00	HQ200	195.00	HE-61 VFO	9.95
COLLINS		Comm. III 6 Meter	\$ 99.00	HQ170A w/Noise Blk	149.00	NATIONAL	
KWM2 w/Waters		HALLICRAFTERS		HEATH		NC270	\$ 89.00
Q #12662	695.00	S-120	29.00	HW12 w/DC sply	99.00	NCX-3 w/AC DC sply	239.00
516E-2 (24V)	85.00	HT-40	40.00	HW32 w/DC sply	109.00	NCX-3 w/AC sply	199.00
515-1	1475.00	HT-37	179.00	HA 14 Linear w/AC sply	179.00	SWAN	
30L-1 Like New	395.00	HT-37	169.00	HR 20 w/DC sply	99.00	Swan 260	\$ 359.00
30S-1	1375.00	SX-111	109.00	VHF-1	99.00	Swan 350 w/AC DC sply	359.00
32S-3	525.00	SX-146 w/500 kc Filter	189.00	HW-10 6 Meter	99.00	406-B	45.00
DRAKE		SX-117	149.00	S8200	209.00	LATE ITEMS	
2B	\$ 169.00	HT-41 5728's	129.00	JOHNSON		Heath SB 101	\$ 395.00
280	\$ 25.00	HA-10	29.95	Valiant	\$ 99.00	Heath SB 101 w/AC sply	395.00
EICO		HAMMARLUND		Ranger One	\$ 89.00	Heath HW22 w/DC sply	99.00
753 & AC	\$ 139.00	HQ100C	\$ 99.00	KNIGHT		Heath SB 610 Scope	69.00
		HQ110C	\$ 99.00	T-150	\$ 69.00		

**HIGHEST TRADES!** NO ONE ANYWHERE will beat our deal!  
 We will **TOP** any advertised or written offer from any other dealer.  
 We trade on both new and used equipment and we service what  
 we sell. Instant credit on both new and used equipment. General  
 Electric revolving charge and Master Card Credit.

**AMATEUR - WHOLESALE ELECTRONICS**  
 A DIVISION OF



International Electronic Systems, Inc.

280 ARAGON AVENUE, CORAL GABLES, FLORIDA 33134  
 Cable "INTEL" 305-444-6207 Export orders our specialty

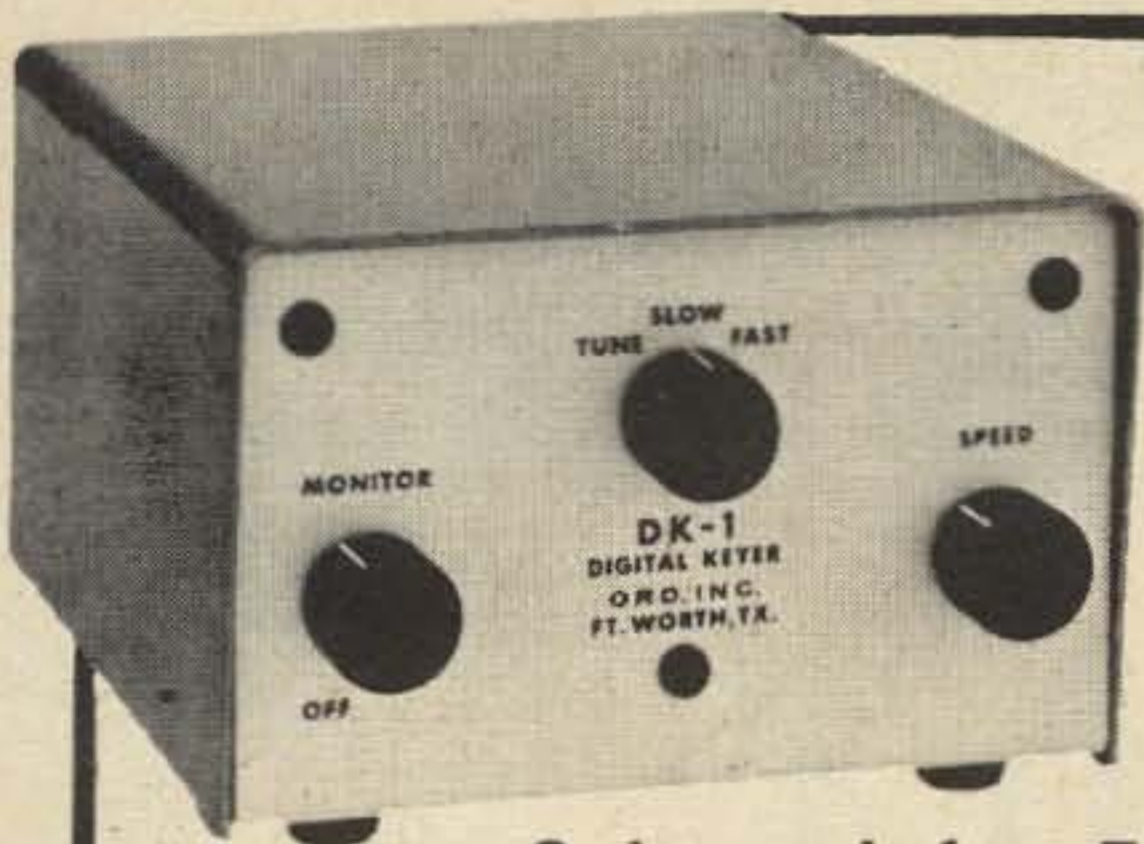

## THE DK-1 DIGITAL KEYS

is designed to allow the CW operator to transmit morse code with a **MINIMUM** of hand motion. No other keyer exceeds the DK-1 in this respect.

- Code speeds from 7 to 60 WPM with correct inter-letter and inter-word spacings
- Mercury reed relay for transmitter keying and receiver muting
- Input for manual key
- Keying monitor with built-in speaker
- 18 integrated circuits, 12 transistors, 5 diodes

These examples illustrate the minimum hand motion required. The dot and dash keys may be closed or released in the order indicated within microseconds of each other.

- "A"—Close dot-dash key. During the dot or dash, release dot-dash key.
- "R"—Close dot-dash key. During the dash or second dot, release dash-dot key.
- "P"—Close dot-dash key. During the second dash or dot, release dash-dot key.
- "L"—Close dot key. During the first dot, flick the dash key. Release dot key during the last dot.
- "B"—Close dash-dot key. Release dash key at any time during the three dots and dot key during the last dot; or, release dash-dot key during the last dot.
- "Double Dash"—close dash-dot key. Release dot-dash key during the last dot or dash.

Note that in the above examples, only one depress-release cycle of the dot and dash keys is required. All letters, numbers and punctuation marks may be generated using variations of this technique.

**\$124.50**

PPD. CONT. U.S.A.  
From Distributor or  
Direct from Factory

WRITE FOR  
FREE  
BROCHURE

**ORD, Inc.**

3201 HANDLEY EDERVILLE RD.  
FORT WORTH, TEXAS 76118  
817 / 268-1611

## ADD SPOTTING TO YOUR VFO

K. N. Gray K8BYO  
1391 Schoolcraft Road  
Copley OH 44321

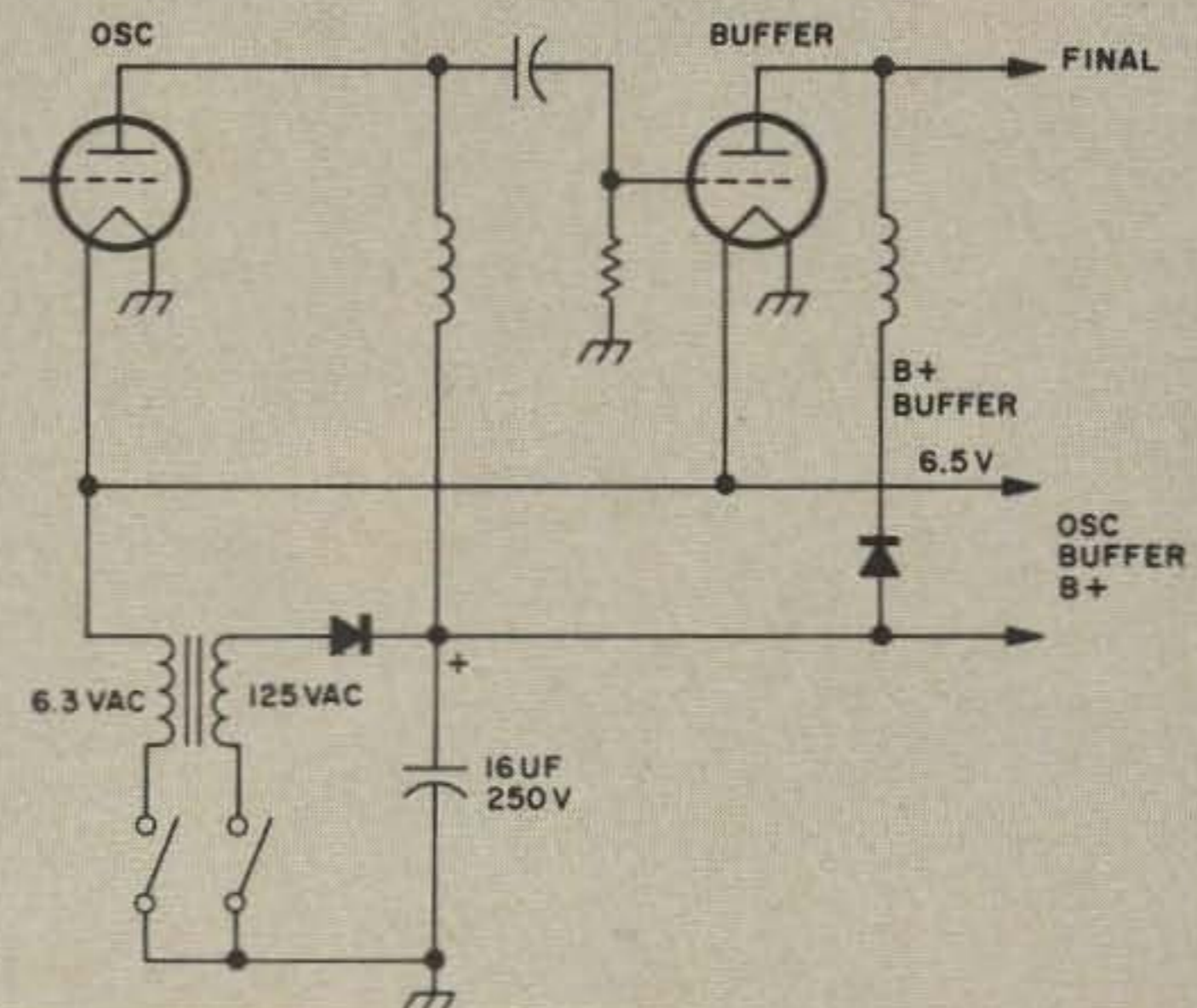

To spot my vfo on a received signal, I needed a quick and easy way to power the oscillator independently from the transmitter.

Normally the ac-driven heaters are on all the time, so why not connect a 6.3V transformer in reverse order, rectify the output, and use it for low B+ for the oscillator?

After some experimentation, I came up with the circuit shown here. As shown, I

connected a double-pole (single-throw) switch in both ground leads of the transformer primary and secondary windings to prevent feedthrough when regular B+ is applied as the rig goes into the regular transmit mode.

A diode in the B+ to the buffer prevents it from operating when spot checking and still allows regular operation.

... K8BYO ■



**TOWARDS  
AN IDEAL  
SOLID-  
STATE  
I-F FOR  
AMATEURS**

**PART 1  
LOW  
FREQUENCY  
MODULES  
USING  
ICs**

... and believe it or not, 455 kHz isn't it!

William Hoisington K1GLL  
Far Over Farm  
Peterborough, NH 03458

This article is a two-part series that deals with design methods, components, and circuits using solid-state devices leading to an i-f system that will meet the special requirements of the amateur builder who wants a reasonable-cost, selective, low-image, tunable i-f for use following converters on 6 or 2 meters, or the UHF regions above 420 MHz. This portion of the series describes design

details of the 1.65 MHz and the 135 kHz i-f modules, using subminiature shielded coils and ICs.

**Requirements**

*Selectivity and Freedom From Images.* The easiest way for the homebrewer to get selectivity is to use a low intermediate frequency; however, this cannot be done without suffering from image trouble unless

several conversions are used. An image is the unwanted signal on a frequency separated from the desired signal by twice the i-f. This is caused by the presence in a mixer collector circuit of several frequencies other than the desired one. For example, if the local oscillator is on 28.5 MHz and the desired signal is on 28 MHz, a beat note at 0.5 MHz will be produced, which is used for the i-f.

Unfortunately, a signal on 29 MHz will also produce a beat note on 0.5 MHz. This unwanted signal is called the image; you can see that it can cause considerable strain on the selectivity requirements of the rf and mixer stages in a 10 meter receiver in order to remove it. This is one of the main reasons for multiple conversion amateur receivers that use a first i-f of 1.65 or 2 MHz, which places the image some 3.3 to 4 MHz away from the desired signal. Here it can be handled by the selectivity of the two tuned circuits of the rf and mixer stages generally found in such a receiver. The requirement for reduction of the image is met in this fashion in our "ideal" i-f.

*Tunable I-Fs.* The use of converters with crystal-controlled local oscillators for stability reasons requires tuning somewhere else down the line. For the fellow interested only in a large, stay-put home station, this can be accomplished by using his 100 lb communications receiver, with switched inputs, etc. However, that does not meet our planned types of operations, such as battery-portable-anywhere, mobile, and emergency use, all of which are applications well suited for solid-state devices. A tunable, selective front end with rf stages, mixer, and tunable oscillator does the trick.

*Practicability.* The next requirement is for available components at reasonable cost. The J. W. Miller Co. has produced a line of shielded, subminiature adjustable rf coils (9050 series) which fill the bill for inductors. They have a threaded core of powdered iron in the center for trimming, an outer magnetic shielding cup which also helps the Q, and an aluminum case for electrostatic shielding (½ in. square by 9/16 in. high). They also are handy because you can easily add extra windings—for coupling with solid-state devices.

Resistors in the 1/8 and 1/10 watt range are available at most mail order houses, along with subminiature capacitors. Subminiature terminal pins have been described in my own previous articles in 73 Magazine.

Active devices having high gain and low internal feedback, that do not need neutralization, are available from Motorola. The HEP 590 is one of these; it is easy to use and performs excellently.

*Demodulation Characteristics.* These articles being mainly concerned with AM on VHF and UHF, the demodulation is important. This is given scant treatment in many handbooks, but I find that when you're actually digging those call letters (at least!) out of the mud, you need the best possible diode circuit available. It seems, from all the tests I've made, that the diode demodulates more af when connected across the entire winding of the last tuned circuit.

*AF Amplification.* Next in order of importance comes a good af amplifier. There is no doubt at all in my mind on this one. The Amperex TAA-300 is it. It has 1W output, a response of 20 Hz to 25 kHz, and an 8Ω transformerless output impedance, and sounds good. With bass and treble controls in front, it really does the job for voice communication frequencies for amateurs.

*Single-Package I-F Pair.* The last requirement (for now) is for a double-frequency i-f. This is just a handy phrase for the combination of the 1.65 MHz and the 135 kHz i-f in one package. You can put more gain—with greater freedom from feedback troubles—into the amplifier when the input is on one frequency and the output on another—a tried and proved method.

#### I-F Considerations

Let's face it, 455 kHz is not the best i-f for amateur communications receivers. Its use as an intermediate frequency dates from the early 1920s which is by now nearly 50 years ago, and was intended for the broadcast band. There was and still is a good reason for using it on the BC band: It is the only i-f that even partially suits a "cheapie" BC set. I say only partially because using a mixer on the BC band, without an rf stage in front, which many millions of BC sets do, you get images from 540 kHz up to about

690 on the dial. I have a \$100 set that covers 540 kHz up to 54 MHz—it is an excellent set for the money and is invaluable for checking harmonics, oscillators, mixer outputs, and the like; but not having an rf stage, it does have an image on the low end of the dial.

Car radios, mostly working on the “me too” design theory, use 262 kHz for the i-f. The reason given: “greater selectivity.” Sure, it is easier to get better selectivity with a lower i-f, but the image is worse also, so they use an rf stage. If this rf stage is properly made and tuned, it solves the problem on the BC band. And I’ll take my hat off to most of the designers of car radios that I’ve had, as most of these have performed pretty well. For many years of mountain-topping on 2 meters, driving home after 2 a.m., I kept awake listening to “Grand Ole Opry” and such, and those car radios did a good job.

But what about amateurs? These bands begin at 160 meters, so up around 10 meters, with an i-f on 455 kHz, the image is only 910 kHz away! You can’t really put an i-f in the middle of the BC band, so the next slot is up at 1.65 MHz, or near that point. This works out fine for the image problem, but now your selectivity has gone to pot.

Of course, you *can* use a Gonset-type i-f with selectivity of around 30 to 40 kHz. In fact, right in this article I describe a “nice little i-f” on 1.65 MHz, with just that kind of selectivity. It works fine with just a single conversion on 6 or 2 meters, but when the band opens, stay away from the low end! I was in Maine one fine evening on a little rise of 400 ft or so when 2 meters opened. I worked Washington D.C. and VE1, but I couldn’t separate one signal from another on the crowded low end using my “tried and true” Gonset III.

So, it is probably best to devote the extra time and money required and try for the ideal i-f, which conquers images and provides excellent selectivity at the same time. There are two components which help the homebrewer reach this goal: the Miller Series 9050 subminiature coils and the Motorola HEP 590 communication IC.

Our ideal i-f will therefore look like the block diagram in Fig. 1. When designed, components selected, the circuit formed up, and packaged with its small battery supply,

it should be a useful addition to amateur VHF, UHF, and microwave equipment.

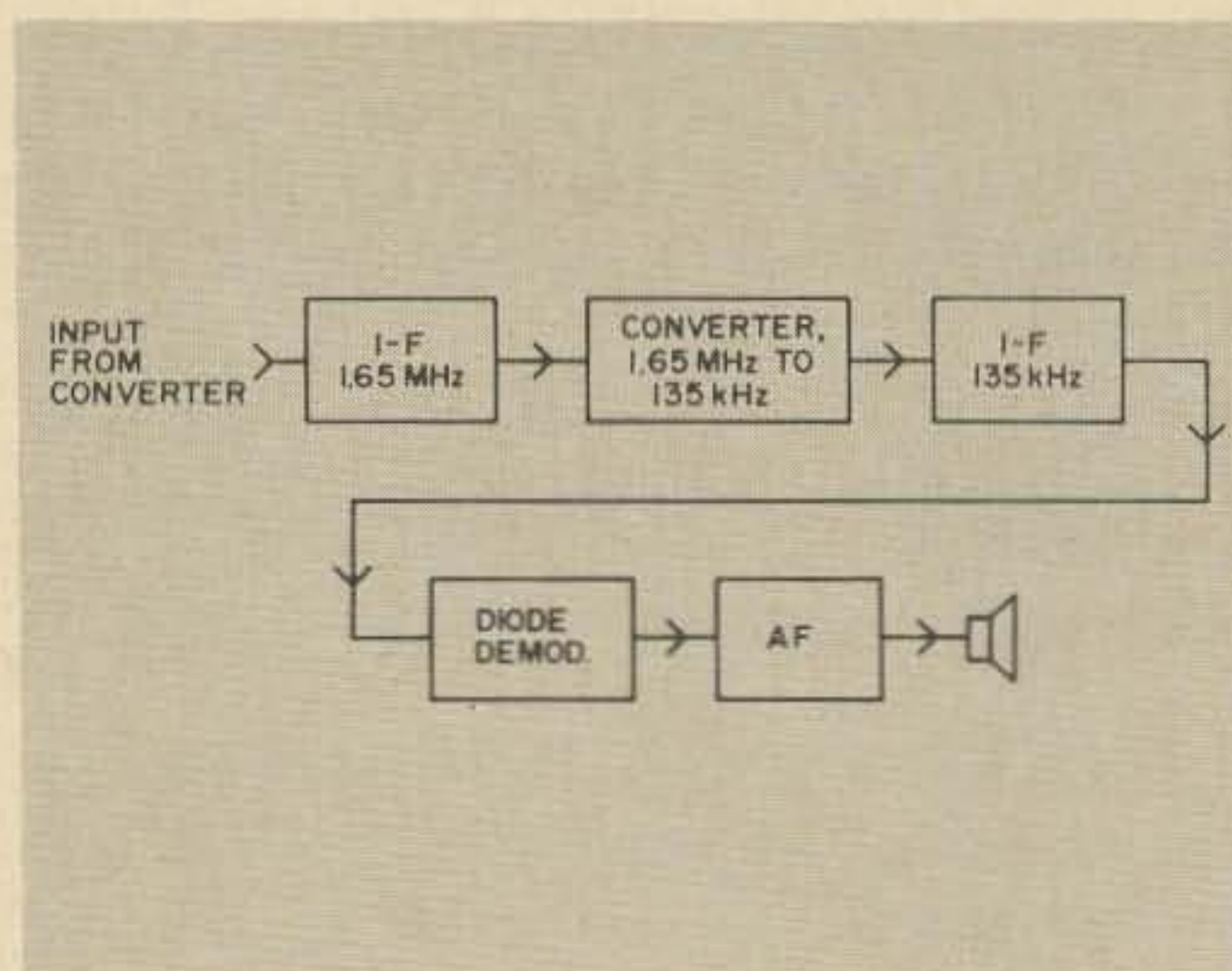

Fig. 1. Block diagram of the “ideal” i-f for amateur use.

### Miller Series 9050 Coils

Here is something good, that you can really tailor to suit your needs. Figure 2 shows the inner workings. The Bakelite base is normally supplied with two pins, but is easily drilled for four extra wires (which you need for a link-coupled base input, for example). The coil form has a neat spiral ridge inside to take the 6/32 in. threaded

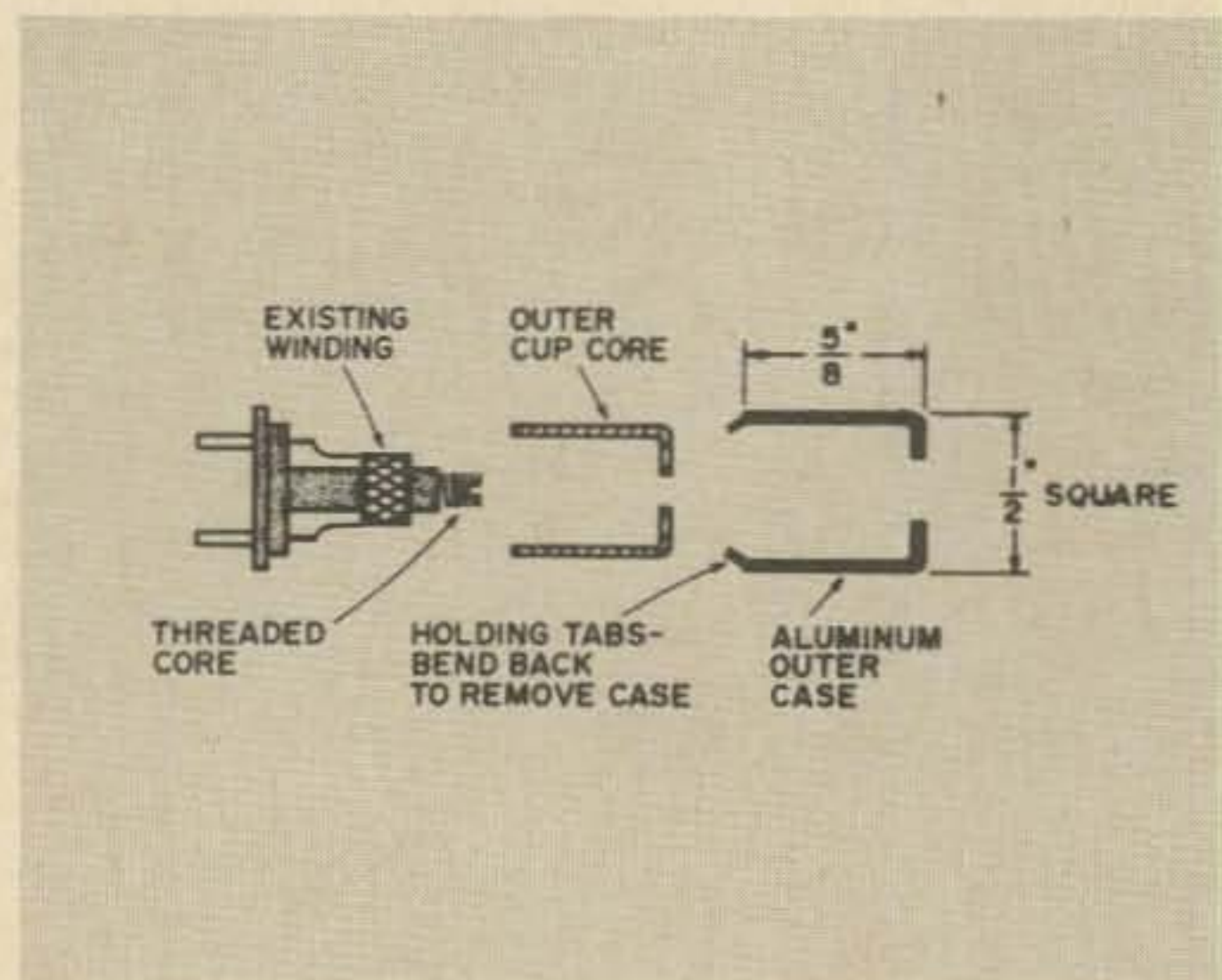

Fig. 2. Miller coils, 9050 series.

core. This ridge type works better than some other types of coil holders I’ve used. The outer powdered iron cup generally has room between itself and the existing winding for the few extra turns needed in solid-state work. The aluminum outer case comes off easily enough after you bend back the four crimped aluminum tabs on the case that hold the coil form in place.

As you will see in the section on coil data, you can wind on 1-10 turns of link coupling and a 5-turn base coil, both on top of the existing winding, for a base input network. I used a small drill to make more holes in the Bakelite end piece to bring out the extra wires, and find the entire series adaptable from 30 MHz down to 135 kHz; and the good Q resulting from the use of these coils is particularly noticeable in the overall selectivity figure of the finished i-f. Figure 3 shows one of them with an extra

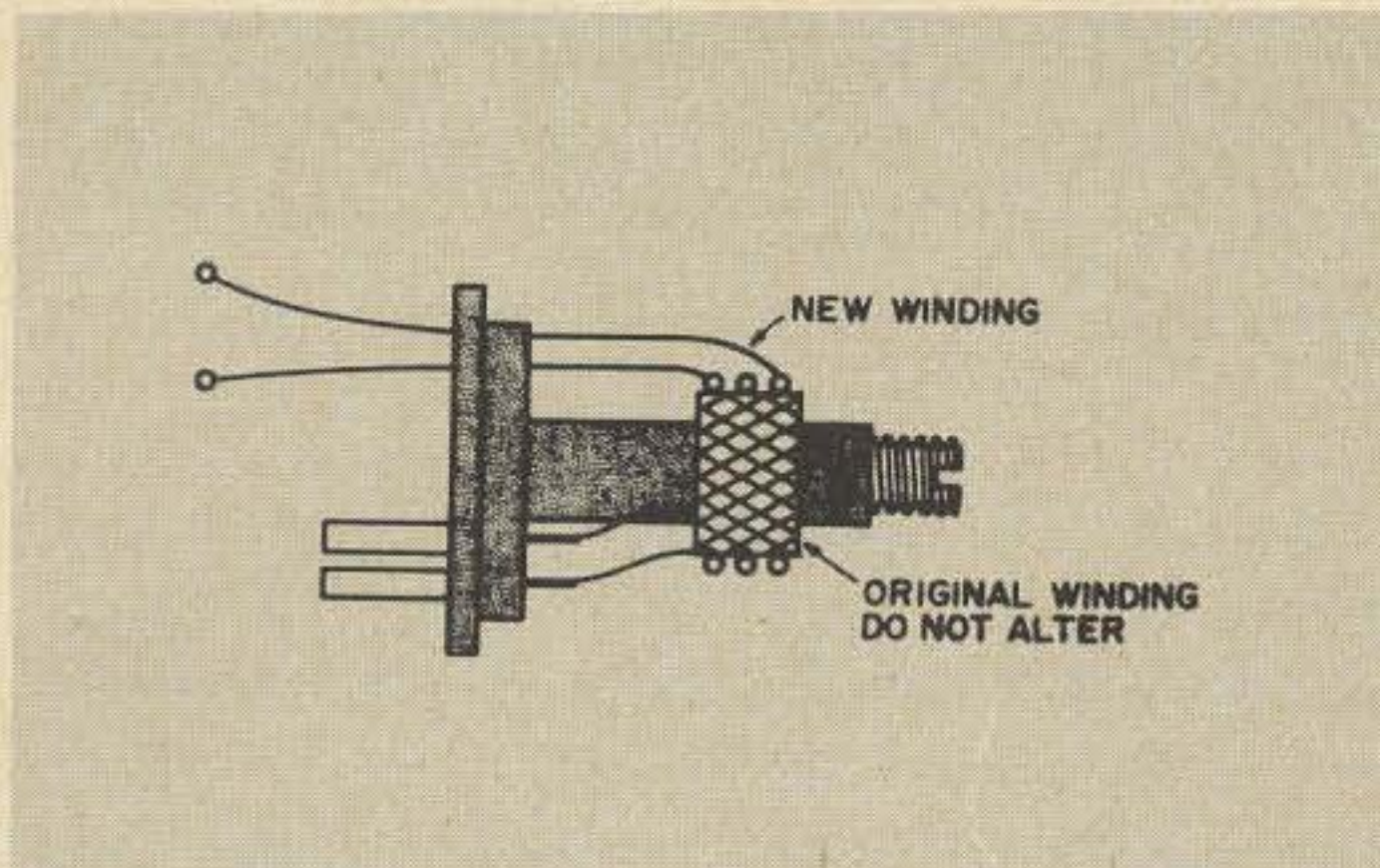

Fig. 3. Two holes at the bottom of the coil permit the two additional leads to be brought out with the original windings.

three turns installed. Until Miller comes up with something better, these are my coils.

*Loaded Q vs Turns.* Various sections of a communications receiver i-f have different amounts of loading, which affects the Q and energy transfer. For example, the HEP 590 input circuit works well with only a single-turn input link at 1.65 MHz, while at the same frequency a 5-turn link is required when going into the diode circuit, which is heavily loaded.

The HEP 590 output circuit, rated at 100 kΩ ac impedance, needs only 2 turns for maximum transfer of energy into a 50Ω cable or link to the next stage. Naturally, a lot depends on what impedance you're looking into, or out of, and how it is treated. The HEP 590 input circuit, rated at 1.8 kΩ ac impedance—if loaded directly onto the inductor—will swamp the Q way down.

Looking at Fig. 1, you can see what has to be done for this type of i-f. A winding of the correct number of turns to suit the impedance of the IC is installed over the existing tuned circuit, which is resonated at 1.65 MHz. A cable input link of only a single

## SOLID STATE BROAD BAND DOUBLE BALANCED MIXER

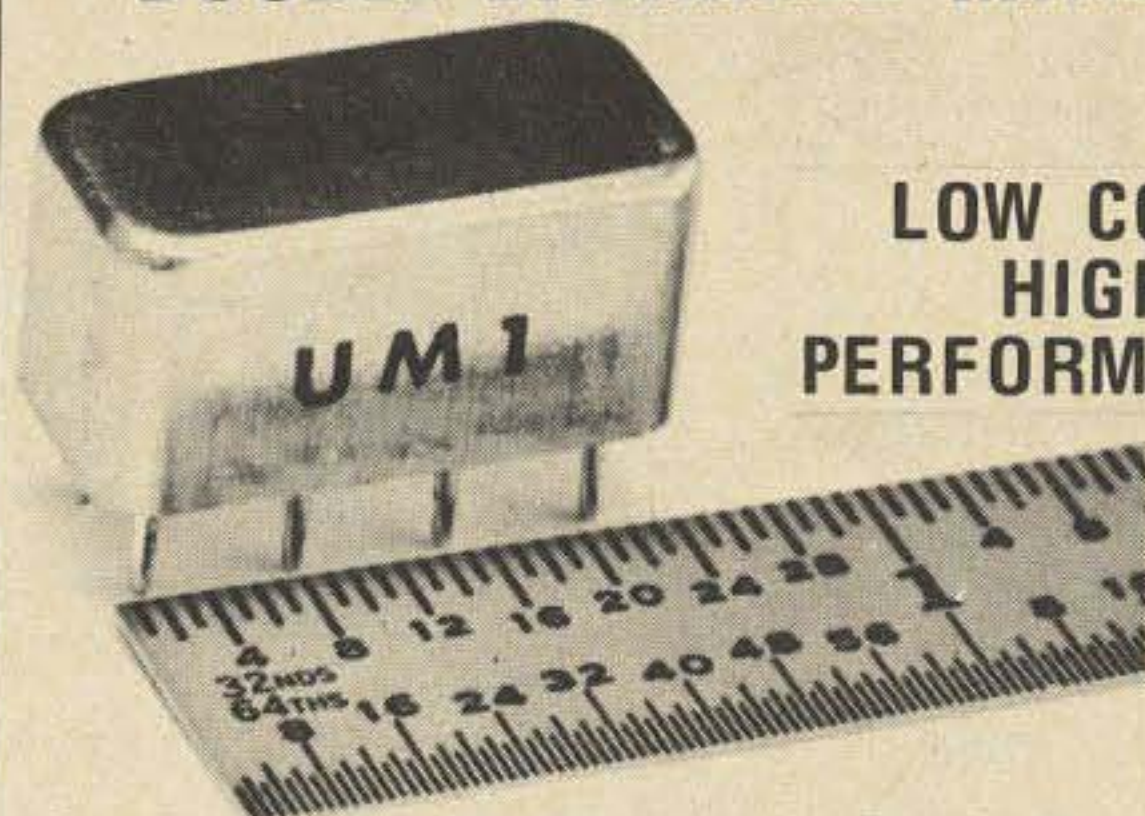

**LOW COST  
HIGH  
PERFORMANCE**

Frequency Range . . . . .200 kHz—200 MHz, 50 ohm system  
(useful range exceeds above)  
Conversion Loss . . . . .6 dB Nominal; 7 dB Maximum  
L.O. Rejection . . . . .45 dB, 200 kHz to 30 MHz  
35 dB to 200 MHz

P.C. Board mounted pins on 0.200 inch centers  
Hermetically Sealed — RFI Shielded Package  
(less than 0.5 cubic inch volume)

Applications Include

- \* Balanced Modulator — ideally suited for filter or phasing type Single sideband generators.
- \* Receiver Mixer
- \* Product Detector
- \* Phase Detector
- \* Voltage Controlled R.F. Signal Attenuator

Model UM-1H incorporates Hot Carrier Diodes for Low Noise applications. The UM-1H meets or exceeds the UM-1 specifications with a guaranteed 7 dB Maximum Noise Figure.

Price: (FOB Milpitas, Calif.)

Model UM-1 . . . . . \$15.00 each

Model UM-1H . . . . . \$17.50 each

(California residents add 5% sales tax)

Send check or Money Order to%

**Electronic Design and Development Associates**  
PO Box 373, Milpitas, California 95035

## WORLD QSL BUREAU

5200 Panama Ave.

Richmond, Calif. U.S.A. 94804

### Plan 1

We forward your QSLs (please arrange alphabetically) to or within U.S.A., Canada and Mexico for 3¢ each, and to all other places in the world for 4¢ each.

### Plan 2

You use our special log form and send us a copy. We supply QSL, make out QSL, deliver QSL, all for 8¢ each.

Write for free information sheet.

## VIBROPLEX

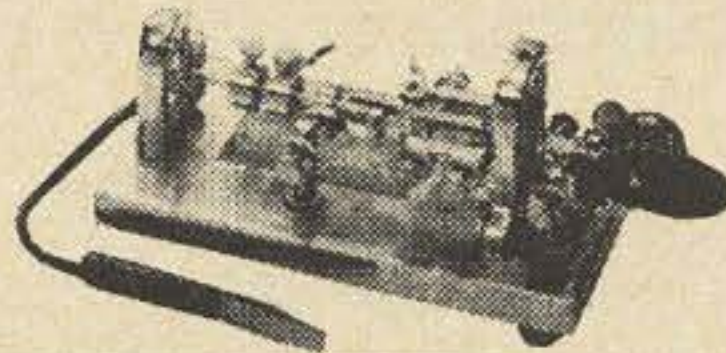

**ENJOY EASY,  
RESTFUL KEYING**

\$21.95 to \$43.95

THE VIBROPLEX

CO., INC.

833 Broadway,

N. Y. 3, N.Y.

## ALL BAND TRAP ANTENNA!

Reduces Interference and Noise on All Makes Short Wave Receivers. Makes World-Wide Reception Stronger. Complete with 96 ft. 72 ohm feedline. Sealed resonant traps. For novice and all class radio amateurs! Eliminates 5 separate antennas with better performance guaranteed 80-40-20-15-10 meter bands. Complete 102 ft. \$19.95. 40-20-15-10 meter bands, 54 ft. (best for world-wide short wave reception) \$18.95. Send only \$3.00 (cash, ck, mo) and pay postman balance COD plus postage on arrival or send full price for post-paid delivery. Complete instructions included.

For ALL Amateur Transmitters. Guaranteed for 1000 Watts Power. Light, Neat, Weatherproof.

WESTERN ELECTRONICS Dept. A Kearney, Nebraska 68847

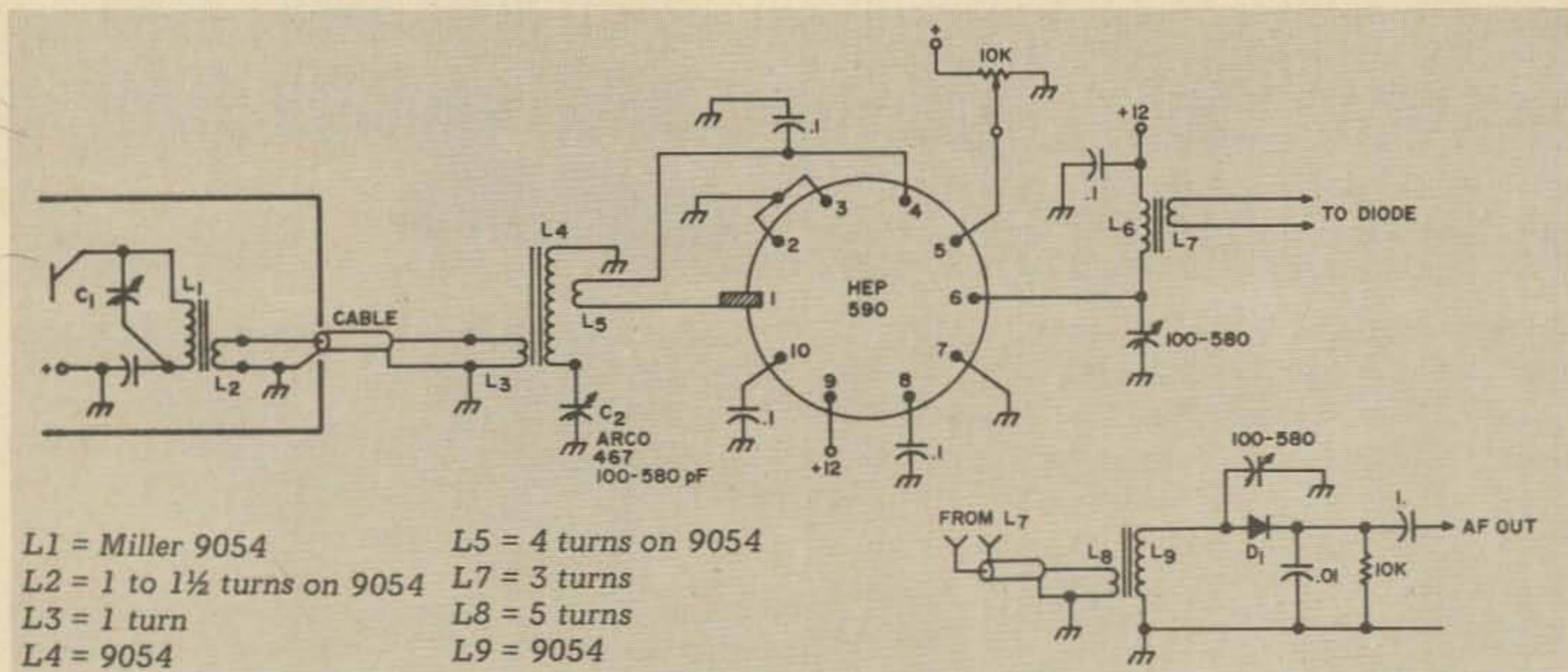

Fig. 4. Coil interconnection and winding data. At left is VHF converter (Part II). Test diode demodulator schematic is shown at lower right.

turn is also wound over the same resonant circuit. Don't forget that the presence of the powdered iron both inside and outside aids this coupling. When the inductor is heavily loaded and the Q is lowered, the number of turns required to effect a transfer of energy may be as much as five times greater. This can also be seen in the coil table in Figs. 4 and 7. The base input is very easy to match by this method of varying the number of turns, as in Fig. 4 (L4) and in Fig. 7 (L3).

When using link coupling, which is very desirable at times *with modulator type units*, be careful not to couple too tightly (by the use of too many turns). This will show up as excessive detuning of one tuned circuit by the one link-coupled to it. It may also cause broad tuning. For maximum selectivity and proper handling, use slightly *less* than the coupling showing maximum energy transfer. Remember, *gain* is cheap, *selectivity* is not.

The 1.65 MHz and the 135 kHz modules will be described in the first part of this article, and the converter and avc detail in the next.

#### The 1.65 MHz I-F Module

This unit is what you could call a "nice little i-f." Following a 6 meter front end, it has *plenty* of gain, and selectivity of 30 to 40 kHz. It is also very easy to tune on 6 or 2 meters.

The schematic is shown in Fig. 4. Each of the seven windings, L1 through L7, has been the subject of considerable work and testing here, for selectivity and general handling

properties. The tunable i-f or VHF converter shown at the left is the subject of other articles and is not taken up here. It does use one of the Miller series 9050 coils, though, as shown for L1, with but one turn added on to it for feeding the 1.65 MHz i-f energy over to the i-f module being described. Inductor L2 is installed on top of the existing winding of the 9054 coil. Also low in turns is L3, with only one turn being needed at 1.65 MHz, due to the high Q of the 9054 design. Coil L4 is another 9054, which has a third winding going to the base of Q1 in the HEP 590 IC. The input of the HEP 590 is rated at 1.8 kΩ.

The input tuning of C2 is very sharp due to the correct amount of coupling to L4 which has a high loaded Q. The HEP 590 communications IC and its advantages have been described several times in 73 Magazine, so only a brief mention will be made here. Inside the IC there are three transistors and a diode. The two transistors that do the amplifying are arranged as in Fig. 5, in a grounded-emitter, grounded-base pair, which is a high-gain configuration with no detectable internal feedback. The third transistor is connected as an avc unit, and the diode is used for temperature control.

Another Miller 9054 is connected to the output circuit on pin 6 and tuned by an Arco 467 mica compression trimmer of 100 to 580 pF capacitance. You can also get the needed capacitance by using fixed dipped micas and trimming up to 1.65 MHz with



the threaded-core tuning slug. If you do it this way, be sure to adjust the fixed capacitors so that most of the slug remains *inside* the winding for best coupling and Q.

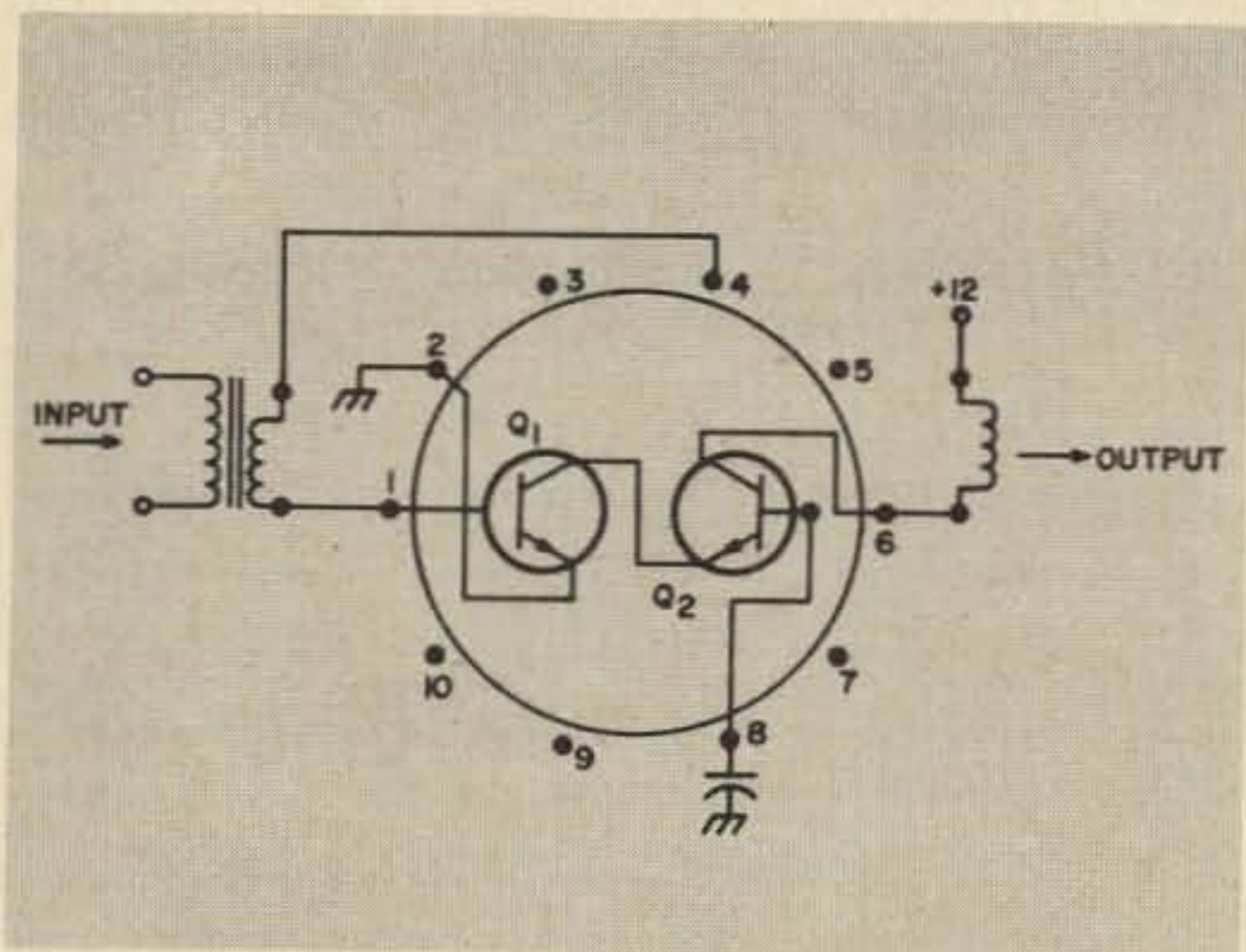

Fig. 5. Internal details, HEP 590, Motorola.

A 3-turn link winding is added to L6, which goes to an output connection. For tuning up, I used L8, L9, and a diode. When used with a tunable front end on 6 or 2 meters, this makes that "nice little i-f." Follow it with a good af and try it. You'll be surprised. It does not have ideal selectivity, but a 6 meter front end is wonderfully easy to tune with it!

Pin 5 of the HEP 590 can be used for a temporary manual gain control with just a

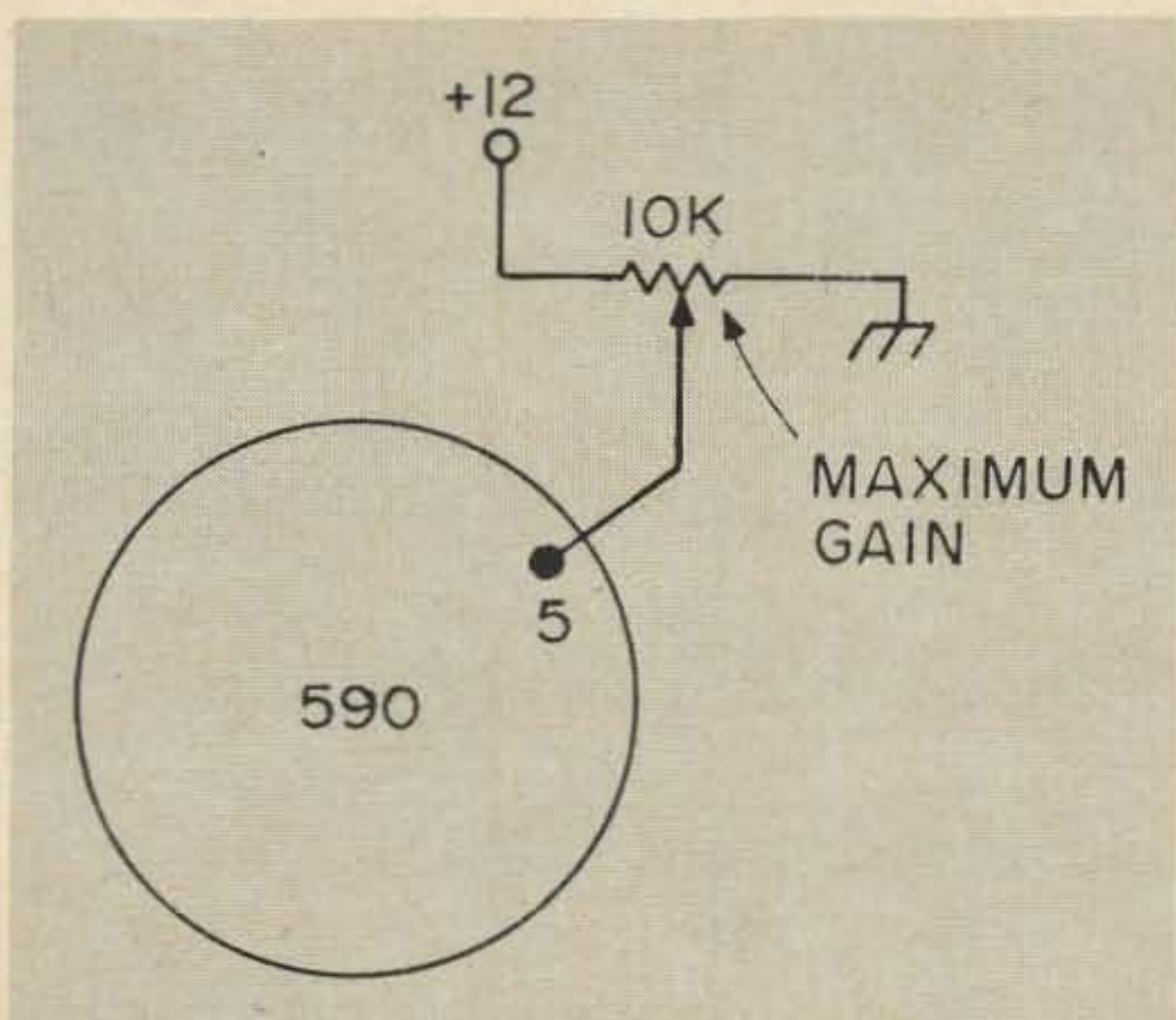

Fig. 6.

pot as in Fig. 6. Nothing else is needed. (The second part of this article deals with the avc circuit for use with pin 5.)

# hold on to your hat!



## THE GIGANTIC FM REPEATER DIRECTORY IS COMING!

... NEXT MONTH

It's new and fresh ... it's accurate and up-to-date. And best of all — it's free to 73 subscribers.

#### CUSTOM TRANSFORMER DESIGN & MANUFACTURE

Write today for a free quotation on any transformer, choke, or saturable reactor. Each unit will be designed and manufactured to your exact specifications. Standard E-I and tape wound "C" cores are available. Quantities from single units to production runs may be accommodated.

PETER W. DAHL CO.

5325 Annette Ave., El Paso, Texas 79924

Tele: 915-751-4856

#### LARGEST ASSORTMENT of BRAND NAMES

You can save enormous amounts of money while choosing from a complete line of transceivers, receivers, transmitters, etc.

**WE HAVE EVERYTHING IN HAM GEAR  
SAVE MONEY ORDER BY MAIL**

**CB Radio Co., Inc.**

89 Aspen Rd.  
617-598-9700

Swampscott, Mass. 01901

#### BUILD YOUR OWN TV CAMERA!!

Imagine transmitting amateur TV pictures over the air...or watching the kids on the living room TV...or monitoring some remote area, such as a driveway, swimming pool, nursery, etc! Select from a variety of starter or complete kits. Also, plans available separately. DETAILED CATALOG FREE.

#### ATV RESEARCH

13th & Broadway N. Dakota City NB 68731

#### PROFESSIONAL REPAIR AND CALIBRATION SERVICE

Specialist in the maintenance and calibration of school's electronic laboratory equipment, test equipment and amateur equipment. Prompt service by holders of amateur and commercial FCC licenses. Write for shipping instructions.

PANTRONICS OF VIRGINIA, INC.

6608 Edsall Rd.

Alexandria, Virginia 22312

### 135 kHz I-F Module

My bypassing of the converter module to describe the 135 kHz i-f may seem abrupt, but the work involved with the i-f coils and the IC units makes the continuity better this way.

Figure 7 shows the schematic of this module using the Miller subminiature 9060 coils (with added windings) and the Motorola HEP 590 IC. The circuit is quite similar to the 1.65 MHz version except for the output.

The Miller 9060 tunes to 135 kHz with an Arco 100 to 580 pF trimmer, but here again you can make up the capacitor with the small dipped mica ones to bring the 9060 near resonance and trim to the exact frequency with the internal threaded slug.

The input cable from the converter module (second part of this article) goes to L1, a 5-turn winding installed over the existing winding of the 9060. I use 32 AWG double cotton-covered for this and put small tabs on the input wires of coil L1 for identification. You can also use different colored wire if you have it on hand.

The HEP 590 was described in the first i-f section. It is treated identically, except that pin 5 is left grounded, keeping the gain full

on, which is best for avc action because this is the unit that drives the avc diode and needs full gain.

The output coil is another 9060, with the diode connected to the *high* end. Some circuits call for tapping down the diode on the coil, but I have never found any connection as good as that shown in Fig. 7 for high quality af output. Only two tuned circuits are shown here but there is a third in the converter module; the total selectivity is thus as sharp as you may want to use, because you can still recognize your friends' voices on the air. It is sharp enough so that using it on 420, for example, I have been able to separate the audio of stations that were heterodyning each other. Of course those \$600 receivers can have crystals and 2.5 bandwidths, but that isn't the class of machine we're building here.

*This first part of two sections on trending towards an ideal i-f system has covered the 1.65 MHz and the 135 kHz modules using modern coils and ICs. The aim is to build the best i-f possible, using reasonable-cost components and homebrew methods. The difficult requirements of an i-f with very low image characteristics and very high selectivity have been met. The second part of this article details the converter and avc systems.*

... K1CLL ■

Fig. 7. 135 kHz i-f, with HEP 590 and Miller coils.

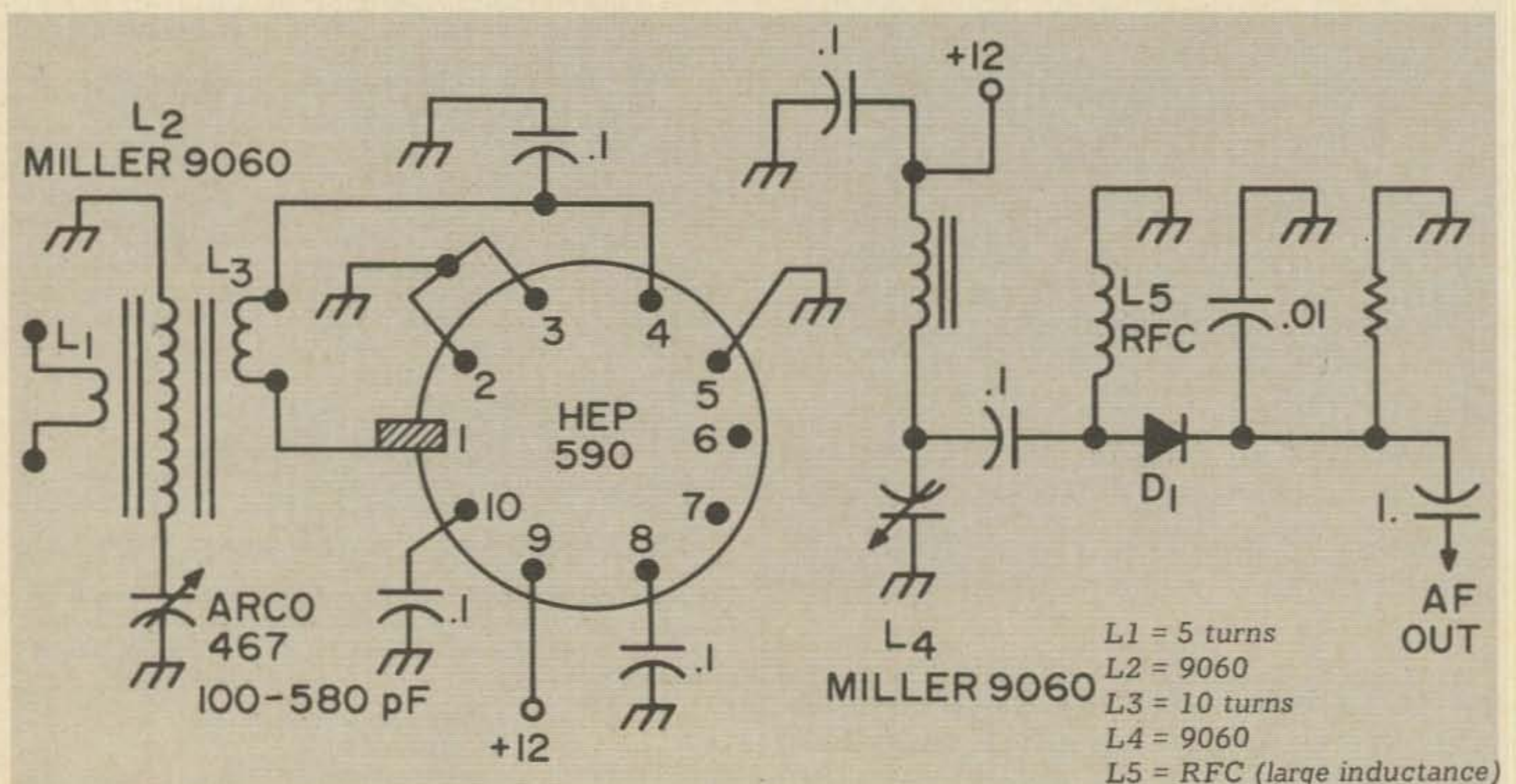

The editors and Engineers Radio Handbook is by far the biggest and the best handbook in print. Here is your chance to get this great book at a substantial discount, if you act fast. We have just 500 copies on hand and when they are sold that will be the end of the bargain. You either will get one of these 500 or else have to pay the full price to buy this fabulous handbook.

## ***THE GIANT* EDITORS AND ENGINEERS HANDBOOK**

Regularly . . . . . \$12.95

**SPECIAL... \$10.00**

What makes the Radio Handbook so different from the others? This is the *only* handbook that has all original material rather than just being a bunch of reprints of magazine articles. The hundreds of construction projects were built specially for this handbook by some of the top amateur radio builders. This is a hardbound book, with some 850 pages of theory, construction projects and reference data covering every aspect of amateur radio.

Ten dollars doesn't stay around very long these days, but this book will be fun to read and valuable for years to come.

These may well be gone by next month, so be sure that you are one of the 500 . . . send in your \$10 today and receive this book in a few days postpaid.

Send to: 73 MAGAZINE, Peterborough, NH 03458

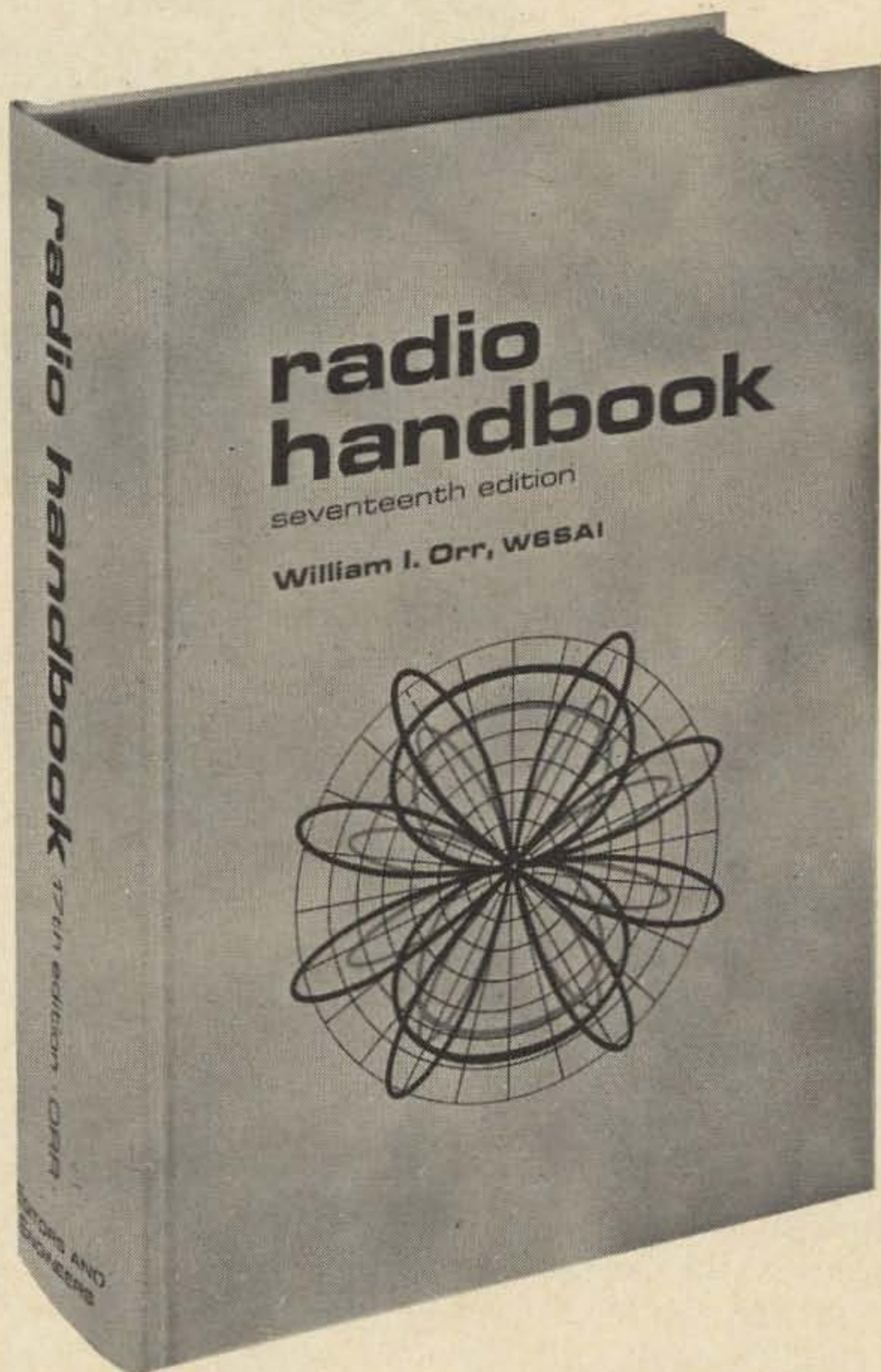

Yes — \$10 enclosed — send me the Radio Handbook!

Name \_\_\_\_\_ Call \_\_\_\_\_

Address \_\_\_\_\_

City \_\_\_\_\_ State \_\_\_\_\_ Zip \_\_\_\_\_

James P. Kirkgasser WA2ELA  
105 Haddonfield Place  
Dewitt NY 13214



The boys from Syracuse had a great time this summer doing something different. Of course, you have read about the idea put forth in 73 concerning Ham Hop, providing foreign hams places to stay when traveling about the U.S. We have already done something like this plus one better. We have set up "Ham Exchange."

This program is aimed at setting up hams going both ways, to Europe and to the U.S., with a home base that provides lodging and food at a ham's home. Thus, a traveler has a home away from home, plus the very important feature of cutting the daily living expense to the bare minimum.

The first test of the program was initiated by Fred Trode DL8VQ/W2, who enlisted the help of Uwe Rehage DL8QP to organize the DL side of the program. And we were off to our first and successful year.

Fred, my XYL, her sister, and four harmonics were the brave ones who met the charter aircraft at JFK airport at 3 a.m. on August 12 of last year. Of course there were the usual customs problems, including Eberhard (DJ9CJ) placing his passport in his luggage which went into the terminal when he needed it to get off the plane. After the normal fumbling in customs, the DL's were cleared at 5 a.m.

Fred crowded five of the hams and their luggage into his station wagon for the drive back to Syracuse where they met their hosts and the first ham exchange was off and running. My wife (Jo), with her sister and husband, took Eberhard and Ilse to see New York City and the one-time-only reception for the moon men. This was unbelievable as far as timing of the trip, etc., because our European visitors watched the Apollo XI all the way—including the walk on the moon (except Eberhard DJ9CJ), who fell asleep. I guess he had watched television eight hours straight and then pooped out at the first step on the moon).

A tour by sightseeing boat was perfect to get the feel of New York for our tired guests. Wall Street, Broadway, and the U.N. Building and two more days filled in the picture of New York City. Then we pulled the biggest goof in history—try and get through the traffic on the way to the first (hope the only one we have to go through) rock convention at Woodstock. Eberhard commented, "I have never seen so many cars boiling over in my life."

Once in Syracuse the variations on the exchange started. Some people wanted to travel, some wanted to work DX, etc. We had used 20 meters early in the summer to

# NEW KRIS SCANNING RECEIVERS

## Spectacular Monitoring with any one of 5 Kris Receivers

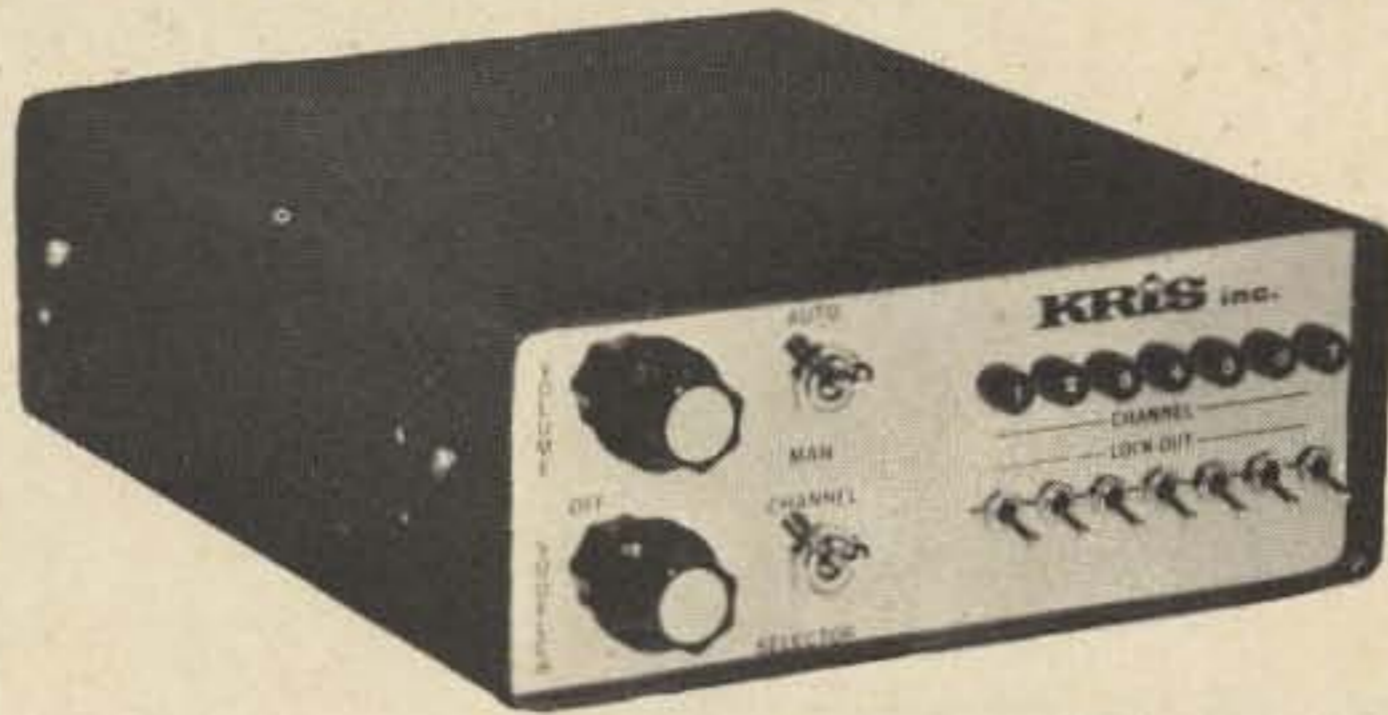

Own the ultimate in Automatic Scanning Receivers. The new Monitor Receivers enable you to lock-out specific channels and scan only the ones you wish. Automatically scans until a channel becomes active. Kris unit will then lock on the active channel and listen until the message is completed. When message is finished, the Kris Receivers will automatically resume scanning, skipping frequencies locked out.

Choose any of the Kris Receivers listed and just sit back and listen. No tuning knobs, no adjustments, no heat, and no service problems. Uses 2 FET's in the front end, all solid state construction for unparalleled performance. Use at home on 115 VAC or mobile 12VDC.

See these Scanning Receivers at  
your Distributor's  
or write us . . .

**1026B S. Washington Ave. Cedarburg, Wi. 53012** Phone A/C **414-377-5090**  
We welcome your inquiries.

### FEATURES

- Lock-out Switches
- Greatest Sensitivity
- Base or Mobile
- Stainless Steel Front
- 7 Channel Capability
- Better Than 1 Microvolt Sensitivity
- Complete with AC-DC Cords and Mobile Mounting Bracket
- Sensitivity—.5 Microvolt for 20 DB (Quieting)
- Selectivity— 6 DB  $\pm$ 12 KC  
60 DB  $\pm$ 20KC
- Signal Acceptance-FM $\pm$ 5KHZ
- Power Consumption  
- 5 Watts 13VDC 18 Watts 117 VAC
- Weight 4 Lbs.
- Sample Rate  
20 Channels Per Second

### PRICES

3302018 Police-Fire 30- 50 MHz	\$149.00
3302019 Police-Fire 150-174 MHz	149.00
3302022 Aircraft 115-136 MHz	159.00
3302024 2 meters	159.00
3302026 6 meters	159.00
CRYSTALS	\$5.00 EACH

Specify frequencies when ordering.

## KRIS INC.

find out that travel was of most interest for Eberhard and Ilse. Boston, Niagara Falls, Montreal, New York City, and the local area were of prime interest. A trip was also arranged to Washington D.C. for Eberhard. Needless to say, we had a full four weeks.

I took a two-week vacation and combined it with the long Labor Day weekend to cover the areas outlined. We used a camping trailer for everyone including the children. This really cut the expenses and placed everyone in the person-to-person situation (where you can learn the most). One perfect Sunday was spent at Tanglewood, where we heard Erich Leinsdorf conduct the Boston Symphony in Beethoven's Ninth Symphony (Ilse's favorite). This is the main point about "Ham Exchange"—the people involved set up their own programs. Some traveled, some used Ham Hop, some sat home and drank beer and just got to know people.

So this is "Ham Exchange." Write your own ticket! Travel to a new land! We will help find a ham at the other end who will provide a place to live and food. The rest is

up to you and your host. We hit the road and covered the northeast quarter of the



United States. Out of pocket, it cost us about \$350 overall for one month, which included a vacation for our family and two additional weeks including New York City, Niagara Falls, etc. For the fun we had, and for six people, this was quite reasonable. Now we are ready for next year, and we are planning our trip to Europe with our two children.

James P. Kirkgasser WA2ELA  
Fred Trode DL8VQ/W2 ■

Larry Jack WA3AQS  
 3 Barry Avenue  
 Bay Ridge  
 Annapolis MD 21403

# SUPER SIXER

... to the rescue

There's just something about a Sixer that can drive a ham crazy with "modification fever." Have you ever noticed the number of improvement articles written on them? It was a touch of such a "fever," induced by TVI, that got me digging into the bowels of my Sixer.

TVI has a bad way of catching up with you, sooner or later. Naturally, it wasn't too long after the little rig was first put on the air that a flood of complaints of television interference began. The use of a lowpass filter was obvious, though I couldn't bring myself to sharing the kW filter on the sideband rig with such a peanut whistle of a tranceiver. Why, the filter looked as large as the Sixer! There must be some other quick way around the interference...

On the premonition that C12 (15 pF) in the plate tank circuit was passing something other than just 50 MHz to the antenna, I changed over to link coupling. L3 was cut down to 6 turns and another coil of insulated wire, LX, of 2 turns was wound over it.

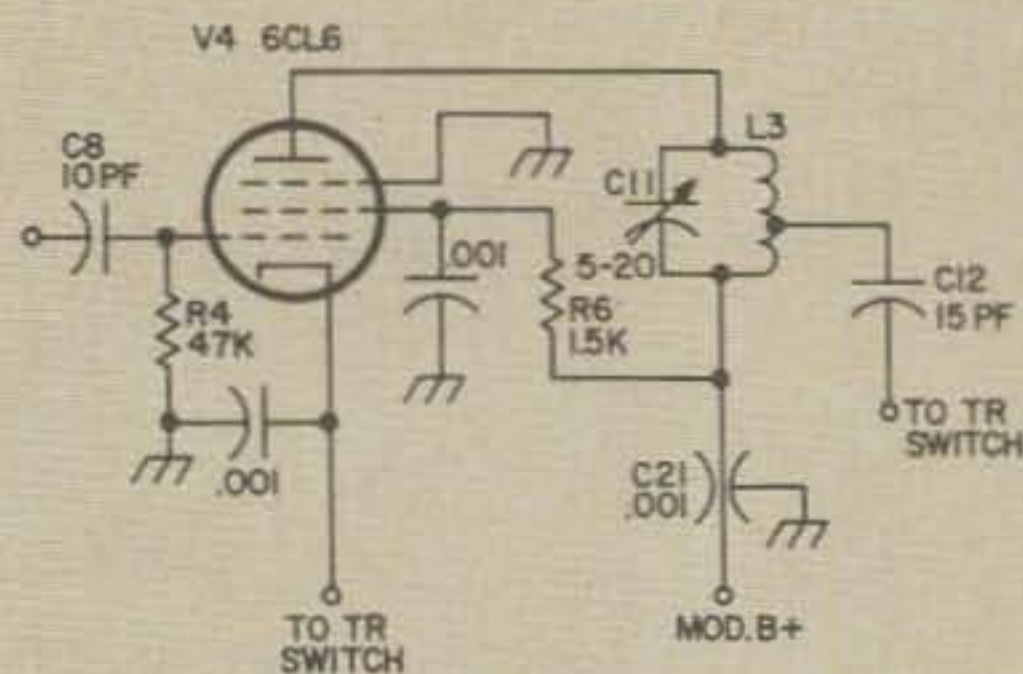

Unmodified Sixer final amplifier.

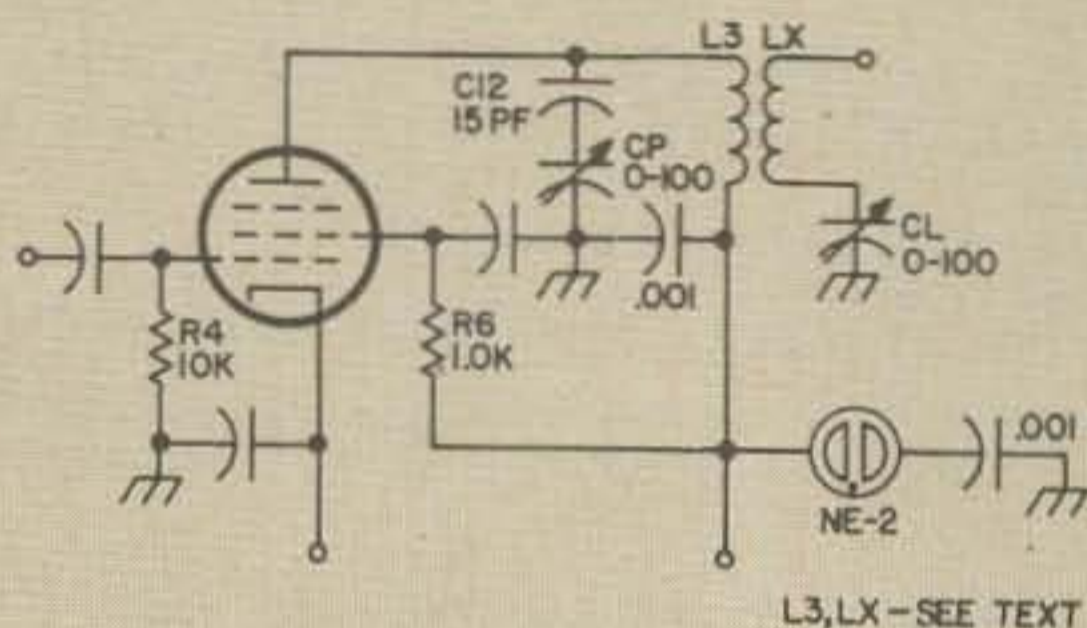

Modified Sixer final amplifier.

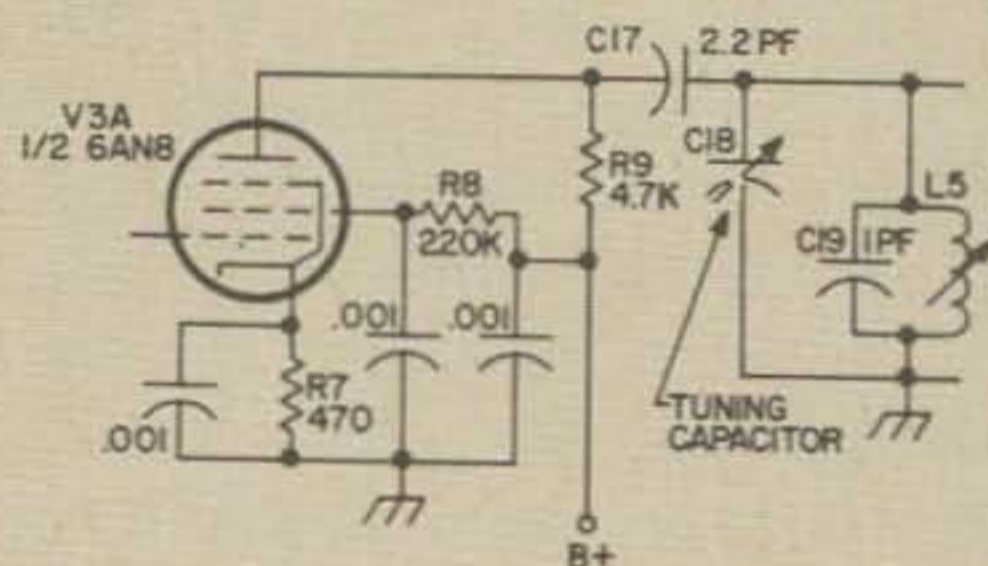

Unmodified Sixer receiver, rf stage.

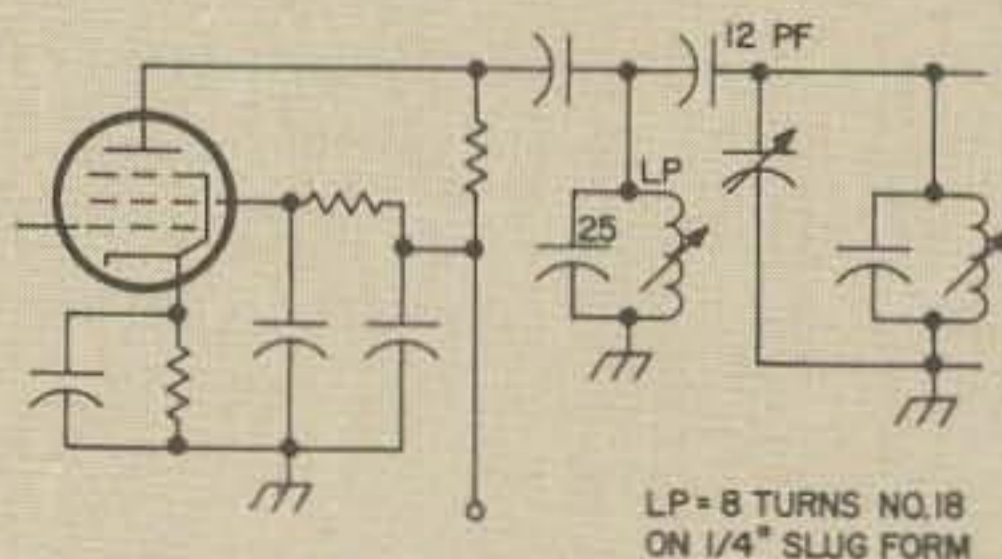

Modified Sixer receiver, rf stage.

The results were amazing. The TVI was not only gone, but in addition, the transmitter loaded into the antenna better. This was great, so other modifications were begun.

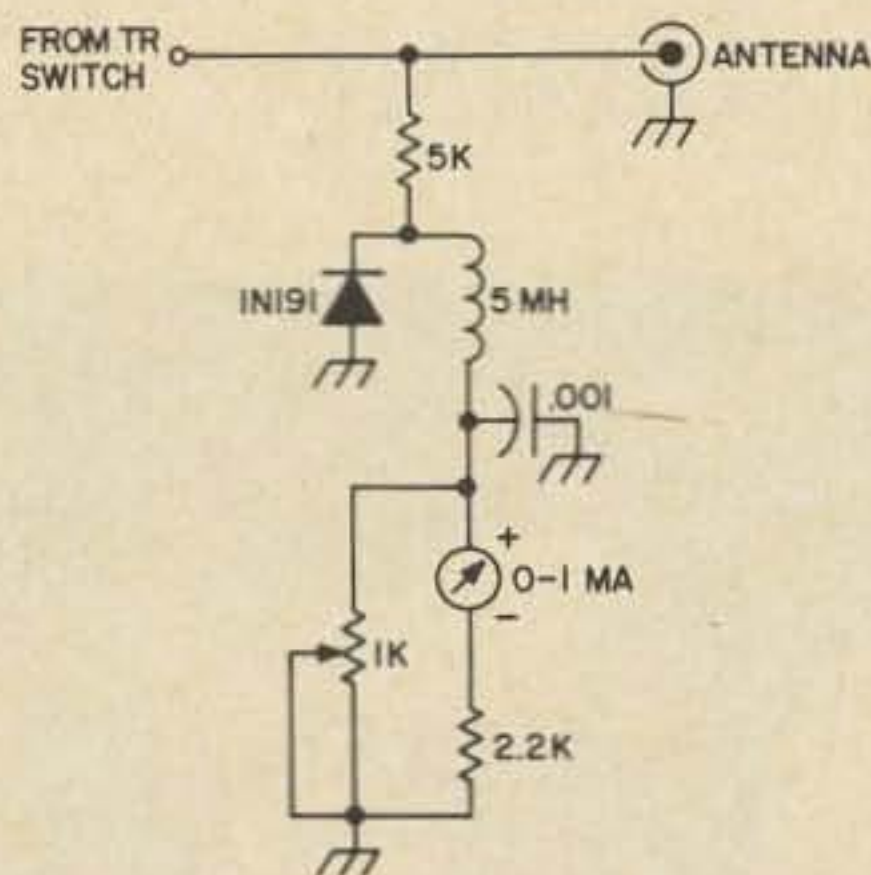

Improved tuning system.

Two holes were next drilled into the front panel, one to mount the new load control, and another for a capacitor to tune the plate of the final (6CL6). Two 0-100 pF variables were used because they were on hand at the time. The plate variable was placed in series with a 15 pF capacitor (the former C12), to make the tuning less critical at resonance.

Next, the grid and screen resistors of the final were changed from 47K and 1.5K to 10K and 1K, respectively. Input power increased two watts. Now some form of visual indicator for tuning the transmitter was needed. The original relative power output measuring arrangement of the Sixer leaves a lot to be desired. With a small light bulb as a dummy load, you can actually see a decrease in power when a meter is inserted into the circuit. A better, less lossy arrangement was substituted to sample the output rf. It is then read out on a 1 mA meter that was installed on the front panel.

Just for fun, a neon bulb was soldered in series with a .001  $\mu$ F capacitor, and then to the cold side of L3. Instant modulation indicator.

The receiver section of the Sixer is its weakest spot. While the sensitivity is good, the selectivity is too broad to be usable

when the band is crowded. A certain degree of selectivity was gained by adding a tuned circuit between the rf and detector stages of V3 (6AN8). How much selectivity was added, is hard to determine, but stations tune more sharply with less overload interference now.

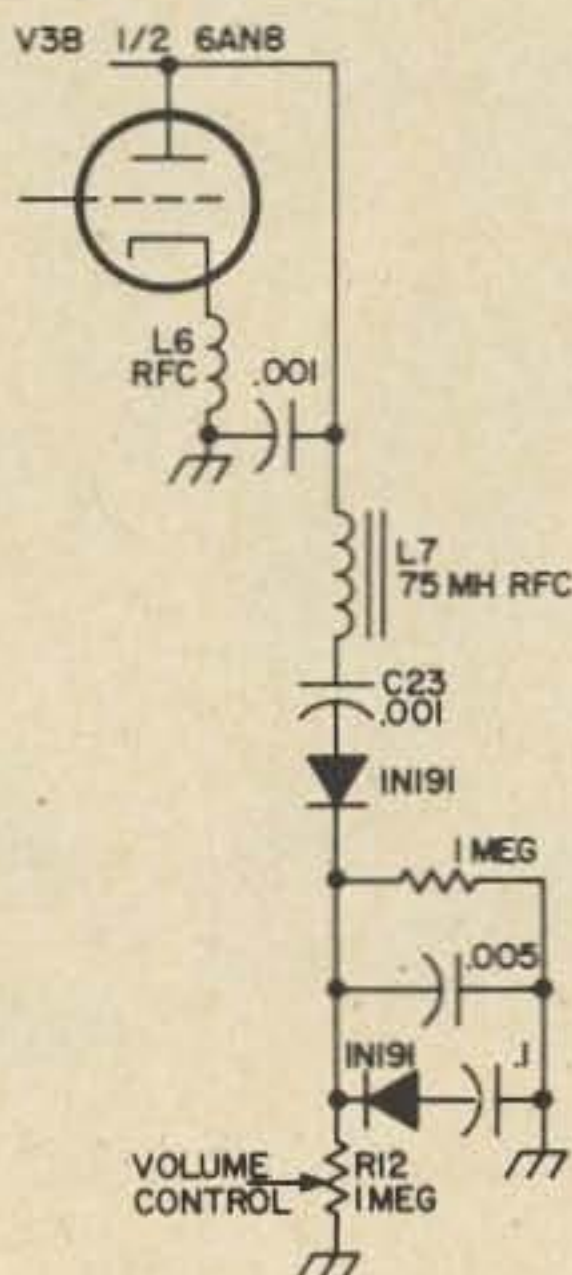

Noise limiter.

Since the ultimate aim was to use the rig in a car, a noise limiter was tried. Even with the good limiting action inherent to a regen receiver, ignition noise was still a problem while operating mobile. From the Diode Handbook (73, Jan. 1968) came a circuit for a shunt diode noise limiter. One was installed between the detector and the first audio stage. Nothing truly spectacular resulted, for the ignition noise didn't disappear. It was reduced to a more tolerable level, however.

The crystal socket was moved to the upper right hand corner of the front panel. Instability was avoided by installing a tube shield over the 6CL6. And last, a 4PDT relay was wired in to allow PTT operation—a must when you're mobile. The Sixer was a nice rig to begin with; it's even better now.

... WA3AQS

## Bob, Bob, Bobbin' Along



K1YSD beside himself beside himself beside himself beside himself beside himself beside him

"This is K1YSD—mind if I get in on your roundtable?"

"Come aboard! What's the handle? Handle here is Bob!"

"It's Bob here, also!"

"Good enough, we got Don K1QES and Don K1NDA, and also another Bob WA1ACH on frequency."

"Oh swell. Say, Bob, what's your QTH?"

"Which Bob?"

"AOH."

"Mugwump Valley—but Don's got the best location."

"Which Don?"

"Whaaaaa me?"

"Me?"

"Who me? You call me? I was out in the sandbox."

"Who's this?"

"Don!"

"Which Don?"

"QES. Who's this?"

"Bob!"

"Which Bob?"

"YSD. Who said that?"

"Said what?"

"Said, 'Which Bob?'"

"Me, Don!"

"Which Don?"

"NDA!"

"Hey fellas, can I join the roundtable? My name is Herschel!"

"Herschel?...Herschel!!! You bet your sweet Aunt Matilda's hand knitted antimacassar you can join! Fact is, we'd appreciate it if you took over as the moderator of this group. Here's the situation as it now stands: We have three Bobs and two Dons on frequency. We can simplify it if we label TFC as Bob 1, AOH as Bob 2, and YSD as Bob 3—then label QES as Don 1 and NDA as Don 2. Now, Bob 2 wants an informal with Don 1 and Bob 3 wants to talk to Bob 2—he has a message from Bob 2's son, Bob Jr. 4—Don 1 wants words with Bob 3 about what Howie 1 said to Howie 3 and Harold 2 about Don 2's meeting with Bob 1.

"Have you got all that Herschel?... Herschel!!!...Herschel???. . .Now, where the devil did he go?"

"I think I heard him mutter something like, 'Good Lord, I've tuned into the 'intra-happy-home-net' just before he pulled the plug!"



"Who said that?"

"I just told you, Herschel said it!"

"Yeah, but who are you?"

"Don!"

"Don who?"

"Number two—who's this?"

At this point something must have snapped, for the next thing I remember is clawing frantically through the metal and cloth grill, reaching in and disemboweling my MS-4 speaker (turning a \$20 speaker into an 89¢ frisbee). Then, standing fully erect, and with all the force of a Paul Bunyan with prickly heat, I cleaved my Drake R4 into



two equal parts with my boom mike (giving myself two R2's, a chromium W.C. Fields cue stick and a possible double hernia).

Shrieking, "GERONIMOOO!!!, I hurled myself through the screened window—straining myself—counted ten and pulled the "D" ring which, as luck would have it, happened to be the snap fastener on my sansaband trousers, and went stomping down the by-ways of our otherwise normally quiet New England town, clad only in a terry cloth robe, knee socks and boondockers with a pair of earphones clamped on my head, from which dangled, 'twixt my knees, the earphone cord and ¼" phone plug, resembling either a grotesque umbilical cord or some other potentially hysterical physical malformation . . . still clutching the misshapen boom in my hand. (I still wake up

nights with the memory of a wild-eyed, horny, but impotent shepherd clomping and frolicking ungainly—not unlike a rhinoceros in heat—down the road to the tune of "Hippity Hop to the Barber Shop.")



I kept up a continuous chanting mumble of, "I'm Bob, no—you're Bob, I'm Don, he's number two, you're Don, he's Bob, I'm number one—Herschel! Herschel?? *Who the hell is Herschel??*"

I might well have gone on like this forever and, since it was summer, there's a good chance I'd have reached route #1 (Blood Alley) and been scrunched into unrecognizable mush by some boat-hauling, arm-dangling, gum-chewing, antique-collecting kamikaze driver from Massachusetts, possibly adhering to one or more of their treadless retreads (though this would have made me a big man in concentric circles, I must confess, that I had no real desire to become a permanent part of the Spaulding Turnpike).

Every summer, these juggernauts—with the instincts of the suicidal lemming and the finesse of a "dropped rock," burst into our State like mindless shrapnel from a fragmentation grenade.

They come, on their annual pilgrimage, like a horde of soldier ants, or locusts, firm in the belief that not only is the shortest

## New Personalized Station Calendar

Dress up your ham shack with this exclusive appointment calendar wall plaque. Full color Apollo glossy photo, 1970 calendar, your name or call personalized on metal plate, all attractively mounted on walnut plaque. Nets, Skeds and Contests can be noted one month at a time. Size 11½" x 22". Mounting hardware included. 1971 replacement calendar available this fall. Only \$4.75 ea. plus 75¢ for prepaid postage and handling.



Send for FREE catalog "Ham Shack Specialties"

**GLOBAL RESEARCH & SUPPLIES**  
P.O. Box 271A, Lombard, Illinois 60148

radio amateur

# callbook



### GET YOUR NEW ISSUE NOW!

Over 283,000 QTHs  
in the U.S. edition  
**\$7.95**

Over 135,000 QTHs  
in the DX edition  
**\$5.95**

These valuable EXTRA features included in both editions!

- QSL Managers Around the World!
- Census of Radio Amateurs throughout the world!
- Radio Amateurs' License Class!
- World Prefix Map!
- International Radio Amateur Prefixes
- Radio Amateurs' Prefixes by Countries!
- A.R.R.L. Phonetic Alphabet!
- Where To Buy!
- Great Circle Bearings!
- International Postal Information!
- Plus much more!

**WRITE FOR FREE BROCHURE!**



RADIO AMATEUR  
**callbook** INC.  
Dept. B. 925 Sherwood Drive  
Lake Bluff, Ill. 60044

distance between two points a straight line, but that the Massachusetts plate gives them license to disregard any and all safety precautions and that nothing should—indeed, nothing could—stand in their way.

Ensnared in a formless, unidentifiable 2000 pound mobile pig-sty, held together by Band-aids, inspection stickers, rusty wire, primer paint, ding-a-ling decals and a modified law of inertia, which, in this case, states that the vehicle—once set in motion—must not only remain in motion, but must do so with ever increasing speed mathematically proportionate with the distance covered, accidents caused and terror instilled in New Hampshire. Failure to comply will result in instantaneous disintegration, creating either a 'Susan Spotless NO! NO!' or a new ski area complete with 200 foot bar.

Dragging a crusty, fish-tailing old boat behind, pushing a huge bug screen in front

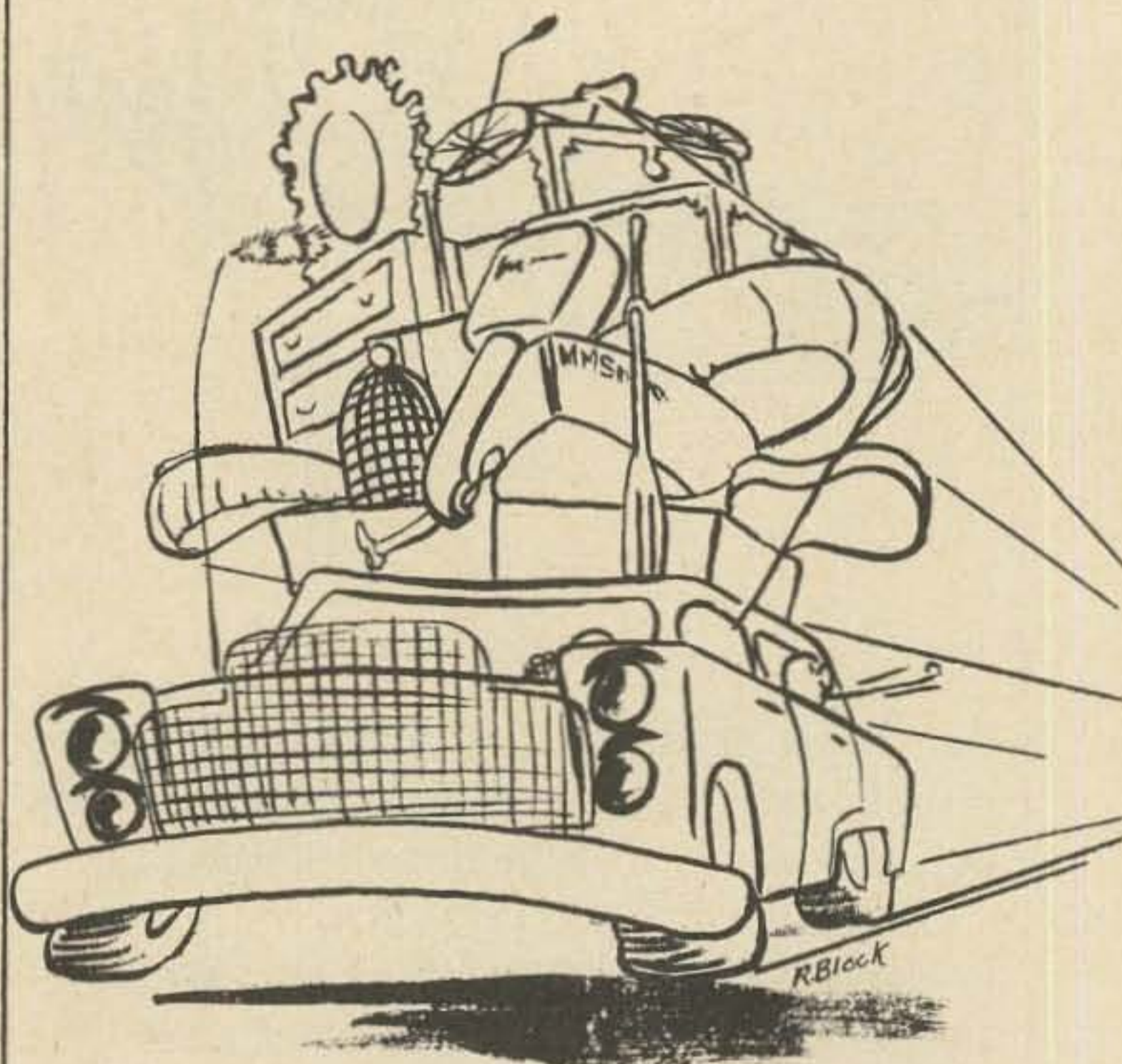

and carrying, overhead, what appears to be next year's entire work load for the Goodwill Industries . . . at the wheel, a wild-eyed nut with at least one loose screw, a skaggy old bag and half a dozen sticky fingered, rock throwing kids with lollipops stuck in their ears and a howling mongrel dog slowly being strangled by 127 feet of 'Discover America' banners . . . they steam roll over stop signs, traffic lights, back yard fences, dogs, cows, kids, pedestrians, historical monuments and especially other mobile pig-sties. (Quite

often they are fired on by irate New Hampshirites and occasionally even by the Welcome Wagon.) All this in search of a pool of stagnant water (even a backed up septic tank will suffice) in which to launch their 22 foot boat (?) with twin 50 hp motors, an antique shop from which to buy a piece of driftwood, a broken rocking chair, a two legged buffalo milking stool, some genuine Indian artifacts (made in Hong Kong) or a hand painted lobster claw with 'Souvenir of Kankgamangus by the Salt Flats' painted on it, or to find some picnic/rest area where they divest themselves of a year's accumulation of HoJo cups, napkins, straws, half eaten Texas-burgers, glad bags and other assorted garbage.

The contamination record (presently held by a family of four) is 2 minutes 19 seconds to turn a picturesque rest area into a mess that has all the charm and beauty of a blighted and deserted land fill project.

Fortunately, however, I was saved from exposing myself to this danger when I was suddenly blocked by a taxi which pulled up in front of me. The driver, noting my garb and hearing my mumbles, quipped, "Need a lift to Foam Rubber City, Buddy?"



I sped around the cab to the driver's side, reached in, grabbed the driver by both lapels, shook and twisted and shook some more while screaming hysterically, "What's your name, What's your name? Just what the hell is your ruddy name?"

"Lillian! Lillian!" she gagged, "What's yours?"

"It's Bob," I replied, "No, it's Don—no, it's Howie—no, it's Herschel—I dunno—maybe it's Lillian."

She swung her dashboard mike like a bolo, catching both my hands and causing my thumbs to become jammed, one in each ear like deer horns (if it had been winter, I'd have been gunned down by a leaky booted Massachusetts hunter carrying a modified bazooka firing 88mm flare rockets). As she careened round the corner, and out of sight, I had the final satisfaction of seeing her hair turn white.

If you're reading this, I'm assuming two things not necessarily in evidence: One, that you have some sort of interest in radio and aren't just an itinerant kleptomaniac that absentmindedly scooped up this magazine as part of your daily quota and, two, that you know what a 'handle' is.

A 'handle,' besides being the mechanical accoutrement for lifting a pot, teacup, or thunderjug, is also, for some inexplicable reason, the colloquial idiom used in amateur radio by the Neanderthal ham in-group as a synonym for the name, 'name'; i.e. 'handle' replaces the name, 'name.'

The apprentice/greenhorn ham (or 'tongue-tied jerk' as he is oftentimes unfairly referred to) just breaking in and, not wishing to sound like an idiot, which incidently, is practically an impossibility on today's bands—it has long been my contention that you could recite any arbitrary excerpt from such books as, "The Orthopedic Surgeon Looks At Your Mattress," "The Abnormal Sex Life of the African Tse Tse Fly" or the prologue to "The Cause and Effect of Rampant Fungus on the Yucatan Peninsula" backwards, in Sanskrit or Pig-Latin and no one would think it strange, probably replying, "Roger O.M. Fine Business—I agree—I got a doublet here fed by 600 ohm twin line etc, etc., C.U.L. . . anyway, not wishing to sound like an idiot, the apprentice invariably slips into the 'dead sea scroll' word, 'handle.'

However, the younger generation—as it gains confidence and wishing to show its individuality and create its own neo-radio-phyte in-group—has started a crusade to substitute the word 'name' for the word 'handle' which, of course, means 'name.' Consequently, if you wish to be of the modern in-group, you'd say, "My name is Bob!" Translated into Cro-Magnon ham lingo, this would mean, "My 'handle' is

## oscillator/monitor<sup>mark 2</sup>

- makes an audible tone to monitor the RF of any CW transmitter from 10Mw to 1 Kw & 100Kc to 1000Mc, using only an 8" pickup antenna.
- can be self-triggered for code practice or the testing of solid state components and circuits.
- aids in tuning up & testing RF oscillator and power circuits.
- 4 transistor, 2 diode circuit, speaker, tone adjust, AA pencil, test tips, 8" ant., & magnetic base.
- cabinet is 16 gauge black & clear anodised aluminum, 3.4 x 2.3 x 1.2" US made & guaranteed for 1 year.



**14.95** complete,  
ppd usa & can.  
send a check or m.o.  
sold by mail only

**James Research company, dep't: AR-M**  
**20 willits road, glen cove n.y. 11542**

Bob!", which, translated into English, would mean, "My name is Bob!"

Logically, it should follow that when you say, "My name is Bob," you in reality mean, "My name is Bob!" but this, by antiquated League standards, is not only totally ridiculous and ludicrous, but downright sacrilegious! (This transgression may be forgiven if you immediately yell, "Hail Huntoon et tu Hart" ten times while ingesting the first fifty pages of the Handbook, having "I LOVE I.C." tattooed on both pectoral muscles, or goosing a non-League member with a hot soldering iron.)

I might also add that the younger—or upstart—generation, as a further impiety, is attempting to do away with speaking CW phrases on the phone bands . . . damned kids. The CW advocate when switching to voice retains a lot of the CW colloquialisms such as "Q" signals. Ever try to talk in "Q" signals? At best it's like trying to pronounce pharmaceutical conglomerations while sucking three jaw breakers underwater with a split palate.

You can get away with 'cue-so' for QSO and 'Q Street' for QST and Quirt for QRT, but you're gonna rupture your larynx pronouncing QRP, QRO, QRV, QSL and QTH (Quith?).

The opening dialogue may have sounded unreal, but tune across 75 meters any evening and ye shall find the truth.

I've been net control on many occasions when there were four Bob's, five Don's, two Bill's, two Walter's, three Howie's and two

Ed's. Occasionally, however, you'll run across a Vladamir or a Katrina to break the monotony and keep you from turning 23-year-old female taxi drivers into white-haired old ladies on a daily basis.

[Funny my mentioning Katrina. Poor ole Katrina—she recently ran amuck when some good intentioned neighbor, thinking that the name 'ham' applied to the male of the species only, called in an ITVI complaint and called her a 'sow.' Katrina took immediate affront to this, cornered the caller and



*force fed* him a mixture of 2 pints of milk of magnesia and 1 pint of vodka (the world's second largest Phillips Screwdriver).

Katrina was brought to trial, convicted and sentenced. Now, I don't know your feelings about capital punishment—in this State the maximum penalty is hanging—but, by golly, I just don't believe a woman should be hung like a man!]

Since the age span of any arbitrary group of clustered hams may range in years from 20 to 70, it is, indeed, a weird phenomenon that you'll find a sickening repetitive duplication of names. It gives one pause to wonder if, by some E.S.P. or precognition on the part of the parents that their offspring would end up being hams, they, through either a singular lack of imagination, some secret sense of humor, bestowed a seemingly endless string of common, lack-luster names on all hams and hams to be.

If you were to recognize any ham by his upraised joystick or slipstick or notice him mounting his hustler, accost him and ask him—point blank—what is *the* most single important item in his shack, he'd like as not

reply, "The receiver, or possibly the antenna." This is a malicious rumor spread by the same group that sponsored Edsels, slipped amateur radio the purple shaft with oatmeal clusters by turning 50% of the ham bands into a vast wasteland, and that is trying to give 10 meters to the CB'ers.

Let me assure you with a conviction born of frustration (mental constipation) that the most important item in your shack is your name and you will be saddled forevermore with the first name you give on the air.

If you've been cursed with a common name, then by all means adopt a *nom de plume* (pen name, for you illiterates).

Selecting the proper 'on-the-air name' should not be handled lightly. Television—especially late night movies—offers the most versatile virgin land for procuring a name.

Horror: Bela, Boris, Igor, Krag, Zandor, Mandrake, Luthor, Kral.

Cowboy: Wyatt, Duke, Matt, Knobby, Windy, Bat, Tex, Bret, Bart.

Ancient: Mars, Herc, Eros, Ajax, Thoth, Vulcan, Cronos, Thor.

War: Sarge, Gunner, Chief, Buck, Cap'n, Doc, Tex.

Misc: Kelly, Sully, Murph, Tab, Ty, Rip, Dash, Rock, Torn, Sue (?).

Just remember that, in real life, every Tom, Dick and Harry is named Tom, Dick and Harry, but in ham radio I've found that every Tom, Dick and Harry is named "Bob!"

One word of caution. Don't get too cute or you could end up like this:

"Name here is Spiro T."

"Spell it!"

"Spiro T—Sierra Papa India. . ."

"Whazzat last?"

"India—India November Delta. . ."

"Whazzat last?"

"Delta—Delta Echo Lima Tango. . ."

"Whazzat last?"

"Hell, I dunno—what am I spelling anyway? Who am I? What's my name? What's my name? It's Bob, no, Spiro T. I'm number one—you're Don, Quirt Quirt cue-ess-why Quirt WAAAAA—HOOOOOOOO! Run for the hills, Lillian, HERE I COME AGAIN. . . GERONIMOOOOOO!!!"

"Look out for that guy wire!"

"What guy wiiiAAAWWWKKK??"

. . . K1YSD ■

## the permaflex key

- both a twin lever & straight hand key in a pivotless 2 paddle design.
- gives instant choice of automatic semi-automatic & straight hand keying when used through an electronic keyer.
- use directly with any transmitter
- 8 amp. gold diffused silver contacts adjust from 0-.060" & 5-50 grams.
- distinctive blue paddles are of rugged G-10 fiberglass epoxy.
- cabinet is 16 gauge polished chrome steel: 1.95" sq. x 3.75", paddles extend 1.25", weight 10 oz.
- silicone rubber feet for stability.
- 100% US made & guaranteed for 1 yr.



1995 complete,  
ppd usa & can.  
send a check or m.o.  
sold by mail only

James Research company, dep't: AR-K  
20 willits road, glen cove n.y. 11542

## DUAL GATE MOSFET PRE-AMPS



to 175 MHz. \$21.95 ppd.  
to 300 MHz. \$25.95 ppd.

NEW FOR 1970!

The above models now have rf gain control.

For 300 to 470 MHz

See Model 202 in our catalog.

- Available from 5 MHz. to 450 MHz. Bandwidth is approximately 3% of frequency.
- Voltage gain 30 to 40 DB depending on frequency.
- Two Dual Gate MOSFET amplifier stages with each having a tuned input and tuned output. Each Dual Gate MOSFET is actually an integrated cascode circuit thus giving you 2 cascode circuits equivalent to 4 triodes.
- Exceptionally low noise (2.5 DB at 175MHz.), greatly reduced cross modulation and 10 times the dynamic range (signal handling capability) of the best bi-polar transistors. Also superior to preamps using junction FETs and Single Gate MOSFETs.
- Internal connections for high impedance AGC or manual gain control if needed.
- Type BNC input and output receptacles for minimum loss at UHF. Standard impedance is 50-75 ohms.
- Carefully tuned at our laboratory with sweep generator and oscilloscope for the best bandpass characteristic.
- Full wave UHF diodes protect input transistor.
- Operates on 6 to 16 volts DC, 5 to 15 Ma.

New York City and State residents add local sales tax.

## VANGUARD LABS

Dept. H

196-23 Jamaica Ave., Hollis, NY 11423

Ed Babudro, VE3ECU/WØ  
118 Arthur Ave. SE  
Minneapolis MN 55414

# THE DIP LIGHT

Have you ever wondered how the grid dip meter got its name? I think it is self-explanatory to a certain extent, indicating that there is a meter in the grid circuit of a tube and that it measures the dip in current that occurs as the energy is absorbed when the oscillator tunes to the same frequency as the circuit under test. The name is all right as long as you think in terms of the tube circuit, but in recent years we have been seeing circuits using transistors and tunnel diode oscillators taking over. In other words, no grids.

So now the name has changed to "dip meter," which is fine as long as you have no objection to the meter part. As I see it, the meter has done a very good job in the past on this instrument, but nowadays we can come up with devices not limited by the constraints imposed on the people who first developed the grid dip meter. Think of a pilot light bulb, for instance. How much better it would serve the purpose, since you would not have to concentrate on it to see a dip as you would with the meter. Many times as I stared at the meter (which happens to be at the opposite end from the coil), I would find that I was getting no dip simply because I had inadvertently moved the coil away from the circuit under test.

A light bulb is much more obvious than a meter needle, and in this use you really

would not need the precision that a microammeter gives. All you really want is a dip. A light bulb is just not sensitive enough to read microamperes. But what if you were to help it with a couple of transistors? This is the crux of the dip light shown in Fig. 1—the little devil that will do everything that a grid dip meter will do, only better. And it can be built more cheaply, to boot.

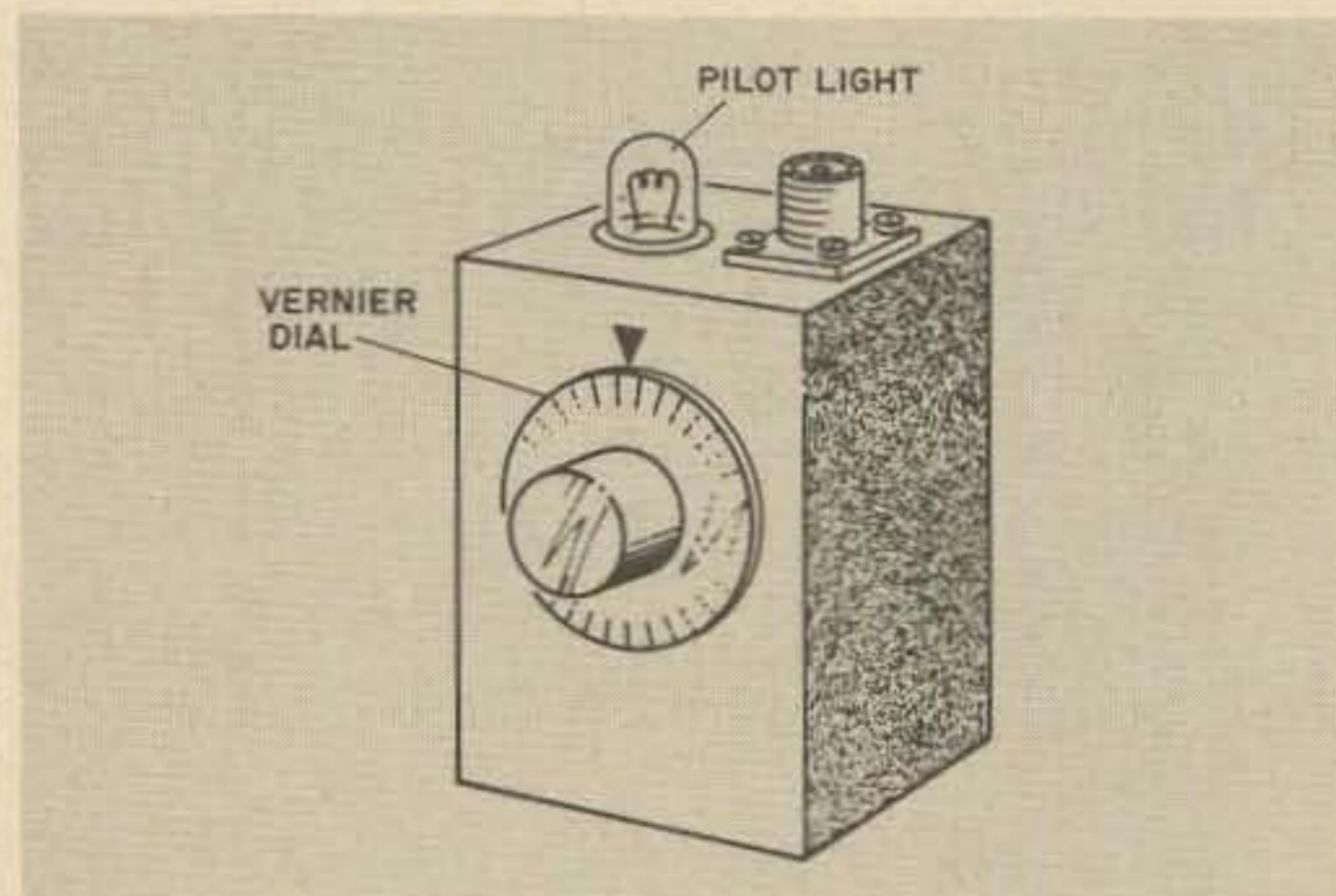

Fig. 1. A vernier dial on the front of the unit can be calibrated without much difficulty. The bulb itself can be held in place by cementing it to an ordinary grommet.

## Construction

You can use regular coax connectors for the coils and build the latter on a stub of coax about 3 in. long, with the connector at one end, the outer cover and shield peeled

back as shown in Fig. 2. The coil is wound on the plastic core, soldered to the center conductor and shield and then covered up with GE crude rubber cement, which is quite soft and flexible even after having cured.

The indicator lamp should go somewhere near the coil, where you can see it and the coil at the same time. For the frequency readout I used a small calibrated vernier drive. You'll find this easier than making

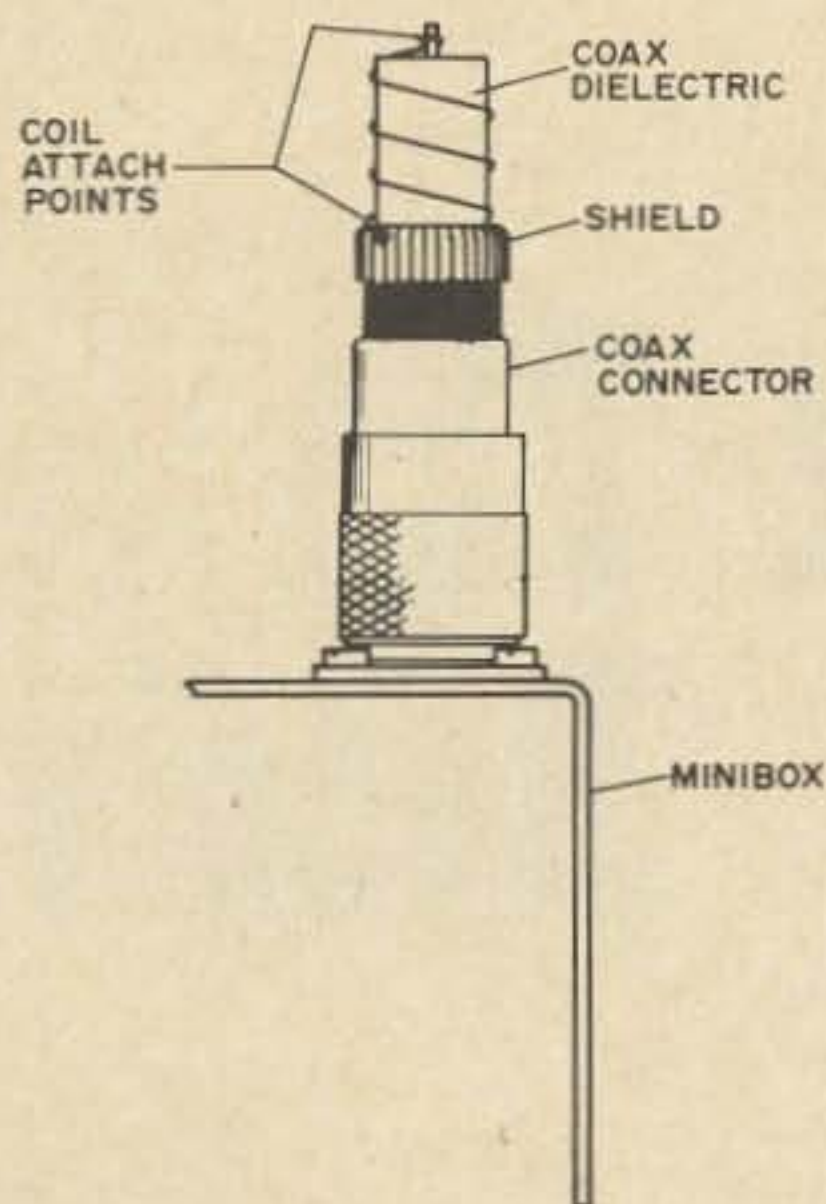

Fig. 2. Coils can be built onto bits of RG-8/U cable and terminated with UHF connector.

your own dial, and you can use a chart or set of curves to correlate frequency with the calibrated increments.

For the tuning capacitor, use an APC with a 1/4 in. shaft. Mine had some plates removed, but I would guess it to be about 30 pF.

The oscillator circuit happens to be my pet one, but since it is not critical, you could use your own circuit. It occurred to me that one could open up one of those two-dollar modules sold as FM wireless instrument broadcasters. At least one that I know of is not encapsulated in epoxy. I built my own (Fig. 3) with GE9 transistors and have no trouble getting this little gem to oscillate up to 120 MHz.

Capacitor C1 should be chosen to oscillate down to the lowest frequency to be used. My unit worked well with a 55 pF capacitor. Resistor R1 should be 100 kΩ initially; then, when you have finished build-

ing you can replace this with a 0.5 MΩ temporarily, adjust this for a good indication on your lamp (I set mine for maximum rf, but don't know how good this might be for the transistor), and then replace with a fixed value to correspond with the setting of your pot. The lamp amplifier is a Darlington circuit to provide a better load for the diode circuit, but you could use a one-transistor circuit almost as effectively.

Be sure that you use high-gain transistors in either case though; they should be medium-power "driver" types to handle the current required to light the lamp, which should be a low-current one such as the 48 or 49 bulbs (coded with pink beads). Use two penlight cells for power and you end up having a really versatile instrument.

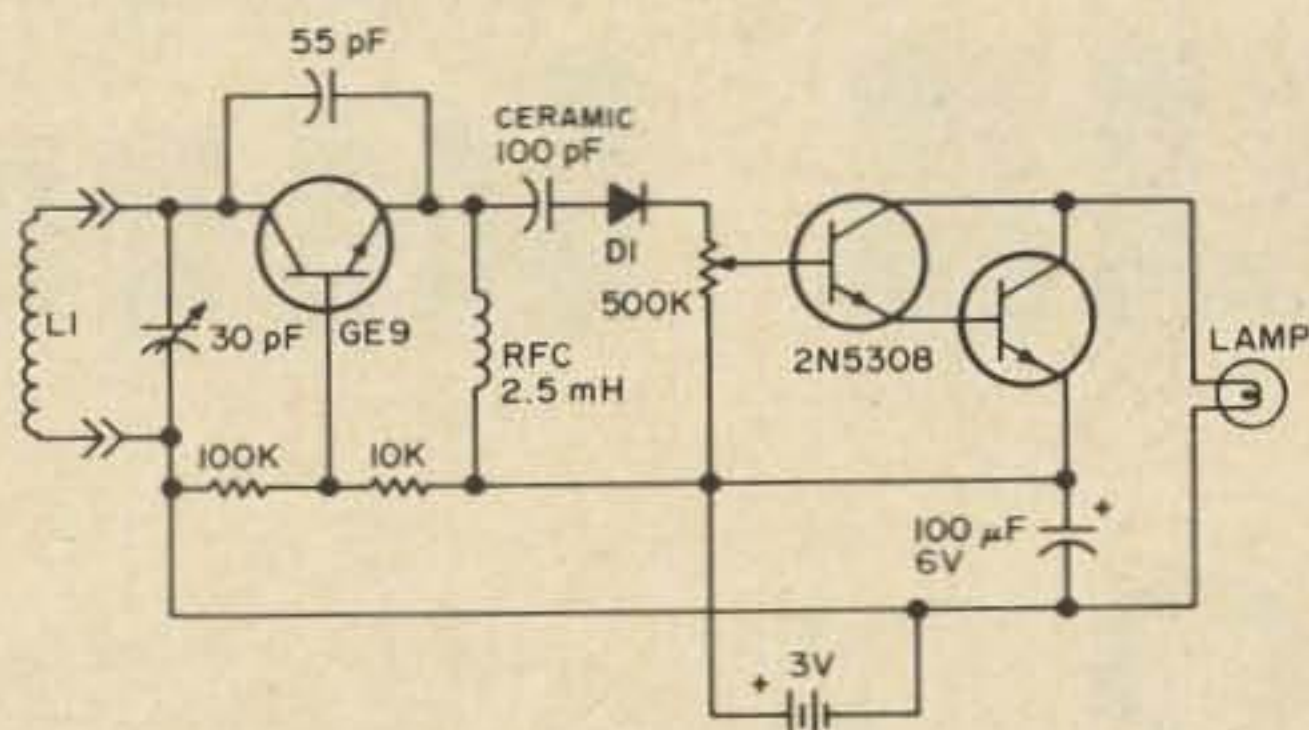

Fig. 3. Dipper is nothing more than a simple oscillator and a Darlington amplifier pair.

### Plotting the Frequency

Making the frequency curves should be a simple enough matter using "science" graph paper and an accurately tuned receiver. Simply tune the receiver to the frequency that you need then find it with the frequency control of your dipper. First find the highest and lowest frequency that the instrument will cover, and mark this along the side of your graph. Mark the maximum number of divisions of your dial along the bottom of the graph. Then spot a few frequencies more or less evenly spaced between the maximum and minimum, and draw your curve to touch all the points. Voila! You have a curve for one coil. Repeat this for the others. This method is good because if you ever wish to make an extra coil, you simply make an extra frequency curve for it and do not have to alter your instrument at all.

... VE3ECU/WØ■

# 73 Checks Out The KRIS Scanning Receiver

One of the most interesting technological innovations in recent ham radio history has been the "scanner"—a transistor FM receiver that has the capability of monitoring a multitude of crystal-controlled channels by sequentially scanning the frequencies at a high rate then stopping and "locking on" to a frequency where a signal is present.

The idea of scanning is not new; there were a number of military "autoscan" receivers in use during the second world war—but these were large and cumbersome, they used mechanical contrivances for slewing, and they tuned at a rate so slow that short-duration transmissions could take place without being spotted. Today, with more and more frequencies being "standardized" for repeater operation in the VHF bands, the scanning receiver takes on more the stature of a necessary part of a truly "mobile" mobile setup, and less that of a conversation piece.

In the New England area, for example, where repeaters stud the hilltops, a user who wants to get the optimum use from his equipment will have to be prepared to

transmit and receive on as many as four repeater frequencies—in addition to those frequencies established as "point-to-point." The problems of monitoring for activity can become trying when you pass through areas where several repeaters—on different frequencies—are operational. I found myself monitoring 146.94 MHz for signs of action on the WIALE repeater while the Mount Snow and Concord machines (146.88 and 146.76, respectively) were hopping. A scanning capability, I felt, would serve as a "funnel" and allow monitoring of all the repeaters and point-to-point channels at once.

So that I could check out the practicality of monitoring with a scanning receiver, I invited the manufacturer of the Kris scanner to lend me a unit for a while for test purposes. I had seen Kris' ads and was frankly impressed with the specifications. The people at Kris were accommodating, and provided a receiver that was tuned up, crystaled, and ready to go.

I was in for a few surprises when I opened the box. The ads I had seen on the Kris units had been for the "Snooper," a



\$139 unit with an "automatic-manual" switch for mode selection. But what I received was the top of the line: a \$149 receiver with a built-in switching capability that permits the operator to "lock out" any channels he does not wish to monitor. Also, I discovered that the unit is not restricted to mobile use; it comes with a built-in power supply to permit use from either 115V house current or the 12V power from a car battery. It also comes with a removable telescopic whip antenna that attaches through a grommeted hole in the cabinet top.

On the negative side, the regular antenna connector on the back of the scanner is made to accept the plug that comes standard on automobile BC radio antennas. This might be great for someone who wants to forego his mobile BC listening in favor of monitoring the local FM nets, but for most of the hams I know, it would be an annoyance. The ideal connector, in my estimation, would be a conventional UHF connector suitable for matching with regular RG-8 or RG-58/U coax. It is probably safe to assume that the unit was originally developed for use by off-duty civil employees and other nontechnical people who would be stopped by so strange a beast as a PL-259 or its mate. At any rate, the required adapter is an Antenna Specialists M46; and the Kris people indicated they would supply the adapter if the request is made at the time of order.

Operationally, the Kris scanner is a wonder. It sits there silently and does exactly what it was made to do—quickly, efficiently, and rhythmically. The receiver scans at the rate of 20 samples per second, so that each channel (there are seven of them) gets "visited" every 0.3 second. The scanning rate remains the same whether some channels are skipped (locked out) or not. Each of the seven channels has a numbered indicator lamp that glows during each "sample-taking" period. When a signal appears and the receiver locks on, the lamp for that channel stays on so the operator can identify the active channel.

I checked the unit out in the 73 Magazine office where the sophisticated test

equipment complement consists of a volt-ohmmeter and a pair of pliers—so there was little in the way of measurements that could be done. But I did have a receiver of known sensitivity for comparison, and all indications were that the Kris performed in consonance with the manufacturer's specs; signals that quieted the known receiver by 20 dB did the same on the Kris scanner. Since the "control" receiver was rated for a sensitivity of 0.5  $\mu$ V for the 20 dB quieting factor, it is safe to assume that Kris' specs (identical to those for the control receiver) are accurate.

With respect to bandwidth, it should be noted that the Kris is a "good" receiver—and, like any good receiver, it is reasonably selective. But a highly selective receiver can't have a broad bandwidth without some compromise. Thus, the Kris scanner should be tuned for the frequency in the center of its range. The performance tends to degrade gradually off either side of the center frequency of interest. Since the degradation is insignificant over a range of several megahertz, this little tidbit of information will be inapplicable to most users. But if you plan on monitoring the local repeaters as well as the police frequencies in the 155 MHz region, try to plan your channels so that the top frequency is no more than 8–10 MHz from the lowest frequency of interest. And even then you'll have to compromise the sensitivity on the low end if you want acceptable performance on the top. For the conventional repeater frequencies, however—between 146 and 148 MHz—you'll find no deterioration in performance over the whole range.

All things considered, I think the scanning receiver will find a home with the FM crowd. Even if you don't have a lot of active channels in your area, it's always nice to monitor the more popular frequencies for transient mobiles, DX, or blossoming FM activity. The scanner is really great . . . easy to get used to . . . easy to get dependent upon. But what I can't figure is why nobody has ever made a scanning transceiver?

...K6MVH ■

# TWO CONVERSIONS FOR THE MOTOROLA 41V

# PART 1: AC POWER SUPPLY

Jim Romelfanger K9PKQ  
117½ 4th Street  
Baraboo WI 53913

**T**his power supply was designed to provide the voltages necessary to operate the 41V Motorola mobile as a base station. The idea behind the supply was to make it possible to convert a unit for ac operation without removing any parts necessary for dc use. This adds considerably to the utility of the unit. An operator can use it at home on ac, but when he wishes, he can reinstall it as a mobile by the simple addition of a jumper plug.

The supply uses a common TV transformer in a full-wave circuit to provide a B+ potential of 325 to 350V, and a divider network for the low B+ stages of the rig. You may have to adjust the divider resistor values to come up with the exact values of low B+ called for.

The relays are supplied by a small filament transformer and a full-wave bridge rectifier. The diodes here can be most anything over a 500 mA rating and 100 PIV or better.

Please note that the diagram shows a supply for a 12V dc rig. If your rig is for 6V, either convert it for 12V or be sure to use a 6V relay supply transformer, and use only one 6V winding on the power transformer (the heaviest, of course).

With this conversion, control connections are made through the normally used 19-pin connector on the front panel. If the rig is a front-mount unit, you are really in business.

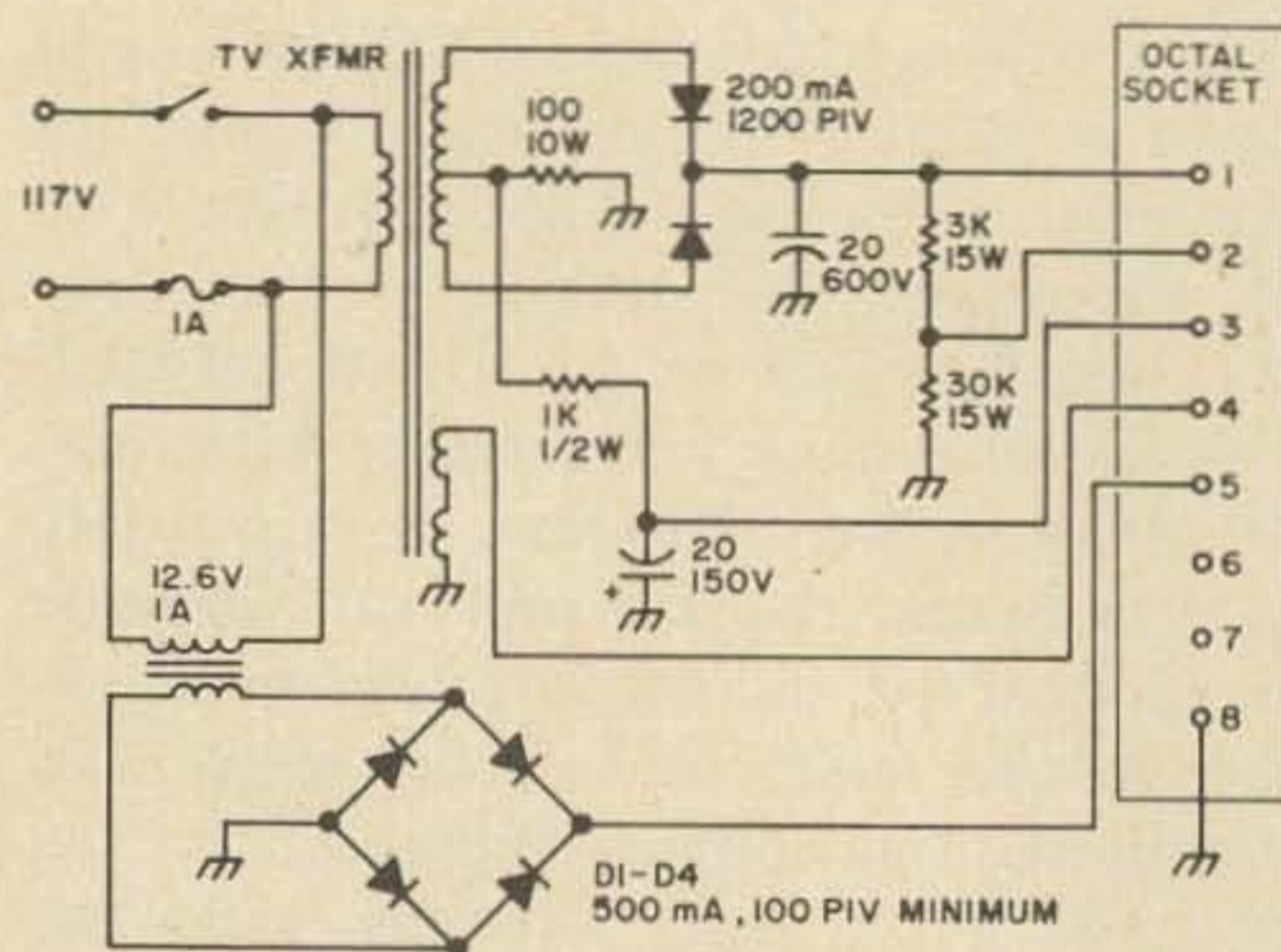

Fig. 1. Ac power supply for Motorola FMTRU-41V. (Original supply is shown in companion article.)

#### Step-by-step modification:

1. Remove RED lead from C10A and connect it to power socket pin 7.
2. Connect power socket pin 1 to C10A.
3. Connect power socket pin 2 to C9A.
4. Connect power socket pin 3 to terminal 10 on transmitter power supply strip.
5. Connect power socket pin 8 to ground.
6. Remove yellow lead from fuseholder and reconnect it to power connector pin 6.
7. Connect power socket pin 4 to fuse.
8. Remove relay lead from pin 2 of driver tube (2E26) and run to power socket pin 5. This step is for 12V units only.

Table 1. Power plug connections.

Pin	Voltage	Current	Mode	Notes
1	350	150 mA	transmit	
2	200	55 mA	receive	
	150	50 mA	transmit	
3	-20		transmit	Bias
4	12.6 ac			6.3V ac in 6V equipment
5	12 dc			Relay supply
6	N/C			
7	N/C			
8	Gnd			

#### NOTE

If the unit being converted is a 6V model, change step 8 as follows: Remove the lead between E2-9 (transmitter supply tie strip) and K1-9/K1-10 (relay). Connect K1-9/K1-10 to power socket pin 5. Supply filament voltage to pin 6

The octal chassis connector plug is mounted on a small aluminum plate on the metal extension above the 19-pin control connector (top side of the power supply chassis).

Note that there is very little filtering in the ac supply. The capacitance in the rig has been found to be adequate to take care of ripple. It is possible, however, that the filters in the unit may have deteriorated and lost some of their ability to filter. In that case, replace 'em. Many units of this type have been subjected to considerable heat, which is rough on electrolytics.

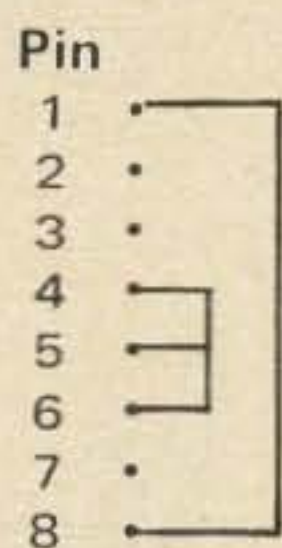

Fig. 2. DC jumper plug wiring.

The jump plug for dc operation can be wired up and then tied to the rig with lacing cord. Then it's there when you want it. Jumper wiring is shown in the schematic.

...K9PKQ ■

# PART 2: 6 TO 12V FILAMENT CONVERSION

Donald L. Milbury W6YAN  
Box 463  
W. Covina CA

Setting up the 41V to operate on two meters is too simple to warrant a complete article on the subject. After a few preliminary value adjustments, the tuneup procedure is perfectly straightforward. This article deals primarily with changing a 6V unit to 12V; but, in the interest of completeness, here is the frequency conversion information:

1. Add 2-5 pF from pin 1 to pin 3 on L1, L2, L3, L4, and L5 of receiver.
2. Add 4 or 5 pF from pin 1 to pin 3 on L7, L7A, and L8 of receiver.

#### Crystal data:

Transmit — Motorola Type R09, 85°C oven. Specify operating frequency; Sentry will correlate.

Receive — Most common is Motorola Type R21 (85°C oven). Specify operating frequency; Sentry will correlate. Sentry address is: Crystal Park, Chickasha OK 73018.

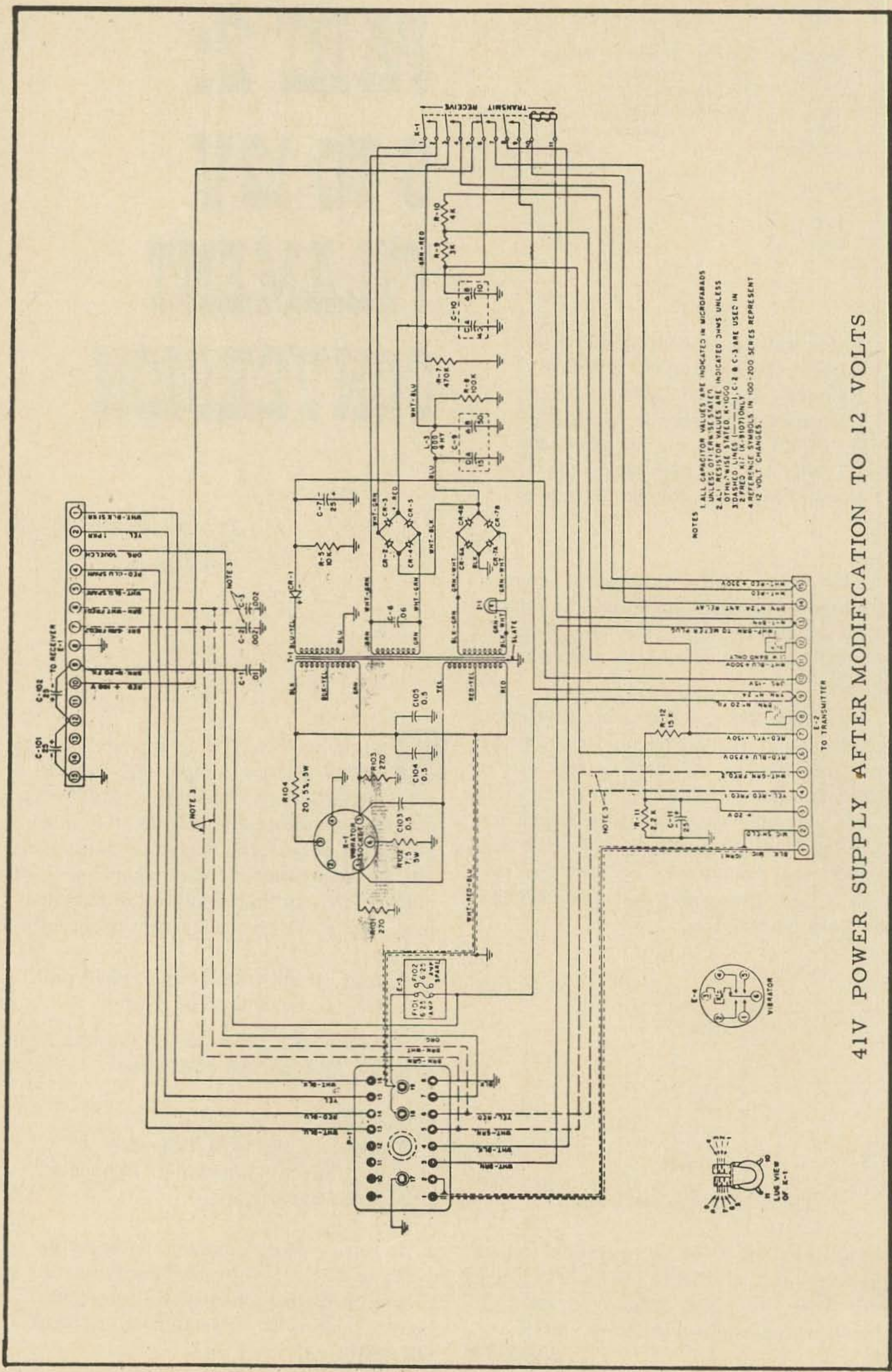

NOTES  
 1. ALL CAPACITOR VALUES ARE INDICATED IN MICROFARADS UNLESS OTHERWISE STATED.  
 2. ALL RESISTOR VALUES ARE INDICATED OHMS UNLESS OTHERWISE STATED. K=1000  
 3. DASHED LINES (---) C-2 & C-3 ARE USED IN 2 PHED KIT (X-810) ONLY.  
 4. REFERENCE SYMBOLS IN 100-200 SERIES REPRESENT 12 VOLT CHANGES.

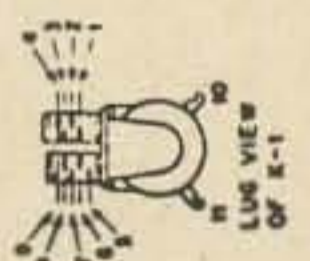
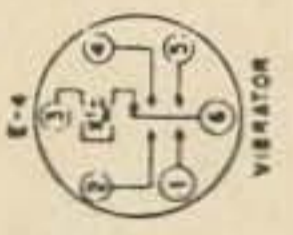

41V POWER SUPPLY AFTER MODIFICATION TO 12 VOLTS

## 6 to 12V Conversion Transmitter

### a. Doubler driver (V106)

- (1) Disconnect and remove the jumper between pins 7 and 8.
- (2) Disconnect the brown-white lead from pin 2 and connect it to pin 7. This connects tubes V106 and V107 in series.

### b. Tube V105: 3rd doubler (25–50 MHz) 2nd doubler (152–174 MHz)

- (1) Disconnect and remove the ground lead from pin 3.
- (2) Disconnect and remove the jumper between pins 2 and 3.
- (3) Connect a jumper between pin 2 and the center shield (gnd).
- (4) Disconnect the brown-white to pin 3. This connects tubes V101 and V105 in series.

### c. Audio Amplifier (V108)

- (1) Disconnect and remove the ground lead from pin 9.
- (2) Remove the jumper between pin 9 and the center shield.
- (3) Connect a jumper between the center shield and ground.
- (4) At the V108 tube socket, disconnect the brown lead (running from tube V109) from pin 4 or pin 5, depending upon which is used, and connect it to pin 9. This connects tubes V108 and V109 in series.

### d. Tubes V102 (modulator), V103 (buffer and 1st doubler), and V104 (2nd doubler – 25 to 50 MHz tripler – 152 to 174 MHz)

Replace the three 6AU6 tubes (V102, V103, and V104) with 12AU6 types.

### e. Antenna Relay

- (1) Remove the three screws that hold the antenna relay cover to the chassis. Unsolder the relay cover from the shield around the rf section.
- (2) Remove the solid bus which connects the relay coil to ground.
- (3) Connect the brown-white lead between the relay coil lug, from which

the ground bus was just removed, and pin 2 of tube 106.

- (4) Replace the antenna relay assembly on the chassis by means of the three screws. Resolder the relay cover to the rf shield. This connects the relay in series with the transmit-receive relay on the power supply chassis.

### f. Crystal Socket (Single-Frequency Models)

- (1) Mount two  $15\Omega$  resistors near the crystal socket by using existing holes in the chassis. Place one lockwasher, one eyelet, and one fiber washer at each end of the resistor. Connect the resistors in parallel.
- (2) Disconnect and remove the ground connection from the crystal socket.
- (3) Connect one end of the paralleled  $15\Omega$  resistors to the crystal socket terminal from which the ground connection was just removed.
- (4) Connect the other end of the paralleled resistors to ground.

### g. No. 2 Oscillator V201 (two-frequency models only)

- (1) Disconnect and remove the jumper between pins 2 and 3 of the V201 tube socket.
- (2) Connect a  $39\Omega$  resistor between pin 3 of tube V201 and the grounded lug on the crystal socket (X202). This connects the filament of tube V201 in series with the  $39\Omega$  resistor across the 12V source.

### h. Crystal Assemblies (two-frequency models only)

- (1) Make a note of the frequency of each crystal and remove the two crystal assemblies from their sockets. The crystals must be removed from each 6V assembly and inserted in the new heater and base assembly as outlined in the following steps. Use care so that 6 and 12V assemblies are not mixed.
- (2) Remove the housing cover by releasing the ring clamp.
- (3) Remove crystal from the 6V base

*(continued on page 93)*

# A CW MONITOR

J. A. Houser WB2GQY  
23 Washington Street  
Rensselaer NY 12144

It seems that selfishness, next to greed, is the greatest incentive to invention — to want some device to accomplish some desire; and when such is not available, the selfish man will create it, if possible.

I found myself in this position with regard to a desire to be able to monitor my CW transmissions on any band — *without* touching the monitor other than to turn it on when required and shut it off when not, without any connections whatsoever to the transmitter, as I detest modifications of equipment.

After scanning handbooks and catalogs, I could find nothing like what I wanted, so I decided I would just have to build one. I felt this could not possibly be a complicated device. Live and learn!

The untunable, nonresonant quality I wanted appeared perhaps to be the most insurmountable obstacle. Transistors seemed to be the most feasible devices to use in view of the fact that self-power was also an objective.

Did you ever try to pick out a particular transistor for a particular application — with the thousands, nay, maybe tens of thousands of transistors to choose from? If you did, perhaps you might do as I did — use what you have! Somehow, you always seem to find something that will work.

But to get on with the project: Of necessity, you have to have an audio oscil-

How to get a 98¢ oscillator module to key on and off with your rf

lator and a speaker. I saw a cheap audio oscillator module in the Lafayette catalog for 98 cents and I figured I couldn't make one for less, so I bought that along with a small steel-encased speaker with a universal bracket (see parts list). This module is designed to work with anything from 1.5 to 6V, but 3V is recommended. One of those battery holders which hold two size D flashlight cells side-by-side seemed ideal for the power. Everything was swell so far; it worked well, with two pieces of hookup wire for the key, as I didn't intend to key it anyhow. An instruction sheet came with the module showing hookup. The note is about 1 kHz with 3V applied.

Now the sticky part of the design started to erupt. You have to have something to switch the module on and off with the CW signal. Seemed like a power-type transistor should work, but how much power? What current does the module draw from 3V? Nothing like measuring it — here is the result:

V	mA	R (load)	W
1.5	19	75	0.030
3.0	32	93	0.096
4.5	38	119	0.18
6.0	45	133	0.27

So you will need a transistor that will handle 96 mW, and this eliminates any of the small audio output transistors such as

used in the little BC radio receivers, because most of them put out only about 20 mW. An audio power output transistor such as used in the auto radios will handle 100 to 200 mW, so it is ideal. Since I just happened to have one of these on hand, I hooked it up as in Fig. 1 to find out what control voltage I would need to fire it.

Now I had to decide whether to do a lot of research to determine whether all the parameters were correct or whether just to hook it up and see if it worked. I decided on the latter. I hooked it up per Fig. 1 and started with 1.5V between X and Y, then 3.0, then 4.5 and 6V. Finally, with 9V, it fired, and the audio oscillator switched on. Now I was almost certain I could not get 9V dc out of rf rectified from a small whip antenna to fire this directly, so I figured I

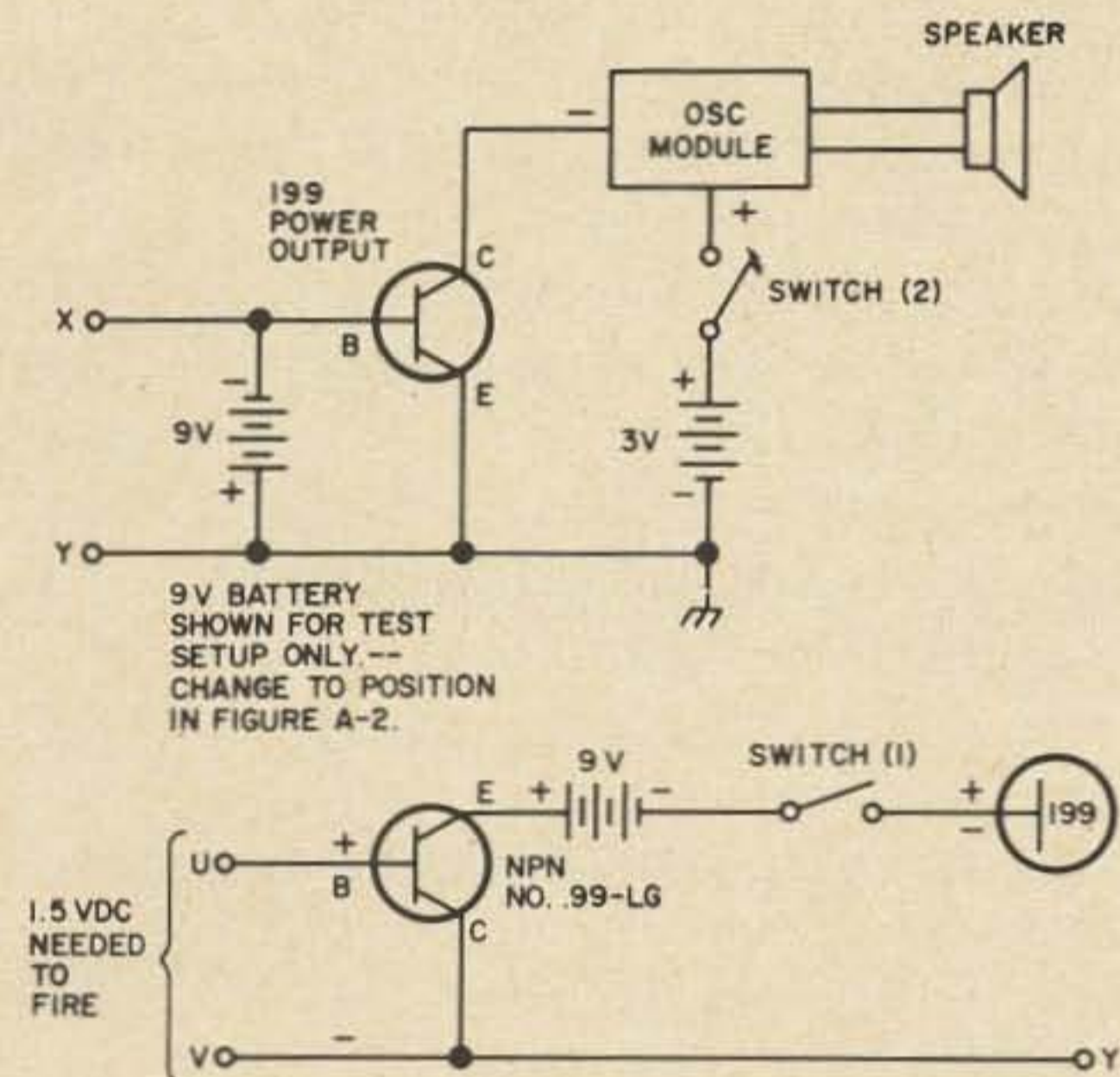

Fig. 1. Test setup. 9V battery is used in test only. Change to position shown in Fig. 1B.

would have to put another control switch (transistor) ahead of this one to control the 9V needed to switch it on. Perhaps I could pick one out that would take about 1.0 to 1.5V dc from rectified rf to switch it on and off — sort of a double switch, if you will.

I just happened to have another audio driver and output transistor such as used in miniature BC receivers on hand, so I tried this. It was an NPN type. I hooked it up ahead of the power transistor to see what voltage dc I would need to fire it, which would then fire the power transistor, which

would then turn on (and off) the audio oscillator module. I found I needed 1.5V at the base to fire this one. It fired the power transistor, which turned on the audio oscillator, and I got a fine 1 kHz note. Everything so far was fine.

Now all I needed was 1.5V dc from rectified rf, and everything would be cooking. I tried a single IN34 diode hooked to a piece of hookup wire for an antenna, and the best dc I could get from this arrangement was about 0.3V.

Well, why not an rf voltage doubler? After all, these work at 60 Hz and are used in many receivers and some low-power transmitters. So I hooked up a voltage doubler as in Fig. 2.

Sure enough, up went the rectified dc voltage. In the 40 meter band it even went as

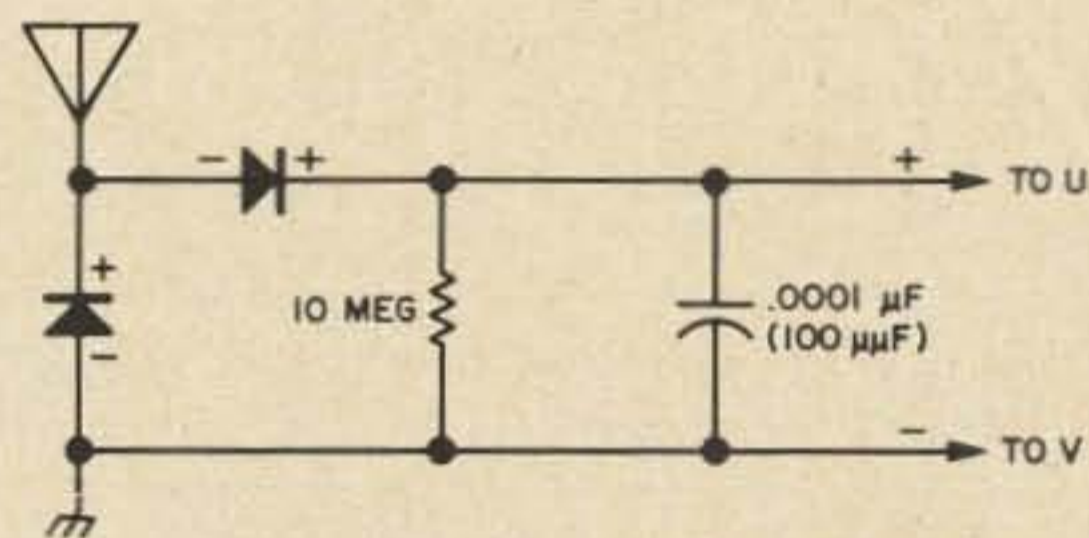

Fig. 2. Voltage doubler rf pickup. 1N34s.

high as 12.0V dc; and in the 80 meter band it was about 1.8 to 2.5V dc, which should be more than enough. However, in the 20, 15, and 10 meter bands, I could get only about 0.3 to 0.9V, which would not fire the first control transistor.

I thought maybe I could improve the antenna pickup to acquire the additional voltage required. I tried all kinds of loops, from 1 turn to 100 turns, figuring the electromagnetic pickup might be predominant over the electrostatic pickup from a unipole antenna, only to find out that no loop at all would work. The pickup just has to be from a unipole! Then I tried a counterpoise along with the antenna, figuring I might end up with a pair of rabbit ears. Nothing except a single unipole would work. I had been working with GE IN34 AS type germanium diodes, so decided to try some surplus ones removed from old IBM computers. All seemed to work about the same,

# PROPAGATION CHART

J. H. Nelson  
Good O Fair (open) Poor □

## March 1970

SUN	MON	TUES	WED	THUR	FRI	SAT
①	②	③	④	5	6	⑦
⑧	⑨	⑩	⑪	⑫	⑬	⑭
⑮	16	⑰	18	⑲	⑳	㉑
㉒	㉓	㉔	25	26	27	㉘
29	30	31				

### EASTERN UNITED STATES TO:

GMT: 00 02 04 06 08 10 12 14 16 18 20 22

	00	02	04	06	08	10	12	14	16	18	20	22
ALASKA	21	14	7	7	7	7	7	7B	14	21	21	21
ARGENTINA	21	14	14	14	7	7	14A	21	21	21	21	21
AUSTRALIA	21	14	7A	7B	7B	7B	7B	14B	14	14	21	21
CANAL ZONE	21	14	7A	7	7	7	14	21	21A	21A	21	21
ENGLAND	7	7	7	7	7	7B	14	21	21	21	14	14
HAWAII	21	14	14	7B	7	7	7	7B	14	21	21A	21A
INDIA	7	7	7B	7B	7B	7B	14	21	14	7B	7B	7
JAPAN	14	14	7B	7B	7	7	7	7	7B	7B	7B	14
MEXICO	21	14	14	7	7	7	7	14A	21	21	21	21
PHILIPPINES	14	14	7B	7B	7B	7B	7B	14B	14B	7B	7B	7B
PUERTO RICO	14	7A	7	7	7	7	14	21	21	21	21	21
SOUTH AFRICA	14	7A	7A	7	7B	14	21	21A	21	21	21	21
U. S. S. R.	7	7	7	7	7	7B	14	21	21	14	7B	7B
WEST COAST	21	14	14	7	7	7	7	14	21	21	21A	21

### CENTRAL UNITED STATES TO:

	00	02	04	06	08	10	12	14	16	18	20	22
ALASKA	21	21	14	7	7	7	7	7	14	21	21	21
ARGENTINA	21	14	14	14	7A	7	14	21	21	21	21	21
AUSTRALIA	21A	21	14	7A	7B	7B	7B	7A	14	14	21	21
CANAL ZONE	21	14	14	7	7	7	14	21	21A	21A	21	21
ENGLAND	7B	7	7	7	7	7	7B	14	21	21	14	14
HAWAII	21A	21	14	7A	7	7	7	7	14	21	21A	21A
INDIA	7B	14	14	7B	7B	7B	7B	14	14	7B	7B	7B
JAPAN	21	21	14	7B	7	7	7	7	7	7B	7B	14A
MEXICO	21	14	7	7	7	7	7	14	21	21	21	21
PHILIPPINES	21	14	14	7B	7B	7B	7B	7	14B	7B	7B	14
PUERTO RICO	21	14	7A	7	7	7	14	21	21	21A	21	21
SOUTH AFRICA	14	14	7A	7	7B	7B	14	21	21A	21	21	21
U. S. S. R.	7	7	7	7	7	7B	7B	14	14	14	7B	7B

### WESTERN UNITED STATES TO:

	00	02	04	06	08	10	12	14	16	18	20	22
ALASKA	21	21	14	7	3A	7	7	3A	7	14	21	21
ARGENTINA	21	21	14	14	7A	7	7B	14	21	21	21	21
AUSTRALIA	21A	21A	21	14	7	7	7	7	14	14	21	21
CANAL ZONE	21	21	14	7A	7	7	7	14	21A	21A	21A	21
ENGLAND	7B	7B	7	7	7	7	7B	7B	14	21	14	7A
HAWAII	21A	21A	21	14	7	7	7	7	14	21	21A	21A
INDIA	7B	14A	14	7B	7B	7B	7B	7	7	7	7B	7B
JAPAN	21A	21	14	7B	7	7	7	7	7	7	7B	14A
MEXICO	21	14A	14	7	7	7	7	14	21	21	21	21
PHILIPPINES	21A	21	14	7B	7B	7B	7B	7	7	7B	7B	14
PUERTO RICO	21	14	14	7	7	7	7	14	21	21A	21	21
SOUTH AFRICA	14	14	7	7	7B	7B	7B	14	21	21	21	21
U. S. S. R.	7B	7	7	7	7	7B	7B	7B	14	14	7B	7B
EAST COAST	21	14	14	7	7	7	7	14	21	21	21A	21

A - next higher frequency may be useful  
B - difficult circuit this period

and I could not get the rectified dc higher on the higher frequency bands. Next I minia-

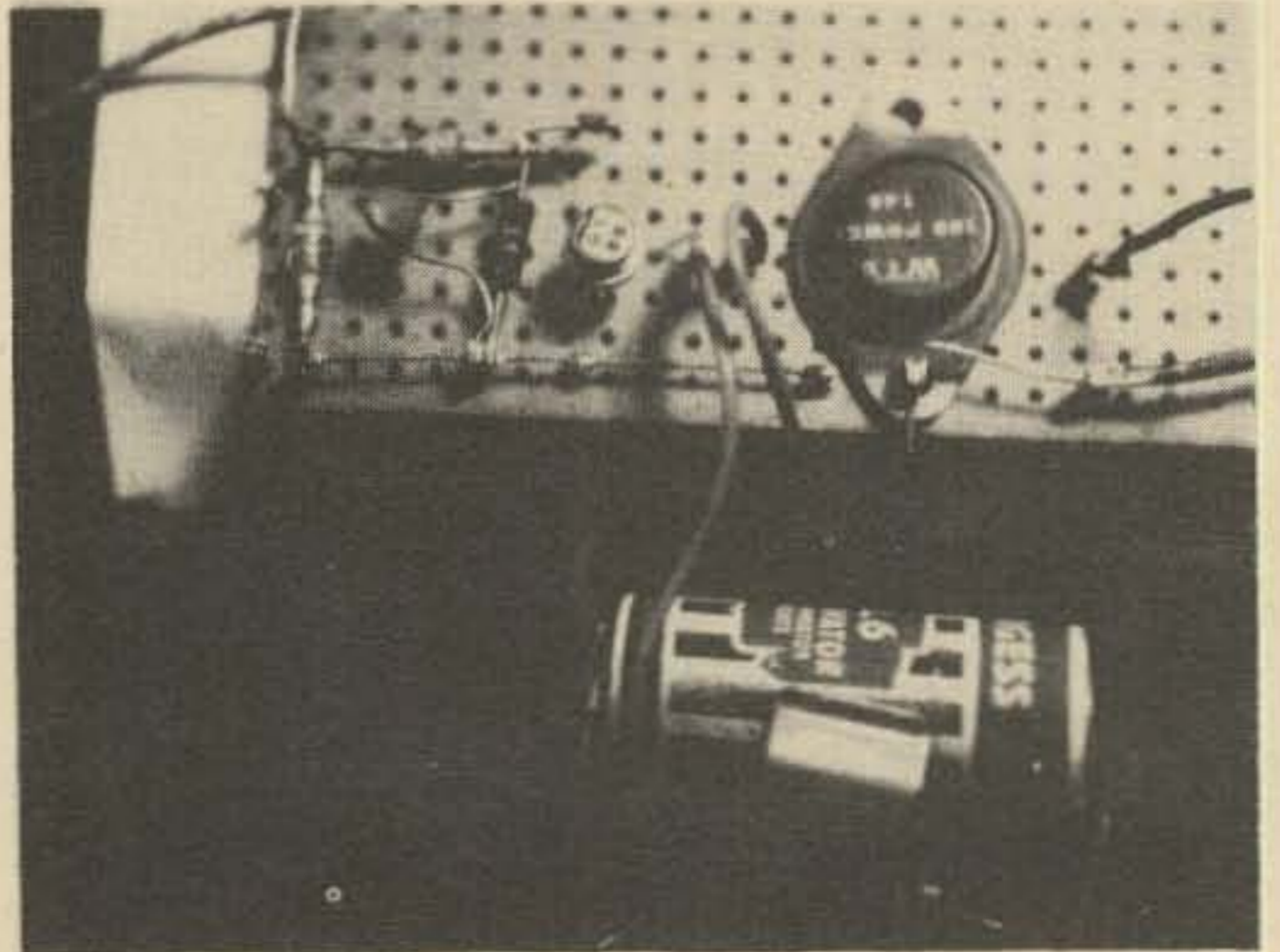

Monitor can be set up simply on a piece of perforated board. It's a lot easier than a PC board.

turized the breadboard layout. Nothing changed, and now it was small enough to put into the speaker case on one side, with the code oscillator module on the other side, and the antenna coming out the top.

So I now have a nice little miniature CW monitor on 80 and 40, which are the two bands I work CW on most. Anyone who wants to use this on 20, 15, or 10 may, with a little more research and development, get it to work on the higher bands.

Here is the parts list with approximate prices:

- 2 diode rectifiers, GE 1N34AS or equivalent (\$1.50)
- 1 pkg. (100) T-28 terminals, Laf. 19-8302 (\$1.55)
- 1 P91 terminal inserter, Laf. 19-8306 (\$.50)
- 1 2" x 4" PC Vector, phenolic punched board—for no. 28 terms. (\$.25)
- 1 3" speaker and case, Laf. 44-5201 (\$6.45)
- 1 9V battery holder—Keystone 173 (\$.35)
- 1 Cordover solid state oscillator module, Model CPO-4, Laf. 19-1513 (\$.98)
- 1 Workman TV transistor NPN, 99-L6, audio output (\$1.00)
- 1 Workman TV transistor, power, WTV-199-140 (\$1.50)
- 1 100 pF capacitor (\$.15)
- 1 5 meg 1/4W resistor (\$.12)
- 1 old antenna rod from TV rabbit ears or old auto antenna
- 1 5/16" rubber grommet
- 1 9V transistor battery
- 2 1 1/2V D flashlight batteries; hookup wire, solder, etc. as required
- 1 DPST slide switch (\$.35)

... WB2GQY ■



# SHOP-BY-MAIL SPECIAL VALUES!

**RF  
Field  
Strength  
Meter  
1-400 mhz**



Comes with 5-section antenna and earphone for modulation checking. Invaluable for tuning any transmitter. Magnetic base for mobile use.

**Model FL-30 ONLY \$8.95**

**24 HOUR  
CALENDAR CLOCK**

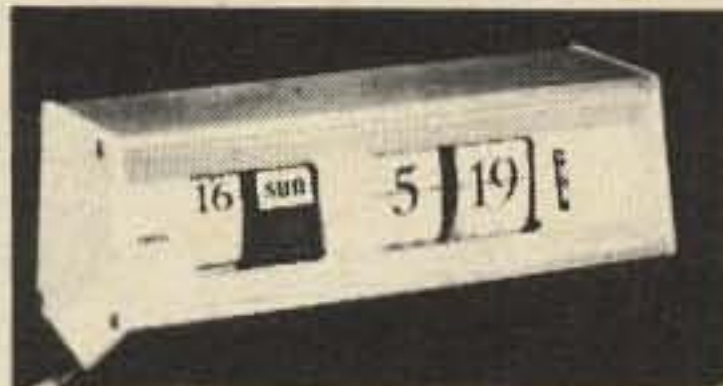

Your operating desk will stand out with this day-date clock. Great for the office too. Set the 24-hour model on GMT and never make a time or date mistake again. 8" x 3 1/2" brushed aluminum case, self-starting, 110 v 60 cy. Please specify 12 or 24 hour clock. **SPECIAL Calendar Clock ONLY \$40.00 postpaid.**



**24 HOUR  
DESK CLOCK**

This clock can be read from 15 feet in a dense fog. Available in charcoal gray, coral red, light blue, white or brown. Please specify 12 or 24 hour clock. They are beautiful. **ONLY \$24.95 postpaid.**

**DESK  
NAME PLATE**



We sold a boodle of these at the last big hamfest. You can order your name and call on this handsome desk plate in up to 20 letters and spaces. Immediate delivery on all orders, too. The plates are brown walnut stained and a real value at only \$2.00 pp.

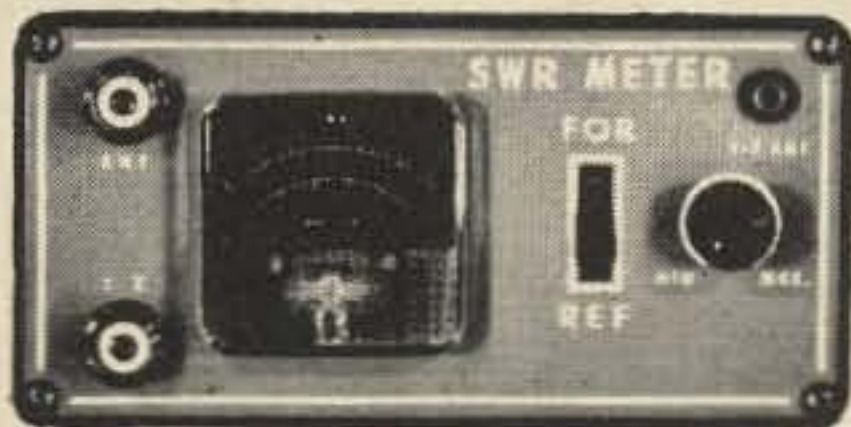

**52 Ohm 1 KW  
SWR Meter  
Simple  
Inexpensive  
Effective  
\$14.95  
Model SE-405**

## MINIATURE TEST LABORATORY



AC Voltmeter  
Ohmmeter  
RF Signal Generator  
Resistance Substitution  
9V DC Supply  
Self Powered

DC Voltmeter  
Milliammeter  
AF Signal Generator  
Capacitance Substitution  
RF Field Strength  
7 1/2" x 3 3/4" x 3 3/4", 1 1/4 lbs.

Thanks to transistors and printed circuits you can hold this complete lab in one hand. Not long ago this would have been a whole shelf full of test equipment. 455 khz generator for aligning if's, 400 hz generator for audio circuits. Plus a normal VOM and R&C substitution. Field Strength meter for tuning transmitters. Everything in one small box!  
**Model SE-400 Mini-Lab ONLY \$25.00**

This is by far the single most valuable piece of test equipment. Built in meter for measuring gain of each stage under test. Easy to find weak or defective stages. Output speaker built in or to VTVM or scope. No line cord since it is self powered.



**ONLY \$22.50  
Model SE-350 Signal Tracer**

**CASSETTE  
TAPE RECORDER**



REDLINE presents the Valiant. This neat little cassette tape recorder has excellent fidelity and an easy push button system that means everyone in the family can use it and have fun. It has a battery level meter, recording level meter, a jack for feeding hi-fi or your receiver (or tv), and operates from a switch on the mike. Record those rare DX contacts as well as your regular friends off the air. The price is ridiculously low. **SPECIAL, ONLY \$33.00 postpaid.**

Send order to:  
**REDLINE Co. Box 431, Jaffrey NH 03452**

Please allow a little extra for postage charges.

- FL-30
- Cal. Clock
- Desk Clock
- Name Plate
- SE-405
- SE-400 Mini-Lab
- SE-350
- Cassette Recorder

NAME \_\_\_\_\_  
ADDRESS \_\_\_\_\_  
CITY \_\_\_\_\_ STATE \_\_\_\_\_ ZIP \_\_\_\_\_

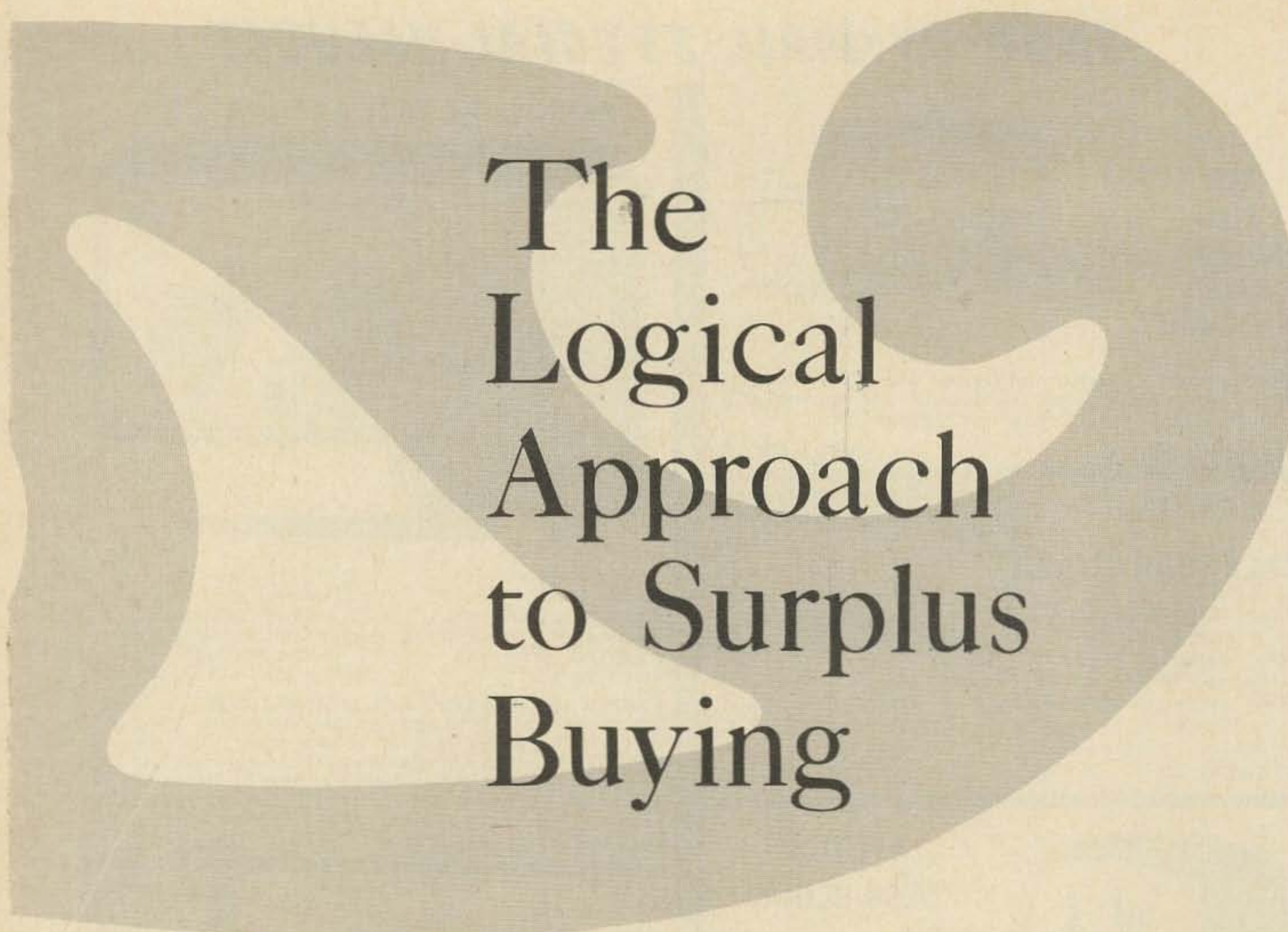

# The Logical Approach to Surplus Buying

*Jim Kyle*

All that's surplus is  
not military . . . or FM.

Take a look at the surplus ads in this issue—and you may be a bit surprised by what is turning up on the market these days.

For instance, a random sampling of a recent issue shows one ad featuring a “6,400 memory drum,” faced by another which offers “brand new RTL integrated circuits.” Elsewhere in the same issue we find “universal logic circuit cards,” and a potpourri of “dual 4-input *nand* gate,” “quad 2-input *nand* gate,” and “J/K flip-flop master slave” IC chips. That's all a far cry from the de-coherer, spark gap, and Alexanderson alternator—or even from the push-pull 304TL's or war-weary ART-13's which used to be the mainstay of the surplus market.

It's probably an insult to most of you to assume that you don't know that all these strange new items in surplus come not from military communications channels, but from

the computer industry— and so it won't be assumed.

But the question just may remain open, as to what earthly (or spacely, either, for that matter) use such gadgets could be in ham radio. And the purpose of this parcel of prose is to attempt to provide a route toward finding some answers to that question.

Now that we have assumed that everybody knows these strange things come from the computer industry, we'll be a bit more specific and point out that it's the *digital* computer industry which provides most of the goodies. Analog computers are still with us, and will be for a long long time because for some purposes, they're better machines—but the big money, and the big market, is for digital computers, and Detroit has nothing on the computer sciences. After all, if you buy a new car you can expect it to

run for at least three years, and maybe even until it's paid for—but the average life of a large-scale computer system is more like two and a half years. By that time, the state of the art has advanced so far that your “brand-new” machine is obsolete.

This rapid obsolescence cycle is what's putting so much computer surplus onto the market now. While most hams are still a bit puzzled by the whole idea of integrated circuits (sort of like we were by transistors way back in 1959 and 1960), the computer people have moved through two whole “families” of IC designs and are now well into the third generation. The obsolete stuff has to go somewhere, and that's where the “surplus” comes from.

“Fine,” you may be saying, “but I don't want to build a computer. What good is this stuff to me?”

Patience. It may turn out to be a gold mine for you. And it may not. Only you can decide that, but in the pages which follow we're going to try to give you enough information to let you make the decision, and to let you use these things for purposes their original designers never had in mind.

### Logic Elements

Right here at the outset it would probably be a good idea to define some of the words and phrases used in the computer industry for these circuits, because the ads cited earlier reveal some lack of understanding—and when the sellers are mixed up, then the buyer who knows what the words mean has a chance to get even better bargains than usual.

Computer designers tend to think in terms of *logic elements*, which can best be thought of as little black boxes which do one and only one job. The most common types of logic elements are flip-flops, gates, and a third type variously called a buffer, a driver, an amplifier, or sometimes an inverter.

*Flip-flops* are logic elements which have at least one and sometimes as many as four input terminals, and usually two output terminals. The signals at the input terminals determine the “state” of the flip-flop, but once the state has been either “set” or “cleared,” the input signals can be removed and the output terminals will continue to

indicate the state without change. The major purpose of a flip-flop is to “remember” a transient signal level or condition; several flip-flops, of some special subtypes, are often connected in cascade one after the other to serve as a counting circuit.

*Gates* are logic elements which have two or more input terminals, and usually a single output terminal. The presence or absence of signals at the input terminals, and especially the combinations of signal levels simultaneously present at all input terminals, determine the signal at the output terminal. Gates have no memory capability; when the input signals change, the output signals change also.

The third class consists of logic elements which normally have only one input terminal and one output terminal. The names buffer, driver, and amplifier mean the same in the computer world as they do in ham radio. This logic element provides isolation between more active stages in a design, and also helps provide driving power (because digital-circuit input terminals represent fairly heavy loads upon their driving circuits). The inverter is a special subclass of this type of circuit, which produces an output signal of opposite value to its input signal.

We'll go into these types of logic elements in more detail a little later, but before we do there are several other terms which are not exactly everyday phrases in amateur radio—which are, still, important in understanding how these circuits work.

Digital circuits are, almost without exception, designed to operate with “binary” signals. A binary signal is one which can take on only one of two possible values. For instance, it may be a +2V level, or a 0V level, with respect to ground. In practice, the actual circuit will be built to interpret any voltage above some specific value as being the higher of the two levels, and any below that value as being the lower. This voltage level, which separates the *high* from the *low* binary signal value is known as the *threshold* of the circuit, and the exact voltage values which are the two values of the binary signal are known as the *logic levels*. Often, one of the logic levels is zero volts, and then only the other logic level is specified.

We mentioned a bit earlier that digital

circuit input terminals represent quite a load to their driving circuits. When we get to the actual schematics, you'll see why. Because of this, digital circuits are rated for *fan-in* and *fan-out*. The units used for rating fan-in and fan-out are usually arbitrary. One type of gate, for instance, might represent a 2-unit load and be rated for a fan-in of 7 and a fan-out of 12.

This would mean that such a gate could accept at any one of its inputs, then, connections to three identical gates, and could drive from its own output terminal six other gates.

If more than 6 gates need to be driven to make the circuit do what the designer intended, he would have to add a buffer as one of the loads on this gate. The buffer might represent a 3-unit load, and that would leave only 9 units of fan-out available so that only 4 other gates and the buffer could be connected.

The fan-in and fan-out ratings are meaningless unless you know the number of units of load represented by each logic element you want to include in a circuit, but they still give you an idea of the relative power output of different elements in the same family. The higher the fan-out rating, the more power is available at the output terminal.

### The Logic of Switches

Before we can make much practical use of the digital circuits available in surplus, we need to know how the circuits work. And to do that, we must know a bit about electronic logic circuits. Fortunately, it's not very complicated. What makes a computer circuit so complex is not the individual circuits—each circuit is about as complicated as a diode detector, and far less difficult to understand than an audio amplifier—but the vast numbers of them involved, and the hundreds of feet of interconnecting wiring hooking them all together.

You can't get much less complicated than a simple switch—but that's just what the basic digital logic circuit amounts to. If the switch arm is in one position, current flows one way; if the switch arm is in the other position, the current flows to the other terminal. The "live" pole indicates the position of the switch—but we usually think of

it in a different way, and believe that the position of the switch tells us which way the current's flowing.

This is fine if it's *us* who has to do the remembering, but in a computer it's the circuit which must remember something. And it may be overstating things to point out that the "up" or "down" position of the switch handle *does* remember for us what we did there last. This small fact is never fully appreciated until you work with equipment which uses "alternate action" switches which you push once to turn on, again to turn off, and after they're pushed you can't tell by looking whether they are on or off.

Let's take that SPDT switch and connect a couple of them to form a logic gate. **Figure 1** shows the circuit. Electricians among the readers may recognize this as the "three-way switch" circuit for turning a light either on or off from either of two locations, but it's a logic gate circuit as well, because the output signal (the fact that the light is one, or off) depends upon both input signals (the positions of each switch individually). If switch A is up and switch B is down, or vice versa, the lamp is off. If both switches are up, or both down, the lamp is on.

In logic, a *truth table* is often used to describe the actions of any logic element. **Figure 2** is a truth table describing the circuit of **Fig. 1**. The important thing to note here is that every possible one of the switch positions is included in the table, and the output condition for each of these possible input conditions is also included.

The truth table in **Fig. 2** uses words to describe the input and output conditions. Truth tables used to describe the functions of various logic circuits usually use either the initials **T** and **F**, for *true* and *false*, or, more often, the numerals **1** and **0**, to describe the two states of the signal level.

Remember that these circuits operate only with binary signals. If we name one logic level **1** and the other logic level **0**, we can then relate the actual voltages at the input and output terminals of any circuit to the **1** and **0** entries in the truth table for that circuit, and the truth table will tell us what output the circuit will produce for any possible combination of input signals.

To illustrate the point, **Fig. 3** is a redrawn

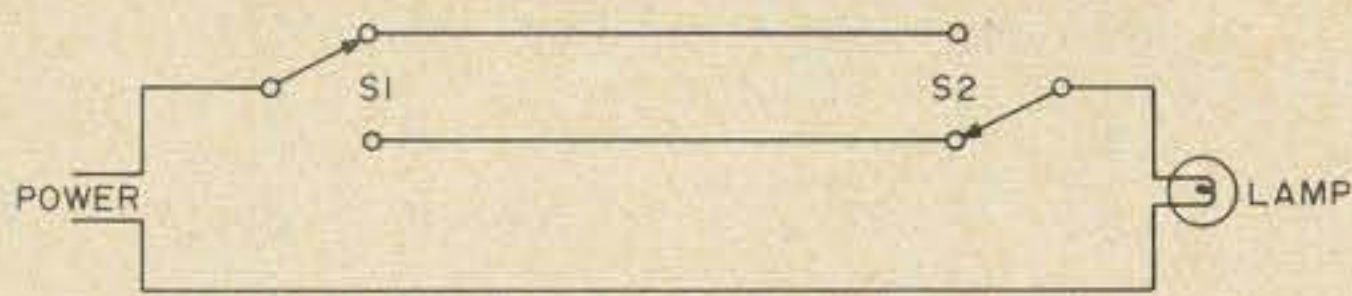

Fig. 1. This simple circuit, known to electricians as a three-way switch, for controlling a light from two separate locations, is also a rather exotic digital logic circuit. No gate used in digital logic is any more complex than this circuit, though it may have more control points.

Switch Positions		Lamp
S1	S2	
down	down	on
down	up	off
up	down	off
up	up	on

Fig. 2. Truth table describes all possible conditions of a three-way switch circuit. Left two columns show switch positions and right column shows lamp condition which results from each combination of switch positions. Systematic tabulation of switch positions insures that all possible combinations are included; positions for S2 alternate from down to up to down to up, changing at each line, while positions for S1 change only when a position of S2 is repeated. If the circuit had three switches, 8 lines would be necessary to describe all

version of Fig. 1 with the switch positions labeled as 1 and 0, and also includes the truth table in 1 and 0 terms. In this table, an output of 1 means the light is on, and a 0 output means the light is off.

If we think only of two-input gates, we could design circuits to fulfill any of 16 truth tables. Figure 4 shows all 16 of these possible truth tables for two-input gate logic circuits. In practice, only a few of these 16 are used to any degree. The most common gate circuits found in surplus are those known as *nand* and *nor* gates. Figure 5 shows the truth table of both the *nand* and the *nor*. The three-way switch circuit of Figs. 1 through 3 is known in logic as an *exclusive or* circuit; you're not likely to find one of these in surplus, because when a logic designer needs an *exclusive or* gate he usually builds it up from several *nand* or *nor* circuits.

Back in the earlier days of computers

## TOROID CORES

Red "E" Cores-500 kHz  
to 30 MHz-  $\mu = 10$

#	OD	ID	H	EACH
T-200-2	2.00"	1.25"	.55"	\$3.00
T-94-2	.94	.56	.31	.75
T-80-2	.80	.50	.25	.60
T-68-2	.68	.37	.19	.50
T-50-2	.50	.30	.19	.45
T-37-2	.37	.21	.12	.40
T-25-2	.25	.12	.09	.30
T-12-2	.125	.06	.05	.25

Yellow "SF" Cores-10 MHz  
to 90 MHz-  $\mu = 8$

T-94-6	.94	.56	.31	.95
T-80-6	.80	.50	.25	.80
T-68-6	.68	.37	.19	.65
T-50-6	.50	.30	.19	.50
T-25-6	.25	.12	.09	.35
T-12-6	.125	.06	.05	.25

Black "W" Cores-30 MHz  
to 200 MHz-  $\mu = 7$

T-50-10	.50	.30	.19	.60
T-37-10	.37	.21	.12	.45
T-25-10	.25	.12	.09	.40
T-12-10	.125	.06	.05	.25

FERRITE BEADS: .125" x .125",  $\mu = 900$ . With Spec Sheet & Application Notes Pkg of 12, \$2.00

KILOWATT TOROID BALUN KIT: Still only \$5.00

EXPERIMENTER'S 2 CORE TOROID KIT—This famous kit contains cores, wire, and charts so that you can make your own high Q modern inductors for hundreds of practical applications.: \$1.50

**MINIMUM ORDER: \$1.00**

Please Add 25¢ per order  
for Packing & Shipping

**AMIDON ASSOCIATES**

12033 Otsego Street  
North Hollywood, Calif. 91607

## Over 250 Pieces of USED EQUIPMENT on SALE

All used equipment advertised in November issue offered at an additional discount of 10%. Be sure to check this list—over \$20,000 worth of good used Receivers, Transmitters and Transceivers offered at these reduced prices! While the stock lasts — let us serve you?

We Are Now Signal One Dealers  
Try Us for Best Trades

Sam Blaylock K4HCU mgr — T.T.Freck W4WL  
FRECK RADIO & SUPPLY COMPANY  
38 BILTMORE AVENUE  
ASHEVILLE, NORTH CAROLINA 28801

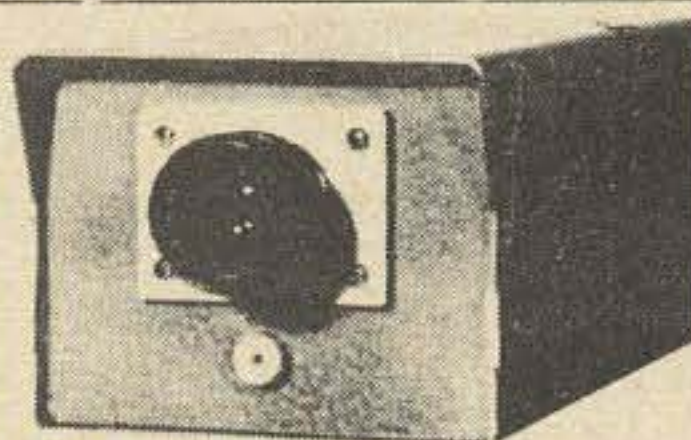

\$219.95 plus shipping  
Complete with lens.

COMPACT, HIGH QUALITY TELEVISION CAMERA for video or rf channel use. 25 transistors, 18 diodes, 500 line resolution. Dimensions 4-1/8" x 5-1/4" x 12". F1.9, 25 mm lens included. Ideal for ATV or closed circuit. Order yours now!!  
F. N. Mertin Co.  
Box 656, Fayetteville, Ark. 72701

## PROFESSIONAL REPAIR AND CALIBRATION SERVICE

Specialist in the maintenance and calibration of school's electronic laboratory equipment, test equipment and amateur equipment. Prompt service by holders of amateur and commercial FCC licenses. Write for shipping instructions.

PANTRONICS OF VIRGINIA, INC.  
6608 Edsall Rd.  
Alexandria, Virginia 22312

S1	S2	OUT
0	0	1
0	1	0
1	0	0
1	1	1

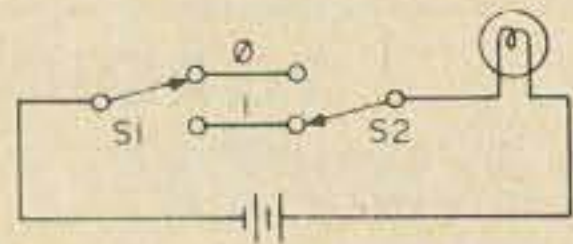

Fig. 3. Redrawn schematic and revised truth table show operation of three-way switches entirely in terms of digital logic and binary signals. Substitution of 1 and 0 for on and off or up and down standardizes the description of circuit action.

IN1	IN2	OUT	IN1	IN2	OUT	IN1	IN2	OUT	IN1	IN2	OUT
0	0	0	0	0	0	0	0	0	0	0	0
0	1	0	0	0	0	0	1	0	0	1	0
1	0	0	1	0	0	1	0	1	1	0	1
1	1	0	1	1	1	1	1	0	1	1	1
ALL 0			AND			3			DRIVER 1		
IN1	IN2	OUT	IN1	IN2	OUT	IN1	IN2	OUT	IN1	IN2	OUT
0	0	0	0	0	0	0	0	0	0	0	0
0	1	1	0	1	1	0	1	1	0	1	1
1	0	0	1	0	0	1	0	1	1	0	1
1	1	0	1	1	1	1	1	0	1	1	1
5			DRIVER 2			X OR			OR		
IN1	IN2	OUT	IN1	IN2	OUT	IN1	IN2	OUT	IN1	IN2	OUT
0	0	1	0	0	1	0	0	1	0	0	1
0	1	0	0	1	0	0	1	0	0	1	0
1	0	0	1	0	0	1	0	1	1	0	1
1	1	0	1	1	1	1	1	0	1	1	1
NOR			NOT X OR			INVERT 2			12		
IN1	IN2	OUT	IN1	IN2	OUT	IN1	IN2	OUT	IN1	IN2	OUT
0	0	1	0	0	1	0	0	1	0	0	1
0	1	1	0	1	1	0	1	1	0	1	1
1	0	0	1	0	0	1	0	1	1	0	1
1	1	0	1	1	1	1	1	0	1	1	1
INVERT 1			14			NAND			ALL 1		

Fig. 4. All 16 possible truth tables for 2-input gates are shown here. Tables 3, 5, 12, and 14 have no names, while ALL 0 and ALL 1 have no practical uses. The rest are all used in logic circuitry, but only some of them are available as actual gates; those which are not available as gates must be synthesized by combining actual gates to produce the desired truth table.

(that is, in the dim dark ages of some three to five years ago), the most common logic circuits were the *and* and the *or* arrangements. Figure 6 shows an arrangement of switches which produces the *and* function, together with its truth table, while Fig. 7 shows switches to create an *or* gate.

The names are almost obvious from the circuits. In the *and*, both (or all, if there are more than two) inputs must be at the 1 logic level in order to produce a 1 output. If any input is at 0 level, the output is 0. In the *or*, either input 1 or input 2, or input 3, or ... being at the 1 level is enough to

IN1	IN2	OUT	IN1	IN2	OUT
0	0	1	0	0	1
0	1	1	0	1	0
1	0	1	1	0	0
1	1	0	1	1	0

NAND

NOR

Fig. 5. Truth tables for nand (left) and nor gates show striking similarities. These two types of gates are the kinds most often found in surplus digital ICs. If all 0 entries in truth table for the nand are replaced by 1 and all 1's by 0, the result will be the truth table for the nor. Because of this similarity, sometimes an identical pair of circuits carries different names—and sometimes the same circuit is used to perform both nand and nor functions, by reversing polarity of all signals at both the input and output for one use, and leaving polarity unchanged for the other.

S1	S2	OUT
0	0	0
0	1	0
1	0	0
1	1	1

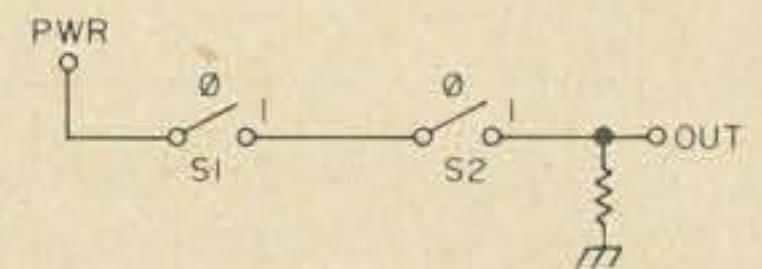

Fig. 6. Schematic and truth table for toggle-switch version of *and* gate. Both switches must be in 1 position for power to appear at output terminal and produce output of 1; either switch being at 0 holds output at 0 also.

S1	S2	OUT
0	0	0
0	1	1
1	0	1
1	1	1

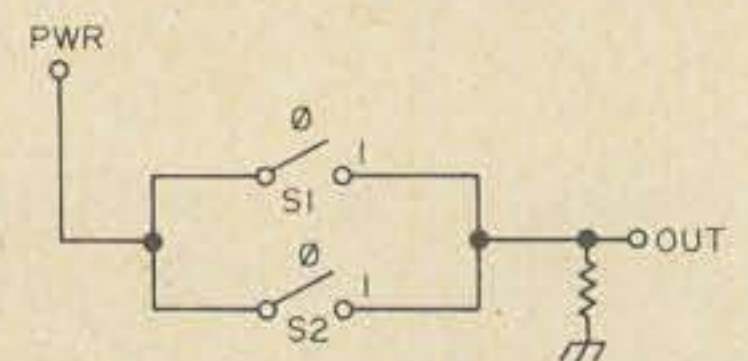

Fig. 7. Schematic and truth table for switch version of *or* gate. Since switches are in parallel, either switch being in 1 position produces a 1 output, and a 0 output occurs only when both switches are open.

produce a 1 output, and a 0 output results only if all the inputs are at 0.

Figure 8 shows both the *and* and the *or* circuits redrawn to substitute transistors for the switches. Notice that the transistor is virtually an exact substitute for the switch—but a transistor can switch from on to off in a microsecond or less, while actual switches take considerably longer.

Let's move back to actual switches one more time, though, to examine the *nor* circuit. This name is a contraction of *not or*, because, as you can see by comparing truth tables, the only difference between an *or*

and a *nor* is that the output of a *nor* is 1 under the input conditions which would make an *or*'s output 0, and vice versa.

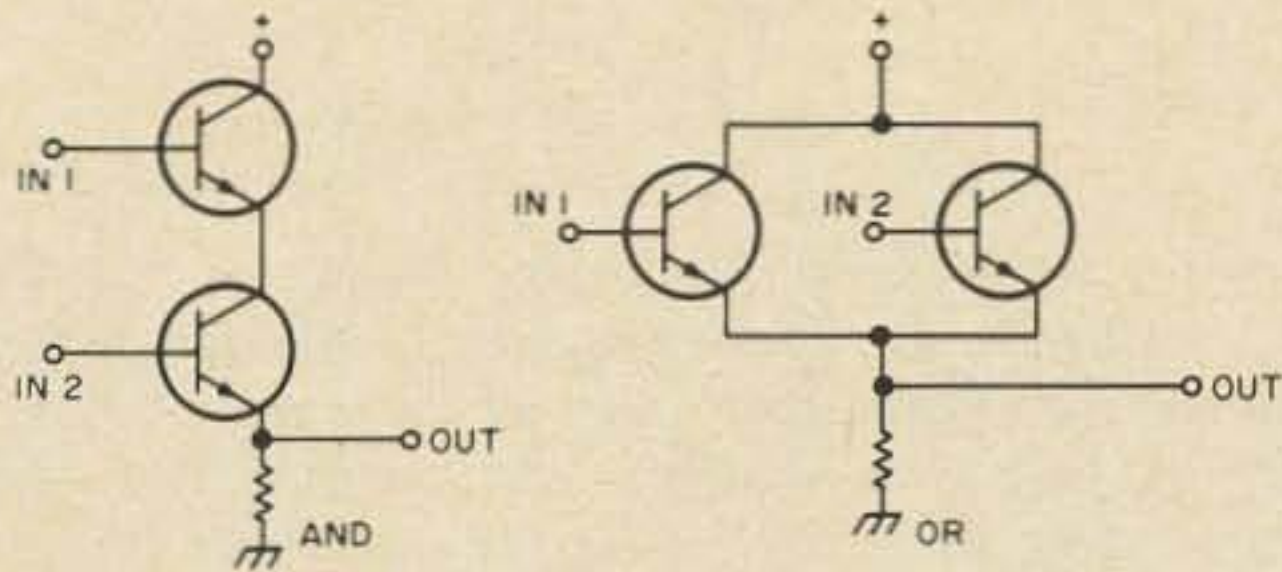

Fig. 8. Substituting transistors for the switches in Figs. 6 and 7 produces these circuits, which are workable transistor-logic versions of the *and* and *or* gates. These exact circuits are seldom used in practice because the input logic levels must swing over a greater range than the output levels. Before IC usage became common, most logic circuits used diode gating; with the advent of ICs, the *nor* and *nand* circuits became the preferred versions.

The circuit of Fig. 9, which is simple enough, produces a *nor* gate. If either switch is closed (the 1 position), the output signal is shorted to ground to become 0 level. If both switches are open (the 0 positions), the output rises to the level of the supply voltage and becomes a logic level of 1.

Just by switching the names of the logic levels and switch positions, so that closed switches mean logic level 0 and ground voltage is an output level 1, we can change this same circuit to a *nand*. If you disbelieve this apparent contradiction, check it out against the truth table. Sketch the circuit four times, setting the switches to each of their four possible combinations, and check the output voltage by name. It will follow the *nand* truth table when closed switches indicate 0 and ground output indicates 1,

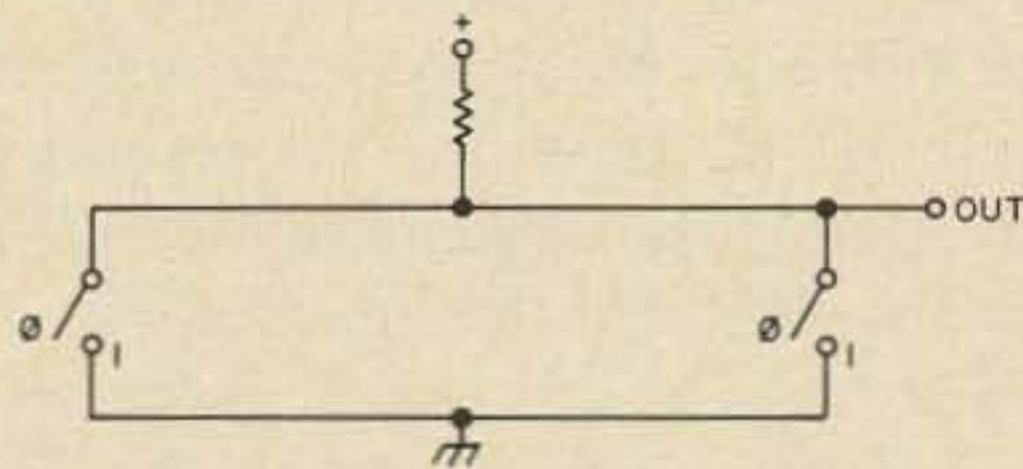

Fig. 9. Two switches and a resistor suffice to form a *nor* circuit, which as you can see by comparison with Fig. 7 is simply an "upside down *or*." Turning the circuit upside down inverts the output, making it "not *or*," which was contracted by busy engineers to *nor*. With switches this circuit offers no advantages over the plain *or*, but when transistors are substituted, a major advantage appears (Fig. 10).

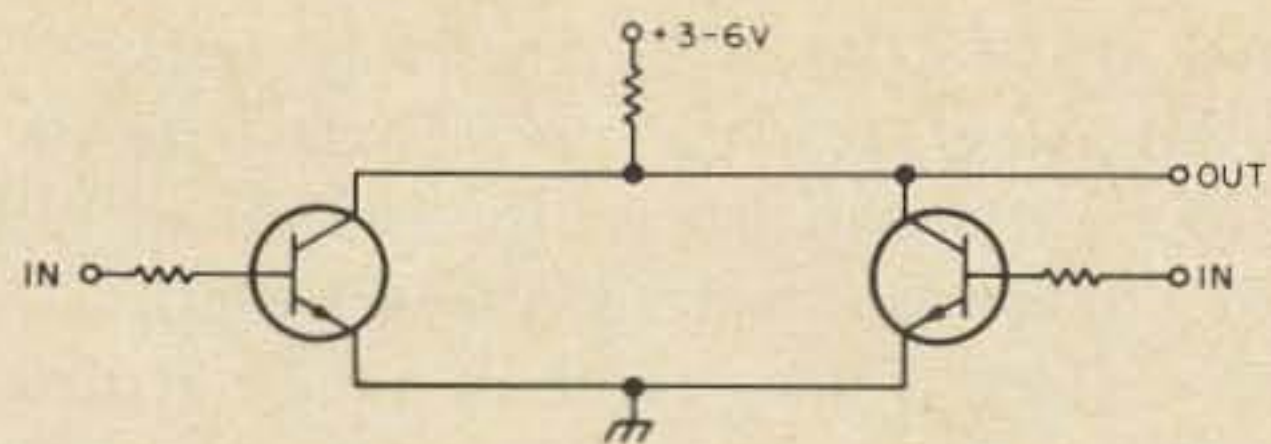

Fig. 10. Schematic of transistorized *nor* gate obtained by replacing switches of Fig. 9 with type 2N706 transistors, and adding series resistors to limit base current. This is the circuit used for each gate element in Fairchild Micrologic type 914 ICs, and any RTL *nor* gate will have similar schematic. Each input requires its own transistor, with all collectors connected together. When any transistor is on, output is at ground level; output is at supply level only when all transistors are off.

and will follow the *nor* truth table if the closed switches indicate 1 and ground output is 0.

In actual digital logic circuits, the usual difference is that one circuit uses NPN transistors and positive supply voltages, while the other uses PNPs and negative supplies. Sometimes, designers actually do use the trick of changing logic levels in mid-circuit, so that physically identical circuits may be *nands* here and *nors* there, with no way to tell the difference.

But we're a bit ahead of ourselves, because we haven't converted the switch-operated circuit of Fig. 9 into its transistor equivalent yet. Figure 10 does so—and takes us one step further.

In Fig. 10, a positive or 1 voltage applied to either base resistor will turn that transistor on, which is the same as closing the switch. The output will drop to 0. You can build the circuit of Fig. 10 using 2N706 transistors, or you can buy it in surplus as a Fairchild Micrologic type 914 integrated circuit. If you buy a 914, you'll actually get a pair of these circuits, completely independent of each other except for the power and ground connections. The 915 is the same except that it has three transistors per logic element instead of two, which makes it a dual 3-input gate (the 914 is a dual 2-input).

Some similar circuits known as quad 2-input gates simply have four independent 2-input circuits similar to Fig. 10 inside.

You may run into circuits called "quad 3-input gate extenders" or words similar to this. The key word in this is *extender*. Beware of them for most purposes, because

they do not include the load resistor or power supply connection. Their purpose is to be connected across the output of some other gate to provide additional inputs. The gate extender does come in handy at times, though, should you want to use some value of collector resistor other than the  $640\Omega$  which is typical of a 914 or 903.

### Flip-flops

In the sometimes illogical world of logic circuits, a flip-flop isn't always. You may meet R-S flip-flops, J-K flip-flops, type D flip-flops, and delay flip-flops. You might even meet a British import here and there which isn't a flip-flop at all but bears the name of one.

The circuit most people think of when they hear the name flip-flop (if they think of a circuit at all) is the counting flip-flop which flips to one of its two states when a pulse arrives, and flops back to the opposite state when another pulse comes in. This one is more accurately called a trigger, or type T flip-flop—but you won't find it in surplus.

In computers, another kind of flip-flop, known as the R-S flip-flop, is often found. This one has two input terminals, and two output terminals. A 1 applied to the S input causes a 1 to appear at the output terminal labeled 1, and a 0 level to appear at the 0 output terminal. Both output signals remain even if the input 1 is removed.

Applying a 1 input to the R input terminal reverses the state of the flip-flop. The level at the 1 output becomes 0, and the level at the 0 output becomes 1.

The R and the S at the inputs stand for *reset* and *set*. Some designers use S and C instead of S and R, to mean *set* and *clear* and thus avoid confusion between the act of resetting or clearing, and the act of re-setting or setting again.

An R-S flip-flop cannot count as does the type T; it merely remembers what the most recent signals applied to its inputs were. You won't find many R-S flip-flops in surplus either, but if you want one you can build it easily by connecting the two halves of a type 914 dual *nor* gate as shown in Fig. 11. A 1 applied to terminal S causes the output of that half of the 914 to drop to 0, and this makes both the inputs to the

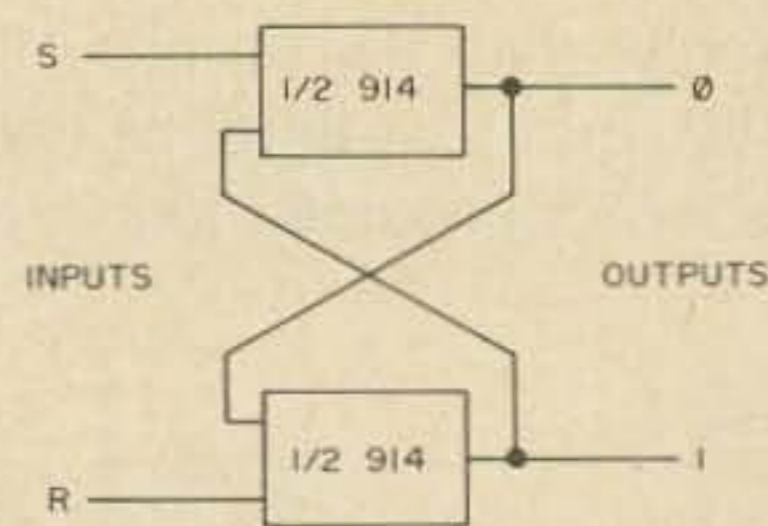

Fig. 11. By cross-coupling two halves of a type 914 IC, a type R-S flip-flop can be constructed. Two inputs for each gate are at left side of box representing gate element, and output is at right. Application of 1 level to either the S or R input makes corresponding gate output a 0, and if other input is also 0, then the opposite gate's output must be 1. This 1 feeds back to original gate to maintain a 1 input, and holds output conditions constant until flip-flop is switched to opposite state by applying a 1 to the other input terminal.

other half 0. With both inputs at 0, this other half produces a 1 output at the 1 terminal. The 1 output is cross-coupled back to the other input of the first half, to hold conditions in case the 1 at terminal S is removed. The *reset* or *clear* condition works the same way, but the roles of the two halves are reversed.

The reason that you won't find either type T or R-S flip-flops in surplus is because a single integrated circuit was developed which can serve either purpose, as well as several additional ones. It is known as the J-K flip-flop. The name comes from IBM names for some of the signal wiring in its computers.

Like the R-S flip-flop, the J-K has two input terminals and two output terminals. However, in addition to these two pairs of terminals, the J-K always has a fifth terminal known as the *trigger* terminal, and often has either one or two additional terminals known as *unconditional set* and *unconditional clear*. The block diagram symbol for a complete J-K flip-flop, as set forth by military standards, appears as Fig. 12, and in this article we'll use the labels shown in Fig. 12. These labels are not actually as standardized as all that, though, and you may find authors using other words to refer to the same terminals.

In particular, any IBM literature you may happen to come across will refer to the S terminal as the J terminal, the T terminal as the Q terminal, and the C input as the K terminal. IBM uses the symbol Q for clock-



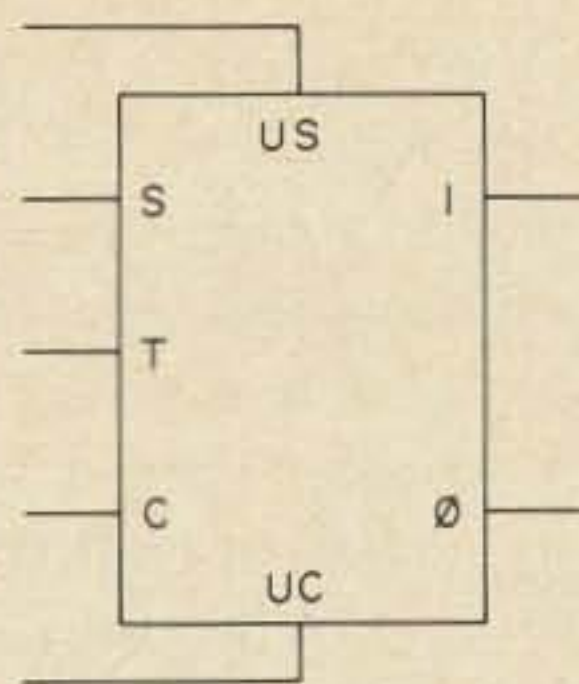

Fig. 12. Military standard symbol for J-K flip-flop, as set forth in MIL-STD-806B. Meanings of letters are explained in text.

pulse signals, while J and K are names for logic level lines to the giant of the industry.

But the military has standardized on other names: S for set, T for trigger, C is for clear, US for unconditional set, UC for unconditional clear, and I and Ø are the outputs.

The J-K flip-flop is a bit difficult to describe by a truth table, since what happens at its outputs depends on the levels present at the S and C inputs at the instant of a pulse transition at the T input. We'll describe action of the Fairchild Micrologic 923 series, which is typical of J-K flip-flop action.

The 923 has six terminals; S, C, I, Ø, T, and US. The UC terminal is omitted. If a positive logic level is applied to the US terminal, the I output terminal will go to ground level and the Ø output terminal will rise to nearly the dc supply voltage (which should not exceed 5V). This action occurs regardless of the conditions at the S, C, and T terminals, and is why the U in US stands for unconditional. This terminal is used for setting the flip-flop to a known condition when equipment is turned on, or whenever you want to clear it.

For the S, C, and T terminals to have any effect, the US terminal must be at ground level, ØV.

Under this condition, the levels at the output terminals will depend upon the levels present at the S and C terminals at the instant the voltage at T drops from positive to ground, and also (in some cases) upon the previous condition of the flip-flop.

If both the S and the C terminals are at high voltage, the negative-going transition at T will have no effect; the state of the flip-flop will remain unchanged.

## SWAN BAND PASS ANTENNAS



Return Loss Response



Band Pass Response

50 MHz to 52.5 MHz	
8 element - 12 dB	..... \$39.95
142.5Hz to 149 MHz	
7 element - 10 dB	..... \$14.95
9 element - 13 dB	..... \$19.95
11 element - 15 dB	..... \$24.95
220 MHz to 225 MHz	
9 element - 12 dB	..... \$14.95
420 MHz to 450 MHz	
*12 full wave elements-12 dB	..\$14.95
*21 full wave elements-14 dB	..\$29.95
(*each is 2 antennas side by side)	
Baluns for above antennas ea.	..... \$ 5.00
All prices FOB STOCKTON, CALIF.	

ORDER FROM:

### SWAN ANTENNA CO.

646 N. Union - Box 1122 Ph. 464-9897  
Stockton, California 95201



BUGS ARE OK... keys are better

Our **ELECTRONIC FIST** is the best!

Send 50¢ for the CONSTRUCTION MANUAL,

And see for yourself.....

(Now with SPACE COMPRESSION).

DEALER  
INQUIRIES  
INVITED

**CURTIS ELECTRO DEVICES** Dept. S, Box 4090, Mountain View, California 94040



## TRANSCIVER AUTO-MOUNT

- Adjustable
- Fits all models
- Simple Installation

**\$795**  
RETAIL

**ARCO MFG. CO.**

P.O. Box 817, Grand Forks, N. Dak. 58201

## NEW! HELP FOR HAMS

**HANDBOOK OF LIGHTNING PROTECTION!!!** Just published, written by a Registered Engineer for Hams, CB'ers, TV antenna installers and Commercial maintenance and installation personnel. Did you know that an arrester and #8 ground wire going to a 10 foot ground rod offers you practically no protection on a direct hit? You CAN protect against direct hit damage by using techniques in this new handbook. Tells you how in 1-2-3 fashion to gain complete protection from direct hits, using little different except technique! In lightning grounding it's all in HOW, not HOW MUCH you do.

**NEW NEW FIRE-RING COAX LIGHTNING ARRESTOR** just developed from research on what it takes to withstand direct hits repeatedly and survive. Permanent gap setting, no change, machined-in gap set for 4000 PEP, 50 OHM cable VSWR 4 or less. Built into PL-259 Plug.

**QUIT QUAKING WITH FEAR EVERY TIME A STORM GOES OVER YOU!** Get both **HANDBOOK** and 1 **FIRE-RING ARRESTOR ONLY \$2.95** ppd in USA; handbooks separately, \$1.00; arrestors separately \$2.50 each ppd S.A.S.E. for tech data sheets. You owe it to yourself & family to find out the truth! You may be sitting in a death trap if you used electrical power code grounding techniques in an attempt to protect yourself from lightning damage. Send direct to

**DUSINA ENTERPRISES**

571 Orange Ave. W., Melbourne, Fla. 32901.

If **S** is at high voltage while **C** is at ground when the voltage at **T** drops from high to low, then the  $\emptyset$  output terminal will go to ground and the **1** output will climb to the positive level. That is, the **1** output will mirror the level at the **S** input, and the  $\emptyset$  output will follow the **C** input.

If **S** is at ground and **C** is high at the transition, the reverse occurs;  $\emptyset$  goes high while **1** goes to ground.

If *both* **S** and **C** are at ground when the transition occurs, the flip-flop will reverse its state. If **1** was high before the transition, it will be low afterward and  $\emptyset$  will be high. If **1** was low before, it will be high afterward while  $\emptyset$  will be low. This is the counting action of the type **T** flip-flop; all that's necessary, then, to turn a **J-K** into a counting or type **T** unit, is to strap both the **S** and the **C** inputs to ground.

We aren't showing you a schematic of this unit, because it's almost unbelievable. The type 923 comes in a TO-5 can or epoxy blob, the same size as most entertainment transistors; the circuit contains 15 transistors and a rather large number of resistors as well. In addition, the way in which the transistors are used to obtain desired circuit action leads directly to mass confusion upon quick study of the schematic. Some of the connections appear impossible; the designers made use of, among other things, differences in switching speed between two almost identical transistors side by side on the microscopic chip, to obtain the action of a capacitor!

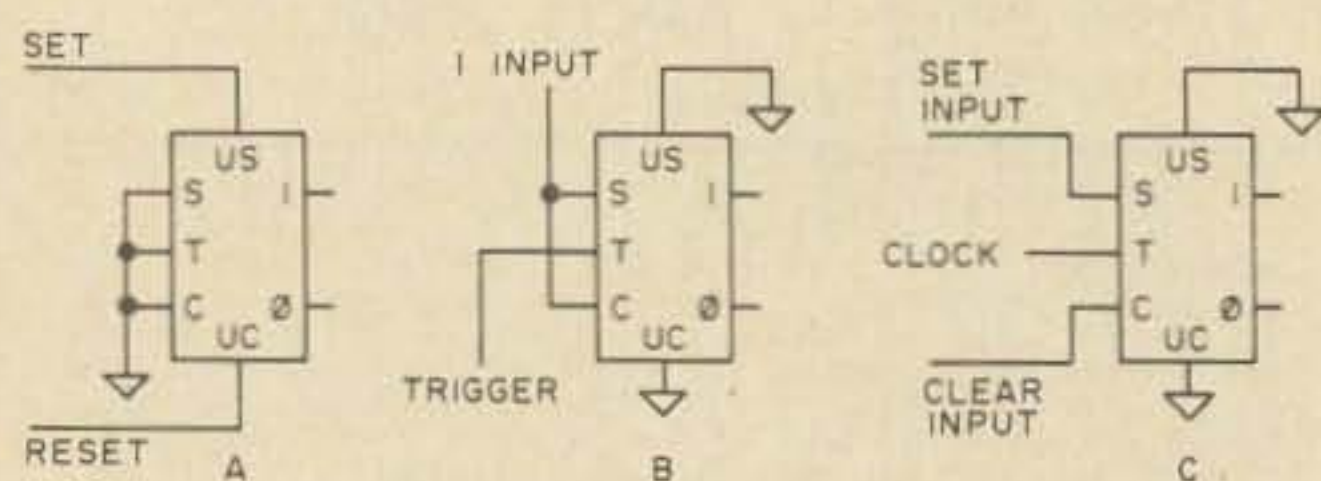

Fig. 13. Hookups for using **J-K** flip-flop as (A) type **R-S** flip-flop, (B) type **T** (trigger, or counting) flip-flop, and (C) delay flip-flop. Hookup A acts just like circuit shown in Fig. 11; outputs retain conditions set in by signals on set or reset lines. Circuit B reverses output conditions with each pulse applied to trigger input. Circuit C is slightly more complex. Conditions at set and clear inputs when clock pulse occurs are reproduced at outputs, until next clock pulse occurs.

Figure 13 shows the connections for using a **J-K** flip-flop as (a) an **R-S** flip-flop, (b) a trigger or counting unit, and (c) a delay flip-flop. The delay unit repeats at its output the conditions which existed at its inputs one trigger pulse time ago; it sometimes has a use in construction of electronic keys, and is the basis of such computer subassemblies as ring counters and shift registers. The situation is similar to that at the cutoff

### What Have You Got?

Assuming that by now you've become sold on the whole idea and sent off for a package of ICs, you probably are in somewhat of a quandary attempting to find out just what you have on hand. Many of the surplus IC units have no identification markings which make any sense.

This comes about because most of the units available (other than those purchased directly from factory distributors) come from industrial surplus, and any identification marks on them are probably the part numbers assigned by the manufacturer who intended to use them, rather than being the type numbers put on by the semiconductor plant which made them in the first place.

Most ICs come in one of two distinct package styles. One is the multilead TO-5 can or epoxy configuration; the Fairchild 914 and 923 are good examples of these. The other is the DIP (for *dual in-line package*) which may have a varying number of connections. This is a small *flatpack* with the connections coming out on the two long sides. Many of them have 14 connections (including power and ground), with 7 coming out on each side.

If you're extremely lucky, the surplus house you bought your units from will have furnished you with a base diagram so you know which pin is which. Otherwise, there's some tedious detective work in store. It's not impossible, though.

It helps, in case you're having to figure it all out with no help from the dealer, to know whether the unit in hand is a flip-flop, a buffer, or a gate. It's also nice to know how many independent units are in the same package, because then you can get some idea of how many pins to test. But you can do without these aids.

The first thing necessary is to connect

power to the unit. Low voltage, with a current-limiting resistor of at least  $1000\Omega$  per volt of supply voltage is safest. A couple of D cells are ideal, with a  $2.2\text{ k}\Omega$  series resistor. This will give you 3V at just under 1 mA — enough to check out most circuits and not enough to harm very many. If you know which pins are power and ground, just connect them. If not, pick any pin at random as the ground and try each of the others, in turn, as the hot side. If you can't get any readings in subsequent tests which make sense, move to another pin with the hot side of the power source; after going all the way around, move to another pin and try again.

Sometimes it's handy to have a milliammeter in series with the power source. If you get nearly a 1 mA of current flowing, the circuit must be full on in the IC, and you probably have your power source connected to a pair of input terminals, or to an output terminal with reversed polarity.

With a 14-pin DIP unit, you might have to run through the whole series of identification tests 196 times to come out with an identification—but the odds favor getting one sooner. From this, you can see just how much it does help to know where the power goes in the first place.

With power connected, measure the voltage from each of the other leads to ground. Some of the leads will undoubtedly measure nearly full supply voltage, and others will measure at ground. Leave the meter on one of those showing high, and short each of those showing ground, in turn, to the supply (at the IC side of the current-limiting resistor; it won't hurt to use another  $2.2\text{ k}\Omega$  resistor in series, if you're the cautious type). If any of these causes output voltage to drop to ground, make a note of the pins involved.

After all the no-voltage pins have been tried, try shorting the other high-voltage pins to ground, one at a time. If one of them brings the meter to zero, make a note of it.

When all of the pins which originally showed voltage have been checked out, move the meter to one of the pins which showed zero volts originally, and try the same thing again with all the other pins, noting any which cause voltage to appear,

## RADIO TELETYPE EQUIPMENT

Teletype Models 35, 33, 32, 29, 28 ASR, 28 KSR, 28 LPR, 28 LARP, 28 LXD, 28 LBXD1, 14, 15, 19, Page Printers, Perforators, Reperforators, Trans-Dist. polar relays, tape winders, cabinets. Collins Receivers, 51J-3, 51J-4, R-388, R-390A. SP600JX, Frequency Shift Converters. D.C. Power Supplies.

ALLTRONICS-HOWARD CO.

Box 19, Boston, Mass. 02101 Tel: 617-742-0048

"Nems-Clarke, CEI, DEI and other special purpose receivers wanted. Send accurate description of what you have to Tucker Electronics, PO Box 1050, Garland, Texas 75040."

### THINKING TOWERS?

30' "Mini-Mast" ..... \$120.00!  
 "Magna Mast"—heavy duty, self supporting  
 Rotating Crank Up Masts And Towers  
*Send for Free Catalogue Details Quickly*

TRISTAO TOWER CO.

Box 115 Hanford CA 93230

What's with UFO's ?

Check in the UFO NET

on 14,300 kc

WEDNESDAY NIGHTS at 9 pm EST



### IN-LINE WATTMETER HALF PRICE!

Hunter Wattmeter, calibrated 0—200, 0—2000 watts, forward and reflected, 10 through 80 meters.

Regular price ..... \$59.95  
**WHILE THEY LAST..... \$29.95**

HUNTER SALES INC.

Box 1128

Des Moines, Iowa 50301

and what was done to each. Go all the way around with this series of tests, too.

By now, your notes will present a complete truth table for the unknown unit. The next step is to study it carefully to see if it falls into any of the patterns of Fig. 4. Any combinations of pins which produce such a pattern probably form an independent gate element within the IC; they should be checked out carefully by connecting the meter to the apparent output pin, and

applying the appropriate high or low levels to all the input pins at the same time.

*A Few Helpful Hints.* Most of the gate functions cannot be detected by single-input-pin tests such as those described here. If you find apparent "inverter" action from several input pins to the same output pin, the apparent output pin is probably the actual output pin of a gate element of some sort, and the apparent input pins are probably the actual gate element input pins. Try combinations of high and low levels at all the input pins simultaneously while reading level at the output pin, to find any similarities to the truth tables of Figs. 4 and 5.

If any of the single-input-pin tests cause an output voltage level to switch and stay in the opposite condition, you probably have a flip-flop; gates do not stay in alternate states, but hold their output levels only so long as inputs are supplied, while flip-flops "remember" inputs and do not need to keep them applied to have a changed output. If you find a suspected flip-flop, try multiple-pin tests by connecting all pins except the one you're testing and the output pin you're measuring from, to ground. When you find the single pin which causes output to reverse when the contact is either made or broken, under these conditions, you know the T input terminal and one of the two output terminals. From there, it's trial and error to find the rest of the connections.

After a little experience with this type of detective work, you'll probably develop a feel for it which may defy explanation. If you want to develop the feel without all the trial-and-error headaches, invest in a few units which come with connection diagrams (if you can find such), and practice with them.

#### Using Logic Elements Illogically.

While it's possible that you may become so fascinated with the possibilities inherent in logic circuitry, as such, and forget all about radio, that's not very likely. It's much more probable that you're only messing with all this Boole (to steal a good pun) because you want to make use of the ICs in some circuit that has nothing to do with electrical logic machines.

In that case, you'll probably welcome this portion of our discourse, because the rest of

this article is devoted to some typical ways of using digital IC elements in ham radio.

The most versatile of the ICs for such uses is probably the 2-input *nor* or *nand* gate, of which the 914 is typical. A glance back at the schematic of this gate, Fig. 10, will show the resemblance between the *nor* gate and a *long-tailed-pair* differential amplifier circuit. All that you have to do to turn a 2-input *nor* or *nand* into a long-tailed-pair is to add the "tail," a resistor, between the IC's ground terminal and the actual circuit ground. The resistor value is not particularly critical; anything from 47 $\Omega$  to 1 k $\Omega$  might do it, depending upon the signal levels involved and so forth.

You may also find it necessary to provide some forward bias to each of the two bases, by connecting a voltage divider to each of the input terminals. The complete circuit is shown in Fig. 14, but parts values must be determined by experimenting for each application. This circuit has been used as a mike preamp, and might also have other uses. High-frequency response is not particularly good, because the series resistors inside the IC (see Fig. 10) act with the junction capacitance to form a lowpass filter.

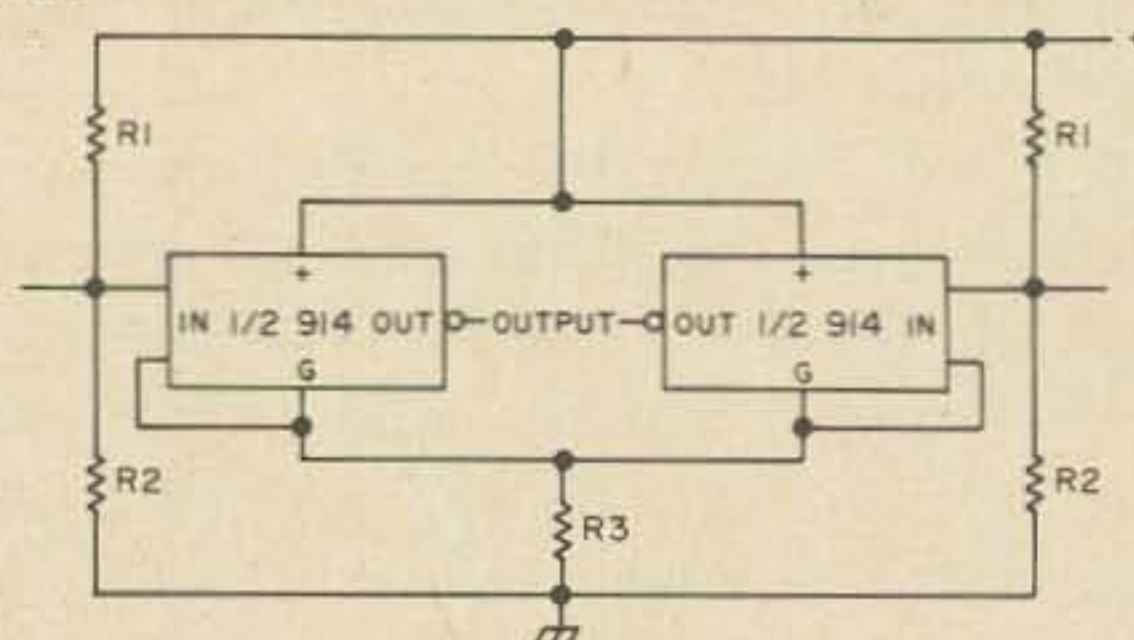

Fig. 14. Use of type 914 RTL logic element as differential amplifier is shown here. Values for R1, R2, and R3 must be determined by trial and error, but one such application has successfully used 1.8 k $\Omega$  at R1, 1.3 k $\Omega$  at R2, and 330 $\Omega$  at R3. These values may be used as starting points. Output is taken directly from output pins of IC.

We already saw, in Fig. 11, how to cross-connect one of these gates into an R-S flip-flop, otherwise known as a *bistable multivibrator*. If we simply duplicate that hookup, but put one capacitor and appropriate resistors in place of one of the direct wires, as in Fig. 15, we have a *one-shot* or *monostable multivibrator* which performs nicely as the frequency divider in a frequency standard. The frequency adjustment depends

upon both the capacitor size and the resistor values. Vary the capacitor until you're in the right ball park, and then use the resistance as a "trim" adjustment.

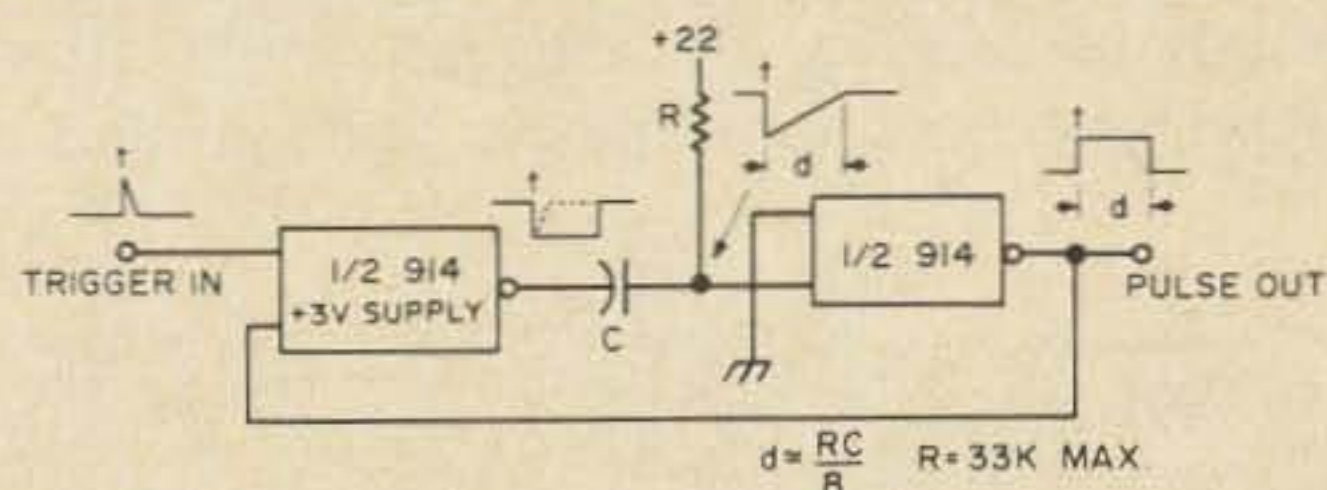

Fig. 15. One-shot circuit is easily built from 914 IC by adding single capacitor and external resistor. If 3V supply is used for IC, and 22V supply to drive external timing resistor, duration of output pulse will be almost exactly 1/8 the RC time constant, with R in ohms and C in farads. Maximum resistance usable for R is 33 kΩ to permit turn-on current to flow. Capacitance C, however, may be any value desired to achieve required output pulsewidth.

By substituting a crystal for the other cross connection, as Fig. 16 shows, we can turn the dual *nor* gate into a crystal controlled oscillator with a high-harmonic waveform. It makes a fine frequency standard, especially if one or two dividers similar to the Fig. 15 circuit are added.

If you want a free-running oscillator, you can get it by using capacitors on both sides. The circuit is just like Fig. 16 except that another capacitor replaces the crystal. Frequency will depend upon values of both capacitors, and both sets of resistors.

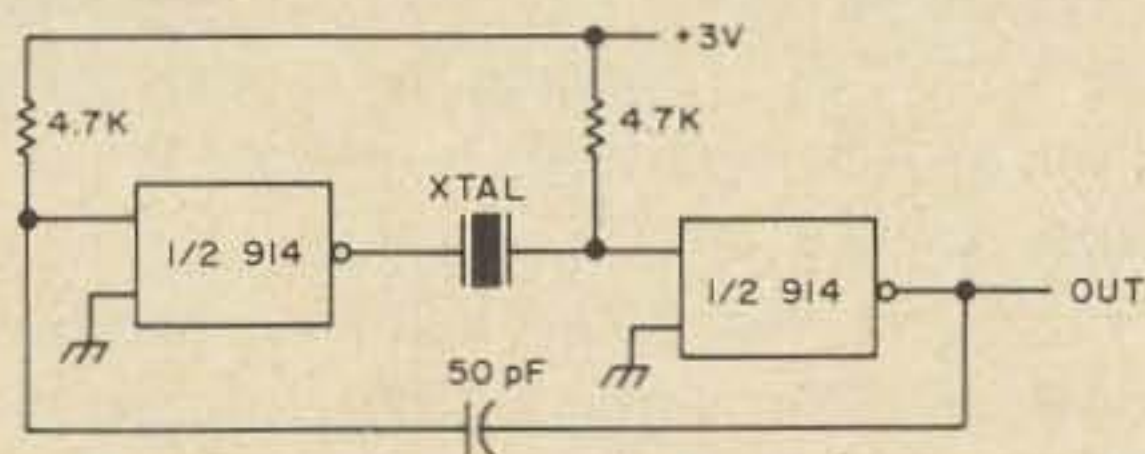

Fig. 16. Minor modifications to one-shot circuit, including substitution of a crystal for the timing capacitor and insertion of a capacitor in the dc feedback loop, turn it into a crystal-controlled oscillator which may be used for a frequency standard. Output is rich in harmonics, and this circuit is not recommended for transmitter use for that reason.

The *synchronous detection* technique for reception of AM, FM, and DSB signals has long been of interest to many of us, but too many transistors or tubes have been necessary in most circuits for synchronous or phase-locked detectors. Surplus ICs may, at long last, make phase-locking practical for

ham receivers. (See W2EUP's frequency synthesizer description in 73, February 1970.) Figure 17 shows a voltage-controlled oscillator (VCO) designed several years ago by a Motorola engineer using the Motorola MECL dual *nor* gate. Frequency varies over a 10-to-1 range as control voltage is varied from 1-7V. Both capacitors are the same value, and they control center frequency. Minimum value is about 110 pF, which provides a center frequency of about 2 MHz; maximum is 100 μF, which provides a center frequency of about 3 Hz (lowest frequencies with these two values are 750 kHz and 0.5 Hz respectively). For a 455 kHz i-f strip, 470 pF values would be about right.

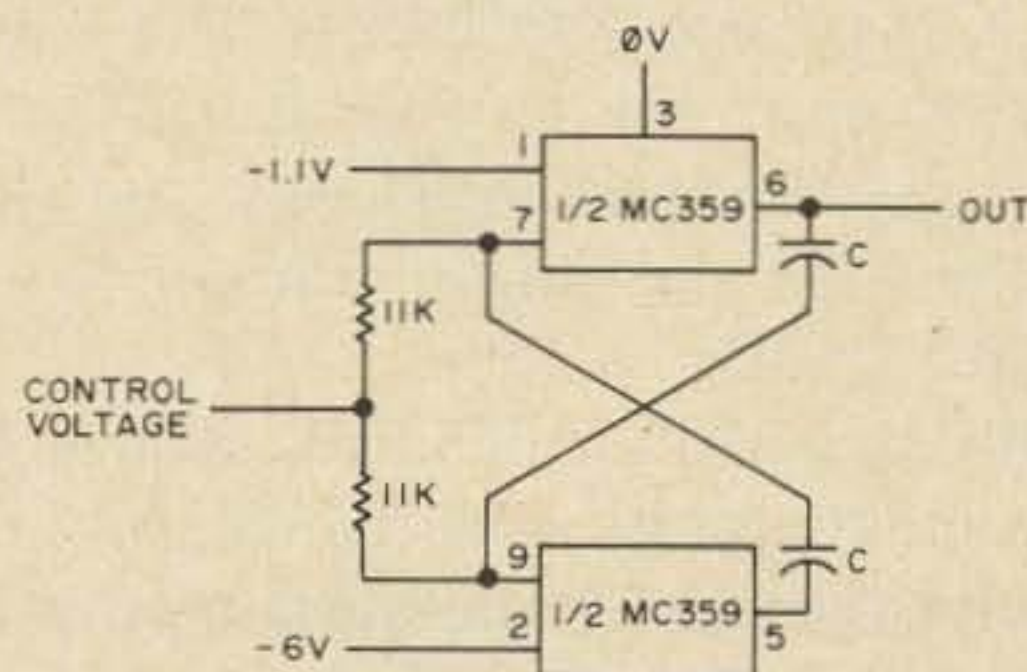

Fig. 17. Voltage-controlled oscillator can be varied over nearly 10-to-1 frequency range simply by varying control voltage. This circuit may be used as part of phase-locked detector.

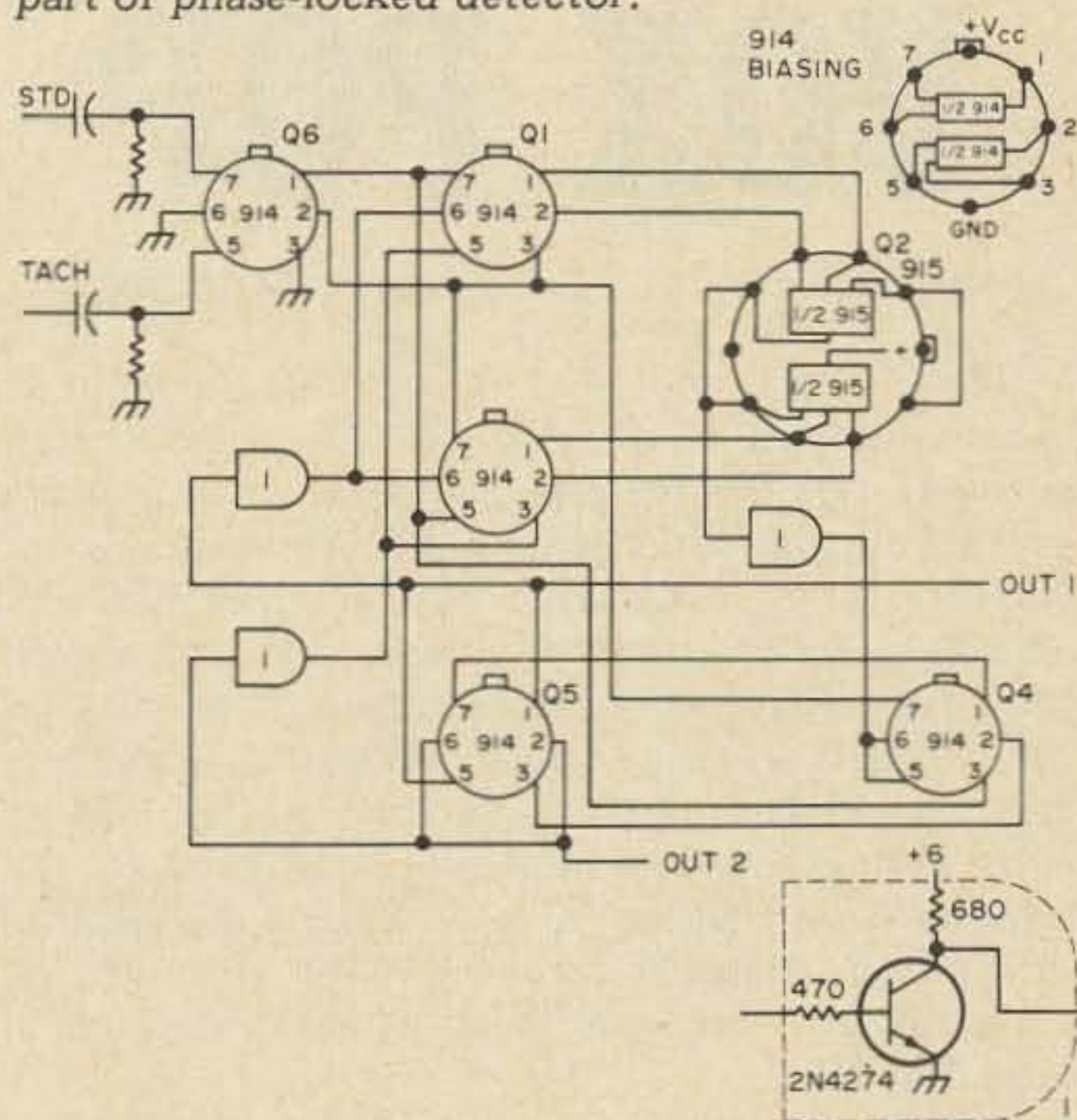

Fig. 18. This rather complex arrangement of ICs is a frequency comparator and phase detector. The unknown frequency is fed into the TACH input and the standard to which it is to be compared goes to the STD input. Output level indicates whether TACH is higher or lower in frequency than STD. OUT 1 and OUT 2 are of opposite polarity. Type 915 IC (Q2) is same as 914 but has 3-input gates rather than 2-input elements.

Figure 18 shows the frequency comparator or phase discriminator which goes with the VCO to provide half of a synchronous detector. This circuit was developed at Fairchild, and is not necessarily directly compatible with the VCO, but it should be possible to blend them together with a little trial and error.

The circuit of Fig. 18 accepts input signals at two connectors, labeled *REFERENCE* and *SIGNAL* in the drawing. It produces a single dc output. If the *SIGNAL* frequency is lower than that of the *REFERENCE*, the dc output level will be low. If the *SIGNAL* frequency is above the *REFERENCE*, the dc output level will be high. If both *SIGNAL* and *REFERENCE* are at the same frequency, the dc output level will be between the low and high levels, and will be determined by the phase relation between the input signals.

Unlike phase discriminators which make use of tuned circuits, this one has no humps in its response curve. The output will follow phase variations of the input faithfully, and can be filtered and used to drive the VCO in

the classic phase-lock detector arrangement.

A somewhat less complex circuit which has nothing to do with radio but which may be of interest to the sports-car fanatics among us is in Fig. 19. This is a combination tachometer and dwellmeter, built around a

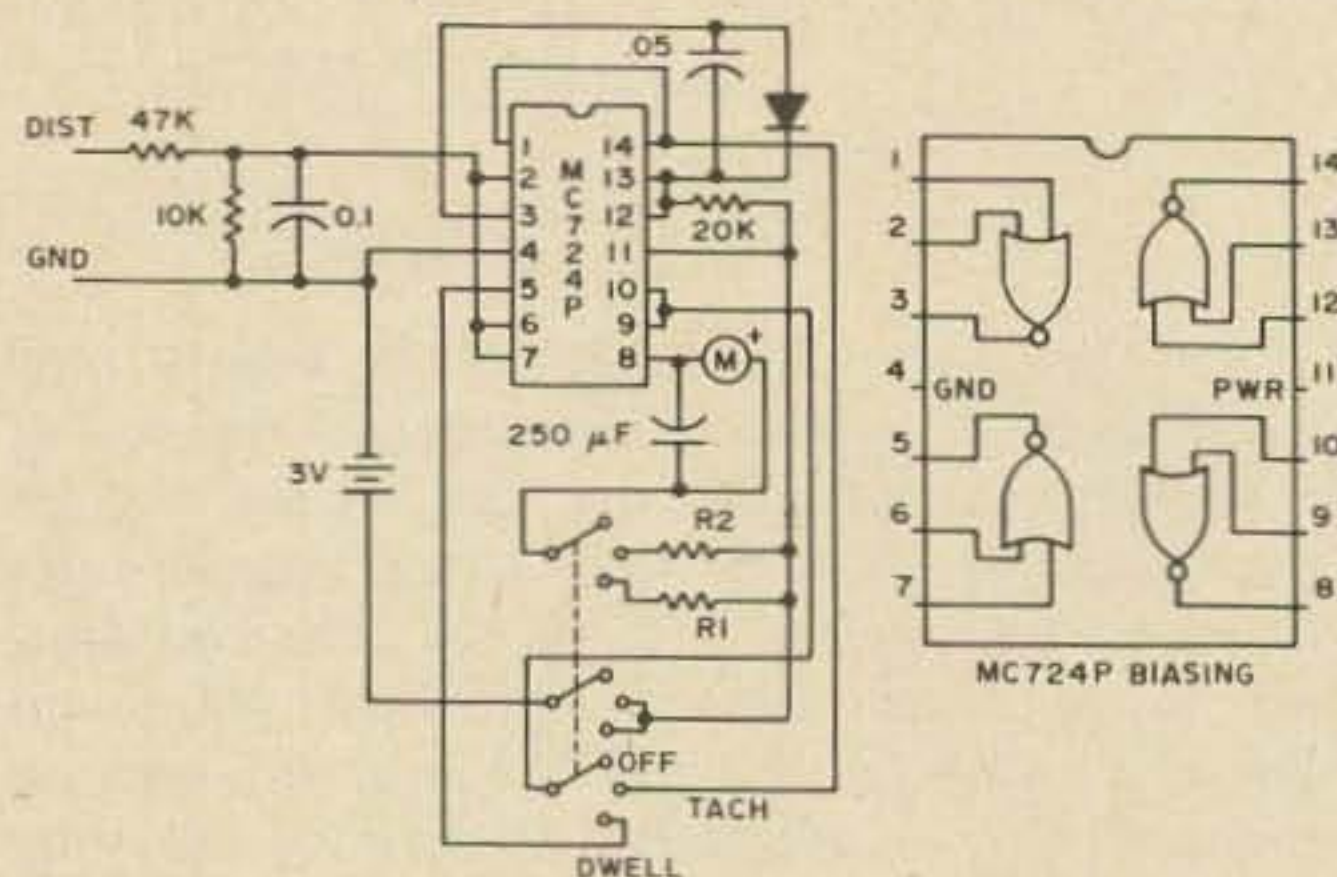

Fig. 19. Single IC chip provides tachometer and dwellmeter for auto enthusiasts. Tachometer uses one-shot formed by gates at terminals 1-2-3 and 12-13-14, with  $20\text{ k}\Omega$  timing resistors and  $0.05\ \mu\text{F}$  timing capacitor. Dwellmeter is driven by gate at terminals 5-6-7. Gate at terminals 8-9-10 is used only as meter driver, and capacitor across meter serves to damp individual current pulses. Power is supplied by 3V battery. Calibration is adjusted by R1 and R2.

# VOX POP

## Monthly Report of Activities on our Bands

Please send reports of interest on the band of your choice to Vox Pop, 73 Magazine, Peterborough, NH 03458. Use a postcard and indicate on the top the band being reported. Any news of interest will be considered grist for the mill...DX reports (including time, frequency, QSL manager), new FM repeaters, nets, emergency operations, contest high scorers, county operations, skip openings on VHF's, aurora, meteor scatter, moon-bounce, anything you think will be of good general interest. The deadline for each issue is the tenth of the month. Material received April 10th will be scheduled for the June issue, which comes out in early May.

### REPORT FORM

Please send all your reports to VOX POP on a postcard or QSL card, keep them as short as you can so we don't have to wear out our blue pencil. At the top of the card print clearly the band that the report is for. All reports will be listed by band, so if you are reporting on more than one band use more than one card.

single quad dual-input *nor* (Motorola MC724P). The gates at terminals 1-2-3 and 12-13-14 form a one-shot flip-flop timed by the  $0.5\ \mu\text{F}$  capacitor and  $20\text{ k}\Omega$  resistor. The gate at 5-6-7 is used simply as a driver, and the remaining gate (8-9-10) is the meter driver. Power is furnished by a pair of dry cells. In switch position 1, power is off. In position 2, the circuit acts as a tach, and resistor R1 should be adjusted to produce a 900 rpm reading when 60 Hz voltage is fed in. In position 3, it's a dwellmeter, and R2 should be set so that full-scale reading on the meter is obtained with the input terminals shorted. This will be 45 degrees of dwell for an eight-cylinder vehicle, 60 degrees for a six, and 90 degrees for a four. The meter can also be read as indicating percentage of time that points are closed, but most specs for tuneup give dwell readings in degrees.

This is, of course, only a sampling of the various uses which you can make of digital ICs. A little experimentation will probably result in several new ways — and now that they're in surplus, they're cheap enough to permit such experimentation. . Jim Kyle ■

(continued from page 75)

assembly and install in 12V base assembly.

**NOTE:**

The letters A and B are stamped on the bottom of the base assembly. Plug the crystal into the socket on the A side.

- (4) Place the spacer plate between the crystal and the heater element and replace the cover. Make sure that the polarity of the cover and base agree.
- (5) Insert the crystal assembly in the proper socket.

### 6 to 12V Conversion Power Supply

#### a. Vibrator Connections

- (1) Disconnect the shielded lead from the two 2.9 mH choke coils located near the center of the chassis (Fig. 1).
- (2) Disconnect the other ends of the two chokes from the two 0.5  $\mu$ F capacitors (C4 and C5). These two choke coils are not used in the 12V circuit.
- (3) Disconnect the black-yellow transformer lead from capacitor C4(0.5) and disconnect the red-yellow transformer lead from capacitor C5(0.5). Tape each lead separately and dress it out of the way.
- (4) Disconnect the sleeve-covered lead from pin 3 of the vibrator socket. Use this lead to connect capacitors C4 and C5 in parallel. Do not solder the connections to C4 and C5 until completing step 15.
- (5) Disconnect the black, yellow, and red leads from pins 1, 2, and 4 of the vibrator socket.
- (6) Remove the lead between vibrator socket pin 6 and ground.
- (7) Remove the 100 $\Omega$  resistors connected between vibrator socket pins 1, 2, 4, and 5 and ground.
- (8) Connect the red and black leads to the ungrounded terminal of C4 or C5 (changed to C104 and C105 on schematic).
- (9) Connect pins 2 and 4 of the vibrator socket and then ground pin 4 at the ground lance near pin 5.
- (10) Connect a 270 $\Omega$  resistor from vibrator socket pin 1 to ground.
- (11) Connect a 270 $\Omega$  resistor from vibra-

tor socket pin 5 to ground.

- (12) Connect a 7.5 $\Omega$  resistor from vibrator socket pin 6 to ground.
- (13) Connect the yellow transformer lead to vibrator socket pin 1.
- (14) Connect a 20 $\Omega$  resistor from vibrator socket pin 3 to the ungrounded terminal of capacitor C4.
- (15) Connect the shielded lead, which was disconnected from the 2.9 mH choke coil in step 1, to the ungrounded terminal of capacitor C5.

#### b. Push-to-Talk Relay Modifications

- (1) Remove the white-black lead connected between terminal 8 of relay K1 and terminal 14 of transmitter terminal strip E2.
- (2) Remove the white-black lead which connects between terminal 14 of terminal strip E2 and pin 4 of power plug P1.
- (3) Connect a black-white lead from terminal 8 of relay K1 to terminal 4 of the power plug.
- (4) At terminal board E1, disconnect the 24 AWG brown lead (running from the relay coil lug) from terminal 9. Reconnect this end of the lead to terminal 14 of terminal board E2.

#### c. Fuses

- (1) Remove the two 15A fuses from the fuseholder.
- (2) Paint out or use tape to mask over the markings on the fuseholder. It is recommended that 6.25A now be marked on the fuseholder to insure that oversize fuses are not used.
- (3) Place two 6.25A fuses in the fuseholder.

#### d. Terminal Strip E1 Modifications

- (1) Connect a 25  $\mu$ F capacitor from terminal 9 to terminal 12 of receiver terminal strip. Connect the negative side of the capacitor to terminal 9.
- (2) Connect a 25  $\mu$ F capacitor from terminal 12 to terminal 15 of the receiver terminal strip. Connect the negative side of the capacitor to terminal 15.

That's all there is to it. The worthless old 6V surplus mobile is ready to go in your 12V auto.

... W6YAN ■

# DIMENSIONAL GEOGRAPHIC PROJECTIONS

A  
MUST  
FOR  
REMOTE  
REPEATER  
REPEATER

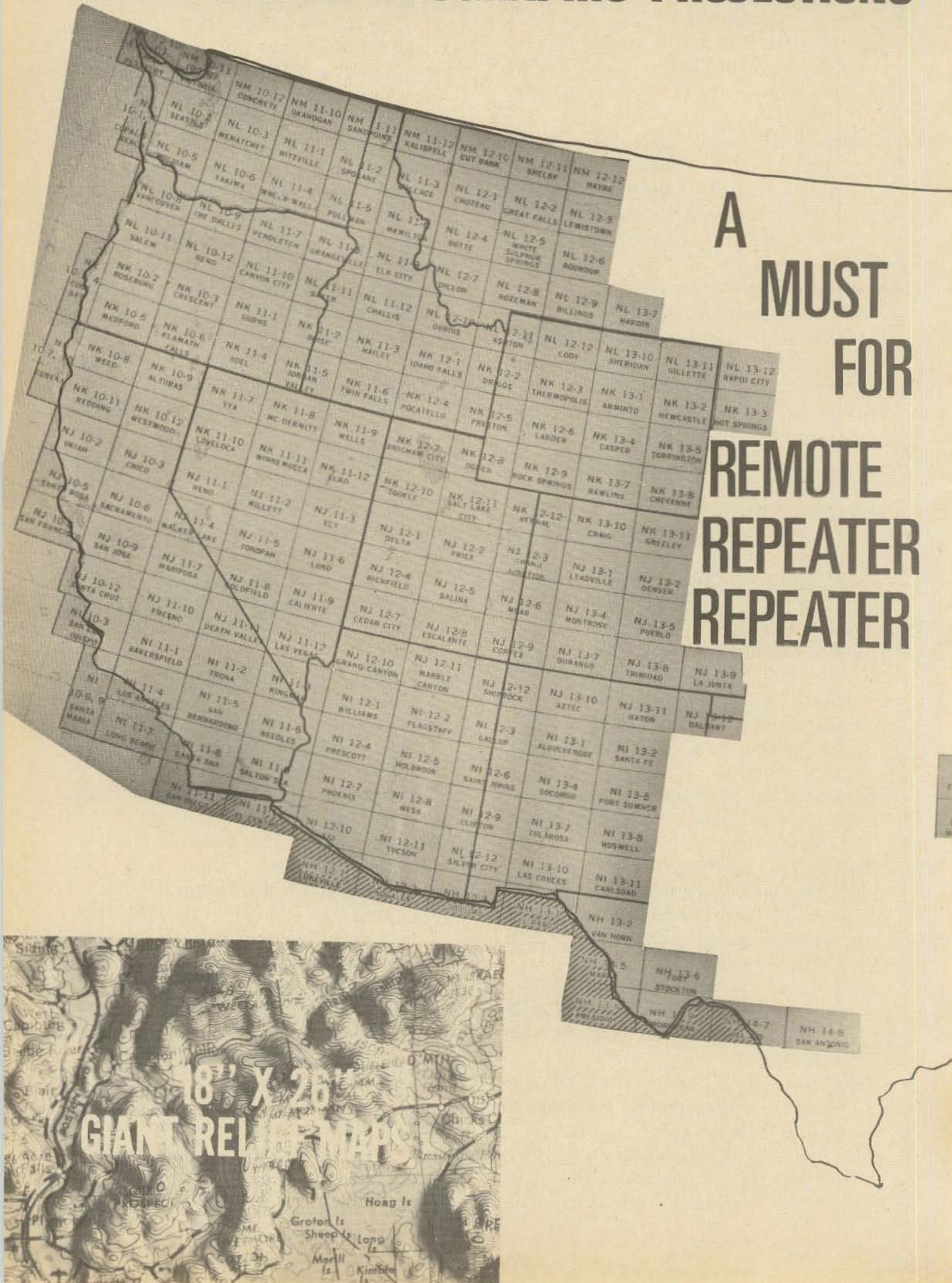



VHF \* REPEATERS \* FM \* SHACK DECORATION \*

Here is the last word in maps for the shack... three dimensional maps of your area. Maps are available for just about any area where there is mountainous or hilly terrain.

These maps are 18" high by 26" wide and are the most exact three dimensional maps ever made. The detail is incredible. Most maps have even the smallest dirt roads shown as well as altitude markings for every 100 feet and the height of taller mountains. Route numbers are given for roads; towers and other outstanding physical features are shown.

Using a repeater or planning one? You'll need this accurate 3D map to see your service area. Active on six or

two meters? Use this map to back your rotating indicator.

These maps are made of permanently molded sturdy plastic, and come to you packaged flat in a large box.

The maps may be cut with a scissors and glued together to form a large mosaic wall mural. You'll need a wall 15 feet high to mount all of California. Each map shows a north-south area of 75 miles and an east-west area of 100 miles.

MAPS ARE \$7.95 each, Postpaid! Send cash; check, money order to DGP, Box 431, Jaffrey NH 03452.

Your maps will be sent to you within three to five weeks.

# OPERATORS OWNERS PLANNERS

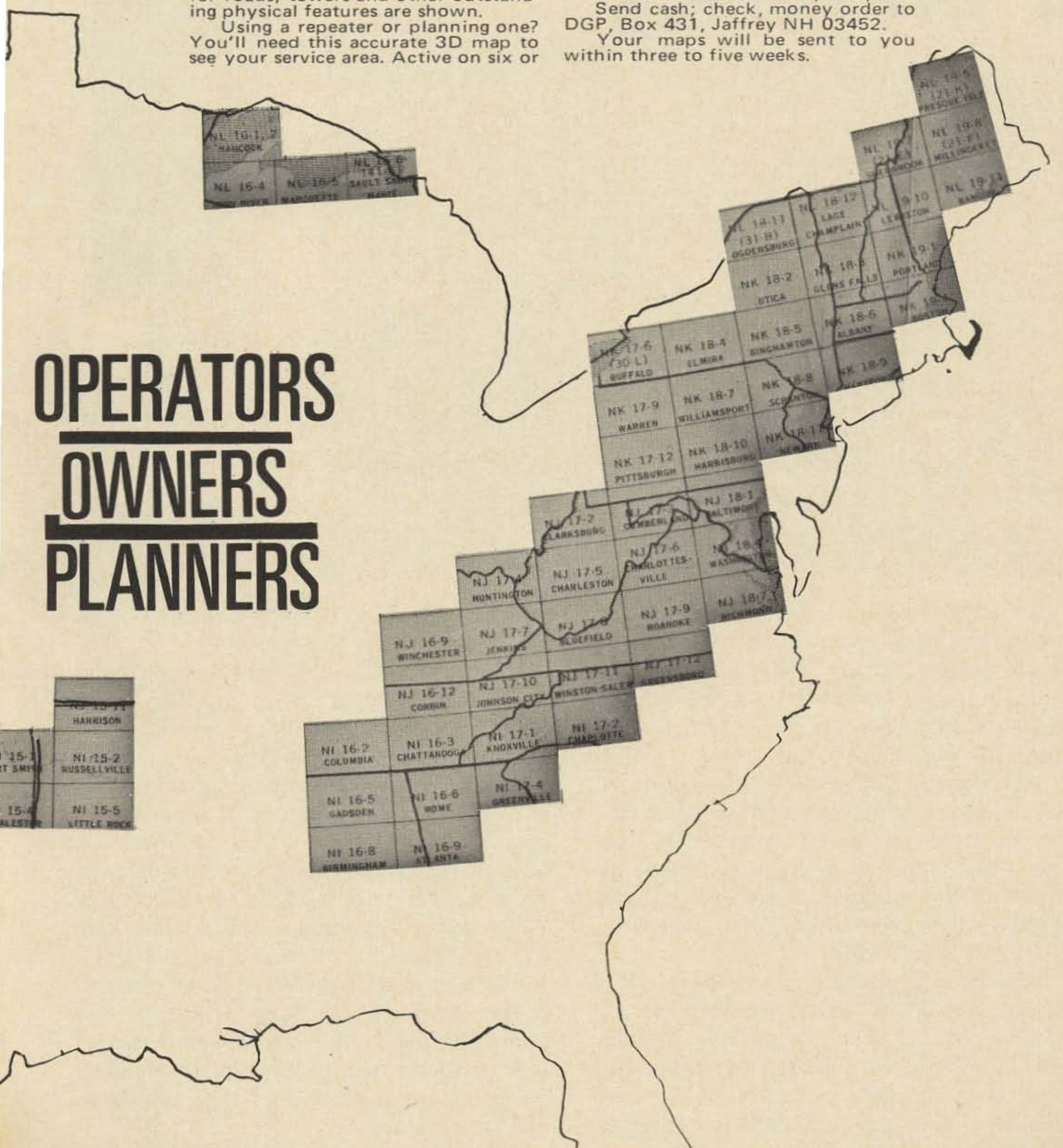

Send me \_\_\_\_\_ maps at \$7.95 each No. \_\_\_\_\_

Name \_\_\_\_\_ Call \_\_\_\_\_

Street \_\_\_\_\_

City \_\_\_\_\_ State \_\_\_\_\_ Zip \_\_\_\_\_

# Converting the AN SSQ-23A Sonobuoy to a 2W FM Rig

Al Denson W1BYX  
Box 85  
Rockville CT 06066

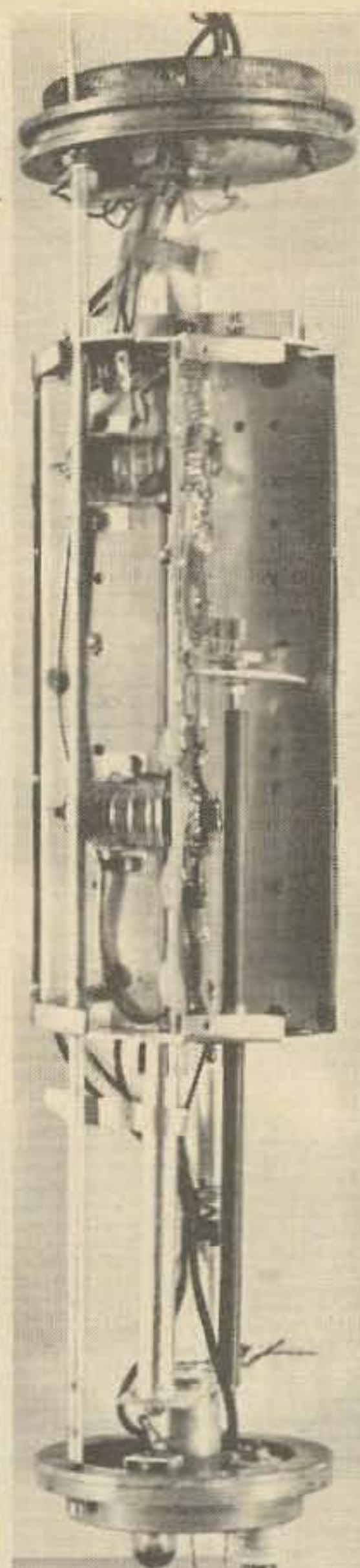
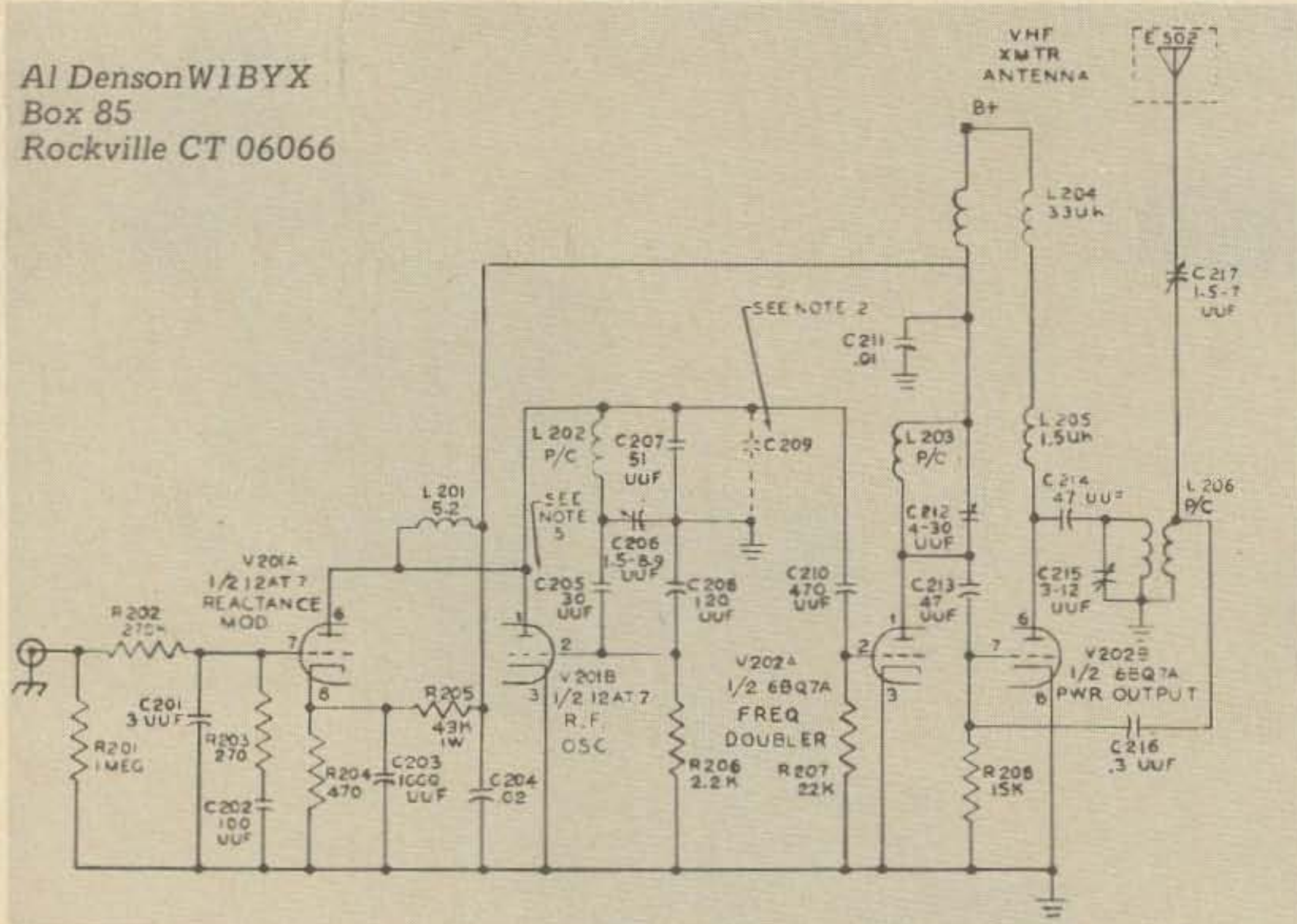

The AN/SSQ-23A "Sonobuoy" transmitter which has recently become available on the surplus market is one of those rare gems in today's depleted surplus market which is adaptable for amateur radio use with little work and low cost.

As originally made for the government, this unit was designed to be dropped into the sea from an aircraft as an expendable unit which detected underwater sounds by means of an underwater microphone. The original frequencies covered the range from 162.25 to 173.50 MHz.

A self-contained battery supply of 13V is tapped at 6.5V to feed a transistorized dc power converter. The normal battery drain was 2.25A total for both 6.5V sections. The dc power converter assembly is a small transistor switching unit which converted the 13V to 160V B+ for the transmitter.

The entire transmitting assembly consists of two printed circuit boards, the first of which contains a 12AT7 tube used as the rf oscillator and reactance modulator with a

6BQ7 used as a frequency doubler and power output stage. The second board contains two 12AX7s; one is used as an audio amplifier, the other as an amplifier/AGC audio network. Diode clippers were used for amplitude limiting of the audio component.

To convert the assembly to 2 meters, add one small 18 pF silver-mica capacitor in parallel with C206 as a pad to lower the output frequency. Connect a microphone to the input formerly used by the underwater "microphone" transducer and connect two 6V batteries in series to the power supply. Voila! You're on 2 meters FM, and ready to operate through the local repeater. And toned repeaters are no problem either; a tone oscillator may be very simply added by means of the built-in neon-tube relaxation oscillator circuit.

The schematic shows the 2W transmitter board only. The poor quality of the schematic is attributable to the fact that it was reproduced from a xerographic print of the original manual.

... W1BYX ■

# WHEN IT COMES TO ANTENNA SYSTEMS... IS YOURS

a space problem? a budget problem? an applications problem? an installation problem? or simply a problem of where to buy?

Your one-stop solution is ANTENNAS, INC.

Exclusively specialists in radiating systems, complete systems or any component part.

Arrays—complete or in kit form, quads, yagis, dipole assemblies, verticals—fixed or mobile, towers, masts, rotors, guy and control cable, transmission line, coax relays and switches, connectors and adaptors, test gear, technical publications, corrosion resistant hardware, corrosion proofing chemicals, insulators, installation and wiring hardware, aluminum tubing and plate, wire, and much, much more.

If your requirements are for a complete system, major components, or the smallest yet important piece of hardware—

*Our prices and deliveries are hard to beat . . . anywhere.*

## ANTENNAS, INC.

Dept. B, 512 McDonald Road  
Leavenworth, Kansas 66048.

ANTENNAS, INC. can be your one-stop, single-source. Write today for our catalog . . . no charge of course.

## EASY DIODE TESTING

Edwin Kirchhuber K4JK  
2804 Broadview Drive  
Huntsville AL 35810

With the advent of "bargain" diodes, we must test before using, especially if they are to be used in series (what else). The simplest method I have found is to use the good old vtm and a power supply capable of providing 1000V. I used a 40 mA transformer (275-0-275V) in a half-wave circuit. The filter is a couple of 450V electrolytics in series. Any value from 8 to 80  $\mu$ F is okay. The hot lead coming from the power supply has a 1 M $\Omega$ , 1W resistor in series to limit the current. The vtm is placed across the diode test points and the readings are taken.

To check the characteristics of the "mystery" diode, put its cathode to the positive test point, and the anode to the

negative test point. Read the voltage on the vtm. If, for instance, it reads 300V, a safe PIV working voltage would be 2/3 of that — or 200V. To test for forward characteristics turn off the supply and reverse the diode. Set the vtm to the 3V scale, turn on the power and read the voltage drop across the diode. It should not exceed 3V. Over that it is no good (open). No voltage indicates shorted diode.

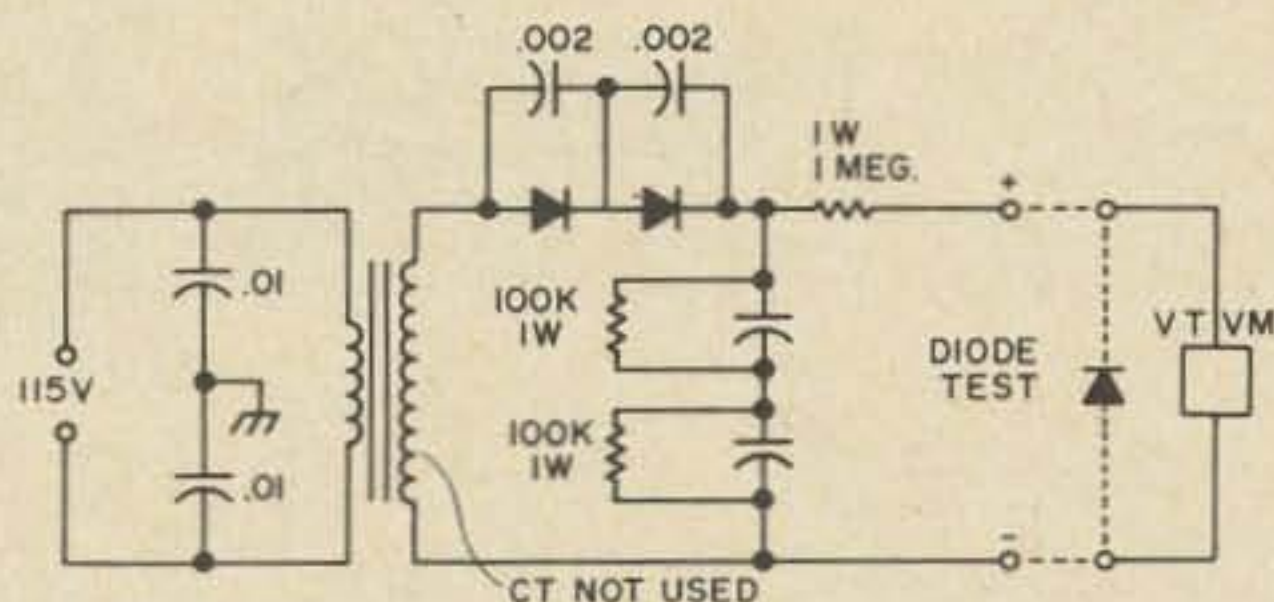

To use diodes in series, select like units and be sure to use a capacitor across each to bypass the possible spikes that come from on-off operation of the power switch.

... K4JK ■

**WOW!** **AN/SSQ-23A** Only \$14.95  $\frac{20}{2+2+2} = \text{FN/FM}$

**Sonobuoy** Include \$2.00 for postage and handling

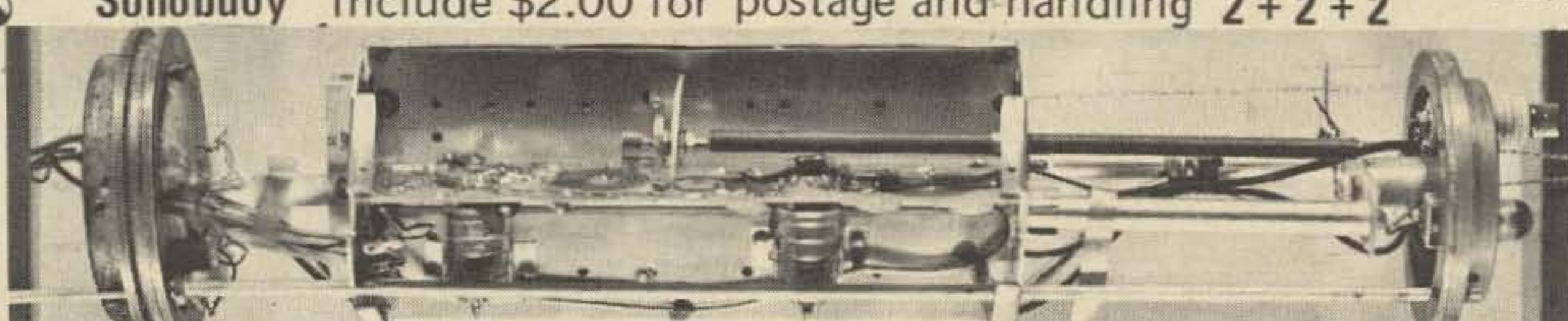

New AN/SSQ-23A Sonobuoy for a quick & easy 2 meter Fun FM Transmitter.

New — with tubes — less Hydrophone, Battery & Antenna, with original instruction book.

Ask for free Flyer 970J1

**DENSON ELECTRONIC CORP.**

PO Box 85, Longview St. (203) 875-5198 Rockville, Conn. 06066

Samuel Kelly W6JTT  
12811 Owen Street  
Garden Grove CA 92641

# TURNING THE AN/GRC-9 INTO A NOVICE RIG

. . . and it puts out a husky 15W on CW.

The surplus situation out here has been pretty bleak for quite a while, so I figured my luck was bound to change. While wandering through a local junkyard I noticed a small olive-drab box on the scrap pile. Inside was a compact transmitter-receiver covering 2 to 12 MHz! The junkie had decided not to melt it down because it had too little copper in it! After brief negotiations I parted with ten bucks and brought home the set. Since then I have run across others. They are apparently being phased out by the army. The sets I have seen have all required minor repairs, but the performance is well worth the effort.

The AN/GRC-9 is a small five-tube transmitter and seven-tube receiver designed for

infantry packset use and for installation in vehicles. The receiver has a built-in 200 kHz crystal calibrator. The actual tuning range is from about 1.8 to 12 MHz so you can cover 160, 80, and 40 meters. The transmitter can be either crystal controlled or vfo. Full break-in is provided and there is a CW sidetone and provision for netting.

The set was designed for CW, MCW, and AM operation. The MCW mode is illegal, and the suppressor grid AM feature is practically worthless. However, CW performance is quite good. Power output is 15W, but can be increased. One of the best features is an ingenious antenna matching system that will match anything from a short whip to a dipole.



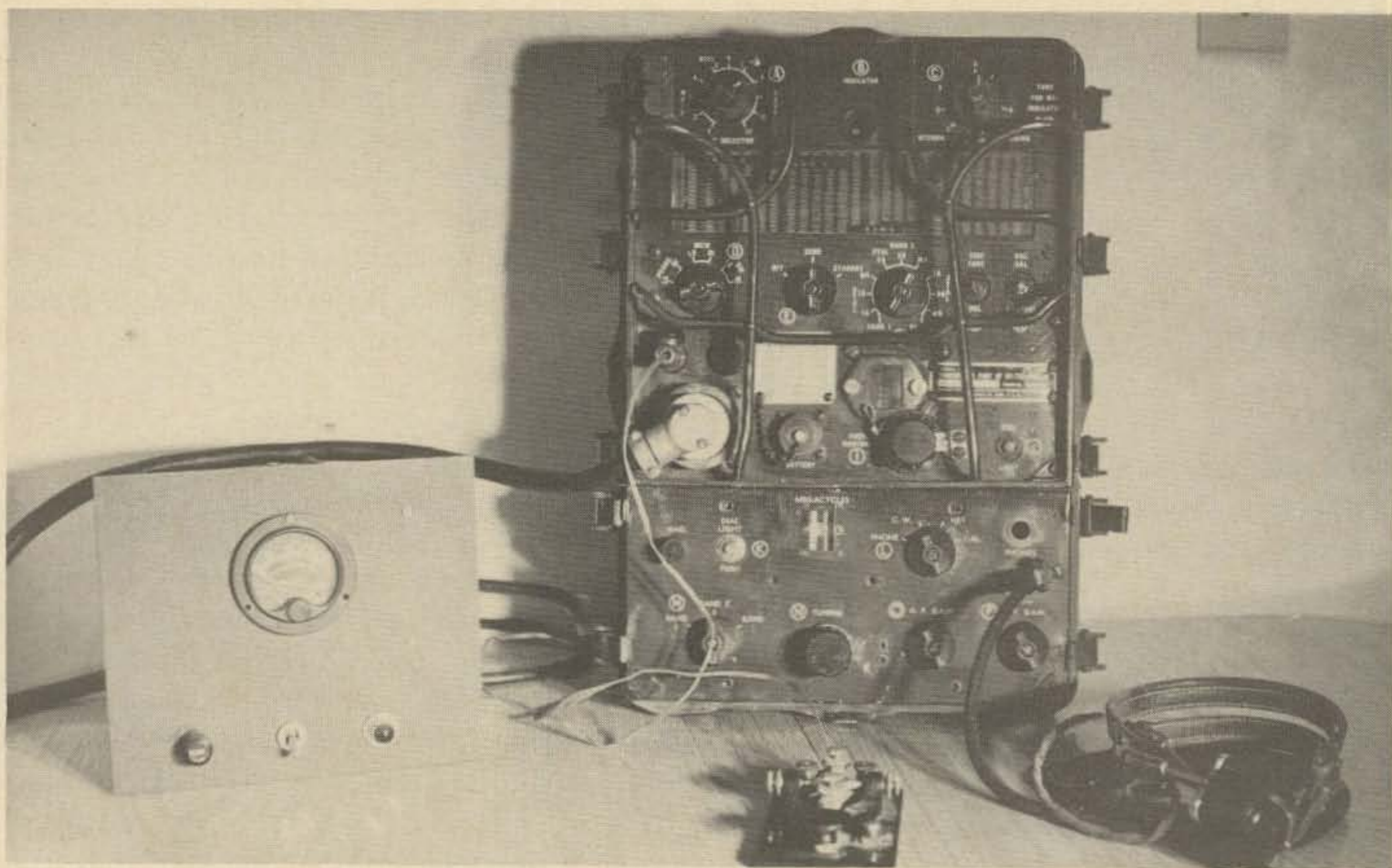

*You can save yourself a lot of grief by using the connector already provided on the AN/GRC-9. In the photo here, the homebrew power supply (left) feeds the unit through its original mating connector on the front of the unit. After minimal conversion, all you need to do is add a key and a set of headphones as shown, and you're on the air.*

for calibrating the transmitter vfo using the screwdriver-adjusted OSC/CAL adjustment (control H).

The transmitter's crystal oscillator always operates into a doubler stage, so the crystals must be chosen to be at half the desired operating frequency. Standard FT-243 types can be used. Provision is made for two crystal controlled channels per band.

With the power supply of Fig. 1, the transmitter will operate break-in in either the SEND or STANDBY positions. After a suitable warmup, tune in the desired signal on the receiver. Switch control L to NET and adjust the vfo for zero beat. Now switch L to CW. Set control A to the highest number for the type of antenna in use. Close the key and adjust control C for maximum brilliance on the indicator (which is an NE-16). This will coincide with maximum plate current. If no peak is observed, change A to the next lowest setting and repeat until a peak is observed.

As with all low-power sets, special consideration must be given to the antenna system. For really portable operation, be

sure to have a good ground or get the counterpoise sets (CP-12 and CP-13) that were designed for use with the set. A doublet antenna made with 72Ω twinlead is recommended. Antennas AT-101/GRC-9 and AT-102/GRC-9 are specially designed longwires having jumpers for adjusting the frequency. These are desirable accessories.

In the PHONE position, the 2E22 filament is turned on by the transmit relay so there is a delay of about 3 sec after you press the push-to-talk switch. The 2E22 is a rare bottle to come by.

You can substitute an 807 by replacing the plate cap connector, clipping the lead going to pin 4 of the socket, and connecting pin 4 directly to the chassis. But the set will operate in the CW mode only now.

Don't jack up the plate voltage for the final amplifier over 600V as the rf components won't take it.

This set is excellent for the Novice as well as the portable CW enthusiast. Detailed troubleshooting information is contained in Technical Manual TM 11-263.

... W6JTT ■



is now \$12 per year  
on the newsstand

Your subscription price  
is unchanged (so far).

\$6 one year

\$12 for THREE YEARS!

**wait at your peril.**

Name \_\_\_\_\_ Call \_\_\_\_\_

Address \_\_\_\_\_

City \_\_\_\_\_ State \_\_\_\_\_ Zip \_\_\_\_\_

- |                                    |                 |                 |
|------------------------------------|-----------------|-----------------|
| <input type="checkbox"/> I enclose | 1 yr. . . \$6   | 3 yrs. . . \$12 |
| <input type="checkbox"/> Bill me   | 10 yr. . . \$25 | LIFE. . . \$50  |

**73 MAGAZINE PETERBOROUGH, NEW HAMPSHIRE 03458**

# 73 Books for Hams

## ADVANCED CLASS STUDY GUIDE

128 pages of up-to-the-minute simplified theory, written with the beginning radio amateur in mind. This unique book covers all aspects of the theory exam for the Advanced Class license and has helped hundreds of hams to sail through the exam. . .nothing else like it in print. **\$3**

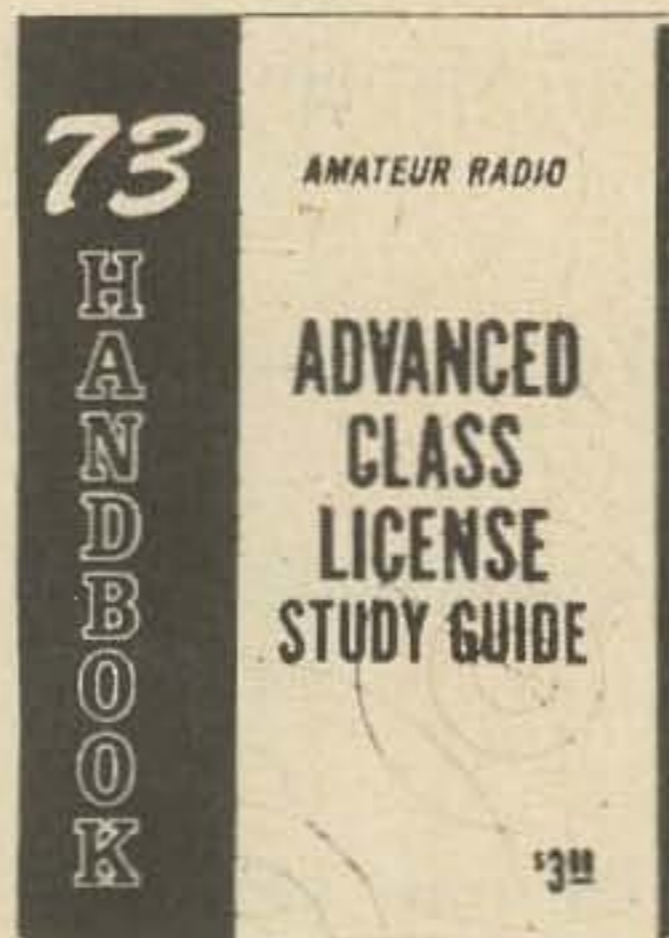

## DX HANDBOOK

Includes giant world country-zone wall map. Articles on QSL design secrets, winning DX contests, DXCC rules, DXpeditions, reciprocal licensing and many more. World postage rates, WAZ record lists, time charts, propagation, etc. Special ham maps and bearing charts. A must for the DXer. **\$3**



## COAX HANDBOOK

Invaluable book for the ham or the lab and for everyone else who doesn't want to have to keep a whole library on hand for reference. . .or even worse, have to write to the manufacturer for coax spec. **\$3**



## PARAMETRIC AMPLIFIERS

For the ham who wants to work DX on the bands about 432 MHz, there is nothing that can beat the gain and noise figure of a paramp. This book shows you how they work and how to build and use them. Lavishly illustrated with photographs and drawings. **\$3**

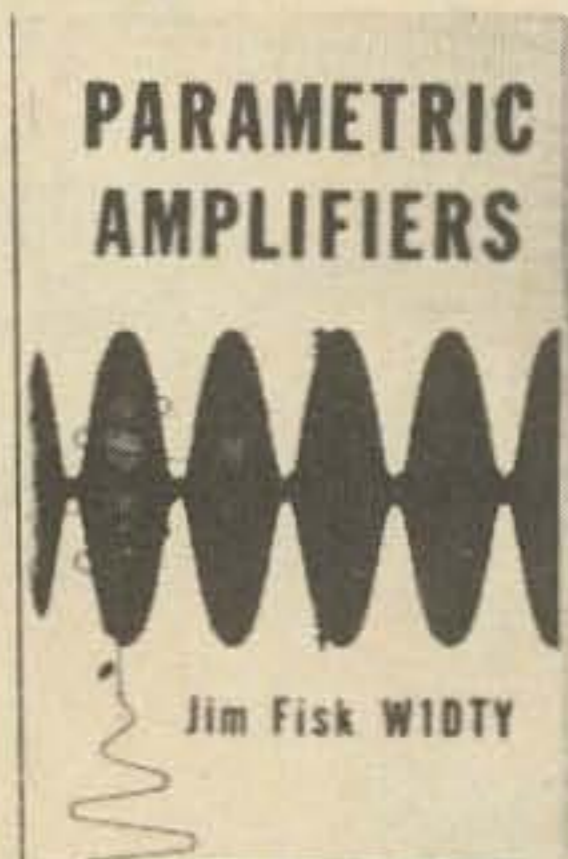

## VHF ANTENNAS

This handbook is a complete collection of up-to-date information about VHF and UHF antennas, with design hints, construction and theory. If you've been wondering what array you need, this book will give you enough background to make the right decision. **\$3**



## INDEX TO SURPLUS

Do you have a piece of surplus equipment that you want to convert but can't find an article? If so, this is the book you need. It lists all of the surplus articles and conversions in popular electronic and amateur magazines from 1945 to 1966. **\$1.50**

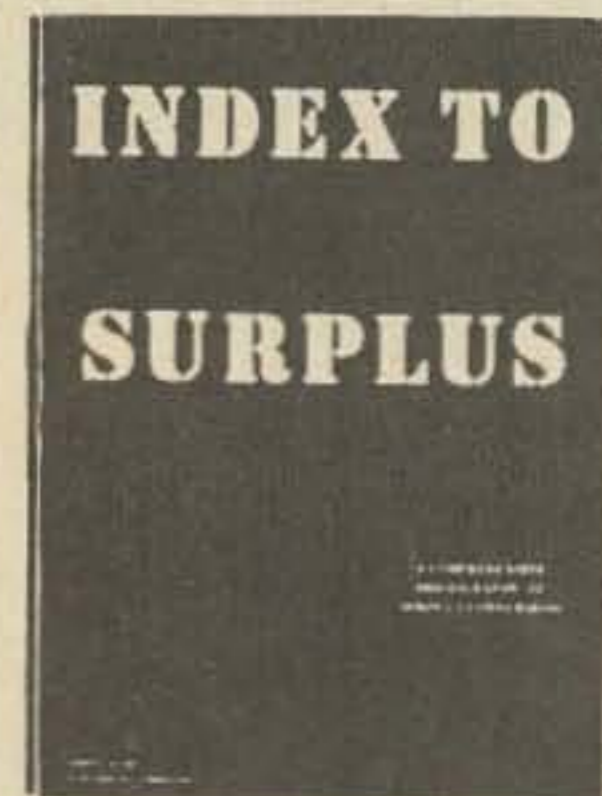



## DIODE CIRCUITS HANDBOOK

An invaluable reference book. Covers rectifiers, mixers, detectors, modulators, FM detectors, noise limiters, AGC, BFO'/Q-multiplier, AFC, Varicap tuning audio clippers, balanced mods, field-strength meters, RF probes, zeners, control circuits, etc. 111 different circuits. **\$1**



## 73 USEFUL TRANSISTOR CIRCUITS

If you've been looking for a transistor circuit to do a special job, chances are there is a circuit in this book that will give you a head start. It covers circuits for audio, receivers, transmitters and test equipment. **\$1**



## HAM TELEVISION

The Amateur Television Anthology is a collection of the technical and construction articles from the *ATV Experimenter*, edited by W0KYQ. If you're interested in ATV, this is the book for you. It covers the gamut from the simple to the complex in amateur television equipment. **\$3**



**RADIO DATA REFERENCE BOOK**, filled with formulas, charts, design specifications for every type of circuit, antennas, power supplies, math tables, conversion tables. Hard bound. While they last— **\$3**

**CW** by W6SFM explains code and how to learn it. **50¢**

## FM ANTHOLOGY

- Vol. I.** This book is largely a collection from *FM Bulletin*, edited by K6MVH and WA8UTB. The material is taken from the editions of February 1967 through February 1968.
- Vol. II.** This book contains selected technical and construction articles taken from *FM Magazine* after March 1968. **\$3**

## Chronicles of an Amateur FM Channel by K6MVH

A humorous account of the antics of a group of lads during the early days of FM in Los Angeles. Included are details, schematics, and plans for a remotely controlled amateur station. **\$3**

**MILITARY SURPLUS TV EQUIPMENT** by W4WKM is a necessity to the surplus-scrounging ATV addict. **\$1**

**CUMULATIVE INDEX** lists all the articles in 73 up through December 1966. **25¢**

- Coax Handbook . . . . . \$3.00
- Transistor Circuits . . . . . \$1.00
- Index to Surplus . . . . . \$1.50
- Parametric Amplifiers . . . . . \$3.00
- VHF Antennas . . . . . \$3.00
- FM Anthology . . . . . \$3.00
- ATV Anthology . . . . . \$3.00
- CW . . . . . \$ .50
- Military TV . . . . . \$1.00
- Cumulative Index . . . . . \$ .25
- DX Handbook . . . . . \$3.00
- Advanced Class . . . . . \$3.00
- Radio Data Ref. . . . . \$3.00
- Amateur FM Channel . . . . . \$3.00

Please send me the books checked at left:

Name ..... Call .....

Address .....

City ..... State ..... Zip .....

Books shipped prepaid in US and Canada.

## 73 Magazine

Peterborough, N. H. 03458

# Getting Your Extra Class License

## Part XIV: Measurement

Most of our discussion, so far in this Extra Class study course, has revolved around the theory of things—the “why” of the subjects covered on the FCC examination.

But you’re undoubtedly aware that when theory and practice agree, at least one (and usually both) is probably in error—at least, so one of Murphy’s famous laws would have us believe.

Actually, a properly framed theory must agree with what actually happens. If it doesn’t, then it’s not properly framed. There’s just one rub—before you can compare theory and “what actually happens,” you have to know what’s “actually” happening. And that’s where the fine art of making measurements comes in.

Measurements are an essential part of all electronics, for exactly this reason. They are the link between theory and practice. What’s more, in ham radio measurements provide the assurance that your operation is within legal limits, both in the amount of power you use and the part of the rf spectrum your signal occupies. Since measurements are so essential, they are included in the Extra Class examination—and this time, we’re going to concentrate on several aspects of the measurement problem which we haven’t examined before.

We’ll be covering the following questions from the FCC study list (as always, the numbers are those in the study list):

4. What precautions should be taken when measuring the rectified grid voltage in an oscillator with a dc voltmeter?

12. An oscilloscope is used to study the relationship between the input and output of an amplifier produced by a voice signal. How would the scope pattern display a linear relationship between the input and output signals?

35. How may an amateur check his transmitter for spurious sidebands?

37. Define the term decibel. How is the decibel used for voltage and power calculations?

60. How does a cathode-ray tube operate? What magnitude of voltage is normally used to bias the plates of a cathode ray tube? What purpose does this magnitude of bias voltage serve?

65. What means may be employed to measure low frequencies? High frequencies? VHF and UHF?

Rather than attempting to provide specific answers to these specific questions, we’ll follow our usual practice of rephrasing the questions into more general terms covering the same subjects.

For openers, let’s find out “How can we make accurate measurements?” Then we’ll turn to rf measurements in particular by asking “How can we measure rf without lab equipment?” Having eliminated lab equipment, we will next turn our attention to an instrument which was considered only as lab

gear up until a few years ago as we find out "Why use an oscilloscope?" and finally we'll tackle a bit of unavoidable (but, we hope, not painful) mathematics by asking "What are dB?" All set? Let's get with it.

*How Can We Make Accurate Measurements?* In order to make accurate measurements, it helps to have a clear idea of just what "measurement" amounts to. We went through this in extensive detail in our earlier Advanced Class study course (now available as a book; order it!) and we won't go through it again, except to point out that any measurement is actually a comparison between an unknown quantity and a standard.

As it happens, only three basic causes of inaccuracy in any kind of measurement exist. If you can get rid of all three, you can't help but make accurate measurements. Unfortunately, we can never escape one of them, and so no measurement can ever be completely accurate. The best we can hope for is an *acceptable* degree of accuracy in our measurements. Just how accurate we must be to be acceptable is determined entirely by the purpose for which the measurement is being made. That is, if we only want to know whether our transmitters are generating output in the 80 meter band or on 40 meters, an accuracy of several dozen kilohertz is acceptable. But if we're hugging the band limit just as close as we dare in hopes of getting a better shot at some DX prize, then we need accuracy measured in hertz or even tenths of hertz.

The three basic causes of inaccuracy in measurement are: 1) improperly calibrated standards and/or instruments; 2) using the wrong instrument for the job; and 3) using the right instrument in the wrong way.

The inescapable inaccuracy in any measurement stems from the fact that perfect calibration is impossible. Even our "standards" have some small degree of built-in error. For most practical purposes this doesn't matter too much, but every now and then it fouls things up rather smartly. One example is in the measurement of frequency. Most of us take it for granted that WWV is an absolutely accurate standard of frequency. In point of fact, it is not. The accuracy of WWV is only about one part in

10,000,000,000,000. For almost any ham purpose, this is adequate, and our assumption is safe. When measuring time intervals of a microsecond or so, however, cumulative error can creep in from this source.

The more important side of our WWV example is that the signal has that accuracy only at the WWV transmitters! As soon as it leaves the transmitting antenna and is propagated several hundred to several thousand miles, often by way of one or more ionospheric jumps, the varying distance over which it travels introduces additional inaccuracies—and these cannot be compensated for by any techniques now known.

The problem was sufficiently serious, in this day of fractional-microsecond accuracies required for space probes, that a special low-frequency service was established to provide ground-wave propagation of the WWV signal on a global basis. This takes much of the propagation error out of the standard—but not all, and the standard isn't precise to begin with.

On a more practical level for us, any instrument which we use for measurements must be calibrated to some kind of standards, and the accuracy of the measurements made cannot be better than that of the instrument's calibration. Fortunately, for most ham purposes an accuracy of 2 to 5% is more than adequate. The only major exceptions are the measurement of frequency and of time, and for both of these far more accurate standards are readily available.

Mention of using the "wrong instrument" for any measurement may bring to mind immediately visions of an elaborate lab filled with exotic test equipment. However, for our purposes most of it is totally unnecessary. The ham who knows what he's doing and how to use the equipment he has can make almost any measurement he's ever likely to need with nothing more elaborate than a good vom, his regular station transmitter and receiver, and a moderately stocked junkbox from which to build any special adapters for special jobs.

It's a little easier if the list of test equipment includes a vvm capable of reading both ac and dc voltages as well as

resistance; in this case the quality of the vom can be considerably less since its primary purpose then will be the measurement of dc. A scope helps too, but that's another question on our list so we'll ignore it for now.

Even with this restricted list of test equipment, it's not too difficult to use the wrong instrument for the job. A classic example, which has probably happened at least once to anyone who has ever used a voltmeter on both ac and dc voltages, is that of leaving the meter set for ac while measuring dc. The needle will still indicate, but the calibration is way off because the rectifiers necessary to measure the ac voltage offer some resistance to dc, and the scale calibration usually includes an automatic conversion from peak-to-peak or average readings (which is what the meter actually measures in almost every case) into rms readings, which are the values we usually use to refer to sine-wave ac voltage or current.

It's also spectacularly easy to leave the meter set on a resistance scale and attempt to measure high voltage; in this case, you usually have no doubt about the fact that something went wrong. Rather than attempt to straighten the bent needle, it's usually best to purchase a new meter!

But a little forethought and caution (and, let's face it, some bitter experience too) will help you avoid this cause of inaccuracy. By far the largest source of inaccuracy in most electrical and electronics measurements comes from using the right instrument, but using it in the wrong way.

The list of examples of using the right instrument in the wrong way is almost endless; we can show only a few. One of the more obvious is to attempt to measure a high value of resistance (say, a couple of megohms or more), using a vtm on the highest scale. So far, so good. But just to make sure that the test probes are in good contact with the resistance being measured, let's grasp one in each hand and press it firmly against the terminal or lead it's supposed to touch.

Surprise! No matter what the actual resistance, the meter reading will usually be around half a megohm. For some people, especially on a hot and humid day, it will be much much less. After all, the human body

has resistance too, and it varies from as little as 10,000 ohms up to two or three megohms (for dry skin). Putting this resistance in parallel with the resistance being measured plays hob with the measurement.

A more subtle error in the use of measuring instruments occurs whenever we forget that any meter requires *some* power out of the circuit being measured. In other words, the meter will load the circuit. This becomes most apparent when you attempt to measure the voltage between a hot chassis and ground, especially if the chassis is hot because of a very-high-resistance leakage path through supposedly good insulation. The "circuit" we're measuring in such a case is the series circuit from power line through several hundred thousand ohms of leakage resistance to the chassis itself, through ground, back to the grounded side of the power line. If a 25-megohm (input resistance) vtm is used to measure voltage between the chassis and ground, you'll probably read about the same voltage as you would get from simply measuring the power-line voltage itself.

But a 20,000 ohm-per-volt ( $\Omega/V$ ) vom is adequate to make this measurement, if it's used properly.

Setting it to the 150-volt or even 300-volt ac scale, however, is not proper use. On those scales, the average hot chassis will measure out at only 30 to 50 volts—from  $\frac{1}{4}$  to  $\frac{1}{2}$  the actual voltage present. Because on the 300-volt scale, the meter's total resistance is only about 1.5 megohms (a 20  $k\Omega/V$  meter typically has only 5  $k\Omega/V$  sensitivity on its ac ranges) and this, in series with approximately equal quantities of leakage resistance, cuts the voltage *at the meter* way, way down.

The proper technique, in this case, is to set the vom to its highest ac voltage scale and then make an educated guess about the reading. After all, if you measure anything over 80 to 100 volts you know something's wrong; absolute precision isn't necessary in this case. And on the highest scale, the meter's resistance is highest so that circuit loading is least.

The same principle applies to measuring ac voltages in receiver circuits, and fre-

quently to the measurement of screen-grid voltages (if they are obtained via series dropping resistors). The series resistance of a typical avc circuit is in the megohms; even a vtm loads such a circuit slightly, and an ordinary vom will impose such a load that the measurement will not only be inaccurate but the circuit will fail to work properly so long as the meter is connected.

This whole business of "loading," incidentally, is the reason that the vtm was invented in the first place. By using a dc amplifier between the test probe and the meter, less power need be taken from the circuit and so less load is imposed by the measurement.

When attempting to measure dc voltages in the presence of rf voltage, things get even trickier. Then an rf choke needs to be connected between the test probe and the measurement point, as close to the measurement point as possible, to keep the rf out of the meter and let only the dc through. At the same time, the possibility of loading the circuit down by too low an input resistance of the meter is present. A typical vom on the 50-volt scale offers only one megohm input resistance; many oscillators, for example, use 470,000-ohm grid-leak resistors. Shunting this with a 1-megohm load will cut the actual resistance in the circuit down to about 300,000 ohms, which amounts to a 33% reduction of the intended resistance. This may cause circuit malfunction.

If the need is to measure rf in the simultaneous presence of dc, the problem is even trickier. RF voltage measurements are usually made by use of an "rf probe" which is simply a crystal diode detector mounted at the end of a test probe. These usually include a blocking capacitor to keep dc out of the diode, but are also usually limited to voltages smaller than about 20 volts peak. If the rf voltage to be measured is greater than that, then a capacitive voltage divider needs to be rigged up to reduce the voltage applied to the probe into the 20-volt range. This, however, increases circuit capacitance—and would undoubtedly detune any oscillator.

The vom and vtm, between them, will take care of just about any measurement of voltage, current, or resistance you normally need to make, except for the measurement

of very small rf voltages (such as those present on the antenna lead-in from received signal). For these, we can use the station receiver—but not in the customary manner of just reading the S-meter. We'll look at this in a little more detail in our next question—for right now, the hint is this: remember that measurement is simply a process of comparison, and almost any indicating instrument has high accuracy when it's used to compare two quantities (in contrast with its undetermined accuracy as a measuring device all by itself).

To measure time, the station receiver comes into play again. Tuned to WWV, it provides a precise source of 1-second timing "ticks." For measuring much longer times, a clock or watch is a little handier—but the measurement of time is not, in the usual course of events, a normal electrical measurement.

To measure power, some professionals use a special wattmeter. We can achieve the same result by measuring voltage and current at the same time, and plugging them into the power formula. If the power we're measuring is rf, we simply use rf instruments. But these aren't on our list, so to manage with the instruments we have, we can rig up an rf probe to permit measurement of rf voltage and then measure the voltage present across a known resistance. Then we square the voltage and divide the product by the resistance, to get the power in watts.

To sum up, we can use the vom and vtm, when we take the proper precautions to avoid loading down the circuit under test and to assure that only the desired power gets into the meter, to find out almost anything we want to know about dc, or about any qualities of ac which can be converted meaningfully into dc levels to drive the meters.

But we cannot use these instruments, directly, to make measurements of those qualities of ac which do not convert readily into dc levels. Some qualities of this type are the frequency, the waveform, and the distortion level of an ac signal. Another is the frequency distribution of a complex signal such as the output of an AM or SSB transmitter.

*How Can We Measure rf Without Lab Equipment?* Any mention of rf measurements, for most people anyway, stirs up immediate visions of highly specialized test gear such as spectrum analyzers, frequency counters, and the like. And let's face it, such equipment is nice to have if you can afford it—but most of us find it hard enough to keep a kilowatt in the shack, and would consider a 5–10 kilobuck outlay on one or two items of seldom-used test gear a needless extravagance.

If one has a spectrum analyzer, a sensitive rf vtvm, a wide-range frequency counter or EPUT (events per unit time) meter, and a good impedance bridge accurate over the entire rf spectrum, and also knows how to use all this gear, measurement of rf (and the special qualities of ac which are difficult to measure with common test instruments) is a snap. Just connect the right gadget in the right way, and read the result off the indicators.

But it's not exceptionally difficult to get the same or even better accuracy in rf measurements with no more test gear than we've already listed as being adequate for dc measurements—a good vom, the station receiver and transmitter, and a well-stocked junkbox.

To show the truth of this statement, let's go down the list of fancy equipment we just set forth and find out what each instrument does, then figure out how to do the same with our restricted set of test gear. We'll start with the spectrum analyzer.

The spectrum analyzer is a device which displays on a cathode ray tube a literal picture of some part of the rf spectrum, as it appears at the input terminal. The horizontal axis of the display represents frequency, and the vertical axis indicates signal strength. If only one signal is present in the band the instrument is set for, the display will be a horizontal line with a single vertical pip on it representing that single signal. If many signals of differing strengths are present, each will be represented by a vertical pip, and the height of the pip will show the relative strength of that signal.

The display looks exactly like the familiar graphs of the spectrum which appear in almost any textbook or magazine article

which discusses it, and that's the main thing that makes the spectrum analyzer so convenient to use.

What the gadget actually amounts to, though, is a highly selective receiver with a circuit in it which automatically sweeps the receiver across the selected portion of the spectrum, while sweeping the beam across the crt face at the same speed. The receiver's output drives the vertical deflection plates of the cathode ray tube.

And there's the clue to our cheap-and-dirty version. We don't have to have the tube display. All we really need is to tune a selective receiver across the spectrum, noting down the relative strengths of every signal we encounter. Then we can take pencil and paper, and draw a graph which shows the same thing as the display would.

One of the major ham uses for this type of measurement is to check a transmitter's output for spurious emissions. The spurious emissions may be unwanted sidebands, splatter out of the desired channel, harmonics, or parasitics.

To make such a measurement on a transmitter, using the station receiver set to its most selective condition, the major problem is preventing overload of the receiver. The transmitter should (initially, anyway) be operated at minimum power, and be connected to a well-shielded dummy load rather than to an antenna. Even so, the chances of overloading a sensitive receiver are rather good. To test for possible overloading, disconnect the antenna cable from the receiver. Theoretically, you should not then be able to even detect your transmitter's signal—but few if any transmitters or receivers have this much shielding or filtering included in them. If you find the desired signal, but no others, you can proceed with the measurement; if you find spurious signals even under these conditions, they may be due to receiver overload—and they may actually be present in the transmitter output.

The simplest way to determine whether they are actually present in the transmitter output is to move the receiver to another location, leaving the transmitter operating into the dummy load. Alternatively, enlist the aid of another ham a half-mile or so

away. *His* receiver shouldn't be overloaded by your signal, if your dummy load is a good one (although the chances are fairly good that he will be able to find it). Increase power until his S-meter gives a comfortably high reading on your main signal, but not higher than S9. Then have him search the regions where your receiver indicated spurious signals. If the signals you found were the result of overload in your receiver, he shouldn't be able to locate them. Similarly, if they were actually present in your transmitter's output, they should be equally detectable to him.

If the spurious signals were due to receiver overload, then increase the shielding and filtering of your transmitter, receiver, or both. Most modern transmitters, in these days of potential TVI, have reasonably adequate shielding and filtering. Few hams do. The shielding and filtering required are the same as that required to TVI-proof a transmitter. Details, of course, will vary from receiver to receiver.

In order to describe the measurement technique, let's assume that your receiver passed this initial test and has adequate shielding and filtering so that the only signal you detected was your own carrier. Adjust transmitter power level to provide a convenient reference level on your receiver's S-meter with carrier alone. It need not be high, since it is merely a reference point. The level should be considerably higher than that at which you made the initial test, though, so that if any spurious signals are present in the output they will now be strong enough to be detected.

Now search the regions of the spectrum in which you suspect the spurious outputs might be present. If you find one, keep the receiver tuned to it and increase the transmitter's output until the strength of the spurious signal is equal to the reference level at which you set the carrier initially. Keep track of how much you had to increase the transmitter power to do this. The ratio of new transmitter power to original transmitter power, when converted to dB, will give you an accurate measure of the strength of the spurious signal.

The measurement of strength will be accurate, despite inaccuracies in your

S-meter's calibration, because the S-meter is used only as an indicator or reference point, and not to make the measurement itself. To put it another way, the S-meter only tells you when you have increased power enough to make the spurious signal as strong as the carrier was originally. The *measurement* is the comparison of transmitter power in the beginning and transmitter power necessary to bring the spurious signal up to the strength of the original carrier.

Checking across a wide stretch of the spectrum by this technique is a tedious business—but we never claimed it would be quick. It *is* a practical way to check for spurious output, with little test equipment. It can also be used to check the modulation index of an FM signal (by locating the point at which carrier disappears as modulation index is increased), and with minor variations to check both carrier and sideband suppression of an SSB signal.

The station receiver can also double as a sensitive rf vtvm. The rf vtvm is, essentially, an instrument for measuring rf voltages which are very small to begin with. If an accurate measurement of the voltage is desired, an accurate standard for comparison will be necessary—but most uses of rf vtvm are more concerned with the presence or absence of rf voltage at some specific frequency, or its relative strength as some adjustment is varied, and for these no standard is needed.

The procedure for using the receiver as a vtvm is essentially the same as that for making a spectrum analyzer of it. You tune in the signal, and use the S-meter as an indicator of signal strength.

If your receiver has no S-meter, don't let that stop you. Simply connect your vtvm to the avc line (most easily located at the cold end of the first i-f transformer, where a bypass capacitor and isolation resistor should be connected) and measure the relative voltage there. If you have no vtvm, it's still possible to get a fair indication by connecting the vom to measure screen voltage on any controlled i-f tube; unless the screens are fed from a regulated source (and in a well-designed receiver with avc, they won't be, because the variation of screen voltage with avc level helps smooth out the

avc action of the receiver and compensate for some nonlinearities inherent in the design of the tubes) this will give you the desired measure of signal strength. Screen voltage will rise with increasing signal strength, as the avc voltage reduces the tube's cathode current.

The frequency counter or EPUT meter is a bit more complex to simulate with a restricted list of test gear, because its purpose is to measure frequency of an ac signal over a very wide range, and the cheap-and-dirty techniques cover only limited ranges.

A frequency counter consists of several different kinds of circuits. One actually counts the individual cycles of the signal and tallies them up on the visual indicators. Another provides an accurate time reference. Still another acts as a gate, to apply the input signal to the counting circuits for a specified period of time and then to shut it off.

All together, the circuits actually count the number of cycles of the input signal which occur during the time the gate is open, and display the resulting count on a set of indicators. If the input signal is ordinary 60 Hz ac power and the selected time interval is one second, the resulting count may be 59, 60, or 61, depending upon what fraction of a cycle happens to get cut off at the beginning or end of the one-second measurement interval.

Setting the time base to 10 seconds provides an extra digit of accuracy. The indication now will probably be 59.9, 60.0, or 60.1. Going up to a 100-second base adds still another digit, but your power company probably doesn't keep the frequency any more constant than 0.1 Hz either side of the nominal 60.

Most commercial frequency counters offer at least 5-digit readings, but few of them offer time bases longer than 100 seconds. The frequency range usually runs from 1 Hz or so at the low end, up into the VHF region, with time bases as short as a microsecond for measurement of very high frequencies.

To measure frequency in the ham shack, it's not very practical to attempt to duplicate the frequency-counter approach.

Instead, we usually divide the ac spectrum into three or four different ranges, and use different techniques for each. For everything except VHF and above, the basic technique is that of comparing the unknown frequency to a known standard.

At audio frequencies, our standards can be 60 Hz ac from the power line, tuning forks, or the 440 Hz and 600 Hz signals broadcast by WWV. Another standard sometimes used is a well-tuned piano.

The ear can be used as a comparison device with surprising accuracy; while few persons have perfect pitch, most of us can tell when two tones differ in pitch—so if enough standards are available, at least one is likely to be fairly close in frequency to the unknown signal.

A variable-frequency audio oscillator can be calibrated by comparison against several standards, and then used as a secondary standard for comparison to the unknown, with the ear still serving as a zero-beat indicator.

Yes, we know a variable-frequency audio oscillator wasn't on our list of equipment—at least, not under that name. But the bfo of the station receiver, together with any source of steady-frequency rf such as the transmitter's oscillator, provides a most handy source of audio tones, and is usually continually variable throughout the audio range!

To increase accuracy of such measurements, a scope can be used as an indicator of zero-beat rather than trusting the ear. Just connect the scope's vertical input leads across the variable audio oscillator's output, and the horizontal input leads to the unknown signal. If the two signals differ in frequency, the tube will display a pattern of varying complexity. When the frequencies become identical (zero beat), the pattern will be either a straight line, a circle, or an ellipse. If it's an ellipse, it may appear to be rotating, and shift through the circle and straight-line conditions as it rotates. This indicates a very slight difference in frequency; the difference in cycles per second is equal to the number of times per second the pattern rotates. Keeping this in mind, it's easy to measure a *difference* of as little as 0.01 Hz in the two frequencies; whether the



final frequency measurement has this accuracy will be determined entirely by the accuracy of the standard you're using.

When the unknown frequency is above the audio range, the same basic technique is still used but the source of frequency standards differs. A standard-frequency crystal oscillator is handy to have in this case; refer to your junkbox and rig one up. Zero-beat it against WWV, using the af measurement technique to get as much accuracy as you can. You now have a source of rf of known frequency—the usual standard is 100 kHz.

The frequency of the unknown signal is first approximated by comparison to other signals of known frequency. Then you turn on the frequency standard, and count harmonics of it from some known point. An easy point for most of us to locate in any ham band is the lower band edge; this is also, always, a harmonic of 100 kHz, and so when the receiver is tuned approximately to the lower limit the harmonic of the standard will mark the exact band limit. Other known points in the spectrum may be located in the same manner—if necessary, by counting multiples of 100 kHz from the nearest ham band.

The 100 kHz standard permits the unknown signal to be bracketed between two points 100 kHz apart, and it's usually not too difficult to determine which of these two it's closest to. This locates the frequency of the unknown signal to someplace inside an area 50 kHz wide; for many purposes this is close enough. If not, we call upon a second frequency standard. This is a multivibrator or frequency divider, slaved to the 100 kHz unit, which provides a 10 kHz signal as accurate as the 100 kHz original. By switching it on, and counting harmonics as we tune up from the known 100 kHz harmonic, we can bracket the unknown signal between two 10 kHz harmonics of known frequency.

If even this isn't accurate enough, we're not done. The 10 kHz frequency is within the audio range, and we've bracketed our unknown between two of these points so the error in our measurement this far cannot exceed 5 kHz. All we need do is measure the beat frequency between our unknown and the nearest 10 kHz harmonic (that is, the

lowest frequency in the receiver's output), using audio measurement techniques, to locate the unknown frequency to an accuracy limited only by that of our standard.

This technique for measuring rf frequencies works equally well from the bottom of the rf region up to the VHF area; as frequency increases, the number of 100 kHz harmonics becomes a bit large so that VHF workers customarily use still a third standard oscillator set to 1 MHz to obtain a good starting point, but the technique remains basically unchanged.

By the time we get to 50 MHz or so, however, the strength of the 10 kHz harmonics is getting a bit weak. Somewhere in this region, most of us switch to a completely different measurement technique which depends upon the constant relationship between frequency and wavelength. Rather than measuring frequency in terms of time, it becomes easier to measure wavelength in terms of distance.

For this, we use what are known as Lecher wires. The term presumably has nothing to do with dirty old men. A set of Lecher wires consists essentially of a parallel-wire transmission line which is at least one wavelength long. For 50 MHz use, that's just under 20 feet. One set will suffice for all measurements. In addition to the two taut parallel wires of the transmission line, which must be uninsulated and supported only at their ends, we have a shorting block which shorts the two together and which can be moved the length of the wires, and a connector at one end to connect the wires to the transmitter output. Often, the shorting block includes some indicator of rf current such as a pilot lamp. In another version of Lecher-wire technique, the short is left permanently in place at one end of the wires and the transmitter is connected to the other end; in this case, an indicator of rf voltage is arranged so that it can be moved the length of the wires to measure voltage between the two conductors at any point along their length.

The idea behind the Lecher wires is that every condition which exists on a transmission line will exactly repeat itself every full wavelength down that line, and many conditions such as peak absolute voltage

(without regard to phase) will exactly repeat every half-wavelength.

Thus if a transmitter is coupled to a set of Lecher wires with the shorting bar set at the far end, and adjusted for a specific amount of plate current at resonance, and then the shorting block is moved closer to the transmitter, the conditions under which the transmitter's output stage operates will change as the shorting block moves. When the block has been moved exactly a half wavelength, however, the conditions will have returned to the exact duplicate of those at the start, and the plate current will again be what it was at the beginning. Simply measuring the distance through which the block was moved and multiplying by two tells us the wavelength; converting wavelength to meters and dividing the result into 300 gives us the frequency in MHz.

As described, the Lecher wires can be used only to measure frequency of a transmitter, and that is their most usual use. They can, however, be used as a tunable trap to trap out the signal, and thus can be used to measure frequency of signals other than those produced by a transmitter—if you have a receiver capable of detecting the signal being measured. The technique is similar; the signal being measured is coupled to the receiver, and the Lecher wires are connected in parallel with the receiver input. The receiver S-meter, or a similar indicator rigged up as we discussed earlier in connection with rf vtvm's, is used to indicate signal strength. At some positions of the shorting bar, signal strength will reach maximum, and at other positions of the shorting bar, signal strength will be minimum. The distance between two points of either maximum or minimum strength will be a half wavelength; you can use whichever is easiest to detect.

The impedance bridge is a device for measuring the impedance of any circuit at any specific frequency, and this is the hardest of all the lab-type instruments to duplicate in a cheap-and-dirty version with limited test gear. Fortunately, its major use for ham purposes is in the matching of antennas to transmitters and feedlines, and this application can be simulated by simple measurement of swr on the feedline.

To measure swr on a feedline, locate a point on the feedline at which the rf voltage is at a maximum. This is simple with open-wire feedlines and not too difficult with twin-lead, but coax poses a difficult problem not easily solved. When the rf voltage maximum is located, if the frequency is known you can find the voltage minimum point a quarter-wavelength in either direction from the maximum point. The vswr is simply the ratio of maximum voltage to minimum voltage.

At sufficiently high frequencies, a variant of the Lecher wires can now be used to adjust the swr to unity. This consists of a length of open-wire transmission line with an adjustable short, at least a half wavelength long, which is connected across the load (or, alternately, at some multiple of half a wavelength back from the load). By moving the short along this line, the swr can be changed to anything from unity to infinity. The principle is that the impedance of the "tuning stub" changes from zero to infinite as the shorting stub moves through a quarter wavelength distance, and is either capacitive or inductive, depending on whether the stub's effective length is greater or less than a quarter wavelength.

When the stub is adjusted to bring swr to unity (1.0 to 1), then the impedance of the stub is exactly canceling any reactance in the load itself, and the resistive element of the stub's impedance is bringing the load's resistance to a match as well. The impedance of the stub can be calculated from its length, and a bit more calculation will reveal the impedance of the load.

This technique is actually that employed in most microwave labs; instead of a "tuning stub" they call the adjustable element a "slotted line," and they perform the calculations graphically by means of a "Smith chart." The result is the most accurate measurement now possible of rf impedance at very high frequencies—but it's more trouble than most of us find convenient.

*Why Use An Oscilloscope?* You may recall that our list of minimum test equipment did not include an oscilloscope, yet the scope is one of the most convenient of all test instruments to use and many hams working with RTTY or sideband feel that

the scope is as indispensable as a receiver or a transmitter. Let's examine the instrument in detail and find out why it's so convenient.

An oscilloscope—any oscilloscope—is built around a cathode ray tube. In addition to the tube itself, the scope includes power supplies. Most scopes also include amplifiers to drive both the vertical and horizontal deflection plates of the tube, and a horizontal-sweep circuit of some type to provide a "time base."

The differences between scopes are, for the most part, differences in the deflection amplifiers and in the horizontal sweep circuitry. An inexpensive "general-purpose" or "service" scope typically has a vertical deflection amplifier with frequency response from the subsonic up into the low rf region (5 Hz to 500 kHz, frequently), a horizontal amplifier with more restricted bandwidth, and a sweep oscillator which provides a sawtooth waveform from 15 to 20 to 200,000 pulses per second.

More expensive "service" instruments often provide a vertical-amplifier frequency response from dc up to 4 or 5 MHz, to provide the capability of viewing all key waveforms in a color-TV chassis.

"Lab-type" scopes are more elaborate; they may provide amplifiers with frequency response from dc up to 50 or 100 MHz, with much more accurately calibrated "triggered-sweep" or even "delayed sweep" time-base circuits. The "X-Y" scope has identical vertical and horizontal amplifier circuits. There are almost as many variations as one can imagine.

But while the variations among scopes lie mainly in the associated amplifiers and time bases, the heart is the cathode ray tube itself; it provides the characteristics which make the scope useful.

Like any other vacuum tube, the cathode ray tube (crt) contains a heater, a cathode, and a grid. But there the similarities end. Instead of a plate, the crt contains several additional electrodes known as "focus" electrodes, and an "accelerator" electrode. In addition, the crt's used in most scopes contain two pairs of "deflection plates." And finally, the "face" of the tube is coated on the inside with a "phosphor," which is a

substance that glows when struck by rapidly moving electrons.

The heater brings the cathode to a temperature which permits electrons to boil off its surface, and these electrons are attracted toward the focus and accelerator electrodes, passing through the grid structure en route.

However, the shapes of all these electrodes are such that the electrons—at least, most of them—never reach either the focus electrode of the accelerator directly. Instead, the same electric forces which attract the electrons away from the cathode shape the stream of electrons into a tight beam, which passes through appropriately shaped openings in the focus and accelerator electrodes and goes on to strike the phosphor at the tube's face.

Once the electrons hit the phosphor, they can bounce back in all directions inside the tube and thus make their way to the accelerator, completing the electric circuit. When the electron beam strikes the phosphor, though, it creates a glow where it hit—and that's the whole purpose of the crt in the first place.

The intensity of the glow depends on the number of electrons which hit the screen (phosphor), and this is in turn controlled by the grid-cathode bias of the crt just as in a conventional vacuum tube.

The physical size of the beam depends upon the balance of the forces which shape the beam in the first place, and so is affected by many things. The beam intensity, the speed at which the electrons are traveling, and the relative voltages between focus electrode and cathode and between focus electrode and accelerator all have some effect upon beam size. The major control of beam size is the voltage present between focus electrode and cathode. If the other factors are in the right general area, the voltage on the focus electrode can be adjusted to shape the beam into the smallest possible physical size—or, by analogy with optics, to "focus" the beam to an apparent point.

The speed at which the electrons in the beam are traveling is determined by the voltage between accelerator and cathode. The greater the voltage, the faster the beam.

Since the electrons are packing more energy when they move faster, this will also affect beam intensity. Most crt's operate with voltages of 1 to 25 kV between accelerator and cathode; typical values for a 5-inch crt would be about 2000 volts. The high voltage is required because of the physical distance between cathode and accelerator, and also in order to establish the proper "electron ballistics" to permit focusing action. While the voltage is high, the current is very small, normally being in the microampere range.

The combination of heater, cathode, grid, focus, and accelerator is known as an "electron gun." The electron gun supplies a steady stream of electrons in a nice tight beam, but all that does on the screen is produce a single intense dot of light. For the tube to serve any useful purpose, that dot must be moved about on the screen and that's the purpose of the deflection plates.

The two pairs of deflection plates are arranged at right angles to each other, so that the beam passes halfway between the two plates of each pair on its way from electron gun to screen (some crt's use "postdeflection acceleration," with an additional accelerator between deflection plates and screen, but this is a complication we won't go into here; the principles are similar).

The electrons in the beam are, of course, negative charges, and are subject to the laws of electrostatic attraction and repulsion. Thus, if one plate in a pair is made positive with respect to the beam, the beam will be attracted toward that plate. If the other plate goes negative at the same time, the beam will be repelled from the negative plate and attracted toward the positive one. By independently adjusting the voltages on each pair of plates, the beam can be moved to any desired location on the crt screen.

In practice, both plates of each pair are usually kept at approximately the same voltage, which is usually 150 to 300 volts more positive than the accelerator. To keep things within reasonable limits, many scopes have the crt hooked up so that its cathode is 2000 volts negative with respect to ground, its accelerator is at ground level, and the deflection plates are 200 to 300 volts positive to ground. This permits direct con-

nection from the deflection amplifier plates to the deflection plates of the crt for better low-frequency response, and all the high-current voltages are kept to moderate levels. In such a hookup, the deflection plates are still around 2200 volts positive with respect to the crt cathode, however. The exact ratio of voltages between one plate and the other of each pair is adjusted as necessary to put the electron beam in the center of the screen with no signals applied; this is the purpose of the "centering" controls on the scope.

The signals to be displayed on the scope are then applied to the deflection plates, and thus move the spot around the crt screen in a manner determined by the waveform and intensity of the signals. If a sine-wave signal is applied to the vertical plates while a sawtooth signal is applied to the horizontal plates, the resulting spot movement will trace a conventional "picture" of the sine-wave on the screen.

Like the more conventional dc meter movement, the scope changes an electrical force into visible movement of something. Where the ordinary meter moves a pointer which has considerable weight and limited speed of response, however, the scope is moving an electron beam which has, for all practical purposes, no weight or inertia at all and so is capable of almost unlimited response speed. An ordinary dc meter cannot follow the fluctuations of a 20 Hz signal rapidly enough to be read conveniently; an ordinary scope can easily display variations in a 50 MHz signal, if its deflection amplifiers are bypassed and the signal connected directly to the deflection plates.

This rapid response, and the ability to draw waveform pictures which correspond to the way most of us imagine waveforms, are the two features that give the scope its chief value. There's something about actually *seeing* a signal that no amount of indirect measurement can provide.

We've already mentioned the use of the sawtooth or "time base" horizontal sweep for waveform viewing, but the scope is equally useful as a direct comparison instrument. If one signal is applied to the vertical plates and another signal to the horizontal plates, the resulting display on the screen

will be an instantaneous comparison of the two signals. If one signal is an unknown frequency while the other is the known standard (or, better yet, an adjustable-frequency secondary standard), the screen display will provide an indication of the relationship between the two frequencies. If the display is a stationary pattern, the unknown is an exact harmonic of the standard or vice versa; at any rate, one of the frequencies is an exact multiple of the other. If the pattern moves, the relationship is not exact.

The signals being compared do not have to be completely separate signals. A signal can be compared against itself. If the same signal is applied to both the horizontal and the vertical plates, the screen display will be a single line inclined at a 45 degree angle from the horizontal. If the vertical plates are fed by the signal from the output of an amplifier's input, the display will show the effect of the amplifier on the signal. Since the amplified signal is stronger than the input signal, the vertical deflection will be greater than the horizontal and the display will be moved nearly vertical. If the only thing the amplifier does to the signal is to amplify it, this will be the only difference in the displayed signal. If the amplifier also introduces distortion, though, the vertical plates will get the distortion components of the signal and the horizontal plates will not—and the display will no longer be a straight line! Instead, it will show "squiggles" indicating the presence of distortion.

If the amplifier changes the phase of the signal, the display won't be a straight line either—instead, it will be an ellipse or a circle (which depends upon the amount of phase shift introduced by the amplifier).

Since this comparison is essentially that of a signal against an amplified version of itself, it can be used at any frequency to which the deflection plates can respond. In practice, this means any frequency below the UHF region.

If linearity of an rf amplifier is being checked by this method, though, it's often more convenient to modulate the rf, then use detectors at both the input and output test points to convert the modulated rf to audio and make the actual comparison on

the audio components rather than the rf itself. When this is done, the scope's internal amplifiers can be used, and the effects of the amplifier's gain canceled out by amplifying the input-side signal a corresponding amount more than the output-side signal. This often makes the distortion easier to see, since it is normally very small in comparison to the original signal level.

*What are dB?* It's almost impossible to do anything in radio any more without running into "dB," the abbreviation for "decibels." It's also almost impossible to find anyone capable of giving a brief yet clear and accurate description of what these beasts really are. Let's give it a try, anyway.

The word "decibel," itself, is the standard metric-system indication for a unit of measurement which is one-tenth of a "bel." This doesn't help much, because even fewer persons are familiar with "bels."

The "bel" is the unit of power ratio, and simply indicates a 10-to-1 power ratio. A 100-watt amplifier is one "bel" more powerful than is a 10-watt unit, and similarly the 10-watt unit is one "bel" more powerful than a 1-watt.

This makes it appear that a 100-watt rig would be only two "bels" more powerful than a 1-watt outfit—and that's exactly right. Each "bel" indicates an additional 10-time increase in power, so that two "bels" means 10 times 10 or 100 times as much power.

It only takes six "bels" to make a million-time power increase. Sailors who are used to the expression "eight bells and all's well" would be floored if they were talking about "bels" instead of "bells," because that's a power ratio of 100 million to 1.

Obviously, the "bel" is far too large a unit for comfortable use. That's why "decibels," which are only one-tenth as large, are the unit in common usage.

It might appear that, since a decibel is 1/10 of a bel and a bel is a 10-to-1 ratio, a decibel would be 1/10 of 10-to-1 or simply a 1-to-1 ratio. However, that's *not* the case, and the reason is far from obvious. It comes about because of the way in which the ratio is converted into a number to make the "bel" unit in the first place. To get one "bel" from a ratio of 10, or two "bels" from

a ratio of 100, what we really did was simply count the zeros in the ratio. The number "10" has one zero, so that's one bel. Similarly, 100 has two zeros, so it's two bels. A million is written as "1" followed by six zeros, and so it's six bels. And so forth.

This business of counting the zeros is the first step of the mathematical process called "taking the logarithm" of a number. If the number happens to be an even multiple of 10, it's also the last step of the process as well—but if it's not, there's much more to it. The "bel" is thus defined as the *log* of the power ratio.

When we stepped down from the massive "bel" to the more conveniently sized "decibel" we applied our factor of 1/10 to the *unit* itself, not to either the ratio of the log of the ratio. The bel is still what it always was; it just takes 10 times as many decibels to make a bel. Since the bel is the log of the power ratio, this means that  $10 \text{ dB} = \log(P_1/P_2)$ . One dB, then, would be 1/10 of  $\log(P_1/P_2)$ ; we usually write this equation a little differently. We turn the ratio upside down so that the log gets multiplied by 10 rather than divided, and come out with the formula you'll find in all the textbooks:  $\text{dB} = 10 \log(P_2/P_1)$ .

We've made this brief excursion into "logs" and equations just to show where the formula came from. In actual practice, you don't need slide rule or log tables to work with dB to as much accuracy as is ever needed in any radio work.

All you need is the knowledge that an additional 10 dB is a 10-time power increase, 100 dB is 100 times, etc., plus a knowledge of the ratios indicated by each dB value from 0 through 9. Even of these 9 ratios, you'll normally use only a couple.

The ratio for zero dB is 1 to 1. If an amplifier is rated for 0 dB gain, its gain is exactly one. To see this most easily, convert the dB back to bels for a moment. Ten times zero is still zero, so 0 dB equals 0 bels. The number of bels, we recall, is equal to the number of zeros following the "1" in the power ratio. One followed by no zeros remains one, so the ratio is 1 to 1.

The most important dB-to-ratio number to remember is that for 3 dB. This is a 1.995-to-1 power ratio, which is so close to

being 2-to-1 that nobody ever pays any attention to the difference. Remember it as 3 dB equals twice the power.

Back at the beginning of this question, we saw that *adding* dB (or bels) is the same as *multiplying* the power ratio. It follows, then, that 6 dB should be just barely less than a 4-to-1 ratio. The actual ratio is 3.931 to 1, but 4 to 1 is close enough for any practical work again.

A single dB is a ratio of 1.259 to 1; the easiest way to remember this is as 5-to-4 ratio, or 1.25 to 1. You don't really need to remember it, except that it gives you the ability to figure out the ratio for any other number of dB.

For instance, working from the 5/4 ratio for 1 dB, we would get ratios of 25/16 for 2 dB and 125/64 for 3 dB.

Let's see what happens when we use both the 3 dB and 1 dB values this way to calculate the ratio for 10 dB (which we already know is really 10 to 1): To tally up 10 dB from our 3 and 1 dB figures, we get  $2 \times 2 \times 2 \times (5/4)$ . This comes out to 40/4, or exactly 10 to 1. The small errors in both the 2-to-1 figure and 5-to-4 figure have canceled each other out.

If we did it with nothing but the 1 dB figure, we would multiply 5/4 by itself 10 times. This comes out to be 9765625/1048576, or a ratio of 9.3+ to 1. In this case, our error has accumulated a bit. The moral is clear; when you figure out the other values, use both the 3 dB and 1 dB values to keep the error to a minimum.

Now let's use these facts we have memorized to find out the power ratio indicated by 37 dB. First, we dissect the number "37" into its components, 30+3+3+1. The "30" gives us a ratio of 1000/1. Each "3" gives us a ratio of 2/1, and the "1" gives us a ratio of 5/4. The total "37" must, then, mean a ratio of 1000/1 times 2/1 times 2/1 times 5/4, or 4000/1 times 5/4, which works out to be 20,000/4 or 5000/1. An amplifier rated for 37 dB gain would, then, produce a power ratio from output to input of 5000 to 1. A hundredth of a watt at the input would produce 50 watts at the output.

You may have noticed that we've only looked at positive dB figures. Often, ratings

are expressed in negative dB. While it's just as easy (or difficult, as the case may be) to work the math for negative as for positive logs, the simple way out is to always think in terms of dB without sign, and then read the sign as meaning "gain" or "loss." Positive dB indicate gain and negative dB indicate loss. An attenuator rated for -37 dB from input to output still involves a 5000/1 power ratio, but now it's in the other direction and the output power is only 1/5000 as great as that at the input.

"Great," we can hear you mumbling, "but what about dB of voltage or current? All you've mentioned yet have been *power* dB, and most of the time we use the other kind!"

Relax. There *is* no other kind. Decibels, *any* decibels, always indicate power ratio. Granted, the textbooks show you a different formula if you're dealing with voltage or current measurements—but that's just to keep you from having to convert the voltage or current into power by using Ohm's law before making the dB conversion.

And since that "other" formula—the one that says  $\text{dB} = 20 \log (E_2/E_1)$ —is a combination of the dB formula, the power equation  $P = E \times I$ , and Ohm's law all wrapped up in one package, it can get you into big trouble with the kinds of questions the FCC puts on its exams.

If, on the other hand, you fix firmly in mind that dB are measures of power ratio and nothing else, you can't go wrong. If the problems fails to mention power and gives you either current or voltage instead, just convert the current or voltage to a power by plugging it into the power equation. Then use the decibel relationships we've already examined.

Many times, both on exams and in practical work, you may find that only a voltage or a current is given; there's only half the information you need to figure out the power. What then?

If the two voltages being compared are both being measured across the same (or equal values of) resistance, you can get the power by squaring the voltage and dividing by resistance. This is just a combination of

the power equation and Ohm's law; Ohm's law tells you the current given the voltage and resistance, while the power equation tells you the power when current and voltage are known.

As a matter of fact, this can be done even when the resistance values differ! And when the resistance values are equal or the same, you don't even have to know what the resistance is, because when you take the ratio of the two power figures, the resistance will cancel itself right out of the calculation.

That means that all you have to do is use the *square* of the voltage in place of the power figure, and everything we've said about dB will still hold true. But this will work *only* if both voltages are measured across the same resistance value; if the input voltage is measured across one value of resistance and output voltage is measured across some other resistance value, then all bets are off. For example, you might measure 1V at the input of an amplifier across a 1-megohm resistor, and find 1V at the output across a 10-ohm load. If you simply work with the voltage ratios, you have 1/2 or 0 dB ratio. But 1V across one megohm is just a microwatt (1/100000000 watt), while 1V across 10 ohms is 1/10 watt, so the amplifier itself must have a power gain of 100,000—which is 50 dB!

In the one very special case of identical resistances, however, the ratio of the squares of the voltages can be used in place of the power ratio; now as it happens, one of the nice properties about log-type numbers is that the log of the square of any number is just two times the log of the number itself. Similarly, the ratio of the squares of two numbers is exactly the same as the square of the ratio of the two numbers—you can take the ratio either before or after squaring, so long as the end result gets both the input and output voltages squared. That means all we have to do to the "power" or universal version of the dB formula is plug in "E" instead of "P," and multiply by two—which is where the "other" formula applies only to a single special case, while the "power" version applies to everything.

... Staff

Glen E. Zook K9STH  
818 Brentwood Lane  
Richardson TX 75080

# VHF FM & ...YOU

Why has this mode made  
such a sweeping impact  
on amateur radio?

The past few years have shown a marked increase in the number of amateurs operating on the 50 MHz, 144 MHz, and higher frequency bands. Many of these amateurs are using surplus or obsolete commercial FM equipment. This rise in FM activity is due to several factors, including the availability of equipment and the need for reliable single-frequency communications. The availability of equipment is due to two prime factors: The "splitting" of commercial FM channels has rendered many older units unsuitable for commercial use. Also, recent trends in miniaturization have made many units obsolete in terms of size, reliability, and battery-power consumption.

The need for a reliable single-channel system stems from several factors: The



# if you've gotta wait for an IC-2F ...it's worth it!

In the meantime, here's an actual-size cut out for your dashboard

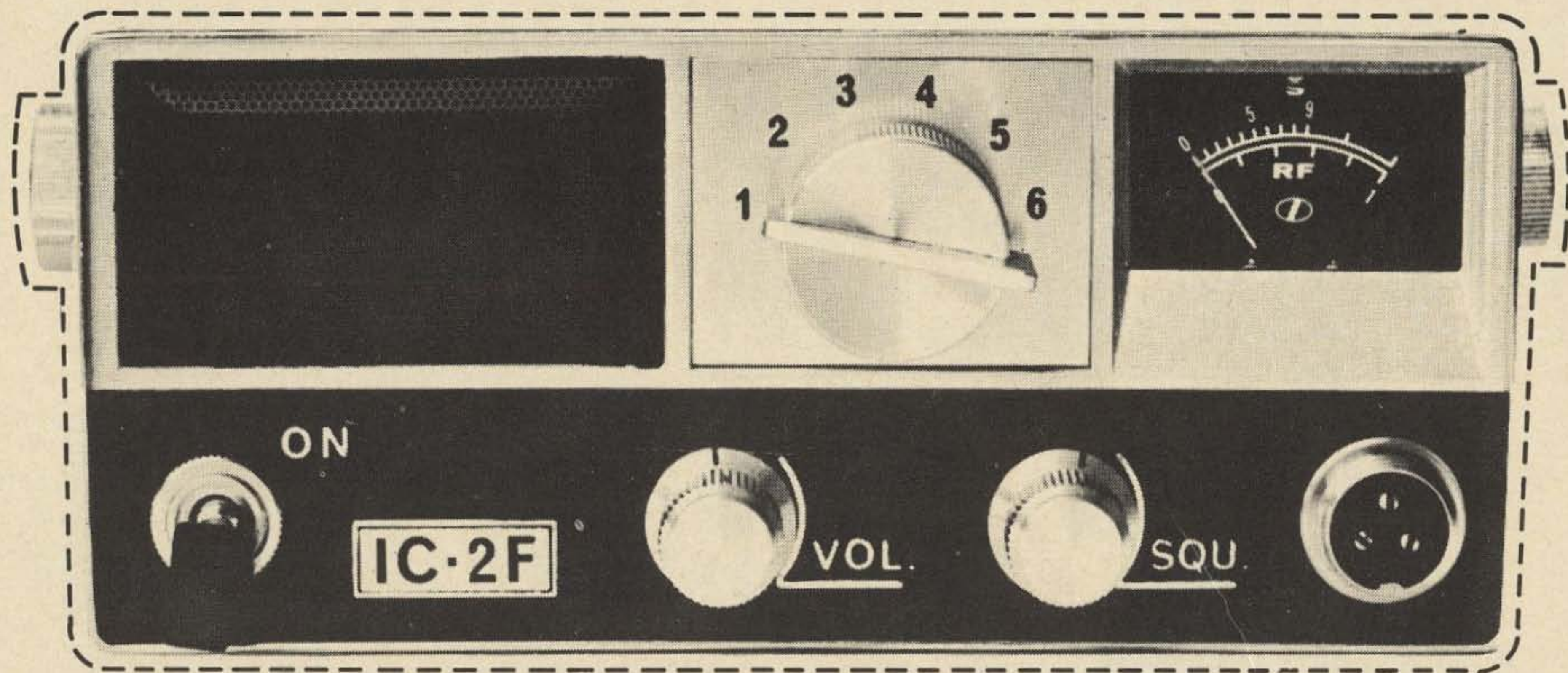

All solid state deluxe 2 meter FM transceiver: 20 watts in; 6 channels; APC; super hot receiver with FET, IC and ceramic filters; beautifully designed and engineered inside and out.

*See it at your dealers.*

## **VARITRONICS INCORPORATED**

3835 North 32nd Street • Suite 6 • Phoenix, Arizona 85018

average American is much more "mobile" than ever before. In previous years of amateur radio operation, people in certain

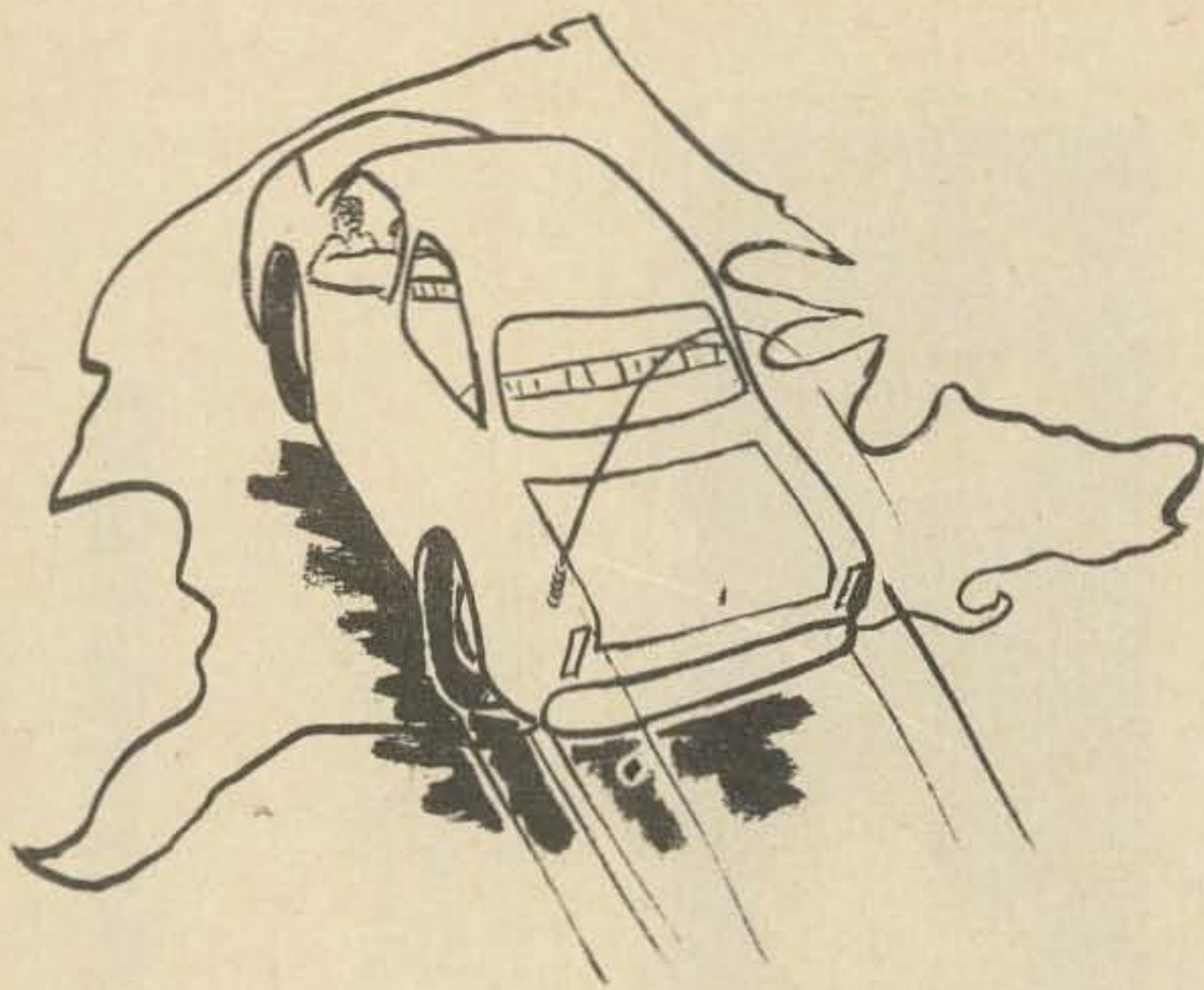

*The average American is much more mobile than ever before.*

areas monitored specific frequencies. Since almost everyone was using AM, close receiving and transmitting tolerances were not required. Today, with the accuracy needed for monitoring and transmitting on specified SSB frequencies, it is becoming less and less popular to do so. Of course, there are a few frequencies that are monitored in certain areas, but these are relatively rare. Also, the congestion on the lower frequencies is increasing, thus requiring more and more power in both mobile and fixed-station equipment.

The trend is thus towards a universal fixed-frequency type of operation in cases where reliability and performance are required. This has been met by using certain specified frequencies and fixed-frequency FM equipment. The most popular of the universally accepted VHF frequencies are 52.525 and 146.94 MHz.

#### Operating on VHF FM

Operation of VHF FM is very much like operation on the lower frequencies, and yet it is very different. It is like AM, SSB, and even CW in that there is much ragchewing, many technical discussions, and even emergency and traffic nets. You can call your buddy, check out equipment, and handle traffic and emergency situations. It is quite

unlike SSB, AM, and CW in that there is no need to retune the transmitter and receiver every time you operate; there is usually no background noise whenever the frequency is not in use (almost every piece of commercial FM gear has a noise-stopping squelch); high power is not needed for general use; and the frequency is almost constantly monitored.

Although the sudden popularity of FM and the increasing availability of specially designed gear threaten to change the picture, the equipment used by the average FM'er has typically been obsolete commercial equipment previously used by police, fire, taxi, utility, and other groups. This equipment has a power *output* of from a few milliwatts to nearly 100 watts, and a frequency selection of from one to four crystal-controlled channels. The design of the equipment is excellent. The receivers often have sensitivity figures of  $0.5 \mu\text{V}$  (for 20 dB of noise quieting) or better. Operation of the equipment is quite simple, for it was originally designed to be used by nontechnical people in business or emergency situations. The controls usually consist of an on-off-volume control, a squelch control, and a push-to-talk microphone.

Many amateurs operate using "wideband" or  $\pm 15$  kHz deviation. Some amateurs in certain areas are gradually shifting to "narrowband" or  $\pm 5$  kHz deviation. This poses no real difficult problems, for narrowband signals can be received on wideband equipment (with an apparent loss of audio volume and subsequent decrease in signal-to-noise ratio). Wideband signals can rarely be received on narrowband equipment without adjustment of the transmitting or receiving equipment, however.

Almost every metropolitan area now has at least one repeater system which will pick up and rebroadcast signals. In most cases, the input of these repeaters is 146.34 MHz and the output is 146.94 MHz. But in areas of extreme spectrum congestion, other frequency pairs are used.

The range of units (without using a repeater) varies with terrain and power output, as well as the type of antenna used. It has been my experience that the average unit now in use by the amateur FM'er (10W

output with a quarter-wavelength whip) has about a 15-mile range of communication.

FM equipment is generally reliable, and when it does become necessary to either repair or service, it is relatively easy to work on. Many units use common tube types in both the receiving and transmitting portions, thus eliminating a parts scarcity problem. Most units are divided into three distinctive portions: transmitter, receiver, and power supply, with interconnecting cables. These "strips" are often interchangeable between units, from base station to mobile and from mobile to base station. Trunk mount units are usually "wife approved," for the control

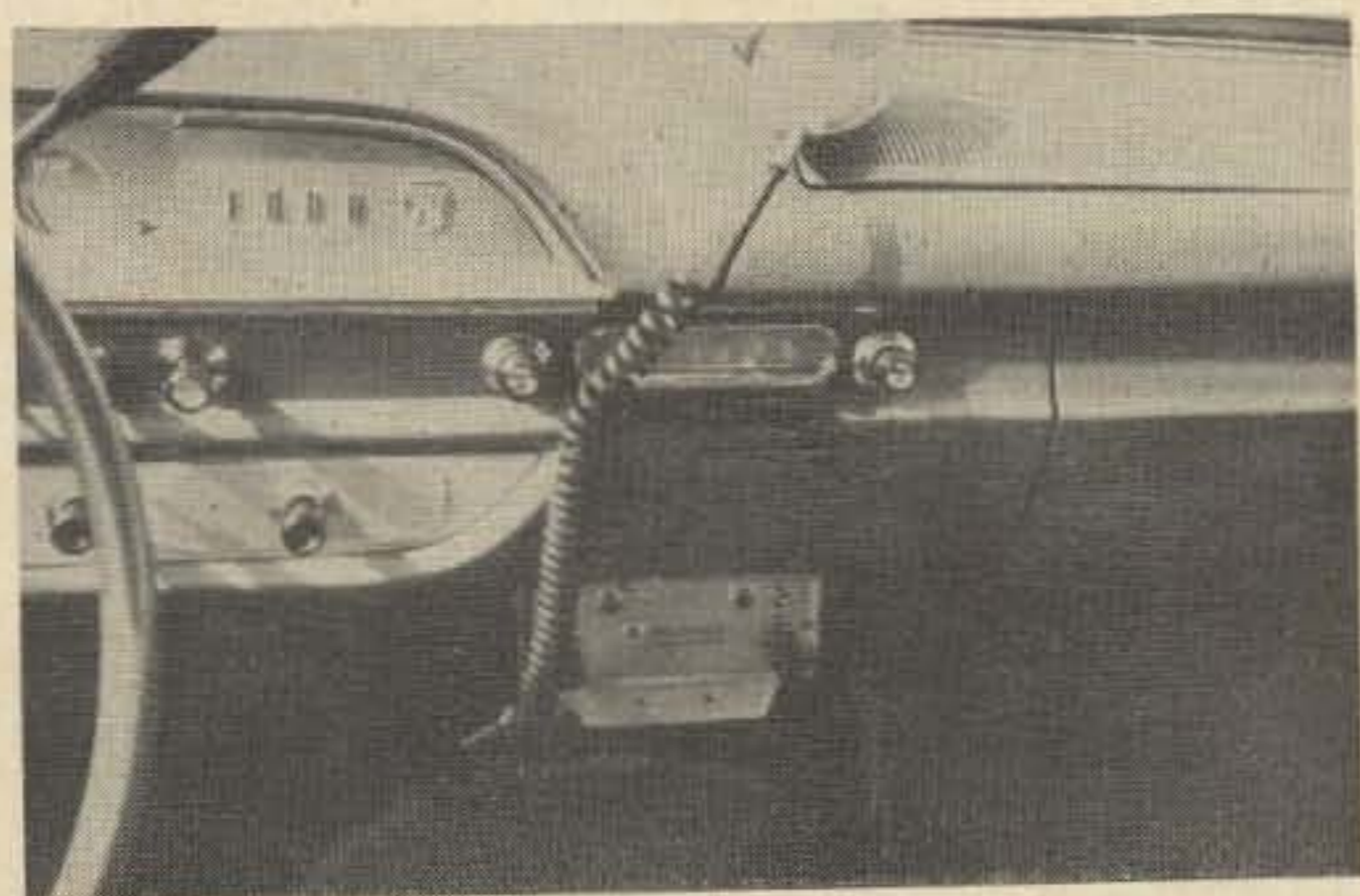

head and speaker take up very little room in the car. However, there is very little difference in performance of trunk mount and dash mount units of the same type.

#### Acquisition of Equipment

The old Bugs Bunny cartoons used to start with Elmer Fudd reading a recipe for rabbit stew. He would quote the first instruction as "First, catch a wabbit." Well, the first instruction in the recipe for good amateur FM'ing is to first catch the unit.

Local sources of equipment vary. The best place to start is another amateur who is already active on VHF FM. Many FM'ers keep spare units around for trading and helping out newcomers. If you don't know any active FM'er in your neighborhood, then you will have to start looking elsewhere. In some localities the police and fire forces are possible sources. However, many departments either trade in older equipment on newer models, or they sell the units to the

members of the department for monitor receivers and for auxiliary squad work.

Another possible source is taxi companies. The two-way radio is the life-blood of the taxi driver, so most cars are usually equipped. Herein problems also lurk. Many taxi companies trade in older units or sell them to the individual drivers. The units sold to the drivers often get resold to other



*Many taxi companies trade in older units or sell them to individual drivers; but the units often get passed along more than once, and they come out the worst for wear in the shuffle.*

drivers and so on until the unit is either so old or so beat up that it is good only for a boat anchor.

The modern railroader is quite dependent upon communications, so FM gear is found around rail yards. Railroading is hard business, and the equipment often sees rough service. However, many amateurs have been able to obtain obsolete equipment from railroads. If there is a repair center in your area, check with the purchasing agent there. If not, talk with someone who works for the railroad and find out who takes care of the radios in your locality.

Sometimes two-way radio repair shops are subcontractors to the major manufacturers and some even buy and sell two-way equipment. However, many of these shops

have a market for monitor receivers, system spares, and the like, and do not like to dispose of any extra pieces of equipment at low prices. There is always a chance, though, and even if the personnel do not have any units to dispose of, they often have information as to where such units can be obtained.

Utility companies usually buy equipment from the two-way manufacturers on an outright basis and seldom trade in older equipment. Often entire fleets of equipment are retired at the same time. Some companies will sell one or two units at a time while others will only sell in lots of 5, 10, 15 or more units. In these cases it is necessary for a group or club to purchase the units in order to meet the minimum purchase requirements. Of course, some utility companies have been known to give the units to a club for distribution to the membership — but such cases are the exception.

It is possible to purchase either portions of units or complete systems from companies who specialize in the surplus FM

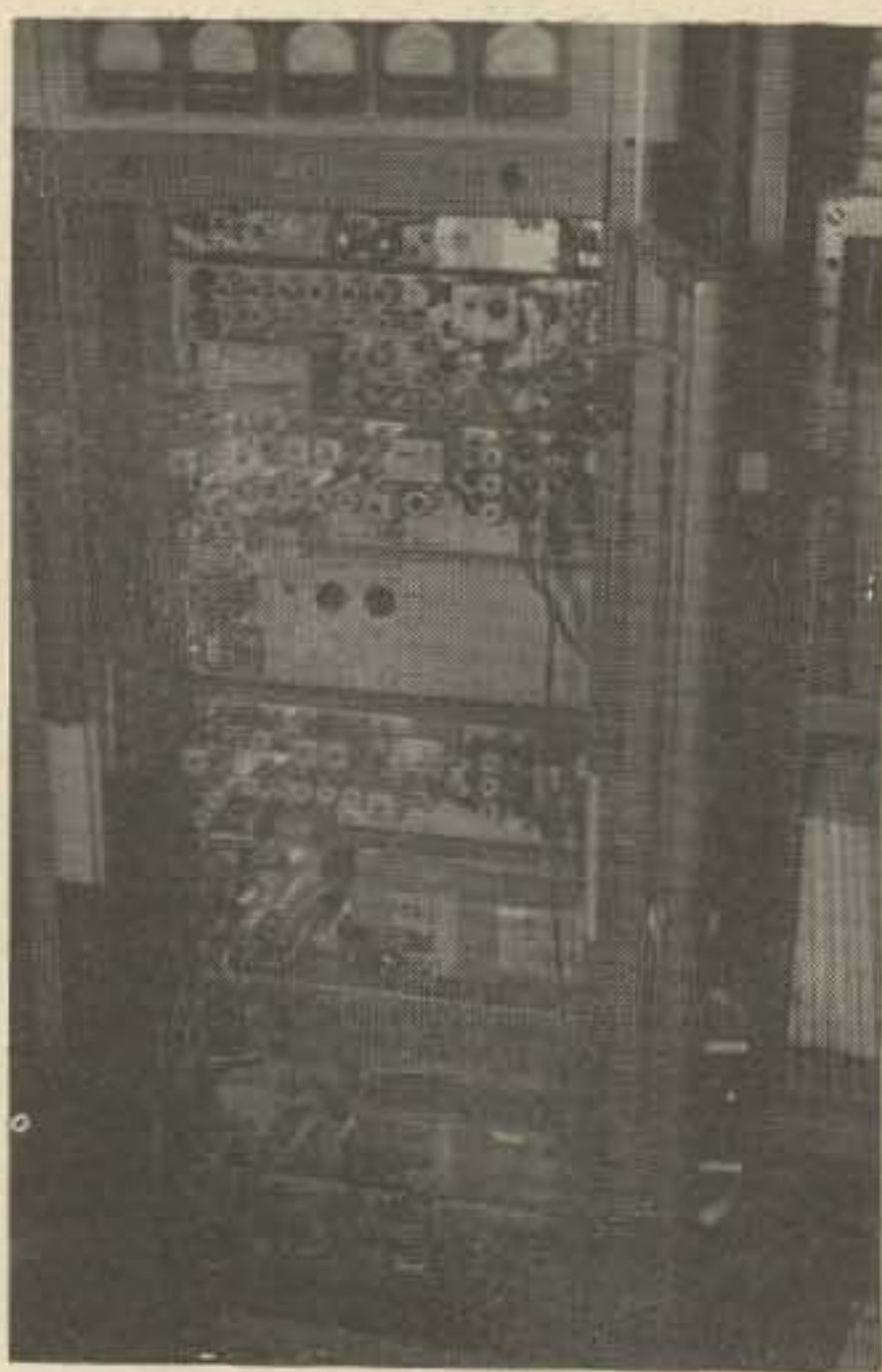

market. These may be found by looking through the pages of this issue of 73. However, the prices are usually higher than would be paid if obtained locally. One advantage of dealing with a surplus house is that you have some recourse if you're not happy with your purchase within a reasonable period. Several of the surplus FM

suppliers offer money-back equipment guarantees. Also, these companies often have a supply of schematics and other information on the equipment.

If you have a selection, always pick a mobile with a transistorized power supply over a vibrator (and a vibrator over a dynamotor, if in the same power output class). Always remember that power output is the measure of FM gear, not power input as in other equipment. If the unit is intended for fixed-station use, pick out the highest powered unit in best condition. If a choice is available between several units pick the newest type.

### General Conversion Techniques

The first step in conversion is to determine the frequency range of your unit. If the source is known, it is a simple matter to check the operating frequency. If the source is not known, a look at the final tank will usually give a clue. Of course, the major manufacturers have a definite system of marking the frequency ranges of the equipment.

The first step in the actual conversion is to acquire a set of crystals on the proper frequency. This is best accomplished by ordering commercial grade crystals from a crystal company that typically supplies crystals to the two-way industry. I highly recommend International Crystal for several reasons: They can supply crystals of the correct cut and frequency for multiplication when given the manufacturer of the equipment and the manufacturer's crystal type; International guarantees crystals for correct operation; and they give excellent service in terms of turnaround time and warranty replacement. Regardless of the source of the crystals, it is important that they are of the correct cut. If the crystal was not designed for the oscillator circuit used in the equipment, it may not "pull" onto the correct frequency if it oscillates at all.

The next step is getting the heater strings on the correct voltage. If the unit is to be used as a base station with an external ac supply this step is unnecessary, for the correct heater voltage can be supplied from the ac supply.

Many 6V units have the heater strings divided into two 6V sections with approxi-

mately the same current requirements for each section. If this is the case, conversion to 12V involves merely lifting the ground side (if any) on one half of the heater strings and forming a series-parallel arrangement. It is necessary, however, to retain a balance in current requirements. That is, do not put a section requiring 5A of heater current in series with a section requiring 6.5A, etc. A small difference can be tolerated, but the better the match, the better the performance. In units where the "strings" do not exist, it is necessary to calculate the heater current requirements and then develop the necessary series-parallel arrangement.

The power supply is the next area of conversion. Fortunately, most transistorized power supplies are found in either 12V only or 6/12V combination units. Thus, I will not attempt to cover them here. Dynamotor units may or may not prove to be difficult to convert from 6 to 12V operation. The cheapest method is to replace the dynamotor with a 12V surplus unit. The DM-35 works very well in higher powered units (50-60W), and other units may be used for lower powered equipment.

The receiver power supply is almost always a vibrator supply, even in dynamotor units. The simplest modification for this supply is to pick up 6V across one of the filament strings. A 2W dropping resistor of 20-47Ω will have to be put in series with the vibrator coil if the vibrator itself is driven directly from 12V.

Vibrator units are generally of two types: Lower powered units (<15W) use a single transformer to provide voltage for both receiver and transmitter B+ lines. Higher powered units use two transformers, one for low B+ and one for high B+. In the case of the single transformer unit, the power supply may be connected across the lower leg of the heater string. In this case, allow for the current required by the power supply when setting up the heater strings or place a resistor of the correct size across the other heater string. In the case of two transformers, each one may be placed across separate heater strings. Make sure that the circuitry formerly grounded goes to the 6V point in the section which is connected

## HAL DEVICES



Your only source for new semiconductor devices and components at lower than surplus prices.



### Semiconductor Devices

Fairchild $\mu$ L 914 or 900 (8 pin epoxy TO-5)	.60 ea.
Fairchild $\mu$ L 923 (8 pin epoxy TO-5)	.90 ea.
Texas Instr. SN 72709N op amp (Dual Inline)	\$2.00 ea., 6/\$10.00
Hewlett-Packard 2800 Hot Carrier Diodes	.90 ea. 12/\$10.00
Motorola 2N5401 PNP 150v, 600 ma	.90 ea.
Motorola 2N5655 NPN 250v, 500 ma	.90 ea.
HAL Designer Cabinets, 3 sizes,	\$2.85 to \$6.25
Resistors, 2.2 $\Omega$ to 2.2 M $\Omega$ (1/2 w, 10%)	.05 ea.
Mixed quantity price:	10/.40, 100/\$3.50
Mercury wetted reed relays (unused)	
6, 12 or 24 v DC coils,	SPDT \$3.00, DPDT \$3.50
Electronic Keys,	\$16.00 to \$46.50

Add postage; excess refunded  
Send for complete listing

HAL DEVICES  
Box 365 L, Urbana, Illinois 61801

### NOW AVAILABLE! A TRANSISTORIZED FM I-F STRIP FOR YOUR HOME BREW PROJECTS FEATURING:

- 4 Stages for Superb Limiting Action
- 455 kHz Center Frequency
- $\pm 5$  kHz Deviation Acceptance
- 3 dB Limiting at Less Than 100 Microvolts
- +12 VDC @10 mA Power Requirements
- Small Size: 4" x 1" x 3/4"
- All Top Quality Components
- Factory Tuned and Assembled

ORDER AS MODEL 703 @\$18.95 PPD FROM:  
**HI-SPEC**, PO Box 387, Jupiter, Florida 33458

radio amateur

# callbook



### GET YOUR NEW ISSUE NOW!

Over 283,000 QTHs  
in the U.S. edition  
**\$7.95**

Over 135,000 QTHs  
in the DX edition  
**\$5.95**

These valuable EXTRA features included in both editions!

- QSL Managers Around the World!
- Census of Radio Amateurs throughout the world!
- Radio Amateurs' License Class!
- World Prefix Map!
- International Radio Amateur Prefixes
- Radio Amateurs' Prefixes by Countries!
- A.R.R.L. Phonetic Alphabet!
- Where To Buy!
- Great Circle Bearings!
- International Postal Information!
- Plus much more!

WRITE FOR  
FREE  
BROCHURE!

RADIO AMATEUR

callbook INC.

Dept. B, 925 Sherwood Drive  
Lake Bluff, Ill. 60044



across the "high" heater string (the string which is not grounded).

The rectifiers used in older FM equipment are usually of the selenium type. If higher voltage is required, or if any one of the rectifiers is defective, replace the entire rectifier with the silicon type. This usually results in higher transmitter output and lower power supply heating.

*Low-band conversions.* Units which were originally designed for the 25–30 MHz range will, of course, work on 10 meters without any modifications. The only thing which needs to be done is to put in the necessary crystals and keep the deviation below the maximum allowed by the FCC. Units designed for the 30–40 MHz range will also usually work on 10 meters without modification. If the receiver will not tune down to 29 MHz, it is usually necessary to place small capacitors (a few picofarads will usually do) across the coils in the rf section. The transmitter final grid and tank coils may be slightly squeezed together to lower the frequency.

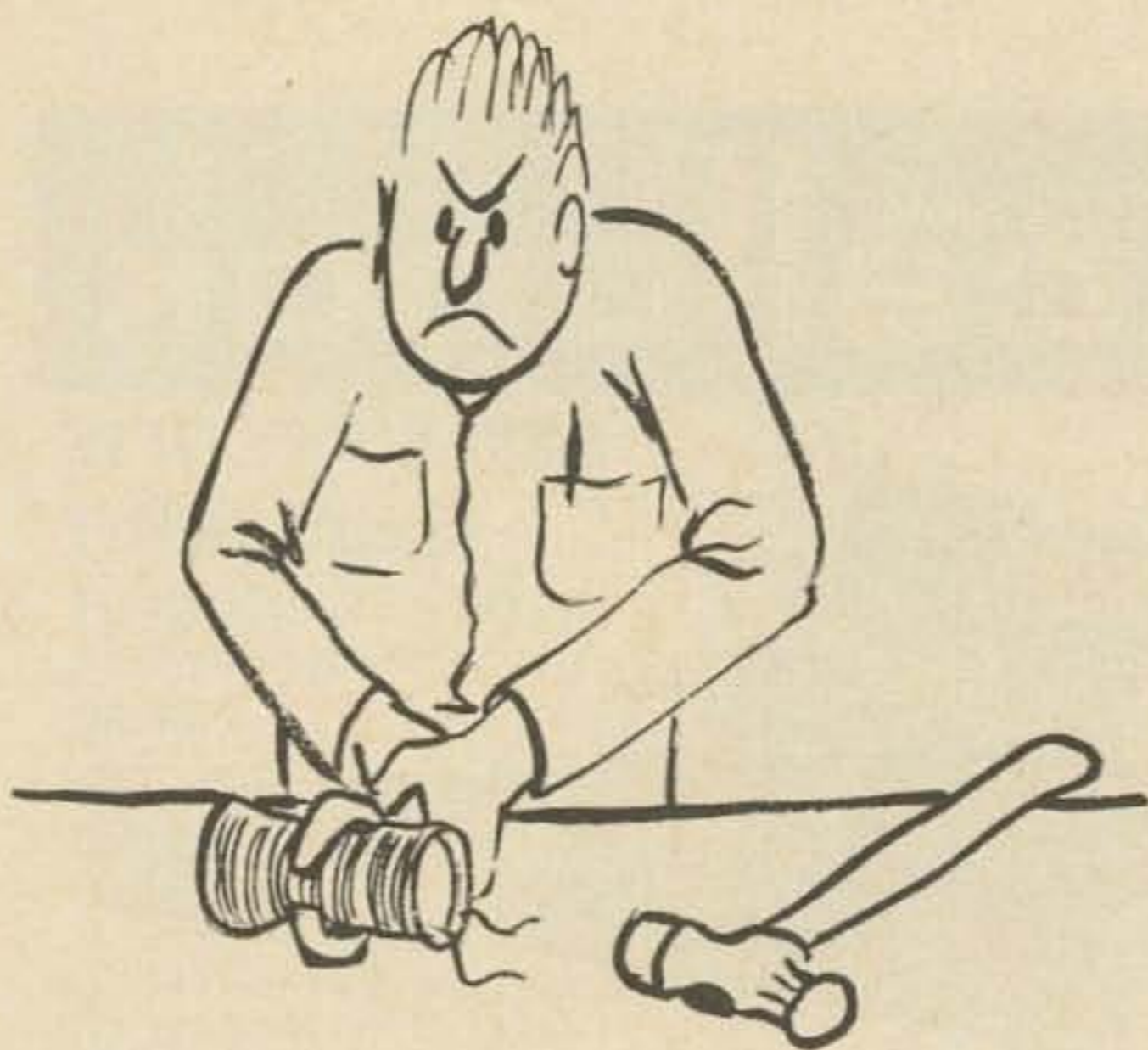

*The transmitter final grid and tank coils may be slightly squeezed together to lower the frequency.*

Use of the 30–40 MHz units on 6 meters sometimes requires a substantial amount of modification. Fortunately, only the rf and first mixer sections need modification in the receiver. These coils must be reduced by either removing turns or decreasing the capacity across the coils. A grid dip oscilla-

tor is a must. The entire transmitter section must be modified. Each coil must be reduced in size until it will tune to the correct frequency.

The 40–50 MHz units can be used on 52.525 MHz without modification. All that is required is the proper crystals. If, for some reason, the unit will not tune up to 52 MHz, it may be necessary to reduce the capacity across the receiver rf coils and slightly spread the turns of the final tank coil to bring them within the tuning range.

*High-band conversions.* Units in the 144–170 MHz range will usually tune up on 146.94 MHz without modification. Units that require modification can usually be brought within range in the following manner: The receiver rf coils may be padded within range by putting small Mylar capacitors of 2–5 pF across each section. The receiver oscillator coil may require as much as 20 pF across it. (Try for proper operation without this capacitor before adding it.)

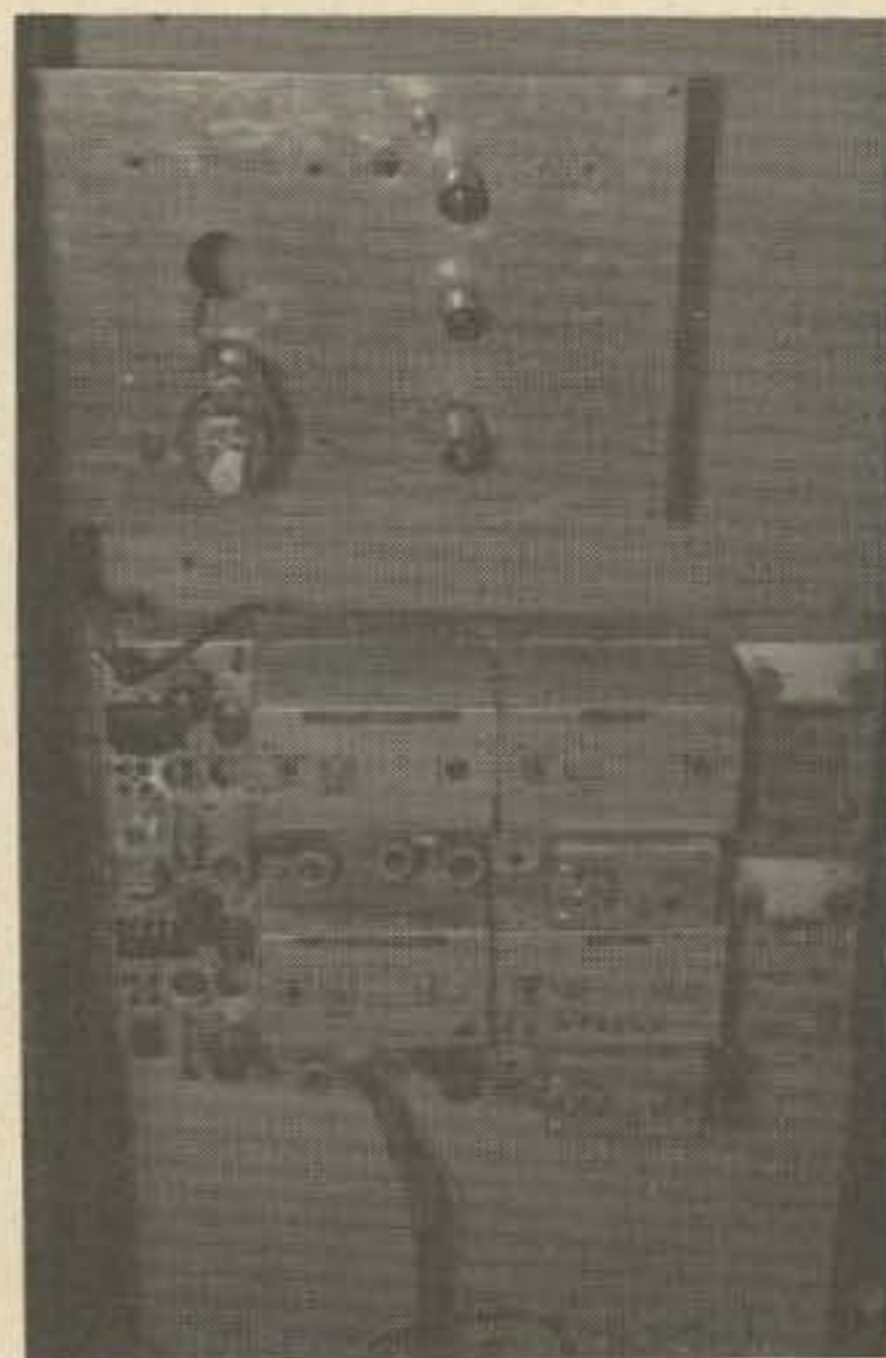

The only transmitter stages usually requiring modification are the driver and final sections. The driver may be brought within range by either squeezing together the turns of the coil (if a coil is used) or by the addition of approximately 5 pF across the tuning capacitor (if parallel lines are used). In the cases where there is not enough capacity in the final tank circuit or where adjustable plates do not exist, it is necessary to add capacitance here also. The simplest

manner is to make a capacitor from about 3 in. of RG-58/U coax. This coax is attached with the shield side to one line and the center to the other. The coax may be trimmed about 1/4 in. at a time until the final tank is resonant with the tuning slider about 1/4 in. from the end.

*General tuning instructions.* For the most part, the FM unit is tuned in each stage for maximum output. Most equipment has either a central metering point or a test jack for each stage. In all cases a VOM may be used as a visual indication. Normally a 0-3V scale is sufficient. The Motorola units may be measured with either a VOM or a 50  $\mu$ A meter. Generally, the only exception to the "maximum output" rule is the discriminator frequency, which is adjusted for a zero reading.

The receiver should be tuned starting with the meter at the second limiter test point. As the tuning progresses, it will become necessary to first reduce the signal input to the receiver and then to switch to the first limiter test point. As the second limiter approaches saturation, the reading will begin to decrease, thus giving a false reading. That is why it is necessary to reduce the signal input. The same thing holds true for the first limiter, but it does not go into saturation as easy as the second limiter and is therefore a better indication at higher signal levels.

When starting from scratch it is usually necessary to begin receiver tuning with the low i-f stage. In almost every Motorola FM unit this stage is at 455 kHz. The low i-f coils are adjusted for maximum reading at the second limiter test point (make sure to keep the signal level low enough to prevent saturation). At this time also adjust the discriminator secondary for zero reading at the discriminator test point.

The next stage to be tuned is the high i-f stage. This stage may be first tuned by injecting a signal at the i-f and adjusting for maximum reading at the second limiter test point. These adjustments may be "touched up" when the carrier frequency is being received.

The rf stages can usually be adjusted by inserting a signal at the antenna jack at a

## MORE RANGE . . . with NO NOISE

FOR ALL  
MOBILE UNITS



CUSTOM SYSTEMS  
KITS • ACCESSORIES

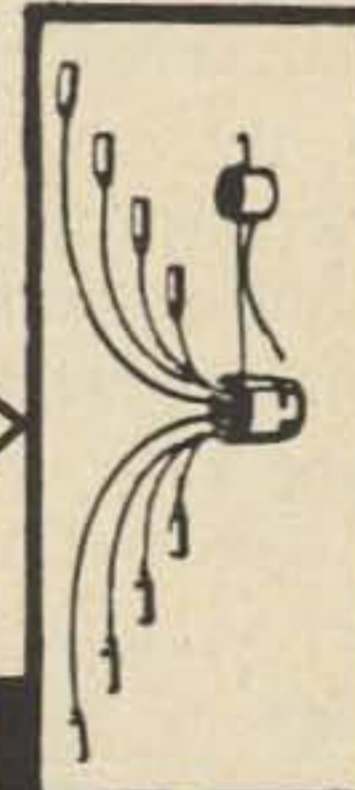

ELIMINATE IGNITION NOISE  
**ELECTRO-SHIELD®**  
YOUR ENGINE

FROM \$44.95

**ESTES ENGINEERING CO.**  
543 W. 184th St., Gardena, Calif. 90247

- JENNINGS VACUUM VARIABLE CAPACITOR. UCS-500. 25-500 pF @10kV. Includes panel mounting bracket. (5 lbs). \$34.95.
- HAMMARLUND AIR VARIABLE CAPACITOR. TCD-240-J. Dual section. 31-250 pF per section @4250 volts. (10 lbs). \$9.95.
- STANCOR CHOKE.C-1001. 10.5 henries @110 mA. 3000 volt insulation. (3 lbs). \$1.00.
- AMPHENOL COAX CONNECTORS. PL-259. \$ .35. All items BRAND NEW factory packaged. Minimum order \$5.00. Please include postage. KAPITAINS KOMPONENTS  
2225 Albion St. Denver, Colorado 80207 303-355-3680

## GET MONEY

Guaranteed top money for any piece of surplus equipment. Payment in 24 hours. We also pay shipping, insurance. Call collect or send list for quick quote. **SPACE ELECTRONCS CORP.** 11 Summit Ave. East Paterson, New Jersey, (201) 791-5050

### THE BEST DEAL DRAKE GALAXY MOSLEY HY-GAIN AMECO

Write or stop in for our price when you buy new equipment.  
We also give top trade-in allowance for your LAB-TYPE or SURPLUS TEST EQUIPMENT or PHOTO EQUIPMENT on NEW HAM GEAR.  
**JEFF-TRONICS**  
4252 Pearl Rd. Dept. N-4, Cleveland, Ohio 44109

#### RF MULTIMETER, RFM-1

Simplifies construction and testing of solid state circuits, antennas and transmission systems.

—MEASURES—

- 1 mv to 100VDC  $\pm 3\%$
- 1 mv to 1 v RF to 500 Mhz  $\pm 5\%$
- VSWR 1.35 and 3.0 fs to 2 Ghz
- 0 to 60 Decibels

Many more features — Write for detailed brochure  
**RADIATION DEVICES CO.**  
Box 8450, Baltimore, Maryland 21234

fairly high level and adjusting the coils for maximum reading at either the second limiter or first limiter test point (taking care not to saturate the stage being measured). In cases where a signal cannot be forced through from the antenna jack, it is necessary to use an injection probe of some type and start at the final rf stage and work towards the antenna.

The carrier frequency may be adjusted by metering the discriminator test point and adjusting the crystal warp capacitor or coil until a zero reading is obtained.

The first step in tuning the transmitter is to put the high-low switch located near the final amplifier section in the low position. Or, if the unit does not have such a switch, disconnect the plate connections to the final amplifier tube. This is to protect the final from damage from prolonged periods of tuneup.

Actual tuning begins with the oscillator section and works toward the final. Each stage is tuned for maximum output. A metering point is usually provided at each stage. If the unit has been modified, especially if modified from 30-40 MHz to 6 meters, it will be necessary to check the output frequency from each multiplier stage. After every stage (except the final and driver) has been tuned, replace the final tube if it was removed. Tune the driver, final grid, and final plate circuits for maximum output. Next, go back through the unit and touch up the various stages.

### Antennas

The vast majority of FM operation is with vertically polarized antennas. These range from the simple quarter-wave whip to corner reflectors and yagis. The most popular mobile antenna for both 10 and 6 meter FM activity is the stainless steel whip with spring base. Next in popularity are the shortened antennas made by Antenna Specialists Company and others. The latter type may be mounted in the center of the roof or on the rear deck for better isotropic radiation.

Three types of antennas enjoy popularity with FM amateurs operating on 2 meters. They are the quarter-wave whip, the coaxial antenna, and the 5/8-wave, 3 dB gain antenna manufactured by Antenna Special-

ists and others. The quarter-wave whip can usually be purchased for under \$5. The coaxial antenna can be purchased for around \$20. The 3 dB gain antennas cost about \$25, but they will effectively double the output power.

Base station antennas are also vertically polarized, and come in various sizes and shapes. The antenna generally in use on 10 and 6 meters is the groundplane, with the coaxial collinear antenna running a distant second. Both these antennas may be either purchased or constructed by the amateur.

In general, the following can be stated about VHF FM antennas: In mobile installations the best place for the antenna is the center of the roof. The next place is the rear

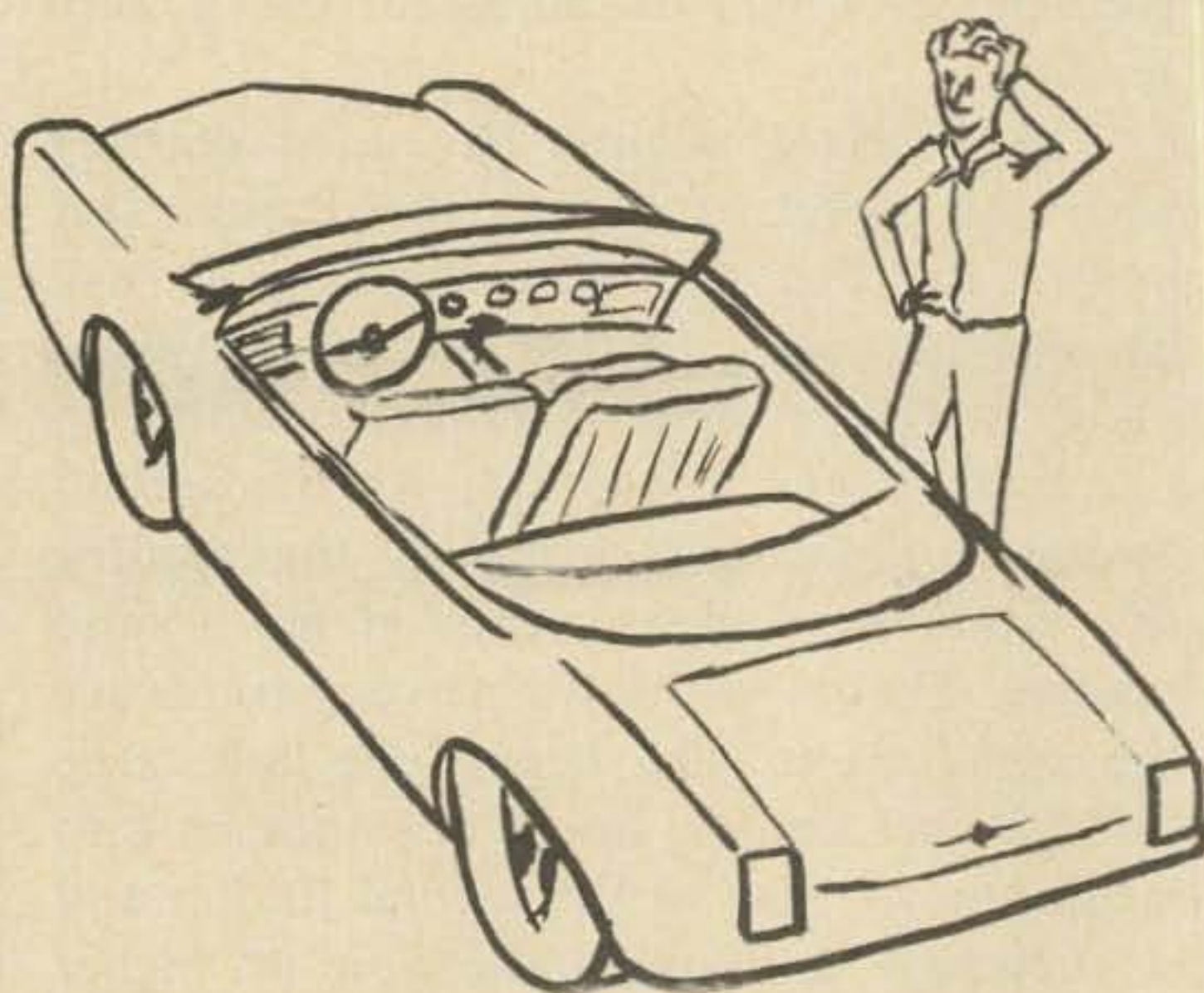

*In mobile installations the best place for the antenna is the center of the roof.*

deck or trunk lid; next comes the fender, and finally a bumper mount. In base stations, the rule is the higher the better while keeping line losses down. Remember that even the best coax has a great deal of loss at 2 meters and higher. If possible, use a very good grade of foam coax. Of course there are lines available with extremely low losses, but these are quite expensive and extremely hard to work with.

### Glossary

Whenever an amateur first starts out he must learn the jargon used on the bands. The same is true when starting out on VHF FM. As an aid, twenty of the more common terms and their usual meanings are listed below.



*Channel Guard:* A registered trademark of General Electric for a system of *continuous tone squelch*.

*Coffin units:* FM units manufactured in the late 1940s and early 1950s such as the Motorola 30D which consisted of separate receiver and transmitter units housed in cabinets with rounded tops which resembled coffins.

*Control heads:* The small box-like unit containing the off-on-volume control, squelch control, and microphone connections of a trunk-mounted mobile unit. The control head connects to the unit via a multiconductor cable.

*Continuous tone squelch (CTS):* A system wherein a low, subaudible tone is transmitted continuously with the voice transmission. This tone activates a reed in the receiver which, in turn, allows the squelch to operate. If the tone is not present, the receiver remains muted. This system allows only the desired stations (those with the correct tone frequency) to be received. Provision is normally made to use either conventional squelch or an unsquelched monitor position.

*Deviation:* The amount the modulated carrier varies from the center frequency. During half of the modulating cycle the deviation is positive and during the other half the deviation is negative. Commercial standards now call for  $\pm 5$  kHz (narrowband). Most amateur operation is  $\pm 15$  kHz (wideband).

*Discriminators:* The discriminator serves to convert the FM signal to AM and then demodulate the AM signal into audio. It is analogous to the diode detector in AM gear and the product detector in SSB gear.

*High band:* The slang term applied to the commercial band from 148 to 172 MHz.

*IDC (Instantaneous Deviation Control):* Motorola tradename for the potentiometer which acts as an "audio gain" which in turn controls the level of peak deviation.

Why does GBC sell more replacement vidicons than all other suppliers combined?



Because GBC offers top quality, fully guaranteed, factory sealed vidicons for less than half the price you'd have to pay anywhere else!

**HITACHI 7038H ..... 29.50**

**HITACHI 7735A**  
High sensitivity ..... **34.50**

**HITACHI 7262**  
(Replacement for Sony & Panasonic)..... **34.50**

**HITACHI 8507**  
(Separate mesh)..... **74.50**

All vidicons sold in lots of five.  
Add 10% for lesser quantities.

**GBC**

**Closed Circuit TV Corp.**

74 Fifth Avenue, N.Y., N.Y. 10011 / (212) 989-4433

**HAMS! DON'T BUY USED TUBES  
COMPARE OUR PRICES  
FOR NEW TUBES  
RCA-GE-EIMAC-AMPEREX-ETC.**

811A-5.75, 4-125A-27.50, 4-65A-12.00,  
5R4GY-1.75, 807-1.75, WE 350(807)-1.25,  
4-400A-38.50, 813-20.95, 4X150A-19.95,  
4-250A-36.50, 4PR60B-55.00,  
4CX250B-21.00, 8236-13.25, 2E26-2.95,  
1625(807-12V FIL)-1.50, 417A-2.25, 404A  
-2.25, 6146-2.95, 6360-3.50, 2X2-.50,  
OD3-OC3-.95, 5879-1.75, 5881-3.25, WE-  
CV677 1000watt tetrode-5.95, Eimac-  
Machlett VT-158 1200-3000 watt bottle-read  
March, 1969 issue 73-How Great This Is-9.95,  
12V-20 amp. diode power supply (less xformer)  
-5.95, RCA 6-12 vdc converter, del. 20 amp-  
19.95, (apr. by Volkswagen), CD 3.4  
mfd-2375V. Oil capacitors-.49, CD 1 mfd.  
5000V-2.95 (Ideal for Iazar), 5BP1-5HP1-5JP1  
scope tubes-4.95 ea., 100 asst. A-B resistors  
1/4-1/2-1-2W-2.50, 12V relays-.79. Add post. &  
ins. Send for our list of over 3000 types of  
American, British & European imported tubes.  
Largest stock of xmitting tubes in the world.  
Send for large parts catalog (prices lowest in  
USA).

**UNITED RADIO COMPANY**

56-A Ferry Street, Newark, New Jersey 07105

**73 Magazine**  
**Foreign Subscription Agents**

**AUSTRALIA**

The Wireless Institute of Australia  
478 Victoria Parade  
East Melbourne

**BRAZIL**

Livraria Stark S/A  
Caixa Postal 2786  
Sao Paulo 1, SP Brazil

**EUROPE**

Eskil Persson SM5CJP  
Frotunagrand 1  
19400 Upplands Vasby, Sweden

**GREAT BRITAIN**

Jim Coote  
56 Dinsdale Avenue  
Kings Estate, Wallsend, Northumberland  
Radio Society of Great Britain  
35 Doughty Street  
London WC1

Short Wave Magazine  
55 Victoria Street  
London SW1

**NEW ZEALAND**

N.Z.A.R.T.  
P. O. Box 1459  
Christchurch

**SOUTH AFRICA**

South African Radio Relay League  
P.O. Box 3911  
Capetown, South Africa

*Limiters:* A circuit i-f which saturates with a fairly low incoming signal, keeping the audio output from the discriminator at a constant level (similar to AVC in an AM unit). This circuit is needed because the audio output from a discriminator is directly proportional to the signal input, thereby varying with any change in signal level.

*Low Band:* The commercial band from 30 to 50 MHz.

*Motrac:* A registered trademark of Motorola for its series of mobile equipment utilizing transistorized receivers and hybrid transmitters.

*Permakay:* A Motorola trademark for its line of selective i-f filters. These are of two types, wideband (marked with a type number ending with the letter "W") and narrowband (marked with a type number ending with the letter "S").

*Pre-Prog:* Slang term usually applied to General Electric units manufactured before

the "Progress Line." Often this term is used to apply to units immediately preceding the Progress Line which are similar in appearance.

*Private Line:* The registered trademark for Motorola's version of CTS.

*Single tone:* The use of a high-pitched tone for control of remotely situated functions. This differs from CTS in that the tone lasts for only a short period of time. These circuits are often used in amateur repeater applications to restrict unauthorized use of the repeater and to reduce intermodulation effects.

*Progress Line:* A General Electric trademark for its pretransistor line of units. These units normally have vibrator power supplies. Newer types, with transistorized power supplies, are called "TPL."

*TPL (Transistorized Progress Line):* A trademark of General Electric used for their line of equipment utilizing transistorized receivers and tube type transmitters. The rear mount versions of this unit have the majority of the receiving circuitry located in the control head.

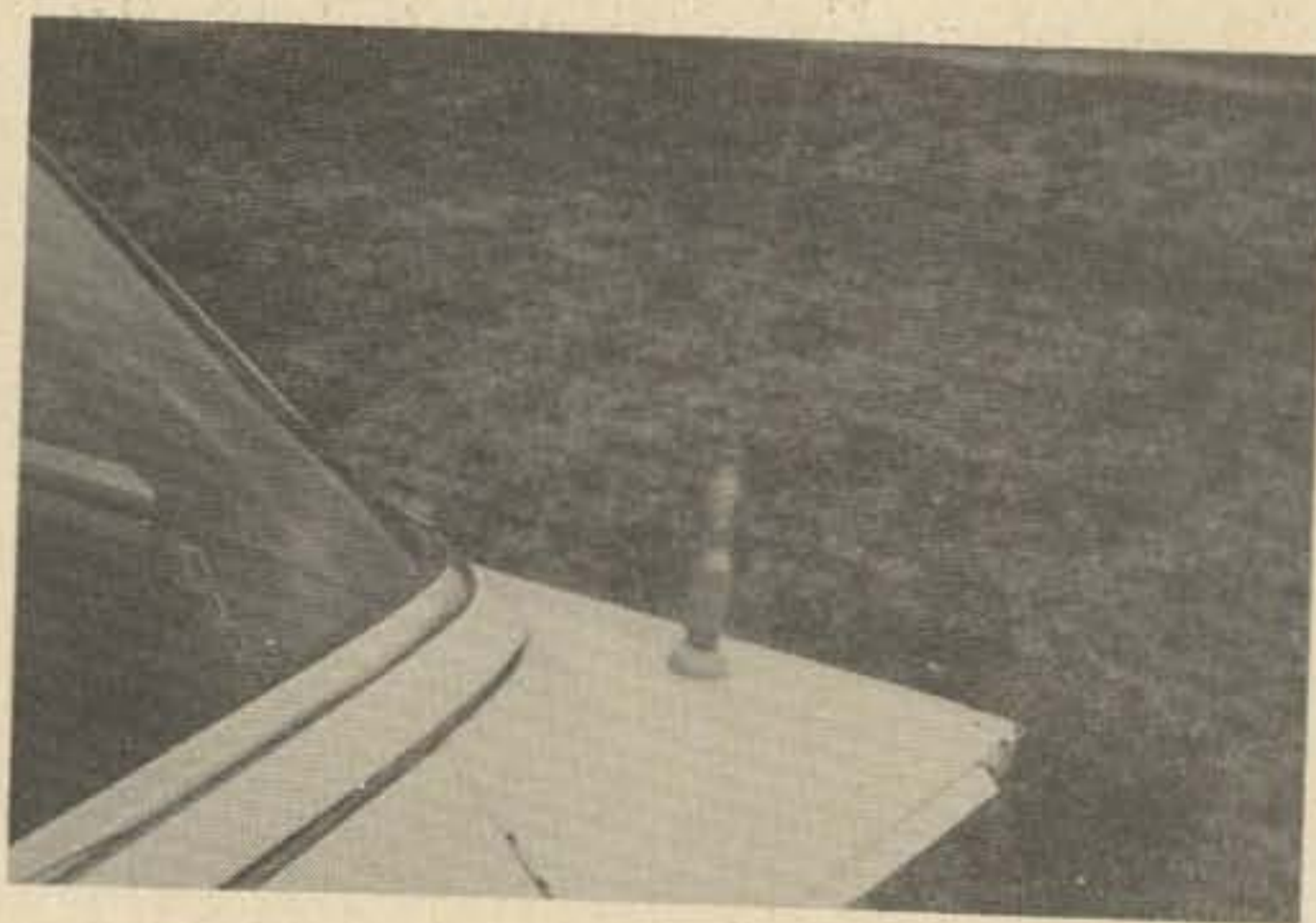

*Twin V:* A registered trademark of Motorola originally applied to mobile units capable of operation from 6 or 12V sources.

*Warp:* The pulling of the operating frequency by either inductance or capacitance changes being introduced in the oscillator or i-f circuit. This technique is also called "rubbering."

... K9STH ■

# SURPLUS CATALOG

A few years ago the word "surplus" was almost synonymous with military. But not today. The day of the government being the only big spender is over forever. And surplus is a natural byproduct in a world of heavy spending and innovative, advancing technologies. The heavy dollar volume pouring out of the computer industry, the concentrated spending of industry for better communications, the necessary cyclic improvement in military systems development—all contribute to the new world of Surplus.

As you look over the ads and articles in this issue of 73, you will see how the surplus field has changed. The amateur's legacy is still the obsolete AN/GRCs and such of the government. But it also includes the myriads of integrated circuit and semiconductor assemblies and components that have been replaced by the computer industry's bid for smaller, more reliable counterparts.

Contributing also to the surplus market was a decision by the FCC to make certain restrictions to commercial two-way radio users that would disallow use of all the older, tried-and-true radio transmitter-receiver units. As established radio users reluctantly parted company with their old wideband mobile units and base stations, the surplus outlets began to bulge with bargains. Since the amateur bands were not affected by the FCC ruling, the hams made excellent targets for the still-quite-usable gear.

All this has worked to the advantage of you and me, the amateurs. We can buy good gear—extremely well designed, well built, rugged, and field-tested—for peanuts! Whether your mode is FM, AM, VHF, or HF, SSB or CW, there should be a lot of available items you'll want. Just remember . . . the surplus issue comes out but once a year. If you miff this opportunity to browse the surplus catalog section, your second chance will be a long time coming.



ALDEN EQUIPMENT . . . . .	141
Westboro MA	
ARROW . . . . .	157
Chicago IL	
B & F ENTERPRISES . . . . .	152
Hawthorne MA	
C & A ELECTRONICS . . . . .	171
Long Beach CA	
C & H SALES . . . . .	146
Pasadena CA	
COLUMBIA ELECTRONICS . . . . .	134
Los Angeles CA	
TED DAMES CO. . . . .	145
Arlington NJ	
DELTA ELECTRONICS . . . . .	154
Lynn MA	
DENSON . . . . .	132
Rockville CT	
ELECTRONICTOWN . . . . .	156
Wilkes-Barre PA	
FM SALES . . . . .	164
Roxbury MD	
G & G RADIO SUPPLY . . . . .	147
New York City NY	
GREGORY ELECTRONICS . . . . .	169
Saddlebrook NJ	
JAN CRYSTAL . . . . .	162
Fort Meyers FL	
JEFF-TRONICS . . . . .	159
Cleveland OH	
JENNINGS INDUSTRIES . . . . .	144
Watsonville CA	
LIBERTY ELECTRONICS . . . . .	140
New York City NY	
MANN COMMUNICATIONS . . . . .	166
Tarzana CA	
JOHN MESHNA . . . . .	130
Lynn MA	
NEWSOME ELECTRONICS . . . . .	170
Trenton MI	
PARK ELECTRONIC PROD . . . . .	139
No. Salem NH	
POLY PAKS . . . . .	161
Lynnfield MA	
QUAKER ELECTRONICS . . . . .	136
Hunlock Creek PA	
R & R ELECTRONICS . . . . .	158
Springfield OH	
SELECTRONICS . . . . .	155
Philadelphia PA	
SLEP ELECTRONICS . . . . .	142
Ellenton FL	
SPACE ELECTRONICS . . . . .	148
East Paterson NJ	
SPECTRONICS . . . . .	168
Oak Park IL	
TALLEN CO. . . . .	151
Brooklyn NY	
TOWER COMMUNICATIONS . . . . .	150
Racine WI	
TRI RIO ELECTRONICS . . . . .	160
LaCrosse WI	

### 5 LEVEL TAPE READER

Made for teletype use but we have been advised they are just as useful for other methods of data transmission when tied in with computers. Removed from used equipment. Last time offered, they sold out in one advertising.  
TAPE READER .. \$15.00

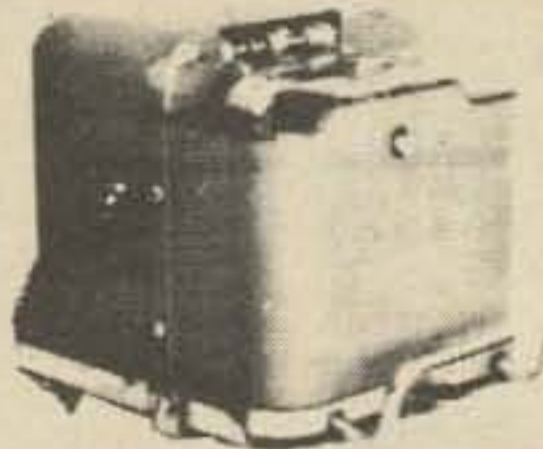

### FT-243 CRYSTALS \$1.00

Gov't surplus, each guaranteed. Range of 5675 thru 8650 kc in 25 kc steps. Such as 5675-5700-5725, etc. Take your pick at \$1.00 each.

### FOUR 2-INPUT "AND" GATES "OR'D" TOGETHER, BUFFERED & INVERTED

Dual inline package ..... #AAAB3 \$1.75

### SYNCHRONOUS RICELESS FLIP-FLOP

May be converted to most any flip-flop mode (R-S, D, J-K, etc.) 4 separate 2-input AND gates, "OR'd" together & fed to universal flip-flop.

Dual inline package ..... #AAFLI \$3.00

### DUAL 4-INPUT GATE W/EMITTER FOLLOWER RESISTORS

Dual inline package ..... #F1116 \$1.00  
12 for \$10.00

### DECODER LAMP DRIVER HIGH CURRENT

Similar to Fairchild SH2001. Dual 2-input gate w/amp. 14 pin dual inline ceramic package.  
..... #SHO-579 \$2.25

### TUBES TUBES TUBES TUBES

Used, guaranteed OK condition.

4X150 ..... \$4.00  
813 ..... 5.00  
6164 ..... 2.00

### 2N706A HI-FREQ. TRANSISTORS

First line factory marked. 400 mc, 15 volt, NPN  
..... #2N706A 3 for \$1.00

### 8000 PIV 50ma DIODE

Small size about the size of 2 watt resistor. Use 'em as scope rectifier, geiger counter supply, photo multiplier, etc. Up-grade your equipment. Made by Paific semiconductor. Actual cost approx. \$30.

\$1.00 each 12/10.00

### TRANSISTOR AUTO RADIOS

Brand new factory packed automobile radios, vintage around 1961. 12 volt neg. ground. No choice of models. The exceptional sensitivity of an auto radio makes it superior for use in car, boat, truck, camper, etc., where you are quite a distance from xmtr location. This is also the best kind of radio to use with short wave converters. Each with large original equipment hi-fi speaker. Some with noise suppressor kit. High quality, most made to sell in the \$100 range. A real "find."  
\$15.00

### CORE-TRANSISTOR LOGIC MODULE

CTR module - digital data storage element used to make shift registers, ring counters, temporary data storage buffers, divide by 10 counter, etc. Unused modules designed w/multiple wound tape magnetic core, transistor delay network, all this in a module about 3/4 inch square. Data with each.

#CTR \$1.50 or 12/\$15.00

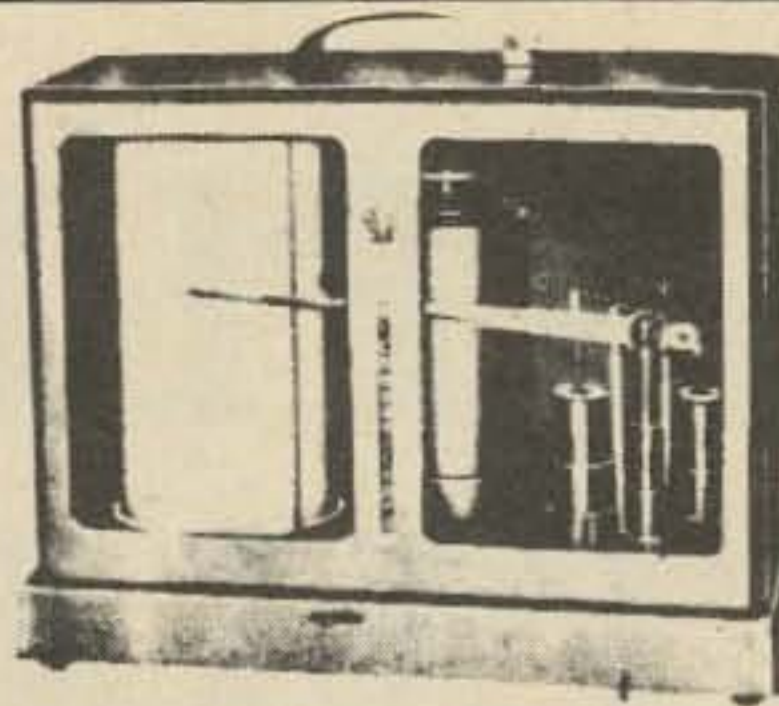

### RECORDING MICRO BAROGRAPH

Surplus U. S. Air Force Bendix-Friez recording barograph. The standard instrument for U. S. Weather Bureau, armed forces,

airlines. Records a full week, powered by a jeweled spring-driven clock mechanism. A valuable instrument for the yachtsman or anyone interested in weather variations. An unusual gift for "the man who has everything." These are checked out, with a year's supply of ink and charts. Should last a lifetime. Gov't. cost \$367.00. Our price \$125.00 plus shipping.

### RADIATION DETECTOR

Original CD issue, like new. Visual meter indication, 3 scales read from 0.01-50 r/hr. Bright yellow plastic case. Sensing element is an air equivalent ionization chamber located within the instrument. With instruction book, carrying strap, less batteries, unchecked. Batteries cost only about \$1.50, easily obtained.

#68-32 \$8.95

### SAPPHIRE ROD

Pure sapphire rod, 1 inch long x 1/16 diameter polished each end and sides. Cuts glass, used for bearings, end-window for UV or IR, etc.

\$1.25 each

### IBM WIRED MEMORY FRAMES

Removed from high priced computers. ExInt condition.

640 Wired Core Plane	\$ 5.00
4,000 Wired Core Plane	\$ 9.00
4,096 Wired Core Plane	\$12.50
8,000 Wired Core Plane	\$13.50
8,192 Wired Core Plane	\$15.00
16,384 Wired Core Plane	\$19.00

### INTEGRATED CIRCUITS

926	Hi-Speed flip-flop (TO-5)	\$1.50
900	Buffer	1.00
910	Dual 2-input NOR	1.00
2-903	Dual input gate	1.00
914	Dual 2-input gate	1.00
914-925	Dual 2-input gate dual expander	1.00
923	JK flip flop	1.00
925	Dual 2-input gate exp	1.00
946	DTL 4 2-input NAND/NOR gate	2/1.00
	DTL Clocked flip flop	2/1.00
1M5	Dual 4-input logic gate	2/1.00
7M6	6 NPN transistors in one package, gen use	3/1.00
12M2	Diff Amp	1.00
711	Dual Comp Amp	2.00

Above equipment on hand, ready to ship. Terms net cash, f.o.b. Lynn, Mass. Many other unusual pieces of military surplus electronic equipment are described in our catalog.

Send 25¢ for Catalog #70

## JOHN MESHNA JR.

19 ALLERTON ST., LYNN, MASS. 01904  
P. O. BOX 62, E. LYNN, MASS. 01904

## ARC-5 REVIVAL

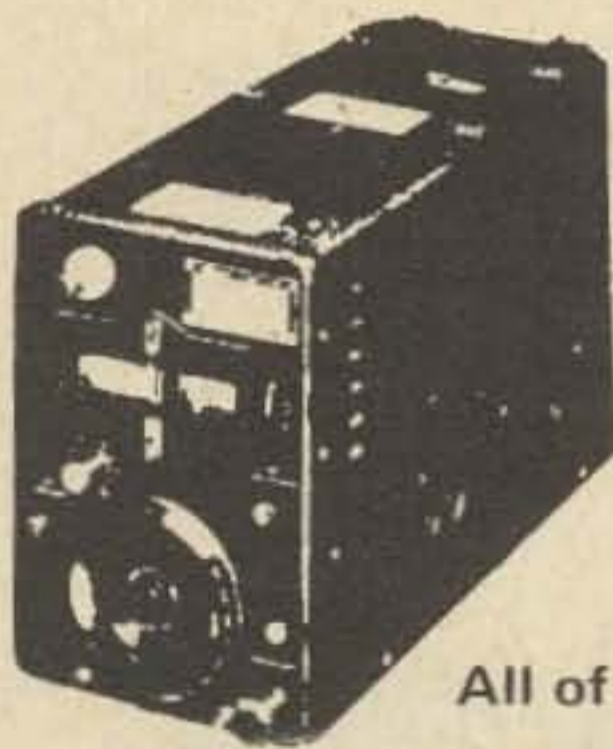

Transmitter:	
3-4 mc	\$17.00 recond.
4-5.3	15.00 new
5.3-7	15.00 new
7-9	17.00 recond.
Receiver:	
190-550	17.00 recond.
3-4	17.00 recond.
6-9	17.00 recond.

All of the above w/conv. sheets.

## HAMMARLUND APC CAPS

Midget style, brand new, 4.5-100 mmfd. .... 3/\$1.00 12/\$3.00



## APC GRAB BAG



Unused assortment of various sizes and styles. Thousands on hand & bargain priced.

5/\$1.00 30/\$5.00

## TOROIDAL CORES

Insulated powdered iron core about the size of 25¢ piece. Very low inductance, hi-freq. Wind your own transistor xmtrs.

#A-70 5/\$1.00 30/\$5.00

## RF FERRITE CORE CHOKE

Hi-permeability, ultra midget style, coated for moisture resistance, color coded. Used in xmtrs, receivers, converters, TV-peaking. Brand new, worth 40¢ each. Assortment of 1.8, 27.0, 330 uh. Pack of 30, \$12.00 value.

#A-71 30/\$1.00 180/\$5.00



## TRANSISTOR MOUNTING PADS

Round fibre glass insulating pads, used under 3 legged TO-5, TO-18, etc. Raises and insulates transistors from PC board. Permits longer leads to be used with less danger of heat destruction. Adds professional touch to finished circuits. Bag of 50 pre-drilled pads.

#A-3 50/\$1.00 300/\$5.00

## SILVER MICAS



Misc. assortment of CM type small silver micas. Supply varies & will give a mix of available on-hand stock. Unused, long leads, standard codes stamped on each.

#A-4 30/\$1.00 180/\$5.00

## 2 METER ARC-3

Just uncovered a batch of the famous ARC-3 rcvrs & xmtrs with all tubes. Range 100-156 mc, 8 xtl channels. Cheap way to get on 2 meters, CD nets, MARS nets, etc. With conversion details. Rcvr \$15, Xmtr \$15;

both units \$25.00

## PHOTOFLASH TRIGGER XMFR

Thordarson #22R44 brand new, produces 15KV pulse. With spec. sheets.

#22R44 \$1.75 each 10/\$15.00

## FIBRE OPTICS KITS WITH IMAGE TRANSMITTER

An experimenters delight, fantastic display of the unique properties of clad-fibre-optics to pipe light as well as images. Kit #1 includes PVC sheathed bundle of glass fibres with polished ends (light pipe), bundle of plastic fibre optics, bundle of glass fibres, coherent light pipe (transmits images), instructions & experiments.

BLISS-FULL PAK #1 \$5.00

Kit # 2 includes all of the above but more fibres, longer lengths, fatter bundles and also includes light source, heat shrink tubing, a 5 ft. light pipe, a longer coherent bundle (image transmitter) & more experiments.

BLISS-FULL PAK #2 \$10.00

## FLEXIBLE FIBER-OPTICS LIGHT GUIDES



## FIBRE OPTIC LIGHT PIPE

1 ft length jacketed glass fibres (200 fibres) each end sealed and optically polished for maximum light conduction. Pipe light around corners, into difficult locations, etc.

#LP-1 \$1.00

## BULK LIGHT PIPE

3 feet of fibre glass (200 fibres) with jacketing. Make your own light pipes, Christmas tree displays, psychedelic lighting, etc. Any length you wish at 3 feet for \$1.00.

## FIBRE OPTIC OPTICAL SCANNER \$5.00

Photo optics scanner, as used in IBM punch card scanner system. We offer the 12 position optical scanner consisting of 2 ft. assembly light pipe fanning out into a 12 channel scanner. All terminations optically polished. Make your own card scanner, light chopper, etc. A value for the 22 inch light pipe alone. With 4 page evaluation & application data. ....#LP-3 \$5.00

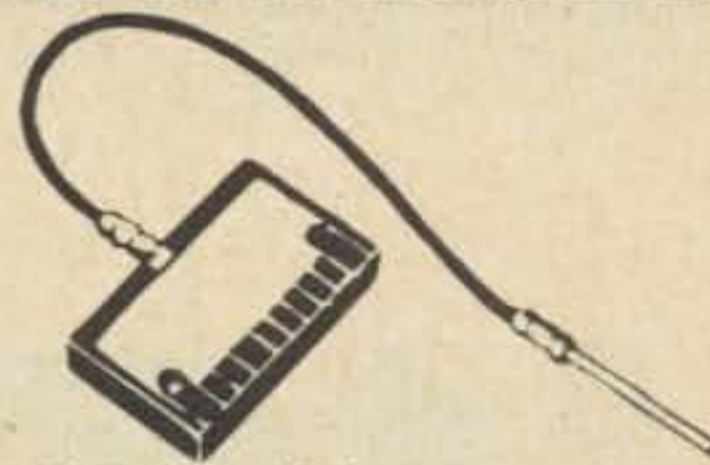

Above equipment on hand, ready to ship. Terms net cash, f.o.b. Lynn, Mass. Many other unusual pieces of military surplus electronic equipment are described in our catalog.

Send 25¢ for catalog #70

## JOHN MESHNA JR.

19 ALLERTON ST., LYNN, MASS. 01904  
P. O. BOX 62, E. LYNN, MASS. 01904

**wow!**

# WORLD'S LARGEST SELECTION OF NEW &

Watch our monthly ads in 73 Magazine for the first opportunity to take advantage of our "Special of the Month" items. Write for your free copies of our 969S1 Flyer featuring TV cameras, lenses, microphones, etc.;

969D1 - Audio consoles, speakers, TV cameras & transmitters and the 970M1 Special Bargains in CCTV & Broadcast TV equipment priced for the amateur's budget.

New Flyer 970J1 - Warehouse Clearance - out Jan. 1st.

**LENSES**  
for VIDICON TV  
CAMERAS

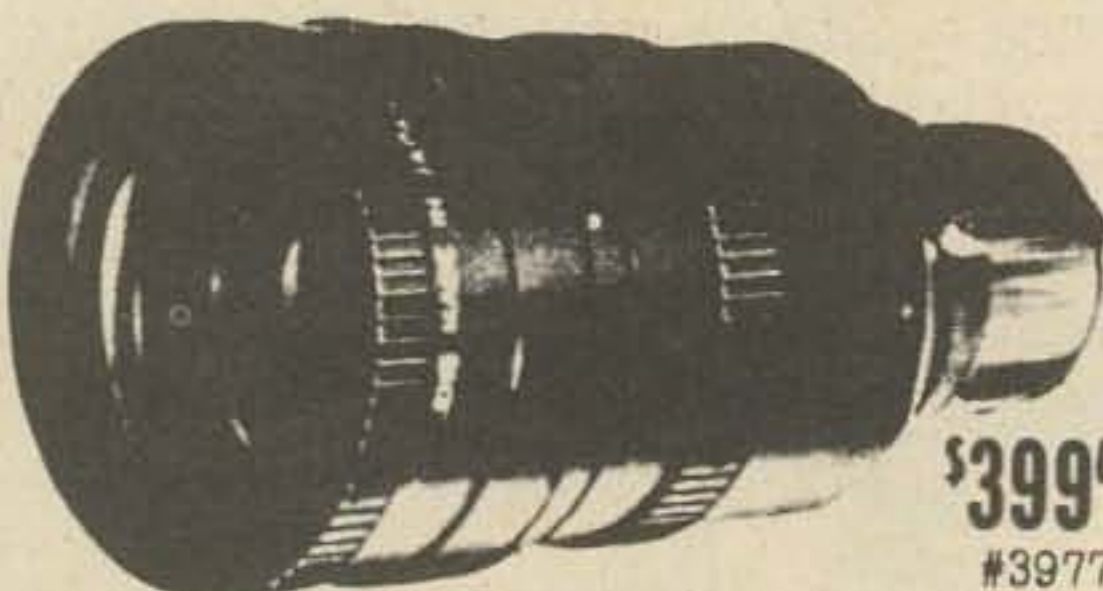

**MANUAL ZOOM LENS**  
FOR  
**INDUSTRIAL TELEVISION**  
CANON ITV ZOOM LENS  
C-16, 25-100 mm, 1:1.8

**\$399.00**  
#3977

An exceptional buy in a first quality new Cannon Zoom lens for your TV or 16mm Camera - Standard "C" mount. . . . . #3977 . . . . . \$399.00  
Excellent condition used lens of same focal range & speed. . . . . #3973 . . . . . \$245.00

(limited quantities on above)

- #3918 - 1" 25mm lens std. "C" mount, adj. iris, fixed focus, speed approx. F2.5 \$12.95
- #3940 - 25mm F1.9 - new - "C" mount lens \$29.95
- #4055 - Special on Cannon type TV-16 1" F1.4 - new \$39.95
- #4065 - Special Value Wide Angle 12.5mm F1.4 \$44.95

## LOW FREQUENCY QUARTZ CRYSTALS

For Your TV Camera 2:1 or E.I.A. Sync Gen



- #4761 31.5 KC \$9.95
- #4762 94.5 KC \$19.95
- #4763 126.0 KC \$19.95
- #4764 15.750 KC \$9.95

## Zoom Lens

**\$9.95**

Allow 50c  
for  
packing &  
shipping



Wollensak F1.8 Raptar  
Zoom lens 9-30mm. No iris.  
Focusing mount 6 ft-inf.  
Ratio 3.3:1. Flat 3 screw  
mounting. Price \$9.95.  
No.3970 "Not 'C' Mount."

#3970

## TV CAMERA TURRETS

No. 19,172-Sylv. brand  
new 4 lens turret 5 3/4" dia.  
w/mounting hole in center  
(1 mounting hole is for-  
ward of the other 3 for  
using close-up lenses) & all  
are threaded for a std.  
16mm "C" lens.  
EXTRA SPECIAL only  
\$7.95 plus postage.  
VIDICON SOCKETS-No.  
2100-brand new - for 1"  
electromag. Vidicons type  
7038, 6198, etc. \$2.95.

ONLY **\$7.95**



**\$14.95**

## 1" VIDICON Magnetic Deflection Yoke

Brand new 1" VIDICON DEFLECTION  
YOKES, either tube - No. 19,168 or transistor  
type No. 1809 (please specify). Complete with  
"How to Build a TV Camera" instructions, etc.  
Only \$14.95 plus post.  
MATCHING FOCUS COIL #19,171 \$19.95  
365 or 85 ohms - Specify.

## VIDEO AMPLIFIERS GPL

**\$14.95**  
Complete

#19,066 Model 5309-21. A brand new chassis complete w/all tubes measuring approximately 9 1/2" L x 5 1/4" W & containing 7 tubes which perform as a complete video amplifier, providing a composite video output to feed a video monitor. An additional tube operates as an oscillator/modulator tuneable from 54 thru 88 mc. These 5.5 mc video amplifiers take all the hard & fussy work out of building your own camera. Use as a video line amplifier, distribution amplifier. RF portion alone may be used as a video Jeep. Wt. 3 lbs.

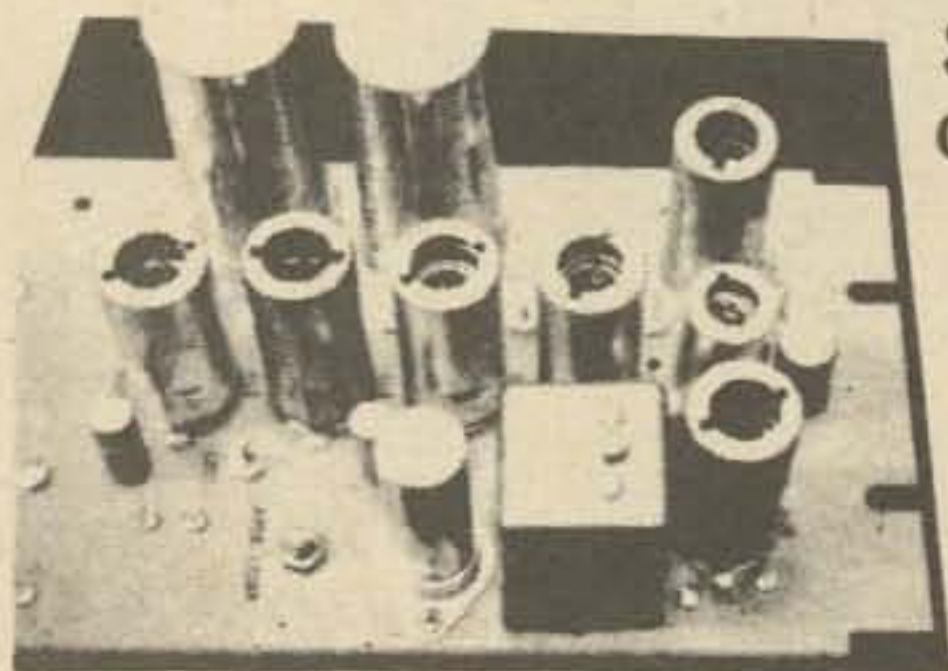

Your check should include transportation charges with your order.  
We issue 5 flyers a year. Write and ask to be put on our mailing list.

The **DENSON ELECTRONIC CORP.**

PO Box 85, Longview St.

Rockville, Conn. 06066 203/875-5198

# USED TV CAMERAS & ASSOC. EQUIPMENT

*wow!*

**RCA**



**TV-EYE**

RCA TV-EYE. See QST Nov. 1962 for Amateur Television Transmitter use. May be wired for Video or RF output. Camera head with control, test vidicon and schematic, less lens. #6130—Used—\$139.95.

**NEW  
SUBMINIATURE**



**CGTV  
CAMERA**

**\$169<sup>95</sup>**  
(less lens)

Free Spec. Sheet 969D2  
Brand new model TK-204 VD-4 TV cameras. Solid state, random scan, 6mc video amplifier, 1V video output composite, 500:1 ALC, 117VAC 60 cycles 10W. 9-1/2"L, 3-3/16"H, 6-13/16"W. Accepts any standard "C" mount lens. Extra Special Value less lens #18,361.....\$169.95

**EXTRA  
SPECIAL!**

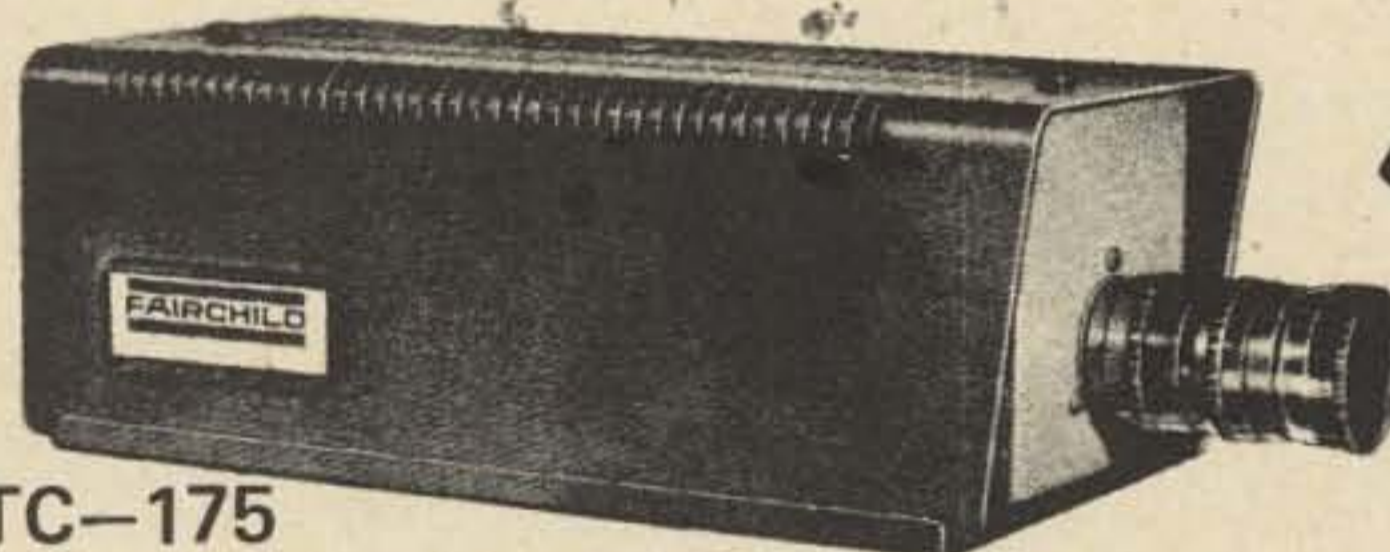

**WOW!**

## FAIRCHILD/DUMONT TC-175

Best Grade Solid State TV Cameras—700 line Resolution—10 ft. Candle Sensitivity. Excellent, like new condition. Complete with Vidicon & schematic. Both Video & rf output. Regular \$1200.00 Net—our SPECIAL \$449.95 less lens. #6129

#20,065 - **GPL 700 CAMERA SYSTEM** - self-contained, highly reliable, transistorized (solid state) TV camera designed for continuous duty under rugged conditions. Lightweight. Fully automatic - simple to operate, with rear controls - including On-Off switch, Beam Target, and electrical Focus. All controls, plus all accessories may be remotely operated. Ideal for unattended installations. 5000:1 light level compensation. Minimum 700 lines horizontal resolution. Multiple scan-rate capability. An exceptional value in a GPL model 700 TV camera. Complete solid-state (except vidicon); 2:1 interlaced sync generator; internal power supply 115V 60 cycles. Used, but completely reconditioned and in excellent operating condition. Complete with grade A vidicon, less lens. Extra Special \$495.00 each.

#20,051 Same camera as described above except with crystal controlled oscillator board making camera ideal for variable scan, slow scan, and other specialized applications such as external EIA etc. \$449.95 less lens.

#20,052 Same 700 camera adapted for slow scan operation with Westinghouse WX5123 **PERMICON VIDICON** Beautiful operating condition \$1000.00 less lens.

**GE SOLID STATE VIDEO MONITOR** mounted on panel 11"W x 14"H. Low impedance video input with operating control mounted on panel. A terrific value and a beautiful high resolution compact, solid-state monitor with 9" diagonal screen. Only \$149.95. #9139.

Get your copy of our new flyer 970MI

**The DENSON ELECTRONIC CORP.** PO Box 85, Longview St.  
Rockville, Conn 06066 203/875-5198

# COLUMBIA MARCH SPECIALS

## COMMAND Receivers

190-550KC Q-5er Good Condition ..	\$14.95
540-1600KC ARC Type R-22 Commercial, Late Model, Exl. Cond. ....	\$17.50
1.5-3MC Marine Band Like New .....	\$19.95
3-6MC 75 & 80 Meters Like New .....	\$14.95
6-9MC 40 Meters Good Condition ..	\$14.95

## COMMAND Transmitters

2.1-3MC T-18/ARC-5 New .....	\$9.95
3.4MC T-19/ARC-5 Exl. Condition ..	\$8.95
4.5-3MC T-20/ARC-5 Exl. Condition ..	\$5.95
4.5-3MC BC-457 New .....	\$9.95
5.3-7MC BC-458 Good Condition .....	\$5.95
5.3-7MC BC-458 Poor Less Tubes & Xtal For Parts .....	\$1.95
MD-7/ARC-5 Plate Modulator For Above Xmtrs Exl. Condition .....	\$6.95

## COLUMBIA Receiver Specials

BC-348 200-500KC & 1.5-18MC Reconditioned 24V DC .....	100.00
ARB 190-9000KC Good Condition with Control Box .....	24.95
RBS 2-20MC Exl. Condition w/AC Power Supply .....	59.95
R-444/APR-4Y AM & FM Excellent Condition .....	49.95
RBB 600-4000KC Reconditioned 115/1/60 .....	100.00
RBC 4-27MC Reconditioned 115/1/60 .....	100.00
ARC-3 100-156MC 24 Channel Exl. Condition .....	24.95
RAL 300KC-23MC 115/1/60 Good Condition .....	49.95
BC-639 100-156MC Tunable Receiver 115/1/60 Reconditioned .....	99.50

## WANTED

We need all types of military electronic equipment & laboratory test equipment. H.P., Tektronix, etc.

We buy for cash, pay all shipping and insurance. Turn your excess into cash - it may be worth more than you think.

Write or call collect for immediate action.

**DON'T WAIT - DO IT NOW!**

## TELETYPE EQUIPMENT

	Untested	Tested OK
M-15KSR Page Printer w/Keyboard	\$135.00	\$170.00
M-14TD Tape Reader	50.00	75.00
M-14RO Tape Reperforator No Keybrd.	50.00	75.00
M-28KSR Page Printer		600.00
M-28KSR Typing Reperforator w/Keybrd.		600.00

All above units have sinc. motor and will be complete and in good Physical condition as removed from service.

## MX-949/U Tube Tester Adapter

With this late model adapter you can test 9 pin tubes on your I-177 Tube Tester. Excellent condition.. \$9.95

## TELETYPE CONVERTER TERMINAL UNIT

AN/FGC-1 Dual Diversity Audio RTTY Converter can be used with any type receiver. These are new and shipped in factory crates with all spares in. .... \$149.50

## TAMAR 12V MOBILE RF POWER AMPLIFIER

This is a very compact RF Amp. Originally mfg. for light aircraft. Frequency 118-128MC. Easily converted to 2.6 or 11 meters. Has built in transistorized power supply. Uses 1 ea. 6360; 1 ea. OB2, supplied with schematic. Less tubes. Special close-out price, .... \$9.95

## HEADSETS

HS-23 Headset 2000 ohm New .....	\$6.95
HS-33 Headset 600 ohm New .....	6.95
Perma Flux HiFi Headsets w/chammi cushions .....	New 14.95

## BRAND NEW TUBES & SOCKETS

810 Tubes .....	\$14.95
5CP1 C.R.T. ....	4.95
5BP4 C.R.T. ....	4.95
4-1000A Eimac SK-500 Airflow Socket & SK-506 chimney .....	25.00
4X150A Tubes .....	15.00
4CX250B Tubes .....	20.00
4CX5000A Socket by Eimac SK-300 .....	50.00

ALL PRICES F.O.B. LOS ANGELES, CALIF.

## COLUMBIA ELECTRONIC SALES, INC.

4365 W. Pico Boulevard • Los Angeles, Calif. 90019

Telephone (213) 938-3731



# COLUMBIA MARCH SPECIALS

## TEST EQUIPMENT SPECIALS

All in excellent condition, recently calibrated by N.B.S. approved standards labs and supplied with calibration certificate.

HP 201C Audio Oscillator	150.00
HP 205A Audio Oscillator	250.00
HP 205AG Audio Oscillator	275.00
HP 400D VTVM	150.00
HP 400DR VTVM	130.00
HP 400H VTVM	200.00
HP 400HR VTVM	200.00
HP 400AB VTVM	125.00
HP 410B VTVM	175.00
HP 430C Microwave Power Meter	150.00
HP 430CR Microwave Power Meter	150.00
HP 415C SWR Meter	250.00
HP 524D Counter	750.00
HP 525A Converter 10-100 mc	150.00
HP 525B Converter 100-220 mc	150.00
HP 686A Sweep Osc. 2.8-12.4 kmc	500.00
HP 686C Sweep Osc. 8.2-12.4 kmc	500.00
HP 683C Sweep Osc. 2-4 kmc	500.00
HP 684C Sweep Osc. 4-8 kmc	500.00
HP 211A Sq. Wave Generator	200.00
HP 212A Pulse Generator	250.00
HP-614A Signal Generator	\$1,000.00
HP-616B Signal Generator	800.00
HP-618B Signal Generator	1,000.00
Measurements 65B Signal Generator	500.00
SG-1A/ARN Signal Generator with PP-348 Power Supply	1,295.00
Boonton 212A Glide Slope Test Set Adapter for SG-1A/ARN	250.00
ARC H-14A VOR Signal Generator	1,250.00
Tektronix 531 Oscilloscope	500.00
Tektronix 533 Oscilloscope	600.00
Tektronix 535A Oscilloscope	750.00
Tektronix 513D Oscilloscope	350.00
HP-160B Oscilloscope w/2 plug-ins	600.00
HP-170A Oscilloscope w/2 plug-ins	700.00
HP-150A Oscilloscope w/2 plug-ins	450.00
HP-175A Oscilloscope w/2 plug-ins	800.00
HP-130A Oscilloscope	300.00
HP-130B Oscilloscope	350.00
HP 200CD Audio Oscillator	165.00
HP 200AB Audio Oscillator	145.00

## 30MC OUTPUT TUNABLE CONVERTERS

CV-253/ALR 38-1000MC New Late Model BRAND NEW	\$195.00
TN-1/APR-1 38-90MC Exl. Condition	24.95
TN-3/APR-1 300-1000MC Exl. Cond.	24.95
TN-18/APR-4 300-1000MC Exl. Cond	49.50
TN-19/APR-4 2000-4000MC Exl. Late Model	49.50
TN-54/APR-4 2000-4000MC Exl. Con.	99.50

## ARNOLD MAGNETICS TRANSISTORIZED POWER SUPPLIES

Model 838 input 12V DC; output  
400V DC @ 100MA. New .... \$19.95  
Model 834 input 6V DC; output  
150V DC @ 130MA. New .... \$ 9.95  
SIZE: 4½" x 3½" x 2" in  
enclosed metal case. These units  
had a retail price of \$49.50

CV-89A/URA-8A RTTY Audio Type  
Terminal Unit. Good condition, less  
cabinet ..... \$125.00

## IP-69/ALA-2 PANADAPTER

This compact unit can be used with most  
Ham Receivers after conversion. Complete  
with conversion info and schematic. Like  
new condition ..... \$24.95

## MAYDAY \* URGENTLY WANTED

Top prices for AN/SGC-1, 1A Navy Teletype Terminals;  
AN/SPA-4A, 4B Navy Radar Repeaters.

Call collect for top offer. .... 213-938-3731

## TRANSMITTERS & TRANSCEIVERS

T-47/ART-13 2-18Mc transmitter Less tubes—Good Condition	\$24.95
T-47/ART-13 with tubes Exl. Condition Condition	49.95
BC-669 Transceiver 1.7-4.4Mc Exl. Good Condition	99.50
RT-18/ARC-1 transceiver 100-156Mc Condition	39.95
ARC-3 transmitter 24 channel 100- 156Mc Exl. Condition	24.95

## BRAND NEW NICAD BATTERIES

Gulton KO-13 1.2 volt 13 amp hrs. Size:  
2¾" wide x 1¼" deep x 4¾" high. Clear  
nylon case. Shipped with self contained  
electrolite. Brand new in factory sealed  
cartons ... \$3.95 ea. .... 10 for \$35.00

ALL PRICES F.O.B. LOS ANGELES, CALIF.

## COLUMBIA ELECTRONIC SALES, INC.

4365 W. Pico Boulevard • Los Angeles, Calif. 90019  
Telephone (213) 938-3731

# LOWEST QUARTZ CRYSTAL

LOW, MEDIUM, AND HIGH FREQUENCY QUARTZ TRANSMITTING CRYSTALS. Also for general purpose applications. Immediate delivery on all below listed crystal units. All crystals are checked for frequency and activity before shipment and guaranteed 30 days from shipment.

When ordering, be sure to give 2nd choice where possible. Payment in full must accompany each order. No COD's. We refund extra monies.

The following listed crystals are low frequency units in the KOLDWELD SEALED TYPE HOLDERS. This group of crystals are hermetically sealed by a koldweld process without heat or flux, to minimize contamination. These crystal units have improved aging and reliability. The holder is a flat pack type with 1/8" pins. These were used in computer applications and mounted on printed circuit boards. Can be easily adapted for other types of mounting. All crystals are brand new. ONLY \$2.50 each postpaid USA.

Available are,  
3.640 Kc 4.400 Kc 5.824 Kc 20.00 Kc

Same as above only price is \$1.05 each postpaid.  
625.00 Kc 1.49600 Kc

LOW FREQUENCY CRYSTALS in hermetically sealed HC-13 or HC-6 type holders with 2 1/2" wire leads. ONLY \$2.50 each postpaid. Frequency listed in kilocycles.

4.0457 16.000 64.000 96.000  
32.000 75.000 128.000

Same type as above, the price is \$1.05 each postpaid.

215.50 216.50 217.50 240.00  
300.00 505.00 530.00 667.00

LOW FREQUENCY CRYSTALS in HC-13 or HC-6 type holders with standard .050 pins and .486" spacing. Crystals listed below sell at \$2.50 ea. postpaid USA. Frequency listed in kilocycles.

25.160 27.900 29.100 48.825  
53.125 54.000 56.000 56.175  
58.000 63.000 66.500 70.000  
81.950 120.000

Same crystals and holders as above only the price is \$1.05 ea. pp. Frequency listed in Kcs.

155.00	200.00	201.87	204.80	216.5	236.0	240.0	268.0
276.00	292.00	300.00	308.00	316.00	324.0	327.8	332.0
335.00	373.00	340.00	348.00	356.00	364.0	372.0	388.0
396.00	400.00	425.70	452.50	500.00	667.0		
767.708	1280.00	1283.00	1370.00	1400.00	1496.00	1843.750	
1875.00	1892.50	1904.125	2112.50	2127.95	2163.75	2165.875	
2176.50	2217.938	2238.500	2243.50	2258.00	2261.00	2302.500	
2387.250	2388.00	2436.00	2437.50	2468.75	2500.00	2513.750	
2600.00	2643.25	2723.00	2725.00	2740.00	2807.20	2811.000	
2827.00	2831.00	2931.00	2935.00	3000.00	3050.00	3112.500	
3134.00	3173.50	3207.50	3243.00	3258.625	3276.125	3369.00	
3455.00	3650.00	3691.667	3683.333	3733.333	3754.00	3775.00	
3780.00	4000.00	4085.000	4498.375	4685.000	4731.50	4929.063	
5027.50	5186.50	5680.00	5655.00	5700.00	5820.00	5870.00	
5970.00	5980.00	5910.00	6091.666	6145.00	6145.733	6209.00	
6258.333	6290.00	6320.00	6400.00	6410.00	6516.666	6533.333	
6708.750	6744.444	6938.889	6955.556	7000.00	7172.222	7202.083	
7250.00	7258.333	7286.111	7323.75	7333.333	7368.75	7387.50	
7416.667	7425.00	7458.75	7500.00	7523.750	7633.333	7637.50	
7665.00	7672.50	7693.75	7725.00	7740.00	7744.444	7759.333	
7822.222	7886.25	7887.50	7923.50	7925.00	7955.556	8007.142	
8029.412	8092.50	8091.666	8116.00	8126.25	8137.50	8184.615	
8190.00	8200.00	8207.00	8207.143	8209.412	8214.286	8236.00	
8258.333	8268.75	8295.00	8350.00	8311.111	8317.860	8364.00	
8364.286	8387.50	8392.00	8415.00	8449.091	8452.000	8476.00	
8485.714	8492.308	8500.00	8547.642	8550.000	8547.642	8564.286	
8587.50	8590.00	8600.00	8612.727	8650.00	8777.778	8786.111	
8786.25	8797.50	8820.00	8865.00	8876.25	8921.250	8955.00	
8956.00	9000.00	9050.00	9112.50	9333.333	9350.00	9405.00	
9500.00	9666.667	9888.89	9927.222	9975.000			

WHEN ORDERING YOU MUST INCLUDE PAYMENT IN FULL. If you send cash I can not be responsible if it does not arrive or is missing from the letter.



P.O. BOX 215

HUNLOCK CREEK, PENNSYLVANIA 18656

717-256-3477

LOW FREQUENCY CRYSTALS in HC-13 or HC-6 type holders. Frequency given in Mcs. \$1.05 ea.

10.02100	10.38889	10.47222	10.58889	10.097220	10.588889
10.60500	10.66666	11.33333	11.39000	12.50000	13.0000
13.3000	14.0000	14.4600	14.65730	15.1500	15.3500
15.5000	15.9500	16.3500	16.3900	16.5050	16.52778
16.527788	16.8000	17.0000	18.0060	18.8000	18.81250
19.73333	20.07778	20.10000	20.977780	21.0000	21.4000
21.57778	21.73333	22.40000	23.0060	23.1730	23.4900
23.71111	24.1000	24.28889	24.84444	24.9000	25.0060
25.86667	26.0060	26.2000	26.42222	27.49583	27.51528
27.56540	27.6500	27.69076	27.86667	28.0000	28.33333
28.46667	28.73333	28.81111	29.7000	30.0000	30.57778
31.18889	31.33750	31.35556	31.48889	31.66667	31.88889
32.400	32.4170	32.58300	32.7000	32.7500	32.9000
32.91700	33.0750	33.08300	33.2500	33.52222	33.700
33.900	34.0000	34.4480	35.0000	35.92593	36.22222
36.25926	36.28889	36.29630	36.4000	36.66667	36.66668
36.73333	37.0000	37.18519	37.24500	37.33333	37.5000
37.77778	38.0000	38.14815	38.17778	38.86667	39.0000
39.2000	39.5000	39.518519	39.555556	39.59259	39.66667
39.73333	39.77778	39.9000	39.91700	40.037037	40.25926
40.296300	40.37037	40.407407	40.5185	41.0000	41.03704
41.70833	42.08333	42.12500	42.22222	42.59259	42.9000
42.91670	42.94000	43.0000	43.1000	43.12500	43.5000
43.58333	43.7000	43.66667	43.7500	43.83333	43.9000
44.29167	44.45833	44.5000	44.63333	44.7000	44.79167
44.91666	45.0000	45.04167	45.30000	45.37500	45.5000
45.62500	45.66667	45.7000	45.83333	45.87500	45.95833
46.10000	46.12500	46.27500	46.3000	46.33333	46.5000
46.54167	46.7000	46.91667	47.0000	47.12500	47.2500
47.3000	47.5000	47.58333	47.7000	47.8333	47.87500
47.88750	47.9000	48.0000	48.16667	48.2500	48.3000
48.5000	48.7000	48.83333	48.9000	49.1000	49.2500
49.5000	49.58333	49.83333	50.0000	50.1000	50.16666
50.16667	50.5000	50.54167	50.7000	52.22222	53.25000
55.8000	57.4000	58.7500	59.6000	61.5699	63.5700
64.30250	65.2500	65.6000	66.0060	66.77420	67.83300
68.05500	69.6000	71.23700	71.6000	75.0000	77.0000
77.833	78.7500	79.58333	80.41666	81.16666	81.2500
82.08333	82.5000	82.66700	82.91666	83.7500	84.58333
85.41666	86.2500	87.38095			

Pins can be furnished making this able to plug into FT-243 socket or stand octal tube socket. Pins are .093" type. They are 15¢ ea.

CRYSTALS IN HERMETICALLY SEALED HC-18/U SUB-MINIATURE TYPE HOLDERS WITH 1 1/2" WIRE LEADS. Ideal where space is limited or units have to be small. Crystals sell at \$1.05 each postpaid USA. Frequency listed in megacycles.

10.03560	10.11250	10.14750	10.15000	10.22500	10.26000
10.48500	10.76500	10.63500	10.9000	10.93500	16.50000
16.95000	17.05000	17.15000	17.25000	17.35000	17.45000
17.50000	17.55000	17.65000	17.75000	17.85000	28.50000
36.05000	36.10000	36.15000	36.25000	36.30000	36.35000
36.40000	36.45000	36.50000	36.55000	36.60000	36.65000
36.70000	36.75000	36.80000	36.85000	36.95000	40.00000
40.35000	46.95000	47.05000	47.25000	47.35000	47.45000
47.55000	47.65000	47.75000	52.50	53.007	64.992
					81.4000

Same crystals as above and same price. These crystals have standard .039" pins.

12.25000 13.35163 17.75391  
17.87109 17.83203 33.58500  
34.08500 38.08500 56.17500

Same type crystal and holder as above except pins are 1/16" long. Adaptable for any purpose. SPECIAL PRICE 55¢ each ppd.

38.592593 39.481481 40.222222  
41.666667 39.037037

# PRICES IN THE U.S.A.!!

CITIZENS BAND or GENERAL USAGE CRYSTALS IN HERMETICALLY SEALED HC-6/U TYPE HOLDERS. Crystals exceed FCC tolerances. All crystals are new & double checked before shipment. Fully guaranteed. The frequency will be listed below in kilocycles. OUR PRICE IS THE LOWEST IN USA. Crystals sell for \$1.05 each postpaid USA.

Available are:

13255.000	13260.000	13265.000	13275.000	13280.000
13285.000	13290.000	13300.000	13305.000	13310.000
13315.000	13325.000	13330.000	13335.000	13340.000
13350.000	13355.000	13360.000	13365.000	13375.000
13380.000	13385.000	13400.000		

The following listed crystals are in sub-miniature HC-18/U hermetically sealed holders. Used in CB Walkie Talkies and some base sets. Crystals exceed FCC tolerances and are fully guaranteed. OUR PRICE IS A LOW \$1.05 each postpaid. Frequency in Mcs.

26.965	26.975	27.005	27.015	27.025	27.035	27.055
27.065	27.075	27.085	27.105	27.115	27.125	27.135
27.155	27.175	27.185	27.205	27.215	27.225	27.255
28.665	28.685	28.735	28.765	28.835	28.845	28.865

The above listed CB crystals in HC-18/U and HC-6/U holders have the standard pins used by all CB crystals.

FT-243 CRYSTALS. Misc. frequencies. Crystals have a tolerance of .05% Pin size .093." Pin spacing .486." All crystals double checked for activity and frequency before shipment. Fully guaranteed. OUR VERY LOW PRICE IS 55¢ each postpaid USA. Minimum acceptable order is \$3.00. Frequency listed in kilocycles.

1900	1905	1910	1915	1920	1925	1930	1935	1940	1945	2895	2915	2925	2935	2945	2965	2975	2985	2990	2995
1950	1955	1960	1965	1970	1975	1980	1985	1990	1995	3025	3035	3040	3055	3060	3070	3075	3095	3105	3110
2005	2010	2015	2020	2030	2035	2040	2050	2055	2060	3115	3125	3130	3135	3140	3145	3150	3155	3160	3165
2065	2070	2075	2080	2085	2090	2095	2100	2105	2110	3510	4300								
1115	2120	2125	2130	2135	2140	2145	2150	2155	2160										
2165	2170	2175	2180	2185	2190	2195	2200	2210	2220										
2225	2230	2240	2245	2250	2255	2260	2265	2270	2275	5675	5700	5720	5725	5750	5775	5800	5825	5840	5850
2280	2285	2295	2300	2305	2310	2315	2320	2325	2330	5875	5900	5925	5950	5975	6000	6025	6050	6075	6100
2335	2340	2345	2350	2355	2360	2365	2370	2375	2380	6125	6150	6175	6180	6200	6225	6250	6275	6300	6325
2385	2390	2395	2400	2405	2410	2415	2420	2425	2430	6340	6350	6375	6400	6425	6450	6475	6500	6525	6550
2440	2445	2450	2460	2465	2470	2475	2480	2485	2490	6575	6600	6625	6650	6675	6677.77		6700	6725	6750
2495	2500	2505	2510	2515	2520	2525	2530	2535	2540	6775	6800	6825	6850	6875	6900	6925	6950	6975	7225
2545	2550	2555	2560	2565	2570	2575	2580	2585	2590	7250	7275	7300	7325	7350	7375	7400	7425	7450	7460
2595	2600	2605	2610	2615	2620	2625	2630	2635	2640	7475	7500	7525	7550	7575	7600	7625	7650	7675	7700
2645	2650	2655	2660	2665	2670	2675	2680	2685	2690	7725	7750	7760	7775	7800	7825	7850	7875	7900	7925
2695	2700	2705	2710	2715	2720	2725	2730	2735	2740	7950	7975	8032	8064	8225	8235	8250	8275	8300	8325
2745	2750	2780	2785	2790	2795	2815	2830	2835	2840	8350	8375	8400	8420	8425	8450	8475	8500	8525	8550
2845	2850	2855	2860	2865	2870	2875	2880	2885	2890	8523.7		8560	8575	8600	8620	8625	8650	8670	

## QUANTITY DISCOUNTS ON CRYSTALS ONLY

\$ 5.01 to \$ 9.99 Deduct 10%

\$ 5.01 to \$ 9.99 Deduct 10%

\$10.01 to \$19.99 Deduct 20%

\$20.01 and up Deduct 30%

This applies only when payment in full accompanies order.

10 PAGE CRYSTAL CATALOG AVAILABLE on  
COMPLETE CRYSTAL INVENTORY for 15¢.

All orders shipped postpaid except where indicated. Minimum acceptable order on crystals is \$3.00. On electronic parts minimum is \$5.00. You may combine the two; however include postage for electronic parts when you do. All orders will be shipped UPS when and where practical.



P.O. BOX 215

HUNLOCK CREEK, PENNSYLVANIA 18656

717-256-3477

# We are the WORLD'S LARGEST SUPPLIER of Military Technical Manuals on Electronic Equipment

... SEND US YOUR REQUESTS

**LOW FREQUENCY CRYSTALS IN FT-241-A TYPE HOLDERS.** Same pin base as FT-243. Ideal for SSB lattice filters, low frequency broadcast stations, marker frequencies and ect. I am closing out this crystal line to make room for more overtone type units. OUR SPECIAL PRICE IS NOW 10 crystals for \$1.25. Minimum acceptable order combined is \$3.00. Crystals checked for activity and guaranteed to oscillate. Frequencies listed below in kilocycles.

370.370	372.222	374.074	375.926	377.778	379.630	381.481
383.333	385.185	387.037	388.889	390.741	392.593	394.444
396.296	398.148	400.000	401.852	403.704	405.556	407.407
409.259	411.111	412.963	414.815	416.667	418.519	420.370
422.222	424.074	425.926	427.778	429.630	431.481	433.333
435.185	437.037	438.889	440.741	442.593	462.963	464.815
466.667	468.519	470.370	472.222	474.074	475.926	477.778
479.630	481.481	483.333	485.185	487.037	488.889	490.741
492.593	494.444	496.296	498.148	501.852	503.704	505.556
507.407	509.259	511.111	512.963	514.815	516.667	

Same crystals as above, however these crystals sell at 3 for \$1.00.

444.444	446.296	448.148	450.000	457.407	459.259	461.111
---------	---------	---------	---------	---------	---------	---------

## CRYSTAL SOCKETS

Socket for FT-243 type crystal.	(Single)	15¢
" " " " "	(Dual )	25¢
" " " " "	(Five position)	35¢
" " HC-6/U " "	(Single)	15¢
" " " " "	(10-position)	\$1.50
" " " " "	(18-position)	\$2.50

THE FOLLOWING LISTED CRYSTALS ARE IN ODD HOLDERS. We will in the near future have literature showing pictures of all types of holders and their dimensions. If you would like one, send 6¢ stamp for same.

100 Kc crystal in FT-249 holder only \$2.00 each postpaid.

470 Kc crystal in DC9 holder only \$1.05 each. (Used in BC-312 & 342 Rcvr.)

200 Kc in FT-241-A holder ONLY 50¢ each (Limited quantity).

*When ordering, be sure to give 2nd choice where possible. Payment in full must accompany each order. No COD's. We refund extra monies.*

*Due to sickness and other problems, my 200 page catalog will not be ready for 3 months. The cost of this catalog and reference will be \$1.00, refundable your first order. To those who have sent me catalog money, I still have it and if you desire a refund, write.*

## CRYSTAL OVENS

High quality instrument crystal oven. 115 VAC 60-1000 CPS. 75 Deg C; 45 watts. Plugs into standard 8-pin type socket. Size is: 4" H x 1 1/4" L x 1 1/2" W. ONLY \$2.50 each ppd.

The above oven accepts one HC-6/U type crystal. It comes with a 257.280 Kc crystal inserted in oven which can be removed. The oven also has an adjusting trimmer so crystal can be zeroed in.

Bliley Type TCO-1 oven. Operates on 6.3 VAC 60 CY; 75 Deg C. Accepts one HC-6/U type crystal. Plugs into standard 8-pin tube socket and is the size of a 6SN7 tube. ONLY \$1.50 ea. ppd.

THE ABOVE LISTED CRYSTAL OVENS ARE BRAND NEW.



P.O. BOX 215

HUNLOCK CREEK, PENNSYLVANIA 18656

717-256-3477

# PEP

## THE 16 BIT MEMORY CELL



14 LEAD  
DUAL IN-LINE PKG

### APPLICATIONS

64 Bit Serial Memory.  
64 Bit Serial Memory with Rail Input and NRZ Output.  
64 Word N-Bit Memory (using 4 memories).

**\$4.25**

The Memory Cell is a bit oriented device, organized as 16 words one bit wide. The device is partitioned into four major functional areas: Data Bus, Storage, Sensing and Writing. The storage consists of 16 two transistor flip-flops arranged in a 4 x 4 matrix, for address selection, which provides non-destructive readout bit storage and destructive read-in. Two sense amplifiers with open collector outputs (tied to Vcc through external resistors) are incorporated to provide double rail outputs and an ORing capability for expansion to a larger word capacity. Separate inverters provide individual control for writing zeros and ones into the storage flip-flops. By using common data buses between each side of the flip-flops, the sense amplifiers and the write inverters, fast reading and writing rates can be implemented into large memory systems.

## RADIATION FREE TUBE FOR COLOR TV



HIGH VOLTAGE • SOLID STATE  
FAST-RECOVERY RECTIFIER

In a time when mankind lives with the constant fear of Nuclear Warfare, it has been discovered that dangerous radiation may be present as close as in your own living room. A recent survey conducted by the county health department of New York State has revealed that approximately twenty per cent of the color television sets studied were emitting radiation in excess of the minimum levels recommended by the National Council on Radiation Protection and Measurement.

**\$10.00**

50,000 Volts. Replaces RCA 3A-3A or equivalent. Guaranteed for life of set or 5 years. Eliminates heat to prolong life of other tubes.

PLASTIC CASE IC's	FIRST LINE UNITS
Quadruple 2 - Input Nand Gate	\$ 1.50
Master Slave Flip-Flop Logic	1.75
Dual 4 - Input Positive Nand Gate	1.50
Dual 4 - Input Positive Nand Buffer	1.50
4 Wide 2 - Input And-or-Invert Gate	1.50
Dual 2 Wide - Input And-or-Invert Gate	1.50

## IC's

dual 4 - input nand gate

**\$1.50**

V<sub>cc</sub> = + 4.5 to 5.5 volts (5.0V. recommended)  
Input signal: '0' level = 0 to 1.0 Volts  
'1' level = 2.0 to 4.5 Volts  
Output signal: '0' level = .3 Volt, Typical  
'1' level = 3.5 Volt, Typical

9 201

This unit is a fast switching-speed, TTL (Transistor Transistor Logic) dual NAND gate which has a wide range of applications in digital control and computer systems. Each gate in the package operates independently, the output being at a '1' level if any one or more inputs of that gate are at a '0' level. The output is a '0' level if all inputs of the gate are at a '1' level. An open input acts like a '1' input.

## IC'S LINEAR OR AMP



**\$1.75! — 709c**

Glass Pack's

J - K FLIP FLOP -- FF101

The Master-Slave J-K flip-flop is a fast switching-speed TTL (Transistor Transistor Logic) circuit which provides the capability of storing or remembering digital information which has been entered into it, either in a synchronous (commanded by the clock input) or asynchronous (independent of clock) manner. It provides raceless operation with a single-phase clock source. Input data is gated into the "master" toggle element while the clock is at a '0' level. When the clock is brought to a '1' level, the input data gates are disabled, and information is transferred to the "slave" toggle element, making it available at the outputs. An internal buffer amplifier is used to reduce the clock input load to one unit load.

This flip-flop finds a wide range of applications in digital control and computers, and will perform such functions as frequency dividing, counting and temporary storage of information.

## PEP LIGHT CONTROL

American Made  
300 Watts - LL-12

Table lamps and other indoor light fixtures plug into this unit which meters the amount of light outside. At dusk, the lamp lights up—and turns off at dawn. Controls up to 300 watts.

**\$4.00**



## PEP DIAL-A-LIGHT

American Made 600 Watts  
LA-600

Perfect home lighting from a candlelight atmosphere to a full 600 watts. Rotary "click" dial regulates initial electricity flow, assuring longer bulb life.

**\$4.00**

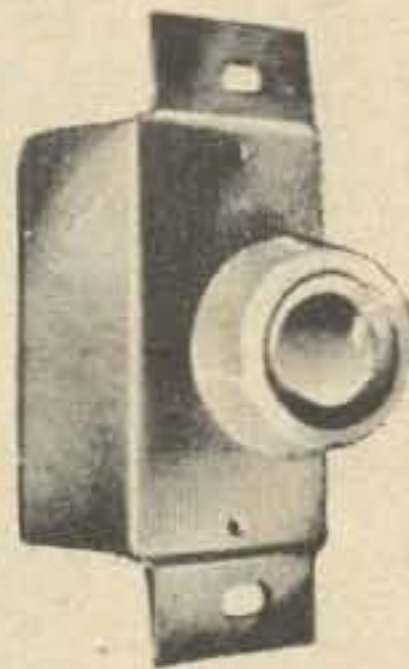

## PEP LIGHT - GUARD

American Made  
300 Watts - LG-5  
Light guardian for entrance, patio, or garage; specifically designed for floodlight as well as conventional outdoor light use. Photoelectric eye turns on lights with 300 watt capacity.

**\$4.00**



LET US TRY TO HELP YOU WITH YOUR ENG. PROBLEMS

## PARK ELECTRONIC PRODUCTS

P.O. Box 78, N. Salem, N.H. 03073

NO SALES TAX—WE PAY POSTAGE

OTHER PRODUCTS ON REQUEST

**LIBERTY  
PAYS**

**MORE!  
WILL BUY  
FOR CASH  
ALL TYPES**

- **ELECTRON TUBES**
- **SEMICONDUCTORS**
- **Military Electronic  
Equipment**
- **Test Equipment**

---

**WIRE, WRITE, PHONE COLLECT! WE PAY FREIGHT ON ALL PURCHASES**

---

**Liberty Electronics, Inc.**

**548 Broadway, New York, New York 10012, Phone 212-925-6000**

**LIBERTY  
OFFERS**

**MORE!**

**PRESTEL FIELD STRENGTH..METER**

**(Model 6T4G)**



Frequency Range: 40 to 230 and 470 to 860 Megahertz. Calibrated outword from 10 to 50,000 Microvolts. Nothing makes it easier to properly and speedily find the correct place to install TV, FM and Communication Antennas. You can measure and hear the signals

with this 4½ volt battery economically powered unit. There is nothing else like it!

**Only \$120.00**

# EXPERIMENTING IN FACSIMILE? INVESTIGATE

Used and Factory Reconditioned

## ALDEN WEATHER MAP RECORDERS



- **MODEL 9137 IN SERVICE 6 TO 12 YEARS**
  - 9137EA** Three speeds (60/90/120 rpm) mechanical shift. Feed rate is 96 lpi. Includes program clock and vacuum tube electronics.
  - Series C** Two speeds (60/120 rpm) electric shift. Feed rate is 96 lpi. Includes program clock and vacuum tube electronics.
- **MODEL 9217 IN SERVICE 5 TO 6 YEARS**

Two speeds (60/120 rpm) electric shift. (Some have 3 speeds with mechanical shifting 60/90/120 rpm). Feed rate is 48/96 lpi or 96 lpi depending on availability. Includes program clock and vacuum tube electronics.
- **MODEL 9244 IN SERVICE 1 TO 4 YEARS**

Two speeds (120/240 rpm) electric shift. Feed rate is 96 lpi. Includes program clock, storage area and vacuum tube electronics.
- **MODEL 9244T (PRESENT PRODUCTION MODEL)**

Two speeds (120/240 rpm). Feed rate is 96 lpi. Completely transistorized, includes storage area. Program clock is extra.

The leading manufacturer of 18" facsimile weather chart recorders is in the process of converting an existing network for fully automated weather chart transmission. This conversion will make available a number of used 18" weather map recorders ideally suited for use by anyone interested in experimenting with facsimile.

All recorders are in operating condition. They include the recording head, all necessary electronics including automatic start, phase and stop circuits. Operating at speeds of 60, 90, or 120 rpm (depending on model), these recorders with suitable receiver and FSK converter, can be used to monitor radio weather chart broadcasts from stations located around the world or modified to accept press wire photo transmissions or transmissions from orbiting weather satellites.

These recorders are available strictly on a first-come, first-served basis. Call or write:

**Mr. Richard J. Boire, Surplus Equipment Sales**

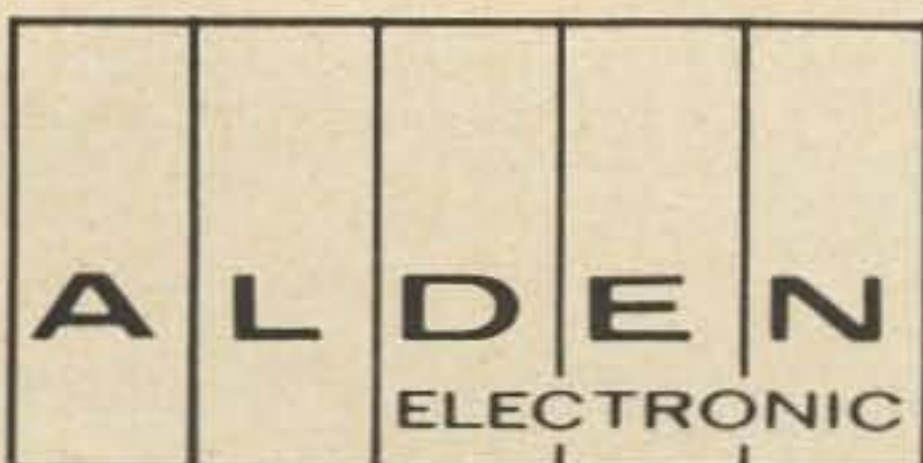

**ALDEN RESEARCH CENTER**

Westboro, Massachusetts 01581 • 617-366-8851

**& IMPULSE RECORDING EQUIPMENT CO. INC.**

● SLEP ELECTRONICS COMPANY ● 2412 North Highway 301 ● Ellenton, Florida 33532 ● (813-722-1843) ●

**Radio Receivers & Transmitters:**

BC-348 Receiver, tunes 200-500kc and 1.5-18mc, 28 vdc, unmodified .....	\$ 65.00
BC-639 VHF Receiver with AC power supply, tunes 100-156mc .....	\$ 65.00
R-444/APR-4Y (ALR-5) Receiver, less plug-in converters, CV-253/ALR or TN plug-ins .....	\$ 37.50
APX-6 Transpondors, famous moonbounce set .....	\$ 18.50
T-47/ART-13 Collins Transmitter, tunes 2-18mhz, 28vdc, still going strong .....	\$ 19.50
T-67/ARC-3 VHF Transmitter, tunes 100-156mhz, 28vdc, popular on 2 meters .....	\$ 18.50
R-77/ARC-3 VHF Receiver, tunes 100-156mhz, 28vdc .....	\$ 18.50
R-5/ARN-7 ADF Receiver, tunes 100-175khz, 115V/400cy & 28vdc, a good VLF receiver .....	\$ 12.50
RUQ Collins VHF Fixed-Tuned receiver, 118-136mhz, single channel, 115V/60cy .....	\$ 19.50
T-23/ARC-5 VHF Transmitter, tunes 100-156mhz, 28vdc, a lot has been written on this one .....	\$ 15.00
BC-645 Transceiver, tunes 460-490mhz, complete with control box, antenna, dynamotor and mount, 12/28vdc input, excellent for conversion to 420mhz ham band .....	\$ 21.50
RT-19/ARC-4 VHF Transceiver, 100-156mhz, 28vdc, good for 2 meter use .....	\$ 15.00
R-19/TRC-1 FM Receiver, 70-100mhz, 115V/60cy, see conversion articles .....	\$ 19.50
Bendix RA-10 RDF Receiver, tunes 150-1100khz & 2-10mhz, use for transmitter hunts .....	\$ 16.50
URC-4 VHF-UHF Emergency Walkie-Talkie, less batteries, good for 2 meter use .....	\$ 18.00
BC-1206 Beacon Receiver, tunes 200-400khz, 24vdc .....	\$ 12.50
BC-733 Receiver, 108-110mhz, 24vdc, a well built set to play with .....	\$ 6.50
TCS-12 Receiver-Transmitter, complete with CMX-46159 receiver, COL-52245 transmitter, COL-21881-A 12vdc dynamotor power supply & COL-20309 115V/60cy power supply, tunes 1.5mhz to 12mhz .....	\$ 69.50
R-81/ARW-20 Receiver set, 28vdc .....	\$ 15.00
AN/DRN-11 Transponder set, has good UHF possibilities .....	\$ 14.00
BC-659 Transceiver, FM, 27-38.9mhz .....	\$ 18.00
IP-69A/ALA-2 Panoramic Indicator, 30mhz IF input, 115V/400cy, see 73 conversion .....	\$ 27.50
RBW-2M Panadaptor, 5.25mhz IF input, 115V/60cy .....	\$ 32.50
R-316/ARR-26 FM Receiver, 162-173mhz, less case .....	\$ 45.00
RT-86/APW-1 Radar Set .....	\$ 18.00
CPR-46ACJ Radar Receiver .....	\$ 20.00
CV-216/URR SSB Converter, requires 200kc IF input, 115V/60cy, goes with Navy receivers .....	\$ 65.00
BC-1032A Panadaptor, 5.25mhz IF input, 115V/60cy .....	\$ 32.50
TBX-5 Transmitter-Receiver Unit, 2-8mhz, less power supply .....	\$ 12.50
RT-157/APN-68 Transponder Set, 214-234mhz, 80&115V/400cy .....	\$ 15.00
ARC R-15 VHF Receivers, tunes 108-135mhz, complete with 28vdc dynamotor .....	\$ 19.50
Collins 17E-2 Transmitter, soon to be a collector's item .....	\$ 12.50
ARN-5 Glideslope receiver, 332-335mhz, 24vdc, has a lot of good components or use it in an aircraft .....	\$ 9.50
Hammarlund SP-600JX-17, tunes 0.54khz to 54mhz, 20 tubes, 19" rackmount receiver with dust cover. The best of all models .....	\$285.00
ARC-1 VHF Transceiver, 100-156mhz, less 832A and 24 volt dynamotor .....	\$ 9.95
BC-1000 Transceiver, 18 tube portable, 40-48mhz, can be converted for 6 meters .....	\$ 14.50
URC-11 Walkie-Talkie, ideal for 220mhz, see May '69 CQ conversion .....	\$ 14.50
Motorola T-416/GR FM transmitter, 152-174mhz, 2 channel, part of VRC-19, 25 watts output, easy to convert for 2 meters .....	\$ 18.50
ARC-2 Transceivers, 2 to 9.050mhz, 30 watts out, superhet receiver, autotone .....	\$ 47.50

**Teletype Equipment:**

Teletype Corp. Model REC-30 power supply .....	\$ 12.00
Northern Type 111 IF Monitor .....	\$ 10.00
Northern Type 105 Frequency Shift Keyer .....	\$ 15.00
Limiter for RSA-1 Frequency Shift Receiver, rackmount .....	\$ 12.00
Model 14AS Tape Printer, Western Union Teletype machine .....	\$ 16.00
C-808/GRC-26A Radio Teletypewriter control .....	\$ 22.00
RA-54-A Teletype Power Supply .....	\$ 17.50
Model 15 KSR Teletype Machine, good condition, synchronous motor .....	\$ 60.00
TT-107B/FG Teletypewriter-Reperforator, 60 or 100WPM, 115V/60cy .....	\$125.00
RA-87 Rectifier Power supply, converts AC to DC for operating teletype line circuits .....	\$ 18.50
CV-57/URR Frequency Shift Converter, use with any 455kc IF receiver, a popular teletype converter .....	\$ 65.00
Radiation, Inc. Model 14-102/103D Teletype Test Set, consisting of 14-200B Tel-A-Scan, TDMS-6EB-R2 Receiver and TBMS-SEB-R-2B Transmitter, used to overhaul late type teletype systems .....	\$175.00

**Radio Part and Associated Equipment:**

Jennings ECS 3-30mmfd, 15KV vacuum variable capacitor, new .....	\$ 17.50
Jennings UCSX 1000, 20-1000mmfd, 12.5KV vacuum variable capacitor, new .....	\$ 24.50
RA-84 AC Power Supply for BC-779 Super-Pro receiver, rackmount .....	\$ 18.50
J-37 Code Key, a very good surplus key .....	\$ 3.00
Brush Dual Channel DC Amplifier BL-530, complete in cabinet .....	\$ 24.50
AM-40A/AIC Interphone amplifier, 4W output, 28vdc .....	\$ 4.00
AM-26/AIC Interphone amplifier, 4W output, 28vdc .....	\$ 4.00
EE-8 Field Telephones, less batteries, price per pair .....	\$ 15.00
Carter Rotary Converter JR1010CW4, 28vdc input, 115V/60cy at 9.6amp output .....	\$ 65.00
Type K-20 Aircraft Camera, a very popular surplus aerial camera .....	\$ 75.00
Cold Cylinder Test Indicator, has beautiful 0-400uadc meter .....	\$ 2.00
BC-709C Interphone amplifier, uses standard batteries, good for plane, car, camper, etc. ....	\$ 3.00
Bendix AN-5851-1 Sextant, Bubble type, used good condition, ideal for navigation, in case ...	\$ 24.00

**Transformers for Surplus Conversion:**

Transformers are with 2-18 volt center tapped windings. Connected in series delivers 36 volts as rated; connected in parallel 18 volts at twice rated current through rectifier bridge will give 12 or 24 volts DC. Primary on below transformers 115V/60 cycle.

1 amp wt. 3	\$ 6.20	12 amp wt. 16	\$23.90	30 amp wt. 27	\$52.00	50 amp wt. 38	\$61.20
4 amp wt. 6	\$11.70	24 amp wt. 25	\$42.25	50 amp wt. 38	\$61.20		

**Junk Box Nightmare:**

For this special 73 Surplus Issue, we have put together 50 lbs. of small valuable electronic components consisting of surplus resistors, capacitors, switches, connectors, circuit boards, transistors, small screws, knobs, variable capacitors, tube sockets, etc. etc. All small components, no heavy transformers, etc. Each box is different, guaranteed to satisfy you.  
**Special postage paid deal \$16.50, two for \$30.00. A once a year bargain.**

**Aircraft Pilots:**

Bendix RT-221A/CNS-220, 118.00 to 135.9mhz, 50khz spacing, 360 channel VHF communications transceiver, weight 4½ lbs., size 3¼" x 2½" x 12", all solid state, 1968 models, 12 or 24 volt, \$345.00, sells new for \$945.00.







**VACUUM VARIABLES** — Largest and best diversified stock in the world — From tiny ECS-30PF 10KV to the big water cooled ceramic units 5000PF @ 60KV. Most types in either glass or ceramic. Every unit individually tested and fully guaranteed. Write for capacitor Flyer No. VC-200.

EXAMPLES (Immediately available from stock plus hundreds more).

UCS	300	(10-300PF @ 7.5KV) also 10 & 15KV available	\$ 48.00
USLS	465	(4-465PF @ 5KV) list price \$310.00	68.00
UCSLPA	750	(5-750PF @ 5KV) list price \$270.00	72.00
UCSL	1000	(7-1000PF @ 5KV) list price \$260.00	78.00
UCSL	2000	(20-2000PF @ 5KV) list price \$460.00	138.00
CVDD	300	(10-300PF @ 7.5KV) ceramic type	88.00
CVCC	2500	(25-2500PF @ 5KV) ceramic type	158.00

(Higher voltages upon request)

All units complete with drive-head and mounting hardware.

● **SPECIAL BIFILAR FILAMENT** chokes for that new 2KW PEP Linear, 2-30 MC, good for 32A continuous. Excellent inductance and low voltage drop. Insulated body and ready to mount.

Ji-FC32	\$ 8.00
Also available 60A version Ji-FC60	14.00
Matching plate choke 800 MA Ji-PC800	5.00
Matching plate choke 2.0 A Ji-PC2000	9.00

(Descriptive literature available upon request)

**COMPUTER GRADE CAPACITORS**

1250 MFD @ 180 VDC	.88
3750 MFD @ 75 VDC	.58
5000 MFD @ 55 VDC	.48
5500 MFD @ 45 VDC	.48
1100 MFD @ 250 VDC	1.88 - NEW!
100 MFD @ 200 V	.48
900 MFD @ 75 V	.38
8000 MFD @ 55 V	.52

Sprague, Mallory, G. E., etc.

● Dozens of other types available. Please ask for Cap Flyer No. C-100. New cad plated mounting brackets for computer grades . . . . .14

● Thousands of capacitors available. Many are brand new in addition to military equipment pull-outs and all tested and guaranteed.

.01 MFD at 1.4KV Disc. ceramics (new) ideal for diode strings . . . . .08 ea

Also PC (shortleads) type disc capacitors .01 and .022 (1KV and 1.4KV). These leads are long enough to bridge the 1.5A diodes . . . . .03 ea

Plastic capacitors .05 MFD at 10KV DC 2 1/2" x 1 1/2" . . . . . 1.75 ea

Glass-mike (Gudeman) .01 MFD at 10KV DC 5" x 1 1/4" . . . . . 2.85 ea.

● **WORLD'S LARGEST SELECTION** of SILICON Rectifiers and Ass'ys from a single source. Each unit is individually power tested and guaranteed. (All units unless indicated are single chip silicon)

STD Top Hat 1.6 a units are available from 50V PIV @ .03 ea to 1400V PIV @ .32 ea. Type junction is also stated (alloyed, diffused)

Epoxy or glass 1.5A units are available in the same ranges as the top-hats from 50V units @ .05 ea to 1400V units at .46 ea.

Ji also has available prem. epoxy controlled avalanche units that will meet or exceed mil specs. These units are unbeatable. They range from 200V @ .12, 800V @ .26, 1200V @ .38, 1600V @ .68, and 1800V @ .88 each.

Epoxy 3 Amp units (soon to be available in controlled avalanche). They range from 50V @ .08, 600V @ .24, 1000V @ .48, 1200V @ .68, 1400V @ .88.

These units have a one cycle short ck't current of 240 Amps.

● 12 Amp stud mounts. Steel or epoxy case (REV. POL. also available). These range from 50V unit @ .14, 400V @ .32, 800V @ .68, 1000V @ .98. Also available 40A, 70A, 100A, 160A, 240A, 275A, and many more. Complete rectifier ass'ys available for everything from battery chargers to hi voltage stacks. Custom building of poly-phase ass'ys for any application from battery chargers to welders to broadcast stations is our speciality. All ass'ys are fully tested and guaranteed before shipment.

● **Sample selection of TUBE INVENTORY** ●

Largest percentage new, tested and guaranteed.

RCA 3E29 (Sim to 829B) w/heat diss. plate caps . . . . .	\$ 2.85
RCA 6146A . . . . .	2.95
RCA 813 . . . . .	8.75
Matched 813's for GG Linear per pair . . . . .	25.00
3B28 (Zeon type 866) . . . . .	2.25
4CX250B/7203 (premium ceramic tetroids) . . . . .	16.00
5R4WGB (Foam Suspension) . . . . .	2.85

Thousands of military equipment pullouts tested and guaranteed in cartons. Ask for Tube Flyer No. T-73.

● **HUNDREDS OF EXCELLENT TRANSFORMERS** available all voltages, currents, sizes and weights. Units tested and guaranteed. Sample selection: (Write for XFRMR Flyer No. TX55).

Pri. 115V 60CPS. Sec. 6.3 volts at 8.0 amps. Triad 10083 . . . . .	.95
Tapped 120V Primary/Sec. 6 to 7V at 1.5 amps (MIL-Spec) . . . . .	.48
Chicago Std. 12H. @ 200MA Mil-spec choke . . . . .	.98
Chicago Std. 15 Henries at 100MA . . . . .	.80
Chicago Std. sw. choke 4/20 H @ 300MA 5KV INS. . . . .	2.40
General Purpose XFRMR 350-0-350 @ 100MA 6.3CT @ 4.0 A . . . . .	1.75

● **NEW • NEW • NEW** ●

Tapped 120V Primary/Sec. 700-800V CT @ 500MA (ideal for that exciter full wave bridge or Amp FW DBLER . . . . .	6.75
Pri. 220V 60CPS (tapped) Secondaries 5V, 7.5V, 10 & 11V CT @ 36A . . . . .	
Chicago Std. Mil Spec type (for 3-400, 4-1000, 813, etc.) . . . . .	18.00
Special XFRMR for that new linear using 3-1000Z or 4-1000A) . . . . .	
Tapped Pri. 220-240V AC 60CPS Sec. 7.5V @ 25A . . . . .	9.50

● **RECTIFIER SPECIALS** ●

Premium 5R4 replacement 6KV @ 1.5A (replaces 4-in Parallel) . . . . .	ea. \$ 4.95
Std 5R4 replacement 5KV @ 400MA . . . . .	2.95
5U4 replacement 3KV @ 1A (replaces 5Y3, 5V4, 5Z4, 5T4, 5AW4, 5931 and 6004) . . . . .	2.45
80 type replaces 82, 83, 83V, & 5Z3 2KV @ 1A . . . . .	1.85
1N34 type Germanium diodes for general work . . . . .	.05
Solid state meter protector (10 micro-amps to 1.6A) . . . . .	.68
"Special" OZ Pak Rect. Ass'y use as FWCT, FWB, or FW DBLR 3.5KV out @ 1.5A . . . . .	28.00
OZ Pak blocks 4" x 2" x 1/2" 1/2 wave silicon ass'y (need 2 for FWCT FWDBLR or 4 for bridge) Min of 7KV PIV @ 1.2A hermetically sealed 6/32 term. . . . .	ea. 4.50
Heavy duty OZ Pak block ass'y (same size) 2.5KV PIV @ 6A output (both units R/C compensated) . . . . .	4.50
Compact FWB ass'y 1/4" x 1/2" 2KV PIV @ 1A . . . . .	1.95
Small (3/4 x 3/8") FWB ass'y 800V PIV @ 1.5A . . . . .	1.25
Small (5/8" x 5/8") Flat Pak rectifier 2KV PIV @ 1.5A . . . . .	.98
Multi-junction ass'y 1" long with std ferrule ends. Controlled avalanche type 4KV @ 300MA (Hi-Freq. type) . . . . .	.85
Multi-junction axial lead avalanche diodes 5KV @ 200MA . . . . .	.75

● Complete power supply only 5" x 5" x 4" input 220V AC output 7.0KV @ 35MA — Xfrmr, rectifiers and filters self-contained. Ideal for scope or experimenter . . . . .2.95

75A series Rect replacement kit (or any good Rx) silicon 5U4 plug-in unit plus 150 Ohm Dale-Ohm type dropping resistor (with instructions) . . . . .2.75

● **Don't Forget Our New JENNINGS ELECTRONIC CENTER at 1280 No. 4th St., San Jose, Calif.** ●

# CQ de W2KUW

## WE NEED YOUR SURPLUS TUBES

1P21	891
2C39	3CX2500
2K25	3CX3000
2K48	3CX5000
2K (any digits)	3CX10,000
3-400	3E29
3-1000	3K (any digits)
3B24	4-65
3B28	4-125/4D21
4-250/5D22	4CX3000A/8169
4-400A/8438	4CX5000A/8170
4-1000A/8166	4CX5000R/8170W
4X150A	4CX10,000/8171
4CX250B	4X150G/8172
4CX250R/7580W	4PR60A or B
4CX300	4PR (any digits)
4CX250A/8321	5-125B/4E27A
4CX1000A/8168	
5R4WGB	304TL
6BL6	VA (all types)
6BM6 or 6A	250TH
6L6	450TH
7D21	450TL
8D21	QK (all types)
9C21	715C
9C25	802
75TL	891R
805	TW (all types)
807	TWT (all types)
810	NL (all types)
811A	4000 series
812A	5000 series
813	6000 series
832A	7000 series
833A	8000 series

### AIRCRAFT EQUIPMENT

AN/ARC-27, 33, 34, 38, 44, 52,  
54, 55, 58, 73, 84  
AN/ARN-14, 21, 59, 65, 67, etc.  
AN/ARR, APR14, etc.

Offers 5% bonus over highest offer.  
**SHIP COLLECT FOR PAYMENT.**  
AN/GRC-3, 4, 5, 6, 7, 8, 9, 10, 19, 26, 46  
RT-66, 67, 68, 70, 77, 102, 104, etc.  
AN/APR-13, 14, 17

### RECEIVERS

URC 14	VRC 24
R-388	R-1051
R-388A	CV-253/ALR
R389	51J-2, 3, 4
R390	CV116 conv.
R390A	AN/URR-
R391	AN/FRR
R-392	AN/SRR
R-220	AN/SLR
R-1125	AN/ARR

### TEST EQUIPMENT

SG-12A/U	SG-2A/GRM	AN/URM-26
SG-1A/ARN	AN/ARM-25	SG-66A/ARM-5
SG-13/ARN	AN/ARM-22	AN/URM-80
AN/URM-32	AN/ARM-26	AN/ARM-8
AN/URM-48	AN/URM-43	AN/ARM-31
AN/ARM-9	AN/UPM-98	AN/ARM-29
AN/USM-16	AN/ARM-68	AN/APM-66
AN/URM-44	OS-8E/U	AN/UPM-99
TS-757	TS-723	AN/USM-44
TS-684	TS-683	AN/UPM-32
TV-7	TV-2	TS-330
SG-24/TRM	ME-30C	TS-710
AN/PSM-4	AN/PSM-6	TS-621
TS-510A	TS-823	TS-505D
AN/URM-25		AN/GPM-15
AN/URM-81		TS-1100

All H-P, Boonton, ARC, GR,  
Bird Measurements Tek, etc.

### COLLINS

17L-4, 7	618M	578X
51X2	621A3	479S
51V	860E	479T, etc.
618S1-4	51R3	
618T	578D	

Please send us your surplus inventory lists. We want to buy other tubes and  
Transceivers — Receivers — Test Equipment.

## The TED DAMES Co.

308 HICKORY ST. ARLINGTON, N.J. 07032  
Phone: 201 998-4246

- WE BUY RIGHT & SELL RIGHT -

## C&H SALES starts off 1970 with a Slam Bang Sale!

H.P. 130A Scope DC-300KC	\$295.00
H.P. 130B Scope DC-300KC	350.00
H.P. 151A High Gain Amp. Plug In.	50.00
H.P. 152A Dual Trace Amp. Plug In.	50.00
H.P. 200T Telemeter Osc. 250 CPS into 100KC output 160mw	75.00
H.P. 202A Function Gen. 0.008 CPS to 1200 CPS	125.00
H.P. 211A Sq. Wave Gen. 1 CPS to 1 MC	100.00
H.P. 212A Pulse Gen. Pulses from 0.07 to 10 microseconds, 50 watts of pulse power	75.00
H.P. G281A Adaptor	20.00
H.P. G370C Fixed Attenuator 10 DB	35.00
H.P. X382A Var. Att.	150.00
H.P. 415B Standing Wave Ind. Freq. 1000 CPS $\pm 2\%$	75.00
H.P. 450A Amplifier Freq. Res. $\pm 0.5$ DB, 10 CPS into 1 MC	25.00
H.P. 475B Bolometer Mount	50.00
H.P. J485B Detector Mount	20.00
H.P. 710A Power Supply output continuously variable from 180 to 360V. 6.3 VAC center tapped also provided. ONLY	15.00
H.P. 712B P.S. 0-500V 200 MA	50.00
H.P. AC 60K Barretter matching Transformer	20.00
H.P. 350D Attenuator Set	95.00
H.P. 430C Power Meter	50.00



### ARC RADIO EQUIPMENT

T-11B xmtr, 118-132 MC.	\$19.95
T-336 xmtr, 118-132 MC.	19.95
T-13A xmtr, 125-148 MC.	19.95
R-10A rcvr, 520-1500 KC.	19.95
R-11A rcvr, 190-550 KC.	19.95
R-22 rcvr, 550-1600 KC.	19.95
B-10A converter	19.95
D-10A 28-volt Dynamotor for use w/above rcvrs.	5.00
Control boxes C-18, 22, 37, 44, 984	ea 7.50
K-12 Relay box	10.00
E-13B/ARN30 Rack	7.50
A-13A Antenna	35.00
R26/ARC-5 Rcvr. 3-6 MC	14.95
R28/ARC-5 Rcvr. 100-156 MC	14.95
BC 603 FM Rcvr. 20-27.9 MC	29.95
BC 683 FM Rcvr. 27.9-39 MC	39.95
TS 403/U Same as H.P. 616A 1800 MC to 4000 MC	450.00
TS 419 Same as H.P. 614A 900 MC to 2100 MC	395.00

Tek 121 Wide Band Pre. Amp	25.00
Tek 161 Wave Form Gen.	35.00
Tek 162 Wave Form Gen.	35.00
Tek 516 15 MC Scope	895.00
Tek 533A 15 MC Scope	895.00
Tek 536 10 MC Scope	895.00
Tek 535 15 MC Scope	795.00
Tek 502 1 MC Scope	895.00
Tek "K" Plug In	75.00
Tek "P" Plug In	50.00
Tek 53/54E Plug In	50.00
Tek 80 Plug In	25.00
Tek TU-2 Plug In	35.00
L & N K2 Pot	150.00
L & N 2666 Ayrton Shunt 10k $\Omega$	35.00
L & N 4395S 10k $\Omega$ Volt. Div.	75.00
ESI DP212 100K Deka Pot	50.00
ESI DB655 Dekabox total res. 1,199,999 $\Omega$	50.00
ESI DC-40 Dekabox Capacitor total capacitance 1,111,000 uuf	50.00
Sierra 137A Dir. Coup.	39.95
Sierra 138A Dir. Coup.	39.95
Sierra 184 Low Pass Filter	35.00
FXR B812A Standing Wave Amplifier	75.00
Shallcross 8285 Res. Box	50.00
Fluke 803 D.V.M. (diff. V. meter)	300.00
DM-34 Dynamotor 12V In. 220V Out 80 MA	3.95
DM-35 Dynamotor 12V in. 625 out. 225 MA	22.50
ARC 3 Transceiver Comp. w/tubes, less xtals. 100-156 MC. A new low	9.95
G.R. 219K Decade Cond.	35.00
G.R. 1219A Unit Pulse Amp.	65.00
G.R. 1432J Decade Res.	75.00
G.R. 1454A Decade Volt. Div. 10k $\Omega$	75.00
G.R. 1482B Std. Inductor 100 UH	25.00
G.R. 1490D Decade Inductor	150.00
G750D Directional Coupler 20 DB	70.00
G870A Slide Screw Tuner	100.00
X885A Phase Shifter	225.00
G910A Low Power Termination	35.00
H.P. 400HR AC V.T.V.M.	195.00
Rutherford B7 Pulse Generator	200.00
Measurements Corp. 82 Sig. Gen. 20 cycles to 50 MC	250.00

**Just arrived H.P. 130C Scope DC to 500KC \$450.00**

Remember, we are your headquarters for  
Test Equipment, Parts, Tubes & Semis, Optics.

IT'S ALL STOCKED UNDER ONE ROOF

# C&H SALES CO.

2176 E. Colorado St. - Pasadena, Calif. 91107  
Telephone: Murray 1-7393

No C.O.D.'s Please—F.O.B. Pasadena unless otherwise specified—Remit full amount with order

# NEW G&G CATALOG! MILITARY ELECTRONICS

24 PAGES, crammed with Gov't Surplus Electronic Gear - the Biggest Bargain Buys in America! It will pay you to SEND 25c for your copy - Refunded with your first order.

**BC-645 TRANSCEIVER** 15 tubes, 435 to 500 Mc. Easily adapted for 2 way voice or code on Ham, Mobile, Television Experimental, and Citizens Bands. With tubes, less power supply in factory carton, BRAND NEW..... **\$16.95**



**SPECIAL PACKAGE OFFER:** BC-645 Transceiver, Dynamotor and all accessories, including mounting, UHF Antenna Assemblies, control box, complete set of connectors and plugs, Brand New ..... **\$26.95**

**R-11 COMMAND RECEIVER** ARC 190-550 Kc. Commercial late model, Excellent Condition ..... **\$12.95**

**R-4/ARR-2 RECEIVER** 234-258 Mc., Tunable, complete with 11 tubes Excellent Used ..... \$5.95  
BRAND NEW, including dynamotor ..... **\$9.95**

**BC-659 FM TRANSMITTER/RECEIVER** 27 to 38.9 Mc. Xtal control on any two pre-selected channels, 80 channels. Complete with 13 tubes speaker, meter. 15x12 1/2 x 6 1/2". NEW..... **\$23.50**



**VIBRATOR POWER SUPPLY** for above, 6V, 12V or 24V (specify when ordering). Like New... **\$6.95**

**McELROY AUTOMATIC KEYS** Suitable for keying transmitter or for code practice. Has photo-electric cell and sensitive relay. 110 V 60 cycle AC. Complete with tubes, Excellent Used..... **\$12.95**

**PE-219 BATTERY CHARGER** Charge one or two 6V batteries at 7 amps, from 6, 12 or 24 volt source. Uses one plug-in vibrator. Complete with 10' power cord, in metal case 11 x 10 x 5 1/2" deep. Weight 40 lbs. Signal Corps equipment. NEW..... **\$3.95**

**TELEPHONE TYPE RELAY** Made by J. H. Bunnell, has adjustable sensitivity. 150 ohm coil. Size 3 1/2 x 4 x 7 1/2". Shpg wt 3 lbs. NEW **\$3.95**

**BC-605 INTERPHONE AMPLIFIER** Easily converted to home or office intercom system. Uses pair of 1619 tubes, delivering 10 watts of audio power. Brand New..... **\$2.45**

### SCR-274-N, ARC-5 COMMAND SET HQ!

Freq. Range	Type	Exc. Used	Like New	BRAND NEW
<b>RECEIVERS.</b>				
190-550 Kc.	Complete with Tubes			
3-6 Mc.	BC-453	\$16.95	\$23.50	\$27.50
6-9.1 Mc.	BC-454	\$16.50	\$19.50	\$22.50
1.5-3 Mc.	BC-455	\$14.95	\$17.95	\$21.50
	R-25		\$19.50	\$21.50
<b>TRANSMITTERS.</b>				
4-5.3 Mc.	Complete with Tubes			
5.3-7 Mc.	BC-457	\$ 6.95	\$ 8.95	\$11.95
7-9.1 Mc.	BC-458	\$ 6.95	\$ 8.95	\$12.95
2.1-3 Mc.	BC-459	\$17.95	\$19.50	\$23.50
3-4 Mc.	T-18		\$ 9.95	\$11.95
	T-19		\$12.50	\$16.95

**CRT AGEING & CHECKING TESTER** Can be used for testing picture tubes as well as ageing. 4 harnesses. Quality instrument by Raytronic. BRAND NEW, in original carton ..... **\$5.95**

**BIAS METER** excellent for measuring DC Voltages or checking polarity of DC Voltages. With adaptor plug, schematic, metal carrying case. Batteries not needed for operation. Brand new ..... **\$3.95**

**EE-99 TELEPHONE REPEATER** Voice frequency amplifier, 4-wire thru or 2-wire terminating, for field use. Adjustable gain & equalization. Dual 2-stage amplifier with neg. feedback. 300-3500 cycles. 2-1N5 and 2-3Q5 tubes. Size 11 1/2 x 14 1/2 x 8". Wt. 25 lbs. NEW ..... **\$4.95**

**BC-906 FREQUENCY METER** portable absorption type, for determining frequency of CW, MCW or pulsed radar transmitters and local osc. Also for calibrating, aligning and checking sensitivity of receivers. Battery operated, 1 1/2 V, 45V DC. Range 150 to 234 Mc. NEW..... **\$10.95**

**TS-126/AP RANGE CALIBRATOR TEST SCOPE** Top quality 2" oscilloscope with all positioning, focus, gain and intensity controls. Sawtooth sweep triggered by external negative pip or can be switched to self-triggering. For 115 V 400-1600 cycle AC operation. Complete with tubes and cables, NEW..... **\$19.50**

**R-22 BROADCAST RECEIVER** ARC Model, tunes 550 to 1500 Kc. Operates on 28 VDC. Complete with tubes, LIKE NEW..... **\$17.50**

**ARC-3 RECEIVER** 100 to 156 Mc. 8-channel xtal control, electric band change. Voltage requ'd: 24 V DC & 210 VDC 125 Ma. 11x7x15". 21 lb. With 17 tubes, Excellent Used..... **\$17.50**

**ARC-3 TRANSMITTER** 8-channel 100 to 156 Mc. Voltage requ'd: 24 VDC and 410 VDC 325 Ma. Size: 15 1/2 x 12 1/2 x 7 1/2". Wt 21 lbs. Output 8 Watts AM. Complete with 9 tubes, Excellent Used ..... **\$18.50**

**JUNCTION BOX** for ARC-3 set ..... \$ 3.95

**PUSHBUTTON CONTROL BOX** for receiver & transmitter, exc. used..... \$ 1.95

### ARC-5 VHF RECEIVER, TRANSMITTER, MODULATOR 100-156 Mc.

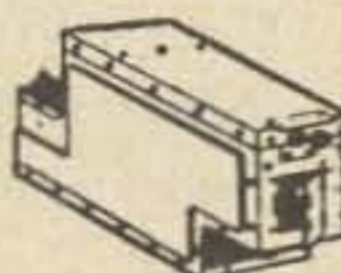

**R-28 Receiver**, with tubes and crystal, exc. Used ..... **\$19.50**

**T-23 Transmitter** with tubes and crystals. Brand New in original carton ..... **\$21.50**

**T-23 Used**, less tubes **\$3.95**

**MD-7 Modulator**, with tubes, exc. used ..... **\$10.95**

### AN/APR-4Y FM & AM RECEIVER "FB" FOR SATELLITE TRACKING!

High precision lab instrument, for monitoring and measuring frequency and relative signal strength, 38 to 4000 Mc. in 5 tuning ranges. For 110 V 60 cycle AC. Built-in power supply. Original circuit diagram included. Checked out, perfect, **\$88.50**  
LIKE NEW .....

All Tuning Units Available for Above

**BC-929 SCOPE INDICATOR** Compact radar display unit, has intensity, focus and positioning controls, DPDT motor-driven switch. Favorite with TTY fans as foundation for converter with cross-line scope presentation. Complete with all tubes including 3BP1. Size: 8 3/4 x 9 x 16". Wt. 22 1/2 lbs. LIKE NEW..... **\$14.95**

**OAP RADAR TEST EQUIPMENT** CHZ-60AB Wavemeter Oscillator, used for checking radar equipment in 140-240 Mc band. Magic eye indicator. Coaxial input-output circuits. 115 V 50-70 cy. AC. Size: 9x16x10". Wt 35 lbs. LIKE NEW ..... **\$9.95**

**ECHO BOX TS-545/UP** for checking radar sets in 1150-1350 Mc range. Tuned cavity manual type. Meter 3 1/2" 0-100 DC microamps. Hand-ringing resonator of hi Q excited by loop connected by flexible cable to RF test point of radar. 16x9x9". Wt. 23 lbs. Excellent Used..... **\$14.95**

**WILLARD 2-VOLT STORAGE BATTERY** rated at 20 Amp.-Hours. Model 20-2. Compact, rechargeable. Non-spill, lightweight polystyrene container 3x4x5 1/2". Shipped dry, uses standard electrolyte. Shpg wt. 3 lb. NEW, each ..... **\$2.79**

**BB-208/AMT BATTERY PACK** contains three BB52 - 36V miniature and one BB51 - 6V lead-acid storage batteries. Shipped dry charge. Uses 1280 acid for cycling service, and 1350 for one-shot. BB52 supplies 3 hrs thru 1200 ohms; BB51 supplies 2 3/4 hrs thru 30 ohms. Made by Willard. Pack size: 4 1/2 x 1 x 1-3/8". Shpg wt. 2 lbs. NEW ..... **\$1.49**

TERMS: 25% Deposit with order, balance C.O.D. -or- Remittance in full. Minimum order \$5.00 F.O.B. NYC. Subject to prior sale and price change

## G&G RADIO ELECTRONICS COMPANY

47 Warren St., (2nd Fl.) New York, N.Y. 10007 Ph. 212-267-4605

# WANTED

NAVY "TED" TRANSMITTERS AN/URR-13,27,35 etc., AN/URA-6,8,17; AN/SPA-4,8,9. AN/URC-9

AN/GRC-3,4,5,6,7,8,9,10, 19,26,46; RT-66,67,68,69, 70,77; AM-65/GR, T-368/UR, PP-112/GR, RT-174/PRC-8, R-108,9/GR, RT-175/PRC-9, R-110/GR, RT-176/PRC-10, T-195/GR, AN/PRC-25, R-125/GR, T-217A, T-235/GR, R-278B, SB-22/PT, MD-129A/GRC-27, AN/VRC-12, etc. AN/PRC-25 & 77

AN/TRC-24:  
T-302A, AM-912,3  
R-417A, AM-914,5, PP-685A & accessories.

AN/TCC-3: AM-682, TA-219

#### COMMERCIAL AIRCRAFT COMMUNICATIONS:

Collins: 17L-4,7, 51X2, 51V3, 618S, 618T, 18S-4, 621A3, 860E-2, 618M, 51R3, 578D, 578X, 479S-3, 479T-2; ARC: R-30A, R-38A, R-34A, RT-11A, T-27A, T-25C, R-31A, 21A system, IN-12,13,14.

Test Sets: H-14, H-14A, etc.

INDICATORS: ID-250,1, ID-387, ID-257, ID-663, ID-1103, ID-637, etc.; all Collins, Weston, and A.R.C. indicators and control units.

#### TEST EQUIPMENT

SG-12A/U  
AN/URM-25  
AN/URM-26  
SG-1A/ARN  
SG-2A/GRM  
AN/URM-80  
SG-13/ARN  
AN/URM-81  
AN/ARM-8  
AN/URM-32  
AN/ARM-25  
AN/ARM-68  
AN/URM-48  
AN/ARM-22  
AN/ARM-66  
AN/USM-26  
AN/ARM-65  
SG-66A/ARM-5  
AN/URM-43  
AN/UPM-98  
AN/ARM-68  
MD-83A/ARM  
AN/UPM-99  
AN/USM-16  
TS-723/U

AN/USM-117  
AN/USM-81  
TS-330  
ME-S7/U  
TV-2C  
TS-621  
TV-7  
TS-710  
SG-376/U  
TS-683  
TS-510A  
AN/URM-52  
AN/USM-44  
AN/TRM-3  
SG-24/TRM  
ME-30C/U  
AN/VRM-1  
AN/GPM-15  
TS-505D/U

We also buy all H-P, Boonton, ARC, GR, Bird, Measurements, TEK, etc.

RECEIVERS: AN/APR-13, 14, 17; R-388, R-388A, R-390, R-390A, R-391, R-392, R-220, R-389, R-1125, R-1051, CV-253/ALR, 51J-2,3,4, AN/URR-, AN/FRR-, etc. AN/SLR, BLR, ULR, etc.

#### AIRCRAFT EQUIPMENT:

AN/ARC-27,33,34,38,44, 45,52,54,58,73; AN/ARN-14,21,54,56,59,65,67,52V. AN/ALT-6,7,8

**SPACE ELECTRONICS CO.**  
division of  
**MILITARY ELECTRONICS, CORP.**

11 Summit Ave. East Paterson, N.J.

201-791-5050

# SELL YOUR OLD GEAR TO GET BIG CASH DOLLARS NOW

URGENTLY NEED FOLLOWING EQUIPMENT

AN/URC-9, SRC-20, SRC-21 AN/GMD-1  
AN/UPX1, 5 and 12 AN/UPM-98  
AN/APR-14 AN/URC-32

We have immediate customers for your old equipment in any condition. We'll pay guaranteed highest price, shipping, insurance, etc. We'll pay in 24 hours, write or call collect for our high offer. P.S. We'll trade or swap equipment too.



## SPACE ELECTRONICS CO.

division of

## MILITARY ELECTRONICS, CORP.

11 Summit Ave. East Paterson, N.J.

201-791-5050

Please rush me a quote on the following gear that I have to sell:

\_\_\_\_\_  
\_\_\_\_\_  
Name \_\_\_\_\_  
Address \_\_\_\_\_  
City \_\_\_\_\_ State \_\_\_\_\_ Zip \_\_\_\_\_

## RELAYS

- LR1**—Potter & Brumfield latching relay SPST 115v-115v dual coils, horizontal mounting. 1 1/4" x 3" x 2".....\$ .75 ea, 5 for \$3.00  
**LR2**—Potter & Brumfield latching relay SPDT 115v-24v/12vdc.....\$ .75 ea, 5 for \$3.00  
**RY1**—Sensitive relay for use in transistorized circuits. 1000 ohms. Pull in 5 mA at 5 v. SPST. Can be used as SPDT. 1 1/4" x 1 1/4" x 1". .....\$ .75 ea, 5 for \$3.00  
**RY2**—Sensitive relay for use in transistorized circuits. 2000 ohms. Pull in 5 mA at 10 v. SPST. Can be used as SPDT. 1 1/4" x 1 1/4" x 1". .....\$ .75 ea, 5 for \$3.00

## TOROID POWER TRANSFORMERS NEW AND UNUSED

- T2**—This toroid was designed for use in a hybrid FM mobile unit, using a single 8647 tube in the RF amp. for 30 watts output. Schematic included. 12 vdc pri. using 2N1554's or equivalent. Sec. 1: 500 volts dc out at 70 watts. Sec. 2: -65 volts dc bias. Sec. 3: 1.2 volts ac for filament of 8647 tube. Sec. 4: C/T feedback winding for 2N1554's. 1 1/4" thick. 2 3/4" dia.....\$2.95 ea, 2 for \$5.00  
**T3**—Has powdered iron core and is built like a TV fly-back transformer. Operates at about 800 cps. 12 vdc pri. using 2N442's or equivalent. DC output of v/dblr 475 volts 90 watts. C/T feedback winding for 2N442's.....\$2.95 ea, 2 for \$5.00

## TRANSFORMERS

- P4**—105-115-125 v 60 cy pri. 6.4 v @ 11A. 205 v @ 1/2A. 17 v @ 45 mA (relay power). Wt. 10 lbs.....\$2.95 ea, 2 for \$5.00  
**P5**—Pri. 117 vac/12 vdc. Sec. 1: 295 vdc (v/dblr) @ 85 mA. Sec. 2: 12.6 vac @ 2.6 A & CT winding for vibrator. Double half shell. Wt. 2 1/4 lbs. ....\$2.25 ea, 2 for \$4.00  
**P6**—Pri. 117 vac/12 vdc. Sec. 1: 275 vdc (v/dblr) @ 150 mA. Sec. 2: 12.6 vac & CT for vibrator winding. Wt. 4 1/4 lbs.....\$2.95  
**SR-42-46** type.....2 for \$5.00  
**P7**—117 vac pri. Sec. 1: 185 vac @ 120 mA. Sec. 2: 6.3 vac @ 4 A. Double half shell mail box type. SX-146 type.....\$2.75 ea, 2 for \$5.00  
**P8**—117 vac pri. Sec. 1: 470 CT. DC out of bridge 660 v 300 mA max. Sec. 2: 100 vac @ 10 mA for bias. Sec. 3: 12.6 vac @ .75 A to 6.3 vac @ 6 A. Half shell HT-46 type. Wt. 7 1/4 lbs.....\$3.50  
**P9**—117 vac pri. Sec. 1: 900 vac @ 300 mA. Sec. 2: 100 vac @ 10 mA bias. Sec. 3: 12.6 vac @ 2 A. Double half shell. Wt. 16 1/2 lbs.....\$4.50  
**P10**—117 vac pri. Sec. 1: 960 vac CT @ 160 mA. Sec. 2: 415 vac CT and tap at 100 vac @ 10 mA bias. Sec. 3: 12.6 vac @ 4.5 A. Double shell mail box type. Wt. 8 3/4 lbs.....\$3.75

## OUTPUT TRANSFORMERS 59¢ each or 3 for \$1.50

- OT1**—Transistor output TO-3 Power Diamond. 15 ohms primary impedance. Secondary 3.2 ohms. Pri. dc resistance 0.6 ohms, secondary 0.3 ohms.  
**OT2**—Pri. imp. 7000 ohms. Sec. 3.2 and 500 ohm for phones or 70 volt line. 3 watts. Full shielded double half shell.  
**OT3**—Primary impedance 5500 ohms. Secondary impedance 3.2 ohms. SX-122 type.

All prices FOB Racine, Wisc. Orders under \$3.00 include 50¢ handling charge. Please allow enough postage, excess will be refunded. All weights are net weights.

## SEMICONDUCTORS

- S1**—Integrated Circuit. Rca CA3012 IF amplifier—limiter. Gain 61 dB at 10.7 MHz. 10 lead TO-5 package. With schematic.....\$ .75 ea, 5 for \$3.00  
**S2**—Amperex 2N2671 100 MHz FT. RF amplifier-mixer, 4 lead TO-5 case.....\$ .40 ea, 6 for \$2.00  
**S3**—Amperex 2N2089 RF amp. mixer oscillator. ....\$ .35 ea, 12 for \$3.00  
**S4**—Delco DTS-413 Silicon NPN planar TO-3 case. 400 Vceo 100 mA continuous. Hfe 20 @ 5 v 500 mA. FT 12 MHz. Used as TV vert. output. ....\$1.00 ea, 6 for \$5.00  
**S6**—RCA 1N3754 Silicon Diode 1.3 A 125 piv. Single ended TO-1 case. Used as biasing diode in power amp base to emitter circuit or general purpose.....\$ .15 ea, 8 for \$1.00  
**S7**—Fairchild FD-100 ultra-high speed switching 2 nano sec. recovery time. Up to 500 MHz. 75 piv 10 mA. Used as general purpose rf and signal diode. Silicon planar type.....\$ .25 ea, 5 for \$1.00  
**S8**—Texas Inst. 1N746 Zener diode 3.3 v 400 mw. ....\$ .50 ea, 3 for \$1.00  
**S9**—Sarkes-Tarzian 1N3020 Zener diode 10 v 1 w. ....\$ .60 ea, 2 for \$1.00

## CAPACITORS

- C1**—Aerovox transmitting capacitors for use in coupling power amps to Pi-nets. High amperage, high voltage (15 kv) type HI-QHPA42BC axial screw terminals 1/4-20 with screws. Size: 1 1/4" by 5/8" long. All silver const. Heavy silver plated terminals and screws. 6800 mmfd. ....\$2.00 ea, 3 for \$5.00  
**C2**—Plastic Cap Inc. Type "OF" high voltage glass capacitor. .005, 8000 v. Size: 1 1/4" x 3/4" x 8-32 screw terminals.....\$1.50 ea, 4 for \$5.00  
**C3**—Mallory computer grade electrolytic capacitors 1550 mfd 150 vdc. Fresh stock for use during 1970. Size: 2" x 4 1/4" with plastic insulating sleeve. ....\$1.00 ea, 10 for \$7.50  
**C4**—PC mounting 900 mfd. 15 vdc. Size 5/8 x 1-7/8" high. ....\$ .20 ea, 6 for \$1.00  
**C5**—Axial lead 250 mfd. 40 vdc. Size 5/8 x 1-1/4" long. ....\$ .20 ea, 6 for \$1.00  
**C6**—Axial lead 15 mfd. 20 vdc. Tantalum Size 1/4 x 1/2" long. ....\$ .25 ea, 5 for \$1.00

## TUBES

- New bulk packaged tubes made by RCA  
**6BA7** — \$1.00 ..... 6 for \$5.00  
**6CX8** — \$1.00 ..... 6 for \$5.00  
**12AU6** — \$ .60 ..... 6 for \$3.00

## CABLE

- RG 196 AU 50 ohm** teflon coaxial cable. Outside diameter .080" RF loss .29 db per foot at 400 Mhz. Silver plated shielding and conductor. Used for internal chassis wiring, antenna coupling, RF coupling between stages, etc. Random lengths from 35 foot to 150 foot. Colors: black, red, brown, blue, grey, orange.  
 Reg. price—23¢ per ft. .... 5¢ per ft/\$3 per 100 ft

## MISCELLANEOUS

- CM1**—Supersonic condenser microphone, 18-25 kc. 3/8" dia. x 3/8". Pigtail leads. \$ .35 ea, 7 for \$2.00  
**CM2**—Same as above with mounting ring 1-1/8" x 7/8" x 3/8" thick. Use for silent sound systems, burglar alarms, control circuits, etc. Originally used as remote TV control.....\$ .50 ea, 5 for \$2.00

# TOWER COMMUNICATIONS

1220-22 Villa St. Racine, Wisconsin 53403 632-9014



# TALLEN CO., INC.

300 - 7th STREET  
 BROOKLYN, NEW YORK 11215  
 212-HY9-6300

SALE

SALE

## Wholesale Only Minimum Order - \$50.00

Canadian Royal Air Force Headset, 600 ohm  
 with 2 receiver units - cord and microphone  
 unit with push to talk switch ... 300 at ... 90¢

\* \*

ARC-1 Transceiver, 100-156 MC - 25 Watt  
 complete with all tubes ... 10 at ... \$20.00

\* \*

ARC-522 Transmitters, 24 channel ... \$25.00

ARC-49 Receivers, 48 channel ... \$40.00

R5A/ARN-7 Receivers, 100-1500 KC  
 complete ... \$ 9.50

ART-13 Transmitters complete ... \$25.00

BC-604 Transmitter FM 20-27 MC, brand  
 new ... \$ 9.50

UPM-6 Test Set ... 10 at ... \$75.00

UPM-11/TS-738 Range Calibrator, 115V at  
 50-1600 cyc ... 10 at ... \$60.00

UPM-18/TS-359 Test Set ... 10 at ... \$40.00

UPM-19 Test Set complete, 2650-2950 MC,  
 160 watts, 115V AC at 1.5 Amp ... 10 at ... \$60.00

\* \*

BC 221 with calibration book ... 6 at ... \$40.00

\* \*

PL-68 on cords, 5' long - NEW ... 2000 at ... 50¢

\* \*

ARC-3 Receivers: 8 channel, 100-156 MC

ARC-3 Transmitter: 8 channel, 100-156 MC  
 \$6.50 each - Both for \$11.00

## SPECIAL SALE!

R-65/APN-9 Loran with 35 tubes ... 40 at ... \$12.50

Connectors, ... 164-10 ... 2.00

164-9 ... 1.00

PL-156A ... 2000 for ... \$100.00

\*

Bendix Amplifier #3611 B with tubes and  
 motor, 24V at 1.2A; 220V at 0.60A ... \$ 4.50

\*

RT 316 Receiver-Transmitter with tubes,  
 115 VAC ... 10 at ... \$10.00

RT 316 Receiver-Transmitter less  
 tubes; ... 20 at ... \$ 5.00

\*

PP-1398/ARR-39 no tubes ... 10 at ... \$ 2.00

\*

OAP Test Sets, Radar ... 10 at ... \$ 9.50

AM 40 Amplifier interphone with  
 motor ... 50 at ... \$ 7.50

ARW-26A Receiving Set ... 5 at ... \$25.00

\*

RT 11/APN-12 Receiver-Xmtr 160-  
 240 MC ... 20 at ... \$17.50

\*

RM-42 Control unit w/handset, cable, plugs,  
 lights ... 10 at ... \$ 9.50

\*

MN 53 ... 20 at ... \$30.00

KY 95/APX-25 Coder ... 15 at ... \$ 9.50

DY 66/ARN-14 Motor ... 20 at ... \$20.00

DY 2 motor in: 28V - output:  
 2500V ... 20 at ... \$ 2.50

ID-169/APN-12 Range Indicator, 0-150  
 mile range ... 10 at ... \$12.50

\*

TS-13/AP Signal Generator, 115V/1 ph/  
 60-80 cyc ... 20 at ... \$25.00

TS-15 C/AP Fluxometer ... 40 at ... \$35.00

TS 69/AP Frequency Meter ... 40 at ... \$35.00

TS 102B/AP Range Calibrator ... 30 at ... \$30.00

TS 207 Echo Box, 2770-330 mc ... 10 at ... \$40.00

TS 685 Range Calibrator ... 30 at ... \$35.00

TS 730/URM-23; 115V/50-1000  
 cps ... 10 at ... \$40.00

\*

BC 1078 Amplifier, ... 40 at ... \$ 3.50

SA 28/APG Altitude unit ... 40 at ... \$ 3.50

C 984/ARN-30 Control Box ... 40 at ... \$ 3.50

\*

I-83 Test Set for dynamotors; 14 volts  
 and 28 volts ... 20 at ... \$12.50

\*

CX 4566 Cable, 52 conductor on reels  
 of 250 feet, (3) ... per reel ... \$14.50

Inverter, 27.5V at 22 amp.  
 #12142-1A ... 50 at ... \$ 4.50

\*

BE 75 Switch Box, 120V at 15 amp  
 with 3 circuit breakers ... 20 at ... \$ 4.50

\*

Inverter, rotary converter type FK;  
 28vdc to AC at 20 amp 19 VAC  
 to 230 amp; 1 ph. 105 cycles ... 20 at ... \$ 6.50

# GOV'T-INDUSTRIAL

## SEQUENCE CAMERA

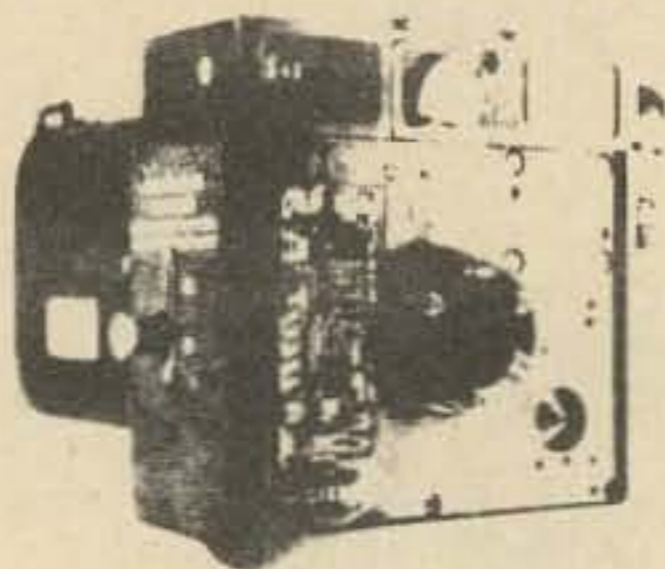

This electrically sequenced camera takes 1600 pictures on a roll of standard 35 millimeter film. The camera is offered complete with a 35 MM focal length F 2.3 Bausch & Lomb Baltar lens with stops to F16. 24 volt operation. Identification of each frame is possible by means of a data recording chamber which permits data card information to record in the corner of each frame. Watches are available which fit in the recording chamber so that the time each shot was taken will also be recorded. Camera may be used for time lapse photography, oscilloscope recording and data panel recording. Complete camera with lens and one magazine \$75.00 ppd. Spare 100 foot magazine \$25.00 ppd. 24 hour recording watch for data chamber \$25.00 ppd.

## EXPOSURE METER CONTROL

This little unit lights up a lamp when illumination is below predetermined threshold. Contains high sensitivity cds photodetector, transistor, potentiometer, lamp & relay. About the size of a quarter. May require relay adjustment to work properly. Complete with circuit applications & design data information . . . . . EMC 2/\$2.00 ppd



## RECORDING HEADS- READ-WRITE

These heads are removed from the magnetic Memory Drum made by Hughes Aircraft at a cost of \$6400.00. D.C. resistance 30 ohms. Frequency response 20 Hz to 12 KHz. A.C. impedance 4K Ohms.

HRH \$1.00 pp . . . . . or 12 for \$10.00 pp.

## 5.5 RPM PERMANENT MAGNET MOTOR

5.5. R.P.M. Permanent Magnet Motor - Reversible, continuous duty, Ball Bearing various mfg. - globe, etc. A planetary gear reduction motor with a 10 oz. in. torque. Motor will efficiently operate with input varying between 3 VDC & 35 VDC producing an output speed between .3 & 5.5 RPM. Motor will serve many useful functions as telescope drives, turntables, and other slow speed drives. Dim: 1-3/8 dia. x 3-5/16 LG, Shaft Dim: 5/16 dia. [lg. G.M.D.C.

Available in two speeds: 10 RPM & 5.5 RPM. Order No.10 GPMM and 5.5 GPMM \$7.50 pp

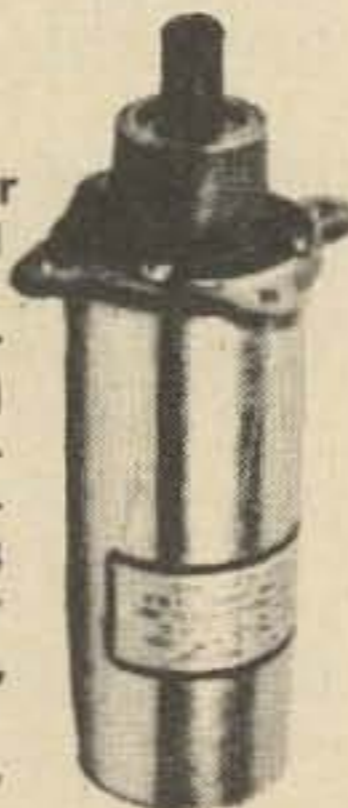

## TACHOMETER KITS

We bought a large quantity of tachometer meter movement and dials as shown, and while we were wondering how to sell them, one of our customers showed us some ingenious tachometers he developed, using this meter movement. We bought the designs and are offering them to you as kits of electrical parts only, which we are selling at far below the price of the meter alone.



Kit 1. Tachometer & dwell meter, operates from distributor of 4, 6 & 8 cylinder engines. Transistorized . . . . . TK1 \$5.00 ppd.

Kit 2. Out board motor, engine tachometer. Simply hold wire lead near spark plug wire & pulses are picked up and registered. Works on 2 or 4 cycle 1, 2, 4, 6 or 8 cylinder engines. Transistorized . . . . . TK2 \$12.50 ppd.

Kit 3. Photo electric tachometer. This is very ingenious. Point the pickup head at propeller of model airplane, or other rotating parts & meter registers rpm by measuring frequencies of interrupted light . . . . . TK3 \$12.50 ppd.

## TANTALUM CAPACITORS

Buy these brand new tantalum capacitors for less than the price of equivalent aluminum foil units, & get high reliability, infinite life, small size, & high temperature performance in the bargain. The regular price of these units is from 10 to 20 times our low price.



Left . . . . .	25 mfd @ 180 volts . . . . .	\$1.75 ppd
Left . . . . .	8 mfd @ 270 volts . . . . .	\$1.75 ppd
Center . . . . .	3.9 mfd @ 75 volts feed thru . . . . .	3/\$1.00 ppd
Right . . . . .	400 mfd @ 75 volts . . . . .	\$2.00 ppd
Right . . . . .	1000 mfd @ 50 volts . . . . .	\$3.00 ppd
Middle . . . . .	26.5 mfd @ 30 volts, non polar . . . . .	\$1.00 ppd
Middle . . . . .	2 mfd @ 100 volts . . . . .	3/\$1.00 ppd
Bottom . . . . .	1 mfd @ 75 volts . . . . .	4/\$1.00 ppd

## POCKET TRANSIT



The army used this transit for roughing in gun emplacements. But any one who needs quick and accurate surveying information will appreciate the precision and convenience of this instrument. These transits are selling at least 50% below current retail prices. We do not expect the supply to last long. For quick, accurate surveying, this transit functions as a sighting compass, prismatic compass, hand level and clinometer. Convenient for topographic and preliminary surveys of all kinds. With case and operating instructions.

BPT \$30.00

## Computer Grade Giant Capacitors

These brand new capacitors are in great demand as filter capacitors for I.C. logic circuits, power supplies, etc. These will take the noise out of the most stubborn circuits, where all else fails. Net price is from \$4.00 to \$18.00 each.



wt.	Size	Price ea.	12 for:
2#	110,000 $\mu$ f 15v	\$2.00	\$20.00
2#	6,000 $\mu$ f 75v	1.50	15.00
1#	4,000 $\mu$ f 50v	1.00	10.00
2#	25,000 $\mu$ f 25v	1.50	15.00
1#	9,300 $\mu$ f 15v	1.00	10.00

**B Enterprises**  
P.O. Box 44  
Hathorne, Mass 01937

617-532-2323

# SURPLUS BARGAINS

## PRINTED CIRCUIT EDGE CONNECTOR

We have been lucky enough to obtain a large quantity of these connectors which take a 4" x 5 1/2" x 1/16" thick printed circuit board (or two 4" x 2 1/2" boards side by side using a 1/2" center partition). The connector has 48 gold plated contacts, spaced on 0.200 inch centers, suitable for solder or wire wrap connections. Manufacturers OEM Price for this connector is \$7.60 each. We have suitable unetched copper clad board approximately 4" x 5 1/2" available to fit this connector as well as pre-etched Universal Logic cards described elsewhere in this ad. Take advantage of this special while they last. From what we have heard the gold alone is worth over 50 cents. **PCEC \$1.50 each, 10 for \$12.00, 100 for \$100.00. PCEC-BOARD Matching, approx. 1/16" x 4" x 5 1/2". Double clad board unetched 25 cents each, and quantity but only available with purchase of connectors.**

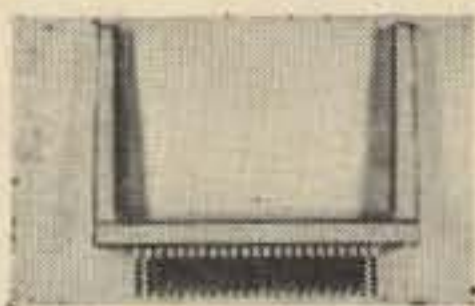

## SYLVANIA TYPE 5ECIC INDICATOR LAMPS

These hard to get lamps are made to operate directly from the output of DTL or TTL Integrated Circuits. Draws only 40 milliamps at 5 volts. Eliminate the complexity of using driver transistors and separate supplies and conserve power. Solder directly to PC Board. Brand new, factory fresh, packaged with full 7/8" leads **S5ESIL 10 for \$4.00 ppd**

## USAF NAVIGATOR WRIST WATCH

These world renown 17 jeweled movements were made with exacting craftsmanship & mil-spec requirements. The watches were made by Bulova, Elgin & Waltham with a hack mechanism by pulling the crown to stop the second hand; so the time may be set to the exact second. All are in good used condition with 24 hour luminous dial, St. St. case & expansion band. **USAF WW ..... \$20.00 ppd.**



## ULTRA MINIATURE VARIABLE CAPACITORS

Use this high quality type MAPC - Hammarlund Steatite - insulated variable capacitor for miniature receivers and transmitters. Also makes a good stable trimmer for X-tal oscillators, etc. Ultra compact, bright plated finish, screw driver adjust. Capacitance 4.5 - 100 mmf. These unused packaged capacitors are a great bargain for the builder. **UCVC 3 for \$1.00 ppd. 12 for \$3.50 ppd**



## SPEED CONTROL APPLIANCE SWITCH

This switch has three positions OFF-1/2ON-ON. The 1/2ON control is obtained by a 3 amp 400 PIV diode wired across the switch. In the half speed position the diode is placed in series with the load. Priced at less than the value of the diode alone ..... **TSSS 2 for \$1.25 ppd**



Send 25¢ for catalog 703. Jam packed with surplus bargains . . . Best yet . . . Just fantastic . . . Free with an order.

Instant Logic!

## UNIVERSAL LOGIC CIRCUIT CARDS



### LOGIC CIRCUIT BOARDS AVAILABLE

TO CB 8 TO 5 - for 9 - 8 pin 5 can I.C.  
TO CB DIP - for 9 - Dual-in-line I.C. TO FP - for 9 - Flat Pack I.C.  
CB FDC - for transistors & components.  
CB 10 TO 5 - for 9 - 10 pin TO 5 can I.C.

### TO NEW LARGER BOARDS TO

Our previous Universal Logic Cards are still available as advertised, but for those of you who like to put more circuitry on a single board, new varieties are available. These boards are the most useful items we have ever offered, and one of the best sellers. We offer them at 1/5 the price of others. How? By using surplus connectors and copper clad board, and etching them in huge quantities. We have sold 10,000 of these boards in the past few months, and orders keep climbing as customers find out how useful they are. The use of the boards is simple. The board has a pattern etched on it for mounting integrated circuits. You drill out the desired hole pattern. The power leads are already routed around the boards. Discrete components and transistors can be mounted in the locations between the I.C.'s. Then you route the wires between the I.C.'s and to the connector, and you are ready to count, compute, or whatever. Here are the cards available: **1LCC - original - pads for 14 pin dual-in-line on one side, 10 pin to 5 on the other, transistor pads on both sides as previously advertised, complete with a surplus PC card with edge connector, and mating connector. You take the connector off the surplus card, and throw it away (or salvage lots of useful components from it). Will mount four integrated circuits, and two transistors. Size 2 1/2" x 2 1/2". See previous ad for illustrations.**

2 Cards & mating conn.	21LCC	\$ 2.50pp
10 Cards & mating conn.	101LCC	10.00
100 Cards & mating conn.	2101LCC	88.00

**L1LCC - New larger size cards 3" x 4" mounts 9 integrated circuits in pattern as illustrated above. Specify which type pattern you want. Pattern on one side only. Same connections and salvage board as 1LCC provided.**

2 Cards & mating conn.	2 L1LCC	\$ 3.50pp
10 Cards & mating conn.	10L1LCC	15.00

### SPECIFY PATTERN DESIRED

**UL1LCC - Still larger 4" x 5 1/2" size, mounts 16 integrated circuits into edge connector PCEC shown on left of page.**

2 Cards & mating conn.	2UL1LCC	\$ 5.00pp
10 Cards & mating conn.	10UL1LCC	22.00

### SPECIFY PATTERN DESIRED

**FREE TOOLS.** If you place your order for \$10.00 or more worth of merchandise before April 1st we will give you a free surplus used high quality American made Kreuter or Utica long nose plier or small diagonal (no choice).



**B Enterprises**

P.O. Box 44

Hathorne, Mass 01937

617-532-2323

# SPECIAL!

## COMPLETE BISTABLE FLIP-FLOP KIT

Includes Sprague printed Circuit, 2 transistors, 2 diodes and circuit diagram.

Stock No. A1100 .50 each, 5 for 2.00, 12 for 4.00

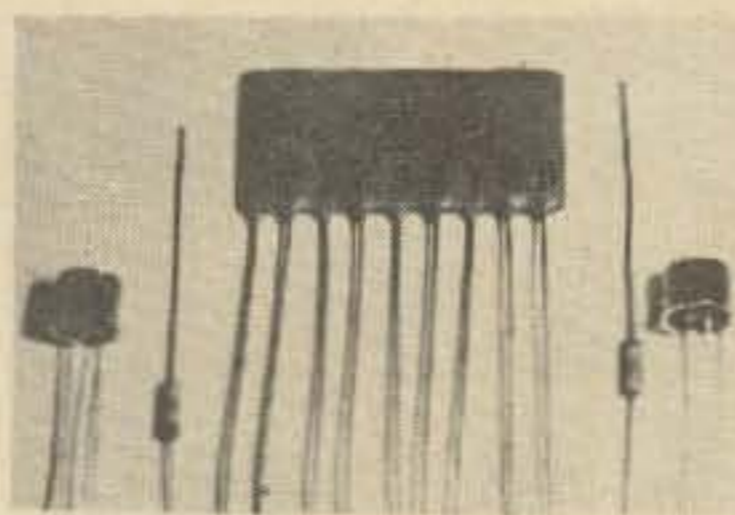

# SPECIAL!

## COMPLETE MONOSTABLE FLIP-FLOP KIT

Includes Sprague Printed Circuit, 2 Transistors, 1 diode, and Circuit diagram.

Stock No. A1101 .40 each, 6 for 2.00, 12 for 3.50

**SPECIAL With every order of \$10.00 or more, select \$2.00 worth of items FREE**

### INTEGRATED CIRCUITS

Stk. No.	Type	Case	Function	
A3000	907	TO-5	Four input gate	.75
A3001	914	TO-5	Dual 2 input gate	1.00
A3008	914	FP	Dual 2 input gate	1.00
A3002	915	TO-5	Dual 3 input gate	1.00
A3003	923	TO-5	JK Flip Flop	1.00
A3007	3M4-923	FP	JK Flip Flop	1.00
A3005	1M4-925	FP	Dual 2 input gate	1.00
A3004	926	TO-5	Buffered JK Flip Flop	1.00
A3006	926	FP	Buffered JK Flip Flop	1.00

(FP-Flat Pack)

### SILICON CONTROLLED RECTIFIERS(SCR'S)

A4200	50 Volts	1 Amp	TO-5	4/1.00
A4201	100 Volts	1 Amp	TO-5	2/1.00
A4202	200 Volts	1 Amp	TO-5	3/2.00
A4203	300 Volts	1 Amp	TO-5	4/3.00

### ZENER DIODES

A4010	1N751A	5.1 Volts, 400mw	5/1.00
A4011	1N3039A	62 Volts, 1 Watt	3/1.00
A4012	1N3822	3.6 Volts, 1Watt	5/1.00
A4013	1N3000B	62 Volts, 10Watts	2/1.00
A4014	1N3048B	150 Volts, 1Watt	3/1.00
A4015	1/4M3.0	3 Volts, 1/2Watt	4/1.00
A4029	1N429	5.6 Volts, 1Watt	4/1.00
A4038	1N961B		
A4040	1N3048	150 Volts, 1.7ma (Matched pair)	.75

### DIODES

A4005	1N629	Hughes PIV 175, 30ma	8/1.00
A4006	1N1200	Sylvania PIV 100, 70ma	8/1.00
A4007	1N2326	RCA Rectifier PIV 200, 100ma	5/1.00
A4008	1N3195	RCA Rectifier PIV 600, 500ma	10/1.00
A4009	1N3255	RCA Rectifier PIV 600, 500ma	10/1.00
A4030	1N541		
A4032	1N3208	Motorola Silicon Rectifier 50 Volts, 15 Amps	3/1.00
A4034	1N4785	RCA	
A4050	1N2071	Sylvania Bullet Diode PIV 600, 750ma	8/1.00



### TRANSISTORS

A4019	2N3904	Motorola	5/1.00
A4022	MP1546	PNP Germanium Power transistor 100W	.75 3/2.00
A4000	2N277	Motorola Power Transistor PNP Germanium 55 Watts	.75 3/2.00
A4001	2N1183B	RCA Power Transistor PNP Germanium 7.5 Watts	.75 3/2.00
A4002	2N1204	Motorola	5/1.00
A4003	2N231	PNP Germanium (RF)	5/1.00
A4004	2N2925	NPN Silicon Gen Purpose	5/1.00

A4016	FET Field Effect Transistor To-18 25 Volt Source to Gate N Channel	.50 5/2.00
A4017	Tunnel Diode Similar to 1N3717	.50 5/2.00

### MISCELLANEOUS ITEMS

A8010	2000 Ohm Multi turn trimmer	.75
A9004	To-3 Power Transistor Sockets	8/1.00
A9040	Fan Motor 110 AC	1.00
A9001	Sun Sub-miniature slide switches	3/1.00
A9003	Fuse Holders (Panel type)	6/1.00
A9032	Dialco 28 Volt pilot light bulb and assembly	3/1.00
A9065	Mercury Wetted Relay Clare HG-1002	1.00
A9066	Powerstat Type 10B 1.75 Amps (Removed from equipment)	2.50
A9067	Isolation Transformer Triad N-51X	2.00
A9062	D.C. Servo Motor, 24 Volts, 4.2 Amps	9.95
A9063	Nickel-Cadmium Batteries 1.25 Volts, 4AH	1.25
A8012	Precision Resistor 1.0 Meg. 0.1%	3/1.00
A8013	Precision Resistor 500 Ohm 0.1%	3/1.00
A9054	Delay Line 10-40 usec Imp. 2000 Ohms	2.00
A2031	Miniature variable Capacitor 3-75 uufd	3/1.00
A9068	Printed circuit boards (no components)	8/1.00
A9069	Printed circuit boards with components	5/1.00
A9000	Slide Switches SPDT	5/1.00
A9005	Earphone elements (used in pillow speakers)	4/1.00
A9018	Neon Pilot light & bulb TEC	4/1.00
A9022	Neon Pilot light & bulb Drake	4/1.00
A9046	Ni-Cad Battery 4AH	1.25
A9050	Motorola MOA 930 A1 single phase .5 Amp voltage doubler 25 volts	4/1.00
A9070	Heinemann Circuit Breaker 0.5 Amps 250 vac	1.00
A9071	Heinemann Circuit Breaker 7.0 Amps 250 vac	1.00
A9072	Heinemann Circuit Breaker 6.0 Amps 250 vac	1.00
A9073	Heinemann Circuit Breaker 10.0 Amps 250 vac	1.00
A9074	Aligator Clips H.H. Smith Insulated red	10/1.00

### VARIABLE RESISTORS

Your Choice 5 for 1.00, can be mixed

A8001	100K Screw Driver Adjust
A8002	Dual 1000 Ohm P.C. Mount
A8003	50 Ohm
A8004	1000 Ohm Miniature P.C. Mount
A8005	100 Ohm P.C. Mount
A8006	2000 Ohm P.C. Mount
A8007	5 Ohm
A8008	500 Ohm
A8009	5000 Ohm Miniature

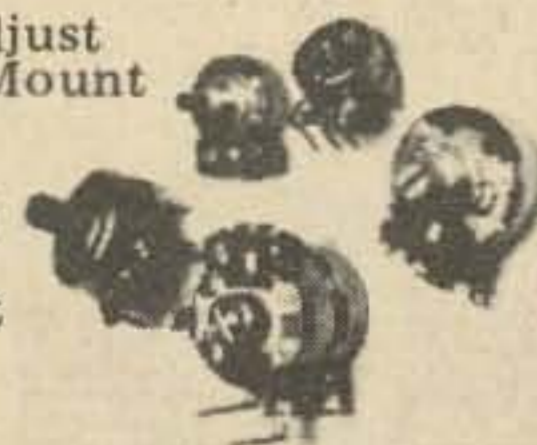

Lots of other items — send for free flier; All merchandise fully guaranteed. Please include postage; excess will be refunded.



## DELTA ELECTRONICS CO.

BOX 1, LYNN, MASSACHUSETTS 01903

1206 South Napa Street  
215-468-7892

# SELECTRONICS

Philadelphia PA 19146  
215-468-4645

## MARCH SURPLUS SPECIALS

### PANADAPTOR NAVY TYPE IP 206/URR

10 micro volts sensitivity. Input 400 to 500 KC ADJUSTABLE. 3" Cathode Ray Tube. 3RPI. CHECKED OUT - GUARANTEED.  
PRICE .....\$74.95

### RECEIVER DECODER

This is a modern unit utilizing transistors and miniature tubes and operates in the 400-500 mhz range crystal controlled. Measures 6 x 8 x 10" and weighs 10 pounds. NO SCHEMATIC AVAILABLE.  
PRICE .....\$24.95 FOB

### TDA-2 RTTY-TEST SCOPE

The Stelma Telegraph Distortion Analyzer type TDA-2 is a self contained portable unit designed to measure bias and distortion of telegraph start-stop signals. Distortion is indicated by vertical pips displayed in a rectangular pattern on the face of a cathode ray tube. Measurements can be made while the machine is operating. Measurements can be made on circuits operating at 60, 75 or 100 WPM on 20 or 60 ma neutral circuits or 30 ma polar circuits. Distortion measurements from zero to 50 percent with an accuracy of plus or minus two percent can be made. The set is patched in series with the loop and direct measurements made. No special skills required to make measurements after a few minutes practice. See your distortion, then adjust and watch it disappear.  
PRICE .....\$49.50 FOB

### OIL FILLED CAPACITORS

4 mfd at 10 KV. Perfect for that ultimate linear.  
PRICE .....\$24.95 ea. or 5 for \$100.00

### TRANSFORMER

115 Volts; 50-60 cycles; 6.3 C.T. at 20 amps; 2000 VAC test.  
PRICE .....\$3.95

### COMPUTER GRADE CAPACITORS

2500 mfd @ 200 VDC  
10000 mfd @ 35 VDC  
PRICE .....\$1.00 ea. or 6 for \$5.00

### SORENSEN "RANGER" REGULATED DC POWER SUPPLY MODEL 600B

SPECIFICATIONS:  
Output Voltage range: 0-600 VDC  
Output Current: 0-500 ma  
% Regulation Line:  $\pm 25\%$   
Load:  $\pm 25\%$   
Ripple (Max. RMS millivolts) 3  
Fil. Supply: 6.3 VAC @ 15A  
Bias Supply: 150 VDC  
Internal Impedance: 2 ohms  
Cabinet Size: 17"W x 14-7/8D x 10 1/2"H  
EXCELLENT CLEAN CONDITION  
NET WT. 85 lbs.  
PRICE .....\$39.95

### SPERRY MODEL FE HIGH BAND

4 channel crystal controlled with 115V AC Power Supply. Uses a pair of #6146's in transmitter. Consists of three units TRANSMITTER, RECEIVER & POWER SUPPLY, WITH SCHEMATICS. NO CABLES AVAILABLE.  
PRICE .....\$60.00 ea.  
LESS POWER SUPPLY .....\$40.00 ea.

### TRANSFORMERS SP 327

1000-0-1000 or 1200-0-1200; 200 ma CCS; 110 or 220 Volts.  
PRICE .....\$9.95 ea. or 2 for \$17.00

### METER PANEL TYPE WESTON MODEL 1238

0-500 microamps Full Scale. Calibrated .005 to 500 Roentgens/hour. Weston Model 1328, 270 degree scale, approx. 3" diameter. Excellent for wavemeter, etc. NEW & IN ORIGINAL BOXES.  
PRICE .....\$1.95 ea. 3/\$5.00

### WINTRONIX MODEL 850 INDUCED WAVE FORM ANALYZER

This unit in conjunction with your present oscilloscope, permits you to view wave forms in the range from audio thru MHZ without any direct connection. The probe is simply placed over the tube in question and the wave form is displayed on the oscilloscope. It may also be used as a high gain amplifier to increase 'scope sensitivity. Excellent for TV, Radio, Amplifier, and Transmitter repair and maintenance. BRAND NEW, WITH PROBE.  
PRICE .....\$19.95 ea.

### WESTON

#### 4 1/2 INCH PANEL METERS

0-30  $\mu$ A DC  
0-1 mA DC  
0-50  $\mu$ A Scale calibrated (0-75 VDC; 0-750 VDC)  
PRICE .....\$4.95 ea

We have a 500 ma regulated Power Supply plus and minus 20 volts, 115V input.  
Contains:

- 7 - 2 N 1613
- 7 - 2 N 1305
- 3 - 2 N 1304

PLUS OTHER PARTS in a small compact case. USED EXCELLENT CONDITION. Wt. approx. 10 lbs.  
PRICE .....\$6.95

All prices are FOB our warehouse, Philadelphia, Pa. All merchandise described accurately to the best of our knowledge. Your purchase money refunded if not satisfied. Terms are cash minimum order \$5.00. All merchandise subject to prior sale.

1206 South Napa Street  
215-468-7892

# SELECTRONICS

Philadelphia PA 19146  
215-468-4645

# WILL BUY FOR "CASH" ALL TYPES MILITARY ELECTRONIC PARTS EQUIPMENT-TEST EQUIPMENT

## ITEMS BELOW FOR SALE

### RECEIVERS

R122A/ARN12 Receivers 75 MC	
Signal AM .....	4.95
BC603 20-27 MC 12V Input .....	40.00
R447/ARN5D 332.6-333.8 MC 24VDC ..	5.00
R89/ARN 5A as above .....	5.00
R268/ARN5A as above .....	5.00
RS38 Mikes .....	4.50
R48/TRC8 FM Receiver	
230-250 MC 115V 60Cy .....	28.00
FM Transceiver 30-50 MC as is .....	ea. 12.50
CV217/ARN30 B10 Convert. ....	ea. 6.00
Gear Head Motor 1/6HP 110VAC	
Reversing 345 RPM output .....	12.95
Meters 0-1 MA (scale in RPM's)	
for cars; uncased .....	1.95
Variacs 20AMP 115V IN 0-130V	
OUT .....	ea. 20.00
Meter 0-50 Microamp .....	ea. 4.00
XFR 115V IN 6.3V 2A OUT .....	99
URC4-URC11 Emergency xmtrs.	
not checked out .....	ea. 15.00
PL359-.25 .....	PL259-.25
CB Walkie-Talkie damaged 100	
MW w/xtals; Need repair .....	ea. 7.50

### GENERATORS

2500 watt Portable, gasoline driven engine generator 120V 60 Cy. 1 cyl. 6.5 HP, 2800 RPM, 250 lbs., used good with oil inhibitor, each .....	\$225.00
Hand Generators for Ringing Telephones or light small bulbs G25/Pt. ....	1.95
Mast Base (for antenna) Flexible w/Feed thru insulator for MS Sections....	3.75
Mast Sections for above, each .....	1.25
EE8 Field Telephone Portable Hand Ringing uses 2 flashlite batteries up to 17 miles used working, each .....	15.00
1/4 Mile Reel of wire on DR8 Reel .....	7.00
Sound Power Handset works without Batteries. Set of 2 Pcs, set .....	15.00
Sound Power Head and Chest Set works without Batteries, each .....	12.50

### HEADSETS—MIKE'S—USED—GOOD

HS33 600 ohm impd. w/cushions....	\$ 6.75
HS30 250 ohm impd. w/604 xfr. ....	1.25
H63/U w/Boom Mike 600 ohms .....	3.95
H113/U 600 ohms .....	3.00
M29/U Hand Lip Mike Press to Talk .....	3.00
M2/UR Announcers Tig Mike .....	3.75
T17 Hand Push Button Mike .....	6.00
Dial Telephone Desk Style .....	4.00
Desk Telephone Less Dial .....	2.95
H33/PT Press to talk Handset w/matching Male & Female audio plugs .....	4.00

### TELETYPE EQUIPMENT

Polar Relays D163119A (255A) .....	2.00
TT52 Transmitter Dist. ....	20.00
TT16FG Reperf. ....	35.00
T372/FCC3 XMTR .....	25.00
T379/FCC3 XMTR .....	25.00
R525/FCC3 Rec. ....	30.00
R533/FCC3 Rec. ....	30.00

### COMMAND TRANSMITTERS

5.3-7MC Less tubes used as is .....	2.50
4-5.3MC Less tubes used as is .....	2.50

### KEYERS

TG34 Keyer Code Practice Set to reproduce signal from inked paper, variable speed, oscillator w/speaker and phone jack 115 & 230V in small trunk (no tape) used good, each .....	12.00
AN/GSCTI Code Practice Set .....	12.00
Code Key J37, each .....	3.00
Thigh Code Key J45, each .....	4.50
Heavy Duty Code Key, each .....	2.50

UPM4A Test Set Complete .....	\$200.00
CV94/FGC5 Tel. Code Converter Rec. ..	15.00
0-100/FGC5 Sig. Dist-Driv Rec. ....	12.50
CV81/FGC5 Tel. Code Conv. Trans .....	15.00
TT64/FGC5 Sig. Dist. Trans .....	15.00

**WE HAVE PARTS & COMPONENTS FOR THE FOLLOWING SETS: BC—SCR—GRC  
GRR—PRC—SB—TRC—VIA—ARN 21—ARC 33—ARC 34—ARC 21—ARC-65—FRC—PE  
TRANSISTOR POWER SUPPLIES—DYNAMOTORS—ARC 44—GRC 27—GRT 3—URC  
GMD1—TA—TCC—BC—VRC—GN—SRC—CD—Hand Sets—Head Sets—Telephone—Cables**

We have millions of items that we do not catalog. We invite you to visit our retail outlet which is open on FRIDAY NITE 5 to 8 PM and SATURDAY 9 AM to 5 PM.

We buy all types of parts and Modules for Army and Airforce Communications. Send sample picture, Fed. Number or Sig. Number. We are buyers not askers.

Send your inquiries by Sig-Fed-Mfr-Mil Dwg Numbers. Manufacturers Prototypes Avail. If it's Electronics we have it or may get it. The largest inventory available.

## ELECTRONICTOWN

"THE EYES AND EARS OF THE INDUSTRY"



1617 South Main Street and Anker Road — Wilkes Barre, Pa. 18702 — Area Code 717 824-7859

## CONSTANT VOLTAGE TRANSFORMERS

STATIC-MAGNETIC VOLTAGE REGULATING TRANSFORMERS

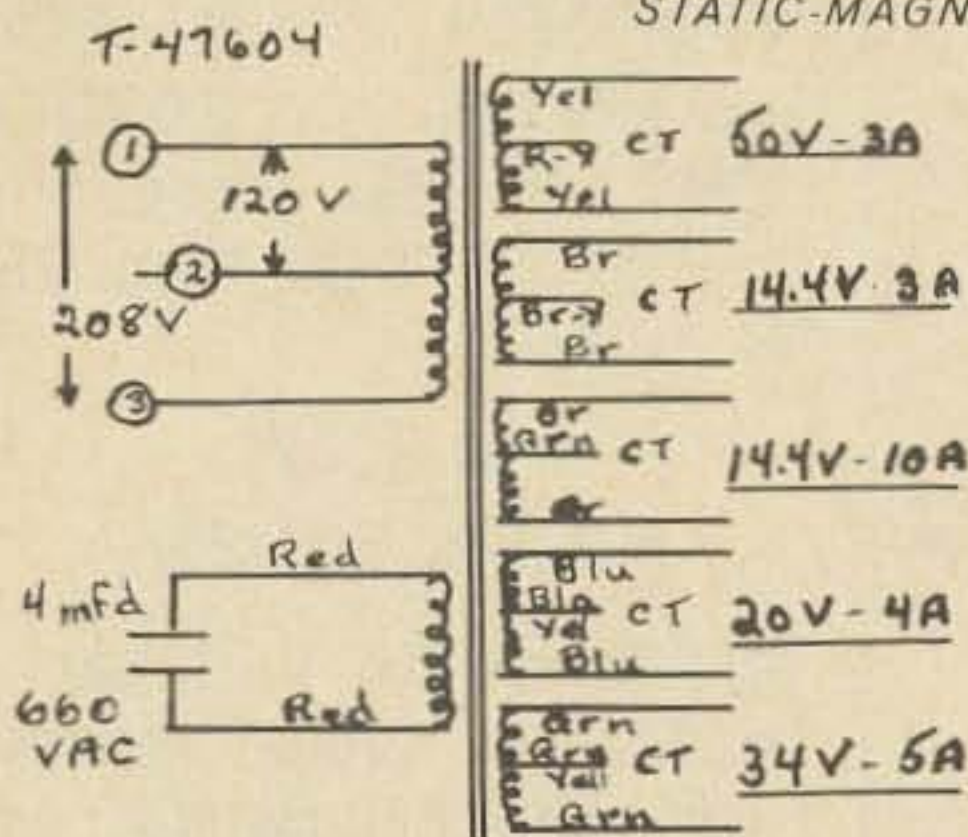

wt. 22lbs. \$12.75  
Capacitor 1.00

Open Type  
External  
Capacitor



Computer grade capacitors and silicon rectifiers for all these transformers are available.

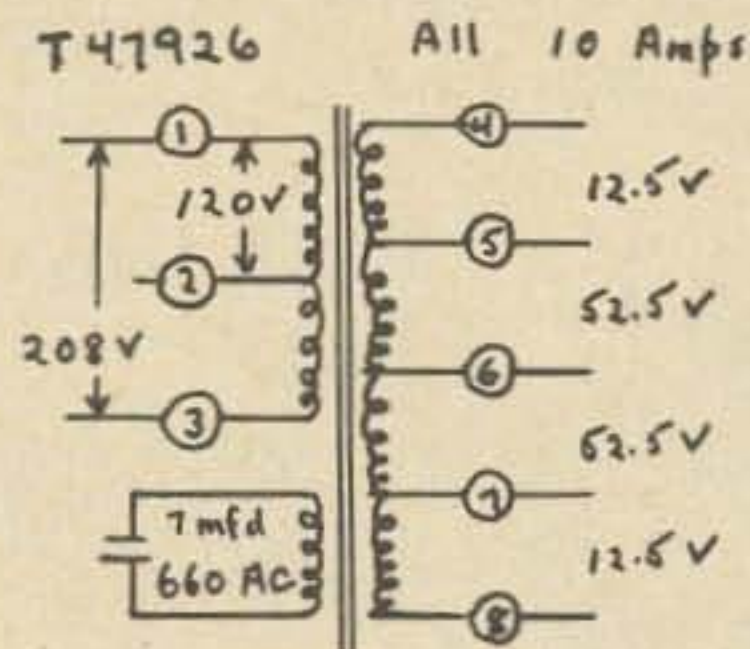

Wt. 33# wt. 33lbs. \$13.75  
Capacit Capacitor 1.50

**T-47927**

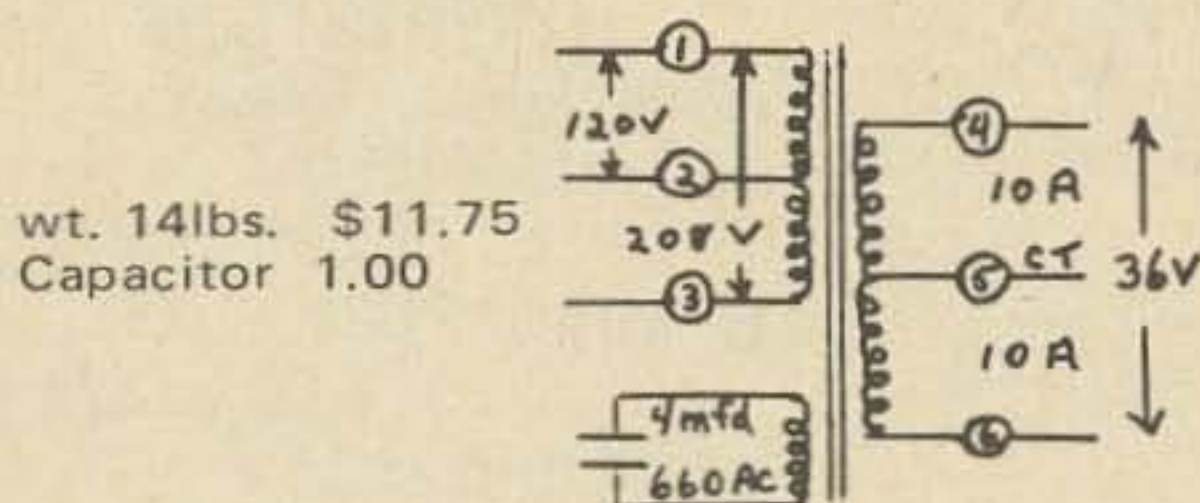

wt. 14lbs. \$11.75  
Capacitor 1.00

**T-57055**

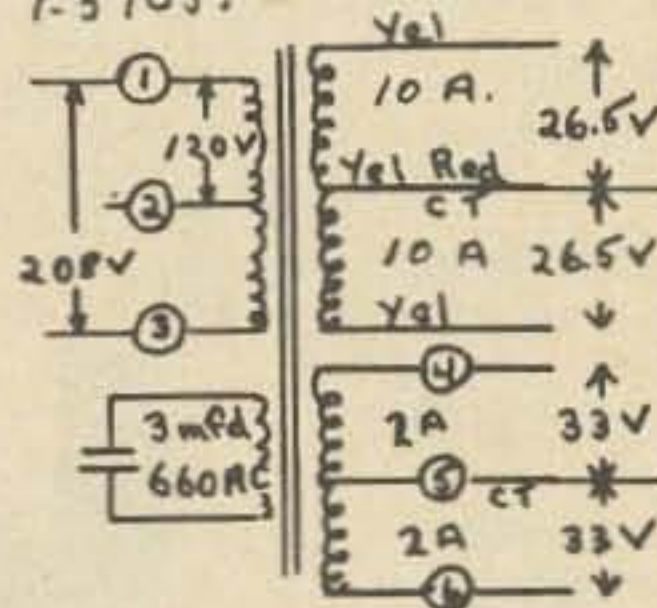

wt. 12lbs. \$10.75  
Capacitor 1.00

### HIGH AMPERAGE

16 volts - 32 volts  
750 VA.

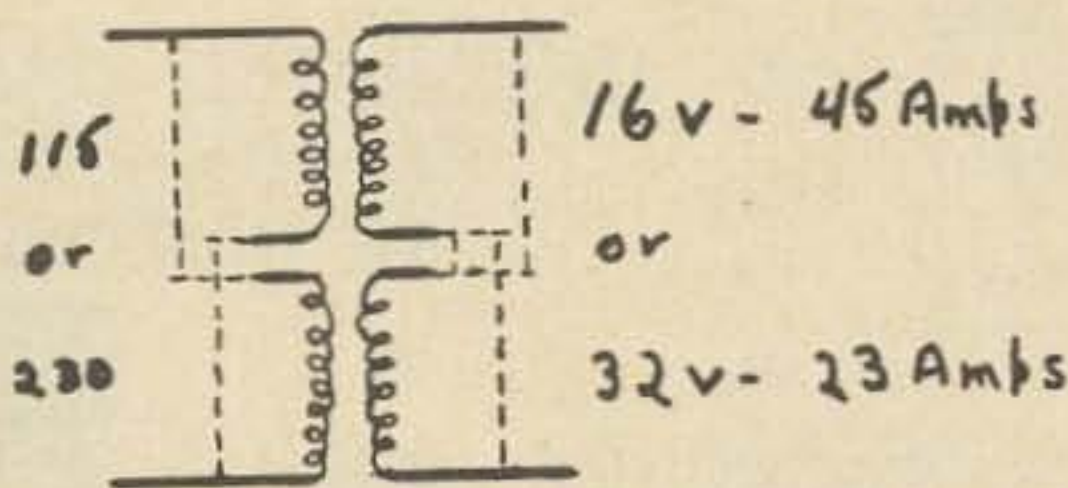

wt. 18lbs. \$17.75

12 volts - 24 volts  
750 VA

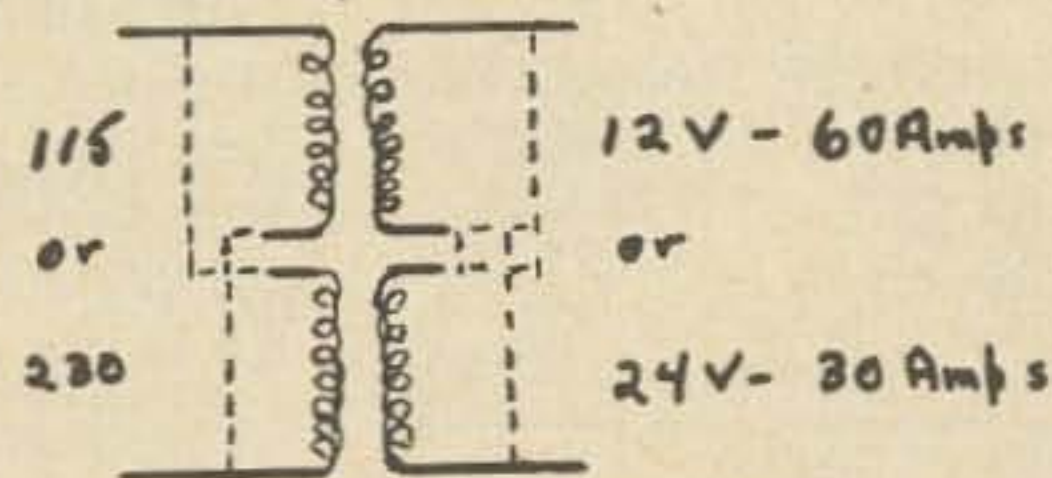

wt. 18lbs \$14.25

### POWER SUPPLIES

25 Volts DC at 10 Amps  
Filtered with 2 - 18000 mfd  
Capacitors  
Plus 33VAC at 2 Amps. Also  
Employs Constant Voltage  
Transformer #57055 Described  
Above; 3 mfd capacitor;  
#368B Silicon diodes; fused. . . . \$22.50

24VDC @ 5 Amps	
17VDC @ 5 Amps	
9VDC @ 7 Amps	\$29.75
6VDC @ 10 Amps	
6VDC @ 5 Amps	

Employs Constant Voltage Trans-  
former #T47604 described above;  
transformer capacitor; 5 sep-  
arate filter capacitors; 10 -  
#368B Silicon diodes.

### JOHNSON CAPACITORS



Type 154-2 15-353 pF; 2KV . . . . .	\$3.75
Type 167-161 4.7-55 pF . . . . .	.69
Type 167-203 Butterfly; 5.9-65 pF . . . . .	.98
VC 375 10-130 pF; 3.5KV . . . . .	1.95
VC 375S 12-100 pF; 2KV . . . . .	1.50
VC 3 2KV Split Stator; 350 pF; (175 per sect.) . . . . .	2.95

### EQUIPMENT SPECIALS

T-67/ARC 3 Transmitter - less tubes . . . . .	\$ 10.95
ART-13 Transmitter - less tubes . . . . .	19.95
T20/ARC 5 Transmitter - with tubes . . . . .	5.95
BC455/ARC 5 Receiver 6-9 MC with tubes . . . . .	19.95
R10/ARC 12 Receiver 550-1500 KC with tubes. New-17.95. . . . .	12.95
R11/ARC 12 Receiver Q-5ev. 190-550 KC with tubes . . . . .	9.75
Less tubes . . . . .	5.95
R13/ARC 12 Receiver 108-135 MC - less tubes & cover - some dents . . . . .	12.95
R105/ARR 15 Receiver Collins Gen. Coverage with tubes . . . . .	54.50
R517/FRR 26 Receiver with tubes. Excellent . . . . .	59.50
R266/URR 13 Receiver 200-400 MC with tubes. Excellent . . . . .	169.50
With tubes - less outer case . . . . .	99.50
IP274/ALA 2 Panadapter - with tubes. Excellent . . . . .	14.95

# ARROW SALES

2508 S. MICHIGAN AVENUE

CHICAGO, ILLINOIS 60616

## JENNINGS VACUUM VARIABLE - NEW

UCSH-50 15 to 50 MMF  
10,000V ..... \$19.95  
UHC-75 10 to 75 UUF  
45,000V ..... 24.95



## COOLING FAN

blower, 4 pole  
110v 60 cyc motor with 4 bladed nylon fan. Very quiet, about 50 CFM 2 1/2"W x 3"H x 2 1/4"D. Sh. wt. 3#. \$2.25 ea.

## HEAVY CHROME CABINETS

Front rolled to hold panel in place. No rear panel 5-1/8"W x 2-5/8"D x 3-1/8"H. NEW  
95¢ ea ..... 10/\$8.95

## METER 0-60 AMP 2 1/2"

Round aircraft type with shunt  
NEW ..... \$2.25

TELETYPE PAPER 8 1/2" wide  
rolls sh. wt. 40 pounds. 12/\$4.95

## CATHODE MAGNETIC TUBE SHIELDS

3".....\$1.49 5".....\$2.49  
500 mmf at 500V Feedthrus  
.001 uf at 600V By-pass 20/\$1.00  
cap ..... 12/\$1.00  
100 BUD 100 UUF 1/4" shaft \$1.50  
20 to 120 mmf per section  
Butterfly 8 1/2" x 6 1/2" x 5"D 1/4" shaft 7500 VAC  
NEW ..... \$7.50

## MICA TRIMMER CAPACITORS

4 to 50 uuf CHOICE  
4 to 130 uuf 15¢ ea.  
5 to 100 uuf 8/\$1.00  
4 to 90 uuf  
Miniature butterfly cap. 2.3 to 8 uuf...75¢ ea.....10/\$5.95

## DUMMY LOAD

50 Ohm 150 Watt Noninductive metallic film.  
\$1.50ea. .... 4/\$5.00



## PISTON TRIMMERS

glass JFD-VC11G panel mount  
.6 to 14 uuf..50¢ ea.. 10/\$4.49

VARIACS GENERAL RADIO & OHMITE 60 cyc. Input 120v, output 0-280v 1 amp or input 240v, output 0-280v 2 amp. Pullouts in excel. cond. (10 lbs.).. \$6.95



## PC BOARDS

2 x 2.....15¢  
3 x 6.....35¢  
4 x 6.....45¢  
Etching solution ..... 99¢ pt.  
Resist paint ..... 79¢ bt.

R & R DOZEN (13) for price of twelve

TWO LOCATIONS

R & R ELECTRONICS  
311 E. South  
Indianapolis, Indiana  
46225



R & R ELECTRONICS  
1953 S. Yellow Springs  
Springfield, Ohio  
45506 Dept. C69

\$2.00 minimum order FOB Springfield, Ohio. COD order 25% deposit. Please add sufficient postage, we refund unused amount. Ohio customers add 4% sales tax. PLEASE refer all mail order to Ohio store. Watch for our booth at this summer's "Hamfests."

## 100 KC CRYSTAL CALIBRATOR

### KIT NO. 1

K100c-2 100 KC CRYSTAL CALIBRATOR. First PC board kit contains components for 100 KC output. The output of this little unit is really very stable, ±.005% or better at 100 KC. Voltage requirement is 4.5VDC (3-1 1/2 V flashlight batt.). Complete with crystal, integrated circuits and all components.  
ONLY ..... \$4.95

### KIT NO. 2

K100C-2A Contains two PC boards with components of Kit No. 1 and has additional components to deliver outputs of 50 KC & 25 KC band edge markers. Complete Kit K100C-2A (shown in photo) will deliver stable harmonic-rich outputs of 100 KC, 50 KC and 25 KC band edge markers. Units deliver a square wave which gives useful harmonics up to 50 MC.  
ONLY ..... \$7.95



Crystal Calibrator Printed Circuit Board Assembly Etched And Drilled Ready For Assembly In 5 Minutes

## TRANSFORMERS NEW All Primaries 110V 60 Cyc.

Jefferson Electric 10,000V 23 Ma.....ea. \$4.95  
UTC-CG-33 6.3V 4 Amp.... 1.95  
12 Volt 5 amp w/circuit breaker ..... 3.00  
CG-131 UTC Plate to Grid Pri. 15K ohm Sec. 135K ohms +28 DBM. Commercial Grade..... ea. 1.25

## AMPHENOL CONNECTOR SALE

PL259..... ea. \$ .45  
10/\$4.00..... 100/\$37.50

## CRYSTAL OSCILLATOR KITS

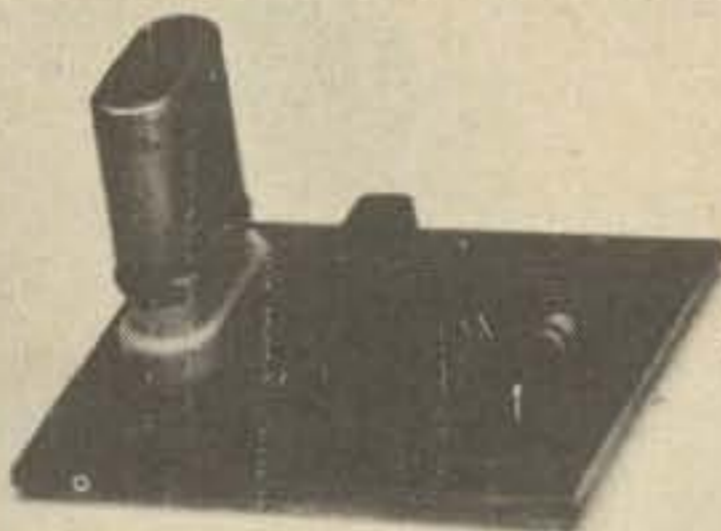

Using IC UL 914 Stable, harmonic-rich output osc. range 100 KC to 10 MC - Kit includes Fairchild IC UL 914, crystal sockets, resistors, capacitor, & PRINTED CIRCUIT BOARD, with instructions for assembly..... \$2.00 per Kit.

## \$10.00 FOR \$1.99

Over-stocked on CAPACITORS. \$10.00 worth for only \$1.99. Less than 25¢ per lb; 8 lbs.

## ALL NEW NO PULLOUTS

Guaranteed to your satisfaction or your money back. Don't miss out on this SALE.

## ELECTROLYTIC CAPACITORS

Power Supply Type  
1000 mfd @ 260V

\$1.75 ea 4/6.25

500 mfd @ 200V

1.50 ea 4/4.95

15,000 mfd @ 35V

1.75 ea 4/6.26

ALL CAPACITORS NEW NO PULLOUTS

1000 PIV 1 1/2 Amps epoxy diodes..... 10/\$3.75

## INTEGRATED CIRCUITS FACTORY FRESH NO REJECTS



## FAIRCHILD

UL 914 w/30 projects dia... 80¢ ea  
10/\$7.50..... 100/\$65.00  
UL 923 J.K. Flipflop with spec. sheet..... \$1.50 ea  
10/\$13.50..... 100/\$110.00

## MOTOROLA

Spec sheet included

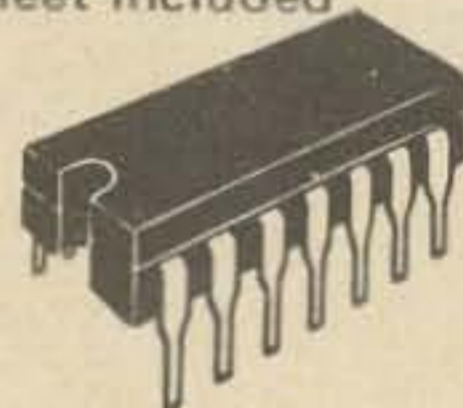

MC790P Dual JK Flipflop... \$2.00  
10/\$18.95..... 100/\$179.50  
MC789 Hex Inverter  
MC724 Quad 2 Input Gate  
MC799 Dual Buffer  
ABOVE 3 IC's Choice... \$1.10 ea  
10/\$9.95

PLEASE refer all mail order to Ohio store



# ◆ JEFF-TRONICS ◆

## TEST EQUIPMENT

Kartron 101-DR Electronic shorted-turn indicator .....	\$ 25.00	SG 87/AQM 2 Sonar Test Set. Low Freq. Signal Gen. w/dB meter, ultrasonic transducer, 3 12AU7 tubes, nice alum. case. New .....	\$ 15.00
Federal 804-CS1 Microvolt Generator, 8-330 MC .....	\$ 95.00	Power Transformer, 275V No Ct., 125 MA, 12V @ 2 amps. Upright mount. 8 lbs. ....	\$ 2.00
Hickok 610 TV Sweep Generator, less case & dial bezel. ....	\$ 25.00	Power Transformer, 490-0-490V @ 75 MA, 5V @ 2 amp, 6.3V @ 5.5 amp. Open frame. 8 lbs. ....	\$ 2.00
Fluke 101 VAW Meter with 3 shunts ..	\$150.00	16 Volt Transformer @ 15 amps. Open frame. 8 lbs. ....	\$ 4.00
G-R 874-LBA Slotted Line. Like New ..	\$140.00	Adjustable Choke, 1-20 Hy. 900 ohms. Fully cased. 2" x 1.3" x 1.3" .....	\$ 1.50
G-4 874-VI Voltmeter indicator .....	\$ 20.00	Oil-filled Capacitor, 1 mf 3000V DC GE Pyranol, .... \$1.50 ea. .... 10/	\$ 12.00
G-R 1213-C Unit time/freq. Calibrator. Less pwr. supp. ....	\$ 85.00	5 mf 440V AC Capacitor, Sangamo, Rect. can. ....	\$ 1.00
Dumont 294-A Oscilloscope, with power supply. 160 lbs. ....	\$125.00	Mica Trimmer Capacitors, 3-30 pf. ea. ..	\$ .10
G.E. ST-4A TV Sweep Generator .....	\$ 75.00	Variable Capacitor, 170 pf max. 1000V Screw driver adj. .... 60¢ .....	2/\$ 1.00
Kay Model RF-P "Marka-Sweep" Sweep and Marker Generator .....	\$ 35.00	Variable Capacitor, Johnson 110R25, 110 pf max. 1250V ... \$1.50 ea. ... 4/\$	5.00
Kay "Mega-Marker Sr." Tv Marker Generator .....	\$ 20.00	Capacitor Assembly, 4 Johnson 160-127, miniature, 17 pf max. on Phenolic strip. ONLY .....	\$ 2.00
Simpson 604 "Multicorder" recording Multimeter .....	\$ 70.00	Micrometer Spindle, LS Starrett #263-M, 0-25 millimeters In .01 mm graduations. ONLY .....	\$ 5.00
Keithley instruments 515 megohm bridge .....	\$100.00	AC Vacuum-Tube Voltmeter, made by Trio Labs. 3" panel meter w/built-in amplifier. Range 0-42V, but w/input divider removed, it is about 10 mv. Requires 100 vdc & 6.3V to operate. w/schematic. Used, good .....	\$ 4.50
Sola 23-90-150 Constant voltage trans. output variable 0-130V @ 7½ amps. max. V & A meters on panel. Like New .....	\$100.00		
Sorensen "Nobatron" 150-5. 0-150 VDC @ 5 amps. max. adjustable current limiting .....	\$150.00		
Philbrick R-100B Dual power supply, +300, -300V at 100 MA .....	\$ 22.50		
Lambda Model 28 pwr. supply, 200-324V DC @ 100 MA .....	\$ 25.00		
TG-34A Code Practice machines. Unused .....	\$ 20.00		
Gear-Head Motors, GE, 50 oz. -In. Torque, 56 rpm. 115V 60 cy., capacitor motor, with capacitor .....	\$ 6.00		
Selsyn Assembly, contains 2 GE 2JIG1 Selsyns, plus gears, etc. Used, good, only .....	ea \$ 2.00		

## MOTORS

12 vdc Auto Heater Fan Motors, shunt wound. 5/16" diam. shaft both ends.	\$ 1.00
6 vdc Auto Heater Fan Motor. 5/16" diam. shaft, one end .....	\$ .50
Induction Motor, 2-pole, 115V 60 Cy. 3/16" diam. shaft. Good for fans, etc. .... 85¢ ea. .... 6/\$	4.50
4-pole Induction Motor, 3/16" diam. shaft, made for tape recorder. .... ea.	\$ 1.25
Power Cord, 3-wire #16, 9 ft. long, green plastic w/grounding plug .....	\$ .75

## RELAYS

DPDT, Ceramic insulation, 28 vdc coil, We've sold hundreds of these in the past, just found some more. Good for antenna relay, etc. 10 amp contacts. ....	\$ .75
DPDT, 220V 60 Cy coil. "Wheelock" made by Signal Engineering. Very high grade. 10 amp contacts. \$1.50 each .....	4/\$ 5.00

On mail orders; please add sufficient money for postage. Any excess is immediately refunded. Minimum order \$2.00  
For our Canadian customers, the Parcel Post rate is \$1.00 for the first 2 pounds, and 30¢ for each additional pound or fraction. U.S. funds.

**TRADE YOUR USED LABORATORY OR SURPLUS TEST EQUIPMENT ON NEW DRAKE OR GALAXY EQUIPMENT OR USED HAM GEAR. WE GIVE TOP TRADE-IN ALLOWANCES.**

Send 10¢ for our catalog listing hundreds of other surplus items, and new and used ham equipment.

# JEFF-TRONICS

4252 Pearl Rd.

Cleveland, Ohio 44109

# IMPULSE COUNTERS



#1. VEEDER ROOT-4 Digit, 0000-9999 115 VAC 6W. Pushbutton reset to zero. Dim.—1¼"H x 2"W x 3"D. Used—Guaranteed Excel. . \$4.50 ppd.

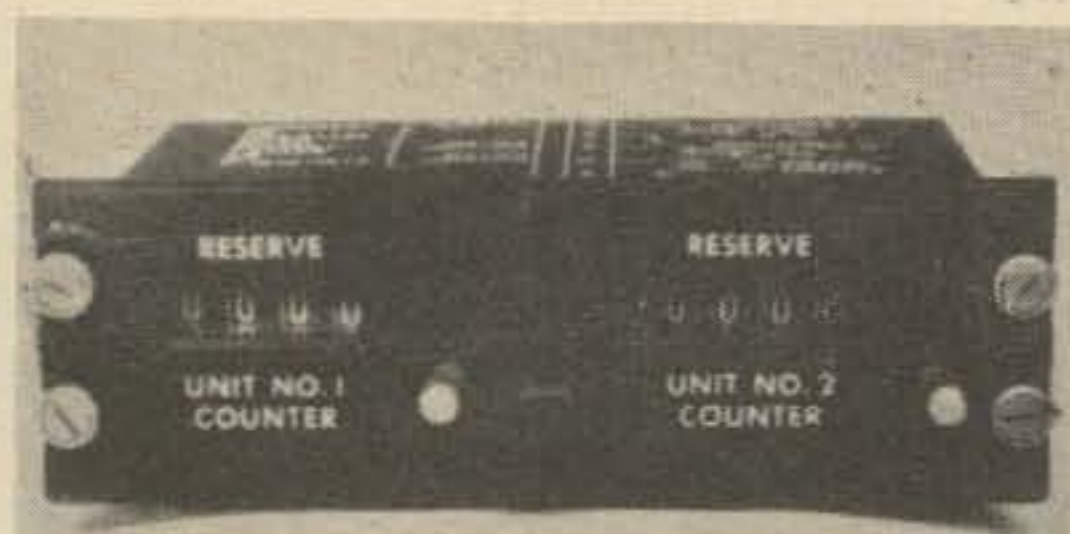

#2. Dual Four-Digit DOWN COUNTERS. Front panel adjusts to any number up to 9998. Counts down to zero. 28 volts DC coils. 2 - 28 volts DC or AC Panel Lamps. Like New. . . . . \$6.50 PPD.

## CIRCUIT BOARD ASSEMBLY



Unusual Find!!! Digital Assembly. 3 Boards mounted on a frame with panel. Fixed center board. Outside boards are hinged and swing out. Use frame for breadboard assemblies. Panel 2 3/8 x 8 5/8. Depth 15". All parts easy to remove. 300 1N658, 77-114 Sw. Xsistors, IN754 Zeners, Uni-junctions, Tantalums, & much more.

Board #1 - As above . . . . . \$4.00  
 Board #2 - As above + 1 Clare Mercury wetted relay module, #HGSM1001 . . . . . \$5.50  
 Board #3 - As above + 3 Clare Mercury wetted relay modules, #HGSM1001 . . . . . \$6.50

SHIPPING WEIGHT 5 LBS.

## TRANSFORMER SPECIALS

- 1. Pri. 115VAC **\$6.50**  
 Sec. 1) 20-0-20VAC @ 10 A.  
 Sec. 2) 14-0-14VAC @ 5 A.

---

- 2. Pri. 115VAC **\$3.50**  
 Sec. 1) 17-0-17VAC @ 2A.  
 Sec. 2) 70-0-70VAC @ 50 ma.  
 Sec. 3) 30-0-30VAC @ 25 ma.

---

- 4. Pri. 115VAC **\$4.50**  
 Sec. 1) 6.3VAC @ 6A.  
 Sec. 2) 18VAC @ ½ A.  
 Sec. 3) 450VAC @ 55ma.

---

- 5. Pri. 115-230VAC **\$8.00**  
 Sec. 1) 1500VAC @ 250 ma.  
 Sec. 2) 115VAC @ 1.5A.  
 Sec. 3) 33VAC @ 0.7A.

ALLOW 20 LBS. SHIPPING ON ALL TRANSFORMERS AND WE WILL REFUND ANY DIFFERENCE. WE SHIP UPS.

## COPPER CLAD LAMINATES

G10 EPOXY GLASS  
 1 oz. Copper 1 Side

Pkg. Quant.	3/64"	1/16"	3/32"	1/8"
1 9x12"	\$1.50	\$2.50	\$3.50	\$5.00
2 6x9"	"	"	"	"
4 4½x6"	"	"	"	"
6 3x4½"	"	"	"	"

This item postage prepaid.

Every order unconditionally guaranteed.

# TRIPRIO

2614 Lake Shore Dr. *Electronics* LaCrosse, 2, Wis. 54601

# POLY PAKS SMASHES

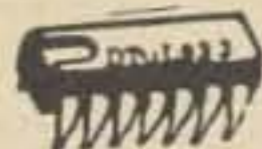

## "IC" PRICES!

By Sylvania! Texas! Westinghouse!  
Fairchild! GE! National!  
Brand New! Spec Sheets & Hookups!

GE PA-237 2-WATT  
INTEGRATED CIRCUIT  
AUDIO AMPLIFIER! **\$2.95**

\*Brand New!

\*Lowest Prices

\*Dual Inline



each  
3 for \$6.00

2 watts continuous 9 to 27 volt supply, 8 mV sensitivity, includes 11 circuits, for phono, tape recorders, dictating, TV, FM, movie.

Westinghouse WC334 one watt audio amp, TO-5 case .....\$1.98

### BRAND NEW! FAIRCHILD\* SYLVANIA RTL-TTL 'ICS'

No.	Description	
<input type="checkbox"/> SG-43SD	Quad 2 Input Gate*	<b>99¢</b>
<input type="checkbox"/> 900F	Buffer	
<input type="checkbox"/> 903T	3 Input N/N Gate	each
<input type="checkbox"/> 910T	Dual 2 Input Gate	
<input type="checkbox"/> 914T	Dual 2 Input Gate	3 for \$2.75
<input type="checkbox"/> 915T	Dual 3 Input Gate	
<input type="checkbox"/> 923F	JK Flip Flop	
<input type="checkbox"/> 925F	Dual 2 Input Gate	
<input type="checkbox"/> 926T	20 mhz 923	

S: Sylvania, D: dual inline, F: flat pak, T: TO-5 case; \*TTL

### GIANT SALE ON EPOXY-GLASS AMPS

- ★ Avalanche Type
- ★ Micro Miniature
- ★ Up to 2 Amps

PIV	3 for
<input type="checkbox"/> 50	.15
<input type="checkbox"/> 100	.19
<input type="checkbox"/> 200	.21
<input type="checkbox"/> 400	.29
<input type="checkbox"/> 600	.42
<input type="checkbox"/> 800	.49
<input type="checkbox"/> 1000	.69

### BRAND NEW! WESTINGHOUSE DTL FLATPAK 'ICS'

- ★ In Mech Pak Carriers
- ★ With Spec. Sheets

No.	Description
<input type="checkbox"/> WC210G	Two 3 input Line Driver
<input type="checkbox"/> WC215G	JK flip flop (clock 15 mhz)
<input type="checkbox"/> WC226G	Triple 3 Input Gate
<input type="checkbox"/> WC227G	10 input diode expander
<input type="checkbox"/> WC261G	Dual 4 input NAND gate with nodes
<input type="checkbox"/> WC266G	Quad 2 input NAND gate



**99¢**  
3 for \$2.75

### SALE ON FAIRCHILD COUNTING "ICS"

GUARANTEED

No.	Description	
<input type="checkbox"/> 958	Decade-Counter	\$3.95
<input type="checkbox"/> 959	Quad Latch	3.95
<input type="checkbox"/> 960	Decoder Driver	5.95
<input type="checkbox"/> SN7475	Quad Latch	4.50

1 AMP 800 PIV 10  
RECTIFIERS for **1.49**

### SOLID STATE 1970 WINNERS

- Philco SC1600 Dual Mosfets .....\$3.98
- Fairchild 9601 Mono Vibrator .....\$3.98
- Fairchild 741 OP. Amplifier\* .....\$2.98
- \*frequency compensated 709
- Westinghouse Voltage Regulator 0 to 40 VDC Positive .....\$1.19
- Shockley Diodes, 4 layers .....3 for \$1.19
- Neon & Nixie Driver 2N4410 .....4 for \$1.00
- SCR/Triac Trigger Diodes .....4 for \$1.19

### HIGH VOLTAGE

PIV	SALE 1 AMP
<input type="checkbox"/> 2000*	1.00
<input type="checkbox"/> 3000	1.35
<input type="checkbox"/> 4000	1.65
<input type="checkbox"/> 5000	2.25
<input type="checkbox"/> 6000	2.96
<input type="checkbox"/> 8000	3.50
<input type="checkbox"/> 10000	3.95

EPOXY SILICON RECTIFIERS

2 AMP  
1000 PRV  
SILICON  
RECTIFIERS for **\$1**

### LOWEST PRICES ON LINEAR AMPLIFIERS

#### 709C OP AMPLIFIER



Guaranteed! With Spec. Sheets!

TYPICAL USES:  
AC AMPLIFIER  
RIAA PHONO PREAMP  
INTEGRATOR MULTIPLIER

**\$1.69** 3 for \$4.75

How's your "MEMORIES" for 1970?  
With Spec. Sheets

- Fairchild 1128 8 bit .....\$ 2.49
- Fairchild 9033 16 bit .....\$ 3.95
- Philco PL5R100 Dual 50 bit .....\$12.50
- 4000 Bit Core Planes .....\$ 8.50

Terms: add postage. Rated: net 30, cod's 25%  
Phone Orders: Wakefield, Mass. (617) 245-3829  
Retail: 211 Albion, St., Wakefield, Mass.

10¢ FOR OUR SPRING BARGAIN CATALOG ON:  
 Semiconductors  Poly Paks  Parts

### POLY PAKS

P.O. BOX 942A  
Lynnfield, Mass.  
01940

### EPOXY SILICON TRANSISTORS

5 for \$1



Type	Sale
<input type="checkbox"/> 2N2222	5 for \$1
<input type="checkbox"/> 2N2368	5 for \$1
<input type="checkbox"/> 2N2711	5 for \$1
<input type="checkbox"/> 2N2368	5 for \$1
<input type="checkbox"/> 2N3396	5 for \$1
<input type="checkbox"/> 2N3565	5 for \$1
<input type="checkbox"/> 2N3568	5 for \$1
<input type="checkbox"/> 2N3638	5 for \$1
<input type="checkbox"/> 2N3641-3	5 for \$1
<input type="checkbox"/> 2N3645	5 for \$1
<input type="checkbox"/> 2N3662	5 for \$1
<input type="checkbox"/> 2N3683	5 for \$1
<input type="checkbox"/> 2N3793	5 for \$1
<input type="checkbox"/> 2N4248	5 for \$1
<input type="checkbox"/> 2N4284-5	5 for \$1
<input type="checkbox"/> 2N4288-9	5 for \$1
<input type="checkbox"/> 2N4290	5 for \$1

# CRYSTALS·CRYSTALS·CRYSTALS

**HC18/U**  
**Wire Leads**  
 1 1/2" for soldering  
**\$1.75** EA  
 3 for \$5.00

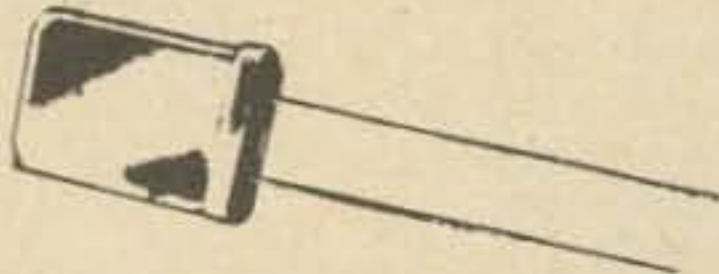

**MINIATURE TYPE** - The popular miniature crystals listed are supplied with wire leads for soldering into circuits and are fundamental frequencies up to 20 megacycles. Those higher in frequency are third, fifth or seventh overtones. All are made with "AT" cut quartz blanks with tolerances of .005% or better over a temperature range of -40 to +70 degrees centigrade. Crystal frequencies listed are in stock for immediate delivery. Fractions of kilocycles have been omitted in the listing. Frequencies are in megacycles. We will make to order any frequency from 10 to 55 MC non-oven miniature crystal at \$4.50 each. From 56 to 105 MC at \$5.50 each. Order by frequency and holder type HC18/U. Crystals listed are \$1.75 each or 3 for \$5.00.

4.294	11.425	16.575	21.701	27.640	36.800	39.148	40.259	41.296	42.481	53.307	61.675	82.992	101.666
4.301	11.475	16.750	22.559	27.670	36.900	39.185	40.296	41.300	42.518	53.357	61.987	83.000	102.866
4.553	11.480	16.950	22.659	27.680	37.395	39.222	40.333	41.333	42.550	53.407	62.150	83.992	102.966
4.653	11.500	17.000	22.759	27.750	37.500	39.250	40.350	41.350	42.555	53.457	64.025	86.000	103.066
4.680	11.510	17.050	22.859	28.250	37.962	39.296	40.370	41.370	42.592	53.507	64.737	88.978	103.166
4.753	12.000	17.100	22.959	29.250	37.982	39.333	40.407	41.407	42.750	53.557	64.992	89.000	103.566
4.853	14.000	17.150	23.050	29.562	38.000	39.350	40.444	41.444	42.850	53.607	65.737	90.000	103.666
4.953	14.100	17.200	23.059	29.750	38.025	39.370	40.450	41.450	42.950	53.657	65.992	90.978	103.766
5.053	14.200	17.250	23.159	29.850	38.037	39.407	40.481	41.481	45.000	53.707	66.666	91.000	103.866
5.153	14.250	17.350	23.259	29.937	38.074	39.444	40.518	41.518	45.041	53.716	66.992	91.978	103.966
5.253	14.300	17.450	23.359	30.000	38.111	39.450	40.550	41.550	45.250	53.750	67.025	92.978	104.066
5.353	14.350	17.500	23.459	30.125	38.148	39.481	40.555	41.555	45.750	53.757	67.500	93.978	104.166
5.453	14.400	17.550	24.050	30.250	38.185	39.518	40.592	41.592	46.250	53.807	67.992	94.978	104.266
5.500	14.450	17.650	24.550	30.312	38.222	39.550	40.629	41.629	46.750	53.857	68.737	95.978	104.366
5.600	14.498	17.750	24.800	30.500	38.259	39.555	40.650	41.650	46.850	53.907	68.987	96.250	104.566
5.650	14.500	17.850	24.900	30.687	38.296	39.592	40.666	41.666	46.950	53.957	68.992	96.750	104.766
6.255	14.600	18.000	26.083	31.437	38.333	39.629	40.703	41.703	47.050	53.987	69.487	96.978	105.000
7.255	14.700	18.250	26.094	31.625	38.370	39.650	40.740	41.740	47.150	54.716	69.987	97.978	110.000
7.280	14.800	19.166	26.111	31.812	38.407	39.666	40.750	41.777	47.250	54.987	69.992	98.000	115.000
9.173	14.850	19.266	26.133	32.187	38.444	39.703	40.760	41.814	47.350	55.383	70.487	99.766	120.800
9.375	14.895	19.433	26.166	32.375	38.518	39.740	40.777	41.851	47.450	55.716	70.987	99.866	120.950
9.496	14.900	19.800	26.194	32.900	38.555	39.777	40.814	41.888	47.550	55.987	70.992	99.966	121.000
9.666	14.950	20.285	26.222	33.100	38.592	39.814	40.851	41.925	47.650	56.987	71.237	100.066	125.000
10.525	15.094	20.375	26.249	33.200	38.629	39.850	40.888	41.962	47.750	57.150	71.487	100.266	126.200
10.625	15.195	20.473	26.277	33.300	38.666	39.851	40.916	42.000	48.250	57.800	71.987	100.366	
10.675	15.295	20.498	26.305	33.333	38.703	39.888	40.925	42.037	48.750	57.850	71.992	100.466	
10.825	15.675	20.568	26.333	33.400	38.740	39.925	40.950	42.050	49.050	57.987	72.487	100.566	
10.875	15.775	20.662	26.349	33.600	38.777	39.950	40.962	42.074	49.716	58.294	72.987	100.666	
11.025	15.875	20.757	26.377	33.700	38.814	39.962	41.000	42.111	49.750	58.394	73.333	100.766	
11.050	15.975	20.851	26.670	33.800	38.851	40.000	41.037	42.148	52.987	58.987	73.487	100.866	
11.075	16.000	20.946	27.145	33.900	38.888	40.037	41.050	42.185	53.007	59.987	73.987	100.966	
11.100	16.075	21.040	27.480	34.125	38.925	40.050	41.074	42.222	53.050	60.000	77.992	101.066	
11.125	16.175	21.135	27.510	34.855	38.962	40.074	41.111	42.259	53.057	60.050	78.992	101.166	
11.150	16.250	21.229	27.560	34.888	39.000	40.111	41.148	42.296	53.100	60.085	79.992	101.250	
11.175	16.275	21.324	27.580	34.955	39.037	40.148	41.150	42.333	53.107	60.400	80.992	101.266	
11.200	16.375	21.418	27.590	35.875	39.050	40.150	41.185	42.370	53.157	60.750	81.000	101.366	
11.225	16.475	21.512	27.620	36.700	39.074	40.185	41.222	42.407	53.207	60.987	81.999	101.466	
11.250	16.500	21.607	27.630	36.750	39.111	40.222	41.259	42.444	53.257	61.150	82.000	101.566	



ANY OF THE ABOVE LISTED FREQUENCIES CAN BE SUPPLIED IN TYPE HC6/U HOLDERS AT \$ 2.50 EACH.

## HOW TO ORDER...

Order crystals by **FREQUENCY** and **HOLDER TYPE**...enclose check or money order... add 5¢ per crystal for postage and handling via Parcel Post...add 10¢ per crystal for **FIRST CLASS MAIL AND PACKING**...add 15¢ per crystal for shipment via **AIR MAIL AND PACKING**...**FOR ALL ORDERS OUTSIDE THE UNITED STATES ADD 25¢ PER CRYSTAL FOR AIR MAIL AND PACKING TO FOREIGN COUNTRIES.**

Make check or money order payable to-

**JAN CRYSTALS, 2400 CRYSTAL DRIVE, FORT MYERS, FLA. 33901**  
 ALL PHONES (813) WE6-2397



DIVISION OF BOB WHAN & SON ELECTRONICS, INC.

# THIRD OVERTONE CRYSTALS HC6/U HOLDER

The crystal frequencies listed are third and fifth overtone types and should be used in an overtone circuit. Order by frequency and holder type HC6/U. Listing is in megacycles. We will make to order any non-oven type HC6/U crystal from 15 MC to 55 MC .005% tol. at \$3.00 each. Be sure to specify exact frequency and whether you want it made at series resonance or parallel. If parallel what capacitance. If possible send a crystal known to be on frequency so that we can correlate and return crystal with order. For overtone receive crystals we must know the exact crystal frequency, the operating frequency, the IF frequency and the number of times the crystal frequency is multiplied. Stock crystals below are listed in megacycles.

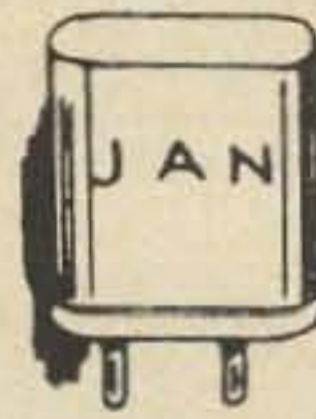

**\$1.75** EA

**3 for \$5.00**

11.311	21.003	26.610	30.155	33.525	37.074	39.680	41.125	43.185	45.083	50.700	64.600
11.381	21.053	26.620	30.200	33.625	37.111	39.703	41.166	43.208	45.100	50.960	65.083
11.406	21.103	26.670	30.266	33.649	37.148	39.740	41.250	43.250	45.125	51.100	65.600
11.431	21.153	26.680	30.375	33.657	37.200	39.777	41.325	43.259	45.208	51.275	66.600
11.450	21.203	26.700	30.575	33.700	37.222	39.800	41.333	43.416	45.275	51.376	66.750
11.456	21.253	26.710	30.700	33.750	37.259	39.814	41.375	43.444	45.300	51.416	67.116
11.481	21.303	26.720	30.711	33.800	37.266	39.851	41.416	43.449	45.700	51.469	67.167
11.500	21.353	26.730	30.822	33.850w	37.300	39.888	41.500	43.458	45.895	51.576	67.600
11.506	21.403	26.750	31.111	33.955	37.333	39.925w	41.583	43.481	45.900	51.750	67.611
11.556	21.435	26.760	31.280	33.975	37.370	39.962	41.658	43.500	46.208	52.275	67.750
11.581	21.437	26.770	31.388	34.400	37.388	40.000	41.666	43.518	46.275	53.275	67.944
11.600	21.453	26.888	31.700	34.444	37.400	40.037	41.687	43.625	46.300	53.416	68.250
11.606	21.503	27.120	31.825	34.488	37.407	40.041	41.833	43.640	46.375	53.458	68.333
11.631	21.553	27.125	31.850w	34.511	37.444	40.074	41.875	43.700	46.395	53.625	68.416
11.681	21.577	27.158	31.888	34.688	37.471	40.083	41.916	43.703	46.750	53.708	68.500
12.056	21.600	27.194	32.000	34.700	37.518	40.111	41.923	43.740	46.885	53.750	68.600
12.477	21.603	27.220	32.222	34.720	37.555	40.148	41.958	43.777	46.900	53.791	68.611
14.935	21.977	27.233	32.250	34.866	37.592	40.185	42.000	43.814	46.916	54.125	68.783
15.006	22.155	27.455	32.282	35.055	37.600	40.208	42.055	43.851	46.979	54.275	69.240
15.325	22.200	27.612	32.287	35.185	37.629	40.222	42.166	43.888	47.100	54.541	69.250
15.360	22.325	27.629	32.302	35.422	37.666	40.250	42.250	43.895	47.110	54.625	69.279
15.435	23.006	27.640	32.307	35.688	37.700	40.259	42.279	43.900	47.275	54.708	69.333
15.506	23.577	27.700	32.350w	35.703	37.703	40.296	42.333	43.925	47.300	54.791	69.750
15.935	23.833	27.705	32.357	35.740	37.711	40.333	42.388	43.958	47.406	54.875	70.000
16.435	24.006	27.994	32.606	35.777	37.740	40.370	42.416	43.962	47.562	55.000	70.083
16.506	24.033	28.022	32.667	35.814	37.777	40.407	42.437	44.000	47.645	55.083	70.450
16.730	24.123	28.050	32.700	35.851	37.800	40.444	42.500	44.041	47.700	55.125	70.500
16.935	24.190	28.054	32.800	35.888	37.814	40.458	42.541	44.080	47.785	55.250	70.600
17.000	24.260	28.150	32.850w	35.925	37.851	40.474	42.592	44.083	47.850	55.275	70.667
17.435	24.400	28.198	32.857	35.933	38.000	40.481	42.625	44.100	47.900	55.625	71.333
17.935	24.444	28.227	32.875	35.962	38.110	40.500	42.658	44.111	48.275	56.275	71.722
18.435	24.455	28.338	32.965	36.148	38.140	40.518	42.703	44.148	48.583	56.500	71.750
18.935	24.588	28.405	32.975	36.200	38.148	40.541	42.722	44.166	48.750	56.750	72.000
19.006	24.615	28.627	32.985	36.222	38.160	40.555	42.740	44.185	48.791	56.918	72.600
19.200	24.668	28.640w	33.015	36.259	38.200	40.583	42.750	44.259	48.979	56.993	72.660
19.916	24.700	28.688	33.025	36.266	38.244	40.592	42.791	44.275	49.000	57.116	72.833
19.935	25.110	28.700	33.035	36.296	38.300	40.629	42.833	44.296	49.125	57.275	73.416
20.000	25.250	28.715	33.055	36.311	38.333	40.666	42.850	44.300	49.177	58.416	73.600
20.006	25.400	28.722	33.065	36.333	38.350	40.703	42.851	44.370	49.208	58.600	73.667
20.435	25.555	28.735	33.075	36.400	38.600	40.708	42.875	44.465	49.275	58.783	73.783
20.500	25.700	28.752	33.085	36.592	38.800	40.740	42.888	44.481	49.290	59.000	74.500
20.506	25.711	28.830	33.105	36.600	38.900	40.750	42.900	44.497	49.312	60.083	75.083
20.533	25.861	28.878	33.115	36.666	38.906	40.777	42.916	44.500	49.666	60.450	75.333
20.700	25.945	28.888	33.125	36.700	38.952	40.791	42.925	44.518	49.730	60.700	75.450
20.703	25.977	28.938	33.135	36.711	39.200	40.814	42.944	44.562	49.850	60.750	80.000
20.733	26.120	29.000	33.155	36.777	39.243	40.833	42.958	44.583	49.875	61.750	81.000
20.753	26.220	29.406	33.165	36.800	39.400	40.851	42.962	44.592	49.895	62.187	83.500
20.777	26.229	29.426	33.175	36.814	39.500	40.888	42.988	44.666	49.906	62.600	83.542
20.803	26.241	29.640	33.185	36.851	39.518	40.925	43.074	44.703	50.121	62.944	83.542
20.853	26.510	29.688	33.195	36.888	39.555	40.962	43.083	44.729	50.122	62.984	85.000
20.903	26.550	29.700	33.225	36.925	39.592	40.963	43.111	44.740	50.250	63.187	86.355
20.935	26.560	29.800	33.255	36.962	39.600	41.000	43.125	44.777	50.275	63.416	90.000
20.953	26.570	30.000	33.333	37.000	39.629	41.037	43.148	44.814	50.427	63.600	94.000
20.977	26.580	30.066	33.350w	37.037	39.666	41.041	43.166	45.000	50.500	63.783	100.000

Write for complete crystal catalog with thousands of in-stock crystals listed.

**JAN CRYSTALS**  
**2400 CRYSTAL DRIVE, FORT MYERS, FLA. 33901**  
**ALL PHONES (813) WE6-2397**

# FM SALES

1100 Tremont Street, Roxbury,  
Massachusetts 02120, 617-427-3513

## House Cleaning Sale-Closing Out Our Inventory of Used Equipment

Motorola 450 MC T44 Trans & Rec Chassis  
Trans. ....\$15.00 ea. Rec. ....\$20.00 ea.

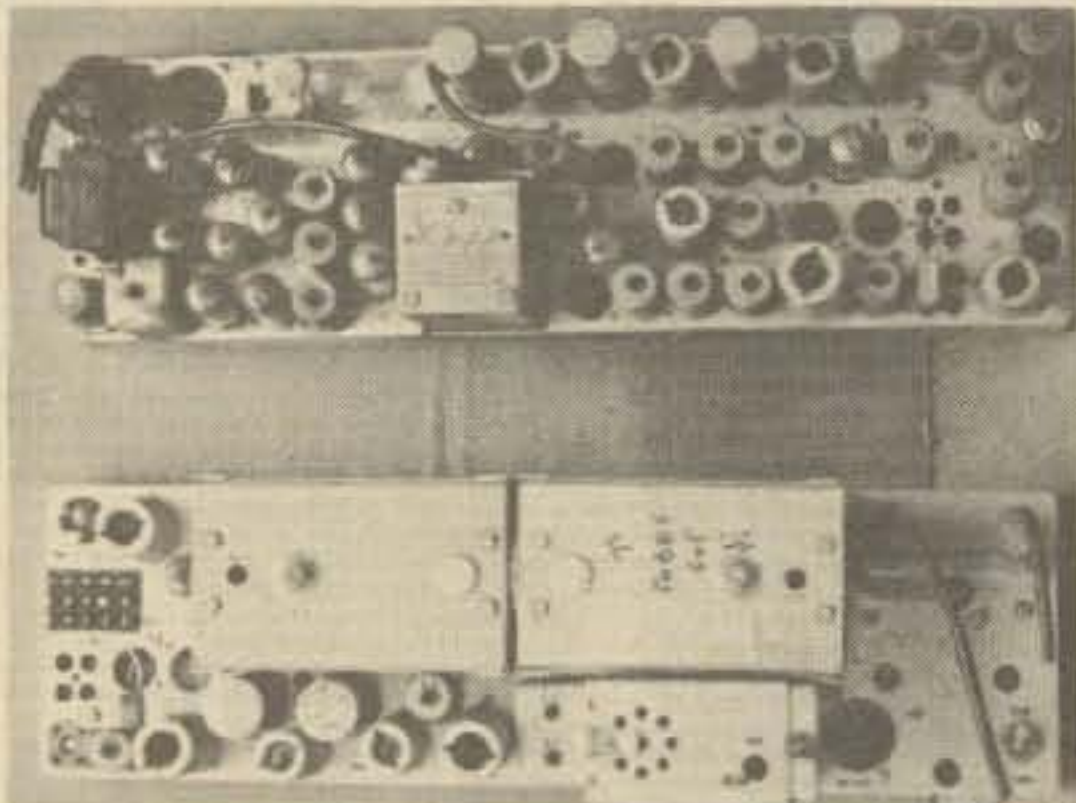

Motorola U43HHT Motrac 2FR Trans & Rec  
150MC 12VDC Private Line. Less Reeds & Xyals.  
Complete Access. .... \$395.00 ea.

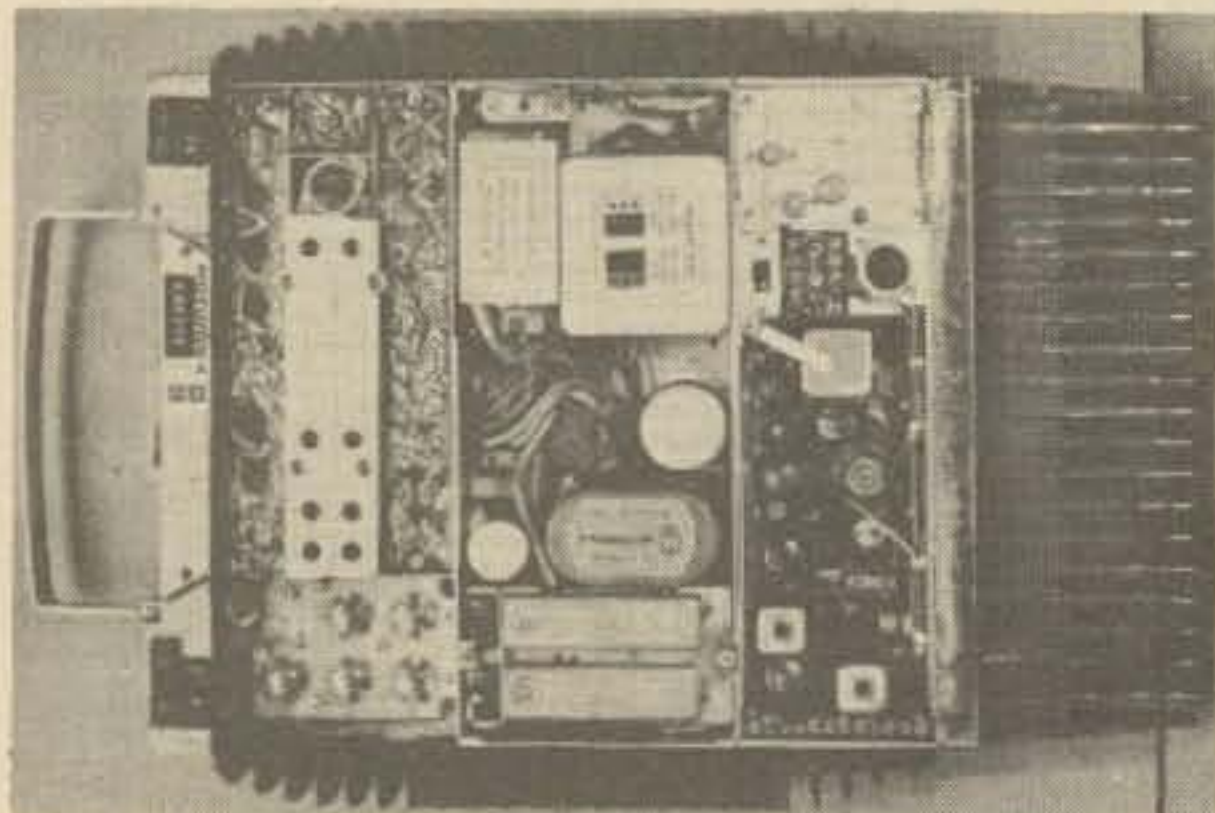

### FM SCHEMATIC DIGEST

New Revised Edition, A Collection of Motorola  
Schematics; 130 Pages Available After March 1,  
1970. \$6.50 Post Paid in U.S.A.

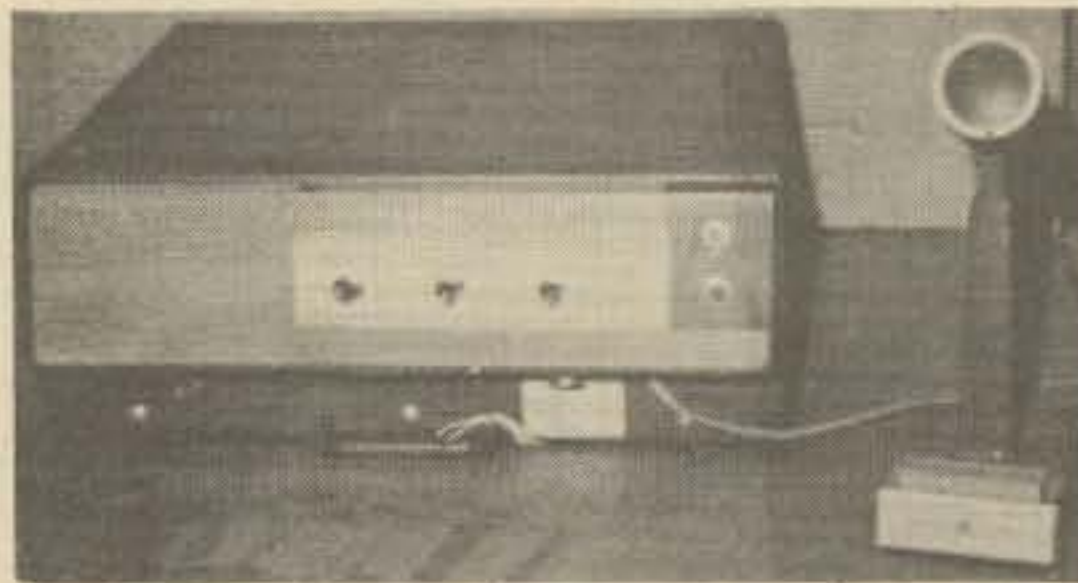

GE Accent 450MC Station Standard Squelch  
115VAC With Desk Mike ..... \$175.00 ea.

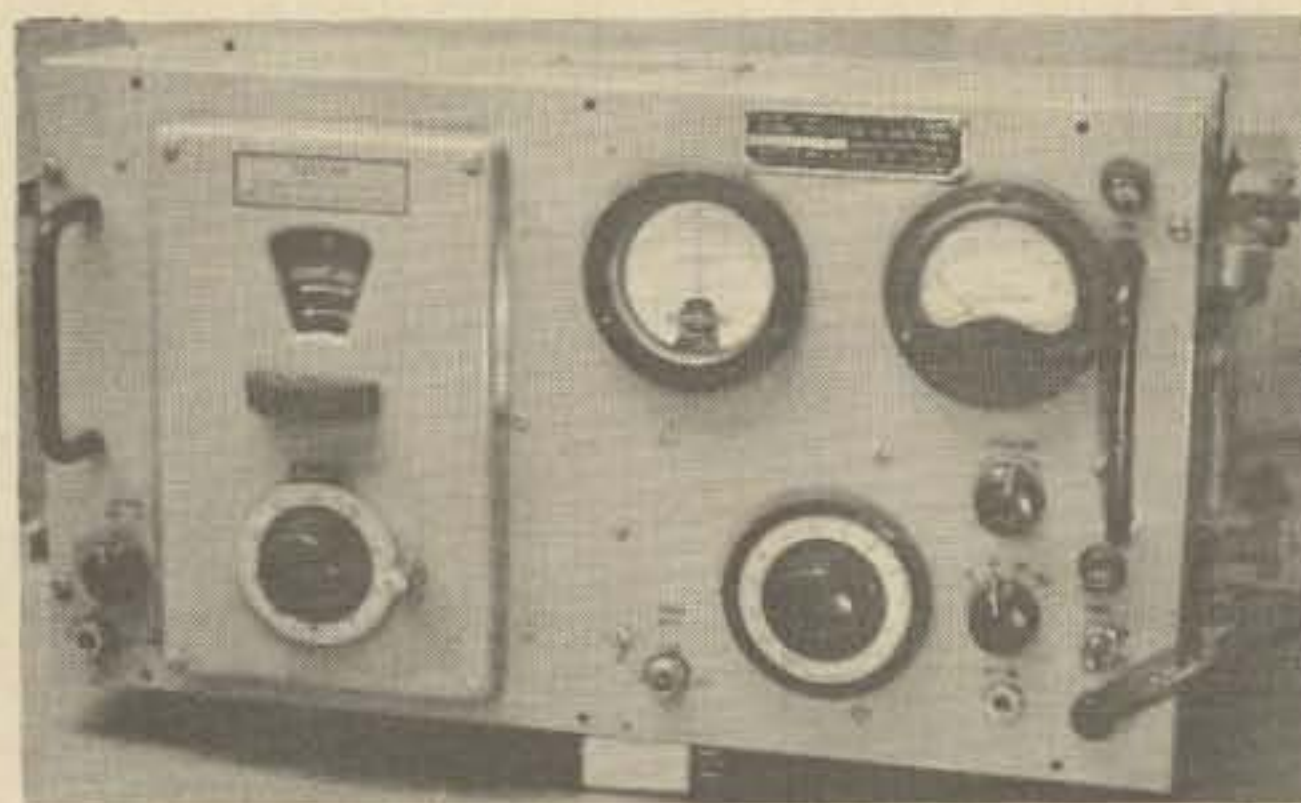

Model TS 497 B/URR Signal Generator \$75.00 ea.

GE Message Mate Pocket Re-  
ceivers. 8 Receivers and 2  
Charger Racks \$100.00 For  
The Lot

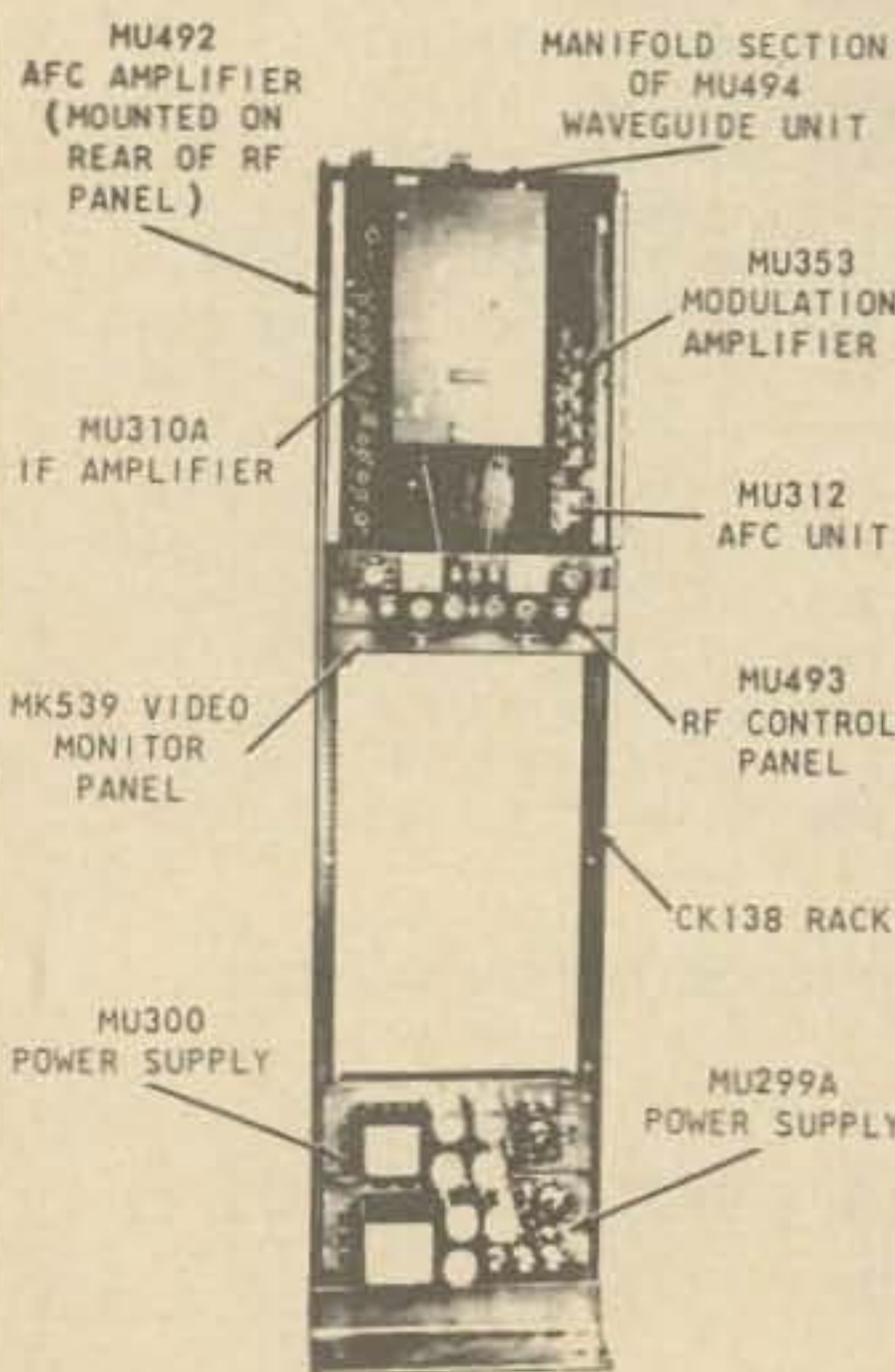

### Motorola

**M R - 4 0**  
MCRWV/System  
12KMC 4 Yrs.  
Old; 2 Terminals  
in Standard  
Racks With Pwr  
Supplies, Dust  
Covers, Full  
Metering,  
Complete With  
Antennas and  
Radomes.  
Complete  
System-Sale  
Only-Price on  
Request.

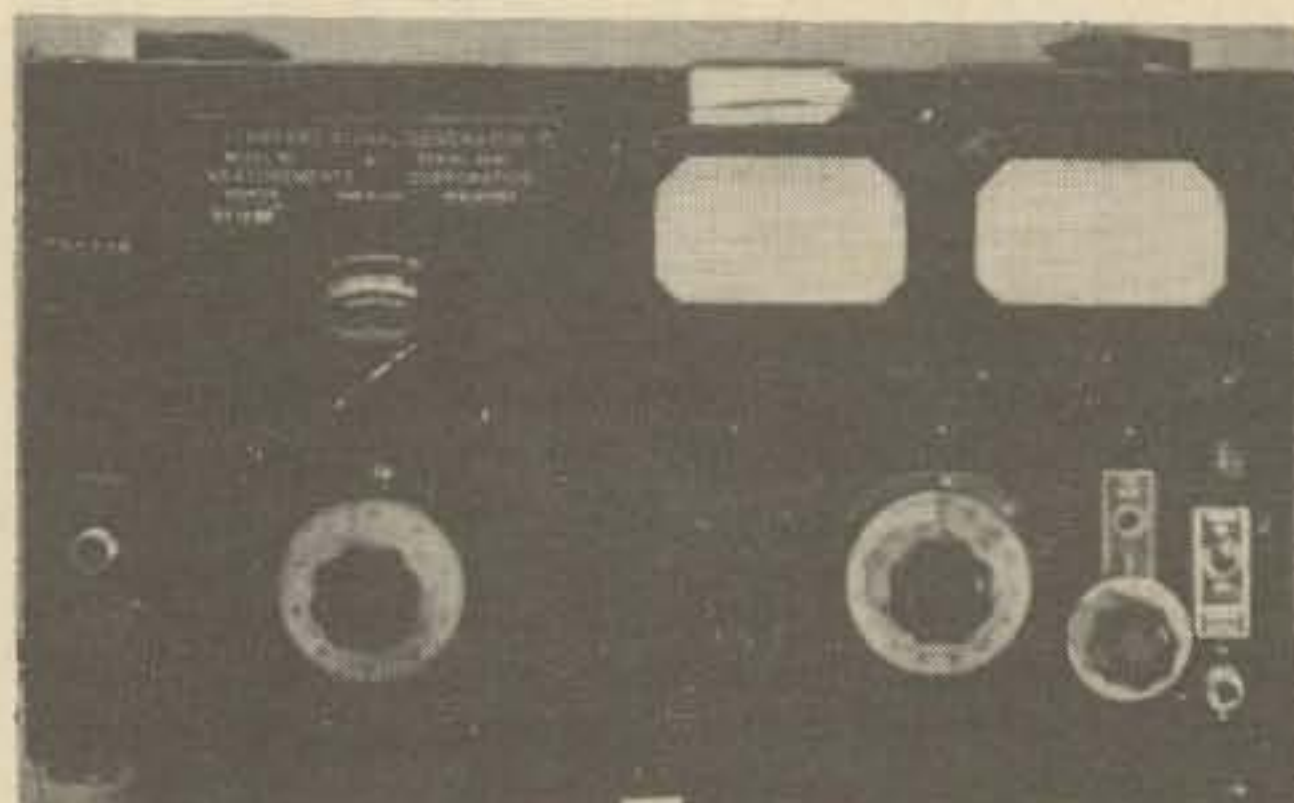

Measurements Corp. Model 80 Signal Generator.  
\$95.00 each.



GE Porta Mobile  
HN 441CS  
11-30-40MCS  
Nicaid Battery  
Power Supply;  
Unused. \$400.00  
ea.

All items are in  
limited quantities;  
subject to  
prior sale;  
terms are cash  
with order  
f.o.b. Boston,  
Massachusetts.

## House Cleaning Sale-Closing Out Our Inventory Of Used Equipment

Motorola 30-50MC Trans Chassis 30Watt \$5.95 60Watt .....	\$ 9.95
Motorola FMTR 80D 24VDC 2FR 40-50 MC With Case .....	\$ 30.00
Motorola FSTR 80 BY 6 Meters 115VAC Desk Top Station .....	\$125.00
Motorola PA 8270 Remote Control Unit .....	\$ 65.00
Motorola W43A-5 150 MC 12 VDC Similar to 80D .....	\$ 40.00
Motorola FMTR 80D Low Band Rec. & P.S. Only, With Case .....	\$ 20.00
Motorola FMTRU 41V 150 MC AC Front Mount, No Case .....	\$ 75.00
Motorola T-1200 Series Remote Control Unit .....	\$100.00
Motorola Desk Sets (Telephone Style Handset/Speaker .....	\$ 15.00
Motorola J44 450 MC Remote Control Station, Outdoor Cab.....	\$100.00
Motorola FSTRU 140 BR 150 MC 115 VAC Station, Indoor Cab. ....	\$125.00
Motorola FSTR 140 Low Band Station, Outdoor Cab. ....	\$100.00
Motorola H or P Series Modules for Early Portables 90 Pcs. Sold as One Lot .....	\$ 25.00
Motorola 30-40MC Station Chassis Only, No Cabinet w/AC-PS .....	\$ 75.00
Motorola D33 150 MC With Case, No Accessories .....	\$ 50.00
Motorola L41GGB 30-40 MC Case, No Accessories 115 VAC .....	\$100.00
Motorola FMTR 41B 30-40 MC 115 VAC No Case .....	\$ 75.00
Motorola T41GGV 30-40 MC 6/12VDC Case No Accessories .....	\$ 40.00
Motorola FSTRU 140 BY 150MC 115VAC Desk Top Cabinet .....	\$125.00
Motorola FSTR 80 BY 30Watt 115VAC 30-40MC Desk Top .....	\$100.00
Motorola FSTR 140 BY 30-40MC 115VAC 60Watt Desk Top .....	\$125.00

---

Collins KWS-1 Power Supply, Only; Very Good .....	\$250.00
Florac Pager Receivers, Super Regen 43MC 1 Lot 30 Units .....	\$ 25.00
Mohawk Message Repeaters W/O Tape Cartridge .....	\$ 5.00
Panalyzor Mod. SB12A W/P.S. SSB Signal Analyzer 500KC IF .....	\$450.00
Panalyzor Mod. SB-8B W/P.S. Spectrum Analyzer 5MC IF .....	\$125.00
Sierra Carrier Frequency Voltmeter 20-500KCS Model KS15538.L2 .....	\$ 50.00
Philco CST-2 Signal and Termination Unit Good Phone Patch Parts .....	\$ 12.50
Baird-Atomic Transistor Curve Tracer Mod.MW-1 .....	\$100.00
LM Frequency Meter With Book And Power Supply .....	\$ 80.00
LM Frequency Meter With Book Less Power Supply .....	\$ 50.00
Model RBW-2 Panoramic Rec. Adapter 500 KC IF .....	\$ 50.00
New Lafayette Priva-Comm III Encoder-Decoder Sel. Call Unit .....	\$ 10.00
RCA Mod. CMV-2E3 30-50MC 25Watt 11 Units Shipped pre-pd. as Lot .....	\$155.00

# FM SALES

1100 Tremont Street,  
Roxbury, Massachusetts 02120, 617-427-3513

All items are in limited quantities; no accessories unless indicated; all items subject to prior sale; terms cash with order f.o.b. Boston, Massachusetts.

# **Mann** COMMUNICATIONS

18669 VENTURA BLVD      TARZANA, CALIF 91356  
Phone (213) 342-8297

**Used Two-Way FM Units**  
**Repeaters · Walkies · Mobile Phone**  
**Bases · Mobiles**

**MOTOROLA    GENERAL ELECTRIC    RCA    OTHERS**

Unless otherwise specified, equipment is used, and is sold as-is. All items shipped FOB Tarzana, California. Crystals, ovens, antennas not included unless specifically stated in catalog. All equipment is sold on a first-come, first-served basis.

**WRITE FOR OUR COMPLETE ILLUSTRATED CATALOG**

## **MANN GUARANTEE**

Money refunded without question if equipment is returned within seven days from shipment, undamaged, freight prepaid.

**HERE ARE SOME EXAMPLES OF THE BUYS AT MANN**

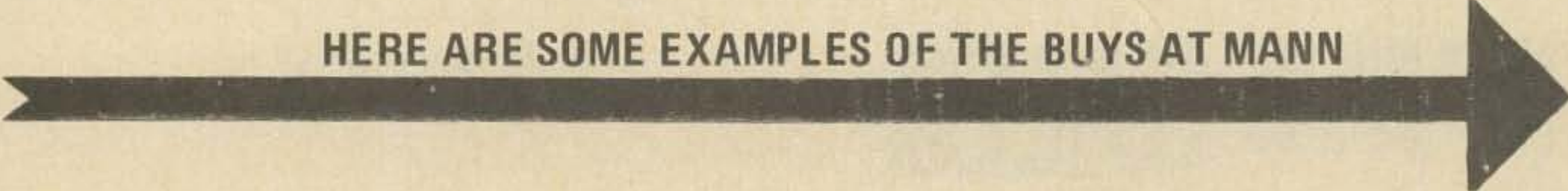



## SIX METERS

FMTR 41V	12V	Mobile	10W Vibrator Supply . . . . .	\$ 30
FMTR 80D	12V	Mobile	25W Dynamotor Supply . . . . .	.30
FMTR 140D	12V	Mobile	50W Dynamotor Supply . . . . .	.50
T51GGV	6/12V	Mobile	50W Vibrator Supply . . . . .	100
U51GGT	12V	Mobile	50W Transistor Supply . . . . .	175
FSTR 140BY	117V	Base	60W Table Top Cabinet . . . . .	125
T41GGV	6/12V	Mobile	30W Vibrator Supply . . . . .	.65

## TWO METERS

FMTRU 41B	117V	Base	10W Table Top Cabinet . . . . .	\$ 75
FSTRU 140BY	117V	Base	60W Table Top Cabinet . . . . .	135
FSTRU 140BR	117V	Base	60W Upright Cabinet . . . . .	150
FMTRU 41V	12V	Mobile	10W Vibrator Supply . . . . .	.45
FMTRU 80D	12V	Mobile	25W Dynamotor Supply . . . . .	.45
FMTRU 140D	12V	Mobile	50W Dynamotor Supply . . . . .	.55
T33GGV	6/12V	Mobile	10W Vibrator Supply . . . . .	.70
T43GGV	6/12V	Mobile	25W Vibrator Supply . . . . .	110
U43GGT	12V	Mobile	25W Transistor Supply . . . . .	175

## 450 MHz

L44AAB	117V	Base	15W Table Top Cabinet . . . . .	\$95
J44AAB	117V	Base	15W Outdoor Cabinet . . . . .	125
Y44AAB	117V	Repeater	15W Upright Cabinet . . . . .	135
T44A6A	6/12V	Mobile	15W Vibrator Supply . . . . .	.25
T44AAV	6/12V	Mobile	15W Vibrator Supply . . . . .	.30
U44BBT	12V	Mobile	15W Transistor Supply . . . . .	175

## PORTABLES

H23AAM	Handie-Talkie	1W Dry Cell Supply . . . . .	\$45
H23AAM	Handie-Talkie	1W Ni-Cad Supply . . . . .	.50
P33AAM	Pack Set	5W Dry Cell Supply . . . . .	.60
P33BAM	Pack Set	5W Ni-Cad Solid State Rcvr . . . . .	.75
T33AAT	Motorcycle 6V	8W Less Tubes & Diodes . . . . .	.30

All equipment quoted is priced less accessories

## ACCESSORIES

	MIKES	HEADS	CABLES	SPKRS
For 80D 140D T44 Series Mobiles	\$3	\$3	\$3 ea.	\$2
For T41 T43 T51 T 53 Series Mobiles	4	5	5	5
For U41 U43 U51 U53 Series Mobiles	5	7	7	5
For All Motrac Motran Series Mobiles	5	10	10	5

Gold Crystal Ovens 85 °C \$1.50 ea.

## MISCELLANEOUS

Transmitter Strip Only	6 Meters	25W "G" Series . . . . .	\$10
Transmitter Strip Only	2 Meters	25 W "G" Series . . . . .	10
Receiver Strip Only	6 Meters	6/12V "G" Series . . . . .	18
Receiver Strip Only	450 MHz	6/12V T44A6A Series . . . . .	18
Gonset Converter	#3247	30-40 MHz New Original Carton . . . . .	\$25
General Electric	ME16	6/12V Mobile 50W Vibrator Supply . . . . .	\$160
General Electric	MT16	12V Mobile 50W Transistor Supply . . . . .	175
General Electric	ME42	6/12V Mobile 15W Vibrator Supply . . . . .	150
General Electric	MT42	12V Mobile 15W Transistor Supply . . . . .	175

# AMATEUR RADIO'S NEWEST MODE

*...the hottest thing since sideband  
the least expensive since the spark gap!*

**FM** 35



**editorial**

When a management move-up at the Sahara Hotel on the first day of the SARIC thing left me homeless, Art Housholder (Spectronics) in a gracious offer to share his quarters I accepted, of course, not only because of the free rent, but because Art is a potential advertiser and I was anxious, too, for the opportunity to expound on the merits of advertising in FM.

Art told me Spectronics does not advertise regularly because they have no large weight item stocks. If they were to advertise pocket size Handie Talkies, for example, they'd receive orders for hundreds—though there may be but five or six in stock. The consequence, he said, would be that he'd have to return money and write letters to probably ninety percent of his prospective clients.

To be quite frank, I was skeptical about this explanation, and asked him to give me some examples of prices. He did. He went through the Motorola databook page by page, quoting on practically low prices on practically every sheet. Probably as a means whereby, I thought (and him later I took notes) Handie Talkie makes \$5, tone decoders \$15, vocal buzzers, \$10, Motorola parts

at fractions of their original costs. I told him I was interested in building up a solid-state repeater and wanted some real low prices on all-transistor strips. "Repeater," he said, mystically. "That's the name of the game." He looked me square in the eye, and added, "You just tell me exactly what you want and I'll deliver."

When I got back to California, I began looking at those notes. The prices seemed too low to be real, so I thought I'd call this big talker's bluff. I made out a check to cover all the most ridiculously priced items he'd quoted, and mailed it off. I was dumbstruck when the merchandise came in the mail about a week later. He'd made good on all his promises!

Since then, I've had the occasion to buy a number of other trinkets unavailable elsewhere, including such exotic gear as a 450 MHz Motorola several high-band "hook" Handie Talkies and an assorted assemblage of low-model transmitters and receiver strips. But NOT ONE of the items I'd purchased had been advertised. I merely picked up the phone and issued my orders. If Art doesn't have it, he gets it!

This little dissertation may sound like a free ad, but it isn't meant to. It's simply that I was supremely pleased with the merchandise and the service. The H.T.'s, for example, weren't sold as "new." But there were no smudges, no scratches, no signs of use or wear on any of the units. They came modestly labeled "used," but as far as I could tell, no one had ever so much as touched one any of the switches.

The all-transistor repeater I'm building is well under way, and I'm grateful to Art Housholder and Spectronics for making it possible. I won't argue with Art about the name of the game. I'll just say I like the way Spectronics plays it!

**MOTOROLA  
GEAR  
AT  
AMATEUR  
PRICES**  
See Page 21

Find out for yourself why Spectronics received rave notices from the editorial staff of FM Magazine! And while you're at it, take advantage of the March Surplus Special — Get 2 Mobile Units (Low-Band or 450 MHz) for the Price of One!

*SPECTRONICS  
is the place  
And NOW  
is the time!*

**GET 2  
MOBILE UNITS**

*(6 meters or 450 MHz)*

**for the price of**

**1**

Offer expires May 1st

Phone: Area Code 312-848-6778

**SPECTRONICS**  
"The FM People"  
1009 GARFIELD AVE. OAK PARK, ILL. 60304



249 Route 46  
Saddle Brook, N.J. 07662  
Phone (201) 489-9000

SEND  
FOR NEW CATALOG.  
QUALITY CERTIFIED  
VALUES.

## FM Surplus at Low, Low Prices!

**NEW! FM 100-Watt Mobile Linear Amplifier**  
High Band — 146-174 MHz  
RF output 90-120 watts into 50Ω. Gonset  
Comtron series — Model 972-A in factory-  
sealed cartons \$148 with brand new install.  
kit FREE

**Bendix MRT10** 30-50 MHz, 35W 12V vibr.  
power supply, complete with access . . . . . \$25

**Bendix IV14AA** 6/12V 30-50 MHz  
vibr. power supply . . . . . \$35  
25W with complete accessories

**IV16AA** 6/12V 30-50 MHz vibr. P.S.  
50W with complete accessories . . . . . \$45  
(less accessories: deduct \$20)

**RCA-CMU15A** 6/12V 450-470 MHz  
complete with accessories . . . . . \$25

**MOTOROLA** 450-470 MHz, with accessories  
T44A 6 or 12V . . . . . \$25  
T44A6 6/12V . . . . . \$28  
T44A6A 6/12V . . . . . \$38  
T44AAV . . . . . \$48

**450 MHz Portables (Radio Specialties)**  
RSTR4N transistorized . . . . . \$38

**Motorola X43 GGV** single squelch 30W H.B.  
& Acc. Receiver has transistorized power supply  
2 freq. transmitter, 2 freq. receiver, private line  
(minus reed) in receiver only . . . . . \$158

**NINIC FM POCKET RECEIVER** with dry  
battery . . . . . \$59.95  
add \$7.50 for nickel cadmium battery. Add \$20 for  
crystals & tuning to your freq. 30-50 MHz or 150-  
170 MHz. All units new. Solid state modular assy.  
construction. Adjust squelch. Sensitivity 0.3 micro-  
volts to brk. squelch. Dual conversion crystal con-  
trolled. With conv. dry cell or rechargeable nic-cad  
battery. Weight: 1 lb. Size: 6-5/8" x 2 1/2" x 1 1/4".

**G-E Schematic  
Outline** and inter-  
connection Diagrams  
for GE 2-way FM  
Radios Vol. 1 Pre-  
Progress Line (49-55)  
25-50 MHz  
72-76 MHz  
Vol. 2  
Pre-Progress line  
(1949-55)  
150-174 MHz  
405-425 MHz  
450-470 MHz  
\$4.50  
each volume

**G-E Progress Line  
4EZ11A10** — 10 wt.  
trans. power  
speakers . . . . . \$15

**RCA CMV4E**  
148-172 MHz 12V  
30W dynamotor power  
supply. TX narrow  
banded, complete with  
accessories . . . . . \$28

**GE MA/E33** 6/12V  
30W — vibrator power  
supply with access.  
\$168

# FM FM FM

FM EQUIPMENT SOLD TO LICENSED AMATEURS ONLY

## Motorola 60 Watt Four Channel 150MC Mobiles

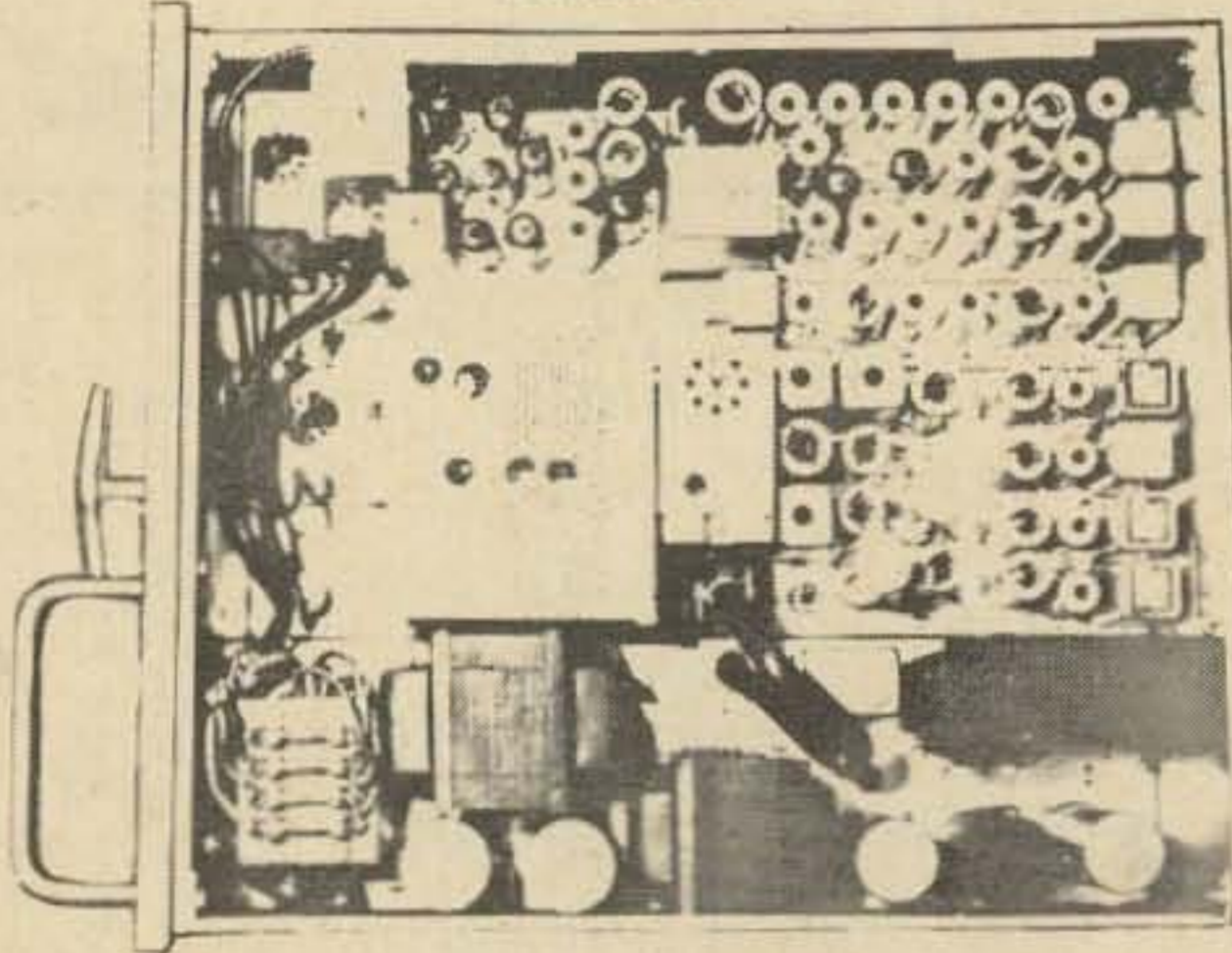

**MODEL T53-GJV 6/12 volt.** These units are exceptionally clean and in mint condition. They are complete with 4 freq. control head, cables, mike, speaker. Xmtr-narrow band, rcvr is wide band. Less crystal ovens & ant. Only \$175.00 ea.

**G.E. PROGRESS LINE—150mc; 60 watt; four frequency-MA/E-36.** These are also very clean and in mint condition. Complete with all access., less crystals & ant. \$225.00 ea.

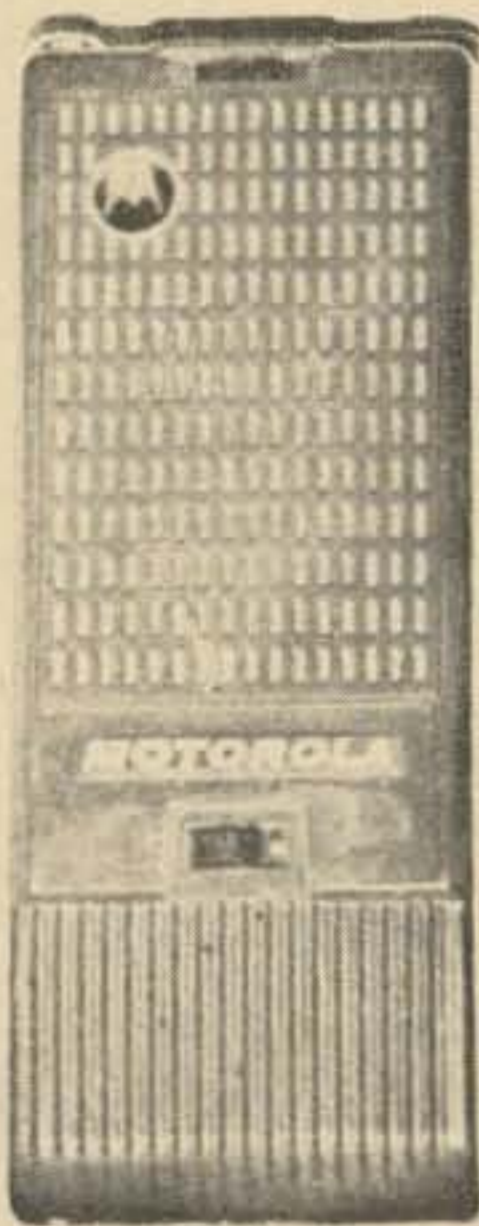

**MOTOROLA 150mc transistorized pocket pager receiver. HO3ANC-1102AQ.** Excellent cond., less battery \$34.95 ea.

**MOTOROLA MOBILE TELEPHONE test set TEK22,** (list price \$550.00) like new \$180.00 ea.

**NICAD battery**s for "HT" series handi-talkies, NLN 6238, untested. \$3.00 ea; Nicads for H11, H13 pocket transmitters, NLN 6117A \$4.95 pr.

**MOTOROLA "HT" series Handi-Talkies.** 150mc. Prices vary according to model: standard, universal, 1 freq., 2 freq., P.L., etc.

**G.E. PROG LINE,** 30-54mc, 6/12 volt, 60 watt. Complete with all accessories. (less ant). Single freq. \$100.00 ea., Dual freq. \$110.00 ea., Four freq. \$130.00 ea.

**MOTOROLA handi-talkies,** 150mc, 1 watt out, fully transistorized rcvr, checked out & operating; w/nicad battery. H23BAM \$69.50 ea.

**DIGITAL decoder, Secode RPD 634** \$19.95 ea.

**MOTOROLA 150mc Handi-Talkies** guaranteed operating, less mike and battery FPTRU1 ..... \$19.95 ea.

**MOTOROLA power supply NPN 6023A** for P31, P33BAC.I/batteries ..... 4.95 ea.



**MOTOROLA** charger for H11, H13 pocket xmtrs, NLN6121A \$9.95 ea.

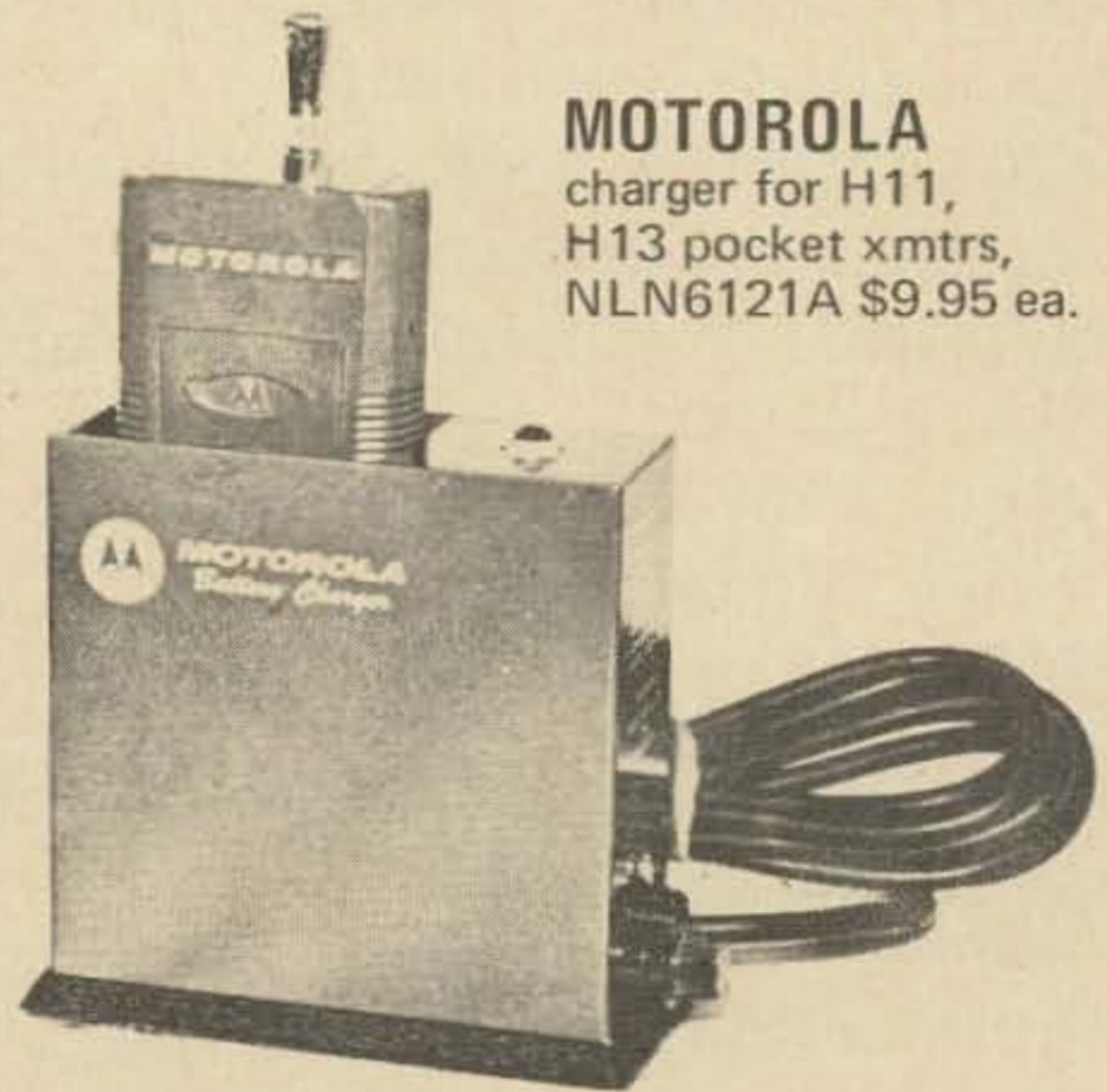

**MOTOROLA 150mc receiver strips;** very clean 6V ..... 25.00 ea.  
30 Watt xmtr strips 6V ..... 20.00 ea.

**MOTOROLA transistorized "Big Voice"** power speakers ..... 19.95 ea.

## SATISFACTION GUARANTEED OR YOUR MONEY BACK!

All equipment unless stated otherwise is complete and guaranteed. Items over 20 pounds shipped freight charges collect. Include sufficient postage for other items. 25% deposit required on c.o.d. orders. Mich. residents ad 4% sales tax. We have a very large stock of FM equipment; however no catalogs or list available. Tell us what you are looking for, we may have it. Prices subject to change without notice.

hours; by appointment only

**NEWSOME  
ELECTRONICS**

19673 ALLEN ROAD

TRENTON, MICHIGAN 48183

PHONE: 313-282-6464

**GE Progress Line Units**

FE-42	450 MHz	219.50
ME-42	15 watts	199.50
MA/E-16	Lowband 50w	189.50
MA/E-33	High band 30w	199.50
MA/E-36	High band 60w	224.95

ALL WITH ACCESSORIES! **LOOK!**

*Lots more equipment available!*

WRITE FOR 1970 CATALOG

**STORE HOURS**

WEEKDAYS: 9 AM to 9 PM

SATURDAY: 9 AM to 5 PM

**C & A ELECTRONIC ENTERPRISES**  
 2529 East Carson St \* Long Beach, Calif. 90810 \* (213) 834-5868

FREEWAY - CLOSE  
 TO LOS ANGELES  
 20 MINUTES FROM AIRPORT

**LOW BAND**

**GE 2-piece units**  
**ET-6 Transmitter**  
**ER-6 Receiver**

Fifty watts, 12 volts  
 with accessories ---  
 only \$ **46<sup>00</sup>**

**motorola T41 GGV-1**  
 6/12 volts \* narrow band  
 with  
 access. 84.95  
 less access.: **64<sup>50</sup>**

**RADIO SPECIALTIES**

SPECIAL LOW PRICES :

MINIPAK	1160-24-1
PORTABLE	\$16.95
PACKSET	1144-62-1
	\$24.50

Grab 'em Quick!

**motorola**

†44AAV-1	T53 GAD	50w	\$159.00
450mHz	T33 GGV	10w	\$79.50
34.95	T51 G	50w	\$125.00
	Accessories		20.00/set

**NEW!! NEW!!**

**STANDARD COMMUNICATIONS**

business band ham  
 telephone marine

Write for prices and literature.

**rca**

CMU-15A	39.50
w/accessories	
CMU-15B	59.95

Note - Accessories consist of power and control cables  
 control head, speaker, mike (as applicable)  
**EQUIPMENT SOLD AS IS \* FOB LONG BEACH**

**REGUL. PWR SPLY FOR COMMAND, LM, ETC., PP-106/U:** Metered. Knob-adjustable 90-270 v up to 80 ma dc; also select an AC of 6.3 v 5A, or 12.6 v 2½ A or 28 v 2½ A. With mating output plug & all tech. data. Shpg wt 50#..... **19.50**

**BARGAINS WHICH THE ABOVE WILL POWER:**  
**LM-(\*) Freq. Meter:** .125-20 mhz, .01%, CW or AM, with serial-matched calib. book, tech. data, mating plug. Checked & grtd..... **57.50**

**TS-323 Freq. Meter:** Similar to above but 20-480 mhz, .001%. With data..... **169.50**

**TS-175 Freq. Meter:** 85-1000 mhz. . . . **75.00**

**A.R.C. R11A:** Modern Q-5'er 190-550 khz... **12.95**

**A.R.C. R22:** 540-1600 khz w/tuning graph... **17.95**

**A.R.C. R13B:** 108-132 mhz w/tuning graph. **27.50**

**HIGH-SENSITIVITY WIDE-BAND RECEIVER COMMUNICATIONS...BUG DETECTION... SPECTRUM STUDIES**

**38-1000 MHZ:** AN/ARL-5 consists of a brand-new Tuner CV-253/ALR and an exc. used rcvr R-444 modified for 120V, 50/60 hz. The tuner covers the range in 4 bands. Packed with each tuner is the factory checkout sheet. The one we opened showed SENSITIVITY: 1.1 uv at 38.3 mhz, 0.9 at 133 mhz, 5 at 538 mhz, 4½ at 778 mhz, 7 at 1 ghz. The rcvr is actually a 30 mhz IF ampl. with all that follows an IF, including an S meter. Has Pan, Video & AF outputs. Has a calibrated attenuator in 6 db steps to -74 db, also AVC position. Select pass of ±200 khz or ±2 mhz. **AND SELECT AM OR FM:** We furnish Handbook & pwr-input plug, all for . . . . . **275.00**

**SP-600-JX(\*) Rcvr:** 0.54-54 mhz. The popular late-type Hammarlund Super-Pro. aligned, grtd, exc. physical cond. too. w/book . . . . . **325.00**

**R-390/URR Rcvr:** Collins xtl-calib. each 100 khz. Aligned & grtd perfect . . . . . **795.00**

**VERSATILE PLATE & FILAM. TRANSFORMER**

**Depot Spares for SP-600-JX:** Pri. 95/105/117/130/190/210/234/260 v 50/60 hz. Sec. 1: 305-0-305 v, 150 ma. Sec. 2: 5 v 3 A. Sec. 3: 6.3 v 5A. Sec. 4: 7½ v, 3/4 A. Sec. 5: 7½ v, 1¼ A. Legend for pins is plainly marked. Herm. sealed. (Add postage for 14 lbs.) . . . . . **2.95**



**HOW TO GET THE BEST BARGAINS**

We buy daily so we change our 26 different Catalogs almost daily. Get yours fresh off our photocopier by asking for the specific Categories you are interested in: Aeron, Radioshop/Amplifiers & Attenuators/Audio Test/Bridges (includes pots, galvos, Q-Meters, etc./Communications/Counters/Freq. Changers/Freq. Meters/Meggers, Megohmmeters/Meters Calibrators (includes Differential Voltmeters & Digital-setting pwr supplies)/Meters, Digital/Meters, Phase Angle, Precision, Lo-freq. Wattmeters/VTVM's/Microwave items/Noise and Field Strength (RFI)/Oscilloscopes/Accessories/Panadapters & Spectrum Analyzers/pwr supplies/Pulse generators & Radar and IFF Testers/Recorders/Regulators, line voltage/Semicond.. Servo & Tube Testers/Signal Generators/Tuning Fork Oscillators/Wattmeters. RF. WE ALSO BUY! WHAT DO YOU HAVE? WHAT ARE YOU ASKING FOR IT?

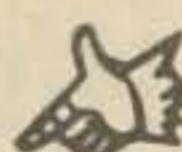

**R. E. GOODHEART CO., INC.**

Box 1220-GC, Beverly Hills, Calif. 90213  
 Phones: Area Code 213, Office 272-5707  
 Messages 275-5342

**WE PAY CASH FOR TUBES**

**Lewispaul Electronics, Inc.**  
 303 West Crescent Avenue  
 Allandale, New Jersey 07401



**Price—\$2 per 25 words for non-commercial ads; \$10 per 25 words for business ventures. No display ads or agency discount. Include your check with order. Deadline for ads is the 1st of the month two months prior to publication. For example: January 1st is the deadline for the March issue which will be mailed on the 10th of February. Type copy. Phrase and punctuate exactly as you wish it to appear. No all-capital ads. We will be the judge of suitability of ads. Our responsibility for errors extends only to printing a correct ad in a later issue. We cannot check into each advertiser, so Caveat Emptor . . .**

**SIGNAL DISTORTION TEST SET TS2B/TG** \$30.00 each. Reader: High speed, tape, Ferranti Mark III \$30.00 each. Atlantic Surplus Sales, 580 3rd Ave., Brooklyn NY 11215.

**ELECTRONIC ORGAN** Transistorized, known brand, electronic assemblies, two manual spinet. \$60.00 f.o.b., send SASE for particulars. W9YCB, Rural Route 2, Box 52A, Angola IN 46903.

**TWIN CITY ARC AUCTION** 1:30 p.m., March 22, 1970, Lambs Auction House, 1600 N. Oak, Champaign IL. Details contact K9QZI, 807 W. Charles, Champaign IL 61820.

**COLLINS 75A4** Excellent shape \$390.00; Collins 32S1 with power supply, used very little \$425.00. Walt Williams, 1706 Parkridge, Arlington TX (817-261-9653).

**RAGS hamfest** Syracuse, New York, April 11, 1970 at Song Mountain. Box 88, Liverpool NY 13088.

**AUCTION, NORTH JERSEY** really different; new equipment booths, prizes; food and drink and bargains galore. Sunday afternoon (April 19) from 1 p.m. til dark, at the Arbor Inn, Rock Ave. and 7th, Piscataway NJ. Easy to reach from Rt. 22 turn south on Rock Ave. 1½ miles; sponsored by Tri-Country Radio Club.

**QSL's???** Samples 25¢ (refunded) Sackers, W8DED, Holland MI 49423 (mention 73 Magazine).

**SELL HEATH H.W. 12** W/extra finals \$90.00; with H.P. 23 power supply \$135.00; S.B. 200 amplifier \$200.00. All gear is clean and in excellent condition. Write Robert Shaw W9E11, Box 154, Rankin IL (217-397-6211).

**SALE:** Clegg Zeus \$300 and interceptor \$325; Drake TR4 with power supply \$500 and R4B \$325; Olson "6" with Lafayette 6 & 2 VFO \$100. All mint condition, factory manuals and cartons. Any reasonable offer considered. Barney Scholl, 1655 Kimberly Road, Sharon PA (412-342-4462).

**GREENE** . . . center dipole insulator with . . . or without balun. . . see 73, November '69, page 107.

**BC-221-M** calibration book and xtal. CW only. Excellent condition. Pick up only. Best offer over \$40. WA2SJW, Ron, 11 Crescent Dr., Old Bethpage NY (516-293-8588).

**TMC GPR-90 RECEIVER** \$250. TMC MSR-4 Receiving mode adaptor, \$100. HR-10 Receiver, \$50. HX-11 Transmitter, \$25. Robert Clauser, 114 Sandhill Rd., Lebanon PA 17042.

**NOVICES!** Interested in traffic? ENTN meets daily on 3726, 7:30 est. All amateurs in Eastern U.S. invited. For information: WA3JSU/1, 200 Washington Street, Middletown, Conn.

**WORLD RADIO** has used gear with trial-terms guarantee! SR34AC \$129.95; HW32 \$89.95; Swan 250 \$199.95; 500C \$379.95; DuoBander 84 \$99.95; 753 \$119.95; SB33 \$189.95; Galaxy 5mk2 \$279.95; 75A \$209.95; 75A3 \$209.95; 75S3B \$499.95; SX101mk3 \$159.95; Drake 2A \$159.95; 2B \$179.95; NC300 \$149.95. Free "blue-book" list for more. Write: 3415 West Broadway, Council Bluffs IA 51501.

**GPR92 \$250** Used 3 years, stored last 3 years. Excellent buy. Ship prepaid. K6ZAM, 6908 Sierra Bonita, Sacramento CA 95831 (916-428-5934).

**MUST SELL** Heathkit HX-20, HR-20, HP-20, \$175., Apache SB-10, \$125., VF-1, \$10., 14AVQ, Radials, \$25. Bob Miller WA6MTY, 1377 Newport Long Beach CA 90804.

**SPECIAL OF THE MONTH** RG11A6U Coaxial Cable, 1st quality, brand new—12¢ a foot or any length to 2500 feet. Antennas, Inc., Dept. B, 512 McDonald Road, Leavenworth KS 66048.

**CHICAGO SUBURBAN RADIO ASSOCIATION** Annual Hamboree on March 22nd at East Avenue and 55th Street, Countryside (La Grange), Illinois. Flea market and prizes. For further information contact Wilson Thomas, W9KWA, 4017 Vernon Ave., Brookfield IL 60513 (312-485-0451).

**SX-130** with speaker — \$110.00; HQ-170AC — \$200; both like new, may make offer. Bob Ensminger, 11388 Campus, Loma Linda CA 92354.

**TECH MANUALS** — TS-173/UR, BC-638A, \$5.50 each; R-390/URR, R-390A/URR, OS-8C/U, URT-7, TED, \$6.50 each. Many others. List 20¢. S. Consalvo, 4905 Roanne Drive, Washington, DC 20021.

**LEARN CODE** with your tape-recorder. Beginners course, up to 9 wpm on 7 inch reel. Price \$5.95. Harold Whaley, Box 2011, Waianae HI 96792.

**COLLINS 310B-1/3 EXCITER** with coils; General Electric 30-50 MHz 250 watt transmitter and modulator \$500. or best offer. SASE. Millen 3 in. CRT magnetic shields \$5. ppd. K8ONM, 37610 Lakeshore, Mt. Clemens MI 48043.

**LOOP** new communications system; details available for \$1.00; write George WA4NQR, 102 Willow Road, Savannah GA 31404.

**WANTED** Turret tuner with coils or old chassis with tuner for Hammarlund SP400X receiver; later model with 13 plate stator and 14 plate rotor; will pay good price. Ralph Williams, Dixfield ME 04224. Box 372.

# GATEWAY ELECTRONICS

6150 Delmar Blvd., St. Louis, Mo. 63112  
314-726-6116

- AN/URT-21 BEACON TRANSMITTER—Fully transistorized, solid state on 243 MHz. Portable bat. operated; new.  
Shipping wt. 1½ lb. . . . . \$ 10.00
- CRYSTAL OVEN—MFG16 BY LAVOIE—115 VAC—75 Degrees Centigrade—Octal Base 4 x 1-7/8 x 1½.  
Shipping wt. 1 lb. . . . . \$ 2.50
- NIXIE TUBES—1" Diameter—0.6 inch numeral w/socket numbers 0 thru 9.  
Shipping wt. ¼lb. . . . . \$ 4.00
- 40-0-40 MICRO-AMP METER—2½"—Ideal for FM Radio Alignment, etc.  
Shipping wt. 2 lb. . . . . \$ 2.95
- TEXTRONIC TYPE 531 OSCILLOSCOPE—w/plug in  
Shipping wt. 125 lb. . . . . \$450.00
- MERCURY WETTED POLAR RELAY—Direct replacement for the WE255A polar relay—factory adjusted and sealed—shielded against noise.  
Shipping wt. 2 lb. . . . . \$ 4.95
- 115 VOLT AC TO 48 DC—Solid state POWER SUPPLY—rated at 3 amps.  
Shipping wt. 25 lb. . . . . \$ 12.50
- AUTOMATIC ICE CUBE MAKERS—For refrigerators and freezers (new) w/diagram & installation instructions.  
Shipping wt. 12 lb. . . . . \$ 9.50

Minimum order \$5.00. Sorry, no catalog at this time. Write for specific items. Watch for our ads in 73. Stop in and see us when you're in St. Louis.

## New! SPEECH compressor

- Increase talk power drastically!
- Installs internally - always with you -  
*Fixed - Mobile - DXpeditioning!*
- Works with Phone Patch
- Fully wired - not a kit
- No Holes 15 min. installation in  
*HW100, SB101, SB401 and others*
- Full year warranty - free literature

MODEL RPC-3 **R<sub>p</sub> Electronics**  
\$24.<sup>95</sup> BOX 1201  
POSTPAID CHAMPAIGN, ILL. 61820



**FREE Catalog** Of The WORLD'S  
FINEST GOV'T  
SURPLUS ELECTRONIC BARGAINS

Now **BIGGER** and  
**BETTER Than Ever!**

MAIL THIS COUPON NOW

NAME: .....

ADDRESS: .....

CITY: ..... STATE: ..... ZIP: .....

For your FREE copy, fill out coupon and mail. Dept. 73

**FAIR RADIO SALES**  
1016 E. EUREKA · Box 1105 · LIMA, OHIO · 45802

# BRIGAR ELECTRONICS

10 ALICE ST. BINGHAMPTON, N.Y.  
13904, AC 607 723-3111

Offices and Warehouse 10 Alice Street  
**COMPUTER GRADE  
ELECTROLYTIC SALE**  
LARGE QUANTITIES AVAILABLE

Minimum Order 10 pcs.  
All Sizes—50¢ ea.

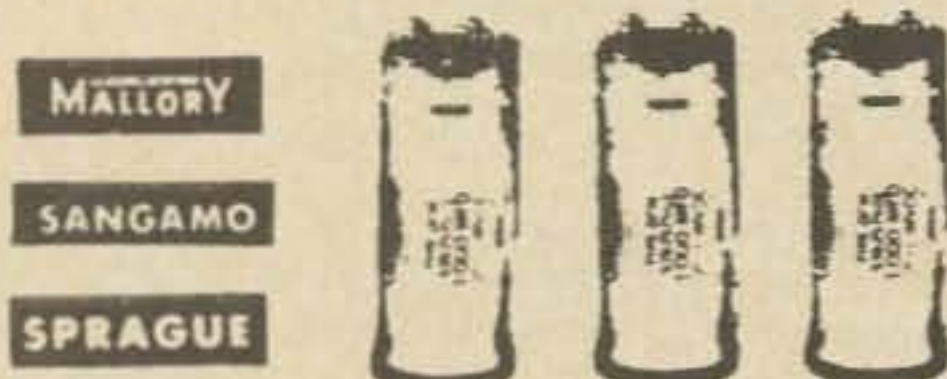

VALUE	SIZE
500 MFD-200 VDC	2" x 4 1/2"
1,250 MFD-180 VDC	2" x 4 1/2"
1,500 MFD-100 VDC	2" x 4 1/2"
3,500 MFD- 55 VDC	2" x 4 1/2"
3,500 MFD- 75 VDC	2" x 4 1/2"
5,000 MFD- 36 VDC	2" x 4 1/2"
5,500 MFD- 45 VDC	2" x 4 1/2"
11,000 MFD- 19 VDC	2" x 4 1/2"
11,500 MFD- 18 VDC	2" x 4 1/2"
12,500 MFD- 16 VDC	2" x 4 1/2"
10,000 MFD- 15 VDC	2" x 4 1/2"
14,000 MFD- 13 VDC	2" x 4 1/2"
15,000 MFD- 12 VDC	2" x 4 1/2"
15,500 MFD- 10 VDC	2" x 4 1/2"
15,000 MFD- 10 VDC	2" x 4 1/2"
25,000 MFD- 6 VDC	2" x 4 1/2"
30,000 MFD- 10 VDC	3" x 4 1/2"
60,000 MFD- 5 VDC	3" x 4 1/2"
20,000 MFD- 15 VDC	2 1/2" x 4 1/2"
15,000 MFD- 15 VDC	2 1/2" x 4 1/2"
35,000 MFD- 12 VDC	2" x 6"
7,000 MFD- 13 VDC	1 3/8" x 4 1/2"
3,000 MFD- 25 VDC	1 3/8" x 4 1/2"
2,500 MFD- 45 VDC	1 3/8" x 4 1/2"
3,750 MFD- 75 VDC	2" x 4 1/2"

No C.O.D. Include necessary postage.

\* JUST BOUGHT OUT ORIGINAL CASE FOR  
CB RADIO. Includes mtg bracket for mobile  
use & slide-in chassis. Holes pre-punched for  
power supply transistor & power cord. May be  
used for mobile power supplies, P.A. system or  
speaker box or many other uses. Size - 3 1/2" H x  
7" W x 8 1/2" D. Weight 3 lbs. Original cost  
\$9.95. Our price . . . . . \$1.95  
MIN ORDER \$5.00 FOB Binghamton

**WE PAY HIGHEST CASH PRICE**  
for Electron Tubes & Semiconductors  
Immediate Payment on Unused Tubes  
**H & L ASSOCIATES**

Elizabethport Industrial Park  
Elizabeth, New Jersey 07206  
(201) 351-4200

## Thousands of Parts

Good Business for sale  
**DOW TRADING CO., INC.**  
ELECTRONIC PARTS & EQUIPMENT  
1829 E. HUNTINGTON DRIVE  
DUARTE, CALIFORNIA 91010 357-3763

SELL: ICO 723 60 watt xmtr—\$30; matching  
Eico vfo—\$30. R. Christie Franklin, 89-29 163rd  
Street, Jamaica NY.

**NOVICE CRYSTALS:** 40-15M \$1.33, 80M \$1.83.  
Free flyer. Nat Stinnette Electronics, Umatilla FL  
32784.

**INDIANA'S MOST PROGRESSIVE HAMFEST**  
Sunday, May 24, rain or shine. Sponsored by  
Wabash Co. Amateur Radio Club. Write Bob  
Mitting, 700 Centennial, Wabash IN 46992.

**COSMIC BLUE** National NC-270 receiver, 80-6  
meters, SSB, AM, CW (.6 hz filter), Notch  
Calibrator, excellent condition. Best offer. Gary  
Prant, 320 White Birch Drive, Cinnaminson NJ  
08077.

**SUPER GAIN (R) ANTENNA** much gain, makes  
exciter sound like linear. See pgs 8 & 144, Oct. 73.  
**GUERRILLA (R)** high efficiency ant. See pgs 57 &  
113, June 73.

**5 x 8" PC BOARD**, 1542 labeled solder points,  
Twin-tracks, 39 rows, 3 power loops, YOURS,  
postpaid. \$2.95 with order No. 1-2-1000. Bert  
Adams Enterprises, PO Box 101, Miami FL 33152.

**WANTED: COLLINS 310B** Does someone, any-  
one, have a 310B that I can borrow or buy? Jock  
White ZL2GX, 152 Lytton Road, Gisborne, New  
Zealand.

**ROCHESTER, N. Y.** is again Hamfest, VHF meet  
and flea market headquarters for largest event in  
northeast, May 16, 1970. Write WNY Hamfest,  
Box 1388, Rochester, NY 14603.

**GET YOUR "FIRST!"** Memorize, study—"1970  
Tests-Answers" for FCC First Class License. plus  
"Self-Study Ability Test." Proven. \$5.00. Com-  
mand, Box 26348-S, San Francisco CA 94126.

**73 IS AVAILABLE** to the blind and physically  
handicapped on magnetic tape from: **SCIENCE  
FOR THE BLIND**, 221 Rock Hill Road, Bala  
Cynwyd, PA 19004.

**RTTY GEAR FOR SALE.** List issued monthly, 88  
or 44 MHz torroids 5 for \$2.50 postpaid. Elliott  
Buchanan & Associates, Inc., 1067 Mandana Blvd.,  
Oakland, California 94610.

**"TOWER HEADQUARTERS!"** 11 brands! Heights  
aluminum 35% off! Strato crank-ups, low cost!  
Rotors, antennas and gear discounts. Phone patch  
\$11.95. Catalog—\$.20 postage. Brownville Sales  
Co., Stanley, WI 54768.

**RG8U FOAM COAX—fresh.** 10¢ per foot—any  
length. PL259-S)239 40¢ each, 15/\$5.00. UG175  
9/\$1.00. FOB. Monte Southward, Rt. 1 A, Upper  
Sandusky OH 43351.



**LIBERTY  
PAYS**

**MORE!**

**WILL BUY  
FOR CASH  
ALL TYPES**

- **ELECTRON TUBES**
- **SEMICONDUCTORS**
- **Military Electronic Equipment**
- **Test Equipment**

**WIRE, WRITE, PHONE COLLECT! WE PAY  
FREIGHT ON ALL PURCHASES WE MAKE**

**LIBERTY  
OFFERS**

**MORE!**

**PRESTEL FIELD STRENGTH..METER**

(Model 6T4G)

★ *Never Anything Like It!*

★ *1 Man Can Do a Better Job  
than 3 in the Same Time!*

★ *A Gold-Mine for Antenna Installers!*

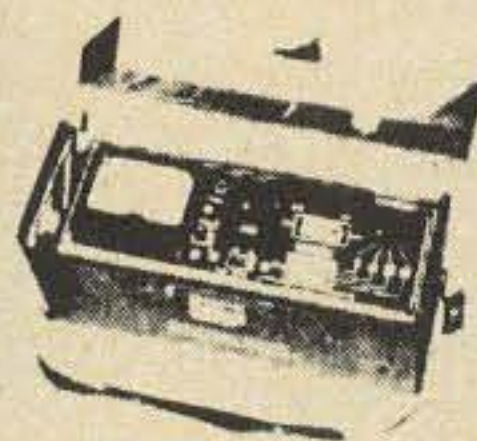

Frequency Range: 40 to 230 and 470 to 860 Megahertz. Calibrated outward from 10 to 50,000 Microvolts. Nothing makes it easier to properly and speedily find the correct place to install TV, FM and Communication Antennas. You can measure and hear the signals

with this 4 1/2 volt battery economically powered unit. There is nothing else like it!

**Only \$120.00 FOB N. Y.**

**Liberty Electronics, Inc.**

**548 Broadway, New York, New York 10012, Phone 212-925-6000**

**MORE LETTERS . . .**

**DX**

I am planning to make several trips between now and 1972 to rare DX locations in Europe and Mediterranean areas. I would like to receive a few QSL cards from U.S. DXers stating the five rarest prefixes in decending order of importance. Underline the particular prefix(es) you need. When trips are planned, an itinerary will be sent to each responcee. Do not list any "U.s." Vandegrift, MATCOM, LSMO, APO, NY 09052.

**Hugh Vandegrift DL4VA/WA4WME**

**Christian Ham Fellowship**

The Christian Ham Fellowship is one of the newest of the many ham organizations among licensed hams in the country today. This new organization now has over 300 members and an explanation of the organization for those hams who might be interested is therefore given in this letter.

The purpose of the organization is to promote Christian fellowship among those hams who are Christians. To a born again Christian this is a vital need and privilege. A Christian Ham Callbook has been published and is available for a mere dollar donation to cover mailing and printing.

The organization also is active in gospel tract mailings, and many of the members have a gospel verse or two on their QSL card as their testimony. Anyone wishing to join the organization and simply believes that Jesus Christ is Lord and Savior is welcome to write in for a free data card on the organization. This data card is then filled

out and their name is listed in the new issue of the Christian Ham Callbook. The main reasons for the organization's existence is to offer Christian fellowship among Christian hams and to learn how a Christian ham can be a witness for Christ to other hams.

**Rus Sakkers W8DED  
Box 218  
Holland MI**

**QRP**

With great pleasure, we wish to report the results to date of a number of QRP experiments, conducted by W7BVV, Bill Gibson, Salem, Oregon, and myself. Path length was computed to be 1650 miles, and frequency of operation is 28.760 MHz.

Date	Power	Mode	Station wrkd/hrd
12/29/69	2.5 $\mu$ W	CW	W7BVV
01/04/70	2.5 $\mu$ W	CW	W7BVV
01/04/70	25.0 $\mu$ W	AM	W7BVV
01/05/70	2.5 $\mu$ W	CW	W7BVV
01/05/70	25.0 $\mu$ W	CW	W7BVV

Our computations and measurements imply that the minimum power required to maintain a CW circuit over the path between W7BVV and this station is on the order of 1 $\mu$ W. We continue to work towards this goal. We have worked many other stations throughout the US and Canada with power outputs down to 100 $\mu$ W AM phone. In addition, we wish to report that we worked CE7DW, Puerto Mont, Chile, 600 miles south of Santiago, with 250 mW AM phone, and received a report of 5 x 7.

**Dick Shoup KL7YU  
Box 5-828  
College AK**

## 73 Readers' DOUBLE BONUS

Want info quick? Just check the box next to the name of the advertiser of your choice in the index below. We'll rush your name to the firm so you can get all the dope direct from the source. (Don't forget to include your name and address at the bottom.)

### ADVERTISER INDEX

- |   |   |
|---|---|
| <input type="checkbox"/> Alltronics 84            | <input type="checkbox"/> Jan Crystal 174        |
| <input type="checkbox"/> Amateur Elect. Supply 33 | <input type="checkbox"/> Jeff-Tronics 125       |
| <input type="checkbox"/> Amateur Wholesale 48     | <input type="checkbox"/> Kaptain 125            |
| <input type="checkbox"/> Ameco 38                 | <input type="checkbox"/> Lewispaul 172          |
| <input type="checkbox"/> American Crystal 109     | <input type="checkbox"/> Liberty 175            |
| <input type="checkbox"/> Amidon 83                | <input type="checkbox"/> Mertin Co. 83          |
| <input type="checkbox"/> Antennas Inc. 97         | <input type="checkbox"/> Military 125           |
| <input type="checkbox"/> Arco Mfg. 87             | <input type="checkbox"/> Mosley IV              |
| <input type="checkbox"/> ATV 55                   | <input type="checkbox"/> National Radio III     |
| <input type="checkbox"/> Brigar 174               | <input type="checkbox"/> Ord 49                 |
| <input type="checkbox"/> Callbook 64, 123         | <input type="checkbox"/> Pantronics 55, 83      |
| <input type="checkbox"/> CB Radio 55              | <input type="checkbox"/> Qument 42              |
| <input type="checkbox"/> Clegg 13                 | <input type="checkbox"/> Radiation Products 125 |
| <input type="checkbox"/> Curtis Elect. 87         | <input type="checkbox"/> RP Electronics 173     |
| <input type="checkbox"/> Dahl 55                  | <input type="checkbox"/> Redline 79, 97         |
| <input type="checkbox"/> Dayton Hamvention 35     | <input type="checkbox"/> Sams 28                |
| <input type="checkbox"/> Denson 97                | <input type="checkbox"/> Sentry 47              |
| <input type="checkbox"/> Dow Trading 174          | <input type="checkbox"/> Signal One 36          |
| <input type="checkbox"/> Dusina 87                | <input type="checkbox"/> Stellar 41             |
| <input type="checkbox"/> Echo Comm. 57            | <input type="checkbox"/> Stuhlman Eng. 15       |
| <input type="checkbox"/> Elect. Design 53         | <input type="checkbox"/> Swan Antenna 87        |
| <input type="checkbox"/> Epsilon 35               | <input type="checkbox"/> Swan 9                 |
| <input type="checkbox"/> Estes 125                | <input type="checkbox"/> Telrex 7               |
| <input type="checkbox"/> Fair 173                 | <input type="checkbox"/> Tristao 89             |
| <input type="checkbox"/> Freck 83                 | <input type="checkbox"/> Tucker 89              |
| <input type="checkbox"/> Galaxy 10                | <input type="checkbox"/> UFO Net 89             |
| <input type="checkbox"/> Gateway 173              | <input type="checkbox"/> United 127             |
| <input type="checkbox"/> GBC America 127          | <input type="checkbox"/> Vanguard 34, 42        |
| <input type="checkbox"/> Global Research 64       | <input type="checkbox"/> Varitronics 119        |
| <input type="checkbox"/> Goodheart 172            | <input type="checkbox"/> Vibroplex 53           |
| <input type="checkbox"/> Gordon, H. 57            | <input type="checkbox"/> WRL II                 |
| <input type="checkbox"/> HAL Devices 123          | <input type="checkbox"/> World QSL 53           |
| <input type="checkbox"/> Heath 17                 |   |
| <input type="checkbox"/> Henry 11                 |   |
| <input type="checkbox"/> Hi Spec 123              | 73 Magazine                                     |
| <input type="checkbox"/> Hunter 89                | Books 102, 103                                  |
| <input type="checkbox"/> H & L 174                | Maps 94, 95                                     |
| <input type="checkbox"/> International Crystal 5  | Radio Handbook 23                               |
| <input type="checkbox"/> James Research 66, 67    | Subscription 101                                |

Haven't got time to browse through the ads? Just put an X by the subject that makes you flip.

- |  |   |
|--|---|
| <input type="checkbox"/> Antennas            | <input type="checkbox"/> Oscillators (rf)   |
| <input type="checkbox"/> Coaxial Relays      | <input type="checkbox"/> PC negatives       |
| <input type="checkbox"/> Code Practice       | <input type="checkbox"/> Preamps            |
| <input type="checkbox"/> Components          | <input type="checkbox"/> Receivers          |
| <input type="checkbox"/> Converters          | <input type="checkbox"/> Receivers (FM)     |
| <input type="checkbox"/> Crystals            | <input type="checkbox"/> Surplus Elec.      |
| <input type="checkbox"/> Equipment dist.     | <input type="checkbox"/> Towers             |
| <input type="checkbox"/> Integrated circuits | <input type="checkbox"/> Transceivers (FM)  |
| <input type="checkbox"/> Keys, Keyers        | <input type="checkbox"/> Transceivers (VHF) |
| <input type="checkbox"/> Linears             | <input type="checkbox"/> Transceivers (SSB) |
| <input type="checkbox"/> Oscillators (code)  | <input type="checkbox"/> TV/Fax             |

MAIL TO 73 Inc., Peterborough NH 03458

Name \_\_\_\_\_

\_\_\_\_\_ Call

Address \_\_\_\_\_

\_\_\_\_\_ Zip \_\_\_\_\_

# DOUBLE BONUS!

Check the top index for specific firms of interest—or check the lower index for the items that turn you on. Either way, you get the dope—and you get it fast.



**NRCI'S**

1 kw Solid State  
TRANSCIVER  
( 80-10 Meters )

# NCX-1000

*The transceiver  
of the 70's*

Rarely is the amateur radio fraternity offered an important new product with the engineered-in reliability found in modern professional and military communications equipment. NRCI's new NCX-1000 is one of these exceptional products. It was conceived and developed for radio amateurs by the same company that gave the Marine Corps its rugged solid-state AN/GRR-17 tactical communications receiver, that gave the Navy its versatile AN/URT-22 exciter-transmitter, and that produced the classic HRO-500 VLF/HF receiver.

The NCX-1000 combines rock-solid design, exceptional performance, and a power punch. It's the finest solid-state, self-contained, 5-band kilowatt transceiver available today—the odds-on choice of the discerning amateur, be he rag-chewer or DX-er. See it now at your dealer's store, or write for complete details.

For complete (and impressive) specifications and details, write:

**NATIONAL RADIO COMPANY, INC.**

**NRCI**

111 Washington Street, Melrose, Mass. 02176 ( 617-662-7700 )

## NEW SINGLE-BAND BEAM FROM MOSLEY

# The Classic 20 WITH EXPANDED DX CAPABILITIES

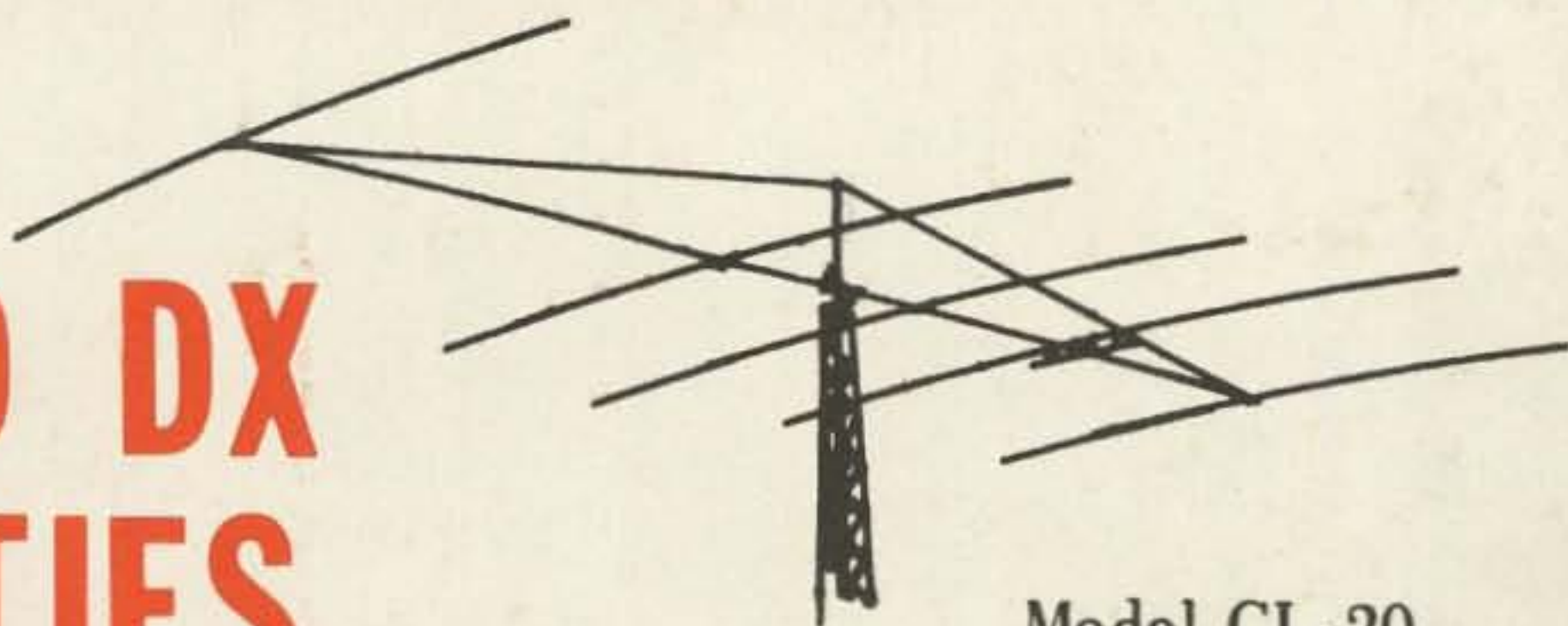

Model CL-20

### ON 20 METERS

DON'T LIMIT YOURSELF!

When you install a 20 meter beam, there is only one antenna investment you can afford . . . The NEW CLASSIC 20 with expanded DX capabilities, thanks to the new Classic Feed System, "Balanced Capacitive Matching".

This new array promises to be the most universally accepted amateur beam ever developed for 20 meters.

TAKE A LOOK AT THE VITAL STATISTICS!

- FORWARD GAIN: 9.8 db compared to reference dipole; 11.9 db over isotropic source.
- POWER RATED: 1 KW AM/CW; 2 KW P.E.P. SSB input to the final.
- SWR: 1.5/1 or better.
- MATCHING SYSTEM: Balanced Capacitive.
- FEED POINT IMPEDANCE: 52 ohms.
- NUMBER OF ELEMENTS: 5. Aluminum tubing; 6063-T832.
- MAXIMUM ELEMENT LENGTH: 38 ft. 1½ in.
- BOOM LENGTH: 46 ft.
- RECOMMENDED MAST SIZE: 3 in. OD.
- TURNING RADIUS: 28 ft.
- WIND SURFACE: 18.7 sq. ft.
- WIND LOAD (EIA Std. 80 MPH): 364.45 lbs.
- ASSEMBLED WEIGHT: Approx. 139 lbs.
- SHIPPING WEIGHT: Approx. 145 lbs. via truck.



Pat. No. 3419872

Mosley is the name. Antennas are our business.  
Designed, engineered and manufactured by hams . . . for hams.  
For detailed brochure on the entire CLASSIC LINE  
of single and multi-band beams, write . . . Dept. 198G

**Mosley Electronics Inc.** 4610 N. LINDBERGH BLVD., BRIDGETON, MO. 63044