

# 73

FEBRUARY 1968

An inflated 60¢

## AMATEUR RADIO

I C Digital  
Frequency Counter

Amateur I C's

Ferris Wheel Antenna

Thin Line Generator

High Quality Hybrid  
Receiver

Hydronics or Radio?

Ham Club Publicity

How's Your Club Paper?

Electronic Temperature  
Measurements

The Quartenna Dummy  
Load

And many more in this  
Issue

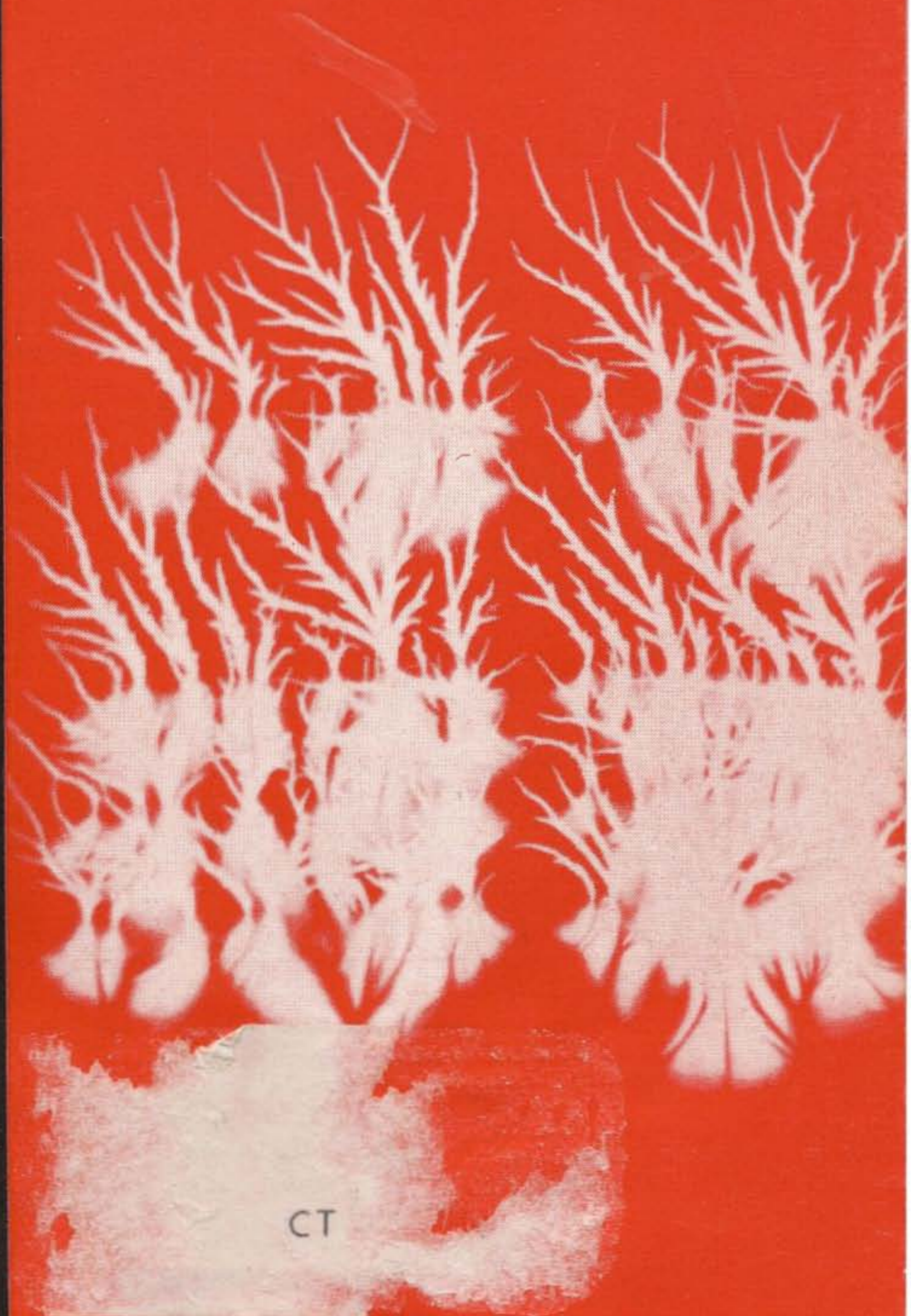

# "Duo-Bander 84"

80-40 Meter  
SSB Transceiver

Ham Net \$159<sup>95</sup>

WRL CHARG-A-PLAN \$8 Monthly

## A Complete 80-40 Meter MOBILE PACKAGE!



Includes 1 ea.: Duo-Bander 84, DC384 Power Supply, one Band-spanner Antenna, BDYF Mount, 350C mic, Mic. Plug, PL 259 Plug, UG176/U Reducer and 25' RG58/U coax Cable. All supply cables are included.

ORDER: ZZA-103 package (\$15 monthly)...Regularly \$299.95 WITH BONUS COUPON...\$279.95. (\$14 monthly)

## A Complete 80-40 Meter FIXED STATION PACKAGE!

Includes 1 ea.: Duo-Bander 84, AC48 250 watt supply, 80/40 Duo-Doublet Antenna kit, 350C mic., Mic. Plug, PL259 Plug, UG-176/U Reducer and 100 ft. RG58/U coax cable.

ORDER: ZZA-104 Package (\$11 monthly)...Regularly \$225.00 WITH BONUS COUPON...\$205.00 (\$10 monthly)

ORDER: ZZA-105 Package (same as above with 300 watt AC supply)...Regularly \$255.00 WITH BONUS COUPON \$235.00 (\$12 monthly)

# NOW — GO MOBILE 300 WATTS AT AN AMAZING SAVINGS!



## SAVE \$20<sup>00</sup> WITH THIS BONUS COUPON!

This coupon may be applied against the package ZZA-103, ZZA-104 or ZZA-105 regular prices, provided there are no trade-ins involved, and will reduce the regular package cost by \$20.00.

Only one coupon may be used. This offer is for a limited time only.

## A GREAT RIG... AT AN AMAZING PRICE!

Designed for the Amateur whose interest is 80 and 40 meter SSB. Here's Power to make good contacts...a Selective Receiver...Stability...Compactness (only 5x11<sup>1</sup>/<sub>4</sub>x10"). A GREAT value at the regular price...NOW SAVE \$20.00 on a package with the BONUS COUPON. Purchase yours NOW with our easy, monthly terms, too!

## Look at these DUO-BANDER 84 FEATURES!

- 300 watts PEP-SSB • Rugged-Reliable Printed Circuitry • 2k-Hz Dial Calibration • Dual-Speed Vernier VFO tuning • E-Z One-Knob Tune-Up — "Just Peak Output" • Built-in Speaker • Mobile Bracket supplied • Combination "S" and Output meter • Crystal Lattice Filter.

Use this Handy, Quick  
Mail Order Form —

**WORLD RADIO LABORATORIES, Inc.**  
3415 West Broadway Council Bluffs, Iowa 51501

73-26X

Please ship me the following:

- Duo-Bander MOBILE Package ZZA-103 @ \$299.95
- Duo-Bander Fixed Package ZZA-104 @ \$225.00
- Duo-Bander Fixed Package ZZA-105 @ \$255.00
- Your FREE 1967 HAM Catalog
- I am enclosing one BONUS COUPON as I have no trades. Deduct \$20.00 from the regular package price above.
- My check or Money Order for \$\_\_\_\_\_ is attached.
- Charge it to my WRL charge Acct # \_\_\_\_\_

Name \_\_\_\_\_

Address \_\_\_\_\_

City \_\_\_\_\_ State \_\_\_\_\_ Zip \_\_\_\_\_

January 1968

Vol. XLVII No. 1

Kayla Bloom WIEMV  
Editor

Published by  
Wayne Green, W2NSD/I

**ADVERTISING RATES**

	1X	6X	12X
1 p	\$328	\$312	\$291
1/2 p	171	163	152
1/4 p	88	84	79
2"	47	45	43
1"	25	24	23

No extra charge for second color (red, usually) or bleed on full page ads. If you're interested in advertising to hams, get our full rate card and other information from Wayne Green W2NSD.

**Cover**

Photograph of static electricity as recorded on file. KIGUU.

73 Magazine is published monthly by 73, Inc., Peterborough, N.H. 03458. The phone is 603-924-3873. Subscription rate: \$5.00 per year, \$9.00 for two years, \$12.00 for three years. Second class postage is paid at Peterborough, New Hampshire, and at additional mailing offices. Printed in Pontiac, Illinois, U.S.A. Entire contents copyright 1967 by 73, Inc. Postmasters, please send form 3579 to 73 Magazine, Peterborough, New Hampshire 03458.

FEBRUARY 1968

An Integrated Circuit Electronic Counter .....WIPLJ..... 6  
A useful piece of ham gear

How Come? .....W4YM..... 14  
A good question

An Amateur Tries IC's .....VE3DAN..... 16  
The uses of integrated circuits

100 KHZ Thin-Line Pulse Generator .....W2DXH..... 24  
Frequency Standard with ICs

The Nurture and Care of a Junk Box .....WØHMK..... 30  
Selective collecting

How to Plan Your Own DXpedition .....W4PJK..... 34  
DXing in style and comfort

How is Your Club Paper—Good or Bad? .....K6GKX..... 38  
Make the readers notice

High Quality Hybrid Receiver .....VEITG/VEIADH..... 42  
Restoring the lost art of home-brew

Tips for the CW Contester and DX'er .....KH6IJ..... 50  
From one of the great CW contesters

How to Publicize Your Club .....K4HKD..... 54  
Getting activities into print

Technical Aid Group ..... 58  
Where to look for help

The Quartenna .....WA6OBH..... 64  
How to shrink a Cantenna

Hydronics or Radio? .....VE7BS..... 66  
Underwater propagation

Electronic Temperature Measurements .....K6EAW..... 70  
Determining temperature rise in components

---

Editorial Liberties ..... 2	Letters .....86
De W2NSD/I ..... 4	Caveat Emptor .....91
Propagation .....72	

# Editorial Liberties

I'm not sure what the typical male reaction will be on finding that the new editor of his favorite ham magazine is a woman. However, I promise to maintain my "cool" and not put a lace border on the magazine. I will continue the present policy of bringing you the best possible articles each month. Keep me in line, fellows, and if I don't give you the kind of magazine you want, let me know.

For a brief background, I was first licensed in 1956 as KH6CKO, then moved to Denver in 1962 and became WØHJL, and am now WIEMV. I hold a General Class license, but am working toward the Extra at the earliest possible time. My background has been primarily as a wife and mother, but math and physics has constituted a good part of my educational background; mainly in the field of statistics and data processing. I am not an engineer, by any means, but I have done a lot of building and experimenting. When in doubt, I shall consult with someone who has an engineering background. In any case, my husband is gone, my children are grown, and here I am.

So much for the personal side of Kayla. I was one of the "save 11 meters" group, way back when. Since we lost the fight, I have not paid too much attention to what is going on on 27 MHz. Recently, a ham friend with CB equipment let me listen in on the CB band. I was completely stunned by what I heard. Calls like, "This is the 'Barefoot Boy' calling 'Yankee Pirate', come on in 'Yankee Pirate' and talk to the 'Barefoot Boy'." I feel certain these calls were not issued by FCC. Meantime, in the background, many legitimate CBers were trying to get through the QRM to deliver messages which *were* legal on CB channels. One poor company was trying to contact one of his trucks which was located about a mile away, but the long skip was in and a relay was finally accomplished by a station in South Carolina. So much for the efficiency of 11 meters for ground wave when the sun spots rise. The choice of CB frequencies was definitely a mistake.

I wonder what will happen when the sun spot cycle gets to a peak and our CB signals (even the legal 5 watters) begin skipping around the world. We must remember that other countries, especially in South America, still use 11 meters for ham band only operation. I remember in 1958 working a station in Kansas (I was in Hawaii) on 10 meters with less than ½ watt. The CB QRM on ham bands in other countries could lead to an international incident of the first water.

My first reaction to the aforementioned illegal CB operation was absolute horror. Amateur radio gave up 11 meters for this? Then I began listening more closely to our own ham bands, and came to the conclusion that before we throw more stones in the direction of the CB people, perhaps we had better clean our own doorstep.

Disregard for regulations, flagrant violations of the rules, malicious interference, and just plain discourteous behavior seems to be the "in" thing these days. The AM operators who deliberately QRM a SSB round table night after night is only equalled by the SSBers who delight in creating QRM for the AM stations. I feel sure AM will not be eliminated from the amateur bands in the near future, nor do I feel it would be right to eliminate this mode at this time. The two modes are, indeed, incompatible, and we are simply going to have to find a means for peacefully getting along with each other. Continuing to make war on each other is not going to solve any of the problems.

The restricted frequencies created by incentive licensing is not going to improve the situation, so it becomes more necessary for us to find a solution to living together.

The letters column this month has a complaint about deliberate QRM of ARRL's code broadcasts. After reading this letter, I decided to listen and see for myself. I'm afraid the complaint is justified. This behavior is not only discourteous and unjustified, but is highly illegal. On 75 meters recently we have had an influx of "broadcast" stations . . . and I'm not referring to the foreign

(Continued on page 73)

# WHERE RELIABILITY & ACCURACY COUNT

**INTERNATIONAL PRECISION RADIO CRYSTALS**  
70 KHz to 160 MHz

HOLDER TYPES

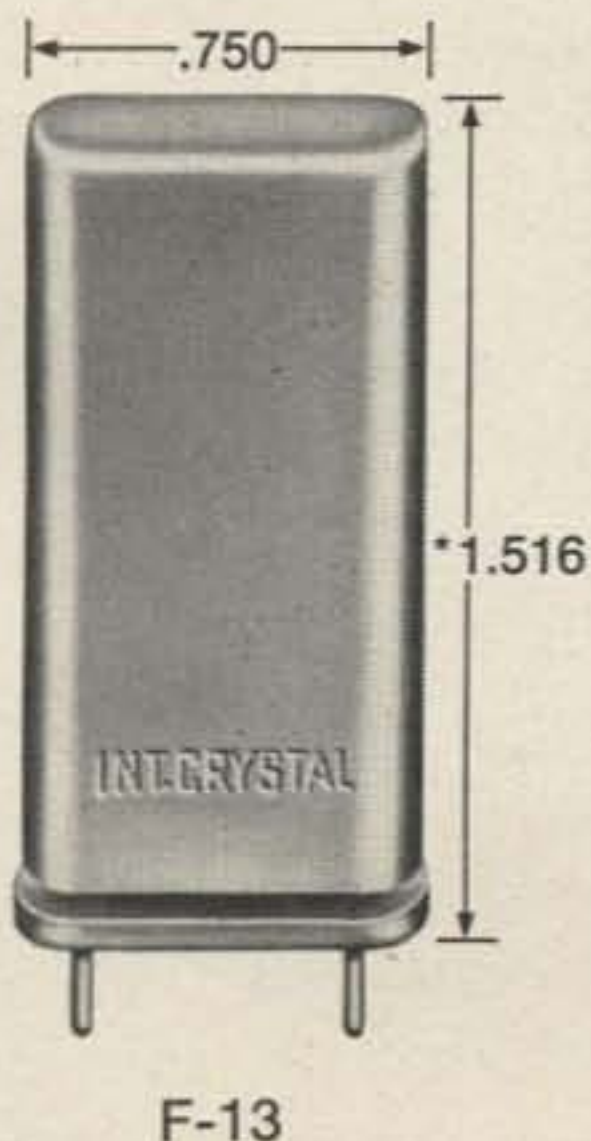
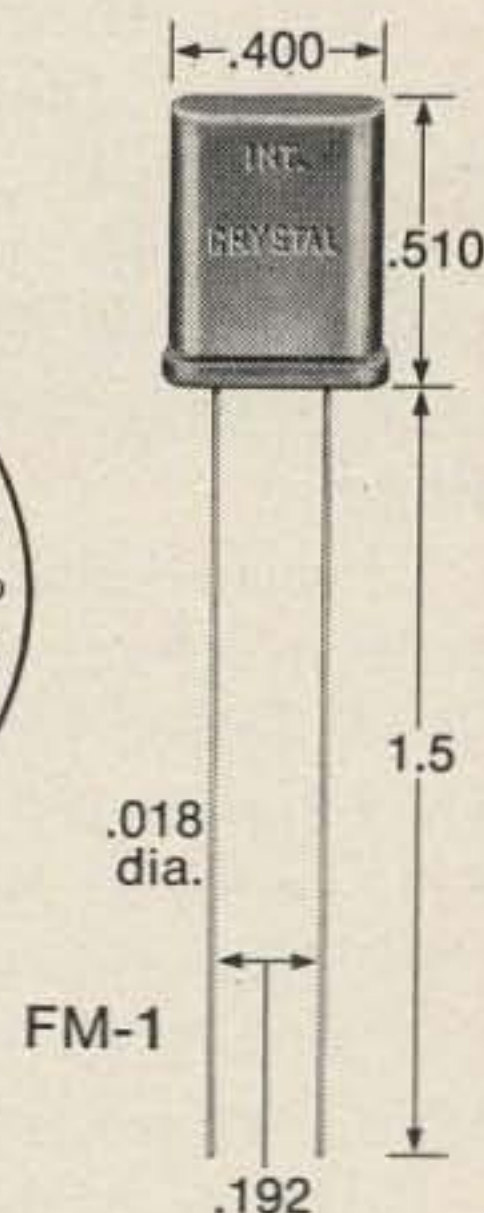
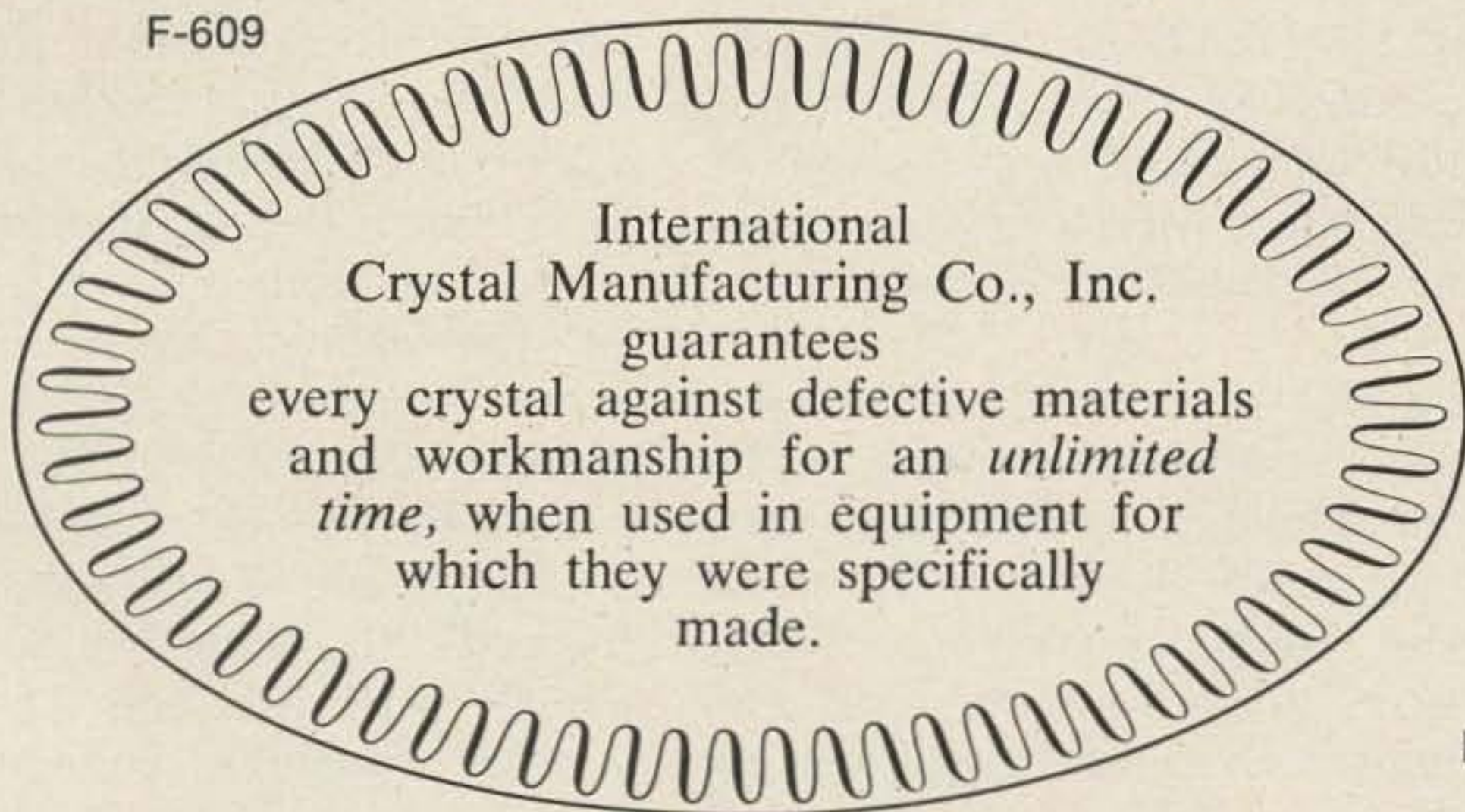
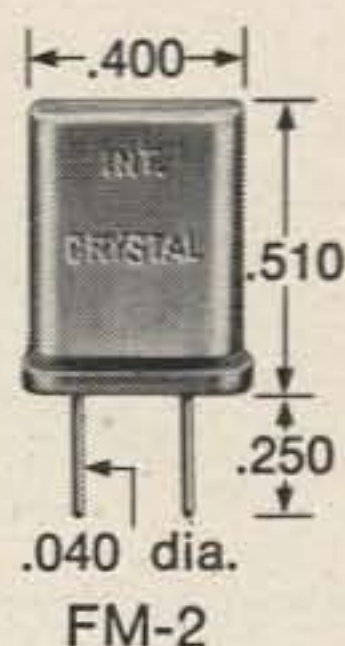
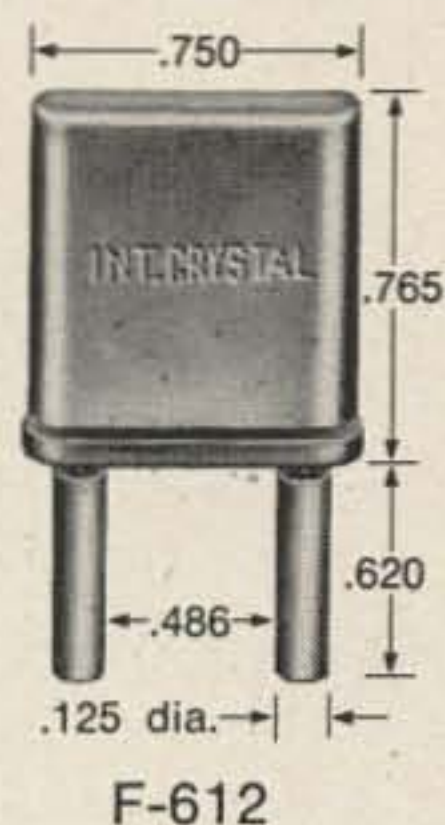
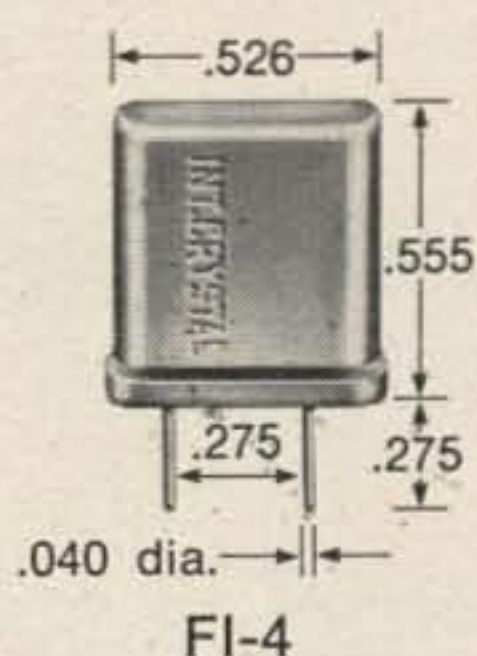
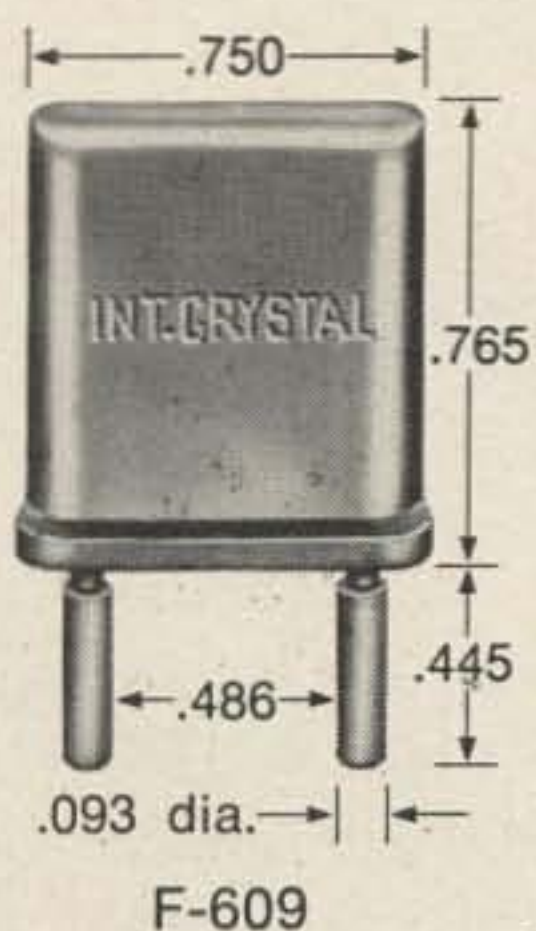
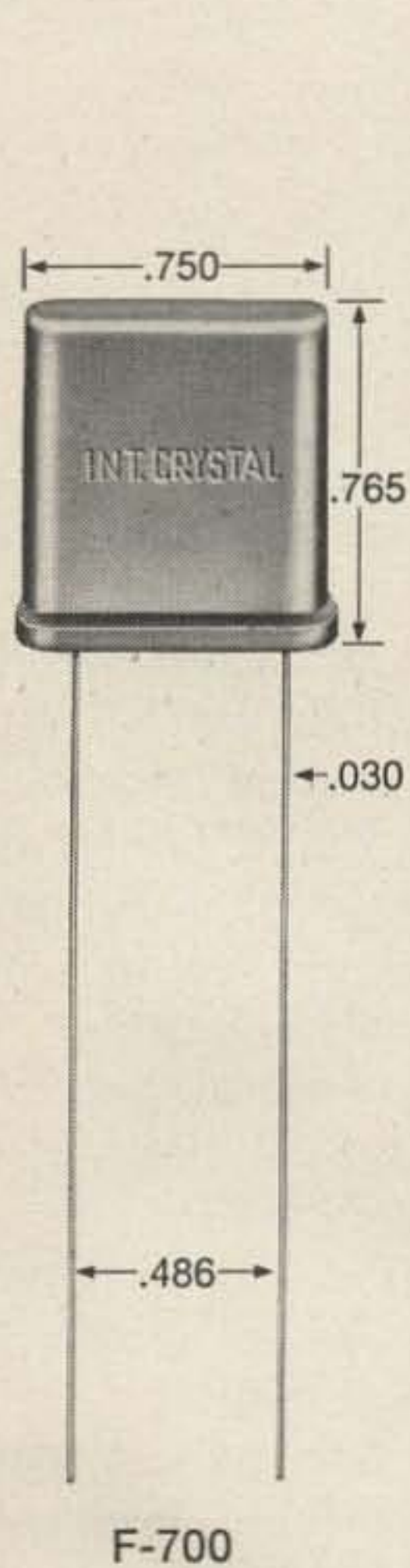

Crystal Types:

- (GP) for "General Purpose" applications
- (CS) for "Commercial" equipment
- (HA) for "High Accuracy" close temperature tolerance requirements

International Crystals are available from 70 KHz to 160 MHz in a wide variety of holders.

Crystals for use in military equipment can be supplied to meet specifications MIL-C-3098C

WRITE FOR COMPLETE CATALOG.



**CRYSTAL MFG. CO., INC.**  
10 NO. LEE • OKLA. CITY, OKLA. 73102



de . . . .

**W2NSD**

### HERE'S WHAT HAPPENED

Subscribers during September and October ran into unreasonable delays on our part. We are trying to make sure that everyone gets every issue they bargained for, but the letters are still coming in from all over the world. While the immediate explanation is programming difficulties with a new computer, the long range explanation is more complicated.

It has been quite a while since I have written about how things are going with 73. A letter from Richard, WB2UMH, asks what happened to some of the old 73 services such as the Radio Bookshop, 6-UP, ATV Experimenter, and the Parts Kits. He also wants to know what has happened to the old aggressiveness of 73.

Perhaps I can put this in perspective if I go back to the beginning.

Ham radio grabbed me during my freshman year in high school, back in 1936. The great bulk of my 35c a day lunch money went into radio parts during high school. I built up a storm and had a wonderful time with my own receivers, transmitters and transceivers. The code bugged me though, and it took several nerve wrenching visits to the FCC before I managed to steady my hand down enough to pass the code test. The only reason I passed, I think, is because I merely went along with a friend who was taking the test and then, at the last minute I decided to give it a try . . . it didn't cost anything in those days. It was

easy when I wasn't worried about passing and soon I had W2NSD.

A year later came the war. I joined the Navy in '42 and went through what I consider one of the world's greatest electronic schools at Treasure Island. I had joined the Navy with the understanding that when I graduated from school I would go to work for the Naval Research Laboratory in Bethesda, but I changed my mind and volunteered for submarines. During 1943-44-45 I was in the thick of the Pacific war as an Electronic Technician 1/c. Then I was "retired" to New London where I taught school until the end of the war.

After finishing college in 1948 I tried my hand at being a broadcast engineer-announcer at a few stations around the country. Then I got into television, putting WPIX on the air as an engineer and later KBTB in Dallas as a producer-director. It was in 1948 that I got interested in ham-RTTY. I was very interested. When I got a job in 1951 with WXEL-TV in Cleveland as a director I immediately latched onto their mimeo machine and started publishing an RTTY bulletin. By the next year I was writing an RTTY column for CQ.

Television was fast turning to formulas so I decided to get out of that business. Those of you who have read, "Only You, Dick Daring" will understand what is wrong with that industry. I went into hi-fi manu-

facturing and, starting with nothing but a small bank loan, built up a million dollar business in about three years. Unfortunately I am a trusting soul and when the business was incorporated I foolishly did not have my own lawyer check the papers. The other stockholder took over and in about a year managed to bungle the business into bankruptcy. Long before the courts could help me there was nothing to fight over.

On January 5th, 1955 Cowan talked me into taking over the editorship of CQ. The magazine was in bad shape and losing a good deal of money every month. Perhaps I could save it. Inside of a year it was in the black and by the second year it was making a handsome profit, on the order of \$100,000 a year.

Cowan and I had our problems. I wanted to change the magazine, dropping the many monthly operating news columns and concentrating on construction and technical articles. He didn't want it changed. I should have left in 1958 when I realized that it was hopeless, but it is awfully difficult to make a major change like that when you really don't know anything much better to do.

By 1959 things were very bad and on January 5th 1960 we parted company. I went to work with a friend in an advertising agency, but the more I thought about starting a new ham magazine the better the idea sounded to me. In May I quit the agency and rented a little two room office up over a small grocery store in the outskirts of Brooklyn. I bought a mimeo machine for promotion letters and started to work. I tried for three months to find a wealthy ham that was interested in backing the magazine, but no dice. So I sold everything I had that would bring in money and got enough together to put out the first issue of the magazine. I wrote to old friends for articles and started selling subscriptions through radio clubs and at conventions.

The first issue came out in October 1960. It was priced at 37c on the cover and a subscription was \$3 a year, \$30 for life. In January 1961 I married Virginia and she helped with cutting subscription stencils. I worked about sixteen hours a day, seven days a week. It was over a year before we could afford our first paid employee. We moved the magazine into a small apartment with us in another section of Brooklyn. When our one year lease expired we moved up

*(Continued on page 74)*

# ROHN®

## Big name in towers

ROHN TOWERS have become the accepted standard of excellence throughout the world — meeting the needs of the communication, broadcasting, transportation, oil, utilities, manufacturing and other industries, including home TV and amateur needs.

Computer engineered and designed ROHN TOWERS are produced in ROHN'S vast manufacturing complex utilizing the latest equipment and methods. Convenient warehousing facilities at strategic locations plus world-wide representatives and complete turnkey tower erection service . . . along with a complete line of tower accessories, lighting systems and microwave reflectors make ROHN the complete tower line — throughout the world.

Representation and  
Distribution Worldwide  
For further information  
contact

## ROHN®

Home Office  
P.O. Box 2000,  
Peoria, Illinois 61601  
Ph. 309/637-8416  
TWX 309/697-1488

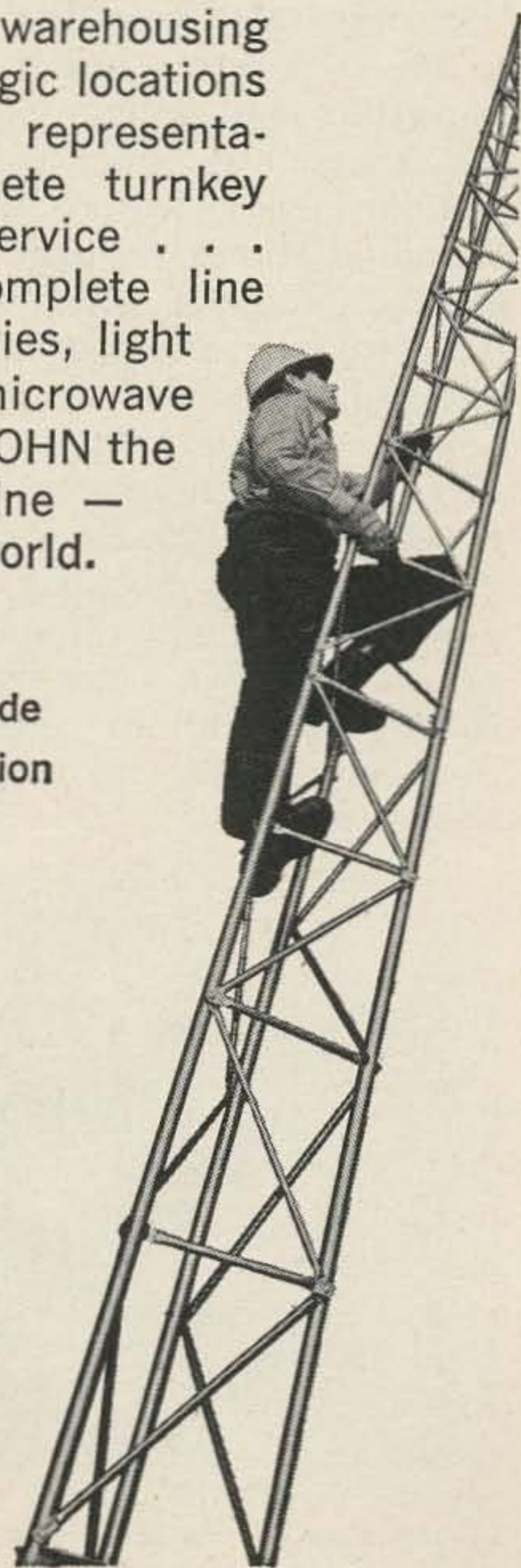

# An Integrated Circuit Electronic Counter

## Direct Decimal Readout to 10 MHz

A digital frequency counter is a useful, though not common, piece of equipment in the ham shack. The writer built a counter many years ago using old fashioned vacuum tubes in order to place high in the ARRL Frequency Measuring Tests. The unit only worked up to 100 kHz, but was adequate for the intended purpose. The recent reduction in the prices of plastic encapsulated integrated circuits prompted the writer to see if a better unit could be built with transistors and integrated circuits. The result is a counter which will go up to 10 MHz and has every feature a ham could want, including direct decimal readout and completely automatic operation. The unit shown is useful not only during the ARRL FMT but also in everyday ham operation. During normal operation it is connected to the VFO of my transmitter-receiver setup and is set on the 100 Hz range, thereby acting as a digital "tuning dial" with 100 Hz divisions; a feature not found on any ordinary receiver or VFO. Later, when I go on RTTY, it will be useful for setting the transmitter frequency shift and aligning the receiver converter.

### Principles of operation

This counter displays the frequency in decimal numbers so that the operator doesn't have to convert from binary to decimal. On the one-hertz multiplier range, the cycles of the input signal are counted for precisely one second, and the progress of the count can be watched on the neon lamps. The final count is then displayed for one second. The count period can be extended to any multiple of one second if greater than one-hertz accuracy is needed and, likewise, the display can be held for as long as desired. At the end of the display period, the counters are reset to zero and the process starts over again. On the 10-hertz multiplier range the same process is repeated five times a second, on the 100-hertz range, fifty times a second, etc. To avoid confusion on the ten-hertz and higher ranges, the neon lamps are not lighted during the counting period and are, therefore, seen only displaying the final count. On the 10-hertz range, the display blinks five times a second, but on the 100 Hz and higher ranges, it appears continuous and appears to change immediately if the input frequency

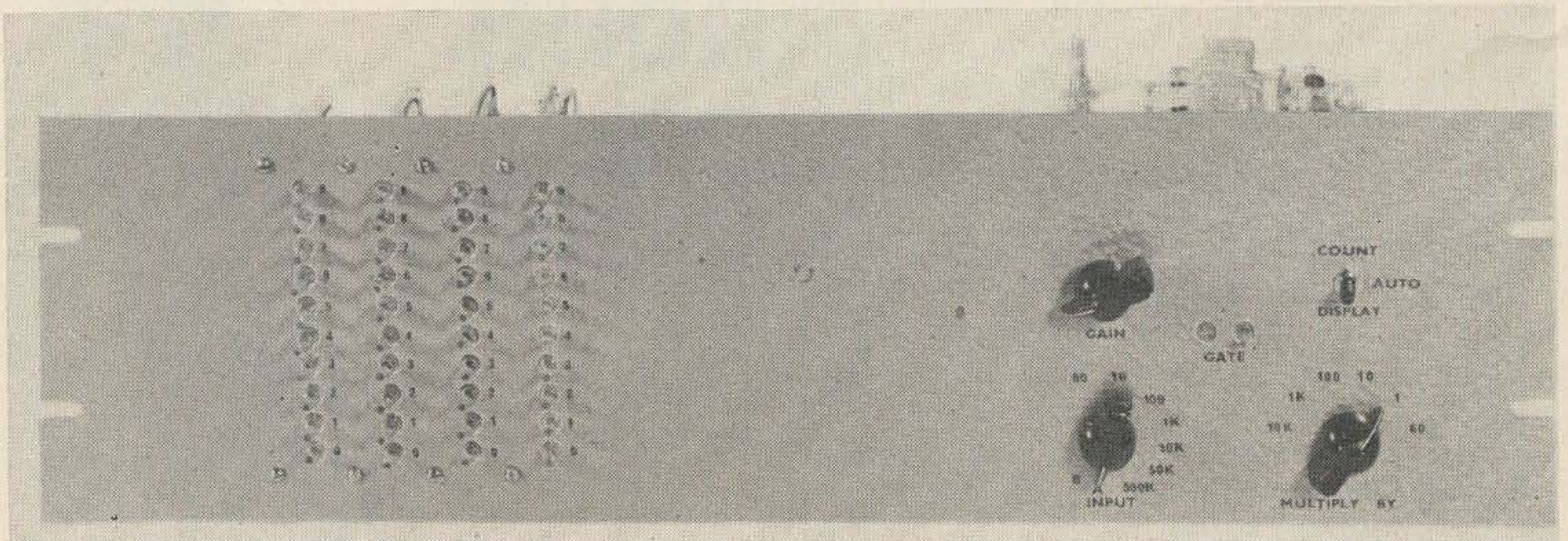

Front view of the integrated-circuit frequency counter. The neon counting decades are on the left, count controls are on the right.



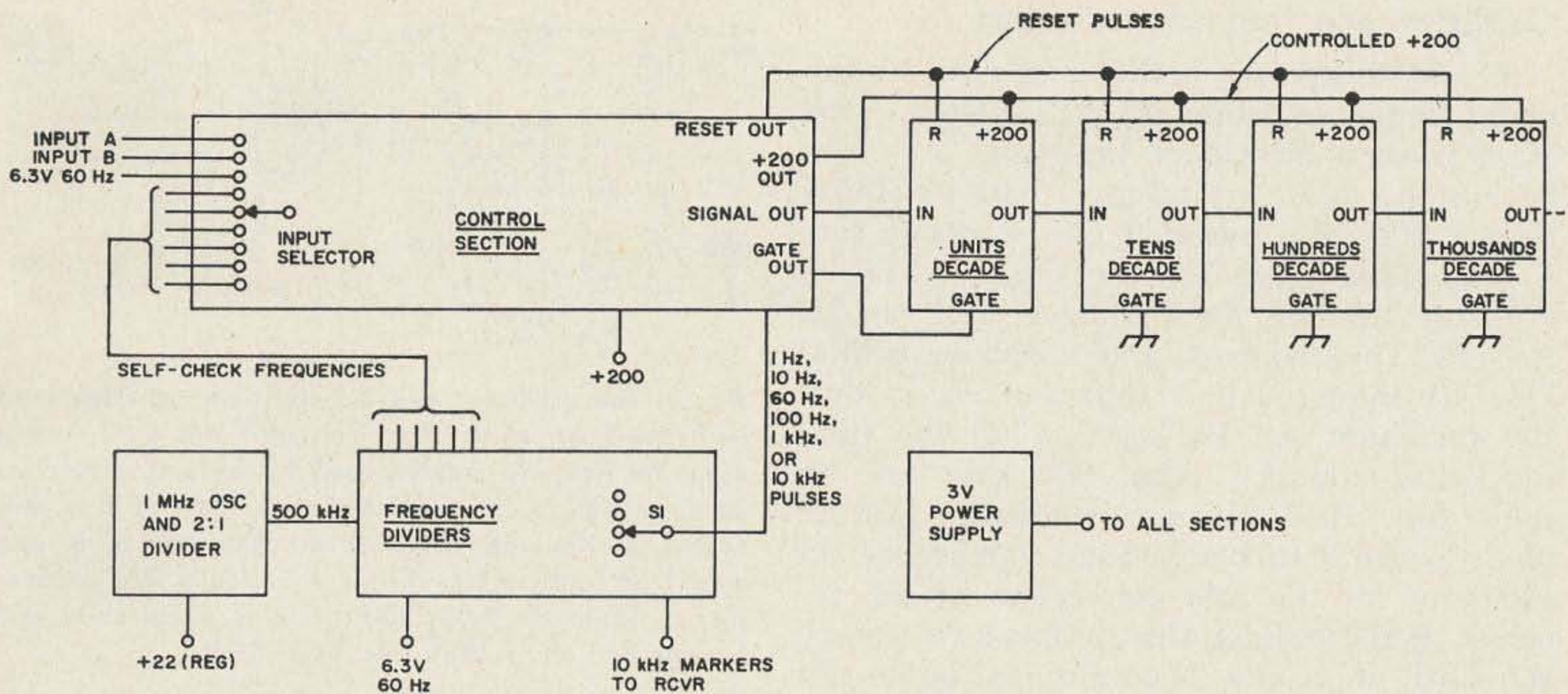

Fig. 1. Block diagram of the complete integrated circuit frequency counter. Any number of decades may be used, but for proper display, the units decade should be to the right, the tens decade to its left, etc.

changes. Therefore, it combines the convenience of an analog display with the accuracy of a digital display. The last digit in this case usually vacillates between two adjacent numbers because of the one hertz per gating period error inherent in a digital count.

The counter consists of three main sections. First, a frequency divider divides the signal from a 1 MHz standard down to 10 kHz, 1000 Hz, 100 Hz, 10 Hz, or 1 Hz, as required. A time base derived from the 60 Hz line could have been used but this would have limited the accuracy to 0.1% and would only have permitted the 10 Hz and 1 Hz ranges. This section also applies 10 kHz markers to the remainder of the frequency measuring setup. The 10 kHz pulses are rectangular in shape and have strong harmonics above 30 MHz. Therefore, they might as well be used as markers.

Second, a control section takes the desired time base frequency and turns on the units counter for the correct length of time. It also shapes the input signal, so that the units counter will accept it, turns on the high voltage supply for the neon lights during the display period, and supplies a reset pulse to all counting decades at the end of the display period.

Third, the counter proper consists of as many counting decades as the builder desires, one for each digit to be displayed. The units decade is gated by the control section and only counts pulses when the control section wants it to. For each ten pulses the

units decade is allowed to count, one is passed on to the tens decade, likewise for each ten pulses the ten decades receives it passes one on to the hundreds decade, etc. The decade counters, after the units decade, are not gated since they only receive pulses if the units decade is supplying them. Although the decades count by binary flip-flops, suitable feedback circuits make them count in decimal instead of binary. A decoding network and ten transistors allow one of ten neon lamps on the decade to be turned on to display one digit of the measured frequency. Each decade can also be reset to zero by a reset pulse from the control section.

### Digital integrated circuits

The counter uses RTL integrated circuits because of their low cost. These have been described in 73 magazine both in articles and integrated circuits, and in two excellent articles about IC electronic keyers; therefore, they will only be described briefly here. The reader who is not familiar with RTL circuits should review these references before trying to understand the counter in detail. He might also find it advisable to build the "Kindly Keyer", before he builds the counter, as the writer did. Although the counter could probably be built and made to work by just following the diagrams, a previous knowledge of RTL circuits, gained by building a simpler device, will help in trouble shooting.

## Oscillator and frequency dividers

A 1-MHz crystal oscillator is used as the main frequency standard at WIPLJ. One MHz is used instead of the usual 100 kHz because a 1-MHz crystal gives better stability than a 100-kHz crystal if one wants to pay a reasonable price for the crystal. This is probably because the 1-MHz crystal can be AT cut. The oscillator and a divider to 500 kHz are mounted in a separate box so that the oscillator can be kept on all the time for better stability. Also, 500 kHz can be used for other purposes including future plans to use it to synchronize a phase-locked oscillator for the first conversion of the receiver. If the builder already has a frequency standard, it is not necessary to build another crystal oscillator for the counter—the existing one can be worked in easily. Conversely, if the builder is interested in frequency measurement but does not yet want to build the counter, he can build the oscillator and the dividers down to 10 kHz and at least have markers for his receiver. The oscillator and first divider are shown in Fig. 2.

The remainder of the frequency divider section, Fig. 3, consists of 2:1 and 5:1 dividers. The 2:1 dividers are simply J-K flip-flops; the 5:1 dividers are J-K flip-flops with an RC network and inverter on the set input which only allows every fifth input pulse to produce an output pulse.

The 5:1 divider can be best understood from the diagram and waveforms of Fig. 4. Without an input signal, the inverter input is held high by the connection to positive voltage thru  $R_1$ . The inverter output is, therefore, low so that low appears on the set input of the flip-flop. If the O output of the flip-flop is initially high, the first negative going transition on the toggle input will make it go low. This change will be passed on to the inverter through  $C_1$  and this will make the set input go high so that the O output cannot go low again when more input pulses come in.  $C_1$  will charge through  $R_1$  and, after a delay, the inverter output and the set input will go low again so that the flip-flop can respond to an input pulse. If the divider is adjusted correctly, it will pass every fifth input pulse. Other division ratios can be obtained, and maybe it would work with a division ratio of ten, but the ratio of five makes the division ratio very stable. In fact, it does not go out of adjustment for a change in the supply voltage from 3.0 to 4.0 volts.

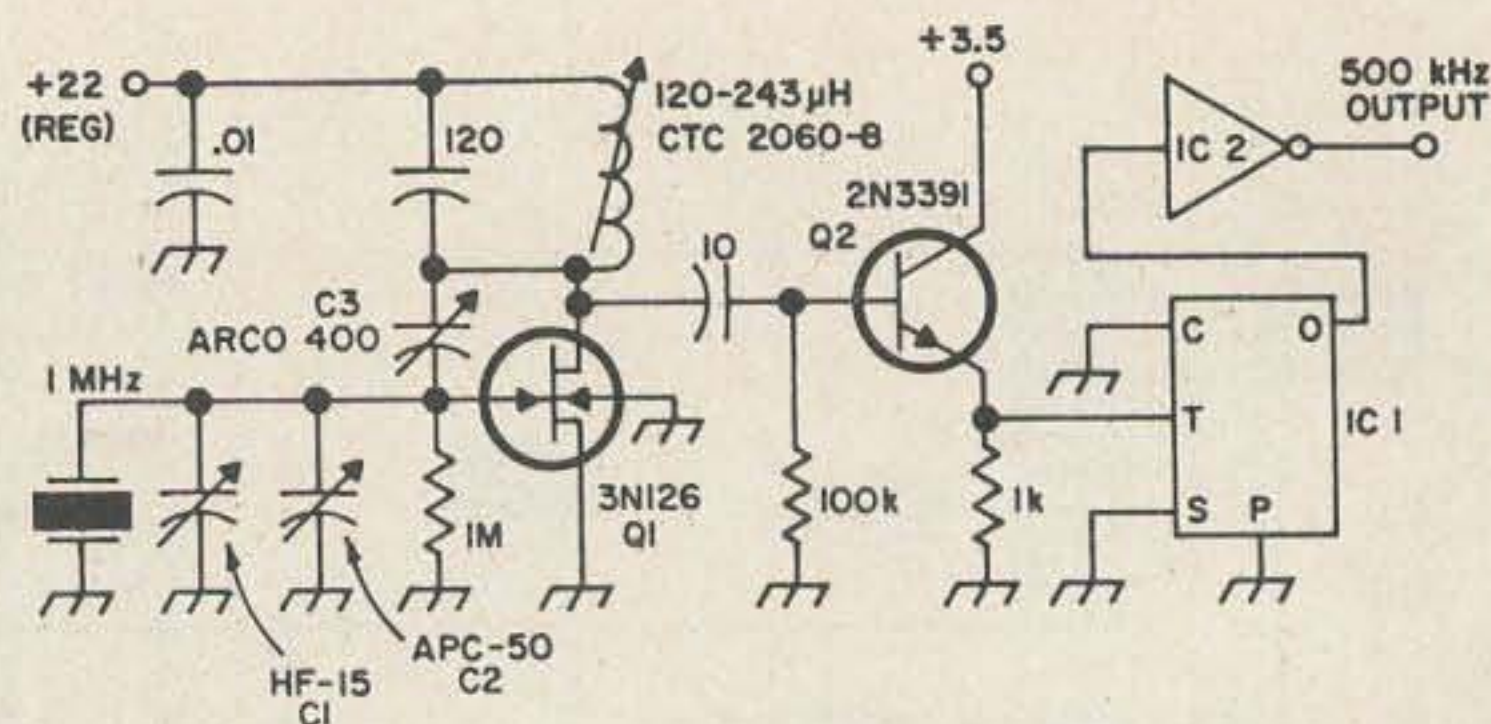

Fig. 2. The oscillator and 2:1 frequency divider used with the decimal counter. This unit was built into a separate box and may be used for obtaining markers as described in the text. Although the FET is a Motorola 3N126, an MPF-105 is less expensive and would probably work. IC1 is a Fairchild 923 or one-half a Motorola MC-790-P; IC2 is a Fairchild 900 or one-half of a Motorola MC-799-P.

The first three 5:1 dividers are identical except for time-constant values. The output of the 10-kHz divider is fed through a buffer to the station receiver and frequency measuring equipment. The markers are very strong through 30 MHz, the limit of the author's receiver. If the receiver calibration cannot be trusted to 10 kHz, the 50-kHz test button, shown in dotted lines in Fig. 2 and not used by the author, can be provided. Pushing this button makes the 50-kHz markers louder and the other 10-kHz markers turn into 25-kHz markers. The counter proper does not read correctly while this is being done, but this doesn't matter since identifying the markers is done separately from making the final count.

The divider from 500 Hz to 100 Hz uses a discreet high-beta transistor instead of a gate, so that a higher resistor value and, therefore, a smaller capacitor value can be used. The dividers to 10 Hz and 1 Hz use decade dividers, with four J-K flip-flops in order to avoid even larger capacitors. This type of circuit could have been used for all the dividers and would have eliminated the need to adjust the dividers. The circuit of these dividers will be described in the section on the counting decades which use the same circuit.

The switch,  $S_1$ , selects the divider frequency whose period is equal to the desired gate time and is calibrated in factors, by which the counter reading must be multiplied, rather than in gate time. The X60 position takes the time base from the ac line instead of the dividers, and is useful in adjusting the dividers. For example, to adjust the divider whose output frequency is 50 kHz the input switch is set to 50 kHz, the multiplier

switch to 60 and the counter should read 833. This reading will jump around a bit, due to instability in the ac line frequency, but the reading for the 10-kHz divider will only vacillate between 166 and 167.

### Control section

The input selector switch,  $S_2$  (Fig. 5), selects the desired input which can be either a signal input for measurement, or one of the divider outputs for self checking.  $IC_8$  and  $IC_9$  can be regarded either as an amplifier with positive feedback, or as a flip-flop. They make the signal into a rectangular wave with sharp edges and reject noise which may appear on the input signal. At any instant of time, either  $IC_8$  or  $IC_9$  will conduct, but not both at once, because the

one that is conducting turns the other one off. The positive half cycle of the input signal will make  $IC_8$  conduct and once it is turned on, the high output from  $IC_9$  will supply holding current through  $R_4$  to keep it on.

The negative half cycle will then overcome this holding current and turn off  $IC_8$  whereupon the holding current will be removed and  $IC_8$  will continue not to conduct. A small amount of noise riding on the input signal will not be able to overcome the holding current and will, therefore, not make the circuit change state. The resulting rectangular wave is fed to the units decade at all times and the necessary gating is done in the first J-K flip-flop of the units decade. Provision for gating already exists in the J-K and it is simpler to use it than to do the gating in the control section.

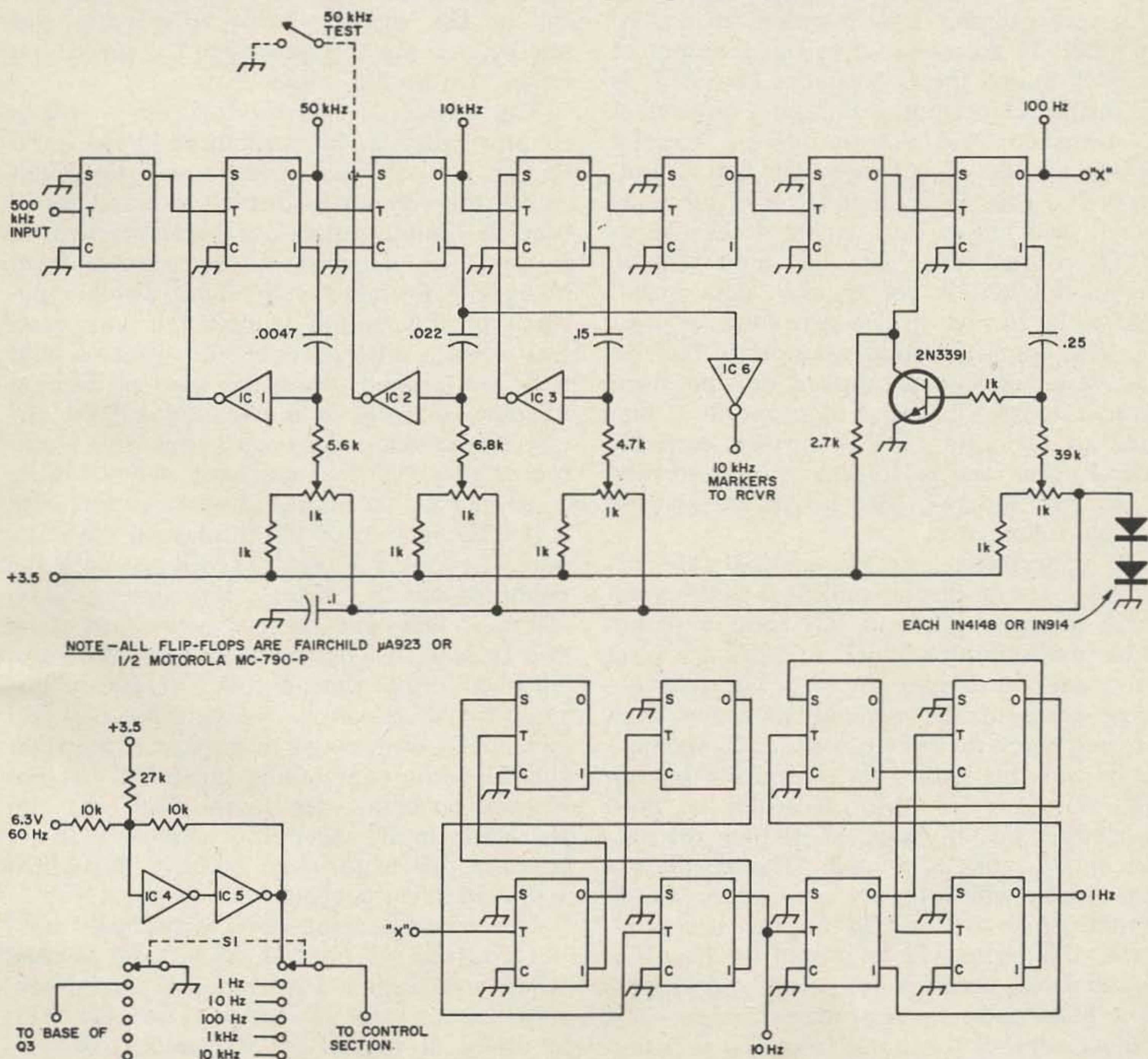

Fig. 3. The frequency dividers used in the IC counter. Integrated circuits  $IC_1$  through  $IC_5$  are one-half of Fairchild 914's or part of Motorola MC-789-P or MC-724-P;  $IC_6$  is a Fairchild 900 or one-half a Motorola MC-799-P.

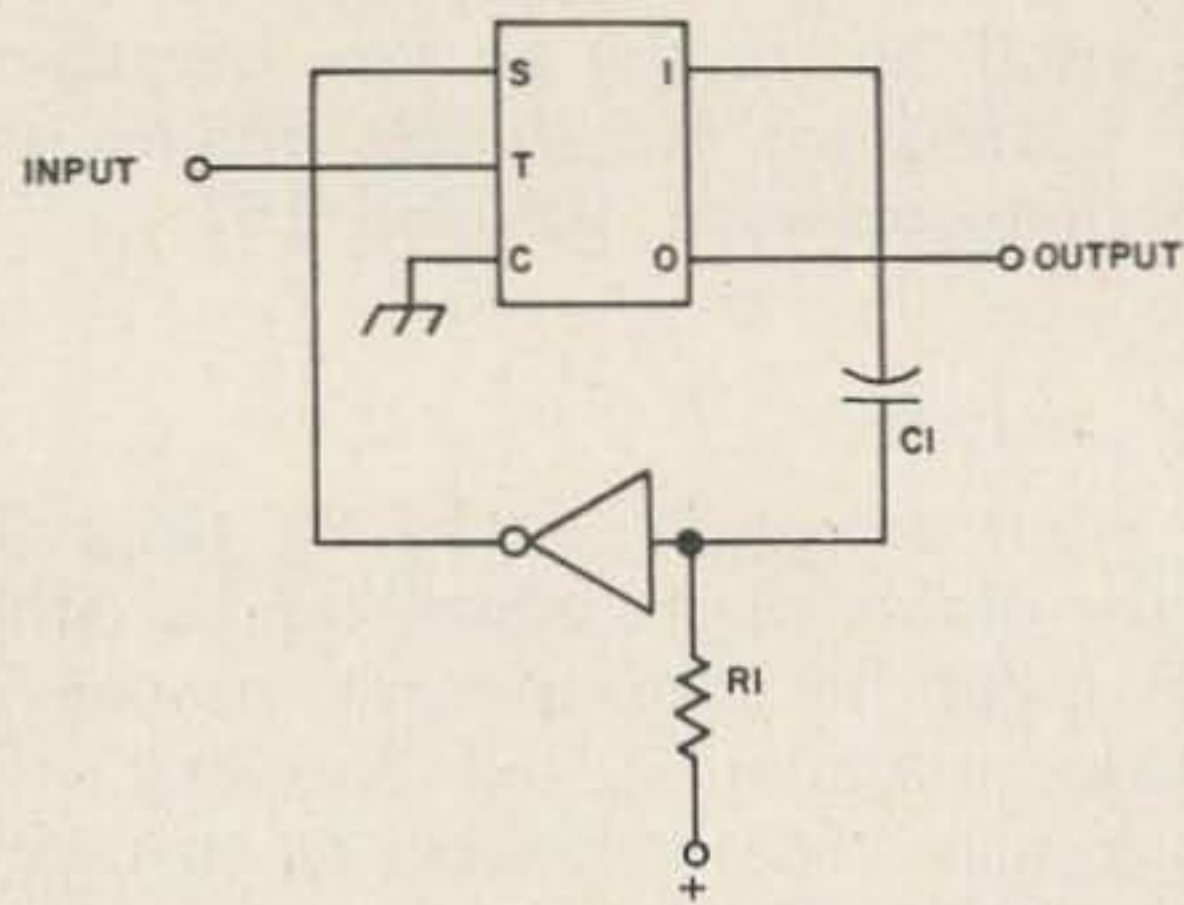
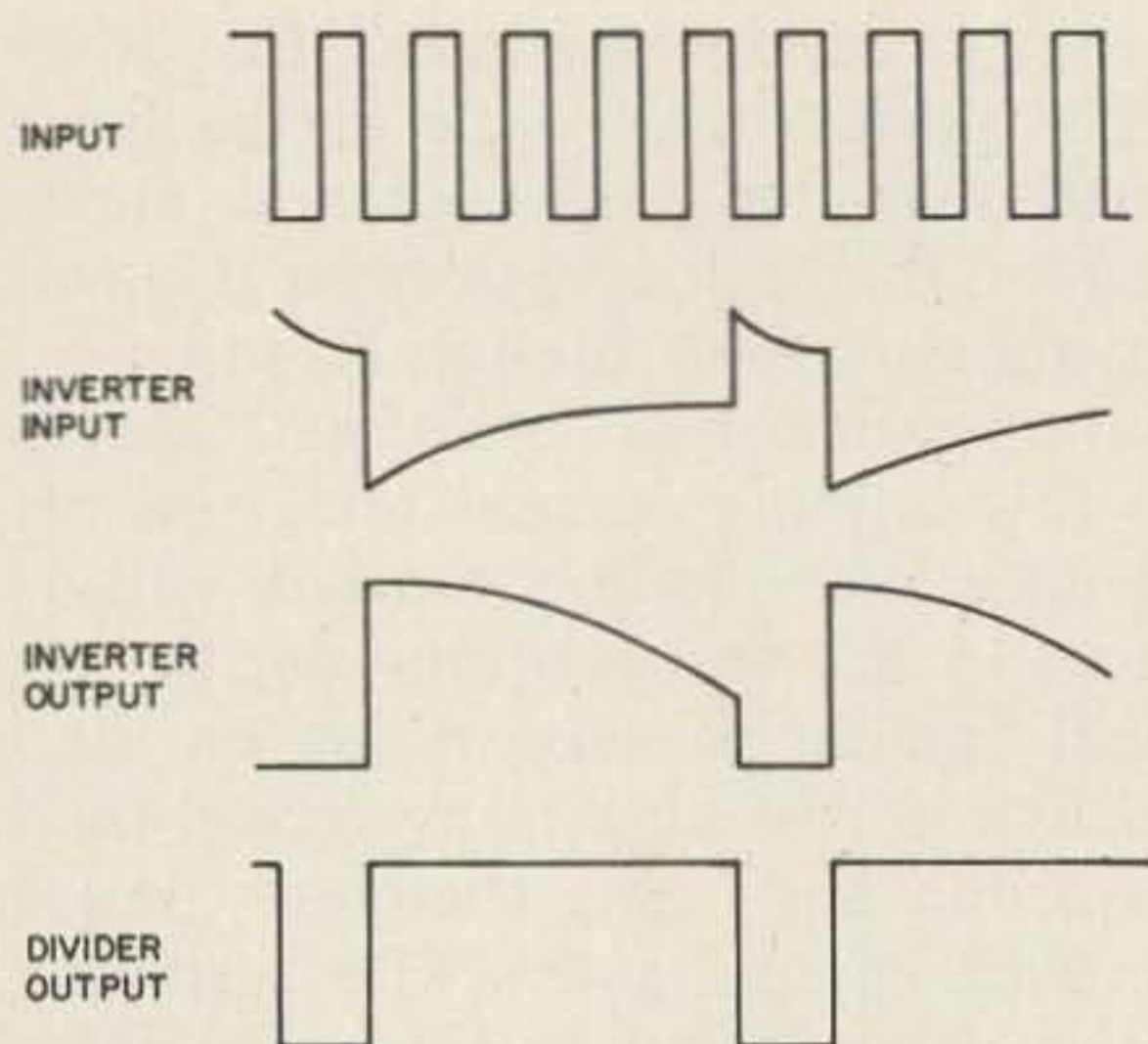

Fig. 4. The basic 5:1 frequency divider using a J-K flip-flop, and RC circuit and an inverter, along with the waveforms.

The remainder of the control section can exist in either of two states, count or display. We will discuss these quiescent states before we examine how it gets from one to the other. In the count state the 1 output of IC<sub>7</sub> is high and the 0 output is low. If S<sub>1</sub> is not in the X1 position, the high 1 output of IC<sub>7</sub> turns on Q<sub>3</sub> and turns off Q<sub>4</sub>, thereby turning off the neon lamps. The low 0 output of IC<sub>7</sub> goes to the gate input of the units decade and allows it to count. It also turns off Q<sub>1</sub> so that the "gate on" light will be illuminated and it permits the "gate pulse" light to be turned on if a gate pulse is present. The opposite conditions exist in the display state. Power is applied to the neon lamps through Q<sub>4</sub>, and a high output is supplied to the gate so that further counting cannot occur, and both Q<sub>1</sub> and Q<sub>2</sub> are turned on so that the two gate lamps are shorted and not illuminated.

To understand how we change state, assume we are on display and S<sub>3</sub> is in the automatic position. IC<sub>1</sub> and IC<sub>2</sub> form a monostable multivibrator which supplies the reset pulse and the trigger for IC<sub>7</sub>. The positive-going edge of the rectangular wave from the frequency dividers turns on IC<sub>1</sub> momentarily and this makes the output of IC<sub>2</sub> go high. Furthermore, this holds IC<sub>1</sub> on until R<sub>2</sub> charges up C<sub>2</sub> again, whereupon the output of IC<sub>2</sub> goes low again. The result is a short pulse which occurs once every timing period. Since we are on display and automatic, this pulse will be passed by IC<sub>3</sub>, IC<sub>4</sub>, IC<sub>5</sub>, and IC<sub>6</sub>, inverted each time, and appears as a high pulse to reset the counters. The trailing edge of the pulse from IC<sub>2</sub> will toggle IC<sub>7</sub>, putting us in the count mode. The next pulse from IC<sub>2</sub> will not reset the counters because IC<sub>4</sub> has a high input from

IC<sub>7</sub> and, reset can only occur if all three inputs to IC<sub>4</sub> are low. The trailing edge of the pulse still toggles IC<sub>7</sub>, however, and we are in the display mode; displaying the number of input pulses that occurred between two timing pulses.

The switch, S<sub>3</sub>, is used if you want to count, or display, for a multiple of the basic timing period. The switch itself does not switch the counter to display or count, since only the timing pulses can be allowed to do this; rather, it prevents the counter from going into the other state. The "display" position of this switch is useful if you have just made a critical count and want to hold it a few seconds to make sure of writing it down correctly. It is also useful if the circuit for blanking the neon lamps isn't working or isn't yet built and you want to make a reading on the higher ranges. In this case it is difficult to read the display on the automatic position because you will see both the counting and the display, but placing S<sub>3</sub> on "display" will hold the last count and allow you to read it. The switch can be thrown to "display" either during count or during display. In either case, a timing pulse will still switch IC<sub>7</sub> from count to display at the right time, but the next timing pulse will not put it back on count due to the high level on the clear input. Also, the counter will not be reset due to the high input of IC<sub>4</sub> which will hold its output low.

The count position of S<sub>3</sub> is normally used only on the X1 position of S<sub>1</sub>, and is used when you want a gate time of several seconds for an error of less than one Hz. This is useful in the ARRL Frequency Measuring Tests where it is desirable to use a 10-second gate time in order to obtain an accuracy of 0.1Hz. With this arrangement,

if you start a ten second run and the signal starts to fade, you can stop the test at the next timing pulse by throwing the switch to display and still obtain a meaningful reading. To make a ten second run, you start with  $S_3$  on display, and throw it to count when everything is ready. The next timing pulse will put you in the count mode, but the next one will not put you back on display.

Each timing pulse will flash the "gate pulse" lamp once, and after it has flashed ten times, you put  $S_3$  back on display. The next pulse will put the counter on display and you will be able to read the frequency in tenths of hertz. With a little practice, you

will find that running a multiple second count is much easier than reading about it.

In wiring the counter it should be remembered that the supply to the neon bulbs is a 200-volt square wave because of the lamp blanking circuit, and also, the collectors of  $Q_1$  and  $Q_2$  (Fig. 5) have 60-volt pulses on them since they turn on neon lamps. Both of these must be kept away from the inputs to the IC's; otherwise, erratic operation will result. In particular, the 200-volt lead to the counters must not be cabled with the signal and gate inputs to the counters and the leads to  $I_1$  and  $I_2$  must be kept at least an inch away from the leads of  $S_3$ . If the counter shows any erratic operation which cannot

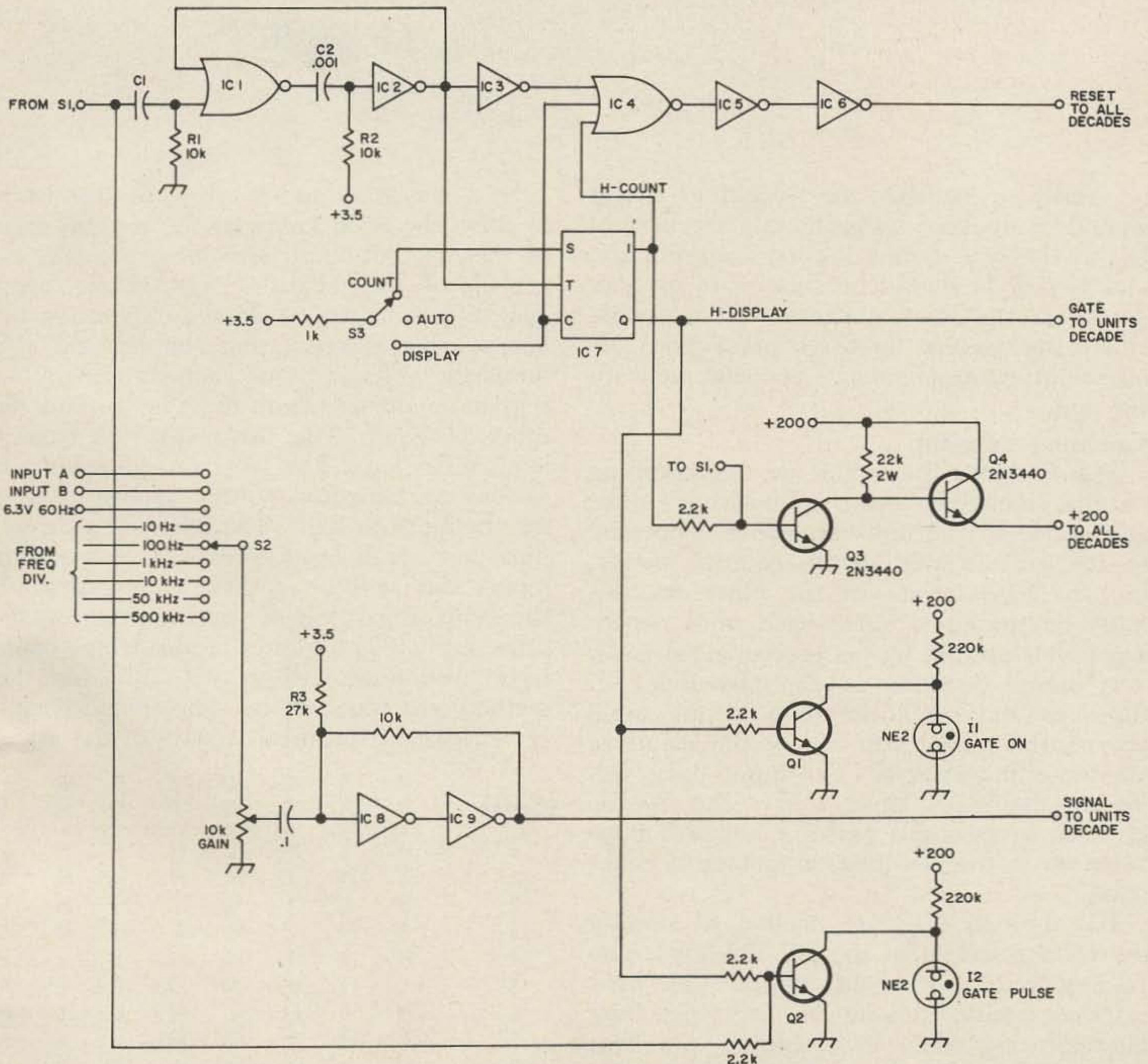
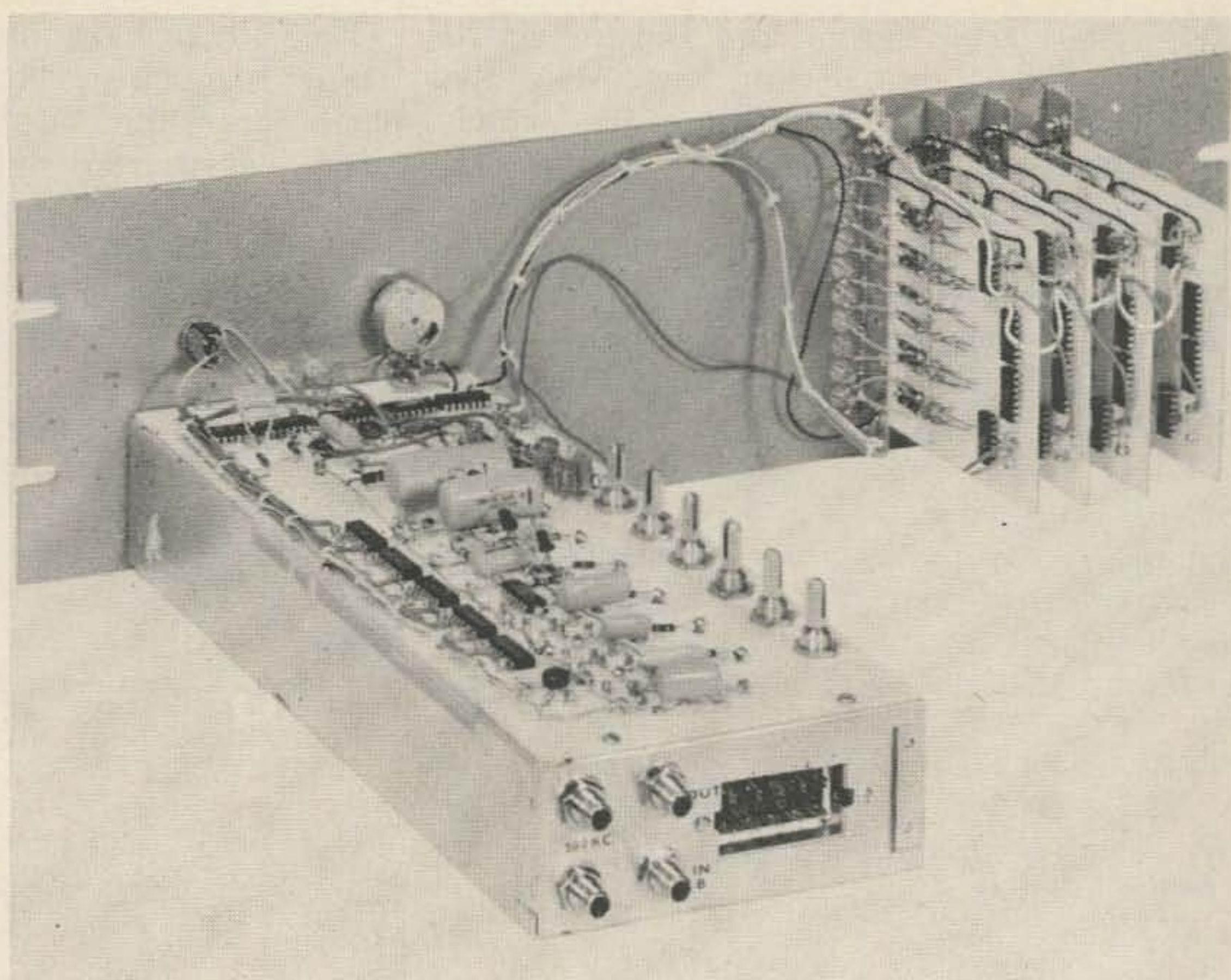

Fig. 5. The control section of the digital frequency counter. IC1 is a one-half a Fairchild 914, one-fourth a Motorola MC-724-P or one-third a Motorola MC-792-P. IC4 is one-third a Motorola MC-792-P. IC2, IC3, IC5, and IC9 are one-sixth of Motorola MC-789-P, one-fourth of Motorola MC-724-P, or one-half of Fairchild 914. IC6 is a Fairchild 800 or one-half a Motorola MC-799-P. IC7 is a Fairchild 923 or one-half a Motorola MC-790-P.  $Q_1$  and  $Q_2$  are 2N3877's or Poly Pak 2N1893's.

All of the count-control circuitry is mounted on the large chassis to the left. The small perforated boards on the right each contain one decade counter.



be easily explained, the blanking circuit should be disabled by grounding the base of  $Q_3$  so that the lamps are on continuously, and  $I_1$  and  $I_2$  should be shorted to ground. A test can then be made to see if the trouble still exists. Except for these precautions, no other difficulties should be encountered with the unit.

### Counting decades

Fig. 6 shows the circuit on one counting decade, including neon lamp drivers. The gate input on the units decade is connected to the gate output of the control section, but the gate inputs on the other decades must be grounded since each must accept any pulses put out by the preceding decade. The actual counting is done by four J-K flip-flops and, with the help of the table shown, the reader can follow the count as an interesting exercise. The input pulse following the ninth count makes the decade go back to zero and passes a negative transition on to the next decade making it count once.

$IC_5$  through  $IC_{12}$  are needed to amplify the voltage output of the J-K flip-flops. The J-K's give only one-volt output with light external loading due to the fact that they internally load their own outputs. This was not found sufficient to drive the resistor gates used for the neon lamp drivers. An inverter, however, gives almost full supply voltage when lightly loaded and drove the resistor matrix satisfactorily.

It is necessary to use discrete transistors to drive the neon lamps at the present state of the art, but these are not expensive, especially if Poly Paks\* 2N1893s are used. The transistors are used as shunts across the lamps. This makes gating simpler and also limits the voltage across each transistor. For a given count one lamp must be on and the other nine off. The driver for the desired lamp must have low level on all its inputs so that the transistor will not conduct, allowing the lamp to light. The other nine drivers must have high level applied to at least one input; this will be sufficient to extinguish the lamp, regardless of what appears on the other inputs. The gating of the lamps could have been done entirely with IC's but this method was found to be simpler and cheaper, at least at the present state of the art.

Count	A B	B A	C D	D C	E F	F E	G H	H G
0	H	L	H	L	H	L	H	L
1	L	H	L	H	H	L	H	L
2	H	L	L	H	L	H	H	L
3	L	H	L	H	L	H	H	L
4	H	L	L	H	H	L	L	H
5	L	H	H	L	H	L	L	H
6	H	L	H	L	H	L	L	H
7	L	H	L	H	H	L	L	H
8	H	L	L	H	L	H	L	H
9	L	H	H	L	L	H	L	H

Table 1. Truth table showing the proper levels on each of the logic lines of the decade counter in Fig. 7.

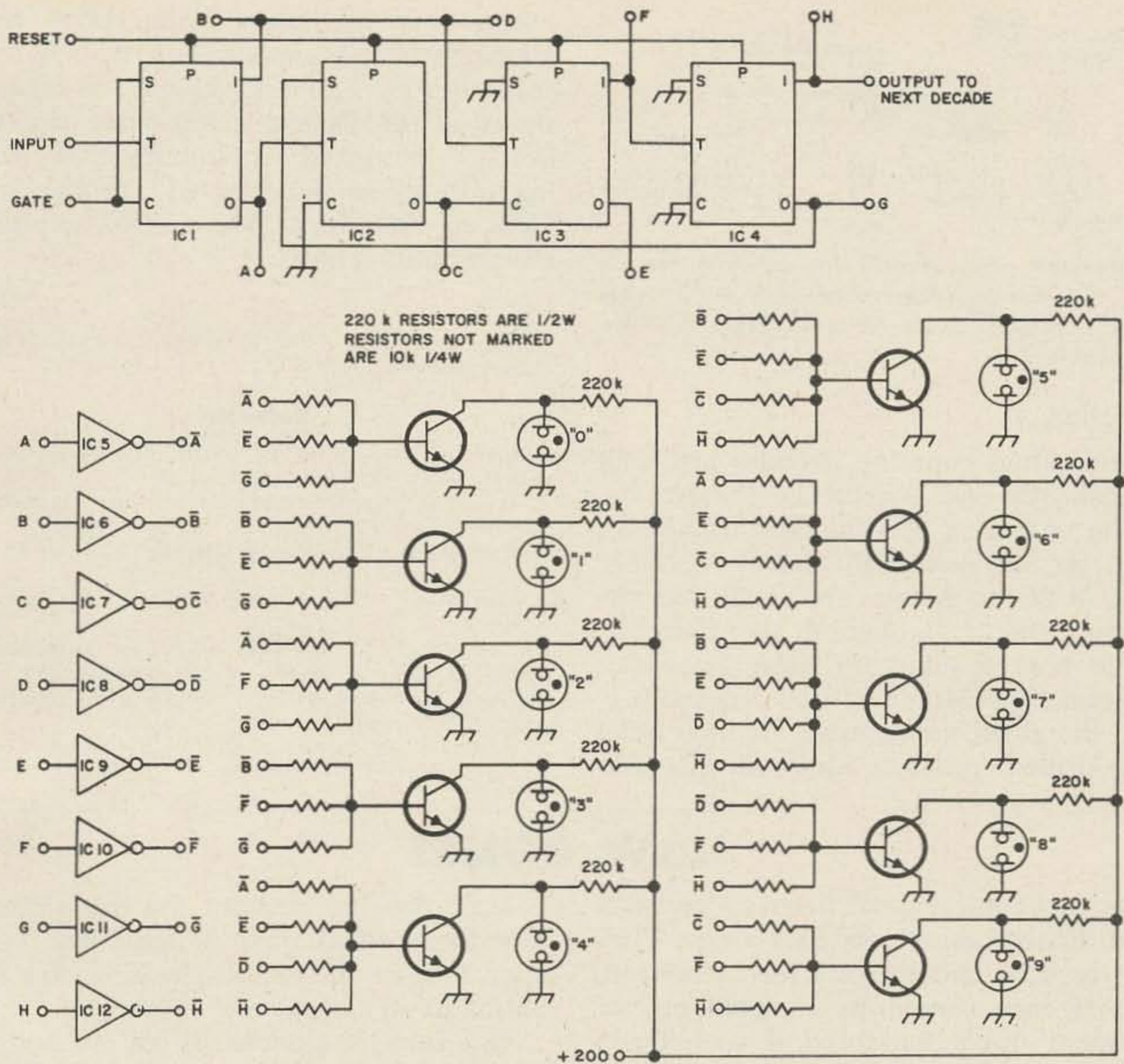

Fig. 6. A typical counting decade. In this circuit integrated circuits IC1 through IC4 are one-half Motorola MC-790-P's or Fairchild 923's. IC5 through IC9 are one-sixth Motorola MC-789-P's, one-fourth Motorola MC-724-P's or one-half Fairchild 914's. All transistors are 2N3877's or Poly Paks 2N1893's. All neon lamps are NE-2's.

In testing the decades, +200 volts must not be applied unless all transistors, which are in place, have neon lamps across them. Otherwise, if a transistor is not conducting, the collector voltage rating will be exceeded since there is no neon lamp limiting the voltage. Also, if +200 volts is applied to a decade but +3.5 is not, all lamps should light since the logic circuitry only acts to short out the undesired lamps. No harm is done by this and it is a quick way to check the lamps and driver transistors. If a lamp does not light under this condition, its driver transistor should be suspected first.

### Power supply

The counter, as shown in Fig. 6, requires about one ampere at 3.5 volts and 40 mA at 200 volts. Neither supply needs to be regu-

lated and the IC's will work on any voltage from 3.0 to 4.5 volts, although  $3.6 \pm 10\%$  is recommended by the manufacturer. The power supply used by the author is shown in Fig. 7. An 8-amp transformer was used because it didn't cost much more than a 2-amp one in the same series. The 2-amp unit would probably work and would save space and weight. For the 200-volt supply, anything from 150 volts on up would work, although with anything much over 200 volts, the 220K collector resistors must be increased or a dropping resistor must be provided. If this voltage is taken from a supply powering other equipment, it must be remembered that the current drawn will be a 40 mA peak square wave at 5, 50, 500, or 5000 Hz which may cause a buzz to be heard on the other equipment.

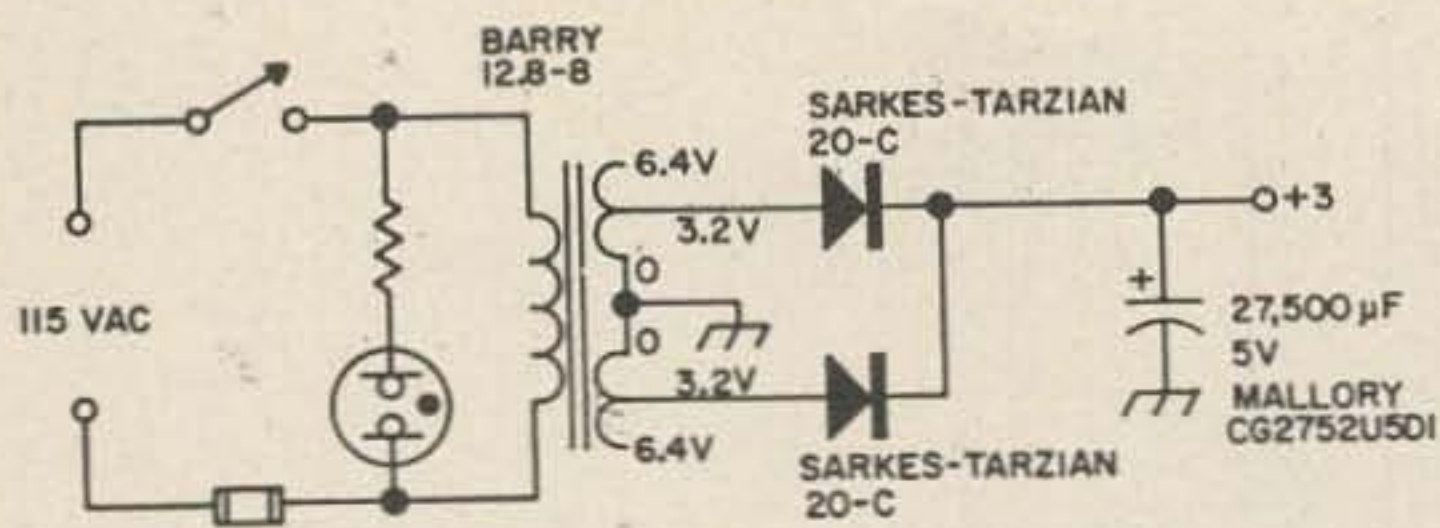

Fig 7. Three-volt power supply for use with the integrated circuit frequency counter. A truth table showing the proper levels on each logic line are shown in Table 1.

## Construction

The individual counting decades are built on See-Zak MM-492 boards and the remainder of the unit on a See-Zak MM-512 board mounted on See-Zak R-25 and R-212 rails. See-Zak M-25 terminals are used for the larger components, including the Fairchild IC's. The hole spacing on these boards is 0.2" whereas the Motorola IC's require 0.1" spacing; therefore, seven extra  $\frac{1}{16}$  inch holes must be drilled for each Motorola IC inbe-

tween existing holes. Connections to the Motorola IC's are made with #26 bare wire covered with Teflon spaghetti. No other construction details are given since the writer is more interested in circuitry than packaging and other builders will probably have ideas of their own. The use of printed circuits would be ideal.

. . . WIPLJ

\*Poly Packs, Post Office Box 942A, Lynnfield, Massachusetts 01940.

## References

1. Skeen, "Low Cost Precision Frequency Measurement", *QST*, January, 1965, p. 32.
2. Brassine, "An Electronic Counter for Amateur Use," *73*, December, 1966, p. 20.
3. Pickering, "The Micro-Ultimatic", *73*, June, 1966, p. 6.
4. Daughters, "The Kindly Keyer", *73*, July, 1966, p. 46.
5. Lancaster, "Using New Low Cost Integrated Circuits", *Electronics World*, March, 1966, p. 50.
6. Olson, "Micro-Logic for Non-Logical Users", *73*, June, 1967, p. 58.
7. Suding, "An Integrated-Circuit Frequency Counter," *73*, November, 1967, page 9.

## HOW COME?

I have two cubical quad beam antennas in my yard. Each is on a forty foot tower. They are separated by about eighty feet. Hundreds of times I have tuned in a signal on the two element quad, measured it with the S meter, and then flipped the co-ax antenna selector switch to the four element quad, and again measured it. The difference in the S meter reading is usually one S unit, or, according to the usual calibration of S meters, about six dbs. This, I suppose, is what it should be. A Collins and a Swan were used in measuring. Remember, both quads are identical in construction, measurements, height, and closeness to foreign objects.

The only difference between the two is that the 4 element quad uses two directors and the two element quad uses no directors. Now, I can switch to transmit, and contact many stations. These amateurs almost invariably report the signal from the 4 element quad from two to three S units greater than on the two element quad. This is from twelve to eighteen dbs.

Obviously there is not that much difference in the two antennas, so where does the extra punch of the four element quad come from? The difference between the four and the two element quad will almost invariably measure this amount, regardless of the type of receiver the amateur is using.

How can we account for this difference? Is it the vertical angle of radiation? Is it the aperature, or the capture area? Is it a combination of several factors?

One thing is obvious. If we put 100 watts, let us say, of r.f. energy into an antenna, it will be distributed in various ways. If the antenna is a vertical, it will be distributed equally in all directions. If it is a beam antenna, then a certain direction will be favored. The greater the F/B ratio, the greater the gain in a certain direction. We cannot get something for nothing. We have to take it off the back if we want to put it out front. Then there is the actual "cone" of the radiation pattern. A two element quad possesses a much broader cone than a four element quad. Hence the actual energy is concentrated in the favored direction much more in the four element quad than in the two element quad. This is apparently not true in the reception of signals. Evidently the old adage that "A good receiving antenna is an equally good transmitting antenna", is not entirely true. In our case, it would appear that, even for a quad, it can be a better transmitting antenna than a receiving antenna.

L. W. Van Slyck W4YM  
406 Bon Air Ave.  
Temple Terrace, Florida 33617



# TRAP

# MASTER

Select Quality....

...Specify **Mosley**

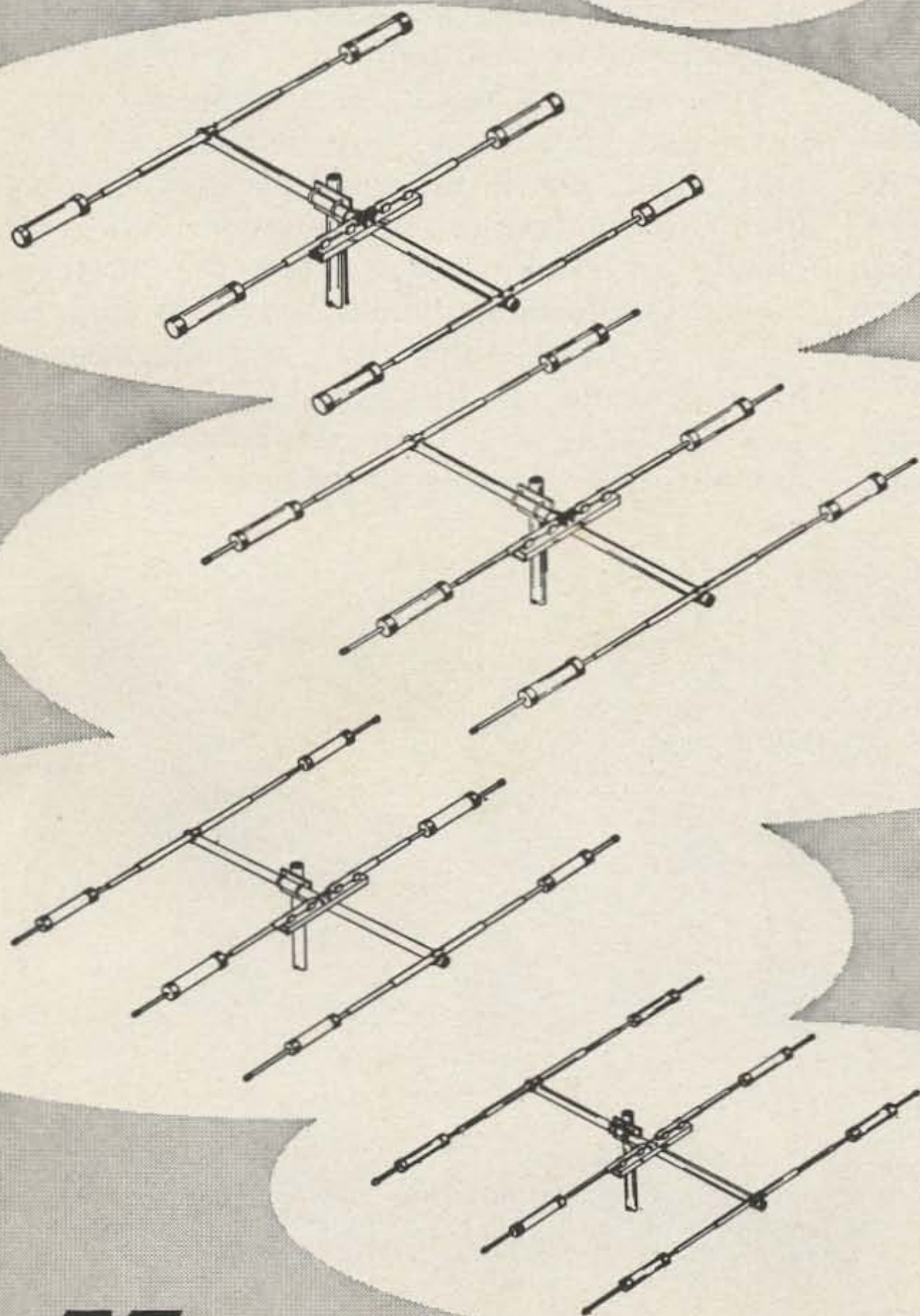

## Classic 10-15

A new beam for 10 and 15 meters. Revolutionary broad band capacitive matching.\* Full power rated. Weatherproof metal encased traps. Lightweight: 27.5 lbs. assembled. May be stacked with 20 and/or 40 meter beams.

\*(Pat. Pend.)

## Classic 33

Hard working for extra gain on 10, 15 and 20 meters. Wider element spacing and improved clamping. Broad band capacitive match.\* Full power rating. Weatherproof traps for constant frequency stability. \*(Pat. Pend.)

## TA-33

Excellent results for full ham bandwidth. Full power rated for 10, 15, and 20 meters. Strengthened center sections of the 28' maximum length elements. Weatherproof traps for constant frequency stability. May be converted to 40 meters.

## TA-33 Jr.

A low power beam with "authority." Rated at 300 watts AM/CW, and 1000 watts P.E.P. on SSB. May be converted to MP-33 for higher power rating. Max. element length is 26' 8"

For more information on these, or any of Mosley antennas see your nearest authorized Mosley dealer, or write.

Dept. 150  
**Mosley Electronics, Inc.**

4610 North Lindbergh Blvd. Bridgeton, Mo. 63042

W. R. McCullagh VE3DAN  
73 Simco Street  
Toronto, Ontario  
Canada

## An Amateur Tries I C's

There is no doubt that the greatest advance in electronics since the transistor is the integrated circuit, where a dozen or more transistors, resistors, and diodes are put in a can no larger than a single transistor. The whole lot in fact on a little chip of silicon less than an eighth of an inch across. Perhaps the day of Dick Tracy's wrist watch size radio is almost here.

Heath has already announced kits using these circuits, and other manufacturers are undoubtedly thinking along the same lines, so it behooves the experimentally-minded amateur to learn something about this latest development.

There have been some excellent articles in *Electronic World*, *Radio Electronics*, and 73, which should certainly be consulted, as well as the manufacturer's literature. The RCA specification sheets and application notes are particularly instructive. My indebtedness to the above sources is gratefully acknowledged.

One of the first confusing things about IC's is the use of transistors to replace

capacitors; this gives the circuit a strange and unfamiliar look which takes a while to get used to.

It would be impossible to incorporate large capacitors or resistors on the small chips, so transistors are used instead. Where large capacitors or resistors are necessary, they are connected externally, as are coils and transformers.

The most commonly used arrangement in the linear integrated circuits, is the emitter-coupled pair, with the emitter current supplied by another transistor. The input is usually differential and the output may be single ended or push-pull.

This approach would be impractical with individual transistors, but because all the components are on the same piece of silicon, their characteristics are similar and are closely matched over a wide temperature range. The basic system is shown in Fig. 1.

One of the simplest IC's and the easiest to understand, is the Fairchild  $\mu$ A 703 C (or  $\mu$ 7703 as it is now designated). Incidentally, there seems to be some disagree-

This photograph dramatically illustrates the number of transistors, resistors and diodes incorporated in one RCA CA 3012 integrated circuit. The CA 3012 IC is shown on the left for comparison.

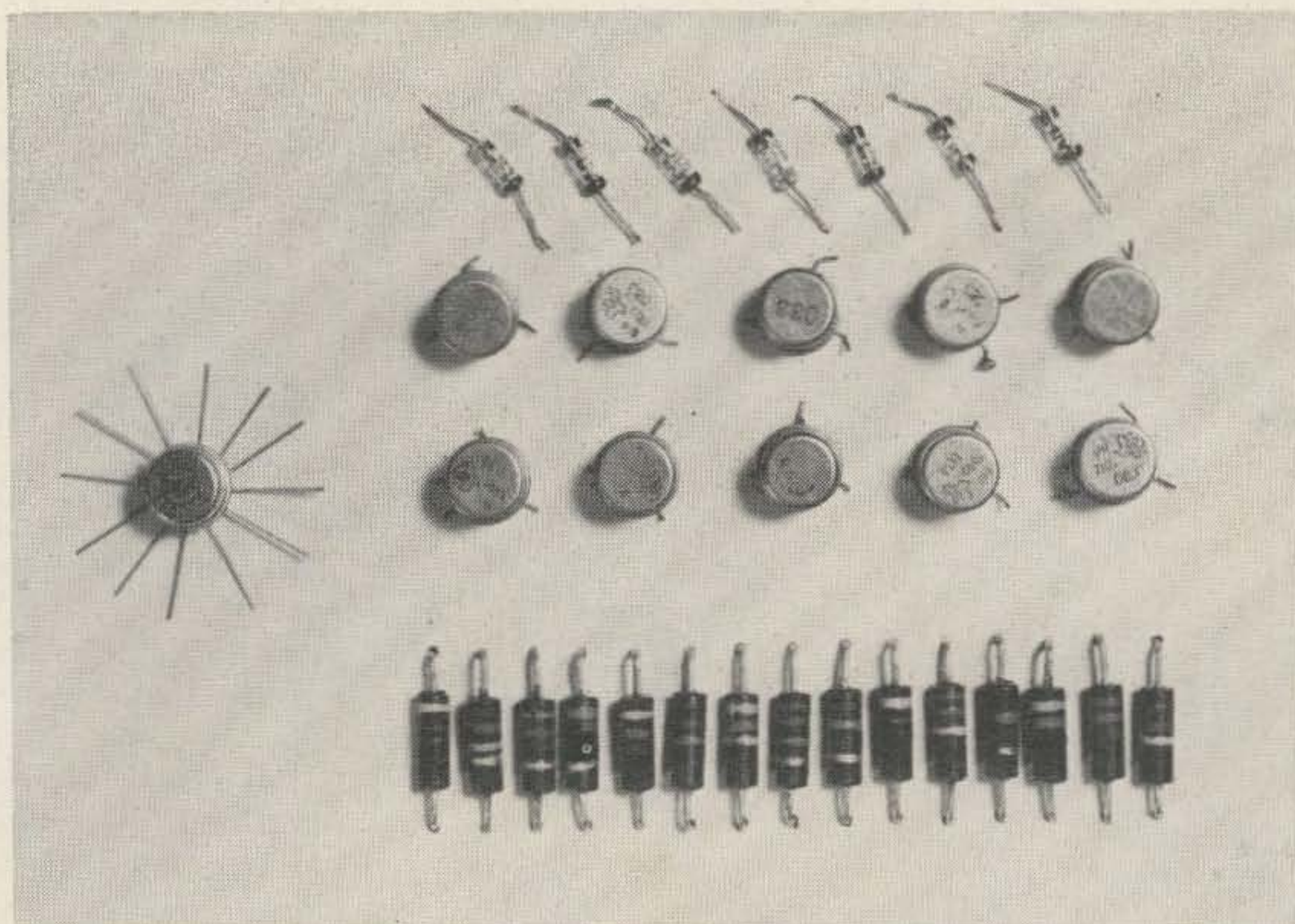

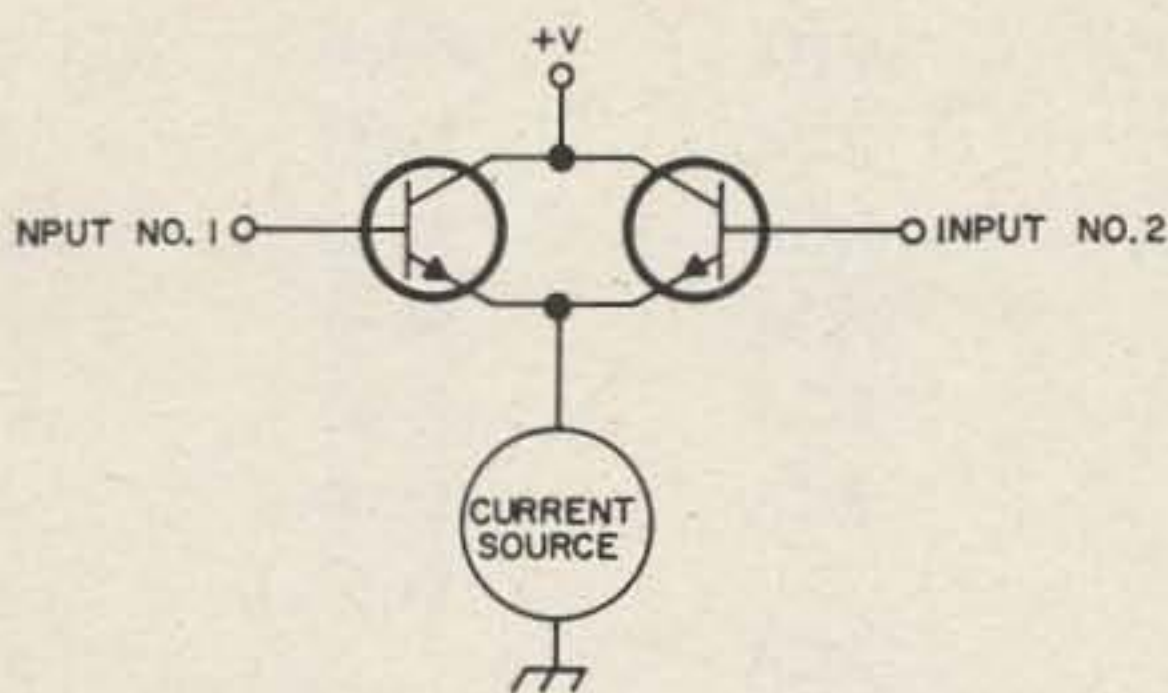

Fig. 1. The basic emitter-coupled pair. This approach is difficult with discrete transistors, but with the IC, all the components are on the same silicon chip, and their characteristics are similar and remain matched over wide temperature ranges.

ment on the numbering of the pins. The numbering used here is from the Fairchild specification sheet dated August 1966 (Fig. 3).

The  $\mu 7703$  is classed as an rf and if amplifier and is one of the least expensive of the Fairchild IC's at about \$4.50 each in small quantities. A diagram of the  $\mu 7703$  is shown in Fig. 3. As will be seen, there are two additional transistors connected as diodes; I don't think we need to go into the theory behind them, but can use the simplified diagram for our purpose. For further technical information see the references. Although the  $\mu 7703$  is listed as an if and rf amplifier, it can also be used as a dc amplifier.

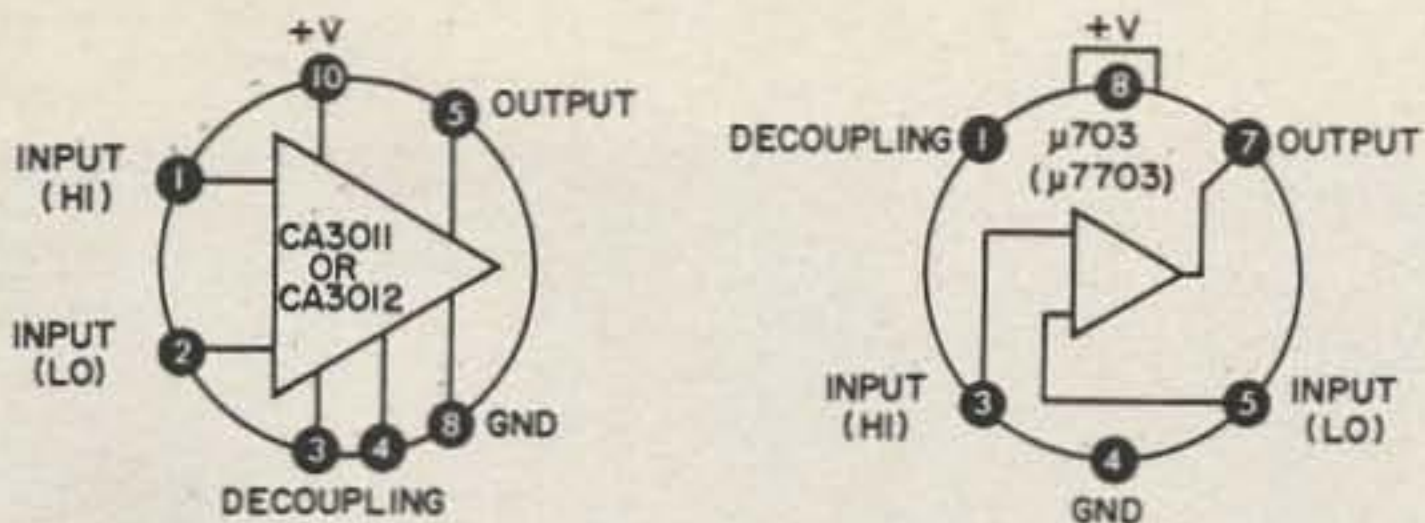

Fig. 2. External connections to the Fairchild  $\mu 703$  ( $\mu 7703$ ), and RCA 3011 and 3012. The internal circuit of the  $\mu 703$  integrated circuit is shown in Fig. 3; the CA 3012 is shown in Fig. 4.

For experimental purposes the  $\mu 7703$  was mounted on a small piece of bakelite. Double-ended Cambion 2044 terminals which (as they always say in radio articles) I just happened to have a thousand of in the junk box, were forced into slightly undersized holes in the board so that it wasn't necessary to use special setting tools. The IC was soldered to these pins and the wiring was done underneath.

The  $\mu 7703$  has a rated working voltage of 12 volts but the first one blew on 9½ volts, so a limiting resistor was used in the

power supply and the current was kept below 3 mA. A look at the chip in the dismantled IC makes one wonder how they can handle any power at all! The chip doesn't seem to be much larger than the head of a pin and a high-power glass is needed to see the actual components.

To familiarize myself with the  $\mu 7703$  and to be sure of not overloading it, I used a Weston photoelectric cell in the input. A few microamps in gave an output in the milliampere range. Using a tuned-input circuit, it became a very sensitive absorption meter.

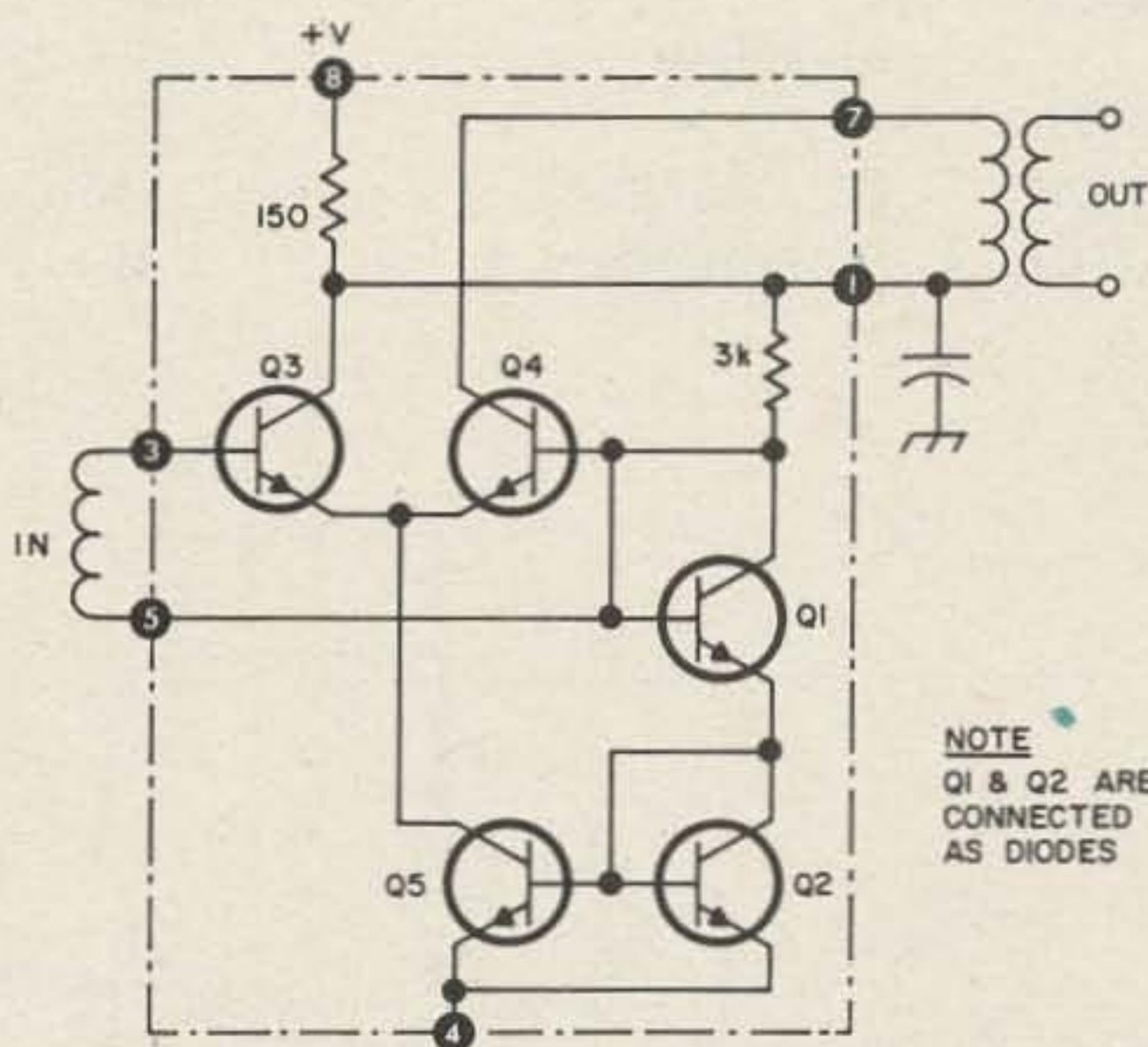
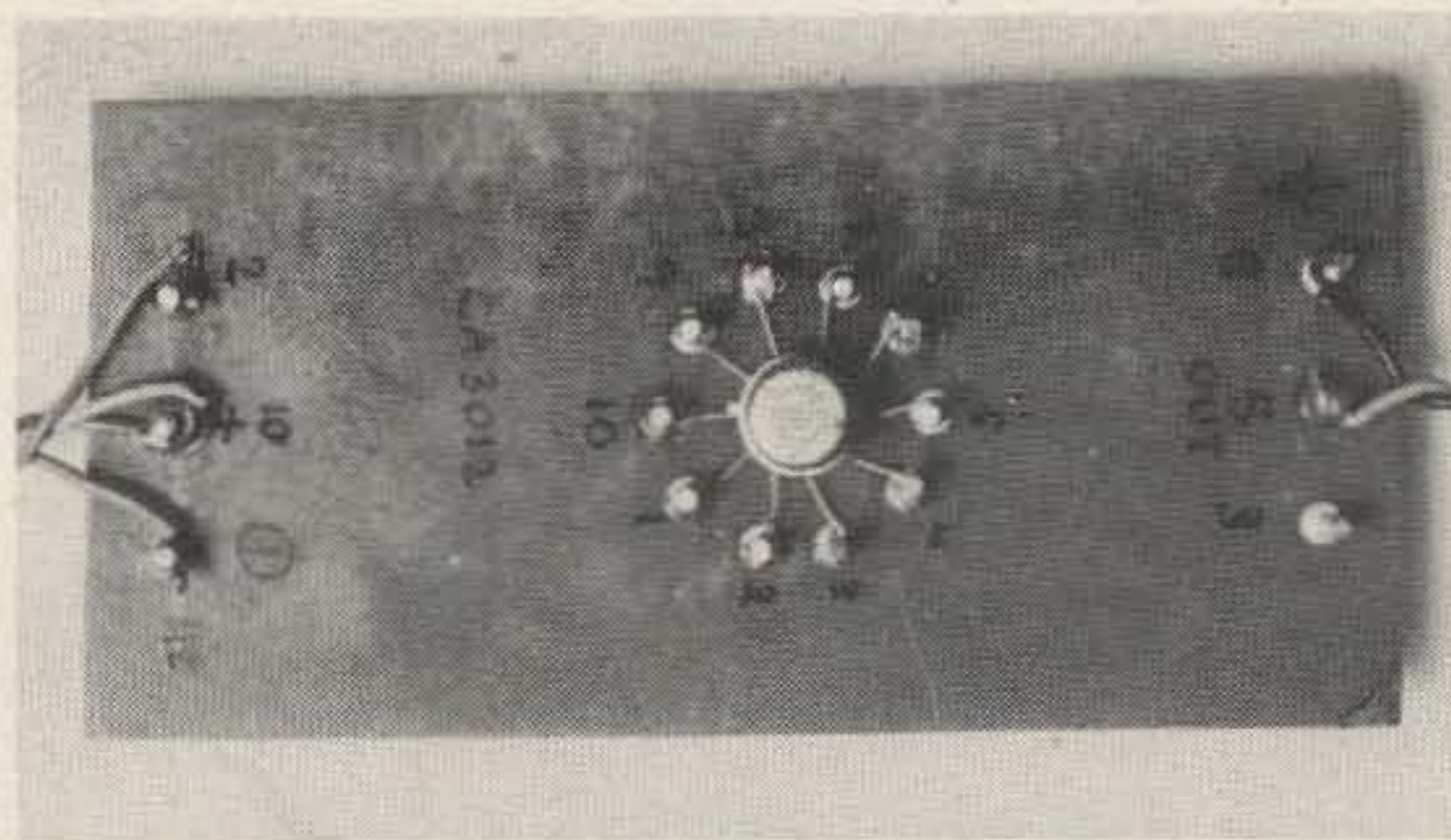

Fig. 3. The circuit of the Fairchild  $\mu 703$  ( $\mu 7703$ ). Basically, this is an emitter-coupled pair (Q3 and Q4) with a constant current source (Q5). Transistors Q1 and Q2 are connected as diodes.

Just looking at the RCA 3000 series of IC's makes one drool and wish for a pocket full of cash to get the whole series. The only trouble is that they seem to be in short supply. I have been waiting for months for some I ordered from Chicago and they haven't arrived yet.



The test setup used for checking out the capabilities of the RCA 3012 integrated circuit.

Type	Circuit Application	dB Gain	Freq. MHz	MfC	Price	Noise dB
CA 3000	Differential Amplifier	37	30	RCA	\$4.70	—
CA 3001	Differential Amplifier	19	video	RCA	\$6.40	5
CA 3002	Differential Amplifier	24	<i>if</i>	RCA	\$4.40	4
CA 3004	Differential Amplifier	12	100	RCA	\$4.40	6.3
CA 3007	Differential Amplifier	22	audio	RCA	\$6.00	—
CA 3011					\$1.55	
	Wide band Amplifier	75	20	RCA		8.7
CA 3012					\$2.25	
	Wide band Amplifier	75	20	RCA	\$2.65	
CA 3014	Discriminators	75	20	RCA	\$3.15	8.7
CA 3020	AF Amplifier	58	6	RCA	\$2.80	—
CA 3021		56	2.4		\$3.60	4.2
	Low Power Wide band					
CA 3022	Amplifiers	57	7.5		\$3.15	4.4
CA 3023		53	16	RCA	\$2.95	6.5
CA 3028	RF Amplifier	39	120	RCA	\$1.55	6.7
$\mu$ 7703	<i>IF</i> Amplifier	41	—	Fairchild	\$4.10	—

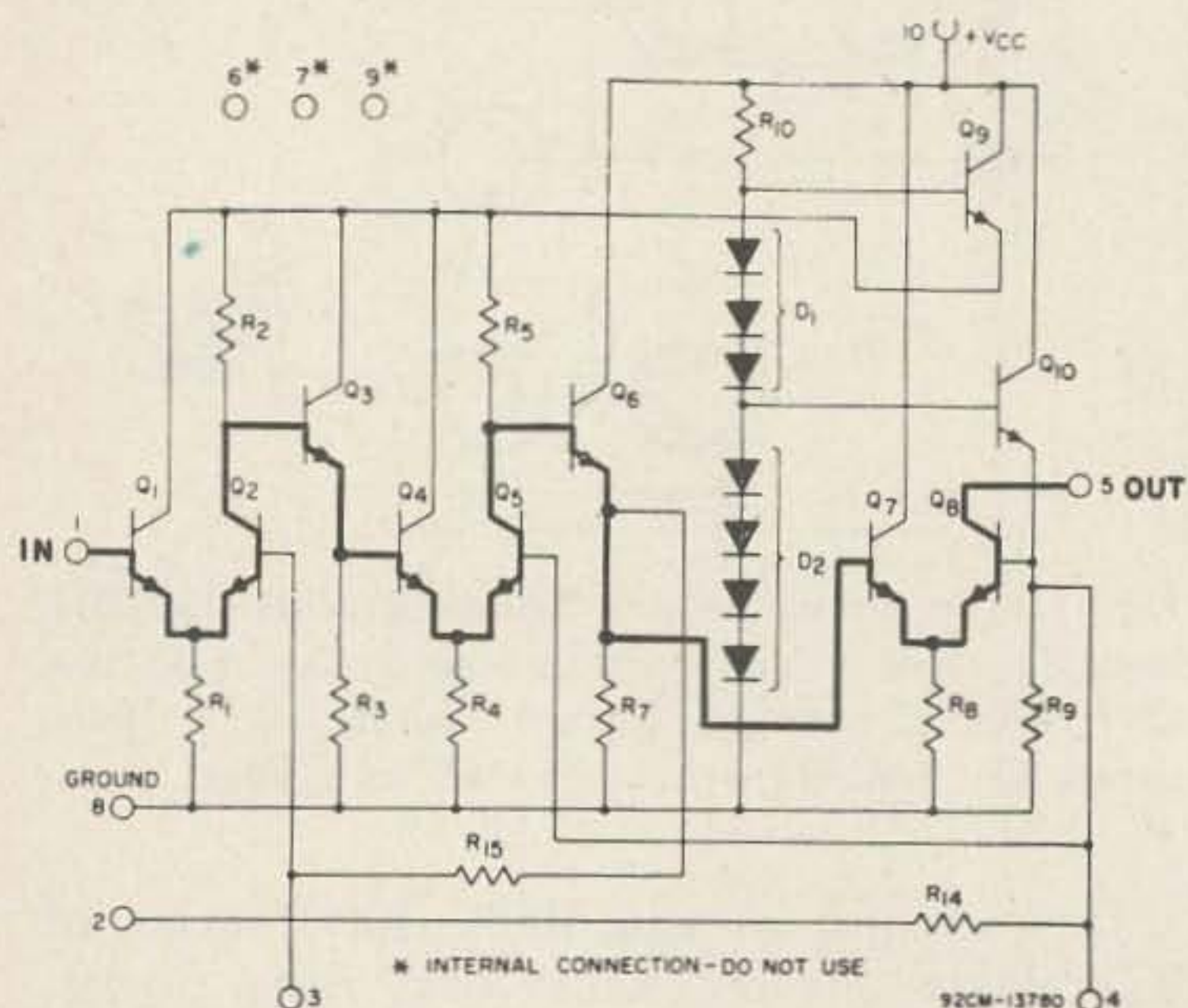

Fig. 4. Internal circuit of the RCA CA 3012 integrated circuit. The signal path through the unit is shown by the heavy line.

Only the larger industrial stock houses seem to be handling the IC's, and the types stocked are for the large users for defense and computer purposes. The RCA line seems to be the lowest priced and most complete of any.

I was able to get a few RCA CA 3012's locally so an *if* amplifier was constructed using two of these. I had planned on using IC's in the converter and audio amplifier, but I had to settle for an imported audio amplifier and a transistor converter. I also made an *if* amplifier using Fairchild  $\mu$ 7703's. The  $\mu$ 7703, because of its fewer pins, was easier to work with and needed fewer

components. After making these up, I discovered 7- and 9-pin connectors for miniature sockets which would have made it easier to interchange IC's.

As this was a preliminary project to see how well IC's worked, no refinements were considered; they will come later. The results obtained with these little jewels were truly amazing.

... VE3DAN

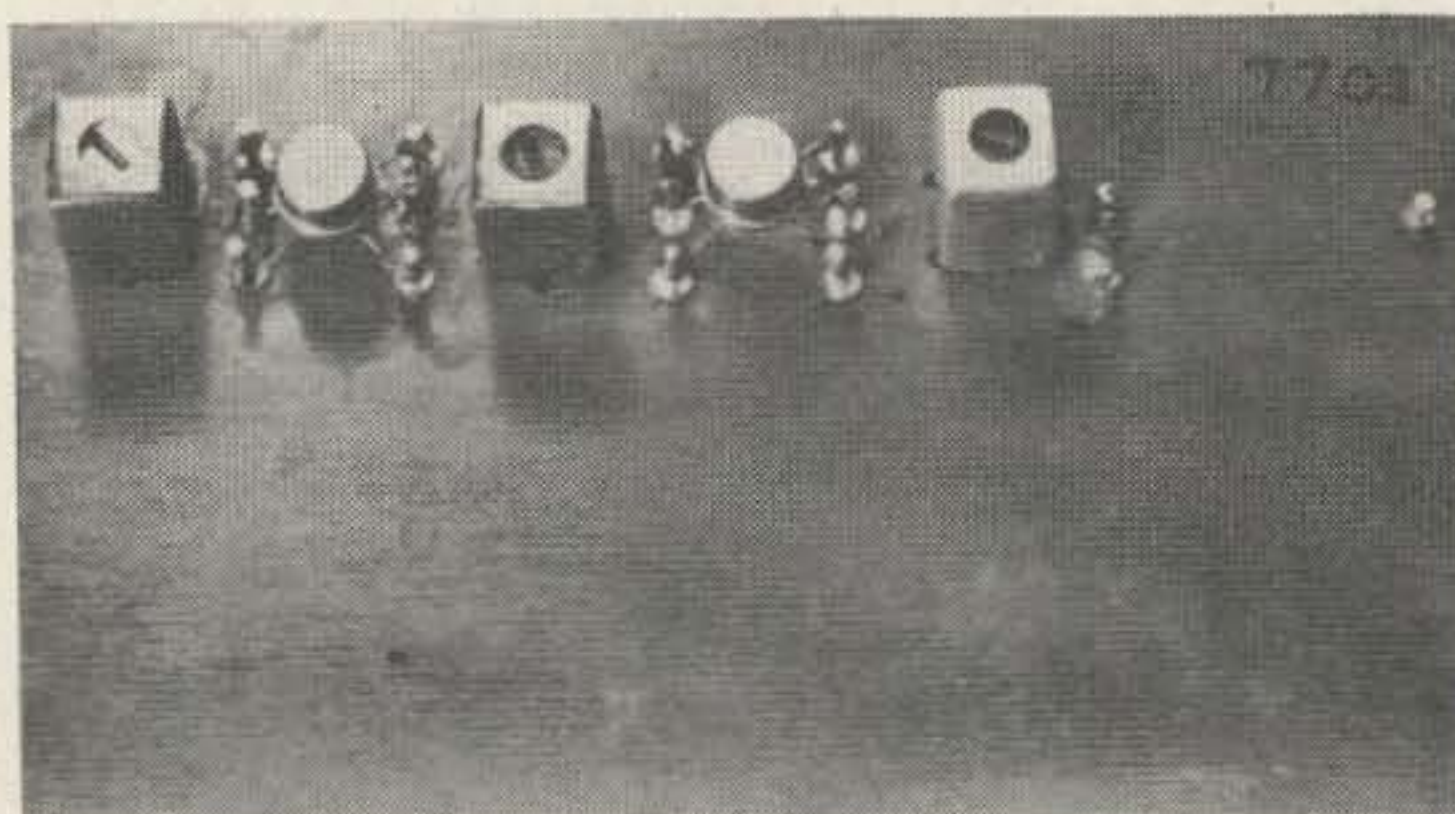

An *if* amplifier and detector built from two Fairchild  $\mu$ 7703 integrated circuits. There is enough room left on the board for an audio amplifier.

#### References

- Radio Electronics*, March 1967.
- Electronics World*, September 1964, October, November, and December 1966, and January 1967.
- Scientific American*, November 1965.
- Fairchild and RCA Data Sheets and Application Notes.

# CRYSTAL GAZING

***NO WAITING for the FUTURE***



*Buy The Best*

PRECISION QUARTZ CRYSTALS AND ELECTRONICS  
FOR THE COMMUNICATIONS INDUSTRY

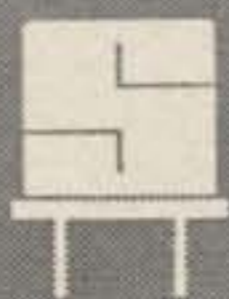

**SENTRY MANUFACTURING COMPANY**

*1634 Linwood Boulevard - Oklahoma City, Oklahoma 73106*

PHONE: 405-232-1431 — TELEX: 071-361 — TWX: 910-831-3175

# The Ferris Wheel Antenna

## for 160- and 80-Meters

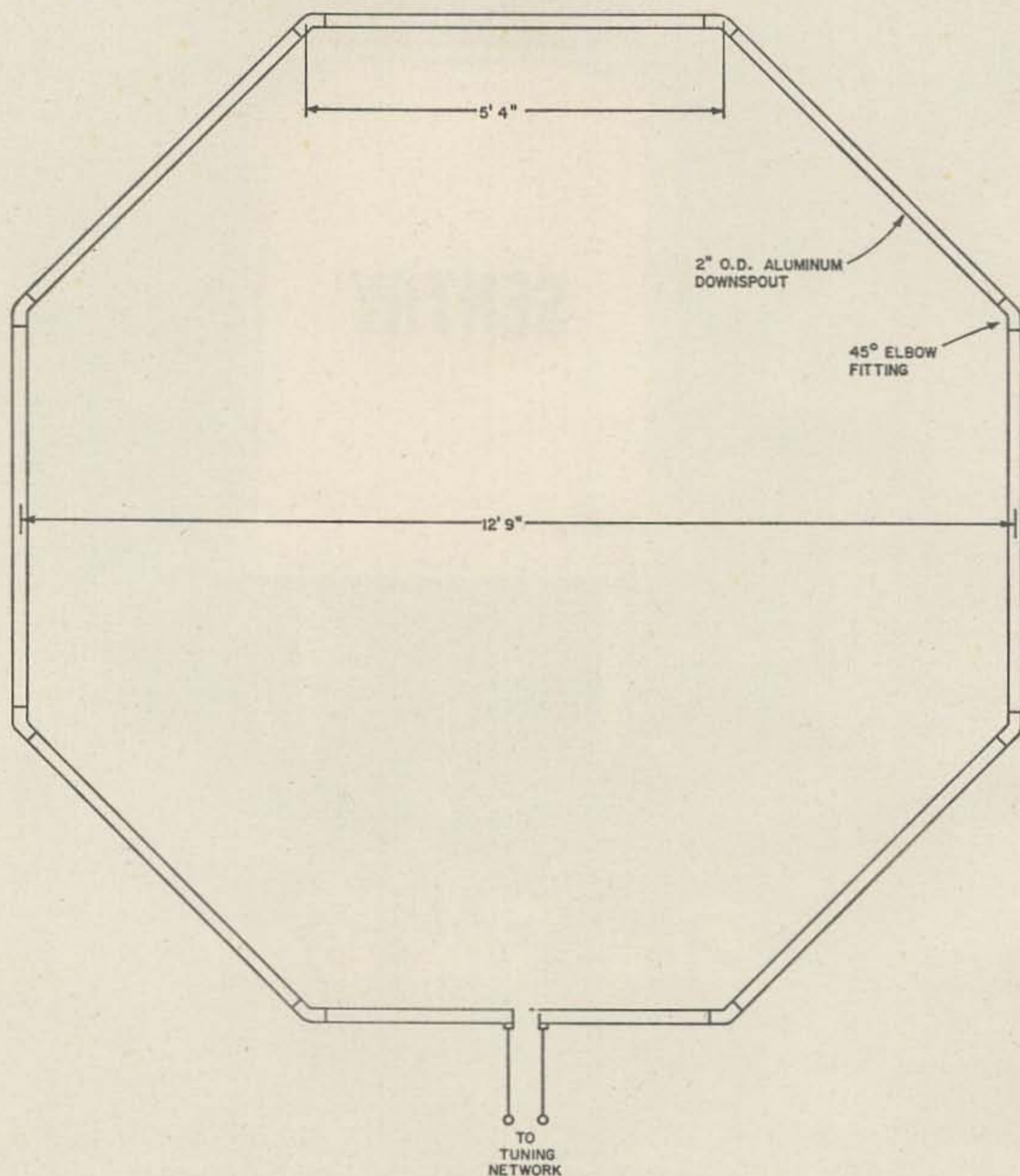
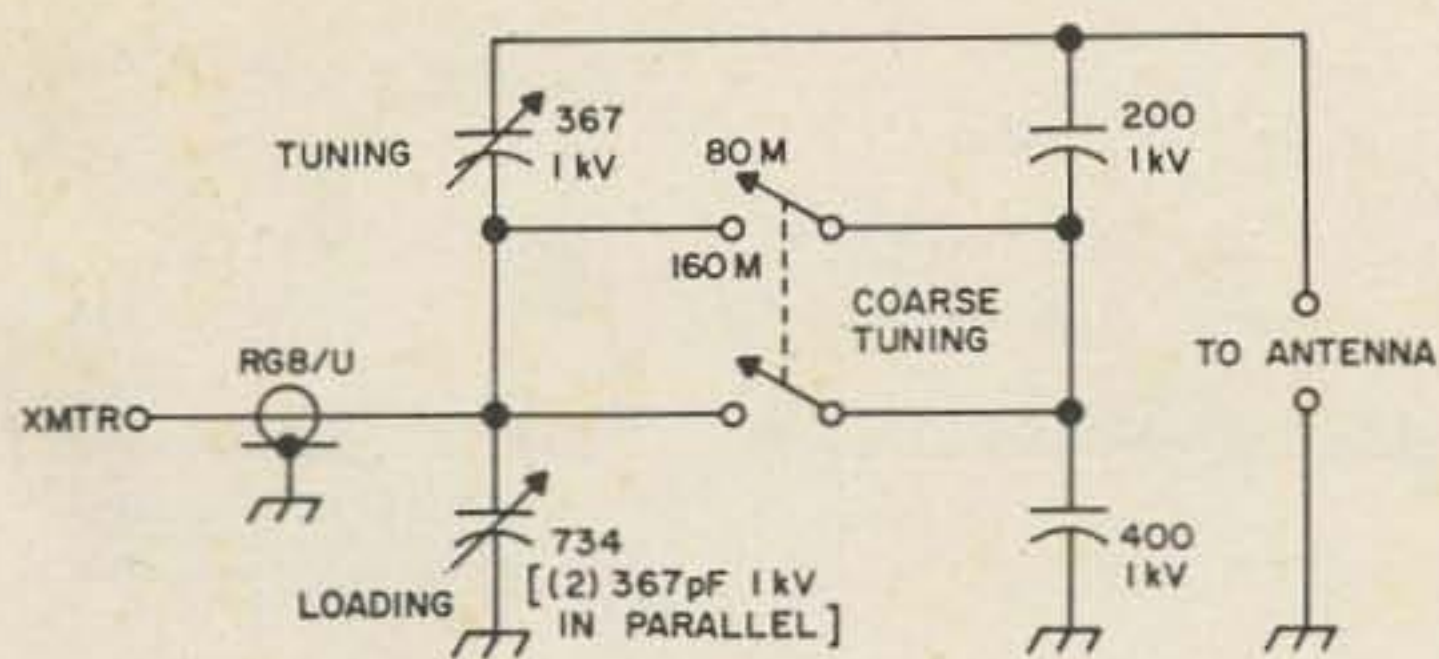

Fig. 1. A Ferris Wheel antenna cut for 160 and 80 meters. This antenna exhibits good efficiency with small size at relatively low height above the ground.

A recent article describing the use of loop antennas in Viet Nam<sup>1</sup> led the authors to plan and build the Ferris Wheel antenna described below. The Ferris Wheel is compact, inconspicuous, inexpensive, portable (if desired), broadband, and reasonably efficient. Its radiation characteristics are quite good—in fact the Army Limited War Laboratory found that a vertical loop antenna surpassed a low dipole in terms of radiated power<sup>2</sup>.

Since the lower bands, particularly the 2 MHz and 4 MHz bands, are transmitted with low-hanging amateur antennas, the Ferris Wheel seemed an ideal antenna for low-frequency work. The antenna is good for both short and long skip, since it has good radiation characteristics at both low and high angles. The Ferris Wheel is an ideal field-day antenna, since it requires virtually no support on a calm day, and only minimal



(A)

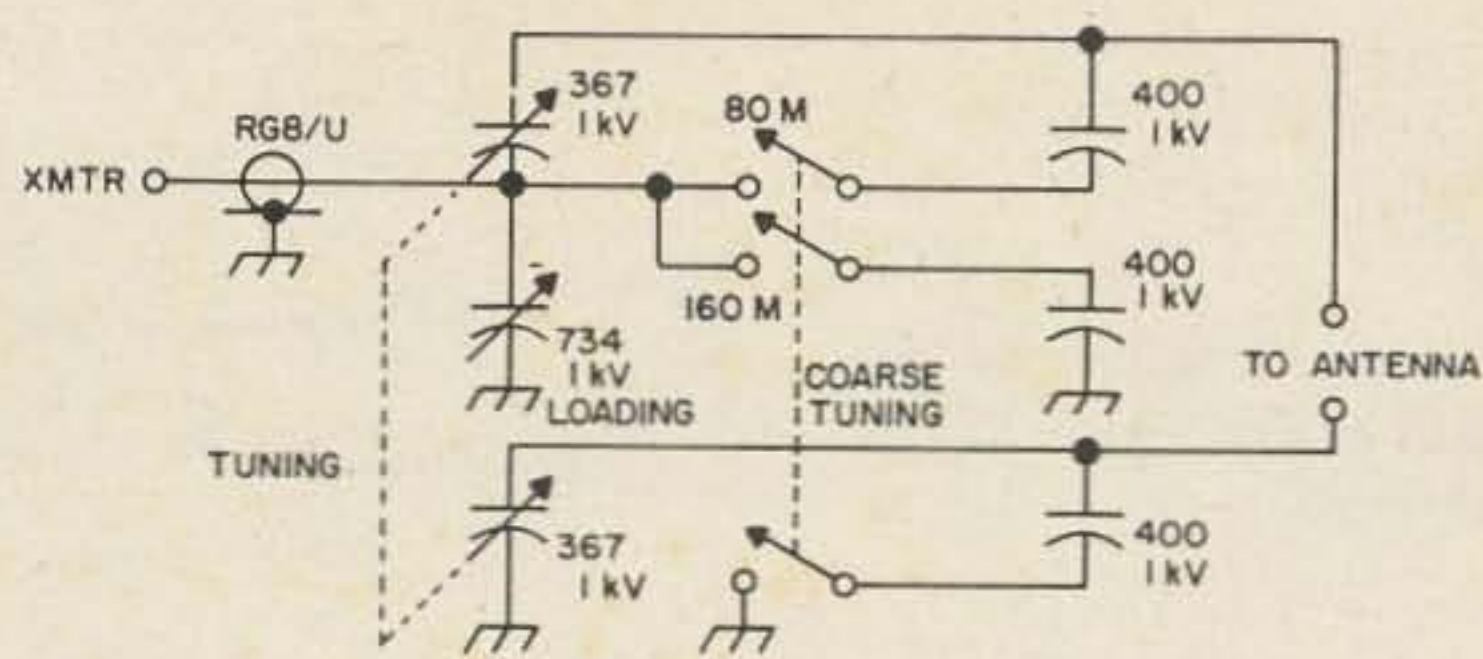

(B)

Fig. 2. Antenna tuning matching networks for the Ferris Wheel antenna. The circuit in A is for low-power applications; the circuit in B for high power.

support on a blustery day. Finally, as a permanent antenna, the Ferris Wheel is quite sturdy, the model built here having survived both small-craft and gale warnings with no ill effects.

The Ferris Wheel antenna (Fig. 1) is a loop antenna mounted vertically upon the ground. Since the radiation resistance of a loop antenna is very small (see Table 1), the conductor forming the loop must be made as large as possible in order to achieve reasonable (if disadvantageous) efficiency. In order to reduce loss resistance, we selected 2-inch aluminum downspout as the conductor of the Ferris Wheel. Obviously, we used unpainted, bare aluminum.

A forty-foot circumference loop antenna, made of 2-inch aluminum downspout, will have reasonable (17.5%) efficiency at 2 MHz and better (70.7%) efficiency at 4 MHz. Conveniently, aluminum downspout is sold in 10-foot sections. Since radiation resistance is proportional to the square of the area of the loop<sup>3,4,5</sup>, an octagonal shape was chosen over a square shape since the octagonal has 20% more area for the same circumference, and thus, the radiation resistance is 44% greater. Additionally, five-foot lengths of downspout are much more convenient to handle than ten-foot lengths in a portable installation, and 45-degree elbows are readily available while 90-degree elbows are not. Both elbows are listed in catalogs, but the 90-degree elbows are generally missing from the local dealers' shelves.

The capacitive tuning network (Fig. 2A) is simple to make and to tune, and it will handle powers of several hundred watts. The values shown tune the antenna within the 160-meter and 80-meter amateur bands. For higher power operation, the balanced network of Fig. 2B may be used. Tuning this network is more difficult, but by no means impossible.

The Ferris Wheel antenna has given excellent results, both on 160-meters and on 80-meters. One evening, on the first try made on that band, we made a contact of 400 miles on 160-meters, and we had several contacts on 80-meters, ranging from 3 to 600 miles.

The key to success with the Ferris Wheel is to maintain low resistance in all joints and connections. To achieve this we force-fit each joint between the downspouts and elbows, and then drilled three holes, approximately 120-degrees apart, and then riveted each downspout-to-elbow joint (Fig. 3) with aluminum rivets. The rivets were inserted with a hand riveter, available for about \$5.00 at either a hardware store or Sears. Aluminum rivets must be used to avoid future electrolysis and corrosion at the joints. At the feed point, an inch-and-a-half was removed from the center of the five-foot downspout, and a paraffined wooden plug was inserted in the downspout as a spacer (Fig. 3). Connection was made to the feedpoint with

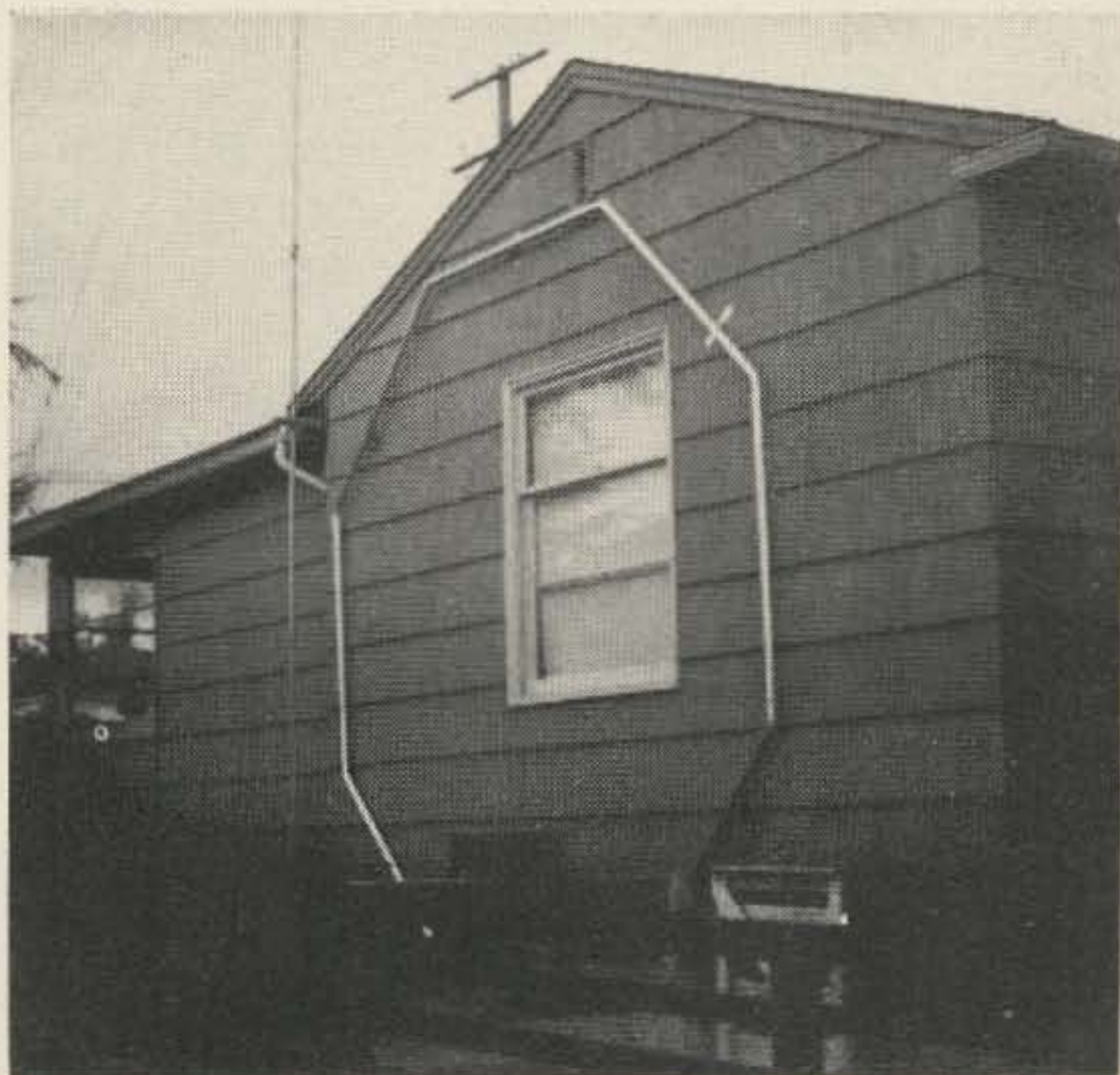

The Ferris Wheel antenna mounted to the side of WA7CUS's house.

Fig. 3. Construction details of the Ferris Wheel antenna.

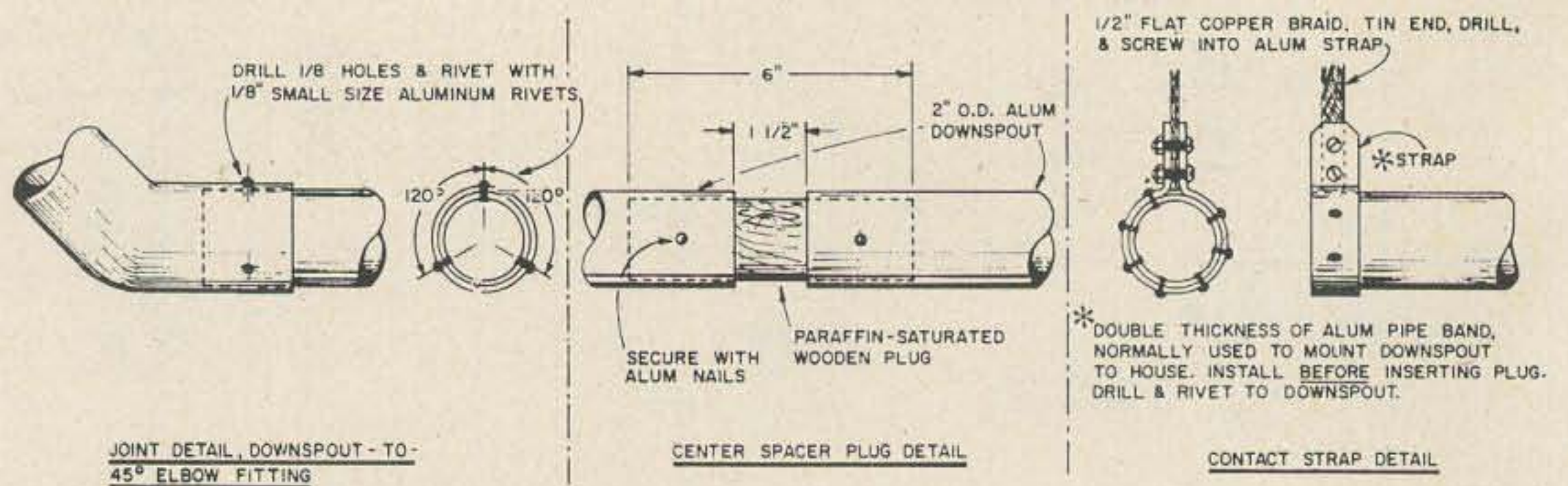

double aluminum strap (available to affix the downspout to a house) riveted to the downspout as shown in Fig. 3. Half-inch tinned copper braid was screwed to the tabs on the aluminum strap (Fig. 3) and used to tie the loop to the tuning network inside the shack. The joints were all sprayed with Krylon (after riveting and attaching the braid) for weather protection. The loop was fixed to the side of the house with five aluminum straps, each made of a pair of downspout straps, and the loop was spaced 1 $\frac{3}{4}$ -inches from the house with square, painted, wooden spacers.

The total time of erection of the Ferris Wheel antenna is less than five hours, including the hacksawing, cutting, fitting, drilling and riveting. The above time includes searching for spacer wood in a basement junk heap, spacer carving with a dull knife, but not paraffin treating, spacer painting, and construction of the tuning network. The network had been built before the antenna was raised. Tuning network construction is straight-forward (although number 14 wire should be used to make all connections), and is left to the imagination of the reader.

The radiation pattern of the Ferris Wheel antenna is directional in a horizontal plane, and is vertically polarized. Both the horizontal pattern and the vertical pattern are shown in Fig. 4. The patterns shown are those of a vertical loop, resting upon a perfectly conducting earth. The patterns do not differ substantially from those of a small vertical loop in space, and thus imperfect ground has little effect on the loop, as long as the loop is close to the ground. Patterson's article points this out, and a few moments analyzing a loop antenna and its image due to a ground plane will substantiate the result. Tests made on the antenna at 3.96 MHz within the state of Washington confirm the theoretical pattern.

The Ferris Wheel is a broadband antenna. Using the network in Fig. 2A, we found that

once the antenna is tuned midband on the 75-meter band, VSWR remains with 1.6:1 throughout the band. But the Ferris Wheel is easily tuned, and with the aid of a VSWR bridge, it can be adjusted rapidly. Patterson's article shows a VSWR bridge built into the tuning unit, and for installations where the antenna is not at arm's reach from the transmitter, a bridge built into the tuning unit would be most convenient. Since the feed point can be anywhere on the loop, the antenna feedpoint can be placed convenient to the transmitter. Initial tuning (within 2:1 VSWR) can be made by tuning the antenna to maximum signal output in the receiver (AVC off). Final tuning is done with transmitter RF power.

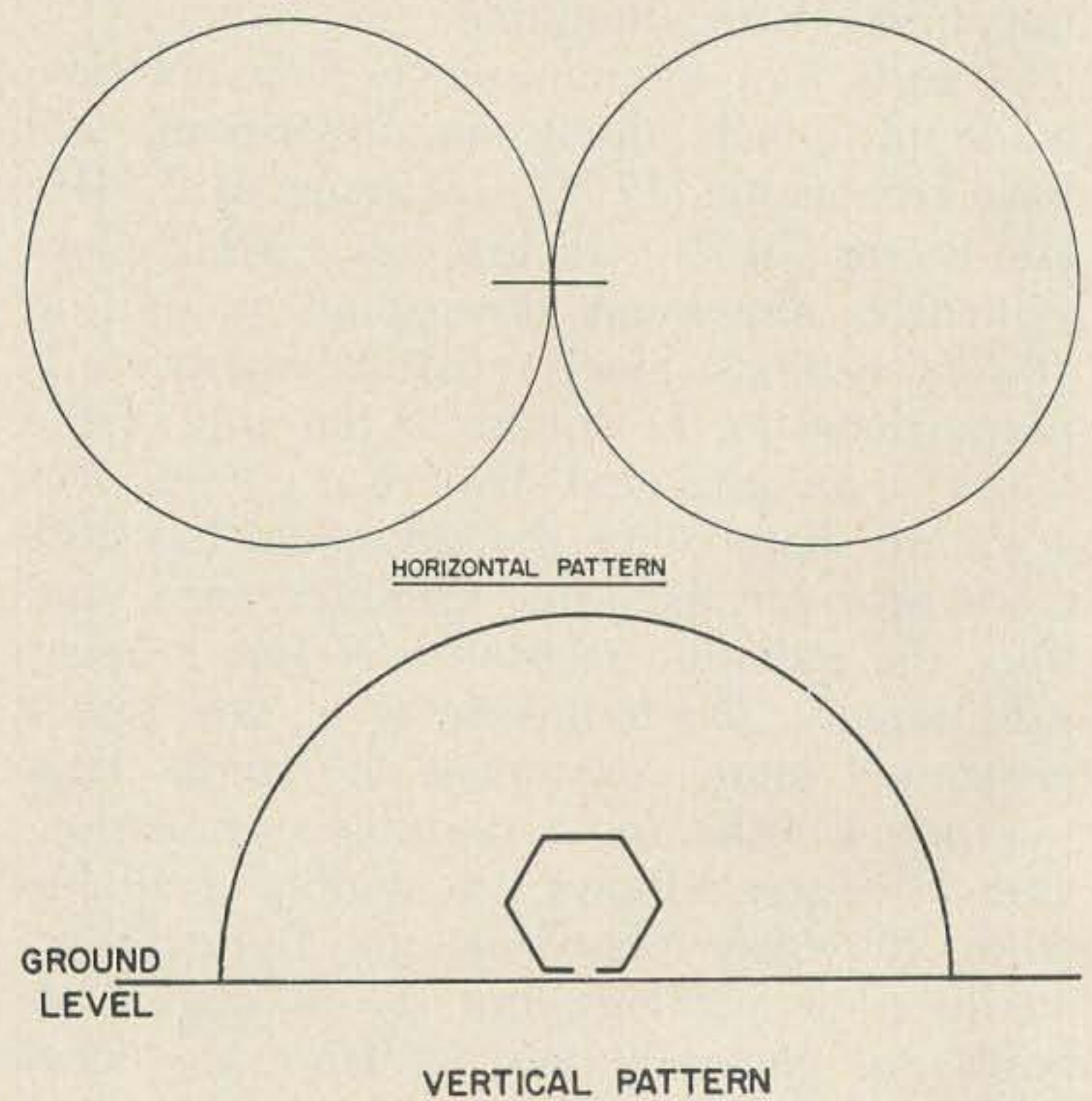

Fig. 4. Patterns for a small vertical loop antenna, resting on a perfectly conducting earth. Tests made by the authors appear to confirm that the Ferris Wheel antenna pattern closely resembles this theoretical pattern.

Since our initial tests on the Ferris Wheel antenna were made using force-fit joints between the downspouts and elbows, and during those tests we had good results from distant (12 miles) stations during the after-



Table 1. Comparison of antenna size, frequency and efficiency.

Frequency	Section Length	Radiation Resistance	Loss Resistance	Efficiency	Circumference
2 MHz	5 ft	$7.5 \times 10^{-3} \Omega$	$3.53 \times 10^{-2} \Omega$	17.5%	40 ft
4 MHz	5 ft	0.120 $\Omega$	$5.00 \times 10^{-2} \Omega$	70.7%	40 ft
4 MHz	3.28 ft	$2.30 \times 10^{-2} \Omega$	$3.28 \times 10^{-2} \Omega$	41.3%	26.24 ft
7.3 MHz	3.28 ft	0.259 $\Omega$	$8.85 \times 10^{-2} \Omega$	74.5%	26.24 ft

noon on 75-meters, we concluded that a force-fit Ferris Wheel would make a useful field day antenna for the two dc bands. Performance is not deteriorated by resting the loop on the ground, so long as losses are not increased at the feedpoint (from moist earth, for example). For the initial tests, our loop was rested upon a wooden 4x4 on the ground, and the loop leaned against the side of a house. In the field, the Ferris Wheel could rest on the ground, and lean against a tree for support. The five-foot lengths of downspout slip easily into the back seat of a car, or into the back of a station wagon, and the elbows are simple to store and carry.

The Ferris Wheel antenna can be made for higher frequencies than 2 MHz and 4 MHz. Table 1 lists radiation resistance, section length, and efficiency for a 2/4 MHz antenna and for a 4/7.3 MHz antenna. At higher frequencies, the advantages of a small loop are far outweighed by the advantages of other types of antennas, and so the calculations are not presented for frequencies higher than 7.3 MHz.

The Ferris Wheel is an inexpensive, simple, and effective antenna at 2 MHz and 4 MHz. It is easily erected for either a permanent installation or for field day. It can be made of readily available materials (Table 2) within an afternoon.

... W7UGV, WA7CUS

Table 2. Material required for the Ferris Wheel antenna.

Part	Quantity
Downspout, 2-in diameter, Aluminum, 10-ft. section	4 each
Elbow, 45-deg., 2-in. diameter, Aluminum	8 each
Strap, downspout mounting, Aluminum	14 each
Rivet, 1/8-in., Aluminum, small	70 each
Nail, Aluminum, roofing	12 each
1 3/4 x 1 3/4 x 24-inch unfinished board	1 each
Plastic spray, krylon spraycan	1 each
Paint, house (to match QTH decor), to paint mounting spacer blocks	As needed
Capacitor, variable, transmitting, 1 kV, 365 pF	1 each
Capacitor, ganged variable, transmitting, 1 kV, 365 pF each section	1 each
Capacitor, silver mica, 1 kV, 400 pF	1 each
Capacitor, silver mica, 1 kV, 200 pF	1 each
Switch, ceramic wafer, 2PST	1 each
Braid, tinned copper, 1/2-inch	6 feet

Antenna efficiency is given by

$$\text{efficiency} = R_r / (R_r + R_l)$$

where

$$R_r = \text{radiation resistance} = 3.12 \times 10^4 \times (A)^2 / (f)^4 \text{ ohm}$$

$$R_l = \text{loss resistance} = 6.25 \times 10^{-7} \times (s) (f)^{1/2}$$

s = circumference in feet

f = frequency in Hz

The logic leading to the above formulas is found in reference 4, Chapter 12, Section 10; Chapter 5, Section 17.

#### References

- 1 Patterson, Kenneth H., "Down-to-earth Army Antenna," *Electronics* (August 21, 1967), 111-114.
- 2 *loc. cit.*, p. 114.
- 3 *loc. cit.*, p. 113.
- 4 Ramo, Simon, et. al., *Fields and Waves in Communication Electronics*, pp. 288-303, 656-657, New York, John Wiley & Sons, Inc., 1965.
- 5 King, Ronold W. P., et. al., *Transmission Lines, Antennas and Wave Guides*, pp. 224-230, New York, Dover Publications, Inc., 1965.



### TELREX (Patd.) "BALUN" FED "INVERTED-V" ANTENNA KITS

EASY-TO-INSTALL, HI-PERFORMANCE LOW-FREQUENCY ANTENNAS

"Mono" Bands from \$23.95—Also "Trapped" 2 and 3 Band Kits.  
3, 4 or 5 Band "Conical-Inverted-V" Antennas from \$52.95  
3, 4 or 5 Band, 5 to 10 DB—"Empirical-I.V.—Logs"—S.A.S.E.

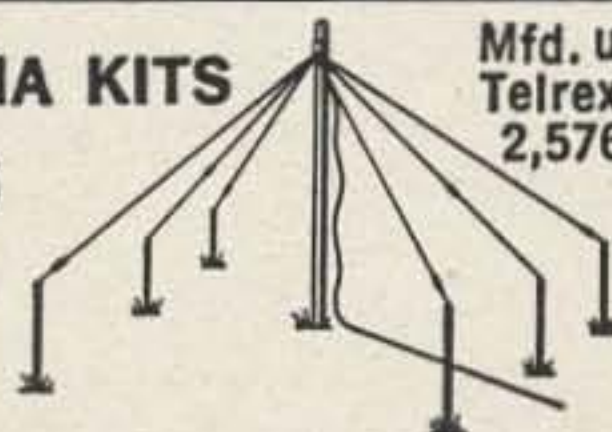

Mfd. under  
Telrex Pat.  
2,576,929

WRITE FOR  
TELREX PL 68

TELREX COMMUNICATION ENGINEERING LABORATORIES—ASBURY PARK, N. J. 07712

# 100 KHZ Thin-line Pulse Generator

Digital integrated circuits are an entirely new kind of electronic component. These finished, ready-to-go devices contain complex transistor circuits in tiny, convenient packages. Until recently they were too expensive for one-off projects, but a burgeoning market and competition between manufacturers have brought some prices to the dollar apiece level. In fact, very good digital IC's are now available on the surplus market.

Perhaps because they are so new, it is hard to see applications for digital IC's outside the computer and industrial control scene. It takes a little while to adjust mental perspective, too, before their input-output characteristics begin to seem natural. Yet, there are applications for them which are not very difficult. For instance, how about a frequency standard?

Ordinary 100-kHz frequency standards are usually audible up to a few tens of megahertz. A good one might be usable at 50 MHz. The circuit described here uses a dual NAND gate to generate a 100 kHz signal

whose harmonics are usable to 432 MHz or higher. And it can be built without benefit of special instruments and knowledge.

## The thin line pulse

One rather surprising result of higher mathematics is that all repetitive signals are composed of harmonically related sine and cosine waves. For example, the familiar square wave is composed of a fundamental frequency, which sets its basic repetition rate, and of odd harmonics only of its fundamental, which contribute to its square corners. If the harmonics' amplitude or phase relationship is upset, the square wave is distorted. This feature makes the square wave very useful for amplifier testing, but its harmonic content is not very good for frequency standard applications.

Now suppose that we start adding up signals of  $F$ ,  $2F$ ,  $3F$ , and so on, phased in so that they all reinforce each other once per cycle. Let's say they are all the same amplitude. What would we get? See Fig. 1A.

External view of the 100 Hz thin-line generator.

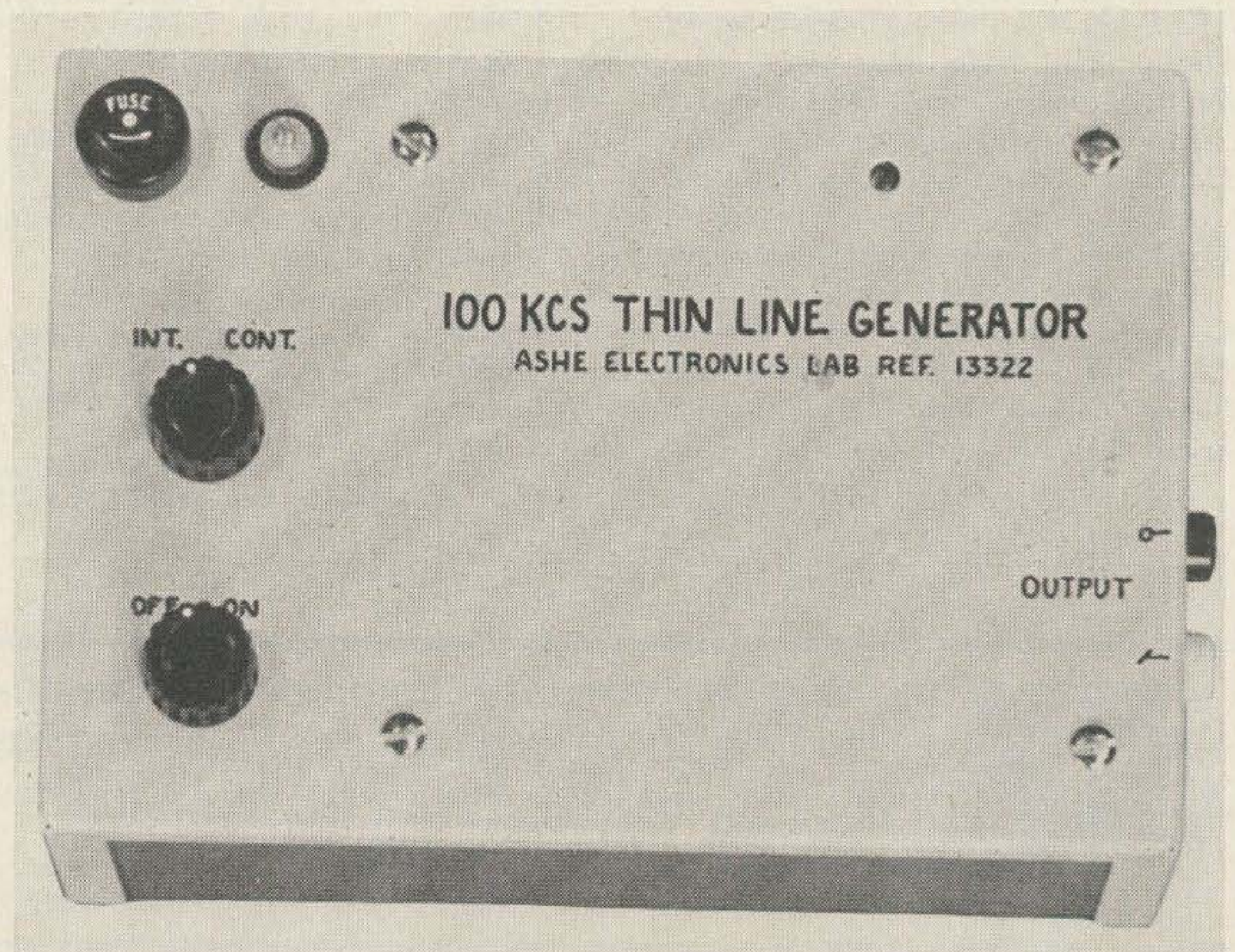

The five equal amplitude sine waves peak simultaneously at the beginning of the fundamental's cycle. Everywhere else, until near the end of the cycle, they are more or less out of phase. Trying to see what will happen, we try adding the first two frequencies. Fig. 1B, the result, might suggest something to a mathematician.

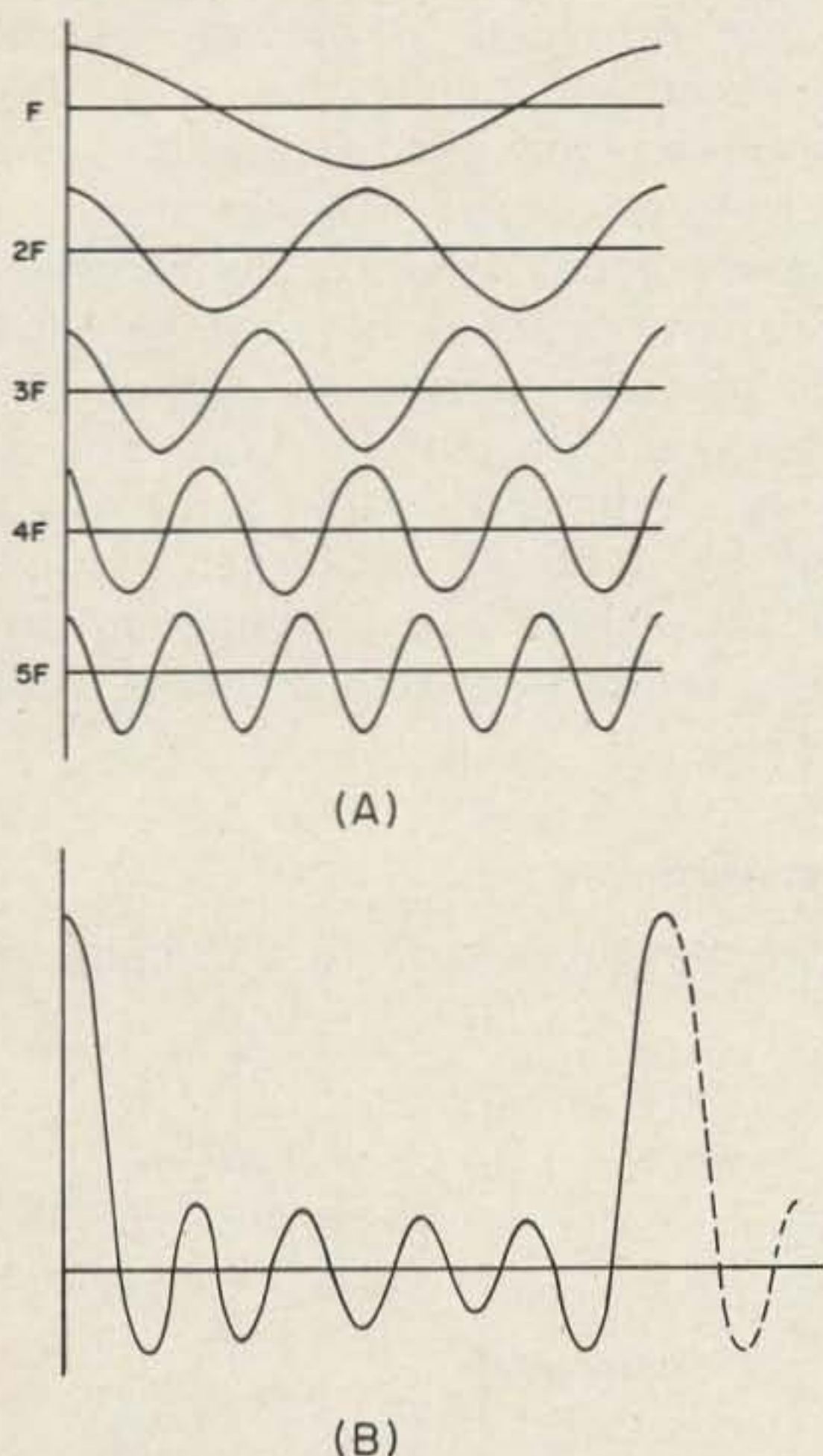

Fig. 1. Five sine waves (A) and the waveform as a result of point-by-point addition (B).

As the number of frequencies is increased, their amplitudes tend to average to zero everywhere except at the beginning of the cycle. Here, they all add up to a short, sharp pulse. It follows that a short, repetitive, one-sided pulse should contain odd and even multiples of the fundamental frequency.

An ideal thin line pulse has infinite frequency content.\* No real signal could meet this spec, but a fast digital IC can produce a very workable approximation. Fig. 2 shows a Tektronix 545A view of the generator output and tests with other scopes indicate the real pulse has better rise time and sharper corners than shown here.

If this pulse is viewed on a low-performance service variety scope, its appearance will be greatly changed. There will be an apparent loss in amplitude, since the pulse occurs and terminates before the slow circuitry can properly respond. The apparent duration is increased, also because of the

slower viewing circuitry. And the fast pulse may excite circuit resonances, so that the thin line pulse appears as a damped oscillation. But these problems do not interfere with constructing the generator, because the very simple NAND gate circuitry contains no critical elements or adjustments.

### How it works

There are four circuit sections, shown in Fig. 3. A 100-kHz crystal-stabilized oscillator sets the basic frequency, and a dual NAND gate circuit converts the oscillator output to a thin line pulse. A 1-Hz astable generates the output marking signal. A 6 volt dc power source is provided by a voltage doubler zener-regulated supply.

Multivibrator oscillators are not ordinarily very stable frequency sources. But if the oscillator is designed to run slightly below required frequency, and an appropriate crystal is connected between transistor base terminals, oscillations are stabilized at the crystal frequency.

The crystal does not change the multivibrator's style of operation. It synchronizes the astable to its own frequency, by triggering the OFF transistor into conduction shortly before normal RC turn-on. The output is a squarish wave with good fall time, but a long rise time as shown in Fig. 4A.

In passing through the first NAND gate the pulse is squared up and becomes slightly unsymmetrical. See Fig. 4B. A differentiating network, C7 and R11, converts the square wave into the pulses shown in Fig. 4C. These pulses, applied to the second NAND gate, reappear as the thin line pulses shown in Fig. 4D.

Since one CW signal sounds just like another and there may be several in the vicinity of a check point, a marker feature is required. This is provided by the 1-Hz astable, which paralyzes the second NAND gate part of the time. Its base bias resistors are unequal, giving a distinctive duty cycle to the output signal. A switch disables the astable if a continuous signal is required. Fig. 5 shows the output when the second astable is operating: the output is locked in the up condition during half of each 1-Hz astable cycle.

Sometimes an astable oscillator will refuse to start oscillating when it is turned on. It does not start because both transistors are

\*Smith, *Applied Mathematics for Radio and Communications Engineers*, Dover Publications, 1961.

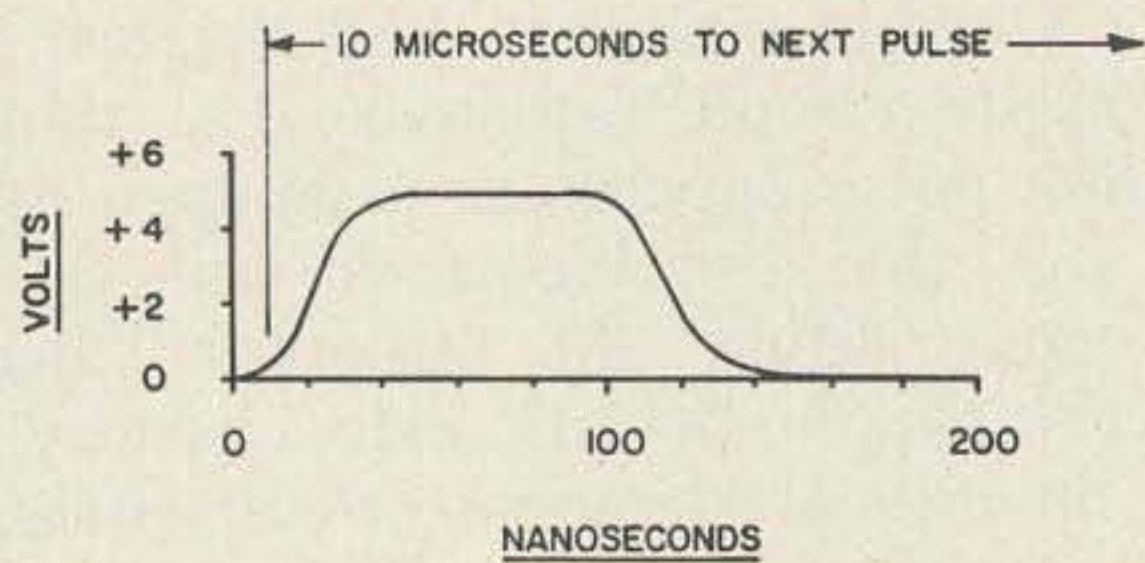

Fig. 2. Real circuit output as seen by a Tektronix 545A oscilloscope. A faster scope shows shorter rise-time and sharper corners.

in saturation. This reduces loop gain so that available noise cannot be amplified around the loop. It would never start without some strong, outside interference.

A pair of diodes, D1 and D2, provide a reliable remedy. The diodes are arranged so that base bias must come from whichever collector is at the higher voltage. If both transistors are in saturation, their collectors are at perhaps 1 volt, which cannot provide enough base current to keep the transistors in saturation. This contradictory situation does not arise in the real circuit, which starts reliably.

Additional diodes, D5 through D8, appear in the base circuit of the 1-Hz astable. These are protective diodes. The collector swing at turnoff of about 5 volts is conveyed powerfully to the opposite base through the large coupling capacitors C5 and C6. The reverse B-E breakdown voltage of these transistors is not known, so the diodes are provided to prevent the turnoff voltage exceeding 2 volts or so.

DC power for the Generator circuitry comes from a voltage doubler supply based on a low-current filament transformer. Its design is conventional, but a large capacitor, C12, is provided across its output to minimize noise on the supply line. The supply could be replaced with some batteries, shunted by a 50  $\mu$ F or larger capacitor to absorb transients. The original breadboard ran very well, powered by four flashlight batteries.

### Construction

The generator is built in a Premier #PMC

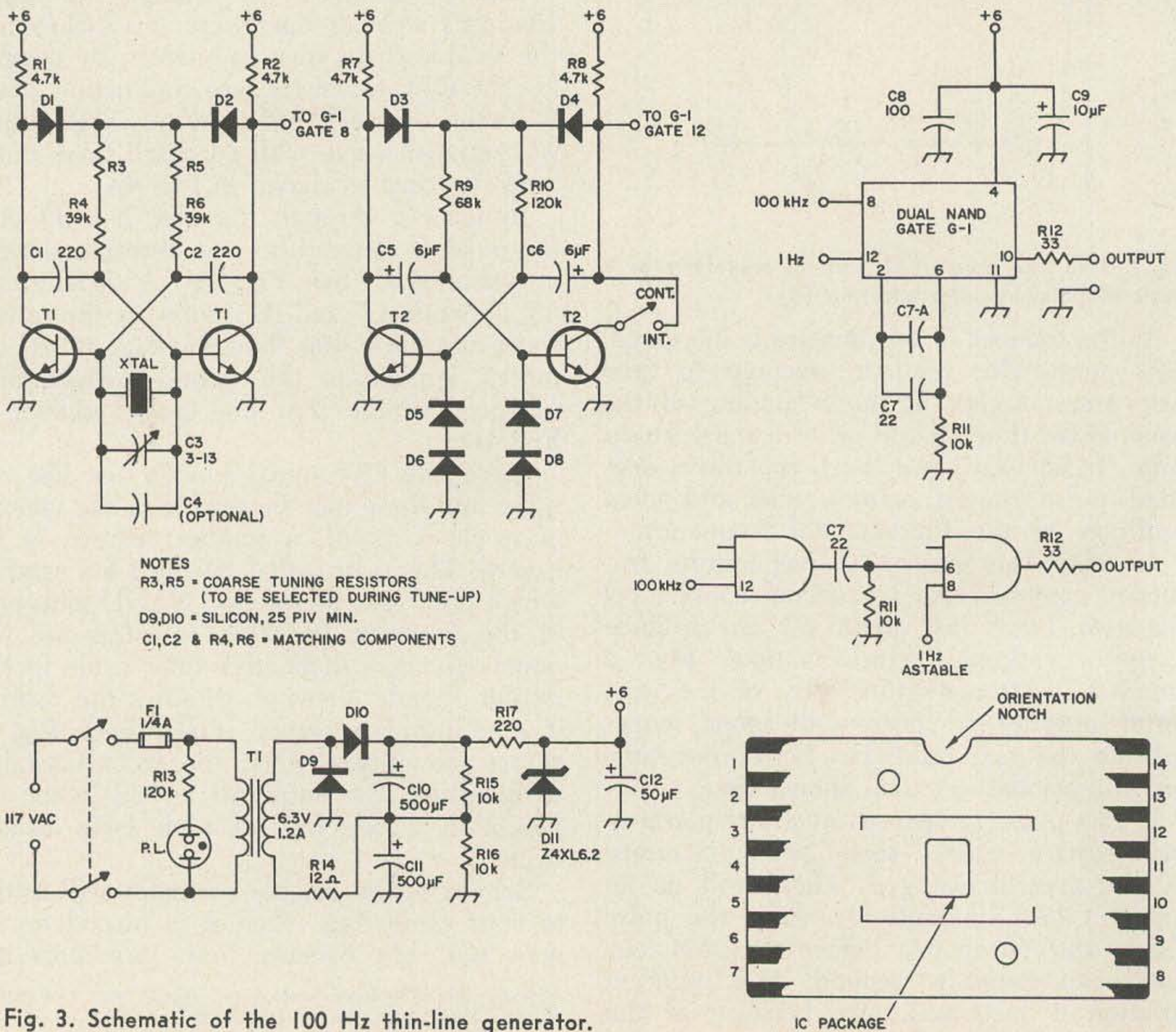

Fig. 3. Schematic of the 100 Hz thin-line generator.

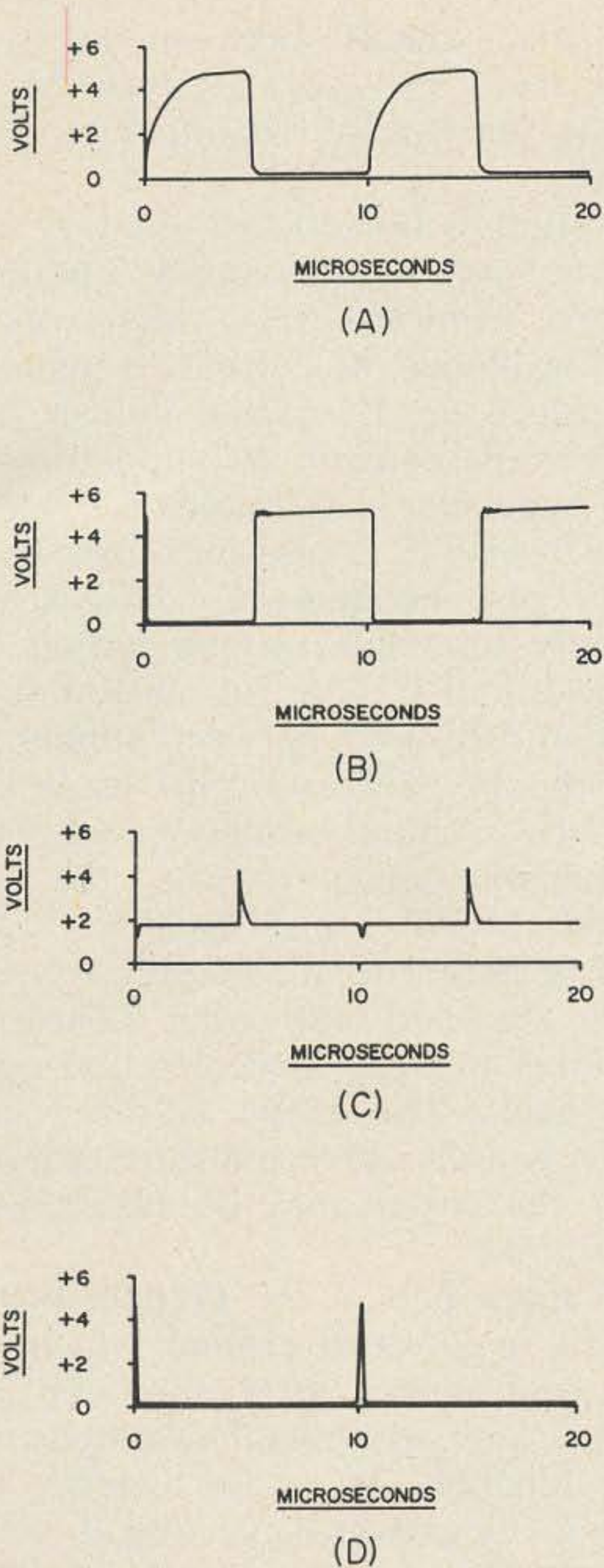

Fig. 4. Signals at four critical points in the generator, as displayed on a Tektronix 545A oscilloscope. They are shown in time coincidence.

1008 3x5x7 inch heavy aluminum box. Its top cover was refinished in light green enamel, and four  $\frac{3}{8}$  inch grommets in the bottom piece serve as protective feet.

Inside the box, the 6.3-volt transformer and cheater cord connector are mounted on the left-hand wall. A pilot lamp, fuse, and two switches are mounted on the horizontal panel, at the extreme left. This leaves just enough open space for the two circuit boards which occupy most of the box. Two banana jack output connectors are placed on the right-hand side, just below the panel.

The circuit boards are cut to  $4\frac{1}{2}$  x 5 inches, from Vector  $\frac{3}{32}$  inch pattern A stock and mounted parallel to the panel. The upper board is spaced an inch from the panel, and carries both astable oscillator circuits. The other board is mounted one half inch below, and carries the digital IC and the

power supply circuitry. Assembled, the two boards make a sandwich with wiring sides together.

Both boards are mounted on the same four centers. These are through the second hole diagonally inward from each corner. The 1 inch 6-32 internally threaded spacers are modified by adding a short length of 6-32 threaded shaft to one end of each, simplifying assembly.

Component assembly on the boards is largely a matter of plugging in Vector T9.4 lugs. The finished product looks much better if some thought is given to facing the lugs in one of two directions. Mounting and transistor holes should be drilled and reamed to size before installing lugs.

The general arrangement puts all wiring on one side of the board and practically all components on the other side. This approach seems a little inflexible but is straightforward and looks good.

Possible board orientation problems may be overcome by working out a handling and wiring procedure that doesn't require constant reference to actual components. A good approach assumes that the board is only turned over an imaginary hinge at its bottom edge, so that top down when one side is up becomes bottom up when the other side is down. This preserves left-right relationships. Another useful convention is that all supply wiring goes to left-hand end of components.

Wiring is carried out one network (plus supply lines; ground lines; interstage lines, etc.) at a time, with prearranged color coding. Bare wire goes for short runs and where there is no chance of a short. Solder each lug when convenient. #22 solid wire fits the T9.4 lugs well, but flexible stranded wire is used for the four lines from one board to the other.

Transistors precede other components into the board, because they are convenient position markers. They are placed in their

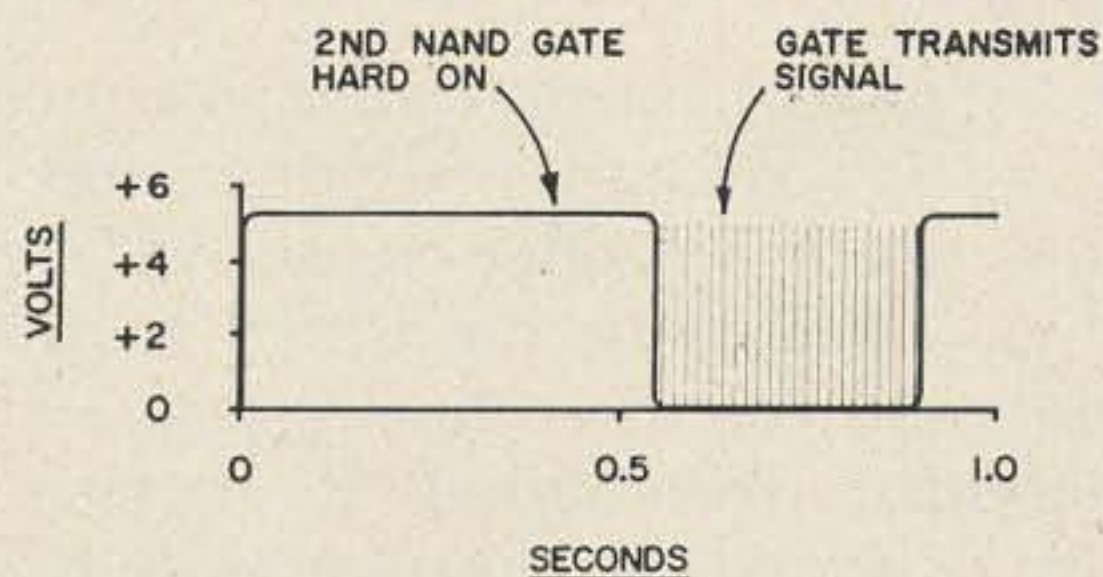
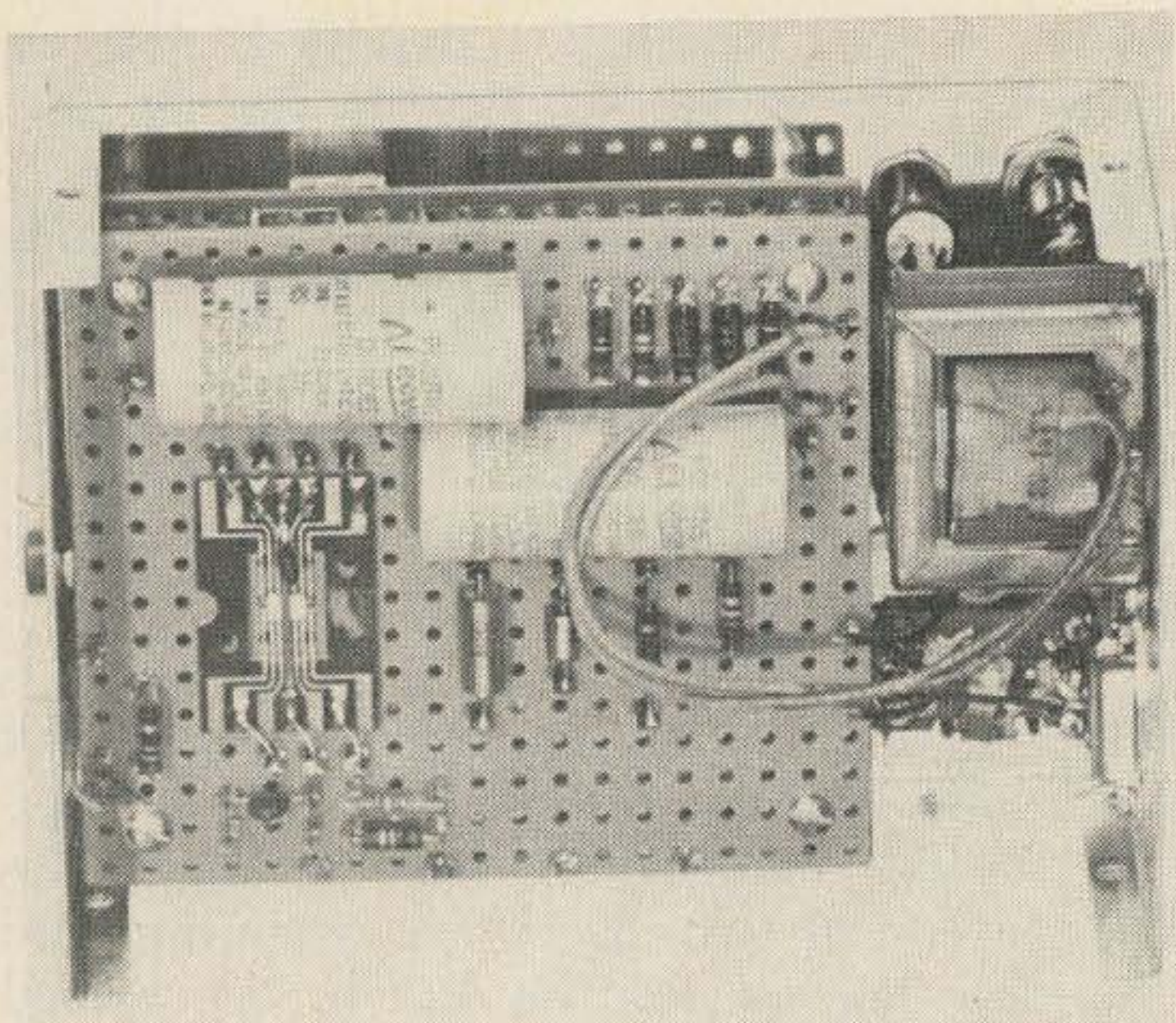

Fig. 5. The second NAND gate locks in its up position part of the time to produce an intermittent output.



Inside the assembled thin-line generator showing the component side of the power supply and IC board.

mounting holes in the board from the component side, and their leads brought to the T9.4 lugs.

Then the other components are mounted on the boards.

Diode and electrolytic capacitor mounting polarity should be double checked. The T9.4 lugs may need a little bending before they will take a good grip on the components, but no component soldering is done until everything is installed.

Trimmer capacitor C3 is mounted on its tabs just under the top panel. Then a small screwdriver access hole is drilled over it in the panel, before painting, for vernier frequency adjustment after final assembly.

Certain components are matched before installation. An ohmmeter and a capacitor checker will do a satisfactory job of selecting C1 and C2, and R4 and R6, for equal values. These components are chosen alike for best symmetry of the 100-kHz oscillator operation. It might be good planning to leave these components unsoldered until tuning is completed, but everything else can be soldered to the board at this point. Note that the R3 and R5 sites do not get resistors until later.

Two optional capacitor sites are included. These are for C4, an additional and probably unnecessary padder across the crystal; and C7A, which can be added to increase the width of the thin line pulse.

Apparently, the digital IC comes in a specially designed package for testing before use. To mount the IC, solder a  $\frac{3}{8}$  inch piece of #22 wire in each of the T9.4 lugs carrying supply and signal voltages to

the IC. Place the IC between the two rows of lugs, bend the wires against the proper terminals, and solder. No other mounting is required.

The original breadboard showed a lot of transient noise in its supply circuit. This originated from the IC, which was trying to get big chunks of current to manufacture pulses. Since the IC cannot deliver frequencies not available from the supply lines, very careful bypassing is indicated.

High-frequency bypassing consists of C9, a  $.01\mu\text{F}$  disc ceramic capacitor across the IC supply terminals on the wiring side of the board, and C10, a 100 picofarad capacitor soldered directly between supply terminals on the IC. The capacitor leads are provided with spaghetti insulation and placed for minimum open space between the capacitor leads and the IC's supply leads.

Testing before final assembly is very easy, because the odd appearing board layouts go together giving a structure that opens out like a book. The hinge is the four leads between boards. Leave transformer leads long, so that the circuit may be tested well free of its cabinet.

The upper half of the Premier box is prepared by a powerful cleaner which removes its original paint. After thorough removal of the cleaner, the metal is roughened with wet sandpaper, rinsed in vinegar solution and then clear water, leaving a very good surface that does not require priming for excellent paint adhesion. Watch out for greasy fingerprints.

Rustoleum #868 Green applied from a convenient spray can gives a fine finish.

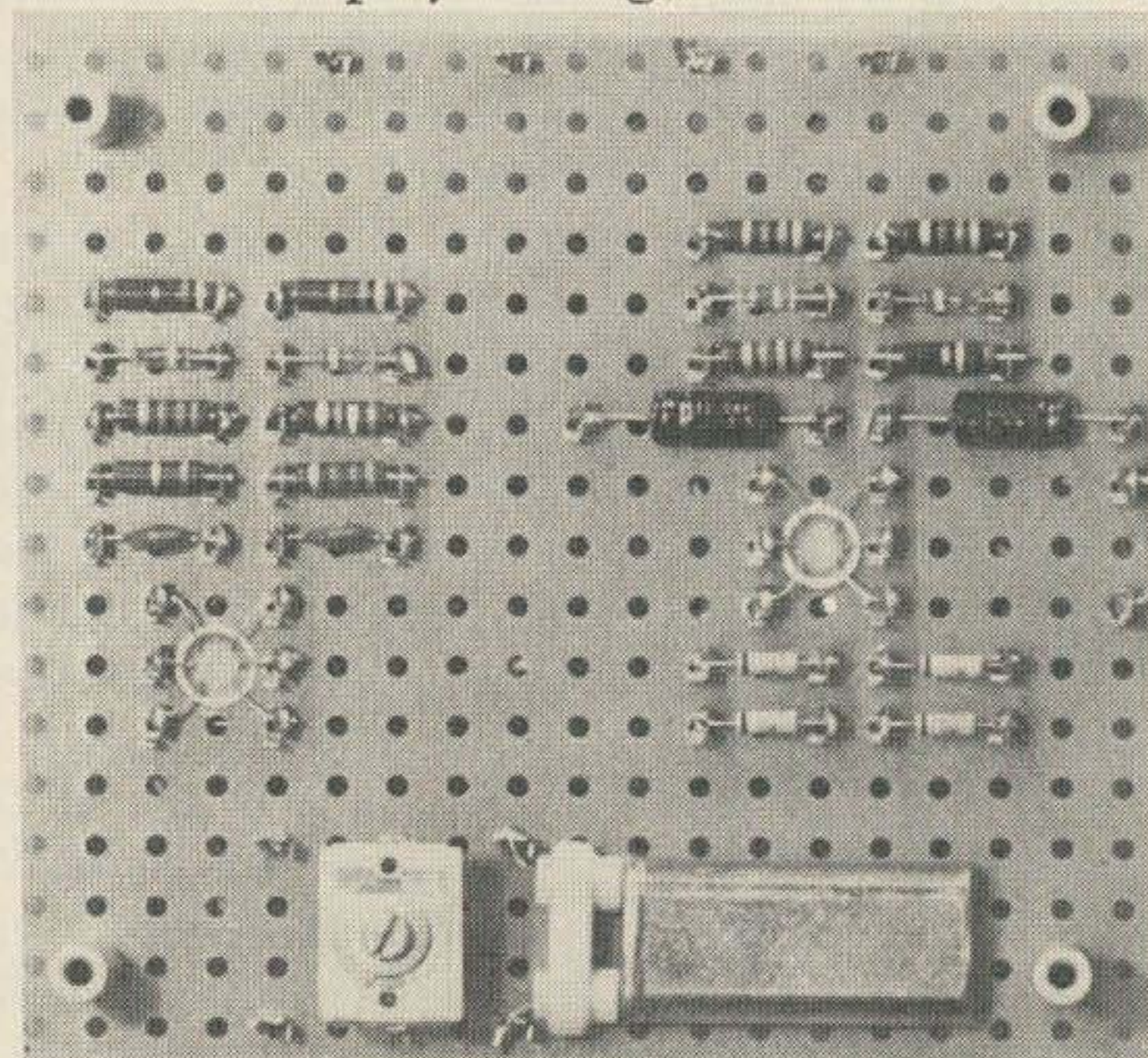

View of the component side of the astable oscillators board.

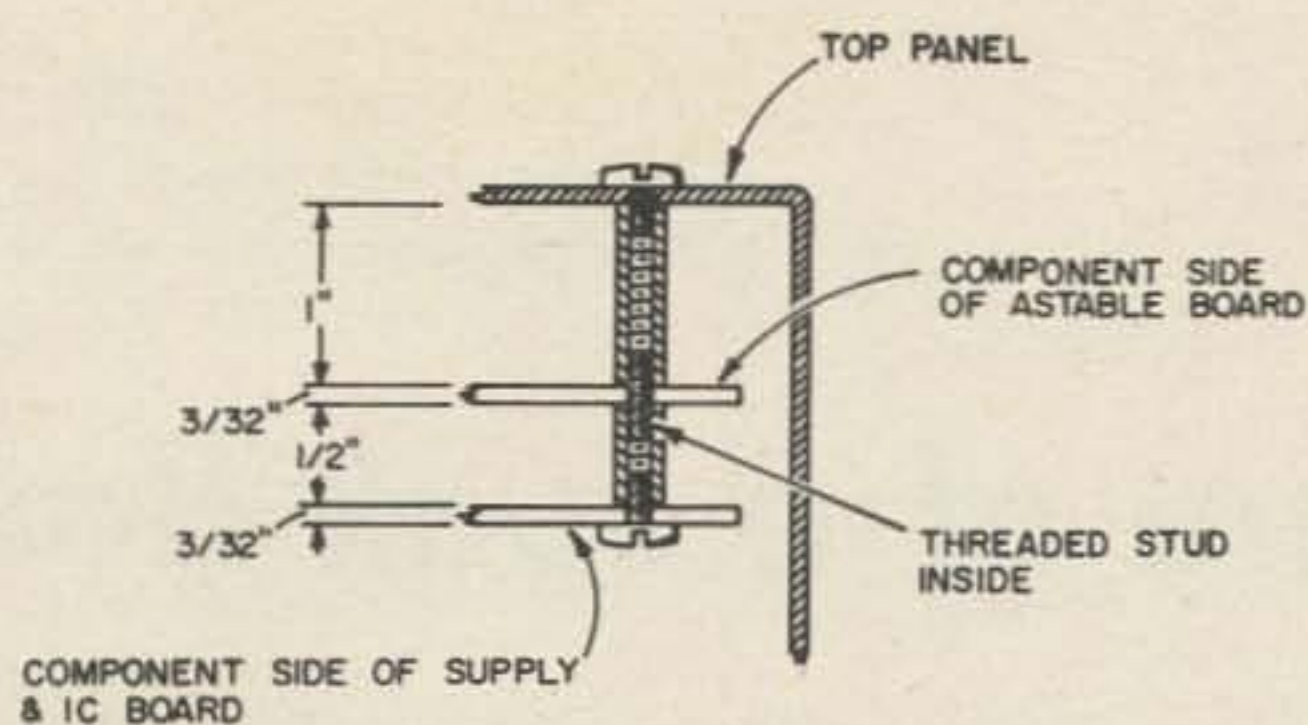

Fig. 6. Mounting dimensions and spacer assembly diagram.

Follow instructions on the can. After drying, the fresh, clean enamel will take waterproof India ink, applied with a Leroy drafting pen. When the ink is thoroughly dry, a final coat of Rustoleum #717 Clear finishes the job. The enamel is soft at first, but hardens into a coat durable in normal lab use.

#### Table of special parts

Crystal: 100 kHz parallel resonant 32 pF. shunt capacitance normally designed quartz crystal.

The following parts were obtained from Solid State Sales, P. O. Box 74, Somerville, Mass. 02143.

T1 & T2: 2N2060 type dual NPN transistor

D1, D2, D3, D4: fast point-contact Germanium diodes coded 1N59

D5, D6, D7, D8: fast point-contact Silicon diodes marked S284GM

G1: surplus digital integrated circuit

Solid State Sales type G1. (comes with data sheet)

#### Tuning up

The generator should be zeroed to frequency before installation in its case. This is a two-step process. First, the 100-kHz astable base resistances are adjusted by choosing resistors for R3 and R5 to bring the oscillator frequency within trimmer range of 100 kHz, perhaps a few hundred cycles high at 15 MHz. Then the trimming capacitor brings the frequency to accurate coincidence with WWV.

To roughly zero the generator, set the trimmer capacitor, C3, at minimum capacitance. Identify WWV on a short-wave receiver, and tune around a bit to familiarize yourself with what's happening in the vicinity. It would be nice if things are fairly quiet.

Then put 4.7k resistors into the astable board at the R3 and R5 sites, turn on the generator, and look around for the signal. Depending upon actual values of C1 and C2, the signal may be on either side of WWV but is likely to be on the high side.

If so, try again with resistors one size larger, which will lower the frequency. You should shortly find resistors that bring the frequency near enough to WWV for final zeroing with the capacitor. Verify tuning range on both sides of WWV.

Correct values for R3 and R5 may be approximated very quickly if a good triggered scope is available. Try selecting resistors for a period of 11.4 microseconds with the crystal removed.

#### Using the thin line generator

A breadboard test showed that (as might have been expected) there should be some way to distinguish generator signals from other CW signals. The continuous/intermittent feature provides the marking, and once the correct signal is located the generator can be switched to "continuous" for accurate work.

At low frequencies, the generator output and behavior resembles a conventional 100-kHz standard. The signal simply is not as strong. A greater difference appears at higher frequencies: the original model yields an audible beat note at 80-MHz from a diode mixer through an inexpensive audio amplifier. And another test shows a usable signal at 432 MHz: the 4,320th harmonic.

Some connection to the receiver or other detector is required. This is a natural consequence of a circuit design that puts the signal where it belongs, rather than spraying it all over the lab. A few picofarads coupling capacitance is sufficient at all frequencies.

Perhaps this circuit can be used for purposes other than a frequency standard. Its moderate amplitude but wideband output should be ideal for detecting changes in receiver sensitivity over a broad tuning range. In fact, with a little decoupling of the input leads and provision of a coax output connector the generator should do well as a stable, reliable small-signal source. A piece of adjustable waveguide-below-cutoff would make an excellent attenuator for work not requiring exact measurements. Another thought that occurs is possible further development by provision of some arrangement for detecting which harmonic is actually being heard.

... W2DXH

Eugene Fleming WØHMK  
328 Gunnison Ave.  
Grand Junction, Colo. 81501

## The Nurture and Care of a Junk Box

The idea of "the junk box" has been laughed at, slandered and otherwise maligned during the past couple of years. This fun-making and detraction has gone on both in the magazines and in QSOs. Maybe it is time to take a second, and a close, look at this institution which is as much a part of ham radio as are DX contests and YL chasing.

Why has there been so much disparagement? My own idea is that writers for ham publications have assumed (usually erroneously) that readers had junk boxes as extensive as, and identical to, their own. When readers figured out the cost of what they had to buy to complete the particular project under consideration, they often gave up rather than strain their budget. However, if those readers had been making a systematic effort to grow themselves a good supply of used parts, they might have built the gismo for less than it cost the author.

Extensive parts collections don't just happen. They are grown more or less intentionally. Here are a few hints on the accumulation of parts and how to handle them after you get them. My XYL says this is the only subject on which I am an expert, so

maybe others will find the techniques useful.

1. Let it be known among your friends and acquaintances that you are interested in electronics. Forthright announcement is sometimes appropriate, but demonstrations are better for they make a more permanent impression. Display of some electronic gadget or your call letters can be used to advantage. Gadgets give you the best openings for conversation on the subject. "Commercial killer" for a TV set or a neon bulb flasher are examples. When it is learned that "he built it himself", not a few friends and relatives will say, "Maybe he can fix that old radio in our attic, and if not, maybe he can use the parts." Needless to say, the radio is beyond repair 99% of the time. When you are offered pay for a small favor ask if there is an old radio or record player you might have. Sometimes these are repairable and can be used for swapping material.

2. The offer of old electronic gear brings us to the second point: Never refuse an offer of anything. Don't refuse even if you are certain beyond any doubt that you can't even get the beast into your basement or





use any part of it. The friend making the offer sees himself as doing you a favor by offering it and at the same time is getting his attic cleaned. And who knows, you might find just what you need in it for a project 5 years later. Such an unlikely prospect as a broken egg beater has been turned into strap to hold a tubular electrolytic in place, and the wood from the handle used for insulating spacers!

3. Approach likely sources of used equipment which can be stripped. Repair shops for TV and radio, 2 way radio, and salvage businesses are good prospects. One fellow got the privilege of hauling away the trash from a TV service shop. No one specified that it was all to go to the dump, and you can bet it didn't. He netted a couple of chassis per month in return for an hour's work, and supplied the local demand for power transformers. He could have developed a tremendous stock of resistors if he had wanted to.

4. If absolutely necessary, buy equipment that has many usable parts. The best example of this is the plug-in units from computers that several of the well known mail order houses currently list in their regular catalogs. These have many parts useful in general construction projects such as standard value resistors, terminal strips, etc. One was recently obtained which had an even one hundred diodes plus almost as many resistors for a single dollar bill. Some military surplus is worth purchasing if the price is very low. Auto junk yards will often sell non-operating radios for a buck or so. The transistors or tubes can be worth much more than that, and if the speaker is thrown in, that makes a real bargain. Some of the best hunting can be done at auctions, both radio club and commercial. Unlike taking gifts mentioned above, be discriminating in what you buy. It is not a bargain if you have no use for the parts.

5. Carefully choose assortments to fill in the gaps in your parts supply while you continue growing your own collection. These can often be bought at half what they would cost if purchased individually. The more precisely you know what is in the assortment the more it will cost however. Experience shows that grab bags of a specific part such as capacitors or knobs from well known mail order houses are well worth the money. This is not always true of as-

sortments from smaller places. For example, a pound of resistors from a relatively obscure supplier contained a half pound of 22,000 ohm 2 watters. That value is great, but who needs 75 of them?

6. Avoid the "5 pound surprise box". The surprise is seldom a pleasant one. These are usually made up from odds and ends which can not be sold otherwise. Even so, some guys will gamble. One such assortment contained 2 pounds of packing!

7. Develop a working swap arrangement with other fellows in your area who have a junk box. This can effectively multiply the stock of parts you have to choose from. Be sure to test the parts before the deal is final. This can save a mutually beneficial friendship.

A place you are likely to find people interested in swapping is the local ham club. Fellows who attend are the ones most likely to be active in building. Putting out feelers on local VHF nets is another way to establish contact between builders. A somewhat unexpected source of possible fellow hobbists is the names found on the book cards of people who have recently checked out electronic books from the library.

Now that you have accumulated the equipment with all those useful components in it, let's don't chuck it under the workbench for future reference. Trying to locate a specific relay or capacitor to fit the specs of that article in the latest issue of 73 can be time consuming as well as frustrating. Two words that are a must in the nurture of a junk box are *organize* and *test*.

To organize those goodies, you have to get them off the original chassis. Hand tools, a soldering gun and soldering aid are essential. Unsolder parts whenever possible rather than clipping leads. This is more time consuming, but will save later frustration when looking for a component with leads long enough to reach without having to splice. Often as much as  $\frac{3}{4}$  inch of wire is wrapped around the terminals. Such items as sockets, relays, and terminal strips, are then ready to use without requiring cleaning. When there is a long evening while waiting for that next magazine, get out the tools and start stripping.

No sensible person is going to dump all those parts into one big box. Everything from shoe boxes to olive jars has been suggested for separating and storing the parts.

The type container is not as important as having some kind of system. If you can pry loose some savings stamps from the XYL's horde, you might get some of the plastic drawer cabinets which are ideal for smaller components.

Don't stop by just putting the parts into the boxes or you will end up looking thru nineteen shoe boxes to find which one the tube sockets are in. A child's wax crayon or a china marking pencil is a cheap, quick, and easy labeling instrument.

Then we come to the testing. Who wants a basement full of parts that he is not sure are usable? Most experimenters have an ohm meter that will take care of the resistors and inductors. Radio clubs often have test equipment they will loan or rent to members. Many amateurs will test components gratis for a fellow hobbyist if they have the equipment to do so, or have access to it. Drugstore tube testers tend to develop bad socket connections. Since they are not checked very often, they may indicate a fault where there is none. If you must use

them, be very cautious in disposing of "bad" tubes. The bases from octal tubes make excellent cable terminals and don't require expensive sockets either.

This isn't the place to get into testing procedures for they are well covered in other articles. It might be a good investment of your time and horde of parts to use some of them in building test instruments for finding the condition of parts you may acquire in the future.

A word of caution is in order. Do not be in too big a hurry to wreck out everything you get your hands on. Such things as audio amplifiers can be used around the shack for a variety of purposes like conversion to an intercom or a modulator. Radios, especially transistor radios, as well as record players and intercoms can be profitably bartered or sold.

Now you can compete with the best of the scavengers. So start saving your pennies. No, not for snapping up the bargains. You're going to need a bigger shack to store all those junk boxes!

... WØHMK

### A word to radio clubs

Fellows, is your club doing the best job it can to encourage new amateurs in your community? Rate your club . . . . .

1. Does your club have an organized program to invite CB'ers to come to club meetings and get acquainted?
2. Does your club roll out the red carpet for newcomers? Are they introduced around? Do you have a committee whose responsibility it is to see that these fellows are made welcome and who answer their questions for them?
3. Do you have a short technical session before or as part of each club meeting? Is this session run by someone who is a good teacher and knows his stuff?
4. Do you have a code practice class run by your club?
5. Does everyone in your club feel wanted and welcome or is there a small clique trying to keep out the Novices and unlicensed fellows?
6. Do long business meetings make your club dull for newcomers?
7. Do you have a refreshment session at the end of a meeting to allow everyone a chance to chew the rag?

8. Do members with technical questions and problems have anyone they can call or turn to for help?

9. Does your club help members to put up beams, towers, and other operations where a group is needed?

10. Does your club have a local VHF channel where members can call in for assistance or information?

Count ten points for each unequivocal yes, less for yes, buts.

The newcomer to amateur radio has a hard row to hoe and it is up to the rest of us to make this path as simple to follow as possible. The Novice license is easy to get, but right at this point the Novice needs help badly if he is not going to waste a lot of money buying equipment which is going to frustrate him. The Novice bands are crowded and are no place for junky gear. You need good receivers and rigs to get any enjoyment out of these busy bands. A poor receiver will end one contact after another due to QRM. This can completely discourage just about anyone. It is no wonder we lose so many Novices each year. The wonder is that as many get through this baptism of QRM as do.

... W2NSD/1



# Can't swing a beam?

Here's the best  
solution  
under the sun.

If you haven't the room or the cash to swing a beam (or if your wife doesn't appreciate the beam's beauty), how can you still get on the air? With a Hy-Gain 14AVQ, the most popular vertical under the sun. And what about versatility? A Hy-Gain 14AVQ goes along on virtually every "DX-pedition."

Hy-Gain 14AVQ is constructed of high-grade heat-treated aluminum and uses high impact polystyrene. No need to worry about rust and deterioration common in others using cadmium plated steel.

This vertical develops an extremely low-angle radiation pattern that insures a powerful signal for short hauls and DX. You get low VSWR across all bands plus the ability to adjust (and easily re-adjust) for peak performance at any specific frequency. "Hy-Q" low loss traps are individually precision tuned to frequency giving a true resonance on each band. It's the only trap vertical at DC ground, resulting in less static and lightning problems.

If you already have a Hy-Gain 14AVQ, why not buy another one and phase 'em? When you do, you'll get the signal directivity of a beam without a tower or rotor and escape the worry of wind and ice damage.

Buy your 14AVQ from one of the best distributors under the sun — those who stock Hy-Gain. Hy-Gain Electronics Corporation, N.E. Highway 6, Lincoln, Nebraska 68501, Dept. AC-12.



# Hy-Gain 14AVQ

HY-GAIN ANTENNAS, FOR THE MOST POWERFUL SIGNAL UNDER THE SUN

Dr. Louis E. Persons W4PJG  
P.O. Box 1647  
Ft. Myers, Fla. 33902

# How to Plan Your Own DXpedition

A DXpedition to the Cayman Islands by K4CAH,  
W4KET, W4PJG, and WA4WIP

First look for some rare or semi-rare country with an exotic call that is easily accessible. We looked in the Caribbean area. Navassa was out of the picture, the VP2's were available, but had really been worked over during the past year. We tried to obtain a VP7 license but were unsuccessful. So Grand Cayman Island was what we were looking for. A new exotic prefix of ZF1 was recently assigned, having been changed from VP5. This, in fact, caused us some trouble. Many stations not finding ZF listed in their "late" 1950 call book, openly accused us on the air of being pirates.

Nice hotels on beautiful beaches were available, that would cooperate with a bunch of hams and their strange array of equipment. And most of all, after completing an application form along with \$14 U.S. funds, two months of waiting, and some help by the country's only active permanent amateur, Frank Scotland, ZF1GC, the call of ZF1EP was issued.

So! We had our country and our license. Let's throw our toothbrush in our pocket (Ernie, K4CAH being a dentist insisted on this) and put our sunglasses on for the Caribbean sun (Lou, W4PJG, an optometrist,

demanding this) and be off—we thought. We soon found that there was just a little more to planning the trip. Questions, such as the following had to be answered: what equipment to take, linears or not, what type of antennas, what to support the antennas, was there commercial power available, how many stations to operate, how long a power cable to take, how much coax, ground rods, spare tubes and parts, test meters, does the plane fly into the island on the day we must go, do we need passports, inoculations, etc. etc.

It was immediately seen that it would take several weeks to answer all of these questions. But we were determined to plan every detail in advance, even to assembling all gear and timing how long it would take to set up two stations with the color coded antennas, and be on the air. This advance assembly and trial paid off in an operation with no problems at all—a rare experience.

So we now have the country and the license along with some basic travel information, we knew we could get there.

In our case, Grand Cayman, British West Indies, is located 150 miles south of Cuba, 180 miles northwest of Jamaica, and about 600 miles from our home in Florida. It is easily reached by direct flights from Miami three days a week by LACSA Airlines. LACSA is a Costa Rican airline that serves that part of the Caribbean. The food and drinks served on this airline is superior to any we have ever experienced.

A U. S. passport is a must for any serious U.S. DXpeditioner. A passport is obtained by taking your birth certificate and two recent "passport size" photographs to your county clerk's office along with \$9.00. It usually takes two weeks for it to be mailed to you. A recent small-pox vaccination form, verified by U. S. Health Dept., is also required to re-



ZF1EP DXpedition. QSL card. The shack in the background shows the hardships the boys had to put up with.



Our shopping bags each contained a TR-4 or power supply. All other gear and antenna in the long package.

enter the U. S. after visiting the Cayman Islands and many other areas. It is of course wise to keep-up other appropriate inoculations such as tetanus, typhoid, etc.

We found by inquiring through the tourist bureau of Grand Cayman that several excellent small hotels were available on the island. The next step was to contact a hotel there and explain what we wanted to do as to erecting antennas etc., and make the reservations. Our choice was the Beach Club Colony Hotel which proved to be in excellent choice in accommodations, cooperation and fine meals. We then made our airline reservations. We were told that 24 hour commercial power was available on the Beach Club Hotel part of the island. This was a relief to find that we did not have to take, or to arrange for, generating equipment and gas. It remained to be seen however, that the voltage never did exceed 100 volts and most of the time was around 95. An autotransformer would have helped. Next on our list was the equipment and antennas. Since commercial power was available, we would only be limited in equipment by the amount of excess baggage charges we wished to pay on the airline. We were allowed 60 pounds apiece or with four of us going, a total of 240 pounds of baggage. If we exceeded this the cost would be 25 cents per pound.

Negotiations were made with the R. L. Drake Company to supply us with two complete stations consisting of the DRAKE TR-4 Transceiver and the RV-4 Remote VFO with the power supplies. This is truly the ideal DX rig. The remote VFO enables one to work different frequencies, with the choice of transmit or receive on either frequency at the flip of a switch. The TR-4 runs 300 watts PEP which we felt was ample power without paying the excess baggage cost

which would be necessary if we took linears for higher power. More on this power factor later.

Probably the biggest decision to make was on the type of antennas to take with us. Again we wished to keep the weight down and this time also the size of the packages. We, of course, wanted the most gain possible for the least size. The discussion of which was best as far as weight, size, and efficiency was whether it would be better to take low power with a high gain antenna or high power with a low gain antenna, assuming that we did not want to take both the linear and the beam antenna. The decision as to taking the beam really also depends on what is going to be taken to support the beam. Then the question of a rotator came into the picture. Gus, Don, and others have shown that the easiest antenna to carry is the HY-GAIN Vertical variety. As we planned to operate all bands 80 thru 10 the HI-GAIN 18AVQ vertical was at once chosen for one antenna as it covers all these bands. The HY-GAIN TH-3 MK11 three element 10, 15, 20 meter beam was at last chosen for the other antenna. It was at first thought that the regular TV type three section 30 foot pushup masts with guys would be taken to support the beam, but it was later decided to take the type mast with 6 pieces of 5 foot interlocking steel tubing. The cost, unassembled length, and weight being less on the latter. The mast is a dispensable item for the return trip to save weight, if you like. Ample wire was also taken to make up coax fed dipoles if the need arose, and it did, due to the need to operate one rig on the 18AVQ on 40, and a dipole for the other rig on 80. Three lengths of coax were taken for each antenna, along with the necessary insulators and guy wire.

With all equipment on hand both stations were set up at the home QTH of Ernie, K4CAH. The antennas were carefully measured and assembled. As each section was tightened, the joint was sprayed with a can of spray paint so it would not be necessary to ever measure again on reassemble, just line up the paint lines. The sections of the vertical were numbered with a marking pen starting with number one at the base. In the case of the beam, each element was sprayed a different color on the joints for easy recognition of elements. A word to the wise here—DO NOT tighten down on the compression clamps too much if you ever expect to take

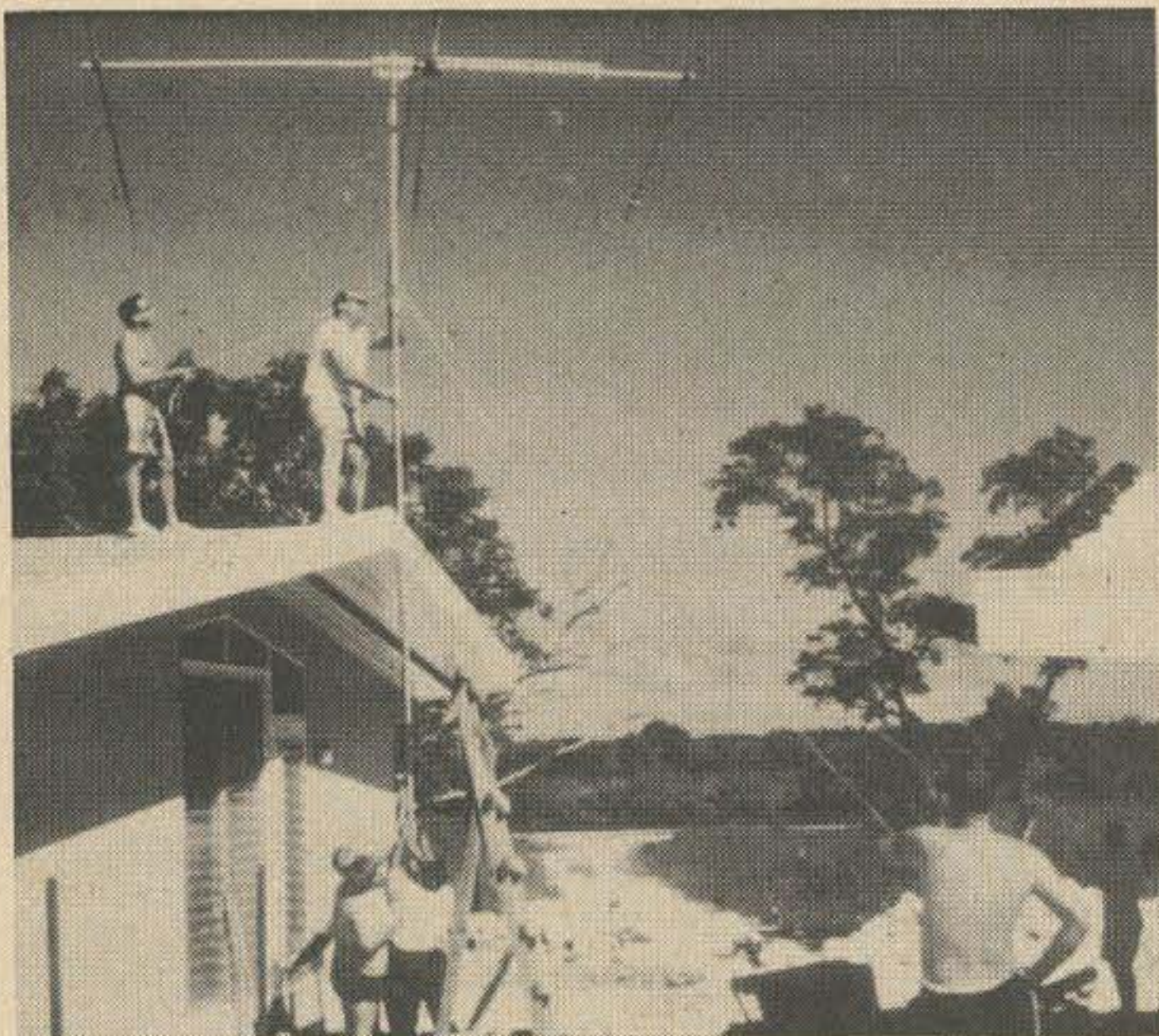

A Beam is a lot more trouble to erect and keep up, but the extra gain may be worth the effort. apart and reassemble the antennas again with ease. Just tighten enough to hold. Once the HY-GAIN 18AVQ vertical has been pre-assembled in this manner, it can be unpacked and on the air in ten minutes. Other miscellaneous equipment included two microphones for VOX or push to talk, keys, W4KET took his TO-Keyer, spare tubes, diodes for the power supplies, fuses (which we almost forgot), small multi-test meter, headphones, ground rods, ground wire, ac extension cords, heavy hammer to drive ground rods, and other items for personal comfort such as insect repellent and sun tan lotions.

It is interesting to note that the above equipment weighed 120 pounds and the package of antennas, ground rods, mast and coax weighed 117 pounds. It is also interesting to remember that airlines very carefully weigh all baggage and charge accordingly for any excess weight, but many times they do not take the time to weigh the contents of shopping bags or hand-held articles if these are not spotted by them until you are going through the gate to board the plane. Needless to say, the four of us were carrying "small" shopping bags with a Drake TR-4, RV-4, or power supply in each as we boarded the plane. As our checked baggage was "light" we paid no extra charges.

The flight from Miami was a pleasant one passing directly over Havana and the Bay of Pigs, Cuba. We were content to just observe the country side rather than attempt a DXpedition to that country.

We were met at the Grand Cayman Airport by Frank Scotland, ZFIGC, who stood by patiently as we made sure that our an-

tennas were unloaded from the plane and as we passed through customs with no problems. We later visited Frank's shack where he owns and operates the power plant for the other end of the island from where we were staying. Frank may be found every night on 3915 SSB, and occasionally on 15 and 20 where he gives many their first ZF. Frank gave a helping hand many times during our stay. He was typical of the people on the island—the most friendly people in the world. The language is entirely English but with a slightly different accent from our own.

Our vertical was set up outside our cottage on the white sand of the beach only a short distance from the beautiful green-blue Caribbean water. Dick, WA4WIP, insisted on keeping the ground system around the base of the 18AVQ vertical well watered down with the salt water for a good ground. Apparently it paid off too. Our first contact from ZF1EP was on 15 meters to W8GCE followed by K7AQB, K8VCT, W8HIZ, K9URA, W5HWB all with 59 reports. On 20 meters the first QSO was with W4NPT, followed by W1BA, G3LGW, WA3EEK/3, W4NJF, WA1FOJ, all 59 reports. So we were "getting out".

Some interesting DX worked the first day on CW was YU1EXY, UB5KAA, LZ1KPG, SP8AJT, VK4AY, OK3UL, HA3GF, OK1HA.

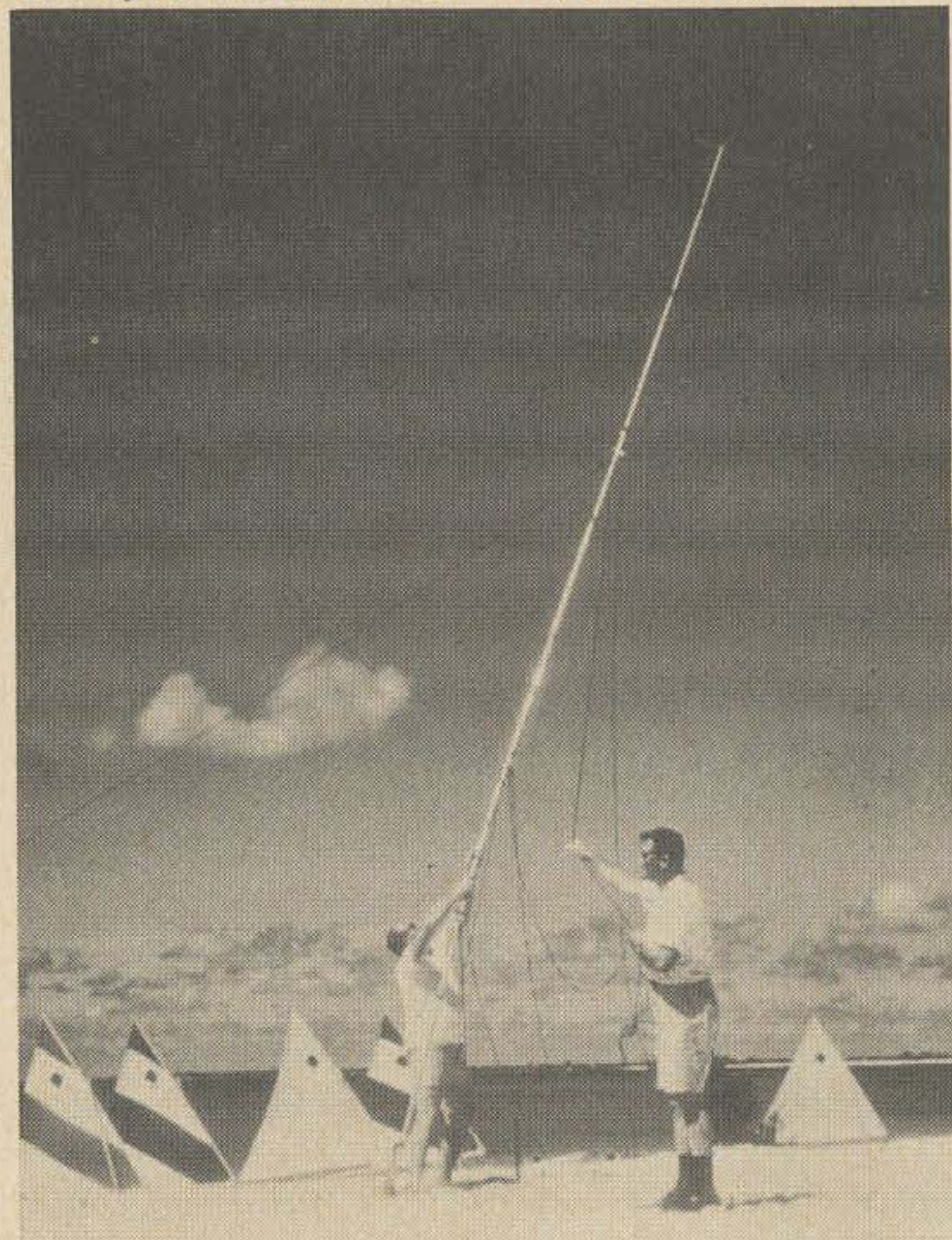

A pre-marked 18AVQ vertical can be unpacked and on the air in ten minutes.

We were pleasantly surprised at the continuous "pile-up" on us during our 4 day stay on the island. We worked 5000 stations during our stay and we were well initiated into rapid operating techniques. During some one-hour operating stretches, over 165 QSO's were made, at times, one contact every 17 seconds. Ten meter pile-ups were the heaviest of all! The speed of operating never seemed to depend on the operator but rather who he was working and the conditions. The courtesy of all of the hams was really great. If we heard a weak station and had only one or two letters of his call the rest of the pile-up would stand by when asked. We were, of course, interested in making a fairly good score in the CQ WW DX Phone contest during our stay as well as giving many a "new country".

It was late at night, when conditions were poor, that we wished for a linear to compete with the South American stations with the higher power and a better multiplier advantage in the contest scoring. Some of the late night DX we did work on 40 SSB was VQ9AA/D Don, CT2YA, UA9DT, YO9CN, and others. Our power output was slightly reduced at night due to the line voltage dropping to as low as 80 volts, but the Drake TR-4s continued to perform even though the power supplies did get a little warm. The results with the vertical were really amazing, at times tests were made in which it equalled the signal of the 3 element beam. It is difficult to compare two antennas unless they are both operating under optimum similar conditions. The vertical was used with an excellent ground system out in the clear on the wet salty beach. The height of the beam was limited and close to the buildings. But these were typical conditions. If you compare the trouble of getting a 3 element beam up in the air, rotating it, and keeping it up in the air to the ease of erecting the vertical you will pick the vertical every time. But then again, how about that extra gain of the beam under poor conditions? If you are activating a rare country, the rest of the world will look for your signal, weak or strong. But if you are also interested in scoring in a contest, the big signal helps. Sunday afternoon came too quickly for us as we had to shut the rigs down to catch our return plane or else remain on the island 4 extra days to wait for the next plane. We had to lose 5 hours of "prime" operating time in the contest because of this, or as Dick,

WA4WIP put it, lose 600 QSO's . . . . .

Upon arriving back home we found the second phase of a DXpedition, the QSLing with 200 QSL's the first day. The mail brought several dozen a day for the first month. Now several months later we are still receiving one or two a day. All of those who sent a Self-Addressed-Stamped-Envelope along with their card were answered as soon as received after the cards were printed. Those who did *not* send a SASE, well, lots of luck, don't be in any hurry for your ZF1EP QSL as they will go by the QSL Bureaus. To those who think DXpeditions make money from all of the contributions sent with the QSL, forget it. Out of the first 1000 cards received, the contributions totaled \$10.00. To those 1% we send our sincere thanks as it did help pay for the QSL cards.

In conclusion, a well planned DXpedition, with good equipment, can be a very enjoyable experience. This group is already planning for another trip to another country in the next few months. We hope it might be a "new one" for you. So that others might get the DXpedition "bug" and activate countries that *we* need, we dedicate this article.

. . . W4PJK

## USED MODEL 501 TV CAMERAS



**\$160.00 FOB Hollis**

Each month we have a limited number of used TV cameras which we make available to hams at greatly reduced prices. These cameras were rented out for temporary surveillance jobs on construction sites, county fairs, conventions, etc. All have been checked out and are guaranteed for 90 days. Complete with vidicon and lens.

**Used Model 501 sale priced  
\$160.00 FOB Hollis**

Don't delay. Only a few used cameras are available each month. For specifications send for our illustrated catalog.

**VANGUARD LABS**

Dept. H, 196-23 Jamaica Ave., Hollis, N.Y. 11423

## How is your Club Paper? Good or Bad?

There are two categories in which papers can be classified. Either they are good or bad. Bad papers have no business to be published as they serve no definite purpose. If your club paper depends on gossip, bits of wit or other nonsense to fill space, your club would be better off ceasing publication.

The reason for having a good paper is to furnish the membership informative news, technical information, projects and activities so that it can be a good communication link for the club membership. Very frequently papers of this type help to interest new members for your club.

Club papers should be planned like a good magazine or newspaper. It must have a set format, good composition, interesting material, appeal and appearance. Many editors of amateur radio club papers follow such planning and turn out excellent papers. These editors lay the ground work of their next edition at least two weeks or more ahead of publications. This gives them plenty of time to turn out a paper which is interesting and a credit to their club. There is plenty of material that an editor can have ready ahead of "deadline" so that he will not be pinched for time when publication date arrives.

Formats can be a credit to a publication and can be the difference between a successful publication or one on the skids. Many ideas can be checked by reviewing some of the national radio and electronics publications and *73 Magazine* is one of them. Formats by these publication editors are well planned and if used by radio club editors it will contribute interest and reader approval by your club membership. Formats need imagination and once you find one, stick to it.

Composition and material are two essential items to be considered with care. Layout of material should not be done in a haphazard way. Each item of interest should be in its proper place. For example, news of

current interest about your club members should be front page copy. Following pages can have announcements of future programs, new F.C.C. regulations, biography of your next guest speaker, editorials, swap lists, auctions and a technical corner. Each column should have a headline to set it apart from the one preceding.

Attractive mastheads are a must. This sets your paper apart from the "run of the mill" publications. Again be original with your ideas, don't copy others. If some member of your club does art work, assign him to the task of designing the masthead. A favorable idea would be to have a contest and to the member turning in the best design, a prize could be awarded. A master stencil could be made of the masthead and used indefinitely. Using a separate color for the masthead adds more zest and imagination here can go the limit.

The printing of a paper has a choice of process. It can be mimeograph, hektograph, offset or letterpress. Using a mimeograph or hektograph process is the cheapest. Many clubs use either of these and have their own machines. In commercial printing, offset is the cheapest; although letter press costs more but has the quality. Letter press is processed by linotype or by hand and, due to labor cost, it is more expensive. Pictures can be reproduced with letter press with excellent results, should you feature them in your club paper. The process for offset printing is by photographing copy of the club paper. It is used by many clubs who wish that professional look. Commercial printing should be given consideration as it adds prestige and in the long run, cheaper than "do-it-yourself" printing.

How can the cost of the printing be raised? There are two angles to consider. First . . . is to increase the membership dues to pay for the cost of printing and the second is to have advertisers take space in your paper. This would take care of the added



expense of commercial printing. Your members can serve as advertising salesmen and a prize can be awarded to the member bringing in the most advertising. Who can be the advertisers? There is no limit to who is a good prospect for advertising. Local amateur radio supply stores, surplus stores, drive-ins, drug stores and many more are good prospects and will advertise for the good will it creates.

Rates for advertising has to be judged by the expense of printing and mailing your paper and the amount of circulation your paper has. A typical budget for figuring your cost and profit is hard to establish as in some sections of the country printing costs are either higher or lower than in your area. As most radio clubs are non-profit organizations, it would be wise to break even. If you have a profit there is usually a tax bite to even things out.

The editorial staff of a paper should be selected by the president. He should appoint a managing editor who possibly has had experience in writing or editing a paper. The managing editor should have full charge of the publication of the paper. He should have as his assistants, a production manager, a technical editor and an advertising manager. The production manager should have the responsibility of getting the paper printed and mailed. The staff should meet once a month, before publication time and plan for the current edition. Each member of the club should act as a reporter and secure news and material for the paper. The managing editor can assign a member for each type of news media, i.e., Civil Defense, member activities, news happenings in the radio amateur world, contests and projects: In plain language, it takes a team to make your club paper a success.

Editorials by the managing editor makes interesting material and if the subjects are timely, it can put spice into the paper. The editor should select subjects which are of interest to the whole membership and avoid out-and-out gossip or witticisms. There are great many subjects which can be discussed about amateur radio or your club, and it is not necessary to list them all here.

It is suggested that the club paper be protected by a notice in each edition stating "This publication or any part of it cannot be reproduced without the permission of the club". This protects your contributors or any material in the paper. Many clubs favor

# NOW!

## IN THE WEST

### Now... 2000 Watts P.E.P.

Full Power/Minimum Size

FOR APARTMENTS • SUBURBAN HOMES

Marine and Portable Operation

Packaged for APO and FPO Shipping

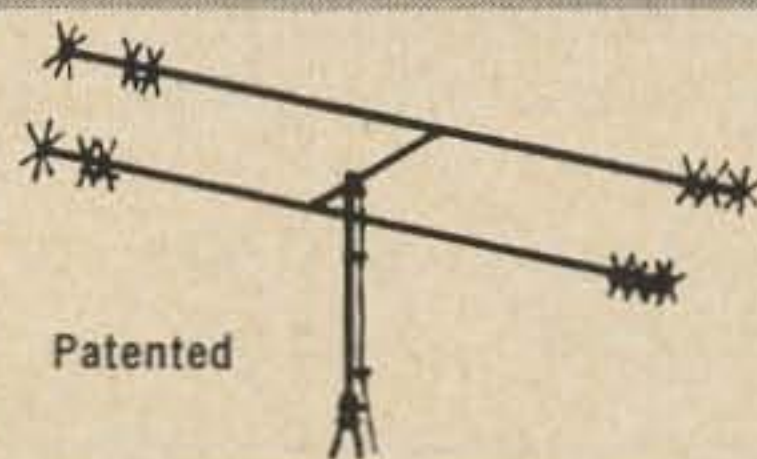

6-10-15-20  
METERS

The time proven B-24 4-Band antenna combines maximum efficiency and compact design to provide an excellent antenna where space is a factor. New end loading for maximum radiation efficiency. No center loading.

Model B-24  
Net \$59.95

Bands	6-10-15-20 Meters
Power Rating	2000 Watts P.E.P.
El. Length	11'
Turn. Radius	7'
Total Weight	11 lbs.
Single Feed Line	52 ohm
SWR at Resonance	1.5 to 1.0 max.

### MULTIBAND COAXIAL ANTENNA for 6-10-15-20 METERS

Needs no ground plane radials. Full electrical 1/2 wave on each band. Excellent quality construction. Mount with inexpensive TV hardware. Patented.

Power Rating	2000 Watts P.E.P.
Total Weight	5 lbs.
Height	11'
Single Feed Line	52 ohm
SWR at Resonance	1.5 to 1.0 max.

Model C4 Net \$34.95



## Free Delivery On "MINI BEAMS" From

# QUEMENT ELECTRONICS

1000 SOUTH BASCOM AVE.  
SAN JOSE, CALIFORNIA

95128

PHONE 294-0464 SINCE 1933

## ME 29/U Test Set

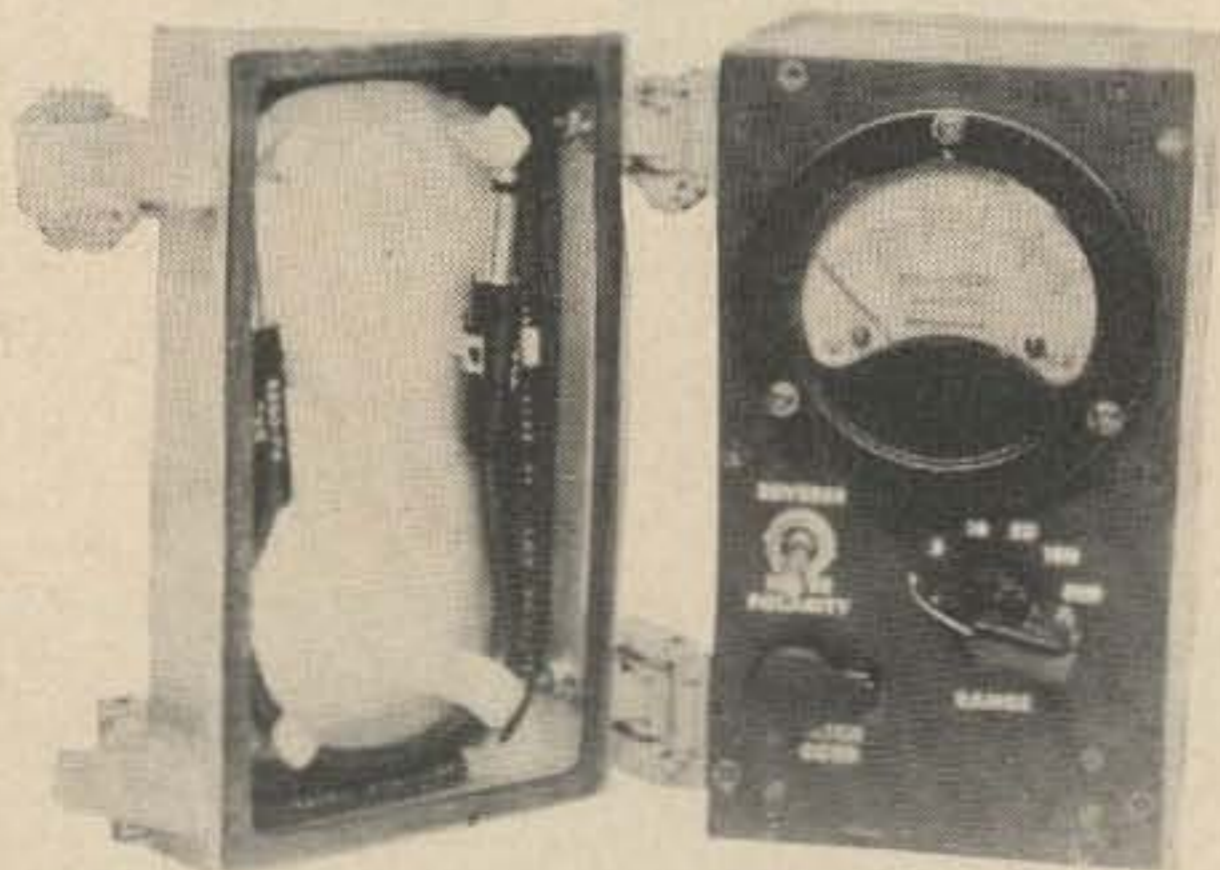

Military gen. purpose DC milliammeter w/range selector switch 1-5-10-100-500 mils. Gray aluminum cased with cover & patch cord. Govt. cost \$95.00

Unused cond. \$10.00

Used good \$6.50

### VARACTOR SIMILAR TO MA4060A

Good for 40 watts at 432 MC, each tested in circuit. W/diagram for 432 MC tripler.

\$5.00 each

### EXPERIMENTAL VARACTOR DIODES

Package of 20 units with experimenters circuit explanation. Pack of 20 \$1.00

RBA-RBB-RBC POWER SUPPLY \$25.00

For 115 volt 60 cycle AC use, brand new in cartons, powers any of the above sets.

Cable with AC plug for above \$4.00

Cable with Rec.-Power supply plugs \$7.50

### 2N706 FACTORY MARKED TRANSISTORS

7/\$1.00

2N697 TRANSISTORS unmarked 15/\$1.00

500 PIV 100 AMP Sil. DIODE \$2.00 ea.

FILAMENT TRANSFORMER \$2.50

115V 60C in, output 5.1 V 14.5 amp  
5.1 V 43 Amps.

12 KV insulated, wgt 25 lbs.

### 866A SOLID STATE TUBE REPLACEMENT

1 year guarantee \$10.00

1968 CATALOG NOW READY 25c

All material FOB Lynn, Mass.

# MESHNA

19 ALLERTON ST., LYNN, MASS. 01904

this practice and in some cases they copyright their paper. All national magazines usually copyright their publications. Look at page 1 of any copy of *73 Magazine* and you will see the copyright notice.

A favorable habit among clubs is to exchange publications. Write to those clubs whom you feel have successful ones, offering to exchange yours for theirs. Reading these will give you an idea of their activities and projects, and may help your club to plan along the same lines. Another good idea for interchange between clubs is to have a column set aside for announcements of "what other clubs are doing". This creates good will and can be beneficial to all concerned.

Another suggestion is to get acquainted with the editors of club papers in your area. Interchange of ideas can be beneficial to all concerned. A state or local editors association can be formed which could meet frequently and discuss ideas to advance the art of publishing good club papers. There are state and local newspaper and magazine editors associations, so why not radio amateur clubpaper editors.

The facts and suggestions in this article are not necessary to carry out to the letter but the fundamentals are worth following if you want a paper which reflects the club it represents. Good papers are popular, bad ones are thrown in the waste-basket.

... K6GKX



Just got the chow call, OM.

# "THE HAM'S HEAVEN"

## CRABTREE'S ELECTRONICS

PRESENTS

### GALAXY V MARK 2

**Hy-gain**

18HT  
HY-TOWER  
Multi-band  
vertical antenna

**\$149.50**



400  
Watts  
Power  
**\$420**

5 BAND TRANSCEIVER

#### WE WANT YOUR BUSINESS

And we are prepared to offer King-Size trade-in allowances on your present gear. Also, we will give you a quote on any package combination you are looking for. The package price in this ad applies to both cash and charge orders.

*Bob Baker*

WA5 BSR/m  
Crabtree's Electronics  
Phone 214-748-5361

**WRITE or CALL For Quotes or  
Trade-in Allowances**

#### \* MONEY SAVING PACKAGE

(DELUXE)

	Reg. Price
GALAXY V Mark 2.....	\$420.00
Hy-Gain — 18HT .....	149.50
AC35 Supply .....	79.95
Standard Console .....	19.95
CAL35 Calibrator .....	19.95
VOX I .....	29.95
50 feet RG8 Coax and Connectors .....	8.50
<b>REGULAR TOTAL .....</b>	<b>\$727.80</b>

#### CRABTREE'S ELECTRONICS

2608 Ross Ave., Dallas, Texas 75201

Please ship me the following:

- Package Advertised — \$639
- Galaxy V Mark 2 — \$420
- Hy-Tower Model 18HT — \$149.50
- Free Catalog with credit form
- Check or Money Order attached

NAME \_\_\_\_\_ CALL \_\_\_\_\_

ADDRESS \_\_\_\_\_

CITY \_\_\_\_\_ STATE \_\_\_\_\_

ZIP \_\_\_\_\_

American Express - BankAmericard - Diners Club

**NOW**

**ALL THIS  
ONLY  
\$639  
COMPLETE**

M. Goldstein VE1ADH  
 9 Edgehill Road  
 Armdale, N. S.  
 Canada

G. Cousins VE1TG  
 RR 2, Box 18  
 Lower Sackville, N. S.  
 Canada

## High Quality Hybrid Receiver

In these days of "commercialized" ham radio, there is such a variety of well designed and readily available equipment on the market as to make a home constructed station almost a thing of the past. This is especially true of the receiver, which has always been considered to be just a little outside the ability of the average home constructor. This view may not be justified, and this article will try to point out a few advantages to be gained by home-brewing a receiver. Let's briefly review the aims of this project:

1. A good SSB and CW receiver, to compare favorably with commercial units in stability, sensitivity, freedom from cross-modulation and overload.
2. Dial tuning should be smooth, with no backlash and no dial cords. Calibration should be very easily read in increments of one kilohertz.
3. Few controls and very simple overall adjustment.
4. Standard components to cut down cost.
5. Construction should require only standard home-workshop tools. Alignment should be accomplished with standard and readily available test equipment.

Throughout the whole concept of this project, the cost factor and ease of construction have been vital considerations as

well as the overall quality of the finished product. To accomplish these features, both old and new receiver circuits were used. Many were obtained from 73, QST, the ARRL Handbook, etc. Some modifications were made to mate all the circuits together, but the best features of each were retained.

The receiver is a combination tube and solid-state design with the basic range being from 3.5 to 4.0 MHz. For other bands, crystal controlled converters are used, so that the receiver can be constructed and other bands added as required. Each converter can be optimized for performance on one band, and each band is designed to cover 500 kHz. No doubt eyes will be looking skeptically at the idea of tubes in this "solid-state" age, but many of us still have a lot of tubes on hand and it seemed pointless not to use them. Neither space nor power drain were problems. Tube types were standardized to reduce both initial requirements and possible spares. Solid-state devices were used in the front end and oscillator circuits in the interests of stability, and of course, could be carried through into other circuits if desired.

Construction was done on two chassis of heavy gauge aluminum to ensure rigidity, good shielding between front end and audio *if* circuits, and also allow part of the receiver to be completed and tested as a

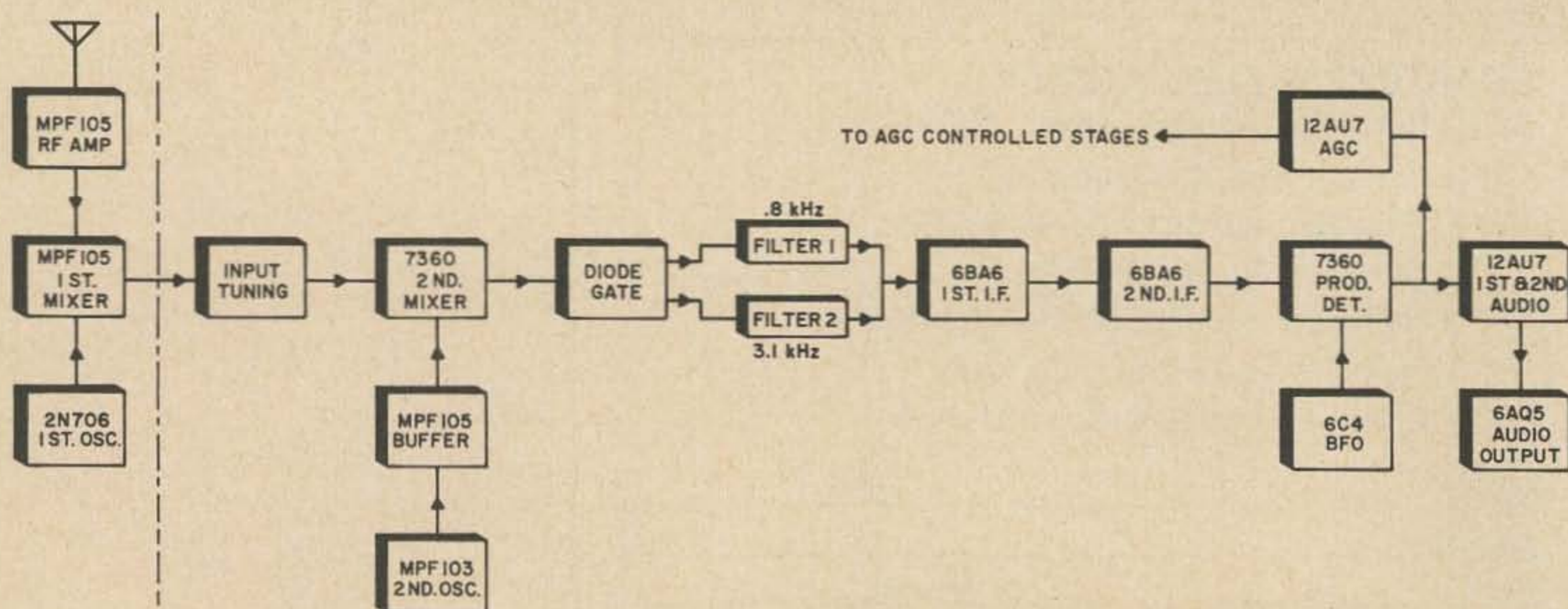
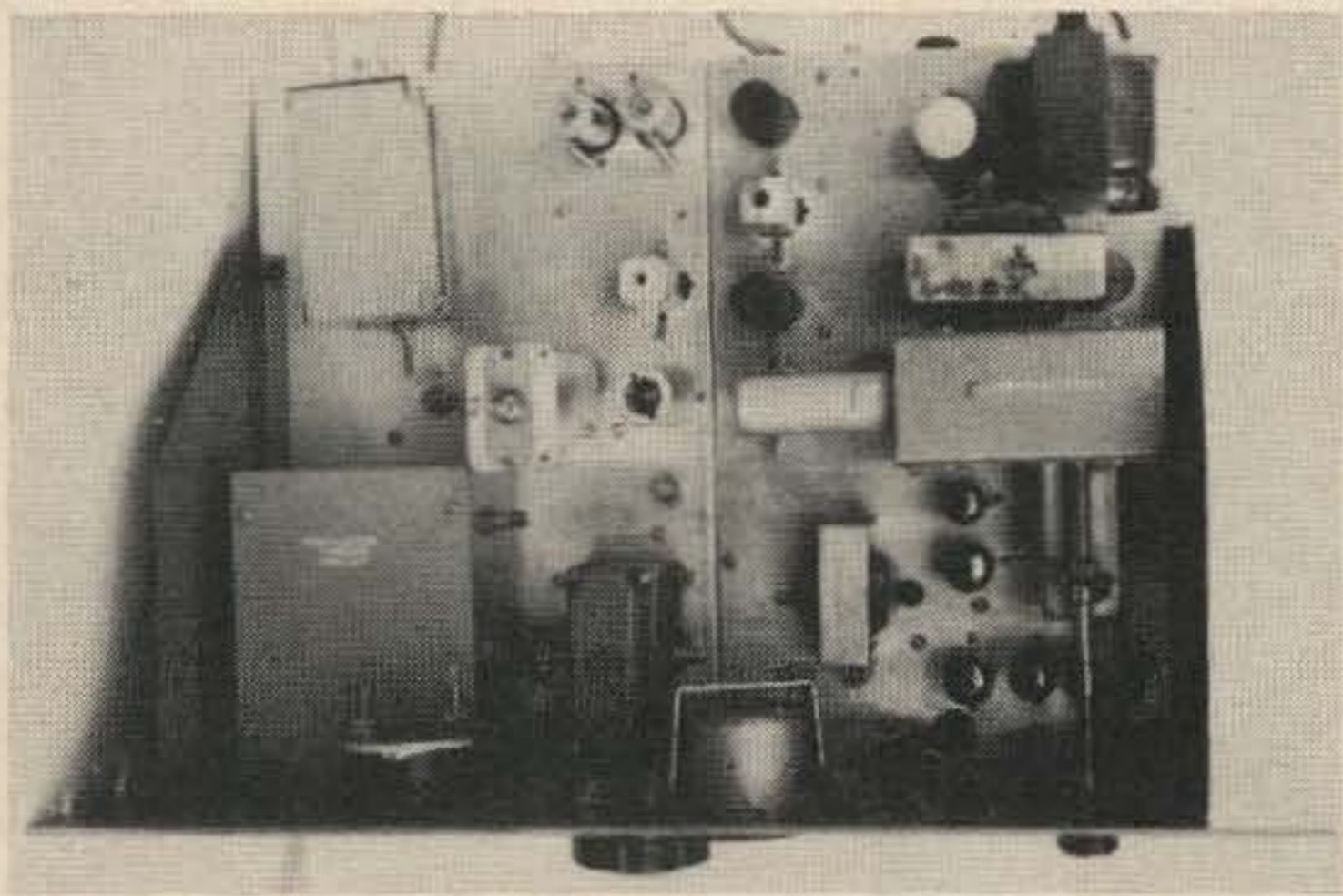

Fig. 1. Receiver block diagram (with plug in converter).



Top view of the receiver. Front-end circuits up to the mechanical filters are on one chassis, and *if*, audio, S-meter, BFO power supply on the other. Mini-boxes contain the oscillator tuned circuit, driven by the National dial, the BFO and product detector, with the BFO tuning shaft extended out to the front panel. A third box is shown plugged in to the converter socket at the rear of the chassis. This is a prototype 20 meter converter, but similar units could be plugged in for any band.

separate unit. In fact, the audio, *if* AGC, S-meter, BFO and product detector circuits could be built as a project in themselves and added to a less expensive receiver to bring it up to higher standards. The audio-derived AGC and variable BFO are especially useful for SSB and CW operation and could be built into a small sub-unit and installed in the present station receiver. Front panel controls are kept to a minimum. Separate gain controls are used for *if* and audio, and also front panel control of the BFO over a frequency range of plus and minus 2 kHz of the 455 kHz *if*. For the main frequency dial, the National NPW dial and drive mechanism was chosen. It provides smooth operation and slow tuning rate, but should first be lubricated with silicon grease. This leaves a thin film on the gears even after extensive use.

Using 000 on the dial as the low end of the band (3.5 for example, 010 indicates 3.510, 020 is 3.520, etc. Admittedly some little effort is required to achieve this tracking, but the result is well worthwhile. This eliminates the need for any other form of dial markings and gives a clear readout of one kHz per division.

The three-inch deep chassis gives plenty of room for neat construction. Liberal use of tie-point strips ensures firm mounting of components. Instead of lacing the cabling, small nylon loop clamps were used. This makes it easy to change the wiring or install

modifications. Every effort was made to keep the wiring and components "in the open" to facilitate servicing.

The receiver was built from the rear end forward, so that the power supply could be used to test each circuit as it was built. The photo of the top of the receiver shows the mechanical layout. While not all *that* critical, it's recommended that not too much variation be allowed. The power supply uses silicon rectifiers in a bridge circuit, and supplies both regulated and unregulated B+. There are also voltage take-offs for the transistors and mechanical filter switching diodes.

To obtain regulated voltage for the BFO, a tap on R1 picks off 150 volts which is regulated by the Zener diode CR1. The diode shown is far larger than necessary, but it happened to be available. An alternate way would be to use a miniature regulator tube such as an OA2 or even one of the octal VR150's.

Voltage for the mechanical filter switching diodes is obtained from the 6.3 volt filament transformer, rectified by CR2, and filtered by C1, C2 and R2 to provide a negative voltage output for controlling the diodes.

Positive voltage for the same diode circuit, and for the transistors, is obtained from B+ via R3 and R4, the latter being a 25,000-ohm pot (2 watts), which is adjusted to provide the necessary +12 volts. This pot is a one-time adjustment and is mounted underneath the chassis. A 12-volt Zener diode is connected from the arm of the pot to ground. This regulates the voltage and absorbs any transients.

This receiver has lots of audio, with a two-stage triode voltage amplifier driving a power output stage. Because of the considerable gain in the circuit, care must be taken to separate the grid and plate circuits and to find the best possible arrangement of components. The audio gain control is placed at the input of the amplifier.

The AGC circuit is quite standard and is found in the December 1965 issue of *QST*. The circuit in the *ARRL Handbook* for the past several years will work almost as well, and reference should be made to these sources for full circuit analysis. The S-meter functions whether or not the AGC is on. Because past experience had proven that different AGC rates were seldom used, no provision was made for them. The AGC on/off toggle switch is the only control required on the front panel. The associated *if* stages must

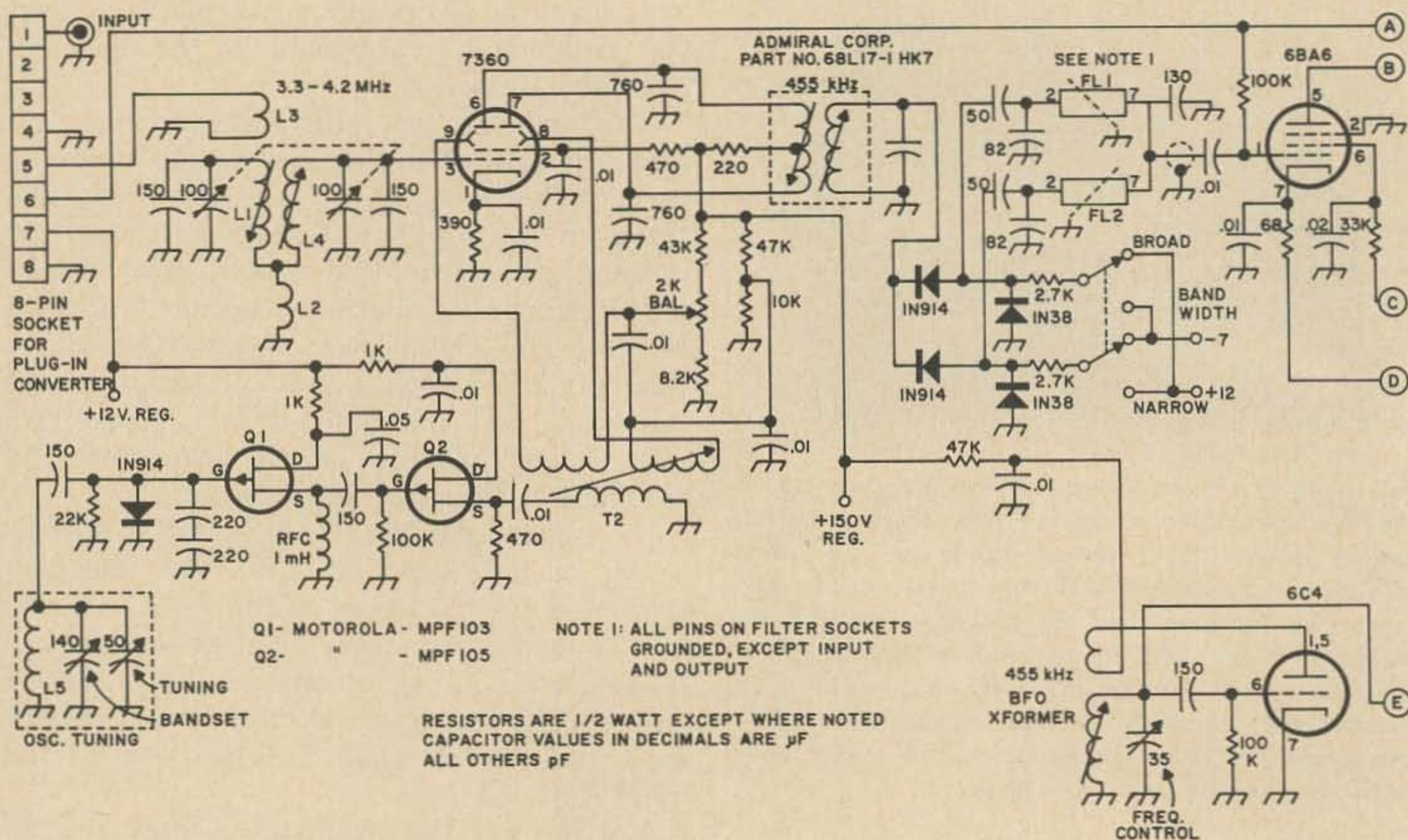

Fig. 2. Front End.

have their grids decoupled from the AGC line with large resistors and bypass capacitors, or even small RF chokes. Shielded wire may also be necessary for the AGC line itself. The S-meter is also adapted from the *ARRL Handbook*, and in this receiver it is not a calibrated function of signal level; it is merely used as a reference indicator. Considering the multitude of ideas about the calibration of S-meters, this is probably just as well. The circuit uses a single 6C4 triode and a milliammeter of one to five milliamps full scale deflection. The adjusting pots are mounted on a small plate under the chassis. To do the initial set-up, pull out the 6C4 and adjust the meter shunt pot for maximum deflection on the meter. Replace the tube, short the AGC to ground, and adjust the 6C4 cathode pot for zero meter reading. Remove the short from the AGC, and the meter will now follow signal variations up to the point where the tube's plate current is cut off.

For solid-state fans, the January 1967 issue of 73 has an excellent article on an equivalent circuit using a field effect transistor. Any other circuit which may be contemplated must have a very high input impedance to not effect the AGC time constant.

The 455 kHz *if* strip uses 6BA6's in two stages of amplification. The main feature

here is gain; the selectivity is determined by the Collins mechanical filters which come before it. An *if* gain control is provided, and short shielded leads should be used for stability. In-line mounting of tubes and *if* transformers ensures a neat wiring job. Good quality shielded transformers should be used. Referring to the photos, notice that the BFO and product detector tubes are mounted sideways and butted up against the side of one *if* transformer. To overcome the problem of changing the tube, the *if* transformer is held in by two screws and has long enough leads to enable it to be unscrewed and tipped over while the tubes are changed. This may not be the best way to do things, but tube

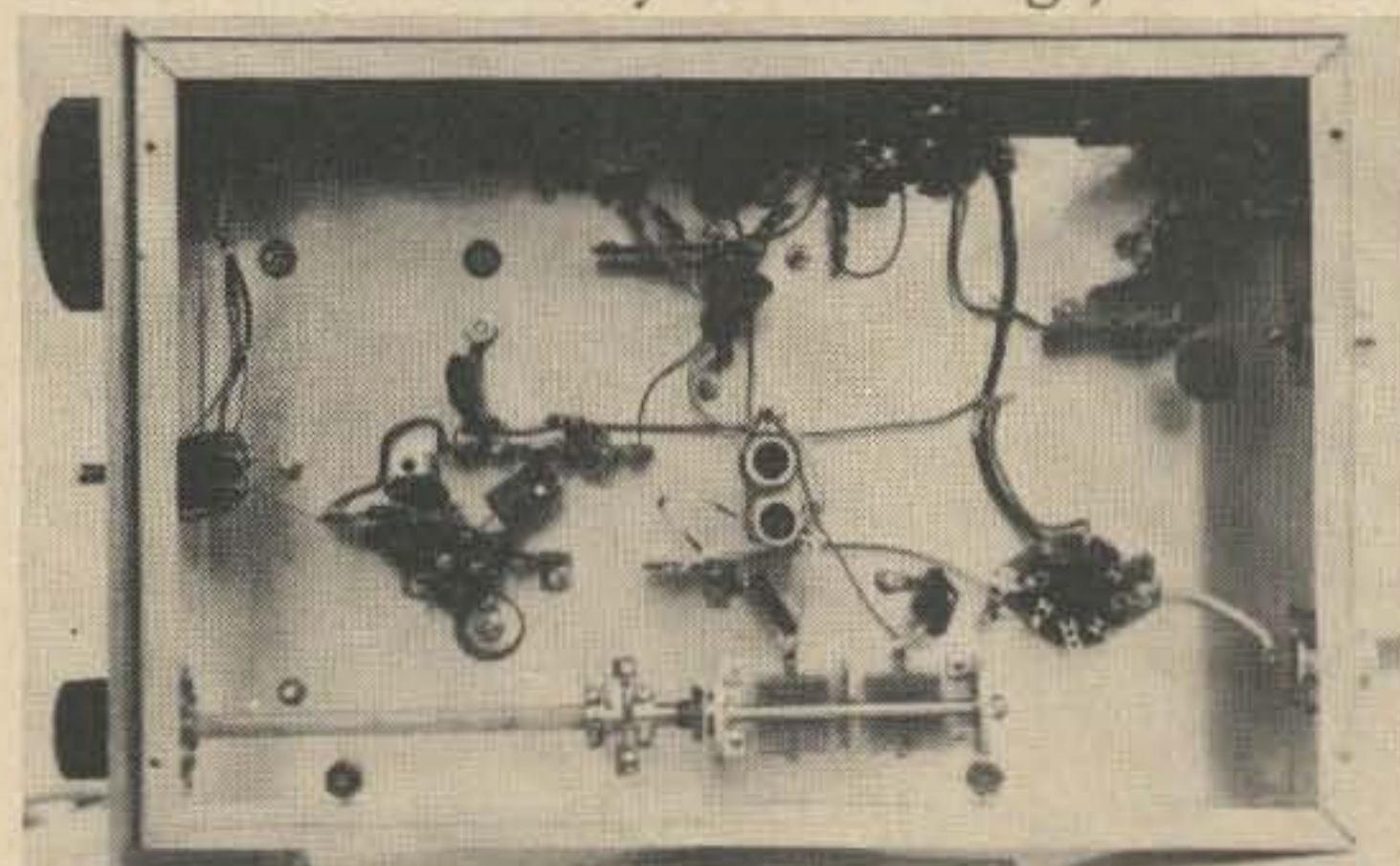

Under chassis view of front-end components. The dual-section input tuning capacitor is coupled to an extension shaft, to keep it physically close to the input transformer. The octal socket is for the plug-in converters.

changing will be rare and the constructional advantages were considerable. Incidentally, the "long enough leads" should only be about 1½ inches or so.

The product detector uses a 7360. Both it and the BFO are built into a small metal box, with the tubes mounted on one side and the BFO transformer on the front. To make the BFO frequency variable, a small tuning capacitor is mounted in the box and the shaft extended out to the front panel. The box prevents any external coupling between the BFO circuit and the *if* strip. It is firmly bolted to the chassis and all leads to it are brought through a grommet-lined hole in the chassis. If a variable BFO is not wanted, a crystal-controlled unit could be used. The circuit must have good sine wave output of at least 10 volts peak-to-peak. A transistor circuit would work just as well. A vernier dial is used on the BFO control to give a slow and precise tuning rate, a necessity for crowded CW conditions and of considerable help in SSB reception.

The selectivity of the receiver is dependent upon the two mechanical filters which have been chosen as 3.1 and .8 kHz for SSB and CW use. The filters plug into miniature 7-pin tube sockets, and small copper shields are

installed directly across the sockets to separate input and output circuits. All pins on the socket are grounded except the input and output. Switching the filters is done by means of silicon diodes.

The mixer circuit is taken from the September 1963 issue of *QST*, and uses a 7360 tube. All supply voltages are regulated and the output is fed through a special coupling transformer to the mechanical filters. The transformer used is an Admiral Corporation part number 68L17-1 HK2.

A pair of Motorola field effect transistors are used in the oscillator. The coil and tuning capacitors are mounted very rigidly in a separate metal box, and all connections made with heavy braid. The capacitors should be very good quality, double-bearing units. Such precautions will pay off with a very stable, low-drift circuit. A second transistor stage provides good isolation between the oscillator and the output to the mixer. The balanced output transformer is home-made, wound on a Millen ½" slug tuned form. Dimensions are given in the coil table. Tests indicate approximately 100 hertz drift during the entire warmup period. Good mechanical stability is indicated by the time-honoured "thump" test.

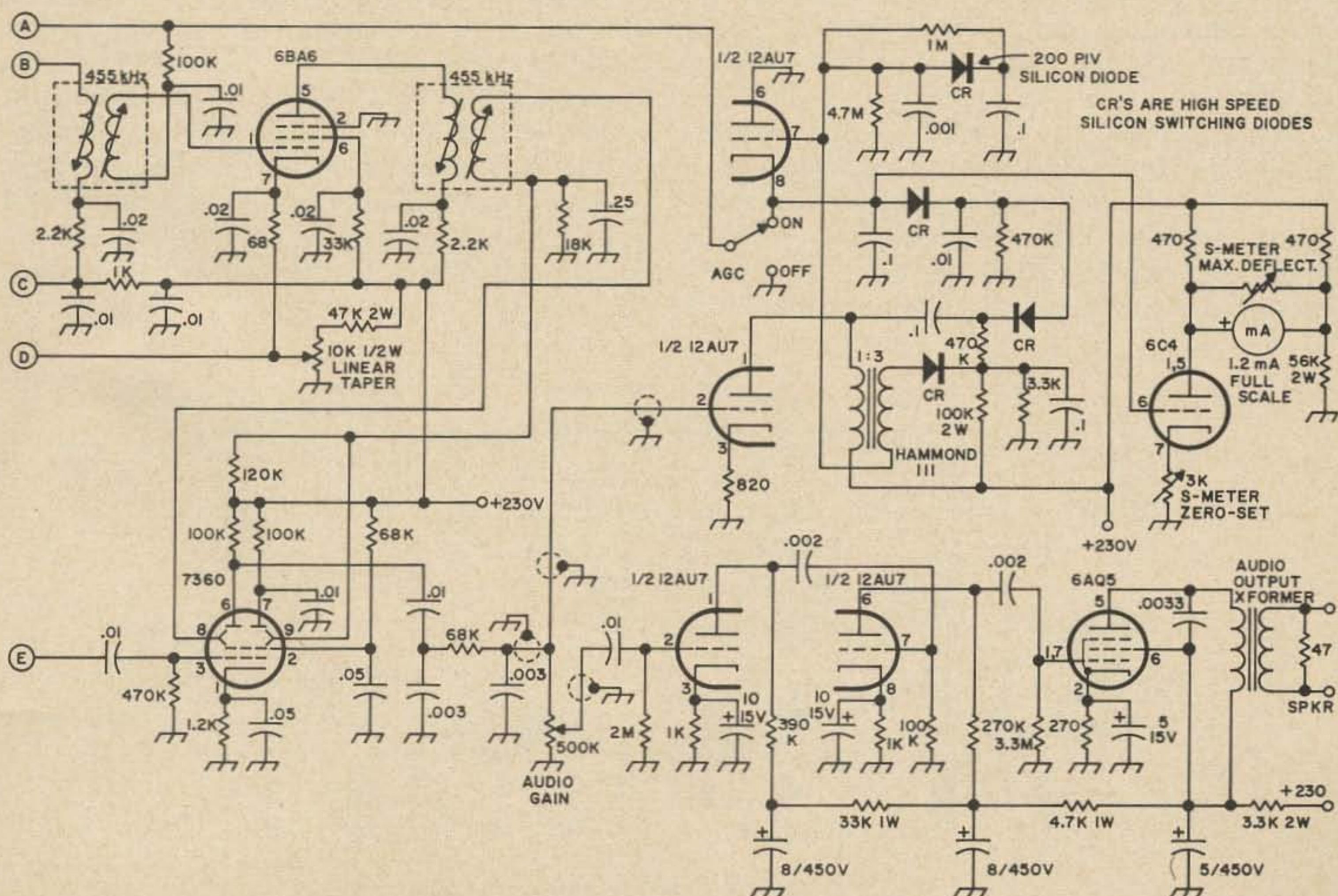
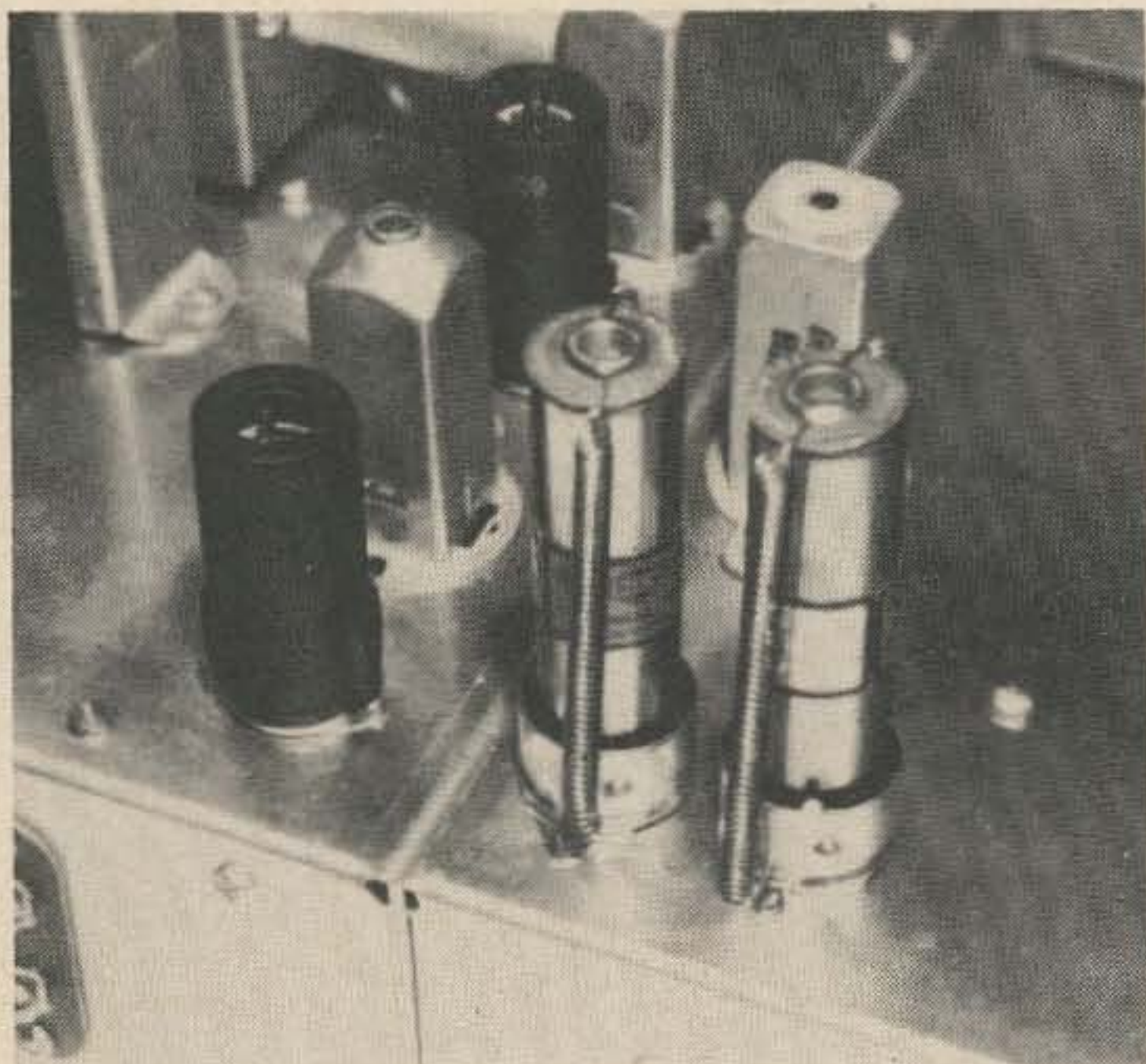

Fig. 3. Complete schematic diagram for the hybrid receiver.



The Collins mechanical filters are shown in their sockets, with spring retaining clamps. The *if* tubes and transformers are immediately to the left of the filters.

Note that there is no rf stage. An octal socket arrangement provides for the use of plug-in converters, and an rf stage can be built on a separate module and plugged into this socket. This will not likely be necessary for good 80 meter reception, of course, the converters will have their own rf stages. To align the receiver, use good test equipment. Items required are a VTVM, an rf Signal generator, and a scope with 5 MHz bandwidth. Do the alignment in the following order:

A. Power supply: Check voltages. B+ should be approximately 230 Vdc. Regulated voltage +150 Vdc. Adjust the positive low voltage to 12 Vdc. The negative low voltage should be approximately 7 Vdc. Test the power supply without the circuits connected

### Coil Table

- L1 30 turns #30 cotton covered wire, on Millen 69046 slug tuned form.
- L2 1½ inches of #18 wire between junction of L1, L4 and ground.
- L3 15 turn link wound on cold end of L1.
- L4 30 turns of #30 cotton covered wire on Millen 69046 slug tuned form.
- L5 17 Turns #18 wire, 7/8 inch long, 1¼ inch diameter. Barker & Williamson 25 watt 40 meter coil with link removed, and 5 turns removed from each end. Inductance 8 microhenries.
- T2 Primary: 60 turns #32 enamelled wire. Secondary: two windings of #32 enamelled wire, 35 turns each, wound over the primary, on Millen 69046 slug tuned form.

to it, and be sure the above voltages are maintained as more circuits are added.

B. Audio section: An audio tone injected at the top of the volume control should be heard without any distortion in the speaker. The S-meter should deflect. Calibrate the S-meter as previously explained. The hum level should be extremely low.

C. *IF* strip: Remove AGC from the strip. Turn the *if* gain control to half position, pull out the first *if* tube, and connect 455 kHz from the signal generator to pin 5 of the first *if* tube socket. Connect the VTVM to the AGC line. Align the last *if* transformer for maximum reading on the VTVM. Replace the first *if* tube. Remove the *if* strip input from the mechanical filter. Inject 455 kHz through a .01 F capacitor to the grid (pin 1) of the first *if* tube. Align the first *if* transformer for maximum on the VTVM. As alignment proceeds, keep the output level of the signal generator as low as possible. Reconnect the AGC line to the *if* strip and remove the VTVM.

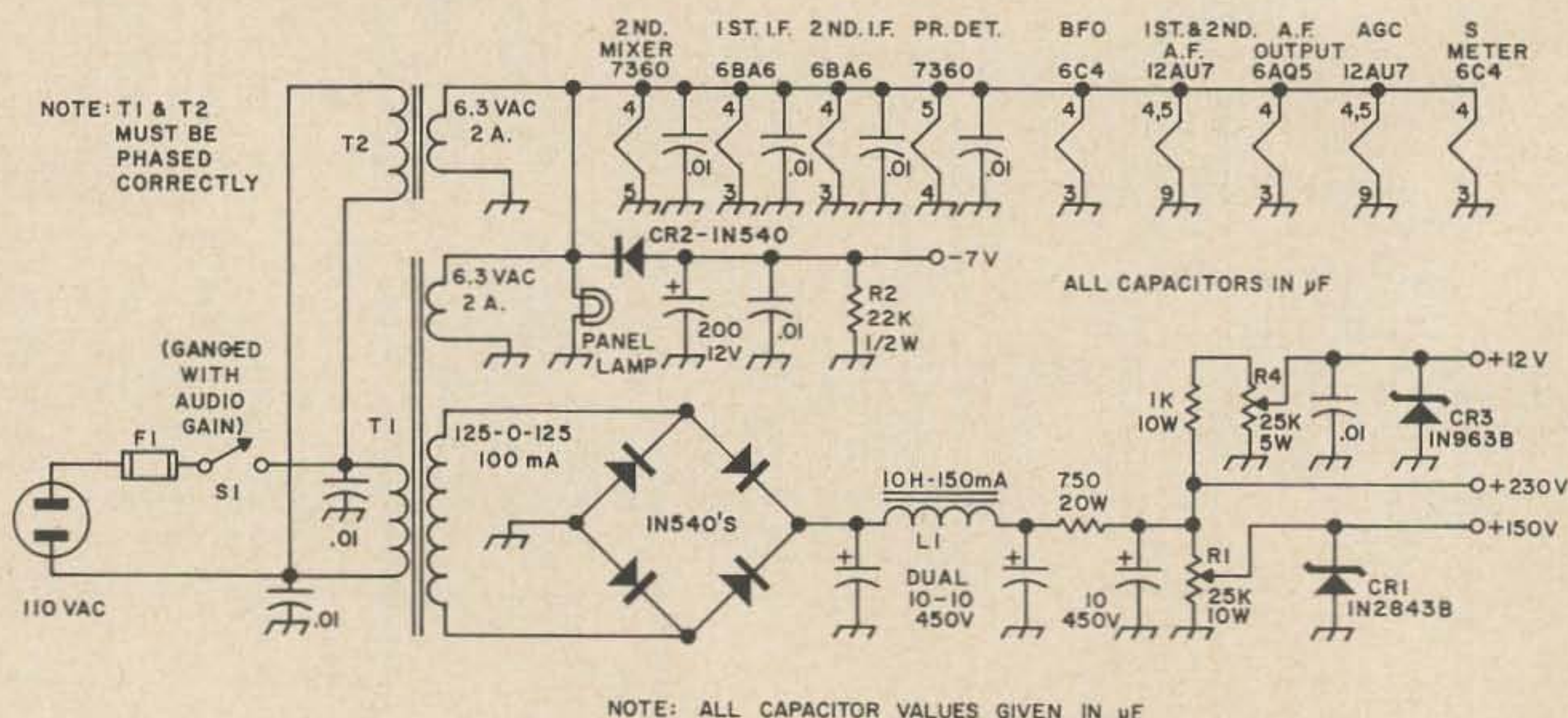
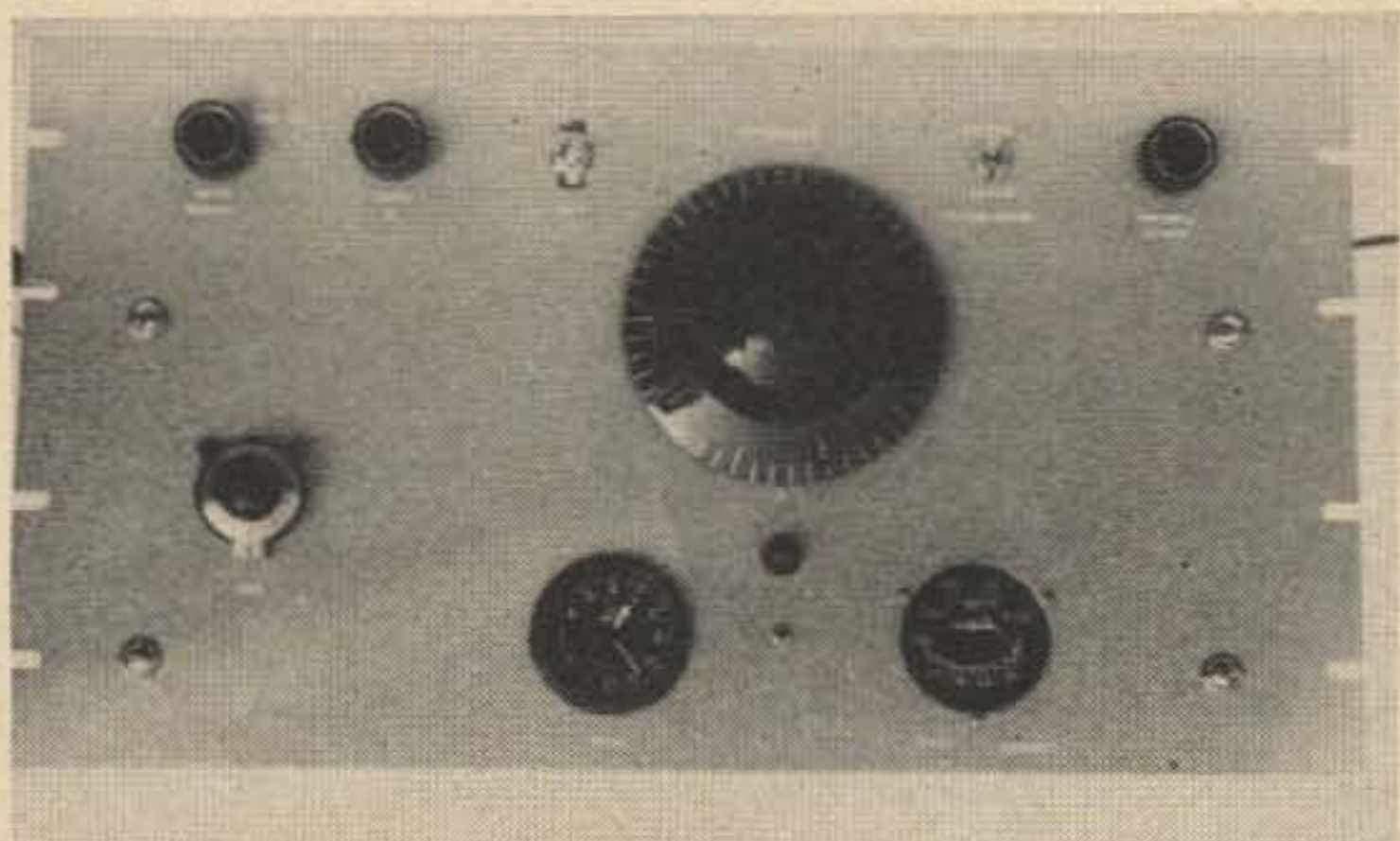

Fig. 4. Power supply for the High Quality Hybrid Receiver





Front view of the completed receiver. Note that controls are kept to a minimum. The S-meter and clock are on opposite sides of the dial illuminating light. A small metal shield normally covers this light and directs the light down to the dial markings. A vernier dial is provided at the right for the BFO tuning capacitor. Bottom controls are: antenna input tuning, mechanical filter selector switch, AGC on/off switch, *if* gain, and audio gain/power on-off. A National NPW dial is used for main tuning.

D. Oscillator, mixer and BFO: Disconnect VFO output transformer from the source-follower transistor. Disconnect pin 3 of the second mixer tube (7360) from its input circuit and ground the grid through a 100,000-ohm resistor. Connect 455 kHz signal to pin 3 via a .01 F capacitor. Adjust the 2000-ohm balance pot for equal voltages on pins 8 and 9 of the 7360. Use the VTVM for this measurement. There will be approximately 35 volts on each pin.

Connect the VTVM to the AGC line. Check that the filter switch circuit is working and the filters themselves are operational. Adjust the 7360 output transformer for maximum reading on the VTVM. Reconnect the VFO output transformer to the transistor. Using the scope, check the source terminals

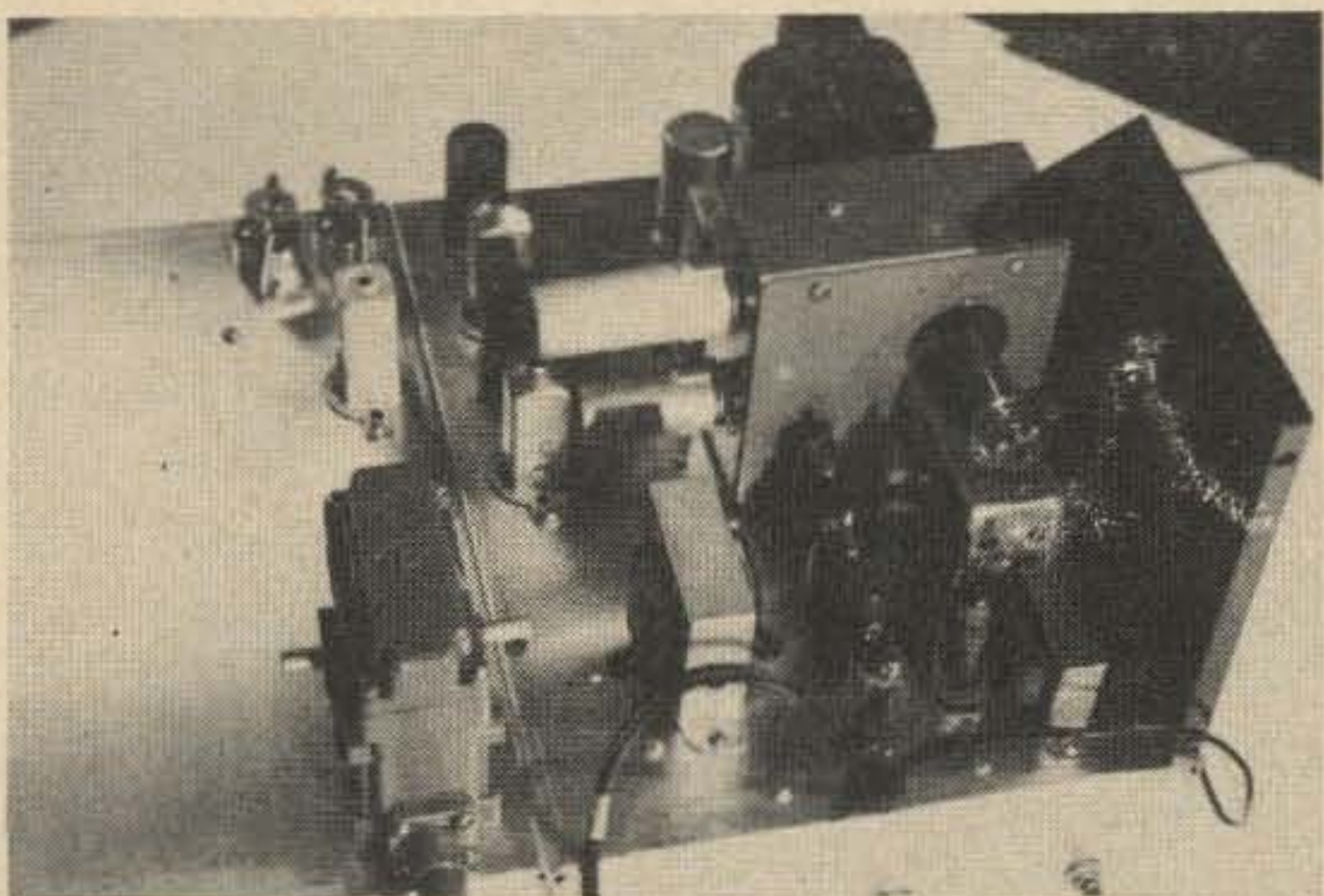

Front panel removed, and the first chassis all mounted and ready for wiring. The mechanical filter sockets are at the rear, behind the dial gear box. The *if* tubes and transformers are in a row along the division between chassis. Audio and S-meter tubes are at the front.

of both transistors for approximately 2 volts peak-to-peak of good sine wave output. With the scope at pins 8 and 9 of the 7360, adjust the VFO output transformer for equal ac voltages on the two pins. This will be about 3 volts peak-to-peak.

At the BFO, adjust the vernier control to put the capacitor at half mesh. Adjust the transformer in the BFO circuit to zero beat on the test signal. Disconnect the 455 kHz input signal from pin 3 of the 7360, remove the 100k resistor from pin 3 to ground, and reconnect the tuning circuit to pin 3. Connect the signal generator to the input of the tuning circuit and set it to 3.6 MHz. Set the receiver dial to 100. Adjust the bandset capacitor for maximum on the VTVM (still connected to the AGC line). The signal should be heard in the speaker. Check the tracking of the receiver over the band. There should be very little error over the whole 80-meter band. Set the dial to 300, and the rf signal to 3.8 MHz. Adjust L1 and L4 for maximum on the VTVM. Remove the VTVM and signal generator.

This completes the alignment of the receiver. Signals should now be heard on the band and the receiver should be performing very well. Take some time to get used to the feel of the control and we think you'll agree the time and effort were well spent.

... VE1TG and VE1ADH



©  
MANN  
TOWNSEND

"How wonderful! I was afraid you might squander your unemployment check on groceries or rent."

Dr. Louis E. Persons, W4PJC  
 P.O. Box 1647  
 Ft. Myers, Fla. 33902

## How to Get Better Returns from Your QSL

To obtain that wanted QSL you must first send your QSL, quickly and accurately. Immediately after the QSO sit down and write out the QSL. In this way you can check and double check on the date and the time in GMT. The *only* time to use is Greenwich Mean Time. If you are not sure of the correct time check WWV. Hams are one of the largest users of WWV, but when one sees the many incorrect times put on QSL's (and logs) it seems all they do is listen to the tick.

It may not seem important to be so accurate, but a rapid DX operator may work 2 or 3 stations a minute. If your time were off 30 minutes on the QSL you might well be 3 or more log sheets off. Your card might be returned marked "not in log". Make sure, if you are changing your local time to GMT time, to change the date also, if necessary. But why not keep the clock in GMT; it will confuse the XYL more. Hi.

The next most important item on the card is the band. Again, if you make the card out after the QSO you can take another look at the bandswitch to make sure. Many stations, in contests particularly, keep the logs by bands.

The mode of transmission is important also as many awards are for Phone, or SSB, or CW separately. The signal report is the next item of information necessary to complete the confirmation of the QSO.

It is unfortunate that there is not a standard form used for QSL design. The easiest design to read quickly is the log form type with all of the printing on one side only. The log form type is made up with a simulated line from the log sheet printed on the card. Everyone is familiar with the standard ARRL log books, so it is only necessary to recopy the line in the log to the QSL card in making out the card accurately. This type QSL may be obtained from World Radio Lab. and others. But whatever form is used, the call letters should appear on the side with the QSO information, so that

constant flipping over of the card is avoided in searching the logs for the contact.

It has been said that a QSL is the final courtesy of a QSO. This is certainly true. QSLing is no burden to the amateur who works several stations a week, or even a day, but think of the station who is working 2 or 3 stations a minute in contest style. He is working in this manner to give as many as possible the chance for a QSO and

ultimately a QSL. QSLing for this station indeed is a chore. It is only right that we should assist this station in his QSL task in some manner. The usual considerate way is to send along with your card a Self-addressed-stamped-envelope. The SASE saves most of the work for the station in not having to address an envelope or card, and also the postage involved. If postage for that country is not available or obtained from W2SAW, then the correct number of International Reply Coupons (as given in the Call Book) are sent along with the addressed envelope.

Also, it is not asking too much to enclose a small donation to help cover the cost of the card or the gas for the generator in the case of a DXpedition station. Those

who go on DXpedition do so for several reasons. First, the enjoyment of travel and operating as rare DX. Second, to give the contacts to those who need them. The QSL is a necessary evil arising from the second reason. One on a DXpedition never expects to make any money on the trip or to even have his travel expenses paid. But somehow those who want the QSL's should assume some small expense involved. The cost of printing a decent special or picture QSL to do a DXpedition justice is around \$20 per thousand and much more in other countries. It is certainly not asking too much to enclose along with the SASE a small contribution to help cover this expense, anywhere from a dime to a dollar is appropriate. While some hams revolt at the thought of "paying for a QSL" these individuals think nothing of paying to enjoy their other hobbies such as the green fee to play golf, the bait boat, gas, etc. for fishing, the film for their camera for photography and the cost of stamps for their stamp collection. QSLing is just one of the small expenses in enjoying the greatest hobby of them all, Amateur Radio.

When working a station ask him where

to QSL or if he is working contest style, listen and he will announce every few minutes QSL information. If he announces the call letters only of the QSL manager or perhaps his home call be sure you have it correct. Then be sure that you look up the QTH in a *recent* Callbook. Recent is one dated the current year. If you do not have one which is recent, borrow one from someone else or look for the correct QTH in one of the magazines. The envelope with the QSL, SASE, and the contribution should be mailed by Air Mail if going out of the country. There are many other secrets used to obtain QSL's such as writing a letter to the station, along with your card in his native language, enclosing pictures, commemorative stamps, and even to sending him a QSL already made out to you just waiting for his signature. Blank cards can be obtained for this purpose.

While the above mentioned procedures may seem elementary to many readers, all QSL managers will agree that most of them are violated daily on cards received. Take pride in your QSL and QSLing procedure and your results will be pleasing.

... W4PJC

# HEY! HOW ABOUT THAT

## S.W.R. BRIDGE

- MODEL SWB-2
- READS FORWARD AND REFLECTED POWER SIMULTANEOUSLY
- "EASY READ" METERS
- USE FOR REFERENCE POWER METER
- DUAL 100-MICROAMP METER MOVEMENTS
- LOW INSERTION LOSS
- SIZE-5"X2"X2"

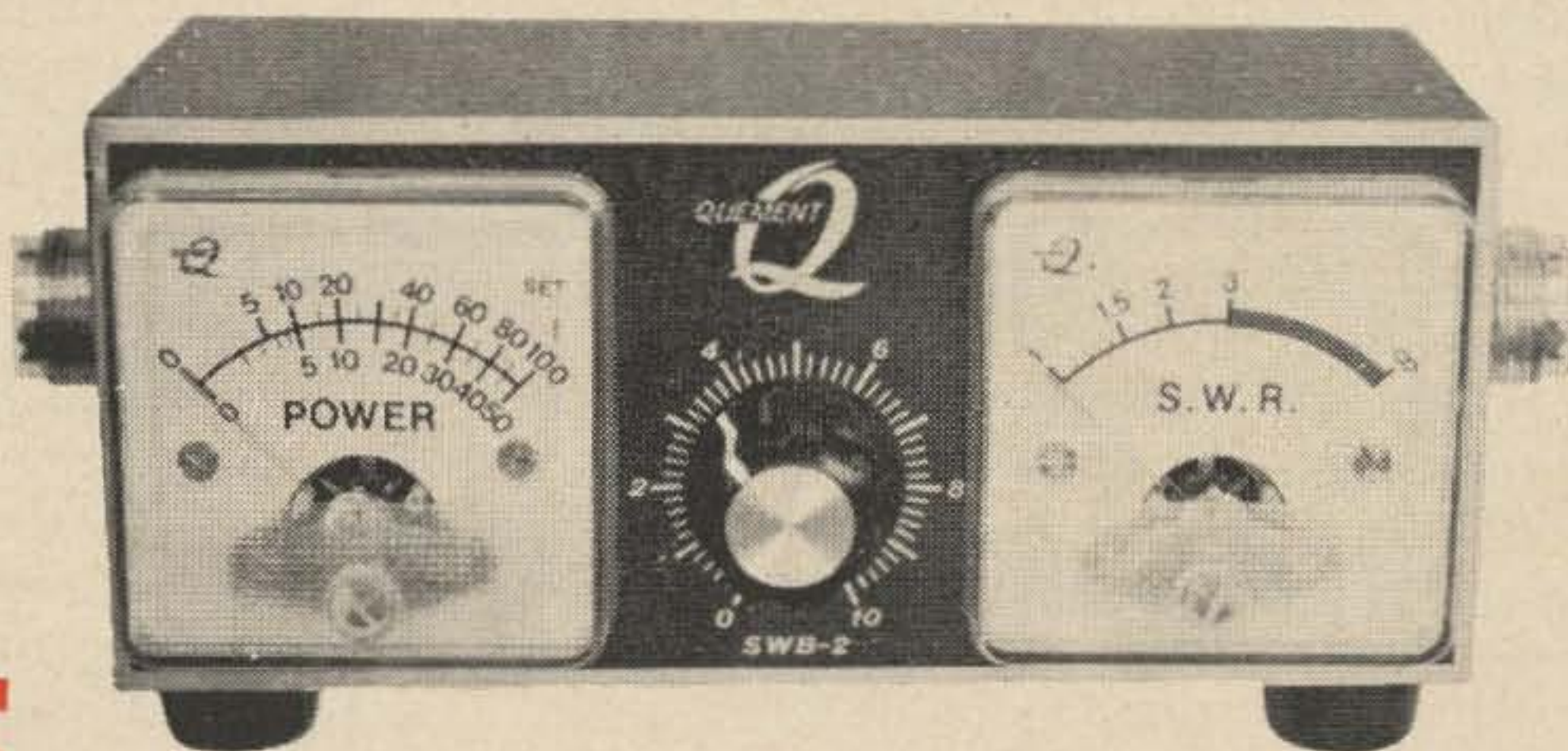

# \$15.95

ALLOW \$1.00 FOR PACKING & SHIPPING. CALIFORNIA RESIDENTS INCLUDE SALES TAX

THE BEST VALUE WE HAVE EVER OFFERED!

MAY BE LEFT IN LINE, UP TO 2000 WATTS.

GOOD THROUGH 2 METERS

SINCE 1933

FAST SERVICE

Phone CY 4-0464

# QUEMENT ELECTRONICS

1000 SOUTH BASCOM AVENUE

SAN JOSE, CALIFORNIA

"Northern California's Most Complete Ham Store"

95128

# Tips for the CW Contester and DX'er

## Equipment

Go as high power (to the legal limit) as your budget and facilities will allow. "Low power is all one needs for DX" is sour grapes and unrealistic. I have worked the East coast of the USA from Hawaii on 160 meter CW with 25 watts to a guy wire and have been on the receiving end of a chap in Arizona using 6 milliwatts on 28 MHz CW, but that's for the birds if you want to enjoy DX without waiting for that freak break.

Low power may be fine for the higher frequency bands but on the lower frequency bands it is a waste of time. Likewise, stacked arrays, long booms, and high structures are fine if you can afford them, but I have found that the mental strain in a wind storm is not worth the price. Frankly, there is little to choose between a quad and a Yagi as long as you have some kind of a Beam with reasonable radiation efficiency. I have been through many cycles including stacked four over four beams, rhombics, and 45 foot booms, some of which are described in the antenna handbook and magazine articles.

A good receiving location is more important than long booms and superheights or yagi versus quad arguments. Let's face it, some of us are not situated to work DX.

Would you care to compete in the Indianapolis Classic in your family car? Get the best there is that you can afford, either homebuilt or commercial made. The qualities to look for in a CW receiver are controllable selectivity, fast recovery and freedom from front-end overloading. My contest contacts jumped a good 25% when I switched from conventional *if* to mechanical filters.

Lest you think that I am a button pusher, let me say that I entered the first few DX contests with a microphonic 201-201-112 combination in which one did the fine tuning by body English (leaning forward and

backward to the right position after each transmission). Later a National FB7 was used which had only  $\frac{1}{4}$  inch (not misprint) of bandspread for the whole 20 meter band. There was no such thing as zero beating a station because one couldn't find zero beat. However, for those who were fastidious, one could shut off the plate voltage and by holding the key down and letting the filament voltage provide a 60 cycle buzz of a sort, one could get near the correct frequency (wavelength in those days.).

## To zero or not to zero

In CW work there is no choice but to zero beat. Listening up five (or ten) merely serves to clutter up the band. How would you like to work in a net in which each station was on a different frequency? A party line is what you want, so that everyone knows what is happening and where he stands.

The average CW man is smart enough to learn very quickly which way the wind is blowing. It doesn't take him long to find out that he is making an ass of himself by getting out of phase.

A good operator can take complete control of a frequency. I have heard operators who spend more time complaining of the QRM on *their* frequency, and trying to line them up in proper numerical order, than working them. If the QRM gets out of hand, one can always get out from under and sneak up on a new frequency.

Work stations and reduce the pile in natural order, the loudest ones first (with exceptions mentioned later) and get rid of them so you can work down into the weak layer. If you find that they are all about the same strength, tune off to one side just a little (something you cannot do with SSB very far). It is very seldom that everybody will be exactly on the same frequency. Work slightly around the edges of your

frequency and back and forth across your frequency. Let your ear separate the slightest frequency differences. If you cannot do this you need more practice.

## The operator

One must keep in condition to be able to work a successful contest. Be able to copy 50 words per minute in your head and to take down 35 words per minute solid. Log-keepers and spotters are a waste of time and as necessary as the fifth wheel.

The bottleneck is not spotting or log-keeping, but the operator on the other end. You can catch up on your log keeping while the other operator is sending. You will find ample time for logkeeping and other bookkeeping chores while the other fellow is sending, except when you hit an operator who has been around contesting a lot. If you meet two or three of these fellows one after another you will find yourself three or four contacts behind in logging. However, there is a trick in this situation too. Simplify your numbering system, what difference does it make to anybody whether you pass out a 599 or 579, you might as well give them all 599. The chances are he will also give you a 599 so why complicate bookkeeping. Moreover, a good report makes the other operator think that he is getting in loud and clear and will make the contact short and fast.

To squeeze out that weak one employ the following technique. Hold your breath, close your eyes, cock your head and concentrate. Incidentally, I have found that this works for hearing tests as well. I presume you use earphones, because if you use loudspeakers you are not a CW Dx'er, note I didn't say phone Dixer because quite a number of hams apparently don't know that one can monitor the quality of ones transmission by using earphones and your own receiver. If you use a transceiver, of course you are out of luck.

The stethoscope type of earphone allows you to wear glasses in comfort since you will be operating for 8 hour stretches. The old earmuff type (Brandes, Baldwin) phones made your ears feel as if they were ready to drop off after a few hours of use.

When your contacts start falling off to less than 30 an hour, it is time to catch up with a catnap. Get a good rest of at least six hours every night.

## Special techniques

Unless you can get into the dense ham population area you might as well forget about becoming one of the top scores. In the ARRL DX Contest, this means that you must put in a good signal into the second and third call areas for at least 14 hours a day. There seem to be a lot of W6s but you will find that they get fished out very quickly. The second and third districts will furnish an inexhaustible supply of weak ones.

If it is a world-wide competition (CQ type), unless you are situated to work into Europe, you are not going to be among the world high. The South American CW con-tester is a rare bird, and you can't get many CW multipliers from the North American continent.

Know when special openings are going to take place and be there with proper schedules. Special openings sometimes are of only a few minutes duration. For instance you can work that W1 on 160 meters just as the sun is rising on the East Coast. He will peak up and rise out of the noise level and disappear again only once.

On the low frequency bands, don't get sucked in by the first loud station who calls you. He can serve a useful purpose by using him as a bait. Let him call you but don't answer for a while. His cry of anguish will alert the band to the fact that something interesting is underneath. When the pack becomes thick, pick them off one by one. This technique will save a lot of CQing on your part on the low frequency bands.

However, certain non-DX types will fool you because he gives up easily and quits after a few calls. Cultivate a clientele and learn their habits and foibles. You will find that certain ones will always be there as soon as you open up on the band. Make a habit of opening up on a certain band at a set time, the old timer contesteer will be there waiting for you. W9IOP, W4KFC, W3MSK, W3GRF, W6RW, to name a few, don't get rattled easily. They will quit if they don't get you in the first few calls, knowing full well that their time will come around when the hue and cry subsides. Learn to recognize fragments of familiar calls.

Don't fold up in the face of competition, the opposition can always blow up a power transformer or have a social engagement

the second weekend. Don't show your hand but keep the opposition guessing, and in this respect serial number sequences are less desirable since it involves one more type of bookkeeping. Multipliers will take care of themselves if you pile up the volume.

Do not keep the other station guessing by changing pace. Set up a definite sequence and stick to it. Deviation from a sequence or change of pace only serves to confuse the operator at the other end. When you go back to a station, his call will be lost in a pile of QRM and he will know who you went back to. Therefore it is important that you reassure him by signing his call at the end of an exchange plus your call. Signing your call at the end advertizes your presence on the band and prevents queries as "what is your call?" Sign your call only once, no more, after all, they know who is being hunted. A mere "break" only serves to get several other stations acknowledging you, each one thinking that he has nailed you.

Learn to copy a fast sender through a slow sender. Many times you will find that someone who calls very slowly will be in harness with a fast caller. Get rid of the fast caller with a fast exchange and then go back to the slow one. He won't know the difference. If the slow caller (long caller) unexpectedly signs early, a short "QRZ" will keep him going for another round until you are ready for him.

Sometimes you will find two stations sending you a serial number each thinking that he has mailed you. A short "ok" at appropriate intervals will hold both for you until you sign out both calls. However, this last trick calls for considerable practice and finesse because you can get into an awful mess by losing synchronism.

## Logkeeping

Use carbon paper and send in the carbon copy (FCC says you must keep original logs.) The standard ARRL logbook is good for only 29 contacts per page and is not

## VHF-UHF

Converters and Preamps  
for 50 thru 432 Mc.

Write for literature.

Parks Electronics, 419 S.W. First Beaverton, Ore.

recommended for contests in the order of 4000 contacts.

It is amazing how well one can keep track of duplications after a few years of practice. The average contester has a pretty foolproof filing system so let him do the work for you. You will not have time to keep track of multipliers at first. Leave that chore to a slack period. You are less liable to make mistakes this way.

Hang on to that ballpoint pen at all times and don't lay it down. Learn to send on the bug while holding the pen in the same hand. The other hand can be arranging papers or adjusting controls while you are sending. Can you imagine picking up a pen and laying it down 8000 times which is what one would do in the course of a good hot contest.

## A parting shot

Over 8000 contacts were made in the 1967 ARRL DX Contest from a 5000 square foot city lot using a tribander and antenna system described in a recent magazine article with a 40 foot tower from 160 meters through 10. Tower guy wires were used as radiators for the low frequency bands. For the contest antagonist, let me say that I have been through the public interest and necessity bit. Ask any old timer about the relay circuit from KA1HR (Manila, OMITB (Agana) to NY2AB (Coco Solo) to W3CXL (Washington DC). There was none of this "a phone match is in progress and a clear channel will be appreciated" stuff. Message traffic ran up as high as 4000. Traffic handling, ragchewing, net operation, RTTY, VHF, have been tried but there is nothing like a good hot DX contest to test men and equipment.

...KH6IJ

### DXERS and DXERS-TO-BE

Want to keep up to the minute of what's happening DXwise? Subscribe to Gus Browning W4BPD's new weekly DXERS MAGAZINE. 16 pages of DX events, coming up DXpeditions, QSL info, pix, etc. Rates, US surface \$8.50. US air mail \$10, West Indies \$16.50, S. America and Europe \$19, rest of world \$28.

### The DXERS MAGAZINE

c/o W4 BPD

Route 1, Box 161-A,  
Cordova, S.C., U.S.A.

# STILL A WINNING PAIR

Year after year Swan and Henry Radio have proven to be tops with amateurs the world over. Why? Because Swan manufactures fine reliable equipment that gives you the most for your money. Because Henry Radio gives you the best deal . . . generous trades, easy payments and the kind of responsible merchandising that amateurs have learned to depend on. That's why we are number one . . . the world's largest distributor of amateur radio equipment.

Attention World Amateurs: Henry Radio makes it simple and easy for you to own the finest American radio equipment. Write for details.

**6% FINANCE CHARGE • 10% DOWN OR TRADE-IN DOWN • NO FINANCE CHARGE IF PAID IN 90 DAYS • GOOD RECONDITIONED APPARATUS.** Nearly all makes.

Our reconditioned equipment carries a 15 day trial, 90 day warranty and may be traded back within 90 days for full credit toward the purchase of NEW equipment. Write for bulletin.

**TED HENRY (W6UOU)**

**BOB HENRY (WØARA)**

**WALT HENRY (W6NRV)**

**Henry Radio Stores**

Butler, Missouri, 64730

11240 W. Olympic, Los Angeles, Calif., 90064

931 N. Euclid, Anaheim, Calif., 92801

CALL DIRECT . . . USE AREA CODE

816 679-3127

213 477-6701

714 772-9200

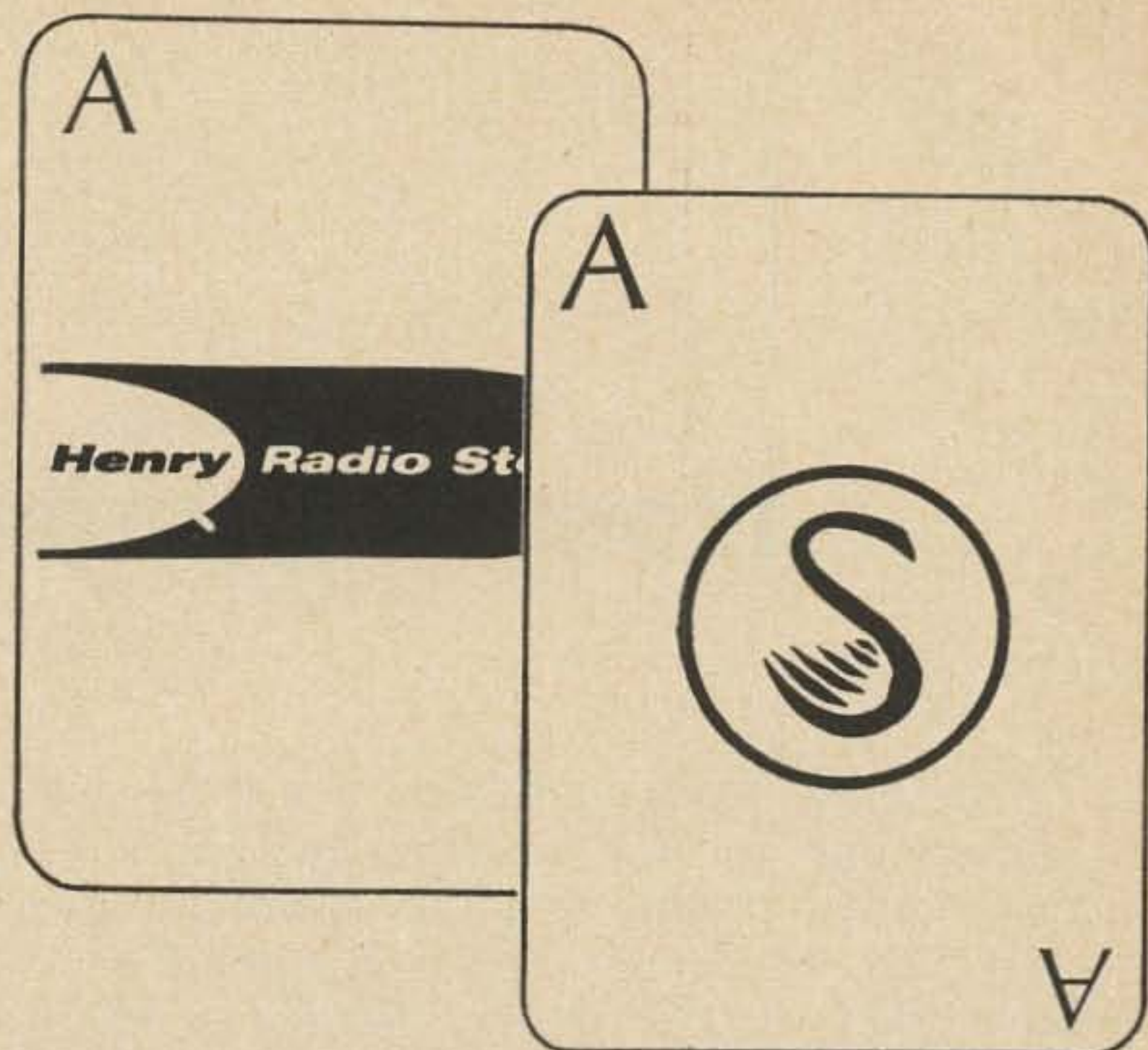

**NEW FROM SWAN!!**



**SWAN 500-C TRANSCEIVER \$520.**

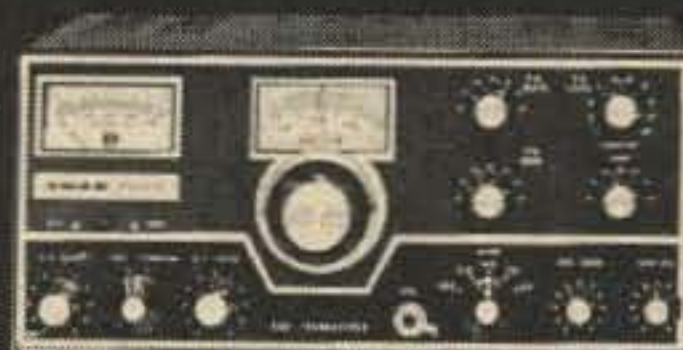

**SWAN 350-C TRANSCEIVER \$420.**



**SWAN MARK II LINEAR AMPLIFIER \$395 (with tubes) With Power Supply \$630.**

Accessories: 12 volt DC supply, Model 14-117 \$130.  
Matching AC supply, Model 117XC \$95.

While you're in, check the improved Swan model 250-C six meter UHF transceiver . . . it's a beauty.

*"World's Largest Distributor of Amateur Radio Equipment"*

Ross Sheldon K4HKD  
3313 Avery St.  
Huntsville, Alabama, 35805

## How to Publicize Your Club

I've never met an editor, nor even seen one—except in “B” movies. But, as a retired army public relations officer and a part-time freelance writer-photographer, I have had no difficulty getting publicity stories into print, without coming any closer to the editor than my mailbox and his. They don't ALL get printed, but MOST of them do.

The only problems I have had with getting stories about the Huntsville Amateur Radio Club into the newspaper and onto the radio are two: Getting the club members to do something worth writing about—and getting up the energy to write it up and drop it off at the local papers and radio stations when there is a good program on TV or the DX is rolling in.

And that last is the principal obstacle to most club publicity chairmen in getting up a good story—getting up the energy to get it out.

But, lest someone say: “It's easy for a pro to talk”, let me show you how easy it really is to get publicity—yet how difficult it really can be, if you don't understand a few simple facts of life about public relations.

Fact Number One: The editor *wants* to print your story.

An editor's favorite dream is of mailbags full of “good copy” sitting on his desk each morning; all well-written and accompanied by a stack of usable pictures. According to this dream-fantasy, all he has to do is shuffle through the pile, pick out those he likes the best and hand them to the copyboy to take to makeup.

Fact Number Two: There are a lot of people in this world trying to make his dream come true—for free.

Each day the metropolitan newspapers receive mailbags full of handouts from every imaginable source, mailed by public relations men trying to get their clients business into print.

Cypress Gardens deluges editors with pictures of sweet young things on water skis. Miss Pickle Week peeks out of another envelope sent by the public relations firm representing the pickle account. A picture of the town mayor signing a proclamation for “National Boy Scout Week” in company with the local scoutmaster and a toothy scout is next. And, as for the government:

“Private Schnertz, son of Mr. and Mrs. J. J. Schnertz—”! The departments of Agriculture (national, state and county agent) give the editor twice as much farm news in a day as he has room to print in a week. Every government agency, official, officeholder (or candidate for same) has an “image” to project.

And anybody who is *anybody* who comes to town, or just passes *through* it, has an advance copy of the event on every editor's desk three days ahead, complete with pictures.

The moral to both Fact Number One and Fact Number Two is Fact Number Three:

The editor wants your story, but it had better be good; because, friend, it's got a *lot* of competition.

Now to give the editor what he thinks is good, what does it take—a degree in Journalism or English Composition?

Well, it *would* help if you could write.

But writing the simple routine news story of club activities is simple. Every ladies club has someone doing it. Take any club meeting story from the daily paper; scratch out the names, dates and places; substitute those for your own club; retype and send it in and you have as good a routine club news story as anyone else.

Maybe even better, if you get the facts straighter, the names spelled right, type it double-spaced with wide margins and have your name and phone number at the bottom in case the editor has a question he wants to check out.

Get these routine stories in from one to



two days ahead of the meeting. It takes time to select, edit and print them—and there is no filing cabinet by the editors desk to “hold until release date”. (The editor knows he will have a new slush pile tomorrow anyway.)

But these routine stories are the *least important* part of your job as public relations man for your club. Your main job is the clubs relations with the public; And the last thing the public wants to know about is that you held a meeting, or what went on in it. They don't belong to your club and could care less. What the public wants to know is—what is your club doing of interest to *them*?

Is your club doing anything which *affects* the public or is in the public interest? Is it doing anything the public would find interesting, informative, entertaining or from which the reading public could benefit in some way? Can any eye-catching picture be used? (Remember Miss Pickle Week and the young lady on water skis? What was *really* “newsworthy” about them? Nothing at all. Many “beauty queens” are non-winners of contests which never happened, merely paid models to advertise a product or an event the public is expected to pay for.)

Getting such “angles” to “make a story” is the public relations man's principal pre-occupation.

And the principal problem associated with this is getting the club to go along with the story. Many club members do not realize that to be in the news they must be newsworthy; *they must do something worth writing about.*

To give you and your club ideas for opportunities to present your club and ham-dom favorably in the press, following are some headlines from the local papers about the HARC—with a summary of the story that accompanied them. All stories included the time and place of the clubs meeting and used pictures wherever possible.

### "Hams Donate Library Book"

Picture of a club representative and the city reference librarian examining the latest issue of the Callbook which the club donated to the library. The story explains that any ham may phone the reference desk and the librarian will give him the address he needs. The meaning of ham calls and how they

differed from CB calls was included in the story.

### "Hams To Help On UNICEF Drive"

The HARC “Spook Patrol” (see 73, Nov 67) is a regular Halloween event. The story tied in with the national UNICEF drive held at the same time.

### "Hams To Promote Mobile Frequency"

A picture of a Sixer under the dash headed a story on how hams used a special high frequency for local emergency nets. Radio wave characteristics, low cost of VHF equipment, hams tie-in with Civil Defense and number of hams in Huntsville (“more than rest of the state combined”) were included in the story.

### "Radio Club Members Practice Tracking Clandestine Transmitter"

A page-wide spread of pictures showed hiding a transmitter and followed a ham with mobile and hand-held “sniffer” as he went directly to it. The civil defense, national security and rescue aspect of the hams tracking ability was stressed.

### "City Ham is State Champ"

A picture of the club member who placed highest in the sweepstakes receiving an award from the SCM.

### "Ham Radios Early Days Talk Planned"

Talk by an oldtimer. Angle: Today's hams bounce signals off the moon, put up their satellites and talk as casually to a ham in Singapore as to one a 100 miles away. Progress made by the hams in developing communications over the years was stressed.

### "Radio Club Demonstrates At The Mall"

Picture of demonstration stations operating inside the city's largest enclosed shopping center. Citizens were invited to send messages by amateur radio from the display area. The National Traffic System and emergency nets were featured both in the story and on posters around the demonstration. Moral: Public relations men use more than a newspaper to get the image of their client across to the public.

**"Charity Drive Calls For Hams"  
"Radio Club To Aid Project"**

Another double. Both stories on the same subject. The March of Dimes asked our help—and the hams said ok. Two stories out of one a few days apart. Moral: When you milk your cow, strip her clean.

**"Radio Club Plans Auction"  
"Wonder If It Still Works?"**

The last headline was under a picture of three hams examining a piece of surplus gear to be auctioned off. A pile of interesting gear in foreground and background made the picture newsworthy and got 10 column-inches in the small morning paper and 24 column-inches in the afternoon. The auction that Friday night was crowded! (Finagle note: None of the pictured stuff was actually for auction. The three hams worked in a local electronics store which stocked the stuff and the picture was taken in the corner of their warehouse!)

**"Ham Club Forms Speakers Bureau"  
"Ham To Speak To Sertoma"  
"Camera Club To Hear Ham"**

The first story listed some of the subjects various members were qualified to speak about (from flower raising to lasers). Later stories featured the ham's picture and subject, and, incidently, something about the club he was talking to. In the public relations trade this is known as "piggy-back", "coat-tail" or "free-ride" publicity. That is, you get in your licks by riding the other fellows wagon.

**"Ham Aids Ship At Sea"  
"Local Operator Helps Man On Ship In Atlantic"**

A local ham was asked by one in New England on twenty if he could get a station in Mobile, Alabama to meet a maritime-mobile later that day. A seaman had heard his brother was in a Mobile hospital as a result of an auto accident. A directional call on 75 on the state frequency got a station up on twenty from, of all places and Glory-to-be-for-Alabama-publicity—the battleship "Alabama" in Mobile Bay! (Absolutely *no* Alabama newspaper editor would have refrained from printing *that* story—complete with a picture from the morgue of "the great battleship"!.) Moral: Sometimes you just *can't* lose.

**"Each Night Hams Sit Down To Talk"**

With half a page of text and pictures of homebrewed fixed and mobile rigs, the feature story told of the nightly Alabama Single Sideband Net, the National Traffic System, emergency operations and mobile units. The low cost of home-brewed gear and the local club activities were stressed.

**"Ham Operators Monitor Storm"**

(See 73, June '67, p 117 "Ham Public Service and Broadcast Stations".) Frequencies of local and regional hurricane nets were given for the benefit of shortwave listeners. Local newspapers and radio and TV stations borrowed receivers and listened to the ham hurricane nets, giving them credit for their activities. Five local stations broadcasted daily tape-recorded reports by a local ham on what the ham hurricane nets were doing.

**"Junior Ham Action"**

Hearing of a CB Jamboree in town, I suggested we display our mobile emergency bus in the parking lot for the benefit of interested CB'ers. We then photographed three of our junior-high hams in the bus with a story whose lead said the kids "stole the show" at the jamboree! (Which they did, but the paper caught H—from the CB'ers for saying so!)

**"Pool Efforts To Curb Accidents"  
"Jeep Patrol, Radio Hams Join Memorial Day Watch"**

(See "El Paso Roadblock", CQ June, 1961). Though from another part of the country, this is included to show a type of skullduggery a public relations man sometimes has to pull to get his client in print.

The local jeep-mounted sheriffs reserve were previously featured in the paper, with a statement that they were handicapped for lack of radios. I suggested to them that, with a long weekend holiday coming up, the sheriffs reserve and hams could team up with a highway safety patrol demonstration stakeout to prevent accidents and as a training exercise.

Both groups agreed, but an immediate impasse was reached.

Neither wanted to take the initiative to organize the operation. Each said: "If *they*

want to put it on, *we* will help *them*”!

So—I phoned the head of each group as a presumed agent of the other which was “putting on the operation” and asking them to help!

To “avoid a clash of plans” (each thought the other was doing the planning) I proposed that as hams were only “communications men” and the sheriff’s reserve were the “police experts”, that each stick to their specialty and the hams provide the communications for the sheriff’s reserve which would conduct all other aspects of the operation. Pictures of ham mobiles and sheriff’s jeeps side-by-side were in all papers for days in advance and when they were seen at highway intersections over the holidays the public held its speed down. (Result, there were no accidents or speeding tickets issued throughout the long weekend.)

Moral: Watch the daily papers for activities and problems of other groups and take advantage of a chance to do a little mutual backscratching—even if you have to sidle up to the other fellow to do it.

Many other stories, with pictures, were the usual routine: Field Day, code classes, hamfest, installation of officers, program topics, etc. All are ideas you can use in your club.

... K4HKD

### Line Noise in the Heath Monitor Scope

For you who have a Heath monitor scope, a note on intermittent line noise. If you experience this, try turning off the scope while receiving a weak signal. A possible cause of this noise is due to the internal construction of the CRT. Checking the schematic, you will find that your transceiver output looped through the scope “hopefully” gives you the trapezoid pattern on transmit. On the receive mode, the scope uses its internal vertical amplifier. However, the capacitive voltage divider, found on the back panel (Xmtr Attn Switch) is in the circuit at all times. After several years of operation, the CRT on my scope became an intermittent cause of much dandruff scratching. After two days on the bench, I found that pin 10, a vertical plate, was arcing to pin 4 deep in the neck of the CRT tube. Cut back the sensitivity on the transmitter attenuation switch, and save \$27.05 for a new tube.

... Ray Kashubosky K8RAY

## Crank-up Towers for the ham with space problems.

**New Design, Light Weight, Free Standing Crank-up Towers!**

Safely supports most TRI-BAND BEAMS in 50 mile winds without guying. “FS” models use new adjustable base flanges and heavy 1” Anchor Bolts for one-man installation away from house without additional support using footing. Standard models use flat hinged base and wall bracket. Takes only one man to erect or tilt for antenna servicing with new TRZ-80 or TRL-80 tower raising fixture. Positive safety and control when raising or lowering the tower is assured with a new style geared winch with automatic locking disc brake, and Tristao’s exclusive “add-a-section” design.

Another “towering” feature from Tristao!

“Towers above all”

### TRISTAO TOWER CO.

P. O. Box 115,  
Hanford, California 93230

**New CZ - FS Series Towers**

Write for Free catalog TODAY or see your distributor.



## radio amateur callbook



### GET YOUR NEW ISSUE NOW!

Over 283,000 QTHs in the U.S. edition  
**\$6.95**

Over 135,000 QTHs in the DX edition  
**\$4.95**

See your favorite dealer or order direct (add 25¢ for mailing in U.S., Possessions & Canada. Elsewhere add 50¢).

These valuable EXTRA features included in both editions!

- QSL Managers Around the World!
- Census of Radio Amateurs throughout the world!
- Radio Amateurs' License Class!
- World Prefix Map!
- International Radio Amateur Prefixes
- Radio Amateurs' Prefixes by Countries!
- A.R.R.L. Phonetic Alphabet!
- Where To Buy!
- Great Circle Bearings!
- International Postal Information!
- Plus much more!

**WRITE FOR FREE BROCHURE!**

RADIO AMATEUR

**callbook** INC.

Dept. B, 4844 W. Fullerton Ave.  
Chicago, Ill. 60639

## Technical Aid Group

If you have a question which can be answered adequately through the mail, look through the following list of TAG members and write to one whose specialty covers your problem area. Be sure to explain your problem clearly and write legibly. Enclose a Self Addressed Stamped Envelope for a reply. Do not ask a member to design a piece of equipment for you. The purpose of this group is to assist the ham with problems he encounters in the course of building or trouble shooting.

John Allen, K1FWF, high school student, 51 Pine Plain Road, Wellesley, Mass. 02181. HF and VHF antennas, VHF transmitters and converters, AM, SSB, product data, and surplus.

Bert Littlehale, WA1FXS, 47 Cranston Drive, Groton, Conn. 06340. Novice transmitters and receivers, AM SSB, HF receivers, test equipment and homebrew projects gone wrong.

Bob Groh WA2CKY, BSEE, 123 Anthony Street, Rochester, New York 14619. Specializes in VHF/UHF solid-state power amplifiers, but will be glad to make comments on *any* subject.

Jim Ashe W2DXH, R.D. 1, Freeville, New York. Test equipment, general.

G. H. Krauss, WA2GFP, BSEE, MSEE, 70-15 175 Street, Flushing, New York 11365. Will answer any questions, dc to microwave, state-of-the-art in all areas of communications circuit design, analysis and use. Offers help in TV, AM, SSB, novice transmitter and receivers, VHF antennas and converters, receivers, semiconductors, test equipment, digital techniques and product data.

Don Nelson WB2EGZ, EE, 9 Greenridge Road, Ashland, New Jersey 08034, VHF antennas and converters, semiconductors, selection and application of vacuum tubes.

Stix Borok WB2PFY, high school student, 209-25 18 Avenue, Bayside, New York 11360. Novice help.

Clyde Washburn K2SZC, 1170 Genesee Street, Building 3, Rochester, New York 14611, TV, AM, SSB, receivers, VHF converters semiconductors, test, general, product data.

Richard Tashner WB2TCC, high school student, 163-34 21 Road, Whitestone, New York 11357. General.

J. J. Marold WB2TZK, OI Division, USS Mansfield DD278, FPO San Francisco, California 96601. General.

Ira Kavalier, WA2ZIR, BSEE, 671 East 78 Street, Brooklyn, New York 11236. SSB transmitting, color TV, computer programming and systems, digital, radio and remote control, rf transmission lines, dipole design, audio amplifiers, linear and class C rf amplifiers.

Fred Moore, W3WZU, broadcast engineer, 4357 Buckfield Terrace, Trevoise, Pa. 19047. Novice transmitters and receivers, HF and VHF antennas, VHF converters, receivers, AM, SSB, semiconductors, mobile, test equipment, general, product data, pulse techniques, radio astronomy, bio-medical electronics.

Theodore Cohen W9VZL/3, BS, MS, PhD, 261 Congressional Lane, Apartment 407, Rockville, Maryland 20852. Amateur TV, both conventional and slow-scan.

Walter Simciak, W4HXP, BSEE, 1307 Baltimore Drive, Orlando, Florida 32810. AM, SSB, Novice transmitters and receivers, VHF converters, receivers, semiconductors, mobile, test-equipment, general.

James Venable K4YZE MS, LLB, LLM, 119 Yancey Drive, Marietta, Georgia. AM, SSB, novice gear, VHF, semiconductors, and test equipment.

J. Bradley K6HPR/4, BSEE, 3011 Fairmont Street, Falls Church, Virginia 22042 General.

Wayne Malone W8JRC/4 BSEE, 3120 Alice Street, West Melbourne, Florida 32901. General.

Bruce Creighton WA5JVL, 8704 Belfast Street, New Orleans, Louisiana 70118. Novice help and general questions.

Douglas Jensen, W5OGJ/K4DAD, BA/BS, 706 Hwy 3 South, League City, Texas 77573. Digital techniques, digital and linear IC's and their applications.

Louis Frenzel W5TOM, BAS, 4822 Woodmont, Houston, Texas 77045. Electronic

keyers, digital electronics, IC's, commercial equipment and modifications, novice problems, filters and selectivity, audio.

George Daughters WB6AIG, BS, MS, 1613 Notre Dame Drive, Mountain View, California. Semiconductors, VHF converters, test equipment, general.

Glen H. Chapin, W6GBL, 3701 Trieste Drive, Carlsbad, Calif. 92008. HF and VHF antennas, novice transmitters and receivers, VHF converters, semiconductors, receivers AM, SSB, general, surplus.

Tom O'Hara W6ORG, 10253 East Nadine Temple City, California 91780. ATV, VHF converters, semiconductors, general questions.

Steve Diamond WB6UOV, college student, Post Office Box 1684, Oakland, California 94604. Repeaters and problems regarding legality of control methods. Also TV, novice transmitters and receivers, VHF antennas and converters, receivers, semiconductors, and product data.

Orris Grefsheim WA6UYD, 1427 West Park, Lodi, California 95240. TV, HF antennas, SSB, VHF antennas and converters, receivers, semiconductors, and general questions.

Hugh Wells, W6WTU, BA, MA 1411 18th Street, Manhattan Beach, Calif. 90266. AM, FM receivers, mobile test equipment, surplus, amateur repeaters, general.

Howard Krawetz WA6WUI, BS, 654 Barnsley Way, Sunnyvale, California 94087. HF antennas, AM, general.

Carl Miller WA6ZHT, 621 St. Francis Drive, Petaluma, Calif. 94952. Double sideband.

Howard Pyle W7OE, 3434-74th Avenue, S.E., Mercer Island, Washington 98040. Novice help.

Ronald King K8OEY, Box 227, APO New York, New York 09240. AM, SSB, novice transmitters and receivers, HF receivers, RTTY, TV, test equipment, general.

Charlie Marnin W8WEM, 3112 Latimer Road, RFD 1, Rock Creek, Ohio 44084. General technical questions.

Michael Wintzer DJ4GA/W8, MSEE, 718 Plum Street, Miamisburg, Ohio 45342. HF antennas, AM, SSB, novice gear, semiconductors.

Roger Taylor K9ALD, BSEE, 2811 West Williams, Champaign, Illinois 61820. Antennas, transistors, general.

Michael Burns Jr. K9KOI, 700 East Virginia Avenue, Peoria, Illinois 61603. AM, SSB, receivers, transmitters, digital techniques, novice help, general.

Jim Jindrick WA9QYC, 801 Florence Avenue, Racine, Wisconsin 53402. Novice transmitters and receivers, general.

John Perhay WAØDGW/WAØRVE, RR #4, Owatonna, Minnesota 55060. AM, SSB, novice transmitters and receivers, HF receivers, VHF converters, semiconductors, mobile, product data, general. Has access to full specifications on almost all standard components presently catalogued by American manufacturers.

David D. Felt WAØEYE, television engineer, 4406 Center Street, Omaha, Nebraska 68105. Integrated circuits, transistors, SCR's, audio and rf amplifiers, test equipment, television, AM, SSB, digital techniques, product data, surplus, general

Tom Goetz KØGFM, Hq Co USAMAC, Avionics Division, APO New York, New York 09028. HF antennas, mobile, airborne communications equipment, particularly Collins and Bendix gear, AM, FM, or SSB-HF, VHF, UHF, general.

Robert Scott, 3147 East Road, Grand Junction, Colorado 81501. Basic electronics, measurements.

PFC Grady Sexton Jr. RA11461755, WA1GTT/DL4, Helmstedt Spt. Detachment, APO New York 09742. Help with current military gear, information from government Technical Manuals.

PFC William A. Youdelman DL4FK/WA6LRS, DSMA B-4, c/o HHB, 6 Bn, 61 Aty. APO New York, New York 09225. Invites questions from members of US Forces in Europe regarding licensing or any technical questions they care to ask.

Eduardo Noguera M. HK1NL, EE, RE, Post Office Box Aereo 774, Barranquilla, Columbia, South America. Antennas, transmission lines, past experience in tropical radio communications and maintenance, HF antennas, AM, transmitters and receivers, VHF antennas, test equipment and general amateur problems. Can answer questions in Spanish or English.

Hundreds of Bargains

# ...SO WHY PAY MORE FOR THE BEST!

Instant Credit, Instant Shipment On Time Payments & Cash Orders

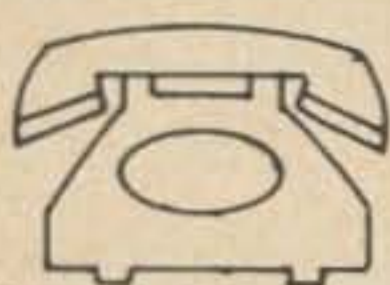

Trigger Electronics ... or your mailbox is as near as your phone

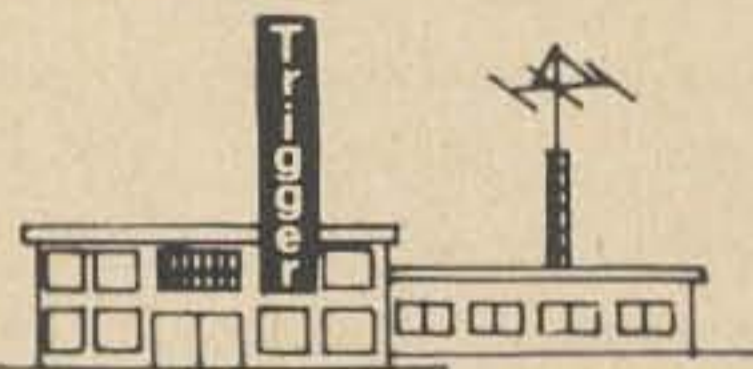

Trigger—for the most complete inventory of amateur and CB equipment. Everything in stock for your convenience!

Trigger has cut the red tape of time-consuming credit delays. Just pick up the phone and call us (no collect calls, please) and your goodies will be on their way—usually the same day!

another important TRIGGER service:  
**WE BUY USED HAM GEAR FOR CASH**  
 PROMPT SERVICE...  
 PROMPT CASH!



No company processes foreign orders and inquiries with greater dispatch than Trigger

TRIGGER Attn: W9IVJ

7361 North Avenue  
 River Forest, Illinois

RUSH THE FOLLOWING:

Amount Enclosed

NAME \_\_\_\_\_  
 ADDRESS \_\_\_\_\_  
 CITY \_\_\_\_\_ STATE \_\_\_\_\_ ZIP \_\_\_\_\_

ORDER BLANK TO: trade ur present gear, order equipment, sell ur gear for cash.

STORE HOURS Weekdays 11:00 A.M.—8:00 P.M.  
 (CENTRAL TIME) Saturdays 9:00 A.M.—3:00 P.M.

ALL TELEPHONES (312) 771-8616

## WHY IT WILL PAY YOU TO DEAL WITH TRIGGER

- Amazing Trades
- No Down Payment Required
- Low Budget Terms
- Midwest Bank Credit Cards Accepted
- Fast, Efficient Service
- No Waiting
- 20 Minutes From Downtown Chicago Or O'Hare Airport
- Near Junction Of Routes 64 & 43
- Plenty Free Parking
- Open Weekdays Until 8:00 PM
- COME IN, BROWSE AND GET ACQUAINTED, AND SEE THE MOST COMPLETE INVENTORY OF HAM AND CB GEAR—ATTRACTIVELY DISPLAYED.

## NEW EQUIPMENT ON LOW BUDGET TERMS

Ameco	Hallicrafters	Numechron
Astatic	Hammarlund	Regency
B & W	Hy-Gain	S B E
C D R	Johnson	Shure
Cush-Craft	Mark Mobile	Swan
Dow Key	Millen	Trimm
Drake	Mosley	Vibroplex
Eico	National	Waters
Finco	New-tronics	Weller

and many other major brands

## LIKE-NEW EQUIPMENT ON LOW BUDGET TERMS

- Ten-Day Trial
- 30-Day Guarantee

Tops in performance and appearance, thoroughly and beautifully reconditioned, and clean as a pin. Alignment, calibration as good as new, and frequently better. Listed below are but a few of the hundreds of items and accessories currently available. Write for complete listing and prices.

### LIKE-NEW BARGAIN SPECIALS FOR JANUARY

SWAN 350.....\$319	SX111.....\$147	EICO 720.....\$ 49
SWAN 250..... 239	SX122..... 199	EICO 730..... 27
117XC AC..... 84	S38D..... 37	HEATH SENECA... 177
SBE 34..... 329	HT32A..... 279	HR10..... 79
SB2LA LINEAR... 189	HQ145C..... 179	DX60A..... 77
SBE33 INVERTER. 37	HQ170AC..... 279	10ER KIT..... 37
100V..... 399	HQ180AC..... 379	2ER WIRED..... 47
INTERCEPTOR B.. 329	NCL2000..... 499	2ER DC SUPPLY.. 17
DRAKE R4A..... 319	NC60..... 44	SB610 SCOPE... 87
PEH LA400C..... 117	NC183D..... 199	SB630 CONSOLE.. 74
ZENITH S/WAVE.. 44	NC303..... 199	KNIGHT VFO..... 27
MATCHBOX W/SWR. 74	220MC CONV..... 19	KNIGHT T60..... 47
GONSET 3 2MTR.. 169	GLOBE V10 VFO.. 37	KNIGHT K600B... 37

### LIMITED QUANTITY NEW EICO KITS

753 SSB TRANSCEIVER \$139
751AC OR 752DC \$59
720 90 WATT CW \$67
725 60 WATT CW \$39
722 VFO W/AC SUPPLY \$34



A SMALL DEPOSIT WILL HOLD ANY UNIT ON LAY-AWAY.



**TRIGGER** Electronics  
 7361 NORTH AVE. • RIVER FOREST, ILLINOIS 60305  
 (WEST SUBURBAN CHICAGO)

SUNDAY TELEPHONE SERVICE  
 11 A.M.—3 P.M.



## PRESENTING THE ALL NEW **AMECO PT** ALL BAND TRANSCEIVER PREAMPLIFIER

- 6 THRU 160 METERS
- FEEDS 2nd RECEIVER

Model PT, with built-in power supply, transfer relay, connecting cables, wired and tested.

Amateur Net ..... **\$49.95**



- A frame grid pentode provides low noise figure with ability to handle strong signals, greatly improving the sensitivity of the receiver section of a transceiver.
- A unique built-in transfer circuit enables the PT to by-pass itself while the transceiver is transmitting. The PT also feeds the antenna input of a 2nd receiver as well as muting it.

### AMECO

**DIVISION OF AEROTRON, INC. ■ P. O. BOX 6527 ■ RALEIGH, N. C. 27608**

Sgt. Michael Hoff W8TLX, Box 571, 6937th Comm. Gp., APO New York 09665.

Help with all types of RTTY both commercial and military. Also data techniques. Covers conversion of military RTTY equipment.

Frank M. Dick WA9JWL, 409 Chester St., Anderson, Indiana 46012. Will answer queries on RTTY, HF antennas, VHF antennas, VHF converters, semiconductors, mobile, general, and microwave.

Gary De Palma WA2GCV/9, P.O. Box 1205, Evanston, Ill., 60204. Help with AM, Novice transmitters and receivers, VHF converters, semiconductors, test equipment, digital techniques and all general ham questions.

Charles Marvin W8WEM, 3112 Lastmer Road, RFD #1, Rock Creek, Ohio 44084. Will help with any general amateur problems.

D. E. Hausman VE3BUE, 54 Walter Street, Kitchener, Ontario, Canada. Would like primarily to help Canadians get their licenses. Would be able to help with Novice transmitters and receivers.

Arthur J. Prutzman K3DTL, 31 Maplewood, Dallas, Pennsylvania 18612. All phases of ham radio. Can assist with procurement of parts, diagrams, etc.

William G. Welsh W6DDB, 2814 Empire Ave., Burbank, Calif. 91504. Club licensing classes and Novice problems.

Ralph J. Irace, Jr., WA1GEK, 4 Fox Ridge Lane, Avon, Conn. 06001. Help with Novice transmitters and receivers and novice theory.

Iota Tau Kappa Radio Fraternity W7YG, Multnomah College, 1022 S.W. Salmon St., Portland, Oregon 97205. This group of radio amateurs will answer any technical questions in the field of electronics.

## A Grey Beard Writes

It is possible that this will refresh the memories of some, and it may remind others, that the things they take for granted, did not happen yesterday or the day before.

Occasionally, during a chat with someone, on the air, the door opens for a look back to the old days, of wireless. There are still a few of us, who have sharp recollections of how it was.

Sixty years ago, landline telegraphy was the best of all hobbies. It did not cost too much, and the idea of sending and receiving messages over a distance, via a single wire, gave us all quite a kick. If you could put together some simple parts to make a sounder and key, and find some bell wire, and an old wet battery, you were in business. In our locality, as it is now, in many parts of the country, there was always the rich kid, who could afford to buy ready made gear. However, most of us had to improvise, invent, scrounge, hustle, and sweat, for the things we needed. We learned the code, the hard way.

In the big city, lines usually ran from apartment to apartment, and across the street, to other buildings. I strung one line beneath an elevated rail structure, and up to the top floor of Smitty's house on the other side of the avenue.

I earned money collecting and selling bottles to liquor stores, delivering race result cards to the corner saloons, and was the general delivery boy for everyone.

There was no such thing as asking Pop for money to buy apparatus, anyone doing so, was asking for the back of the hand. Many people were still scared stiff after the panic of 1907. The scare persisted for a long time, and anyone who could save, did so, in spades. It was a hard school, and a very thorough one.

I visited the old neighborhood after fifty years, and could find only two familiar names on the store fronts. The schools, the elevated railroad, the house I lived in, are all gone. The fire house is all that remains.

I had a momentary feeling of sadness, and wished I could go back to those dear days. And to shake that dull feeling of being alone, I went into a local watering place and had a drink of leopard's milk.

While resting my arm on the bar, I remembered the five miles to Mesco, where the sales clerk used the telegraph key to talk to people in other part of the store; and the Electro Importing Company at 233 Fulton Street. If you wanted anything in the telegraph, wireless, or electrical line, such as wire, tubing, sliders, binding posts, ear phones, castor oil for the special variable condensers; these two places had the stuff.

If you wanted to go downtown to buy or browse, you either walked, or hitched a ride on the rear of a brewery truck. Any money you had, was for more important things than transportation.

The causes of landline telegraphy going out, and the new art of wireless coming in, were, a magazine called "The Electrical Experimenter", and the catalogue of the "Electro Importing Company." That catalogue was a masterpiece of descriptive literature. It was filled with choice items, such as coherers, electrolytic detectors, tuners, wire, loading coils, galena, iron pyrites, and some marvelous looking receiving sets.

Books on the new art, were non-existent, and we gathered our ideas and knowledge from reading those two articles. For code practice, we listened to the Navy stations, and the few commercial stations.

I was impatient and wanted to go farther and faster in wireless. I first tried Western Union, but was turned down for some reason, I still haven't been able to figure out. It is ironic that they hired me as a relief operator at the local Maritime Observatory, at Quarantine, fifty years later. They needed a blinker operator.

I found a job at DeForest's plant, which was located on the Harlem River, near Highbridge. My job was sweeping up, and cutting wires to length, with an old paper



cutter. I did not stay long in that job, it was too confining, and besides, I wanted to see everything that went on.

The factory was in an undeveloped area, nothing but weeds and scrub trees surrounding the place. This made it easy for some fellows to throw parts out the rear windows, and come back at night to pick up the stuff. The bolder ones would slip an ULTRA AUDION panel under their shirts, and sneak it out during lunch hour.

Our parents were very strict, and we all knew the penalty for bringing home anything, without a good explanation of its origin. Anything that smelled of thievery, meant a wallop.

One day, I scraped together six dollars, and bought a vacuum tube, with pigtailed coming out both ends. It lasted three hours, and while it lasted, the gang came to my house at night to listen for recorded music sent out by DeForest's station. He was permitted to transmit music, after 11 p.m. and for a distance no further than 27 miles. Which was just the distance from New York to Ossining, where his engineer lived and worked. The one thing that annoys me now, is that I can't remember his name. The name Gowan, rings a bell, but I can't be sure.

From 1907 to 1924, more and more people worked on wireless research and development. DeForest held U. S. patent #879,532 filed Jan. 29, 1907, and British patent #1427, filed Jan. 21, 1908, for the third electrode in a vacuum tube, which was mounted between filament and plate. As a result of this invention, direct wire telephony from New York to San Francisco was successful in 1914.

DeForest, Armstrong; and C. S. Franklin and H. J. Round, of England, worked on the discovery that a vacuum tube had oscillating properties.

Speech was transmitted from Arlington, Va., to Paris and Honolulu in 1915. The station used about 300 tubes, rated at 25 watts each, as oscillators, modulators and power amplifiers.

Armstrong developed a system for receiving radio signals in 1919, and he called it a Superheterodyne. Three years later he came up with Superregeneration.

C. W. Rice and L. A. Hazeltine, in 1920 and 1924, respectively, found ways to stop unwanted oscillations.

Finally, W. Schottky installed a second

grid in a vacuum tube in 1919, and we know this as a screen grid.

If you attended the Radio Show at the Grand Central Palace, just before Xmas 1922, this is what you saw. A fine assortment of spark and arc transmitters; a new type of transmitting condenser by Dubilier; demonstrations of superregenerative receivers with loop antennas; iron core rf transformers; and some new ideas in synchronous rotary spark gaps.

Today, you can hit Pop for a few hundred bucks and rush right down to the nearest radio store, and buy a beautiful piece of gear, a half gallon or so, wheel it home in a taxicab, load up a brass door knob and you are a "HAM".

... K2TAJ

## 2000 ARTICLES?

In the 75 issues of 73 between October 1960 and December 1966, over 2000 articles have appeared. Find the ones you want quickly with our NEW six year cumulative index. It lists all articles by subject in easy-to-find form. The index is available now. Index 25¢

73 Magazine Peterborough, N. H. 03458

Reflectometer SWR Bridge w/Meter. 30-1000 mc. LN 8.50  
T465/ALT7 100W Xmitter 168-352mc w/2-6161s ..EX 18.75  
6161 Tube w/Connectors. 100 watts to 1200 mc. ...EX 6.75  
R443/ARN5D Receiver w/6 Xtals and 11 Tubes. ..EX 6.50  
T465/ALT7 100W Xmitter. 168-352mc w/2-6161s ..EX 18.75  
ID91B/ARN6 Bearing Indicator for ARN6 Recvr. ..EX 7.50  
AS313B/ARN6 Station Seeking Loop. 100-1750 kc. EX 6.25  
RT316/APN12 160-234mc Transceiver w/tubes EX 12.50  
ID169C/APN12 Scope. 3JP1 CRT. DPDT Coax Switch EX 9.75  
OAA-2 150-240mc Test Set. 115V 60cy Supply...EX 14.75  
AM300 Interfone Amplifier w/pp 6AQ5's output...EX 4.75  
Cabinet, Slope Front w/3 Meters (15, 25, 50ma) ..EX 7.50  
AT339/PRC 37-55mc Hand Held Loop w/cord. Bag EX 12.50  
PP336 Main Power Supply for APR9 Receiver ...EX 16.50  
PP337/APR9 Klystron Supply for TN130, TN131 ..EX 10.50  
ID226/APR9 Panoramic Indicator w/schematic ....EX 14.50  
SN36B/APS31 5-807's, 46 other tubes, 2 blowers ..EX 9.25  
SN7C/APQ13 Synchronizer w/24 octal tubes.....EX 8.50  
R316A/ARR26 14-Tube 162-174mc AM/FM Superhet 22.75  
PP468 Power Supply for R316A Receiver. 400cy. ..LN 4.75  
C610 Control Box w/4 tubes for R316A Recvr. ...EX 4.50  
Adaptor connects PL259 to BNC Panel Socket ...LN 3/1.75  
OHMITE Z-50 RF Choke .....EX 6/1.00  
Scope Xformer 1950V@3ma, 5 Fil windings, 60 cy NEW 4.75  
SA325/U Coaxial Switch. SP4T. 28VDC Motor ...EX 6.50  
Coax Switch. DPDT. Thompson Prod. No. E18B22CA LN 4.25  
3JP1 CRT w/Mount, Shield, Socket, HV Cap .....LN 4.75  
Complete Manual for TS726/UPM8. Postpaid .....EX 1.90  
Battery Charger 115V60cy to 6VDC @ 20amps ..NEW 9.75  
Panel w/15 Leach 24VDC Relays. 10amp 3PDT NEW 6.50  
Rt Angle Drive w/Gears, Universal, 1/4" Shafts ....EX 1.35  
Capacitor. Feed-thru. 15 on Panel .....Three Panels/1.00  
BNC (UG290/U) Coaxial Panel Socket .....EX 6/1.00  
Coax 6" long w/BNC (UG260A/U Plug each end..EX 4/1.00  
Coax 8" w/1 BNC Plug & 1 BNC Panel Socket ..EX 3/1.00

**E. C. HAYDEN** Box 294, Bay Saint Louis, Mississippi, 39520.  
Prices: FOB Bay Saint Louis. Terms: Net, Cash.

## The Quartenna

In my opinion, and that of many other hams, I'm sure, the Heathkit Cantenna is one of the best ham test equipment bargains on the market today. Its popularity is obvious from the number of articles propounding its virtues or suggesting modifications to further enhance its usefulness that have appeared in ham publications in the past few years. I would like to offer here a "modification" that will remedy what I feel is the Cantenna's greatest drawback—its size.

For those of us who run a full gallon to a rig complete with VOX, phone patch, antenna switching, and nice, neat hidden cabling, a Cantenna on the floor behind the operating console is the answer to the tuneup problem. But what about those of us who run a small transceiver set up on the kitchen table, or what about the VHF experimenter whose bench is already three feet deep with the latest project? For these hams the Cantenna is large—in fact, *four times* as large as it needs to be. The category I fall into is that of a VHF experimenter. As with most VHF operators, (we'll ignore the moonbounce and tropo scatter boys) I seldom have more than fifty watts of rf to handle from any one piece of equipment. It was with this need in mind that I came up with the Quartenna.

The Quartenna is essentially a 50 ohm nominal resistive element mounted in an oil-filled quart paint can. The resistive element is made up of ten 510 ohm 2 watt resistors connected in parallel to provide a 51 ohm load. Either a resistor value of 470 or 510 ohms is sufficiently close to the 50 ohm value which would make a perfect 50 ohm load. (I used 510 ohm resistors because my favorite surplus dealer has them for three cents apiece.) As can be seen from the photograph, the resistors are mounted between two  $1\frac{7}{8}$ " copper discs in a  $1\frac{1}{4}$ " circle. This spacing allows the cooling oil to circulate between the resistors. Be certain to maintain at least  $\frac{1}{16}$ " clearance be-

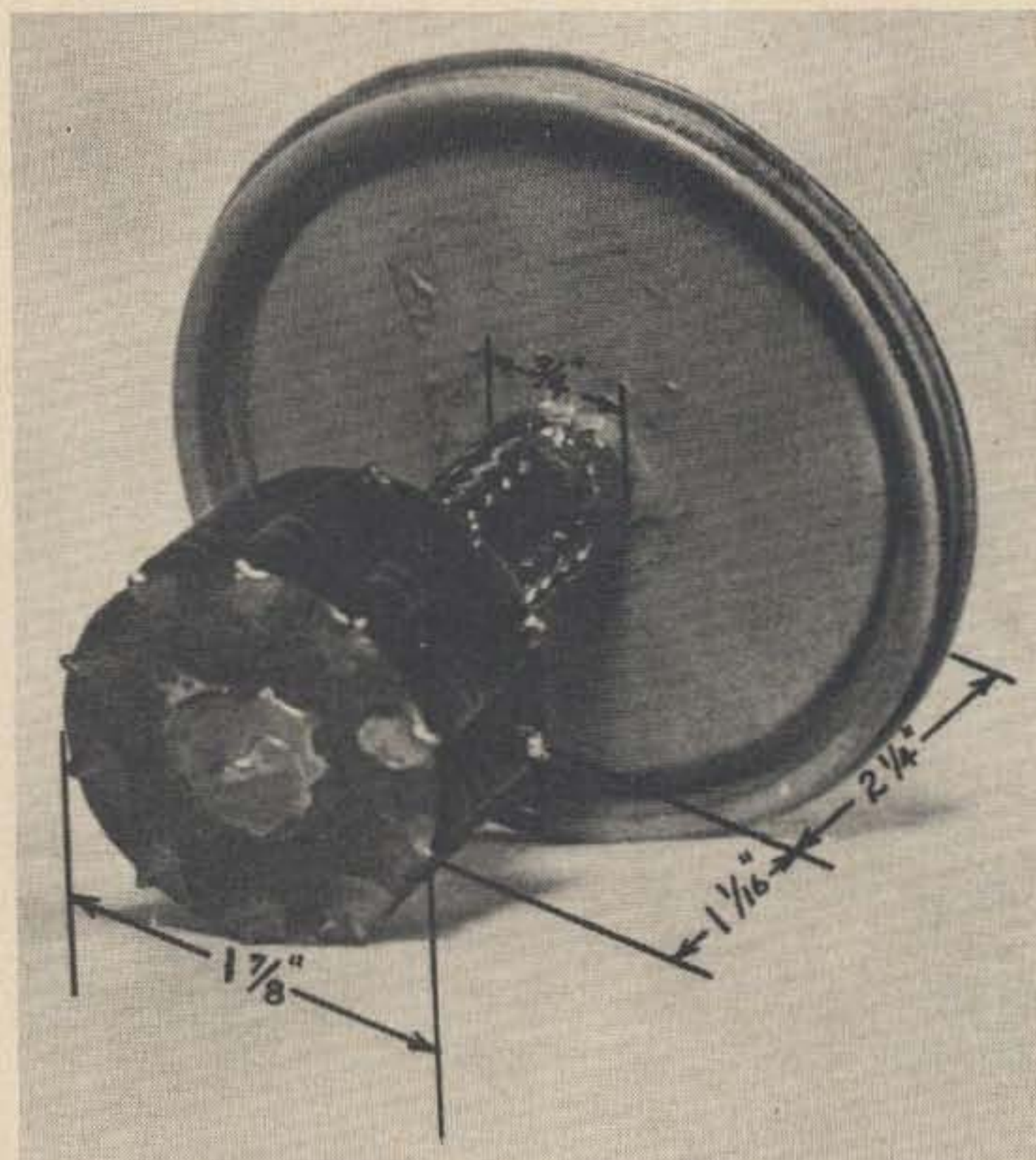

tween the resistor bodies and the discs; this minimizes the mechanical stress and strain on the resistors caused by heating and cooling. The center of the bottom disc is drilled to accept the center conductor of the coaxial support. The top disc is drilled and filed out to  $\frac{3}{4}$ " to accept the outer conductor of the coaxial support. The support conductor sizes were chosen to provide a characteristic impedance close to 50 ohms. In my unit I used a short length of RG-17/U coax with the insulation (both inner and outer) removed and with the ends of the shield braid tinned to help it hold its shape. If you use tubing for the outer conductor, drill a small hole near the end that mounts to the end of the can. This will keep the oil from being forced out the coax connector. The top end of the center conductor is drilled to accept the center stud of the coax fitting. The connector I used is a single hole mount UHF fitting. A screw mount fitting should work as well. The center of the lid of the can is drilled to accept the coax fitting.

Begin assembly by soldering the resistors

between the two discs. Next solder the coax fitting to the lid of the can. Solder the center conductor to the center stud of the fitting, being careful to keep the center conductor perpendicular to the plane of the lid. Solder the outer conductor to the lid after centering it around the coax fitting and making sure it is perpendicular. Slip the assembled resistors and discs in place and solder the upper disc to the outer conductor and the lower disc to the inner conductor. Fill the can to within about 1" of the top with oil.

Transformer oil is superior, but salad or motor oil will work. Put the lid on the can, give the outside a coat of flat black paint, and presto!

Results: I must say that the results were, at the least, quite gratifying. Some of you are probably wondering why no vent in the can for leaking oil as the Cantenna has. Well, a unit of this simplicity can't have everything! Seriously, I found that the load "breathes" through the coax fitting and there is no problem of pressure buildup. If you use a fitting which is sealed, a vent will be necessary. The VSWR of the unit measured as follows: 4 MHz, 1.05:1; 30 MHz, 1.05:1; 50 MHz, 1.05:1; 144 MHz, 1.08:1. The reactance at 44 MHz is capacitive. The unit was tested at 50 watts rf for thirty minutes. At the end of this period the can was not too warm to hold and the resistance of the element had drifted upward only 0.5 ohms. After operating at 50 watts for thirty minutes, the power input to the load was raised to 200 watts for five minutes. The can was still not too hot to hold and the resistance of the element had

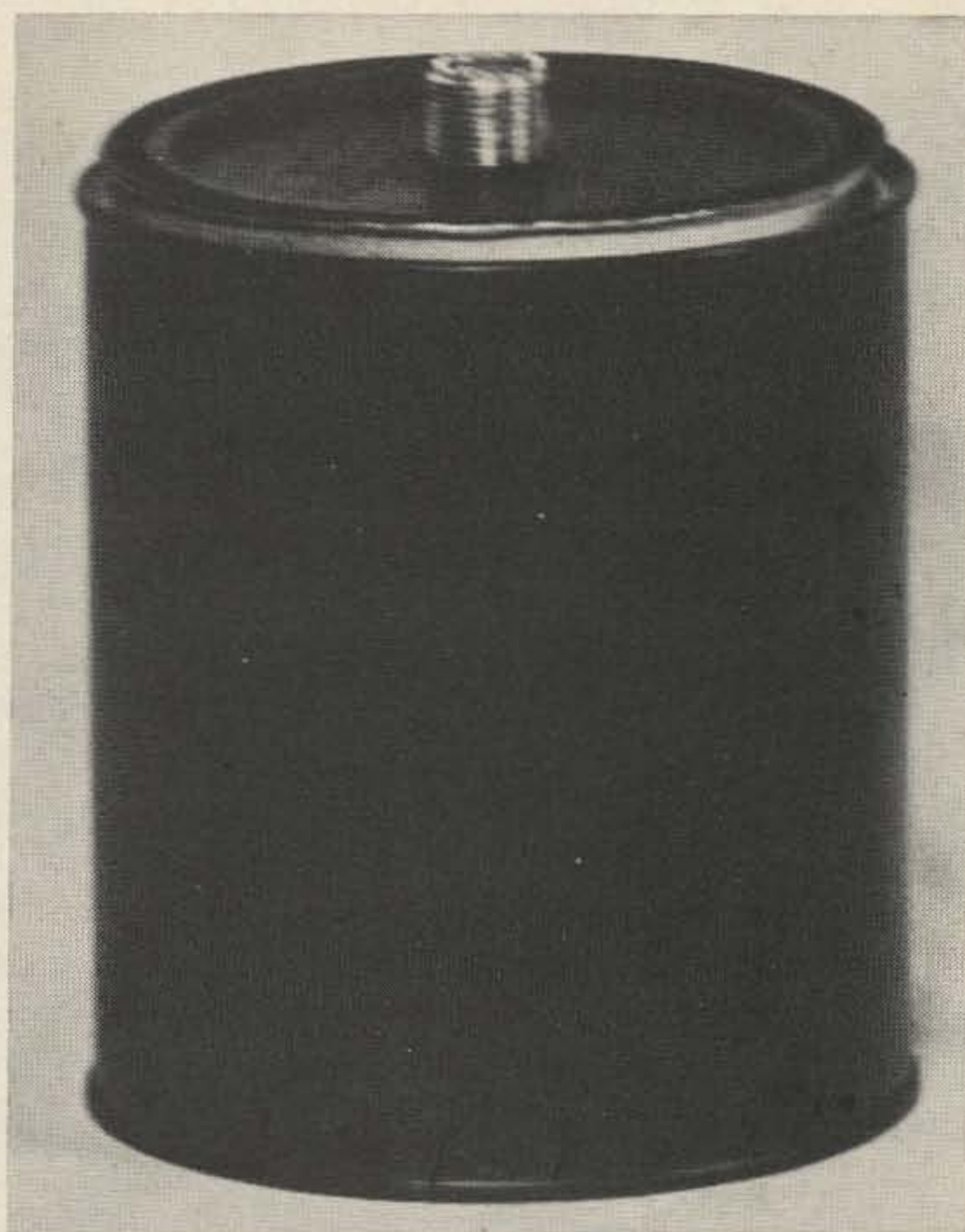

drifted upward only 1 ohm. I think you can see what I mean by "gratifying". It appears to me that the Quartenna should handle 50 watts continuously or 200 watts RMS or 400 watts PEP on an intermittent basis.

Suffering from cramped quarters or a flat pocketbook? Need a good dummy load? Then why not shell out about three bucks, a few feet of solder, a pleasant evening's work, and build yourself a Quartenna?

My thanks to WA6IHX for his help with the photography.

... WA60BH

**NEW!**

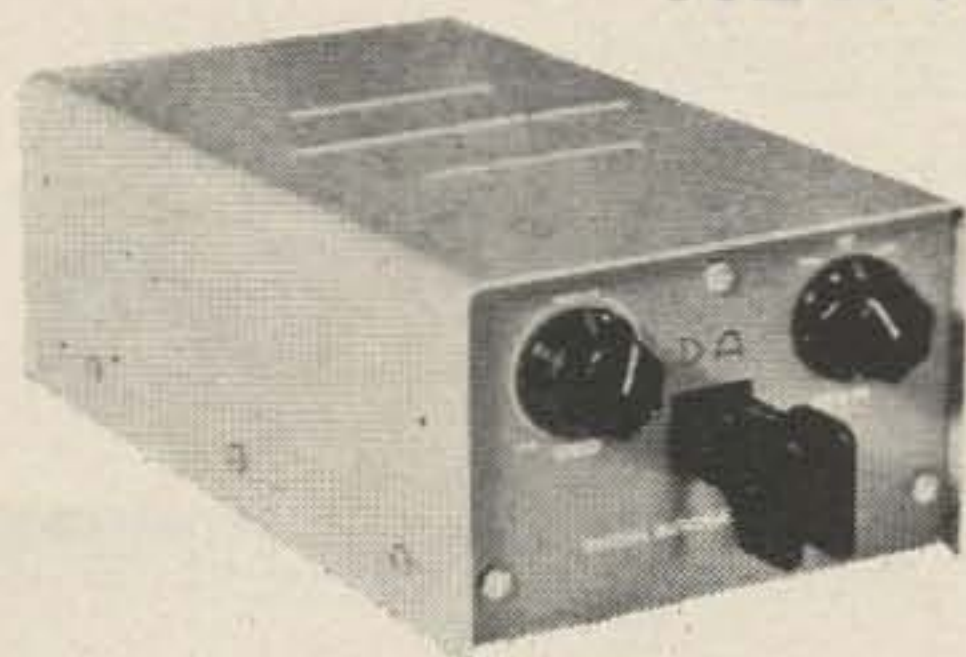

**\$85.00**

**WIRED AND TESTED**

the

DA

**DIGITAL AUTOMATIC I.C. KEYS**

Portable  Dot and dash memories  IC's and transistors for best performance  50 V.A. reed relay  Easy to use —two squeezes send "CQ"  6-60 WPM  Precision double paddle—built in (provision for external paddle)  Monitor—including speaker, tone and volume controls  "lambimatic"—squeeze for alternate dot and dashes  Send for free brochure

**OMEGA ELECTRONICS CO.** 10463 ROSELLE STREET  
SAN DIEGO, CALIF. 92121

Bob Eldridge VE7BS  
805 East 20th Avenue  
Vancouver, British Columbia  
Canada

## Hydronics or Radio?

In the May 1966 publishorial Wayne Green made brief mention of the reports from Sarasota, Florida on the probable existence of a new form of radiation termed, for want of an existing word, hydronics. Just a year later, in the May 1967 *Radio-Electronics*, an article appeared which described practical experiments in the new form of underwater communication. In the 1966 *Proceedings of the Joint Technical Advisory Committee (IEEE/EIA)* there are several references to hydronic radiations and a considerable amount of memoranda on the subject.

I do a lot of reading. For the benefit of those who do not, I thought it might be interesting to go over some of the arguments and add a few of my own. The people at Sarasota say that most of the conventional explanations of their results have been advanced by scientists who have not witnessed the full gamut of such demonstrations. I haven't seen *any* of their demonstrations, so the only thing that doesn't drop me right into the group of explainers is that I am not a scientist either. Fools step in. . .

But hams have uncovered things that scientists have overlooked, and real results are sometimes achieved from persistent serendipity (the process of talking and talking and talking about something until eventually a fundamental truth pops out that none of the talkers was aware of originally). So much for my unqualifications to discuss hydronics. If you aren't interested in my own observations, just ignore the paragraphs in italics.

### What is it all about?

There must be somebody who hasn't heard of hydronics, so let's go over the basics briefly. It has been discovered that if a pair of special antennas are submerged in water several miles apart, an AM signal can be sent from one to the other. If the antennas are brought closer to the surface, the signal increases; if they are brought

above the surface, the signal disappears or is greatly reduced. If one antenna is left below the surface, communication is possible with certain other types of antenna above the surface and at a distance. Communication can be achieved over a distance greater than that predicted by the normal electromagnetic radiation formula used to show the attenuation expected on an underwater path.

From this, the proponents of the "Hydronics Theory" deduce that there is a form of radiation from the transmitter somewhat different from electromagnetic radiation, possibly a form of energy heretofore not proven to exist, although hypothesized by some of the early experimenters in radio and electricity.

This becomes interesting to the JTAC subcommittees because the thought rears its ugly head that besides all the pollution of the radio spectrum by the emissions we already know about (No, not the VOA in the 7-MHz band!), there may be a whole slew of emissions using the same frequencies but of a different nature. Can't you just hear the groans of the landlubbers being echoed by resounding cheers from the naval types!

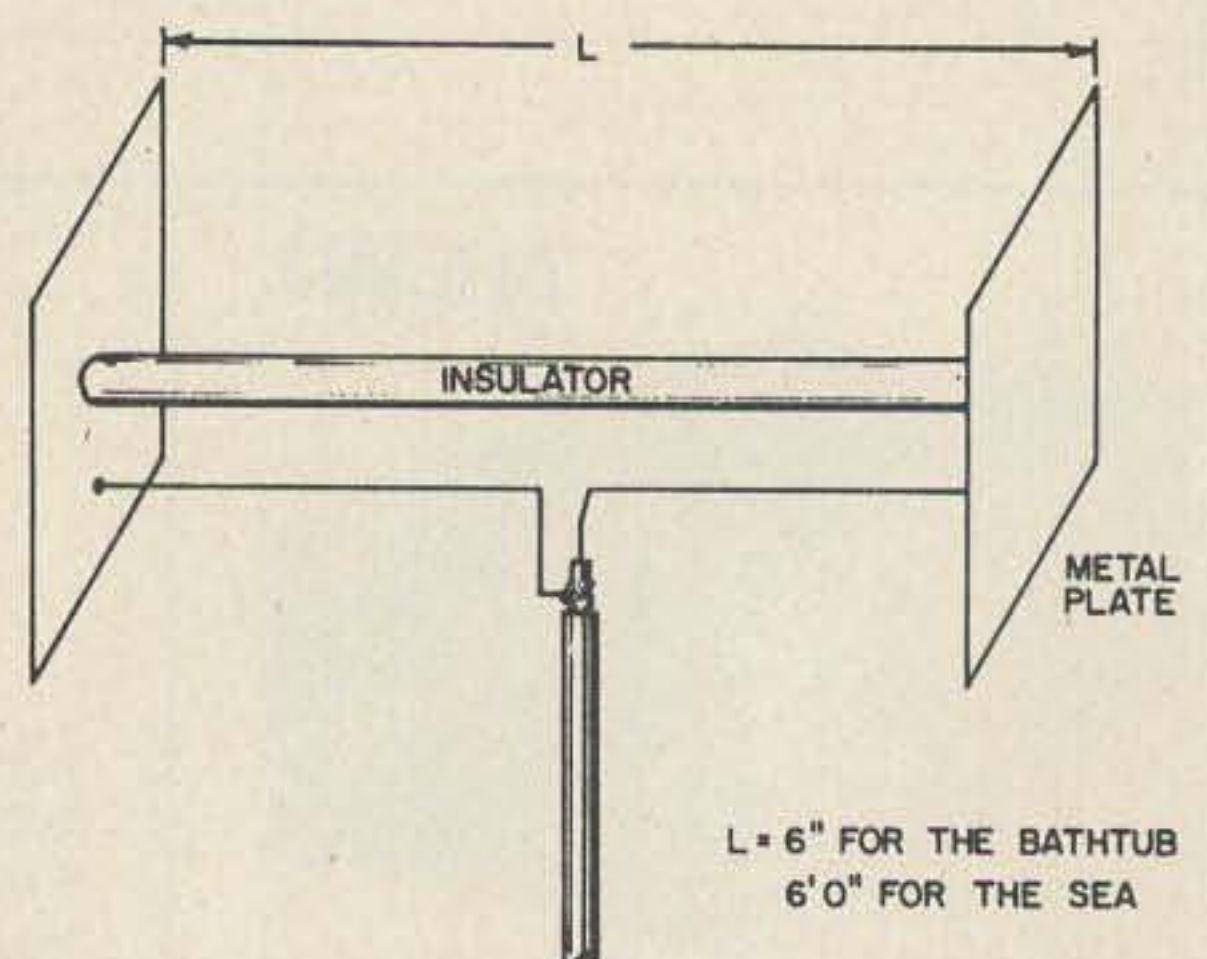

Fig. 1. Underwater dipole for studying the effects of underwater radio transmission. For bathtub experiments the dipole can be about 6 inches long; for ocean testing six feet is preferred.

## Practical details

Typical antennas are short dipoles with flat plates at the ends, center fed with an insulated balanced feeder (see Fig. 1). For simple experiments in a bathtub, Jack Althouse's article<sup>1</sup> shows a simple one-transistor oscillator modulated by a one-transistor tone generator. There isn't any magic claimed for the gear, but it is easier to build something like that than it is to figure out a way to modulate your VFO!

Bathtub antennas can be any size you find convenient. The longer they are and the larger the endplates, the stronger will be the radiation. If you go whole hog and do it in the sea, try 6-foot dipoles with plates one foot square, and do it on 160 meters. If you use a full-scale transmitter you will need some walkie-talkies or something for "order-wire" because the transmissions will go a long way. Very low power and furious waving of arms or shouts works out to be more convenient in the long run. Go QRP.

No magic about the receiver either—anything that will receive on the frequency, detect the modulation, and couple to a dipole will work. If it isn't screened, you may have some perplexing results!

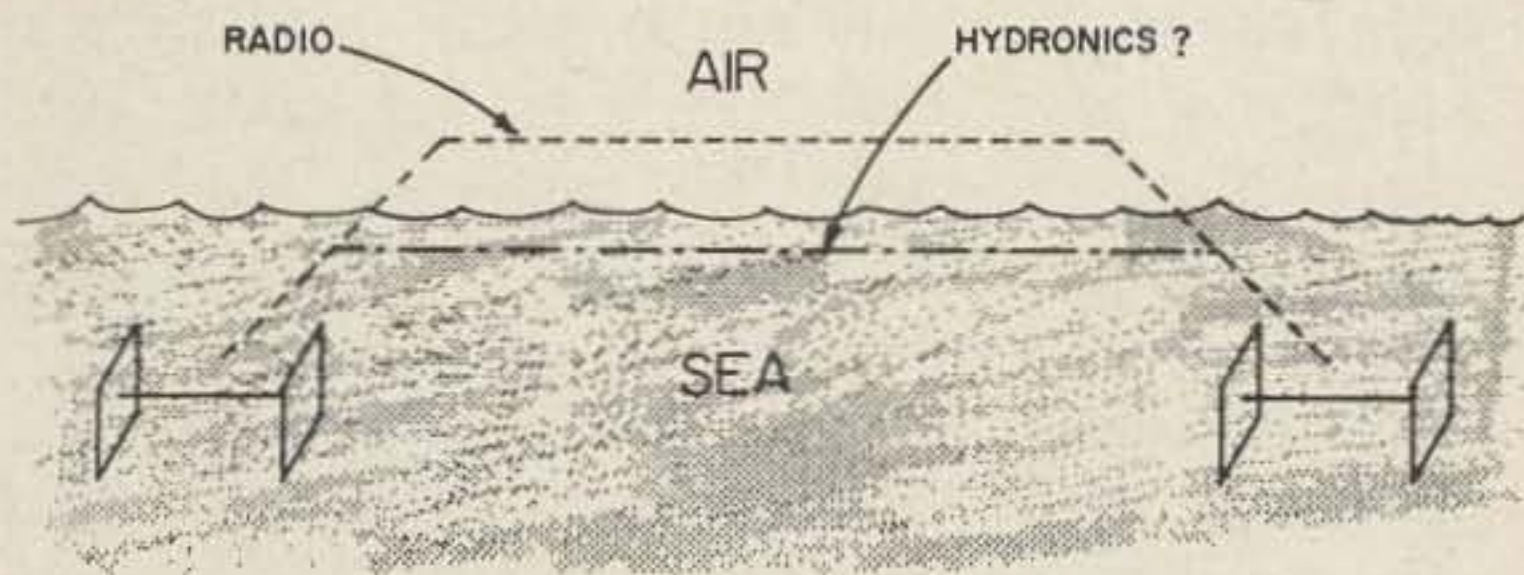

Fig. 2. Do the signals travel above or below the sea-air interface?

## Experiment 1

Two antennas are immersed in the ocean, 100 meters apart. Each antenna is a 6-foot dipole with metal end plates. A signal transmitted from one antenna to the other is found to be maximum when the antennas are in line with each other, minimum when they are broadside, Fig. 2. Sarasota says, "With radio waves, maximum signals would be received when the transmitting and receiving antennas are broadside, and a minimum signal when they are coaxial."

Although everyone remembers that the maximum lobes of horizontally polarized waves are at right angles to the wire of a horizontal dipole, many people forget that the maximum vertically polarized waves are

emitted from the ends, Fig. 3. If you consider for a moment that this might be normal radio propagation, you will agree that horizontally polarized waves would not travel far across the surface of land or water before being attenuated by the short-circuiting effect of the horizontal surface. So, along the lines of, "if it's radio, it would have to be vertical polarization", we would expect the antennas to be end on to each other.

## Experiment 2

The receiving antenna is replaced by a single plate. The transmitting antenna is rotated and it is found that the signal is at a maximum when the transmitting antenna is end on. Communication ceases when either or both antennas are removed from the water.

## Experiment 3

The antennas are exchanged end for end. The dipole shows the same directivity when used as a receiving antenna. Communication ceases when either or both antennas are removed from the water.

Let us assume that a radio emission has emerged from the water at a point close to the transmitting antenna and then travels along the surface as a vertically polarized wave. The receiving antenna, when removed from the water, would only respond to the wave if it has the capability of receiving signals from a horizontal angle. Although a horizontal dipole transmits or receives vertically polarized signals off the ends, this is almost all high angle radiation. This is one reason you work so well off the ends of your 40-meter and 80-meter horizontal dipole—it surprises many hams, but it shouldn't!

From the description of the experiment it seems that the single-plate antenna (termed a monopole) consists of a plate perpendicular to the water surface and fed by a single horizontal wire. It would be interesting to know whether a vertical stick monopole above the water would receive the signals that the vertical-plate-on-a-wire could not. See Fig. 4.

## Experiment 4

Two monopole antennas are used. Both act omnidirectionally. Communication ceases

when either or both are removed from the water.

### Experiment 5

A dipole antenna below the surface transmits to "an antenna" above the surface. Rotation of each shows maximum signal when they are collinear.

*It is difficult to comment on this because it is not clear what kind of antenna is at the receiver. The same goes for Experiment 6.*

### Experiment 6

A sealed transmitter with 0.1 watt output to a two-meter-long dipole antenna is lowered into 30 meters of sea water. A vertically disposed dipole just below the surface is connected to a receiver. Measurements show that as vertical distance between the antennas is varied, the attenuation varies as the square of the distance. Similar experiments in a horizontal plane, with the antennas end on, give the same results at the same distance.

*This only shows that if the signal travels through the water all the way, water has the same conductivity in one direction as in another. If we consider the signal emerges from the water, travels horizontally across the surface of the water in the air, and returns part of its energy to the water continuously as it travels along, then Experiment 7 is not of much interest, as it only proves what we already know—that water is a rather poor medium for the internal propagation of radio waves.*

Sarasota says, "The attenuation of a 6-kHz radio signal after traversing 100 meters of sea water is about 250 dB. To receive a signal over that distance on a receiver with a sensitivity of  $10^{-9}$  watts would require a transmitter power of  $10^{61}$  watts . . . Since the power required to transmit a radio signal under these conditions is so great, it is unthinkable to ascribe these phenomena to conventional radio waves."

*But what if the signal goes a few meters through the water, best part of 100 meters through the air, and then into the antenna through another short water path? There is plenty of literature supporting the theory that if a radio signal passes through an interface between two media of radically different density, the signal will be refracted along the surface of the interface. Staiman*

*and Tamir<sup>2</sup> say that the only necessary condition is that the signal must arrive at the interface at the critical angle. As the signal travels along the surface of the sea, in the air, it constantly returns a portion of its power to the sea, entering the surface and propagating downward at the same critical angle. It will be intercepted by a receiving antenna below the surface.*

*If you have forgotten your high school physics, fill a glass with water and hold a knife blade in the water, entering at an angle of  $45^\circ$  or so. View the blade from various angles looking down into the water, and the knife will appear to be bent. This is optical refraction. If you have ever tried to spear a fish from a boat you will already have learned about this the hard way!*

*So now we have a possible explanation for the underwater communication. The heavily end-loaded horizontal dipole radiates vertically polarized waves off the ends towards the surface of the sea at such an angle that when the wave emerges from the surface it is refracted to the horizontal. It then propagates over the surface of the sea. The attenuation over the main portion of the path is that of a surface wave in air over a good conducting layer. All the way along the over-water path, part of the energy of the wave front is fed down into the water, entering the water at the same critical angle which gave rise to the propagation of the wave. Staiman and Tamir go into an extensive dissertation on the features of the lateral-wave component of the surface wave. This gets a bit deep even for those hams not unhappy about the provisions of the new incentive licensing law.*

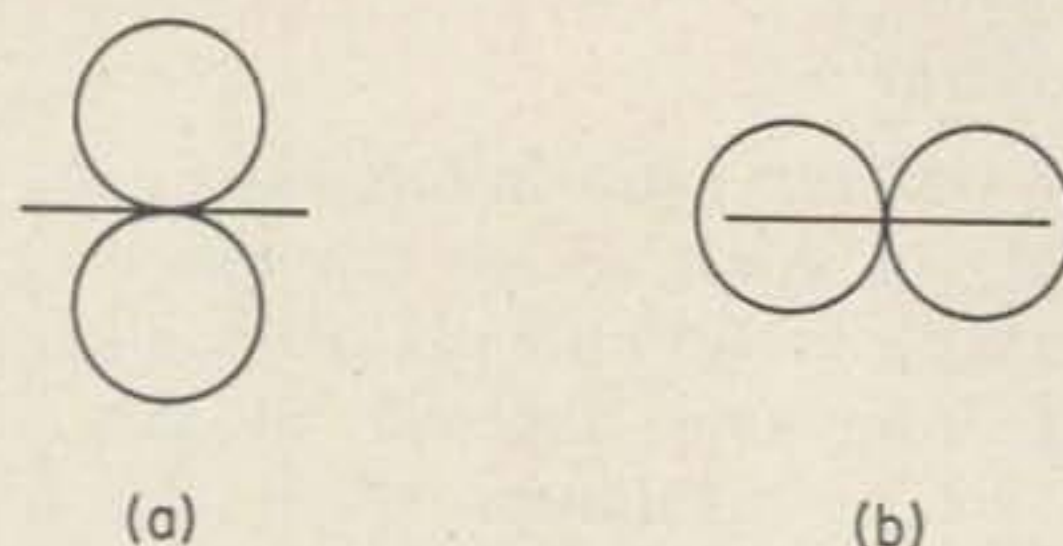

Fig. 3. The directional pattern of a short horizontal dipole is shown in A (horizontally polarized waves). Directional pattern of a short horizontal dipole showing the high-angle vertically polarized waves.

### So What?

So what conclusions can we draw from this? Anyone who sticks out his neck by drawing positive conclusions has courage. But at least there is good reason to believe

that the scientific world will continue to be skeptical about the existence of a new form of energy until considerably more detail has been published of controlled tests.

It would be very interesting to make some tests on UHF or microwave over a very short path and see what happens when a metal plate is suspended first in the air and then in the water at the mid-point of the path—or is that too simple a way to determine where the wave is travelling?

### Signals from fish

Sarasota Research & Development also reports some very interesting experiments with fish. One hundred thirty species have been studied, and they all emit signals receivable on an electronic receiver. Each kind of fish can be identified from the character of the signal. For example, sea robins transmit short pulses at 170 Hz, black drum transmit on a carrier frequency of 6.5 kHz, and pinfish on 28 kHz.

The part of the fish said to give rise to the omissions is the skin surface along the lateral line. The skin transmits a signal even after having been separated from the rest of the body, and radiations have been monitored 100 meters away from the fish.

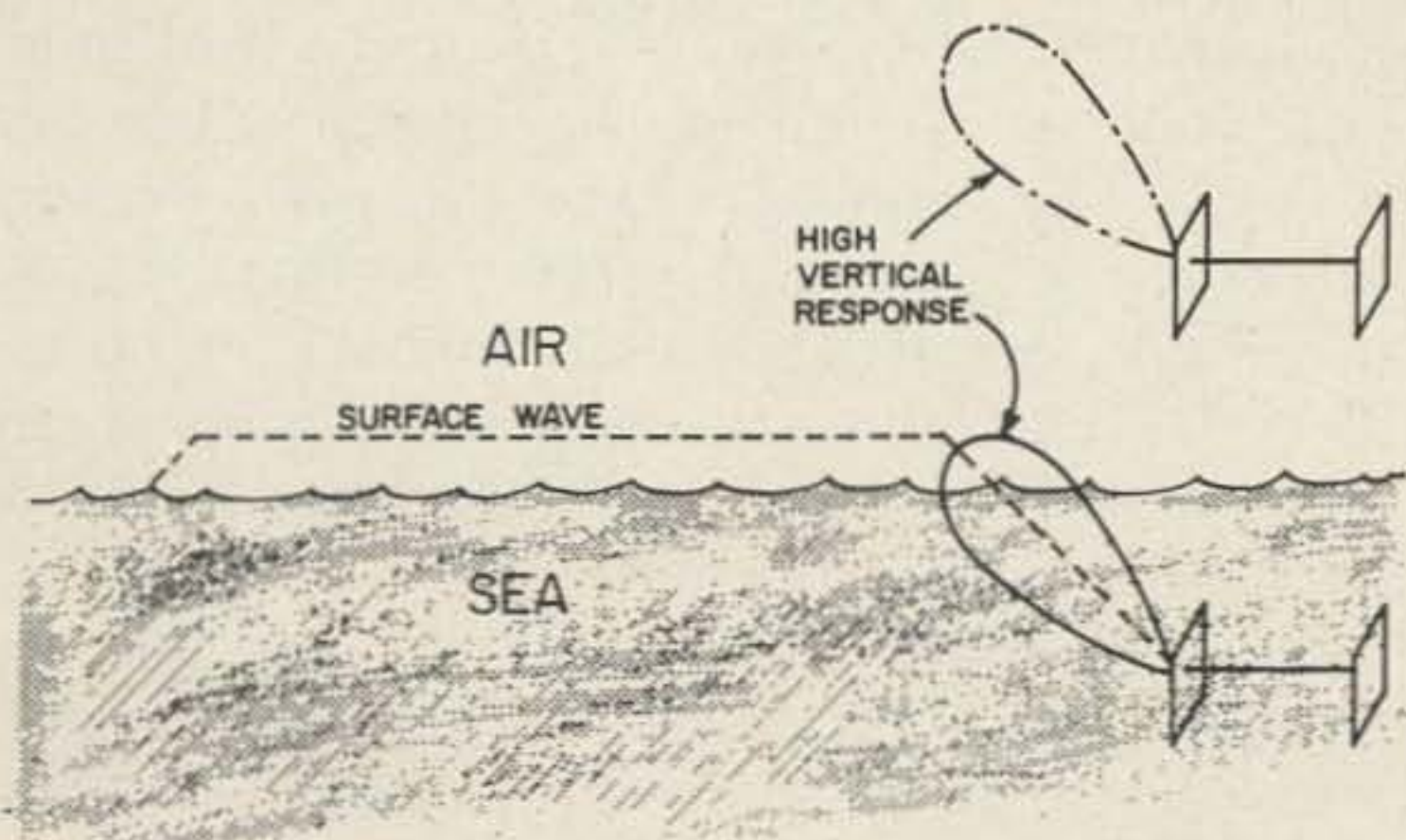

Fig. 4. An antenna with maximum response at a high angle might work fine under the water, but pretty poorly above it.

### Who needs transmitters?

Another interesting report is, that using a dipole with end plates of dissimilar metals immersed in sea water, radiations are emitted from the antenna even when no transmitter is attached! Yet a VTVM with an input impedance of  $10^{14}$  ohms connected across the feed point of the dipole shows no potential gradient to exist. One of the plates was of zinc and the other of copper, and the signal was receivable 100 meters away.

So there you are. Undoubtedly there are some very interesting things going on in Florida, and before long there may be some new electronic aids for fisherman, and for divers. Whether it be hydronics, plasmonics, or just plain old radio, the search for better communication goes on. And, I guess, so will the argument.

. . . VE7BS

### References

1. J. Althouse, "Build Hydronic-Radiation Transmitter," *Radio-Electronics*, May 1967, page 37.
2. Staiman and Tamir, "Nature and Optimization of the Ground (Lateral) Wave Excited by Submerged Antennas," *Proceedings of IEEE*, Volume 113, Number 8, August 1966.

VARIABLE CAPACITORS				TUBES			
APC 15	.25	max cap	15uuf	2AP1—	\$13.95	250TH—	25.00
MC 20S	.50	max cap	20uuf	5UP1—	14.95	304TH—	39.95
MC 25S	.50	max cap	35uuf	5UP7—	14.95	811	2.50
MC 100S	.50	max cap	100uuf				
ELECTROLYTIC CAPACITORS				FT-243 XTAL—\$1.00 ea			
160 mfd @	450 vdc		1.50	8.100 mc	8.500		7.575
1000 mfd @	25 vdc		.35	8.200 mc	8.650		7.700
20-20-20 mfd @	250		1.00	8.30 mc	Socket for		
40-40-40-40 @	450		2.50	FT243	.....		10 ea

Thousands of items in inventory—inquiries welcomed.  
Get on our mailing list.

**BOB-FRANK ELECTRONICS, Box 1327, Harrisburg, Pa. 17105**

**LIGHTS! ACTION! CAMERA!**

**SMILE . . . You're on TV**

Just think! Televising your family and relatives on the living room TV set with **YOUR OWN TV CAMERA**. Interested?? No matter whether you're considering a camera built primarily from junkbox parts or from a complete kit, **ATV RESEARCH** has just what you need. Over 8 different tube and transistor models to select from. **STARTER KITS \$18.95 up . . . MAJOR COMPONENTS KITS \$58.25 up . . . COMPLETE KITS (transistorized & printed circuit) \$149.50 up.**

Get started in this **FASCINATING HOBBY** today by writing for a copy of our **NEW 1968 catalog**. It contains a comprehensive listing of kits, lenses, vidicon tubes, tripods, focus/deflection coils (both regular and slow scan); plus plans, automatic light kits, charts, etc. Please include 10¢ to cover cost of mailing.

**Established dealer inquires invited.**

P.O. BOX 453-S **ATV RESEARCH** Dakota City, Nebr. 68731

# Electronic Temperature Measurements

Frequently in electronic work it is necessary to determine the temperature rise of components located in areas that are inaccessible. When use of a thermometer is inconvenient or impracticable, in industry we generally turn to thermocouples and potentiometric recorders. Alternately, thermistors can be used, if the curve of resistance vs. temperature is available. These can be purchased for around \$5.00 from Allied Radio. An accurate meter to measure the thermistor is to be desired.

For the single shot type of temperature measurements the average amateur is likely to encounter, such as determining the temperature rise of a TV transformer used in a home-built transmitter, or the temperature rise in the compartment of a VFO where installation of a temperature compensating capacitor is contemplated, there is a far less expensive method. This involves very simple calculations based on the change in resistance of copper wire as its temperature is raised. Since these are relative resistance measurements absolute accuracy is not required. The percentage change is the important criterion. Hence an ordinary ohmmeter can be used providing it gives repeatable readings and is used on a scale where changes of 20 to 50 percent can be readily recognized.

Let's take the transformer discussion first. Ordinary type commercial transformers use Class A insulation and should be limited to about 212° Fahrenheit or 100° Celsius (formerly called Centigrade). The ambient or room temperature plus the temperature rise should not exceed this value. In case you've forgotten, to go from degrees F to degrees C, simply subtract 32 then divide by 1.8 (or multiply by 5/9 if it seems easier). Now then, copper which has been annealed, like soft drawn magnet or transformer wire, has a temperature coefficient of resistivity of 0.00393, so each ohm of it will increase 0.00393 ohms for each degree C of temperature rise. This isn't perfectly

linear of course, but is accurate enough for all practical purposes. By juggling a few figures, or checking a reference book, we find that the temperature *rise* of the transformer winding will be:

$$T = 255 \left( \frac{R_{\text{hot}}}{R_{\text{cold}}} - 1 \right) ^\circ\text{C}$$

So, the procedure is to simply measure the transformer primary resistance when it is cold, watching out for parallel circuits that might cause false readings. Then operate as usual for the maximum expected time. If you use CW, don't lock the key down. Then, at the end of the session, again measure the primary and calculate the temperature rise. Add this to the room temperature. This tells you the temperature inside the transformer, where it counts.

It may be of course, that some will insist on more accurate measurements, since the transformer did cool down somewhat between the time power was disconnected and you got around to checking it. Lets say it took one minute. Then at one minute intervals take several more readings. Draw a simple graph and plot it back to time  $T = 0$ . This gives the actual hot resistance. The graph will be nearly linear and a smooth curve easy to plot.

To calculate the required temperature compensating capacitor to use in parallel with the tuning capacitor to compensate for drift; we must find the temperature rise in the area of the enclosure where the TC is to be located. A simple sliderule is available for only 18 cents to perform the calculations. (Allied 19U916). To find the temperature rise, suspend a tiny transistor interstage transformer in the VFO. Don't let it touch the chassis. A tiny one should be used to insure that it will have a short thermal time constant. This is necessary if we want to follow the changes in the air temperature. As with the power transformer, measure the coil resistance when it is cold, and as the equipment goes through its warm-up cycle. Then calculate the temperature rise as indicated for the power



transformer. An important difference; *do not* add the room temperature. The °C rise is all that is required for calculating the change in capacity of a TC capacitor. If you don't feel like spending the 18 cents for the calculator, you can always figure that for small changes in capacity, the frequency shift is nearly linear, and work it out from there.

Since two other methods of temperature measurement were also mentioned as a teaser, a brief discussion of them might be in order. Allied Radio has, in their Industrial Catalog, a one percent accuracy thermistor, with curve, for about 5 dollars. Or, in their wishbook for Everyone, they have a kit of 4 glass beads (thermistors), probes, manual, and curve computer for the same price. Discs are less than a dollar, but you calibrate them yourself.

In using thermistors at least two precautions are necessary. First of all the measuring instrument must not supply appreciable power to the thermistor, or else self-heating effects will nullify the calibration. Second, with beads, remember they have a very short time constant, the same as many other semiconductors. In other words, they blow out faster than they can be disconnected. And, as was mentioned, the tiny ones can get lost when you suddenly sneeze. See: *Which Way is UP?* 73-Feb. '62.

While thermocouples are widely used and simple to make, they have one great big disadvantage. The output is in the order of millivolts and the lead resistance is high. Hence, unless a very sensitive meter is used, the meter and thermocouple must be closely matched. Clip the leads short and the accuracy is gone. If a sensitive millivoltmeter is available, a conversion chart can be readily obtained which will give accurate temperature readings. This permits making several simultaneous measurements in a chassis by switching in numerous thermocouples. Leeds & Northrup Co. (see the yellow pages) has a conversion table booklet at a very nominal price, like free. That is, if

you can convince the person who answers the phone that you do a lot of such work. These conversion tables are generally based on using a reference thermocouple at 32° F or 0°C. This requires icy slush, and can get messy. Of course the chipped ice can be used for cooling other stuff which may help pass the time during the temperature run.

With a small VFO, you may be able to sneak it into your place of employment, or have a good friend take it in and check it for you, doing the measurements with professional equipment. Most industrial electronic and chemical plants make considerable use of temperature measurements obtained by thermocouples and recorded or indicated on potentiometric recorders. The recorder is generally a bridge circuit which is balanced by a servo mechanism driven by the error signal from the bridge. At balance, the voltage from the thermocouple is matched by an equal but opposite voltage from the recorder. The net result is an apparently infinite input impedance, so the thermocouple is not loaded and the length and resistance of the leads is of no consequence. This isn't really true of course, since at balance we wouldn't know if the reading is steady or the recorder dead. A little jitter is generally added to make things look alive. Far off balance the recorder input impedance may be 1K ohms or less. But the readings there are, of course, unimportant. Of importance is the fact that up to 12 automatically switched inputs may be available, allowing one to locate thermocouples all over the VFO chassis to find the hot spots. And a continuous recording helps to tell what causes the frequency to drift back and forth. No ice bath is required in most set-ups since automatic temperature compensation is generally included.

Other temperature sensing elements, such as diodes and transistors are available. For simplicity, the copper resistance method is hard to beat. For economy, it *can not* be beat.

... K6EAW

## ▶ LEARN CODE ▶ the right way - with ▶ Code Sound Language!



"The specialized language of sound" brings you a complete study of the International Morse Code. Satisfied users say—"Complete in every detail"—"Easy to learn!"—"CSL is the best!"—Increase YOUR receiving speed, master the code now! ★★★★★

CSL NR 1 & NR 2 (1 tape) for the prospective Novice, Technician, General or Amateur Extra First. 3 to 25 wpm.

CSL NR 3 & NR 4 (1 tape) for the advanced operator with a sincere desire to copy code sounds at rapid speeds. How to copy behind, etc. 25 to 55 wpm. Both tapes, plenty of copy—plain and scrambled, numerals and punctuation.

Magnetic tape, 7" reel, dual track, 2 hours. Immediate delivery. Send check or money order. (Specify which tape.) \$6.95 each.

Both tapes on one order, only \$13.50.

Sound History Recording, Dept. 73, Box 16015, Washington, D. C. 20023

# GET IT from GOODHEART!

EVERYTHING UNCONDITIONALLY GUARANTEED

TEKTRONIX #531 15 mc scope w/dual-trace plugin, w/NBS-traceable Certif., books, probes .....775.00  
Other Tekt., Hewl-Pack, DuMont scopes .....ASK!

COUNT FREQ. DIGITALLY 10 cy to 220 mc with crystal accuracy, at the lowest price available anywhere; andl each set has been completely checked and comes with a dated CERTIFICATE OF CALIBRATION (and stickers) traceable to the National Bureau of Standards. You get Hewl-Pack #524B with #525A & 525B plugins, and complete set of books .....1275.00

Brand new VHF revrs in original cartons; look exactly like the familiar BC-453 Command Revrs but are 9-tube superhet 108-135 mc AM revrs and very easy to power & control without touching anything inside the unit; you can even connect an S-Meter externally. We furnish schematic and complete instructions on all pin connections and also a spline tuning knob; we furnish graph of freq. vs knob turns. 2 uV sensitivity. 2 RF, 3 IF stages. Shpg wt 7 lbs fob Los Angeles. BRAND NEW .....\$22.50  
R32 is same but w/adjustable squelch .....\$27.50

R-23/ARC-5 Command revr 190-550 kc. ....14.95  
A.R.C. 12 #22 Command revr 540-1600 kc. ....17.95  
RA-62-B is AC pwr sply for SCR-522, only.....17.95  
LM-14 freq. meter, .01% 125 kc-20 mc. ....57.50  
TS-323/UR freq. meter 20-480 mc., .001% .....169.50  
BC-221's OK .....\$67.50 TS-175 OK .....127.50  
CLOSING OUT Radio Receivers 38-4000 mc at CRAZY LOW PRICES! Ask for APR-4/4Y/CV-253 sheet.

ALL-BAND SSB RCVR BARGAIN: Hallicrafters R-45/ARR-7., 550 kc to 43 mc continuous. Voice, CW, MCW, aligned, grtd, w/book; 2-RF, 2-IF's, S-meter; noise lmtr: 3 xtl, 3 non-xtl selectivity choices. 149.50  
Less pwr sply .....  
60 cy pwr sply: \$30. SSB product detector .....\$30

Collins R-390 Receiver, Exc. Cond., w/book .....750.00  
SP-600-JX Revr .54-54 mc. Exc. Cond., w/book .....325.00

Super. EMT 6220Y 3 ph 20 kva Line V Regulator....450.00  
Sorens. 10000S 10 kva Line V Regulator .....695.00  
And others from 250 VA up. Ask for Regulator List.  
Automichron Cesium-Beam Freq. Standard .....ASK!  
Regulated Power Supplies, Meter Calibrators .....ASK!  
All kinds of AUDIO Test Equipment .....ASK!  
Standard Signal Generators CW/AM/FM/Sweep .....ASK!  
Bridges, Potentiometers, other Lab Standards .....ASK!  
Electronic & Rotary Frequency Converters .....ASK!  
Noise & Field Strength Meters .....ASK!

TIME PAY PLAN: Any purchase totaling \$160.00 or more, down payment only ... 10%

Above is a small sampling of our terrific inventory. We ALSO BUY! We want Tektronix scopes, Hewlett-Packard eqpt., Aeronaut, radio-shop equip., etc. . . . AND Military Communications of all kinds.

## R. E. GOODHEART CO. INC.

Box 1220-GC, Beverly Hills, Calif. 90213

Phones: Area 213, office 272-5707, messages 275-5342

WE PAY HIGHEST PRICES FOR ELECTRON TUBES AND SEMICONDUCTORS

**H & L ASSOCIATES**  
ELIZABETH INDUSTRIAL PARK  
ELIZABETH, NEW JERSEY 07206  
(201) 351-4200

## NEW! RTTY

The famous RTTE-3/4 now with even more features:

- MARK hold.
- Minimum acceptable level circuit.
- Plug-in modular design.

All with no increase in price. Write for information on the new RTTE-5/6 - the COMPLETE teletype terminal for amateur or commercial use.

TUCK ELECTRONICS  
235 Market Street  
New Cumberland, Pa.

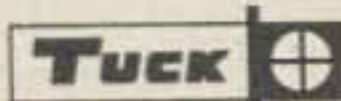

Phone: 717-232-3431  
Zip 17070

# Propagation Chart

FEBRUARY 1968

J. H. Nelson

## EASTERN UNITED STATES TO:

	GMT: 00	02	04	06	08	10	12	14	16	18	20	22
ALASKA	21	14	7	7	7	7	7	7B	14	21	21A	21
ARGENTINA	21	14	14	7A	7	7	14A	21A	21A	21A	28	28
AUSTRALIA	21A	14	7B	7B	7B	7B	7B	14	14	14	21	21A
CANAL ZONE	21	14	7	7	7	7	14A	21A	28	28	28	21A
ENGLAND	7	7	7	7	7	7B	14	21A	21A	21	14	14
HAWAII	21	14	7B	7	7	7	7	7B	14	21A	21A	21A
INDIA	7	7	7B	7B	7B	7B	14	21	14	7B	7B	7
JAPAN	14	14	14B	7B	7B	7	7	7	7B	7B	7B	14
MEXICO	21	14	7	7	7	7	7	14A	21A	21A	21A	21
PHILIPPINES	14	14	14B	7B	7B	7B	7B	14	14	14B	7B	14B
PUERTO RICO	14	7	7	7	7	7	14	21A	21A	21A	21	14
SOUTH AFRICA	14	14B	7	7B	7B	14	21A	28	28	28	21A	21
U. S. S. R.	7	7	7	7	7	7B	14	21A	21	14	7B	7B
WEST COAST	21	14	7	7	7	7	7	14	21A	21A	28	21A

## CENTRAL UNITED STATES TO:

ALASKA	21	14	7	7	7	7	7	7	14	21	21A	21A
ARGENTINA	21	14	14	7	7	7	14	21A	21A	21A	28	28
AUSTRALIA	28	21	14	7B	7B	7B	7B	14	14	14	21	21A
CANAL ZONE	21	14	7	7	7	7	14	21A	28	28	28	28
ENGLAND	7	7	7	7	7	7	14	21	21A	21	14	7B
HAWAII	21A	21	14	7	7	7	7	7	14	21	28	21A
INDIA	14B	14	7A	7B	7B	7B	7B	14	14	14B	14B	14
JAPAN	21A	14	14B	7B	7	7	7	7	7	7B	14B	21
MEXICO	14	14	7	7	7	7	7	14	21	21	21	21
PHILIPPINES	21	14	14B	7B	7B	7B	7B	14B	14	14	7B	14
PUERTO RICO	21	14	7	7	7	7	14	21A	21A	21A	21A	21
SOUTH AFRICA	14	14	14B	14B	7B	7B	14A	21A	21A	21A	21	21
U. S. S. R.	7	7	7	7	7	7B	14B	14A	14	14	7B	7B

## WESTERN UNITED STATES TO:

ALASKA	21	21	14	7	7	7	7	7	14	41	21A	21A
ARGENTINA	21A	21	14	14	14	7	7	14	21A	21A	21A	28
AUSTRALIA	28	28	21A	14	14	7	7	7	14	14	21	21A
CANAL ZONE	28	21	14	7	7	7	7	14	21A	28	28	28
ENGLAND	7B	7	7	7	7	7	7B	7B	14A	21	14	7B
HAWAII	28	28	21	14	7A	7	7	7	14	21A	28	28
INDIA	14	21	14	7B	7B	7B	7B	7B	14	14B	14B	14B
JAPAN	28	21	14	7A	7	7	7	7	7	7B	14B	21
MEXICO	21	14	7	7	7	7	7	7A	21A	21	21	21
PHILIPPINES	21A	21A	14	14B	7B	7B	7B	7	7	14B	7B	14
PUERTO RICO	21A	14	14	7A	7A	7	7	14A	21A	28	28	28
SOUTH AFRICA	14	14	7	7B	7B	7B	7B	14	21	21A	21A	21
U. S. S. R.	7B	7B	7	7	7	7B	7B	7B	14	14B	7B	7B
EAST COAST	21	14	7	7	7	7	7	14	21A	21A	28	21A

A - Next higher frequency may be useful.  
B - Difficult circuit this period.

**Good: 1, 2, 7-11, 13, 14, 16-18, 25, 26, 28, 29**

**Fair: 3, 4, 6, 12, 15, 19, 20, 22, 24, 27**

**Poor: 5, 21, 23**

**VHF: 2, 3, 9-11, 13, 27, 28, 29**

(WIEMV from pg. 2)

ones. We have broadcasts of music, hate messages designed to create racial riot, obscene language, and wild drunken parties. The assumption is that these are amateur operators who don't care about their tickets anymore. But, assuming that they are intruders who have taken this means to give amateur radio a black eye, we still have a long way to go to clean house.

We keep talking about the problem of attracting new hams. The idea being that the more hams we have, the better our chances will be of keeping our share of the radio spectrum when (and if) there is another frequency allocations conference. However, our choice of newcomers should not be indiscriminate. Before you "sell" our hobby to a casual acquaintance, look at him with an objective eye. Is he (or she) a normally courteous person? Is he the kind of person you would like to work side-by-side with on the same band? If not, don't encourage him to join the hobby. From a psychological view, there are some people who will use ham radio to make like a "big shot", and no amount of incentive legislation will change a basic personality defect. Let's attract the people who will be an asset to the hobby and fight to keep the others out.

Many of our readers have expressed the opinion that the amateur exam (even the General) is too hard. The code should be eliminated so they could pass the exam, etc. I began working for the General license when my kids were still young and required lots of my time. I set a goal for myself to go from knowing nothing about code or theory to the General in a period of four months. I made it, but it was hard work under trying circumstances. I think my license means more to me because I had to work for it. I don't want to see the requirements lowered. This would only bring in more people to whom the hobby is simply a lark and the license unimportant.

... WIEMV

### YOUR CALL

Please check your address label and make sure that it is correct. In cases where no call letters has been furnished we have had to make one up. If you find that your label has an EE3\* & \* on it that means we don't know your call and would appreciate having it.

FOR THAT

# "Extra Class"

YOU NEED THE



Listen for the hundreds of LK-2000 linears now on the air and judge for yourself. Write for free illustrated brochure or send \$1.00 for technical and instruction manual.

## BTI LK-2000 LINEAR AMPLIFIER

For SSB, CW, RTTY  
Maximum legal input  
Full loading 80-10M  
Rugged Eimac 3-1000Z  
Dependable operation  
Easy to load and tune  
No flat topping with ALC  
Distinguished console  
Instant transmit  
High efficiency circuit  
Designed for safety  
Fast band switching  
Real signal impact

Price . . . . \$795<sup>00</sup>  
READY TO OPERATE!

BTI AMATEUR DIVISION

### Hafstrom Technical Products

4616 Santa Fe, San Diego, Ca. 92109



### FM EQUIPMENT FOR SALE

We have the following equipment for delivery upon receipt of your check or money order:

Motorola Highband Sensicon A FM receivers. This receiver is usually associated with the 80D series of equipment, and uses tuneable cavities in the front end. Filaments are wired for both 6 & 12 volts. Chassis is housed in a metal shell with a quick connector on the rear panel. Price . . . . . \$35.00

Motorola 30 watt high band transmitter. This is a crystal controlled FM transmitter. Power output is 30 watts from a pair of 2E26's driven by a 2E26. Also housed in a metal shell with connector on rear panel. Matches above receiver. Price . . . . . \$15.00

Power supply. This 12 volt power supply provides all operating voltages for the above transmitter and receiver. Receiver section uses a vibrator, with a dynamotor for the transmitter. Price . . . . . \$15.00

Mounting rack contains wiring to interconnect above transmitter, receiver and power supply, all of which plug directly into rack. Size, approximately 22" x 22" x 9". Price . . \$5.00

Order all four of the above units, transmitter, receiver, power supply and mounting rack for only . . . . . \$65.00

These are all used units but are in good condition with only an occasional tube missing. If you are not satisfied you may return the unit in 10 days for refund or replacement of the bad chassis.

Bendix MRT-6. This is a high band 10 watt transmitter, receiver and power supply, all housed in one package. Smaller than an 80D this is ideal for trunk mounted mobile. Power supply is 64 volts, but this may be converted to 110 VAC for portable use, or substitute your own 12 volt supply. I will supply schematic for these units. Price . . . . . \$30.00

#### ONE OF A KIND ITEMS:

Motorola dispatcher receiver, for high band . . . . . \$15.00

Link 1498- 70 to 100 mc. 110 volt input. Easily converted to 6 meters as I will supply the original manual for this set. In rack with line termination unit. . . . . \$45.00

Bendix MRT-6; 110 volt input, 30 watt output on high band. This was just removed from a commercial system and is in good condition. Price . . . . . \$60.00

Send check or money order to DUPAGE FM, P.O. Box 1, Lombard, Ill. 60148.

Illinois residents add 5% sales tax.



# SWAN 500

5 BAND—480 WATT SSB TRANSCEIVER  
FOR MOBILE—PORTABLE—HOME STATION

### ACCESSORIES:

- Full Coverage External VFO. Model 410 .....\$ 95
- Miniature Phone Band VFO. Model 406B .....\$ 75
- Crystal Controlled Mars Oscillator. Model 405X ...\$ 45
- Dual VFO Adaptor. Model 22 .....\$ 25
- 12 Volt DC Supply, for mobile operation.  
Model 14-117 .....\$130
- Matching AC Supply. Model 117XC .....\$ 95
- Plug-in VOX Unit. Model VX-1 .....\$ 35

## SCOTT RADIO SUPPLY, Inc.

266 ALAMITOS AVENUE  
LONG BEACH, CALIF. 90802

## EQUIPMENT BOUGHT

ANY SURPLUS MILITARY EQUIPMENT

Guaranteed highest prices. Payment in 24 hrs. We'll trade or give you new ham equipment also. Write or Telephone collect. (212) CY 9-0300

**MILITARY ELECTRONICS CORP.**  
4178 PARK AVE. • BRONX • NEW YORK • 10457



### HAM TUBES SPECIALS BRAND NEW—GUARANTEED

4CX350A	.....\$25.00	866A	.....\$ 1.50
4CX250B	.....20.00	5881	.....1.75
4X150A	.....11.00	5894	.....14.00
4-1000A	.....85.00	6360	.....3.00
FG-17	.....4.50	6939	.....5.00
404A	.....3.80	6907	.....16.00

TOP \$\$\$ PAID FOR TUBES!  
FREE—Ham tube catalog



120 W. 18th St., N. Y. 10011  
212-242-7400

### ROTRON 100 CFM FANS

- SENTINAL—4-11/16 SQ x 1-1/2D 115 V 60 cy. ....7.95
  - SENTINAL—4-11/16 SQ x 1-1/2D 220 V 60 cy. ....9.95
  - GOLD SEAL—4-11/16 SQ x 1-1/2D 115 V 60 cy. ....6.95
  - 4 Pole Single Throw Contactor 115 V 60 cy.  
15 amp. Mfg. AH & H, Rowan, etc. ....9.95
- All fine condition, working, removed from equipment. Post-paid Continental U.S.A.

### LEEDS RADIO

575 Warren St., N.Y.C., N. Y. 10007

to New Hampshire and set about getting the subscriptions straightened out from the foul-up created by a subscription agency that had been handling them for us.

The shortage of money kept us from hiring anything but drop-outs, with the result that few things were ever done right and the letters of complaint generally were about equal to the subscriptions. The rich get richer and the poor get poorer. When these problems did seem to be ebbing I immediately bit off another big bite to chew . . . Radio Bookshop never made money, but it was, I felt, a valuable service. 6-UP lost a bundle for us. As did the parts kits and ATV Experimenter. But we were providing a service, so I kept them going.

Eventually, as usually happens to fellows who are totally immersed in their work, I found my wife fed up and divorcing me. I reacted about the same as everyone else who has been through that misery . . . I went into apathy. I could no longer work. Paul Franson, who had been our bookkeeper, took over as editor. All of the services depended heavily on me and they had to go. I stopped trying to sell advertising and our ad sales dropped off badly. The great bulk of the advertising during this time was unsolicited.

In order to try to break out of my depression I made a couple of trips to Europe, my safari to Africa and trip around the world. Unfortunately the management of the magazine was left in very weak hands and when I got back from my trip I found that the magazine had dropped a month behind. My safari and trip around the world cost about \$3500, but in the meanwhile the magazine had lost about \$25,000 and was in a sick condition.

I set right to work solving the problems again. My apathy was solved by the simple expedient of finding a fabulous girl and getting married again. I solved the late magazine problem by moving to a new printer that could get us out on time. This is a complicated and expensive procedure. Circulation problems were still bugging us and I decided to make the big changeover to a computer for the subscriptions. We're still getting a lot of QRM from irate subscribers who have been ill-treated by the new computer, but I hope that we will eventually get it tamed and be able to provide the best subscription service of all.

I'm working on the advertising again, so I hope that we will be pulling ahead a little more in the number of ads in 73. The ads, as I have mentioned often before, are the things that pay for your magazine, so don't look your gift horse in the mouth. Be nice to our advertisers, patronize them, encourage them.

Kayla has taken over as editor and I think we will all be seeing the difference. You may find some of her opinions controversial, but you won't find her writing boring and pedantic. Her interest in building should result in a lot more coverage of construction projects and VHF developments. She has some wonderful ideas for improving the magazine.

It was too bad that I had to give up the Radio Bookshop. While this activity never made us enough money to even think about, it did provide a good service to our readers and made radio books easily available. This took a lot of my time. I had to check into all new books published to find those that would be of value to hams. Then, when I found them, I had to order them, make sure they were delivered, pay for them, write up ads to run in 73 for them, make sure that orders were filled, keep the books straight, and keep after publishers to fill our orders. There was a lot of correspondence with customers who couldn't understand why we would advertise a book and then not deliver for a month or so after his order. I would have to explain that the publisher had promised delivery, but hadn't made good yet. It took an awful lot of my time so it had to go when I found myself unable to work more than a few hours a day.

The parts kits were another giant headache. The idea of the project was to make kits of parts available for various 73 construction articles so that the ham with the weak junk box could get in on the fun of building without having to order parts from a dozen different sources. We thought that since few distributors were trying to sell parts that there would be little trouble from them, but we reckoned without the help of CQ. They got right to work and wrote letters to all the distributors screaming that we were trying to put them all out of business. A few of the more hysterical distributors believed CQ, but most realized that our project would hurt no one and, to the contrary, might just encourage more

## COMPLETE YOUR GEAR TWENTY-FOUR CLOCKS IN ONE

**NEW  
AND  
MODERN  
AS THE  
SATELLITE**

**\$12.95**

ppd  
Model D-300

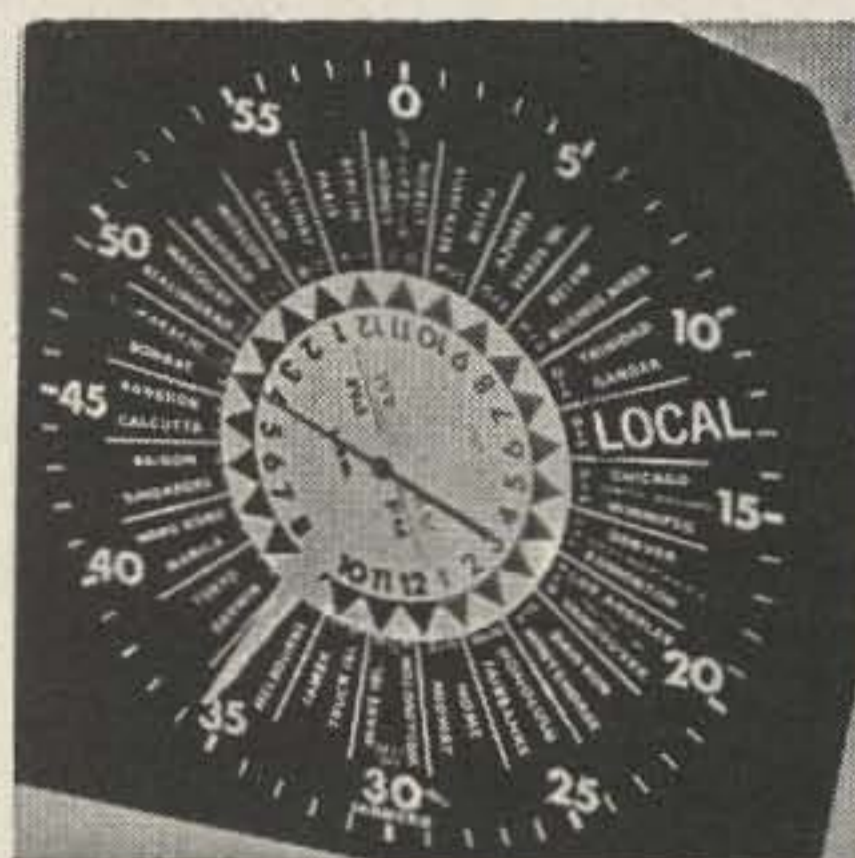

## TIME ANYWHERE

**AT A GLANCE!**

**THROW YOUR CONVERSION CHART AWAY**

When clock is accurately set in any local time zone the correct time is automatically shown in each of the other 23 zones.

### Farmerie World Time-Zone Clock

CASE: wall or desk  
22 ga. steel 8" x 8" x 2 3/4"  
MOTOR: G-E 110-volt, 60 cycle  
Other models available

**THE FARMERIE CORPORATION**

Box 36

Glenshaw, Penna. 15116

## MORE RANGE . . . with NO NOISE

**FOR ALL  
MOBILE UNITS**

ENGINEERING  
★  
**ESTES**  
COMPANY

**ELECTRO-  
SHIELD**

CUSTOM SYSTEMS  
KITS • ACCESSORIES

ELIMINATE IGNITION NOISE  
**ELECTRO - SHIELD®**  
YOUR ENGINE

FROM \$44.95

**ESTES ENGINEERING CO.**

543 W. 184th St., Gardena, Calif. 90247

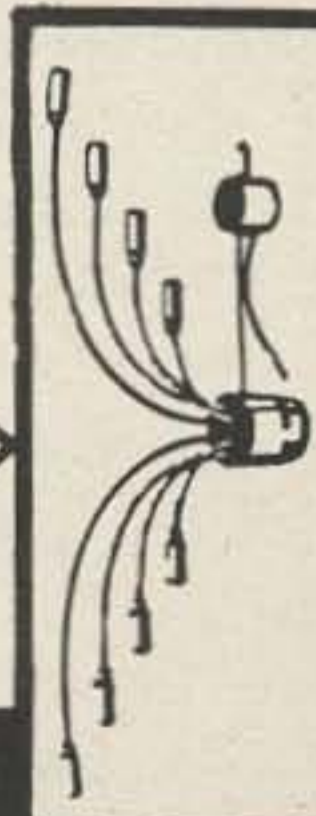

# 20TH ANNIVERSARY SPECIALS FROM

# ALVARADIO INDUSTRIES

## GIANT SIZE SPINNER TUNING KNOB!!!!

3" knob for 1/4" shaft complete with handle bushing for fast and careful DX tuning. Makes it easy to sweep the entire band when looking for those tough ones!!!! Much easier to buy than make, and faster too.

POSTPAID IN USA \$2.00

## BENDIX MRT-9 TRANSCEIVERS

**RECEIVER**—Double conversion 13 tube superheat. Better than 1 micro-volt sensitivity. Complete with crystals set at 138 mcs. Easy to adjust to Satellite frequencies. **TRANSMITTER**—over 1 watt output to 148 mcs. FM. Complete with vibrator supply (less 6v Vib.) with all tubes and crystals. Original Selling price in commercial form \$295.00

### Our 20th Anniversary Special \$39.95

IP71C Kit; for above MRT-9, contains power supply, speaker, 6, 12, 24, 32 dc and 117 volts AC which holds MRT-9 and makes complete mobile package for industrial use. Limited quant. Used, good cond.

\$24.50

Both units, MRT-9, IP71C, ordered at one time. **SPECIAL!! \$59.95**

## VARIABLE INPUT FILTER

Discriminates against spurious signals either in exciter or received signals. Originally used in exciter of Navy transmitter. Brand new boxed in 4" x 3" x 3" aluminum container. Contains band switch, dual gang variable, iron core coils (6), resistors, condensers, tuning range 2-1.5 mcs. Makes good foundation unit for VFO, GD, etc. See previous CQ articles and comments by Wil Scherer and Gordon White.

POSTPAID IN USA \$3.95

## LIMITED QUANTITY ITEMS

**CV-473 FACSIMILE TRANSMITTING CONVERTERS** Mfd by Crosby Electronics. Outgoing freq. 1500 to 2300 cyc. 0-900 cycles DC Picture frequency. Can be used for TT with some modifications. Operates on 117 volts 60 cyc. 600 ohm input and output.

### BRAND NEW. A STEAL AT \$49.50 TP-14 TELEPHONE REPEATERS.

Loaded with 600 ohm hybrid transformers and many parts. Get your buddies together and make several fone patches and have parts left over for other projects.

used. \$14.95

## MAKE YOUR OWN VIDEO RECORDER!!!

**POTTER MODEL 3232** Digital Magnetic Tape Transport as used in Computers. Complete with Hysteresis Drive motor and basic deck parts. No recording head. Comes with schematic and instruction booklet and reprint of article showing "How to Make" Video Tape deck for recording TV programs.

A REAL BUY AT \$49.50 each. While they last!!!!

## WE WANT TO BUY!!!!

AN/UPX-5, 12  
AN/APA-89

AN/APS-20  
AN/APG-56

## FILTER CONDENSERS

**SPRAGUE** Type P50015 15 mfd—5000 volts (Removed from Eqpt)  
**GENERAL ELECTRIC** 1 mfd—18,700 volts Brand new.

Your choice \$35.00 each.

**APA-38** Scope units, make pan-adapters. 110 v. 400 cyc. power. Complete with tubes, used. \$17.95

## TELETYPE CONVERTERS

**CV-89A / URA-8A** Frequency shift converters.

Used Navy surplus \$179.50

## ALVARADIO INDUSTRIES

3101 Pico Blvd., Santa Monica, Calif. 90405  
All phones: 213-870-0216 Ask for Harry W6ATC

hams to get in on the fun of building and that everyone might be the winner in the long run.

The parts kits took a tremendous amount of my time. I had to make sure that all the parts were on hand and put the parts into the kits for each one. I had to get boxes, write and print instructions, keep the records, pay the parts bills, etc. Such aggravation. It was nice to stop all that.

One more year of red ink just might sink us, so I've been encouraging a cut back in our staff. Paul went down with Davco. Jack has retired. And Jim is busy trying to start his own ham magazine. I gather that he has been working with a wealthy New Hampshire ham for almost a year now on the plans. With our reduced staff of four paid employees I think we will be able to get 73 back into the black and even be able to keep our subscription rates as their present level for some time to come. I notice that CQ is raising their rates.

I'm back on my sixteen hour work days again. I don't know how long Lin will put up with it, so I hope that we can get enough advertising and subscriptions so I

can occasionally take a day off for some skiing or a dinner out with her. I had hoped to be able to take her to Europe, paying for the trip by running a tour next spring, but I can see now that there really is no way that I can get away from the magazine for the three weeks required while I am handling the advertising and publishing. It is very disappointing to have to give up our plans for the trip, but it will take longer than spring before we are back on solid financial ground.

Perhaps the apathy over my own problems explains the lack of aggressiveness for the last couple of years in 73. It must be that because things certainly have not been going well in our hobby. Incentive licensing has done a lot to change ham radio. CB has had an effect too. There are probably a lot of other factors which have acted to reduce interest in ham radio and to cut down the sales of equipment and parts to hams. I don't think there is much purpose in bearding the villain. It seems to me that we should now get started at meeting our world as it is and stop grumbling about how it is or who made it that way.

The bulk of us are having to face the

reality that if we are going to continue to enjoy all of the ham frequencies we are going to have to go down to the FCC and pass a new and tougher examination. During the next year I would like to publish a lot of good basic theory articles which, taken together, will make it possible for all of us to pass these new tests. This is a good opportunity for those of you who have done some teaching and who would like to do some writing to put together some articles for us. I want to see simple and complete explanations which will give us the understanding to handle the new exams. How about it?

Another thing I'd like to see is some more humorous articles. There is no shortage of foibles in ham radio to be kidded. If you enjoy writing a good humor story you might turn your talent to any of the major ham interests . . . traffic handling . . . mountain topping . . . VHF pioneers in empty bands . . . the loneliness of the moon-bounce operator . . . DX contests . . . DXpeditions, unless Miller has killed them for everyone . . . I see that Miller has found a publisher for his DX book. I looked over his outline, decided it was a hodge-podge, and wrote my own book which, with luck, will be out by the time this is printed. Articles . . . the 75M DX crowd . . . the 160M DX addicts . . . the poor souls who are stuck high up on the ARRL Honor Roll . . . the mobile DXer . . . the CW mobileer . . . etc. All you have to do is listen in on any band for a few hours and the articles will write themselves. We'll print them if I laugh.

If you don't mind too much we'll let the other ham magazines stick to being serious. Our hobby may be a service in the eyes of the ARRL, but to me and a lot of others it is enjoyable . . . it is fun. I suspect that as soon as amateur radio stops being fun it is going to fold up, so let's stress the fun side of our hobby. It is fun to build . . . it is fun to operate . . . it is fun to do unusual things. Let's see what we can do to make as much of amateur radio fun as we can. I always remember a fellow TV director who explained that he used to go in for boxing, then one day he found himself being beaten to a pulp in the ring. He suddenly discovered that he wasn't having any fun and that was the last time he ever fought.

## ANTENNA SPECIALS

Hy-gain	was	Special
5BDT	39.95	24.50
4BDT	29.95	17.50
3BDT	19.95	12.50
2TD traps	14.95	9.00
TH-2 Beam	74.50	50.00

## H C J ELECTRONICS

E. 6904 Sprague Ave.  
Spokane, Wash. 99206

## GO VHF

Go VHF the easy VHF Associates way. Send for descriptive Technical Bulletins describing our complete line of TRANSISTOR RECEIVING CONVERTERS and VARACTOR FREQUENCY MULTIPLIERS for 50, 144, 220, 432 and 1296 MHz.

## VHF ASSOCIATES, Inc.

P.O. Box 22135  
DENVER, COLORADO 80222

## GLEN SEZ:

The following list represents a few of the more popular items included in our used inventory:

Collins		Drake	
75A2A	\$209	TR3	\$419
32S1	419	T4X	339
		R4A	339
Hammarlund		MS4	10
HX50	279	HC4	65
HQ170AC	239		
HQ110	99	Swan	
		400	275
Hallicrafters		406	50
HT44	249		
HT37	249	SBE	
SR500	345	SB34	325
W/AC		SB2LA	189

## Adirondack Radio Supply, Inc.

185-191 W. Main St.  
Amsterdam, N. Y. 12010  
518-842-8350

**VALUABLE books from E. & E.**

**NEW SINGLE SIDEBAND: THEORY AND PRACTICE**

by *Harry D. Hooton, W6TYH*. The one-source guide to ssb. Covers the origin and principles of ssb, derivation of ssb signals, carrier suppression techniques, sideband selection, carrier generators,

speech amplifiers and filters, ssb generators, balanced mixers and converters, low-power ssb transmitters, linear r-f amplifiers, ssb communications receivers, transceivers, tests and measurements. Includes chapters on how to build air-tested linear amplifiers. 352 pages. Hardbound. Order No. **EE-350**, only . . . **\$6.95**

**NEW 17TH EDITION OF THE FAMOUS RADIO HANDBOOK**

Tells how to design, build, and operate the latest types of amateur transmitters, receivers, transceivers, and amplifiers. Provides extensive, simplified theory on practically every phase of radio. Broadest coverage; all original data, up-to-date, complete. 816 pages. Order **EE-167**, only . . . . . **\$12.95**



**RADIOTELEPHONE LICENSE MANUAL**



Helps you prepare for all commercial radio-telephone operator's license exams. Provides complete study-guide questions and answers in a single volume. Helps you understand fully every subject you need to know to obtain an operator's license. 200 pp. Order **EE-030**, only. **\$5.75**

**LEADING BOOK ON TRANSISTORIZED COMMUNICATIONS EQUIPMENT**

**TRANSISTOR RADIO HANDBOOK**, by *Donald L. Stoner, W6TNS, Lester A. Earnshaw, ZL1AAX*. Covers a wide range of communication uses for both amateur and commercial applications. Includes audio and speech amplifiers, VHF transmitting and receiving equipment, SSB exciters, and complete SSB transceivers. 180 pages. Order **EE-044**, only . . . . . **\$5.00**



Order from your electronic parts distributor or send coupon below.

**EDITORS and ENGINEERS, Ltd.**

P.O. Box 68003, New Augusta, Ind., Dept. 73E-2

Ship me the following books:

- No. EE-350     No. EE-030  
 No. EE-167     No. EE-044    \$\_\_\_\_\_encl.

Name \_\_\_\_\_

Address \_\_\_\_\_

City \_\_\_\_\_ State \_\_\_\_\_ Zip \_\_\_\_\_

You can make ham radio fun for others by keeping in good spirits on the air and refusing to let illegitimate sons wear you down. You can make publishing 73 fun for me by putting up with our bumbling here and encouraging other amateurs to read the magazine. I'll do everything I can for you and I'll try to let you know what is actually going on in our hobby, good and bad.

**Merchant Marine**

There is a great shortage of shipboard ops these days. I thought this might be of interest to some of you younger fellows who are looking for a way to make ham radio pay off for you. You could do worse than check into the requirements and the draft avoiding possibilities. The money is rather nice too, running about \$600 to \$800 a month and most of that in the clear.

**Burma**

Editorially I am still wandering around the back reaches of Asia. In truth I am sitting comfortably back in New Hampshire waiting for the heavy snows to bring the skiing season to northern New England. The whole trip, including the safari hunt in Africa of two weeks, only lasted about twelve weeks.

I might have skipped Burma if they hadn't tried so hard to keep me from coming. I'm that way, as you probably know if you've been reading 73 for any length of time. By tenacity and amazing luck I managed to find myself deplaning last September at Rangoon airport late one afternoon. My visa for Burma was by far the most difficult to get; requiring days of waiting on the Burma Mission to the U.N. in New York. I had no idea what lay ahead since, as far as I could find out, nothing had been written in any of the popular or travel magazines or books about Burma since the army coup five years ago. The amateurs had been put off the air at the time, so I had no personal contacts to follow up as I had in most other countries.

There were just three of us on the entire plane flying from Calcutta to Rangoon and the other two were obviously Burmese government officials. They were met by cars at the airport, leaving me to run the gauntlet of customs and immigration alone.

The first step was to fill out a currency declaration listing every bit of money that I



had with me. They check this when you leave the country to make sure that you haven't exchanged any foreign currency at other than the official exchanges. You have to have a receipt for every dollar exchanged. The reason for this is that they have a very serious inflation there and the world exchange rate is about 15 kyats to the dollar, while the official rate is under 5 to the dollar. This means, practically speaking, that everything costs you about three times normal.

Then, while the customs men were examining my baggage, I signed into the log book for entering the country. I looked back through a few pages to see if any other Americans had visited recently, but could only find entries for U.S.S.R. and the People's Republic of China for the last few weeks. Apparently I was the only American to visit Burma in quite a long time.

A small bus drove me from the airport about twenty miles to downtown Rangoon and the Strand Hotel. My room was \$12 a night, but it was a large room with air conditioning and a bath. This was over three times the price of the same accommodation in India. It was about dark when we got to town so I didn't get a chance to see very much.

My first move was to try to locate a local amateur that I'd heard about from the amateurs in India, but he wasn't listed in the phone book. I asked the hotel manager about Miller's visit there the year previously. He said that he had no record of a Miller visiting and was sure that no radio amateurs had either visited or been permitted to operate from his hotel. I didn't know what to make of this for Don had claimed to have been there.

After dinner I decided to make a major try to locate the local ham. I asked the bellhop to get a taxi for me and, after quite a wait, he arrived with a fellow on a bicycle with a small side seat fastened on. I gave him the address and he said he knew right where it was. Well, we drove around the back streets of Rangoon for about an hour, with him asking people where the street was we were looking for. Finally we found it; an old shabby building, all black. It looked deserted. The whole neighborhood looked deserted. I knocked.

There was a long silence, then the door opened just a crack. I quickly shoved in a QSL card. The door was flung wide open; "Come on in, I'll get my father, sit down." The

## NEW! IMPROVED! SOLID STATE FREQUENCY CONVERTERS



Priced from only \$14.95 to \$49.95

Many new models available from .45 MHz. to 450 MHz. Some with dual gate MOSFET R. F. stages and mixers. Crystal-controlled oscillators, full wave UHF diodes for transistor protection and many more desirable features. Send for your free converter catalog. Vanguard Labs., 196-23 Jamaica Ave., Hollis, N.Y. 11423.

## VANGUARD LABS

196-23 Jamaica Ave. Dept. H Hollis, N.Y. 11423

## VHF/UHF ANTENNAS

FOR  
MORE  
DX PUNCH

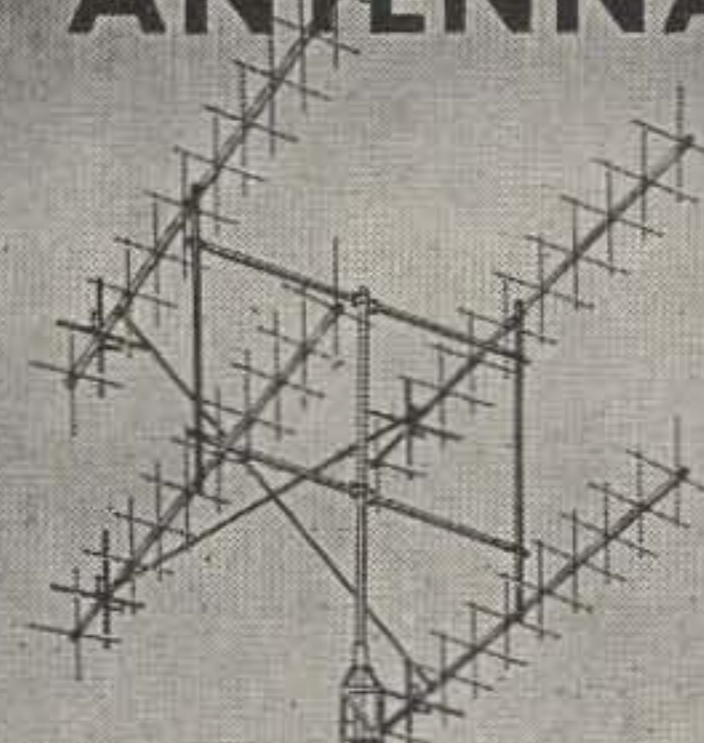

The standard of comparison in amateur VHF/UHF communications. Cush Craft antennas combine all-out performance with optimum size for ease of assembly and mounting at your site. They can be mounted vertically, horizontally, in pairs, quads, or virtually any combination allowing you to design the antenna system to meet your exact requirements.

A144-11	2	meter	11 element	\$14.95
A144-7	2	meter	7 element	11.95
A220-11	1 1/4	meter	11 element	12.95
A430-11	3/4	meter	11 element	10.95
A144-20T	2	meter	Multi polarized	29.50
A50-3	6	meter	3 element	15.95
A50-5	6	meter	5 element	21.50
A50-6	6	meter	6 element	34.95
A50-10	6	meter	10 element	54.95
A26-9	6 & 2	meter	10 element	29.95

SEE YOUR DISTRIBUTOR OR WRITE FOR CATALOG

**Cush Craft**

621 HAYWARD STREET  
MANCHESTER, N.H. 03103

## 73 SUBSCRIPTION BLANK

\_\_\_\_\_ \$5 one year

\_\_\_\_\_ \$3 DX Handbook

\_\_\_\_\_ \$9 two years

\_\_\_\_\_ \$2 VHF Antenna Handbook

\_\_\_\_\_ \$12 three years

\_\_\_\_\_ \$1.50 Index to Surplus

\_\_\_\_\_ \$50 LIFE

\_\_\_\_\_ \$3 Parametric Amplifiers

\_\_\_\_\_ \$2 HAM RTTY

\_\_\_\_\_ \$1 Transistor Circuits

Name ..... Call .....

Initials

Last name

Address .....

City ..... State ..... Zip .....  
or Country.

whole family gathered around and explained what had happened to Burma and amateur radio in their country.

Rangoon used to be a paradise. It had a large middle class population and was one of the fastest growing and most advanced cities in southeast Asia. The people owned and ran the businesses . . . they had beautiful homes and nice summer places, clubs, restaurants. Then, about five years, ago, the army overthrew the government and everything changed. First they took over all of the banks and confiscated the bank accounts. Next they issued new currency to be sure that no one had any savings in cash put aside for the future. The largest denomination of the new currency was about equal to a dollar (five kyats). This made it so that even if someone was able to gather a good deal of money it would be so bulky that he would have a very difficult time carrying it around.

The new government then proceeded to take over every business in the country, large and small, excepting only small family run restaurants. They gave no compensation for this takeover. They put the pressure on all foreigners living in the country to get out as

soon as possible, cutting off all possible income, food supplies, clothes, and even visiting friends. They harassed them and most of them left, including people who had devoted their life to working and living in Burma. Most of the businesses appropriated by the government simply closed. All amateur radio privileges were suspended.

Schools, hospitals and all other such organizations were taken over and the bulk of the staffs dismissed or changed. Clubs and restaurants were taken and closed. Every business that is running today, large or small, is owned and run by the government. All automobiles were confiscated. Machinery of any value was removed from all companies that closed down.

This has been very hard on the people. They were used to a relatively high standard of living, now, with everything at a virtual standstill, the smallest item is rationed and government red tape stands between you and any purchase. Prices are astronomical. Just about all trading is done via small suitcases in the rapidly moving black markets. For instance soap is rationed one bar to a family per month. . . one suit of clothes per year. If someone is fortunate enough to have

# ALL BAND TRAP ANTENNA!



Reduces Interference and Noise on All Makes Short Wave Receivers. Makes World Wide Reception Stronger. Clearer on All Bands!

For ALL Amateur Transmitters. Rated at 1000 Watts AM 2000 SSB PiNet or Link Direct Feed. Light, Neat, Weatherproof.

Complete as shown total length 102 ft. with 96 ft. of 72 ohm balanced twinline. Hi-impact molded resonant traps. You just tune to desired band. Excellent for ALL world-wide short-wave receivers and amateur transmitters. For NOVICE AND ALL CLASS AMATEURS! Eliminates 5 separate antennas with excellent performance proven. Inconspicuous for Fussy Neighborhoods! EASY INSTALLATION! Thousands of users.

75-40-20-15-10 meter bands. Complete .....\$19.95  
40-20-15-10 meter. 54 ft. (best for swl's). Complete ..\$18.95  
SEND ONLY \$3.00 (cash, ch., mo) and pay postman balance COD plus postage on arrival or send full price for postpaid delivery. Free information.  
MIDWAY ANTENNA • Dept. A-2 • Kearney, Nebr. 68847

## DON'T BUY TUBES

UNTIL YOU GET OUR LOWEST PRICES IN THE WORLD ON BRAND NEW SPECIAL PURPOSE, BROADCASTING, RECEIVING TYPES. ESTABLISHED 1920. SEND FOR OUR CATALOG.

**UNITED RADIO CO.**

56-B FERRY ST., NEWARK, N.J. 07105

## NOISE BLANKER



Removes high intensity ignition noise and other pulse interference before it enters your receiver.

\*Connects between converter and receiver. For 50-93 ohm coax.

All solid state design features Field Effect Transistors for minimum cross-modulation and maximum reliability.

Send for technical brochure

WESTCOM ENGINEERING CO., P.O. Box 1504, San Diego, Cal. 92112

## COMMUNICATION RECEIVER



RCAF GR-10 COMMUNICATION RECEIVER—115 Volt 25-60 cyc., 6 Bands; 195 to 410 KC & 1400 to 31000 KC., electric band spread, var. selectivity, adj. crystal filters, noise limiter, AVC, carrier strength meter, crystal control on any one

freq. to 6.8 MC., temp. & voltage reg. of oscillator, sensitivity better than 5 Mic. V. 2:1 sig. to noise ratio. Max. undistorted output 3 watts. With Tubes: 3/6SK7, 1/6K8, 1/6SJ7, 1/6H6, 1/6SQ7, 1/6F6G, 1/5Y3G, & 1/YR-105. Beat freq. osc. control & prov. for speaker & headset. Size: 10 1/2 x 20 x 11 1/2"; Wt.: 85 lbs. (Cabinet design may vary.)

Prices: Used — Not Checked .....\$89.95  
Used — Checked .....\$99.95

## TRANSMITTER—RECEIVER W/S CDN No. 29 "B" SET

Approx. 230 to 240 MC. with 12/24 VDC Power Supply self contained, and Tubes: 4/6AG5, 2/6AK6, 2/6C4, & 3/6J6. Two preset channels in the freq. range. (Ideal set for local netting on 1 1/4 meters.) Size: 4 1/2 x 8 x 11"; Wt.: 18 lbs. Price: Used .....\$18.95



NAVY TCS RECEIVER AM—1.5 to 12 MC in 2 bands. For details see our ad in the January, '68 issue. Used: \$44.95

NAVY TCS TRANSMITTER AM—1.5 to 12 MC in 3 bands. See full description in our Jan., '68 issue ad. Used .....\$34.50

Both above items—Checked for Operation: \$10.00 additional.

Prices F.O.B. Lima, O.—25% Deposit on COD's.

**BIG FREE CATALOG**—New edition just off the press! Send for your FREE copy today. Address Dept. 73.

**FAIR RADIO SALES**

DEPT. 73 — P. O. Box 1105 — LIMA, OHIO 45802

**WANTED:** July 1962, July and August 1966 issues of 73 Magazine. WA1GHW, Rt. 1, Box 571, Terry Rd., Gales Ferry, Conn. 06335.

**MECHANICAL ELECTRONIC DEVICES CATALOG 10¢** . . . Teletype Model 14 reperforator with automatic tape take up rewriter 115VAC60cy. Both units new, unused \$69.95 . . . ARR27 Receiver 29 tubes 465-510 MHz w/60 MHz if new, unused \$35 . . . 1/16 laminated copper clad 2 oz. 2 sides, for printed circuits 9 1/2 x 4 1/2 \$1 . . . 3/\$2. Transistor boards bonzana \$5.95 . . . Wide band balanced modulator \$4.95 . . . 30 MHz IF Assembly \$5.95 . . . Transmitter TDG w/Modulator easily converted to 2 meters \$49.95 . . . Low pass filter 0-32 MHz 52 ohm \$9.95 . . . 5KV/2KV/1KV at 750 ma/200ma/250ma Power supply write for details. Fertik's, 5249 "D", Phila., Pa. 19120.

**TOROIDS**, uncased 44 or 88 mH, also individually epoxy encased 88 mH for standards, any 5 \$1.50, 255A relay \$2.10, 18B socket 70¢ all PP USA. E. W. Evans K40EN, 220 Mimosa Lane, Paducah, Ky. 42001.

**FOR SALE.** Ranger \$60., SX110 \$89, ARC-3, two meter Xmtr \$20. wanted FM equipment. WA5FFK 804 So. 6th, Blackwell, Okla. 74631.

**GONSET 2 METER SIDEWINDER:** CW-AM-SSB, complete with AC & DC power supplies. Recently factory aligned. \$230. K7DGV John Stiles, Sweetgrass, Mont. 59484.

**WRL's** used gear has trial-guarantee-terms. NC270 — \$139.95; HQ170AC — \$239.95; HQ110AC — \$169.95; 75S-1 — \$299.95; 75A1 — \$169.95; SX100 — \$134.95; HA10 — \$189.95; HT32 — \$249.95; GSB100 — \$179.95; Ranger 2 — \$169.95; G76 — \$99.95; 650 & VFO — \$89.95; Thor VI & AC/PS — \$169.95. Hundreds more. Free "Blue-Book" list. WRL, Box 919, Council Bluffs, Iowa 51501.

**SELLING:** HQ-145C, \$150; Valiant, \$140; BC-221 frequency meter, \$50; C.E.-20A plus VFO, \$100; HT-37, \$200; Wanted: Drake DC-3. K9FWF/9, 114 North Orchard, Madison, Wisconsin.

**FCC 1ST CLASS RADIOTELEPHONE LICENSE COURSE.** Current, used, complete including radar ind. 70 lessons \$60. W6UPZ, 508 Grape St., El Cajon, Calif. 92021.

**BRAND NEW** Factory fresh test equipment and other electronic items at unbelievable prices. Send for complete catalog. DRC, 215-28 Spencer Avenue, Queens Village, N.Y. 11427.

**TRADE** Teletype equipment, Vidicons or what have you for G.E. Progress Line FM units or parts. All inquiries answered. W4OCQ, 1037 Creamer Rd., Norfolk, Va. 23503 Ph. 703-587-6287 Collect.

**ROCHESTER, N.Y.** headquarters again for the big Western New York Hamfest and VHF Conference Saturday, May 11.

**HALLICRAFTERS SR-42A** new, never used, original carton, matching HA-26 VFO, Shure 404c Mike — \$200.00. Jeff Ross 125-12 Cronston Avenue, Rockaway Park, N.Y. 11694.

**GALAXY V, AC SUPPLY** in mint condition used very little \$290. WAØJYC, 1208 Gail Ave., Millard, Nebr. 68137.

**NATIONAL NCX-3 and NCX-A** perfect condition. Sacrifice for college \$225. Randy Brook WA2PPE, 534 W. 114th St., N.Y.C. 10025 (212-662-0232).

# Caveat Emptor?

★ Price—\$2 per 25 words for non-commercial ads; \$10 per 25 words for business ventures. No display ads or agency discount. Include your check with order.

★ Type copy. Phrase and punctuate exactly as you wish it to appear. No all-capital ads.

★ We will be the judge of suitability of ads. Our responsibility for errors extends only to printing a correct ad in a later issue.

★ For \$1 extra we can maintain a reply box for you.

★ We cannot check into each advertiser, so Caveat Emptor . . .

**SALE:** Eico 753 Transceiver, \$140. Eico 753 Kit, unopened box \$140. HW-12/HP-23/mic, \$140. All excellent and transceivers on the air. First check takes either . . . Specify. K9VWQ, 1205 Tanglewood Rd., Manitowoc, Wisconsin.

**SWAN 350** with 117Xc Power Supply \$375. Heathkit Seneca Six-Two transmitter with external VFO \$125. Stephens, W2NTZ, 3048 Wilson Ave., Bronx, New York 10469.

**SUPER SALE,** Micro Switch 10A 250V—99¢, 5894—\$9, 6883 (6146)—\$2, 2C39—\$3, 416B—\$5, 4X150—\$5, 4-400—\$19, 833—\$19, 3CX10,000—\$39, 4-125—\$14, 6155—\$14, 7378—\$19, 5867—\$19, 3X3000—\$19, 3WP1—\$9, 6166—\$49, 7038—\$29, Eimac SK300 Socket—\$19, SK712 Socket—\$9, Vac. Var. Condensers—\$19, 5 Ft. dish—\$49, Dual Xtal Ovens—\$1, 50-0-50 $\mu$ a Meter—\$3, Incrm. Osc. Units, 10Xtals 10 to 11 Mc., Toroid Step Relay, Switch, Etc. Beautys, \$3, Sola Regulator. Xformers 120PRI, 350 Sec.—\$4, 5% resistors, any value 5¢, Daven Pads—\$4, WA8GFR, 1423 West 52nd., Cleveland, Ohio 44102.

**DAYTON HAMVENTION** April 27, 1968—Wampler Arena Center, Dayton, Ohio, sponsored by Dayton Amateur Radio Association. QSO in person at the nations foremost radio event of the year. Technical sessions, exhibits, hidden transmitter hunt. Bring the XYL for an outstanding Ladies Program. Join the satisfied participants who return year after year. Watch the Ham ads for information or write Dayton Hamvention, Box 44, Dayton, Ohio 45401.

**WANTED**—Will pay good price for clean unmodified SX-115 Receiver. Albert Horn WA2WMQ, 1135 Glenwood Rd., Toms River, N.J. 08753, Phone 201-341-9286.

**TRADE** HQ-110 for Johnson KW Matchbox, table top linear, or SB610 Monitor Scope, Tom Thurman Jr., Rt. 5, Sparta, Tenn.

**NATIONAL NC303,** 6 meter converter, XCU-27 calibrator, mint condition, \$275. Utica 650 Six meter transceiver, VFO, mike, \$130. Richard Ravich, 10 Coolidge Road, Marblehead, Mass. 01945.

**WANTED** broadband coil also crystal for 100v for 160 meters. WA6WXJ, Charles Harper, 131 Hillcrest Drive, Daly City, California 94014.

**3000 V @ 3 $\mu$ F** brand new GE Pyronal oil capacitors \$3 each. Can mail. 3-lbs each shipping wt., FOB P. Wandelt, RD #1, Unadilla, New York 13849.

**COLLINS 32V3** Very good condition \$150.00, manual included, extra 4D32 final \$10.00, WB2GPR Bill Donson, 5 Division St., Binghamton, New York 13905.

**REGULATED POWER SUPPLY.** 225v @ 550 ma.-115v @ 100 ma. 4/6.3v @ 12a. Fully metered. 19 inch rack panel. 150 lb. \$39.95. Write, Electronics Surplus Co., P.O. Box 1225, Boston, Mass. 02104.

**HIGH VOLTAGE RADIO GENERATOR.** Type (1) 3000 Volt. Type (2) 250/1500 Volts. Unused. Ship anywhere. \$75.00. FOB Boston. Write Electronics Surplus Co., P.O. Box 1225, Boston, Mass. 02104.

**HALLICRAFTERS SX-101A,** speaker, headphones, spare tubes, manual. Perfect condition, Professionally maintained. Wollensak T-1500 Electronic control recorder. Bob Yarmus, K2RGZ, 5900 Arlington Ave., Riverdale, N.Y. 10471. 212-884-6336.

**WANTED**—Gonset 2 meter linear, II or III, must be mint—cash. Sale or Trade: NC-303 Cal. spk & manual mint—\$275. SP-600 RX in cabinet \$300. J. Gysan W1VYB, 53 Lothrop St., Beverly, Mass. 01915.

**SWAN 350** with VOX and Calibrator, Mike. Excellent condition, no modifications, like new \$300. K1EJW—Roland, Lowell, Mass. 458-1892.

**AUCTIONFEST — B.A.R.C. —** February 17th. Bargains unlimited. Location—Chaminade High School, 500 North 51st Ave., Hollywood, Florida. Doors open 8:00 AM, auction starts 9:00 AM. Free Coffee.

**THE NORTH JERSEY DX ASSOCIATION** is sponsoring its annual DX Round-Up on Saturday, March 23, 1968. This is the Saturday following the IEEE Convention in New York and it is expected that many out-of-towners will find it convenient to attend. Site of the Round-Up is the Holiday Inn, Wayne, N.J. at the intersection of Route 46 and Route 23, just 30 minutes west of the George Washington Bridge. The afternoon program starts at 2 P.M. and banquet at 7 P.M. Further details available from W2PXR.

**COLLINS SSB STATION:** KWS-1 Ser 1246, 75A4 Ser 4950, SC101 Station Control, Bandpass filter and table top. Will deliver to 400 miles., lot \$900.00. Also Swan 350, 117X power supply, 14X DC module and mobile cables. Little used, \$400.00 FOB W4CNC Vernon A. Sanders, 3105 Dyas Dr. NW., Huntsville, Ala. 35810.

**100 EPOXY DIODES** 1.2 amps, 1000PIV \$20.00. 800 PIV \$18.00. 600 PIV \$14.00. See page 96 Dec. 73. Check with order. Postage Paid. Pete Fragale W8AEN, Box 585, Clarksburg, W. Va. 26301.

**COLLINS 62S-1** like new \$600.00 or best offer. Will trade on Collins 30S-1 KW Amp. W4LZP, 327 Chamberlain St., Nashville, Tenn. 37209.

**LATE MODEL SWAN 350** w/AC p/s \$300.00. Will accept Delta or equal wood lathe, jointer or shaper in trade. John E. Bagwell, Somerville, Tennessee 38068.

# Sale



**SOLID STATE**  
**STEREO PREAMP 4<sup>95</sup>**

- ★ 8 TRANSISTORS
- ★ Ready to Play thru tape Amplifier, radio, TV
- ★ Volume, Tone, Controls sw



**2N3235**  
NPN SILICON  
(Watts) 115  
BV CBO 100  
(AMP) 15 **\$2<sup>25</sup>**

## FIELD EFFECT TRANSISTORS

**RAYTHEON 2N3608**  
"MOST." IGFET p-channel  
Input **2<sup>99</sup> ea.**  
10 million meg-

### GLASS ONE AMP SILICON RECTIFIERS

ALL TESTS

PIV	Sale	PIV	Sale
50	19¢	600	20¢
100	21¢	800	25¢
200	32¢	1000	32¢
400	45¢	1200	45¢

### 1 AMP Actual Size MICROMINIATURE SILICON RECTIFIERS

PIV	Sale	PIV	Sale
50	5¢	600	20¢
100	7¢	800	25¢
200	9¢	1000	32¢
400	12¢		

### 1 AMP TOP HAT AND EPOXIES SILICON RECTIFIERS

PIV	Sale	PIV	Sale
.50	5¢	800	21¢
100	7¢	1000	32¢
200	9¢	1200	45¢
400	11¢	1400	65¢
600	17¢	1600	75¢

**2000 PIV 1.5 A \$1**

### ONE WATT ZENER DIODES 39¢

Factory Tested

Volts	Volts	Volts	Volts
5.4	12.	47.	82.
6.4	15.	50.	100.
8.2	22.	56.	120.
9.1	24.	68.	150.
10.	27.	75.	180.

### SILICON POWER STUD RECTIFIERS

PIV	3A	6A	12A	55A
50	.06	.16	.20	.50
100	.07	.22	.25	.75
200	.09	.30	.39	1.25
400	.16	.40	.50	1.50
600	.20	.55	.75	1.80
800	.30	.75	.90	2.30
1000	.40	.90	1.15	2.70

TRIACS\* AND SCRS

PRV	6* AMPS	8 AMPS	16 AMPS	25 AMPS
50	.42	.61	.79	.95
100	.59	.89	1.25	1.75
200	.89	1.15	1.69	2.75
400	1.29	1.69	2.65	3.50
600	1.95	2.65	3.25	4.25
800	2.60	3.25	3.95	
1000		3.50		

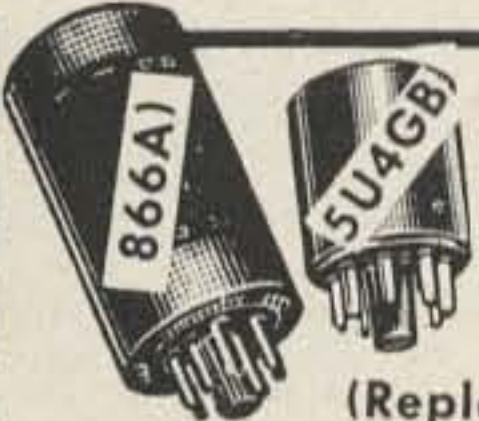

### HAM SILICON TUBE SPECIALS

(Replaces)

1N1238	5U4GB)	2.39
1N1239	5R4)	4.39
1N1237	0Z4)	2.39
1N1262	6AU4GTA)	2.39
1N2637	866A)	9.99
	3DG4)	2.39

### 400 mc NPN SILICON

**5 for \$1**  
**2N706**

Watts | V<sub>cb</sub> | I<sub>c</sub> | I<sub>ma</sub>  
.5 | 30 | TO-300 | 150

### 2 AMP SILICON RECTIFIERS • GLASS CAPS

PIV	Sale	PIV	Sale
200	12c	1000	45¢
400	16c	1200	59¢
600	19¢	1400	69¢
800	29¢	1600	89¢

### SOLITRON DEVICES, INC. 5 AMP Epoxy Rectifiers

PIV	Sale	PIV	Sale
50	19¢	600	59¢
100	25¢	800	69¢
200	39¢	1000	79¢
400	45¢		

### SUPER SPECIAL! 500 MIL All Tests TOP HATS

PRV	Sale
50	10 for 25¢
100	10 for 35¢
150	10 for 40¢
200	10 for 45¢
250	10 for 50¢
300	10 for 55¢

### 85 WATT NPN Like 2N424

**2 For \$1**

### 1 AMP 4000 PIV MICROMINIATURE SILICON RECTIFIERS 1<sup>45</sup>

### 2 AMP 1000 PIVs SET OF 3

### Delco PNP 100 Watt/15 Amp Hi Power T036 Case! 2N441, 442, 277, 278, DS501 up to 50 Volts for 3 \$1<sup>00</sup>

**100 MICROAMP PANEL METER 2<sup>99</sup> ea.**

Made in U.S.A!  
D'Arsonval Meter Movement!



GIANT SPRING CATALOG ON: PARTS RECTIFIERS TRANSISTORS SCRS ZENERS

TERMS: include postage Rated, net 30 days. CODs 25%

**POLY PAKS** P.O. BOX 942 A LYNNFIELD, MASS. 01940

ALL ITEMS GUARANTEED AS ADVERTISED OR YOUR MONEY BACK

## Waterproof Connections

Just a hint for anyone who needs a permanent type of seal for wire splices and connections which are to be exposed to the weather.

A liquid plastic called "Plasti-Goop" is on the market for kids toys. It is distributed by Mattel for "Thing Makers" and other toys. The plastic liquid can be applied directly to the connection, or whatever one wishes to be sealed, then it must be heated to about 300 degrees for a few minutes to cure it. The Plasti-Goop is not flammable, and may be heated with a propane torch or over a gas burner for curing. Plastic coated wires, such as twin-lead, must be treated with care not to melt the insulation.

Two or three layers are needed to make a good seal and insulator. This has been used to good success here, especially on rubber covered wires. If you have a circuit which must be exposed to the weather and need not be disassembled or adjusted, the entire circuit can be filled and baked in an oven to cure at about 200 degrees. The plugs on the end of extension cords are a good place for this. It makes a neat, waterproof, and electrically sound connection. . . . James L. Townsend K9BXG

## New Books from Sams

*ABC's of Radio and TV Broadcasting*, by Earl J. Waters, tells what is involved when you turn on a radio or TV set in terms a layman can understand. It describes how the radio and television signals are formed, built up, and transmitted and presents a basic survey of transmitter equipment and operation.

Mathematics has been avoided and the material is easy to read and understand. Many illustrations are used to make the information completely clear. Catalog No. 20575 List Price \$2.25.

*FET Circuits*, by Rufus P. Turner, starts with the principles of FET operation and describes their construction, but stresses the application of FETs in practical circuits. It discusses oscillator and amplifier circuits and presents examples of these circuits for use in receivers, transmitters, and accessory equipment. Various test instruments which can use FETs are also covered. Catalog No. 20585 List Price \$3.25.

## "ARCTURUS" SALE

- Tube Bargains, to name just a few:
- #6146 ....\$2.95 #5725/6AS6 ..... 59c #6AQ5 .....56c
- #6360 .... 3.50 #5842/417A .....\$2.50 #6BQ7 .....94c
- #6688 .... 3.50 #5847/404A ..... 2.50 #6CG7 .....59c
- #6939 .... 3.50 #1AX2 .....49c; 5 for 2.00 #6J6 .....49c
- #7025 .... .59 #6K7 .....39c; 3 for 1.00 #6T8 .....84c
- #7788 .... 3.75 #12BN6 ...39c; 3 for 1.00 #6U8 .....77c
- #2D21 ... .49 #25L6 ....59c; 3 for 1.49 #12AU7 .....59c

- Any unlisted receiving tube, 75% discount off current list prices.
  - Tube Cartons: 6AU6 etc. size, \$1.75 per 100. 6SN7 etc. size, \$2.10 per 100. 5U3GB size, \$2.50 per 100. 5U4G size, .03c each.
  - Obsolete Tubes: #UX200, \$1.69; #80, \$1.20; #10Y, 69c.
  - 7 inch 90 degree TV bench test Picture Tube with adapter. No ion trap needed. Cat. #7BP7, \$6.99.
  - Silicon Rectifier octal-based long-life replacement for 5U4, 5Y3, 5AS4, 5AW4, 5T4, 5V4, 5Z4. With diagram. Cat. #Rect 1, 99c each.
  - OZ4 Silicon Rectifier replacement, octal based. Cat. #Rect 2, 99c each.
  - 10 Flangeless Rectifiers, 1 amp, 400 to 1000 p.i.v. Cat. #RS10, \$2.98.
  - 10 Silicon Rectifiers, 750 MA, 50 to 300 p.i.v. Cat. #330F, 99c each.
  - Condensers: 50-30 MFD at 150 v., 39c each, 3 for \$1.00. Cat. #80; 850-400-100-15 MFD at 16-16-4-115 v., 3 for 79c. Cat. #82Y.
  - 2 Silicon Controlled Rectifiers, 1 amp, general purpose units with instructions. Cat. #SCR 1, \$1.00.
  - 5 Transistor Circuit Boards containing up to 6 transistors, plus diodes, resistors, capacitors, etc. Cat. #TB10, 99c.
  - Needles: values such as #AS22 Sapphire, 39c; Diamond, 99c
  - Color Yokes. 70 Degree for all round color CRT's. Cat. #XRC70, \$12.95. 90 degree for all rectangular 19 to 25 inch color CRT's. Cat. #XRC90, \$12.95.
  - Transistorized U.H.F. Tuners used in 1965 to 1967 TV sets made by Admiral, RCA, Motorola, etc. Removable gearing may vary from one make to another. Need only 12 volts d.c. to function. No filament voltage needed. Easy replacement units. Cat. #U.H.F. 567, \$4.95.
  - General Electric U.H.F. miniature Transistorized Tuner. G.E. Part #ET85X-33. Cat. #GE85, \$4.95.
  - F.M. Tuner, Hi-Fi amplifier tuning unit complete with diagram, 2 tubes. Sam's Photofacts #620 lists 2 applications. Cat. #FM20, \$3.98.
  - Flyback Transformer in original carton. Made by Merit or Todd. Most with schematic drawing of unit. Please do not request specific type. Cat. #506, 99c each.
  - Flyback Transformer Kits, 2 flybacks per kit. #502E, Emerson; #502Y, Silvertone; #502W, Westinghouse; #507, Philco; #502, RCA. Any kit \$2.99.
  - Kit of 30 tested Germanium Diodes. Cat. #100, 99c.
  - Kit of 10 NPN Transistors. Cat. #371, 99c. 10 PNP Transistors. Cat. #370, 99c. All tested.
- Send for our Free Catalog listing thousands of similar best buys in tubes, parts, kits, transistors, rectifiers, etc. Order under \$5.00, add 50c handling charge. Include 4% of dollar value of order for postage.

## ARCTURUS ELECTRONICS CORP.

502-22nd St., Union City, N.J. 07087 Dept. M73  
Phone: 201-UN 4-5568

## GO COMMERCIAL - - -

That's right. Get your FCC commercial operator's license, and then work, at good pay, in your "hobby" field—radio and electronics. We prepare you by **correspondence**, under our "get your license or your money back" warranty. Get full details in our free "FCC License Course Brochure". Write:

**Grantham School of Electronics, Dept. R.**  
1505 N. Western Ave., Hollywood, Calif. 90027

## SURPLUS ELECTRONICS

Parts & Equipment—New & Used Ham Gear.  
Send 10c for our latest flyer, and we'll put you on our mailing list.

### JEFF-TRONICS

4252 Pearl Rd.

Cleveland, Ohio 44109

**A COMPLETE LINE OF  
BROADBAND BALUNS  
From The Quality Leader**

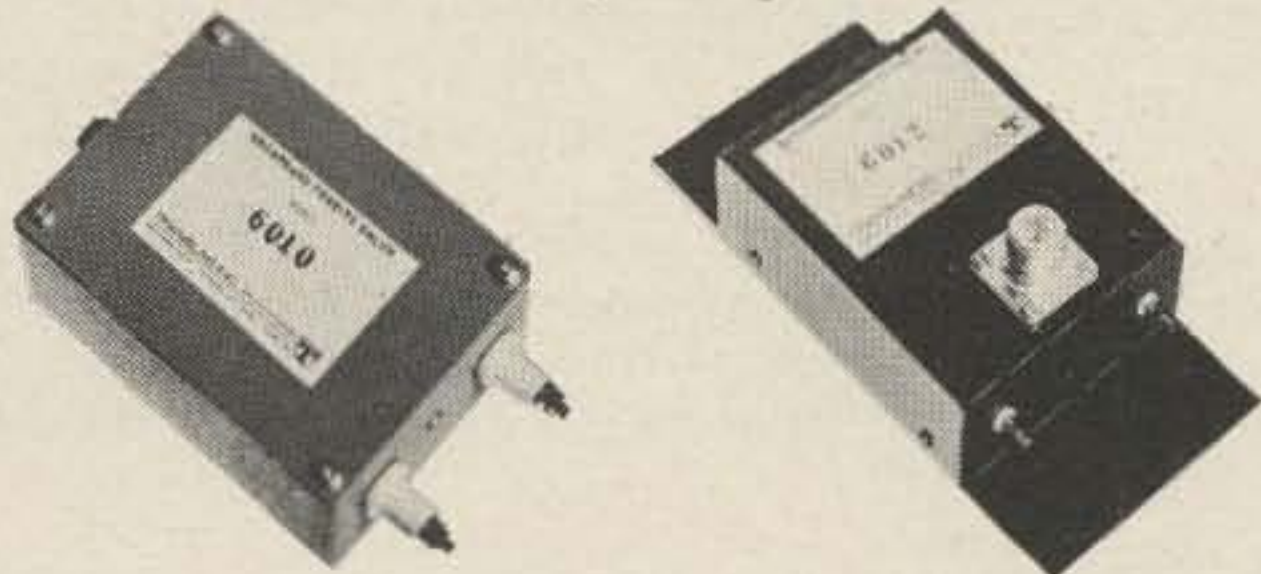

Model	Impedance* Ratio	Power (PEP)	Price Ppd. in USA
6010	50U-50B	2 KW	\$15.95
6011	50U-200B	2 KW	15.95
6012	50U-200U	500	14.95
6020	75U-75B	2 KW	15.95
6021	75U-300B	2 KW	15.95
6022	75U-300U	500	14.95

\*U—Unbalanced  
B—Balanced

All Units are Rated at Full Power from 2-32 mc  
Complete with Hardware & Mating Connector

**NEW**

- Model 615 Toroidal Filament Choke—3-30 mc —15 amp cont.
- Completely encased and ready for mounting
- Now used in the Henry 2K and 4K amplifiers!

**ONLY \$10.95 PPD. USA**

TRANSLAB INC.

Creates Concepts in Communications



4754 FEDERAL BLVD. SAN DIEGO, CALIF. 92102 TELEPHONE 714/263-1876

# WE PAY CASH FOR TUBES

**Lewispaull Electronics, Inc.**  
303 West Crescent Avenue  
Allandale, New Jersey 07401

**NEW! Ham License Frames**

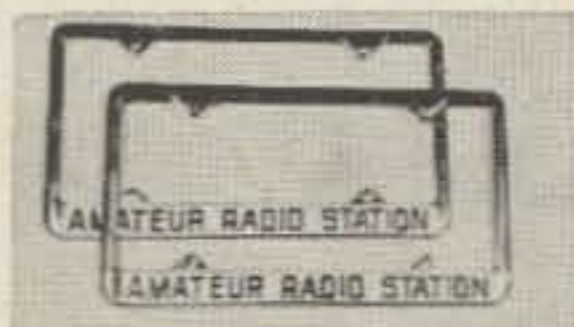

\$3.95 pr (5% Cal. tax) postage paid

Triple chrome plated, fits all 6 x 12 plates

Blue letters on white background

**Ken Walkey Engineering**

P.O. Box 3446  
Granada Hills, Cal. 91344

**LARGEST SELECTION in United States  
AT LOWEST PRICES—48 hr. delivery**

**JAN  
CRYSTALS**

Thousands of frequencies in stock. Types include HC6/U, HC18/U, FT-241, FT-243, FT-171, etc. SEND 10¢ for catalog with oscillator circuits. Refunded on first order. 2400B Crystal Dr., Ft. Myers, Fla. 33901

Dear 73,

The following equipment was stolen from me during Thanksgiving week: HQ120 and large speaker. Numbers and dates marked beside each tube socket; HQ140 and defective speaker (both gray) most knobs have white indicator marks added; KLH-8 FM radio and matching speaker in wood cases; Triplet #630 VOM; RDO Shack—small tube tester; Zenith "Long Distance 66" transistor portable radio (black); and Bausch and Lomb 20X Black target spotting scope. Notify Police Detective Bureau, Weymouth, Mass.

Art Bates W1RY  
Hingham, Massachusetts

## Cheap and Rugged Portable Speaker Enclosure

Having a spare speaker which we wanted to use for an extension from the shack when monitoring a net frequency and for the car when we went mobile, we found the perfect solution in the plastic foam boxes in which electronic equipment is shipped.

It takes only a little work with a knife to hollow out the inside to fit the speaker, plus an icepick to punch holes for mounting bolts. The porous nature of the plastic foam makes punching holes for the sound unnecessary, however, the material was so easy to work we punched the extra holes anyway.

The cushioning effect of the foam prevents damage to the speaker when moving it from place to place.

... Ross A. Sheldon K4HKD

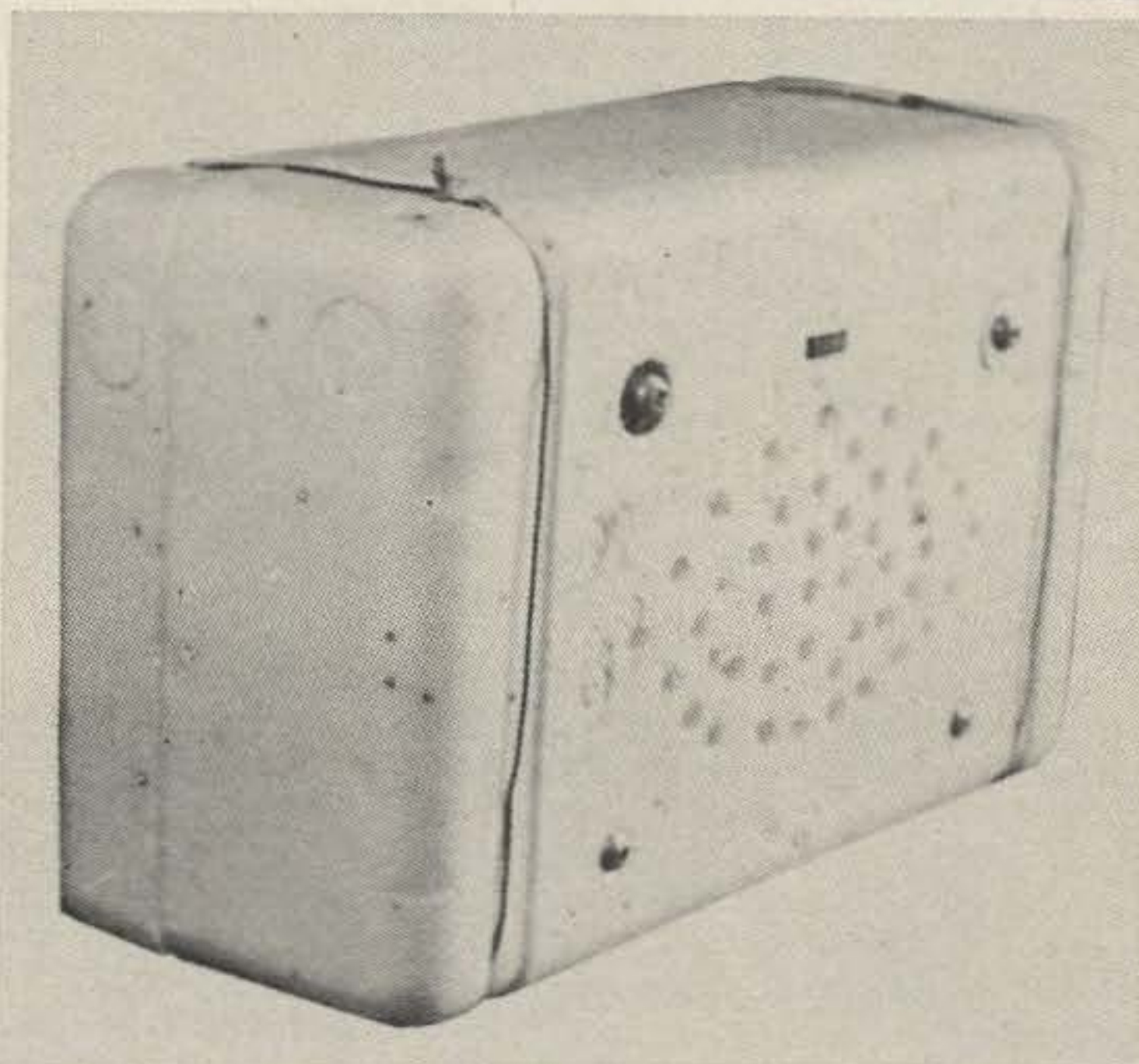

Portable speaker case made from styrofoam box.

## RADIO TELETYPE EQUIPMENT

TELETYPE MODELS 29 KSR, 28 ASR, 28 KSR, 28 LPR, 28 LARP, 28 LXD, 28 LBXD1, 14, 15, 19, Page printers, Perforators, Reperforators, Transmitter-distributors, Polar Relays, Collins Receivers 51J-3, R-388, 51J-4, R-390A. Hammerlund SP-600JX. Frequency Shift Converters.

**ALLTRONICS-HOWARD CO.**  
Box 19, Boston, Mass 02101 Tel: 617-742-0048

. . . . What I am trying to bring out is that we should clean our own house first. I'm sure that every-time you tune across an active ham band you will be able to find signals that are splattering across 6 to 8 kHz of the spectrum. I'd appreciate being notified if mine is doing that.

With the present conditions, and incentive licensing becoming a reality quite likely we will find that more, rather than less, used equipment is being made available to the CB'ers or whoever might desire to buy it.

Max Casselman WAØGSY  
Conway Springs, Kansas

Dear 73,

Hail to Ron Zurawski! Finally, someone comes out with an intelligent view of SSB, as well as something to do about the CB mess.

His article contains some very good suggestions for what to do with the 11-meter circus which is now in full swing. The most important idea is to increase the FCC monitoring force. This is urgently needed. I know many CB'ers who work with well over 100 watts, and I even know those who have worked into the midwest and west coast with only five watts. The thing is, as long as there are CB'ers, there will be violators. Still, if the laws were harsher and strictly enforced, there would be less CB'ers, and much less violation.

So, bravo to WA8FVD.

Mark L. Cohen WN3HST  
Philadelphia, Pennsylvania

Dear 73,

I'm writing in the hope that this letter may be published. My message is extremely simple. Lay off W1AW when code practice is being sent! I'm not interested in the views as regards ARRL, incentive, Don Miller or anything else. These are unimportant. The intentional QRMing that has been going on since the FCC acted on incentive does nothing to hurt ARRL; it only damages amateur radio.

I have the very great pleasure to teach an advanced theory and CW course for our local radio club. It is something that every capable ham should try when his time permits. Recently, my students have told me that the CW broadcasts sent by W1AW have been subjected to an increasing amount of QRM. Typically, they reported that the call-up for practice (QST de W1AW, etc.) is clear for almost the whole of the first five minutes. Then the fun begins.

At first, I was inclined to attribute the complaints to a lack of receiver selectivity available to some of my students. When some of them suggested that they were hearing signals zero-beating W1AW, I decided to check up on the reports.

A few nights of monitoring with a selective receiver was enough to convince me that something was going on. As a result, using an R4A+ Hamscan and an SB301+ monitor scope, I have literally watched the zero-beating occur and have even copied high speed CW QSOs in which the operators seemed to be proud of the fact that they were covering W1AW.

Gentlemen, and I am really using the term loosely, how low can you go? There is literally no excuse for this behavior. It doesn't help amateur radio a bit to keep new hams from licenses or keep those who already have tickets from advancement. Besides, it is clearly not legal.

William J. Webster, Jr. WB2TNC/8  
East Cleveland, Ohio

*Bill, if this is really going on, ham radio has reached a new low. A tape recording should be made and sent to the FCC and their monitor stations alerted. The casual QRM on W1AW is bad enough without malicious interference being added.*

Dear 73,

I think you have the only ham magazine on the market. I do wish you would put all adds in a catalog section. I have fussed about this before.

I sure am enjoying back issues you had on special.

Orville Gulseth W5PGG  
Clarksdale, Mississippi

*Most advertisers prefer to be separated from the others, but perhaps we could convince them if enough readers voiced an opinion. Let me know how you feel about having advertising all in one place in the book.*

Dear 73,

Thanks for the excellent November '67 articles on "I. C. Frequency Counter" and "I. C. Pulse Generator". Let's have more from WØLMD and W6GXN. Please give us lots of digital circuits using the Fairchild I. C.s (#900, 914, 923) as you have been doing

Bill Bentley  
Westbury, L. I., New York

Dear 73,

The only reason I subscribe to your rag is so I won't miss the April issue. Being a long time fan of Harvey Kurtzman, I enjoy good satire. MAD never had it so good.

In a more serious vein, I would like to reminisce about an experience I had while stationed on Okinawa in 1962.

Being a rather new ham, all starry-eyed and full of the -uh- propaganda put out by the League, I wrote to them and asked if they could put me in touch with fellow League members. I also explained that it took about three months for magazines to reach the island and was there any arrangement whereby they could airmail QST to me. I would be glad to pay the extra postage. The letter I got back from them said, "Duh, Gosh, I don't know, maybe you could contact Okinawa Amateur Radio Club to meet some of the fellows". No mention of airmailing QST. I sent a similar letter to 73 explaining about the delay in getting the magazines.

I received, shortly thereafter (in a plain wrapper), an airmailed issue of 73, and I received them that way for the rest of my stay on Okinawa (about 22 months). I wrote Wayne asking what I owed for the courtesy he showed me, but I never received a reply. Perhaps it embarrassed him, getting caught out of his tough guy act.

Robert L. Katz WA5CZX  
White Sands Missile Range, New Mexico

Dear 73,

I always wondered what Caveat Emptor above the ad section in 73 meant until I started studying Latin. Perhaps all of your readers who buy equipment from this section should get a dictionary of foreign words and phrases and look this up, hi.

Kenneth Bishop WA5MIN  
Victoria, Texas

Dear 73,

We have just started the Radio Club Andino, located 10,000 feet up in the Andes Mountains; a group of construction men and miners, U.S. and Chilean. We are on the air on all modes 10 through 80 meters. CE2RE, CE2AD, CE2RG and CE2RM are all English speaking and could show up under the club call of CE2SA. Our QSL manager is ex-TG9BC. She hasn't received her call yet, but she will see that all club contacts are confirmed. If you want run-down on Chile, just QRZ.

Max Bond CE2RM  
Los Andes, Chile



## Letters

Dear 73,

My mail box is flooded with letters wanting me to renew my subscription to your fine publication. This warms my soul greatly. Now the last one states, "Throw my stencil out and save money". I am so sad that you are giving up, as 73 is the best damn magazine that I have ever received.

Now, it may be that my friendly postman may be high-jacking my monthly magazine and sending it to his daughter, who is in a home for unwed mothers, or the neighbors, who I give TVI to, but somehow we have our wires crossed.

So please check with the quite efficient young thing who handles the subscription renewals, and see what she has done with my twelve dollar check that I sent you on September 21, 1967. This was for a three year renewal, and I have not received any magazine since the one with the cute little "DANGER LAST COPY".

I already have the cancelled check back and know that somehow my name got lost in the pot, so would appreciate that you get me back in the groove and start the wonderful world of written confusion coming to my door again, and if the sweet thing blowed my twelve dollars on song, drink, and dance, that's all right, just get that 73 back in the mailbox.

Ray Winstead Evans WA5FDO  
Marmaduke, Arkansas

*Ray, we share your frustration and that of hundreds of other subscribers to 73 at the time we changed over to a new computer. The idea was to take advantage of the latest computer techniques for handling subscriptions. This would give us a much more perfect and rapid system of handling subs, as well as save us enough money to let us put off any increases in subscription rates for a while longer. The "routine change-over" went badly. Hundreds got their November issues very late, or not at all. Renewal forms were sent to hundreds of others who had already renewed. Normally we expect a few fellows to get renewal notices after they have renewed because it takes a few days for renewals to be made and it is not unusual to run off the notices during this period. Most subscribers realize this and just throw out the notice, but a few excitable ones write to us and Doty gets a few minutes further behind checking his subscription to make sure that it really is OK. Hopefully, everything will be in good order by this issue. We are trying hard to give you the very best service possible. We are, by the way, the first ham publication to change over to a computer for subscriptions.*

Dear 73,

In my opinion the whole controversy engendered by Jim Fisk's article condemning AM is very amusing. What both of the warring phone factions seem to forget is that there is a simpler, cheaper, and much more rewarding mode of operation. While the SSBer pays his kilobuck, and the AMer his centibuck to get on the air and fight the QRM, the CW who pays his decibuck and sets out confidently to communicate farther and faster, and derives much more pleasure from cultivating his skill than either of his more sophisticated cousins. After all, any boob can talk into a microphone. Anybody who says CW is outmoded, a waste of time, boring, ridiculous, etc., obviously doesn't know what he is talking about. When all else fails, my friend, and ham radio has lost its thrill for you, try CW.

R. T. Wood WA3EPQ  
State College, Pennsylvania

*There have been hundreds of letters on the AM/SSB controversy. However, since Jim is no longer with 73, I refuse to carry on his battle for him. I think there is a place for all modes, and we have to find a means of living together in peace.*

Dear 73,

Have tried TAG and can only say "WOW". My question went out and came back like now. Almost believe the postman answered it. Thanks.

Dick Heydt

*Dick is referring to the Technical Aid Group. Elsewhere in this issue you will find a list of the members who devote time to answering technical questions from the readers of 73. On this score, may I ask that you keep a copy of this list handy and refer your queries to the appropriate member of TAG rather than to the Editor. I would like to be able to help you, but the job of production of 73 is a time and a half job and I just can't answer each question which comes in.*

Dear 73,

Enjoyed K6BIJ's story on underwater radio signals. I'm sure it stirred the heart of many ex Sonarmen like myself. I served on a DDE for '51 to '55 and we had an underwater SSB rig that we could communicate with subs by either voice or CW. It was called the "Gertrude" for some unknown reason. The official Navy designation was something like AN-UQCO1. It worked quite well and the "antenna" was inside the sonar dome beneath the ship. We used to have CW drills with other destroyers using it at ranges of about 1000 yards.

Also to kind of answer K6BIJ's question, we were taught and of course found to be true, that salinity, pressure, and density affect sound in water. Sound tends to bend away from warm water too. Sound in water traveled at about 4800 ft/sec, and increased as the salinity and other factors went up.

Don McCoy WAØHKC  
Wheatridge, Colorado

Dear 73,

Please keep up the good articles!! I dropped the other two mags and am reading Tom Swift books instead, I notice little difference between them and the "other two"; they're both far-fetched!

Thomas Dulisch WA9TDD  
Park Ridge, Illinois

### The Death of Amateur Radio

Dear 73,

I have just finished reading the article, "The Death of Amateur Radio" from the November issue. I wondered if you bothered to do the same? I am very surprised to think you would print such trash.

Richard N. Burne K3KAW  
Scranton, Pennsylvania

Dear 73,

Having read 'The Death of Amateur Radio' by WA8FVD, I have some opinions to express.

First of all, his idea of keeping old AM equipment when purchasing new rigs is, in my opinion, absurd. Suppose for example, we all kept our old automobiles when buying new ones because we might not like the prospects of where our old vehicles would go or for what they might be used.

## The XYL Pleaser Mobile Mount

The XYL put up with having the rig in the car on trips, but served notice she wanted nothing left in the car when the rig was returned to the shack at the end of the trip.

So—an old U-shaped chassis was found which, turned upside down, fitted over the hump in the floor boards. Two pieces of metal were bolted to it and one of them bent upwards to rest against the front of the seat cushion. Two notches were filed in the end of the upper piece to receive the front legs of the SR160. A portable speaker in a plastic box was wedged on the metal platform between the rig and the engine firewall.

It takes only ten minutes to install or remove the rig and the only things left behind are the power cable and coax.

... Ross A. Sheldon K4HKD

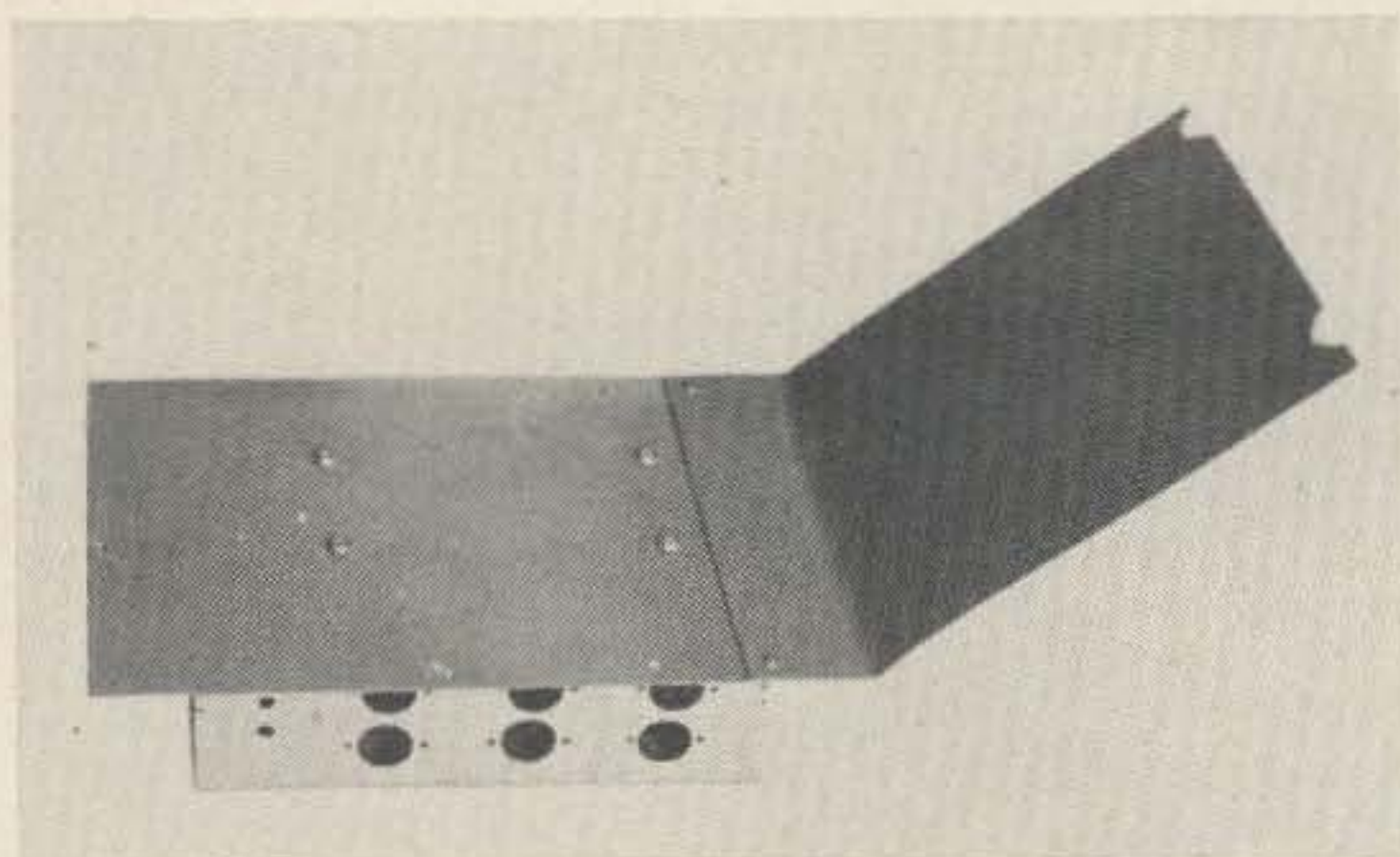

The XYL pleaser mobile mount.

## LINE OF SIGHT

We hear much about the so called "line of sight" on UHF and VHF bands but after mentioning it, not much more is known; especially how to figure it.

Lets say you have a fifty foot tower on the old 2 meter beam. What is your line of sight? 50 miles, 25 miles, 10 miles, 5 miles?

There is a simple formula for calculating this distance. It is  $D(\text{distance in miles}) = 1.23\sqrt{\text{Height of antenna}}$ . The squart foot of fifty feet is 7.07. Multiplying this by 1.23 we have 8.69 which is your line of sight from the tower at the antenna.

Actually the radio horizon is 15% more than this or a total of 9.99 miles. If you wish to figure it even more quickly simply take the formula of  $(\text{Distance in miles}) = \sqrt{2H}$ . This works out to 2 times your height —100 feet and take the square root of that which would be 10 miles.

This is "YOUR" line of sight. If the fellow is on the other end, his line of sight is figured the same way and is additive. In other words, his line of sight is say—eight miles. Yours is ten so you have a line of sight of eighteen miles.

This is why the fellow with the higher tower gets out a bit better even though he may have the same rig etc. etc.

(Tongue in cheek) As you raise the tower, so do you run up the losses in the coax feed line. You can't get something for nothing—or hardly.

... Bill Roberts W9HOV



— with a MATERIAL DIFFERENCE!

Use, is one of the most dependable testimonials of endorsement, and Telrex products are in use in 139 Lands

## "Beamed-Power" ANTENNAS, "BALUNS" I. V. KITS and ROTATOR SYSTEMS!

Most Technically-Perfected, Finest Communication Arrays in the World! Precision-Tuned-Matched and "Balun" Fed for "Balanced-Pattern" to assure "TOP-MAN-ON-THE-FREQUENCY" Results

Enjoy, World renown TELREX performance, value and durability! Send for PL67 tech. data and pricing catalog, describing professionally engineered communication antenna systems, rotator-selsyn-indicator systems, "Baluns", I.V. Kits, Towers, "Mono-Pole", "Big-Berthas", accessories, etc., etc.

COMMUNICATION SYSTEMS SINCE 1921 **telrex** Laboratories  
 ASBURY PARK, NEW JERSEY 07712, U.S.A.

# WANTED

## SALES ENGINEERS

### EARN \$20,000 per year

Based on commission from sales and installation of just 3 Vanguard TV cameras per week!

#### Full or Part Time

Closed circuit TV is recognized as a definite necessity for many businesses to combat rising costs. Thousands of factories, office buildings, banks and schools will welcome your demonstration.

Using our list of applications as a guide you will be able to show how any establishment can use several cameras and how each one can save thousands of dollars through the resulting increase in efficiency and security. If you are over 21, have a working knowledge of TV and are financially responsible, we need you as a sales engineer to demonstrate our Model 501 in your area. To receive your application and additional details, send us a resume of yourself and include a self-addressed, stamped envelope.

## VANGUARD LABS

Dept. H, 196-23 Jamaica Ave.  
Hollis, N. Y. 11423

## SPACE AGE KEYS

Only  
\$67.50



- Planar epitaxial integrated circuits for reliability. No tubes—No separate transistors.
- Precision feather-touch key built-in.
- Fully digital—Dot-dash ratio always perfect.
- No polarity problems—Floating contacts switch 1-amp.
- Rugged solid construction—will not walk.
- Send QSL or postcard for free brochure.

## PALOMAR ENGINEERS

BOX 455, ESCONDIDO, CAL. 92026

Conference. It has been several years since I've had a chance to see all my friends out there, so don't disappoint me.

On June first I will be speaking at the Swampscott ARRL Convention and showing some of my African slides. After being excluded for two years from this affair it will be nice to get back and see everyone.

May I caution convention committees not to get all excited and expect me to be available. First of all I will be tied down at 73 for quite a long time to come and it is extremely difficult to get away even for a day. Secondly, my wife Lin will be coming with me anywhere I go, and we just don't have the money to make extensive jaunts. The bookkeeper complained the other day that she needed a bottle of black ink, but that if she bought it we would be back in the red again.

... Wayne

### Our Advertisers

The advertising in 73 is as important to you as it is to us. As I've mentioned before, it is the advertisers that are paying for the magazine, since the subscription money just barely covers our cost of sending out the magazines. If you like a bigger magazine then it is up to you to encourage advertisers to use 73. We try to run about 30% advertising, running a little under that now and then and a bit higher at times to get back even again. This means that every page of advertising is bringing you two pages of articles.

You can help us a lot with this. When you write to advertisers ordering something for heaven's sake please tell them that 73 tipped the balance. If you've got a gripe tell them someone else sent you.

I know that a lot of you are buying Heath equipment, but you sure haven't told Heath about it. From now on, when you send an order to Heath for something, mark it to the attention of Earl Broihier. Earl is in charge of advertising up there. Don't let me down on this; show him that the 73 readers are good customers and that you want to see more Heath advertising in the magazine. Fold down the corner of this page so that you can remember to mark your next orders to Heath to go to Earl. Don't forget!

that one. My head ached and every muscle and joint in my body was wracked with pain.

By late morning I was feeling a lot better. Joe stopped by and we talked a bit more. He wanted me to send him some strings for his badminton racket from Bangkok and gave me the sizes for clothes for his family so I could send some when I got back home. They need everything, but clothes are the most wanted.

When the airline bus got me to the airport I found that Royal Thai had not notified the immigration people about my delay. They raised a big fuss over this and seemed about to haul me off to jail. I got them to tackle their phone system and call Royal Thai. They finally managed to get through and reluctantly stamped my passport for the extra 24 hour visa.

Burma was certainly interesting, but I don't think I'll go back right away. A couple hours later we landed at Bangkok where I was met by John Nolan, a chap who used to work for us in Peterborough a couple years ago and who at this time was with the U.S. Army in Korat, Thailand. He got a couple of days off to do Bangkok with me.

Things are still very rough in Burma and, if you ever have a notion to do some good, you might just drop a note to one of the fellows listed in XZ land in the Callbook and find out what you can send him that will be helpful. I've been corresponding with Joe and have sent over a big box of clothes for him and his son.

## Public Appearances

For the last couple of years I have not been at my best and I have thus tended to avoid hamfests and conventions as much as I could. I'll probably be getting out a little more this year and I would like to meet as many readers of 73 as I can. Say hello, and tell me what you think of the magazine . . . what would improve it . . . what isn't so hot . . . etc. And give a lot of thought to ideas for peppering up our hobby.

First I'll be speaking after the dinner given by the Northern New Jersey DX Association on March 23rd at the Holiday Inn, Wayne, N.J. This is at the intersection of routes 46 and 23. The program starts at 2 PM and the banquet at 7. Write W2PXR for details and a reservation. Be there if you can.

On May 11th I will be the guest speaker at the Western New York Hamfest and VHF



VANGUARD  
MODEL 501  
Made In USA.

**\$279.95**

SHIPPING COLLECT  
COMPLETE WITH LENS

### SUB-MINIATURE SOLID STATE TV CAMERA

#### FOR CLOSED CIRCUIT OR AMATEUR TV

THE VANGUARD 501 is a completely automatic closed circuit television camera capable of transmitting sharp, clear, live pictures to one or more TV sets of your choice via a low-cost antenna cable (RG-59U) up to a distance of 1000 ft. without the need for accessories or modifications on the TV sets. The range can be extended indefinitely by using line amplifiers at repeated intervals or by using radio transmitters where regulations permit. There are hundreds of practical uses in business, home, school, etc. for any purpose that requires you or anyone chosen to observe anything taking place anywhere the camera is placed. Designed for continuous unattended operation, the all-transistor circuitry of the 501 consumes only 7 watts of power.

For complete specifications  
send for our illustrated catalog.

**VANGUARD LABS**  
196-23 Jamaica Ave. Dept. H Hollis, N.Y. 11423

## WANTED

### MILITARY SURPLUS AS TRADE-IN'S

WE OFFER new boxed Ameco, Drake, Eimac, E-Z Way Towers, Gonset, Hammarlund, Hy-Gain antennas, Ham-M Rotors, National, SBE, Sonar, Swan, Also reconditioned ham equipment taken in as trade.

WE NEED unmodified surplus equipment with prefix ARC, ARN, ARM, APN, APX, APS, APR, BC, FRC, GRC, UPX, GPM, GRM, PRC, MD, URM, UPA, UPM, URC, USM, URR, VRC, TED, TRC, TS, also Bendix, Collins, Boonton, Bird, Measurements, ARC, GR, Tektronix, Commercial Equipment, Collins 18S-4, 17L, 51V, 51Y, 618S, 618T, 51X, 51R, 51J, and R-278/GR Receivers, T-217/GR Transmitters, MD-129/GR Modulators, MT-686/GR Racks, AT-197/GR Antennas, Tech Manuals and Tubes.

CLEAN OUT YOUR SHACK by sending us your list of surplus for trading. It might be worth more than you think. List what you have and what you want.

Write, Wire, Phone Bill Slep, W4FHY  
**SLEP ELECTRONICS COMPANY**

Drawer 178P, Highway 301  
ELLENTON, FLORIDA 33532  
Phone (813) 722-1843

# DON'T QRT!

## LT-5



When you leave your QTH put your **LT-5** portable 40-80 meter CW transmitter in your pocket!

**\$24.00** KIT  
**\$35.00** WIRED

**SEND FOR FREE DATA SHEET**

**OMEGA ELECTRONICS COMPANY**

10463 Roselle St. • San Diego, Calif. 92121



Interested in what European hams are accomplishing at the higher frequencies?

Read UKW - BERICHTE, the authoritative German quarterly, now with English summaries! Applications of the latest VHF and UHF techniques; equipment and antenna construction details. Each sixty-page issue packed with practical articles written by the most outstanding amateurs in Europe.

Annual subscription U.S.A. \$3.00, Canada \$3.25  
H. Ingwersen, PA6AFN Box 87, Topsfield, Ma. 01983

## AMI-TRON

### Ferromagnetic Products

Red "E" Cores — 500 kHz to 30 MHz:

T-200-2	\$3.00
T-94-2	.75
T-80-2	.60
T-68-2	.50
T-50-2	.45
T-37-2	.40
T-25-2	.30

Yellow "SF" Cores — 10 MHz to 90 MHz:

T-94-6	.95
T-80-6	.80
T-50-6	.50
T-25-6	.35

Black "W" Cores — 30 MHz to 200 MHz:

T-50-10	.60
T-37-10	.45
T-25-10	.40

FERRITE BEADS: Package of 12

+ Spec Sheet: \$2.00

KILOWATT TOROID BALUN KIT: \$5.00

EXPERIMENTER'S 2 CORE

TOROID KIT: \$1.50

Minimum Order: \$1.00

Please add 25c per order for packing and shipping

## Ami-Tron Associates

12033 Otsego Street

North Hollywood, Calif. 91607

Courtesy To Distributors

and you have to worry about stepping in strange substances like betel nut chewings, little bright red wet splotches that are around in profusion, or nice surprises left by rather large dogs.

You don't just in and out of a pagoda. This monster was the size of a very large city block and had small temples for each area of the country, with places to sit, rest, worship and even eat. There were all kinds of Budhas . . . sitting Budhas, reclining Budhas, standing Budhas. The professional prayers were hard at work burning candles and praying loudly at many of the shrines, pouring water over the Budha in the shrine.

We stopped several times at the Royal Thai Airline ticket office to make sure that my flight out was going to be on time. The fellow in charge unfortunately couldn't speak English so we had a little problem. He tried several dozen times to get in contact with the airport by phone, but the telephone service is run by the army with the same efficiency that they run everything else and it wasn't until about noon that we finally made contact. My flight had been cancelled and Royal Thai would see that my visa was extended one more day. They would also pay my extra day of hotel and meals.

This was nice, but I was feeling more and more ill and I was not at all anxious to come down with something serious in a country which had hospitals run like the telephone service. I had the distinct impression that they might just ship me out of the country on a stretcher, if this was where I was when my plane left. I would much rather get sick in friendly Thailand.

I managed to last through a nice Chinese lunch with Joe and a visit to the Rangoon zoo, but I was weakening badly when we went to an afternoon billiard tournament. I did have an opportunity to talk with a chap from the British embassy who backed up everything Joe had told me about Burma. They wanted to take me out to dinner after the match, but I was about ready to pass out and just got back to the hotel in time to drop into bed for the night. I couldn't even eat the free Royal Thai meal.

During the night I was violently sick, complete with a raging fever and icy chills. There were two beds in my room and I put all the blankets on one and crawled underneath to shiver. The room was about 90°. When I soaked the bed completely I moved the blankets over to the second bed and used

a bicycle he can get a ration book for it which permits the purchase of one tire per year at about \$40.

Joe pointed to the receiver up on a shelf and said wistfully that he tunes twenty meters now and then just to listen in. There seems little hope that amateur radio will be permitted again in Burma for a long time. He saw that I was having trouble believing that things were so bad in Rangoon and said that he would take me on a short tour of the town when he drove me back to my hotel. The car? Well, the army used it until it fell apart and refused to run any longer and then returned it. He and his son managed to get it working again and kept it just barely running so they wouldn't take it back again.

We drove through Rangoon at 10 pm and, as he said, everything was closed. Everything. I explained that I had to catch a flight out the next afternoon since it is impossible to get more than a 24 hour visa. Joe said he would show me the town in the morning so I could see for myself what it was like these days.

When I asked him about Don Miller's visit and how Don had managed to stay in the country for two weeks and get permission to operate when the locals were not allowed on the air, Joe said that as far as he had heard from the other hams in Burma Don had never been there. They had heard about Don's "Burma" operation, but were quite sure that he could not get a license or be permitted to bring any equipment into the country. Also there was virtually no way to overstay a 24 hour visa without going to jail. He said that the Burmese hams were convinced that Don had operated from somewhere else, probably Thailand.

The next morning Joe drove up to the hotel in his jalopy and picked me up for the grand tour. Sure enough, as he had said, almost every store and factory in the city was closed tight with barred doorways. The main department store for the city (run, like everything else, by the army) had virtually no merchandise. The little government food stores had small dirty boxes of the grimmest rice and beans you ever saw, and little else.

Next we started on the pagodas. The biggest one is right in the middle, of town and it is a corker. The big problem, for a tender-foot like myself, is that you must remove your shoes to visit the pagodas. This is no problem if your feet are accustomed to walking on tiles that are baking in a tropical sun.

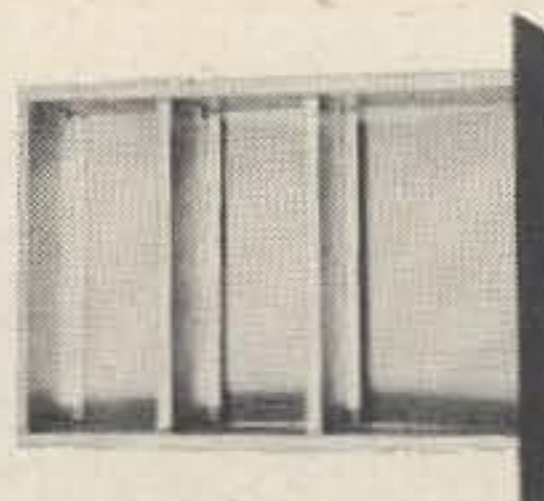

3 1/2" x 1/2" RACK PANEL  
10" Depth \$5.00 PPD  
Check or M.O. No COD  
NYC Res. Add 5%  
NYS Res. Add 2%

## DEVICES

BOX 136 BRONX N.Y. 10463

## CONSTRUCT YOUR EQUIPMENT THE EASY WAY—USE THE UNIT CHASSIS

Wire and test the subchassis outside where everything is accessible. Assemble the subchassis into the unit chassis and you have a professional package.



3" x 6 1/2" subchassis

### JUNK BOX ANEMIC?

We have a cure—electronic parts, hardware, tubes, assemblies and such for sale by the pound. The parts are unused or removed from new equipment. Limited supply:

17 pounds \$ 3.00 Plus postage for 21 pounds  
100 pounds \$14.95 F.O.B. Bluffton, Ohio (truck shipment)  
We also have a number of part assortments listed in our "Free" catalog along with regular electronic parts and tools. Just a post card will do, but list your zip code.

### BIGELOW ELECTRONICS

P.O. Box 71, Dept. 73B, Bluffton, Ohio 45817

## oscillator/monitor

- a sensitive broadband RF detector gives audible tone signal in the presence of any RF field from 10mw to 1 kw and 100kc to 1000mc
- a CW monitor with positive "RF" switch uses only 8" pickup antenna and NO connection to rig or key
- a code practice oscillator with adjustable tone & built in speaker
- high gain 4 transistor circuit powered by long life AA pencil
- 16 gauge aluminum cabinet in white & black epoxy finish, 3 1/2" by 2 3/8" by 1 1/4", weight 8 ounces
- 100% US made and guaranteed



1295 (batt incl)  
ppd usa & can  
send cert ck or m.o.  
ny res add 5% tax

the James research company  
11 schermerhorn st., brooklyn n.y. 11201

R19/ARC12—118 to 148 mc Tunable Receiver complete with 9 tubes and schematic. . . \$29.95

DAVEN Frequency Meter—Direct indicating frequency meter covering 25 to 5000 cycles in four ranges (.1-5-1-5 kc). Exc. Con. . . . \$29.75

Hallicrafters—HA12A Encoder, New . . . . \$7.50

### Panadapter

IP-274/ALA—See June 1964 73. Furnished in excellent condition with tubes and conversion data . . . . . \$12.95

R10/ARC12—Broadcast Receiver . . . . . \$19.95

### RTTY Discriminator

Sub unit for frequency shift converter CV-89A/URA8A. New . . . . . \$34.50

Send for Catalog #132

## ARROW SALES-CHICAGO, INC.

2534 S. MICHIGAN AVENUE  
CHICAGO, ILLINOIS 60616



## U. S. CRYSTALS

Surplus Crystals — Amateur

FT243, DC34, CRIA/AR, FT241, HC6/U and other misc. crystals

Write for Free Catalog

## U. S. CRYSTALS

P.O. Box 78397  
Los Angeles, Calif.

**ELECTRONIC/COMMUNICATIONS SLIDE RULE,** "Ricoh" Model 156LAI computes L, C, F<sub>0</sub>, X<sub>c</sub>, X<sub>1</sub>, ± db, and many other most used formulae in three settings or less. Seventeen red or black 10" scales (±db, DF, CF, CIF, CI, C, D, A, X<sub>c</sub>, X<sub>1</sub>, K, KI, S, T, F<sub>1</sub>, F<sub>2</sub>, DI) engine engraved on hard glare-free white plastic, bonded to warp resistant laminated bamboo. Accessories: Genuine leather case, plastic decimal point table, instruction booklet. Made in Japan. Save \$9.00!! Cash price prepaid to any US post office . . . \$15.95! Yukon Electronic Sources, INC., Drawer "O", College Alaska 99701.

**9 1/2 by 10 1/2 CLOCK CONVERSION CHART.** Reads all times at a glance, a must for every ham shack. Only .75 check or M.O. only. J. F. Siemietkowski, 3039 East Thompson St., Phila., 19134 Penna.

**IDEAL COMPANION FOR HT-44** Hallicrafters SX117, receiver. Needs slight repair. \$225 or best offer. Rob Martin WB2WBA, Box 36, Katonah, New York 10536.

**GOODIES,** cash for Teletypewriters, parts. List. Sell 14s, 15s, 19s, 28s, parts. Toroids, 6/\$2 postpaid. Typetronics, Box 8873, Ft. Lauderdale, Fla. 33312.

**HALLICRAFTERS SX140** Novice receiver, 80-6 meters, \$65 shipped in continental U.S. Heathkit DX-100, good condition, FOB Lynn Ziegler WA5LTC, Route 3, Denison, Texas 75020.

**HEATHKIT SENECA VHF-1,** six and two meter transmitter, looks and operates fine, only \$145.00. K1PNI, 133 Larchmont Road, Warwick, R.I. 02886.

**POWERSTAT,** type 136, 20 amps, brand new, includes triplet 0-150 vac meter, only \$30.00. K1PNI, 133 Larchmont Road, Warwick, R.I. 02886.

**EICO 720** perfect \$60. 75A-2 \$175. ART-13 nice unmodified \$25. K8ZID Henry S. Allgyer, Gnadenhutten, Ohio 44629. 614-254-4172.

**HY-GAIN 153-B** full size three element 15 meter beam, \$22.50. Also BC-696A \$12.50. W6IH, 12252 Hartsook St., No. Hollywood, Calif. PO 1-8979.

**HW12, 22, 32, OWNER ("A" SERIES ALSO):** Convert your rig to three bands with SSB & CW coverage. Send \$3.95 for assembly manual or 10¢ for illustrated brochure. DRC, 215-28 Spencer Avenue, Queens Village, New York 11427.

**HR060 100 kc-54mc, spkr.** \$289; HQ-180C, spkr. \$169; HC-10 SSB converter \$100; all like new. T. C. Howard, 46 Mt. Vernon St., Boston, Mass. 02108.

**WANTED:** R-390A/URR, 51J-4, R-388, Model #28 Teletype, etc. Cash or trade. Alltronics-Howard Co., Box 19, Boston, Mass. 02101 (617-742-0048).

**STEP ATTENUATOR,** Kay 432d, precision, -0-101db in 1 db steps, 50 ohm, good to 500 MHz. \$50 ppd. Herbst, 2F, 3001 Edwin, Fort Lee, N.J. 07024.

**6 METER CONVERTER,** 3 FET transistors. Printed circuit board construction, 14MCs output, less power and xtal, \$8.50 FOB. Bill Deane, 8831 Soverign Rd., San Diego, Calif. 92123.

**TELETYPE TEST SET I-193C.** Brand new surplus. Tests RTTY transmitters, converters, relays, \$24.95, F.O.B. Harrisburg, Pa. Telemethods International, P. O. Box 18161, Cleveland, Ohio 44118.

## ARNOLD'S ENGRAVING

Personalized



Works on 110 VAC—\$10.95



Metallex label bar—\$1.50 or Tie Clip—\$2.25

### ARNOLD LINZNER

2041 Linden St.

Ridgewood, N.Y. 11227



#### TUNAVERTERSII

10 to 2 meters for HF & VHF AM-FM Marine, SW, and Police, Fire, etc! Tunable RF converters.

For all auto and home radios! Transistor & 6-1 tuning!

(See Complete listing in Jan. '68 73 ad page 81)  
Dept. 79, Woodboro, Texas 78393

HERBERT SALCH & CO.

## DON'T ASK! TELL US!

If you have any Gen. Radio, H-P, Tektronix and other military and commercial gear to sell, tell us flat out what you want for it! You call the shot!

You name your own price for your ARC, GRC, TED, PRC, VRC, ARN, URR and APN equipment. No matter what others promise, we guarantee to pay more for it! BUT YOU GOTTA TELL US TO SELL US! Write, call, cable or telegraph today!

### COLUMBIA ELECTRONICS, Dept. 7

4365 W. Pico Blvd., Los Angeles, Calif. 90019  
Phone: (213) 938-3731 Cable: COLECTRON

#### BUILDERS NOTICE

If you like to design and build with transistors, we have the following components packaged up as assortments. These kits are excellent for value and quality. You will truly be pleased.

- I Transistor & rectifier mounting hardware for TO3's, TO5's, TO6's, TO66's, etc. . . . . \$1.50
- II Spagetti tubing, plastic, cambric, Temflex, Teflon, over 100 ft all sizes you need . . . . . \$1.95
- III 50 transistor electrolytics, p.c. and axial lead types, assorted sizes and voltages. Fresh stock. If you build you need them . . . . . \$4.50
- IV Volume and squelch controls, panel mount, asst of 5 . . . . . \$1.00
- One each of above kits—#1-2-3-4 . . . . . \$8.00
- 115v line cords UL APPR, 6 ft. . . . . 5 for \$9.95
- Sarkes Tarzian 1N3020A 10v-1w zener 55c . . . . . 2 for \$1.00
- NEW—These transistors are factory firsts, brand name
- 2N2671 PNP trans. Amperex mix/rf shielded case 4-lead FT 100 mc \$5.00, 12 for \$4
- 2N2089 PNP Amperex rf/osc/mix FT 75 mc, case lead terminated. \$.40 each, 12 for \$3.50
- 2N1526 PNP RCA osc FaB 33 mc. Use as fundamental tal osc. \$.35 ea., 12 for \$3.25
- 2N1524-1525 PNP's, i.f. . . . . \$.35 ea., 12 for \$3.25

922-24 Elm St., RACINE, WISC. 53403  
TOWER COMMUNICATIONS

### B-C FLIPS THE LID ON SURPLUS

TV-10/UHF-VHF transverter, 8 channel crystal controlled ARC-12 transmitter, 228-258 mc and receiver-converter, converts incoming 228-258 mc to 118-148 mc to feed into R-19/ARC-12 receiver, using 110 mc crystal oscillator. NEW, with instruction book. ....\$35.00

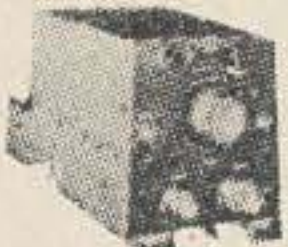

R11A/ARC, complete with all tubes, has hi-Q ceramic 85 kc i-f's (see Sept. 1963 73 "Q-5er Reborn"). Very excellent used (12) .....\$15.95



IP274/ALA10, 2 meter panoramic adapter, 30 mc± 5 mc input, 400 cy power supply with instructions for solid states 60 cy supply and to 14 mc input Internally complete, 3BP1 & 17 tubes. Excel. (45) Reduced to close out .....\$15.00



MN-26LB, Bendix direction finder & communications receiver, 3 band, 200-410, 550-1200 kc, 2.9-6 mc. Internally complete, 12 tubes. Excel. used (40) .....\$12.95

MH-20D loop antenna for above, not rotatable. NEW ....\$1.95



Lazy Man's Q-5er, 1020 cycle filter, 3 position switch-RANGE passes 1020 cycle VOICE rejects 1020 cycles, both no filtering. A "MUST" for CW & Teletype. Lowest price. NEW (3) .....\$2.25

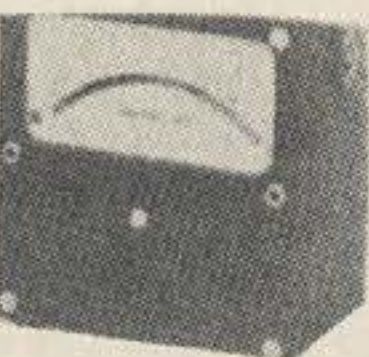

WESTON model 742, AC/DC mirror scale, accurate voltmeter. DC scales 0-30 & 0-300 v. AC scales 0-1.5, 0-15 & 0-150, 4½" square, provision for edgelighting; complete with all necessary multipliers, on an assembly 1 ma DC basic movement. BRAND NEW .....\$20.00

Hamfest schedule: Wheaton Swapfest, Du Page County Fairgrounds, Feb. 18th.

All orders, except in emergency, or I'm at a hamfest, shipped same day received. For free "GOODIE" sheet, send self-addressed, stamped envelope—PLEASE, PLEASE include sufficient for postage, any excess returned with order. I carry private (Travelers) parcel post insurance, for domestic parcel post. For items too heavy, or too large for parcel post, I suggest bus parcel express. Please advise name of bus line, and city, where you can pick up the shipment. Canadian customers—PLEASE add sufficient for postage—\$1.00 first two pounds, 30c each additional pound or fraction.

### B C Electronics

Telephone 312 CALumet 5-2235

2333 S. Michigan Avenue Chicago, Illinois 60616

### S S B's—SWAN 500's NOW IN STOCK—\$495.00

KWS-1 .....	\$795.	Viking 500 .....	\$375.
KWM-2 .....	795.	NCX-3 .....	199.
Poly-Comm 62 .....	225.	Eico 753 .....	159.

LARGE STOCK OF USED EQUIPMENT ON HAND

### FRECK RADIO & SUPPLY CO., INC.

38 Biltmore Ave., Asheville, N. C. 28801

Ph. 704-254-9551

T. T. Freck, W4WL

CLOSED SATURDAYS

Sandy Jackson, WN4AAL

### ATV'ERS

For the largest US ATV magazine; Technical reports & ATV directory SEND \$1 for special introductory (\$2 after March First)

1 year subscription TO:

**A5 MAGAZINE**

150 Delong Ave.,  
Dumont, NJ 07628

## LEARN RADIO CODE

### THE EASY WAY!

- No Books To Read
- No Visual Gimmicks To Distract You
- Just Listen And Learn

Based on modern psychological techniques—This course will take you beyond 13 w.p.m. in LESS THAN HALF THE TIME!

Also available on magnetic tape. See your dealer now!

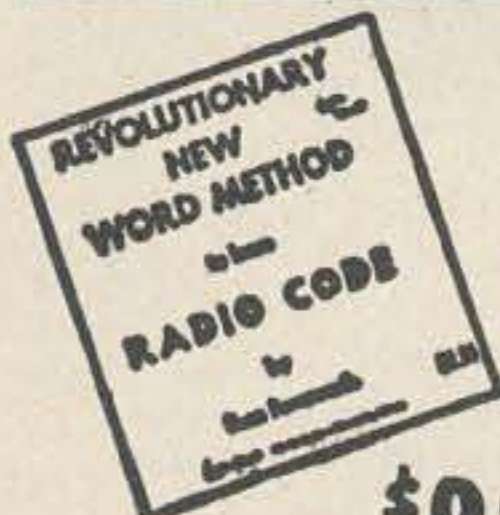

**\$9.95**

Album contains three 12" LP's 2½ hr. Instruction

## EPSILON [E] RECORDS

206 East Front Street, Florence, Colorado

Feb 1968

**WANTED:** Record, tape, or lyrics of the song "Gloomy Sunday" from the early 1930 era. WØHJL, P. O. Box 224, Dublin, N.H. 03444.

**WANTED: TEST EQUIPMENT,** laboratory quality such as Hewlett-Packard, General Radio, Tektronix, etc. Electronicraft, Box 13, Binghamton, N.Y. 13902. Phone (607) 724-5785.

**MOTOROLA** new miniature seven tube 455 kc if amplified discriminator with circuit diagram. Complete at \$2.50 each plus postage 50¢ each unit. R and R Electronics, 1953 South Yellow-springs, Springfield, Ohio.

**TOROIDS—DIODES—COAX—CONNECTORS.** 88 mH toroids—45¢ each, 5/\$2.00. 1000 PIV 1 Amp Top-Hat Diodes—55¢ ea. 2/\$1.00. Connectors, PL259, SO-239, M359—45¢ ea. 10/\$4.00. Button feed-throughs (while they last) 500 pF @ 500 V. 20/\$1.00. Add sufficient postage. R and R ELECTRONICS, 1953 S. Yellow-spring St., Springfield, Ohio.

**VARIACS**—General Radio and Ohmite. 60 cycles Input 120V—output 0-280 V. 1 amp or input 240 V—output 0-280 V. 2 amp. PULLOUTS IN GUARANTEED EXCELLENT CONDITION \$6.95 plus postage. Shipping weight 10 lb. R & ELECTRONICS, 1953 S. Yellow-spring St., Springfield, Ohio.

**WANTED:** Military, commercial, surplus, Airborne, ground, transmitters, receivers, testsets, accessories. Especially Collins. We pay freight and cash. Ritco Electronics, Box 156, Annandale, Va. Phone 703-560-5480 collect.

**WANTED:** Tubes, transistors, lab instruments, test equipment, panel meters, military and commercial communications equipment and parts. Bernard Goldstein, Box 257 Canal Station, New York, N.Y. 10013.

**BEST BUYS** from America's smallest ham dealer. Jerry Hirsch has all major brands and needs used gear, big trades call me last! Hirsch Sales, 219 California Dr., Williamsville, N.Y. 716-632-1189.

**RTTY GEAR FOR SALE.** List issued monthly, 88 or 44 MHy torroids 5 for \$1.50 postpaid. Elliott Buchanan & Associates, Inc., 1067 Mandana Blvd., Oakland, California 94610.

**LAWTON-FORT SILL HAMFEST**—February 11, 1968. Contact David R. Tancig, WA9FRE/5, 1923 Kinyon, Lawton, Oklahoma 73501.

**DUMMY LOAD** 50 ohms, flat 80 through 2 meters, coax connector, power to 1 kw. Kit. \$7.95, wired \$11.95, pp Ham KITS, Box 175, Cranford, N.J.

**COPPER CIRCUIT BOARD** Epoxy glass base 7½ x 8½ single sided 3 oz. copper. \$1.00 ea., two for \$1.50 postpaid. Electrographics, 2440 Wildoak Drive, Dallas, Texas 75228.

### CLUB SECRETARIES NOTE

Club members would do well to get their club secretaries to drop a line to 73 and ask for the special club subscription scheme that we have evolved. This plan not only saves each club member money, it also brings badly needed loot into the club treasury, if desired. Write: Club Finagle, 73 Magazine, Peter Boro Ugh, New Ham Shire 03458.





From the birthplace of the greatest inventor of all ages, Leonardo Da Vinci, comes this made-in-Italy—world's most practical for the price,

## PRESTEL FIELD STRENGTH METER (Model 6T4G)

Calibrated from 40 to 860 Megahertz, from 10 to 50,000 Microvolts. Nothing makes it easier to properly and speedily find the correct place to install TV, FM and Communication Antennas. You can measure and hear the signals with this 4½ volt battery economically powered unit. There is nothing else like it!

**Only \$120.00**

We continue to purchase **FOR PROMPT CASH** small and large inventories of electronic equipment, tubes, semiconductors, etc.

**Wire, write, phone collect!**  
**We pay freight on all purchases!**



# Liberty Electronics, Inc.

548 Broadway, New York, New York 10012, Phone 212-925-6000

*"Your Friendly Supplier"*



**OFFERS**

### THE *hallicrafters* SX-146 AMATEUR BAND RECEIVER

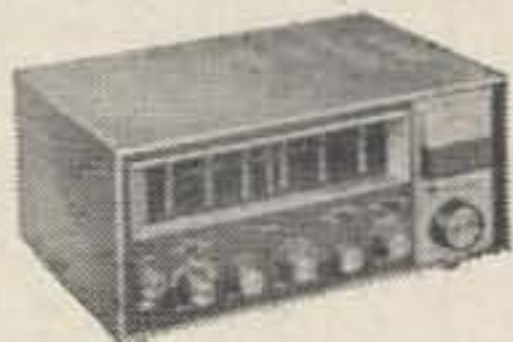

The Hallicrafters SX-146... Amateur Band Receiver of advanced design, employing a single conversion signal path and pre-mixed oscillator chain to assure high order frequency stability and freedom from adjacent channel cross-modulation products. Employs a high frequency quartz crystal filter and has provision for the user installation of two more crystal filters. Tranceives with HT-46.

SX-146 **\$269.95**  
HA-19 100 Kc Crystal Calibrator **\$19.95**

ALSO IN STOCK: HT-46 Transmitter **\$349.95**

#### USED EQUIPMENT SPECIAL

SX-111 **\$139.95**  
SX-140 **\$59.95**

WRITE FOR LATEST COMPLETE LIST

# Evans RADIO

P. O. BOX 312

PHONE  
603-225-3358

CONCORD, N. H.

## INDEX TO ADVERTISERS

Adirondack, 77  
Aerotron (Ameco), 61  
Alltronics, 88  
Alvaradio, 76  
Amitron, 82  
Arcturus, 89  
Arnold's, 93  
Arrow Sales, 81  
ATV Research, 69  
A5 Magazine, 94

B C Electronics, 94  
Bigelow, 81

Ceco, 76  
Columbia, 93  
Crabtree, 41  
Cushcraft, 79

Devices, 81  
DuPage FM, 75  
DX'er Magazine, 57

Editors & Engineers, 78  
Epsilon Records, 94  
Estes Engineering, 77  
Evans Radio, 96

Fair Radio, 92  
Famerie, 77  
Freck Radio, 94

Goodheart, 72  
Gotham, 95  
Grantham School, 89

H & L, 72  
Hafstrom (BTI), 75  
Hayden, 63  
HCJ Electronics, 77  
Henry Radio, 53, IV  
Hy-Gain, 83

International Crystal, 3

James Research, 81  
JAN Crystals, 88  
Jeffronics, 89

Leeds, 74  
Lewispaal, 88  
Liberty, 96

Meshna, 40  
Midway, 92  
Military, 74  
Mosley, 15

Omega, 65, 82

Palomar, 84  
Parks Laboratories, 52  
Poly Paks, 90

Quement, 39, 49

Radio Amateur Callbook, 57  
Rohn, 5

Salch, 93  
Scott, 76  
Sentry, 19  
Slep, 83  
Sound History, 71  
Swan, III

TAB, 95  
Telrex, 23, 85  
Tower, 93  
Trigger, 60  
Tristao, 57  
Tuck, 72

UKW Magazine, 82  
United Radio, 92  
U. S. Crystals, 81

Vanguard, 37, 79, 83, 84  
VHF Associates, 77

Walkey, 88  
World Radio Labs, II  
Westcom Engineering, 92

# ...EVOLUTION!

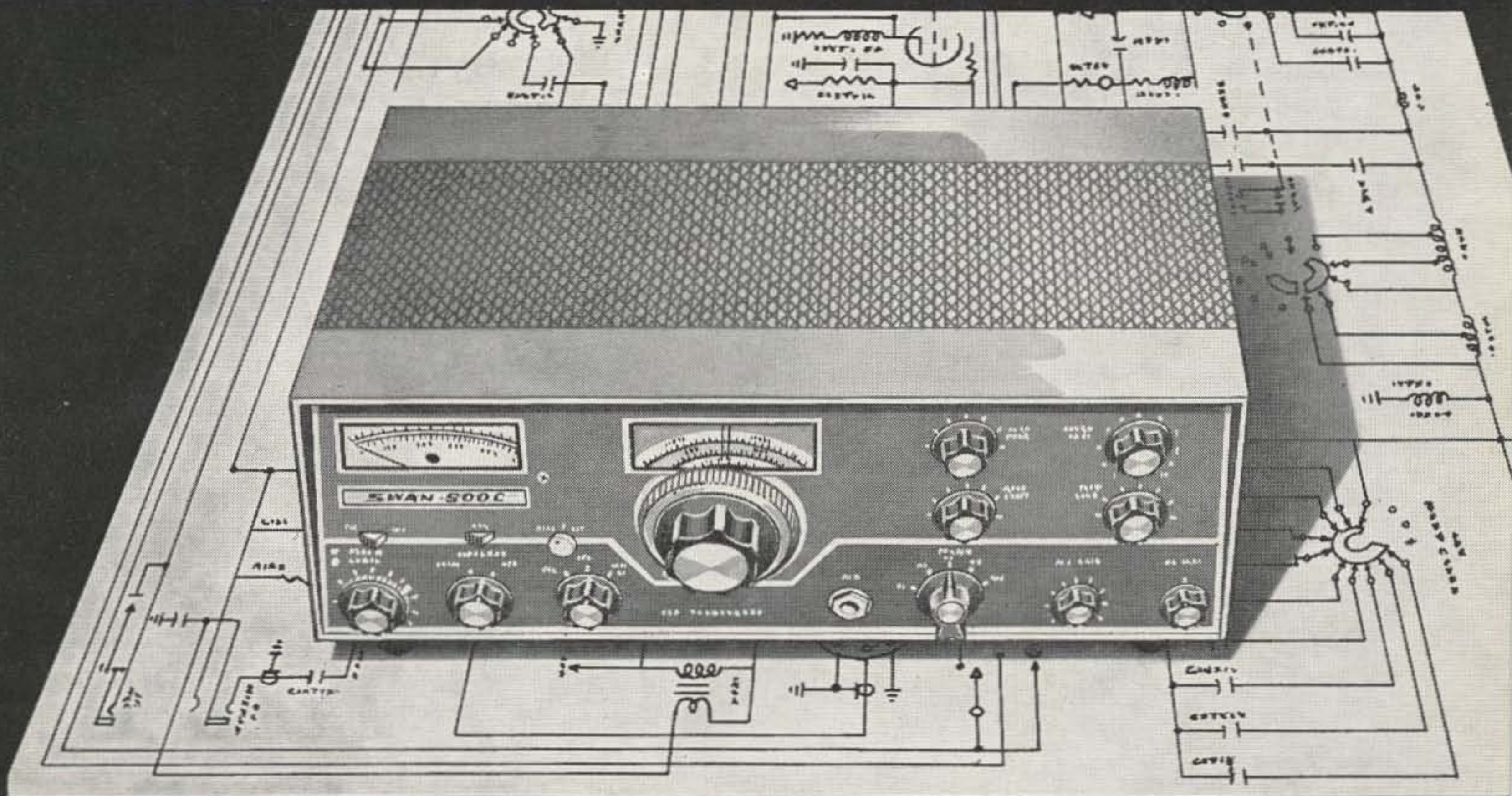

## THE NEW SWAN 500C

### 5 BAND—520 WATT TRANSCEIVER

SSB-AM-CW      HOME STATION-MOBILE-PORTABLE

The new model 500C is the latest evolutionary development of a basic and well proven design philosophy. From the very beginning, with the introduction in 1961 of the first single band SSB Transceiver, Swan has followed a steady course of improvement by evolution. You might think that we would finally reach the point of leaving well enough alone, but with some 18 licensed hams in the engineering, sales and production departments of our organization, it just isn't possible. Thus, the new model 500C, with greater power and additional features for even more operator enjoyment.

RCA recently introduced a new heavy duty "blast rated" tetrode, the 6LQ6. With a pair of these rugged tubes the final amplifier operates with increased efficiency and power output on all bands. PEP input rating of the 500C is conservatively 520 Watts. Actually, an average pair of 6LQ6's reach a peak input of over 570 Watts before flat-topping!

Further refinement of the famous Swan VFO results in even greater mechanical and thermal stability and more precise dial calibration. Custom made planetary drives, machined to extremely close tolerance, provide velvet smooth tuning.

The 500C retains the same superior selectivity, of course, that we have been offering. The filter is made specially for us by C-F Networks, and it's no secret that it is a better filter than is being offered in any other transceiver today. By moving the I.F. to 5500 KC, and increasing the number of tuned circuits in the receiver, we have

achieved substantial improvement in image and spurious rejection. These improvements, coupled with additional TVI filtering, result in what we believe is the cleanest transceiver on the market.

For the CW operator the 500C includes a built-in side-tone monitor. Also, by installing the Swan Vox Accessory (model VX-2) you will have break-in CW operation. Thus, the model VX-2 now fulfills a dual function, both automatic voice control and break-in CW keying. Grid block keying of a pure CW carrier is employed with off set transmit frequency.

The 500C embodies the Swan's well known dedication to craftsmanship, performance and reliability, with a service policy second to none. When you visit your Swan dealer and look over the 500C, we are sure that you will be glad we couldn't 'let well enough alone.'

**\$520**

**SWAN 350C** Our improved standard model, now in production, and still only ..... **\$420**

#### ACCESSORIES

##### MATCHING AC POWER SUPPLY

Model 117XC ..... **\$95**

##### 12 VOLT DC POWER SUPPLY

Model 14-117 ..... **\$130**

**MODEL 410 FULL COVERAGE EXTERNAL VFO** ..... **\$95**

**MODEL 22 DUAL VFO ADAPTOR** ..... **\$25**

**MODEL 405X CRYSTAL CONTROLLED MARS OSCILLATOR** **\$45**

**MODEL VX-2 VOX and BREAK-IN CW UNIT** ..... **\$35**

SEE IT AT YOUR  
SWAN DEALER



**SWAN**

**ELECTRONICS**  
Oceanside, California

A SUBSIDIARY OF CUBIC CORP.

# WE EVEN SURPRISED OURSELVES

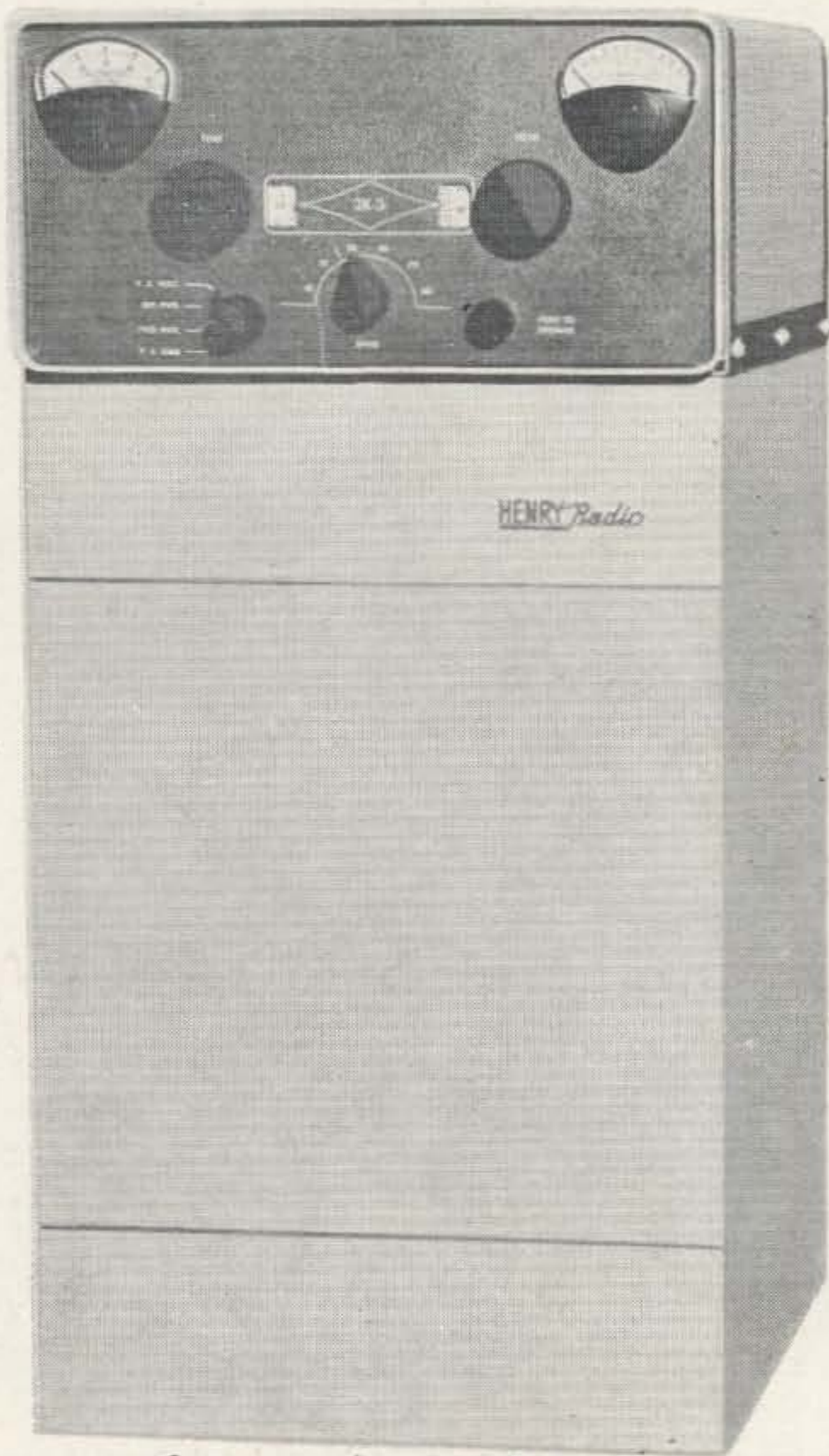

*(We improved the 2K-2)*

The 2K-2 was good . . . in fact, it was the best linear amplifier for the amateur on the market. But now, thanks to a pair of new and improved Eimac 3-500Z tubes, providing 1000 watts of plate dissipation, the 2K-3 operates with even greater power output and less drive. (It's so much better we're going to call it the 2K-3 now.) Still endowed with the same rugged and reliable mechanical construction, inspired design and using only the very best components, the 2K-3 is unquestionably the finest. You have heard the strong clear signals of the 2K-2 by now. Why not go on the air with an even better signal? You can NOW with the new 2K-3. Console or desk model \$745.00. Let us send you a descriptive brochure.

6% FINANCE CHARGE • 10% DOWN OR TRADE-IN DOWN • NO FINANCE CHARGE IF PAID IN 90 DAYS • GOOD RECONDITIONED APPARATUS • Nearly all makes & models. 15 day trial. 90 day Warranty. 90 day trade back on NEW apparatus. Write for bulletin.

TED HENRY (W6UOU)

BOB HENRY (WØARA)

WALT HENRY (W6NRV)

**Henry Radio Stores**

CALL DIRECT . . . USE AREA CODE

Butler, Missouri, 64730	816 679-3127
11240 W. Olympic, Los Angeles, Calif., 90064	213 477-6701
931 N. Euclid, Anaheim, Calif., 92801	714 772-9200

East Coast Rep.: Howard Laughrey, 2 Elizabeth St.,  
Chappaqua, N.Y. 10514, (914) CE 8-3683

"World's Largest Distributor of Amateur Radio Equipment"