

73

NOVEMBER 1964

NOT \$1.00

MERELY 40c

*Amateur Radio*

**ANNUAL  
NOVEMBER  
ISSUE**

**25 Feature Articles 25**





# "S" SERIES

## AUDIO & POWER TRANSFORMERS & REACTORS For Complete Ham Systems

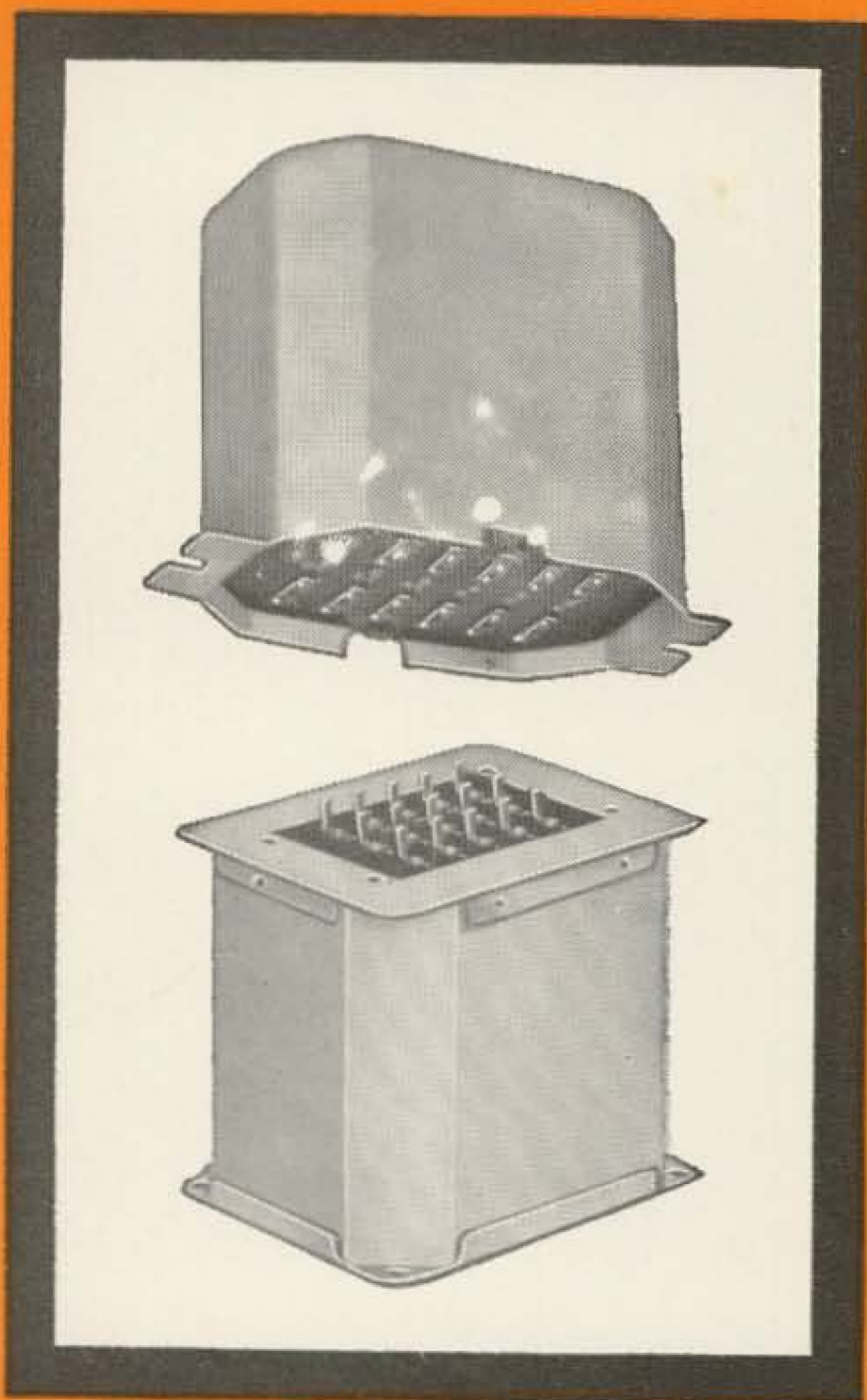

**Popular Priced  
Matched Components  
for  
Power Supplies  
Modulation  
Pre-Amp &  
Power Amplifiers  
... for entire ham rigs**

Thirty years of attention to ham requirements have resulted in a complete line of reliable, high quality components geared especially to your needs. The "S" series of audio and power transformers and reactors, designed specifically for ham and PA service, are completely matched for compatibility in constructing a rig. These are popular priced units which afford the ham the full benefits of UTC's established excellence for quality components coupled with high reliability.

Write for catalog of over  
1,000 STOCK ITEMS



### UNITED TRANSFORMER CORP.

150 VARICK STREET, NEW YORK 13, N. Y.

PACIFIC MFG. DIVISION: 3630 EASTHAM DRIVE, CULVER CITY, CALIF.  
EXPORT DIVISION: 13 EAST 40th STREET, NEW YORK 16, N. Y.

CABLES: "ARLAB"



# 73

## Magazine

Wayne Green W2NSD/1  
Editor, etcetera

November, 1964

Vol. XXV, No. 1

Cover:

No Cover This Month

73's Advertising Rates			
	1-5 times	6-11 times*	12 times**
2 pages	\$520	\$488**	\$456**
1 page	268	252**	236**
1/2 page	138	130	122
1/4 page	71	67	63
1/8 page	37	35	33
1/16 page	20	19	18

Add fractional page prices for sizes not listed.  
 $\frac{3}{8} P = \frac{1}{4} P + \frac{1}{8} P$ .  
 \*We must have a written contract for frequency discount.  
 \*\*No extra charge for second color for full page ads on contract.  
 Second color (usually red, but our choice) . . . \$25 per page or fraction.  
 Half or full page bleeds are 10% extra.  
 No special positions can be promised for color pages.

VHF Log Periodic Beam	VE3AHU	6
SSB VFO	K9ALD	10
Color the Grommet Gone	K7IDF	12
Cartoon	B. Rogers	14
Tuneable Antenna for 432	K1CLL	16
On the Air on 432	K1CLL	18
Precision Audio Attenuator	K9QYI	22
6 meter VFO Transmitter	WA2GCF	24
Sterba Curtain for Two	W2ZBS	30
Electrolytic Saver	WØHMK	31
KWM-2 Voltage Regulator	WA4NXC	33
80-40 Vertical	WB2CQM	34
Transistor AFSK	K9MLD	36
2 Meter Mobile	W2CJN	38
Mobile Phone Patch	W2LNP	40
KWM Operating Notes	WA4NXC	44
SJS Part III	K5JKX	46
UHF Transistor Circuitry	K1CLL	48
6 Meter QRP Station	Popovich	54
Mobile Noise Limiter	KØPOX	60
Amateur Radio Operating, FCC Version	W5EHC	62
Designing Phase Shift Network	K5JKX	66
The Easy Way	K3LNZ	68
Failsafe Power Supply Control	W3CJM	70
Incremental Tuning for the NCX-3	K2DXO	72
Lawrence Modification Kit	K1TVD	74
IoAR: The Amateur Radio Position	W2DUD	76
SB-33 and MP-10	W6VAX	79
Amplidyne 621	KØCER	80
Return to the Art	K3DSQ	82
Heath Applications Series	K8AJD	84
Kentucky DXpedition		90
Propagation	Nelson	96

Editorial Claptrap	2	New Products	73
More Frequencies for the		Professional Touch	86
Drake 2B	45	Crystal Holder Tip	87
Drake 2B and Heath HO-10	75	Letters	92

73 Magazine is published monthly by 73, Inc., Peterborough, N. H. The phone number is 603-924-3873. Subscription rates \$4.00 per year, \$7.00 for two years, \$10 for three years world wide. Second class postage is paid at Peterborough, New Hampshire and at additional mailing offices. Printed in the U.S.A. Entire contents copyright 1964 by 73, Inc. Postmaster: please send form 3579 to 73 Magazine, Peterborough, New Hampshire. All those interesting articles and here you are wasting your time with the small print!





### Conditional Class to be Virtually Eliminated

The FCC announced recently proposed rule making to drastically change the eligibility for a Conditional Class license. The new rules would permit only amateurs living more than 175 miles from an FCC examination point to qualify . . . and this would include their quarterly and semi-annual examination spots. With the exception of a few remote corners of the country, this blankets things pretty well. About one half of one percent of our population lives in these remote areas, so I expect that our present 20% Conditional Class will start dropping.

The new rules would not effect present holders of Conditional Class licenses or renewals, nor would it affect those unable to travel or those in the military.

\* \* \*

Now see what all that fuss about the Conditional Class license by ARRL has done? The FCC is proposing that it virtually be abolished. And since they have proposed that all current holders of the license will be able to renew as Conditional Class, I somehow doubt if they will get much opposition to their proposed new rule. I'm awfully sure that the League will back this one up since it will almost eliminate the Conditional license, a move which they have already endorsed, and it gives even more power over amateur radio to the FCC, another move which they have endorsed.

A few years back amateur radio was essentially run by the ARRL. The League consulted its members, gave careful consideration to the difficulties to be surmounted and then proposed legislation to improve our lot. The FCC automatically rubber stamped the rules through and our hobby ran fairly smoothly. Though many attribute the decline of the League with the loss of Maxim, it seemed to me that things came to a head soon after the war when it became apparent that ARRL had lost its perspective and was heavily CW oriented. This culminated in the National Amateur Radio Council, a loss of over 20,000 ARRL members in 1948, and the revamping of the FCC regu-

# de W2NSD

never say die

lations so that amateurs would henceforth represent themselves instead of being represented by the League.

Now, instead of working hard to re-establish the faith of the FCC in the League, we find ARRL petitioning the FCC for "firm guidance and leadership." You can probably imagine the impact upon the Commission of the furor over RM-499 too.

Are we going to continue to turn more and more of ham radio over the federal "guidance and leadership?" Just because we have to obtain a federal license to operate our equipment doesn't mean that we can't decide for ourselves, within international regulatory limits, how we want to go about it. We've turned a lot of the running of ham radio over to the FCC, maybe it is time to stop this trend and be responsible for ourselves.

Let's take a look at the present case, the Conditional Class license. There is a valid need for this type of license. Roughly 20% of the amateurs today are Conditional Class. A great many fellows live far enough away from a regular exam point so that it is a definite hardship to appear before an FCC examiner. Quite a few amateurs would be very hard put to lose the two or three days pay that this trip would entail.

The only valid reason that I can see for changing the rules is that we amateurs have failed to honestly conduct these license exams. Undoubtedly we have in certain cases failed. But the FCC proposal certainly is not the only answer to our failure.

When the Conditional Class license was first instituted there was just a small fraction of the present number of amateurs around the country. Today, with approximately one amateur to every 800 population, even the smallest towns have one or two amateurs and few amateurs are beyond easy driving distance from one or more ham clubs. I would like to see more recognition given to the thousands of ham clubs throughout our country for I feel that they, perhaps even more than the individual operator, are the strength and hope for the future of ham radio. I propose that Conditional



# NOW

## DIRECT CRYSTAL CONTROL TO 160 mc With AOC Plug-In Transistor Oscillators

- Portable Signal Standards • Signal Generators For Receiver Alignment • Band Edge Markers
- Frequency Markers For Oscilloscopes • Quick-Change Plug-In Oscillators • Accessory Cases

### HIGH FREQUENCY (20 mc – 160 mc)

Five transistor oscillators covering 20 mc - 160 mc. Standard 77°F calibration tolerance  $\pm .0025\%$ . The frequency tolerance is  $\pm .0035\%$ . Oscillator output is .2 volts (min) across 51 ohms. Power requirement: 9 vdc @ 10 ma. max.

OSCILLATOR TYPE	OSCILLATOR RANGE	CRYSTAL TYPE	TEMPERATURE TOL. -40°F to 150°F	OSCILLATOR (LESS CRYSTAL) PRICE	CRYSTAL FREQUENCY	CRYSTAL PRICE
OT-24	20-40 mc	CY-7T	$\pm .0035\%$	\$ 9.10	20-60 mc	\$ 6.90
OT-46	40-60 mc	CY-7T	$\pm .0035\%$	9.10	60-100 mc	12.00
OT-61	60-100 mc	CY-7T	$\pm .0035\%$	15.00	101-140 mc	15.00
OT-140	100-140 mc	CY-7T	$\pm .0035\%$	15.00	141-160 mc	18.00
OT-160	110-160 mc	CY-7T	$\pm .0035\%$	15.00		

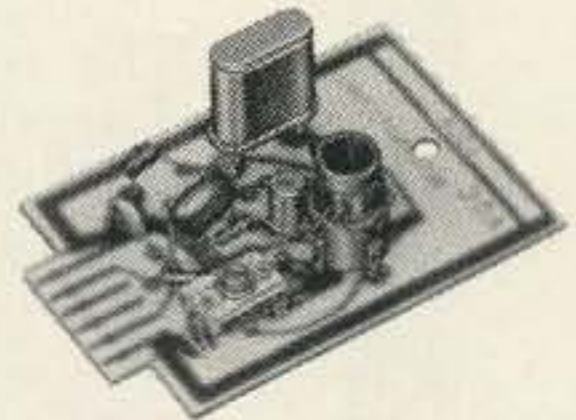

Order direct from  
International  
Crystal Mfg. Co.

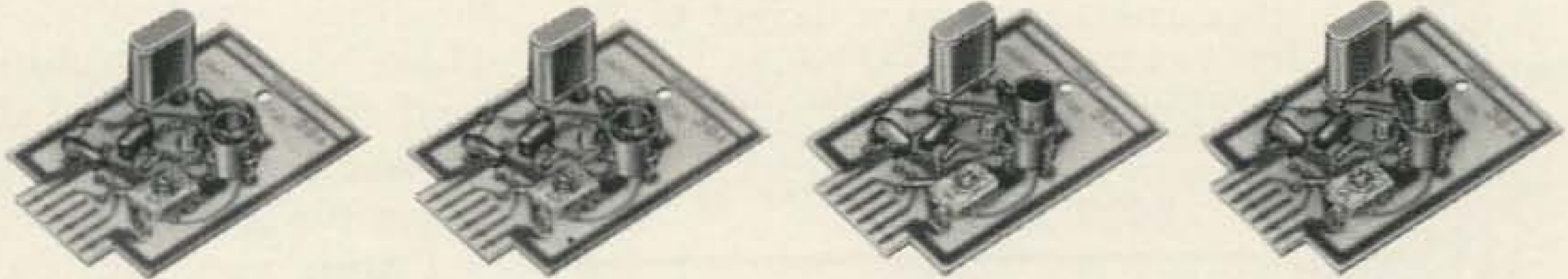

### LOW FREQUENCY (70 kc – 20,000 kc)

Four transistor oscillators covering 70 kc - 20,000 kc. Trimmer capacitor for zeroing crystal. When oscillator is ordered with crystal the standard will be  $\pm .0025\%$ . Oscillator output is 1 volt (min) across 470 ohms. Power requirement: 9 vdc @ 10 ma. max.

OSCILLATOR TYPE	OSCILLATOR RANGE	CRYSTAL TYPE	TEMPERATURE TOL. -40°F TO + 150°F	OSCILLATOR (LESS CRYSTAL) PRICE	CRYSTAL FREQUENCY	CRYSTAL PRICE	
OT-1	70-200 kc	CY-13T	$\pm .015\%$	\$7.00	70-99 kc	\$22.50	
OT-2	200-5,000 kc	CY-6T	200-600kc	$\pm .01\%$	7.00	100-200 kc	15.00
			600-5,000kc	$\pm .0035\%$	7.00	200-499 kc	12.50
OT-3	2,000-12,000 kc	CY-6T	$\pm .0035\%$	7.00	500-849 kc	22.50	
					850-999 kc	15.00	
OT-4	10,000-20,000 kc	CY-6T	$\pm .0035\%$	7.00	1,000-1,499 kc	9.80	
					1,500-2,999 kc	6.90	
					3,000-10,999 kc	4.90	
					11,000-20,000 kc	6.90	

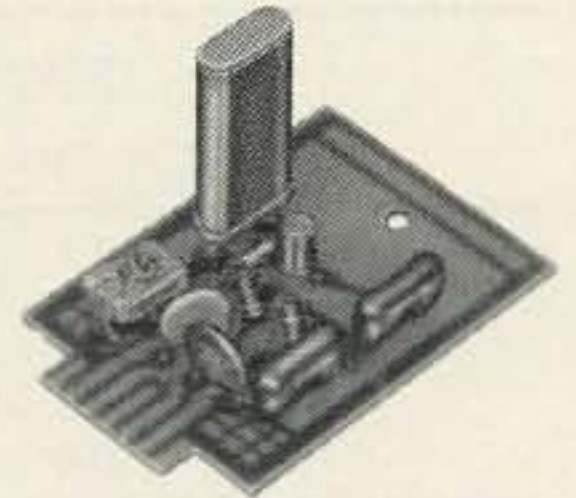

**INTERNATIONAL**  
CRYSTAL MFG. CO., INC.

18 NORTH LEE OKLAHOMA CITY, OKLA.

### AOC OSCILLATOR CASES

Small portable cases for use with the OT series of plug-in oscillators. Prices do not include oscillators. (When oscillator and crystal are ordered with FOT-10 case a 77°F tolerance of  $\pm .001\%$  may be obtained at \$2.00 extra per oscillator/crystal unit. When oscillator/crystal units are ordered with FOT-20 case, a single unit can be supplied with temperature calibration over a range of 40° F to 120° F. Correction to  $\pm .0005\%$ . Add \$25.00 to the price of FOT-20 and oscillator/crystal unit.)



FOT-20



FOT-10

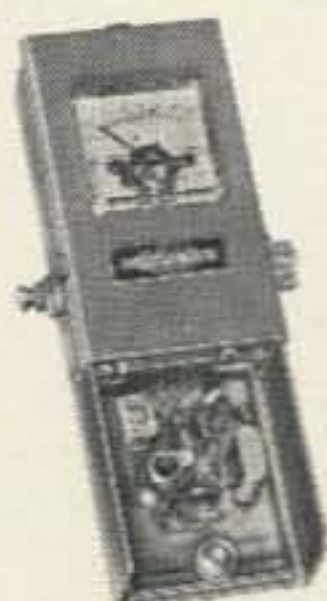

**FOT-20** For high accuracy calibration requirements. Includes battery and output jack, output meter circuit and battery check, as well as thermistor temperature measuring circuit. **\$87.50**

**FOT-10** Basic case with battery and output jack for general wider tolerance applications. **\$14.50**

**MT-1** Oscillator board mounting kit. **\$4.95**



# the LEADER in CRANK-UP TOWER DESIGN

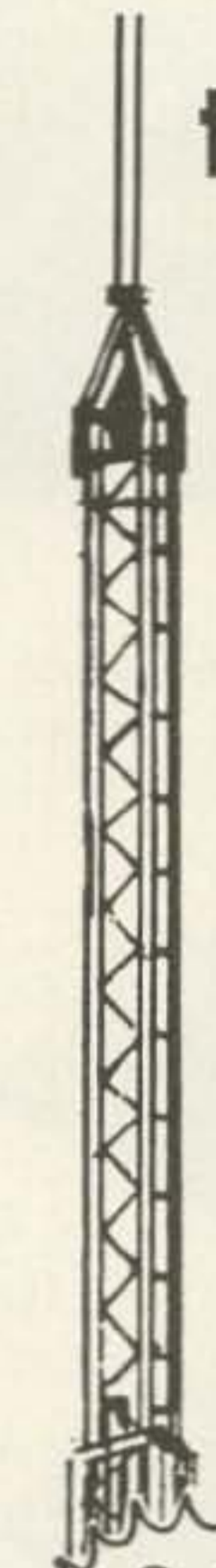

The full-strength Hercules 66-3 has diagonal bracing—a unique feature in all E-Z Way Towers. It's designed to support a large 20 m or 40 m beam; 4 el. Du-band; or 6 el Triband Wind area 22 feet at 66 feet in 60 MPH winds.

The 3 sections of the Hercules telescope from a minimum height of 30 feet to a maximum 62 feet.

A worm gear winch tilts the tower over for easy access to your beam.

Only  
**\$955.00**

**MODEL TORBZ 66-3**

### WIND LOAD CHART

Model	Ant. Wind Area	Full Hgt.	Height MPH	Half Hgt.	Height MPH	Min. Hgt.	Height MPH
TORBZ 66-3	22.2	66	60	50	86	32	125
TORBZ 66-3	13.2	66	75	50	90	32	140
TORBZ 66-3	8.2	66	90	50	100	32	150
TORBZ 75-3	17.0	75	60	55	86	33	125
TORBZ 75-3	10.0	75	75	55	100	33	140
TORBZ 88-3	12	88	60	65	86	38	140

### NEW E-Z WAY HERCULES

#### DELIVERS THE ULTIMATE IN TOWER POWER

HERCULES	Painted	Galvanized
TORBZ 66-3	955.00	1,095.00
TORBZ 75-3	1,055.00	1,240.00
TORBZ 88-3	1,187.50	1,393.50

100' 115' Heights available

### MOTOR WINCH

The E-Z Way Motor Winch raises and lowers towers to any height without guys. When towers are motorized a larger beam can be used because the tower is normally lowered to safer elevations. Standard features: Combination worm gear drive; totally enclosed motor and gear box; remote control switch; spiral grooved winch drum; positive crank down and limiter switches. Assembled complete with hardware and instructions, just \$389.50 for TORBZ 66-3; \$399.50 for TORBZ 75-3 and \$495.00 for TORBZ 88-3.

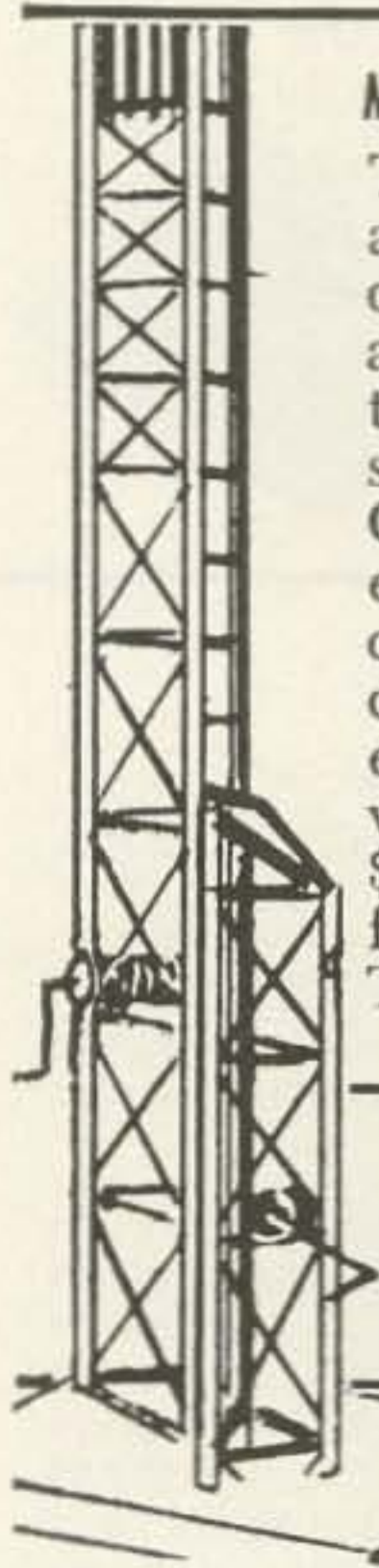

**E-Z WAY  
TOWERS, INC.**

5901 E. BROADWAY  
TAMPA, FLORIDA

Class licenses be administered by valid ham clubs, with at least three licensed amateurs present during the entire test as witnesses.

Frankly, I'd like to see the same procedure for the administration of Novice and Technician licenses. And if this system works out to be as fool-proof as I think it may be, perhaps we could make an FCC appearance optional even in cities where there is a regular examining point. Self determination of this nature on our part could free many FCC employees for work in other regulatory fields where their help is badly needed . . . we might even get more help in prying some of the commercial intruders out of our ham bands.

Now, you have the choice of turning from this editorial and seeing what articles I've got for you this month, or you can sit back for a moment, snap 73 shut and fire off a letter to the FCC protesting this proposed change. Those of you with duplicating facilities should send the 15 copies. I don't know if I will ever convince you that what is happening is your responsibility . . . but I'm trying.

I hope you will also accept some responsibility about the League and make some effort to have all of us, and the FCC, regain confidence in it. You, as an individual, and your club as a group can do a lot to help us regain face. You won't do it by letting things happen and hoping for the best . . . you've already tried that system and it is a dismal failure. You can help by knowing what is going on, talking about it . . . and setting up a holler when some one or group hurts you. Be loyal to amateur radio first.

If we all accept responsibility for what is going on we can easily prevent the reoccurrence or continuance of such dismal things as:

- Censorship in QST by HQ
- Defiance of Directors in interpretation of by-laws by HQ
- Secret submission of RM-499
- Scuttling of WA2USA by HQ
- K2US debacle
- Lack of support of amateurs in legal difficulties
- Lack of a program for perpetuating amateur radio at Geneva
- IARU Region II debacle
- Feud with W2BIB
- Withholding of important information on Building Fund
- Commercial favoritism
- Illegal operation of WIAW
- Fascinating "retirement" pay for Budlong
- Incredible salaries (secret) of top HQ staffers

(List continues on page 87)



All in  
 one low cost receiver  
 the  
**HQ-110A-VHF**



Now, for the first time, complete amateur band coverage from 2 to 160 Meters\* in one low cost high performance receiver—the new HQ-110A-VHF. Outstanding operating convenience is combined with the highest standards of communication receiver design including separate 2 & 6 meter Nuvistor front ends for superb sensitivity and signal to noise ratio. Convertors, antenna plugs, external power supplies, jury-rigged switches have been eliminated—now you can *enjoy* VHF operation.

Every operating convenience for ALL bands and ALL operating modes—CW, SSB, and AM—are contained in one compact package. Separate detectors for CW/SSB and AM—Variable selectivity Q-Multiplier—High electrical and mechanical stability—Full dial coverage from 2 to 160 meters—Built in crystal calibrator—Automatic Noise Limiter—Sensitivity of 1.5 uvolts AM, 0.7 uvolts CW for 10:1 S/N—Built in S meter.

Compare the HQ-110A-VHF with any competitively priced unit—feature for feature, it can't be beat, (and the others don't have VHF).

\* VHF in the incomparable HQ-170A-VHF too.  
 Send for details.



**HAMMARLUND MANUFACTURING COMPANY**

A GIANNINI SCIENTIFIC COMPANY

73-88 Hammarlund Drive • Mars Hill, North Carolina 28754



# A Wide-Band, High-Gain Antenna

A. E. Blick VE3AHU  
 Box 37  
 Collins Bay, Ont., Canada

The goal of every Amateur so far as an antenna is concerned is to have one that will give a respectable gain; is relatively small in size; can be fed directly by a standard feed-line; is easily constructed without recourse to off-beat materials or parts; is cheap; and will give the same performance, especially input impedance and radiation pattern, over a wide band of frequencies.

Such an antenna is the Log-Periodic, the principles and initial design of which were first investigated by Dr. DuHamel in 1956. Other experimenters followed and one of the designs evolved was the Log-Periodic Dipole. A study of the different types brings the conclusion that this is the most practical design for amateur consideration. Basically, the antenna consists of a number of parallel, linear dipoles arranged side-by-side in a plane. The lengths of the elements, the spacing between them and the dimensions of the boom are all determined from a series of mathematical formulas. Full details on the theory and design can be found in Dr. Carrell's report, *Analysis and Design of the Log-Periodic Dipole Antenna*, and anyone wishing to adapt this design to his own needs should obtain a copy.

The finished antenna



This article will deal with a Log-Periodic Dipole that covers the frequency range of 140-150 mc, having a gain of 10 db over a reference half-wave dipole, and directly fed with 72 ohm coax cable. Over the range, the swr is less than 1.5:1, the E-plane beamwidth is approximately 47° and the H-plane beamwidth 85°. The booms are made from 3/4 inch, the elements from 1/4 inch aluminum tubing (recommended type 65ST6) and each element is fastened to its boom with a 3 inch TV standoff pipe clamp. There are six dipole elements and Fig. 1 a-d shows the plan of each section and how they are combined into one array. Table I gives the lengths of each element and their spacing from the feed-

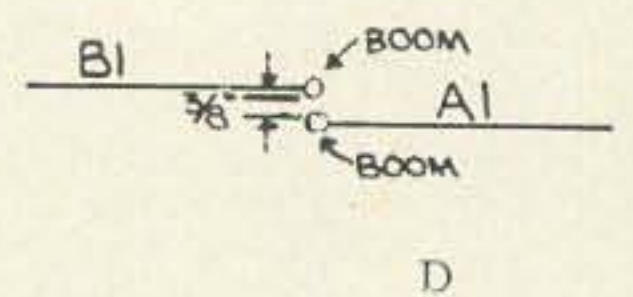
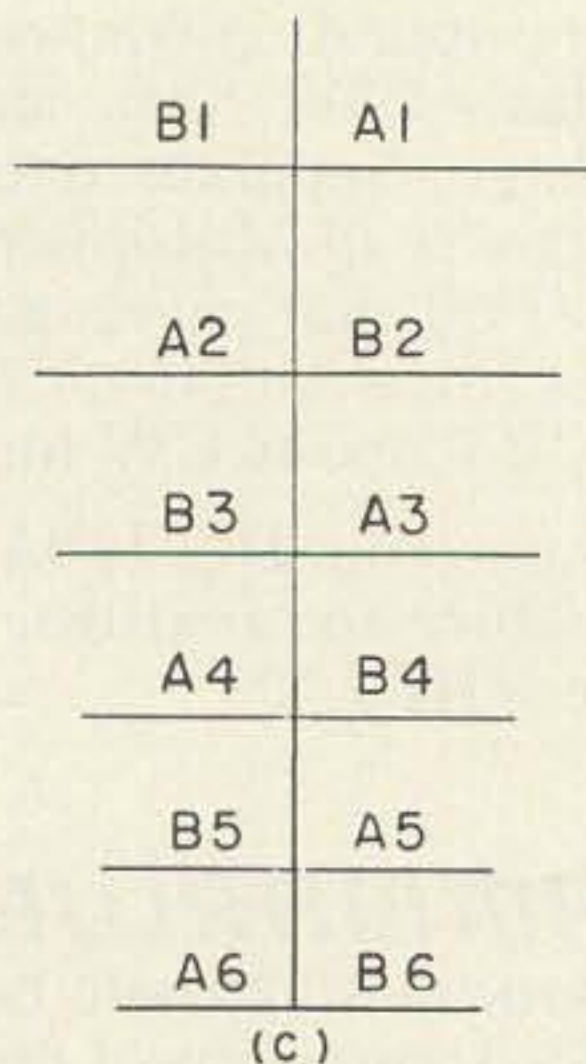
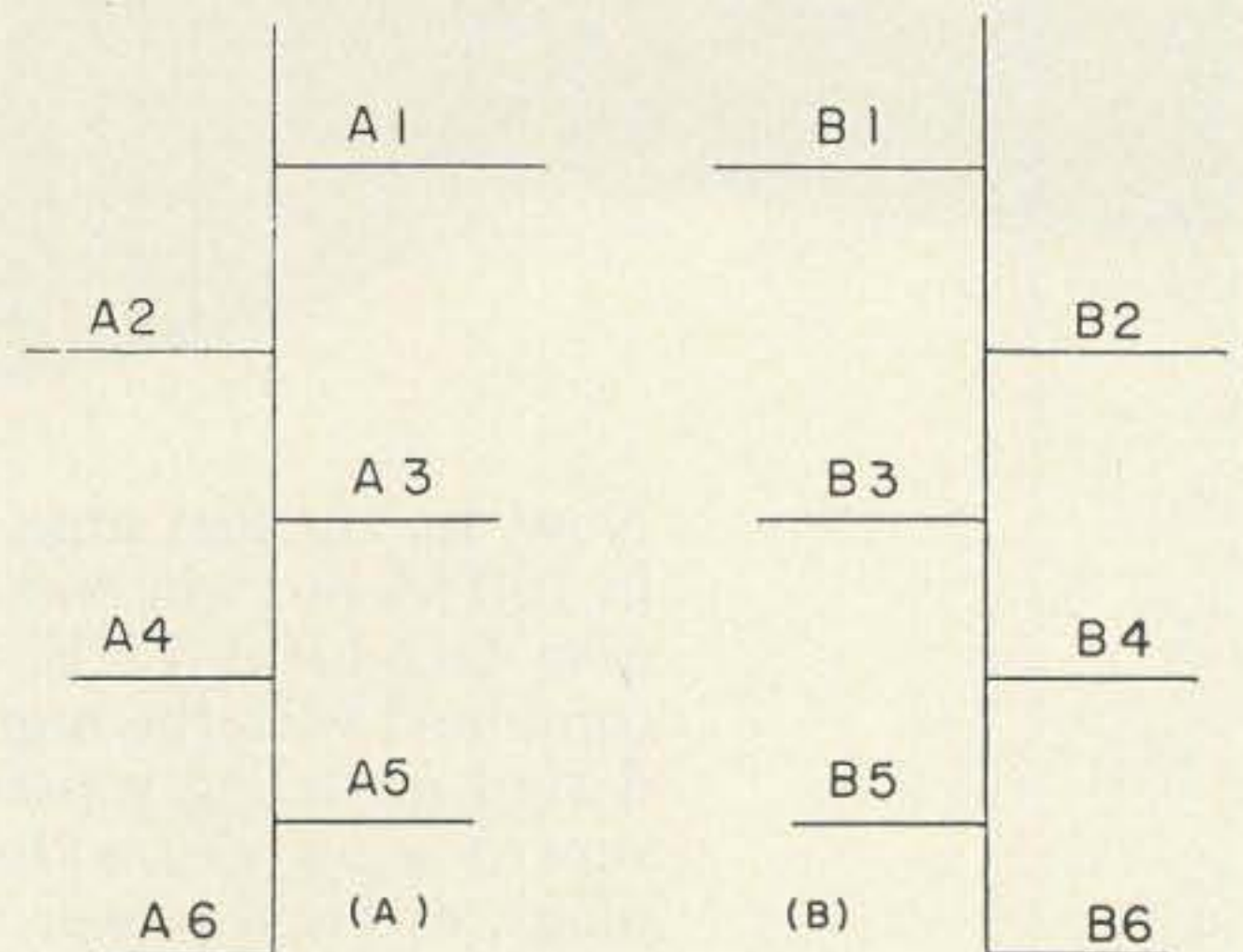

FIG. 1 Plan of LPD



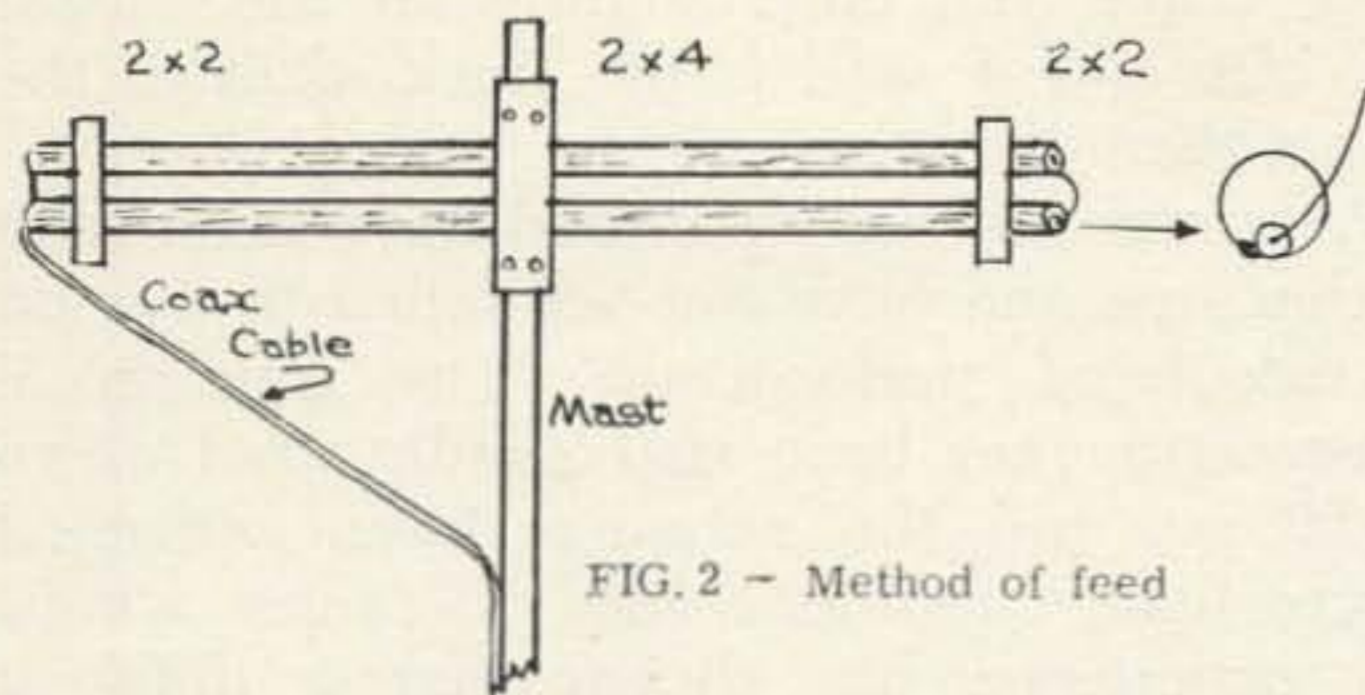

FIG. 2 - Method of feed

point which is the end with the No. 6 element.

Table I—Dimensions of LPD array

	Length of Element	Spacing from Feed-point
A1 = B1	20.8 in.	60.3 in.
A2 = B2	19.0	46.0
A3 = B3	17.4	33.0
A4 = B4	16.0	21.0
A5 = B5	14.6	10.0
A6 = B6	13.3	0

The boom length is 72 inches so that the boom will project past the last element 11.7 inches. The two booms are shorted together at this point (see Fig. 2).

The antenna is fed with 72 ohm coax cable at the feed-point, with the center conductor attached to one boom and the outer sheath to the other boom. It is recommended that the coax be inserted in the lower boom as shown in Fig. 4 but it can be taped under the lower boom with only a slight decrease in performance.

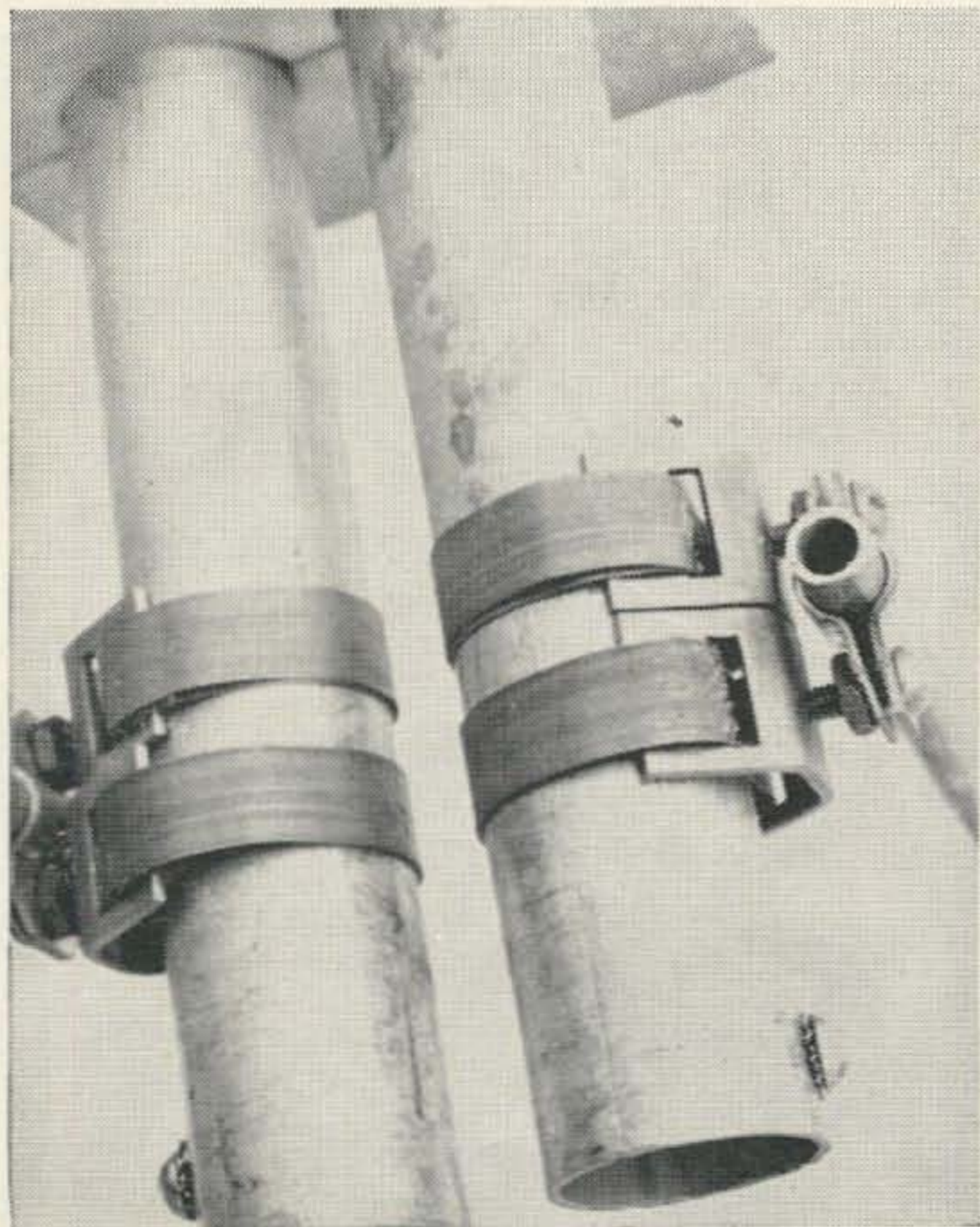

Our first attempts at securing the elements to the booms were very satisfactory but more costly than the method outlined in the article



Feed point of the antenna and view of the first element and separator block.

The two booms are separated by a distance of  $\frac{3}{8}$  inches throughout their length. This is done by making two separators and one mounting block. Wood, preferably hardwood, can be used for this. Two pieces of 2 x 2 lumber, 3½ inches long and one piece of 2 x 4 lumber 6 inches long, are required. Two  $\frac{3}{8}$  inch holes are drilled centrally in each block, spaced 1  $\frac{1}{8}$  inches center-to-center in the 2 inch face. Two additional  $\frac{1}{4}$  inch holes are made in the blocks so they can be clamped together when sawed apart, as shown in Fig. 3. The boom is clamped by the three blocks, and holes are drilled in the center 2 x 4 block to accommodate two TV mast U-clamps on the 4 inch face. All the wooden parts are then coated with 2 to 3 coats of exterior varnish.

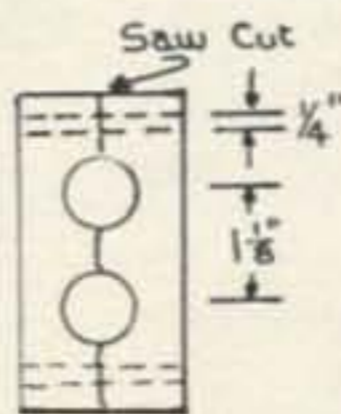

FIG. 3 Separator block

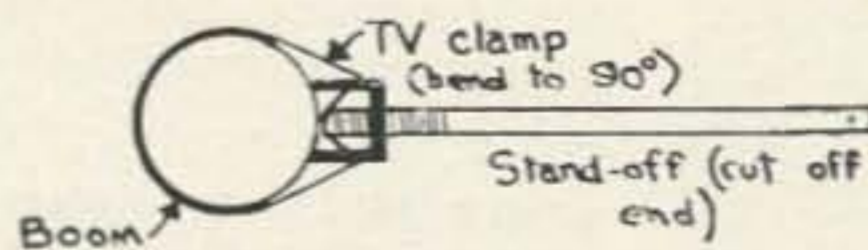

FIG. 4 Attaching Stand-off

The elements are held onto the boom as shown in Fig. 4. The 3 inch TV stand-off is threaded to the pipe clamp on the boom. The end is cut off and the  $\frac{1}{4}$  inch element is put on over the stand-off extension. If 0.035 inch wall tubing is used, you can now thread the tubing over the  $\frac{1}{2}$  inch or so of thread that projects past the clamp. If thinner wall is



# NEW callbook

**HOT OFF  
THE  
PRESS!**



**Over 60% of listings  
changed in only a year!**

**PLUS THESE EXTRA FEATURES:**

- Great Circle Bearings
- Great Circle Charts
- Prefixes by Countries
- "Q" and "Z" Signals
- World Time Chart
- Int'l. Postal Rates

**United States Listings...\$5.00**  
**DX Listings..... 3.00**

**RADIO AMATEURS  
REFERENCE LIBRARY OF MAPS  
ORDER YOUR SET TODAY!**



**WORLD PREFIX MAP**—Full color, 42" x 29", shows prefixes on each country . . . DX zones, time zones, cities, cross referenced tables.....postpaid \$1.00

**POLAR PROJECTION MAP**—Azimuthal equidistant projection. Shows prefixes on each country, DX zones, cities, prefix index by countries, 29" x 25" .....postpaid \$1.00

**UNITED STATES MAP**—All 50 States with call areas, prefixes, DX and time zones, FCC frequency allocation chart. Plus interesting information on all 50 States. 29" x 17".....postpaid 50c

**WORLD ATLAS**—Only Atlas compiled for amateurs. Polar projection, six continents, prefixes on each country . . . full color, 16 pages.....postpaid \$1.00

Complete reference library of maps—set of 4 as listed above.....postpaid \$2.50

**WRITE FOR  
FREE  
BROCHURE!**

**RADIO AMATEUR  
callbook INC.**  
Dept. B, 4844 W. Fullerton Ave.  
Chicago, Ill. 60639

See your favorite dealer or order direct (add 25¢ for mailing)

used, crimp the ends slightly so the thread will bite and if wall is too thick, drill to the proper diameter.

Antennas built as described have been built in this area and have not yet failed to live up to calculated performance. The mechanical construction has been successfully used down to 50 mc and the antennas have withstood severe icing conditions and gale force winds. But experience has shown that a different method of clamping tubing to the booms is necessary below this frequency. One approach might be to drill the boom and insert the element through the boom with some suitable method of clamping, but no research has been done as yet in this direction. I have calculated the dimensions of a tri-band beam for operation in the 20, 15, and 10 meter bands, fed with 72 ohm coax, to give a gain of 7 db on all frequencies within the bands with a swr less than 1.5:1. This would be constructed using 1½ inch tubing for the booms—each 20 feet long—and ¾ and ½ inch tubing for the elements with longest dipole element 33.5 feet long.

The Log-Periodic principle, in practice, will give an antenna that is frequency independent over large bandwidths with frequency ratios of 10:1 being easily obtained. One antenna constructed and in use has a gain of 8 db over a frequency range of 50 to 250 mc, a boom length of 10 feet, and is fed with 300 ohm twinlead with an swr of less than 1.5:1. This has been used for amateur operation on the 6, 2, and 1 ¼ meter bands, and for TV (all VHF channels) and FM broadcast reception. Unfortunately it worked too well and is now used as the family's TV antenna!

I wish to thank Dr. Carrell of Collins Radio for his assistance and permission to use certain parts of his reports and the gang in Kingston who rendered invaluable assistance in trying out these designs.

... VE3AHU

## TRANSTENNA 102A

A PRESELECTOR SECOND TO NONE AND A T-R SWITCH BEYOND COMPARISON

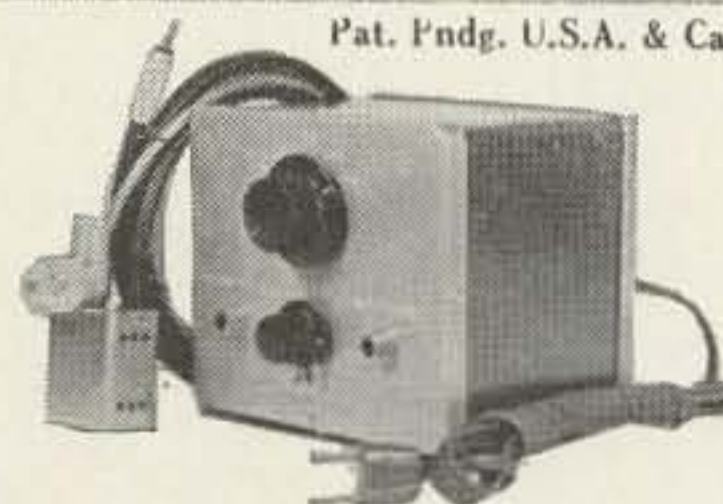

Pat. Pndg. U.S.A. & Canada

**MODEL 102A**

**\$69.45** (Add \$7 for Sidetone — either model)  
15 DAY TRIAL

Return For Full Refund If You Burn It Out Or Are Not FULLY PLEASSED

- Std. coax coupler (xmtr to feedline)
- No TVI or Suck out
- 30 DB Min. Gain (10-30 mtrs)
- No Effect on Transmission
- Monitor d switching
- Full Legal Input
- Burnout Proof
- CW Sidetone (optional)

Improved 102A Adjustable Mute Circuit Breaks Any Xmtr-Rcvr Between Dots & Dashes Without Clicks. Improved Semiconductor Through-Position Switch Switches Rcvr Directly to Antenna for Unity Gain 6-80 Mtrs.

Write for Free Literature

**FICHTER ELECTRONICS**  
33 Myrtle Avenue  
Cedar Grove, N. J.  
Tel: CEnter 9-6412

102B, \$59.00 like 102A exc. rcvr. muting





GONSET SIDEWINDER  
TRANSCEIVER Model 900A

*SOLID STATE "SCOOP" FROM GONSET!*

## FIRST AND ONLY TRANSISTORIZED SSB-AM-CW TRANSCEIVER FOR MOBILE, PORTABLE AND FIXED COMMUNICATIONS

The totally new Gonset Model 900A *Sidewinder* is the first and only transistorized SSB-AM-CW transceiver (except mixer, driver, final stages in transmitter) to provide complete coverage of the 2 meter amateur band in 4 segments 1 MC wide. Yet it's so compact it fits quickly under the dash of the newest cars! Transistor design makes possible a primary power requirement in the receiver of less than 1/2 amp! Separate power supply accessories snap-fasten jiffy-quick to back of transceiver, or may be used for remote installation. Here's the trouble-free, solid state transceiver with power to spare for any fixed, portable or mobile application!

*For complete information, visit your Gonset Distributor, or write Dept. ST-11.*

### CHECK THESE HIGH-PERFORMANCE SPECIFICATIONS:

**TRANSMITTER:** Transistorized (except for mixer, driver, final states)  
 • **Frequency Range:** 144-148 MC • **Power Input:** 20 watts PEP SSB, 6 watts AM, 20 watts CW • **Spurious Suppression:** -50 db • **Carrier Suppression:** -50 db on SSB • **Unwanted Sideband Suppression:** -40 db • **Stages:** 3 stage MIC Amplifier; 15 MC Mixer • **Diodes:** 2 Balanced Modulator; Meter Rectifier • **Tubes:** 6EA8 Doubler, Mixer; 12BY7A Driver; 6360 Power Amplifier

**RECEIVER:** All-transistorized • **Frequency Stability:** Highly stable; utilizes same VFO as transmitter • **Sensitivity:** 1/2 microvolts or better for 10 db  $\frac{S}{N}$  • **Selectivity:** Lattice crystal filter for both receiver and transmitter • **Audio Output:** 3.0 watts • **Spurious Suppression:** -50 db or better • **Image Rejection:** -50 db (receiver and transmitter utilize double conversion) • **Stages:** RF; Mixer; Doubler; 9 MC Mixer; 2 9 MC IF; SSB, AM, CW Detector; Audio Driver; Push-Pull Audio Output • **Diodes:** AM Detector; AGC Detector; RF Gain Control

**TRANSCEIVER:** 9 MC BFO; 15 MC IF; High Frequency Crystal Oscillator; VFO; VFO Regulator; AGC; 9 MC IF • **Dimensions:** 8 7/8" W., 4 7/8" H., 7 1/16" D. • **Wt.:** 10 lbs.-8 oz. • **POWER SUPPLY:** **Dimensions:** (AC or DC) 8 7/8" W., 4 7/8" H., 5 15/16" D. • **Wt.:** 13 lbs.-8 oz.

**PRICE:** TRANSCEIVER: \$399.50 Amateur Net; POWER SUPPLY: AC-\$67.75 Amateur Net • DC-\$79.50 Amateur Net



© ALTEC LANSING CORPORATION

# GONSET, INC.

ALTEC LANSING CORPORATION

LTV A Subsidiary of Ling-Temco-Vought, Inc.

1515 S. MANCHESTER AVENUE, ANAHEIM, CALIFORNIA



# A Stable VFO for SSB

One of the main problems in building SSB equipment is the need for a really stable vfo. Most commercial units are mechanical nightmares which have various types of temperature compensation. Adequately compensating these type vfo's is often beyond the means of the average ham and his limited test equipment. Even so, these best commercial units only say that eventually they will settle down to a 100 cycle drift per some time or other. The three main causes of drift or frequency change in the usual order of difficulty are: 1. Heat, 2. Mechanical Stability, 3. Voltage variations. Therefore, to have a stable vfo simply eliminate these three items. It really isn't that hard.

Let's take the heat problem first. Instead of isolating the tuned circuit from any heat producing sources, we isolate the whole circuit from any heat source. That is, put the

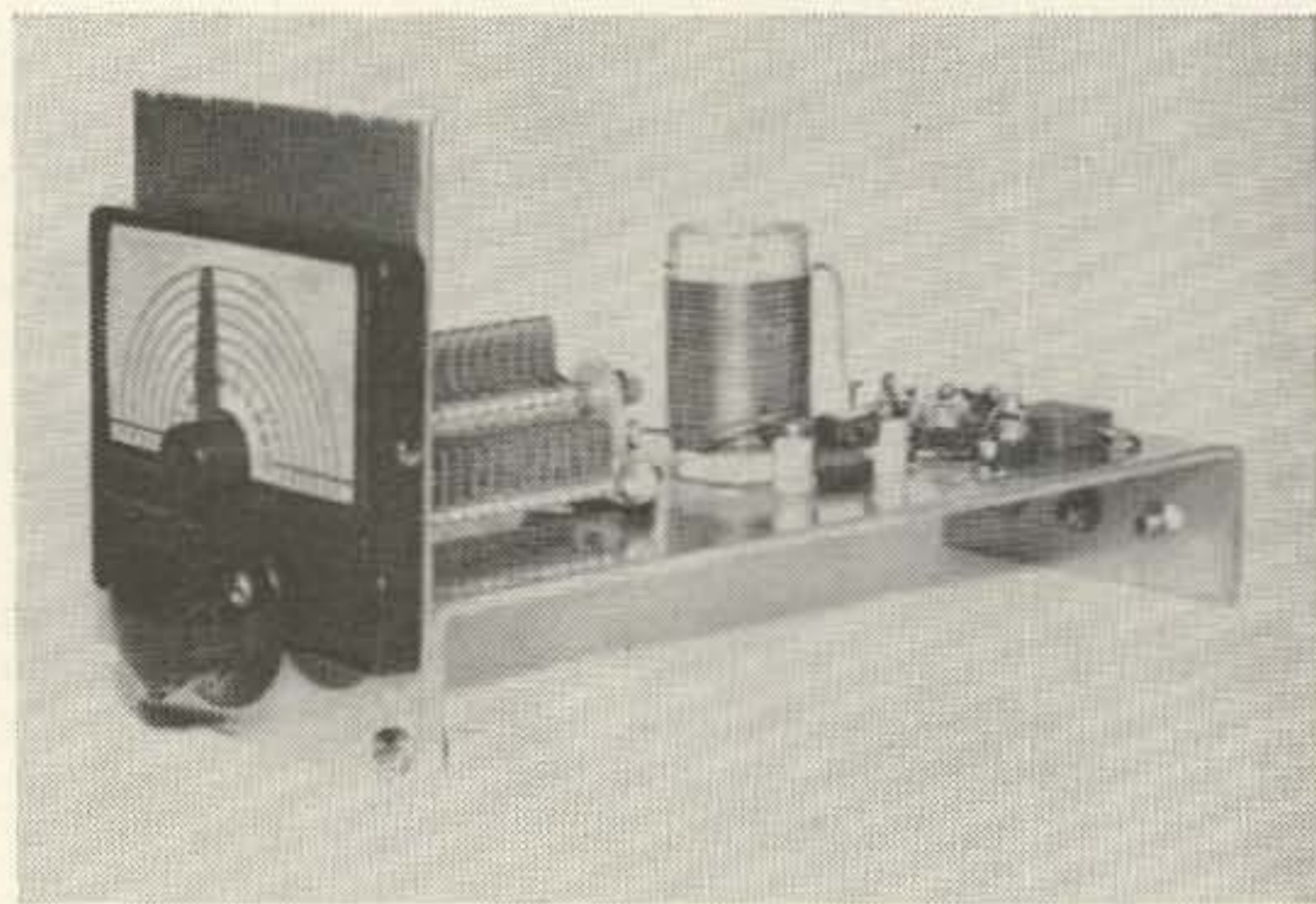

whole thing on a separate chassis. Next, we use transistors at very low power levels. Finally we mount the transistors in and the components on a 1/8 inch thick aluminum chassis. The thirty milliwatts of input power is dissipated into about 2 pounds of aluminum. Thus room temperature prevails.

The "wobbliest" part in any variable capacitor vfo is, of course, the variable capacitor. Using a ruggedized capacitor with small, thick plates and double end bearings is essential. The capacitor must be firmly mounted, thus the 1/8 inch thick chassis again. The coil

and *other* components must be rigid also.

Finally, since very little power is used and that at a low voltage, batteries are ideal as a stable power source. There, see how easy it is? So let's build one.

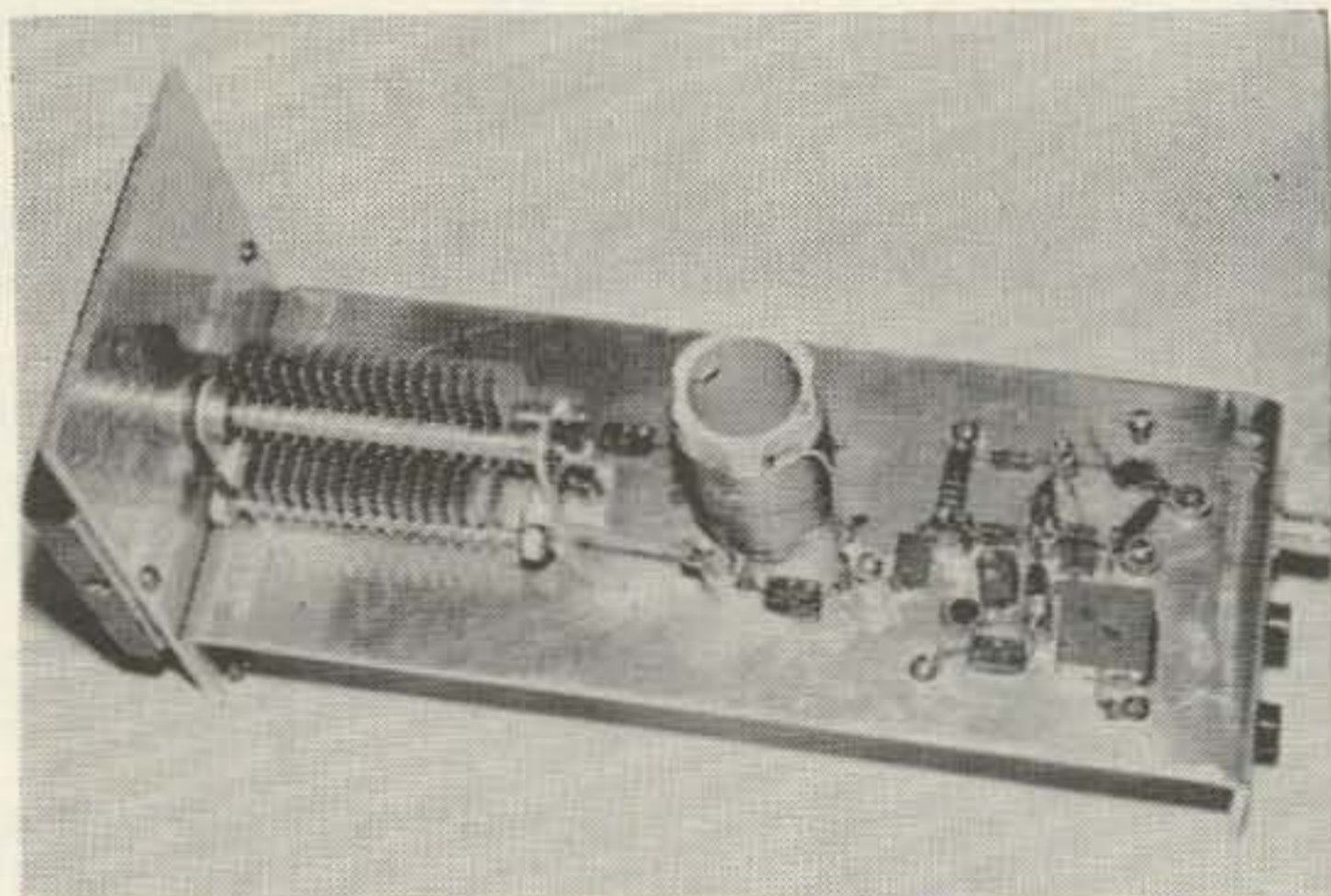

Fig. 1 shows the schematic. Similar circuits have been published before. There are several innovations however. Silicon transistors are used because they tend to change characteristics much less than germanium units with temperature changes. Since the input capacitance of the 2N2219 is only 20 pfd, much less capacitive swamping is needed. In larger capacitors, the actual capacitance change per degree of temperature change can be larger than that of the transistor. Since the 2N2219 is a high gain, high frequency transistor, it can be very loosely coupled to the tuned circuit and still function well. A much less expensive 2N697 or other transistors could probably be used by increasing the coupling somewhat. All fixed capacitors are silver mica units for best stability. The variable capacitor is a Johnson Type R ruggedized unit with wide (.071) spacing. The actual value isn't too important since  $C_2$  and  $C_3$  are used to set the value of capacitance across  $L_1$ . The series-parallel combination of  $C_2$  and  $C_3$  reduce the range of  $C_1$  to the value needed, and more important, make any changes in  $C_1$  due to heat or vibration much less noticeable.  $L_1$  is a coil from an ARC/5 unit. Be sure to clean out carefully all extraneous windings



# telrex

## "BEAMED-POWER" ANTENNAS and ANTENNA SYSTEMS

The Choice of the Discriminating  
Communication Engineer . . . the  
Man who Never Settles for Any-  
thing Less than THE-VERY-BEST!

You too—can enjoy world renowned TELREX performance and value! Send for PL65 condensed data and pricing catalog, describing the lowest priced antennas on the market, in relation to materials and performance! Expanded data sheets—including your favorite band, are also available.

"The performance  
with a line"

MATERIAL DIFFERENCE  
—IN USE IN 135 LANDS!

ANTENNAS  
SINCE  
1921

COMMUNICATION SYSTEMS  
**telrex** LABORATORIES

ASBURY PARK 25, NEW JERSEY, U.S.A.

and make sure no turns are shorted.

The vfo is constructed on chassis which is bent from a single piece of  $\frac{1}{8}$  inch thick aluminum. This is the basis of the exceptional mechanical rigidity. A second piece of  $\frac{1}{8}$  inch aluminum forms the front panel and holds the Millen 10039 dial. These must be fastened rigidly together. Fig. 2 is an oblique view of the unit. The variable capacitor is not only bolted to the chassis by the mounting feet, but spacers (the black spot under the right rear end of the ceramic support) are

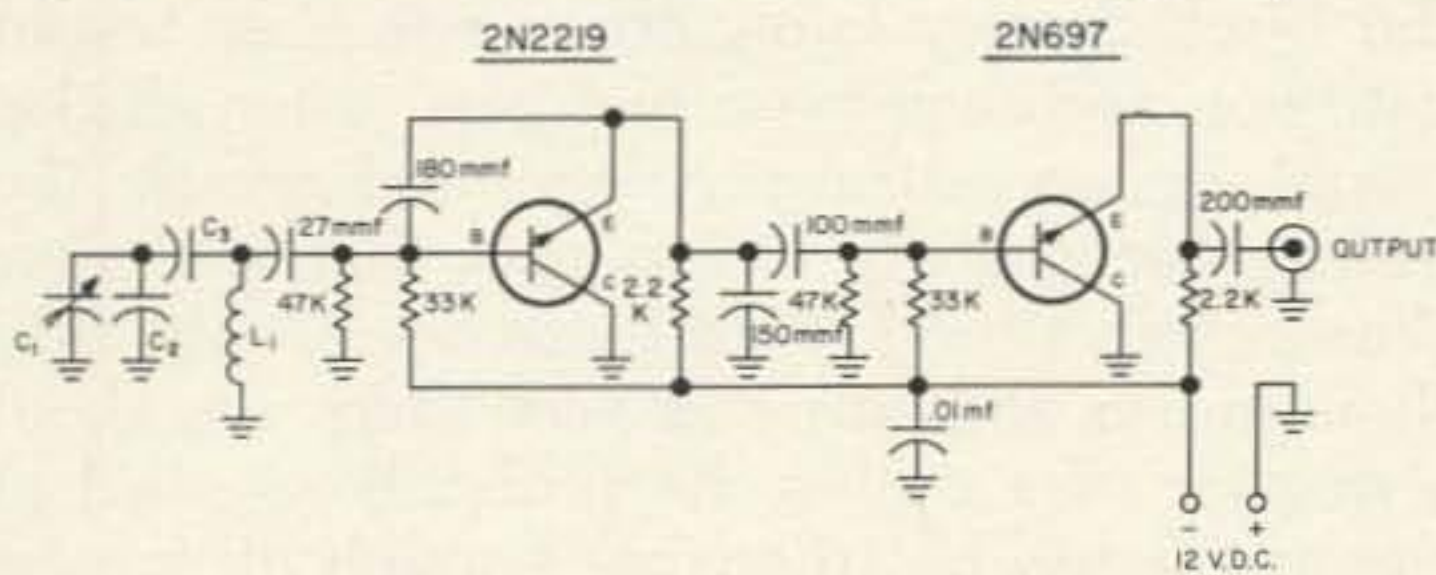

- C1 Johnson Type R, ruggedized variable .071 spacing 3" long.
- C2 82 mmfd
- C3 200 mmfd
- L1 21  $\frac{1}{2}$  turns of #16 wire on 1  $\frac{1}{4}$ " dia. ceramic form.

glued in under the ends of the ceramic supports to take up any torque forces. A large whole was cut in the chassis and the ceramic coil also glued in place. The front panel extends above the dial so that the case for the unit does not get too close to the "hot" end of the coil and thus lower the Q. All components are wired to ceramic insulators or standoffs. All components are also glued to the chassis for maximum rigidity. The transistors are mounted upside down in press fit

holes in the chassis and also glued in place. This "glue" is Ross epoxy weld which is available in most dime stores. Most two tube epoxy glues will work well. Fig. 3 shows a top view of the unit. The bottom two terminals on the rear are for voltage input and the BNC jack is the rf output. These are connected to the top of the chassis by two ceramic feedthroughs.

The output of the unit is about 6 volts peak to peak of nice clean sine wave. If the output is not good looking, juggle the values of the 180 and 150 pf swamping capacitors. This particular unit covers from 4.95 to 5.6 mc for use with a 9 mc crystal filter. When in its case (a box built of  $\frac{1}{8}$  inch aluminum naturally) and when the unit has reached room temperature (don't cart it in from outside when its 10° below) the total change in frequency around the nominal value should be less than 25 cycles, with reasonably constant room temperature. Don't try to prove it by your receiver; it took a Hewlett-Packard 5243L frequency counter to prove the VFO even changed. There is a little more drift right at turn-on but nothing like those tube (UGH!) units. Since the whole thing only draws 4 milliamps, there is no reason why it can't be left on continuously. Size D cells or lantern batteries will last practically for their shelf life. This way, when you come back next week, you will be precisely where you were when you left. This is a fairly simple project which will give your crystal hetrodyne oscillators reason to blush.

. . . K9ALD



# Color the Gromment Gone

A man in his forties should know what he wants to be when he grows up and I wanted to be a writer but when my writer kit came I checked off the parts list like it said and there was no punctuation included so I only learned how to spel but it was a good kit and we had hours of family fun working on it sitting around the fireplace one of those Swedish funnels and we looked just like the happy folks on the cover of the kit catalog but finally it was finished and I didn't know what to do next because no editor would buy stories that began quote darling exclamation point unquote editors are already overtaxed with their own personal problems which are

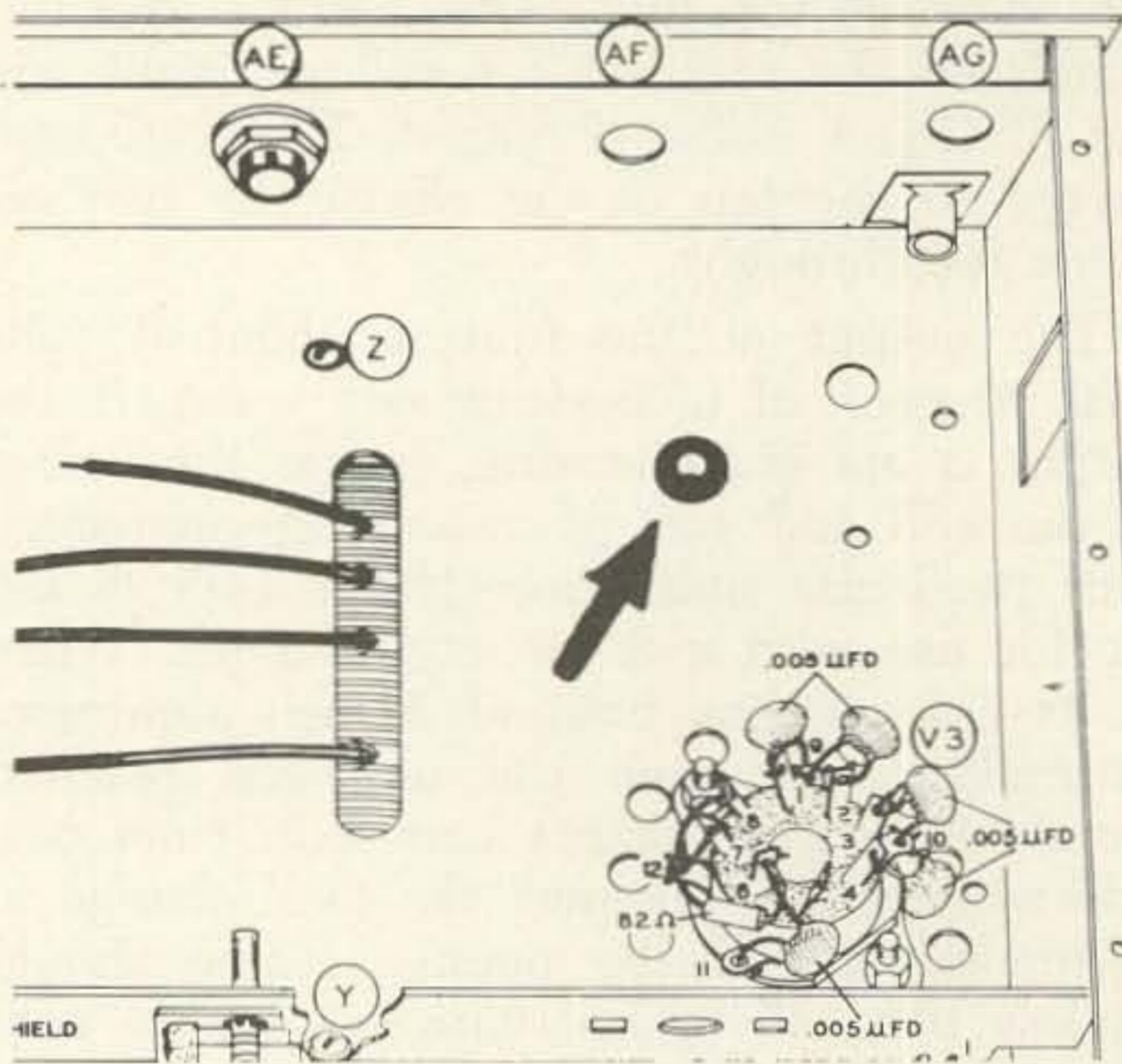

often terrible and you will never read about these in their magazines either well if you just sit around smiling at your family eventually it bugs everybody and they look at you like you had an icepick up your sleeve and plans to use it period

Frustrated in my effort to project creatively like folksingers and little theater people I took my doctor's advice and became a ham because punctuation is no problem on phone and the CW nuts only use it to show off until somebody says to them ge you must have a commercial ticket OM and they kick the Variac to weak and come back with QSB om vy

sri unable copy last xmission hamming has other advantages too now I can go down in the basement put on the headphones and relax sometimes I even turn on the receiver by the way this doctor is a very active ham on the air all the time since he got mad and gave up his practice because a lady had a baby when he was trying to work FO8AA it turned out the lady was his wife now he works sideband exclusively spreading good will all over the world and he says he really gave up practicing when he switched from AM to SSB but that is a joke for generals and better and if we bring up the subject of licenses Extra Class is unavoidable although I think they are a bunch of soreheads if you try to explain to them the consolation they should find in the idea of personal achievement and never mind any added privileges they always say what is the point they know how dumb they are without a certificate to prove it personally I think the real significance of that fancy license is that it means you are in a minority and if the Birch Society knew about you they would hate you and make you feel good after all this would be an extra privilege and worth the trouble incidentally Green says that just after the second World War there were only fifty thousand or so hams and now there are about a quarter of a million he probably guessed at the first figure but there are enough of us now that we can accommodate some very large minorities in fact we do and I think this gives our hobby a lot of class it also gives us grounds for yelling murder we should have five times the bandwidth we were deemed entitled to in 1946 and if we want to startle Geneva with a demonstration of selfless magnanimity I suggest we concede the frequency economy possible with single sideband and settle for two and one half times what we had in forty six and further that the restoration of equity be effected by proportional expansion thwartships of our present bands which in the lower part of the spectrum are notoriously polluted by broadcast operations of doubtful quality and dubious value accompanied by power mad



jammers usually off their mark because of an itchy curiosity about the programs they are supposed to be jamming incidentally these counterpropaganda megawatters should take lessons from our heavy weight DX sharpshooters on twenty and find out what merciless efficiency means in this connection for some reason California comes to mind and that reminds me a friend claimed W7's think of W6's as an army standing between them and every kind of DX certificate W6's have been known to refer to the middle ground W9's and W0's as the backbone of the nation a euphemism I believe W8's the descendants of north woods loggers Henry Ford recruited to test drive the Model T nine out of ten W7's work for Boeing and the tenth is the Nevada ham you need for WAS W4's and W5's are the only foreigners operating under reciprocal licensing privileges in our country W1's W2's and W3's are just Easterners generally acceptable as DX to west coast novices anyway the author of this flip filing system was a CW speed demon who sad to say picked up his own echo during an auroral spasm and bugged himself to death but I had a lot of respect for him since the time his neighbor handed him a portable TV and said I hear you like to play with radios you can fix this for me and my friend who had fought the sawteeth of this junk box back and forth across eighty for what seemed most of his life just let it drop on the pavement and after the implosion died away said OOPS and smiled I bet he is still smiling those were the good old days before he dropped CW and went the phase and filter route started using gold color solder from Los Angeles and worked only the upper sideband no matter what because he thought it was swankier until somebody told him the advantage was only semantic and he thought they meant he was just a switch flipper too dumb to understand SSB theory so his feelings were hurt and he went back to breaking speed records on eighty and that was the end which reminds me about this DX60 I put it on the bench to replace an intermittent meter switch afterwards plugging in a dummy load so I could check out my absent minded wiring which turned out ok after the meter leads were reversed but I guess there was a bad connection to the dummy load because when an attempt was made to dip the final there was one of those spitting sounds you hate to hear especially when it is accompanied by a little smoke which it was aha an arc I thought and managed to catch the dummy load connection before doing something else wrong but after that the final just would not dip although the

## A NEW MOBILE CONCEPT MOBILTRANS 40

Complete 40W Transmitter and  
Receiving Converter in a Single Unit  
Including Power Supply!

40/75/160



### LOW COST • NEW DESIGN

MOBILTRANS provides the amateur with a low cost mobile installation utilizing the existing car radio for receiving. New design provides exceptionally low battery drain. **6 METER COMING**

- Modulated carrier amplitude controlled by voice.
- Stand-by drain less than 300 ma at 12 volts.
- Contains 9 transistors, 6 diodes, one tube.
- Available for either 40, 75 or 160 meters.
- Accessory coils available for band change.
- Three position crystal selector (FT-243 type).
- Operating wt. 5 lbs. Size: 2 $\frac{7}{8}$ " H, 8" W, 8 $\frac{1}{4}$ " L.
- For 12 volts negative ground ONLY.

**\$99.50**

For  
Detailed  
Brochure,  
Write or  
Wire:

## justin, inc.

BOX 135, SAN GABRIEL, CALIFORNIA

voltages and drive were ok and testing the tank with a dip meter indicated resonance although a little sluggishly I thought aha again the mica blocking condenser has opened but replacing it made no difference then when another ham was helping me eyeball the underside of the final h esaid look at the little burned spot on that grommet never mind his call he is a smart aleck I would have seen it myself in another second if he had kept his mouth shut anyway looking at the grommet I wondered what Heath was thinking of when they said put one in there and what was I thinking of when I put it in after all what good is a piece of rubber in a hole with a conductor carrying the 6146 rf output besides there is plenty of room and air is a good cheap insulator so I cut the grommet loose and measured the resistance through the burned spot it was seven hundred ohms no wonder the 6146 acted funny but now everything was fine it was just like solving a Cape Canaveral malfunction except this one was my fault and I didn't have to send a ship to fish it out of the ocean although admittedly for a few minutes there I was thinking of ocean depths in terms of a certain transmitter period

... W7IDF



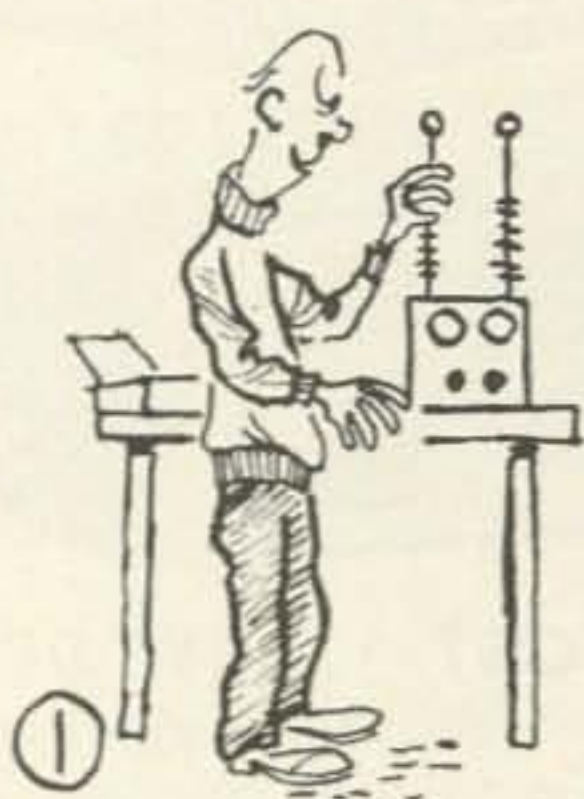

① I'LL BET THIS POWER SUPPLY I INVENTED WILL...

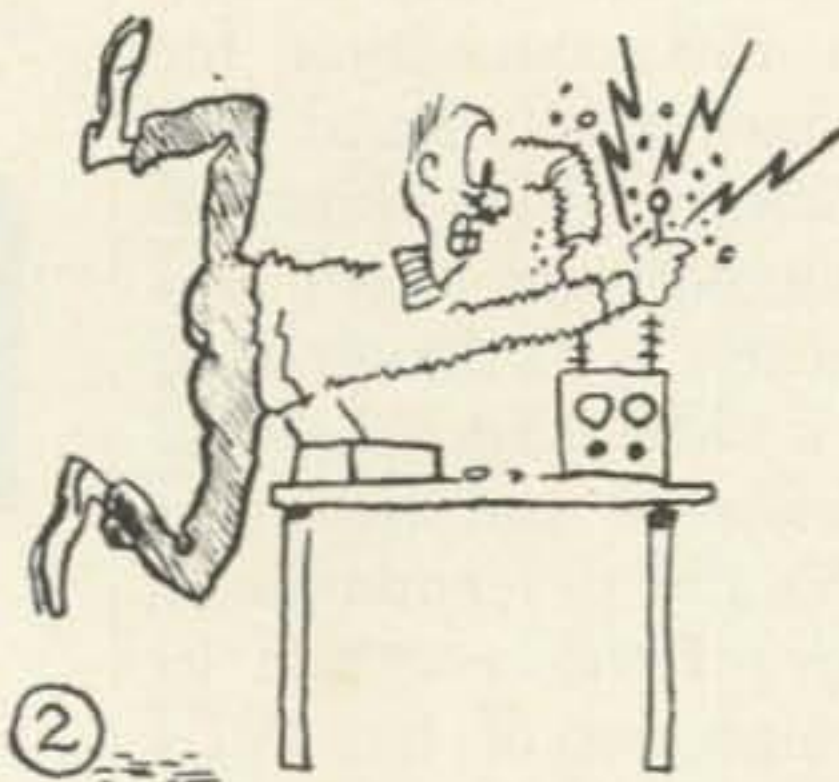

⑤



⑥ HORACE! WHAT DO YOU THINK YOU ARE DOING?



⑦



⑧

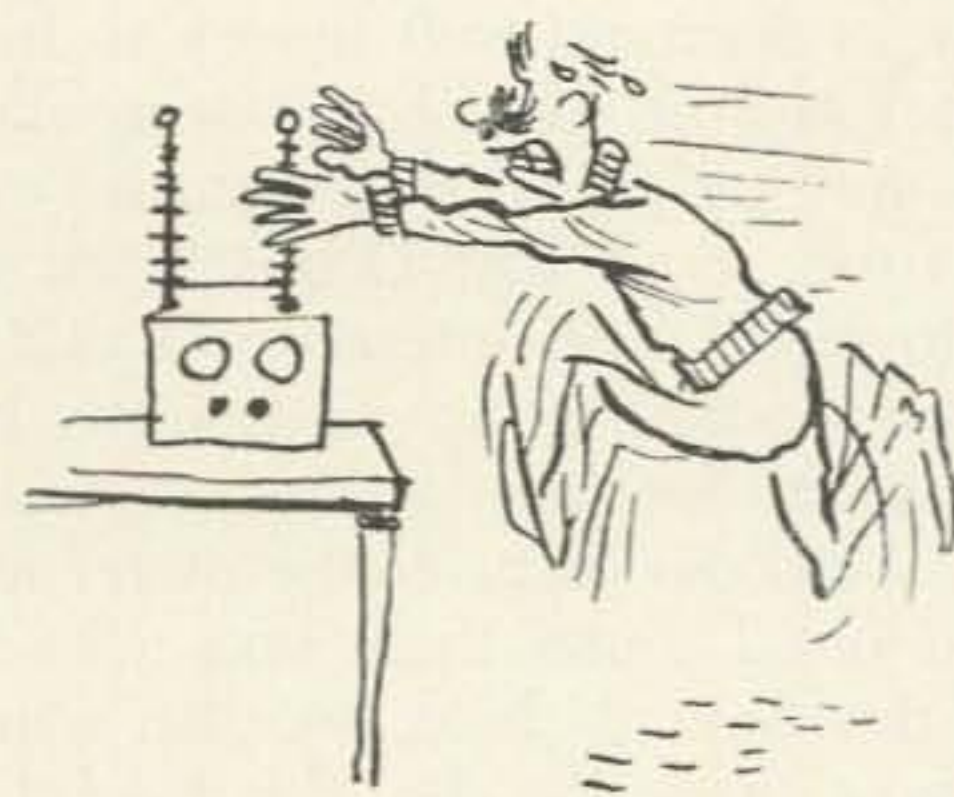

B. ROBERTS



# A Christmas CQ . . .

to the XYL whose OM wks CW.

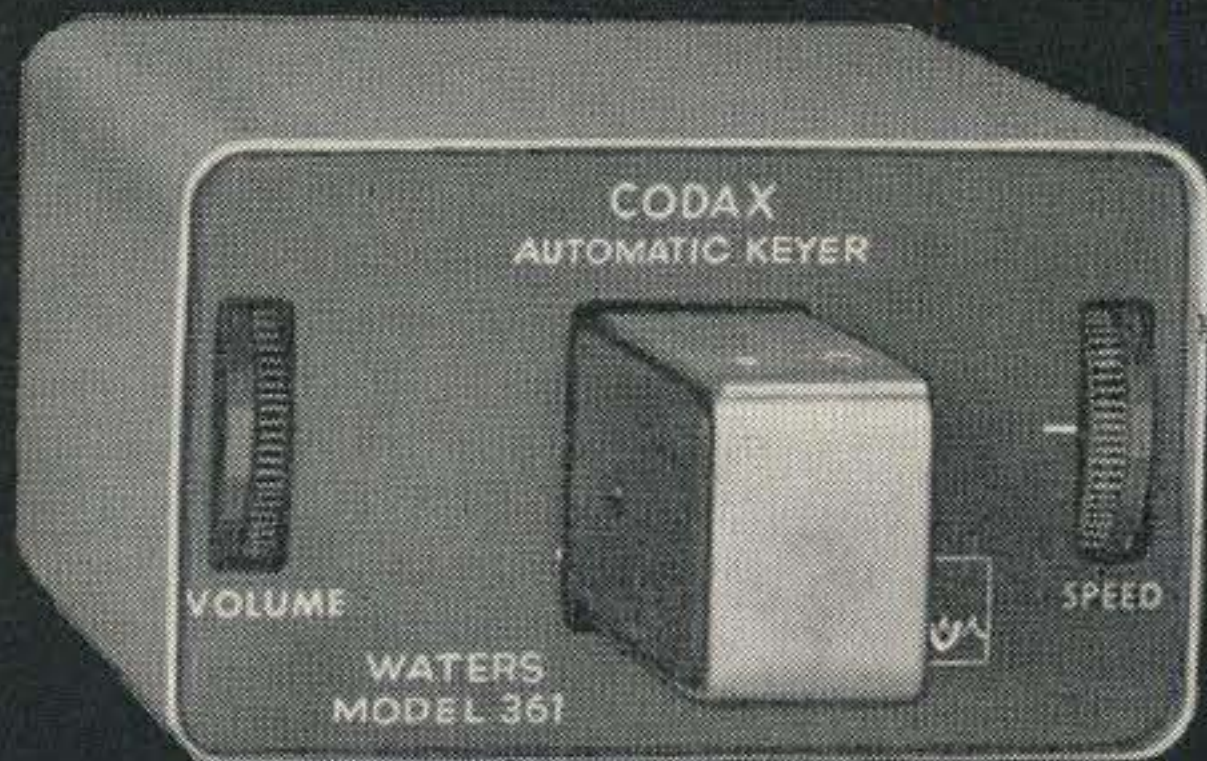

**NEW**

*Waters* **CODAX**<sup>T.M.</sup>

## **AUTOMATIC KEYER**

For the happiest ham on frequency come Christmas Day, surprise that OM with the smooth-performing new Waters CODAX, Keyer. Never anything like it!

Each paddle of the built-in double paddle keyer adjusts individually to his touch for gap and tension with spacing and timing from 5 to 50 WPM fully automatic. Plugged into the mike jack CODAX works CW on **either** upper or lower sideband . . . . AM too, of course! With the receiver's phone-output plugged into CODAX he can monitor his own signal as well as the station he's working. CODAX employs solid state digital circuitry, has an hermetically sealed "Reed" relay and is self-powered. Interconnects with any rig in a jiffy without drilling or modification. Won't even need gift-wrapping it's that attractive. So if you'd be wearing mink on your birthday, give the OM a CODAX Keyer for Christmas. \$92.50

*New too!*





# A Tuneable Antenna For 432 MC.

Bill Hoisington K1CLL  
83 Bellevue Ave.  
Melrose, Mass.

A novel and interesting tuneable type of UHF antenna has been developed here for indoor test use, antenna range work, and amateur phased array use, on 432 mc's.

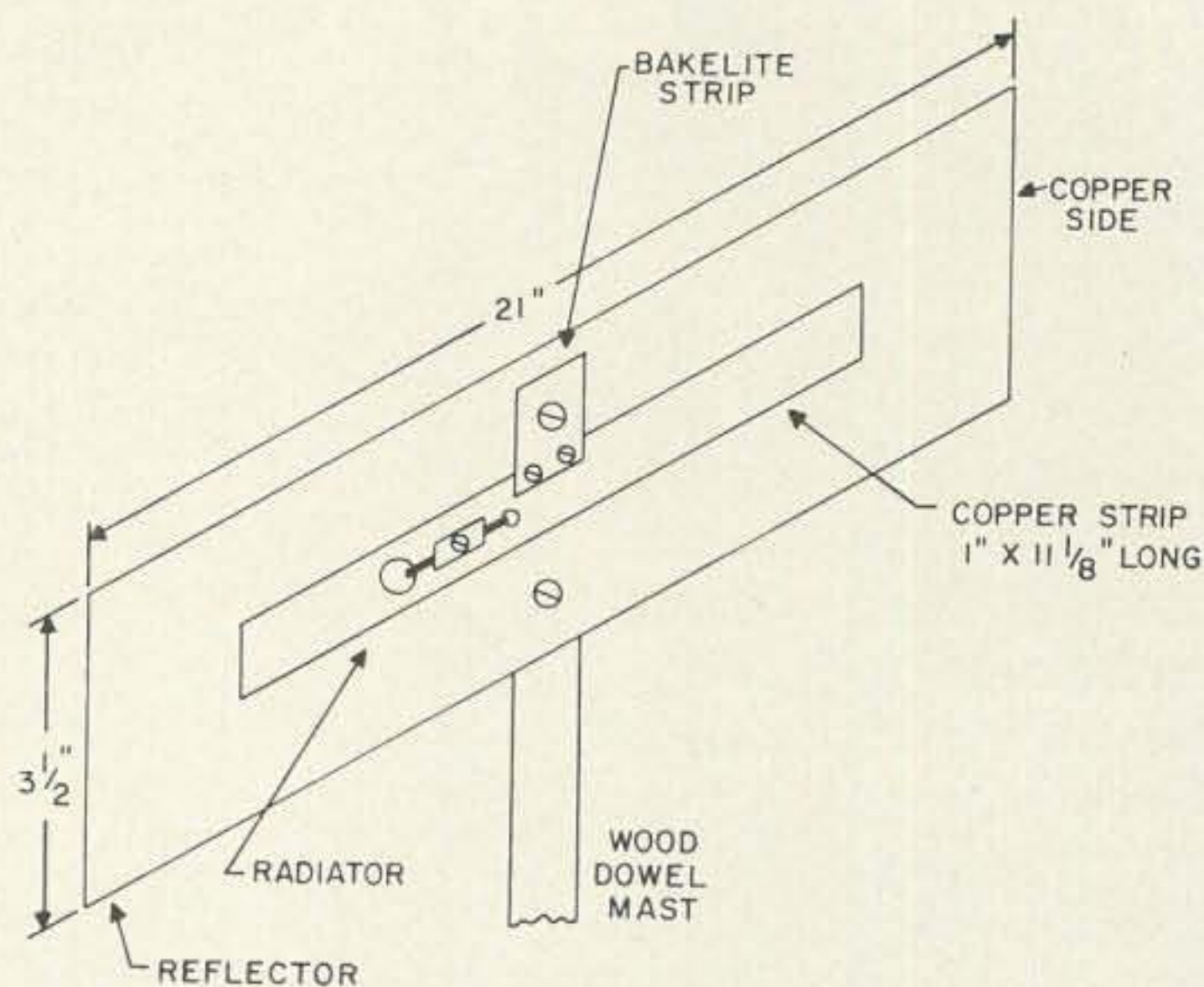

Fig. 1. Front view; 432 mc Test Antenna.

Figs. 1, 2, and 3, show views of the single unit. It is particularly suitable for use with a large screen reflector where many would be used, spaced a certain distance apart in proper phase; with each fed by a separate 50 ohm matched cable. Note that this is a tuneable antenna with a knob and plenty of gain and front-to-back ratio, also. A one-to-one SWR can be obtained by juggling the spacing of the radiator from the reflector using the threaded rod in the center; adjusting the trimmer in the matching section; the position along the radiator of the trimmer; and the tuning or length of the radiator versus the "penny" tuning of the end capacitor C2.

The tuneable feature can be very useful for working different portions of the band, such as on 440 for ATV. The average antenna cannot cover such a range properly. There are "fancy" new ones that can, but they take some doing as yet. This one can be cut and

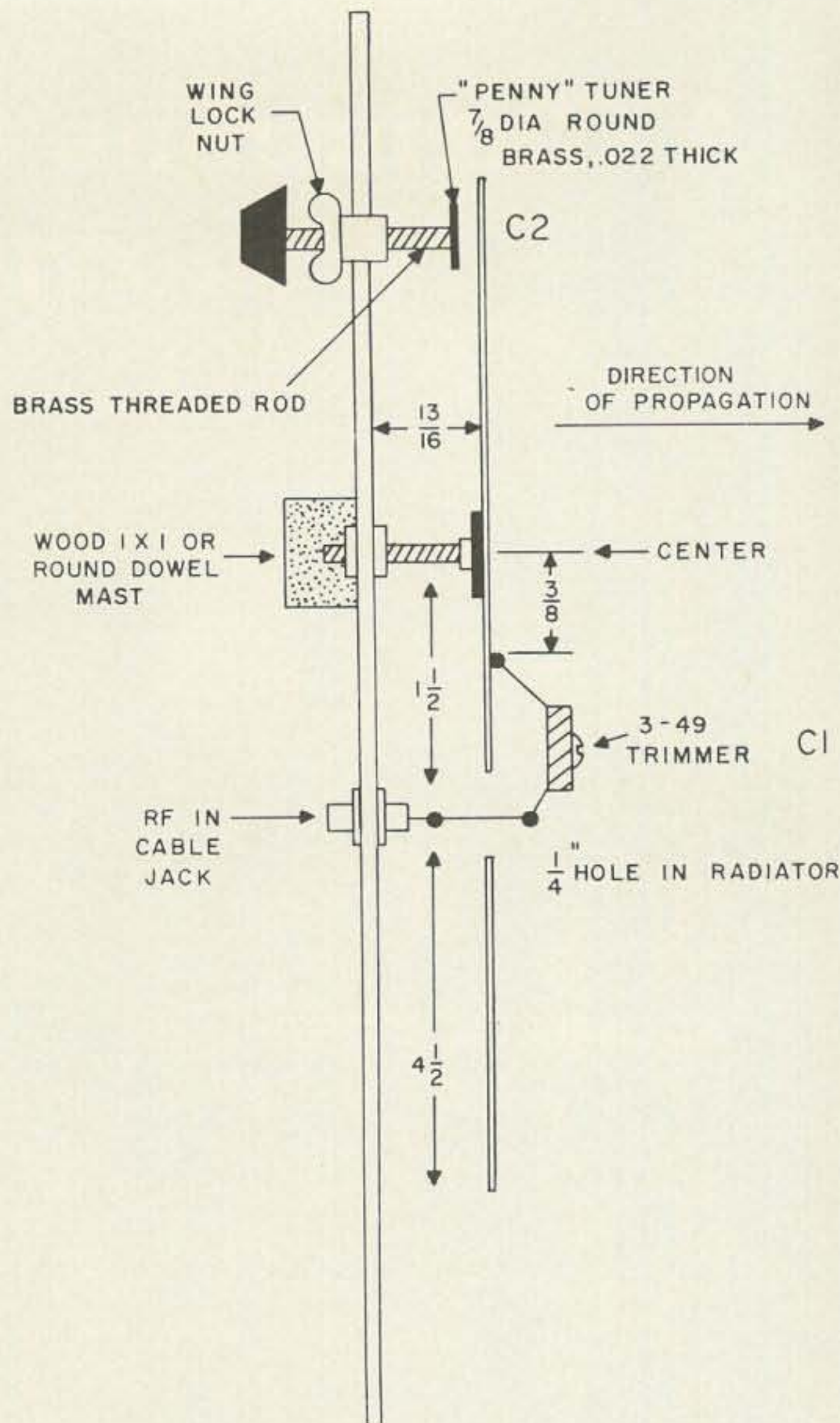

Fig. 2. Top view, 432 mc Test Antenna. tuned as needed and then retuned with a knob!

Note that the tuning knob and input cable can be tuned from the back of the antenna.

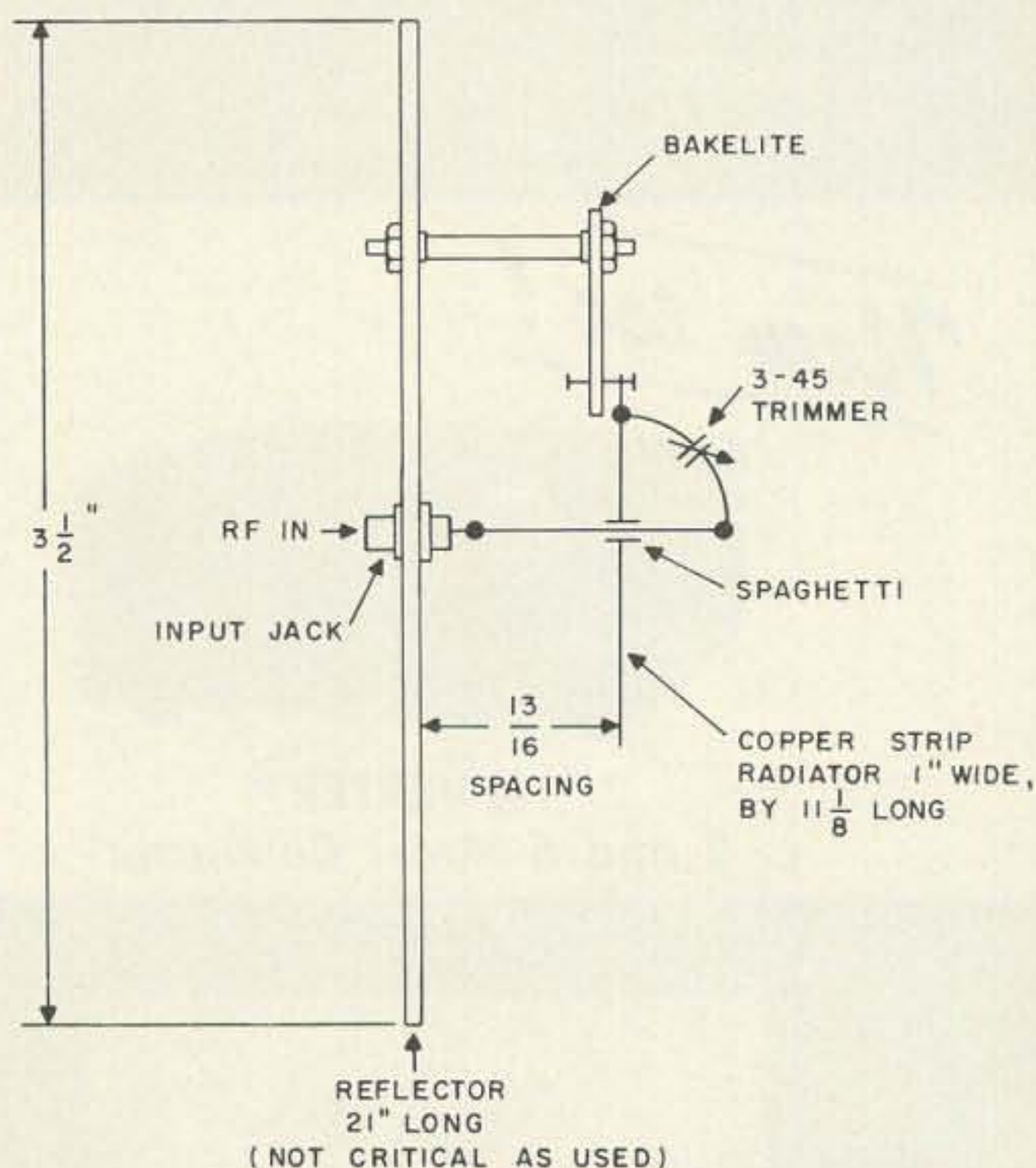

Fig. 3. Side view, 432 mc Test Antenna.



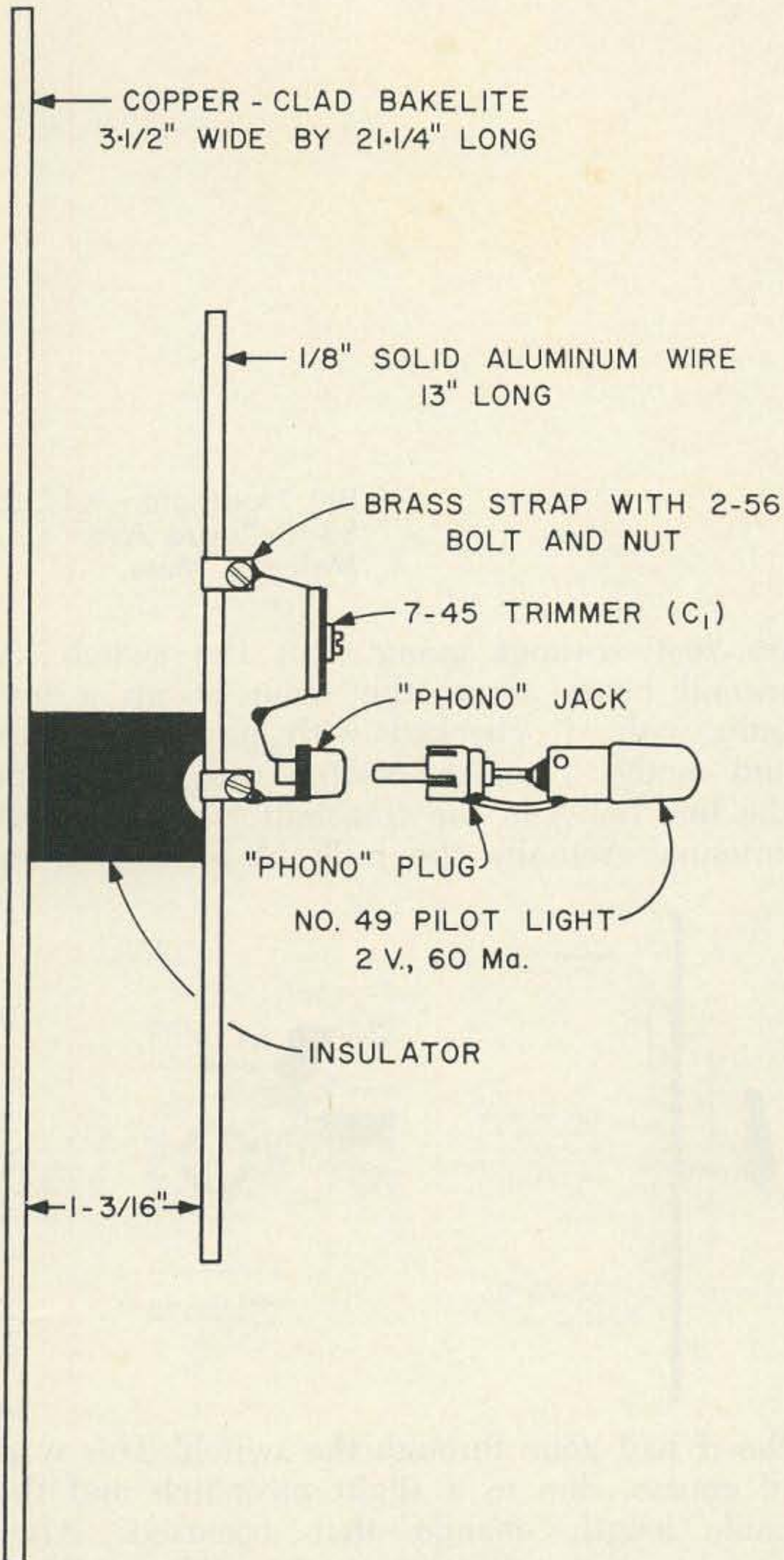

Fig. 4. Top view, 432 mc Test Antenna.

The matching capacitor C1 can also be turned around and tuned from the back through a hole in the reflector with a full-insulator screwdriver. These are useful features and it is quite surprising to see how dead it is in the back. Of course, a larger reflector will have an even greater front-to-back ratio. Note also the resemblance to the famous low frequency "Windham" antenna, with its single-wire feed.

For on the air indoor tests, and small antenna range work, a lamp bulb receiving antenna is shown in Fig. 4. The reflector and radiator assembly are somewhat similar to that of Fig. 1, except that the no. 49, pink bead, 120 milliwatts, is shunted across a section of the radiator which is a piece of solid aluminum wire. Both these antennas can be used on table-top or on floor stands.

... KICLL

# SQUALO

ANOTHER  
CUSHCRAFT  
FIRST!

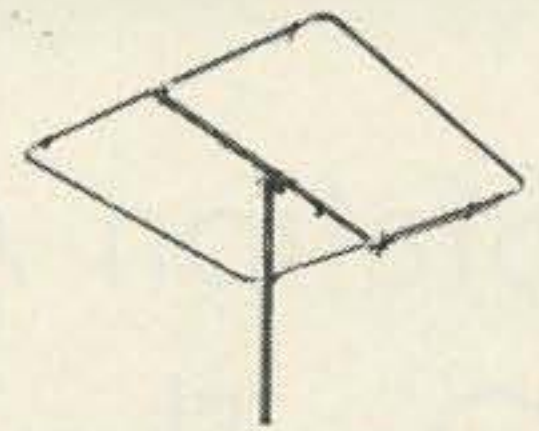

SQUALO is a full half wave, horizontally polarized, omni-directional antenna. Outstanding all around performance is achieved through a 360° pattern with no deep nulls. The square shape allows full electrical length in compact dimensions. Direct 52 ohm Reddi Match feed provides ease of tuning and broad band coverage.

The 6 meter Squalos are completely universal for mounting anywhere. They are packaged with rubber suction cups for car top mounting and a horizontal center support for mast or tower mounting. The 10-15-20 and 40 meter Squalos are designed for mast or tower mounting. Squalo is ideal for net control, monitoring, or general coverage.

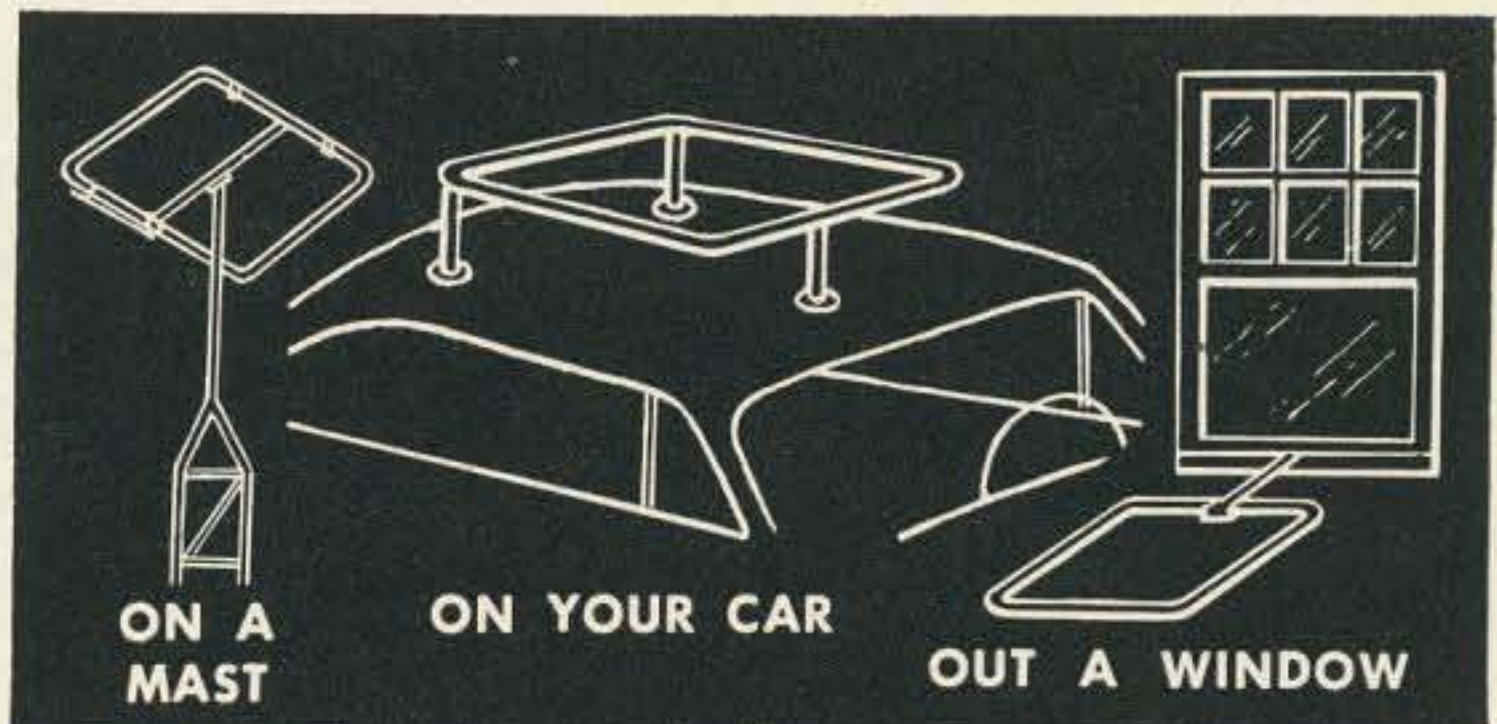

MODEL NUMBER	DESCRIPTION	NET PRICE
ASQ-6	6 Meter 30" square	\$12.50
ASQ-10	10 Meter 50" square	19.50
CSQ-11	11 Meter 50" square	19.50
ASQ-15	15 Meter 65" square	23.50
ASQ-20	20 Meter 100" square	29.50
ASQ-40	40 Meter 192" square	66.50

## SQUALO TREE

Design a complete multi band antenna system to meet your own requirements. Squalos can be mounted one above the other or above existing beams on a single mast. The Squalo tree is a horizontally polarized, omnidirectional system in any combination of the 6 through 40 meter amateur bands. The Squalo tree takes a minimum amount of space, and does not require extra radials, ground wires, or rotators common to most multi band systems.

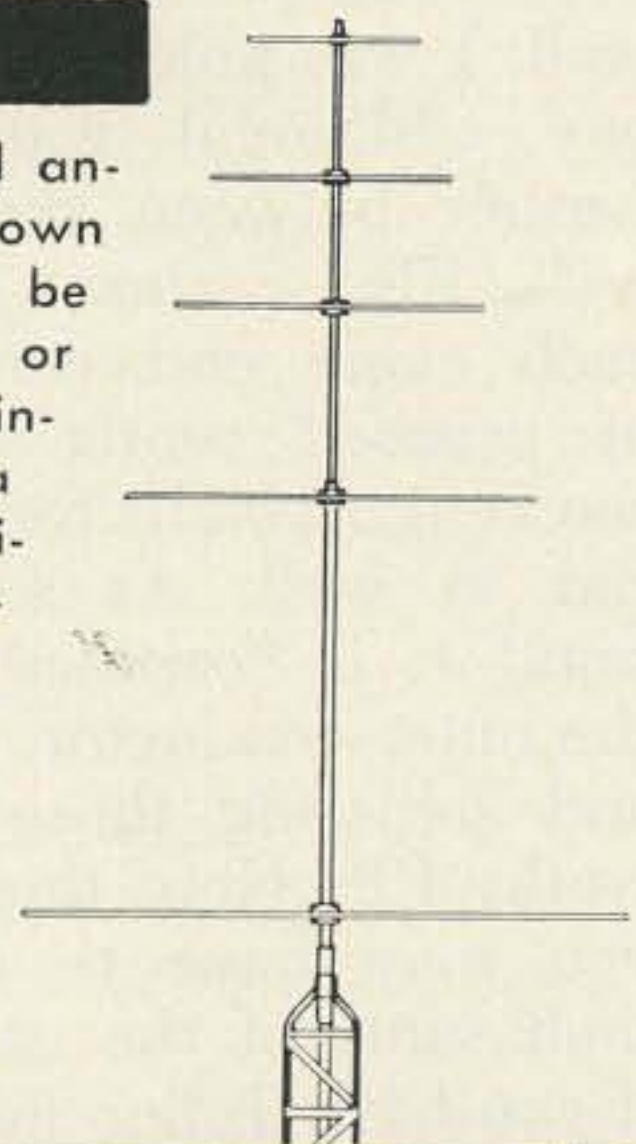

BUY FROM YOUR DISTRIBUTOR  
OR WRITE FOR FREE CATALOG

**Cushcraft**

#65

621 HAYWARD ST.

MANCHESTER N. H.



# The 432'er

## Station Assembly and On The Air Tests

Bill Hoisington K1CLL  
83 Bellevue Ave.  
Melrose, Mass.

There comes a time when you have to put everything together. That new beam must be mounted and the cable led into the shack, a send-receive switch installed and tested (see below), along with the transmitter turn-on switch, or switches, the receiver mute switch, etc.

First attention must be paid to the send-receiver switch. If a rotary wafer switch will do a good job this will maintain the low-cost philosophy of the 432'er as designed. An ordinary porcelain (Steatite, Isolantite, or what have you, but not bakelite) switch was taken apart and remounted very close up against a copper-clad bakelite "ground-wall." See Figs. 1 and 2. The spacing between the porcelain wafer and the copper is actually less than a 16th of an inch. This wafer is 1 and  $\frac{7}{8}$  inches in diameter. The switch can be any good make of the material mentioned, but should be of flat construction. That is, viewed from the side as in Fig. 1, the switch contacts should lie as flat as possible to the copper wall. I was able to sue the original bolts with one additional washer added to the fiber washer between the wafer and the copper wall. Fig. 2 shows a face-on view. Prepare each cable end carefully using a minimum of *exposed* center conductor. This includes the center conductor inside the insulator material as well. As soon as it is outside the braid it is "exposed." I find that separating the outer conductor, or braid, into two pigtails and soldering those flat to the copper wall works FB. Note that if you use solid copper you may have to use too much heat and melt some of the cable insulation. Of course, if you have Teflon insulated cable, FB for you. I used ordinary RG-58/U, and *care*.

This should cover reworking the wafer switch. Now for the results. An exact duplication of on-the-air conditions was set up in the shack. A two-element beam was fed with matched RG-58/U cable from the transmit-

ter *first* without going thru the switch. A second beam across the room lit up a test bulb with rf, checked with power detector and meter. Then the switch was inserted in the line between the transmitter and the test antenna. Actually the bulb lit *brighter* after

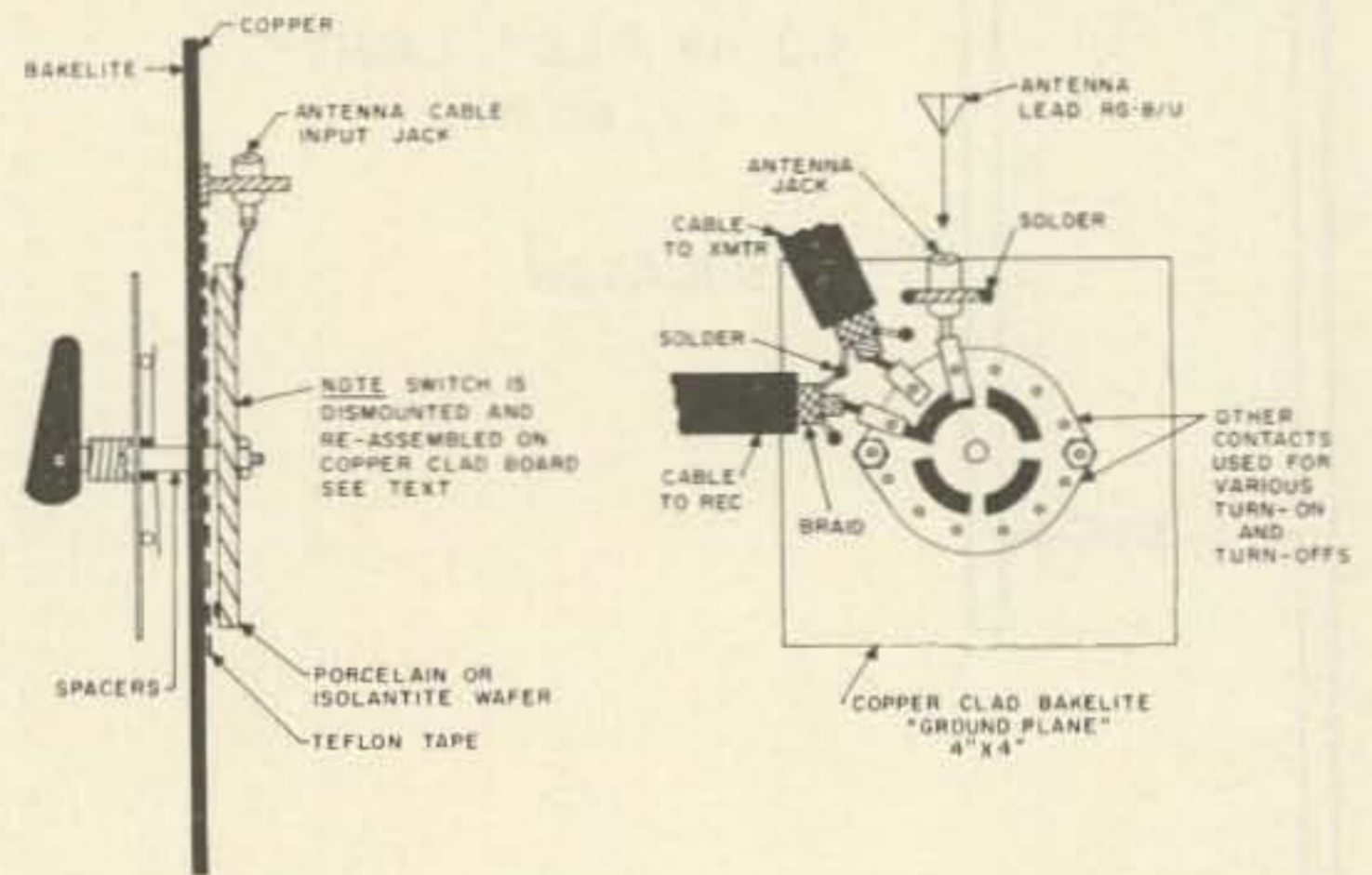

the rf had gone through the switch! This was, of course, due to a slight mismatch and the cable length change that occurred. After matching everything again I could detect no difference in rf in the second beam between switch and no switch. So that works. I also checked later with small signals on reception. Still no detectable difference.

Notice that the flat-line construction makes for a sort of "strip-line" configuration which is quite "legal," well up into microwaves.

### Power Supplies

I actually used three power supplies. 325 volts (needed more) on the modulator, 400 volts on the three 2C39's, and 150 to 250 volts on the crystal oscillator and first doubler.

As soon as I get a VR tube on the 6CL6 oscillator I may reduce the number of power supplies to two. See also "On The Air Tests" below about oscillator stability on 432. The ac center taps on the power transformers are brought out on well insulated cables to disable the HV on "Transmit." Also on "Transmit" the receiver voice coil is opened. So far this



# NEW! LAFAYETTE



## 10-80 METER DUAL CONVERSION AMATEUR RECEIVER

MODEL  
HA-350

99-2524WX  
**189<sup>50</sup>**

*Uses Mechanical Filter For Exceptional Selectivity— Offers 2KC Bandwidth!*

Lafayette's newest! A dual conversion superheterodyne communications receiver covering the 10 through 80 meter amateur bands and offering a high order of electrical and mechanical stability for superior AM, CW and SSB operation. Check some of the exceptional features!

- Sensitivity 1  $\mu$ V or Better
- 7 Band-Switching Positions—3.5, 7, 14, 21, 28, 28.5 and 29.1 MC, plus WWV on 15 MC
- Tuning Dial Covers 600 KC for Each Band
- 12 Tubes
- Crystal-controlled 1st Oscillator
- Transmitter-type VFO for 2nd Oscillator
- Preselector Tuning
- Crystal-controlled BFO (Dual frequencies)
- All Heterodyning crystals supplied
- Selectable upper and lower Sidebands
- Geared Tuning Mechanism
- 100 KC Calibrator Circuit (crystal optional extra)
- Separate Diode AM Detector and CW/SSB product Detector
- Coax Antenna Input
- 8 and 500 ohm outputs
- Imported

### LAFAYETTE 10-80 METER BAND TUNEABLE VERTICAL ANTENNA

40-0104WX

**14<sup>95</sup>**

- Single adjustment for tuning antenna
- Omni-directional—overall height 18 ft.
- Rugged, wind-resistant—Irridite-treated
- For Ground, Roof or Tower Installation
- 52 ohms impedance—1000 watts power rating



### NEW! LAFAYETTE "BEAT-BANDER" EXTERNAL BFO

99-2502

**11<sup>95</sup>**

- Stable, Transistorized Circuit
- Provides "beat" frequencies from 3.5-32MC
- Connects to Receiver's Antenna Input
- Ideal for receivers without BFO, or those using a combined Q-Multiplier/BFO
- Complete with coax cable and 9-volt battery
- Imported

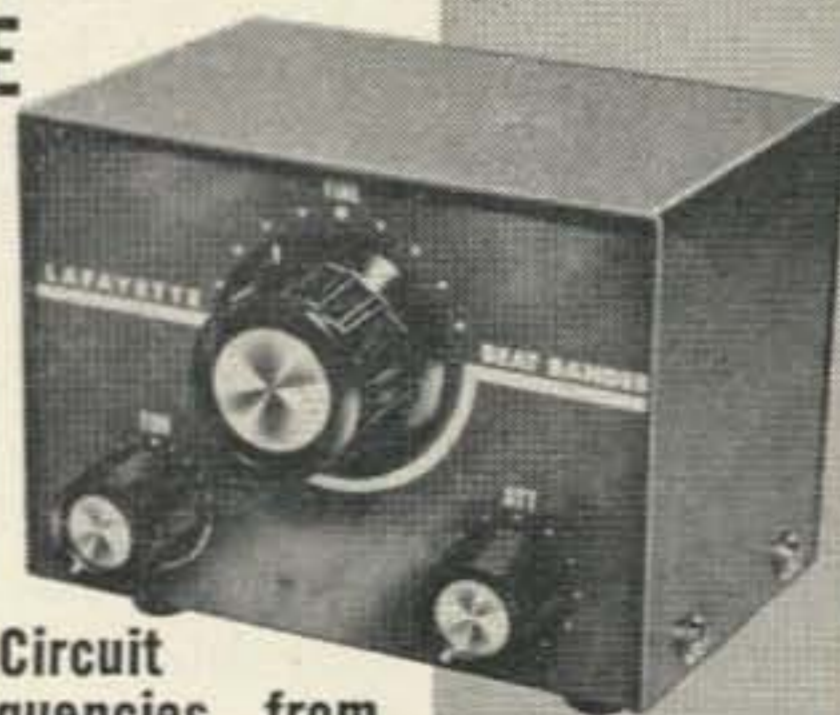

**FREE!**

Lafayette 516—Pg. 1965 Catalog No. 650. Write:  
Lafayette Radio Electronics Corp., Dept. 73K-4, P.O. Box 10, Syosset, L. I., N. Y. 11791



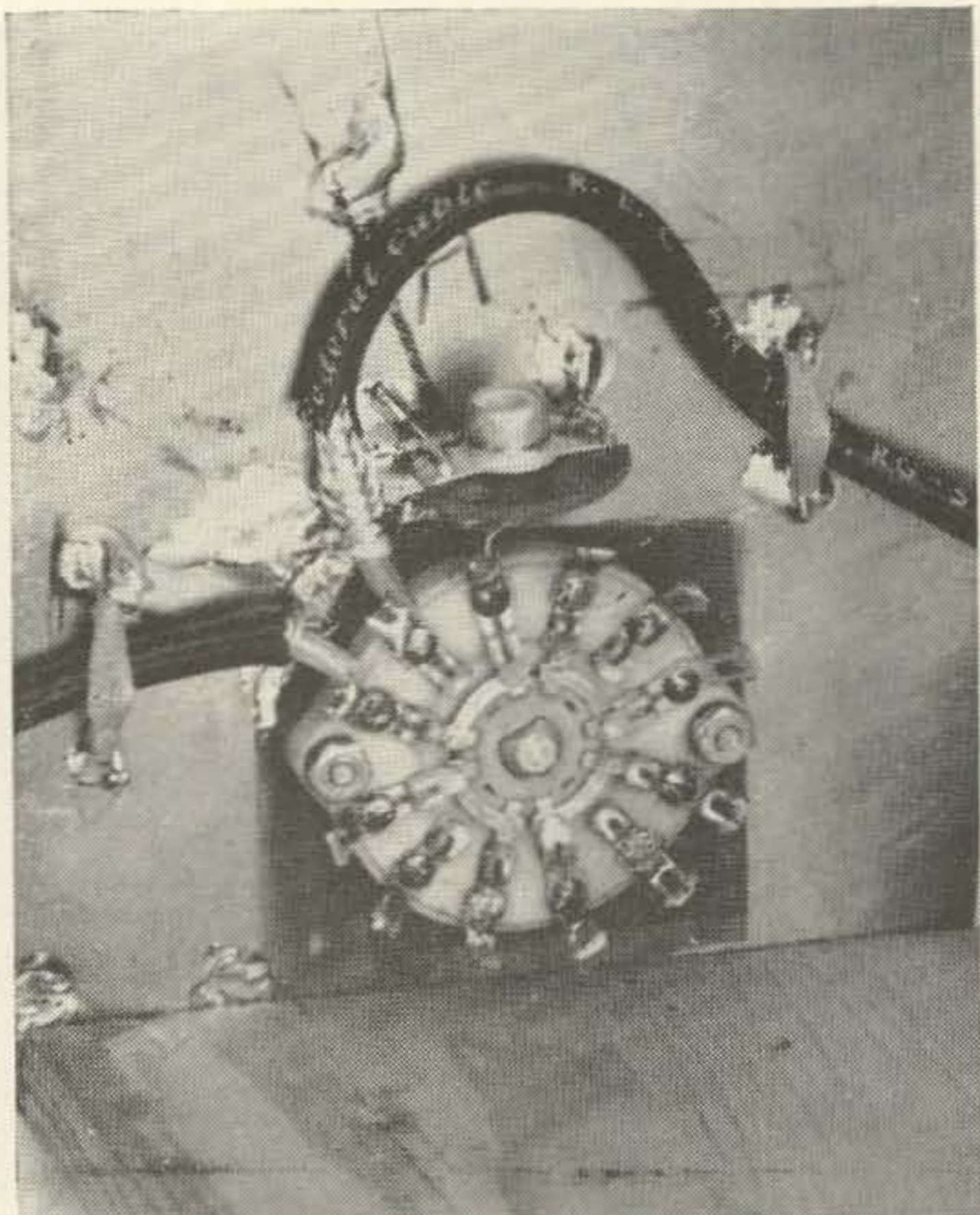

"compact" is pretty well spread out but it will go together eventually for mountain-topping. Don't forget to connect the two grounds, that is the modulator chassis and the rf base plates.

That's about it for station assembly except for some details taken up in the "On The Air" section, and one more item that is hard to do without. You've got to know, while tuning, making bias adjustments, turning voltages up and down, testing tubes for *frequency* operation, etc., whether more or less rf is going into the antenna cable. This item is simply to allow you to see whether such adjustments make an rf increase or not, in the power into the cable. Like the power meter on the rf output of a Gonset. This must be done *on* the cable and must *not* pick up rf from the rest of the rig anywhere. I settled it, at least for the shack operation, by coupling a 432 mc power detector (see 73 Mag.) into the antenna cable which is RG-8/U, about 10 feet along towards the beam where there happens to be a connection with about ¼ inch open to the breeze. (Not desirable.) Three quarters of an inch of the end of a 5 foot piece of RG-58/U cable was stripped of the outer braid and looped through the connector, but not touching the center conductor of the antenna cable, which is carrying some 5 to 10 watts of rf. About ⅛ inch away. Plenty of 432 rf registered on the detector output meter. Of course, if you have an antenna bridge good for 432, and also if you want to keep it for the 432 rig in your shack, that's OK also. I'm thinking about

checking into what makes a good one for 432 and 1296 for amateurs. If possible.

The gimmick described above does show the sum total of everything you do to the rf, even like forgetting to throw the antenna switch!

### The 432'er on the Air

The great day. For me. For you, when you come to it. Nervous as a cat all day. Changing modulation transformers in mid-stream didn't help either. Like building a test dreamcar and then finding the drive shaft is open in the middle of somewhere.

In 1946, yours truly wrote an article in QST, "Getting Started On 420." (And they say History never repeats!) So now, 18 years later I get on the air once more on 432. It's my own fault of course, that I missed those years. The ranks of the 432 faithful have been growing making me now a real newcomer. I got a nice welcome though, I must say. If you want a real friendly band just try 432 (Even more so, try 1296!) They soak up new stations like a dry sponge. I hope my efforts with strong assistance from W2NSD for a good low cost 432'er, will help the situation.

So away I went, modulator on the left, rf section in the middle with the antenna switch, then receiver rf amplifier, mixer, Lo. chain, and Morrow receiver on the right, buzzing away merrily on 28 megacycles.

Couldn't wait for 8 PM Wednesday, the magic hour for 432 in this section of the U.S.A. Went on at 7 PM. An immediate answer from W1BU. He has a "band scanner" running, with receiver lock-on. Very FB. This of course is good old Frank, W1EHF, perhaps *the* most faithful of the 432 fanatics in New England. I can't tell for sure yet but later on after a few mobile visits I might judge better. A few modulator checks on the 432'er and we carried on for a good hour. First thing, frequency stability, with shift and drift. Cured almost 100% of it by cutting down on the crystal oscillator plate voltage. Should have remembered! 40 to 50 mc crystals do *not* like more than 100 volts. Frank is trying transistor oscillators in thermos bottles! Darn good idea too. More later on that. My *receiver* also jumps around in frequency when the XYL turns her Tee Vee on or off, dishwasher starts, etc. I find this is par for the course on 432. Frank even has an ac voltage regulator down there in the Reddydendron Swamp. (300 feet high incidentally.) This just goes on my list of "things-I-didn't-know-about-432-til-now." A couple of dc voltage regulator tubes, will go in here very soon.



Frank says even filament voltage causes some drift. Maybe transistors will be the answer. What about 1296? Wow. At least I will be watching for it.

Let's see what else happened. "Ur signal 62 db above noise in Medfield." 25 miles away, flatland. Sounds good, for only 8 to 10 watts out here. Not pushing anything *yet*.

Frank says the transmission he was making last week was a varactor multiplier putting out about 2 watts. Was S7 over here then. He gave me a FB rundown of the stations on the air, but *that* I hope to report myself, first hand, soon. Nashua, N.H.; Springfield, Mass.; Rhode Island; 2GRI near Saratoga Springs, N.Y.; etc. Wednesday night at 8 PM is the big date at present.

A good CW signal was CQ'ing as soon as WIBU signed off. "CQ de K1JIX" Another old faithful, of course. He used to be W2BVU in Poughkeepsie, N.Y. Knew him when. Swung the beam from SW to West on Harvard, Mass. 30 miles away and JIX boomed in over 9. He also answered on fone pronto. Plenty of good info as well on everything about 432. What did I tell you? The welcome mat is *really* out on 432! Will sure visit his shack soon as I get mobile on 432.

W1OOP, still another real old-timer, was calling next at 8 PM. 20 miles away. Hank had plenty of real dope on receiver front ends; is very partial to crystal mixers for the first stage at present. Well, I've got one here, recently described in 73 Mag. Will check with on-the-air tests. Incidentally, *all* these lads are in the 100 watt and over class! I'll *have* to go mountain topping to compete with *that*. Or maybe four of these 14 element jobs?

Then, to top the evening off, as if it was needed, K1JIX has asked for 9 P.M. with W2GRI who is in N.Y. state, some 145 miles airline from me. JIX is on a 500-600 foot ridge in Harvard, Mass., some 30 miles nearer him. At any rate, I heard GRI's carrier every time he came on, peaking nicely on the beam West-N.W. About 10% of the audio came through.

I certainly hope to QSO 2GRI before many days. Have to be on CW for now though. I have an old rusty key somewhere. Not as rusty as my first I am sure, but I can do it if I must.

That's all for now. All I have to do is to put it all in one box with a handle. Well, maybe two boxes first. We'll see.

When will *you* be on 432?

... K1CLL

# ROHN

## sets the standard



K7ASK

### for CRANK-UP TOWERS

**Why settle for less than the best?**

### TWO CATEGORIES TO CHOOSE FROM

Standard Duty Guyed in Heights of 37 - 54 - 88 - 105 and 122 feet

Heavy Duty Self Supporting and Guyed in Heights of 37 - 54 feet (SS) 71 - 88 feet (guyed)

### ROHN has these 6 IMPORTANT POINTS:

**Ease of Operation**—roller guides between sections assure easy, safe, friction-free raising and lowering. **Strength**—welded tubular steel sections overlap 3 feet at maximum height for extra sturdiness and strength. Unique ROHN raising procedure **raises all sections together**—uniformly with an equal section overlap at **all heights!** **Versatility**—designed to support the largest antennae with complete safety and assurance **at any height desired!** **Simple Installation**—install it yourself—use either flat base or special tilting base (illustrated above) depending on your needs. **Rated and Tested**—entire line engineered so you can get exactly the **right** size and properly rated tower for **your** antenna. The ROHN line of towers is **complete**. **Zinc Galvanized**—hot dipped galvanizing a standard—not an extra—with all ROHN towers! Prices start at less than \$100.

#### SEND FOR ROHN TOWER HANDBOOK

—\$1.25 Value

—**ONLY \$100** postpaid (*special to readers of this magazine*). Nearest source of supply sent on request. Representatives world-wide to serve you. Write today to:



## ROHN Manufacturing Co.

P. O. Box 2000

Peoria, Illinois

*"World's Largest EXCLUSIVE Manufacturer of Towers; designers, engineers, and installers of complete communication tower systems."*



# Precision Audio Attenuator

It is very desirable to use an attenuator for all types of audio work, whether in the hi-fi field, in checking a modulator, or in investigating a new clipper or limiter. This professional quality attenuator was designed for these purposes and was further designed to use the standard 5% tolerance carbon resistors. Since the resistors were used in pairs in parallel, the 5% is reduced a little so that perhaps 3% tolerances are reached in the overall result.

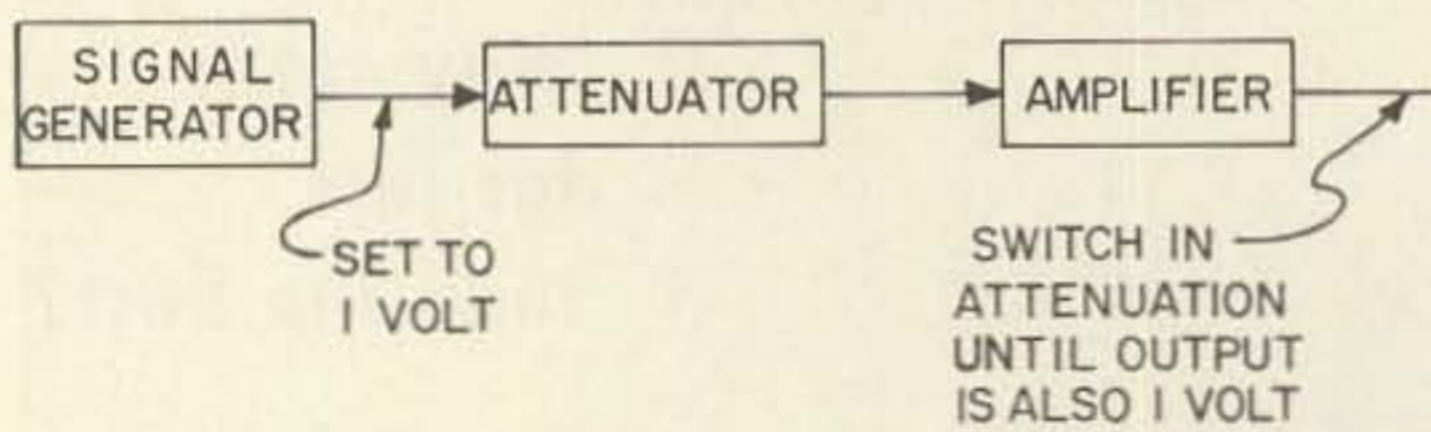

FIG. 1

Since the attenuator has a total of 100 decibels total attenuation, it is necessary to keep the input and output far apart and use an enclosed metal box to prevent feed-thru. A long metal box with the input on one end and the output on the other and all the switches in a straight line between them is recommended for construction. Also, the at-

a pi-section or a short bypass. The switches will carry very little current and can be of lightweight construction and should be easily operated to keep from moving the entire box, since the whole unit is not very heavy.

The meter and the input resistor will aid in the establishment of an initial level, and db can then be set in as db below, say, 1 volt. The meter can be one of the small VU meters currently available, or the adjustable resistor and meter can be eliminated if a metered output is available from your signal generator. The attenuator must always be terminated in 600 ohms, but since a proper termination is usually not available, a 600 ohm load is available at the output and can be switched in as desired. The normal high input impedance of amplifiers will not shunt the output enough to disturb the calibration. When feeding the output into a carbon mike input, the input impedance should be adjusted to 600 ohms with aid of a resistor in parallel with the input, or a resistor in series with the carbon mike input. Measure with an ohmmeter to be sure, and then connect the attenuator output.

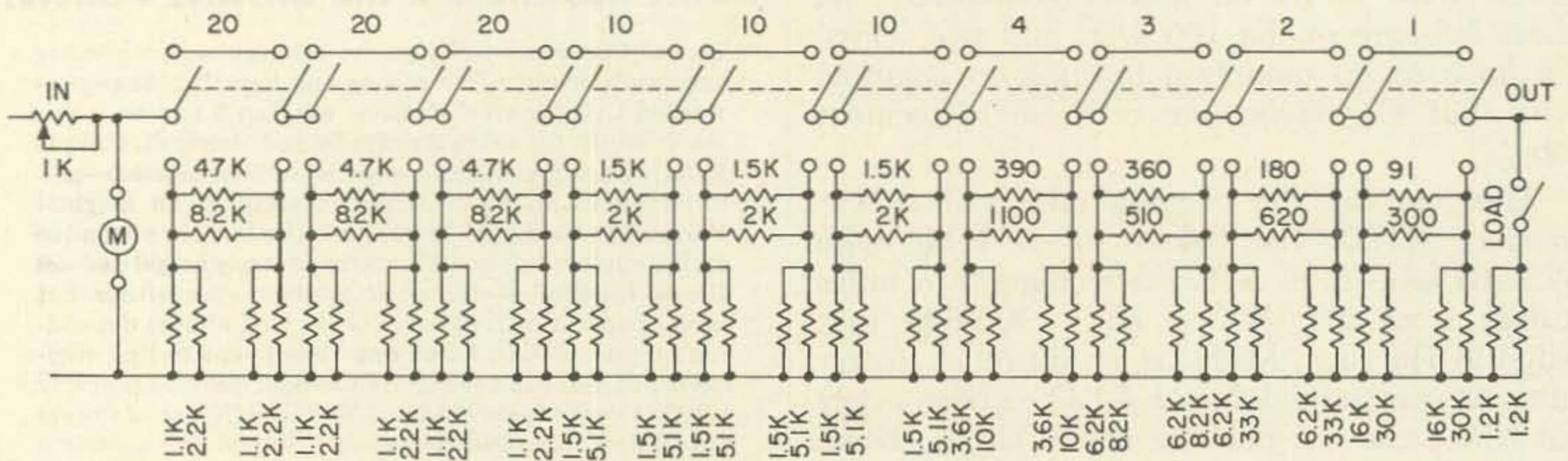

FIG. 2

tenuation sections have been designed in the form of pi-sections so that the resistors can be supported by the switch terminals and a straight length of No. 12 copper wire which passes thru as the ground from the input to the output ends. Protect the resistors from excessive heat with long nose pliers while soldering.

The switches are of the double pole double throw (dpdt) type and alternately switch in

To measure amplifier gain, for example, the signal generator is applied, and the output adjusted to 1 volt at the desired frequency. Then the output of the amplifier is monitored, and when the output is also 1 volt, the attenuation of the attenuator is the gain of the amplifier. (See Fig. 1) This is the most straightforward way of using the attenuator in making amplifier gain measurements.

... K9QYI



# HERE'S THE ORIGINAL!

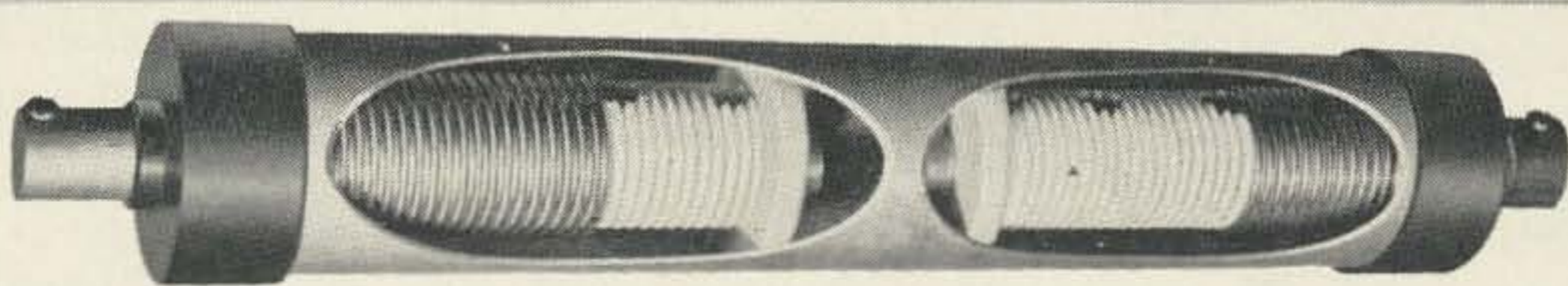

## None Better <sup>HAS EVER BEEN</sup> Made!

Choose  
from the  
complete  
line of  
multi-band  
antennas...

**DON'T** BE FOOLED BY IMITATION!  
BE MISLED BY ADVERTISING  
CLAIMS!

The original all metal encased trap was first produced in 1957 by Mosley for use with the World Famous TA-33. The Mosley trap design has been imitated by many manufacturers of amateur antennas. This is both a compliment and proof of the outstanding engineering built into every Mosley Multi-Band Antenna.

*Consider the facts*  
**Mosley**

MULTI-BAND ANTENNAS have been

- 1 Used by HAMS all over the world!
- 2 Specified by the U. S. Government!
- 3 Produced for Military Installations!
- 4 Chosen by "Vanguard" and "NASA"!

When your communications need a dependable antenna . . . Get The Finest . . . Get A Mosley!

**Mosley**



*Electronics Inc.*

4610 NORTH LINDBERGH BLVD.  
BRIDGETON, MISSOURI, 63044

Export Division: 64-14 Woodside Avenue, Woodside 77, New York.



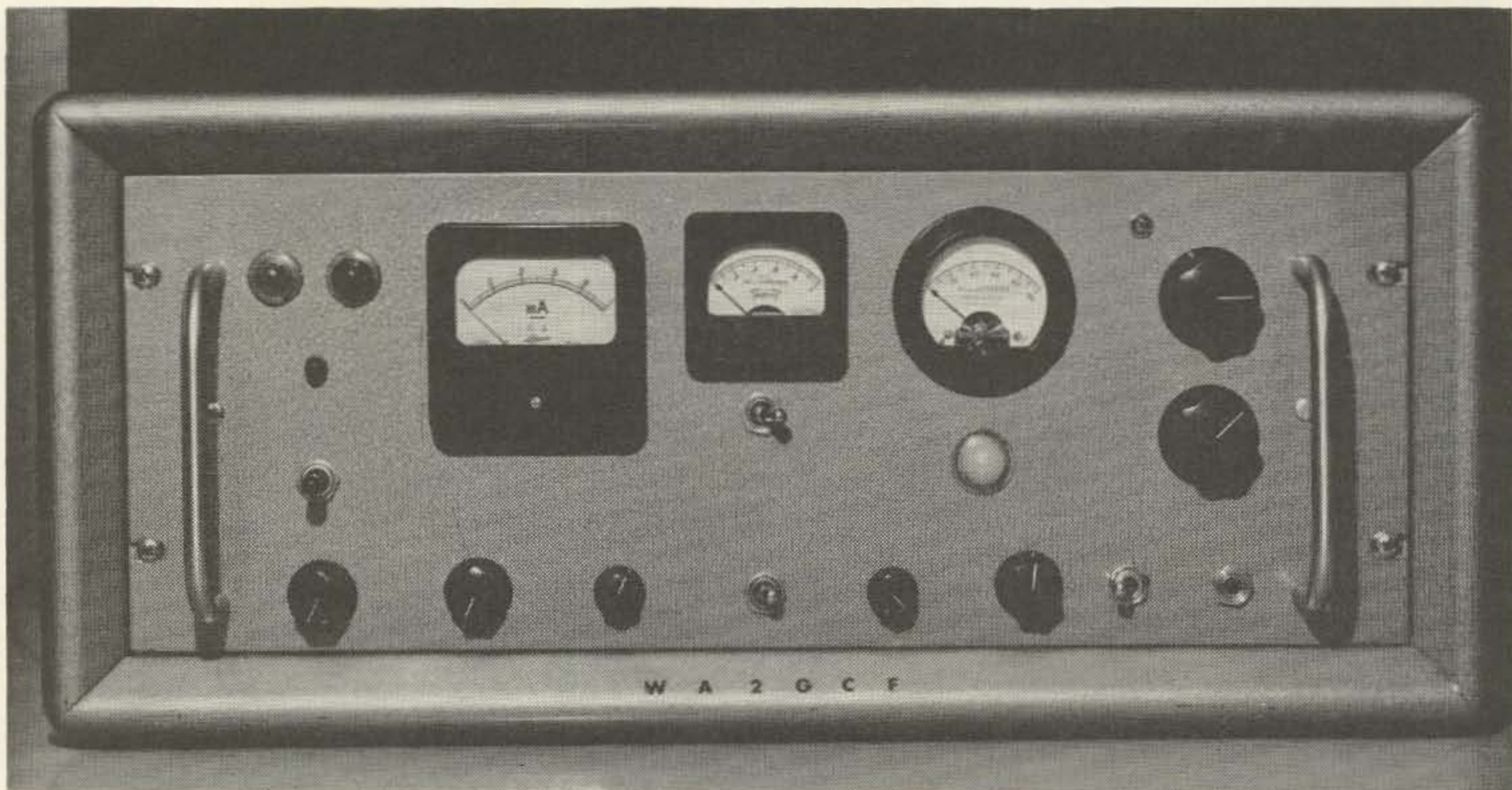

## SIX METER VFO TRANSMITTER

the HAMTRONICS SPECIAL

Jerry Vogt WA2GCF  
160 Grafton Street  
Rochester 21, N. Y.

SOME TIME AGO, a prominent editor made a statement that there wasn't enough homebrew equipment being built any more. It was then that I decided that it might be fun to start a small business building special equipment that might not be found on the market due to lack of interest on the part of the amateur consumer in general. Thus came the name "Hamtronics."

As was suspected, the enjoyment and satisfaction of building this type of equipment is unequalled, especially when it doesn't cost anything for parts since this burden is borne by the customer who wants such equipment. The transmitter-plus, which is described herein, is the result of this idea.

As seen at first glance, we have here a low power six meter transmitter. So, big deal! But, it is a big deal because this is no ordinary six meter rig. It incorporates some frills which just aren't available in the commercially built type of gear. It has extras, such as VOX, speech clipping, flashy lights, single function switch, modulation indicators, output meter, mute defeat, and . . . it is broad banded. It

will cover 50 to 50.8 mc without even touching anything but the vfo. It can be built by anyone who has a few tools and appreciates goodies. Convinced? If so, read on. If not, think of that last contest when you had to constantly fiddle with controls to chase that rare multiplier.

### Circuit Details

The vfo is a 12.5 mc Clapp circuit employing a 6AH6 oscillator tube. Solid mounting and short leads are the secret of stability for a vfo of this type. The oscillator grid tank coil consists of 32 turns of a B & W Miniductor coil #3007 permanently mounted on a 1" by 3" piece of 1/4" thick plexiglass. Polystyrene would work equally well. The coil is temporarily clamped to the block with alligator clips while a good thick coating of Q-dope is poured onto the assembly. After a few hours, the clips may be removed and additional coatings applied. Mount the plastic block using one 8-32 machine screw at each end with a heavy metal spacer approximately 3/8" long on each screw. NPO condensers are used







in critical places and the screen circuit (which acts as oscillator plate) is voltage regulated for stability. The output plate tank circuit takes the form of a  $\frac{3}{8}$ " slug-tuned form with 16 turns of #20 wire closewound on it. The 4700 ohm resistor helps to broadband the tank circuit so it has uniform output over a wide range. The vfo is built in a 3" x 5" x 2" mini-box. It is not on the chassis with the rest of the rig because of the heating problems encountered when first tested. Now the vfo is mounted separately on the rack in which the transmitter is housed.

The rf amplifier section employs a 5763 doubler operated with cathode resistor bias for added safety. A short length of RG-U/58 connects the vfo to the phono jack in the first amplifier stage. Plate tank with  $L_2$  is tuned to the low end of the expected frequency range which in this case is 24.9 mc. Then, the next stage grid tank is tuned so that  $L_3$  resonates at the high end of the expected range or about 25.5 mc in this case. The net result of tuning the tank circuits in this manner produces a uniform coupling coefficient throughout the range of frequencies to be used. Similarly, the 5763-multiplier-driver tank is tuned to 49.8 mc at the plate and the 2E26 final grid circuit is tuned to 51 mc. Thus the driver controls, once set, will never have to be touched again.

The final amplifier, with its 2E26, is grid-neutralized for freedom from spurious radiation and linearity of modulation abilities exist. The parasitic choke, mounted on the plate cap, is made with 6 turns of #22 bare wire with  $\frac{1}{4}$ " inside diameter and is spaced with one wire diameter between each turn. The total length is about  $5/16$ ". rf chokes are common Ohmite Z-50, 7uh. solenoid types. A phone jack in the cathode circuit may be used as shown if cw operation is contemplated. The 33k/5w screen resistor may be made from 3 100k/2w resistors connected in parallel.

The final amplifier output tank circuit consists of a pi-network in which a moderately low Q is employed to good advantage. By using this type of arrangement, effectively, the output circuit is broad-banded, for at least as much as 700-800 kc. This can be a very convenient extra for use during contests since it eliminates two more control-settings that would ordinarily take place when you QSY to catch a rare DX station and still want the final to be tuned efficiently. A .001 mfd/-3kv disk or mica condenser is in series with the tank circuit to prevent dc from being coupled to the antenna. The plate capacitance is almost enough to tune the input of the tank

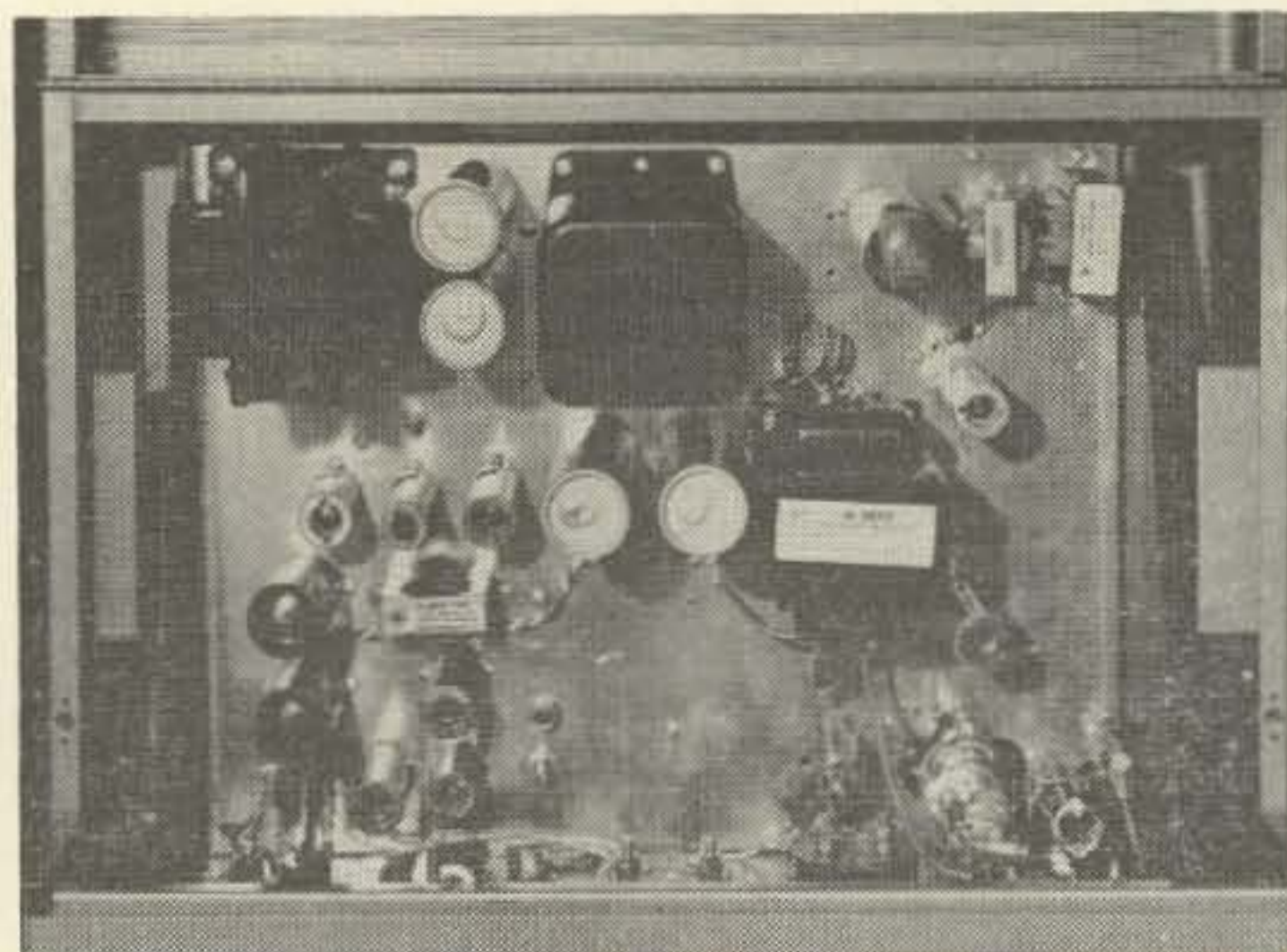

so only a small, 20 mmfd tuning condenser is used. The tank coil itself, is only 3 turns of B & W #3010 coil stock and the output or loading condenser is a big 100 mmfd shunted by a fixed value of an additional 100 mmfd mica, 1000 volt condenser. The rf choke from antenna to ground provides two functions. First, it smokes in case the dc blocking condenser breaks down so that you know there is high voltage on the antenna line. Second, it provides a means of kicking out the high voltage fuse after the smoke signals appear.

The metering section has three meters with useful functions. On the right hand side of the panel is the 0-100 ma meter used to measure the plate and screen input current to the final amplifier stage. The center meter is a 0-1 ma meter used as an rf voltmeter to measure the relative rf output level. The third of the meters, left, is a larger size meter, 0-1 ma, used to measure the relative modulating level. While the latter is not really necessary, it provides an interesting conversation piece and may be used as a check on the modulation if you should move back from the mike, etc. When first set up, it may be checked against a scope to determine full scale at about 100% modulation. The NE-51 panel lamp also indicates that the modulator isn't loafing. It blinks as you reach modulation peaks.

The modulator and speech amplifier stages line up as follows. A 12AU7, two stage speech amplifier is operated from the power supplied directly from the high voltage output of the supply and is not controlled by the relay,  $K_1$ . This allows its use in conjunction with the vox circuit. A 6AL5 operates as an adjustable, symmetrical speech clipper and is followed by a low pass filter scheme in order to reduce harmonic distortion which is generated by the squared wave-form produced by the clipper. A 6AN8 pentode section is used as a high gain driver and the triode section is used as a phase inverter. This feeds into the 6L6, class AB<sub>1</sub> modulator stage, producing a solid 15



watts of audio from the modulation transformer. The latter is a 60 watt Stancor-Poly pedance type. This, while over-rated, allows the audio to reach the final rf stage without showing the ill effects of saturation in the core of the transformer. Another good reason is that it costs only a little more than the smaller version.

The vox and control section employs a rather standard circuit. One half of the first 12AT7 is used as a vox amplifier with its 500k vox level control. The opposite half is an anti-trip amplifier with its associated 50K level control. These amplifiers feed their respective signals into the 6AL5 detector stage which rectifies and phases the signals so they can be used to bias the second 12AT7 relay tube. The vox can be defeated with the defeat switch, which shorts the relay contacts. In either case, the switching action closes one side of the other relay coil circuits and the other side is switched by the proper function switch. The switch on the left hand side of the panel acts as spot switch when thrown to the right, and the spot relay and yellow (left hand) light operate. When thrown to the left, it acts as a transmit switch, turning on both the power relays, K<sub>1</sub> and K<sub>2</sub> and also operates both function lights. The small light in the center of the light-triangle is a power-on indicator which shows the power supply is operating. K<sub>1</sub> switches the high voltage for the modulator and rf final amplifier stages and switches the receiver and antenna circuits. The receiver mute may be disabled by the mute defeat switch, should you like to listen to yourself talk for testing purposes. K<sub>2</sub> applies high voltage to the driver, multiplier and vfo stages.

The power supply section consists of a 5U4 rectifying the output from an 800 volt center-tapped television transformer, separate 6.3 volt heater windings for modulator heaters and rf heaters and a silicon diode rectifying the output from a 250 volt transformer for the vfo and vox circuits. Since it was available, a 6.3 volt winding on the same transformer was used for the vox section heaters. Still another transformer is used for the vfo heater so that stability would result from leaving the heater on when the rest of the transmitter was turned off. Standard condenser input filter systems were used in each case. Special notice is given to fusing of the main high voltage supply so that if the high voltage output from the 5U4 was shorted out, the 1 amp fuse would go—not the rectifier or the transformer.

The transmitter is built around a 7" rack panel so it may be mounted on a rack as shown in picture 3 or else it may be enclosed

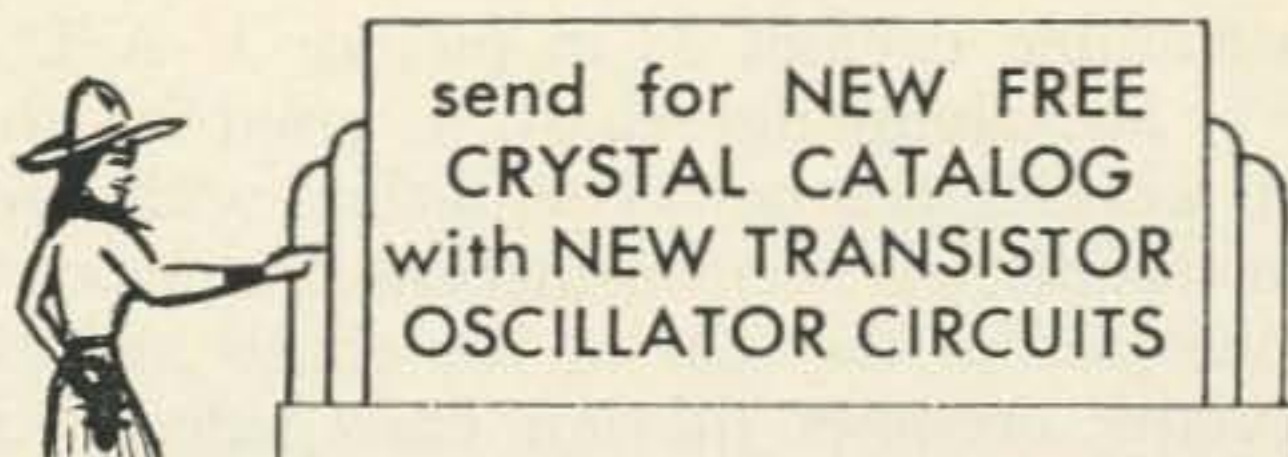

### 3 BIG MODERN PLANTS TO SERVE YOU BETTER

2 in Fort Myers

1 in Los Angeles



### HERMETICALLY SEALED PRECISION GROUND CUSTOM-MADE NON-OVEN CRYSTALS

Top performance assured with quality controlled throughout manufacture. Gold or silver plating acts as electrodes. Crystals are spring mounted and sealed under vacuum or filled with inert gas. Very high frequency stability. Max. current capacity is 10 milliwatts—5 for overtone type. Conformity to military specifications guaranteed.

1000KC to 1600KC (Fund. Freq.)	Prices on Request
1601KC to 2000KC (Fund. Freq.)	.....\$5.00 ea.
2001KC to 2500KC (Fund. Freq.)	..... 4.00 ea.
2501KC to 5000KC (Fund. Freq.)	..... 3.50 ea.
5001KC to 7000KC (Fund. Freq.)	..... 3.90 ea.
7001KC to 10,000KC (Fund. Freq.)	..... 3.25 ea.
10,001KC to 15,000KC (Fund. Freq.)	..... 3.75 ea.
15MC to 20MC (Fund. Freq.)	..... 5.00 ea.

### OVERTONE CRYSTALS

15MC to 30MC Third Overtone	.....\$3.85 ea.
30MC to 40MC Third Overtone	..... 4.10 ea.
40MC to 65MC Third or Fifth Overtone	..... 4.50 ea.
65MC to 100MC Fifth Overtone	..... 6.00 ea.

DRAKE 2-B Receiver Crystals .....\$4.00  
(All Channels—Order by Freq.)

### OVEN-TYPE CRYSTALS

For Motorola, GE, Gonset, Bendix, etc.  
Add \$2.00 per crystal to above prices  
SUB-MINIATURE PRICES slightly higher

CITIZEN BAND Class "D" Crystals .....\$2.95  
Over 50,000 CB crystals in stock for all sets and channels, both HC6/U and miniature types. To insure proper correlation and correct freq. operation, order by manufacturer model number and channel.

### NOW . . . 48 HOUR SHIPMENT

ALL TEXAS CRYSTALS are made to exacting specifications, quality checked, and unconditionally guaranteed!

Send for new Citizen Band Crystal Interchangeability Chart with Texas Crystals Code System.

### ORDER FROM CLOSER PLANT



DEPT. 73-10  
1000 Crystal Drive  
FORT MYERS, FLORIDA  
Phone 813 WE 6-2109

Division of

AND  
4117 W. Jefferson Blvd.  
LOS ANGELES, CALIF.  
Phone 213-731-2258





in a suitable cabinet as in picture 1. A 2" x 17" x 14" aluminum chassis is used so that metal working can be accomplished with minimum trouble. As seen in picture 2, the power supplies are in the rear of the chassis and the modulator occupies the left hand side of the front and the rf section occupies the right hand side. Much could be done to improve appearances if, now that the difficulties have been found, we could build another unit. However, that job is up to you. The basic layout can be seen and it is one that is very easy to work with, since all critical circuits have controls mounted within close proximity. This eliminates need for long shafts, shielded cables and compartmental construction.

The neutralizing condenser, seen mounted at the left side of the final tube, is actually supported by a small piece of #10 wire soldered to the plate cap of the 2E26 and the stator lead runs 3" down through a hole in the chassis to the grid tank coil. The final plate tank components are mounted on the panel, the loading control being on the bottom and the tuning condenser is on the top, while the coil is mounted between the two condensers. The fixed mica condenser, which shunts the loading condenser, is soldered to the loading condenser stator and runs to a lug at the chassis with very short leads.

The remainder of the layout isn't critical, however, this plan is recommended since it results in short lead lengths and ease of construction. Good solder connections are important and a little extra care will eliminate headaches later on.

Controls across the bottom of picture 1 are left to right as follows: audio gain, clipping level, mute defeat, am-cw, vox delay, drive level, power off-on and key jack. The switch immediately under center meter is vox defeat and the light under the right hand meter is the modulation indicator. The loading control is the lower of the two at the right and the final tuning control is above it. Handles provide a means of protection for the controls and also dress up the front panel.

Alignment is relatively simple compared with some kit type transmitters. A good way to start is by disconnecting the second 5763 and tuning the tank of the first 5763 plate for maximum rf output at 24.9 mc. Then tune the second condenser so that with 5763 re-connected, maximum response occurs at 25.5 mc. This may be measured with an rf probe and a vtvm or a grid-dip meter. Tune the plate tank of the second 5763 to 49.8 mc and the final amplifier grid tank to peak at 51 mc. The final plate voltage is then applied and both the final tune and loading controls are

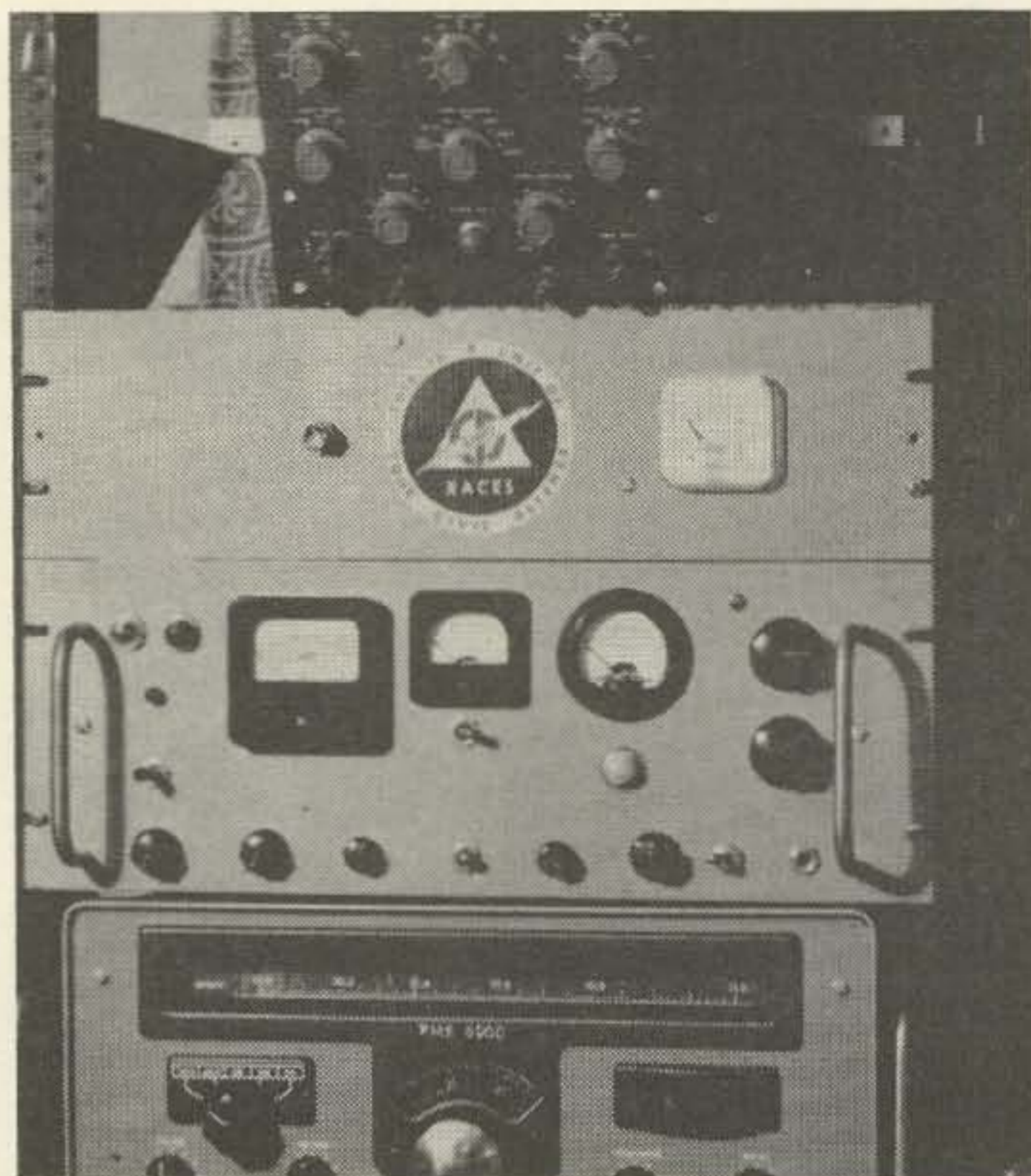

set for maximum reading on the rf output meter with a dummy load or antenna connected.

With a scope coupled to the final tank coil or by having someone listen to your signal, you can then set the speech clipping control for 100% negative modulation peaks. Positive modulation peaks will be about 80-90% which is very good for this type of transmitter. Perfectly symmetrical modulation is difficult to obtain due to the common power supply setup, however, don't hit the mike too hard when working locals since they aren't used to turning their af gain controls down because the speaker cone hits the other wall! In short, you have good, heavy modulation which must be respected. In my case, I have had people say they could hear neighbors five doors down the street when I keep the window open.

This rig has given me more fun per hour of operation than any commercially produced type has. It will do the same for you. If you are tired of going on the air and chewing the fat all the time like I was, start building gear. No matter how simple a piece of homebrew gear is, *you* built it! That counts. Your editor, Wayne, must be commended on his homebrew campaign. Many people have told me they started taking an interest in construction projects because they saw it in 73. I, myself did, and for this reason I would personally like to thank "Mr. 73".

If and when you build this transmitter, please drop me a note and let me know how you enjoy it. Then the purpose of this article will be completed. If this project makes one more homebrew addict, it will be a success!

. . . WA2GCF



*in* **SYSTEMS**

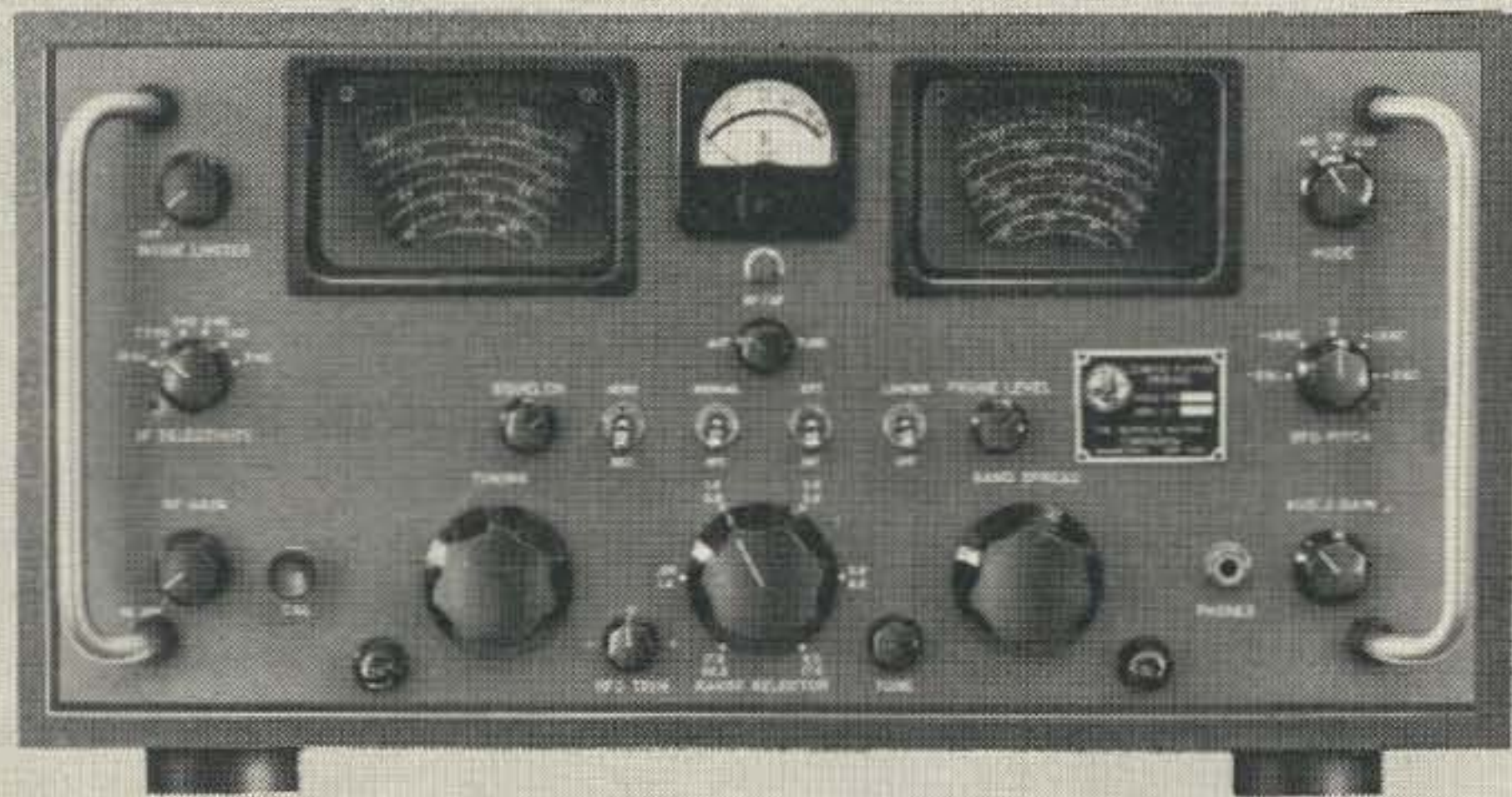

GPR-92C

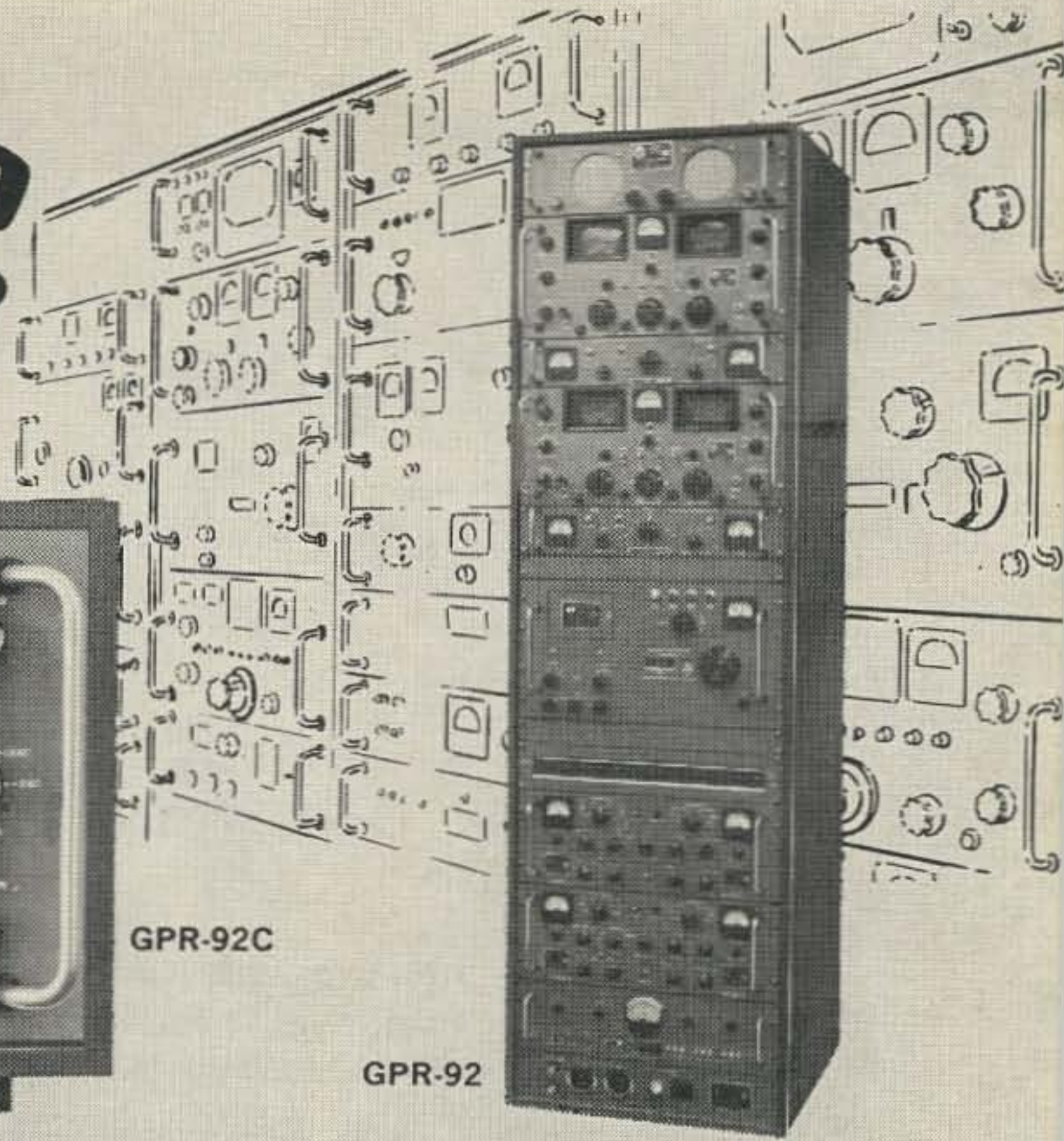

GPR-92

*or* **SINGULARLY**

**A COMPLETELY NEW...**

**GENERAL PURPOSE COMMUNICATIONS RECEIVER**

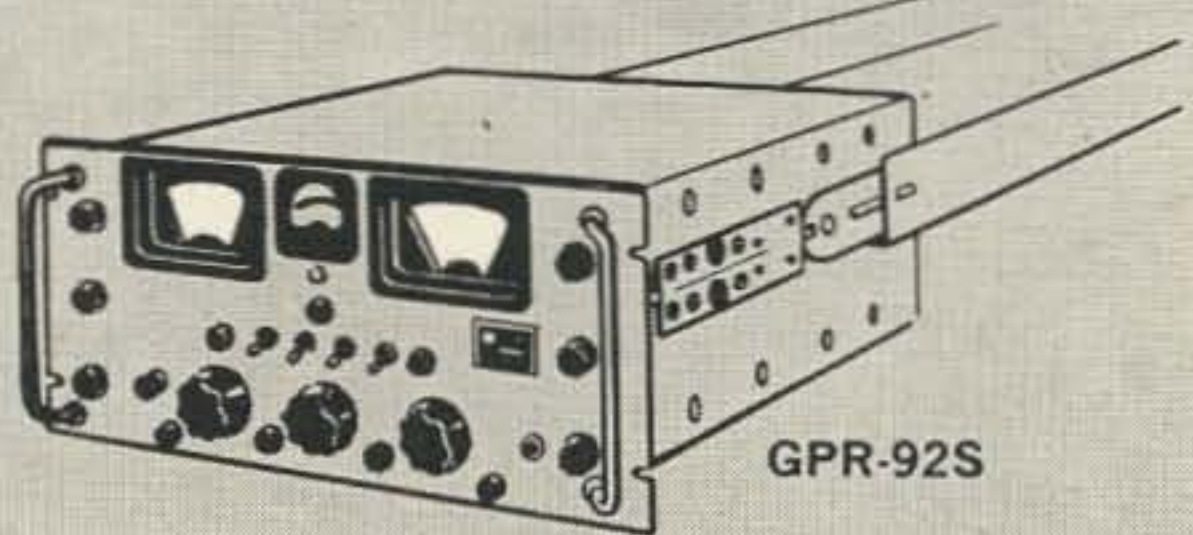

GPR-92S

**CW • MCW • AM • AME\* • SSB • ISB • FSK • FAX**

**MODEL GPR-92 ( )**

- 6db NOISE FIGURE
- BETTER THAN 1 MICROVOLT SENSITIVITY

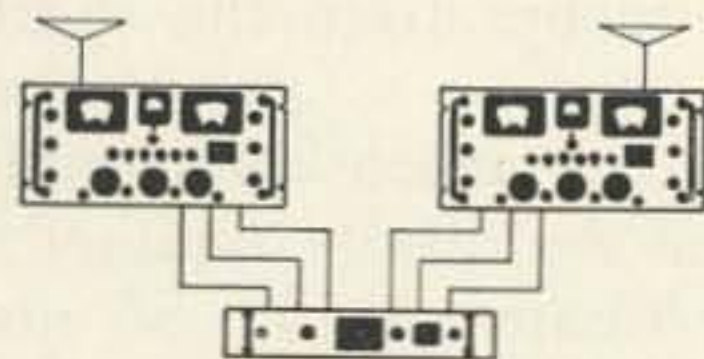

TRX-1

Selectable IF bandpass up to 15 kc as well as front panel selection of a product detector or a conventional detector allows reception of the above modes. (Adapters required for processing of ISB, FSK and FAX signals.)

Built-in buffer amplifiers permit control of the oscillators in a pair of these receivers from Model TRX-1 stabilized crystal oscillator to provide high stability diversity reception.

This general purpose receiver fulfills almost all of today's communication requirements from .54 to 32 mcs. Special bandspread dials offer ease in tuning on ham bands, international broadcast bands with a third optional dial for general tuning purposes.

Other options offered include rack, cabinet and slide mounted models. Write for Bulletin 3006.

\*AME- AM EQUIVALENT



**THE TECHNICAL MATERIEL CORPORATION**  
MAMARONECK, NEW YORK

and Subsidiaries

- OTTAWA, CANADA • ALEXANDRIA, VIRGINIA • GARLAND, TEXAS • OXNARD, CALIFORNIA
- SAN LUIS OBISPO, CALIFORNIA • LUZERN, SWITZERLAND • POMPAÑO BEACH, FLORIDA



# A Sterba Curtain for Two Meters

Rolf Carlsen W2ZBS  
57 Alda Drive  
Poughkeepsie, N. Y.

Having just acquired a nuvistor converter for two meters, the author cast around for a suitable antenna with which to listen to the local gang. Being in the middle of winter at the time, any outdoor projects were out of the question. Since the house here is a Cape Cod type with an expansion attic, the idea of using an indoor broadside array came to mind. It seems that here in the Hudson River valley, the majority of activity is concentrated in a north and south direction from this QTH. The house is so situated that a broadside array would favor these directions, the bidirectional aspects of the antenna taking care of the two directions.

Therefore the project was begun and actually took about an hour and a half to fabricate the antenna and install it in the attic. As can be seen from Fig. 1 the outside dimensions of the antenna are 10 feet long by 6 feet 8

inches high. The matching stub increases the height by another 20 inches, but the stub can go out parallel to the floor if height is a problem. The antenna is made out of #14 soft drawn copper wire. The insulators were cut to 1 1/4" lengths from 3/8" lucite rods. The phasing sections were made of 450 ohm wire feed line. All connections are well soldered to keep rf resistance as low as possible. Make sure the phasing sections are transposed (twisted) as shown on the drawing. This is necessary in order to get the currents in the dipole sections in the proper phase with each other. The antenna is 9 half waves in phase with a theoretical gain in two directions of 9.5 db. The author uses RG 58/U coax transmission line from the basement to the attic and then into a coaxial balun to drive the antenna through the 1/4 wave stub. The proper point to attach the balun to the stub was found by using a transmitter, a Jones micro match SWR bridge, and a pair of alligator clips on the balun so it could be slipped up and down the stub for the

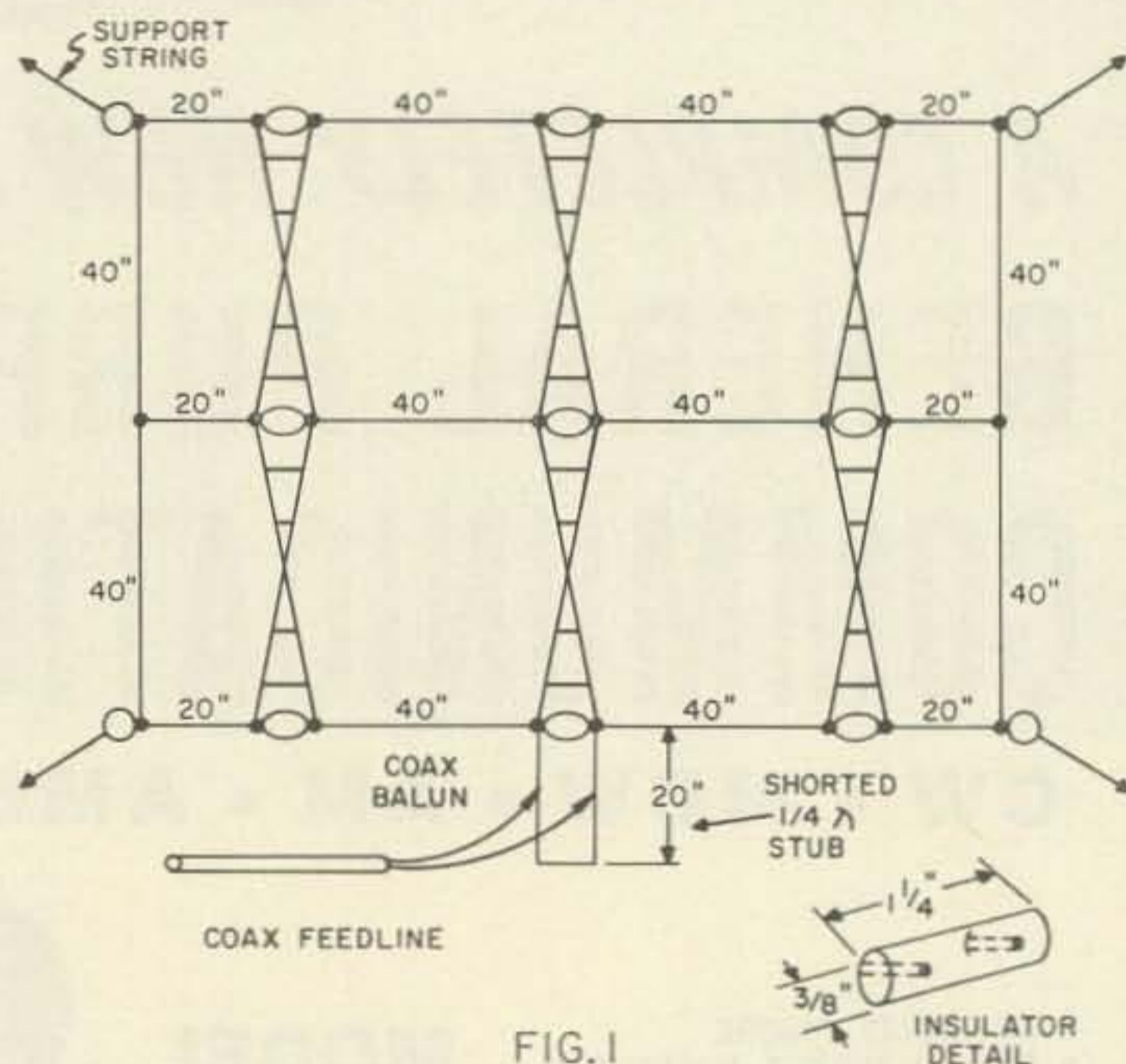

FIG. 1

## DISCOVER EXCITING NEW FIELD OF COMPUTER DESIGN

Build and learn TRANSISTOR circuits used in today's computers. DIGICATOR I assembles in less than 1 hr without special skills, experience, or tools. Simple 20 page manual leads you through nine computer experiments. Pre-punched 8 1/2x11 circuit board, solderless connections, wire, transistors, bulbs, resistors, included in kit.

Order now and start learning the basics of computer systems. Money back guarantee. Only 9.95 pp.

DIGICATION ELECTRONICS Dept. H-11

83 Concord St.

Framingham, Mass. 01701

## HYE-QUE ANTENNA-FEEDBACK CONNECTOR

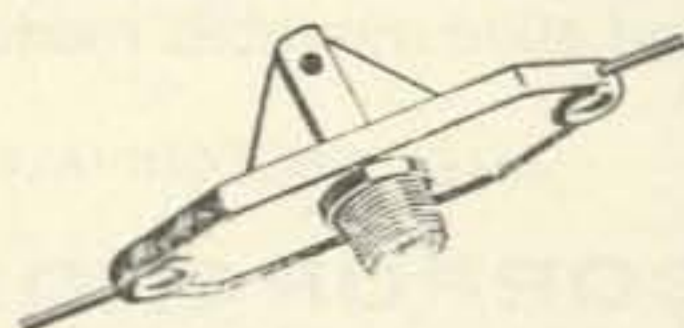

New 3-in-1 molded plastic-and-metal fitting provides: coax feeder connection, heavy copper leads to elements, antenna center support. Hye-Que I Connector fits standard PL259. Reinforced, weather protected, ultra-efficient. At your ham store, or \$2.95 ppd. Companion insulators, 2 for 99c ppd. Includes complete instructions.

BUDWIG MFG. CO., P.O. Box 97, Ramona, Calif. 92065

lowest SWR reading. The proper point will give close to a unity SWR reading and in the author's case, was 15 inches from the shorted end of the stub.

Performance? Well no article is complete without a description of the results obtained. In this case, stations in Albany, N. Y., 85 north of this QTH and stations in New York City, 85 miles south of here are copied with ease.

The equipment here consists of a nuvistor converter into an HQ-129X and the transmitter is a pair of 6146's running about 100 watts. The antenna . . . a STERBA CURTAIN.

Try this wire array. It doesn't cost much in time or money and its performance may surprise you.

. . . W2ZBS



Eugene Fleming WΦHMK  
Box 884  
Grand Junction, Colo.

# Electrolytic Saver

Photos by Bob Droulard WΦCNH

The explosion of an electrolytic capacitor is not only unnerving, it is downright dangerous. True, there are not many capacitor explosions in sacks across the country, but filter capacitors with deformed electrolytes are a major source of smoke during the initial testing of power supplies. The instrument described here can pay for itself by preventing the destruction of only a handful of electrolytics.

After a nerve shattering explosion of a lytic salvaged from some unremembered de-funct gear, I decided to prevent recurrence of the episode.

First the cause of the smoke and explosions needed to be known. That meant searching through theory books looking for information on a subject seldom mentioned. Such a problem does not occur in industry or repair shops since new units are always used. Here is a summary of available information:

Electrolytic capacitors are made of two plates of metal foil separated by a thin film of chemicals called electrolyte. Under electrical tension this film is an insulator. However,

when no voltage is applied to the foil plates for many months, as happens when a unit is stored in a junk box or is in unused equipment, the film tends to "deform." This means it is no longer a good insulator. When voltage is applied, current is permitted to pass through the

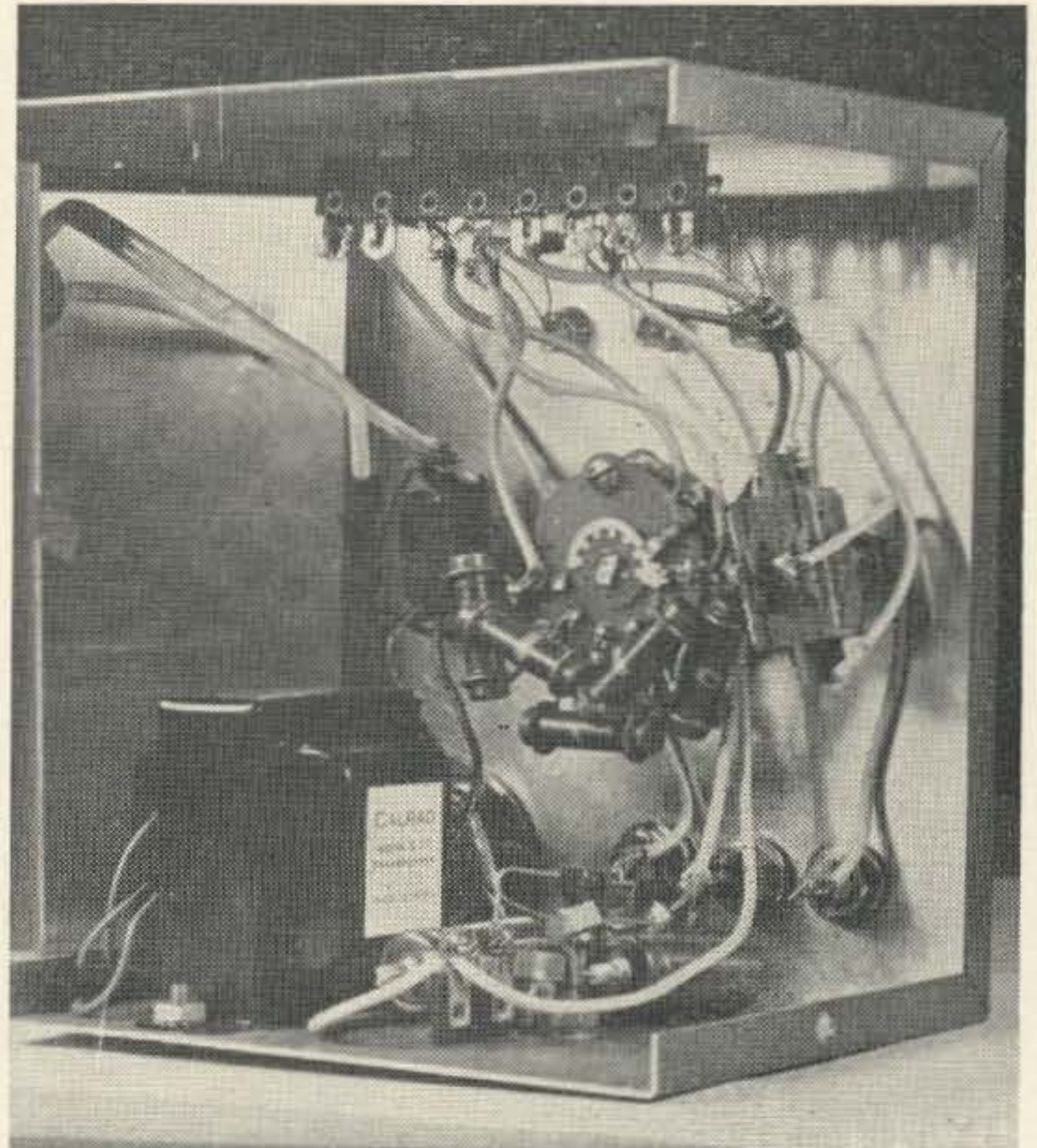

film. Heat is generated in the resistance. The heat becomes great enough to vaporize some of the electrolyte if the current is high. Pressure builds up, and something's gotta give. A unit which has one end sealed with a rubber-like compound will seldom explode, but will break open and fill the shack with stinking yellow smoke. Capacitors firmly sealed will give more thrilling results.

The electrolyte can be "reformed" by applying a gradually increasing voltage and keeping the current below about 1 ma. This voltage can come from a capacitor tester, since most models have variable voltage provisions. The drawback to this approach is that the testers usually have a spring releasing safety switch that applies the voltage. To rejuvenate a capacitor then means sitting with thumb on switch or laying the tester on its back and weighting the switch with a spare transformer.

Neither of these alternatives is particularly





attractive. I figured that it should be fairly simple to design a gadget that could provide a variable voltage and a current limited to a safe value for reforming the electrolyte.

To start with, we need a voltage source that will provide adequate potential to reform most capacitors in common use. A voltage doubler working directly off the power line would be cheap and simple, but also dangerous, since one side of the line is grounded. This is easily remedied by using an isolation transformer. A full wave voltage doubler gives slightly more than twice the transformer rms output voltage when the drain is light.

A voltage divider of five 22K resistors will draw about 3 ma. At the same time, multiples of 60 volts are available so they can be applied to the capacitor.

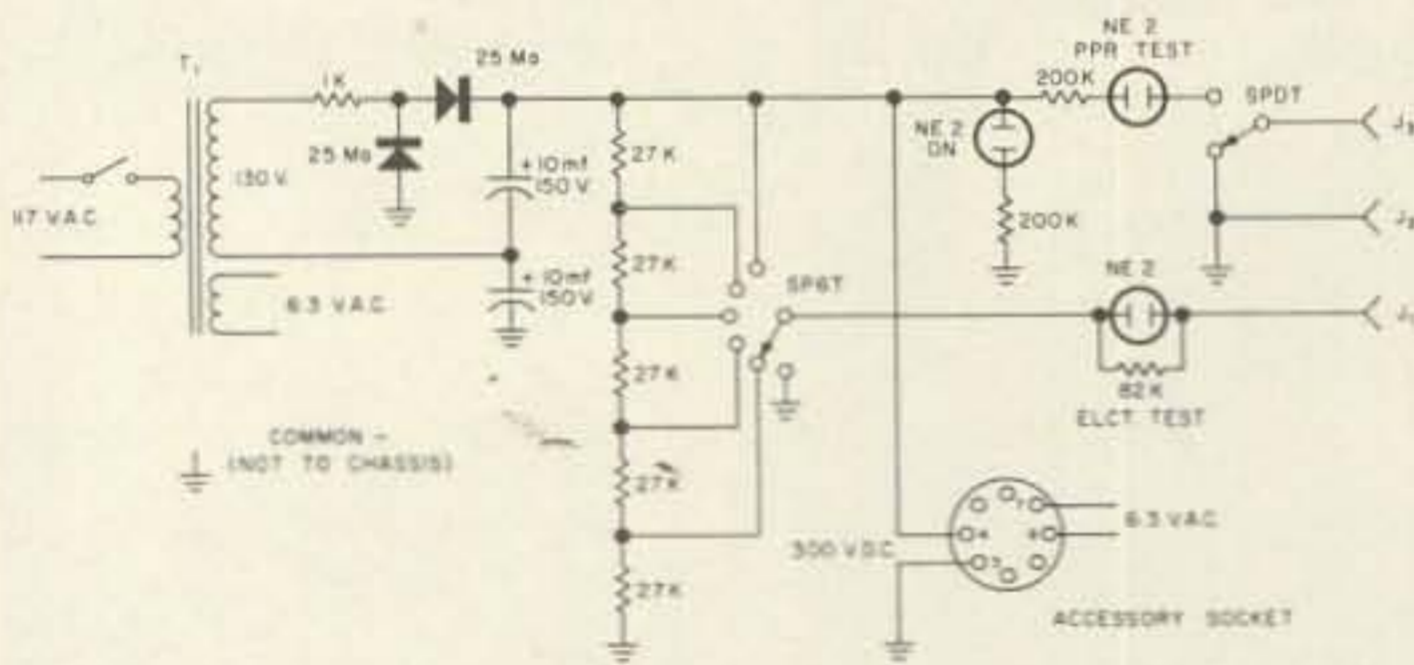

An 82K resistor is used to limit the current through the reforming capacitor. Some means is needed to know when the capacitor can withstand the applied voltage. A meter would be nice, but expensive. A neon bulb connected across the current limiting resistor will be extinguished when the current is less than about 1 ma.

Since the voltage was available, and the drain was light, it was decided to include a leakage checker for paper capacitors. Only four additional parts were required: a 200 K resistor, a NE-2 bulb, S3, and J3. This makes possible a quick and simple, but positive leakage test for tubular condensers.

Construction of the rejuvenator-leakage tester is straight-forward. Wiring is critical only to the extent that everything should be inside the 4"x5"x6" box used to house the project. The voltage doubler was assembled on a terminal strip before mounting it in the box.

The neon bulbs used as indicators were GE plastic encased units that mount snap-in fashion without need for other hardware.

Test leads using insulated clips are a must since there is as much as 300 volts applied to them when the instrument is in operation.

An accessory socket was added so that power from the 6.3 volt winding and voltage doubler could be used to operate one-tube projects. Some enterprising builders might use the spare room inside the case for "the Lazy Man's Coil Evaluator" described in the June '63 issue of 73. This section could be calibrated for capacitance measurements as suggested in the original article.

Labeling of the original unit was done by typing the label on a narrow strip of paper. This was held in place by the nef clear plastic tape. Decals with proper lettering were not obtainable. Doubtless, more attractive schemes can be found for this part of the project.

To rejuvenate a capacitor, connect its negative lead to the ground jack and the positive to the voltage divider terminal. The voltage level should be at zero during connection. After it is properly connected, advance the voltage level control to the first position. The indicator light in the circuit should light briefly. Leave the switch in this position for a few minutes, then advance it to the next level. Repeat this procedure until the capacitor is charged to its rated voltage. With the five steps used in the original model each advance represents an increase of 60 volts. CAUTION: Before attempting to disconnect the rejuvenated capacitor, return the voltage level control to the zero position. This shorts the capacitor, thus discharging it.

The instrument produces only a little over 300 volts. However, no capacitor reformed to this voltage by the author has broken down in any circuit using up to 400 volts.

To use the leakage checker section, simply connect the capacitor to the appropriate leads and depress S3, which is a spring return switch. The leakage test lamp should blink only once. If it blinks on continuously, the unit under test is leaky. If it fails to blink at all, the capacitor is probably open. The range of values over which the open test is effective is .001 to .5 mfd. Releasing the switch discharges the capacitor.

**DOW-KEY**

## New DK72

### SINGLE POLE THREE THROW COAXIAL SWITCH

Weatherproof coaxial relay for remote switching of r.f. sources. Designed for mounting on mast and remote switching up to 3 antennas. Not a rotating or stepping switch. Simplify installation, save money by running one cable instead of several to your antenna array.

See your dealer for catalog sheet and complete specifications, or write:	MODEL DK72 with UHF Connectors . . . . .	<b>\$22.95</b>
	With type N, BNC, TNC or C connectors	<b>\$26.95</b>

DOW KEY CO., Thief River Falls, Minn.

... WØHMK



# HERE'S THE ORIGINAL!

## MODEL TA-36

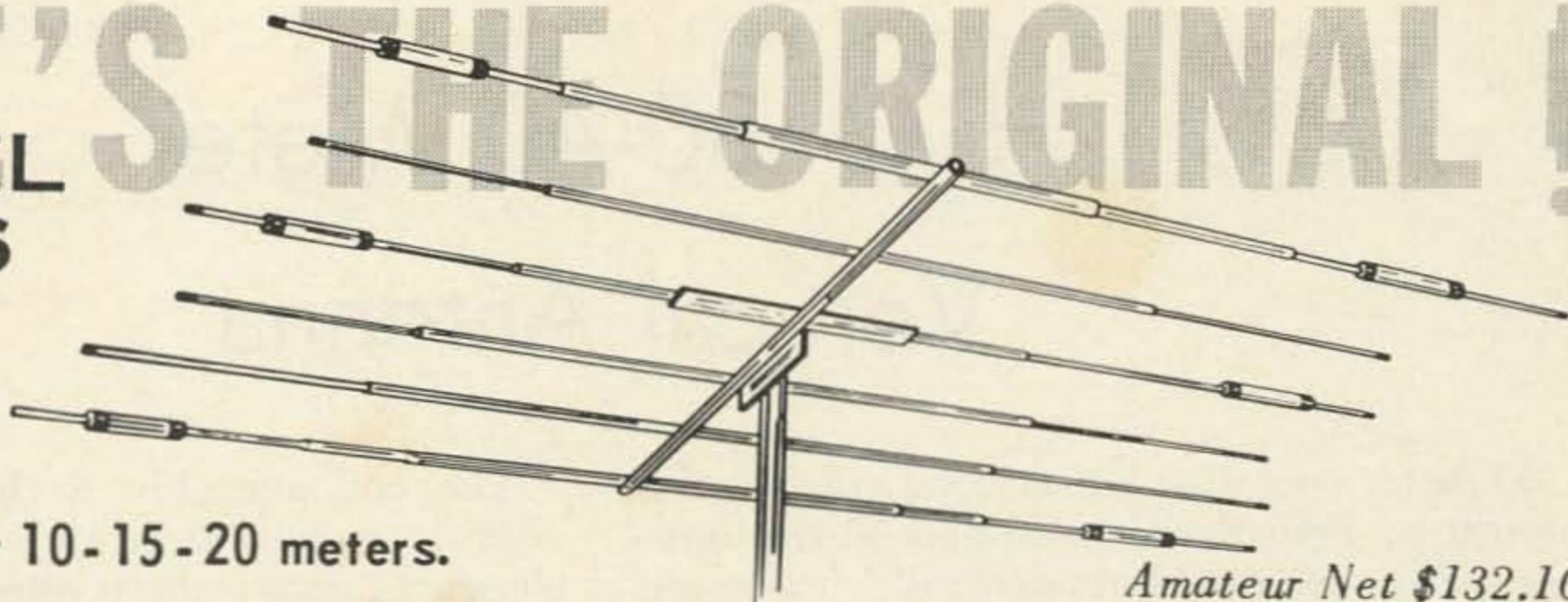

**TRAP  
MASTER**

for 10-15-20 meters.

Amateur Net \$132.10

The new Clean-line TA-36 . . . the three band beam that will give your signal that DX punch! This wide spaced, six element configuration employs 4 operating elements on 10 meters, 3 operating elements on 15 meters and 3 operating elements on 20 meters.

Automatic bandswitching is accomplished by means of exclusive design high impedance, parallel resonant "Trap Circuits". Built for operation at maximum legal amateur power.

Traps are weather and dirt proof offering frequency stability under all weather conditions. Just one coaxial feed line is needed. 52 ohm, RG-8/U is recommended.

Antenna comes complete with illustrated booklet and color coded elements for ease of assembly.

SPECIFICATIONS & PERFORMANCE DATA: ■ Fwd. gain, 10 meters - 9 db., 15 meters - 8.5 db., 20 meters - 8 db. ■ Front-to-back, 20 db. or better. ■ SWR, 1.5/1 or better at resonance. ■ Transmission line - 52 ohm coaxial. ■ Maximum element length, 29 ft. ■ Boom length, 24 ft. ■ Turning radius is 19' 3". ■ Assembled weight - 69 lbs. ■ Wind load (EIA Standard), 210.1 lbs. ■ Wind surface area, 10.7 sq ft.

**Mosley**

Export Division: 64-14 Woodside avenue, Woodside 77, New York.

Electronics Inc., 4610 N. Lindbergh Blvd., Bridgeton, Mo., 63044.

### KWM-2 Voltage Regulator

I use the KWM-2 transceiver on CW and found the keyed signal to have a chirp when driving a KW amplifier. This was caused by the amplifier loading down the line voltage a few volts.

The voltage regulator described here was installed, and the chirp was eliminated. Only the plate and screen of the vfo is regulated.

The VR assembly is a modified tube socket with an OA2 voltage regulator tube plugged into it. The modified tube socket along with the VR tube plugs into J-26, a spare phono jack on the chassis.

Underneath the chassis, the spare phono jack is wired to the former voltage divider consisting of R-73 (15K) and R-131 (33K), with the necessary change made as shown in the diagrams "before" and "after."

If the noise blanker is used, the VR tube is wired electrically the same, but must be physically mounted in another position since the noise blanker uses J-26.

The VR tube holder is made from an Amphe-nol seven pin "Zip-In" socket. All pins protruding from the bottom that are normally soldered to are removed except pins one and seven.

An RCA phono plug is pushed over the

center connection and a stiff piece of bare wire soldered from there to pin seven. The center post of the phono plug has its connection made by running a piece of insulated hook up wire, with one half inch of insulation removed, down through the center of the tube socket and soldering it to the center post. The free end of the hook up wire is bent down the side of the tube socket and soldered to pin one. The assembly is then plugged into J-26 and the tube installed.

There are three things to do underneath the chassis. First, remove the ground from R-131. Second, tape the end of R-131 so it will not short to anything. Third, run a wire from J-26 to the junction of R-73 and R-131.

When using an OA2 as a regulator, the theoretical value of the series resistor (R-73) should be 8.8K. A resistor was tried shunted across the 15K to give that value, but the chirp was not present with the relatively high value of 15K, so the original value was left in place, reducing the number of changes made to the unit. With the smaller value of series resistance, the OA2 glows with a brighter light and draws more current. Regulation will take place as long as the tube glows and does not extinguish at any time.

. . . WA4NXC



# Hi Q 80-40 Meter Vertical Antenna

80 meter operation has enjoyed considerable interest by both the General and Novice amateur. The reliable but generally moderate transmission range has been welcomed by the "old time" amateur for trouble-free "local" round table "rag chews," whereas, the novice, because of FCC restriction, is relegated to this particular niche in the spectrum.

To secure maximum transferral of power, the time proven half-wave dipole has been the standard method of radiation; however, few operators are fortunate enough to construct this type of system due to the demanding erection area. As a consequence, the vertical base loaded antenna has been the logical substitute. Notwithstanding several inherent defects, the small space requirements and low angle of radiation justify its employment.

## Construction

The radiator segment is constructed from two 12' lengths of telescoped aluminum tubing. The lower base section is  $\frac{3}{4}$ " diameter, and the upper section is  $\frac{5}{8}$ " diameter (both .058" wall) and telescoped about one foot. The uppermost part of the base section was slotted lengthwise and a  $\frac{7}{8}$ " stainless steel clamp positioned to secure both elements.

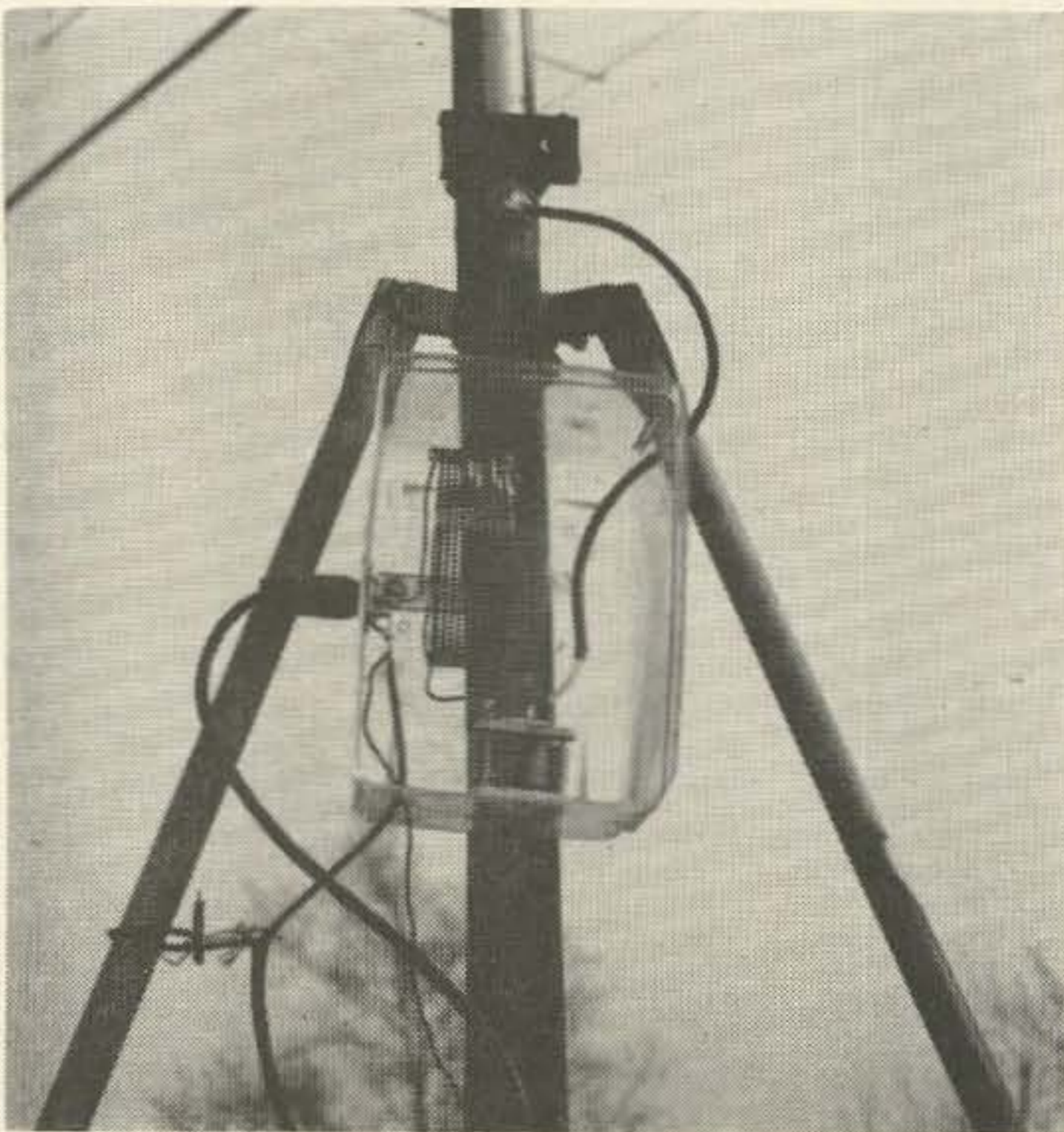

The coil assembly is the most electrically critical component feature. A HI-Q ratio was chosen to insure sharp attenuation of spurious harmonics since the proximity of a number of concentrated city-located television antennas

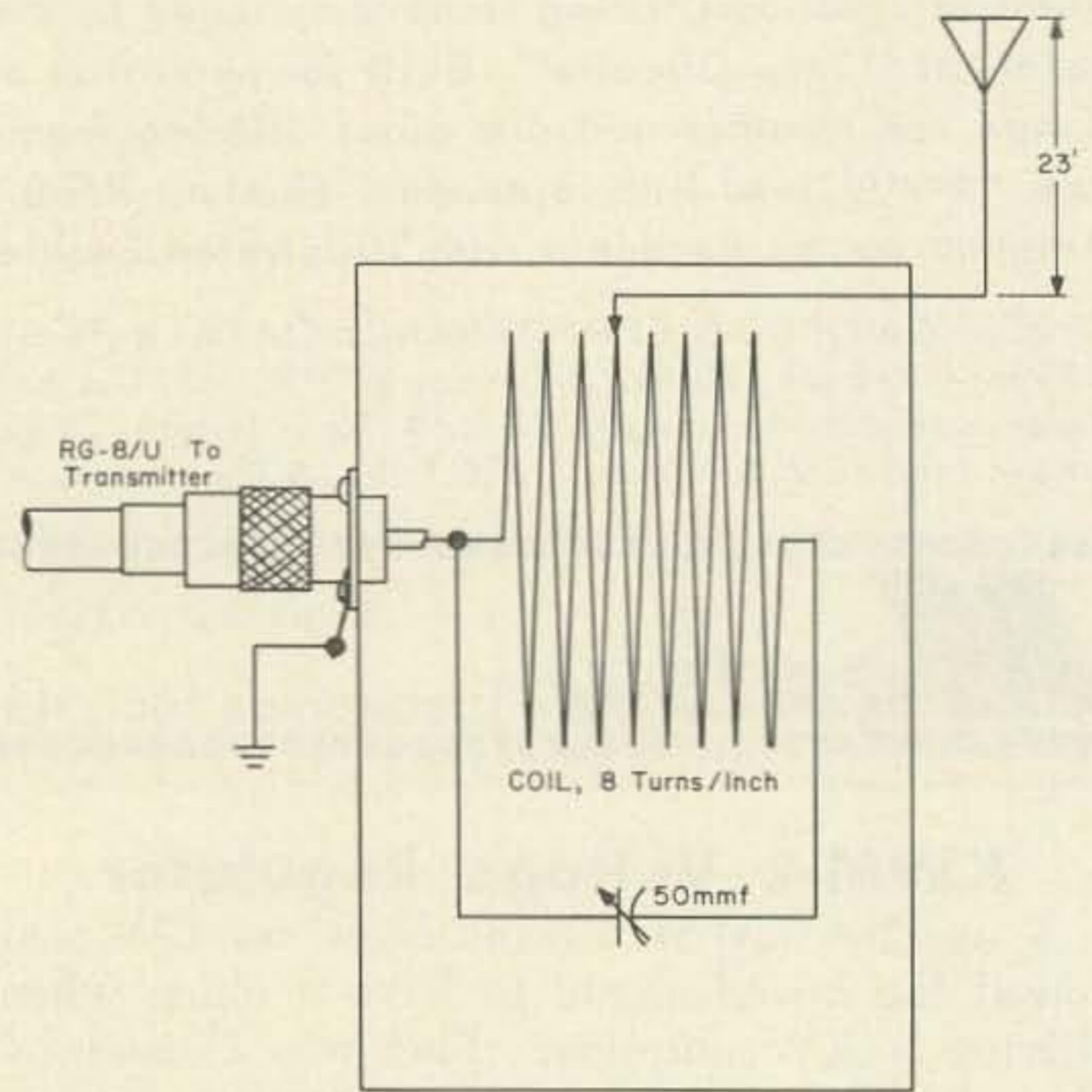

COIL ASSEMBLY

would normally have led to serious TVI complaints. The coil was constructed from #14 magnet wire stock. A tin can of  $3\frac{1}{2}$  inch dia. will serve as the coil form. Approximately 12-14 turns were close wound and removed from the form. Adjust 8 turns to occupy 1" insuring that equal spacing has been provided throughout. In order to reinforce the coil, short lengths of polystyrene strips ( $\frac{1}{4}$ " x  $1\frac{1}{2}$ " ) were placed across the winding and glued with liberal amounts of liquid polystyrene or Duco cement for low loss. One strip can be made somewhat longer and a hole drilled to allow for subsequent securement to a  $3\frac{1}{2}$  x 5 x 7" plastic food container. The container will afford a measure of protection from direct moisture accumulation. One end of the coil is soldered directly to the center terminal of a mounted SO-239 connector. A moderately spaced 50mmfd variable capacitor is placed across the coil to allow for initial tuning and/or retun-



# HERE'S THE ORIGINAL!

## MODEL TA-33

for 10-15-20  
meters.

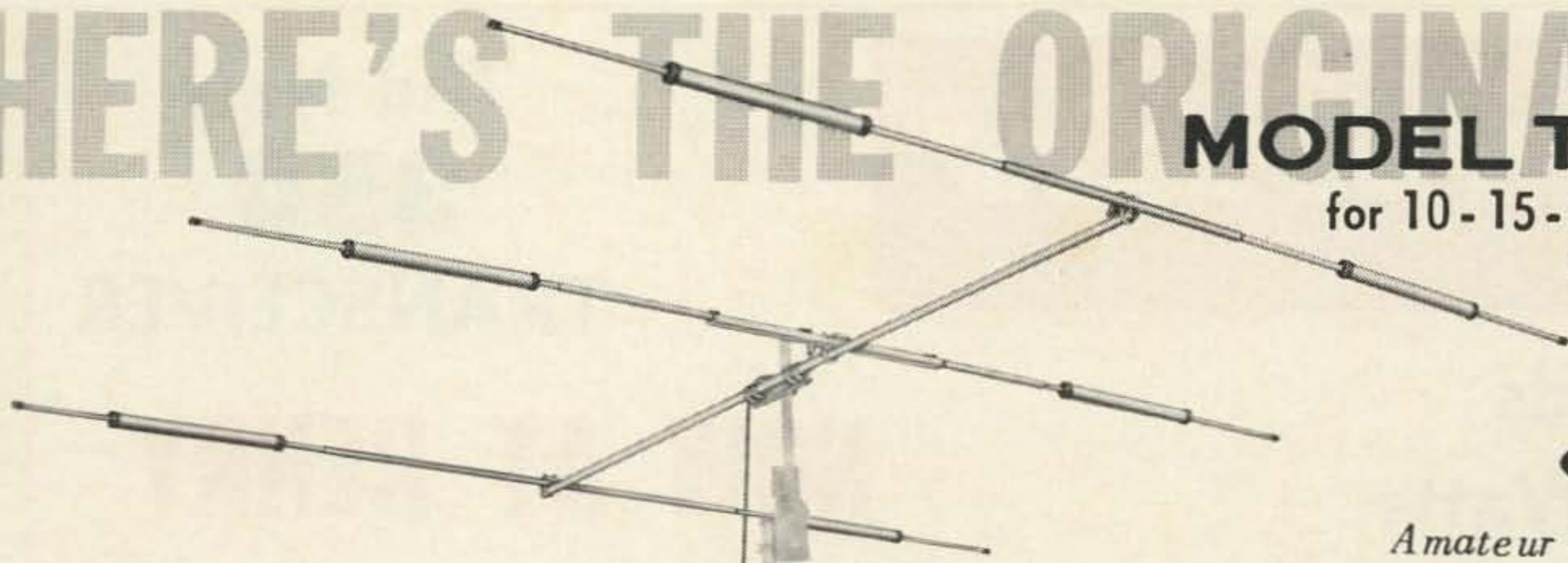

**TRAP  
MASTER**

Amateur Net \$104.75

Three element beam provides outstanding performance on 10, 15 and 20 meters. Exceptionally broadband for excellent results over full Ham bandwidth. Exclusive MOSLEY trap design provides resonant frequency stability under all weather conditions. Easily handles full KW, amplitude modulated. Traps enclosed in aluminum are weather and dirt proof. Element center sections of double thickness aluminum, minimizing sag. Boom requires no bracing. Heavy duty universal mounting plate fits masts up to 1½ inch O.D. Feed with one coax line. RG-8/U is recommended. See your nearest amateur equipment dealer or write for literature describing the TA-33, only one of the famous TrapMaster family of fine amateur antennas.

SPECIFICATIONS AND PERFORMANCE DATA: ■ Fwd. gain up to 8 db. ■ Front-to-back is 25 db.  
■ SWR, 1.5 or less, at resonant frequencies. ■ Maximum element length is 28 feet. ■ Boom length is 14 ft.  
■ Turning radius is 15.5 ft. ■ Assembled weight is 40 pounds. ■ Wind surface area is 5.7 square ft.  
■ Wind load is 114 pounds. ■ Shipping weight is 53 pounds.

**Mosley**

Export Division: 64-14 Woodside avenue, Woodside 77, New York.

Electronics Inc., 4610 N. Lindbergh Blvd., Bridgeton, Mo., 63044.

ing due to minor frequency excursions.

A short length of 58U cable is soldered 10 turns from the input terminal and the other end is connected to the vertical antenna base. A grid dipper tuned to desired frequency will assist in adjusting the capacitor-coil factor once the entire antenna assembly is operative. A resistive bridge placed in the line will indicate the characteristic 30-35 ohm resistive load. The antenna is coupled to the transmitter via 50 ohm cable with a minimum SWR reflection. A reasonably non-floating ground is necessary at the transmitter and SO-239 connector for proper loading and propagation.

For those interested in tuning the vertical for 40 meter operation, either a remote or manual low-loss ceramic shorting switch might be integrated to shorten the coil length to 4½ TPI from the input terminal. As a consequence, the assembly will be resonate at 7mc.

Although antenna placement is not especially critical, some care should be exercised to prevent resonating the vertical supports of neighboring TV antenna or similar power-absorbing objects.

The HI-Q characteristics of the coil results in a sharp dipper null at the operating frequency and will insure a maximum transferral of RF potential.

... WB2CQM

## WILL YOU HAVE TO

- Add a Plate Modulator For Full Talk Power?
- Add A Coax Relay To Switch One Output to Two Antennas?
- Add A Relay to Actuate A Coax T-R Relay?
- Add A Relay For Push To Talk.
- Add A Relay For Receiver Muting And VFO Control?
- Modify Your Rig For A 220 mc. Adapter?
- Add A Crystal Box For Convenient Crystall Selection?
- Use an External Dummy Load For Tune Up and Testing?
- Repair Frequently Because Your Rig Is Not Rated For Continuous Operation?

**Not if your first choice is the  
Amplidyne 621 which incorpor-  
ates all these features and more**

Order Direct or Contact Your Local Distributor  
Stocking Distributor of the Month: Harrison, N. Y.  
Write For Your Free Copy Of Our Latest Catalog.

**AMPLIDYNE LABS**  
KINGS PARK LI NY

516-AN-9-6186





# The New 350 TRANSCEIVER

**5 Bands  
400 Watts**

**NOW AT HENRY**

**World's Best Terms**

6% finance charge

10% down or trade-in down

No finance charge if paid in  
90 days

**Henry Radio Stores**

**TERMS ONLY**

**395.00!**

**Call us direct**

**"Use Area Code"**

Butler 1, Missouri	813	679-3127
11240 West Olympic, Los Angeles, Calif.	213	477-6701
913 North Euclid, Anaheim, Calif.	714	772-9200
431 East Green St., Pasadena, Calif.	213	684-0861
		MURRAY

**"World's Largest Distributors of Short Wave Receivers"**

### Transistorized AFSK

An AFSK unit using a unijunction transistor develops a saw-tooth oscillation, not a sign-wave, but it has worked very satisfactory on 2 meters with the W6NRM TU.

I built the original unit on a breadboard and it still is functioning well with its self contained battery supply.

In operation, I merely unplug the frequency shift cable running into the transmitter and insert into the transistor AFSK and adjust the frequency shift control on the TU to give the proper shift as indicated on the tuning eye and scope.

In the unit I used a 2N492 transistor which is rather expensive, but a 2N1671 Texas Instrument should work as well. The voltage used was 20 to 30vdc. Caution must be taken in conjunction with the unijunction not to ground the emitter in operation, for this will damage the junction.

5V rms was developed on the audio output which will drive any audio circuit.

The unit may be used as MCW oscillator by breaking the battery supply and inserting a key.

Joel Eschmann K9MLD

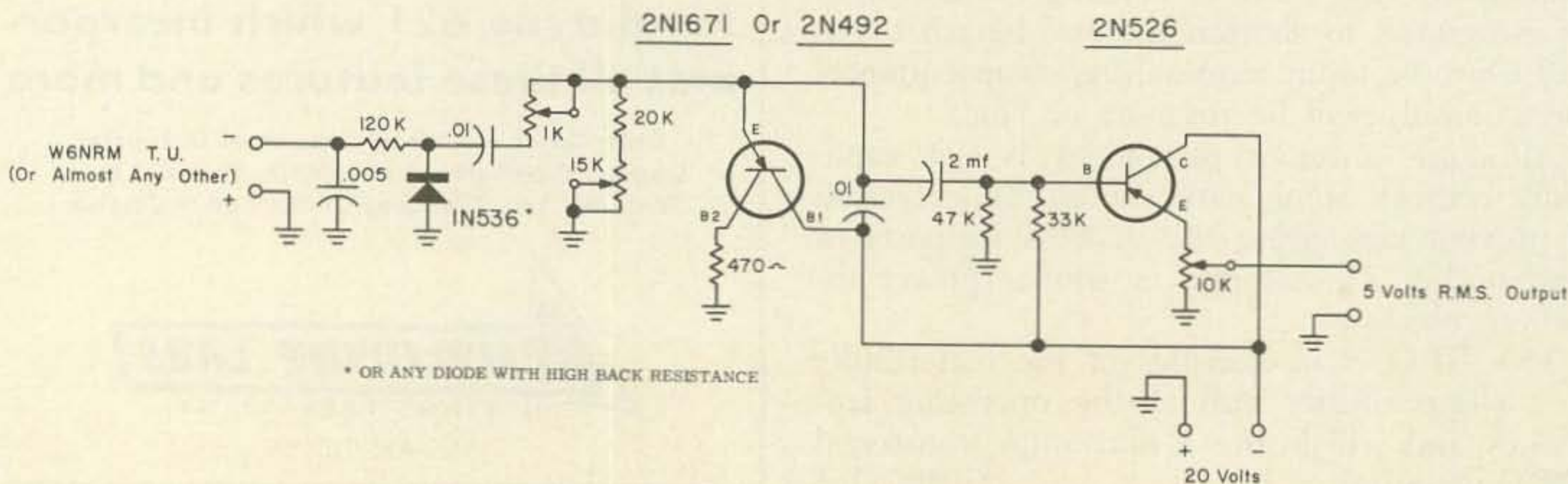



ONCE AGAIN SWAN LEADS THE FIELD BY INTRODUCING THE MOST TREMENDOUS TRANSCEIVER VALUE EVER OFFERED TO THE RADIO AMATEUR!



If you want the finest voice quality with maximum talk power at the most reasonable price . . . then you must see . . .

## THE NEW **SWAN-350** TRANSCEIVER



**5 BANDS — 400 WATTS — \$395**  
**HOME STATION — MOBILE — PORTABLE**

- 3.5 - 4.0 mc, 7.0 - 7.5 mc, 13.85 - 14.35 mc, 21.0 - 21.5 mc, 28.5 - 29.0 mc (10 meter full coverage kit available.)
- Transistorized VFO, temperature and voltage stabilized.
- Precision dual-ratio tuning.
- Crystal lattice filter.
- ALC . . . AGC . . . S-Meter.
- 5½ in. high, 13 in. wide, 11 in. deep.
- 400 watts SSB input  
320 watts CW input  
125 watts AM input
- Sideband suppression: 40 db  
Carrier suppression: 50 db  
Third order distortion: 30 db
- Lower sideband on 80M and 40M.  
Upper sideband on 20M, 15M, and 10M.  
(Opposite sideband kit available.)

*SWAN SPEAKS YOUR LANGUAGE and continues to set the pace with unequalled performance, proven reliability and superior craftsmanship.*

**ASK THE HAM WHO OWNS ONE!**

**ACCESSORIES:**

- AC power supply, matching cabinet with speaker. Model 117-C.....\$ 85
- 12 Volt DC Power supply. Model 412.....\$130
- Plug-in VOX. Model VX-1 .....\$ 35
- Accessory kits to be announced.

**SEE THE NEW SWAN-350  
 and THE DELUXE SWAN-400  
 AT YOUR DEALERS NOW!**



**SWAN**

**ELECTRONICS CORP.**  
 Oceanside, California









easily replaced by the usual cigar lighter receptacle plug.

The platform for the transceiver was made from masonite with four plastic cups of the type used under table legs fastened on the platform to prevent the transceiver from sliding. Two metal straps are fastened to the front of the platform to which are attached springs with metal clips bent to hook under the lower edge of the car's dash board. The rear edge of the platform has two holes through which a piece of venetian blind cord is threaded. The cord is tied to a piece of wood which holds against the back edge of the driver's seat.

With the platform hooked to the dash board, adjust the cord to hold the platform's edge on the edge of the front seat.

The transceiver will now have a nice shock mounted base and its front panel will be in a most favorable position for operation by either person in the front seat. The antenna cable is routed under the front seat and out the rear window to the antenna.

The antenna used is a Halo designed especially for this installation which is light weight and very simple to construct. The aluminum tubing used was 20 inches long (approx.  $\frac{1}{4}$

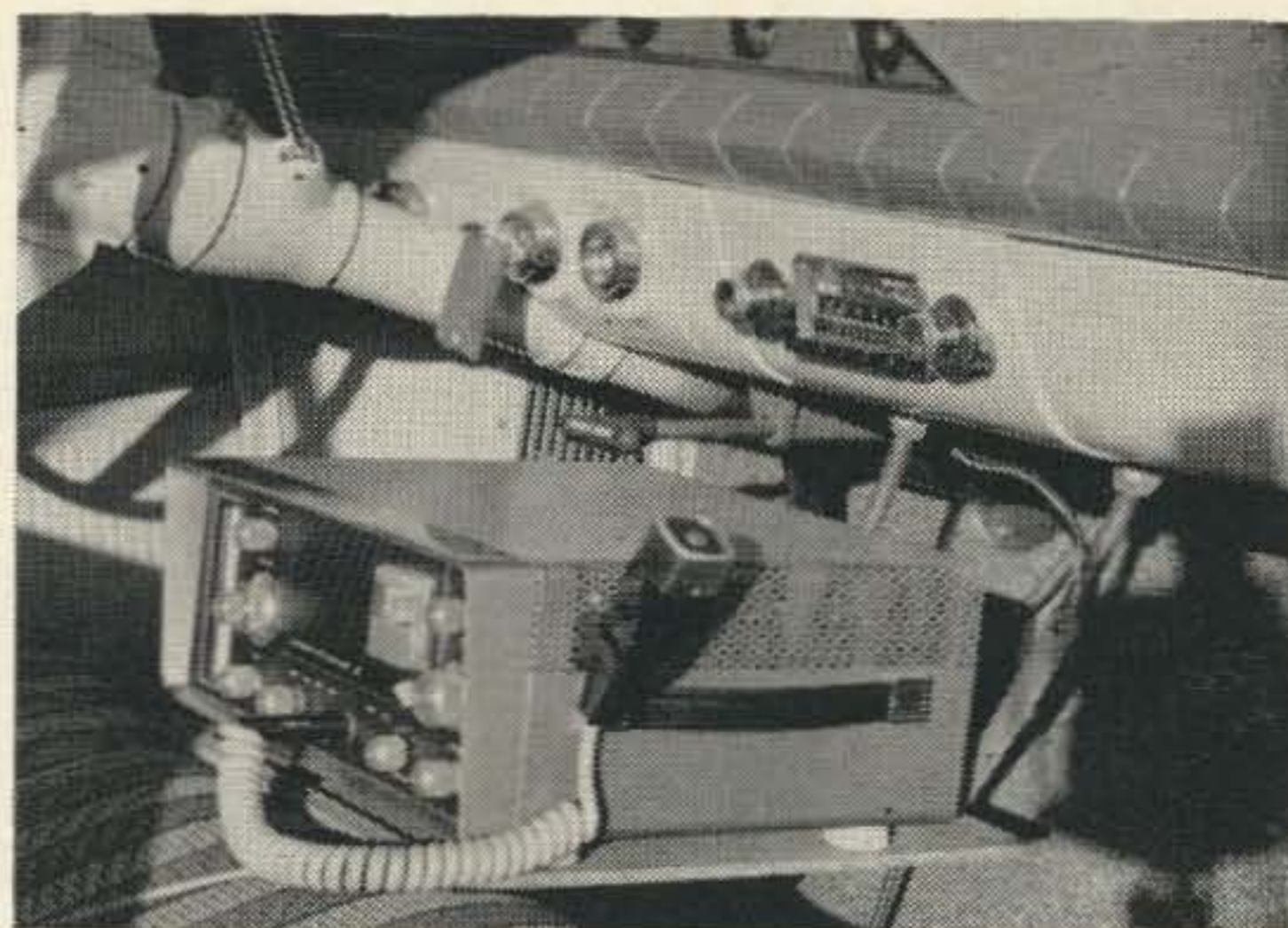

Details of transceiver installation.

wavelength) to allow placing the halo in the center of the car's metal roof. A surplus magnetron magnet holds the antenna to the car roof at all legal speeds and then some. Thin mylar type was used on the pole faces of the magnet and a plastic plug cap was placed on the tubing's lower end to protect the car.

The halo antenna's element is made from flat stock of 24 ST aluminum which is the springy variety. This allows bowing a flat piece into the circular shape. A simple gamma match made from a piece of  $\frac{3}{8}$  aluminum tubing having a short piece of wire (inner part of a piece of RG-8/U) inside of it for capacitive

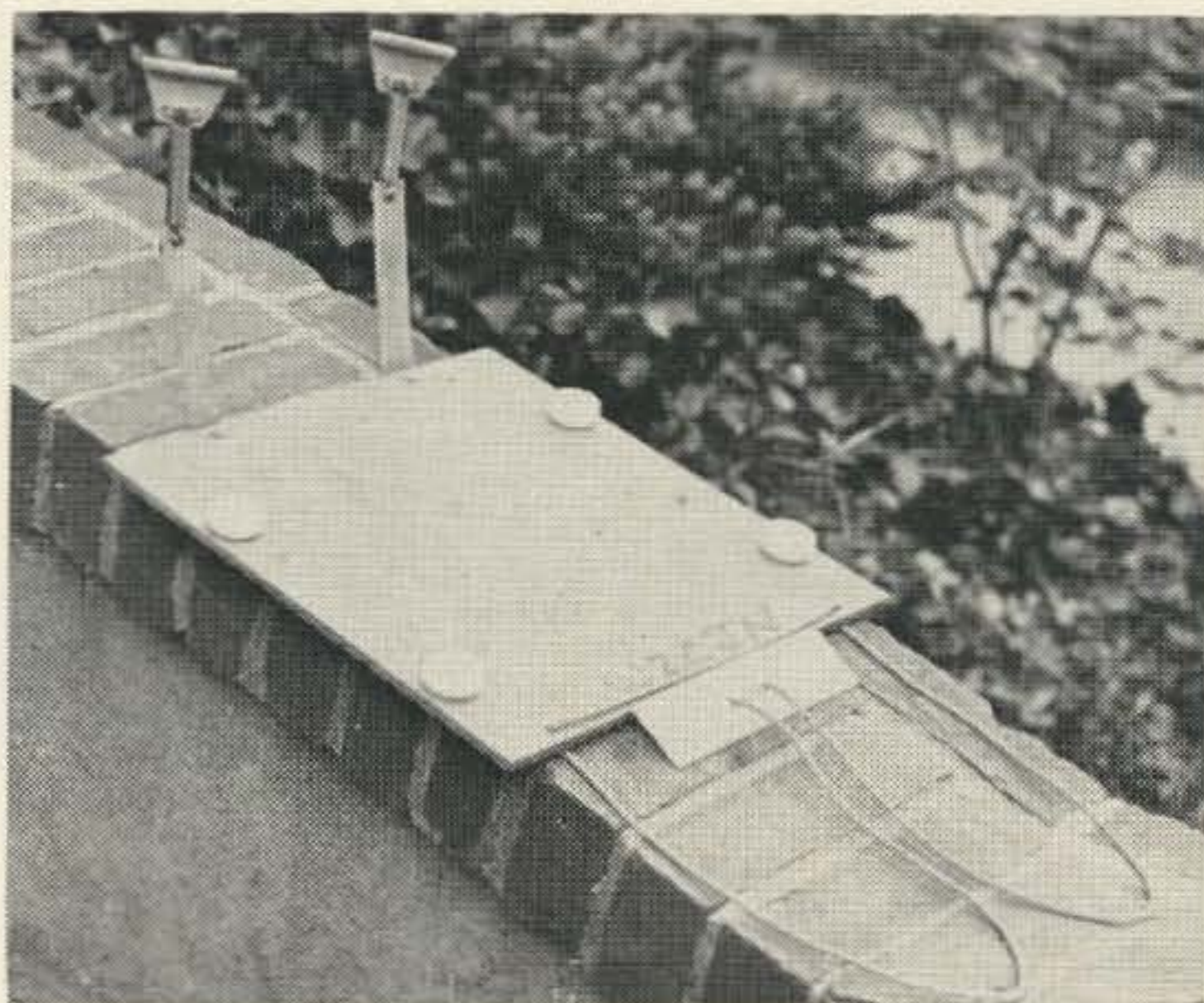

Platform for transceiver.

coupling to the tubing. No adjustments are included for the VSWR should be under 2:1 over the 2 meter band if it is constructed as shown. The nominal impedance of this halo is 50 ohms. The spacing between the ends of the main element will increase or decrease the frequency band at which the optimum VSWR is obtained.

The performance exceeds that of the other 2 meter mobiles in our CD net and has been completely satisfactory in all respects.

... W2CJN



# Mobile Phone Patch

## (For Home Use Too)

Have you ever been mobiling through a strange town, or even your own area, and worked someone who said to you half jokingly, "If you only had a mobile phone patch, I could speak to Aunt Emily, or Lisa, my best girl."

Well, you can! The hero of this article, usable at any pay phone without any wire connection (and suitable for use without connections at the home QTH's phone, as well), is a coil of 200 to 500 turns which can be wound using any insulated wire. Any wire size from No. 26 to 45 will do—the finer the wire the better, because of the greater number of turns that can be put on the coil in a given space. The form for winding the coil is any cylindrical surface about 2¼ inches in diameter and at

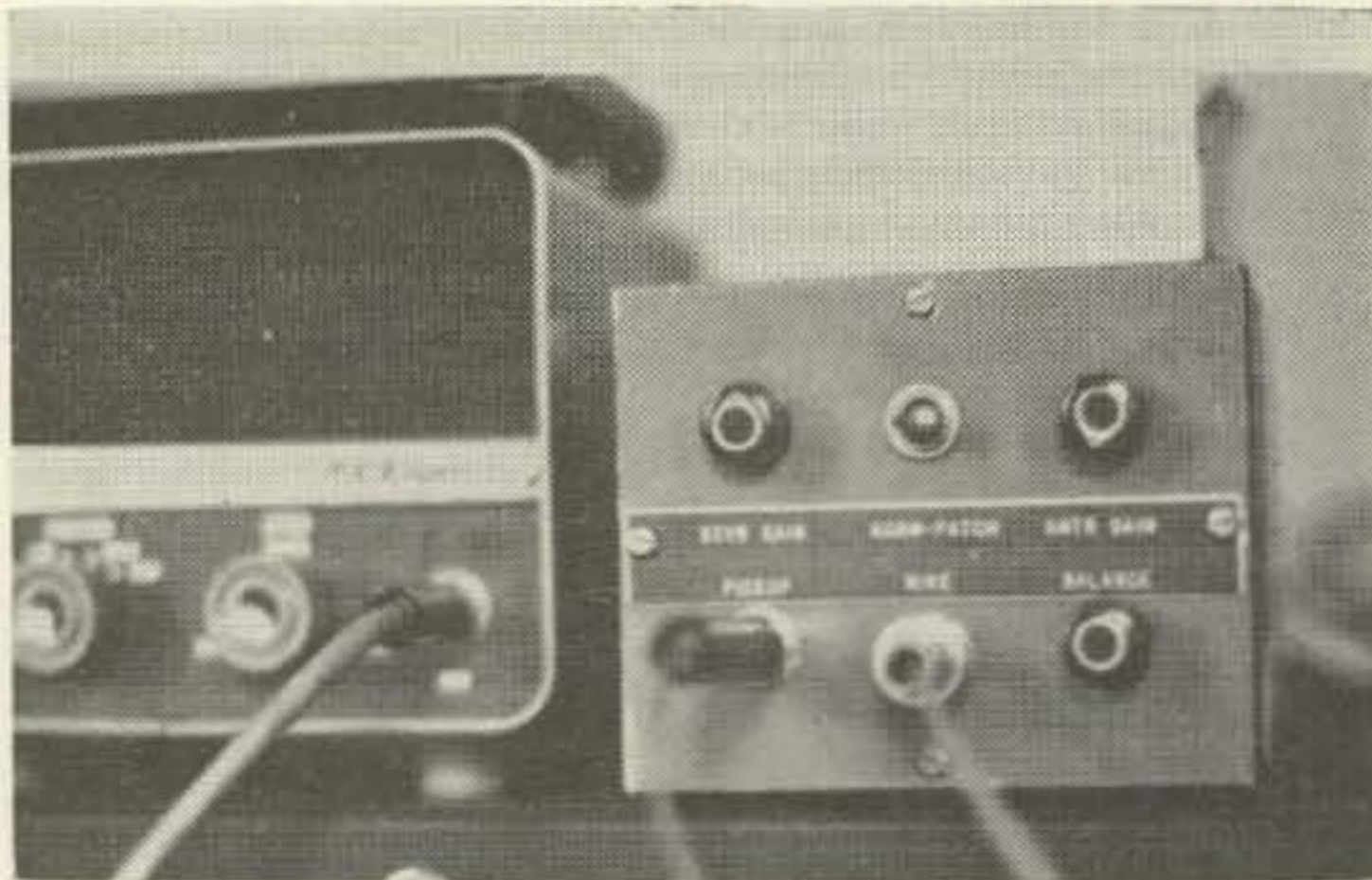

Patch at home.

least ½ inch long. Since the coil is designed to eventually go around the outside part of the ear piece of a type F, G, or H telephone handset, the telephone ear piece may also be used as the form.

Wind one or more layers of vinyl tape on the handset ear piece or winding form, *sticky side out*. The coil turns are then scramble wound onto this tape (cardboard may also be used instead of tape). The ends are then soldered to leads and taped after sliding the core off the form. The number of turns and their final O.D. will determine whether or not you will be able to leave the "wireless connection," used for receiving the phone signals and transmitting to the phone, permanently in place

on your home telephone or not. If you wish to do so, the outside diameter of the coil, plus tape wrapping, cannot be greater than the space between the ear piece and the cradle. This

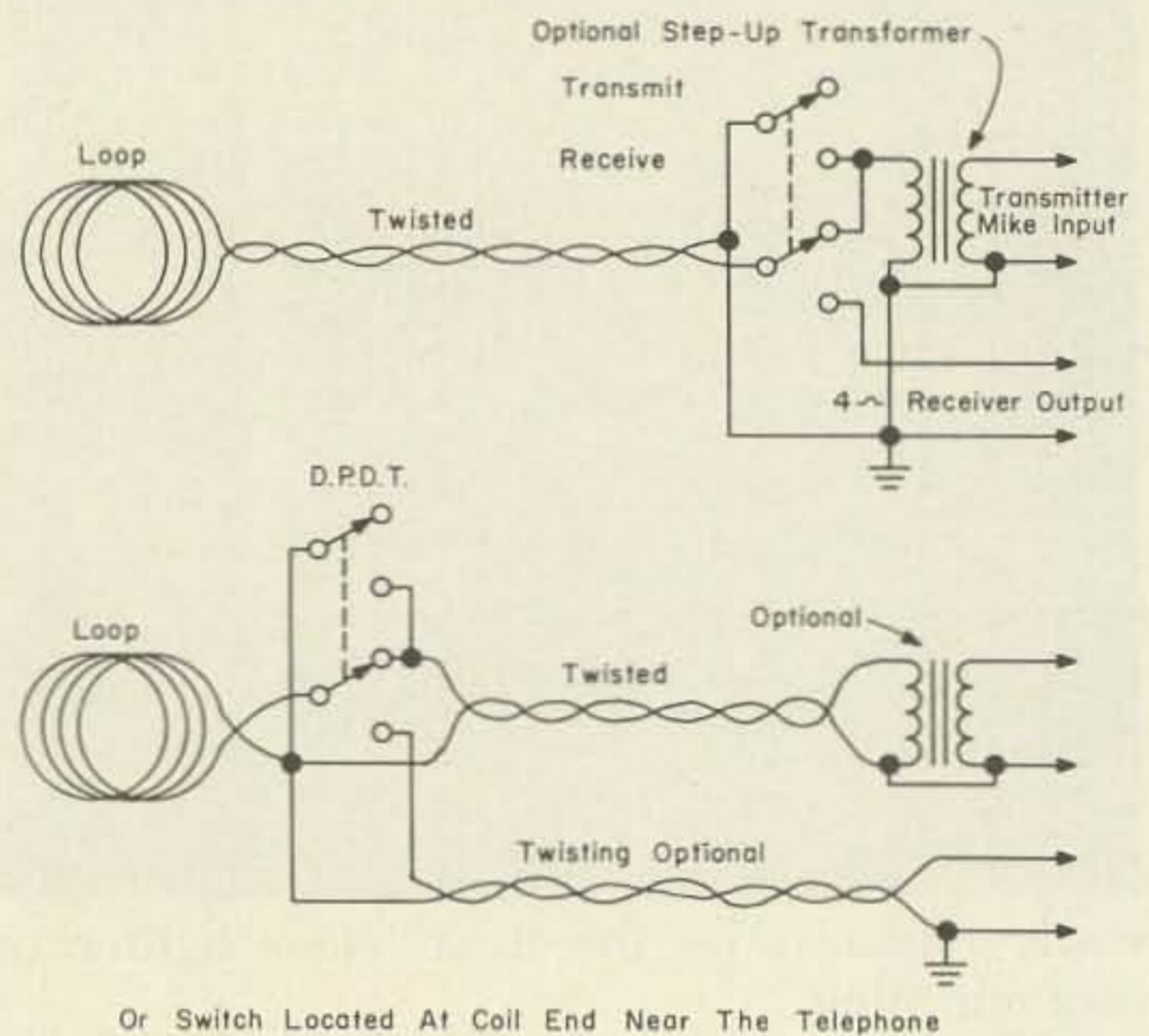
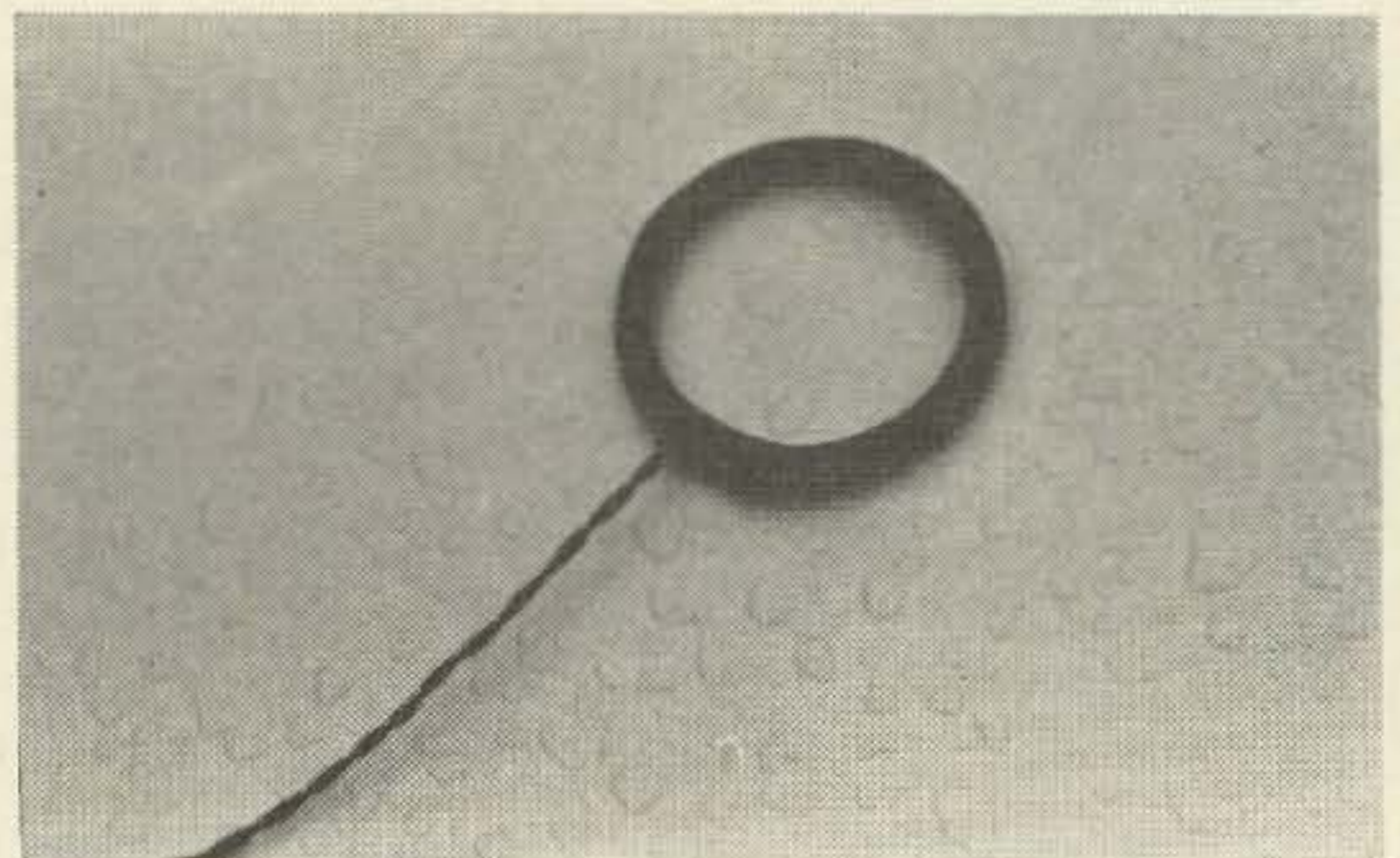

FIGURE 1

will still allow the telephone to be hung up with the coil in place. If you wish to remove the pick-up and playback loop after phone patching, as you should do at a pay station, then there is no limitation to the outside diameter. The inside diameter should be as close to the ear piece wall as possible and is limited only by the final wrapping of tape used to hold the coil together in one piece and protect it and the leads from damage.

The simplest version of the wireless phone



Pickup-feed coil.



patch consists of the coil, one or two sets of leads, and a double pole-double throw snap or

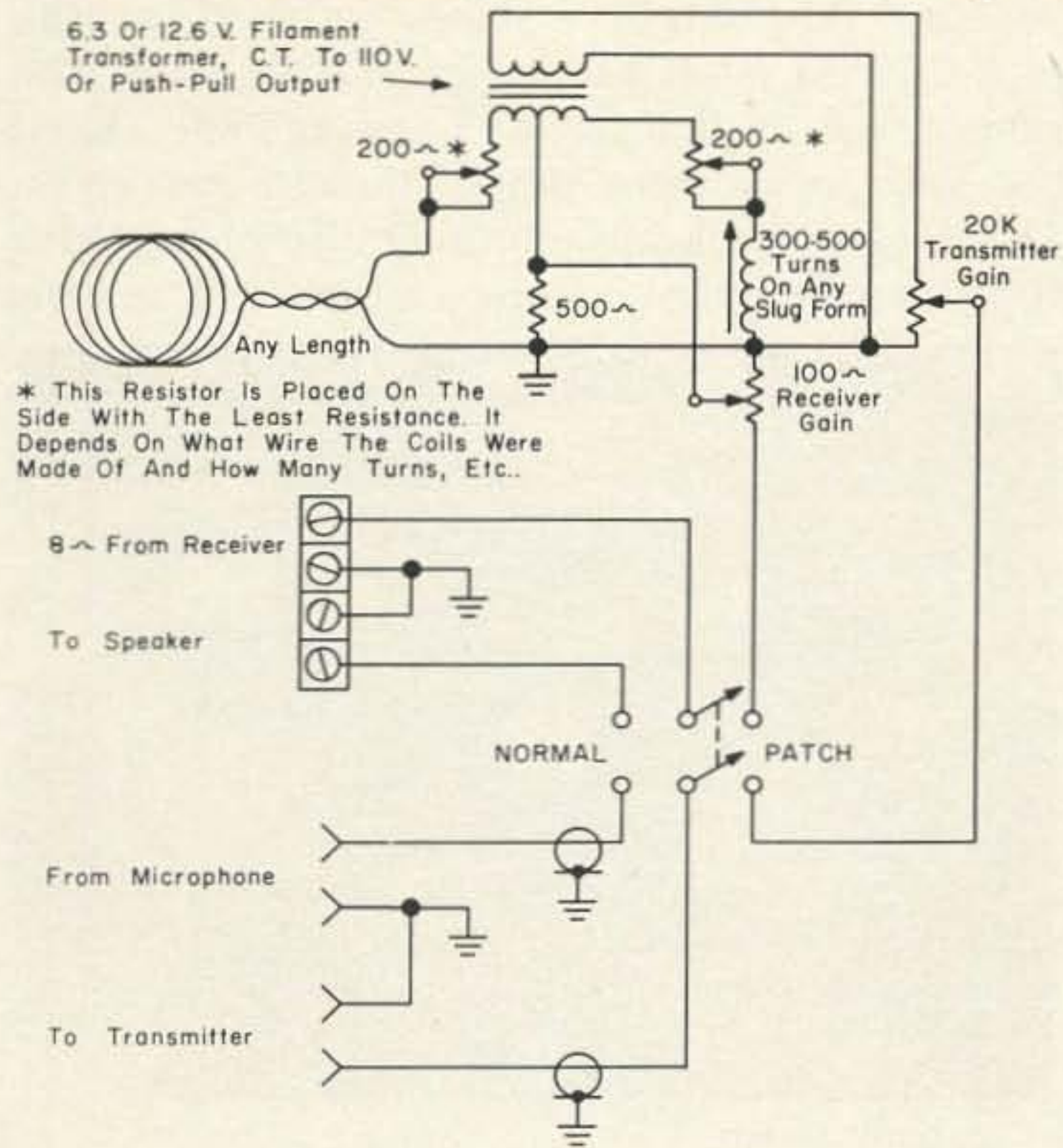
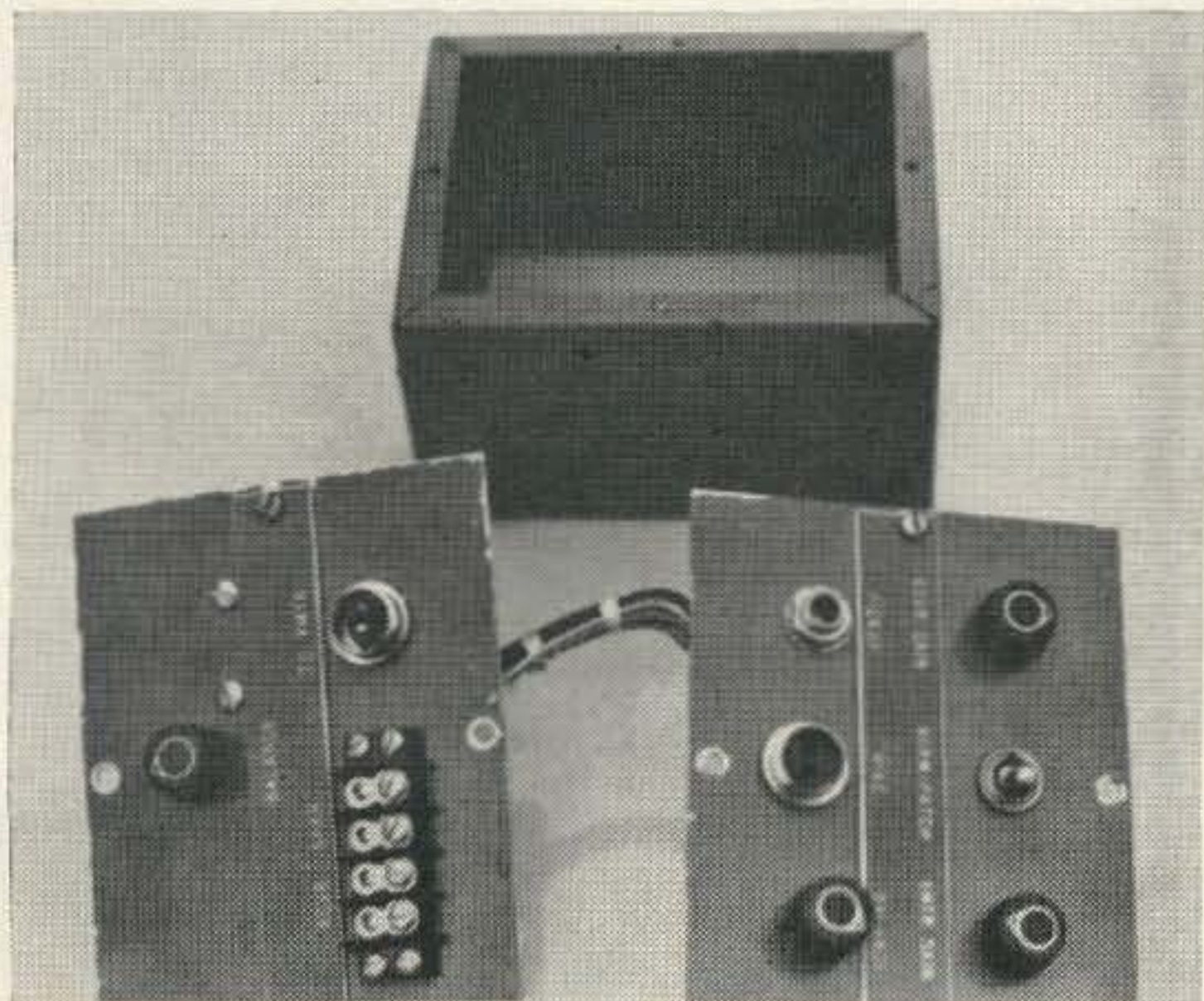

FIGURE 2  
"STANDARD" VERSION

slide switch. Whether one or two sets of leads are used depends on where the switch is placed (at the loop end and of the rig end). Because of the low impedance of the pick-up coil, there may not be enough gain to operate the microphone input of a transmitter directly. In such cases, an output transformer, used backwards, of 1000 to 2000 ohms to voice coil, or a step-down 100 v to filament voltage also used in reverse, or an inexpensive transistor output to speaker transformer may be used to better match the pick-up loop with consequent voltage gain in the mike input circuit (Fig. 1).

The adjustment of the simple patch is accomplished quite easily. With the switch on



Patch disassembled, front view.

"transmit" position, a normal telephone voice is picked up on the patch and the transmitter mike gain is adjusted for proper average modulation. On "receive" position when the output of the receiver is fed to the coil, the level, as heard in the earphone part of the telephone, should be about four to five times louder than you would normally hear on a telephone. A check of the actual level on the line (which is much lower) is easily obtained from the party on the other end, or by making tests with a cooperating friend or ham at the other end of the land line. The reason why the telephone will be four to five times louder is that there is a severe loss of audio going back through

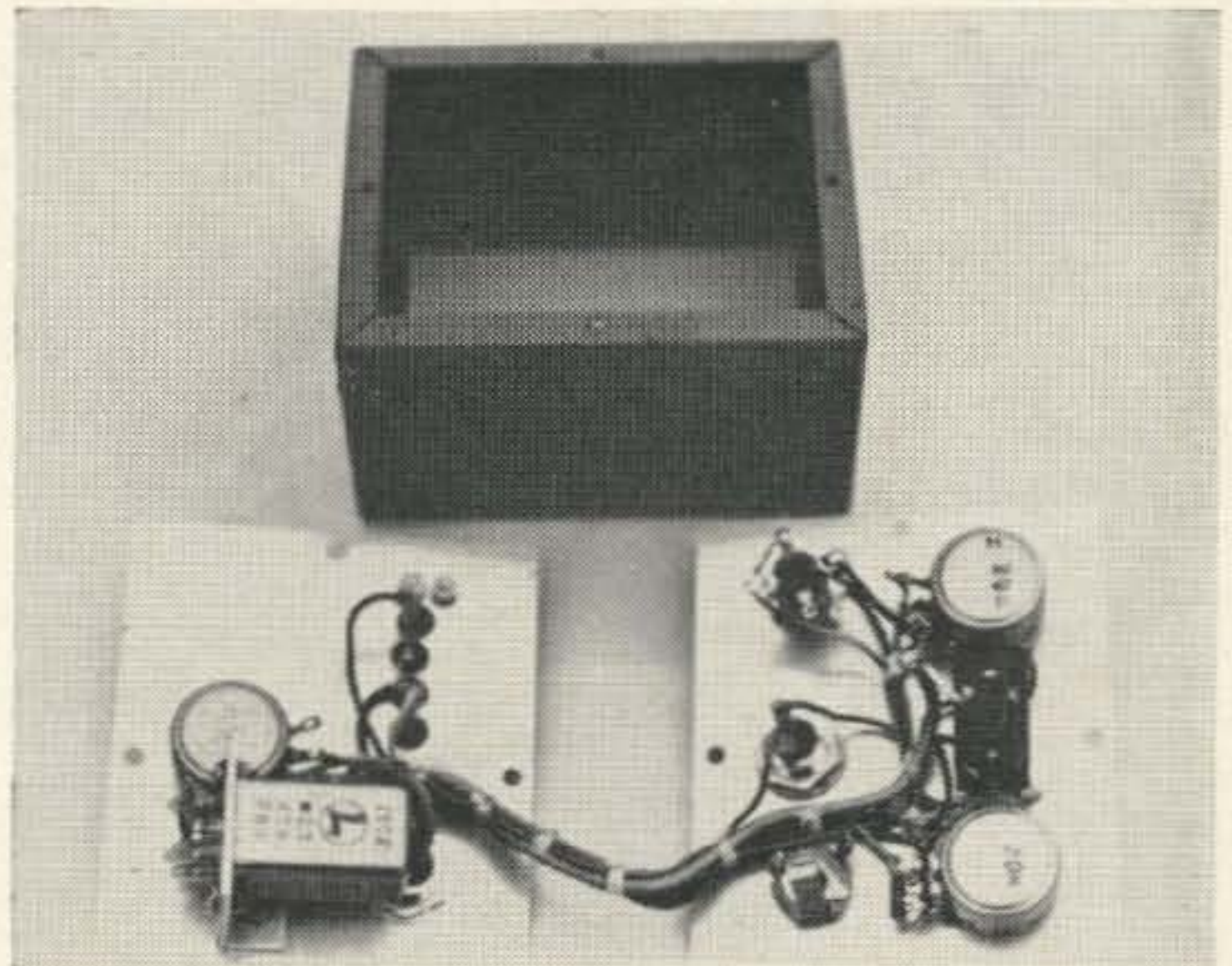

Rear view.

the telephone receiver path back down the line, but much less loss for signals coming into the line from the remote telephone. Monitoring of the patch may be done by using the telephone itself to listen to both ends of the conversation, and you may break in and speak, using the telephone mike for both your own transmissions as well as to talk to the party on the remote end of the line at the same time.

This simple pick-up with a matching transformer may also be used in place of a direct wire connection, if there is enough gain in a standard hybrid phone patch, or, as shown in Figs. 2, & 3, you may construct your own out of junk box parts. In the simplified version (Fig. 2) it is necessary to insert resistance in series on one side of the balancing arm or the other, depending upon which coil has the lower resistance. If the balancing coil has more resistance than the pick-up coil, it is necessary to insert additional resistance in the pick-up coil arm for proper balance. If a pick-up transformer is used, as in the de luxe version (Figure 4), the balancing arm will usually consist of resistance only. The adjustment for best balance is obtained by placing a pair of earphones across the hybrid coil output to the



transmitter. The balance is then adjusted until the sound, as fed from the communications receiver, is heard at the transmitter side at the lowest level possible.

Because of the low impedance of the pick-up loop, it has not been found necessary to shield it. However, it is desirable to twist the leads

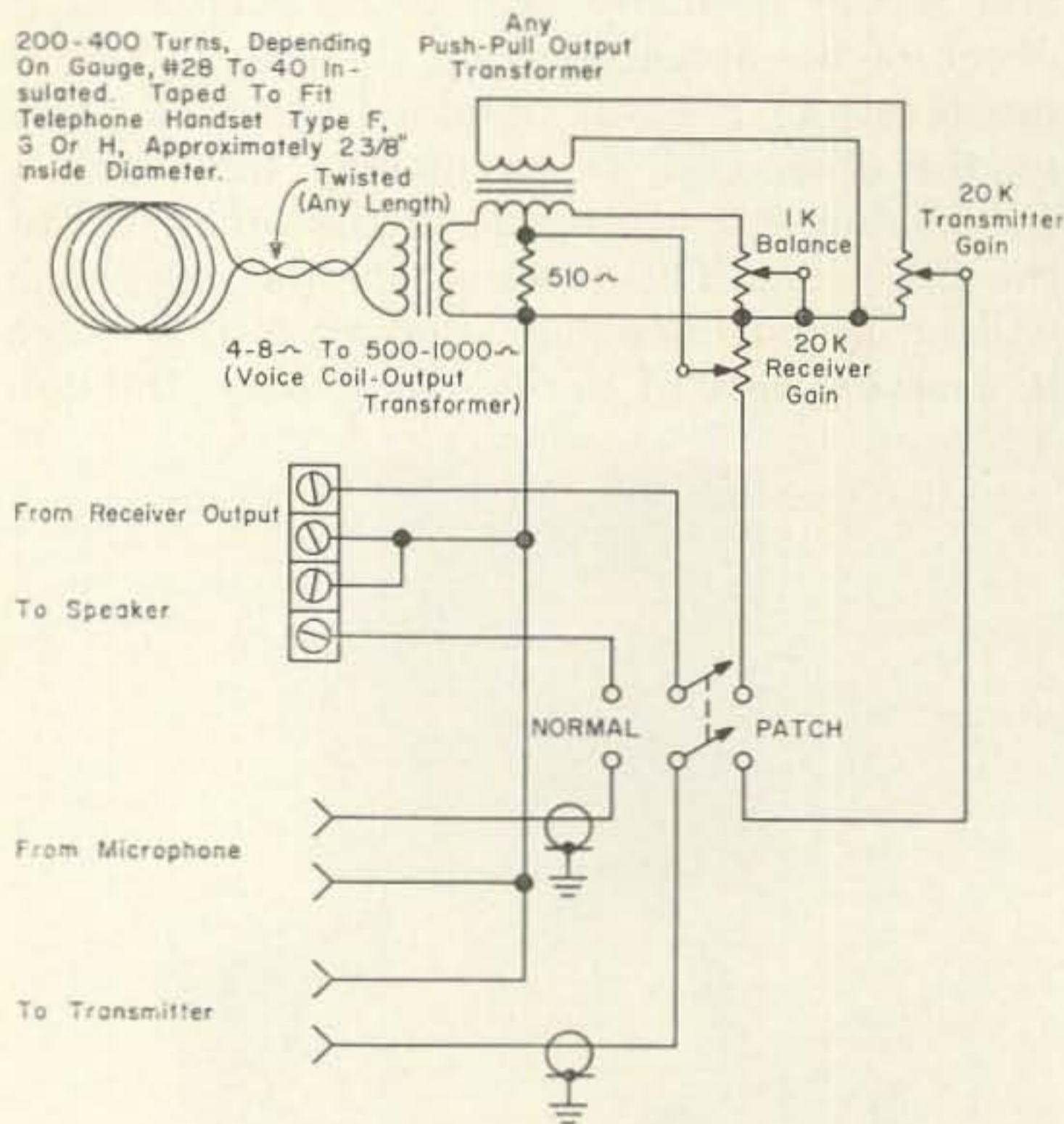
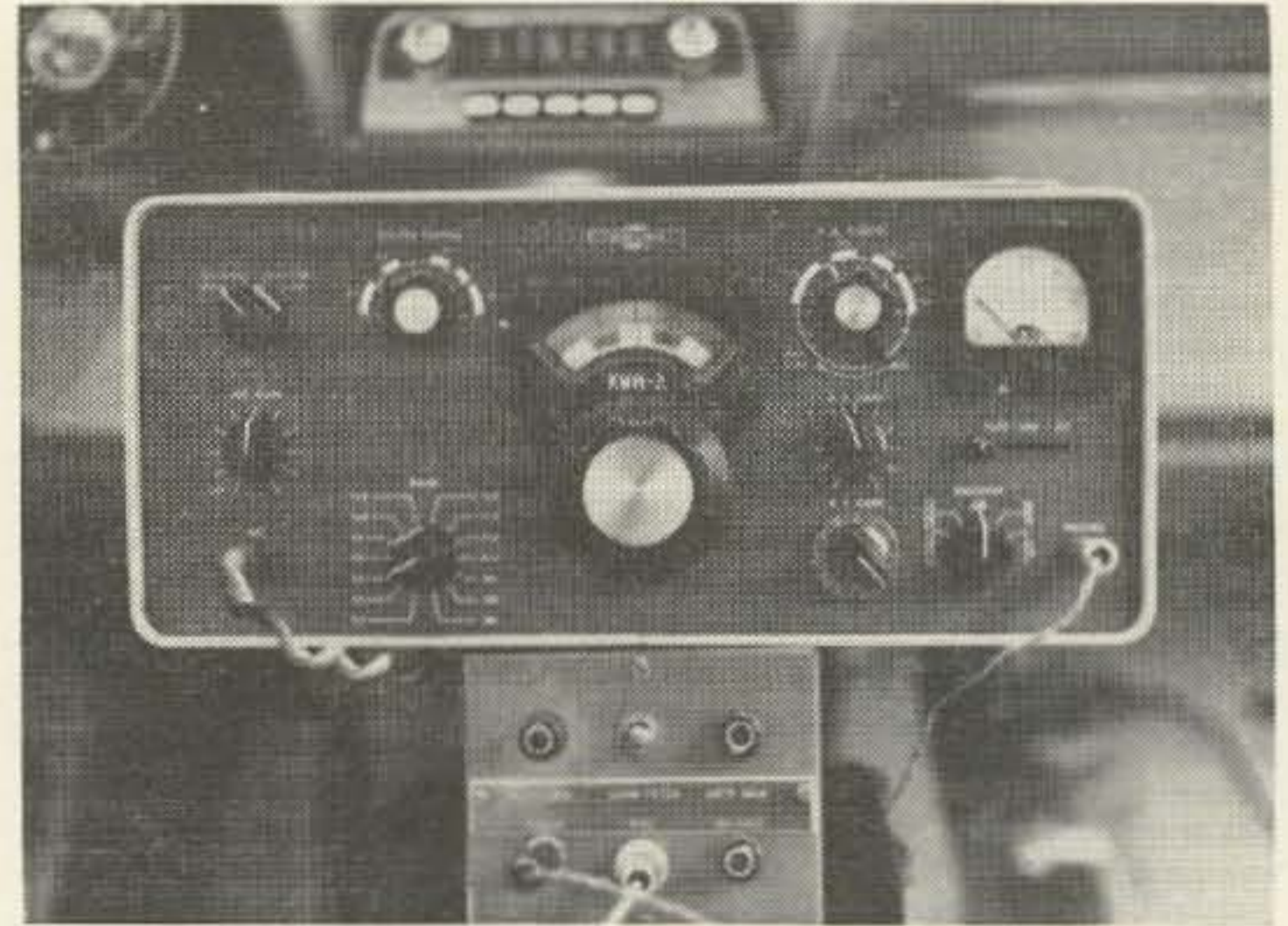

FIGURE 3  
"DELUXE" VERSION

from the pick-up loop to the transmitter input in order to minimize noise and hum pick-up, because the output voltage induced in the pick-up coil from the telephone is about the same level as that from a microphone. Keep the loop away from power transformer cores.

The same pick-up loop may also be used for recording telephone conversations on a tape



Mobile patch.

recorder by connecting the pick-up loop to the tape recorder in place of a microphone. Similarly, the output of the tape recorder may be played back through the telephone by feeding

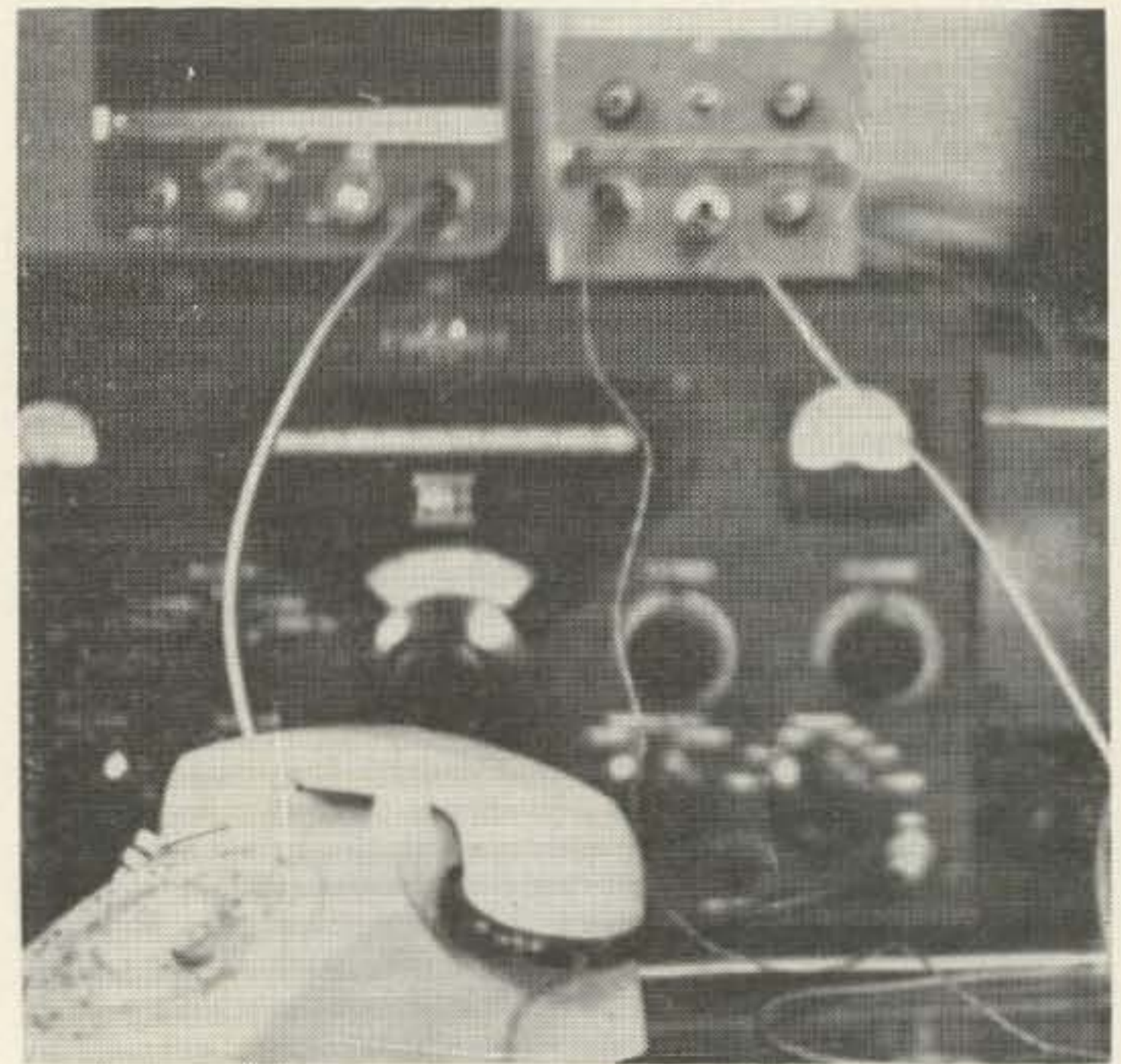

Note coil in place on telephone.

the low impedance output (4 ohms or so) back through the pick-up loop.

The pictures show one version of the patch as constructed in a Bud, 3" x 4" x 5" case. One installation is mobile with a KWM-2, the other at the home QTH with a KWS-1.

P. S. After concluding your mobile patch, don't forget to reclaim the pick-up coil and hang up the receiver, before driving away from the pay telephone. You'd be surprised how many pick-up coils you can lose this way!

... W2LNP

## F. M. SPECIALS

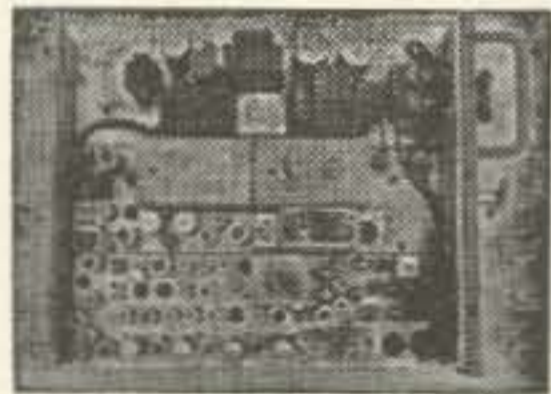

MOTOROLA T44A

432 MC FM CRYSTAL CONTROLLED MOBILE Motorola T44A-6 6/12 DC Power Supply 18 W Transmitter 2C39 Tripler 2C39 Final Receiver is triple-superhet with 0.8 uv. sensitivity. Simple mechanical changes necessary to convert these 450-460 MC units to 432 MC

All Units Complete with 2C39s and Crystal Info., and Schematics

T44A-6 ..... \$52.50  
T44A-6A Later, Improved Version ..... 64.50  
Cases for above ..... 2.50

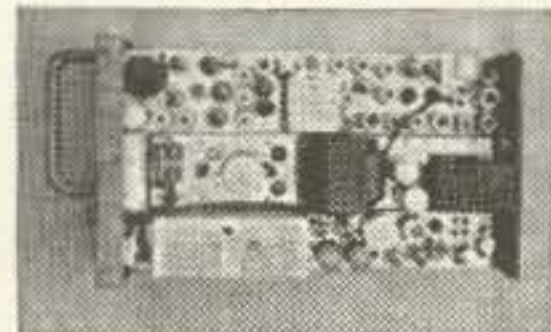

FMTR-41V

150 MC CRYSTAL CONTROLLED MOBILES Motorola 41V 10W RF 2E26 Final 12VDC Schematic Included

FMTRU-41V 12VDC ..... \$34.95  
Cases for above ..... 4.00

SEND FOR LATEST FLYER  
SALES LIMITED TO AMATEURS  
NO CONTROL HEADS OR  
CABLES AVAILABLE

**F M SURPLUS SALES CO.**

1100 TREMONT ST., ROXBURY 20, MASS.  
617-427-3513



# NEWS

## B & W OFFERS AMAZING Model 6100 TRANSMITTER **FACTORY DIRECT!**

OR THROUGH  
YOUR LOCAL  
DISTRIBUTOR



# NOW ONLY

# \$495<sup>00</sup>

NO  
TRADES

FOB FACTORY

**Here's why B & W's Model 6100 has been called  
the "Most Amazing Transmitter of Our Time"!**

- The Barker & Williamson Model 6100 Transmitter has been engineered and built to give the discriminating operator the ultimate in SSB, CW and AM communications.
- The 6100 uses the B & W crystal controlled frequency synthesizer, producing an order of stability which up to this time has been available only in costly military and commercial communication systems.
- The crystal lattice filter method of sideband generation is employed. Superior sideband suppression results.
- Solid state rectifiers are used.
- Dual automatic level control (ALC) with adjustable threshold prevents overdrive of output stages.
- Digital Dial System offers a high degree of dial accuracy.

**WIRE, WRITE OR PHONE - FACTORY DIRECT - DEPT. M**

## **BARKER & WILLIAMSON, Inc.**

A SUBSIDIARY OF RENWELL INDUSTRIES, INC.

Complete Radio Communication Systems and Equipment

**Beaver Dam Road, Bristol, Pa., • 215 788-5581**





# Operating Notes On The KWM

Robert Renfro Jr. WA4NXC  
6329 Teresa Ave.  
Charlotte 14, North Carolina

The notes given here pertain mostly to the operation of the KWM-2 transceiver in the CW mode, and were obtained in a two year period of operation of the unit both on SSB and CW.

On CW, a tone is fed into the audio circuits to activate the vox circuits and generate the output signal. The tone frequency is fixed at 1500 cps and the amplitude is adjustable with the MIC GAIN.

The output signal is composed of several frequencies, all of them suppressed to a high degree except the desired one. The desired signal is higher in frequency than the dial reading by 1.5 kc. Another signal present is the carrier which is at the indicated dial frequency and suppressed 50 db from the desired signal. The degree of suppression is determined by the adjustment of the balanced modulator. When adjusting the balanced modulator, the upper side band should be favored to result in a cleaner CW signal. 1.5 kc below the dial reading is another signal, the lower side band and is suppressed 50 db from the desired signal. The balanced modulator does not affect the degree of suppression on this signal, it is determined by the mechanical filter alone.

If the MIC GAIN is advanced further than recommended, clipping will occur in the balanced modulator and harmonics of the 1500 cps tone frequency will be generated and cause more spurious signals to appear in the output, even through they are outside the passband of the mechanical filter.

To exactly zero beat a received CW signal, an easy way is to match the beat note of the received signal with the internal tone. The level of the received signal and the internal tone should be approximately equal. The internal tone level is adjusted with the af gain and the received level with the rf gain. When they are about the same amplitude, they can be matched in frequency within a couple of cycles or better by tuning for a zero beat between the two tones. This is similar to tuning

a musical instrument against a tuning fork. When the signals are matched, the beat note of the received signal will be exactly the same as the internal tone generator, or 1500 cps. When transmitting, the transmitting frequency will be exactly zero beat with the received signal. To keep the transmitter from coming on during the matching, turn the vox gain ccw.

When the band is crowded, the hair line can be set to a reference point on the dial to be returned to when transmitting and the dial tuned to lower the beat note of the received signal. The lower beat note is easier to copy when interference is present. Any interference lower in frequency can be tuned below the audio passband, for instance, the desired signal is 300 cps, and any interference below this frequency will be attenuated by the audio circuits. If the desired signal is 300 cps and an interfering signal comes on higher in frequency, the audio must be inverted to reject this. This is accomplished by switching the EMISSION switch to LSB and retuning the dial 1 kc higher in frequency. The interfering signal will then be on the low frequency side and can be rejected by the audio rejection as before.

When switching to LSB from the CW position, the transmitter will come on for an instant, but no signal will be transmitted. The factory people have assured me this is normal.

When going from receive to transmit, return the EMISSION switch to CW and set the dial back to the original transmitting frequency. Pull out the mic plug to keep the vox from energizing when receiving CW in the LSB mode.

To decrease the vox energizing time, turn the anti-vox gain ccw.

The Heath Q-Multiplier model HD-11 can be used without modification with the KWM-2. Plug it into the Q-Mult jack on the chassis, and it is ready to go. Sometimes L 9 may have to be adjusted for long cable lengths to the Q-Multiplier. This is adjusted so the



Detroit, Michigan: "Does an excellent job of swinging a 20-40 combination and stacked Finco 6-2 beam."

San Diego, California: "I am well pleased with the rotor to date, holds and turns stacked 40M and up beams in 50 mph winds with no difficulty."

Los Angeles, California: "I have personally installed 3 other HAM-M Rotors in the past 3 years (all of them OK) so I feel that I'm buying the best."

Houston, Texas: "Wonderful! Was using the AR-22 (the CDE TV automatic) and it did a fine job for 4 years, but put up a larger beam and needed more power."

Anchorage, Alaska: "Due to below-zero weather, it took quite a while



to get up but the last couple of weeks it has proved perfect. Wish I had one years ago."

Alamo, California: "Works very well and purchased on recommendation of my friend who has been using one for 4 years and likes it quite well."

Swarthmore, Pa.: "Am very pleased with the results. More than meets my expectations."

Pluckemin, New Jersey: "The HAM-M rotates and two TR-15's tilt the 6-foot parabola for 432 and 1296 mc."

Chicago, Illinois: "It really does the job."

New York, N. Y.: "This is a perfect rotor. Can't see where you can improve it."

### (a sampling of mash notes received by our HAM-M)

At \$119.50 amateur net, the HAM-M is the greatest rotor value around! For technical information, contact Bill Ashby K2TKN. Your local CDE Radiart Distributor has the HAM-M in stock.



CORNELL-DUBILIER ELECTRONICS, DIV. OF FEDERAL PACIFIC ELECTRIC CO., 118 E. JONES ST., FUQUAY SPRINGS, N. C.

CDE makes a complete line of the world's finest rotors: Ham, heavy-duty automatic, heavy-duty manual, standard-duty automatic, standard-duty manual...and the industry's only wireless remote control rotor system!

receiver will break into oscillation with the Q-Multiplier set to sharp and the peak adj set to 8 or 9. No signal should be in the receiver passband when adjusting this.

When the Q-Multiplier is oscillating, this tone can be matched to the internal tone oscillator as previously described, then when receiving a CW signal in the peak position you will be set up on the same frequency for transmitting, using the Q-Multiplier as a zero beat indicator.

When operating SSB, and it is desired to operate CW without the other operator tuning his receiver, a frequency correction must be made in the KWM-2 when operating

Lower Sideband. The correction is to move the frequency dial 3 KC lower in frequency. No adjustment is needed if the SSB operation is Upper Sideband.

When operating at the top end of the band, care must be taken to remain in the band during tune up. For instance, if it is desired to operate on 3999 kc, Lower Sideband, the KWM-2 must be tuned up with the frequency dial indicating 3997.5 kc since the transceiver is operated in the Upper Sideband mode during tune up and the actual tune up carrier would be 1.5 kc higher than the dial reading.

... WA4NXC

### More Frequencies for the Drake 2-B

The Drake 2-B hamband receiver has fast become an extremely popular receiver. Many operators, however, are unaware that their receiver will tune many of the short-wave broadcast bands and other crystals are not needed.

This is possible because the rf amplifier and mixer are tuned separately (the Pre-selector) from the local oscillator.

The following table lists the frequencies and bands which can be tuned in this manner. In many cases the preselector tuning is quite critical.

Band	Preselector	Crystal	Socket	500	300	100	-100
80	7 to 10	None	—	4.41	4.61	4.81	5.01
40	5 to 4	11Mc.	40	6.59	6.39	6.19	5.99
C	4	18Mc.	C	9.5	9.7	9.9	10.1
C	7 1/4	11Mc.	C	14.5	14.7	14.9	15.1
C	7 3/4	18Mc.	C	15.5	15.3	15.1	14.9
C	6	25Mc.	C	11.833	12.033	12.233	12.433

WN4QGQ



# SJS Receiver: Part III

Jim Kyle K5JKX

Text for SJS will be found in September & October 73's.

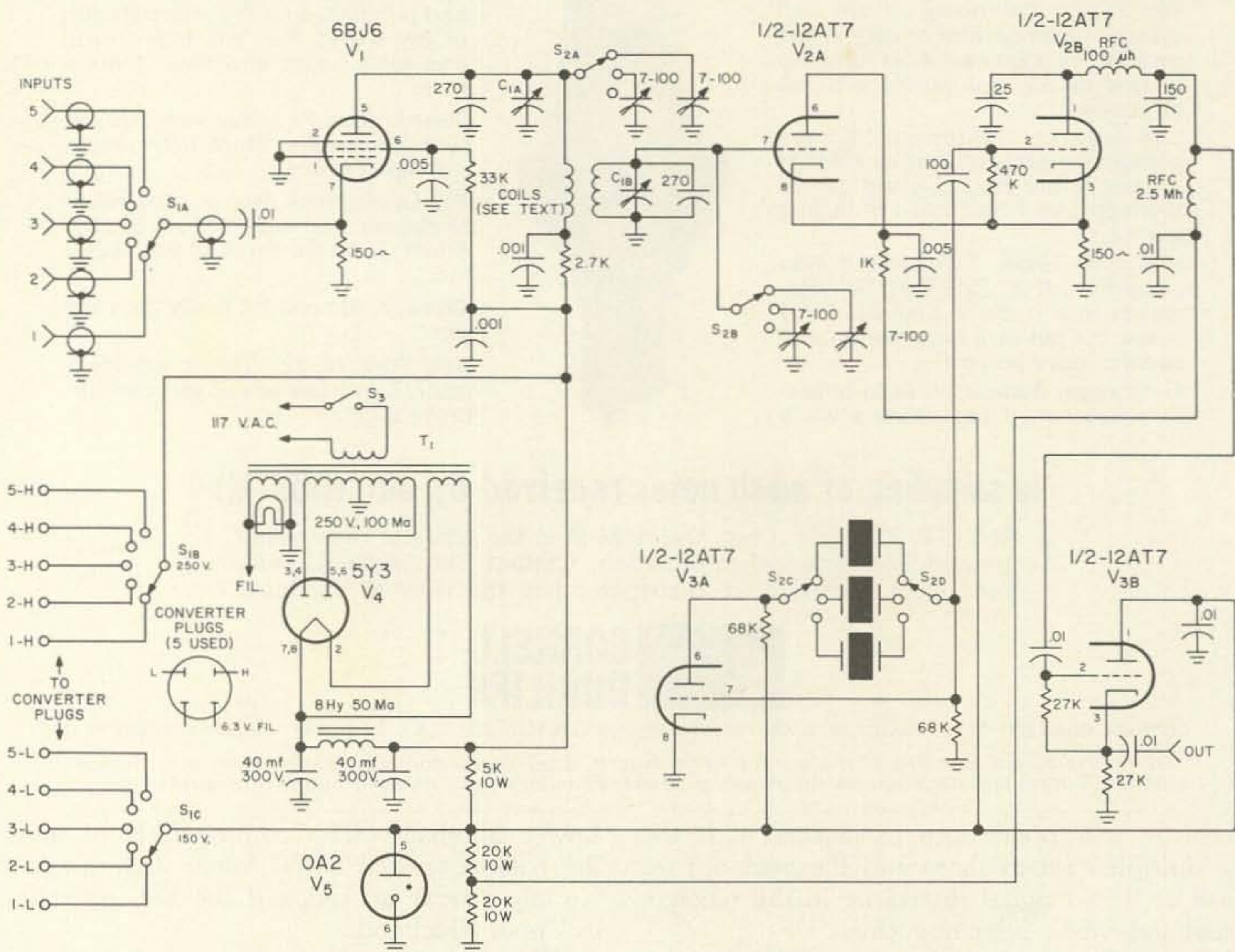

FIGURE 1

Schematic—7000-8050 KC converter

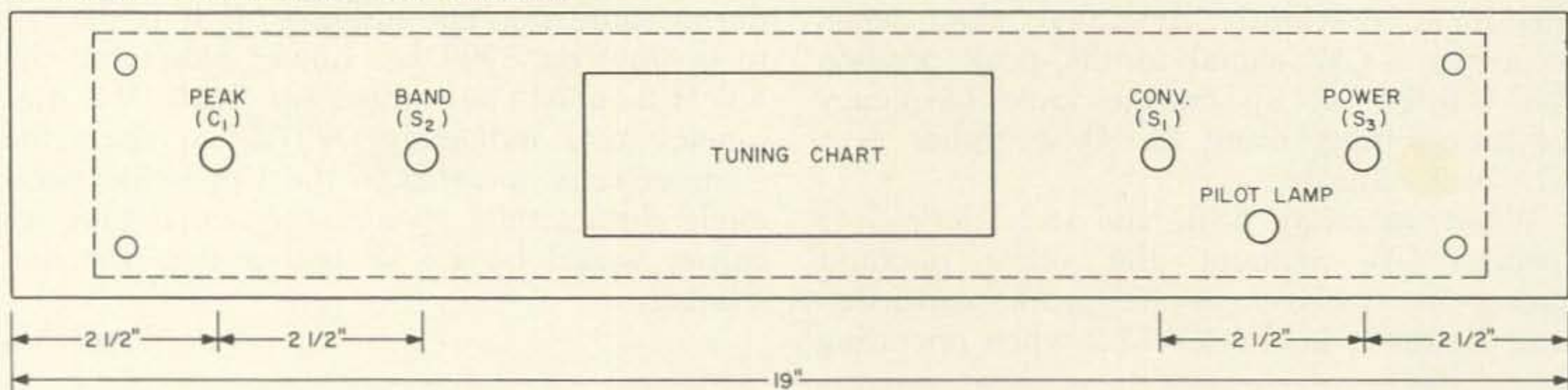

FIGURE 2  
FRONT PANEL LAYOUT

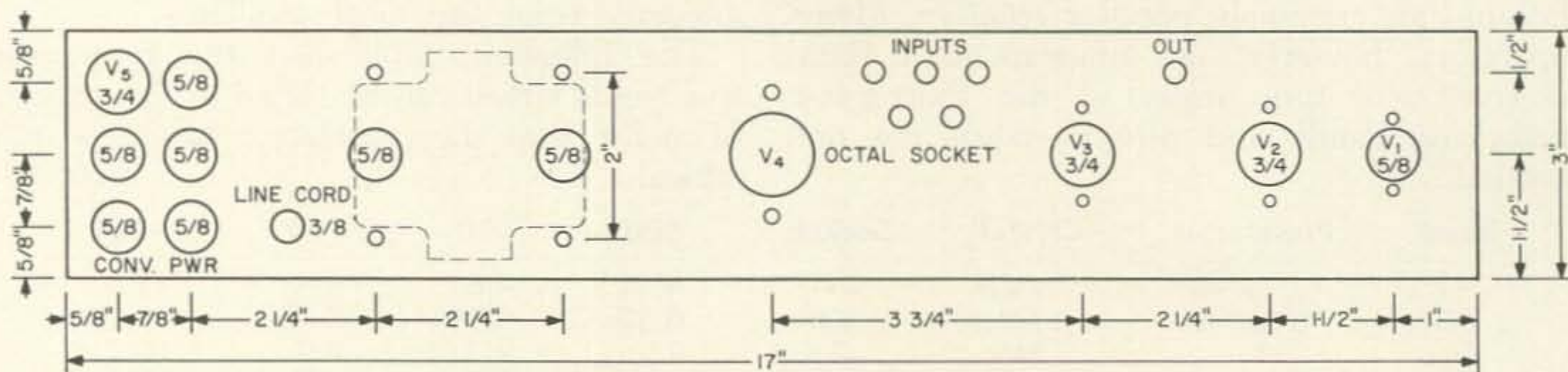

FIGURE 3  
REAR LAYOUT



# 1000 WATTS..WITH WHEELS

The mobile SSB kilowatt . . . once rare indeed, special and costly . . . becomes easy to achieve, and economical too using only standard SBE units. This is **advanced** equipment, sophisticated, in which transistors and diodes replace vacuum tubes in all low-level applications including the outstanding receiver. Current drain is reduced . . . **substantially**. Equipment size is scaled down materially. And these exclusive

SBE transistorized designs reduce selling price by eliminating duplicate parts and wiring through the use of bi-lateral circuits that operate both during transmit and receive. Using these big-value items—SB-33 for the exciter and SB1-LA for the linear, a KW (p.e.p. input) fits handily into the family car . . . and space-wise, the family will never know the difference! See below how W6JPM did it.

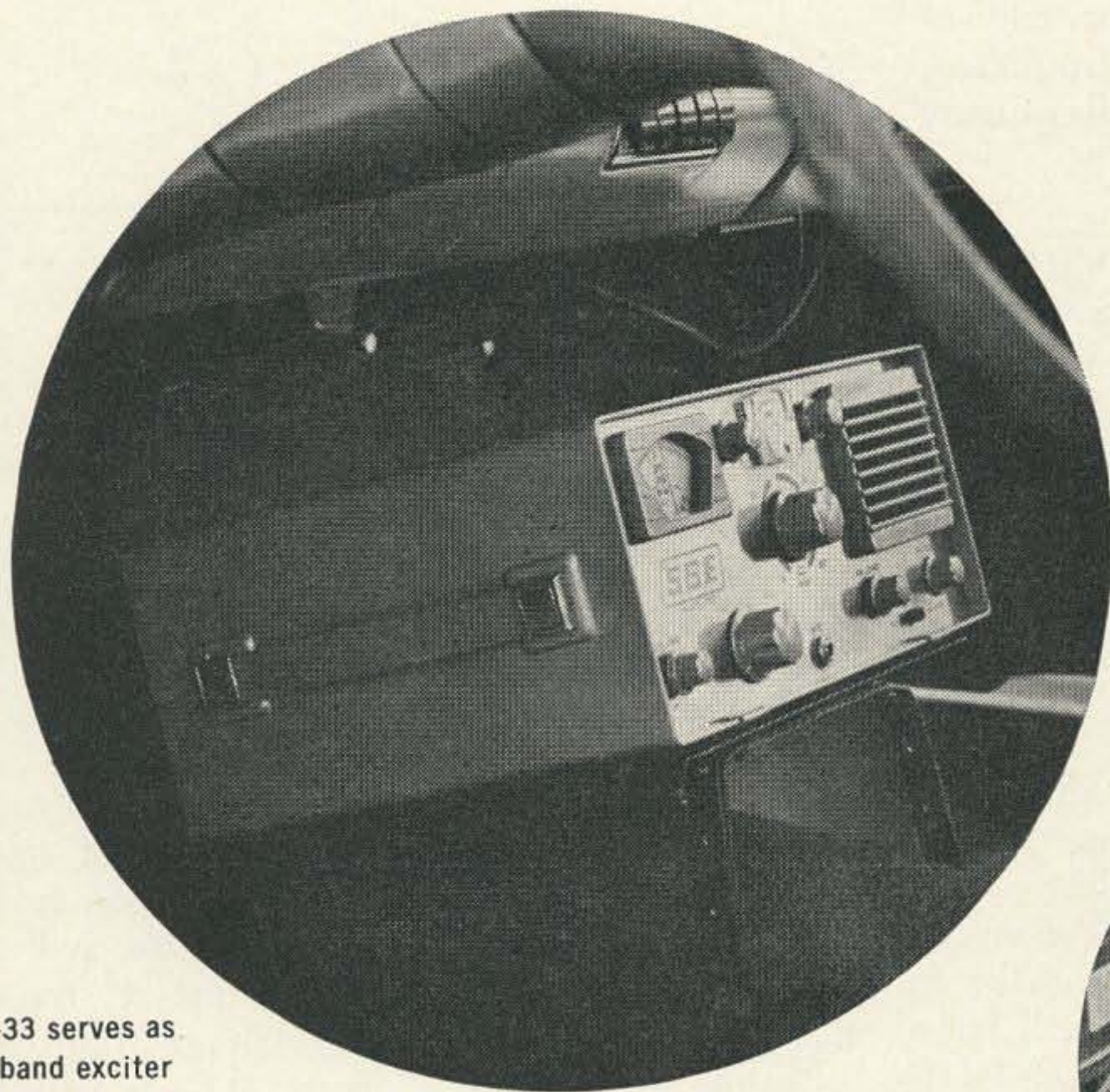

SB-33 serves as 4-band exciter (80-40-20-15) Note how little space it occupies.

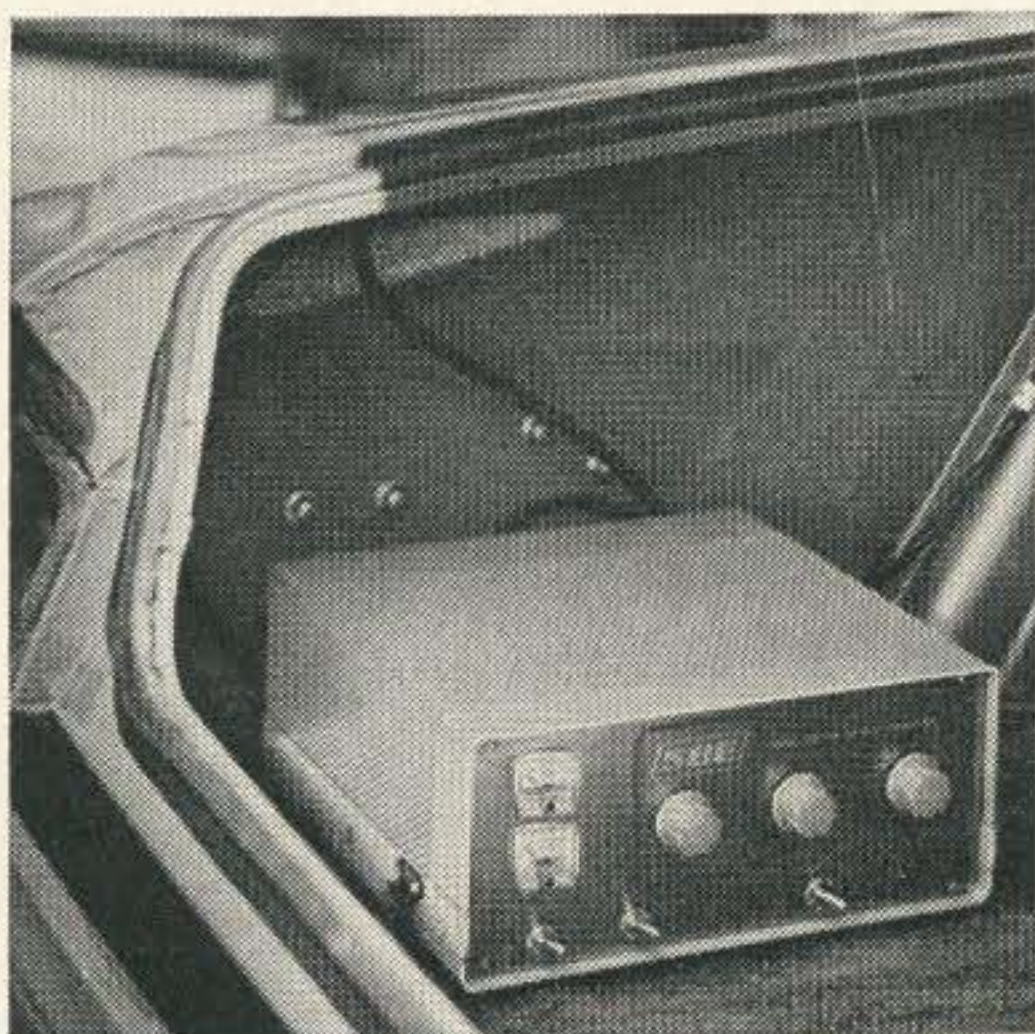

The SB1-LA 4-band linear occupies modest space in a seldom-used corner of the rear trunk.



Band-spanner "top-sider" antenna with one of the new "gallon" coils, tops off this powerhouse on wheels.

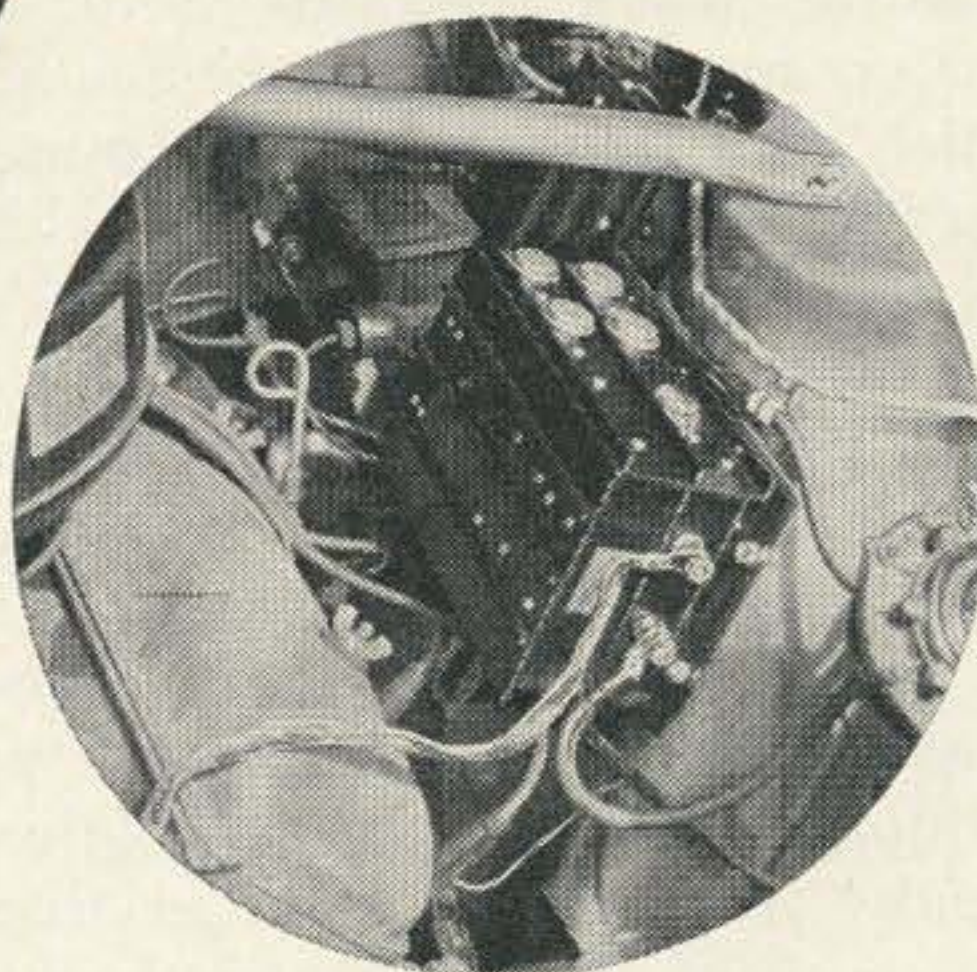

Power supplies, SB2-DCP for SB-33 and SB3-DCP for SB1-LA are tucked into engine compartment.

**SB-33 . . . . . 389.50**

**SB1-LA . . . . . 279.50**

Please send SBE full-line catalog describing all units used in the mobile KW.



**SIDEBAND ENGINEERS**  
317 Roebling Rd., So. San Francisco, Calif.



Export sales:  
Raytheon Company, International Sales & Service, Lexington 73, Mass. U.S.A.

NAME \_\_\_\_\_  
NUMBER STREET \_\_\_\_\_  
CITY \_\_\_\_\_ ZONE STATE \_\_\_\_\_



# UHF Transistor Circuitry

Practical Transistor crystal oscillators and VHF-UHF transistor frequency multipliers to 144, 432, and 1296 megacycles, for use as converter local oscillator chains, spot frequency signal generators, and VHF-UHF frequency calibration.

## Introduction

As in tube work, going through VHF and UHF up to microwaves, transistor circuits change quite radically. Bypassing, always a problem, is of even greater importance with transistors, due to the lower impedances of their input and output circuits. The use of large but thin (solderable) brass plates, insulated by sticky Teflon tape for bypassing, can be a technique of considerable importance to the amateur experimenter. Teflon is used because, when soldering onto the brass plates *after* mounting, the Teflon does *not* melt. Mica is alright, but it is more fragile and must be glued on or otherwise held.

Nylon anti-shortening bolts are very convenient for fastening the brass plates tightly to each other or to ground so that you will have mechanically rigid and electrically good UHF capacitors. This avoids the use of the shoulder washers which would have to be used with metal bolts, where the shoulders may have to be thinner than the brass plates, which are already only 22 thousandths thick. Also, I hope you won't be fed up with my talking every so often about copper-clad bakelite, but it is the handiest stuff for building UHF prototypes. You can even make shielded boxes out of it.

## Circuit and Construction Details

In UHF, where *configuration* and *shape* assume greater and greater importance as you go up in frequency, you eventually wind up leaving out the two-conductor principle entirely and find yourself with hollow pipes otherwise known as waveguides. So, it becomes necessary to talk about the construction along with the circuit, as you will see.

The crystal oscillator is shown in two versions. Some amateurs definitely prefer 8 mc rocks, and have lots of them, and some like the higher frequency ones. I must admit I haven't completely made up my mind yet my-

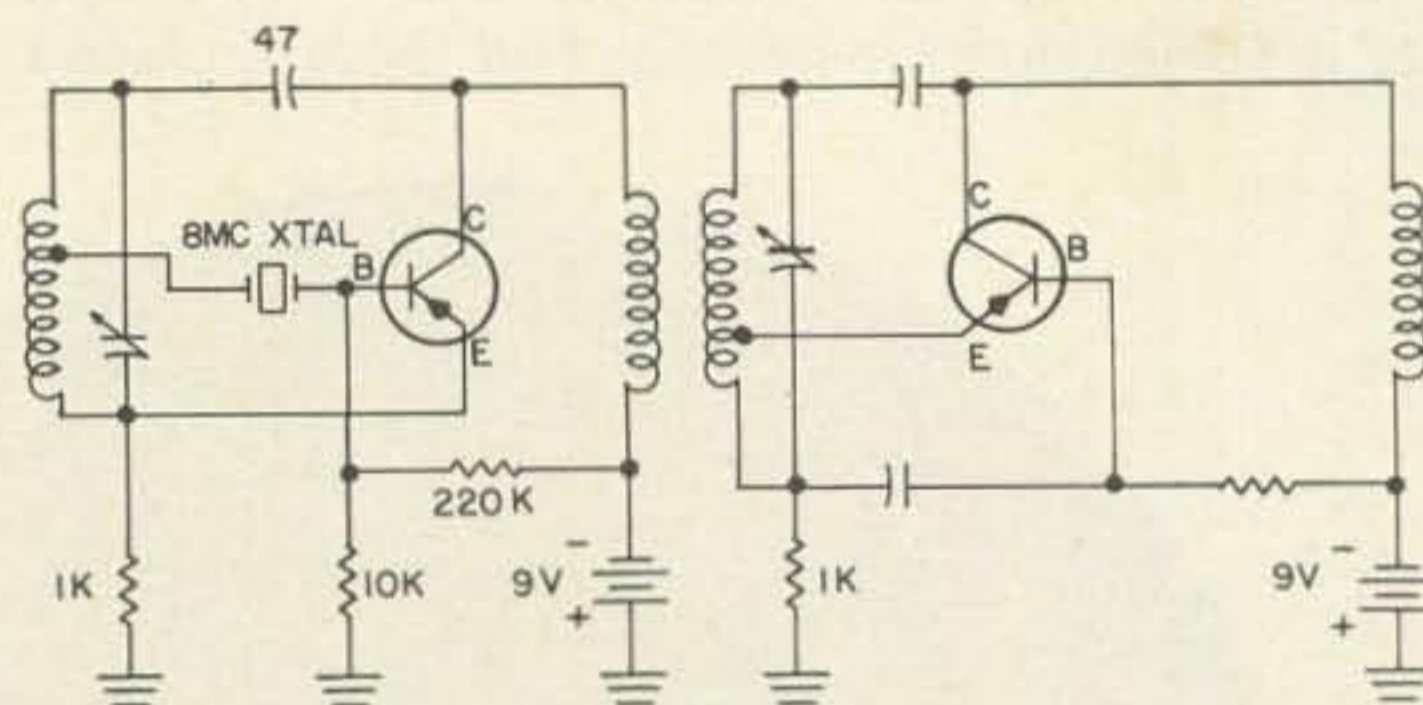

FIG. 1

FIG. 2

self. I like 48 mc crystals fine, but every once in a while I get a jumpy one.

Fig. 1 is the circuit used. Note that the phase reversal in the crystal (a positive voltage on one side and a negative voltage on the other) at any given instant, makes this work. When the crystal frequency is reached the phase reversal of the crystal makes it oscillate, but good! A quickie sequence of operation of a pnp transistor oscillator, non-crystal, as in Fig. 2., goes like this. (We will use letters, B for base; E for emitter; C for collector) 1) With no B to E voltage there is no collector current, so C rests at -9 volts. 2) Negative voltage, with respect to E, is applied to B, C then draws current and goes toward positive voltage. As E is tapped up towards the C end of the coil, E is in phase with C. This means that E is moving positive with respect to B which is the same as applying more negative voltage to B. This causes more current, more positive travel of C, etc. When sufficient action of this sort takes place, several million times a second, you have an oscillator. Now go back to Fig. 1. The B and E are reversed. "It won't oscillate." Correct. That is, it won't until the crystal reverses the phase. You may not remember but Paul Curie (Madame Curie's OM) used to travel around France banging on crystals with a hammer to show, by sparks jumping across a gap and wires connected to each side of the crystals, that mechanical compression of such piezoelectric devices did indeed generate electricity. The mechanical compression wave bouncing back and forth etc., does the job. I'm not insinuating that you don't know how a crystal works. But let me know if you real-



# NEW... Low Frequency Converter for Drake 2-B Receiver

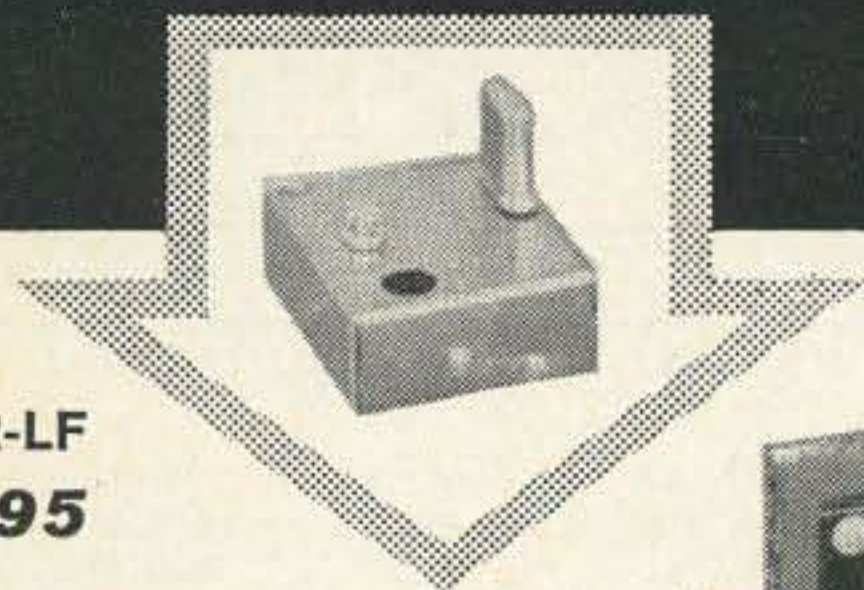

Model 2-LF  
**\$24<sup>95</sup>**  
AMATEUR NET

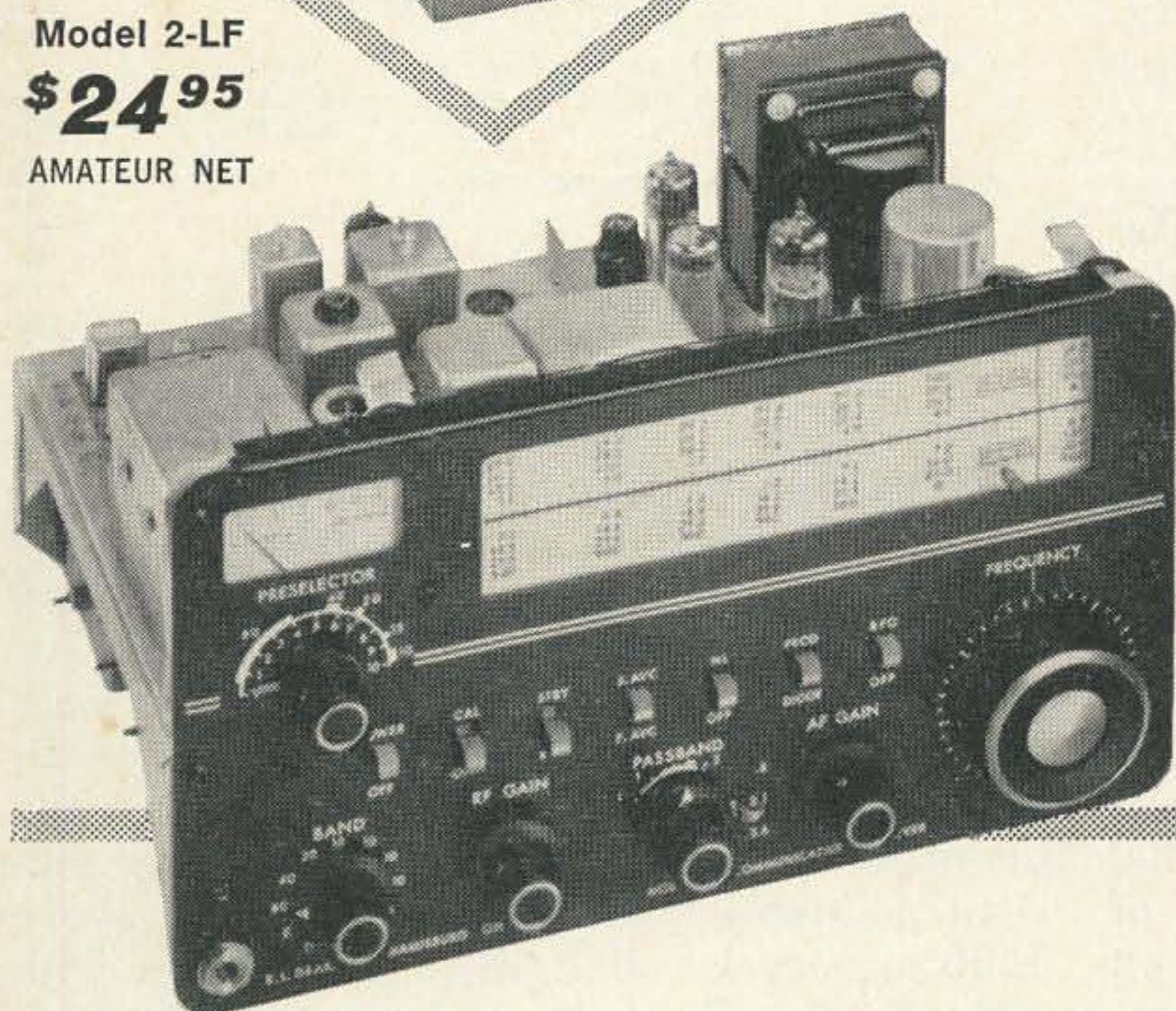

The new **Model 2-LF Low Frequency Converter** plugs into the Calibrator Socket of the Drake 2-B Receiver. It converts low frequencies into 10 Meter ranges. Extends the range of the 2-B to include Broadcast, 160 Meters, Marine, Mars, etc. **Covers .1 to 3.5 Mc** in two ranges. Crystal for .1 to 1.8 Mc is furnished. Accessory crystal is available for 1.8 to 3.5 Mc.

#### FEATURES:

- All solid-state circuitry
- Diode ring mixer
- Transistor crystal oscillator
- Sensitivity less than 2 micro-volts for 10 db S/N
- I.F. rejection better than 50 db
- Conversion oscillator attenuation 40 db
- RF input impedance 50-500 ohms, unbalanced

**R. L. DRAKE COMPANY**  
MIAMISBURG, OHIO

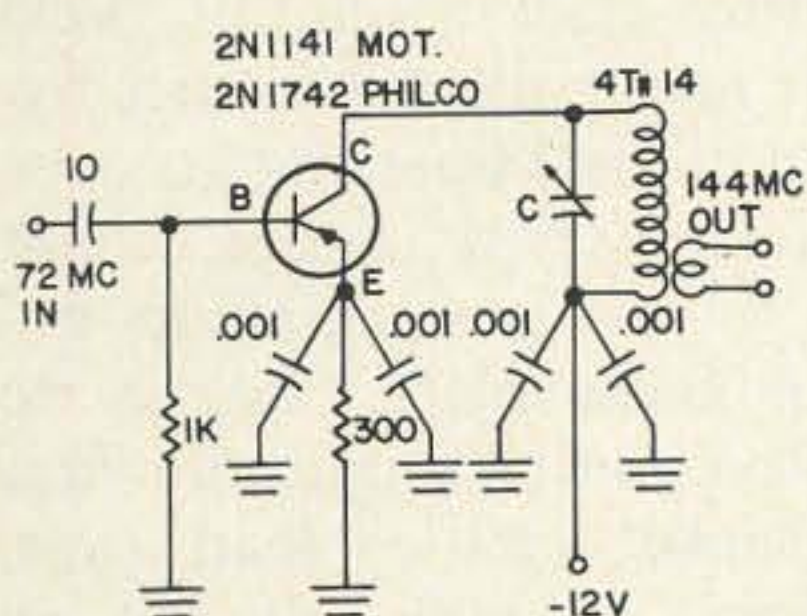

FIG. 3A

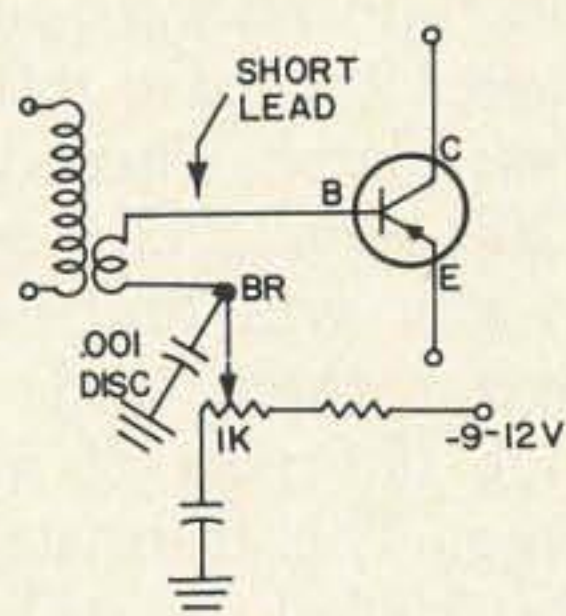

FIG. 3B

ized that it reverses the phase also! So, that is how the oscillator of Fig. 1 not only works, but why it won't take off any frequency except the crystal frequency! No more delicate feedback adjustments, etc. Patent pending.

### Frequency Multiplication

When I first started out to double, triple, etc., from 8 mc, I coupled over to the next base, see Fig. 3, with a fairly large capacitor. It worked. After several stages though, each one getting more and more jumpy and hard to tune, I arrived up on 144 mc and the circuit acted as though the tuning capacitors had faulty contacts. Getting desperate I finally *listened* to the output on 144 mc with a tuned diode detector and audio amplifier. What a racket! It sounded like a dozen super-regens all going at once. The remedy was low capac-

ity on the base inputs.

Fig. 3A shows a typical capacity-coupled doubler stage going from 72 to 144 mc. The 10 mmfd input capacity is tapped down on the previous collector coil, 72 mc, to match the base input. Note that there is no external dc voltage on the base. This is developed by rectification in the base-emitter diode portion of the transistor. A collector milliammeter makes an excellent excitation indicator in this case.

In tubes excitation is known as grid drive. Here you are driving the B-E diode. I have a little box full of "Dead Soldiers" reminding me that it is very easy to burn out transistors with rf. If you take care with the input and never exceed the rated rf voltage, maintain a self-biasing emitter resistor, and another in the base return, watch out for creeping collector mills, use proper heat sinks, (what a nuisance *they* are for rf stages) and keep high-powered transmitters away, it just may keep going.

Actually, if you don't try for *watts* out, you can run a 6 transistor local oscillator chain, or low-power exciter from the 6-8 mc region up to 1300 megacycles, and have it keep going pretty good. I have one that I built over a year ago and it still puts out several volts



(not watts) of rf at 1200 mc. It was built as a local oscillator chain for a 1296 converter, and for a test signal.

This circuit is suitable up to around 300 mc. 3B, an experimental set-up, may be used for untuned base inductive coupling—3A works exactly as is. I have it running here now. If you lack sufficient drive from the preceding stage, negative dc bias, actually dc excitation voltage in the case of transistors, may be put on the base also, as shown in Fig. 3B. Otherwise ground point BR (base return) through a resistor which may be checked as per rf drive available.

Did someone ask about protective bias? The emitter has 300 ohms in this circuit. I usually start off with one thousand ohms. However, in frequency multiplication there is an optimum point for the three parameters of rf drive, base resistor, and emitter resistor. The fixed values shown are working. In case you want to experiment yourself, a variable circuit can be used.

### Going Up

Above 50 megacycles the collector inductance becomes increasingly important. At 300 megacycles I have achieved a good Q, lots of good rf volts (this means anything over a volt with reasonably priced transistors at these frequencies) by the use of copper strap coils, and very short disc-cap bypass leads using several at each point, such as the collector return and emitter lead.

Another Bug. Transistors are very capable of putting out almost any ratio of volts at the fundamental to volts at the multiple frequency. Example: while working with the 650 to 1300 megacycles shown in Fig. 5., at times my rf output detector was off scale at 650 megacycles, while the 1300 mc detector showed less than 10 microamperes. The doubler stage shown however is the other way around, off scale at 1300 and very little at 650! It also tunes like magic and even is quite active on the collector current meter when tuning thru 1300 as a doubler.

Back to 300 mc again, briefly. By using a collector "coil" of copper strap, the Q is raised, undesirable frequencies lowered, and more rf is stored for use in driving the next stage. I have one stage, as per Fig. 3A, doubling from 150 to 300 megacycles, for use in going to 600 and then 1200, which has a collector coil of 5 turns of 3/16 wide copper strap, parallel tuned by a store-bought rotating variable capacitor, Hammarlund Mal. type to 300 megacycles. I still think a parallel-tuned coil at 300 mc is pretty good!

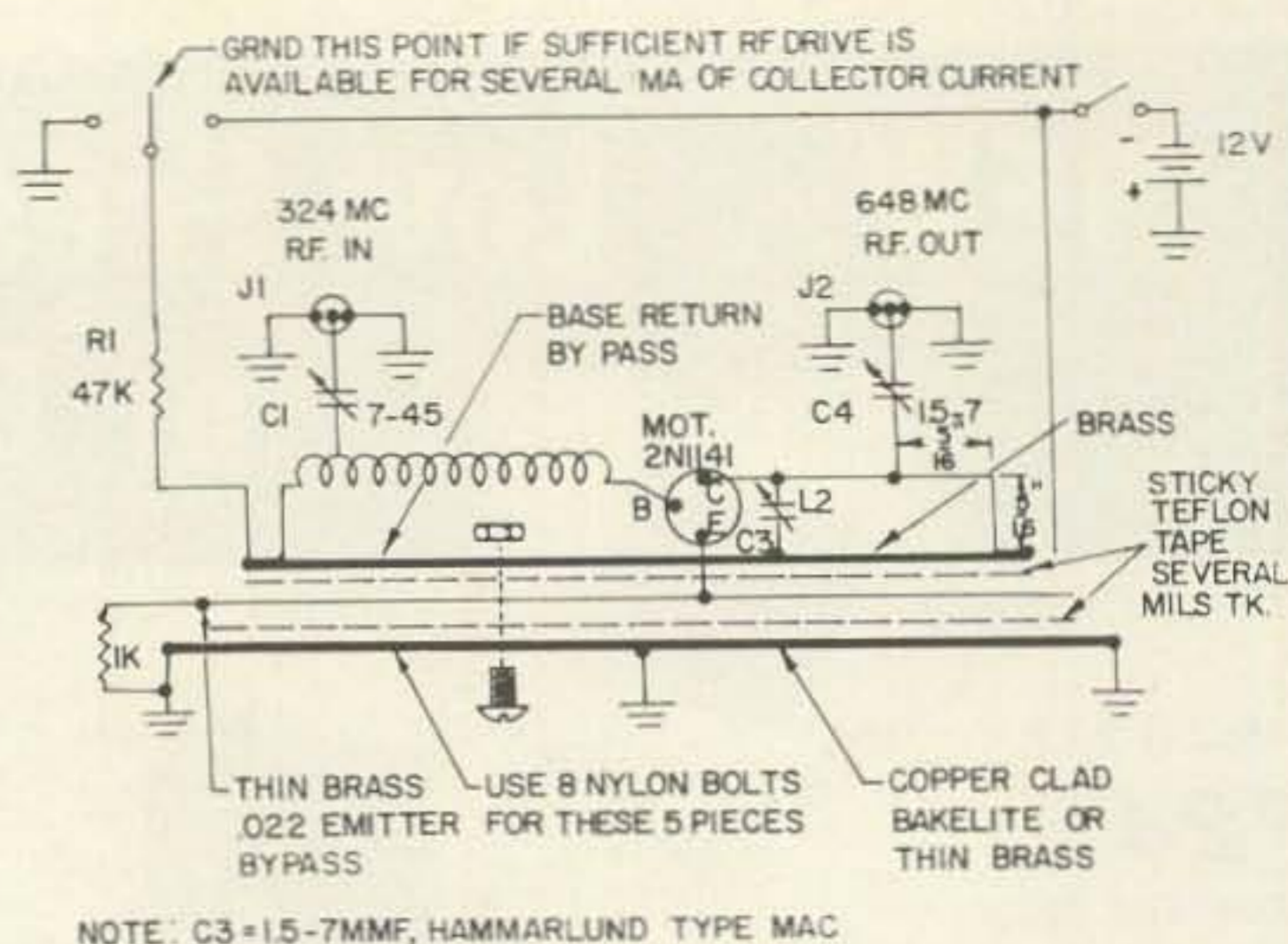

FIG. 4

### UHF Doubler

#### The Transition Region

This is where coils become straps, or "line" circuits. Above 300 mc things begin to get tough, as mentioned. Fig. 4 shows a good working doubler, 300 to 600 megacycles. (or 650; don't mind my losing or adding a mere 50 mc, please). Find photo. The use of an insulated emitter ground plate on top of the dc main, or "chassis" base plate allows efficient emitter bypassing for frequencies above 1200 megacycles. Bolt all plates together with eight 6/32 nylon bolts and nuts. Again, Teflon tape allows soldering *after* assembly. Next comes the base-return and collector-return bypass plates. These also allow bypassing to over 1200 megacycles and *form part* of the circuit as you will find out if you put anything between them and the base plate. Begins to look like part of a waveguide? Right the first time. The transistor socket emitter lead (yes, the socket is still there on 600 but not on 1200!) can be soldered in next. Use as short a lead as physically possible. Then the tuned base strap coil (300 mc) with its 50 ohm input matching capacitor, C1, and its tuning capacitor C2 are soldered in. Then repeat for the collector strap circuit. Due to the efficiency of the ground plate bypassing, the input and output jacks may be grounded directly to the base plate and still get proper rf to and from the base plate and the collector return plate. This allows the coax cable connections to be grounded throughout the rig. (Have you ever tried to insert rf capacitors good for over 1300 mc in RG-58/U?) (First of all you can't *buy* any!)

Rf drive into the base circuit may be tested as follows. Ground the base return resistor R1. With a 0-10 ma meter in the collector circuit apply the collector voltage. I would advise sticking at first to minus 12 volts. Try



# QUEMENT

"Northern California's Most Complete Ham Store"

*Does it again!*

## ALL-TRANSISTORIZED GRID DIP METER

- Compact
- Light Weight
- Accurate
- Self-contained
- Highest Stability
- Heavy Dip



Assembled & tested, complete with six coils, ear phone and battery.

TUNES 500 Kc  
THRU 150 Mc

DOZENS OF USES

NEVER BEFORE  
HAS A PRECISION  
INSTRUMENT LIKE  
THIS BEEN OFFERED  
AT SUCH A LOW PRICE.

# 29<sup>95</sup>

Allow \$1.00 for packing and shipping. California residents include 4% sales tax.

## QUEMENT ELECTRONICS

1000 SO. BASCOM AVE. SAN JOSE, CALIF.

"Your Collins Headquarters"



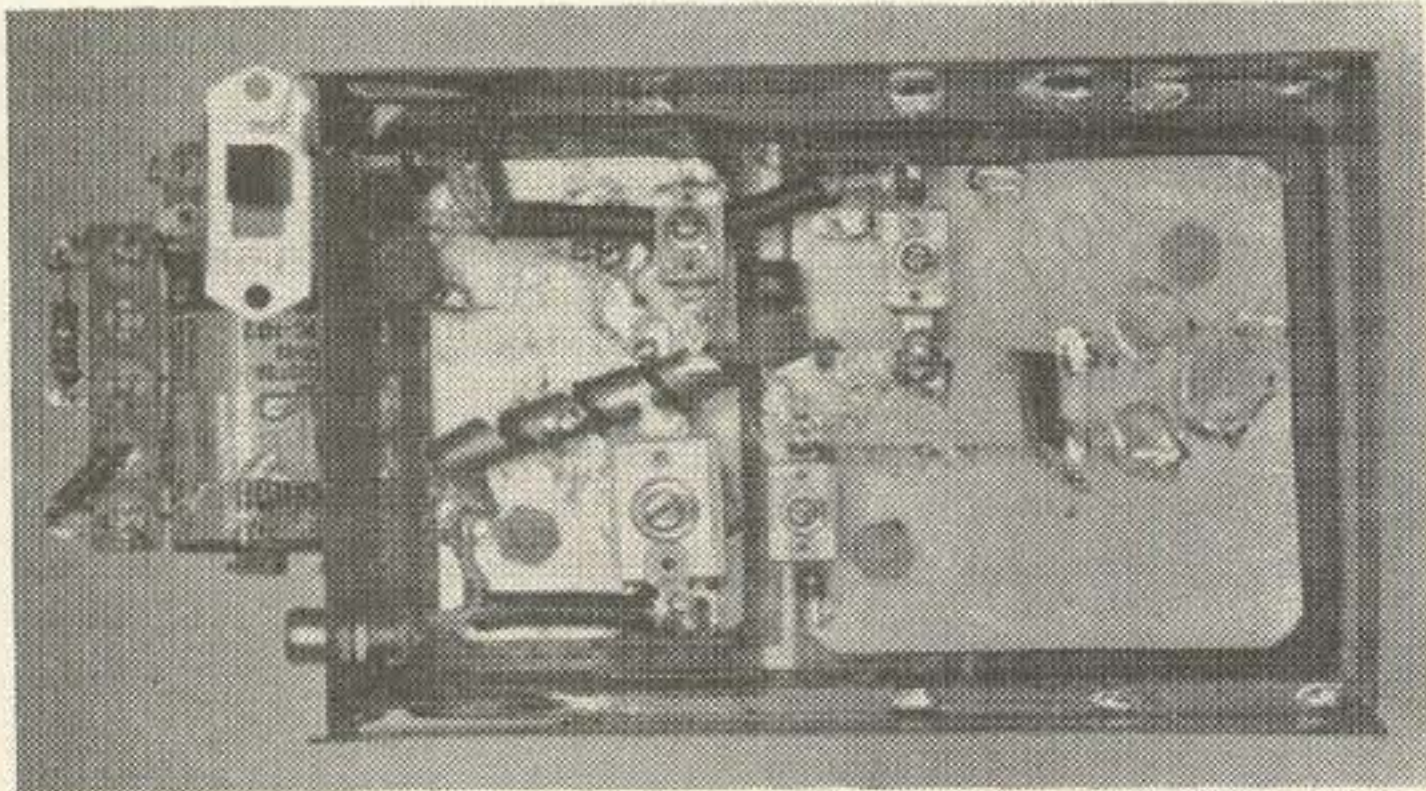

Doubler

more later if you have plenty of spare transistors for these frequencies. The collector current should read zero. On the application of rf drive at 300 megacycles, some tens of milliwatts, with a Motorola 2N1141 as shown above, and the base circuit L1-C2-C1 tuned, the collector meter should rise. At somewhere between 5 and 10 ma the doubling output will be at a maximum. L2-C3 should be tuned by watching an output meter plugged into a power-detector cavity as described before. I must repeat, it is of ever increasing importance as one goes up in frequency multiplication, to have an rf power detector that tunes positively over a wide enough range to take in both the fundamental and the *expected* multiplication frequency, (but not at the same time) and show you how much of each is present in the collector output circuit. J1 and J2 are "phono" jacks. Suit yourself on that question. At least they work and don't cost much.

### Doubling vs Tripling

Before going to the final unit, with which you can get a good stable signal, modulated if you need it, on 1296, or use it as a 1296 crystal controlled local oscillator chain, this seems like a good time to mention why I like to use doubling instead of tripling when going to over 200 or 300 megacycles. Some time ago I learned, while making and tuning up crystal controlled 50 to 100 watt cavities on UHF, that doubling always produced more power than tripling. This may seem somewhat obvious, but it is the overall plan that counts. If you look back to the pre-war days of 5 meters, you will see that the bands were then 160, 80, 40, 20, 10, 5, 2½, 1¼, etc. This was for *doubling* and to make the harmonics fall into other amateur bands. At any rate, I hereby present my main reasons.

1) It is just possible, by pushing things, to maintain rf power up to 1200 megacycles by doubling. If you triple you won't. Oh yes, you *can* interspace *amplifier* stages *in-between*, or use \$80 disc-seal beam power tubes. However, I'm naive enough to think that if I can't

afford them, most other amateurs can't either.

2) The *undesirable* frequency content is less when doubling. If you go up in frequency, the first wiggle of the plate meter (don't expect too much from a *transistor* collector meter) and the first jump on the rf output meter will be at *twice* the frequency, which is doubling. Don't ask about push-pull. Did you ever see a push-pull coax cavity? It can be done, but not now, please.

If you are tripling you have to tune up past the nice big bang at the doubling frequency and then find the much smaller peak of energy at 3 times the fundamental.

3) Lots of good tubes are almost through in ¼ wave plate line coax circuits at 1200 megacycles. If you want room to tune around you have to use 3 quarter waves on the plate line. We will take this up again later, but the idea here is that the ¼ wave cavity tuning point of 1200 mc is quite removed, when doubling, from the fundamental tuning point. Believe me, this helps. As a last word I just checked doubling vs tripling, to 1300 mc, with a low-cost (\$2 to \$3) transistor. Almost three times the power out with *doubling*.

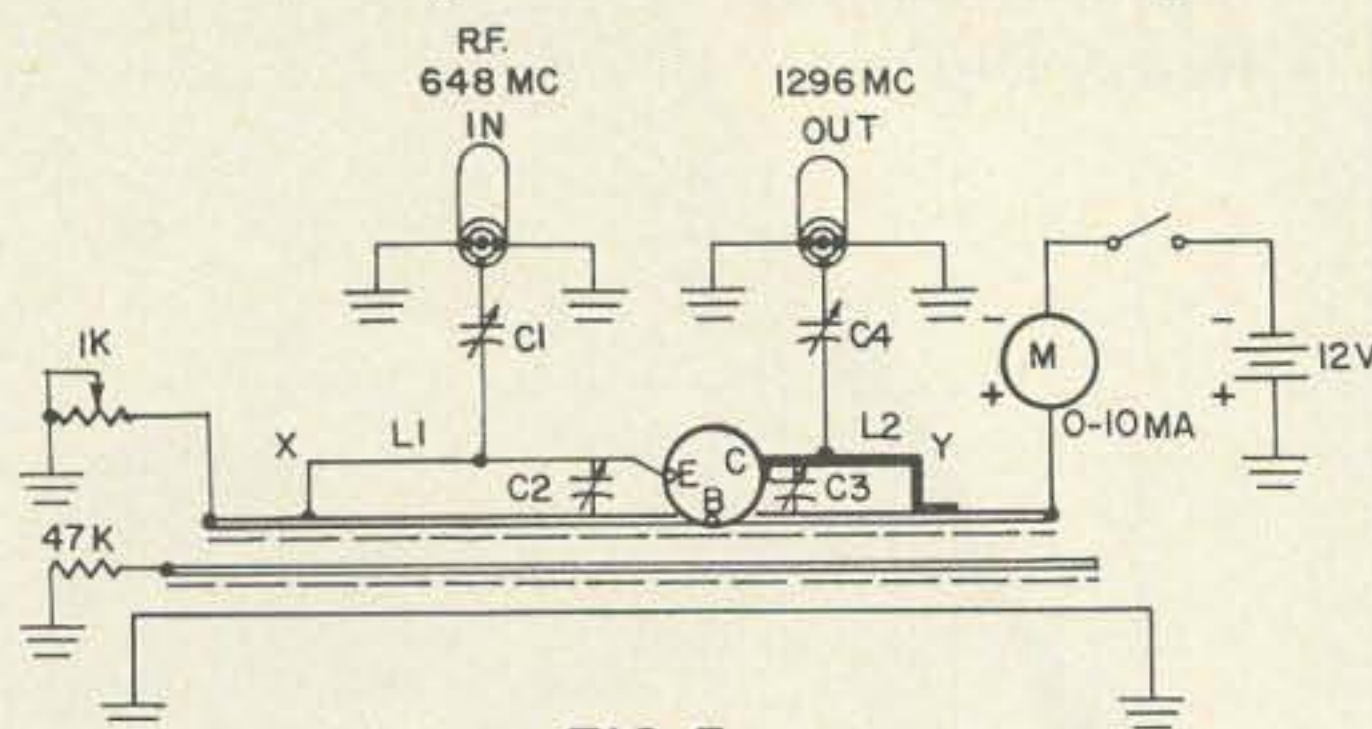

FIG. 5

Schematic—1200 mc doubler

### The Tough One

Next we double from 600 to 1200 megacycles with a low-cost transistor. The circuit, Fig. 5, and the photo, look similar to the preceding stage, but there are some differences. Most important of all, the base is now grounded instead of the emitter. Perhaps the term "common-base" describes it better. L1 is now tuned to 648 and L2 to 1296. This latter takes a little doing, and is right near the end of the line for transistors in little thin cases with thin leads, all on one end. However, it does work and puts out good stable volts of rf at 1296 megacycles with only a trace of 648 in the output. I do have a good coax circuit with a \$20 *coax* transistor in it that is even better, but who wants to pay \$20? The 1296 mc collector circuit, its tuning, and output connection, are a little fussy, as I mentioned, but after all, look at the waveguide microwave circuits they use on L band



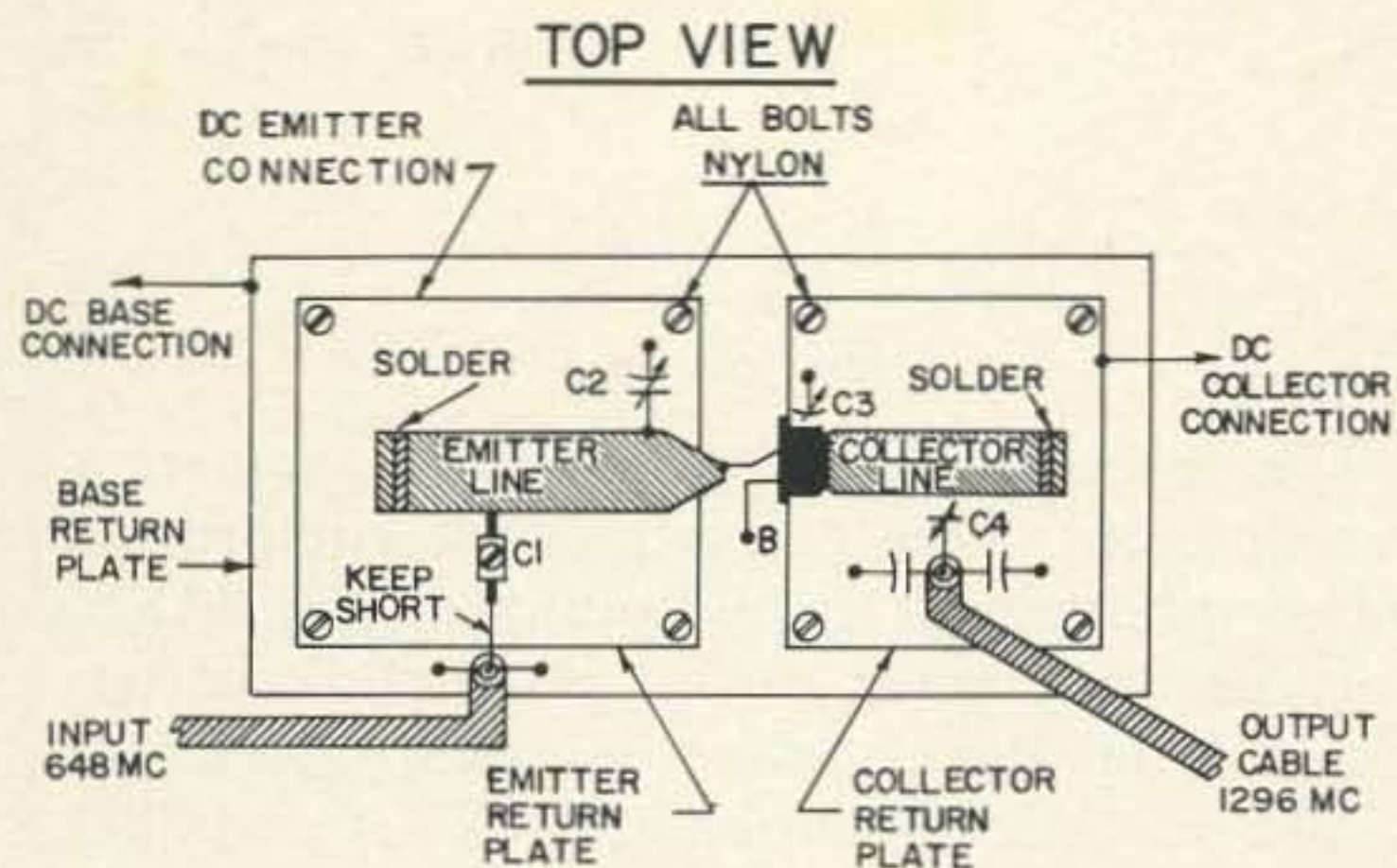
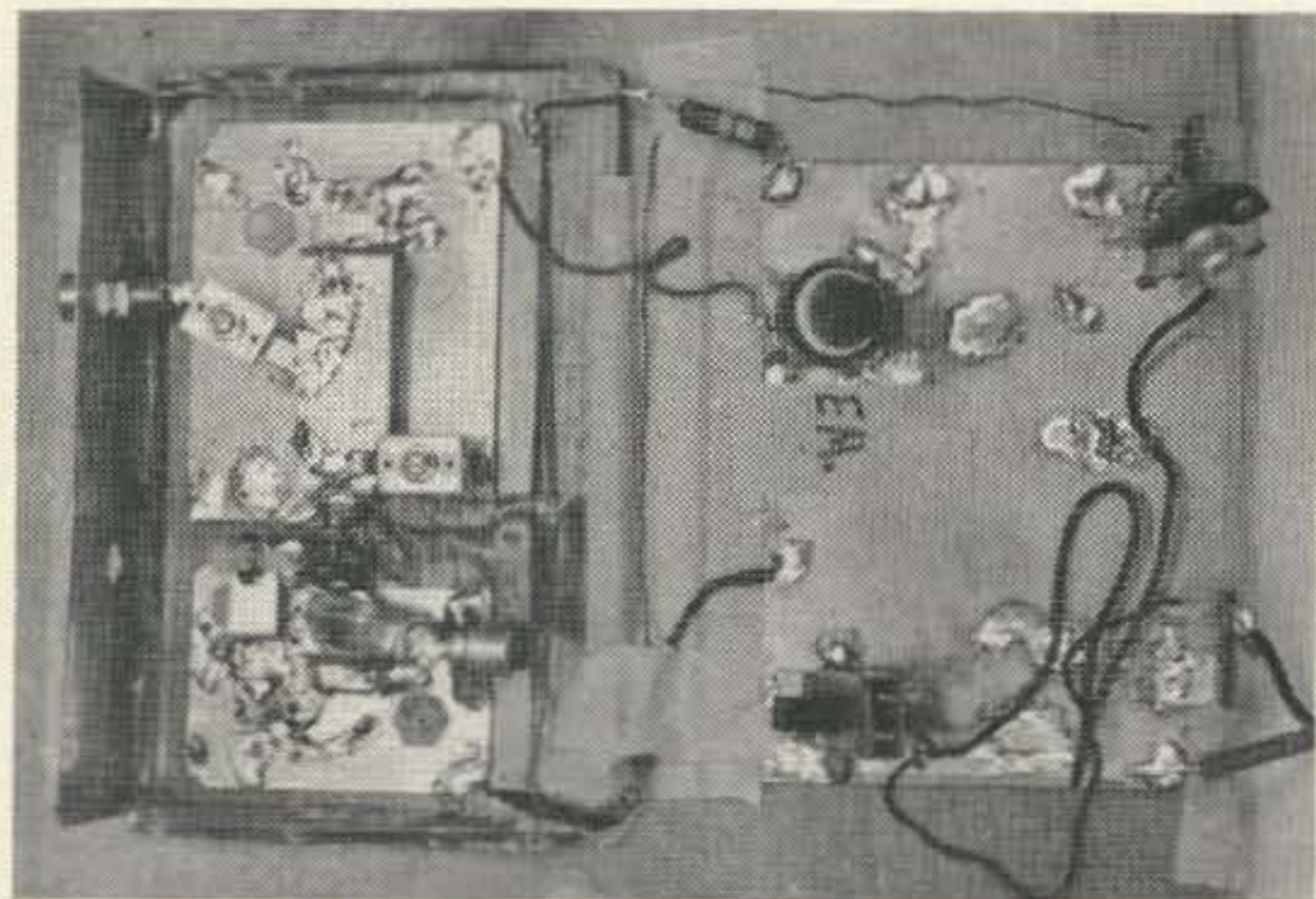

FIG. 6

Layout—1200 mc doubler



Photo—1200 mc doubler

and the fantastic \$ they get for them. So, amateurs, in line with the "Amateur Service" idea, let's go.

In Fig. 5 the actual dimensions used are as follows. L1 is 1¼ inches long from the transistor to the point marked X. It is made of ½" wide brass strap .022 thick. C1 and C2 are very small mica compression trimmers, .9-7 mmfd, the kind with about ¼ of a plate on one side. Solder this side to the inductance L1.

L2 is 7/16" long from the top of the transistor can to point Y. L2 is soldered directly to the can of the transistor (I can see Motorola engineers falling on the floor in a dead faint, but it still works). Note that in the Motorola 2N1141 the can is also the collector terminal. Or perhaps I should say that the collector is also tied to the can, because it already has its own lead. In this circuit just cut that lead off short. The can is *not* the collector in lots of other transistors, so watch that. Again, I say, 1296 isn't just any old dc band.

C3 is a spring strap about ½ inch long soldered to the collector return bypass plate, with a nylon 6/32 bolt adjusting its distance from the collector can. It also has Teflon tape on it. C4 is a copper tab ⅜" wide by about ¾" long soldered to the output jack, also with tape for insulation.

**Long John**  
for Six Meters . . . . . **\$34<sup>95</sup>**

**FEATURES**  
Designed for maximum forward gain.  
Gamma Match for co-ax feeder.  
Finest grade aluminum tubing.  
Exceptionally strong since there are no drilled holes.  
All aluminum construction eliminates electrolysis.  
Entire beam and supports can be grounded for lightning protection.

We are proud of this new Long John Antenna. We've tried to put in every feature you could want. The result is a reasonable cost high gain beam which can easily be put up and which will stay there practically forever. It has a wide enough lobe so you don't have to swing it around all the time, yet gives you tremendous gain where you want it.

AT YOUR DISTRIBUTORS OR WRITE DIRECT

**HI-PAR Products Co.**  
FITCHBURG, MASSACHUSETTS

GUARANTEED RECONDITIONED  
HAM GEAR

*Amrad*

Phone: (415) DI 2-5757 **ELECTRONICS**  
999 HOWARD AVE-BURLINGAME, CAL.

WRITE NOW FOR MONTHLY FLYER.

Fig. 6 shows the top view (I said it was a *little* fussy). C1 goes to a front panel jack. The front panel is brass and is soldered to the ground plate. The plate type bypassing allows the 600 mc to get over to L1 but keep everything short, short! The output assembly may be mounted on a small extra plate mounted on the collector return plate, insulated from it by the usual means described here. This keeps the collector negative voltage off the cable. It is only minus 12 to maybe 18 volts, and you won't feel it with your fingers, but there is no use finding next day a lot of applesauce running out of one end of what was a good battery.

Suggested crystal frequencies for oscillator-multiplier stages to UHF. For 144 mc, 48 mc; for 432 mc, 54, 108, 216, 432.; for 1296 mc, 27 mc, then triple to 81, then double to 162, 324, 648, and 1296.

. . . K1CLL



# 6m QRP Station

The unit described in this article proved the theory that it is possible to establish contacts at quite respectable distances with very low power.

Designed primarily for mobile use, the station is operated from a six volt battery. For 12 volt operation, the heaters will have to be rewired and changes made in the power supply. An ac supply is included, making it a station for all-around use.

Before going into the details of construction, here is a brief description of the various parts:

## Transmitter

The oscillator is a Jones circuit which, compared with other circuits, furnishes a high range of potent harmonics. The crystal is of the highest possible frequency so that enough drive is available for the final. The final uses push-pull 6AK5's which, at low input, give 1 to 1½ watts of output. 6AK5's were used because of their low heater drain (175 ma) and good high frequency efficiency.

## Receiver

The receiver is a superhet with a regenerative detector. This gives the best compromise between battery drain and performance. 6AK5's were used wherever possible to reduce battery drain. The lineup uses a 6AK5 oscillator, 12AT7 cascode rf amplifier, 6AK5 *if* amplifier, 6AK5 regenerative detector, and 6AK5 audio output. The output is enough to drive a pair of headphones or a small, sensitive, speaker. If more output is desired, a 6AQ5 could be used at the most of higher battery drain.

## Modulator

The modulator is extremely simple, consisting of one tube. A carbon microphone provides enough output to drive a 6AQ5, plate and screen modulating the final amplifier. The microphone is coupled to the 6AQ5 through a carbon microphone transformer. The quality is good and there is plenty of modulation.

## Power Supplies

There are two independent power supplies

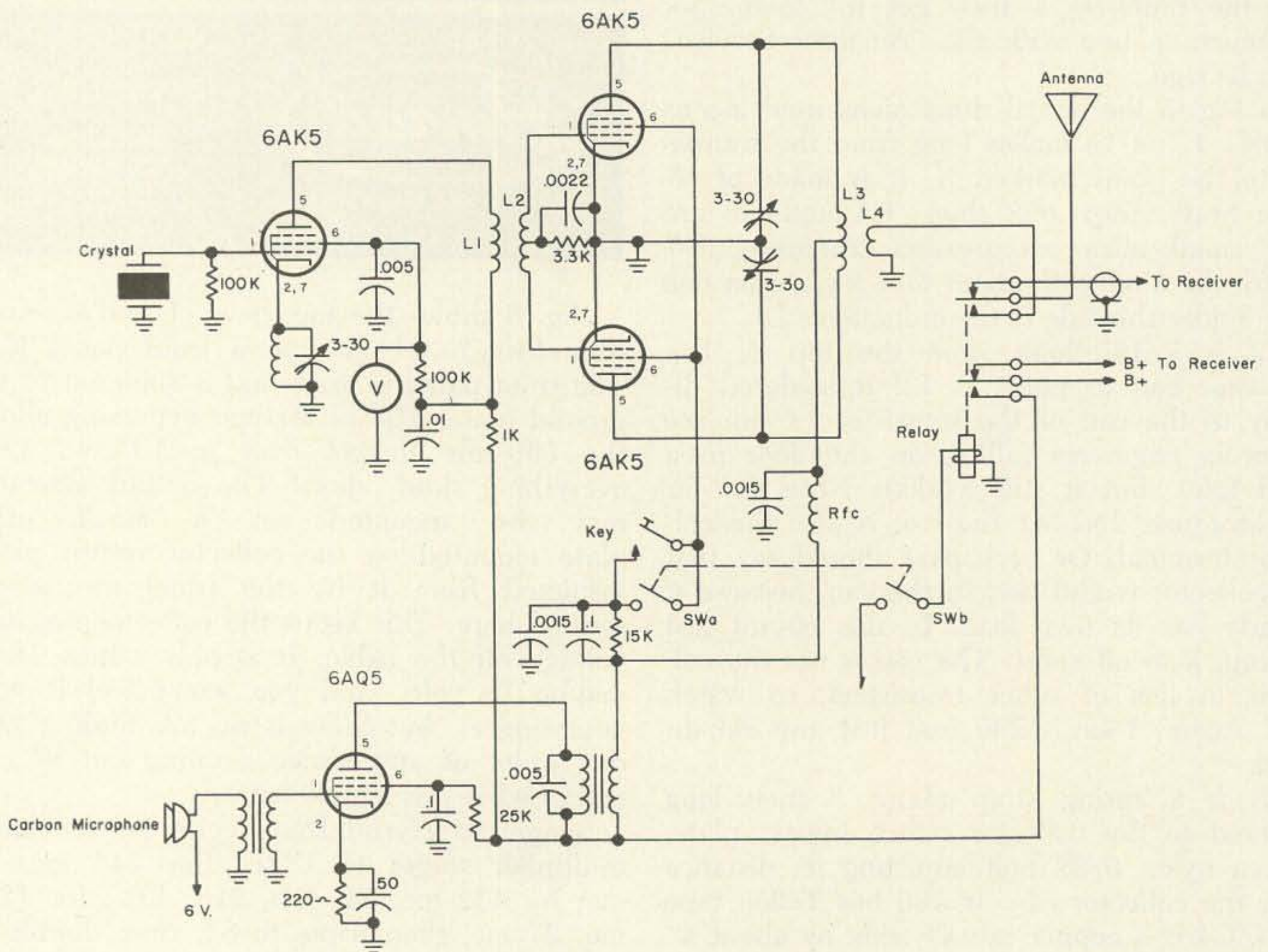

FIGURE 1  
QRP transmitter.



# SERVICE TESTED EQUIPMENT

from



HERE IS A PARTIAL LIST OF OUR QUALITY RECONDITIONED HAM GEAR, FULLY GUARANTEED, AND SHIPPED FREE WITHIN THE CONTINENTAL U. S. WITH CASH ORDERS.

## RECEIVERS

Collins 75A1	\$159.00	Central Electronics 20A	119.00
Collins 75A2	199.00	Central Electronics VFO	19.50
Collins 75A3	259.50	Collins 32S3 (new demo)	679.00
Collins 75S1	369.50	Collins 32V1	129.00
Collins 75S3 (like new)	529.00	Collins 32V3	189.00
Elmac PMR-6A	39.00	Elmac A-54H	29.50
Elmac PMR-7	59.00	Elmac AF-67	49.50
Gonset G-66	69.00	Elmac AF-68	129.50
Gonset G-66B	79.00	Elmac M-1070	49.50
Gonset 3 way power supply	15.00	Globe Chief	34.50
Gonset Super 12 Converter	39.50	Globe Scout 680A	55.00
Hallicrafters S-85	69.00	Globe Sidebander	64.00
Hallicrafters S-120	54.00	Globe 755A VFO	39.50
Hallicrafters SX-42	89.00	Globe Matcher AT-4	34.50
Hallicrafters SX-101	199.00	Gonset Commander	39.50
Hallicrafters SX-101A	239.00	Gonset G-77	99.00
Hallicrafters SX-111	179.00	Gonset GSB-100	219.00
Hallicrafters SX-115 (like new)	425.00	Hallicrafters HT-17	25.50
Hallicrafters SX-140	89.00	Hallicrafters HT-32B (like new)	549.00
Hammarlund HQ-100	95.00	Hallicrafters HT-33	325.00
Hammarlund HQ-110C	129.00	Hallicrafters HT-37 (like new)	289.00
Hammarlund HQ-145C	199.00	Hallicrafters HT-41	289.00
Hammarlund HQ-150	149.00	Heath Apache	169.00
Mosley CM-1 (SSB Rec.)	99.00	Heath DX-20	24.50
National HRO-7	89.00	Heath DX-35	34.00
National HRO-60	269.50	Heath DX-40	39.00
National NC-60	39.50	Heath DX-60	79.50
National NC-173	75.00	Heath HX-20	165.00
National NC-183	119.00	Heath MT-1	49.50
National NC-200	65.00	Heath SB-10	59.00
National NC-240C	65.00	Johnson Adventurer	29.00
Pierson-Holt KE-93	89.00	Johnson Viking Mobile	35.00
Pierson-Holt AC Supply	29.00	Johnson Challenger	59.00
Pierson-Holt DC Supply	15.00	Johnson Ranger	119.00
RME DB-23	27.50	Johnson Ranger II (like new)	209.00
		Johnson Valiant	219.00
		Johnson Valiant II (like new)	349.50
		Johnson Valiant II (new)	420.00
		Johnson Courier	119.00
		Johnson Navigator	99.00
		Johnson Mobile VFO	24.50
		Johnson 122 VFO	19.50
		Johnson Invader 200 (new)	525.00
		Johnson Invader 2000 (like new)	695.00

## TRANSMITTERS

B & W 5100	\$139.00
B & W 6100 (new)	495.00
B & W LPA-1 linear	299.00

"THE STORE OPERATED BY HAMS FOR HAMS"  
K6LOS, K6GCD, K6DXD, K6EF, K1SFQ, W6SEY

# MISSION HAM SUPPLIES

3316 Main Street  
Riverside 3, California 92501  
Phone 683-0523 (area code 714)

**ORDER  
TODAY**

### MISSION HAM SUPPLIES

3316 Main Street, Riverside 3, Calif. 92501

Attn: Bill Hullquist, K6LOS, Please Ship me the following:

\$ \_\_\_\_\_ enclosed. (Cash orders shipped FREE in continental U. S.)

- QUOTE trade allowance and terms.  
 Please send latest HAM flyer.  
 Put me on your mailing list.

NAME \_\_\_\_\_ Call \_\_\_\_\_  
(please print)

Address \_\_\_\_\_

City \_\_\_\_\_ Zone \_\_\_\_\_ State \_\_\_\_\_ Zip \_\_\_\_\_  
(Calif. orders add 4% tax)



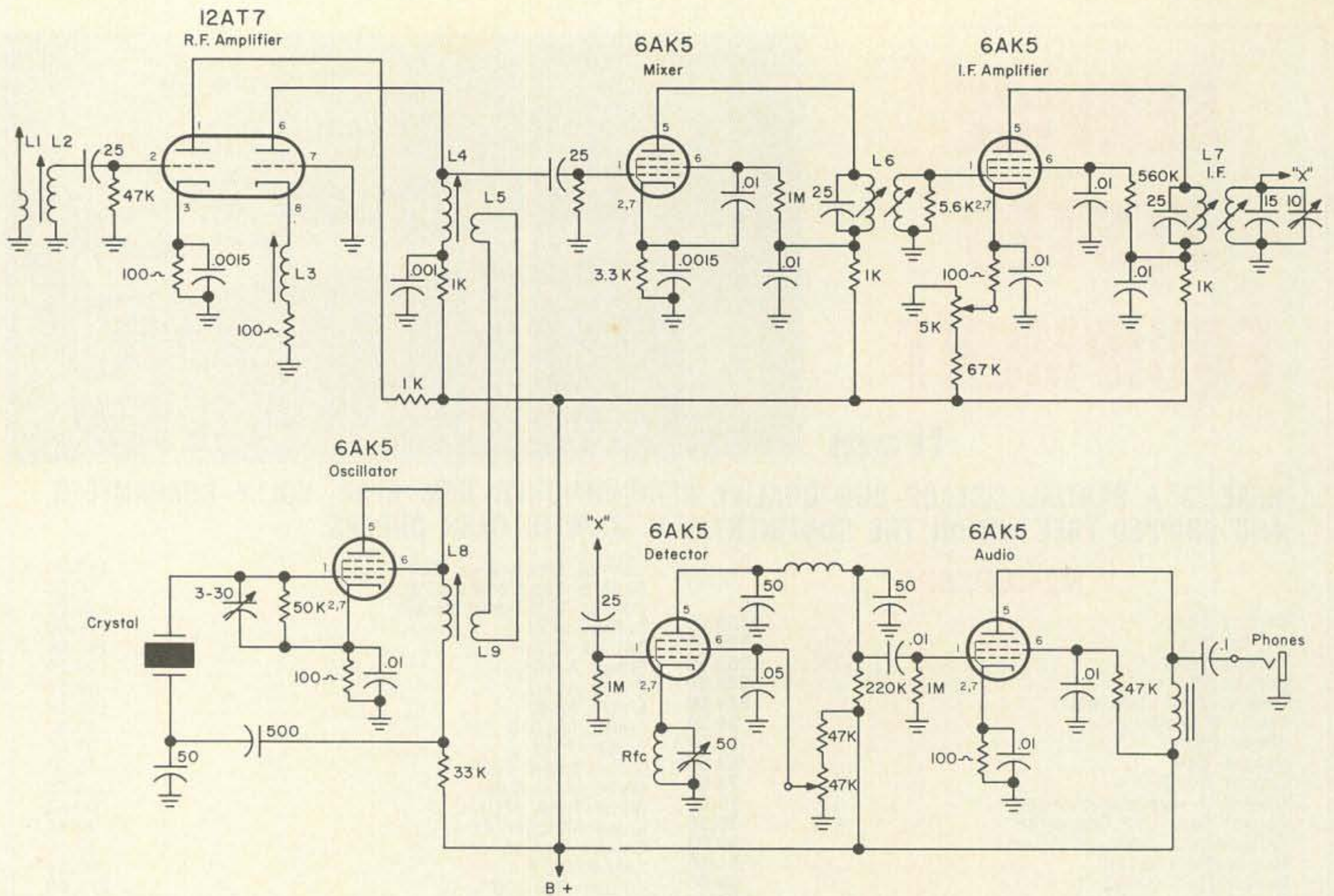

FIGURE 2

Receiver. Add 100 mmf capacitor from pin 1 to pin 8 of 12AT7.

in the transceiver. The mobile supply is a conventional vibrator supply delivering about 200v @80 ma. The ac supply is also conventional and delivers the same voltages in addition to rectified and filtered low voltage dc for the operation of the relay and microphone.

Now that I've given you a description of the transceiver, the next step is to drag out the soldering iron and begin the construction. The schematic for the transmitter and modulator is shown in Fig. 1. The Jones oscillator is of the cathode feed-back variety, the feed-back being caused by the rf voltage drop across the rfc in the cathode. A small rf choke in parallel

with a 3-30 mmfd trimmer is used. The trimmer adjusts the amount of feed-back to compensate for the lack of activity of some crystals. To adjust this, use an inactive crystal and set the trimmer so that the oscillator cuts in smoothly and reliably. This setting will be good for all other crystals. The choke in the cathode consists of #28 wire close wound 1" on a 3/8" slug-tuned form. The crystal can either be 12.5 or 16.5 mc. The screen supply of the oscillator has a form of voltage regulation caused by feeding voltage through a 10K re-

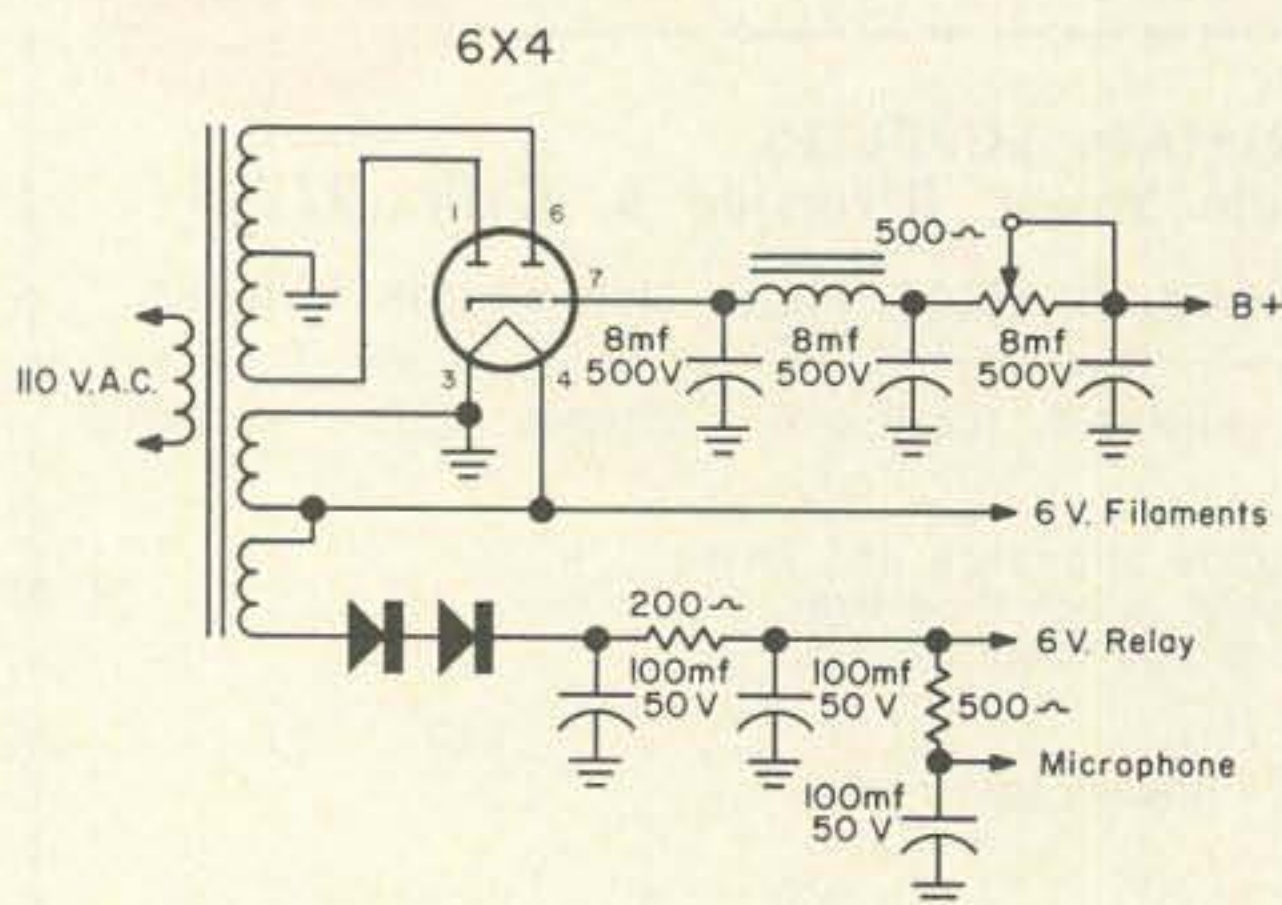

FIGURE 4

AC power supply.

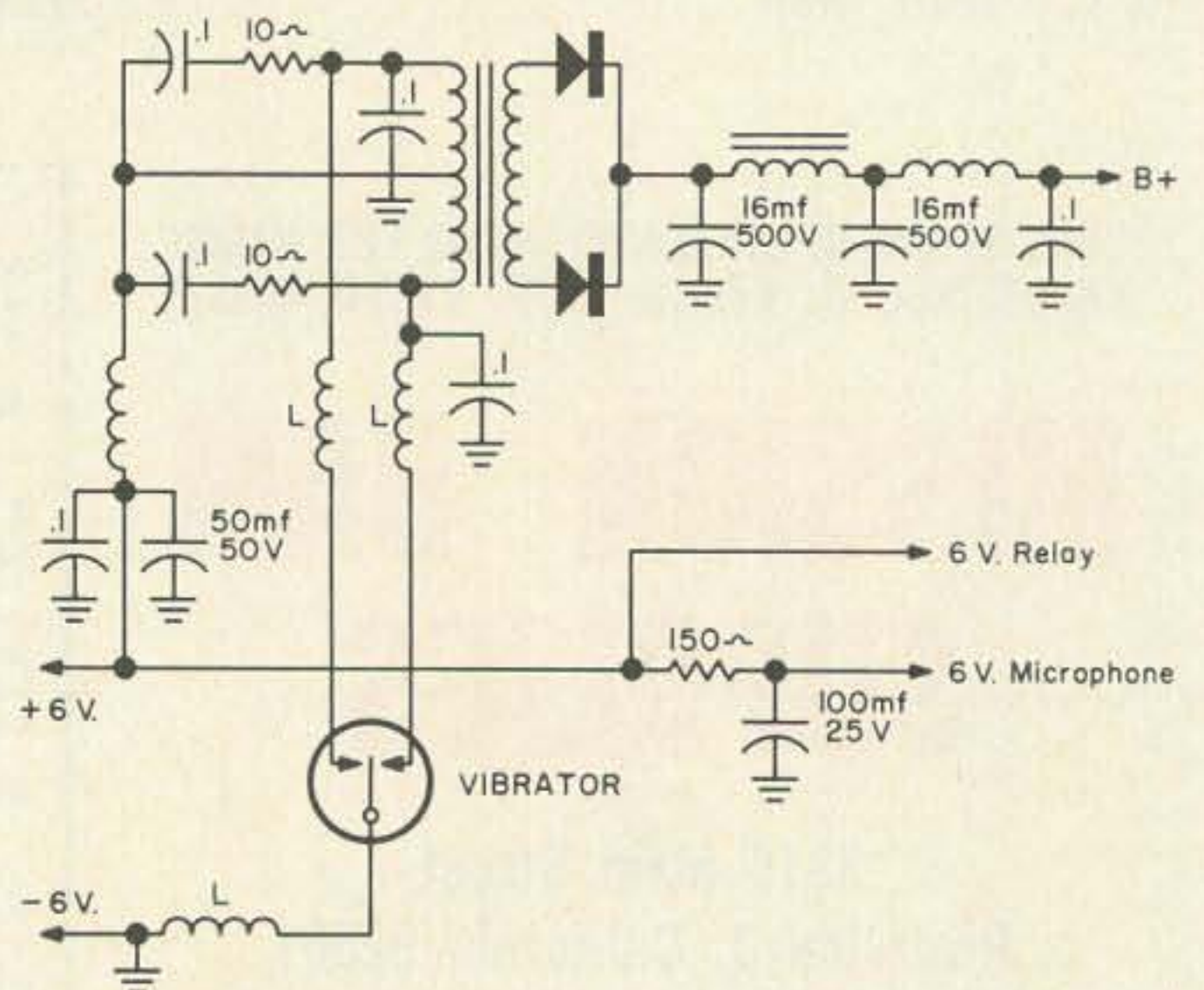

FIGURE 5

6 volt power supply.



BRYAN EDWARDS, JR.

# W5KFT

## "The Kid from Texas"

RECOMMENDS

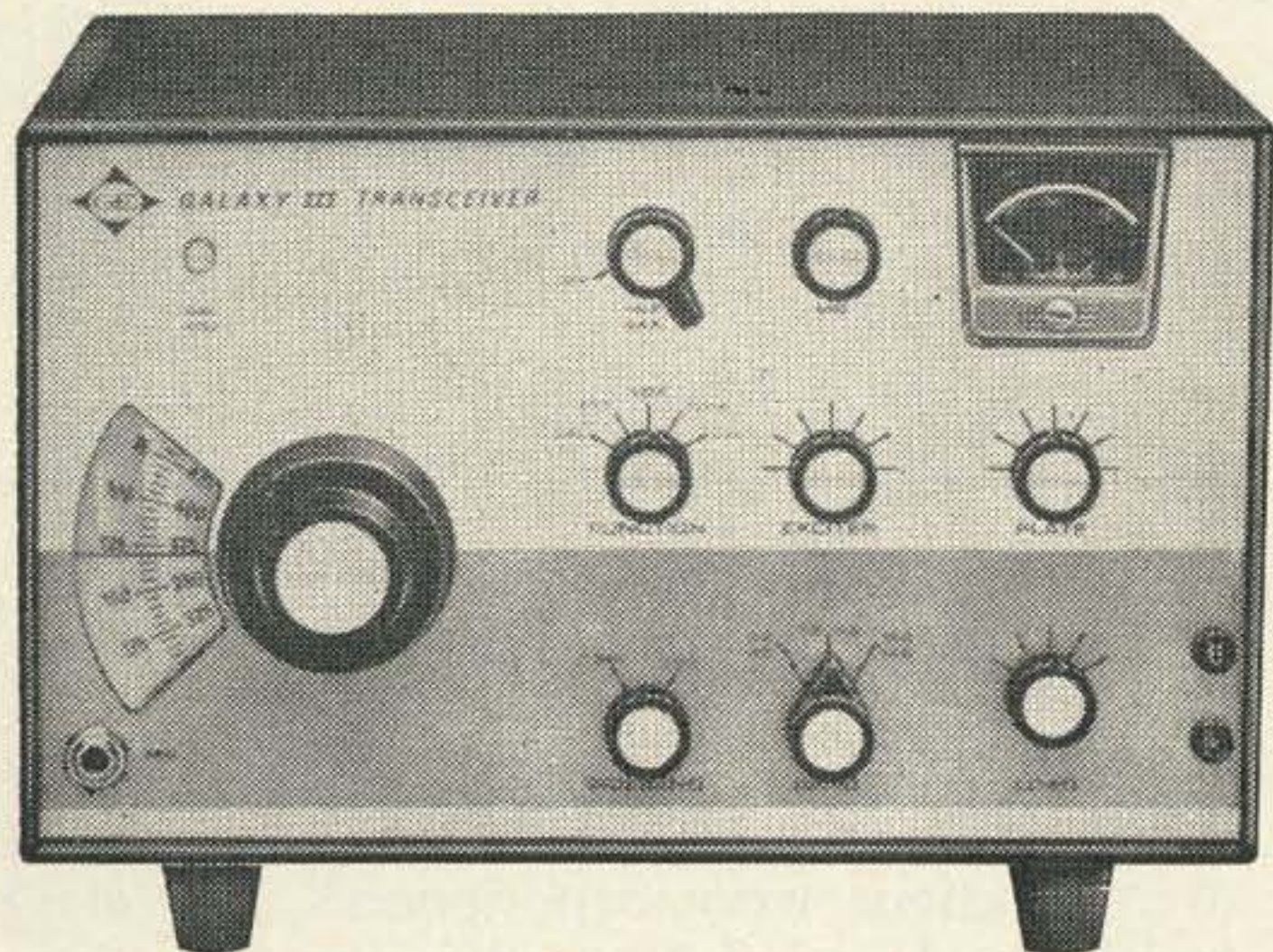

**GALAXY III** \$349.95  
80-40-20 METERS (Illustrated)

**GALAXY V** \$469.95  
80-20-15-10 METERS

IMPORTANT FEATURES OF THE GALAXY III AND GALAXY V . . .

- ✓ 300 Watts SSB/CW Input conservatively rated.
- ✓ "Hottest Receiver" because of advanced design.

- ✓ Best Filter Available: 2.1 kc bandwidth with exceptional 1.8: 1 shape factor. The only 6-crystal filter used in amateur equipment.
- ✓ Most Compact 300-Watt Transceivers: 6" high, 10¼" wide, 11¼" deep; weight —only 13 lbs.

### ORDER TODAY!

★ LUBBOCK, TEXAS  
THE HOME OF

### THE KID FROM TEXAS

WHO GIVES TEXAS-SIZE TRADES

### P.D.Q. DELIVERY

AND A  
TIME PAYMENT  
PLAN.

### PERSONAL INDIVIDUAL SERVICE GUARANTEED

### WE WANT YOUR BUSINESS!

# Edwards Electronics

TELEPHONE POrter 2-8759  
1320 19TH ST. / LUBBOCK, TEXAS 79401

Edwards Electronics  
1320 19th Street  
Lubbock, Texas 79401

Yes, Kid From Texas  
I'm interested!

- Enter order for equipment listed on attached sheet.
- Send Galaxy III and V literature.
- Send quotations for trade in allowances on equipment listed on attached sheet.

Name \_\_\_\_\_ Call \_\_\_\_\_  
Address \_\_\_\_\_  
City \_\_\_\_\_ State \_\_\_\_\_



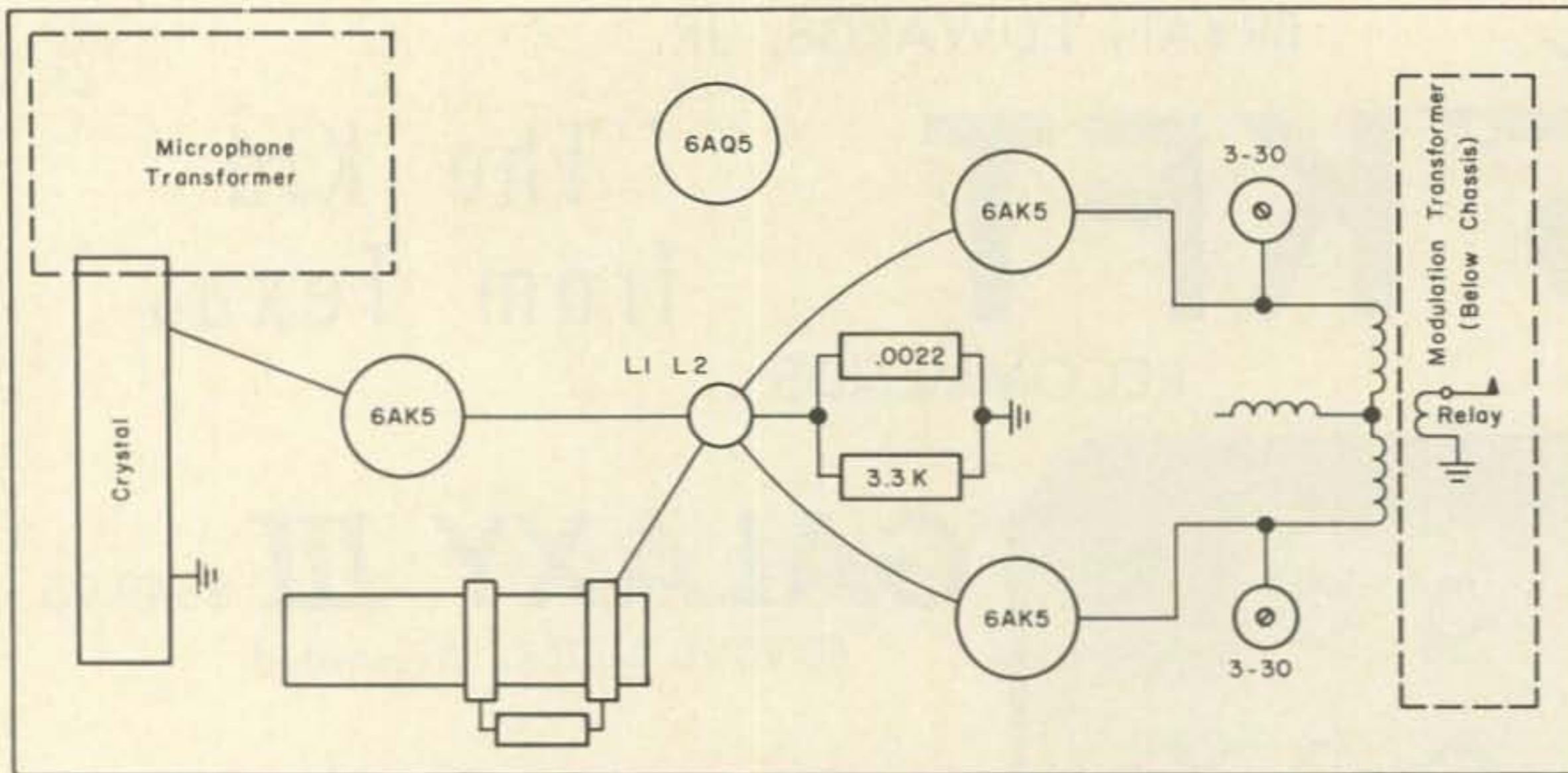

FIGURE 6  
Transmitter layout.

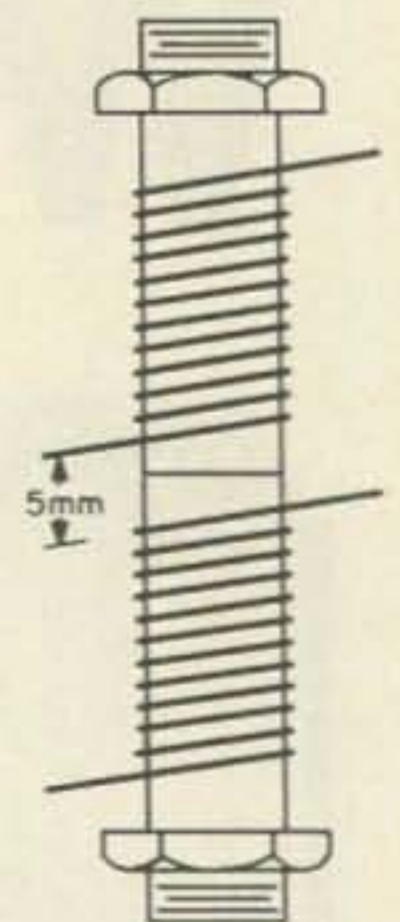

FIGURE 3  
Rcvr if.

sistor with an NE 2 or similar neon connected from the screen to ground. The plate of the oscillator is connected to a transformer consisting of L1 and L2. The final amplifier is a conventional push-pull circuit with L2 as the grid coil and L3 as the tank circuit. The modulator is not critical as to lay-out, the only precaution being necessary is to keep the plate leads away from the grid leads. A .005 mfd condenser is placed across the primary of the modulation transformer to prevent any undesirable feed-back. Although I wound the modulation transformer myself, this is done because there weren't any available here at the time. The transformer that should be used is a Triad M4Z or similar unit.

The receiver requires that some attention be paid to the lay-out. The rf amplifier is a

cascode using a 12AT7 or 6BQ7. Although the cascode was not neutralized, no feed-back or oscillations were experienced. The stage is bandpassed with L2 tuned to the high end, L4 to the center, and L3 to the low end. A 10 mc crystal is used on its third overtone giving an *if* of 20 mc. It is then coupled through L6 to the regenerative detector. An rf gain control is used to prevent overload of the detector. The detected signal passes through a filter network which removes rf from the audio. The audio output stage has a choke in the plate circuit which should be as large as possible when used with phones. An audio output transformer with a speaker could be used instead. The *if* transformers may appear difficult to build, but they are really no problem. The coils are wound on two forms 8 mm (ap-

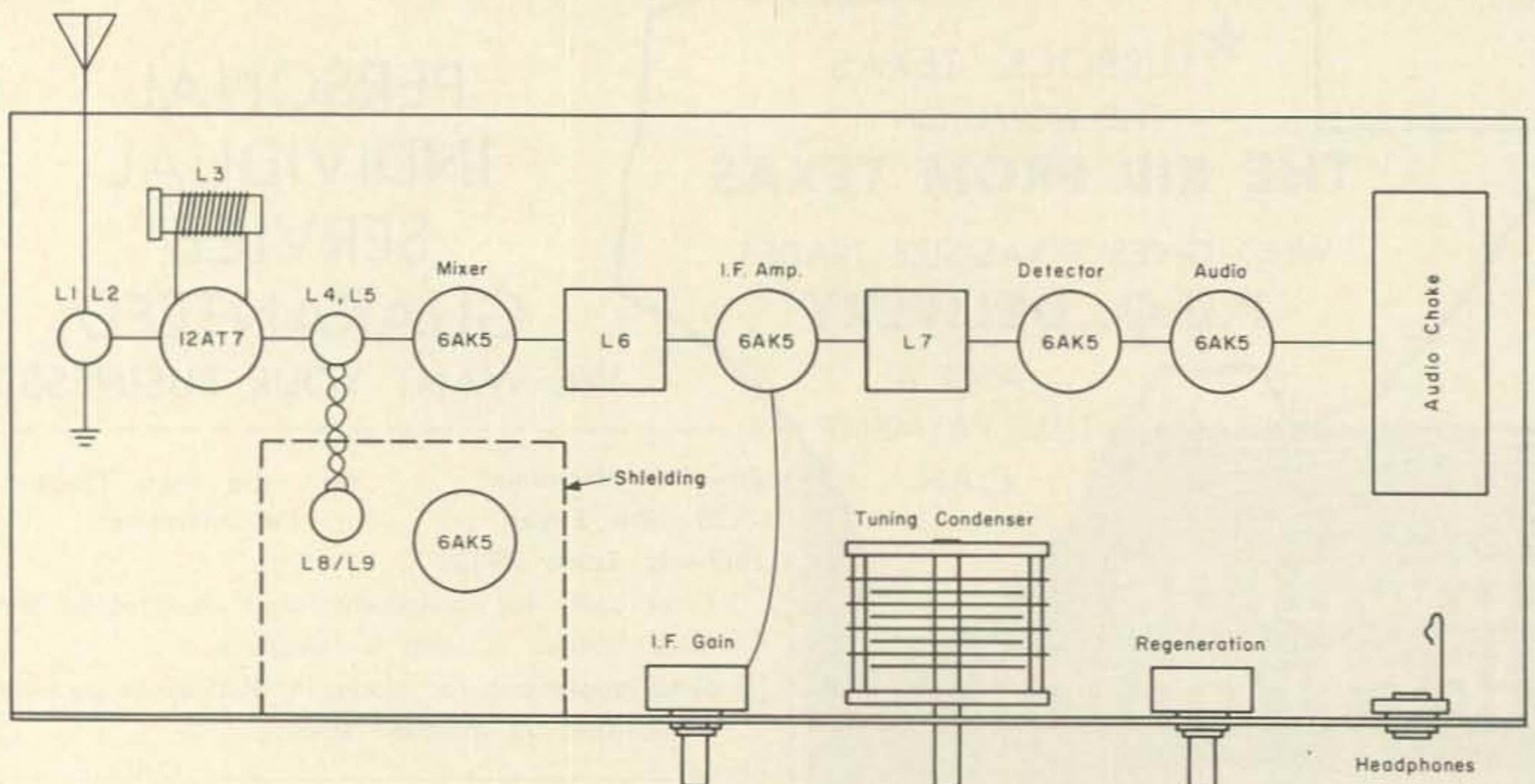

FIGURE 7  
Receiver layout.



### Coil Table

#### Transmitter

- L1—6 turns #20 on  $\frac{3}{8}$ " slug—tuned form
  - L2—5 turns of insulated wire, closely wound over L1
  - L3—3 turns #12 tinned,  $\frac{1}{2}$ " space and another 3 turns.  
Coil is 1" diameter, 1" long
  - L4—3 turns #14 enameled between the two halves of L3
- #### Receiver
- L1—2 turns wire coupled to the cold end of L2
  - L2—9 turns of #20 wire  $\frac{1}{2}$ " diameter 11/16" long with a 20 mmfd trimmer across the coil
  - L3—7 turns #20  $\frac{1}{2}$ " diameter 11/16" long with a 20 mmfd trimmer across the coil
  - L4—8 turns of #20  $\frac{1}{2}$ " diameter 11/16" long with a 20 mmfd trimmer across the coil
  - L8—11 turns #20  $\frac{3}{4}$ " diameter  $\frac{3}{4}$ " long with a 20 mmfd trimmer across the coil. This coil is tuned to 30 mc. proximately  $\frac{3}{8}$ " in diameter which are joined together as shown in Fig. 3. Standard 21 mc television *if* transformers can be substituted.

The power supplies are standard and no special precaution has to be taken. The two filament windings are connected in series and rectified to provide low voltage dc for the relay and microphone. There is a resistor for adjusting the output voltage of the transmitter. This should be set to about 200 volts in order to prevent damaging the 6AK5's. The filament leads are shielded to prevent pickup of vibrator buzz when used in mobile operation. The mechanical layout for the chassis are shown in Figs. 6 and 7.

#### Testing and Alignment

Check all voltages and make sure that they are correct. When checking the plate voltage of the 6AK5 detector tube, a click should be heard, indicating that the audio works. The most critical part is the *if* alignment. Using a signal generator or a grid dip meter, couple a 21 mc signal into the grid of the 6AK5 mixer and tune the 2 *if* transformers for maximum signal. If the signal is too strong, the indication of this being a strong whistling sound, it may be necessary to slightly drop the screen voltage of the detector. The oscillator is then tuned to the correct frequency. L2, 3, and 4 are tuned as described earlier and adjusted for maximum sensitivity.

The transmitter tune-up is simpler. Tune the plate circuit of the oscillator to 50 mc and adjust the trimmer in the cathode and plate coil for maximum output. Then insert a less active crystal and adjust the cathode trimmer so that it will oscillate without using excessive feed-back which can damage the crystals and cause poor stability. Next adjust the final coils for maximum output.

The unit is now complete. After using this a while, you will be amazed at the performance of such a simple rig. If care is used, you will have a station for use at home, in the car, or anywhere you care to take it.

. . . exYU1FR

*"Your Friendly Supplier"*

**A SPECIAL OFFERS**

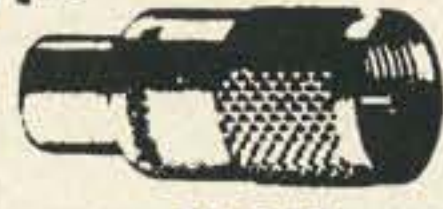

PL-259  
STOCK NO. 25

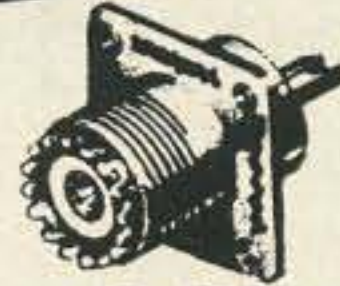

SO-239  
STOCK NO. 23

**ONLY 32¢ EACH  
IN LOTS OF 10 OR MORE**



**NEW!** RG-8U Coaxial Cable

**9¢ per foot**

Minimum order 100 feet Stock No. 7328

For Prepaid Shipment Continental U. S.  
Order by above Stock Numbers

---

ALSO—we can handle your antenna requirements! We stock ANTENNA SPECIALISTS, CUSH-CRAFT, HY-GAIN, MOSLEY, NEW-TRONICS, & WEBSTER—both fixed station & mobile, plus accessories.

*"Write for Latest Used Equipment List"*

# Evans RADIO

P.O. BOX 312      FONE 603-225-3358      CONCORD, N. H.

## DOW-KEY DK60 SERIES COAXIAL RELAYS

Size  
2 3/4 x 3 3/4 x 1 1/8  
Less than 9 oz.  
DK60-G2C

**4 Standard Models, AC or DC,  
UHF, N, BNC, TNC or C Conn.**

Outstanding favorite for amateurs . . . Versatile combinations for industrials! Low VSWR less than 1.15:1 from 0 to 500 mc. LOW LOSSES . . . High Contact Pressures. LOW CROSS-TALK through use of patented "isolated connector" arrangement. HIGH POWER RATING. All coils encapsulated in epoxy resin for quieter operation and resistance to moisture.

- ★ UNCONDITIONAL GUARANTEE for one year. (We will repair if faulty within 1 year.)
- ★ See one of our 700 dealers and distributors in U. S. and Canada for catalog sheets or write:

- ★ All Relays available in weatherproof boxes for exterior installation.
- ★ Ganged, multiple position switch arrangement available for remote control selection of antennas.

STANDARD RELAYS: DK60, DK60-G, DK60-2C and DK60-G2C —  
PRICED FROM . . . **\$12.45**

**DOW-KEY CO., Thief River Falls, Minn.**



# Silicon Diode Noise Limited For Mobile Receivers

Don Springer KØPOX  
264 Oakview Road  
West St. Paul 18, Minn.

A noise limiter, as any real mobile enthusiast knows, is a necessary evil for the satisfactory performance of the familiar converter-broadcast receiver combination. The installation of this type of limiter usually entails unsoldering and rewiring the second detector and replacing the seven pin socket with a nine pin socket for which a larger hole must be filed or punched. Or, another tube may be installed, often at a distance of several feet and connected to the receiver by at least four dangling wires that pick up almost as much noise as the limiter cuts out.

With the advent of the high back-resistance, quick recovery silicon computer diode all this can be done away with forever and at a price

of only \$1.58 for the diode (Allied Radio) and a few parts from the junk box. No more heaters to wire, no new sockets or holes to punch. The only change required in the original second detector circuitry is to unsolder the lead at the hot end of the volume control ( $R_5$ ). The limiter is then installed between this lead and the control.

The noise limiter is a typical series-gate type.  $R_1R_2$  form a voltage divider. The tap is at a lower potential than the hot end of  $R_1$ . Because of the potential difference between these two points, the anode of the diode is more positive than the cathode and conduction takes place within the diode. The audio passes through the diode and out to the amplifier section. A noise peak of higher amplitude than the modulation peaks will drive the anode negative in respect to the cathode, since a rapid change in voltage at the cathode is prohibited by the large time constant of  $R_3C_1$ . At the point where the anode becomes negative, conduction in the diode ceases and no audio is passed on to the following stages. Because the period in which the

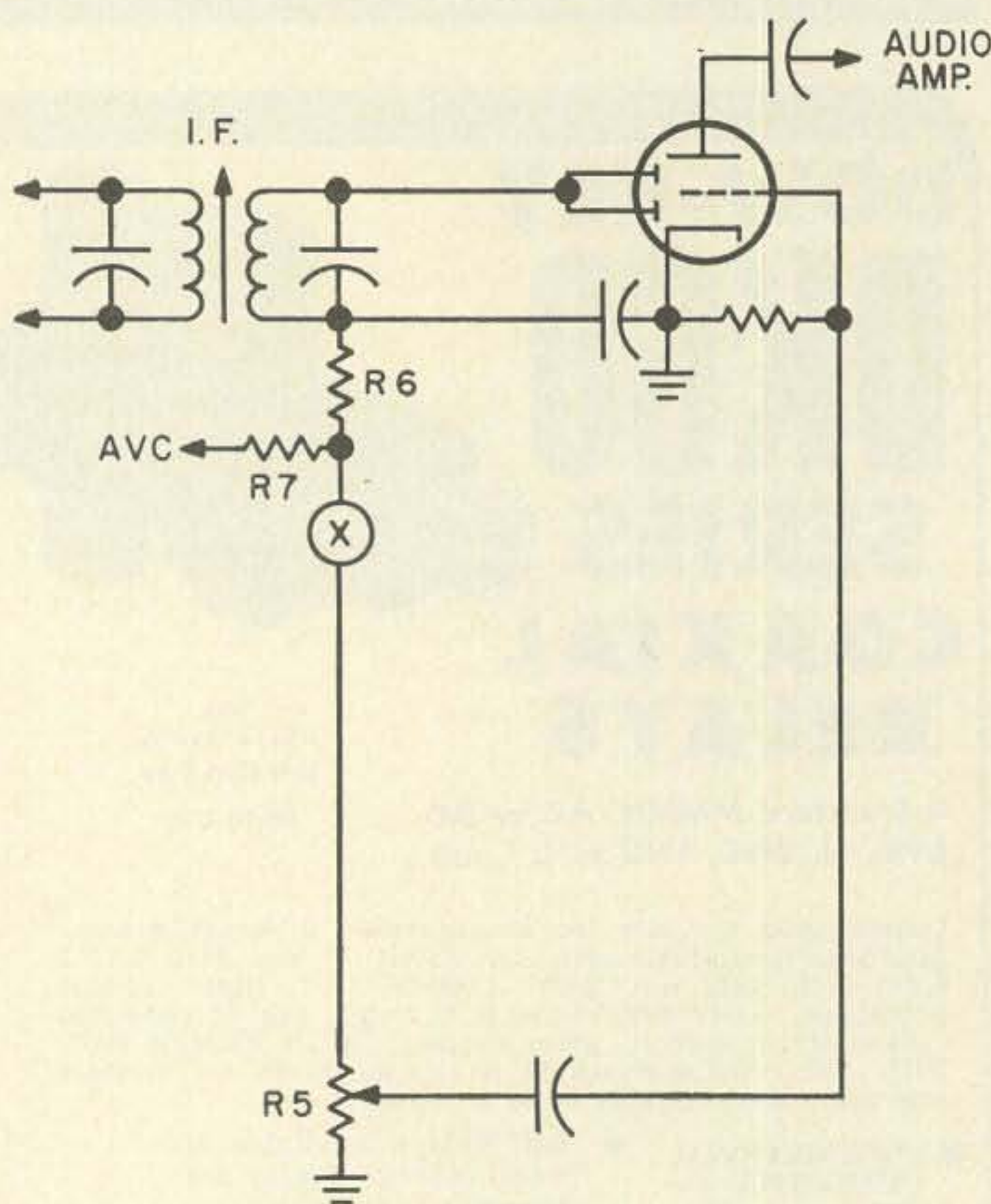

FIGURE 1A

The circuit of the second detector of the average automobile broadcast receiver. X denotes the point where the circuit is broken.

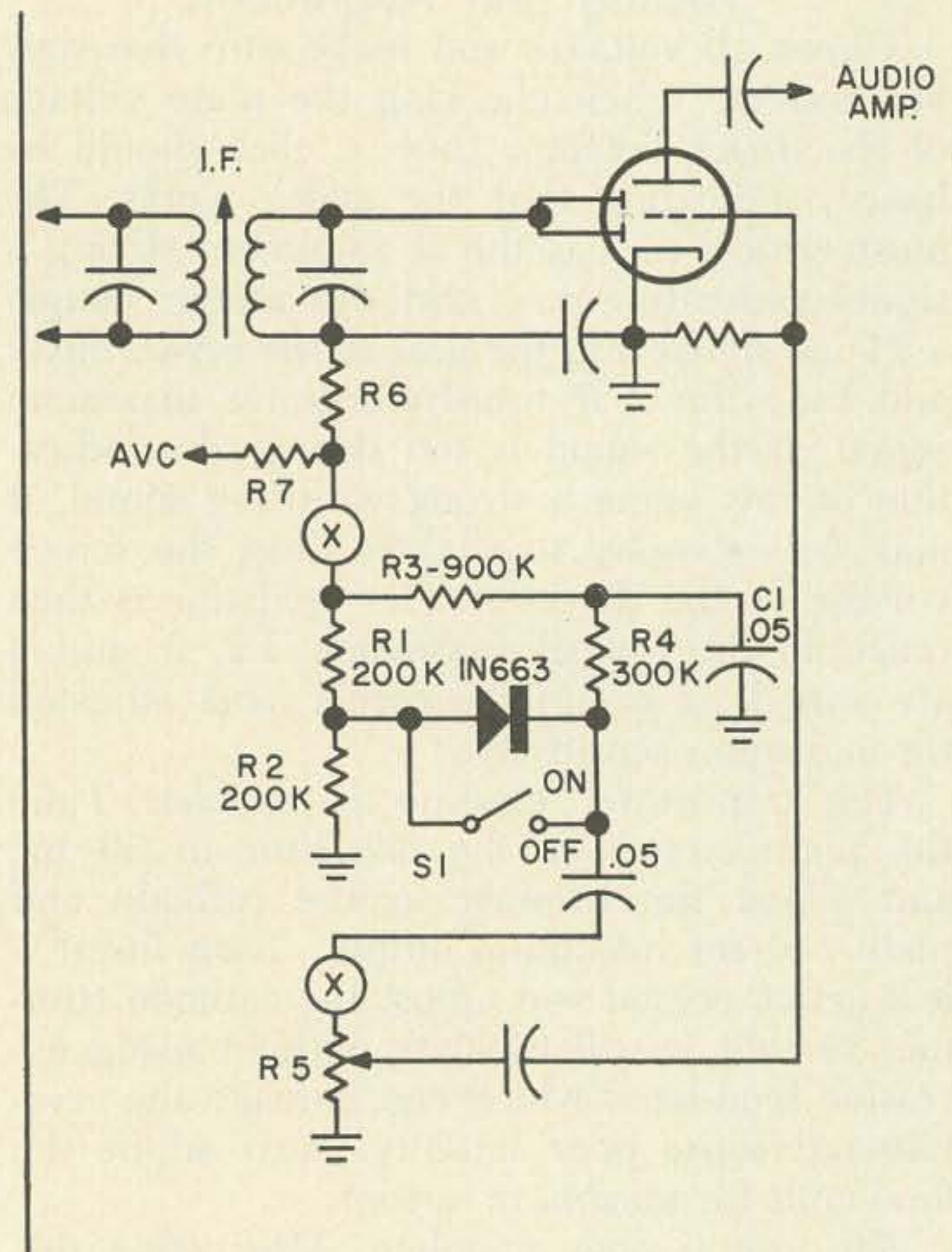

FIGURE 1B

Fig. 1B shows the same second detection with the limiter inserted at this point.



# WHO MAKES IT?

Solid conductor hook up wire  
 Stranded hook up wire  
 Shielded hook up wire  
 (7 kinds)  
 Unshielded audio cable  
 (16 kinds)  
 Multi-conductor jacketed cable  
 (56 kinds)  
 Multi-conductor shielded cable  
 (11 kinds)  
 Intercom cable (24 kinds)  
 Audio cable (18 kinds)  
 Unshielded speaker wire  
 (7 kinds)  
 Phono wire (only 2 kinds)  
 Microphone cable (9 kinds)  
 Test lead wire (7 kinds)

Hi voltage wire (4 kinds)  
 E-Z zip cord (6 kinds)  
 Rotor cable (4 kinds)  
 Twin lead (16 kinds)  
 Open wire transmission line  
 (9 kinds)  
 Coaxial cable (17 kinds)  
 Tinned copper wire (24 kinds)  
 Copperweld (7 kinds)  
 Guy wire (steel, aluminum,  
 copperweld, fibre glass)  
 Messenger cables (12 kinds)  
 Antenna wire (7 kinds)  
 Aluminum ground wire  
 (6 kinds)  
 Ignition wire  
 Telephone wire

## SAXTON MAKES IT!

Specify Saxton Wire. We go to a lot of trouble to design and make the finest wire that is available, so please don't rush out and buy imitations. Our catalog is free, whether you buy inches or miles of wire . . . if you buy miles, call collect!

## SAXTON

215 NORTH ROUTE 303  
 CONGERS, N. Y.  
 914 CO 8-6846

diode is not conducting is very short, the listener does not hear these holes in the audio signal.

For those who are perfectionists,  $R_1$  and  $R_4$  may be adjusted until the maximum amount of limiting and the minimum distortion are found. The values of the components are not very critical, though only a high back-resistance computer diode should be used. Several types of diodes were tried. The 1N663 silicon diode gave the best account of itself while germanium types were almost worthless. If  $S_1$  is located some distance from the limiter it would be wise to shield the leads. One unit is presently in use in a transistorized receiver, the only difference is that smaller values are used in the voltage divider, although this might not be necessary. As shown, the limiter is designed for a negative audio voltage. For a positive voltage, as encountered in some transistorized receivers or from an infinite-impedance detector, simply reverse the polarity of the diode.

The limiter outperformed most vacuum tube diode limiters previously encountered, but like all units of this type, it causes some distortion and is best turned off when listening to broadcast stations.

. . . KØPOX

●●●●● CLIP AND MAIL ●●●●●

# FREE!

**EXCLUSIVE HAM CATALOG**  
 Now! the most complete amateur catalog ever compiled.



**WORLD RADIO LABORATORIES**  
 3415 West Broadway, Council Bluffs, Iowa  
 Rush my Free WRL 1965 Catalog

HAM/CB

- 100's of Bargains for the Ham, CB'ers & experimenter.
- Exclusive WRL "Charge-A-Plan" Application.
- The best prices available anywhere!

CLIP AND MAIL

NAME \_\_\_\_\_

ADDRESS \_\_\_\_\_

CITY \_\_\_\_\_ STATE \_\_\_\_\_

SEND FOR IT TODAY FREE

CLIP AND MAIL

●●●●● CLIP AND MAIL ●●●●●



# Amateur Radio Operating:

## FCC Version —

Carl Drumeller W5EHC  
5824 N.W. 58th St.,  
Oklahoma City 22, Okla.

Not many radio amateurs are familiar with the FCC Rules and Regulation affecting the Amateur Service. Rules make dry reading. If read at all, it usually is during a frantic cram for an examination. Quickly "learned," quickly forgotten. The purpose of this article is to discuss these regulations in everyday amateur language. It is hoped the discussion will decrease the number of unintentional violations.

As a starter, let's see what the FCC says about just what *is* the purpose of amateur radio. There's no better way to get this information than from a direct quotation. Here's what Paragraph 97.0, Basis and Purpose, says:

The rules and regulations in this part are designed to provide an amateur radio service having a fundamental purpose as expressed in the following principles:

(a) Recognition and enhancement of the value of the amateur service to the public as a voluntary non-commercial communication service, particularly with respect to providing emergency communications.

(b) Continuation and extension of the amateur's proven ability to contribute to the advancement of the radio art.

(c) Encouragement and improvement of the amateur radio service through rules which provide for advancing skills in both the communication and technical phases of the art.

(d) Expansion of the existing reservoir within the amateur service of trained operators, technicians, and electronic experts.

(e) Continuation and extension of the amateur's unique ability to enhance international good will.

Say, you didn't realize the lawmakers thought you were such an important person, did you? Now that you know, can you honestly say you've been living up to such a high standard? Look those paragraphs over again, reading carefully. Do you see anything in them pertaining to yap-yapping across town about how much beer you can drink or some other non-technical subject? Do they lead you to believe the FCC thinks highly of the "plug-in appliance" type of amateur? Looking at the other side of the coin; doesn't it make you believe the FCC has in mind the type of amateur who can handle message traffic in a standardized, efficient manner? An amateur who can diagnose, locate, and repair trouble appearing in a piece of communications equipment? Who can contribute new circuits or new methods of applying circuits that advance the state of the art? Who can communicate with a foreign amateur in a fashion that will "leave a good taste in his mouth" . . . . . will create a feeling of friendliness toward W/K amateurs and nationals?

Let's go on a bit farther and see what the FCC says about portable and mobile amateur stations. Paragraph 97.4 says:

The term "amateur portable station" means an amateur station that is so constructed that it may conveniently be moved about from place to place for communication, but which is not operated while in motion.

You should also note that Paragraph 97.93 goes into a definition of non-portable stations that are operated at other than their regular locations. It states that when operated under these conditions, portable identifications shall be employed. Note the distinction: One is



truly portable, the other is not portable but uses the portable identification procedure.

Paragraph 97.5 defines a mobile station in this manner:

The term "amateur mobile station" means an amateur station that is so constructed that it may conveniently be transferred to or from a mobile unit or from one such unit to another, and is ordinarily used while such mobile unit is in motion.

That tells a rather definite story. You'll note that there was *no* mention of "fixed portable," "fixed mobile," or "mobile in motion."

Now let's go tearing over to Paragraph 97.83 and see what the FCC has to say about call signs. Let's first talk about "portable" and "mobile" call signs. If you're on CW, here's the way the FCC says you must transmit your call if you're operating portable and calling another station . . . . . whether that station is fixed, portable, or mobile: W1ABC W1ABC W1ABC DE W2DEF/3 W2DEF/3 W2DEF/3 AR. That AR, with the bar over it, in case you've forgotten, in ditdahditdahdit, the International Signal for "end of message," which is used at the end of a call before two-way communication has been established. The next example given by the FCC is to show how a fixed station answers the call of a mobile station: W2DEF W2DEF W2DEF DE W1-ABC K. Note three things about this example: No "/3" was transmitted; the calling station does *not* make use of the portable designator, only the station that actually is portable does this. The station responding to the call gave his call only *once*; no need to send it the three times used in the other instances. The responding station ended his call with K, indicating that two-way communication had been established and that the called station was to go ahead.

If you're operating portable and using voice, the basic procedure is the same . . . . . but with one important difference: You *must* give the *geographical location* of your station. Note that again. It didn't say "portable 3" or anything like that. Here's the example the FCC gives:

W1ABC W1ABC W1ABC this is (or from) W2DEF W2DEF W2DEF operating portable 3 miles north of Bethesda, Maryland, over.

There are several things you should carefully note about this example. Note that there are only two legal ways of calling on phone. You may give the call of the station being called, say "this is," and then give your call. Or you may give the call of the station being called, say "from," and then give your call. All other

ways are illegal. Note also that the location was given only once, not after each call-letter transmission, as on CW. And, finally, note that the ending signal was "over." It was *not* "go" or any other faddish wording.

For mobile, the CW procedure is the same as that for portable operation. On phone, the only difference is the substitution of "mobile" for "portable" in the foregoing example.

Aeronautical or Maritime mobile has a few more requirements. In the first place, you should note that Paragraph 97.82 (2) (e) plainly states that Maritime mobile operation is that on the high seas . . . . . not on an inland lake or on coastal waters. Aeronautical mobile is defined as that "aboard an aircraft enroute on an international flight." That rules out flights between points in the United States. In such instances, you're just plain mobile . . . . in an aircraft.

The significant differences between Maritime mobile and ordinary mobile is that on CW you use "/MM" instead of a call area designator and at the end of each transmission you must give the name (or number) of the vessel and its geographical location. For phone, you say "this is (or from) maritime mobile W1ABC." Of course, you must give the name (or number) of the vessel and its location at the end of transmission, too.

It is much the same with Aeronautical mobile, the differences being that you use the designator "/AM" on CW and say "this is (or from) aeronautical mobile W1ABC" on phone. In each case, you must give the number of the aircraft and its geographical location at the end of transmission.

If you're planning either Maritime or Aeronautical mobile operation, it's a good idea to read the regulations in detail. For instance, not all amateur frequencies are available for such operation. Those that *are* available vary with location. Another requirement is that the amateur station equipment must be wholly independent of the vessel's or the aircraft's equipment . . . . . and must cause no interference to the vessel's or aircraft's equipment.



What about your license? There are only two legal places it may be (if it is not being sent back to the FCC for some sort of action): On your person or displayed in a conspicuous place in the room occupied by the operator. A photocopy of the station license may be made and used, but there's no need to make a copy of your operator license. Any sort of copy of an operator license is just so much scrap paper in the eyes of the FCC.

Now to take up license examinations. One of the favorite alibis of holders of Technician



# FEEDLINE!

## TWIN LEAD

Economy (7 strand)	100'	\$1.00	3 lbs
	250'	2.25	5 lbs
Crusader (10 strand)	100'	1.25	3 lbs
	250'	2.50	5 lbs
Heavy Duty (20 strand) Deluxe Copperweld	100'	1.98	3 lbs
	250'	4.75	6 lbs
Spongee 	100'	3.30	5 lbs
	250'	8.00	12 lbs
Tubular 	100'	2.00	3 lbs
	250'	4.75	8 lbs
Classic (41 strand)	100'	2.50	5 lbs
	250'	6.00	12 lbs

Price and efficiency are closely allied. If you want the lowest loss possible you would do well to use Classic or Spongee Lines. The formula is simple: the more copper and the better dielectric used, the more expensive the line.

## COAX

RG-8/U 52 Ohm Foam	100'	\$12.50	12 lbs
RG-11/U 75 Ohm Foam	100'	11.00	10 lbs
RG-58/U 53 Ohm	100'	4.75	4 lbs
RG-59/U 73 Ohm Foam	100'	5.00	4 lbs

## OPEN WIRE LINE

300 Ohm Copperweld	100'	\$2.15	3 lbs
	250'	4.85	5 lbs
300 Ohm Copper Formvar (insulated)	100'	3.50	3 lbs
	250'	8.50	5 lbs
450 Ohm Copperweld	100'	2.75	3 lbs
	250'	6.00	5 lbs
450 Ohm Copper Formvar	100'	3.50	3 lbs
	250'	8.50	5 lbs
450 Ohm Copperweld (#12 wire, 2" space)	100'	7.50	5 lbs
	250'	18.00	13 lbs
450 Ohm Insulated (Type INS-500)	100'	4.00	5 lbs
	250'	10.00	12 lbs

## STANDOFFS

5 1/2" Nail type	10/\$1.50	1 lb
7 1/2" Wood screw	10/\$1.50	1 lb
7 1/2" Pole clamp	10/\$1.75	1 lb
INS-500 type	5/\$1.50	1 lb

These standoffs have slots for 300, 450, 600 Ohm wires

## ORDER DIRECT AND SAVE

Minimum order \$5. Please enclose postage as below.

Postage	300 mi	600 mi	1000 mi	1400 mi	1800 mi	beyond
First 2 lbs.	.35	.39	.45	.51	.58	.64
Ea. add'tl lb.	.06	.08	.10	.13	.16	.19

## REDLINE

**JAFFREY, N. H.**

Class licenses, upon failure to pass the written portion of the General Class license examination, is that the General is stiffer than the Technician. Not true; it's exactly the same (Elements 2 and 3(B) in each case). It just seems tougher when you don't have a "buddy" at hand to help you look up the answers in the License Manual!

Do you know how the FCC classifies the International Morse Code tests? It's quite enlightening. They define them in these terms:

Element 1(A): *Beginner's code test.* Code test at five words per minute.

Element 1(B): *General code test.* Code test at thirteen words per minute.

Element 1(C): *Expert's code test.* Code test at twenty words per minute.

That's the only recognition a holder of an Extra Class license gets: He's officially recognized as an expert. This classification should help to settle some arguments as to whether the FCC considers holders of Technicians Class licenses as beginners or as journeymen. This shows that they are classified as *beginners*.

Paragraph 97.45 has some interesting aspects. It plainly states that holders of any class of license, the examination for which was not administered by a FCC representative, may be called in at any time to take an examination before a Field Engineer. If the license holder flunks the examination, his "mail order" license is cancelled, and he may not apply for another of that grade. Tsk, Tsk. Do you suppose the FCC really believes that some "mail order" licenses may have been obtained by perjury? Perhaps the fact that failures on "mail order" examinations run practically zero percent . . . . . and failures on FCC-administered examinations run over 60 percent may have some slight bearing on the unholy suspicions held by the FCC.

The subject of "one-way" transmissions seems to cause some confusion among amateurs. It shouldn't. Paragraph 97.106 tells the four legal types: Emergency communications or drills for such, information bulletins of interest to amateurs, round-table or net-type operations, and code practice.

Paragraph 97.113 may cause some burning hearts among the devotees of nets. It says: "Transmissions by an amateur may be on any frequency within any authorized amateur band." So take it with a grain of salt the next time some Net Control Station threatens to sic' the FCC on you just because you happened to be operating on what he thought was his exclusive frequency!

Logs are a much-debated subject. There are about as many opinions about how a log



should be kept as there are individual amateurs. Paragraph 97.136 sets down a few guidelines. Such things as the date and time of each transmission, the call sign of a station being called, the input power to the final stage (some modification of this on grounded-grid stages) of the transmitter, the frequency band, the type of emission used, and the location of the station are the commonly-understood items that give very little trouble. Where the trouble shows up is in the matter of log entries when some third party uses your station. What then? Well, if he had the proper grade of license and operates your station, have him sign the log. The FCC doesn't spell out how this must be done in amateur stations. It would be well, though, to follow the practice designated for commercial stations: Have him sign his signature on a line across the body of the log (not at one side). Have him use his legal signature, just as it appears on his license. Just to be safe, have him add his call. Have him sign "on duty" and "off duty."

What about the non-licensed person who talks over your radiotelephone station? Here's what the FCC says: . . . . . "the name of any person not holding an amateur operator license who directly or by recording transmits by voice over a radiotelephone transmitter or operates a teleprinter keying a radiotelegraph transmitter" . . . . . must be entered on the log. So if you run a phone patch, be sure you get the legal name of the person whose voice goes out over your station. If you leave the mic open and the af gain turned high when you're throwing a beer party in your shack, you'd better hire a sober shorthand expert to keep log! And don't forget that if you run back a recording to show the other chap how good (or how rotten) his signal sounds, you must log *his* legal name, too.

Most amateurs know that they are required to keep their logs on hand for one year, but do you know you're also required to preserve a copy of each message handled (received or transmitted) for one year?

That about brings us to the end of the less-understood aspects of the law. Of course, all amateurs are aware of the law against transmitting profanity or obscenity, the law against transmitting unidentified signals, and the law against causing willful interference. If you have any doubt concerning what is lawful and what is prohibited, purchase from the Superintendent of Documents, Government Printing Office, Washington 25, D. C., a copy of Volume VI, Rules and Regulations. Read it. It may save your license!

. . . W5EHC

# FINCO 6 & 2 Meter Combination Beam Antennas

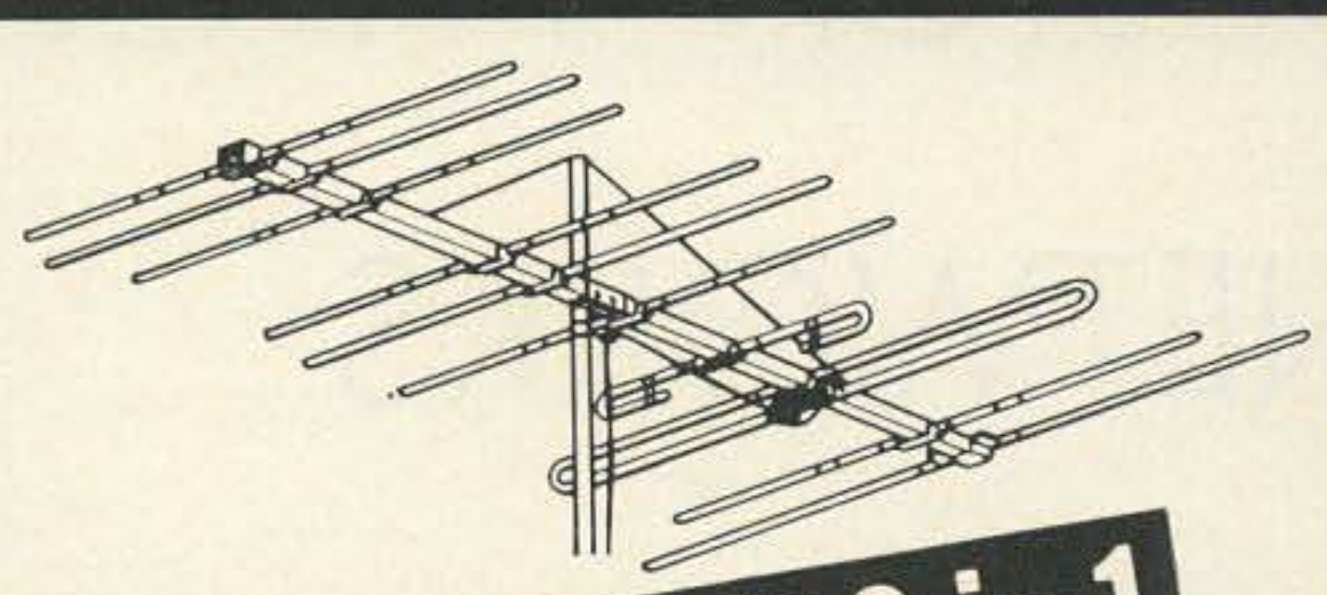

**2 ANTENNAS in 1**

## MODEL A-62 · 300 OHM

<b>On 2 Meters:</b>	<b>On 6 Meters:</b>
18 Elements	Full 4 Elements
1-Folded Dipole Plus Special Phasing Stub	1-Folded Dipole
1-3 Element Colinear Reflector	1-Reflector
4-3 Element Colinear Directors	2-Directors

Amateur Net . . . . \$33.00  
Stacking Kit . . . . \$2.19

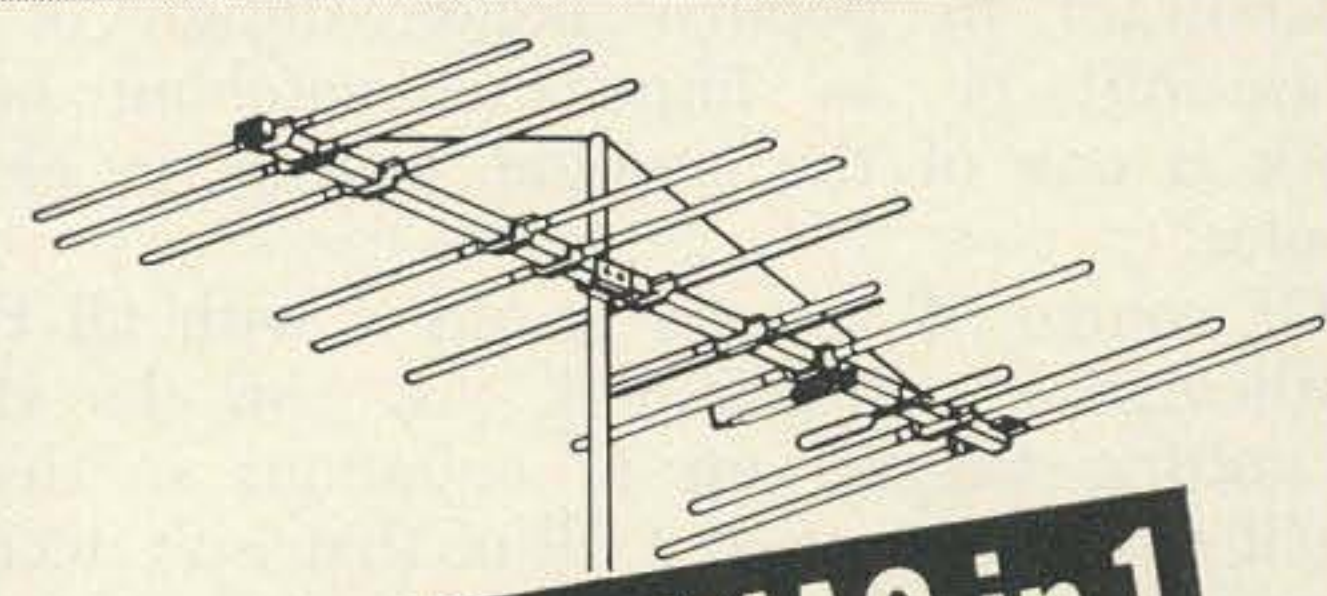

**2 ANTENNAS in 1**

## MODEL A-62 GMC · 50 OHM

<b>On 2 Meters:</b>	<b>On 6 Meters:</b>
Equivalent to 18 Elements	4 Elements
1-Gamma-Matched Dipole	1-Gamma-Matched Dipole
1-3 Element Colinear Reflector	1-Reflector
4-3 Element Colinear Directors	2-Directors

Amateur Net . . . . \$34.50  
Stacking Kit . . . . \$18.00

### MODEL AB-62 GMC

<b>On 2 Meters:</b>	<b>On 6 Meters:</b>
Equivalent to 30 Elements	Equivalent to 6 Elements

Amateur Net . . . . \$52.50

### Also:

- 5 New 6 Meter Beams
- 3 New 2 Meter Beams
- 1 New 1 1/4 Meter Beams

Gold Corodized for Protection Against Corrosion  
See Your Finco Distributor or write for Catalog 20-226

**The FINNEY Company - Bedford, Ohio**



# HOW TO DESIGN PHASE-SHIFT NETWORKS

Jim Kyle K5JKX  
1236 N.E. 44th St.  
Oklahoma City, Okla.

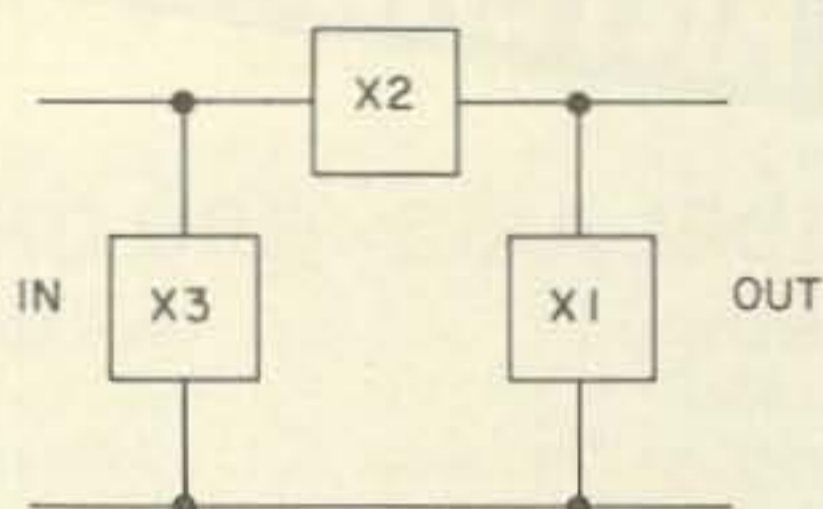

FIG. 1

Contrary to popular belief, design of a phase-shift or an impedance-matching network is one of the simplest matters in electronics!

Of course, if you try to do it with all the mathematics and formulas, you run the risk of getting tangled up in equations so deep you'll never get out—but all of that isn't necessary.

Because a "graphical design" technique exists which makes the whole thing as simple as drawing six lines on a sheet of paper, then solving three problems in long division.

Before showing just how it's done, though, let's see what we're going to do. In "graphical design" we use the length of lines to represent voltages or currents; if you've ever drawn a load line on a tube characteristic chart you've been using the principles of graphical design.

To keep things simple, we'll consider only the type of network usually called a pi-network in this article. An almost identical technique is used for T-networks, however, and if you're interested we'll describe it at a later time.

In a pi-network, we have three impedances arranged as shown in Fig. 1. The impedances are shown as blocks labelled merely X1, X2, and X3 because at this point we do not know for certain which are inductors and which are capacitors.

Before we can begin the design, we must know a few facts about what we want to do.

We can either specify the input and output impedances together with the required phase shift through the network, or we can specify reactances looking into and out of the network together with phase shift.

The phase shift specification, however, is important—because without it, an infinite number of solutions are possible.

Once we know the characteristics of the network we want, we're ready to proceed with the graphical design. It's much simpler if you use polar plot paper such as K&E No. 359-31, available through any engineering supply house, but you can get by with ordinary paper, pencil, and a protractor.

Start by drawing a horizontal line representing the output circuit. If you use polar plot paper, run the line along the zero-degree radial, from the origin outwards. Assume an arbitrary voltage across the load, and by Ohm's Law calculate the current which would flow with this voltage. Using any convenient scale, measure off a length corresponding to the voltage from the origin along your line, and mark it  $V_o$ . Measure another length representing current, and mark this  $I_o$ .

Next, lay off an angle at the origin which corresponds to your desired amount of phase shift. Draw a second line at this angle, meeting the first at the origin point, and again determine a voltage-current ratio which equals the desired input impedance. Scale off voltage and current, and mark them  $V_{in}$  and  $I_{in}$  respectively.

At this stage, connect  $V_{in}$  and  $V_o$  with a straight line. Erect a line perpendicular to the  $I_o$  line and meeting it at  $I_o$ , and a second line perpendicular to  $I_{in}$ . Draw a third line from the intersection of these two back to the origin.

Mark the  $V_{in}$ - $V_o$  line as  $V_1$ . The line perpendicular to  $I_o$  is  $I_1$ , that perpendicular to  $I_{in}$  is  $I_3$ , and the one from their intersection to the origin is  $I_2$ .

Now, measure all the lines and scale them back to voltage and current values. Plug the



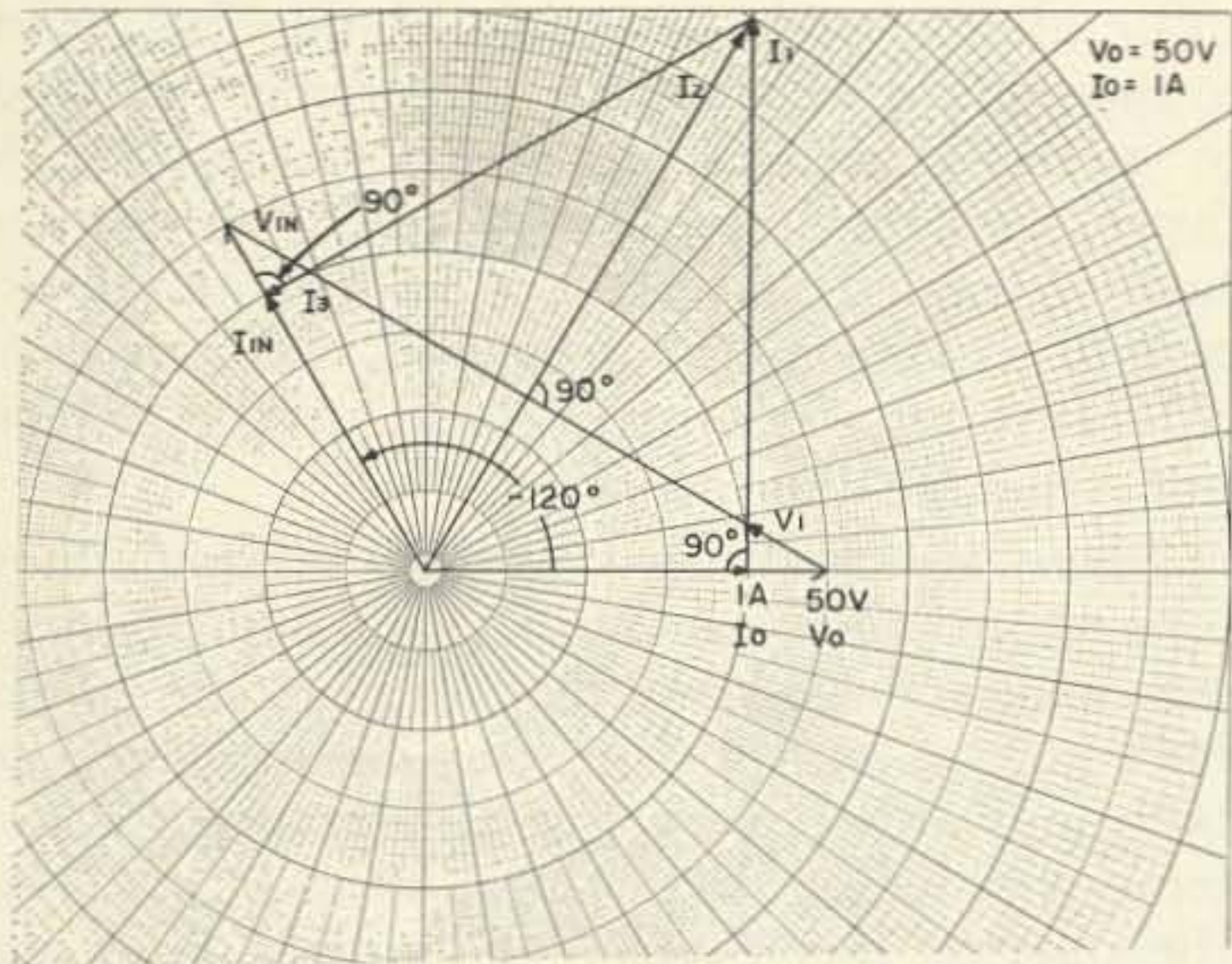

voltage and current values into the following three equations:

$X1 = Vo/I1$ , answer is in ohms of capacitive reactance.

$X2 = V1/I2$ , answer is in ohms of inductive reactance.

$X3 = Vin/I3$ . Answer may be either inductive or capacitive.

If  $I3$  line meets  $Vin$  from the right, looking outward along  $Vin$  line from the origin point, answer is in ohms of capacitive reactance. If  $I3$  meets from the left, answer is in ohms of inductive reactance.  $I3$  may be parallel with  $Vin$ , in which case  $X3$  is infinite and the pi-net reduces to an L network.

At this point, things may be a bit confusing, so let's try it out on a specific problem. Let's assume we want a network to shift the phase of a signal by  $-120$  degrees, with 50 ohms input impedance and a 50 ohm load.

Fig. 2 shows the drawing for this problem. The 50 ohm load has been converted to a ratio of 50 volts and 1 amp, with each major division of the polar-plot paper representing either 10 volts or  $\frac{1}{4}$  amp.

After all the lines are drawn and  $Vin$ ,  $I1$ ,  $I2$ , and  $I3$  scaled back to volts and amperes, we find that  $V1 = 86.5$  volts while  $I1$  and  $I3$  both equal 1.72 amps and  $I2 = 2$  amps.

Then  $X1 = 50/1.72$  or 29.07 ohms capacitive;  $X2 = 86.5/2$  or 43.25 ohms inductive, and  $X3 = X1$  because  $V0 = Vin$  and  $I3 = I1$ .

Aside from normal accuracy requirements, only one precaution need be observed to keep the design obtained through this procedure as accurate as one worked out with a 10 inch slide rule. The power in the load must equal the power at the input; this is to say that  $Vin \times Iin$  must equal  $V0 \times Io$ .

Networks such as these are primarily used for antenna phasing in the 3-30 mc region where phasing lines tend to become unwieldy in use; they find secondary application as rf

phasing networks in SSB transmitters.

This design procedure is not easily applicable to transmitter tank circuits since phase shift of these circuits is usually not specified. Normal tank circuits have phase shifts between 120 and 165 degrees; the greater the phase shift, the higher the Q of the tank. To use this procedure for tank circuit design, begin with a phase shift of about 140 degrees and determine Q after the design is finished.

The procedure *does* throw some light on why pi-net tank circuits frequently misbehave, especially when used to feed a line having standing waves on it. The graph in Fig. 3 shows the complete range of solutions for a network matching 100 ohms to 500 ohms; note how the impedance of  $X3$  starts as inductive reactance, climbs to infinity, then comes back from infinity as capacitive reactance. If the tank happens to be operating in the region near 70 to 80 degrees phase shift (for this example), a small change in phase shift makes a large change in reactance for  $X3$ . It's easy to run out of capacitor, or even hit that "infinity" point, if the feedline happens to be putting some reactance of its own into the act!

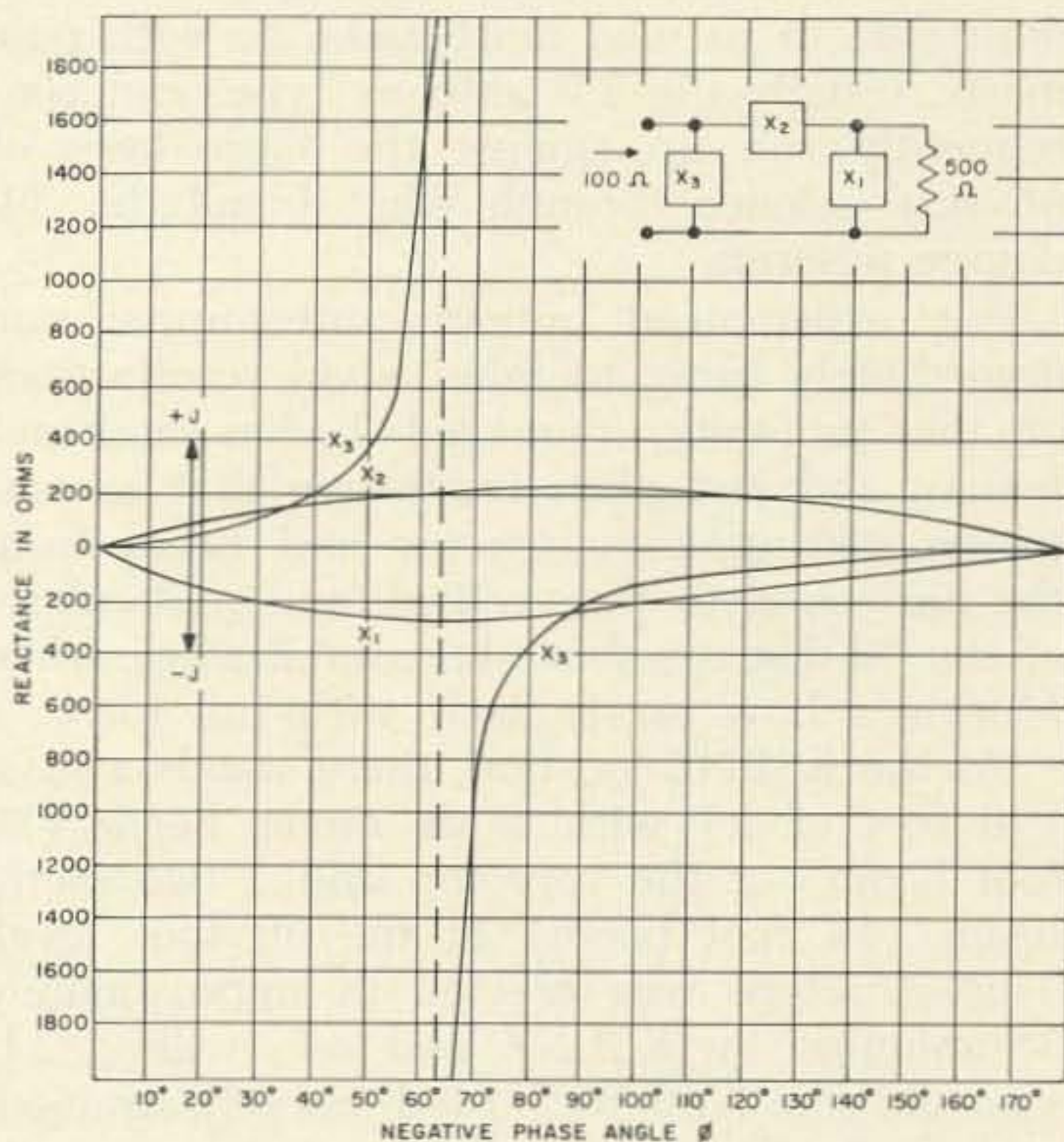

FIG. 3

This procedure, incidentally, was originally described in "Radio Antenna Engineering" by Edmund A. Laport, chief engineer of RCA's International division and a Fellow of the I.R.E., which was published in 1952 by McGraw-Hill Book Company, Inc. Additional details may be found in this book, which can be obtained through Radio Bookshop.

... K5JKX



# THE EASY WAY

Terry Banks K3LNZ  
Uss Intrepid (CVS-11)  
FPO, New York, N. Y. 09501

Some hams are fortunate, and have towers of either the crank-up or climable varieties on which to hang beam antennas of any conceivable dimension. And then there are the other 95% of us who must make do with pole masts, usually the TV antenna type, and consequently run up against the basic laws of physical science through what I call the 30-degree miseries.

Any experienced 'antenna-putter-upper' can immediately bring to mind vivid recollections of the profanity, damaged bodies and antennas, and just plain frustration that accompanies getting a pole, rotor and beam from the horizontal to the vertical, and particularly at the 30-degrees-above-horizontal stage when Murphy's Law exerts itself with full force.

At the K3LNZ location, there stands a mast (40 feet of it) with a six meter beam (10 foot boom) at the very top and a two meter beam (14 foot boom) at the 30 foot level. This structure was erected in approximately 15 minutes by K3LNZ and one willing 11-year old son. Nothing busted, nobody strained, and profanity was totally unnecessary.

The solution lies in using the scientific approach (otherwise known as the lazy man's way!) rather than brute force, so let's take a look (sitting down, of course) at the nature of the beast we are out to slay. This, as we can see, is simply (?) that at an angle of about 30 degrees we are unable to exert any influence in a useful direction. It's too far up to get underneath and push, except at risk of life and limb, and it's not far enough up

to be able to pull. Additional things that want to happen are the bottom of the mast wanting to go up while the top tries to come back down, and the mast itself bending, it not actually breaking, if we apply enough push and pull to make something happen via the classical 'brute force' method. These are the effects, but what is the cause?

There are really two causes, although they interact to some extent so that elimination of one makes it possible to disregard the other. However, a still better way is to eliminate both and either work less and/or put the antenna up higher than usual. Cause No. 1 is the obvious fact that all the weight is at one end of the mast, which just happens to be the wrong end from a mechanical standpoint. Cause No. 2 is that the average pole-type mast will support relatively heavy loads in a vertical position, but does not have the necessary strength to support much weight when tilted. The solution to No. 1 is to reduce topside weight to a bare minimum. The solution to No. 2 is not a stronger mast as this is going back to brute force; it is simply to arrange things so that the mast stays vertical, or nearly so, while putting it up.

Elimination of the topside weight has an obvious solution, as there is only one thing up there that doesn't absolutely have to be there—the rotator. Most rotators weigh more than the mast and antenna combined, and any will support the mast as well as the antenna, so simply put the doggone things down at the bottom and turn the whole mast, antenna and all. The mechanical details are simple, and we will pass them by for the moment and get specific later in the article.

Keeping a mast vertical can also be accomplished more easily than most of us think. Practically any roof has a chimney, sewer vent, skylight, trapdoor, or simply an edge, down which a mast can be dropped while we fasten an antenna and guywires to the top, and then raised up to the desired height. Even if there is absolutely no place to go downward, such as in rocky ground at a field day site, it is still possible to get things situated so that the maximum height at which we have to actually touch the mast with our hands is 10 feet. This will be sufficient to meet our requirements of keeping the mast vertical, or at least nearly enough vertical to avoid any undue strain, so that we can theoretically erect a pole mast of any height whatsoever.

Now for the details. Putting the rotator at the bottom of the mast requires that we find



some means of attaching guy wires to a mast which must turn. For 65c, we can purchase a swiveling guy ring intended for use with TV antenna installations. Although this looks as though it would provide a lot of friction, it works out very well and the first experimental installation using this equipment held up for several months with no difficulties and obviously would have lasted much longer. However, a trip to New York resulted in discovering a ball-bearing guy ring (Crown Co. GR-2) at Harrison Radio for \$1.98, so this is what is in use now and it is an unqualified success. Our rotor is an AR-22 (CDR) which is rated for 150 pounds dead load and has no trouble at all with a mere 40 feet of mast and two antennas. Other rotors would require thrust bearings, which are quite cheap, to support the added weight. The mast itself is the top 40 feet of a 50-foot telescoping TV mast. The bottom section wouldn't fit into the rotor, but some day we'll make up an adaptor and raise the antennas another 10 feet. Finally, a loop in the feedline is required to permit the mast to turn without the feedline dragging the guy wires around. Ours is about a foot in diameter at the mid-point of rotation, and will permit things to go 180 degrees in either direction from there with no sweat.

Keeping the mast vertical was accomplished by means of a large packing crate on which K3LNZ stood to reach the top of the telescoped mast at 10 feet above the flat roof. The six meter beam was affixed, then the top 10 feet hoisted into the air and the two meter beam attached. The guys had already been attached, so the next 10 foot section was hoisted away and the 11 year old son then went around and tied off the four guys temporarily while #2 and #3 mast sections were bolted together. Then the son went around in circles loosening each guy while the mast was steadily pushed upward to use up the slack. This involved the top of the mast revolving drunkenly, but only goes to prove my contention that anything even approximately vertical is good enough if you don't get all shook up and try to wrestle it back to exactly vertical. Finally, all 40 feet of mast was standing more or less upright, at which point the guys were slackened still more to permit getting the bottom of the mast about 8 inches off the roof and the rotator inserted underneath and bolted on. Finally, the bottom was positioned exactly where it was wanted and the son stood back criticizing angles while K3LNZ went around making final adjustments to the guys and for the first time in the process getting things exactly vertical.

Now it is impossible, or at least not practical, to put packing crates, stepladders or what have you on sloping roofs, but the foregoing method can still be utilized by using one of several possible variations. A chimney or vent will always provide at least 10 feet of space in a downward direction, if not enough to assemble a whole 40 or 50 feet of mast with the top still at roof level. It is also possible to sit on the peak of the roof at one end of the house, or up on top of a car at a field day site, or just about anywhere at all where you are in no danger of falling, but can still lift the weight (surprisingly little) of mast and antenna. The basic principle is to hoist things up first, and move around to the exact position desired in gradual steps later.

Let's try a sloped roof installation for drill. We'll presume there is a chimney about half-way down one side of the roof, but that it isn't a very deep one. Place the telescoped mast as far down as it will go, and you will find you still can reach the top to bolt on an antenna (and rotator too, if you insist on putting it up there the old fashioned way). Add guy wires and hoist up as far as you dare, then tie down the guys quite loosely. A helper on the ground will come in handy here, but one man can go it alone by using a loop of rope to hold the mast up as high as it has been pulled while he goes down to play with guy wires. Now alternately slacken guys and raise mast, with necessary stops to fasten ten foot sections if necessary, and in a short time you'll find that the antenna is up, and you didn't have to strain or swear to do it. If you didn't want to fasten the bottom on or near the chimney (or whatever you used), simply slacken the guys some more and move the base around until it is where you want it. If this involves going up a sloping roof, a rope to the bottom of the mast passed over the peak and down the other side to be tied will hold things. This will require a helper, to be sure, but even a wife can be trusted to perform this simple function.

Finally, a word on guying. As you may have noticed, we stressed not worrying about guys being too loose during the erection process. This also applies at all times. Just enough to keep the top from really moving around will do the trick and will actually survive sudden gusts of wind better than something that is already as taut as a banjo string. By putting the rotator on the bottom, correspondingly lighter guys can be used anyway. Let me know how your new cloud-scraper works out. . . . K3LNZ



*This 1200 v power supply control gives automatic reserve power, prevents shock hazard and uses inexpensive TV components*

## Simple Automatic Failsafe Power Supply Control

Zoltan Bogar W3CJM  
1921 Marymont Road  
Silver Spring, Md.

If you are building a high voltage power supply for your transmitter and really want to save money, or if you are going sideband with your transmitter where doubling the rated voltage on the final is the accepted thing, this is just for you.

Instead of using a 1200-volt transformer and using high voltage condensers, build two 600-volt supplies, or if your transmitter already has a 600-volt supply, just build another 600-volt supply and add it on.

If it is already grounded, lift it free from the chassis and tie all negative connections together.

Now use a 24-28 volt spdt surplus relay and connect the coil in series with the bleeder resistor if one is used in the power supply. If the coil resistance of the relay is around 1000 ohms, then a 25,000 ohm 15 watt resistor should produce around 24 volts to op-

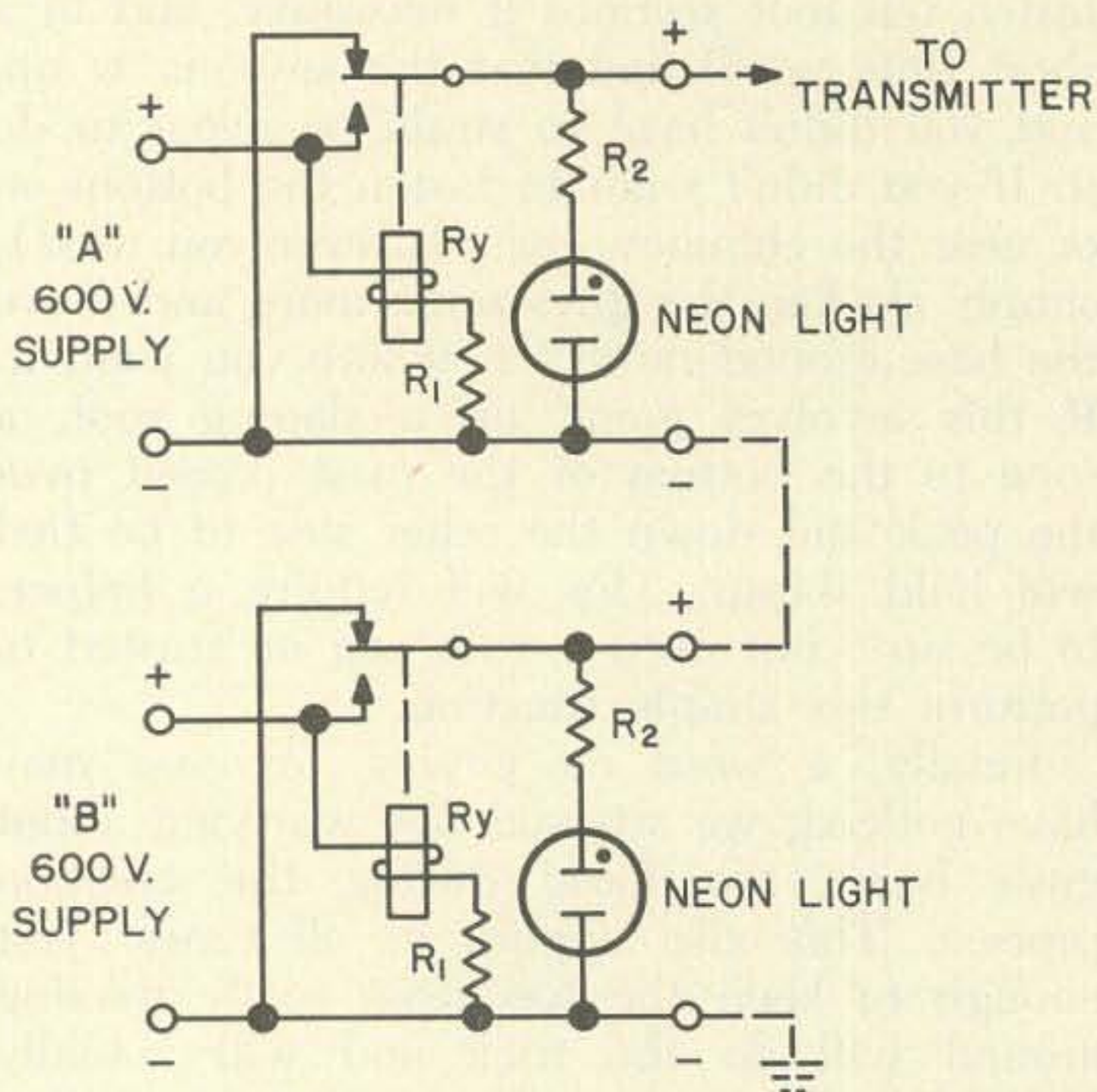

- Ry—spdt 24-28 v. surplus relay with 1000 ohm or higher coil.
- R1—2400 ohm 15 w. bleeder for 600 v supply and 1000 ohm relay.
- R2—1 meg. ½ w. (for 600 v supply).
- NL—NE2 neon light.

erate the relay. Use a relay with good insulation at the contacts. Insulating the relay itself on a piece of phenolic board is also a good idea.

I built a relay into each power supply, under the chassis, and brought the armature connection of the relay contact to the positive output terminal and the minus lead to the negative terminal post. Of course, the relay can be connected externally just as well.

After the relays are wired up as shown in the diagram, the two power supplies are merely connected up in series. The positive of one goes to the transmitter plate, the negative to the second power supply positive, and the remaining negative is grounded.

A glance at the diagram now will show that, with both power supplies turned off, the transmitter plate is not just disconnected from the power supply, but grounded. No chance of getting a nasty shock from the filters when making any changes on the transmitter. When the power is turned on to the power supplies, the relays energize and both outputs are in series supplying 1200 volts.

One of the most appreciated parts of this simple arrangement is experienced when either power supply fails. Without lifting a finger, the defective supply just drops out of the picture and the remaining one keeps the transmitter in operation. Should this happen during an enjoyable rag chew, DX with a rare QTH or in a contest, the automatic reserve power alone makes the effort of building this arrangement worthwhile.

If you want to go on sideband with your push-pull 6146 AM transmitter and double your power at the same time without making a lot of changes to hurt the resale value, this is just the thing. Remember, if you want 600 volts to go on AM again, all you have to do is just turn off the 120 v. AC to the input of either one of the supplies and you have 600 volts. Just that easy.

Neon lights with sufficient series resistance may be connected up as indicated on drawing, to show which power supply is operating.

... W3CJM



# **YOU KNOW ABOUT THE** **CENTURY** **MOBILE POWER SUPPLIES**

You know about the advanced circuitry\* used in the design of the CENTURY to provide the most outstanding D-C transistorized converter on the market today. Now in widespread use with commercial and amateur transceivers, the CENTURY is proving daily to be "the best supply money can buy".



MODEL  
400-12  
\$145

### A Few of the Features Include:

- POWER OUTPUT — 400 W SSB — 300 W AM
- EFFICIENT — Over 90%
- TOTALLY ENCLOSED
- COOL — Only 25°C Rise
- REVERSE POLARITY PROOF
- REGULATION — 8% No Load to Full Load
- QUIET — No Hash or Audible Noise Generated
- COMPACT — 6 x 7 x 3 1/2 — 7 lbs.
- CIRCUIT BREAKER PROTECTED

## **BUT DO YOU KNOW**

that **LINEAR SYSTEMS**  
now has the

# **STELLAR**

series of Frequency Stable 60 Cycle  
**POWER INVERTERS** based on the  
revolutionary design\* of the **CENTURY**?

Did you know that prior to the development of the STELLAR, truly frequency stabilized inverters were very expensive and that to run a tape recorder, clock, etc. from a conventional inverter was impractical due to the frequency instability?

Did you know that the STELLAR series of **Frequency Stable** Inverters maintain a stability of 0.5 cycles over the voltage/load range?

And of course the STELLAR Inverters are of exclusively Solid State construction, eliminating the necessity of using tuning forks or vibrators.



MODEL  
12-1000SM  
1500 W PEAK

The **STELLAR Frequency Stable** Inverters are available with power output ranging from 10 to 2000 VA and output voltages at 115 or 230 V.AC. Priced from \$60 (Model 12-10S, 15 VA Synchronous Motor Drive).

WRITE FOR FULL INFORMATION ON YOUR SPECIFIC REQUIREMENTS TO:



**LINEAR SYSTEMS INC.**

605 UNIVERSITY AVENUE  
LOS GATOS, CALIFORNIA

\*PAT. APPLD. FOR



# Incremental Tuning for the NCX-3

The wide variety of transceivers that have recently been offered by several manufacturers are certainly a boon to many of us apartment dwellers. The XYL is sure to squeal with delight as the old rock-crusher is rolled out to make room for what looks like an ac-dc radio. Unfortunately, she may make more familiar sounds if she gets a load of the price tag on that little box.

The situation being what it is, most amateurs have to compromise between versatility and price. One of the most popular compromises appears to be the National NCX-3.

The most serious drawback of the NCX-3 and similar medium-priced transceivers is the lack of incremental tuning, that is, being able to tune the receiver a few kc's either side of the transmitter frequency. This is especially true on CW, since the transmitter frequency

ferent frequencies, but this guy with the transceiver keeps switching!

It is pretty obvious that incremental tuning has its advantages. Now let's talk about the price of including it in your transceiver. If you buy everything new, the price could run as high as seven dollars. The average junk collector can probably get away with \$1.65 for the Hughes varicap.

The incremental tuning circuit is shown in Fig. 1. It can be built and installed in about an hour and completely removed in about 15 minutes. The parts inside the dotted line are mounted on a single terminal strip which can be mounted under one of the bolts near tube socket V5. The end of the Hughes varicap marked with an H should be grounded. Point (a) is tied to pin 1 (the grid) of the vfo tube V5. A wire is run from point (b), along the wire harness to the middle relay terminal on the rear chassis apron. I ran a wire from the OA2 tube to an empty pin on the xtal calibrator octal socket on the rear apron of the chassis and used it as a power plug. The rest of the components can be mounted in a little box. Lead lengths between (a) and (b) should be kept short; all other leads carry only dc and can be any length.

The theory of operation of the circuit is very simple. The varicap acts as a variable capacitor; its capacity depends upon the back bias applied. In the transmit mode, a preset voltage is applied; when in the receive mode, the voltage can be varied to tune the receiver. When the relay switches from the receive to the transmit mode, the 25 mmfd capacitor acts as a very low impedance source to change the varicap bias to the transmit value in a matter of microseconds. Since this frequency change is accomplished in much less than the transmitter rise time capability, no chirp is heard. The tuning range available can be varied by changing  $C_1$ .

The parts are not critical; however, care should be taken not to exceed the PIV rating of the varicap if the biasing network is changed.

Adjustment and operation are straight forward. With the I.T. switch in the off position, set the *calibrate* control to about mid

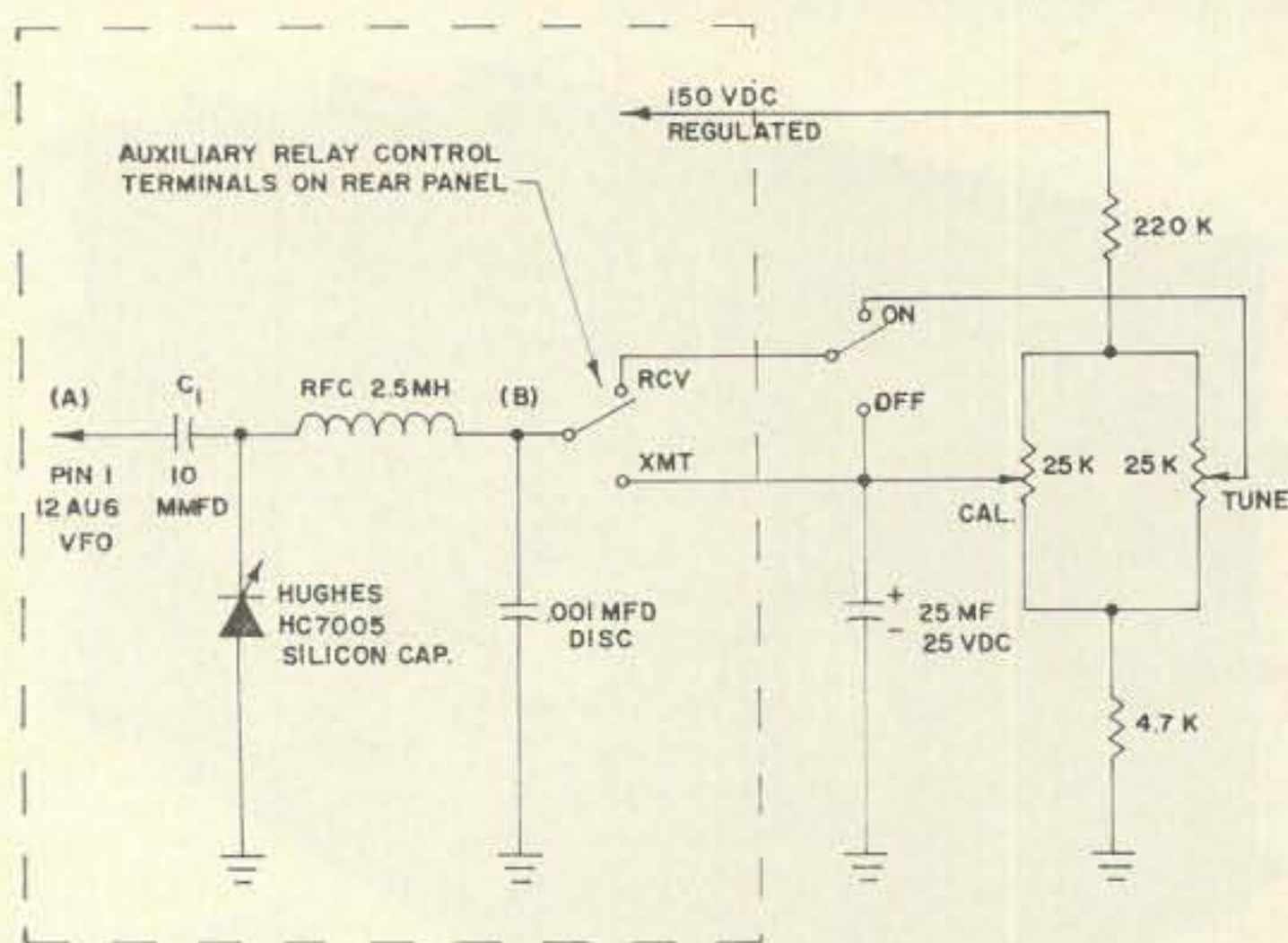

FIG. 1

is approximately 1 kc from the receiver frequency. This leads to a frustrating follow-the-leader game. If a station zero beats your frequency, then he doesn't produce a beat note and you must tune to one side; this changes your transmitter frequency, so when you come back, he sees that he is off frequency and zeroes you again; now when he comes back . . .

Let's consider another situation. There are three guys in a round table, one is a few hundred cycles off frequency. The guy with the transceiver ends up using the frequency of the last station to transmit. This is confusing since not only are the stations on dif-



scale. Now adjust the vfo trimmer capacitor on each band so that the calibration is correct. Small changes in calibration should hence forth be made with the *calibrate* control. That's all there is to it.

When calling a station, zero beat him with the I. T. switch off. Flip the switch on and do all subsequent receiver tuning with the I.T. control.

This circuit can be easily applied to transceivers similar to the NCX-3; the details are left to the reader.

... K2DXO



HQ-88

This new Hammarlund receiver has been particularly designed for frequency stability and will sit there without a quaver while you beat it or drop it (a short distance). It covers 10 thru 160 meters, MARS, CB, WWV, and the marine bands. Selectivity is 2.2 or 5 kc. There are separate AM and SSB detectors. Price is \$299! Sounds like quite a package. Drop a card to Hammarlund, 53 West 23rd Street, New York 10 for info.

### Lafayette 1965

Just as we're getting used to writing 1964 out start coming the 1965 catalogs. Lafayette has one of the largest there is, so you'd do well to make sure that you are on their list for it. Lafayette is the major importer for a lot of parts and gadgets that you won't find elsewhere, in addition to carrying all of the popular lines of equipment and parts. Lafayette, Box 10, Dept 73, Syosset, L. I., N. Y. 11791.

### OOPs

Corrections to W1OOP article in September 73.

Fig. 1: 2N176 emitter resistor should be one ohm. 2N214 collector load should be 4.7 k.

Fig. 2: Short the terminals labeled "DC open." Eliminate capacitor "add temporarily." Break between emitter and junction beneath emitter. Add temporary capacitor across break.

Fig. 5: Oscillator base bias resistor should be 22 k rather than 2.2 k.

Fig. 7: Should be labeled "Optional Squelch Circuit."

### Free Publications

For the price of a self-addressed stamped envelope you can learn the real details which others have attempted to obscure in CQ, the Washington News, and elsewhere.

"CUKE" . . . A discussion of the letters to the editor of CQ appearing in the July issue, together with the facts and testimony to support the facts.

"WARN-June" . . . A paragraph by paragraph expose of the lies and distortions published in ARRL's Washington News June issue.

"WARN-July" . . . Ditto for their July issue. This stuff is sickening.

"WA2USA" . . . Full details by Dana Griffin W2AOE.

### DOW-KEY

## DK2-60B NEW COAXIAL TRANSFER SWITCH

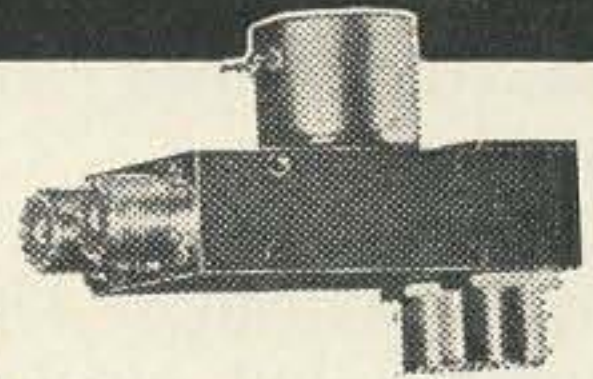

A DPDT unit internally connected in the de-energized position. Ideal for switching in and out a power amplifier between an exciter and an antenna.

1 kw power rating to 500 mc; VSWR 1.15:1 to 500 mc; Isolation 60 db @ 1 mc; All standard AC and DC coil voltages available.

See your dealer for catalog sheet or write:

DK2-60B with UHF Connectors . . . \$19.00  
DK2-60B-2C with UHF Connector and DPDT auxiliary contact. \$20.95  
(BNC, TNC, N and C slightly higher)

DOW KEY CO., Thief River Falls, Minn.



### IT'S YOUR QSL CARD - WEAR IT!

YOUR CARD ACTUALLY REPRODUCED IN PERMANENT METAL, THEN MOUNTED ON A FINE TIE CLASP

SPECIAL CLUB DISCOUNTS

WEAR YOURS WITH PRIDE. ORDER ONE TODAY! JUST SEND YOUR CARD AND \$4.00 (P.P. AND F.E.T. INCL.) TO

HE MAY HAVE EVERYTHING, BUT HE DOESN'T HAVE THIS BOX 73, NORTHFIELD, OHIO 44067. GIFT SHOP

## FT-243 Crystals

3000 To 8700 KC.

\$1.00 Each ± 2 KC Setting

\$2.00 Each .01% Setting

Air Mail — 10c per unit extra

DENVER CRYSTALS

776 So. Corona, Denver, Colorado - 80209

## 10-15-20M QUADS

*Pre-Cut	*Pre-Tuned	*Triband
	Bamboo	Fiberglass
Two Element → \$59.95		\$99.95
Three Element → 99.95		<b>New</b> \$149.95

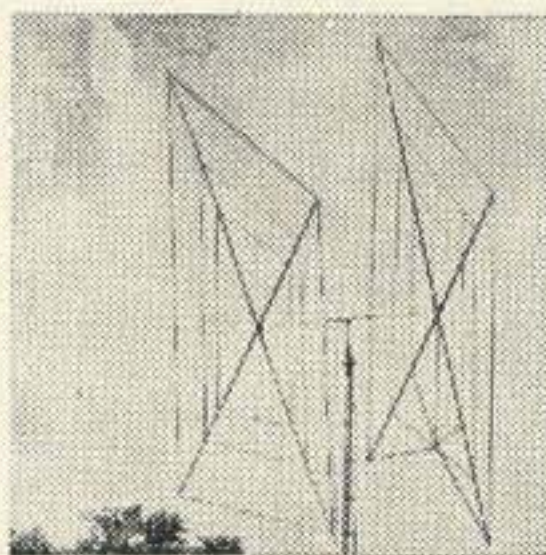

- \* ROTATE WITH TV ROTOR
- \* HIGH F/B RATIO
- \* VERY LOW SWR
- \* LOW Q BROADLY TUNED
- \* HIGH GAIN
- \* EASY TO MATCH
- \* LOW WIND RESISTANCE
- \* ONE FEED LINE FROM XMTR FOR ALL 3 BANDS NO SWITCHING

Skylane PRODUCTS

406 Bon Air Dr.  
Temple Terrace, Florida  
Phone 988-4213



# The Super Two'er

It was a great man who said, "Everyone talks about the weather, but no one does anything about it." For a long time the receivers in the Heath Two'ers and Six'ers have been in the same category—Enough sensitivity to make everybody talk about them—but poor enough selectivity to make everyone swear at them. Yet no one ever seemed to do anything about them. Now, however, someone has come along and done something about the Two'er.

When Lawrence Engineering announced the modification kit for the Two'er, I was skeptical but anxious. When the kit arrived I was impressed from the beginning. The step-by-step manual runs 31 pages and does everything but tell you what hand to solder with. There are 7 clear, well defined illustrations, including photographs of the unit in its stages of preparation. The illustrations come out of the manual so that they can be referred to separately without the need of flipping pages back and forth as you try to keep your step-by-step place and consult figures at the same time.

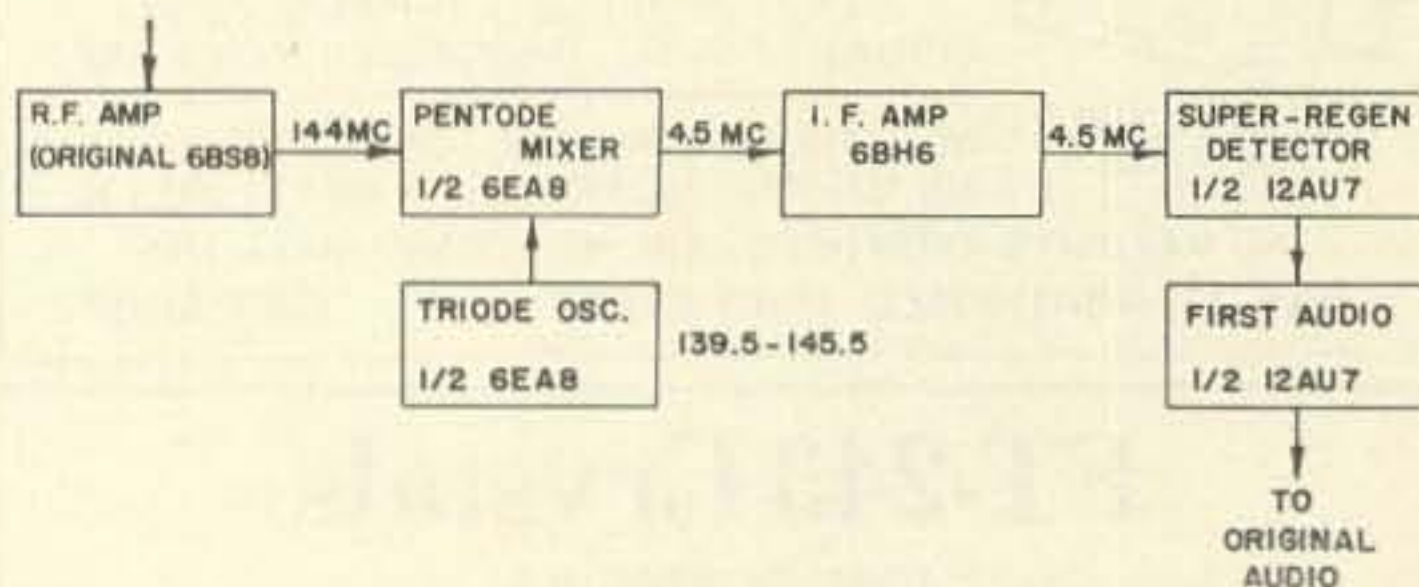

The entire modification took me about 9 hours, which includes the tune up. Following the step-by-step procedure is easy—they must have been written with the raw novice in mind. At times, however, I felt they were too simple, that there was too much explanation. Nevertheless, although I've built many a kit, I followed them as if I could do only two things: 1) read, and 2) solder. There was no trouble getting it to purr. If there had been, there are four pages at the end of the manual entitled "Trouble Shooting Guide."

The circuit of the modification is fairly simple and is best given by a block diagram.

Basically the diagram is self explanatory. The old detector-amplifier is converted to a two stage radio frequency amplifier and a simple heterodyne oscillator and *if* strip and added on a subchassis. This is where the selectivity come from. The superregenerative type

detector is retained but only because it performs several functions and so helps the tight space problem. This type of detector is an excellent noise limiter as well as a very sensitive detector eliminating the need of additional *if* stages. Its usual defect, lack of selectivity, is largely eliminated by putting the oscillator and *if* strip ahead of it.

Mechanical assembly of the new subchassis is done first, followed by a few mechanical modifications to the original chassis. Then the old rf amplifier-detector is converted to a cascade (two stages) rf amplifier. This part of the conversion sounds complicated but actually requires only 7 wiring changes and a couple of components which are supplied. The new two-gang tuning capacitor is then mounted and the subchassis dropped into place and given a preliminary tune-up, then a bit more wiring. After a final tune-up, the whole thing is put back into the original case and you're back in business.

To make the conversion you'll need, beside what is provided with the kit, a  $\frac{1}{4}$ " drill and reamer (there are a couple of  $\frac{3}{8}$ " holes), a soldering iron and grid dipper. A signal generator could be used for the final tune-up but the grid dipper gets the slugs close enough and an on-the-air signal lets you peak it right on the button.

Operating the unit afterwards is a revelation. The old superregenerative hiss is still there so it still sounds like your old Two'er—but that first signal you tune causes an almost traumatic experience—your eyes and ears tell you that it's a Two'er you're tuning, but your mind tells you it can't be—it's too sharp.

On the debit side of the ledger is the superregen hiss and lack of vernier tuning. I for one, however, agree with the introduction in the manual which says you can't beat the old superregen for simplicity, noise limiting action, and what's more important, sensitivity. The superregen detector now operates fixed at 4.5 mc and is isolated from the antenna by several stages so that there is no receiver radiation whatever. Tuning is still direct drive but the boys at Lawrence Engineering tell me there just wasn't room to use a vernier mechanism on the capacitor they felt was needed to do a top job. Furthermore the vernier would have increased the price of the kit \$5 to \$7. If you wanted to add your own



I'm sure it could be done, outboard, at the expense of looks.

Stability in both mobile and fixed-station use has been very good. I've enjoyed first telling a contact that I'm using a Two'er and then a transmission or so later telling him, within a few tenths of a per cent or so, what his frequency is. It leads to some interesting contacts. Selectivity is quite adequate so that even with WIGB (a kw monster) operating a few miles away, I can work other signals as close as 15 kc without any difficulty. Try that without the modification. Sensitivity is definitely improved by the two stages of rf amplification and signals that used to be down in the mud are now readable. A big plus for net operation is that lack of receiver radiation. Where the net used to be squiggles and squeals, now you're not sure there is anyone on—until they transmit. Then they're where they should be, and only there.

The kit is sold by Lawrence Engineering, 36 Lawrence Road in Hamden, Connecticut, for \$29.50 with tubes.

LE calls the kit 2NT6301 but everyone locally refers to it as the "Super-Tow'er" and it is! . . . KITVD

## 2B and HO-10

Jack Browne W6TTD

I recently purchased a new Heath HO-10 Monitor Scope and upon connecting it to my Drake 2B Receiver was a little disappointed with the results.

Though the Scope was connected to the last *if* stage as prescribed in the Heath Manual, the height of the envelope pattern displayed on the Scope was only  $\frac{3}{4}$ " and was not ample to give an honest analysis of the waveform.

After consulting Drake, plus considerable experimentation, I connected the scope to the plate (pin 7) of the AVC amplifier and detector tube V6 and immediately the Scope pattern filled the screen and was easily controlled by the Vertical Gain knob on the Scope's front panel.

No retuning is necessary, nor is there any deterioration in the operation of the Drake 2B I used a coupling capacitor of 12 mmfd, which falls within the specified range of 5-15 mmfd suggested by Heath.

This little Scope has since proved a most versatile piece of station equipment for all modes of operation.

. . . W6TTD

### AMAZING 572B

Direct replacement for the 811A—but runs twice the power. Now only \$9.95 pp.

### MO-2000 ZERO BIAS TRIODE

Equal to four 572B's. \$29.95 pp.

Both tubes now being manufactured by the designer:

### O'Malley Tubes

525 Lehigh Avenue, Union, N. J.

## VHF-UHF

Converters & Preamps.  
50 thru 432 Mc.

Write for literature

Parks Electronics, Rt. 2, Beaverton, Ore.



Reduces Interference and Noise on All Makes Short Wave Receivers. Makes World Wide Reception Stronger. Clearer on All Bands!

For ALL Amateur Transmitters. Guaranteed for 600 Watts AM 1200 SSB Pi-Net or Link Direct Feed. Light, Neat, Weatherproof.

Complete as shown total length 102 ft. with 96 ft. of 72 ohm balanced twinline. Hi-impact molded resonant traps. (Wt. 3 oz. 1" x 5" long). You just tune to desired band for beamlike results. Excellent for ALL world-wide short-wave receivers and amateur transmitters. For NOVICE AND ALL CLASS AMATEURS! NO EXTRA TUNERS OR GADGETS NEEDED! Eliminates 5 separate antennas with excellent performance guaranteed. Inconspicuous for Fussy Neighborhoods! NO HAY-WIRE HOUSE APPEARANCE! EASY INSTALLATION! Complete Instructions.

75-40-20-15-10 meter bands. Complete . . . \$15.95  
40-20-15-10 meter. 54-ft. (best for swl's) Complete . . . \$14.95

SEND ONLY \$3.00 (cash, ck., mo) and pay postman balance COD plus postage on arrival or send full price for postpaid delivery. Complete installation & technical instructions furnished. Free information on many other 160-6 meter antennas.

Available only from:

WESTERN RADIO • Dept. A7-11 • Kearney, Nebraska

### CRYSTALS FOR CHANNEL A

\*Most CB rigs can easily be retuned for ten meter operation.  
\*Channel A will help bring activity back to ten meters.  
\*Put your CB rig on Channel A with a Texas Crystal.  
Texas Crystals is making special crystals for all popular makes of CB rigs so they can operate on:

CHANNEL A	28.60 mc
CHANNEL B	28.65 mc
CHANNEL C	28.70 mc

These crystals would normally sell for \$3.85, however, in the interests of encouraging activity on these channels, we are making them available for only:

**\$2.95 postpaid**

When ordering please specify channel and make and model of CB rig you are using so we can match the crystal to your particular rig. ORDER DIRECT from:

### TEXAS CRYSTALS,

1000 Crystal Drive, Fort Myers, Florida

### LOOKING? SHOPPING? TRADING? TRYING TO SAVE MONEY?

Write Bob Graham for Special Deals on New and Re-conditioned used gear. Cash or Budget.

### Graham Radio

Dept. C., Reading, Mass.

Tel: 944-4000.

### Reyco Multiband Antenna Coils

Traps for dipoles . . . high strength . . . moisture proof guaranteed to handle a full KW. Model KW-40 coils will, with a 108 foot antenna, provide operation on 10-15-20-40-80. \$12.50 set.

For information on other models write:

FRED L. REYNOLDS W2VS, 492 Ravenswood Ave., Rochester 19, New York





# Our Man in Washington and an Appraisal of our Amateur Radio Position

Wells Chapin W2DUD  
118 Woodmancy Lane  
Fayetteville, N. Y.

A man in Washington is important and rather obvious when we find that all other associations have full staffs and building locations in Washington. The whole problem of holding our present amateur band and status is much more basic than just a man in Washington. Let's get right to the point. The present international aspects of amateur radio demand that we do all the things necessary to protect our very important and useful hobby. This is the time for serious appraisal of our Amateur Radio position. Our 40 meter band is seriously threatened. We are in a blue chip poker game where the stakes are the portions of the spectrum we use and these are worth billions of dollars—yes, you read right, billions of dollars. So let's be professional in our approach to holding onto them. Let's ask ourselves the searching questions that any good businessman would ask if he were trying to hold onto this very valuable natural resource. For instance: have we lost or gained prestige and bands? Do we have a written plan based on the future considering that we will grow—the population of the world will grow—and there will be a general increased demand on our spectrum by ourselves and others. What are the projected figures of our numbers by the 70's and 80's? Should we start our counter-action and demands now? What should they be? A name is important—does the name Institute of Amateur Radio or ARRL better describe our activities?

Now if you are satisfied that all is well, then relax and let our bands be continually nibbled away. If you are interested in protecting amateur radio then read on—and we will discuss a few of the issues.

Everyone resists change. Corporations that have resisted change have died. Let's look at this problem with an open mind. The ARRL has done a lot of good things for amateur radio and unquestionably will do more. However, many years have passed! Have we examined the structure of ARRL to see that it is in tune with the times? Perhaps it is, but we must be sure. The ARRL has had some

wonderful assists by many men who have given time and money to preserving our hobby. To name a few—Reinartz, Schnell, Sterling, Maxim, Hebert, Herbert Hoover, Sr., and our present President Herbert Hoover, Jr., Mathews, Tuska and hundreds of others. The writer has had the pleasure of knowing many of the fine men—and believe me, fellows, we are here today because of the work of these men and the ARRL.

Now let's take a look at a few of the issues and enlarge on them.

Have we lost or gained bands? Facts are facts. We used to have amateurs on 32 meters, 33, 34, 36, our bands in those days was 37.5 to 42 meters, and then on an international basis we started in again at 43, 44, etc. In addition, we had other bands. Browsing through the IFRB (International Frequency Registration Book) we find more than 5,000, repeat 5,000 registrations between 7,000 and 7,300 KC—so it's no wonder we have intruders in our bands—they are there legally agreed to by international treaty signed by our government. Now go to your local radio store and pick up the 1964 Edition of the World Radio and TV Handbook. It is about 33% larger than two years ago. Turn to page 245 if you use the 80 meter band. If you operate 40 like I do and you bless the foreign broadcast—turn to pages 252 and 253. Browse through this book—it is interesting reading and a good deal cheaper than the hundred dollars for the four volumes with the fourth volume in 4 parts of the IFRB. Yes, gentlemen, we have been like Rip Van Amateur Winkle and we are awakening from a long sleep and find intruders in the bands—and bands missing that we had before our sleep. Also, one finds after careful reading of the 1962 ITU (International Telecommunication Union) activities report that amateur radio does not get a single mention and as a matter of fact you cannot find the word amateur mentioned in the report.

Let's go to the next point. What numbers of amateurs will be around in the USA and internationally in the 70's and 80's? Quot-



ing 200 Meters and down, in 1910 there were 90 amateurs listed in the Wireless Blue Book. So that you are not bored with a lot of statistics, we will quickly jump to 1958 where we find in the FCC record that there were 185,000 Amateurs, the FCC record of 1959 lists 195,776, the FCC record of 1960 lists 217,000, the FCC record of 1961 lists 222,170, and the record of 1962 lists 237,159. The Spring call book of 1964 lists 268,113 US and 111,304 foreign. Thus, it looks like our average growth rate has stabilized to about 13,000 additions per year. Now if this growth continues, in 1980 we will have at least 500,000 Amateurs all crowded into the same space or less unless we act now. However, with the citizens-banders getting interested in Amateur Radio perhaps the average per year will accelerate at a more rapid pace—perhaps to as many as 600,000 by 1980. Guess I'll buy some stock in the amateur radio equipment manufacturing business and get lined up with QST, and 73 as they will have plenty of potential readers—or should I—will we survive?

We know that the projected population of the world shows substantial growth and of course, this means that foreign Amateur radio will grow along with commercial and military interest thus creating additional further demands on the spectrum. Short wave broadcasting will grow because we are in a world wide market and economy and the world will need this medium to tell their story. Take a look at the radios on store counters—many have short wave bands here as little as two years ago you found these only in amateur radio type receivers. Who would ever think we would hear our favorite cereal and soft drink advertised on shortwaves—but you can now. Just listen to and around the forty meter band—or should I have said in the 40 meter band? Have you heard our VOA broadcasts from Africa in the 40 meter band? This is legal too, by international agreement our country has agreed, to the ITU international zone that Africa is a part of, must use this amateur band for broadcast purposes. Another fact should awaken us to the fast growing use of the rf spectrum is that to keep up

with its work of registration of world wide frequencies the IFRB has installed computers. Just recently the FCC announced the first computer issued license for amateur radio. Growth? Should it worry us? Enough said!

Do we need planning? Planning in the commercial world is a full time job. Our allocation problem is extremely complex and has other intricate political tie-ins in the USA and world wide. Psychological problems are also tied into it. Certainly, it is mandatory that a team of men be doing nothing but planning and working for our survival and have no other duties IE: such as publishing a magazine along with P&L responsibility. We should now be in the process of researching all the aspects of the problem including our public image, projected increase of amateurs, population of the world increase and its affect on future allocations etc., etc., etc., etc. Nothing much has been mentioned about national and international military demands that are now based quite heavily on electronics. Plans realistically look at where you have been—where you are and where you want to go and most important how you are going to get there. You don't go from New York to Chicago without a road map and knowledge of the problem. You don't fiddle around when billions of dollars are at stake or where you know that there is just so much of this resource with many countries wanting it and then there just "ain't no more" when this runs out. Good planning will anticipate the demands of intruders on our allocation and what we will do to counter. Plans include minute things such as who will buttonhole what individual from what country and what will he say, etc. This work should be done right now—by men who do not have a magazine to publish and keep in tip top shape. We should have operating right now, many committees, of the best brains in amateur radio planning various aspects of our attack and defense. Yes, planning is very, very important. Perhaps it can start with a team in Washington with cooperation from all sources.

In our appraisal of where we stand another issue should be discussed. Should an association and a magazine be one and the same?



### TELREX ROTATOR-INDICATOR SYSTEM MODEL TS250-RIS

**Mast Feeds Thru Rotator For Safe, Easier, Installation**

- 1300 IN./LBS ROTATION TORQUE
- SELF LOCKING BY STURDY WORM GEARS
- SELSYN AZIMUTH INDICATION
- ACCOMMODATES 2" O.D. MASTING
- MALLEABLE CAST MASTING CLAMP SUPPLIED
- OUTPUT SPEED APPROX. 1 RPM
- WILL FIT INTO OR ONTO A 6" SIDED TOWER

Write for FREE PL65 Describing Rotators and Antennas

A Really Sturdy  
ROTATOR-INDICATOR  
SYSTEM—  
NOT a Modified  
TV Rotator!  
Designed To  
Out-Perform, Outlast!

**\$25000**  
F.O.B.

ALSO:

TS325-RIS \$325.00  
TS435-RIS \$435.00  
TS535-RIS \$535.00  
TS585-RIS \$585.00

**TELREX LABS.**

ASBURY PARK, N.J.





We find a very fine successful association (which incidentally is headquartered in Washington) that is comparable to our amateur radio situation: IE they use spectrum and have similar problems of diverse groups within the association having different goals, etc. We find that this association has a very large very competent and complete staff headed by a very important influential, prominent, and very competent individual much like our present President Herbert Hoover, Jr. This non-profit group has a full staff whose sole job is to support and perpetuate their industry. The magazine that covers the news and activities of the association, and is of general interest to the association members, is entirely independent and has its own set of officers and P&L statement. This magazine has been at times, quite critical of some of the activities of the association and some of its members and has done a really fine job of reporting and is of great general worth to the group they serve.

It is not healthy to have an association print its own magazine. Many times there must be conflicting interests in arriving at editorial policy, advertising policy and what is good for the association. When you are the publisher it is difficult to be critical of your own work. Hi. That old Biblical quote is so true "You cannot serve two masters."

What's in a name? While this is a side issue—it could be an important one. You constantly project who you are, what you are, by your name. We just cannot afford to miss a single thing. Every day in our electronic business we find large companies merging and changing their names. They always pick the most descriptive appropriate and meaningful name. One well-known oil company very recently, and still is, in the process of changing its name. If they can and do change their name—so can we if we feel it would gain us something. Does ARRL or IOAR fit us or should it be some other name? Our name is a front to those who do not know us. What sort of image do we want to project? Ask any Amateur of the world what ARRL is and he immediately recognizes it. However, where we are hurting, our image to the general public of the world, you would find many people

who would not know what ARRL was. Heaven forbid I've tread on sacred ground on this one and I'm sure the Hartford Radio Club members in the Ham Shack in the sky are already sending an SOS. Hi. Those men who carefully picked an appropriate name in 1910 would really be unhappy—or would they? Maybe their love for ham radio would have surmounted even this obstacle. Well—anyhow—let's not cloud the main issue with this one—but consider it along with all the rest of the issues. Know the ARRL, work with the ARRL, know your director, work with IOAR. These are trying times. We need all the help we can get. Time is rapidly running out. We must act now.

As you have probably guessed—our job is not an easy one. A separate Amateur Radio Organization takes funds and will not come easy. You don't have a magazine to support it—the bucks must come from your pocket and mine. I've already anted up my \$10 to IOAR, have you, and will you? Let's have as our slogan—What will you do for amateur radio—not—what will amateur radio do for you.

... W2DUD

## Letter

Dear Wayne,

Occasionally in my rummaging for information I come across something that is useful to other people.

If any hams are looking for azimuthal maps, there are a variety available from the U. S. Navy. The following are the chart numbers and the center point and price:

5199A	San Francisco, Cal.	\$.30
6700	Fairbanks, Alaska	.40
6701	Seattle, Wash	.40
6702	Honolulu, Hawaii	.40
6703	Guam, Marianas	.40
6705	Washington, D. C.	.50
6706	Moscow, U.S.S.R.	.40
6707	Adak, Alaska	.40
6708	Kodiak, Alaska	.70
6711	San Diego, Cal.	.40

The above should be ordered from the Hydrographic Office, U. S. Naval Supply Depot, 5801 Tabor Avenue, Philadelphia 20, Pa., if you live east of the Mississippi. If you live west of the Mississippi order from the U. S. Navy Hydrographic Distribution Office, Clearfield Annex, Ogden, Utah.

There is also one centered on New York City, but this must be ordered from the U. S. Coast & Geodetic Survey, U. S. Dept. of Commerce, Washington 25, D. C. Specify chart 3042 and enclose \$.40.

While none of these have the amateur prefixes that are on the ARRL map, they should prove invaluable to anyone near the mentioned centers who is trying to align a beam.

John McDermott  
Stratford, Conn.



### telrex "BALUN" FED INVERTED "V" ANTENNA KITS

SIMPLE-TO-INSTALL, HI-PERFORMANCE ANTENNA SYSTEMS:

- 1 KW P.E.P. Mono-Band Kit... 1KMB1V/81K... \$16.95\*
- 2 KW P.E.P. Mono-Band Kit... 2KMB1V/81K... \$21.00\*

\*Kit comprises, encapsulated, "Balun," copperweld, insulators, plus installation and adjustment instructions for any Mono-band 80 thru 10 Meters. Also available 2, 3, 4, 5 Band Models.



Mfd. under Pat. 2,576,929  
Write for TELREX PL 65  
**TELREX LABORATORIES**  
ASBURY PARK, NEW JERSEY



## SB-33 and MP-10

So you are planning on buying one of the new transceivers! After complete evaluation of the available models (see "73" magazine for April), I chose the Sideband Engineers model SB-33. Everyone's reasons are usually quite personal for their choice of a transceiver—mine included:

1. I didn't want to give up 15 meters.
2. I liked the lower priced units as a personal investment.
3. I liked the small package with a built-in ac power supply and speaker—good portable rig.
4. I liked the idea of mostly transistors for reliability, less heat, low level handling of rf and inherent stability.
5. I wanted selectivity—2.1 kc mechanical filter was just right.
6. Easy conversion to mobile by an ac inverter appealed to me (here is where my story really begins).

So I traded for an SB-33 Transceiver!

At the home station with a beam antenna for 15 and 20 and a trap inverted V antenna for 40 and 75, the transceiver met my fondest expectations. I even worked out barefooted on 20 meters on weekends reasonably well.

There was one small awakening, however, I tried several microphones which were not recommended, only to receive reports of questionable or poor audio quality. Ceramic mikes won't work even acceptably on the SB-33. Most dynamic mikes represent a sufficient mismatch so as to provide less than the desired audio quality. Finally, I purchased the recommended Turner model SR 90-D with an impedance of 25,000 ohms and, Eureka!

I have also tried various antennas on the rig. The receiver is very responsive with a resonant antenna for the band being used. The latitude of impedance matching of the transmitter seems limited but is adequate for resonant antennas with an impedance in the 50 ohm to 75 ohm range. With appropriate antennas, it is a great transceiver.

So far, the special Inverter provided by the manufacturer had not been available in my area. Being impatient to try the rig as a mobile, I ordered the Heathkit Model MP-10. The ratings of the Heathkit Marine Inverter

are more than ample. It is rated at 175 watts continuous power output with 12 volt input, while the SB-33 requires only 165 watts for rated PEP of 135 watts input. The SB-33 works on the MP-10 Inverter, but two things were readily apparent. First, there was a terrific 120 cycle hum in the receiver. The Heath Instruction book states this will happen and provides a solution: put 1 or 2 mmfd 200 volt capacitors (non polarized) across the ac output of the inverter. Two 1-mmfd capacitors reduce the hum to an acceptable level.

Next, the power input and output of the SB-33 using the MP-10 was only about ½ of that from the self-contained ac power supply when connected to the power lines. This comes about because the voltage tripler in the high voltage supply looks at the peak value of the power line voltage, or 166 volts rather than the 117 RMS. What to do? I finally decided to take the transformer of the MP-10 apart. After removing the laminated core, it was apparent that I could add one layer of wire and connect it in series with the output winding to provide the required higher voltage. Experimentation proved that one layer (about 75 turns) of no. 24 enamel wire provided the desired voltage and would fit the space in the window of the transformer after first removing the outer covering and using brown paper sprayed with Krylon for insulation between layers.

The original output of the Inverter is connected to pins 1 and 4 of the SB-33 socket on the rear of the transceiver. The new winding on the MP-10 is connected in phase to ad voltage by connecting from pin 4 to pin 5. This, of course, is actually done inside the MP-10, and I replaced one of the ac receptacles with an octal socket and wired to the same pin numbers as on the 11 pin socket on the SB-33. Now I can operate with full power as a mobile using my modified Heath MP-10 Inverter. I'm not sure I would go to this trouble again if the special Inverter were available. However, the Heathkit Inverter costs about half as much as the special Inverter and the modification is quite easy to make. The result is gratifying and on the air I can tell about rewinding a transformer to make my transceiver mobile.

. . . W6VAX

### TV CAMERA

We have the lowest prices and complete stock of all components for making your own Ham TV or closed circuit TV camera plus exclusive VANGUARD printed circuits and incredibly low prices on F1.9 lens with focusing mounts. Complete ready-to-operate cameras also available at the lowest prices you'll ever find.

For more information, price list, and photos, send 10c coin or stamps.

VANGUARD ELECTRONICS LABS Dept. H-11  
190-48—99th Ave. Hollis, N. Y. 11423



# The Amplidyne 621

In the past several years, the Technician license plus decreasing solar activity has given VHF quite a shot in the arm.

To keep pace, manufacturers have become more competitive in the VHF field, offering many fine pieces of gear from Nuvistor converters to complete SSB rigs.

One of the new rigs on the market is the Amplidyne 621, a complete AM/CW rig for six and two meters with external accessories for 220 megacycle operation. The rig, measuring 8" x 14" x 10", is manufactured by Amplidyne Labs in Kings Park, New York and sells for \$274.50.

The new Compactron final, an 8150, is rated at 60 watts input with an output of 40 watts on both six and two. A check with a wattmeter bears this out. This is accomplished through the use of separate link coupled tank circuits for each band with individual SO-239 antenna connectors.

Modulation is excellent according to both

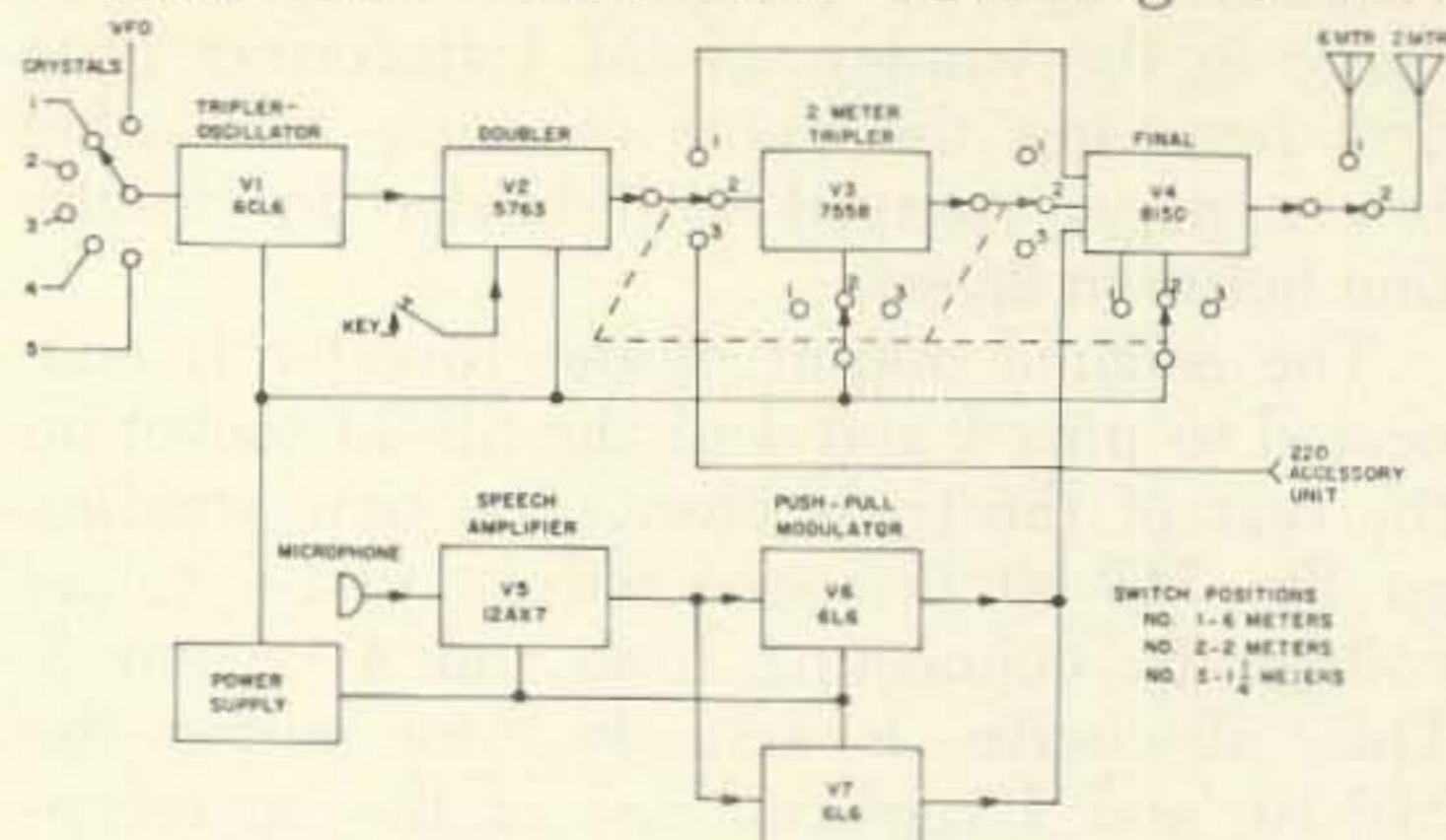

local and skip reports . . . and it should be. The rig is 100% modulated with a pair of 6L6's. With this rig the fellow on the other end won't have to strain his ears to hear audio on a 30 over nine carrier, a fault that is common on the VHF bands.

W6AJF says the best modulator is a key. Amplidyne has not overlooked this.

They have actually built a VHF rig with a key jack! And the CW note is excellent. Keying is done in the 5763 doubler stage and is chirp and click free, real T9X quality with

crystals (I do not own a VFO).

The only feature that I don't care for in the CW end of the 621 is that the oscillator/tripler, a 6CL6, runs continuously and I don't like to hear it when I'm pounding brass . . . but that's a small price to pay for a fine note.

One thing I'll never figure out is why VHF manufacturers won't add CW when they are designing a rig. Technicians should be able to take 5 wpm and many of them can. If you don't believe that CW is up and coming on six meters then you haven't tuned below 50.1 during openings.

On one recent opening the CW band here in South Dakota sounded like the low end of 40. Remember, CW has a 16 to 20 db gain over AM . . . and that's a lot.

The fused power supply is solid state using silicon diodes to provide dc for the B-plus and bias. It is built on a separate subassembly, making any necessary repairs easy.

The oscillator is a 6CL6 with tuned plate and will accept 6, 8 and 12 megacycles crystals in FT-243 holders or an external vfo. One external and four internal crystal sockets are provided; selection is made with a front panel switch.

A 5763 is used in the doubler stage. Here the output of the oscillator-tripler is doubled, the bandswitching achieved and the rig keyed. On 50 megacycles, the doubler is tuned to six to drive the final, and on 144 megacycles, the doubler drives a 7558 tripler which feeds the final.

The tripler is not used for six meter operation.

For 220 megacycle operation, only the oscillator is used and voltages to the other rf stages are disconnected. Modulation and power for the (Amplidyne 221) 220 megacycle adaptor is taken from a BNC connector on the rear of the chassis.

A spotting and tune-up button on the front panel is convenient. It is used when tuning the oscillator, doubler and tripler stages, and



## DX CHASERS

HEAVY 8X10 QSO RECORDER IS BEST DX AWARD FOR WALL. SIMPLY TURNING SPINNERS ALWAYS SHOWS EXACT NUMBER COUNTRIES QSOED AND QSLED. ALSO, EXPLAINS DX CHASING TO VISITORS AT A GLANCE. \$2.50 PPD.

## VIKING PRODUCTS



**ALL HAMS** UR CALL AND NAME GOLD EMBOSSED ON HANDSOME PEN AND PENCIL SET. IDEAL GIFT FOR THE CHIEF OP. SPECIFY RED, BLUE, WHITE OR BLACK. REQUEST SPECIAL PRICE ON QUANTITIES WITH DUPLICATE LETTERING FOR GROUP EVENTS. PRINT NAME AND CALL CLEARLY. PEN OR PENCIL ONLY \$2.75 PPD. PAIR \$4.50 PPD.

DEPT. B-3, 196 SO. MAIN ST., ORANGE, MASS.



for checking your frequency before firing up.

Along these lines, Amplidyne has come up with a built-in 50 ohm dummy load. With this, the operator can tune-up without putting a signal on the air and little touch-up should be needed when the antenna is connected . . . if it is matched. I've noticed that the link coupled tank circuit doesn't take kindly to an SWR of more than 2 to 1 and full loading is impossible. The SWR should be better than this anyway and it would seem Amplidyne may force some antenna systems to be cleaned up.

The dummy load is selectable from the front panel and a flashing red light tells the operator when the dummy load is switched into the circuit.

The entire rig is well metered with a large, easy-to-read Honeywell meter. The meter reads oscillator, doubler, tripler, final, modulation and relative rf output with a six position ceramic rotary switch. The 621 uses ceramic switches and sockets throughout.

So far, I've been using the 621 with a ground plane antenna and have been working most everything I can hear, but, of course, a beam will be in use by the time you read this. Those 40 watts of CW and 100% modulated rf "do make a hole" even with the ground plane.

No trouble has been encountered, and I don't really expect any with this fine little rig.  
 . . . KØCER



Wayne,

Enclosed please find a photo of what is left of a six meter halo antenna after going through an automatic car wash while the attendant was reassuring me that it would fit with no trouble.

Ed Bratek, K8VPH  
 Whitmore Lake, Michigan

## GOVERNMENT WAREHOUSE

FREQ.-METER BC-906, 150-235 mc. Can be tuned to 2 Meters. With cal. chart, schematic, parts list and antenna. Includes 500 microamp meter. . . . \$9.95  
 Shipping weight 19 lbs.

4CX300A's pull outs/good . . . . . \$11.50  
 With socket . . . . . \$16.50  
 Socket alone . . . . . \$7.50  
 4X150's pull outs/good . . . . . \$3.50

Overhaul Instruction Book for ARC-27 and ARC-55 . . . \$2.50

**Government Warehouse, Inc.**

264 Shrewsbury Ave.  
 Red Bank, N. J.

**Phantom Antenna, A-83**, used with SCR-608. 27-38.9 mc. Consists of: variable capacitor 5.3-75.3 mmf air trimmer, 8 turn rf coil, spst toggle switch, 500 ohm 5 w resistor and 50 ohm 25 w non-inductive resistor. All mounted in metal case, 1-3/8 x 2 x 3-3/8. New \$1.25. Ship. wt. 3/4 lb. 2 for \$2.

**5 vac-70 a filament transformer**, 22 kvw, 115/60/1 primary. 6 x 7 x 12 overall, potted-oil, new ship. wt. 50 lb. \$15.00.

## HIWAY COMPANY

SATISFACTION GUARANTEED

1147 Venice Blvd., Los Angeles 15, Calif.

### NEW TCS DYNAMOTOR

12 v dc input. 400 v dc @ 200 ma output.  
 Weight 12 lbs.

\$3.95 postpaid west of Denver.

\$4.95 postpaid east of Denver.

**Dow Trading Company**

N. Dowdell W6LR  
 Elliott 7-3981

111 Spanner Street  
 Monrovia, Cal. 91016

SG93/URM75 5-220mc Sig & Sweep Gen. W/Xtal. Mod. EX 67.75  
 Manuals (4) with SG93 (Philco Com. Type H-1147) EX 4.75  
 T61A/AXT2 TV X'mittr. Like Navy type ATJ-ATK. NEW 17.50  
 R23/ARC5 190-550T kc. The "Q5-er" . . . . . GOOD 11.75  
 SA325/U Coaxial Relay. SP4T. W/28 VDC Motor. EX 2.75  
 UG210/U Coaxial Plugs for SA325 Relay, used . . . EX 3/1.00  
 CU119A Coupler. W/13 1-tube amplifiers, tubes . . . EX 4.75  
 RT82/APX6 Converts to 1215-1296 mc X'ceiver . . . NEW 21.75  
 TS726/UPM8 Tests APX6./27 Tubes, 10 Diodes . . . GOOD 14.50  
 UPM8 Manual Navships 91537A . . . . . Postpaid NEW 2.90  
 KT18/ARC1 100-156mc Xceivr. W/tubes & DN9 . . . GOOD 22.75  
 MT230/ARC Mounting for ARC1, ARC4 and ARC12 EX 2.85  
 C45 Control Box for ARC1 and ARC12 X'ceivrs . . . GOOD 1.35  
 T465/ALT7 Xmittr 168-352mc W/2-6161s, 100W out. EX 22.50  
 Schematic for T465/ALT7 with parts values . . . . . 1.00  
 6161 TUBE 100 watts @ 900mc, 63 watts @ 2000mc. EX 7.25  
 Socket, Air System Type for 6161 tube, used . . . EX 1.25  
 SWR Bridge, Micromatch-Reflectometer, 50-1000mc. EX 8.25  
 Blower, Axivane Type 60 C.F.M., 12-24V, AC/DC EX 4.75  
 Set of 120 Xtals, Type FT243 5675 kc thru 8650 kc in  
 25 kc increments, US tested & packed . . . . . 120/17.75  
 HV Probe 50 KV Insulation, 500 meg series res. . . NEW 2.45  
 Meter, Weston Model 843 500-0-500 microamp. 3" . . EX 3.85  
 RE2/ARC5 Ant Relay W/Meter & Vacuum Capacitor EX 1.85  
 T19-6.75 T20-4.75 T21-4.75 T22-8.75 . . . . . ALL GOOD  
 SN36/APS31 W/5-807s, 46 other tubes, 2-Blowers EX 9.25  
 ID59/APA11 W/3BP1 & 16 tubes EX for Panadaptr. EX 11.75  
 APX1 less tubes. 30lbs of high quality parts . . . . . GOOD 2.75  
 Tuning Unit for APX1 with 3 tubes . . . . . GOOD 1.00  
 APN1 Xceivr 420mc W/Wobulator. Less tubes . . . . . GOOD 3.85  
 R122A/ARN12 75 mc Superhet w/9 tubes & xtal . . . EX 3.85  
 MN42D Bendix Dual Indicator . . . . . GOOD 3.50  
 Rt. Angle Drive W/Gears & Universal. 1/4" shaft. EX 1.00  
 UPM11A AFC Chassis W/8 tubes & schematic . . . NEW 3.75

**E. C. HAYDEN**

BOX 294 Bay Saint Louis  
 Mississippi

Shipment: FOB Bay Saint Louis.

Terms: Net, Cash.



# Return to the Art and ...!!

DL4VQ, ex-AFA3DSQ  
Dan Davis, K3DSQ

Over three years ago I was forced to "disinterest" myself from amateur radio for—as I had thought at the time—a rather brief period. I had enlisted in the Air Force and concluded that I would get back on the air as soon as I had completed basic training and become settled on my first permanent base. I was fortunate enough to receive an assignment to a top rate electronic tech school at Denver, Colorado, but this proved to be unfortunate insofar as amateur radio was concerned. I learned soon enough that barracks life is not always conducive to firing-up therig at weird hours of the night. Twelve months later I found my self on my way to Germany, and amateur radio was, most assuredly, the least of my concerns.

During the twenty-four months I have been stationed in Germany the thought of assembling a station and getting back on the air has occurred many, many times. However, military or other duties have always precluded my doing so—until recently. A change in my duty assignment afforded me the opportunity I needed. I applied for, paid for, and received my German license and call letters. At the present time I'm waiting for the arrival of some equipment from the States. During this interim period I've been avidly catching-up on the latest changes and innovations that have affected amateur radio during my absence from the air. Recently, I picked-up a copy of 73 and read an editorial that had an effect on my constitution identical to that of accidentally coming into contact with the "wrong side of ground." I am, of course, referring to the recent announcement of the ARRL stating that it would no longer represent the interests of American amateurs.

What's happened? Frankly, I am rather confused by this turn of events. Confused, disgusted and frightened would, perhaps, be a better description. My own interest in amateur radio dates back nigh unto ten years ago when I can remember trying to tune in old super-regenerative, sitting in a cold, dimly-lit attic. It was then when I also became aware of the ARRL's existence and its mission. I formulated my own opinion of the League and concluded that it had to be a fine organization to represent the amateurs' interests to the FCC. As the years went by, I became more

convinced of my findings and became almost fanatical in my devotion to the boys in West Hartford. To me, the League could certainly do no wrong, and anyone who was not a member, was simply "not with the program." I had become a member of the League long before I obtained my Novice ticket and gladly went through the annual ritual of paying my membership dues. If I looked forward to one particular day of the month, it invariably had to be the day I received my copy of QST. On one occasion I even had my photo appear in the magazine, thereby increasing my support of the magazine and the League! I had become as pro-ARRL as it was humanly possible. So, imagine my surprise when I read W2NSD's editorial.

Seriously, what actually has happened and what will happen as a result of the League's policy announcement? I, for one, feel as though I've been taken for a ride by the ARRL. A small ride, perhaps, but nevertheless, a ride. After all has been said and done, it now becomes very apparent that I had not been receiving everything I had paid for—most of all, "protection from" and representation to the Great White Fathers. This could be construed as the disgusting element in this case. At most, however, I think I could accuse the League of dishonesty in this particular instance (offhand, I know of no others). I am certain there are many others who must feel the same as I, and I'm sure there are still others who will disagree with me.

Perhaps you think I'm knocking the League too hard, and maybe I am. Looking back over the record, we must honestly admit that the League has done "beaucoup" good for amateur radio. There can be no denying this. If it hadn't been for Mr. Maxim and his group in the post-WWI period, I would now have no reason for even writing this article. What about the League sponsored Amateur Radio Emergency Corps? Then, there's always the code practice from W1AW. The ARRL had represented our interests in an admirable manner and had certainly created a favorable overall impression of the typical amateur. The League has, however, dropped the ball in an extremely vital and important area, and this should be of concern to all of us—VHFer, DXer, RTTYer or the plain ragchewer.



Let's now view the situation in a realistic manner from a fresh and different angle. What is the present value of membership in the ARRL? The value is probably similar to that of belonging to the RCC or DXCC—a certificate and nothing more. Of course, we must not forget QST. I have always felt and still do feel that a subscription to QST is definitely deserving of my hard-earned money. And I certainly intend to renew my subscription. But what about the protection and representation that had formerly been associated with the subscription? Obviously, this is a new era. So, where does this now leave us? Allow your imagination to run wild somewhat and suppose that a proposal is made by the FCC that would only remotely affect the amateur service. How many of us would take it upon ourselves to write Washington (since we are now devoid of representation there) either yeaving or naying it? I'd venture to say very few of us. And those who would take the time and effort would be analogous to the "voice crying out in the wilderness." Unless the proposal were extremely grave in nature, I'd probably keep pen in pocket and mouth shut. But what would develop if a series of seemingly "minor" proposals were enacted and all linked together? Might this not seriously affect that which we hold so dear to heart? No matter how naive one might be, he must admit that this possibility does exist. I am not taking the stand nor even implying that the FCC is out to get us and forever rid itself of the amateur service, but through ignorance on their part and inattention or silence on ours, it is possible for regulations to be enacted that could have a detrimental effect on amateur radio. Without backing from a representative group we would probably never muster sufficient strength to make our feelings clear to the FCC. We could very well be presented with a "faite accompli."

Basically then, what we now need is an organization that can pick up what the ARRL has dropped—protection and representation. Our need can be expressed in the statement "Protection by Representation." Be it the Institute of Amateur Radio, an organization fostered by CQ or another magazine, or even the RCC, but let us have some group represent us in Washington! "United we stand, divided we fall"—this old cliché could never hold more truth as far as we are concerned. The present state of affairs, if allowed to continue, could develop into what will in the future be called "The Boys' Period of Laissez Faire," the period when they could have saved amateur radio, but instead lost it. . . . K3DSQ

## CONVERTER SALE

New model series 300 with 3 VHF transistors, crystal, and more than 30 high quality parts. Carefully assembled and tested. Measures only 3" x 2 1/4" x 2". Low noise and better than 1 microvolt sensitivity. Made in USA and guaranteed. Available in the following models for 12 volts DC:

Model	Input mc.	Output mc.	Price
300-A	26.965-27.255	1.0-1.255	\$10.95 ppd.
300-B	50-51	.6-1.6	\$10.95 ppd.
300-C	50-54	14-18	\$10.95 ppd.
300-D	144-148	50-54	\$12.95 ppd.
300-E	144-145	.6-1.6	\$12.95 ppd.
300-F	144-146	28-30	\$12.95 ppd.
300-G	14.0-14.35	1.0-1.35	\$10.95 ppd.
300-H	5.0 (WWV)	1.0	\$10.95 ppd.
300-X	Choice of 1 input freq & one output freq between .6 & 160 mc		\$14.95 ppd.

Note: All above converters have a tuned R.F. Stage.

Order now while prices are still low.

All above converters are supplied with Motorola type connectors. For two SO-239 connectors instead, add 75c. N.Y.C. residents add 4% sales tax.

**VANGARD ELECTRONICS LABS Dept. H-11**  
190-48-99th Ave. Hollis 23, N. Y.

## "RW" NOVEMBER BARGAINS

- L & N KELVIN-VARLEY PRECISION VOLTAGE DIVIDER—20,000 OHMS 0.1% accuracy, Ratio 1:10,000 0.01% accuracy, with 100ua Galvanometer. Ship wt. 37 lbs. Used, Good . . . . . \$49.50
- TS-13/AP "X" BAND SIGNAL GENERATOR—9305 to 9445 MC. Pulsed or CW. Also Wave Meter & Power Monitor. XInt. . . . . \$29.95
- JENNINGS VARIABLE VACUUM CAPACITOR—Type UCS 10-300mmf, 15KV, with 20 turn dial & FM2 Flange mount. Removed from New equipment. . . . . \$49.50
- TS-36/AP RF POWER METER—8700-9500MC. Measures average power CW or Modulated RF. Portable-Battery powered. New w/accessories. Less Batt. . . . . \$14.95
- RA-42B POWER SUPPLY—115/230 v. 60cy. Output 210vDC 60MA. & 6.3vAC 3.5A. Dual Choke, Oil Cap., 5V4, Cabinet & schematic. Used. Good. . . . . \$6.75
- RT-82/APX-6 TRANCEIVER—1296MC. Complete with 2C42, 2C46 & 29 other tubes, Excellent Condition . . . . . \$15.95
- 2 M FIELD STRENGTH METER—100-156MC. Takes 1 1/2v & 45v batteries. Used, Excellent. . . . . \$5.95

WRITE FOR BULLETIN #40 — LOADS OF BARGAINS  
Send Check or Money Order with Order-Minimum \$2.50  
PLEASE INCLUDE POSTAGE—Excess Promptly Refunded  
Minimum C.O.D. Order \$10.00 with 25% Deposit

### R. W. ELECTRONICS, INC.

2430 So. Michigan Ave.  
Chicago, Illinois 60616

Dept. 7311  
Phone CALumet 5-1281

WANTED

WANTED

### R-390A/URR RECEIVERS

Any quantity, any condition  
Top prices paid. Call collect

### Space Electronics

4178 Park Ave, Bx, N. Y., CY 9-0300

## BUILD A TV CAMERA!!

~ EXPERIENCE THE FUN OF HAM RADIO'S NEWEST FRONTIER ~

New low cost vidicon focus & deflection coils now make it possible to construct your own budget priced TV camera. Each coil kit comes complete with assembly instructions plus an "easy-to-build" 5 tube camera schematic. Complete kit only \$19.90. Postpaid delivery in U. S. and Canada.

Send 10c in coin for further information.

ATV RESEARCH, Box 396, South Sioux City, Nebraska



## Heath Application Series

Many hams like myself are not electronic engineers. We have become hams because we enjoy the fascination and the challenges it offers. But to be honest, we have to admit that we have obtained a rather sketchy background in the theory and knowledge of electronics. We can make basic measurements and tests. But when it comes to really getting the most out of our rigs and test gear, when it comes down to solid knowledge of its operation, our limited background and training becomes painfully evident. Speaking from personal experience, the ham who does try to up-grade his electronic education often finds himself going in several erratic directions at the same time.

Correspondence courses are one answer. But often the house payments and shoes for the junior operators don't leave much for final amplifiers and beams, much less home study plans. The Heath Company has an answer for the ham who would really like to know more about electronics and test equipment. As usual, the price is reasonable.

The Heath Company has produced a "Heath Application Series" which is based around three most useful pieces of electronic gear, the VTVM, signal generator, and oscilloscope. The manuals are well written. Along with the pictorials they are easy to understand. The experiments are clearly and well illustrated. Purchase of the test instruments is optional as most hams have some of these pieces of equipment. If you don't have any of this gear, try first for the VTVM and its course. Second get the signal generator and its course. These two alone will be of immense help to you at once. Later on the os-

cilloscope makes a good addition to your bench.

Each manual starts with very basic concepts and leads you via study up to a very sound level of electronic know-how. In addition you will have gained the knowledge to enable you to get the utmost out of your test gear.

You do more than just read—you experiment too. Furnished with the VTVM manual is a small transformer operated power supply. This unit is just as easy to assemble as it is useful. I have mine out on the bench all the time for use as a source of variable low power ac and dc. It could easily be modified for a gem of a bias supply.

In addition to the study of ac and dc current flow, Ohm's law, voltage dividers, and plenty more, the VTVM series really teaches you how to operate and understand the VTVM. It is really surprising to know about the many things a VTVM will (and will not) do. If you don't have a VTVM, get one with this manual. No ham can live without one.

When you get the signal generator course, you get in addition to a very comprehensive manual, a uniquely designed test chassis complete with a 150  $\mu$ a meter, speed clips, transistors, and components used in performing experiments. Heath also offers either a rf signal generator or an af signal generator to go along with the manual if you so desire. The purchase of a signal generator is optional as with the other kits and manuals.

The signal generator course again starts with basic electronics, but very soon gets into a study of oscillators, amplifiers, modulators and signal generator operation. One note about

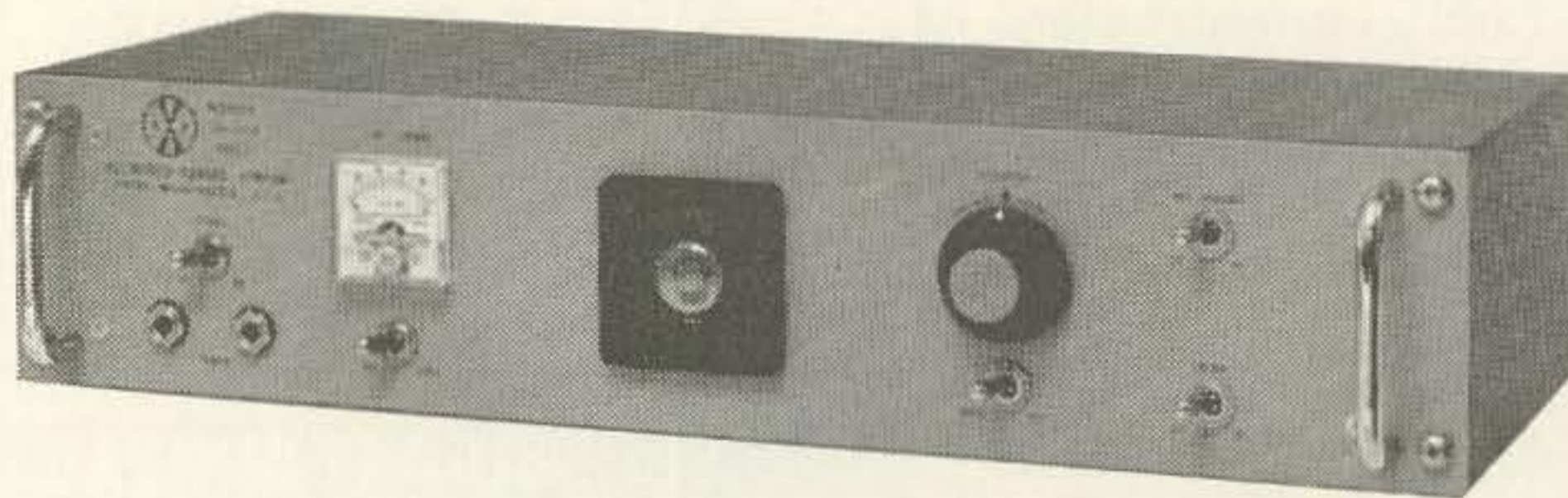

TELEWRITER  
MODEL "L"  
FREQUENCY  
SHIFT  
CONVERTER

\$199 (dual eye indicator)  
\$279 (CR tube indicator)  
\$14.50 cabinet

Audio input. Scope or dual eye indicator. Plug-in inductors for wide or narrow shift. Axis restorer & Limiter can be switched in or out of circuit, to suit conditions of fading or interference. Copies on Mark only or Space only automatically Mark hold circuit. Loop & Bias supply for optional polar relay for keying transmitter. Keying tube keys magnet. Terminals on chassis for external keying relay & scope indicator.

**ALLTRONICS-HOWARD CO., Box 19, Boston 1, Mass.**



the experiments. They are made easily and quickly. After initially soldering speed clips to the components, you can put the soldering gun on the shelf. No more soldering or unnecessary work is required. It is no trick at all to convert from a modulated transistor rf oscillator to a multivibrator or to a simple receiver or any of the many other experiments covered in the course. After studying this course you can use the knowledge gained not only in your hamming, but you can probably start servicing some of the neighbors radios and pay for the course. As a side note, the experimental chassis is just the answer for experimenting with solid state devices such as silicon controlled rectifiers, diode devices, etc. Mine has seen lots of use.

The third part of this course deals with the status symbol of the ham shack, the oscilloscope. Most hams have been using the scope for monitoring purposes—and not getting full value for this versatile piece of gear. This course does a good job of explaining the scope, its circuitry and its operation. This knowledge can make your scope a real asset to your test bench as well as your ham shack. In this course as in the others, you study test equipment maintenance and trouble-shooting. You can keep your ham gear in good shape without a scope. But with a good scope and a good knowledge of its operation, you will do a better job of maintaining your station and have more time left for operating the rig. Also, this course shows how you can keep the frau's hi-fi in tip-top condition. (You remember the hi-fi set that you had to buy for her when you got the transceiver.) The scope also includes another experimental chassis which really makes the breadboard look ancient. The unit is complete with all transistors, speed clips and parts used in the experiments. If you don't have a scope and can't buy the little lady a hi-fi set to go along with said scope, get the manual and experimental unit just the same. Sooner or later the knowledge is going to get you out of a jam.

When all is added up, it is hard to see how a ham can afford to stay ignorant when Heath has put out such a good study-experiment course at such a reasonable price. Your time and study investment will be small in comparison to the cost of a new rig, the embarrassment of a pink ticket, and in general the enjoyment of ham radio that sound knowledge can bring. You won't become an electronic engineer, but you will be way ahead of the local ham who asked me what kind of an "oscillating" scope he should buy.

... K8AJD

## 10-15-20M QUADS

*Pre-Cut	*Pre-Tuned	*Triband
	Bamboo	Fiberglass
Two Element	\$59.95	\$99.95
Three Element	99.95	\$149.95

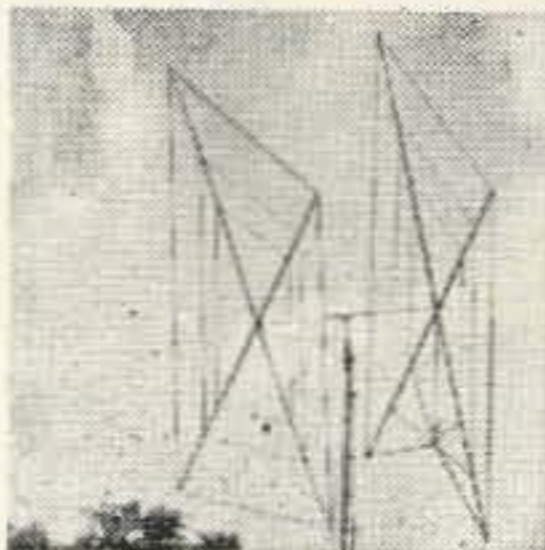

New

- \* ROTATE WITH TV ROTOR
- \* HIGH F/B RATIO
- \* VERY LOW SWR
- \* LOW Q BROADLY TUNED
- \* HIGH GAIN
- \* EASY TO MATCH
- \* LOW WIND RESISTANCE
- \* ONE FEED LINE FROM XMTR FOR ALL 3 BANDS NO SWITCHING

Skylane PRODUCTS

406 Bon Air Dr.  
Temple Terrace, Florida  
Phone 988-4213

## SEMI-CONDUCTOR SALE

FACTORY TESTED! GUARANTEED!

- 15 Texas Swit'g Transtrs, pnp 'n npn \$1
- 25 Silicon Glass Diodes, untested .. \$1
- 3 Texas 2N1038's, w/h. sink .....
- 10 Zeners, gold, axial leads .....
- 30 Transistors, untested, TO5 .....
- 5 30MC Transtrs, 2N247, TO5 case .. \$1
- 1 4W Rheem 2N1613 type transistor \$1
- 25 Germanium Diodes, IN34 equals \$1
- 3 40W Transistors, TO36, untested \$1
- 1 25 Amp 100 PRV sil-contr. rect. \$1
- 10 Power Transistors, untested, TO3 \$1
- 4 G.E. 2N170 Transistors, RF, npn \$1
- 6 Upright Zener Diodes, asst volts .. \$1
- 2 IN429 Zener References, 6 volts .. \$1
- 1 3N35 Tetrode 150 MC npn, TO18. \$1
- 1 2N705 300 MC, 300 MW, sil, npn \$1
- 1 2N718 npn sil. "Planar", 100 mc \$1
- 6 Texas 750 mil 400V Rectifiers .. \$1
- 10 PNP Switching Transistors .... \$1
- 10 NPN Switching Transistors .... \$1
- 1 20W Silicon Mesa, npn, 2N1648 .. \$1
- 3 Zener 6 volt diodes, 1 watt, axial \$1
- 2 One watt 2N341 npn, sil., TO8 .. \$1
- 3 20W transistors, 2N1320 pnp, TO10 \$1
- 2 Mesa npn Silicon Transistors 4W .. \$1
- 4 G.E. 2N107 Transistors, pnp .. \$1
- 2 500 mc Mesa pnp Transistors .... \$1
- 15 pnp Transtrs, asst types & cases \$1
- 15 npn Transtrs, asst types & cases \$1
- 10 Famous CK722 Transistors, pnp \$1
- 2 25-amp Silicon Power Rects. stud \$1

SYLVANIA  
EPOXY  
DIODES  
1 amp 400V  
 6 for \$1

PHILCO  
Transistor  
XMTR/OSC  
• Crystal  
controlled  
41 to 58 MCS  
• Printed  
circuit  
• 2-in. square  
• Wired  
• Uses Philco  
2N1742  
• Complete  
with  
transistor,  
crystal,  
thermistor,  
tuning coil,  
etc.  
 \$1.98

POLY PAKS P.O. BOX 942A  
SO. LYNNFIELD, MASS.

### 118 to 148 MC

R19/ARC—Aircraft Frequency Receiver  
Tunable 18# exc. \$29.95

### PANORAMIC INDICATOR

IP69/ALA-2 See June 73 for conversion data shipping  
wt 18 lbs, October special \$22.50  
BC453—Less tubes—12# 12.95  
R4ARR2 Receiver—12# 6.95  
Transformer 530-0-530 volts—425MA—15# 6.95  
W2EWL—SSB—RTTY—Phone Patch Transformer—  
Lionel 6 for 4.95  
RG54—58 ohm coax—370 ft.—15# 9.95  
BC458 (T21 ARC5) exc.—15# 4.95  
BC696 (T19 ARC5) less tubes—15# 5.95  
Beam Filter—Q-5'er—Navy 1.95  
Vibrapack—VPI—6v 2.95

All orders FOB Chicago—  
Subject prior Sale.  
Illinois Residents add 4%

ARROW SALES-CHICAGO, INC.

2534 S. MICHIGAN AVENUE  
CHICAGO 16, ILLINOIS



# NOW!

## THE NEW

**MODEL SW350 - - - \$395**  
with built-in VFO

# SWAN

## SINGLE SIDEBAND TRANSCEIVER

IN STOCK AT

# QUEMENT ELECTRONICS

1000 SOUTH BASCOM SAN JOSE, CALIFORNIA

"Northern California's Most Complete Ham Store"

SINCE 1933

(Stuff from page 4)

Approximately 90% of ARRL funds being spent on the publishing business  
Rubber stamp Directors meetings

I've probably omitted some important items from the list; these just came immediately to mind. All of these problems . . . and those as yet unborn or uncovered . . . can be cured if *you* care enough to speak up. These are not problems of differences of opinion, they are mostly abuses of power and they reflect on all of us for permitting them to happen and to continue. Let's push hard for honesty and integrity and try to get back to where we are the captains of our own fate.

Remember . . . we are extremely fortunate to have some excellent hams running the amateur section of the FCC . . . fellows who seem to be doing better for us than our own League. But these chaps are not selected by us and if we should suddenly find new men antagonistic to ham radio later replacing our friends we would have little recourse since we have already turned our fates over to them. If we can regain control of our hobby through our representative organization we will stand a far better chance of having a secure future. I think we can do this by working to improve the Institute and the League and by speaking up loudly and clearly when something shady

## Radio Bookshop

**1—CARE AND FEEDING OF HAM CLUBS—K9AMD.**—Carole did a thorough research job on over a hundred ham clubs to find out what aspects went to make them successful and what seemed to lead to their demise. This book tells all and will be invaluable to all club officers or anyone interested in forming a successful ham club. Hundreds of grateful letters have been received from clubs who have applied the ideas in this book. **\$1.00**

**2—SIMPLIFIED MATH FOR THE HAM-SHACK—K8LFI.**—This is the simplest and easiest to fathom explanation of Ohm's Law, squares, roots, powers, frequency/meters, logs, slide rules, etc. If our schools ever got wind of this amazing method of understanding basic math our kids would have a lot less trouble. **50c**

**3—INDEX TO SURPLUS—W4WKM.**—This is a complete list of every article ever published on the conversion of surplus equipment. Gives a brief run-down on the article and source. Complete to date. **\$1.50**

**6—SURPLUS TV SCHEMATICS.**—You can save a lot of building time in TV if you take advantage of the real

bargains in surplus. This book gives the circuit diagrams and info on the popularly available surplus TV gear. **\$1.00**

**7—AN/ARC-2 CONVERSION.**—This transceiver sells in the surplus market for from \$40 to \$50 and is easily converted into a fine little ham transceiver. Covers 2-9 mc (160-80-75-40 meters). This booklet gives you the complete schematics and detailed conversion instructions. **\$1.00**

**9—COILS—K8BYN.**—Basic book which covers the theory and practical aspects of the many different types of coils found in ham work. Well illustrated. **50c**

**12—CW—W6SFM.**—Anyone can learn the code. This book, by an expert, lays in a good foundation for later high speed CW ability. **50c**

**14—MICKEY MIKER—WØOPA.**—Complete instructions for building a simple precision capacity tester. Illustrated. **50c**

**15—FREQUENCY MEASURING—WØHKF**—Ever want to set yourself up to measure frequency right down to the gnat's eyebrow? An expert lets you in

on all of the secrets. Join Bob high up on the list of Frequency Measuring Test winners. **\$1.00**

**ATV ANTHOLOGY. WØKYQ and WA4WH.**—A collection of the construction and technical articles from the ATV Experimenter. Includes a complete, easy to build vidicon camera and 50 other projects. The only book available about ham TV. **\$3.00**

**PARAMETRIC AMPLIFIERS. WA6BSO.**—Parametric amplifiers are probably the most practical way for hams to get a low noise figure at VHF and UHF. This book is the only one available that covers both theory and practice. **\$2.00**

**TEST EQUIPMENT HANDBOOK. W6VAT.**—Every ham needs to have and know how to use test equipment. This book tells you how to make valuable ham test gear easily and cheaply. It also covers the use of test equipment. **50c**

**RECEIVERS. K5JKX.**—If you want to build a receiver or to really understand your receiver, this is the book for you. It covers every aspect of receiving in author Kyles usual thorough manner. **\$2.00**



or shabby happens to us.

You can get information on the problems we face by reading 73, The Monitor (Box 4133, Sta. A, Dallas, Texas 75208, send for sample), and K6BX Xtra Newsletters (Box 385, Bonita, Calif., send 50c for sample).

The Institute of Amateur Radio needs your support (\$10 year) in its program to lobby in Washington for amateur radio and help amateurs with legal ham problems. The Institute is the *only* amateur radio organization registered to lobby for our hobby. The Institute is the only national amateur group providing direct financial support to amateurs fighting legal battles that can affect us all. Support the Institute.

#### CB Delay

The new CB regs have been held up from the November first deadline until thirty days after the FCC has a chance to act on petitions submitted by several groups and manufacturers. I note that S-9 magazine is still encouraging CB'ers to ham it up, in spite of the coming regs.

#### Tower Case

The Mace Warner WØJRQ case was postponed until January 26th when Andy Bohley KØOOA, the Engineer in Charge of the FCC office, a key witness, died suddenly on the day of the trial. Andy had been with the FCC for twenty years and was well known for going out of his way to help local amateurs.

#### K6BX Quits CQ

Cliff's Xtra News Letter #19 just arrived. It's worth every bit of the \$2.00 a year he charges. In this issue he goes into details about his association with CQ and his problems in getting paid, along with his final blowup and revulsion with their way of doing business. Hey Cliff, how about a club for all us ex-CQ staffers? Anyone that is interested in much of the behind-the-scenes maneuvering in our hobby would do well to subscribe: Box 385, Bonita, California.

#### Clubs!

Please make sure that 73 is on the mailing list for your bulletin, or, if you don't have a bulletin, that we have an address for your club. We send out information bulletins every now and then to clubs . . . information that you cannot get elsewhere. Plus other benefits which we can't mention here.

Say, I could use a couple 417A's if anyone has some spares. Also I'm looking for a 416B and a 4CX1000.

. . . W2NSD/1

## FREE Catalog

OF THE WORLD'S FINEST  
ELECTRONIC GOV'T  
SURPLUS BARGAINS



**HUNDREDS OF TOP QUALITY ITEMS**—Receivers, Transmitters, Microphones, Inverters, Power Supplies, Meters, Phones, Antennas, Indicators, Filters, Transformers, Amplifiers, Headsets, Converters, Control Boxes, Dynamotors, Test Equipment, Motors, Blowers, Cable, Keyers, Chokes, Handsets, Switches, etc., etc. Send for Free Catalog—Dept. 73.

**FAIR RADIO SALES**  
2133 ELIDA RD. • Box 1105 • LIMA, OHIO

### 6 METER CONVERTER WITH NUVISTOR PRE-AMP

Unbeatable performance at an unbeatable price. Only \$10.00 ppd. Complete with 6U8A, 6CW4 tubes and choice of 36 mc. crystal for 14-18 mc. output or 49.4 mc. crystal for broadcast band output. Fully assembled, tested and guaranteed. Sensitivity .1 microvolt. Noise figure 2.5 db.  
**VANGUARD ELECTRONICS LABS**  
198-48—99th Ave. Dept. H-11  
Hollis 23, N. Y.

TONS OF AMATEUR EQUIPMENT IN STOCK

## WESTERN RADIO

SAN DIEGO

1413 India Street BE 9-0361  
MON - FRI 8:30 to 8:00 SAT 8:30 to 5:00

ARC-1 TRANSCEIVER 100-156 Mc., 25 watts AM. Makes fine 2-meter station. With 28 tubes, schematic & conversion info for 2-meters. Less dyn. & xtals. Vg good used cond. 60 lbs. **\$24.95**

POWER SUPPLY for ARC-1. 115 v. 60 cy. Supplies fil. & plate voltages. Complete with power trans, silicon rect., punched chassis, etc. Fits inside ARC-1 case. 10 lbs. **\$19.95**

TUNING CAPACITOR, for your 6- or 2-meter final. 1.6-17.6 pf. 2000 vdc. spacing. 5/16" shafts extend out both ends. This was made for the ARC-3 VHF xmtr. 1 3/4 sq. 2 3/4" overall. **\$1.00 each.**

5/16" to 1/4" brass coupling. **35c each.**

TUNING CAPACITOR, 6-170 pf. 1500 vdc. Bud type CE, slotted shaft for s.d. Adj. 1 3/4" sx. 2" long. **60c each. 2 for \$1.00, 5 for \$2.00**

Selenium Rectifiers, 3-phase, 14 volts, 60 Amps. Leece-Neville #30605, for use with Leece-Neville Alternators. Ship. Wt. 6. lbs. **\$7.73**

Selenium Rectifiers, single-phase, full-wave bridge 55 volts, 3 amps. 3 1/2" x 4 1/2" x 8 1/2". Useful for powering surplus relays, motors, etc. 3 lbs. **Only \$1.00, 6 for \$5.**

BC-221 Technical Manuals. 3 different books available. Specify (Models N, AA); (Models P, T, AF, AH); (Model AK). **\$1.50 each book.**

**Minimum order \$2.00**

*Please enclose sufficient money with your order to cover shipping costs.  
Send for our latest flyer.*

## JEFF-TRONICS

4791 Memphis Ave., Cleveland, Ohio 44109



# GIANT BOOK SALE!

## UP TO 50% OFF!

### SPECIAL SPECIAL SPECIAL

**Radio Handbook, 15th Edition**, written by Bill Orr W6SAI, over 800 pages. Covers every phase of amateur radio from the very basics right up through the construction of just about everything you could want in ham gear. Originally published at \$8.50. Superseded by the new 16th edition which is the same except for new construction projects and selling for \$9.50 (see number 11). Special, until the last few copies are gone, only \$5.95!

### Gernsback

- Maintaining HiFi Equipment \$2.90 (2.00)
- Elements of Tape Recorder Circuits \$2.90 (2.00)
- TV and Radio Tube Troubles \$2.90 (2.00)
- Guide to Mobile Radio \$2.85 (2.00)
- Rapid Radio Repair \$2.90 (2.00)
- Tubes and Circuits \$3.45 (2.50)
- Fun with Electricity \$2.65 (2.00)
- Installing HiFi Systems \$3.20 (2.50)
- Auto Radio Service and Installation \$2.95 (2.00)
- Radio Control Handbook \$4.95 (4.50)
- How to Fix Transistor Radios and Printed Circuits V. 2 \$3.20 (2.50)
- A to Z in Audio \$3.20 (2.50)
- Ind. Electronics Made Easy \$3.95 (3.00)
- TV Trouble Analysis \$3.20 (2.50)
- Basic TV Course \$4.10 (3.00)
- Practical TV Troubleshooting \$2.35 (1.50)
- Fun with Radio Controlled Models \$3.20 (3.00)
- Basic Audio Course \$2.75 (2.00)
- Understanding Hi Fi Circuits \$2.90 (2.00)
- Basic Industrial Electronics Course \$4.10 (3.50)
- The Oscilloscope 2nd Ed. \$3.65 (3.00)
- Rider**
- Basic Mathematics Vol 1-4 \$15.60 (10.00)
- Basic Oscillators \$4.50 (3.50)
- Photoelectric Controls \$3.50 (2.50)
- Basic Prin. and Appl. of Relays \$2.90 (2.00)
- How to Use Grid Dip Oscillators** \$2.50 (2.25)
- Electronic Equipment Made Easy for the Boat Owner \$5.95 (4.50)
- Radio TV Electronics Dictionary \$3.50 (3.00)
- Elem. Industrial Electronics \$3.90 (3.00)
- Repairing TV Remote Controls \$2.50 (1.50)
- Communications Dictionary \$1.50 (1.25)
- Useful Electronics Shop Hints \$1.95 (1.25)
- Master Cartridge Substitution Guide Book \$2.00 (.75)
- How to Build Electronic Equipment \$6.95\* (6.00)
- Repairing Transistor Radios \$3.50 (2.50)
- Basic Transistors \$3.95 (3.00)
- Semiconductors and Transistors \$2.90 (2.00)
- Energy \$1.25 (.75)
- Transformers \$2.00 (1.00)
- Vacuum Tube Rectifiers \$2.00 (1.00)
- DC Circuit Analysis \$2.00 (1.00)
- Resonant Circuits \$1.25 (.75)
- CL Oscillators \$2.00 (1.00)

- Superhet Converters and IF Amplifiers \$1.25 (.75)
- Wave Propagation \$1.25 (.75)
- Blocking Oscillators \$1.25 (.75)
- Amplitude Modulation \$1.25 (.75)
- Multivibrators \$1.25 (.75)
- AM Detectors \$.90 (.50)
- Frequency Modulation \$.90 (.50)
- Color TV Receiver Practices \$4.50 (3.50)
- Intro to Color TV \$2.70 (2.00)
- TV and How it Works \$4.60 (3.50)
- Hi Fi Speakers and Enclosures \$4.60 (3.50)
- Handbook of 630 TV Repairs \$3.50 (2.50)
- Basic Vacuum Tubes and their Uses \$3.00 (2.00)
- Basic Electricity Vol 1-4 \$8.00 (5.00)
- Basic Radio Vol 1-6 \$15.20 (10.00)
- Servicing TV AFC Systems \$2.70 (1.50)
- Computer Arithmetic \$3.00 (2.00)
- Radio Control for Model Builders \$4.25 (4.00)
- Stereophonic Sound \$2.90 (2.00)
- Industrial Control Circuits \$3.90 (2.00)
- Basic TV Vol 1-5 \$11.25 (7.00)
- Electronic Test Equipment \$4.00 (3.00)
- Sams**
- ABC's of CB Radio \$1.95 (1.00)
- ABC's of Radio Navigation \$1.95 (1.00)
- Amateur Radio Station Manual \$3.95 (3.00)
- First Class Radiotele. Lic. Hand.** \$4.95 (4.25)
- CB Radio Manual \$2.95 (1.75)
- Comm. Equip. Sch. Manual \$3.95 (3.50)
- CB Antenna Guide \$2.50 (1.50)
- CB Radio Service Guide \$2.95 (2.00)
- Electronic Test Inst. Handbook \$4.95 (4.00)
- Modern Dict. of Electronics \$6.95 (5.50)
- Electronic Toys and Games** \$2.50 (2.00)
- ABC's of Electronics \$1.95 (1.00)
- Elect. Eng. and Tech. Handbook \$4.95 (4.00)
- Building up your Shack \$2.50 (1.75)
- Handbook of Elect. Tables and Formulas \$3.95\* (3.00)
- Low Power Telecasting \$2.95 (1.50)
- RF Interferent Control Handbook \$6.95\* (5.50)
- How to Read Schematics \$1.50 (1.00)
- 1964 North American Radio TV Guide \$1.95 (1.00)
- SSB Handbook** \$6.95\* (6.50)
- Two Way Mobile Radio Maintenance \$4.95 (3.50)
- Servicing Transistorized 2-Way Radio \$2.95 (2.00)
- ABC's of SW Listening \$1.95 (1.00)
- Tube Substitution Handbook Vol. 6 \$1.50 (1.00)
- General Class License Handbook** \$2.50 (2.25)
- Amateur Radio Antenna Handbook** \$2.50 (2.25)
- Troubleshooting Amateur Radio Equip. \$2.50 (2.25)
- Oscillator Circuits \$2.95 (2.00)
- Radio Circuits \$2.95 (2.00)
- Ham Antenna Construction Projects** \$2.95 (2.50)
- So You Want to Be a Ham \$2.95 (2.50)
- ABC's of Ham Radio \$1.95 (1.50)
- Handbook of Ham Radio Circuits** \$2.95 (2.50)
- Electronics Math Simplified \$4.95 (4.00)
- Eliminating Man Made Interference \$2.95 (2.50)

**104—SCIENCE HOBBIES**—Eleven American made semiconductors with instructions for making an automotive tachometer, a photocell light meter, a transistor preamplifier, an audio oscillator, a transistor regulator power supply, speech clipping, cathode biasing and screen biasing circuits. A \$29.95 value **\$2.98**

- Ne Pad \$2.95 (2.00)
- Solder Sipper \$1.50 (1.00)
- Dietzgen 10" Slide Rule \$2.85 (2.50)

**94—KIT OF SOLDERING TOOLS**—Used to was a soldering iron was all that was necessary, now you have to have a kit of fool tools. Little doohinkies like scrapers, reamers, forks, and brushes. Forsooth! Made of varnished maple and spring steel (vastly superior to winter steel). **Now \$3.75**

### Radio Publications

- Novice and Technician Handbook** \$2.95 (2.75)
- Better Shortwave Reception \$2.85 (2.00)
- S-9 Signals \$1.00 (.75)
- Cubical Quads** \$2.85 (2.50)
- CB Station \$1.00 (.50)
- How to Get CB License \$1.00 (.50)
- Beam Antenna Handbook** \$3.75 (3.50)
- Electronic Construction Practices \$2.95 (2.25)
- VHF Handbook** \$2.95 (2.75)
- Editors and Engineers**
- Surplus Conversion Manual Vol 1 \$3.00 (2.75)
- Surplus Conversion Manual Vol 2 \$3.00 (2.75)
- Surplus Conversion Manual Vol 3 \$3.00 (2.75)
- Surplus Handbook Vol 1 \$3.00 (2.75)
- Radio Handbook, 16th Edition** \$9.50 (9.00)
- Callbook**
- Radio Amateur's World Atlas \$1.00 (.75)
- World Prefix Map \$1.00 (.75)
- Radio Amateur DX Guide \$2.00 (1.50)
- Misc. Publishers**
- Basic Radio Servicing EIA (1.50)
- Elements of Magnetic Tape Recording \$7.95\* (6.00)
- Practical Radio Servicing \$8.50\* (6.00)
- Practical Dictionary of Electricity and Electronics (5.00)
- Techniques of Magnetic Tape Recording \$7.95\* (6.00)
- Sound of HiFi \$3.95\* (2.50)
- Radio TV and Electrical Repairs \$2.94\* (2.75)
- Synchros, etc.\* (1.00)
- Electronic Communication: Shrader\* (13.00)
- TV Servicing Handbook \$4.20\* (2.00)
- Practical TV Servicing \$7.95\* (4.50)
- Closed and Industrial TV (1.00)
- Transistor Circuit Analysis and Design: Fitchen \$9.00 (8.75)
- SSB Transceiver from BC-453 \$3.00 (1.50)
- TVI: Rand \$1.75 (1.50)
- Rohn Tower Manual \$1.25 (1.00)
- ITT Reference Data \$6.00 (5.75)
- Radiotron Designer's Handbook \$7.50 (7.25)
- CQ Mobile Handbook \$2.95 (2.00)
- First CQ Anthology \$2.00 (1.50)
- Phillips Code (1.00)
- GE Tube Manual \$1.50 (1.25)

Many books are one of a kind. Please give second choice if possible. Books marked with an asterisk (\*) are hardbound. Please include 15c postage with each order.

**Radio Bookshop**

**Peterborough, N. H.**



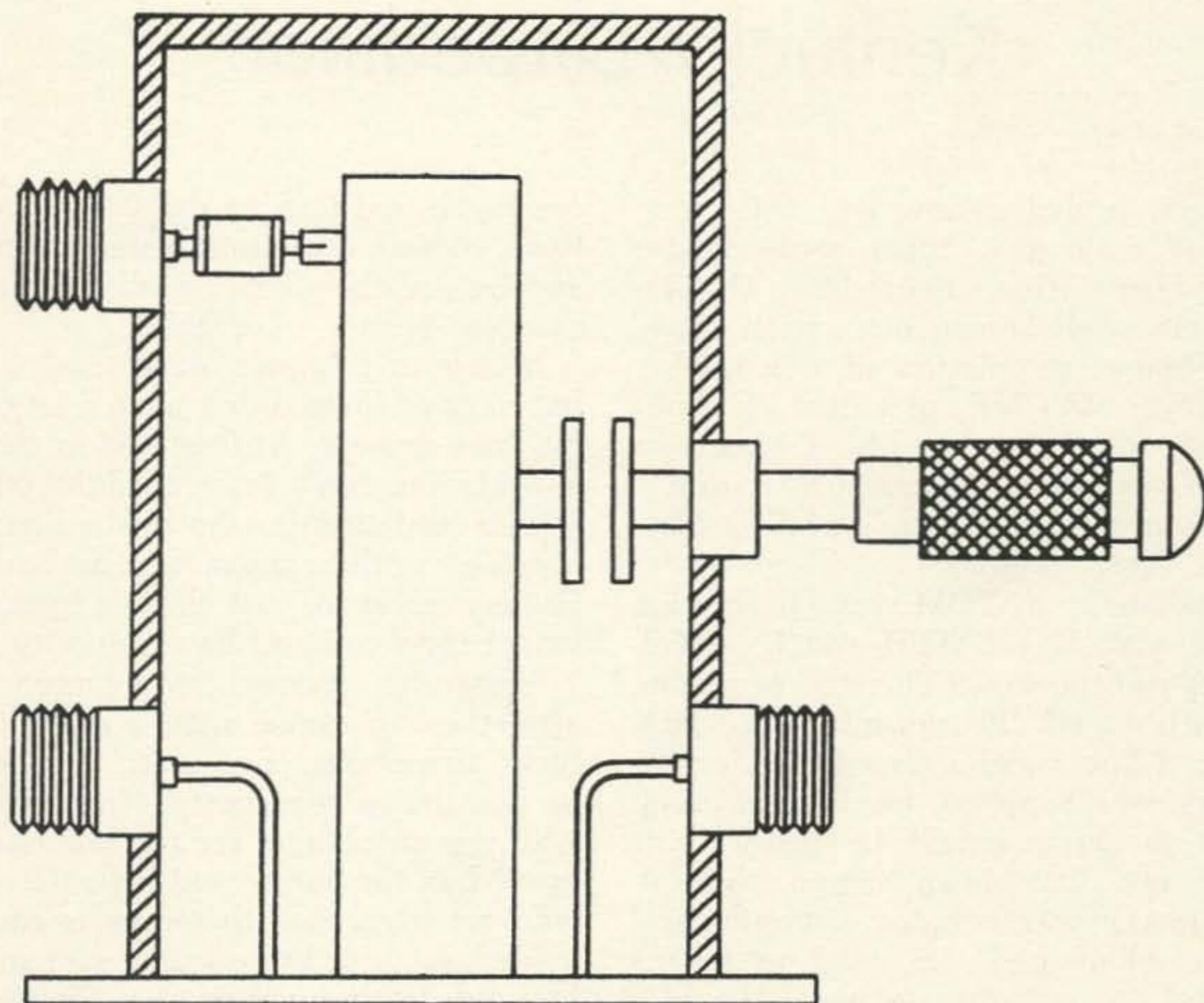

# PARAMETRIC AMPLIFIERS

by Jim Fisk WA6BSO

## A New Book Published by 73

This book, the first on parametric amplifiers for the ham, is written for the average amateur and explains in simple language how they work, how to build your own for the various UHF bands, and how to tune them up. Parametrics have helped

UHF move into the space age, but don't forget that the first working parametric amplifier was built by W1FZJ and worked on six meters.

Order this book direct from Radio Bookshop, \$2.00 postpaid, or from your local parts distributor.

**RADIO BOOKSHOP**

**PETERBOROUGH**

**NEW HAMPSHIRE**



# Kentucky DXpedition

Hammarlund pulled a new one this time, one that just may give them some future trouble. The Hammarlund DXpedition Of The Month is pretty well known now, particularly to the DX hound population of our hobby. Well, Stu Meyer W2GHK, president of Hammarlund, set up a rare county DXpedition which racked up over 1500 contacts during a three week tour of the backlands of Kentucky, Virginia and West Virginia.

Arthur Shahan Jr. K8YOM was DXpedition master while Alan Day K8ITH and Paul Keller Jr. K8EJN did the work. The station wagon, equipped with an HX-50 transmitter, an HQ-170 receiver, a linear and a trap dipole for 80-40-20 meters was supplied by Hammarlund. Since there obviously would be many spots where ac was not available an Antenna Specialists Zeus generator was included. Camping and cooking gear eliminated the need to find a friendly motel . . . a fortunate precaution, for few such places were found.

The original plan was to visit 20 hamless counties, but the three weeks allotted to the



trip was over before all were reached, so only 16 were actually activated. The back country of Kentucky was a lot harder going than anticipated.

The DXpedition started in Columbus, Ohio on August 11th with the first stop being Olive Hill in Carter County, Kentucky. Time ran out in Pocahontas County, West Virginia on September 2nd. Seldom did they find a combination of sleeping quarters and an antenna site, so many of the nights were spent sleeping on the ground or in the station wagon with the mosquitoes, flies, and thousands of nameless but weird insects hungrily gnawing at

every exposed inch of flesh. Meals were sometimes cooked, sometimes eaten out of a can . . . and frequently ptomaine was chanced at local eateries. Beans . . . ecch!

Motels in this area were tried a few times, but most of them didn't have a lot to offer over the bare ground. At least out in the middle of a field you don't have to fight off enormous spiders and lizards who are indignant at your presence in their room. You do have to admit, as they advance, that they've been there a lot longer than you and have seniority.

Campsites seemed even more acceptable after the experience with a motel in the Kentucky mountains. The motel owner was away so permission was gotten from his daughter, who was in charge, for the antenna to be put up. When the owner and his wife returned the wife got frightened that spies or revenueurs had moved in and hysterically screamed for her husband to throw them out. He threw himself into the situation and soon was running around threatening to break the equipment if things didn't get packed up immediately. Tempers were held, even when the owner kicked Paul in the slats.

Kentucky. Roadsigns riddled with bullet holes . . . half the houses deserted . . . that motel. In Owsley County a judge was asked for permission to hang the antenna from the court house steeple. After glancing at the letter of introduction from Hammarlund he asked that it be read to him. Finally he grumbled, "Ah dunno anythin' 'bout these thangs. Y'all come back tomorrow and ah'll find somebody knows somethin' 'bout it."

One setup was in a small building on a tobacco and pig farm. Unwashed children begging for candy, teenage girls and an old drunk who fell all over the feedlines slowed down operations. The shack set up in a combination kitchen-bathroom will not ever be forgotten either. Honest.

Either in spite of or because of the difficulties everyone had a fine time. It is just possible that Hammarlund might back another DXpedition of the Month like this some day, so be on the watch for it.

The logs for the trip are still on hand, so if you haven't QSL'd yet, send your card to DXpedition of the Month, G. P. O. Box 7388, New York 1, N. Y.



# We Need Your Help

You can help ham radio as well as us by encouraging friends to subscribe to 73 or giving a gift subscription or two. The more hams that read 73 the more that may take an interest in the preservation of our hobby . . . the more that may be intrigued by the large number of construction articles and start building.

<b>1st Gift Subscription</b> .....	<b>\$4.00</b>
<b>2nd Gift Subscription</b> .....	<b>\$3.50</b>
<b>3rd Gift Subscription</b> .....	<b>\$3.00 (yours?)</b>

(further Gift Subscriptions are \$3.50 per year)

Name: _____ Call: _____ QTH: _____ City: _____ State: _____ Zip: _____ .. New .. Renewal	Name: _____ Call: _____ QTH: _____ City: _____ State: _____ Zip: _____ .. New .. Renewal
Name: _____ Call: _____ QTH: _____ City: _____ State: _____ Zip: _____ .. New .. Renewal	Separate paper may be used for your subscription if you are hesitant about shredding your copy of 73.

**CLUBS:** Five or more subscriptions sent in at once are \$3.50 each for one year, \$6.50 for two years. Club secretaries should send for our Special Christmas Club Offer. . . . It is worth the effort.



# Letters

Dear Wayne,

Last May I was able to visit the World's Fair for half a day. I made a bee-line for the Coca-Cola pavilion. After a long wait I was able to enter. Before very long I found myself back in the sunlight with a strange craving for a Coke and no sign of K2US. Finally my myopic eyes lighted on that little door. I went up the stairs, sure that I was where I shouldn't be, when suddenly, near the rest-rooms, I found it. I went in and was greeted rather coldly. I will not say that the man on duty was rude, but he did look at me as if I was three-legged. After reluctantly being permitted to operate I left a short piece of traffic addressed to my parents at home. It is now August, that piece of traffic has yet arrive, and I have lost what faith I had in the National Traffic Handling system.

Charles S. Peavis K6PVS  
Alexandria, Indiana

Dear Wayne,

May I request that you print some information on the origins of WA2USA and its brief existence. Many local amateurs are aware that there was another station at the Fair besides K2US, but few know much about it.

Several weeks ago I had the sad experience of representing the Radio Club of Brooklyn for one whole day at K2US. I departed late that night for Brooklyn, very depressed and tired. Wayne, no one has been able to tell me why K2US even exists, except that it is run by HARC. Can you tell us why this station was ever brought into existence, who did it, and what they thought they would accomplish with the setup?

Lew Levitt WB2NDI  
Brooklyn, N. Y.

*Well, Lew, some of the facts are hard to come by, but here is the story as I know it: It was generally agreed that there should be a ham station at the World's Fair. The reasoning behind this was that with all those millions of people visiting the Fair this would be wonderful publicity for ham radio. At the suggestion of W8OLJ the ARRL got together with Coca-Cola and a big ham station was planned as a feature of the Coca-Cola exhibit. Everything was going just fine when word leaked out that HQ had decided that only equipment of one single manufacturer would be on exhibit. No explanation for this decision has ever been released, a fact which has led many amateurs to suspect the worst. When word of this reached Coca-Cola they were furious. The next thing we heard was that the man who made the agreement with the League for Coca-Cola had been fired and that instead of having the feature spot in the pavilion, K2US had been moved up into the attic where virtually no one except hams would ever see it. Several of the manufacturers who had been frozen out of this exhibit decided that this was too much and within a few days arrangements had been made for a ham station to be a feature of the not yet completed Venezuelan Pavilion. The prestige of the Pan American Radio Club, made up largely of amateurs who could speak Spanish, helped to convince Venezuela to donate this valuable space. The club obtained the call WA2USA and had their station on the air in time for President Johnson's official opening of the Pavilion on May 9th. It is estimated that over \$50,000 was spent on this station!*

*Back at K2US there was trouble. The League finally admitted sponsorship of the station when Coca-Cola gave them an ultimatum to either sponsor it or take it out. Running of the station had been turned over to the Hudson Amateur Radio Council, the local ARRL satellite.*

*Though it may have been coincidental, you'll never convince one of the WA2USA ops that the interference from K2US was anything other than intentional. After a couple days of this nonsense they put in a receiver a couple miles away with a phone line and solved the problem, much to the consternation of the K2US group.*

*The ARRL was not taking this calmly. They'd been made the fools and they knew it. They went to work on Venezuelan officials, on the FCC, and on a couple unhappy Pan*

*American Club members. At length a loophole for stopping the station was discovered. A fault was found with the station application which forced the FCC to cancel the license until it was corrected. By the time the license had been straightened out enough Venezuelan officials had been pressured to prevent the station from getting back on the air.*

*It is doubtful if WA2USA will return to the air except under ARRL domination. A lot of very sad hams have found that they couldn't fight the Hoover name and a multi-million dollar publishing corporation.*

*References: Myers-Coca-Cola letters, Bulletin #4 and WA2USA White Paper by W2AOE, Bulletin #53. Both available at no charge from 73. SASE please.*

Dear Sirs:

Recently, I visited K2US at the Worlds Fair, and I believe I saw there one of the worst representations of Ham Radio I have ever witnessed. I am not going to speak of the location or equipment, but only of the attitude of those present.

From the start, I was made to feel about as welcome as a participant in an 11 meter ragchew. Those present seemed bored with the whole idea and I was told in no uncertain terms "Our main purpose is not to entertain visitors, but to handle traffic." In short, the entire atmosphere was less than cordial.

Up to now, every single Ham I have ever met has been the nicest most helpful sort of person you could hope to see but those at K2US showed an attitude found only in the CB band.

I was almost ready to become a member, but if this attitude is representative of how the ARRL feels toward K2US, I regretfully say I want no part of your organization!

Craig E. Buck, WN4TUF

Dear Wayne,

Three mailorder companies advertize 2N1907 high power transistors for about \$2.00.

Since this is the only large unit available designed for RF service, I bought 6 of them (2 from each source), and tested them both in transistor tester, and in actual service: as a 4mc oscillator and amplifier. Results:

4 units—defective on a tester (short, open, etc.)

2 units—about 20% output compared with a known good transistor.

All units came evidently from the same source—Texas Instrument—and are of no use to hams.

Most of the outfits replaced them with different merchandize.

Gus K6BIJ

Hi O.M.,

On page 24 of the March 1964 issue, in the text accompanying circuit board illustration, instructions are given to remove resist with thinner or gasoline. Well, the purpose of this qsl is to stress that gasoline should never be used as a solvent, cleansing agent, or thinner—in the home or home workshop. It's simply too dangerous to be trusted and besides, modern leaded gasolines are very toxic to the skin.

My objection is based on the assumption that any ham radio construction work will be done indoors. Gasoline doesn't belong indoors, no matter how careful one may be. Agreed?

W6DMB

Boom!

Report from D. K. Lovett K8BXT in "Q-Match," the bulletin of the Warren (Ohio) Amateur Radio Association.

73 Magazine has been the target of much criticism regarding lack of facts, statements based upon "unfounded rumors," etc. CQ and QST have been strangely quiet about Wayne Green's expose of K2US, the amateur radio



station located in the Coca-Cola pavilion at the New York Worlds Fair. I had the opportunity(?) to observe the K2US setup at the Worlds Fair and I can report from actual experience that much of what Wayne Green says about K2US is true and that QST in two articles, one in April 1964 and the other in August 1964, misrepresents the facts, in many instances, regarding K2US. The vast majority of QST readers will not get the opportunity to visit the worlds fair perhaps and therefore would not be able to expose the inaccurate reporting on K2US as published in QST.

It is a shame that amateur radio is not properly represented at the Worlds Fair. The station K2US, contrary to QST reports, is out of the way, in relative obscurity, and would be easily passed by if one were not specifically trying to locate an amateur radio station in the Coca-Cola pavilion. The station is not at all a typical amateur radio station—rather a showplace for Hallicrafter products. This alone is a great injustice to the many quality amateur gear manufacturers all across the country, many of whom would probably have welcomed an opportunity to contribute toward the equipment in the station. You could find a more representative station at most any field-day site or at most hamfests.

The station is operated by club members from member clubs of the Hudson Amateur Radio Council and certain guests. The group operating the station during my visit were from the Rockaway Amateur Radio Club. The group on duty were in general aloof and unfriendly. Only one operator, W2YBU, talked to me or offered any semblance of hospitality. He heeded my rattling on the locked door at the station room.

I was allowed to come into the station and look around. I located a register and "signed in." After several minutes, W2YBU mentioned that I would have been able to operate if I had brought my Amateur Radio operators license. He was quite surprised when I told him that, in fact, I had brought my license with me and would like to operate one of the rigs in the station. I produced my license, in a frame, which W2YBU very carefully examined. He checked the license for my signature, looked for the US Government Printing Office number on the license edge (this does not necessarily have to be on the license if the license edge has been trimmed as directed on the license) looked on the back (the last two checks were made after removal from the frame—done at his request). It was obvious to me that he was trying to find something out of order with the license. Unable to do so, he exclaimed, "Well, I guess its your license all right." I emphatically informed him that it was. W2YBU informed me that I might be able to operate in 20 or 30 minutes. I noticed that the 75 meter station that had not been in use for several minutes suddenly had an operator again. The two meter stations was in trouble, as assigned operator could not load up the two meter gear and the 20 meter SSB station was in constant use for DX contacts by W2EVV. It appeared to me that they were not at all interested in allowing me to operate.

I am surprised at the tone of the K2US progress(?) report in August 1964 QST. Again, they misrepresent facts, and would lead one to believe that all but 900 who visited the station did not care to operate or were "content" to watch the activity. The article does not state the number of the 900 who are members of the member clubs of the Hudson Amateur Radio Council or whether the 900 were all different operators. The August QST report was a good opportunity to correct the many inaccuracies in the first QST report but they failed to do so. Some reports are being circulated that the station had been moved from a spot that fits the April 1964 QST description. No mention is made of this in the August issue however. I wonder how many amateurs missed the station from the inaccurate description they may have read in QST.

In my opinion, K2US has done little to enhance the amateur radio image in either the eyes of the public or in the eyes of radio amateurs.

To keep the record clear—I did not operate at Amateur Radio Station K2US. After what I had seen and heard regarding the operating bit, I promptly excused myself and left K2US to the Hudson Amateur Radio Council and, thoroughly disgusted, continued to see the Worlds Fair.

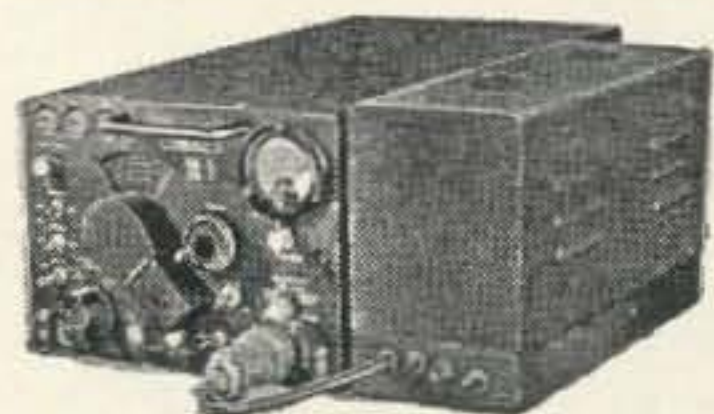

**ALL-BAND RECEIVER BARGAIN:** Continuous tuning 550 kc to 43 mc Voice, CW, MCW. R-45/ARR-7 has 2 stages RF, 2 stages 455 kc IF, separate Local Osc. w/VR AF, S-Meter, Noise-Limiter, Crystal & non-crystal IF Pass in 6 pass selections. Less pwr sply but w/pwr sply dwg. complete Handbook, and much other data. Checked 100% perfect, fob Los Angeles, only **149.50**  
Add \$30 for 115/230 v 50/60 cy pwr sply. Add \$20 for modification by us to SSB by addition of Product Detector.

**TIME PAY PLAN:** Any purchase totaling \$160.00 or more, down payment only **10%**

**ARC-5 Q-5'er Rcvr** 190-550 kc w/85 kc IF's. Use as 2nd converter for above or other rcvrs. Checked electrically, w/lots of tech. data, w/spline knob. 9 lbs fob Los Ang. **14.95**  
(Add \$3 for extra-clean selected unit.)

**NAVY'S PRIDE, RBS RECEIVER** 2-20 mc 14-tube superhet. checked & ready to use, w/pwr sply, tech data, fob Charleston, S. C. **69.50**

**AN/APR-4 RECEIVING SET:** Tune 38 to 1000 mc. Includes TN-16, 17, 18/APR 4; plug: handbook; checked, grtd OK, fob Los Angeles **179.50**  
Add \$60 for TN-19, 975-2200 mc; add \$125 for TN-54, 2175-4000 mc; add \$30 for AM/FM version of the rcvr, w/60 cy pwr sply; add \$90 for 60 cy Panadapter 30 mc  $\pm 1\frac{1}{2}$  mc IP-111; add \$125 for RDP Panadapter w/5" CR, 30 mc  $\pm 5$  mc.

**FM RCVR/XMTR** 30-40 mc, 50 W Po. 120v, 60 cy. AN/FRC-6A; in rack cabinet w/meters, spkr, etc. Xlnt **79.50**

**LM FREQ. METER** 125 kc to 20 mc is combin. heter. freq. meter & signal source, CW or AM, accuracy .01%, xtl calib. Clean, checked, 100% grtd. w/plug, data, 16 lbs fob LA **57.50**  
Add \$22 for LM sply w/plugs, data, or \$10 for EAO, converts for LM w/parts, data, included.

**TS-323/UR,** 20-400 mc, similar GERTSCH FM-1. Crystal. 001%. W/handbook supplement giving supplementary xtl check points & instruct. to ". . . closely approach crystal accuracy." W/schematic, instruct., pwr sply data, clean, checked, 100% grtd. fob Los Ang. **199.50**

**BERKELEY COUNTER** #5571 is basic 0-2 mc freq. meter plus extender to 42 mc 100% OK grtd. w/book. fob Los Angeles, only **795.00**

**PWR SPLY FOR ART-13 & OTHER XMTRS.** 115v 50/60 cy in both HV's out. New **79.50**

**TEST SCOPE TS-34/AP** 40 cy—3 mc  $\pm 3$  db. Lens simulates 5" screen. Ready to use **39.50**

**TEKTRONIX SCOPES** grtd OK & gorgeous, w/books: #514A: DC to 10 mc; sensit. 30 mv/cm; sweep calib. uv/cm; calib. deflection **395.00**  
#514AD is same plus Video Delay Line **450.00**  
#513: HV accel. for pulses. 20 mc pass **495.00**  
#315D 3" scope adds very slow sweeps **395.00**

**HEWLETT-PACKARD GOODIES** grtd OK & w/books:  
#100D Secondary Low Freq. Standard **295.00**  
#202A Low-Freq. Function Generator **295.00**  
#410A all-purpose. VTVM up to 700 mc **150.00**  
#520A Decade Scaler changes 10 mc to 100 kc. If Schmidt Trigger added, how nice! **295.00**  
#400D ac vtvm plus Ind. Contr. #200A dc: mc converter enables ac & dc VTVM use down to as low as 1 mv full scale. As pair **265.00**

**LP SIGNAL GENERATOR**  $9\frac{1}{2}$  mc to 50 mc 1%. calib. Vo to 1.0 v. Complete, certified **199.50**

**TS-413A/U SIGNAL GEN.** .075-40 mc 1%, xtl calib., Vo calib. to 1.0 v. Certif. **279.50**

**GEN. RADIO #805-C MICROVOLTER** 16 kc to 50 mc. 2 v into  $37\frac{1}{2}$  ohms. Like new, 100% grtd. w/book. Regular \$2250, only **750.00**

**MEAS. CORP. #80 SIGNAL GEN.** 2-400 mc,  $\frac{1}{2}$ %, Vo calib. to 100,000 uv. Certified **375.00**

**NAVY LAE-2 MICROVOLTER** 520-1300 mc, new, w/all charts, cords, book **129.50**

**C-BAND MICROVOLTER AN/URM-35,** 4.45-8 kmc. —100 to 0 dbm, w/all pulse mod. capabilities. Internal 400 cy pwr sply **295.00**

**BOONTON #202-F MICROVOLTER** 175-225 mc, up to 0.2 v CW/AM/FM, new, with book **275.00**

**BOONTON #152A CITIZEN'S BAND MICROVOLTER** 1-5 mc for IF, 20-28 mc for RF. AM & FM, w/5 mod. freq. Up to 100,000 uv. Terminated cord, pwr sply, book, grtd. **225.00**

**X-BAND MICROVOLTER TS-739B/UPM-10,** 8.5-9.6 kmc CW/FM/PM. —83 to +30 dbm **395.00**

**WESTON INDUSTRIAL-TYPE TUBE ANALYZER** Mod. 686 Type 9B has 6 meters, 42 controls. W/book, exc. cond., regular \$1100, only **179.50**

**NEW LOW PRICE** on ungraded SILICON DIODES, various PIV's & Currents, some good, some bad, you grade them with Instruction included. 100 for only **2.95**

**PLENTY MORE WONDERFUL MATERIAL!** Ask for your needs! We ALSO BUY your excess mdse.

**R. E. GOODHEART CO., INC.**  
Box 1220-GC BEVERLY HILLS, CALIF. 90213  
Phones: Area 213, office 272-5707, messages 275-5342.



## INDEX TO ADVERTISERS

To aid you in finding ads which are not running in this issue we  
have listed the last ad run by each company in 73.

Jan. 64	Adirondack	73	Gift Shop	July 64	Quaker
Oct. 64	Afco	June 64	Glass, J. J.	51	Quement
Mar. 64	Alcom	9	Gonset	May 64	Rand
June 64	Algeradio	93	Goodheart	May 64	Ready Radials
Aug. 64	Alliance	81	Government Warehouse	64	Redline
84	Alltronics-Howard	75	Graham Radio	75	Reyco
July 64	Amateur Elect. Supply	Jan. 64	Groth	Apr. 64	Roberts
35	Amplidyne	5	Hammarlund	21	Rohn
53	Amrad	81	Hayden	83	RW Electronics
Sept. 64	Antenna Specialists	May 64	HCJ	61	Saxton
85	Arrow Sales, Chi.	July 64	Heath	Aug. 64	Scientific Assoc.
Oct. 64	Atlantic	Aug. 64	Heed	Apr. 64	Seatronics
83	ATV Research	Oct. 64	Hefron	47	Sideband Engineers
95	BC Electronics	36	Henry	73, 85	Skylane
July 64	Bell	53	Hi-Par	Mar. 64	Slep
Apr. 64	Best	81	Hi-Way	83	Space
30	Budwig	Aug. 64	Hornet	Sept. 64	Spencer
Oct. 64	Burghardt	Oct. 64	Hy Gain	Sept. 64	Spitz
43	B & W	3	International Crystal	Oct. 64	Squire-Sanders
Apr. 64	Byron Airpack	Oct. 64	Jaro	91	Subscriptions
8	Callbook	87	Jeffronics	Apr. 64	Super-Q
Oct. 64	C & H	July 64	Joseph's	May 64	Surplus Spec
July 64	Chemung	13	Justin	37	Swan
Apr. 64	Cleveland Institute	Aug. 64	Kit-Kraft	June 64	T A B
Oct. 64	Columbia	Mar. 64	Knox	29	Technical Materiel
45	Cornell-Dubilier	Sept. 64	Lafayette, N. H.	Sept. 64	Technical Syst.
Sept. 64	Cubex	19	Lafayette Radio	Sept. 64	Telemarine
17	Cushcraft	Sept. 64	Lawrence Eng	Feb. 64	Telemethods
Jan. 64	Dames	71	Linear Systems	11	Telrex
73	Denver Crystals	Apr. 64	Mach	Sept. 64	Teltrol
94	Denson	July 64	Madison	July 64	Tepabaco
30	Digication	Sept. 64	Mann	27, 75	Texas Crystal
32, 59, 73	Dow Key	Oct. 64	Master Mobile	Feb. 64	Thermoelectric D.
81	Dow Trading	July 64	McCoy	Oct. 64	Topaz
49	Drake	95	Meshna	Oct. 64	Transistors Ult.
Apr. 64	Editors & Engineers	May 64	Metro	Sept. 64	Tucker
57	Edwards	Sept. 64	Mini-Products	Cover II	U. T. C.
July 64	Electronic Specialists	55	Mission	83, 87	Vanguard
May 64	Epsilon Records	Oct. 64	M & M	July 64	V & H
59	Evans	23, 33, 35	Mosley	July 64	VHF Associates
Oct. 64	E-Z Etch	Cover IV	National	Sept. 64	Viking
4	E-Z Way	Apr. 64	Newark	15	Waters
87	Fair	Sept. 64	Newtronics	87	Western (Calif.)
73	Fichter	Feb. 64	Northwest	75	Western (Neb.)
65	Finney	75	Parks	Oct. 64	Western Sales
42	F-M	Jan. 64	Pauls Surplus	Jan. 64	Wildcat Press
Sept. 64	FM Ham Sales	Mar. 64	Pausan	July 64	Woodruff
July 64	Fulton	Oct. 64	P & H	Cover III, 61	World Radio Labs
July 64	Galaxy	85	Poly-Paks	91	73 Subscriptions
Mar. 64	Gavin Instruments	Sept. 64	Propagation Products	86	73 Products
Aug. 64	Gem Electronics	77	O'Malley		

**YOUR ONE COMPLETE SOURCE**  
for HAM-TV, ATV, CCTV  
Equipment . . .

Test Monotrons type  
1698 only \$9.95 pp

**FREE FLYER**  
#771 . . . Full of  
Bargains!!!!

**CATALOG 50c**  
#1273 . . . "How To Build  
Low Cost TV Cameras"

Catalog #1273 plus  
LARGE Size schematic \$1.50

**Phone: 203-875-5198**

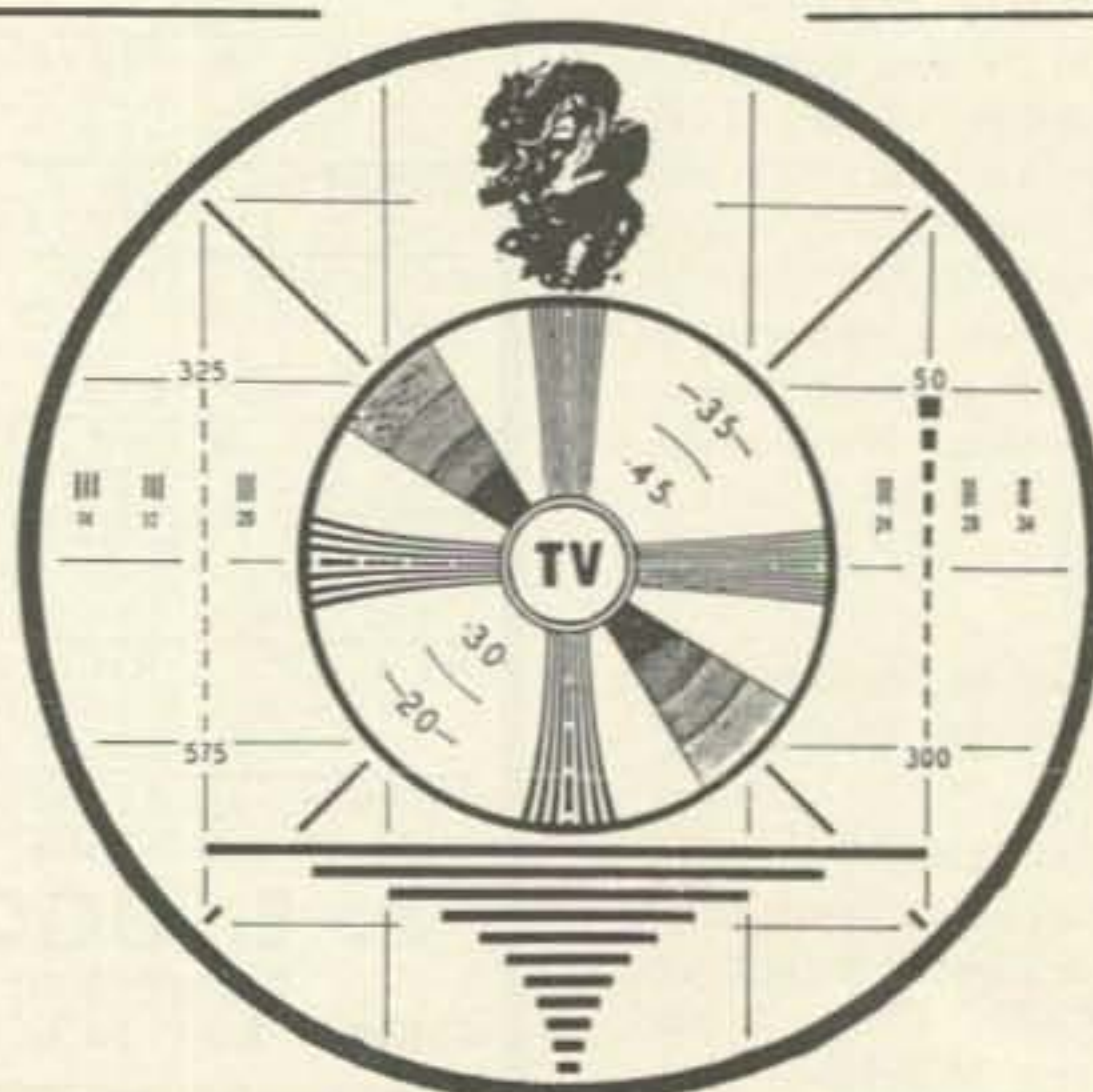

**VIDICONS: \$34.50 up**  
1" electromagnetic or  
2" electrostatic, your  
choice: Grade C: \$34.50  
Grade B: \$60.00  
Grade Ham A: \$100.00  
All types Ham-TV  
equipment Bought-Sold-  
Traded . . .

**WRITE!**

**DENON  
ELECTRONICS  
CORP.**

**Rockville, Connecticut**



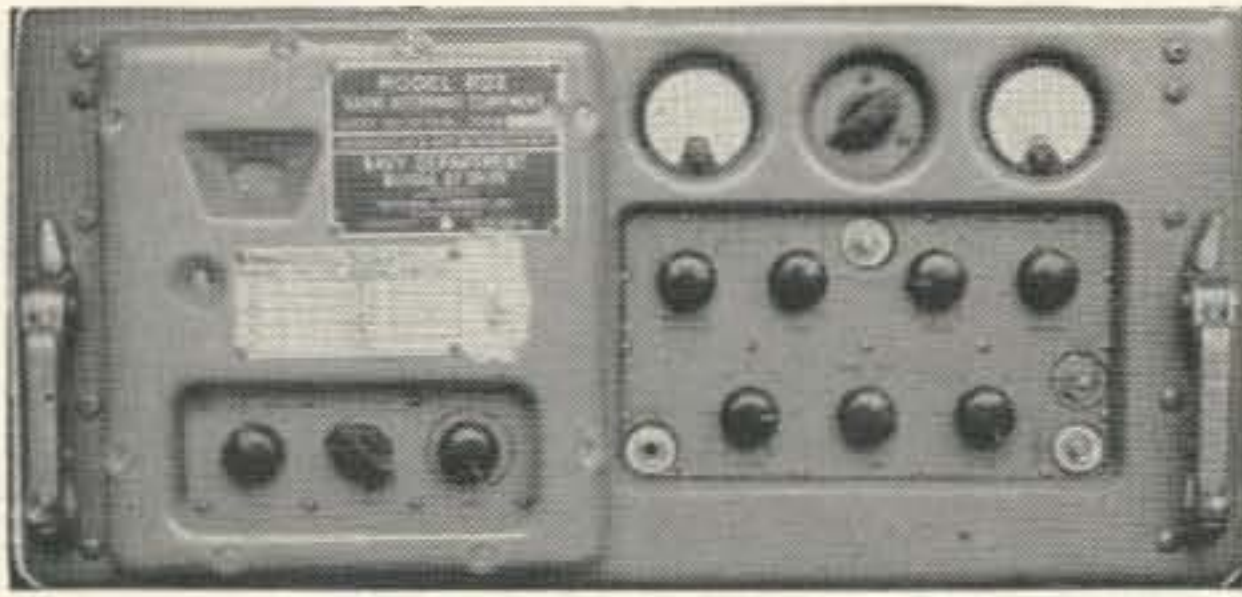

**RDZ RECEIVER**, 10 channel crystal controlled, 200-400 mc, 115 volt 60 cycle power supply. Navy surplus and made to highest standards. Cost \$2,500.00 each. We offer brand new units, original boxed, with antenna, plugs, schematic and crystal figuring data. Shipping wgt. 235 lbs.

**\$125.00**

**88 MH TOROIDS.** Two types available. Open and potted. Used for many applications such as power supplies and teletype.

Open style            50c each  
Potted style         65c each



**FL-5 NAVY BEAM FILTER**, used as 1,000 cycle filter. Wonderful for CW use. These are brand new, boxed, with cord & PL-55 phone plug.

**\$3.00**



**SNIPERSCOPE, M-3**, late model, permits viewing in total darkness. Ready to use, includes 20,000 volt power supply. You furnish 6 volts DC to operate. Used, checked out. Rifle shown in picture not included.

**\$225.00**

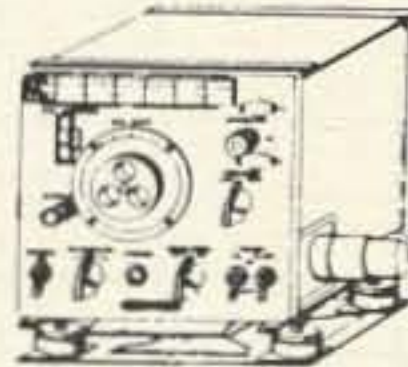

**LM FREQ. METER.** Just bot another batch. Condition xlt. with original calib. book and xtl, power plug, schematic.

**\$55.00**

We have a few original Navy power supply transformers, so that you can make up an AC power supply. Xfmr only.

**\$2.00**

# MESHNA

19 ALLERTON ST., LYNN, MASS.



## Rebel

Col. David Danser W4GVQ was presented with the "Confederate States Amateur Radio Club "Distinguished Service Award for his outstanding devotion and leadership in the advancement of amateur radio communication at a joint meeting of the club with the Fort Belvoir Amateur Radio Club.

## THANKSGIVING BARGAINS

To show our appreciation and thanks, for your response to our ads, the past year. Prices good to Dec. 31, 1964, must mention this ad!

T-18/ARC-5, 2.1 to 3 MC, BRAND NEW ... \$6.00  
As above, excellent used ..... \$5.00  
T-20/ARC-5, 4 to 5.3 MC ex. used ..... \$4.50  
T-21/ARC-5, 5.3 to 7 MC ex. used ..... \$6.00

## NEW ARRIVALS—TUBE SOCKETS

Ceramic wafer, for 829B, 832A, 3E29 ..... 79c ea.  
7 pin 826, 4-65A, SYLVANIA, NEW ..... 3 for \$2.25  
7 pin as above, take-outs, clean, good, NAT'L ..... 50c ea.  
7 pin shield base, for 829B, etc. EFJ #122-201, take-outs, clean, good ..... 3/\$1.95 ..... 69c ea.  
Heavy duty steatite, ring or saddle ..... 29c ea.  
4 pin mount, with both. AMPH # 49rSS4, NEW ... 4/\$1.10

## FLASH — Too Good To Keep

A "STOP THE PRESSES ADDITION" barely received in time. NICKLE-CADMIUM BATTERIES.

Removed from unused assemblies of 24 for 28v operation. 1.2v DC & 4 amp-hour. 3/16x2x6", 1/2 LBS. See June 1964 issue of 73 for data. Needs DISTILLED water to activate. \$1.65 each; 4 for \$6.00; assembly of 24. .... \$35.00

EFJ 12G70 Variable Capacitor  
5.3 to 12 mmf, 5000v DC, 3/16" spaced. Two 1/4" shafts, 3/4 & 5/8" long. One bearing, ceramic insulation. NEW. 79c each, 4 for \$3.00

EFJ 250 E 30 Variable Capacitor.  
250 mmf, 2000v DC, 1/16" spaced. Two 1/4" shafts, 1 1/4 & 3/16". BRAND NEW \$3.50 each ..... 3 for \$10.00

All orders, except in emergency, shipped same day received. Flyer included with every order. FLYER ONLY—PLEASE send self addressed, stamped envelope. PLEASE—include sufficient for postage. Excess returned with shipment. CANADIAN CUSTOMERS—we cannot accept your orders if you remit insufficient postage.

## B C ELECTRONICS

phone 312 CALUMET 5-2235  
2333 S. Michigan Ave. Chicago, Ill. 60616



# Propagation Chart

## EASTERN UNITED STATES TO:

GMT -	00	02	04	06	08	10	12	14	16	18	20	22
ALASKA	14	7	7	7	7	7	7	7#	14	14	14	14
ARGENTINA	7*	7#	7#	7	7	7	14	21	21	21	21*	14
AUSTRALIA	14	7#	7#	7#	7#	7#	7#	14	14	14	21	14*
CANAL ZONE	7	7	7	7	7	7	14	21	21*	21	21	14
ENGLAND	7	7	7	7	7	7#	14	14*	14*	14	7#	7
HAWAII	14	7#	7	7	7	7	7	7#	14	21	21	14
INDIA	7	7	7#	7#	7#	7#	14	14	7*	7#	7#	7
JAPAN	14	7#	7#	7#	7	7	7	7	7#	7#	7#	14
MEXICO	7*	7	7	7	7	7	7	14	21	21	21	14
PHILIPPINES	7#	7#	7#	7#	7#	7	7	7*	7#	7#	7#	14
PUERTO RICO	7	7	7	7	7	7	14	14*	14*	14	14	14
SOUTH AFRICA	7#	7#	7	7#	7#	14	14	21	21	21	14	14
U. S. S. R.	7	7	7	3.5*	7	7#	14	14	14	7#	7#	7
WEST COAST	14	7	7	7	7	7	7	7	14	21	21	14

Good: 4-8, 14-22  
 Fair: 1, 2, 3, 9, 10, 11  
 Poor: 1-3, 9-11  
 Es: 12-13, 23-30  
 (High MUF and/or freak conditions)

## CENTRAL UNITED STATES TO:

ALASKA	14	7*	7	7	7	7	7	7	14	14	14*	14
ARGENTINA	7*	7#	7#	7#	7	7	14	21	21	21	21*	14
AUSTRALIA	14*	14	7#	7#	7#	7#	7#	14	14	14	21	21
CANAL ZONE	14	7	7	7	7	7	14	21	21	21*	21*	14
ENGLAND	7	7	7	7	7	7	7#	14	14*	14	7#	7#
HAWAII	14	14	7	7	7	7	7	7	14	21	21	21
INDIA	7	7	7#	7#	7#	7#	7#	14	7*	7#	7#	7
JAPAN	14	14	7#	7#	7	7	7	7	7	7#	7#	14
MEXICO	14	7	7	7	7	7	7	14	14	14*	14*	14
PHILIPPINES	14	14	7#	7#	7#	7	7	7	7	7#	7#	14
PUERTO RICO	7	7	7	7	7	7	14	21	21	21	21	14
SOUTH AFRICA	7#	7	7	7#	7#	7#	14	21	21	21	21	14
U. S. S. R.	7	7	7	3.5*	7	7	7#	14	7*	7#	7#	7#

J. H. Nelson

## WESTERN UNITED STATES TO:

ALASKA	14	14	7	7	7	7	7	7	7	14	14*	14
ARGENTINA	14	7#	7#	7	7	7	7#	14	21	21	21*	21*
AUSTRALIA	21	14	7#	7#	7#	7#	7#	7	14	14	21	21
CANAL ZONE	14	7	7	7	7	7	7	14	21	21*	21*	21
ENGLAND	7	7	7	3.5*	7	7	7#	7#	14	14	7#	7#
HAWAII	21*	14	7	7	7	7	7	7	14	21	21	21*
INDIA	7	14	7*	7#	7#	7#	7	7	7*	7	7#	7#
JAPAN	14*	14	7#	7#	7	7	7	7	7	7#	14	14*
MEXICO	14	7	7	7	7	7	7	14	14	14	21	14
PHILIPPINES	14*	14	7#	7#	7#	7	7	7	7	7#	7#	14
PUERTO RICO	7	7	7	7	7	7	7	14	21	21	21	14
SOUTH AFRICA	14	7	7	7#	7#	7#	7#	14	14	21	21	14*
U. S. S. R.	7#	7	7	7	7	7	7	7*	7*	7#	7#	7#
EAST COAST	14	7	7	7	7	7	7	7	14	21	21	14

# Very difficult circuit this hour.

\* Next higher frequency may be useful this hour.



CLIP AND MAIL CLIP AND MAIL

# WRL SELLS TO YOU DIRECT!

## NO ONE CAN MATCH THESE PRICES!

(Fill in coupon and check items wanted—send to WRL)

Name \_\_\_\_\_ Call \_\_\_\_\_

Address \_\_\_\_\_

City \_\_\_\_\_ State \_\_\_\_\_

Cash  Charge  COD (25% cash with order).

If new customer, send credit information with your charge order.

**RUSH ME**

**WRL'S NEW UNIVERSAL PSA-63A "MULTI-PAK" AC SUPPLY.** Will power most any AM-SSB-CW XCVR-XMTR

Silicon rectifiers. Dual HV 600V/300V @ 300 MA, 210W. Max. bias 95 VAC. Wt. 15 lbs.

- \* Wired \$39.95
- \* (2-week trial)

Kit \$24.95



**RUSH ME**

**WRL'S WVG-II "BEST BUY" ALL BAND VERTICAL ANTENNA 10 THRU 80 METERS**

Simple to mount—completely self supporting. Rated: Full KW-AM or CW-2KW PEP. Massive base clamp. 3-30 Mc Continuous Coverage.

FIXED • PORTABLE  
(2-week trial)  
**\$15.95 POSTPAID**



**RUSH ME**

**WRL'S TC6A COMPACT LOW COST 5 WATT 6 METER TRANSCEIVER**

Fixed—Mobile. Size 5" H, 9 1/4" W, 6" D, 5 W input with 8 Mc XTALS, PTT. Rec. 1/2 UV, tunes 49-54 Mc, AVC, ANL, Stable, selective, speaker inc. Wt. 9lbs. (less P.S.)

Kit \$39.95  
Matching AC Supply  
Separate Kit \$15.95



**RUSH ME**

**WRL'S NEW! IMPROVED PORTABLE 12R GENERATOR**

Shielded ignition. Alternator type communicator. Inherently regulated. 3 point mount. Carrying handle. 1250 Watts peak, 115 VAC, 60 cy.

**\$149.95**  
(FOB Milwaukee Wisconsin)



**RUSH ME**

**WRL'S SS-3 "Q" MULTIPLIER SELF POWERED. NO-RECEIVER MODIFICATIONS**

Improve your receiver performance. New and improved design of SS-3 Circuits with ultra high "Q" coils. Selects the signals you want and rejects the undesired ones. Complete with 115 VAC "built-in" power supply. Use with any superhet having 455KC I.F.

Kit \$15.95



**RUSH ME**

**WRL'S MM-100 ANTENNA TUNER**

Specifically designed to match end-fed long wire which is 1/2 wave, or multiples thereof, to 50 ohm transmitters. Panel lamp indicator. For inputs up to 150 watts SSB, 100 watts CW, 75 watts AM. 4x5x4 steel case. Reduces TVI.

Kit \$10.95



**RUSH ME**

**WRL NUVISTOR PREAMP PRINTED CIRCUITS**

PA50—2 Stage preamplifier for 6 meters. Use 2 RCA 6CW4 nuvistors. Highest grade glass epoxy board. Assembled and pre-aligned for 50 ohm input-output. Requires 60—120 VDC @ 10 MA & 6.3 VAC. (Less 6CW4 tubes) Size 2 3/4" x 2 1/4"

PA50-2 Wired \$6.37 (2-week trial)  
PA—144 Same as above except only 1 6CW4 nuvistors & for 2 meters.  
PA-144 Wired \$4.98 (2-week trial)



PA50-2



PA-144

**RUSH ME**

**FREE!**

**NOW! THE MOST EXCLUSIVE HAM/CB. CATALOG EVER COMPILED. SEND FOR IT TODAY—100's OF BARGAINS—CHARG-A-PLAN APPLICATION. BEST PRICES ANYWHERE.**

Rush Me "Blue Book" Listing of Reconditioned equipment.  
 Rush me my new 1965 Catalog.



**WRL**

**WORLD RADIO LABORATORIES**  
3415 West Broadway  
Council Bluffs, Iowa 51504

CLIP AND MAIL CLIP AND MAIL



# rockcrusher

National's new 2000 watt linear amplifier is desk-top dynamite. Every component in the NCL-2000 is rated for operation at a "DC" kilowatt. If you want to check power output you'll need a bigger wattmeter than those now available on the amateur market. On any band the '2000 will pin a meter that only reads 1000 watts full scale.

Addition of the NCL-2000 to your desk-top station allows you to run at the maximum power allowed by law. It's no half-way linear with TV components and a "Christmas tree" string of receiving tubes straining to deliver a doubtfully efficient 500 watts (average) input. The two 8122 ceramic tetrode output tubes were designed specifically for SSB, and provide 800 watts of plate dissipation to assure conservative operation — and at a replacement cost of only \$31.50 each.

Not only does the NCL-2000 deliver the power, but it does it cleanly. Third and fifth order distortion products are down 30 to 45 db, hum and noise down a minimum of 40 db. Operate in areas of high humidity? Don't worry about power supply or plate circuit breakdown. The '2000 is rated for full output at 90% ambient humidity. Properly safety conscious? You would have to work to get by the lid interlock that positively breaks all power to the plate relay, or the automatic shorting bar that discharges B+ directly

to ground (throwing out the overload relay) in case of the remote possibility of interlock or bleeder failure. In addition, the equipment itself is protected through a one minute time delay relay and a plate overload relay.

Very simply, no other amplifier on the market at any price gives you even half of these features: ■ 2000 watt PEP input on SSB, 1000 watt input on CW, RTTY, or AM ■ Equal power output on all bands 80 through 10 meters ■ Completely self-contained desk-top package with built-in power supply ■ Exclusive grid-controlled AB<sub>2</sub> operation for high efficiency and linearity ■ May be driven to full output with any exciter delivering 20 watts to 200 watts PEP ■ Passive grid with internal 50 ohm exciter dummy load and relative exciter output indication for simplest tuneup ■ All necessary relays built in for transceiver or transmitter-receiver operation ■ Instantaneous switchover to exciter-only operation when desired ■ ALC output ■ Separate precision plate and multimeters ■ Most complete safety and overload protection, including 1 minute time delay relay, overload relay, lid interlock and automatic shorting bar ■ National's exclusive One-Year Guarantee.

Your National dealer has the NCL-2000 in stock right now . . . at only \$585, better buy one in self defense.



**NATIONAL RADIO COMPANY, INC.**

37 Washington Street, Melrose, Mass. 02176

World Wide Export Sales: Ad Auriema Inc., 85 Broad St., N.Y.C.; Canada: Tri-Tel Associates, 81 Sheppard Ave. W., Willowdale, Ontario

**This handsome desk-top station includes the NCL-2000 Amplifier (\$585), the NCX-3 Triband Transceiver (\$369) and the NCX-A AC Power Supply (\$110). The NCX-D DC Power Supply is available for the NCX-3 at \$119.95.**

