

December 1961

37¢

73

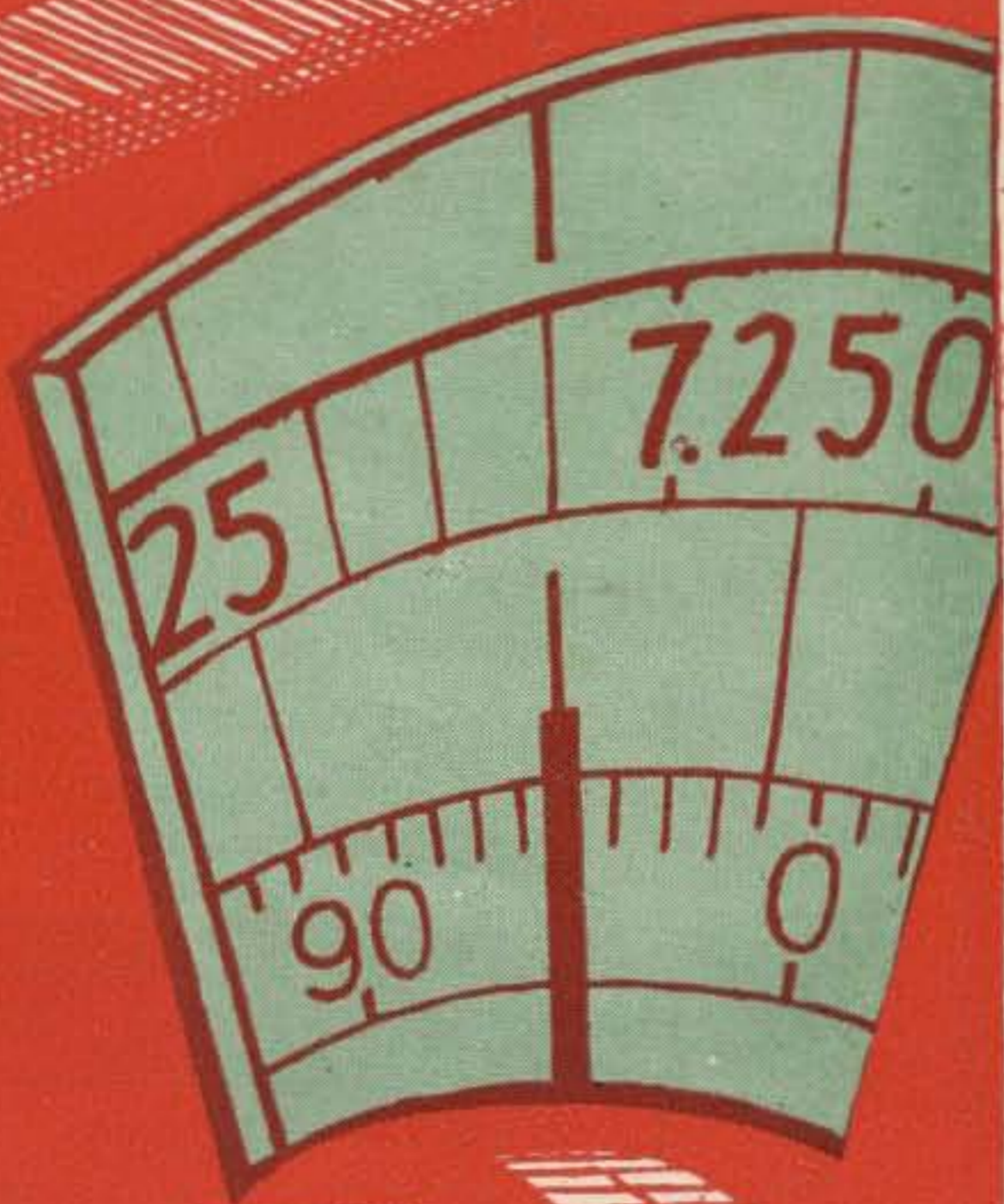

Watch for Mystery Antenna Contest

GET RELIEF FROM GRIEF

FIRST

Corrosion-free
all stainless ball
and spring mount

FIRST

basically
improved design



**TUNABLE ANTENNA FOR CB
and AMATEUR (28-30 MC)**

MODEL CB-27



Extends to 60".
Collapses to 27"
Swivel ball base.
Sealed loading coil
5' of RG58/U cable
PL-259 connector
Tunable stainless
top rod section
has etched tuning
scales permitting
field adjustment
for either 27 MC
Citizens Band or
28-30 MC Amateur
Bands.

Pat. Pend.

WITH

NEW-TRONICS COMMUNICATION PRODUCTS

Mechanically better . . .

. . . Electrically superior

MODEL NTS-1 — ALL STAINLESS
Ball, base and spring assembly
NO EXPOSED MOUNTING BOLT HEADS
(Long leakage path)

ONE MAN INSTALLATION

LIGHTER WEIGHT

REDUCED SPRING ASSEMBLY LENGTH

Engineered and built to meet the most critical standard, this base, ball and spring assembly has no equal. It will provide long and carefree service. Also available in chrome plated and cadmium plated models.

TUNABLE ANTENNA for COLLINS NOISE BLANKER

MODEL NB-40 (40 MC)

Similar in appearance to MODEL CB-27. Has different electrical characteristics. Broad banding characteristics and tunable feature permits attenuation of power line and car ignition noises.

Complete line of stainless steel whips with set screw type removable adaptors, other antenna models, cable and accessories available for immediate delivery.

NTS-1 All Stainless Base, Ball & Spring	\$19.44
NTS-2 All Stainless Base & Ball	\$ 8.97
NTS-3 Stainless Spring	\$10.47
CB-27 Complete Assembly	\$10.44
NB-40 Complete Assembly	\$10.44

IF YOUR DISTRIBUTOR CANNOT SUPPLY YOU, SEND CHECK OR MONEY ORDER. PRICES INCLUDE SHIPPING CHARGES.

NEW-TRONICS

3455 Vega Avenue
Cleveland 13, Ohio

73 Magazine

1379 East 15th Street—Brooklyn 30, New York

Wayne Green W2NSD—Editor, etcetera

December 1961 • Vol. 1, No. 15

CONTENTS

Write Your Congressman	Dick Carruthers K7HDB	6
Ten Meter Midget Rig	Jim Kyle K5JKX/6	8
Versatilizing Meters	Joseph Leeb W2WYM	12
Regenerative Detectors	Howard Burgess W5WGF	16
Another Two Meter Conversion	Roy Pafenberg W4WKM	22
Economical Custom Construction	Roy Pafenberg W4WKM	33
Avoid Precise Inaccuracy	Jim Kyle K5JKX/6	37
Wayout Measurements	Carl Henry	41
On Soldering	David Heller K3HNP	43
Two Meter Transceiver	Larry Levy WA2INM	45
Capacitor Substitution Box	John Ellison W6AOI	50
Antenna	Jim Kyle K5JKX/6	52
73 Test the Knight R-55 Receiver	Don Smith W3UZN	58
RTTY in The United Kingdom	Arthur Gee G2UK	62
Propagation Charts	Dave Brown K2IGY	64
73 Reviews the QX-535 Receiver	Al Brogdon K3KMO	66

Cover: Pen and Ink drawing by Bob Kelly K2VLO.

Associate Editors: W3UZN, W4API, K5JKX/6, VE3DQX
Western Representative: Jim Morrissett WA6EUX
6923 Etiwanda
Reseda, California
Ph: (213) DI 5-2077

Misc. & Short Items:		New Products	32, 56
de W2NSD	2	Letters	63, 68, 76
Pilot Light	14	Club Subs	55
Lamp Loads	20	Old Xsistrs	59

73 Magazine is published monthly by Amateur Radio Publishing, Inc., 116 Main Street, Norwalk, Connecticut. Business Office, 1379 East 15th Street, Brooklyn 30, New York. Telephone: DE 6-8880. Subscription rates: U.S.A. and possessions, APO, FPO, Canada and Mexico; one year \$3.00; two years \$5.00; three years \$7.00. Foreign: one year \$4.00; two years \$7.00. Second-class postage paid at Norwalk, Connecticut. Printed in the U.S.A. Entire contents copyright 1961 by Amateur Radio Publishing, Inc. Postmaster: Please send form 3579 to 73 Magazine, 1379 East 15th Street, Brooklyn 30, New York.

never say die

WOULD you like to know why the reciprocal licensing bill now up for Senate consideration will never see the light of day? Not enough interest, that's why. In spite of editorial treatment in all three magazines, little action was stirred up and few letters have been received by the legislators. In addition to this general apathy on the part of the amateurs there is noticeable resistance to the bill from the Justice Department.

Why should we get involved in this? Basically it is a question of being fair. We expect to be able to be licensed in other countries when we travel, and foreign amateurs feel the same way when they visit us. It is important to our international reputation that we be fair about this. The proposed law takes care of any possible security problems quite satisfactorily, though it is obvious upon reflection that this is an emotional problem much more than a real one. It is my opinion, based upon countless discussions with amateurs high in our own government, amateurs visited in many foreign countries, and lengthy talks with delegates to the last Geneva conference that amateurs will have a better chance of coming out of the next conference with usable bands if the U. S. modifies the Communications Act of 1934 to permit reciprocal licensing of foreign amateurs visiting us where there is no possible security consideration.

All of us are anxious to keep our bands intact against the pressures from other services. We are also anxious that the cloud of misinformation and confusion which bewilders most of the world about our motives be dispelled and that our image of a war-like country be brought into better perspective. Ham radio certainly won't cure anything, but it sure can help.

What to do? I don't see any solution. What is needed is someone with the time to personally visit each and every Congressman, Judicial Department official, State Department official, etc., that is in any way involved in this. We need a lobbyist and we don't have one. Those of you who saw the movie "Ikiru" know what I mean. If you didn't see it, by the way, you missed one of the finest motion pictures ever made.

Letters to Congressmen will help, but they won't do the complete job. If only I didn't have to stick with 73 every minute of every day!

Even keeping at it every minute I'm behind on many things, as those of you with manuscripts submitted will testify. Isn't there someone who can spend about a month in Washington this January when Congress reconvenes and make it his business to personally see everyone involved? I'll be happy to fill anyone in on the complete background of reciprocity so they will have answers to all questions that can be raised. If I leave my desk for more than a day or two a month then there won't be a next issue. Any volunteers?

Clubs should seriously encourage their members to write per my editorial in the October 73. This does not mean that the club secretary should write a letter for all the members to sign, which is a waste of everyone's time. We will have to come up with thousands of letters. I might even put it so bluntly as to say that any amateur who does not write is effectively casting his vote *against* our hobby.

Mohawk Airlines

Niagara Falls is a little far away for us to drive, so Virginia and I flew up for the ARRL Convention a few weeks ago. Excess baggage prices being what they are, I shipped copies of the magazine, promotion literature, subscription blanks, etc., ahead two days early by Mohawk Airlines. Having had trouble with packages being held at the airport for me in the past I particularly specified that this shipment was to be delivered to the Niagara Hotel. I was assured that everything would be there for me in plenty of time. You probably can write the rest of the story for me.

We arrived at noon on Friday . . . no packages. Hmmm. I called Mohawk to see what had happened. They were out at the Buffalo airport waiting for me to pick them up. I pointed out that each individual label carefully explained that they were to be delivered and not held at the airport and that they should find this message repeated on the bill of lading. They said OK, they'd get them right over. By three I was figidy and called again. A new man was on duty and the packages were still there. Too bad, the last truck has gone for the day, maybe on Monday. I indulged in some emotion at this point and the chap suggested that I call a private company that made pickups at their office. It was difficult to locate

LAFAYETTE RADIO

WORLD WIDE STATION FOR AMATEUR EQUIPMENT

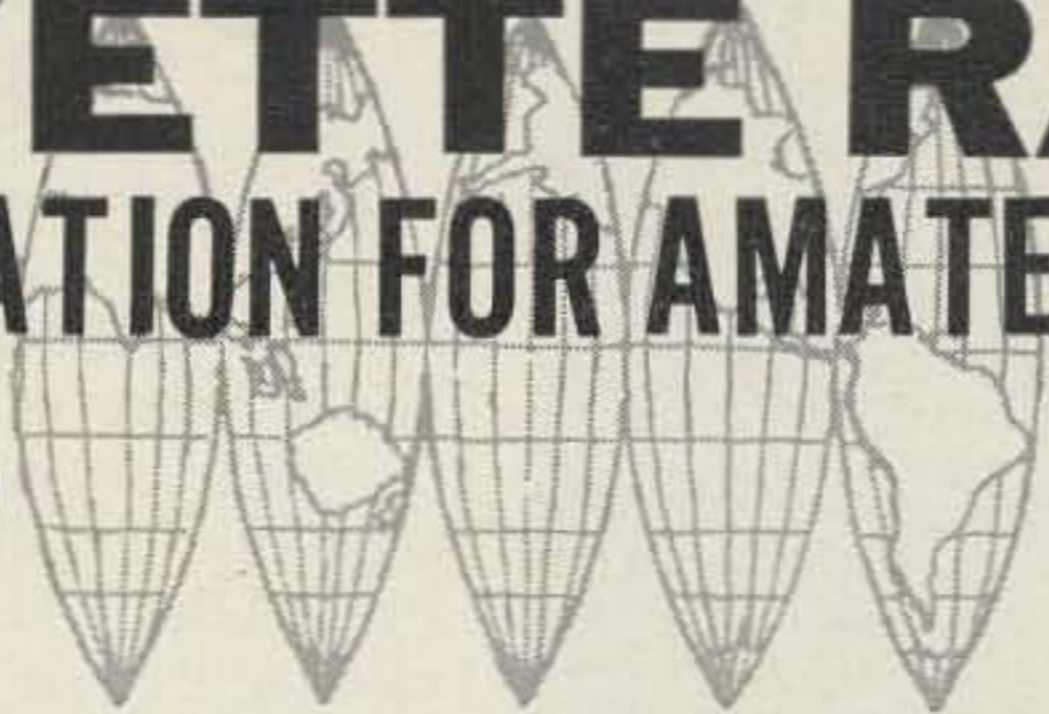

THE LAFAYETTE HE-30

Professional Quality
Communications Receiver



NO MONEY DOWN

KT-200WX
in Kit Form
64.50

TOP VALUE
COMMUNICATIONS
RECEIVER

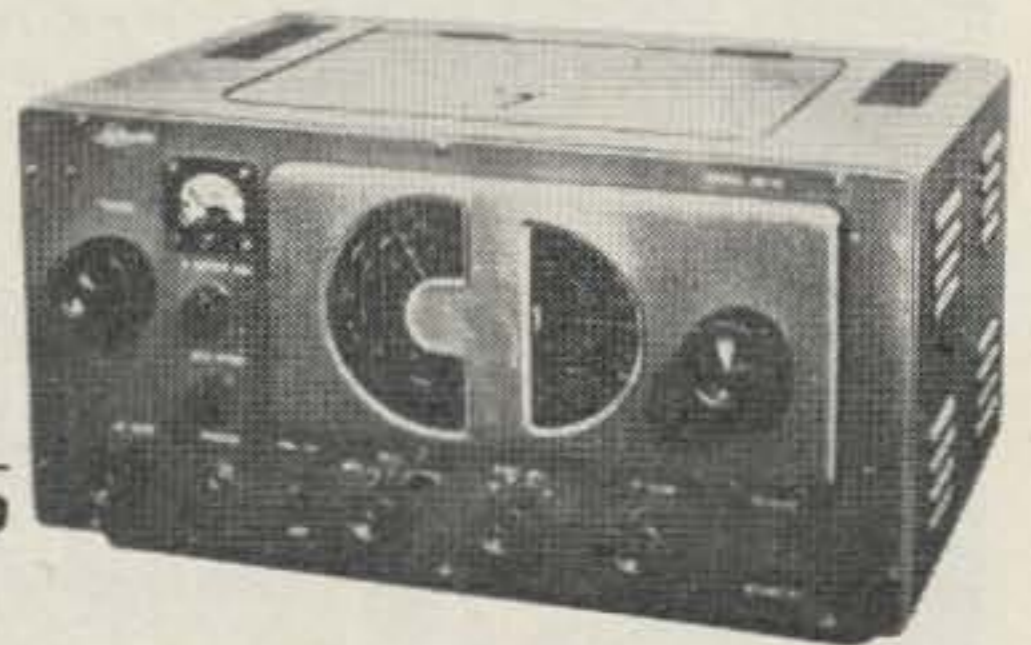

99.50

HE-10 WIRED AND
TESTED
79.95

- TUNES 550 KCS TO 30 MCS IN FOUR BANDS
- BUILT-IN Q-MULTIPLIER FOR CROWDED PHONE OPERATION
- CALIBRATED ELECTRICAL BANDSPREAD ON AMATEUR BANDS 80 THRU 10 METERS • STABLE OSCILLATOR AND BFO FOR CLEAR CW AND SSB RECEPTION • BUILT-IN EDGEWISE S-METER

Sensitivity is 1.0 microvolt for 10 db, Signal to Noise ratio. Selectivity is ± 0.8 KCS at -6db with Q-MULTIPLIER. TUBES: 6BA6—RF Amp, 6BE6 Mixer, 6BE6 OSC., 6AV6 Q-Multiplier—BFO, 2-6BA6 IF Amp., 6AV6 Det-AF Amp. ANL, 6AQ5-Audio output, 5Y3 Rectifier.

- SUPERHET CIRCUIT UTILIZING 8 TUBES AND RECTIFIER TUBE • BUILT-IN "S" METER WITH ADJUSTMENT CONTROL • FULL COVERAGE 80-10 METERS • COVERS 455KC TO 31 MC • VARIABLE BFO AND RF GAIN CONTROLS • SWITCHABLE AVC AND AUTOMATIC NOISE LIMITER

The Communications Receiver that meets every amateur need—available in easy-to-assemble kit form. Signal to noise ratio is 10 db at 3.5 MC with 1.25 microvolt signal. Selectivity is -60 db at 10 kc, image reflection is -40 db at 3 MC. Tubes: 3-6BD6, 2-6BE6, 2-6AV6, 1-6AR5, 1-5Y3.

New!

LAFAYETTE HE-45 DELUXE 6-METER TRANSCEIVER

- Highly Sensitive Superheterodyne Receiver Section for 50-54 Mc
- Effective Series Gate Noise Limiter
- 3-Stage, 12-Watt Transmitter with 2E26 Final
- Illuminated Panel Meter for Plate Current and "S" Readings
- Pi-Network Transmitter Output
- Built-in 117 VAC and 12 VDC Power Supplies
- Push-To-Talk Ceramic Microphone

Provides maximum convenience and flexibility in either mobile or fixed operation.

LAFAYETTE HE-50 10-METER TRANSCEIVER

Similar to above except for 10 meter operation

NO
MONEY
DOWN

109.50

MADE IN U.S.A.



LAFAYETTE HE-34 SWR AND FORWARD POWER METER **16.95**

- Reads SWR and Relative Power Output up to 1 KW
- For Continuous Use in 52 Ohm Lines
- Switch Selects SWR or Forward Power—No Reversing Necessary
- Highly Compact—Only 2 1/2 x 5 x 2 1/2"

The ideal aid in adjusting beams, trap antennas, matching networks, etc., or for tuning transmitters for maximum output.

LAFAYETTE HE-29A 9-TRANSISTOR C.B. "WALKIE-TALKIE"™

39.95 2-For-78.88



NO MONEY
DOWN

- 9 Transistors plus Diode and Thermistor
- Transmits and Receives up to 1.5 Miles
- Crystal Control on Transmit and Receive
- Uses Inexpensive Penlight Batteries
- 46" Telescoping Antenna
- Push-To-Talk Operation
- Complete With Leather Case, Earphone, Batteries and Crystals for Channel 10

SEND FOR LAFAYETTE'S
NEW 1962 CATALOG

FREE!



LAFAYETTE RADIO, DEPT. 73L-1
P.O. BOX 10
SYOSSET, L. I., N. Y.

Send FREE 1962 Catalog 620 featuring the full line of Lafayette Amateur Equipment
..... enclosed for Stock No.....

Name.....
Address.....
City..... Zone..... State.....

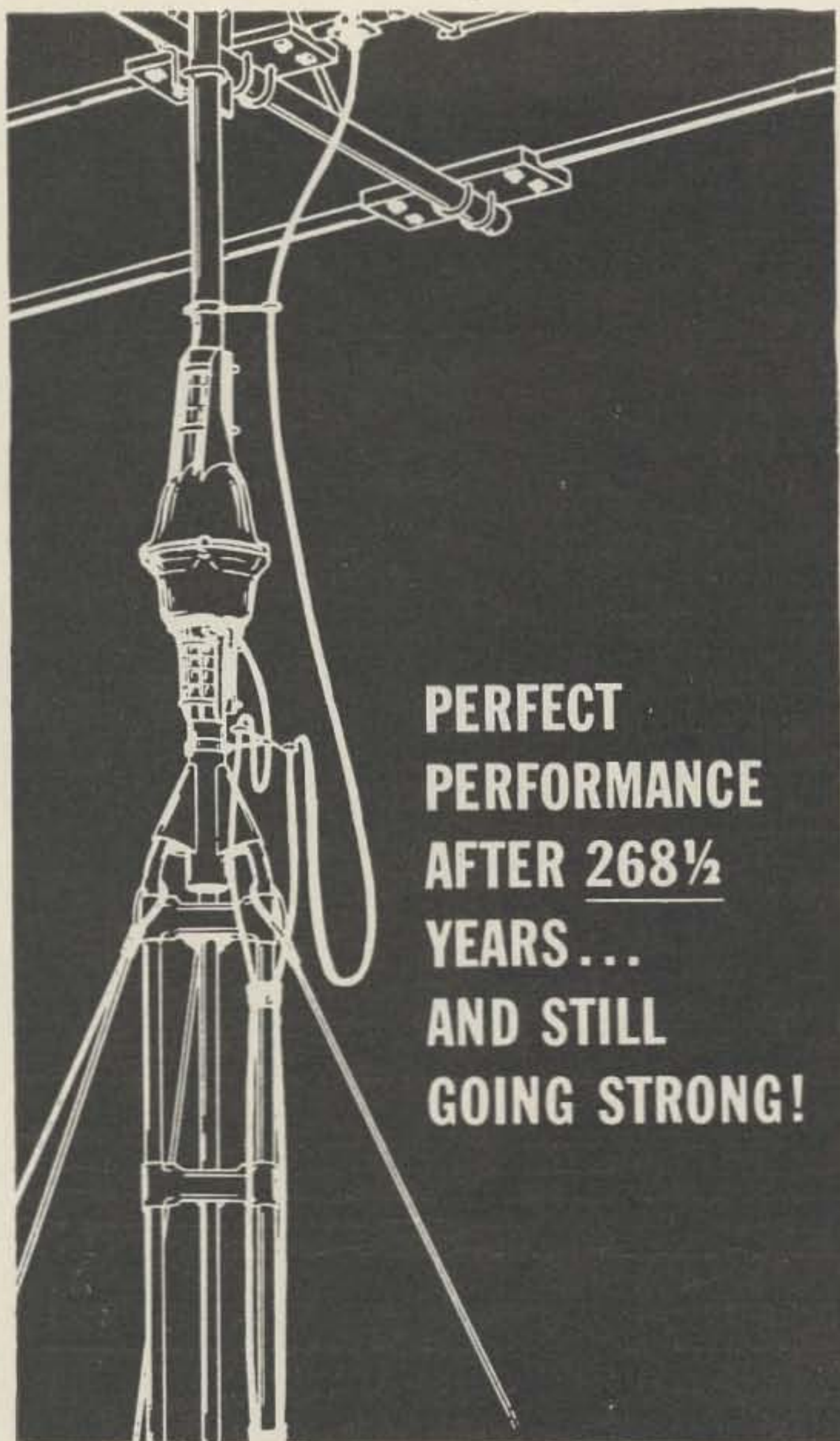

**PERFECT
PERFORMANCE
AFTER 268½
YEARS...
AND STILL
GOING STRONG!**

Some years ago, we installed several of our rugged, precision HAM-M antenna rotors on the roof of our plant and set them in motion. They've been going constantly ever since—under heavy antenna loading, through ice storms and hurricane-force winds—at the reversal rate of once every 1 min. 40 secs.

That's the equivalent service, per rotor, of over 268½ years. Now that's dependability, the kind of dependability you have the right to expect from Cornell-Dubilier! What's more, the HAM-M is backed by the famous CDE lifetime factory service policy.

At \$119.50 amateur net, the HAM-M is the greatest rotor value around! For further information, contact Bill Ashby K2TKN, or your local CDE Radiart Distributor.

CDE **CORNELL-
DUBILIER**

CORNELL-DUBILIER ELECTRONICS, DIV. OF FEDERAL PACIFIC ELECTPIC CO., 118 E. JONES ST., FUQUAY SPRINGS, N. C.

the company from the obscure clues I had been given, but I was driven by desperation. The Convention opened at 6 P.M. and I wanted to be able to use my \$100 booth.

By 5:30 I was getting nervous. The private company was closed for the night and their phone just rang and rang. Mohawk said the boxes were still there. If they weren't picked up that night then they would positively be sent out by limousine and I would have them by 8 A.M. I checked in again later at nine and midnight, but got the same story each time.

When nothing had arrived by 9 A.M. I got on the long distance phone again and found that the boxes were still at the Mohawk office. The private company had come for them at 12:30, but Mohawk wouldn't let them pick them up since there was a question as to whether the shipment was prepaid or collect. In a slightly hysterical voice I explained that the shipment was prepaid when it left me. They checked the bill of lading and weren't sure so they called New York and checked there. Along about two o'clock they had things straightened out and again promised delivery. Wonder of wonders, in came the boxes just 30 minutes before the Convention closed on Saturday. Bright side: Virginia and I had ample opportunity to see everything there is to see at Niagara Falls and vicinity. We had a fine (and expensive) vacation.

It sure is nice to have some way to blow off steam like this. It doesn't do any good, of course, but it does feel good. Actually, I need a lot larger magazine than 73 to keep up with my gripes. Being wishy-washy, as I am, things are always happening to me. Someday I'll sound off on hotels . . . my convention and wanderlust travels have put me in some three hundred hotels so far and I have a few observations. The one I remember with the most distaste is the St. Nicholas in Springfield, Illinois where my little Sony two band transistor radio was removed along with the towels. This is the only thing I've ever had stolen in a hotel. When I complained the management explained that I should have put the radio in the hotel safe if I didn't want to lose it. Grrrrrr.

Buyer's Guide

Much as I hate to back down on something, I've decided to put off the Buyer's Guide until I have more time to devote to it. That's the trouble with these one-man deals, there's only one man. Material has been coming in for the book quite satisfactorily, and quite a bit of advertising accompanied it. The problem was that I didn't have the time to send out a couple more letters to all prospective advertisers, followed up by phone calls to larger advertisers, explaining that the major purpose of the publication was for them to list their entire line of parts or equipment. As the ads
(Turn to page 70)

your choice of 2 GREAT **EICO**[®] TRANSMITTERS...

designed
by Hams...
for Hams...

to the highest
Ham standards



**90-WATT
CW TRANSMITTER* #720**
Kit \$79.95 Wired \$119.95
*U.S. Pat. #D-184,776
"Top quality"—ELECTRONIC
KITS GUIDE

Ideal for veteran or novice.
"Clean" 90W CW, 65W AM-
phone with EXT plate modu-
lation. 80 through 10 meters.

**60-WATT
CW TRANSMITTER #723**
Kit \$49.95 Wired \$79.95
"Compact; well-planned lay-
out. Clean-sounding, abso-
lutely hum-free carrier;
stable." — ELECTRONICS
WORLD.

Perfect for novice or ad-
vanced ham needing low-
power standby rig. "Clean"
60W CW, 50W AM-phone with
EXT plate modulation. 80
through 10 meters.



New!



**VARIABLE
FREQUENCY
OSCILLATOR
(SELF-POWERED)
#722**
Approaches
crystal stability.
80 through
10 meters.
Kit \$44.95
Wired \$59.95

New!



**CITIZENS BAND
WALKIE-TALKIE #740**
Complete with re-
chargeable battery and
charger. 9 trans-
istors, 1 diode. Full
superhet. U.S. made.

Kit \$54.95
Wired \$79.95



**CITIZENS
BAND
TRANSCIVERS**
Superhet; pre-
aligned xmitter
osc; match dif-
ferent antennas
by variable "pi" network. Single
& multi-channel models.
From Kit \$59.95 Wired \$89.95



**HIGH-LEVEL
UNIVERSAL
MODULATOR-
DRIVER #730**

Kit \$49.95 Wired \$79.95
Delivers 50W undistorted audio for
phone operation. Can plate-modu-
late transmitters having RF inputs
up to 100W. Unique over-modu-
lation indicator. Cover E-5 \$4.50.

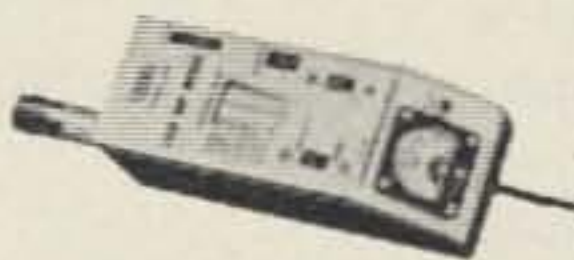

**GRID
DIP
METER
#710**

Kit \$29.95 Wired \$49.95
Includes complete set of coils
for full band coverage. Continu-
ous coverage 400 kc to 250 mc.
500 ua meter.



**PEAK-TO-PEAK
VTVM #232**
& exclusive
*UNI-PROBE®
Kit \$29.95
Wired \$49.95

VACUUM TUBE VOLTMETER #221
Kit \$25.95 Wired \$39.95

*U.S. Pat. No. 2,790,051



**DC-5MC
LAB & TV 5"
OSCILLOSCOPE
#460**
Kit \$79.95
Wired \$129.50

5" PUSH-PULL OSCILLOSCOPE #425
Kit \$44.95 Wired \$79.95

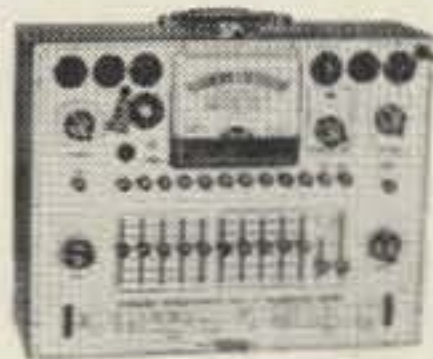

**DYNAMIC
CONDUCTANCE
TUBE
& TRANSISTOR
TESTER #366**
Wired \$100.95

Kit \$69.95
TUBE TESTER #625
Kit \$34.95 Wired \$49.95



**RF SIGNAL
GENERATOR
#324**
(150kc-435mc)
Kit \$26.95
Wired \$39.95

**TV-FM SWEEP GENERATOR
& MARKER #368**
Kit \$69.95 Wired \$119.95

EICO[®]

3300 Northern Boulevard,
Long Island City 1, New York
Export Dept., Roburn Agencies Inc.,
431 Greenwich St., N. Y. 13, N. Y.

EICO, 3300 N. Blvd., L.I.C. 1, N. Y.

Send free Catalog & name of
neighborhood distributor.
 Send free "Short Course for
Novice License." Send
36-page **STEREO HI-FI GUIDE**:
25c enclosed for postage
& handling.

Name..... 73-12

Address.....

City..... Zone..... State.....

Add 5% in the West.

ENGINEERS: Excellent career opportunities in creative electronics design. Write to the Chief Engineer.

Write Your Congressman

—*Making a pest out of yourself
in a big way.*

Dick Carruthers K7HDB
Warrenton, Oregon

IF YOU aren't already deluging your elected representatives with passionate pleas for reciprocity in the granting of amateur operating privileges, you should be. You and I may never travel to DX-land, but if by some welcome chance it became possible, it would be nice to know we could take along the portable and operate as DX with no more difficulty than notifying the FCC and the licensing bureaus of the countries we planned to visit. It could work this way, but it is up to you to put the pressure on the lawmakers. Your elected representatives are very sensitive to your desires and if you can convince them that 'reciprocity' would be a Good Thing they will ably carry the ball.

Reciprocity in the granting of any radio operating privileges is forbidden by the Communications Act of 1934 which limits the granting of operating licenses to citizens of the United States. The one exception is a treaty with Canada concerning Public Service and Emergency radio services in which amateurs share only incidentally. The attitude of the FCC is governed by this law, and unless asked to comment by a law making body, they can only point out that according to the law, reciprocity is illegal. Any inquiry to the FCC will receive Form Letter 7400 pointing out that amateur radio operating privileges can only be granted to citizens of the United States. Unless you are persistent, this will probably be the end of it.

Your Congressman, unless he is blessed with insight and intelligence as well as vote getting ability, will probably turn your letter over to an Administrative Assistant who will forward it to the FCC, who will in turn send Form Letter 7400 to the Congressman, who will attach an autographed letter, stuff same into an envelope on which you have paid the postage, and rest in the hopeful assurance of your grateful vote come November. To avoid this runaround, make it clear in your letter that what you are suggesting is at present, Illegal, and that you feel a change in the law is

called for—that this requires the passage of Senate Bill S. 2361—that it would be good for the country and especially good for the legislator who endorsed it—that the reciprocal granting of amateur operating privileges is consistent with the administrations liberal attitude toward tourists.

Above all, don't be discouraged by seeming inattention from official Washington. This is their method of natural selection. Only the strong survive—and persistence will work to your advantage.

Now, with this in front of you, here are some people who merit your attention.

Your Senator

The Honorable,
United States Senate,
Washington, D. C.

Dear Senator:

Your Representative

The Honorable,
House of Representatives,
Washington, D. C.

Dear Congressman:

Members of the Committee on Foreign Relations

John Sparkman
Hubert Humphrey
Mike Mansfield
Wayne Morse
Russell B. Long
Albert Gore
Frank J. Lausche
Frank Church
Stuart Symington

J. W. Fullbright,
Chairman
Alexander Wiley
Bourke B. Hickenlooper
George D. Aiken
Homer E. Capehart
Frank Carlson
John J. Williams

If at first you fail to get the attention 'reciprocity' merits, buck and kick a little, and above all be persistent.

FREE

INTERNATIONAL 1962 CATALOG

*... your buying
guide for precision
radio crystals
and quality
electronic
equipment ...*



- Amateur Crystals
- Transmitters
- Transistor Subassemblies
- Commercial Crystals
- Oscillators
- Power Supplies
- Citizens Band Crystals
- Converters
- Citizens Band Transceivers
- Citizens Band Antennas/Accessories

AMATEURS • EXPERIMENTERS • CITIZENS LICENSEES

Mail today for your FREE copy of International's 1962 complete catalog.

**INTERNATIONAL
CRYSTAL MFG. CO. INC.**

18 NORTH LEE — OKLA. CITY, OKLA.

International Crystal Mfg. Co., Inc. 73
 18 North Lee, Oklahoma City, Okla.
 Please rush FREE 1962 International Catalog.

NAME.....
 Please Print

ADDRESS.....

CITY.....ZONE.....STATE.....

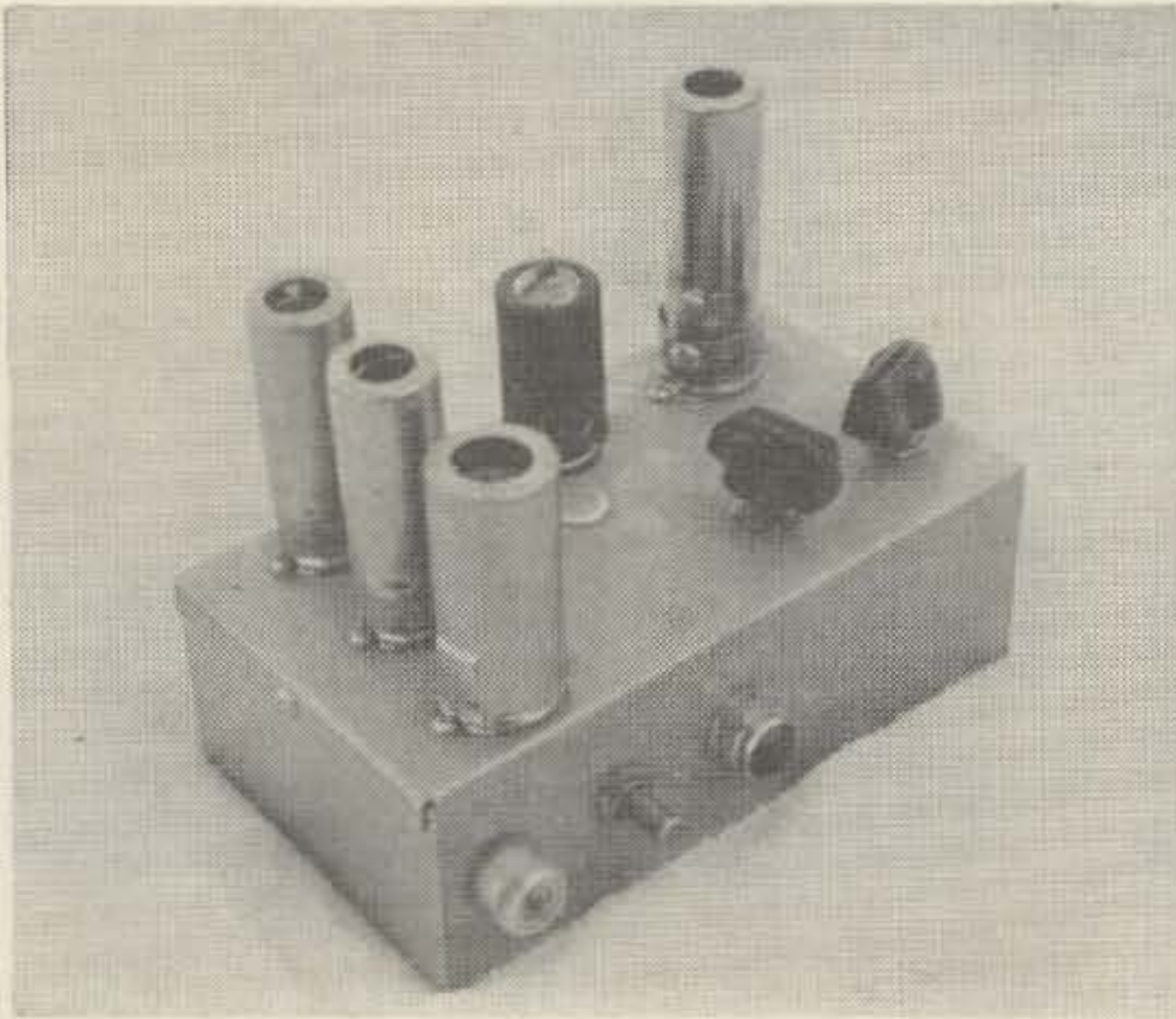

10 Meter Midget Rig

Jim Kyle K5JKX/6
1851 Stanford Ave.
Santa Susana, Calif.

IN this day of 12-volt auto receivers, transistor power, kilowatt amplifiers built into the mobile whip, and other exotic goodies, a simple little low-power 10-meter mobile rig designed for 6-volt autos and which swipes its B+ from the car's BC receiver sounds almost obsolete.

However, a goodly number of 6-volt-plus-vibrator horseless chariots still abound on our nation's highways, and for the benefit of their owners (and anyone else who's interested in a big-sounding little rig) we present this 10-meter midget, designed and built by K6JIM.

The special feature of K6JIM's little rig is in the audio section, and is adaptable to any mobile operation. It produces screen-modulated, controlled-carrier AM—but with a difference. While rf power output is only 10 watts, the talk-power achieved in operation is equivalent to that of many 30-watt rigs due to the tricks employed.

The rf section, consisting of a 6C4 overtone oscillator and a 5763 final, appears completely conventional with the exception that it includes no parasitic chokes. This was not accidental. The hole plugs visible in the photos bear mute testimony to the hours Ron spent achieving a parts layout which would do away with parasitics; we recommend that the same layout be followed unless you like chasing whistles. However, the operating band can readily be changed to anything from 75 to 6 meters simply by changing X1, L1, and L2.

The most obvious unusual feature of the audio section is the extreme amount of decoupling used in the plate circuits of the

12AU7. This eliminates all traces of rf in the power line, thus avoiding rf feedback into the audio—one of the most annoying problems of 10-meter mobile operation.

The decoupling would also improve bass response, except that the audio coupling capacitors are chosen to cut it back for best speech characteristics. Their values should not be increased. The circuit, incidentally, is designed for operation with a ceramic mike; a dynamic will short out first-stage bias while a crystal will melt under mobile heat.

The next unusual feature resides at pins 5 and 6 of the 6AV6. This bottle was originally designed as a combination detector-AVC-first audio tube for ac-dc sets, and includes two diodes. When used in ham rigs, the diodes are usually grounded. However, Ron uses the two diodes as a peak limiter to improve the average modulation level, thus overcoming one of the more major objections to screen-modulation systems.

The diodes are biased by the 2000-ohm cathode resistor, so that they do not conduct for low-level signals. However, when a peak comes along the diodes short its positive side to ground. Nothing happens to negative peaks at this stage; they are taken care of in the final. This limiter allows considerable extra gain to be used without splattering.

The final feature of the audio section is tune-operate switch S1. When closed (TUNE position) it allows full output power from the 5763 by removing all cathode bias from the 6AQ5 modulator tube. The final is then tuned and loaded. Next, S1 is switched to the OPERATE position, and you're all set.

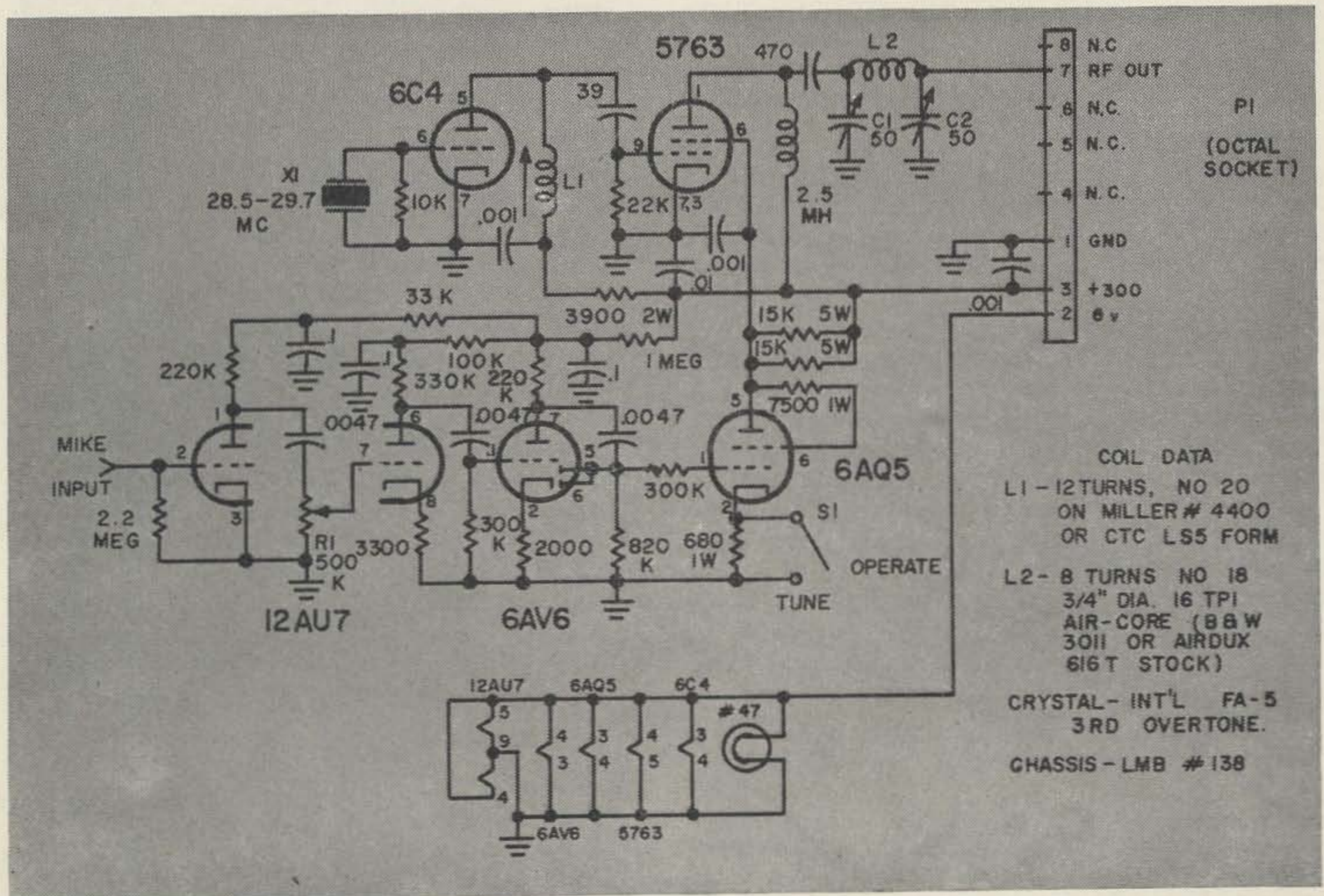
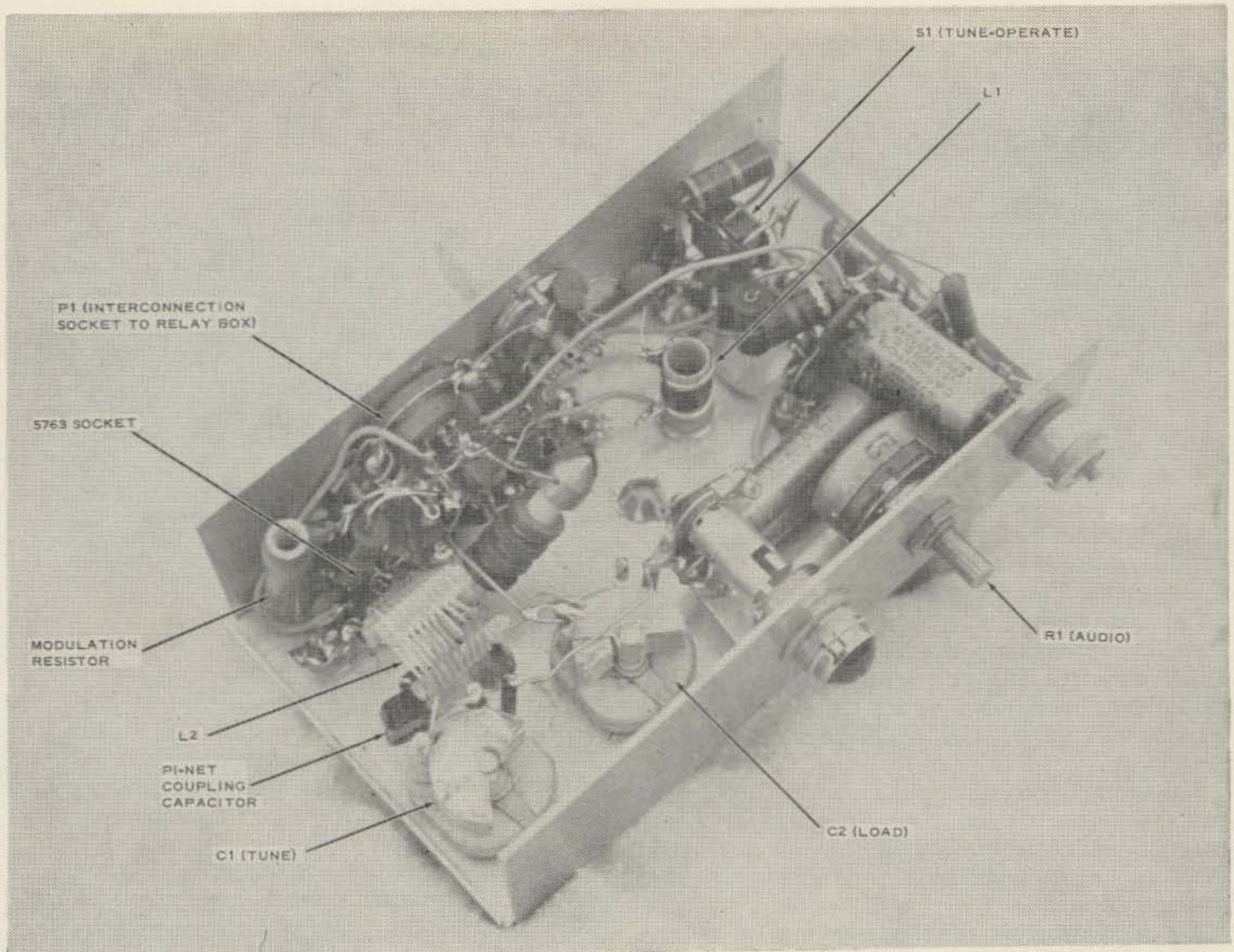
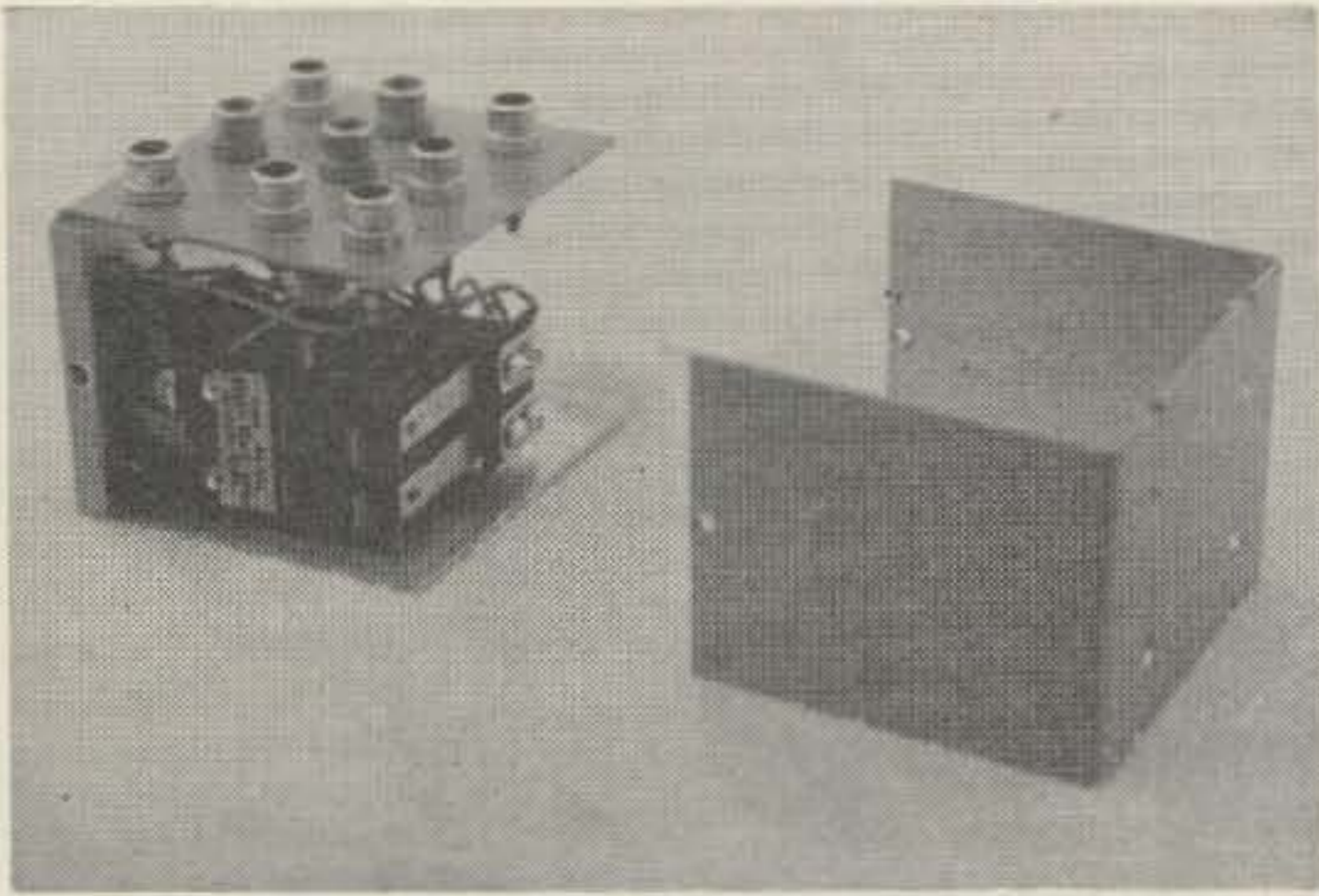

Fig. 1



A few paragraphs earlier we said that negative peaks of audio are taken care of in the final; this action is worth a few more words at this point.

A positive audio peak at the grid of the 6AQ5 can reduce rf power output almost to zero, by increasing the 6AQ5 plate current. This increases the voltage drop through the modulation resistors, which in turn reduces screen voltage of the 5763 and cuts power output.

However, a negative peak at the 6AQ5 grid can do no more than to cut the 6AQ5's plate current off entirely. When this happens, the 5763 is on its own and produces maximum power output.

Since splatter is produced primarily by the sudden cutoff of rf output power, no negative peak at the 6AQ5 grid can possibly cause splattering.

Construction Tips

The chassis layout, photos, and schematic show most of the construction details of this rig. The original is built on an LMB No. 138 interlocking box chassis, which measures $6\frac{1}{4} \times 3\frac{1}{2} \times 2\frac{1}{8}$ inches. However, you are at liberty to bend your own from sheet copper or brass if you so desire.

Contacts 1 and 2 of the 6C4 socket must be removed to prevent parasitics in the oscillator, and tube shields are necessary on all tubes. The 12AU7 shield's open top should be covered with copper screen on the inside.

All components used are standard items, which should be easily available at your favorite supplier. If not, they are stocked by any of the larger mail-order houses. Note that many of the resistor values are obtainable only in 5-percent tolerance units; the 2000-ohm 6AV6 cathode resistor is one of these, and its value should not be changed. Unless otherwise indicated, all resistors are $\frac{1}{2}$ -watt.

If you have a 12-volt car instead of a 6-volt model, you can still use this rig by substituting 12-volt tubes and modifying the filament wiring. The 6C4 can be replaced by one section of another 12AU7 (changing the socket

to 9-pin, naturally; remove contacts 1 through 3); the 6AQ5 by a 12AQ5; the 6AV6 by a 12AV6; and the 5763 by a 6417. The existing 12AU7 will need only its filament wiring

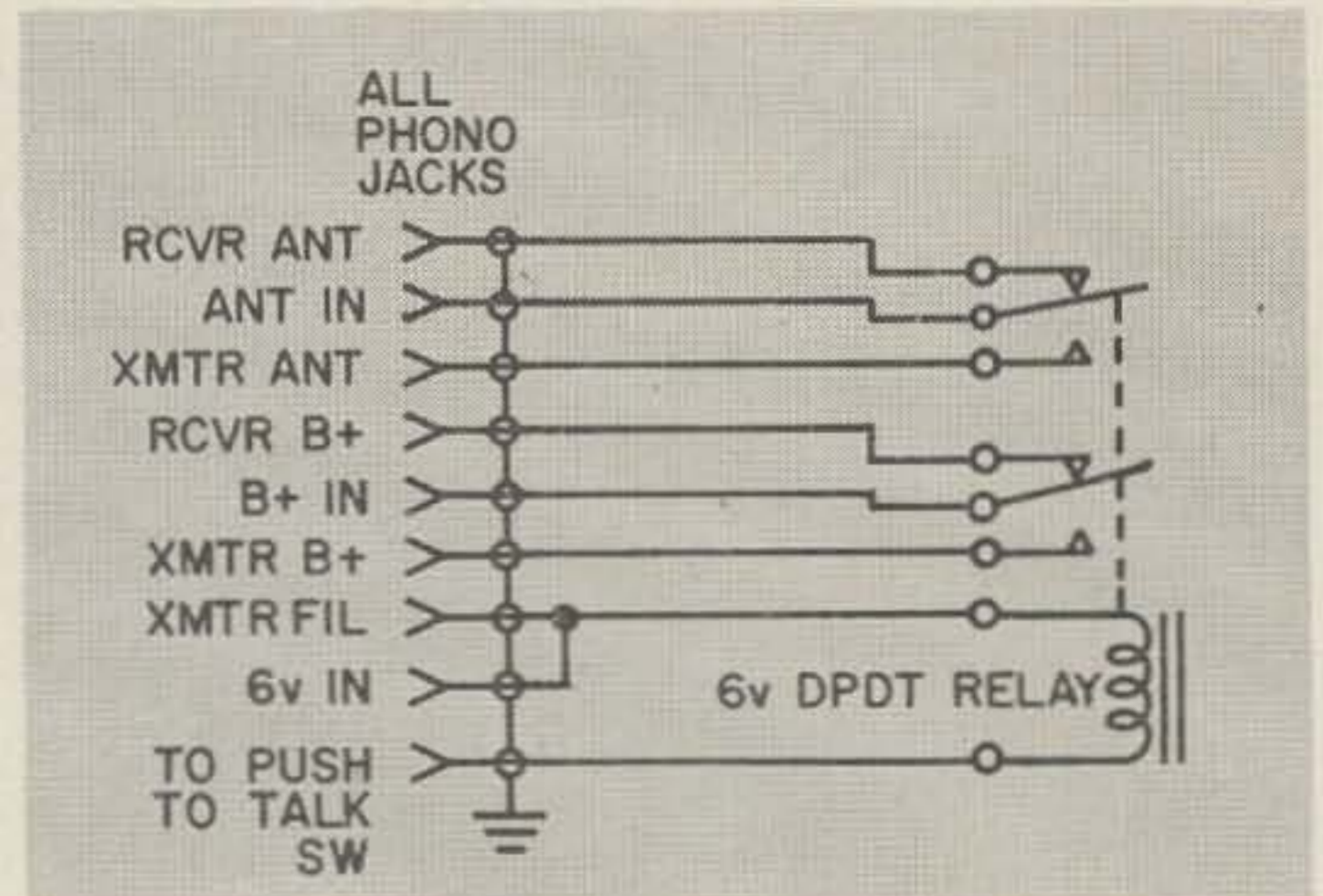

Fig. 2

changed.

Power Supply and Control Circuits

As mentioned earlier, this rig swipes its power from the car receiver. This is done through interconnection socket P1 and a relay box. The relay box is wired as shown in Fig. 2 and the photos.

In the car BC receiver, the B+ line is broken between the power-supply output and the audio output stage and replaced by a 3-contact socket, as shown in Fig. 3.

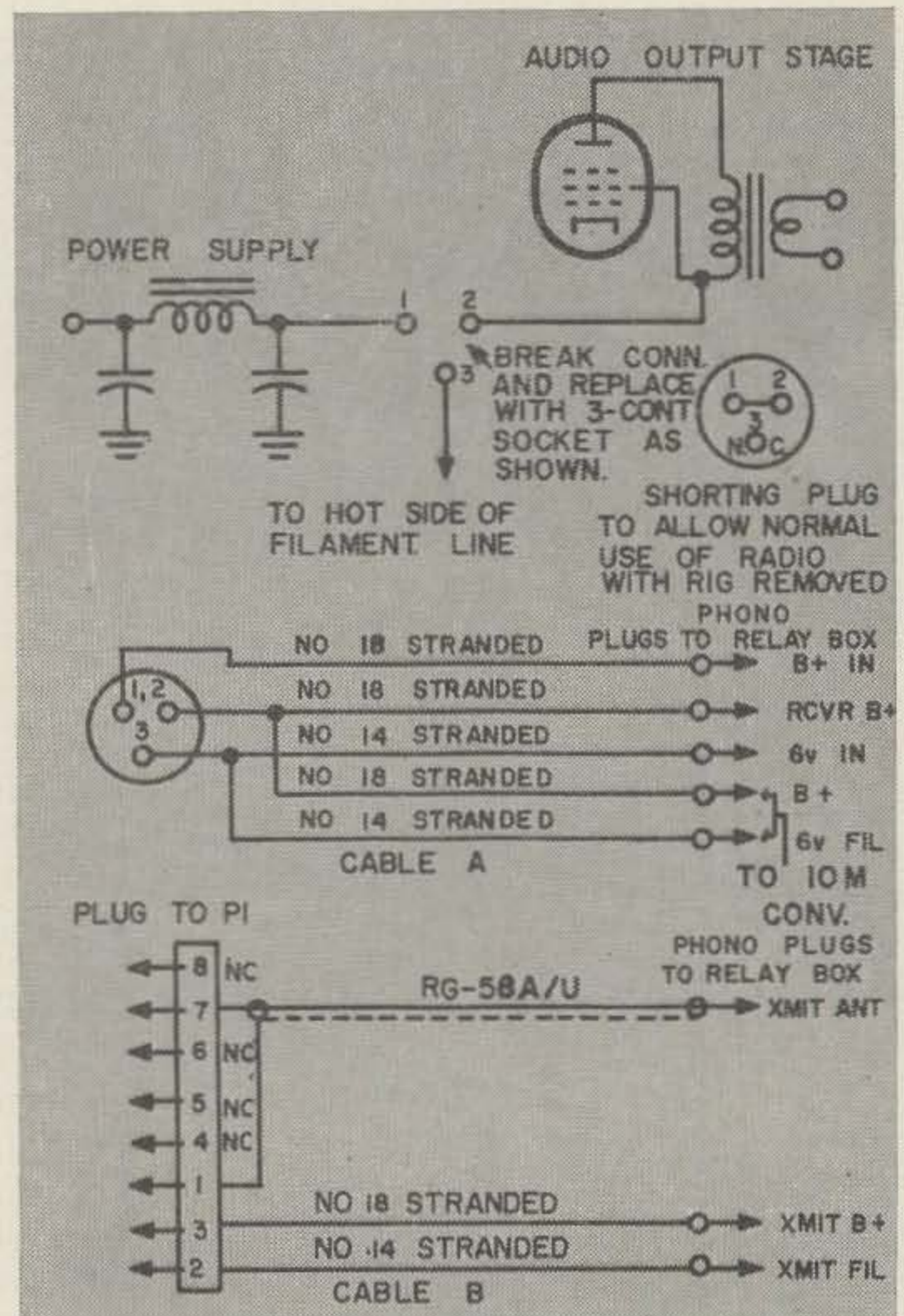

Fig. 3

NEW FOR YOUR STATION

For mobile operation, Cable A (Fig. 3) is plugged into the car receiver and the appropriate relay box jacks. The separate 10-meter converter is also connected to Cable A on the receiver side. Cable B is plugged into P1 and its relay box jacks. The antenna lead connects to the relay box, and a separate coax cable connects the "rcvr ant" jack of the relay box to the converter input. (This all reads considerably more complicated than it is in practice.)

With all connections made, the rig itself can be hidden under the front seat or against the firewall under the dash, since it requires no adjustment during operation. Only the mike and the push-to-talk switch need be accessible for use of the rig. Pressing the switch operates the relay, which switches B+ from receiver to transmitter and also changes over the antenna.

Tune-up Procedure

You can see that no metering or meter jacks are included in this little midget. The reason for this is that the rig is designed for fixed-frequency operation; you tune it up on initial installation, then forget it. Here's the procedure:

First, measure the voltage at the junction of L1 and the 3900-ohm resistor, using a VTVM, while tuning L1 for a peak reading. Once you have the peak, take a quick check at the 5763 grid for approximately —30 volts. Now place S1 in the TUNE position, C2 fully meshed, and use a field-strength meter to determine transmitter output while tuning C1 for maximum.

With C1 tuned for maximum power output and C2 fully meshed, reduce the capacitance of C2 slightly and retune C1 for a new maximum. This reading should be greater. Continue this adjust-and-retune sequence until the power output drops just perceptibly from the preceding reading. Touch up the tuning of L1; if power output increases, continue the adjust-and-retune sequence. The object is to apply maximum grid drive, and to load the transmitter until the power output just begins to drop from the maximum obtainable—this is the tuning requirement for all screen-modulated rigs, but S1 makes this one simpler than most.

When tune-up is complete, switch S1 to the OPERATE position—and talk.

Problems and Consultation

The designer and builder of this rig is Ron Nelson, K6JIM, owner and operator of Custom Electronics, 19315 Sherman Way, Reseda, Calif. All questions, problems, and comments should be directed to him, with S.A.S.E., please. . . . K5JKX/6

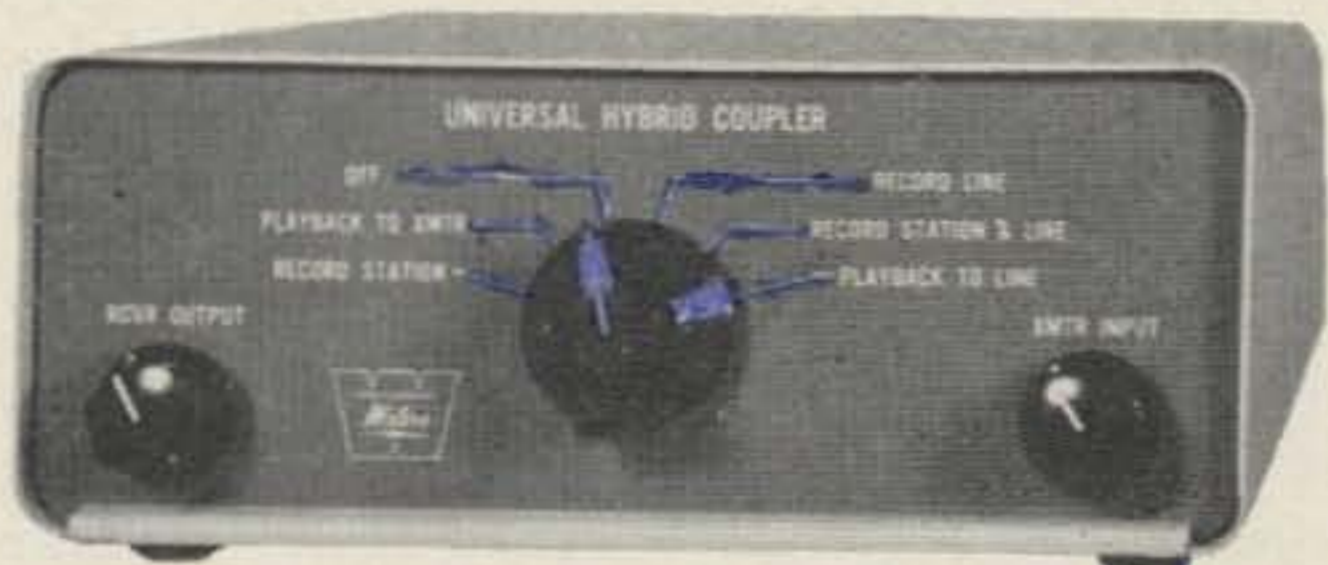

UNIVERSAL HYBRID COUPLER by *Waters*

Now you can use your tape recorder in your station. The universal Hybrid Coupler connects receiver, transmitter, tape recorder, speaker, microphone and 600 ohm line. With ONE switch and NO adjustment you are ready to:

1. Record BOTH sides of QSO.
2. Transmit recorded QSO on the air or to a 600 ohm line.
3. Record information from 600 ohm line now, transmit later.
4. Operate your transmitter from 600 ohm line.

Unique and simple to operate. Uses a new wide band hybrid network with an easy to set-and-forget broad balance null control. Convenient terminals and standard audio-type connectors. Operates either VOX or push to talk with AM or SSB with any high impedance microphone, crystals or dynamic. Mounts horizontally or vertically. Requires no power. Compact size: 6½" wide, 2½" high, 8¾" deep. Attractive two-tone gray finish. Furnished complete with installation instructions and easy-to-follow set-up procedures. Adds hours of pleasure and utility to your station. \$49.50. Order today from any of the following distributors:

HARRISON RADIO CORP., 225 Greenwich St., N. Y. 7, N. Y.
 NEWARK ELECTRONICS CORP., 223 W. Madison St., Chicago 6, Ill.
 RADIO SHACK CORP., 730 Commonwealth Ave., Boston 17, Mass.
 EVANS RADIO, INC., P.O. Box 312, Concord, N. H.
 LEW BONN CO., 67 South 12th Street, Minneapolis, Minnesota
WATERS MANUFACTURING, INC.
 Wayland, Mass.

Versatilizing Meters

Joseph Leeb W2WYM
549 Green Valley Road
Paramus, New Jersey

METERS, though one of the less-abundant items in the average shack, are very versatile and lend themselves nicely to conversion to various ranges and types of current.

Take, for example, the familiar 0-1 dc milliammeter. This instrument can be adapted to measure practically any range of dc current, with the proper shunt, or any dc voltage range if the correct multiplier is used. By adding a meter rectifier the instrument becomes an ac meter. RF can also be measured with the same instrument, using a diode to rectify the current to dc.

Shunts and multipliers are relatively easy to make. For the ham who is allergic to mathematics, the cut-and-try method is the least painful. Suppose we wished to increase the range of our 0-1 mil meter to measure 10 amperes. The handiest material around the shack is some copper magnet wire. The question now

arises: what size wire and how much? Let's start with two feet of #16. This size can carry 10 amperes safely, and two feet allows for trimming the shunt to proper size.

Hook up the circuit as shown in Fig. 1. Start with the full resistance of the rheostat in the circuit. If the meter under test reads too high, the shunt wire is too long; unsolder one end of the shunt from the terminal, shorten the wire a little, and resolder. *Be sure the switch is open* when making any changes. The meter may show a reading for a minute or so after re-soldering the shunt wire, even though the battery is disconnected. This is due to the thermocouple junction produced by the dissimilar metals at the soldered joint. As the joint cools, the meter reading will gradually drop to zero.

Neglecting the economy angle, copper is not the best material for shunts or multipliers.

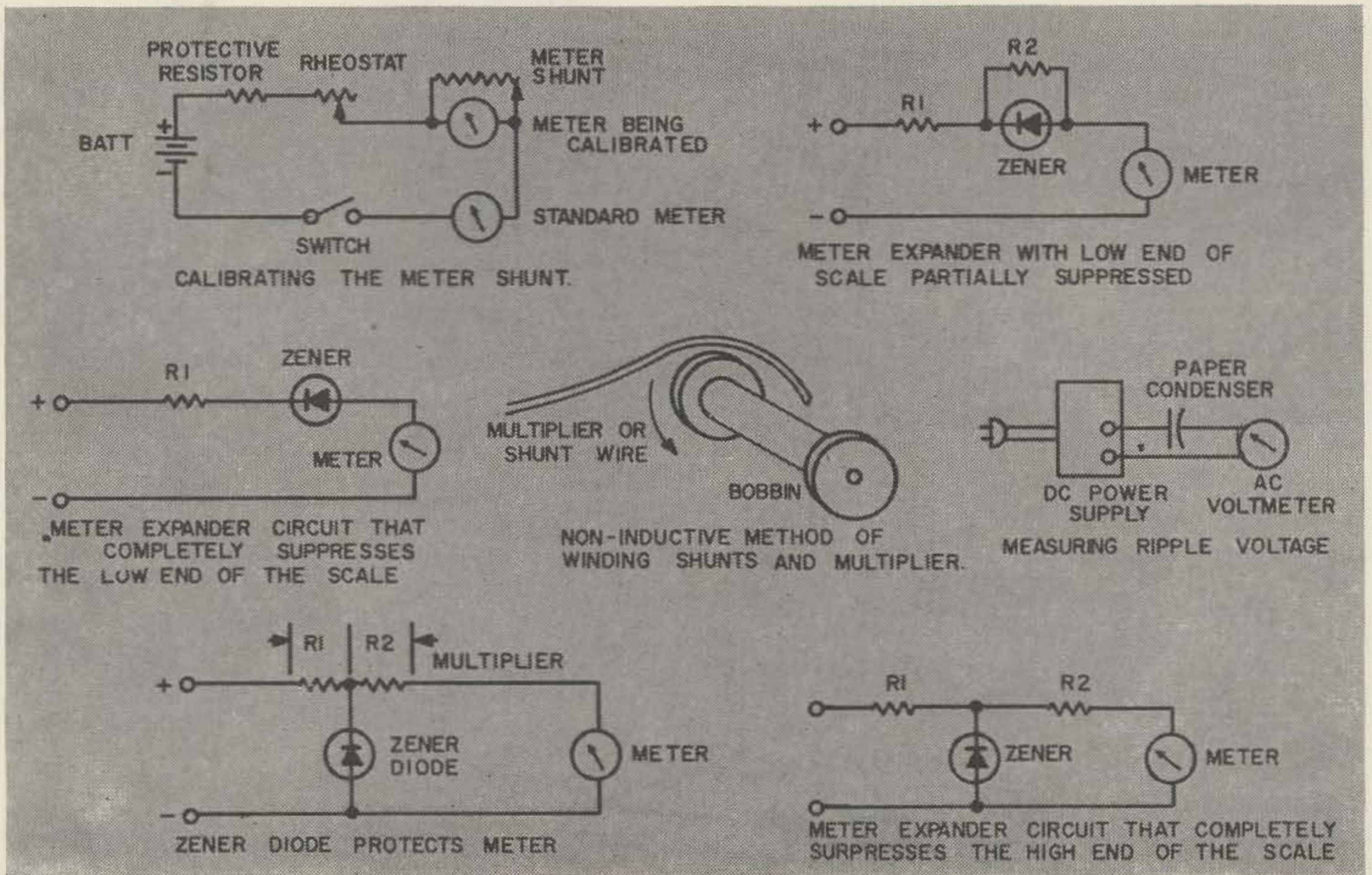

6

1
4

2

5
7

3



*Merry Christmas
and a
Happy New Year*

THE TECHNICAL MATERIEL CORPORATION

MAMARONECK, N. Y.

OTTAWA, ONTARIO, CANADA
ALEXANDRIA, VIRGINIA
GARLAND, TEXAS
LA MESA, CALIFORNIA
POMPANO BEACH, FLORIDA

The resistance of copper changes with temperature, resulting in inconsistent readings on our meter. If you can lay siege to some low temperature coefficient wire (manganin, nichrome, etc.) you will have a more consistently accurate instrument.

On cold, dry days an amazing phenomenon rears its ugly little head in the shack,—meter needles deflect *before* the current starts to flow, and readings jump suddenly in a most mysterious manner. What causes this? Static! Rub the glass window of any meter with a silk cloth (the bare finger will do for people who lack affluence). The friction produces a static charge at the area of contact, and the meter needle will be attracted. Deliberate rubbing is not always necessary,—a passing breeze sometimes changes a meter reading. Fortunately, there is a cheap and dirty method of squashing this static bug. Take a damp strip of chamois leather and lay it on the meter face so as to make contact with both the window and the flange, and the static charge will be dissipated as fast as it forms. Another method is to mount a piece of coarse-mesh wire screening inside the glass. This, by the way also helps in preventing rf leaks in a transmitter, and is a point to keep in mind when TVI-proofing your rig.

Meter multipliers, as well as meter shunts, require some special treatment. Having the proper resistance, and being wound with low temperature coefficient wire is not enough. The multiplier must have no magnetic field around it when current flows through it. This little trick is accomplished by winding the multipliers non-inductively. A length of insulated wire having the desired resistance is first measured off. The wire is then strung out, doubled, and wound on a bobbin, starting with the loop in the center of the wire. (See Fig. 2).

RF has a nasty way of getting into a dc meter movement, sometimes with disastrous results. A high-grade mica bypass condenser across the meter terminals will help keep the rig on the air.

Where both ac and dc are present in a circuit (such as the output of a power supply that has insufficient filtering), the ripple voltage can be measured quite easily if we connect an ac voltmeter in series with a paper condenser across the output terminals of the power supply. The condenser passes only the ripple component to the meter, and holds back the dc (Fig. 3).

Overload protection for meter movements is obtained efficiently with zener diodes. These little watchdogs are faster and more reliable than fuses, and, best of all, they are self-healing. The zener is one of the oddballs of the diode tribe. Unlike the common diode, which conducts in one direction but is an insulator when the current reverses direction the zener does not pass any current to speak of, in either direction, until the applied voltage rises

to a certain critical value, at which point the zener breaks down and conducts. When the voltage falls below the breakdown point, the zener once again becomes an insulator. Zener diodes are made for a wide range of breakdown voltages. Two or more zeners may be connected in series to provide any required voltage breakdown characteristic.

At this point it might be wise to mention that zener diodes cannot be tested like the ordinary unilateral conductor. An ohmmeter check will not indicate the true condition of a zener; it is necessary to apply rated breakdown voltage to see if conduction takes place.

Fig. 4 shows how a zener diode is connected to protect a meter against burnout. R1 and R2 are the two sections of a multiplier or voltage divider. Values of R1 and R2 are chosen so that the voltage at their common point is near the breakdown voltage of the zener diode when rated current flows in the circuit. Any voltage in excess of the safe maximum value will cause the zener to break down and conduct, relieving the strain on the meter.

Another interesting application of the zener diode is in the suppressed-zero and expanded-scale meters. Fig. 5 shows a circuit in which the low end of the scale is partially suppressed. This feature is useful where the low end of the scale is of no particular interest. The meter remains at zero until the current reaches the desired minimum value, at which point the zener diode breaks down and conducts. R1 is used for upper scale calibration, while R2 is adjusted for the required degree of low end suppression. If it is desired to completely suppress the low end of the scale, connect up according to Fig. 6.

There are cases where only the low end of the meter scale is important, and the high end is to be suppressed. In Fig. 7 this is accomplished by causing the zener to break down before the voltage exceeds a certain predetermined value.

... W2WYM

Miniature Pilot Light

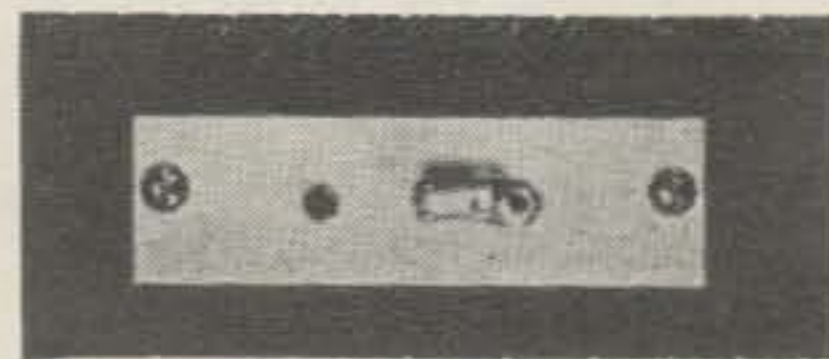

The limiting factor in compact construction is often the available "front of panel" space for adequate marking and operation of the various controls. One low cost, readily obtainable item to assist in easing this problem is available from automotive supply stores.

The miniature jewel indicator lamp shown in the photograph may be purchased, at a cost of 27¢, from Western Auto under their part number 2L6208. The socket part of the lamp is of standard size, but the 5/16" diameter, ruby jewel mounts in a 1/4" hole and its use does much to reduce front panel congestion.

... W4WKM

IN A REMOTE DESERT TRACKING STATION ...

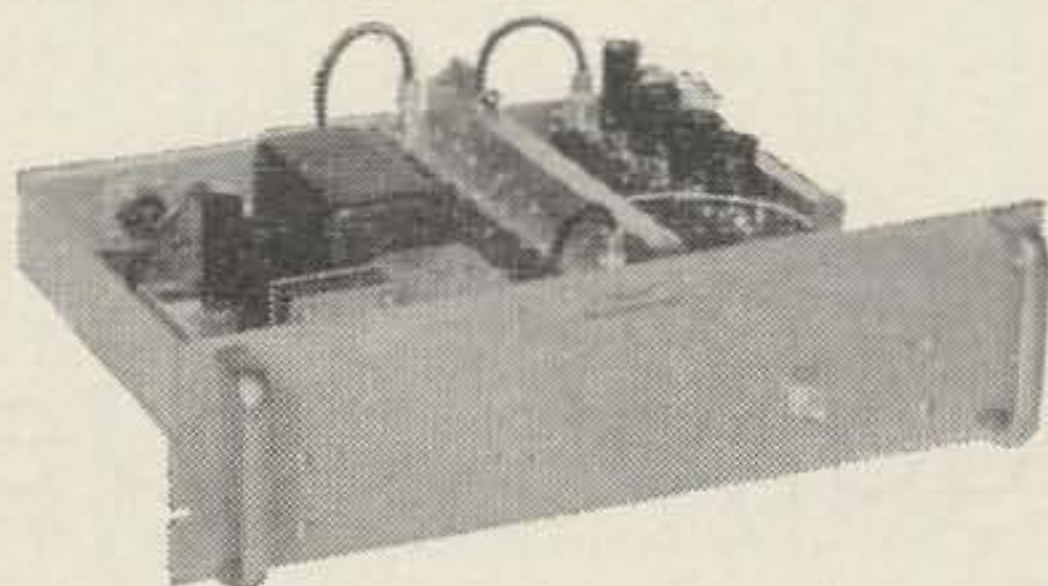

... this unusual converter is operating. It's not a ham converter (its front-end tubes alone are more costly than most complete ham converters). It tunes several crystal-controlled spot frequencies near 890 Mc. Its noise figure is under 9db. It is phase locked. It is part of a satellite tracking system.

It was designed and built by Centimeg.

Like many Centimeg converters, this one was tailored to a specific set of requirements through adaptation of standard RF and injection module designs. It could have been supplied for antenna mounting instead of control-room environment; it could have been furnished in a monopulse configuration.

Centimeg converters and RF amplifiers are in use at tracking stations, laboratories and communications facilities throughout the free world.

Centimeg has produced much unusual hardware, including devices for SSB generation at 960 Mc; phase-stable balanced modulators at 30 Mc; and synthesizers for many frequencies.

We'd like to tackle your problems, too. A new brochure awaits your letter or call.

Meanwhile, back at the shack

We have a new line of converters for hams who need something better than is presently available. These are for the "Project Oscar," moonbounce and TV men. Featuring General Electric's 7077 planar ceramic triode in the grounded-grid front end, these are *really* low noise devices. Prices are \$149.50 for 144 and 220 Mc, \$189.50 for 432 Mc. Write for full details and a copy of our free "Notes on Noise Figure."

JOBBER AND MILITARY / INDUSTRIAL REP OPENINGS IN MOST TERRITORIES.



312 East Imperial Hwy. — El Segundo, California
SPring 2-1032 EAstgate 2-2703

The Regenerative Detector

MORE regenerative detectors have been built and cussed than any other circuit in radio. More weird noises have come from regenerative detectors than from any other "instrument of the devil." In spite of all of this they refuse to die, even though their obituary has been written by a number of authorities.

The circuits were far from ideal in their early uses but they served a purpose. Their great sensitivity reduced the number of tubes required at a time when tubes were expensive, delicate, and crude.

No one should ever plan on reviving the regenerative detector for general use but it does have some characteristics that recommend it for special applications.

The following story is not intended as a "how to build it" for these particular uses but only as a suggestion to amateurs who like to design their own projects.

For those who have never nursed a sick detector through the early hours of the morning, it might be well to list a few good features as well as the bad. The good points run something like this.

A. The regenerative detector is capable of very high gain. A gain of over 18,000 can be realized in one tube.

B. It does not require a separate BFO for CW reception.

C. It can be made highly selective.

D. It will operate with very low plate voltage and current.

On the other side of the ledger are a number of bad points that have given the circuit a poor reputation. Several of them are:

E. The regeneration control must be continually varied as the detector is tuned.

F. The selectivity curve becomes very broad on strong signals.

G. Simple AVC circuits are not practical.

H. When connected directly to an antenna, the detector suffers from instability and dead spots.

The last four items are enough to discourage all but the hardy souls. However A, B, C, and D would indicate the circuit has something to offer where space and current drain are important, such as in small portable equipment.

If the operator is willing to sacrifice AVC for space and power savings, three of the four objections can be overcome by using the circuit as the second detector of a simple superhet receiver. The regeneration control becomes quite stable because the detector is operating on a fixed frequency. The selectivity can be kept quite good by limiting the signal that reach the detector, and antenna coupling is no longer a problem.

The items A, B, C, and D will all contribute to a compact, high gain *if* system that requires very little power to operate.

The simple superhet using a regenerative detector is not new. It has been in use for years, but there seems to be very little data available on what to expect from such a circuit. To get firm figures rather than speculation several circuits were wired and tested.

One of the circuits tested is shown in Figure 1. It is the well-known electron-coupled regenerative detector that has been in use for years. The sensitivity and selectivity tests were run at 4.5 megacycles. This frequency is satisfactory as an *if* for six or ten meter receivers. If the frequency of the detector is decreased for use on the lower bands, its characteristics will actually improve.

It is well known that the regen circuit has high gain and is very sensitive but the number one question was, "How sensitive?" or, "What is the weakest signal that we can receive?"

As a practical approach, a pair of high impedance headphones were connected in the plate circuit of the detector and a known sig-

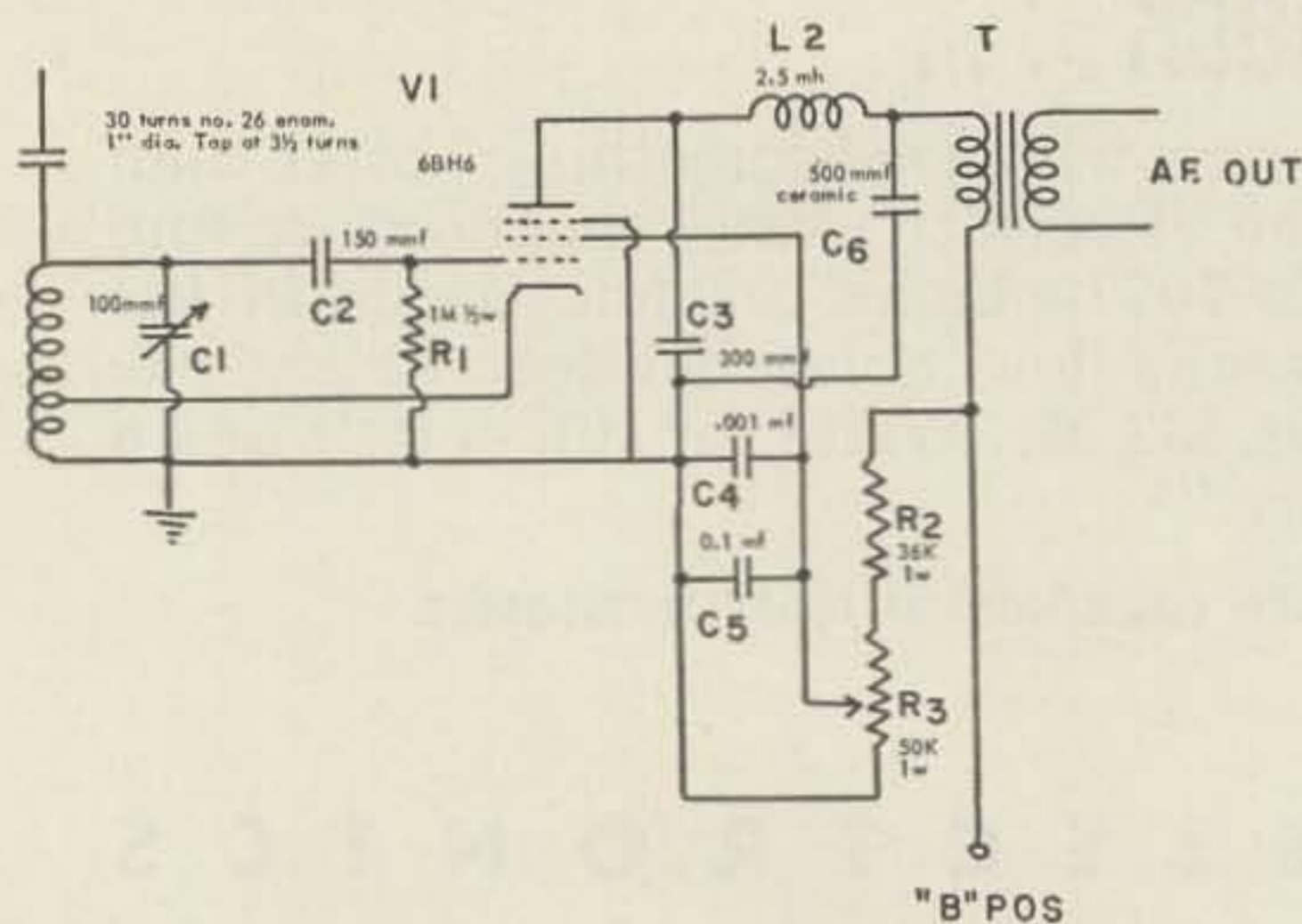

Fig. 1. The electron coupled regenerative detector circuit was used in sensitivity and selectivity tests.

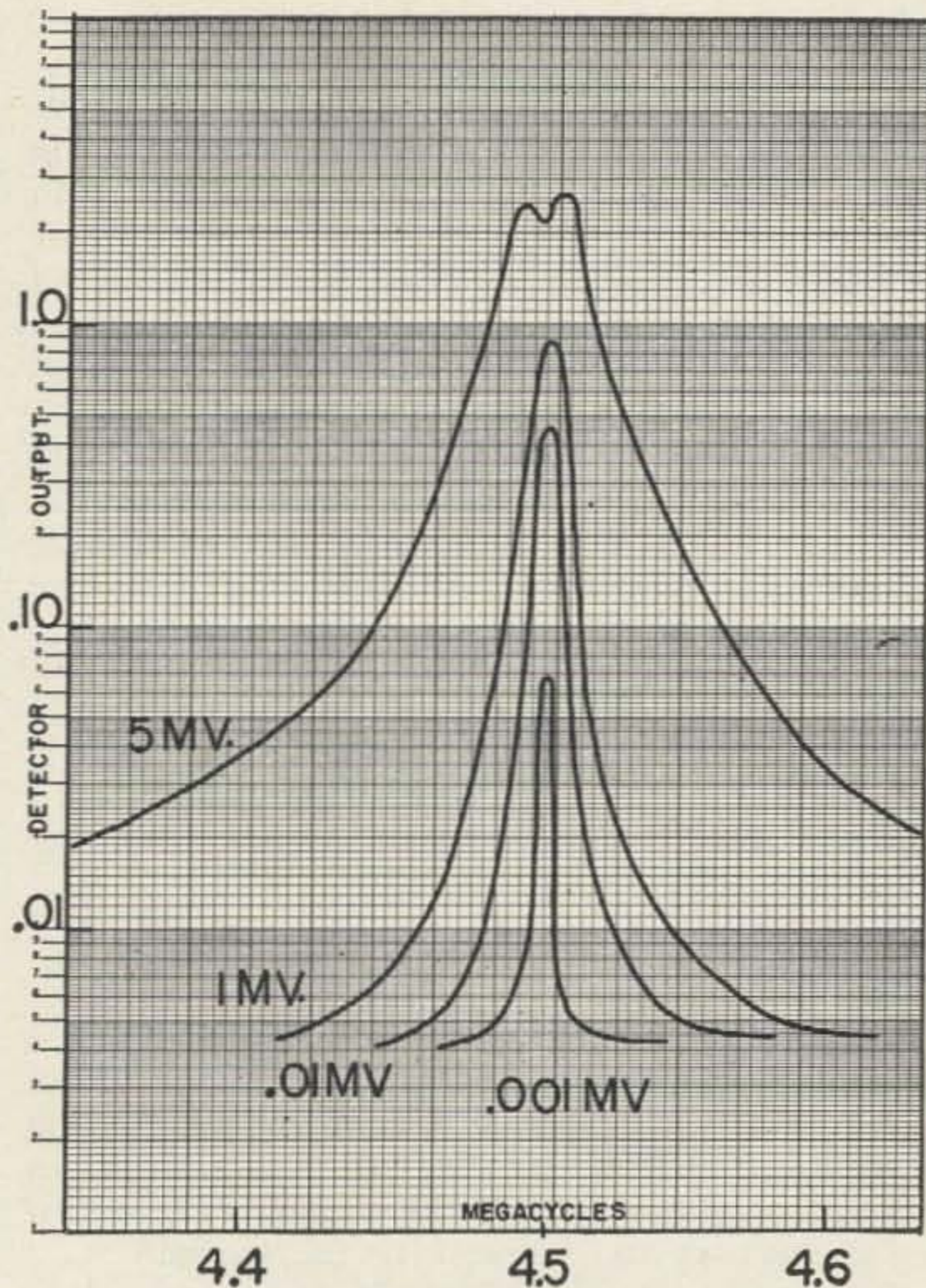

Fig. 2. The selectivity curves show the broadening effect of increasing signal strength.

nal level fed to the input. The signal was reduced to the lowest readable value and the results were surprising. A one microvolt CW signal could be copied and a modulated signal of six microvolts was quite readable. This would indicate that very little gain would be required ahead of such a second detector.

Item F says that the selectivity curve broadens out with a strong signal. To find out just how much, several curves were run. The results are shown in Figure 2. The regeneration control was set just below the critical point of oscillation and the signal was modulated with a 400 cycle tone. The most selective curve shown was obtained with an input of 10 microvolts. The next curve shows the effect of increasing the signal to 100 microvolts. The following curve is that of 500 microvolts input and is followed by the 1 millivolt and finally the broad 5 millivolt curve.

On the basis of these measurements an experimental *if* system operating at 1600 kc was constructed. The final results are shown in Figure 3. A simple amplifier was placed ahead of the regen detector, not to give additional gain but to give greater control over the signal level reaching the detector. However, because the amplifier does contribute to the gain of the system, a simple triode detector circuit can be used.

The system was designed to operate on any available voltage from 45 to 100 volts. This allows it to be used on a B battery or the

NOW!

Space Raider

brings you the K6CT

D
I
V
E
P
O
L
A
R
I
Z
E
D
P
O
L
A
R
I
Z
E
D
P
O
L
A
R
I
Z
E
D
P
O
L
A
R
I
Z
E
D
P
O
L
A
R
I
Z
E
D
P
O
L
A
R
I
Z
E
D
P
O
L
A
R
I
Z
E
D

BEAM!

—a major advancement in antenna design concept and performance.

The famous "K6CT POLARIZED DIVERSITY BEAM." One year of observation brought forth the design. More than another year in actual test (not range but normal installation) proved the validity of design concept, which vastly improves forward gain, front/back ratio and reduces the 80% of QSB caused by polarization shift to a very low minimum.

The new SPACE RAIDER Polarized Diversity Beams provide the ultimate in performance, with forward gain, front/back and side rejection advanced to a new all-time high.

SPACE RAIDER Beams priced from \$34.50 to \$114.50. F.O.B. Pasadena, Calif. Inquire direct:

Space Raider

ANTENNAS

1076 EAST WALNUT STREET
PASADENA, CALIFORNIA

DDD area 213

• SY 2-2526

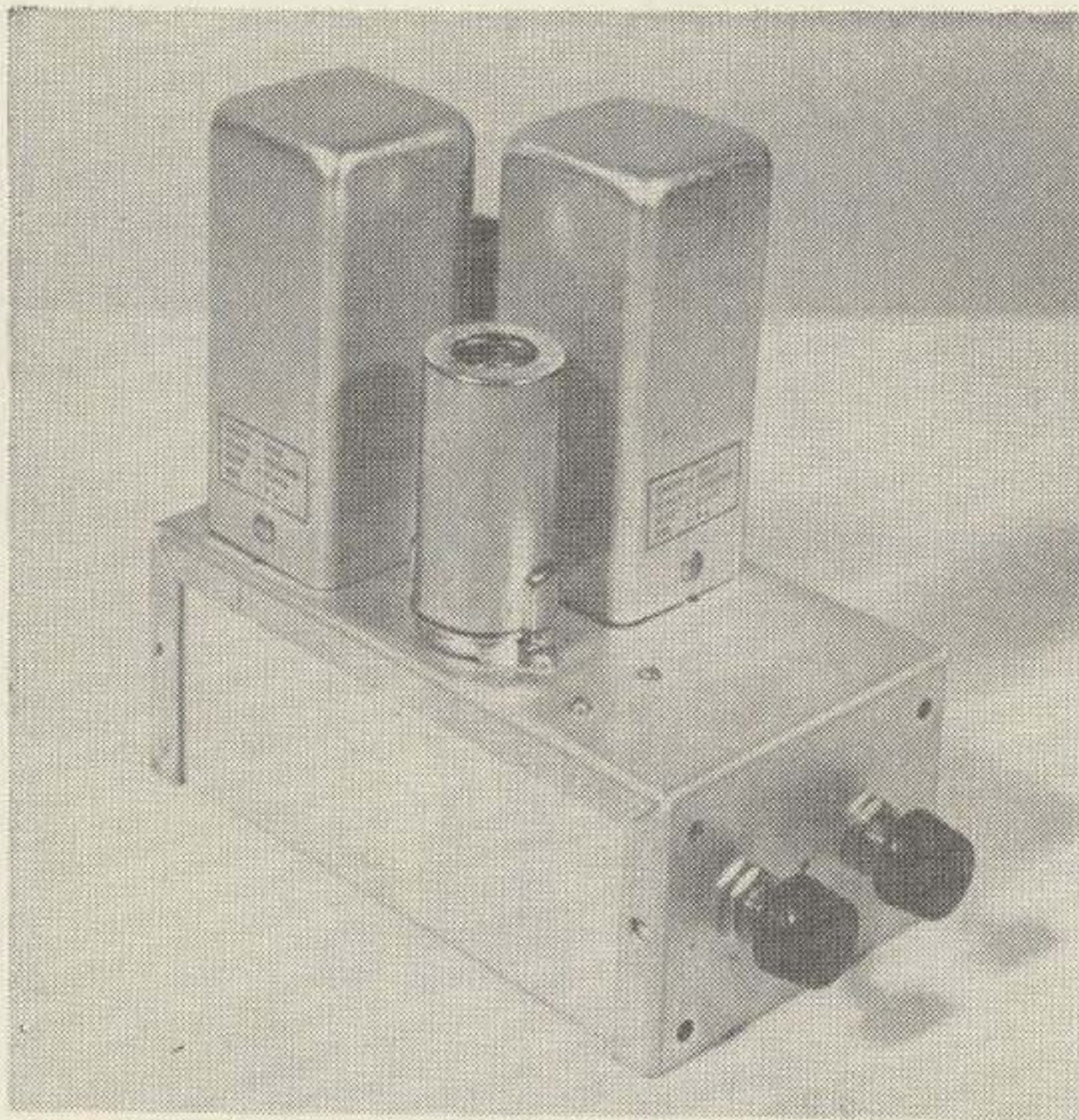

The final circuit uses two tubes to give a sensitivity of one microvolt.

simplest of vibrator supplies to conserve power. The completed unit consists of the *if* amplifier, detector and a stage of audio amplification. The total current drain from the B supply is 7 mils at 75 volts.

The measured sensitivity shows a signal 10 db above noise with an input of 3 microvolts. A one microvolt modulated signal is audible. This *if* system, using only two tubes, has more gain than many communication receivers.

It is clear from the photos that no attempt was made to miniaturize this experimental model, but even with the large *if* cans the entire unit measures only 3" x 5" and has room to spare. With small coils and some crowding it could probably be put in half the space of the

original.

For those who are interested in constructional details, the diagram and photos tell the whole simple story except for the coil added to the second *if* transformer. The cathode coil of the detector consists of four turns of No. 30 insulated wire wound tight against the secondary pie of the transformer. The coil must be correctly polarized, give the desired regenerative action. If the detector does not break into oscillation somewhere in the range of R8, the connection to the cathode coil should be reversed. If other types of *if* transformers are substituted, more turns may be required on this coil to give enough feedback.

If good phone signals are being received the regen control can be operated somewhat below the point of oscillation. For very weak phone signals the control can be pushed up to the critical point just on the verge of oscillation, and for CW the control is advanced to the region where the detector is in actual oscillation.

The *if* gain control in the amplifier stage should be kept reduced to a point where the detector is not overloaded with the signal. As this control is reduced, the regen control can be moved up and selectivity increased.

We have not given details for a complete receiver; this will be left to amateur designers. Almost any tunable convertor intended to be used with a broadcast receiver will work as a front end. More audio amplification can be added as desired.

One word of restraint should be added. A receiver designed along these lines is not intended as a replacement or substitute for the regular communications receiver. It is suggested rather as a means of filling the spot where, for either size or current drain, the

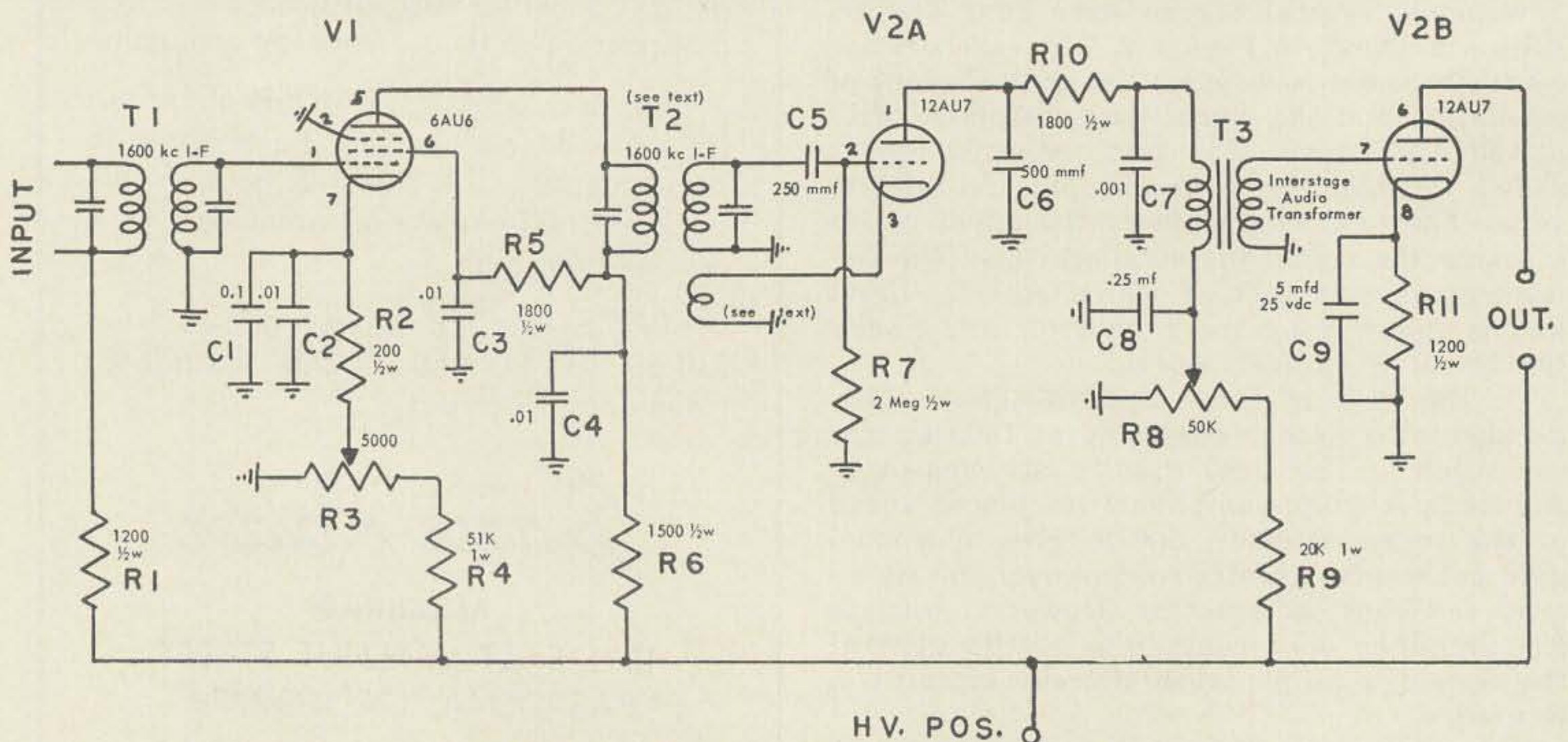

Fig. 3. The IF and audio system is a simple module that can be used with various front ends.



THE MULTIPHASE MODEL MM-2 RF ANALYZER

- Monitors the RECEIVED and TRANSMITTED signals. Shows flat-topping, overmodulation, parasitics, keyed wave shape etc. Silent electronic switching keyed by transmitted RF.
- No tuning required. Broadband response flat 1 MC to 55 MC at power levels of 5 watts to 5 KW.
- New variable sweep control for transmit and receive.
- RF attenuator controls height of pattern. Calibrated in 3 DB steps.
- Function selector for ENVELOPE, TRAPEZOID and BOW-TIE patterns on transmit. For SSB, DSB, AM and CW.
- Built-in 1 KC audio oscillator, less than 0.5% distortion. With 3" scope, is ideal for complete alignment of SSB exciters.
- For use in series with 52-72 ohm coax lines. A short pickup antenna may be used with other systems.
- Plug-in adaptors available to match 50 KC, 60 KC, 80 KC or 455 KC receiver IF systems. Only one simple connection to receiver.

MM-2 Kit ... (less IF adaptor). \$119.50
 Wired ... (less IF adaptor). \$149.50
 Plug-in IF adaptors (wired only)
 RM-50 (50 KC), RM-80 (60-80 KC),
 RM-455 (450-500 KC)... ea. .. \$12.50

THERE IS NO SUBSTITUTE FOR A SCOPE IF YOU WANT THE CLEANEST, MOST PERFECTLY MODULATED SIGNAL YOUR TRANSMITTER CAN PROVIDE. THE MM-2 IS BY FAR THE MOST DEPENDABLE and EASIEST TO USE, SINCE IT WAS DESIGNED STRICTLY FOR THIS PURPOSE.

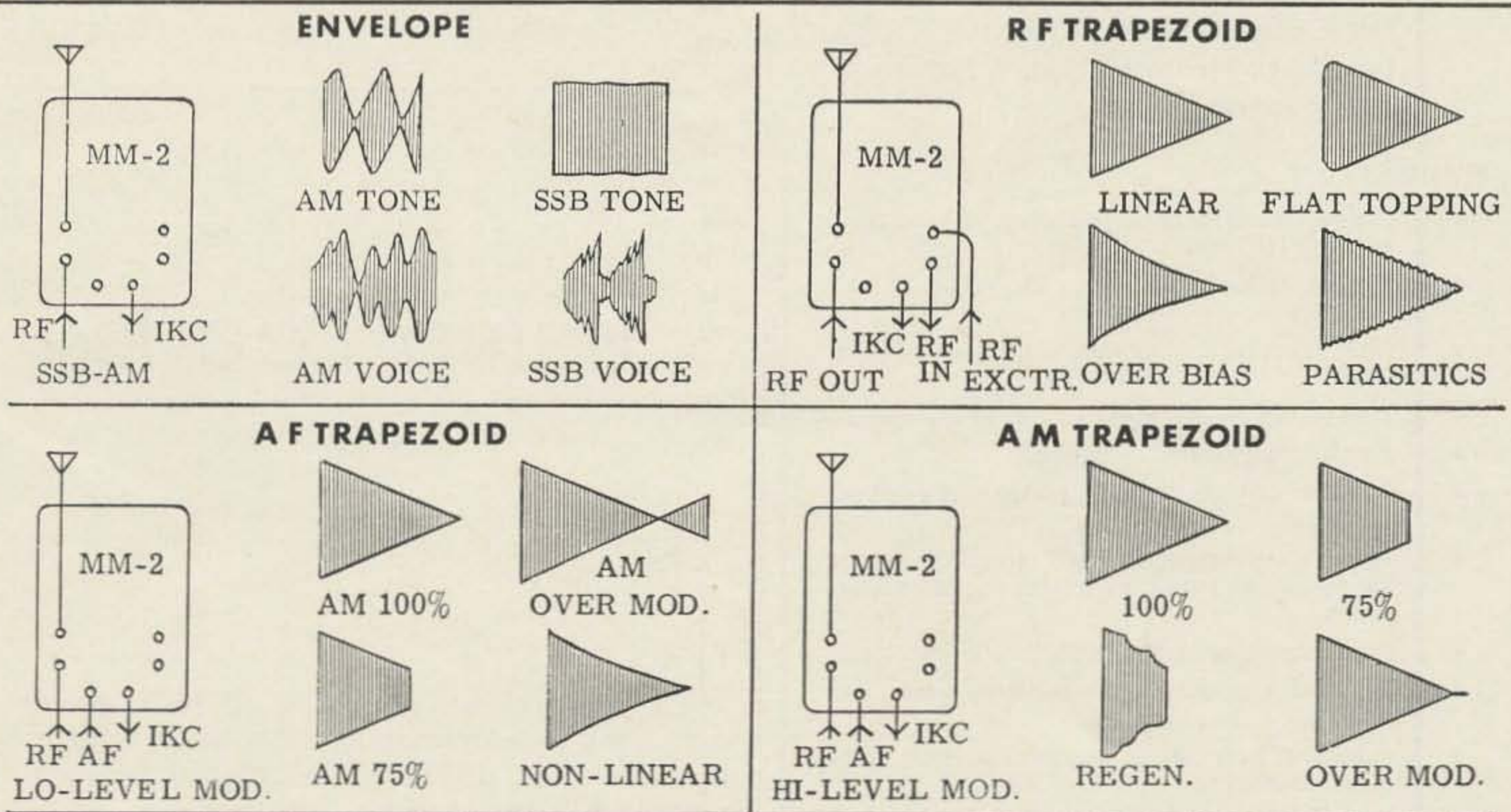

WRITE FOR LITERATURE

**THE
SSB
PIONEER**

MULTIPHASE
EQUIPMENT

Central Electronics, Inc.

1247 W. Belmont Ave.

Chicago 13, Illinois

A subsidiary of Zenith Radio Corp.

NEW FEATURE-PACKED TRANSMITTER

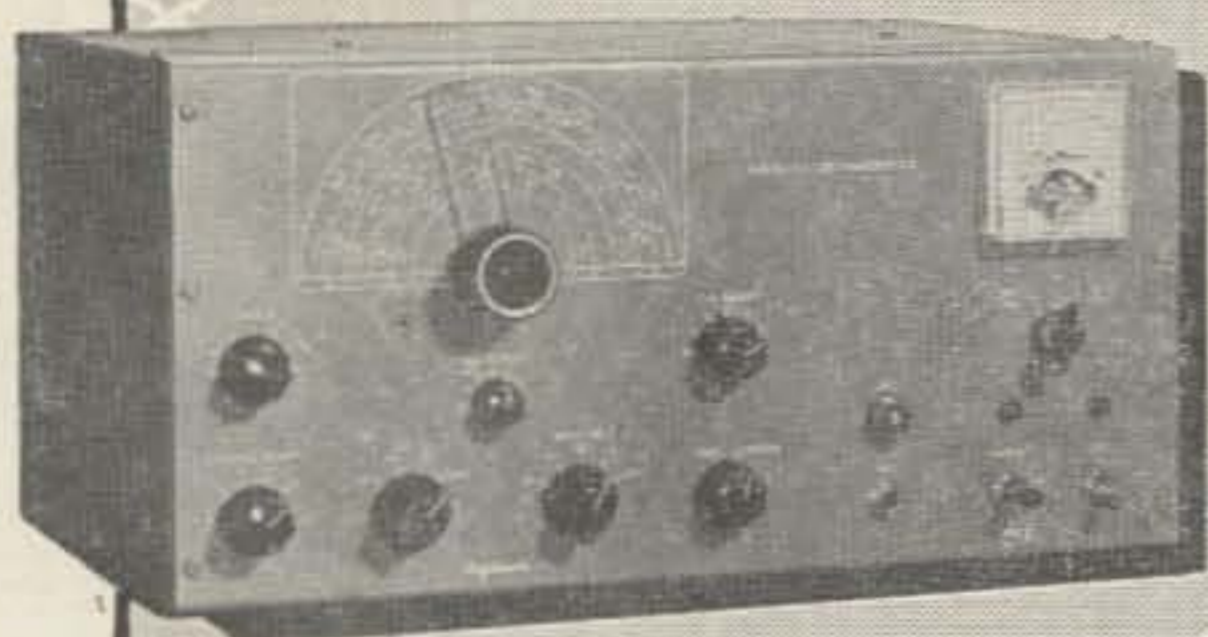

CT-120

combines real operating convenience and dependability with the high performance usually associated with more costly equipment.

Expressly designed for the amateur who wants a complete general-purpose transmitter in a single, easy-to-operate package, the CT-120 provides all the most important features at a truly economical price.

FEATURES

- Completely self-contained, including VFO and power supply (115 vac)
- Single-knob band-switching on 10-15-20-40-80 meter bands
- Plate power input: 120 watts CW; 80 watts Phone (AM)
- Time-proven reliable 807's parallel final amplifier
- High-efficiency screen modulation
- Oscillator cathode keying with clamp-tube key-up protection
- Temperature-compensated VFO accurately calibrated on all five bands. VFO/three-crystal selector switch
- Pi-network output matches 30- to 600 ohm loads
- Built with high-quality, conservatively-rated components
- Functional panel layout provides maximum operating convenience
- Cabinet Dimensions: 15 $\frac{1}{4}$ " W x 8" H x 9 $\frac{1}{4}$ " D.

ORDER DIRECT FROM FACTORY:

Amateur net price: \$189.00 f.o.b. Santa Clara, Calif., completely wired and tested, with tubes, less crystals, key, microphone. Shipping weight: 40 lbs. Complete descriptive literature available on request.

CRAFTRONICS

920 Shulman Ave. • Santa Clara, California

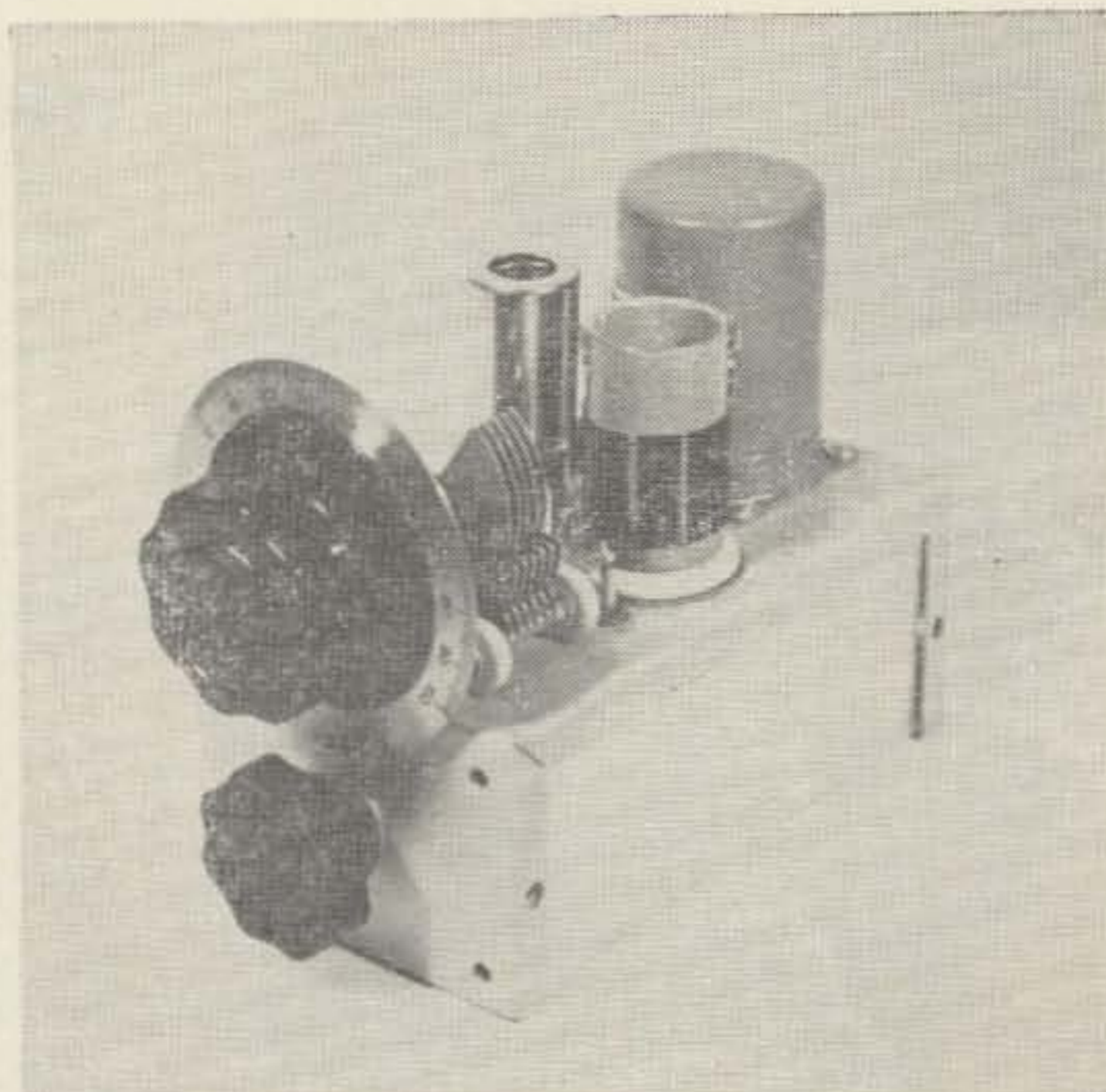

The one tube module used in the original test will be used in future combinations.

regular receiver cannot be used.

Of course, you don't have to tell an old-timer that a simple one-tube regen can be an excellent "last ditch" receiver just as it stands—"barefooted."

... W5WGF

Lamp Loads

The general unsuitability of the incandescent lamp as a dummy load for radio transmitters has been discussed in references too numerous to cite. Among the problems are the wide excursions of impedance at various power levels and the high level of radiated signal. As a point of fact, the variation of load impedance with transmitter modulation can often produce misleading results.

Be this as it may, the easy availability and economy of these dummy loads results in their general amateur use. Termination of the lamps in standard coaxial fittings and lamp sockets will serve to reduce radiation and, if an impedance match is possible, serve to reduce the SWR. The photograph shows a number of adaptors that simplify the connection of the

lamp load. In each instance, the coaxial connector is a version of the PL-259 UHF plug. Brass lamp sockets, without switch, are used for the standard and intermediate screw base lamps. The PL-259A plug is used in these loads.

Connection between the lamp socket and the coaxial plug is made by means of a modified UG-176/U reducing adaptor. The larger diameter bushing on the end of the fitting is sawed off and this end is threaded into the coaxial plug. The unthreaded ferrule is slipped into the threaded bushing of the lamp socket shell and secured by the set screw. The unit is wired by soldering a short lead to the inside of the socket shell and connecting this lead to the sleeve of the socket. The center connection is wired straight through with a length of insulated wire.

The miniature bayonet base lamp load is fabricated from a PL-259 (do not use the PL-259A) plug. The retaining pins on the lamp are snipped off and a bare lead soldered to the center contact. The split ferrule of the PL-259 is spread slightly and the lamp inserted. The center contact of the plug is then soldered and the job is finished.

Photo Credit: Morgan S. Gasman, Jr.

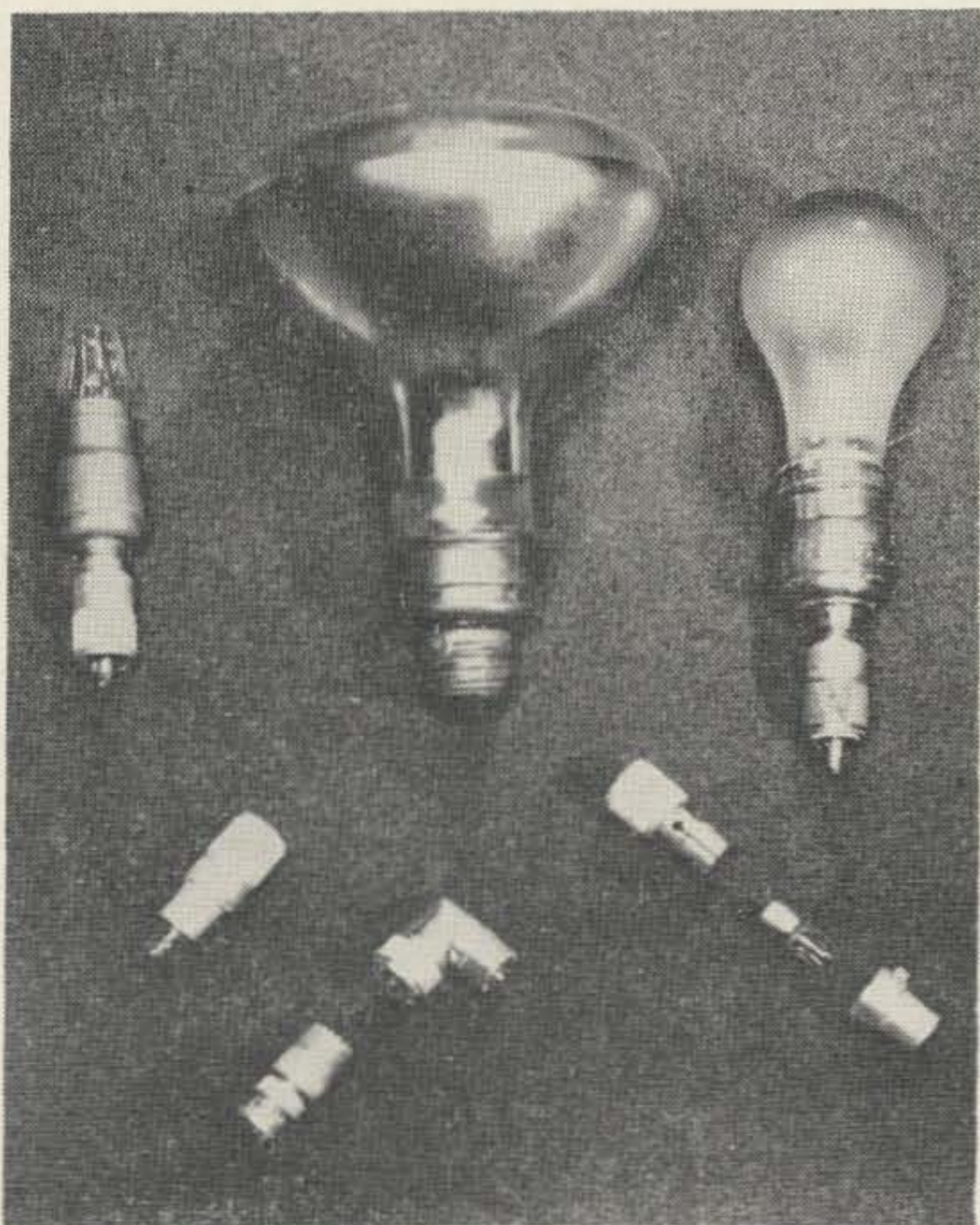

These dummy loads are very convenient to use. Their versatility can be extended through the use of standard connector-adaptors, two of which are shown in the photograph. If you must use lamps for dummy loads, the method shown is as good as any and better than most.

... W4WKM

G·A·M

HIGH GAIN ANTENNAS

VHF
144-160

UHF
450-470

You've Seen Our Ad, You Purchased Our Antenna and You've Proven . . .

- 1 That it's tops in performance
- 2 That it's tops in quality
- 3 That it's a bargain at the price

PRICES FROM \$19.75 LIST UP

TG-5-S FIXED STATION
\$95.00 LIST

- Heavy duty construction
- Two half wave elements
- Can be cut to frequency
- Mounts on standard 1 1/4" pipe
- 52 Ohm Impedance
- SWR less than 1.5-1

Write for Catalog Listing
All Models, Gain Figures
and Radiation Patterns

CONTACT YOUR DISTRIBUTOR OR GAM DIRECT

G·A·M *Electronics* Inc.

138 LINCOLN ST. MANCHESTER, N. H.

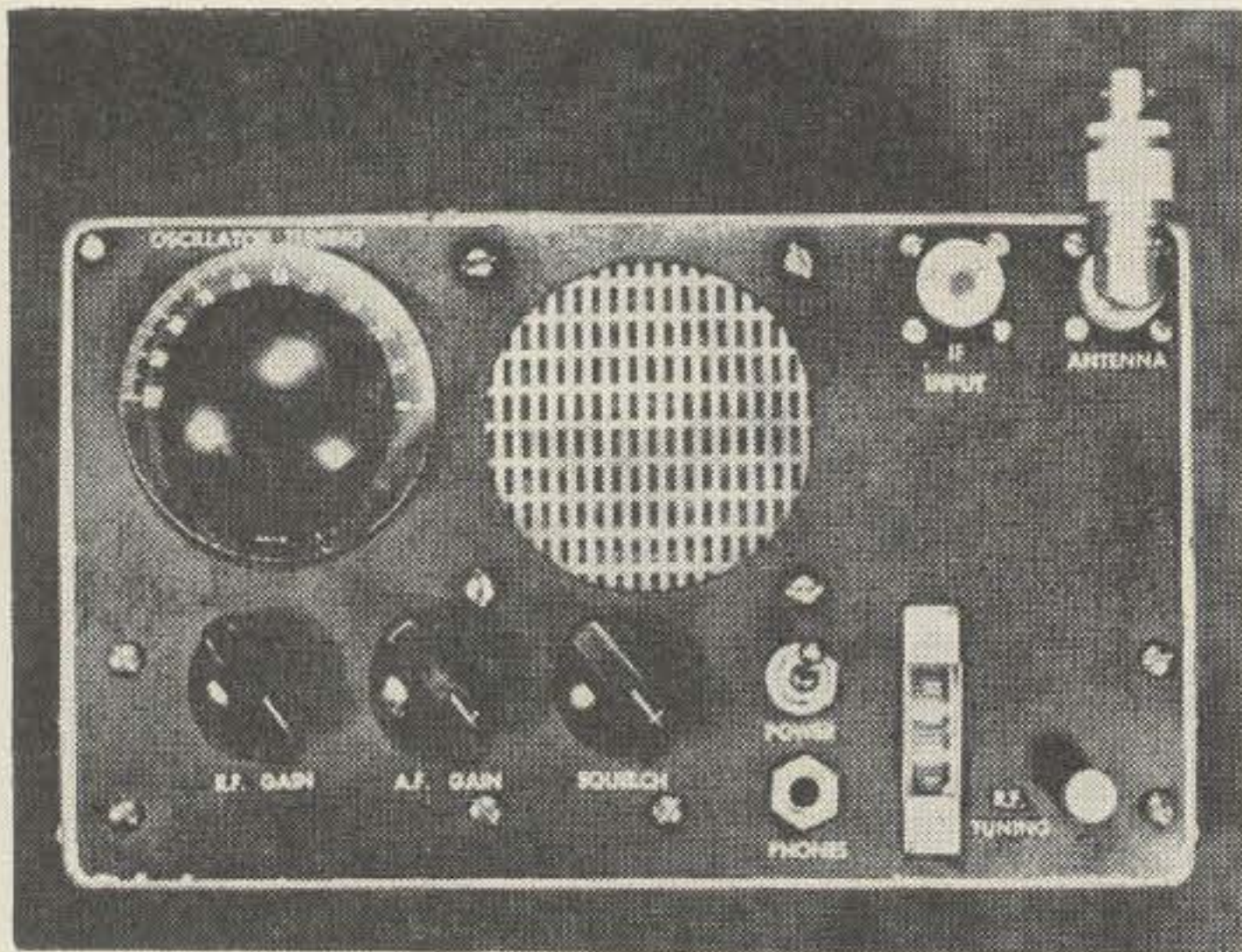

End-on view of the converted receiver. New finish plate is fitted over old front panel and decals applied to show location of new controls.

Conversion of the R-77/ARC-3 Receiver Provides Continuous Coverage From 100 to 156 mc Without Undue Sacrifice of 2 Meter Bandspread.

Roy E. Pafenberg W4WKM
316 Stratford Avenue
Fairfax, Virginia

Photography by: Morgan S. Gassman, Jr.

Another 2 Meter Conversion

THE major components of the AN/ARC-3 Radio Set have reached the surplus market in quantity and are priced so attractively they are difficult to pass up. The AN/ARC-3 is an airborne receiving and transmitting equipment designed to provide plane-to-plane and plane-to-ground VHF communication. Remote control facilities are provided in both the transmitter and receiver to permit automatic tuning to any one of 8 crystal controlled frequencies in the range of 100 to 156 mc. The equipment consists of the R-77/ARC-3 receiver, the T-67/ARC-3 transmitter and the DY-21/ARC-3 dynamotor; all designed to operate from the usual 28 volt dc aircraft supply.

The R-77/ARC-3 receiver holds promise as a 2 meter, home station receiver and this article describes such a conversion. This unit is a 17 tube, crystal controlled, superheterodyne receiver. The 8 operating channels are selected by an electrically operated, motor driven tuning system that is entirely automatic.

The variable capacitors are driven by a motor which is controlled by the output of the harmonic generator so that the tuning drive mechanism is automatically stopped when the tuned circuits resonate at the desired harmonic of the crystal oscillator. "Lock out" of undesired harmonics on each channel is accomplished by "pre-set" switches mounted on the front panel. These switches, which are calibrated in mc, "unlock" the control system in those segments of the spectrum in which the desired harmonics occur.

The circuit employs an rf stage with a pre-selector and a five stage crystal controlled har-

monic generator, which produces a signal 12 mc lower than the incoming rf signal. This voltage is used to operate the tuning system and is also mixed with the incoming rf signal to produce the if frequency of 12 mc. Three stages of if amplification are provided, followed by a diode second detector. Delayed AVC, noise limiter and squelch circuits are employed and are followed by a three stage audio amplifier. The audio system uses heavy inverse feedback and provides a maximum output of 1.3 watts into a 600 or 30 ohm load.

In this conversion the motor drive is removed, the exterior is demilitarized, a new front panel with the required controls is added and an ac power supply and speaker are installed. Other changes include conversion of the crystal oscillator to a continuous tuning HFO, rf gain, audio gain and squelch controls. As the photographs show, the result is a commercial appearing receiver that, while not "state of the art," will produce acceptable results for local VHF work.

Initial work clears the deck for action. Remove the unit from the shock base and scribe marks on the oversize bottom plate, using the sides of the case as a guide. Remove the bottom plate and have the plate sheared to these marks. The local gutter shop will probably do the job gratis. Remove the top and the wrap-around sides and back. Drill out the rivets securing the 4 stabilizer brackets to the sides of this cover and discard the brackets. Retain the bottom plate, wrap-around cover and top, along with the mounting hardware. Remove and discard, along with mounting hardware, the crystal compartment door, the relay adjustment cover plate and the nomenclature

Christmas Suggestion



our word for it. Any owner of a Clegg Zeus or 99'er will tell you. Ask him about the wonders he's working with DX — the plaudits he's receiving from fellow hams about his signal — and the incomparable design, construction and operating features so unique with his Clegg unit!



CLEGG ZEUS VHF TRANSMITTER for 6 and 2 Meters

- ★ Highly efficient 185 watt AM, high power VHF transmitter for full coverage of amateur 6 and 2 meter bands and associated Mars frequencies.
- ★ Automatic modulation control with up to 18 db of speech clipping. Gives you "talk power" greater than many kilowatt rigs!
- ★ Self-contained stable VFO. Simple band switching and tune-up.

Amateur net price: \$675. Completely wired and tested with all tubes, Modulator, Power Supply, VFO, cables, etc.

For giving or getting . . . what more exciting gift can you imagine than one of these great ham stations by Clegg! But don't take



99'er 6 Meter TRANSCEIVER

- ★ A true ham station, ideal for both fixed station and mobile operation.
- ★ Double conversion superhet gives you extreme selectivity and freedom from images and cross modulation.
- ★ Transmitter section has an ultra-stable crystal oscillator which also may be controlled by external VFO.
- ★ Efficient, fully modulated 8 watt final works into flexible Pi network tank circuit. Large S meter serves for transmitter tune-up procedure.

Amateur net price: \$139.95.

We're sure you've heard glowing reports like these typical unsolicited comments that we are constantly receiving:

About the Zeus

" . . . I have been in amateur radio since 1912 and have been active ever since and will say that this transmitter is the finest that meets my opinion of what a transmitter should be . . ."

George R. Mathias, W9ZHR, Illinois

" . . . more than exceeds my expectations. I am in QSO with stations I never knew existed before . . ."

Leo Winter, Jr., D.D.S., WA2TIA, New York

"Have been using this rig for less than a month and all ready have worked twenty or more states on six meters. It is equally good on two meters. Get wonderful reports up and down the coast of California . . ."

Jay Mahoney, W6YDF, California

" . . . I am doing very FB with the Clegg, getting more than my share of DX . . . I have had some remarkable QSO's on your Clegg . . ."

William T. Shaw, W6BWK, California

ABOUT THE 99'er

" . . . Like all hams the first thing I did when I got home was to take it apart. We were amazed with the wiring job. Clegg did it better than the wiring in equipment costing \$1,000 . . ."

Ellis B. Hersh, W3IXL, Pennsylvania

Write for complete information today!

Clegg LABORATORIES

504 ROUTE 53, MT. TABOR, NEW JERSEY
OAKWOOD 7-6800

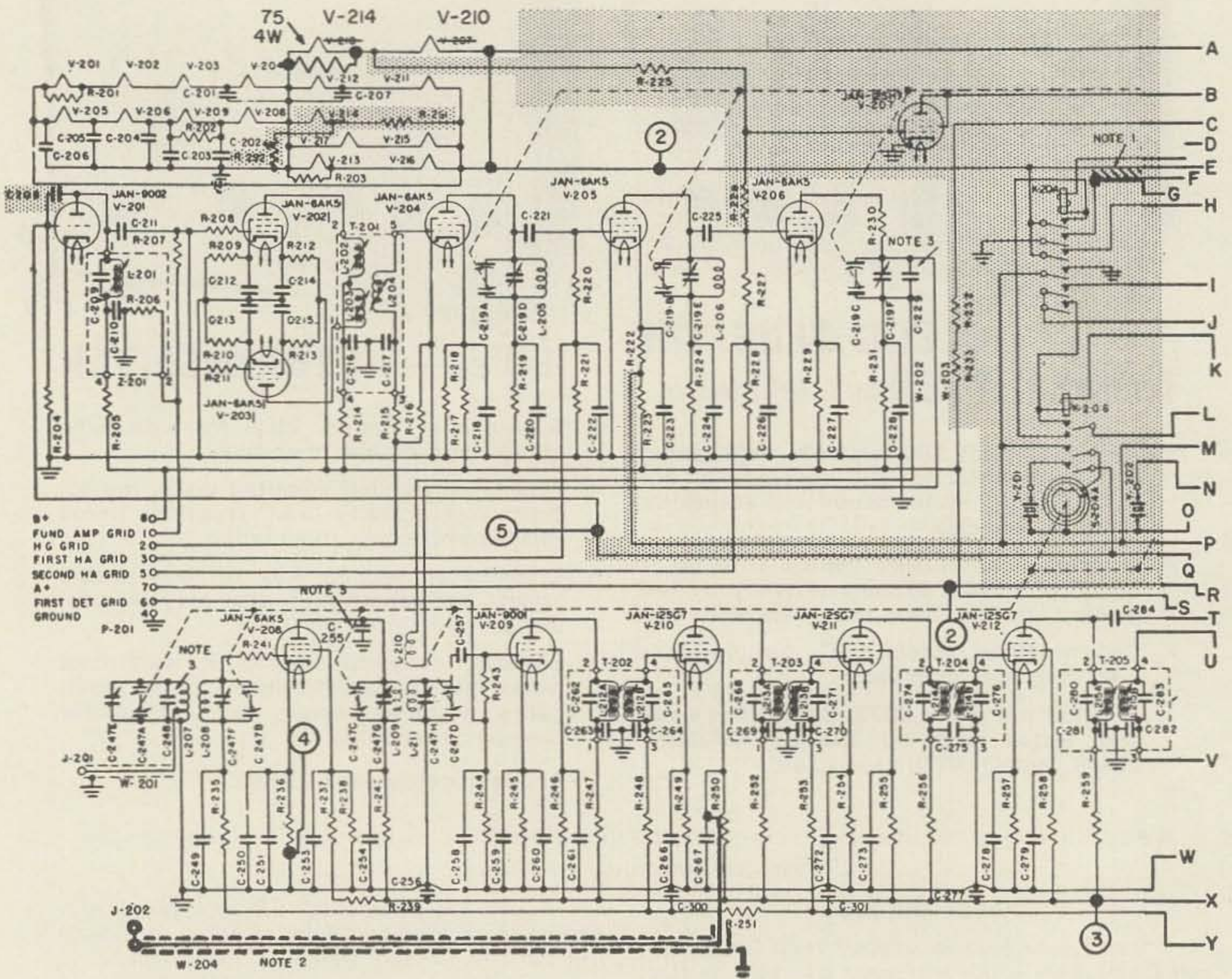

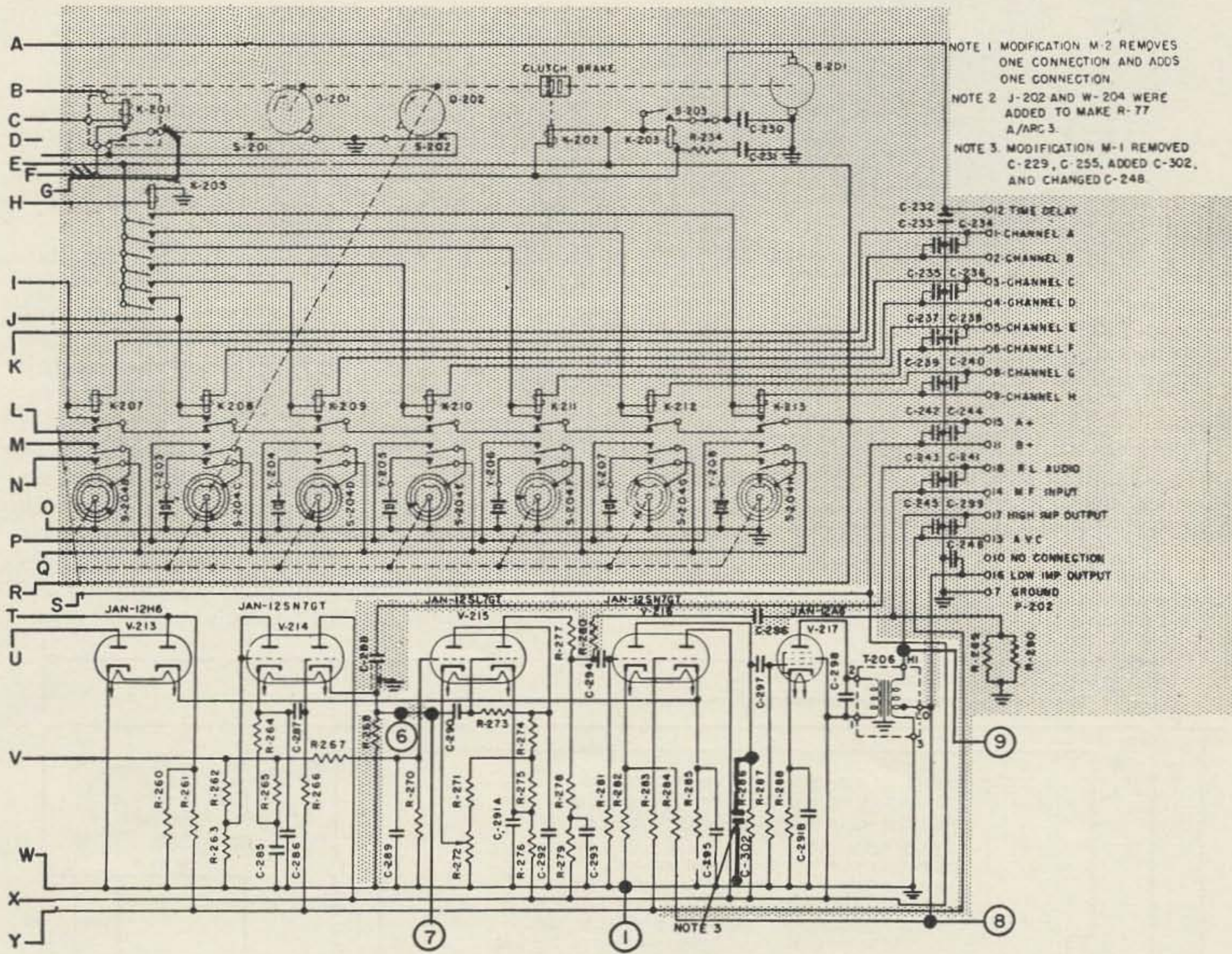

NOTE 1 MODIFICATION M-2 REMOVES ONE CONNECTION AND ADDS ONE CONNECTION
 NOTE 2 J-202 AND W-204 WERE ADDED TO MAKE R-77 A/ARC3
 NOTE 3 MODIFICATION M-1 REMOVED C-229, C-255, ADDED C-302, AND CHANGED C-248

NOTE 3

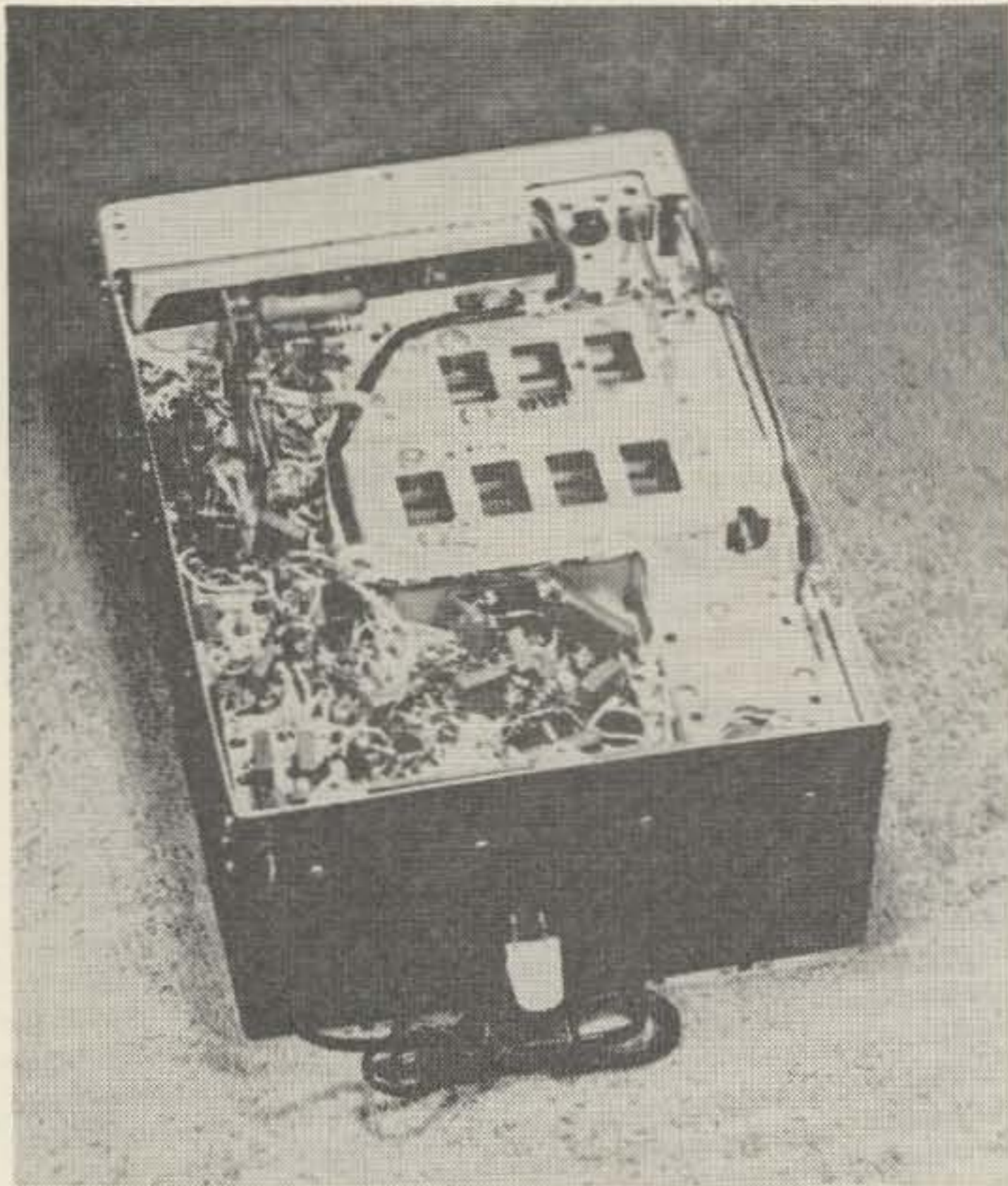

Bottom view of the converted receiver shows power supply components in the upper left corner of the chassis. Note that the tuning motor is removed.

plate.

Unsolder the two white wires from the drive motor terminal board. Solder these two wires together, insulate and dress next to the chassis. Remove and discard the following wiring:

From	Color Code	To
Junction R-234— K-202 Coil	White-Black-Orange	Pin 4, K-201

Pin 4, K-201	White-Black-Orange	Contact, K-203
Junction C-230— B-201	White-Brown-Blue	Contact, S-203
Contact, S-102	White-Brown-Blue	Contact, K-203
Coil, K-203— Contacts K-204 and K-205	White	R-201
Coil, K-204	White-Black-Red	Pin 3, K-201
Pin 3, K-201	White-Black-Red	Contact, S-202
Contact, S-201	White-Black	Pin 2, K-201
Pin 2, K-201	White	Contact, K-204
Contact, K-204	White-Black	Chassis Ground
Contact, K-204	White-Orange	R-223
Pin 5, K-201	Resistor Lead	R-232
Pin 1, K-201	White-Red	Pins 6 & 8, V-207
Pin 4, V-207	White-Green	R-226

Remove and discard the following parts, leaving other wiring undisturbed: Capacitor, C-231; relay K-201 and its socket; switches S-101, S-102 and S-103; and motor drive B-201 along with clutch, K-202.

Remove all hardware that mounts components to the front panel and the screws which secure the panel to the chassis. Remove the panel, drill out the rivets which hold the crystal door reinforcing strip in place and discard the strip. Cut the old panel as shown in Figure 1 and peen the extruded mounting for P-202 over to form a smooth surface. Sand or steel wool the old panel to a bright finish. Drill and cut the new face panel as shown in Figure 2. Make sure that the holes in the two panels register to allow mounting of the controls. Finish the new face panel in your favorite color and set both panels aside.

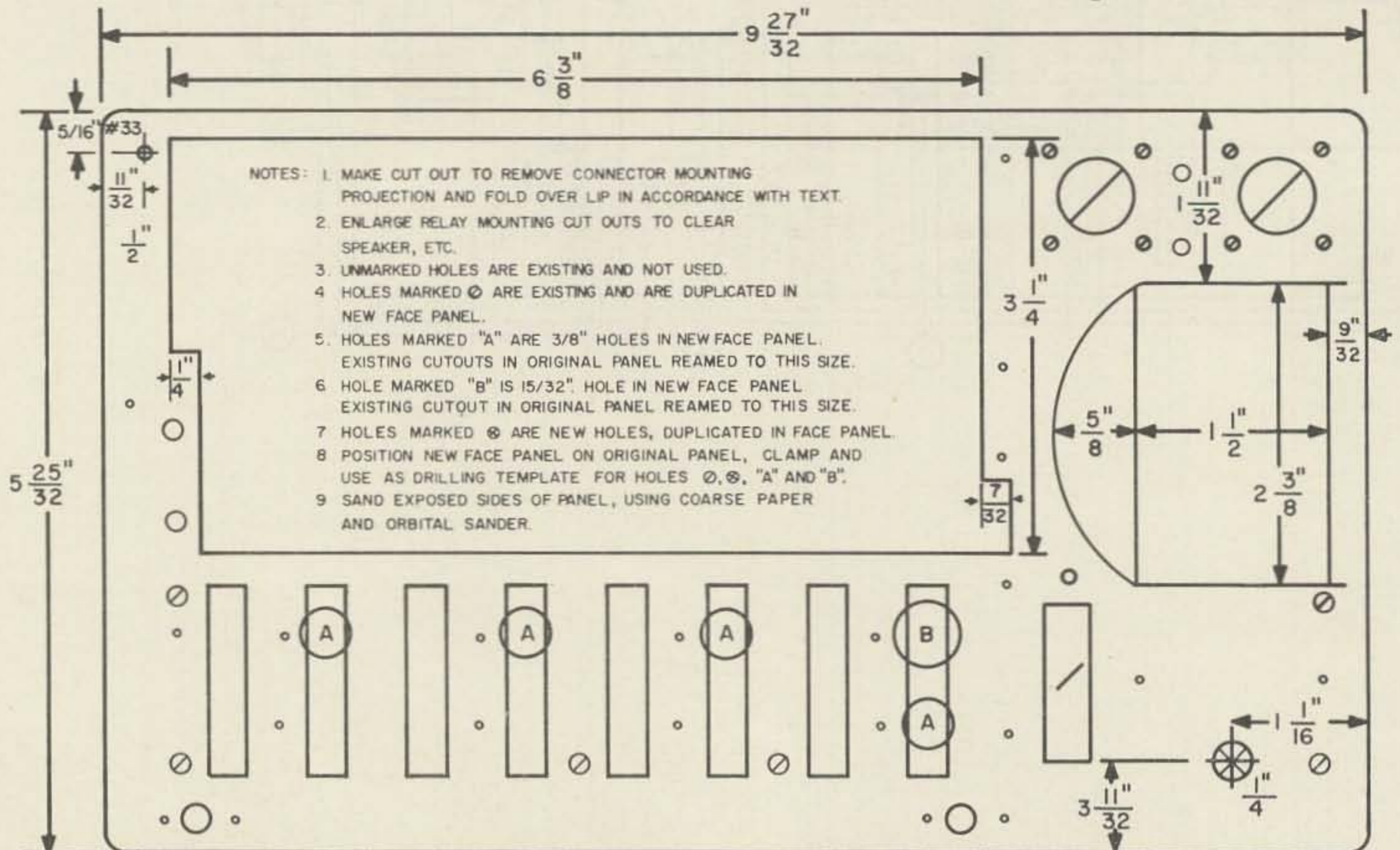

Fig. 1

BULLSEYE BUYS at ARROW!

R.C.A. POWER LINE MONITOR

Keeps a constant check on your line voltage.

- Expanded Scale • 100 to 140 V. RMS
- Accuracy $\pm 2\%$ at 120 V., $\pm 3\%$ at 100 or 140 V.
- Large 4" meter face
- Convenient wall mount

Mod. WV-120A \$14.95



AMECO NUVISTOR CONVERTERS

Choice of separate models for 50, 144 or 220 mc bands. Output frequency easily changed for present and future requirements. Three RCA 6CW4 Nuvistors used, two as RF amps, one as mixer with 6J6 oscillator. Noise figure: 2.5 db for 50 mc model, 3.0 db for 144 mc, and 4.0 db for 220 mc model. Image, spurious and IF rejection better than 70 db. Power required: 100-150 V @ 30 ma, 6.3 V @ 1 amp.

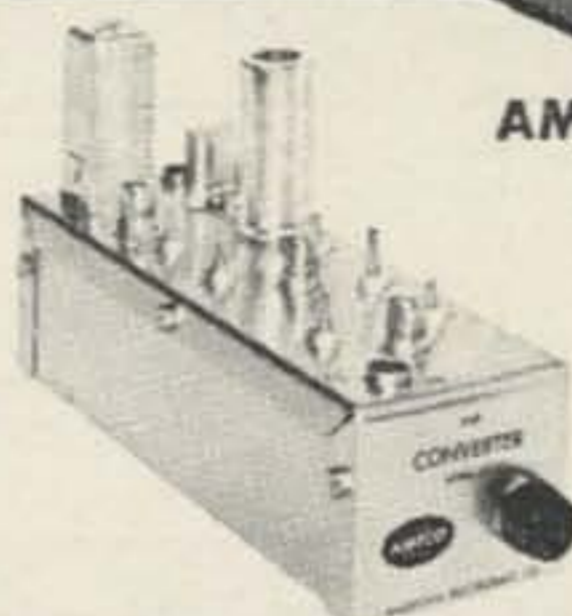

Specify desired IF output for converter model selected.

Kit: CN-50K, CN-144K, or CN-220K, each \$31.95

Wired & Tested: CN-50W, CN-144W or CN-220W, each \$44.95

PRECISION PLANETARY-VERNIER

for exceptionally fine tuning
Superb craftsmanship by Jackson Bros. of England. Ball bearing drive, 1/4" dia. shaft, 1 1/8" long, 6:1 ratio, V_y FB for fine tuning. Easily adaptable to any shaft. Comparable value — \$5.95.

Amateur Net \$1.50 ea.
10 for \$13.50

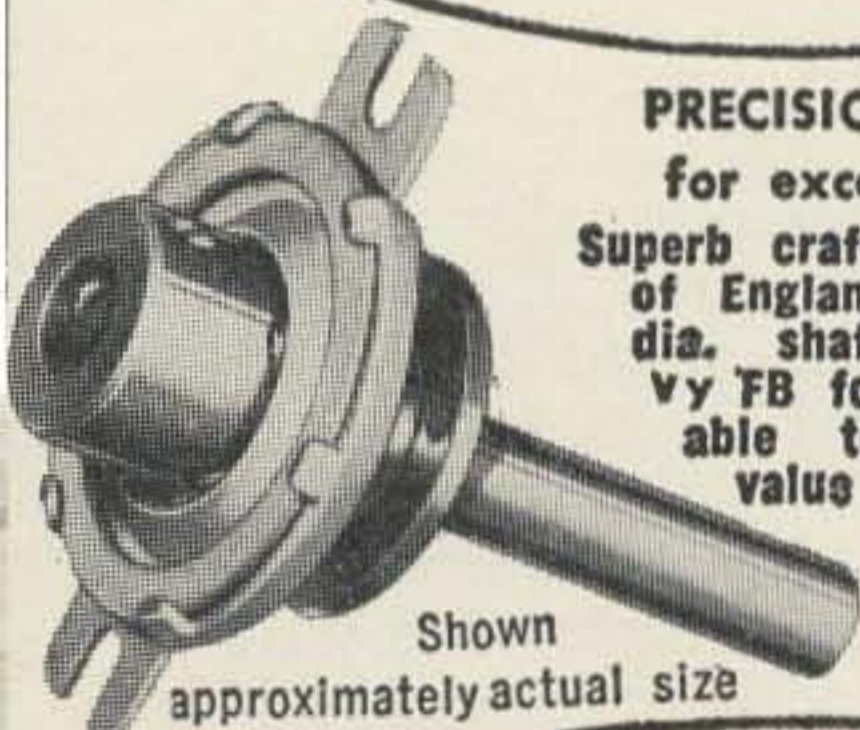

Shown approximately actual size

24 HOUR CLOCK

24 hr. chrome plated 8" metal wall clock. Inner dial with south polar projection map of world indicates time around world. Polar projection dial adjustable for various time zones. Shpg. wt. 2 lbs.

110 V. 60 cy. \$8.47

12", 24 hr. clock,

110 V. 60 cy., without world map. \$13.95

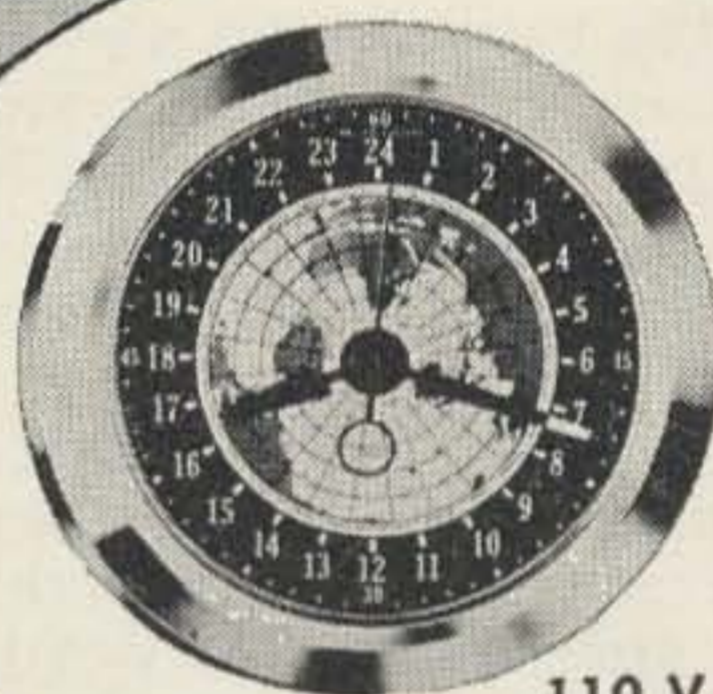

PRECISION BALL DRIVE DIAL

Another superb product of Jackson Bros. of England. 4" dia. dial with 6:1 ball drive ratio. Fits standard 1/4" shaft. For that velvet touch...

Amateur Net \$3.95

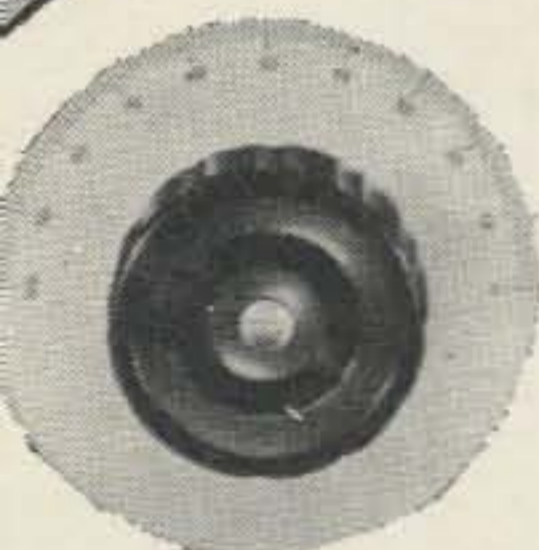

COMANCHE SIGN

Controllable, illuminated sign that tells the XYL and guests you're transmitting. Cuts down background QRM. Can hook right into coil of antenna change-over relay for controlled

"ON THE AIR" signal when XMTG. Heavy gauge all steel construction with handsome black or gray baked finish. Can be used on desk or tabletop or mounted directly on wall. Dimensions 10 1/2" long x 3 1/2" high x 3" deep. Specify desired finish in black or gray and operating voltage: 6 or 12 VDC, or 110 AC.

Amateur net \$6.95



AMECO NUVISTOR PREAMPLIFIER

FOR 50, 144 or 220 mc.
Over 20 db gain plus a lower noise figure, 2 tuned ckts, 6CW4 Nuvistor completely neutralized. Noise figure is 2.5 db @ 50 mc, 3.0 db @ 144 mc and 4.0 db @ 220 mc. Power requirements: 100-150 v. @ 8 ma, and 6.3 v. at .13 amps. Specify frequency desired.

Mod. PV, wired and tested \$13.95

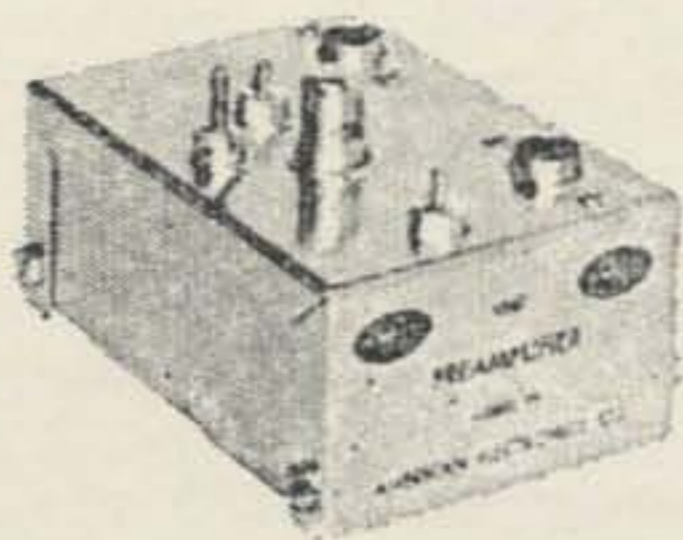

MAIL ORDERS PROMPTLY PROCESSED
SAME DAY SHIPMENT FROM STOCK

ARROW ELECTRONICS, INC.

65 Cortlandt Street, New York 7, N. Y. • Dlghy 9-4730
525 Jericho Turnpike, Mineola, N. Y. • Ploneer 6-8686

TO SAVE C.O.D. CHARGES, PLEASE INCLUDE SUFFICIENT POSTAGE WITH YOUR ORDER. ANY EXTRA MONEY WILL BE RETURNED.

ALL PRICES F.O.B. N. Y. C.
Arrow's Export Dept. Ships To All Parts Of The World!
Prices Subject To Change Without Notice.

SAY! YOU SAW IT IN 73

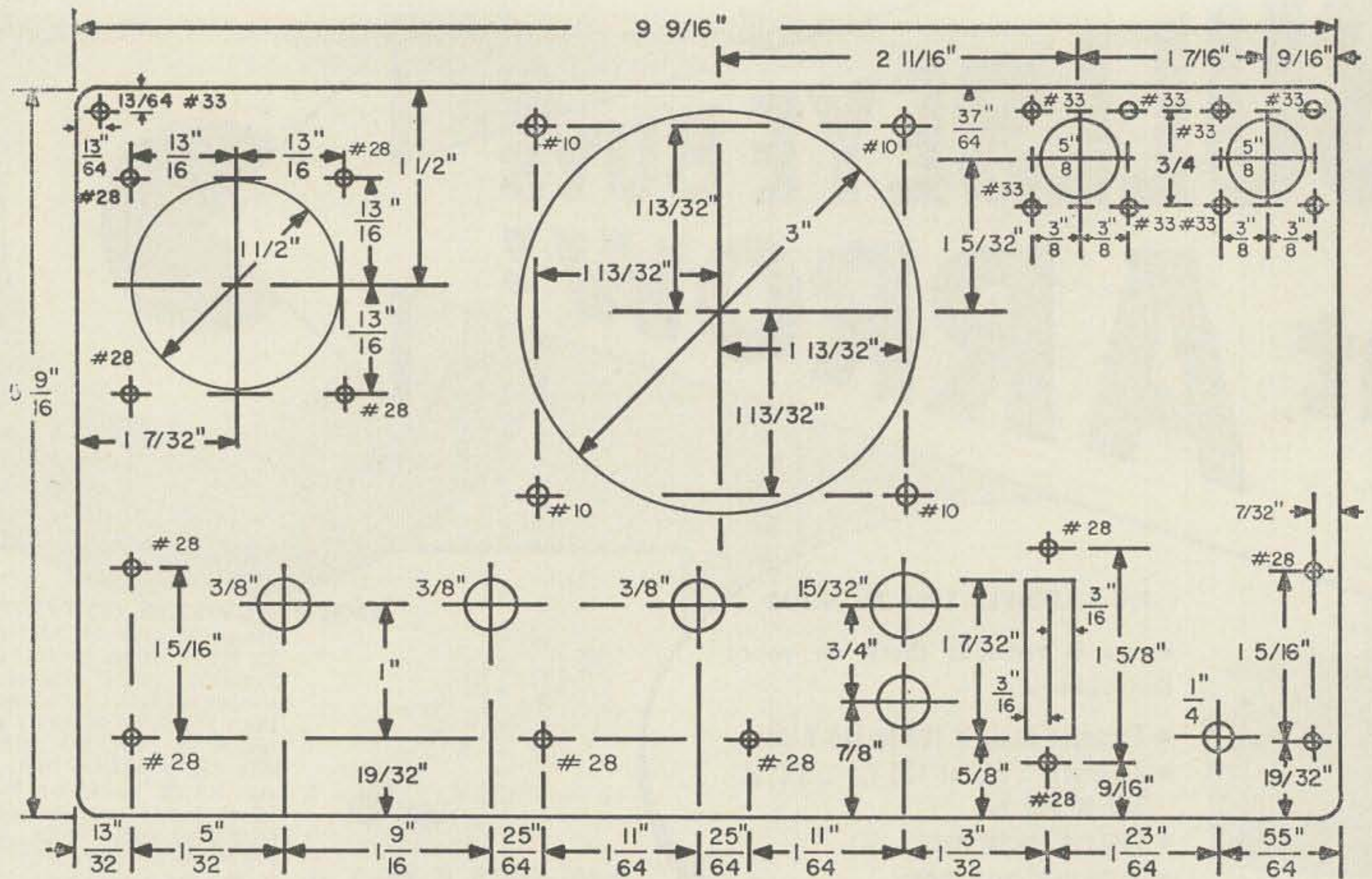

MATERIAL: 16 GAUGE ALUMINUM
 FINISH: MACHINE SAND BOTH SIDES. PRIME AND APPLY TWO COATS FLAT BLACK LACQUER TO FRONT ONLY.

Fig. 2

Clip the 8 leads running between the crystal sockets and their respective relays and discard the socket. Cut out and discard capacitors C-233 through C-240 and clip the leads attached to pins 1, 2, 3, 4, 5, 6, 8 and 9 of P-202. Of the two white leads attached to pin 15, clip the one that runs to a contact of K-213. Clip and remove the 8 leads running between the relay bank and the selector switch. Unsolder the green and white lead from pin 6 of V-201, along with one end of capacitor C-208. Clip the other lead of this capacitor and discard. Remove the screws mounting relays K-203, K-204 and K-205 and clip the single ground lead still attached to these relays. Leave the cable intact that is connected to the relays and discard all 11 relays.

Loosen the set screws which secure the flexible shaft to the selector switch-dial assembly. Remove and retain the worm gear drive and mounting screws. Loosen the set screws holding the spring-loaded gear, shaft collar and the 8 switch rotors. Slide out the shaft and retain along with the spring washer, shaft collar and dial drum. Discard the 8 switch rotors; remove and discard the 8 switch stators. Reassemble the shaft, dial drum, shaft collar and spring washer in their original positions.

Remove the nut retaining the worm gear, saving the ball bearings. Drill on the front end of the mounting bracket to clear a 3/16" shaft. Form the end of a 7/8" length of 3/16" brass rod to fit the recess in the front end of the

gear. Tin both parts, clamp in alignment and sweat solder the shaft in place. Install spacer washers between the front of the gear and the bracket to place the gear in its original position. Place the bearings in the retaining nut, securing them in place with a smear of grease. Install the nut in position, tightening so that the shaft turns easily without excessive play. Re-install the gear assembly on the bracket, properly meshing the spring-loaded gear. Set the assembly aside.

On connector P202, cut loose and discard capacitors C-232, C-241, C-242, C-243, C-244, C-245, C-246 and C-299. Slit the lacing on the cable leading from P-202 to the point where it is clamped to the chassis. Remove and discard the white-brown-orange lead running from pin 12 of P-202 to pin 2 of V-207. Clip the white lead attached to pin 15 of P-202, pull through the wiring harness and coil in the vicinity of V-207 socket for future 24 volt ac connection. Remove and discard the white-brown-brown lead running between pin 13 of P-202 and pin 8 of R-291.

Remove and discard the white-brown-red lead which runs between pin 14 of P-202 and the junction of R-289, R-290 and C-296. Remove and discard these components along with the chassis ground lead connected to R-289 and R-290. Remove and discard R-280 along with the white-orange lead which was connected to C-296. Clip the white-red lead attached to pin 11 of P-202 and pull through the wiring har-

with the great new

SHURE

440 SL

HAM MICROPHONE

minimize
splatter

ONLY
\$28⁵⁰*



- Sharp Cutoff Below 300 and Above 3000 cps — Minimizes Splatter, Reduces Unwanted Sideband.
- Elimination of resonant peaks permits higher average power — more audio punch.
- Shaped frequency response — Superb Intelligibility — Naturalness of voice.
- Trouble-Free Controlled-Magnetic Design — Hi-Output — 52.5 db — Extraordinarily Rugged — No humidity problems.
- Complete with Grip-to-Talk Switch, Desk Stand, 2-Conductor Shielded Cable. Will operate VOX and Grip-to-Talk.

Complete with stand, grip-to-talk switch, 7 ft. highest quality 2 conductor shielded cable. Cable connector equivalent to Amphenol MC3M plug.

WRITE FOR LITERATURE: Dept. No. 52-H

Shure Brothers, Inc., 222 Hartrey Ave., Evanston, Ill.

*Amateur Net

MICROPHONES, HIGH FIDELITY AND ELECTRONIC COMPONENTS

ness to where it terminates at the junction of R-223 and R-233. Coil the lead at this point and retain for future B+ connection.

Clip the white-brown-blue lead attached to pin 16 of P-202 and coil in the vicinity of the cable clamp for future loudspeaker connection. Clip the white-black-brown lead attached to pin 17 of P-202 and coil in the same location for future phone jack connection. Clip the shielded lead attached to C-288, discarding C-288, its mounting bracket and P-202. Pull the shielded lead through the wiring harness to where it terminates at C-290. Unsolder and discard this lead.

Remove resistor R-291 from its socket and insert a blank plug to prevent future, inad-

vertent use of the socket. Unsolder the white-brown lead from pin 7 of V-207 and connect to pin 2 of R-291 socket. Remove the white-brown lead running from pin 7 of R-291 to pin 7 of V-214. Install a 75 ohm, 4 watt resistor between pins 2 and 7 of V-210. Discard V-207 and clean up the socket for installation of a plug-in filter capacitor.

Remove and discard R-268 which is connected between pin 3 of V-214 and ground. Unsolder the white-orange lead which joins pin 3 of V-214 and C-290 from C-290 and connect to the terminal board pin to which R-280 was formerly terminated. Connect a two conductor, shielded cable, one lead to this point and the other to C-290, and route to the front panel

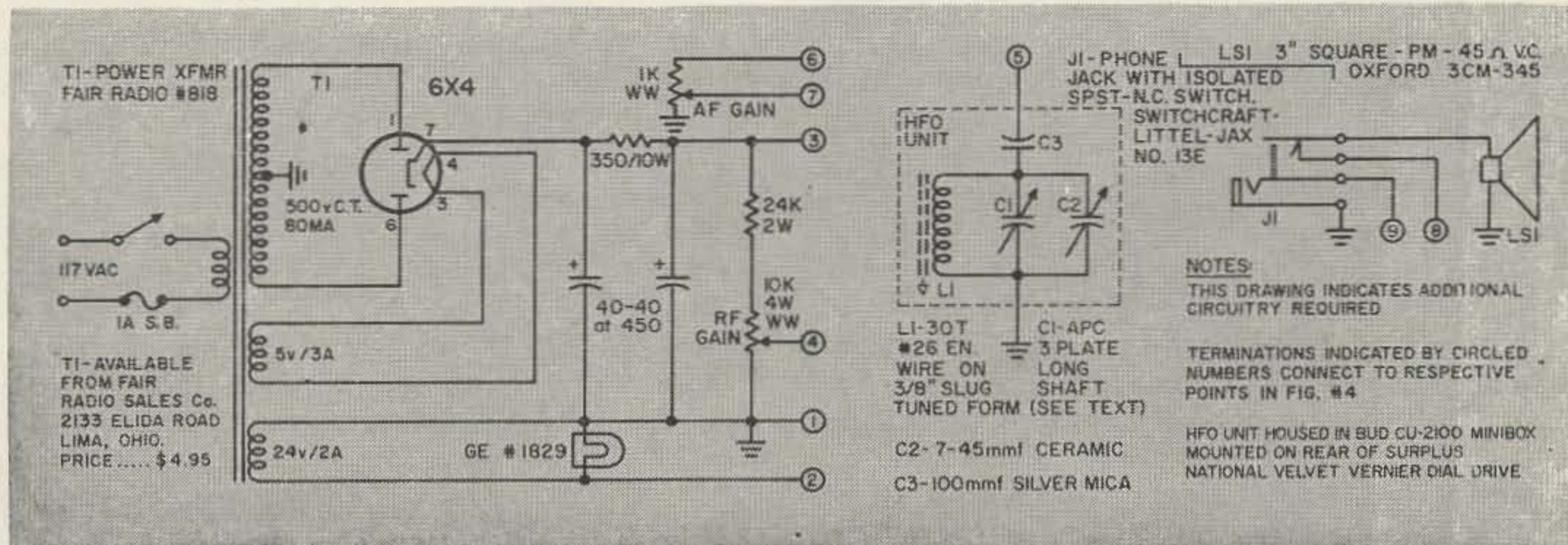

Fig. 4



Top view of the converted receiver shows the HFO box and the speaker mounted on the front panel. Power supply components are mounted in the upper right corner of the chassis.

area for future audio gain control connection.

Lift the ground lead of the rf stage cathode resistor, R-236, and connect to an insulated wire. Route this lead through an existing cable run to the vicinity of the front panel for future rf gain control connection. This completes the preparatory work on the chassis and we are now ready for the new wiring.

The first step is to mount and wire the ac power supply components. The Fair Radio Company power transformer specified in Figure 4 is designed for surplus conversions and its use greatly simplifies such jobs as this. Mount the power transformer, the 6X4 socket, the fuse holder and the other components in the general areas shown in the photographs. If a plug-in filter capacitor is available, it may be installed in the empty V-207 socket. Otherwise, remove the socket and install a twist-lock type capacitor.

Drill a clearance hole in the back of the case for the power cord and wire the power supply in accordance with Figure 4, making interconnection to the previously mentioned B+ and 24 volt ac points. Route the ac switch leads to the vicinity of the front panel, along with a 24 volt ac lead for the pilot light.

Place the new finish plate over the old front panel and mount all components except the HFO dial assembly in the locations shown in the photograph. Note that the squelch control is replaced by a standard shaft, 1,000 ohm control. Mount the modified selector switch-dial assembly in its former location and install a bayonet type socket with a #1829 lamp so as to illuminate the dial scale. Remove the knob from the top of the old tuning drive

motor and install on the new shaft which extends through the front panel.

Wire and ground to the panel all common ground points of the panel mounted components and install the lead between the phone jack switch and the speaker. The 45 ohm voice coil speaker provides a reasonable match to the 30 ohm output tap and saves the cost of a line matching transformer.

The new HF oscillator tuning assembly should now be constructed. The dial drive is a National Velvet Vernier unit salvaged from a surplus tuning unit and fitted with a scale from the junk box. A Bud Minibox is supported on standoff posts from the rear of the drive. The tuning capacitor, a 3 plate APC unit with a 1/4" shaft, is installed in the top-center of the box and sub-mounted 3/8". Mount the capacitor and drill 4 holes in the top of the box to match the drive unit mounting holes.

Mate the capacitor shaft with the dial drive coupler and mount 4 internally threaded standoff posts of appropriate length to the front of the box. Set the capacitor to maximum capacity and the tuning dial to 100. Press the posts firmly against the rear of the drive unit and tighten the coupler set screws. The assembly will be mounted by screws running through the front panel, the dial drive flange and threaded into the standoff posts. Mount the coil form and the ceramic trimmer capacitor, drilling clearance holes for adjustment. Drill a hole in the right end of the box to pass the grid lead.

Decision must now be made as to the projected frequency coverage of the converted receiver. Crystals in the range of 8,000 to 8,727 kc were used in the original circuit and full coverage obtained by using various harmonics in accordance with the following chart:

<i>Air Frequency (mc)</i>	<i>Crystal Harmonic</i>
100-108	11
108-116	12
116-124	13
124-132	14
132-140	15
140-148	16
148-156	17

If you are content with the 2 meter band spread over 30% of the HFO dial, then full coverage from 100 to 156 mc may be obtained by making the grid circuit tune from 8,000 to 8,727 kc. If you desire maximum bandspread on 2 meters and are not interested in other coverage, then construct the unit to tune from 8,250 to 8,500 kc. Wind the coil and wire the circuit as shown in Figure 5. Extend a heavy, solid conductor wire for the grid connection. Using a grid dip meter, juggle the coil slug and trimmer capacitor to obtain the desired coverage. Number of coil turns and tuning capacitor plate spacing may also have to be adjusted. Final adjustments must be made

after the set is working.

Install the cover on the HFO unit and mount on the front panel. Position the panel assembly at the front of the chassis and wire the components in accordance with Figures 3 and 4. Install the wrap-around sides and back, using the original hardware. Slide the panel into final position, engaging the flexible shaft in the coupler. Install the panel mounting screws. Set the capacitor gang to minimum capacity, the dial drum to 156 and tighten the coupler set screws.

Inspect your work, make an ohmmeter check and, if all is well, apply power. Tune in the high frequency oscillator signal on a local receiver and touch up the coil slug and trimmer capacitor to give the desired coverage. The HFO dial scale may be calibrated directly or calibration charts made up. In either case, determine the proper harmonic from the preceding chart and apply the following formula to determine the HFO setting:

$$\text{HFO FREQUENCY} = \frac{\text{AIR FREQUENCY} - 12\text{MC}}{\text{HFO HARMONIC}}$$

Connect an antenna, advance the gain controls and the squelch and you should be in business. Set the HFO and the capacitor gang to the desired frequency and then touch up the capacitor gang tuning for a noise peak. Signals should be received with good volume and excellent quality. If 2 meter activity is limited in your area, the 100 to 108 mc segment of the FM broadcast band is a good place to get the feel of the receiver. Slope detection of the FM signals results in amazingly good quality. In normal use, set the HFO to the desired frequency and use the capacitor gang tuning control as you would an antenna trimmer.

Attractive, functional control knobs and commercial decals dress up the equipment and give that commercial appearance. In the unit shown in the photographs, the wrap-around cover was given a coat of flat black, spray lacquer. This contrasts nicely with the bright aluminum sides of the original panel.

Other refinements may be added as desired. A cascode preamplifier would undoubtedly improve the signal to noise ratio and provide more gain. A touch up of the alignment, both *rf* and *if* is definitely recommended and may be accomplished on a weak signal in the most used portion of the band. If the audio gain is considered inadequate, it may be substantially improved by removing the inverse feedback resistor, R-284.

All in all, this is a very satisfactory conversion. There is lots of work involved but the low initial cost compensates for that. While not a "hot" receiver, the stability and reliability, effective noise limiter and the overall performance make it FB for local work.

... W4WKM



**NO
"ANTENNA PARTIES"
with the NEW TRI-EX
CRANK-UP/CRANK-OVER
TOWERS**

New Two-Way-Hinge-Over Pilot Base, either in concrete or earth mounting models, eliminates climbing . . . eliminates cranes or A-frames . . . eliminates "antenna parties" (one man job) . . . gets your beam up faster . . . gets you on the air faster.

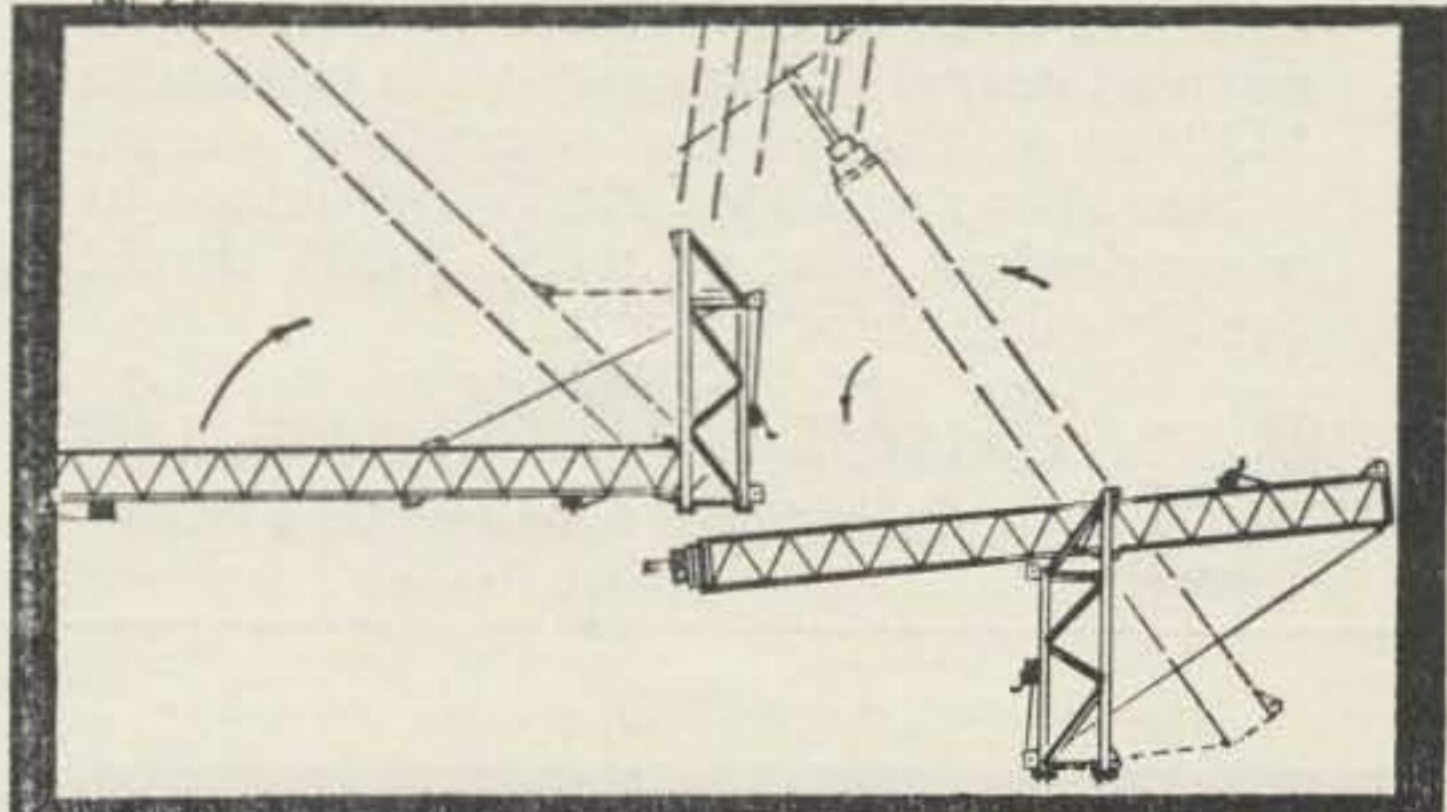

3-STEP INSTALLATION

- 1—Install foundation unit either directly in earth excavation, or concrete, as desired.
- 2—Attach upper base unit and fasten tower to lower bracket.
- 3—Raise tower to vertical position with 9-to-1 winch on pilot base, swap holding bolt positions, and you have a hinged, crank-up/crank-over SELF-SUPPORTING tower. That's all there is to it!

The new Tri-Ex series is available in 37 and 54 foot models (actual full height is exclusive of mast). Design of tower permits use without guying, and the unique 30-degree bracing of alternating design assures highest degree of strength and wind resistance.

HEAVY DUTY SERIES

Model HDM-237	2 Section	37 feet
Model HDM-354	3 Section	54 feet

Tri-Ex manufactures a complete line of communications towers for every ham, commercial, industrial and military requirement.

See your distributor for complete literature and prices on the complete line of Tri-Ex Towers, or write direct to:

TRI-EX TOWER CORP.
2920 WEST MAGNOLIA BLVD.
BURBANK, 3 CALIFORNIA



pi-network coils provide complete line



Model 851
\$16.50



Model 850A
\$35.00

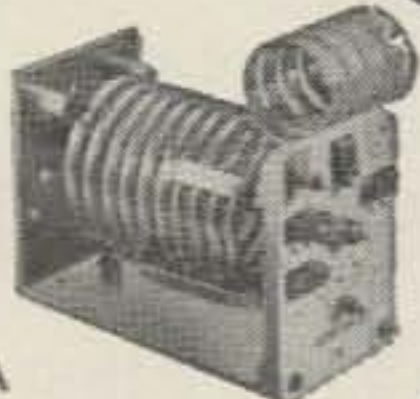

Model 852
\$39.50

Now—Pi-Network inductors specially tailored for your needs. Here are highly-efficient, super compact tank coils incorporating the unique feature of integral band switching.

Model 850A and Model 852, now complement the famous B&W Model 851. All are designed for single or parallel tube operation on 80, 40, 20, 15, 11 or 10 meters, with top efficiency in Class "C" or linear operation. Windings give ample current carrying capacity with optimum "Q" over the entire operating range.

See these superior B&W inductors at your dealers *now*, or write B&W direct for detailed information.



Barker & Williamson, Inc.

Canal Street & Beaver Dam Road
Bristol, Penna.

New Product

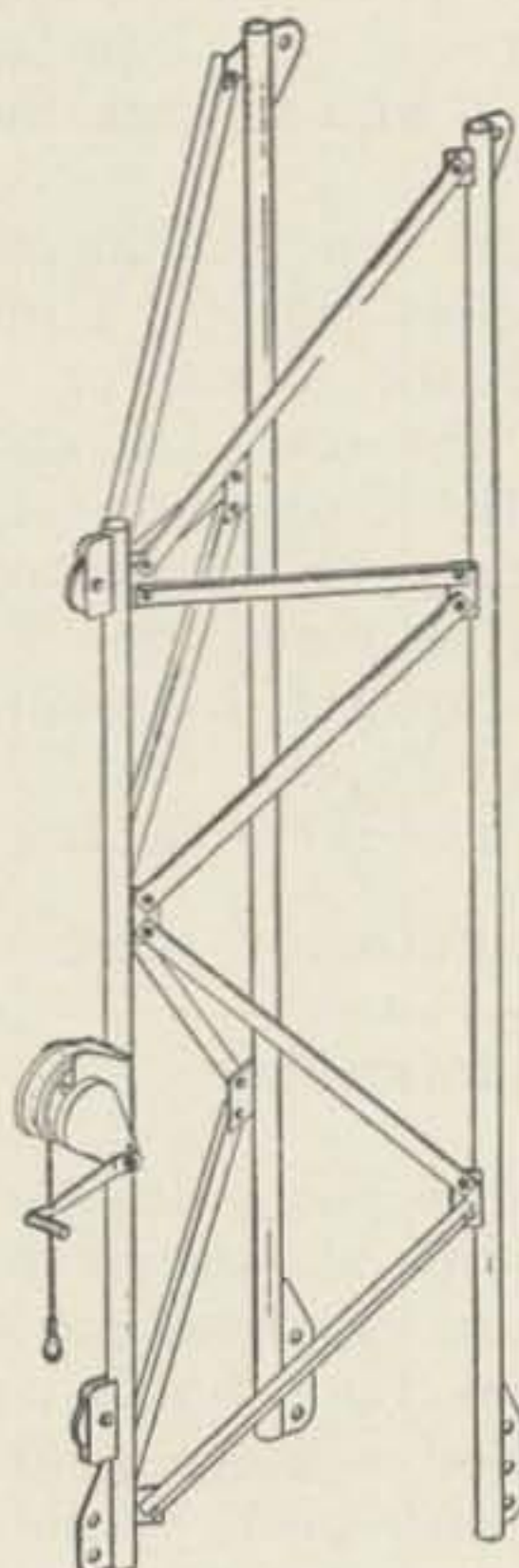

New two way hinge over base.

Starting with the tower lying flat on the ground, one man can hoist this husky, self-supporting TRI-EX tower without the help of half the neighborhood or a crane. The secret is a new two-way-hinge-over pilot base which works so slick you will "ooh" and "ah" when you see it. After the initial hoisting job, the tower pivots on the higher point of the two-way base and can be raised and lowered for antenna adjustments just as easily as cranking up the old Model T. And this is a hefty tower, too, all first class hardware. Another feature that insures maximum tower strength at any given height is the fact that as the tower rises, the telescoped sections space out *evenly*, that is, maintaining uniform overlap and therefore uniform tower strength. Neat, huh? Minimum overlap 3' with precision fitting for maximum rigidity. All sections are heavily built and the top section (13 $\frac{7}{8}$ "") will accommodate large rotators. Tower can be any height you wish, up to maximum, as large heavy duty raising/lowering cable renders "stops" unnecessary. Take a look at one, or send for their literature. It's in that rare class of hardware that's an aesthetic pleasure just to see, or to watch in operation. *Really*, as the saying goes, *built*.

TRI-EX Tower Corporation, 2920 W. Magnolia Blvd., Burbank, Calif.



Stop That Noise with HYPASS® FEED-THRU CAPACITORS

- Exclusive Sprague 3-Terminal Networks
- Extremely Effective as R-F Filters Above 2 Mc. Effectively Suppress TVI from Transmitters, Diathermy Equipment, etc.
- Mobile Applications Include Elimination of Generator and Regulator Hash, as well as Primary Ignition Noise
- Available in a Variety of Ratings from .002 to .5 μ F, from 15 to 40 amps, from 50 to 5000 volts
- GET THEM FROM YOUR LOCAL ELECTRONIC PARTS DISTRIBUTOR

SPRAGUE PRODUCTS COMPANY

world's largest manufacturer of capacitors
NORTH ADAMS, MASS.

Sturdy, Professional Appearing Custom Equipment Housings Made From Readily Available Materials, Using Woodworking Tools and Techniques. "Post and Plate" Construction Method Eliminates the Chassis Problem and Makes for Easy Assembly.

Economical Custom Construction

WHILE an ever increasing number of electronic equipment cabinets are reaching the market, it seems that the exact size and style to suit the immediate construction project is never available. While the modular type housings provide an answer, the current prices on these items preclude their use in many amateur construction projects. On the other hand, if an enclosure is on hand to house the particular circuitry envisioned, the ugly problem of locating a suitable chassis takes over.

The obvious answer to both the chassis and cabinet problem is to build your own. However, we are not all experienced sheet metal workers and, even if we were, lack of suitable machinery can make the work very difficult. The photographs show a harmoniously compatible solution to both problems. Cabinet construction uses rectangular panels of laminated hardboard and "do it yourself" aluminum, rigidly secured by slip fit, interlocking sections of outside corner, tileboard moulding. The "post and plate" technique of assembly solves the chassis problem by eliminating the conventional chassis and using easily fabricated aluminum plates supported from the panel surface by standoff posts.

The cabinet panels are made of $\frac{1}{8}$ " tempered masonite which has .02" embossed sheet aluminum bonded with contact cement to what is normally the back side of the hardboard. The aluminum used is Reynolds Metals Company "do it yourself" stock which is available in all hardware stores. The stock shown in the photographs is Reynolds #28 square embossed pattern and is priced at \$2.99 per .02" thick, 36" x 36" sheet. Other styles, available at the same price and appropriate to this method of construction, are the #1 plain aluminum, #2 leather grain embossed, #27 wood grain em-

Roy E. Pafenberg W4WKM
709 North Oakland Street
Arlington, Virginia

Photography by: Morgan S. Gassman, Jr.

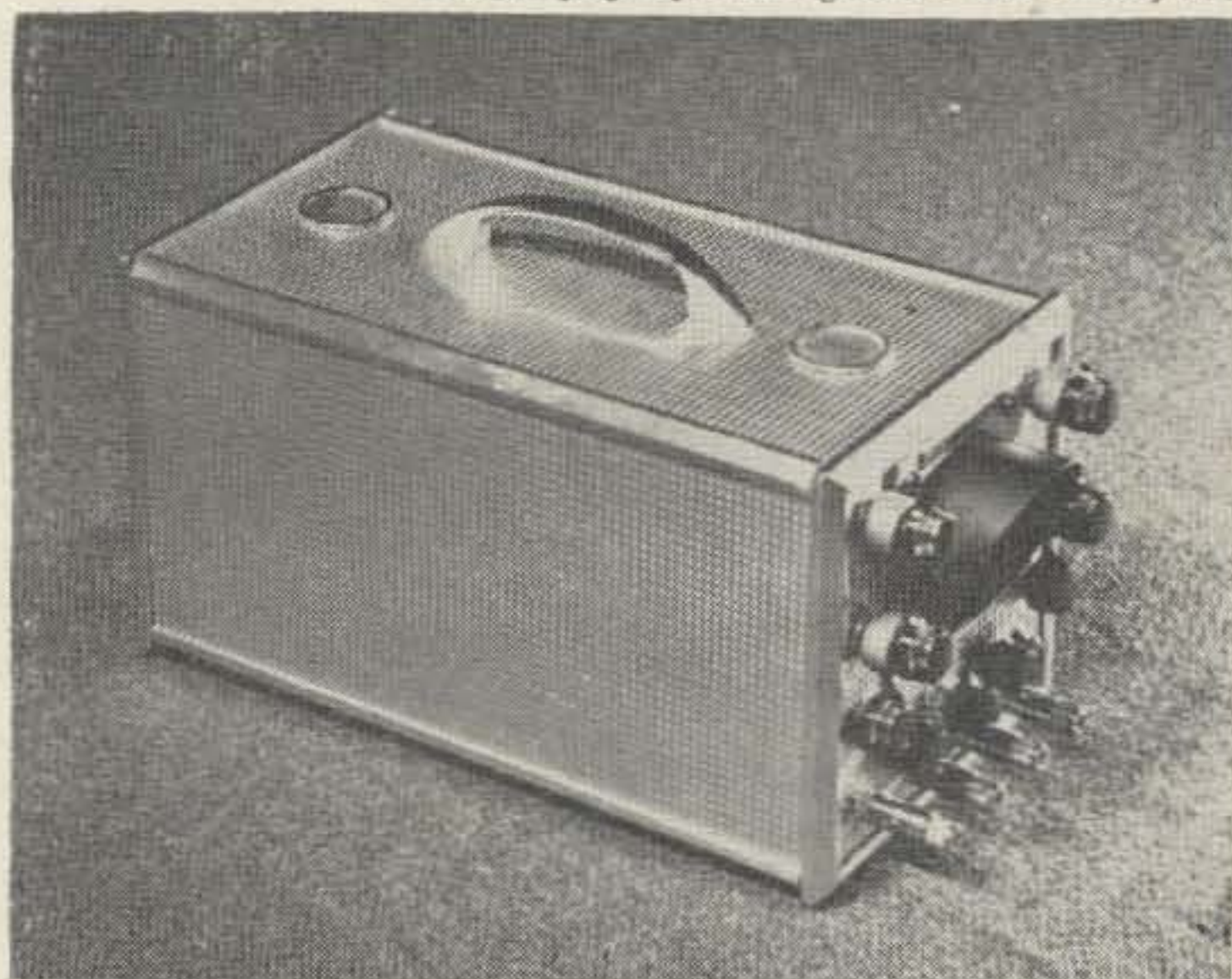

This compact scope unit is an example of construction using the techniques developed in the text.

bossed and the #33 lincane perforated sheet.

The tempered masonite is smooth on one side and rough on the other. Since the aluminum extrusions are designed for use with $\frac{1}{8}$ " thick material, it is necessary to remove stock from the rough side of the hardboard equal in thickness to the aluminum sheet and contact cement used for bonding the laminate. When the material is purchased, have the lumber yard run the masonite through a planer and make a $\frac{1}{2}$ " cut on the rough side. Some static may develop to the effect that the masonite is super-hard and the planer blades would be ruined on the job. This is not true. The reverse side of the tempered masonite is little more than fuzz to the indicated depth and a perfectly smooth surface results with none of the vibration or noise symptomatic of equipment abuse. Many lumber yards will make the planer cut at no cost in the interests of good

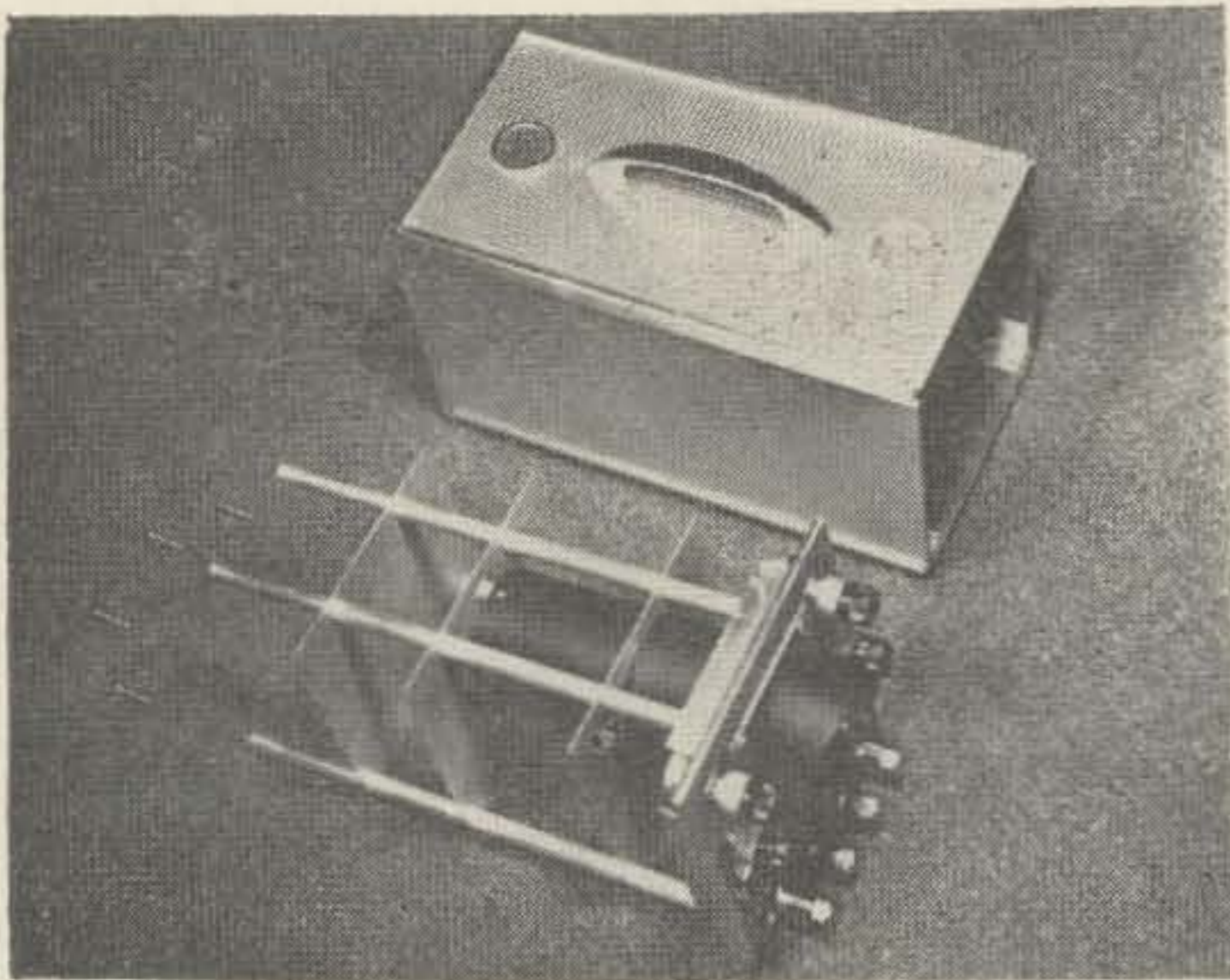

Scope foundation unit uses "post and plate" construction described in text. Screws through the back of the cabinet are threaded into the posts and clamp the cabinet together.

will. If not, the charge will be nominal.

The most economical panel size will be dependent on the capacity of the planer. Since the masonite is available in 2' x 4' panels at around \$1.00 per sheet and 24" is the maximum capacity of many planers, this is probably the size you should buy. Cut, or have cut at the time of purchase, the planed masonite in two pieces, 2' x 3' and 1' x 2'. Cut a sheet of aluminum to the same sizes and retain the 1' square piece for future projects. The aluminum is soft and may be cut with tin snips or, according to Reynolds, with household shears. Roughen the back side of the aluminum with coarse sandpaper and apply contact cement to this surface and to the back side of the masonite. There is nothing difficult in the use of this adhesive but the instructions on the container must be followed to the letter.

When the cement is thoroughly dry, position the aluminum over the hardboard and press together. Be careful. Once the two prepared surfaces meet, they can not be separated. Follow the paper slip technique described on the cement container and all will be well. After the work is in position and the paper removed, roll the aluminum surface with a rolling pin to insure a good bond. You are now the proud possessor of 8 square feet of laminated cabinet panel material.

The laminated material may be treated from this point on as if it were ordinary masonite. Common woodworking tools and techniques apply. Always work with the aluminum up when sawing. When planing and filing, exert the tool pressure from the aluminum toward the masonite to avoid separating the bond. While a hand saw may be used to cut the panels to the desired sizes, a table saw with a cabinet combination blade will cut the panels so smoothly that no further edge finishing of any kind will be required.

A few words are now in order on the proportions and dimensional relationships of cab-

inets assembled from the laminate and the outside corner aluminum extrusions shown in the photographs. The front and back panels are framed with mitered lengths of the aluminum extrusion which are slipped over the edges of the panels and secured in position with machine screws and/or panel mounted components. The top, bottom and side panels are slipped into side rails made from the extrusion and are, in the final assembly, rigidly clamped in position by the interlocking angles secured to the front and rear panels.

The aluminum extrusion is so proportioned that the *inside* dimensions of the finished cabinet will exactly equal the size of the panel used in each plane. The height of the front and back should equal the height of the side panels; the width of the front and back should equal the width of the top and bottom panels; the length of the top, bottom and side panels should be the same and will be the inside depth of the cabinet. The outside dimensions of the finished cabinet will, including the projections of the corner extrusions, equal the size of the panels used plus $\frac{1}{2}$ ".

The extrusion used is polished aluminum outside corner trim moulding designed for use with $\frac{1}{8}$ " tile or tileboard. The moulding is widely available and sells for less than \$2.00 per 8' length. The photograph shows the methods used in mitering the moulding. A small miter box is employed and a piece of $\frac{3}{4}$ " plywood is cut to fit the bottom of the box and slotted to hold the aluminum extrusion at the

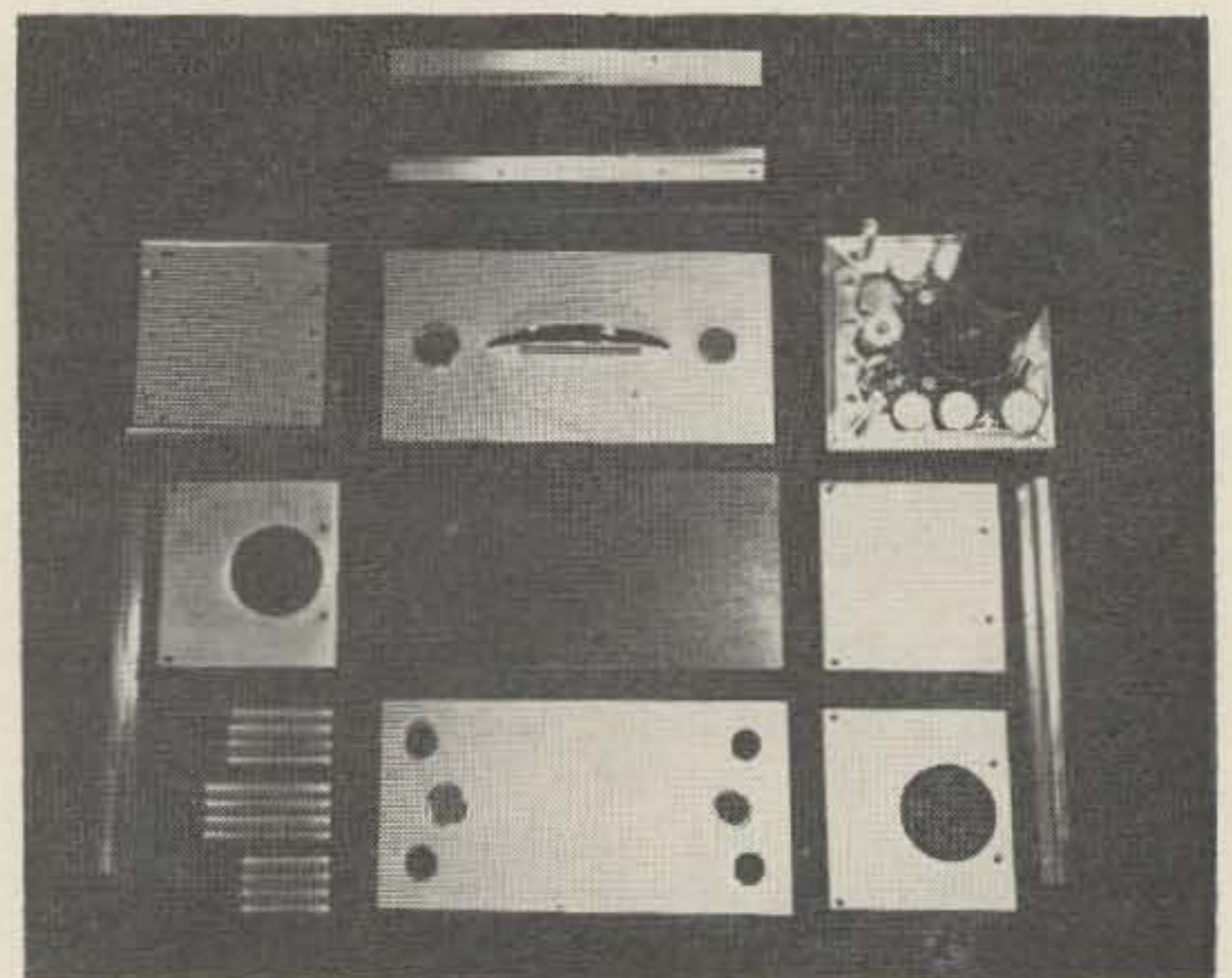

These modular elements comprise the complete cabinet.

proper angle. Both angle and straight cuts are easily made with this arrangement and a fine tooth hacksaw. A couple of swipes on a sheet of sandpaper will remove the burrs. The notches for the butting angle clearances are easily made with another jig shown in the photograph. This is a rectangular piece of $\frac{3}{4}$ " plywood with a similar slot located near one edge and two short slots in either end to guide the hacksaw blade. A right angle slot is cut near the center of the jig to complete the cut-out required at the mitered corners.

The aluminum trim, as supplied, is formed to angle slightly less than 90°. This is to allow it to be tapped into place and provide a perfect fit with the contour of the work. The 100° angle sawed on the edge of the other jig shown in the photograph is used to shape the extrusions for a snug fit at the panel junctions. Two 40° cuts on a table saw will complete the

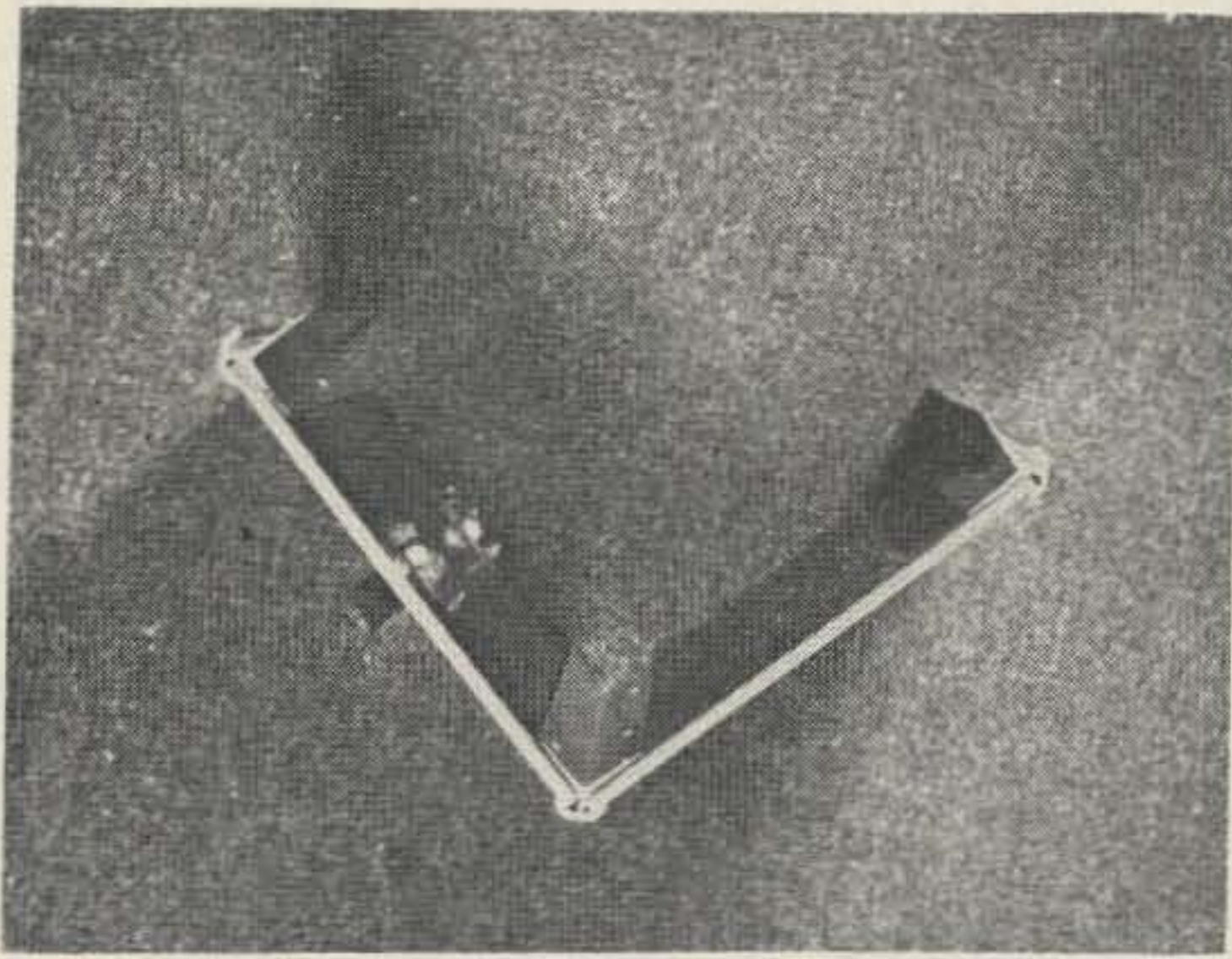

"End on" view showing how the laminated stock assembles in the outside corner aluminum trim.

jig. To form the 100° angle in the extrusion, place the open side of the angle over the beveled edge of the jig, place a wood block over the aluminum to protect the surface and tap lightly with a hammer.

Ventilation of the inclosure should receive early consideration. If solid panels are used throughout, screened type hole plugs such as those shown may be used. Aluminum eyelets are also suitable and will provide a professional appearance. The article by John Howard, "Aluminum Eyelets Make Good Fever Medicine," which appeared in the September, 1960 issue of QST, describes the technique. Holes for this and other purposes are easily bored with a brace and wood bit. A standard expansion bit may be used for the larger holes. Drill from the aluminum side and back up the masonite with scrap wood.

If the equipment dissipates a great deal of heat, perforated stock should probably be used for one or more of the cabinet surfaces. Reynolds #33, lincane pattern perforated stock provides 43% free air space and, if properly framed, is sufficiently rigid for the average size panel. A frame of 1/8" x 3/4" flat bar stock, Reynolds #4, should be carefully mitered to the exact size of the desired panel. Secure the frame to the inside surface of the perforated stock, cut to the same size, with 1/8", #4 or #6, round or binding head machine screws tapped into the bar. These screws should be located about 3/8" in from the edge of the panel to clear the retaining lip of the extrusion.

After the component parts of the cabinet are completed, refinements such as mounting feet and carrying handles may be added.

Though this is a matter of taste and actual requirement, the photographs show the methods used. Finish is also a matter of personal taste. The polished aluminum extrusions require no finish and, as supplied, dress up the finished product. The embossed aluminum, in all styles, has an attractive luster and, unless desired, requires no further treatment. The same is true of the lincane pattern perforated stock. The plain aluminum sheet, which is ideal for panels where marking decals are required, will require finishing. The spray lacquers, available in pressurized cans, are ideal for this purpose. Clean the metal with solvent, roughen the surface with very fine

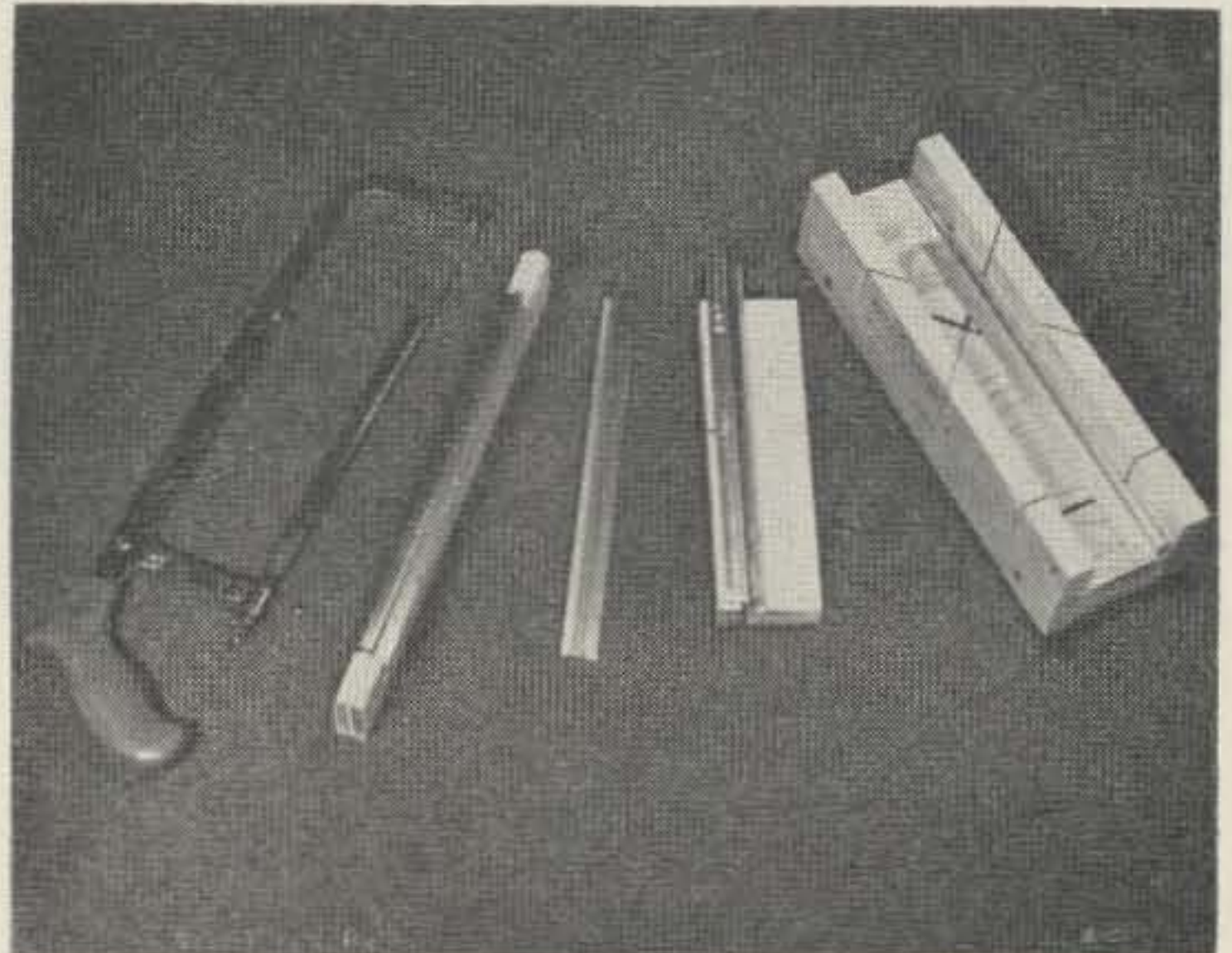

Jigs and tools used to work the aluminum extrusion. While not essential, they speed up and improve the quality of the work.

sandpaper and apply a coat of zinc chromate primer. Krylon No. 1319 and Krylon No. 1320 are both suitable. Allow to dry, wipe off the dust and apply the finish coats. Matching or contrasting colors may be used on the various panels. A wide range of colors is available and factory appearance is easy to achieve.

Considerable variation is possible in the type of panels used. Styles may be the same or mixed, depending on the effect desired. The photographs show one extreme case. Side panels are cut from green anodized, heavy weight, corrugated aluminum lawn edging which is available from Sears Roebuck and other hardware outlets. This stock is sold in 20, 30 and 40 foot rolls in 2, 4, 6 and 8 inch widths. The corrugations are compressed to fit in the slots in the extrusions and the lengths are made such that, in the final assembly, considerable end pressure is exerted. The result is a lightweight, stressed aluminum housing that is amazingly strong for the thing gauge stock used. The reverse side is not colored so that the panels may be reversed or painted for contrasting color effects.

The small oscilloscope foundation shown in the photographs is an ideal example of the cabinet problem, the custom approach and the techniques used. The writer has a require-

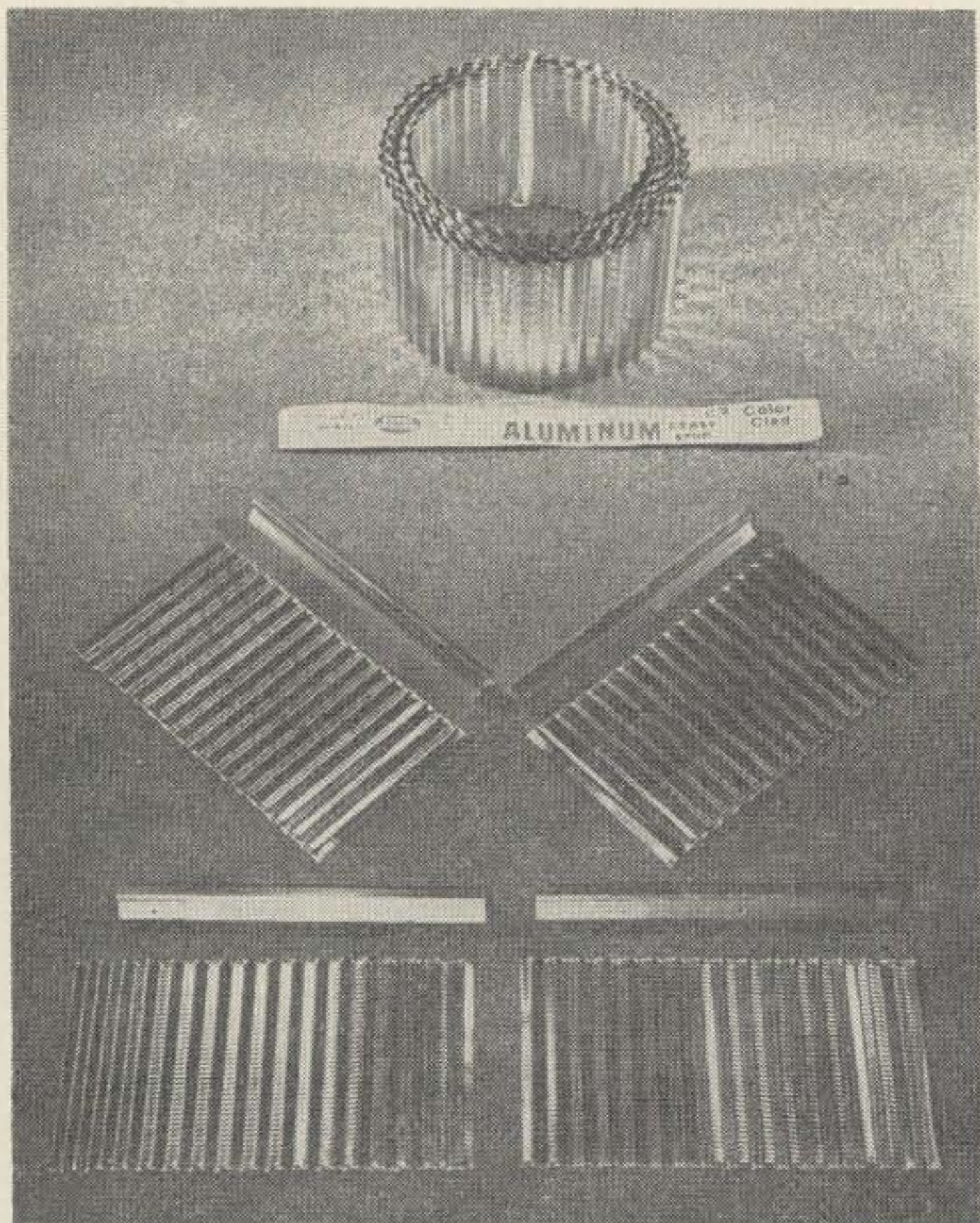

Corrugated aluminum lawn edging can be used for the side panels in this version of the cabinet. End clamping the sheets stresses the light stock and gives strength.

ment for a small, portable scope. While the kits provide an answer, the physically smaller kits and commercially manufactured scopes are prohibitively priced. The obvious answer is to build the instrument from scratch. Here the problems really start. No line of commercial cabinets is available in the configuration ideally suited to oscilloscope construction. Further, the scope is one instrument that does not lend itself to the conventional front panel and chassis pan approach.

The "post and plate" method of chassis construction is adaptable to commercial cabinets, standard relay rack panels and the enclosures described herein. Flat component mounting plates are supported from the rear of the front panel by standoff posts. As many decks may be used as the complexity of the equipment warrants. The material used for the plates may be flat aluminum, insulation stock or perforated Vector circuit board if that method of assembly is preferred.

An ideal material for the standoff posts is Reynolds $\frac{3}{8}$ " round aluminum rod. This material is easy to work, sufficiently strong for most jobs and may be found in any hardware store. While the rod may be cut to size, dressed square, drilled and tapped with hand tools, access to a metal turning lathe makes the job so much easier. Turn to size, drill each end of the posts with a number 21 drill and tap to a depth of about $\frac{3}{4}$ " with a 10-32 tap.

The rectangular component mounting plates are cut from sheet aluminum stock. While

sheet aluminum in the required thickness is a bit more difficult to locate than the consumer packaged Reynolds products, no real problems should be encountered. Since the dimensions are small, as contrasted to the stock required for an equivalent chassis pan, scrap stock may often be used. Since no bending is required, the harder grades of aluminum are suitable and will give greater strength. Hole drilling and cutting is a snap as no close quarter work is involved in working with the flat plates. Clearance holes may be used to clear components protruding from adjacent decks and will permit close stacking. The photographs show this treatment of the scope tube shield. After all drilling and cutting is completed, an attractive finish may be given the plates by sanding with coarse grit paper or cloth in an orbital sander. This will give a "General Radio" type finish that may be further enhanced by etching.

Wiring of the plates is easy if most of the work is done prior to assembly. If stacked component mounting plates are used, bring all interconnecting wiring to one edge of the plates. If this technique is followed, the wiring may be completed and maintenance performed by loosening the spacers and opening the plates up like the leaves of a book. Of course, if plenty of space is available, use long standoff posts and full accessibility can be obtained without disassembly.

Use of the construction techniques described above can result in equipment that will be a continuing source of pride to the builder. There is, of course, work involved. However, far less effort and skill are required than if conventional methods are used. Care in cutting

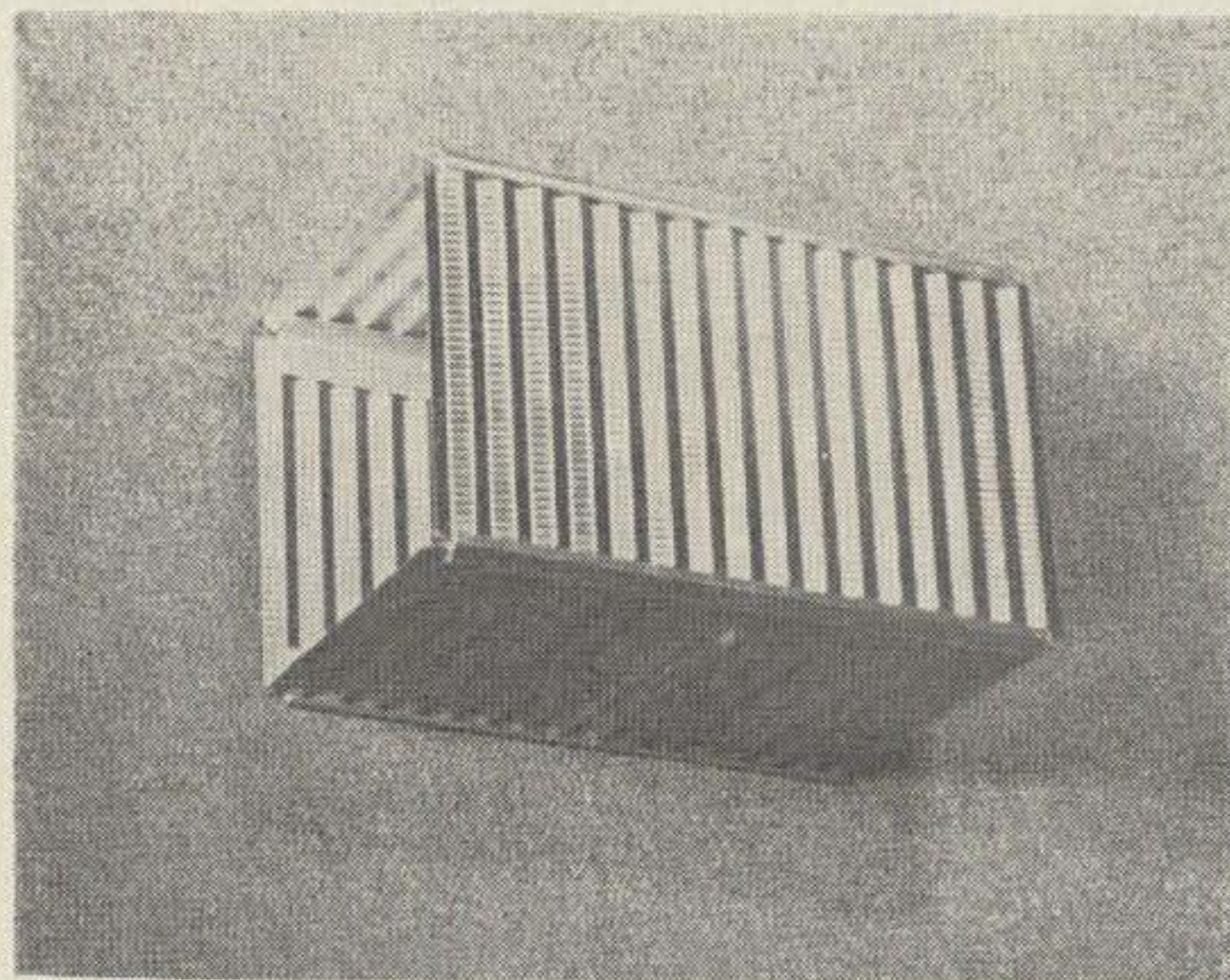

The corrugated stock assembled in the side rails forms the top, sides and bottom in this variation of the enclosure.

the miters in the extrusions is a must for decent appearance. Otherwise, no particular attention is necessary because all worked edges are concealed by the trim. Try this construction method and enjoy the freedom of not being bound to the dimensions of stock cabinets.

... Pafenberg

Avoid Precise Inaccuracy

SOME years ago, the noted British scientist Lord Kelvin declared that, to be able to discuss a result or to work with it in any way, you first must be able to put it in numbers.

Nowhere is this more true than in radio measurements. Sometimes, in fact, we tend to be slightly exuberant about "Putting it in numbers," as witness the number of "60 db over S-9" signal reports being bandied about!

Unfortunately, much of our test equipment is just about as accurate as that notorious signal report. Sure, we can tell whether we have 10 or 100 volts at a given test point—but can *you* say with assurance that the voltage at that point is 19, rather than 18 or 20? If you can, you have a most extraordinary meter!

"But I calibrated the meter just like the book said," you may reply. We aren't disputing your word. However, the usual calibration procedures issued by kit makers and instrument manufacturers don't guarantee extreme accuracy or precision.

There's nothing wrong with the procedure, but one important fact is often overlooked: the calibration can't be any more accurate than the standard source you use.

Many otherwise-conscientious hams follow a slightly confused course of reasoning at this stage. "If the meter is only accurate to 3 percent," they say, "then the calibration standard I use doesn't need to be any more accurate than 3 percent either. The meter won't be able to tell the difference."

A few minutes' work with some actual figures will soon show you that the standard-voltage source you use for calibrating a meter has to be absolutely accurate if you hope to get the 3-percent accuracy the meter movement is capable of:

Suppose that the meter's full-scale reading is 3 volts, a common value. That means that its accuracy is ± 0.09 volt if calibration is exact. If the meter is calibrated to absolute accuracy, and reads 1.5 volts, you know that it's measuring a voltage somewhere between 1.41 and 1.59 volts.

Now let's suppose that you're calibrating the meter for the first time, and in accordance with the kit-makers instructions you're using a fresh size D flashlight cell as a voltage stand-

ard. The known voltage, says the kit-maker, is 1.561 volts. You adjust the calibration control until the needle points just to the right of the 1.56 mark, and the instrument is calibrated.

How closely?

The flashlight cell's exact accuracy is unknown, but is probably somewhat poorer than 5 percent. Let's suppose that it's 5 percent low, and let's suppose still farther that your meter's error at this exact point on the scale is the full 3 percent, on the high side.

Your true standard voltage was 1.553 volts, instead of the 1.561 you thought it was. In addition the meter introduced its own 0.09-volt error. Effect of the meter error was to indicate a voltage 0.09 volts greater than the actual voltage. You set the needle to read 1.561 with a 1.553 volt input. Pretty close. Now put an accurate 2-volt source onto the meter, and read the result as 1.892 volts if all the errors jump to the other side. Not so good, eh? Nearly 10 percent error!

If all the small-voltage differences seem to you like splitting hairs for no good cause, reflect a moment. Most kit-type meters are calibrated at $1\frac{1}{2}$ volts with a size D cell, and that calibration is expected to hold true *for all other ranges*.

Following up our earlier example, suppose we switch ranges to the 1000-volt scale to measure the output voltage of a power supply for a 100-watt transmitter. We read 550 volts under load.

But what's our accuracy?

The original calibration involved a 5 percent error from the standard used, plus a 3-percent meter error. This makes 8 percent error in calibration. Add 3 percent for the meter again (we switched scales, remember?) and we have more than 10 percent error. This 10 percent error must be multiplied by the full-scale reading to find the probable error in volts; the answer is 100 volts.

So our reading of 550 volts means that the actual voltage is somewhere between 450 and 650 volts—and the 600-volt capacitors in the power supply may suddenly explode from over-voltage despite that fact that you measured the unit out well under ratings!

Let's suppose some more. Switch up to the 3000-volt scale to read the input to your KW

final. Read it out as 2,500 volts on the nose. Measure the voltage drop (using this same meter on the 100-volt scale) across a 100-ohm resistor in the B+ line, and by Ohm's law calculate the input at 400 ma.

Exactly one kilowatt. Nice and legal.

How's the error? Remember that 10 percent. Suppose it's all on the low-reading side. You actually had 2,800 volts going in, at 500 ma, for a total plate power input of 1,400 watts. The FCC was watching. What was your call?

We hope we've made our point about accuracy and precision. At this stage, your question should be, "But how do I get any better accuracy without spending a small fortune?"

One of the basic causes for error—which is easily corrected—is the assumption that a calibration made on one range will hold true for all other ranges. You can take a long stride toward better accuracy by calibrating each range of the instrument individually.

However, most instruments have only one calibration control, which affects all ranges. How can you calibrate them individually?

For a starting point, calibrate the highest range first instead of the lowest as you're normally told to do. Then check the calibration on each lower range, recording the error at each check point.

If you record each error as a percentage of full-scale, rather than as an absolute error in volts or what have you, you can readily see the average calibration error. Then all you have to do to reduce it to a minimum is to adjust the instrument to be *one half the average calibration error* toward perfection on any of its scales.

For instance, if the average calibration error is 4 percent in the low direction, and on the 300 volt calibration you read a 150-volt standard as 151 volts, you would set the meter to read 156 volts instead. You get this figure by taking half of the 4-percent low average error, or 2 percent low, of the 300-volt full-scale reading. Two percent of 300 is 6 volts, and the average error is on the low side, so you would set the instrument to read 6 volts higher than the standard.

Note that in this example the absolute error on the scale used was increased by the

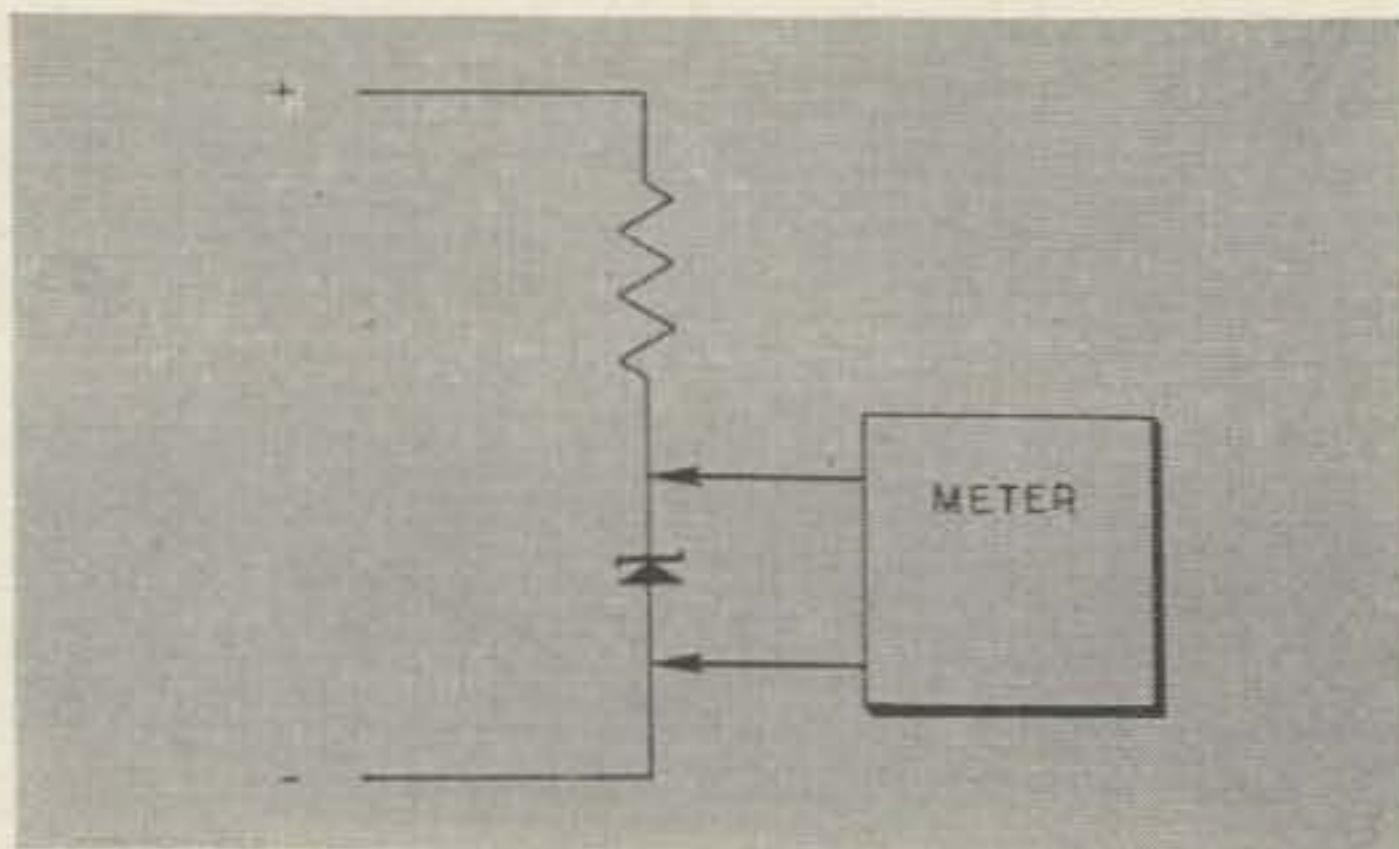
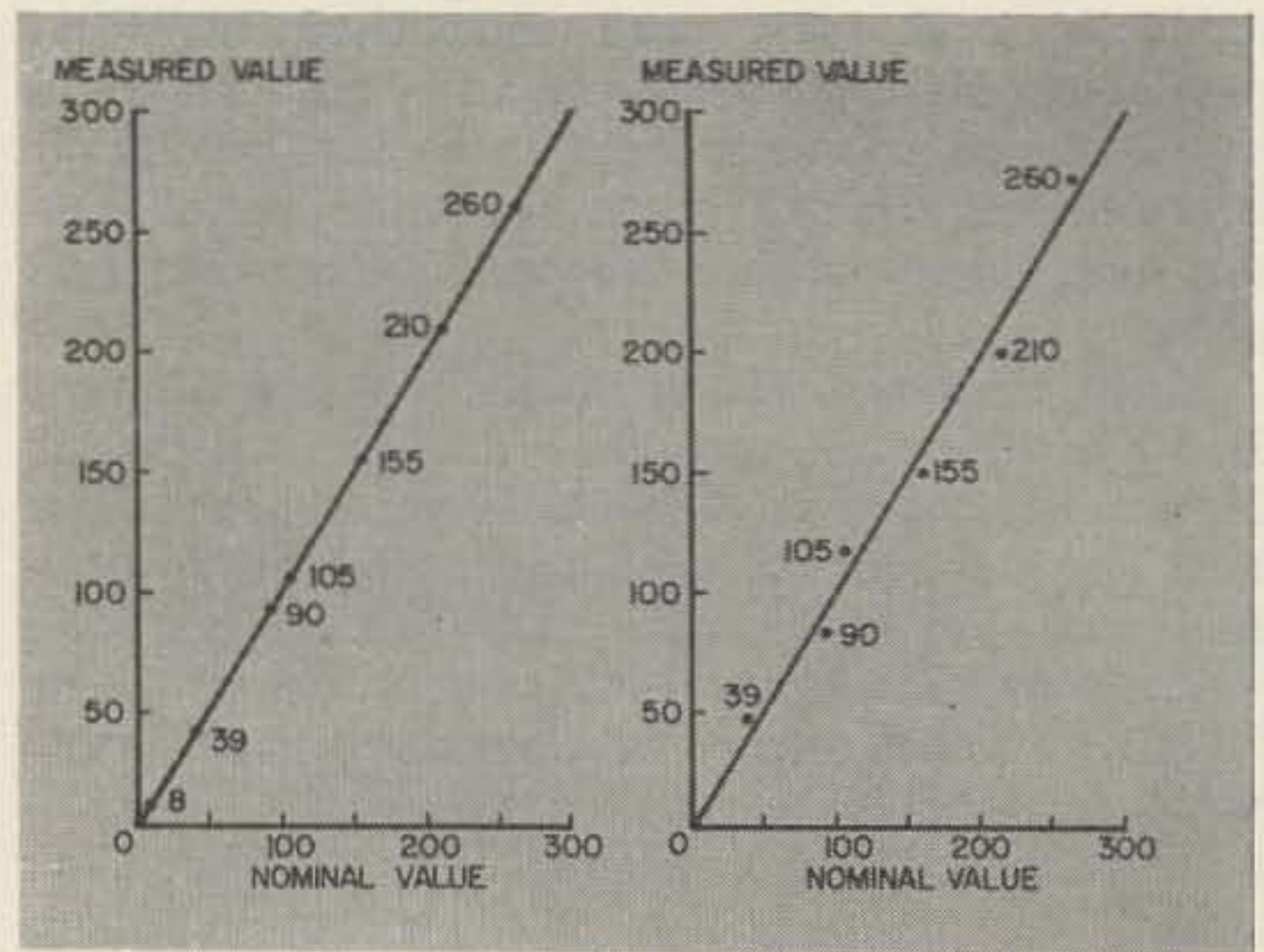

Fig. 1

correction rather than reduced. However, a recheck of all scales would reveal that average calibration error had been reduced to almost zero, since as many scales would read high as would read low.

If this approach doesn't appeal to you, your only recourse is to either calibrate the meter on the scale you use most often and prepare correction charts for other scales, or to redesign the meter to include separate calibration controls for every scale. Either route involves its difficulties.

So far, we've talked a lot about calibration standards but we haven't actually described anything of the sort. This brings us face to face with the question, "Where do we find a standard to check against?"



Figs. 2 and 3

If you're rich, you can buy a Weston Standard Cell, which delivers 1.08 volts at zero load (and will be instantly destroyed by any load) for about \$100. This is the kind of standard the people at WWV use.

However, for ordinary usage, cheaper standards are available. Taking into account its probable 5-percent error, the size D flashlight cell is the least expensive and is accurate enough for calibration of 3-volt ranges on most meters.

If you want to be more accurate, though, a 1.5-volt nominal-rating mercury cell delivers 1.34 volts throughout its useful life; using one of them for a standard will bring you to the meter-imposed limit of accuracy on the 3-volt range, and 10 of them in series will give you the same accuracy on the 15- or 30-volt ranges.

At the other end of the scale, VR-tube voltage regulators provide a fair standard for the price. They are rated at 3 percent accuracy for their nominal voltages, and most are closer than that. Averaging out the readings from five tubes will bring you within one percent—but this is still a 1.5-volt error at 150 volts.

In between, Zener diodes offer accuracies to 1 percent at a high price, and to 5 percent at more reasonable figures.

One way of getting 1-percent accuracy at a

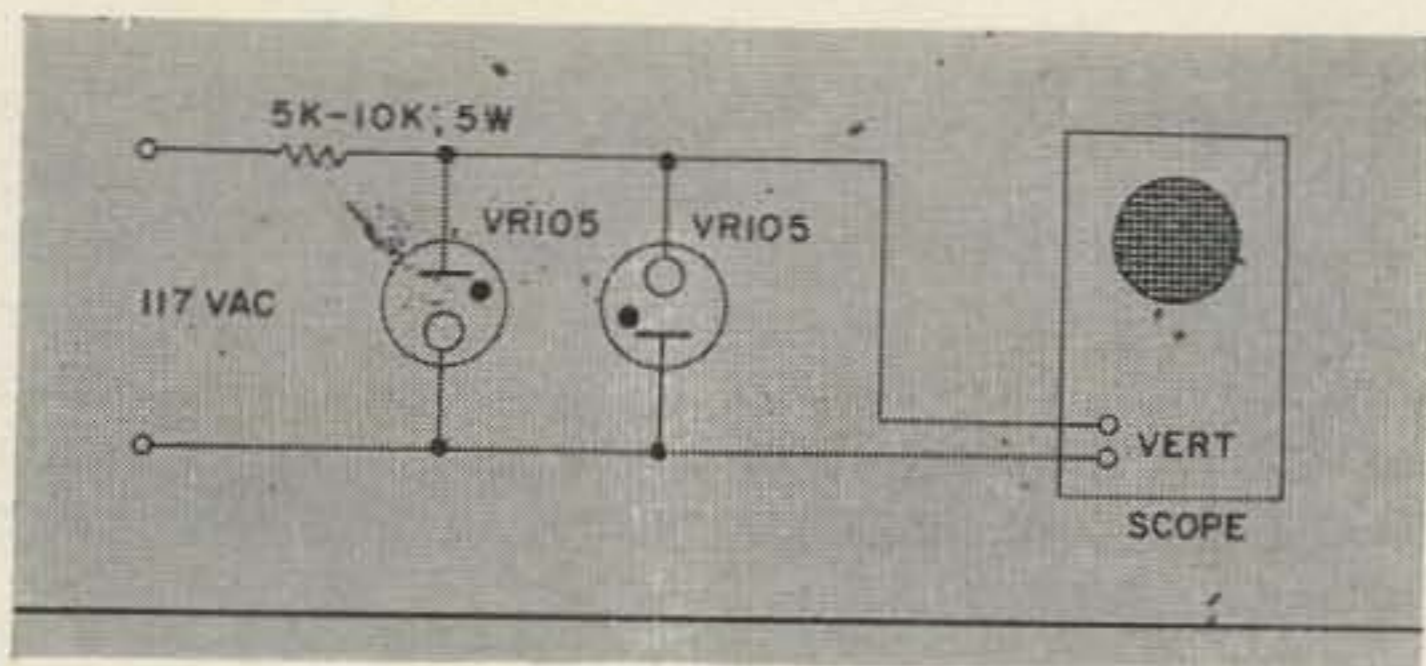

Fig. 4

5-percent price is by use of probability theory. Since it requires a large number of standards for each value, it's strictly a club-project type of operation. Here's how:

Suppose you want an absolutely accurate 39-volt standard. First you buy, beg, promote, borrow, or steal as many 39-volt Zener diodes as you can get (the same principle applies to VR tubes since the tolerances are tighter, you don't need so many of them).

If you get enough units, the laws of probability tell us that five percent of them will be within 2 percent of rated value and that 2½ percent of them will be within 1 percent.

Set up a test jig (Fig. 1 shows how), and measure the voltage across each diode in turn. Use the same meter on the same scale for all measurements to eliminate calibration errors. Then average out the readings. The average reading, minus the rated voltage of 39, is the meter error. If the average reading is 42 volts, the meter is reading 3 volts high.

Now, go back through the stack of diodes, still measuring with the same meter, until you find one which indicates exactly 42 volts. That one is your exact 39-volt standard diode. You can now return the other 999 units to the manufacturer for a refund.

Another meter calibration scheme which avoids the astronomical numbers of standards involved in the preceding idea is to plot a graph.

To do this, you use any standards you can scrounge. However, try to get standards which will produce readings at about the same point on the meter scale.

Measure each of the standards and record the readings. On ordinary graph paper, plot the nominal value of the standard on the horizontal scale and the measured value on the vertical scale.

If your meter and standards have no error, a line connecting the zero point and the plot of the highest standard measured should pass through every plot on the graph, as shown in Fig. 2. Naturally, in practice, it won't.

Stick a pin through your graph at the zero point, and swing a straightedge until you find the line which passes through the middle of the plots, leaving as many on one side as on the other, with about the same distance from the plots to the line on either side. Fig. 3 shows how.

Alternatively, if one of your standards is

much more accurate than the rest, draw a line through the zero point and the accurate-standard plot and extend the line across the graph.

Now plot the points where the line you just drew crosses the *vertical* lines which correspond to the readings you recorded. Read back to the vertical scale to find the corrected values of your standards.

This procedure is actually the same as the average-calibration-error technique described earlier, and on the first run through will lump together both calibration and standard errors. To eliminate calibration errors, borrow a couple of meters from friends.

Measure each standard with each meter, and average out these readings before plotting the graph. After finding the corrected values of the standards, recalibrate all three meters. For a check on accuracy, locate another standard with a value different from any used in the procedure and measure it with each meter. Readings should agree, within the 3-percent-of-full-scale limit of accuracy.

AC

You may be saying at this point that all we've talked about has been dc voltage calibration, and you're right. The voltage scales of a meter are the ones most frequently miscalibrated, and dc calibrations are the easiest to break yourself in with.

In fact, for an accurate ac calibration you must have access to a scope. In addition, an accurately-calibrated dc meter can help out.

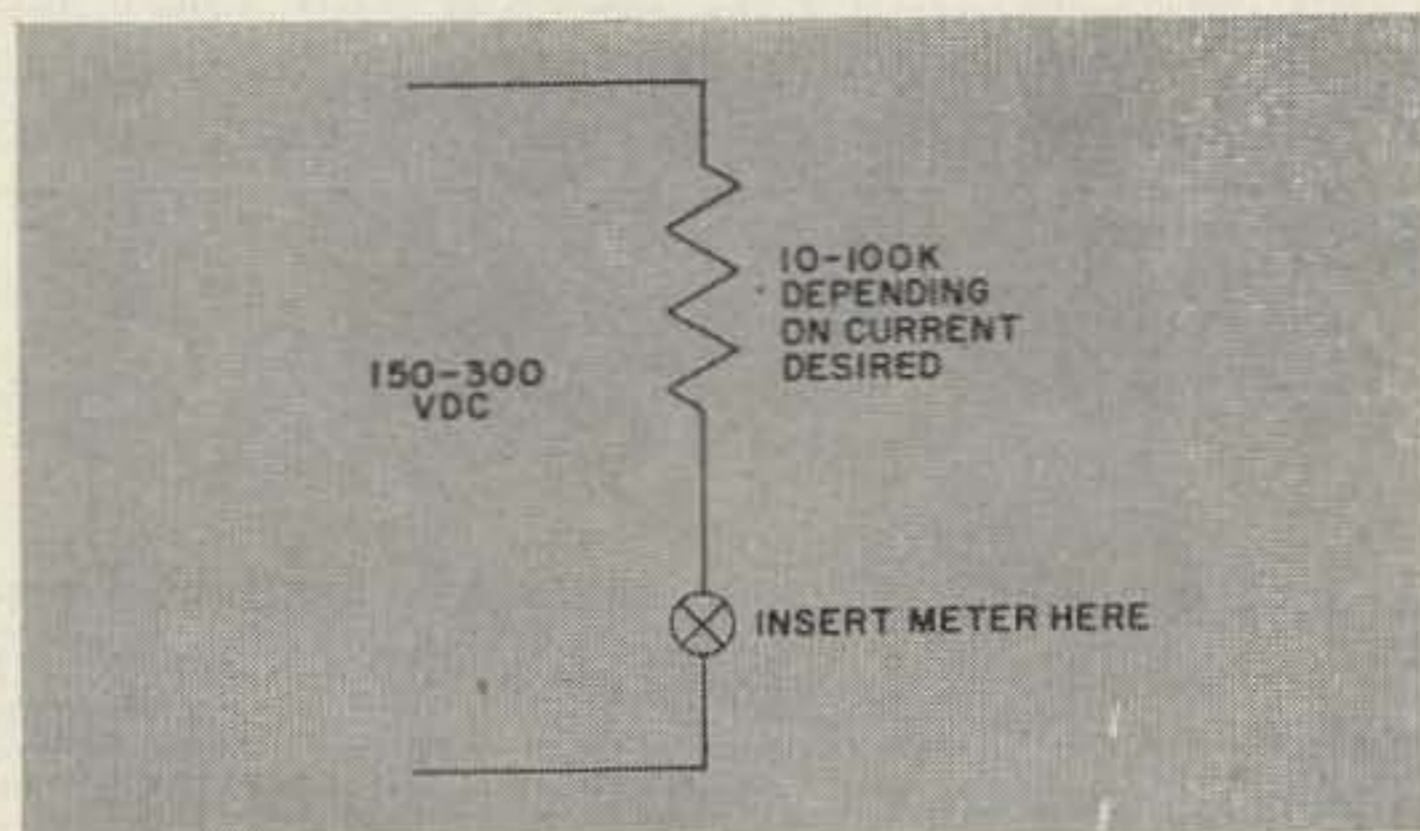

Fig' 5

The first step in an ac calibration is to temporarily calibrate the scope screen. This is done by using a pair of 105-volt VR tubes and a resistor together with the 117-volt ac line as shown in Fig. 4, and adjusting the scope vertical gain controls until the flat tops of the clipped sine waves are 21 horizontal divisions apart. At this adjustment, each horizontal division represents 5 volts (to 5 percent accuracy). You can check the calibration with a known dc source by connecting the dc source to the scope input and noting where the top of the resulting pulse hits the scope screen scale.

Next, hook up a stiff voltage divider across your ac supply and adjust it for a peak-to-

peak output of 141 volts, as measured using the calibrated scope. RMS voltage of the divider will be 100, to the same accuracy as the scope calibration. The divided output becomes your standard for meter calibration.

If your scope has an accurate voltage-divider COARSE vertical gain control, you can pick up additional calibration points at 10-volt and 1-volt RMS levels. Make the initial calibration with the COARSE gain at X100, and proceed as described above for the 100-volt calibration.

Then switch the COARSE gain to X10 without changing other scope settings, and adjust the voltage divider for the same indication on the screen. Divider output will be 10 volts RMS. Adjustment of the divider with COARSE gain in the X1 position gives an RMS output of 1 volt.

However, even with only one calibration point at 100 volts, your readings will be far more accurate than if you follow the normal kit-calibration procedure of assuming that line voltage is 117—when it regularly varies between 100 and 130 volts at most locations, depending on time of day!

Ohms

With both ac and dc voltage scales calibrated, all that's left for you to do is to make the current and resistance scales accurate. For not-so-obvious reasons, let's look at the resistance scales first.

By far the simplest, fastest, and least expensive way to calibrate an ohmmeter is to use 1-percent deposited-carbon resistors as

your standards. These are available for less than \$1 each in virtually all standard values; get one for each scale, picking the midscale value. Tape the standard resistors to your ohmmeter, and calibrate it before each use instead of zeroing it in the usual manner. This will give you more accurate readings over more of the scale.

Amps

Now, with both the voltage and the resistance scales calibrated, the current scales can easily be set to comparable accuracy. Set up a calibration jig as shown in Fig. 5, and measure the resistance of (with power off) and the voltage across (with power on) the resistor. Plug the figures into Ohm's Law to determine actual current through the circuit (accurate to the same degree as your earlier readings).

Then break the circuit at the point marked X and insert the meter, set to the proper current scale. The difference between the measured and the calculated current values is your meter's error.

These adjustments take some time, and you may wonder if there's any way of speeding up the process. The answer, unfortunately, is no. As we said at the beginning, accuracy is expensive—and if you don't pay the price in cash, you must pay it in time. However, it's a worthwhile investment—for when you can put your readings into *accurate* numbers, then you can discuss them and work with them. If the readings are precisely inaccurate, they're worse than useless. . . . K5JKX/6

Does Your Rig Have "Hangover"?

My low-power home-brew rig had the annoying habit of blocking the receiver for several seconds each time the "TRANSIT-RECEIVE" switch was thrown to "RECEIVE." This was especially noticeable when the transmitter and receiver were tuned to the same frequency.

After exploring several possible causes of this phenomenon, the search narrowed down to the high-voltage power supply. The filter capacitors did not have sufficient time to discharge, and kept the transmitter "alive" for an agonizing eternity whenever I signed over to the OM at the other end of the QSO.

The bleeder resistor was checked, and found to be OK. Reducing the ohmic value of this component would discharge the capacitors faster, but the voltage would be pulled down, and the bleeder would waste power. The final solution was simple and effective. A single pole, double throw switch was substituted for the original SPST in the negative return of

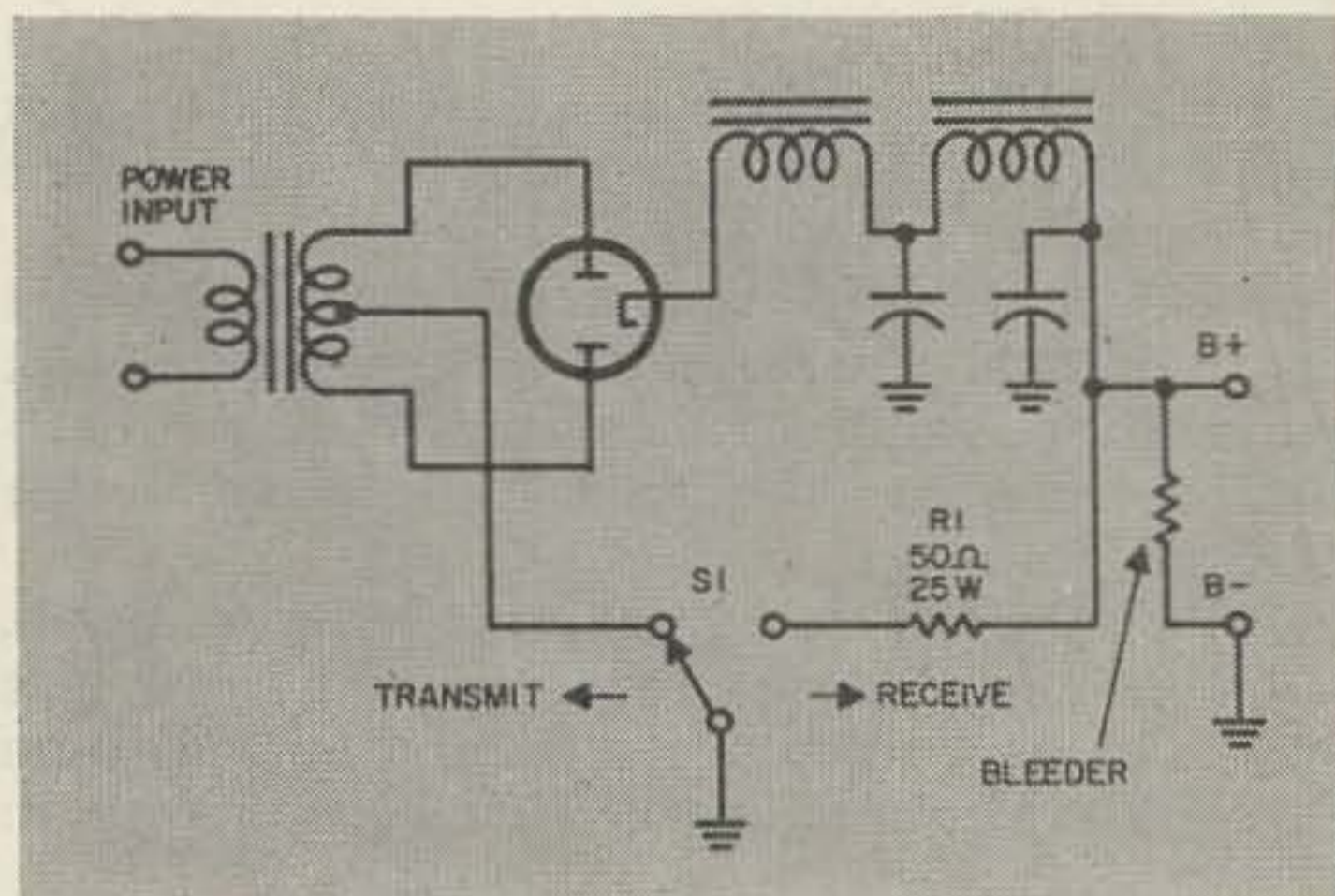

the high voltage supply. Connected as shown in the diagram, the switch opens the B— return and shorts out the B+ when thrown to the "TRANSMIT" position. R1 is a 50 ohm, 25 watt resistor whose function is to protect the switch from burnout by limiting the discharge current. . . . W2WYM

Wayout Measurements

with close at hand equipment

or

you to can be a standard

Carl Henry
1910 Kirby Ave.
Chattanooga 4, Tenn.

EVERY carpenter sharpens his tools before using them. Most electronics workers do not. Electronics is the only field I know of in which measurement equipment is considered separately. Perhaps this is because many of us view measurements and calibration as the special task of the instrument laboratory. Anyway, why bother? My VOM is pretty accurate. Or is it? Of all the measuring instruments, the D'Arsonval movement is the easiest to lose its accuracy due to shocks, magnetic fields and temperature. If ten hams or technicians compared voltage or current readings with their VOM's, there probably wouldn't be two alike. The service technician avoids this problem by allowing 50% tolerance on all his readings. In fact, most current commercial equipment allows this much variation in most circuits. But times are changing. Color TV, transistor radios, industrial applications of electronics, all require a greater accuracy of equipment. Modern equipment is using circuits whose margin for error is close to zero. This is a direct result of greater finesse in design, but knowing this doesn't help you troubleshoot equipment that apparently has every voltage and resistance wrong.

Okay, so you will agree with me. But you say, my junk box doesn't have any General Radio equipment in it. Well OM, clamp those cans tight; you are about to hear some methods of checking to 1% with equipment you have on hand, or can get for less than \$1

You will need at least one rf ammeter, 1 to 10 amps, 1 or 2 59¢ 1% resistors, and a standard cell. Ah ha, you say, that guy's been under a bench in an instrument lab too long!

But really, almost everyone has a poor man's standard cell around. A mercury cell, of course. All manufacturers state their mercury cells to be 1.345 volts, but all we need to know is that they are 1.35 volts within 1%. 1% is a very good place to stop in calibration work; any less will not be accurate enough, and any more will drive you crazy trying to maintain it. Calibration is really very simple, isn't it? Wipe that smile off your face, though, because you will have to know differential equations to understand the rest of this article.

Shook you up with that I bet! Oh well, go on to the next article on "how to transistorize your mother-in-law." But for the rest of you stalwart amateurs, I shall continue.

The first item we are interested in is the measurement of voltage. The mercury battery can be used to check up to 10 volts or so. For higher ranges, use a setup as in Fig. 1. The accuracy of the meter used for this is not important. The resistor's accuracy will determine the accuracy of the voltage.

The ac section of your VOM is harder to check. For this you must have an rf ammeter. About 1 amp is fine, but you can make do with a higher range. The purpose of this meter is to compare a dc volt, which we can now measure with some degree of precision, with an ac volt. We can do this since a thermocouple type meter depends on heating effect for its indication, and is good from dc to the frequency where skin effect begins. However, for best accuracy, reverse the meter and average the readings. Fig. 2 illustrates the comparison method of getting an accurate ac voltage from 6 to 600 volts. The rf ammeter will also allow you to compare dc to ac current, if your meter has such scales.

Now you have an accurate dc volt, dc resistance (59¢ precision resistors, remember?), and ac volt. Using Ohm's law you also have an accurate dc and ac amp, with one other item. The other needed item are several 1%, 20 or

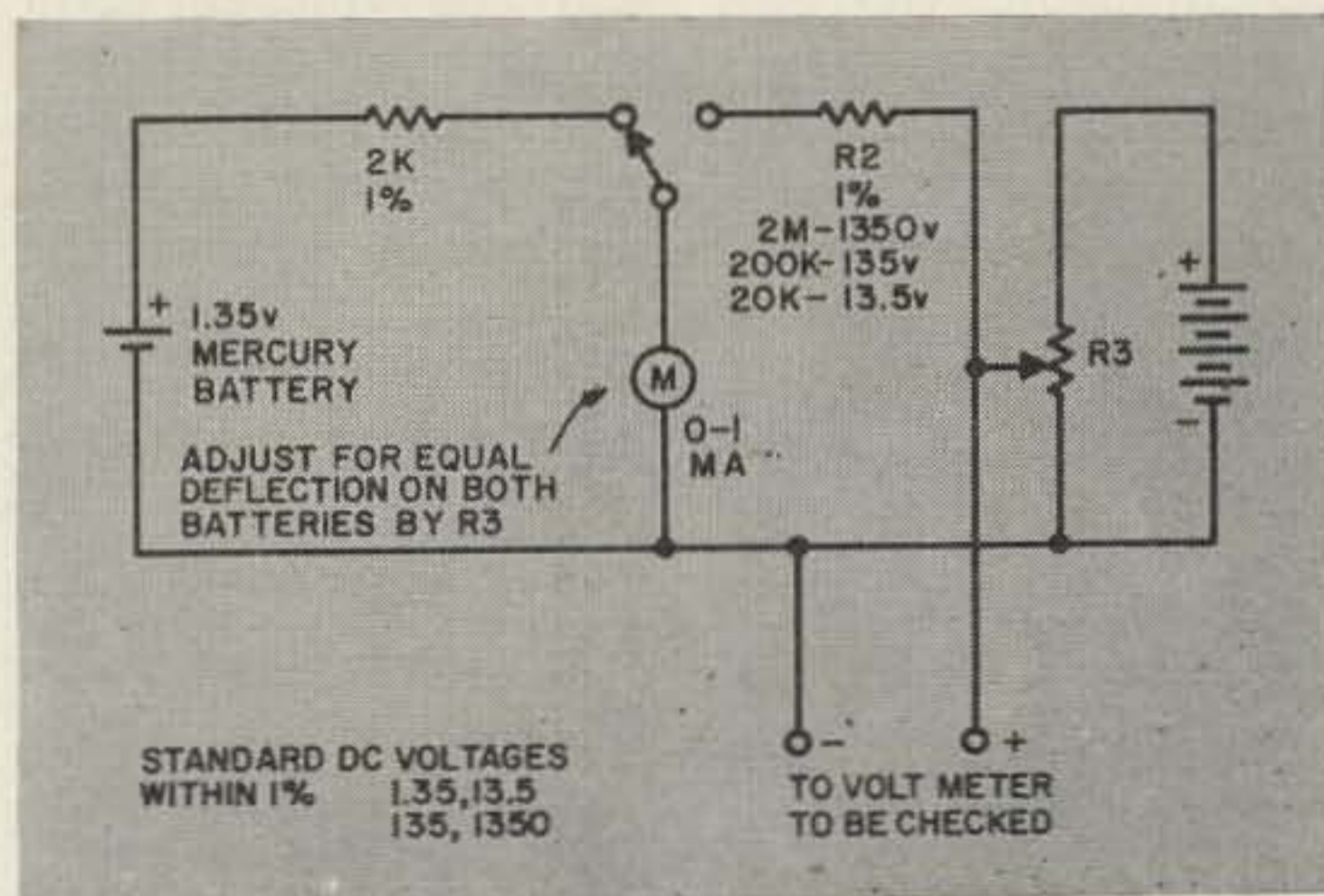

Fig. 1

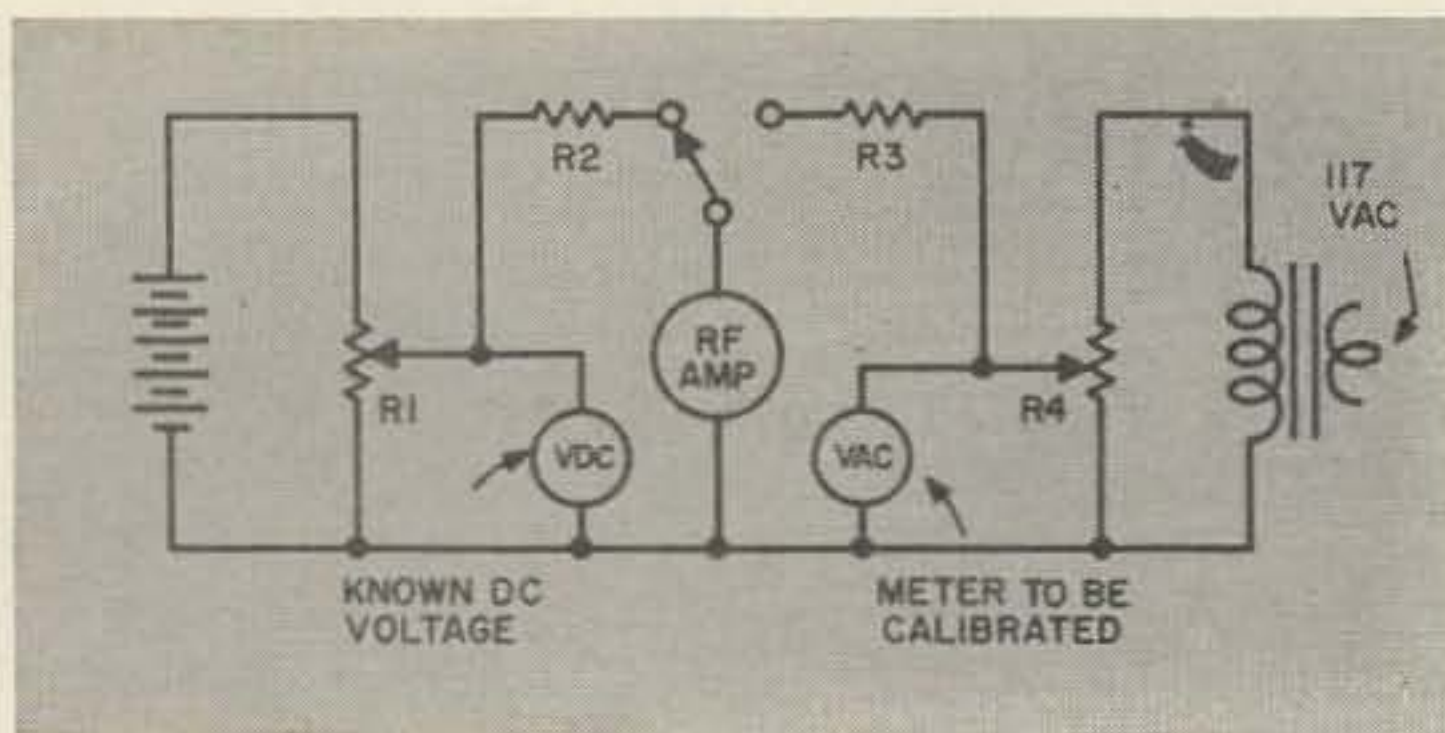

Fig. 2

30 watt resistors. You probably have many of these already. Due to the way they are made, power resistors are usually within 1% tolerance. They make very good precision resistors, and will allow you to check up to 10 amps with a known voltage, giving you of course a known current.

Now you have an accurate volt, ohm, and amp. What's left? Well, how about impedance? Also, from time to time you need to know capacitance, inductance, Q, and dissipation factor. To measure these items, we will call on more comparison circuits and an accurate ohmmeter.

Use the circuit of Fig. 3 to determine the total impedance of the component under test, at the desired frequency. You can check the component at several frequencies, and graph the results if you wish. The method is one of comparison, and the accuracy of the indication meter is not involved.

To determine inductance or capacitance, use the following method. First determine the impedance using the system shown in Fig. 3. Then, set up the circuit in Fig. 4. Using graph paper, set up the vector shown. To do this, draw out the measured voltage E_2 on the X axis, to the right. Draw an arc from the center of the graph, having a radius or length E_1 , and draw an arc from the end of the E_2 vector. At the intersection of these area, to the zero point, draw in E_1 . Draw in E_3 , and drop a perpendicular line from the E_1 - E_3 point to the X axis. You can do this with a protractor. Now, if you have set up the graph in volts per division, you can read the voltage drop across the resistive component of the impedance directly from the graph. Voltage and resistance ratios are directly comparable, so you can determine the resistive part of the

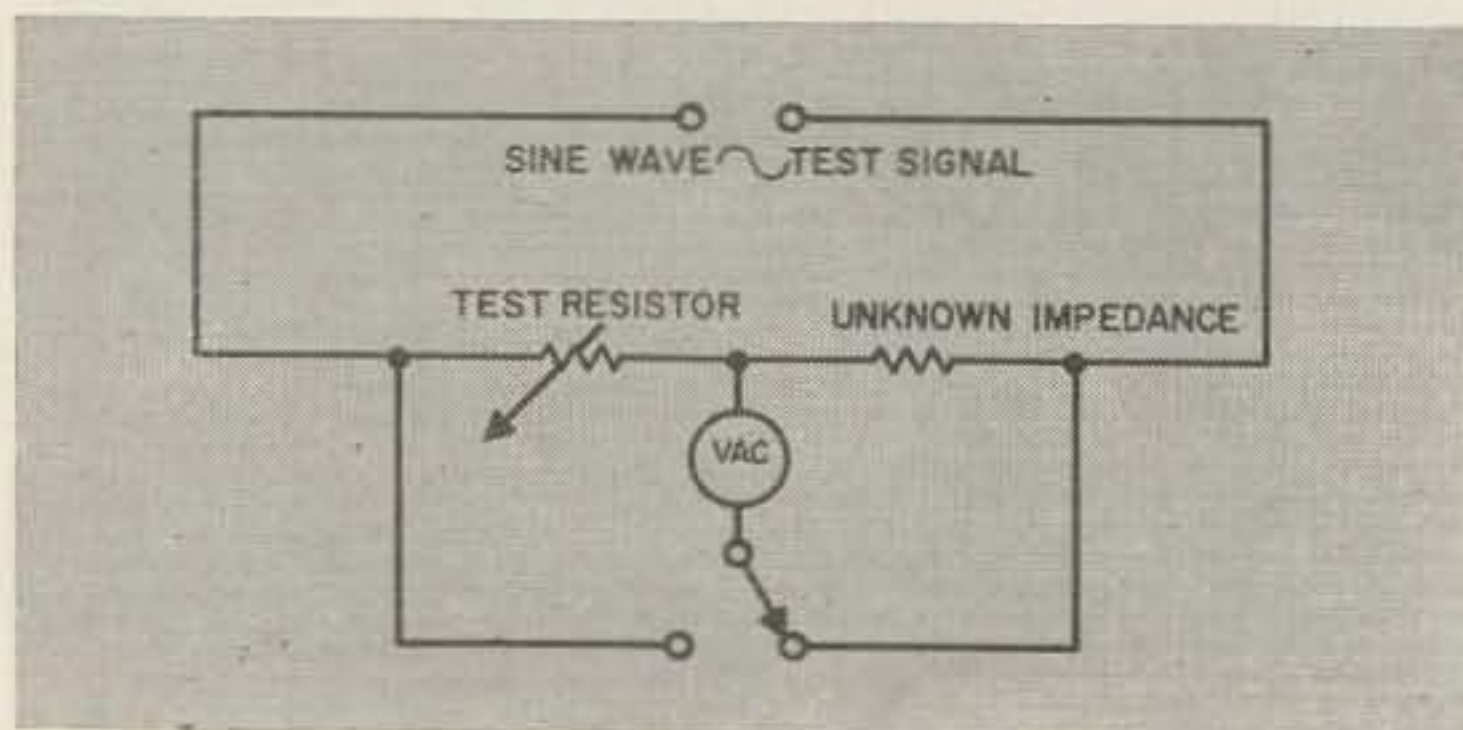

Fig. 3

impedance by $\frac{E_z R_2}{E_2}$. Now you have the re-

actance by the following relationship: X equal $\sqrt{Z^2 - R^2}$. Remember to graph inductive reactance upward, and capacitive reactance downward. The capacity or inductance can be calculated directly from the reactance value. Remember too that nothing holds still in electronics, so check at several frequencies if you want a more accurate result. The Q of a coil can be found without further measurements. Use this formula: Q equal $\frac{Z_x}{R}$ or $\frac{X_L}{R}$.

The dissipation factor of a capacitor is a reciprocal relationship, or: D equal $\frac{Z_r}{X_c}$ or $\frac{R}{X_c}$.

I don't expect there to be any drop in the sales of impedance bridges when this method is published, but it does demonstrate that many types of accurate measurements can be made with simple equipment.

From time to time you may have occasion to measure the output impedance of an amplifier or oscillator. This can be done with a simple method. First measure the output voltage with an open circuit. Then add a variable resistance across the output, and vary it until the output drops to half its open circuit value. Dis-

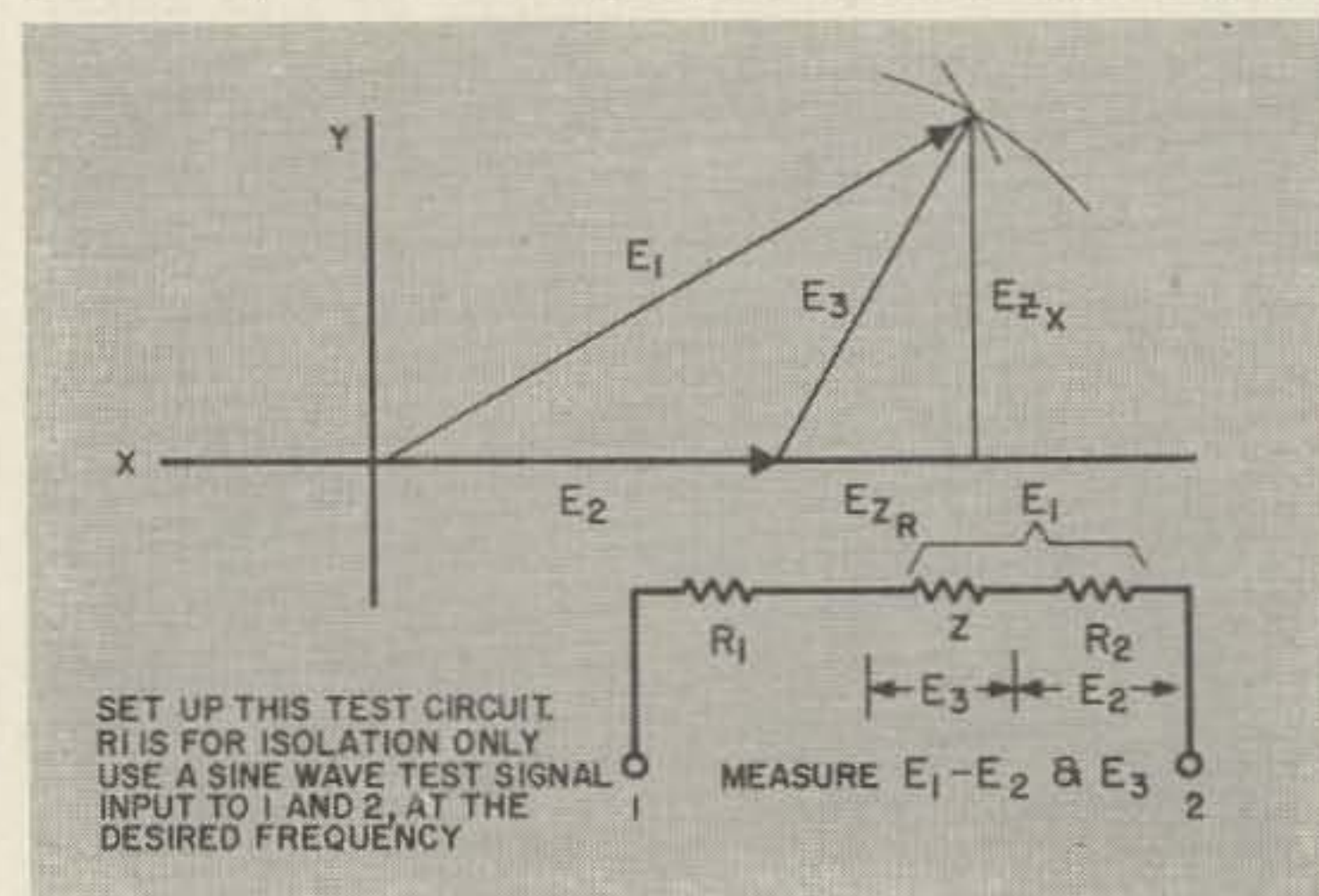

Fig. 4

connect the resistance and measure it. This is the complex output impedance at whatever particular frequency you are using. Be especially careful of distributed capacitance in test leads at the higher frequencies. Keep all circuit connections short. Microphone impedances can be determined in a similar fashion, but due to low level from the mike, you will want to use an amplifier between the mike and resistance, and the indicator.

To determine the input impedance of an amplifier you use the same method on the input. Leave the indicator (voltmeter or 'scope) on the output, and connect a variable resistor in series with the input. With some source of a signal such as an audio oscillator on the input, adjust the input voltage for some convenient output, but don't overload the amplifier. Now increase the value of the variable resistor, which has been set at zero, until the output

drops to half its value. The complex input impedance is equal to the value of the variable resistor. This impedance is a combination of series and parallel capacitance, inductance, and resistance. You can see that the term complex means exactly that!

Loudspeaker impedances can be determined using this method. Try a speaker at several different frequencies in the audio range. You'll be surprised at what you find.

Transformer ratios can be determined by checking the input impedance with the output winding loading determined by a known fixed resistor.

In all these measurement methods, remem-

ber to use sine waveforms, if at all possible. Most ac voltmeters will read incorrectly in the presence of harmonics. Keep test circuit capacitance and inductance to a minimum by using short (relative to frequency) test leads.

The above discussion will serve to demonstrate to you that accurate measurements can be made using very simple tools. Or, "most progress concerns sharper tools and simpler methods."

References: ELECTRONIC MEASUREMENTS—Ter-
man and Petit.
RADIO ENGINEERING HANDBOOK—
Henney

On Soldering

David Heller K3HNP

MUCH is available in the handbooks, construction guides and in the minds of communications people everywhere on how to solder. There's probably no question that every amateur must make frequent soldered connections even if he never built a thing in his life, and it's unfortunate that much soldering is improperly done — either with improper solder, the wrong flux, the wrong iron — or with improper technique. But technique is seldom the cause of failure. Most hams are pretty good with the soldering iron. Because they've been using the wrong equipment so often they'd have to be good to have their equipment work at all.

About the solder itself: it is a mixture (alloy) of tin and lead—as you know—and comes in various grades, such as 40-60, 50-50, 60-40, etc. The first number is *always* the proportion of tin. The difference between grades is the melting point, strength and cost.

Melting points of various combinations are:

40-60	460° F
50-50	425°
60-40	371°
63-37	361°

But the solidification temperature is 361° for all. The in-between range (such as 361° to 425° for 50-50) is the plastic range, in which the solder has no strength, and is mushy. If a joint is moved even slightly while cooling through this plastic range the all-too-familiar "cold-solder" joint inevitably results. Please note now that the 63-37 mix has no plastic range. Is this a solder that won't produce cold joints? Strangely enough, it is! It's possible to make a bad joint with 63-37 (Eutectic) solder, but not if any attempt is made not to. As the mix gets lower in tin content the plastic range expands, making good soldering more and more difficult.

I like to solder with the least possible heat, for I'm somewhat annoyed to see the wax flow out of little condensers and the insulation melt

off wires. It seems as though the diode and transistor people warn about too much heat, also. So why not choose 63-37? It does melt at a lower temperature than any other solder.

Is there any difference in strength between grades? Not enough to talk about. How about cost? Today lead sells for 13 cents a pound, and tin, \$1.04 per pound. So the tin content determines the price, and 63-37 should cost about 1½ times as much as 40-60. It does.

So it would seem from above that 63-37 solder is the best for radio construction. It is. Get a small piece from one of your engineer friends and try it. Second best is 60-40, which has a big advantage—it's much more easily available. If you are now using a lower grade 60-40 will seem so much better that you'll probably be satisfied. But 63-37 is even easier to use—and costs only about 5 cents a pound more. Bother your dealer until he stocks what you want.

About flux: this is a bigger unknown than anything else in soldering. In my work I've accumulated several hundred different flux samples; seldom do the claims correspond with results. The important thing to remember is: Use a rosin radio flux only. Never use a chloride "acid core" flux or the "non-corrosive" paste fluxes on electronic equipment; they're as non-corrosive as hydrochloric acid and a lot harder to get rid of. Don't even use your radio soldering iron with acid core or paste fluxes—the stuff won't evaporate away, and the corrosive materials will end up just where you don't want them. The only way to remove these chloride fluxes is by scrubbing with hot soapy water! Follow the warning in kit instruction manuals: don't use acid or paste fluxes.

Even in rosin cores there are many different compositions. Those of the reputable manufacturers are properly compounded and both safe and effective; bargains can give much trouble. Satisfactory fluxes include National Lead (Dutch Boy) Hyax, Kester '44', and others. Some have rather interesting claims based on special shapes of the flux cores: multiple cores, stars, etc. These have no demonstrated value at all.

There are many special fluxes for aluminum, corroded brass, steel, etc. which can be used in electronic equipment under controlled conditions. These are best neglected—the uses are specialized and the fluxes are not generally available.

The choice of soldering irons seems usually to be made on the basis of convenience—not by what the job requires. The soldering iron needs only get sufficient heat to the work to get the joint (not just the solder) to the solder's melting point. Most of the small "pencil irons" won't do this on larger joints. The proper tool for most soldering is a 100 watt iron with a 3/8 inch plug tip. The pencil iron is often good for fine wires in tight places, but the big one will do a better job faster most everywhere.

The quick-heating gun is a common tool

these days; this is a poor choice for construction, though acceptable where only one or two rapid connections need be made. The proper heat is almost impossible to maintain, and heat transfer is poor. Too small an iron will often overheat parts simply because it must be kept on a joint too long.

Chassis soldering requires a 200 or 300 watt iron. If one isn't available, better use screws. But a big iron is nice to have for soldering antenna connections on windy days. A big iron is a good tool to have in the shack—the uses are more frequent than might first be thought.

No—nothing here about how to solder once you have the proper solder, flux and iron. That's all covered in the various handbooks, and especially in the construction manuals of Heath, Eico and other kit manufacturers.

Surplus Audio Accessories

Lately released surplus handsets, microphones and speakers are fitted with a new type, 10 contact quick connect-disconnect audio connector. The accessory plug is the Amphenol number 164-28 (Military U-77/U) and the Amphenol 164-7J (Military U-79/U) is the mating chassis receptacle. The schematic shows the connections of the H-33/PT handset which is representative of the types available. Termination is standardized, although some handsets have only a single section switch.

Before you reach for the cutters to snip off the new fangled termination and substitute the old familiar PL-55 and PL-68, THINK. These connectors are rugged enough to withstand the roughest field conditions and, at the same time, attractive enough to grace the panel of the most sophisticated equipment. The receptacle mounts in a single 1" round hole with lock nut. The photograph shows the simple assembly details of the plug and receptacle. To cinch the argument, Olson Electronics, 260 S. Forge Street, Akron 8, Ohio, lists the U-79/U chassis receptacle on page 21 of their spring catalog at 19¢ each or six

for a dollar.

The accessories reaching the market today are only a trickle of what will come and the new connector is the standard. The photograph shows two of the currently available handsets. One is the new configuration and one the old. Both are fitted with the new style connector. Get in line . . . you can't afford not to. . . Pafenberg

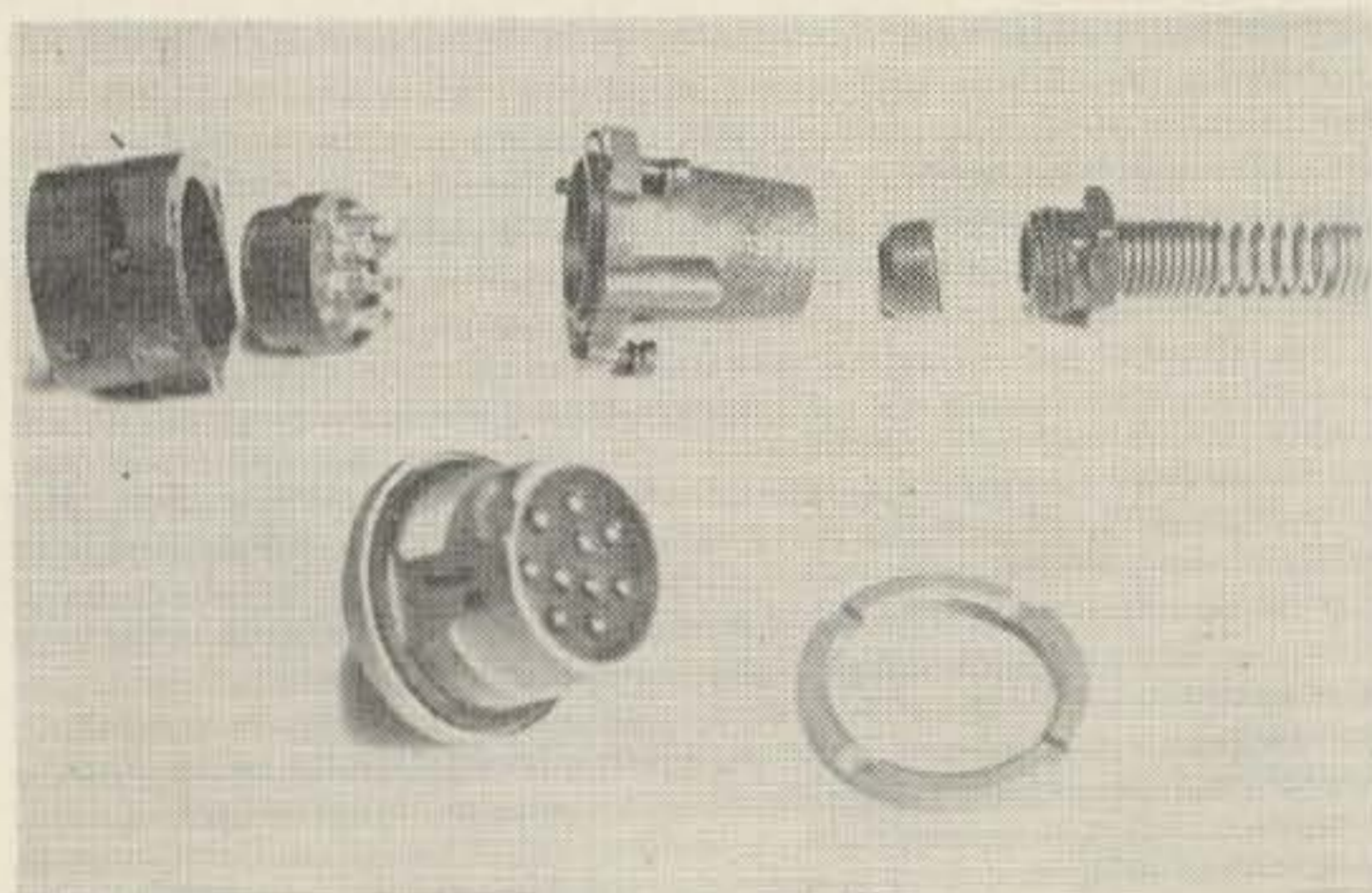

The U-79/U female chassis receptacle (Top) and the U-77/U male plug (Bottom), shown in the exploded view, are the most popular of the new audio connectors.

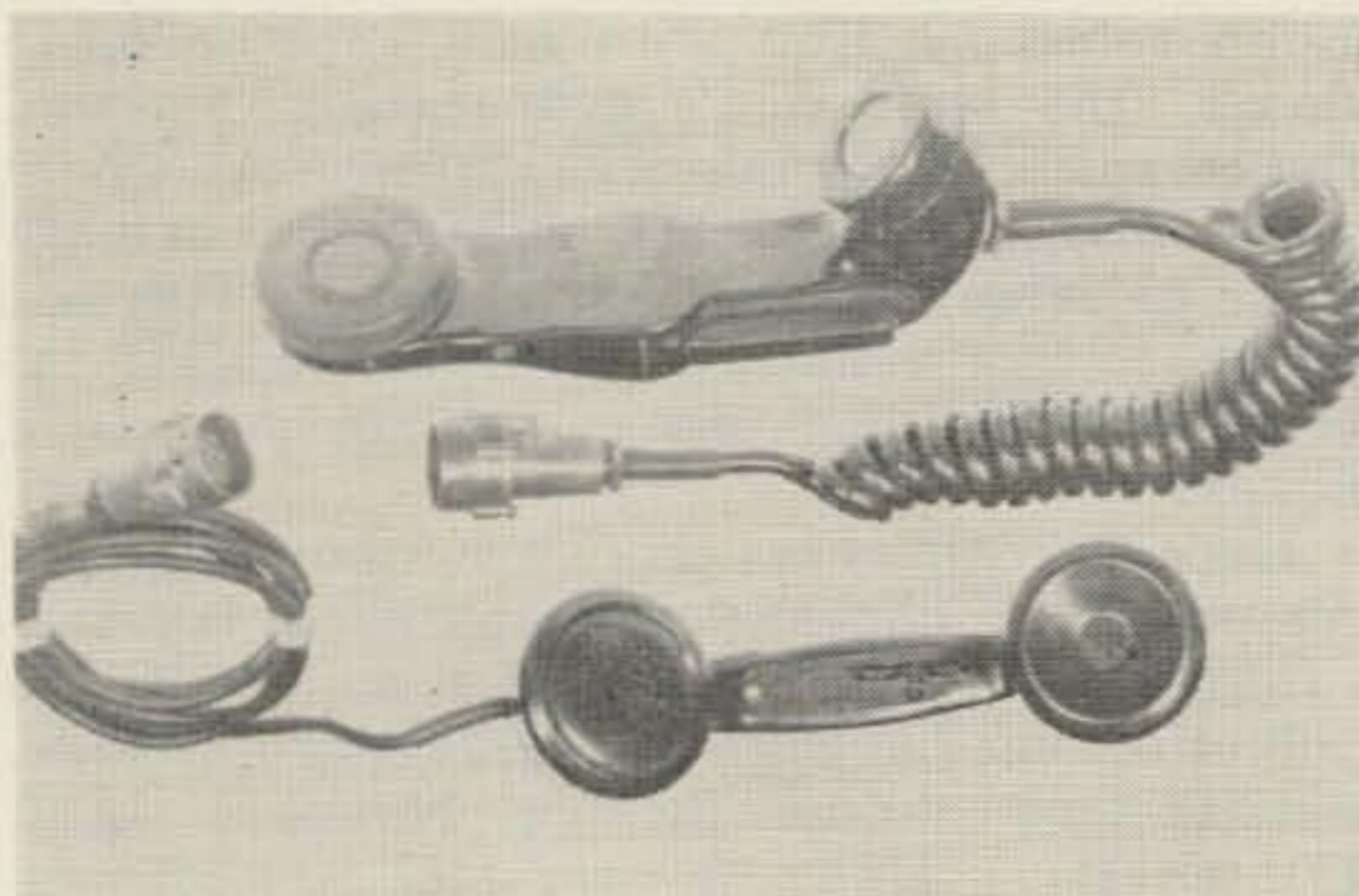

Handset, H-33/PT (Top) is the most common field radio handset. Handset, H-90/U (Bottom) is a conventional communications handset, fitted with the new connector.

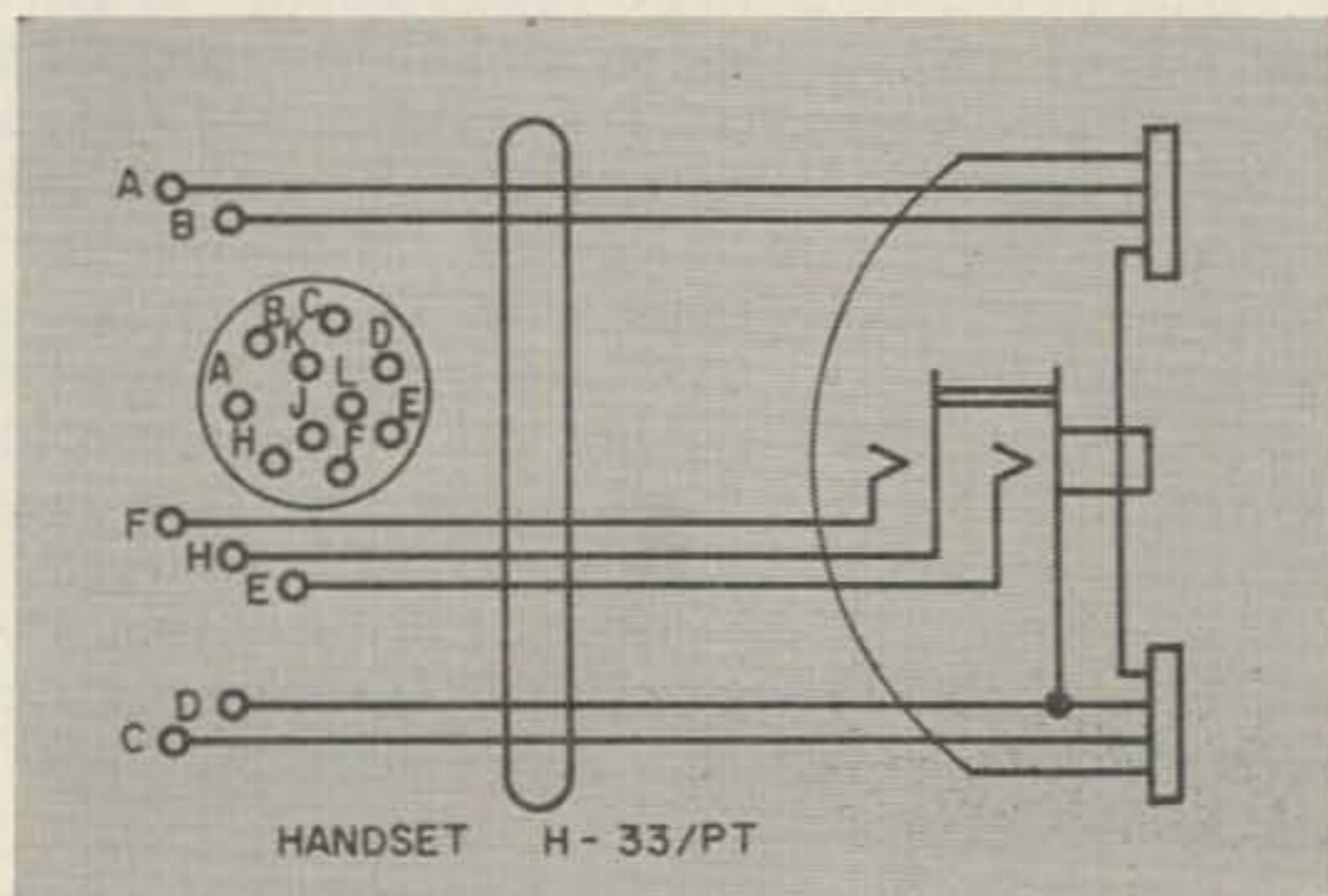

Schematic diagram of Handset, H-33/PT. The wiring of many other handset types is identical.

Two Meter Transceiver

Larry Levy WA2INM
1114 East 18th Street
Brooklyn, N. Y.

If you have been listening on the VHF bands lately, you must have noticed that almost everybody is using a transceiver of one type or another. Almost all of these transceivers are commercial. Most amateurs sound horrified if you suggest building, instead of buying, a transceiver. The typical arguments are that it is cheaper to buy than to build, the parts are very expensive, they never work right, commercial units are easier to use, home-brew units do not have the appearance of commercial gear, or, some other ridiculous statement. It is not cheaper to buy than to build, even if you buy all the parts new. Parts are not expensive and the majority of them can be gotten out of the junk box. If any care is taken in the construction of home-brew equipment it will work just as well, if not better, than commercial equipment. With a little planning, home-brew equipment can be easier to use than commercial equipment. As far as appearance, most commercial equipment does look better than home-brew, but I have seen home-brew equipment that will compare with commercial gear.

I wanted a two meter transceiver for the mobile that would have reasonably low power requirements because I use the rig a good part of the time with the motor off. The object of the project was to build a good mobile rig at the lowest possible cost.

A careful look through my junk box disclosed that most of the necessary parts would not have to be purchased. An old television set can provide approximately 75% of the parts needed. The remaining parts can be obtained from a defunct FM tuner, the junk box, or by purchasing them. Most values of resistors are not very critical, and one close enough to the necessary value can be found in almost any television set. The same applies to condensers except where one is being used in a resonant circuit. Tubular condensers are not very good for rf by-passing. For rf by-passing ceramic discs are recommended, and are necessary above 50 mc. It is permissible, however, to substitute values slightly different than the specified value. For example a .002, .005 or some other similar value can usually be substituted for a .001, although a .001 is recommended above 100 mc. At two meters, the



inductance of the leads becomes important, and the condensers should have the smallest possible physical size.

The chassis is an open end type with aluminum plates on each end to form the front and back panels. The chassis is not used in the conventional manner because the wiring is on what normally is the top to make the construction easier. The size is not critical, but it should be big enough to fit everything on it without excessive crowding. The chassis used for my transceiver was 8" x 10" x 2" with the end plates being 8" x 4½". This size was chosen only because the chassis was in my junkbox.

The power supply used in the mobile is external to prevent vibrator hash. It is the power supply from an old auto radio, but any supply delivering about 250-300 v at approximately 50-75 mils can be used. The heaters are wired for 12 volt operation but they can be wired in parallel if the rig is going to be used on 6 volts. An ac supply was included in the unit because it increases the usefulness of the transceiver. The power transformer was taken from an old fm tuner. Since the transformer did not have a 12 volt winding, the 5 volt and the 6.3 volt winding were connected in series and phased to give 11.3 volts. Although this is slightly lower than the tubes are supposed to have, the rig works fine at this voltage. If the transceiver is to be wired for use on 6 volts, only the 6 volt winding is used.

Any power transformer giving between 250 and 300 volts will work fine. The rectifiers used were 800 volts piv. silicons, although a 6x4 or 12x4 will work. Filter choke "L" can be any small choke. If one is not available, a 200 ohm 10 watt resistor can be substituted, but this will result in slightly reduced plate voltage. S2 is a DPDT rotary switch and should have a low loss type of insulation as it is also used for switching the antenna. The tuning indicator is a 1629 tube which is available on the surplus market for about 25¢. For 6 volt operation, a 6U5 or similar tube can be used. These tubes have different bases and pin connections than the 1629.

The transmitter section uses two tubes and is quite simple to build. It uses 8 mc rocks and the final runs straight through. The approximate power input is 5 or 6 watts, which is sufficient for local work. When conditions are right, quite a large distance can be covered with this power. One-half of a 6AW8 is used as the osc.-tripler. "RFC" can be a 2½ mh rfc with "C1" being about 150 mmfd. A smaller rf choke like the ones used in the 21 mc if strips of old TV sets can be used by changing the value of C1 to approximately 35-50 mmfd. The plate coil is a slug-tuned coil tuned to 24 mc. Slug-tuned coils were used throughout the multipliers and once tuned up around the center of the band are broad

enough to work over the entire band without readjustment. To help prevent oscillation in the final, a shield is placed across the socket of V2 to prevent coupling between L6 and L7. C4 is run through a small hole drilled in the shield, not over or around the shield. The shield is made from the top of a beer can. The top is cut in half and soldered across the socket. No trouble was experienced with oscillation in the final, but the final was neutralized anyway. For those who are interested in neutralizing the final, a 1" neutralization stub was soldered on the grid pin of the final. Plate and screen voltage was removed from the final and grid drive was applied. The position of the stub was adjusted for minimum feed-through, using a GDO as an indicator. No trouble should be encountered in getting the transmitter to operate properly if all the leads are kept as short as possible and grid leads are kept away from plate leads. The layout is not very critical although keeping the stages in a straight line is recommended. There is more than enough drive to operate the final properly if everything is working and all the multipliers are tuned properly. A 6AW8 can be substituted for V2 but a 6AU8 doesn't seem to give enough drive as V1. Substituting a 6CX8 for V2 is not practical for 12 volt operation because of the difference in heater currents. I tried one just to see how much dif-

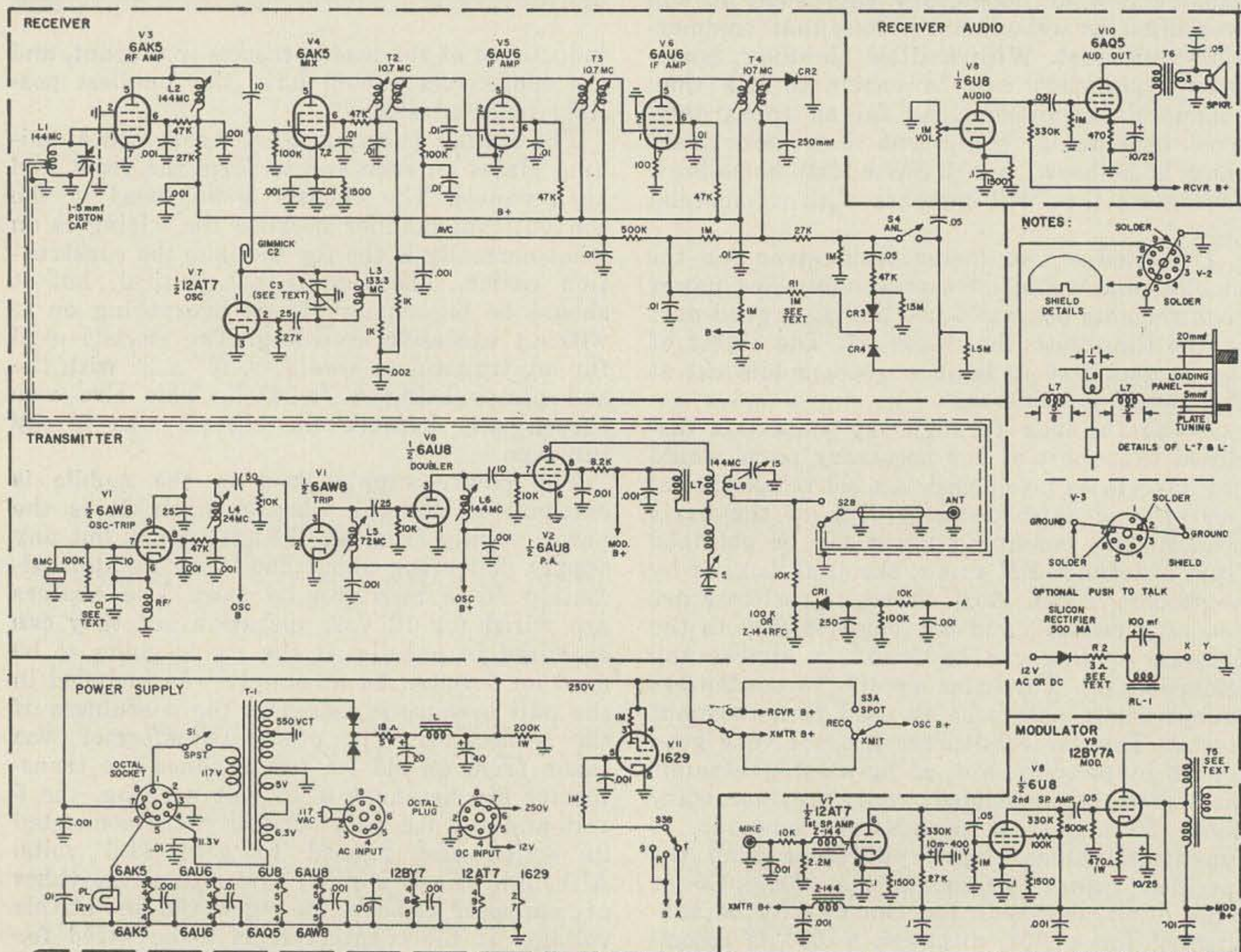

Note: L7 mounts to pin 9 of socket with NO lead.

ference there was, using a 955 as a heater ballast in parallel with V1 to make up the difference of 150 mils in the heater current. The efficiency of a 6CX8 on 2 meters proved to be much poorer than a 6AU8 or 6AW8, so that idea was quickly discarded. To use a vfo with the transceiver, short the cathode of the osc. tube to ground. The 8 mc output of the vfo is fed into the xtal socket. The stage acts as a tripler.

The final amplifier is high level plate and screen modulated by a 12BY7A. Since I did not have a suitable modulation transformer in the junkbox and I did not like the idea of going out to buy one at the current prices, I used a vertical blocking oscillator transformer from an old TV. It works fine and I have gotten excellent reports on the quality and percentage of the modulation. The unit used had a 1:1:1 ratio with impedance being unknown. It was connected as a 1:1 auto transformer leaving the other winding disconnected. The speech amplifier is $\frac{1}{2}$ of a 12AT7 followed by the pentode half of a 6U8. For anybody who is curious as to why I did not use the triode half of the 6U8 as the other speech amp, the reason is that one half of the 12AT7 is being used as the local oscillator of the receiver and using the other half as the receiver audio might affect the stability. A Z-144 is used to keep rf out of the modulator, as any rf getting into the modulator can cause some awful feed-back. A 10 mfd electrolytic and a 27K resistor are used to decouple the first speech amp and prevent any tendency toward motor-boating. The modulator has more than sufficient gain for even low output crystal microphones.

The receiver section is a single conversion superhet and although it is not very complicated it works quite well. 10.7 mc *if* transformers were used because they were available from an old FM tuner. The image frequency is far enough away to keep the level of the images low enough so they are not noticeable without using any kind of bandpass circuitry. The layout should be in a straight line for the best and most stable performance. The first rf amplifier has a shield across the socket to prevent oscillation caused by coupling between L1 and L2. L1 is a air-wound coil tuned by a small piston capacitor. A slug-tuned coil could be used but I felt that a higher Q coil would help image rejection. The tap on L1 is adjusted for maximum signal to noise ratio. It will be approximately $\frac{1}{4}$ of the coil from the ground end. L2 is a slug-tuned coil tuned to 144 mc. The coil forms should have a slug as designed to operate at this frequency. (The same goes for the multiplier coils in the transmitter.) The coil forms used came out of the tuner of a television set and were used for tuning the higher channels. Care should be taken to prevent any coupling between the input and output of the rf amplified by leads running near both coils that could couple rf between them,

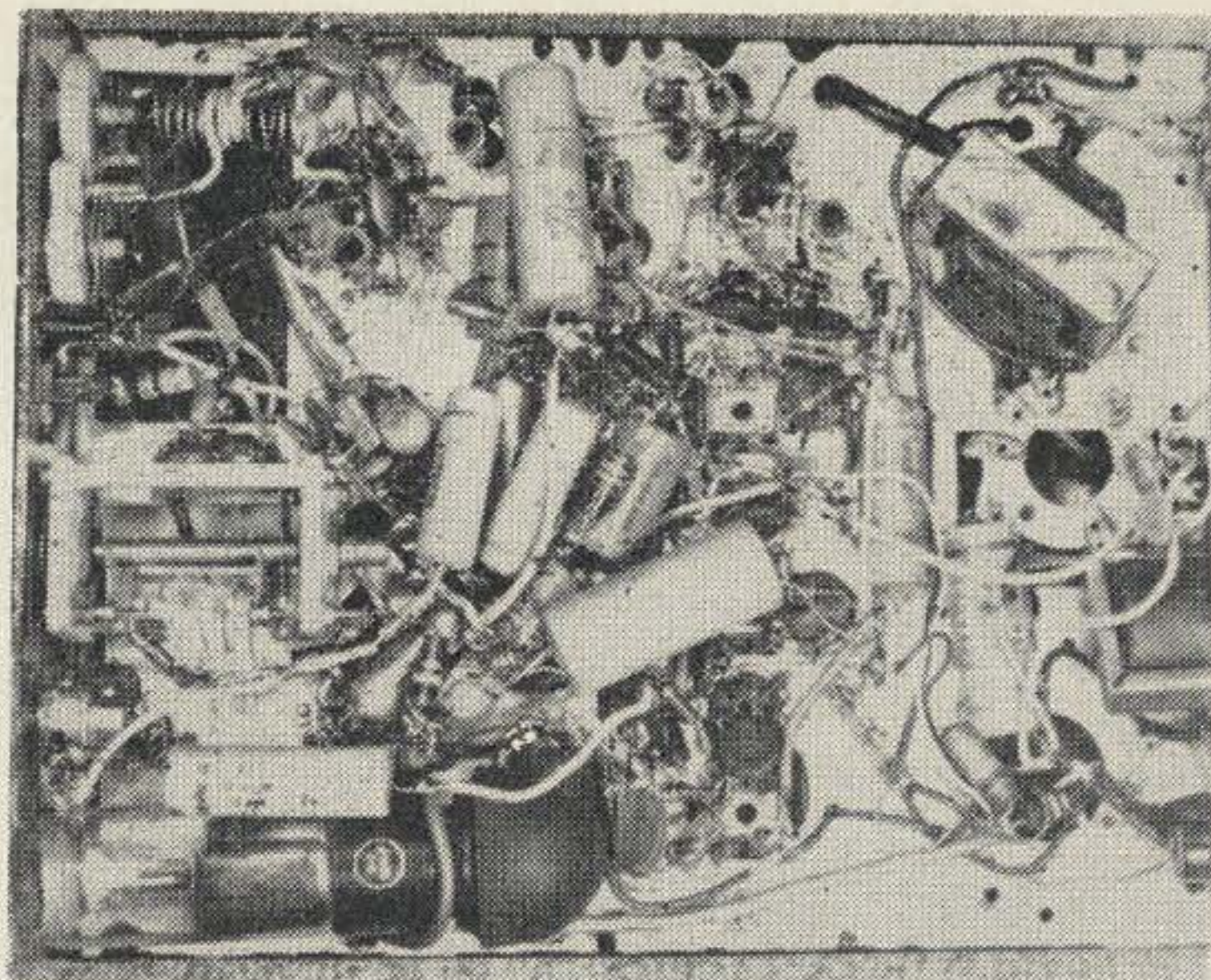

as this stage will oscillate quite easily. The oscillator is tuned 10.7 mc lower than the received signal. The oscillator tuning condenser, C3, is a dual condenser of about 5 mmfd per section. One like this was not available so it was made by ripping plates off a condenser with more capacity leaving one rotor and one stator plate in each section. To get a more favorable tuning ratio a small ceramic trimmer of about 1-5 mmfd can be placed across the entire winding of L3, and by playing around with the inductance of L3 and the trimmer, almost any tuning range of C3 can be achieved (within reason). C2 is made up of two one inch pieces of insulated wire hooked around each other. The way the unit was laid out, V7 was nowhere near the mixer so a 20 mmfd capacitor was connected from the plate of V7 to a 6 inch piece of RG58/u and C2 connected to the other end of the coax. The *if* amplifiers are not very much trouble to wire, the only precaution necessary is to keep the grid leads away from the plate leads. CR4 and CR3 are used as a full wave series noise limiter. The value of R1 should be adjusted to limit at 100% modulation, the value depending on the diodes used. CR2, CR3, and CR4 should all be of a type that has a fairly high back resistance and low forward resistance.

Push-to-Talk

Push-to-talk was not included in the rig. If anyone would like to include it in the rig, the only additional parts required are a 500 ma. silicon rectifier, a 12 vdc dpdt relay, a 100 mfd 25v miniature electrolytic condenser, and a 3 or 4 ohm resistor. The use of a dc relay permits usage in the mobile. The rectifier changes ac to dc when the rig is used on ac and has no effect when the rig is used in the mobile. The electrolytic eliminates relay chatter. The ptt switch is connected between X and Y. The relay replaces S2. R2 can be omitted but it protects the silicon rectifier from damage due to surge currents. This ptt system is in use in another rig and it works fine. For 6v use, a 6v relay could be substituted and will probably

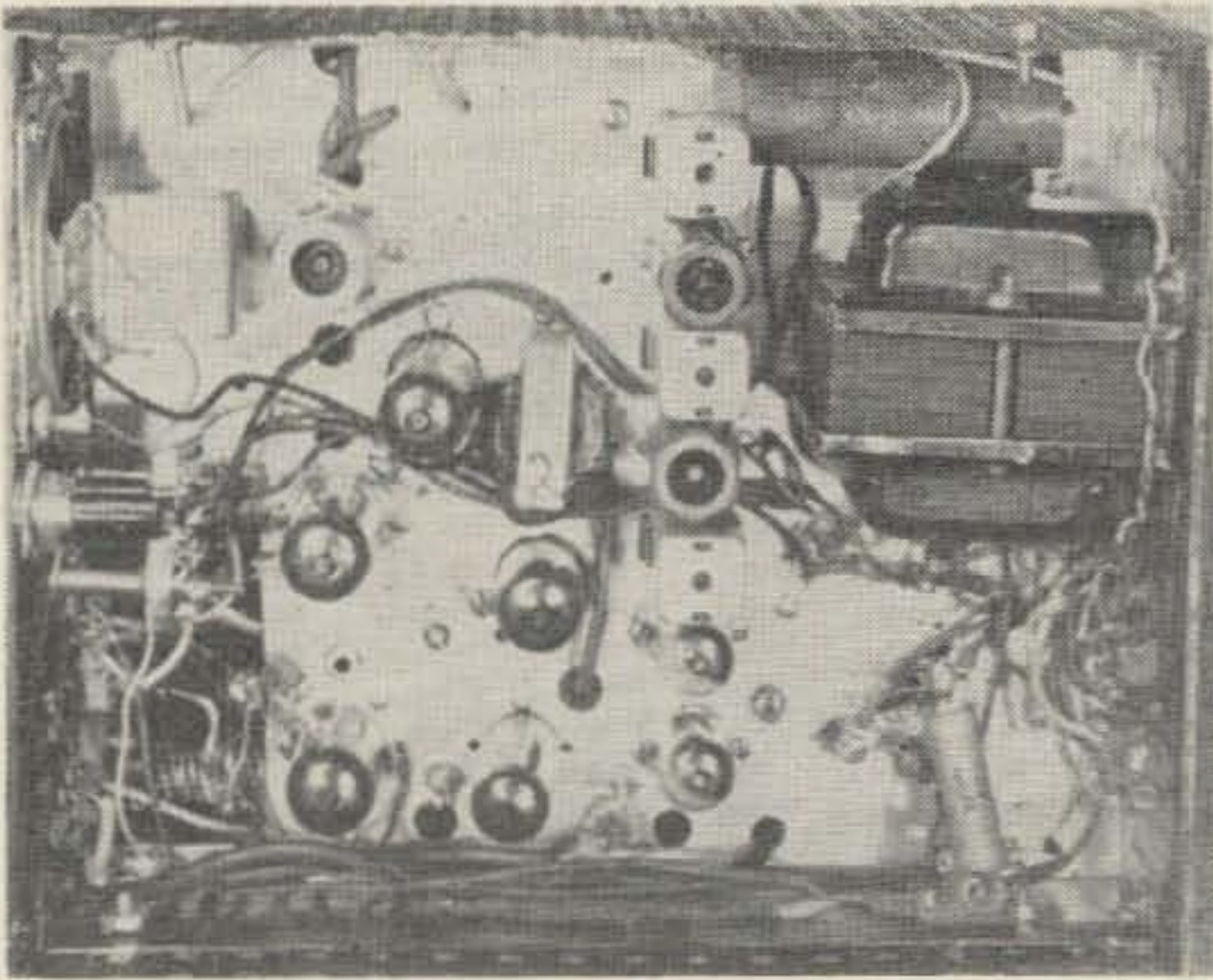

work as well, although the voltage drop across the rectifier may cause problems with some relays. The way the rig is wired, only one pole of the relay is needed to switch from transmit to receive, the other pole switching the antenna.

Smoke Test

After the wiring is complete and carefully checked for errors, shorts, and similar things, the next step is usually to give it the smoke test. This consists of turning it on and watching for any smoke, as from burning resistors, etc. If there is none, and everything looks normal, you can try tuning up the transmitter. Using a grid dip meter in the diode position, tune L4 for maximum output, using a crystal near the center of the band. Do the same for L5 and L6. If everything is operating correctly it should be possible to load the final to full output. For testing, a dummy load made from a number 47 pilot will work. Assuming the transmitter is now working, plug a mike in and test the modulator. If you are using a pilot for a dummy load, it should get considerably brighter when you speak into the microphone.

To align the receiver disable the oscillator by pulling out V7. Using a signal generator, apply a signal at the grid of V6 and tune T4 for maximum. Then work back to V4 using the same procedure. Now plug in V7 and make sure the oscillator is tuning the proper frequency. Using a 2 meter signal or the spot position on the transceiver tune L1 and L2 to maximum output. The tuning indicator, V11, can be used as an indicator for alignment. Next, using a weak on the air signal, adjust the tap on L1 for the best signal to noise ratio.

The transceiver should now be ready for on the air tests. Before putting the transmitter on the air make sure that there are no parasites and that all the coils are tuned to the correct frequency. To use the transceiver the only tune-up necessary will be the final tank circuit, all the other coils being broadband enough not to require retuning. Tune the

transmitter for maximum indication on V11. V11 will also be a tuning indicator for the receiver. The case was made from a piece of perforated steel which can be purchased very reasonably in most hardware stores. Putting the case on slightly detunes L3 but this was quite easy to correct, as the difference is only a few hundred kc.

I have gotten excellent results with this transceiver, and it seems to compare favorably with commercial equipment. The total outlay for my unit was approximately \$5.00, with the rest of the parts coming from the junkbox. Even if most of the parts are purchased, with a little shopping around it should be possible to build this transceiver for approximately \$30 to \$35. At this price, it is almost impossible to get anywhere near the performance per dollar by buying a rig. It works wonderfully in the mobile, and the receiver doesn't drift noticeably with changes in operating voltage that are typical of mobile operation. The appearance is greatly improved by spraying the panels and the use of decals.

The unit described here has given me many enjoyable hours of operating, both at home and in the mobile. . . . WA2INM

Coil Table

- L1—5t #20 wire $\frac{3}{8}$ " dia. spaced approximately $\frac{1}{2}$ " tapped at $1\frac{1}{2}$ t. from grounded end.
- L2—4t #20 wire on $\frac{1}{4}$ " slug tuned form spaced $\frac{1}{2}$ ".
- L3—3t #20 wire $\frac{3}{4}$ " dia. spaced approximately $\frac{3}{4}$ ", ct.
- L4—15 turns #20 enameled wire on $\frac{1}{4}$ " slug tuned form.
- L5—5 turns #20 enameled on $\frac{1}{4}$ " slug tuned form spaced $\frac{3}{4}$ ".
- L6—4 turns #20 wire on $\frac{1}{4}$ " slug tuned form spaced $\frac{3}{4}$ ".
- L7—10 turns, ct #20 wire $\frac{1}{2}$ " dia. wound 5 turns, $\frac{1}{4}$ " space and 5 more turns, the overall length being approximately $1\frac{1}{2}$ ".
- L8—3 turns insulated wire in the $\frac{1}{4}$ " space in the center of L7.

Note: The coils as given should resonate at the correct frequency. If one of them fails to do so, this can be corrected by either spreading or squeezing the turns, depending on whether the coil is lower or higher in frequency.

Errata

A couple of clarifications of the diagram are in order: The plate choke is an Ohmite Z-144. The B-plus for the V8 doubler should connect to the "xmtr B-plus" to give less signal on "spot."

Soldering Tips

Emergency tips for the Weller and similar type soldering guns can be made from a piece of #12 copper wire (solid). To make a tip, just bend the wire to the approximate shape of the original soldering tip and squeeze the center $\frac{1}{2}$ inch together to form a heat sink with which the soldering is done. WA21NM

Swan Engineering Co. SSB Transceiver



SW-175 3.5-4MC, SW-140 7.2-3 MC
SW-120 14.2-14.35 MC

If it's watts per dollar you want
If it's receiver per dollar you want
If it's operating pleasure you want. Home or mobile. Check this one.

130 watts PEP input to 6DQ5 Power Amplifier.

High frequency crystal lattice filter; 3 Kc. nominal bandwidth, used for both transmit and receive.

Unwanted sideband down approximately 40 db. Carrier suppression approximately 50 db.

Transmits automatically on receiving frequency.

Exceptional mechanical, electrical and thermal stability. Frequency is practically unaffected by voltage or temperature variations, or by vibration when driving over rough roads.

Receiver sensitivity better than 1 microvolt at 50 ohm input.

Smooth audio response from 300 to 3,000 cycles provides excellent voice quality for both transmitting and receiving.

Control system designed for greatest ease of mobile operation. Front panel controls include: Main Tuning, Volume, Carrier Balance, Microphone Gain, Exciter Tune, P. A. Tune, P. A. Load, T-R Switch, Supply On-Off Switch, and Tune Switch.

Main Tuning control is firm and smooth, with 16:1 tuning ratio. Calibrated in 2 Kc. increments.

Transceiver produces approximately 25 watts carrier output on AM by simply adjusting the Carrier Balance control. Receives AM signals very satisfactorily.

3-Circuit microphone jack provides for Push-to-Talk operation.

POWER SUPPLY REQUIREMENTS:

275 volts DC, nominal, at 90 ma., receive and transmit.

650 volts DC, nominal, at 25-200 ma., transmit only.

80 volts DC, negative bias, at 6 ma., receive and transmit.

12.6 volts AC or DC at 3.45 amperes, for filaments. Heath HP-10-HP-20.

A revolutionary new design by Swan Engineering provides single sideband communication at a surprisingly low cost. The one-band design gives exceptional high quality performance in all respects on the chosen band. The following models are available—

SW140-SW120

ELLIOTT ELECTRONICS, INC.
418 N. 4th AVE., TUCSON, ARIZ.

\$275
NET
PRICE

IS YOUR SIX METER CONVERTER

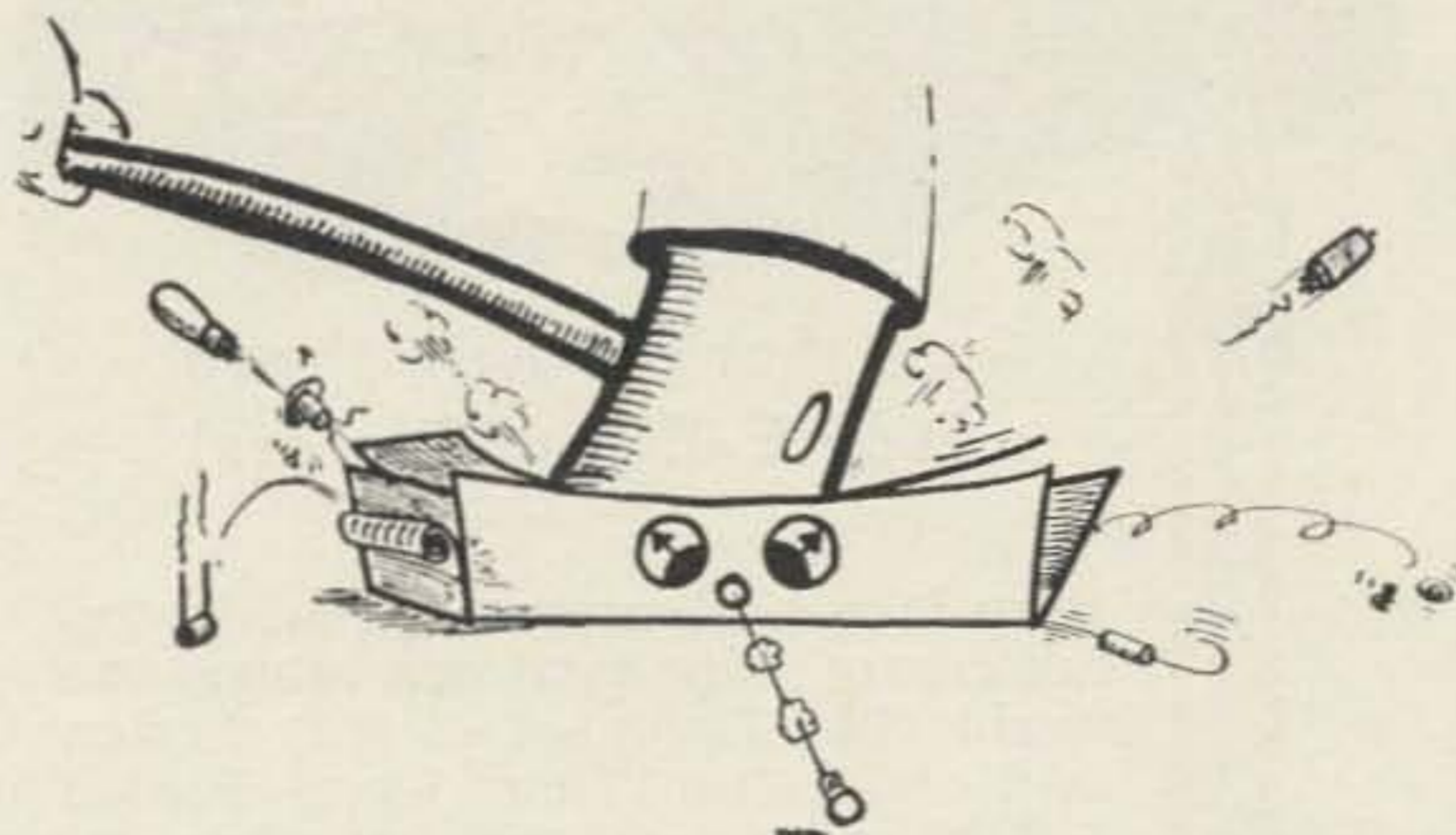

OVERLOADED?

GOOD GRIEF!

We solved that problem months ago. We are working on your 2 meter low noise converter now.

If you are STILL having overload problems with your six meter converter why don't you buy our new Telco Model 201. Only costs \$37.40 post-paid.

Make check payable

TO

TAPETONE ELECTRONIC LABORATORIES

99 Elm Street, West Newton 65
Massachusetts

NOW! from E-Z WAY
THE Medalist
"40"

Grab that DX with these sturdy E-Z Way Towers!

Here is a self-supporter that is top favorite of radio amateurs around the world. The famous E-Z Way design is Now Better Than Ever! 55,000 PSI high tensile steel has been incorporated into our tried and proven design to assure you of the sturdiest, most versatile tower your money can buy! Cranks up—cranks down—tilts over—stands alone. See the complete E-Z Way line at your nearest distributor.

- ★ Put your Tribander at 41' in 70 mph wind (125 mph cranked down to 24').
- ★ Tilts over for E - Z access to array.
- ★ Mounts Ham-M Rotor inside tower head. Top radial bushing and vertical thrust bearing.
- ★ Safety rest locks tower at desired height. No weight on the cables.
- ★ E.I.A. RS-222 specs. Heavy wall structural steel tube legs, solid steel rod diagonal and horizontal bracing - arc welded. ALL STEEL 55,000 PSI!

MODEL RBS-40P. Dip painted **\$169⁵⁰**

MODEL RBS-40G. Hot dipped galvanized, Am Net \$209.50

(Mounting Kits)
 MODEL GPK-S40. Tilt-Over Ground Post. Am. Net. \$75.00
 MODEL BAK-S40- Galvanized wall bracket and hinge base. Amateur Net \$10.50

E-Z WAY TOWERS, Inc.

P.O. BOX 5767

TAMPA 5, FLORIDA

Economical Capacitor Substitution Box

A capacitor substitution box is an absolute necessity in any development work involving the audio frequency and low radio frequency ranges, if a job is ever to get finished. While it is no substitute for a capacity bridge, by the same token, the bridge is no substitute for the substitution method of finding the proper capacity value for a particular situation. Examples of its use are, tuning RTTY filters, audio filters, speech clipper filters, determining the proper capacitor size for shaped audio response in amplifiers and modulators, determining suitable coupling values in multi-vibrators to achieve a desired wave shape, just to mention a few. Most of us rear back in dismay at the cost of capacitor decades and try to get around the problem by an excessive expenditure of time on a trial and error basis (lots of both). But the need keeps reoccurring to "bug us" or the friend down the street.

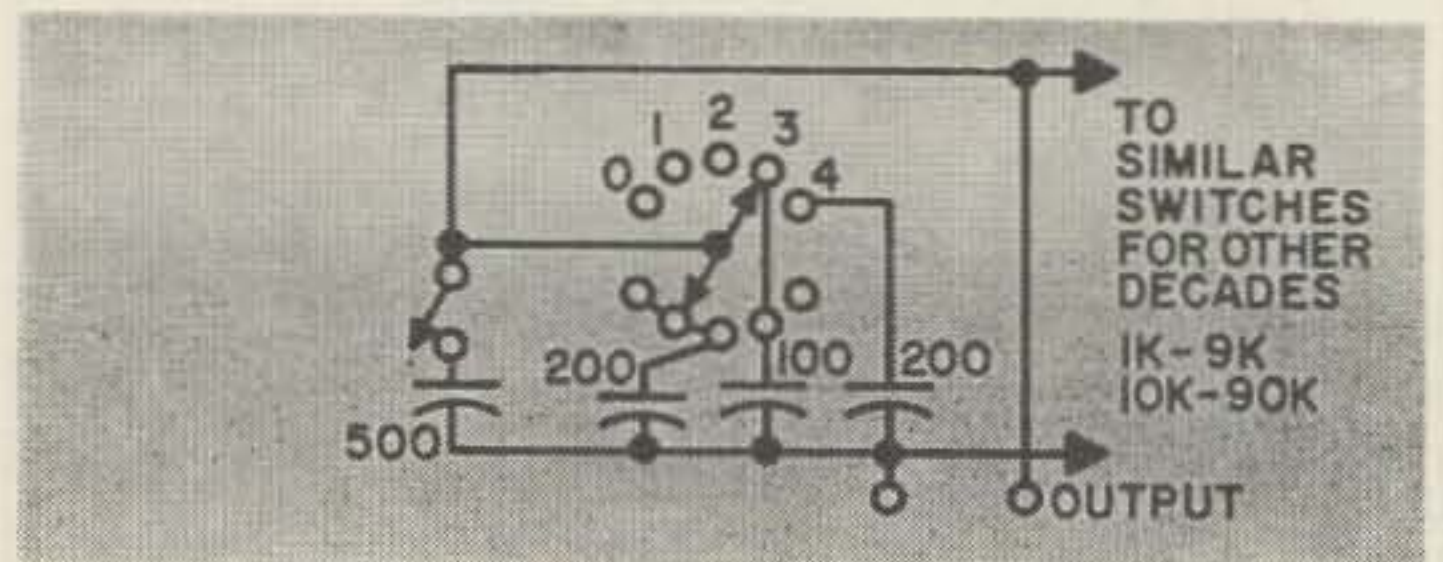

By a simple circuit trick we can build a box which will give us 1000 different values at a fraction of the cost of a commercial three decade box. Practically the whole story can be gleaned from an examination of the circuit diagram, or you can read on to learn how it came about. The three decade box uses twenty-seven capacitors to build up the 1000 different values. But if we take a tip from the Chinese Abacus we see they count to 1000 with 15 beads instead of 27. We can do the same with 15 capacitors instead of 27 by using 4 units of one and 1 unit of five to give each decade. We count up to 4 by ones, take off the ones and add a 5 and then add the

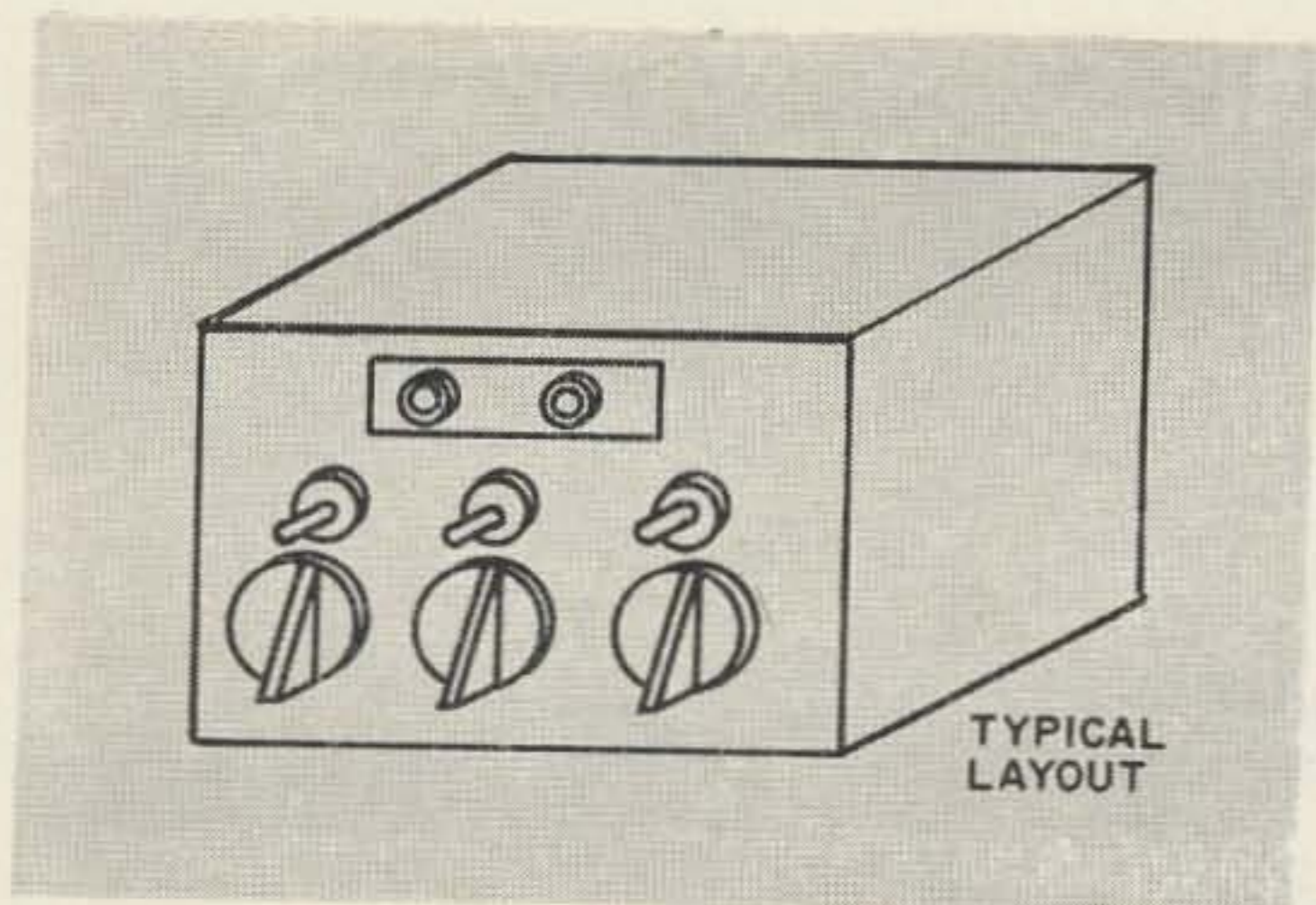

Capt. John Ellison W6AOI
1720 Holly Avenue
Menlo Park, California

ones to get to nine. Then we take off all nine and move over to 1 on the next decade, and so on. We arrange the ones on rotary switches and put the fives on each of three toggle switches, simple.

Next we find that there is no way to parallel condensers without using either a progressive shorting switch or using a two pole switch. Considering the second alternative we make a pleasant discovery, we don't need 15 capacitors, we can do it with 12 and still get the 1000 different values. Now in each decade we have a 1, two 2's and a 5 and the switch will do the combining to give us the unit count from one to four. This is shown in the circuit.

If we want to be real sneaky about it, and spend some time with an oscillator, a calibrated Broadcast receiver and a junk box of random values of capacitors we can end up with a three decade box of better than one-half percent accuracy by buying (or calibrating on an accurate bridge) three capacitors of one percent accuracy in the "two" value for each decade and building up the other values by comparison. Actually, it took me four hours from a cold start to check a box of capacitors to get suitable values, and assemble the whole thing in a 3" x 4" x 5" box. I chose to make mine to cover the range from 100 mmfd to .1 mmfd as the most useful ranges.

With twelve inch leads and all decades at zero setting, the residual capacity is approximately 26 mmfd. Cutting in each decade adds about 5 mmfd as stray capacity. Mallory makes a small inexpensive rotary switch in 2 pole 6 position size which is ideal for compactness. You should use an insulated strip for the terminals so that the box can be hooked into a hot circuit. I found three new uses for it in a week. . . . W6AOI

NEW P & H LA-400-C LINEAR AMPLIFIER NOW 800 WATTS PEP FOR ONLY \$164.95



PANORAMIC SPECTRUM ANALYSIS

Odd order distortion products (1kc, separation) using popular 100 watt SSB exciter and LA-400C.

	3rd order	5th order
EXCITER ONLY	-37 db.	-47 db.
EXCITER AND LA-400C	-37 to -40 db.	-47 to -50 db.

Certified by ITT FEDERAL LABORATORIES

The 80 thru 10 meter band-switching pi network is designed for 800 watts PEP SSB, 400 watts CW, FM or FSK and 230 watts Linear AM (controlled carrier) or 185 watts (constant carrier) with 50-70 ohm output. Popular 100 watt SSB exciters require no swamping or matching networks to drive the low Z untuned input. Grounded grid circuit uses four 1625's or 837's on customers request. Meter reads RF drive, plate current, RF amps output. New modern compact 9" X 15" X 10 1/2" gray cabinet also contains power supply using 816's. TVI suppressed, Parasitic Free.

One-Year Warranty on all Parts and Tubes
SEE THE NEW LA-400C AT YOUR DEALERS

LA-400C Kit Complete with tubes \$164.95
LA-400-C Wired and tested \$219.95

P & H ELECTRONICS INC.
424 Columbia Lafayette, Ind.

WALKIE-TALKIE RADIOPHONES



For 6 & 10 Meters

from

24⁹⁸

Send for free literature on the Springfield semi-kits and Vanguard factory assembled radiophones.

VANGUARD ELECTRONICS
LABORATORIES

190-48 99th AVENUE • Dept. H-12 • HOLLIS 23, N. Y.

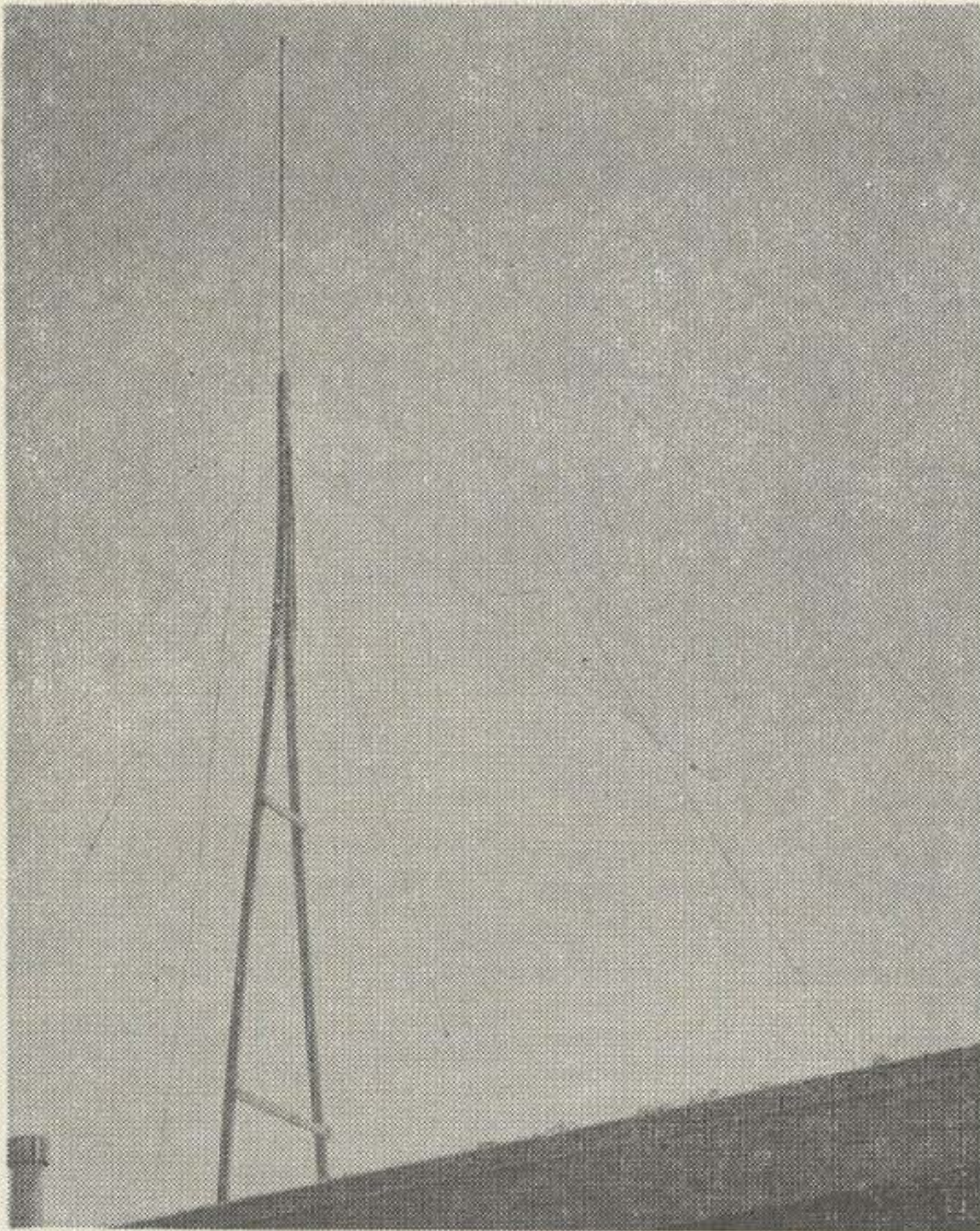

Antenna

*Simple, inexpensive,
small, quick,
works!*

Jim Kyle K5JKX/6
1851 Stanford Avenue
Santa Susana, California

ANTENNAS are important! From the lowliest Novice struggling to make the window-screen take a load, to the most advanced old-timer with a farm full of rhombics, we all know that fact.

This article does *not* describe a perfect antenna; it *does* describe an inexpensive antenna which requires exceptionally small space, makes an equally small dent in the pocketbook, and can be put together in approximately one hour.

The actual cost of the antenna, aside from guying materials and feedline, is less than \$5 even on the slightly-expensive California coast. Add another \$10 for coax and the ultimate in guying, and the cost is still less than half that of any comparable commercial antenna. Best of all, though, is its performance; while it's not intended to substitute for a beam, this antenna will outperform most omnidirectional types, due to near-perfect impedance matching.

Although it's not too evident from the photo, the basic ancestry of this antenna is the old familiar ground-plane. This writer fell in love with the ground-plane for any band above 20 meters while working with W5ZUS on a 10-meter version which—in his not-too-good location—outperformed the 3-element beam it replaced.

The apparent complexity of the photo is due entirely to mechanical considerations; electrically, the unusual thing about this ground-plane is the matching system. While stub-matched ground planes have been around for some time (the ARRL handbook provides complete design information for them, and has for a number of years), few hams have done anything with them so far as the litera-

ture shows.

Briefly, the electrical design philosophy is this: An ordinary ground-plane antenna has a feedpoint impedance between 25 and 30 ohms; when fed with coax, the usual case, this produces a mismatch giving standing waves as high as 3 to 1. In this day of pi-network output circuits, an SWR higher than 2 to 1 is likely to damage your transmitter; and at any rate, good engineering practice dictates that the SWR be kept as low as is practical.

By shortening the vertical element of the ground-plane, the radiation resistance can be raised to any desired amount. However, the short antenna is no longer resonant, and as a result reflects a capacitive impedance back to the feedline. This situation is even worse.

However, the capacitive reactance can be tuned out by an inductive stub at the feedpoint, so that the feedline sees only a 52- or 75-ohm resistance; SWR goes to perfection and the signal strength goes up.

The design equations to determine just how much to shorten the antenna, how long to make the radials, and how to build the inductive stub, are rather complex and are intimately connected with the mechanical design of the antenna as well. They have been worked out (for this mechanical design only) for coverage of the 20, 15, 10, and 6 meter bands and are listed in Table 1. However, it must be emphasized that the diameter of the vertical element and the size of wire used in the radials are key points in the design procedure, and if either is changed, the values in Table 1 may not apply.

At this point, let's look at the complex-appearing mechanical structure of this antenna. It's not pretty, but it's inexpensive.

The heart of the structure is the A-frame made of two 14-foot chunks of 1 x 2 lumber; its total cost was 85¢ for the lumber plus another half-buck for the nuts and bolts which hold it together. When the entire antenna is mounted atop a one-story residence, this frame lifts the active part of the antenna more than 26 feet in the air; this height is enough to minimize ground effects on all bands except 20.

The vertical element itself is made from 1¼-inch TV mastings; total cost was \$1.69 for a 10-foot length (the 15- and 20-meter models require two lengths). One end was flattened for a distance of 20 inches, with the aid of a sturdy vise, and was then clamped between the 1 x 2's of the A-frame. The entire sandwich was then drilled for ¼-inch by 2½-inch aircraft bolts, which were pulled up firmly but not so tight as to split the wood. The other end of the masting, after being cut to length as shown in Table 1, was drilled through twice (at right angles to each other) with a ¼-inch drill to provide anchoring spots for the upper guys.

The next step in construction of the antenna is installation of the lower guys which double as radials. Two holes, each ⅛ inch in diameter, were drilled through the A-frame at a point about ½ inch below the bottom of the vertical element. A length of No. 14 stranded copper wire about 18 inches longer than twice the radial length given in Table 1 is then passed through each of the two holes.

To connect the four resulting radials together, a 10-inch length of the same wire is passed around the perimeter of the A-frame, and is wrapped once around each radial where it emerges from the ⅛-inch hole. The two ends of the 10-inch wire are twisted tightly to-

FREQUENCY IN MC.	USING 52 OHM FEEDLINE		USING 75 OHM FEEDLINE		R
	H	S	H	S	
14.2	15' 5"	6' 11½"	13' 11"	5' 8"	16' 11½"
21.3	10' 2"	4' 6"	9' 1"	3' 8"	11' 3½"
29.0	7' 4½"	3' 3"	6' 6½"	2' 8"	8' 3½"
50.5	4' 2"	1' 10"	3' 7½"	1' 5½"	4' 9"
52.0	4' 1"	1' 9"	3' 5½"	1' 5"	4' 7½"

H- Height of vertical element, made of 1¼" tube.
R- Length of radials, made of #14 copper wire.
S- Length of stub, made of RGS/U (regardless of feedline imp.)

Table 1. Antenna dimensions.

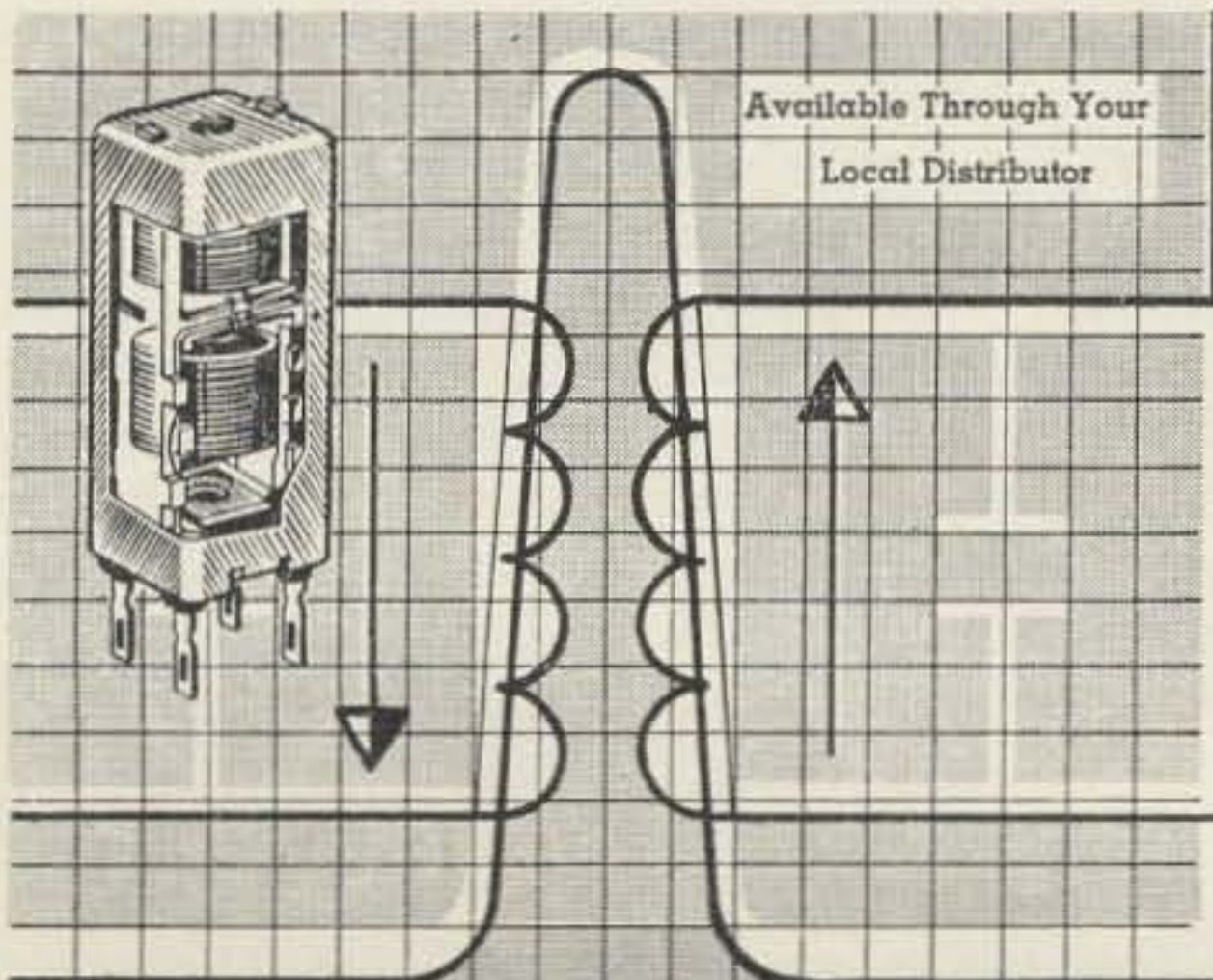

Available Through Your
Local Distributor

COMMUNICATION I.F. Transformers

TYPE	ITEM	6 db*	20 db*
12-C30	455 kc. Input/Interstage I.F.	11.5 kc.	30.1 kc.
12-C31	455 kc. Output I.F.	13.6 kc.	32.6 kc.
13-W1	1500 kc. Input/Interstage I.F.	130.0 kc.	264.3 kc.
13-W2	1500 kc. Output I.F.	121.4 kc.	240.5 kc.
913-C1	455 kc. Input/Interstage I.F.	8.5 kc.	24.3 kc.
913-C4	455 kc. Output I.F.	10.9 kc.	28.6 kc.
913-W1	1500 kc. Input/Interstage I.F.	19.5 kc.	61.5 kc.
913-W4	1500 kc. Output I.F.	25.6 kc.	73.4 kc.

J. W. MILLER COMPANY *Tolerance: ±10%
5917 So. Main St., Los Angeles 3, California

MULTI-ELMAC MOBILE EQUIPMENT

CHOSEN
for use aboard the S.S. HOPE!



AF-68

TRANS-CITER

PMR-8

RECEIVER



M-1070

POWER SUPPLY

Manufactured by

MULTI-PRODUCTS COMPANY
21470 COOLIDGE HWY., OAK PARK 37, MICH.

DOW-KEY PANEL MOUNT



Durable, silver plated, precision made. Only 5/8" hole is needed, no screws.

DK60-P

.70 ea.

CONNECTORS



DOW-KEY DOUBLE-MALE CONNECTOR

DKF-2

Favorite everywhere. Precision made, rugged locking type. Silver plated.

\$1.25 ea.

At your electronics dealer or write:

DOW-KEY CO., Thief River Falls, Minn.

HAMS—Insure peak performance from your gear with **SECO**

2-WAY RADIO TEST SET

Combination Crystal Checker, RF Signal and Field Strength meter. 0-50 ma. meter for final amplifier tuning. Use as RF output indicator. Checks activity on third overtone transmitter crystals—checks fundamental and high overtone crystals at fundamental frequency. Powered by two 1.5 V. "C" cells.



Model 500—wired and factory tested
\$29.95 Net

TRANSMITTER TESTER

For low power transmitters up to 160 MC. Calibrated for direct percentage reading of amplitude modulation; 0-5 watts RF output; 0-400 ma. RF output. Connection provided for headphones or scope. Optional "T" pad attenuator adapts to transmitters rated up to 50 watts.



Complete with all necessary cables and adaptors
Model 510—\$46.95 Net

ANTENNA TESTER

For 50 ohm coaxial line applications. Simplified direct reading scales for SWR Antenna System Efficiency (read in percent and a Good-Poor scale), Forward Power and Reflected Power. Instrument insertion loss is negligible up to 160 mc. Power ranges are 0-10, 0-100 and 0-1000 watts maximum.



Comp. with instructions
Model 520—\$42.95 Net

ATTENU-LOAD

Dual purpose 50 ohm-50 watt unit—ten db "T" pad attenuator reduces power levels by 10 to 1 ratio . . . plus fully shielded 50 ohm termination for coaxial cable applications. Noninductance resistance load bank for low frequencies as well as VHF to 160 mc. With SO-239 coaxial jacks for input and output.



Model 511A
\$21.50 Net

SECO TUBE TESTERS

GRID CIRCUIT TUBE TESTER—full TV tube coverage—MODEL GCT-9
\$32.95 net

GRID CIRCUIT AND TUBE MERIT TESTER—full TV tube coverage—Model 78
\$69.50 net

COMPLETE TUBE TESTER—tests Dynamic Mutual Conductance, Cathode Emission and Tube Merit—includes Grid Circuit Test—MODEL 107 \$139.50 net

DYNAMIC TRANSISTOR CHECKER—tests PNP and NPN types—Model 100 \$19.95 net

BATTERY ELIMINATOR—for transistor equipment—yields 0 to 15 V.DC from 105-125V. 60 cycle AC—Model PS-2 \$13.95 net

See your dealer or send coupon.



SECO ELECTRONICS INC.

5015 Penn Ave. S., Minneapolis 10, Minn.

Please send me full information on Model

500 510 520 511A 107 78
 GCT-9 100 PS-2

FREE Selling and Installing Citizens Band Equipment Bulletin

Name _____

Address _____

City _____ State _____

gether, and all connections are soldered.

The other end of each radial is terminated in an egg-type strain insulator; length of each radial is adjusted to the value given in Table 1 at this time. These lengths are to be measured from the center of the vertical element to the bend in the radial where it passes through the strain insulator.

Now, the feedline and matching stub can be connected. Prepare the stub by cutting a length of RG/8-U to the length shown in Table 1, and carefully shorting the shield to the center conductor at one end. At the other end, separate the shield braid for about an inch and remove enough of the inner dielectric to allow a firm connection to be made to the center conductor. Prepare the feedline end in the same manner. Connect both center conductors to the vertical element—a No. 6 sheet-metal screw and a pair of solder lugs come in handy here—and both shield braids to the radials. Attach the stub securely to one leg of the A-frame, and the feedline to the other leg.

You're almost ready to hoist the structure aloft; the only steps remaining are the spreading of the lower ends of the A-frame, and provision for guying.

The lower ends of the A-frame should be held about 30 inches apart by a short chunk of 1 x 2 tacked lightly to the A-frame stringers. The final spreading will be secured by the mechanical connections between the base of the A-frame and the roof.

For guying, you have a choice of several types of material. This writer recommends using Glasline, despite its apparent expense. The upper guys, especially, must be non-conducting. This rules out any metallic guys, leaving only Glasline, plastic clothesline rope, and nylon cable. Both the clothesline rope and the nylon cable have unhappy tendencies to stretch under the influence of weather, and this stretch can be enough to dump your antenna to the ground some fine night.

The extensions of the radials aren't so critical, and metallic guys can be used here if expense is critical. However, it's simpler to use just one type of material, and the difference in cost isn't that great in most cases.

The upper guys are connected to the vertical element by lining the ¼-inch holes in the metal with rubber grommets, feeding the Glasline through the grommets until you have enough on each side to reach to the base of the A-frame and halfway back up the structure, then tying a loop knot in the Glasline *inside* the tubing (pull some slack out, tie the knot, feed it back). The knot won't go through the ¼-inch hole in either direction, thus giving you a firm connection at the top with no danger of a joint pulling free during gusty winds.

Note that four guys are used at the top, and four at the middle. While three are nor-

mally considered enough to hold any structure, four were used for simplicity in mechanical attachment to the antenna as described above.

The top guys and the middle guys are *not* anchored to the same points; anchor points for the two sets are offset 45° from each other. That is, top guys are anchored at points 90° apart, and middle-guy anchor points are located halfway between top-guy anchors. This staggering of the anchor points gives some of the sturdiness to be expected from eight-point guying.

To erect the structure, an assistant is helpful. Stand the structure against the side of the house, then lift it vertically (while standing on the roof) and carry it, still vertical, to the installation position. Have the assistant hold the antenna vertical (it weighs only a few pounds) while you temporarily anchor the middle set of guys. When they are tied in, the structure will be almost self-supporting. At this stage, you can install the bottom mount plates.

These plates are adapted from 2-inch angle brackets; the right angle built into the brackets is bent a bit wider open (just how much depends on the pitch of your roof) and the bolt holes (four per bracket) are enlarged to clear a 1/4-inch bolt, before climbing to the roof. With the antenna in place, attach the brackets first to the roof, using 1/4 by 2-inch lag screws. Then drill through the A-frame legs for 1/4 by 1 1/2-inch machine screws or aircraft bolts to attach the other part of the brackets.

The only thing left before trying the antenna out is to anchor the top guys, and to make permanent the anchoring of the middle set. This procedure is similar to any guy-wire anchoring procedure, with one exception: Glasline shouldn't be subjected to sharp bends. Use eyebolts and "thimbles" to guide the Glasline smoothly around the bolt, and secure the Glasline with a bowline knot, for complete freedom from worry about breaking guylines.

Now feed the coax through to the shack in any manner the XYL will okay (a 1/2-inch hole through the roof is ideal if permission can be wangled), hook the antenna up, and prepare to enjoy operation. For either DX or extended ground wave work at the frequencies for which it's cut, this antenna will give you good results. . . . K5JKX/6

Club Subscriptions

\$2.50 each in groups of five or more — subscriptions start with next published issue.

NEW Your Call and home state in a single custom decal!



In six attractive colors. Unequaled in appearance. Ideal gift. \$1.95 each. Add 4% tax in Calif. Approx. size 3 3/4" x 9". Mailed P.P. within 7 days. No COD's please.

CALL-D-CAL

P. O. BOX 3915, TERMINAL ANNEX
LOS ANGELES 54, CALIFORNIA

Act-WRITE NOW!

Better Yet — WIRE OR CALL TODAY FOR

1. Burghardt's "Deal of the Month" For December.
2. Our December Listing of Reconditioned Equipment Carrying Burghardt's "Seal of Satisfaction."

YOU'LL BE GLAD YOU DID!

- * Featuring . . .
Central Electronics, Collins, Drake, Gonset, Halli-crafters, Hammarlund, Hy-Gain, Johnson, Mosley, National.
- * Your Direct Line to Every Manufacturer.

Burghardt
— Since 1934 —

Phone TU 6-5749
Box 746B
Watertown, So. Dakota

BARRY

**BUYS
TUBES
&
EQUIPMENT**

SELLS

**FAST
& FAIR**

**Barry
Electronics**

**HAM
GEAR**

SWAPS

512 Broadway
New York 3
WA 5-7000

Send for Catalog



KITS
MAILED POSTPAID
ANYWHERE IN USA.



Send for FREE list of
more than 80 models

Let's "kit" Together
Use YOUR Parts & PAPPY'S wiring

IRVING ELECTRONICS CO

POST OFFICE BOX 9222 SAN ANTONIO 4, TEXAS

New Products

1962 Allied Radio Catalog



The 444 page catalog is now available for the asking. The ham section lists gear from over 45 major manufacturers plus Allied's own Knight brand 60 watt transmitter, receiver, G.D.O., etc. This is the most complete distributor catalog in the world and it should be on every amateur reference shelf. Drop a line to Allied Radio Corp., Chicago 80, Illinois or read their ad on page 80.

Eico Vfo

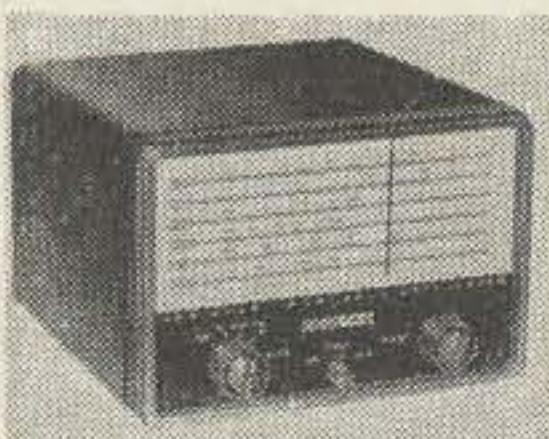

The model 722 VFO uses the Clapp circuit for stability and covers all ham bands from 80 through 10 meters. The power supply is built-in so you don't have to borrow power from the transmitter, possibly overloading it and at least giving you fits in hooking up the connections. The 722 has a spotting switch and can be operated by the transmitter by means of a built-in relay. Lengths are gone to in order to have drift-free operation: large air-wound coil, temperature compensating capacitors, high L-C, double-bearing tuning capacitor, and solid construction. Also a VR tube. Priced at \$44.95 in kit form and \$59.95 wired, ready to go. Write EICO, see page 5.

Hammarlund HX-50



This is a new filter-type SSB transmitter, rated at 50 watts PEP. The VO is readable to one-half kc. Price \$399.50. You'd better check into this one, looks like they did a nice job on design. Hammarlund, 460 West 34th Street, N. Y., 1, N. Y. Sorry, no ad to refer you to as yet.

Eico Transistor Tester



The model 680 not only measures actual transistor parameters, but is designed to be able to test all transistor circuits with its VOM ranges. 3½" meter with 50 ua movement. Details? Write EICO, see page 5. Priced at \$25.95 in kit form, \$39.95 wired and ready.

Lafayette HE-40 S-W Receiver

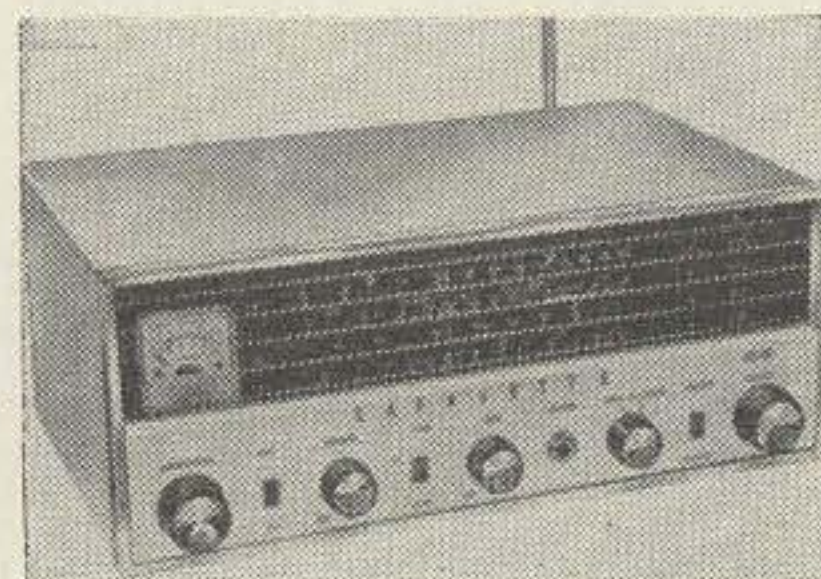

Priced at \$54.50, this general coverage receiver tunes from 550 kc to 30 mc, covering all major ham bands. It has a separate bandspread tuning condenser, an "S" meter, BFO, and a built-in 5" speaker. It uses a built-in ferrite loop for the broadcast band, a 58" telescoping whip for the short-waves, and has connections for external antennas. 117v ac/dc. Write Lafayette for info, see add on page 3.

New Book

Basic Radio

John Rider has just published a six volume set of books which add up to a rather complete course on radio theory. The books are done in the usual Rider style of profuse illustration through drawings, photographs, and charts. Almost every page of every volume has one or two large illustrations. The entire course costs \$13.85 in soft covers and \$14.85 in hard cloth cover. The course covers: DC Electricity; AC Electricity; Electron Tube Circuits; AM and FM Receivers; Transistors; and AM and FM Transmitters. This set should be a fine adjunct to whatever you might suggest for the novice as a beginning text on radio. It might even help sharpen you a bit. John Rider, Publisher, 116 W. 14th St., N. Y. Sorry, no ad. Rider #197.

Seco Tube Tester

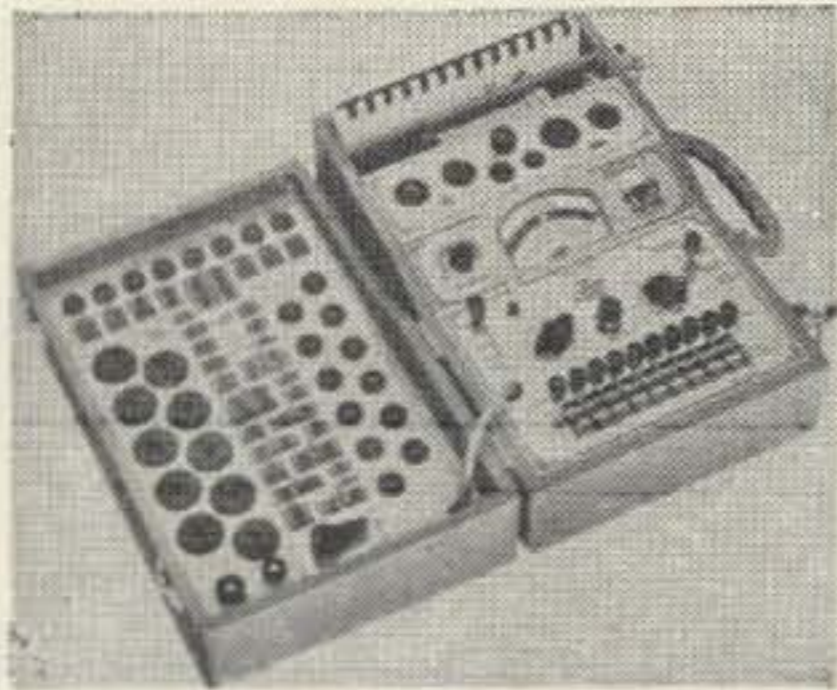

Tube testers are getting to be more like the dash of a jet-liner, what with all of the new tubes: nuvistors, compactrons, novars, UV-201's, European tubes, and such. The Seco 107A tests 'em all, dynamic mutual conductance test too, not just a look for shorts and open filaments. Price \$149.50. A recent survey of ham shacks indicated that 14% of them boasted a tube tester. Here's your chance to join this exclusive group. If you do any test work or experimenting this gadget will be worth its weight. Write Seco for even more convincing data. Ad on page 54.



Lafayette

Xtal



Calibrators

TE-27 (transistorized, naturally) provides 100 kc and 1 mc signals and sells for only \$18.95. It gives harmonics up to 54 mc. The TE-29 provides only 100 kc signals and sells for \$11.95. Both are powered from built-in 9 volt batteries. More data? Write to Lafayette, ad on page 3.

Wall Chart

Stancor has an 8½ x 11 wall chart that not only covers up finger smudges, but also gives you color codes for their power, audio, output and if transformers. No charge. This can save you a lot of lost motion when you need it. Write: Mr. Cook, Stancor Electronics, 3501 Addison St., Chicago 18, Illinois. Sorry, not advertising yet.

Variac

A note from the chairman of the board of General Radio Company pointed out that our article in the October issue of 73 on Variacs did not mention that "Variac" is a registered trade-mark of his company. The Teletype Corporation has the same problem.

VHF Colinear Arrays

FEATURES



- LIGHT WEIGHT
- MECHANICALLY BALANCED
- HIGH FORWARD GAIN
- HIGH FRONT TO BACK RATIO
- LARGE CAPTURE AREA

32 AND 64
ELEMENT
STACKING
KITS
AVAILABLE

430 MC. 16 Element \$ 9.85
220 MC. 16 Element \$12.95
144 MC. 16 Element \$16.00

See your distributor or write for
FREE CATALOG

CUSHCRAFT

621 HAYWARD ST.
MANCHESTER N. H.

JIM CLARK * W1ULU

KIT WIRING & TESTING LABS

REPAIRS & SERVICE ON ALL MAKES OF HAM GEAR
AND

TEST EQUIPMENT, CITIZENS BAND GEAR & HI-FI

2 Aiken St.

Tel. HEmlock 2-3600

Derry, N. H.

ALL WORK GUARANTEED

2 meter - 6 meter

NEW

TRANSISTOR CONVERTERS

NEW

Low Noise RF,
Mixer Transistors

NEW

Compact Design,
Only 2¼ x 2¼ x 5"

NEW

Printed Circuit Boards,
Coil Sets & Kits also avail-
able - write for prices!

2M \$49.95, 6M \$44.95, Wired, with Xtal

HAMBOARDS

P. O. BOX 13158

PINECASTLE, FLORIDA



73 Tests

Knight R-55 Receiver

Don Smith W3UZN

THE new amateur is faced with quite a problem when buying a receiver. Of course it is nice to be able to walk into the store and buy one of the \$600 ham-band-only receivers, but most of us have to start a lot more modestly. Look then, if you will, at the Knight R-55 receiver. This is a general coverage receiver, which means that even if you finally decide to go for one of the multi-hundred dollar communications receivers, you still will have plenty of use for this.

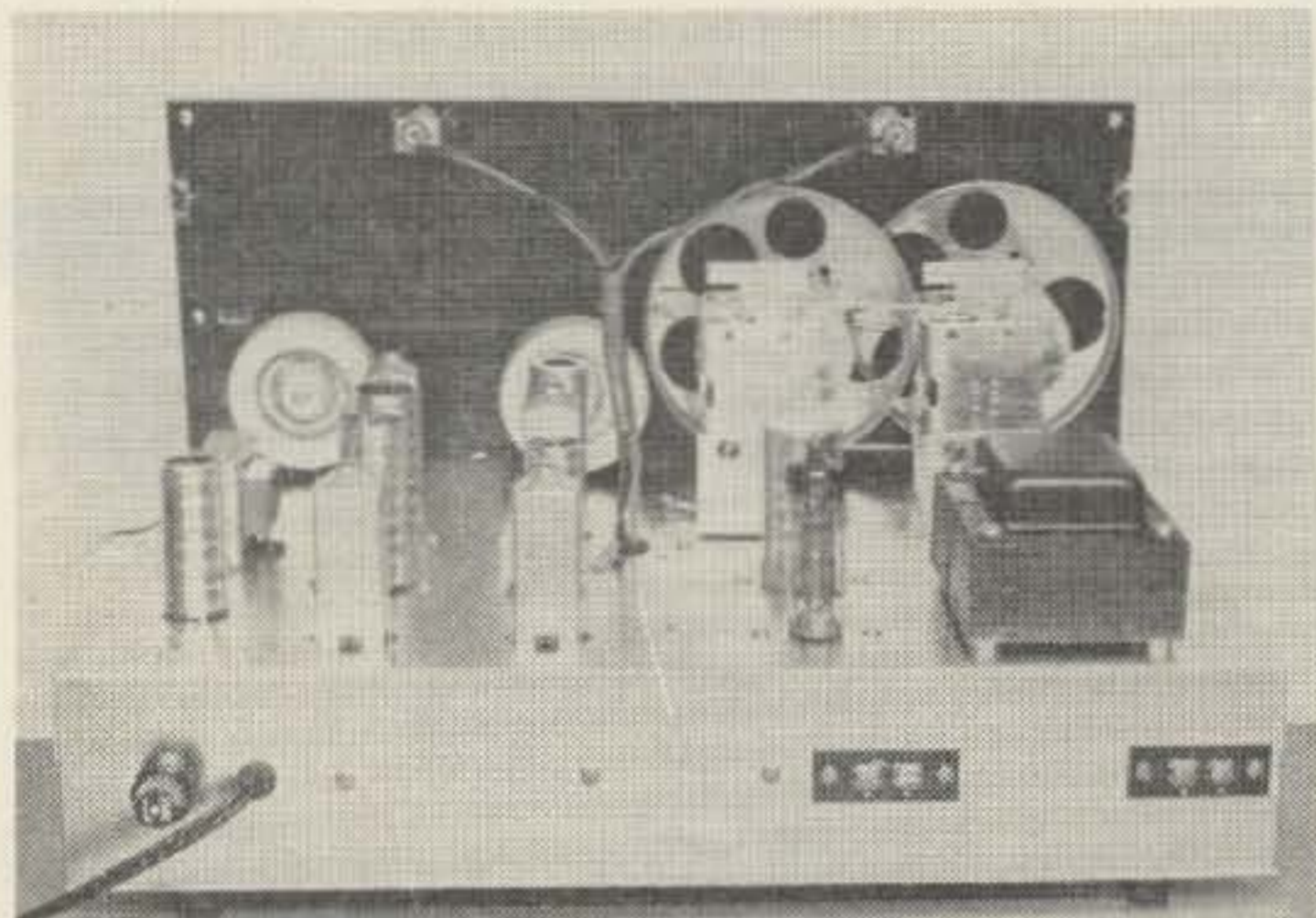

There are so many times when a general coverage receiver is needed that a ham shack certainly is incomplete without one. There are the obvious uses such as listening to the short wave broadcast stations, which can become a hobby all by itself. Or you can use it as a tunable *if* for a VHF converter . . . you can't do that with the bandspread receivers. WWV and CHU run interesting time programs, though I prefer the material broadcast by CHU, which

seems to have a better program director. If you decide to try RTTY you will want a receiver to copy press and weather stations. Let's not forget the broadcast band either. Plus a hundred other uses if you do any experimental work at all, or engage in three-way contacts or cross-band contacts. You can quickly check for harmonics, parasitics, and things like that. You may get the idea that a general coverage receiver is necessary . . . it is.

The Knight R-55 has several advantages. First of all is that \$67.50 price. It comes in kit form, but all the hard work is already done and the instruction manual is so simple that the rest is a breeze. It covers from 530 kc to 33 mc, which includes all of the short-wave broadcasting bands, and all of the ham bands from 160 through 10 meters. It also covers from 47-54 mc, which is the six meter amateur band. It is ac operated, using a power transformer, and has a separate BFO oscillator tube, fly-wheel tuning and an antenna trimmer for matching the receiver to your antenna.

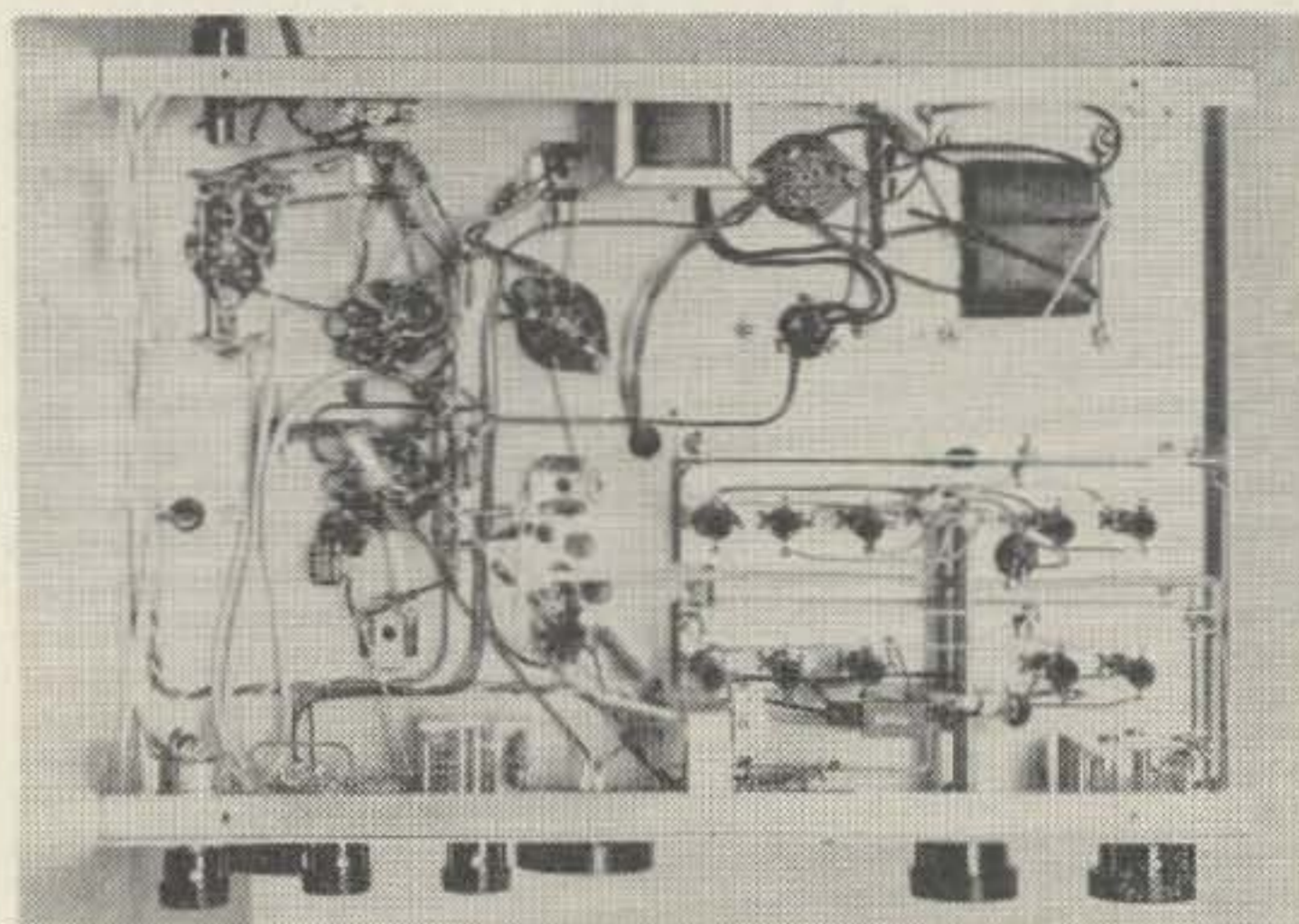

The kit is a pleasure to assemble. All wires are color coded and cut to the right length. All resistors are mounted on cards with their part number printed so you can't make a mistake, even if you are color blind. The manual is full of clear diagrams and pictures to eliminate any question about what goes where or when to put it in. Figure about ten hours for the whole job.

Now, about the results. I was surprised and pleased to use the R-55. The bandspread is ample on all amateur bands and both sensitivity and selectivity were fine. Even up on six meters there were stations coming in with

R-55

Tuning ranges: 530 kc to 1.9 mc Band A
1.8 mc to 6.3 mc Band B
6.0 mc to 14.5 mc Band C
11.5 mc to 33. mc Band D
47 mc to 54. mc Band E

IF frequency: 1650 kc

Sensitivity: 80 meters = 4uv 40 meters = 6uv
20 meters = 8uv
15 meters = 7uv 10 meters = 6 uv
6 meters = 10uv

Antenna impedance: 52 ohms

Power consumption: 60 watts @ 117 vac

Dimensions: 11" deep, 14 $\frac{1}{4}$ " wide, 8 $\frac{5}{8}$ " high

Weight: 19 lbs.

Price: \$67.50

good signals. I suspect that one of those Nu-visor pre-amplifiers would help a lot there, though. On the other bands the R-55 was easy to tune and fun to use. For \$67.50 this is quite a deal.
 . . . W3UZN

Using Old Transistors

Don't throw away your old transistors they may be useful in more ways than one. Usually when they burn out it is between collector and emitter. Sometimes base to collector is the bad section.

Here is the way I do it—start out with 5 v or 6 v ac to a pair of test leads and a pilot light such as a #49 something with low current drain so you will not ruin what is left of the transistor.

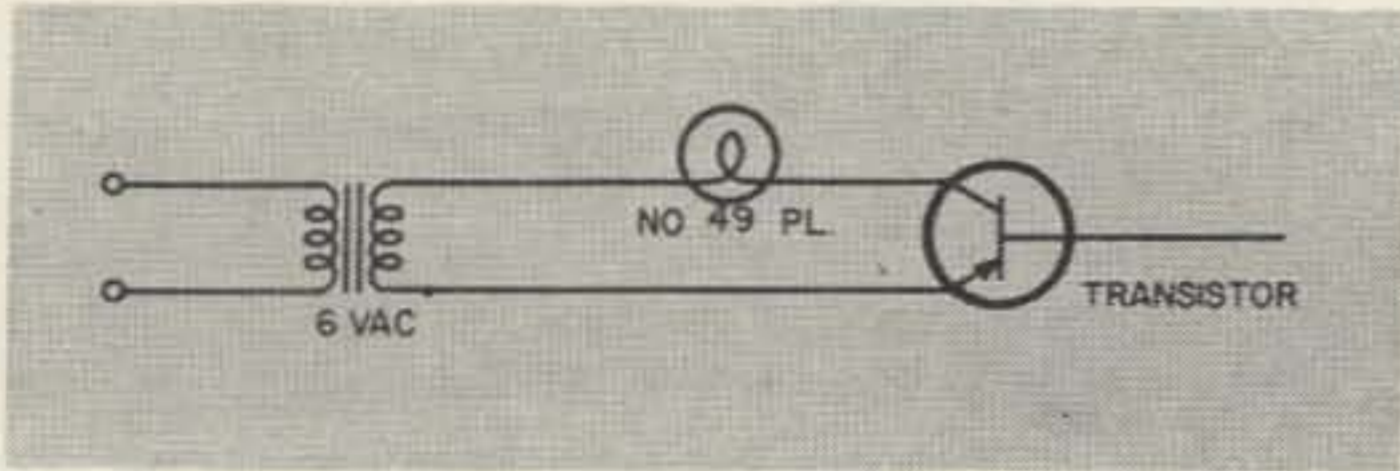

Check any two terminals of the transistor at a time collector to emitter, base to emitter etc. until you find two that pass current to the pilot light. Clip the unused wire and you have a diode for various purposes. If you don't have any results only thing to do is to throw the transistors away, it happens now and then. A word of caution—if for example the base emitter sections are okay and it is a P.N.P. transistor the base would be plus output and emitter negative etc. I have used them for relays noise limiters and the power type can be used for battery chargers—be sure to keep within voltage ratings.

. . . K8BYO

TV INTERFERENCE?



A B&W low pass filter will end interference with your neighbors TV reception. B&W Model 424 is a three-section low pass filter which installs in the antenna coaxial line. Reduces all frequencies within the TV band by 60 db (a reduction of 1-million times).

The B&W Model 424 offers negligible filtering to frequencies below 30mc. Made for installation in 52 and 72 ohm coax lines. Ideal for any transmitter (up to 100 watts) operating between 1.5 and 30 mc.

At your dealers for only **\$8.65**



BARKER & WILLIAMSON, Inc.
 BRISTOL, PENNSYLVANIA

DUMMY LOAD

Here is a dummy load that has a flat SWR thru 6 meters will take 250 watts for brief periods complete with so 239 conn. and instructions, Glo-bar type postpaid. **\$4.75**

HAM KITS BOX 175
 CRANFORD, NEW JERSEY

Give "him" the
 All-season

Gift

GREATEST VALUES EVER OFFERED

INCOMPARABLE

telrex
BEAMS



Arrays priced to every budget:

Arrays for 3/4-2-6-10-15-20-40 meters from \$5.95 to \$590.00—catalog on request.

ANTENNAS
 SINCE
 1921

Communication and TV Antennas
telrex LABORATORIES

ASBURY PARK 40, NEW JERSEY, U.S.A.

The design, craftsmanship and technical excellence of Telrex —

"Beamed-Power"
 "Balanced-Pattern" Rotaries

have made them the standard of comparison throughout the world! Every Telrex antenna model is engineered, precision machined, tuned and matched, then calibrated for easy and correct assembly at your site for repetition of our specifications without 'cut and try' and endless experimentation.

Radio Bookshop

Quiz

What is one of the best Christmas gifts you can possibly give to a ham, be he family or friend? That's right, a subscription to 73. How about second best? Got you that time! Well, running a close second you will find his eyes sparkle most when you let him unwrap a copy of the Radio Handbook (#40). If he already has that gem, then you can't go wrong with #37, #36, etc. Any of the Bill Orr books are great to read: #21-22-23-24-57-69. Get your order in right now, the books are all in stock for immediate shipment from Radio Bookshop, and we pay the postage!

1—ELECTRONICS & RADIO ENGINEERING—Terman. One of the most complete text books ever printed. 1078 pages. Theory, but easy on the math. **\$15.50**

2—ELECTRICAL ENGINEERING HANDBOOK — McIlwain. Formulas, tables, circuits. A read handbook. 1618 pages. **\$10.00**

5—ANTENNAS—Kraus (W8JK). The most complete book on antennas in print, but largely design and theory, complete with math. **\$11.50**

6—VACCUUM - TUBE CIRCUITS AND TRANSISTORS—Arguimbau. Designed for both beginners and engineers. Math kept to a minimum. Simple explanations of complex ideas. You'll know a lot more about radio after you read this book. 646 pages. **\$10.25**

8—RADIO-TELEVISION & BASIC ELECTRONICS—Oldfield. Logical presentation and descriptive illustration make this an ideal book for the beginner. 342 pages. **SPECIAL FOR CHRISTMAS. \$3.00**

9—LICENSE Q & A MANUAL—All the dope for commercial FCC licenses, 720 pages, become a professional for **\$6.00**

13—REFERENCE DATA FOR RADIO ENGINEERS. Tables, formulas, graphs. You will find this reference book on the desk of almost every electronic engineer in the country. Published by International Telephone and Telegraph. **\$6.00**

16—HAM REGISTER—Lewis (W3VKD). Thumbnail sketches of 10,000 of the most active and well known hams on the air today. This is the Who's Who of ham radio. Fascinating reading. **Now Only \$2.50**

18—SO YOU WANT TO BE A HAM—Hertzberg (W2DJJ). Second edition. Good introduction to the hobby. Has photos and brief descriptions of almost ever commercially available transmitter and receiver, plus accessories. Lavishly illustrated and readable. **\$2.95**

21—VHF HANDBOOK—Johnson (W6QKI). Types of VHF propagation, VHF circuitry, component limitations, antenna design and construction, test equipment. Very thorough book and one that should be in every VHF shack. **\$2.95**

22—BEAM ANTENNA HANDBOOK—Orr (W6SAI). Basics, theory and construction of beams, transmission lines, matching devices, and test equipment. Almost all ham stations need a beam of some sort . . . here is the only source of basic info to help you decide what beam to build or buy, how to install it, how to tune it. **\$2.70**

23—NOVICE & TECHNICIAN HANDBOOK — Stoner (W6TNS). Sugar coated theory: receivers, transmitters, power supplies, antennas; simple construction of a complete station, converting surplus equipment. How to get a ham license and build a station. **\$2.85**

24—BETTER SHORT WAVE RECEPTION—Orr (W6SAI). How to buy a receiver, how to tune it, align it; building accessories; better antennas; QSL's, maps, aurora zones, CW reception, SSB reception, etc. Handbook for short wave listeners and radio amateurs. **\$2.85**

28—TELEVISION INTERFERENCE—Rand (W1DBM). This is the authoritative book on the subject of getting TVI out of your rigs and the neighbors sets. **\$1.75**

32—RCA RADIOTRON DESIGNERS HANDBOOK—1500 pages of design notes on every possible type of circuit. Fabulous. Every design engineer needs this one. **\$7.50**

33—WAVE PROPAGATION & ANTENNAS—Welch. Highly recommended by the propagation experts as the best Book on the subject. **\$5.75**

36—CALL LETTER LICENSE PLATE—Regulation size license plate. Please give your call and the color of letters and background. **\$3.00**

37—101 WAYS TO USE YOUR HAM TEST EQUIPMENT—Middleton. Grid-dip meters, antenna impedance meters, oscilloscopes, bridges, simple noise generators, and reflected power meters are covered. Tells how to chase trouble out of ham gear. 168 pages. **\$2.50**

40—RADIO HANDBOOK, 15th EDITION—Orr (W6SAI). This is far and away the best amateur radio handbook ever printed. Over 800 pages. **\$8.50**

47—PRACTICAL ELECTRONICS—Hertzberg (W2DJJ). Almost solid with pictures. Touches lightly on many aspects of electronics: ham radio, TV, transistor radios, hi-fi, microwaves, trouble-shooting, Novice station, antennas, test equipment, etc. **\$2.50**

49—ELECTRONIC COMMUNICATION—Shrader. Huge book aimed at giving all information necessary for FCC commercial and amateur licenses. **\$13.00**

50—MICROMINIATURIZATION—This is the standard text on the subject. Don't see how a company library can be without this one. Everything is going to have to be built smaller, you know. **\$11.00**

52—HOW TO READ SCHEMATIC DIAGRAMS—Marks. Components & diagrams; electrical, electronic, ac, dc, audio, rf, TV. Starts with individual circuits and carries through complete equipments. **\$3.50**

54—HAM RADIO HANDBOOK—Hertzberg (W2DJJ). This is a lavishly illustrated book to interest people in the hobby of ham radio. Tells how to get your ticket, select a receiver and transmitter, learn the code. Pictures and info on just about every commercial piece of ham equipment. Better than a catalog. **\$2.50**

55—TRANSISTOR CIRCUIT HANDBOOK—Simple, easy to understand explanation of transistor circuits. Dozens of interesting applications. **\$4.95**

57—QUAD ANTENNAS—Orr (W6SAI). Theory, design, construction and operation of cubical quads. Build-it yourself info. Feed systems, tuning. **\$2.85**

58—ANTENNAS FOR CITIZENS RADIO—Orr (W6SAI). General coverage, mobile and directional antennas for 27 mc. band. Build & tune 'em. **\$1.00**

69—5-9 SIGNALS—Orr (W6SAI). A manual of practical detailed data covering design and construction of highly efficient, inexpensive antennas for the amateur bands that you can build yourself. **\$1.00**

72-ABC'S OF HAM RADIO-Pyle (W7OE). Designed for the Novice ham. Includes all of the information needed to qualify for the Novice License 112 pages. \$1.50

74-HANDBOOK OF ELECTRONIC TABLES & FORMULAS-Formulas & laws, constants, standards, symbols and codes. Math tables, misc. data. \$2.95

76-MODERN OSCILLOSCOPES & THEIR USES-Ruiter. Second edition. Shows what a 'scope is, what it does and how to use it for radio, TV, transmitters, etc. 346 pages. \$8.00

79-TRANSISTOR PROJECTS-Skip the theory and start having fun. Radios: self powered, shirt pocket, regenerative, carrier-power, headphone. Instruments and accessories: sine-square wave generator, preamps for VTVM's, gain checker, shortwave calibrator, phase shifter, substitution box. Plus remote transistor ear, electronic compass, simple oscillator, lamp control, multi-impedance amplifier, electronic counter, portable power supply . . . etc. \$2.90

86-CONVERTING BC453 TO SSB \$3.00

87-MRT-90 CONVERSION MANUAL-This 12-page booklet contains full information on converting the 19 tube MRT-9 or MRT-90 transceivers into hot little dual conversion rigs for two meters. Complete conversion plus original diagram. \$1.50

88-WESTERN ELECTRIC 255A POLAR RELAY-This will be of interest primarily to the RTTY ops. \$3.50

90-TELEPRINTERS, MODEL 31A-This midget printer, complete with case, measures only 11" x 16" x 12" and is light enough to throw in the car for portable use. Complete with keyboard, ready to operate. \$80.00

73-1-Ham TV Manual. \$3.00
See ad page 77)

BEO-OSCILLATOR CIRCUITS. One of the most thorough treatments of the subject yet to be published. Uses the new four-color system for explaining what actually goes on in the oscillator circuits. \$2.95

BON-FIRST CLASS RADIOTELEPHONE LICENSE HANDBOOK. Everything you need to know to get your 1st license. More than a Q & A book, you'll understand what it is all about when you get through this one. \$4.95

EGT-ELECTRONIC GAMES AND TOYS YOU CAN BUILD. 15 Original games and toys, none available commercially. Test your steady nerves; your reaction time, battle a lie detector, etc. Guaranteed rouser. \$2.50

731-HAM TV-W4KYQ. This is the only book available on this fascinating branch of ham radio. Describes complete ham TV station that costs under \$50. Very simple. \$3.00

IYB-INTERNATIONAL YEARBOOK-The 1691-62 edition of the International Radio Amateur Year Book is now out. It contains a review of the years VHF activities, a synopsis of DX activities and new countries activated, a propagation forecast for the coming year for the Eastern, Central and Western U.S., to all parts of the world, an ARRL countries list, world QSL bureaus, etc. Published in England. \$1.75

MMD-ELIMINATING MAN MADE INTERFERENCE-What makes it, how to find it, how to cure it in homes, factories, automobiles, aircraft, boats, etc. Or maybe you haven't been plagued lately. 160 pages. \$2.95

NHP-BUILDING UP YOUR HAM SHACK-Pyle (W7OE). A practical discussion of points to consider when you are buying ham equipment, complete with descriptions of much of the available commercial gear. It's just possible that Pyle might keep you from making a mistake which would cost a lot more than his book. \$2.50

QAN-SECOND CLASS RADIOTELEPHONE HANDBOOK-Noll (W3FQJ). Everything you need to know to pass the FCC exam and get started servicing two-way equipment. Much more than just a Q & A manual \$3.95

TWD-1-TWO-WAY MOBILE RADIO MAINTENANCE. Written by a serviceman, not an instructor. Full of practical information. Chapters on receivers, transmitters, remote controls, towers, installation, noise elimination, test equipment, FCC tests and measurements. \$4.95

R-197-BASIC RADIO-Tepper. In six volumes with 700 illustrations. Quite complete course in radio: DC, AC, tubes, receivers, transistors, and transmitters. Complete six volume set. \$13.85

R235-RADIO CONTROL FOR MODEL BUILDERS-Winter. One of the best and newest books available on RC. \$4.25

G-83-FUN WITH ELECTRICITY-This book ought to fire the imagination of the experimenter. Build a galvanometer, a dc motor, an ac generator, a solenoid, a spark coil, a Tesla coil, etc. Helps teach the basics of electricity while having fun with simple projects. 128 pages. \$2.65

G91-RADIO CONTROL MANUAL. For both do-it-yourselfers and commercial equipment buyers. Skips theory and gets right into the how-to-do-it aspects of radio control. \$3.20

G94-TRANSISTORS. Selected articles from Radio Electronics on how to test transistors and how to build all-transistor test equipment. \$1.95

G95-SHORTCUTS TO TV SERVICING. This two volume set is practically a course in TV servicing. It is based upon a home-study course prepared for a prominent TV manufacturer. This is a set that technicians will keep on the workbench for reference. \$5.90

G97-A-Z IN AUDIO. This is a dictionary-type listing of audio terms and people. First printed in England and reprinted in several foreign languages, this is the first U.S. edition. Well illustrated, wittily written. \$3.20

G99-INDUSTRIAL ELECTRONICS (made easy). This is where the money is, why aren't you? Read about it. Induction, dielectric, microwave and supersonic generators. Servos, etc., etc. \$3.95

1	2	5	6	8	9	13	16	18	21	22	23
24	28	32	33	36	37	40	47	49	50	52	54
55	57	58	59	61	69	70	72	74	76	79	80
81	82	83	86	87	88	90	73-1	BEO	BON		
EGT	IYB	MMD	NHP	QAN	TWD-1	R197	R235				
G83	G91	G94	G95	G97	G99						

Circle the book numbers you wish to order.
Please include cash, check, money order . . .
or something we can deposit in the bank.

Name Call

Address

City State

RADIO BOOKSHOP
1379 East 15th Street, Brooklyn 30, N. Y.
(N.Y.C. add 3% tax)

The Progress of RTTY in The United Kingdom

Dr. Arthur C. Gee G2UK

Hon. Sec. British Amateur Radio Teleprinting Group

DUE to a variety of reasons, RTTY has been slow to appear on the British amateur radio scene. While in the States the post-war years have seen a steady increase in interest in this aspect of amateur radio, it was not until a small group of enthusiasts decided in 1959 to really investigate the administrative and practical difficulties which were preventing RTTY getting started in the U.K. that any move towards its establishment was made.



The author reading "the slip" from his Creed Type 3 Tape machine.

To their surprise, this group of enthusiasts found these difficulties far less formidable than they had anticipated. The G.P.O. proved most cooperative and raised no licensing difficulties whatsoever. When it came to obtaining teleprinters, it was soon found that provided someone was prepared to take a chance and put down enough money to purchase a "disposals lot" of twenty or thirty or so, suitable machines could be got at around the £3 to £4 mark.

This was in fact one of the first steps which the group took. The teleprinters acquired were Creed Type 3 Tape machines and while they were more or less obsolete in present day commercial practice, they have proved eminently suitable for amateur use, being small in size, very rugged, easily dismantled and

reassembled and not at all critical in adjustment. This type of machine is now used by the majority of active RTTY-ers in the U.K. It has its limitations it is true, the chief one being that its figure shift does not work into more modern machines and it has a very messy type-face inking system. However, these are but minor faults.

Once some activity started, it was surprising how news soon spread around of the availability of other suitable equipment. A number of the more up to date Creed Type 7 Page printing machines began to make their appearance in the shacks of the RTTY-ers. Some excellent T.U.s were discovered on the surplus market and were snapped up by the lucky few. The rest soon found suitable chokes and relays for adapting the various T.U. circuits published in various American radio journals available in this country. The mysteries of F.S.K. were soon explored and transmitters modified for this mode of emission and before long, the first RTTY QSO's were taking place on the 80 meter band.

Since then interest has increased rapidly and activity somewhat less quickly, but nevertheless very steadily. It is probably true to say that at the time of writing, most RTTY activity in the U.K. is on 2 meters. There is also some very consistent activity on 80 met-

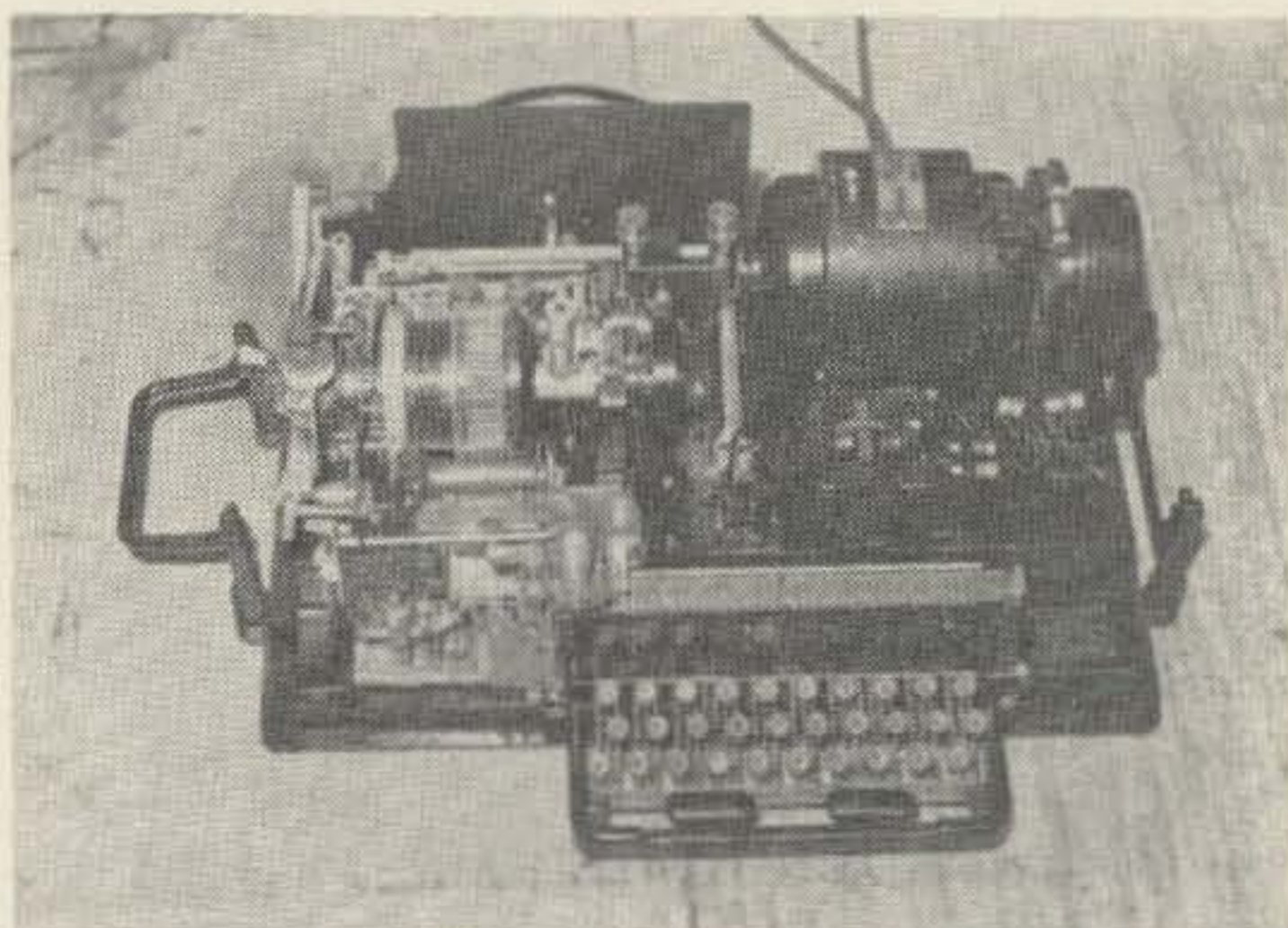

The Creed Type 3 Tape teleprinter.



The other teleprinter used by British radio amateurs, the Creed Type 7 Page printer.

ers, mostly in the form of group nets and personal skeds. And there is a small but devoted band of dxers headed by Bill Brennan, G3CQE, whose signals are well known to many U.S.A. RTTY dxers.

Two monthly radio journals now publish RTTY articles and the RSGB Bulletin has just started a quarterly RTTY feature. The small band of enthusiasts who started things in the summer of 1959, has now grown into the British Amateur Radio Teleprinting Group, with a membership of over a hundred, many of whom are—in spite of its title—amateurs in other European countries, in Africa and in the States. The Group has recently been granted affiliation to the RSGB.

The future activities of the Group are obviously going to be full of interest. Currently, a RTTY Manual—English version—is being prepared. A regular News Sheet is circulated to members and committee members keep in touch by a Circular Letter sent round by the Hon. Sec., upon which members of the managing committee record their views on matters concerning the conduct of the group's affairs. Various social visits to places of a RTTY interest are being planned for the future.

In the writer's opinion, RTTY activity will be somewhat slow to "catch on" in the U.K. There are numerous difficulties which preclude all but the really keen from participating in this mode of amateur communication. One such, is the inability to type of all but a few!

However, those who do go in for this latest phase of amateur radio activity are really dedicated to it! And amongst them there is to be found a brand of the "ham-spirit" which is truly delightful to behold! . . . G2UK

Letter

Dear Sir:

Does anyone reading this magazine have a proven, practical working audio derived, hang-type-AVC circuit installed in an HRO-50-T receiver giving step-by-step procedure? For this I will be truly grateful. Thank you.
Russ Smith W6ONK



SATURN 6

the original

HALO

How come thousands of these little gadgets are riding around on the backs of cars all over the country? And how come so many are in use at fixed locations?

WELL

Verticals were tried first for mobile work. Most fixed stations used horizontal polarization and could hardly hear the mobiles. Flutter was a serious problem. When Hi-Par introduced the Saturn 6, mobiles found they could work fixed stations over amazing distances and that flutter was a thing of the past. Ignition noise was greatly reduced too. The antenna became very popular for fixed stations too since it was omnidirectional and horizontally polarized. Beams are great, but much of the time you want to talk to stations in more than one direction at a time.

Saturn 6 Antenna only . . . \$11.95
Saturn 6 plus mast &
bumper mount \$16.95

We make a lot of other antennas, but this is our best seller. Write for info on this and other antennas. Order through your local parts distributor or direct.

HI-PAR
Products Co.
FITCHBURG, MASSACHUSETTS

PROPAGATION CHART

EASTERN UNITED STATES TO:

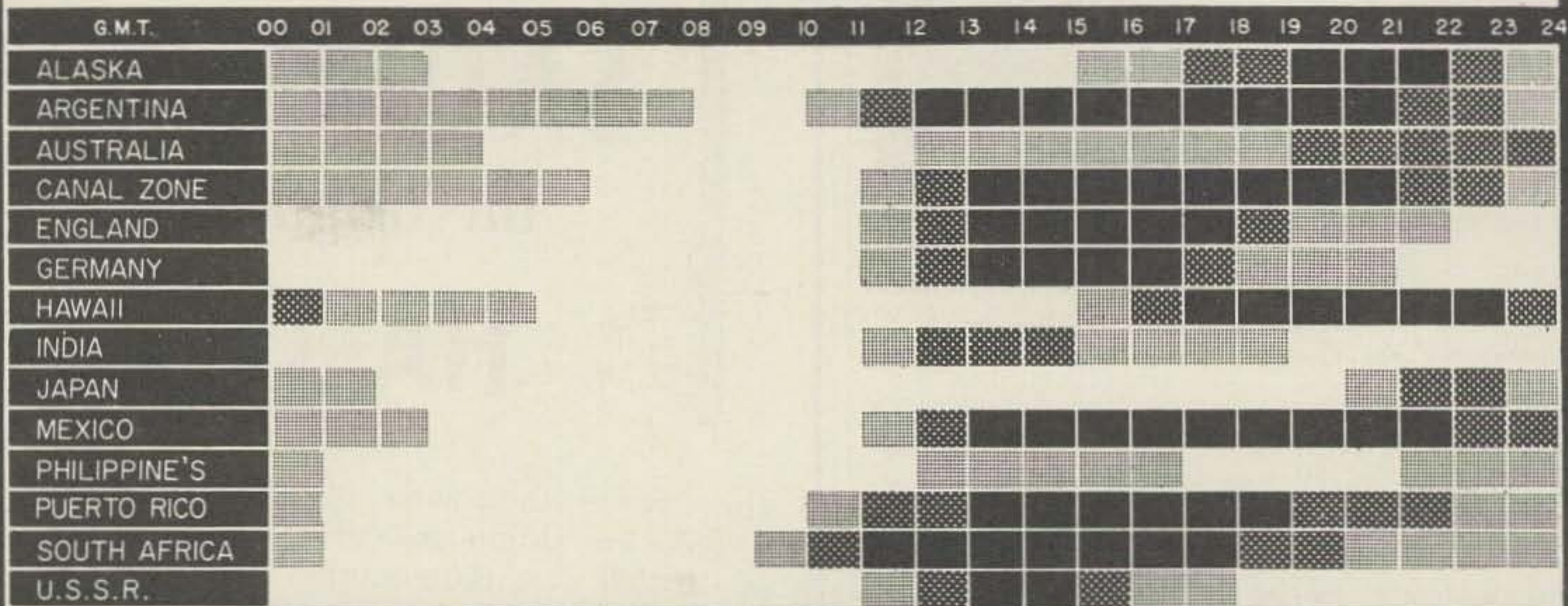

CENTRAL UNITED STATES TO:

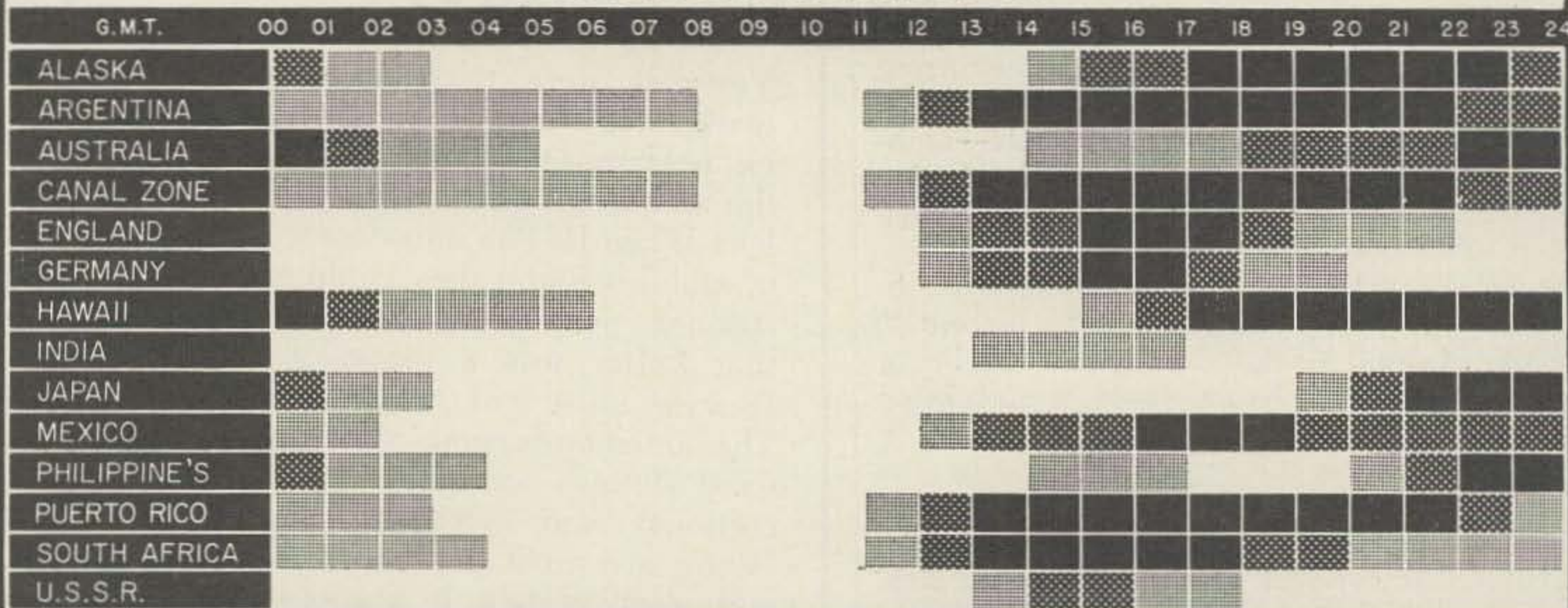

WESTERN UNITED STATES TO:

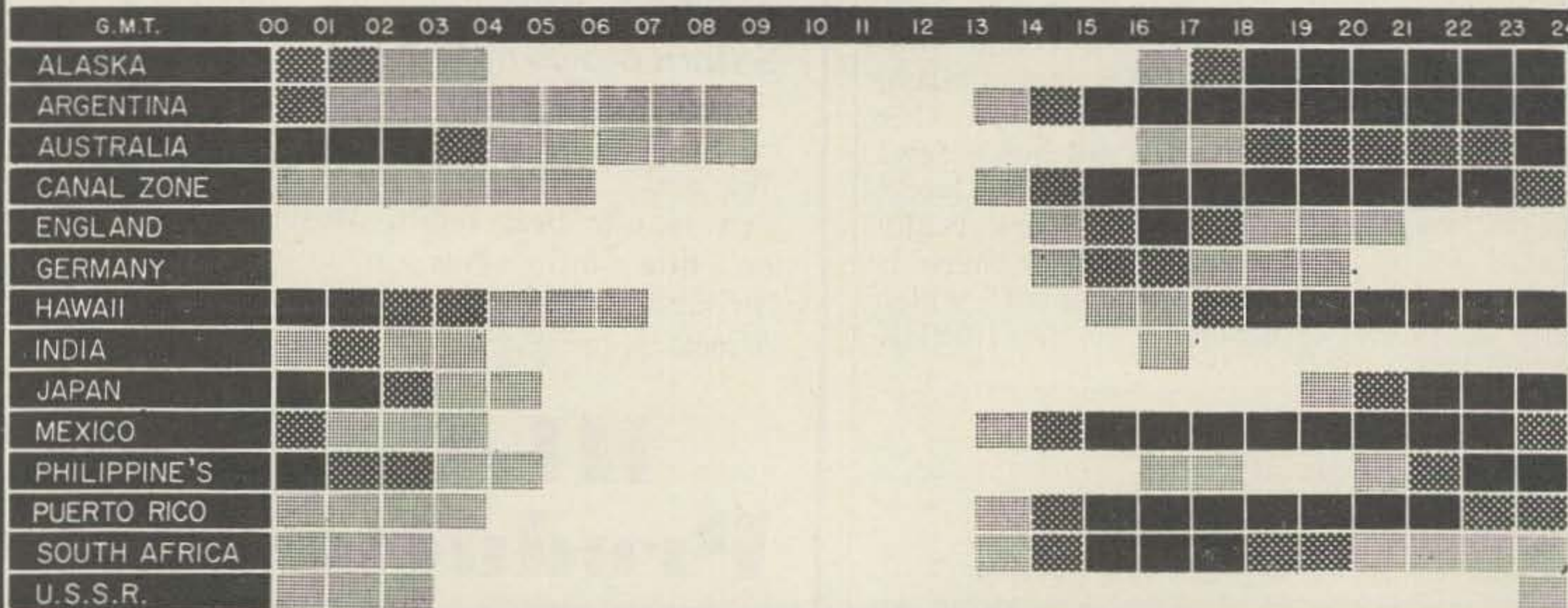

LEGEND

7 MC

14 MC

21 MC

28 MC

Propagation Charts

David A. Brown K2IGY
30 Lambert Avenue
Farmingdale, N. Y.

For the DX propagation chart, I have listed the HBF which is the best Ham Band Frequency to be used for the time periods given. A higher HBF will not work and a lower HBF sometimes will work, but not nearly as well. The time is in GMT, not local time.

Advanced Forecast, December 1961

Good: 7-13, 19-31

Fair: 1-3, 5-6, 14-15, 18

Bad: 4, 16-17

The Short Path propagation chart has been set up to show what HBF to use for coverage between the 48 states. Alaska and Hawaii are covered in the DX chart. The use of this chart is somewhat different than the DX chart. First, the time is the local time centered on the mid-point of the path. Second, the distance given in miles is the Great Circle path distance because of the Earth's curvature. Here are a couple of examples of how to use the chart. A.) To work the path Boston to Miami (1250 miles), the local time centered on the mid-point of the path is the same in Boston as in Miami. Looking up the HBF's next to the 1250 mile listings will give the HBF to use and the time periods given will be the same

Give your shack that professional look—



install an

ALDEN HAM BENCH

with power facilities.

See our full page ad in the January 73 (page 45) and order yours today. For further information see your dealer or write to

ALDEN PRODUCTS CO.
10186 North Main Street, Brockton, Mass.

at each end of the circuit. B.) To work the path New York to San Francisco (2,600 miles), the local time centered on the mid-point of the path will be 1½ hours later than at San Francisco and 1½ hours earlier than in New York (the time difference between New York and San Francisco is 3 hours). Looking up the HBF's next to the 2,500 mile listings will give the HB to use. In San Francisco subtract 1½ hours from the time periods listed for local time and in New York add 1½ hours to the time periods listed for local time.

SHORT PATH PROPAGATION CHART																									
DECEMBER 1961																									
LOCAL TIME	00	01	02	03	04	05	06	07	08	09	10	11	12	13	14	15	16	17	18	19	20	21	22	23	
2500 MILES																									
2250 MILES																									
2000 MILES																									
1750 MILES																									
1500 MILES																									
1250 MILES																									
1000 MILES																									
750 MILES																									
500 MILES																									
250 MILES																									

LEGEND 3.5 MC 7 MC 14 MC 21 MC 28 MC



Al Brogdon, W4UWA/K3KMO
 RDI, Box 531
 State College, Pennsylvania

73 Reviews

The QX-535 Receiver

THE R. E. Goodheart Company's QX-535 is a 200 to 550 kc receiver which, although useless for amateur frequencies "as is," is a very valuable addition to many communications receivers for use as a "Q5-er," or, with the addition of crystal converters, may be used as a high-quality communications receiver itself.

The QX-535 is basically a BC-453 receiver that has been repackaged in a trim, attractive case, complete with fused transformer-type power supply, speaker and all controls. The photo shows the physical arrangement of the components inside the QX-535 case. Note that the tube compartment cover of the BC-453 has been removed. This, along with the use of a perforated case, insures adequate cooling of the receiver.

The circuit is a six-tube superhet with an *if* of 85 kc (with three double-tuned circuits at this *if*), and another tube in the full-wave rectifier circuit. The *if* transformers have an

adjustable coupling consisting of a slug that may be reached by removing the screw-on caps on the *if* cans, and pulling a small shaft in and out. The coupling is at minimum in the "shaft-out" position, and this position should be used for maximum selectivity.

By tuning the QX-535 to the *if* of your present receiver, then coupling it to the output of your receiver's *if* strip, the QX-535 serves as a "Q5-er," or outboard selectivity aid. Most receivers use an *if* at 455 kc, but the QX-535 may be used as a Q5-er for any *if* in the 200 to 550 kc range. This conversion to a second *if* of 85 kc with the QX-535 will give you a bandwidth of only 2.0 kc at 6 db down, and 6.5 kc at 60 db down. This means an AM (double-sideband) station will just barely fall within the QX-535 bandpass, and even close adjacent-channel interference will be reduced to a great extent. Offsetting the BFO to one side of the center frequency of the *if* will provide exceptionally good single-sideband and single-signal CW reception. Unfortunately, the BFO pitch control is not very convenient to adjust, being located near the rear and at one side of the BC-453 case. However, it is possible to make a minor modification to use the front-panel "align input" control as a BFO pitch control (reference 1).

When using the QX-535 as a Q5-er, it is quite impressive to use both the normal receiver's speaker and the QX-535 speaker, and tune across a few signals. As you tune across a given signal, you will hear it in the receiver speaker first, then it will come in and *pass through* the QX-535 bandpass before it disappears from the receiver's speaker. This, besides being an impressive demonstration of the QX-535's selectivity, may be a useful feature to use, for instance, in AM phone nets. The normal receiver may be used to listen for the net stations on their usual ten kc spread of "net" frequencies, while the QX-535 may be

Condensed Specifications, QX-535

Price.....	\$37.50 FOB Los Angeles (16 lb.), or \$39.95 delivered in USA.
Tuning range.....	200-550 kc, with dial divisions each 10 kc.
Intermediate Frequency..	85 kc with three double-tuned circuits.
Selectivity.....	2.0 kc at 6 db down, 6.5 kc at 60 db down.
Possible Use.....	(1) As a second-conversion unit, tuned to the receiver <i>if</i> , or (2) with crystal converters as a complete receiver.
Manufacturer.....	R. E. Goodheart Co., Box 1220, Beverly Hills, California.

used for added selectivity in rough copy conditions. This would also be of use in contest operation, using the main receiver to tune for calls, and the QX-535 to narrow the bandwidth for maximum interference-rejection.

In addition to the possibility of using the QX-535 as a Q5-er, is the use of the QX-535 as a tunable *if* with band-switching or separate single-band crystal converters. This has been described several times in amateur radio publications, and only brief details of this technique will be discussed here. For circuits and full information, check the references at the end of this article. This approach to a communications receiver for the ham bands is not only a very effective one, but it is inexpensive.

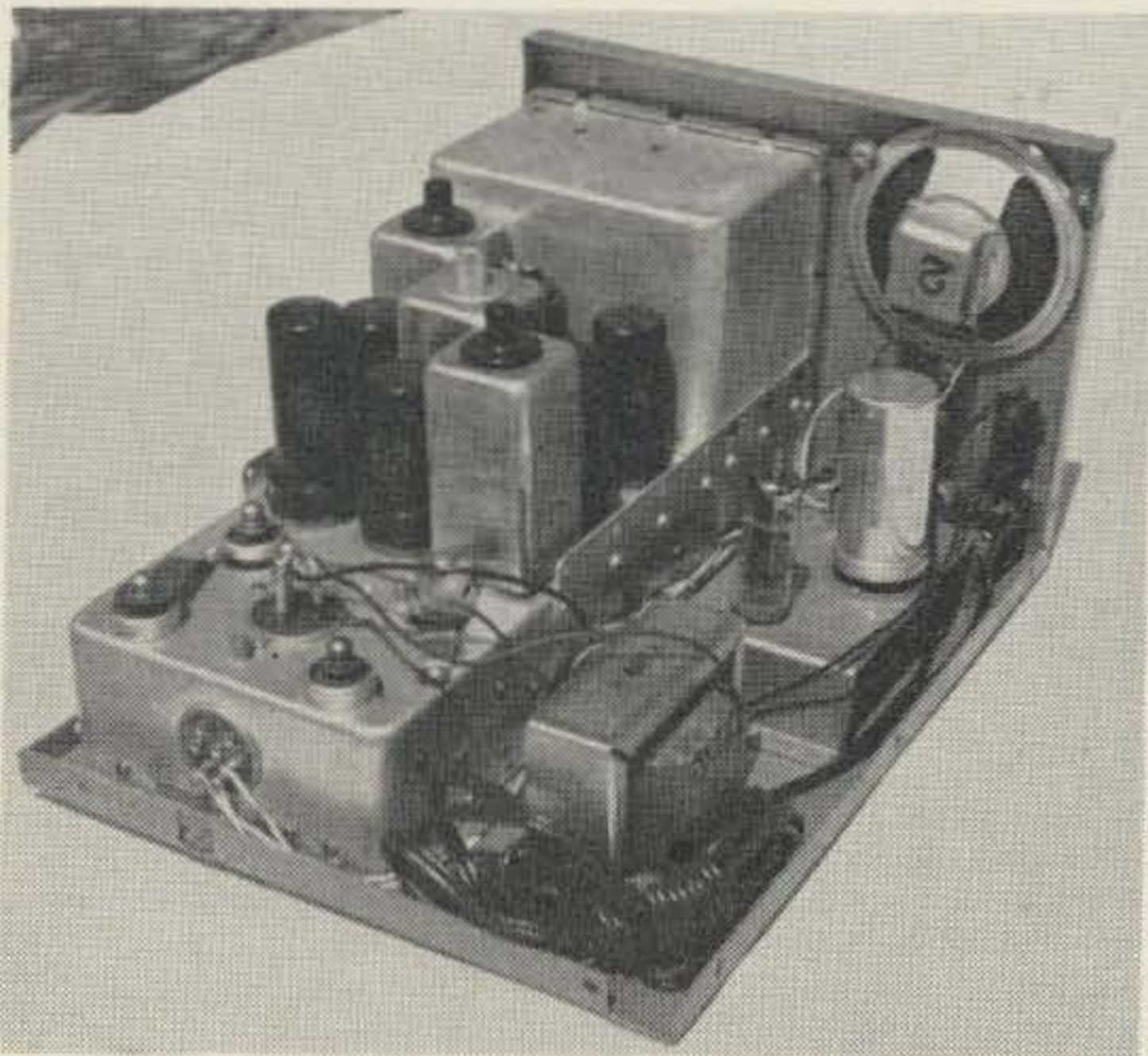

For instance, let us consider the case of a new ham who must limit his receiver budget to \$100. You know as well as I what kind of performance he could buy in a commercial receiver for \$100. Well, the new ham could take \$40 of his budget and buy a QX-535. Then he could build a deluxe all-band crystal converter—even without a good junkbox for the components—for less than the remaining \$60. And that ham would have a receiver, when he was finished, that would be very hard to beat as to stability, selectivity and sensitivity. W3SMV uses a homebrew converter with a BC-453 in this type of circuit and has the features of (1) stability from warm-up to within 400 cps, and after warm-up to within 20-30 cps; (2) bandwidth of less than 2 kc; and (3) sensitivity of less than one microvolt.

There is enough space left in the QX-535 case to build in a two-tube single-band crystal converter. One approach that could be used in making an all-band receiver out of a QX-535 would be to build an 80 meter converter inside the QX-535 case, then build an outboard all-band converter to cover 40 through 10 (or 6) meters, using the 80 meter range as a tunable *if*. Of course, the 80 meter converter should be provided with two crystals and a crystal

(Turn to page 76)

COLUMBIA GEMS!

COLLINS MBF TRANSCEIVER

60-80MC 5-watt crystal controlled AM desk-top unit. Built-in 110VAC/DC power supply. Easily converts to 6, 10 or 11 Meters. Excellent Condition. Hard to get at any **\$49.95** price, but ours is only.....

ARC-2 TRANSCEIVER — 2-9 Mc. **\$39.95**
Good Condition

TDQ 2-METER TRANSMITTER: 50 Watts Output!

At last, we got 'em! The ones the VHF boys have been crying for for two years, and at 1/2 the price many have been sold for! Complete— One of the most versatile high power AM transmitters available. No conversion required. Manufactured by RCA. Separate modular Power Supply, RF and Modulator sections. Excellent condition. Final uses 829B driven by 829B. 110V 60 cycles. Like Wow? **THIS IS IT.**

Excellent condition — USED..... **\$89.50**

BRAND NEW 174.50

MOBILE RADIOTELEPHONE 150-170 mc FM. 6v input. Output 25 watts. Consists of Transmitter, Receiver, Antenna & connecting cable. Manufactured by West Coast Electronics. Good cond. **\$24.95**

WIRE RECORDER—1-C/VRW-7. Operates on 28VDC @ 3A. Good Cond. **9.95**

COMMAND SETS!

R-28/ARC-5 100-156 MC. Exc. Cond..... **22.50**
Q-5'er RECEIVER: 190-555 kc. Excellent.... **\$9.95**
3-6 MC RECEIVER: Excellent..... **7.95**
6-9 MC RECEIVER: Excellent..... **7.95**
2.1-3 MC TRANSMITTER: Excellent....NEW **5.95**
3-4 MC TRANSMITTER: Excellent..... **6.95**
4-5-3 MC TRANSMITTER: Excellent **4.95**
5-3-7 AC TRANSMITTER: Excellent **4.95**
7-9 MC TRANSMITTER: Excellent. Like New **14.95**
MD-7/ARC-5 PLATE MODULATOR: For all of the above Transmitters. Excellent...Only **4.95**

RCA COMMUNICATIONS RECEIVER

Navy Model ARB 4-band superhet covers 195-9000 KC. Complete with remote control, remote tuning dial, connectors, 24V dynamotor and schematic. **BRAND NEW..... 39.50**

ID-59/APA-II PULSE ANALYZER

Contains 3BP1 plus ten other tubes. Excellent for modulation indicator, etc. **EXCELLENT CONDITION 9.95**

ID-6/APN-4 LORAN INDICATOR

20 TUBES including 5CP1, plus 100 KC Xtal and a storehouse of high quality parts. Excellent for 'scope, modulation indicator, etc. **EXCELLENT CONDITION 8.95**

NEW GUARANTEED TRANSMITTING TUBES

4-65A **9.95** 829B/3E29 **4.95**
4X150-A **12.95** 35TG **2.95**
4-400A **25.00** 100TH **9.95**
4-1000A **75.00** 250TH **25.00**
2C39-WA..... **12.95**

RA-105 POWER SUPPLY

115 vac, 60 cyc input, multiple outputs: 2400 @ 10 ma., 540 v @ 175 ma., 295 v @ 100 ma., 6.3 vac @ 12 a, 6.3 vac @ 10 a. Tubes: 3-5U4G, 3-2X2, and 1-6X5. With tubesExc. Cond. **\$9.95**

BC-611 Handie-Talkie case, brand new.. 4.95

WE BUY! BC-610, GRC, VRC, TS Equip. & parts! TUBES, etc. TOP PRICES PAID! What do you have?

WRITE IN for new Bargain Bulletin!

All orders FOB Los Angeles. 25% deposit required. All items subject to prior sale. **NOTE MINIMUM ORDER, \$3.00. WRITE TO DEPT. 73**

COLUMBIA ELECTRONICS

4365 WEST PICO BLVD. LOS ANGELES 19, CALIF.

Letter

Dear OM:

W6SLK suggested that I write to you about A.C.A.R.N. because he said that you are not the kind that backs away from a new idea. So I am writing you in hopes that you will find this cause worth your helping out.

A.C.A.R.N. stands for Anti Communist Amateur Radio Network. The purpose of A.C.A.R.N. is to educate the radio amateur operator on the dangers that threaten the existence of their amateur radio hobby, as well as that of the nation as a whole.

It may be claimed by some, that anti communism is not a proper subject for amateur radio—that it is political etc. Nothing could be more incorrect. Communism has been ruled on by the U.S. Supreme Court as an instrument of a foreign government — not a political party. Secondly, Communism presents a very real threat to the existence of amateur radio. Communism is the enemy of all American institutions, including amateur radio, and is sworn to destroy them. Communism has declared total war on the American people. Radio amateurs must use their equipment to protect their hobby and their country from conquest on the installment plan.

All radio amateurs must give serious thought to the future of amateur radio and the continuing existence of the United States Government. Radio amateurs should acquire knowledge on what is happening to their country. The Communist noose is slowly but surely tightening. Unless we stop it, there will be a time when there will be no more amateur radio operating, no free speech and no liberty.

The above three paragraphs are the text of A.C.A.R.N. bulletin number 2 of October 28th. A.C.A.R.N.'s address is P.O. Box 558, Berkeley 1, California. All letters are answered and inquiries from licensed amateurs are invited.

Incidentally, Mr. Huntoon of the ARRL has turned thumbs down on this idea, terming it political etc. He refused my insertion of a 29 word ham ad on this network idea. However, CQ magazine did accept the ad.

I feel that amateur radio offers a large untapped potential for alerting the nation on the dangers of communism. The chips are down—our lives are at stake. I sincerely hope you will be interested in helping out. It would be great if you could give it a mention in your editorials. I would be more than willing to write a short column if you desire.

Here is an opportunity for you to get in on the ground floor of a good thing. I hope you will grab it. No other

publication has been approached in this way—as yet. I am sending out frequent bulletins such as above, by cw automatic tape. Today I got a qso after the bulletin, with LA7RF/MM. He says A.C.A.R.N. should cover free world amateurs, as well as those of the U.S.

Wat sa OM?

F. Huntley W6RNC

Dear Fred,

Much as it pains me to miss the boat on getting in on the ground floor of a good thing, I'll have to beg off on this one. You are right on one count, I am not the type to back away from a new idea. . . . I am stepping up to the plate and taking a good swing at this one.

Fred, I'd say, offhand, that you have, singlehandedly, managed to ferret out, all by yourself, the most efficient way yet discovered to kill off our beloved hobby of ham radio problems. At the inception of that conference it was my editorials or you would not be offering this barrel of hemlock to the amateur fraternity.

Let me bring you up to date on current events. In 1959 a conference was held in Geneva to iron out the worlds' radio problems. At the inception of that conference it was the educated estimate of those involved that amateur radio would suffer serious deletions of the ham bands. The U.S.A. went into the conference in the poorest of bargaining positions: asking for nothing and hoping for the minimum number of cuts. The votes of most of the rest of the world seemed to be against us. The only unknown was the position of the U.S.S.R. and their controlled votes. When the U.S.S.R. backed up the U.S. position our bands were saved until the next conference, about three years from now.

Suppose you were able to enlist the help of amateurs to unleash a barrage of propaganda at the U.S.S.R. What would be the result? In all probability it would be just the same medicine they applied to the Voice of America broadcasts: intensive jamming. It seems quite likely that most of the jamming stations throughout Russia are being operated by radio amateurs. An attempt to blast through the Iron Curtain on the ham frequencies would merely see these chaps spending their leisure buzzing our ham bands instead of QSO'ing us and learning more about us. We are doing a much better job of corrupting Communism by just being ourselves and talking with the Russian hams than we could ever do with an overt attack through ham radio which would inevitably end in complete disaster for our hobby. Ham radio exists today in its present form be-

IN THE . . . WEST - It's
WESTERN RADIO
and TELEVISION
SUPPLY
CO.



FOR OVER 25 YEARS ONE OF THE WEST'S OLDEST AND LARGEST FIRMS
DEVOTED EXCLUSIVELY TO AMATEUR AND ELECTRONIC EQUIPMENT.

1331 India St.
P. O. Box 1728

San Diego 1, Calif.
BElmont 9-0361

cause of the support of the U.S.S.R.

Further, after reading your letter carefully, I find absolutely nothing positive in it. There is no suggestion of what amateurs can do to help, only a jumble of emotional clichés and half truths. When you broadcast on our ham bands (where broadcasting is prohibited by federal law) that communism is the enemy of amateur radio, that communism has declared total war on the American people, and use hack phrases like the "noose is tightening" . . . "chips are down" . . . "our lives are at stake" . . . etc., then you are hurting us all.

It would be helpful to provide DX operators with an article explaining what can be discussed with the Russian amateurs and what can't. It could then go on to point out what information we could impart to them without causing them difficulty and still get the message across. How long would you sit still and listen to a torrent of emotion from a Russian amateur station?

My congratulations to John Huntoon and the ARRL for turning down your idea. I am sorry to learn that CQ is supporting your venture and I hope that they will think better of it before your ad gets into print.

. . . W2NSD

Statement of Ownership

STATEMENT REQUIRED BY THE ACT OF AUGUST 24, 1912, AS AMENDED BY THE ACTS OF MARCH 3, 1933, JULY 2, 1964 AND JUNE 11, 1960 (74 STAT. 208) SHOWING THE OWNERSHIP, MANAGEMENT, AND CIRCULATION OF 73 MAGAZINE, published monthly at Norwalk, Connecticut for September 20, 1961.

1. The names and addresses of the publisher, editor, managing editor, and business managers are:

Wayne Green, 1379 E. 15th St., Brooklyn 30, N.Y.

Editor: Wayne Green, 1379 E. 15th St., Brooklyn 30, N.Y.

Managing editor: Wayne Green, 1379 E. 15th St., Brooklyn 30, N.Y.

Business manager: Wayne Green, 1379 E. 15th St., Brooklyn 30, N.Y.

2. The owner is: (If owned by a corporation, its name and address must be stated and also immediately thereunder the names and addresses of stockholders owning or holding 1 percent or more of total amount of stock. If not owned by a corporation, the names and addresses of the individual owners must be given. If owned by a partnership or other unincorporated firm, its name and address, as well as that of each individual member, must be given.)

Amateur Radio Publishing Inc., 1379 East 15th St., Brooklyn 30, N.Y.

Wayne Green, 1379 East 15th St., Brooklyn 30, N.Y.

3. The known bondholders, mortgagees, and other security holders owning or holding 1 per cent or more of total amount of bonds, mortgages, or other securities are: (If there are none, so state.) None.

4. Paragraphs 2 and 3 include, in cases where the stockholder or security holder appears upon the books of the company as trustee or in any other fiduciary relation, the name of the person or corporation for whom such trustee is acting; also the statements in the two paragraphs show the affiant's full knowledge and belief as to the circumstances and conditions under which stockholders and security holders who do not appear upon the books of the company as trustees, hold stock and securities in a capacity other than that of a bona fide owner.

5. The average number of copies of each issue of this publication sold or distributed, through the mails or otherwise, to paid subscribers during the 12 months preceding the date shown above was: (This information is required by the act of June 11, 1960 to be included in all statements regardless of frequency of issue.) 15,166.

WAYNE GREEN

Sworn to and subscribed before me this 20th day of September, 1961.

AUGUSTUS F. PETERSON

(My commission expires March 30th, 1963.)

IT'S CANDEE FOR CHRISTMAS!

WIVES, CONCUBINES! Stuff one of these in the OM's stocking on Christmas morning! Hear him howl with pain when he tries to slip into his sox and stubs his toe on this hardware. Watch him hopping with joy (on the other foot, of course) when he finds out what it is!

ARC AIRCRAFT RECEIVERS — IDEAL FOR LIGHT AIRCRAFT, CAR, HOME, BOAT

R-19: 118-148 MC. Excellent condition. With 28V dynamotor \$49.73
R-22: 540-1600 KC. Excellent condition. With 28V dynamotor 49.73
Either of above, without dynamotor. 39.73

Set up a complete, compact standby or mobile rig with reliable

COMMAND GEAR

Famous Q-5'er. 190-550 kc. The receiver you've been looking for at only \$9.73
BC-454/R-26: 3-6 Mc. 7.73
BC-455/R-27: 6-9.1 Mc. 7.73
MD-7 MODULATOR: Special 3.73
T-18/ARC-5 XMTR. 2.1-3 MC excellent condition \$4.73
T-19/ARC-5 XMTR. 3-4 MC excellent condition 7.73
T-20/ARC-5 XMTR. 4-5.3 MC excellent condition 4.73
T-21/ARC-5 XMTR. 5.3-7 MC excellent condition 4.73

'Tis a wise spouse who, considering the wintry season and those long evenings at home, procures for the Chief Op a pair of our

SPECIAL SOUNDPROOF EARMUFFS

with built-in "privacy" speakers. Just think! You won't hear him, he won't hear you. Ideal! Buy a set for yourself, too, to plug into the TV, HI-FI, or just leave unplugged and read a book.

HEADSET BARGAINS!

HS-23: Hi impedance. Leather covered headband. Brand new. Great buy. Only \$5.73
HS-33: Low impedance. Leather covered headband. Brand new. A J. J. Candee Special 6.73
Hi Fi Headset: 15,000 cycles! Brand new with chamois cushions. Terrific! Only 9.73
CD-307A Headset Extension Cord: Brand new. Approximately 5 ft. length. Only37

Hear the OM cry "UHF!" when you plunk this one in his lap:

APX-6 TRANSPONDER

A midget warehouse of parts! Blowers, three Veeder-Root counters, I. F. strips, cavity, over 30 tubes, etc. Includes 3E29 tube. Good cond. A STEAL AT ONLY \$9.73
APX-6 Manual \$1.37

YOU GOT IT! WE WANT IT! LET'S DEAL?
We're paying top \$\$\$ for GRC-9; PRC-6, -8, -9, -10; GN-58A; All electronic test equip.

All items FOB Burbank, Calif., subject to prior sale.
In Calif. add 4%. Min. order \$3.73.

J. J. CANDEE CO.

509 No. Victory Blvd., Burbank, Calif.
DDD area 213 — VI 9-2411

244 S. Park Avenue, Tucson, Arizona
DDD area 602 — 624-2014

THE FIRST MULTIBAND COAXIAL ANTENNA for 6-10-15-20 Meters

**needs no ground
plane radials—**

Ideal for . . .

Emergency nets and citizens band wherever omnidirectional coverage is desired.

Campers and apartment residents or *wherever* space is a problem.

A second antenna for low angle radiation.

The New C-4 features . . .

- Full electrical half waves on all bands . . . eliminating the need for awkward ground plane radials.
- Easy, inexpensive mounting with regular TV hardware such as simple chimney mount as shown.
- Compactness . . . only 12' over-all height.
- End-loaded to provide maximum radiator current for maximum radiation.
- Quick installation . . . about ½ hour.
- Power rating . . . 300 watts AM.
- Feed line . . . RG58AU or equivalent.
- SWR . . . less than 1.5 to 1 at resonance.

Model C-4
amateur net **\$34.95**

Two other 6-10-15-20 meter antennas:

Model B-24 Four Band Beam
Element length 11' — boom length 5'
Turning radius 7'
amateur net **\$54.95**

Model M-4 Four Band
Mobile • 5'-3" high
Fits all standard mounts
amateur net **\$16.95**

The above antennas are also available for 6-10 or citizens band operation.

Write for literature and the name of your nearest Mini-Products distributor. Patents pending

Mini-Products, Inc.

1001 West 18th Street
Erie, Pennsylvania

SPECIALISTS IN COMPACT ANTENNAS
Order direct or from your distributor.

(W2NSD from page 4)

began to come in I could see that most of them were the same as you would also be seeing in the pages of 73. No one needs a buyer's guide around to tell them to send for a catalog.

The golden lining: much of the material submitted for the Guide is just what we like to have on hand to fill in the spaces between major articles in 73. Most readers want to have their articles run continuously and not jump to the back of the book, which means that we have to have a good assortment of small items on hand to patch things together. It is much more difficult to put a magazine together like this.

Europe

Those of you who have been following my editorial ramblings for any length of time may remember that I frequently get in references to the Porsche. I hasten to explain to the more cubical readers that a Porsche is a make of car, not a new transmitter. Ahhh, but what a car. I won't go into a long sales pitch on it, but I must explain that most of the well versed authorities on cars agree that the Porsche is the finest designed car in the world today.

It is only natural that the owners of these amazing cars should rally together into clubs where they could laugh with contempt at people who buy Cadillacs and Mercedes. The national club, the Porsche Club of America, has grown to some 2000 members . . . which is rather remarkable when you consider that there is probably only about 10,000 of the cars in the U. S.

Regional clubs hold monthly meetings where the technical aspects of the car are discussed and sports car films shown. They also organize events such as gymkhanas, rallies, concours, hill climbs, races, etc. The national PCA publishes a nice little monthly magazine and organizes a yearly trip to Stuttgart, Germany for members to visit the factory and buy new cars if they wish. Most of them do buy the car since it is over \$1000 less at the factory than delivered in the U. S., and the shipping costs of getting it back plus duty on the used car are usually about half of that. Thus you get the best of transportation for traveling around Europe and still have a bargain priced car when you get back.

The flight came at the wrong time for me in 1958 and I missed it. I did the next best thing and organized my own personal flight over about a month later and picked up a car. I drove 4000 miles through Europe, visiting hams and talking to ham clubs as I went. You can be sure that I made it my business to be available for the 1959 trip. I conned Steve, W2OKU, who lives just a few blocks from me, into going on this one too. I already had

a 1958 and 1959 Porsche, so I really didn't need a third car. Fortunately I managed to talk Ed Bedersen, K2QWO into buying a new Porsche which I would pick up for him at the factory and gently break in on the German Autobahns. Heh, heh.

I was off on a rally in New Jersey and missed the cocktail party given by the U. S. representatives of the Porsche factory. Steve turned up and won the raffle, with the prize being a free flight back from Germany for his new Porsche via Lufthansa Airlines. Quite a prize.

The next afternoon two DC-7 loads of Porsche Club members, 185 of us (including a lot of wives), were on our way to Stuttgart. We were fed almost constantly all the way across. We arrived at the Stuttgart airport about 9 AM and found a champagne party waiting for us on the patio of the administration building. There they stamped our passports, accepted payment for the new cars and gave us all the necessary papers of ownership and for driving anywhere in Europe. Our luggage had been transferred to some beautiful German busses. Taking a few more gulps of champagne, we boarded the busses and were driven to a magnificent castle a few minutes away. There, as we rounded the balcony, was an amazing panorama: in the background lay the city of Stuttgart, and in the foreground were one hundred Porsches spread out over the huge lawn.

Each of us were called individually forward and were introduced to the mayor of Stuttgart and Ferry Porsche. We were then given an armload of gifts (wine, cute German dolls, scarfs, books, etc.) and escorted to our own car. There were mechanics there from the factory just in case everything wasn't exactly perfect. They weren't needed. One of them helped Steve put the top down on his convertible model. Once we had inspected our cars, looked over those of our friends, and taken plenty of pictures of the whole proceedings, we adjourned to the side of the castle where Lufthansa was treating us to a fine catered lunch.

The cars had been arranged in lines according to the hotel accommodations so it was simple for us to form lines behind factory cars and convoy to the hotels. Since no plans had been made for our dinner that night I rounded up Steve and Earl Grainger W2NXZ and headed for the TV tower which overlooks Stuttgart. They have a wonderful restaurant right up on top of this tower. We took the elevator up and as I got off there was Lothar Woerner DJ1BZ sitting in front of me. The last time I had seen Lothar was the evening just about one year before when we had dinner at this very spot. Lothar was more surprised than I for this was the first time he had been

(Turn to page 73)

SCR-522 SPECIAL

Rcvr, xmtr, rack, case. Exc. cond. 19 tubes include 832A's! 100-156 mc AM. SATISFACTION GRID! Specify fob Bremerton Wn. or Buffalo, N. Y. Sold at less than **\$16.95** tube cost!

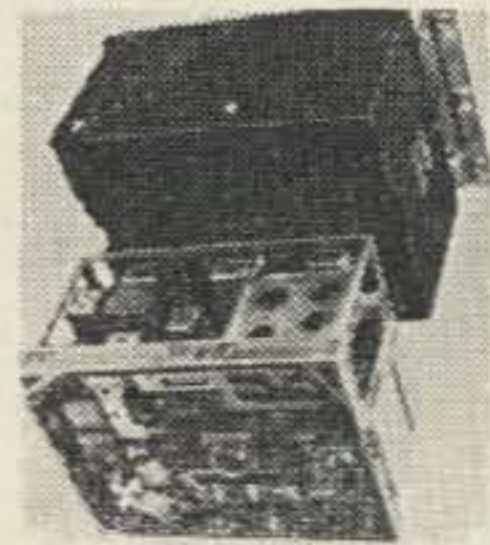

Add \$3.00 for complete tech. data group, includes schem., parts list, I.F., xtl formulas, rcvr cont. tuning, xmtr 2-meter use and convers. to 6 and 10 meters, pwr data, etc. RA-62-C: AC pwr sply for SCR-522, exc. cond. fob San Diego.

\$49.50

TDQ TRANSMITTER

115-156 mc, 45 W carrier can be 100% AM by Voice or 85% AM by 1 kc tone, key up to 40 wpm. Complete set, pwr 115/230 v 50/60 cy. 829B final. Checked, OK'd. FOB Los Angeles. **\$149.50**

TDZ TRANSMITTER

Brand New! 225-400 mc AM, 30 W Po. 10 chnl Autotune. Pwr 115/230/440 v 50/60 cy 1 ph. FOB San Diego, California. **\$149.50**

POPULAR Q-5'ER

BC-453-B: 190-550 kc; I.F. 85 kc. Use as rcvr, as tunable I.F., as double-conversion for other rcvrs. Checked out, good cond., w/schem., align. instr., pwr sply data, etc. RailEx only, fob Los Angeles. **\$12.95**

QX-535 RECEIVER

Above rcvr in handsome cabinet, pwr sply, spkr, ready to use. **\$37.50**

NAVY'S PRIDE RECEIVER

RBS: 2 to 20 mc 14-tube superhet has voice filter for low noise, ear-saver AGC, etc. Strictly for communications! Very hot! I.F. 1255 kc. Checked, aligned, w/power supply, cords, schematic, instructions, fob Charleston S.C. or Los Angeles, Calif. **\$99.50** Only

ALL-BAND RECEIVER

R-45/ARR-7: 0.55 to 43 mc. NEW! W/60 cy pwr supply includes DC for aut. tuning motor. Has everything! Xtl I.F. filter, 6 selectivities, BFO, S-meter, AF/RF Gain, Noise Limit., etc. 455 kc I.F. w/schem. FOB San Antonio. **\$179.50**

RCVR/SPECTRUM ANALYZER

AN/APR-4 rcvr is 11-tube superhet as I.F., S-meter, etc. for the 30 mc output of the tuning units. Aligned, OK, fob Los Angeles. **\$69.50**

TN-16, 17, 18 tune 38-1000 mc; checked OK; the set of 3. **\$85.00**

TN-19, 975-2200 mc. **\$59.50**

LM FREQUENCY METER

Good, used cond. With matching calibration book, xtal., schematic, power supply data. F.O.B. Pensacola, Florida. Only. **\$49.50**

SAME, but less calibration book. **25.00**

EQUIPMENT WANTED!

Our need is your gain! Urgently need: TS-382, TS-505-A, TV2/U, other TS, UPM, URM, USM equipment! Also, Hewlett-Packard and SG materials.

WE CURRENTLY PAY HIGHEST PRICES!

R. E. GOODHEART CO.

BOX 1220-GC BEVERLY HILLS, CALIF.

This announcement is neither an offer to sell nor a solicitation of an offer to buy any of these securities. This offering made only by the Prospectus. This offering available to adult New York State residents only. September 13, 1961.

200,000 Shares

Neil Electronic Systems Corp.

795 Monroe Ave., Roch. 7, N. Y. (A New York Corporation)

Common Stock

(par Value \$.05 per share)

Price \$1.50 per share

Copies of the Prospectus may be obtained from Neil Electronic Systems Corporation, 795 Monroe Avenue, Rochester 7, N. Y.

Reader's Service

As mentioned last month, one of our local publishers has forced us to temporarily discontinue the service postcard in each issue. We'll try to have it back in the January issue for you. In the interim please either use this blank or make one of your own and send it in. Write your name and address in the small square, put in the name of the advertisers that you would like further information from, and we'll cut out the square and send it along for you. This enables you to send in a subscription or gift subscription at the same time in the same envelope. Heh, heh!

.....	12
Adv.:	
.....	12
Adv.:	
.....	12
Adv.:	
.....	12
Adv.:	
.....	12
Adv.:	

(W2NSD from page 71)

back since our dinner a year before. We had quite a QSO. Incidentally, the food is terrific there and very reasonable by U. S. standards.

Breakfast comes free with the hotel room in Europe. After breakfast we all drove to the Porsche factory and were given a guided tour. You really have to see it to believe it. Every part of the car is fitted carefully by craftsmen. They take extraordinary care in putting it together. We were all snapping pictures right and left. Be careful when you visit me or else you may see the whole trip, including every corner of the factory, in detail.

There was a cocktail party midway in the tour, complete with a snack and more gifts (thermometer, picture album, etc.). The tour ended in the accessory sales department where we were able to indulge ourselves with Porsche ashtrays, handbags, scarfs, cigarette lighters, badges, decals, spare parts kits, etc. From there we drove to a nearby racetrack which had been rented for the day. After an outdoor lunch of hot dogs, potato salad and beer we tried out the track.

This was my first experience on a racetrack and I really put my foot down hard. All of a sudden I was in a double hairpin turn and spinning around! I got straightened out and took it much easier until I got the feel of the track and the Michelin tires, which were new to me. The track was about five miles around and had a couple places where I could open the car up to about 110 before I had to brake for a turn. After a half dozen rounds I was familiar with the track and keeping up a reasonable average speed. I stopped and talked Steve into going around with me once . . . heh, heh. He'll never forget that ride. The factory had their most famous drivers there with the Porsche racing cars and were giving the hardier souls a memorable experience around the track. I was having so much fun seeing how fast I could go without wrecking Ed's car that I missed the free rides.

That night the factory gave a dinner for us all and gave away a huge pile of door prizes. I won an ashtray, but watched others win watches, FM radios for their cars, etc.

We had the next two days to ourselves, being due in Locarno, Switzerland (down near Italy) three days hence for the International Porsche Club meeting. Most of us headed for Zurich as the first stop. I paid a visit to the Hanhart factory, where they make the Hanhart stopwatches, in Schwenningen. Hanhart is the largest selling stopwatch in the world.

As a dealer in Hanhart watches I was given a friendly greeting. When I got interested in sports car rallying I did a rather thorough

(Turn to page 74)

KTV TOWERS

KTV
P. O. Box 137
Sullivan, Illinois

Dear Sirs:

I would like to place my order for one of your 60 foot model KTVHT series 1600 towers and track assemblies. Your letter of October 10 specified 10 days required for shipment from your plant.

By the way, I have been using a track arrangement for my beams for the last 6 years, first in the Virgin Islands, and later in Fort Myers, Florida, however, they were tracks on 65 foot creosoted poles and not very practical to move from one location to another. CQ magazine for August 1957 has a description of the one in St. Croix, together with a page of pictures taken by Wayne Green when he was editor of CQ and visited me there.

Very truly yours,

William C. Thomas
KZ5CG/W4CG ex KV4BB

KTV Hy-Track towers are now located in the following areas:

Boston	Richmond, Mich.
Stamford	Chicago
Passaic	Shelbyville, Ill.
Troy, N. Y.	Lincoln, Neb.
Cleveland	Ogden
Toledo	Albany, Ga.

Jacksonville

If you'd like to see what they look like just drop a card and we'll send the call and QTH where you can see it.

Write re. custom built towers for labs and experimental work.

(See our ad on page 6, March, 73 Mag.)

WARNING! GLASS

has broken down and brought you the best surplus deals in history. Read further and you will be in grave

DANGER

of buying everything in this ad whether you want it or not, simply because you can't afford to miss such a chance. You will find yourself, canny reader that you are, cooking up ways to go into the surplus business yourself to resell this stuff at a profit to un-canny non-readers of 73.

TRANSFORMER SPECIALS

2350-0-2350 @ 400 MA. Brand New!.....\$24.73
 515 0-515 @ 250 MA, 5V @ 3 A, 2.5 VCT
 @ 5 A 2.37
 12 V @ 3 A. Brand New!..... 1.37
 Modulation Transformer, COLLINS, 20 Watts. Response 200-5000 cyc. Primary 6000 ohms, Sec 6000 ohms. New Condition73c each!

CRYSTAL BUYS

1000 KC Crystal in Metal-Sealed Holder...\$1.37 each
 200 KC Crystal in Metal-Sealed Holder.... 1.73 each
 500 KC Crystal in FT-241 Holder.....73c each
 SPECIAL! 100 KC Crystal, 3-prong Bakelite Holder\$2.37

TUBES

Bulk Tube Specials! Any 4 Tubes for \$1!
 6SN7 6SL7 6H6 715A 6V6 6SH7 6AC7
 6Y6 12L8 25L6 3B24

SUPER SPECIAL—717A, Famous DOORKNOB Tube, used as heavy duty 6SK7. High Gain for High Frequency. Brand New. 6 for \$1!!!

WE ARE MOVING TO LARGER QUARTERS AT 1624 S. MAIN, LOS ANGELES—across the street from the old location. Large selection of new material—See You There! New open Fridays til 9.

J. J. GLASS CO.

1624 S. MAIN ST. LOS ANGELES 15, CALIF.
 DDD area 213 RI 9-1179



CITIZEN BAND All 22 Frequencies in Stock CLASS "D" CRYSTALS

3rd overtone. .005% tolerance—to meet all F C C requirements. Hermetically sealed HC6/U holders. 1/2" pin spacing—.050 pins. (.093 pins available, add 15¢ per crystal).

\$2.95
EACH

The following Class "D" Citizen Band frequencies in stock (frequencies listed in megacycles): 26.965, 26.975, 26.985, 27.005, 27.015, 27.025, 27.035, 27.055, 27.065, 27.075, 27.085, 27.105, 27.115, 27.125, 27.135, 27.155, 27.165, 27.175, 27.185, 27.205, 27.215, 27.225.

Matched crystal sets for all CB units. . . . \$5.90 per set. Specify equipment make and model numbers.

RADIO CONTROL CRYSTALS IN HC6/U HOLDERS
Specify frequency, 1/2" pin spacing . . . pin diameter .05 (.093 pin diameter, add 15¢) . . . \$2.95 ea.

FUNDAMENTAL FREQ. SEALED CRYSTALS
In HC6/U holders
From 1400 KC to 2000 KC .005% Tolerance . . . \$4.95 ea.
From 2000 KC to 10,000 KC any frequency .005% Tolerance . . . \$3.50 ea.

SEALED OVERTONE CRYSTALS
Supplied in metal HC6/U holders
Pin spacing .486, diameter .050
15 to 30 MC .005 Tolerance . . . \$3.85 ea.
30 to 45 MC .005 Tolerance . . . \$4.10 ea.
45 to 60 MC .005 Tolerance . . . \$4.50 ea.



QUARTZ CRYSTALS FOR EVERY SERVICE

All crystals made from Grade "A" imported quartz—ground and etched to exact frequencies. Unconditionally guaranteed! Supplied in:

FT-243 holders MC-7 holders
Pin spacing 1/2" Pin spacing 3/8"
Pin diameter .093 Pin diameter .125
CR1A/AR holders FT-171 holders
Pin spacing 1/2" Pin spacing 3/8"
Pin diameter .125 Banana pins

MADE TO ORDER CRYSTALS . Specify holder wanted
1001 KC to 2600 KC:
.005% tolerance . . . \$4.50 ea.
2601 KC to 9000 KC:
.005% tolerance . . . \$2.50 ea.
9001 KC to 11,000 KC
.005% tolerance . . . \$3.00 ea.

Amateur, Novice, Technician Band Crystals
.01% Tolerance . . . \$1.50 ea.—80 meters (3701-3749 KC), 40 meters (7152-7198 KC), 15 meters (7034-7082 KC), 6 meters (8335-8650 KC) within 1 KC
FT-241 Lattice Crystals in all frequencies from 370 KC to 540 KC (all except 455 KC and 500 KC) . . . 50¢ ea.
Pin spacing 1/2" Pin diameter .093
Matched pairs + 15 cycles \$2.50 per pair
200 KC Crystals, \$2.00 ea.; 455 KC Crystals, \$1.25 ea.; 500 KC Crystals, \$1.50 ea.; 100 KC Frequency Standard Crystals in HC6/U holders \$4.50 ea.; Socket for FT-243 crystal 15¢ ea.; Dual socket for FT-243 crystals, 15¢ ea.; Sockets for MC-7 and FT-171 crystals 25¢ ea.; Ceramic socket for HC6/U crystals 20¢ ea.
Write for new free catalog #961 complete with oscillator circuits

ASK YOUR PARTS DEALER FOR TEXAS CRYSTALS
See big red display . . . if he doesn't stock them, send us his name and order direct from our Florida factory.

NOW! Engineering samples and small quantities for prototypes now made either at Chicago or Ft. Myers Plant. 24 Hour Service!

IN CHICAGO, PHONE GLadstone 3-3555

RUSH YOUR ORDER TO OUR NEW PLANT

Use coupon below for 1st Class shipment.

TEXAS CRYSTALS

Dept. G-121, 1000 CRYSTAL DRIVE, FORT MYERS, FLA.
For extra fast service, Phone WE 6-2100

ATTACH THIS COUPON TO YOUR ORDER FOR SHIPMENT VIA 1ST CLASS MAIL AT NO EXTRA COST

TERMS: All items subject to prior sale and change of price without notice. All crystal orders must be accompanied by check, cash or M.O. with **PAYMENT IN FULL.** G-121.

investigation of stop watches and found that the best one by far was the Hanhart. There seemed to be no dealer setup in the U. S. so I imported the watches I wanted for myself. It wasn't long before other rallyists wanted them too and I found myself in business . . . selling at cost. Some business! Everyone liked them very much for they were easier to read, kept better time, and were less expensive than other watches.

After looking over the latest Hanhart watches I drove on to Zurich and left my car with the local Porsche dealer for the 300 mile inspection. Hotel reservations had been made by the PCA. I shopped around town during the afternoon and then took a cab to the garage. On the way I spotted Steve, obviously lost. I left the cab and directed Steve to the Porsche garage. My car was done, so we left his and drove back down town. Earl had gone to visit an HB9 chum of his some 50 miles away so Steve and I sight-saw and had a fine dinner.

I drove Steve back out to the garage the next morning, but his car still wasn't finished. No wonder, I believe that 80 out of the 100 PCA Porsches had been brought in for inspection and service. Even with the help of a group of mechanics from the factory they couldn't keep up with that number of cars. I couldn't wait for Steve if I was going to make it to Liechtenstein and then down to Locarno all in one day. I crossed the border into Liechtenstein by noon and found the tiny Curta factory by 1 PM.

The Curta is the world's smallest computer. We use it for rallying and find it far better than even a Monroe Computer. Indeed, I did at one time have a Monroe mounted in my Porsche. I had become a dealer in Curtas for the same reason as the Hanhart watches . . . it was the only way to get them in the U. S. Beware of the Curta though, for every ham that I've shown one to, has immediately wanted one for himself.

After taking some pictures in the Curta factory (mostly automated), I drove a couple miles north to Austria for lunch. Porsches had been passing me every few minutes on their way to Locarno, so I fell in behind a pair of them, one with a Swiss license and the other Austrian. They both obviously knew the road quite well for they were doing over 100 on the stretches and slowing down to 70 on the hard curves. No car but a Porsche could have done it. I managed to keep up with them, but it was hair-raising. I watched the exact spot where I saw their tail lights go on and braked there . . . sure enough I was able to make it through the turn without careening into a chasm. Traffic was slight and they drove as though there was a possibility

of a car appearing around the turns. Madmen.

Everyone should have a chance to go over a Swiss mountain pass in a Porsche before they depart this world. There is no experience like it. We whizzed across the San Bernardino Pass, with its hundreds of switch-backs, sliding through every turn. We passed a Cadillac on one turn and I felt a moment of pity for the fat cigar smoking chap inside who had to stop at almost every turn and back up once or twice to get around. The madmen finally stopped for gas and I continued on at an easier pace.

Next month, if anyone is really interested, I'll carry on with the International Porsche Club meeting in Locarno, my visit with ILOV, and the I.T.U. conference at Geneva.

All this was brought on by the announcement of the P.C.A. that the 1962 trip will go over in April. Now that I'm married, I sure would like to take Virginia over and show her all of those things that I enjoyed so much. If it is possible to get away we'll make the trip. The cost is about half the regular fare, so we'll probably be able to swing it. I know all the tricks for getting along in Europe for under \$5 a day for each of us, which helps. I know that a disproportionate number of hams are Porsche owners (I know of at least ten), so maybe some of you'll be with us this time.

Regarding Subscribing

You may have noticed that most magazines make a big fuss and try to get you to subscribe. There are good logical reasons for this. Number one reason is that most advertisers seem to put a lot of store by the number of subscribers a magazine has. I should think that the total number of copies sold per month would be more to the point, but they always ask about subscriptions. Then there is the chance that you might miss a few copies during the year due to the newsstand being sold out or your not liking a particular issue. There are a page full of other logical reasons. All in all, it is pretty important to us that you subscribe.

Granted that it is quite a logistical problem to round up a subscription form, an envelope, a pencil and three dollars all at one time. We are desperate. We will cheerfully accept any scrap of paper in lieu of one of our own blanks. We will accept anything negotiable in payment: cash, check (on a U.S. bank), money order, foreign currency, stamps, etc. We are holding our subscription rates down as long as we can, but it is getting close here and they may have to go up soon.

GENERALIZE YOURSELF! LEARN RADIO CODE

The EASY WAY

No Books To Read—No Visual Gimmicks To Distract You. Just listen and learn

Based on modern psychological techniques — This course will take you beyond 13 w.p.m. in

LESS THAN 1/2 THE TIME

Available also on magnetic tape
See Your Dealer Now!



PRICE
\$9.95

Album Contains
Three 12" LP's
2 1/2 Hr.
Instruction

**EPSILON
RECORDS**

2769 CAROLINA
REDWOOD CITY, CALIF.

TECHNICAL MANUALS CO.

P.O. BOX 406 — 805 COURT STREET — UTICA, N. Y.

TM-11-300—BC-221. All MODELS	\$7.50
TM-11-352—TG-7, TG-37. MODEL 15.....	7.50
TM-11-2222—TT-12/FGQ, TT-21, TT-25, TT-26, TT-52. Including 14 TD	7.50
TM-11-2223—TYPING and NON-TYPING MOD- EL 14	7.50
TM-11-2234—TELETYPE AN/TT-4/FG	5.00

SEND CHECK WE PAY POSTAGE

WE ALSO BUY OR TRADE FOR MANUALS

U.S. #1 ELECTRONICS

a division of AMBER INDUSTRIAL CORP.

1920 E. EDGAR ROAD (Right on Highway U.S. 1)
LINDEN, N. J. — across from ESSO RESEARCH LABS

COME TO OUR BIG, BIG STORE!

— FREE PARKING —

Send for our new, free, bargain list.

TELETYPE

RT-45	XCVR	14-50 mc, 807 final, 0-200 ma mtr	NEW \$18.00
SCR-522	XCVR	100-156 mc, 832 final, 30Watts	EXC \$22.40
BC-1158	XMTR	50-97 mc, 815 final AM, w/8mc xtl	NEW \$29.45
BC-617	RCVR	30-50 mc, FM, xtal controlled	EXC \$22.45
BC-458	XMTR	5.3-7 mc, can run 120 Watts	EXC \$ 8.45
R8/ARN8	RCVR	75 mc, 7 tubes, FB for parts	EXC \$ 2.95
I-196B	Sig Gen	150-230 mc, beautiful box	NEW \$ 1.45
DQ-15	DYN	12/24 in; Out 265/540v 120/26 ma	NEW \$ 8.45

MN26 DIRECTION FINDER—Complete New — \$49.80

GO-9 Xmtr 3-18 mc 100W.....NEW \$41.50

CITIZENS' BAND Mobile or Fixed—BC-260 Xcra

6-12-24 VDC - 115VAC \$10.95

Pair Plus A Spare..... \$26.50
(2 Excellent, One As-Is for Parts)

BC-604 XMTR 20-28 mc, w/tubes. EXC \$ 8.45

BC-654A XMTR 3.8-5.8 mc xtal cal. EXC \$29.50

PE-103 DYN 6/12 vdc to 500 v @ 160 ma. EXC \$14.95

PE-73 DYN 24 vdc to 1000 v @ 300 ma. EXC \$ 7.95

Pwr. Supplies: DC—\$5.95

AC—\$12.95

TUBE SPECIALS

304th — \$18.95; 813 — \$8.25; 2C39A — \$8.95; 717A — 45¢

BARRY'S SPECIALS

Plate Xformer, pri: 115v. 60 cy.; sec.: 3000-2500-0-2500-3000 @ 350 ma.....	\$34.95
Super Pro S-meter.....	\$4.95
Eveready #1565 Hot Shot 5-cell pwr. battery, 7.5 v.....	\$3.95
Mallory 1250 mfd./180 v. dc...	\$1.25
Fahnsteel FWCT selenium rectifier 50 v. @ 200 amps., 20 lbs...	\$25.00
304TH/TL tube sockets.....	\$1.15
R.C.A. CRV-59 AAC TV camera xmitter with 1846 icon.....	\$95.00
TBK-20 500 watt CW rig, 2.0-18.1 mc., new, less ps, f. o. b. Atlanta	\$275.00

Write for green sheet supplement.

BARRY ELECTRONIC CORP.

512 Broadway, New York 12, N. Y.
WA 5-7000

BC-221 FREQUENCY METER. Like New	\$69.50
With original calib. book.....	
BC-603 FM Receiver	18.95
20-27.9 MC. New	
BC-603 orders will include a fine 2M conversion by K9MDN.	
DM-34 Dynamotor,	3.95
brand new	
DM-35 Dynamotor,	9.95
brand new	
BC-923 A FM Receiver	29.95
27-38.9 Mc. Brand New	
ART-13 Transmitter	39.50
with tubes & meters, used.....	
BC-604 MF Transmitter	4.95
with tubes. Brand New	
RT-157/APN-68 IFF Radar Transceiver	7.95
20 tubes in all.....	
Antenna Mast Base	2.95
& 3-39" Mast Sections.....	
85kc IF Transformers	2.25
ARC-12, New. 79¢ ea. 3 for.....	
ID-6/APN-4 Indicator	2.95
less tubes	
B-442 Antenna Relay	1.95
with Meter & Vac. Cap.	
ARR-2 Receiver,	4.95
11 tubes with CB conversion.....	
ARC-3 AM Receiver	12.95
100-156 Mc. Excellent	
ARC-3 AM Transmitter	14.95
100-156 Mc. Excellent	
I-130A Signal Generator,	7.95
100-156 Mc.	
I-95B Field Strength Meter,	7.95
100-156 Mc.	
KY65/ARA-26 Automatic Keyer	2.95
as converted in Oct. '73'	

Send Money Order or Check with Order

Write for Latest Flier—LOADS OF BARGAINS!

R W ELECTRONICS

2430 S. Michigan Avenue
Phone: CAIumet 5-1281

Dept. 73
Chicago 16, Illinois

(QX1535 from page 67)

switch for complete band coverage, tuning perhaps 3500-3850 and 3700-4050 kc. This would cover all of the ham bands up to ten meters, where switched crystals should be again provided in the outboard converter for complete band coverage.

The QX-535 as a basic unit could prove to be a useful addition to almost any receiving set-up. The references to follow include several different ideas various hams have had on how to use the BC-453. The QX-535 may be used in all of these ways, and is nice to use since it not only is complete with power supply and controls, but is a nice-looking package, and, far from being the least consideration, quite inexpensive.

... K3KMO

Letter

Dear Wayne,

In the plastic bag you will find some braid which has been soaked in flux and oven dried. This may not be new to you but it was to me and I have never seen anything about it in any of those other pubs., so I would like all the people and hams, too, who read your magazine to know about it. The deal is this; if you need to repair some gear, especially surplus equipment, lay an end of the braid on the solder joint and apply a hot solder iron to the braid and watch the braid soak up the solder! Brush the joint with some solvent and it will shine like new. Try it. I use this method to make old tube sockets "New."

I am taking advantage of your three year offer before the price goes up like on the last job you had.

Floyd K. Pevoto K6JHT

FAMOUS BRAND (just about the most famous, but we can't reveal) **Citizen's Band Transceiver**, 1-channel, crystal, full 5 watts input. 6/115V or 12/115*. Complete
\$39.50 ea.

with cables, instruction book, FCC forms, mike-spkr.
\$75.00 pr.

11 lbs. shipping wgt. per unit.

*Specify which.

Original **COLLINS KWM-1 DX Adapter Kit** with instructions. Allows xmitting and receiving on different channels. NEW \$15.00 postpaid.

Western Electric dial telephone. Exc. cond....\$4.95 ea.
2 for \$8.95

Radioonde Transmitter—T-304/AMT-4A, 1650 MC with RCA 5794 tube and gnd-plane antenna.....\$2.50 pp

Write for **FREE CATALOG**

ALVARADIO INDUSTRIES

PO. BOX 151-A

NO. HOLLYWOOD, CALIF.

HAM SHACK NOVELTY

Authentic-looking, two-color certificate claiming tongue-in-cheek ownership of an acre on the Moon's surface. Ideal gift or conversation piece for shack, bar, den or office. (See Pg. 119—Jan. 61, CQ.) With gold seal and name and call inscribed only \$1.00 each. Six for \$5.00. Send check or M.O. to—

BOX DXG, 1738 — 201 St., Bayside 60, N. Y.

Anyone for Ham TV?

Ham TV is no longer a complicated or expensive hobby. It is quite simple to put a signal on the air when you know what you are doing. This book tells you how. Used TV receivers are available very reasonable these days . . . find out how to convert these old sets for Ham TV. This book is light on theory, presenting just enough so you'll have a good idea of what you are doing.

Here are some of the contents of this book: Introduction to Ham TV; Image converters; video amplifiers; the TV receiver; the station; flying spot scanner; the camera scanning unit, pickup unit, mixer unit; monitor receiver; slides for the camera; video transmitter; video modulator; transmitter test equipment; transmitter adjustments; audio; antennas; converters; station operation suggestions.

This is the first Ham TV Manual ever published. Order one now!

\$3.00 per copy.

Name..... Call.....

Address

City..... Zone..... State.....

Order for copies of the Ham TV Manual
@ \$3.00 each.

ORDER FROM "73" MAGAZINE
1379 East 15th Street, Brooklyn 30, New York

DKC-RFB *SIGNALS 'POP OUT'*

WITH DOW'S PREAMPLIFIER

Get signals you didn't hear!

Not a gimmick, but a tested and proven accessory. Precision made, fully backed by Dow-Key's traditional Factory Warranty.

HELP YOUR RECEIVER!
The DKC-RFB Booster is a 50 to 70 ohm impedance matching "broadband pre-amplifier" guaranteed to increase the over-all gain by 1 to 6 "S" units on all bands (1.5 to 30 mc). To improve sensitivity, work with DX, and bring up weak unintelligible signals, you'll want a DKC-RFB. Designed for receivers up to the \$300 class.

price . . . **\$10.75**

DOW-KEY COMPANY • THIEF RIVER FALLS MINNESOTA



TELEWRITER FREQUENCY SHIFT CONVERTER

The New Model "K" Telewriter Converter (designed by M. J. "Don" Wiggins W4EHU) includes: 1. Linear audio discriminator with high Q toroids for maximum interference rejection. 2. Advanced keying tube circuit to compensate for distortion with front panel control. 3. Separate magnet current supply with milliammeter. 4. Dual eye indicator. 5. Chassis terminals for polar relay bias, S-R relay, and loop. 6. Front panel jacks for keyboard and printer. 7. Send-Rec. and Polarity Reversing switches. For further information and reconditioned teletype list, write: Alltronics-Howard Co., Box 19, Boston 1, Mass. (Richmond 2-0048)

★ ★

CUBICAL QUADS ★

10-15-20 meters — \$59.95 ★

Separate parts or complete quads ★
Fiberglass spreaders ★

SKYLANE PRODUCTS —Dep't C ★

406 BON AIR ● TEMPLE TERRACE, FLORIDA ★

★ ★

"TIME AT A GLANCE" G.M.T.

24-HOUR NUMERAL CLOCK

Model
100-24H¹/₄

\$15

Plus
applicable
tax



This Standard Universal 24-hour electric numeral clock gives you instant "Time at a Glance" wherever split second time control is essential. Walnut or ebony plastic case. Glolite dome-shaped full vision window **GLOWS IN THE DARK**. Large-easy-to-read numerals. 4" high, 7³/₄" wide, 4" deep. Weight 3 lbs. 110V 60 cy. A.C. UL approved motor and cord. Self starting. 1 year guarantee.

At Your Dealer . . . or WRITE TO

PENNWOOD NUMECHRON CO.

7249 FRANKSTOWN AVE. • PITTSBURGH 8, PA.

EXCLUSIVE

Did you know Bob Graham deals only in Amateur Radio Equipment? Did you know he has two stores handling only equipment such as Collins, National, Hallicrafters, Hammarlund, Gonset, Johnson, Central Electronics, Clegg, Globe, etc.? Did you know he services all types of ham gear as well as buys, trades, swaps, rents, and installs equipment? Did you know he has a large selection of reconditioned and guaranteed used gear? You didn't! Well now you do.

GRAHAM RADIO INC.

505 Main St., Reading, Mass. • Tel. 944-4000
1105 No. Main St., Randolph, Mass. • Tel. WO 3-5005

Reyco Multiband Antenna Coils

Traps for dipoles . . . high strength . . . moisture proof guaranteed to handle a full KW. Model KW-40 coils will, with a 108 foot antenna, provide operation on 10-15-20-40-80. \$12.50 set.

For information on other models write:

FRED L. REYNOLDS W2VS, 492 Ravenswood Ave., Rochester 19, New York

ALL BAND TRAP ANTENNA !



Reduces interference and Noise on All Makes Short Wave Receivers. Makes World Wide Reception Stronger. Clearer on All Bands!

For ALL Amateur Transmitters. Guaranteed for 500 Watts Power for Pi-Net or Link Direct Feed, Light, Neat, Weatherproof

Complete as shown total length 102 ft. with 87 ft. of 72 ohm balanced feedline, Hi-impact molded resonant traps. (Wt. 3 oz. 1" x 5" long). You just tune to desired band for beamlike results. Excellent for ALL world-wide short-wave receivers and amateur transmitters. For NOVICE AND ALL CLASS AMATEURS! NO EXTRA TUNERS OR GADGETS NEEDED! Eliminates 5 separate antennas with excellent performance guaranteed. Use as Inverted V for all band power gain. NO HAYWIRE HOUSE APPEARANCE! EASY INSTALLATION! 80-40-20-15-10 meter bands. Complete. . . . \$14.95 40-20-15-10 meter bands. 54-ft. ant. (best for w-w swl's) 13.95 20-15-10 meter bands. Dual Trap. 24-ft. antenna. . . . 19.95 SEND ONLY \$3.00 (cash, ck., mo) and pay postman balance COD plus postage on arrival or send full price for postpaid delivery.

Available only from:

WESTERN RADIO - Dept. A7-7 - Kearney, Nebraska

Amateur & CB Crystals

\$3.00 2500 kc to 15,000 kc, fundamental frequencies 15 mc to 30 mc, third mode

\$3.50 30 mc to 50 mc



All crystals for amateurs are set at 20 mmfd, hermetically sealed with pins optional: .050" (CR-1); .093" (FT-241/3); .125" (HC-6); 1/2" centers.

Citizens Band transmitter crystals in stock for the following equipment: JR-800, 761A, CD1, GW10, CD5, CD100, CD100A, TR330, C27, AT20, Messenger, MK7, R2700, TR910, 27C2, ED27, CR117, CDD5, CT1, RP115, CD27, TECT. Guaranteed .004% of nominal: \$3.00.

AMERICAN CRYSTAL CO.

P.O. BOX 2366 • KANSAS CITY 42, MO.

Advertisers

Alden	65
Allied Radio	80
Alltronic-Howard	77
Alvaradio	76
American Crystal	78
Arrow Electronics	27
Barry	55, 76
Burghardt	55
B & W	32, 59
Call D Cal	55
Candee	69
Centimeg	15
Central Electronics	19
Clark	57
Clegg	23
Columbia	67
Cornell-Dubilier	4
Craftronics	20
Cushcraft	57
Dow Key	53, 77
EICO	5
Elliott	49
Elmac	53
Epsilon	75
E-Z Way	50
Gam	21
J. J. Glass	73
Goodhart	71
Graham	78
Ham Boards	57
Ham Kits	59
Ham TV Book	77
Hi-Par	63
International Crystal	7
Irving Electronics	55
KTV	73
Lafayette Radio	3
Miller	53
Mini-Products	70
Multi-Products	53
National Radio	Cover IV
Neil	72
Newtronics	Cover II
Novelties	76
Penwood Numechron	77
Petersen	Cover III
P & H	51
Radio Bookshop	60
Reyco	78
R-W Electronics	76
Seco	54
Shure	29
Skylane	77
Space Raider	17
Sprague	32
Springfield Enterprises	51
Subs for Clubs	55
TAB	79
Tapetone	49
Technical Manuals	75
Technical Material Corp.	13
Telrex	59
Texas Crystals	74
Tri-Ex	31
U. S. #1 Electronics	75
Waters	11
Western Radio (Nebraska)	78
Western Radio (San Diego)	68

"TAB" FOR THE BEST KITS!

Each "TAB" Kit Contains The Finest Selection!!!

- Kit 75 Mica Condensers
- Kit 8 Crystal Diodes
- Kit 200ft Hook Up Wire
- 4 Rolls, 50ft/ea. Asstd. Color
- Kit 100 Ceramic Condensers
- Kit 5 FT243 Xtal Holders
- Kit 4 Microswitches
- Kit 8 Xtal Osc-Blanks
- Kit 4 Asstd Rectifiers
- Kit 100 Self/Tap Screws
- Kit Adj Wire Stripper & Cut
- Kit Hi Gain Xtal Mike
- Kit 6 ea Phonoplugs & Jacks
- Kit 2 pair SO239 & PL59
- Kit 12 Binding Posts Asstd
- Kit 35 Precision Resisters
- Kit 10 Switches
- Kit 75 Resistors 1/2" & 1/4"
- Kit 12 Electrolytic Cond's
- Kit 15 Volume Controls
- Kit 65 Tubular Condensers
- Kit 500 Lugs & Eyelets
- Kit 10 Bathub Oil Cond's
- Kit 5 lbs. Surprise Package
- Kit 10 Transist Mica Cond's
- Kit Glyptal & Cement
- Kit 3 Phone/Patch Xfms
- Kit 6 Insld Tuning Tools
- Kit 4 "Suncells" Asstd.
- Kit 5 Sub-Min Tubes

Order Ten Kits—We Ship Eleven!!!
ONE EACH ABOVE KIT ONLY.....
99¢

Order Ten Kits—We Ship Eleven!!!
ONE EACH ABOVE KIT ONLY.....
99¢

SPECIAL! TRANSISTORS & DIODES!!!

Factory Tested & Guaranteed!
FULL LENGTH LEADS

2N123 NPN	45¢	12 for \$5	100/\$37
2N292 NPN	45¢	12 for \$5	100/\$37
2N293 NPN	45¢	12 for \$5	100/\$37
2N223 PNP	80¢		100/\$65
2N597 PNP	\$1.90		6/\$10
2N598 PNP	\$1.90		6/\$10
2N599 PNP	\$3.50		3/\$10



\$10 or More. This Item Postpaid U. S. A.

SELENIUM F.W. BRIDGE RECTIFIERS

DC AMP	18VAC	36VAC	72VAC	150VAC
	14VDC	28VDC	54VDC	100VDC

1/2	\$1.00	\$1.90	\$3.85	\$5.00
1	1.30	2.00	4.90	8.15
2	2.15	3.00	6.25	11.10
3	2.90	4.00	8.00	13.45
4	4.15	8.00	18.75	31.90
10	6.10	12.15	26.30	41.00
12	7.75	14.90	30.95	43.45
20	12.85	24.60		
24	15.00	29.45		

Write For Rectifier Catalog

TAB FOR XMAS SPECIALS

SILICON TUBE REPLACEMENTS WITH BUILT IN RE SURGE & SERIES BALANCING PROTECTION



TYPE VRMS/PIV	AMPS	PRICE
T866	5000/10400	0.3 \$16
T5R4	1900/2800	0.5 \$7

Leece Neville Charger Systems
"SILTAB" Silicon Rectifier
Direct Replacement
Non-Aging Hermetically Sealed
FOR 6 or 12VDC @ 100A, Type YJ9 \$24

GTDI POWER-DIAMOND-TRANSISTORS
Factory Tested
***MFGD in U.S.A.
Replaces Medium & HiWattage Types
2N155, 2N156, 2N234, 2N256, 2N307, 2N554

General to 3GP 59¢ @, 20 for \$10 (\$10 or more this item we pay P.P./U.S.A.)

XMAS SPECIAL!
Power CONVERTER
12VDC to 500VDC up to 200MA
100 Watts; Top of 250VDC
DB500 \$33

12VDC to 250VDC up to 150MA
Type CI225E \$30

Send 25¢ for Catalog

DECEMBER 1961

"TAB" THAT'S A BUY

"TAB" Tubes Factory Tested, Inspctd,
Six Months Guaranteed! No Rejects!
Boxed! GOVT & MFRS Surplus! New & Used

We Swap Tubes! What Do/You Have?

0A289	6BZ7 1.25
0A380	6C445
0B265	6C569
0C370	6C6 1.08
0D350	6C8 1.08
0Z479	6C8 1.08
1A790	6CB689
1B399	6CD6 1.49
1L482	6CF685
IR4 5/\$1	6CL6 1.40

We Buy!

2C43 6.50	6F799
2C51 2.00	6F8 1.39
2D2165	6H659
2E22 1.75	6J4 1.72
2E24 1.90	6J559
2E25 2.50	6J659
2E26 2.75	6J799
2E30 Q	6J8 1.39
2E35 1.60	6K659
2K25 9.75	6K779

We Sell!

2K26 34.00	6K899
2K28 30.00	6L6 1.19
2V3 2/\$1	6SN772
2X248	6T898
3A470	6V6GT90
3A5 1.00	6X549
3AP1 5.95	12AT659
3BP1 3.99	12AT789
3C24 3.50	12AU663
3D23 3.95	12AU769

We Trade!

807 1.10
5/\$5, 10/\$12
811 3.45
811A 4.41
812 3.30
813 9.95
815 1.75
82699
828 9.00
829B 8.00
832A 6.00
833A 36.00
837 2/\$2
866A 2.25
954 10/\$1
955 3/\$1
957 3/\$1
958A 2/\$1
991 5/\$1
1614 2.75
1619 5/\$1
1620 2.00
1625 3/\$1
1626 5/\$1
1629 4/\$1
2050 1.25
5517 1.25
5608 3.95
5618 3.25
5651 1.35
5654 1.20
5656 4.25
5663 1.15
567090
5686 1.75
5687 1.15
5691 4.70
5725 1.95
5732 2.00
5736 85.00
5749 1.95
5750 2.75
5751 1.25
5814 1.20
5879 1.20
5894 \$12.00

Send 25¢ for Catalog!

Send 25¢ for Catalog!

2C43 6.50	6F799	388A 3/\$1
2C51 2.00	6F8 1.39	350A 2.45
2D2165	6H659	350B 1.75
2E22 1.75	6J4 1.72	371B95
2E24 1.90	6J559	5146 3.90
2E25 2.50	6J659	416B 16.00
2E26 2.75	6J799	450TH 43.00
2E30 Q	6J8 1.39	450TL 43.00
2E35 1.60	6K659	460 11.50
2K25 9.75	6K779	703A Q
2K26 34.00	6K899	707B 3.50
2K28 30.00	6L6 1.19	715C 10.90
2V3 2/\$1	6SN772	717A 5/\$1
2X248	6T898	723AB 5.00
3A470	6V6GT90	725A 2.75
3A5 1.00	6X549	803 3.50
3AP1 5.95	12AT659	804 8.85
3BP1 3.99	12AT789	805 6.00
3C24 3.50	12AU663	
3D23 3.95	12AU769	

All Tubes Stocked at Low Prices!

All Tubes Stocked at Low Prices!

4-125A 27.50	6L6 1.19	703A Q
4-250A 34.00	6SN772	707B 3.50
4X150A Q	6T898	715C 10.90
4X250 36.00	6V6GT90	717A 5/\$1
4X500 37.00	6X549	723AB 5.00
5AP1 2.95	12AT659	725A 2.75

Wanted Test Sets and Equipment

5BP1 Q	12BZ799	828 9.00
5BP4 7.95	12H675	829B 8.00
5CP1 4.99	12J569	832A 6.00
5CP7 9.00	12J769	833A 36.00
5R4 1.00	12J8 1.35	837 2/\$2
5T490	12K889	866A 2.25
5U499	12SA789	954 10/\$1
5V489	12SC789	955 3/\$1
5Y360	12SF569	957 3/\$1
5Z389	12SG789	958A 2/\$1

Send 25¢ for Catalog!

Send 25¢ for Catalog!

15GP22 89.00	12SH789	991 5/\$1
6A7 1.00	12SJ775	1614 2.75
6A899	12SK775	1619 5/\$1
6AB459	12SL779	1620 2.00
6AC772	12SN769	1625 3/\$1
6AG565	12SQ769	1626 5/\$1
6AG775	12SR769	1629 4/\$1
6AK569	15E 1.19	2050 1.25
6AL559	15R 4/\$1	5517 1.25
6AQ566	FG17 Q	5608 3.95

Top \$\$\$ Paid for 304TL, 813, 811A, 812A Tubes

6AR6 1.95	19T8 1.16	5618 3.25
6AS7 3.49	24G 3.50	5651 1.35
6AT6 2/\$1	25A6 1.19	5654 1.20
6AU679	25A7 2.19	5656 4.25
6B8 1.35	25C581	5663 1.15
6BA659	25L672	567090
6BE659	25T 4.00	5686 1.75
6BG6 1.49	25Z572	5687 1.15
6BH679	25Z675	5691 4.70
6BJ672	26A7 3.69	5725 1.95

Top \$\$\$ Paid for XMTTR Tubes!

6BK799	FG27 8.28	5732 2.00
6BL7 1.35	HV27 19.39	5736 85.00
6BN469	28D789	5749 1.95
6BN6 1.08	FG33 15.00	5750 2.75
6BN7 1.99	EL34 3.49	5751 1.25
6BQ6 1.19	35A569	5814 1.20
6BQ799	35L659	5879 1.20
6BX7 1.11	35T 4.49	5894 \$12.00
6BY5 1.19	35Z5 1.25	
6BZ691	RK39 2.99	No See—Write!

TERMS: Min Order \$3—25% with order F.O.B. New York. Ten day guarantee, price of mdse. only. Our 17th year. Prices shown are subject to change.

111NJ Liberty St., N. Y. 6, N. Y. ● RE 2-6245

"TAB", SILICON 750MA * DIODES

Factory Tested Gtd.! Cap. or Batt. Derate 20%

EPOXY		EPOXY	
rms/plv	rms/plv	rms/plv	rms/plv
17/25	35/50	70/100	140/200
10¢	14¢	24¢	29¢

rms/plv	rms/plv	rms/plv	rms/plv
210/300	280/400	350/500	420/600
39¢	50¢	64¢	74¢

rms/plv	rms/plv	rms/plv	rms/plv
490/700	560/800	630/900	700/1000
87¢	93¢	\$1.10	\$1.50

Low Priced T200 SILICON DIODES
rated 380piv/266rms @ 200 Ma @ 100°C
36¢ each; 3 for \$1; 7 for \$2; 20 for \$5

GTD! OCTAL SILICON—5U4G—Tube Replacement — 112ORms, 1600 Piv, \$3.90; 3 for \$10

GTD! HIPOWER-15 AMP TRANSISTORS Factory-Tested SIMILAR DELCO T036

2N277 or 2N441	@ \$2.45
2N278 or 2N442	@ \$3
2N173 or 2N443	@ \$4
2N174	@ \$5

(\$10 or more this item we pay P.P./U.)



"TAB"—THAT'S A BUY. BARGAINS

New Variacs/or equiv 0-135V/7.5A \$15.30
New Variacs/or equiv 0-135V 3 Amp \$10.65
DC-METER DeJur 800 Ma 2 1/2" \$3.00
DC MTR 100Ma/2 1/2" \$3.00
RF-MTG GE/475 Ma & 5 Amp \$4.00 2/\$7
DC-METER One Ma/4" Rd. \$5.00 2/\$8
SNOOPERSCOPE TUBE 2".....\$5.00 2/\$9
MINI-FAN 6 or 12VAC/60 Cps \$2.00 3/\$5
Xmitting Mica's .006 @ 2500V, 5 for \$1.00
4x150 Ceramic/LOKTAL.....2 for \$1.00

"THAT'S A BUY" — XMAS SPECIALS —

POWER DIODES—STUDS 50PIV/35Rms U.S.A. MFR FACTORY TESTED—GTD!

1.5 Amp 30¢ @	100 for \$ 27
3.0 Amp 50¢ @	100 for \$ 45
6.0 Amp \$1.50 @	100 for \$100
12 Amp \$1.45 @	100 for \$125
35 Amp \$2.30 @	100 for \$200
70 Amp \$3.90 @	50 for \$175
240 Amp \$4.50 @	50 for \$220

*Derate 20% for Capacitive & Battery.
Ratings for Studs on Heat Sink!!!

NEW BATTERY CHARGER BC6-12V FOR 6V OR 12 VOLT BATTERIES, TRICKLE & FULL CHARGE up to 10 AMPS

Built BC6-12V10. Special Price Complete \$14.
XMAS SPECIAL
6 & 12V Battery Charger up to 1 1/2 Amps. Circuit Breaker, Charge Indicator. Special Post-paid U.S.A. \$8.99



Two 866A's and FILAMENT \$6 XFMR 10 Kv Insld SPECIAL!

DIAMOND BASE MICA MTG KIT..\$.30
ROUND BASE MICA MTG KIT.....\$.30
DELCO PWR HEAT SINK 80 SQ".....\$1.75
KIT TRSTB NPN or PNP. 36¢ ea.; 8, \$2
IN34A DIODES.....19¢ ea.; 6 for \$1

2N155	\$1.39	2N176	\$1.80	2N177	\$1.
2N178	\$1.75	2N247	\$1.50	2N255	\$1.20
2N270	\$.95	2N274	\$1.25	2N408	\$.80
2N544	\$1.20	2N578	\$1.80	2N579	\$2.20
2N581	\$1.25	2N582	\$2.10	2N670	\$1.60
2N671	\$2.				

VARIABLE AUTOTRANSFORMER "SUPERIOR" POWERSTAT TYPE 165W 0 to 132V SPECIAL \$10 \$6 ea.; 2 for.....

General Purpose — PNP — Computer Grade
Use as Amplifier—Oscillator—HiFi, RF, IF
Logic—Servoamp—Power Supply
Pulse Amplifier or High Current Sw
Veb, Vce, Veb Approx. 40V
CP 3C rated 300 Mw. 50 ea.; 10 for \$4
CP 10C rate one watt. 75 ea.; 10 for \$6

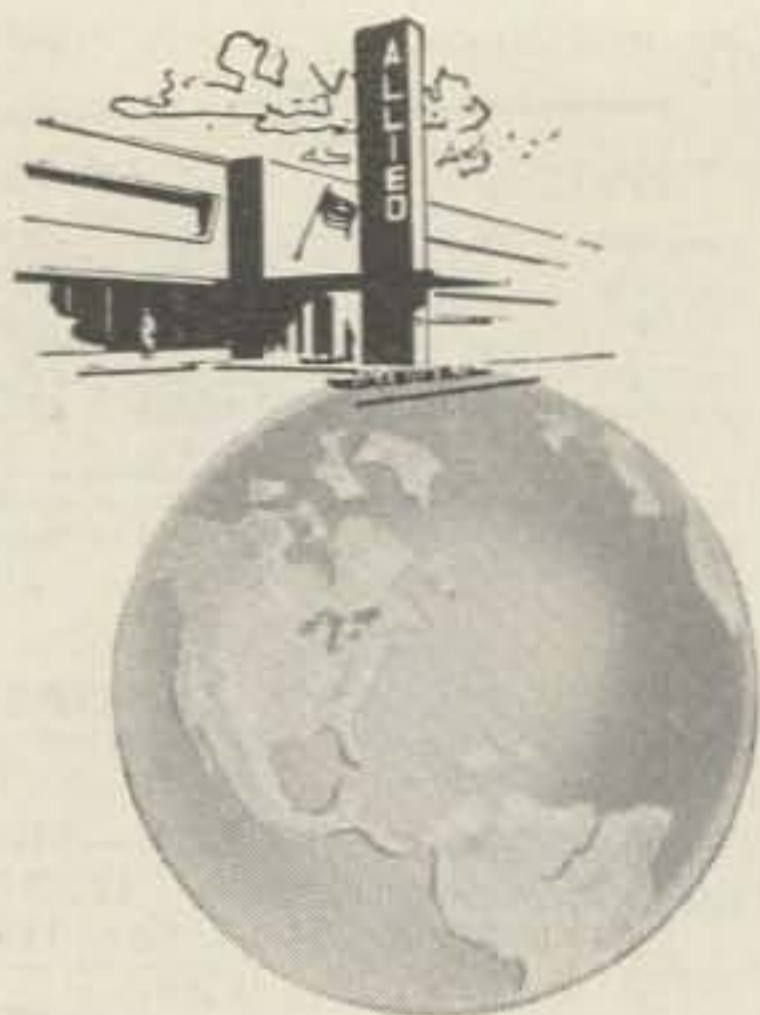

Holiday Greetings

to all our Ham Friends
the world over

from the **ALLIED** Ham Shack—



W9WHF
Jim Sommerville
(Ham Division
Manager)



W9VHI
Don Kobiljak
(Trades & Tech Help—
Mail or Phone)



W9BHD
Joe Huffman
(Ham Shack)



K9LOK
John Chass
(Ham Shack)



W9HLA
Joe Gizzi
(Ham Shack)



W9QBB
Tasker Day
(Ham Shack)



In Milwaukee
W9NGV
Lowell Warshawsky

and from all the gang (50 strong) at Allied

WN9ACE Arnold Klein
K9BDF Jason Thomas
W9BUD Larry Blostein
KØBYU/9 Charles Kaiser
K9BYU Marty Barone
W9CCW Rudy Ackermann
K9CDJ Joel Bolker
KØCNR/9 Don Harris
W9DCB Milton Fojtik
W9ECC Bob Gumm
K9EIL Don Saxon
W9ENK Bob Patejunas
W9EXQ Bob Stone
W9FUD Ron Brust

KN9GQU John Fehlandt
K9GSB Norman Eastman
K9GXK Jack Wolfson
K9HOB Don Wisniewski
W9JUC Dick Earl
K9KVQ Roger Nordlund
K9KWT Bob Oatley
K9KWY Sherwin Berger
HH2LR Louis Roumain
W9NPF Don Rossi
K9OAL David Gunzel
W9OCG Dick Stiebel
W9RND Jack Matin
W9SFW Lou Dezettel

W9SIA Franklin Swan
W9THG Leo Borek
K9TMP Peter Berg
W9UIW Robert Ferguson
W9UWM Cliff Ratliff
W9VES Phil Simmons
W9VOB Burt Fischel
W9VVI Gerry Marsh
K9WLB Lou Green
K9WOD Nick Martakis
W9WOV George Bercos
K8YUK/9 James Marker
K9ZDG Francis Jancek
W9ZJU "Doc" Towler
KN9ZWK Emmett Paschke



serving the Amateur since 1921

ALLIED RADIO

100 N. WESTERN AVE., CHICAGO 80, ILL.

QUALITY

IS THE CHEAPEST THING YOU BUY!

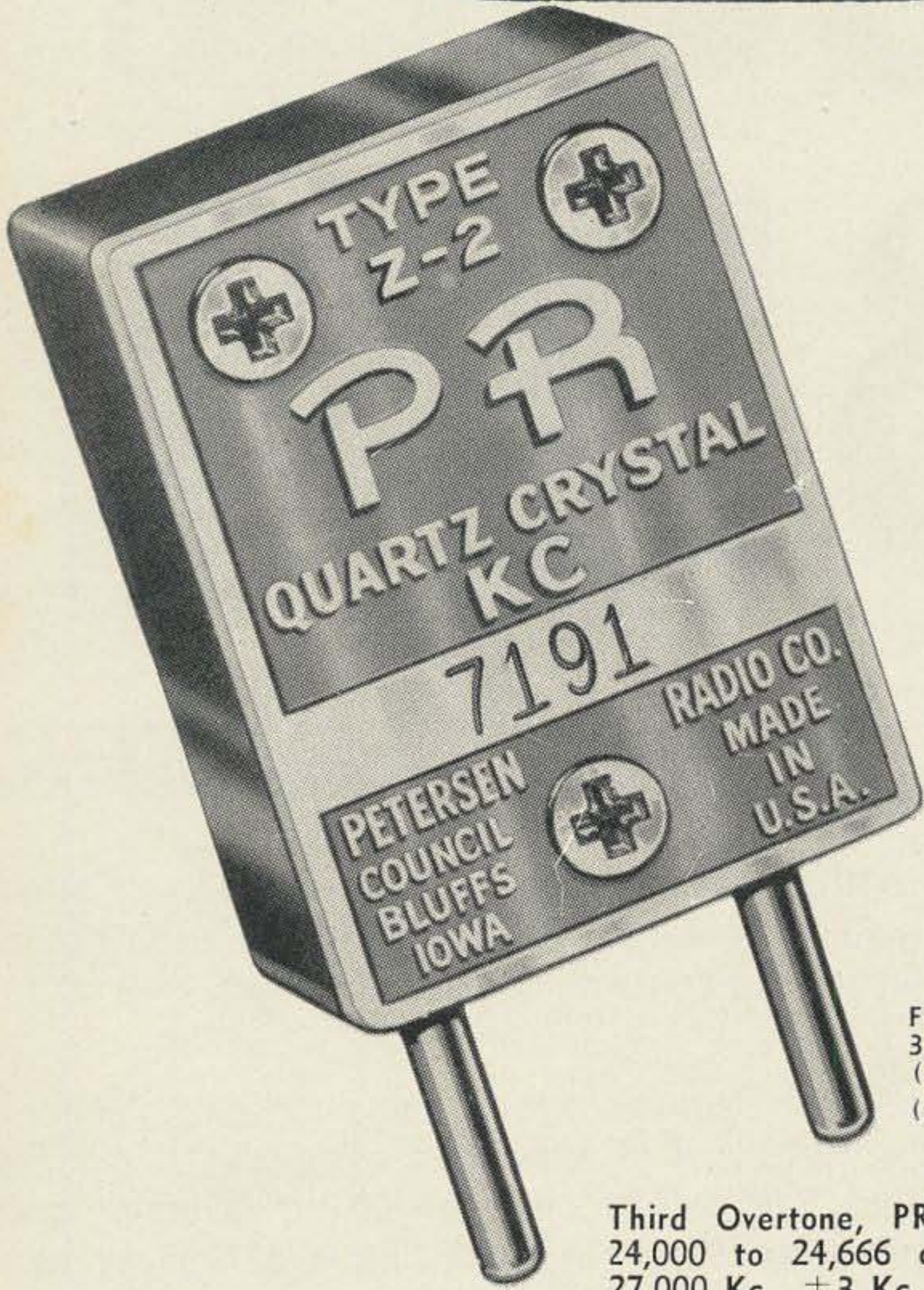

There is a deep, understandable satisfaction in owning something truly fine. It can't be exactly measured in dollars or in words. Maybe it boils down to this: A good thing is worth a hundred times its price; a poor thing isn't worth having around. It's this way with Crystals. When you buy PRs you know you're getting many times your money's worth. You're buying the finest precision frequency control that modern science has made . . . you get (in super-abundance) the things you want most . . . dependability, accuracy, long life, freedom from drift, unfailing activity. Yes—you can be proud to own PRs . . . everybody is!

FUNDAMENTAL, PR TYPE Z-2—Frequency Ranges in Kcs.: 3,500 to 4,000 (80M); 7,000 to 7,425 (40M); 8,000 to 8,222 (2M); 8,334 to 9,000 (6M). ± 500 Cycles.....\$2.95 Net (All Z-2 Crystals calibrated with a load capacity of 32 mmfd.)

Third Overtone, PR Type Z-9A, 24,000 to 24,666 and 25,000 to 27,000 Kc., ± 3 Kc.....\$3.95 Net

6 Meters, Fifth Overtone, PR Type Z-9A, 50 to 54 Mc., ± 15 Kc. \$4.95 Net

Citizens Band, PR Type Z-9R, .005%.....\$2.95 Net

PR

Crystals



USE **PR** AND KNOW WHERE YOU ARE

PETERSEN RADIO COMPANY, INC.
2800 W. BROADWAY • COUNCIL BLUFFS, IOWA

EXPORT SALES: Royal National Corporation, 250 W. 57th Street, New York 19, N. Y., U. S. A.

1

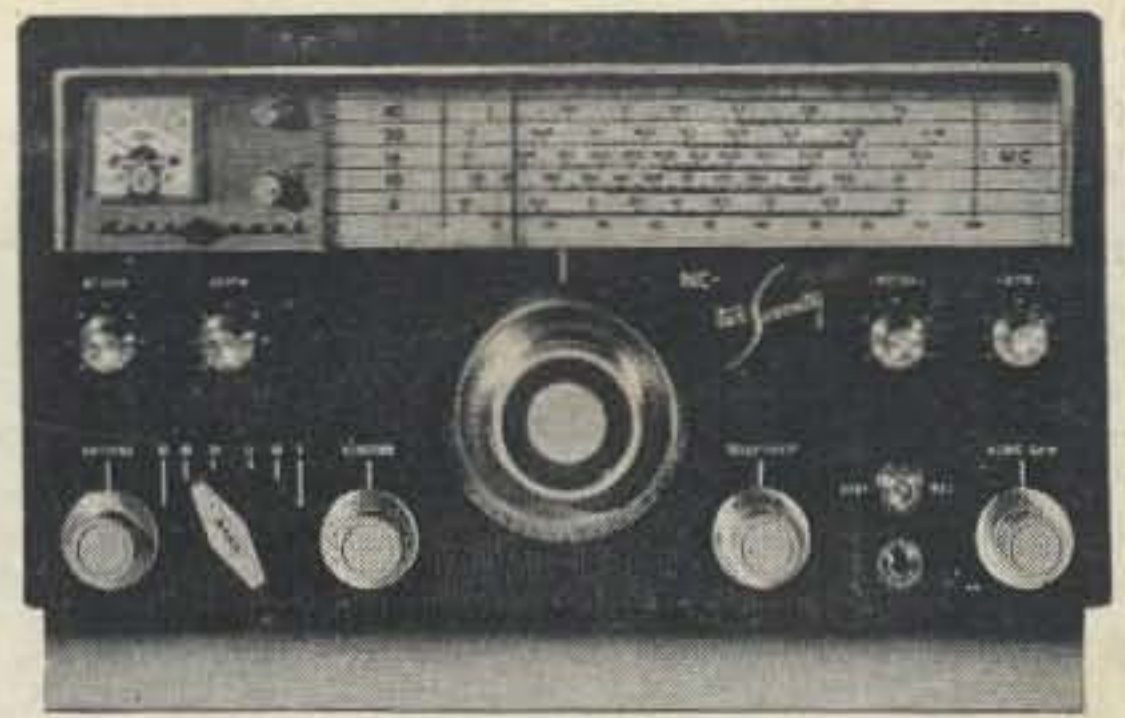

NC-270

2



NC-190

3



NC-155

NATIONAL'S TRIO OF PACE-SETTERS

Here are the three new receivers that are already setting the pace for the industry—Each offering you more solid performance in its price area than you will believe . . . until you tune one. We invite you to try all three—then select the one that best suits your requirements.

NC-270 . . .

Precision double-conversion 80 through 6 meter amateur receiver featuring rock-like stability and unchallenged VHF performance. Five degrees of variable IF selectivity, including selectable SSB with product detector, 1.0 uv sensitivity, 60 db deep T-notch filter, built-in 100 KC calibrator, crystal controlled 2nd converter. More features than any other receiver in its price range. **\$279.95 am. net.**

NC-190 . . .

The 540 KC—30 MC general coverage receiver that tunes like a ham-band-only unit. 1.0 microvolt sensitivity, double conversion with five main tuning ranges, 5.0 KC, 3.0 KC, and 600 cycle variable IF selectivity, full SSB/CW AGC and product detector, 60:1 bandspread vernier drive and National's exclusive dial selector, providing instant choice of calibrated amateur or foreign broadcast bands. **\$219.95 am. net.**

NC-155 . . .

National's newest—A double conversion 80 through 6 meter ham-band-only receiver offering super performance completely out of proportion with its price. With its basic design derived from the famous NC-270, the NC-155 features 5.0 KC, 3.0 KC and 600 cycle variable IF selectivity, full SSB/CW AGC and product detector, and a velvet 60:1 dial drive that makes SSB signals as easy to tune as AM. 1.0 microvolt sensitivity on 6 meters, too! **\$199.95 am. net.**



NATIONAL RADIO COMPANY, INC. MELROSE 76, MASS.

A WHOLLY OWNED SUBSIDIARY OF NATIONAL COMPANY, INC.

Export: AD AURIEMA, INC., 85 Broad St., New York, N.Y. Canada: TRI-TEL ASSOC., LTD., 81 Sheppard Ave. W., Willowdale, Ont.