

COYNE
PRACTICAL APPLIED
ELECTRICITY

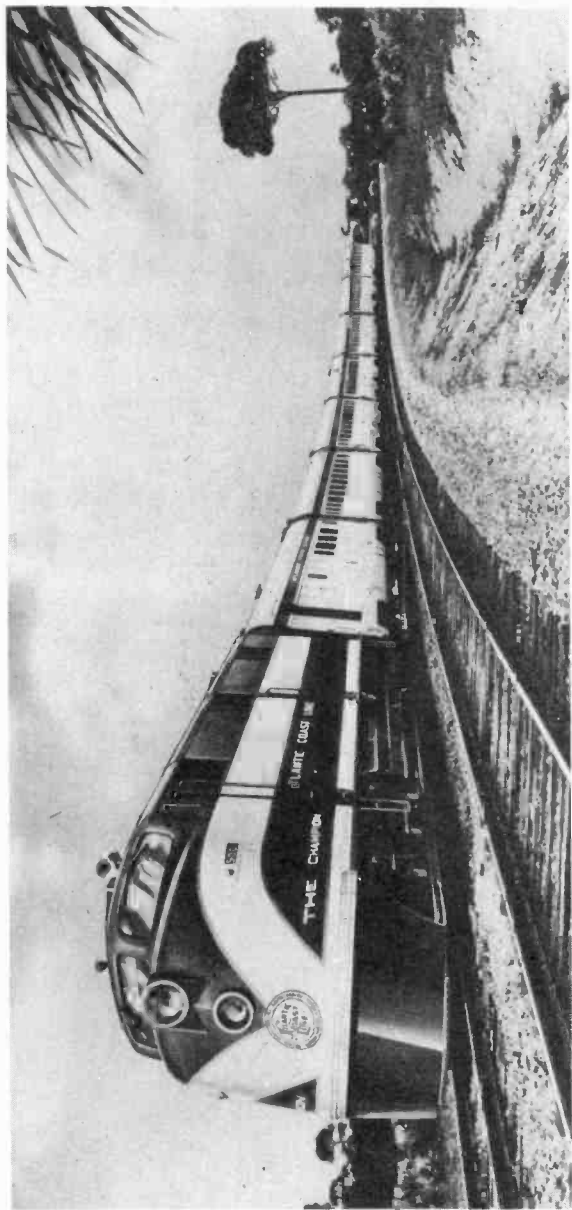

The A. C. L. streamliner, "The Champion". One of America's finest diesel electric trains.

Photo Atlantic Coast Line Ry.

COYNE PRACTICAL APPLIED ELECTRICITY

A Set of Complete Practical Books
For Home Study
and
Field Reference
On

Electrical principles, telephones, wiring, meters, D.C. and A.C. motors, controls, and equipment, household appliance repair, Rural Electrification, Armature winding, Generators, Diesel Electric Plants, Automotive Electricity, Batteries, Electrical Refrigeration and Air Conditioning, Industrial Electronics, Radio Electric Welding — laws, rules, etc. — Over 3,000 subjects, 5,000 Electrical facts, thousands of photos and diagrams.

By
THE TECHNICAL STAFF
of the
COYNE ELECTRICAL SCHOOL

Copyright 1945 by
COYNE ELECTRICAL SCHOOL
500 So. Paulina St.
Chicago, Illinois

All rights reserved. This book, or any parts thereof may not be reproduced in any form without written permission of the Publishers.

Printed in United States of America

FOREWORD

ELECTRICITY is the greatest force known to mankind.

ELECTRICITY is leaping ahead at an unbelievable rate. It is moving into practically every part of the world and has become **the most important factor in modern civilization**. Practically every month the Kilowatt hour demand sets a new high—it has been doing this for the past 25 years. **ELECTRICITY**, even though it is one of America's youngest industries, already employs directly and indirectly over 3 million people.

All of our marvelous developments in Radio, Television, Electronics, Radar, etc., employ **electrical power** and the principles of **Electricity**. It is truly **one of the world's greatest industries**.

Because of the tremendous opportunity in the field of **Electricity**, there have been many books written on the subject. Most treat with **one specific phase of Electricity**. This set of books—Coyne Practical Applied Electricity (of which this volume you now read is an integral part)—covers the entire field.

This set is **NEW**. It includes the very latest methods and explanations of Electrical installation, operation and maintenance.

COYNE PRACTICAL APPLIED ELECTRICITY WRITTEN BY A STAFF OF EXPERTS

Most Electrical publications are written by **one man** and can therefore **only** cover **his** own specific knowledge of a subject. **COYNE PRACTICAL APPLIED ELECTRICITY**, however, represents

FOREWORD

the combined efforts of the entire Coyne Electrical School Teaching Staff and the assistance of other authorities on the subject. These men have a wide field and teaching experience and practical knowledge in electricity and its allied branches.

HOW THIS SET WAS DEVELOPED

In submitting any material for these books these experts kept two things in mind—1. MAKE IT SIMPLE ENOUGH FOR THE “BEGINNER”—2. MAKE IT COMPLETE, PRACTICAL and VALUABLE FOR THE “OLD TIMER”. All material that was submitted for these books by any individual was then rewritten by an editorial group so that added explanations for the benefit of clarity and easier understanding could be included.

Coyne Practical Applied Electricity can pay you big dividends every day “on the job”. However, if you only use the set occasionally when you **MUST BE SURE** before going ahead on a job—the set will pay for itself many times over.

Coyne Practical Applied Electricity is to an electrician what a set of complete law books is to a lawyer or a set of medical books is to a doctor. Regardless of whether a lawyer or a doctor is “just starting out” or is an “old timer” and has been practicing his profession for many years he has many occasions to refer to his reference books. Many doctors and lawyers spend thousands of dollars on complete sets of reference books—they find it a very wise investment.

In **ELECTRICITY** the need for good reference books is just as great. So, when you make a purchase of this set you are not just buying a set of books—you are making an investment in your future that can pay dividends all your life.



PRESIDENT
COYNE ELECTRICAL SCHOOL

TABLE OF CONTENTS

AUTOMOTIVE ELECTRICITY 1 to 200

starters, ignition, coils, armatures, generators, principles, controls, carburetors, valves, combustion, rings, crankshafts, breakers, cylinders, distributors, drives, lighting, engine types, gauges, gears, magnetos, pistons, sparkplugs, charging rate, rods, timing, speeds, strokes, switches, testing, questions.

BATTERIES201 to 314

assembly, charging and discharging, cycling, capacity, electrolyte, internal resistance, voltage test, retainers, plates, construction, chemical action, cells, types, servicing, buckling, questions.

DIESEL ELECTRIC POWER.....315 to 512

types, maintenance, operation, tools, construction, rings, cooling, silencers, trains, starting (gasoline and air), HP consumption, speeds, valves, pumps, firing order, compression, semi-diesels, charging, distributor, systems, filters, fuel injectors, governors, housings, hydrometers, injection, pressure, pyrometers, rules, shafts, thermo-couples, turbulence, weights, questions.

The detailed index for this book can be found at the back beginning on page 515. The index is a classified directory telling you where each specific subject in this book is located. We furnish both the **Table of Contents** and the **Index** for your convenience.

ACKNOWLEDGMENTS

We wish to acknowledge and express our appreciation for the assistance and co-operation given by the following companies, in supplying data and illustrations for the preparation of this Electrical Set.

GENERAL ELECTRIC COMPANY
WESTINGHOUSE ELECTRIC & MFG. CO. .
ALLIS CHALMERS MFG. CO.
POWER PLANT ENGINEERING JOURNAL
AMERICAN BROWN BOVERI CO.
CUTLER HAMMER, INC.
PHILADELPHIA ELECTRIC CO.
EDISON STORAGE BATTERY CO.
PHILADELPHIA BATTERY CO.
WALTER BATES STEEL CORP.
FAIRBANKS MORSE CO.
HOSKINS MFG. CO.
ALLEN-BRADLEY CO.
DELTA STAR MFG. CO.
NATIONAL CARBON CO.
CENTRAL SCIENTIFIC CO.
OHIO BRASS CO.
GRAYBAR ELECTRIC CO.
WELSH SCIENTIFIC CO.
CENTRAL SCIENTIFIC CO.

You will note that in some places in this Set we have explained and shown illustrations of some of the earlier types of Electrical equipment.

WE HAVE A DEFINITE REASON FOR 'DOING THIS, namely, many of the earlier units are much easier to understand. An important point to keep in mind is that the **BASIC PRINCIPLES** of these earlier machines are the same as those of the modern equipment of today.

Modern equipment has not materially changed in principle — **IT IS MERELY REFINED AND MODERNIZED.** It is from the earlier basic theories and simple beginnings that the complicated mechanisms of today have been developed. **IT IS TO THESE EARLY BEGINNINGS WE MUST OFTEN TURN IN ORDER TO GET A FULL UNDERSTANDING OF THE PRESENT ADVANCED TYPES OF EQUIPMENT.**

In the early days many of the parts and mechanism of Electrical equipment were visible whereas today much of it is not. However, the **PRINCIPLES OF THE EARLY EQUIPMENT ARE SIMILAR TO THOSE OF MODERN ELECTRICAL APPARATUS.**

SO IN VARIOUS PLACES IN THIS SET, WE SHOW YOU SOME OF THIS EARLIER EQUIPMENT BECAUSE ITS CONSTRUCTION IS SIMPLER AND EASIER TO UNDERSTAND AS YOU STUDY THE MODERN EQUIPMENT. THEN FROM THESE EARLIER TYPES OF EQUIPMENT WE CARRY YOU ON TO THE VERY LATEST DEVELOPMENTS IN THE FIELD.

HOW TO USE THIS SET OF BOOKS

Coyne Practical Applied Electricity will be of use and value to you in exact proportion to the time and energy you spend in studying and using it.

A Reference Set of this kind is used in two distinct ways.

FIRST, it is used by the fellow who wishes to make Electricity his future work and uses this Reference Set as a home training course.

SECOND, it is especially valuable to the man who wishes to use it strictly as a Reference Set. This includes electricians, mechanics or anyone working at any trade who wishes to have a set of books so that he can refer to them for information in Electrical problems at any time.

You, of course, know into which group you fall and this article will outline how to properly use this Set to get the most value for your own personal benefit.

How To Use This Set As A Home Training Course In Electricity

The most important advice I can give the fellow who wishes to study our set as a home training course in Electricity is to start from the beginning in Volume 1, and continue in order through the other 6 volumes. Don't make the mistake of jumping from one subject to another or taking a portion of one volume and then reverting back to another. Study the set as it has been written and you'll get the most out of it.

Volume 1 is one of the most important of the entire Set. Every good course of training must have a good foundation. Our first volume is the foundation of our course and is designed to explain in simple language terms and expressions, laws and

How To Use This Set of Books

rules of Electricity, upon which any of the big installations, maintenance and service jobs are based. So, become thoroughly familiar with the subjects covered in the first volume and you will be able to master each additional subject as you proceed.

One of the improvements we made in this set was to add "review" questions throughout the books. You will find these questions in most cases at the end of a chapter. They are provided so "beginners" or "old timers" can check their progress and knowledge of particular subjects. Our main purpose in including the "review" questions is to provide the reader with a "yardstick" by which he can check his knowledge of each subject. This feature is a decided improvement in home study material.

Above all, do not rush through any part of these books in order to cover a large amount at one time. You should read them slowly and understand each subject before proceeding to the next and in this way you will gain a thorough understanding as you read and think it out.

For the special benefit of the fellow desiring to learn Electricity at home, we have prepared a great number of diagrams and illustrations. Refer to these pictures and diagrams in our books regularly.

How To Use Coyne Practical Applied Electricity Strictly As A Reference Set

The man who is interested in using these books mainly for reference purposes will use it in a little different way than the fellow who is trying to learn Electricity as a trade. Some of the types of fellows who use this set strictly for reference purposes are: home owners, electricians or mechanics, garage owners or workers, hardware store owners, farmers or anyone who has an occasional use for electrical knowledge. Those types of fellows should use this set in the following manner.

If some particular type of electrical problem presents itself, refer immediately to the Index—it will give you the section in which the subject is covered.

How To Use This Set of Books

Then, turn to that section and carefully read the instructions outlined. Also read any other sections of the set mentioned in the article. As an example, in checking over some information on electric motors, some reference might be made to an electrical law of principles contained in Volume 1 of the Set. In order to thoroughly understand the procedure to follow in working out the electrical problem, you should refer to Volume 1 and get a better understanding of the electrical law on principles involved.

Use The Master Index To Locate Electrical Subjects

Thousands of men use this Set in their daily problems, both on the job and around the home as well. If you follow the instructions outlined you will be able to locate any information you may want at any time on your own electrical problems.

And here's a very important point. Although this set of books starts in Volume 1 and proceeds through the other 6 volumes in order, it makes an ideal home study course—nevertheless, **any individual book in the series is independent of the others and can be studied separately.** As an example, Volume 3 covers D.C. motors and equipment. If a man wanted to get some information on D.C. machines **only he could find it completely covered in this volume** and it would not be essential to refer to any other volume of the set unless he wanted some additional information on some other electrical principle that would have a bearing on his problem.

This feature is especially beneficial to the "old timer" who plans to use the set mainly for field reference purposes.

We believe, however, that the entire set of 7 volumes should be read completely by both the "beginner" or the expert. In this way you get the greatest benefit from the set. In doing so the experienced Electrician will be able to get very valuable information on subjects that he may have thought he was familiar with, but in reality he was not thoroughly posted on a particular subject.

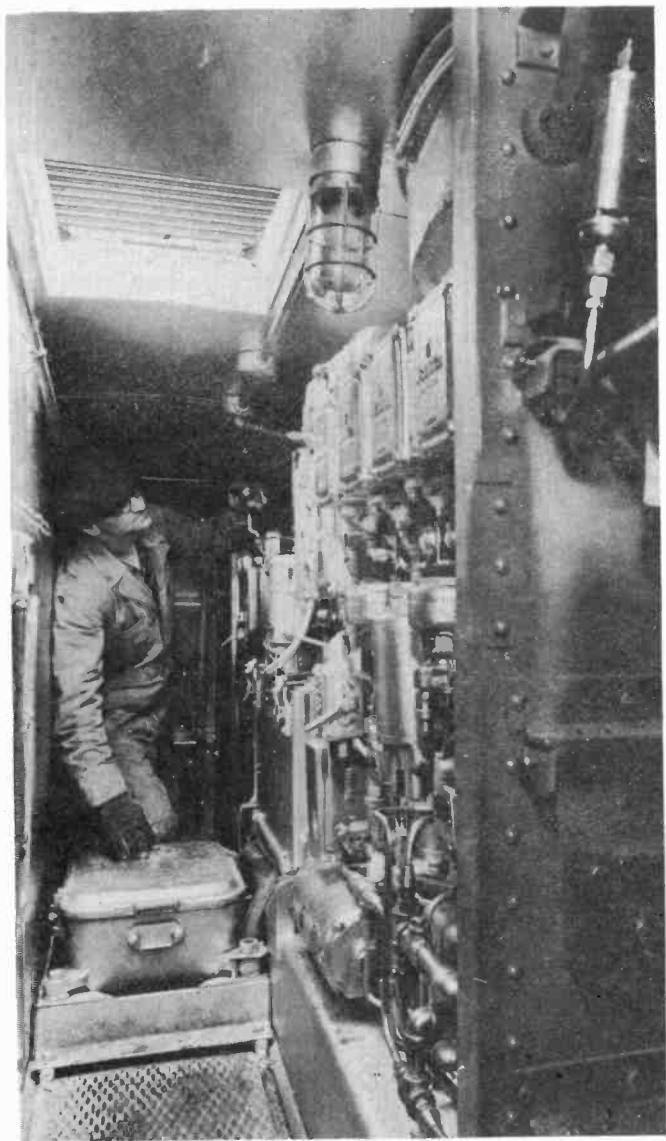

View in cab nose of modern diesel electric train showing diesel electric control equipment.
Photo General Electric Co.

AUTOMOTIVE ELECTRICITY

With the tremendous number of automobiles used today for pleasure and for commercial purposes, there is a splendid field of opportunity for trained men in ignition and battery service and general automotive electrical work.

There are in the U. S. over 25,000,000 automobiles, trucks, tractors, and busses which use electricity for ignition and other very essential features of their operation.

One of the reasons for the growth of the automobile industry, which is one of the very largest of all industries in this country, lies in the improved efficiency and convenience obtained through the use of electricity for numerous things in connection with the operation of automobiles, as well as in the great improvements made in their mechanical design.

Electric ignition makes possible the high engine speeds and resulting high efficiencies of the engines used in modern motor cars. In addition to using electricity for ignition, or the igniting and exploding of the fuel at the correct time in the engine cylinders, electricity is also used: to start the engine by means of an electric motor; to provide illumination for night driving; and to operate the horn, windshield wiper, radio, stop light, tail light, dash light and electrical instruments, cigar lighter, heater, and numerous other safety and convenience devices.

In fact, the modern motor car—with its generator, starting motor, storage battery, ignition devices and wiring, lights, horn, and other equipment—can be said to have a complete small electric power plant of its own and it has quite a variety of electrical devices and circuits which must be maintained in the best of condition for efficient operation of the car.

There are throughout the country thousands of garages which require trained electrical service men to take care of the electrical equipment on their

Gasoline Engines

customers' cars. This ignition and battery work is in general much cleaner, lighter, and more interesting than making mechanical repairs on automobiles. The salaries paid to experts in this line are generally a great deal higher than those of ordinary mechanics.

There are also thousands of places where a good ignition and battery man can establish a shop or business of his own and just specialize in this branch of automotive repair work.

In addition to the millions of pleasure cars there are in use a vast number of huge trucks and busses for hauling produce and carrying passengers all over the country; and there are also many thousands of tractors, which are becoming more and more extensively used in farming areas.

With the recent developments in automobile radio there is another vast field of opportunity opened up for the man with general training in electricity, radio, and ignition. Several millions of automobiles are already equipped with radio receiving sets; and, millions more are still to be equipped. Installing and servicing these sets requires the services for many trained radio and ignition service men.

The aviation industry also affords tremendous opportunities in good paying and fascinating work for practically-trained ignition men. The safe operation of an aeroplane depends, of course, upon continuous operation of its engines, and the majority of these engines use electrical ignition for igniting their fuel. Therefore, it is extremely important that the magnetos, spark plugs, wiring, and all other electrical equipment on these engines be kept in perfect condition at all times. This work requires men who have a very thorough knowledge of electricity and ignition equipment and affords splendid opportunities to get into the aviation field.

Whether you ever specialize in ignition work or not you will find it very convenient and valuable to have a good general knowledge of this subject in connection with the operation of your own car, as

Automotive Electricity

a great deal of time and money can often be saved just by being able to quickly locate and repair some minor electrical trouble in the ignition system or wiring of your automobile.

In order to be thoroughly capable in ignition or automotive electrical service work a **thorough general knowledge of practical electricity in its several branches is essential**, as well as a knowledge of the operating principles of the common types of internal combustion engines. It is the purpose of this lesson to show you how the knowledge which you have already obtained of electricity and circuits can be applied to automotive equipment. The operation of common types of automobile engines is also briefly explained.

1. OPERATION OF INTERNAL COMBUSTION ENGINES

It is not our purpose to cover in this material all of the details of theory or design of internal combustion engines, but merely those practical points regarding their operation which will be essential to the automotive electrical service man.

In addition to being able to locate and repair troubles in the electrical wiring and electrical devices on automobiles, trucks, and tractors, the "tuning" of the ignition system is very important.

The term "internal combustion engine" is used on account of the fact that the energy which operates the engines is generated by the combustion or burning of a fuel mixture inside the engine itself.

One of the first commercially practical internal combustion engines was developed in France by J. J. Lenoir in 1860, and was known as a "two-stroke-cycle engine." Later in 1876 this engine was greatly improved by a German named Nicholas Otto who produced an engine of the "four-stroke-cycle type." The basic principles of these latter engines are the same as those on which all automotive engines operate.

Gasoline Engines

As has been previously stated, power is developed within an internal combustion engine by the explosion or burning and expansion of a fuel mixture in a manner to apply pressure to the pistons, which in turn drive the crank shaft and flywheel of the engine.

For continuous operation of these engines it is necessary to maintain a certain series of events known as a **cycle**. These cycles are then continuously and rapidly repeated as long as the engine operates.

In the four-stroke-cycle engine these steps of each cycle are as follows: 1. Intake of fuel charge. 2. Compression of fuel charge. 3. Ignition and combustion of fuel charge. 4. Exhaust of burned or waste gases.

To complete all of these steps for one cycle in any one cylinder of an ordinary automobile engine requires four strokes of the piston and two revolutions of the crank shaft. This is the reason they are called "four-stroke-cycle engines," or sometimes just "four cycle engines."

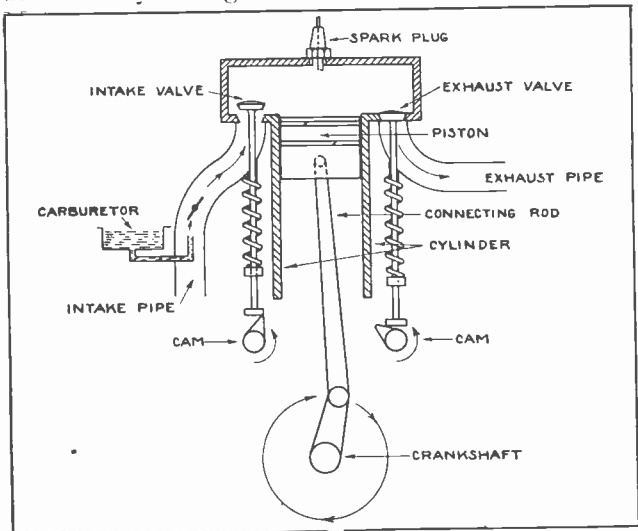

Fig. 1. This diagram illustrates the operating principle of a simple one-cylinder internal combustion engine. Study the diagram carefully while reading the explanation.

Automotive Electricity

Fig 1 is a simple diagram showing a sectional view of one cylinder of an automobile engine, and shows the following important parts: Cylinder, piston, connecting rod, crank shaft, valves and valve operating cams, and carburetor.

In this diagram the piston is shown at the commencement of the intake stroke; the intake valve on the left is open and the exhaust valve is closed. If the crank shaft is rotated to the right, or clockwise, the piston will be drawn downward on the **intake stroke** and, as it fits tightly in the cylinder, a suction or vacuum will be formed in the combustion chamber and will draw in a mixture of gasoline and air from the carburetor and through the intake pipe.

When the crank shaft revolves far enough so that the piston is about 30 degrees beyond **lower dead center** the intake valve is allowed to close by the cam moving out from under its lower end. Then, with both valves closed, the piston moves up on the **compression stroke**. This compresses the fuel charge into the relatively small space in the cylinder head called the **combustion chamber**.

When the piston arrives at the upper end of its stroke, or **upper dead center**, a spark is forced across the points of the spark plug, igniting the gas charge. Once this mixture of gasoline vapor or gasoline and air is ignited it burns at a very rapid rate. In fact so rapidly that this combustion action is often called an "explosion."

This burning of the fuel creates a very high temperature of about 3000° F. maximum, and an expansion pressure of about 300 to 400 lbs. per square inch which is exerted on the top of the piston.

The pressure is, of course, due to the tendency of the gas to expand when heated. This pressure generated by the rapidly expanding gases, forces the piston to move downward on the **power stroke**, both valves remaining closed until the piston reaches a point about 40° before the lower dead center position. At this point the exhaust valve opens through the action and timing of its cam. This stroke is known as the **power stroke**.

Gasoline Engines

With the exhaust valve remaining open, the piston again moves up to the upper dead center, forcing the burned gases out through the exhaust pipe. The exhaust valve then closes and one cycle is completed. This brings the engine back again to the position first mentioned, with the piston again ready for a downward intake stroke.

As long as the engine continues to operate this cycle is rapidly repeated, with the piston moving up and down and transmitting the force of each power stroke to the crank shaft through the connecting rod. The crank shaft converts this force into rotary movement of the flywheel attached to its end.

2. VALVES, PISTON, CAMSHAFT, CRANK-SHAFT, and OTHER ENGINE PARTS

From the foregoing facts it is easy to see the importance and necessity of having the valves operate at exactly the right instant with respect to the position and direction of movement of the piston. This is accomplished by the rotation of the cam shaft, which is connected to and driven by the crank shaft. The valves are normally held closed by the action of springs shown in the diagram in Fig. 1, and are forced open at the proper instant by the rotation of the cams or projections on the cam shaft, which press against the lower ends of the valve stems or push rods which are sometimes placed underneath the stems.

You can also see the importance of having the spark occur at exactly the right instant to ignite the fuel mixture, that is, when the piston is at the top of its compression stroke and just ready for the downward power stroke. The method by which this is accomplished will be explained in later paragraphs.

Fig. 2 shows at the upper right a pair of valves for an automobile engine, and at the bottom is shown the cam shaft which operates the valves by means of the short push rods shown directly beneath the valves on the right. These push rods are located between the cams and the lower ends of the valve stems.

Automotive Electricity

At the upper left in this figure are shown the gears and chain by means of which the cam shaft is driven from the end of the crank shaft of the engine. On engines having overhead valves the valves are often operated by means of long push rods and overhead rocker arms. A set of these rocker arms are shown above the cam shaft on the left in Fig. 2.

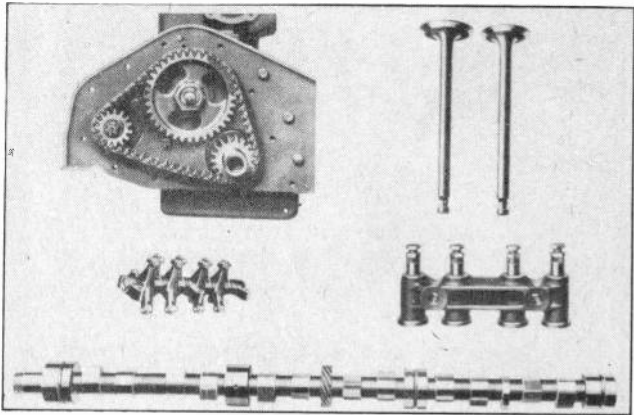

Fig. 2. This figure shows valves, push rods, rocker arms, cam shaft and cam shaft drive gears of an automobile engine. Courtesy Oldsmobile Mfg. Co.

Fig. 3 shows at the top a crank shaft and flywheel for a 6-cylinder engine. At the lower left in this figure is shown a piston attached to the connecting rod by means of which the piston imparts its energy to the crank shaft.

Note the piston rings which are located in grooves around the top of the piston to secure a tight fit to the cylinder walls and prevent leakage of any of the force from the expanding gases. These rings also help to maintain the proper suction and vacuum to draw in the fuel during the intake stroke.

At the lower right in Fig. 3 is shown the cylinder block of a 6-cylinder engine with the cylinder head removed. In the block you can see the intake and exhaust valves for each cylinder, some of these valves are open and some closed. The intake and exhaust ports or openings which admit the gases to

Gasoline Engines

and from the valve chambers are shown along the side of the cylinder block. In the cylinder head can be seen the combustion chambers with their spark plug openings. When the head is in place on the cylinder block these combustion chambers each fit directly above their respective cylinders and valves.

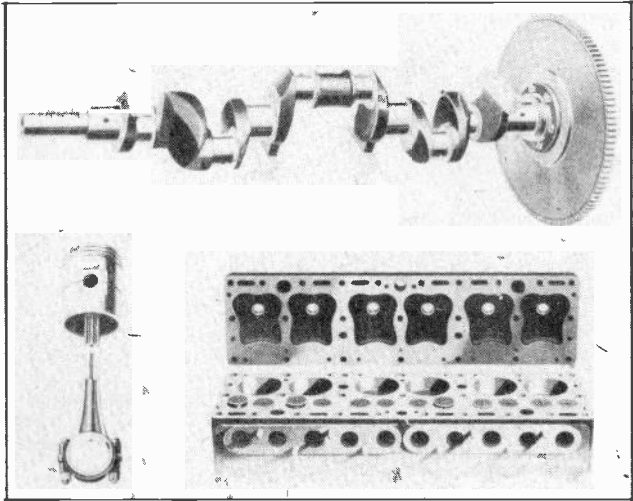

Fig. 3. At the top of this figure is shown a crank shaft and flywheel for a six-cylinder engine, and below are shown a piston and connecting rod and cylinder block with the head lifted to show the cylinders, valves, etc. Courtesy Oldsmobile Mfg. Co.

Fig. 4 shows an excellent sectional view of the end of an automobile engine of the side valve or L-head type. In this view the piston can be seen at the top of the cylinder and the connecting rod is shown leading from the piston to the crank shaft. Just above and to the left of the lower end of the connecting rod can be seen the end of the cam shaft with one cam projecting to its left. The push rod can be seen directly above and resting upon this cam, and above the push rod are the valve and valve spring. The tubular guide through which the valve stem slides up and down is called the "valve guide."

The intake and exhaust manifolds are shown projecting from the left of the cylinder block, and the

Automotive Electricity

passage through which the exhaust gases leave the cylinder through the valve can be clearly seen. The spark plug is located on top of the combustion chamber, and is connected by a wire to one of the terminals of the ignition distributor mounted on top of the engine.

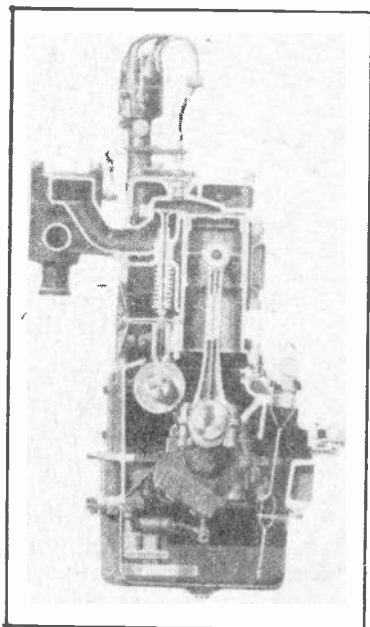

Fig. 4. This sectional end-view of an automobile engine clearly shows the arrangement and location of important parts such as piston, connecting rod, crank shaft, cam shaft, valves, etc. Courtesy Oldsmobile Mfg. Co.

3. VALVE TIMING

Theoretically each stroke of an automotive engine begins and ends at either the **upper dead center** or **lower dead center**, and we might think that the valves should open and close at these positions. However, in actual practice the valves are timed to open and close at points earlier and later than the exact upper and lower dead centers, because of the inertia of the gases.

For example, the closing of the intake valve is usually delayed to about 30 degrees after lower

Gasoline Engines

dead center (L.D.C.), in order to allow the engine to draw in the maximum gas charge and develop its maximum power. During the intake stroke the column of gas mixture moves through the intake manifold to the cylinder with a velocity of about 200 feet per second, and the gas due to its momentum continues to crowd into the cylinder even after the piston has passed L.D.C.

As long as this gas fuel is flowing into the cylinder the valve should remain open, in order to take in the maximum fuel charge; and this is the reason for delaying the closing of the intake valve until about 30 degrees after L.D.C.

On the power stroke the exhaust valve generally opens when the piston reaches a point about 40 degrees before L.D.C., thus allowing the exhaust gases to start their escape while there is still a little pressure in the cylinder (approximately 50 lbs. per square inch). This loses a little of the pressure from the fuel combustion, but it actually increases the total power of the engine by effecting a more thorough cleaning or scavenging of the exhaust gases from the cylinder, and also by eliminating all back pressure on the piston as it starts to move up on the exhaust stroke.

When the U.D.C. is reached the exhaust valve closes, and about 10 degrees later the intake valve opens. The purpose of this slight delay in the opening of the intake valve is to create a slight vacuum in the cylinder before opening it, and also to eliminate the possibility of fuel loss through the exhaust valve which has just closed.

Fig. 5 is a diagram illustrating this valve timing or the points at which the valves open and close with regard to upper and lower dead center in each revolution of the crank shaft. In this figure the time is expressed in degrees of crank movement, allowing 360 degrees for one complete revolution of the crank shaft.

The diagram not only shows the positions at which the valves open and close but also shows in degrees the length of the intake, compression, power, and exhaust strokes.

The timing values given in this diagram represent popular or general practice, but it should be re-

Automotive Electricity

membered that different engines require widely varying valve timing, according to their design, speed of rotation, compression used, fuel efficiency, etc.

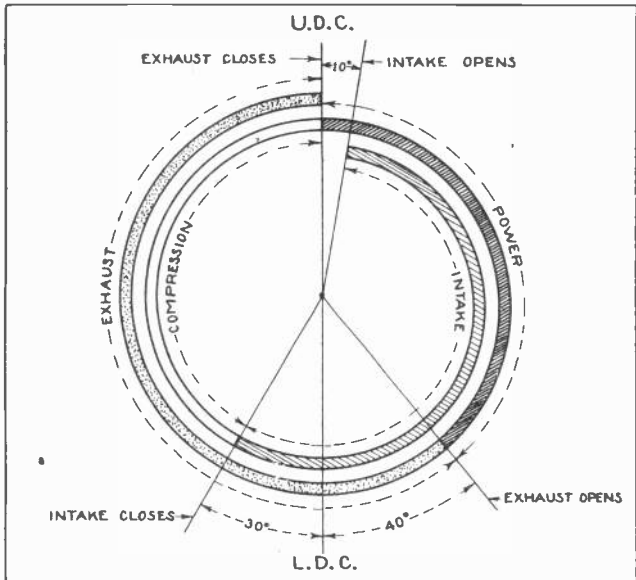

Fig. 5. Diagram illustrating valve timing or showing the points at which the valves open and close, and also showing the degrees of open and closed periods during each revolution of the crank.

4. PRINCIPLES OF CARBURETION

The purpose of the carburetor on an automobile engine is to supply the proper mixture of gasoline vapor and air for fuel to be burned in the cylinders. The carburetor also provides a means of controlling the speed and power output of the engine by admitting more or less fuel under the control of a throttle valve.

Raw gasoline will not burn in the cylinders, so the function of the carburetor is to mix a spray or jet of gasoline with a proper amount of air to provide combustible fuel.

Fig. 6 is a diagram showing a sectional view of a simple elementary type of carburetor. The gasoline enters the fuel bowl through a small tube or pipe from the gas tank, vacuum tank, or fuel pump. The float in the fuel bowl automatically keeps the gaso-

Gasoline Engines

line at the proper level in the bowl by shutting off the flow from the pipe whenever the float rises high enough. From the fuel bowl the gasoline is drawn through either the high-speed jet or low-speed jet, according to the speed at which the engine is operating. Note the positions of these jets in Fig. 6.

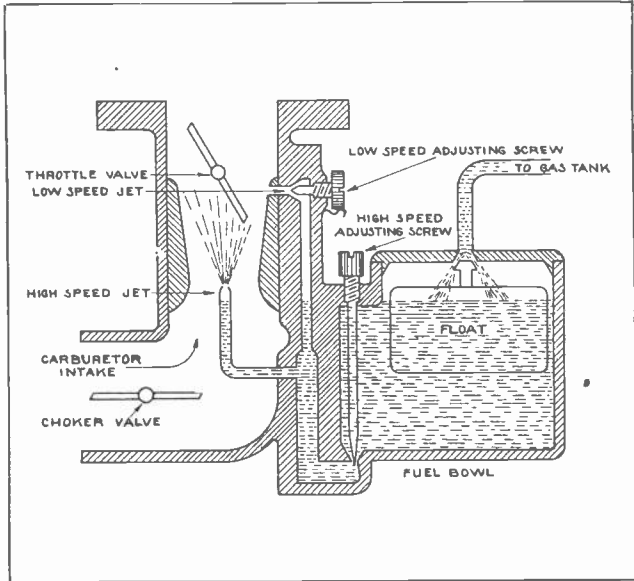

Fig. 6. Diagram showing a sectional view and the operating principles of a simple carburetor used for supplying the proper mixture of gasoline and air for fuel to the engine.

As long as the engine operates at moderate or high speeds, the rapidly repeated intake strokes of the pistons in the various cylinders maintain a practically constant suction, which draws a steady stream of air in through the carburetor barrel and intake manifold. This air, rushing upward through the narrow or restricted opening in the carburetor barrel, sucks gasoline from the high-speed jet in the form of a fine spray which mixes thoroughly with the air, and passes on into the cylinders as combustible fuel as long as the throttle valve is open.

When the throttle valve is closed it cuts off the supply of gasoline from the high-speed jet and creates a higher vacuum or suction above the valve.

* Automotive Electricity

This raises the gasoline and draws it from the low-speed jet for idling or low speed operation of the engine.

For satisfactory engine operation the proper mixture or proportion of fuel and air must be maintained at all times. If there is too much gasoline the mixture is said to be too "rich", and this will cause irregular operation and may stop the engine entirely. **An excessively rich mixture is generally indicated by heavy, black smoke coming from the exhaust pipe.**

If, on the other hand, there is too little gasoline and too much air, the mixture is said to be too "lean", and the engine will misfire and lack power.

For average conditions a mixture consisting of about sixteen parts of air to one part of gasoline (by weight) gives the best results. A mixture of less than seven parts of air to one of gasoline is too rich to burn at all, while at the other extreme more than twenty parts of air to one of gasoline will cause the engine to misfire and develop very little power.

When starting up a cold engine a rich fuel mixture is required, and to obtain this a choker valve in the lower end of the carburetor barrel is partly closed in order to shut off part of the air and create a higher suction at the fuel jets and draw more gasoline. As soon as the engine is running smoothly and slightly warmed up, this choker valve should be opened to again thin the fuel mixture and prevent fouling of the spark plugs and cylinders.

From the preceding explanation of carburetor principles it is easy to see the importance of correct carburetion or carburetor adjustment for smooth, and efficient operation of an internal combustion engine.

The adjustments for the high-speed and low-speed jets are made by adjustable needle valves which control the flow of gasoline to each jet. The one marked "low-speed adjustment" controls the flow of fuel issuing from the jet located in the carburetor barrel above the throttle valve, and which is generally known as the idling jet. This jet supplies the fuel up to speeds of about twenty miles

Gasoline Engines

per hour in high gear.

As the throttle is opened farther than this it breaks the high suction at the upper jet and will not draw the gasoline up to this level any longer. From this point on the fuel is supplied by the lower jet for the higher speeds.

Fig. 7 shows a photograph of a carburetor of a dual type design, for use on 8-cylinder engines.

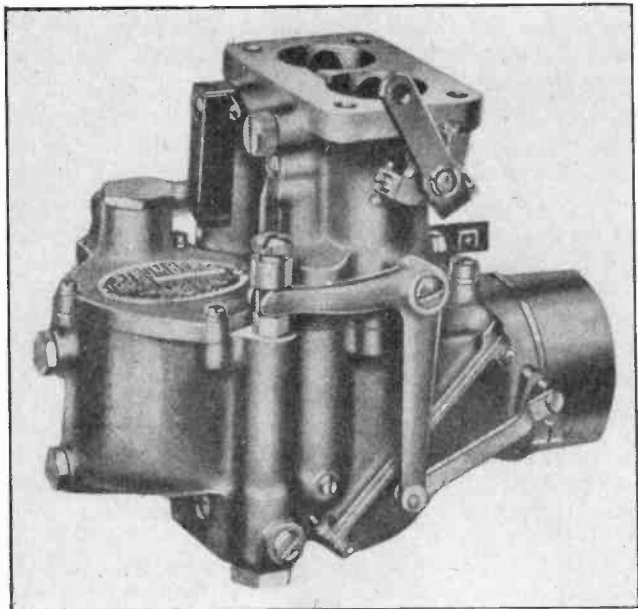

Fig. 7. Photograph view of a double or twin barrel carburetor with some of the operating levers and adjustments in plain view.

You will note the fuel bowl on the left and the air intake opening on the right. The openings which connect with the intake manifold on the engine are shown on the top. The adjusting screws for both the high-speed and low-speed jets can be clearly seen in this view. You can also see the levers which operate the throttle and choker valves.

Improper carburetor adjustment will often cause faulty and irregular operation of the engine that is sometimes blamed upon the ignition or valve tim-

Automotive Electricity

ing; so, when "tuning" an engine one should make sure that the carburetor is properly adjusted for smooth operation.

5. FUEL COMBUSTION and SPARK ADVANCE AND RETARD

When the fuel charge that is supplied to the cylinders by the carburetor is ignited by a spark from the plug it requires a very small fraction of a second for the flame to spread throughout the entire charge in the combustion chamber. In other words, the combustion of the gasoline vapor is not actually an instantaneous explosion, but instead requires a certain small period of time after the charge is ignited before combustion is complete.

The period of time required between ignition and the complete combustion of the fuel depends on the amount of compression, the type of fuel used, the shape of the combustion chamber, location of the spark plug, etc. On an average, this time period is about .003 of a second.

In order to obtain maximum pressure on the piston the ignition spark should be timed so that combustion will be completed just when the piston is on upper dead center. Because of the short period of time between ignition and complete combustion **the spark must, therefore, occur at some point slightly ahead of the upper dead center position** or just before the piston reaches this point.

This is known as **advancing the spark**, and is very important in obtaining maximum speed and power for modern automobile engines, because at the speed these engines operate the piston will travel a considerable distance in even as small a period of time as .003 of a second. Just how far the spark should be advanced depends upon the operating speed of the engine, the degree of compression used, and the grade of fuel.

As the amount of spark advance depends upon the engine speed, it is generally necessary to advance and retard the spark according to the speed at which the car or engine is being operated. This enables one to obtain the maximum power both at low speeds, such as when climbing steep hills, and also at high speeds on good level roads.

Gasoline Engines

Ordinarily the spark is so timed that during low-speed operation of the engine ignition will occur when the piston is at U.D.C. The spark is then advanced as the speed of the engine is increased. This is usually accomplished by rotating the ignition timing device or distributor, and thus causing the spark to occur a little earlier with regard to the piston stroke.

On some cars this spark adjustment is made by hand from a control on the steering wheel, while on many of the modern automobiles it is made automatically by a sort of governing arrangement which operates whenever the engine changes speed.

Excessive spark advance will cause the engine to knock while insufficient advance will result in a loss of power and overheating of the engine.

Generally the best position of spark advance for any certain speed is reached when a little more advance will cause the engine to knock. The amount of spark advance varies from 15 to 45 degrees in different types of pleasure cars, according to the design of the engine.

The method of adjusting the spark advance and retard mechanism will be covered later in connection with ignition distributors.

6. ARRANGEMENT OF VALVES

One of the most important things in gasoline engine design, and one that has a material effect on their efficiency and operating characteristics is the shape of the combustion chamber and the arrangement of the valves. The valves which admit the fuel and discharge the burned gases from the cylinder may be placed either alongside the cylinder as in "side valve" engines or they may be in the cylinder head as in "overhead valve" engines.

Fig. 8 shows the four different valve arrangements, giving both side sectional views of the cylinder and top views looking down on the cylinder and valves. At "A" both valves are located in the cylinder head above the piston. An engine of this type is known as the "overhead valve" type.

"B" shows a cylinder of a side valve engine in which all of the valves are placed on one side of the engine. Engines of this type are commonly

Automotive Electricity

called "L-head" engines because the combustion chamber and cylinder form a sort of inverted L shape.

At "C" is shown one cylinder of a "T-head" engine in which the exhaust valves are located on one side of the engine and the intake valves on the other.

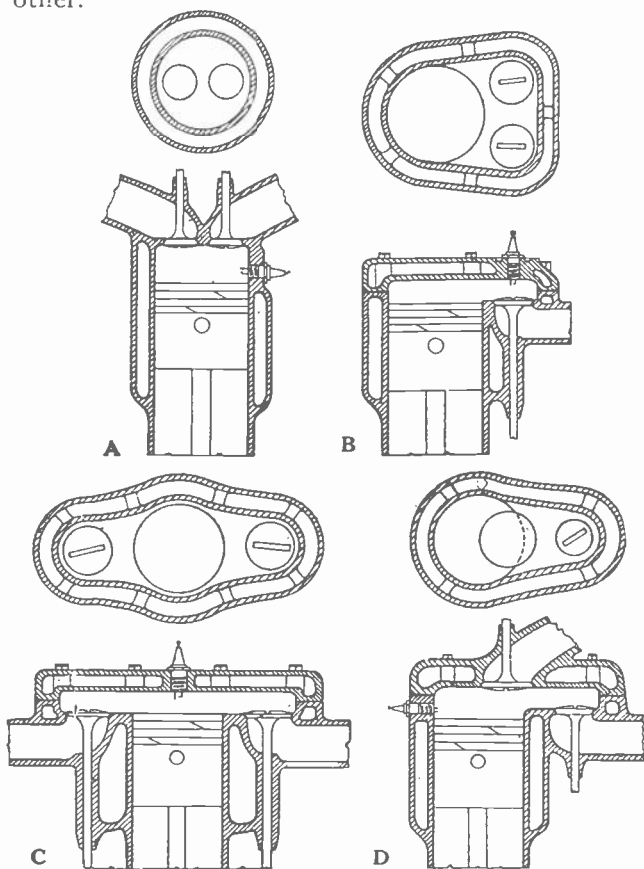

Fig. 8. The above diagrams show the location and arrangement of valves with respect to the cylinder in various types of automobile engines.

At "D" is shown the valve arrangement for what is called an "F-head" engine, which uses a combination of the first two types, the intake valves being located in the head and the exhaust valves on the side.

Gasoline Engines

Fig. 9 shows an end view of an engine with overhead valves. The cam shaft shown at the left of the connecting rod operates a long push rod which in turn operates a rocker arm at the top of the engine. The right-hand end of this rocker arm opens the valve by pushing it downward into the combustion chamber.

Probably 80% of modern automotive engines are of the L-head type and most of the remainder use the overhead type. One decided advantage of both the L-head and overhead valve types of engines is that all valves are arranged in one line, and therefore only one cam shaft is required to operate all of the valves. This results in a very definite arrangement of the valves from the front to the rear of the engine.

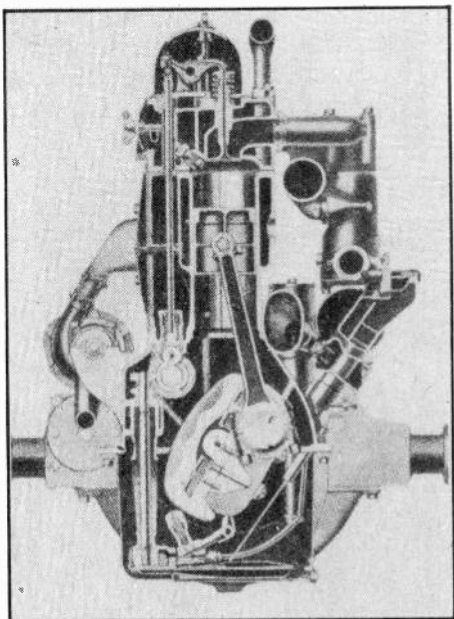

Fig. 9. End and sectional view of a Buick engine showing the overhead valve construction, the method of operating valves by means of long push rods, and overhead rocker arms.

In Fig. 10 you will note that the first and last valves are exhaust valves and the intermediate ones are arranged in alternate pairs of intakes and exhausts. While this sketch shows the valves for a

Automotive Electricity

4-cylinder engine the same arrangement is used regardless of the number of cylinders as long as they are all in one line. This valve arrangement provides a convenient means for setting the engine on U.D.C. when timing the ignition.

In order to obtain even torque and better balance in automobile engines the crank shafts are generally made so that the pistons move up and down in pairs, the first and last piston always moving up and down together. The two pistons of any pair, however, are always on different parts of the cycle.

For example, when the last piston is moving up on exhaust the first is coming up on compression, and when the last piston arrives at U.D.C. position the last valve on the engine will close, as it is an exhaust valve. Therefore, when the last valve on the engine closes, No. 1 piston is on upper dead center on the compression stroke and the engine is set on the timing position or ready for the spark to occur in No. 1 cylinder. This method is particu-

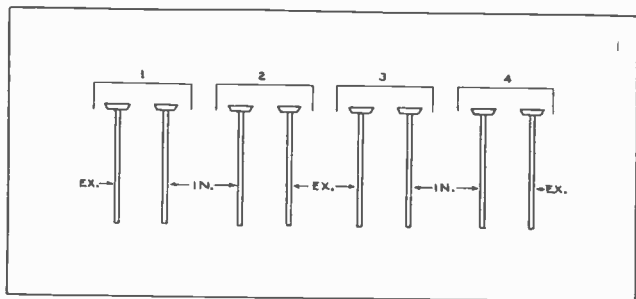

Fig. 10. This sample sketch shows the order or arrangement of exhaust and intake valves which is used on practically all automobile engines. Knowing this arrangement will be a great help in locating certain valves when timing an engine.

larly applicable to overhead valve engines and is a very good rule to remember.

No. 1. Cylinder on an automobile engine is always the one next to the radiator or on the cranking end, the remainder of the cylinders are numbered in order from here back to the flywheel end.

7. MULTIPLE CYLINDER ENGINES

A single-cylinder, four-stroke-cycle engine receives only one power impulse for every two revolutions of the crank shaft, as four strokes are required

Gasoline Engines

to complete the cycle and only one of these strokes is a power stroke. In single-cylinder engines, therefore, a rather heavy impulse is required on the power stroke in order to build up sufficient momentum to keep the fly wheel turning through the three idle strokes which follow.

Due to the severe strain imposed on the engines by this heavy power impulse such engines had to be very strongly constructed, and as a result both the stationary and moving parts were excessively heavy. In addition, they required a very heavy fly-wheel, capable of storing sufficient energy on the power stroke to keep the engine running at approximately constant speed through the rest of the cycle.

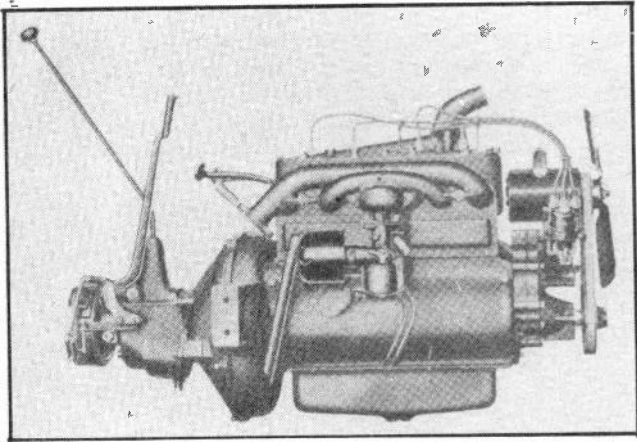

Fig. 11. Side view of a four-cylinder automobile engine. Note the position of the carburetor, intake and exhaust manifolds and spark plugs.

Such engines cannot run at high speeds without severe vibration, and this disadvantage along with the excessive weight has led to the production of multiple-cylinder engines which provide more frequent power impulses, run more smoothly, and have greater flexibility and lighter weight for a given power output.

The greater the number of cylinders the more frequently the power impulses occur and the more even is the flow of power applied to the crank shaft. For a given power output the size and weight of the

Automotive Electricity

moving parts of the engine become less as the number of cylinders increases, and this makes possible higher engine speeds and higher efficiencies.

On any engine with more than four cylinders there is no point in the rotation where the engine is not receiving power from the expanding gases on one or another of the power strokes.

For the above reasons six and eight-cylinder engines are the most popular for automobiles, although a number of "fours" are still being built. Twelve and sixteen-cylinder engines are also used and deliver extremely smooth power to drive the car.

8. FOUR-CYLINDER ENGINES. FIRING ORDER

Fig. 11 shows a side view of a four-cylinder engine.

Any four-stroke-cycle engine fires all cylinders in two revolutions of the crank shaft, or 720° of crank rotation. Therefore, the angle between the power impulses of a four-cylinder engine of this type will be $720 \div 4$, or 180° .

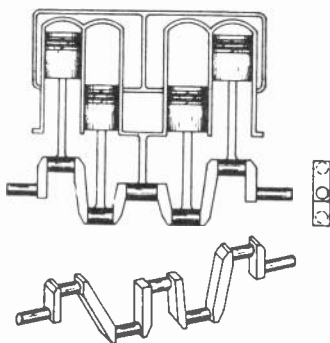

Fig. 12. Sketch showing the design of the crank shaft and arrangement of pistons in a four-cylinder engine.

The crank shaft for the four-cylinder engine is designed so that the pistons travel up and down in pairs, 1 and 4 traveling up and down together and 2 and 3 traveling together. In this manner, when 1 and 4 are at upper dead center 2 and 3 are at

Gasoline Engines

lower dead center, as the crank throws to which they are attached are 180° apart. See Fig. 12, which shows a sketch of the pistons and crank shaft of an ordinary four-cylinder engine.

Fig. 13 is a sectional view of a four-cylinder engine, showing the crank shaft and other important parts.

When piston No. 1 is moved to L.D.C. on its power stroke the crank shaft has turned 180° from the point of ignition, and at this time another power stroke should commence in one of the other cylinders. At this time pistons 2 and 3 will be at U.D.C. and the one that is fired will depend on the design of the cam shaft, as the operation of the valves will cause one of these pistons to be up on compression stroke and the other on exhaust stroke. If 3 fires after 1 it must be followed by 4, and then by 2, so the firing order of the engine in this case will be 1-3-4-2.

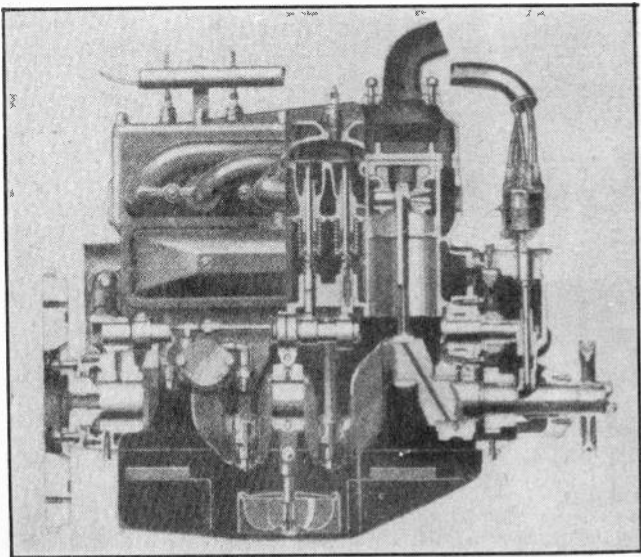

Fig. 13. Side sectional view of Chrysler Plymouth four-cylinder engine showing the shape of the crank shaft and arrangement of pistons, valves, etc.

Automotive Electricity

If the cam shaft is arranged so that No. 2 cylinder fires after 1, then the firing order will be 1-2-4-3. These are the only two firing orders used on four-cylinder automobile engines. The last firing order mentioned is used on the four-cylinder Ford and Chevrolet engines.

It is very important to know the firing order of various engines on which one may be working, in order to be able to properly connect the ignition wires from the distributor to the spark plugs.

Firing orders of various engines can be obtained from the manufacturers or dealers, and garages and ignition service stations generally carry a book which gives the firing orders for all of the common types of engines. The method for determining the firing orders by checking directly on the engine will be explained a little later.

Fig. 14 shows a sectional view of a heavy-duty four-cylinder engine and gives the names of many of the important parts. Examine this figure carefully.

9. SIX-CYLINDER ENGINES. FIRING ORDER

Six-cylinder engines are generally preferred to four-cylinder types as the power strokes overlap each other and occur more frequently, or at smaller angles in the revolutions of the crank shaft. As six-cylinder engines of the four-stroke-cycle type fire all cylinders in only two revolutions of a crank, or in 720° , their power strokes will be $720 \div 6$, or 120° apart.

The cranks are arranged at this angle so that they project out at three different points around the crank shaft. This is shown in the small sketch at the right in Fig. 15 which shows the arrangement of the crank throws and pistons in a six-cylinder engine.

By referring to the lower view of the crank shaft in this figure you will note that the cranks are also arranged in pairs, so that pistons 1 and 6 will move up and down together, 2 and 5 together, and 3 and 4 together. Remember, however, that no two pis-

Gasoline Engines

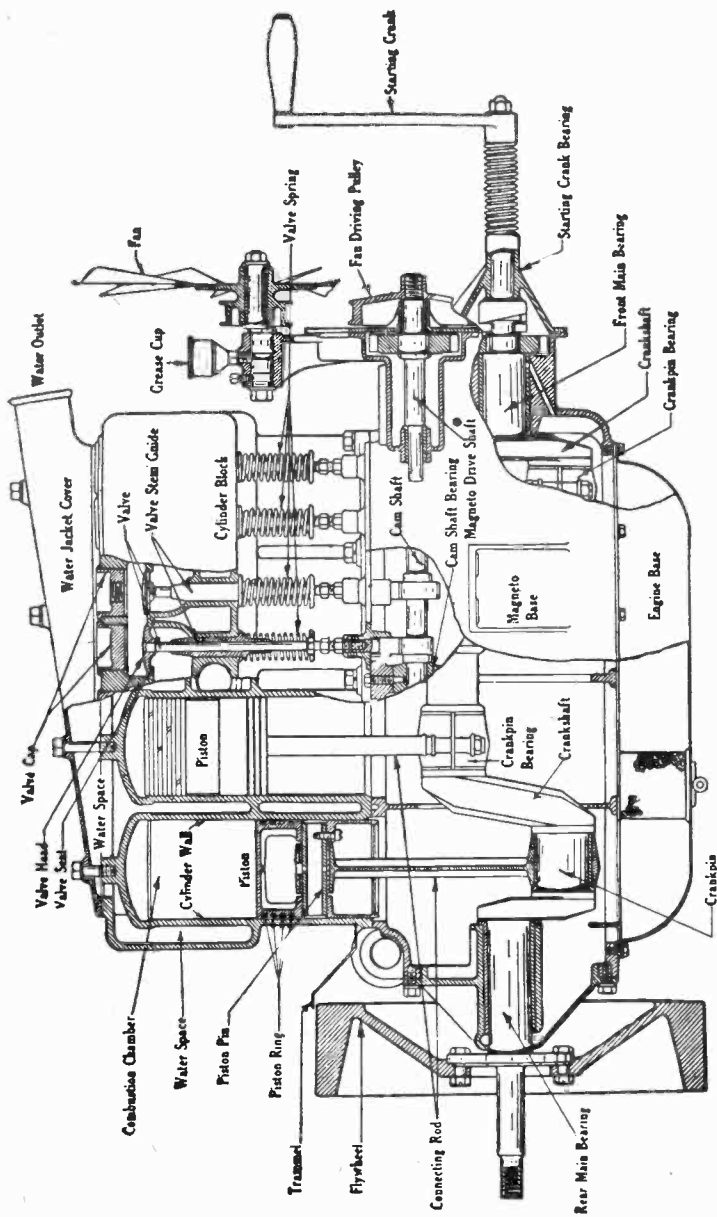

Fig. 14. This diagram shows a sectional view and a number of the important parts of a heavy-duty four-cylinder engine. Note the names by which each of these parts are called. Also note the water jacket around the cylinders for cooling them.

Automotive Electricity

tons which travel up and down together are on the same part of the cycle at the same time, as when one is going up on its compression stroke the other piston is going up on its exhaust stroke.

By referring back to Fig. 3 an excellent view of a six-cylinder crank shaft can be seen. This view

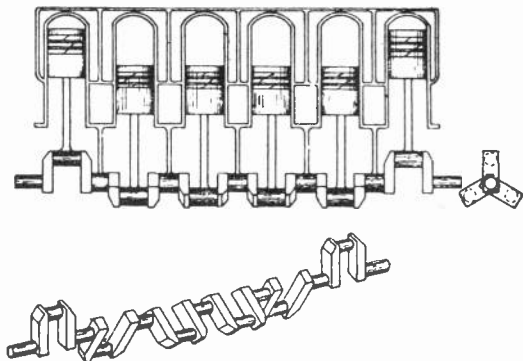

Fig. 15. Diagrams showing the design of the crank shaft and the arrangement of pistons for a six-cylinder engine. Note that the cranks are arranged in pairs 120° apart around the shaft.

shows quite clearly the position of the cranks with respect to each other, and also shows the main bearings of the crank shaft.

In Fig. 15 four of the pistons seem to be at about the same position, part way between the lower and upper ends of the stroke; but by noting the position of the crank throws in the lower view of the crank shaft you will find that if pistons 2 and 5 are traveling downward at this point, pistons 3 and 4 will be traveling upward.

Because of their more frequently occurring power impulses six-cylinder engines deliver much smoother power than four-cylinder types. There are several firing orders possible with six-cylinder engines having crank shaft arrangements such as shown in Fig. 15, but the only two firing orders which are used are as follows: 1-5-3-6-2-4, or 1-4-2-6-3-5; these having been adopted as more or less standard by various engine manufacturers.

Firing in the proper order is very important in

Gasoline Engines

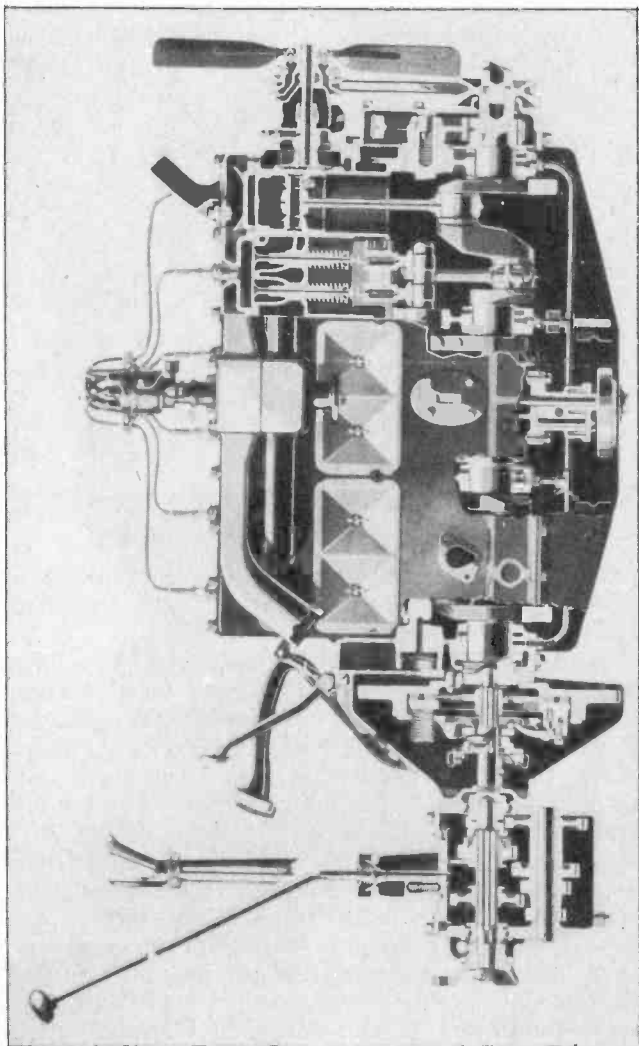

Automotive Electricity

balancing the internal forces in the engine. The firing order is determined by the design of the crank shaft.

By this time you can, no doubt, readily see the great importance of the firing order in wiring the ignition system of an engine; because if the distributor wires were connected wrongly to the spark plugs the sparks would occur at the wrong time in the cylinders, and the engine would misfire, operate irregularly, and deliver very low power; or possibly not even start.

For example, if the spark occurred in a cylinder when the piston came up on exhaust stroke instead of compression stroke there would be no fuel mixture present at the time of the spark and therefore no explosion.

Fig. 16 on page 30 shows a side-view of a six-cylinder engine with sections of the casing cut away to show some of the important parts. No. 1 cylinder is completely open, showing a sectional view of the piston, wrist pin, connecting rod, etc. No. 2 cylinder is arranged to show a sectional view of the exhaust and intake valves, valve guides, valve springs, push rods, and a section of the cam shaft.

On the left end of the engine are shown the fly-wheel, clutch, and transmission. The distributor, high-tension ignition wires, and spark plugs are shown on top of the engine.

10. EIGHT-CYLINDER ENGINES. FIRING ORDER

The decided advantages of the engines with a greater number of cylinders, both in smooth power performance and in reduced manufacturing cost per horsepower, have resulted in a definite trend toward the construction of engines of this type, and quite a number of the latest automobiles are equipped with "straight-eight" engines. This term "straight-eight" refers to engines having eight cylinders in line. There are other very popular eight-cylinder engines which are of the V-type and which will be discussed later.

The straight-eight engine produces a remarkably

Gasoline Engines

smooth torque, as its power impulses occur every 90° , or $720 \div 8$. Fig. 17 shows an eight-cylinder engine of this type. Practically all of the straight-eight engines use the firing order: 1-6-2-5-8-3-7-4.

Straight-eight engines are used by Chrysler, Oldsmobile, Packard, Buick, Studebaker, and other manufacturers of popular cars.

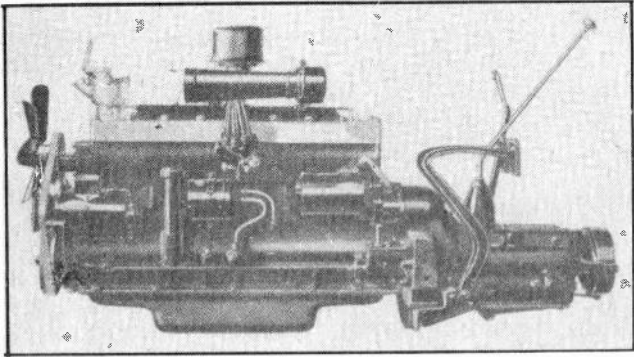

Fig. 17. Popular "line eight" automobile engine with eight cylinders in line. Engines of this type are very extensively used on modern cars and deliver extremely smooth power.

V-type eight-cylinder engines have their cylinders arranged in two rows or "banks" of four each, as

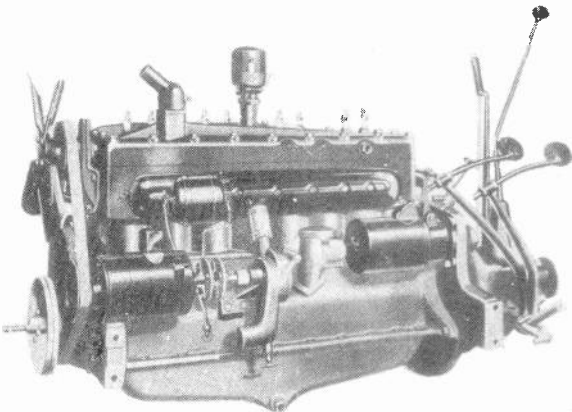

Fig. 18-A: The Studebaker "Dictator Eight" engine embracing many of the advances in automotive engine construction.

shown in Fig. 18. Engines of this type are used in Lincoln, Cadillac-LaSalle, and Ford cars.

Automotive Electricity

The firing order of a V-type engine alternates consecutively, firing first one cylinder on the right bank and then one on the left bank, and so on down the bank, following this arrangement as closely as the design of the crank shaft will permit.

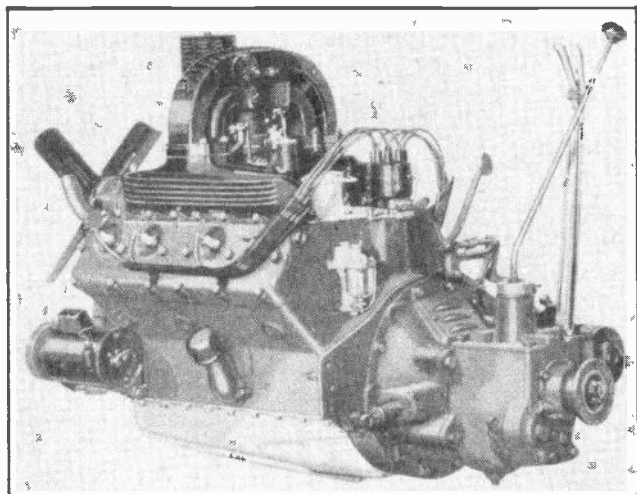

Fig. 18. V-type, eight cylinder engine with cylinders arranged in two banks of four each. Carefully compare the construction of this engine with the "line eight" type shown in Fig. 16.

In the earlier types of V-eight's crank shafts similar to those used in four-cylinder engines were employed, having two pistons one from each bank connected to each crank throw, as shown in Fig. 19.

The firing order for this type of engine is either 1R- 4L- 2R- 3L- 4R- 1L- 3R- 2L-; or 1R- 4L- 3R- 2L- 4R- 1L- 2R- 3L. The letters "L" and "R" denote cylinders on the left and right banks, as viewed from the drivers seat, and always keep in mind that **number one cylinder is the one nearest the radiator.**

Most of the more modern V-eight's use a crank shaft with the cranks arranged 90° apart instead of 180° , and thus obtain still better balance and smoother operation. Engines of this type are used by the Cadillac-LaSalle and Ford cars.

They require a different firing order from the earlier type V-eight's. The firing order of the Cadillac-LaSalle engine is: 1L- 4R- 4L- 2L- 3R- 3L- 2R-

Gasoline Engines

1R.

The firing order of the Ford is 1R- 5L- 4R- 8L- 6L- 3R- 7L- 2R.

The firing order of the Lincoln is: 1R- 4L, 2R- 3L- 4R- 1L- 3R- 2L.

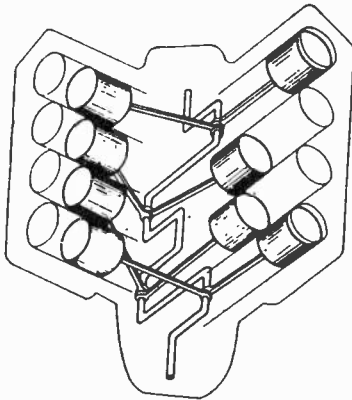

Fig. 19. Diagram showing the type of crank shaft and arrangement of pistons used with V-type, eight-cylinder engines.

Fig. 20 shows a photo of a crank shaft such as used in these later type V engines, and Fig. 21 shows an excellent sectional end-view of a V-eight engine. In the foreground can be clearly seen the crank shaft with its counter-balancing weights and two connecting rods attached to the one crank. Note the position of each of the pistons attached to this crank and observe that one of the pistons is at the extreme outer end of its stroke, or U.D.C., while the other piston on the left is approximately midway on its downward stroke. Also note the position of the spark plugs and valves in the combustion chambers.

The end of the cam shaft can be seen located between the cylinders. The cams of this shaft operate short rocker arms, which in turn press against the valve stems to operate the valves in the proper order. The carburetor, air filter, and intake and exhaust manifolds are shown above the engine in this view.

One of the types of multiple-cylinder engines is the Cadillac V-16, which is in reality two straight-

Automotive Electricity

eight's mounted at an angle of 45° to each other. This engine delivers remarkably smooth power and a tremendous amount of horsepower for its weight, and is a very good example of the weight reduction possible with an increase in the number of cylinders. The weight of this engine is only 25% greater than that of the Cadillac Eight, but its horsepower is double.

The firing order of the V-16 is: 1L- 4R- 5L- 7R- 2L- 3R- 6L- 1R- 8L- 5R- 4L- 2R- 7L- 6R- 3L- 8R.

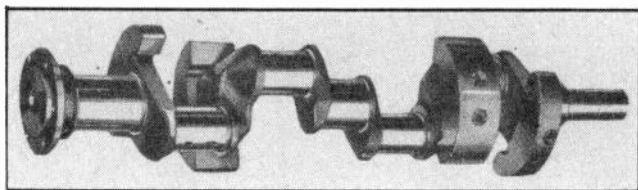

Fig. 20. Photograph of crank shaft used with V-type, eight-cylinder engines. Note that there are only four cranks, each of which have two connecting rods from pistons in opposite banks connected to them.

11. DETERMINING FIRING ORDERS BY TEST

In case the firing order of any engine is not known it may be quickly determined by any one of several methods. The simplest and most popular of these is the **compression method**.

We know that each piston must move up on its compression stroke just before its cylinder is fired, and the order in which these compression strokes occur in the different cylinders must be the same as the firing order. Keeping this fact in mind, the firing order may be quickly and accurately determined in the following manner.

Remove all spark plugs and seal the plug hole in cylinder No. 1 with a piece of paper or waste. Then slowly crank the engine until the paper blows out. Stop cranking at this point and seal the remaining spark plug holes, and then slowly turn the crank, noting the order in which the remaining wads are blown from the cylinders. This will indicate the firing order.

As each successive wad is blown from the cylin-

Gasoline Engines

der a chalk mark may be put near that plug opening denoting the number of the wad blown—as 1, 2, 3, 4, etc. When all cylinders are marked the firing order can be read from cylinder 1 to the last cylinder.

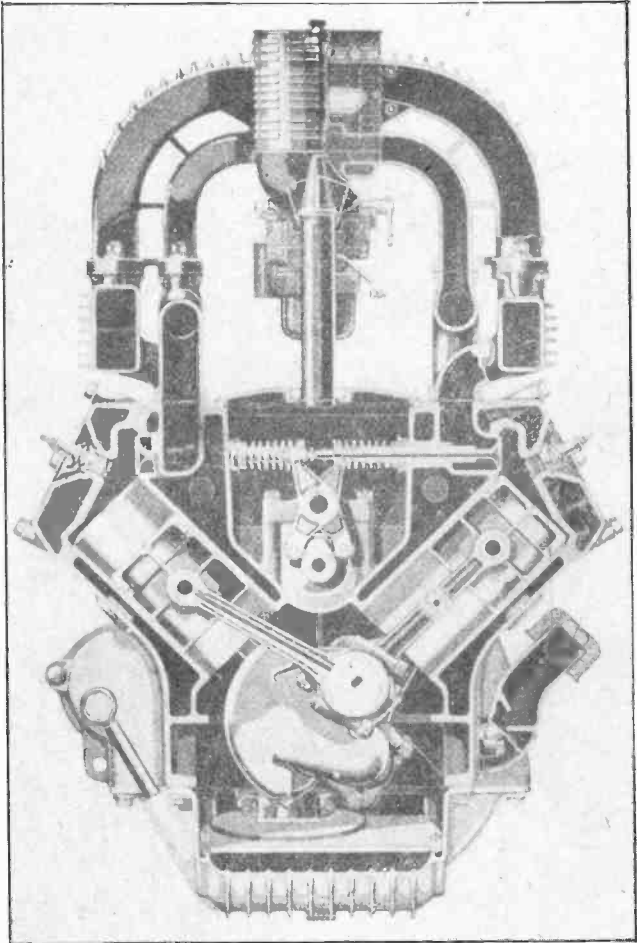

Fig. 21. An excellent end sectional view of a V-type, eight-cylinder engine. Note carefully the arrangement of the pistons, valves, cam shaft, rocker arms, spark plugs, carburetor, and intake and exhaust manifolds.

Keep in mind that the firing order of an engine cannot be changed, as it is determined by the design

Automotive Electricity

of the crank shaft and cam shaft. These would have to be changed before the firing order could be altered.

Another method of determining the firing order—and one that is sometimes more convenient than that just given, particularly when the engine is of the overhead valve type—makes use of the fact that the valves open and close in the same order as the firing order.

When the intake valve closes on No. 1 cylinder the piston is rising on the compression stroke. Since the compression stroke takes place in each of the different cylinders in the same order as the firing order, the order in which the intake valves close must be the firing order.

To determine the firing order by this method, first locate the intake valve of each cylinder and then rotate the engine slowly until the intake valve on No. 1 cylinder closes. The next intake valve to close will be located at the cylinder that follows No. 1 in the firing order, or the one which fires second.

Continue turning the crank slowly and note the order in which the remaining intake valves close. This will show the firing order.

The same procedure could be used with the exhaust valves if desired.

EXAMINATION QUESTIONS

1. What is one of the most important uses of electricity on automobile engines?
2. Briefly explain what happens during each stroke of a four-stroke-cycle automobile engine.
3. Briefly explain the function of the cam shaft and valves on an automobile engine.
4. In the timing of engine valves why is the closing of the intake valve usually delayed until about 30 degrees beyond lower dead center?
5. Why is the exhaust valve usually opened about 40 degrees ahead of lower dead center?
6. A. What is the purpose or function of the carburetor on a gasoline engine?
B. What mixture or proportion of gasoline and air (by weight) usually give best power results?
7. What is meant by "advancing the spark" and why is it done?
8. Which cylinder on an automobile engine is always called number one cylinder?
9. Why is it important to know the firing order of an engine when connecting or checking ignition wiring?
10. Describe briefly how you could determine the firing order of an engine by the compression test method.

IGNITION SYSTEMS. PRINCIPLES

As previously explained, the purpose of the ignition system on an automobile engine is to provide a means of setting fire to or igniting the fuel charge in the combustion chamber each time the piston comes to U.D.C. on the compression stroke.

A number of different methods of igniting the gas charge in internal combustion engines have been tried, but electrical ignition has proved to be the most positive and reliable for the high engine speeds required in automotive service.

Many modern automobile engines rotate at speeds of about 4000 RPM and require from 200 to 300 sparks per second, depending upon the number of cylinders. Electrical ignition is the only type capable of giving sufficient instantaneous heat to ignite fuel charges at such speeds, and has the added advantage of being easily and accurately controlled.

The important parts of a common electrical ignition system are:

1. **A battery or generator** for a source of current supply.
2. **A spark coil or magneto** to produce high-voltage sparks at certain regular intervals.
3. **Spark plugs** to introduce the sparks into the combustion chamber of the engine.
4. **A distributor** to direct the high-voltage current to the spark plugs in the correct order.
5. A means of varying the time of the spark with relation to the piston position.

Each of these devices will be explained in the following paragraphs.

1. STORAGE BATTERIES

Storage batteries are commonly used as the source of current for ignition and other uses on modern automobiles. The majority of these batteries are the three-cell, six-volt type, but some are of the twelve-volt type.

Fig. 1 shows a common type six-volt storage battery in a rubber case, with the connector straps and terminal posts showing on top of the battery.

Ignition Systems

Storage batteries provide a convenient small portable device for supplying electricity for ignition, lights, horn, starting motor, etc. These batteries are fully charged when installed in a new car, and are then kept charged by current supplied from a low-voltage generator which is driven directly from the engine as long as it is running. This prevents



Fig. 1. Common three-cell, six-volt storage battery of the type extensively used to supply current to ignition and lighting systems on automobiles.

the battery running down or discharging and eliminates the necessity of removing it from the car for frequent recharging.

The combination of this battery and generator provide a dependable supply of low-voltage energy as long as the generator charging rate is properly maintained and the battery is not abused or used excessively when the engine is not running. Both storage batteries and generators for automobiles will be discussed more fully in later lessons.

Automotive Electricity

2. IGNITION COILS

Electrical ignition is accomplished by forcing a spark across a small air gap in the combustion chamber. The voltage required to break down the resistance of this air gap and form a spark will depend principally upon the length of the gap and the degree of compression. With a compression pressure of about 100 lbs. per square inch and a spark gap length of about .025 inch, the voltage required to produce the spark will range from 6000 to 10,000 volts. These values of compression and spark gap length represent common practice in modern automobile engines.

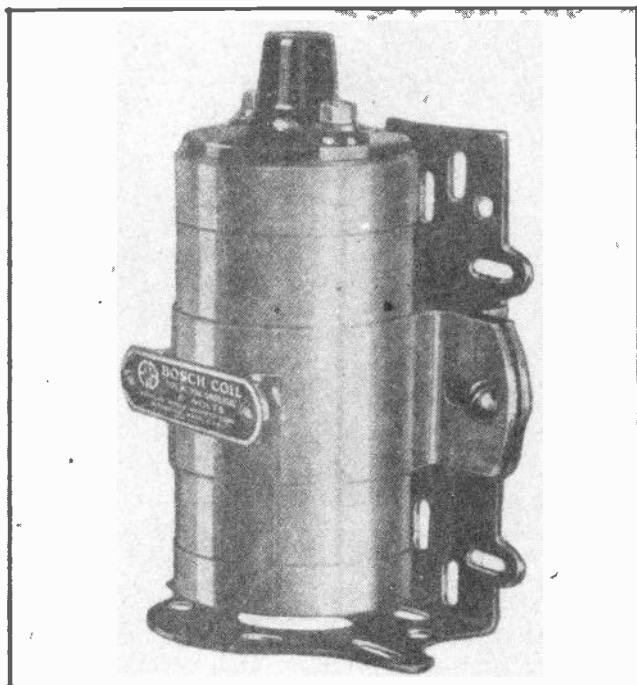

Fig. 2. High-tension ignition coil such as used for supplying high voltage impulses to the spark plugs on the ignition systems of automobiles. The heavily insulated bushings on the top of the coil is where the high voltage lead connects.

We can readily see that the six-volt energy supplied by the battery will not be of high enough

Ignition Systems

potential to break down the gap and form a spark, and that this voltage will need to be increased or stepped up considerably for ignition purposes. To accomplish this we use a special type of direct current transformer called an **ignition coil**.

Fig. 2 shows a high-tension ignition coil such as used with many automobiles. In this figure the coil and core are shown enclosed within a waterproof case which is attached to a bracket for convenient mounting on the engine.

An ignition coil consists essentially of a soft iron

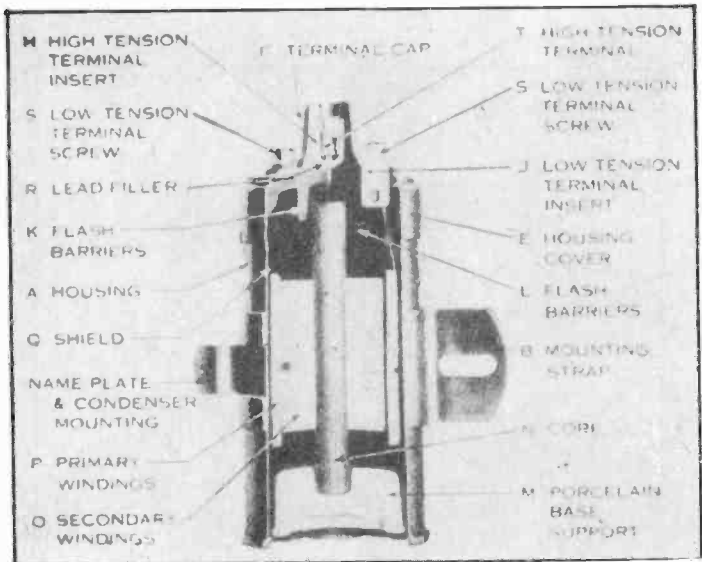

Fig. 3. Diagram showing a sectional view of an ignition coil and the location and names of each of the important parts.

core which is laminated or built up of a bundle of soft iron wires, on which are wound two separate windings called a primary and secondary. The primary winding generally consists of about 200 turns of No. 18 wire and is connected in series with the battery and a make and break contact or **interrupter**. The secondary winding generally consists of about 12,000 turns of No. 36 wire and is connected in series with the spark plug gap.

Automotive Electricity

Fig. 3 is a sectional view of an ignition coil, showing the position of the core and coils within the case and also giving the names of the more important parts.

You already know that with a transformer of this type, when alternating current or pulsating current is passed through the primary winding consisting of a smaller number of turns, a much higher voltage will be induced in the secondary winding because of its greater number of turns. As the current supplied by the automobile battery or generator is D. C., it is necessary to provide some form of make and break device in the primary circuit of the ignition coil, in order to cause the variation of the current and magnetic flux necessary for the induction of the high voltage in the secondary.

Fig. 4 is a diagram showing some of the essential parts and the operating principles of a modern battery ignition system. When the switch, SW., and the contacts, A, of the interrupter are closed, current will flow from the positive terminal of the battery, through the primary winding of the ignition coil, through the interrupter contacts; then, through the grounded connections and metal frame of the car, back to the battery.

This flow of current sets up a strong magnetic field around the iron core of the ignition coil. As the engine operates, the cam (B) is caused to rotate and each of its projections bump the movable spring contact, causing the circuit to be momentarily opened at "A".

Each time the circuit is thus opened the magnetic flux around the core in the ignition coil collapses and induces a momentary high voltage in the secondary winding. You will note that one end of this secondary coil is connected to the primary terminal and has a circuit back through the battery to ground G. The other end of the high-tension winding goes to the spark plug, so that the high voltage will flash across the spark plug points in the form of a hot spark; then from the shell of the plug to the ground connection, G2, and back through the metal frame of the engine to the grounded battery

Ignition Systems

terminal, and on to the start of the secondary coil. This completes the high-tension circuit for one plug.

The voltage induced in the secondary winding of the coil not only depends upon the number of turns in the secondary and the amount of flux set up by the primary, but also depends upon the speed of flux collapse around the coil and core when the breaker points open the circuit.

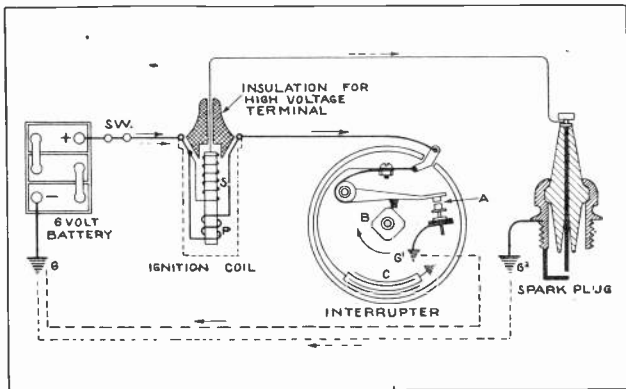

Fig. 4. This simple sketch shows both the primary and secondary circuits of a battery type ignition system. Trace the primary current through the heavy wire and ground connections, and the secondary current through the small wire, spark plug, and ground connections.

When the primary circuit is opened the current flow does not stop instantly because of the effect of self-induction in the windings. The collapsing flux induces a rather high voltage in the turns of the primary winding, and tends to maintain a current flow in the form of an arc across contacts A for a small fraction of a second after these contacts are open.

This tends to slow up the flux collapse and thereby reduce the voltage induced in the secondary. The arc that is caused at the breaker points by this self-induction would also tend to burn and damage the surface of these points if something were not done to quickly extinguish the arc.

3. IGNITION CONDENSERS

To eliminate the arc at the breaker points and also

Automotive Electricity

to counteract the tendency of current to flow after the primary circuit is broken, a device known as an **ignition condenser** is used.

In Fig. 4 this condenser is shown at "C", and is connected directly across or in a parallel with the contact points at "A".

These condensers consist of a number of layers or small sheets of tinfoil separated by sheets of insu-

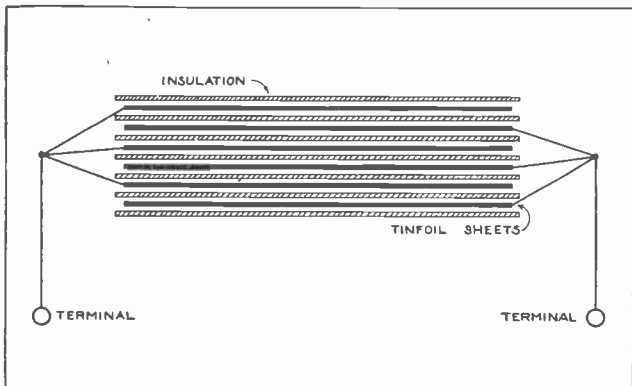

Fig. 5. Diagram showing the construction of a simple condenser with groups of conducting sheets separated by sheets of insulation. In ignition systems it is very important that this insulation be in good condition and have no shorts or grounds.

lating material, usually paraffin paper or mica. Alternate tinfoil sheets are connected together forming one terminal of the condenser, and the remaining sheets form the other terminal, as shown in Fig. 5.

With the condenser connected across the points as shown in Fig. 4, when the points open the primary circuit the self-induced voltage* which tends to keep current flowing through the primary is absorbed by the condenser. This induced voltage, which at times reaches an instantaneous value of 200 volts, charges the condenser instead of forming an arc at the breaker points.

The charged condenser then applies a back voltage to the primary coil and circuit, thus effecting an almost immediate stoppage of current flow and greatly speeding up the demagnetization of the iron core.

Ignition Systems

This increase in the speed of flux collapse greatly increases the voltage induced in the secondary and applied to form the spark at the plug points. In fact, a coil with a good condenser of the correct capacity may often produce a spark ten times as great as a coil without any condenser. If the condenser is defective the ignition system will not operate properly.

In addition to this great improvement in the ignition itself, the condenser greatly increases the life of the breaker contacts and enables them to operate for long periods without attention, by almost entirely eliminating the arc when these points open the primary circuit.

4. EFFECTS OF SELF-INDUCTION

A fact that has a very important effect upon the operation of ignition coils is that it requires a small fraction of a second for the current in the primary coil to build up to full value after the breaker points are closed. This is also due to the counter-voltage of self-induction. The time required for the current to build up to maximum value depends upon the design of the coil and the self-induction of the primary circuit.

This becomes a very important factor, particularly with high-speed engines with a large number of cylinders, because, as already mentioned, it may be necessary for the breaker points to open and close several hundred times per second. If there is not sufficient time between the closing and opening of the breaker points for the primary current to build up to full value, then when the points are opened there is less flux to collapse across the secondary turns, and there will be less induced voltage in the secondary and at the spark plug points.

An ordinary ignition coil may require approximately .012 of a second for its primary current to build up to full value after the points are closed. By changing the design of the coil and providing a magnetic circuit of lower reluctance and a primary winding with less turns, it is possible to reduce the

Automotive Electricity

amount of self-induction in the winding and thereby speed up the action of the coil.

Referring to Fig. 6 and carefully comparing the curves for the fast and slow ignition coils, you will note that on the coil design for fast operation the current can build up to its full value of approximately 6 amperes in a time of .006 second; while the slow coil requires approximately .012 second, or twice as much time, to build up to its maximum current.

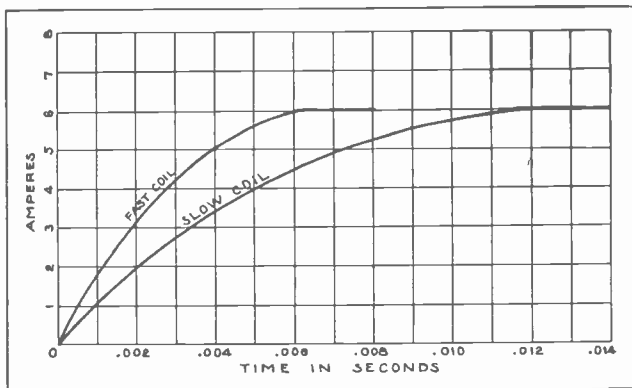

Fig. 6.—The above curves show the difference in time required for different types of coils to build up their full primary current after the breaker points close.

From this we can see that the design or speed of operation of ignition coils is very important and must be considered when changing or replacing coils, particularly on high-speed engines.

A slow speed coil would require the breaker contacts to be closed for nearly .012 second in order to build up full current and obtain a good spark on each break, and with high-speed engines the period during which the breaker points remain closed may be considerably less than .006 second.

This matter of speed or time lag in the operation of ignition coils also explains why the sparks supplied by the battery ignition system become weaker as the engine approaches higher speeds; because, as the speed increases, the period of time during which the breaker contacts remain closed becomes less.

Ignition Systems

5. IGNITION COIL RESISTANCE

Decreasing the number of turns in the primary winding of an ignition coil to speed up the action of the coil has the undesirable effect of reducing the primary resistance to a point that will cause it to take an excessive current at low engine speeds when the breaker points are allowed to remain closed for longer periods. This tends to cause the coil to overheat

To prevent this a current-limiting resistance is connected in series with the primary winding of the ignition coil. This resistance is made of material of such a nature that its resistance increases with its current and temperature.

When the engine is operating at high speed and the breaker points are closed only for very short periods the current flow through the primary and the resistance is less. This allows the resistance unit to remain cool and keeps its resistance low, so that it does not interfere much with the flow of current through the coil primary.

As the engine speed is reduced and the breaker points are closed for longer periods, allowing the coil to draw a heavier current, this increased current raises the temperature of the resistance unit, causing its resistance in ohms to increase and thus limiting the primary current to the proper value to prevent overheating of the winding and coil.

This small resistance unit also protects the coil from burning out in case the ignition switch is left turned on when the engine is stopped, and also during the periods of high voltage which may occur due to faults in the generator.

Excess current from either of these causes will heat up the resistance element to a point where its resistance becomes very high, thus limiting the current flow and protecting the coil.

In case the switch is left on too long or the generator fault is not removed, the resistance unit may be burned out and thus open the circuit; but this unit is much easier and cheaper to replace than a burned out coil would be.

Automotive Electricity

This action continues until the upper spring strikes a stop on the under side of the adjusting bar; and at this point a quick, snappy break is effected.

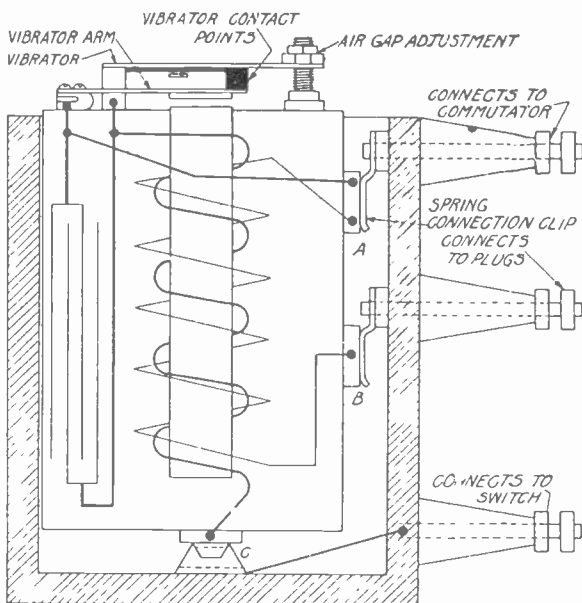

Fig. 7. Diagram of a vibrating type spark coil such as used on older model Fords and single-cylinder gasoline engines. Note the location of the condenser and trace out both primary and secondary circuits carefully.

6. VIBRATING-TYPE IGNITION COIL

Some of the earlier types of ignition systems used the vibrator-type spark coil. On these coils the circuit is made and broken by a magnetically operated armature and a set of contacts attached directly to the end of the coil, instead of being broken by the breaker points in the distributor as with modern ignition systems.

Fig. 7 shows a coil of this type mounted in a wooden box equipped with spring contacts and screw terminals for completing the circuits through the ignition wires. When this coil is connected in the ignition circuit the current enters the terminal marked "connect to switch" and flows around the

Ignition Systems

primary winding, through the vibrator contacts, to the terminal marked "connect to commutator".

From this point it flows through the timer or "commutator", and back to the battery. When the current flows through the coil the iron core becomes magnetized and pulls down the steel spring or armature to which the lower contact is attached, thus breaking the primary circuit and inducing the high voltage in the secondary.

Breaking the circuit by demagnetizing the core allows the spring to move up and again close the contacts, thus repeating the operation very rapidly as long as the primary circuit is completed by the timer.

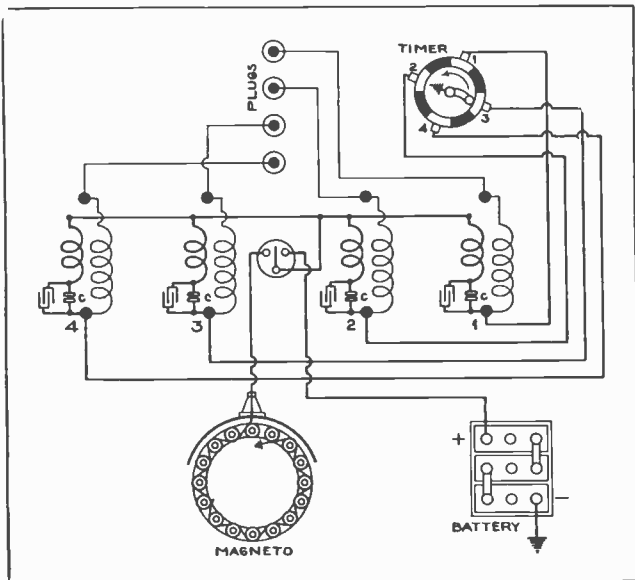

Fig. 8. Wiring diagram of the ignition systems used on the Model T or older type Fords.

These contacts when properly adjusted vibrate with a speed of 200 breaks or more per second. To prevent the contacts from opening before the coil is fully magnetized, the upper contact is also mounted on a spring and tends to follow the lower contact down a short distance when it is attracted

Automotive Electricity

to the core.

This action continues until the upper spring strikes a stop on the under side of the adjusting bar; and at this point a quick, snappy break is effected.

The vibrator can be adjusted by turning the nut at the end of the adjustment bar, thus varying the distance between the spring and the iron core. Coils of this type were used extensively on model T Fords, but are now considered obsolete for automobile use.

Fig. 8 shows a wiring diagram of the ignition equipment for the model T Ford. You will note that these systems used four separate spark coils, one for each cylinder, and that the current from the battery was supplied to the primary of each spark coil at the proper time by means of the timer, or "commutator."

By tracing out this diagram you will find that current flows from the positive terminal of the battery to the switch which is used for connecting the ignition system to either the battery or the magneto. From the switch the current is supplied to a common bus or battery connection which feeds to all primary windings of the ignition coils.

Tracing the circuit of coil 3, the current would flow through the primary, then through the vibrator contacts, C, and out along the wire to terminal 3 on the timer; then through the rotor or movable arm of the timer to ground. From the ground connection it returns to the grounded negative of the battery, thus completing the circuit for this coil.

As the timer arm rotates counter-clockwise, as shown by the arrow, it closes the circuits to the primaries of the various coils in the order 1, 2, 4, 3. As each coil is excited in turn it delivers a spark from its secondary directly to the spark plug to which it is connected.

From this we find that systems of this type use four ignition coils instead of one coil as used by modern systems. The vibrating contacts on these coils also have a tendency to wear out or become burned and blackened, so that they require more or less frequent attention.

Note that the timer, which at the proper instant

Ignition Systems

supplies the current to the various coils in order to create sparks at the right time in the different cylinders, is located in the primary circuit to the coils.

Modern ignition systems use a distributor in the secondary circuit and this will be explained in later paragraphs.

7. SPARK PLUGS

In order to introduce the ignition sparks inside the cylinders or combustion chambers, some highly insulated heat-resisting device is needed to carry the high voltage through the metal cylinder-head to the spark plug point located inside. For this purpose spark plugs are used.

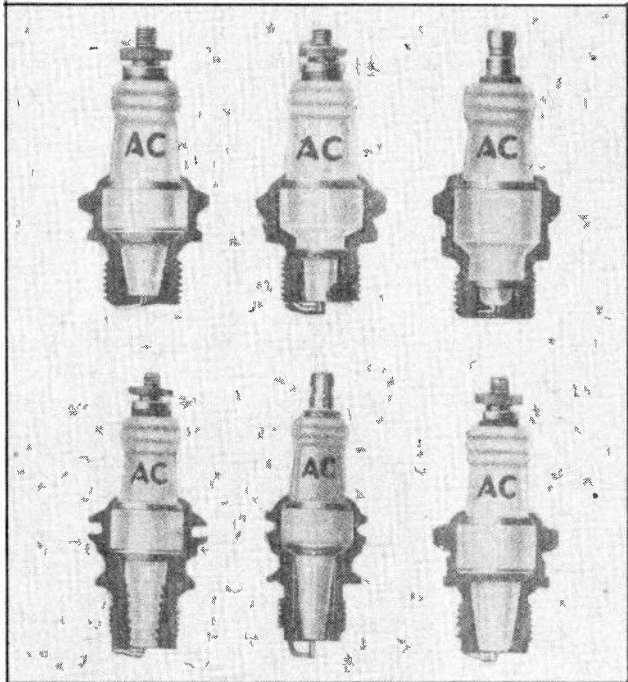

Fig. 9. Above are sectional views of several types of spark plugs showing their construction and the arrangement of the metal and porcelain parts, as well as the electrodes or points.

Spark plugs are made in a number of different

Automotive Electricity

types, but in general they consist of a threaded metal shell which screws into the opening in the cylinder-head and which contains the electrodes or spark gap terminals, and a heavy porcelain or mica insulator which has the high-voltage terminal run through its center. The outer end of this insulated high-voltage terminal is equipped with a nut or clip for attaching the high-tension ignition wire.

Fig. 9 shows several different styles of spark plugs, and Fig. 10 shows sectional views of several plugs with each of the various parts marked and

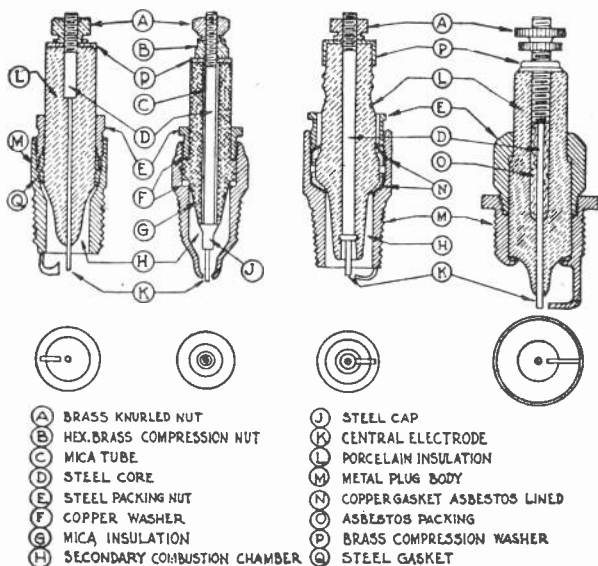

Fig. 10. This diagram also shows sectional views of several different spark plugs and gives the names of the various parts.

named. Examine this figure very carefully until you are sure you are thoroughly familiar with the construction of these devices.

Because of the very severe conditions under which spark plugs operate they must be carefully designed both as to materials and shape, and it is also very important to use the proper plugs when replacing old ones in an engine. The porcelain insulator for the center electrode must be a good insulator capable of withstanding at least 8000 volts or more, and

Ignition Systems

should maintain its insulating qualities at very high temperatures. Under certain conditions this insulator may be subjected to temperatures of over 3000° F.

If this insulator cracks or breaks down in any way the high voltage will leak from the center electrode directly to the shell of the plug and be grounded to the engine without passing across the spark gap between the electrodes inside the cylinder. Porcelain is used almost entirely for insulation in spark plugs made by leading manufacturers.

The metal used for the electrodes themselves should have a rate of expansion approximately equal to that of the insulation, so that it will not crack the insulator with changes of temperature and will not loosen and allow leakage of the compression or expanding fuel gases. This metal should also be of such a nature that it will not be rapidly burned away by repeated sparks, and it should not distort or change the length of the spark gap appreciably with various changes in temperature. The metal generally used for these electrodes is a nickle alloy.

The spark plug shells are made of steel and they are threaded on their lower ends to fit tightly into the threaded openings in the cylinder head and also to allow the plugs to be conveniently removed for cleaning, adjustment, or replacement.

If the plug points become badly fouled with carbon, it may tend to short circuit them and reduce the heat of the spark. In such cases the plugs should be removed and scraped or sand blasted clean. If the points become bent or badly burned away this may interfere with the efficiency of the spark and ignition of the fuel mixture, and such points should be adjusted or the plug replaced with a new one.

The top or outer end of the porcelain insulator should be kept free from dirt and moisture; otherwise the high-voltage energy may leak from the connection terminal down over the surface of the insulator to the metal plug shell, instead of flashing across the points inside the cylinder as it should.

Automotive Electricity

8. SELECTION OF PROPER TYPE PLUGS

There are two different sizes of spark plugs used in automobile engines and these are classified according to the type of threads used on the plug shell, and according to the diameter of the threaded portion of the shell.

The S.A.E. plug, so called because it has been declared standard by the Society of Automotive Engineers, has a diameter of $\frac{7}{8}$ of an inch at the threaded portion and is still used by the majority of automobile manufacturers. The other type of plug is known as the "metric" plug, because it uses metric threads and has a diameter across the threads of 18 millimeters (approximately $\frac{11}{16}$ of an inch).

Due to the definite tendency toward higher compressions and higher operating temperatures in modern engines, the metric plug is coming into favor with engine manufacturers. Its smaller diameter results in less distance between the plug points and the water-cooled metal of the engine, and this means that the heat from the plug points is dissipated more quickly, thus enabling the plug to run cooler at very high engine temperatures.

When changing spark plugs in an engine, the manufacturer's recommendations should always be followed; that is, plugs should be replaced with those of the same type as originally supplied.

Extreme operating conditions may occasionally make it necessary to change the type of plugs, but in general this should not be done. One reason for using the same type of plugs is that the thickness of metal in the cylinder head varies with different engines, so various engines require longer or shorter plug bodies below the threaded portions in order to locate the points in the best igniting position in the combustion chamber.

Spark plug bodies are made in different lengths—short, medium, and long. If a long bodied plug is used in an engine built for short plugs the lower end of the plug will extend too far into the combustion chamber, as shown at the left of Fig. 11, and it may be bumped and damaged by a moving

Ignition Systems

valve or the top of the piston. This will also cause the plug points to overheat and may cause pre-ignition or early firing.

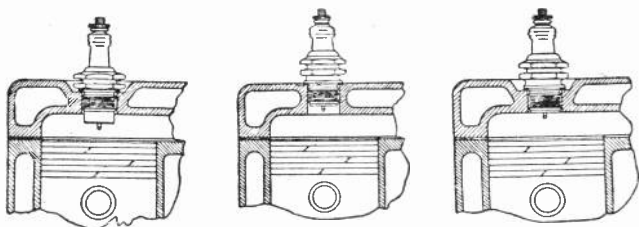

Fig. 11. The above sketches show spark plugs improperly fitted to the cylinders on the left and properly fitted in the cylinder on the right.

On the other hand, if a plug that is too short is used the points will be located in a pocket above the combustion chamber, as shown in the center view in Fig. 11. There is a tendency for dead gas to lie in this pocket and cause such a plug to misfire. This position of the plug points will often cause them to become badly fouled with carbon. In a few cases of extreme operating conditions short plugs may be temporarily used to avoid overheating and other troubles.

On the right in Fig. 11 is a plug of the proper length with its lower end just flush with the upper surface of the combustion chamber, and with the electrodes or spark points projecting about $\frac{3}{16}$ of an inch into the chamber.

The distance or spacing between spark plug points has a very definite effect upon the performance of the engine. Incorrect setting of these points will often cause irregular operation and sometimes complete failure of an engine.

For low compression a gap of approximately .030 inch gives best results. High-compression engine will usually operate more satisfactorily with a shorter plug gap of about .025 inch for engines with compression pressure exceeding 80 lbs. per square inch.

In many cases the exact proper setting can only be determined by experiment or test, the best setting depending upon the running speed at which perfect performance is desired. For example, good

Automotive Electricity

low-speed operation can best be obtained with a rather wide gap setting while at very high speeds best performance is often obtained by closing up the plug gap slightly.

9. SPARK PLUG HEAT RANGES

To give satisfactory performance spark plugs must operate within a certain temperature range. They should not run too hot or too cool. The temperature should be high enough to burn away oil or carbon as they collect on the insulator, otherwise the plug will become short-circuited, and require cleaning. On the other hand, if the operating temperatures are too high, blisters will form on the insulators, electrodes will wear away rapidly and pre-ignition may occur with its loss of power and poor engine performance.

The heat range of a plug is determined by the ability of the insulator to conduct heat away from its hot lower end, to the metal shell of the spark plug. The metal shell is cooler because of its contact with the water-cooled engine block. Just how fast this heat can be carried away depends largely on the length of the path the heat will have to follow.

For example, if the path is long as in plug A, in Fig. 12, heat dissipation will be slow, and the insulator will maintain a high temperature. This type of plug is known as a "hot plug" and is suitable for engines that tend to run cool, due to design or operating conditions. Used in such an engine, the temperature of the insulator will be high enough to burn away oil or carbon as they collect on the plug.

On the other hand, if the path of heat travel is short as in plug C, the heat will be carried away rapidly, which would prevent the insulator from becoming overly hot even when used in an engine that has a tendency to run at high temperatures. This plug would be known as a "cold plug."

Automobile and engine manufacturers, always select a plug having a heat range that is satisfac-

Ignition Systems

tory for average driving conditions. However, a plug that is correct for average driving conditions may not be satisfactory if the car is operated at high speed over long periods, or under a constant heavy load. The heat generated under these conditions may not get away fast enough and the plug will become too hot causing pre-ignition, fast burning away of the plug electrodes and in some cases blistering of the insulator, which will eventually lead to short-circuited plugs and faulty engine operation.

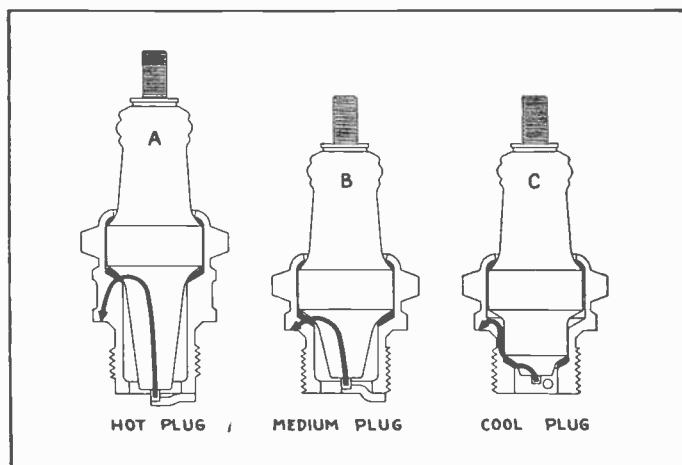

Fig. 12. Sectional views of A. C. spark plugs. Note length of heat path as shown by arrows.

If a cold type plug is used in an engine that is only driven for short distances and allowed to idle for long periods, the heat generated in the plug may be carried away so fast that the insulator may operate at too low a temperature, causing the plug to carbonize rapidly. Or if the engine has a tendency to pump oil, the cold plugs will become oil fouled.

To meet these unusual driving and engine conditions spark plug manufacturers build plugs having different heat ranges. One prominent manufacturer makes plugs with 18 different heat ranges, running from an extremely cold plug, suitable only for racing engines that operate at high temperatures, to a

Automotive Electricity

very hot plug suitable for engines that run cool and tend to pump oil.

All A. C. plugs have a number on the insulator. This number indicates in sixteenths of an inch, the length of the insulator that is exposed to the heat of the combustion chamber, or the length of the path that the heat has to travel in order to reach the metal shell of the plug. The lower the number, the shorter the path, and the cooler the plug. The higher the number, the longer the path, and the hotter the plug.

Manufacturers and distributors of spark plugs put out heat range charts that are useful in selecting plugs to meet unusual operating conditions. Service manuals always give the type of plug that the engine builder found to be best for average driving conditions, and this is the plug that should be used in replacing plugs that have worn out in service. But if you have a case of chronic fouling, then a plug "hotter" than the original should be tried.

In cases of pre-ignition, blistered insulators, or electrodes burning away rapidly, you should try a cooler plug. If the plug develops "Blow-by" which will be indicated by a black streak on the outside or upper part of the insulator, try a cooler plug.

In making a change from the plugs or recommended heat range, it is not a good policy to make too much of a change at once. It is best not to lower or raise the heat range more than two numbers for a trial.

10. DISTRIBUTORS

On a modern ignition system the ignition coil produces the high-voltage impulses at the right time by the operation of breaker points or an interrupter such as was shown in Fig. 4. To deliver these high-voltage impulses to the proper spark plugs or to the cylinders in their proper firing order a device called a distributor is used.

The diagram in Fig. 13 illustrates the operation of this distributor. The rotor, R, is driven by a

Ignition Systems

direct connection to the engine, so that it always revolves at a definite speed with respect to the engine speed. This rotor arm is connected to the high-tension lead from the ignition coil; so that as it revolves it delivers the spark impulse to the spark plugs in the various cylinders in the order in which they are connected to the stationary contacts in the distributor cap, which is made of insulating material.

The current flows from the distributor wires through the center electrodes of the various plugs; then across the spark gaps to the plug shells, which, of course, are grounded to the engine and allow the current to flow back through the engine and frame to the grounded terminal of the battery, and then to the return of the ignition coil secondary.

The term "distributor" is generally applied to the complete unit which contains both the interrupter points and the distributor rotor and contacts.

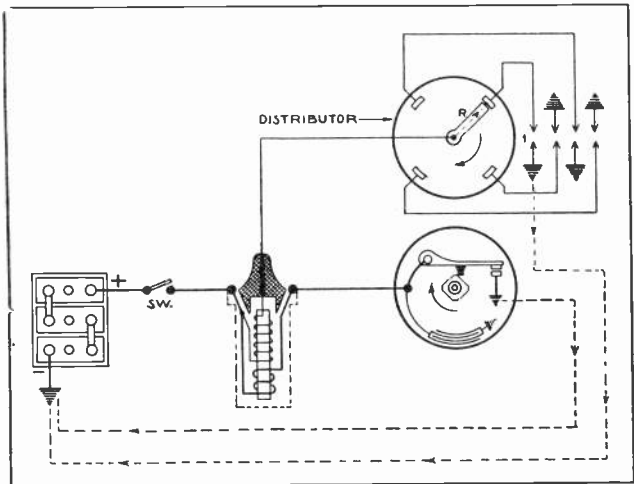

Fig. 13. Diagram of a battery ignition system showing both the primary circuit through the breaker points and the secondary circuit through the distributor arm contacts to the spark plugs.

Fig. 14 shows a photograph of a distributor with the "cap" or "head" removed. This cap is shown at the upper right with its terminals for connecting

Automotive Electricity

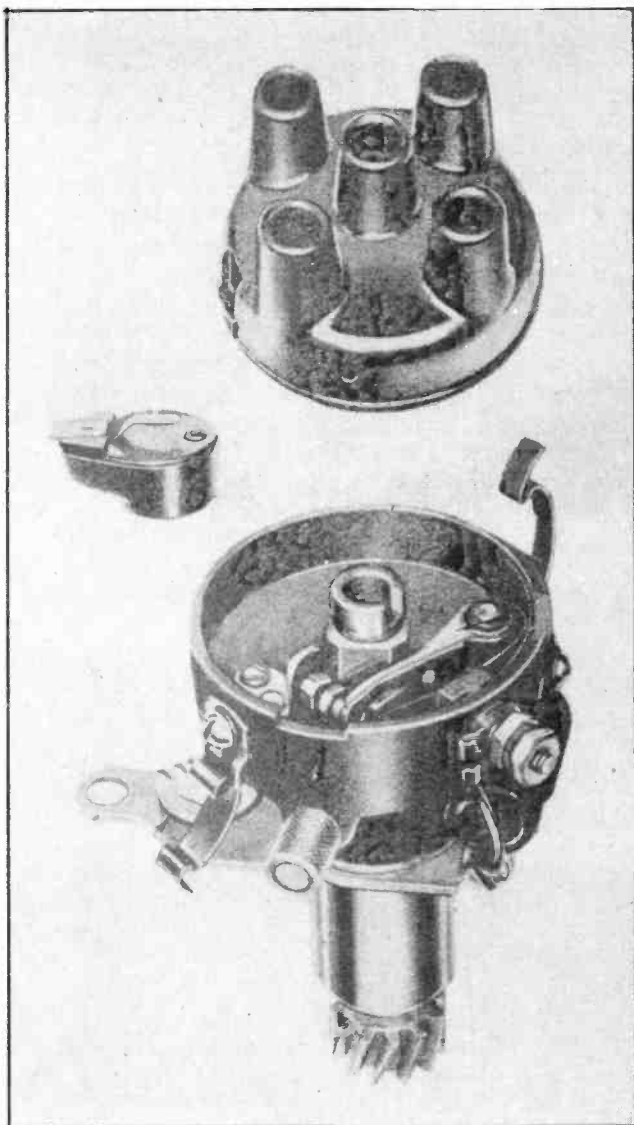

Fig. 14. This view shows a distributor with the high tension cap and rotor removed so that the primary breaker points and cam can be clearly seen in the distributor housing.

Ignition Systems

the high-tension ignition wires. The one high-voltage wire from the ignition coil always connects to the center terminal of these caps, while the spark plug wires connect to the outer terminals in the proper order.

This distributor cap or head is made of bakelite or a compound of high insulating quality. On the inner-side of the cap are located metal electrodes or stationary contacts for each terminal. The small rotor shown at the upper left fits on the top of the distributor shaft directly above the cam and rotates when the engine is running, delivering high-voltage impulses to the plugs through the stationary contacts in the distributor caps as it passes them.

In the lower part of Fig. 14 is shown the interrupter mechanism with the breaker points and cam in plain view. The small metal lever projecting to the left and fitted with a round eye is for shifting the distributor to advance or retard the spark by moving the breaker points a slight distance around the cam.

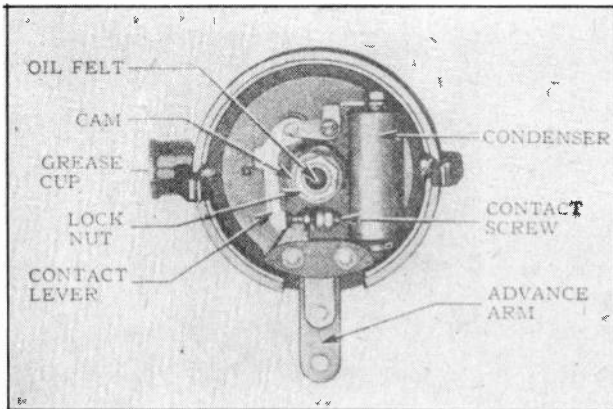

Fig. 15. Top view of the breaker mechanism and condenser of an ignition distributor. Note the names of the various parts.

Fig. 15 is a top view of a distributor with the cap removed to show more clearly the breaker arm or contact lever, breaker contacts, cam, and condenser. The arm for shifting the breaker mechanism to ad-

Automotive Electricity

vance and retard the spark is also shown in this view.

The number of sparks generated per revolution of the distributor shaft will depend upon the number of corners or projections on the cam. If the cam is four-cornered four sparks will be produced, and if the cam is six-cornered six sparks will be produced for each revolution.

As any automotive engine fires all cylinders in two revolutions of the crank shaft and the distributor is built to generate the sparks required for all cylinders in one revolution of the distributor shaft, the distributor therefore must be geared to the engine so that it rotates at one-half engine speed. This rule applies to all automotive engines.

11. METHODS OF ADVANCING THE SPARK

We have already mentioned the necessity for advancing the spark to obtain earlier ignition of the fuel charge and maximum power and efficiency when the engine is operating at very high speeds. There are two general methods used for advancing and retarding this spark through shifting the breaker plate or housing around the cam in the distributor.

These methods are the **manual control**, or hand-operated method, and the **automatic control** obtained by means of governor weights which advance the spark automatically with an increase of engine speed and without any attention from the drivers.

The manual method advances the spark by moving either the breaker plate or the entire distributor housing to shift the breaker contacts a slight distance around the cam. Moving the breaker contacts in the opposite direction to cam rotation causes the contacts to open sooner and advance the spark; while moving the housing or breaker in the direction of rotation of the cam will retard the spark. This movement is generally obtained by the driver moving a small lever attached to the steering wheel and connected through a rod to the lever on the side of the distributor.

Ignition Systems

Efficient engine operation requires a gradual advance of the spark as the engine speed is increased and a proportional retarding of the spark as the engine speed is reduced. It is practically impossible to meet this condition by hand operation, but the spark advance and retard can be much more accurately regulated by automatic control.

Automatic spark advance is generally accomplished by shifting the position of the cam with relation to the distributor shaft. The cam is mounted in a such a manner that it can be moved around the shaft a slight distance in either direction.

The operating mechanism consists of a set of weights which are attached to and rotate with the distributor shaft. As the speed of the shaft increases with an increase in engine speed, centrifugal force causes the weights to move outward from the shaft, the amount of this movement being proportional to the speed of the engine.

The governor weights are attached to the cam so that they cause it to shift around the shaft in the direction of rotation as the weights fly outward, thus advancing the spark. When the speed is decreased the weights are drawn in by springs and the cam gradually moves back against the direction of rotation and retards the spark.

Fig. 17 shows a distributor of the automatic spark-advance type, with the cap and breaker element removed and the governor unit raised up out of the housing to show the weights and springs clearly. A loose cam is shown directly above the governor unit. When this cam is set in place on the shaft the wings on each side of its lower end fit over the pins on the governor weights; and, as these weights are thrown out or drawn in, the pins shift the position of the cam with respect to that of the shaft, thus effecting smooth and automatic adjustment of the spark with various engine speeds.

12. TIMING THE IGNITION

Timing the ignition means setting the distributor so that it supplies the spark to the correct-cylinder at the right time; that is, not too late or too early.

Automotive Electricity

The method used to accomplish this vary somewhat with differences in distributor design; but the general procedure should be as follows:

GENERAL IGNITION TIMING RULES

1. Turn engine over slowly until No. 1 piston is at T.D.C. of the COMPRESSION STROKE, or IGNITION TIMING MARKS line up with TIMING POINTER with No. 1 piston on COMPRESSION stroke. To determine compression stroke:

Method 1. Remove No. 1 spark plug and feel for pressure with thumb as piston comes up on compression.

Method 2. Watch last valve (exhaust valve). As last valve begins to close No. 1 piston is approaching T.D.C. of the compression stroke.

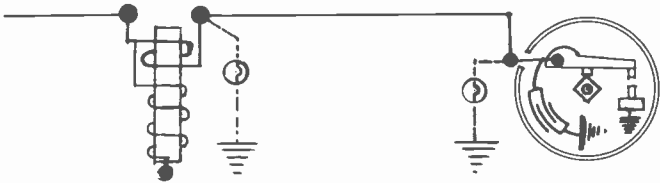

Location of ignition timing marks:

- (A) FRONT FACE of flywheel (viewed through timing window in flywheel housing)
 - (B) ON RIM of crankshaft pulley at FRONT END of engine.
2. Have breaker unit completely installed. Primary lead, spark advance equipment, etc., all connected. BREAKER POINTS adjusted to manufacturer's specifications. (If no data is available set at .018")
 3. If octane selector or fuel selector is provided, set at ZERO or MID SLOT. If manual spark advance is used, set manual spark advance control in RETARDED POSITION.
 4. Connect 6 volt timing lite in PARALLEL with breaker points. (See Diagram.) Diagram shows two places where timing lite can be connected.
 5. Turn ignition "ON".

Ignition Systems

6. If solid cam type unit: Loosen clamping screw under breaker housing and rotate housing AGAINST normal cam rotations until breaker points just begin to open (6 volt lite lights up) and distributor rotor lines up with distributor contact No. 1 if cap is numbered, if not numbered any contact segment that the rotor lines up with becomes No. 1. Tighten clamping screw. If locked cam type: Loosen breaker cam and rotate WITH normal cam rotation until breaker points begin to open and distributor rotor lines up with distributor contact No. 1 if cap is numbered. If not numbered, any distributor cap contact that rotor lines up with becomes No. 1. Tighten cam locking screw.
7. Install spark plug cables according to numbers on distributor cap or if not numbered according to firing order and rotor rotation.
8. Testing:
 - (A) Shop test: (If timing marks are provided) Connect neon timing lite in SERIES with spark plug No. 1. Start engine and run at SLOW idle. Hold neon lite so that its flash will illuminate timing pointer. If timing is not correct, correct by LOOSENING and ROTATING housing or cam according to type of unit. DO NOT MAKE CORRECTIONS WITH OCTANE SELECTOR OR FUEL SELECTOR. CORRECTIONS ON SOLID CAM TYPE UNIT MADE WHILE ENGINE IS RUNNING AT SLOW IDLE.
 - (B) Road test: With engine WARM, drive car at 7-8 m.p.h., then push throttle wide open. If engine is sluggish, spark is too late. If engine knocks very noticeably, spark is too early. Correct either condition with octane selector or fuel selector. A slight ping should be heard as car speed increases from 10 to 20 m.p.h. on a level road with wide open throttle.

On some distributors the spark lever is riveted to the housing and cannot be moved. In such cases timing is effected by adjusting the cam on top of

Automotive Electricity

the shaft to a point where the rotor is lined up with segment 1 on the distributor cap as the breaker contacts are just opening. The cam is then locked in position by the locking screw or lock nut.

After the ignition has been timed, it is a good plan to carefully check the wires in the distributor cap to see that they are correctly connected. To do this the firing order of the engine and the direction of rotation of the rotor arm must be known.

The firing order is usually stamped on some part of the engine; but, if not, it can be readily determined by the methods explained in previous articles.

For example, on a six-cylinder engine with the firing order 1-5-3-6-2-4, No. 5 cylinder fires immediately after No. 1 and the wire from No. 5 spark plug should connect to the distributor cap segment that the rotor arm passes next after No. 1. The wire from No. 3 cylinder should connect to the next segment. And so on until they are all attached in the proper order. This method applies to all distributors using a single rotor arm.

13. SETTING THE ENGINE ON UPPER DEAD CENTER

One of the easiest methods of setting No. 1 piston on U.D.C. and one that can be applied to all side valve engines, is the "spark plug leakage" method. Unscrew the plug in cylinder No. 1 a few turns so that air can leak past its threads. Then pour into the recess around the plug just enough oil to seal this air leak. A couple of shots from an oil can will generally be sufficient.

Next, crank the engine slowly until bubbles are seen coming through the oil, which means that the piston is coming up on the compression stroke. Now bump the crank around just a little bit at a time and at each movement watch for the bubbles. When a point is finally reached where no bubbles arise when the crank is moved, that will be U.D.C.

Ignition Systems

The above method cannot be used on overhead valve engines as the plugs are generally screwed into the side of the cylinder instead of the top. With engines of this type the U.D.C. for cylinder No. 1 can be found by watching the valves. It

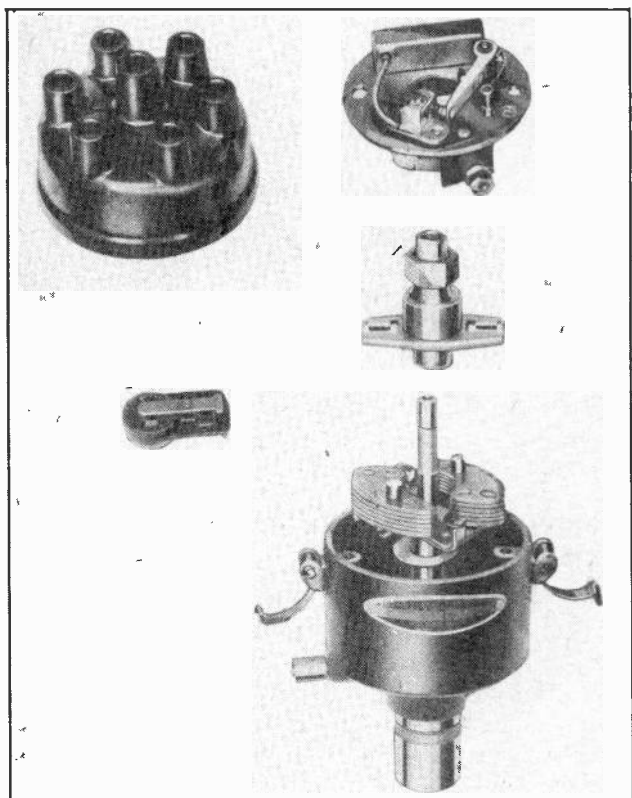

Fig. 17. Disassembled view of a distributor with automatic spark advance, showing the governor weights in the view at the lower right.

is reached just at the time the exhaust valve of the last cylinder closes or seats. This point can be determined by slipping a small piece of paper between the valve stem and rocker arm. As long as the rocker arm is holding the valve open against the

Automotive Electricity

tension of the spring the paper will be held firmly in place; but just as soon as the valve seats or closes, this tension will be removed from the paper and it will slip out if lightly pulled upon.

Remember that it is the **exhaust valve** in the **last cylinder** which is to be observed to determined upper dead center for **No. 1 cylinder**.

EXAMINATION QUESTIONS

1. Name five important parts of an Electrical ignition system.
2. Briefly describe the construction of an ignition coil, and explain why it is used.
3. A. Why are condensers used in an ignition system?
B. In what part of the circuit are they connected?
4. What is the approximate spark plug gap most commonly used for modern automobile engines operating at the higher compressions?
5. Briefly explain the difference in construction between a "hot plug" and a "cold plug."
6. What kind of a spark plug would you select for use on a motor which has a tendency to run cold?
7. How does the speed of the distributor rotor compare to the speed of the engine?
8. Name two methods used for advancing or retarding the spark on an automobile engine.
9. Which method of spark control do we find in use on most modern cars? Why?
10. Explain how you would time the ignition system on an automobile engine.

SPECIAL IGNITION SYSTEMS FOR HIGH-SPEED ENGINES

Some of the high-speed, high-compression engines used on late model automobiles require specially designed ignition systems for maximum operating efficiency. This can be better understood if we consider the fact that a six-cylinder engine using a six-cornered cam in the distributor and rotating at 3000 R.P.M. will have its breaker contacts opening 150 times per second, and these contacts remain closed only for about .004 second each time after making the primary circuit. These periods will be still shorter on a high-speed eight-cylinder engine.

In order to secure satisfactory operation at such speeds the ignition coil must be fast enough in action to build up its current during the short period of contact closure, and the breaker must do its work very accurately.

During the very short period that the contacts are closed a good contact without chatter or vibration must be made; otherwise the coil will not have time to completely magnetize and a very weak spark or complete miss will be the result.

1. DOUBLE OR "DUAL" IGNITION

To reduce the period of time required to burn the fuel charge and insure more complete combustion at high speeds, some engines are now being equipped with two ignition systems which operate together to supply two sparks to each cylinder.

These sparks occur at the same instant at different points in the combustion chamber, thus spreading the flame more quickly through the entire fuel charge.

The advantages claimed for the dual system are increased horsepower and efficiency, and also greater dependability because there are two separate ignition systems. If one should fail the engine can still be run on the other.

Fig. 1 shows a simple diagram of the coils, breaker, and high-tension leads to the distributor of

Ignition Systems

such a system. From this diagram you can see that there are simply two separate sets of breaker points,

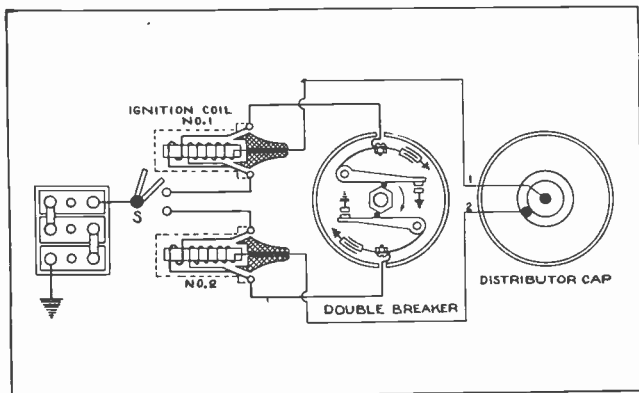

Fig. 1. This diagram shows the parts and connections of a dual ignition system used for firing two plugs in each cylinder. See the rest of this system in Fig. 2.

condensers, ignition coils, and high-tension leads to the distributor.

The only point at which these two systems are connected together is at the ignition switch, S; and, even though the two breaker arms are both operated by the same cam, they are electrically insulated or separated from each other.

Both breaker contacts are caused to open at the same time by the cam, and this causes a collapse of flux in both coils at the same time, in turn causing them to send high-voltage impulses to the two distributor terminals at the same instant. From this point the two impulses are delivered separately to the two spark plugs located in opposite sides of the combustion chamber.

Early types of double ignition systems used two separate distributor units, but these were later combined into one by changing the design of the rotor arm and distributor cap.

In Fig. 2 is shown a diagram of the connections from the distributor head to a six-cylinder engine equipped with dual ignition. The distributor cap has 14 terminals, 12 of which connect to the spark plugs, and the other 2 are connected to the high-tension terminals of the ignition coils.

Automotive Electricity

The rotor arm for such a distributor really consists of two arms electrically insulated from each other and rigidly connected together at an angle as shown in the figure. One arm conducts current from coil 1 to the spark plugs on one side of the engine. The other arm supplies current from the other coil to the plugs on the opposite side of the engine.

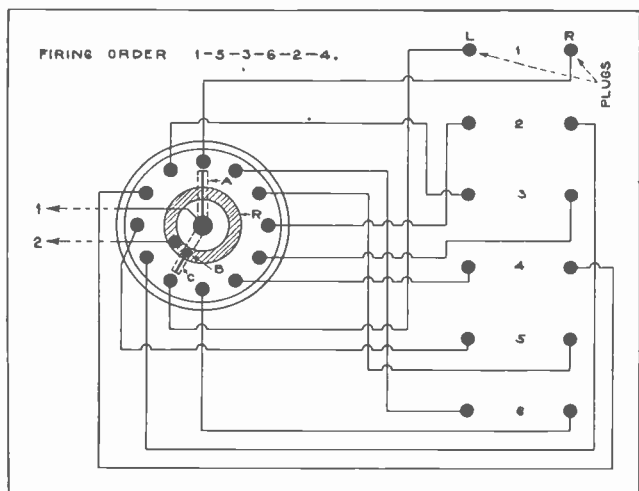

Fig. 2. Diagram showing distributor rotor arms and high voltage leads from the distributor cap to the spark plugs of a six-cylinder engine with a dual ignition.

The high-tension lead from coil 2 connects to a conducting ring or slip ring, R, imbedded in the insulation material of the cap. From this ring the current is collected by a small carbon brush, B, that is mounted on the upper side of No. 2 rotor arm. From this point it travels along the arm to the plug segments on the cap and then to the spark plugs.

Six double sparks occur during each revolution of the distributor which means that sparks are produced every 60° of shaft travel, or $360 \div 6$. However, the angle between the segments is only 30° , or $360 \div 12$, and from this it can be seen that the rotor arm, A, for example, doesn't fire at every terminal

Ignition Systems

it passes, but only at every other one. The same applies to rotor arm, C.

From the diagram you will note that when A is in position to fire any certain cylinder, C is in line with the segment which connects to the opposite plug in the same cylinder.

To obtain the best results from a double ignition system the sparks should occur at exactly the same time, and if they do not the breaker contacts should be adjusted so that they both open at the same instant.

To synchronize these breaker contacts, connect a six-volt test lamp in series with each set and then rotate the distributor shaft very slowly until one light goes out. Now adjust the other set of contacts which are still closed so that the second light goes out. If both contacts are correctly set both lights will go out at the same instant when the distributor shaft is slowly turned.

Fig. 3 shows the methods of connecting lamps for synchronizing and adjusting the breaker points of a double ignition system.

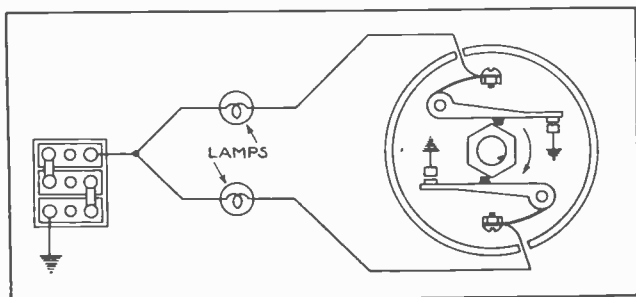

Fig. 3. This sketch shows the method of using test lamps for synchronizing breaker points of a dual ignition system.

2. SPECIAL DISTRIBUTORS FOR EIGHT-CYLINDER ENGINES

On account of the high operating speeds of modern eight-cylinder engines and because of the fact that every ignition coil requires a certain def-

Automotive Electricity

inite fraction of a second to fully magnetize its iron core, ordinary distributors have been replaced by specially designed units to meet high-speed requirements.

On earlier types of eight-cylinder distributors an eight-cornered cam and a single set of breaker contacts were used. This arrangement did not give good ignition at high speeds, as the period of contact closure was too short to allow the coil to become fully magnetized.

With eight-cylinder engines eight sparks must be produced in one complete revolution of the distributor shaft and cam, or one spark must occur for every 45° of shaft rotation, or $360 \div 8$. This means that the breaker contacts must open and close once in every 45° .

After the contacts have opened the insulated cam follower which is mounted on the movable breaker arm has to travel over the corner of the cam and down the other side before the contacts are closed again. For this reason the contacts are held open for a longer period than is necessary. This results in the contacts being closed for only 20° out of each 45° of rotation, and being open for the remaining 25° .

As the contacts need to be open for only 10° to effect a clean break of the primary current, we can see that 20° of opening is unnecessary. What is required, then, for high-speed eight-cylinder engines is a distributor which will open the contacts for 10° and allow them to remain closed for the balance of the 45° interval during which each break must occur.

This has been accomplished by using distributors equipped with a four-lobe cam and two breaker arms which are mounted at an angle of 45° to each other, as shown in the center view in Fig. 4. With this arrangement the breaker arms are raised one at a time or alternately at 45° intervals so that one set of contacts closes 10° after the other set opens.

As both sets of contacts are connected in parallel in the primary circuit, the circuit is kept closed ex-

Ignition Systems

cept for the 10° intervals during which both contacts happen to be open.

As each set opens four times in one revolution of the distributor shaft and also opens at a point 45° from the opening of the other set, eight sparks per revolution are obtained, thus providing the proper number of sparks for an eight-cylinder engine.

Keep in mind that with this type of distributor when either set of contacts opens the other set is still open for another 10° ; so, even though the contacts are in parallel, this effects a complete opening in the circuit for a period of 10° once during each 45° .

The sketch on the left in Fig. 4 shows 45° of the rotation of the old type distributor, illustrating

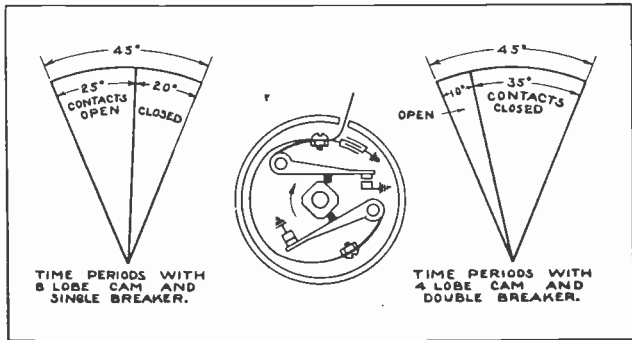

Fig. 4. Diagram showing construction of breaker mechanism for high-speed distributor and also showing periods of time which contacts remain open and closed with both single breaker and double breaker distributors.

the 25° period during which the contacts are open and the 20° period during which they are closed.

The sketch on the right in Fig. 4 shows a 45° period of the rotation of the new type distributor. In this sketch you will note that the contacts are open for only 10° and are closed for 35° , thus giving the ignition coil much more time to build up maximum flux and resulting in much better sparks at high speed.

The top view in Fig. 5 shows one of the double-breaker-arm, high-speed distributors in use with a single ignition coil on an eight-cylinder engine, and in the lower view in this figure a distributor of the

Automotive Electricity

same type is shown in use with two separate ignition coils, one of which is used with each set of breaker points.

With this system the distributor contact arms are not connected in parallel, but each one is connected to its own coil and each coil only produces a spark for every other plug or cylinder. This only requires the coils to operate at the same speed as for a four-cylinder engine and therefore gives them plenty of time to build up to full magnetization in the period during which the contacts are closed.

It also allows the coils to operate at a much lower temperature.

So we can see that this arrangement accomplishes the same results as the distributor and connection in the top view.

With either of the types of distributors shown in Fig. 5 each set of breaker contacts fires only every other cylinder, or one set firing four cylinders and the other set firing the remaining four.

For example, if the firing order of an engine is 1-6-2-5-8-3-7-4 one set of breaker contacts would fire cylinders 1-2-8-7, the other set firing cylinders 6-5-3-4. Therefore, if each cylinder is to get its spark at the correct time the angle between breaker openings must be exactly 45° . Any variation from this angle would mean that four of the cylinders would fire later in the piston stroke than the other four, and this would result in loss of power and poor, uneven engine performance.

To check the setting of breakers of this type a six-volt test lamp can be connected in series with the contacts. With a system such as shown in the upper view in Fig. 5, only one test lamp is necessary in the primary lead to the distributor. With the other system shown in the lower view in Fig. 5 two test lamps should be used, one connected in each of the primary leads to the separate sets of breaker contacts.

Then turn the distributor shaft very slowly by cranking the engine until the light goes out. Mark the position of the rotor arm on the edge of the distributor housing at this exact point. Then slowly turn the distributor again to the point where the

Ignition Systems

light goes out once more. Mark this position of the rotor arm, and the space between the two points marked should be exactly 45° of the circle around the housing. Special gauges for accurately measuring this angle and instructions for their use can be obtained from the manufacturers of these special distributors.

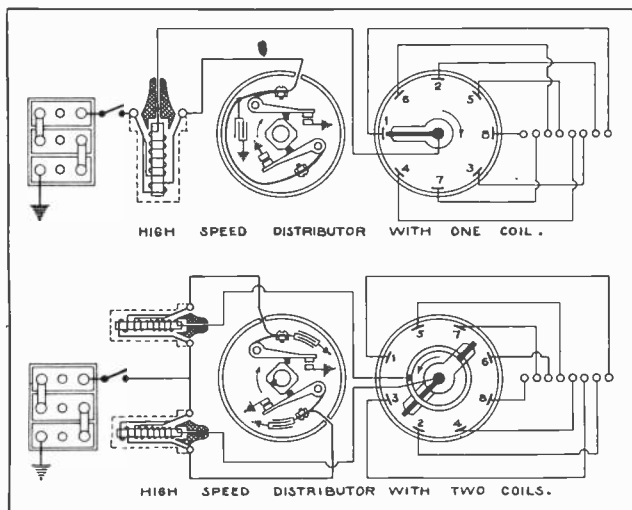

Fig. 5. The top diagram shows the connections for a high-speed distributor using one coil on an eight-cylinder engine. Below is shown the same type breaker using two coils and a slightly different arrangement of the secondary rotor arms and distributor cap contacts.

In the case of the first system mentioned where one test lamp only is used the marks should be made at two points where this lamp goes out. In the case of the second system the first mark will be made where one lamp goes out and the second mark where the opposite lamp goes out.

3. IGNITION LOCKS

All automobiles are equipped with a key switch to close the primary ignition circuit when the engine is to be started and during running, and to open this circuit when the engine is to be stopped and the car to be left standing. Key switches of this type make it difficult for anyone but the owner of

Automotive Electricity

the car to turn on the ignition to start the engine and thereby tend to prevent automobile thefts. However, ordinary ignition switches can be quite easily wired around by anyone knowing something about electricity or ignition circuits, and for this reason such switches do not give very complete protection from theft.

Many of the later types of cars are equipped with special ignition locks and primary wiring that is a great deal more difficult to tamper with. Cars so equipped are therefore more nearly theft proof.

Fig. 6 shows a diagram of a system of this type. By examining this sketch you will note that when the ignition switch is turned off it not only breaks the primary ignition circuit, but also grounds the wire which leads to the insulated movable arm of the breaker contacts. As the stationary breaker point is already grounded, this short circuits the breaker points, thus making it impossible for them to open the circuit and create a spark even if the ignition switch is shorted out with an extra wire.

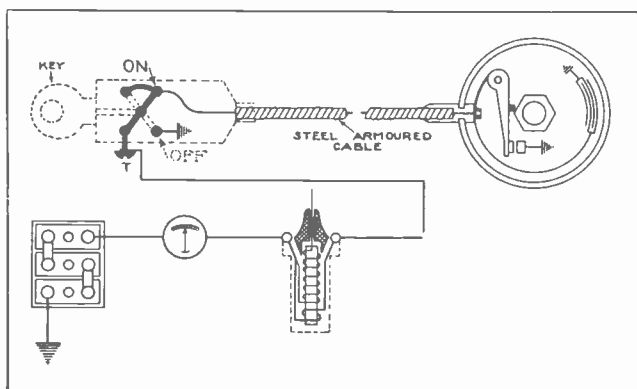

Fig. 6. The above sketch shows the primary ignition circuit through a special ignition lock switch and cable. Study the principles of this circuit carefully while reading the accompanying explanation.

The wire leading from the ignition lock or switch to the distributor is enclosed in heavy, steel-armored cable, to make it very difficult to cut this wire and release the locked short on the breaker points. Locks of this type are, of course, not absolutely theftproof but they make it so much more difficult for a car to be tampered with that they

Ignition Systems

afford a great deal of additional protection against theft of the car.

In the case of trouble in an ignition system it may be necessary to test the switch to determine whether or not the fault is located in it. To test these lock switches use a six-volt battery and a head light bulb connected in series with a set of test points or leads.

To make the test proceed as follows: Turn the engine until the breaker contacts are fully open and then remove the coil wire from the switch terminal, T. Next place one test point on the insulated or movable breaker arm and the other on the switch terminal. With the switch turned on the lamp should light and with the switch off the lamp should not light.

Then place one test point on the insulated breaker arm and the other on the lock case. With the switch off or locked the lamp should light. With the switch turned on or unlocked the lamp should not light. If the lamp lights with the switch in the "on" position, the insulated breaker arm has become grounded due to defective insulation, the condenser is grounded, or there is a ground in the lock itself.

Disconnect the condenser and repeat the test. If the lamp does not light now the condenser is defective. If the lamp does light, disconnect the breaker arm and repeat the test again. If this puts the lamp out the breaker arm was grounded. If the lamp still remains lighted the trouble is undoubtedly in the lock, and will necessitate removing the lock to disassemble and test it.

4. TROUBLE-SHOOTING ON IGNITION SYSTEMS

In order for an automobile engine to start readily and operate satisfactorily throughout its entire speed range it must have fuel of the correct mixture, good compression, and a good spark or ignition.

Automotive Electricity

Failure of any of these will result in poor performance or may prevent the engine starting at all.

When checking to locate troubles and causes of poor operation or refusal to start, the automobile trouble-shooter will generally commence with the ignition system, partly because it is one of the easiest things to check and also because trouble more frequently develops in the ignition than any other part of the engine.

Ignition systems and devices have been greatly improved in the last few years, but because of the number of small parts necessary in these systems and the delicate nature of some of these parts, there are numerous possibilities of small troubles developing which may interfere with the operation of the engine.

When we also consider the fact that the ignition devices and wiring of the systems are subjected to very extreme service conditions due to the severe vibration, dirt and dust, engine heat, and oil which the ignition devices and wiring are subjected to, we can understand better why some of these troubles occur.

We should also consider the fact that on an automobile ignition system there are used both extremely low-voltage circuits and extremely high-voltage circuits. In the six-volt circuits to the primary of the ignition coil to the starting motor, lights, horn, etc., the slightest loose connection or resistance in the circuit will greatly interfere with the current flow.

In the high-voltage circuits from the ignition coil and distributor to the spark plugs, the slightest defect in the insulation will allow leakage or grounding of this energy.

It is estimated that approximately 75% of the ordinary engine failures encountered by the service man are due to ignition faults. However, as many engine failures are due only to an empty gasoline tank, clogged fuel line, choked or flooded carburetor, leaky vacuum tank or fuel pump, loose intake mani-

Ignition Systems

fold or poor compression, it pays to keep these things in mind and not overlook them before going into any elaborate overhauling or repairs to the ignition system.

It is so easy to check to see whether the gas tank is empty or not, or whether gasoline is reaching the carburetor, and also to check the engine compression by merely turning the engine slowly with the crank, that every electrical service man should watch for these troubles and know how to check them. Keeping these possible troubles in mind, as well as those that may occur in the electrical system, may also save you considerable time and money with your own car when it fails to operate properly out on the highway.

If the compression of an engine is poor because of leakage past the piston rings or through poorly fitting valves, the engine will operate irregularly because of loss of part of the fuel charge on such cylinders and loss of power or misfiring due to the low pressure of the fuel charge.

Therefore, it is necessary for smooth operation of the engine that the pistons and valves be in good condition to maintain good and uniform compression in all cylinders.

If the intake manifold or carburetor connections are loose the suction on the carburetor jet may not be sufficient to raise the proper amount of fuel, or the amount of extra air drawn in through these openings may be great enough to make the fuel mixture so "lean" that it will not fire properly.

In electrical trouble-shooting on an automobile engine two of the most important things are **careful and close observation of the wiring and parts of the system, and the use of a definite systematic method of testing each part of the system.**

Very often electrical troubles are caused by loose connections, broken wires, defective insulation, or faults in some of the devices which can be easily seen by carefully checking over the system. There is probably no single rule or method of trouble-

Automotive Electricity

shooting that will apply to all cases, because of the various types of equipment used and the varying trouble indications that may sometimes be produced by the same fault.

One very good general rule, however, is to **start at the unit which appears to cause the trouble and work from that point back toward the battery.**

For example, with a failure in the ignition system start at the spark plugs and check from there back from the high-tension wire to the distributor. Check the distributor for faults both in the high-tension and low-tension circuits, and then if the fault is still not located, check the wiring back to the ignition coil.

Next check from the ignition coil to the ignition switch; and so on, making sure before leaving any particular point that the system is O. K. up to that point and cannot be the cause of the trouble.

Some of the various defects which commonly occur in ignition systems and also their symptoms and remedies will be discussed in following paragraphs.

5. COMMON ELECTRICAL TROUBLES AND REMEDIES

First, let us suppose that an automobile engine will not start. One of the first things to check in this case, after making sure that there is fuel in the carburetor is the battery.

Try to operate the starting motor and if the starter turns the engine over quite lively the battery is O. K. If the engine turns over sluggishly or not at all the battery should be checked for low-voltage, low gravity of the acid, or loose connections. The tests for voltage and acid conditions will be covered more fully in the lessons on Storage Batteries.

Very often starter trouble and weak ignition are a result of loose connections at the battery terminals. Because of the very heavy currents required at low-voltage to operate the starting motor, the battery connections should be very securely tightened and the terminal posts and connecting clamps should be well cleaned. Otherwise the small amount

Ignition Systems

of resistance placed in the circuit by dirty or loose connections will cause so great a voltage drop during the flow of the heavy starting currents that the starting motor will not develop sufficient torque to turn the engine.

Even if it does turn the engine the voltage drop during operation of the starting motor may be great enough to reduce the current flowing to the ignition coil and produce sparks too feeble to ignite the fuel mixture.

Battery connections may be good enough so that the lights and horn will operate alright when the car is standing idle, but yet not good enough to supply sufficient current to the starting motor and ignition coil to start the engine.

One of the reasons why an engine that will not start when being slowly turned over by the starter,

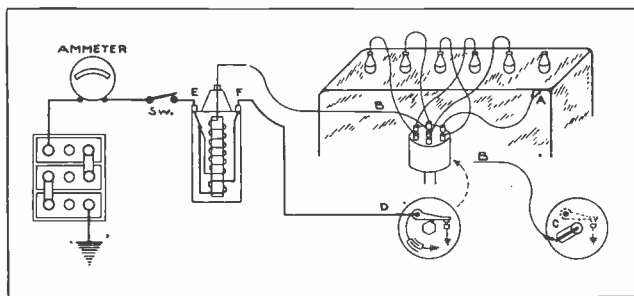

Fig. 7. Sketch illustrating methods of testing for ignition troubles. Refer to this sketch frequently while reading the paragraphs on this subject.

can often be started by cranking, is that when the starting motor is left out of service it allows the battery to supply more current to the ignition coil and produces a hot enough spark to ignite the gasoline mixture when the engine is cranked.

6. TROUBLE AT SPARK PLUGS

After the battery and its connections prove to be O. K., next test for a good healthy spark at the plugs. Remove one of the high-tension wires from its plug terminal and hold it about one-fourth of an

Automotive Electricity

inch away from the engine as at "A" in Fig. 7, to see if a good spark can be obtained when the engine is turned over.

If regular and healthy sparks can be obtained in this manner from each plug wire, the trouble is either in the plugs themselves or the ignition is out of time.

In judging the spark obtained on such tests remember that a thin, weak, threadlike, blue spark may not be sufficient to ignite the gasoline mixture in the cylinder, and also remember that a spark will jump considerably farther in open air than it will under compression inside the cylinder. In order to dependably ignite the fuel mixture, the spark should be hot and fiery appearing, or "fat" as it is often called. It is not alone the voltage of the spark that ignites the gasoline mixture but also the amount of current and the heat developed that make a good spark.

If good hot sparks can be obtained from all of the plug wires and yet the engine will not start, remove the plugs and examine them. If they are dirty or carbonized they should be cleaned and the points should be checked to see that they are set about .025 inch apart. If any of the plugs have cracked insulators or the points are badly burned away, they should be replaced.

Also be sure to see that the outer ends of the plug porcelains are clean and free from dirt and moisture, as sometimes a layer of moisture or damp dirt will allow the spark to creep along the surface of the porcelain and short circuit to the plug shell in this manner, rather than jump across the plug points inside the cylinder. Carefully wiping the plugs with a clean cloth or a cloth dampened with kerosene will generally remedy this.

Very often a car that has become water-soaked in a heavy rainstorm or has had snow blown in through the radiator and melted on the plugs will refuse to start because of the combination of water and dirt on the surface of these insulators.

7. DISTRIBUTOR TROUBLES

If the plugs are in good condition and receiving good sparks and the engine still doesn't start, check

Ignition Systems

the timing. Crank the engine around to bring No. 1 piston at U.D.C. on the compression stroke. Then retard the spark lever and remove the distributor cap.

The rotor arm should be in line with the contact on the cap that is connected to cylinder No. 1, and the breaker points should just be opening. If this condition is not found then retime the ignition as explained in lesson 76.

If no sparks are obtained when a plug wire is held near the engine, pull the high-tension coil lead, B, from the center terminal of the distributor cap and hold it close to the engine. If a hot spark jumps regularly to the engine with this test, the trouble is in the distributor cap, rotor arm, or plug wires; because you have proved that the ignition impulses are being delivered from the coil to the distributor but are not getting from the distributor to the plugs.

In this case remove the distributor cap and hold the high-tension coil lead close to the rotor arm, as at "C" in the small illustration in Fig. 7. Make and break the circuit at the interrupter points, and if a spark jumps to the rotor it is defective and should be replaced. If the rotor is O. K. examine the distributor cap. If it is wet, dirty, or oily it should be thoroughly cleaned with gasoline and a cloth. If the cap is cracked or burned it should be replaced.

In the type of distributor caps now in general use the end of the rotor arm doesn't make actual rubbing contact with the cap terminals but instead allows the spark to jump through a very small air gap as it passes from the rotor arm to the cap contacts. This spark in time burns away the contacts and forms upon them a scale which has a very high resistance and may weaken the spark to a point where it can no longer ignite the fuel charge.

To remedy this, remove the scale with emery cloth or sandpaper. If the contacts are badly burned away the air gap will be too great and the cap and arm should be changed.

If the high-tension section of the distributor has been carefully checked and found to be in good con-

Automotive Electricity

dition, carefully inspect the high-tension wires leading from the distributor cap to the plugs. These wires are heavily insulated with rubber and are generally protected by an additional coating of varnished braid, as they must carry the very high voltage impulses to the plugs without allowing leakage or grounding to the metal parts of the engine which they are near to and often come in contact with.

The insulation of these wires is subjected to very severe conditions, due to heat of the engine and the oil which is often thrown upon them and is very damaging to the insulating qualities of rubber. Leakage through the insulation of one of these wires would not be likely to interfere with the starting of the engine, although it would probably cause missing when the engine is operating.

However, if several of these wires should become grounded or leak badly it might prevent the engine from starting. If these wires are found to have cracked or brittle insulation, or if the rubber has become soft and mushy due to the action of oil and particularly if sparks or leaks are detected along the surface of these wires, then they should be replaced.

8. BREAKER POINT TROUBLES AND DEFECTIVE CONDENSERS

If no spark can be obtained from the high-tension wire of the ignition coil when the engine is cranked or when the breaker points are opened, the breaker contacts should be carefully inspected to see that they make good contact when closed and that they are separated the proper distance (.020 inch) when fully open.

The surface of these contacts very often become burned or dirty, and a very small amount of dirt or blackening can increase their contact resistance to such an extent that the primary of the ignition coil will not receive anywhere near enough current. Small particles of grit or sand stuck to one of these points may prevent the engine starting.

Dirty breaker-contacts can be cleaned by drawing a piece of fine sandpaper through them, with a

Ignition Systems

light pressure applied to hold the contact surfaces against the rough side of the paper. They can also be cleaned by use of a thin breaker point file. Contacts that are badly burned or pitted should be replaced, as the cost of new contacts is very low compared to the trouble bad contacts may cause.

To determine whether these contacts are properly making the primary circuit to the coil, snap them apart and watch for a small spark as they open. If this spark occurs it indicates that primary current is flowing through them. The trouble with the system is then likely to be in the condenser or coil.

Bad sparking and heating of the breaker contacts generally indicates an open-circuited condenser. A shorted condenser will prevent current flowing through the breaker points at all. A good way to check the condenser is to disconnect it and connect in another one that is known to be good. If the breaker points and condenser are proven to be O.K. then the trouble is probably in the ignition coil and the coil should be removed and tested.

9. TROUBLE TESTS ON IGNITION COIL AND PRIMARY WIRING

If the coil tests O.K. then carefully check the primary circuit for high resistance caused by poor contacts or loose connections. If the coil delivers no spark when the primary circuit is broken the failure may be caused by a ground between the coil and the breaker arm, or by the breaker arm being grounded, the condenser grounded, or an open circuit somewhere between the distributor and the battery.

Disconnect the primary wire, D, from the distributor and touch it to the engine, and if a flash is obtained it proves that this wire is good and is carrying current from the battery to the distributor and that the trouble is probably in the breaker arm.

Disconnect the condenser and touch the primary wire to the distributor arm while the breaker contacts are open. If this produces a flash the arm is grounded. Repeat this test on the insulated ter-

Automotive Electricity

terminal of the condenser and if a flash is produced it indicates a grounded condenser. If the primary wire, D, fails to produce a flash when touched to the engine it should be disconnected from the coil terminal and replaced by another wire.

If the new wire gives a flash when touched to the engine the original wire must have been grounded or open. If no flash can be obtained with the new wire then remove the other wire from the opposite primary coil terminal, E, and touch it to the engine. If a flash is obtained in this manner it proves that current was supplied from the battery to the primary of the coil and that the ignition trouble is probably in the coil.

This trouble is likely to be a burned out resistance element, a burned out primary coil, or a grounded coil. With the wire, D, between the coil and the distributor connected and the breaker points closed, or with a direct ground connection from coil terminal F to the engine, if no flash can be obtained on the other coil terminal it indicates an open circuit such as a burned out resistance or burned out primary.

With the connection entirely removed from terminal F, or the distributor side of the coil, if the lead touched to the other side produces a flash it indicates that the coil is grounded. If no flash can be obtained when touching to the engine the end of the wire which has been removed from terminal E and should feed current to the coil, this indicates an open circuit, probably due to a fault in the ignition switch or a poor connection at the ammeter, or possibly it is due to a break in the wire underneath the insulation.

The ammeter itself will often give some helpful indications in ignition troubles. If when the breaker contacts are known to be closed the ammeter gives no reading when the ignition switch is turned on, this indicates an open circuit in the primary ignition wiring, or dirty high-resistance breaker contacts.

The open circuit may, of course, be a broken wire, loose connection, or a defective coil or coil resist-

Ignition Systems

ance. It may also be in the ignition switch itself.

If the ammeter gives an excessive reading or throws the needle clear across the scale when the ignition switch is turned on, this indicates a ground in the primary wiring or one of the devices of this circuit.

From the foregoing explanation we can see that electrical trouble shooting on an automobile ignition system is just a process of systematic elimina-

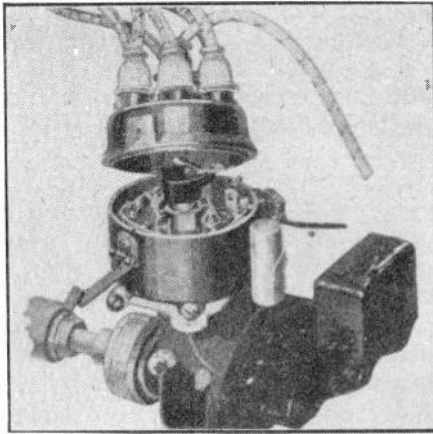

Fig. 8. Photograph of distributor with high-tension cap removed showing rotor arm in place and double breaker points beneath. Also note the high-tension wires connected to the cap and the water shields which are placed over the connections.

tion. By testing one part at a time in the manner suggested, it is possible to definitely and accurately corner the trouble in whichever part of the device or wiring it may be located.

For this reason it is well to thoroughly study the very simple diagram given in Fig. 7, or the diagram of any particular ignition system on which you may be working, and also to have the circuit well in mind before starting to shoot trouble. You can easily locate any trouble if you know exactly where the current ought to flow to operate the various devices and then check to find just how far it does go along this path.

After the first general inspection to see if any broken or grounded wire or loose connections can

Automotive Electricity

be noted, one should avoid jumping from one part of the system to the other but should rather follow the system straight through, testing one part at a time, each in order, as explained.

10. IGNITION TROUBLES THAT CAUSE ENGINE TO MISS

Various faults can occur in ignition systems which, while they do not prevent the engine starting, will cause it to fire very irregularly or miss on certain cylinders and operate with greatly reduced power.

One very common cause of an engine missing is faulty spark plugs. To check the spark plugs, short circuit the plug gap by bridging between the plug terminal and the engine with a screw driver. This grounds the plug and prevents a spark from occurring at its points. When the engine is running and a good plug is shorted in this manner the engine will slow down and run more unevenly than before.

Shorting out a bad plug, however, will have no noticeable effect on the operation of the engine. In this way a bad plug can often be quickly located and adjusted or replaced. This same test, however, might also indicate a cylinder that is not firing because of poor compression due to leaky valves or some other cause, so the test is not always an indication that the plug is bad.

When an engine with many cylinders is being tested in this manner it is sometimes difficult to tell whether a plug is firing or not, as one bad plug in an eight-cylinder engine, for example, would not produce a very noticeable indication or slowing down.

To overcome this and quickly detect the missing cylinder or cylinders, the engine can be run on one-half of its cylinders by removing the plug wires from the spark plugs in the remaining half. While operating in this manner the missing cylinder can be easily and positively located, because of the great difference that will be noticed when one of the good plugs is shorted out.

When a bad plug is found it should be cleaned

Ignition Systems

and adjusted or replaced.

Missing may also be caused by defective insulation on the high-voltage secondary wiring, either between the distributor and the plugs or between the secondary of the coil and the distributor. This can generally be found by carefully inspecting these wires for cracked, softened, or defective insulation, and also by feeling along their surfaces for slight leakage which will produce a shock when the spot is touched.

Sometimes by carefully watching and listening when the engine is running you can detect sparks or light, snapping noises from leakage sparks which are flashing through the insulation on the wires to the metal parts of the engine or to the tube or clamps in which the wires are supported.

When any of these wires begin to leak high-voltage energy, the best remedy is to replace all of them with new ones.

Distributor faults may also be the cause of missing and irregular engine operation. Some of the more common of these faults are breaker contacts dirty, pitted, or improperly adjusted; movable breaker arm sticking in its pivot; untrue breaker cam; distributor shaft wobbling due to worn bearings, or distributor housing loose in its socket.

If the bearings allow the distributor shaft to move off center more than .003 inch they should be replaced. If the engine runs smoothly at low speeds but misses at higher speeds it may be caused by the plug points being set too far apart, breaker contacts set to open too far, insufficient spring tension on the movable breaker arm, worn cam follower, defective condenser, etc.

All battery ignition systems produce weaker sparks at high speeds because of the shorter period of contact closure and less complete magnetization of the coil between breaks. Therefore, anything which tends to further reduce the very short period of time that the coil primary circuit is closed (such as weak breaker springs or worn and lengthened cam follower) will interfere with ignition at high speeds.

Automotive Electricity

Any of the causes of missing previously mentioned might also be responsible for poor engine performance at high speeds.

If the engine lacks power and overheats, the ignition timing should be checked to see that the sparks are not occurring too late or too far retarded.

Late ignition will always decrease the power of an engine and cause it to overheat, and it should be corrected by timing the engine properly as explained in an earlier article.

If the timing is right the carburetor adjustment should be checked. If changing this adjustment fails to "pep" up the engine, next check the valves and see that the clearance between the end of the valve stem and its tappet or rocker arm is correct. This clearance varies with different engines and the manufacturer's recommendation should always be followed when it is known, but if the manufacturer's figure is not known, a clearance of .006 inch for intake valves and .008 inch for exhaust valves will generally give good results.

These settings should be made while the engine is warm and the clearance should be determined by a feeler gauge.

Another possible cause of an overheated or sluggish engine may be improper valve timing.

A good general rule to follow when checking engine trouble is to first check the ignition, then the fuel system, and then the valves, always keeping in mind that any of these can be the cause of the various troubles outlined in this section.

11. RESISTANCE TYPE GASOLINE GAUGES

This type of gauge is very popular and is standard equipment on a large number of cars. It is composed of two units, an instrument panel or indicating unit and the tank unit. These two units are connected together as shown in the diagram (Fig. 9). The current supply is obtained from the coil side of the ignition switch, or if an electro-lock type of switch is used a special terminal is pro-

Ignition Systems

vided on the switch for this purpose. Drawing the current from this point renders the gauge inactive whenever the ignition is turned off, so there will then be no drain on the battery.

The instrument panel or dash unit consists of 2 coils set at an angle of 90 degrees, with an armature and a pointer mounted where the coil axis intersects. The 2 coils are wound so as to produce the same polarity. An extended pole piece is used. Since the extended pole piece is fastened to the

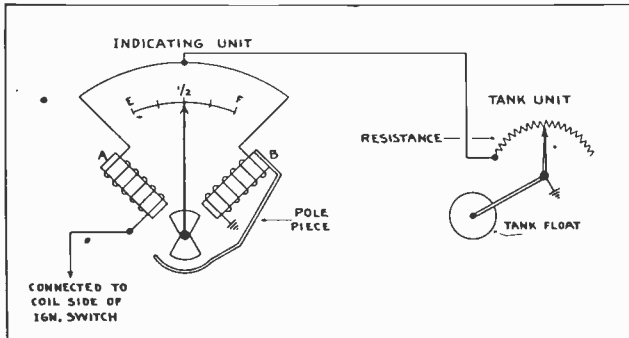

Fig. 9. Diagram of a resistance type gasoline gauge.

top of one of the coils, its polarity will be opposite to that of the lower end of the coil cores.

The tank unit is simply a rheostat, the moving contact of which is operated by a cork float resting on the surface of the gasoline in the tank.

The indicating unit is not operated by voltage changes brought about by the action of the rheostat but by a change in the relationship of the current flow in the 2 coils.

When the tank is empty the resistance is all cut out providing an easy path for the current to flow to ground through the tank unit. This practically short circuits coil "B" so that very little current flows through it, the greater part of the current flowing through coil "A." Thus coil "A" is strengthened and coil "B" is weakened, pulling the armature and pointer to the empty position on the indicator.

Automotive Electricity

Raising the level of the gasoline in the tank will increase the resistance in the tank unit circuit, reducing the current going to ground through the tank unit but increasing the amount of current going to ground through coil "B." This increases the strength of coil "B" and the armature and pointer are pulled toward the right end of the indicating scale.

If the gauge fails to operate disconnect the wire from tank unit. When this is disconnected, the indicating unit should read "Full." Grounding this lead should cause the indicating unit to read "Empty." If it performs in this manner the tank unit is defective and should be replaced.

If the gauge fails to indicate when the ignition switch is turned on the trouble may be due to a broken lead from the ignition switch to the indicating unit, or to a ground between the indicating unit and the tank unit.

If it shows "Full" under all conditions, the trouble may be due to a break in the wire between the indicating unit and the tank unit, or no contact between the stationary and moving parts of the tank unit resistance, due to wear. Wear or poor contact at this point will cause the gauge to read high.

A quick check can be made by disconnecting the lead from the tank unit and connecting this lead to an extra tank unit that is known to be in good order. Ground the extra tank unit against any clean metal part of the car chassis and operate the float manually, moving it from "Empty" to "Full" positions. If the indicating unit registers corresponding readings, the trouble is in the original tank unit.

When connecting the wires to the indicating unit care must be taken to see that they are connected to the correct terminals, otherwise the gauge will not operate. The terminals are all plainly marked so that with reasonable care no mistake can be made. The current required to operate the gauge

Ignition Systems

is from about 125 M.A. when tank is full, up to 175 M.A. when empty.

12. THERMAL OR BI-METAL TYPE GAUGE

In this type the tank unit is known as the "sender" and the indicating unit on the dash is known as the "receiver." The controlling elements of both the "sender" and the "receiver" are bi-metal strips around which, heater coils are wound. See Fig. 10.

When the tank is empty the two contacts in the "sender" or tank unit are just touching. When the ignition is turned on current will flow through the circuit causing both heater coils to warm up and the bi-metal strips will bend. Since the contacts in the sender are just touching the circuit will be immediately broken, and the heater coils will cool off causing the contacts to come back together again. With the tank empty this will require a very small amount of current, so that the bi-metal strip in the "receiver" will be bent but very little and the pointer which is linked to the end of the receiver bi-metal strip will indicate "empty."

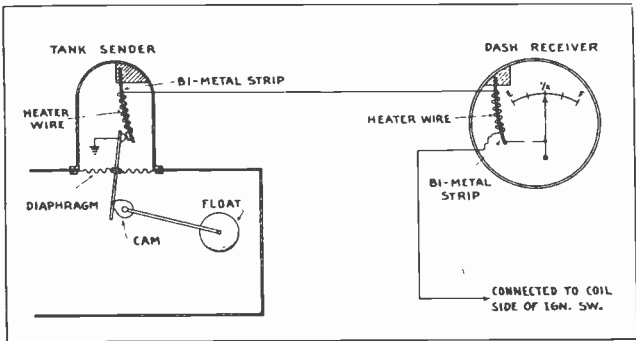

Fig. 10. The thermal or bi-metal gauge.

As the gasoline level is raised pressure on the "sender" contacts is increased by means of a float operated cam. As pressure is increased it takes more current to bend the "sender" strip in order to break the circuit. This increased current will also raise the temperature of the heater coil around the "receiver" strip causing it to bend more and

Automotive Electricity

move the indicating pointer to the right. The two bi-metal strips must be exactly similar, so they will bend an equal amount and since they are in series they will both be heated at the same temperature. The circuit is made and broken approximately once a second. This type of gauge is also used in some cases to indicate oil level in the crank case.

Due to make and break action in the "sender" radio interference may be set up which can be eliminated by connecting a condenser between the sender terminal and ground.

Over-reading is caused by a ground in the lead between the two units, or by a shorted condenser if one is used.

Other faults can be checked by substituting units that are known to be good. When an extra "sender" is substituted and the float is manually operated allow the "receiver" 10 or 15 seconds to read "Full" scale as this is a heat operated unit.

The current required to operate this type of gauge will range from $1/25$ of ampere when tank is empty to $1/5$ of ampere when full.

It is not convenient to make repairs to this type of unit in the field, so defective parts are generally replaced.

Ignition Systems

EXAMINATION QUESTIONS

1. A. Briefly explain what is meant by the term "dual ignition".
B. What are its advantages?
2. What is the advantage of the double breaker arm type of interrupter shown in Fig. 4?
3. How does the ignition lock shown in Fig. 6 help to prevent theft of a car by anyone who might try to bridge the ignition switch with a "jumper" wire?
4. What are two important rules to follow when checking an ignition system for faults or troubles?
5. Name several common troubles which occur in ignition systems.
6. What simple test can be used to determine whether or not the coil is supplying proper spark impulses to the distributor.
7. A. What trouble frequently occurs at the distributor interrupter points?
B. At the distributor cap?
8. A. What is a common symptom of an open condenser?
B. Of a shorted condenser?
9. What ignition fault is likely to be the cause of an engine running sluggishly and overheating?
10. If a resistance type gasoline gauge fails to indicate when the ignition switch is turned on, what is likely to be the cause of this trouble?

Automotive Electricity

HIGH-TENSION MAGNETOS

High-tension magnetos are extensively used in the ignition systems of trucks, tractors, and aeroplane engines. Their principle of operation is almost the same as that of the high-tension ignition coil, except that magnetos generate their own low-voltage primary current instead of receiving it from a battery.

You are already well familiar with the principles of operation of D.C. and A.C. generators, so it is not necessary to go into great detail as to these principles of magnetos.

High-tension magnetos consist of the following important parts:

1. A set of permanent magnets for producing a magnetic field.
2. A rotating iron core or armature on which the coils are wound.
3. A primary winding to generate low-voltage energy, and a secondary winding to step up this voltage.
4. A set of breaker contacts to interrupt the primary circuit and cause the flux to collapse.
5. A condenser to prevent arcing at the breaker contacts and increase the secondary voltage.
6. A distributor to direct the spark impulses out to the different spark plugs.

Fig. 1 shows a common type of magneto for use with six-cylinder engines. The two large horse-shoe-shaped permanent magnets which supply the magnetic field can be seen over the body of the magneto. On the lower right-hand end is the housing which contains the breaker points, and on the upper right end is the distributor housing with the terminals for the six spark plug leads clearly shown. On the left end of the magneto is shown a coupling by which its armature is driven by connection to the engine. The armature revolves between pole faces attached to the lower ends of the permanent magnets.

Magnetos

Fig. 2 shows a magneto armature removed from the housing and field frame. The heavily-insulated primary and secondary coils are shown wound on a simple spool form, or the center leg of the armature core at No. 1.

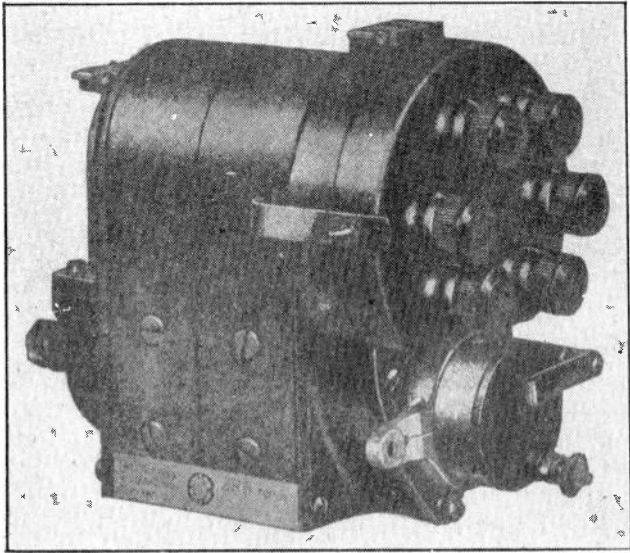

Fig. 1. Photograph of a high-tension magneto used for ignition purposes on trucks, busses, tractors, etc. Courtesy Bosch Magneto Corporation.

At 2 is shown the condenser, which is also contained in the armature. The ground on the iron armature core is shown at 24, and one of the primary leads is grounded or connected to this core at B.

No. 23 is the gear which drives the distributor mechanism, 27 is the insulated slip ring at which the high-voltage energy from the secondary is collected by means of the brush and carried to the distributor.

At 30 are the ball bearings in which the armature rotates, and at 29 is the end of the shaft by which the magneto is coupled to the engine.

Automotive Electricity

1. CIRCUITS AND OPERATING PRINCIPLES

Fig. 3 shows a diagram of the primary and secondary windings of a magneto armature. You will note that the upper end of the primary connects to one side of the condenser and then through the breaker points to ground, while the lower end of the primary connects to the other side of the condenser, and directly to ground. This places the breaker points in series with the primary winding and the condenser directly across the breaker points.

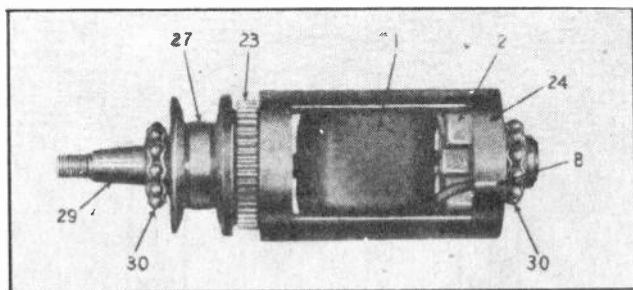

Fig. 2. Magneto armature removed from housing to show bearings, slip ring, armature core, windings, and condenser.

The inner end of the high-voltage secondary coil is connected to the primary and thus obtains a ground connection, while the outer end of the secondary is connected to the insulated slip ring, and delivers the high-voltage energy from this ring

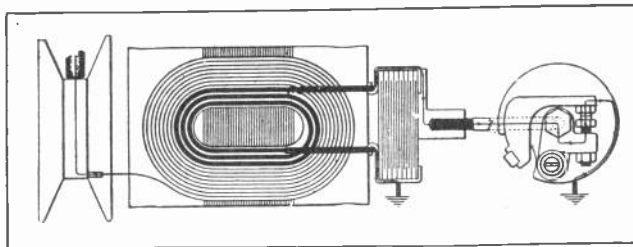

Fig. 3. Diagram of primary and secondary windings of a common magneto armature. This diagram also shows condenser and breaker points on the right and the high-tension slip ring on the left. Courtesy Bosch Magneto Corporation.

to a brush and then through the distributor to the spark plugs.

Magnetos

Fig. 4 is a diagram showing the position of a magneto armature between the pole faces of the permanent magnets, and also shows the direction of magnetic flux travel through the armature from the north to the south pole.

With the armature core in its present position, the flux built up between the two field poles is at maximum; but as the core is turned to a point at right angles to its present position it doesn't provide nearly as good a path for the magnetic lines and thus causes a great reduction or sudden collapse of the flux, twice during each revolution.

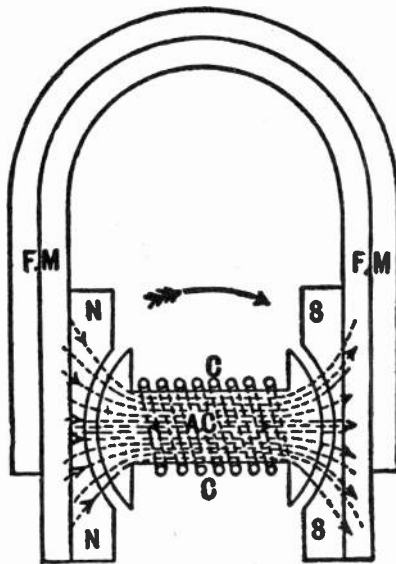

Fig. 4. This sketch shows the position of the armature between the pole pieces of a magneto and shows the path of the flux from the permanent magnetic field.

This collapse and building up of the magnetic field as the armature is rotated causes the magneto to generate low-voltage A.C. in the primary winding. By using in this primary coil circuit a set of breaker contacts to interrupt the current flow just as the field flux is collapsing, the flux around the primary turns is also allowed to collapse, with the result that the double flux collapse induces a very

Automotive Electricity

high-voltage impulse in the secondary winding, which consists of a great number of turns of fine wire.

To obtain maximum voltage the primary circuit should be broken just at the point when the greatest amount of voltage and current are being induced in it.

Referring to Fig. 5 we find that with the magneto armature in a position shown at "A" flux is passing from the north pole downward through the core to the south pole.

If this armature is revolving clockwise we can see that its top and bottom sides are just about ready to break away from the poles they have been passing and approach the opposite poles. As they pull away from the poles the strong magnetic field which was passing through the armature core collapses and shifts over in the opposite position shown at "B". Here the flux is still passing from the north

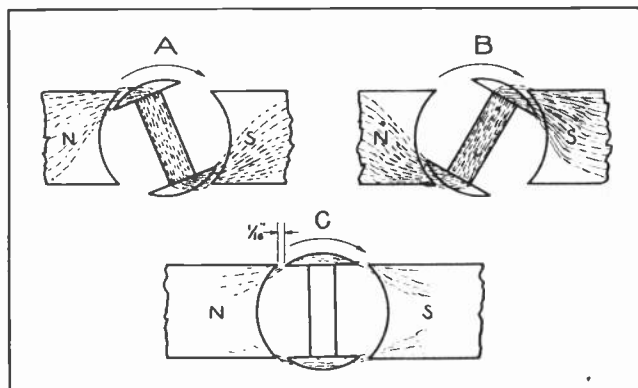

Fig. 5. The above sketches illustrate the shift and collapse of flux as a magneto armature rotates between the field poles to cause the induction of voltage in the armature coils.

to the south poles of the permanent magnets, but it is now passing upward, or in the reverse direction, through the armature core.

We find, therefore, that the point of maximum flux movement or change, and also the point of maximum voltage generated in the primary, will be just as the magneto armature breaks away from one set of poles and passes on to the next, or while it is

Magnetos

moving from the position shown at "A" to that shown at "B".

The maximum voltage will be generated in the primary winding when the armature is in the position shown at "C" in Fig. 5, and this is the point at which the breaker contacts should interrupt the circuit.

Magnetos are so constructed by the manufacturer that when the breaker housing is in the full advance position the breaker contacts will open the primary circuit when the armature is in the position shown at Fig. 5-C, or when the armature tip has left the pole tip by a distance of about 1/16 of an inch.

Any variation from this setting would greatly weaken the spark, and to prevent altering the timing of the breaker contacts when the magneto is taken apart for inspection or repair, a keyway is cut in the armature shaft to receive a key on the breaker plate so that the two will always be locked together in the proper position.

Fig. 6-A shows a diagram of the primary and secondary circuits of an ordinary magneto, and also shows the connections and locations of the various important parts. Trace this circuit carefully and compare it with Figs. 1 and 3 until you thoroughly understand the general construction and wiring of a magneto.

Note how a number of the circuits are completed by grounding the connections to the armature core and metal parts of the magneto frame. The solid black parts of the sketch indicate the insulating material which separates various metal parts of the magneto and parts of the circuit.

In tracing this circuit you will find that the breaker points are in series with the primary coil and that the condenser is connected across these breaker points. One end of the secondary coil is connected directly to the primary winding to obtain a ground through this low-resistance winding, although in many magnetos it is connected directly to ground at the other end of the primary. The other end of the high-voltage secondary delivers its impulses to the distributor through the insulated

Automotive Electricity

collector ring, brush, and conductor rod or pencil. From the distributor the impulses are sent in the proper order by means of a timed rotor to the spark plugs.

2. MAGNETO SAFETY GAPS

Note the safety gap which is connected between the high-tension and ground, to protect the

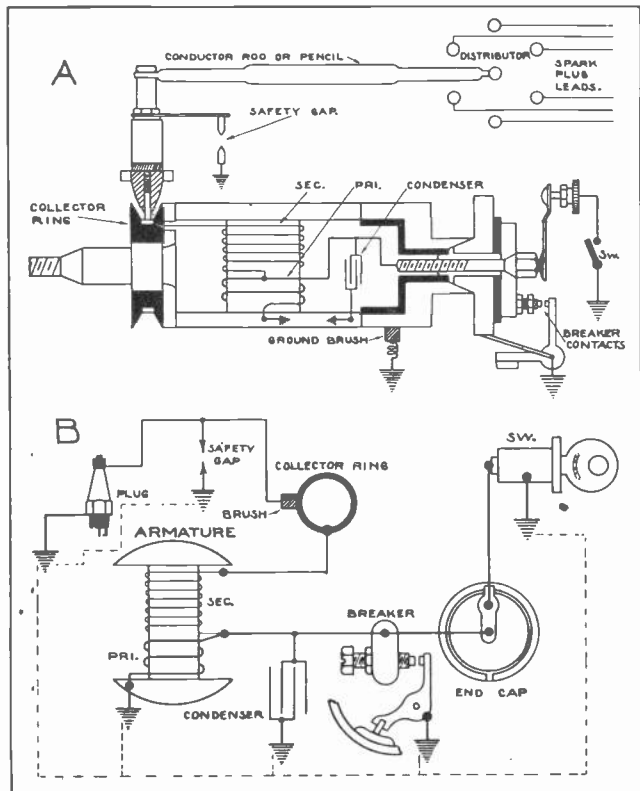

Fig. 6. Diagram showing complete primary and secondary circuits of a magneto. B. Another diagram showing a different arrangement of the primary and secondary circuits and important parts of the magneto.

secondary winding from excessive voltage strain in case the spark plug gaps become open too far or the secondary lead becomes broken.

As long as the spark plugs remain in proper con-

Magnetos

dition and connected to the secondary leads the magneto needs to build up only about 6000 volts to flash across the 100,000 ohms approximate resistance of the spark plug gaps under compression.

If the resistance of this secondary circuit is increased by a broken secondary wire or the spark plug gaps becoming too widely open, the secondary voltage will rise to an excessive value. This places a very high strain on the insulation of the windings and if allowed to continue will eventually puncture and break down this insulation. As the armature insulation cannot easily be repaired this generally means that the entire armature will have to be replaced.

The safety gap connected in the manner shown is really in parallel with the spark plug gaps and the entire secondary winding to ground. With this gap set at about 5/16 of an inch, 8000 volts will send a spark across it, so the voltage strain on the insulation can never rise above this value, and the possibility of puncture is greatly reduced. Under normal operating conditions the spark will jump the plug gaps, as their resistance is lower than that of the safety gap.

Fig. 6-B shows a simplified wiring diagram quite similar to the one in Fig. 6-A, except that the various parts are shown further apart to make the circuit easier to trace. In this diagram it is very easy to trace the circuit of the primary coil through the breaker points and to note that the condenser is connected across these points.

The secondary circuit can also be easily traced through the collector ring, brush, the single spark plug shown, and back through the grounded connections, primary coil, and to the start of the secondary. The dotted lines in this circuit show the ground path created through the metal parts of the magneto by grounding one end of each of the various devices.

Automotive Electricity

3. GROUND BRUSH AND IGNITION SWITCH

Magneto armatures are generally supported in ball bearings, and in order for the secondary current to complete its circuit from the frame to the armature through the grounded connections, the current would ordinarily have to flow through these bearings. This would tend to pit the balls and ball races of the bearings and also to carbonize the grease with which they are lubricated, and thus would result in very rapid wear of the bearings.

To avoid this a small carbon brush is inserted through the base of the magneto and held in contact with the rotating armature by a light spring. This brush is called a **ground brush**, and provides a path of lower resistance than the bearings, so that most of the current will flow through this brush circuit.

To prevent any current at all from flowing through the bearings most manufacturers insulate them from the magneto frame with pressed paper or fibre insulation.

In both Figs. 6-A and B you will note that a grounding switch is used to shut off the magneto and ignition by short-circuiting the breaker points. When these points are short-circuited by the switch they cannot open the primary circuit any longer, and this prevents the sudden collapse of flux and the induction of high-voltage impulses in the secondary, thus stopping the spark.

This is a very effective method of shutting off the ignition to stop the engine and is much more convenient than trying to place a switch to open the primary circuit, as this circuit is all contained within the armature of the magneto itself.

The ignition switch in this case merely grounds the insulated breaker point, thus entirely shorting out the breaker contacts.

4. BREAKER MECHANISM

The breaker assembly of the armature-type magneto consists of five principal parts, as follows:

1. A circular metal breaker-plate which supports

Magnetos

the contacts.

2. Contact points, one of which is attached to the breaker plate but insulated from it, and the other mounted on the grounded movable breaker arm.

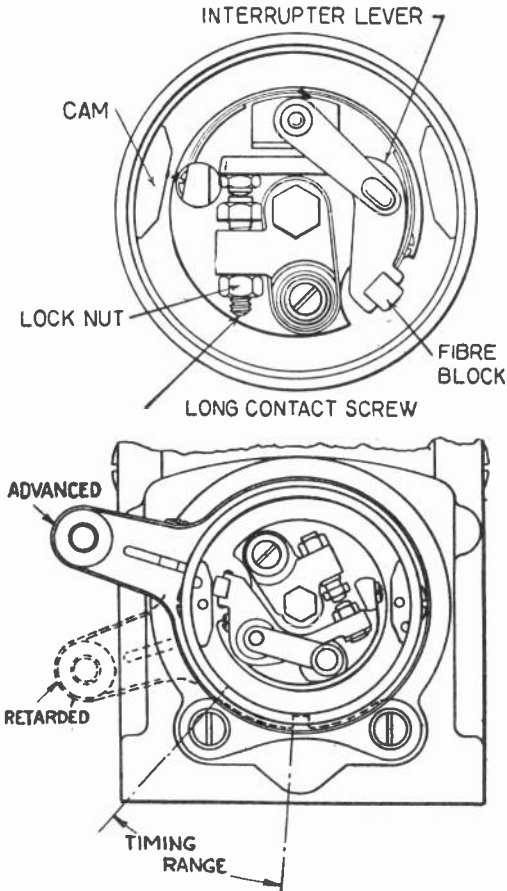

Fig. 7. The top view in this figure clearly shows the breaker mechanism of a magneto. Below is shown another view of a breaker with the points open and the cam under the breaker arm, and also showing the method of advance and retard of the spark by means of a lever on the breaker housing. Courtesy Bosch Magneto Corporation.

3. Breaker housing.

4. Steel cams attached to the inside surface of

Automotive Electricity

the breaker housing.

5. Fastening screw which holds the breaker plate to the armature and also makes connection between the insulated breaker contact and the ungrounded end of the primary winding.

The upper view in Fig. 7 shows a diagram of the breaker mechanism of a magneto in which both the stationary and movable contacts can be seen. As the breaker plate and contacts are rotated the fibre block on the outer end of the arm rides over the cams attached to the inside of the breaker housing, thus causing the breaker points to open. When the fibre block drops off the cams the breaker points are closed by the action of a small spring attached to the movable arm.

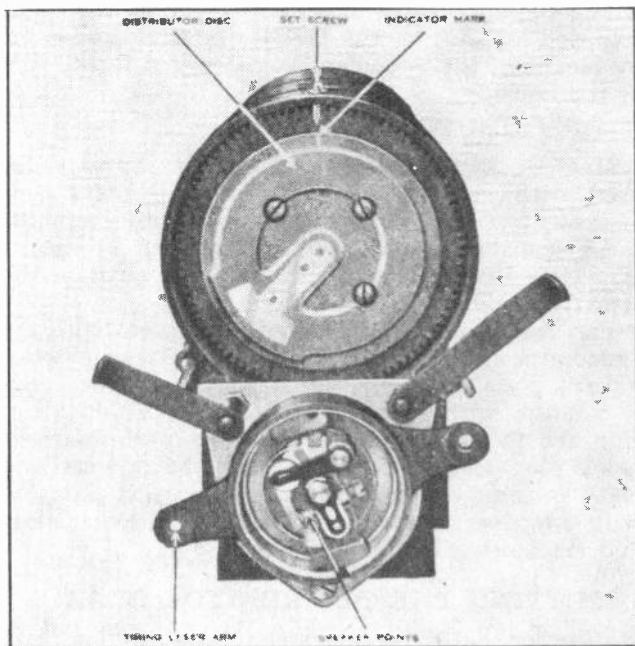

Fig. 8. Photograph of a magneto with covers removed showing the breaker mechanism below and the high voltage distributor disk and contact arm above. Courtesy Eisemann Magneto Corporation.

Contact points are generally tipped with platinum as this metal stands up very well under the

Magnetos

continuous sparking and make and break action and doesn't burn or corrode as easily as most other metals.

Magneto contacts are generally set for a maximum opening at .015 of an inch, although certain variations of this gap may be necessary with different magnetos under various operating conditions.

It is just as important to keep these contact surfaces bright and clean and properly fitted as it is with those of interrupters on battery ignition systems. For efficient ignition, breaker contacts must make a good low-resistance closure in the primary circuit each time they touch, and must make a quick, clean break when they open.

The lower view in Fig. 7 shows the manner in which the spark of a magneto can be advanced or retarded by shifting the breaker housing and cams by means of the advance lever attached to the side of the housing.

5. DISTRIBUTOR

Magneto distributors are quite similar to those used with battery ignition systems, except that instead of using a small distributor arm, magnetos use a distributor plate which is rotated by means of a gear that is driven from a small gear on the armature shaft.

Fig. 8 shows an end view of a magneto with the distributor cap removed to show the plate and gear. As this plate revolves its metal arm makes contact in rotation with the stationary contacts which are mounted in the cover and connect to the various spark plug leads. Below the distributor gear and plate in Fig. 8 can be seen the breaker housing with the cover removed, showing the breaker points and mechanism inside.

6. SETTING THE DISTRIBUTOR GEAR

In order that the rotating contact or segment will be at the correct position when the breaker contacts open, it is very important that the distributor gear and its smaller driving gear on the end of the armature be properly meshed together. If these gears are not properly meshed it may result in the

Automotive Electricity

rotating brush or segment being at a point midway between the stationary segments when the spark occurs.

This would tend to make the spark jump the gap between the rotating and stationary contacts as well as the plug gap, and in all probability the increased resistance would result in the spark occurring at the safety gap of the magneto or at the wrong plugs of the engine.

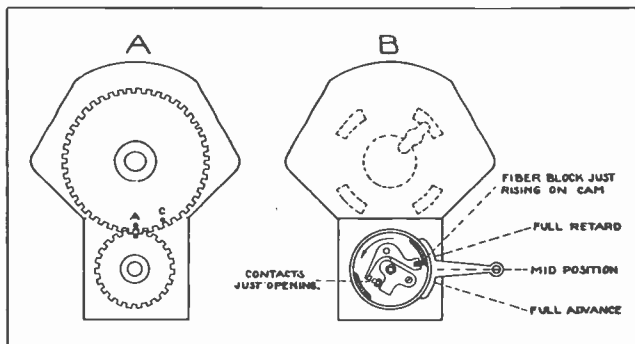

Fig. 9. A shows method of properly timing or setting the distributor gears by means of marks on their edges. B shows breaker arm, spark advance lever and breaker points all in proper position for timing the magneto.

To insure proper operation and make it easier to properly set and time the magneto in overhauling, manufacturers generally place small punch marks on the edges of the gears, one mark on the armature gear and two on the distributor gear, as shown in Fig. 9-A.

Magnetos are often arranged so that by making small changes they can be driven either clockwise or anticlockwise, according to the most convenient connection to the engine. If the magneto is for clockwise rotation, the C mark on the distributor gear should line up with the mark on the armature gear when meshing the gears together. If the magneto is to be driven anticlockwise, the A mark on the distributor gear should be lined up with the mark on the armature gear. See Fig. 9-A.

The direction of magneto rotation is always designated as clockwise or anticlockwise when facing

Automotive Electricity

the drive end of the magneto. The direction of rotation for which the magneto is intended is gen-

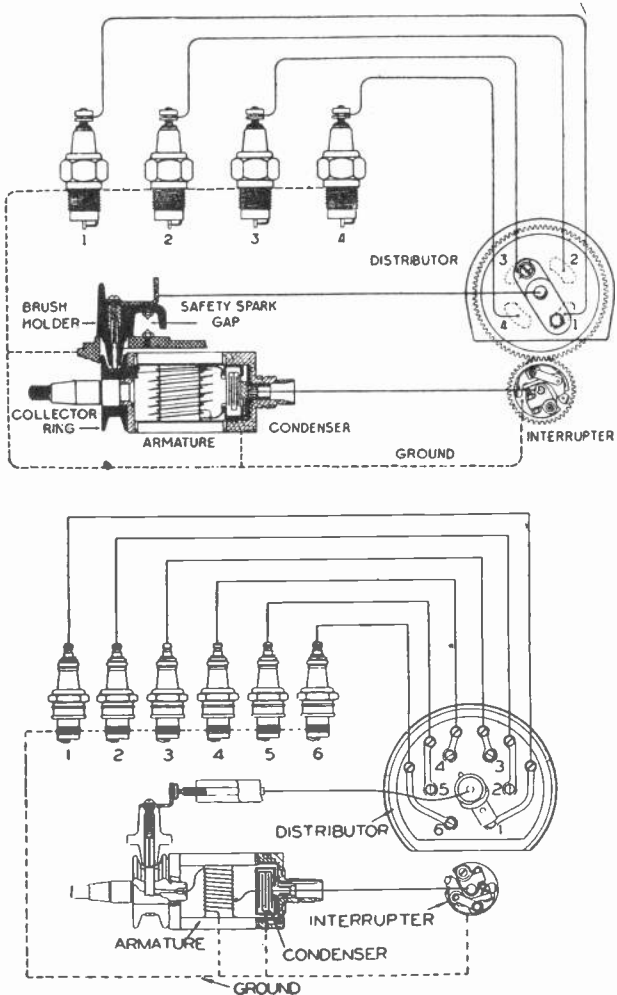

Fig. 11. The upper view shows complete primary and secondary circuits of a magneto with the high-tension leads connected from the distributor to the spark plugs of a four-cylinder engine. The lower view shows the circuits of a magneto for use with six-cylinder engines. Note that the spark plugs are lined up numerically in these figures and are not in their proper order on the engine.

erally marked by an arrow on the oil cover over the drive end bearing.

Magnetos

Sometimes a magneto is found which has already been overhauled several times and on which the original marks may have been obscured or scratched off, and other marks may have been made by the men who previously overhauled the magneto.

As these marks cannot be depended upon, the gears should be carefully meshed or set by the following procedure and as illustrated in Fig. 9-B. Set the breaker housing in mid position, half way between full advance and full retard. Turn the magneto armature in the normal direction of rotation until the fibre block on the breaker arm is just moving up on the cam and opening the contacts. Then rotate the distributor gear to a point where the brush is in the middle of the segment, as shown. Now, while making sure that the armature and distributor gear maintain these positions, move the gears into mesh with each other.

To check the setting move the breaker housing to the full retard position and, turning the magneto armature in the correct direction of rotation, see if the brush is still on the segment with the breaker contacts open. Make the same test with the breaker housing in the full advance position. The brush should be on the segment in both positions.

Magnetos are made with distributors for various numbers of cylinders, according to the types of engines they are to operate with. The upper view in Fig. 11 shows a complete wiring diagram of a magneto connected to the plugs of a four-cylinder engine, while the lower view in this figure shows another magneto connected to the plugs of a six-cylinder engine.

The arrangement of the distributor brushes and segments and also of the primary connections are slightly different in these two diagrams, but the circuits and principles are in general the same. In both diagrams the breaker contacts are shown in the circuits of the primary coils, and the high-voltage secondary circuit is shown leading from the collector ring through the brush to the distributor, and from the distributor contacts to the plugs,

Automotive Electricity

which in turn are grounded to complete the circuit back to the magneto frame.

The ground circuit and connections in each case are shown by the dotted lines. The wires leading from the distributor terminals to the spark plugs in this figure are connected to the plugs according to their firing order, and the rows of plugs are arranged this way also and **not in their actual positions** on the engine.

7. TIMING A MAGNETO TO THE ENGINE

When connecting a new magneto to an engine or when reinstalling one that has been taken off for repairing or overhauling, the magneto should be carefully timed to the engine in the following manner, which you will note is very similar to the method used for battery ignition systems.

Set the engine so that No. 1 piston is at top dead center on the compression stroke. Fully retard the magneto breaker housing and turn the magneto armature in the normal direction of rotation until the distributor brush is on segment No. 1 of the distributor cap and the breaker contacts are just beginning to open.

Then connect the magneto to the engine through the drive coupling, being very careful not to allow the armature or distributor to change position while making the connection. Some magneto manufacturers place on the distributor disk or gear a mark which when lined up with a mark or screw on the distributor housing indicates that the distributor brush or rotating segment is in position to contact with the stationary segment which connects to No. 1 cylinder. These marks can be seen by referring to Fig. 8.

Fig. 10 shows a sectional view of one type of magneto, giving the names of the various parts. Examine each part very carefully and make sure that you understand the function of all of the important parts which have been explained in the preceding paragraphs.

You will note in this figure that the ground brush is located in the revolving breaker plate and rubs

magnetos

against the metal collar or frame of the magneto in the back of the breaker housing. In this position the brush not only makes a good return for the grounded secondary current, but also makes a positive ground connection from the rotating breaker mechanism to the magneto frame, to make more certain the shorting or grounding action of the ignition switch when the magneto is turned off.

The path of the high-tension energy can be traced from the upper right-hand end of the secondary coil to the collector ring, collector brush, up through the metal strip imbedded in the insulation of the distributor cap to the center distributor brush, across the rotating strip on the distributor disk, and out of the upper distributor brush to the spark plug wire. Only one of the outer brushes that connect to the spark plugs is shown in this view.

Fig. 12 shows another sectional view of a different type of magneto and, while the construction is different in some respects, you will note that the general arrangement and principles are the same. Note the position of the oil holes and the ground brush shown in this figure.

8. DISASSEMBLING MAGNETOS

The exact procedure for taking apart a magneto to make repairs or for overhauling will vary somewhat with different types of magnetos and detailed instructions for these can be obtained from the manufacturer of any certain magneto.

The following general rules, however, will prove to be very helpful and any magneto can be disassembled by this method with a little care and observation on the part of the workman so as not to overlook other small details.

First remove the breaker housing and distributor cap. Then remove the breaker plate by taking out the holding screw. Next remove in order the magnets, high-tension collector plug, high-tension pencil or conductor bar, ground brush, bearing plate at the interrupter end, distributor gear, and then the armature.

Automotive Electricity

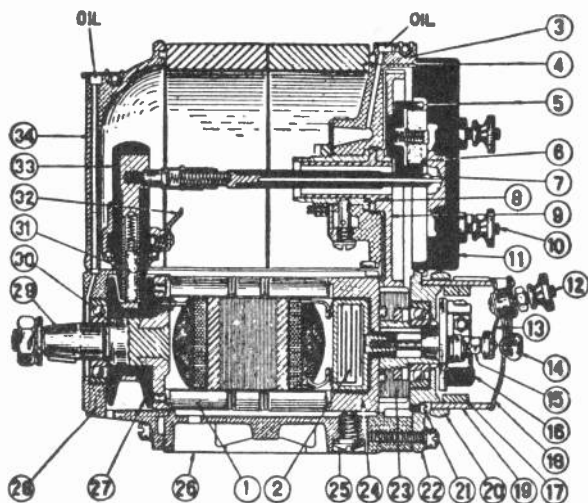

1. Armature wound core

NOTE: Complete armature consists of parts indicated by the following numbers: 29, 1, 2, 24 and 27.

2. Condenser
3. Gear housing
4. Magnet
5. Distributor brush holder
6. Distributor brush
7. Conducting bar
8. Distributor gear bearing
9. Distributor gear
10. Distributor plate terminal screw
11. Distributor plate
12. End cap terminal nut
13. End cap contact spring with brush
14. End cap holding post and spring
15. Interrupter fastening screw
16. Interrupter complete
17. Interrupter cam
18. Magneto end cap
19. Interrupter housing
20. Timing arm
21. Interrupter housing stop screw
22. Rear end plate
23. Armature gear
24. Armature flange—condenser end
25. Grounding brush with holding screw
26. Base plate
27. Collector ring
28. Shaft end plate
29. Driving shaft and flange
30. Ball bearing—either end
31. Collector brush
32. Safety gap electrode
33. Collector brush holder
34. Waterproof hood

NOTE: The numbers given above are for reference only. Do not use these reference numbers when ordering parts.

Fig. 12. Diagram showing sectional view and names of important parts of a magneto of somewhat different type than the one shown in Fig. 10. Courtesy Bosch Magneto Corporation.

Magnetos

It is very important to remember that the **armature should be removed last**, for if this rule is not followed it may result in cracked collector ring insulation and broken ground brushes.

To reassemble the magneto follow the same procedure in the reverse order. Extreme care should be used not to batter, scratch, or damage any of the finely machined metal parts and not to crack or injure the molded insulation.

When removing field magnets their magnetic circuits should be kept closed by slipping an iron bar or keeper across the pole ends before completely removing them from the pole shoes. This bar should be left on the field magnets as long as they are off the magneto, in order to prevent weakening the poles, which will occur if the magnetic circuit is broken and left open.

Magneto magnets can be easily recharged by means of a powerful electro-magnet operated from a storage battery or other source of D.C. When fully magnetized the average magneto magnet should lift about 20 lbs.

In replacing these magnets be careful to get all like poles on one side. It doesn't matter which side the north or south poles are on as long as all north poles are kept together and south poles together. If some of the poles are reversed the magnetic flux will short directly between adjacent poles and will not pass across the armature gap between the pole pieces. This results in no field or a very weak field across the coils and practically no induction or spark.

Like poles can easily be determined by holding the magnets side by side or end to end in a position so that their poles tend to repel.

Field magnets should not be banged around or handled roughly when they are off the magneto, as such treatment causes them to lose their charge. The armature should also be very carefully handled in order not to damage the insulation on the coils or harm the bearings.

Automotive Electricity

On some magnetos when the distributor gear and shaft are put back in place the end of the shaft may catch upon an oil wick in the lower side of its bearing. This wick can be held down with the end of a screw driver or other slender metal tool inserted in the back end of the bearings while the shaft is pushed in the front end.

HIGH TENSION MAGNETO

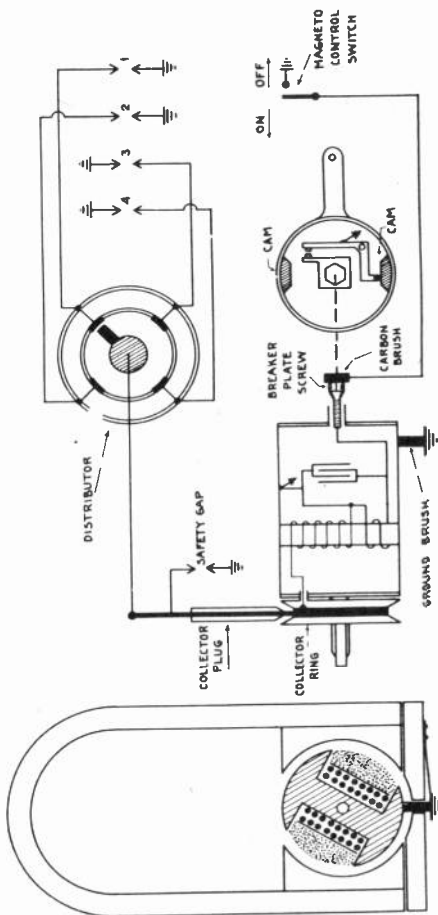
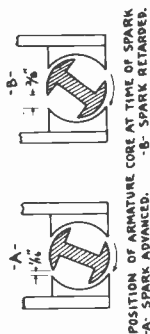
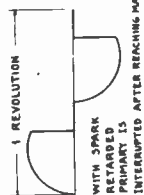
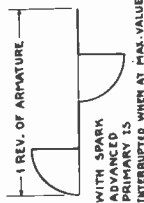

Magnetos

TWO-POLE SCINTILLA ROTATING MAGNET MAGNETO PRINCIPLE OF OPERATION

Current is generated in the primary winding by rotating a permanent magnet which produces an alternating magnetic field in the stationary core which supports primary and secondary winding.

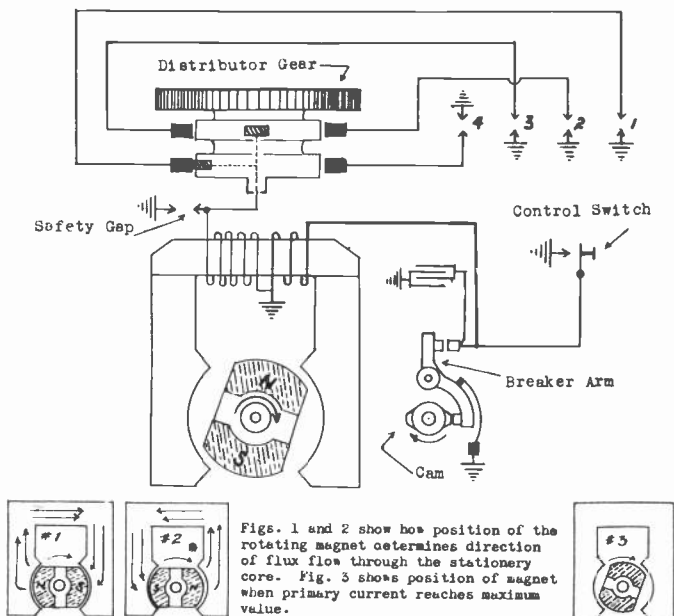

For one revolution of the 2-pole rotating magnet, the magnetic flux will change direction 2 times or once every 180°. The primary current will reach maximum value in the primary circuit just as the magnetic flux in the stationary core reverses in direction.

At this point, the 2-lobe cam opens the breaker points and interrupts the primary circuit causing a rapid collapse of the primary magnetic field, which in turn induces a high voltage in the secondary winding.

Automotive Electricity

WICO MAGNETO TYPE E. K. (For Single Cylinder Engines) WICO MAGNETO CYCLE OF OPERATION (TYPE EK)

1. When laminated steel armature is in contact with ends of the stationary cores, a complete magnetic circuit is formed which is energized by a set of bar magnets at opposite end of stationary cores.

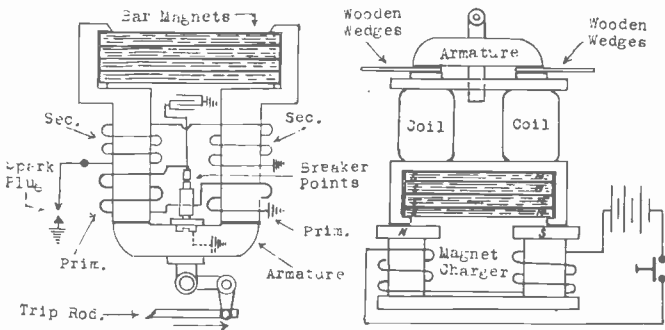

2. When armature is pulled away from the ends of the stationary cores, the magnetic circuit is broken, and the magnetic field generated by the bar magnet collapses, cutting across the two primary windings, causing a current to flow in these two windings. This current builds up the primary magnetic field.
3. As the primary current reaches maximum value, which will be when the armature clears the ends of the stationary cores $\frac{3}{32}$ of an inch, the breaker points, one of which is actuated by the moving armature, break the primary circuit, causing the primary magnetic field to collapse and cut across and generate a high voltage in the two secondary windings to which the spark plug is connected. A condenser connected across the breaker points speeds up the collapse of the primary magnetic field and at the same time reduces arcing across the breaker points.

CHARGING MAGNETS

1. Remove outer sheet brass housing.

Magnetos

2. Wedge armature open with wooden wedges $\frac{1}{16}$ of an inch thick.
3. Determine N and S end of bar magnets.
4. Set entire magneto across magnet charger as shown in diagram with N end of bar magnets on South pole of magnet charger.
5. Turn on charger current and charge for 20 to 30 seconds. Strike magnets lightly while charging.
6. Remove wooden wedges.
7. Remove magneto from charger, and re-install outer sheet brass housing.

9. MAGNETO TROUBLES AND CARE. RECHARGING FIELD MAGNETS

Some of the common magneto troubles which may be the cause of an engine missing or starting hard, or complete failure of the ignition system, are as follows:

When the field magnets become weak it will cause very poor sparks at low engine speeds and make the engine start hard. The magnets should be removed as previously explained and recharged by holding or rubbing their poles in contact with the poles of a powerful electro-magnet.

Regular magnet chargers can be purchased for this work or a very effective charger can be made by winding about 500 turns of No. 14 magnet wire on each of two soft iron cores about two or three inches in diameter and six inches long and bolting the bottom ends of these cores securely to a soft iron plate to form a keeper for a closed magnetic circuit across their ends. See Fig. 13.

With these coils connected in series in a manner to create unlike poles at the top ends of the electro-magnet and then connected to a six-volt storage battery, a very powerful magnetic field will be set up across the open pole ends.

For added convenience these ends can also have small square pieces of soft iron bolted to them, in order to make a broader surface for the ends of the horseshoe magnets to contact with. If the inner edges of these pole pieces are made 1 to $1\frac{1}{2}$ inches

Automotive Electricity

apart and the outer edges from 7 to 8 inches apart, they will accommodate almost any of the ordinary sized magneto magnets.

Care should be taken to place the horseshoe magnet on the charging magnet in the proper position to strengthen the poles it already has, rather than to reverse them and build them up in the opposite direction. The proper polarity can easily be determined by suspending the horseshoe magnet above the electro-magnet when the current is turned on. If the horseshoe magnet is free to turn its poles will be attracted to the proper poles of the electro-magnet.

The charging magnet should be bolted to a bench in a vertical position so that the horseshoe magnet can be rubbed or rocked across the ends of the electro-magnet poles for several seconds with the current turned on.

When removing the magneto magnets from the charger always remember to place the iron keeper or bars across their ends first. A fully-charged magnet should pull about 20 lbs. on an iron bar attached to a small spring scale, as previously mentioned.

During the test and after magnet poles are in contact with the scale bar, the temporary keeper bar should be removed in order to get maximum pull. It should, however, be placed on the magneto magnet again before removing it from the scale to replace it on the magneto, otherwise a great deal of the charge will be lost.

10. BREAKER TROUBLES

If the breaker points on a magneto are set too close or if they are dirty and not making a good contact, it will probably cause the engine to miss, particularly at low speeds. By means of a thin gauge obtainable for this purpose the breaker points should be kept set to open the proper distance. As previously stated, the maximum gap or opening between these points should be about .014 or .015 of an inch.

Magnetos

The contact surfaces should be kept clean and bright and should meet squarely when they are closed. If the platinum tips or surfaces of the breaker points have been burned off or filed off,

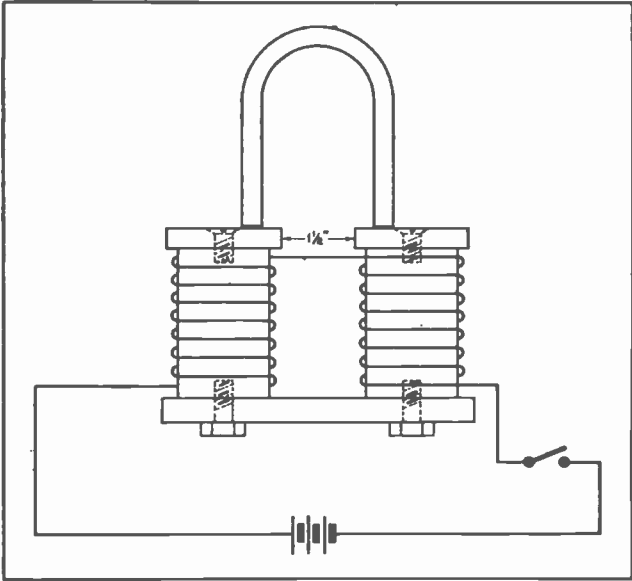

Fig. 13. This sketch shows the method of constructing a simple electro-magnet for recharging field magnets of magnetos.

the points should be replaced with new ones, because efficient operation cannot be obtained with points that are badly burned or those that have had the contact metal ground away.

If the points are only slightly burned or blackened they can be dressed off with fine sandpaper drawn between the contacts when they are pressed lightly together. They can also be dressed or resurfaced with a fine breaker-point file. These files should be carefully used because if not they can do more harm than good.

One should never hold the file rigidly in the hand or attempt to file one contact at a time. Instead, the file should be held between the contacts by pressing them lightly together against the file sur-

Automotive Electricity

faces. Then draw the file easily back and forth, always allowing its surfaces to align with those of the contacts which are pressed against it.

Sometimes the stationary contact becomes loose or the pivot of the movable arm becomes worn or loose, and either of these will result in faulty ignition. When found in this condition they should be tightened or replaced.

If the spring tension on the movable breaker arm becomes weak or if this arm is allowed to bind on its pivot, the engine will miss at high speed. The correct tension on the breaker arm should be approximately 16 ounces when the contacts are closed. A temporary repair or increase in spring tension may be affected by bending the spring or shortening it until a new one can be obtained.

11. CONDENSER, ARMATURE, SLIP RING, AND DISTRIBUTOR TROUBLES

An open-circuited condenser will generally cause excessive arcing and severe burning of the contacts and greatly reduce the high-tension spark. If the condenser is shorted it will also prevent the magneto operating, because it shorts out the breaker contacts and prevents the opening of the primary circuit.

The only remedy for a condenser that is actually open or grounded inside is to replace it with a new one. A ground in the armature windings due to defective insulation may result in weak ignition and missing, or in complete failure of the engine. Unless the trouble is right in one of the leads or connections of the coils, the best remedy is to replace the magneto armature with a new one.

If the insulating rings or material on each side of the collector ring become oily and dirty it will allow the high voltage to creep over the surface and to ground. In such cases the rings should be carefully washed with gasoline and well dried before being put back in service.

Magnetos

These rings or insulating barriers sometimes become cracked or punctured and in some cases must be replaced with new ones. To remove a damaged ring, first pull the inner bearing race off the armature shaft. Then stand the armature on end with the collector ring down and apply a little alcohol to dissolve the varnish which cements the secondary lead to the ring. Be careful not to drop any alcohol on the winding insulation, as it will ruin it.

When the varnish is soft the secondary lead can easily be removed, after which the ring is pulled off the shaft with a special puller. If such a puller is not available expand the ring by immersing it in hot water, after which it can generally be tapped off with a hammer or sometimes pulled off by hand.

Distributor plates and caps sometimes become dirty or carbonized and should then be carefully washed out with gasoline and dried with a clean cloth. Never use sandpaper to clean blackened surfaces of the distributor plate, as this roughens the surface and makes it collect additional dirt much more rapidly.

The magneto ground brush should always make good contact with the rotating armature, and if it doesn't the armature should be cleaned and a new brush installed when necessary.

Some of the other faults which may cause defective magneto operation and for which the remedies can be clearly seen are: Wrong timing, wrong breaker plate, incorrect meshing of armature and distributor gears, cracked distributor cap, broken distributor brush, worn bearings, wrong direction of rotation of armature, etc.

Magnetos are supposed to operate in one direction only, but the direction of rotation can be reversed if necessary in many magnetos by changing the breaker plate for one made for opposite rotation and resetting the meshing of the armature and distributor gears as previously explained.

It is a good plan to check and clean the distributor and interrupter mechanisms of magnetos and readjust the breaker points after every 1,000 miles

Automotive Electricity

of operation on trucks and busses, or after every 100 hours of operation on tractors and stationary engines.

Cleaning and adjustment are required more often than this on aeroplane engines where the ignition is extremely important.

At these intervals the magnetos should also receive one or two drops of good light machine oil in each of the oil openings. Be very careful not to oil them excessively because too much oil is very often the cause of magneto trouble due to damaged insulation or collection of excessive dirt.

EXAMINATION QUESTIONS

1. For what purposes are magnetos used?
2. Why are magnetos equipped with a secondary winding?
3. In which circuit are the magneto breaker points located?
4. Why are condensers necessary, and where are they connected in a magneto?
5. How are magnetos protected against excessive voltage in case the spark plug circuits become open?
6. Why are ground brushes used on magnetos?
7. Briefly explain the method usually used in shutting off magneto ignition.
8. Briefly explain the procedure which should be followed when timing a magneto to the engine.
9. What precaution should be taken to protect the magnets when necessary to remove them from the magneto?
10. In the case of excessive sparking at the breaker points, where would you expect to find the trouble?

Automotive Electricity

STARTING MOTORS

One of the greatest conveniences provided by electricity on the modern automobile is the electric starter which eliminates the necessity of cranking the engine by hand as with earlier model cars. The electric starter which turns the engine over at a mere touch of the starting switch is so much quicker, safer, and more convenient that every car owner wants the starter to be in good condition at all times.

Electric starters are very rugged and simple devices, and do not often get out of order, but there are a few simple faults which do occasionally occur that interfere with their proper operation. These troubles can be easily corrected by an experienced service man.

As it requires considerable torque to turn the automobile engine over rapidly when starting, and particularly when the oil is cold and stiff, series motors are used for this work. You have already learned that series motors have an excellent starting torque characteristic. The series D.C. motors used for automobile starters are constructed and operated on the same general principles as those you have already covered in the D. C. Power lessons.

The principal difference between power motors and those used for starting automobiles is that the automobile starting motor is smaller and is designed for operation on 6 or 12 volts.

Fig. 1 shows a starting motor with the brushes and a commutator on the right end, and on the left end the driving pinion that meshes with the flywheel gear of the engine.

Fig. 2 shows the location of the starting motor mounted on the engine near the right-hand end, near the flywheel. In this view you will note that the starting motor housing is bolted securely to the flywheel housing. The shaft and driving pinion of the starting motor project through into the flywheel

Starting Motors

housing to mesh with the teeth of the flywheel gear and turn the engine over when the starting motor switch is closed. The switch in this case is mounted on top of the starting motor where it is operated by a small lever and a pedal which projects through the floorboard of the car.

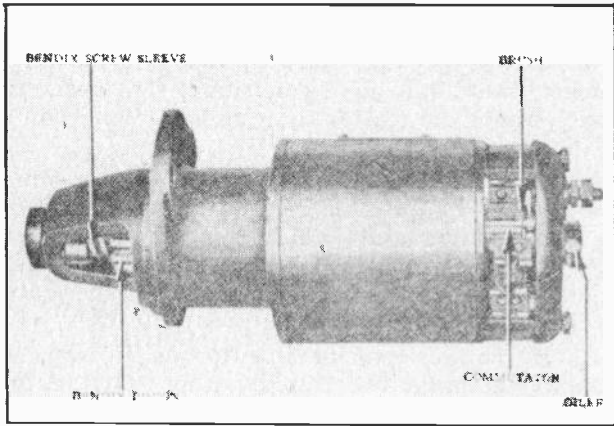

Fig. 1. Photo of common type of automobile starting motor, the commutator and brushes shown on the right and driving pinion on the left.

Starting motors consist of the following principal part:

1. Cylindrical field frame.
2. Armature.
3. Brushes and brush rigging.
4. End plates in which the bearings are supported.
5. Mechanism used to connect and disconnect the motor armature to the engine flywheel.

As starting motors operate on very low voltage and require heavy currents, both their armatures and fields are wound with very heavy conductors, generally in the form of copper bars or strips. This makes their construction very rugged and tends to eliminate troubles due to short circuits, grounds, and defective insulation which occur more frequently with smaller insulated wires.

Automotive Electricity

The commutator and brushes of starting motors, however, are necessarily rather small and are sometimes sources of trouble on account of the very heavy currents they are required to carry.

Starting motors are made to develop from approximately one-half to one horse power, according to the size of the automobile engine they are to operate. At six volts this results in very heavy operating currents ranging from 100 to 200 amperes when the starter is turning the engine over at about 125 RPM.

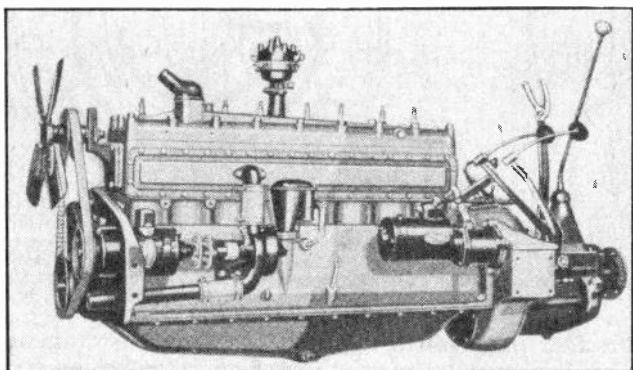

Fig. 2. Side view of an eight-cylinder Studebaker engine showing location of starting motor attached to the flywheel housing on the right.

During the first instant of operation, however, when the starter is just getting the engine in motion starting currents may run as high as 400 or 500 amperes for a fraction of a second.

From this we can see the necessity of having tight connections and a good low-resistance circuit from the battery to the starter, and through the brushes and windings of the starter itself.

Fig. 3 shows a simple circuit diagram of the field and armature connections of a series starting motor of the four-pole type. You will note that the motor only has one connection terminal, which is insulated from the frame and feeds the battery current through the field coils and armature in series. Two of the brushes are grounded, thus giving the armature current its return to the other side of the

Starting Motors

battery, which is also grounded.

The upper view in Fig. 4 shows the commutator end of a starting motor with the cover and brush-

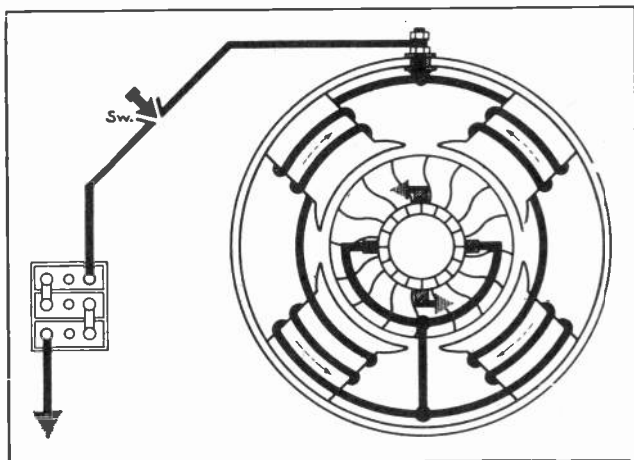

Fig. 3. Diagram showing connections of series wound automobile starting motor. Carefully trace the circuit from the battery through the switch, field coils, armature, and from the grounded brushes back to the battery.

holder mechanism removed. Note the arrangement of the brushes, one set of which is grounded to the metal cover, and also note the heavy armature bar conductors attached to the commutator. The large leads projecting from the field frame are those of the series field coils. The insulated connection terminal by means of which the heavy starter cable is attached to the motor can be seen on the lower left corner of the field frame.

In the lower view the opposite end of the starter is shown, and the heavy armature conductors can again be seen projecting from the frame. This view also shows the special pinion and coupling arrangement by which the starting motor is connected to the engine flywheel.

2. BENDIX DRIVE FOR STARTERS

When the electric starter on an automobile is brought into use it must momentarily connect with the engine flywheel in order to turn the engine, but

Automotive Electricity

as soon as the engine is started and running under its own power, the starter must be immediately disconnected, or it would otherwise be driven at an excessive speed, because of the high gear ratio between the starter and the engine flywheel.

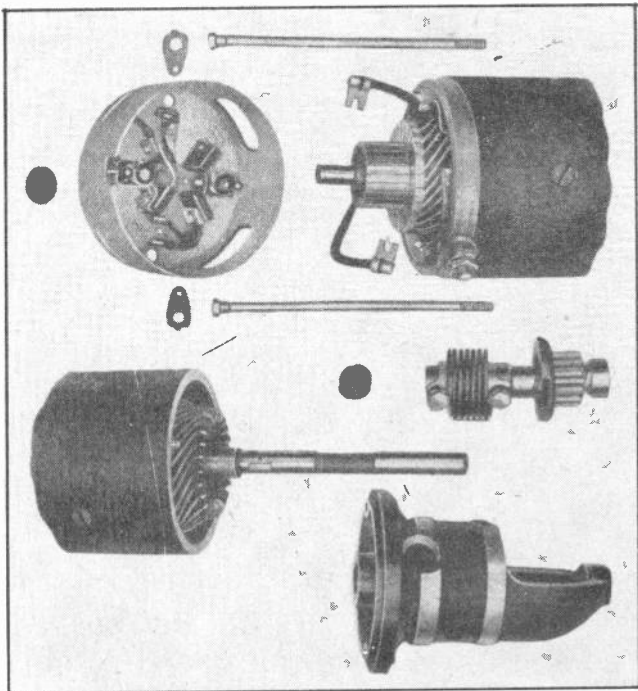

Fig. 4. Disassembled view of a starting motor showing commutator end and brushes above, and drive end with Bendix drive and pinion below.

This gear ratio is generally about 15 to 1 and enables the starter to crank the engine at a speed of about 125 RPM. When the engine is running under its own power, however, the normal speed will range from 500 to 3500 RPM, which you can readily see would drive the starter at a terrific rate if it were left connected to the flywheel.

To avoid this requires some form of device which will automatically and reliably connect the starting motor to the engine flywheel when it is desired to

Starting Motors

start the engine, and quickly disconnect it as soon as the engine begins to run under its own power.



Fig. 5. Photograph view of Bendix drive mechanism showing spring, sleeve, and pinion.

One of the most popular arrangements developed for this purpose is known as the **Bendix drive**, which is shown in Fig. 5. This device connects to the end of the starter armature and consists of a coarsely threaded sleeve mounted on the end of the armature shaft, a small gear or pinion which has threads cut in its inner surface to correspond with those on the sleeve over which the pinion fits, a

Automotive Electricity

strong coil spring, and the necessary studs to attach the assembly to the drive head.

Fig. 6 shows a sectional view photo of a starting motor with the Bendix drive attached to its armature. Keep in mind that the drive head or left end of this Bendix drive is rigidly attached to the armature shaft and the rest of the assembly is driven through the coil spring.

When current is sent through the motor by press-

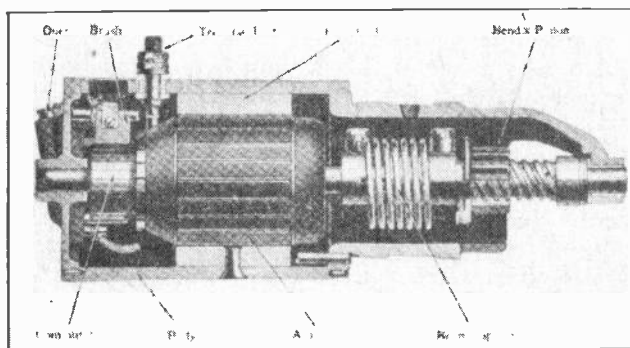

Fig. 6. Sectional view of an automobile starting motor showing commutator and brushes on the left and Bendix drive on the right. Examine this figure carefully while studying the lesson.

ing the starter switch, the armature almost immediately goes up to a speed of about 4,000 r.p.m. As the small gear has a certain amount of weight its inertia tends to prevent its accelerating with the motor, and as it is loose on the threaded sleeve it tends to turn slower than the sleeve, which causes the threads to force it outward to engage the teeth of the flywheel. The coil spring then absorbs the shock as the motor starts to crank the engine.

As soon as the engine starts to operate under its own power the speed of the flywheel tends to exceed that of the starter gear and causes it to revolve faster than the drive sleeve, so that the threads force the gear back toward the starting motor and out of mesh with the flywheel teeth.

To avoid the possibility of the small pinion or gear revolving and creeping along the threaded sleeve due to car vibration and thus possibly engaging the

Starting Motors

flywheel when the engine is running, the gear has attached to it a flange one side of which is much heavier than the other. This heavy side tends to hang downward and prevents the gear from revolving except when the starting motor operates it.

In addition to this weighted flange, an added precaution is provided in the form of a small stop pin which can be seen in the lower edge of the flange in Fig. 6.

When the pinion gear is thrown to the idle position this little pin is forced by a light spring into a shallow groove in the driving head, thus holding the gear in this retarded position.

Two of the great advantages of the Bendix drive are its very simple construction and the fact that it allows the starting motor to come up to full speed before connecting it to the engine, thus giving the motor a tremendous "break away" or initial starting torque to crank the engine.

3. MANUAL PINION SHIFTS

Another method that is sometimes used for engaging the starter pinion with the flywheel gear is known as the **manual shift**. With this system the pinion is attached to the starter pedal by a lever arrangement which, during the first downward movement of the starter pedal shoves the pinion into mesh with the flywheel gear.

Further movement of the pedal operates the starter switch, starting the motor and cranking the engine. Just as soon as the engine starts the foot should be removed from the pedal to allow the strong spring which returns the pedal to normal position to also withdraw the pinion from the flywheel gear.

Starters of this type generally also have in the pinion a form of slipping clutch arrangement which will prevent the motor from rotating at excessive speeds in case the pinion should stick or jam in the meshed position when the engine starts.

Automotive Electricity

Fig. 7 shows a starter with the manual-type shift mounted on the transmission of an engine and with a section of the flywheel casing cut away to show the manner in which the gears are meshed. Attached to the starter pedal is the lever with which first moves the small gear into place and then presses the starter switch, which is located on top of the motor.

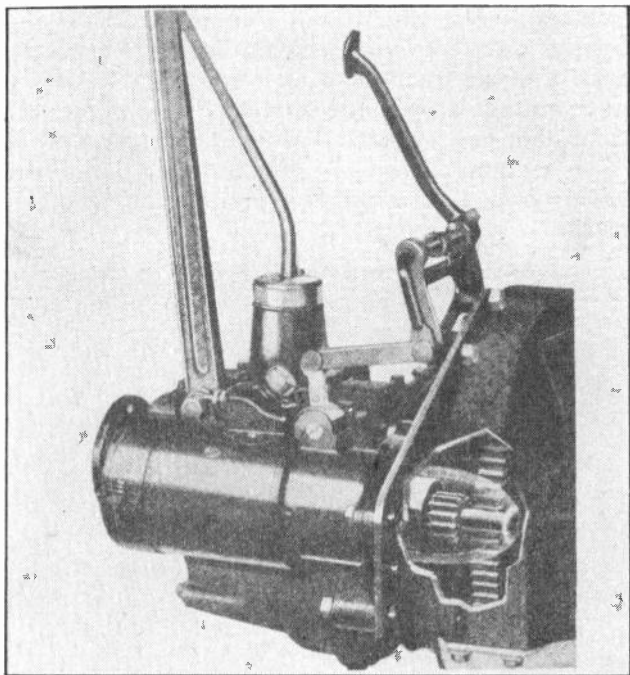

Fig. 7. This view shows method of meshing the starter pinion with the flywheel gear by means of the starter pedal which operates both the gear and starter switch.

Fig. 8 shows a starting switch of the foot-operated type for mounting in the floorboard of the car. The connections from the battery to the starting switch, and also from the starting switch to the terminal of the starting motor, are made with heavy stranded copper cable which is equipped with soldered lugs to secure low-resistance connections to the battery, switch, and motor terminals.

Starting Motors

It is very important to see that the lugs of this starter cable are well soldered to the conductor, and that they are securely tightened to all terminal connections. When you consider that it is necessary for the 6-volt battery to send several hundred amperes through this circuit, you can readily see that the slightest amount of looseness in these terminal connections, or even a thin layer of dirt or corrosion at such terminals, would create enough resistance to greatly interfere with efficient starter operation. Even a small fraction of an ohm would cause too much voltage drop at the starter. For example, $1/50$ of an ohm in a circuit carrying 200 amperes would cause a voltage drop of $1/50 \times 200$, or 4 volts, thus leaving only 2 volts effective pressure at the starter brushes.

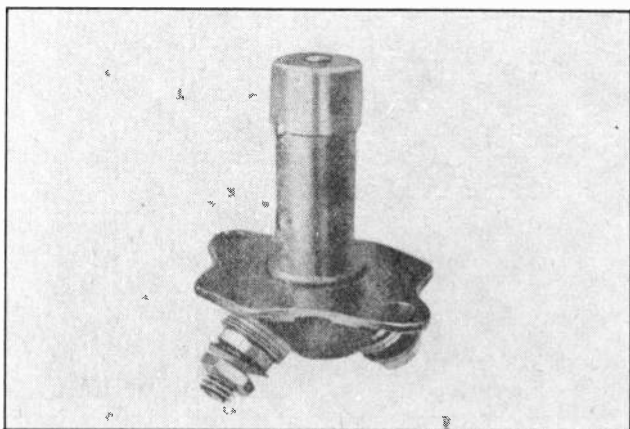

Fig. 8. Starter switch for mounting on the floorboard and connecting in series with the lead from the battery to the starting motor.

For this same reason it is very important to keep the contacts of the starting switch clean and in good condition and the switch properly operating, to avoid unnecessary resistance at this point. These contacts sometimes become burned and pitted, due to making and breaking the heavy current circuit, and they then require scraping and polishing to provide a bright new surface.

Automotive Electricity

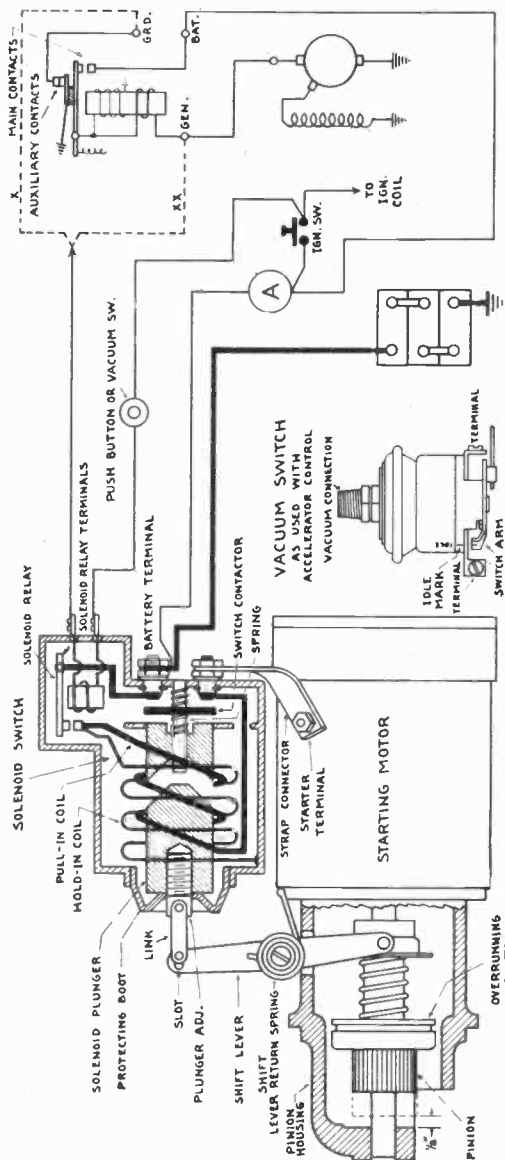

Fig. 9. Wiring diagram for a common type automatic starter switch.

Starting Motors

4. AUTOMATIC STARTER CONTROLS

Automatic starter controls are used to provide a positive and convenient means of operating the starter drive and closing the starting switch contacts. Control may be through a push-button on the dash, or a switch attached to the throttle, or accelerator pedal. Either method starts the engine automatically and as soon as the engine starts firing the starter circuit is broken and the gears are disengaged. In most cases the solenoid relay circuit is connected to the coil side of the ignition switch if an electro-lock type of switch is used, so that the starting system will operate only when the ignition is turned on.

Fig. 9 shows a diagram of a common type of automatic starter switch. Examine all the parts and connections carefully.

The control consists of a small relay known as the solenoid relay, and the solenoid switch. The solenoid relay is a small relay energized by means of a push-button switch, or a throttle or accelerator operated vacuum switch. The function of the solenoid relay is to energize the solenoid switch, which operates the starter drive and closes the starting motor switch contacts. This unit will be found mounted directly on top of the starting motor.

To insure positive de-energizing of the relay circuit as soon as the engine begins to fire, this circuit is usually grounded through auxiliary contacts on the generator cut-out, as shown by the dotted line X in Fig. 9. These contacts will open when the main cut-out contacts close. The second method is to ground the solenoid relay circuit through the main brushes of the generator as shown by dotted line XX. As soon as the engine begins to fire, the rising generator voltage will oppose the flow of current through the solenoid relays and cause its contacts to open.

With ignition turned on, if the push-button is pressed, or accelerator pressed down on cars using vacuum switch control, current will then flow from the coil side of the ignition switch, through the push-button or vacuum switch to one of the sole-

Automotive Electricity

noid relay terminals, then through auxiliary contacts on generator cut-out. (Trace this circuit in Fig. 9.) This energizes the solenoid relay and closes the contacts.

When these contacts close, current will flow from the battery through the heavy winding or pull-in coil of the solenoid switch to ground through the starting motor windings and armature. At the same time current will also flow through the hold-in coil to ground. The powerful magnetic field set-up by these two windings will draw in the plunger that operates the starter drive, causing the small gear or pinion on the drive to mesh with the ring gear on the flywheel of the engine. As the pull-in coil is in series with the starting motor the armature will be rotating slowly when the gears are brought together, thereby assisting the meshing action.

As the plunger reaches the end of its movement, it closes the main starting switch and current flows directly from the battery to the starting motor. The closing of the main switch shunts out the pull-in coil, but the hold-in coil will hold the plunger in as long as the small solenoid relay is energized.

As soon as the engine begins to fire, releasing the push-button will break the solenoid relay circuit, which in turn will open the solenoid switch contacts. With the solenoid coils no longer energized, the shift lever return spring draws back the plunger, which opens the main starter switch and also disengages the gears. Should the operator fail to release the push-button as soon as the engine starts, the solenoid relay circuit would be rendered inoperative either by the opening of the auxiliary contacts on the cut-out relay or by the use of the opposing voltage depending on which hook-up was used.

When a throttle or accelerator vacuum switch is used, as soon as the engine begins to fire the vacuum built up in the intake manifold will open the solenoid relay circuit. In case the vacuum switch should stick, the opening of the auxiliary contact on the cut-out, or the opposition of the rising generator voltage would render the solenoid circuit inoperative.

Starting Motors

5. AUTOMATIC STARTER CONTROL ADJUSTMENTS

Solenoid relay contacts should close with a maximum terminal voltage of 4 volts, and should remain closed until the voltage drops to 1.6 to 2 volts. If the operation of this relay is not satisfactory, check the contact gap which should be .030" to .045" and the air gap which should be .010" to .014" with the contacts open. When the solenoid relay circuit is grounded through auxiliary contacts on the cut-out, the gap for these contacts should be .015" to .025" when the main generator contacts are closed. Total failure of this system might be due to poor contact in the push button, vacuum switch, or auxiliary contacts on the generator cut-out. If the solenoid relay circuit is grounded through generator brushes, failure could be caused by a dirty commutator.

There is only one adjustment on the solenoid switch but it is very important. The clearance between the end of the pinion gear and the housing should be $\frac{1}{8}$ of an inch when the shift plunger is at the inner end of the stroke. See Fig. 10.

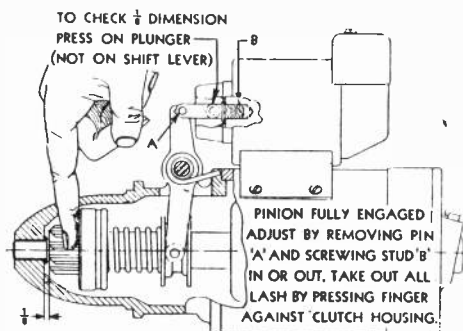

Starter pinion and solenoid plunger adjustment on Delco Equipment.

Fig. 10. This diagram shows the proper adjustment for the solenoid plunger on a Delco starter.

The only adjustment on the vacuum switch is the "off" position. When the accelerator pedal is released and the engine is not running, the line at the end of the switch arm should line up with the "idle"

Automotive Electricity

mark on the case of the vacuum switch as shown in the sketch. If these marks do not line up, adjust the rod that operates the switch arm.

6. STARTER TROUBLES AND REMEDIES

Because of the very rugged electrical construction of starting motors, troubles of an electrical nature are not very often encountered within the motor itself. In most cases electrical troubles will be found to be at the commutator, brushes, brush holders, or leads. This fact should be kept well in mind by the trouble shooter or ignition service man.

When the starting motor gives trouble, it is generally in the form of low cranking torque or complete failure of the motor. It should be kept in mind that satisfactory operation of the starter depends not only on the condition of the motor itself, but also on the condition of the battery, connecting cables, and starter switch, and one should carefully check each of these items before spending the time necessary to remove the starting motor for thorough inspection or overhauling.

8. LOW VOLTAGE AT STARTING MOTOR

If the starting motor fails to crank the engine properly, a good test to determine the cause of the trouble is to switch on the lights and press the starter pedal. If the lights are extinguished when the starter switch is closed, the trouble is generally due to a loose or dirty connection in the starter circuit. Carefully check the battery terminals, cell connectors, and ground connection.

To help locate the trouble, hold the starter switch closed for about one-half a minute and this will cause the loose connection to heat up so that it can be readily located by feeling along the different parts of the circuit with the hand.

If the lights gradually dim down and go out when the starter switch is closed, this generally indicates a dead battery. The battery should be removed from the car and tested with a high rate discharge test, which will be explained later in the Battery Lessons.

Starting Motors

8. MECHANICAL TROUBLES

If, when the starter switch is closed, the lights dim slightly, but do not go out, it generally indicates mechanical trouble, which may be either in the engine or the starter and is causing an overload on the starting motor. Crank the engine by hand to see if it is unusually tight, as might be the result of cold, heavy oil, tight bearings, etc.

Sometimes the starter pinion becomes jammed or locked just as it starts to mesh with the flywheel gear. The pinion can usually be released by putting the car in high gear and rocking it back and forth to disengage the pinion. If none of these troubles seem to be present, then remove the starting motor and check it for a bent armature shaft or loose bearings.

Sometimes the starter may stick because of loose bearings which allow the armature to rub the pole pieces and lock magnetically when current is applied.

If, when the starter switch is pressed, the lights do not dim at all, there is probably an open somewhere in the starter circuit. This trouble will generally be found at the starter switch or at a loose cable connection, or sometimes at brushes stuck in the brush holders so that they do not rest upon the commutator. An extremely dirty commutator or brushes may also give this indication.

If the starting motor operates and spins at high speed without cranking the engine, it may be due to hardened or gummed oil on the Bendix sleeve which prevents the pinion from traveling into mesh with the flywheel gear. Washing off the threaded sleeve and parts with a brush and gasoline will generally cure this trouble.

Sometimes the Bendix spring or studs become broken or there may be several teeth broken out of the flywheel, thus preventing the starter pinion from meshing at a certain point. If the starter uses a manual pinion shift, check carefully for disconnections or excessive play in the pedal rods or levers.

If, when the starter is operated, a loud clashing or

Automotive Electricity

banging noise occurs when the pinion meshes with the flywheel, check the bolts that hold the starter to the flywheel housing to see that they are tight. If this doesn't remedy the trouble, move the starter and examine the teeth on the flywheel gear.

The edges of the teeth on both the flywheel and pinion gears are beveled to allow them to engage with each other easily. If these teeth are badly burred, due to rotating with only the entering edges meshed, noisy starter operation will result. This condition can only be remedied by replacing the gears.

Burred teeth are generally caused by improper alignment of the pinion, which may be due to a bent armature shaft, worn starter bearings, or loose starter. Clashing may also be caused at times by the threaded Bendix sleeve sticking or "freezing" to the armature shaft, and thus preventing the slight lateral movement which is necessary for silent gear meshing.

To correct this trouble, the Bendix drive should be removed and disassembled and the armature shaft carefully polished with fine emery cloth. Any rust should also be removed from the inside of the Bendix sleeve. Then apply a little light oil and reassemble.

When the starting motor cranks the engine very slowly, the trouble may be due to short circuits or high-resistance connections in the motor, or loose connections and high resistance at the starter switch or cable. If the switch gets hot, remove it and look for burned contacts. Also inspect the switch for possible defects in the insulation. Examine the starter cable carefully for loose connections or for damaged insulation where it rubs against the car frame and may have become grounded.

The starting motor should be carefully checked for poor brush contact, weak brush-spring tension, dirty commutator or brushes, or unsoldered field or armature connections.

If the trouble is still not located, the armature,

Starting Motors

field, and brushes can be tested for grounds. A weak battery may also cause the starter to crank the engine very slowly.

9. ELECTRICAL AND MECHANICAL TROUBLES IN MOTOR

If no trouble can be located at the battery, starting switch, or cable and there appears to be electrical trouble within the starting motor, it should be taken apart and carefully examined for both mechanical and electrical defects, such as the following:

Armature rubbing on the pole shoes, worn bearings, bent shaft, broken brushes or brushes stuck in the brush holders, loose connections to the brushes or field coils, grounded cable terminal, poor brush-spring tension, loose connections between commutator bars and armature leads due to solder having been melted and thrown out of the commutator risers, high resistance in the field circuit caused by solder melting and running out of the joints between field coils, etc.

Always remember that anything that increases the resistance of the motor or its circuit will greatly decrease its torque. The mistake that is sometimes made by inexperienced or untrained automobile service men is that of replacing worn starter brushes with brushes of the wrong grade or material.

In order to be of sufficiently low resistance, the brushes for starting motors are made of carbon and powdered copper, the copper content being the greater portion of the material used in these brushes. If these brushes are replaced with ordinary carbon or carbon-graphite brushes, their resistance will be altogether too high for use on such heavy currents at low voltage.

Sometimes wrong brushes of this type become redhot when the starting motor circuit is closed, but they will not allow enough current to flow to start the engine.

You are already familiar with the methods of testing field coils or armature windings for grounds,

Automotive Electricity

shorts, opens, etc., as covered in the Lessons on Armature Winding and Motor Repairs.

An ordinary 110-volt test lamp can be used very conveniently for checking for these faults on starting motors. The brush holders should also be checked to see that those which are supposed to be insulated have not become grounded to the starting motor frame.

After a starting motor has been repaired and overhauled it can be thoroughly tested before it is replaced on the car by means of a regular garage test bench such as is used in most medium and large-sized garages or automotive electrical service stations.

On these benches the starting motor is securely clamped in a special vise and a spring scale and lever arrangement are attached to the shaft to measure its torque when battery voltage is applied.

10. AUTOMOBILE HORNS

Automobile horns are made in many different types and sizes, but most of them are of two general types as far as their mechanical operation is concerned. One type uses a small motor to drive a notched or toothed wheel that rubs against a pointed button mounted on a diaphragm, as shown in Fig. 11.

When the horn button is pressed, current flows through the motor and causes the toothed wheel to rub on the button and vibrate the diaphragm rapidly. This vibration is transmitted out through the horn in the form of air waves or sound.

The other common type of horn uses a magnetic vibrator with one or two electro-magnets and an armature, and operates very much on the principle of an ordinary vibrating bell or buzzer.

The armatures of automobile horn vibrators are generally much heavier and are fitted with special springs to obtain the loud notes required to be heard in automobile traffic. The different high and low pitched notes are obtained by designing the vibrators or motor wheels for different speeds to get dif-

Automobile Horns

ferent frequencies of vibration of the horn diaphragm.

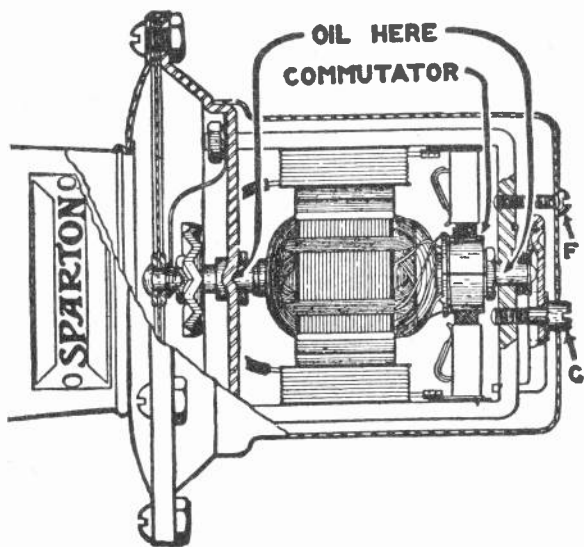

Fig. 11. This diagram shows a cut-away view of a motor-driven automobile horn. Note the notched wheel which vibrates the diaphragm by rubbing on the pointed button at its center.

The care of motor-type horns is very similar to the care of any small D.C. motor such as those with which you are already familiar. Commutator and brushes generally require the most frequent attention and the bearings should be occasionally lubricated, unless the horn is of a type using ball bearings, or has inside of it permanent lubricating cups which do not require attention for a year or more at a time.

The greater number of troubles affecting horn operation are in the wires leading to the horn or at the horn button, rather than in the horn itself, except perhaps in some of the very cheaper grades.

Care of the vibrating-type horn is similar to the care that would be given any heavy-duty vibrating bell, in that it will possibly require occasional cleaning of the make-and-break contacts or adjustments of the armature spring.

A great many horns are equipped with an adjusting screw either against the back end of the arma-

Automotive Electricity

ture shaft or sometimes located down inside of the horn at the center of the diaphragm. By means of this screw the pressure of the diaphragm button against the notched wheel or vibrating armature can be adjusted to slightly change the pitch or note of the horn, or to improve the operation of the horn in case the button or wheel becomes worn away with use.

Some special types of horns are operated by air supplied by a small motor-driven air pump of the rotary type which is built right into the back of the horn. The connections of the horn and horn button to the switch or ammeter terminal are shown in some of the complete wiring diagrams of automobiles.

11. HORN RELAYS

Horn relays are used to improve the tone of horns by providing a shorter and more direct circuit from the source of current supply to the horns.

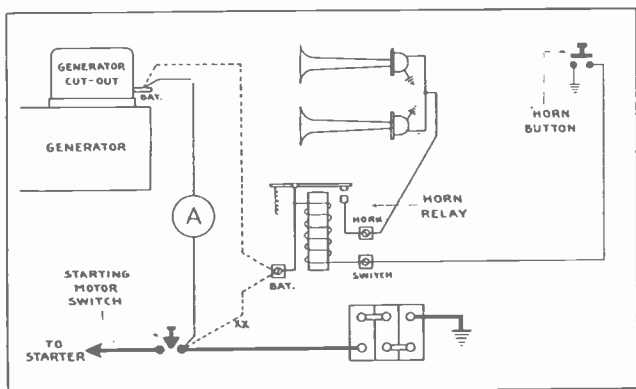

Fig. 12. Diagram of horn relay circuit.

The conventional horn-circuit is rather long since the current that operates the horn or horns must be carried up through the horn button which is located at the top of the steering column. When a large horn or twin horn is used, the resistance of this long circuit to the flow of the rather heavy current required, causes considerable voltage drop, which reduces the current flow through the horns, thus effecting the tone.

Automobile Horns

By means of a relay this circuit can be considerably shortened, because the full horn current need not be taken through the horn button. (See Fig. 12.) When the horn button is pressed, current will flow from the battery or the generator through the relay coil winding, and through the horn button to ground. The current required by this relay coil circuit is only a fraction of an ampere, but it will be sufficient to close the relay contacts and complete the circuit to the horns.

Horn relays are usually located in the forward part of the engine compartment. The horn current can be taken from the battery side of the generator cut-out as shown by dotted line X, in Fig. 12. With the engine running, this hook-up supplies the horn with full generator voltage, which is always a trifle higher than battery voltage. The disadvantage of this type of connection is that when the generator is not charging, the full horn current will have to flow from the battery back through the ammeter, and if the horn current is greater than the ammeter capacity, the meter may be damaged. So it is always a good policy to check the amount of current that the horns require and see that it does not exceed to capacity of the meter before using this hook-up.

Sometimes these relays are connected to the battery side of the starting motor switch as shown by dotted line "XX." This hook up does away with any possibility of damaging the ammeter.

To secure the best operation and tone of the horns with these relays, the wire used in the circuit that carries the full horn current must be of ample capacity. No 12 wire is generally used but in case of heavy twin horns, No. 10 may be needed.

These relays come as standard equipment on some of the higher priced cars, but can be obtained from automotive supply stores and installed in any car. Quite often they make a remarkable difference in the tone of a horn.

EXAMINATION QUESTIONS

1. Why are starting motors of the series connected type?
2. According to Watt's Law how many amperes will a starting motor draw from a 6-volt battery in order to develop $\frac{1}{2}$ horsepower?
3. What are two advantages of the Bendix drive method of starting the automobile engine?
4. When trouble develops in the starting motor where is it most likely to be?
5. What kind of material is used in the construction of starting motor brushes? Why?
6. Why is it necessary to use a heavy cable to carry current from the battery to the starting motor?
7. What are the correct settings of the contact gap and air gap on automatic starter controls?
8. Briefly describe the operating principle of automobile horns.
9. In case the horn fails to operate where is the trouble most likely to be?
10. Briefly explain the advantage in using a horn relay.

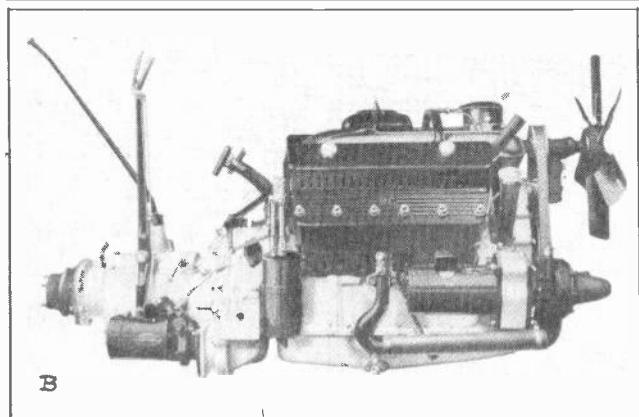
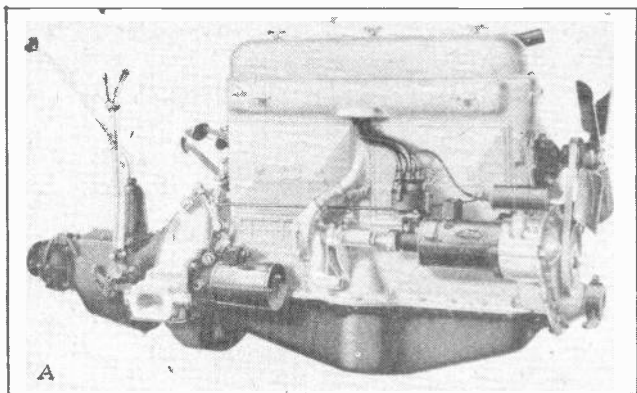

"A" shows right side view of Buick engine. Note clean-cut appearance and compact installations of ignition, generator and starting systems.

"B" Cadillacs famous V-8 engine. Cadillac pioneered this type of engine embodying an entirely new principle in engine design.

Automotive Electricity

AUTOMOTIVE GENERATORS

As stated in an earlier article, the generator is a very important piece of the electrical equipment on a modern automobile. With the extensive use of electric current for lights, ignition, horn, starting motor, and various other purposes, any ordinary-sized battery would soon become discharged if there were no means for supplying it with current.

The length of the battery discharge could, of course, be prolonged by using batteries of larger sizes, but as this would add considerable weight and additional expense, it is much more practical to equip each car with a small low-voltage D.C. generator to keep the battery charged, and also to supply the current for various uses and prevent drain on the battery when the engine is running at normal speed.

For this purpose a small shunt-wound D. C. generator is connected to the engine by means of a chain, belt, or gear, and is driven at a speed of about one and a half times engine speed, producing from 6 to 8 volts within the normal speed range of the engine.

Fig. 1 shows two very common types of automobile generators, and Fig. 8 on pages 16 and 17 shows a generator attached to a bracket and mounted upon the engine at the right-hand end. In this figure you will note the "V" belt used to drive the generator and fan.

The general construction and operating principles of D. C. generators have been thoroughly covered in the previous section on D. C. power equipment, and the principles of automobile generators are very much the same. Because of the peculiar conditions under which they operate, however, there are certain special features in their design that are very important and interesting to consider.

For example, a generator must be capable of rotating at very high speeds without injury, as it may often be revolved at speeds of 6,000 r.p.m. or over. Another special feature is the very interesting voltage control, which has been developed to enable

Generators

the generator to produce high enough voltage to charge the battery and supply current when the car

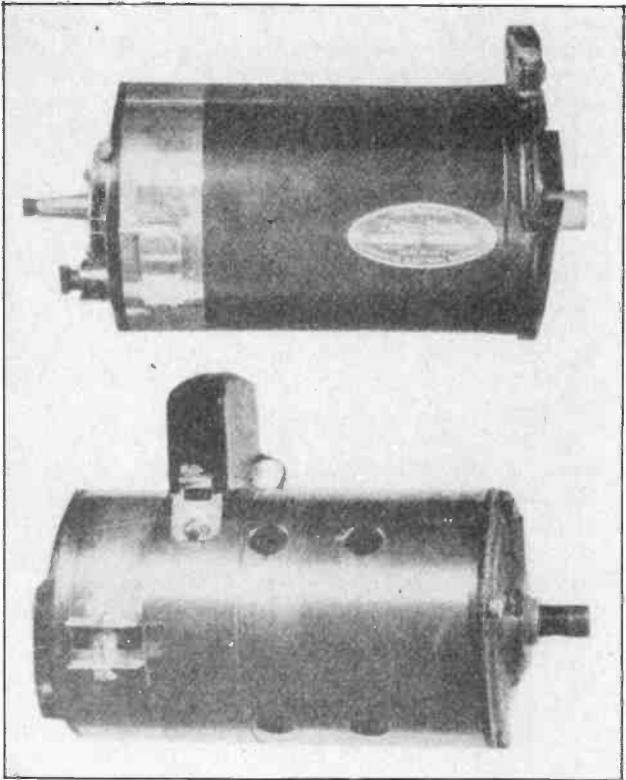

Fig. 1. Photograph views of two types of automobile generators. Note the metal band on the left end of each generator which can be removed for access to the brushes and commutator. Also note the cut-out mounted on top of the lower generator.

is operating at comparatively low speeds and yet prevent the generator from developing excessive voltage and charging currents at high speeds. When we consider that it is desired to have the generator commence charging the battery at a car speed of about 12 miles per hour and yet not charge excessively or develop too high voltage at speeds of even 60 or 70 miles an hour, this voltage regulation is quite an accomplishment.

Automotive Electricity

Another feature of the automobile generator is the convenient means provided for adjusting or changing the charging rate so that it can be set to suit various driving conditions.

1. THIRD BRUSH REGULATION

One of the most commonly used and popular types of automobile generators which fulfills the above requirements is known as the "third brush" type, because it uses a small third or auxiliary brush to regulate the voltage at different speeds.

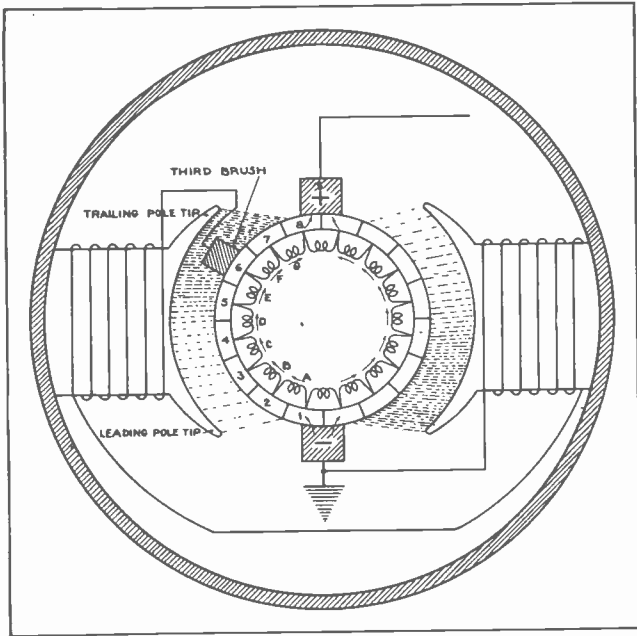

Fig. 2. Diagram showing the armature reaction, field distortion, and principles of third brush voltage regulation on an automobile generator.

This brush is connected to one end of the field winding and is placed in such a position on the commutator that it tends to decrease the field voltage and current when the generator speed increases, and so prevents the armature voltage and current from rising above the limit for which the brush is set.

Generators

The location and connection of this third brush is shown in Fig. 2.

You have already learned in an earlier Lesson on D. C. Motors and Generators that when the armature windings are carrying current there is set up around them a strong magnetic field which tends to distort the lines from the field poles, and cause the pole flux to shift around the pole faces in the direction of rotation. This armature reaction results in weakening the flux at one pole tip and strengthening it at the other, as shown at Fig. 2.

In this diagram the coils A to G are under one field pole and will have generated in them a voltage proportional to the speed at which they are rotated and to the strength of the magnetic field of the generator. Assuming that each coil generates 1 volt, the voltage between adjacent commutator bars will be 1 volt; and the voltage between the main brushes will be the sum of the voltages generated in the separate coils in one side of the winding, or in this case 7 volts.

Note that the two sides of the armature winding form two parallel paths from the negative to positive brush. With a pressure of 1 volt between bars, the voltage applied to the field coils which are connected between the negative brush and third brush will be 5 volts.

This voltage doesn't remain constant, but varies with the shifting of the field flux due to the change of current load in the armature conductors. For example, if the armature develops a certain voltage and delivers a current of 10 amperes at a speed of about 1,800 r.p.m., then if the speed is increased the voltage and current will tend to increase.

Slight increase in the armature current increases the field distortion, moving the more dense field flux farther toward the pole tips. This weakens the field through which coils A, B, C, D, and E are moving thus reducing the voltage applied to the field coils, cutting down the total generator field strength, and tending to prevent the voltage at the main brushes from rising in proportion to the increase of speed.

In actual practice this third brush method of voltage regulation allows the charging rate to gradually increase up to generator speeds of about 1,800 r.p.m.,

Automotive Electricity

at which point the correct relation between armature current and field voltage is obtained. From this point the charging rate gradually falls off as the speed is increased above this limit. This is generally a desirable feature, particularly in the summer time, when the car may often be operated for long periods at high speeds, as it protects the battery from being overcharged and the generator from overheating.

As the voltage applied to the field varies immediately with any change of generator speed and armature current, resulting in a change of field distortion, this regulation is entirely automatic and maintains a fairly steady voltage even with sudden variations in the engine speed.

2. ADJUSTING CHARGING RATE

To adjust the charging rate of a generator of this type, all that is necessary is to slightly shift the position of the third brush on the commutator to include more or less bars between it and the negative brush.

You can readily see that if the third brush in Fig. 2 were shifted farther to the right it would include more armature coils in the field circuit and supply higher voltage to the field, thus causing the generator to develop higher armature voltage at the main brushes and increase the charging rate.

On the other hand, if the brush were shifted to the left to cut out part of the winding between it and the negative brush, there would be less voltage applied to the field coils, and the generator voltage and charging rate would be decreased.

The third brush holder is generally arranged with a set screw or locking nut which normally holds it securely in one position, but which can be loosened to allow the brush to be shifted, either by lightly tapping against the holder with a screwdriver or by the adjustment of an auxiliary shifting screw. This provides a convenient method of increasing the charging rate during winter months when the engine starts hard, due to cold, stiff oil and therefore requires considerably more starting current. This is also the season when the daylight hours are shorter

Generators

and the headlights are used a great deal more on an average.

In the summer time, to prevent overcharging the battery, the generator charging rate should be cut down by adjusting the third brush. This is particularly true when the car is being used on long trips at high speeds, as the battery would otherwise be overcharged and overheated, and the generator would also tend to overheat due to the continuous high operating current through its armature.

It is important to know by merely looking at the generator in which direction to shift the third brush. To increase the charging rate, the brush should be shifted in the direction of rotation of the commutator, and to decrease the charging rate the brush

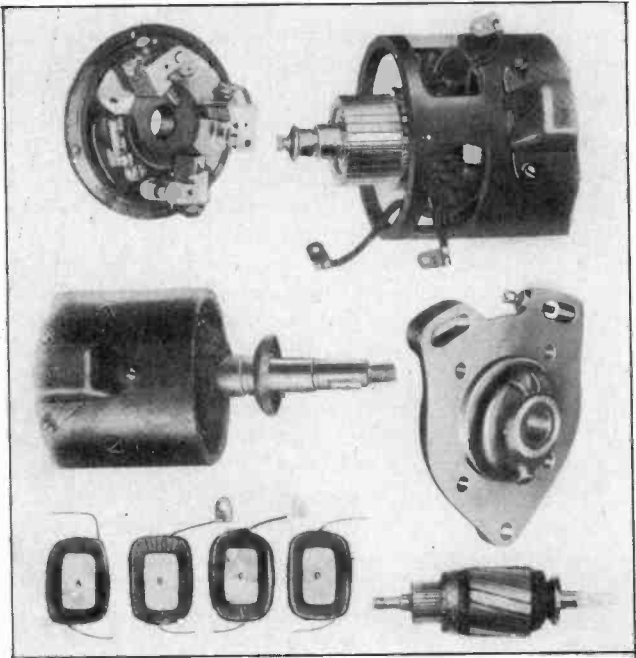

Fig. 3. Disassembled view of an automobile generator showing commutator and brushes above, drive end of generator in the center, and small views of field coils and armature below.

should be shifted in the direction opposite to that of commutator rotation.

Automotive Electricity

The upper view in Fig. 3 shows the commutator end of an automobile generator with the end-plate and brush rigging removed. The two large brushes placed at right angles to each other are the main brushes and the smaller brush is the third brush, or voltage regulating brush.

The center view in this figure shows the opposite end of the generator, opened up to show the end of the armature winding and the drive shaft by which the unit is coupled to the engine.

At the bottom of this figure are shown four field coils and an armature completely removed from the generator frame.

Fig. 4 shows a set of curves which indicate the variations in voltage and current at different engine speeds and for generators operating both cold and hot. Note the difference in the operating current due to the increased resistance of the generator windings after the unit has been operating for some time and is warmed up.

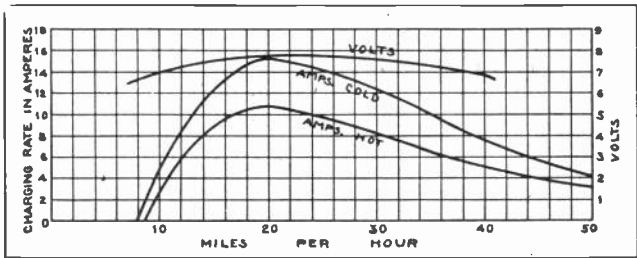

Fig. 4. These curves show the variation in generator voltage and charging current with changes of car speed and variations in generator temperature.

3. GENERATOR CUT-OUTS

In order to prevent the battery discharging back through the generator when the engine speed falls too low to allow the generator to develop a voltage equal to that of the battery, a device known as a reverse current cut-out is commonly used.

This device is simply a magnetically operated switch or relay equipped with both a series and shunt winding and a set of contacts, as shown in Fig. 5. The cut-out is generally mounted on top

Generators

of the generator, as shown in Fig. 5 and also on the photographic view of the lower generator in Fig. 1.

The shunt winding consists of a good many turns of fine wire and is connected directly across the

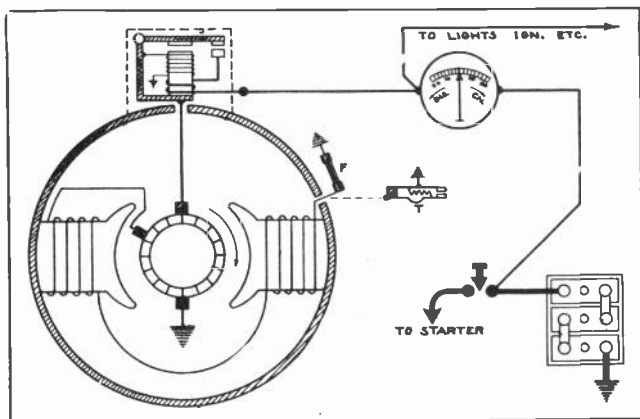

Fig. 5. This diagram shows the connection of an automobile generator and complete charging circuit, including the cut-out, ammeter, battery and field protective devices.

main generator brushes, as can be noted by carefully tracing the circuit from the top brush of the generator in Fig. 5 up through the cut-out frame and shunt coil to ground, by which it returns to the lower brush of the generator. This means that the strength of the shunt coil will always be proportional to the voltage output of the generator.

When the generator voltage rises to about 7 volts the shunt coil becomes strong enough to magnetize the core and attract the armature, closing the contacts in the charging circuit through the ammeter to the battery. This charging current flows through the series coil consisting of a few turns of heavy wire, and this coil is wound so that the current flows in the same direction as through the shunt coil, thus adding the magnetic strength of the series coil to that of the shunt coil and holding the contacts firmly closed.

Whenever the generator speed falls below a certain value, its voltage drops below that of the bat-

Automotive Electricity

tery and the battery commences to discharge back through it. This discharge current flowing through the series coil in the opposite direction sets up a magnetic field which opposes that of the shunt coil and demagnetizes the core, allowing the spring to pull the armature back and open the contacts.

A reverse current or discharge current of not over 2 amperes should be sufficient to release the cut-out contacts. These cut-outs not only prevent the battery from discharging through the generator at low speeds, but also prevent the generator from being overheated and burned out in case the engine was stopped and the battery discharged a heavy flow of current through the generator armature in an attempt to motorize the generator. The generator is connected to the engine and cannot turn it because of insufficient torque to rotate the engine.

Fig. 6 shows two types of cut-outs, one with the cover removed showing the coil and contacts.

By referring to Fig. 5 again you will note that the ammeter is connected in series with the generator and the battery so that it will register the current flowing to the battery by a movement of the needle over the side of the scale marked "Charge." This instrument will also register the flow of current out

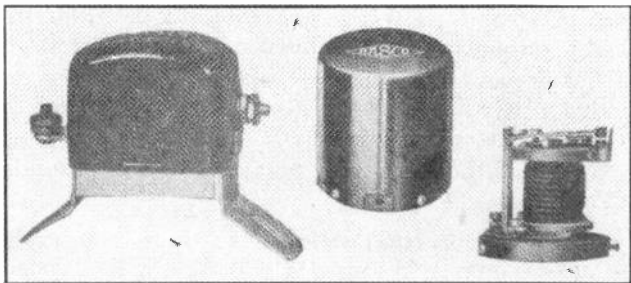

Fig. 6. This view shows two types of generator cut-outs and the one on the right has a cover removed showing the coil and contacts.

of the battery whenever the battery is discharging through the lights and other equipment.

The ammeter should always be observed when looking for battery or generator troubles, because it

Generators

gives a good indication of possible reasons for the battery being discharged or overcharged due to too low or too high charging rates, and will also indicate sticking contacts in the cut-out by showing a very heavy discharge when the engine is stopped. Note that the starter connection to the battery is made in such manner that this very heavy current doesn't flow through the ammeter.

4. FIELD PROTECTION

Since the third-brush generator depends upon the current flowing through the armature to produce the field distortion necessary for voltage regulation, we can readily see that if the charging current were interrupted it would entirely destroy the regulating action of the generator.

In fact, if the battery becomes disconnected or the charging circuit open, the generator voltage may rise to 30 or 40 volts, because of insufficient current flowing through the armature to distort the field and keep the voltage reduced in those coils between the third brush and the grounded main brush.

With the field flux in a normal, evenly-distributed position over the pole face these coils would generate much higher voltage, excite the field much more strongly, and allow the generator to develop sufficient voltage to quickly burn out the field coils.

To prevent this, field protection is generally provided either in the form of a fuse or a thermostatic cut-out placed in series with the field windings.

In Fig. 5 the fuse is shown at "F" in the grounded field lead.

If the field current rises above the normal value of approximately 5 amperes this fuse will blow and the generator will become dead. Another method of field protection and one that is rapidly replacing the fuse for this purpose is the **thermostatic cut-out**, such as shown at "T" in Fig. 5.

These devices consist of simply a set of contact points, a small resistance, and a spring-like blade made of two dissimilar metals welded together so

Automotive Electricity

that when they become overheated they warp in a manner with which you are already familiar.

With this thermostat connected as shown by the dotted line to the field terminal, in place of the fuse, whenever an excessive current flows through the generator its temperature increases and the strip becomes heated and bends, opening the contacts and thus inserting the small resistance in the field circuit and reducing the charging rate about 40%.

As soon as the temperature in the generator drops enough to allow the strips to cool off the contacts automatically close and bring the generator back into normal operating condition. This device is also a precaution against the generator overheating.

For maximum life of the generator insulation the temperature inside the unit should not exceed 180° F., so the thermostat is designed to open the cut-out points at this temperature and thus reduce the charging rate by inserting resistance in the field.

When the generator cools off again the contacts close and allow the charging current to again rise to normal value. We can see, therefore, that the thermostatic cut-out not only protects the field winding from burning out due to excessive voltage, but also protects the generator against overheating due to heavy charging currents and high engine temperatures.

5. AUXILIARY GENERATOR CONTROLS

While the generators used on modern cars are still of the third brush type, many of them are equipped with auxiliary controls. These controls make it possible for the generator to meet unusual operating conditions, such as extra load due to auto radios or other electrical accessories, or the operation of the car at high speed, which tends to reduce the output of the generator.

Auxiliary controls are designed to either increase the output of the generator to meet an increase in load on the electrical system, or to charge the bat-

Generators

tery at a high rate until it reaches a charged condition after which the rate is reduced. The first system, known as the **two-rate or step-down control** keeps the battery from being robbed by an increase in load, since the output of the generator is stepped up until the battery is fully charged, and then the charging rate is stepped down. The second system, known as the **vibrating regulator control**, quickly brings the battery up when it drops to a certain voltage. Auxiliary control is obtained by means of resistance connected in series with the field circuit of the generator.

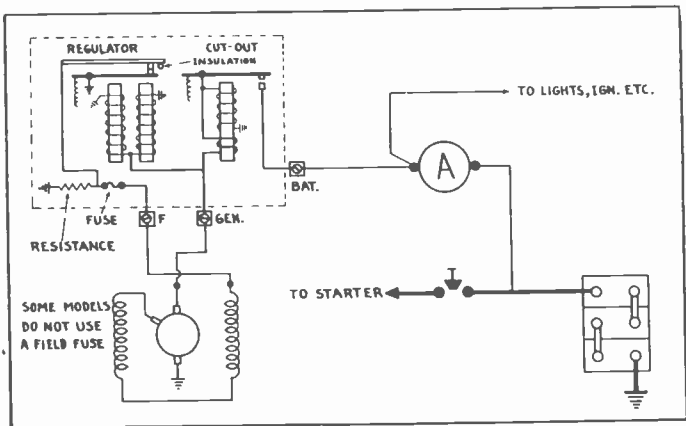

Fig. 7. Circuit and connections for a two-rate or step-down charging control.

6. TWO-RATE STEP-DOWN CONTROLS

This type of control is generally built on the same base and housed in the same casing as the generator cut out. The control consists of one or two potential coils which are connected across the brushes of the generator, (Fig. 7) a moving contact, a stationary contact, a field resistance, and in some cases, a field fuse. The contacts and the resistance are connected in parallel with each other, between the field terminal and ground, and the fuse will be in series with both the resistance and the contacts.

This type of control is designed to charge a battery at a high rate, the value of which will be de-

Automotive Electricity

terminated by the third brush setting, until the battery is charged, after which the rate will be reduced one-half.

7. OPERATING PRINCIPLE OF THE TWO-RATE CONTROL

Since the coils of this field control are connected across the brushes of the generator, the voltage applied to them will be generator voltage. As the voltage of the generator under normal conditions depends upon the state of charge of the battery, the voltage applied to the field control coils will rise or fall as battery voltage rises or falls. Under normal conditions the voltage of the generator will be $\frac{1}{2}$ to $\frac{3}{4}$ of a volt higher than that of the battery. This difference represents the voltage drop in the connections between the generator and the battery. So when battery voltage is about six volts, generator voltage will be between $6\frac{1}{2}$ and $6\frac{3}{4}$ volts. A well charged battery with charging current flowing through it, will reach 7.5 volts which would raise the generator voltage to 8 or $8\frac{1}{4}$ volts.

As long as battery and generator voltage are low the amount of current forced through the coils of the field control will not be sufficient to build a magnetic field strong enough to pull the contacts open, so the field current has a circuit directly to ground through these contacts without going through the control resistance.

As long as the contacts remain closed and keep the control resistance shunted out of the field circuit, the field current will be at maximum value and the charging rate will be high. As the battery becomes charged, its voltage will increase, causing the voltage of the generator to also increase, which will increase the amount of current forced through the coils of the field control. When the voltage of the generator reaches 8 or 8.25 volts, the current flowing through these coils will build a field strong enough to open the contacts, breaking the field circuit at that point and causing the field current to flow through the resistance. This causes the field

Generators

strength to decrease and the charging rate is automatically reduced.

When battery voltage drops to a point that brings the generator voltage down to about 7 volts, the contacts close and the battery charges at a high rate again.

8. TROUBLES AND SERVICING OF TWO-RATE CONTROLS

Since the operation of this control depends upon the voltage of the generator, anything that causes the generator voltage to rise will cause this control to operate. Bad connections in the circuit between the generator and the battery or between the battery and ground would cause the voltage of the generator to rise, regardless of the condition of the battery, and the control contacts would open and thereby reduce the charging rate. This would cause the battery to run down quickly. So it is important that all connections, over which the generator current flows, be kept clean and tight.

In some cases, the constant pull exerted by the moving contact spring upon its anchorage bracket will bend the bracket slightly, and reduce the spring tension; thus allowing the contacts to open before the correct generator voltage is reached. This would also tend to cause the battery to run down, especially during winter months.

To check and adjust these controls, 2 pieces of equipment are required: A $\frac{1}{8}$ ohm, 30 ampere rheostat is used to artificially raise and control the voltage, and an accurate voltmeter should be used to check the voltage at which the contacts open.

With the engine of the car stopped the generator lead is disconnected from the terminal marked "Bat." on the cut-out. The rheostat is then connected in series with that terminal and the generator lead that has just been disconnected. One side of the voltmeter is connected to the terminal marked "Gen." on the cut-out case. If it is difficult to make connection at this point, connect to terminal marked "Bat." instead. The other side of the voltmeter is

Automotive Electricity

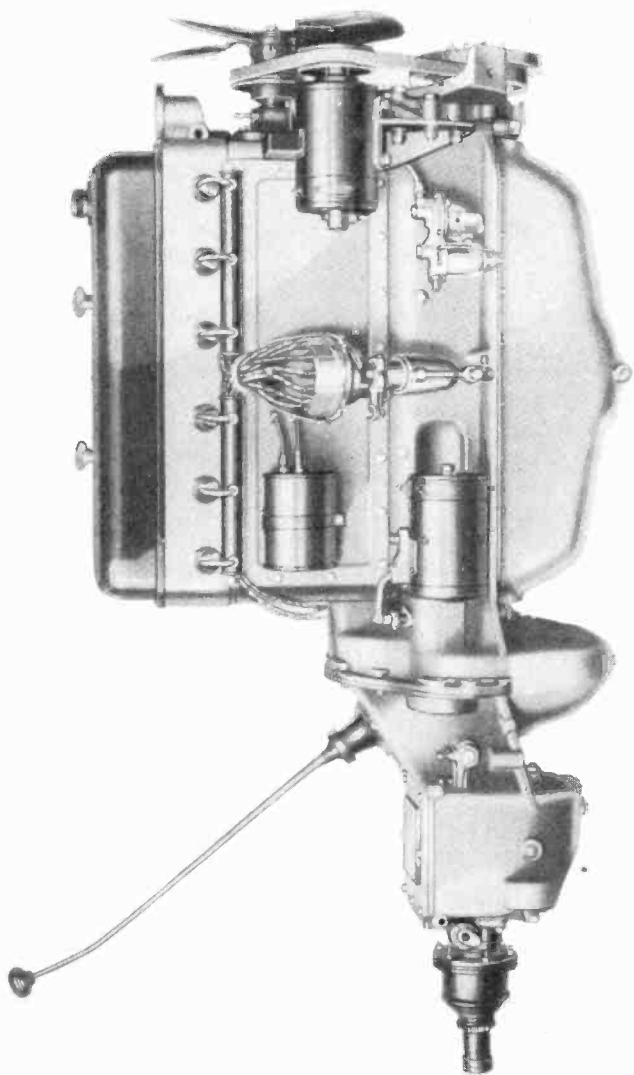

Fig. 8. Side view of a six-cylinder Nash engine showing the location of the starting motor, generator, double ignition distribution, and fuel pump. Note the generator driving belt which drives both the generator and fan.

Generators

grounded. If the "Bat." terminal is used for a voltmeter connection, it is highly important that the cut-out contacts make good connection, as high resistance at this point would make it impossible to set the control correctly.

With the rheostat set so that all resistance is cut-out, the engine can be started. The throttle should be set so that the generator charges at 10 or 12 amperes. Now gradually insert resistance, which will cause the voltage of the generator to rise. When the voltage reaches 8 or 8.25 volts, the contacts of the field control should open. When they open, a slight drop in voltage will be noticed on the voltmeter, so it won't be necessary to watch the contacts.

If the points open too early, increase the tension on the contact spring by bending the bracket. If the points open too late decrease the tension in the same manner. To set third brush for maximum charging rate on a generator equipped with a 2 rate control, ground the field terminal and set the rate at maximum recommended by manufacturer. After rate is set, be sure to remove ground on field terminal.

9. VIBRATING TYPE REGULATOR

This type of regulator is also designed to charge the battery at the maximum rate allowed by the third brush setting, as long as the battery is in a discharged condition, and then gradually reduce the rate when the battery reaches a fully charged condition. Construction and action are somewhat different from the two-rate or step-down type. See Fig. 9.

Two windings are used on the regulator unit. The series or heavy winding is connected in series with the field and the regulator contacts, so that full field current can flow only when the regulator contacts are closed. The shunt or fine winding is connected at a point near the battery, usually the coil side of the ignition switch, and being connected at this point, this winding is actuated by battery voltage, rather than generator voltage.

Automotive Electricity

When the regulator contacts are closed, current flows through both windings, creating a magnetic field which will attract the armature of the regulator and open the contacts when the maximum volt-

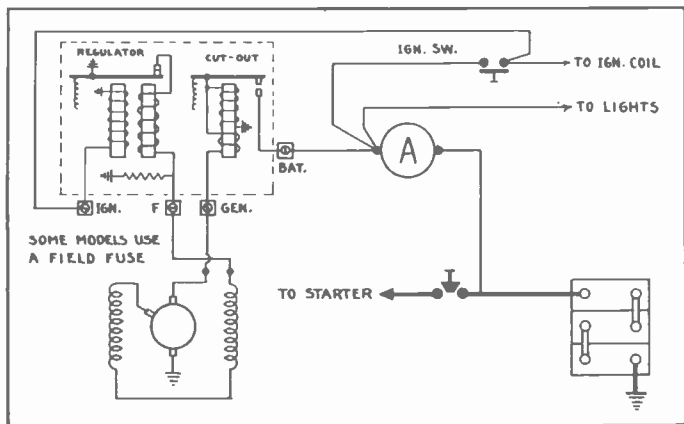

Fig. 9. Circuit diagram of a vibrating type generator control.

age for which the regulator has been set is reached. When the contacts open, the field current through the series winding is interrupted, but it can still flow to ground through the resistance unit at a reduced rate. This reduces the strength of the field coils in the generator and also the strength of the magnetic field built up by the regulator coils, so that the contacts will immediately close. This opening and closing of the contacts is an extremely rapid vibrating action, and it holds the voltage of the generator fairly constant. With this type of control, the generator will charge a discharged battery at the maximum rate for which the third brush is set, but the rate will taper off as the voltage of the battery reaches maximum because the voltage of the generator is limited by the vibrating action of the regulator.

In some cases where this type of control is used, the third brush is eliminated, full control being obtained from the regulator. However, this method is seldom used for pleasure car service, since the

Generators

elimination of the third brush does away with maximum current control, which would be dangerous in case of a ground in the wiring, or a shorted battery.

10. TROUBLES AND SERVICING OF VIBRATOR REGULATORS

If the generator fails to charge, then with the engines running at a speed equivalent to 25 M.P.H. ground terminal F on the generator. If this causes the generator to start charging the trouble is in the regulator or the lead between the field terminal on the generator and the regulator. If the generator does not charge the trouble may be in the cut-out or inside of the generator itself.

If the charging rate is too high or too low, this may be caused by incorrect spring tension on regulator armature, or to a fault in the regulator, such as bad contact at regulator points, defective shunt winding, etc. With a fully charged battery installed, after the generator has operated at a speed equal to 25 M.P.H. for 15 minutes, the charging rate should be less than 10 amperes, if the charging rate should be of greater than 10 amperes, the setting is too high. With a discharged battery in the car, the charging rate should not be less than 14 amperes. If it is less than 14 amperes, temporarily ground the field terminal on generator. If this causes the rate to increase, the regulator setting is too low, or the battery is sulphated, or there may be a loose connection in the circuit over which the charging current flows.

To check the regulator operating voltage, connect a variable resistance between "Bat." terminal of the control unit and the ammeter of the car. Disconnect the lead on "IGN" terminal of control, and connect a jumper wire from this terminal to "Bat." terminal. Connect an accurate voltmeter between ground and the lead that was disconnected from the "IGN" terminal. Then start the engine and operate at approximately 25 M.P.H. and adjust the rheostat or resistance so that the charging rate will be about 8 to 10 amperes, and check the voltage.

Automotive Electricity

With the control at room temperature (about 70 degrees F.) voltage should be between 7.7 and 8.0 volts. With the regulator hot, (about 150 degrees F.) the voltage should be between 7.45 and 7.55 volts. Adjustments are made by bending the spring anchorage brackets.

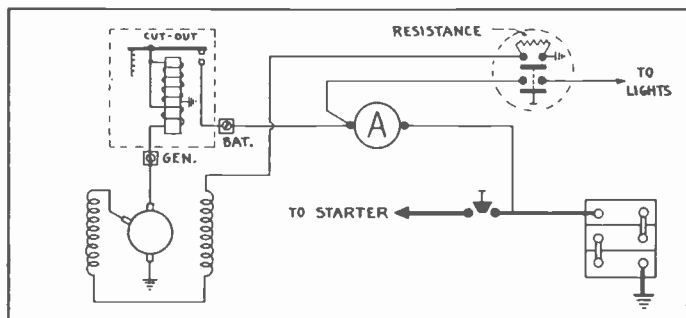

Fig. 10. Wiring diagram showing the Chevrolet lamp load control.

11. CHEVROLET LAMP LOAD CONTROL

This is a very simple type of control designed to increase the output of the generator when the lights are turned on. The control consists of a resistance and a short-circuiting device both of which are built in as part of the lighting switch. See Fig. 10.

When the lights are turned off, the field current flows through the resistance and the battery charges at a normal rate, usually about 10 amperes. When the lights are turned on, the field resistance is short-circuited and the field current automatically increases, thereby increasing the output of the generator. This increase in output makes it possible for the generator to supply the current for the lights without a reduction in the battery charging current.

The standard resistance used is 1 ohm. Resistors of $\frac{1}{2}$, $\frac{3}{4}$, and $1\frac{1}{2}$ ohms may be obtained to meet different operating conditions, or if head light bulbs other than standard sizes are used. To set the third brush, the field terminal of the generator should be temporarily grounded and the third brush

Generators

set so that the output will be between 16 and 17 amperes. If set too high there is some danger of burning out the generator, especially during summer months.

12. GENERATOR TROUBLES AND REMEDIES

The generator circuit consists of a generator, cut-out, ammeter, and battery, and the wires which connect these units together. So whenever the battery doesn't charge properly the trouble may be in any of these devices or wires of this circuit.

Normally the generator begins charging the battery at a car speed of about 12 miles per hour and reaches its maximum output at about 25 miles per hour. If the battery doesn't charge properly or the generator performance is not satisfactory the generating system should be checked over until the trouble is found and remedied.

Some of the more common troubles encountered are as follows:

If the generator doesn't charge at any speed it may be due to faults in the generator itself or to a defective cut-out, open circuits or grounds somewhere in the charging circuit, or defective drive where the generator connects to the engine.

A good place to start tracing the trouble is at the cut-out. Remove the insulated wire from the cut-out and touch it to the car frame or engine. If a flash results there is no break or opening in the charging circuit, but if no flash is obtained the circuit should be checked for loose or broken wires.

If the circuit is O. K. start the engine and remove the cut-out cover, and see if the contacts close when the engine is accelerated. If they do not, close them by hand and if the generator then charges the battery the cut-out must be defective.

Quite often the shunt winding will be found to be burned out and in this case the cut-out should be replaced with a new one.

If with the engine running at moderate speed the

Automotive Electricity

generator doesn't charge after the cut-out contacts are closed by hand remove the cut-out from the circuit and connect the generator directly to the battery. If the generator now charges, there must be a ground in the cut-out and this unit should be replaced or repaired.

Sometimes the cut-out contacts may be found burned or dirty so that they do not close the charging circuit to the battery. In this case they should be carefully cleaned with fine sandpaper.

A defective field protection device may also prevent the generator from charging. If a fuse is used for this protection see whether or not it is blown, and if not see that it is making good contact with the fuse clips.

If the generator is equipped with a thermostat examine this device carefully for dirty or pitted contacts or bent spring blade. If the thermostat is defective it should be adjusted or replaced.

If no trouble can be located in any of the above devices or in the wiring of the generator circuit then the fault is likely to be in the generator itself and it should be removed, and carefully tested.

If the generator charges, but at a very low rate it may be due to a loose drive belt, poor brush contact, high resistance in the field circuit because of loose or dirty connections, improper setting of the third brush, or partial short circuits in the winding. The remedies for each of these troubles can be clearly seen without further explanation.

If the generator charges at too high a rate when the car is run at high speed this may be caused by a grounded third brush; or, in case the generator has been recently repaired, the field leads may have been connected wrong. Where one end of the field is connected to the ungrounded main brush the grounding of the third brush will cause the generator to operate as a straight shunt-wound machine and the regulating action of the third brush is eliminated.

Generators

If the generator charges when the car operates at low speeds but the charging current falls to zero at high speeds, this is usually the result of poor brush contact, which may be caused by burned or glazed commutator surface, commutator out of round, high mica, loose bearings allowing the commutator to vibrate, weak brush-spring tension, worn or dirty brushes, or brushes stuck in the holders.

If the commutator is out of round or has a very rough surface it should be turned down in a lathe and the mica should then be carefully undercut. The brushes should be sanded in, as explained in the D. C. Motor and Generator Lesson No. 36, to see that their faces properly fit the commutator and are clean and free from gum or dirt.

Be careful to see that the brush springs are at the proper tension and that the brushes do not stick in the holders.

If the generator overheats badly it may be due to shorted armature coils, or to the armature laminations having been burred together by rubbing on the pole faces, or by rough handling while being repaired.

Burred laminations promote eddy currents which overheat the core and the trouble can be corrected by taking a very light cut off from the core in a lathe or by replacing the armature.

A loose connection in the charging circuit causing high field voltage will also result in the generator overheating; and wrong setting of the third brush allowing an excessive charging rate may be another cause.

If the generator voltage is too high and causes the lights to flare or burn out this is generally due to loose or dirty connections in the charging circuit. High resistance in this circuit prevents the normal flow of current through the armature of the generator and thereby prevents field distortion and the voltage regulating action of the third brush. So

Automotive Electricity

an open circuit or loose connection at the battery, ammeter, or anywhere in the generating circuit will cause excessive voltage and may result in a burned out field winding if it is not quickly corrected. In such cases all connections should be carefully cleaned and tightened.

When the generator brushes squeal during operation at certain speeds or at all speeds this may be remedied by cleaning the commutator and sanding off the faces of the brushes; or, in case it is caused by hard brushes, by boiling them for a few minutes in paraffin wax. If the trouble cannot be corrected in this manner replace the brushes with those recommended by the manufacturer.

When testing a generator for internal troubles first take the machine apart and carefully examine it for mechanical defects or any electrical troubles which can be noted. Then test the armature for opens, shorts, or grounds, as previously explained in the section on Armature Winding and Testing.

Next test the fields for the same troubles. Test each of the brush holders for possible grounds due to defective insulation, check the commutator to see that its surface is clean, that there is no high mica, and no short circuited bars. Check the brushes to see that they are all properly fitted, have the right spring tension, and move freely in the holders.

Replace any defective parts before reassembling the generator.

EXAMINATION QUESTIONS

1. Are automobile generators series or shunt connected?
2. What is the voltage output of automobile generators?
3. Briefly explain why the charging rate on the third brush type generator decreases after the generator reaches a certain speed.
4. A. What change is necessary to increase the charging rate on the third brush type generator?
B. How is the charging rate decreased?
5. What piece of equipment is used to prevent the battery from discharging back through the generator when the generator voltage drops below the battery voltage?
6. In what two ways may the generator field be protected against excessive voltage?
7. Copy Fig. 7 and trace the circuit through which the field current would flow when the generator is charging at the high rate.
8. Briefly explain how the lamp load control operates.
9. How do loose or dirty connections usually affect the lights?
10. Where would you expect to find the trouble when the charging rate is O. K. at low motor speed, but drops off abnormally when the motor speeds up?

Automotive Electricity

LIGHTING EQUIPMENT

The lights are a very important part of every modern automobile, as it is impossible to drive safely on unlighted country highways without two good headlights. The headlights also provide a great safety feature by indicating the position and approximate speed of an approaching car even on lighted streets and highways.

The headlights of a modern automobile should illuminate the road surface for several hundred feet ahead of the car, in order to enable the driver to see people or obstructions in the road in time to bring the car to a full stop from the high speeds at which modern cars are commonly operated.

In order to avoid "blinding" an approaching driver, the headlights should throw definite beams of light which can be kept down on the road surface and below the level of the eyes of other drivers.

Electric lights meet these requirements very nicely by supplying a concentrated beam of high candle power that can be quickly and easily focused and controlled. Therefore, electric lighting is now used without exception on all modern automobiles.

The headlights are generally provided with a dimming device which enables them to be dimmed or their beams to be dropped lower when meeting another car, and then brightened or the beams raised for vision farther ahead on a dark country road.

In addition to the headlights, most cars are equipped with cowl lights, tail light, stop light, dash light, and dome light, while some have additional small convenience lights at various places in the car.

Cowl lights are small lights located one on each side of the body of the car just in front of the wind shield. These lights can be left on when the car is parked and they serve to show the position of the car to another driver. They are much smaller and require a great deal less battery current than would be used if the headlights were left on. Small parking lamps are sometimes located above the main bulbs in the head lamp housings.

Lighting Equipment

A tail light is very essential to indicate the rear of the car to a driver approaching from behind and also to illuminate the license plate as required by state laws. The tail light should always be kept in good condition so that it shows a distinct red light to the rear of the car, as this affords a great amount of protection from rear end collisions both when the car is in operation and when parked. A car should never be operated or left parked without a good tail light.

The stop light is also a very important light which goes on when the brake is pressed and indicates to a following driver that the car ahead is about to slow down or stop. Stop lights also afford a great amount of protection to the rear ends of automobiles; and, for reasons of one's own safety as well as courtesy to fellow drivers, cars should never be operated without a good stop light.

The purpose of the dash light or lights is to illuminate the various instruments on the dash or instrument board of the automobile, enabling the driver to see his speedometer and the meters and instruments which indicate various conditions, such as engine temperature, fuel level, oil pressure charging rate, etc.

Dome lights illuminate the interior of the car and are particularly convenient when getting in and out of the car at night, or whenever one desires to see within the interior of the car. Dome lights, however, should not be left on when a car is driven along a dark highway as they interfere with the view of the road ahead.

All automobile lamps are designed to operate at low voltage, generally six volts, and are connected to the battery through the ammeter and conveniently located switches.

The bulbs for the various lights are designed with filaments of various resistance and wattages according to the amount of light required. The headlights, of course, are the larger and the various other lights use smaller bulbs.

Automotive Electricity

A single-wire system is now in general use for the wiring of automobile lights, and the other terminal of each light socket is grounded so that the current returns through the car frame to the grounded terminal of the battery. This arrangement greatly simplifies and reduces the cost of wiring systems, and also lessens the possibilities of trouble in the circuits.

Many people are inclined to operate their cars with one or more defective lights because they do not realize the importance of lights as a safety feature, or do not realize how easily and cheaply lights can all be kept in good condition. It is a simple matter for the experienced or trained service man to quickly locate and repair almost any trouble in the lighting system, and every attempt should be made to encourage customers to have defective lights repaired or replaced immediately and keep them in good conditions at all times.

1. HEADLIGHTS

Headlights, as previously mentioned, are the most important of any lights on the automobile. Headlights are carefully designed to project the light beams on the roadway in the proper manner to give the driver a good view of its surface some distance ahead and to avoid glare in the eyes of approaching drivers.

Each headlight consists of the following important parts: Electric light bulb which supplies the light; reflector which controls and concentrates the light beam; lamp housing in which the bulb and reflector are supported; bulb adjusting devices used to focus the light; front glass or lens; and lamp standard or bracket which attaches the headlight to the car.

Fig. 1 is a diagram showing a sectional view of a headlight and in which each of the above parts can be noted.

The lamp housings are made in various styles and shapes to fit the design of the car, and the reflectors are made of silvered metal of the proper shape to

Lighting Equipment

gather all the light rays thrown backward and side-wise from the bulb and concentrate them forward in one beam upon the road surface.

Headlight lenses are of various types, some having specially cut or ground glass with ribs or corrugations to aid in directing or diffusing the light as desired.

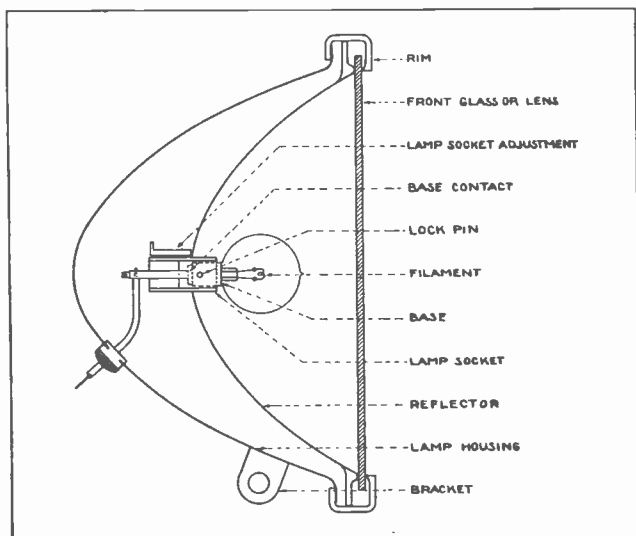

Fig. 1. Diagram showing the construction of one type of automobile headlight. Note that the lamp socket is adjustable for focusing the light rays properly with the reflector.

The lamp adjusting device allows the bulb to be moved either forward or backward in the socket to adjust the focus of the light beam and make it broader or narrower.

Automobile headlight bulbs are constructed quite similarly to regular incandescent light bulbs, with which you are already familiar, except that their filaments are designed for lower voltage and are therefore made of lower resistance and to take heavier currents in order to produce the desired wattage. These bulbs have a concentrated filament which produces the light from a source of a very small area, thus making it easy to focus and direct with the reflector and lens.

Automotive Electricity

The bulbs are small, ranging in diameter from about an inch to an inch and a half, and are secured to a metal base or ferrule by means of which they are held into the socket and connected to the electric circuit.

Some headlight bulbs are of the single filament type but most of those used on recent makes of cars are of the double filament type, having two separate filaments located one above the other and either of which can be turned on at will by the light switch.

One filament is used for directing a bright beam a long distance down the road, while the other is used for directing a beam of less brilliancy slightly downward and at a spot on the road closer to the front of the car. This latter filament is used when

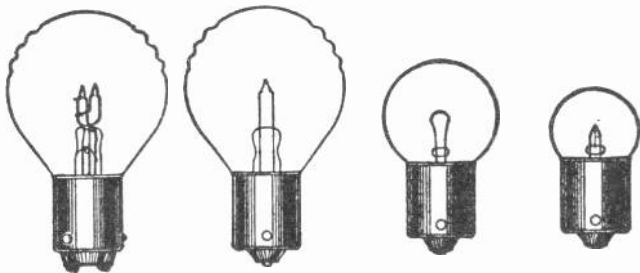

Fig. 2. Several types of double and single filament bulbs used for headlights and other lights on automobiles.

meeting another driver and helps to further reduce the blinding glare in his eyes.

On single filament lamps one end of the filament is connected to the outer metal ferrule of the lamp base which is grounded to the lamp housing when the lamp is placed in the socket. The other filament lead is insulated and connected to a small terminal in the base of the socket by which it makes contact with a spring terminal attached to the insulated light wire leading from the battery and switch to the lamps.

Double filament bulbs have one end of each filament grounded to the ferrule and the other two ends brought to separate insulated contacts in the lamp base.

Lighting Equipment

On the left in Fig. 2 are shown two headlight bulbs, one of the double filament and one of the single filament type and on the right are shown two of the smaller bulbs such as are used for dash lights, tail lights, etc.

2. DIMMING OF HEADLIGHTS

As mentioned before, it is desirable to provide some means of dimming or dropping the headlight beams when meeting another driver, and thus avoiding throwing in his eyes a glaring light which would make it impossible for him to see the road or the exact location of the approaching car.

There are two methods of dimming, one by using a resistance that is cut in series with single filament bulbs, and the other and more popular method of using double filament bulbs.

Fig. 3-A shows a diagram of the wiring for headlights using the resistance method. When the switch is at the left in the position shown, the resistance is in series with the bulb filaments and reduces their current and light output. When the switch is moved to the right the resistance is cut out, bringing the bulbs up to full brilliancy.

In Fig. 3-B is shown the wiring for the double-filament type lamps. When the switch is on the left contact the lower wattage upper filaments of the lamp are in use. These filaments being located somewhat above the center of the reflector cause the beam to be thrown downward and closer to the front of the car. When the switch is thrown to the right-hand contact the heavier wattage lower filaments are in use, and as these filaments are in the center of the reflector their light beams are thrown slightly higher and farther ahead along the road.

The smaller or dimmer filament is generally of 21 candle power, (C.P.) and the larger filament or main headlight filament of 32 C.P.

The light switch for turning headlights on and off and for dimming them was formerly located on

Automotive Electricity

the dash of automobiles, but on modern cars the dimming switch is often located either on the steering wheel or column; or a foot switch is placed near the clutch pedal. Either of these arrangements is much more convenient than the dash switch for dimming the lights when necessary.

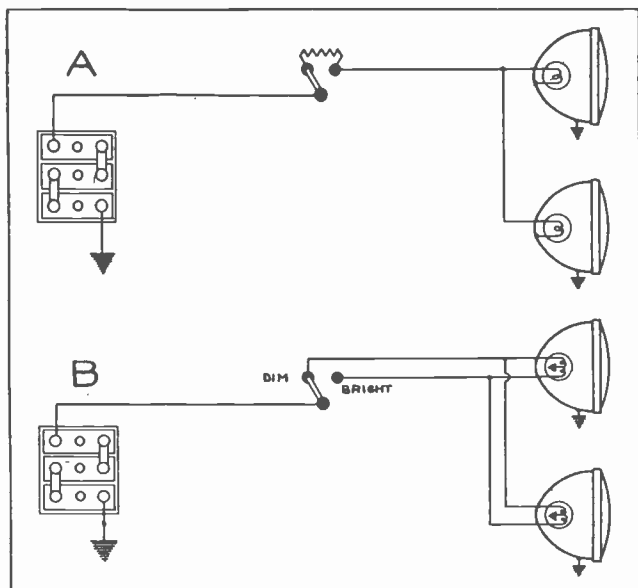

Fig. 3. A. Diagram showing resistance method of headlight dimming. B. Double filament method of dimming or "dropping" headlight beams.

3. LIGHTING SWITCHES

The upper view in Fig. 4 shows several types of operating levers for lighting switches and below are shown the switch contacts mounted on the insulating base of the switch. When the switch levers are mounted on the dash the switch mechanism and contacts are generally mounted directly behind them. When the switch levers are mounted on the top of the steering column the switch mechanism is generally mounted on the lower end of the column and operated by a long rod which runs from the lever down through the column.

The switch-lever positions are generally marked

Lighting Equipment

according to the lights that are turned on in each position, such as cowl or side, bright or head, dim,

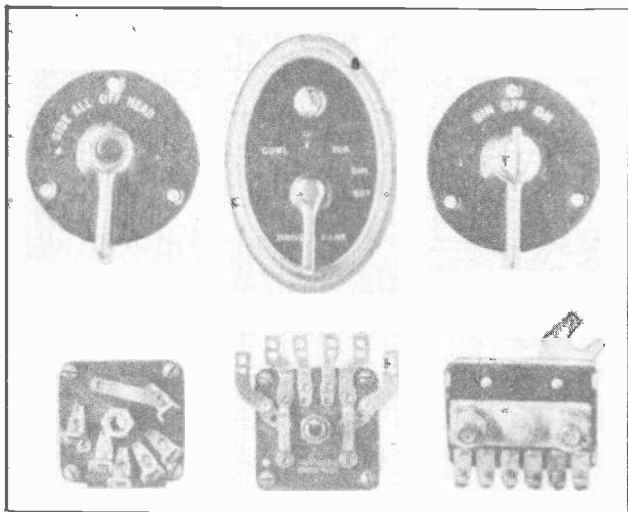

Fig. 4. At the top of this figure are shown several types of light switches and below are shown the backs of the switches with their various contacts for the different light circuits.

off, on, etc. The stationary contacts on the switch bases are also usually marked, so that it is an easy matter to connect the various light wires to the switch.

One of the contacts is connected directly to the battery. When the switch is turned on the contact fingers slide around to close circuits from the battery contact to the various sets of lights, according to the position the switch is placed in.

In case the switch contacts are not marked the battery terminal can be located by testing with a piece of wire or a test lamp grounded to the frame of the car. The battery terminal is the one which will give a light or flash when touched with this grounded wire and with the switch in the off position.

Now connect one end of the test wire to the battery terminal and try out the remaining contacts with the other end, and note the results. When the end of the wire is touched to the headlight contact

Automotive Electricity

the headlights will light; and if the tail light contact is touched this lamp will light, etc., and in this manner the different terminals can be quickly and easily located.

If a switch has been removed for repairs and all the wires are disconnected they can be tested out and connected up as follows:

Test between the car frame and each of the wires that connect to the switch until one is found which gives light or a flash. That is the live wire from the battery and should be connected to the battery contact on the switch. Touch the remaining wires on the battery contact until the tail light wire is found by the tail light burning when a certain wire is touched. Then connect this wire to the contact marked "tail light," or to the one which will give a light when the switch is on in any position. The tail light is generally switched on when any of the other lights are on.

The wires to the other lights can be found in the same manner and connected to the properly marked switch contacts or to the contacts which will give a light when the switch lever is in the proper position for whichever light is being connected.

The stop light is generally controlled by a small switch located under the floorboards of the car and operated by a wire and spring attached to the brake pedal.

Dome lights and other convenience lights around the car are generally operated by small snap or push button switches located in convenient places.

The dash light on modern cars is generally switched on whenever the headlights or other driving lights are on. In some cases it is left off when only the parking lights are on, and in other cases it is equipped with a special snap switch of its own so that it can be turned off when desired.

Dash lights are sometimes connected in series with the tail light, so they will go out and warn the driver any time the tail light burns out.

Lighting Equipment

4. TROUBLES IN LIGHTING SYSTEMS

Although there is considerable wiring on a modern automobile, one who has a good knowledge of circuit testing and a few simple test instruments should be able to check the system for such common troubles as opens, shorts, grounds, loose connections, etc.

A simple low-voltage test lamp made up with a six-volt bulb, or a low reading voltmeter is often very convenient. However, in many cases a screw driver and a short piece of test wire are all that is necessary to locate troubles.

Some of the more common troubles and remedies of automobile lights are covered in the following paragraphs.

If all of the lights fail to light when the switch is turned on, check to see if the main fuse is burned out, and if it is not, see that it is making good contact with the fuse clips.

If a circuit breaker is used, check to see if the contacts are dirty or pitted, or if the plunger is sticking.

Test with a short test wire from the battery terminal on the switch to ground or to some metal part of the car, and if a flash is obtained this indicates that battery current is reaching the switch and that the trouble is very likely in the switch itself. By removing and checking the switch, the loose, dirty, or bent contacts can generally be located.

If no flash results when the battery contact on the switch is grounded with the test wire, check for a broken wire between the switch and battery or for a burned out ammeter.

Failure of all lights might also be caused by all of the bulbs being burned out due to a surge of high voltage from the generator, but this is very unlikely as all the lights will not usually burn out at once and such a surge would be noticeable if they did.

If at any time during the operation of the car the lights all brighten up considerably, shut off the engine immediately and check for a loose connec-

Automotive Electricity

tion in the generator charging circuit, since this is the most probable cause of an abnormal increase in generator voltage as previously explained.

5. HEADLIGHTS FAIL

If the headlights do not light up but all of the other lights do, the trouble will be in the headlight bulbs or the headlight circuit somewhere.

If the lighting system is one in which each of the light circuits is separately fused, examine the headlight fuses first. Next remove the insulated plug which leads to the lamp housing and connects to the bulb socket, and test between this plug and the back of the lamp housing or car frame. If no light or spark occurs it indicates a break between the headlight and the battery, probably in the switch but possibly in the wire.

If no light is obtained when this terminal is tested, next test the headlight contact on the switch to ground, and if no light occurs here connect the test wire from the battery terminal on the switch to the headlight contact. If the lights then burn the trouble is proved to be in the switch.

Remove the switch and check for dirty, burned, or pitted contacts and switch fingers. Also see if the contact fingers have lost their spring tension due to overheating. The switch lever must be in the headlight positions while making these tests.

If the test lamp lights when connected between the insulated headlight plug and the car frame, the trouble must be in the headlight. Remove the lens and examine the bulb or test it, and if it is burned out, replace it. If the bulb is all right, the trouble may be due to the fact that the contact on the insulated plug is not making good contact to the bulb. It may also, be caused by rust forming between the reflector—in which one end of the light filament is grounded—and the lamp housing, or between the lamp housing and the car frame.

Rusty or dirty connections at these points mean an open or high-resistance circuit between the grounded terminal and the battery.

To test for an open or high-resistance connection between the reflector and the grounded terminal of

Lighting Equipment

the battery, place one end of the test lead on the wire which carries the current to the headlights and touch the other end to the reflector. If no light is obtained, check for poor contact between the lamp contacts and housing, or between the housing and car frame.

The various other lighting circuits can be tested out in the same manner as outlined for headlights. Check to see if the current is carried through the wire all the way up to the light, and then test for burned out bulbs and poor grounds between the lamp housing or socket and car frame.

6. FLICKERING AND FLARING OF LIGHTS

Headlights and other lights are sometimes caused to flicker by loose connections in the lighting circuits, and very often this trouble is found to be at the insulated plug which connects to the lamp housings.

The small springs which connect the plug and bulb terminals together either become weak or stuck, or burned and dirty. Sometimes it is only a small amount of corrosion that is responsible for high resistance in the circuit and causes the lights to dim or flicker occasionally.

In this case the trouble may be remedied by merely working the plug back and forth in its socket to rub off the corrosion and brighten the contacts. When the trouble is due to weak contact springs, these springs may be stretched out or the trouble may be remedied by adding a small drop of solder to the bulb contacts, thereby increasing the pressure and tension on the spring contacts.

If the flickering is not due to trouble in the lamps or at the plug connections, then check over the entire circuit, cleaning and tightening any dirty or loose connections; and, if it is necessary, check the switch for loose or burned contacts.

As previously mentioned, flaring lights are generally caused by loose connections in the generator circuit or defects in the generator. In such cases all connections in the generator and charging circuit should first be carefully cleaned and tightened.

If the lights still burn excessively bright, the

Automotive Electricity

trouble may be a partially broken wire in the generating circuit or some defect in the generator itself. If the trouble seems to be in the generator, it should be removed and checked for broken wires, poor brush contact, sticking brushes, or grounded third brush.

7. TEST PROCEDURE

When checking the electrical system on a car for faults or troubles, always follow the plan of testing out first those parts of the circuit that are easily accessible and therefore most easily eliminated as possible sources of trouble.

For example, when lights fail, always check the fuses or circuit breaker first before checking over the switch contacts and wiring. Never disassemble the lighting unit to check for bulb and other lamp troubles without first making a test with the light switch on, and the test lamp connected between ground and the plug at the lamp housing to make sure that current is reaching the lamp. If a light is thus obtained, it indicates that the trouble is in the lamp itself.

If the car lights burn dim, it is generally caused by a weak battery or connections that are loose, corroded, or dirty and of high resistance.

If only certain lights burn dimly, check that circuit carefully, cleaning and retightening any contacts or connections that appear doubtful.

If all lights are dim, the battery and its connections should be checked first of all. Poor contact due to corrosion or rust forming between the terminals of the lamp base and the spring connection to the plug are often the cause of dim lights, and in other cases they are caused by rust forming between the various parts of the lamp housing or between the lamp housing and the car frame where the light obtains its ground circuit.

Sometimes rust or a poor connection between the lamp housing and car frame can be burned out or welded into a better connection by connecting one lead of a battery to the housing and the other to the frame, thus passing a heavy current through this circuit.

If this doesn't work, the housing should be re-

Lighting Equipment

moved and the contact surface sandpapered or scraped clean, and then remounted and securely tightened.

High-resistance connections between the ammeter and battery will cause the lights to flare when the engine is speeded up.

8. SHORT CIRCUITS and CIRCUIT BREAKERS

As some of the wiring on automobiles is run along the metal parts of the frame and held in small clips, and as the frame is used for the other conductor of the circuit, it is quite common to find short circuits resulting from chafed or damaged insulation, allowing the wires to touch the frame or metal parts of the car.

These wires are subjected to very severe service, due to road vibration, dirt and oil accumulating on them, and occasional abuse by careless mechanics working on other parts of the car. Oil tends to rot the rubber insulation, and vibration tends to chafe the insulation off the wires where they rub under the clips or against other metal parts. Sometimes the insulation becomes damaged by being jammed with a heavy tool or metal part during some mechanical repair or overhauling of the car.

To protect the wires in case of such grounds and short circuits, and also to eliminate the fire hazard as much as possible, the lighting and accessory circuits of automobile electric systems are generally protected by fuses or circuit breakers.

Fuses and circuit breakers are never connected in either the generating or ignition circuits. In some cases fuses are used in each separate circuit, while in other cases one main fuse is used to protect all the circuits. In this case the fuse is generally placed on the back of the lighting switch.

The small circuit breakers which are often used in place of fuses are very simple devices consisting of a switch operated by an electro-magnet or solenoid, as shown in Fig. 5-A.

When the normal load current, which is generally under 15 amperes, is flowing through the coil and contacts of the circuit breaker it doesn't create

Automotive Electricity

enough magnetism in the coil to lift the plunger and open the circuit; but if the current should rise to a value of 25 amperes or more, due to a short circuit in the wires, it creates sufficient magnetism to raise the plunger, causing it to strike the contacts and break the circuit.

When the contacts are thus opened and the circuit is broken, the coil is demagnetized and allows the core to drop, due to the action of gravity and of a small spring, which also tends to pull it back.

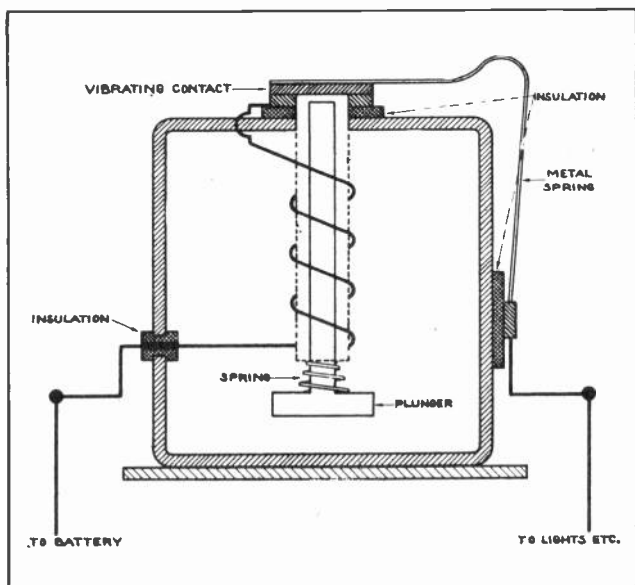

Fig. 5. Diagram of a simple magnetic circuit breaker for protecting automobile wiring circuits in cases of shorts and grounds.

This again completes the circuit, magnetizing the coil and once more raising the plunger to break the contacts.

From this we see that the breaker continues to vibrate somewhat on the order of a vibrating bell, thus limiting the current to prevent overheating of the circuits and also making considerable noise to call attention to the fault so that the defective circuit will be switched off and the trouble removed.

Lighting Equipment

9. TESTING FOR SHORTS

When a short occurs in the wiring to the lighting system or horn, it may be either in the wires themselves or at the switches, lamp, socket, connectors, etc. To locate the short, first determine whether a fuse or circuit breaker is used.

If a fuse is used, connect a 21-candle power lamp across the fuse clip to serve as a trouble light. If a circuit breaker is used, just turn on the switch and let the breaker buzz. If the lamp lights or the breaker buzzes with the lighting switch in the "off" position, then look for the trouble in the stop light and accessory circuits.

Disconnect the wire from the stop light switch and if this stops the breaker buzzing or extinguishes the trouble lamp the fault is in the stop light circuit between the switch and the lamp, and in the majority of cases it will be found in the switch itself.

As the horn is generally connected through the fuse or breaker, the same test should be made on it. Disconnect the wire from the horn to see if the breaker stops or the light goes out. If it does, the fault is in the horn; and if not, the trouble is in the wire. If the fault is in the wire leading from the horn to the button, the horn will blow continuously.

If a short circuit occurs only when the light switch is on, turn the switch lever from one position to the other to determine which part of the circuit the trouble is in.

If the circuit breaker stops buzzing or the trouble lamps burns dimly in certain positions of the switch, it indicates that these circuits are clear, and the trouble lamp burns dimly in such cases because it is in series with the other lights.

If a clear indication is obtained with the switch on all positions except the head light position, this indicates that the trouble is in the headlight circuit, and you should next remove the plugs which connect the wires to the lamp housings and bulb sockets.

If the breaker then stops or the trouble lamp goes out, the short is due to the plug contacts or wire

Automotive Electricity

touching the lamp housing in some way. Careful inspection will then generally show where the fault is and the trouble can be remedied by properly adjusting or reinsulating the wires or sockets according to the nature of the fault.

If the trouble lamp remains lighted or the breaker continues to buzz after the plugs have been removed from the lamps, it indicates that the trouble is in the wiring. To locate the exact point, start at the lamp and trace each circuit back, paying particular attention to any point where the wire is secured to the frame by clips. Pulling or moving the wire will often help to locate the trouble, because, if the breaker stops buzzing or the trouble light goes out when the wire is moved to a certain point, the fault is evidently close to that position.

In certain cases where the system is wired with armored cable and the short is hard to locate, it is cheaper to rewire the circuit with new wires than to spend too much time trying to locate the fault.

Sometimes an intermittent short will occur and last just long enough to blow the fuse and then disappear. This is generally caused by a loose wire touching the car frame when the machine is in motion, and this wire may strike against the frame when the car hits a bump. Try to determine what position the switch was in when the short occurred and then carefully inspect that circuit for loose wires, defective insulation, etc.

If the trouble is noticed in all switch positions, the fault is very likely to be in the tail light circuit; while, on the other hand, if the short occurs with the lighting switch off, look for trouble in the stop light and accessory circuits.

10. LEAKY INSULATION

Sometimes a partial short or high-resistance ground will allow a slow leakage of current from the battery that is not enough to blow the fuse or operate the breaker, but will cause the battery to continually run down. Generally this trouble will be indicated by a low reading on the ammeter when all the electrical devices are turned off, but the am-

Lighting Equipment

meter would not indicate a fault in the starting circuit or in the wire from the battery to the ammeter.

In some cases the leak may not be great enough even to show a noticeable reading on the ammeter.

To test the system for such leaks, disconnect one of the cables from the battery terminal and connect in the circuit a low-reading voltmeter with a range of 6 to 10 volts. With all switches and electrical devices turned off, the voltmeter should not give any reading, and if it does a leak is indicated.

First disconnect the stop light wire and see if it causes the meter to read zero, and if it does the leak is in that circuit. If the trouble is not in the stop light circuit, then disconnect the wire which leads from the battery to the ammeter by removing the connection at the meter.

If the voltmeter now reads zero the trouble is in or beyond the ammeter. Next remove the wires from the other ammeter terminal and touch then one by one on the "hot" lead to the battery. When the faulty wire is touched to the battery lead the voltmeter will show a reading, and in this manner the defective circuit can be located. This circuit can then be carefully checked over for defective insulation or leaks. Very often it is easier and cheaper to entirely rewire the circuit.

Of course, one should not assume that such a leak is always the cause of a run-down battery, as it is more often due to too low a charging rate or the car is not being operated enough hours per week or month to keep the battery well charged.

Excessive operation of the starter or driving mostly at night with the lights on, or equipping a car with too many additional electrical accessories will also result in a run-down battery.

Remember that to keep a battery fully charged in the winter, so that it will properly operate both lights and starter, requires a considerably greater charging rate than during the summer months.

With normal driving the winter charging rate should be about twice as great as that for summer use.

From the foregoing explanations of lighting cir-

Automotive Electricity

cuit troubles and remedies you can readily see the advantage of having a good general knowledge of electrical principles and circuits, as trouble shooting on the electrical systems of automobiles is simply a matter of definite circuit tracing and testing the same as with any electrical power or signal devices.

With all the general training that you have had in this line and the knowledge you can obtain from this section on automotive electrical devices and circuits, it should be quite an easy matter for you to locate troubles in any part of the wiring system of a car.

11. COMPLETE WIRING SYSTEMS

Fig. 6 shows a complete wiring diagram for a Model A Ford. Note carefully the general arrangement of the various parts and circuits, and trace out each circuit one at a time.

For example, first trace the starting circuit from the battery, through the starting switch and starting motor to ground. Then trace the generator and charging circuit from the generator through the cut-out, ammeter, and battery. Next trace the ignition circuit from the battery through the ignition switch, primary coil winding, breaker points, and back to the battery; and the secondary circuit from the high-tension lead of the coil through the distributor to the spark plugs.

Finally trace out the lighting circuit from the battery through the ammeter, lighting switch, and to the various lights.

Note that the wires of different parts of the system have insulation with different colored markings, which is a great aid in tracing circuits on the car and shooting trouble in various parts of the system.

Fig. 8 shows the wiring system of an eight-cylinder Packard automobile, using two coils and the double breaker contacts.

In addition to the automotive electrical equipment made by the Delco Remy Company of Dayton, Ohio, there is also that supplied by two other leading manufacturers—The Northeast Electric Company, Rochester, N. Y., and the Autolite Corpora-

Automotive Electricity

tion of Toledo, Ohio. These concerns make most of the electric devices for automobiles; while magneto ignition systems for trucks, tractors, marine engines, etc., are supplied by the American Bosch Corporation at Springfield, Mass.; Eisemann Magneto Corporation, New York, N. Y.; Sims Magneto Company, Orange, N. J., and several others.

It is a very good plan to keep in mind that special information on various ignition devices or repair parts can always be obtained by writing directly to the manufacturers or by getting in touch with their nearest local distributor.

For those who may wish to specialize in automotive electrical service there are special service manuals or books containing wiring diagrams of practically all cars and trucks manufactured.

These diagrams are very convenient to have on hand when tracing troubles or testing circuits of certain makes of cars, but these systems are a great deal alike in many respects and are far too numerous to include all of them here.

The wiring diagram for any certain make of car can generally be obtained without charge from the automobile manufacturers, or we will be glad to supply at any time information as to where you can obtain special books on wiring diagrams for any students or graduates who may make a specialty of automotive electrical work.

Whether or not you make automotive electricity your regular trade or business, remember that to be able to locate and repair electrical troubles on your own car will often come very handy and will save you considerable time and money and it may also enable you to make extra money on the side by repairing the ignition equipment of someone else's car.

Keep in mind at all times that systematic, thoughtful circuit tracing and testing will locate any electrical trouble that can possibly occur in any part of an automobile ignition or wiring system; and that in a great majority of cases these troubles arise from such simple things as loose connections, shorts or grounds, all of which can be easily repaired by anyone with the general knowledge of electricity.

Wiring Systems

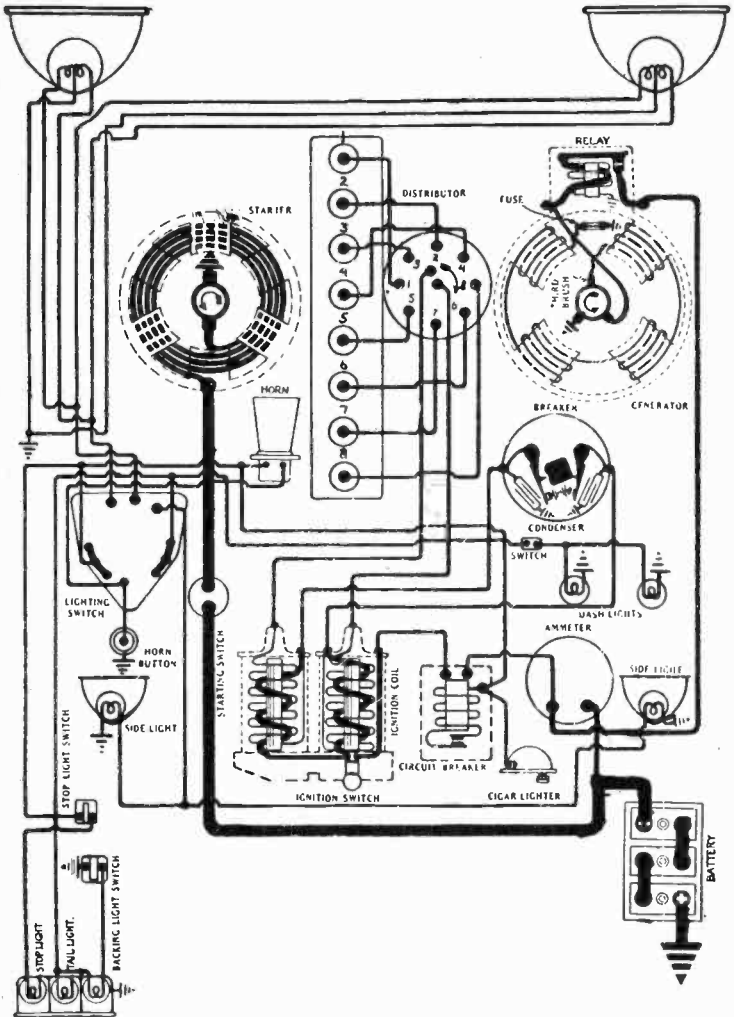

Fig. 8. Complete wiring diagram of an eight-cylinder Packard automobile. Note the two ignition coils and high speed distributor with double breaker arms used on this "line eight" engine. Also note the peculiar field coil construction in the starting motor by which one large coil wire around the motor frame is used to produce alternate poles in the field pole cores. Courtesy National Automotive Service.

Automotive Electricity

Automotive Electricity

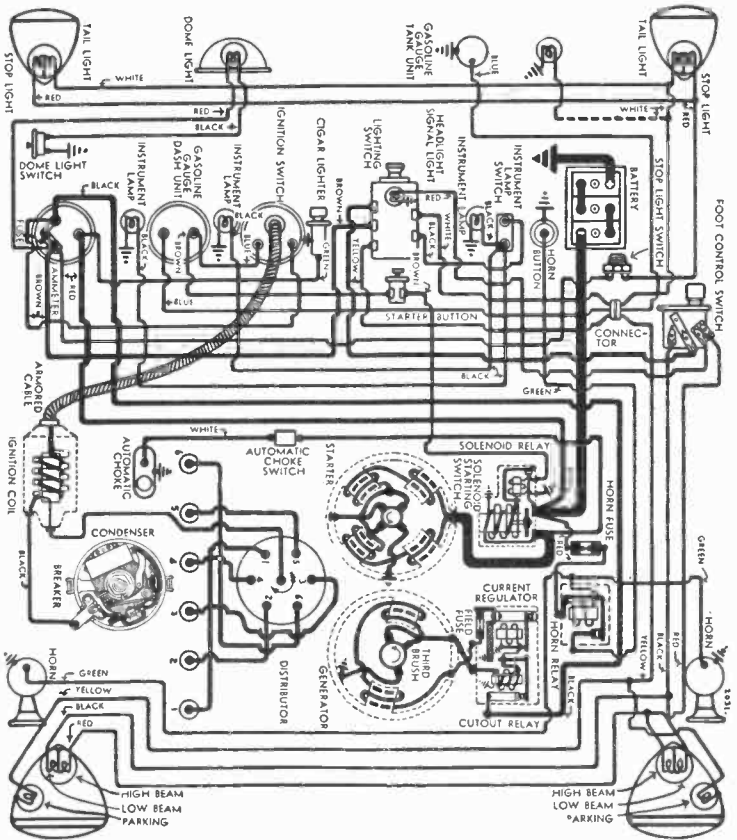

Fig. 11. The above is a wiring diagram for a

six cylinder Chrysler.

Automotive Electricity

EXAMINATION QUESTIONS

1. Name at least four different uses of lights on automobiles.
2. Why is it very important to have the headlights, tail light, and stop light in good working condition at all times?
3. How are headlight beams dimmed or dropped when meeting other cars?
4. State several common faults that might interfere with proper headlight operation.
5. Where would you check first to locate troubles in car lighting circuits?
6. What is common cause of all lights on a car burning too brightly?
7. Describe briefly how you would proceed to test for shorts in car lighting circuits.
8. How would you test for leaky insulation, or low current leaks that were draining the battery?
9. How many separate complete circuits can you locate in Fig. 9?
10. Referring to Fig. 10, what color wires are used for the following circuits? A. Headlamp low beam. B. Headlamp upper beam. C. Tail lamp. D. Ignition wire from ammeter to coil. E. Gasoline gauge wire.

Storage Batteries

STORAGE BATTERIES

Storage batteries are used by the millions in automobiles, radios, telephone and telegraph systems, railway signal systems, electric trucks, train lighting, farm lighting plants, and for emergency power reserve in substations and power plants.

These batteries require charging, testing and care, and although they are very rugged in their construction, they require occasional repair due to the natural wear occurring on their elements by charging and discharging in normal use. So there are numerous opportunities for trained men in electric storage battery work.

It is also very easy for one to start a nice, profitable, small business of their own with very little capital in the repairing and servicing of automobile and radio batteries.

Fig. 1 shows a neat installation of storage batteries such as used for emergency lighting in public buildings, or with farm lighting plants.

Fig. 2 shows a single cell of a large power storage battery such as used in substations and power plants for supplying thousands of amperes during short periods.

1. LEAD-ACID CELLS. PLANTE PLATES

One of the most common types of storage batteries is known as the **lead plate battery**. This is the type that is used very extensively in automobiles, for battery operated radio sets, and in large power plant batteries.

In 1860 a Frenchman named Gaston Planté discovered the principles of the lead plate storage cell. He found that if two strips of pure lead were immersed in an electrolyte of dilute sulphuric acid, a thin coating of **lead sulphate** would soon be formed on the surfaces of the plates.

He then discovered that by passing current through the cell the lead sulphate on the plate at which the current entered the solution would be changed to **lead peroxide**, or a compound of lead and oxygen. The lead sulphate on the other plate at

Battery Plates

which the current left the solution changed to pure lead in a spongy form. The term sponge lead is generally used in describing lead in this condition.

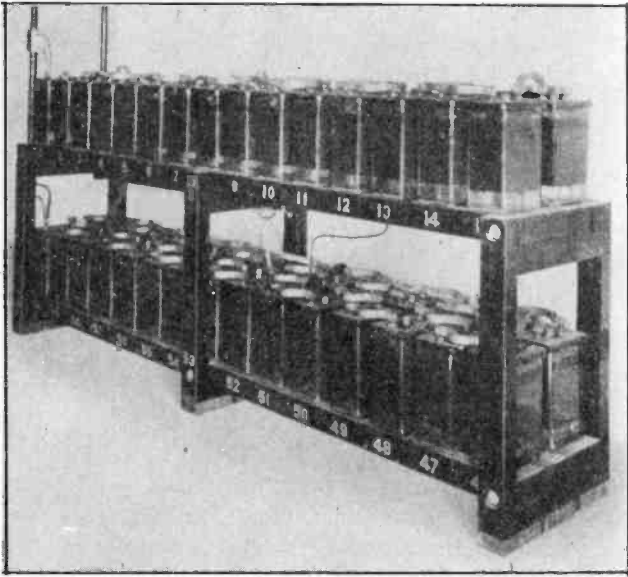

Fig. 1. This photo shows a large group of lead plate storage cells in glass jars. This battery installation is typical of those used for emergency lighting or farm lighting service, or for signal work. (Courtesy of Electric Storage Battery Co.)

Thus the unlike materials required to produce the action in a cell were created by electrolytic action on lead plates which were formerly both alike.

After thus charging the cell, Planté found that it would give off current in the opposite direction.

While discharging, the lead peroxide on one plate and the sponge lead on the other are again changed back to lead sulphate, and when all of the lead peroxide and sponge lead are changed back to lead sulphate, the plates are alike again and will not supply any more current.

However, if charged again by having current passed through them in the same direction as at first, the plates can again be made unlike and the cell brought back to charged condition, ready to produce current once more.

Storage Batteries

The lead peroxide plate from which the current flows during discharge is called **positive**, while the

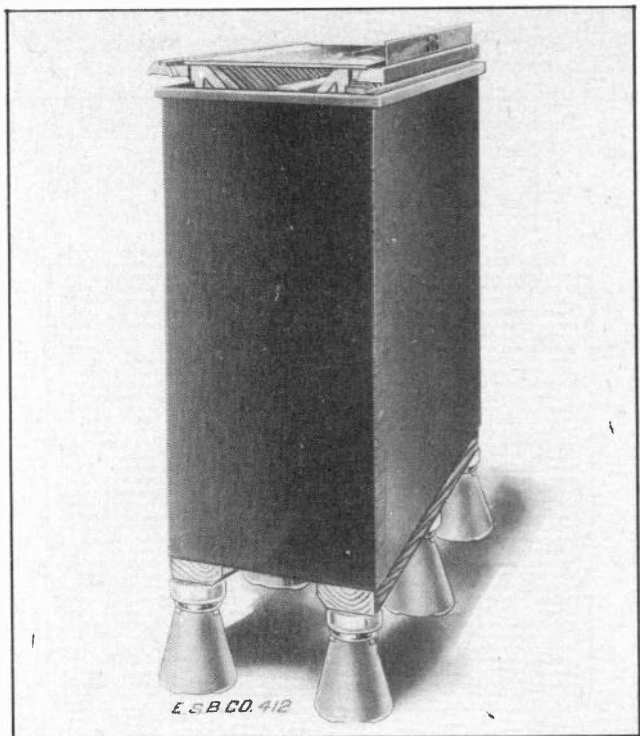

Fig. 2. Large lead plate storage cell in which the plates are supported inside of a lead lined wood tank which is in turn supported on insulators. Cells of this type are commonly used for emergency power and for D. C. control busses in power plants. (Courtesy of Electric Storage Battery Co.)

sponge lead plate at which the current enters during discharge is called **negative**.

From this we see that when charging a lead plate storage cell the **charging current does not store electricity in the cell** but merely makes the plates unlike by changing them chemically.

When a load or closed circuit is connected across the terminals of such a cell, current flows in the opposite direction to that in which the charging current flowed, and as the unlike material on the

Battery Plates

lead plates is gradually changed back to lead sulphate the voltage across the cell terminals becomes lower and lower, reaching zero when all of the material is reduced to lead sulphate and both plates are again the same.

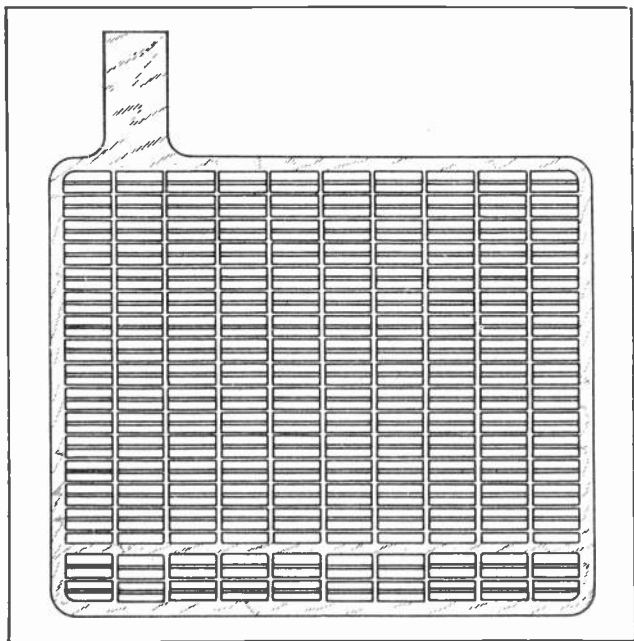

Fig. 3. The above drawing shows the construction of one common type of grid used for pasted plates. This drawing shows the grid before the paste has been applied.

The positive and negative plates for storage cells of the Planté type both consist of a sheet of pure lead, with grooves, or corrugations on each side to increase the active area in contact with the electrolyte and thereby increase the capacity of the cell.

2. PASTED PLATES

One of the disadvantages of the Planté plate storage cell was the fact that the lead plates being non-porous had to be charged and discharged a considerable number of times before the coating of

Storage Batteries

active material was of sufficient thickness to give the required capacity. This charging and discharging process was known as **forming** and was too lengthy and costly a process to make batteries of this type commercially practical.

To overcome this difficulty another Frenchman named Camile Fauré produced battery plates of pasted construction in 1880, and these plates turned out to be so much more efficient that they are the type still used in modern lead plate storage batteries

Pasted or Faure plates consist of a grid or framework of **lead** and **antimony**, upon which is applied a paste of **lead oxide**. The antimony is used with the lead to increase its mechanical strength and also to prevent the chemical action during charging and discharging from converting the grid into active material, as it would if pure lead only was used.

Fig. 3 shows a standard grid with a square mesh, and Fig. 4 shows a grid of the diamond type as used by one of the leading battery manufacturers.

The original Fauré plates had both positive and negatives pasted with **red lead**. In modern batteries **litharge** is also used with the red lead. The chemical term for red lead is: Pb_3O_4 , and that for litharge is PbO . These terms or symbols are fully explained in the next lesson.

The paste commonly used for positive plates contains a large percentage of red lead while that used for the negative plates contains a large percentage of litharge. **Lamp black** is often added to the negative plate to make it more porous, as the negative plates tend to be rather dense on account of the large amount of litharge used in the paste.

The finished positive and negative plates are generally distinguishable by their difference in color, the positive being of a dark brown color and the negatives dark gray in color.

The upper part of Fig. 5 shows a positive plate on the left and a negative plate on the right. Note

Battery Plates

the difference in their color and also note the manner in which the paste is pressed into the grid flush with the surface so that both sides are smooth.

The lugs provided on the top corners of the plates are for attaching the terminals or group connectors to the cell.

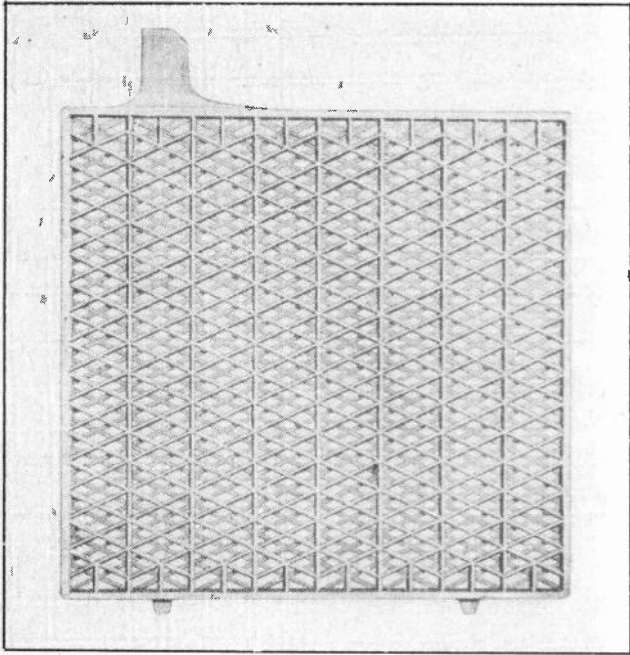

Fig. 4. Photo of another type of grid of the diamond type construction. The lead bars serve both as a frame to hold the paste or active material and as conductor to carry the current from the active material to the plate lug. (Courtesy of Philadelphia Battery Co.)

In the lower part of Fig. 5 are shown a positive plate group and a negative plate group attached together by their connectors and terminal posts, and ready to place in the cells.

New battery plates for repairing worn out ones are generally purchased from some battery supply company, as the plates can be made much cheaper in factories equipped for this work than they can in the average repair shop. However, a general knowl-

Storage Batteries

edge of plate construction and manufacture will be found interesting and possibly very valuable at some time or other; particularly if you should obtain a position in a battery manufacturing concern.

The following formula gives the materials commonly used in making the paste or active material for lead plates:

PLATE PASTE FORMULA

(Parts by weight)

POSITIVE

Red lead, 5 parts
Litharge, 1 part
1.120 S. G. electrolyte,
1 part

NEGATIVE

Litharge, 5 parts
Red lead, 1 part
1.150 S. G. electrolyte, 1
part
1 ounce of lamp black per
100 lbs. of litharge.

As lead oxides are dry powders some liquid must be used to mix them into a paste so they can be applied to the grids. Dilute sulphuric acid is generally used for this purpose. When mixed with the lead oxides the sulphuric acid causes a chemical action to take place which changes part of the oxides to lead sulphate, causing the paste to harden rapidly, so that it is necessary to work fast when applying paste to the grids.

In making battery plates the paste can be applied either by hand or by special machines made for this work. When done by hand the pasting is generally done on a glass or marble covered table with sheets of blotting paper being placed between the grids and the table top. The paste is then applied to the grids from the top by means of a trowel, pressed firmly into the grid, and smoothed off flush with the surface.

After pasting, the plates are dried in a rack by circulating air over and around them at room temperature. The drying causes the paste to set and become hard and at the same time cements it firmly to the grid. As soon as the plates are dried they are ready for forming.

Battery Plates

3. FORMING OF PLATES

We mentioned previously that it was necessary to form or condition lead plates of the Planté type by charging and discharging them. It is also necessary to form pasted plates by giving them one prolonged charge that changes the oxides of the paste into active material

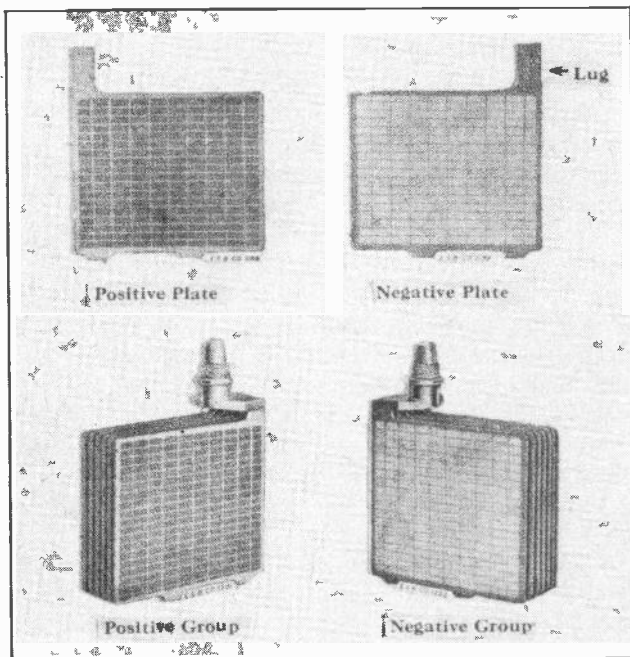

Fig. 5. The above views show completed or pasted plates of both positive and negative types. Single plates are shown above, and below the plates are shown grouped or connected together to the cell terminals. (Courtesy of Electric Storage Battery Co.)

For forming the plates are assembled into groups, the positives together in one group and the negatives in another, and the plates separated far enough apart so that separators are not necessary between them.

These two groups are then placed in a tank filled with 1.150 specific gravity electrolyte, with the positive and negative plates in alternate positions, or

Storage Batteries

one negative between each positive and the next, the same as they are arranged in the finished battery.

Direct current from a D. C. generator or line is then passed through the forming tank, being careful to connect the terminals so that the current flows into the tank at the positive plates and out at the negative plates. In other words connect the positive terminal of the line or generator to the positive plate group.

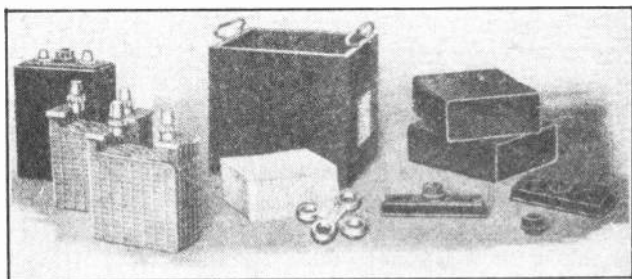

Fig. 6. This view shows the more important parts of a lead plate storage battery for automotive use. Note carefully these various parts when reading the accompanying paragraphs. (Courtesy of Universal Battery Co.)

The paste in the positive plates where the current enters will be changed to lead peroxide, or PbO_2 , while the paste on the negative group at which current leaves will be changed to sponge lead or Pb .

When the electrolyte begins to gas or bubble quite freely and the voltage between the positive and negative groups tests between 2.1 and 2.2, the plates are fully formed.

When the forming process is completed the plates are dried and are then ready for use in a battery.

4. STORAGE BATTERY CONSTRUCTION AND PARTS

So far we have discussed only the plates, which are the most important part of any storage battery. To complete the battery, however, requires a number of additional parts, such as container, jars, separators, connector straps, terminals, cell covers, etc.

Battery Plates

Fig. 6 shows a number of these parts required for a complete battery. On the extreme left and in the background is a complete cell and in front of this and to the right are shown two more positive and negative plate groups assembled together. In the center is shown a wood battery box or case and in front of it a stack of wood separators and two cell connector straps. On the right are shown two empty cell containers or jars with their covers and vent caps.

In constructing a storage battery of the lead plate type a number of positive plates are connected together by "burning" or welding them to a lead connector strap equipped with a terminal post, as shown in the lower left view of Fig. 5.

The number of plates selected depends on the size and capacity of the cell to be built. **The greater the number or total area of the plates the greater will be the capacity of the cell.**

A group of negative plates consisting of one more than the number of positives is then fastened together in the same manner and the positive and negative groups meshed together, as shown in the left foreground of Fig. 6.

The reason for always having one more plate in the negative group of a cell than in the positive group is because the capacity of cells is rated and determined according to the number and size of positive plates, and in order to work both sides of the positives it is necessary to have a negative plate on each outer side of the positive group, and this requires one additional negative in each cell.

The voltage of any single cell or group of positive and negative plates is slightly over 2 volts in the ordinary lead plate battery when fully charged. Lead plate cells are usually classed as a 2 volt cells. The standard automobile battery consist of three such cells, connected in series, and develops 6 volts. Twelve-volt batteries have been used to some extent for automotive work but are rapidly becoming obsolete, because of the tendency of car manufacturers to standardize on six-volt starting and lighting

Storage Batteries

systems.

Fig. 7 shows three groups of positive and negative plates assembled together for a three-cell battery. Such positive and negative groups are called **elements**.

5. SEPARATORS

After the positive and negative groups are fitted together as explained, the positives must be insulated from the negatives by inserting thin wood or rubber **separators** between them.

These separators are used to keep the plates from touching each other and thereby forming internal short circuits. The separators must be porous so the electrolyte can pass through them and so that they will offer the least resistance to the passage of current. They must also be designed to allow free circulation of electrolyte over the surface of the positive plates.

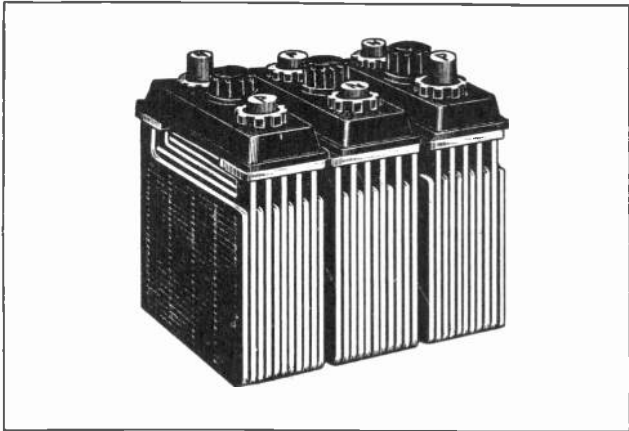

Fig. 7. Above are shown three groups of positive and negative plates assembled together and ready for separators before being placed in the cells of a battery.

Although separators are made of both wood and rubber the wood separator is most generally used. Cedar and cypress separators are generally used because of their porosity which reduces the internal resistance of the cell, and because of their ability to

Separators

resist the action of the acid in the electrolyte.

Separators made of basswood and of hardwood are also sometimes used.

Separators are provided with grooves on one side and when inserted between the plates they should always be placed with the grooved side next to the positive plates and with the grooves running vertically, or up and down, so as to provide free circulation of the electrolyte.

After being sawed and grooved, cedar and cypress separators are always treated in a hot alkaline solution and then washed thoroughly. The purpose of this treatment is to remove certain substances from the wood which would otherwise form acetic acid

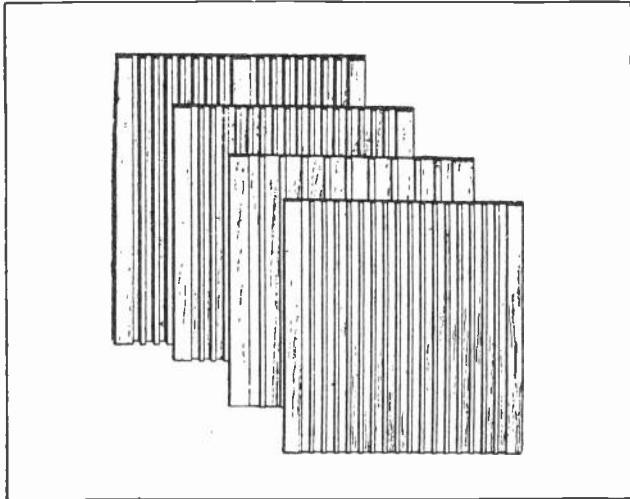

Fig. 8. Several different sizes of wood separators with different types of grooves. These separators are used to insulate the positive and negative plates from each other and prevent them from short circuiting within the cells.

if not removed. Acetic acid interferes with proper chemical action in the battery and may also damage the battery as it tends to corrode the lead. Sometimes plate lugs are so weakened and corroded due to presence of this acid that the plates drop off the lugs. The treatment also tends to increase the porosity of the separators and thereby reduce their

Storage Batteries

resistance to the passage of current through the cell.

As the separators are treated at the factory where made they are shipped wet or damp and **must be kept damp until they are put into service**. If they are kept in water a small quantity of sulphuric acid should be put in the water to prevent the separators from becoming slimy or moldy

Fig. 8 shows several different styles of wood separators with grooves of different sizes and various spacings.

When separators are fitted between the positive and negative plates they should be trimmed and set so that their tops will come at least $\frac{3}{16}$ or $\frac{1}{4}$ of an inch above the tops of the plates, in order to prevent short circuits that might otherwise be caused by foreign material dropping in the cell through the vent opening when the vent plugs are removed.

Special cutters or separator trimmers can be obtained for trimming wood separators to proper size. A separator trimmer consists of a flat board with a knife attached to its edge by a hinge, so that separator edges can be sheared off by placing them on the board under the knife.

Another type of separator developed by the Willard Storage Battery Company is known as the **threaded rubber** separator. This separator is made of a thin sheet of hard rubber which has a large number of short threads placed crosswise through the rubber when the separator is molded. These threads number over 6000 to the square inch and serve as wicks to allow the electrolyte to circulate through the separator, and also to afford a path for the passage of current through the acid soaked threads.

The threaded rubber separator has ribs or corrugations on one side which correspond to the grooves on wood separators. When installed between the plates the ribbed side of the rubber separators must be placed next to the positive plates with the ribs running vertically, or up and down.

Separators

6. RETAINERS AND ISOLATORS

Some battery makers use thin perforated sheets of hard rubber about $1/64$ of an inch thick, which are placed between the ribbed side of the wood separator and the positive plates. These thin rubber sheets are called **retainers** and are used to pre-

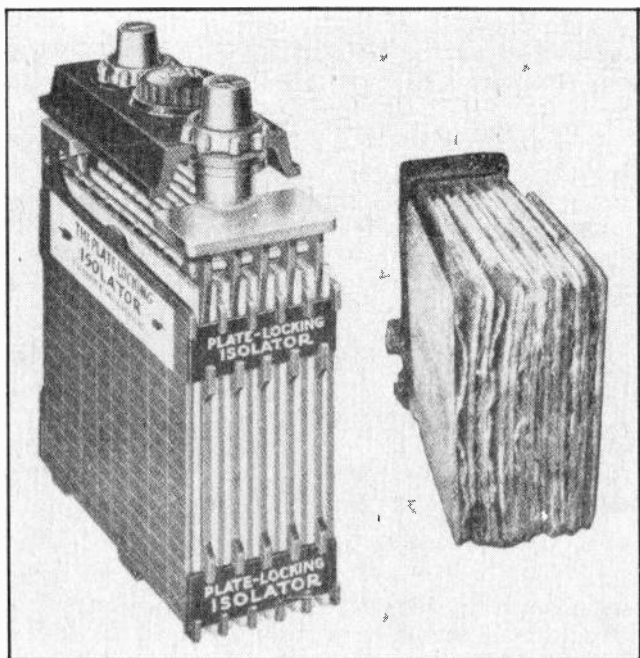

Fig. 9. This photo shows on the left an excellent view of a cell element equipped with isolators for holding the plates in position and preventing warping or buckling; and on the right is shown a group of badly warped plates which were not equipped with isolators of this type. (Courtesy of Vesta Battery Co.)

vent the active material from shedding or falling out of the grids of the positive plates.

These retainers, however, have the disadvantage of a tendency to clog up, and thus increase the internal resistance of the cell.

One large battery manufacturing company uses additional notched strips of hard rubber which are

Storage Batteries

fitted into slots cut in the edge of the grids. These strips are called **Isolators** and are for the purpose of locking the edges of the plates rigidly in position to prevent warping and distortion of the plates with age or severe use.

The use of these isolators doesn't eliminate the necessity for separators but the isolators give a great deal of added strength and rigidity to the plate groups, and prevent the plates buckling and cutting through the separators where the plate corners would otherwise become warped against them.

When a separator becomes worn through by pressure from warped plates it allows the plates to short circuit and puts the cell out of commission.

The view on the left in Fig. 9 shows an element or group of positive and negative plates equipped with isolators and on the right in this same figure is a group of badly warped plates showing what may happen to a plate group that is not equipped with isolators.

The position of the wood separators and the manner in which their tops are allowed to project slightly above the plate tops are also shown in left view of Fig. 9.

Isolators were formerly made from celluloid, but the disadvantage of this material was its tendency to melt or dissolve at high temperatures, so hard rubber is the material now used.

7. CELL CONTAINERS AND BATTERY CASES

After an element or group of positive and negative plates has been assembled with separators it is ready to be placed in the cell container. Each cell must, of course, be insulated and separated from the other cells in the battery, and the containers used for this purpose must be acid resistant and able to withstand a certain amount of mechanical abuse and vibration.

Hard rubber meets this condition very well as it resists the action of the acid and is fairly tough and

Cell Containers

strong. Glass is also acid resisting and can be used in the construction of batteries for stationary use where they are not subjected to any mechanical abuse or severe vibration.

Fig. 10 shows a hard rubber jar or cell container on the left and a rubber jar cover on the right. Ribs or ridges about one inch high are provided in the bottoms of these jars to strengthen them and also to keep the plates up off the bottom of the cell, and prevent their being shorted by any active material which may shed from the plates during use and settle to the bottom on the container. The ribs in the jar bottoms form spaces in which this loosened active material settles and prevent it from reaching the lower edges of the plates.

Until recent years automotive battery cell groups or elements were all placed in individual jars of this type and the three or six jars, or complete cells, then mounted in a wood box such as shown on the left in Fig. 11.

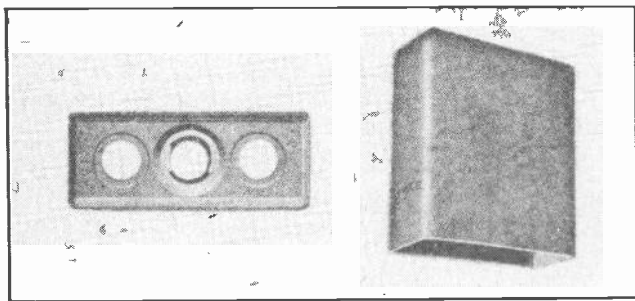

Fig. 10. This view shows a common type of hard rubber cell jar and cover such as used in automobile batteries with wood cases.

Wood battery cases have the disadvantage of being subject to rotting and rapid deterioration due to the action of the acid fumes or any acid spilled upon them. Their life can be greatly prolonged by coating the wood with acid-proof paint, but even then wood cases are not very satisfactory for auto-

Storage Batteries

motive batteries or other uses where they receive rough treatment.

A much better battery case which has come into very general use for automotive and radio batteries in the last few years is the hard rubber case, such as shown on the right in Fig. 11. These cases are not affected by acid and, therefore, last much longer than wood cases and they are very strong and compact.

You will note that the cell partitions of hard rubber are built right into these cases so they do not require separate cell jars but are complete when fitted with rubber cell covers, such as shown beneath the cases in Fig. 11. These covers are used to close the tops of the cells and keep out dirt, water, etc., and to prevent spilling of the electrolyte.

The covers are each provided with three openings. One in the center for the vent and filler cap and one near each end for the terminal posts of the plate groups to project out to the connectors. The sides of the covers are so shaped that when they are installed in a jar or case a V-shaped space or groove is formed all around their edges between the cover and the side of the battery. Into this groove is poured hot sealing compound which hardens as it cools and forms an acid-resistant seal between the cover and container.

Fig. 12 shows two complete automobile batteries. The one above being built in a wood case and the one below in a rubber case.

8. ELECTROLYTE

After a new battery is completed or an old one repaired each cell must be filled with electrolyte, and the level of this electrolyte should always be kept from $\frac{3}{8}$ to $\frac{1}{2}$ inch above the tops of the plates.

The electrolyte used in lead plate storage batteries consists of chemically pure sulphuric acid (H_2SO_4) and distilled water. A commercial grade of acid should never be used, as it contains certain impurities which may cause local action and rapid

Cell Containers

deterioration of the battery plates even when the battery is not in use. For the same reason **distilled water only should be used**, as ordinary well water or water from a faucet contains chemicals that are detrimental to battery action and life. You will recall from an earlier article on primary cells that local action is caused by impurities in the plates or

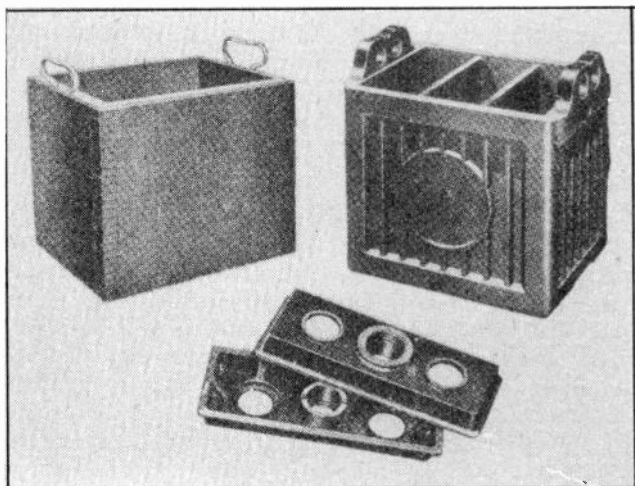

Fig. 11. Above are shown two types of cases commonly used with automobile batteries. The one on the left is made of wood and the one on the right is made of molded hard rubber. Two-cell covers are shown beneath the cases.

electrolyte, setting up local short circuits or small active cells at various spots on the plate surface wherever the impurities lodge or collect.

9. SPECIFIC GRAVITY

The term **specific gravity** has already been mentioned and is one with which we should become thoroughly familiar at this point. Specific gravity refers to specific weight of any liquid or substance compared to the weight of an equal volume of pure water, or, in other words, the ratio of the weight of the substance to the weight of an equal volume of water.

Storage Batteries

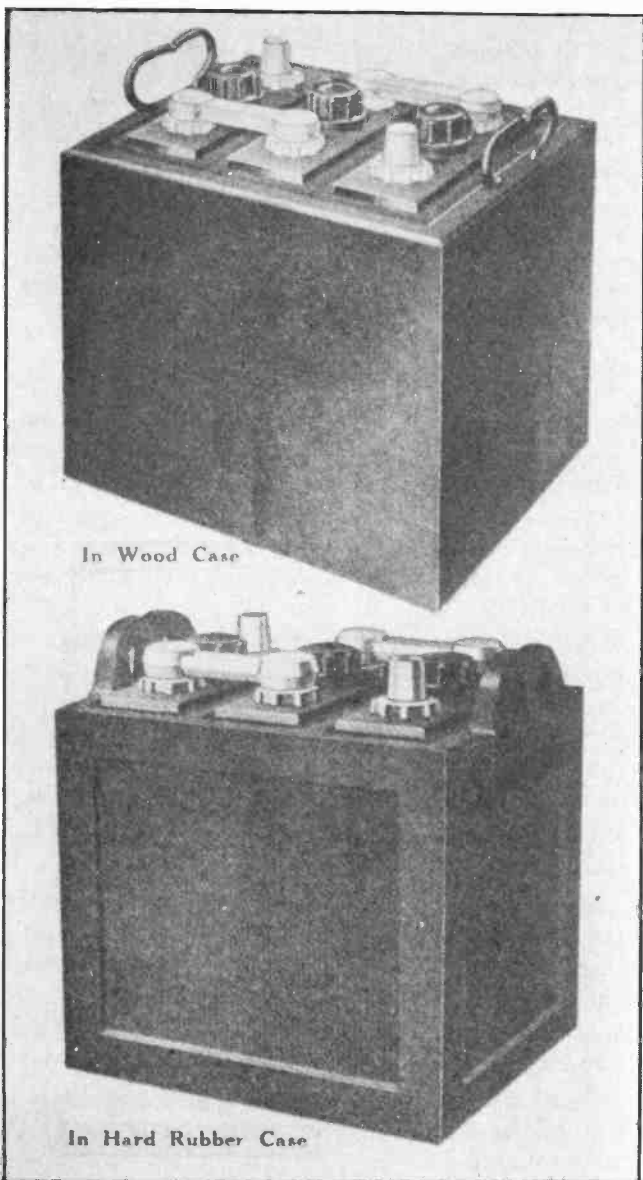

Fig. 12. Top view shows a completed wood case battery of the 3-cell, 6-volt type, and below is shown a complete battery of the same type but in a rubber case.

Electrolyte

The specific gravity (S. G.) of pure water is assumed to be 1, usually written 1.000, and is used as a standard for comparing the weights of similar volumes of other materials and thus establishing their specific gravity.

One pint of water weighs approximately one pound and one pint of sulphuric acid weighs 1.835 pounds. So we say the specific gravity (S. G.) of sulphuric acid is 1.835. This shows us the acid is about 1.8 times heavier than water.

10. HYDROMETERS

The specific gravity of any liquid can be easily and quickly determined by means of a device called a **hydrometer**.

Fig. 13 shows a hydrometer on the left, and in the view on the right one of these devices is shown in use to test the specific gravity of the electrolyte in a battery.

A hydrometer consists of a glass tube syringe containing a small float inside of the glass tube as shown in Fig. 13. The float is weighted at the bottom end so that it will float upright when the outer tube is filled with liquid which has been drawn in by the rubber bulb. The upper end of the float is marked with a graduated scale from 1.100 to 1.300 for ordinary automotive battery testing.

In speaking of specific gravity or hydrometer readings for battery electrolyte, instead of stating the figure in full as a fraction, we generally drop the decimal and shorten the expression. For example the reading 1.200 would be called twelve hundred, and the reading 1.275 called twelve seventy-five, etc. The decimal is also commonly left out of the figures marked on the scales of battery hydrometers.

In order to indicate the specific gravity of the liquid which is drawn into the hydrometer tube, the float is weighted just the right amount so that it

Storage Batteries

would float in water with the mark 1 just at the surface of the water. Sulphuric acid being heavier than water the float will not sink as far in the acid but will float higher, and the specific gravity of the acid can be read at the float mark which is at the surface of the acid.

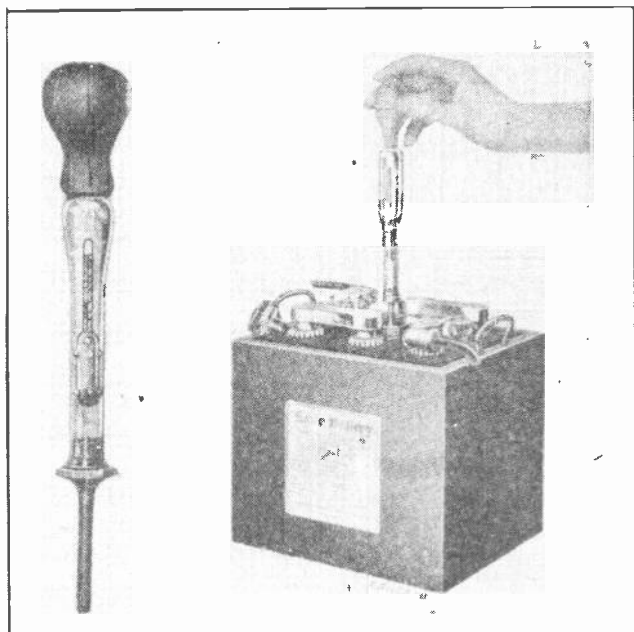

Fig. 13. On the left is shown a common battery hydrometer. Note the small float within the glass barrel of the hydrometer and also the rubber bulb on the top for drawing in the electrolyte. The view on the right shows the method of using a hydrometer for testing the electrolyte of a battery.

In using a hydrometer the bulb is depressed and the syringe tip immersed in the liquid to be tested. Releasing the bulb then draws the large glass tube partly full of liquid and causes the float to rise. Care should be taken to see that the float doesn't stick to the glass tube but rises freely in the liquid. If too much liquid is drawn into the hydrometer the top of the float may be held against the top of the syringe tube or up in the bulb, and some of the liquid should be forced out so that the float will ride

Electrolyte

freely at a convenient level for reading.

As the amount of acid in the electrolyte of a storage battery varies during charge and discharge and thereby varies the gravity of the electrolyte, hydrometer readings are a good indication of the state of charge. This method of testing will be explained later.

11. PREPARATION OF ELECTROLYTE

In preparing electrolyte for lead plate storage batteries for automobile use sufficient water is mixed with the sulphuric acid to bring its specific gravity to about 1.280 or 1.300 according to the strength desired. Sulphuric acid can be obtained in the concentrated form (1.835 specific gravity) but is more generally supplied partly diluted to 1.400 specific gravity for use in preparing battery electrolyte.

When mixing concentrated or 1.835 S. G. sulphuric acid and distilled water always add the acid to the water slowly, and stir the solution continuously while adding the acid.

If the water is added to the acid the mixture will heat up so much that it may break the container and injure the operator, or the violent boiling may splash acid in one's eyes.

Sulphuric acid even in its diluted form in battery electrolyte is very injurious to clothing and will burn the skin of the hands if not immediately washed off. Strong sulphuric acid is very dangerous if carelessly handled and allowed to splash into the eyes or on the face and hands of the operator. Ammonia and strong soda water are good neutralizers for this acid, and should always be on hand and immediately used to wash off any acid from the flesh or clothing in case of an accident.

Mixing of electrolyte should be done in an acid-proof container of hard rubber, glass, earthenware, or lead. A wooden paddle or glass rod should be used to stir the solution. Don't use metals for this purpose.

Storage Batteries

The electrolyte should be allowed to cool below 90° F. before being put in battery cells.

When preparing electrolyte with prediluted sulphuric acid of 1.400 S. G. and distilled water it doesn't matter which one is poured into the other, but care should be used not to mix large quantities too fast and it is well to stir the solution while mixing.

A convenient table for preparing battery electrolyte from 1.400 S. G. acid is shown in Fig. 14.

MIXING ELECTROLYTE BY VOLUME			
WATER		DILUTED ACID	Sp. Gr. OF ELECTROLYTE
ADD 3½ PINTS	OF DISTILLED WATER	TO 1 GAL. OF 1.400 ACID	FOR 1.300 ELECTROLYTE
" 4½ "	" " "	" 1 " " " "	" 1.280 "
" 5 "	" " "	" 1 " " " "	" 1.275 "
" 5½ "	" " "	" 1 " " " "	" 1.260 "

Fig. 14. This convenient small table shows the amount, by volume, of water and acid to be mixed together to produce battery electrolyte of four different strengths.

This table shows the number of pints of distilled water to be added to each gallon of 1.400 acid to produce electrolyte ranging from 1.300 to 1.260 S. G.

MIXING TABLE			
SPECIFIC GRAVITY OF SOLUTION OR ELECTROLYTE AT 70° F.	PARTS OF WATER TO 1 PART OF C.P. SULPHURIC ACID 1.835 SP. GR. AT 70° F.		PERCENTAGE OF SULPHURIC ACID IN SOLUTION
	BY VOLUME	BY WEIGHT	
1.120	8.00	4.40	17.40
1.150	6.15	3.36	21.40
1.180	4.95	2.70	25.20
1.200	4.33	2.36	27.70
1.220	3.84	2.09	30.20
1.250	3.22	1.76	33.70
1.270	2.90	1.57	36.10
1.280	2.75	1.49	37.30
1.300	2.47	1.34	39.65
1.350	1.95	1.06	45.20
1.400	1.56	0.84	50.50

Fig. 15. This table shows the amounts, both by volume and by weight, of water and full strength acid which should be mixed together to produce electrolytes of different specific gravities.

Another convenient table for mixing electrolyte ranging from 1.120 S. G. to 1.400 S. G., from concentrated acid of 1.835 S. G. is shown in Fig. 14.

Electrolyte

This table gives the amounts of water both by volume and by weight so that either method of measuring can be used according to which is most convenient. The table also gives in the last column the percentage of sulphuric acid in the electrolyte solution.

12. TEMPERATURE CORRECTION

You will note that in the table in Fig. 14 the temperature of both the acid and electrolyte is specified to be 70° F. This temperature is mentioned because all hydrometer readings are based on an electrolyte temperature of 70° F., due to the fact that at other temperatures the readings will change, because the liquid expands and becomes lighter for a given volume when heated and contracts and becomes heavier when cooled.

As the weight or density of the liquid determines the height at which the hydrometer float will rest in the liquid and the reading which will be obtained, we can readily see that the temperature of the electrolyte will affect the hydrometer readings.

This is a very important point to remember when making hydrometer tests on electrolyte during mixing, or on the electrolyte of batteries that may have become overheated during use or charging, or that may be extremely cold or warm due to climatic conditions.

For correcting hydrometer readings according to the temperature of the electrolyte a device called a **correction thermometer** is commonly used. Fig. 16 shows a thermometer of this type which can be inserted in the electrolyte when mixing or into the electrolyte of the battery through the vent opening.

This correction thermometer has two scales. The scale on one side being used for the temperature readings and the one on the opposite side is the correction scale.

The reading on the correction scale at the point where the thermometer indicator line rests will give

Storage Batteries

the number to add to or subtract from the hydrometer readings to get the corrected reading. The

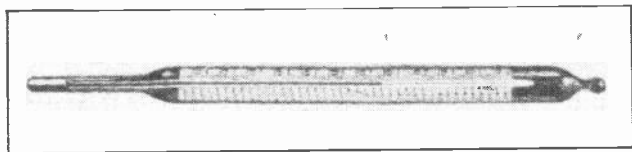

Fig. 16. Convenient type of battery thermometer for making corrections in hydrometer readings according to temperature of electrolyte.

scale also shows by a + or — sign before each figure whether the number should be added to or subtracted from the hydrometer reading.

A convenient rule to use in making temperature corrections when a correction thermometer is not available but the temperature of the battery or electrolyte is known as follows:

For every three degrees above 70° F. one point is added to the hydrometer reading, and for every three degrees below 70° F. one point is subtracted from the hydrometer reading.

For example, if we have electrolyte at a temperature of 100° F. and the hydrometer shows a reading of 1.270, then the electrolyte temperature being 100°, or 30° above 70°, we will divide 30 by 3 and find that 10 points must be added for correction of the hydrometer reading. Then 1.270 plus 10=1.280 or the correct gravity reading.

EXAMINATION QUESTIONS

1. a. What is the main difference between primary cells and secondary cells?

b. Do storage batteries consist of primary or secondary cells?

2. Name at least three important uses for storage batteries in addition to their use on automobiles.

3. What change takes place on the plates when charging current is passed through a storage cell?

4. Why is Lamp black often added to the paste used on negative plates?

5. What is the difference in appearance between positive and negative plates?

6. Why does the negative group of plates in a cell consist of one more plate than is used in the positive group?

7. a. Why are wood or rubber separators necessary in a secondary cell?

b. Name two requirements for a good separator.

8. a. Why are Retainers sometimes used in storage batteries?

b. For what purpose are isolators used?

9. a. What kind of electrolyte is used in lead plate type storage batteries?

b. What device is used for testing the mixture or specific gravity of battery electrolyte?

10. Briefly describe the proper method of mixing concentrated sulphuric acid and distilled water.

Storage Batteries

CHEMICAL ACTION IN CELLS DURING CHARGE AND DISCHARGE

In order that you may more fully understand some of the tests used with storage batteries and be able to recognize certain trouble symptoms and give the batteries the proper care, it will be well at this point to consider the action that takes place within the cells while they are charging and discharging.

It is also particularly valuable to know the condition of the plates and electrolyte both in charged and discharged condition. Let us start first with a new battery that is fully charged and consider the action that takes place during discharge.

When a lead plate battery is fully charged the active material in the positive plates is in the form of **lead peroxide** and is brown in color. In the negative plates the active material is in the form of **sponge lead** which is gray in color. The electrolyte will be at **maximum density** which is between 1.280 and 1.300 S. G. for automotive batteries.

With the battery in this condition the **open circuit voltage** of each cell will be between 2.1 and 2.2 volts. Now if the cell is connected in a closed electrical circuit current will flow due to this voltage or pressure, from the positive terminal of the cell through the circuit, and back to the negative terminal.

As the cell discharges certain chemical changes take place within it. **The acid in the electrolyte is gradually absorbed by the plates** in the process of changing the lead peroxide and sponge lead into lead sulphate. Thus the plates which were unlike when the cell was charged tend to become alike on discharge, or both change to lead sulphate.

The specific gravity or density of the remaining electrolyte decreases in proportion to the acid absorbed by the plates, so as the discharge progresses the electrolyte becomes weaker and weaker. When the specific gravity shown by the hydrometer read-

Battery Testing

ing drops to 1.150 if we test the cell voltage with a voltmeter you will find that it is down to about 1.7 or 1.8 volts, and we then consider the cell discharged.

So we find that in a discharged cell we have two conditions to observe. First, the active material on both plates has been changed to lead sulphate. Second, the density or specific gravity of the electrolyte is very little above that of pure water. It is, of course, possible to obtain considerable current from a battery after the cell voltage has dropped below 1.7, but it is generally not considered practical and is not good for the battery to discharge it much below this point. So when the voltage drops this low and the hydrometer readings show about 1.150 the batteries should be recharged.

During charging a reverse action to that which occurred during discharge takes place. To charge a cell direct current is sent through it in a direction opposite to the flow of current when the cell was discharging. This causes the sulphuric acid to be driven out of the plates back into the electrolyte, thus raising the density or specific gravity again. At the same time the lead sulphate in the positive plates is changed back into lead peroxide and the lead sulphate on the negative plates changed back into sponge lead.

When practically all of the acid has been driven out of the plates and the lead sulphate converted into lead peroxide and sponge lead the cell is said to be **fully charged**, and should show a **specific gravity reading of between 1.280 and 1.300** and a **cell voltage of 2.1 and 2.2 on open circuit test**.

When the cells are fully charged some bubbling or "gassing" of the electrolyte will be noticed. This is due to the fact that when the charging current has no more lead sulphate to work on, it will convert the water in the electrolyte into hydrogen and oxygen gas which will come to the surface of the electrolyte in the form of small bubbles, thus indi-

Storage Batteries

cating that the cell is about fully charged.

1. CHEMICAL TERMS AND FORMULAS OF BATTERY ACTION

While it is of no great importance to the average battery service man to know the exact chemical reaction that takes place within the batteries during charge and discharge, it is often very interesting to know this action as described in chemical terms.

The chemical reaction which takes place in the cell during charge and discharge can be described as follows:

We know that the electrolyte is composed of sulphuric acid and water, or H_2SO_4 , the H_2 representing two parts of hydrogen gas, S one part of sulphur, and O_4 four parts of oxygen. The lead peroxide on the positive plates consists of PbO_2 , in which Pb represents one part of lead and O_2 represents two parts of oxygen. The sponge lead on the negatives can be represented by the chemical symbol Pb which is one part of lead.

The lead sulphate which is formed on both positives and negatives during discharge is designated by the symbol $PbSO_4$, in which Pb represents one part of lead, S one part of sulphur, and O_4 four parts of oxygen.

The action which takes place in the positive plate during discharge, or the uniting of the lead peroxide with hydrogen and sulphuric acid from the electrolyte, can be chemically explained as follows:



The action on the negative plates during discharge, or the uniting of sponge lead with sulphuric acid to form lead sulphate, is described as follows:

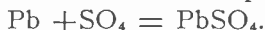

The action on the positive plate during charging and when current is sent backwards through the solution and plates, causing the chemical elements to reunite into their original form, is as follows:

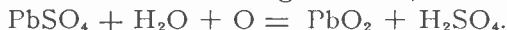

Battery Testing

The action on the negative plate during charge is $\text{PbSO}_4 + \text{H}_2 = \text{Pb} + \text{H}_2\text{SO}_4$.

As previously stated no particular effort needs to be made to study these chemical formulas, and they are given here only for convenient reference in case special questions arise regarding them.

2. BATTERY TESTS

There are a number of different tests which can be made easily with hydrometer, voltmeter, ammeter, etc., to determine quite accurately the condition of lead plate storage batteries. These are of particular value for the practical battery service man to know.

This lesson should be carefully studied until you are sure you are thoroughly familiar with methods of making each test and the battery conditions indicated by them.

One of the most commonly used tests on storage batteries is the gravity test which is made with a hydrometer as previously described. In the preceding article we found that the specific gravity of the electrolyte in a battery changes considerably as the battery charges or discharges.

The **gravity increases** as the acid is driven out of the plates and into the solution **during charge**, and **decreases** as the acid is absorbed from the electrolyte by the plates **during discharge**. So we can readily see that a hydrometer reading taken at any time will indicate the approximate condition of charge or discharge.

Automotive batteries are commonly made so that when they are fully charged the specific gravity of the electrolyte will be 1.280 to 1.300, and when the gravity drops to 1.150 they are considered to be practically discharged and should be put on charge immediately as it is very harmful for a battery to stand in a discharged condition.

Automotive batteries built for use in tropical climates are made so that they are fully charged at

Storage Batteries

about 1.200 S. G. The reason for this is that in such climates there is no danger of freezing, and the electrolyte being always warm is more active.

Furthermore electrolyte of the same acid strength will give a lower gravity reading because of its expanded and less dense condition at the warm temperatures.

The convenient chart in Fig. 1 shows the conditions indicated by various gravity readings. Fig. 2 shows the position of a hydrometer float in three samples of electrolyte taken from charged, half charged, and discharged batteries. Careful observation of the hydrometer sketches in this figure will be of great assistance in learning to properly read these devices.

BATTERY CONDITIONS INDICATED BY GRAVITY TESTS			
1.150 Sp. Gr.-----	DEAD	} AUTO BATTERIES IN TEMPERATE CLIMATES	} ELECTROLYTE TEMPERATURE AT 70°F.
1.215 Sp. Gr.-----	½ CHARGE		
1.280-1.300 Sp. Gr.-----	FULL "		
1.200 Sp. Gr.-----	FULL CHARGE	} AUTO BATTERIES IN TROPICS	
1.225 Sp. Gr.-----	" "	} STATIONARY AND VEHICLE BATTERIES	

Fig. 1. Chart showing conditions of charge indicated by various hydrometer readings on lead plate storage batteries in different climates.

3. VOLTAGE TEST

While the hydrometer test must be used to determine the condition of the electrolyte and is generally a rather good indication of the state of charge of a battery, it is not altogether reliable for this latter purpose.

We know that there should always be a definite relation between the voltage of a cell and the specific gravity of its electrolyte, but in some cases the gravity of the electrolyte may have been altered by adding strong acid or by replacing a large quantity of spilled electrolyte with distilled water.

In either of these cases a gravity reading would not be an accurate indication of the true condition of the cell. So a voltage test made by connecting

Battery Testing

the terminals of a low-reading voltmeter across a cell or battery is a more reliable means of determining whether the battery is fully charged or not, and whether the positive and negative plates have been made as unlike as possible by the charging current; because it is only when the active material of these plates is fully converted back to its original charged state that the voltage between the positive and negative terminals will be at maximum.

Comparing such a voltmeter reading with the hydrometer reading will also indicate whether the electrolyte is over-rich or weak. For example, if the electrolyte shows a S. G. of 1.280 or 1.300 and a voltmeter only show a reading of 1.8 volts per cell, this indicates that the electrolyte is too rich in acid and should be diluted with distilled water.

On the other hand if the voltmeter indicates a cell voltage of 2.2 and the hydrometer reading shows the gravity of the electrolyte to be only 1.230, this indicates that the electrolyte is too weak and should be slightly strengthened by adding more acid.

4. ON-THE-LINE VOLTAGE TEST

Voltmeter readings obtained when testing a battery will vary somewhat according to whether the battery is charging, is open-circuited and disconnected from the charging line, or is discharging under load.

The **on-the-line** voltage test is made while the battery is connected **in the charging line and charging**. At the end of the charge or when the cell is about fully charged the maximum cell voltage on this test will be about 2.5 volts. This voltage indicates a complete chemical change of the material in the plates. Old batteries often do not rise above 2.3 volts per cell on this test due to the negative plates retaining some of their lead sulphate.

Once the voltage of the cell reaches 2.5 volts there can be no further rise of gravity since the plates are free from lead sulphate. If the gravity is below or above the full charge specific gravity of the cell

Storage Batteries

it should be corrected by adding acid or water accordingly.

It is not advisable to attempt to correct the density or gravity of the electrolyte before bringing the voltage up to maximum by charging.

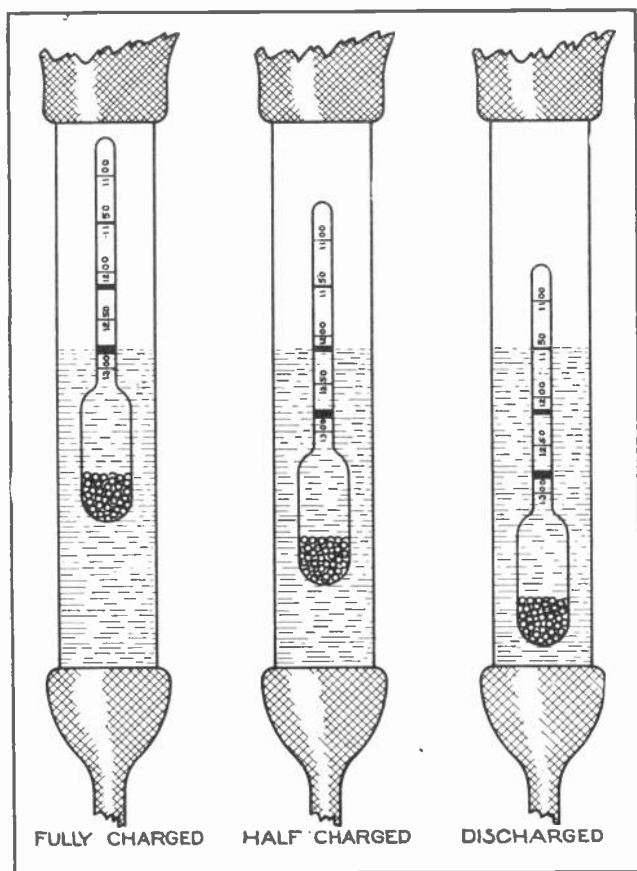

Fig. 2. This drawing clearly shows how to read an ordinary battery hydrometer. Study each of the three views very carefully while reading the accompanying explanation.

5. OPEN CIRCUIT VOLTAGE TEST

As soon as a battery is removed from the charging line the cell voltage drops rapidly until it

Battery Testing

reaches 2.1 volts in from 2 to 3 minutes. This is caused by a thin layer of lead sulphate forming on the surface of the negative plates and between the grid and lead peroxide of the positive plate, due to a slight chemical or discharge action which occurs within the cell as soon as the charging circuit is broken.

Once this thin layer of lead sulphate is formed the rapid voltage drop ceases due to the resistance of the lead sulphate film. This discharge or local action doesn't cease entirely, however, and a lead plate cell will not stay charged indefinitely but will gradually become discharged even though not connected to any circuit or load. An idle lead plate battery will become discharged in about 100 days of idleness if not charged during the idle period.

During discharge of the battery, lead sulphate is formed on both groups of plates and causes the open circuit voltage to drop. Theoretically a cell can be discharged to zero voltage, but for all practical purposes the discharge should be stopped when the cell voltage drops to 1.7 volts on the open circuit test or voltmeter test made with the battery discharging at a very low rate.

If the discharge is carried beyond this point, so much of the active material will be converted into lead sulphate that the plates will be almost useless. The plates are then said to be **sulphated**. Plates which have been allowed to get into this condition require a long slow charge to free them of all the lead sulphate.

Fig. 3 shows a D. C. voltmeter of the type which can be conveniently used for testing storage batteries. You will note that this meter has a low reading scale so that quite accurate tests can be made on one cell or on several cells of a complete three-cell battery. This meter can be equipped with flexible test leads and points and either mounted on a wall or bench, or carried to a car to make tests on the battery before removing it. A portable meter in a wood case is also very convenient for testing

Storage Batteries

batteries while in the car.

Fig. 4 shows another type of battery voltmeter particularly adapted for portable use. This instrument has a test point or prod directly attached to its lower side and forming one terminal of the meter. The other terminal on top of the case can be fitted with a flexible lead and test point. This meter has a scale which will allow the needle to read in either direction and only up to a maximum of 3 volts, thus

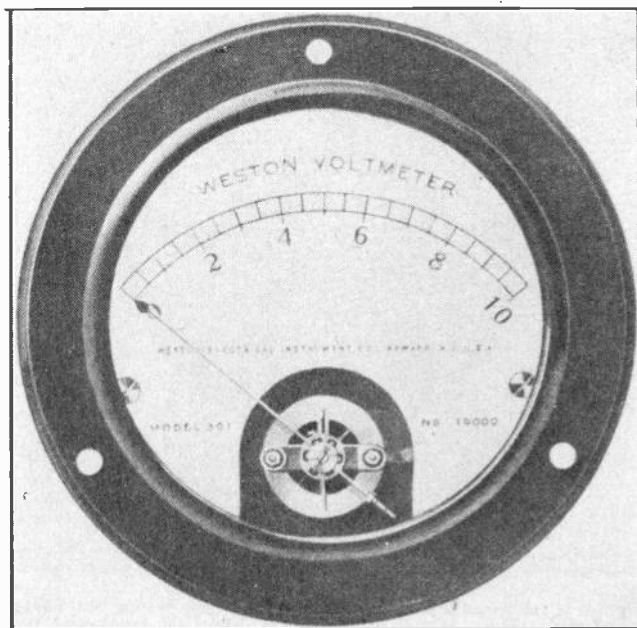

Fig. 3. Popular type of low reading voltmeter which can be mounted on a bench, panel or portable test panel, and used for testing the voltage of storage cells or batteries. (Photo courtesy of Western Electrical Instrument Co.)

giving very accurate readings on the low voltage of single cells.

6. CADMIUM TEST

The Cadmium method of testing a battery is very reliable as it reveals the actual condition of the

Battery Testing

plates better than any other test. With the Cadmium test we can determine two important facts regarding the condition of the battery.

1. Whether or not the capacity of both positive and negatives are equal.
2. Whether the battery is charged or discharged.

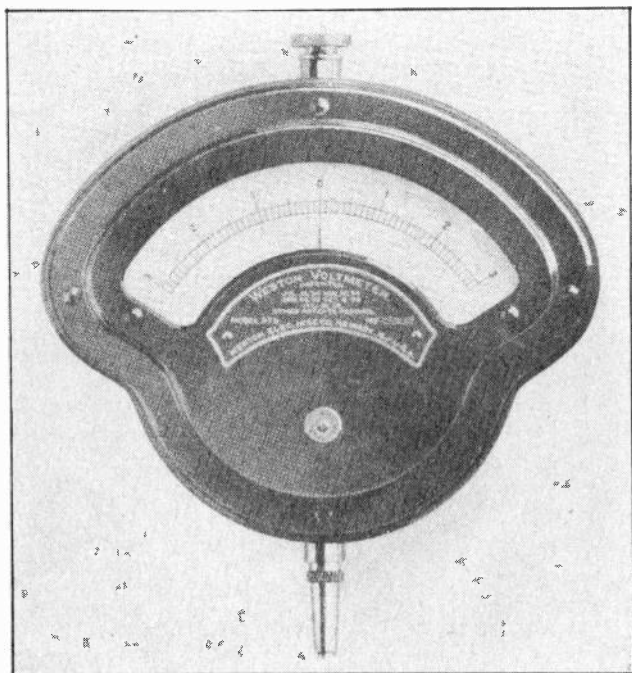

Fig. 4. Convenient type of portable voltmeter for testing the voltage of single cells. (Courtesy of Western Electrical Instrument Co.)

This test also serves as a check on both the voltage and specific gravity. The Cadmium test derives its name from the fact that a stick of cadmium metal is used in place of the usual negative voltmeter test point.

Fig. 5 shows a pair of voltmeter leads and test points for use in making cadmium tests. You will note the small round rod or stick of cadmium metal attached to the test point on the left.

Storage Batteries

This cadmium is a metallic element and not a mixture or alloy, and convenient small rods or cadmium sticks can be purchased from any battery material supply house.

When the cadmium stick is placed in the electrolyte of a cell with a voltmeter connected between the stick and one of the cell terminals, a definite

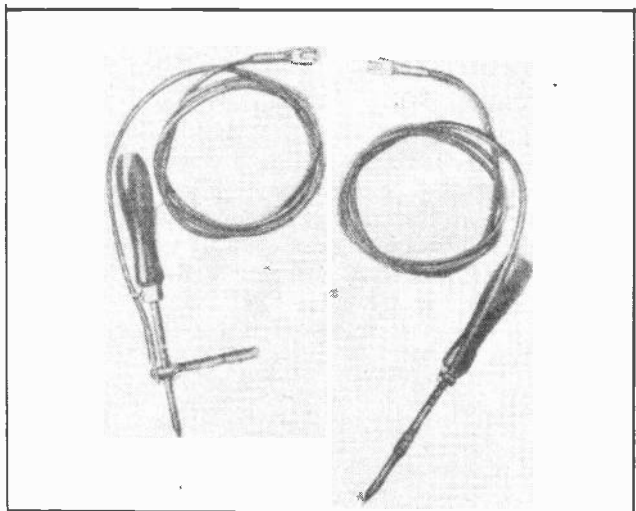

Fig. 5. This view shows a pair of test leads, one of which is equipped with a Cadmium stick for making Cadmium tests on storage batteries.

voltage will be set up due to the difference in chemical action of the acid on the cadmium stick and the battery plates.

If the voltmeter is connected between the cadmium stick and the negative plates or terminal the voltage reading will vary according to the condition of the plates. If the plates are pure sponge lead or fully charged the voltage will be about .1 volt, the cadmium stick being positive and the plates negative in polarity. In this case the reading will be to the left side of zero on the voltmeter scale.

If the voltmeter is connected between the cadmium stick and the positive plates or terminals a

Battery Testing

different reading will be obtained. If the plates are pure lead peroxide or fully charged the voltage reading will be 2.4 volts and the cadmium stick will now be negative to the lead peroxide or positive plate.

When the cadmium stick is used in combination with lead sulphate or discharged plates a still different voltage will be obtained, all depending on the amount of lead sulphate on the plates tested.

Fig. 6 shows a voltmeter with a specially marked scale for cadmium tests, and Fig. 7 shows an enlarged drawing of the scale of a meter of this type.

Voltmeters for this work should be of high resistance for cadmium tests and should have a scale calibrated from 0 to 2.7 volts to the right of zero, and .3 volt to the left of zero. These same voltmeters can also be used to make all ordinary battery voltage tests, but they should never be connected across more than one cell because their voltage capacity is low.

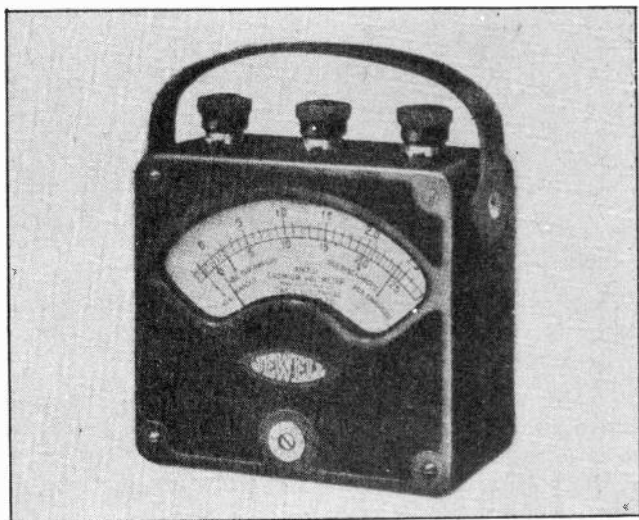

Fig. 6. Convenient portable voltmeter with special scale for making Cadmium test on lead plate battery. (Courtesy of Jewel Electrical Instrument Co.)

Cadmium tests should only be made with the battery on charge at the regular charging rate. The

Storage Batteries

test lead to which the cadmium stick is attached should always be connected to the negative terminal of the voltmeter, while the plain test lead to be used on the cell terminals is to be connected to the positive terminal of the meter.

With the battery on charge the cadmium stick is inserted through the vent hole of the cell cover until it makes good contact with the electrolyte. The cadmium stick must not touch the plates and for this reason many of these sticks are equipped with insulating tips or with a perforated rubber tube over their ends.

The cadmium should remain in the electrolyte for a minute or two before taking the readings so that a thin coating of cadmium sulphate will form on the stick. The other test point can then be shifted between the positive and negative cell terminals to make the tests.

By attaching it to the negative terminal the condition of the negative plates can be determined, and when it is in contact with the positive terminal the condition of the positive plates can be determined by the voltmeter readings.

With the battery on charge the voltage reading between the cadmium stick and the positive terminal will be about 2.4 volts if the positive plates are pure lead peroxide or fully charged.

With the free test point on the negative terminal a reading of .1 volt to the left of zero will be obtained if the negative plates are pure sponge lead or fully charged.

If these two readings are added together their sum should equal the reading of a voltage test taken from positive to negative terminals. These voltages would indicate that both positive and negative plates are fully charged and in good condition.

If when making such a test the positive reading was 2.4 volts and the negative reading to the right of zero, the voltage of the cell would be obtained by subtracting the negative reading from the positive reading. Such a test would indicate that the

Battery Testing

negative plates are in bad condition since they are not charged while the positives are.

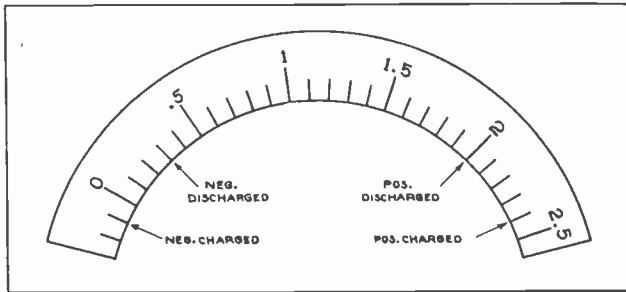

Fig. 7. Diagram showing the scale of a Cadmium test meter with the important test readings marked.

The cadmium test is the most reliable test that can be made and determines if both the positives and negatives are at the same state of charge, as they should be if both groups of plates are in good condition.

7. HY-RATE DISCHARGE TEST

The hy-rate discharge test is made on storage batteries by taking voltmeter readings across the individual cells while the battery is discharging at a heavy rate.

This test is particularly valuable in determining the condition of the various cells of a battery and is very commonly used in testing automobile batteries, as these batteries must maintain their voltage without excessive voltage drop while operating the starting motor which, as we have already learned, may draw several hundred amperes during starting of the engine.

For making this test some form of high rate discharge test set is generally used. These sets consist of a variable resistance, generally of the carbon pile type, an ammeter of sufficient capacity, and a voltmeter.

On some of these test sets three voltmeters are used, one being connected across each cell to elimi-

Storage Batteries

nate the necessity of shifting the meter terminals from one cell to the next.

Fig. 8 shows three types of high rate discharge testers. The one above has a long tube filled with carbon disks and equipped with a knob and threaded rod at the right hand end to vary the pressure applied to these disks, and thereby vary their resistance and the rate of discharge of the battery connected to the set. The ammeter and voltmeter are also mounted on the base with the variable resistor.

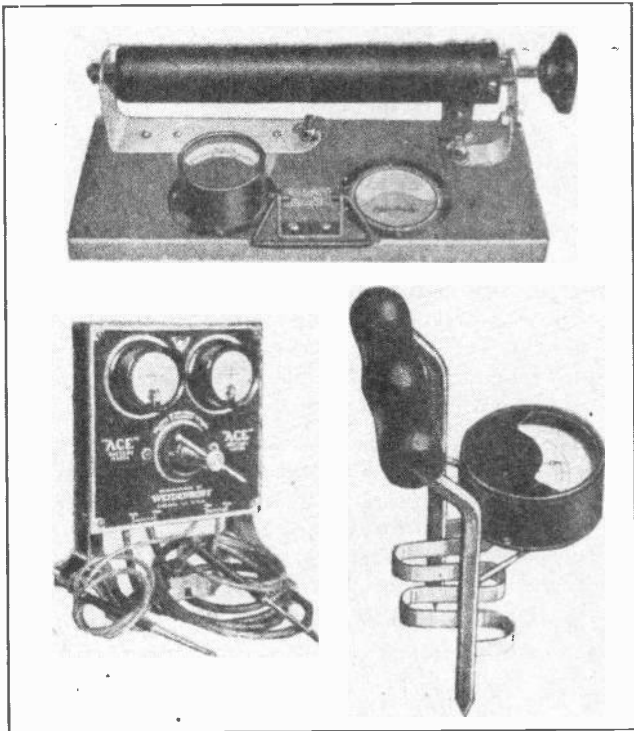

Fig. 8. Several styles of hy-rate discharge test sets. The one above is for either portable or bench use. The one at the lower left for bench use, and the one at lower right for portable use for testing individual cells.

On the lower left in Fig. 8 is shown another type of high rate discharge set with the meters and rheo-

Battery Testing

stat handle located on a vertical panel and equipped with both heavy-duty terminal clips and test prongs.

On the lower right in Fig. 8 is shown a convenient portable test device for making high rate discharge tests on individual cells. This device consists of a pair of heavy test prongs with a resistance element shunted across them, and the meter also connected across the prongs to read the voltage during the test.

This tester is conveniently portable and can be used right at the battery either on the charging bench or in the car, by merely pressing the sharp-ended test points down against the terminals or straps of the cell to be tested.

The discharge rate for making these tests is based on the number of plates per cell, the usual rate being 20 to 25 amperes per positive plate, figuring only the positive plates in one cell.

For example an 11-plate battery having eleven plates per cell would have 6 negatives and 5 positives in each cell. As the discharge rate is based on the number of positives the high rate discharge current for testing such cells would be 5×20 , or 5×25 , or 100 to 125 amperes.

While the battery is discharging at this rate the voltage of each cell is measured separately, and if the battery is in good condition and fully charged the voltage should not drop below 1.75 or 1.78 volts per cell during the test. This voltage drop is caused by the heavy current flowing through the internal resistance of the cell.

If the cell's internal resistance is normal the voltage drop will not be excessive but if the cell is in bad condition the voltage drop will be much higher than usual.

The internal resistance of a cell is due to the resistance of the several parts and materials in the internal circuit of the cell. When the cell is discharging through some load the discharge current also flows through the internal circuit and must pass through the plates, separators, and electrolyte; so

Storage Batteries

the resistance of these materials determines the internal resistance of the cell.

Excessive voltage drop may be due to several causes such as spongy or worn out plates, clogged separators, or wrong specific gravity of the electrolyte.

Thin and worn separators may also be the cause of large voltage drop by allowing the plates to be short circuited during heavy discharge tests. A high rate discharge can be used to very good advantage to locate defective cells in batteries that are being brought in to a shop to be charged.

The exact readings obtained on this test are not as important as the difference in readings between the several cells. **A cell that gives a reading of more than .1 volt less than the other cells is generally defective and should be opened and examined.**

Sometimes a high rate discharge test will cause one cell to give a reverse reading which indicates that the cell is dead.

8. STORAGE BATTERY CAPACITY

The capacity of storage batteries or individual cells is rated in **ampere-hours**. This term refers to the product of the discharge current multiplied by the number of hours that the discharge can be maintained.

Capacity ratings for storage batteries of the automotive type are based on a discharge started from a fully charged condition, and continued until the battery reaches normal discharged condition with its voltage down to 1.7 volts per cell.

The discharge rate for capacity tests on automobile batteries is generally based on an eight-hour discharge period. For example, a battery rated at 80 ampere hours should be able to deliver 10 amperes for eight hours. The capacities of stationary batteries and those for use in electric vehicles are generally figured on a five-hour discharge rate.

One of the characteristics of storage batteries which it is very important to remember is that their

Battery Testing

capacity is affected by the rate of discharge, the capacity in ampere hours decreasing as the rate of discharge is increased.

For example, an 80 ampere-hour battery will not discharge at the rate of 80 amperes for one hour, but will deliver 4 amperes for considerably more than 20 hours. In other words, they will deliver more energy and show a higher efficiency at low rates of discharge than at high discharge rates.

The ampere-hour capacity of the storage battery depends upon several factors among which are: (a) plate area (b) porosity of active material (c) strength of electrolyte.

For all practical purposes the plate area is the most important factor, and principally controls the capacity of the battery. Therefore, all capacity formulas are based on plate area.

The chemical activity of a battery is always greatest at or near the surface of the plates where the active material and the acid are in contact with each other. This is particularly true during high rates of discharge when the acid is being used up very rapidly. So by increasing the plate surface exposed to the electrolyte we increase the amount of active material in contact with the acid, and thereby increase the capacity of the cell.

A simple formula for determining the approximate ampere-hour capacity of storage batteries according to the plate area is as follows:

$$\frac{W \times L \times 2 \times P. P.}{144} \times 50 = \text{ampere hour (A.H.) capacity.}$$

In which: W = width of the plates
 L = length of plates
 2 = number of sides on each plate
 $P. P.$ = number of positive plates in one cell
 144 = square inches in 1 sq. ft.

The average positive plate for use in automobile batteries is approximately $4\frac{1}{2} \times 5\frac{1}{2}$ inches. So if we apply this formula to an ordinary 11-plate, 3-cell automobile battery the problem would be as follows:

$$\frac{4.5 \times 5.5 \times 2 \times 5}{144} \times 50, \text{ or approximately } 85.5 \text{ A.H.}$$

Storage Batteries

This battery would be rated in round figures as an 80 ampere-hour battery, allowing the slight excess capacity for reduction in efficiency with age.

The above formula is used in determining the capacity of only one cell, but since most storage batteries have series connected cells, the capacity of the complete battery is the same as the capacity of the one cell. However, if the cells are connected in parallel, the capacities of all cells would be added together. As an example, if in the above battery, the three cells were connected in parallel, the battery would furnish 3 times as many ampere hours, which would be 256.5.

It is well to remember, however, that the amount of work the battery is capable of doing remains the same whether the cells are connected series or parallel. The amount of work in Watt hours is found by multiplying ampere hours by the battery voltage.

Let us take 3 two volt cells with a capacity of 80 ampere hours each and determine the number of Watt hours available, both when the cells are connected in series, and when they are connected in parallel. In a series connection, the capacity will remain at 80 ampere hours, but the voltage increases to 6 volts; therefore, the Watt hour capacity will be 6×80 or 480 Watt hours.

Now let us take the same 3 cells and connect them in parallel, thus increasing the current capacity to 3×80 or 240 ampere hours. The voltage in a parallel connection does not increase so the voltage will remain at 2 volts. The Watt hour capacity will now be 2×240 or 480 Watt hours. Thus we see that the amount of work the battery is capable of doing remains the same regardless of the connection used, but the quantity or electricity the battery will furnish, and the voltage under which the current flows may be changed according to the method of connection.

The thickness of battery plates has very little effect on the ampere-hour capacity of the battery as under normal conditions a plate doesn't discharge actively clear through the plate, but discharges mainly on and near the surface. This is due to the fact that the pores in the active material soon be-

Battery Testing

come clogged and choked with lead sulphate.

When a battery is discharged down to the normal discharged condition it is very seldom that more than 25% of the active material is used, and that is largely at the surface of the plates.

While the plate thickness doesn't materially affect the ampere-hour capacity it does affect the discharge capacity or rate in amperes at which a cell or battery can be discharged.

Surprising as it may seem, thin plates always have a higher discharge capacity in amperes than thick plates. This is due to the fact that the electrolyte will diffuse through the thin plates much more rapidly and will quickly replace the acid used up by the active material during the discharge action of the plates.

Plates for automobile batteries are made in slightly different sizes in order to fit different styles of battery cases and to provide more or less capacity, according to the requirements of the car. This is well to remember when ordering plates for repairing various batteries and a good plan is to carefully measure or check the size of those removed when ordering the new ones to replace them.

Three common plate sizes are as follows:

Type	Symbol	Dimensions
Small	S	4½" high × 5⅝" wide
Medium	M	4¾" to 5¼" high × 5⅝" wide
Large	B	6" high × 5⅝" wide

These plates can also be had in three different thicknesses as follows:

Type	Symbol	
Thin	T	3/32" thick
Regular	R	⅛" "
Thick	T.T.	5/32" "

9. CAPACITY TESTS

The purpose of a capacity test on a battery is to determine the amount of work that it is capable of doing before its voltage drops to 1.7 volts per cell, or the normal discharge condition.

While formulas give us a theoretical idea or approximate knowledge of what the rated capacity of

Storage Batteries

a battery should be, the actual capacity can be much more accurately determined by a test.

This test is performed by charging the battery fully and then discharging it through a variable resistance and ammeter until the battery reaches the normal discharged condition.

In order to obtain accurate results from a capacity test of this kind the following two factors must be carefully watched and checked:

1. Discharge rate must be maintained constant from start to finish.
2. The time required for the battery to reach normal discharged condition must be noted.

In order to maintain a constant rate of discharge throughout the entire test period an ammeter and some form of variable resistance are necessary; the ammeter to check the amount of current flow and the rheostat to keep it adjusted to a constant value.

When the battery is first put on test its voltage is high but as the test progresses the voltage gradually drops and the discharge rate would tend to de-

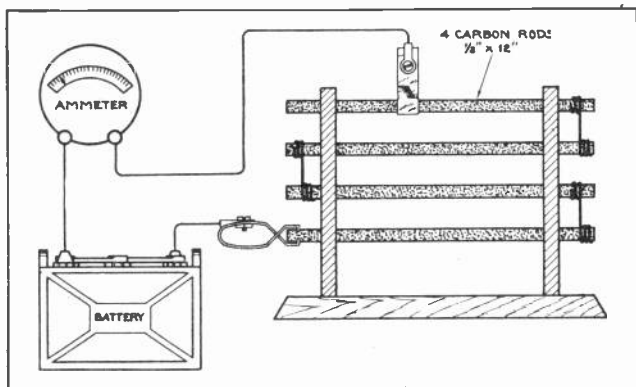

Fig. 9. Diagram showing construction and connections of a simple capacity test discharge resistance, which can be easily and cheaply made of carbon rods supported in an insulating frame of heat resisting material.

crease. It is, therefore, necessary to cut out a little resistance about every 15 minutes in order to keep the discharge rate in amperes constant.

Battery Testing

Fig. 9 shows a diagram of a simple capacity test arrangement, the equipment for which is very low in cost and simple to set up for any battery shop. The battery is connected in series with an ordinary ammeter of the proper capacity and several carbon rods such as ordinary arc carbons.

These round carbon rods can be mounted in strips of heat-resisting material of an insulating nature, such as asbestos, marble, or slate with their ends securely connected together in series as shown. A heavy test clip can then be used to vary the resistance in the circuit by sliding the clip along the rods or moving it from one rod to another.

Convenient carbon pile rheostats can also be obtained for this work but are, of course, a little more expensive than the simple shop tester shown in Fig. 9.

The discharge rate at which to start a capacity test in an automobile battery can be determined by dividing the assumed or approximate ampere-hour capacity of the battery by 8, because as previously stated these tests are generally made at the 8-hour discharge rate.

For example, if we wish to run a capacity test on an automotive battery which we assume from the number of plates used is an 80 ampere-hour battery, the discharge rate would be obtained by dividing 80 ampere-hours by 8 hours, or $80 \div 8 = 10$ amperes discharge rate.

If this battery when placed on capacity test can maintain a discharge rate of 10 amperes for 8 hours or more before the voltage drops to 1.7 volts per cell, and the gravity drops to 1150, then the capacity is actually known to be 80 ampere-hours or more.

For example, if it required $8\frac{1}{2}$ hours at the 10 ampere rate to bring the voltage and gravity down to the above mentioned figures then the capacity would be $8\frac{1}{2} \times 10$, or 85 ampere-hours.

The ampere-hour efficiency of a storage battery can be determined by dividing the discharge in am-

Storage Batteries

pere-hours by the charge in ampere-hours required to bring it back to the same state of charge as the test was started from. This efficiency of ordinary lead plate batteries often runs as high as 90% or over.

10. CYCLING STORAGE BATTERIES

Before putting into service a new lead plate battery on one that has been recharged and has had some of the old plates replaced with new ones the battery should be **cycled**, or charged and discharged several times.

This process more completely **forms** the new plates and greatly improves their condition and efficiency by more completely converting the paste into active material.

New batteries are generally cycled two or three times at the factory before being shipped out and this considerably increases their capacity and serviceability.

The original forming process described in an earlier article doesn't always change all of the paste into active material, and unless a new battery or one in which new repair plates have been installed is cycled, it will not deliver its rated capacity and may give trouble when first put in service.

A battery that has been neglected and allowed to become sulphated by standing for long periods in a discharged state will often fail to come up to full gravity and voltage when charged, due to the fact that one ordinary charging cannot convert all of the lead sulphate back into active material. Such a battery if given only the ordinary charge will not deliver its full rated capacity in ampere-hours and its performance will be rather poor.

Cycling a sulphated battery will convert more of the lead sulphate back into active material, thereby increasing the capacity and improving the performance of the battery. The rate of charge or discharge for cycling a battery should be at about the ordinary

Battery Testing

8-hour rate, or a little slower generally, so that the battery can be discharged during the day and put back on the charging line throughout the evening.

As a rule the rate of discharge for cycling is between 2 and 3 amperes per positive plate in each cell. For example an 11-plate battery having 5 positive plates per cell would be discharged at about 10 to 15 amperes.

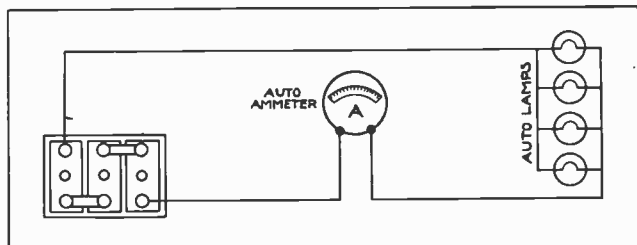

Fig. 10. This sketch shows the connections for using an ammeter and a group of automobile lamps for discharging a storage battery during a cycling process.

The same rheostat and ammeter used for making capacity tests can also be used along with a battery charger for cycling. However, as it is not necessary to keep the discharge rate constantly at the same value when cycling, a very simple and low cost discharge resistance can be made up from several automobile lamps connected in parallel and an ordinary automobile dash ammeter in series with them, as shown in Fig. 10.

If desired several small switches can be arranged to quickly connect more or less lamps in parallel, to vary the discharge rate for cycling different sized batteries.

The ability to properly test storage batteries is of tremendous importance not only to the man in a battery business, but also to the man in automotive electrical work, radio, telephone work, power plants, etc.

In order to successfully locate trouble in any system using storage batteries it is necessary for the trouble shooter to be able to make accurate tests on the batteries. So the knowledge you have gained in this lesson will be extremely helpful to you as

Storage Batteries

you continue your studies on battery charging, care, and repair. Refer to this lesson from time to time to refresh your memory on proper testing methods.

EXAMINATION QUESTIONS

1. What is the average specific gravity reading on a fully charged battery?
2. What will be the approximate voltage on a fully charged cell if tested when the battery is on the charging line?
3. Which method of battery testing is used to determine the condition of either positive or negative plates?
4. Briefly describe how a Hi-Rate discharge test is made.
5. What is the indication of a defective cell when making a Hi-Rate discharge test?
6. a. What unit is used in measuring the capacity of a storage battery?
b. Upon what factor does the capacity of a battery principally depend?
7. Using the formula given in article eight, figure the current capacity of a battery made up of series connected 13 plate cells. Assume the plate size to be 5" \times 5".
8. What would be the Watt hour capacity of a 3 cell storage battery made up of 2 volt cells, each having a current capacity of 120 ampere hours?
9. Briefly describe how you would make a test to determine the ampere hour capacity of a battery.
10. What treatment would you recommend for a battery that has been allowed to stand in discharged condition until badly sulphated?

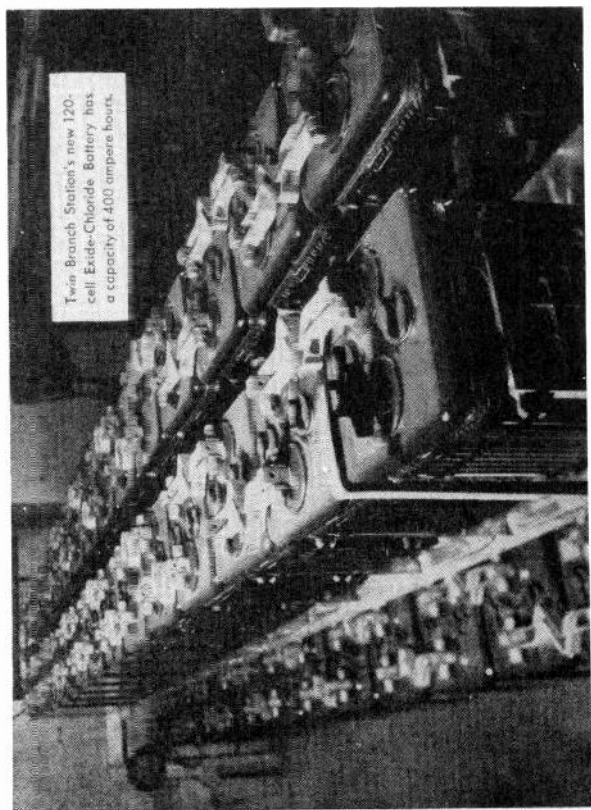

Bank of batteries used at Twin Branch Station of Michigan Electric Co. Courtesy Electric Storage Battery Co.

Storage Batteries

BATTERY CHARGING

As previously stated whenever the voltage of a lead plate storage battery drops down to 1.7 volts per cell the battery must be recharged. For charging storage batteries **direct current is required** because, in order to convert the lead sulphate back into active material on the plates and drive the acid from the plates back into the electrolyte, we must pass current constantly in one direction opposite to that of the discharge current.

This means that **when connecting a storage battery for charging, the positive battery terminal must be connected to the positive side of the charging line** or direct current source, so that the charging current will be forced into the battery at the positive terminal and out at the negative.

If there is any doubt about the polarity of the charging line wires, a simple test can be made by immersing the wire ends in a small glass of water to which has been added a small amount of acid. When the wire ends are held about an inch apart bubbles will rise from each, and the wire at which the most bubbles are formed is the negative. Some resistance, such as a 100-watt lamp or similar devices which will limit the current to about 1 ampere should be connected in series with the line when making this test.

The polarity can also be determined by a compass test with current flowing in the line, as explained in an earlier lesson.

Where only alternating current is supplied it can be rectified or changed to direct current for battery charging purposes, by means of bulb type rectifiers or motor-generators. If 110-volt D. C. is available all that is required is suitable resistance connected in series with the battery to reduce the voltage of the line and regulate the charging current.

There are two general methods in use for charging batteries, one known as the constant current method and the other as the constant potential method.

Battery Charging

The constant current method is sometimes known as series charging, because all of the batteries are connected in series and are all charged at the same current rate regardless of their size or condition. With this system about the same charging rate in amperes is maintained from start to finish of the charging period.

Constant potential charging systems generally use a motor-generator set for changing A. C. to D. C., and all of the batteries are connected in parallel directly across the low voltage D. C. generator bus bars. This system is sometimes called **parallel charging**, as the batteries are all connected in parallel and each battery forms an individual or separate circuit between the positive and negative busses.

The motor-generator consists of either an A. C. or D. C. motor, according to the available current supply, driving a low-voltage D. C. generator which connects to the charging busses, and supplies a constant potential of about 7.5 volts for charging 6-volt batteries or 15 volts for charging 12-volt batteries.

With the batteries connected across the bus bars in parallel and a constant voltage maintained by the generator, the current through each battery will be governed by the voltage and condition of that battery.

If a completely discharged battery is connected across the bus bars the charging current through that battery will be quite high at the start, since the voltage of the battery is very low and offers very little opposition in addition to the internal resistance of the battery, to the current flow from the generator.

As the battery becomes charged its voltage gradually increases and opposes the voltage of the generator, thereby causing the charging rate to decrease or taper off.

Constant potential charging is also often referred to as 8-hour charging, because the rather high rate of charge used with these systems generally charges the average battery in about 8 hours.

Storage Batteries

1. CHARGING RATES

Charging rates depend largely on the size of the battery and the type of equipment used. In commercial charging it is not always practical to regulate the current to suit each individual battery and in cases of this kind a rate is used that best suits the average battery.

Where the charging current can be regulated a good rule to determine the charging rate for any certain battery is to start charging at $\frac{1}{8}$ of its rated capacity in ampere hours, and when it is a little over one-half charged reduce this rate to one-half the starting rate.

For example, if the capacity of a battery is 80 ampere-hours, the charging rate at the start would be $\frac{1}{8}$ of 80, or 10 amperes and the finishing rate about 5 amperes. The reason for reducing the charging rate toward the finish of the charge is to prevent overheating of the plates, as the amount of lead sulphate and acid in the plates and being worked upon by the charging current is gradually being reduced, and the heavy charging current would develop too much heat.

In constant current or series charging it is not possible to regulate the current to suit individual batteries, since they are all connected in series and the same amount of current flows through each.

A commercial charging line may have connected to it batteries of different capacities, ranging from 80 to 120 ampere hours. In addition to having different ampere-hour capacities these batteries will probably vary a great deal as to their state of charge, so it is necessary to select a rate suitable for the group.

2. ELECTRON BULB CHARGERS

A very popular type of battery charger used for rectifying or changing A. C. to D. C. and for charging batteries on constant current systems is the **electron bulb rectifier**, also commonly known as the **Tungar bulb charger**.

Battery Charging

Due to the low capacity current of ordinary electron bulbs these chargers are generally used with constant current or series charging systems. Bulb type chargers are made in two types known as **half wave** and **full wave** chargers.

A half wave charger is equipped with one bulb and has a maximum current output of 6 amperes of pulsating D. C. from one-half of the A. C. wave, or every other alteration only.

Although the current output is low the voltage on the D. C. side of these chargers can be raised high enough to charge from 10 to 15 six-volt batteries in series. The voltage is regulated by means of a tap changing control which increases or decreases the number of turns in the winding of an auto transformer.

Full wave Tungar chargers use two rectifier bulbs and rectify both sides of the A. C. wave. The current output of these units is double that of the single wave chargers or about 12 amperes maximum. The voltage is controlled in the same manner as with single wave type. These chargers can, of course, be made to deliver more than the above mentioned amounts of current for short periods, but this will shorten the life of the rectifier bulbs much below their rated life which is between 800 to 1000 hours of operation.

For this reason their rated current capacity should not be exceeded. Vibration of the charger will also tend to reduce the life of the bulbs so these units should be mounted where they are free from excessive mechanical vibration. The efficiency of a well designed Tungar rectifier on full load is about 75%.

Fig. 1 shows two types of electron bulb chargers, the one at the upper left being the larger size full wave type for wall mounting, and the one below is a smaller charger of the single wave type for shelf mounting or portable use. Note the ammeters for indicating the charging rate and the knob controls for adjusting the transformer taps to vary the charging rate.

Storage Batteries

A complete description of the operating principles and circuits of Tungar rectifiers was given in Alternating Current lesson 59, and it would be very well for you to review this material at this point.

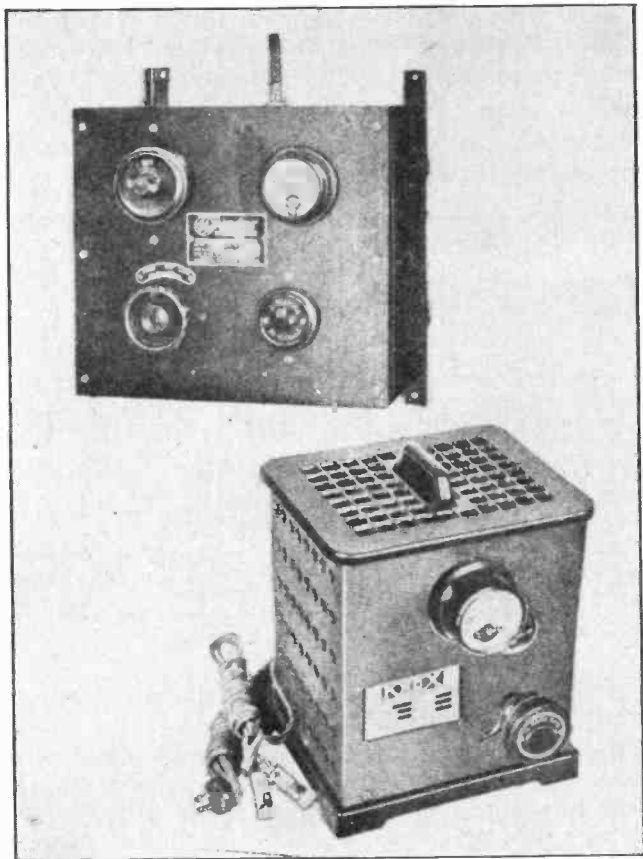

Fig. 1. Above are shown two common makes of bulb type rectifiers or battery chargers. The one above is a full-wave type, while the one below is a half-wave type.

3. OPERATION OF BULB TYPE CHARGERS

While these rectifiers are very simple in design and easy to operate, there are a few rules that must

Battery Charging

be observed to secure best results with them. Half wave rectifiers may be equipped with one or two control dials, but full wave rectifiers are generally equipped with four controls, two for each bulb.

Where two controls are used for each bulb one is used to raise or lower the voltage in large steps while the other is used to regulate the voltage in smaller steps. The regulation of the voltage, of course, regulates the charging current sent through the battery or batteries.

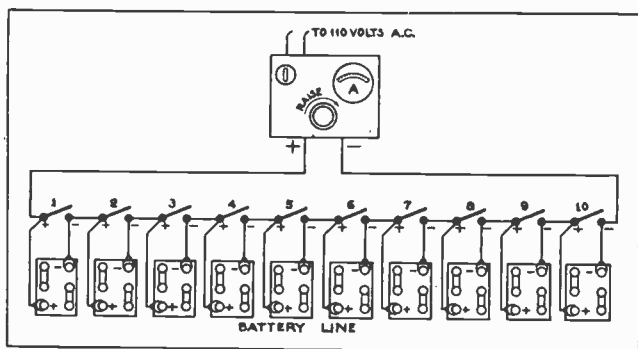

Fig. 2. Diagram showing the connections for charging up to ten batteries in series by means of a bulb type rectifier or the constant current system. Knife switches are used to close the circuit when a battery is removed from the line.

The following simple rule should be followed when starting Tungar chargers.

First be sure all controls are turned back to zero, then turn on the starting switch and observe the bulb to see if it lights or burns. Now with the batteries properly connected turn the lower or close-regulating dial clockwise until the proper current value is shown on the ammeter. If the ammeter fails to show a reading turn this dial back to zero and try the upper or coarse-regulating dial. Bring the charging rate as close as possible to the proper value with this coarse dial, and then use the lower dial for final adjustment.

As more batteries are added to the line the charging rate drops so it will be necessary to readjust

Storage Batteries

the controls to maintain the same current value. If a battery is accidentally connected backwards on a constant current charging circuit the charging rate will increase instead of decrease.

When part of the batteries are removed from the line the charging rate will automatically increase and if the controls are not readjusted the fuses will be blown. If the fuses are not of the proper size the bulb may be burned out instead. Ten-ampere fuses will generally give the proper protection.

If the Tungar charger fails to operate you can look for the following common troubles:

1. Examine supply line fuses.
2. Bulb filament may be open or burned out. Test bulb for open circuit or try a new bulb.
3. Make sure that the bulb is screwed tight in its socket.
4. If points of contact on bulb or in socket are dirty, clean them with sandpaper.
5. If the bulb glows but the ammeter fails to register examine the battery connections. Most troubles or interruptions with chargers of this type are caused by poor connections at the batteries.
6. Some chargers are provided with one fuse in series with the battery and if this fuse is blown no charging current will flow even though the bulb is glowing.
7. The rectifier bulb may fail to operate due to a slow leak in the glass having destroyed its vacuum, or due to a badly sagged filament.
8. Control contacts may be loose or dirty and not making proper connection in the circuit.

4. CONSTANT POTENTIAL CHARGERS

As already explained a constant potential charger consist of a motor-generator set, the motor being either D. C. or A. C. and designed for 110 or 220 volts, according to the available supply, and the generator producing direct current at $7\frac{1}{2}$ volts for charging 6-volt batteries, or 15 volts for charging 12-volt batteries.

Battery Charging

Fig. 3 shows a compact motor-generator charger of this type; the motor and generator units both being built into one frame. This machine is equip-

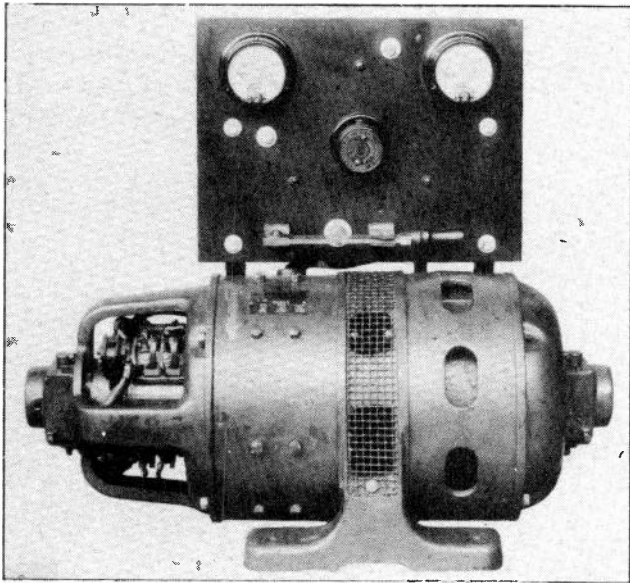

Fig. 3. This photo shows a neat, compact type of motor generator with its control and panel, for use in charging batteries by the constant potential method. (Courtesy of Roth Bros. Manufacturing Co.)

ped with a panel on which are mounted the voltmeter and ammeter, voltage-regulating rheostat by which the charging rate is controlled, and a knife switch for closing the circuit to the bus bars and batteries.

Fig. 4 shows a neat charging bench equipped with a constant potential charger and the bus bars and batteries can be clearly seen in this view.

You will note that the batteries are all connected to the bus bars in parallel by means of flexible leads and battery clips, and the small knife switches are provided for disconnecting individual batteries.

Constant potential charging differs considerably from constant current or series charging in that with constant potential charging each battery regulates its own charging rate to quite an extent by its voltage and condition.

Storage Batteries

When a battery is first connected across the bus bars it charges at a very high rate due to its voltage being considerably lower than that of the generator, but this charging rate gradually decreases or tapers off as the battery voltage comes up to full charge.

When a completely discharged battery is placed on a constant potential system the charging current

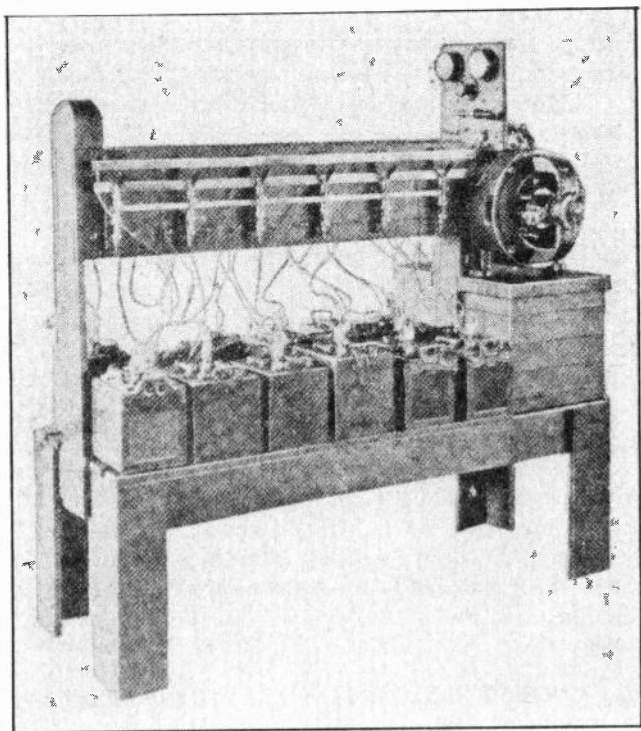

Fig. 4. Neat type of charging bench equipped with constant potential motor generator charger and convenient busses and switching arrangement for connecting and disconnecting the various batteries.

at the start may be as great as 20 amperes but will rapidly taper off as the battery voltage increases, dropping down to as low as 2 or 3 amperes when the battery becomes fully charged. Because of this action this form of charging is sometimes called a tapering charge. It is also very often referred to as "eight-hour charging service."

Battery Charging

From this we can see that it is possible to have a number of batteries connected in parallel to one of these chargers and each of the batteries charging at a different rate, according to their state of charge and condition.

The charging rate is limited only by excessive heating, and when any battery overheats the charging rate should be reduced by connecting a resistance in series with one of the leads to that particular battery. Convenient small resistance units equipped with a clip at the lower end for attaching direct to the battery terminal are obtainable for this use.

The temperature of the batteries should never be allowed to exceed 110° F. during charging and temperature tests should always be made on a cell in the center of the battery, as these cells tend to heat more than the outer ones because of poor ventilation, due to the fact that they are between the outer cells.

Where both 6 and 12-volt batteries are to be charged two 7.5-volt generators can be connected together in series and their terminals connected to three bus bars, as shown in Fig. 5.

This makes it possible to obtain two different voltages from the bus bars, $7\frac{1}{2}$ volts between the center bus and either of the outside ones and 15 volts across the two outside busses. Six-volt or twelve-volt batteries can be connected as shown in the diagram and both types charged at the same time.

5. OPERATION OF CONSTANT POTENTIAL CHARGERS

When operating constant potential battery chargers the following simple rules would be well to keep in mind:

1. Batteries must be connected in parallel across the bus bars, with the positive terminal of each battery connected to the positive bus and negative terminals to negative bus. When the generator is idle the main switch on the control panel must be opened

Storage Batteries

before connecting batteries.

2. When starting the machine the motor of the M-G set is first started and allowed to come up to speed. The voltage is then regulated by means of the generator rheostat and is set at 7.5 volts for charging 6-volt batteries. This voltage adjustment is very important and must not be neglected.

3. When the voltmeter registers 7.5 volts the main switch on the control panel can be closed, completing the charging circuit and starting the batteries charging.

4. If it is necessary to stop the set for any reason, first open the main switch on the control panel in order to prevent the batteries from feeding current back through the idle armature of the generator. It is also advisable to disconnect the battery leads or open the individual battery switches when provided, and thus disconnect the batteries from the bus bars, or otherwise current will circulate between the batteries. This is caused by the ones which are of higher voltage or nearer to full charge discharging through the ones that are of lower voltage or have not been on charge as long.

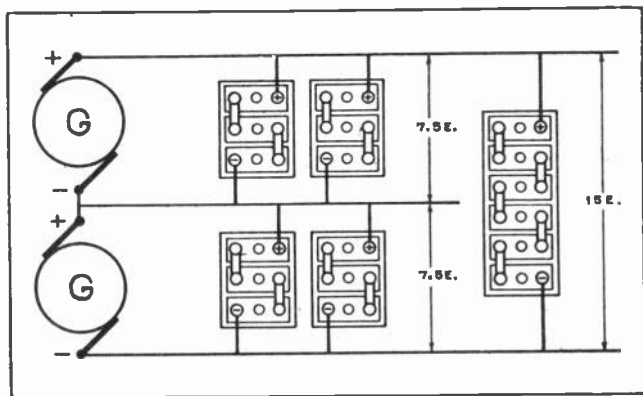

Fig. 5. This sketch shows the method of connecting two low voltage D. C. generators for charging both 6E and 12E batteries at the same time.

The ammeter on the control panel will indicate the total charging current passing through all bat-

Battery Charging

series. Each battery will take current according to its state of charge and condition, and if it is desired to know the charging current of any individual battery this can be obtained by connecting a small ammeter in series with one of the leads to that battery.

Caution: Be very careful never to accidentally connect a charging lead across the bus bars or from positive to negative bus, as this short-circuits the D. C. generator and you may receive a severe burn due to the heavy rush of current.

6. CHARGING DIRECT FROM D. C. LINES WITH RHEOSTATS

We have already mentioned that when a supply of 110-volt direct current is available, batteries can be charged directly from such a line by connecting a proper resistance in series with them. For charging in this manner the batteries are all connected in series, as with the constant current or Tungar charger systems.

Very economical charging resistance in the form of lamps banks, consisting of a number of lamps in

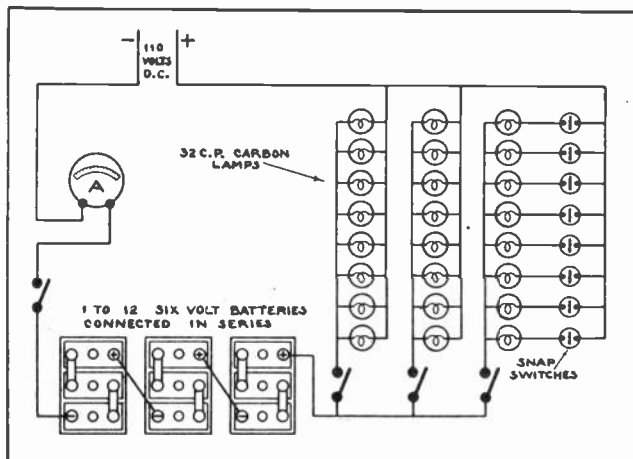

Fig. 6. Diagram showing the connections for using a lamp bank to charge from one to twelve six-volt batteries directly from a 110-Volt D. C. line.

parallel, can be made for this use or a simple water rheostat can be used. Adjustable factory-made rheo-

Storage Batteries

stats can also be purchased for this use.

Fig. 6 shows a diagram of the connections for charging several automotive batteries with a lamp bank.

Any ordinary 110-volt incandescent lamps can be used for such lamp banks but it is quite common practice to use 32-candle-power, carbon filament lamps as they are very rugged and low in cost. A 32-C.P. lamps offers 110 ohms resistance and will allow 1 ampere to pass through it when connected directly across a 110-volt line.

However, when these lamps are used in a lamp bank and a string of batteries connected in series with them, the current through each lamp will naturally be a little less than 1 ampere due to the counter voltage and internal resistance of the batteries.

It is, therefore, necessary to use a number of lamps in parallel in order to obtain the desirable charging rate. The charging rate can be easily regulated by turning on or off one or more of the lamps by means of switches placed in series with them. With a lamp bank adjusted for a charging rate of 6 amperes the average automotive battery will be fully charged in 24 hours.

The diagram in Fig. 6 shows a sufficient number of lamps in the charging bank to enable a line of 10 or 12 batteries to be charged at a fairly good rate. It is, of course, not necessary to use all of these lamps when only charging a few batteries. The knife switches shown can be used to turn on or off complete groups of lamps, and the small snap switches shown in series with each of the lamps in the right-hand group can be used to turn on or off individual lamps of this group for final regulation of the charging rate.

The upper view in Fig. 7 shows a method of connecting a rheostat in series with a group of batteries for charging them directly from a 110-volt line, and the lower sketch in this figure illustrates the use of a water rheostat for the same purpose.

Battery Charging

A simple water rheostat is a very convenient device for occasional charging of batteries, and can be made from a large earthen jar filled with water to which a small amount of sulphuric acid or salt has been added, to increase its conductivity and reduce its resistance.

The electrodes can be made of a couple of old battery plates or most any flat pieces of metal, and the charging rate can be varied by raising or lowering one or both of the electrodes in the solution.

Care must be taken with a water rheostat to see that the liquid doesn't over-heat or boil away. It is a good plan to place a strip of wood or some other porous insulating material between the electrodes of a water rheostat to prevent them from accidentally becoming shorted together. Be careful to see that the insulator does not form a complete barrier and tend to prevent current flow from one electrode to the other.

The advantage of a water rheostat is that it can be quickly and easily made up from ordinary parts around a battery shop and used for emergency charging from 110-volt D. C. lines. In general, however, the lamp bank or commercial form of rheostat will be found more dependable and will require less attention.

7. BATTERY TROUBLES AND REMEDIES

Because of the very severe conditions under which the average automobile battery operates they require frequent inspection and occasional repairs. Automotive batteries are subjected to severe vibration, very heavy discharge rates, and very often excessive charging rates, and they are also quite generally subjected to neglect on the part of the car owner. These things will tend to shorten the life of a battery and to cause it to give unsatisfactory service, unless some battery service man who knows how, is frequently inspecting the battery and making the necessary repairs from time to time.

If given proper care, which simply means keeping

Storage Batteries

it well charged, filled, and cleaned, a good grade of battery should ordinarily last from 2 to 3 years. On the other hand, a very good battery can be ruined or put in bad condition within a few months by abuse and improper care.

One of the most common abuses to which the average automobile battery is subjected is low electrolyte level caused by neglecting to inspect and re-

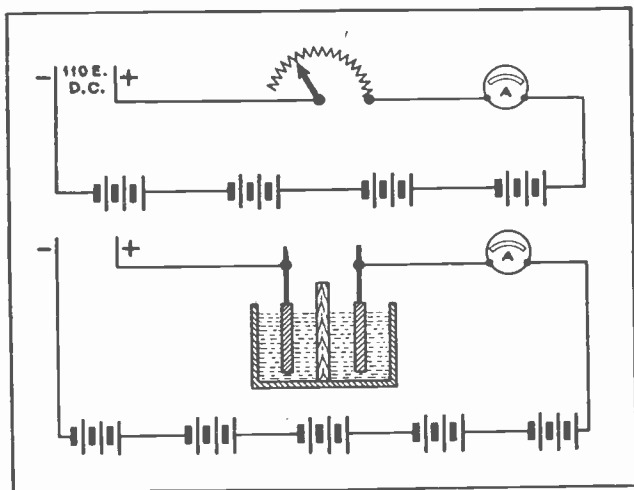

Fig. 7. The above sketch shows method of using an ordinary factory made rheostat and ammeter for charging batteries from 110-volt D. C. line. The sketch below shows a home-made water rheostat used in place of the commercial rheostat.

fill at proper intervals. Many car owners forget that the water in their battery electrolyte is constantly evaporating and thereby lowering the electrolyte level. This evaporation is particularly rapid during hot weather and the battery should be inspected and refilled with distilled water at least every 2 weeks in Summer and 4 weeks in Winter, or oftener in case of heavy use.

Another common abuse of automotive batteries is operating them in a semi-discharged condition, which causes the plates to sulphate and the battery to give poor service. This can be prevented by simply removing the battery from the car and having

Battery Charging

it fully charged in the shop, or by slightly increasing the charging rate of the car generator.

In many cases batteries are also damaged by maintaining an excessive charging rate which causes gassing and overheating. This can be avoided by simply adjusting the charging rate of the automobile generator. Some of the more common battery troubles with their symptoms and remedies are given in the following paragraphs.

When a battery will not hold a charge but runs down immediately after being fully charged this is generally due to broken down insulation caused by failure of the separators between the plates. Or, in some cases, it is caused by high sediment in the bottom of the parts due to the shedding of active material from old or abused plates.

In either case the cells will have to be opened and either new separators installed or the sediment removed.

Separator troubles or failure may be due to a number of causes such as wearing thin or completely through due to normal wear or buckled plates; carbonizing of the wood due to strong electrolyte, or overheating; cracks sometimes caused by low electrolyte exposing the upper portion of the separators to the air; poor quality of wood used in the separators. The only remedy for any of these faults is to replace the old separators with new ones.

When the battery appears weak and fails to operate the starter or lights properly the trouble may be either in the battery itself or in its connections. It may be that the battery is not fully charged due to too low a charging rate, or to excessive use of lights and starting motor. The trouble may be due to low electrolyte which allows only part of the plate surface to be active, or it may be due to worn out plates or broken plate connections. It may also be due to loose or corroded terminals or to the battery being too small in capacity for the load of drain placed upon it by the electrical equipment of the car.

Sulphation is quite a common cause of battery trouble. This condition occurs when the lead sul-

Storage Batteries

phate on the plates has had a chance to harden into a white crystal formation, which is a very poor conductor of electricity and tends to clog or seal the pores of the plates, reducing their porosity and activity.

Sulphated plates will not take a charge properly and even though the charging rate may be normal the battery constantly appears weak and low in voltage. Sulphation may be caused by allowing the electrolyte to evaporate to a very low level. It may also be caused by the battery never having been fully charged or by overrich electrolyte.

Sulphation tends to reduce the ampere-hour capacity of the battery and in many cases causes the plates to warp or buckle. The only remedy for a sulphated battery is a prolonged charge at a low rate of between two to six amperes after which it should be cycled or discharged and recharged a couple of times as explained in Lesson 83.

8. BUCKLED PLATES

Buckled plates are quite often the cause of separator failure and defective battery operation. Warping or buckling of the plates may be due to overheating, over-discharging, or allowing the battery to stand a long time in a discharged condition.

When the plates warp or buckle in this manner their corners exert excessive pressure on the separators and, due to the vibration of the battery in the car, will soon wear completely through the separator and short circuit the cell.

If the negative plates are in good condition otherwise except for being warped they may be straightened by pressing them in a **plate press**, and put back into service. The straighten plates in this manner the positive and negative groups are separated and thin boards inserted between the plates of the group that is to be pressed.

This whole assembly is then placed in the plate press and pressure applied very gradually until plates are again straight and flat. Positive plates cannot be straightened successfully by pressing, as the active material cracks and drops from grids.

Battery Troubles

Fig. 8 shows two styles of plate presses which are commonly used in battery shops for this work.

Another trouble that is often caused by allowing batteries to become overheated is known as **granular plates**. When the temperature of batteries is allowed to become higher than 110° F. the plates gradually become soft, the positives loosening or shedding their active material and the negatives tending to swell up and become spongy or sandy appearing. The only remedy for granular plates is to replace them with new ones.

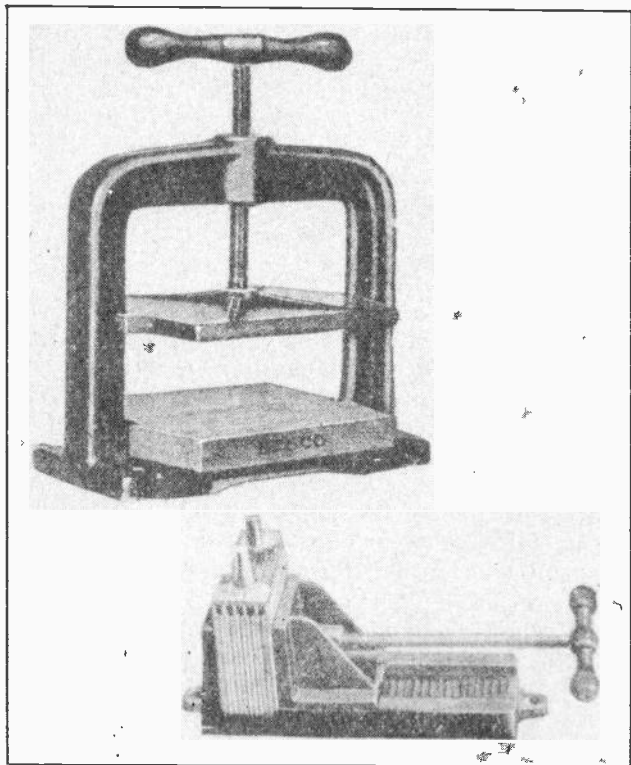

Fig. 8. Two types of plate presses used for straightening negative plates which have been warped or buckled out of shape, but are otherwise in fair condition.

Lead plate batteries will freeze in cold weather if the electrolyte is allowed to become too low in spe-

Storage Batteries

sific gravity by operating the battery in a nearly discharged condition. Frozen plates can be readily detected when the plate groups are separated as the active material will fall off the positive plates in hard flakes, having been forced loose from the grid by the expansion of the electrolyte when it froze.

Frozen plates are always an indication that the battery was not fully charged, because it requires a temperature of 94° F. below zero to freeze electrolyte at 1.300 specific gravity.

The only remedy for frozen plates is, of course, to replace them with new ones.

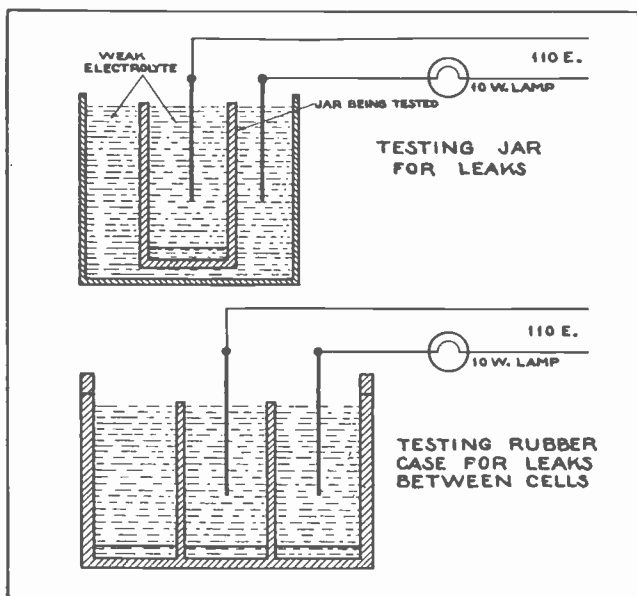

Fig. 9. The above two sketches illustrate the method of testing single cell jars or complete rubber battery cases for possible cracks or leaks.

Sometimes a battery will develop a cracked case or jars due to vibration, buckled plates, or freezing. The indication of a cracked case or jar is excessive loss of electrolyte in one cell, making it necessary to fill this cell more frequently than the others to keep the electrolyte at the proper level.

Battery Troubles

Where a rubber case is used electrolyte will also be noticed on the outside of the case if it is cracked. Where rubber jars are used in a wood box the bottom of the box will be wet with electrolyte and if the condition has existed for some time the wood may be badly rotted and softened by the action of the acid.

Fig. 9 shows how to test single battery jars or rubber battery cases for leaks. The method shown in the upper sketch is used for testing a rubber jar, by filling the jar with weak electrolyte and immersing it in electrolyte as shown. A pair of metal electrodes connected in series with a 10-watt lamp and to a 110-volt D.C. or A.C. line are then placed as shown, one in the electrolyte within the jar and the other in the electrolyte around the jar.

If the jar is cracked the lamp will light, but if the jar is good the lamp will remain dark. In making this test be sure to keep the upper edges of the jar slightly out of the electrolyte so that the whole jar is not immersed.

For testing rubber battery cases, as shown in the lower sketch in Fig. 9, each of the cell compartments is filled nearly to the top with weak electrolyte and tests made with the electrodes on each side of both partitions.

The lamp will indicate a leak in either partition by lighting when the electrodes are placed on opposite sides of the cracked rubber wall.

9. BATTERY CARE

A few general rules that can be followed by the battery repair man and also by the car owner to avoid many of the common battery troubles are as follows:

1. Keep the battery well charged and frequently test the voltage and gravity. Also keep the electrolyte one-fourth inch or more above the tops of the plates at all times.

2. Use only pure distilled water for refilling the battery and replacing evaporated water from the

Storage Batteries

electrolyte.

3. In cold weather be particularly careful to keep the battery fully charged to prevent its freezing.

4. Inspect the battery every two or three weeks during the Winter and weekly in the Summer. Several times a week is not too often during long, fast trips in hot weather.

5. Do not allow the battery to overheat by excessive charging but instead reduce the charging rate either by adjusting the generator third brush or by burning the headlights while driving.

6. Do not overload the battery by using too many extra electrical accessories or light bulbs that are too large.

7. Do not use the starter excessively.

8. Keep the battery terminals tight and free from corrosion. Clean off any corrosion that may have formed by wiping terminals with a cloth soaked in ammonia or strong soda water, and prevent further corrosion by coating terminals with vaseline.

9. See that the generator charges at the proper rate to keep the battery well charged but not high enough to overheat it.

10. If the gravity fails to come up to full charge reading when the car is in service, check the generator charging rate and increase it if necessary.

11. Keep the top of the battery dry and clean at all times.

12. Always remember to switch off the ignition even though the engine may have stopped due to stalling, and also remember to turn the light switch to the parking position when the car is idle at night, and thus prevent excessive drain on the battery.

10. STORAGE BATTERY SERVICE

In working in an automotive battery service station or operating a shop of your own, there are a number of common repairs and service operations which are most frequently performed. Some of the most common of these jobs and the methods of

Battery Service

performing them are explained in the following paragraphs.

The battery service man is frequently called upon to inspect batteries on the cars, to determine the level of the electrolyte, and refill the battery with distilled water if necessary. This is an extremely simple operation but one which should be carefully done in order to be sure that all three cells of the battery are properly filled.

As previously explained the level of the electrolyte should be brought up to between $\frac{1}{4}$ and $\frac{1}{2}$ inch above the tops of the plates, but care should be

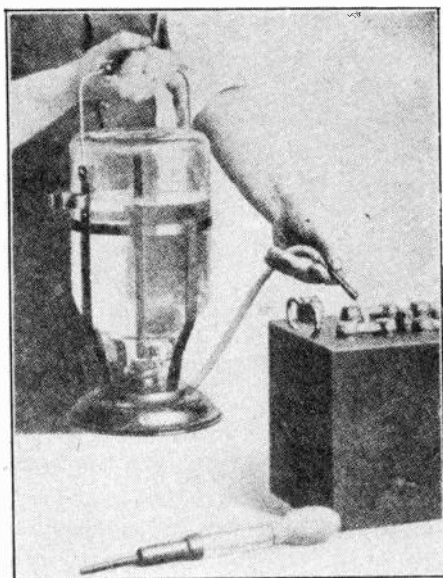

Fig. 11. Above is shown a very convenient type of battery filler used for adding distilled water to the cells of lead plate batteries for automotive or radio use.

taken not to fill the cells too full, so that the electrolyte will not be up to the tops of the filler openings where it will leak or splash out through the small openings in the filler or vent caps.

Water or acid spilled on the top of an automobile battery tend to collect dust and create a muddy

Storage Batteries

condition, and also tend to cause the battery terminals and connections to corrode.

Fig. 11 shows a convenient form of battery filler outfit consisting of an inverted one gallon glass bottle mounted in a carrier frame and stand which has a cork to fit the neck of the bottle, and a flexible rubber tube for running the water into the cell openings.

These devices provide a small stream with which it is easy to fill the cells and yet easy to avoid spilling the water. They also permit the operator to see the level of the electrolyte inside the cell, which cannot be done if a funnel is used. When the cell is filled to the proper level the water can be immediately shut off by merely pinching the rubber tube. If a cell is too full some of the electrolyte can be removed by sucking it out with a hydrometer, or with a regular syringe made for this purpose and having a large rubber bulb and a slender rubber stem.

The operator in a battery shop should always encourage his customers and local automobile owners to come in regularly for this inspection and service on their battery, as the small amount of time required will be much more than repaid by the longer and more satisfactory service obtained from a battery that is kept properly filled.

A small charge can be made for this service if desired, or in many cases giving this service free will bring in a great deal of profitable battery business in the form of other repairs from customers whose good will and regular patronage has been obtained through this free service.

Another test that is commonly made on the batteries while in the cars is the test of the battery voltage and of the specific gravity of the electrolyte. This test is also very easy to make with a portable voltmeter and a battery hydrometer.

In many cases the car owner's battery may be giving fairly good service in the operation of the lights and starter, and yet be getting very close to the discharged condition, where it will fail him just at some time when he most needs it.

Battery Service

This can be avoided by testing the voltage and gravity regularly and keeping the generator charging rate adjusted so that it will keep the battery well charged. In the Winter time these tests are particularly useful in avoiding frozen batteries, as frozen batteries are always due to having allowed the batteries to operate in a nearly discharged condition.

Leaky cells and cells with shorted plates or other defects can also be detected by these tests in time to correct the trouble before all the plates of the cell are ruined by sulphation, due to low electrolyte, or badly damaged by short circuiting.

EXAMINATION QUESTIONS

1. What kind of current must be used for charging storage batteries?
2. What are the two general methods used for charging batteries? Briefly describe each method.
3. When charging a battery, on what does the charging rate depend?
4. When charging several batteries at one time by use of a bulb type rectifier, are the batteries connected in series or parallel with each other?
5. What is the voltage output or motor generator sets used for constant potential charging?
6. Does the charging rate of a battery connected to a constant potential system, increase, decrease, or remain the same as the battery approaches full charge? Why?
7. What is the proper procedure to follow when charging a sulphated battery?
8. Briefly explain how you would test a battery jar for leaks.
9.
 - a. Under what conditions will storage batteries freeze?
 - b. May storage battery plates be used after they have been frozen?
10. Give at least two causes of battery plate buckling.

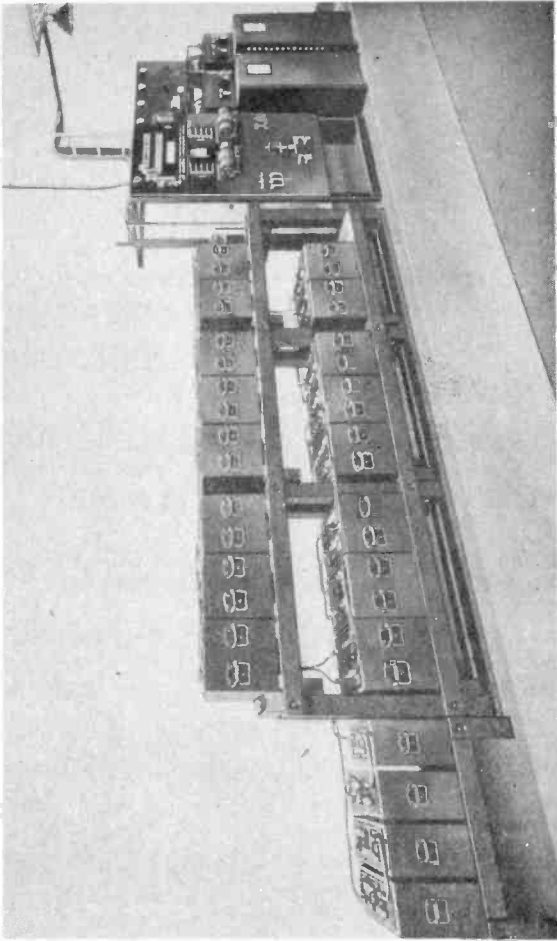

AUTOMATIC PRIVATE BRANCH EXCHANGE EQUIPPED WITH PHILCO SPRAY-PROOF P W R BATTERY

22-VOLT — 238 AMPERE HOURS — 8 HOUR
 RATE—SPACE REQUIRED: LENGTH 2' 2 $\frac{1}{4}$ "
 WIDTH 2' 6 $\frac{3}{8}$ ", HEIGHT 3' 1 $\frac{1}{2}$ "

48-VOLT — 932 AMPERE HOURS — 8 HOUR
 RATE—SPACE REQUIRED: LENGTH 17' 4 $\frac{1}{4}$ "
 WIDTH 1' 10 $\frac{3}{8}$ ", HEIGHT 4' 9 $\frac{1}{2}$ "

Storage Batteries

STORAGE BATTERY REPAIR

When a battery needs to be removed from the car and taken into the shop for repairs one of the first problems in the shop is to properly open the battery with the least loss of time, and without damaging any of its parts. There are three operations necessary to open any automotive battery and these are as follows:—

1. Cell connectors or straps must be removed.
2. The sealing compound and cell covers must be softened and removed.
3. The elements or plate groups must be drawn from the cells.

The cell connectors or straps can be removed from the terminal posts by means of a large drill of about the same diameter as the top of the post. First mark the exact center of the posts and connectors, and then using a $\frac{1}{2}$ " , $\frac{5}{8}$ " , or $\frac{3}{4}$ " diameter drill, depending on the size of the post, drill about half way through the welded or burned-on portion of the strap and post connection, as illustrated in Fig. 1.

The connector straps can then be easily removed by means of a heavy pair of gas pliers.

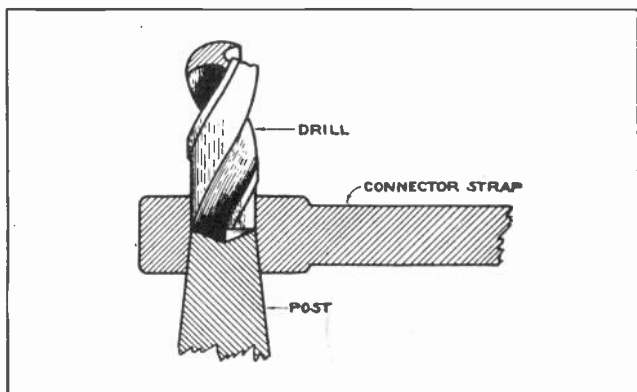

Fig. 1. Diagram showing the method of drilling out the tops of posts to remove connector straps when taking a battery apart.

Another way in which these connector straps are often removed is by using a lead burning torch to melt or soften the top of the strap directly over the

Battery Repair

post connection, while keeping an upward pressure exerted on the strap by prying from underneath with a screw driver.

As soon as the top of the strap has become melted or softened about half way through it will release from the post and pry upward.

The sealing compound and covers can be softened and loosened by heating or steaming. This is usually done by means of a regular battery steamer, such as shown in Fig. 2, and which supplies steam under low pressure through several rubber tubes which can be inserted into the cells through the vent openings.

This method requires from five to ten minutes to soften the compound so that the cell covers can be

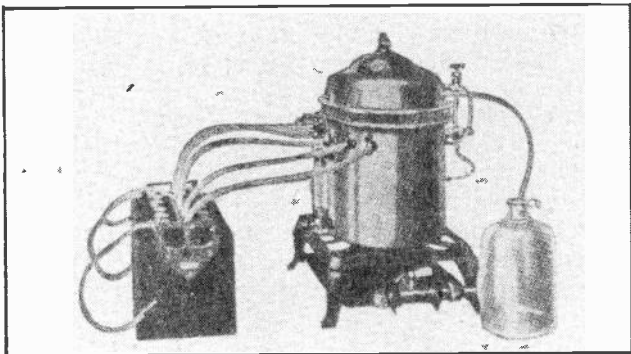

Fig. 2. Common and convenient type of battery still and steamer, used both for steaming and softening compound when disassembling batteries, and for supplying distilled water for use in mixing electrolyte for refilling battery cells.

removed and the elements taken out. The device shown in Fig. 2 is a combination steamer and still.

By boiling water in this container placed over the gas flame, pure distilled water can be obtained from the hose on the right, which is shown placed in the top of the glass jar, and the unit also supplies steam from the tubes on the left for opening batteries.

When not in use for opening a battery these steam tubes can be shut off by means of small cocks or valves, and the steam allowed to condense in the upper part of the still and drip from the right hand tube into the jar in the form of distilled water.

Storage Batteries

The compound can also be softened by lightly playing a soft torch flame over the top of the battery in case no steamer is available.

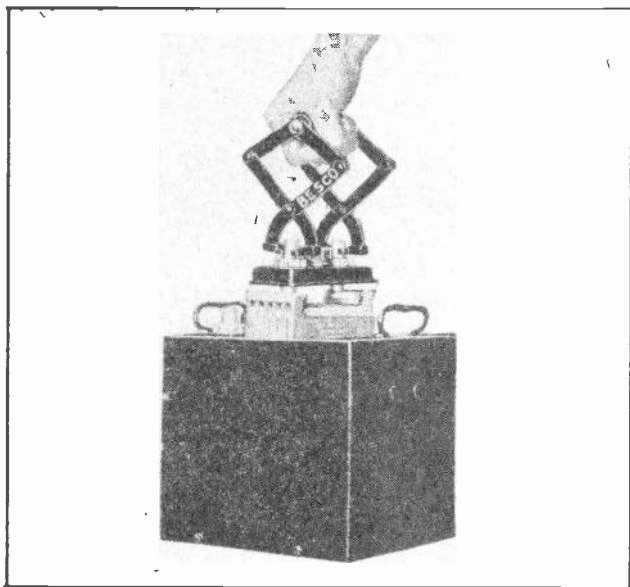

Fig. 3. This view shows a convenient type of cell puller used for lifting plate groups or elements from cell jars when taking down a battery for repairs.

When opening a battery it is not necessary to remove all of the electrolyte from the cells, but it is advisable to drain it down to the top of the separators by means of a filler syringe or hydrometer, as the steam process will add some distilled water to the cell and might cause it to overflow if the electrolyte level was high.

After softening the compound the elements, including the covers, are removed by taking hold of the cell posts with two pairs of pliers or with a regular cell group puller, such as shown in Fig. 3, and pulling upward. The elements can then be left setting in a slanting position on top of the jars, to permit them to drain and allow the electrolyte which runs from them to drip back into the jars.

After draining all compound should be carefully cleaned off from the covers and jar tops by means of

Battery Repair

a heated putty knife or scraper, both of which are shown in Fig. 4.

1. REPLACING DEFECTIVE PLATES AND SEPARATORS

After the elements are removed and the positive

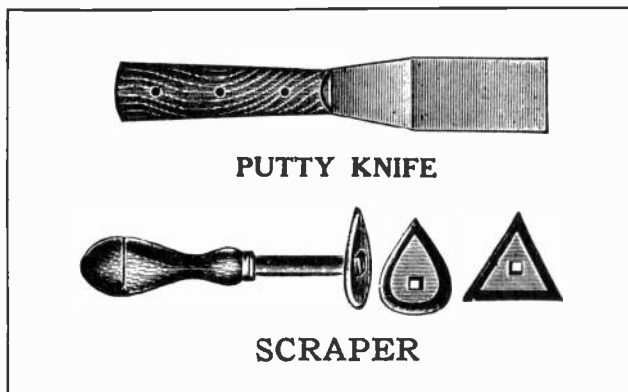

Fig. 4. A putty knife and scraping tool such as shown above are very convenient tools for removing or trimming sealing compound on storage batteries.

and negative plate groups separated, it is easy to tell by examining them and the separators what repairs are necessary.

If the separators are cracked, worn thin, or punctured they should be replaced with new ones, and if both sets of plates are in good condition they may not need to be renewed.

When either set of plates are badly worn or have lost considerable of their active material they should be replaced with new plates. Badly warped negative plates should either be straightened in a plate press or replaced with new ones. Granular plates or badly sulphated plates should also be replaced, unless perhaps in the case of sulphated plates the sulphation is not so bad but that it can be corrected by a prolonged charge and cycling.

The positive plates usually wear out somewhat faster than the negatives, and in some cases where the positive plates are in very bad condition, and the negatives still comparatively good, a new set of positives may be used with the old negatives

Storage Batteries

and considerable service obtained from a battery rebuilt in this manner.

However, a battery which has had all of the plates replaced will be likely to give much more dependable and considerably longer service. A good point to remember in this connection is that it seldom pays to put back any parts into a battery if their life or service would be questionable, because even if your work is well done on the part which you repaired and some other part fails very shortly after the battery is back in service the customer is likely to blame your work for the failure.

In many cases, where all the plates are in bad condition, it is just about as cheap for the customer and much more profitable for the battery man to sell a new battery. This is particularly true where labor costs and wages are rather high and where factory made batteries can be obtained at low cost.

In other cases, however, where labor costs are low it may pay to replace the plates and rebuild the battery, using the case or jars and covers over again.

Where a new battery is sold to the customer the best of the used plates can be saved and used in rebuilt batteries for loan service. A small allowance can be made to the customer on his purchase of a new battery if the parts from the old one are worth it.

Very often the only thing wrong with a battery or the cell will be the separators, in which case they should all be replaced with new ones, and the cost of this repair job is low enough to be very practical.

2. REASSEMBLING REPAIRED BATTERIES

After repairs have been made on a battery it can be reassembled in the following manner. First assemble the positive and negative groups with the separators between the plates. Then place the groups in the jars or cell compartments of the battery case, taking care to arrange them according to polarity, or so that positive and negative terminals are in the proper position for conveniently connecting the cells in series for the battery.

Battery Repair

When replacing the covers if there is any difficulty in forcing them onto the cells the covers should be steamed or heated until slightly softened, after which they will go in place very readily.

After the elements and covers are all in place the cells must be sealed with hot compound, the sealing compound being heated in a small pot over a gas flame, or in an electrically heated dipper which can be obtained for this purpose.

Before pouring the compound make sure that the covers fit snugly all around so that no compound will be allowed to run into the cell and also make sure that all surfaces are dry, as compound will not stick to wet spots.

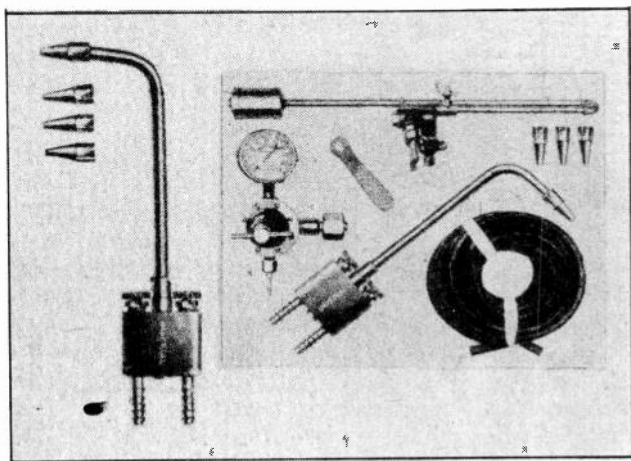

Fig. 5. On the right is shown a complete lead burning outfit, with the exception of the gas cylinder, and on the left is shown a larger view of the torch with its adjusting screws and extra tips for obtaining various sized flames.

The cover channels can be dried out by passing a soft-flame torch quickly and lightly over them.

After the battery is sealed the freshly poured compound can be given a much neater and better finished appearance by passing the torch flame lightly back and forth over it.

3. LEAD BURNING

After the cells are back in place and the covers

Storage Batteries

sealed, the next step is to connect the cells together in series by means of connector straps running from the positive post of one cell to the negative of the next, attaching these straps to the terminal posts by a process known as **lead burning**.

This is not really a burning process but merely refers to the melting or welding the lead of the straps and posts together, to make a very rugged and low-resistance joint that will carry the heavy battery currents at low voltage.

Connections that are properly made in this manner are mechanically strong and will not become loosened by vibration. They will also resist corrosion much better than bolted connections would.

For lead burning a small and intensely hot flame is required. These flames are generally obtained by a combination of two gases such as oxygen and acetylene, oxygen and hydrogen, or oxygen and illuminating gas.

Compressed air instead of oxygen is sometimes used with illuminating gas or acetylene.

Where regular city gas or illuminating gas is available, oxygen can be purchased in steel cylinders and used with this gas. In other cases both oxygen and acetylene can be purchased in cylinders, and the two gases used together by means of a mixing valve and light weight torch, such as shown on the left in Fig. 5.

On the right in this figure is shown a complete lead burning outfit with the exception of the gas cylinders. This outfit consists of the torch and mixing valve, pressure-regulating valve and gauge, a trap and valve for the city gas line, extra tips for the torch, and a length of small flexible rubber tubing for connecting the torch to the gas cylinder and gas line.

Both of the torches shown in Fig. 5 have the gas mixing valves with their adjusting screws attached directly to the torch. Mixing valves can also be obtained for mounting on the bench so that one tube will carry the mixed gases to the torch, thus providing a little more flexibility in handling the torch.

Battery Repair

4. ADJUSTING THE LEAD BURNING TORCH

In order to do a good job of lead burning it is very important to have the correct pressures and mixtures of the different gases. The gases which are obtained in steel cylinders are stored in these cylinders under very high pressure, and this is the reason for the necessity of the pressure-regulating valve, shown in Figs. 5 and 6.

This valve when properly adjusted allows the gas to escape very slowly from the cylinder, and keeps it supplied at the proper pressure to the mixing valve and torch. When oxygen and hydrogen, or oxygen and acetylene are used each gas should be at a pressure of about 2 lbs. per square inch. When using oxygen and illuminating gas the oxygen should be at about 10 lbs. pressure and the illuminating gas at whatever pressure it is supplied, which is generally about 8 ounces

With these pressures right it is a comparatively simple matter to mix the gases in the right proportions with a mixing valve. This adjustment, however, is of the greatest importance in obtaining the proper kind of a flame for a good job of lead burning.

If too hot a flame is used the lead will oxidize rapidly on the surface and make the welding or uniting of the strap and post very difficult or next to impossible. If the flame is not hot enough the work is very slow and before melting temperature is obtained at the desired points, the entire terminal may be heated too much by the spread of heat and may melt down and run on to the battery.

The illuminating or acetylene gas is used to supply the body of the flame, and the oxygen is used to increase the heat of the flame. If too much gas or too little oxygen is used the flame will be yellow and will tend to carbonize and blacken the surface of the lead, making the burning or welding job very difficult. A plain gas flame doesn't give sufficient heat for this work.

If too much oxygen is used the flame will be too hot and the excessive heat and excess of oxygen will tend to oxidize the surface of the lead, giving it a

Storage Batteries

yellow or sort of rainbow color, and producing a wrinkled and rather tough skin on the surface.

When a torch is first lighted with only the gas turned on, the flame will be long and yellow, with a soft brushy tip shaped as shown at "A" in Fig. 7. Then when the oxygen is first admitted, a slender blue flame will appear within the yellow flame near the tip of the torch, as shown at "B" in Fig. 7. This greatly increases the heat of the flame but doesn't yet produce sufficient heat for satisfactory lead burning.

As the proportion of oxygen is increased the blue flame gets shorter and hotter, forming a small blue cone which will be shaped as shown at "C" in Fig. 7. With the ordinary lead burning torch the oxygen should be adjusted until this blue flame is from

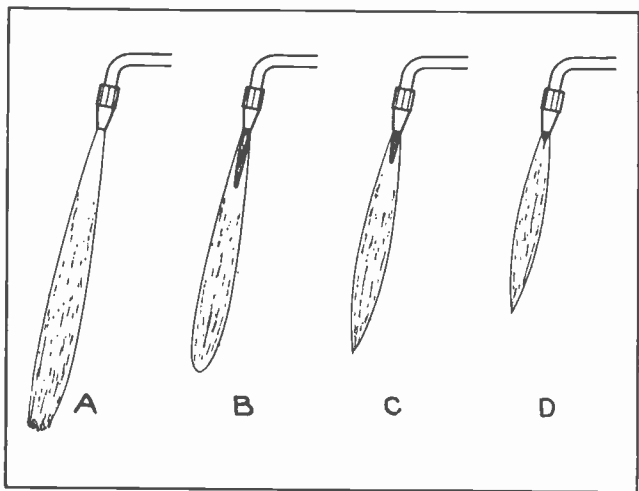

Fig. 7. The above sketch clearly shows the various steps in adjusting a lead burning torch. Examine each of these views very carefully while reading the accompanying explanation.

$\frac{3}{8}$ to $\frac{1}{2}$ inch in length, with its tapered sides fairly straight or slightly full, and its tip very slightly rounded.

If too much oxygen is admitted the blue flame becomes very small and sharp-pointed as shown at "D" in Fig. 7, and the flame will be too hot and will tend to oxidize the lead. Admitting still more

Battery Repair

oxygen will often cause the flame to blow completely out on the ordinary small lead burning torch.

When the flame is correctly adjusted as at "C" in Fig. 7, it is then ready to use for lead burning.

The hottest part of the flame from a torch of this kind lies just beyond the tip of the blue cone, so the flame should be held in such a position that the blue cone almost touches the surface of the lead to be melted. Experience and practice will soon show the correct position for holding this flame.

It is very important to remember that to perform a good lead burning job all of the lead surfaces that

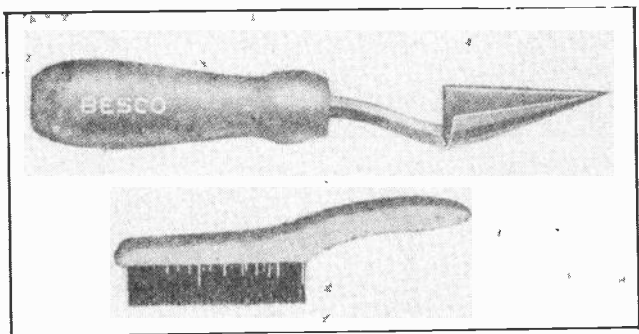

Fig. 8. Above is shown a convenient type of combination lead scraper and reamer, and below is a wire brush such as used in connection with lead burning on storage batteries.

are to be welded together must be absolutely clean and free from dirt, scum, or grease of any kind.

The inner surface of the openings in the connector straps can be cleaned and also reamed to fit the posts by means of a hand reamer, such as shown in the upper view in Fig. 8, while the tops of posts and various other surfaces can be cleaned with a wire brush, such as shown in the lower view in Fig. 8, or with a coarse file.

5. PROCEDURE FOR BURNING A CONNECTION

Before starting to burn a connector strap in place on the terminal posts of a battery one should see that the tops of the posts properly fit the circular lugs of openings in the strap ends, so that there are

Storage Batteries

no large openings between the post and strap, or otherwise the molten lead will run through on to the top of the battery.

The top of the post should project only about half way up through the opening in the strap. If the crack around the edge of the post is practically closed or only very small, the top of the post can be softened with a torch flame, and by pointing the tip of the flame into this corner between the post and strap and working the flame round and round in the cup-like depression, the lead of the post and strap will be melted and run together in a smooth, rounded joint.

The torch should then be removed quickly by raising it straight up. Additional lead melted from the tip of a slender lead filler stick or bar can now be run into the cup to build up the post a little at a time, **thoroughly welding each added bit of lead to the top of the post and to the strap.**

Right here is a point on which many inexperienced battery men fail to produce a good lead burning job. A good permanent connection can be made only by having the built up top of the post and the upper half of the strap connection melted together as one, so it will not do at all to merely run or drip hot lead from the "filler stick," or bar, onto the hardened or cold metal of the cup as the hot lead will not unite with cold lead that has been allowed to harden.

There is always a slight, almost invisible, film or scum which forms on the surface of the lead almost immediately when it cools and this film will prevent additional molten lead from properly uniting with the lead beneath, making a very weak joint and one that offers very high resistance to the flow of current through the battery connections.

For this reason **the surface of the lead in the bottom of the cup must first be melted by momentarily applying the torch, before additional molten lead is run in.** This requires a sort of double operation with the torch flame that can be acquired only by practice.

Battery Repair

In order to get the molten lead from the filler stick into the cup before the molten spot in the bottom cools, it is necessary to keep the torch playing on the molten spot and feed the end of the filler bar into the flame at the same time. This requires plenty of practice because there is quite a tendency for the end of the strap to become overheated and melt down, making it very difficult to complete the connection, because the solid ring or lug on the strap end is needed as a form or mold to hold the molten lead and build up a good connection.

If the strap edge is accidentally melted down in this manner it is often better to remove the strap entirely and replace it with a new one. This trouble can be avoided by being very careful to keep the torch flame directed into the center of the lug and not allow it to play for any length of time over the edges of the strap lug.

It is also a good plan to build one post only part way up and then work on another post for a short time, giving the strap on the first one time to cool. By working from one connection to another, and building each one up a little at a time in this manner, none of the terminals is as likely to overheat.

Where only one or two connections are being worked upon the strap can be cooled occasionally by placing a wet cloth around it. When doing this, however, be extremely careful not to get any water into the cup, or it may cause molten lead to be blown into one's face when the lead burning is resumed.

When the post has been built up flush with the top of the lug or ring on the strap a very neat job can be done by adding a little more lead, and slightly rounding off the top of the connection.

This is a very critical operation and requires considerable skill and accuracy to avoid running the lead over the edge and melting down the side of the strap lug. Before placing this little additional cap on the connection it is well to let the work cool somewhat and brush off the top surface with a wire brush so that it is bright and clean.

Storage Batteries

The very center of this spot can then be slightly melted with the torch and a medium sized drop of lead run onto it. Then by raising the torch slightly and using a part of the flame which is not quite so hot, and running this flame quickly around in a circle the drop of molten lead can be pushed out just to the edge of the connection, making a very smooth and neat-appearing cap.

One should always be very careful not to jar or move a lead burned connection until the lead has had time to cool and harden, or otherwise the lead may be caused to crystallize as it sets, making a very weak and high-resistance joint.

6. CAUTION

Extreme care should be used when working with a torch on batteries that have just been removed from the charging line, as the cells may have quite a little hydrogen gas under their covers. This gas is highly explosive, and if a flame is brought near the small vent openings in the cell caps it is likely to blow the caps or covers completely off the cell.

It is, therefore, best to remove the vent caps and blow out each cell with compressed air if it is available. If no air pressure is available gas may be burned out by removing all vent caps, examining the electrolyte to see that it is below the lower edge of the vent hole tubes, and then using a soft flame with all oxygen turned off.

Standing at arms length from the battery direct this flame into each vent hole for a second or two, and any gas will be safely burned out.

After the gas has been removed in this manner the battery may be safely worked upon. It is good policy, however, to have all vent plugs out when using a flame on the top of a battery, even after the gases have been removed, because it is still possible that some additional gas might form within the cells. This same precaution of removing vent caps should also be observed when batteries are placed on a charging line, or otherwise the hydrogen gas generated while they are charging may be ignited by a

Battery Repair

spark at one of the clips or charging connections.

Battery rooms in which large power plant batteries are located, or rooms in which a large number of small batteries are being charged or plates being formed, should always be kept well ventilated to avoid the accumulation of large quantities of hydrogen gas and the danger of serious explosions.

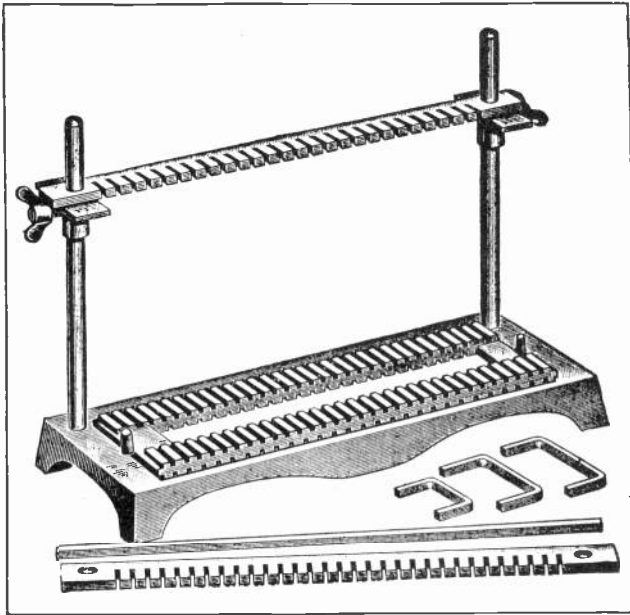

Fig. 9. Convenient racks of the above type are used for grouping and holding plates when burning on the terminal lugs on plate connectors.

7. ASSEMBLING PLATE GROUPS. MOLDING STRAPS AND POSTS

The lead burning torch is also used when assembling plate groups, for welding on or attaching the terminal posts to the tops of the plate lugs.

Fig. 9 shows a burning rack used for spacing and holding the plates in a vertical position while the terminal posts are burned on to them. The small square bars shown beneath this rack are used for lengthening the lugs on plates, by laying the plate flat on a piece of hard asbestos or similar material,

Storage Batteries

and using the little bars around the lug as a form in which to melt additional lead and run it together with the lead of the plate lug.

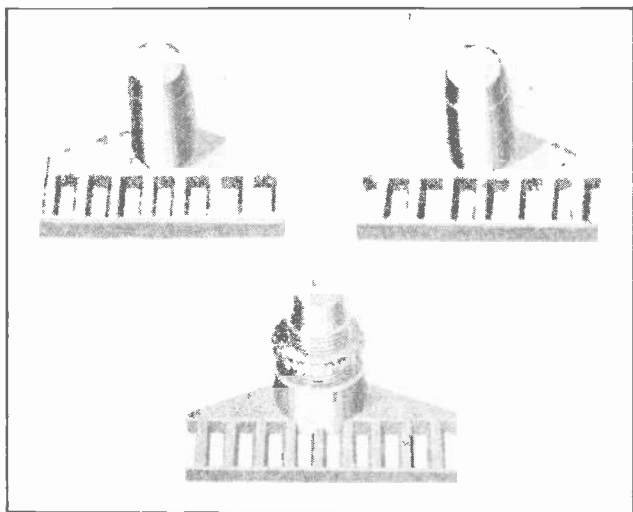

Fig. 10. Plain and threaded terminal posts and plate connectors for attaching positive and negative plates together in groups.

Fig. 10 shows several terminal posts which have been cast from lead and are ready for attaching to plate groups. The one on the upper left is a plain post for a positive group, and the one on the upper right a plain post for a negative group. The one shown below is called a "threaded type post" and has a cast lead nut which screws down on top of the cell cover after it has been slipped over the post.

Battery terminal posts and connector straps can be purchased from various battery supply houses, or they can be molded and cast from hot lead by means of special molds right in the battery shop.

Fig. 11 shows two types of strap molds, the one in the upper view being made for molding single straps of a certain length and the gang mold in the lower view is made for molding straps of three different lengths.

These molds are simply clamped in a vise in an upright position and the molten lead poured from a

Battery Repair

lead ladle into the funnel-shaped openings at the top of the mold.

When the mold is full and the lead has been given time to cool enough to set or harden, the mold is

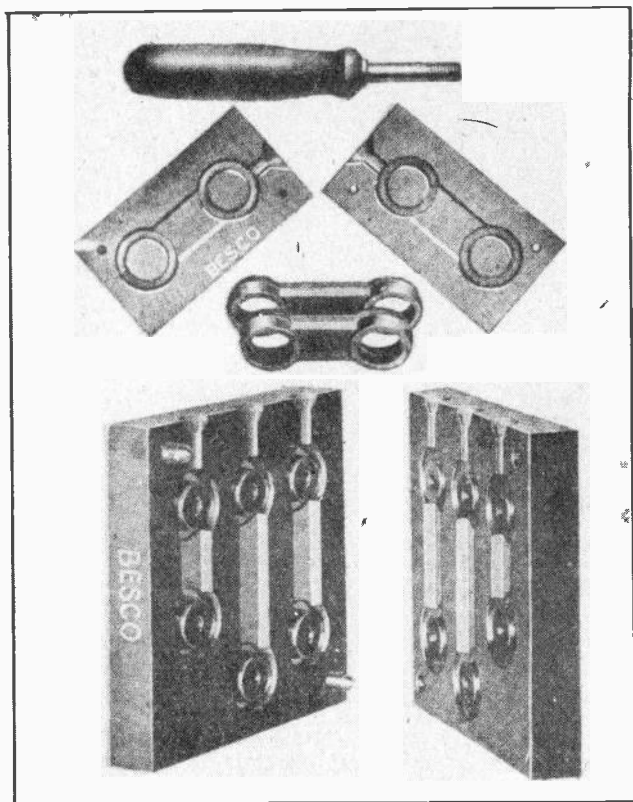

Fig. 11. Above are shown two types of strap or connector molds for molding lead straps of different lengths to be used in connecting together the separate cells of automotive batteries.

then removed from the vise or clamp and pried carefully apart. The straps can be removed by tapping on the back of the mold, or by prying up the filler tips and pulling them out with a pair of pliers.

Carbonizing or blackening the surface of the mold with a plain gas flame torch will help to remove the straps more easily and prevent them sticking in the mold.

Storage Batteries

The upper view in Fig. 12 shows a combination mold for casting threaded posts and lead nuts to go with them, while the lower view in this figure shows a simple mold for pouring straight slender bars of lead which are used for filling strap lugs and making cell connections.

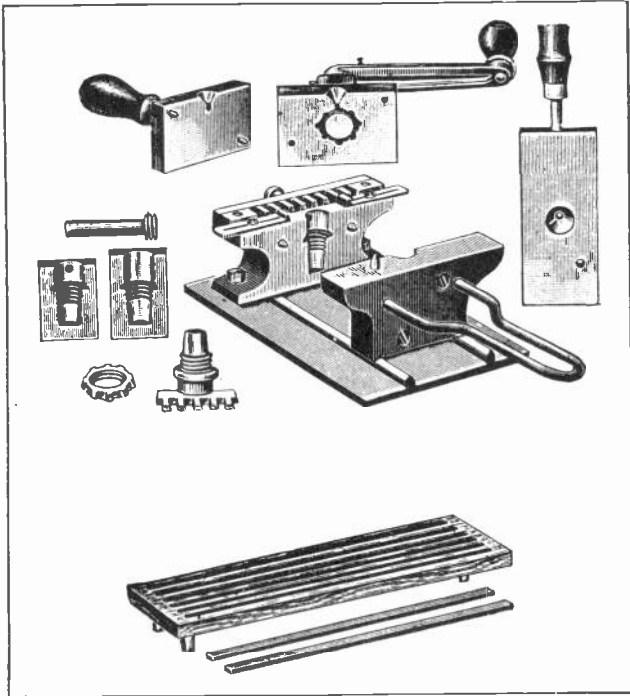

Fig. 12. Above is shown a combination mold used for casting threaded type posts and nuts, while below is a simple mold used for casting plain lead bars to be used in filling lugs when burning on connections.

Fig. 13 shows several types of post cutters which are used for trimming off the tops of battery posts that are too long, in order to make them properly fit the strap lugs and to keep the straps down close to the top of the battery.

8. PREPARATION OF BATTERIES FOR STORAGE WHEN NOT IN SERVICE

There are two common ways of storing batteries when they are not in service, one known as the **dry**

Battery Repair

storage method and the other as the **wet storage**. If a battery is to be taken out of service for a long period of time, and if it is not possible to give it a monthly charge, it should be stored dry.

For **dry storage** the following procedure should be taken:

1. Give the battery a thorough charge.
2. Remove the cell connectors and draw out the elements.
3. Remove the covers from the elements and separate the positive and negative groups.
4. Immerse the plates in distilled water for 10 to 12 hours keeping the positives and negatives separate.
5. Remove the plates from the water and allow them to dry. If the negatives heat up when exposed to air they should be immersed in the water again to cool them, repeating this as long as they tend to heat, and then drying them thoroughly.
6. If the old separators are wood they should be discarded; if rubber they may be saved if they are in good condition. Clean the cell covers and all parts thoroughly and allow to dry.
7. When plates are perfectly dry put the positive and negative groups together, using cardboard instead of regular separators, and replace them in the jars or case in their proper positions.
8. Replace covers and vent plugs but do not seal the covers. Store in a dry place until ready to be put into service again.
9. To put the battery in service install new separators and reassemble the plate groups in the cells, replace the covers and seal them. Fill the cells with 1.320 specific gravity electrolyte, and allow the battery to stand for ten to twelve hours before putting it on charge. Then place the battery on charge at the normal rate of 1 ampere per positive plate until the gravity stops rising and remains stationary for five hours. At the end of the charge the gravity should be between 1.280 and 1.300. If the gravity is not between these limits it should be adjusted by

Storage Batteries

withdrawing some of the electrolyte and replacing it with 1.400 electrolyte if the gravity is too low, or with distilled water if the gravity is too high.

For placing a battery in wet storage, first give it a complete charge and then remove it from the charging line, and clean the outside of the battery thoroughly. Apply vaseline or light cup grease to the terminals and check the level of the electrolyte, adding distilled water if necessary.

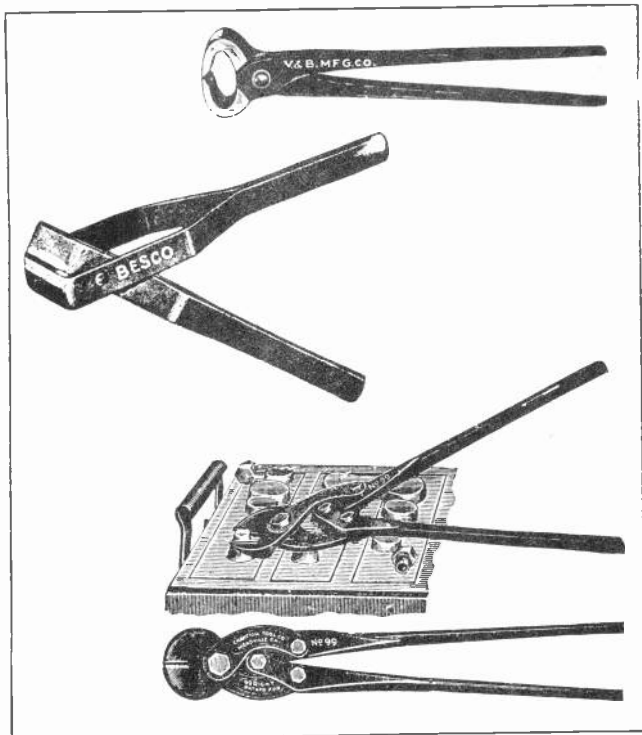

Fig. 13. Several different styles of posts cutters or trimmers for clipping off the tops of battery posts.

Store the batteries on dry shelves, allowing a little air space between each battery and the next. Once each month replace with distilled water any electrolyte lost by evaporation and then give the battery a charge in the usual manner.

Battery Repair

Before putting back in service batteries which have been in wet storage give them a thorough charge and make a high rate discharge test.

9. CHARGING NEW BATTERIES

After the parts for a new battery have been assembled and the battery is ready to be charged the procedure should be as follows:

First fill the battery with 1.250 specific gravity electrolyte. If stronger electrolyte is used the plates may overheat and become damaged.

After filling let the battery stand from six to twelve hours to allow the electrolyte to soak well into the plates and separators.

Next put the battery on charge at 1 ampere per positive plate. (5 amperes for 11-plate batteries, 6 amperes for 13-plate batteries, etc.) Keep the battery on the charging line until the voltage reaches from 2.4 to 2.5 volts per cell, with voltage test being made while charging. This voltage indicates that the active material on the positive plates is pure lead peroxide and that on the negative pure sponge lead. A gravity reading at this stage would be slightly below 1.250 if wet separators were used in assembling the battery.

The next step is to "set" the gravity by emptying out the electrolyte and replacing it with an equal amount of 1.350 specific gravity electrolyte. Then put the battery back on charge at 1 ampere per positive plate to equalize the electrolyte, and take the gravity reading after the battery has been on the charging line 30 minutes. The gravity should then be between 1.280 and 1.300. If it is below 1.280 withdraw some electrolyte and replace it with 1.400 specific gravity acid and put the battery back on the charging line again for 30 minutes, before taking another reading. If the gravity is above 1.300 remove some of the electrolyte and replace it with distilled water.

Correcting the gravity of a battery in this manner is sometimes known as "balancing", and it can be done while the battery is on the line and charging.

Storage Batteries

When the battery is ready to be removed from the line each cell should have a voltage of 2.4 to 2.5 volts, and the gravity should be between 1.280 and 1.300. **Caution: Be sure that the battery is charging at the correct rate when making a voltage test.** Otherwise the above mentioned voltages will not be obtained.

10. SHOP EQUIPMENT

You may desire at some later date to start a shop and enter into a battery repair business of your own. It doesn't require a great deal of capital or material to start a shop of this kind.

The following is a list of tools and equipment needed for a small shop:

- 1 10 or 20 battery Tungar charger
- 1 battery steamer and still
- 1 lead burning outfit
- 1 plate burning rack
- 1 hot-plate and compound pot
- 1 6-in. vise
- 1 low-reading voltmeter (Cadmium type)
- 1 temperature correction thermometer
- 2 hydrometers
- 1 pair of terminal tongs
- 2 pair nut pliers
- 1 10-in. screw driver
- 1 6-in. screw driver
- 1 battery carrier
- 1 putty knife
- 1 Cherokee tool for reaming down size of tapered posts
- 1 set of post builders
- 1 set of steel number stamps
- 1 set of positive and negative stamps
- 1 paint brush
- 2 wire scratch brushes
- 1 separator trimmer
- 1 triangular lead scraper
- 2 Vixen lead files

- 1 pair of end cutters
- 1 drill press and drills $\frac{1}{2}$ ", $\frac{5}{8}$ " $\frac{3}{4}$ "

Battery Repair

- 1 plate press
- 1 high-rate discharge set
- 1 cycling set
- 1 acid container
- 1 funnel.

Other tools such as saw, hammer, etc., will be found convenient. If a lead pot is used to melt lead for molding posts, straps, etc., in the shop, a set of assorted molds can be added.

Battery plates, separators, posts, straps, battery jars and cases, etc., can all be purchased from any regular battery supply company.

If you plan to open a shop of this kind at any time, remember at all times that courtesy, promptness, and first class workmanship are the essentials in building up trade and holding customers once obtained.

A sign on your place of business and some display of your work or supplies, along with some novel window attraction in the front of the shop, are great helps in getting attention and business.

Small ads placed in the local newspaper or little folders left at the homes of car owners in the locality will also help obtain business.

In many cases co-operative arrangement can be made with other local garages which may not have a battery shop, they sending their customers who need battery service to you, and you sending your customers who need general ignition or mechanical service to them.

11. GENERAL

Most of the material on lead plate batteries so far covered has been applied to the common small storage battery, such as used by the millions for automotive and radio work as this is the field in which you will be most likely to have opportunity to make profitable use of storage battery knowledge.

However, it is well to keep in mind that there are numerous installations of large lead plate storage cells in power plant batteries, and that most

Storage Batteries

of the general information covered in these lessons can be applied to these batteries also.

Large cells such as shown in Fig. 2, in lesson 82, and having plates with a surface area of several square feet are quite commonly used. These plates are generally set on porcelain bars or insulators laid in the bottom of lead-lined wood boxes.

Dozens or hundreds of these huge cells are then connected in series or series-parallel by means of heavy lead bus bars or lead coated copper cables, and kept in well-ventilated battery rooms at power plants or substations where they are used.

Such batteries are generally kept charged by means of motor-generator sets supplying D. C. at the proper voltage. In some cases the batteries are kept normally connected across the D. C. power busses, so that they are kept constantly charged up to the bus voltage, and ready to supply or feed current to the busses and load, as soon as any failure of the generators or any voltage drop on the system occurs.

In other cases special motor-generator sets known as **boosters** are kept connected to the batteries and are equipped with special relays or field connections so that they start charging the batteries at any time their voltage drops a certain amount.

Some large battery installations are equipped with additional cells known as **end-cells**, which can be manually or automatically cut in series with the main group as the voltage of the main battery drops slightly during discharge. By cutting in these end-cells one at a time the line voltage can be kept constant.

When charging batteries equipped with end-cells the steps of the switching process are just reversed, and the cells cut out one at a time after each has been charged the right amount. This gives the longest charge to those cells which were longest in service.

The voltage, electrolyte gravity, and the temperature are all kept carefully checked on such large

Battery Repair

battery installations.

It is well to give any storage battery about 10 to 15 per cent overcharge at regular periods to keep them in best condition.

Reversible ampere-hour meters are often used with batteries in power plants, farm lighting plants, emergency lighting installations, etc., to keep accurate records of the amount of energy flow during charge and discharge, and to enable the operator to see that the right amount of charge is given both on normal charging and for the periodic overcharges.

12. EDISON NICKLE-IRON STORAGE CELLS

Edison storage cells differ from lead plate storage cells in that no lead is used in their construction; nickle being used for the positive plates and iron for the negative. The electrolyte is also different and instead of using sulphuric acid the Edison cell uses an alkaline solution of potassium hydroxide and distilled water.

The positive plates for these cells consist of a layer or group of perforated steel tubes $\frac{1}{4}$ inch in diameter and $4\frac{1}{4}$ inches long, which are filled with alternate layers of nickle hydrate and pure flake nickle. The nickle hydrate is a green colored powder-like compound and is the real active material in the positive plates, while the flake nickle is put in to improve the electrical conductivity and reduce the resistance of the nickle hydrate.

These two materials are packed into the thin perforated steel tubes under high pressure. The tubes are then banded with eight equally spaced steel rings which fit tightly around the thin walled tubes, reinforcing and strengthening them, and preventing them from bulging with the tendency of the active material to expand.

The proper number of these tubes, according to the size of the plates and cell, are then clamped in a steel frame to make up the plate. For plates longer than $4\frac{1}{2}$ inches two or more sets of tubes are arranged end to end and held in a nickle plated steel frame, as previously explained.

Storage Batteries

Fig. 14 shows a complete positive plate for an Edison storage cell and also one of the separate positive tubes from which the plate is made up. Note the manner in which the tube is constructed of a spirally-wound, thin steel ribbon, and also note the numerous small perforations to allow the electrolyte to penetrate through the active material in the tube.

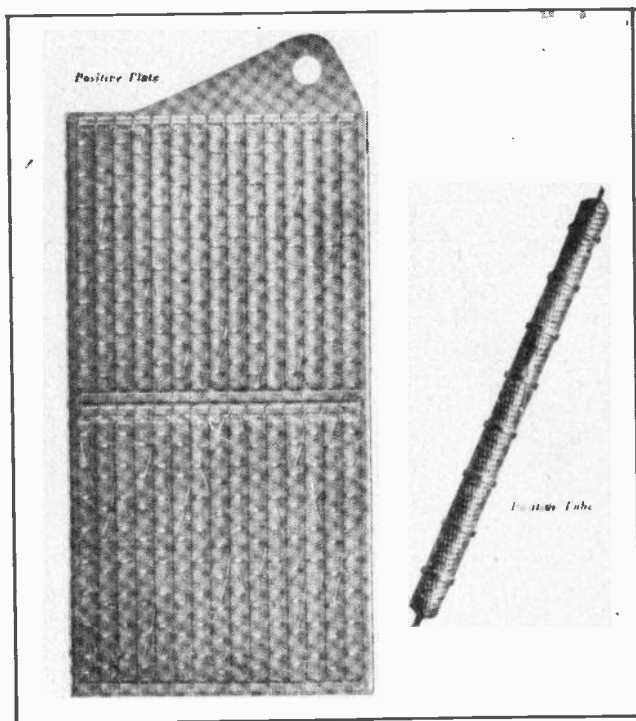

Fig. 14. This excellent photo view clearly shows the construction of the positive plate and individual positive tube for an Edison nickel-iron storage cell. Note the rugged construction of these parts. (Courtesy of Edison Storage Battery Co.)

The negative plates in Edison storage cells consist of a group of perforated flat steel pockets which are filled with iron oxide as the active material of these negatives. Iron oxide is also commonly called "black iron rust".

Battery Repair

A group of these small pockets are then arranged edge to edge and clamped in a steel frame to make up the complete negative plate, as shown in Fig. 15. These positive and negative plates are then assembled in groups by clamping them securely on a threaded steel rod with nuts which draw them tight, the plates being equally spaced by means of steel washers between their lugs where they attach to

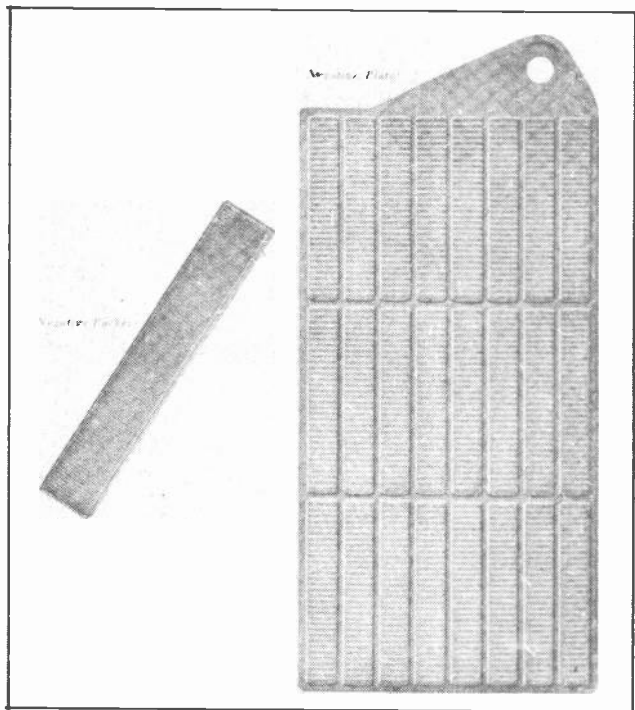

Fig. 15. Photo of complete negative plate and one separate negative pocket used in nickel-iron storage cells. The active material is contained within these pockets which are all grouped together in a steel frame. (Courtesy of Edison Storage Battery Co.)

the rod. A vertical terminal post is also securely attached to this rod.

The positive and negative plate groups are then meshed together similar to those of lead plate storage cells, except that in the Edison cells slender, hard rubber rods called "pin insulators" are placed

Storage Batteries

vertically between the positive and negative plates to act as separators and insulators.

The assembled positive and negative groups or cell elements are then placed in containers of nickle plated steel with welded seams. Thin sheets of hard rubber are placed between the elements and the metal container to act as insulators, and after slipping a hard rubber washer down over each terminal the metal covers are welded permanently in place on the containers. This permanent closing of the cell is possible because of the very long life of the cells, and due to the fact that they require practically no mechanical servicing or attention throughout their life.

The sides of these containers are corrugated to give maximum strength with light weight material. The terminal posts are insulated and sealed into the cover by means of rubber gaskets.

The cell tops are fitted with combination check valves for allowing the escape of gases formed in the cell, and a filler cap which can be opened to add distilled water to the electrolyte or to change the electrolyte when necessary.

Fig. 16 shows an excellent sectional view of a complete Edison alkaline or nickle-iron cell. Note carefully the arrangement of all the parts, and the general construction of this cell.

The completed cells are filled with a solution of potassium hydroxide and water, the specific gravity of which should be 1.200. This electrolyte doesn't attack iron or steel the way sulphuric acid does, and it is thus possible to use the steel containers and obtain a much more ruggedly built battery. A group of cells of the desired number are commonly assembled in trays or frames for convenient handling.

The voltage of Edison nickle-iron storage batteries when fully charged is 1.2 volts per cell which you will note is a little lower than that of lead plate storage cells.

13. ADVANTAGES OF NICKLE-IRON CELLS

The Edison cell has a number of decided advantages, however, which make it much more suitable

Battery Repair

for many classes of work than lead plate storage cells.

Some of these advantages are as follows:

The all-metal construction provides a cell of maximum mechanical strength and durability, and the construction of the plates makes them much more rugged and able to stand severe vibration, such as batteries are subjected to when used on electrical vehicles or in train lighting service.

The electrolyte, being of a non-acid nature, will not corrode any of the metal parts of the battery or other metal parts on which it might be spilled. Neither does this alkaline electrolyte solution attack or use up the active material of the plates when the battery is not in use, as does occur with lead plate storage batteries if they are not frequently recharged. For this reason Edison cells can be left standing idle for long periods in a discharged condition without injury.

These cells can be reversed and charged backward, or can be charged and discharged at very heavy rates, or even short-circuited without injury. The active material of the plates, being encased in steel tubes and pockets, doesn't shed so these cells do not have to be dismantled for plate repairs or cleaning out of sediment.

Another great advantage is that the plates of Edison cells are not subjected to warping and buckling under excessive current rates, and, being equipped with hard rubber separating strips, it is almost impossible for them to become short circuited as so often occurs with plates of lead and acid storage batteries.

14. CHARGE AND DISCHARGE ACTION

The basic principle of the Edison cell is the reduction and oxidation of metals in an electrolyte which doesn't combine with or dissolve the metals or their oxides. Due to this fact the specific gravity of the electrolyte is always constant whether the cells is in a charged or discharged condition.

Hydrometer readings are, therefore, of no use in determining the state of charge of Edison storage cells.

Storage Batteries

After about 300 cycles of charge and discharge the electrolyte gravity tends to become lower and the old solution should be emptied out and replaced with new solution of the correct gravity.

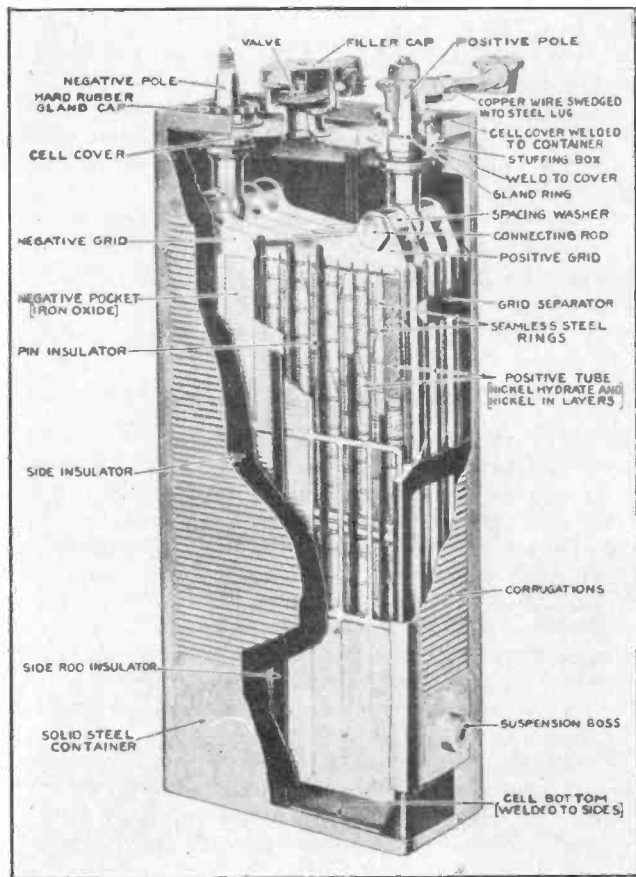

Fig. 16. This excellent cut-away view clearly shows the construction and parts of an Edison nickel-iron storage cell. Note the very rugged construction throughout, and also the strong sheet metal container used with these cells. (Courtesy Edison Storage Battery Co.)

During charge the chemical reactions in Edison storage cells are as follows: The nickle hydrate or active material of the positive plate becomes oxidized and is changed to nickle oxide; while the iron

Battery Repair

oxide or active material of the negative plate is reduced to metallic iron.

Thus, for practical purposes, the charged positive plate can be considered to consist of nickle oxide (NiO_2) and the charged negative plate consists of pure iron (Fe).

During discharge some of the potassium from the electrolyte in the cells unites with the nickle oxide of the positive plate and reduces it to a lower oxide of nickle (Ni_3O_4), and some of the oxygen unites with the pure iron, changing it to iron oxide (Fe_3O_4).

When the cell has been discharged these actions can be reversed and the plates and electrolyte both changed back to their original charged condition, by passing current through the battery in the direction opposite to the flow during charge.

15. CHARGING NICKLE-IRON CELLS

The charging voltage required for Edison batteries is from 1.7 to 1.85 volts per cell. These batteries can be conveniently charged by means of the constant current system, or with the batteries connected in series to the source of direct current of the proper voltage.

They are also sometimes charged by the constant potential or parallel method, but the handling of this system is very critical, because if the generator voltage rises at all above 1.7 volts per cell there will be a very heavy current surge through the battery, which may cause it to overheat.

External series resistances are sometimes connected in series with each battery when they are to be charged by the constant potential or parallel method. These resistances serve to limit the current flow and prevent heavy surges and charging current through the batteries.

The open circuited voltage of a fully charged Edison storage cell is about 1.5 volts per cell, but this falls off very rapidly as the rate of discharge is increased so the average discharge voltage of a well-charged cell is about 1.2 volts.

When the voltage drops to .9 volts per cell these batteries are considered to be discharged and should

Storage Batteries

be put back on the charging line again. In many installations of batteries of this type they are recharged as soon as the voltage falls to 1 volt per cell. Nickle-iron storage batteries can be completely discharged, however, without damaging the plates as occurs with lead plate batteries.

While a hydrometer is of no use to indicate the state of charge of the nickle-iron storage cell, it should be used occasionally to check the specific gravity of the electrolyte to determine whether the solution should be changed or not.

As previously mentioned, the gravity of the electrolyte gradually becomes lower with repeated cycles of charging and discharging, and when this gravity drops as low as 1.160 it should be changed and renewed with 1.200 gravity electrolyte.

Edison cells should not be operated with electrolyte of lower gravity than 1.160, or they become sluggish and lose capacity and are also subject to breakdown on severe service.

Caution: When using a hydrometer to test the specific gravity of the electrolyte in nickle-iron cells, if this device has been used with lead plate cells be sure that it is free from all traces of acid. Be careful never to use with Edison cells any utensils that have been used with sulphuric acid, as even a slight amount of acid may cause serious trouble or ruin the cells if it gets into the alkaline electrolyte solution.

16. INTERNAL RESISTANCE AND EFFICIENCY

The internal resistance of nickle-iron cells is approximately three times as high as that of lead storage cells of the same capacity and voltage, and will cause a voltage drop of about 7% of the open circuit cell voltage when the cell is discharging at the five-hour rate.

Edison cells have a rather peculiar temperature characteristic in that their capacity falls off very rapidly when they are operated at cell temperatures below about 50° F. Under normal conditions, however, the charge and discharge action generally keeps the internal temperature of the cells considerably above this point, particularly if the batteries

Battery Repair

are enclosed in a box with temperature insulation when they are to be used in cold places.

The efficiency of nickle-iron cells is considerably lower than that of lead storage cells, so they require considerably more current in ampere hours to charge them than can be obtained from them during discharge.

Their efficiency is about 60% in ordinary operation. This lower efficiency is more than made up for, however, by the many other advantages previously mentioned which these cells have over lead plate batteries.

17. CARE OF NICKLE-IRON STORAGE CELLS.

In order to give the most satisfactory service nickle-iron storage cells should be recharged often enough to keep their voltage above .9 volts or 1 volt per cell, and will give still better service if used in such a manner that they can be given frequent boosting charges at intervals between the discharge periods, in order to keep the voltage up nearly to the full charged value.

It has already been mentioned that the electrolyte in these cells should be renewed approximately once every six or eight months, or after the cells have been charged and discharged about 300 times.

The cells should be refilled with standard refill solution obtainable from the Edison Storage Battery Company. Don't pour out the old solution until you have received the new and are ready to refill the cells with it, as they should not be allowed to stand empty.

When renewing the electrolyte, first completely discharge the battery at normal rate to zero and then short-circuit it for one or more hours. This is done to protect the battery elements. Next pour out half the solution and shake the cell vigorously, and then empty the balance.

Never rinse the cells with water but instead use only the old solution. Never use a galvanized funnel or one that has soldered seams, or anything else

Storage Batteries

of this nature in handling solution for these batteries. Glass, enamel ware, or plain iron funnels and utensils should be used.

Under good operating conditions and with proper care the total life of these cells should be somewhat over 1000 complete cycles of charging and discharging. When the electrolyte level becomes too low due to evaporation these cells should be refilled with pure distilled water, the same as used for lead plate storage cells, except that it is well to use water that has not been exposed to air for any length of time, but which has instead been kept in a corked bottle or sealed container after distilling.

The level of the electrolyte in nickle-iron cells can be conveniently tested by lowering a $\frac{1}{4}$ inch diameter glass tube vertically into the filler opening, until its lower end touches the tops of the plates. Then, by placing the finger tightly over the top end of this tube, it can be raised out of the cell and will hold a small amount of the electrolyte at its original level inside of the tube.

This level can be measured from the bottom of the tube, thus determining the height of the electrolyte above the plates.

A small piece of rubber tubing fitted tightly around the top end of the glass tube helps to provide a better air seal when the finger is placed against it.

The metal containers of nickle-iron cells must be kept carefully insulated from each other at all times or there will be a small leakage of current between them, and the cell containers may become punctured due to electrolytic action.

The cells and their trays should be kept well cleaned and free from collections of dirt and moisture. They can be cleaned by blowing with compressed air, or with a steam hose, but the steam hose should not be used on the cells while they are located in their compartments.

It is a good plan to coat the tops of these cells with a light coat of rosin-vaseline which has been warmed to about 180° , and thinned to paint con-

Battery Repair

sistency with benzine. This material can be applied with a small paint brush. The outsides of the cell containers should be kept painted with some good alkali-resisting insulating paint. Nickle-iron batteries should not be operated at temperatures above 120° F.

18. LOCATION AND CONNECTIONS

When locating nickle-iron cells in storage or carrier compartments, the compartments should be lined with wood and constructed to afford ample ventilation, good drainage, and ease in cleaning. A compartment should be provided with slots about an inch wide, running the full length under each battery tray where bottomless trays are used, and between the trays when trays with bottoms are used.

Openings should be provided in the sides of compartments above the highest point of the battery. These openings should have a total area slightly greater than the total of the bottom openings and they should be located to keep out as much dirt and water as possible.

If the battery is used out-of-doors in cold climates these openings should be closed during cold winter weather.

Nickle-iron cells can be connected in series or series-parallel, the connections being made and tightened under the nuts provided on the top of the terminal poles. Regular steel jumper connectors with terminal lugs are provided with batteries of this type. These lugs seat firmly on the terminal posts if the steel jumper wires are properly bent and shaped to allow them to.

The lugs should never be driven or hammered into place, but should have their jumper so shaped and adjusted that the lugs slip easily in place where they can be securely locked by means of the nuts.

It is good practice to slightly grease the threads on the terminal posts, after the lugs are in place and before the nut is put on. Make sure that all contact surfaces between terminal posts and lugs are clean before making connections, and always see that all connections are kept tight and clean.

Storage Batteries

For removing these connector lugs after they have been forced tight with the terminal nuts, a small disconnecting jack or terminal puller is shipped with each battery. This jack can be placed straddle of the terminal post so that it engages the lug and will then pull the lug loose if the screw of the jack is turned.

One should be very careful **never to handle flames of any kind around these cells when they are charging or discharging, as explosive gases are liberated from the cells during these periods.**

The material covered in this Section on Storage Batteries of common types has been applied particularly to automotive batteries of the lead and acid type, and to nickle-iron storage batteries which are so extensively used for operation of electrical vehicles, and in train lighting, and various classes of signal work.

However, a great many of the principles and rules given can also be applied to larger storage batteries of the lead plate type, which are used in power plant work and which have been generally explained.

A good understanding of the material covered in this Section can be of great value to you in various classes of electrical work, such as telephone, telegraph, railway signal, farm lighting, radio, automotive, and power fields.

EXAMINATION QUESTIONS

1. Briefly describe two methods which may be used for removing the lead connector straps from a battery.

2. What is meant by the term LEAD BURNING when used in connection with battery repair work?

3. What precaution should always be taken to prevent explosions when working with a torch on batteries that have just been taken from the line?

4. Briefly explain how a storage battery is placed in WET STORAGE.

5. Under what conditions would you recommend DRY STORAGE of batteries?

6. Should new batteries be placed on the charging line immediately after the electrolyte has been added?

7. What is the recommended charging rate for new batteries?

8. For what purpose are END-CELLS some times used in large battery installations?

9. A. What material is used in building the plates for Edison storage cells?

B. What kind of solution is used as the electrolyte in an Edison storage cell?

10. A. What voltage does an Edison storage cell develop?

B. How are Edison cells tested to determine the state of charge?

DIESEL ELECTRIC POWER

We hear a great deal these days about Diesel Engines and Diesel-Electric Power, the rapid development and growth of this comparatively new industry and the many wonderful opportunities it offers to the man with the RIGHT KIND OF PRACTICAL TRAINING.

Contrary to general opinion, the Diesel engine is not a recent development or invention. The Diesel principle was patented by Dr. Rudolph Diesel, a German Engineer, away back in 1893. These engines formerly were designed especially for stationary service only, and heavy duty Diesels have been in use both in this country and in Europe for about forty years.

They have also been used quite extensively in power plants, oil fields, mills, and on ships and dredges for sometime. See Fig. 6.

While it has been only in recent years that Diesel Engines have made much of an important advance in the Power Field, Diesel Engines are today being built in sizes ranging from 5 H. P. to 20,000 H. P. each, and are being adapted to many different uses, including thousands of power plants, trucks, tractors, busses, automobiles, ocean liners, freighters, barges, launches, tugs, and practically all types of ships at sea, dredges, mills, mine motors, road machinery, industrial plants, hoists, railroad trains, etc., in fact in almost any place where power is used. See Figs. 7 to 10.

Of particular interest to you men in ELECTRICITY is the important fact that ELECTRICITY is so closely related to Diesel power. Because Diesel engines are so often used to drive electric generators, which in turn furnish the power for the operation of electric motors and many other electrical devices, it can readily be seen that a knowledge of Diesel engines and electricity is of great importance and value, to the man who is employed in the field of Diesel electric power or wherever this power is used.

A good example of the importance of electricity in connection with Diesel operated power units can be found in the new Diesel electric streamlined trains. These trains use a Diesel engine directly coupled to large electric generators which supply

Engines

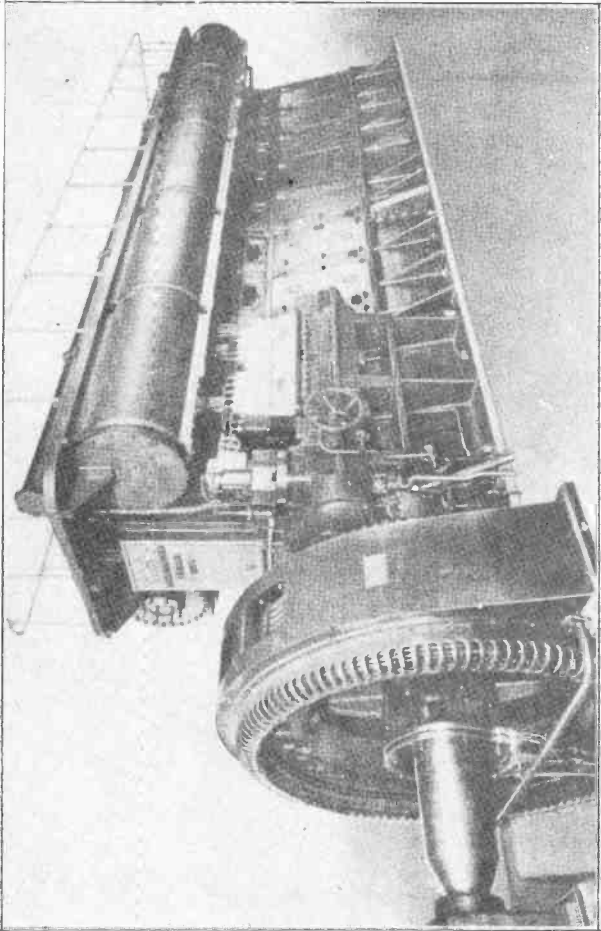

Fig. 1. Diesel-engines of the type shown above can be made in very large sizes for power plants and ships. This unit develops 14,000 h.p. Note the electric generator on the left. Many Diesel-Electric generating units of this type are used in power plants of utility companies and industrial plants. (Courtesy of the Busch Sulzer Engine Company.)

Diesel Electric Power

current to electric motors which drive the train.

It is also important to note that these new Diesel electric trains require, in addition to the man who

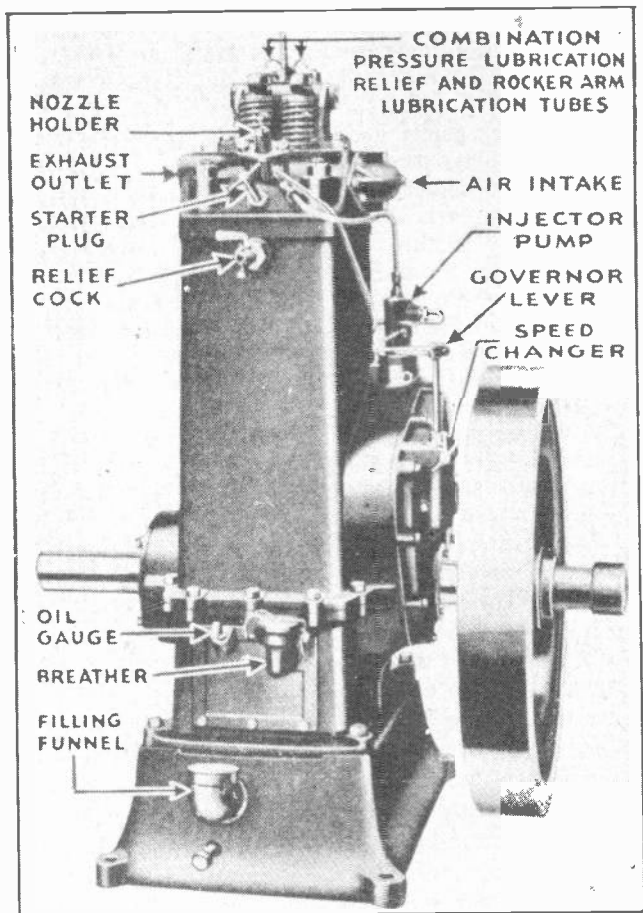

Fig. 1. This illustration shows a popular type of vertical, single cylinder, 10 h.p. Diesel-engine for stationary use. Note the names and locations of the various parts shown on this engine. (Courtesy of the Atlas Imperial Engine Company.)

operates the Diesel engine, many trained electricians to install, inspect, service, repair and maintain the electric generators, motors, controls, lights, heaters, batteries, refrigerators, and air-condition-

Engines

ing equipment, and other electrical devices used on these trains.

If you wish to engage in the new fast growing field of Diesel electric power, the practical information contained in this book should be very helpful in securing a knowledge of the operating principles, care and adjustment of Diesel engines of various types.

Therefore, the material in this book will deal principally with the practical phases of operation, care and adjustments of engines, rather than the design and overhaul, as these latter items are not so necessary to the Diesel electric operator.

One of the most important reasons for the tremendous popularity and the great increase in the use of Diesel engines is primarily because of their economical operation. These engines burn cheap fuel oil, which is ignited not by electricity, but by the heat of compression.

Diesel engines are in fact, regular internal combustion engines very similar to gasoline engines used in automobiles and for stationary power units. See Figs. 1 to 6.

The principle differences between the Diesel engine and the gasoline engine is that it operates on cheap fuel oil instead of gasoline, and this fuel is infused into the combustion chamber with a high pressure fuel pump instead of being drawn in through the carburetor, and in the full Diesel engine the fuel is ignited by heat of compression instead of with electric ignition or sparks, as is the case in automobile engines.

Modern high-speed Diesels are made in single and multiple cylinder types, in sizes ranging from 10 to 300 h.p. and more. Slow speed and medium speed units are made in single or multiple cylinder types, in sizes from 5 h.p. to 20,000 h.p. and over.

Some of the advantages of the modern Diesel engines are: that they operate on cheaper fuel of higher B.T.U. (heat) content; they use less fuel per h.p. hour due to their higher compression and resulting higher thermal efficiency; and they are more simple and rugged due to the elimination of carbure-

Diesel Electric Power

tors and ignition devices. Some of their disadvantages when compared with gasoline engines are: they are heavier, noisier and more costly for a given h.p. size.

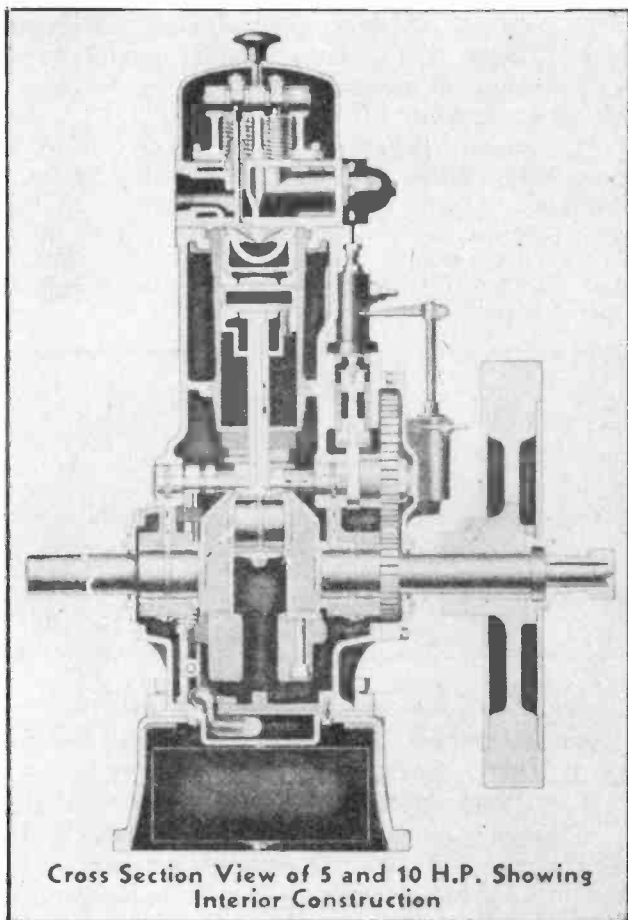

Fig. 2. A sectional view of the same engine shown in Figure 1. Note carefully the construction and arrangement of the cylinder, water jacket, piston, valves, crank-shaft, cam shaft, etc. (Courtesy of the Stover Engine Company.)

Many thousands of Diesel engines are being made each year for use in trucks, busses, tractors, etc. In time, they may even be developed to a point

Engines

where they will replace many of the gasoline engines now in use in pleasure cars.

However, it is interesting to note that in a great many installations of Diesel engines in this country they are used in conjunction with electric generators, because of the much greater flexibility and wider range of smooth speed control of electric power equipment.

This same principle of Diesel-Electric drive, besides being used in the new, streamlined trains, is also used in some busses, ships, dredges, etc. Then there are the Diesel-Electric power plants in use in industrial plants, municipal generating stations, and public utility company plants. See Figures 3, 8, 9 and 10-A.

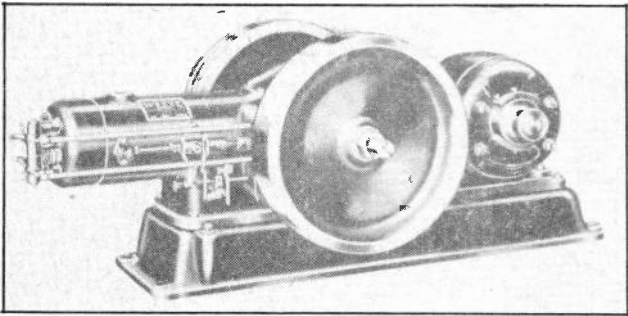

Fig. 3. Another very popular type of small Diesel-engine of the horizontal, single cylinder type. Note the electric generator which is connected to one fly-wheel by "V" belts, making a very convenient small light-plant unit. (Courtesy of the Witte Engine Company.)

1. DIESEL ENGINE CONSTRUCTION FEATURES AND OPERATING PRINCIPLES

As previously mentioned, Diesel engines are similar in many respects to gasoline engines. They both have cylinders, pistons, crank shafts, connecting rods, valves and cam shafts. See Figures 2 and 5. The principal difference lies in the fuel system, the method of introducing the fuel to the cylinder or combustion chamber, and the method of igniting the fuel.

The Diesel engine uses a high-pressure fuel pump to measure the liquid fuel charge and inject it

Diesel Electric Power

through a nozzle in the form of a high-pressure spray into the cylinders. The gasoline engine uses a carburetor to mix air and gasoline into vapor which is drawn into the cylinder by the vacuum on the intake stroke. Where the gasoline engine uses a spark to ignite the gasoline vapor, the Diesel engine uses the heat of highly compressed air to ignite the oil spray.

All atmosphere or air normally contains a certain amount of heat. If such air is quickly compressed to very high pressure, the concentration of the heat

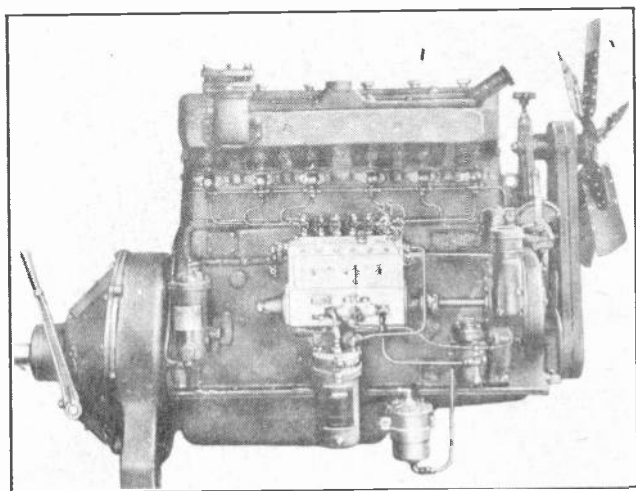

Fig. 4. This photo shows a modern six cylinder automotive type Diesel engine. Note the similarity to the ordinary gasoline engine except for the fuel pump and the injectors which replace the ordinary carburetor and spark plugs. (Courtesy of the Buda Company.)

into the smaller space will greatly increase the temperature of the air. You have probably experienced this condition in working with a tire pump or an air compressor at some time or other.

The higher the pressure to which the air is compressed the higher its temperature will be raised. In the full Diesel engine the compression pressures range from 450 to 575 lbs. per sq. inch.

When air at normal temperatures is quickly compressed to 500 lbs. pressure, if no heat was absorbed

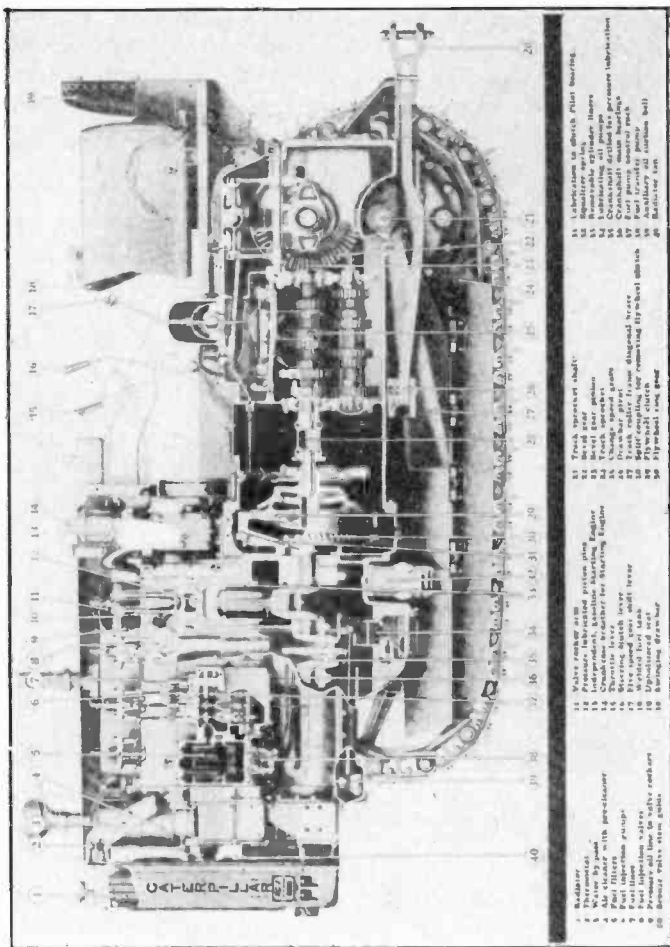

Fig. 5. This excellent sectional view of a modern six cylinder Diesel-engine clearly shows many important construction features. Note the pistons, connecting rods, crank shaft, timing gears, valves, and cylinder liners. (Courtesy Caterpillar Tractor Company.)

Diesel Electric Power

by the cylinder walls, its temperature would rise to about 1050 degrees F. Since the metal cylinder walls and piston head quickly absorb some of this heat, the temperature at the end of the compression stroke will usually be about 850 degrees F.

If fuel oil is broken up into finely divided spray, it will ignite in air at temperatures about 680 degrees F. Therefore, if fuel oil is injected through a spray nozzle into the cylinder at the end of the compression stroke in a full Diesel engine the oil charge will immediately ignite and burn. See Figure 15. The resulting heat of about 3000 degrees F., and the expansion of the burning gases, delivers the pressure to the piston head for the power stroke. For this reason Diesel engines are sometimes called **compression ignition engines**.

2. FULL DIESEL AND SEMI-DIESEL ENGINES

Not all engines that operate on fuel oil are true Diesel engines. Fuel oil engines are divided into three general classes, called the **Full-Diesel**, **Semi-Diesel**, and **Spark Ignition** injection engine.

The full Diesel engine has a compression ratio of about 15 to 1, (meaning that the air in the cylinder is compressed or squeezed down to 1/15 its former volume), resulting in compression pressures of about 500 lbs. per sq. inch, as previously mentioned. This engine generally starts quite readily on fuel oil without the aid of any auxiliary heat for ignition. In some cases, however, hot **glow-plugs** may be used to assist in starting, especially in very cold weather.

The semi-Diesel or oil engine has a compression ratio of about 8 to 1, resulting in final compression pressures of 200 to 225 lbs. per sq. inch. This type of engine requires the application of some extra heat besides compression heat to start, and the heat must be applied until the engines warms up to operating temperature.

Blow torches are used on some types of semi-Diesel engines. The cylinder heads are so designed, that the head or a hot plug which extends into the combustion chamber, can be heated red-hot with a

Engines

torch. - For this reason, these engines are sometimes called "hot plug" or "hot tube" engines.

Some modern semi-Diesel oil engines are started and kept running with the aid of **electric glow-plugs** which are screwed into the cylinder like spark plugs. These plugs have a heating element consisting of a spiral of heavy resistance wire, which is heated red-hot or white-hot by the application of low voltage D.C. or A.C. current from a battery or transformer.

The spark ignition type of oil engine uses an injection pump and nozzle to introduce the fuel into the cylinders, and also uses a magneto and set of spark plugs to ignite the fuel, both during starting and running. The compression ratio of this type of

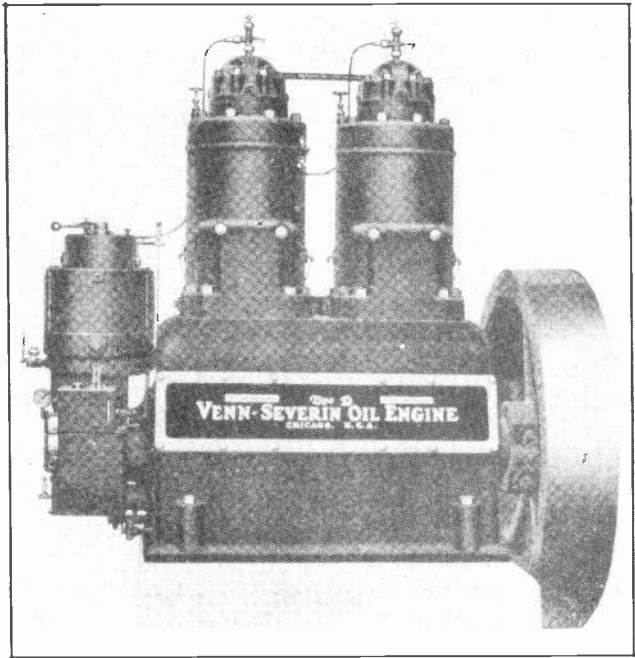

Fig. 6. Heavy duty two cylinder semi-Diesel engine for stationary power purposes. (Courtesy of the Ven-Severin Engine Company.)

engine is about 7 to 1, and the compression pressure about 150 lbs. per sq. inch. This lower pres-

Diesel Electric Power

sure does not raise the air temperature high enough to ignite the fuel oil without the aid of ignition sparks.

Due to the lower compression, this type of engine can be cranked by hand. The Waukesha-Hesselman engine is an example of this type of spark ignition oil engine. Many of these engines are in use in trucks and busses.

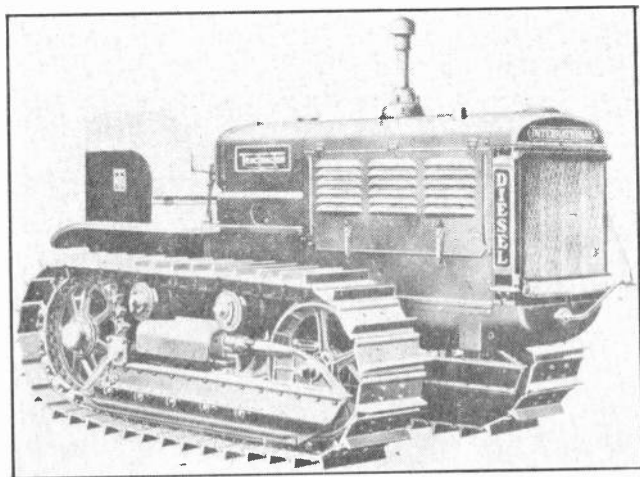

Fig. 7. Thousands of Diesel powered tractors are built each year for operating farm machinery, road building, construction and lumbering equipment. (Courtesy International Harvester Company.)

3. FOUR STROKE CYCLE, FULL DIESEL ENGINE

The four stroke cycle or "four cycle" Diesel engine, like the four cycle gasoline engine, requires four strokes to complete each cycle that produces one power stroke. The strokes follow each other in the same order that they do in the carburetor type engine, namely—intake, compression, power and exhaust strokes.

During the intake stroke the piston moves downward, with the intake valve open, drawing air only into the cylinder. See "A" in Figure 10. No fuel enters the cylinder of a Diesel engine during the intake stroke. During the compression stroke the intake and exhaust valves are closed and the air in the

Engines

cylinder is compressed, raising its temperature high enough in the case of the full Diesel engine to ignite the fuel oil. See Figure 10-B. At the end of this stroke, when the hot air is compressed above the piston head, the fuel pump plunger forces a measured (or metered) quantity of liquid fuel oil under high pressure into the cylinder through the injection nozzle, which breaks the oil up into a fine spray, so that it ignites immediately upon contact with the hot air. See Figure 10-C.

Some Diesel engines are equipped with pre-combustion chambers into which the fuel is injected,

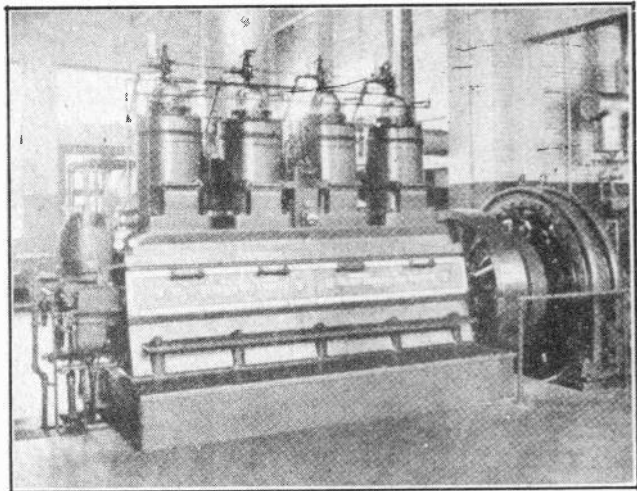

Fig. 8. Four cylinder 300 h.p. engine driving a 200 kw. D.C. generator for electric power supply in a foundry and machine shop. (Courtesy of the Ven-Severin Engine Company.)

instead of directly into the cylinder. The turbulence of the hot air which rushes into this chamber during compression, and also the turbulence set up in the cylinder by the rush of partly burned fuel out of the combustion chamber, promotes better combustion. It also permits the use of larger openings in the injector nozzle, and these are less likely to become clogged. The engine illustrated in Figure 10 uses a pre-combustion chamber. Also see Figures 17 and 20, which show pre-combustion chambers.

Diesel Electric Power

During the power stroke the intake and exhaust valves are still closed and the piston is being forced downward by the pressure of the hot expanding gases produced by the burning of the fuel oil. See Figure 10-D.

A little before the piston reaches lower dead center (L.D.C.) on the power stroke the exhaust valve opens and allows the burned gases to start

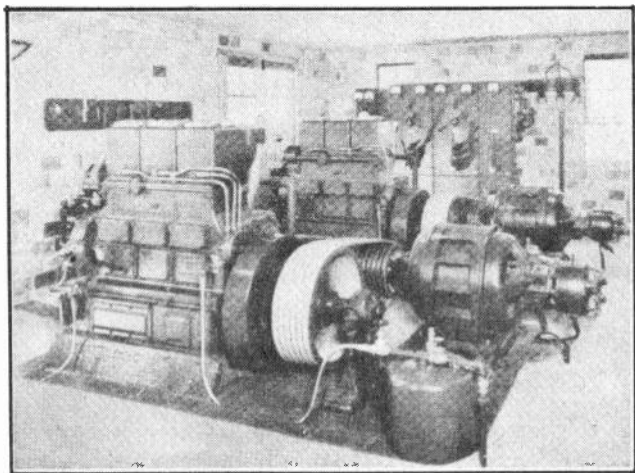

Fig. 9. Two Diesel-Electric generating units in a small town municipal power plant. Note the neat compact arrangement of this plant. (Courtesy of the Cummins Engine Company.)

flowing out of the cylinder into the exhaust line.

During the exhaust stroke the piston travels upward, forcing the exhaust gases out of the cylinder, thus completing the four stroke cycle and putting the cylinder back in condition for the beginning of another intake stroke. See Figure 16-E.

Like the 4 cycle carburetor engine, the 1 cylinder, 4 cycle Diesel engine requires 2 revolutions of the crank shaft to produce one power stroke. If the engine has more than one cylinder, all cylinders will be fired in two revolutions of the crank shaft.

4. TWO STROKE CYCLE DIESEL ENGINES

Many of the larger Diesel engines used for marine and stationary power units are of the two stroke

Engines

cycle type. One of the advantages of the two cycle engine is that it produces one power stroke for every two strokes of the piston, or for every revolution of the crankshaft, while the four cycle engine only produces one power stroke in four strokes or two revolutions of the crank shaft; thus the two stroke cycle engine will produce twice as many

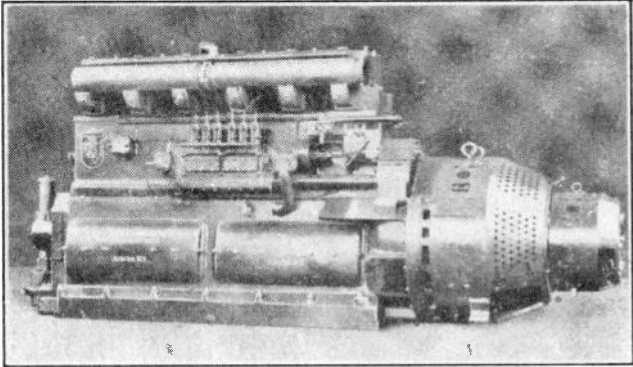

Fig. 10. This photo shows a 600 h.p. Diesel-Electric unit for railway locomotive service. Note the direct coupled main generator and auxiliary generator. (Courtesy of the McIntosh & Seymour Company.)

power strokes and somewhat greater horsepower for a given speed and weight of engine.

Another feature of the two stroke cycle engine is that it does not use the conventional intake and exhaust valves. Instead, a system of ports or openings in the cylinder walls take the place of ordinary valves. These ports are opened and closed at the proper time by the movement of the piston as it slides over them. See Figure 17. This feature eliminates the necessity of periodically grinding and repairing valves.

Most two stroke cycle engines depend on crank case compression, or the air pumping action of the piston, to remove the exhaust gases and charge the cylinder with the air needed for combustion of the fuel oil. For this reason the crank cases of these engines must be practically air-tight. In multiple cylinder engines of this type the crank case is divided by metal partitions, into separate air-tight

Diesel Electric Power

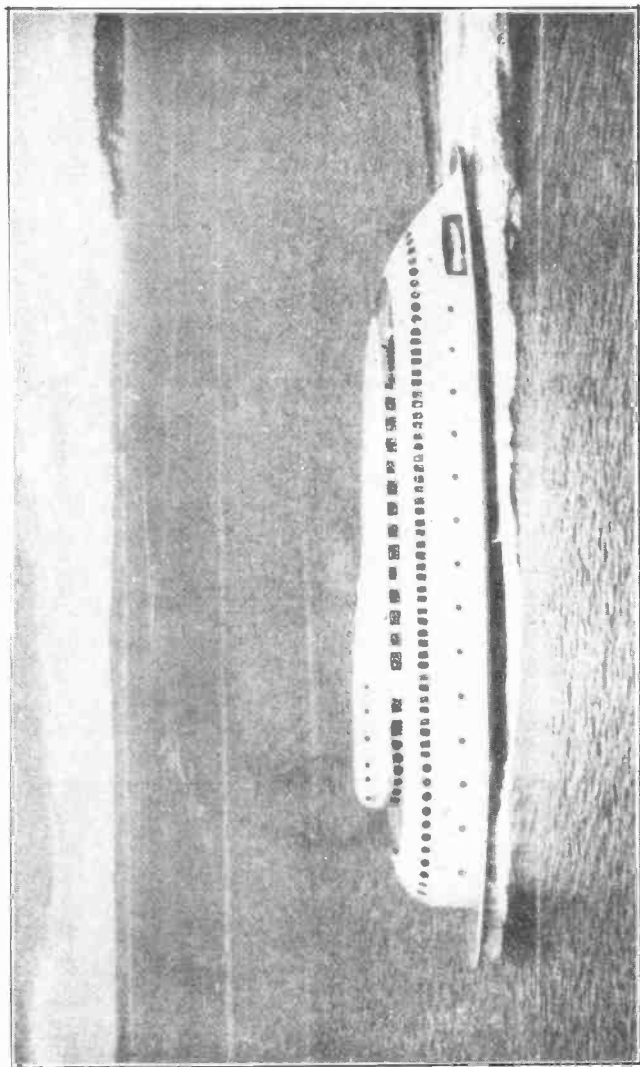

Fig. 11. A Modern Diesel powered, streamline ferry boat.

Engines

compartments for each cylinder. Special seals are sometimes used to prevent excessive air leakage



Fig. 12. This view shows a modern motor bus equipped with a Diesel-Electric drive unit such as shown in Fig. 12A. (Courtesy of the Hercules Engine Company.)

where the crankshaft passes through these partitions.

In this manner, the up and down movement of the piston, and the slight vacuum and air pressure which it alternately produces in the crank case, can

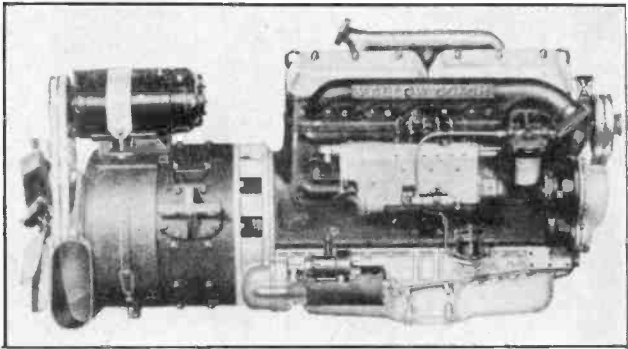

Fig. 13. Diesel engine and generator for use in the bus shown in Fig. 12.

be used to draw in outside air and force it through proper ports to the cylinders. Carefully observe this action as shown by the arrows in Figure 15-B and C.

When the air is blown through the cylinder to

Diesel Electric Power

remove the exhaust gases, it is called "scavenging." The remaining clean air which is to be compressed and used for fuel combustion is called "charging" air.

5. TWO STROKE CYCLE PRINCIPLES. THREE PORT TYPE OF ENGINE

The three port type of engine illustrated in Figure 15 requires no mechanical valves whatever, as the scavenging and charging air is taken in through the crank case and forced through the cylinders entirely by means of the ports which are opened and closed by the pistons. During most of the upward travel of the piston on the compression stroke the

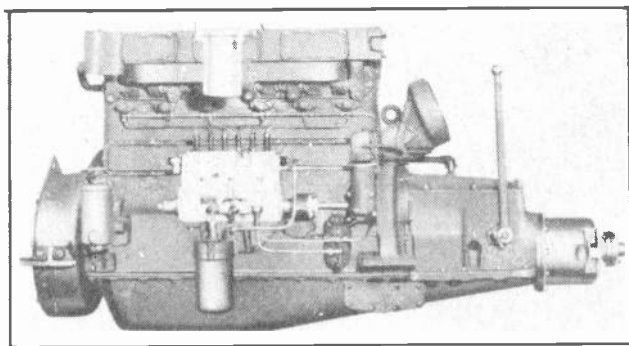

Fig. 13. Photograph of a modern marine type Diesel-engine such as used in pleasure craft and small service boats. Note the oil filter, fuel pump, and fuel lines running to the injector nozzles. (Courtesy of the Buda Engine Company.)

ports I, S and X are closed and a partial vacuum is created in the crank case. See Figure 17-A. When the piston approaches top dead center as at B in Figure 17, the port I is uncovered, allowing air to be drawn into the crankcase with a rush. This port I starts to open when the piston reaches about 30 degrees from top dead center.

When the piston reaches top dead center, as shown at B, the fuel oil is injected and ignites, starting the power stroke. As soon as the piston moves downward a short distance, port I is closed and both I and S remain closed during most of the power stroke. See Figure 17-C. The downward

Engines

motion of the piston during this stroke compresses the air in the crank case to about 5 to 7 lbs. pressure.

About 50 to 60 degrees before the piston reaches lower dead center the exhaust port X starts to open or become uncovered as at D, Figure 17. This permits the exhaust gases to start to escape under their own pressure and allows the pressure in the cylinder to drop rapidly. About 10 degrees after the exhaust port is uncovered, the by-pass port S is

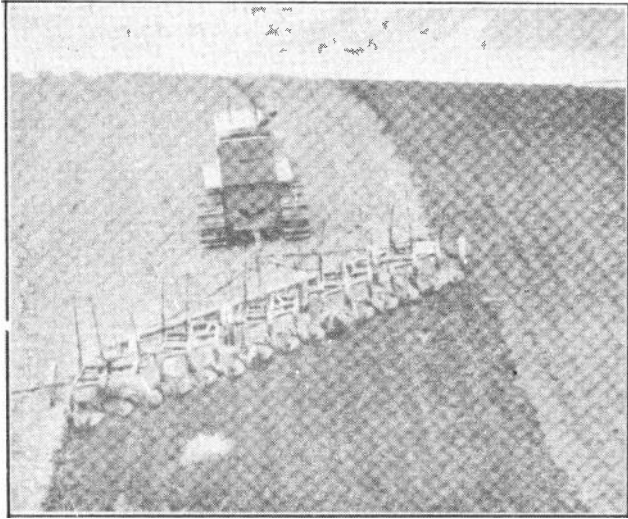

Fig: 14. This photo illustrates the enormous pulling power of a tractor equipped with a Diesel-engine. (Courtesy of the International Harvester Company.)

uncovered as at E, allowing the air under pressure in the crank case to rush into the cylinder and force out the remaining exhaust gases. The shape of the piston head causes this air to be deflected upward into the cylinder as shown by the arrows in Figure 17-E, in order to more thoroughly scavenge or clean the cylinder of exhaust gases.

As the piston moves upward on the next compression stroke, the by-pass port S is covered first, then the exhaust port X is covered, and the new supply of clean air is again compressed to ignite and burn the next fuel charge. Thus, one power

Diesel Electric Power

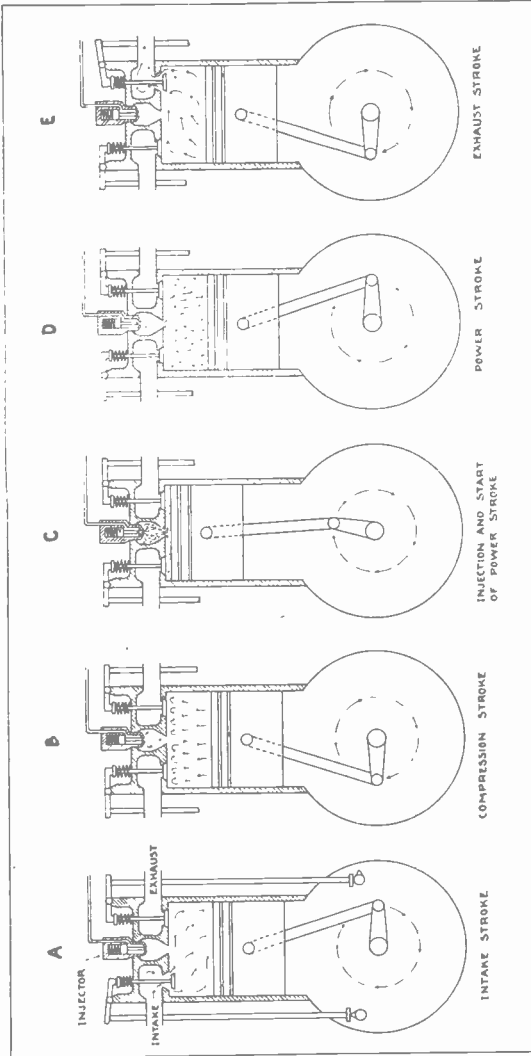

Fig. 16. The above sketches illustrate the operation of a four stroke cycle Diesel engine. Examine each of these views carefully while studying the explanation on the accompanying pages.

Engines

stroke is produced in each revolution of the crank shaft. See the cycle chart shown in Figure 18, and note the points at which the various ports open and close, and also the length in degrees of each stroke or operation.

6. TWO PORT TYPE OF ENGINE

This type of engine has only two ports, the bypass and exhaust ports, in the cylinder. The air intake is through a spring loaded valve in the side of the crank case. See Figure 19. This intake valve is not mechanically operated by any cams or connections to moving parts of the engine. Instead it is held closed by a light spring until the vacuum in the crank case allows the external atmospheric pressure to open the valve. This takes place almost as soon as the piston starts upward to compress the air in the cylinder.

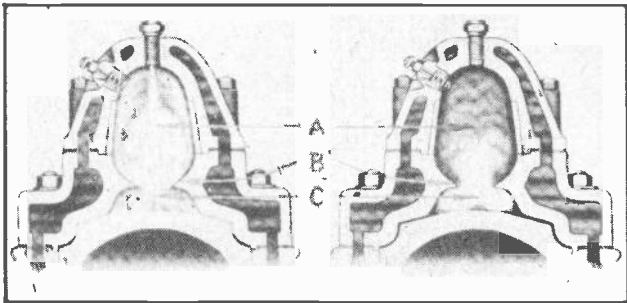

Fig. 17. On the left, the fuel charge is shown being sprayed at high pressure through the injector nozzle into the heated air of the combustion chamber. On the right the burning oil and gases are expanding into the cylinder and exerting pressure on the piston head. (Courtesy of the Ven-Severin Company.)

This valve is open during a longer period of the stroke, than is the cylinder port type valve, and therefore permits better charging of the crank case and improves the operating efficiency of the engine due to the greater charge of air supplied to the cylinder for combustion. This system is the one most commonly used on large Diesel engines' using crank case compression. With the exception of this feature the two port engine operates the same as the three port type. See the photo in Figure 20 which shows

Diesel Electric Power

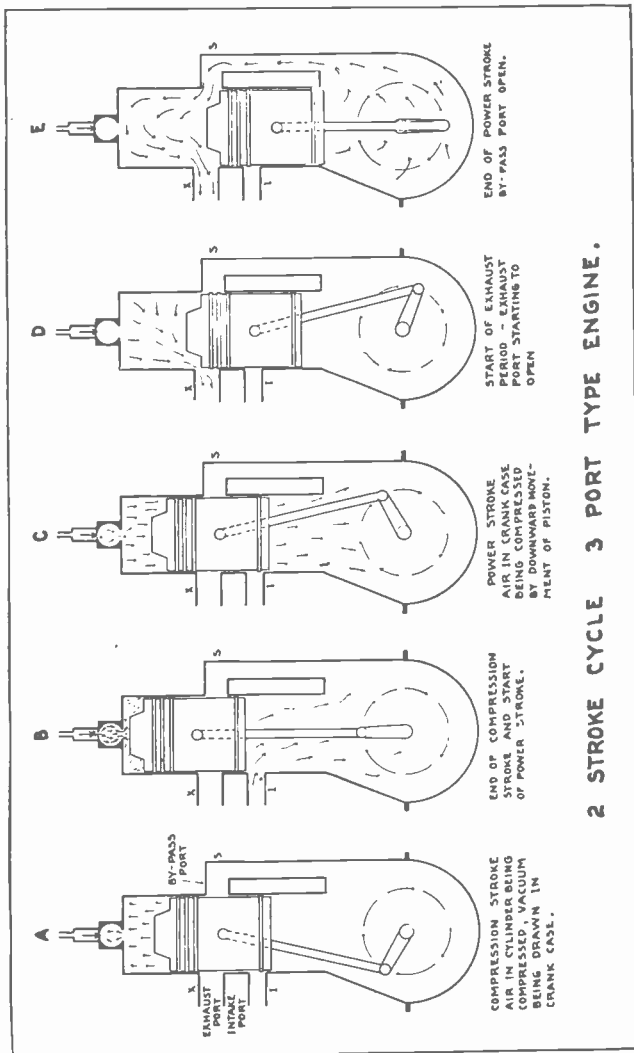

Fig. 15. Diagrams illustrating the operation of a two stroke cycle Diesel-engine. Note carefully the operation of the cylinder ports and the admission of air and fuel.

Engines

a sectional view of this type of engine. Examine it carefully and note the air travel as shown by the arrows.

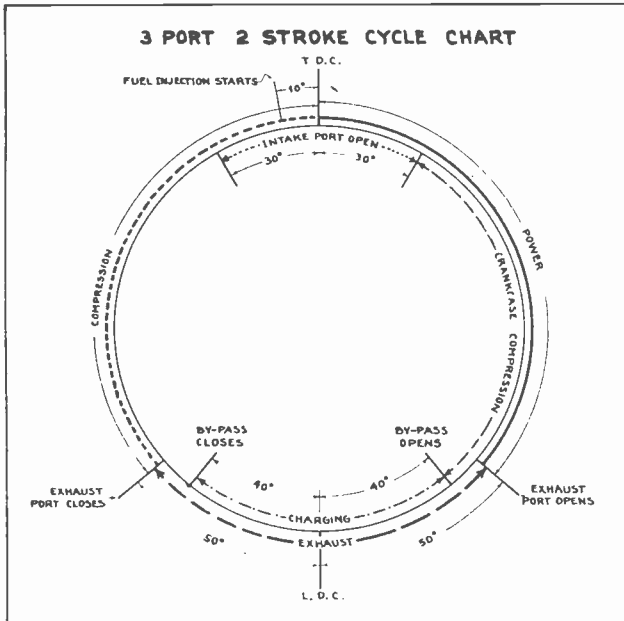

Fig. 18. The above cycle chart shows the order and length of the strokes and also the periods of port openings for a two cycle engine.

7. BLOWER OR COMPRESSOR CHARGING

The efficiency of the two stroke cycle engine depends partly upon the thoroughness with which the exhaust gases are removed and the amount of fresh air with which the cylinders are supplied for combustion of the fuel charge. The amount of air drawn into the crank case is proportional to the volume of space swept by the piston as it moves upward during the compression stroke.

The amount of air actually retained in the cylinder for compression is less than the amount of air forced into it from the crank case, as some air is lost through the exhaust port which does not completely close until the piston has traveled up part way on the compression stroke. Generally

Diesel Electric Power

only about 65 per cent of the air charge is retained in the cylinder for compression. Since a certain amount of air and oxygen is required to burn a given amount of fuel charge, this air loss reduces the efficiency of the crankcase compression type of engine.

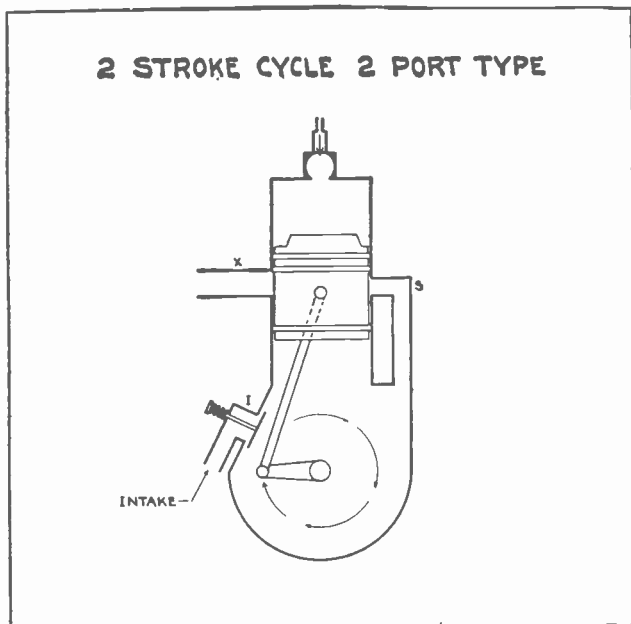

Fig. 19. This diagram illustrates construction of a two cycle, two port type engine which uses a valve "I" to admit air to the crank case during the upward stroke of the piston.

In order to overcome this loss some of the larger Diesel engines obtain their scavenging and charging air from a low pressure, high volume blower or compressor, instead of getting it from crank case compression. See Figure 21. Instead of the limited quantities of air at 5 to 7 lbs. pressure from the crank case, these blowers supply larger quantities of air at 10 to 25 lbs. pressure. This provides more complete removal of exhaust gases and more complete charging of the cylinders with fresh air, thereby improving the efficiency of this type of engine.

Engines

Air compressors for scavenging and charging Diesel engine cylinders are frequently built as a part of the engine and operated by the same crank shaft. See Figure 21-A. Some blowers are driven

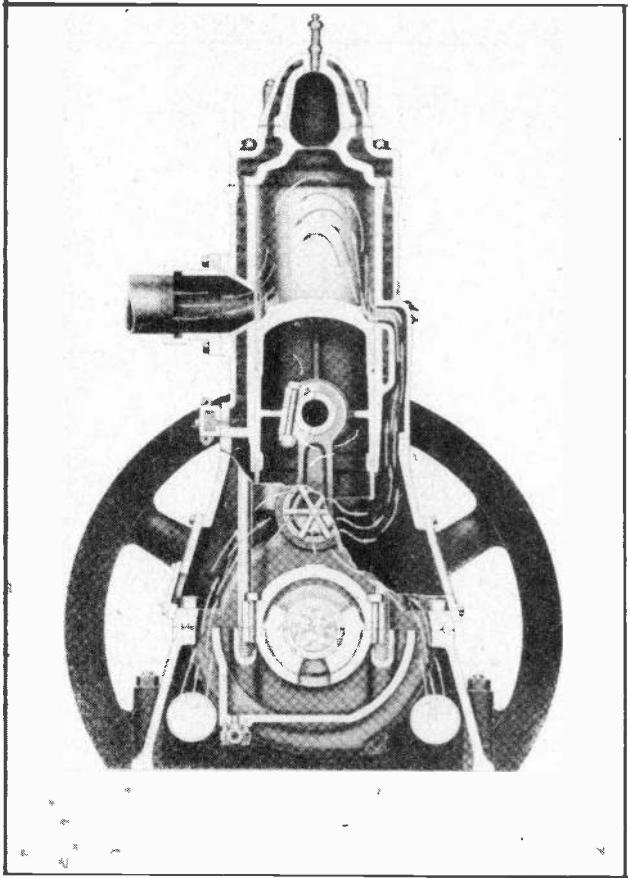

Fig. 20. Sectional view of a two stroke, two port Diesel engine clearly showing the path of the air and exhaust gases. (Courtesy of the Ven-Severin Company.)

by a separate small engine or by an electric motor.

The capacity of these blowers is usually about 1.6 times the air displacement volume of the engine, and thus one blower can serve all cylinders.

Diesel Electric Power

8. SEMI-DIESEL OR OIL ENGINES

Semi-Diesel engines are always of the two cycle, two or three port type. These engines are very similar to the full Diesel engines except that they operate at lower compression pressures and must

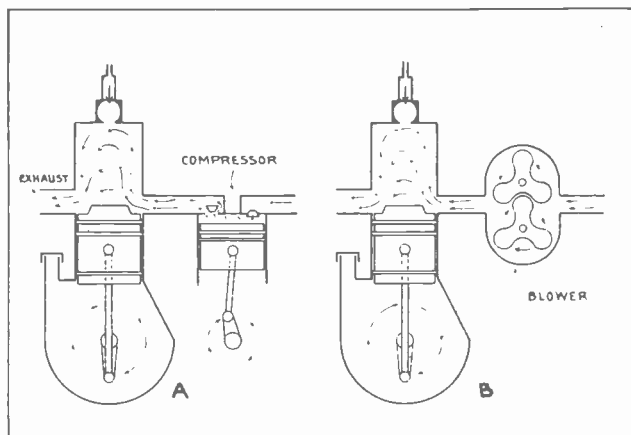

Fig. 21. The above sketches illustrate the operation of air compressors and blowers for charging and scavenging Diesel-engines.

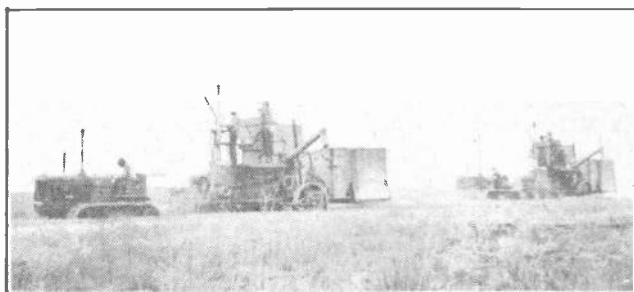

Fig. 22. Diesel-tractors are extensively used for operating harvesting combine machines. (Courtesy of the International Harvester Company.)

therefore be supplied with auxiliary heat to start the engine and keep it running until it is heated up enough to automatically ignite the fuel when it is injected into the cylinder.

One method of accomplishing this is to build the engine with a portion of the cylinder which is not water-jacketed. This part of the cylinder can then

Engines

be heated with a gasoline or kerosene blow torch until the metal reaches a dull cherry red heat. The same effect can be accomplished by use of a hot



Fig. 23. This photo shows a Diesel-tractor used for dragging out logs in the lumber woods. (Courtesy of the International Harvester Company.)

plug or tube projecting into the cylinder or combustion chamber. The injection nozzle is so placed that it will spray the fuel against this hot portion of the cylinder head, or the hot plug, to quickly vaporize and ignite the fuel. This is sometimes called "surface ignition." The torch must be kept in use until the engine has been thoroughly warmed up.

Modern semi-Diesel engines use electric glow plugs as previously explained. These glow plugs are located, so that part of the injected fuel oil spray sweeps across the red-hot wires of the plug, thus instantly vaporizing this portion of the fuel.

Semi-Diesel engines are not as efficient as full Diesel engines and will not idle or run without load as smoothly as full Diesel engines. Semi-Diesel engines are sensitive to temperature changes, and will operate better if the cooling water outlet temperature is maintained above 180 degrees F. If the temperature is allowed to drop below this point

Diesel Electric Power

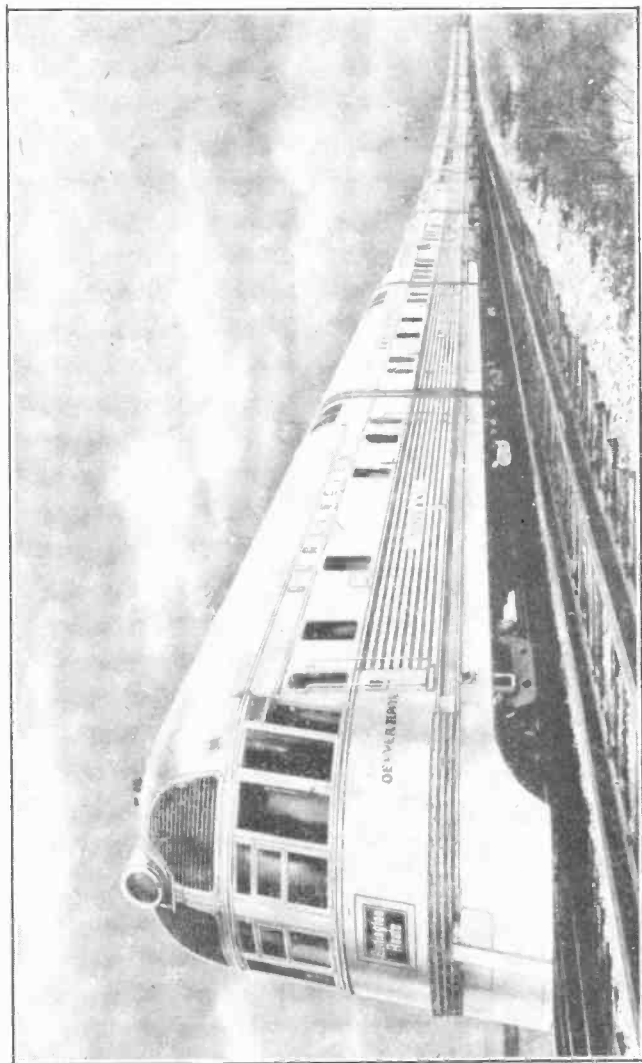

Fig. 24. Powerful Diesel-Electric generating units are becoming extensively used for the operation of modern high-speed trains such as shown in the above photo. (Courtesy of the Burlington Railroad.)

Engines

the engine will stop unless the torches or glow plugs are again turned on.

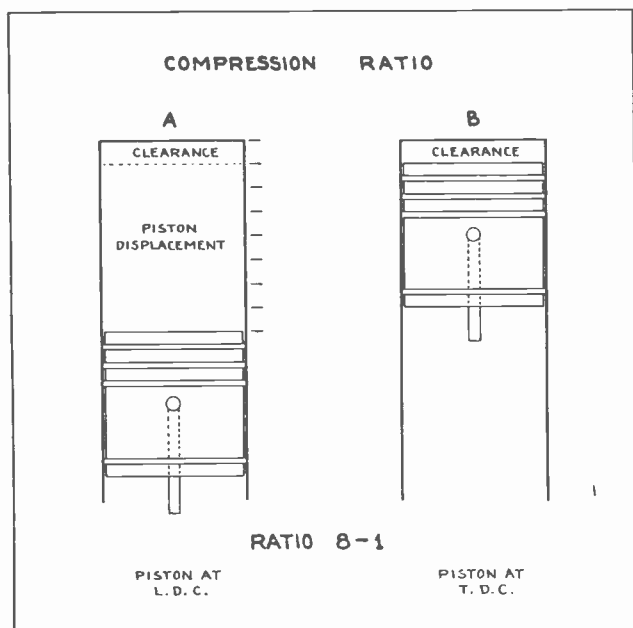

Fig. 25. This diagram illustrates what is meant by the term "compression ratio." Note how the air in the cylinder at "A" is compressed at "B" to $\frac{1}{8}$ of its original volume.

9. SPARK IGNITION OIL INJECTION ENGINES

This type of engine is always of the four stroke cycle type, and uses valves similar to those in the regular gasoline automobile engine. They use a fuel pump and injection nozzle instead of a carburetor, and inject the fuel into the cylinder 50 to 60 degrees ahead of top dead center. Spark plugs and a magneto are used to ignite the fuel spray, as the compression of this type of engine is too low to provide sufficient heat for ignition.

To start these engines they are often primed with a small quantity of gasoline from a priming pump.

Diesel Electric Power

10. COMPRESSION RATIO

Since the final pressure at the end of the compression stroke in any internal combustion engine depends largely upon what is known as compression ratio, you should have a good understanding of this factor in connection with Diesel engines. Many persons have an incorrect conception of the meaning of the term "Compression ratio."

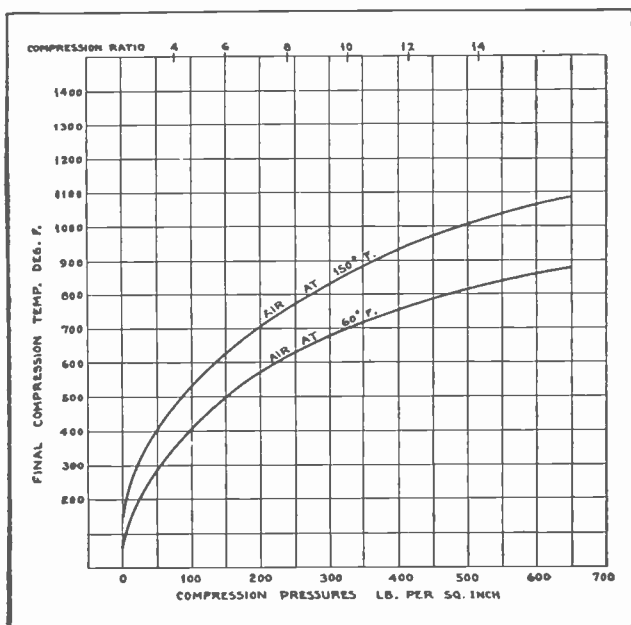

Fig. 28. The above chart shows the relation between compression ratios, air pressures, and temperatures of Diesel-engines.

Compression ratio is not the ratio of piston displacement to the clearance left in the top of the cylinder when the piston is at top dead center. Instead it is the ratio of piston displacement plus clearance, or maximum cylinder volume, to the final clearance.

When the volume of air is reduced by being compressed, both the pressure and the temperature changes depend upon the ratio of the volume of air at the start of the compression stroke to the volume at the end of the compression stroke. At the start

Engines

of the compression stroke air fills the entire cylinder including the clearance, as shown in Figure 25-A. At the end of the stroke the air has been all compressed into the clearance above the piston, as shown at B in Figure 25.

The smaller the clearance at the end of the compression stroke, the higher the final pressures will be. Since compressing air will increase its temperature, the more the air is compressed, the higher the temperature will be.

Adiabatic compression is compression without the loss of any heat to the engine parts. The actual compression in any internal combustion engine is only approximately adiabatic, because some of the heat is absorbed by the cylinder walls, pistons, cylinder head, etc. For this reason a high cranking speed is highly important in starting a Diesel engine, because high piston speeds reduce the time that the air is in contact with the engine parts, thereby reducing heat losses. As soon as the engine is started with normal piston speeds of 600 to 1200 feet per minute, compression is so rapid that very little heat is lost to the engine parts.

The final temperature at the end of the compression stroke depends not only on compression ratio and heat losses, but also on the temperature of the air before it was drawn into the cylinder. Figure 26 shows the relation between compression ratios, pressures, and temperatures, for intake air at 60 degrees F., and also at 150 degrees F.

11. FIRING ORDERS

Firing orders used by Diesel engines depend upon the number of cylinders and whether the engine is a 4 stroke or 2 stroke cycle type.

The following firing orders are used by 4 stroke cycle Diesel engines:

3 cylinders	1-3-2
4	" 1-2-4-3- or 1-3-4-2
5	" 1-3-5-4-2
6	" 1-4-2-6-3-5 or 1-5-3-6-2-4
8	" 1-5-2-6-8-4-7-3

Diesel Electric Power

Two stroke cycle firing orders are as follows:

3 cylinders	1-2-3
4	“ 1-3-4-2 or 1-4-2-3
5	“ 1-4-3-2-5
6	“ 1-4-5-2-3-6 or 1-6-2-4-3-5
8	“ 1-6-4-7-2-5-3-8 or 1-8-6-4-2-7-5-3
10	“ 1-10-5-7-2-8-3-9-4-6
10	“ 1-6-4-9-3-8-2-7-5-10

EXAMINATION QUESTIONS

1. A. Name three advantages that the Diesel engine has over gasoline engines.

B. Name three disadvantages.

2. What method is used in igniting the fuel charge in a Diesel engine?

3. Briefly describe the difference between the Full-Diesel and the Semi-Diesel engine.

4. Of what does the electric glow plug consist, and how is it used in connection with some types of Semi-Diesel engines?

5. How many revolutions of the crank shaft are necessary for each power stroke in the 4 cycle Diesel engine?

6. What is one advantage the two stroke cycle engine has over the 4 cycle engine?

7. What is the compression ratio on a full Diesel engine?

8. Why is it necessary to supply auxiliary heat from a torch when starting some Semi-Diesel engines?

9. What is the advantage of using blower or compressor charging on large two cycle Diesel engines?

10. Referring to Fig. 26, what would be the final compression temperature at 500 lbs. pressure, with charging air at 150° F.

FUEL INJECTION SYSTEMS

One of the principal differences between Diesel engines and the carburetor type gasoline engine, is found in the fuel system. Diesel fuel oil does not evaporate or vaporize as readily as gasoline, so its vaporization for rapid combustion is accomplished by injecting the fuel into the cylinders under high pressure and at high velocity, through properly designed spray nozzles.

This requires the use of a high pressure fuel injection pump which forces the proper amount of fuel to each cylinder at the proper time for the beginning of each power stroke. By referring to Fig. 1, we see that the Diesel engine fuel system consists of the oil supply tank, supply line, transfer pump, filter, high pressure injection pump, high pressure fuel lines and the injector nozzles.

Sometimes the fuel oil flows from the supply tank to the injection pump by gravity, while in other cases a small gear type transfer pump such as shown in Fig. 1 is used to create a more positive flow of oil to the injection pump. The purpose of the filter is to remove from the oil, any dirt which might otherwise clog the small openings in the injector nozzles, or score the cylinder walls and piston. Note carefully the path of the fuel oil as shown in both views in Fig. 1.

1. METHOD OF FUEL INJECTION

The fuel cycle and system just described is known as the **solid injection system**, meaning that the fuel oil is injected into the cylinders in liquid form, without any previous mixing with air. A more correct term might be liquid injection. This system is used on practically all modern Diesel engines, and is standard for all high speed Diesels. The fuel oil is delivered to the injector nozzles under pressures ranging from 1,500 to 2,000 lbs. per square inch, and leaves the nozzle tips at velocities of about 300 feet per second. This high velocity discharge breaks the oil up into a **very fine spray** so that it mixes readily with the hot air inside the cylinders, and easily ignites.

The original Diesel engines used an **air injection system** to introduce the fuel oil into the cylinders,

Fuel Injection Systems

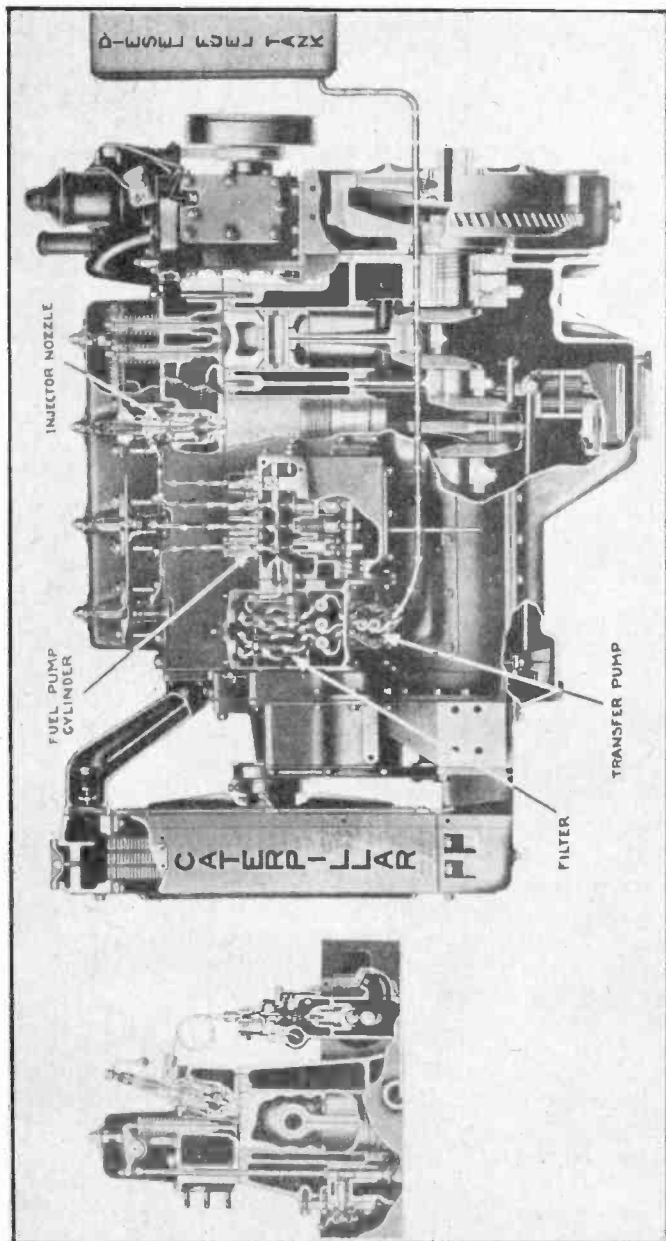

Fig. 1. This illustration shows a sectional view of a Diesel engine including the important parts of the fuel system. Note the fuel tank, fuel line, transfer pump, filter, fuel injection pump, and injector nozzles, and trace the path of the fuel oil through the system. Courtesy Caterpillar Tractor Company.

Diesel Electric Power

and this method was used for many years on large heavy duty Diesel engines. This system uses a blast of air at about 900 lbs. pressure, to force the oil into the cylinder through a mechanically operated nozzle.

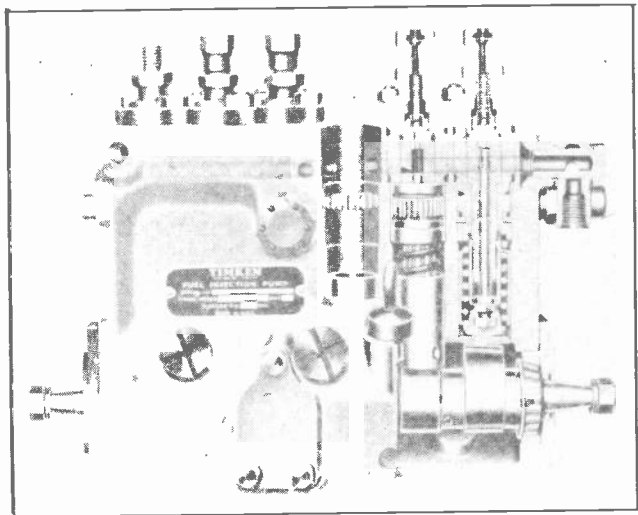

Fig. 2. This sectional view of a modern fuel pump for a 6 cylinder Diesel engine clearly shows the pump plungers, cylinders, check valves and camshaft of this high pressure fuel injection pump. Courtesy Timkin Roller Bearing Co.

The disadvantage of this system lies in the rather complicated injection system, the need of a high pressure air compressor, and the possibility of air leaks. Although the air injection system gives very good results with fuels having a high carbon content, it has been practically abandoned in favor of the less complicated solid injection system.

2. FUEL PUMPS

On Diesel engines using the solid injection system the fuel or injection pump is a highly important unit, and the correct operation of the engine depends very largely upon the condition and adjustment of this pump.

The fuel injection pump for a single cylinder engine consists of a small plunger which is closely fitted in a pump cylinder, and operated by a cam

Fuel Injection Systems

on a cam shaft. On multiple cylinder engines, the fuel pump unit consists of a number of separate pumps, one for each engine cylinder, all mounted or cut into one pump block. See Figures 1 to 6, and note carefully the construction of the fuel pumps shown.

Note the pump plungers and cylinders and the cams which operate the plungers causing them to make their stroke and deliver fuel oil to the in-

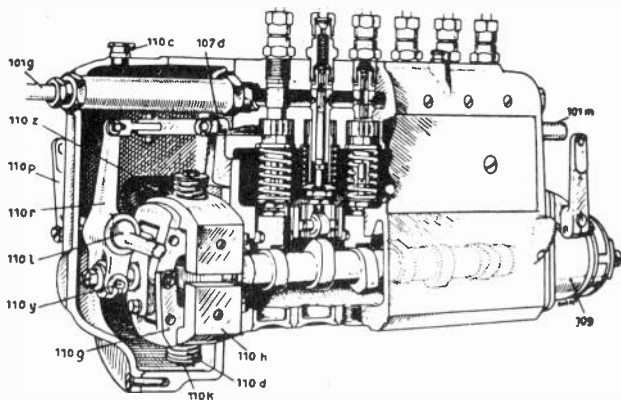

Bosch Fuel Injection Pump model PE 6 B, with governor

101g = Fuel Inlet Connection	110d = Spring	110p = Control Lever
101m = Control Rod Stop	110g = Bell Crank Levers	110r = Floating Lever
107d = Control Rod	110h = Fly Weights	110y = Coupling Pin
109 = Advance Device	110k = Adjusting Nut	110z = Access Plug
110c = Oil Cup	110l = Eccentric	

Fig. 3. This sectional view of a Bosch fuel injection pump for a six cylinder engine shows the cam shaft, cam rollers, pump cylinder, plungers, springs, check valves, and governor. Also note the descriptive references in the figure. Courtesy United American Bosch Corp.

jector nozzles in each cylinder at the proper time. Also note the by-pass ports or valves which meter or regulate the amount of fuel charge delivered on each stroke, and note the check valves in the fuel lines.

Diesel fuel injection pumps must be capable of building up very high pressures, since the breaking up of the fuel is accomplished by means of high fuel velocities. While the pressure on the fuel as a rule does not exceed 2,000 lbs. modern pumps are capable of building up to 10,000 lbs. pressure. These pumps are all of the plunger type, and the parts are so accurately fitted that the plungers re-

Diesel Electric Power

quire no packing, the clearance being only .00003 of an inch.

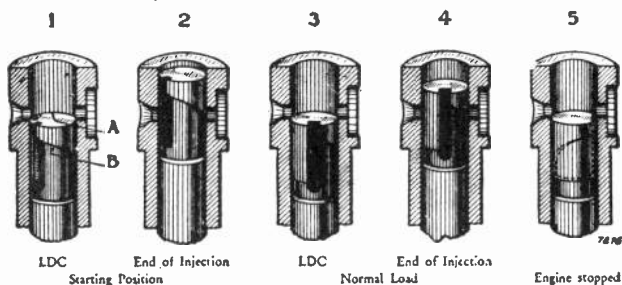

Fig. 4. The above sectional views of Bosch fuel pump cylinders and plungers show the plungers in five different positions of the stroke, and rotated at different angles to illustrate the variable discharge feature of this type of pump. Courtesy United American Bosch Corp.

Besides being capable of building up very high pressures, these pumps must measure or meter out the fuel for each power stroke in order to control the speed and power output of the engine, because under a light load the engine will require only a small quantity of fuel, but if the load is increased the amount of fuel will also have to be increased.

Fuel pumps are divided into two types, as to the method used to regulate the amount of fuel delivered. The most popular type is known as a **constant stroke pump**. This means that the length of the pump stroke will be the same regardless of the load on the engine. The second type is known as the **variable stroke pump**, the stroke being varied as the load on the engine varies.

3. CONSTANT STROKE, PORT METHOD OF REGULATION

This system is used by all Bosch injection pumps, which are very popular, for high speed Diesels. It is also used in the Timken, Caterpillar, and other pumps.

This method of regulation requires a specially designed pump plunger. Inspection of Fig. 4 shows that the plunger has a helical cut located just below its top. This helical cut we can see is connected to the plunger top by a narrow passage. Referring to illustration No. 1 in Fig. 4 we see the plunger at its lowest position. Level with the top of the

Fuel Injection Systems

plunger are the two intake ports through which the fuel is supplied to the injection pump. With the plunger in this position, the space above the plunger and the helical cut around the plunger would be filled with fuel oil, the oil being brought to the injection pump either by gravity or a small transfer pump.

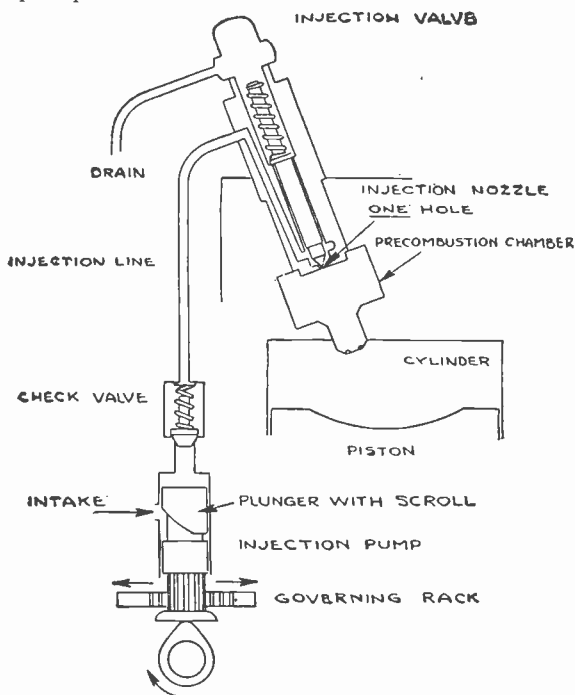

Fig. 5. This sketch shows a single cylinder Bosch constant stroke, variable discharge fuel pump, with check valve, injection nozzle, pre-combustion chamber, and drain line. Refer to this figure often while reading the accompanying explanation. Courtesy United American Bosch Corp.

As the cam forces the plunger upward, the two intake ports will be covered and closed and the fuel oil above the plunger will be forced through the fuel line to the nozzle and injection starts. Injection continues until the upward movement of the plunger causes the upper edge "B" of the helical cut to uncover one of the intake ports. This allows the remaining fuel in the pump barrel to escape and flow back to the intake side of the pump,

Diesel Electric Power

and injection stops. From this we can see that the length of the injection period determines the amount of fuel that will be injected into the cylinder, and also that the length of the injection period depends on the length of time that the intake port is covered by the pump plunger at any given speed.

When the engine is heavily loaded the injection period will have to be of maximum length to provide the proper amount of fuel to carry the load, and the intake port will have to be kept covered for the maximum length of time. When the load is reduced the amount of fuel must also be reduced.

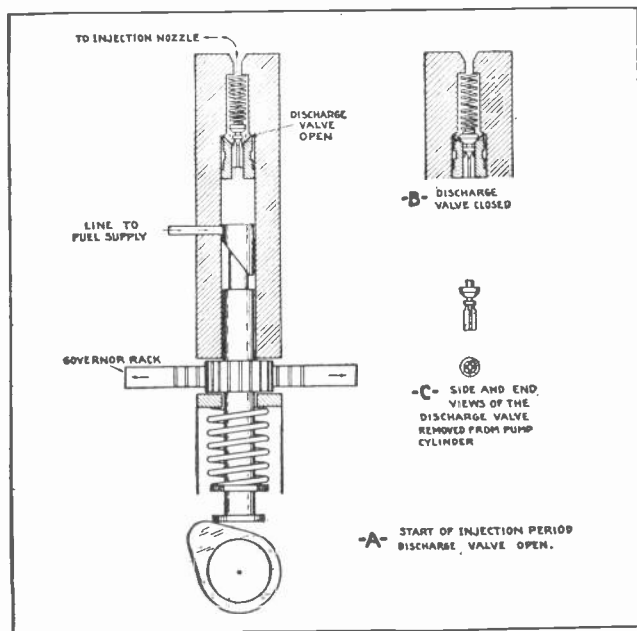

Fig. 6. Sectional view of one cylinder element of a Bosch fuel pump, showing cam, plunger, return spring, governor rack, cylinder and discharge valve.

This is accomplished by shortening the injection period by slightly rotating the entire pump plunger and shifting the helical cut around so that the intake port is uncovered earlier as the plunger moves upward. See illustration "4" in Fig. 4. Comparing the position of the pump plunger in illustration "4" with illustration "2," you will notice that in

Fuel Injection Systems

4 the plunger has traveled only one-half the distance that it has in 2 when the intake port was uncovered and injection ended. To stop the engine the plunger is rotated so that the vertical passage between the plunger top and the helical groove is in line with the intake port. In this position as the plunger moves up the fuel oil in the pump barrel by-passes back to the intake side of the fuel system. This stops the delivery of any fuel to the injector nozzles and thereby stops the engine.

The pump plungers are rotated by means of a gear segment on each plunger. This segment engages a toothed rack which in turn is connected to a governor or throttle. See Figs. 5 and 6.

4. FUNCTION OF THE DISCHARGE VALVE

The discharge valve or check valve shown in Figs. 5 and 6 serves two purposes. It acts as a non-return valve to prevent the backward flow of fuel when the helical groove uncovers the port at the end of the injection period; and it also reduces the pressure in the fuel line between the injection pump and the injection nozzle. This is highly important, because reducing the pressure in the fuel line allows the valve in the injection nozzle to close with a quick, snappy action and prevent dribble of oil into the cylinder after the fuel injection is ended.

The discharge valve is an ordinary mitre faced valve with a guide that is divided into 2 sections. The upper part of the guide is a small piston that accurately fits the passage below the discharge valve seat. The lower part of the guide has four grooves that extend up the piston-like part of the guide. See Fig. 6.

As soon as the pump plunger moves upward and covers the intake port, fuel pressure rises and the discharge valve is pushed up until the piston-like part of the guide is above the discharge valve seat as shown in Fig. 6-A, and fuel is forced under high pressure to the injection nozzle.

When the port is uncovered at the end of the

Diesel Electric Power

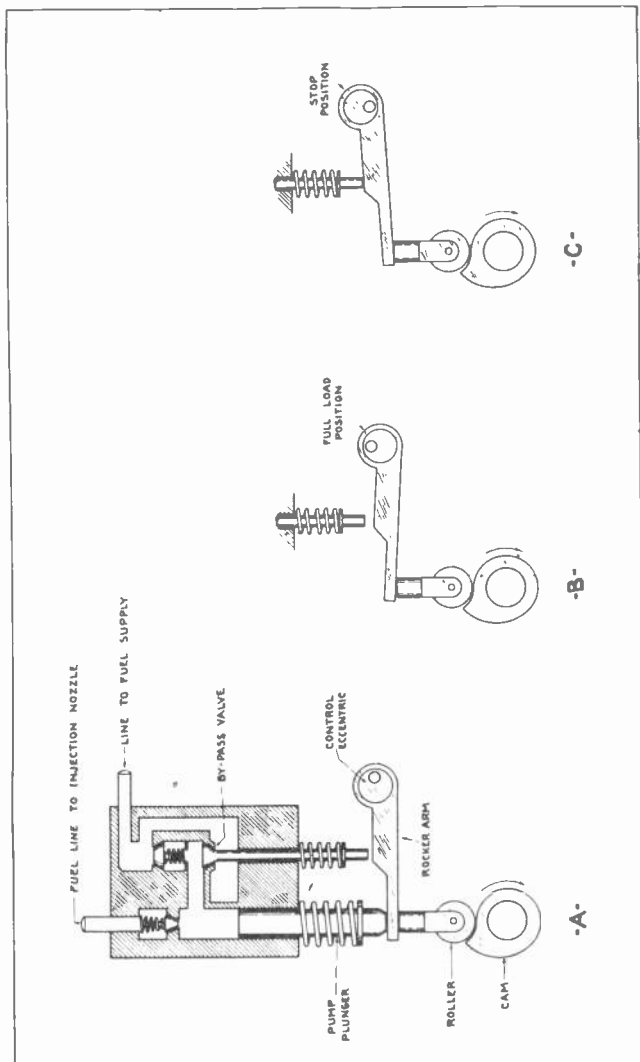

Fig. 7. The above figures illustrate the operation of a diesel fuel injection pump using the by-pass valve method of fuel control. Note how the time of opening of the by-pass valve, and the amount of fuel charge is governed by the position of the eccentric.

Fuel Injection Systems

injection period, the pressure in the pump barrel drops, allowing the discharge valve to drop back on to its seat under the action of its spring. As the discharge valve with its piston-like guide drops, the space above the discharge valve is increased. This sudden increase in space reduces the pressure in the fuel line to almost atmospheric pressure and the valve in the injection nozzle can close with a snap, thus resulting in an abrupt, clean-cut termination of the injection period.

5. BY-PASS OR RELIEF VALVE METHOD OF FUEL CONTROL

Some constant stroke fuel pumps use a mechanically operated valve to control the quantity of fuel injected into the combustion chamber of the engine, as shown in Figs. 7 and 8. This valve operates in connection with the pump plunger, being opened to by-pass the fuel back to the low side of the pump at the end of the injection period.

The by-pass valve is operated by means of a short rocker-arm, one end of which moves up and down with the plunger of the pump. The other end of the rocker-arm is pivoted on an eccentric. Rotating this eccentric through part of a revolution will raise or lower the pivoted end of the rocker-arm.

The illustration in Fig. 7, shows the cam that operates the pump plunger, just about to start moving the plunger upward. At "A" you will see that there is a small clearance between the lower end of the by-pass valve stem and the rocker-arm. As the cam lifts the pump plunger, the rocker will also move up, but the by-pass valve will not be lifted off of its seat until the movement of the rocker-arm eliminates the clearance. At this point the by-pass valve is lifted off of its seat and the remaining fuel in the pump barrel is by-passed back to the low side of the pump and injection stops.

The amount of clearance between the rocker-arm and the lower end of the by-pass valve at the start of the injection stroke of the pump plunger determines the length of the injection period. For example, if the clearance was $\frac{1}{16}$ of an inch as shown at "A," Fig. 7, and the point of lift was mid-

Diesel Electric Power

way between the pivoted end, and the outer end of the rocker-arm, the pump plunger would move

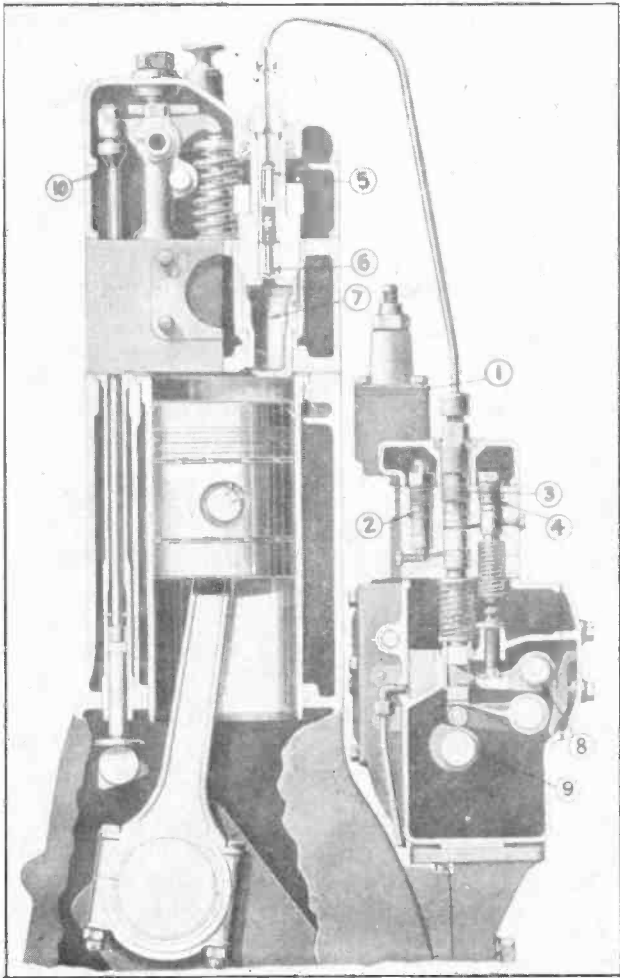

Fig. 8. This excellent sectional view of a Diesel engine cylinder, fuel pump, and injector nozzle clearly shows the construction and arrangement of these important parts of a Diesel engine, using the by-pass method of fuel control. Study this illustration in detail while reading the lesson material which refers to it. Courtesy International Harvester Corporation.

up $\frac{1}{8}$ of an inch before the by-pass valve opened to terminate the injection period. By rotating the

Fuel Injection Systems

eccentric, a quarter turn as at "B," the pivoted end of the rocker-arm would be lowered increasing the

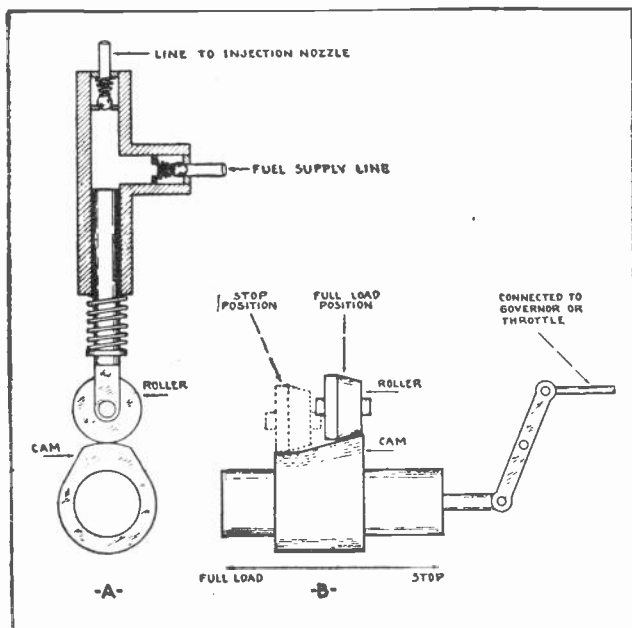

Fig. 9. The above diagrams illustrate the variable stroke type of Diesel fuel injection pump. Note how the amount of fuel charge is controlled by shifting the tapered cam.

clearance $\frac{1}{8}$ of an inch at the start of the injection stroke and the plunger would move $\frac{1}{4}$ of an inch before the by-pass valve opened, thus delivering twice as much fuel.

To stop the engine, the eccentric would be rotated to position "C" raising the pivoted end of the rocker-arm so that there would be no clearance between the by-pass valve and rocker, the by-pass valve being held slightly off of its seat. This would prevent any fuel from being injected into the combustion chamber, because as soon as the pump plunger moved upward, the fuel would by-pass back to the low side of the pump. Fig. 8 shows a sectional view of a fuel pump that uses the by-pass method of fuel control. Also note the fuel line running from the fuel pump to the injector

Diesel Electric Power

nozzle, which on this engine injects into a pre-combustion chamber above the cylinder.

6. VARIABLE STROKE PUMPS

The amount of fuel that is injected into the combustion chamber can also be controlled by varying

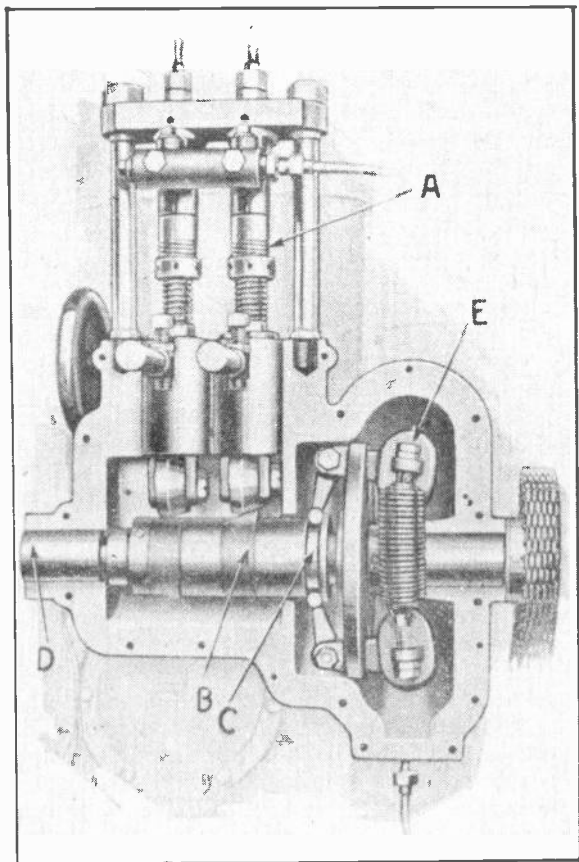

Fig. 10. Sectional view showing cams, fuel pump, cylinders and governor of a variable stroke fuel pump for a two cylinder engine. Courtesy Anderson Engine Company.

the stroke of the fuel pumps; a stroke of maximum length being used when the load is heavy, and shortening the stroke as the load becomes lighter. Two very simple methods can be used to vary the pump stroke. One is known as the **variable lift cam**

Fuel Injection Systems

control and the other is known as the wedge method of control.

With the variable lift cam control, the cams that operate the pump plungers are cut with a taper or slope as shown in Figs. 9 and 10. The roller on the pump plunger is also beveled so that it will have more bearing surface on the sloping face of the cam.

The stroke of the pump is varied by moving the entire cam assembly back and forth. At "B" in Fig. 9, when the cam is moved to the left as far as it will go, the pump stroke will be maximum because the roller will ride the highest part of the cam and push the pump plunger up the full distance. If the cam is shifted to the right, due to the sloping face, it will not lift the roller so high and the stroke will be reduced, thereby reducing the amount of fuel delivered. If the cam is moved to the right as far as it will go, the lift will be zero, no fuel will be delivered and the engine will stop. Fig. 10 shows this method of control as applied to the fuel pump for a 2 cylinder, 2 stroke cycle oil engine. Note the governor incorporated in the pump assembly and the simplicity of the entire unit.

7. THE WEDGE METHOD OF CONTROL

This type of control uses a sliding steel wedge to vary the stroke of the pump as shown in Fig. 11. The stroke is varied by shifting the wedge and controlling the distance that the plunger drops as the cam leaves the plunger roller. At "B," Fig. 11, the wedge has been drawn to the right as far as it will go, and as the cam rolls away from the plunger roller the plunger drops maximum distance, the clearance between the roller and the back side of the cam being zero. When the cam lifts the plunger, the stroke will be of maximum length, and the maximum quantity of fuel will be delivered.

If the wedge is moved to the left as in "A," the plunger will drop until the stop pin rests on the wedge. This will increase the clearance between the back side of the cam and the roller, and the pump stroke will be shortened. For example, if at "B" with the clearance zero, the pump stroke was $\frac{1}{4}$ of an inch, and at "A" the clearance was $\frac{1}{8}$ of

Diesel Electric Power

an inch, the pump stroke would be only $\frac{1}{8}$ of an inch and only 50% as much fuel would be delivered.

At "C" the wedge has been shifted to the left as far as it will go, resulting in a very wide clearance between the back side of the cam and the

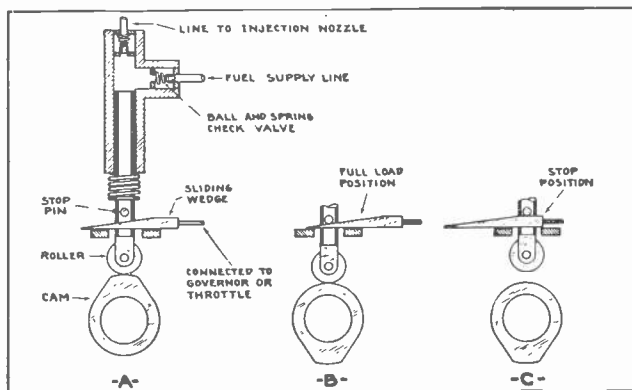

Fig. 11. The above sketches illustrate the method of operation of the wedge system of fuel control on a Diesel engine fuel pump.

roller. If this clearance is equal to or greater than the maximum stroke of the pump, the cam will be unable to reach and lift the plunger, so the plunger movement will be zero and no fuel will be injected into the combustion chamber of the cylinder, thus stopping the engine.

8. FUEL PUMP TROUBLES AND CARE

If a Diesel fuel injection pump does not deliver any fuel, the probable causes are:—empty fuel tank, closed fuel tank valve, chocked inlet pipe, dirty filter element, air lock in pump, damaged pump plunger (sticking in pump barrel), delivery valve clogged with dirt and sticking.

If the pump does not deliver fuel uniformly the probable causes are:—air lock in pump (shown by air bubbles issuing with oil when delivery valve holder is unscrewed), broken delivery valve spring, damaged delivery valve face or guide, broken plunger spring, plunger sticking due to dirt, insufficient fuel supply to pump, due to partly clogged supply line or filter, or because of faulty operation of trans-

Fuel Injection Systems

fer pump, or not enough gravity head to supply tank.

If the pump fails to deliver enough fuel per stroke the cause may be:—a leaky delivery valve or leaky joints in pressure system. If the pump delivers too much fuel per stroke, the cause may be a loose

Notes on Dismantling and Re-assembling of pumps

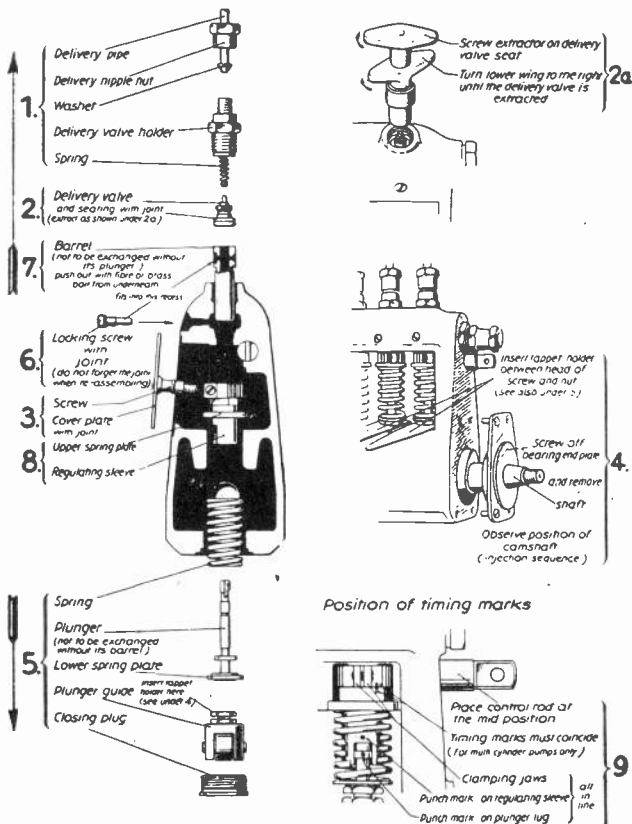

Fig. 12. This figure shows the proper steps in dis-assembling a Bosch fuel injection pump for cleaning and repairs. Carefully note the instructions printed at the various steps. Courtesy United American Bosch Corp.

clamp screw on toothed regulating quadrant (in case of multi-cylinder pumps). If the time of injection starting has changed, it may be due to a

Diesel Electric Power

loose adjusting screw in the tappet, or to damaged cam surfaces due to poor lubrication. In some cases, the control rod may become jammed due to dirt or poor lubrication.

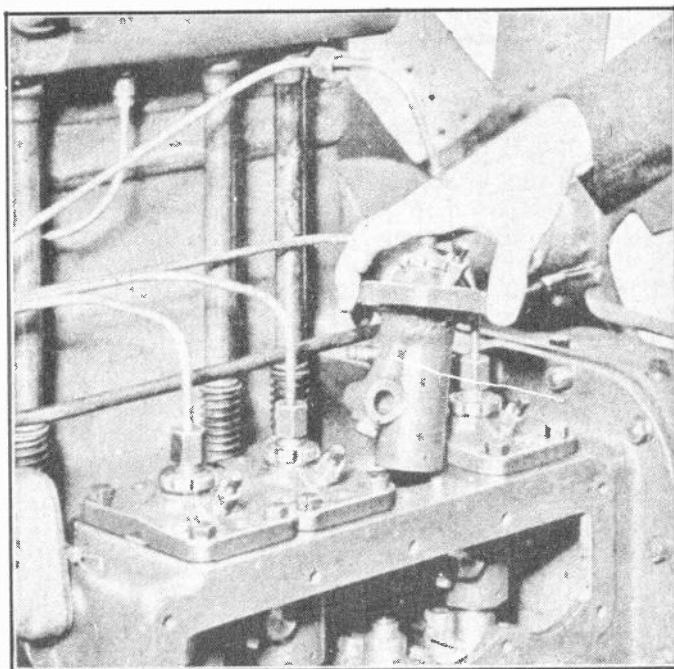

Fig. 12-A. This photo shows the ease with which a fuel pump element can be replaced on the Caterpillar Diesel tractor engine. Courtesy Caterpillar Tractor Co.

When dismantling a fuel pump, the work bench should first be covered with clean grease-proof paper (oiled or waxed paper) and all dirt removed from outside of pump by thorough washing and brushing in kerosene or gasoline.

Then proceed with extreme care in the order or steps shown in Fig. 12. Reassembling is done in the reverse order, with particular attention being given to point 8 in Fig. 12.

In case of any damage to pump plunger or barrel these should always be replaced as a pair or set, and never singly, in order to get a perfect fit. This also applies to delivery valves and their seats.

Fuel Injection Systems

These parts have been lapped and fitted together with extreme accuracy at the factory and should never be rubbed down with grinding powder or it will ruin them.

Some pump repairs are best made at the factory where proper tools and skilled specialists are available. For this reason spare fuel pumps are sometimes carried in Diesel engine plants for exchange or use while defective pumps are returned to the factory for service.

Some fuel injection pumps have removable pump elements (barrel, plunger, and discharge valve) so that on multi-cylinder pumps any one defective cylinder or element can be quickly replaced with a spare unit. See Fig. 12-A.

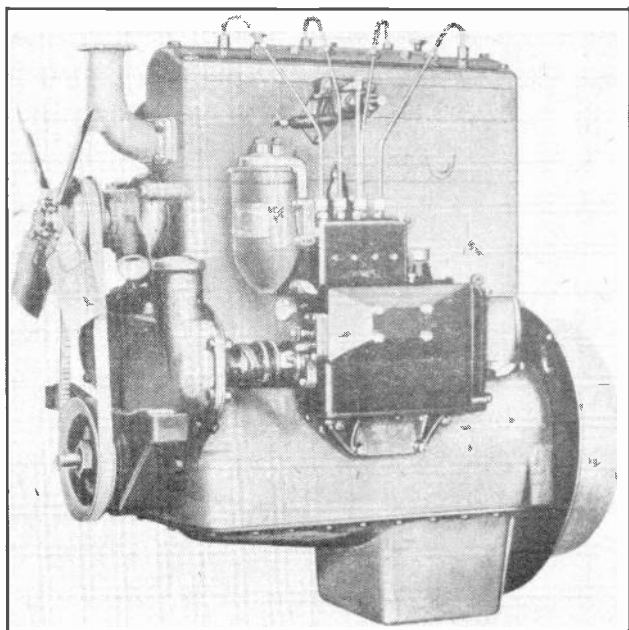

Fig. 13. Photograph of a four cylinder truck or tractor engine showing the fuel pump, governor and filter unit properly mounted on the side of the engine. Note the fuel line connections from the pump to the injection nozzles. Courtesy International Harvester Co.

9. FUEL NOZZLES

With solid injection fuel systems some means

Diesel Electric Power

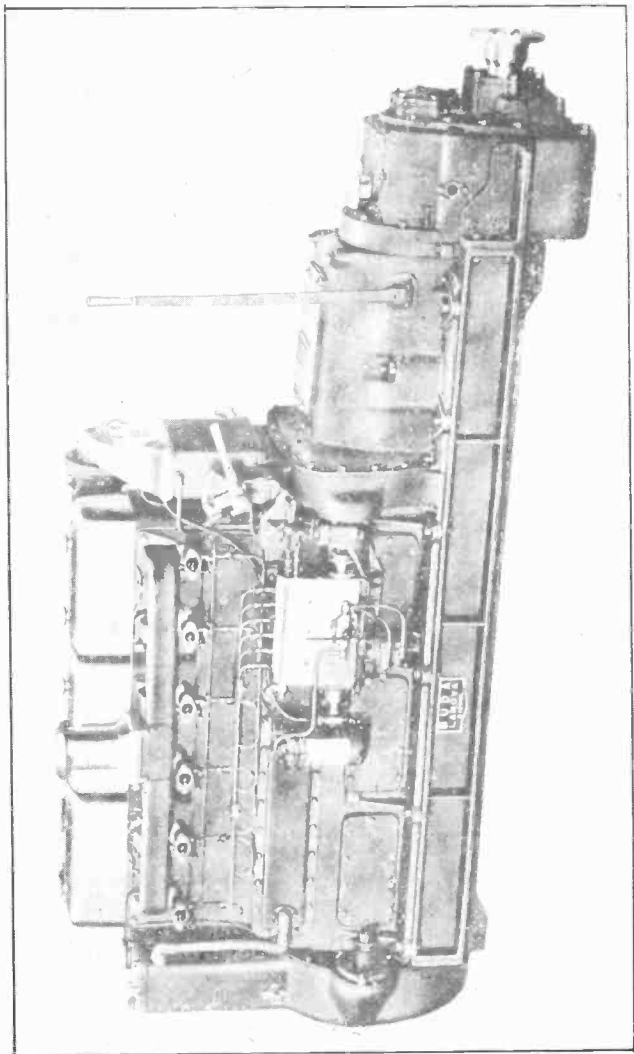

Fig. 14. This photograph shows the mounting and arrangement of the fuel injection pump, filter, fuel lines, injector nozzles, and throttle control on six cylinder marine type Diesel engine. Courtesy Buda Manufacturing Co.

Fuel Injection Systems

must be used to break the fuel oil into a very fine spray as it is introduced into the combustion chamber at the end of the compression stroke. Fuel nozzles are used for this purpose. They not only break the fuel oil up into very small particles, but also control the shape of the spray as it issues from the nozzle. This is important in order to thoroughly mix the fuel and the air together.

The breaking up of the fuel oil is accomplished by forcing the fuel through the very small opening or orifice of the nozzle under pressures running from 1,200 to 2,000 lbs. per square inch. The shape of the resulting spray is controlled by the shape or number of orifices that the nozzle has. In general, nozzles are divided into two classes:

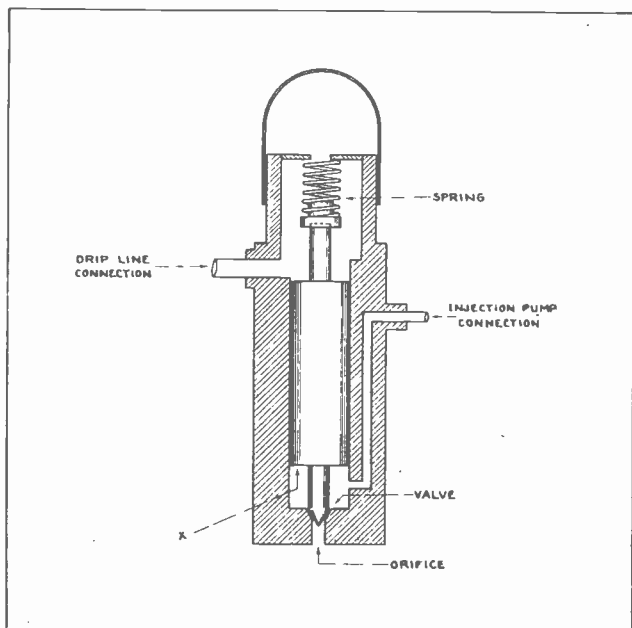

Fig. 15. Sectional view showing the construction of a closed type injector nozzle. Note the spring loaded valve which keeps the nozzle orifice closed until the oil pressure underneath the piston overcomes the spring pressure.

closed type, which is the most popular, and the open type used on some engines.

A closed type nozzle is one that has a spring

Diesel Electric Power

loaded valve that seats on a conical seat just above the orifice of the nozzle as shown in Fig. 15. When the injection pump plunger begins to move up, the pressure in the fuel line and nozzle will immediately rise because both are at all times filled with fuel oil. This rising pressure will act on shoulder "X" on the nozzle valve. As soon as the pressure exerted on this shoulder is greater than the resistance of the spring that holds the valve down on its seat, the valve is lifted. This now allows the pressure to also act on the tapered or pointed part of the valve, with the result that the valve is lifted full distance immediately, and will remain open until pump delivery ceases. At the end of the delivery stroke the pressure on the fuel line between the injection pump and the nozzle drops, and the nozzle valve snaps shut.

Closed-type nozzles are classified according to the type of orifice that they have. A single hole nozzle like that shown at "C," Fig. 16, produces a cone shaped spray having an angle from 4 to 15 degrees. This type is used on engines that are equipped with pre-combustion chambers. The ad-

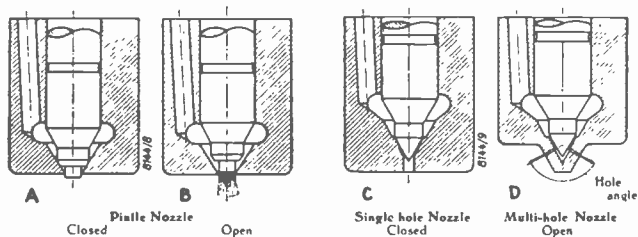

Fig. 16. The two views on the left above show closed and open positions of a pintle type nozzle valve. On the right are shown closed and open positions of single hole and multiple hole injector nozzles and valves. Courtesy United American Bosch Co.

vantage of this type is that having but one orifice it can be made rather large, which reduces the tendency to clog up. The multi-orifice nozzle has several very small holes, as shown at "D," Fig. 16. Some have as many as 6 openings. This type is used where a fan-shaped or very wide angle spray is required, which is the case where no pre-combustion chamber is used.

The pintle type nozzle has a valve that has a short extension known as a pintle that projects

Fuel Injection Systems

through the single hole in the nozzle body as shown at "A" and "B" in Fig. 16. By properly shaping this pin either a hollow cylindrical spray or a tapered spray with an angle ranging from only a few degrees up to 50 or 60 degrees, can be obtained. By using a pin that is tapered or made in 2 cylin-

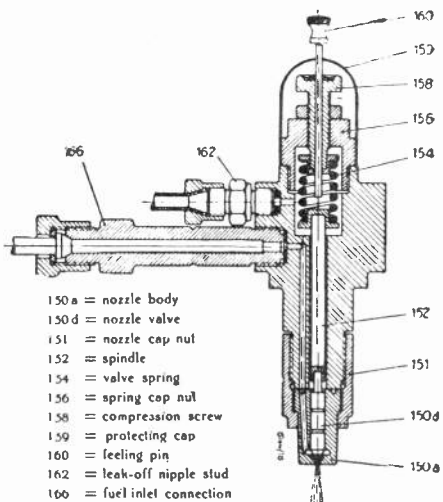

Fig. 17. Sectional view of Bosch fuel injection nozzle, nozzle holder and valve, showing pintle valve in open position. Refer to this figure and the numbered parts while studying the explanation in the lesson. Courtesy United American Bosch Corporation.

drical steps, the orifice can be opened gradually. This would cause but a small quantity of fuel to be injected as the valve began to lift, increasing as the valve reached maximum lift, causing the pressure produced by the expanding gases in the combustion chamber to rise gradually, thereby reducing fuel knock.

10. DISASSEMBLING INJECTION NOZZLES

When the small orifice openings of an injector nozzle become clogged with carbon or dirt they can be cleaned with a special small cleaning drill or tool supplied by the pump manufacturers. Be very careful not to enlarge these orifice openings, and not to make them smaller by accidental battering or rough handling of the nozzles. Great care must be exercised if a nozzle has to be taken

Diesel Electric Power

apart. To dismantle a Bosch nozzle in order to clean it, unscrew nozzle cap nut 151, Fig. 17. This will allow the nozzle body 150 "A," and nozzle valve 150 "D" to be removed for inspection and cleaning. The inside of the nozzle body can be cleaned with a thin wood strip, after soaking the nozzle in kerosene. The nozzle valve can be cleaned with a soft gasoline-soaked cloth. Never use hard sharp tools or emery paper or powder for this work. When replacing valve and nozzle body all parts must be absolutely clean, special attention being given to all ground joints in this respect. All parts should be lubricated with clean engine oil before reassembly.

If the spring is removed, it must be done without disturbing the threaded spring compression adjusting member, otherwise the spring tension will have to be readjusted. This requires special equipment. To remove the spring, remove protecting cap 159 and unscrew spring cap nut 156. Do not unscrew compression screw 158 as this will destroy the spring setting. The feeling pin 160 is used to check the operation of the valve while the engine is running. With the finger resting on the head of the feeling pin slight knocks indicate that the nozzle is operating.

11. DRIP LINES

The valve stems of closed type nozzles are very accurately fitted to the nozzle bodies and no packing is required. When new, there is very little oil leakage past these stems in spite of the extremely high pressure at which these nozzles operate, but with wear, leakage will develop. This is taken care of by a drip or leak-off connection 162, Fig. 17. In multi-cylinder engines, the drip connections are connected to one common line and the fuel that leaks past the valve stems is returned to the fuel tank or to a special tank.

12. OPEN TYPE NOZZLES

Some manufacturers prefer the open type nozzle shown in Fig. 18. Instead of a heavily spring loaded valve, this type uses a series of ball checks. Sometimes as many as 3 of these ball checks are used in an open type nozzle. These ball checks are

Fuel Injection Systems

held against their seats by light springs, and their function is to prevent an up flow of air and gases into the fuel lines during the compression and power strokes of the engine. The oil passage just above the orifice is equipped with spiral grooves. This gives the fuel oil a rotary or corkscrew motion so that the spray leaves the nozzle in a conical form.

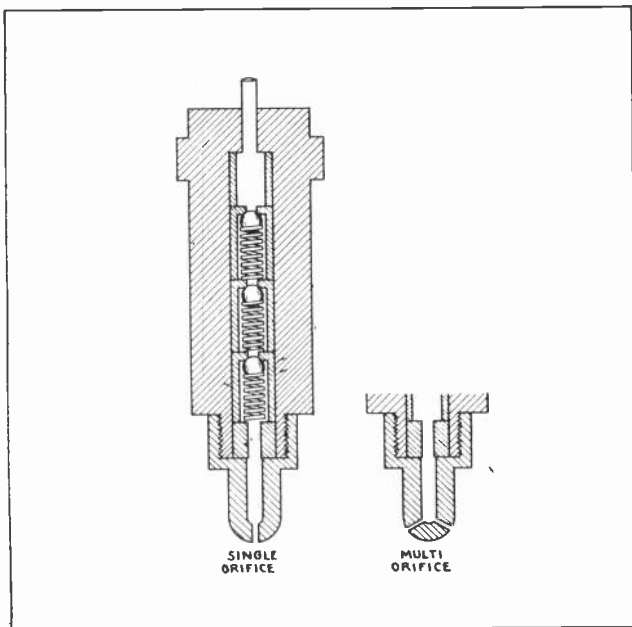

Fig. 18. Sketch showing a sectional view of single orifice and multi-orifice open type injector nozzles. Note the series of spring loaded ball check valves.

Since this type of nozzle does not use a heavily loaded spring valve, the fuel pressure will be determined by the size of the orifice and the rate at which the engine is turning over.

13. TIMING OF INJECTION

Since the fuel oil is automatically ignited as it is injected into the hot air in the combustion chamber; it is highly important that the injection pumps be correctly timed. Injection always starts before the piston reaches top dead center of the compression stroke. In some cases only, 7 degrees before

Diesel Electric Power

top dead center, in others as much as 30 degrees, depending upon the type of engine. In most cases the flywheel of the engine is marked to make it easy to correctly set the engine in order to time the injection pumps, the mark on the fly wheel being lined up with a pointer on the fly wheel housing or frame of the engine.

If the engine has more than 1 cylinder, the mark will be for cylinder No. 1, which is the farthest away from the fly wheel. When setting 4 stroke cycle engines care must be taken that No. 1 cylinder is on the compression stroke and not the exhaust stroke. This can be determined by watching the valves. The compression stroke starts just as the intake valve closes.

When the engine has been correctly set, the next thing to do is to set the injection pump. If a port control type of pump such as shown in Figs. 2, 3, 4, and 5 is used, injection starts as soon as the plunger covers the port as it moves upward. Some pumps of this type have a vertical mark on the drive end bearing plate, and two marks on the coupling hub. These marks are labeled "R" and "L," for right and left-hand rotation. Remove the side inspection plate from the pump and rotate the pump hub in the direction that it is normally driven by the engine until number 1 plunger is just beginning to lift. If the rotation is clockwise or right hand, rotate until the "R" on the hub lines up the vertical mark on the drive end bearing plate and then insert the cap screws in coupling members.

On some engines the two halves of the pump coupling have marks that must line up. In a case of that kind, set the engine flywheel as before and rotate the pump half of the coupling until the two marks line up perfectly.

If a variable stroke or relief valve type of pump is used, injection starts as soon as the pump plunger begins to move up. So all that one has to do to time this style of pump is to first set the engine and rotate the pump drive until number 1 plunger just begins to lift and then couple the pump to the engine.

Fuel Injection Systems

14. COMMON RAIL SYSTEM

While most builders of Diesel engines favor the pump injection systems just described, there are some that use the **common rail** or **constant pressure** type of fuel injection system. Among manufacturers that use this system on some or all of their engines are: Winton, Cooper-Bessemer, National, and Atlas-Imperial.

In this type of fuel system the pump is not used to meter the amount of fuel injected into the cylinder or to time the injection. It is used only to maintain a constant pressure on a heavy fuel line, known as a header, to which all of the injection valves or nozzles are connected as shown in Fig. 19. This pump is always of the plunger type and may have one or two main plungers which are operated by eccentrics instead of cams. This pump keeps the header filled with fuel oil under a pressure of from 3,500 to 6,000 lbs. per square inch. A relief valve or pressure regulator connected to the header is used to keep the oil under the correct pressure. A pressure gauge on the header indicates the pressure on the fuel oil. Note the location of the pressure valve and pressure gauge in Fig. 19.

A receiver or fuel bottle is connected to the extreme end of the fuel header to absorb fluctuations in pressure due to plunger action. An air vent valve at the end of the line is used to release any air that might be trapped in the header if the fuel system should run dry.

On the common rail system, the injection nozzles or fuel valves are not opened by fuel pressure, but are mechanically operated by means of a cam. The cam is timed to lift the needle valve at the proper time just before the piston reaches top dead center. The pressure in the header forces a spray of fuel oil into the cylinder as long as the cam holds the needle valve off of its seat.

A sliding steel wedge placed between the cam and the rocker arm that operates the valve, controls the lift of the needle valve, which in turn controls the power output of the engine. See Fig. 19. With the thick part of the wedge between the rocker-arm and the cam, the needle lift would be

Diesel Electric Power

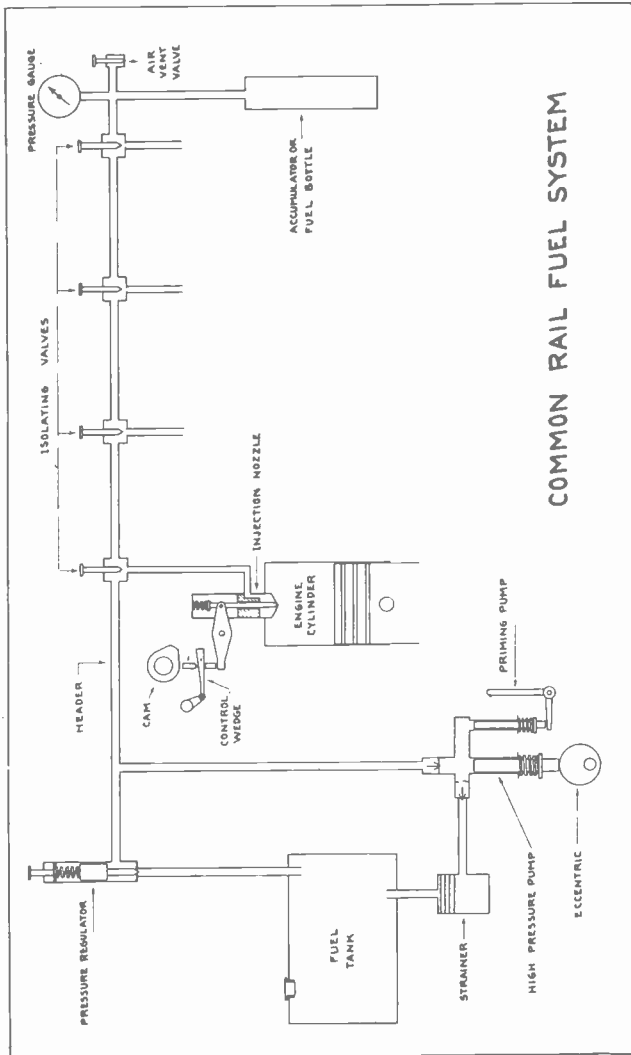

Fig. 19. Diagram showing the essential parts of the common rail fuel system for a Diesel engine. Carefully note the arrangement and purpose of each part while studying the accompanying explanation.

Fuel Injection Systems

maximum and the power output of the engine would also be maximum. If the wedge was shifted so that the thin part was between cam and rocker arm, the needle would not be lifted and the engine would stop.

Isolating valves are used with this type of common rail system so that any of the fuel nozzles may be cut off from the fuel header. This might be done to make repairs, or in some cases if the engine is lightly loaded or idling one-half of the cylinders may be cut out.

Before the engine can be started, the pressure in the header should be between 1,500 and 2,000 lbs. If for any reason the pressure is less than this, it can be quickly raised by means of a hand operated priming pump built in as part of the main high pressure pump. If air finds its way into the fuel system, it can be expelled by opening the air vent valve shown in Fig. 19, and operating the priming pump until fuel free from air bubbles flows from the air vent valve, after which the valve should be closed tightly and the fuel pressure raised to 1,500 or 2,000 lbs., and the engine is ready to be started.

15. DISTRIBUTOR TYPE FUEL SYSTEM

The distributor type fuel system used by the Cummins engine is divided into four parts: a low pressure gear pump that draws the fuel from the supply tank, a metering pump that controls the amount of fuel delivered to the engine, a rotary distributor, and mechanically operated injection nozzles. See Fig. 20.

A feature of this system is the rotary fuel distributor, which as it rotates, first connects the metering pump to the transfer pump so that it can receive the fuel, then to the proper injection nozzle so that the metering pump can force the required fuel to the nozzle. By using a distributor only one metering pump is required.

As the piston in the engine cylinder moves downward on the intake stroke, the rotary distributor will connect the metering pump with the injection nozzle in that cylinder. This will allow the metering pump to force a measured quantity of fuel into a space between the inner and outer cups at the

Diesel Electric Power

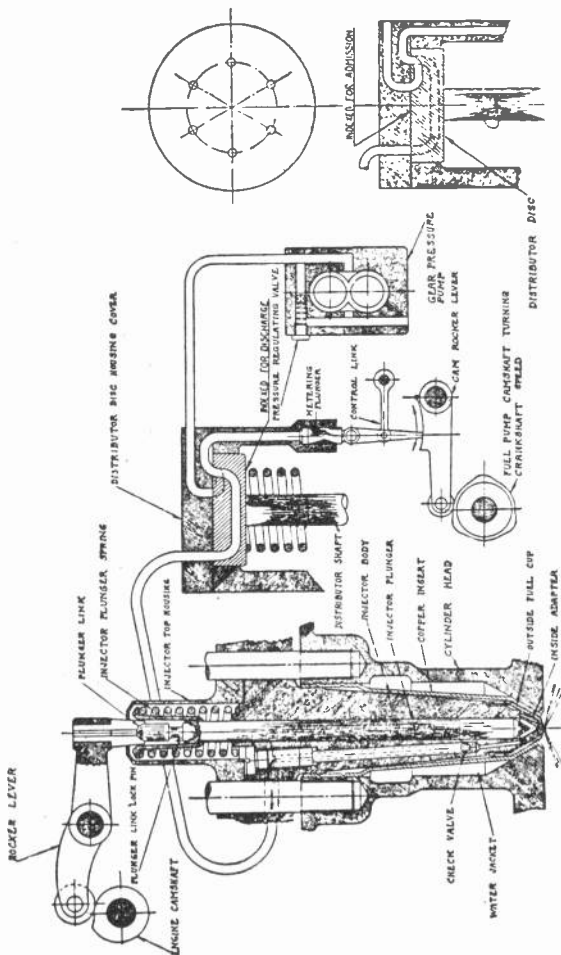

Fig. 20. Diagram showing distributor type fuel oil system of Cummins Diesel engine. Note the gear pump, distributor, metering plunger, and the injection plunger within the injector nozzle. Courtesy Cummins Engine Co.

Fuel Injection Systems

lower end of the injection nozzle. Since this space is always filled, the addition of this fuel will cause a like amount to be forced into the plunger chamber of the nozzle.

In order to make room for this fuel in the plunger chamber, the nozzle plunger is lifted upward as shown at "A" in Fig. 21. The lifting action of the nozzle plunger also creates a vacuum in the plunger chamber which holds the fuel in suspension during the engine piston intake stroke and prevents fuel leakage into the cylinder.

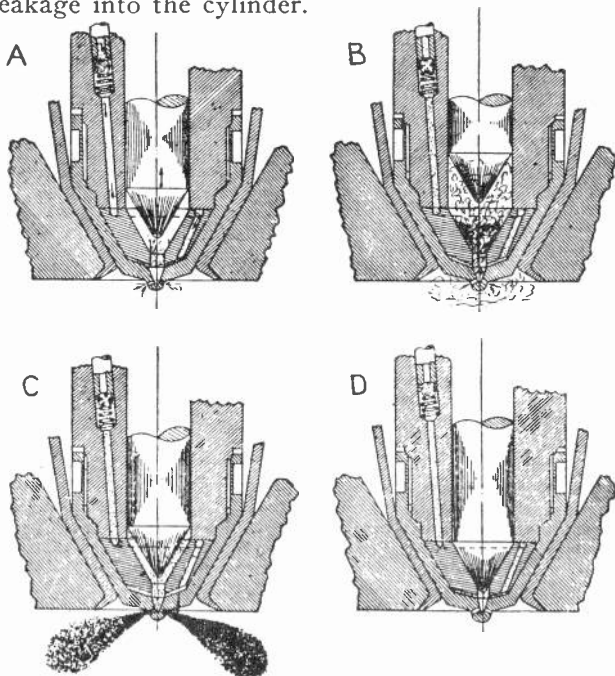

Fig. 21. Four sectional views of Cummins fuel injector nozzle. A—During the engine intake stroke, the ball check valve is open, plunger is moving up and heated fuel oil is entering plunger chamber. B—During engine compression stroke the ball check valve is closed, plunger is at the top of its stroke, correct amount of fuel oil is in the plunger chamber being mixed with hot compressed air from the engine cylinder. C—Power stroke, plunger moving down and driving gasified fuel charge into the engine cylinder. D—Exhaust stroke, plunger seated, next fuel charge being pre-heated in space between inner and outer cups in the end of the nozzle. Courtesy Cummins Engine Co.

At the start of the compression stroke, the nozzle plunger will be at the top of its stroke and the correct amount of fuel will be in the plunger cham-

Diesel Electric Power

ber as shown at "B" in Fig. 21. During the compression stroke, hot air will be forced through this fuel, vaporizing it into a rich gas. At the end of the compression stroke the nozzle plunger is forced down by means of a cam and the vaporized fuel is driven into the combustion chamber, as at "C" in Fig. 21, and ignites automatically.

During the exhaust stroke, the nozzle plunger is seated as at "D" in Fig. 21 and the fuel in the space between the inner and outer cups is being heated. The distributor passages being in the position shown at "B" in Fig. 20, the transfer pump is connected to the metering pump, so that the latter receives its fuel for the next charge.

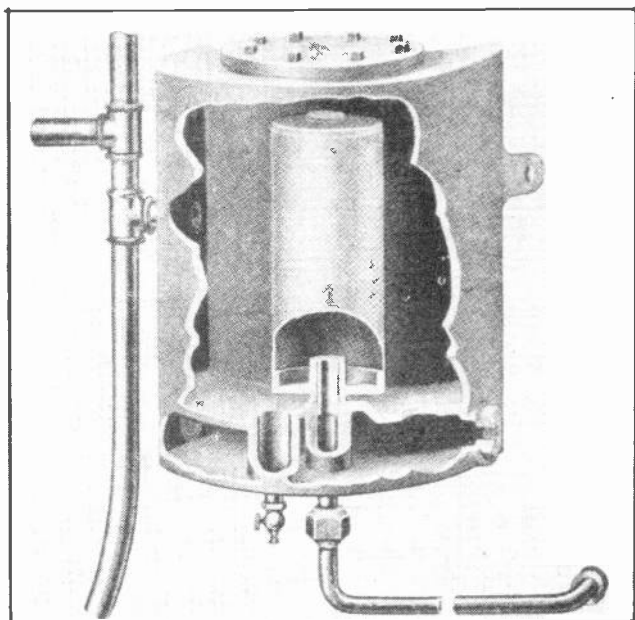

Fig. 22. Cut-away view of auxiliary fuel oil tank, showing filter screen, water sump and valve, and hot water chamber for pre-heating heavy fuel oils. Courtesy Venn-Severin Co.

The nozzles used are of the multi-orifice type, some having 5 holes, others 6 holes. It is highly important that all holes function. Should one hole in a nozzle become clogged, it tends to lower the

Fuel Injection Systems

power of that cylinder due to an unbalanced distribution of the fuel. To counter-act this condition,

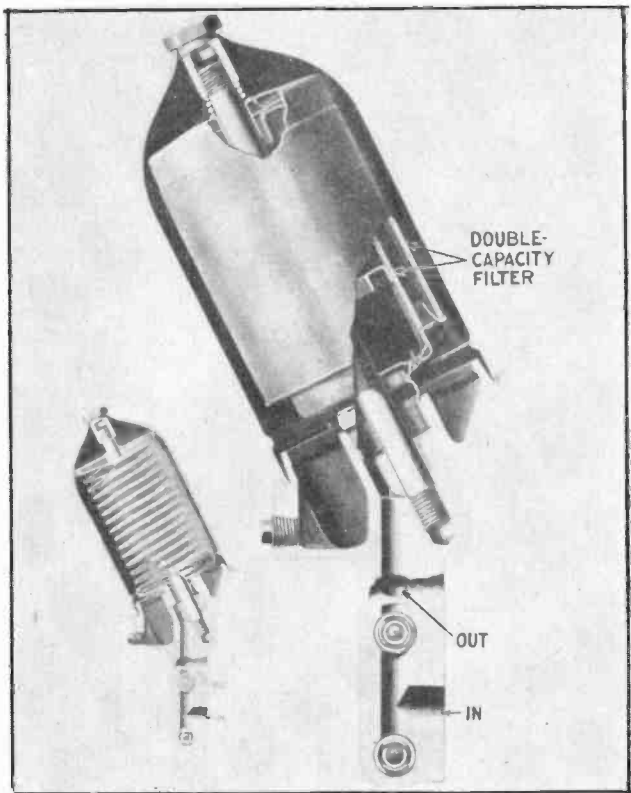

Fig. 23. The above sectional views show the construction of metal screen and cloth bag type fuel oil filters as used on International Harvester Diesel engines.

the governor causes the metering pump to deliver more fuel which will cause overloading of the engine and a very smoky exhaust. The Cummins Co. supplies special drills to clean clogged spray holes.

The metering pump is a low pressure variable stroke pump. The stroke of the pump is varied by means of a control link and shifting the lower part of the plunger that contacts the rocker lever in Fig. 20. If shifted to the left, the pump stroke would be long, while shifting to the right shortens the stroke.

16. AUXILIARY SUPPLY TANKS AND FILTERS

Diesel engine fuel oil for small portable engines and tractors is generally stored in drums or storage tanks, and poured into the fuel tanks on the engines when needed. For large stationary Diesel engines, the fuel oil is usually delivered by tank truck or tank car to large storage tanks holding several thousand gallons.

From the large storage tank, the oil may flow by gravity or be pumped to a smaller underground tank for safety reasons, or it may be pumped directly to small auxiliary tanks on the engines.

Some of these auxiliary tanks are arranged so that heat from the engine exhaust or cylinder cooling water preheats the fuel oil to facilitate handling and to permit settling or precipitation of water or heavy dirt particles in the oil. A tank of this type as shown in Fig. 22. Note the hot water chamber in the bottom, and also the water trap and drain cock for removal of any water or dirt that settles from the fuel oil. Also note the strainer which removes any coarse dirt.

As previously mentioned, fuel oil filters are generally located in the fuel oil line near to the fuel injection pump, to remove dirt and grit which might clog injector nozzles, or cause excessive wear in the fuel pump and engine cylinders. Some of these filters have a very fine screen of special construction as shown in the larger view in Fig. 23. Some filters also have a cloth filter supported by special wire springs as shown in the smaller insert in Fig. 23. Some of these filter screens are arranged so that they can be cleaned by merely rotating them against a brush or scraper built right in the filter. Others may have to be removed and cleaned with gasoline and a brush. A badly clogged filter may cause enough restriction to the oil flow to interfere with proper operation of the engine.

To clean the filters shown in Fig. 23, remove the cap nut at the top of the filter case and the filter cover or housing can then be removed. Filter bags of the type shown in Fig. 23 can be unscrewed and washed with kerosene or light fuel oil. After washing the inside of the bag, it should be flushed

Fuel Injection Systems

or rinsed with clean fuel oil to be sure that no dirt particles are left on the inside when it is reassembled.

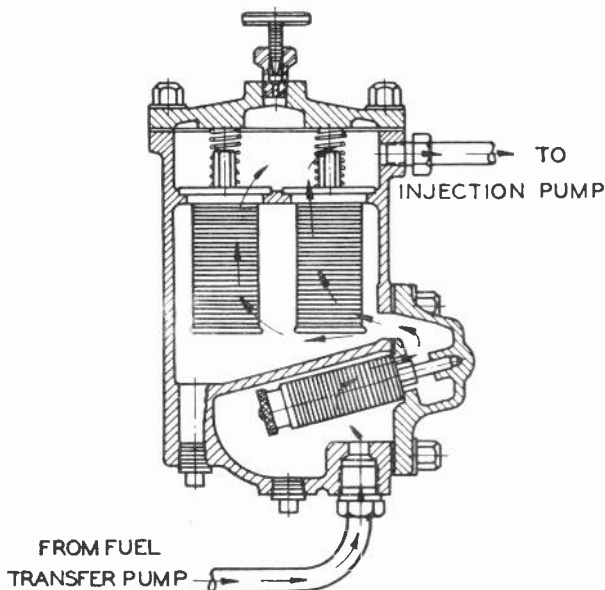

Fig. 24. Diagram showing sectional view of a fuel oil filter using metallic filter elements which can be easily removed for cleaning. Note the air-vent in the top of the filter cover. Courtesy Caterpillar Tractor Co.

When reassembling such filters, be sure that the gasket between the two sections of the filter case is in good condition or a leak may develop and cause loss of fuel oil or an air lock in the fuel system. After reassembling a filter, it should be filled with fuel oil and any air allowed to escape by loosening the air vent screw or cover cap screw while oil is in the filter under pressure. Note the sump (settling cup) and drain at the bottom of the filters in Fig. 23, for removal of accumulated dirt or moisture.

Some filters use felt pads, or cloth filter elements of different shape than shown in Fig. 23. These cloth, felt or fabric elements should be cleaned periodically by washing in kerosene.

Fig. 24 shows a two stage filter using a set of coarse filter elements below and a set of finer ele-

Diesel Electric Power

ments above. The coarse elements are made by winding thin metal ribbon edgewise on a tubular form, and keeping the turns of ribbon spaced very slightly by crimped projections on their surface. The finer element is made by winding fine spaced crimped wires on a tubular form. These filter elements can be removed for cleaning by simply removing the side and top cover plates of the filter case. This is the type of filter shown at the left of the fuel pump in Fig. 1.

17. GOVERNORS

The injection pumps in Diesel engines govern the power output of the engine by controlling the amount of fuel injected by the fuel pumps, into the combustion chambers, and the fuel pumps are in turn controlled by means of a governor.

The function of the governor is to maintain any desired engine speed regardless of the load on the engine. If the load is suddenly reduced the governor immediately acts on the fuel pump control reducing the amount of fuel injected, thus preventing the engine racing or materially increasing its speed. On the other hand if the load is increased, the governor will cause the pump to deliver more fuel to meet the increase in power required and prevent the engine from slowing down. Even for automotive work where engine speeds have to be varied, the manual control is never connected directly to the injection pump, but is used to change the governor setting which in turn changes the speed of the engine.

18. TYPES OF GOVERNORS

Diesel engines other than those used for automotive work generally use centrifugal type governors. Some automotive type Diesels also use centrifugal governors, while others use a vacuum type governor.

Spring loaded centrifugal governors consist chiefly of a pair of metal weights mounted on a yoke which in turn is keyed to a revolving shaft. See Fig. 25-A. The shaft is driven by the engine or in some cases by the same drive that operates the injection pump.

Fuel Injection Systems

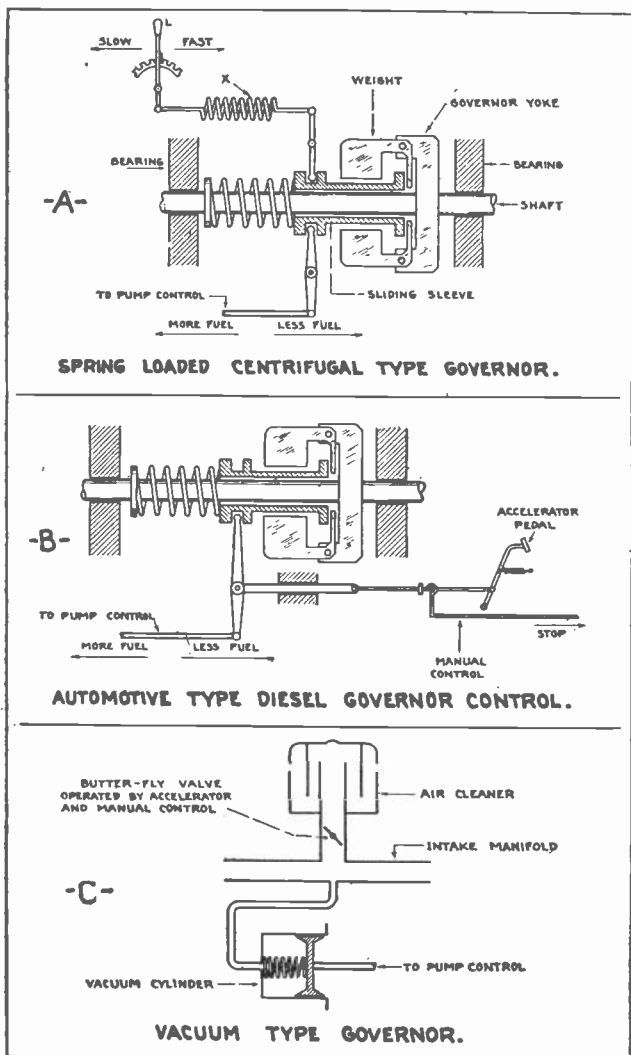

Fig. 25. The above three diagrams show the construction and operation of centrifugal type and vacuum type Diesel engine governors

Diesel Electric Power

When the engine is running, the weight and yoke assembly being keyed to the revolving shaft, rotate with it. Centrifugal force acting on the weights causes them to be thrown outward, forcing the sliding sleeve against the governor spring. When the resistance of the spring balances the force of the weights, there will be no more outward movement of the weights and the pump control which is shifted by the sliding sleeve will be held in that position and the engine will maintain a fairly constant speed.

If the load is increased the engine tends to slow down slightly and as it does so the centrifugal force acting on the weights is reduced and the governor spring forces the sliding sleeve to the right. This causes the injection pump to deliver more fuel to meet the increased load and the engine increases its speed until the original speed is again reached.

On the other hand if the load is reduced, the slight increase in engine speed increases the centrifugal force applied to the weights, so that the sliding sleeve is moved to the left until again the resistance of the spring balances the centrifugal force acting on the weights. Moving of the sleeve to the left shifts the pump control so that the amount of fuel delivered will be reduced, and the speed of the engine is brought back to its original rate. As these governors are very sensitive and quick acting, the variations in speed as to load changes are very small.

To change the speed at which the governor will hold the engine two methods may be used. In Fig. 25-A an auxiliary spring "X" is used to change the spring resistance offered to the sliding sleeve. Increasing the tension of this spring would increase the speed of the engine, while reducing the tension would reduce the speed. The tension of this spring can be controlled by the manual speed control lever "L." For automotive service, the arrangement shown in Fig. 25-B is used. In this case the governor is used to prevent racing or stopping when idling and also to limit the maximum speed of the engine.

On the road, speed variations are obtained by shifting of the pump control rod by means of the

Fuel Injection Systems

accelerator pedal or manual control independent of the governor. If it is desired to maintain a certain road speed, the manual control is set for this speed and the governor maintains the predetermined speed over wide variations of road condi-

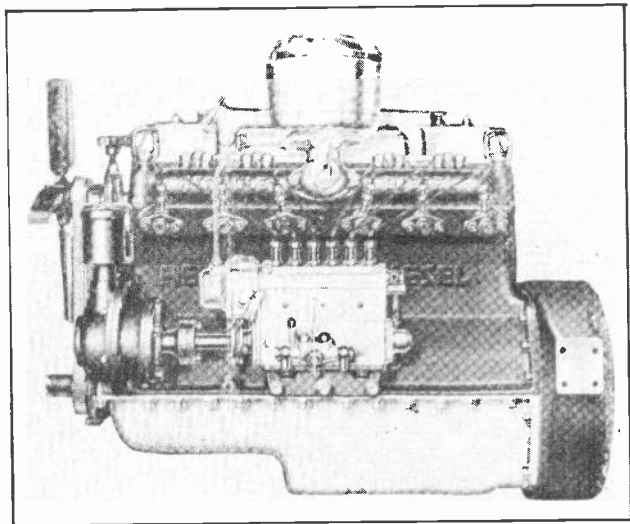

Fig. 26. Photo of Hercules automotive type Diesel engine showing vacuum type governor unit attached to left end of fuel pump, and connected by tubing to the intake manifold.

tions. The manual control is also used to set the idling speed and to stop the engine.

Quite often the governor is built in as part of the injection pump assembly. This makes a very compact unit.

19. VACUUM TYPE GOVERNORS

The vacuum type governor is much simpler in design than the centrifugal type, but can be used only where the engine can maintain a uniform intake manifold vacuum. For this reason it is found only on high speed multiple cylinder engines. It is used widely on the automotive type Diesel engines which have to operate over a wide range of speeds.

This governor consists mainly of a vacuum cylinder and piston as shown in Fig. 25-C. The piston is spring loaded and connected to the pump control.

Diesel Electric Power

The vacuum cylinder is connected by means of tubing to the engine's intake manifold.

A butterfly valve, similar to the throttle is located in the intake manifold just below the air cleaner. This is in turn connected to a hand throttle or foot accelerator. When the butterfly valve is wide open the vacuum in the intake manifold will be practically zero and the spring in the vacuum cylinder will force the vacuum control piston to the right as far as it will go and the injection pump will deliver maximum fuel, and maximum power and speed will be developed.

If the throttle valve is partly closed, vacuum in the intake manifold will increase and the vacuum control piston will be drawn to the left until the resistance of the spring balances the force exerted by the vacuum, and the pump control is held in that position. Since moving the piston to the left reduces the amount of fuel delivered, the speed of the engine decreases.

This type of control will maintain a fairly constant speed for any setting of the throttle, because a reduction of engine speed caused by an increase in load will cause the vacuum in the intake manifold to drop, and the fuel delivered will be increased, whereas an increase in engine speed due to a reduction in load will cause the vacuum to increase and the amount of fuel will be decreased. This type of control is built in as part of the injection pump.

Fuel Injection Systems

EXAMINATION QUESTIONS

1. What are the principle parts of the fuel system on a Diesel engine?
2. a. What is meant by the term "solid injection" as applied to Diesel engines?
b. At about what pressures is Diesel fuel supplied to the injection nozzles?
3. Describe briefly how the amount of fuel charge per stroke is varied on the constant stroke type of fuel injection pump.
4. What is the purpose of the discharge valve on constant stroke fuel pumps?
5. Briefly explain the difference between the bypass valve and the variable stroke pump methods of fuel control.
6. What are some of the common troubles or faults that may occur with Diesel fuel injection pumps?
7. Briefly explain the difference between closed type, open type, and pintle type injection nozzles.
8. Tell briefly how you would proceed to time a fuel injection pump on a Diesel engine.
9. Briefly describe the construction and function of Diesel fuel oil filters and tell how you would clean them.
10. Name two common types of Diesel engine governors.

DIESEL ENGINE FUEL COMBUSTION SYSTEMS

The operating efficiency of a Diesel engine depends to a great extent upon the use of the proper fuel and the manner in which the fuel is injected into the cylinders or combustion chambers. Therefore a general knowledge of this subject is quite important to the Diesel plant operator.

Oxygen is required for the burning and combustion of any fuel. You undoubtedly know that the fire in a furnace or the wood or coal in a stove will not burn without air. The more draft or air you feed a furnace the hotter the fire burns. Theoretically, 14 lbs. of air are needed to burn each lb. of oil. Actual air requirements are nearly double this amount. The oxygen needed for burning of the fuel oil charge in a Diesel engine, is obtained from the charge of compressed air in the cylinder. Therefore, in order to secure efficient combustion and complete burning of the entire fuel charge, it is highly important to have the fine oil spray thoroughly mixed with all of the heated air charge in the cylinder.

Solid injection Diesel engines that turn at less than 900 R.P.M. employ **direct injection**, the injection nozzle spraying the fuel oil directly in the clearance between the top of the piston and the under side of the cylinder head. In order to reach all parts of the clearance space with fuel oil, a multi-orifice nozzle is always used for this type of engine.

To assist the mixing of the fuel oil spray and air, many Diesel engines using direct injection have pistons with concave heads as shown in Figure 1. This concentrates the highly compressed air in the center of the clearance space, and directly under the injection nozzle, so that the fuel spray can easily reach all parts of the clearance space.

1. CONSTANT PRESSURE AND CONSTANT VOLUME CYCLES.

In slow speed Diesel engines using direct injection, the fuel is sprayed in rather slowly so that there is no great increase above the final compression pressure, but as the piston moves downward, increasing

Fuel Combustion Systems

the space above it, this pressure is maintained, until the injection period ends. Then the expanding highly heated air and gasses from the burning fuel drive the piston the rest of the way down on the

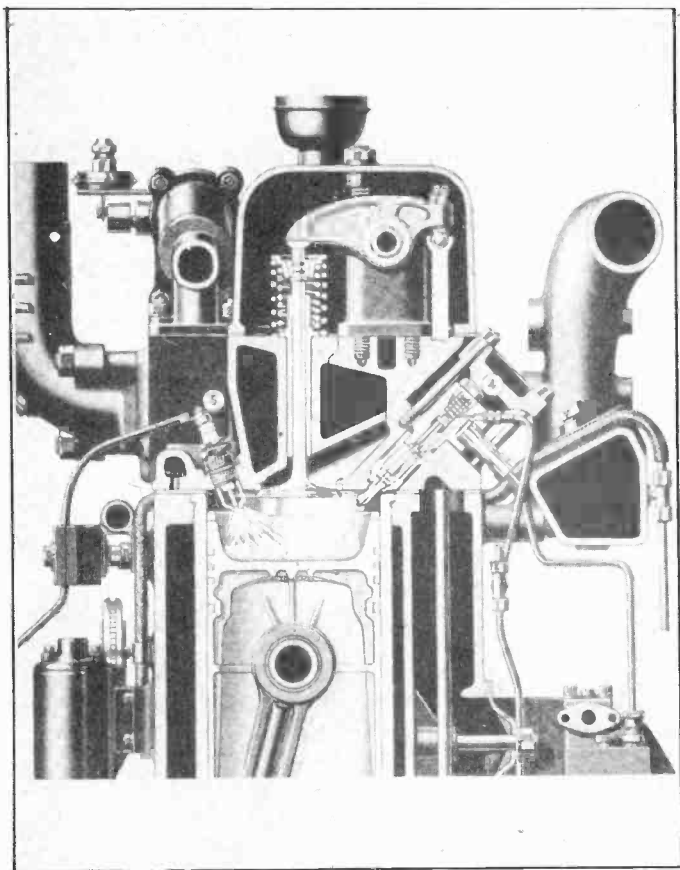

This sectional view of a controlled ignition oil engine shows the injection nozzle, combustion chamber in the piston head, and also the spark plug used to ignite the fuel oil in this type of engine. Courtesy of Allis Chalmers Mfg. Co.

power stroke. This is known as the constant pressure cycle.

In high speed engines, the time interval for ignition and combustion being very short, the fuel oil

Diesel Electric Power

must be injected slightly before the piston reaches top dead center, and the fuel combustion is actually

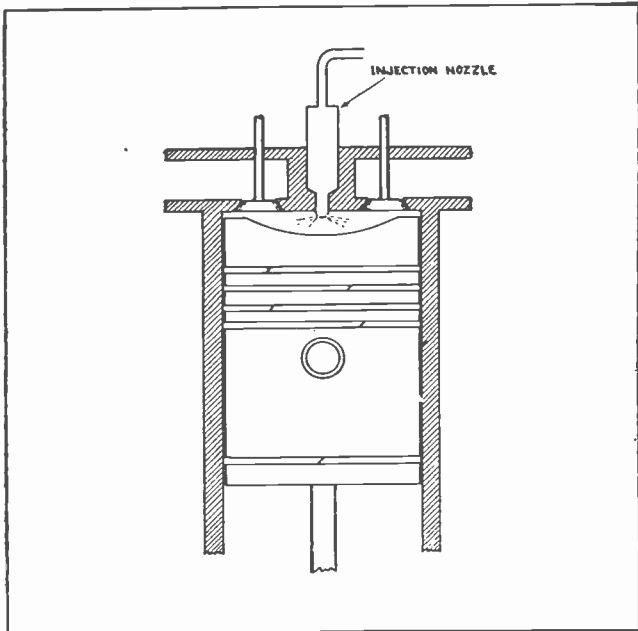

Fig. 1. The above diagram shows the shape of the piston head used in certain types of Diesel engines to concentrate the air charge in the center for thorough mixing with the fuel spray.

completed before the piston begins to travel downward. Since combustion takes place and is completed in a space that does not increase in volume during the combustion process there is a considerable rise in pressure, in some cases running as high as 800 lbs. per square inch. This is known as the **constant volume cycle**. All high speed Diesel engines operate on the constant volume cycle.

2. INDIRECT INJECTION AND PRE-COMBUSTION CHAMBERS.

In some Diesel engines the fuel oil is not sprayed directly into the clearance above the piston, but into a small chamber that is connected to the cylinder by a small passage. These chambers are called **combustion chambers** or in some cases **pre-combus-**

Fuel Combustion Systems

tion chambers. See Fig. 2, in which the pre-combustion chamber is shown at the upper left of the cylinder. Combustion chambers are designed to ac-

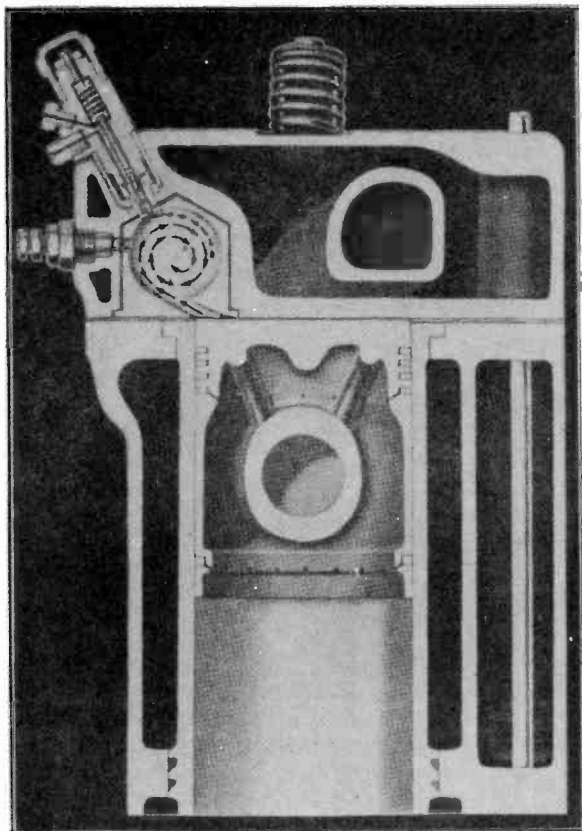

Fig. 2. Sectional view of a cylinder for a Comet Diesel engine, showing the injector nozzle and combustion chamber which produces turbulence for thorough mixing of the air and fuel oil. Note that when the piston is at top dead center, practically all of the air is compressed into the combustion chamber in this type of engine. (Courtesy Waukesha Engine Co.)

comply two things. First, to provide a thorough mixing together of the fuel oil spray and the air in a very short interval of time and second, to make it possible to use a single orifice nozzle by concentrating the heated air into a very small space directly

Diesel Electric Power

in line with the tip of the injection nozzle. You will recall previous mention of the fact that single orifice nozzles are easier to maintain and less likely to become clogged because the hole is much larger than those used with multi-orifice nozzles.

The combustion chamber shown in Fig. 2 is of the Ricardo type. In this case when the piston is at top dead center practically all the air is compressed into the spherical combustion chamber. Due to the shape of the chamber and the location of the passage between it and the cylinder, the air will rotate or whirl at a high rate as it is compressed in the combustion chamber, as shown by the arrows in Fig. 2. This creates what is known as air turbulence, and is highly important because it improves combus-

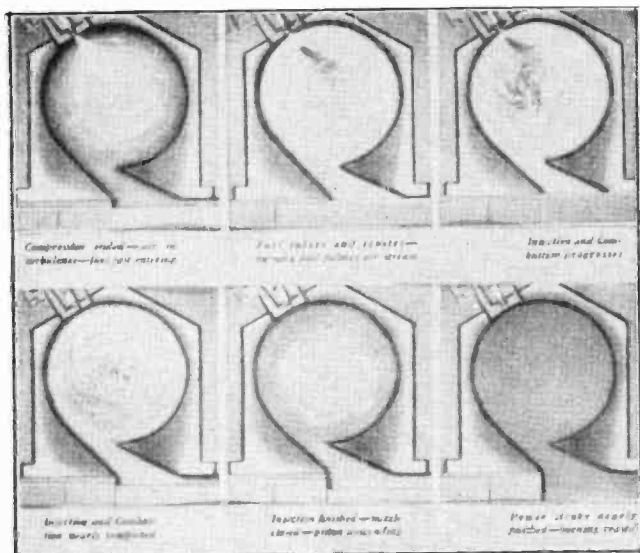

Fig. 3. The above illustrations show the fuel injection, turbulence and combustion, in a pre-combustion chamber of the Waukesha Comet Diesel engine. Examine each view carefully and note the various stages through which the fuel oil passes during ignition and combustion, all within a small fraction of a second.

tion by thoroughly mixing the fuel and air together in a very short interval of time. As the piston starts down on the power stroke, and the air begins to discharge from the combustion chamber it tends to

Fuel Combustion Systems

rotate in the opposite direction. In a properly designed combustion chamber turbulence will be maintained during the entire combustion period.

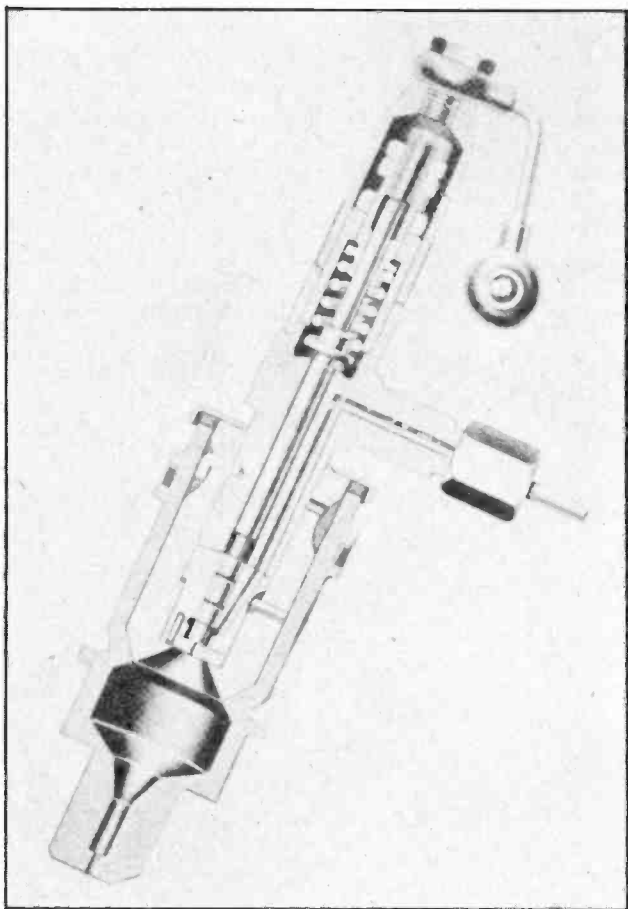

Fig. 4. Injection nozzle and pre-combustion chamber of Caterpillar Tractor Diesel Engine. Note that this pre-combustion chamber is attached right to the end of the injector nozzle and has a rather small opening which somewhat restricts or slows down the discharge of partly burned fuel to the cylinder.

In the combustion chamber just described, all of the fuel injected into it is burned within the chamber, and the hot expanding gasses rush into the cylinder and force the piston downward. Fig. 4

Diesel Electric Power

shows a pre-combustion chamber such as used on the Caterpillar Diesel engine. In this case only a portion of the fuel is burned in the pre-combustion chamber. As the injection nozzle sprays fuel into the chamber, the highly heated air will ignite a small portion of the fuel, and as injection continues,

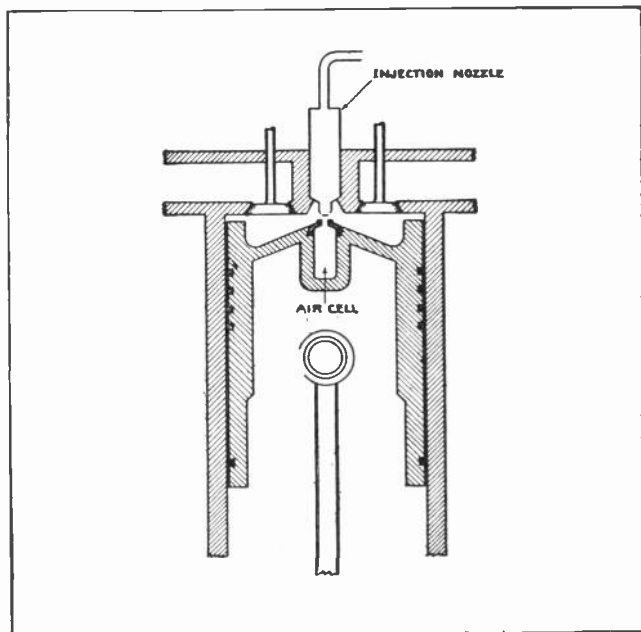

Fig. 5. Sectional view of another type Diesel engine cylinder and piston showing the specially shaped piston head and air cell used to provide turbulence and proper mixture of fuel and air for thorough combustion.

the heat produced in the pre-combustion chamber will vaporize the remaining fuel, and the high pressure developed will force it out into the clearance above piston, where combustion will be completed.

3. AIR CELLS.

Some Diesel engines are equipped with auxiliary turbulence devices designed to agitate the burning mixture after ignition has taken place, thereby improving combustion. Fig. 5 illustrates a cylinder and piston in which mechanical turbulence

Fuel Combustion Systems

of the air is obtained by the use of a piston top having a raised edge, and an air cell or chamber in the center of the piston head. As the piston moves upward on the compression stroke the air is driven toward the center of the cylinder producing considerable turbulence. At the same time, air is compressed into the small air cell in the center of piston head.

At the end of the compression stroke, the pressure in the air cell and in the combustion space above the piston will be the same. At this point, the fuel is sprayed into the combustion space and ignition takes place, and the piston is forced downward on the power stroke. This increases the space above the piston and the pressure in the cylinder immediately drops, allowing the highly compressed air in the air cell to rush out and strike the tip of the injection nozzle, breaking up the rich fuel mixture at this point. This action also tends to blow away any soot that might be forming on the tip of the injection nozzle. This type of piston and air cell is used on the Cummins Diesel engine.

LANOVA COMBUSTION SYSTEM.

Fig. 6 shows the method used in the Buda-Lanova engine to secure turbulence of the fuel and air mixture. In this system as the fuel leaves the tip of the injection nozzle it passes along the common center of two circular cavities under the intake and exhaust valves, and some of it enters the minor and major air chambers, shown. As the fuel ignites, the pressure in the air chambers will increase causing a violent discharge back into the main combustion chambers. This discharge or back fire from the air chambers sets up a violent turbulence, which causes the air and fuel mixture in the main combustion chamber to rotate with a right and left rotary motion. This self induced turbulence thoroughly mixes the air and the fuel together, providing thorough burning or combustion of the entire fuel charge.

Other specially shaped combustion chambers and piston heads are used with various types of Diesel engines, but all for the same general purpose.

Diesel Electric Power

5. DIESEL FUELS.

While Diesel engines will operate on a wide range of inexpensive petroleum fuels, and in tropical coun-

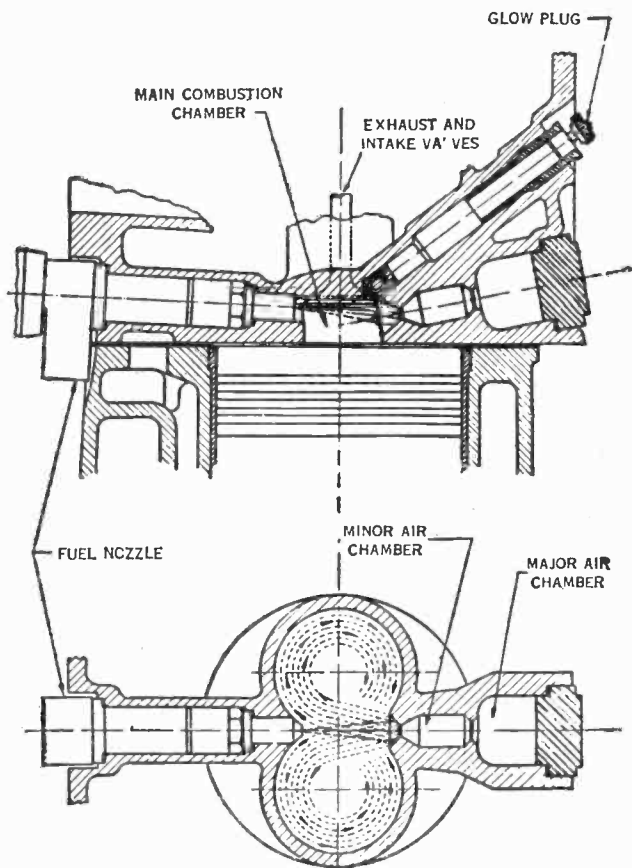

Fig. 6. This illustration shows side and top views of turbulence chamber of the Lanova combustion system used with the Buda Diesel engines. (Courtesy of Buda Engine Co.)

tries sometimes on vegetable oils, the successful operation of these engines depends largely on the quality of the fuel used. Experience shows that no one type of fuel will suit all Diesel engines. Each different type of engine will perform better if supplied with some particular type of fuel.

Contrary to popular belief Diesel engines are very

Fuel Combustion Systems

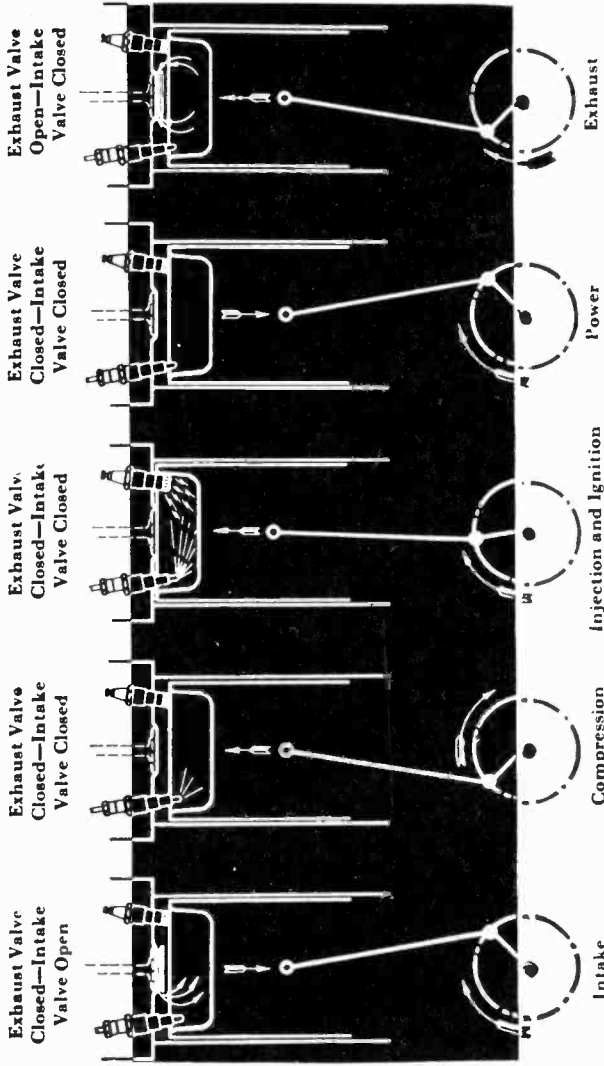

Fig. 7. The above views show the shape of the piston head, the angle of fuel injection and the combustion cycle of a Waukesha Hesselman engine. This engine is one of the lower compression types using spark plug ignition. The shape of the depression in the piston head mixes the fuel spray with the air and also directs the mixture against the spark plug. (Courtesy Waukesha Engine Co.)

Diesel Electric Power

seldom operated on crude oil. Pumping stations on oil pipe lines usually burn crude oil in their Diesels because it eliminates the cost of transportation of other fuel oil. In a case of this kind the crude oil is put through a special cleaning process before being used as fuel for the engines.

The reason why crude oils are not favored as Diesel fuels is that in some cases the oil carries a high percentage of water in emulsion, which interferes with combustion. The crude oil from some fields contains a high percentage of wax which may clog the fuel lines between the injection pumps and the fuel nozzles, especially when subjected to high pressures. Sometimes sulphur is present in crude oils in such large quantities that it causes serious corrosion of the engine cylinders. Thus it can be seen that crude oils are hardly suitable for general Diesel operation, and when used at all these crude oils should be given a thorough cleaning.

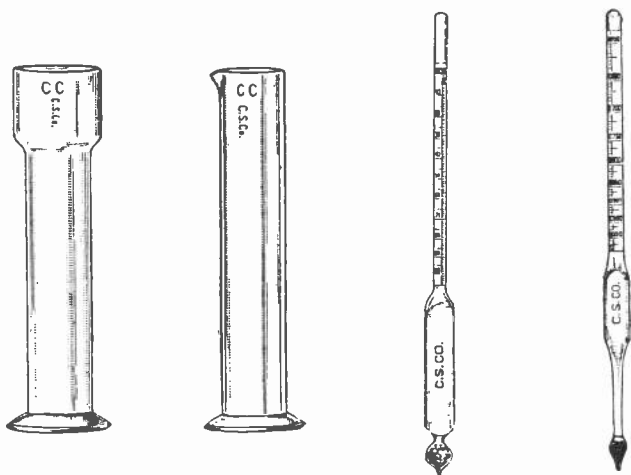

Fig. 8. Glass containers and hydrometers of the type shown above are used for checking the gravity of Diesel fuel oils. The glass container is filled to a convenient level and the hydrometer allowed to float in the oil, the gravity reading being taken on the scale of the hydrometer at the surface of the oil.

For medium or high speed engine operation, Diesel distillates give best results. These fuels are distilled oils and as a general rule are very clean, and therefore a desirable class of fuel. These distillates

Fuel Combustion Systems

are often sold under different names such as "gas oil," "Diesel distillates," or "distillate". Some domestic furnace oils come under this classification. Some fuel oils are blends of distillates and residue from oil cracking stills. These fuels are satisfactory for slow or medium speed engines, but often give poor performance in a high speed engine, due to ignition lag.

In order to be suitable for Diesel engines, fuel oil should meet four requirements:

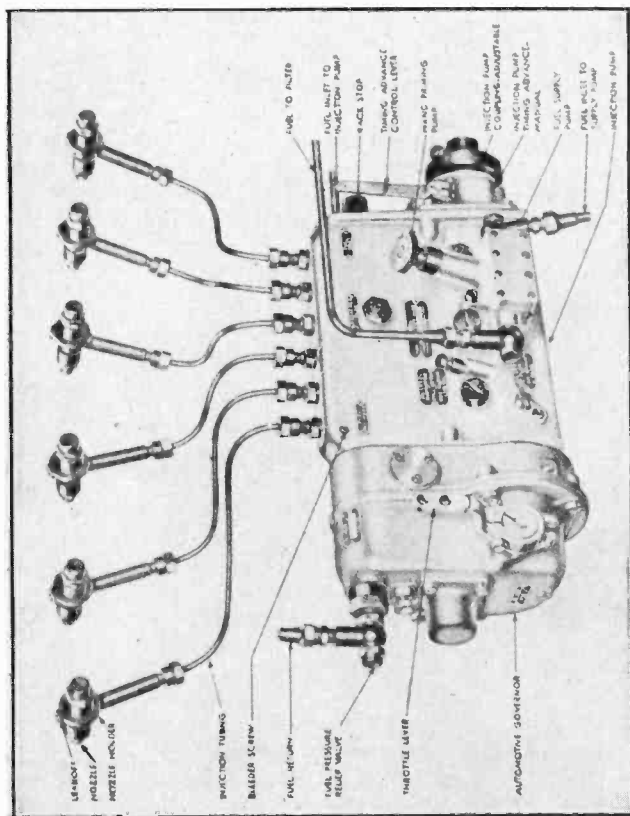

Fig. 9. The high pressure fuel injection pump of any Diesel engine is one of the most important elements or units in the entire fuel system. Note carefully all of the important parts indicated on the fuel pump shown above.

1. It should ignite easily: This is especially important for high speed operation. A slow igniting

Diesel Electric Power

fuel tends to cause combustion knock, by allowing too much fuel to accumulate before ignition occurs. Fuels of paraffin base, give the smoothest combustion in Diesel engines.

2. Diesel fuel oil should be free from excessive amounts of sulphur, ash, asphalt, sludge, etc., since these ingredients cause corrosion, excessive wear and sticking of the piston rings and fuel pump plungers.

3. Diesel fuel oil should contain a certain amount of lubricant. This is important, because if the fuel lacks lubricant the injection pump parts and the plungers of closed type nozzles will wear rapidly, causing excessive leaking and finally total failure. For this reason white fuels such as kerosene should never be used. Even straw colored fuel oil often lacks the required amount of lubricant. Should it become necessary to use such fuels, one gallon of clean lubricating oil should be added to every 20 gallons of fuel and thoroughly mixed.

4. The specific gravity of the oil should be correct. The gravity or weight of the fuel that an engine can use depends upon the speed at which the engine runs and also upon temperature conditions. The last is especially true if the engine is operated outdoors. In summer a heavier fuel can be used than in winter. Heavier fuels contain more heat per gallon and will therefore do more work, besides costing less money.

6. FUEL OIL GRAVITY.

Most fuel oils are purchased on a basis of specific gravity or weight. Instead of using the usual specific gravity scale which uses the weight of water as basis of comparison, the Beaume or A. P. I. (American Petroleum Institute) scale is used. Since temperature will cause the fuel oil to expand, the gravity is always given for a temperature of 60 degrees F.

To check the gravity of fuel oil a hydrometer such as shown in Fig. 8 is used. Since oils weigh less than water the hydrometer must be designed for the purpose. If a direct reading Beaume or A.P.I. hydrometer is not available, a regular light liquid

Fuel Combustion Systems

specific gravity hydrometer can be used, and the readings converted into Beume (Be) or A.P.I. values by the following formula :

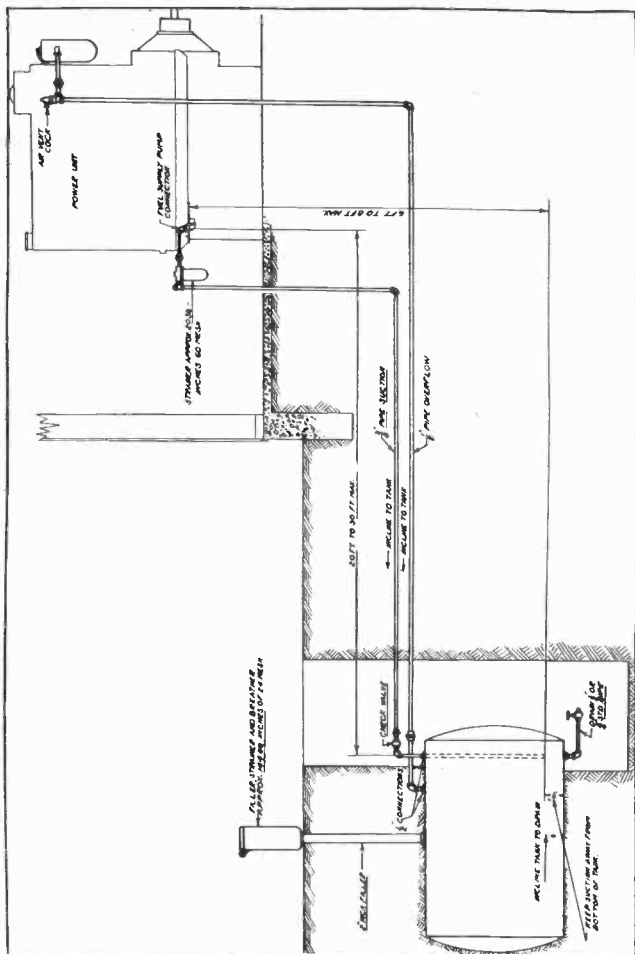

Fig. 11. This diagram illustrates a convenient arrangement of an outdoor fuel supply tank and pipe lines for the fuel supply to a small Diesel engine. (Courtesy McCormick Deering Co.)

$$\frac{140}{\text{Sp. Gr.}} - 130 = \text{Be. or A.P.I.}$$

On the other hand if a Be. or A.P.I. value has to

Diesel Electric Power

be converted to a specific gravity value the following formula is used:

$$\frac{140}{\text{A.P.I.} + 130} = \text{Sp. Gr.}$$

The flash point of fuel oil, refers to the temperature at which the vapor which rises from fuel oil when it is slowly heated, will ignite. This does not mean that the oil itself would burn at that temperature. The flash point of Diesel fuel varies from 150 degrees up to 200 degrees. The flash point of oil can be tested by slowly heating a small quantity in an open container with a thermometer in the oil,

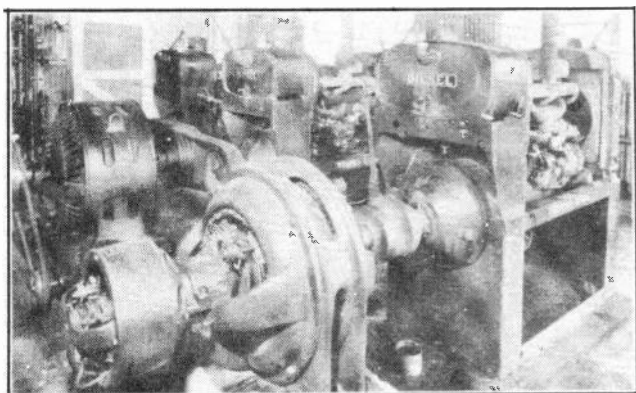

Fig. 12. This photo shows 3 McCormick Diesel engines used for driving electric generators in a small industrial Diesel-Electric power plant. Note the fuel tanks located right on the engine stands. Also note the "V" belt drives used on one generator and the direct shaft coupling on the other unit.

and a lighted candle held above the oil surface, note at what temperature the oil vapors ignite, and then go out. If the oil is heated 50 to 125 degrees above the flash point the vapor will continue to burn. This is known as the burning point.

FUEL SPECIFICATIONS

	A	B	C
A.P.I. Gravity	16-20	24-28	30-35
Ash content (by weight).....	.04	.02	.02
Carbon residue (max.)	5%	3%	2%
Water and sediment			
(by volume)6	.2	.05

Fuel Combustion Systems

7. ENGINE SPEEDS AND FUEL REQUIREMENTS

The gravity of the fuel used in a Diesel engine depends largely on its rate of turn-over. Heavy duty slow speed engines having a long injection and combustion period can be operated on heavy fuels, whereas a high speed engine with its short injection

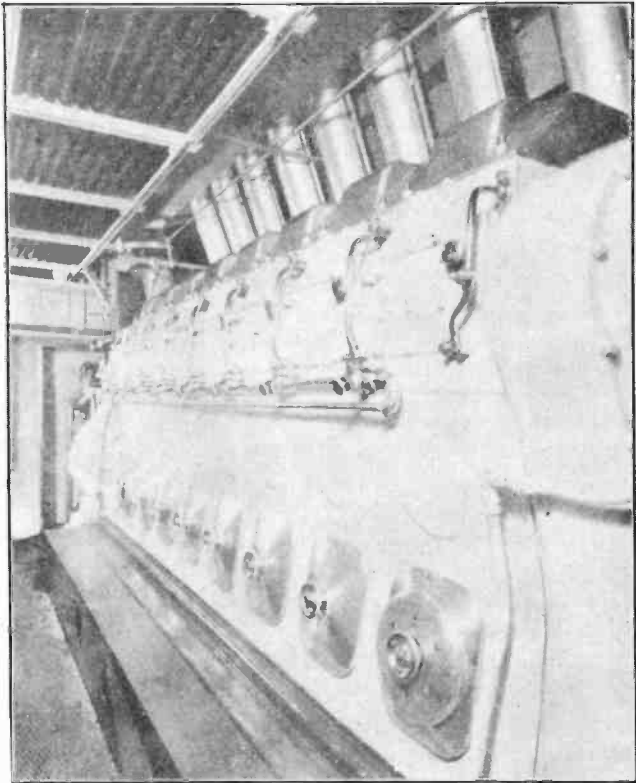

Fig. 13. The above photo shows the fuel supply and drip lines on one side of a "V" type Diesel engine used on a Diesel-Electric locomotive. (Courtesy Burlington Railway.)

and combustion period requires a light, volatile fuel.

Slow speed engines that do not run over 350 R.P.M. can be operated on fuels having an A.P.I. gravity varying from 16 degrees to 20 degrees. Medium speed engines that operate at speeds up to

Diesel Electric Power

1000 R.P.M., usually require a fuel having a gravity from 24 to 28. High speed engines which operate at speeds of 1000 to 2000 R.P.M. require fuels of from

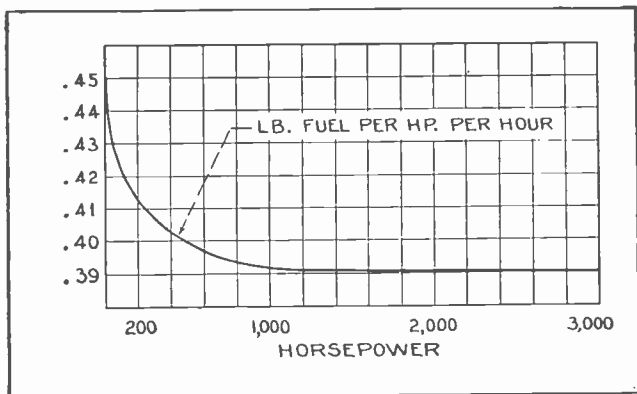

Fig. 14. This chart shows the approximate consumption per horsepower hour for Diesel engines ranging in size from 50 to 200 horsepower.

30 to 35 degrees gravity. The amount of power or expansive force available from a pound of fuel oil depends upon its heat content in B. T. U. (British Thermal Units.)

Fuel oils such as used in Diesel engines usually contain from 18,000 to 19,000 B.T.U. per pound. The heavier fuels having the higher heat contents.

8. FUEL CONSUMPTION

The amount of fuel required to develop 1 Brake horsepower hour (or 1 horsepower for 1 hour) depends on the size of the engine and its mechanical condition. Engines of 100 h.p. usually require about .5 of a pound of fuel per horsepower hour. Engines of 100 to 500 h.p. usually require from .4 to .45 lb. per horsepower hour. Large modern engines of 500 to 3,000 h.p. may operate on as little as .35 of a lb. of fuel per horsepower hour.

The convenient fuel consumption chart shown in Fig. 14 gives the approximate fuel consumption rates in pounds per horsepower hour for engines ranging from 50 to 3,000 h.p.

With this information at hand, it is a simple matter to calculate the approximate cost of generat-

Fuel Combustion Systems

ing electric power with a Diesel-Electric unit of any given size. If we wish to calculate the cost of electricity per kilowatt hour from a Diesel-Electric unit, we generally allow about $1\frac{1}{2}$ h.p. of engine size per kilowatt, or divide the horsepower rating of the engine by 1.5 to find the kilowatt size of generator it will drive. Or to determine the required size of engine, multiply the kilowatt rating of the generator by 1.5 to determine the engine horsepower required.

Manufacturers of Diesel-Electric generating units usually quote the fuel consumption of their units in pounds per kilowatt hour. These figures can then be multiplied by the cost of fuel oil per pound to determine the fuel costs. You will note from the table of fuel gravities and weights, the Diesel fuel oil averages about 7.5 pounds per gallon.

There are, of course, other costs to be considered such as lubricating oil, engine maintenance and repairs, depreciation and interest on the cost of the unit, operator's salary, etc.

The fuel requirements of various Diesel engines can also be obtained from their manufacturers test data. Such information is important when checking the operating condition or efficiency of a Diesel engine, or when calculating the cost of Diesel or Diesel-Electric power.

Bunker "C" oil is the cheapest fuel that can be obtained for Diesel engines. It is satisfactory for slow speed air injection engines and also for some slow speed solid injection engines. It costs much less than standard Diesel fuel but contains considerable dirt, water and carbon and so it must be centrifuged or cleaned in a centrifugal oil separator. Even after cleaning the foreign matter and carbon contents may be high enough to increase cylinder wear and cause rings to stick. The rate of wear may be 100% higher with this fuel than with a standard Diesel fuel, so it is economical only as long as it can be obtained at prices much lower than the better grade oils.

Diesel Electric Power

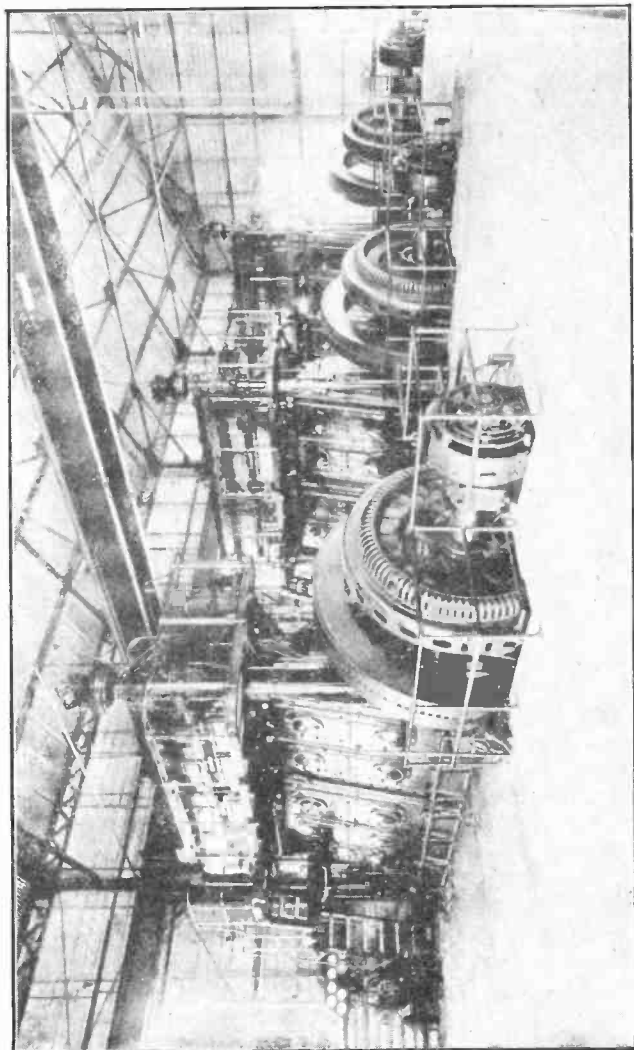

Fig. 15. Modern Diesel-Electric power plant showing three 500 kilowatt, 2300 volt, 3-phase alternators driven by direct connection to 180 R. P. M. Diesel engines. (Courtesy Allis-Chalmers Manufacturing Co.)

Fuel Combustion Systems

TABLE OF FUEL GRAVITIES AND WEIGHTS

A.P.I. Gravity	Specific Gravity	Pounds Per Gallon
16	0.959	7.99
17	0.952	7.94
18	0.946	7.89
19	0.940	7.83
20	0.934	7.78
21	0.927	7.73
22	0.921	7.68
23	0.915	7.63
24	0.910	7.58
25	0.904	7.53
26	0.898	7.49
27	0.892	7.44
28	0.887	7.39
29	0.881	7.35
30	0.876	7.30
31	0.870	7.26
32	0.865	7.21
33	0.860	7.17
34	0.855	7.12
35	0.849	7.08
36	0.844	7.04

9. CENTRIFUGING

When using Bunker "C" fuel or fuels of a similar type, centrifuging is required to remove dirt, water, carbon, etc. A centrifuge is similar to a cream separator and operates on the same principal, separating the water and heavier materials from the oil by whirling at high speed. Before heavy fuel oils can be centrifuged, they must be heated. In some large Diesel plants the hot water from the engine jackets is used to bring the fuel oil to the proper temperature before centrifuging. Electric heating elements with automatic temperature control are also used.

Fuel oil vapors are highly explosive when mixed with air. Therefore never allow open flames or sparks of any kind within 25 feet of an open fuel tank, hose or pipe line.

Diesel Electric Power

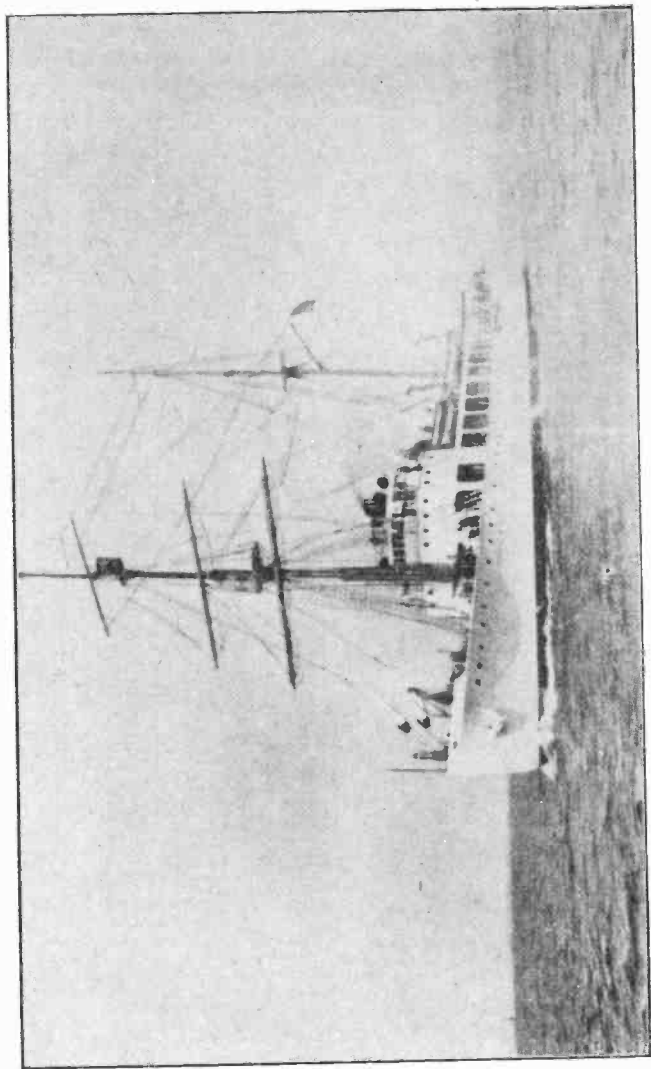

Fig. 16. Diesel-powered coast guard cutter ship. Many modern ships, ferries and dredges are Diesel or Diesel-Electric Driven.

Fuel Combustion Systems

Empty fuel oil tanks should be blown out with air before entering them, or working near them with any heat sufficient to ignite oil vapor.

TEST N° D-146

FIRM HERCULES MODEL DRX SERIAL N° _____ DATE 8-3-34

N° CYL 6 BORE _____ STROKE 5 1/4 DISPLACEMENT _____ COMPRESSION RATIO _____

FUEL FUEL OIL - COMPRESSION-IGNITION ENGINE -

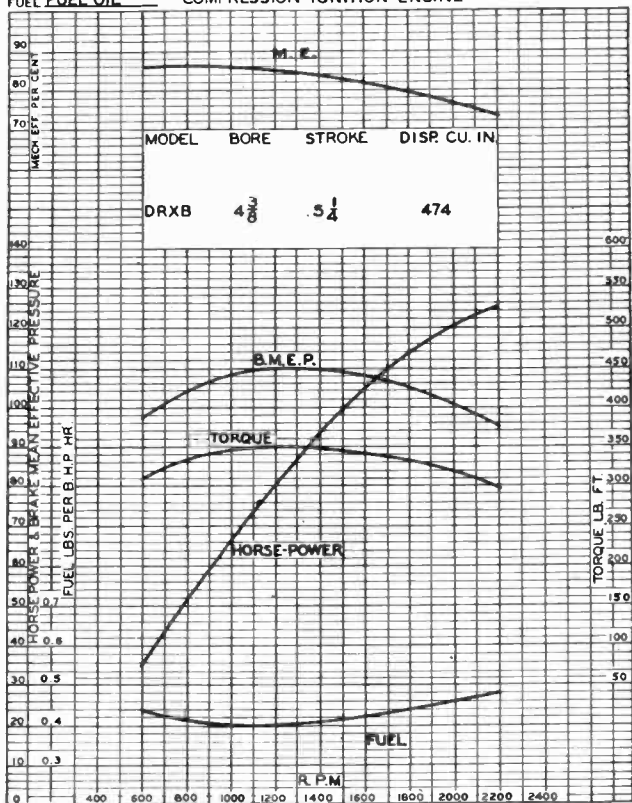

Fig. 17. The above chart and curves show the horse power, torque, efficiency and fuel consumption in pounds, per H. P. hour for a 6 cylinder engine, when operated at speeds ranging from 600 to 2200 R. P. M. Note that the H. P. increases with the speed, and that the torque is greatest at speeds from 1000 to 1400 R. P. M., and fuel economy best at speeds from 900 to 1300 R. P. M.

The amount of ash or non-combustible residue in fuel oil can be determined by what is known as an "open-cup" combustion test. This test is made by placing 100 grams of fuel sample in a standard type

Diesel Electric Power

of copper cup in which the oil is burned. The oil can be lighted by placing a teaspoonful of gasoline on its surface and lighting it with a match. The cup should be protected from drafts that might extinguish the flame before the fuel is entirely consumed. After all the fuel has been burned, the residue should not weigh over 2 grams. Some of these test cups are equipped with a mark or rolled bead in the cup rim to show the proper level for filling, and also a small raised point in the bottom of the cup to indicate the amount of residue without weighing. If this point is covered with residue, it indicates too much impurity in the oil, while if the point is still exposed after the oil is burned, the amount of residue is within the limit of 2%.

When purchasing fuel oils for any Diesel engines it is best to follow the engine manufacturers recommendations. Most large oil companies also have fuel experts who are able to recommend the proper type and grade of fuel for use with any certain type of engine.

Use of wrong grade or poor quality fuels is generally not economy in the long run, due to increased clogging of fuel pump valves, injector nozzles, sticking piston rings and increased wear on fuel pump parts, injectors and engine pistons and cylinders.

All fuel lines, tanks and connections in a Diesel engine fuel system should be kept tight and free from leaks, and also kept clean and free from dirt, water and air locks.

Fuel strainers and filters must be kept cleaned and water should be drained from any water sumps or traps by cocks or valves generally provided for this purpose.

Fuel Combustion Systems

EXAMINATION QUESTIONS

1. What is the difference between direct and indirect injection as applied to Diesel engines?
2. Briefly explain the difference between the "constant pressure" and "constant volume" cycles used with Diesel engines.
3. What is the purpose or advantage of a pre-combustion chamber?
4. What is meant by turbulence, and in what way does it improve Diesel engine efficiency?
5. How is turbulence obtained in some Diesel engines which do not use pre-combustion chambers?
6. Why are crude oils not generally used for Diesel engine fuel?
7. State four requirements of good Diesel fuel oil.
8. A. What should be the A. P. I. gravity of fuel oil for high speed Diesel engines operating at 1,000 to 2,000 R.P.M.?
B. What should be the maximum ash, carbon, and water content of this grade of oil.
9. What is the approximate fuel consumption in pounds, per h.p. hour for a modern 600 h.p. Diesel engine?
10. What safety precautions should be taken when working around open fuel oil tanks or lines?

DIESEL ENGINE STARTING SYSTEMS

As Diesel engines are internal combustion engines, they must be "turned over" or rotated by some other form of power in order to start them. They are similar to gasoline automobile engines in this respect. Diesel engine starting systems in general use are: 1, Hand cranking for small units; 2, Electric starter motors; 3, Auxiliary gasoline starting engines; 4, Diesels which operate on gasoline during starting only; 5, Compressed air starting.

Small stationary type Diesel engines up to 10 h.p. are started by hand cranking. Since cranking speed must be high, some means is provided to release the compression until the engine has been brought up to speed by means of a hand crank. Some engines have a compression release that prevents the exhaust valve from closing, while others have a relief valve cock which can be opened, so that the engine can be turned over rapidly.

In full Diesel or cold starting Diesel engines, as long as the exhaust valve is held open, the fuel pump is set in neutral or stop position. This prevents fuel oil from accumulating in the cylinder while the engine is being brought up to speed.

With the engine being cranked rather rapidly, the compression release lever is quickly shifted to running position, or the relief cock closed, and the engine pulled through one or more compression strokes by continued cranking, aided by the fly-wheel momentum. It should then start.

1. ELECTRIC STARTING MOTORS

High speed Diesels used for trucks, tractors, busses, motor boats, or stationary service, are usually started by means of a battery and low voltage electric starting motor equipped with a Bendix drive. In trucks, tractors, or motor boats, the same battery is also used to take care of the lights. This starting system is similar to that used for general automotive service, but a 12 or 24 volt battery is used instead of the regular 6 volt automotive type.

Starting Systems

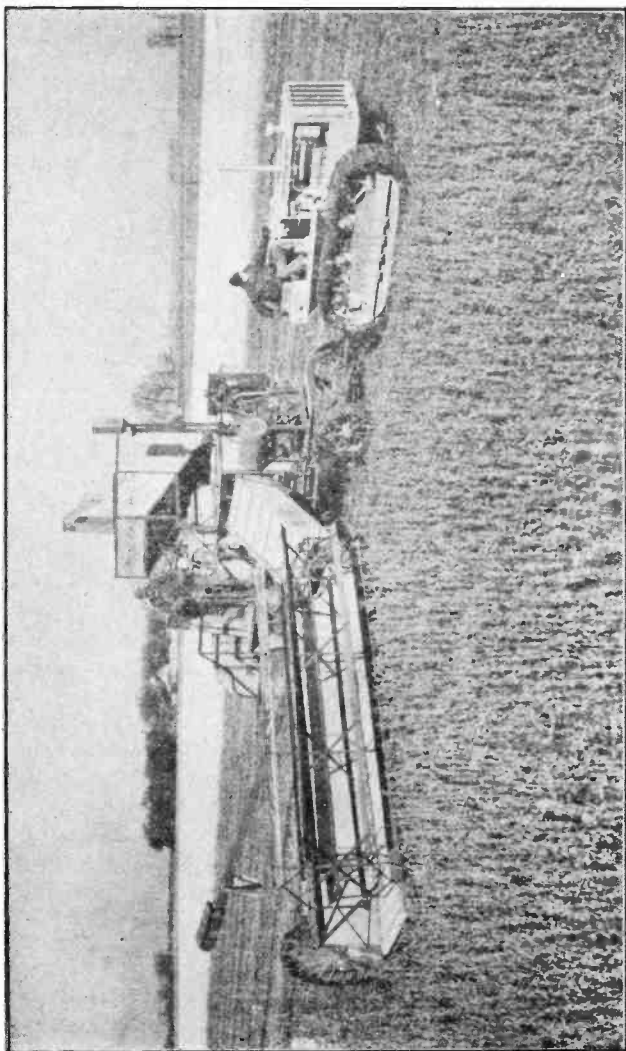

This photo shows a Caterpillar Diesel tractor pulling a 16 foot combine machine harvesting soy beans. Thousands of tractors of this type are now used in farm work.

Diesel Electric Power

See Fig. 2, which shows a Diesel engine equipped with an electric starting motor.

With temperatures of 80 degrees F., 100 to 300 amperes are required to crank the engine, whereas

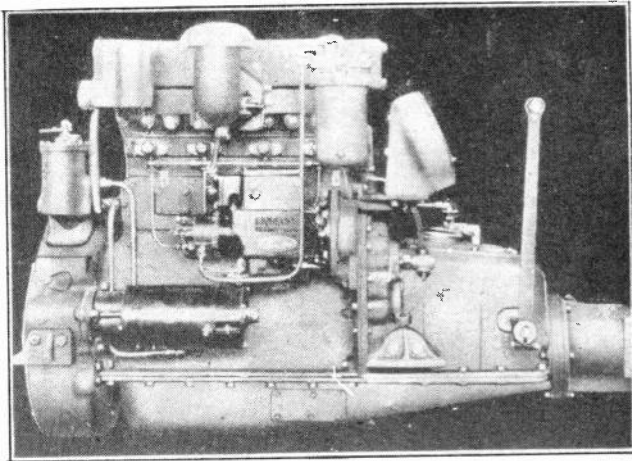

Fig. 2. Above photograph shows a Diesel engine equipped with an electric starting motor similar to those used for starting automobile engines. Diesel engines, used on trucks and busses are commonly equipped with this type of electric starter. Courtesy Buda Engine Company.

low temperatures of 0 to 20 degrees F. might call for 800 to 2000 amperes, depending on the size of the engine. Batteries having as many as 25 plates per cell are used. A small generator mounted right on the engine keeps the battery charged. This method of starting is suitable for engines up to 300 h.p.

Engines of 300 to 1200 h.p., as used in railcars and Diesel-Electric trains are started by using the large generator which the Diesel engine normally drives, as a starting motor. Current from a 32 or 56 cell (64 or 112 volt) battery is sent through the armature and a special series field in the generator, causing it to operate as a motor.

2. AUXILIARY GASOLINE ENGINE STARTERS

Where batteries are not practical, small gasoline engines are sometimes used. This applies especially

Starting Systems

to tractors and stationary Diesel engines, or Diesel engines used on portable equipment. These small gasoline engines are usually 2 or 4 cylinder, 4 stroke cycle engines, mounted on the side of the Diesel as shown in Fig. 3, or across the back of the engine above the flywheel as shown in Fig. 4.

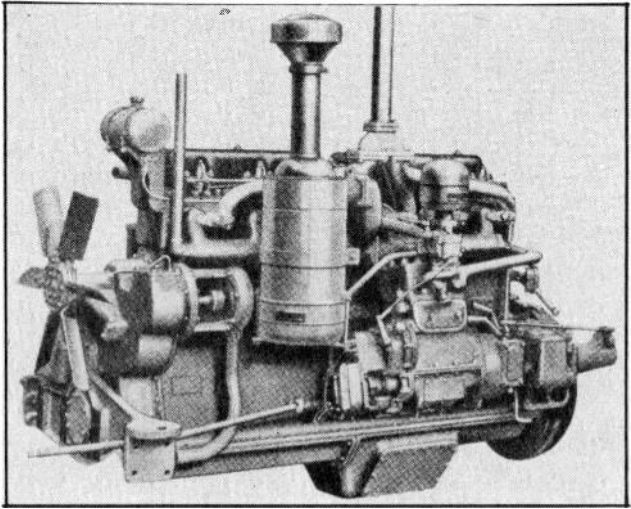

Fig. 3. This view shows a Diesel tractor engine with a small gasoline engine built right on the side of the Diesel for use in starting. The gasoline engine is first started by hand and then connected to the Diesel engine flywheel by means of a clutch and Bendix drive, thus rotating the Diesel engine until it starts on its own fuel. Courtesy Caterpillar Tractor Co.

The small engine is cranked and started by hand, and then connected to the Diesel through a clutch and Bendix drive. Note the clutch control handles between the gasoline engine and the flywheel in Fig. 3. Also note the small magneto located on the left end of the gasoline engine for ignition of the gasoline vapor in this starting engine.

To assist in starting, especially in cold weather, the exhaust heat from the small starting engine is often used to heat the intake manifold of the Diesel. Warm intake air produces a higher temperature at the end of the compression stroke and promotes quicker starting. At temperatures slightly below zero, the starting engine should be allowed to run for 8 to 10 minutes to warm up the Diesel air in-

Diesel Electric Power

take manifold before attempting to start the Diesel.

3. GASOLINE STARTING DIESEL ENGINES

The International Harvester Diesel is started directly as a conventional gasoline engine, by admitting gasoline instead of fuel oil to the cylinder during starting. This engine is equipped with a magneto, carburetor, spark plugs, extra clearance chamber and valve, and duplex intake manifold, which are only used during starting. See the sectional view of one cylinder of this type of engine shown in Fig. 5.

To start this engine, the operator applies crank (1) shown in Figs. 5 and 6, which through a cam mechanism opens valve (3) between the cylinder proper and the auxiliary combustion chamber (4). This added space reduces the compression pressure so that the engine can be easily cranked by hand. A spark plug (5) is located in each auxiliary combustion chamber. When valve (3) is opened, the

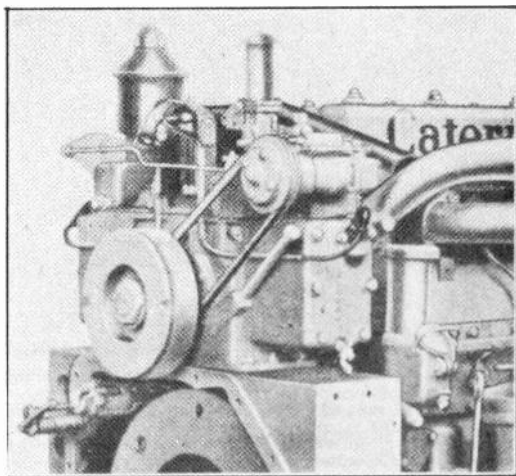

Fig. 4. This figure shows the gasoline starting engine mounted above the flywheel at the rear of the Diesel engine. Courtesy Caterpillar Tractor Co.

double butterfly valve (6) closes one side (the Diesel air intake side) of the duplex manifold, but

Starting Systems

opens the other side which is connected to a standard carburetor which supplies a mixture of gasoline and air for starting.

A high tension magneto which supplies current to the spark plugs is also engaged and the engine is ready to operate as a gasoline engine.

As soon as the engine starts and has made 700 revolutions, the rod (2) which is operated by an automatic device built into the injection pump assembly, releases the shaft that was turned manually by crank (1), and valve (3) closes, cutting out the auxiliary combustion chamber (4), raising the compression pressure to 500 lbs. At the same time the double butterfly valve cuts off the carburetor, the magneto is disengaged, and the engine runs as a full Diesel

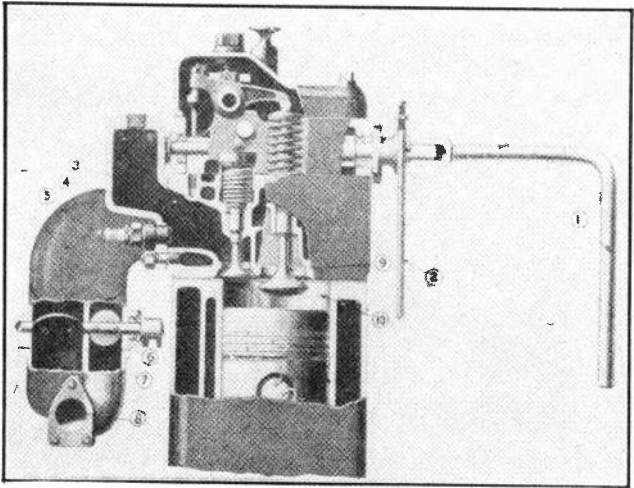

Fig. 5. This excellent sectional view of a Diesel engine cylinder shows the auxiliary combustion chamber (4), which is opened up by valve (3) to permit this type of engine to start on gasoline fuel. The starting valve is opened by the hand crank (1) shown at the right. Also note the valves in the intake manifold which change over from air to gasoline vapor for starting. Note the spark plug (5) which ignites the gasoline vapor in the auxiliary chamber during starting. Courtesy International Harvester Co.

4. COMPRESSED AIR STARTING

Large Diesel engines are often started by means of compressed air. This also applies to some of the

Diesel Electric Power

smaller ones where battery or gasoline engine starting is not desirable. Air under pressures of 200 to 300 lbs. per square inch from a pressure tank or cylinder is admitted to the engine cylinders. A rotary air distributor valve starts admitting air to the proper engine cylinder when the piston is a few degrees past top dead center, or just as the piston is starting downward on the power stroke. This

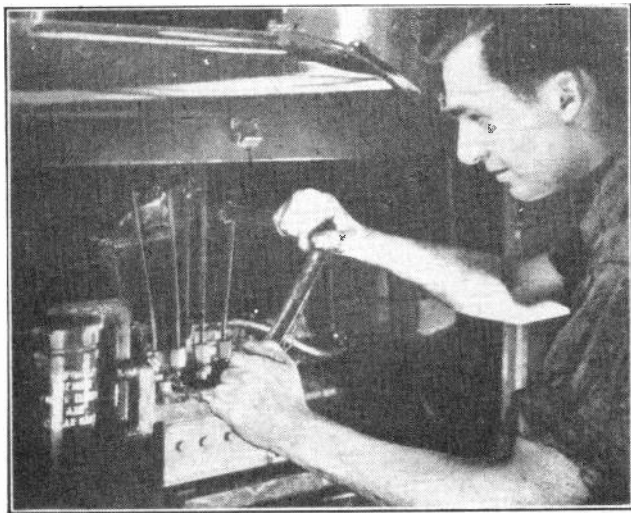

Fig. 6. This photo shows an operator attaching the hand crank to shift the valves for starting an International Harvester Diesel on gasoline fuel.

high pressure air forces the piston down and starts the engine rotating. As the engine rotates the rotary air distributor valve turns and admits air to the different cylinders in the same order that the engine fires, thus causing the engine to rotate until it begins to fire.

As soon as the engine starts to operate by compression igniting the fuel oil, the main air valve is closed, shutting off the starting air. Fig. 1 on page 2 shows a large Diesel engine with the air cylinders and starting controls in the foreground. Fig. 7

Starting Systems

shows a smaller engine equipped for air starting. Note the rotary air valve mounted on the right hand end of this engine, and also the air lines leading from this distributor valve to each cylinder.

To prevent back flow of hot gasses through the air starting lines to the rotary distributor valve, air starting valves are used. These are simple spring loaded, bevel faced valves, as shown in Fig. 8 where the air line enters the engine cylinder. The pressure of the starting air is sufficient to overcome the resistance of the spring, so the valve opens automatically, as soon as the rotary distributor allows the air to flow to any cylinder. The instant the air stops flowing the starting air valve closes, and thus prevents back fire from the engine cylinder.

5. STARTING AIR SUPPLY

The air used to start Diesels is generally supplied by separately driven air compressors, and stored in tanks or cylinders under proper pressure until needed. Usually these compressors are of the two stage type such as shown in Figs. 9 and 10. A two stage compressor has two cylinders, one larger in diameter than the other. The air is first compressed by the large or low pressure cylinder from which it passes to the small or high pressure cylinder, which compresses it to still higher pressure and forces it into the storage tank or tanks.

Since compressing air tends to increase its temperature, the air connection between the low and high pressure cylinder is always designed to remove some of the heat. Fig. 9 shows a 2 stage compressor with a heavily finned air connection pipe or "intercooler" between the two cylinders. Some air compressors are water cooled to keep them from overheating during long periods of operation.

As a rule, air compressors are driven with an electric motor, as shown in Fig. 11. In large Diesel plants, gasoline engine driven compressors such as shown in Fig. 12, are often installed in addition to the regular motor driven units, to be used in case of electric power failure.

Diesel Electric Power

In some cases air compressors are direct connected to one or more of the Diesel engines in a Diesel plant, and used to store up in pressure tanks an ample supply of starting air while the engines are running. In plants where several Diesel engines are installed, in emergencies an idle engine can

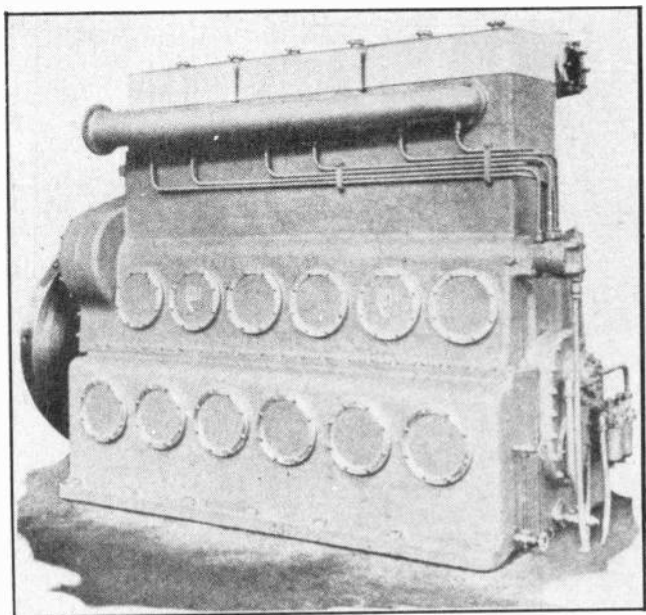

Fig. 7. On the right of the above Diesel engine can be seen the rotary air distributor valve which admits air under several hundred pounds pressure to the proper cylinders at the proper time, for starting this type of engine. Courtesy Da La Verne Engine Co.

sometimes be started by connecting an air line from one cylinder of a running engine, with a check valve in the line to store up air in a tank. In this manner the compression pressure of one cylinder of the running engine can be used to compress air in a starting tank. The fuel oil must of course be shut off from this cylinder to prevent firing while it is being used as a compressor.

Starting Systems

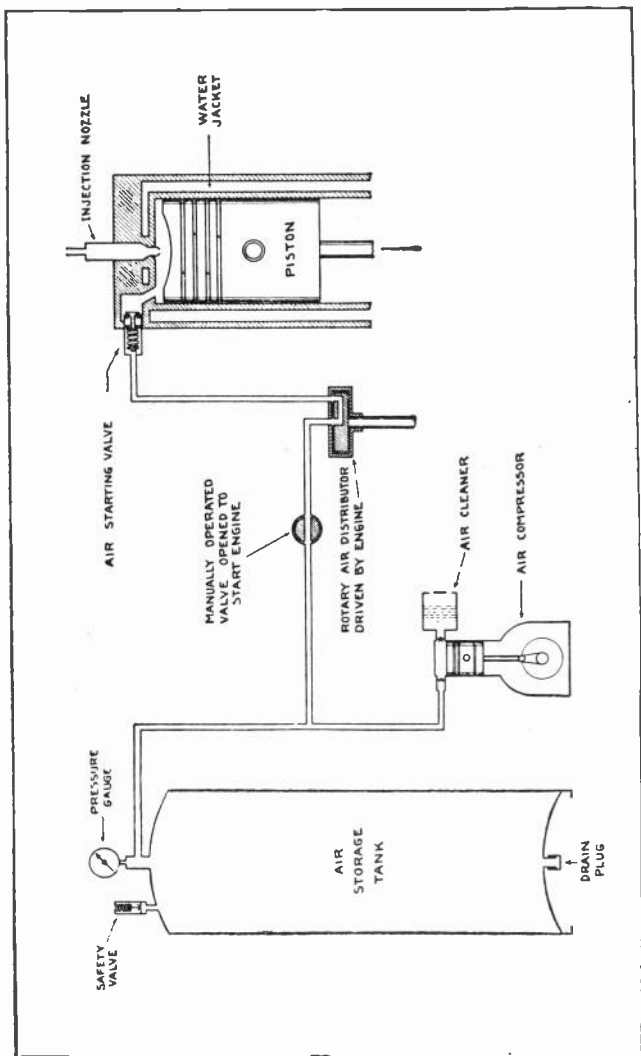

Fig. 8. This diagram shows a complete air starting system for a Diesel engine. Note the air compressor, air storage tank, manual starting valve, rotary distributor valve, and check valve or air starting valve at the engine cylinder.

Diesel Electric Power

Air compressors are generally equipped with a hand "unloader valve" on top of the cylinder, for releasing compression while the driving motor or engine is started. This unloader valve should always be opened before starting the compressor.

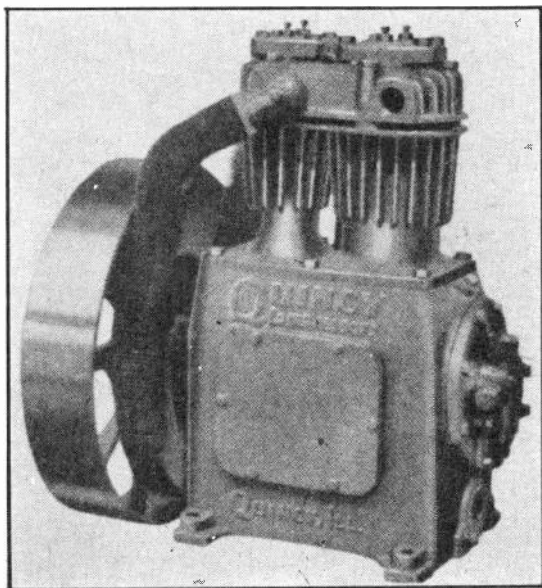

Fig. 10. Two stage air compressor equipped with a pulley for belt drive from an electric motor or Diesel engine. Note the cooling fins on the connecting tube between the low pressure and high pressure cylinders. Air which is circulated across this finned tube by the fan blades in the pulley removes some of the heat that is generated when the air is compressed. Courtesy Quincy Compressor Co.

6. STARTING AIDS

Several schemes are employed to assist starting Diesel engines at low temperatures. One of the most common is the use of glow plugs which are similar to spark plugs in general appearance and construction, but have a piece of heavy resistance wire in place of a spark gap. See Fig. 14-A. When

Starting Systems

electric current is sent through this resistance wire, it immediately heats up until it becomes red hot. The glow plug is so located that some of the oil spray from the injection nozzle will strike the red hot heating element and ignite readily with this heat added to that of compression.

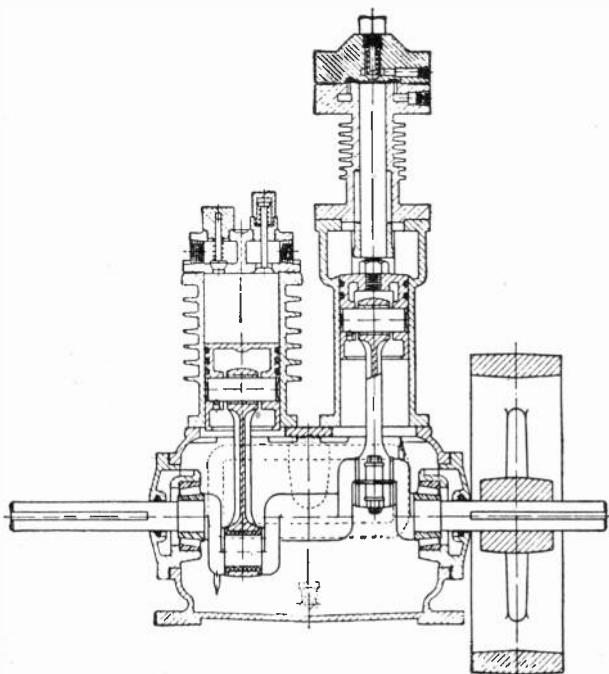

Fig. 10. Sectional view of a 2 stage air compressor used for supplying starting air for Diesel engines.

Some glow plugs are designed to operate from a 6 volt source, while others require only 2 volts. The current drawn by each glow plug will vary from 20 to 30 amperes. As a rule current obtained from a battery is used to heat these glow plugs, but A.C. stepped down to the correct voltage, by means of a transformer can also be used. In plants where

Diesel Electric Power

A. C. is available, this is the best method, since it does away with the need of a battery. On truck and tractor engines batteries must of course be used to heat the glow plugs.

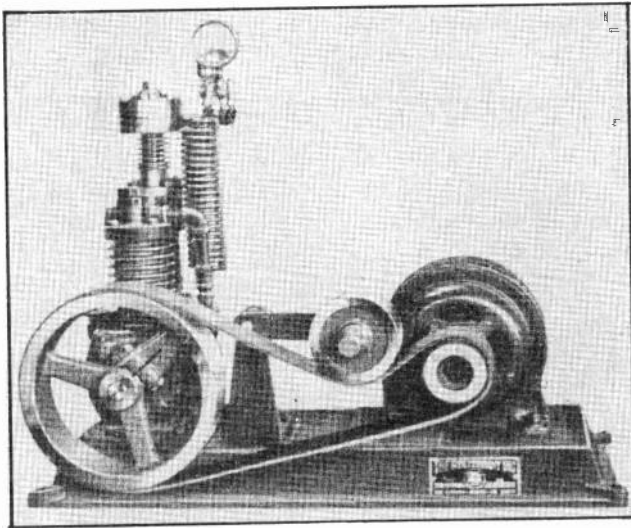

Fig. 11. Above view shows a 2 stage air compressor driven by an electric motor. Note the pressure gauge and cooling coil attached to the compressor. Courtesy Rix Compressor Co.

Glow plugs are usually designed to operate connected in parallel. While sometimes series type glow plugs are used, they are not favored because the burning out of one plug opens the entire circuit and puts all the others out of commission at the same time.

As a rule glow plugs are connected directly to the source of supply and controlled by a switch as shown in Fig. 14-B. In this case the switch is turned on and the plugs allowed to heat for 15 or 30 seconds before the engine is started. If the engine is a full Diesel, the glow plug switch is opened as soon as the engine begins firing. When used on

Starting Systems

semi-Diesel or oil engines, the glow plugs are left on until the engine is hot enough to run without their assistance.

Fig. 14-C shows a system used on the Waukesha Comet Diesels. The glow plugs are connected in parallel to a bare copper bus bar which in turn is

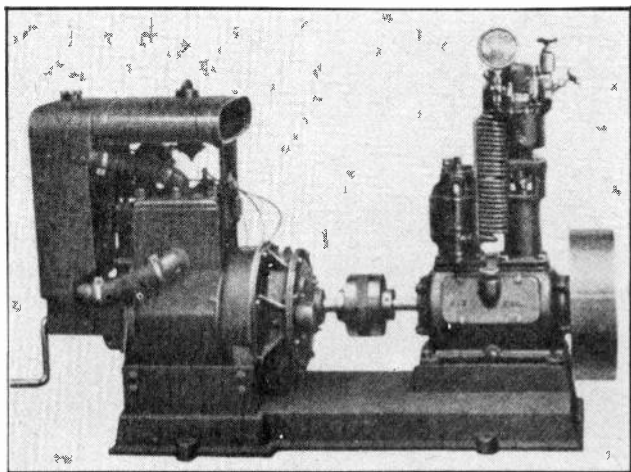

Fig. 12. Two stage air compressor driven by direct connection to a small gasoline engine. This type of unit provides a dependable supply of starting air in Diesel engine plants regardless of possible failure of the electric power supply when all Diesel engines are stopped. Courtesy Rix Compressor Co.

connected between the starting motor and the grounded side of the electrical system. When the starting switch is closed part of the starting motor current flows through the glow plugs and through the ground connection on the engine, back to the battery. The 6 glow plugs have a total current capacity of 180 amperes, so the remainder of the starting motor current is carried to ground by means of an external resistance which is in parallel with the glow plugs between the copper bus and ground.

Diesel Electric Power

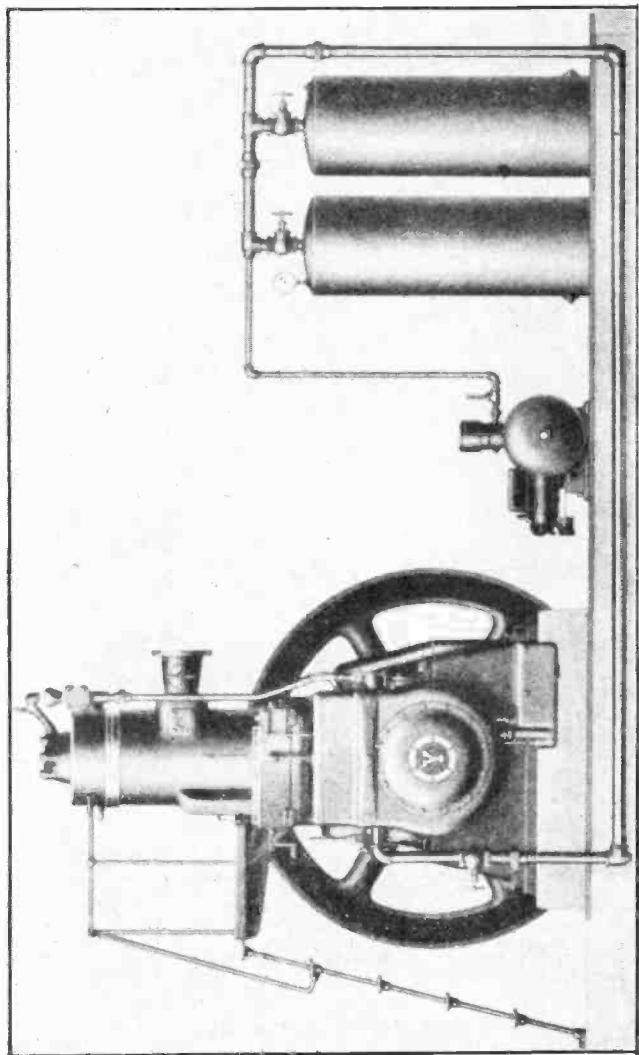

Fig. 13. Complete starting equipment including gasoline engine driven compressor, air storage tanks, and air line connected to an earlier type of stationary Diesel engine. Courtesy Fairbanks Morse Co.

Starting Systems

The plugs being of the quick heating type heat up immediately and assist in starting the engine. As soon as the engine starts and the starting

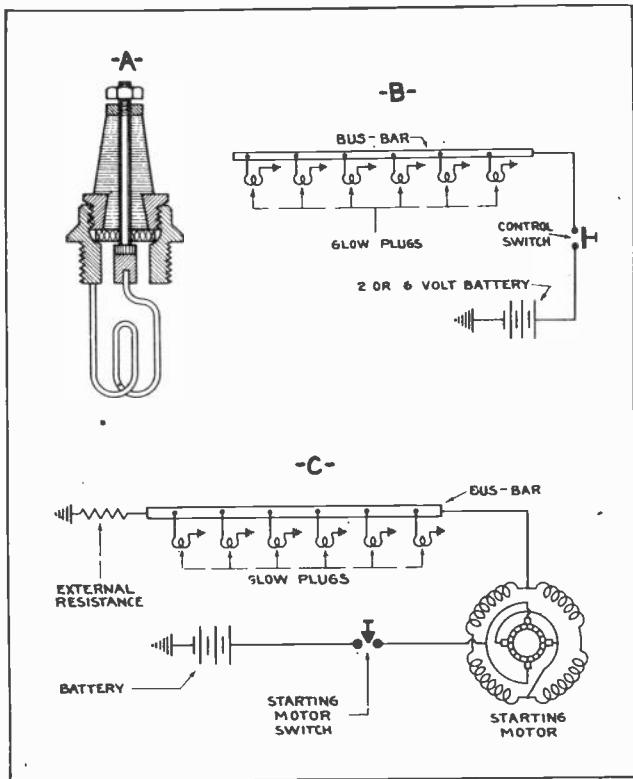

Fig. 14. At "A" is shown a glow plug using a loop of high resistance wire which is heated red hot with electric current to aid in starting certain types of Diesel engines. At "B" is shown the connections for the glow plugs of a 6 cylinder engine. These plugs are operated from a storage battery and controlled by a hand or foot switch. At "C" is shown a set of 6 glow plugs connected in series with the starting motor of a Diesel engine so that the glow plugs are automatically heated whenever the starting switch is closed.

motor switch is opened, the glow plugs are cut off. If the external resistance between the bus-bar, and the engine becomes disconnected, or if its connections become corroded, the engine will not start

Diesel Electric Power

readily and the glow plugs receiving more than their normal current will burn out.

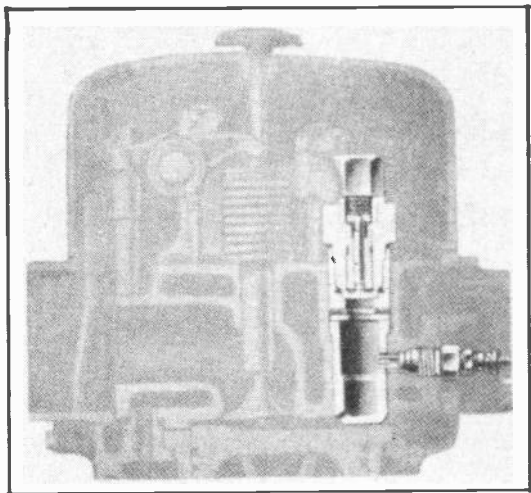

Fig. 15. The above view shows a glow plug mounted on a Diesel engine cylinder with a heater wires extending into the side of the combustion chamber directly beneath the injector nozzle.

7. HOT BULB OR TUBE

Some semi-Diesels use a hot bulb or tube to ignite the fuel when the engine is cold. This tube which is hollow but closed at one end, extends into the combustion chamber with the open end on the inside as shown in Fig. 16. The flame of a kerosene or gasoline torch is directed against the closed end of the tube until it is red hot, and the engine is then started. When the engine is turned over, part of the fuel charge from the injector nozzle strikes the inner end of the hot tube and ignites quite readily. The torch is kept on until the engine is hot enough to run with out its assistance. Several types of hot tubes or hot bulbs are used with certain Diesel and semi-Diesel engines to facilitate starting in this manner, especially in very cold weather.

Some semi-Diesels or oil engines use **starting wicks** instead of a hot tube. A starting wick con-

Starting Systems

sists of a piece of cotton sash cord pressed firmly into a hollow fitting, called the starting plug. To use this device the wick is dipped into fuel oil, then

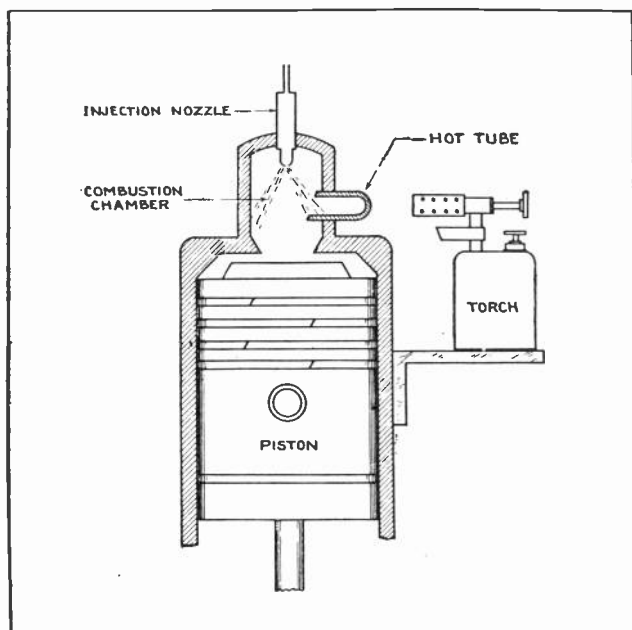

Fig. 16. Diagram showing a sectional view of a Diesel engine cylinder equipped with a hot tube and torch for aiding in the combustion of the fuel charge during starting.

lighted with a match, and held with the flame up so that it will not burn the entire length of the wick. It is allowed to burn until the tip glows red, then the starting plug is screwed into place in the combustion chamber, and the engine is ready to start. The glowing coal on the end of the wick helps to ignite the fuel oil charges until the engine gets hot.

8. FAILURE TO START

Failure of a Diesel engine to start may be due to:

1. Lack of fuel.
2. Air in the fuel system.
3. Improper timing of injection.

Diesel Electric Power

4. Low compression.
5. Low cranking speed.
6. Low glow plug voltage.

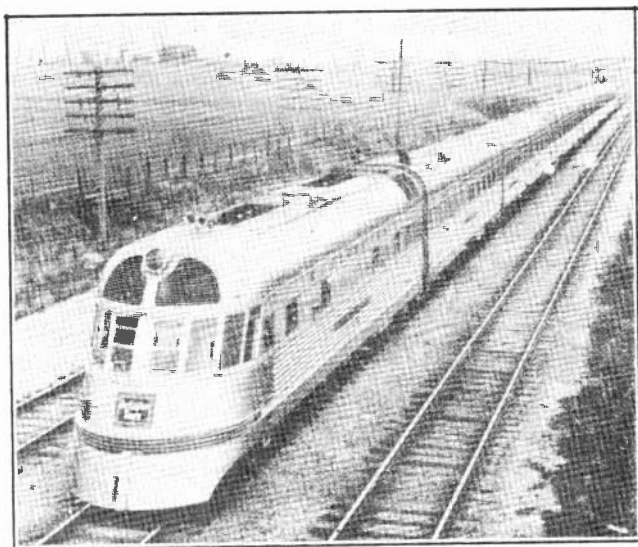

Fig. 17. Modern high speed Diesel Electric train. The operation of trains of this type is made possible through the economy and efficiency of the Diesel engine, plus the flexibility and ease of control of the electric generator and electric driving motors. Courtesy Burlington Railway Co.

In case the engine will not start, the fuel supply should be checked. If the fuel tank is full, be sure the tank valve is open. To check the fuel line between the tank and injection pump, loosen fuel line at injection pump. If the fuel is fed by gravity, it should flow freely when the fuel line is loosened. If a transfer pump is used, turn the engine over and then fuel should flow freely. If it does not flow freely check the filters and the fuel line for clogging obstructions.

Air in the fuel system will cause starting failure or erratic operation of the engine. For this reason, the fuel tank should never be allowed to run dry. Should the system become air bound, be sure that fuel reaches the injection pump, then open the air

Starting Systems

bleeder screws, or loosen fuel lines at the injection nozzles. Turn the engine over, or operate the injection pump plungers manually until fuel free from air bubbles, flows from the bleeder opening or loosened fuel line connection.

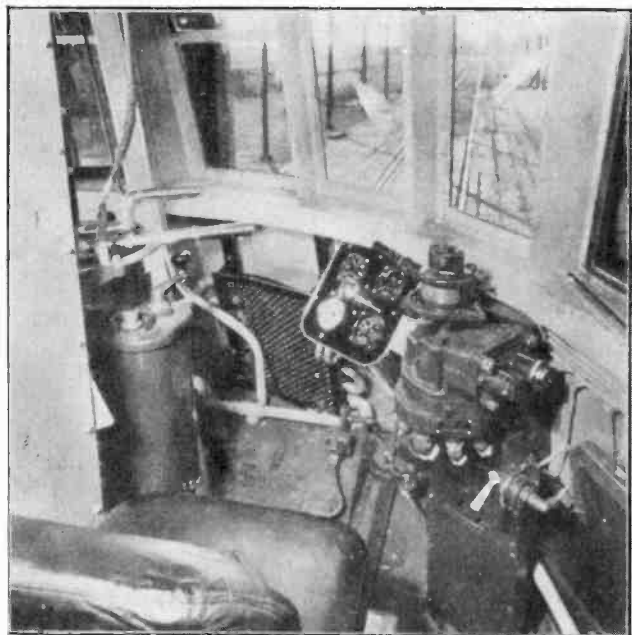

Fig. 18. Photo of the inside of the engineer's cab of a Diesel-Electric locomotive showing the engine and generator controls. Courtesy Burlington Railway Co.

If the injection pump has just been installed, it may be improperly timed, very likely too late.

Low compression, especially if no starting aids are used, will often cause starting failure. Causes of low compression are leaky valves, stuck or worn piston rings and leaky gaskets. For a full Diesel engine about 350 lbs. is considered to be the minimum starting compression.

If a starting motor and battery is used the battery must be kept well charged, otherwise the starting motor will be sluggish and much of the compression heat will be lost and starting will be difficult.

Diesel Electric Power

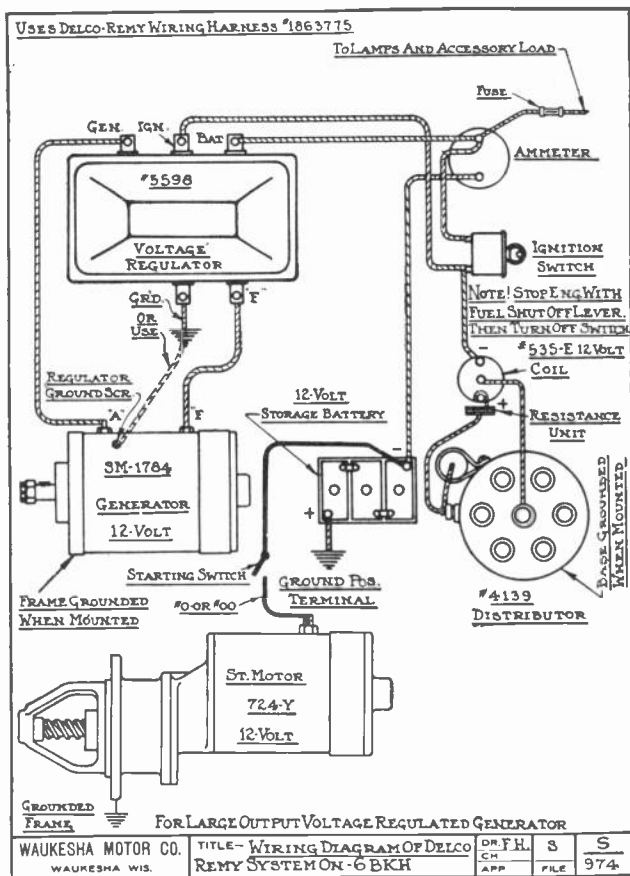

Fig. 19. Circuit diagram of the electric starting motor, battery, generator and ignition equipment of a Waukesha engine, which uses spark plug ignition. Note the instructions for stopping this type of engine. Courtesy Waukesha Motor Co.

Starting Systems

Glow plugs, are very sensitive to voltage changes. A 20% drop in battery voltage will often cause the glow plugs to fail to generate sufficient heat to provide ignition. Since using the starting motor tends to lower battery voltage, it is best to check the battery while it is under load.

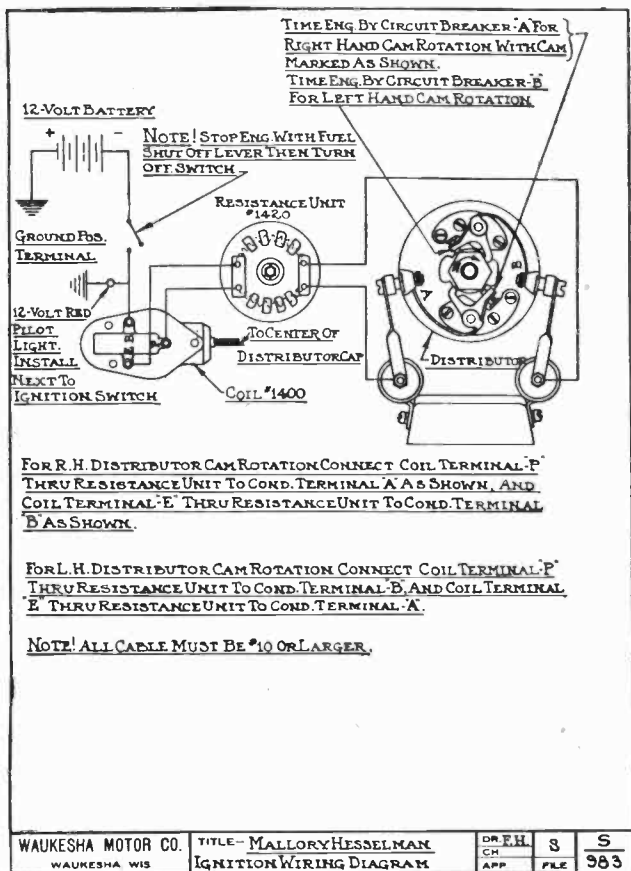

Fig. 20. Ignition wiring diagram for Waukesha Hesselman fuel oil engine. Note the printed instructions for timing and stopping this engine. Courtesy Waukesha Motor Co.

Diesel Electric Power

EXAMINATION QUESTIONS

1. Why are compression releases used on Diesel Engines designed for hand cranking?

2. How are high speed Diesel Engines such as used on trucks, tractors, busses, and motor boats, usually started,

3. When using a small gasoline engine for starting large Diesel Engines, why is the exhaust manifold of the small engine arranged near the intake manifold of the Diesel Engine?

4. Briefly describe the method of starting Diesel Engines by use of gasoline fuel instead of regular fuel oil.

5. Of what value is the air starting valve as in Figure 8.

6. Describe two methods which are used in cooling air compressors.

7. A. For what purpose are GLOW PLUGS used in Diesel Engines?

B. Describe their construction.

8. Briefly describe the Hot Bulb as used in connection with Diesel Engine starting.

9. How are starting wicks used in starting some types of Diesel Engines?

10. Give five reasons why Diesel Engines may fail to start.



A.A.R. 1983—Engineer at controls in the cab of Santa Fe Diesel-Electric freight locomotive.

Courtesy Santa Fe Railway

Diesel Electric Power

DIESEL ENGINE EXHAUST AND COOLING SYSTEMS

Disposal of the exhaust gases and heat produced by Diesel engines is an important problem, especially in connection with large engines where exhaust noises and fumes may be considerable, and where the heat may be utilized instead of wasted.

Small high speed Diesels used outdoors for either portable or stationary service usually release their exhaust gases to the open air, through a short open exhaust pipe or stack. If for any reason the exhaust noise is objectionable, a muffler can be used. Diesel engines in trucks are generally equipped with an exhaust pipe* that discharges the exhaust gases above the cab. This keeps the smoke and odor well above road level.

For larger engine installations indoors, a more extensive exhaust layout is required. In designing an exhaust system, it is highly important that the size of the piping and fittings be large enough so that the back pressure be kept down to a minimum. Any back pressure in the exhaust system raises the cylinder pressure during the exhaust stroke, which results in poor scavenging* or cleaning of the exhaust gases. This in turn reduces the power output of the engine, and means that more fuel must be burned to deliver the same power. This is especially true of 2 stroke cycle engines because of the short exhaust period and the low pressure of the scavenging air, unless the engine happens to be equipped with a blower or scavenging compressor as explained in one of the earlier lessons.

The back pressure in an exhaust line is the sum total of two losses. In order to cause a gas to flow through a pipe some pressure will be required. Added to that will be the pressure loss due to friction of the gases in the pipe.

If the pipe is too small the velocity of the gases will have to be higher and will therefore require a greater pressure difference between the engine and outer end of the exhaust system, to obtain the

*You will recall from an earlier section that the term scavenging as applied to Diesel engines, means cleaning the cylinder of exhaust gases.

Exhaust Systems

required velocity. An increase in gas velocity means an increase in pressure loss due to friction. For this reason a small exhaust line will offer a higher back pressure than a larger line. The piping should be of such a diameter that the back pressure measured at a point close to the engine does not exceed .5 lb.

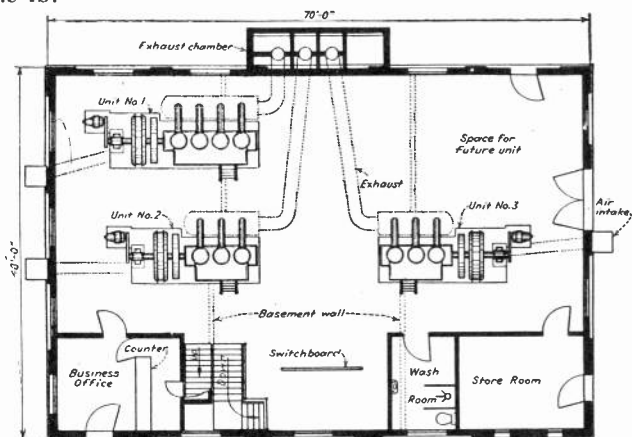

Fig. 2. This diagram shows the layout of a Diesel-Electric power plant with 3 engines driving electric generators. Note the arrangement of the exhaust and air intake pipes. Courtesy Diesel Power Magazine.

Assuming that the mean effective pressure on the piston is 75 lbs. the loss due to exhaust back pressure would be $0.5 \div 75 = .066$ or approximately $2/3$ of one per cent. If on the other hand the back pressure was 5 lbs., the loss would be $5 \div 75 = .66$ or about 7%. This would mean an increase of 7% in fuel consumed to produce the same power. So you can readily see the importance of having properly sized exhaust lines.

1. EXHAUST SILENCERS

In localities where the noise of the exhaust is objectionable, mufflers or silencers are part of the exhaust system. Many large Diesel plants reduce the noise of the exhaust by running the exhaust line from the engine into a concrete pit filled with large stones. The expanding of the gas through the crevices in the rock mass, reduces its velocity and absorbs or deadens the noise. The pit has a tall stack

Diesel Electric Power

that carries the gases well above the roof line of the surrounding buildings.

Figure 3 shows a typical exhaust system and muffler for a large Diesel engine plant. Notice that the exhaust pipes are generous in size and that wherever possible gradual bends are used. You will also notice that the system is laid out so that all parts are free to move in order to allow for expansion and contraction due to changes of temperature, as these exhaust pipes get very hot. The piping is free where it goes through the walls and the muffler is mounted on a set of rollers.

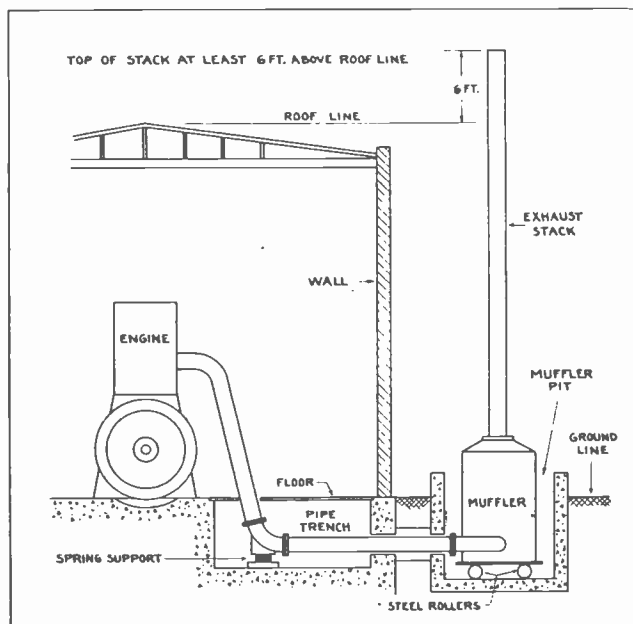

Fig. 3. Diagram showing layout of exhaust system in Diesel engine plant. Note the exhaust pipe, muffler and stack, and the provision for movement due to expansion.

Figure 2 shows the interior of a Diesel plant, in which the exhaust from each cylinder is taken through the floor by a separate exhaust pipe. The three exhaust pipes discharge into a common header under the floor, shown by the dotted lines in Figure 2, from which the exhaust is carried by a single line to the muffler chamber.

Exhaust Systems

A number of silencers specially designed for Diesel engines are on the market. Three common types offered are: (a) Baffle type, (b) Absorption type, and (c) Expansion type.

In the baffle type shown in Figure 4, the sound wave is suppressed by passing around a system of baffles or barriers, thus cushioning and breaking up

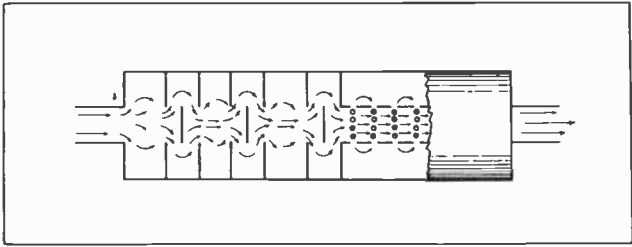

Fig. 4. This sketch shows how the exhaust gases pass through a muffler of the baffle type.

the gas pressure waves which create the noise. This smooths out the flow of exhaust gases to the discharge end of the muffler and greatly reduces the noise or sharp "barking" which would otherwise result.

The absorption type muffler shown in the two upper views in Figure 5, consists of an outer casing with a perforated tube running through the center, the space between the two being filled with a fire proof, absorbent material. Part of the gases pass through the perforations at one end of the inner tube, filter through the absorbent material and flow back through the perforations at the other end of the tube, thus breaking up the sound waves in the absorbent material. Since the central gas passage is free from obstructions, the back pressure offered by this type is practically zero. The lower view in Figure 5 shows a combination baffle and absorption type muffler.

In the expansion type muffler shown in Figure 6, water is sprayed into the exhaust chamber. This cools the gases, reducing their volume by contraction, and thereby reducing the velocity of the pressure wave that is responsible for the noise. The water spray also washes the exhaust gases and carries away some of the carbon, thus reducing the amount of smoke.

Diesel Electric Power

2. FLEXIBLE EXHAUST CONNECTIONS

To compensate for expansion and contraction of exhaust lines due to changes in temperature, sections of **flexible metallic tubing** such as shown in Figure 7, are often installed in the exhaust line close to the engine. Some of these flexible tubes are made of thin corrugated or ribbed metal, while others are made of tightly fitted overlapping metal rings with their edges crimped together. The use of flexible sections also prevents transmission of stresses and vibration from the engine to the exhaust line. Figure 8 shows the exhaust lines of a Diesel engine with flexible sections connected between the rigid pipes on the engine and the pipes leading to the muffler. The insert on the upper right shows a flexible section of exhaust tubing connected from the engine manifold to the roof stack.

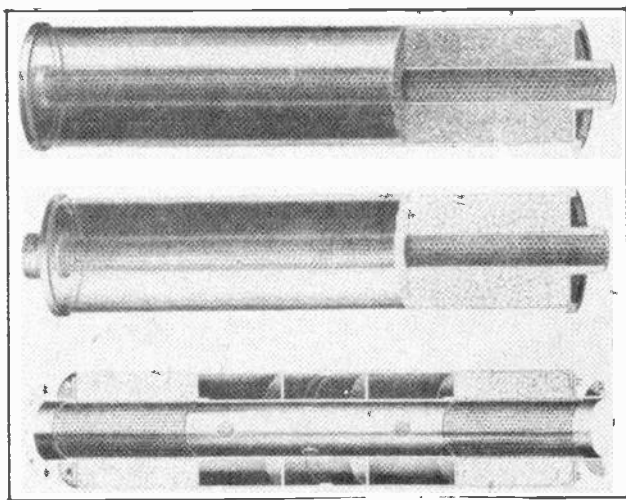

Fig. 5. Sectional views of 2 absorption type mufflers above, and a combination absorption and baffle type muffler below. Note that the center pipe is perforated to permit exhaust gases to expand into the absorbent material and then flow back into the center pipe. Courtesy Burgess Battery Company.

3. DIESEL ENGINE EXHAUST TEMPERATURES

One of the chief problems that a Diesel engineer is faced with is to detect trouble before it becomes serious enough to cause a lengthy shutdown of the

Exhaust Systems

engine. As the Diesel is a heat engine, its power output can be measured by the heat it produces.

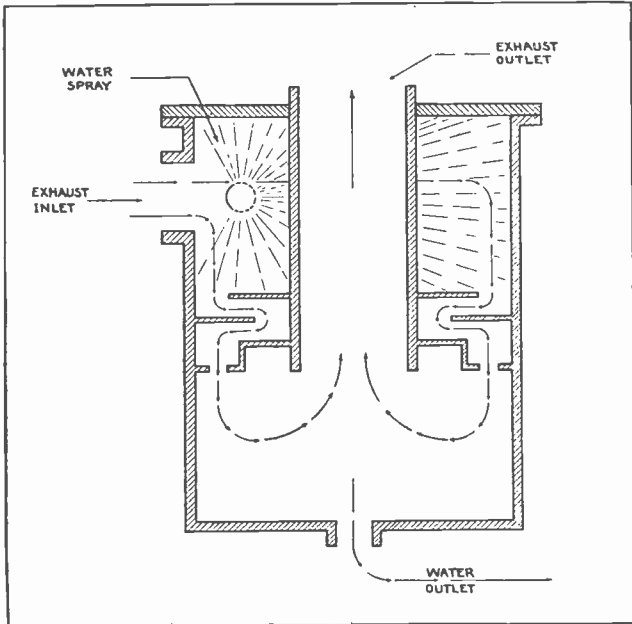

Fig. 6. Sectional diagram showing construction and operation of an expansion type muffler for Diesel engine exhaust. Note how the water spray chills and washes the exhaust gas.

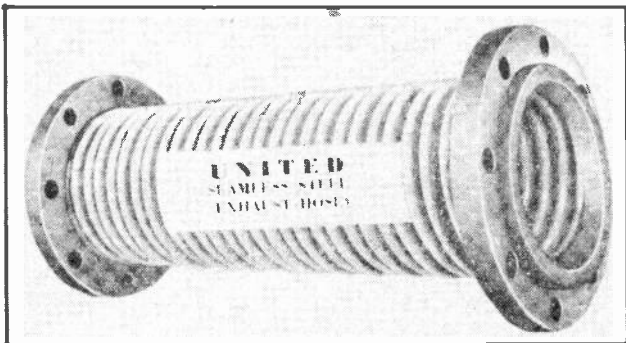

Fig. 7. Short section of flexible exhaust tubing such as frequently connected in exhaust pipe lines to reduce vibration and to allow for expansion and contraction. Courtesy United Steel Tubing Company.

Therefore checking the exhaust temperature is an ideal method of determining general engine operat-

Diesel Electric Power

ing conditions.

As an example, a 4 cylinder Diesel engine is in reality four separate units, since each cylinder has

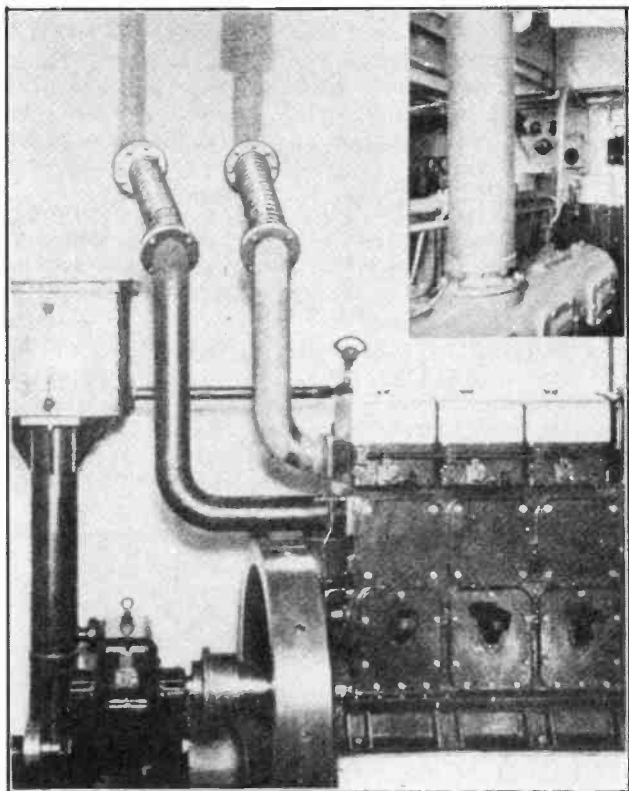

Fig. 8. Photo showing the use of flexible tubing sections installed in the two exhaust lines on the left. The small view inserted on the upper right shows a section of large flexible exhaust tubing connected from the engine exhaust manifold to the roof stack.

its own fuel pump, injection nozzles, pistons, valves, etc. In order to obtain satisfactory operation of the engine, the load must be distributed so that each cylinder carries its share. If, for any reason, one cylinder does not carry its share of load, the remaining cylinders may be overloaded and damage may be the result.

Since the power output is measured in terms of heat, checking the temperature of the exhaust of

Pyrometers

each individual cylinder will indicate whether each is carrying its share of the load or not. If the temperatures are uniform, the cylinders are all carrying their share of the load. If the temperatures vary greatly, it indicates that some cylinders are loafing, and others are carrying more than their share. If allowed to continue, this unbalanced condition might result in scored cylinder walls, broken pistons, damaged bearings, or even broken crank shafts.

4. PYROMETERS

Pyrometers are used to check exhaust temperatures. Ordinary electrical pyrometers operate on the principle that if two wires made of dissimilar metals are brazed together, a potential or voltage difference will be produced at the junction of the two wires when they are heated. This potential difference varies with the temperature, so a millivoltmeter connected across the cold ends of the two wires to measure the potential difference, can be made to indicate the temperature at the joint. See Figure 9.

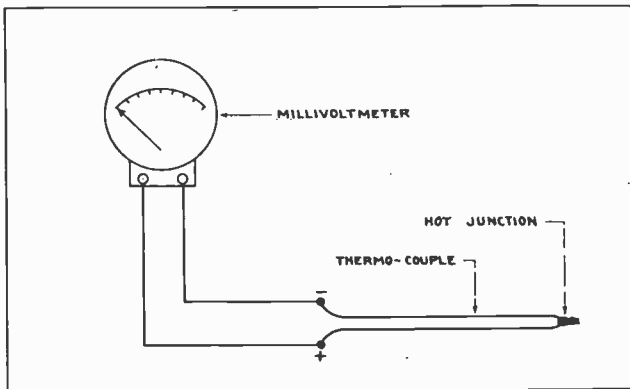

Fig. 9. Diagram showing the connections of a thermo-couple and millivolt-meter used for indicating exhaust gas temperatures on Diesel engines.

The part of the pyrometer consisting of the two dissimilar metals is known as a thermo-couple, and is generally made of iron and constantan metal. The two wires of the thermo-couple are protected by a steel tube as shown in Figure 10. This tube is

Diesel Electric Power

fitted with a threaded section so that it can be screwed into the exhaust pipe of the engine. The scale of the millivoltmeter is calibrated in degrees of temperature instead of in millivolts.

Each cylinder should have its own thermo-couple screwed in the exhaust pipe as close to the cylinder as is practical, and in such a way that the stem of the thermo-couple extends to the center of the exhaust passage. On large engines, the thermo-couples are connected to the indicating unit by means of permanent wiring. A selector switch built into the indicating unit makes it possible to check the temperature of each cylinder separately by merely shifting this switch to connect the meter to the various thermo-couple elements, one at a time. See Figure 11. Figure 10 shows several types of pyrometers and selector switches for use with Diesel engines.

Portable pyrometers, such as shown in Figure 12, are sometimes used on smaller engines. In this case, the indicating unit is not connected directly to the thermo-couple, but its two pointed prods are held against the terminals of the thermo-couples as shown in the left view. Since portable pyrometers have prods made of the same metals as the thermo-couples, they can also be used to check the temperature of the cylinder head, or any clean metal surface by simply holding them in firm contact with the metal as shown on the lower right in Figure 12. When used in this manner it is good practice to indent the surface of the metal with two punch marks in order to make better contact with the points of the test prods.

The temperature of the exhaust will depend to quite an extent on the load carried by the engine, and on the efficiency of the exhaust system. Four cycle engine exhaust gases will have a temperature range up to 1000 degrees Fahrenheit, and two stroke cycle engine exhaust gases will range up to 700 degrees Fahrenheit. The lower temperature of the two stroke cycle engine is due to the cooling effect of the scavenging air on the exhaust gases.

If the power output of the engine decreases the exhaust gas temperature drops, while if the power output increases the exhaust temperature also in-

Pyrometers

creases. Once the operator of the engine becomes familiar with the relation between the power and the temperature of his engine, he should immediately notice any change from normal operation.

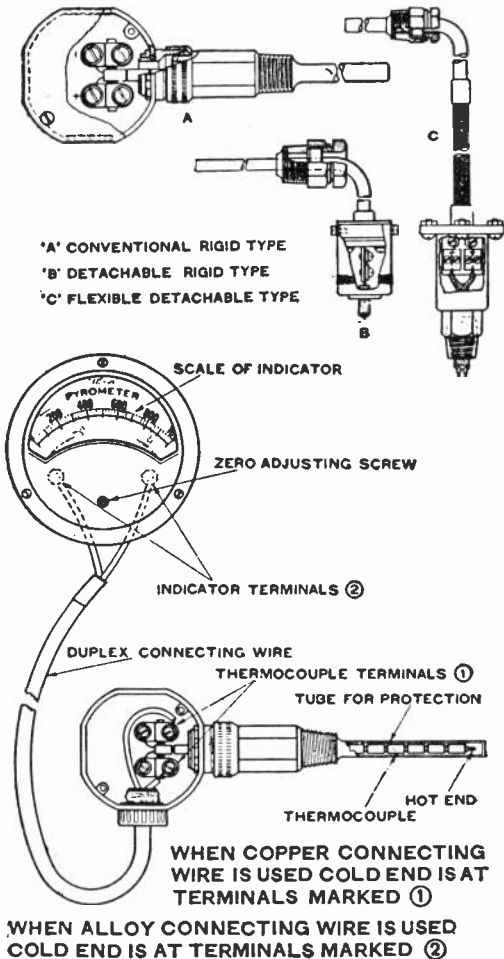

Fig. 10. The above view shows several different types of thermo-couple pyrometers for measuring Diesel exhaust gas temperatures.

5. CAUSES OF OVERHEATING

A general increase of temperature of all cylinders would indicate that the engine is carrying a heavier

Diesel Electric Power

load than usual. A gradual increase in general temperature with no increase in load might be caused by scale deposits in the water jackets, due to impure water. This scale acts as insulation between the water and the cylinder walls, causing them to run abnormally hot, and may burn away the lubricating oil film, resulting in scoring the cylinders and pistons

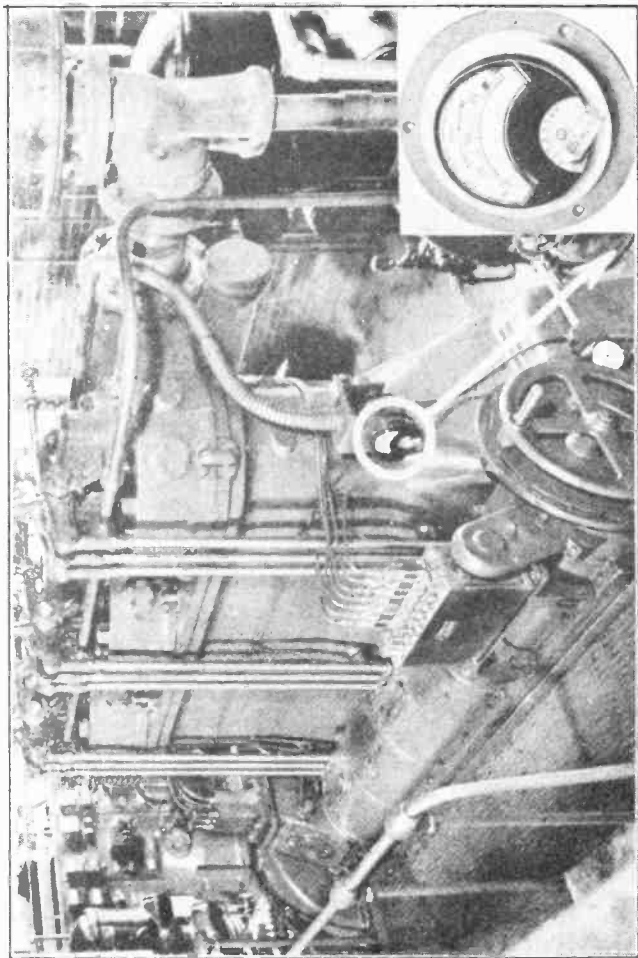

Fig. 11. This photograph shows the pyrometer indicating meter located on the right end of the engine and marked by the white circle. The wiring runs from this meter through the flexible tubing shown, to the thermo-couples located in the exhaust outlet of each cylinder. The insert on the lower right shows a larger view of the meter and the selector switch which is used for taking readings of the temperatures of individual cylinders.

With individual pump plungers supplying fuel to each cylinder, there is always the possibility of a

Pyrometers

variation in the fuel delivered to each cylinder, due to pump defects. If for any reason a plunger delivers less fuel than it should, the exhaust temperature will be lower in that cylinder, and higher than normal in the others that have to carry more than their share of the load. Leaky valves or worn piston rings would also mean a higher temperature due to inefficient performance.

If the injection pump had just been installed, high temperatures in all cylinders would indicate

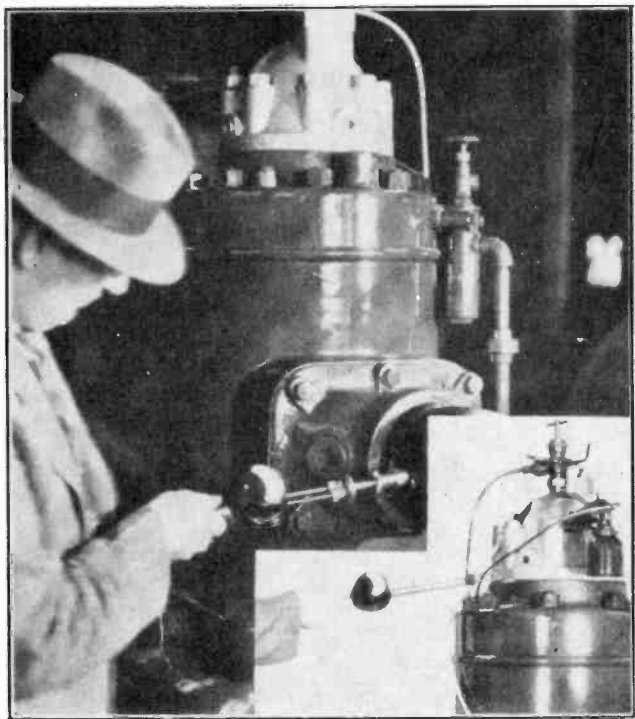

Fig. 12. The above views show portable pyrometers being used to check exhaust gas and cylinder head temperatures of Diesel engines. Courtesy Illinois Testing Laboratories.

late injection timing whereas if the fuel was injected too early, the temperature would be lower than usual.

In order to obtain accurate readings the stems of the thermo-couples must be kept reasonably free

Diesel Electric Power

from carbon, as this would insulate them. How often they should be cleaned depends upon how clean the engine runs. If the exhaust is smoky they will require frequent attention. When removing thermo-couples that have wires attached, be sure that each wire is re-connected to the same terminal from which it was disconnected.

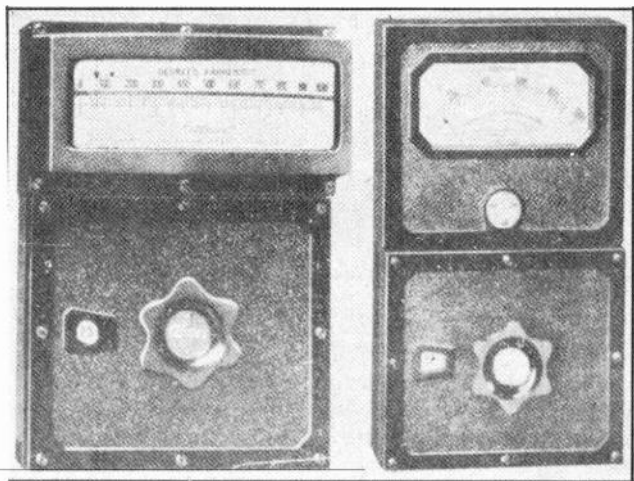

Fig. 13. Two common types of pyrometer meters and switches for panel or switchboard mounting.

When two Diesel engines are belted to the same load, pyrometers and thermo-couples are sometimes used to divide the load equally between the engines. In this case each engine is equipped with an extra thermo-couple, besides the regular ones used to check the exhaust temperature of the individual cylinders. This extra thermo-couple is installed in the main exhaust line at a point where it will be swept by the exhaust gases from all of the cylinders, thereby being affected by the average temperature of the entire exhaust gases from that engine.

If the load is evenly divided, the exhaust temperatures of the two engines will be the same. If one is carrying more than its share, its exhaust temperature will be higher because it is using more fuel. The operator can quickly remedy this condition by re-adjusting the governor of the engine that is not carrying its full share, so that the injection

Pyrometers

pump delivers a little more fuel. When both engines operate with the same exhaust temperatures they are properly balanced.

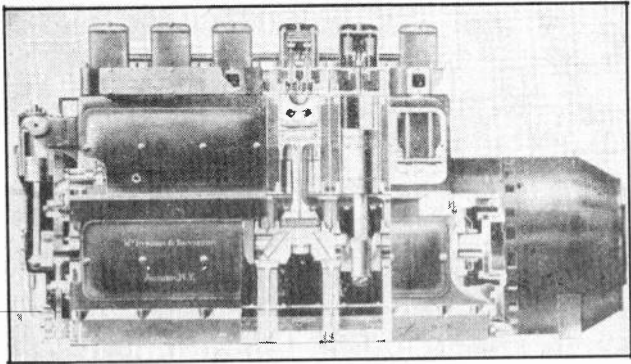

Fig. 14. The above sectional view shows how the cooling water surrounds the cylinders, cylinder heads, and valves of a Diesel engine. Courtesy McIntosh & Seymour.

Sometimes automatic governor controls operated by thermo-couples are used to properly divide the load between the engines.

COOLING SYSTEMS

Since the Diesel engine, like all internal combustion engines, burns its fuel within its cylinders, and generates very intense heat, some means must be provided to cool the parts that are exposed to this terrific heat. If some of this heat were not carried away the valves would quickly warp and leak; the oil film on the cylinder walls would break down or burn away and the pistons would "sieve" or stick, putting the engine out of commission.

With the exception of air-cooled engines designed for air craft uses, Diesel engines are water-cooled. Water is circulated through passages that surround the cylinder walls and also through passages in the cylinders heads. These passages are generally referred to as water jackets, and the water that circulates through them is often referred to as the jacket water. Figures 14 and 15 show sectional views of two different types of Diesel engines with cylinders cut away showing cooling water jackets.

Diesel Electric Power

There are several different types of cooling systems in use. The system that is selected depends largely on the size of the engine to be cooled, and also on the purity of the water that is available. Among the systems in use are: (1) Radiators with pump circulation of the water, (2) Thermo-syphon system, (3) Circulating non-return system, (4) Open and closed cooling systems. The last two are used for large installations.

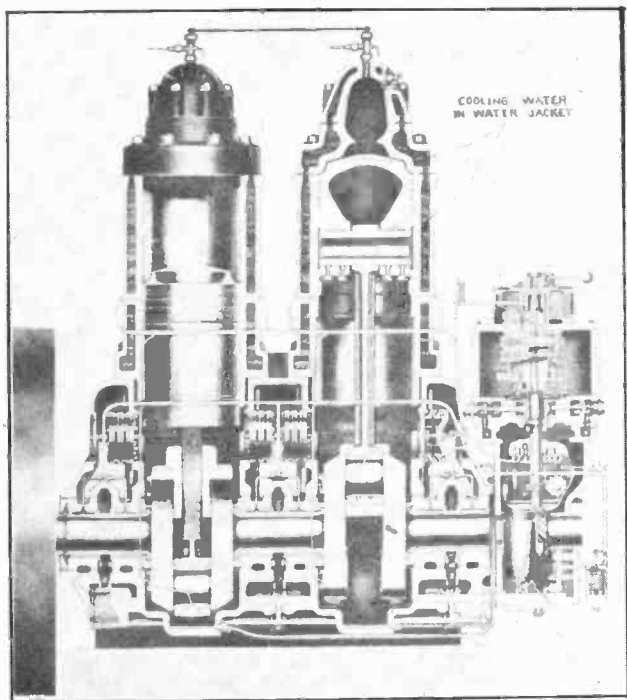

Fig. 15. This sectional view shows the cooling water in the water jacket around the cylinders, cylinder head and pre-combustion chamber of a Diesel engine. Also note the oil lines which carry lubricating oil to the bearings and piston surfaces. Courtesy Venn-Severin Engine Company.

6. RADIATOR COOLING SYSTEMS

With the development of high speed Diesels, radiators similar to those used for automotive engine cooling came into use because, in many cases, these engines are complete power units and must

Cooling Systems

be independent of any outside source for a continuous water supply. This applies especially to trucks, tractors, Diesel locomotives, and engines used on portable equipment. Even for highspeed stationary Diesel engines radiators are sometimes used because they provide a very compact, effective and reliable cooling system. See Figure 16.

The core of these radiators consists of a large number of small round or flat tubes. These tubes are finned to increase the radiating surface. The tubes run vertically with the top and bottom ends opening into tanks or headers.

The cooling agent is air. The water is merely used to absorb the heat from the hot parts of the cylinder and carry that heat to the radiator where

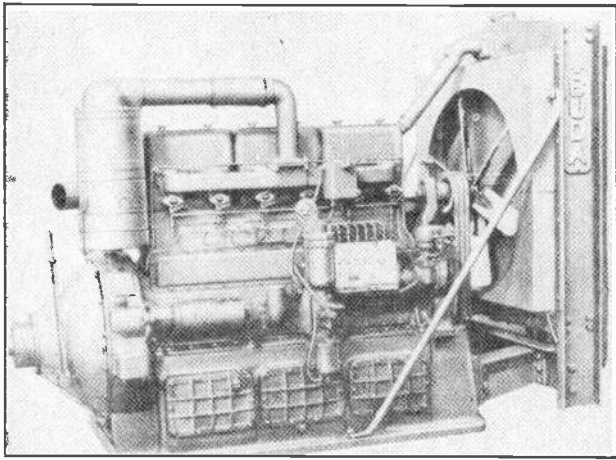

Fig. 16. Photograph of a six cylinder Diesel engine with cooling radiator and fan attached. The cooling water is circulated through the radiator and cooling jackets by means of a pump located beneath the fan. Courtesy Buda Engine Co.

it is absorbed from the water by the finned tubes in the radiator core. A fan behind the radiator draws air through the core and removes the heat from the tubes. So as the heat laden water enters the top of the radiator it loses some of its heat as it travels downward and is returned back to the lower part of the water jackets to absorb more heat. Circulation of the water is maintained by means of a pump mounted on the engine.

Diesel Electric Power

Sometimes the core of a radiator is made up of a number of separate vertical sections instead of one piece. In radiators of this type, very often one or two of the sections are used to cool the lubricating oil, the remaining sections being used to cool the water. There are partitions in the upper and lower tanks between the oil and water cooling por

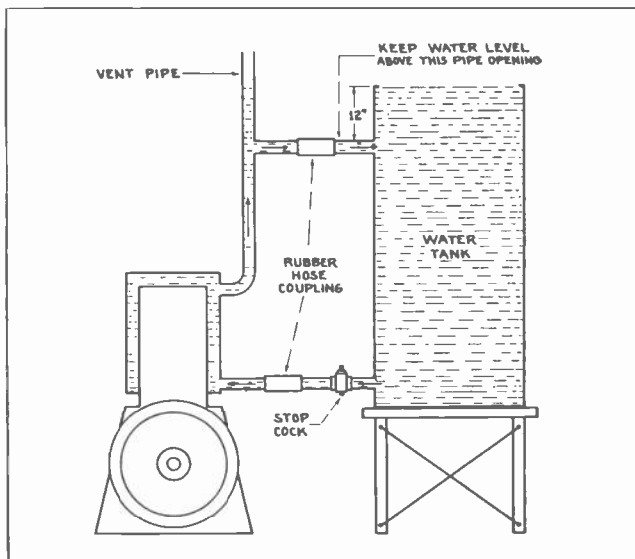

Fig. 17. Diagram showing the tank and pipe arrangement for a thermo-siphon cooling system for a stationary Diesel engine.

tion of the radiator so that the two systems are entirely separate, although mounted in the same frame and cooled by the same fan.

7. THERMO-SYPHON COOLING

This is the simplest engine cooling system in use, and is practical for small stationary engines up to 10 h.p. Above this h.p. rating the size of tank required makes the system impractical. This system consists of a tank and connections as shown in Figure 17. No pump is used, the water circulation being maintained by thermal action. As the water in the engine jacket heats it expands and becomes lighter in weight and tends to rise, as shown by the arrow, and discharges into the top of the tank.

Cooling Systems

The sides of the tank being exposed to the air radiate some of the heat absorbed from the water. The air also absorbs some heat from the upper surface of the water. This lowers the temperature of the water, reducing its volume and increasing its weight, causing the cooled water to drop to the bottom of the tank. Thus, continuous circulation is maintained without the help of a pump. Since circulation depends upon thermal action, the rate of circulation will be determined by the amount of heat generated in the engine, which in turn will depend upon the load that the engine is carrying. In some ways this system is ideal because circulation will not start until the engine has had a chance to warm up, and the water begins to warm up and expand.

While this system is extremely simple, there are rules that must be observed in making an installation of this type and getting the tank of the proper size. For a 5 h.p. engine, the tank should be 60 inches deep and 24 inches in diameter, which will provide a capacity of 110 gallons. For a 10 h.p. engine, a 210 gallon tank, 70 inches deep and 30 inches in diameter should be used. The tank outlet at the bottom must be level with the lower water jacket connection on the engine. If the tank outlet is set any lower than the connection on the water jacket, the water circulation will be restricted.

The tank should be set as close to the engine as is practical. For best results the lower water connection in Figure 17 should not be over 30 inches long. For both 5 and 10 h.p. engines, 1 inch pipe is used for the lower connection and 1¼ inch pipe for the top connection. The top tank connection should be about 12 inches from the top of the tank, and the vent pipe should extend about 8 inches above the top of the tank. Rubber hose couplings 12 inches long are used on both lower and top connections, to relieve vibration and misalignment strains. A stop cock should be installed in the lower connection as close to the tank as possible, so that the engine jacket can be drained when idle in freezing weather, without emptying the entire cooling tank. While the engine is in operation, the water level must be maintained above the top connection in the tank, otherwise the engine will overheat.

Diesel Electric Power

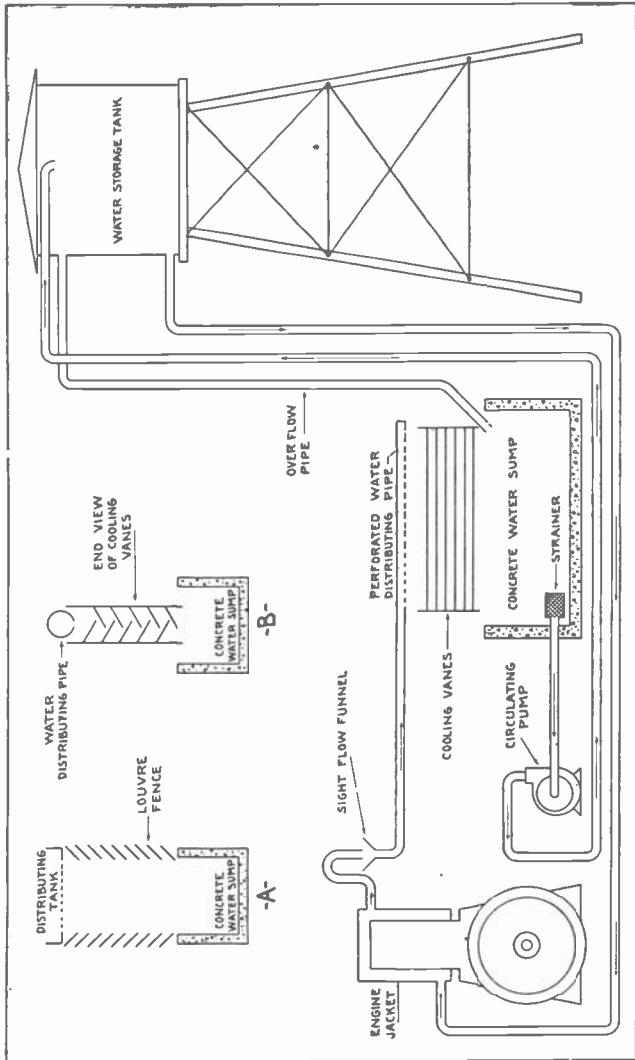

Fig. 18. Diagram of a single flow, open type cooling system for a Diesel engine plant. Trace the flow of water through the various pipes and parts of the system.

Cooling Systems

8. CIRCULATING NON-RETURN SYSTEM

This system is used only where large quantities of clean water may be obtained cheaply. In this system the engine is supplied with water from a continuous source, and the hot water discharge is allowed to go to waste. A manually or thermostatically operated valve is used to control the flow of water in order to maintain the operating temperature of the engine at the correct value. Since this system demands a continuous supply of water and is wasteful, it is not often used except on boats, where an unlimited amount of water is always available. On boats a pump driven by the engine circulates the water. If the water supply is already under pressure, no pump is required.

9. OPEN TYPE COOLING SYSTEMS

In large Diesel plants where radiators are not practical due to their limited cooling capacity, single or double flow cooling systems are employed. Where water of reasonable purity is obtainable, the single flow or open type cooling system such as shown in Figure 18, can be used. The cooling water is fed from a storage tank to the jackets of the engine by gravity. The hot water from the engine jackets discharges into an open funnel so that the operator can check the rate of flow. From the sight-flow funnel, the water is discharged by means of a perforated distributing pipe over a series of sheet metal vanes installed outdoors. As the water trickles downward from vane to vane, it is cooled by evaporation and by the air absorbing some of the heat. The cooled water collects in a concrete sump (trough or basin) under the cooling vanes and is pumped back to the storage tank. The circulating pump is sometimes located so that it can be driven by the main Diesel engine, or in a power house it might be electric motor driven.

In some cases, instead of being discharged into a perforated distributing pipe and allowed to run down over vanes, the hot water is discharged into a large, shallow, square or rectangular tank with a perforated bottom. The water drops in small streams through the air which absorbs some of the heat. The water then collects in the concrete sump below.

Diesel Electric Power

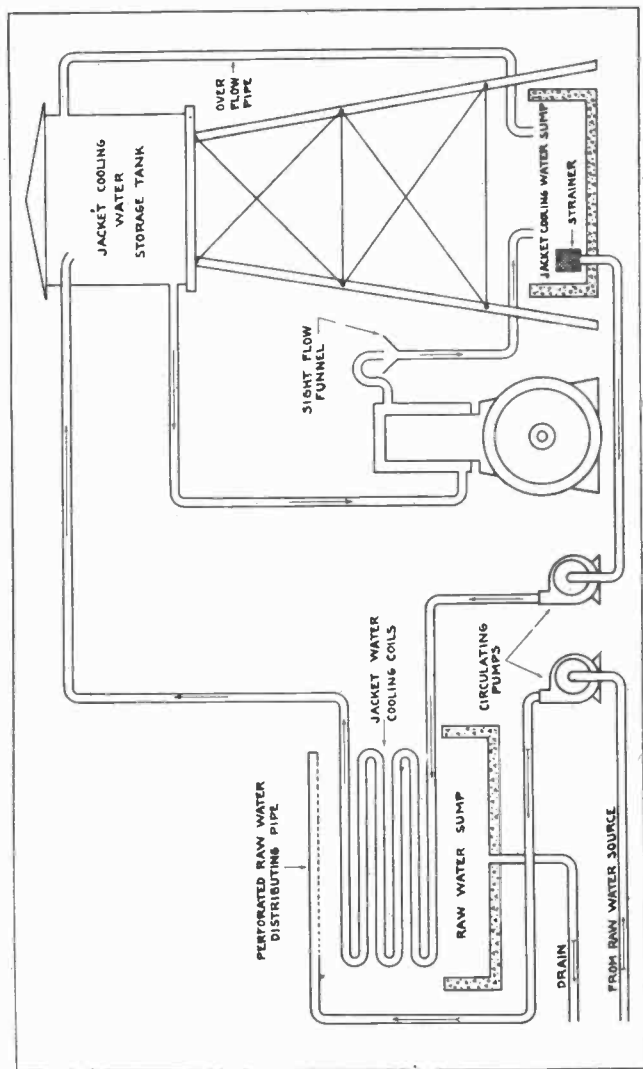

Fig. 20. Diagram showing the water tank, piping, pumps, and arrangement of a double flow, closed type cooling system for a Diesel power plant.

Cooling Systems

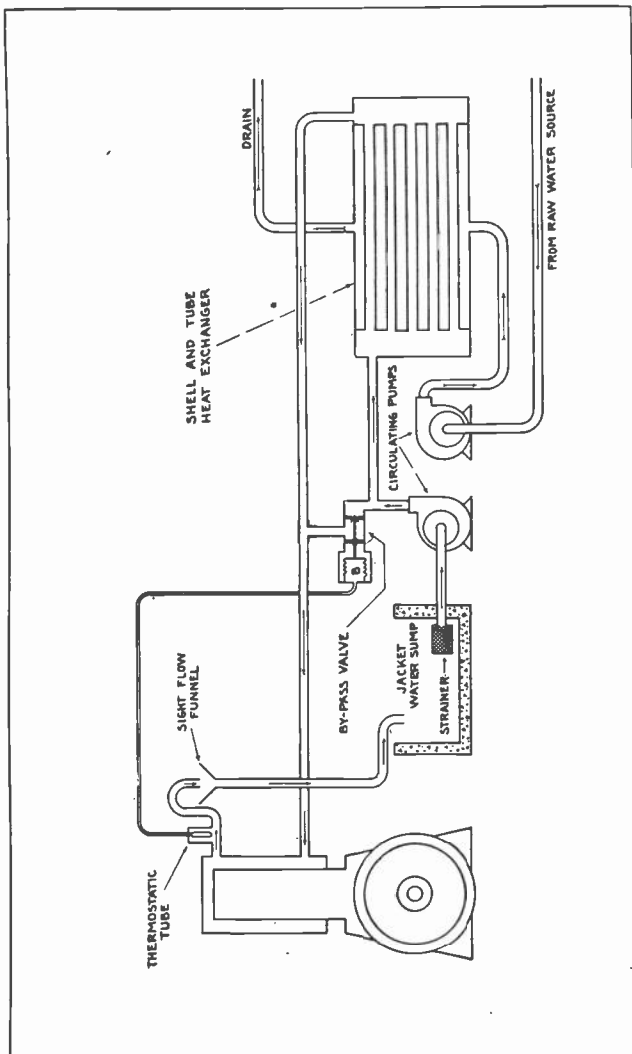

Fig. 21. This illustration shows the piping and water circulating arrangement of a closed type cooling system using a shell and tube heat exchanger and automatic temperature regulating valve.

Diesel Electric Power

The two methods just described for cooling the engine jacket water are known as atmospheric cooling systems and the equipment used is known as an atmospheric cooling tower. To prevent the wind from picking up and carrying away some of the water these towers are surrounded from top to bottom by what is known as a *louvre fence*. See the insert at "A" in Figure 18.

Since this method of cooling evaporates some of the water to cool the remainder, there is a continual loss that has to be replaced. The approximate loss is 1 gallon per 1000 gallons of water cooled, for each degree of heat lost. Thus, if the temperature of the water is lowered 30 degrees, 3 gallons of water will have to be replaced for every 100 gallons cooled. Since the evaporation of water leaves behind whatever minerals, salts, etc., that were contained in it, this system can be used only in localities where water is free from such material. Otherwise excessive deposits of scale will form in the jackets of the engine, causing serious overheating.

10. DOUBLE FLOW COOLING SYSTEMS

Where water contains impurities that might cause scale deposits in the engine jackets, the cooling water must be chemically treated. Since this is rather costly, the water loss must be reduced to a minimum. In such cases, the single flow, or open type, cooling system is not practical. To reduce the loss of treated cooling water, a double flow or closed cooling system is used. See Figure 20. In this case, the hot water from the engine jackets is not cooled by trickling over sheet metal vanes as in the open type system, but instead it is pumped through a series of pipe coils over which cool untreated or raw water flows. Thus, the temperature of the treated jacket water is reduced without exposure to the air or evaporation losses.

If there is an unlimited supply of cheap raw water available it may be used only once, and then allowed to go to waste. Otherwise it may be used over and over again by cooling it with sheet metal vanes similar to those used in an open cooling system.

A cooling coil made up of twelve 2 inch pipes, 20 ft. long will be sufficient to take care of a 100

Cooling Systems

h.p. Diesel engine.

11. SHELL AND TUBE HEAT EXCHANGERS

Double flow or closed cooling systems sometimes use a shell and tube heat exchanger such as shown in Fig. 21. These heat exchangers are so designed that the treated jacket water is continuously re-circulated through the tubes, while the raw water surrounds the tubes. This type of cooling system is highly efficient because the raw water entirely surrounds each tube and readily absorbs the heat of the inner water, through the metal pipe walls.

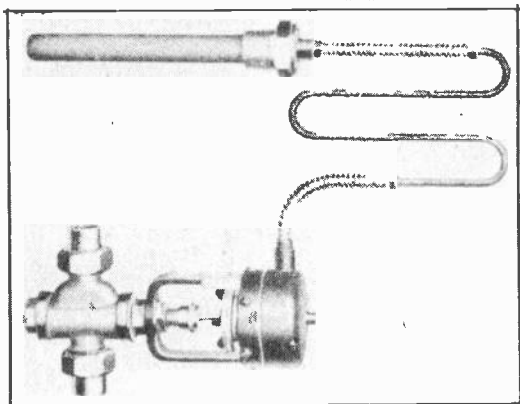

Fig. 22. Temperature control valve for regulating the flow of cooling water to a Diesel engine. The valve is operated by the expansion and contraction of the liquid in the bulb and tube shown connected to it.

Fig. 21 also shows a method of maintaining the temperature of the jacket water at a constant value over a wide range of engine load. A thermostatic tube filled with a volatile (easily evaporated) liquid is installed so that it will be immersed in the water that discharges from the engine jackets. This thermostatic tube is connected to a metal expansion bellows "B" that operates the by-pass valve between the discharge side of the jacket water circulating pump, and the water line connected to engine jacket.

As long as the temperature of the water discharging from the engine jackets is below normal, the pressure developed by the liquid in the thermostatic tube will not be sufficient to close the by-pass

Diesel Electric Power

valve, so that most of the jacket water will return to the engine without passing through the heat exchanger, therefore losing very little of its heat. As the temperature of the cooling water approaches

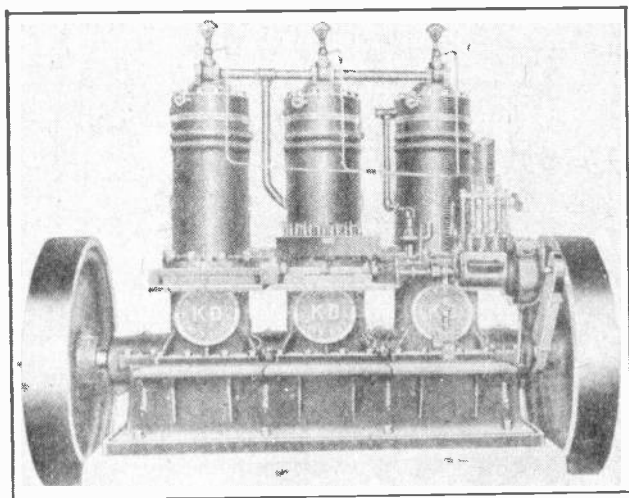

Fig. 23. Note the temperature indicating thermometers located on the top of each cylinder of this heavy duty stationary Diesel engine. Courtesy Anderson Engine Co.

normal, the liquid in the thermostatic tube expands and builds up pressure which is transferred to the metal bellows, causing it to expand and close the by-pass valve so that the jacket water must pass through the heat exchanger.

12. QUANTITY OF COOLING WATER REQUIRED

The amount of water required to absorb the heat from the cylinder walls depends upon the size and design of the engine, and the desired difference in temperature between the water that enters the jackets and the water that leaves the jackets. As a general rule, the water capacity should be sufficient to handle 3000 B.T.U. per hour, per horsepower rating of the engine

The maximum temperature of the discharge water should not exceed 165 degrees F. at any time, and 145 degrees is better, especially in very large

Cooling Systems

engines. The smaller the difference between the "in and out temperature" the better. In many large installations a 10 degree difference is maintained between the water that enters and the water that discharges from the engine jackets. This narrow "in and out" temperature difference reduces temperature strains in the iron cylinder walls.

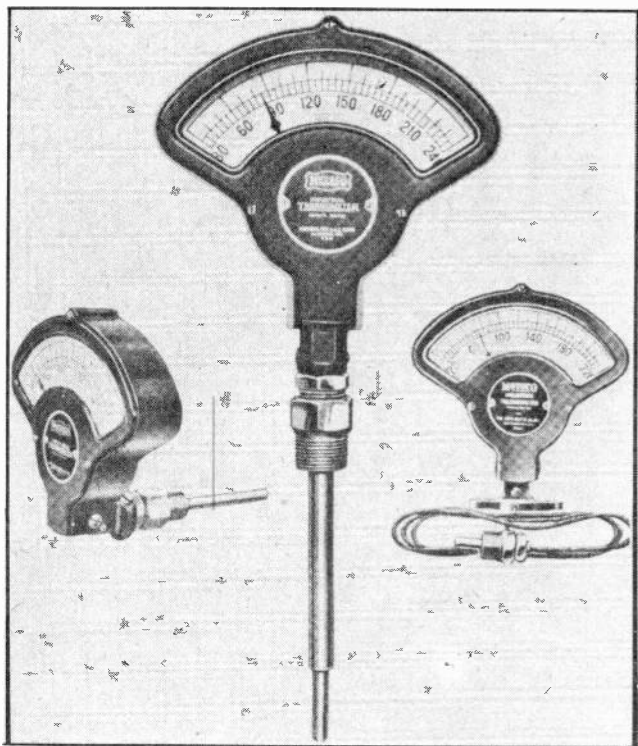

Fig. 24. Three common types of thermometers used for checking the temperature of Diesel engine cooling water. Courtesy Motor-Meter Co., Inc.

To calculate the quantity of water required to cool an engine, the following formula can be used:

$$\frac{\text{h. p.} \times 3000}{\text{"Out" temp.} - \text{"in" temp.}} = \text{Lbs. of water per hour}$$

Example: If a 300 h. p. engine is to operate with a water inlet temperature of 135 degrees and an

Diesel Electric Power

outlet temperature of 145 degrees F., then

$$\frac{300 \times 3000}{145-135} = 90,000 \text{ lbs. of water per hour}$$

$90,000 \div 60 = 1500$ lbs. per minute, and as 1 gal. weighs 8.3 lbs., $1500 \div 8.3 = 180$ gal. per minute.

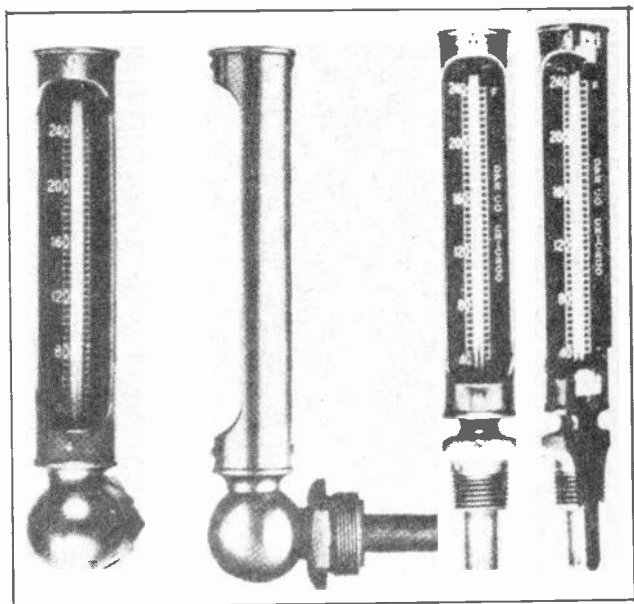

Fig. 25. Several types of mercury column thermometers used to indicate the temperature of Diesel engine cooling water. Courtesy Diesel Specialties Corp.

It is very plain to see from these figures that the wider the "in" and "out" temperature range, the less water is required.

13. COOLING WATER THERMOMETERS

Thermometers are used to check Diesel engine cooling water temperatures; one being installed on the discharge side of each cylinder jacket, so that the water temperature of each individual cylinder can be observed. In Fig. 23, thermometers can be seen on top of each cylinder.

Three types of commonly used thermometers are shown in Fig. 24. This type of thermometer is ac-

Cooling Systems

tually a pressure gauge, calibrated to read in degrees temperature. The pressure to operate the pointer is produced by a very volatile liquid sealed in the slender tube seen at the bottom of the thermometer. The thermometer is installed so that the liquid filled tube is surrounded by the hot water at a point where it leaves the engine jackets. The heat from the water causes the liquid in the sealed tube to expand, building up pressure which in turn moves the pointer over the thermometer scale.

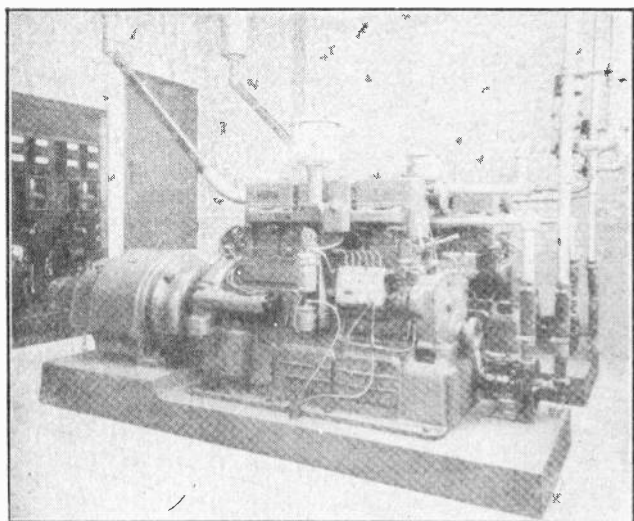

Fig. 26. Photo of Diesel-Electric power plant showing two high-speed six cylinder engines with the generators and switchboard. Note the exhaust and cooling water connections.

In some of these instruments, the sealed tube is air filled; the heat causing the air to expand. The advantage of this type is that the indicating part can be connected to the unit that is immersed in the water, by a long slender flexible tube, so that the thermometers for all the cylinders can be grouped together at some point on the engine or on a control panel which is convenient to the engine operator. This is especially convenient on large engines, where thermometers mounted at the point where the water leaves the jackets would be some distance from the floor of the engine room and difficult to read.

Diesel Electric Power

Thermometers similar to standard thermometers having a mercury or alcohol column are also used. See Fig. 25. This type cannot be grouped like the pressure type, and is somewhat more difficult to read from a distance.

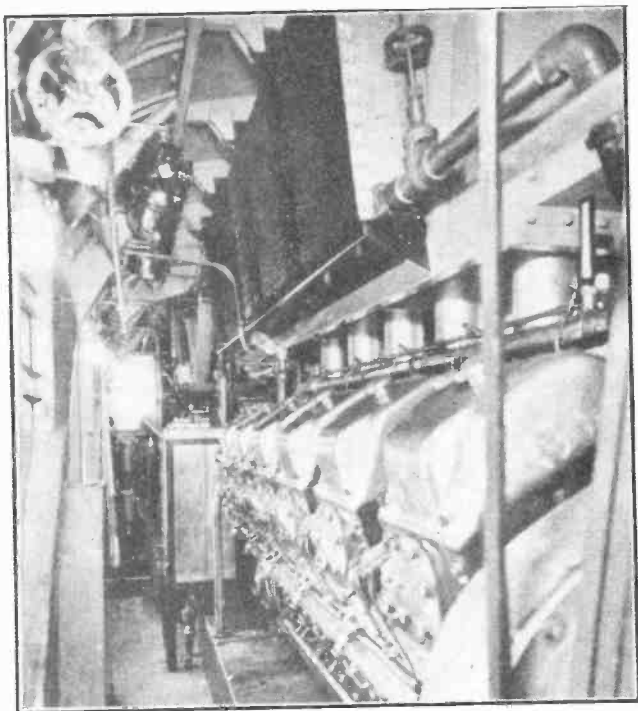

Fig. 27. Photograph showing one side of the engine compartment and engine in a modern Diesel-Electric locomotive. Note the large radiator located above the engine cylinders. Air is passed into the engine compartment through louvres at the front end and out through the radiator and a duct through the roof of the locomotive. Courtesy of Burlington Railway.

14. UTILIZATION OF DIESEL ENGINE HEAT

In some Diesel engine installations, the heat from the exhaust and also from the cooling water is used to heat all or part of the building in which the engines are located, thus obtaining double use of the fuel burned in the engines. This can be accomplished by pumping the engine cooling water through

Cooling Systems

room heaters or radiators of the unit type, behind which fans are located to blow the heat off into the room.

The hot engine exhaust gases are sometimes sent through a heat exchanger in which they are passed over a set of water pipes. The water absorbs a large part of the exhaust gas heat, and is then circulated through radiators or room heaters of the type above mentioned.

In some cases the cooling water can be circulated through one or more ordinary large wall or ceiling type radiators located in another room or part of the plant.

The use of the heat from Diesel engines in this manner, makes them even more practical and economical for use in certain types of plants where this waste heat can be well used.

EXAMINATION QUESTIONS

1. Why is back pressure in Diesel engine exhaust lines highly objectionable?
2. Name three types of Diesel engine exhaust silencers.
3. Why should flexible connections be used in exhaust lines?
4. Approximately what temperatures are normally found in exhaust gases of two cycle and four cycle Diesel engines?
5. What instrument is commonly used to indicate exhaust gas temperatures?
6. Why is it important to watch the exhaust gas temperatures of multiple cylinder Diesel engines?
7. What are several causes of excessive temperature of exhaust gases?
8. Name three types of cooling systems commonly used with Diesel engines.
9. What is the advantage of the "double flow" type of cooling system?
10. How many gallons of water per minute will be required to cool a 500 H. P. Diesel engine, with inlet water temperature 140° and outlet water temperature 150° ?

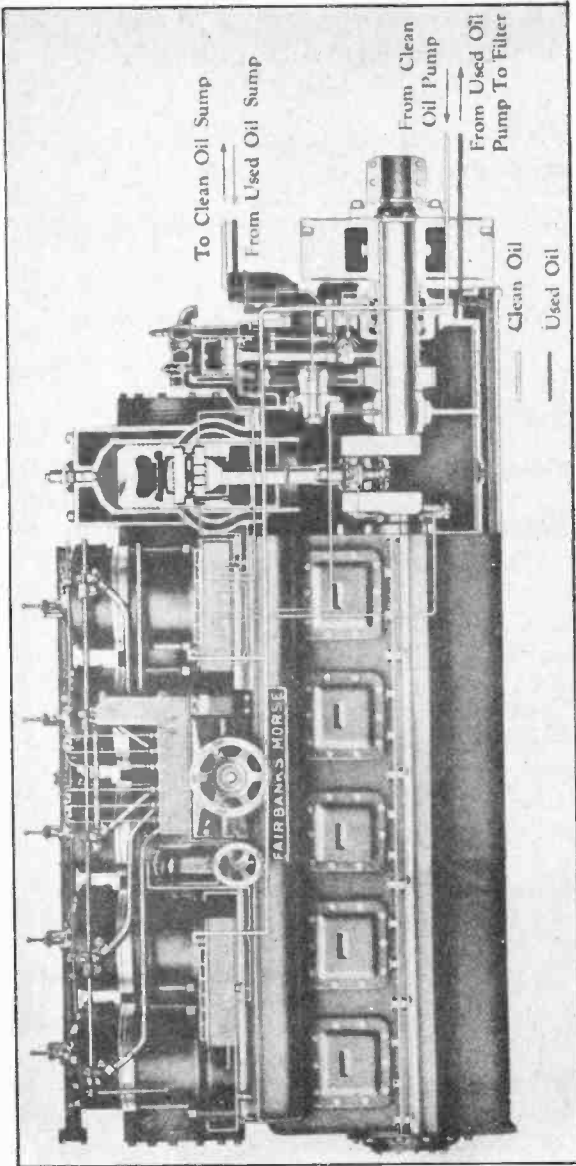

Fig. 1. This six cylinder heavy duty Diesel engine is equipped with two mechanical lubricators. Note the oil lines and the path of the oil to the cylinders and bearings. Courtesy Fairbanks Morse Co.

DIESEL ENGINE LUBRICATION

Lubrication is one of the most important operating factors that a Diesel engine operator has to contend with. Long engine life and freedom from trouble depend largely on the proper lubrication of every moving part on the engine. Lubrication also plays an important part in assisting the piston rings in maintaining a tight seal between the piston and cylinder wall, which prevents a loss of compression and power. Therefore, it is highly important for a Diesel engine operator to have a good knowledge of Diesel engine lubricating systems and equipment, and also of the proper or most efficient lubricating oil to use.

The principal parts of a Diesel engine which require lubrication are the crank shaft, main bearings, connecting rod or crank pin bearings, pistons, and cylinder walls, piston pin bearings, cam shaft bearings, cams, push rods, valve rocker arms, valve stems, timing gears, fan and water pump bearings and governor. On engines which have a scavenging air pump or starting air compressor attached, the pistons, bearings and connecting rods of these units must also be kept well lubricated.

1. TYPES OF LUBRICATING SYSTEMS

Three types of lubricating systems will be found in general service. Light weight high speed Diesel engines usually depend on a force feed circulating system similar to that used on gasoline automobile engines, and consisting of an oil pressure pump, oil filter, and oil lines or tubes which carry the oil under pressure to the important bearings and wearing surfaces. In addition to the oil tubing, lubricating oil is also carried through holes or passages bored in the crank shafts, cam shafts and connecting rods to reach these important bearings.

This system, while simple and compact in design, is not suitable for large slow speed engines. Such engines use a **mechanical lubricator** consisting of a number of separate plunger type pumps, to supply the oil to all moving parts, including the main crank shaft bearings. Or in some cases, a mechanical lubricator is used for the cylinders and crank pins, and an oil circulating pump for the main

Lubrication

crank shaft bearings.

2. FORCE FEED PRESSURE SYSTEM

In light weight high speed Diesel engines, the oil supply is carried in the lower part of the crank case as shown in Figs. 2, 3 and 4. A gear type pump, shown in the crank pan sump, Fig. 2, and driven from the cam shaft, draws oil from this supply and forces it under pressure to the main bearings.

The oil is usually carried from the pump to the main bearings by holes or passages drilled in the crank case, or cylinder block. In some engines a main oil pipe "or header" runs the entire length of the crankcase, and small tubes feed oil to each main

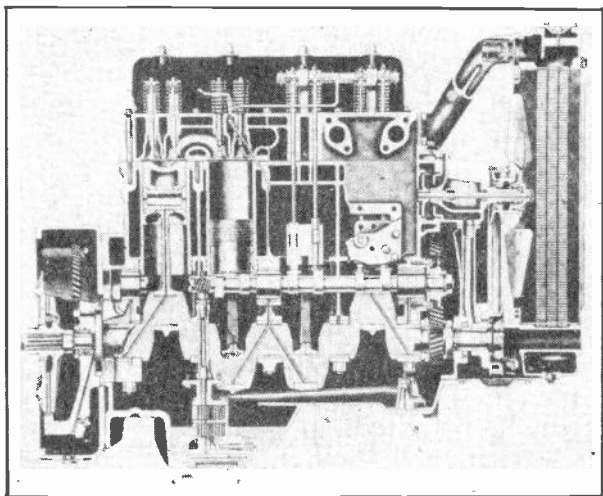

Fig. 2. The above sectional view of a Diesel tractor engine shows the lubricating oil lines and the holes drilled in the crank shaft and connecting rods for conveying oil to the various bearings. In the lower part of the crank case can be seen the gear type oil pump, which feeds oil under pressure to the oil lines and bearings. Courtesy Caterpillar Tractor Co.

bearing. Sometimes the cam shaft is hollow and serves as a "header," with passages drilled between the cam shaft bearings and the main bearings feeding the latter with oil.

From the main bearings, the oil is carried to the crank pin bearings by means of drilled passages in the crank shaft. The wrist pin bearings are lubricated by passages drilled the whole length of the connecting rods, the oil being fed under pressure

Diesel Electric Power

from the crank pin bearing oil supply at the lower end of the connecting rod. Carefully note these oil passages shown in Figs. 2, 3 and 4.

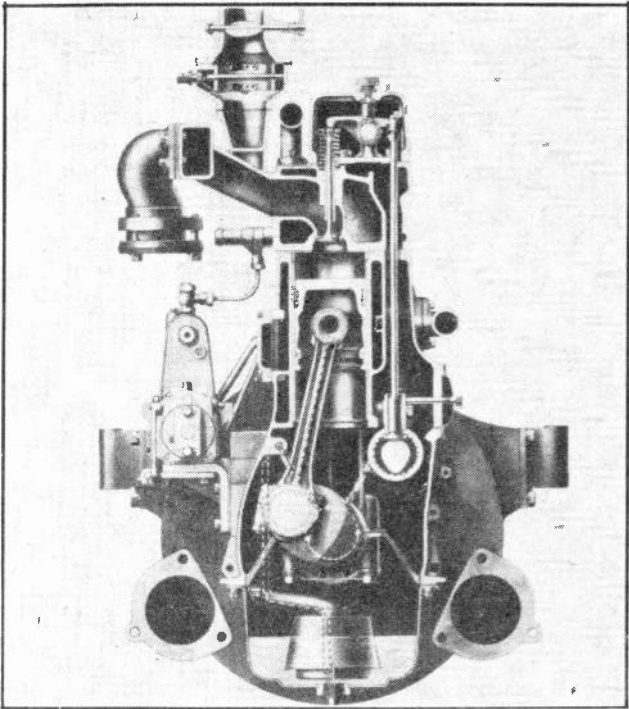

Fig. 3. This end sectional view of one cylinder of a Diesel engine shows by dotted lines the path of the lubricating oil to the main bearings, crank shaft bearings, wrist pin bearings and cam shaft bearings. Courtesy Buda Engine Co.

The cylinder walls are lubricated by the oil that seeps out at the connecting rod bearings. Oil is also thrown up into the cylinders as the crank shaft revolves. Oil lines from the main oil header carry oil to the timing gears at the front of the engine and also to the overhead valve mechanism, as shown in Figs. 2 and 4.

Since the engine uses but a very small amount of the oil pumped, the surplus returns back to the crank case oil sump to be again pumped through the system. Thus all the moving parts are continually

Lubrication

supplied with an ample amount of lubricating oil.

The oil pressure maintained on a system of this type will range from 10 to 45 lbs., depending on the make of engine. A spring loaded relief valve is used to regulate the pressure, which in some cases is adjustable and in others non-adjustable.

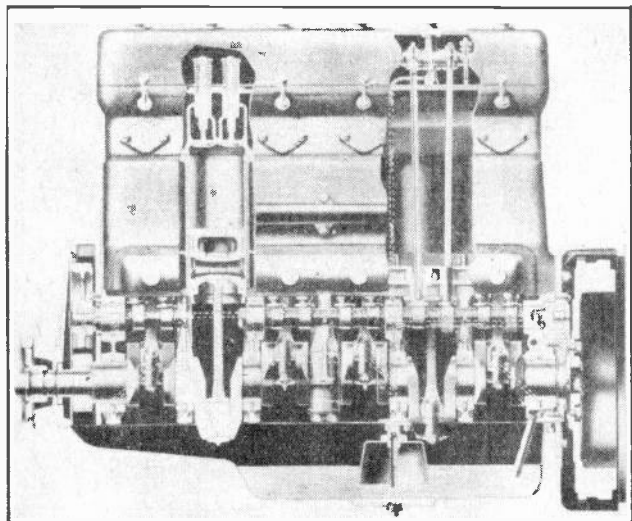

Fig. 4. This photograph also shows the oil passages to the main bearings, crank bearings, wrist pins, cam shaft, and to the overhead valve rocker mechanism of a Diesel engine.

Oil filters are used to keep the oil clean and may be connected in the system so that all of the oil that the pump forces to the main oil header has to pass through the filters. Sometimes as many as three of these filters are used on one engine. With this system an extra oil line or "by-pass" around the filter is used so that lubrication will not be interrupted in case the filters become clogged due to neglect. In other engines, the oil is pumped directly to the header, and a tube by-passes a part of the oil through the filter, this clean oil returning to the crank case.

3. MECHANICAL LUBRICATORS

Large Diesel engines cannot depend on the oil thrown off of the crank shaft to lubricate the cylinder walls, because of the slow speed at which the

Diesel Electric Power

crank shaft rotates and the distance from the crank shaft to the cylinder walls.

In the case of 2 stroke cycle engines, the crank case compartments must be kept relatively free from oil fog or vapor because the charging air coming through the crank case would carry this oil vapor into the combustion chambers, where it would be burned, resulting in high oil consumption and formation of carbon in the combustion chambers and on the piston heads. Such engines may employ mechanical lubricators to oil all the points that require lubrication, or in some cases a mechanical lubricator is used to oil the cylinders and crank pins, and a low pressure pump and oil circulating system is used to lubricate the main crank shaft bearings.

4. AMOUNT OF LUBRICATING OIL REQUIRED

On some engines no provision is made to collect the excess oil, so the amount of oil that each pump delivers has to be regulated closely, because if too much is fed, the oil consumption will be high. On the other hand, too little oil would result in damage or rapid wear.

If the right grade of oil is used, very little will be needed. As a rule, 0.2 of a pint of oil every 10 hours, will lubricate 1500 to 2000 sq. ft. of cylinder wall surface covered per minute. In figuring the surface on this basis, the stroke times the cylinder circumference, both measured in feet, should be multiplied by twice the revolutions per minute. One pint of oil will equal from 12000 to 16000 drops, depending on the thickness or viscosity of the oil.

As an example, if the stroke was 2 feet, the circumference 3.5 feet, and speed 300 R.P.M., then:—

$$2 \times 3.5 \times 600 = 4200 \text{ sq. ft. covered per minute.}$$

$$4200 \div 2000 = 2.1$$

$$2.1 \times 0.2 = .42 \text{ pint of oil per 10 hrs. of operation}$$

$$16000 \times .42 = 6720 \text{ drops per 10 hrs.}$$

$$10 \times 60 = 600 \text{ minutes in 10 hrs.}$$

$$6720 \div 600 = 11.2, \text{ or about } 12 \text{ drops per minute to each cylinder.}$$

Sometimes the name plate on the engine or the instructions shipped with the engine will state the

Lubrication

correct number of drops of oil required per minute.

In some engines, the excess oil from the lubricators is collected in a sump or oil well under or at the end of the crank case. From this sump it is forced through a filter by means of a pump and from the filter it is returned to the lubricator. Such a system is shown with the engine in Fig. 1 on page 2.

Sometimes only the cylinders and crank pins on the crank shaft are lubricated by means of a me-

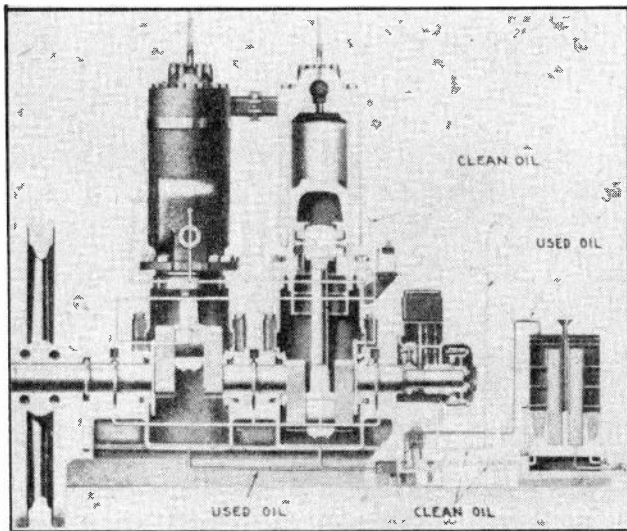

Fig. 6. Sectional view of a heavy duty two cylinder Diesel engine showing the path of the clean oil from the filter, through the oil pump to the engine bearings and also the path of the used oil from the crank case back through one section of the pump, to the filter. Courtesy Fairbanks Morse Co.

chanical lubricator. The main crank shaft bearings being supplied with oil under low pressure by a pump, or oiled by means of oil rings that pick up oil from pockets directly under the bearings as shown in Fig. 6. These pockets are kept full of oil by a pump.

In this type of system the excess oil is returned to the mechanical lubricator. To keep the mechanical lubricator from flowing over, an over-flow line is provided, which usually carries this surplus oil to

Diesel Electric Power

lubricate some part of the engine such as the governor mechanism or the fuel pump drive.

5. PROPER GRADES OF OIL FOR DIESEL LUBRICATION

While there is practically no crank case oil dilu-

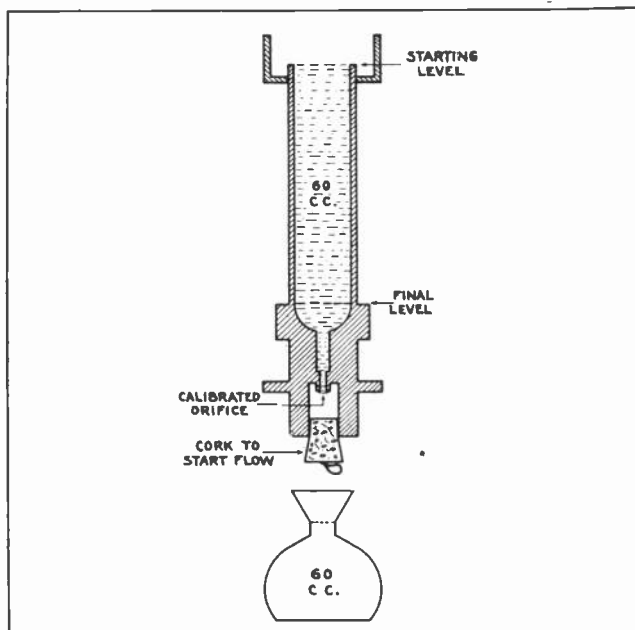

Fig. 7. This diagram shows a Saybolt viscosimeter such as used for testing the viscosity of lubricating oils.

tion in a Diesel engine, due to the fact that the fuel is not mixed with the air during the entire compression stroke, Diesel engines do however subject the lubricating oil to more deterioration than other engines. This reason for this is that compression and working pressures are higher in the Diesel engine. High compression pressures mean higher temperatures, and though they exist for only a small fraction of a second at a time, they re-occur very rapidly and these high temperatures tend to carbonize the oil, resulting in stuck piston rings and partially clogged exhaust passages, which reduce the power and efficiency of the engine.

Lubrication

For this reason, oils that might give first class results in a gasoline engine may not be suitable for

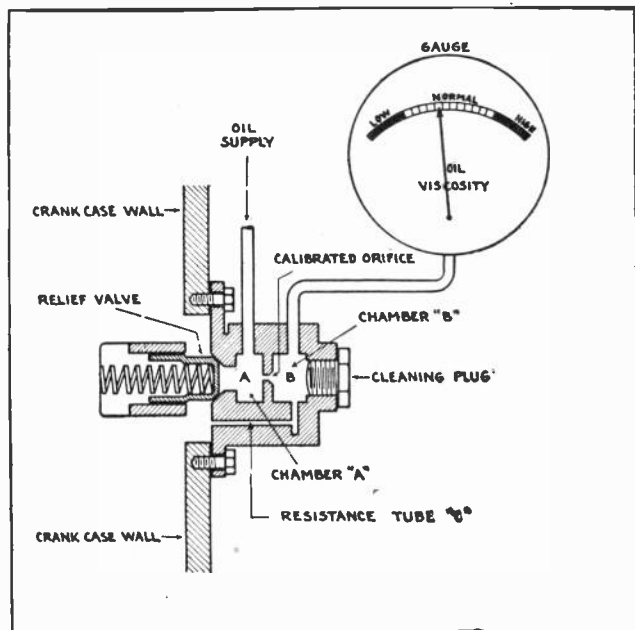

Fig. 8. This type of viscosity meter is sometimes mounted right on the side of Diesel engines to give a continuous indication of the viscosity condition of the oil during engine operation.

Diesel engines. High speed Diesel engines subject the oil to such severe operating conditions that there is a tendency for the oil to thicken or form excessive sludge deposits if the oil is not of a grade suitable for this type of service.

The major oil companies, through their re-search laboratories and tests made in numerous Diesel plants, have developed lubricating oils for every type of Diesel engine in common service.

6. VISCOSITY OF LUBRICATING OILS

The stickiness or "body" of an oil is known as its **viscosity**. The viscosity of oils is tested by allowing 60 cubic centimeters of oil to flow by gravity through an opening of a certain standard size, and noting the time that it requires. This is sometimes referred to as the "Saybolt" test. Fig. 7 shows a

Diesel Electric Power

Saybolt viscosimeter for testing lubricating oil viscosity.

When we hear the expression "75 seconds Saybolt at 210 degrees F.," it means that it requires 75 seconds for the 60 C. C. (cubic centimeters) of oil to flow through the standard opening with the temperature of the oil at 210 degrees F.

Temperature causes a change in the viscosity of all oils, the higher the temperature the lower the viscosity becomes. For example, an oil with a viscosity of 600 seconds Saybolt at 100 degrees F. may drop to 75 seconds Saybolt at 210 degrees F. Some oils thin out more than others when heated. As a rule, oils made from a good grade of Pennsylvania paraffin base crude oil, do not thin out as much as oils made from asphalt base crudes.

For tractors, trucks, or other Diesels that have to operate outdoors, it is important that the oil be not too viscous at low temperatures, otherwise starting may be difficult. However, the oil must maintain a reasonable viscosity at high temperatures in order to maintain an oil film on the bearing surfaces under the severe operating conditions imposed on these engines.

For this type of service, the flatter the viscosity-temperature curve, or the less variation of viscosity with temperature changes, the better the oil. For engines that are located indoors in heated buildings, this is not so important since the oil is not subjected to low temperatures.

The best policy to follow is to use an oil recommended by the builder of the engine. For the smaller Diesel engines, S.A.E. No. 30 or 40 Diesel oil is usually recommended, if outdoors or room temperatures do not fall below 50 degrees F. For engines operating in temperatures below 50 degrees F., S.A.E. No. 20 Diesel oil is generally used.

7. VISCOSITY METERS FOR ENGINE MOUNTING

Some engines are equipped with visco meters such as shown in Fig. 8, so that the operators can tell when the oil is too thin for safe operation. Oil from the main header enters the supply side of the instrument and passes into an automatically controlled chamber "A," which has a spring loaded re-

Lubrication

relief valve on one side and a calibrated orifice on the other. (The term "calibrated" here means an orifice or opening of a certain pre-determined size to admit a certain amount of oil.)

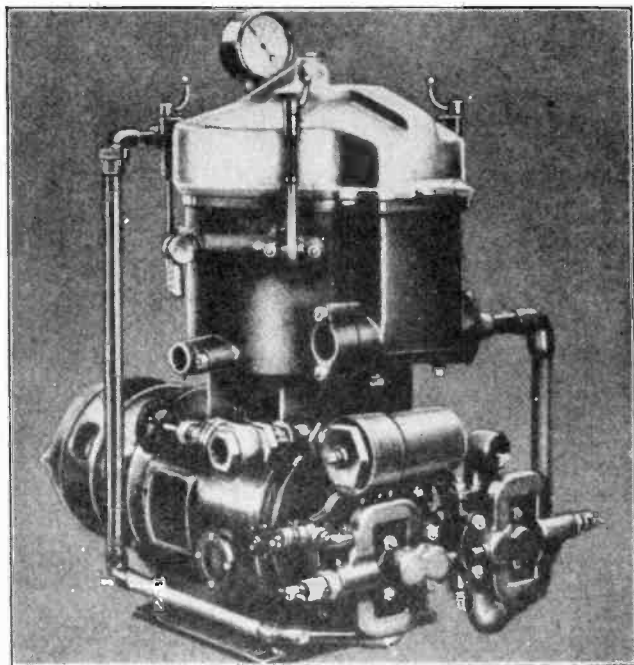

Fig. 9. Centrifugal oil purifier such as commonly used for cleaning and purifying the lubricating oil in Diesel engine plants. Courtesy Goulds Pumps, Inc.

The oil may enter this instrument at any pressure, but the relief valve is set at a pressure low enough so that oil in chamber "A" (Fig. 8) is held at a constant pressure, unless the engine oil pressure becomes less than the setting of this relief valve. The excess oil flows past the relief valve and is returned to the crank case. The remainder of the oil flows through the calibrated orifice into a small chamber "B", to which the indicating meter or gauge is connected. A calibrated resistance tube "C" drains the oil from this chamber back to the crank case.

While the pressure in chamber "A" will remain constant, the oil pressure in chamber "B" will vary

Diesel Electric Power

according to the ease with which the oil can flow through the resistance tube "C". This in turn will depend on whether the oil is thick or thin. Thick oil will mean a high pressure in chamber "B" with a corresponding high reading in the gauge, while thinner oil would reduce the pressure, and lower the gauge reading.

This instrument, with the exception of the gauge, is mounted directly on the crank case of the engine. The supply tube is kept as short as possible, and is insulated so that the oil which passes through the calibrated orifice and resistance tube will be kept at the same temperature as the oil which is fed to the engine bearings.

Readings should be checked with the engine at normal operating temperature, and at all times during engine operation the pointer should indicate in the "normal" section of the gauge. A "low" reading would indicate that the oil used is too light or badly diluted, and in either case would result in damage or rapid wear of engine parts.

A high reading would indicate that the oil is too heavy. Due to the small clearances at some bearings, oil that is too heavy sometimes cannot reach all the parts that require lubrication, with the result that wear will be excessive.

8. OIL FOAMING. OIL CLEANING

Two important points to keep in mind, besides using a high grade lubricant are, to keep all oil screens clean and free from lint and dirt, and to drain the crank case of high speed Diesels every 50 to 100 hours of service. It is a good policy, in connection with such engines to flush the crank case with kerosene every other time that it is drained.

Foaming of the oil in the crank case of slow speed engines is usually due to air being drawn in by the oil pump, and churned into the oil. This might be due to an air leak on the intake side of the pump, or to the oil level being a little too low.

In high speed engines using cylinder liners, foaming is often caused by leaky rubber gaskets at the lower end of the cylinder liners, which allows water to drip into the crank case, and mix with the oil.

Lubrication

When oil persists in turning to a slate grey color, after a short period of service, the cylinder block should be very carefully inspected for water leaks.

In very large plants where draining and throwing away of the crank case oil would be costly, "centrifuging" or cleaning in a centrifugal oil separator is standard practice. The oil may be drained and "centrifuged," or the centrifuging equipment may be permanently connected to the engine oiling system and the oil subjected to a continuous cleaning process. Fig. 9 shows a centrifugal oil purifier such as commonly used with Diesel engines.

DIESEL ENGINE CONSTRUCTIONAL FEATURES

In your study of Diesel engines this far, you have of course obtained considerable general knowledge of their constructional features and principal parts. However, there are certain details of construction of important parts such as pistons, piston rings, cylinder liners, connecting rods, crank shafts, bearings, etc., with which you should be familiar in order to better understand the care and maintenance of Diesel engines. Therefore, we would advise that you carefully study the following pages which explain these important points.

A thorough knowledge of these engine parts and their purpose or function will also make your study of the following material on operation and maintenance of Diesel engines much more interesting.

9. PISTONS

The pistons used in ordinary Diesel engines are made of cast iron or aluminum, and fall into two general types, called **trunk** type and **crosshead** type pistons. Each has its own particular field of application. The trunk type piston being used in the smaller and medium sized engines, and the crosshead type in the larger engines.

The upper left view at A in Fig. 10 shows a trunk type piston. This type is similar to the pistons used in gasoline automotive engines. During the compression and power strokes of a Diesel engine, the pressure on the piston tends to crowd it against the side of the cylinder, due to the angle of the

Diesel Electric Power

connecting rod during part of each stroke. This is known as side thrust.

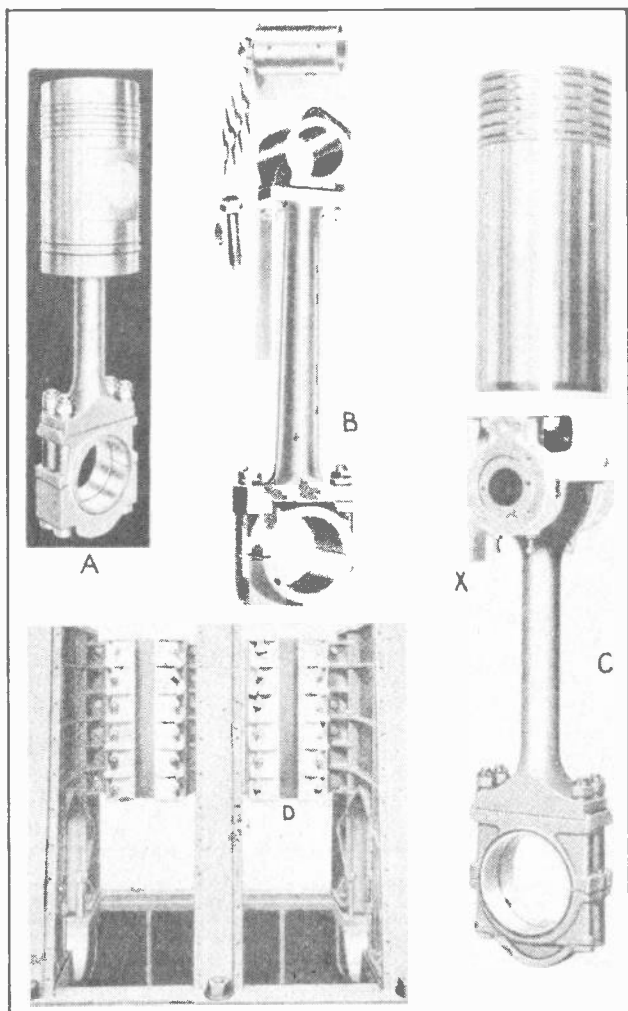

Fig. 10. A trunk type Diesel engine piston is shown at "A" and a crosshead type piston at "C". Note the crosshead pad at "X" which slides up and down in the guides shown at "D". At "B" is shown a connecting rod for a large Diesel engine. Note the provision for adjustments to compensate for wear at both the top and bottom of the bearings of this rod.

Pistons

In the trunk type piston, all side thrust is taken on the skirt of the piston. This causes the piston and cylinder to wear more on these sides and become out of round. Fig. 11 shows a sectional view of an engine with the piston on the down stroke with the connecting rod at an angle and all side thrust being taken by the left side of the piston.

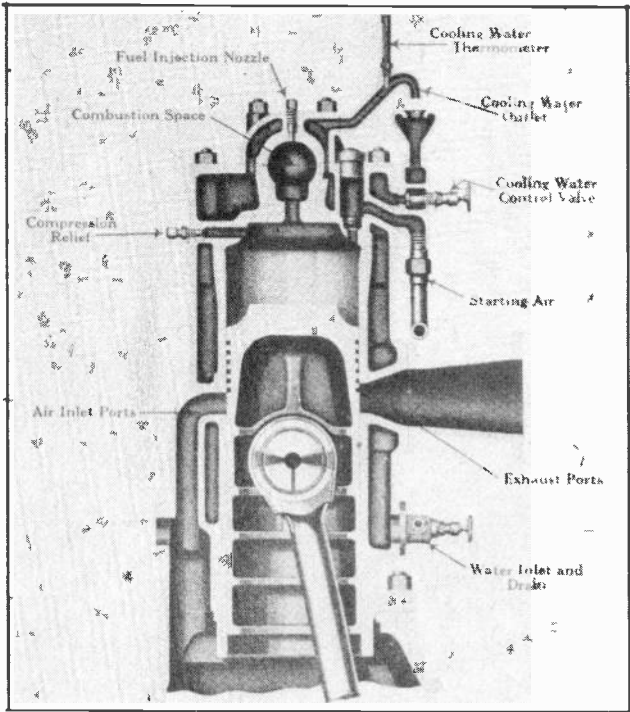

Fig. 11. Sectional view of a Diesel engine showing the piston on its down stroke and the connecting rod at an angle. Note how this would cause the piston to be forced against the left hand side of the cylinder, increasing wear at this point during the power stroke. Courtesy Fairbanks Morse Co.

In Diesel engines, the piston skirts are always longer than those used in general gasoline engine practice because of the higher working pressures and side thrust during the compression and power strokes.

For very large engines with a cylinder bore of large diameter, the trunk type piston becomes im-

Diesel Electric Power

practical, because side thrust increases as the square of the cylinder diameter, and the length of the skirt required to carry this side thrust would

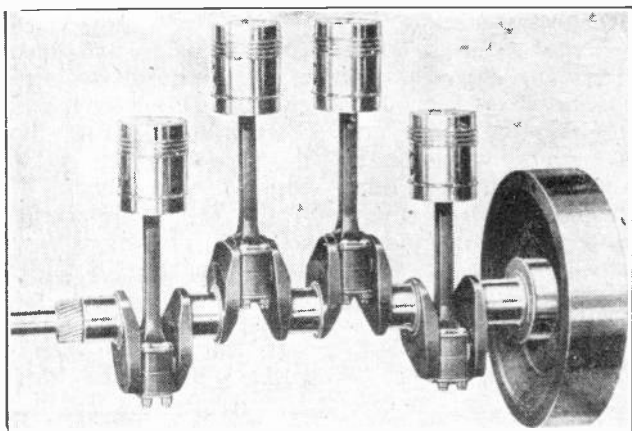

Fig. 12. Photograph showing the crank shaft, connecting rods, pistons and flywheel of a four cylinder tractor type Diesel engine. Courtesy International Harvester Co.

increase the weight of the piston beyond practical values.

To meet this condition, the crosshead type piston is used. Such a piston, with its cross head pad "X" and connecting rod are shown on the right at "C" in Fig. 10. With this type, no wrist pin is used in the piston itself. The piston is rigidly fastened to a crosshead pad "X" which slides up and down between two vertical guide bearing surfaces, shown at "D" in the engine frame section at the lower left in Fig. 10.

The connecting rod is attached to the lower end of the piston rod by the hollow crosshead pin which is similar to the wrist pin of the trunk type piston. By this arrangement, all side thrust is taken up by the lower end of the piston rod, and the crosshead pad, and a much shorter piston skirt can be successfully used, thus reducing the weight of the piston assembly.

10. PISTON RINGS

Piston rings are necessary on Diesel engine pistons. the same as with gasoline automobile engines, to provide a good seal with the cylinder wall and

Piston Rings

prevent leakage or loss of power and compression. Piston rings being made thin, and being compressed when inserted in the cylinder, thereby tend to spring out against the cylinder wall and maintain a tight fit, even after some wear.

On account of the high compression and power stroke pressures, Diesel engines require more piston rings on each piston than are used with gasoline engines. Small tractor type engines may have five rings per piston, while large stationary engines may have from 8 to 10 rings on each piston. To protect the top ring from the high temperatures generated during combustion, the top ring is sometimes located some distance from the top of the piston as shown in Fig. 12.

When piston rings become worn, they allow leakage or "blow-by" of the hot gasses and the charging air, thus lowering the efficiency of the en-

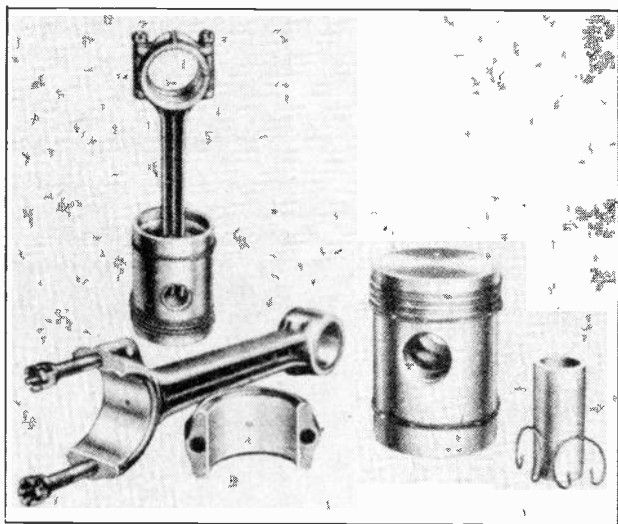

Fig. 13. Pistons, connecting rods, piston pin and retainer springs for a high speed Diesel engine.

gine and sometimes causing difficult starting. Worn rings should therefore be replaced with new ones.

Special double seal or split piston rings with inner expanding rings are sometimes used to replace the original rings in engines with badly worn cylin-

Diesel Electric Power

ders, to reduce loss of power and improve compression. More about piston rings will be covered in a later section on maintenance.

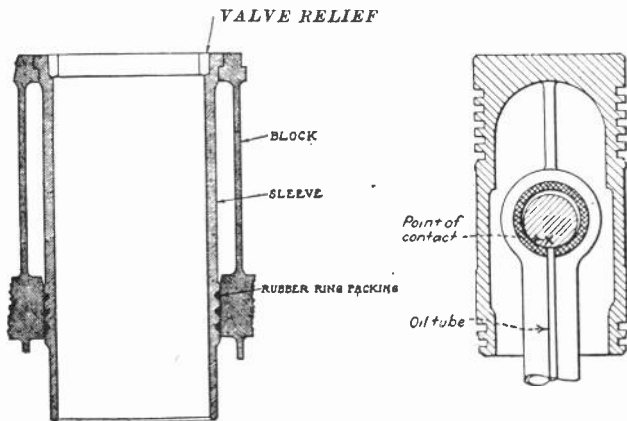

Fig. 14. On the left is shown a cylinder liner pressed into the skeleton cylinder block of a Diesel engine. Note the water space between the liner and the block. This type of liner is known as "wet type" because the water is in direct contact with the outside surface of the liner. Note the rubber packing rings to prevent leakage of cooling water into the crank case. On the right is shown a sectional view of a piston and wrist pin bearing showing how the constant pressure on the lower side of the bearing causes the greatest wear at this point and also tends to prevent proper flow of lubricating oil.

11. CONNECTING RODS AND WRIST PINS

The connecting rods of Diesel engines serve to connect the pistons to the crank shaft as shown in Fig. 12. They also serve to transfer to the crank shaft the power that is applied to the piston during each power stroke by the force of the expanding gasses of the burning fuel oil. Connecting rods are generally made of forged steel.

On the smaller engines the connecting rods are similar in design to those used in automotive service, only the lower end being adjustable to take up wear. See Figs. 12 and 13.

Larger engines are generally equipped with connecting rods that are adjustable at both the crank shaft and wrist pin ends as shown at "B" in the top center view in Fig. 10. One of the most difficult points to lubricate in a Diesel engine is the wrist pin in the piston. This is especially true in a two stroke cycle Diesel because the pressure is always

Connecting Rods

downward, as shown on the right in Fig. 14. The wrist pin is stationary in the piston and free in the connecting rod. On the power stroke, the piston is pushing down on the rod and the piston pin contacts the connecting rod bushing at "X" during the entire stroke. On the compression stroke, the connecting rod is pushing the piston upward and the point of contact is still at "X".

Even though the wrist pin is fed oil through a drilled connecting rod as shown in Fig. 14, the constant pressure at "X" prevents this point from re-

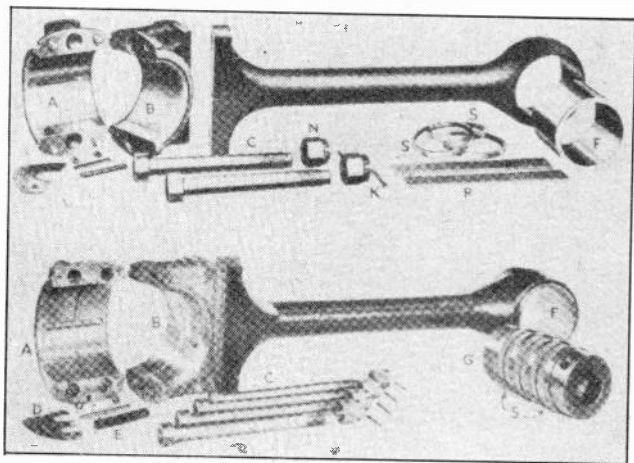

Fig. 15. The above connecting rods are equipped with quill type roller bearings at the right hand or wrist pin ends. Plain split type bearings are used on the crank ends at the left. The split feature allows convenient adjustments to take up the slack due to wear.

ceiving much oil. To overcome this handicap, large engines use what is known as a needle or quill type bearing at this point. See Fig. 15. This is simply a roller type bearing using rollers of very small diameter, the ratio of diameter to length being 1 to 10. If the bearing is long, several rows of these needles or quills are used as shown at "S" in the lower view in Fig. 15. Narrow rings are placed between the rows of needles and one is placed at each end. The narrow black bands shown around the bearing assembly "G" in Fig. 15 are retaining cords used to keep the needles in place until the whole assembly can be slipped into the connecting rod eye.

Diesel Electric Power

These bearings reduce lubrication troubles at this point for two reasons: First, they require very little oil, due to reduced friction of a roller type

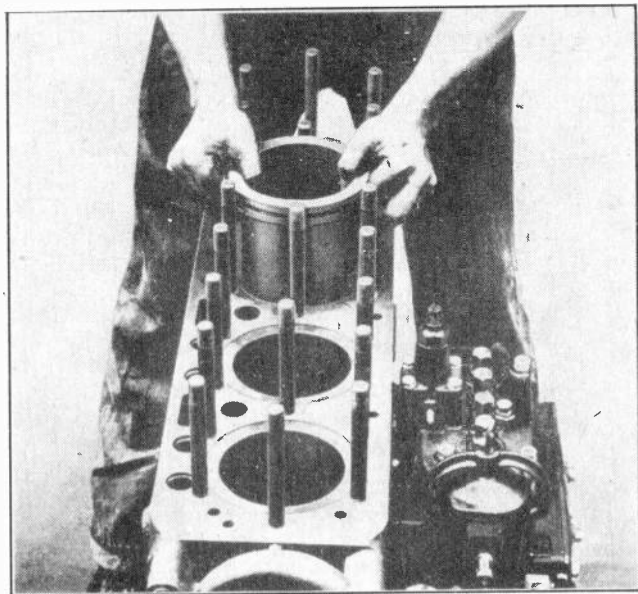

Fig. 16. Photograph showing how cylinder liners can be conveniently removed and replaced on Diesel engines of this type of construction. Courtesy International Harvester Co.

bearing; second, because of the clearance between the individual rollers, it is an easy matter to get oil to the pressure point of the bearing. This type of bearing also tends to make the engine run quieter, because it eliminates piston slap that is often caused by static friction at the wrist pin.

Connecting rod bearings of the plain babbitt lined type can be seen at "A" and "B" at the left ends of the connecting rods shown in Fig. 15.

12. CYLINDER LINERS

The majority of the modern Diesel engines in service are equipped with removable cylinder liners, as shown in Fig. 16. Cylinder liners are favored for two reasons. First, they make the re-conditioning of an engine less costly, as when they become worn they can be removed and replaced with new

Connecting Rods

liners. Second, they can be made of a harder, better wear resisting material than the rest of the cast iron engine block.

There are two common types of cylinder liners called dry type and wet type. Dry type liners are

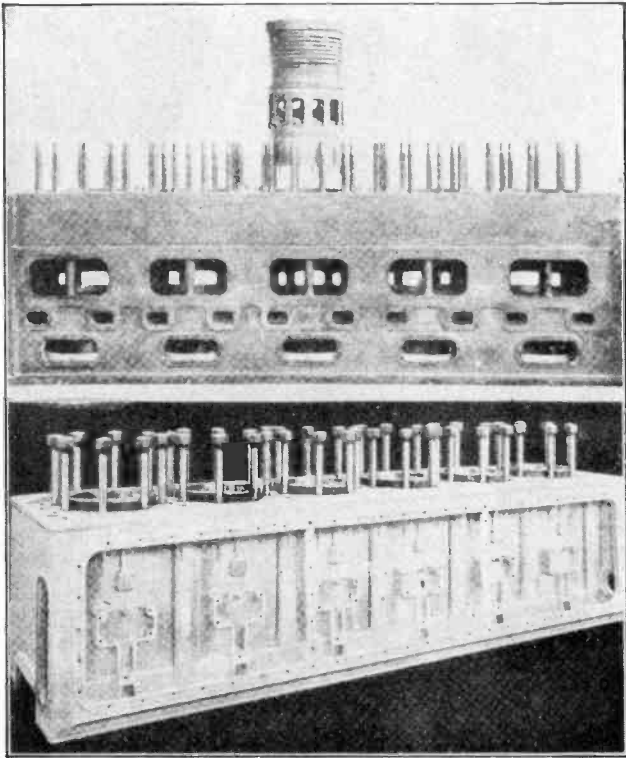

Fig. 17. In the top view is shown the upper section of a Diesel engine frame or cylinder block with one of the cylinder liners removed. In the bottom view is shown a six cylinder engine block with the liners all in place.

sleeves that slip into over-sized bores in the cylinder block. In order to get good contact between the liner and the bore in the block, sometimes these liners are made a trifle larger than the bore, then chilled with dry ice to shrink them so that they will slip easily into place. Then when the metal warms up the liners expand into a very tight pressure fit with the cylinder block.

Diesel Electric Power

Some engines use a **wet type** liner. In this case, the cylinder block merely serves as a water jacket and support for the liner, as shown in Fig. 17, the cooling water being in direct contact with the outside wall of the liner.

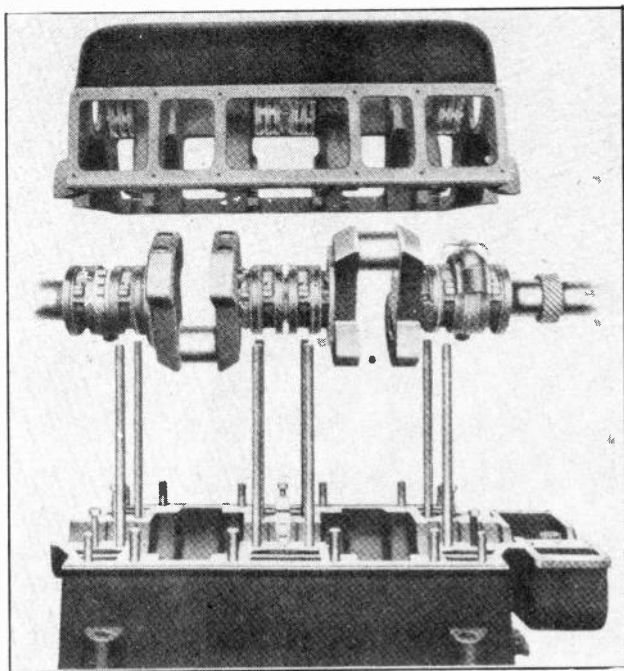

Fig. 18. This view shows the upper and lower sections of a two cylinder Diesel engine crank case with the crank shaft and bearings removed. Note the various bolts which hold these parts in place. Courtesy Fairbanks Morse Co.

The top view in Fig. 17 shows a cylinder block for a large 2 stroke cycle engine with a liner about to be placed in position. Note the exhaust and intake ports in the liner.

While small high speed Diesels usually have the cylinder block and crank case cast in one piece as in automotive practice, large Diesels have the crank cases built up in two sections. The lower part is called the bed plate and carries the crankshaft bearings as shown in Figs. 18 and 19. The upper part

Cylinder Liners

supports the cylinder sleeves or, in some cases, completely water jacketed individual cylinders. See Fig. 17.

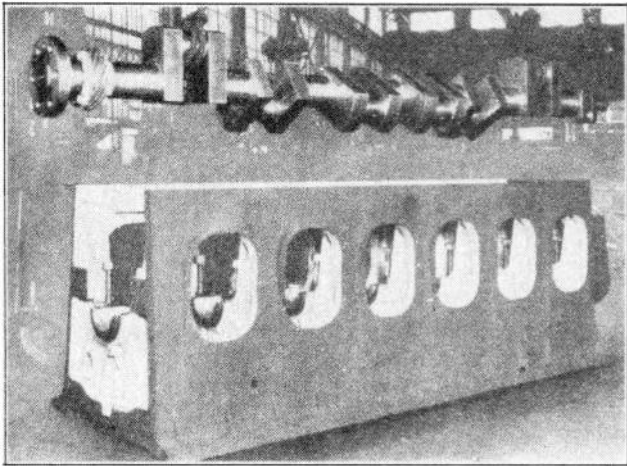

Fig. 19. Lower section of large Diesel engine but with crank shaft removed. Courtesy Busch-Sulzer Co.

13. VALVES

As mentioned in an earlier lesson, valves are used on many types of Diesel engines to admit the charging air and allow the escape of exhaust gases. These valves are made of forged steel to enable them to stand the wear and heat to which they are subjected.

To make it easy to grind the valves, large stationary type Diesels have both intake and exhaust valves installed in cages that can be removed without disturbing the cylinder head. The lower view in Fig. 20 shows a cylinder head assembly using caged valves. Removing two nuts makes it possible to remove the valve assemblies as shown in the upper view, for servicing.

Small Diesel engines have the valves mounted directly in the cylinder heads without cages, and the entire cylinder heads must be removed to grind the valves. See Fig. 21. The heads are usually divided so that each section covers only two cylinders.

Diesel Electric Power

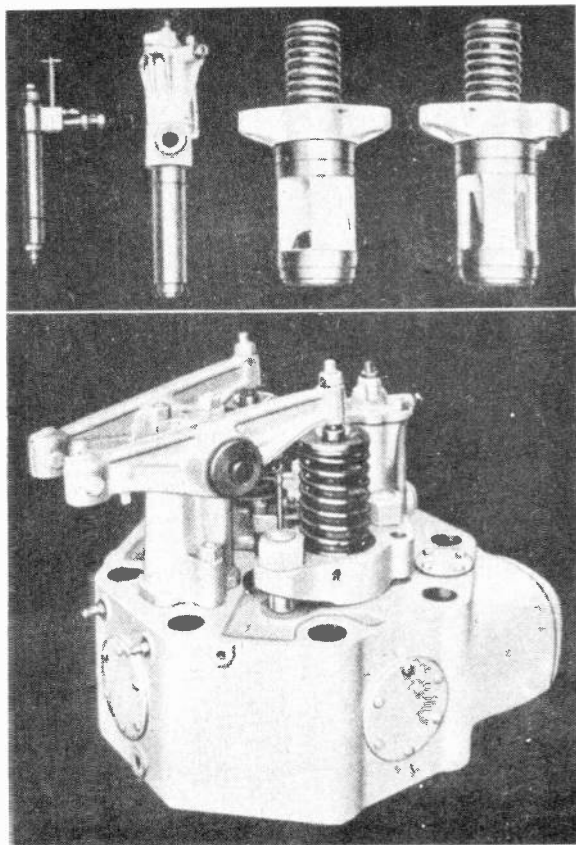

Fig. 20. In the lower view is shown a removable cylinder head which is equipped with removable valve cages and assemblies. In the upper view are shown in order from left to right, the fuel valve, starting air valve, intake and exhaust valves as they appear when removed from the cylinder head shown below.

Valves — Crankshafts

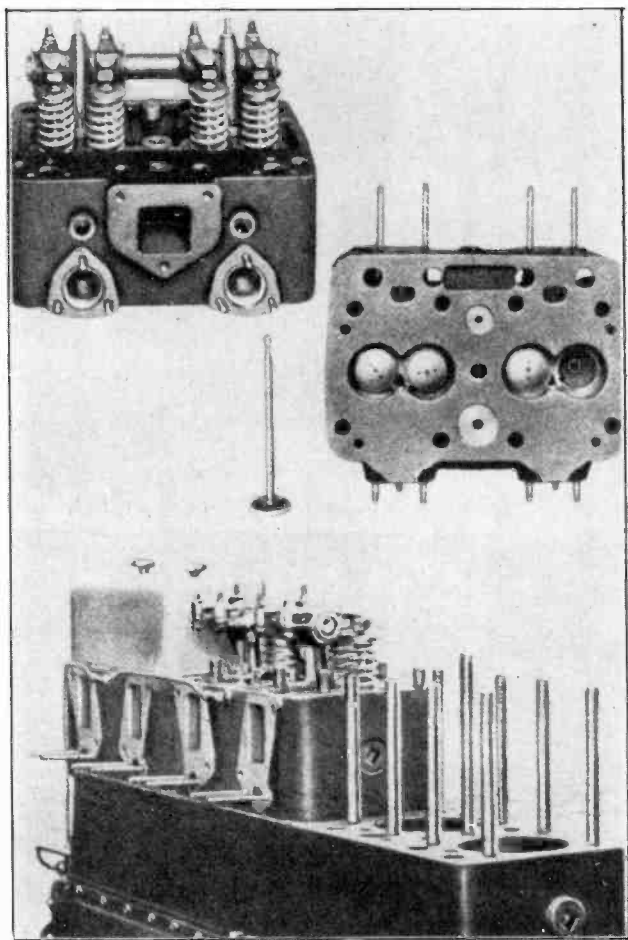

Fig. 21. In the lower view is shown a six cylinder Diesel engine from which one section of the cylinder head has been removed. Note that each cylinder head section covers two cylinders and is equipped with the intake and exhaust valves which are located right in the cylinder head.

Diesel Electric Power

14. CRANKSHAFTS

Due to the very high pressures used with Diesel engines, their crankshafts have to be extremely rugged and always have one main bearing on each side of every crank throw. A four cylinder engine having 5 main bearings and a 6 cylinder engine, 7 main bearings, etc. (See the crankshafts shown in Figs. 12, 18 and 19.)

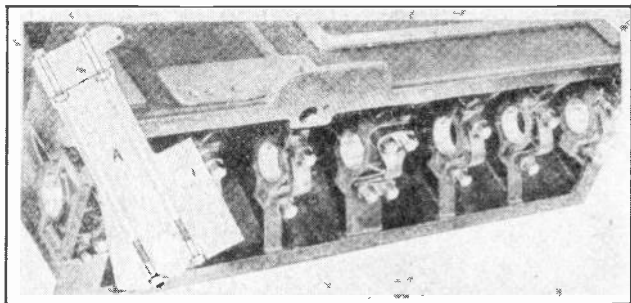

Fig. 22. Photograph showing the arrangement of the bearings in a six cylinder Diesel engine. Note the bottom ends of the through bolts which are shown full length in the insert at "A." These bolts run clear through from the crank shaft bearings to the cylinder head.

On some Diesel engines, steel tie rods extend through the cylinder block tying the cylinder heads and lower crankshaft bearing caps together as shown by both the photo and the insert "A" in Fig. 22. This system relieves the cylinder block of load strains, making possible a lighter block.

Accessibility of the wearing parts is extremely important, especially in large engines designed for stationary work, because all moving parts have to be inspected periodically. To make inspection and adjustments easy, removable covers and doors are provided, in the crankcase. This permits access to the bearings and other wearing parts.

Crankshafts

EXAMINATION QUESTIONS

1. Name two common types of lubrication systems used with Diesel engines?
2. How does lubricating oil reach the crank pin and wrist pin bearings of a Diesel engine?
3. Briefly describe the construction and operation of a mechanical lubricator.
4. How many drops of oil per minute would be required to lubricate each cylinder of a 500 R.P.M. Diesel engine with an 18 inch bore and a 24 inch stroke?
5. For what purpose is a viscosity meter used?
6. What are three very important items for the Diesel engine operator to keep in mind regarding the lubrication of engines?
7. Name six important parts of a Diesel engine.
8. What is the advantage of the crosshead type piston in large Diesel engines?
9. Why are quill type bearings used in wrist pins of some Diesel engines?
10. What is the advantage of using cylinder liners instead of cylinders bored in the engine block?

Diesel Electric Power

DIESEL ENGINE OPERATING PROCEDURE

1. GENERAL RULES FOR STARTING DIESEL ENGINES

The procedure to be followed to start a Diesel engine depends upon the type of engine and type of starting equipment used, as explained in previous articles covering types of starting systems and equipment.

Regardless of type of equipment however, there are two rules that apply in all cases. First, **the fuel system must be free from air**, otherwise the engine may not start or if it does start, it will run erratically. As a rule, fuel systems will hold their prime, but if the fuel tank has been allowed to run dry or if any part of the fuel system has been removed, and replaced, all air will have to be expelled or "bled" out, of the fuel system before the engine can be started.

To free the system of air, the air bleed valves in the injection nozzles should be opened or if no valves are provided, each fuel line should be loosened at the nozzle. If the fuel transfer pump is equipped with a manual priming handle, operate the transfer pump manually until fuel, free from air bubbles, flows from the air bleed valves or loosened fuel lines.

When this method is followed, if the injection pump is one that uses the port method of regulation, the pump control should be set in the **stop** position. On other types, the pump control can be set either in stop or full load position.

If the transfer pump has no manual handle, set the fuel control in **full load**, position for all types of pumps, and operate injection pump plungers by **turning the engine over with the starter** or by working each plunger up and down with a heavy screw driver, until fuel free from air spurts from the air bleed valves or the loosened ends of the fuel lines.

The second rule is to **be sure that the engine is supplied with lubricating oil and that the cooling system is supplied with water**. In starting light

Operating Procedure

weight high speed Diesels that are equipped with separately heated glow plugs and compression release, proceed as follows:

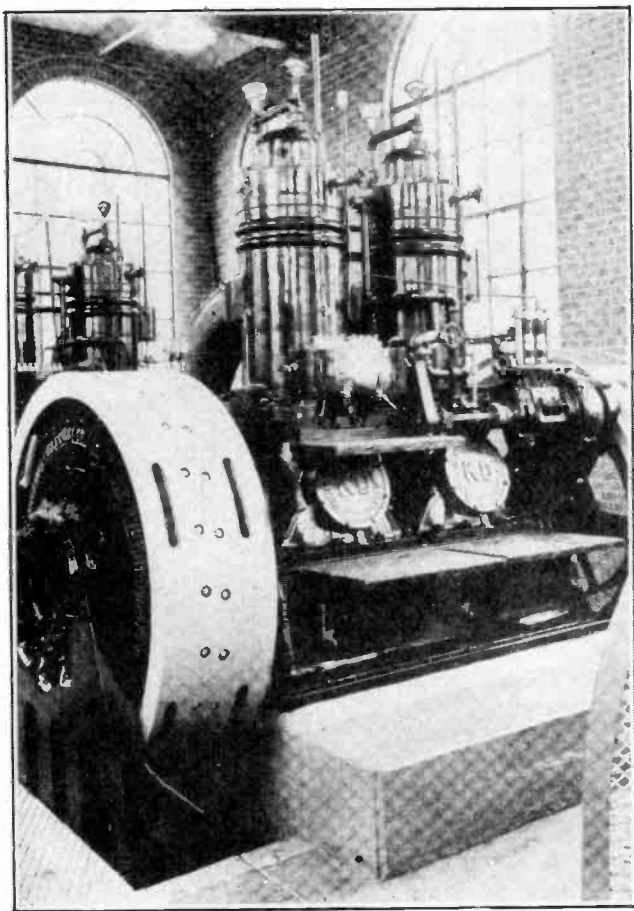

Rugged two-cylinder Diesel engine driving direct connected flywheel type generator. Note the cooling water thermometers on top of each cylinder, the fuel pump, lubricator, and the removable plates for connecting rod bearing inspection. Courtesy of Anderson Diesel Engine Co.

1. Set the manual fuel control in starting or idling position.
2. Turn on the glow plug switch.

Diesel Electric Power

3. Set compression release lever in the "off" position.
4. After 15 or 20 seconds, close starting motor switch and as the engine starts to turn, throw the compression release lever back to "on" position.

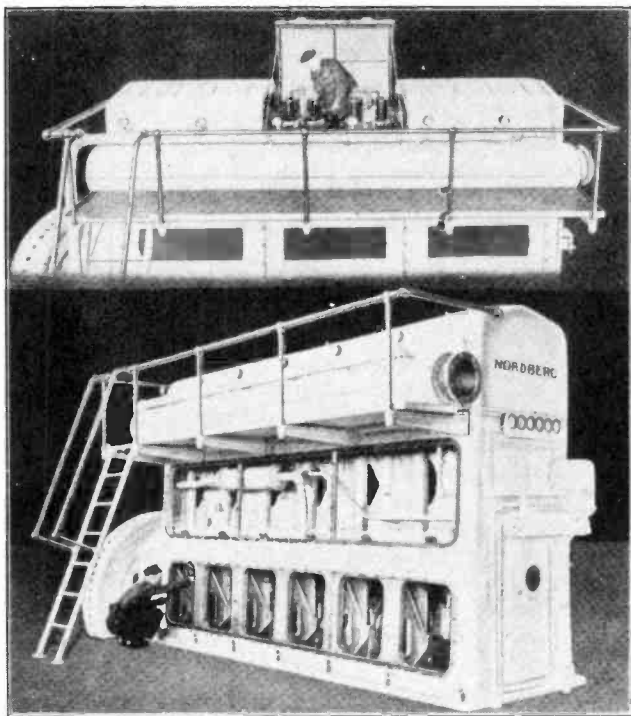

Fig. 1. Some Diesel engines are equipped with covers or housings such as shown above and which make them neater in appearance and quieter in operation. Note in the upper view how the top covers can be conveniently opened for access to the valve mechanisms and cylinder heads. Note in the lower view how the side plates can be removed for access to connecting rod and crank shaft bearings.

5. As soon as engine begins firing open starting motor and glow plug switches.

If the glow plugs are connected to the starting motor circuit and no compression release is used, set the manual fuel control to starting or idling position and apply the starting motor.

Operating Procedure

If a gasoline engine is used for starting purposes, when the Diesel engine is cold allow the gasoline engine to run for a few minutes before attempting to start the Diesel engine. The exhaust heat which is used to heat the intake manifold of the Diesel will make starting easier.

To stop the engine, set the manual fuel control to "stop" position.

2. STARTING WITH COMPRESSED AIR

In starting large engines with compressed air see that the air pressure is between 250 and 300 lbs. All lubricators for cylinder lubrication must be full. Be sure that no tools are left lying on the engine platform and that all belted machinery, generators, etc., are clear.

If the engine is equipped with motor driven cooling pumps they should be started and the cooling water circulation checked. If the engine has less than 4 cylinders, it will have to be turned over until one of the pistons is slightly past top dead center. Marks on the fly wheel are provided to set the engine properly. The engine is turned over by inserting an iron bar into holes, drilled in the rim of the fly wheel.

With the engine properly set, the fuel control handle is put in starting position, and the air is turned on. As soon as the engine begins firing, the air is turned off, and the fuel control handle is set in full load position, which turns the control over to the governor.

If glow plugs are used, they should be turned on and allowed sufficient time to heat before any attempt is made to start the engine.

In starting semi-Diesels or oil engines which use blow torches, sufficient time must be allowed for the hot tubes to heat up before the engine is started.

3. STOPPING

To stop these engines, move the fuel pump control to stop position. If the engines use separately driven cooling pumps, they should be left running until the outlet water temperatures are not more than 5 or 10 degrees above the inlet temperatures.

Diesel Electric Power

This prevents local overheating which tends to cause scale deposits to form in the jackets if hard water is used. If the cooling pump is driven by the engine, the engine should operate with a light load or idle for 10 minutes before stopping. This allows it to cool down enough to be safe to stop the cooling water circulation.

After the engine is stopped, it should be gone over thoroughly to see that everything is in good order. Bearings and other parts should be checked to see if any are abnormally warm.

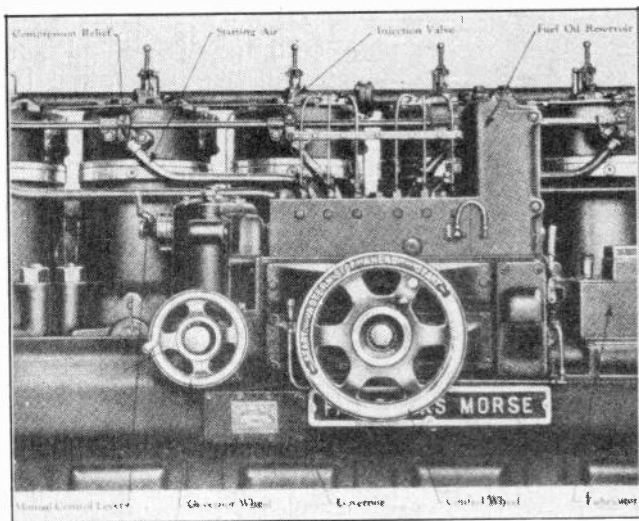

Fig. 2. This view shows the starting, stopping and reversing controls of a heavy duty Diesel engine. Note that the start, stop, and reverse positions are marked on the control wheel. Also note the governor wheel and the manual throttle or control lever. Courtesy Fairbanks Morse Co.

Engines should not be allowed to stand continuously idle for more than a week in dry climates, or for more than a day or two in damp climates or sea air. Short periods of running without load, or merely turning the engine over several times with a bar will maintain a protective oil film on the bearing surfaces. If there is any danger of freezing, all water jackets and pipes should be thoroughly drained, otherwise serious damage to the equipment may result.

Operating Procedure

4. REVERSING

For marine operation, the larger Diesel engines are built so that they can be reversed. This eliminates the need of a reverse gear and gear box, thereby reducing the weight of the power plant. The entire operation of stopping the engine and reversing the direction of rotation is accomplished by means of a control wheel such as shown in Fig. 2. The complete operation of reversing some engines requires four revolutions of the hand wheel.

The first turn puts the injection pumps out of action and the engine begins to slow down to a stop. Next the angular position of the shaft that drives the injection pumps and the rotary air distributor is changed for proper timing for reverse operation. If the engine is a 4 stroke cycle type the angular position of the cam shaft is also changed. The third turn puts the injection pumps back into action and at the same time opens the main air starting valve, causing the engine to rotate in the opposite direction and start firing. At the end of the 4th turn, the main air valve is closed and the engine is in full operation. The entire operation requiring not more than 3 or 4 seconds.

Some reversing equipment is designed to reverse the engine with less than one turn of the hand wheel, the order of events being the same as described above.

5. STARTING AND STOPPING THE HESSELMAN SPARK IGNITION INJECTION ENGINE

The normal procedure to start a Hesselman type engine is as follows:

Prime the engine with 2 or 4 strokes of the gasoline primer pump. Then crank the engine by hand or with the electric starter if it is equipped with one. As soon as the engine starts to fire, watch the exhaust and continue to feed gasoline with the primer pump until engine runs smoothly.

Watch the exhaust for $\frac{1}{2}$ minute more and if smoke appears, one or more strokes of the primer pump should clear it up.

Diesel Electric Power

To stop this type of engine, set the pump control in stop position. After the engine has come to rest, if it is equipped with battery ignition, turn the ignition switch off.

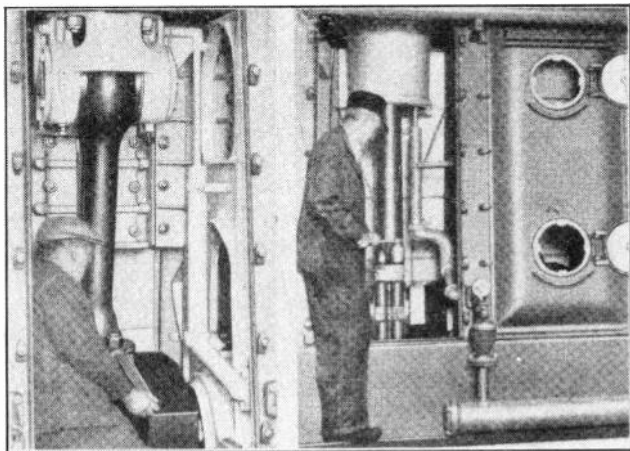

Fig. 3. These photos show how the side plates can be removed from a large heavy duty Diesel engine to permit the operator or repair man to get at the connecting rod and crank bearings to adjust them for wear. Note in the left hand view the crosshead between the top of the connecting rod and the bottom end of the piston to which it is bolted. Also note the guide bearing directly behind the crosshead and connecting rod.

Caution: Never stop a Hesselman engine by turning the ignition off. Always cut off the fuel supply first by setting pump control in "stop" position.

6. INSPECTION DURING OPERATION

In large Diesel plants, a running engine should be thoroughly inspected at least once every half hour, and the operator should check the lubricating oil pressures, the action of the mechanical lubricators, and the outlet water temperature from each cylinder. Figs. 1 and 3 show how cover plates may be removed for special inspection and adjustments.

Inspect the valve mechanism regularly. All parts not automatically lubricated should be oiled every two hours. Exhaust valve stems should be given a few drops of kerosene every 3 or 4 hours to keep them in good working condition. Keep the top of

Operating Procedure

cylinder heads and all parts of the engine wiped off clean.

If a pyrometer is used, note the exhaust temperatures. These should be no higher than the values recommended by the manufacturer of the engine, or the value given on the name plate.

Note the appearance of the exhaust gas. Normally it should be clear. If the engine is overloaded, the exhaust may become cloudy. Black, smoky, exhaust is caused by too heavy load, leaky fuel nozzles, injection too late, plugged holes in multi-orifice nozzles, low compression, or a dirty air filter.

A bluish exhaust is sometimes caused by an excessive amount of lubricating oil. This might be caused by defective oil rings, too high oil pressures or incorrectly adjusted mechanical lubricators.

If, for any reason, the cooling water or oil should stop flowing, or any part of the engine become overheated, stop the engine immediately and allow it to cool off gradually. **Under no circumstances admit cold water to a hot engine**, as this may cause the pistons to seize, or it may result in cracked cylinder heads or liners.

In case of low air pressure if the compressor equipment is out of commission, two methods may be used to obtain the necessary pressure for starting. Tanks of compressed air may be obtained from concerns that sell oxygen. As the air in these tanks is under 2000 lbs. pressure, they should be connected to and equalized into the regular air starting system.

If compressed air cannot be obtained, a tank of carbon-dioxide may be obtained from dealers in soda fountain supplies and connected to the air starting system. This gas is a liquid at ordinary temperatures and 800 lbs. pressure. The application of heat by pouring hot water over the carbon-dioxide container or applying rags soaked in hot water may be necessary to bring about evaporation.

Caution: Never use oxygen for starting purposes, as it is highly explosive when mixed with oil and may result in a wrecked engine.

Check over exterior of entire engine once each day for leaks at fuel line connections, fuel pumps,

Diesel Electric Power

injectors, filters, etc. Also for loose nuts or bolts and any other noticeable defects.

Check cylinder safety valves to be sure they are operating properly. Loosen safety valve spring nut while engine is running, until valve starts popping and then tighten the nut just enough to stop the valve popping.

Check air compressor safety valve daily by pumping up pressure to blow off point.

Check injector valve timing weekly.

Check operation and oil feed rate on mechanical lubricators hourly. Screw down grease cups on reverse gear mechanism weekly. Inject lubricating oil into air compressor intake daily when starting up the engine.

Lubricate rocker arms and rollers, service pump plungers, cam shaft ends, governor pins and water pump plunger connecting rods twice daily. Oil valve stems with lubricating oil and kerosene mixture every 6 or 8 hours.

Clean fuel strainers and filters daily. Clean lubricating oil strainer every 200 to 300 hours.

Inspect cylinder and cylinder head water jackets every 60 or 90 days for any signs of scale formation.

Check for clogged or faulty injector nozzle valves by opening cylinder exhaust test cocks and listening for weak cylinders, and noting any excess smoke in blow-off.

DIESEL ENGINE MAINTENANCE

Diesel engine maintenance can be divided under four headings: cleaning, adjusting, renewal of parts, and re-conditioning.

In the smaller plants, which as a rule are not equipped with machine tools, precision gauges and skilled machinists, the common practice is to replace any defective parts with spare parts kept on hand. In large plants that have a machine shop, worn or broken parts can be machined, re-fitted and repaired right in the plant.

Even in such plants, however, certain parts such as fuel pumps and injectors which require extremely accurate fitting, are often sent to the engine or pump manufacturer for repairs, spare units being kept on hand for temporary use.

Maintenance

7. CLEANING

No matter whether the plant is small or large, cleaning is a part of the operator's daily routine, and too much emphasis can not be put on this point.

The engine should be wiped frequently enough to keep it free from oil, grease and dirt. Frequent cleaning has two advantages; first, it keeps the engine looking neat and also removes dirt that might work into some of the bearings or working parts, and second, the operator may, while regularly cleaning and inspecting the engine, detect a fault before it becomes serious.

A systematic cleaning routine should be applied not only to the engine, but to the electric generators and switchboards in Diesel-Electric power plants, and all other equipment used in the plant.

Every Diesel plant operator should take sufficient pride in his engines, generators and entire plant to keep it spotlessly clean at all times, both for reasons of appearance and efficiency.

It is particularly important to have a clean work bench or place in which to make any repairs to fuel pumps or injectors, as any small particles of dust or dirt may seriously impair their operation.

8. LOW COMPRESSION

Engine compression should be watched closely, and maintained within 20 lbs. of the recommended pressure. The most probable causes of low compression or leaky valves, leaky gaskets, worn or stuck piston rings, and badly worn cylinders. Low compression causes difficult starting and reduces the operating efficiency of Diesel engines.

Leaky exhaust valves are caused by burning and pitting of the valve edges and valve seat, and also by valve stems becoming stuck due to carbonized oil. A leaky valve can usually be detected by overheating of the valve or cage, and by the sound of escaping gas or air.

Valves should be ground periodically, the frequency depending upon operating conditions.

Diesel Electric Power

9. VALVE GRINDING

To grind valves, the cages or cylinder heads are removed, and disassembled. A light coating of grinding compound, is put on the valve face, then it is rotated back and forth on the valve seat until a bright seat $\frac{1}{8}$ of an inch wide shows all around the seating surface. After valves have been ground, the clearance between the valve stem and rocker arm, or valve lifter should be checked and set according to the manufacturers specifications.

When replacing valve cages in the cylinder head after grinding valves be sure the copper covered gaskets are in place, all surfaces clean and a good tight fit secured. Fig. 4 shows a cylinder head and valve mechanism in the lower view, and above are shown the valve cages and valves removed.

10. WORN RINGS. RING CLEARANCES

Worn rings allow leakage because the ring gap or slot and side clearance become too great. While it is impossible to give general rules that would give the correct clearance in all cases, a gap of .003" for each inch of ring diameter is considered safe. When a new ring is fitted, it should be inserted in the smallest part of the cylinder liner, and the gap measured with a feeler gauge. The smallest part of the liner is near the bottom, because at this point, wear takes place slower.

While piston rings must be free in their grooves, side clearance between the side of the ring and the ring groove must not be excessive. As a rule, the top ring is given a little more clearance than the others because it is in a hotter zone and therefore, expands more than the lower rings. Following are the side clearances used on a number of engines:

MINIMUM SIDE CLEARANCES IN THOUSANDTHS OF AN INCH

Cylinder Diameters	4 Cycle Engines		2 Cycle Engines	
	Top Ring	Other Rings	Top Ring	Other Rings
Under 6 inches	.003	.002	.005	.004
6 to 12 "	.004	.003	.006	.005
Over 12 "	.006	.004	.008	.006

Maintenance

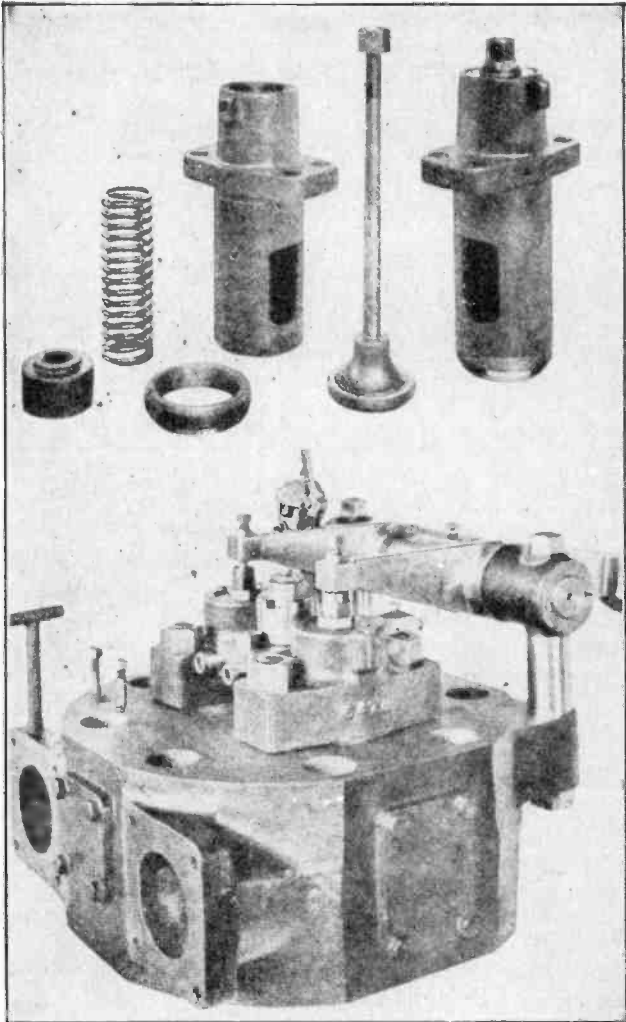

Fig. 4. Another type of Diesel engine cylinder head showing removable valve cages and assemblies and rocker arms. In the upper view one of the valves with its seat ring and spring has been completely removed from the cage. Courtesy Bush-Sulzer Co.

Diesel Electric Power

11. BEARING WEAR AND CLEARANCES

The connecting rod bearings should be checked periodically for excessive clearance. On large engines this can be done by removing the inspection doors on the side of the crank case and using a long bar for a pry, test for up and down play. If excessive clearance is noticed, the amount can be checked by removing the lower half of the bearing and placing two pieces of soft lead wire lengthwise across the babbitt lining. The bearing is then replaced and drawn up tight, see Fig. 3. This will flatten the lead wires, and when the bearing is again removed, the lead wires are measured with a micrometer.

The normal clearance is .001 inch, per inch of crank pin diameter. As an example, if the crank pin is 5 inches in diameter, the normal clearance should be .005 inch. If the lead wires used to test the clearance measured .012 inch, then enough shims to measure .007 inch should be removed from between the bearing halves. When replacing bearing bolts, be sure that all cotter pins are in place, to prevent bolts working loose during engine operation.

Wrist pin clearance for a 4 stroke engine should not exceed .00075 in. per inch of pin diameter (.003 in. on a 4 inch pin.) Two stroke cycle engines require .001 in. clearance per inch of pin diameter, because the higher temperatures occurring in 2 stroke cycle engines bring about more expansion and distortion of bearings and parts. Soft lead wire 1/16 of an inch in diameter should be used to check the clearances, by the same method described for rod bearings.

Main bearing wear should not exceed .002 inch in 4000 hours of operation. The usual clearance should be .001 inch per inch of crank shaft diameter. The lead wire method is also used for measuring or checking this clearance. The lower view in Fig. 5 shows how a crank case cover can be removed for access to the crank shaft and connecting rod bearings.

Maintenance

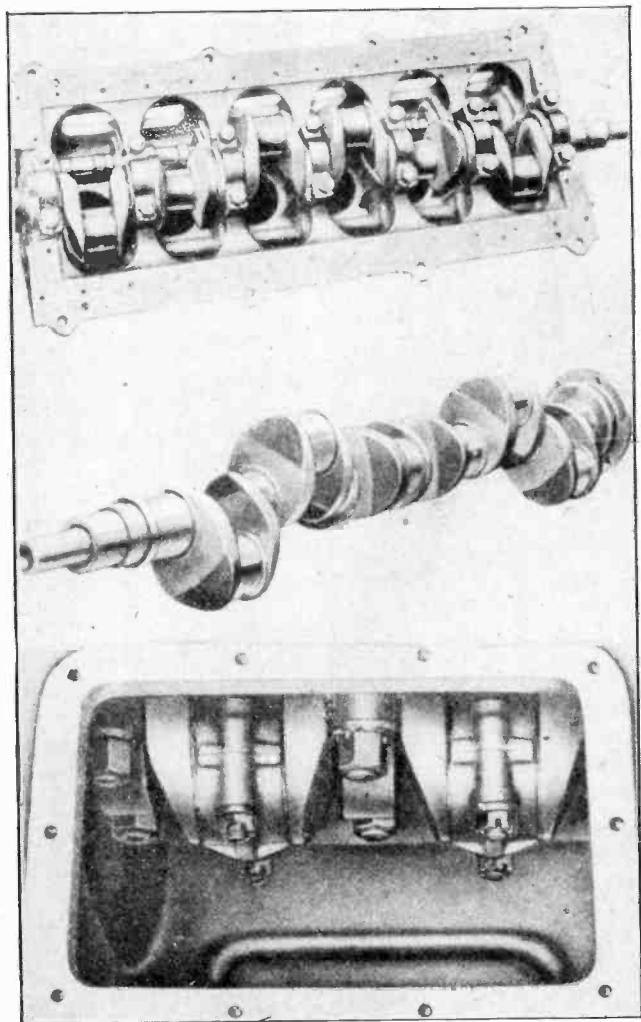

Fig. 5. At the top is shown a crank shaft mounted in the bearings and crank case while in the center view it is shown removed. Below one of the side plates is shown removed to permit accessibility to the crank shaft bearings for easy adjustment.

Diesel Electric Power

12. PISTON AND LINER WEAR AND CLEARANCES

The two parts subjected to the most wear in a Diesel engine are the pistons and the liners. The rate of wear of these parts is determined by several

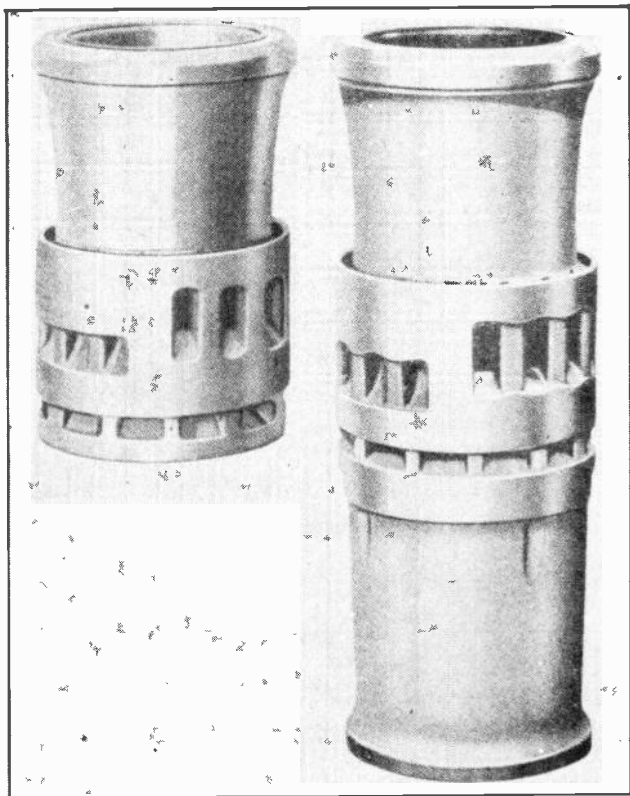

Fig. 6. Two types of removable cylinder liners for Diesel engines. The one on the right is for a trunk type piston and the one on the left for a crosshead type piston. Note how the use of the crosshead bearing reduces the necessary length of the cylinder liner. Also note the intake and exhaust parts in these liners.

factors, among which are piston speed, quantity and quality of lubrication, and grade of fuel used.

In slow speed engines, the rate of liner wear may be as little as .001 inch per 1000 hours of operation,

Maintenance

while in a high speed engine, the wear may run as high as .001 inch per 400 hours. Inferior lubricating oil, and fuel with a high ash content will also mean short liner life. Fuel containing more than .05% ash by weight will cause rapid liner wear, and greatly increase the cost of maintenance.

As a general rule, the clearance between the skirt of the piston and the liner is .001 inch, per inch of cylinder diameter for cast iron pistons, and .0015 inch, per inch of cylinder diameter for aluminum pistons. At the upper or "fire end" of the piston, the clearance should be .005 inch, per inch of cylinder diameter for cast iron pistons and .010" for aluminum. The reason for this piston taper or difference in clearance at the top and bottom ends is because of the greater expansion that occurs at the top due to higher temperatures at this point.

Renewal of the liners should be considered when they show, .006 inch wear per inch of cylinder diameter. If the wear reaches .009 inch, per inch of cylinder diameter, engine operation will be unsatisfactory. The wear is always greatest at the top of the liner because this part is exposed to higher temperatures and pressures.

Fig. 6 shows two cylinder liners for large Diesel engines. The one on the left is for an engine using a crosshead type piston and the one on the right is for a trunk type piston. Fig. 7 shows a method used to pull cylinder sleeves from a Diesel engine.

Compression and operating efficiency of engines with badly worn cylinders can often be improved by use of special flexible, double seal piston rings which will shape themselves to the worn contour of the cylinder walls.

After cylinder walls or liners become too badly worn, the liners should be replaced, or cylinder

Diesel Electric Power

walls re-bored and fitted with new pistons and rings.

Pulling cylinder sleeves or liners on Waukesha engines. A—Old sleeve being withdrawn. B—Blocking used as yoke for puller. C—Long stud with nut pulls sleeve when nut is screwed down as shown. D—Water jacket and crankcase. E—New sleeve; Head gasket holds joint tight at top of flange. F—Rubber sealing rings. Rings are placed in grooves of case before sleeve is inserted.

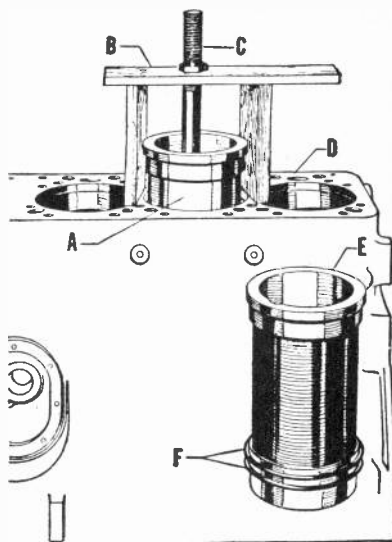

Fig. 7. This illustration shows a convenient method of removing cylinder liners from a Diesel engine. Note the printed explanation above.

Figure 8 shows on the left the condition of a piston that has been lubricated with an inferior grade of oil. Note the gummy condition of the piston, the stuck rings and indication of blow-by. On the right in Fig. 8 is shown a piston that has been lubricated with a high grade Diesel oil. Note the free condition of the rings, and the general clean condition of the piston, although it was operated for the same time period as the one on the left.

13. CLEANING CYLINDER JACKETS

Once a year the cylinder jackets and cylinder heads should be inspected for mud or scale deposits. Mud and sand can be flushed out with a hose. If there is a deposit of scale, it should be removed with some special scale remover or with a solution

Maintenance

of one part muriatic acid to 10 parts of water. This solution should be mixed in a barrel, and circulated through one cylinder jacket, at a time with a pump.

If no pump is available, the jackets can be filled with the solution and allowed to remain for 10 hours, after which it should be flushed out thoroughly with water. All copper or brass fittings should be removed before this solution is used, or they will be damaged by the action of the acid.

14. TOOLS AND SPARE PARTS FOR REPAIRS

The amount of shop equipment and the stock of replacement parts that a Diesel plant should be provided with depends largely on the size of the plant, location in respect to machine shops, and maximum allowable length of time that an engine can be kept out of service.

If no machine shop is available, the Diesel plant should have one of its own to handle the general repair and overhaul work. The equipment should include a lathe, drill press, forge, vise, tool grinder, valve grinder lathe attachment, rig for pulling pistons, pipe cutting and threading tools, flaring tool for copper tubing, micrometer, mandrils for various bearings, scrapers, wrenches, dies, taps, punches, chisels, hammers, files, blow torch, etc.

Replacement parts that should be kept in stock depend upon the ease with which they can be obtained from the engine factory or a supply house in case of an emergency. In the case of an isolated plant (plant which is located far from any source of parts) the following list of parts should be kept on hand.

- Two or 3 spare injection nozzles
- 1 injection pump
- 2 exhaust valves complete with cages (4 stroke cycle engines)
- 2 exhaust valves only (4 stroke cycle engines)
- 1 spare piston
- 1 set of piston rings (for 1 cylinder)
- 1 complete connecting rod assembly
- 1 of each type of gasket used on engine
- 1 of each type of spring used on engine

Diesel Electric Power

- 1 set rings for air compressor
- 1 suction and 1 discharge valve for compressor
- 1 pump unit for lubricator

The service department of the engine builder can often suggest special spare parts that should be kept in stock at the Diesel plant for any particular make of engine.

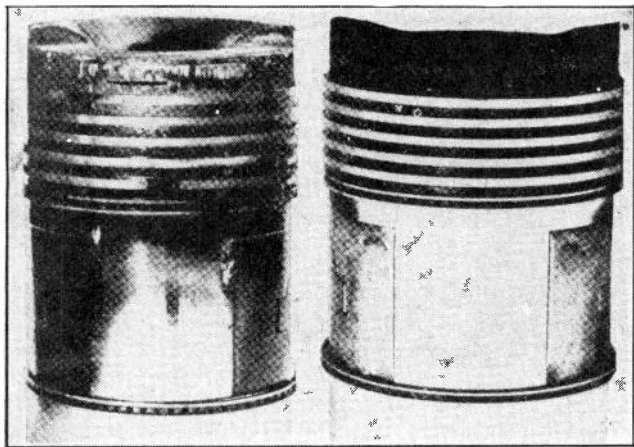

Fig. 8. This view shows two pistons which were both operated for the same period of time but with different grades of lubricating oil. The piston on the left shows signs of badly stuck rings, blow-by and wear, while the piston on the right which was operated with the better grade of oil shows all rings free and the piston and rings in very good condition.

15. DIESEL-ELECTRIC PLANT OPERATION

If you are an operator in a Diesel-Electric power plant, the same general operating rules as given in Lessons 35, 36, 43 for D. C. generators, and in Lessons 49, 50, 70, 72, 73 for A. C. generators and switchboards, can be applied to the care and operation of the electrical equipment.

Special attention should be given to the cleaning, lubrication, operating temperatures and ventilation, synchronizing, paralleling and load adjustment of the generators. Full instructions on these items, as well as care and repair of bearings, brushes, commutators, windings and switchboard equipment are given in the above mentioned lessons. Review them thoroughly in case you wish to prepare for work as an operator in a Diesel-Electric power plant.

Maintenance

Combination Diesel-Electric operators have excellent opportunities for pleasant, interesting, good paying jobs in municipal, industrial, railway, oil field and ship power plants of this type. Therefore, this combination training should be very valuable to you if you are interested in this class of work.

EXAMINATION QUESTIONS

1. State two important general rules to be observed when starting Diesel engines.
2. Explain briefly how you would proceed to start a high speed Diesel engine equipped with glow plugs, compression release, and electric starting motor.
3. Explain briefly how you would proceed to start a large Diesel engine equipped with an air starting system and glow plugs.
4. How should Diesel engines be stopped?
5. How are marine Diesels often reversed?
6. State five important items that should be frequently checked in Diesel Engine inspection during operation.
7. Explain briefly how Diesel engine valves are ground.
8. A. How would you check the clearance of crank pin or main crank-shaft bearings?
B. What is the normal clearance for crank pin bearings, and main bearings of four inch diameter?
9. A. What is the normal clearance between piston skirt and liner of 12 inches diameter cast iron pistons.
B. For aluminum pistons?
10. When should cylinder liner replacement be considered.

INDEX

A

- Action chemical during charge, 227
- chemical during discharge, 228
- Aids starting, 421
- Air compressor, 422
- Air Cells Diesel, 393
- Armature Slip Ring—
troubles, 120
- Arrangement valves of, 16
- Assembly battery plate groups, 292
- Automatic starter controls, 136-137
- Automotive modern motor car
equipment, 1
- spark advance, 64
- Auxiliary controls, 159

B

- Battery
 - assembly of plates groups, 292
 - burning a connection, 288
 - charge & discharge action, 306
 - charging Nickle Iron cells, 308
 - Cadmium test, 235
 - charging with DC rheostat, 264
 - charging bench, 261
 - charging—motor generator
 - constant potential method, 260
 - charging in series, 258
 - charging rates, 255
 - charging of, 253
 - cyclng of, 249
 - capacity of, 243-245
 - charging NEW batteries, 298
 - chemical action—charge, 227
 - chemical action—discharge, 228
 - cells, 201
 - construction of, 209
 - cases, 215
 - cell containers of, 215
 - Electron Bulb charging, 255-257
 - Edison storage cells, 302
 - electrolyte, 217
 - defective plates—replacing, 282
 - hy-rate discharge test, 240
 - hydrometers, 220
 - internal resistance of, 309
 - lead burning, 284
 - adjustment torch, 286
 - isolators, 214
 - meters for testing, 236-238
 - Nickle Iron cells,
 - advantage of, 305
 - (photo), 307
 - care of, 310
 - on-the-line voltage test, 232
 - open circuit voltage test, 233
 - operation of constant pot. 262
 - plates, 201
 - buckled, 269
 - preparation for storage, 295
 - questions, 251
 - questions, 277
 - questions, 314
 - questions, 226
 - retainers of, 214
 - reassembly of, 283
 - repair of, 279

- storage, 201-315
- service of, 273-275
- shop equipment, 299
- separators, 211
- specific gravity of, 218
- storage (photos), 35-36
- testing of, 228
- terms—battery action, 229
- troubles of, 266
- terminal posts, 293
- thermometers, 225
- voltage test, 231
- Bearings diesel, 491
- wear & clearances of, 505
- Bench charging, 261
- Bendix drive mechanism of, 130
- Block—cylinder, 6
- Blower—charging, 336
- Brushes—Bendix, 129
 - 3rd brush regulation, 151
- Breakers—construction (diagram)
72
 - distributor mechanism, 58
 - magnetic circuit, 187
 - setting, 73
- Buckling plates battery, 269
- Bulb—electron charging, 255-257
- Burning lead, 284

C

- Cadmium test, 235
- Capacity—battery, 243-245
- Carburetor operating levers, 14
 - principles of, 11
- Cases, battery, 215
- Cells, lead acid, 201
 - lead plate (photo), 203
 - Nickle Iron, 305
- Center upper dead, 9
 - lower dead, 9
- Centrifuging, 406
- Charge, battery, 306
 - adjusting the rate of, 153
 - charging various methods, 117
 - with motor generator, 260
 - in series, 258
 - battery, 253
 - new batteries, 298
- Chambers combustion, 7
- Chevrolet lamp load lighting, 167
- Chrysler engine (photo), 22
- Circuits, primary & secondary,
 - magnetos, 101
 - primary (diagram), 40
 - secondary (diagram), 40
 - complete, 109
 - shorts, 186
- Cleaning cylinder, 509
- Clearance rings of, 504
- Clearances bearings, 505
- Coil vibrating type, 45
 - ignition (cutaway photo), 37-38
 - parts, 38
 - Bosch, 37
- Combustion Waukesha Hesselman
Engine, 396
- Lanova system of, 394-395
- fuel, 15

Commutator, 129
 Compression low diesel, 502
 Compressors Diesel Rix Co. 423-424
 air—diesel, 422
 Condenser, construction of (diagram), 41
 ignition, 40-42
 Connections, burning a, 288
 Connecting-rods, 8
 Connecting-rods, 483-484
 Consumption fuel, 403-404
 HP. Diesel engines (chart), 403
 Construction of—breakers, 72
 battery, 209
 condenser, 41
 Containers—cells, 215
 Control—Wedge method diesel, 360
 Chevrolet lamp load, 167
 2 rate step down, 160
 auxiliary, 159
 automatic starter, 136-137
 Contacts—cut out, 169
 Cooling—quantity of water, 459
 closed type system of, 456
 double flow system of, 455-457
 open type system of, 454
 single flow system of, 453
 thermo-syphon system of, 451
 radiator systems of, 449
 Diesel systems, 448
 Crankshaft—(diagram), 21
 V type (photo), 31
 diesel types of, 487
 Cut outs—generators, 157
 contacts of, 169
 Cycle, 4
 constant pressure, 387
 Cylinders—Waukesha Engine (photo), 390
 diesel types (photo), 427
 diesel types (diagram), 428
 liners of, 485
 liners—diesel, 507
 pulling sleeves of, 509
 cleaning of (Diesel), 509
 Cycling—battery, 249

D

Dashboard—lighting, 181
 Dead Center—upper (diagram), 11
 Diesel Electric Power, 315-512
 Maintenance of equipment, 501-522
 electric plant operation, 511-512
 tools for, 510
 piston rings for, 481
 engine construction of, 478
 cooling—quantity of water 459
 overheating causes of, 444
 exhaust silencers, 486
 engineers cab (electric train), 430
 electric train (Burlington), 429
 air compressors (diagram), 422
 starting aids, 421
 air system of starting, 420
 starting air supply, 418
 compressed air starting, 416
 auxiliary gasoline starting, 413-415
 electric starting motors, 411

Diesel—(Cont.)
 ship—diesel powered, 407
 centrifuging, 406
 HP. consumption (chart), 403
 engine speeds, 402
 drip lines, 369
 fuel nozzles, 364
 discharge valves, 354
 fuel control by-pass—relief valve method, 356
 fuel pumps, 349
 fuel injection system, 347
 compression ratio (chart), 343
 firing order of, 344
 2 stroke engine principles, 331
 2 port type—operation, 334
 blower & compressor charging, 336
 semi-diesels, 339-340
 4 stroke engines, 325
 full diesels, 323-325
 engine construction, 320
 Direct Current
 charging with rheostats, 264
 Discharging hy-rate test, 240
 batteries, 306
 Disk high voltage distributor, 105
 Distributors
 primary breakers of, 55-60
 breaker mechanism of, 58
 setting the gear, 106
 connection diagram, 74
 8 cylinder engine types, 70
 Drives Bendix (photo), 131
 Bendix for starters, 128
 Dual Ignition 6 cylinder types, 69
 Dome—lighting, 181
 Dismantling—pumps, 362

E

Edison storage battery-cells, 302
 Eight cylinder engines—firing order, 27
 crankshaft (diagram), 30
 Electrolyte-preparation, 222
 mixing table, 223
 Electron Bulb-operation, 255-257
 Engines, diesel types, 315-512
 Internal combustion, 3
 origin of, 3
 stroke of, 4
 internal combustion principles, 4
 compression stroke, 5
 L head type (diagram), 8
 Oldsmobile (diagram), 8
 F head, 17
 T head, 17
 Buick (photo), 18
 Multiple cylinder, 19
 4 cylinder (photo), 20
 Chrysler (photo), 22
 8 cylinder, 27
 Studebaker, 28
 V type (photo), 29
 6 cylinder Nash, 163
 Caterpillar Tractor Co. diesel, 322
 Atlas Imperial diesel, 317
 Busch Sulzer—diesel, 316
 Buda Co. diesel, 321
 Witte Engine Co. diesel, 320
 Stover Engine Co. diesel, 319
 Int. Harvester Co. diesel, 325

Engines—(Cont.)

- Ven Severin Engine Co. diesel, 324
- McIntosh Seymour Co. diesel, 328
- Cummins Engine Co., diesel, 327 diagram, 375
- Allis Chalmers Co., diesel, 388
- De La Verne Co., diesel, 419
- Quincy Compressor Co., diesel, 421
- Fairbanks Morse Co., diesel, 466
- Anderson Engine Co., diesel, 459
- Waukesha Hesselman Co., 396
- Lanova, 394
- Waukesha Co., 390
- Electro—magnet, 120
- Equipment—lighting, 173
- shop—battery, 299
- Exhaust diesel systems, 437
- flexible connections, 439
- flexible tubing, 440
- Exchangers shell & tube heat, 458

F

- Failing—headlights, 183
 - Fields—protection, 158
 - Filter—diesel metal screen type, 378
 - Firing order, 23
 - diesel, 344
 - to determine, 33
 - determining by test, 31
 - 6 cylinder engines, 23
 - 8 cylinder engines, 27
 - 4 cylinder engines, 21
 - Fitting
 - spark plugs (diagram), 52
 - Flickering—lighting, 184
 - Flywheel—(diagram), 8
 - Ford
 - model T (wiring diagram), 46
 - Formula
 - plate paste, 207
 - Forming—plates battery, 208
 - Four cylinder engines—firing order, 21
 - Fuel
 - consumption, 403
 - requirements, diesel, 402
 - specifications, 401
 - pumps—troubles & care, 361
 - combustion, 15
 - control—by-pass method, 356
 - Fuel Injector—sectional view, 376
 - common rail system, (diagram), 372
 - systems diesel, 347
- Fuel nozzles, 364
 - Fuel Pumps, 349
 - Fuel Systems, 387
 - distributor type of, 374

G

- Gasoline Engines, 1-34
- Gauges
 - thermal or bi-metal types of, 92
 - resistance type, gasoline, 89
- Gears
 - drive (diagram), 6
 - setting distributor (diagram), 107

Generators, 149-172

- Delco Remy (photo), 150
- disassembled, 154
- variations in voltage (diagram), 155
- charging circuit, 156
- step down charging control, 160
- vibrating type (diagram), 165
- troubles & remedies, 168
- questions, 172
- Governors
 - vacuum type diesel, 384
 - diagrams, 381-384
- Grades—oil, 473
- Gravity—fuel oil, 399
- specific, 218
- Grid—plates, 206
- Guide—tubular, 8

H

- Headlights—dimming (diagram), 178
- Heat—utilization of, 463
- Heat Ranges—spark plug, 53
- Horns—auto—construction, 143
- relays (diagram), 143
- Housings—diesel engines, 495
- magneto breakers, 104
- Hydrometers, 220
 - diesel types, 397

I

- Impulse—power, 20
- Insulation—leaky, 189
- Induction
 - effect of, 42
- Injection
 - diesel timing, 370
 - indirect—pre-combustion, 389
 - fuel pump, 398
- Internal combustion—definition, 3
- Ignition, 35-66
 - condensers, 41
 - definitions of, 35
 - double or dual, 67
 - missing—remedy, 87
 - locks, 74
 - rules, 61
 - spark oil injection, 342

L

- Lead—acid cells, 201
 - burning, 284
 - plate cells, 203
- Lever—carburetion, 14
- Lighting, 173-200
 - complete wiring systems, 191
 - Chrysler diagram, 197
 - dome & dashboard, 181
 - equipment, 173
 - flickering & flaring of, 184
 - Ford V8 wiring diagram, 198
 - headlights fail, 183
 - diagram, 175
 - leaky insulation, 189
 - magnetic circuit breaker, 187
 - Packard wiring diagram, 194
 - questions, 199
 - short circuits, 186

- Lighting—(Cont.)
 - switches (photo), 179
 - testing procedure, 185
 - troubles in systems, 182
 - wiring diagrams, 192
- Locks—ignition, 74
- Lubrication
 - amount of oil needed, 471
 - grades of oil, 473
 - mechanical aspects, 470
 - oil foaming—cleaning, 477
 - systems diesel (photo), 467

M

- Magnetos, 95-124
 - Bosch (diagram), 113
 - breaker mechanism, 103
 - circuits, 101
 - collapse of flux (diagram), 97
 - operating principles of, 97
 - disassembly of, 112
 - ground brush ignition switch, 103
 - high tension (diagram), 115
 - high tension, 95-96
 - rotating magnet, 116
 - 2 pole Scintilla, 116
 - parts—sectional view, 108
 - Wico—EK, 117
 - safety gaps, 101
- Maintenance—diesel, 501-522
- Manifolds, 8
- Mechanisms—drive-Bendix, 130
- Meters—pyrometer, 447
 - viscosity, 474-476
- Motors—starting, 128
 - diesel starting, 411
- Mufflers—diesel (Burgess Battery) 439
- Multi-Cylinder—engines, 30

N

- New Batteries—charging methods, 298
- Nickle Storage Cells—care of, 310
- Nickle Iron Cells
 - charging, 308
 - characteristics, 305
- Nozzles
 - Injector—Caterpillar Tractor Co., 392
 - disassembly, 368
 - open type diesel, 369

O

- Oil amounts needed—grades, 471
 - cleaning—foaming, 477
- Overheating causes, 444
- Operation
 - diesel engines, 511
 - internal combustion engines, 3
- Overhead—valves, 18
- Order—firing, 344

P

- Packard—wiring diagram, 194
- Parts—4 cylinder engine, 24
- Pinion—starter (photo), 133

- Piston, 8
 - diesels (diagram), 389
 - diesels, 479-481
- Plants—Allis Chalmers diesel, 405
- Plates—buckling, 269
 - replacing defective, 282
 - forming of, 208
 - paste formula, 207
 - pasted, 204
 - grid, 204-206
 - presses (photo), 270
 - storage batteries, 201
- Plugs, selection of, 51
- Posts—terminal, 293
- Potential—constant, charging, 262
- Preparation—storage battery, 295
- Presses—plates battery, 270
- Pressure—cycle constant, 387
- Primary
 - breaker points, 55-60
 - circuits, 109
- Pulling—cylinder sleeves, 509
- Pumps—dismantling, 362
 - Fuel injection system, 398
 - variable stroke diesel, 359
- Pyrometers—diesel, 442
 - thermo-couple (photo), 444

Q

- Questions
 - Battery, 226
 - battery, 251
 - battery, 277
 - battery, 314
 - lighting, 199
 - diesel, 346
 - diesel, 386
 - diesel, 410
 - diesel, 465
 - diesel, 492
 - diesel, 512

R

- Rate
 - adjusting charging, 153
 - charging of, 255
- Regulation
 - 3rd brush, 151
- Regulators
 - vibrator types service, 166
- Repair—batteries, 279
- Resistance—ignition coil, 44
 - internal, 309
- Retainers—battery, 214
- Rings
 - diesel, 481
 - worn & clearance, 503
- Rocker Arms—diagram, 6
- Rods
 - connecting, 8
 - diesel, 483
 - push (diagram), 6
- Rules
 - starting diesel engines, 493
 - timing ignition, 61

S

- Scavenging, 435
- Secondary—circuit, 109
- Selection—plugs, 51

Semi-diesel, 339
Separators—battery, 211
 isolators, 214
 retainers, 214
 wood, 212
Service—battery, 273-275
Setting—the gear, 106
 breakers, 73
Six Cylinder Engine
 crankshaft, 25
Shafts
 cam—diagram, 6
 crank, 487
Shifts
 manual pinion, 132
Shop equipment—battery, 299
Silencers—exhaust diesel, 436
Spark
 advance & retard, 15
 methods, 59
Spark Plugs
 troubles, 80
 sectional views, 54
 diagrams, 48
Special Ignition System Hi
 speed motors, 67-95
Speeds
 engine, 402
 charts, 408
Starting Motors, 125-148
 aids of, 421
 low voltage at, 139
Starters
 auxiliary gasoline diesel, 413
 automatic adjustment of, 138
 controls, 136
 compressed air type, 496
 complete equipment (Fairbanks
 Morse), 425
 diesel systems, 498
 (photo), 494
 Waukesha Motor Co., 432
 Delco Remy, 431
 air system diesel, 420
 air supply for, 418
 failure to start—remedy, 428
 mechanical troubles, 140
 electrical troubles, 142
Stroke
 pumps—variable, 359
 power, 10
Storage Batteries, 201-315
Storage Cells—Edison, 302
Studebaker—8 cylinder, 127
 (photo), 28
Systems
 cooling—radiator, 449
 single flow, 453
 thermo-syphon, 451
 open type, 454
 closed type, 456
 cooling—double flow, 455-457
Ignition, 27

Synchronizing—with test lamps, 70
Switch
 automatic (common type), 135
 starter (photo), 134

T

Tanks—diesel auxiliary supply, 379
 fuel oil—Venn Severine Co., 377
Terminal—posts, 293
Terms—battery, 229
Testing
 battery, 228
 ignition troubles, 80
 lighting, 185
 on-the-line—voltage, 232
 open circuit voltage, 233
 voltage, 231
Thermo-couples—pyrometers, 444
Thermometers—battery, 225
 diesel, 460
Throttle, 14
Timing ignition, 60
 magneto to engine, 111
 valve, 9
Torch
 lead burning adjustment, 286
Train—diesel electric, 429
Troubles—
 armature—slip ring, 120
 breakers, 119
 breaker points, 83
 distributors, 81
 electrical, 79
 ignition coil—primary, 84
 ignition systems in, 67-79
 magnetos, 118
 starters, 139
 spark plugs, 80
Two Rate Controls
 troubles & servicing, 162
 operating principle of, 161
Turbulence—Waukesha Comet
 Engine, 391

V

V type—engines, 28
Valves, 4
 arrangement of, 16
 chambers, 7
 diesel (photo), 488-460
 timing, 9
 throttle, 12
 location of (diagram), 17
 overhead (photo), 18

W

Weights—tables of, 406
Wear—bearings of, 505
Wiring—systems, 191
Worn—rings, 503



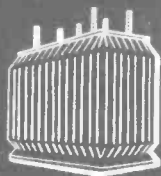

PRACTICAL
Electrical and Radi
Books
for
PRACTICAL MEN

