

WESTINGHOUSE

Engineer

ONE
WAY

SAFETY
ZONE

SEPTEMBER 1957

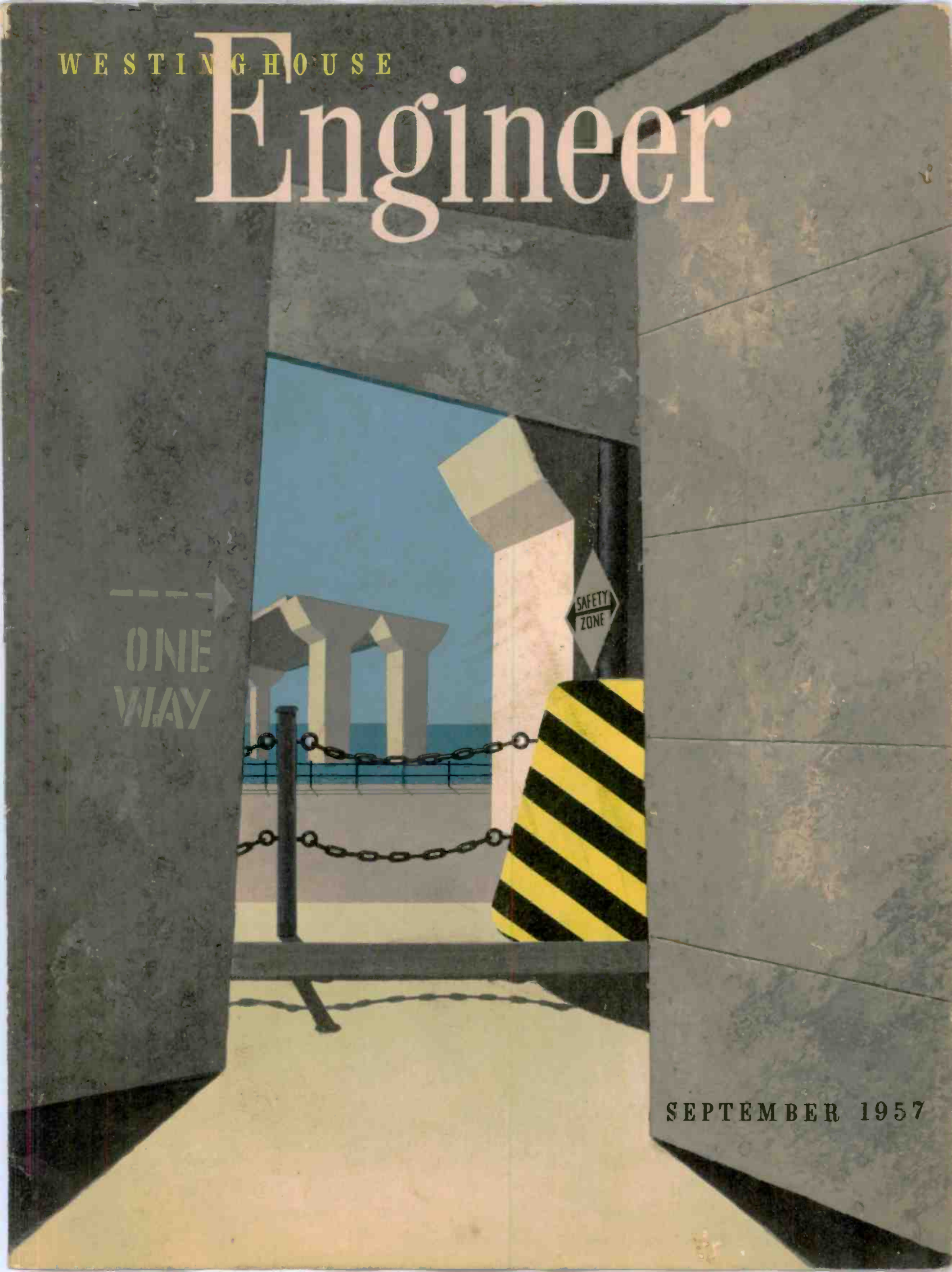

For Your Convenience

This slip is a routing list, which may be used in sending this issue of **WESTINGHOUSE ENGINEER** to other members of your staff who should read it.

DO NOT TEAR OFF

Simply fold the slip upward and around the top of the front cover. The routing form then appears at the front and is ready for use.

nuclear power plants to join the Navy's new atomic fleet.

The *Skate's* reactor—a pressurized-water type—is similar in principle to that in the *Nautilus*, but incorporates new concepts and advances in reactor design based on improved nuclear technology. These advancements have enabled engineers to develop a new reactor plant using components of improved design that will operate more efficiently, permitting construction of a smaller craft to satisfy special service requirements.

Construction of the nuclear power plant for the *Skate* was started during the same month that the *Nautilus* went to sea for the first time under atomic power—January, 1955. The keel plate of the *Skate* was laid July 21, 1955, and the submarine was launched on May 16, 1957.

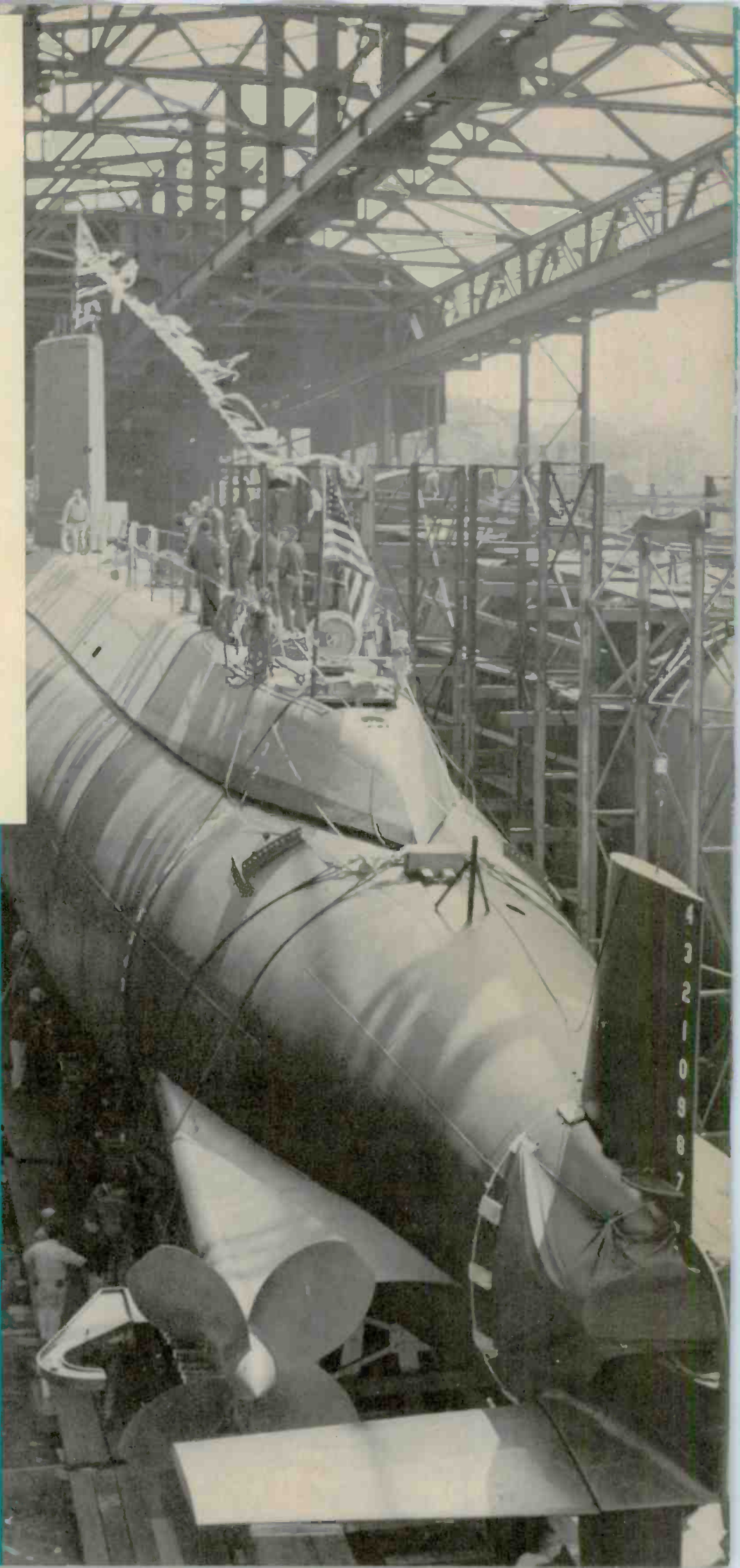



COVER DESIGN: The likeness of art can sometimes be scrupulously accurate—especially when the depicted subject can also serve as the artist's medium. Cover artist Dick Marsh developed a paint formula that included portland cement and fine gravel to produce this bona fide symbolization of modern concrete application.

RICHARD W. DODGE, *editor*

MATT MATTHEWS, *managing editor*

EDWARD X. REDINGS, *design and production*

J. A. HUTCHESON, J. H. JEWELL,

DALE McFEATHERS, *editorial advisors*

PUBLISHED bimonthly (January, March, May, July, September, and November) by Westinghouse Electric Corporation, Pittsburgh, Pa.

SUBSCRIPTIONS: Annual subscription price in the United States and possessions is \$2.50; in Canada, \$3.00, other countries, \$3.00. Single copy, 50¢. Address all communications to Westinghouse ENGINEER, P.O. Box 2278, 3 Gateway Center, Pittsburgh 30, Pa.

INDEXING AND MICROFILM: Westinghouse ENGINEER contents are regularly indexed in Industrial Arts Index. Reproductions of the magazine by years are available on positive microfilm from University Microfilms, 313 N. First Street, Ann Arbor, Michigan.

THE WESTINGHOUSE ENGINEER IS PRINTED IN THE UNITED STATES BY THE LAKESIDE PRESS, CHICAGO, ILLINOIS

The following terms, which appear in this issue, are trademarks of the Westinghouse Electric Corporation and its subsidiaries:

Kovar, Automex, Discaloy, Thermalastic

Table of Contents

OPERATING A NUCLEAR POWER PLANT

R. L. Witzke and A. R. Jones

As nuclear power has progressed, design and economics were the most talked about subjects. Now, operation is becoming of equal importance.

130

A MULTI-MEGAWATT MAGNETRON

E. C. Okress, C. H. Gleason, and W. R. Hayler, Jr.

New technological developments and manufacturing processes were required to develop this most-powerful magnetron.

135

TELEOLOGICAL CONTROL—IT LEARNS BY DOING

A. Kerstukos

While no computer can think, it can be "trained" to evaluate a situation and choose the best course.

138

AIRPORT LIGHTING AND THE JET AGE

W. A. Pennow

The speed of modern jet aircraft leaves no margin for error. Airport lighting must therefore give positive and ready identification of runways.

140

RECIPE FOR CONSTRUCTION—PORTLAND CEMENT

Man searched for this recipe for centuries—the universal building material that resulted finds ever increasing application.

144

CEMENT PLANT POWER

Anthony C. Lordi

Electricity is also a vital ingredient in modern cement manufacture. From quarry to finished product, electrical equipment does the work.

147

SELECTION OF FAN TYPES

A. V. Rogers

For any given service, one fan type will best meet the operating conditions.

152

SUPER-PRESSURE TURBINE DESIGN

C. C. Franck

Most of the new engineering developments for the 5000-lb super-pressure turbine are in the relatively small, super-pressure unit.

156

operating a nuclear power plant

R. L. WITZKE, Manager A. R. JONES
Application Engineering Department
Atomic Power Department
Westinghouse Electric Corporation
Pittsburgh, Pennsylvania

■ A nuclear-fueled steam generator will replace the boiler in many steam power plants of the future. In fact, atomic plants already in design exceed a million kilowatts capacity. However, the industry has been deeply involved in the evaluation of capital and fuel costs of nuclear plants; as a result, more attention has been devoted to these problems than to those concerned with operation of the plants.

The time has come to look more closely at the details of nuclear plant operation. One estimate indicates less than one mill per kwhr variation in the ultimate total cost of power between five reactor types. While these are rough estimates, they indicate that rather small factors of cost, such as operation and maintenance, may influence strongly the final selection of reactor types.

The operational problems discussed here concern the pressurized water reactor; not only is more information available on this type plant, but also it will be the most common type in the immediate future. Of the first seven large nuclear plants planned for construction, three will utilize pressurized-water reactors and a fourth is a modification.

The pressurized-water reactor, Fig. 1, derives heat energy from the fission of uranium and other heavy atoms, which are maintained in a fuel structure of solid rods or plates, inside a reactor or pressure vessel. This energy is transported in hot water, approximately 2000 psia and 500 to 600 degrees F, to the steam generator, where water in a separate system is boiled to produce steam for the turbine. Depending upon the plant size, one or more heat transfer loops and steam generators are used to remove the heat from a single reactor. The water in these loops is maintained with less than two parts per million impurities by a purification system. A makeup and drain system, with connections to a water supply of high purity and a waste-disposal system, is required to keep the appropriate water level in the system. When heat energy is not required to drive the turbine, heat must be removed from the reactor by the shutdown cooling system. Reactor control and radiation monitoring of high reliability are required for plant safety.

The normal performance of a nuclear plant is generally accepted as excellent for power production. Most of the problems discussed here have to do with auxiliary systems and emergency conditions, and are grouped under the following operational headings: start-up; normal operation; shutdown; maintenance; refueling; manpower.

This article is part of an AIEE-sponsored paper presented at the 1957 Nuclear Engineering and Science Congress.

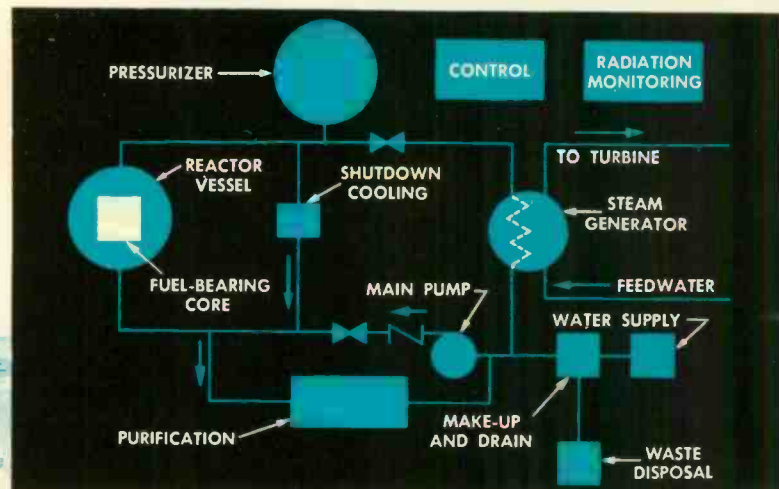

Fig. 1—Schematic of pressurized water reactor plant.

Start-up of the Reactor

Start-up problems depend to some extent on the previous history of plant operation. For example, certain special precautions must be observed in the initial start-up of a new plant, or when a new fuel structure is put into operation. The first case is encountered only once in the plant lifetime and the second can be expected at perhaps one to five year intervals in the early plants and less frequently with time. These functions normally would be supervised by the equipment manufacturer, and are not considered here.

The start-up of a cold plant will occur at irregular intervals, should be accomplished by the normal operating crew, and is therefore of more immediate and general interest. Assume that the systems, primary and secondary, approximately 300 to 600 gallons per mw capacity, are filled with water of the desired purity—about one to two ppm.

The first requirement of start-up is the check-out of instrumentation and components to insure proper function. The items to be checked and the procedure will be peculiar in many cases for the nuclear plant, but the problem is not essentially different from that encountered in any other plant.

Cranking power to drive the plant auxiliaries must be supplied. For the electric-utility application this usually means energizing the auxiliary power bus from the system. For isolated units a diesel generator can provide this power. Present data¹ indicates that auxiliary requirements are about eight to nine percent of rated output, and a sizeable fraction of this, at least one-third and perhaps two-thirds, is needed during start-up.

Oxygen scavenging² may require appreciable time (up to four hours) prior to actual start-up if the system has been refilled with supply water. Scavenging is accomplished by the addition of hydrazine. The system is pressurized sufficiently to provide the required net positive suction pressure (100 to 200 psi) at the main coolant pump intakes either with the pressurizer or with the charging pumps. These pumps are then operated to circulate the hydrazine solution and permit the hydrazine-oxygen reaction to take place. During the oxygen scavenging and the whole start-up procedure, all main coolant valves should be open.

Design practice is such that the reactor will be shut down before full insertion of the control rods is reached. However, operating practice is to take advantage of this extra margin of available rod insertion as a safety factor on shut down. Therefore the control rods must be pulled out for a considerable distance before the reactor reaches criticality and begins to produce power. To avoid accidental overshooting, rod withdrawal is at a very slow rate and a period of one-half hour may be consumed. This approach to criticality should be made only with the main coolant pumps operating. Likewise, the electric heaters in the pressurizer should be operating so that a steam bubble space is available in the system for water expansion. Having obtained criticality, the plant is ready for warm-up.

This operation requires careful coordination with the pressurizer for two reasons. First, the temperature of the steam bubble in the pressurizer must exceed the maximum fuel surface temperature to prevent boiling and burnout. Second, the required net positive pressure must be maintained at the pump suction to prevent cavitation. Maximum pressurizer heater power demand occurs at this time. The actual rate of system warm-up is limited to avoid excessive thermal stresses in the reactor vessel walls. One hundred to two hundred degrees per hour may be permitted. The allowable rate of rise is

influenced by the material selection and is inversely proportional to the wall thickness. The rise from room temperature to 500 degrees F will require, then, about 2½ to 4 hours.

During the warm-up period the density of the water will drop from 62.4 to 49.6 pounds per cubic foot at 500 degrees F. To accommodate this expansion, from 30 to 60 gallons per mw capacity must be drained from the system. The purity of this water is such as to make it economically desirable to store rather than waste it.

The time required for a cold plant start-up may be up to eight hours. This compares with five to six hours for a conventional plant. The time required for a hot-plant re-start is short, perhaps one to two hours, and compares favorably with that for a conventional unit.

Normal Operation of the Plant

As far as manual control is concerned, the operation of an atomic plant in the normal power range is an exceedingly routine task. The reactor is designed with a negative temperature coefficient, which makes the unit self-regulating to a large degree. The control system is automatic in most cases and is normally designed to assist the inherent self-regulating characteristic of the reactor. This means that the reactor follows the power demand of the turbine-generator unit essentially without adjustment by operators.

The reactor plant can be designed to follow the load swings demanded by system requirements. This means that the normal turbine limitations are the main restrictions on plant operation.

The plant is capable of sustained operation at any fraction of full load above the minimum, five to ten percent, set by turbine-generator restrictions.

The radioactivity present throughout the primary system during operation prevents approach for maintenance. This does not apply to many of the auxiliary systems. However, the design must minimize the need for attention for long periods if the plant is to meet the requirements of the electric-utility application. This is obtained by the use of such components as the canned motor-pump, where bearings are lubricated by the pumped fluid and shaft seals and packing boxes are eliminated by hermetically sealing the entire rotating portion of pump and motor inside the system.

Despite this inherent dependability, however, the plant should not be left unattended. Most of the auxiliary systems can and possibly should be manually controlled to take full advantage of the plant personnel. This will minimize the capital expenditure for automatic control and self-operating systems. Those auxiliary systems not required to operate continuously should be designed as close to conventional practice as possible for the same reason.

Normal Shut-down of the System

Production of heat can be stopped in three distinct ways. In certain cases the system power demand will be zero for short periods. In such instances the reactor should usually be kept at temperature and critical without producing appreciable power. The auxiliaries are kept in operation during such down time, and the power required taken either from the main turbine or the system. In other cases the power demand will be zero for extended periods of time, and the reactor should be made sub-critical by complete insertion of the control rods. The plant can then be cooled down and will require the minimum of attention during the shutdown period. The same

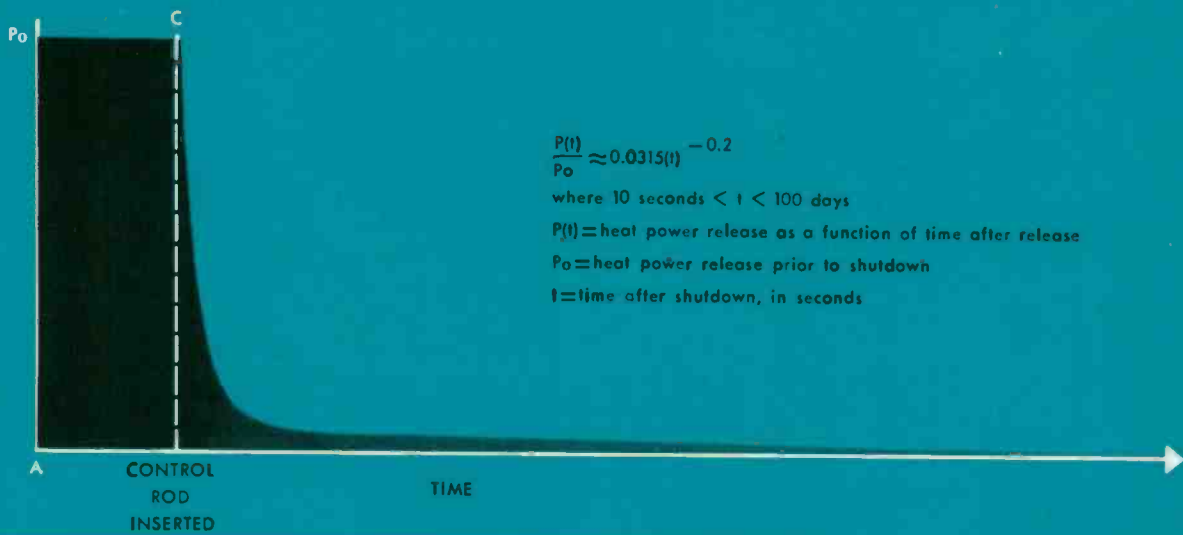

Fig. 2—Typical curve of heat after shutdown.

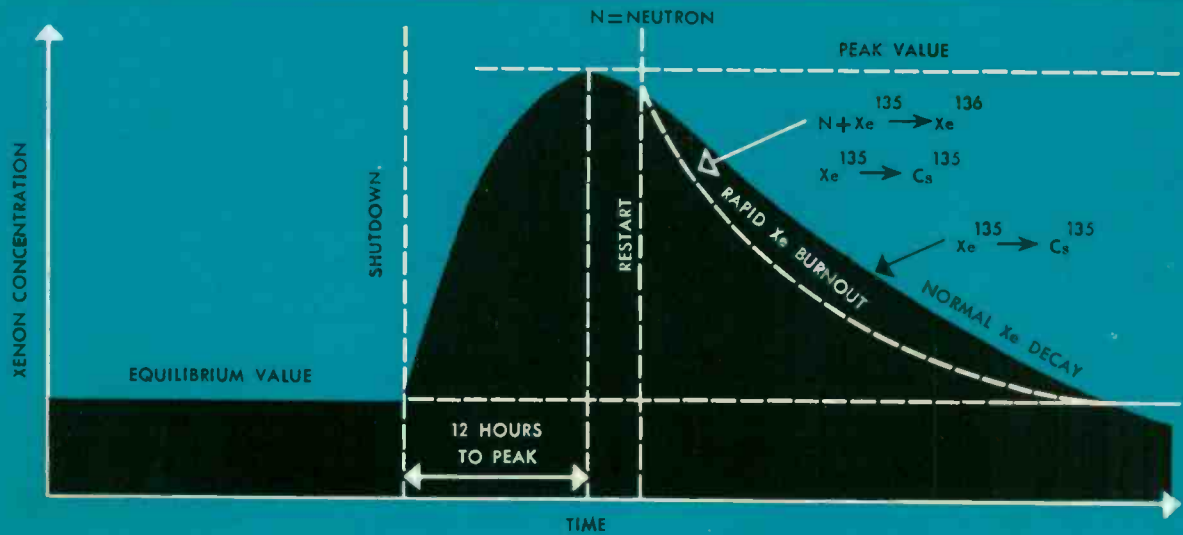

Fig. 3—Typical curve of transient xenon after shutdown.

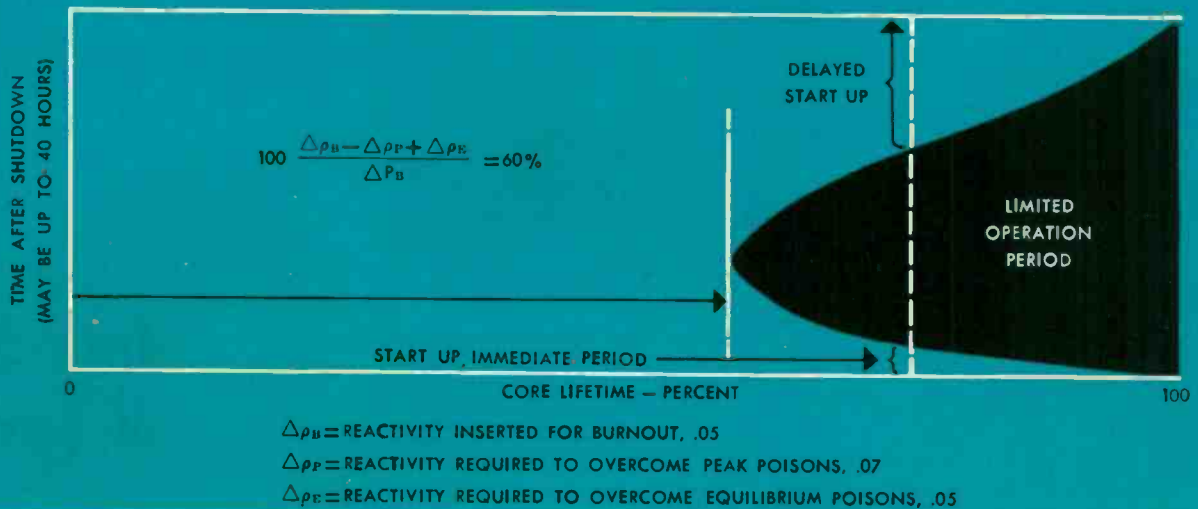

Fig. 4—Illustration of xenon limitation on reactor operation.

thermal stress considerations limit reactor cool-down as were discussed under start-up. The restart corresponds to that described previously. These two shut-down conditions are routine operations. The third is an emergency procedure and is covered in the next section.

Regardless of the manner in which the plant is shut down, two important problems must be solved. One is the removal of heat that the fission products continue to release even after the chain reaction has been arrested. This condition is indicated in Fig. 2. A reactor, operating at power P_0 , is shut down by inserting the control rods at time C. While the heat release after shutdown is not large, it would damage the reactor core if not removed. The plant design must be worked out to assure proper function after shutdown. The plant layout is made to insure circulation of water in the primary loop by thermal siphon action. Even in the extreme case of loss of auxiliary power to the main coolant pumps, the heat after shutdown is thereby removed.

When the loops are to be taken out of service for maintenance or refueling, the heat must be removed with a separate auxiliary shutdown cooling system (see Fig. 1). This system consists of a pump and heat exchanger, along with suitable valves and piping; it can be manually controlled and is not required during plant operation at power.

The second important problem after shutdown is the build-up of poisons. When the uranium atom fissions, the two parts form atoms of different chemical materials. As the result of this process many new materials are formed in the core. Some of these present large target areas for the absorption of neutrons. The worst offender is xenon (Xe^{135}). A relatively small amount of Xe is formed directly, but over five percent of the fissions produce tellurium (Te). By the process of radioactive decay this element decays to iodine (I) and then to Xe. Thus an appreciable amount of Xe is present in a reacting core.

The magnitude of the neutron-absorbing characteristic of Xe^{135} is indicated by its target area of 3 200 000 barns. By comparison, cadmium (Cd) is considered a good control rod material with a target area of 3300 barns.

This xenon disappears from the reactor in two ways. It decays naturally to cesium (Cs) or, absorbing a neutron, becomes Xe^{136} , an isotope with only 0.15 barns target area. When the chain reaction is in progress, both of these processes are operative to limit the build-up of xenon to a definite equilibrium value. Immediately following shutdown from power, xenon concentration rises sharply as the tellurium and iodine decay into xenon, and only the xenon decay to cesium operates to remove it. Gradually these decay actions are carried toward completion and the xenon concentration again falls off as shown by the solid curve in Fig. 3.

The equilibrium xenon concentration must be compensated by the addition of fuel beyond the critical mass. This is in addition to the fuel added for burnout, i.e., the uranium destroyed by fission. If the reactor operating schedule is such as to call for restart during the period that transient xenon exceeds equilibrium (which may be as large as 40 hours), an additional amount of fuel must be included. For the electric-utility application this requirement is not considered essential. The fuel added for burnout is adequate in most cases to provide transient xenon over-ride for the first 50 to 75 percent of core life. During the remaining portion of core life, the operation of the plant is limited. The power output and hence the neutron flux must be maintained at such a level as to control the xenon concentration. The plant can be operated at outputs throughout the permissible range of turbine operation, although the rate of change of power may be limited

near the end of core life. This should not work any hardship where the plant is part of a utility system. However, it becomes more important in the design of units for isolated service, for example, for ship propulsion where maneuverability demands wide power swings.

Another aspect of this problem has to do with the rapid burnout of transient xenon, which occurs when the plant is started near the peak xenon period. This is shown by the dotted line in Fig. 3. Relatively rapid control-rod insertion is required to compensate for the removal of this neutron absorbing material. In fact this is the criterion for control-rod speed in most cases.

To illustrate the xenon control problem, simplified calculations were made on an assumed thermal reactor designed to generate 150 million Btu's per hour of heat energy with an average neutron flux of 1.6×10^{13} neutrons per square centimeter per second. The limitation on operation is shown in Fig. 4. During the first 60 percent of core lifetime the poisons impose no limit on operation. During the final 40 percent of core lifetime, a period of ten hours or less, decreasing to zero at the end of life, is available for normal restart. This curve, that is the limited operation portion of core life, is influenced almost directly by neutron flux and hence by power level. During the "limited operation period" the plant can also be restarted at reduced temperature.

Emergency Shut-down

The reactor designer struggles to produce a trouble-free unit, and the operator inspects and checks for every conceivable weak link before starting the plant. In spite of this, power plants will get into trouble on occasion. The plant should be shut down as rapidly as possible under certain conditions to avoid overheating and damage to the core. The condition to be avoided is that situation where the heat being generated in the reactor core cannot be transferred to the coolant and thereby removed. This can occur, for instance, if the neutron flux rises above the safe level, causing the heat generation rate to rise. Another cause would be loss of system pressure, causing boiling of the cooling water and inability to transfer heat to the coolant. A third cause, loss of coolant flow, results in inability to remove heat from the core.

Protection against these emergencies is obtained by the application of an over-riding automatic shutdown system, called "scram" circuitry because it is usually designed to operate very rapidly. The "scram" signals must be selected carefully. Too few "scrams" fail to protect the reactor. Too many shutdown signals cause unnecessary expense, operating effort, and shutdowns. In general, three parameters—neutron flux, low pressure, and low flow—are adequate to protect the plant.

The period of interest in shutdown situations is the first few seconds following the occurrence of the difficulty. Some time must elapse before the reactor is shut down. The case of loss of power to the main coolant pumps is a good illustration. The inertia of the coolant systems must be examined in each design and in some cases additional inertia added to insure that the transient heat energy is safely removed¹.

The design of the reactor system should be predicated on fail-safe shutdown on loss of auxiliary power. However, the radiation detection equipment, as well as certain other auxiliary loads should be continuously supplied with power. These loads are normally connected to a "vital bus," which is supplied from a combination of sources including the auxiliary bus, a battery, and even a diesel generator.

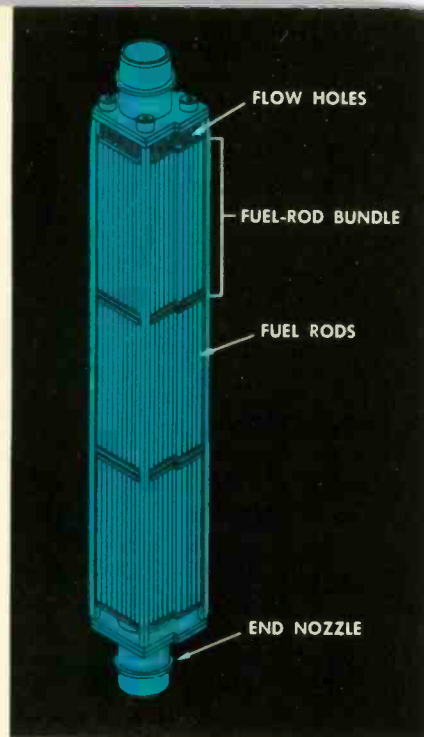

Fig. 5—Reactor fuel assembly.

Maintenance of the Plant

The maintenance of a nuclear-power plant differs from that associated with conventional plants for a single reason—radiation. When the plant is in operation the primary coolant loop cannot be approached for maintenance. Special design considerations are observed to obviate the necessity for frequent attention⁴. Corrosion products, which would become highly radioactive, are removed to minimize the activity in the loop. Valve and pump seals and packings are eliminated by the use of hermetically sealed units. Provisions are made to valve off malfunctioning components.

In plants above 20 000-kw rating, more than one heat transfer loop and steam generator would be utilized. In such units a major leak in the heat exchanger is isolable in this manner. Of course, the unit must be operated at part load pending maintenance.

All maintenance of a pressurized-water nuclear-power plant can be performed in complete safety by the strict observance of fairly simple ventilating, waste disposal, and health physics practices. Careful training and supervision of maintenance personnel is of great importance. For example, crew members should be trained to use radiation monitoring equipment and protective clothing, hats, gloves, coveralls, boots, etc. Control of tools and equipment prevents the spread of contamination throughout the plant.

Appreciable quantities of water are required for rinse prior to any maintenance of systems handling radioactive coolant. In those instances where radioactive particles have plated out on the surface of the malfunctioning part, an acid rinse followed by water rinse can materially reduce the difficulty, time, and manpower required for maintenance. Such a technique would be particularly applicable if fuel-element failure had been experienced.

Refueling the Reactor

The refueling of a pressurized water reactor usually involves taking the plant off the line, cooling down, and opening the reactor vessel. Present fuel elements are designed for continuous operation of approximately one year. Intensive testing and development work is being carried on to extend this period. Present estimates indicate that a well-trained

crew can reload a plant with a total down time of one week. Maintenance of the primary coolant system should also be performed during this period.

By proper design of the reactor compartment, so that the area above the reactor can be flooded with water, the refueling operation can be carried out without the use of heavy shielding coffins. The adequate visibility obtainable with water makes such an operation desirable. The cost and technical complexity of the manipulating equipment is minimized, as is the time required for the operation.

A large portion of the reloading period is taken up in the removal of shielding sections, auxiliary power and cooling connections, and the removal of the reactor-vessel head. Present practice is to weld the closure with either strength or seal welds. However, experience indicates that gasket closure should be adopted to reduce cost and handling time. The handling of the heavy reactor vessel head requires carefully designed jigs and fixtures to prevent damage of control mechanisms and core during removal and replacement.

After the spent fuel charge has been replaced and the plant is in operation, the crew can devote its attention to the preparation of the spent fuel for shipment to the reprocessing center. Underwater tools can be utilized to remove non-fuel bearing parts such as the end nozzles (see Fig. 5). After cooling, the fuel-bearing assemblies are loaded into lead coffins (approximately ten inches in wall thickness) for shipment. The water in the fuel storage pit will probably be contaminated and these coffins will therefore require scrubbing to remove radioactive material from their outer surface.

Waste-disposal facilities will be most heavily loaded at the refueling and maintenance period and storage for subsequent disposal should be considered in the design.

Manpower Requirements

Conclusions as to manpower requirements for an atomic plant are hard to reach. Early plans indicate about 129 positions for the Shippingport plant⁵. At least 26 of these will be engaged in the development portion of the project; estimates indicate that the final operating crew can probably be reduced to 81. This compares with a complement of about 66 men for a conventional plant of the same rating. This data points up the extra effort needed to get a new plant type in operation and the extra personnel needed to take and analyze the operational data obtained from the first plants.

During the early years of the nuclear-power program the operating crew will require special training and skills. All of these special requirements will become commonplace as the industry develops and should be regarded as developmental.

The time when nuclear-power plants will go into operation on utility systems is not far off. While the special operational problems are not difficult, all aspects of the situation should be carefully reviewed and planning completed for each new station. ■

REFERENCES:

1. "New Problems in Auxiliary System Design—Supercritical Pressure and Nuclear Plants," A. R. Jones and C. S. Baldwin, AIEE paper under consideration for the Winter General Meeting, January 1957.
- 2,3. "Getting PWR on the Line," L. R. Love, G. N. Oldham, *Nucleonics*, July 1956, pp 27-29. Original papers presented at the Tenth Annual Mechanical Engineering Conference on Nuclear Power Plants, Pittsburgh, Pa., May 1, 1956.
4. "Planned Operation Keeps Nuclear Plants on Line," R. E. Crews and M. L. Yadon, *Power*, Aug., Sept., and Oct. 1956.
5. "The Industrial Atom," The Pressurized Water Forum, held Dec. 2 1955, Mellon Institute, Pittsburgh; available from the Office of Technical Services, Dept. of Commerce, Washington 25, D.C.

a multi-megawatt magnetron development

E. C. OKRESS, C. H. GLEASON, AND W. R. HAYTER, JR.

Electronic Tube Division
Westinghouse Electric Corporation
Elmira, New York

■ A new 10-million watt magnetron with an average power output of 17 kilowatts is the heart of the most powerful shipborne radar set ever put in service. Installed on a Navy cruiser, the radar equipment has detected targets at distances exceeding 400 miles.

Since radar range is proportional to the fourth root of the average radiated power, substantial power increase was required to produce a significant (2 to 1) increase in range. The required power of 10 megawatts represented an increase of over ten times the prevailing 1945 power levels. Since the transmitted radar signal consists of pulses of r-f energy of several microseconds duration, followed by a relatively longer empty period, average power can be increased with very large increases in pulse power. Engineers had to undertake considerable pioneering work to come up with a magnetron capable of generating, at relatively long pulses, the extremely high power required—over 10-million watts for a 10 millionth of a second—in a volume the size of a coffee can! At pulse durations shorter than 10 microseconds, even higher power is obtainable.

The new magnetron, shown symbolically in the box (below), is operated as a self-excited oscillator and is known as the WL-6285. It is a sealed-off, fixed-frequency magnetron with an a-c heated cermet cathode.

The performance charts, such as shown in Fig. 2, represent attainable operation of a particular WL-6285 magnetron with matched load at 1310 megacycles per second, about 10 microseconds pulse duration and about 0.0018 duty. Lines of constant magnetic field and contours of constant peak power output are plotted in the vicinity of the indicated input impedance lines, governed by the characteristics of a particular user's pulse transformer.

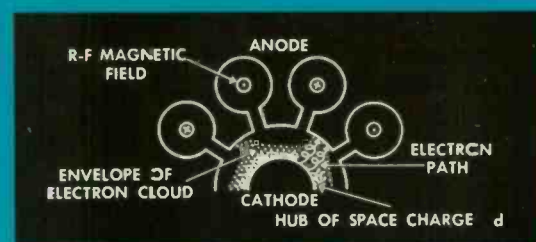
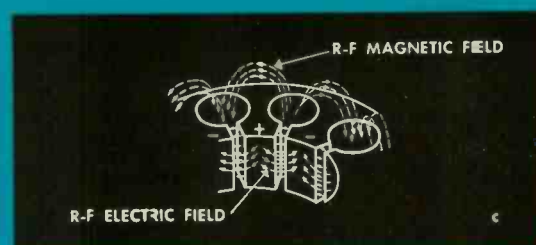
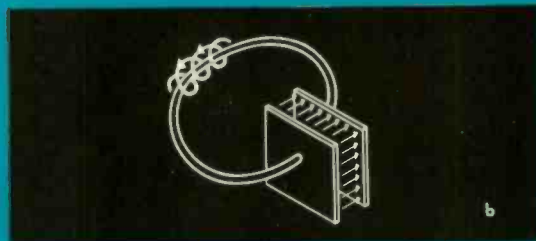
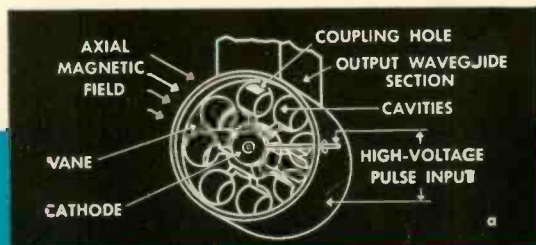

MAGNETRON OPERATION

The resonant-cavity magnetron is a completely self-contained transmitter. A single vacuum envelope houses the resonant tank circuits, the cathode and anode of the generator, and the coupling circuit to deliver high-frequency power. The internal construction is shown pictorially (a). Only a summary explanation of the principles of magnetron operation will be given here.

In operation, the cathode is heated indirectly, and bursts of high voltage applied between the cathode and anode pull electrons from the cathode. Acted upon by crossed electric and magnetic fields, the electrons form moving spoke-like space-charge clouds, which deliver energy to the anode resonant cavities in pulses as they pass the anode gaps.

Essential to the operation of the tube is the constant axial magnetic field supplied by an external magnet, uniform over the entire anode-cathode region. Each resonant anode cavity behaves much like a simple capacitance-inductance resonant circuit (b), setting up an r-f magnetic field between cavities, and an electric field between adjacent vanes (c). When the input voltage pulse is applied between the cathode and anode, electrons are attracted from the cathode toward the anode. However as they gain speed, the axial magnetic field perpendicular to the electrons' direction of motion deflects them at right angles causing them to travel in cycloidal paths from the cathode to anode. Groups of these cycloidal paths form spoke-like electron clouds, which rotate around the cathode. As the ends of these "spokes" brush past the anode segments, they transfer charge from the cathode to the anode, of signs indicated by (c). The resulting displacement current, produced by the rotating space charge, creates the r-f energy in the anode circuits. A slot in the rear of one of the cavities feeds into a quarter-wave section of constricted waveguide, which serves as a transformer to a standard size waveguide.

Design Considerations

Anode and Transducer—The original design of the WL-6285 magnetron evolved from considerations relating to: (1) establishment of stability conditions for the principle mode of oscillation; (2) development of a wide-bandwidth output window that would permit flow of r-f power from the tube at full power in air at atmospheric pressure; (3) development of a cathode capable of withstanding high backbombardment power with reasonable life; (4) development of methods for fabricating such a large magnetron; (5) elimination of voltage breakdown in various parts of the magnetron; (6) generation and measurement of one to ten microsecond pulses at about 100 kilovolts and 400 amperes; (7) development of a calorimetric load of low thermal capacity for testing the magnetron at full power.

The inherently rapid rise time of the applied pulse from a line-type modulator together with its impedance characteristics, and the fact that the build-up time of oscillation in the magnetron is directly proportional to the generated frequency, required challenging compromises in efficiency and stability characteristics in magnetron design.

All components of the anode assembly are fabricated from oxygen-free, high-conductivity (OFHC) copper except for the stainless steel rings on the anode and transducer. These rings serve to support the end covers and window. The anode assembly is water cooled.

The window assembly comprises a Kovar-glass seal with 705 glass flare to which the 707 glass dome is sealed. A soft OFHC copper lip is brazed to one end of the Kovar cylinder so that when the tube is coupled to the waveguide, negligible

stress is transmitted to the window. The glass dome window of the transducer is forced-air cooled. The transducer termination is a direct coupling type adapted for a 6½ inch inside-diameter circular waveguide. The design is such that no pressurizing or auxiliary gas insulation up to the maximum peak power-duty capacity of the magnetron is needed.

The Cathode—The cathode design had to solve three basic problems: (1) selection of a suitable emissive surface, (2) support for the emissive surface, and (3) means for heating the emissive surface to its operating temperature. As the result of experience gained with several approaches, a successful non-inductive indirectly heated cathode was developed without resort to any supporting insulator for the heater.

The cathode lead-glass bushing, across which the cathode-anode pulse voltage appears, was designed to run in air rather than be immersed in oil or a pressurized gas. While use of still air insulation entails a somewhat longer cathode arm, handling and operation of the tube is made simpler and safer.

Getter—For a sealed-off tube of this volume and mass, a vacuum getter was desirable for emergency use. Therefore, an independently heated zirconium getter was incorporated in the pumping arm of the tube. This getter can be used intermittently or continuously, as the situation requires. For example, cooling water failure can occur. The operation of this getter for a short period of time has been relatively successful in restoring the required degree of vacuum.

Fabrication Considerations

A tube of this size and complexity quite naturally presented difficult assembly problems. It was logical to assemble

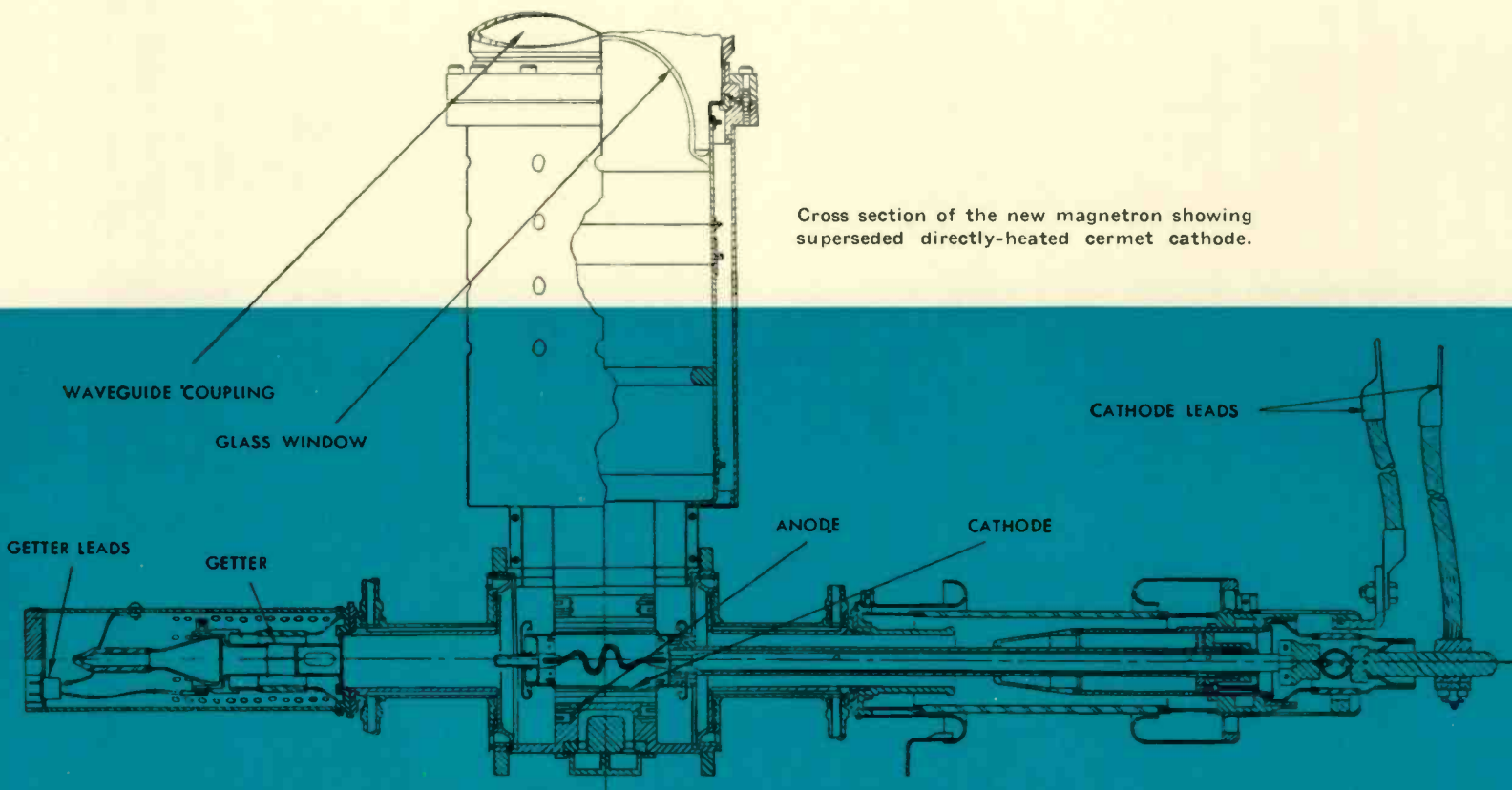

Cross section of the new magnetron showing superseded directly-heated cermet cathode.

the tube from sub-assemblies; the anode, cathode, and output window. Thus many electrical, mechanical, and vacuum-joint tests could be performed prior to the final assembly of the tube.

Welding—A very reliable and, if possible, convenient method of joining the sub-assemblies was necessary. Arc welding offered advantages in simplicity, localized heating of the work, and the prospect of good vacuum-tight performance of the welded joints. A survey of arc-welding methods pointed to the inert-gas-shielded technique, in which the arc is established between the material to be welded and tungsten welding electrode in an inert atmosphere such as argon or helium. Such an arc can be precisely controlled and no filler material is required if the joints are properly designed. A particularly attractive feature of this method is that heating is localized, so that assemblies containing glass can be joined without concern for the glass-softening point. Also, precision fixturing can be employed with the advantage that the fixtures are not subjected to high temperature.

A number of considerations entered into choosing the metal to be welded. Among these were mechanical, magnetic and thermal properties, and availability. From these considerations, type 347 and 304 stainless steels were chosen. However, as most of the magnetron was of materials other than stainless steel, each sub-assembly was fitted with a brazed-on stainless steel welding termination.

Brazing of stainless steel to the other metals posed a problem. Even in hydrogen atmospheres normally available, the chromium content of the stainless steel tends to form chromium oxides that prevent the desired wetting by the brazing material and often results in a faulty brazed joint. The solu-

tion was a sintered nickel plating, applied to the stainless steel before brazing. Briefly, the technique consists of plating about one-thousandth of an inch of nickel on the stainless steel, and sintering this coating in about -50 degrees C dew-point hydrogen at about 1000 degrees C for one-half hour. The dense coating of nickel that is formed suppresses the formation of chromium-oxide layers during subsequent brazing operations.

Exhaust—Thorough outgassing and the establishment of a suitably high degree of vacuum are extremely important for the sealed-off magnetron. Because of the extensive amount of silver and copper external surface involved, some sort of oxidation protection during the extensive bake-out period was required. A protective atmosphere exhaust oven was designed and built, in which forming gas (10 percent hydrogen and 90 percent nitrogen) provided the protective atmosphere. In this oven the tube is baked while continuously pumped for 24 hours at 450 degrees C. The temperature limitation is imposed by the glass assemblies involved.

The magnetron is next subjected to high-voltage seasoning from 60-cps, 80-kv half-wave rectified supply. The tube is then sealed off from the vacuum pumps and transferred to the operation-test position, which contains a complete pumping system of its own. The magnetron is sealed onto this vacuum system for initial operation seasoning. This transfer from exhaust to test positions is accomplished without disturbing the vacuum within the magnetron by means of a special pumping assembly containing a "break through" glass bubble. The magnetron is continuously pumped during operation seasoning and test. The tube is then sealed off permanently and retested prior to shipment. ■

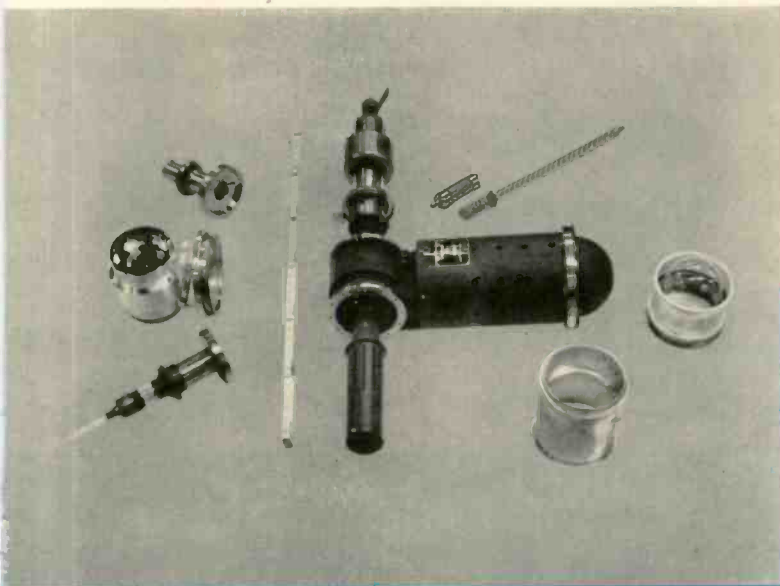

Fig. 1—Typical sealed-off WL-6285 magnetron. The component parts that make up the tube are also shown.

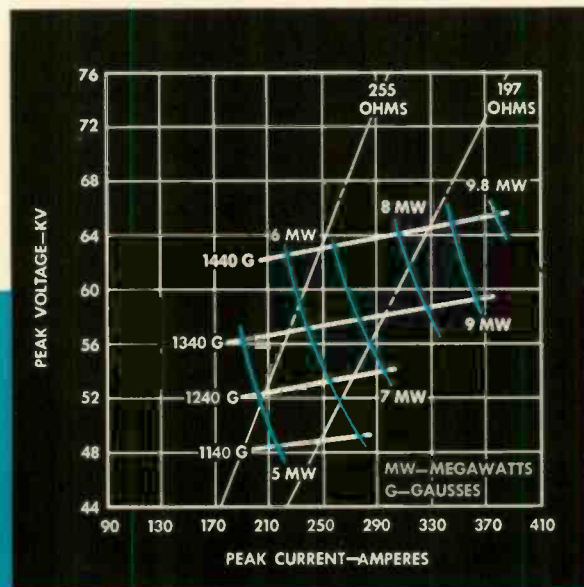

Fig. 2—Performance chart of a particular WL-6285 magnetron, at 9.5 microsecond pulse duration and 0.0017 duty.

teleological control

... it learns by doing

ALBERT KERSTUKOS

New Products Engineering
Westinghouse Electric Corporation
Cheswick, Pennsylvania

■ Every plant manager has recognized for a long time that two functions are performed by his employees: manual and mental. The manual effort of drilling a hole is distinct from the mental effort of deciding which drill to use. The equipment and machinery developed by industry to decrease manual effort has been phenomenal. Little work, however, was done until the last 20 years to replace mental effort. There is a good reason why this is so. The manual operations of a process must be replaced by some mechanical device before a substitute for the mental function of the worker can be made. Most of the early work on the mental function has been to supplement the mental effort rather than to replace it. By attaching instruments to processes, the operator receives more information and is able to make better decisions quicker. This of course led to the development of automatic controls.

Controls are generally thought of as either open loop or closed loop. If a control is not completely automatic and an operator is required to make some adjustment to a process, then the process has an *open-loop control* (Fig. 1). If, on the other hand, the control is completely automatic, i.e., does not require an operator to perform any function except observation, this is a *closed-loop control* (Fig. 2).

There is a vast field of application for which closed-loop controls cannot be built because certain elements within the process are not understood. Even though computers are used for more complicated closed-loop systems, they cannot do original thinking. The computer can replace the mental function of the operator only if the process variables can be expressed mathematically and can be predicted and preset into the mechanism, or if the computer can apply logical interpretation of information fed to it. However, automatic controls can be developed for those processes not heretofore handled by conventional feedback-control techniques because of lack of knowledge about all of the variables.

The output of a process depends upon its input, and to be controllable the output must (1) remain constant, (2) change in a predictable way, or (3) provide information about the output with the passage of time. This latter case becomes useful when the desired value of the output is vague or unknown, as for example, the optimum yield where the value of the optimum is not known. A machine to control such a process must be able to cope with changing situations, must have the ability to change the input variables to achieve a goal, and maintain stable operation of the process indefinitely.

This type of machine has been given a name: *teleological control*. The definition of teleology is the fact or character of being directed towards an end or shaped by a purpose. This simply means "goal seeking."

Fig. 1—Simple diagram of open-loop type control where the operator himself is part of the control circuit.

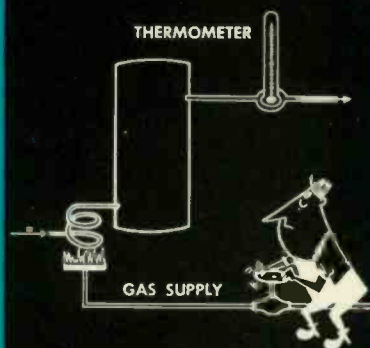
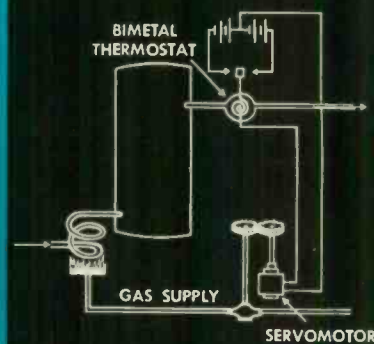

Fig. 2—The control circuit shown in Fig. 1 has been converted to a closed-loop type of control by making a temperature-sensitive bimetal strip control a servomotor, which in turn raises or lowers the gas flame.



Teleological control is a new concept in the field of automatic controls. Unlike conventional controls that force the controlled process to conform to their instructions, a teleological control is allowed to experiment with the process until it finds the goal as determined by a set of built-in rules.

This concept stems from the fact that many present industrial processes can be operated only through the use of human operators. The efficiency of such operation is certainly subject to question. Improvements undoubtedly can be made by the use of proper controls; these controls must be capable of decision making based upon observation and memory, much as the human operator. The control must create a change in the process so that its effect can be observed in the output. This change to the process and subsequent changes must be designed to direct the process towards a predetermined goal. If this procedure is carried out in an intelligent fashion, then the goal can be reached efficiently. After reaching the goal, the intelligence of the control should recognize this fact and maintain operation of the process at this value.

However, the operating point must be changed when a disturbance to the process causes a drift from this optimum point. This means either a new value or location of the goal, which is then sought out.

The new Automex control is a teleological device. Actually it is an automatic experimenter that operates by intelligent trial and error. Hence, its name, from the words "*Automatic Experimenter*." The purpose of this device is to control a system where optimum output can be achieved by properly adjusting each of several input variables, and where the best adjustment for any one input changes with time.

For example, consider a cruising airplane. The combination of engine rpm, fuel mixture, speed, and airplane trim that will give the maximum number of miles that can be flown with one gallon of gasoline is required information. While the aerodynamic properties of an airplane are fairly well known because of wind-tunnel tests, the dynamic behavior in actual flight changes in unpredictable ways due to atmospheric changes. At present, a skilled human operator must exercise control of the airplane. He watches the instrument reading of the inputs and outputs of the machine, and then uses his knowledge and experience to decide in what direction the controls should be adjusted. The adjusted inputs bring new output readings, which have to be interpreted by the operator to determine whether the optimum condition has been reached. Thus, the operator is a human experimenter.

Consider another example. In many factories, an electronic bridge must be balanced to either test or calibrate a product. While there are many types of bridges, all have the same basic

principle of operation. The legs of the bridge (which are impedance elements) must, for a balanced condition, divide the current supplied to cause a minimum amount of this current to flow through a meter or a detector connected across the bridge. An operator balances the bridge by varying the impedance of the individual legs. One leg of the bridge is varied to reduce the current in the detector to as low a value as possible. Then the adjacent leg is adjusted to reduce the current further to a lower value. By operating alternately on the legs of the bridge, a condition is reached where no further reduction can be made in the value of current to the detector. At this point, the bridge is "nulled" and the position of the adjusting knobs of the operator's instrument can be interpreted to give a test or calibration value. Based upon this value, the product is accepted, rejected, or calibrated. The operator needs no knowledge of circuitry, merely the ability to adjust two or more knobs to obtain a minimum value of meter indication. A teleological control to outperform this operator can be built. A teleological control can be built for any process, regardless of the number of input variables involved, if there is an operator at present controlling this process. A minimum of knowledge of the process is required to effect control.

Learning all about a process before an attempt is made to control it can be an expensive proposition. Also, extreme accuracy of the controlled behavior cannot be expected even if the properties of the controlled system have been determined. Any manufacturing process always introduces small differences into supposedly identical objects. Also, any engineering system is subject to small variations with respect to time. This may be caused by the normal deterioration of the system caused by wear and fatigue, or by the drift of conditions in the environment in which the system operates. In short, the properties of an engineering system can never be known exactly prior to the instant of actual operation. Furthermore, control systems are still designed from the standpoint of static or steady-state processing; that is, their primary function is to maintain operating conditions constant despite the effect of load changes or other disturbances. Since these environmental conditions can and do affect process equilibrium quite often, these systems require human guidance (an operator).

A teleological control approach can cope with the problem of environmental disturbances. It can maximize or minimize the output without knowledge of all the variables involved. Thus, production processes can be designed without consideration of human physiology because human guidance can be eliminated. ■

Automex control device (right) built to demonstrate the principle of teleological control and compare its speed and accuracy with that of a human operator.

Surface of the contour board (far right) of the Automex control device represents a two-dimension range of inputs.



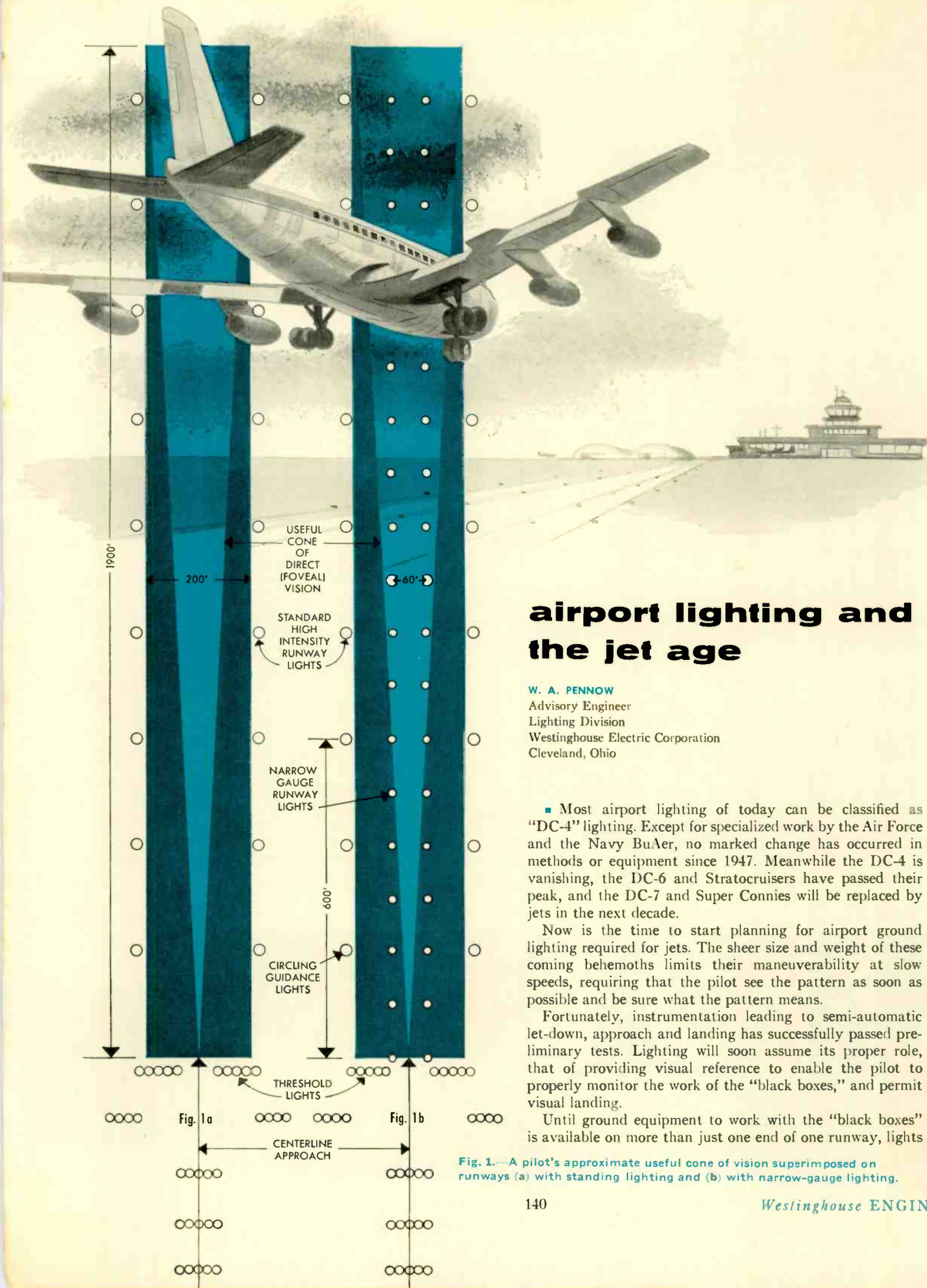

airport lighting and the jet age

W. A. PENNOW
 Advisory Engineer
 Lighting Division
 Westinghouse Electric Corporation
 Cleveland, Ohio

Most airport lighting of today can be classified as "DC-4" lighting. Except for specialized work by the Air Force and the Navy BuAer, no marked change has occurred in methods or equipment since 1947. Meanwhile the DC-4 is vanishing, the DC-6 and Stratocruisers have passed their peak, and the DC-7 and Super Connies will be replaced by jets in the next decade.

Now is the time to start planning for airport ground lighting required for jets. The sheer size and weight of these coming behemoths limits their maneuverability at slow speeds, requiring that the pilot see the pattern as soon as possible and be sure what the pattern means.

Fortunately, instrumentation leading to semi-automatic let-down, approach and landing has successfully passed preliminary tests. Lighting will soon assume its proper role, that of providing visual reference to enable the pilot to properly monitor the work of the "black boxes," and permit visual landing.

Until ground equipment to work with the "black boxes" is available on more than just one end of one runway, lights

Fig. 1.—A pilot's approximate useful cone of vision superimposed on runways (a) with standing lighting and (b) with narrow-gauge lighting.

will have to do the whole job during clear, or VFR weather, when wind direction precludes use of the instrument runway. These lights need not have ultra-high candlepower, but will need good circling guidance so the pilot can see and understand the pattern before he commits the landing maneuver.

During the last three decades airport lighting has gone through four distinct cycles, from flush lights along runways, to tipover cones, to semiflush lights, to elevated lights.

With the advent of instrument let-down and approach systems, the need for better lighting to help the pilot the rest of the way to a landing became apparent. The high-intensity runway light was developed to assist the pilot in this transition from instrument to visual flight during final approach and landing.

Airport lighting has always been a controversial subject. Discussions among airport operators, pilots, and lighting engineers often brought forth complete disagreements.

High-intensity runway lighting is an excellent example of such disagreement. Three distinct types of such lights are in general use, each covered by a CAA specification, each designed to do the same job in a different way.

Perhaps the best known is the Bartow, or controllable beam light, a high-candlepower, 500-watt unit, where the beam brightness, toe-in, and elevation are changed to meet specific weather conditions. The control part of these lights has varied from motor-driven devices in each light, requiring several control cables, to a simple automatic device that works directly from the brightness control.

The most universally used high-intensity light is a wide-beam, fixed-focus type, which is simple, low in first cost, and easy to maintain. This is a 200-watt, relatively low candlepower unit providing good all-around lighting.

The third type uses sealed-beam lamps to provide the high-intensity fixed-focus beams, and has a separate source and optic for clear weather, medium intensity use. This is the only unidirectional high-intensity light wherein only the beam pointing toward the incoming pilot is lighted, thus avoiding any tendency of the light to "halo" due to lighting a fog wall, raindrops, or snow flakes behind the unit. This type is the most expensive to install but is the least expensive to operate, because the high-intensity lamps are only 100 watt, and the medium-intensity lamp is 30 to 45 watts. The high-intensity lamps have a rated life at full brightness of 7 to 10 times those of the other types, while the medium intensity unit uses standard 1000-hour lamps.

Considerations

So far, runway lighting has consisted of two lines of lights, each line located at, adjacent to, or near one edge of the runway (Fig. 1a). Spacing of the lights in each line is usually 200 feet apart, but the separations range from 165 feet to 330 feet. Lighting engineers, and others, in studying the effectiveness of runway lighting, have urged that high-intensity runway lights be spaced closer together, at least along the approach end of the runway to a point 500 feet or more beyond the touchdown point.

A reduction in spacing from 200 to 100 feet gives the pilot of an incoming airplane a more effective line of lights. With one-eighth mile visibility the pilot may see 10 to 11 lights in each line instead of 4 to 5 lights per line (see Fig. 2). The gain in effectiveness is greater than 2, because the eye sees at least one additional space by being more accurately led along the line, so the actual length of line perceived is 1000 to 1100 feet instead of 800 to 1000 feet.

Lighting engineers and pilots have been restudying the runway lighting problem, this time on the basis of what the pilot sees and how he sees it. One of the most interesting results of these studies is the realization that, when rows of lights are spaced 200 feet or more apart, the lights close to the airplane are more difficult to see than those farther down the runway. Pilots have talked about the "black hole" beyond the threshold lights for years without much understanding of just what they meant.

The advent of centerline approach lighting has helped to clear up the meaning of the term "black hole." Pilots now fly down the approach path with a line of lights directly in front of them, just as if the airplane were sliding down a "bannister of light." Everything is clear and in full range of direct vision. The pilot sees all lights from the far visible limit to the point of disappearance below the airplane. As the airplane continues its slide, the runway threshold lights across the end of the runway appear, and beyond it—nothing.

As weather worsens, this condition becomes even more pronounced. The pilot, with eyes attuned to a stare condition by the centerline approach lights, finds it difficult to perceive the start of lines of runway lights spaced outside the limits of his direct vision. He has to pick up the lines of the lights far down the runway, where parallax brings the lights into the field of his direct vision, then follow them back along the runway toward him, using parafoveal, or side vision.

Fig. 2a—With lights spaced at 200-foot intervals along runway, pilot sees 4 to 5 lights in each line with 1/8-mile visibility. But with lights spaced at 100-foot intervals (2b), he not only sees 10 to 11 lights per line, but also sees at least one additional light per line because his eye is led more accurately along the line.

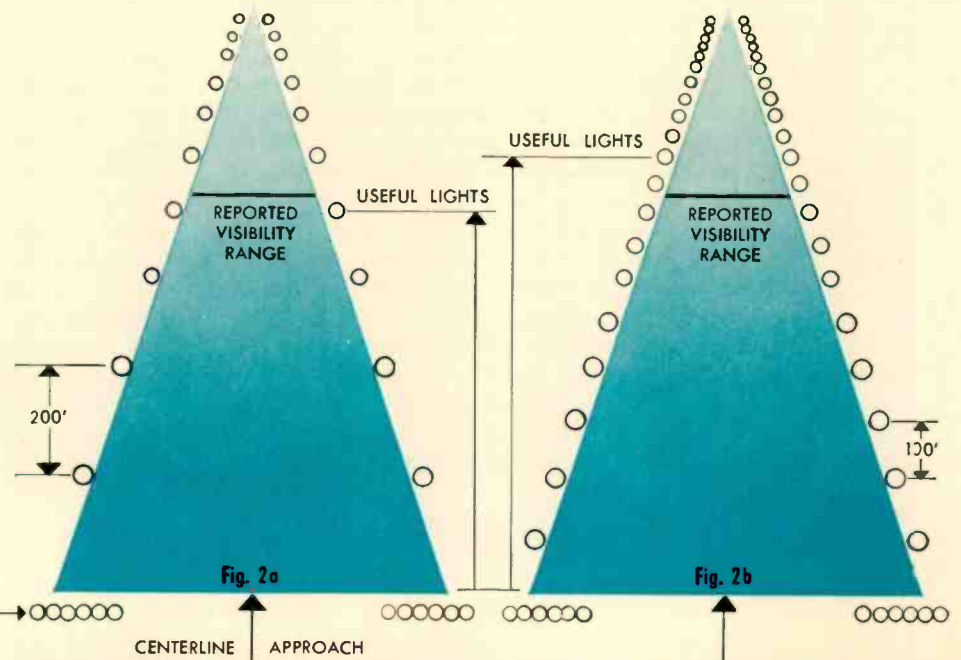
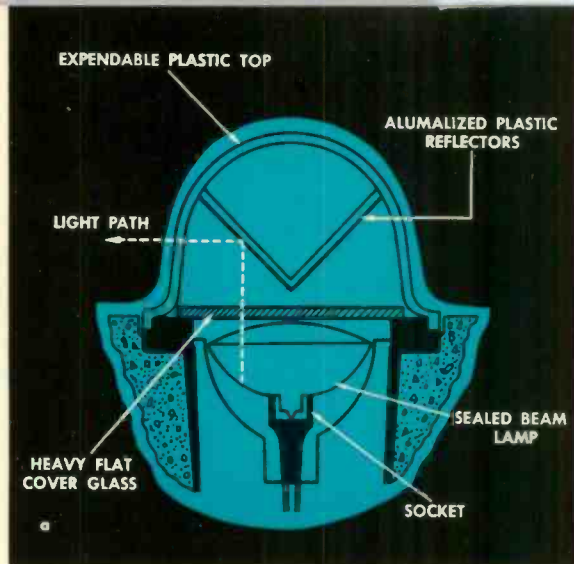

Fig. 3—Diagrams of three different lights that might be used for narrow-gauge service. From left to right: (a) a two-part housing, with the part containing the lamp being flush with the runway and the light distribution element an expendable plastic shell; (b) a concrete pit covered by a steel grating such that light distribution is controlled; and (c) a light that protrudes a fraction of an inch above the runway, but will withstand all normal hazards.



Without going into the mechanics of the pilot's seeing machinery, the included angle of direct vision can be assumed as about three degrees. Then with runway lights spaced 200 feet between the lines, only those visible lights over 3000 feet ahead of him are in range of his direct vision. With 150 feet width spacing visible lights over 2500 feet ahead of him are in range. As the transition from foveal (direct) vision to parafoveal (side) vision is gradual to a degree, only those lights appearing within an included angle of six degrees are of real use in the landing procedure. Then, with 200 feet lateral spacing, all visible lights over 1900 feet ahead of him are seeable (Fig. 1a), and with 150 feet spacing this distance is about 1500 feet. This difficulty of seeing two rows of lights accounts for the usually unconscious maneuver by many pilots to bring the airplane down off the centerline, attempting to get lined up nearer the left row of runway lights so he can see more of them.

At present, a new trend, *narrow gauge lighting*, is receiving enthusiastic pilot support, and making sense to the lighting engineers. Narrow-gauge lighting (Fig 1b) is just what the name implies, two rows of runway lights straddling the runway centerline, with the rows comparatively close together. Present thinking is that these rows should be as close together as 60 feet with none exceeding 100 feet between rows.

Several considerations must be evaluated before a specific row spacing receives general acceptance. As the lights have but one function—maximum assistance to the pilot—the spacing chosen should provide no more than a three-degree angle at the point of disappearance below an approaching airplane having the best downward visibility forward. Unfortunately, airplane structures get into the act; such things as landing-wheel tread width, ability of landing gear to ride over minor bumps, and natural frequency of the entire airframe while partially airborne are problems to be reckoned with.

Natural frequency problems can be serious. If light spacing and airplane speeds are right, even a one-inch high light may cause the airplane to "porpoise," or develop a rocking motion that can collapse a nose gear. Part of the answer is that the airplane's speed is changing as it touches down and rolls when landing, and is changing rapidly during the roll on takeoff. In the critical touch-down areas, a progressive change in spacing, with the spacing lengthening as the speed decreases, may completely avoid the problem.

The light pattern, or distribution, needed from lights in a narrow-gauge installation has been widely discussed. The first thought was that the distribution should be the same as for lights now used at the edges of runways. A study of where an airplane may be in the approach zone when the lights are

needed to complete a successful landing shows that a somewhat narrower beam spread is adequate, allowing better use of the lumens emitted by the lamp.

The peak beam candlepower necessary is also being considered. Again, as these lights are largely in the cone of a pilot's direct vision, a much lower candlepower is as visible as the higher candlepower from lights outside the cone of direct vision. The ratio may run four to one, or greater, depending on the spacing between rows.

Other points also need watching. The advent of narrow-gauge lighting does not mean that *runway* widths can be lessened. The present 150 feet minimum, 200 feet preferred, will remain. The pilot still will need the width to cope with cross winds, flat tires, and near misses of the runway on landing.

Experience may show that the present high-intensity runway lights will need some modification, to reduce the chances of a pilot mistaking the area between a row of high-intensity lights at the edge of the runway and the nearest row of flush lights as the center area of the runway. If the lateral distribution of the flush lights is properly controlled, such chances may be very remote. A pilot centered on one of the side strips should see the high intensity lights as being very bright, while the nearest row of flush lights should be very dim.

One proposal is that lights along the edges of the runway be changed to give circling guidance only, being non-visible to the pilot lined up with the runway. However, some light should be present to show the pilot the area available for his landing or take-off maneuver, particularly when he has to contend with some cross-wind component, or slight malfunctioning of his airplane, such as landing with an engine out, or a flat tire.

Several types of lights are proposed for narrow-gauge service, and experimental installations are being made to get some answers. However, these installations are not likely to give positive answers. Only when all types of lights, not mock-ups, under consideration are installed on the same runway, for observation by the same pilots under the same conditions on successive landings, will valid data be obtained.

One type of light with good performance consists of two parts: the part containing the lamp is completely flush with the runway surface, while the element that produces the useful light distribution is a thin plastic shell, about five inches high (Fig 3a). This plastic shell snaps onto the flush section, and is considered expendable; it is sufficiently fragile that it cannot damage any part of the airplane that it contacts.

A second type consists of a large precast concrete pit covered by a steel grating (Fig 3b). Sealed-beam lamps are mounted at one end of the pit, directly under the grating, and

recipe for construction . . . portland cement

▪ The ingredients: lime, silica, iron oxide, and alumina; carefully proportion, blend, and bake to a clinker; then grind and add a dash of gypsum. Not a recipe suitable for the kitchen use, but nonetheless a carefully controlled recipe—for portland cement, today's most universal building material.

History of Portland Cement

The original formula for portland cement was developed in the kitchen of Joseph Aspdin, a bricklayer and mason in Leeds, England. By burning a mixture of powdered limestone and clay in his kitchen stove, he produced a hydraulic cement (hardens under water) far superior to existing cements. In 1824, he was granted a patent on his cement, which he called "portland" because it resembled in color an excellent building stone quarried on the Isle of Portland off the English coast. The recipe has since been improved considerably, but the idea of carefully proportioning the ingredients to obtain a predetermined chemical combination of lime, silica, iron oxide and alumina was a real contribution to the art.

Man had been searching for this formula almost since he first started piling stones. The ancient Egyptians are credited with the discovery of lime and gypsum mortar as a binding agent. The Greeks made further improvements, but the Romans probably developed the first real cement with hydraulic characteristics. They discovered a mixture of volcanic ashes and lime that hardened under water and hence could be used in the construction of aqueducts, cisterns, and other projects that required this quality. The Romans built foundations for their buildings with a form of concrete (from the Roman word *concretus*, meaning "growing together") placed to a

depth of as much as 12 feet. Their best mortar was made from lime mixed with a volcanic material called pozzolana, named from a place called Pozzuoli, near Mount Vesuvius. Unknown to the Romans, the volcano had provided pozzolana with its cementing properties, much as the modern kiln does today.

Through the dark ages, no new contributions were made to the art, but by the eighteenth century, Europeans again began the search for better building materials. One of these was John Smeaton, an Englishman, who had the job of rebuilding the Eddystone Lighthouse on the rocky coast of Southeast England. Failure of mortar to withstand the effects of sea water led Smeaton to experiment with mortars in both fresh and salt waters. A widely held belief at that time was that the purer the limestone, the better the mortar; he discovered that lime made from a limestone containing a considerable proportion of clay had much better hydraulic qualities. To make his cement he heated the impure limestone in a kiln at a low temperature and then ground the burned limestone into a fine powder. He was on the right track. Forty years later in 1796, another Englishman, Joseph Parker, took out a patent for "Roman cement," which was made by burning argillaceous, kidney-shaped nodules that were washed up on the shores of the Isle of Sheppy. Neither Smeaton nor Parker, however, carried their burning to the point of near fusion, an essential step in the manufacture of portland cement as we know it today. In fact, there is doubt that Aspdin originally carried his burning far enough to have a true portland cement, but rather that the process evolved in the years following his original patent. Portland cement got its first real trial in 1859 in the construction of the London drainage canal. By this time, certainly, the value of producing a clinker by burning

the raw materials almost to the fusing point had been discovered.

In the United States, the first large use of cement was for canal building. The American cement industry began in 1818 when a natural cement-rock was discovered near the route of the Erie Canal, then being constructed. (This, of course, was a natural cement.) The first portland cement was shipped to the United States about 1868 from Europe. European manufacturers used the cement as ballast in ships, thereby obtaining low freight rates. Shortly after this, Americans began experimenting with the manufacture of portland cement, and the David O. Saylor Company of Coplay, Pennsylvania, probably manufactured the first portland cement made in the United States about 1875.

The next big development in cement production was made by F. Ransome, in 1885, an English engineer who patented a slightly tilted horizontal kiln that could be rotated. The rotating kiln made possible continuous furnace operation, eliminating the previous batch-type vertical kiln. Thomas Edison pioneered further development of the rotary kiln and in 1902 introduced a kiln that was 150 feet long, the first long kiln used in the industry. The long rotary kiln is the vital process of modern portland cement production.

Manufacture of Portland Cement

The exacting nature of portland cement manufacture today requires some 80 separate operations, although most of them can be grouped into three fundamental steps—grinding and blending, burning, and a final grinding and blending.

The modern cement plant is a far cry from Aspdin's original



LIMESTONE AND SHALE FROM QUARRY



CRUSHING

RAW MATERIAL STORAGE
LIMESTONE, SHALE,
IRON ORE, SILICA SAND, ETC.

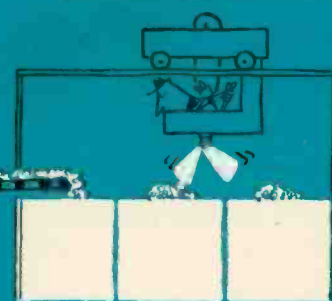

WATER ADDED—
IN "WET PROCESS"



RAW GRINDING



Ingredients for portland cement—both before and during processing—are stored in these huge bins.



These huge rotary kilns are the heart of the cement processing plant. Once fired, they run continuously 24 hours a day, 7 days a week. All processes are geared to keep the kilns in operation.



Huge ball mills are used for both raw and finish grinding.

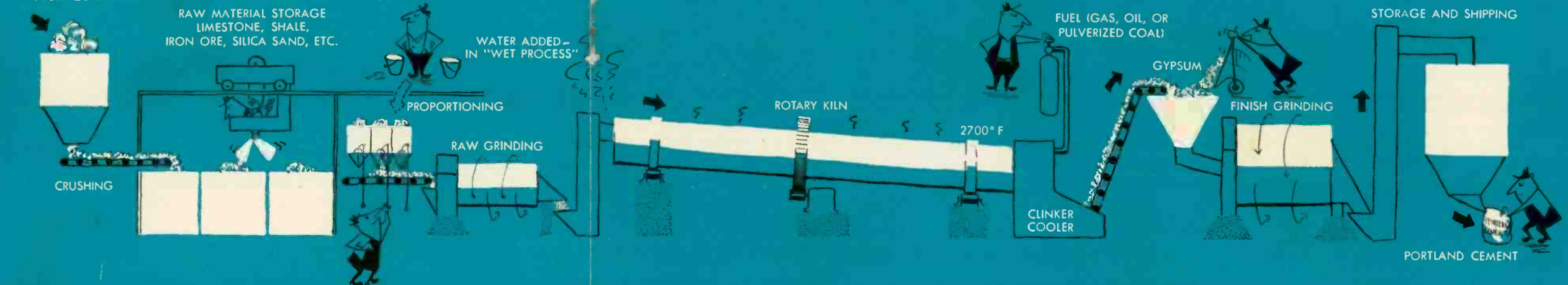

Artist's conception of Joseph Aspdin working in his kitchen workshop developing the recipe for portland cement.

Simplified flow diagram of portland cement manufacture. Actually, more than 80 separate and continuous operations, carefully controlled, are needed to satisfy the exacting requirements of portland cement manufacture.



All states are engaged in programs of extending and improving present highway facilities—with concrete (above).

This reinforced concrete arch bridge (right) spans the Penn-Lincoln Parkway in Pittsburgh, Pa. The bridge is 251 feet long and rises to 40 feet above the roadway.



kitchen workshop. Whole mountains of calcareous (lime marl) and argillaceous (shale, clay) material are fed through huge crushers. The first crushing reduces the rock to a top size of six inches. Secondary crushers or hammermills further reduce rocks to a two-inch size or smaller. The raw materials are then proportioned to obtain the proper chemical combination, and ground to a powder in huge ball mills. This step may be done by adding water to the raw materials to form a slurry (wet process), or the materials can be mixed and ground dry (dry process). The resulting mixture, wet or dry, is fed to the huge cylindrical rotating kiln. The mixture is gradually raised to a temperature of approximately 2700 degrees F as it tumbles down the inclined kiln. Some of the modern fire-brick lined kilns are as much as 12 feet in diameter, and over 300 feet long.

The kiln is heated by burning a blown-in mixture of air and powdered coal, natural gas, or fuel oil. The intense heat generated carries the material to incipient fusion, chemically uniting the elements into a new substance called "clinker."

In a final grinding operation, gypsum is added (to regulate the "setting" time), and the mixture ground into a powder so fine that most of it will pass through a screen containing 40,000 openings to the square inch. This powder is portland cement, now the basic ingredient for many building-material recipes—concrete, mortar, stucco, and plaster to name a few.

Concrete and Construction

It is difficult to imagine what the world would be like without portland cement, and its most common end product, con-

crete. World production is something over one billion barrels (376 pounds per barrel) of cement yearly. Over 267 million barrels of portland cement are manufactured in the United States alone.

Modern concrete made with portland cement has an average compressive strength of 3000 pounds per square inch, but this figure can vary from 2500 to 5000 psi, depending upon the ratio of the mix and type of aggregate.

With dense aggregates, concrete can weigh as much as 250 pounds per cubic foot; light aggregates or special processes will yield a concrete so light that it will float, and can be sawed or nailed like lumber—weighing as little as 25 pounds per cubic foot.

Air-entrained concrete is a relatively recent development. Used largely for highway construction, air-entrained concrete contains millions of microscopic air cells per cubic foot. When water in the concrete freezes, these cells relieve internal pressure. The amount of entrained air is usually from three to six percent of the total concrete volume. Air-entrained portland cement is made by grinding small amounts of soaplike resinous or fatty materials with the normal cement clinker.

Scientists, architects, and engineers are constantly finding new and improved ways of using concrete. *Pre-stressed* concrete is an example. In conventional reinforced concrete, the high tensile strength of steel adds to the concrete's natural compressive strength. However, this combination seldom takes full advantage of the high compressive strength now readily obtained in concrete. Pre-stressed concrete is made by pretensioning or post-tensioning the steel reinforcement. In pretensioning, the steel is stretched before the concrete is placed or has hardened; after hardening, the stretching forces are released. In post-tensioning, the steel is stretched after the concrete has hardened, and fastened externally by means of anchors or other gripping devices. With pre-stressed concrete, lighter and shallower concrete structures can be designed and built without sacrificing strength.

Tilt-up construction is another technique gaining favor. Whole reinforced concrete panels are cast in horizontal forms and then tilted up vertically and fastened into place. Tilt-up is especially advantageous for one-story structures, but has been used successfully on many multi-story buildings. Using tilt-up techniques, projects can be laid out readily for mass-production assembly.

Shell construction is another technique that has been gaining recognition in the United States since World War II. Although the principle of shell construction is as old as the first pre-historic egg (imagine how little strength an egg shell would have if it were flat), application of reinforced concrete to shell-roof construction dates back only some 30 years to developments started in Germany. Today, shell construction has been found an excellent roof for certain industrial and commercial buildings that require large amounts of clear floor space and high ceilings. Concrete shell roofs can span large areas without support and with a low ratio of dead weight to span. Curved ribs or stiffening members are placed at intervals along the entire length of the shell to maintain the curved shell, so that a relatively thin shell of concrete is required. A Chicago hangar has a floor area of 45 000 square feet, covered by a concrete shell roof with a clear span of 257 feet, and a clear ceiling height at midspan of 60 feet—yet the shell at most points is only 3½ inches thick.

The list of new uses for cement and concrete is ever growing. The principal ingredients of modern portland cement are much the same as those used centuries ago—but the recipe has been improved many times. ■

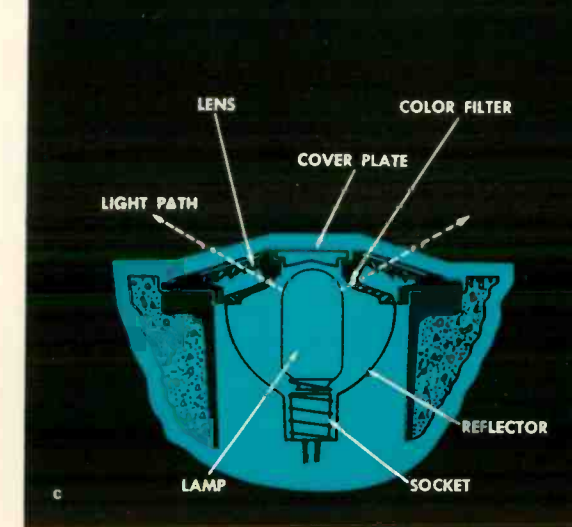
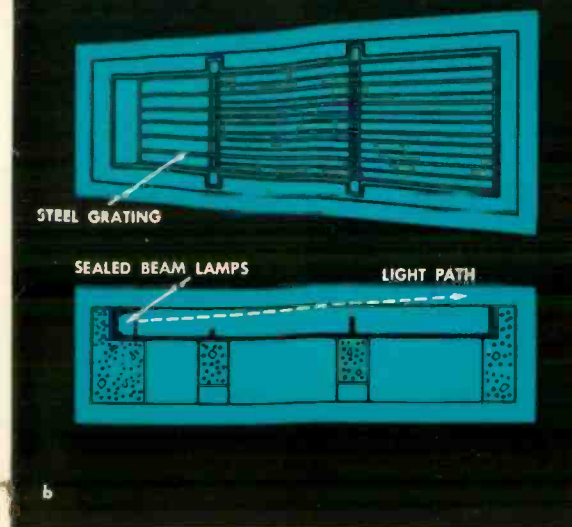

shine out through the grating near the opposite end. The lateral divergence of the emitted light is restricted by the steel grating.

A third type fits any of the standard bases and protrudes about three-quarter inch above the runway surface at the center, sloping to the runway surface at the edge (Fig 3c). This light is intended to withstand all service hazards, including snowplows and other land vehicles, as well as the heaviest airplane now proposed.

Other types, having somewhat greater protrusion above the runway surface, are being developed. As performance, by laws of physics, is largely limited by the visible area of the light-emitting part of the fixture, this problem of how much protrusion above the runway surface is allowable is a controversial point. Pilots want lots of light. To get it, the engineer wants lots of height above the runway surface, while the pilots want lights as nearly flush as possible.

With a new type of flush taxi-light a taxiway can be lighted with a single row of lights on its centerline. This should remove many of the confusions caused by present two-row elevated light installations.

Narrow-gauge runway lighting will pose a real problem on existing runways. Cutting holes for the lights, ranging from 16 inches in diameter to 2 feet wide by 6 feet long—depending on the type of light—is bad enough. Cutting in for the power-supply cable is much worse. On most 150-foot runways, and some 200-foot strips where soil conditions permit, the best scheme is to jack a conduit from the runway edge under the paved area into each hole.

Where deep crushed-rock fill, or natural-rock formation exist under the paving, surface cuts will have to be made from edge to hole at each location. These cuts may be shallow and narrow, 3 to 5 inches deep and about 2 inches wide. Where the pavement is steel reinforced, neoprene insulated cable can be grouted into the cut. Pavement subject to cracking may require grouted-in conduit to protect the cable.

Other points that will affect the final choice of fixture for a narrow-gauge installation include snow and snow removal equipment; amount and frequency of blowing dirt and sand; ability to withstand jet blasts, particularly the blasts from thrust reversal that will be used for braking during landings; what the fixture might do to an airplane tire when landing on it with brakes locked; and methods of servicing and maintenance costs.

The approach-light controversy appears to have been resolved, at least for the Americas. The Slopline system has been forgotten. The Calvert, or British system, is steadily losing out. The International Civil Aviation Organization

(ICAO) has listed the centerline system as preferred, and in another five years should be in a position to list it as a standard. The Civil Aeronautics Authority has an ambitious program to replace all left-side row and many neon-ladder systems with the centerline. Five centerline installations are now equipped with condenser-discharge lights, and many more are in the new CAA program.

Summary

The general pattern of lighting for jets is thus taking shape. Basic factors that influence the new pattern are the increased speed on the let-down and approach; the lessened maneuverability of larger, heavier airplanes; that the landing must be committed at a much greater distance from the runway; and that there is a relatively large economic penalty in the form of time and airplane fuel for not completing a committed landing.

The pattern starts with a centerline approach system with condenser-discharge lights. Lighting is now a 24-hour day aid to navigation. Lights are useful in clear daytime to improve the identification of the runway. At the greater distances airports appear like a postage stamp, and the runway location is often indistinct until the airplane is well along the let-down and approach path. Approach lights with flashers can provide quick and positive identification and location of the runway.

When landings are to be made on a runway not equipped with approach lights, the circling guidance lights set the pattern and show the pilot where the runway is before he makes his turn into the let-down position of his landing. The runway lights take over as he comes on-course and completes the job under VFR (Visual Flight Rules).

Under IFR (Instrument Flight Rules), day or night, the let-down and first part of the approach is entirely on instruments. Somewhere along the last mile before touch down, but not less than one-half mile, the approach lights become visible. Perhaps only a portion of the centerline can be seen at first, but as the airplane continues along the approach more lights become visible, with the distance marker, 1000 feet from the threshold, being quite distinct. The centerline then splits into the narrow gauge-runway lights and the landing is completed between the lines of lights.

Operations under IFR are most benefitted by narrow-gauge lighting. The closely spaced lines of runway lights appear in the pilot's cone of direct vision as soon as they are visible and both lines stay within that cone, defining the center of the runway without any searching by the pilot. The "black hole" condition never appears. ■

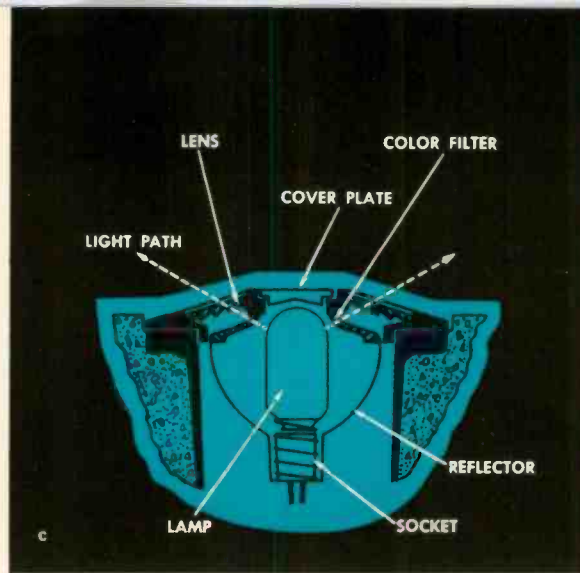
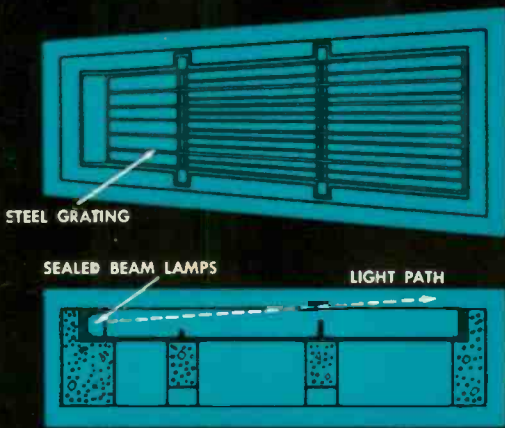

shine out through the grating near the opposite end. The lateral divergence of the emitted light is restricted by the steel grating.

A third type fits any of the standard bases and protrudes about three-quarter inch above the runway surface at the center, sloping to the runway surface at the edge (Fig 3c). This light is intended to withstand all service hazards, including snowplows and other land vehicles, as well as the heaviest airplane now proposed.

Other types, having somewhat greater protrusion above the runway surface, are being developed. As performance, by laws of physics, is largely limited by the visible area of the light-emitting part of the fixture, this problem of how much protrusion above the runway surface is allowable is a controversial point. Pilots want lots of light. To get it, the engineer wants lots of height above the runway surface, while the pilots want lights as nearly flush as possible.

With a new type of flush taxi-light a taxiway can be lighted with a single row of lights on its centerline. This should remove many of the confusions caused by present two-row elevated light installations.

Narrow-gauge runway lighting will pose a real problem on existing runways. Cutting holes for the lights, ranging from 16 inches in diameter to 2 feet wide by 6 feet long—depending on the type of light—is bad enough. Cutting in for the power-supply cable is much worse. On most 150-foot runways, and some 200-foot strips where soil conditions permit, the best scheme is to jack a conduit from the runway edge under the paved area into each hole.

Where deep crushed-rock fill, or natural-rock formation exist under the paving, surface cuts will have to be made from edge to hole at each location. These cuts may be shallow and narrow, 3 to 5 inches deep and about 2 inches wide. Where the pavement is steel reinforced, neoprene insulated cable can be grouted into the cut. Pavement subject to cracking may require grouted-in conduit to protect the cable.

Other points that will affect the final choice of fixture for a narrow-gauge installation include snow and snow removal equipment; amount and frequency of blowing dirt and sand; ability to withstand jet blasts, particularly the blasts from thrust reversal that will be used for braking during landings; what the fixture might do to an airplane tire when landing on it with brakes locked; and methods of servicing and maintenance costs.

The approach-light controversy appears to have been resolved, at least for the Americas. The Slope-line system has been forgotten. The Calvert, or British system, is steadily losing out. The International Civil Aviation Organization

(ICAO) has listed the centerline system as preferred, and in another five years should be in a position to list it as a standard. The Civil Aeronautics Authority has an ambitious program to replace all left-side row and many neon-ladder systems with the centerline. Five centerline installations are now equipped with condenser-discharge lights, and many more are in the new CAA program.

Summary

The general pattern of lighting for jets is thus taking shape. Basic factors that influence the new pattern are the increased speed on the let-down and approach; the lessened maneuverability of larger, heavier airplanes; that the landing must be committed at a much greater distance from the runway; and that there is a relatively large economic penalty in the form of time and airplane fuel for not completing a committed landing.

The pattern starts with a centerline approach system with condenser-discharge lights. Lighting is now a 24-hour day aid to navigation. Lights are useful in clear daytime to improve the identification of the runway. At the greater distances airports appear like a postage stamp, and the runway location is often indistinct until the airplane is well along the let-down and approach path. Approach lights with flashers can provide quick and positive identification and location of the runway.

When landings are to be made on a runway not equipped with approach lights, the circling guidance lights set the pattern and show the pilot where the runway is before he makes his turn into the let-down position of his landing. The runway lights take over as he comes on-course and completes the job under VFR (Visual Flight Rules).

Under IFR (Instrument Flight Rules), day or night, the let-down and first part of the approach is entirely on instruments. Somewhere along the last mile before touch down, but not less than one-half mile, the approach lights become visible. Perhaps only a portion of the centerline can be seen at first, but as the airplane continues along the approach more lights become visible, with the distance marker, 1000 feet from the threshold, being quite distinct. The centerline then splits into the narrow gauge-runway lights and the landing is completed between the lines of lights.

Operations under IFR are most benefitted by narrow-gauge lighting. The closely spaced lines of runway lights appear in the pilot's cone of direct vision as soon as they are visible and both lines stay within that cone, defining the center of the runway without any searching by the pilot. The "black hole" condition never appears. ■

**recipe for
construction . . .
portland cement**

▪ The ingredients: lime, silica, iron oxide, and alumina; carefully proportion, blend, and bake to a clinker; then grind and add a dash of gypsum. Not a recipe suitable for the kitchen use, but nonetheless a carefully controlled recipe—for portland cement, today's most universal building material.

History of Portland Cement

The original formula for portland cement was developed in the kitchen of Joseph Aspdin, a bricklayer and mason in Leeds, England. By burning a mixture of powdered limestone and clay in his kitchen stove, he produced a hydraulic cement (hardens under water) far superior to existing cements. In 1824, he was granted a patent on his cement, which he called "portland" because it resembled in color an excellent building stone quarried on the Isle of Portland off the English coast. The recipe has since been improved considerably, but the idea of carefully proportioning the ingredients to obtain a predetermined chemical combination of lime, silica, iron oxide and alumina was a real contribution to the art.

Man had been searching for this formula almost since he first started piling stones. The ancient Egyptians are credited with the discovery of lime and gypsum mortar as a binding agent. The Greeks made further improvements, but the Romans probably developed the first real cement with hydraulic characteristics. They discovered a mixture of volcanic ashes and lime that hardened under water and hence could be used in the construction of aqueducts, cisterns, and other projects that required this quality. The Romans built foundations for their buildings with a form of concrete (from the Roman word *concretus*, meaning "growing together") placed to a



Ingredients for portland cement—both before and during processing—are stored in these huge bins.



LIMESTONE AND SHALE FROM QUARRY



RAW MATERIAL STORAGE
LIMESTONE, SHALE,
IRON ORE, SILICA SAND, ETC.

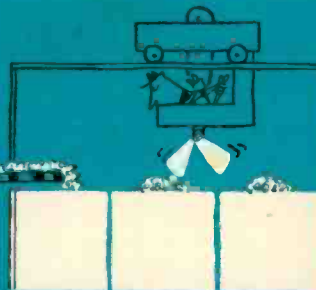

WATER ADDED -
IN "WET PROCESS"

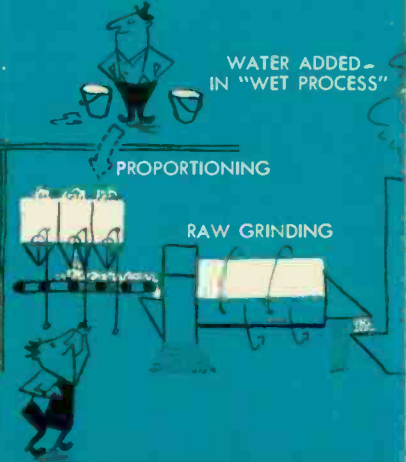

Artist's conception of Joseph Aspdin working in his kitchen workshop developing the recipe for portland cement.

depth of as much as 12 feet. Their best mortar was made from lime mixed with a volcanic material called pozzolana, named from a place called Pozzuoli, near Mount Vesuvius. Unknown to the Romans, the volcano had provided pozzolana with its cementing properties, much as the modern kiln does today.

Through the dark ages, no new contributions were made to the art, but by the eighteenth century, Europeans again began the search for better building materials. One of these was John Smeaton, an Englishman, who had the job of rebuilding the Eddystone Lighthouse on the rocky coast of Southeast England. Failure of mortar to withstand the effects of sea water lead Smeaton to experiment with mortars in both fresh and salt waters. A widely held belief at that time was that the purer the limestone, the better the mortar; he discovered that lime made from a limestone containing a considerable proportion of clay had much better hydraulic qualities. To make his cement he heated the impure limestone in a kiln at a low temperature and then ground the burned limestone into a fine powder. He was on the right track. Forty years later in 1796, another Englishman, Joseph Parker, took out a patent for "Roman cement," which was made by burning argillaceous, kidney-shaped nodules that were washed up on the shores of the Isle of Sheppy. Neither Smeaton nor Parker, however, carried their burning to the point of near fusion, an essential step in the manufacture of portland cement as we know it today. In fact, there is doubt that Aspdin originally carried his burning far enough to have a true portland cement, but rather that the process evolved in the years following his original patent. Portland cement got its first real trial in 1859 in the construction of the London drainage canal. By this time, certainly, the value of producing a clinker by burning

the raw materials almost to the fusing point had been discovered.

In the United States, the first large use of cement was for canal building. The American cement industry began in 1818 when a natural cement-rock was discovered near the route of the Erie Canal, then being constructed. (This, of course, was a natural cement.) The first portland cement was shipped to the United States about 1868 from Europe. European manufacturers used the cement as ballast in ships, thereby obtaining low freight rates. Shortly after this, Americans began experimenting with the manufacture of portland cement, and the David O. Saylor Company of Coplay, Pennsylvania, probably manufactured the first portland cement made in the United States about 1875.

The next big development in cement production was made by F. Ransome, in 1885, an English engineer who patented a slightly tilted horizontal kiln that could be rotated. The rotating kiln made possible continuous furnace operation, eliminating the previous batch-type vertical kiln. Thomas Edison pioneered further development of the rotary kiln and in 1902 introduced a kiln that was 150 feet long, the first long kiln used in the industry. The long rotary kiln is the vital process of modern portland cement production.

Manufacture of Portland Cement

The exacting nature of portland cement manufacture today requires some 80 separate operations, although most of them can be grouped into three fundamental steps—grinding and blending, burning, and a final grinding and blending.

The modern cement plant is a far cry from Aspdin's original



These huge rotary kilns are the heart of the cement processing plant. Once fired, they run continuously 24 hours a day, 7 days a week. All processes are geared to keep the kilns in operation.

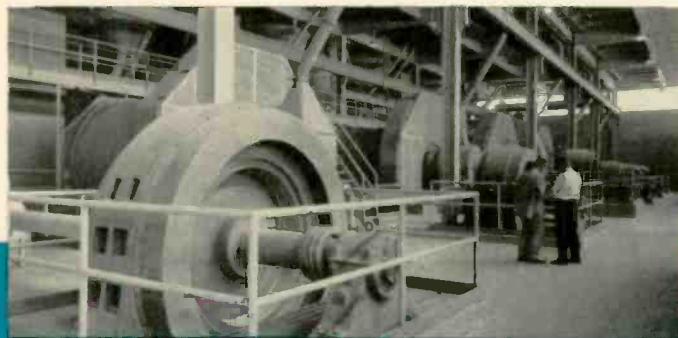

Huge ball mills are used for both raw and finish grinding.

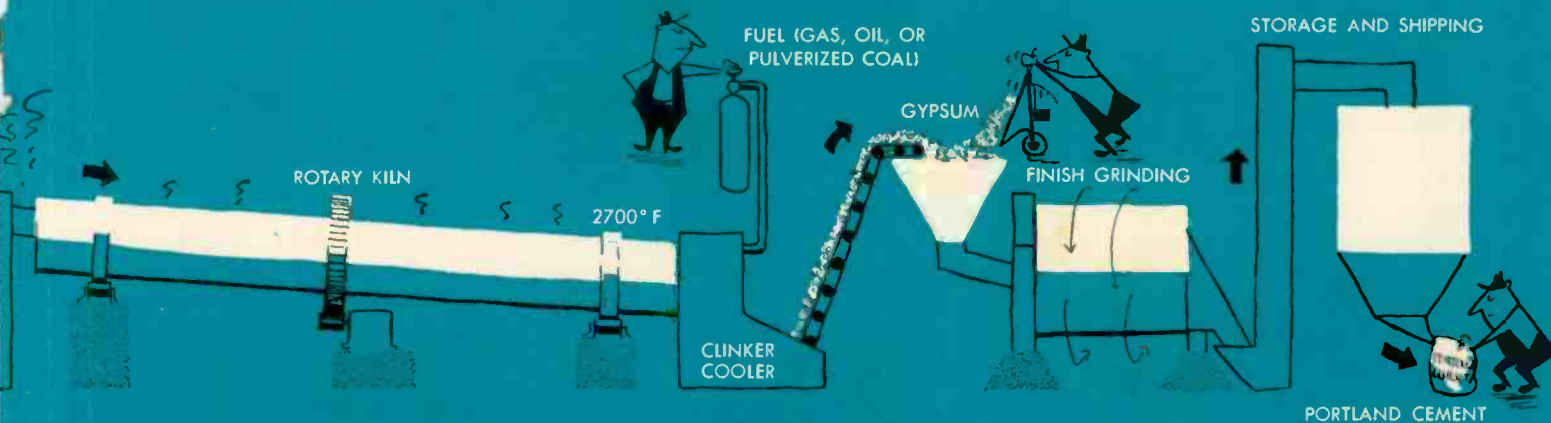

Simplified flow diagram of portland cement manufacture. Actually, more than 80 separate and continuous operations, carefully controlled, are needed to satisfy the exacting requirements of portland cement manufacture.



All states are engaged in programs of extending and improving present highway facilities—with concrete (above).

This reinforced concrete arch bridge (right) spans the Penn-Lincoln Parkway in Pittsburgh, Pa. The bridge is 251 feet long and rises to 40 feet above the roadway.

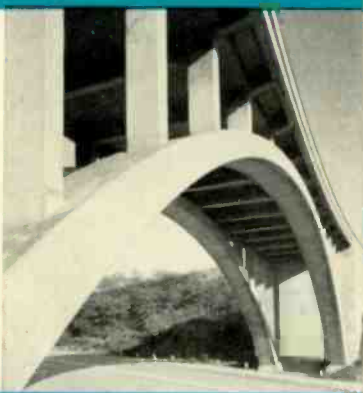

kitchen workshop. Whole mountains of calcareous (lime marl) and argillaceous (shale, clay) material are fed through huge crushers. The first crushing reduces the rock to a top size of six inches. Secondary crushers or hammermills further reduce rocks to a two-inch size or smaller. The raw materials are then proportioned to obtain the proper chemical combination, and ground to a powder in huge ball mills. This step may be done by adding water to the raw materials to form a slurry (wet process), or the materials can be mixed and ground dry (dry process). The resulting mixture, wet or dry, is fed to the huge cylindrical rotating kiln. The mixture is gradually raised to a temperature of approximately 2700 degrees F as it tumbles down the inclined kiln. Some of the modern fire-brick lined kilns are as much as 12 feet in diameter, and over 300 feet long.

The kiln is heated by burning a blown-in mixture of air and powdered coal, natural gas, or fuel oil. The intense heat generated carries the material to incipient fusion, chemically uniting the elements into a new substance called "clinker."

In a final grinding operation, gypsum is added (to regulate the "setting" time), and the mixture ground into a powder so fine that most of it will pass through a screen containing 40,000 openings to the square inch. This powder is portland cement, now the basic ingredient for many building-material recipes—concrete, mortar, stucco, and plaster to name a few.

Concrete and Construction

It is difficult to imagine what the world would be like without portland cement, and its most common end product, con-

crete. World production is something over one billion barrels (376 pounds per barrel) of cement yearly. Over 267 million barrels of portland cement are manufactured in the United States alone.

Modern concrete made with portland cement has an average compressive strength of 3000 pounds per square inch, but this figure can vary from 2500 to 5000 psi, depending upon the ratio of the mix and type of aggregate.

With dense aggregates, concrete can weigh as much as 250 pounds per cubic foot; light aggregates or special processes will yield a concrete so light that it will float, and can be sawed or nailed like lumber—weighing as little as 25 pounds per cubic foot.

Air-entrained concrete is a relatively recent development. Used largely for highway construction, air-entrained concrete contains millions of microscopic air cells per cubic foot. When water in the concrete freezes, these cells relieve internal pressure. The amount of entrained air is usually from three to six percent of the total concrete volume. Air-entrained portland cement is made by grinding small amounts of soaplike resinous or fatty materials with the normal cement clinker.

Scientists, architects, and engineers are constantly finding new and improved ways of using concrete. *Pre-stressed* concrete is an example. In conventional reinforced concrete, the high tensile strength of steel adds to the concrete's natural compressive strength. However, this combination seldom takes full advantage of the high compressive strength now readily obtained in concrete. Pre-stressed concrete is made by pretensioning or post-tensioning the steel reinforcement. In pretensioning, the steel is stretched before the concrete is placed or has hardened; after hardening, the stretching forces are released. In post-tensioning, the steel is stretched after the concrete has hardened, and fastened externally by means of anchors or other gripping devices. With pre-stressed concrete, lighter and shallower concrete structures can be designed and built without sacrificing strength.

Tilt-up construction is another technique gaining favor. Whole reinforced concrete panels are cast in horizontal forms and then tilted up vertically and fastened into place. Tilt-up is especially advantageous for one-story structures, but has been used successfully on many multi-story buildings. Using tilt-up techniques, projects can be laid out readily for mass-production assembly.

Shell construction is another technique that has been gaining recognition in the United States since World War II. Although the principle of shell construction is as old as the first pre-historic egg (imagine how little strength an egg shell would have if it were flat), application of reinforced concrete to shell-roof construction dates back only some 30 years to developments started in Germany. Today, shell construction has been found an excellent roof for certain industrial and commercial buildings that require large amounts of clear floor space and high ceilings. Concrete shell roofs can span large areas without support and with a low ratio of dead weight to span. Curved ribs or stiffening members are placed at intervals along the entire length of the shell to maintain the curved shell, so that a relatively thin shell of concrete is required. A Chicago hangar has a floor area of 45 000 square feet, covered by a concrete shell roof with a clear span of 257 feet, and a clear ceiling height at midspan of 60 feet—yet the shell at most points is only 3½ inches thick.

The list of new uses for cement and concrete is ever growing. The principal ingredients of modern portland cement are much the same as those used centuries ago—but the recipe has been improved many times. ■

cement plant power

ANTHONY C. LORDI

Mining, Petroleum, and Chemical Section
Industry Engineering Department
Westinghouse Electric Corporation
East Pittsburgh, Pennsylvania

■ The increased use of Portland cement in road and building construction programs has triggered an explosive expansion in the cement industry. This expansion has been manifested both in the increase of existing plant capacity, and in new plant construction. Cement plant locations are widely dispersed, since the calcareous (lime, marl) and argillaceous (shale, clay) materials from which cement is made are found in large deposits in almost every state. The economic shipping radius of this inexpensive heavy product is rarely more than 300 miles from the quarry.

The cement plant utilizes a connected-horsepower per man-employed ratio of over 100 to 1. Crushers, grinding mills, kilns, cranes, and conveyors with ever increasing single-motor horsepowers characterize the electrical equipment involved. Ball mills with drives up to 2000 horsepower grind the rock products to the consistency of talcum powder. Twenty-five to thirty kilowatt hours of electrical energy are required for each barrel of cement produced. (One barrel is the equivalent of four 94-pound bags.) The typical plant produces two to three million barrels per year, and one plant produces 12 million barrels of Portland cement per year. A 15 000-kva substation is usually required for a 3-million barrel per year plant.

Plant Distribution

In older cement plants using short kilns, the waste heat available from kiln exhaust gases was used to produce steam for power generation. The recent trend is to use longer kilns or pre-heaters, which efficiently utilize kiln exhaust gases to heat the incoming charge. Existing plant generating capacity is being abandoned in favor of purchased power.

A typical Portland cement plant distribution system is shown in Fig. 1. Utility line voltages range from 22.9 kv to 115 kv, while existing plant generation is usually at 2400 volts, 3 phase, 60 cps. Plant distribution voltages are at either 2400 or 4160 volts. At these voltages, power is economically distributed with acceptable voltage drops and power losses to power centers at load concentrations. These voltages are also

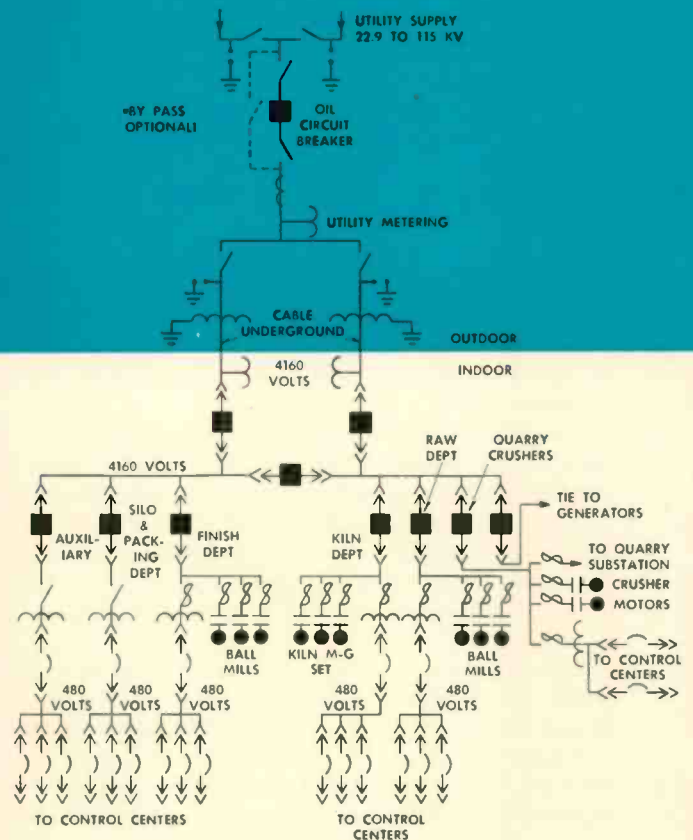
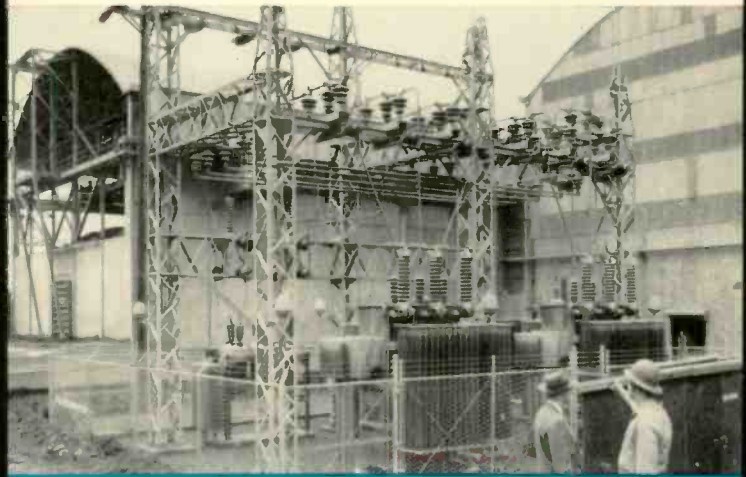

Fig. 1—Typical cement plant distribution system.



Control centers for auxiliary 440-volt motors.

economical for large motor operation. In substation sizes above 7500 kva, the 4160-volt distribution system is preferred over a 2400-volt system because savings in copper, lower power losses, better voltage regulation, and more usable circuit-breaker capacities are realized. The 4160-volt distribution system is neutral grounded, either solidly or through grounding resistors to minimize transient voltages to ground under fault or surge conditions. Existing 2400-volt systems are usually ungrounded with the trend toward neutral grounding where feasible. A relative cost comparison of (1) a double-ended substation, (2) a three single-phase transformer, single-ended substation, and (3) a three-phase transformer single-ended substation is shown in Fig. 2. In the range of substation sizes usually required in cement plants, the double-ended substation with its greater degree of continuity is preferred. The double-ended substation is advantageous since it permits periodic insulator and bushing cleaning without total loss of power. The next higher class of insulation level is chosen for substation bushings and insulators to minimize insulator flashover due to the cement dust accumulation. Where possible the substation is located on the windward side of the plant to minimize the dust problem.

Indoor-metalclad drawout air circuit breakers protect feeder circuits to the various operating departments. Underground cables in ducts terminate in incoming line cubicles of low-voltage power centers, or in high-voltage motor starters located in the plant departments. A typical cement plant lineup of 5-kv switchgear includes two incoming line circuit breakers and individual department feeder breakers for (a) quarry and crushers, (b) silo and packing department, (c) finish department, (d) kiln department, (e) raw department, (f) plant auxiliaries, and (g) a tie to the generator bus, when it exists.

Emergency diesel-generator capacity is often provided in wet-process Portland cement plants. Stand-by power is necessary in the event of power failure to supply air compressors that maintain a continuous source of compressed air for the agitation of storage tanks and slurry thickeners. Without air agitation, the material in suspension will settle out in about 30 minutes. Subsequent removal of this material usually requires jack hammers.

Development of the plant distribution system is usually radial; however, the selective radial system with alternate sources of power in the event of cable faults is coming into more general usage, and provides an increased degree of reliability. Where the simple radial system has been used, multiple cables with an excess of installed capacity enables quick restoration of power subsequent to a cable fault.

Power Centers

The use of 480-volt indoor power centers located at operating-department load concentrations is the preferred arrangement in cement plants. These power centers are usually single ended and consist essentially of an incoming line compartment with a load-break primary switch and power fuses, an air- or inerteen-insulated transformer, and a low-voltage compartment housing drawout switchgear, all close-coupled. The dry-type air-cooled power-center transformer offers advantages of lighter weight, reduced support requirements, and eliminates the hazards associated with liquid-filled transformers. However, if the transformer is to be in an extremely dusty or wet location, the inerteen transformer is preferred. The modern trend is to locate the power centers in relatively clean pressurized rooms and use dry-type transformer units.

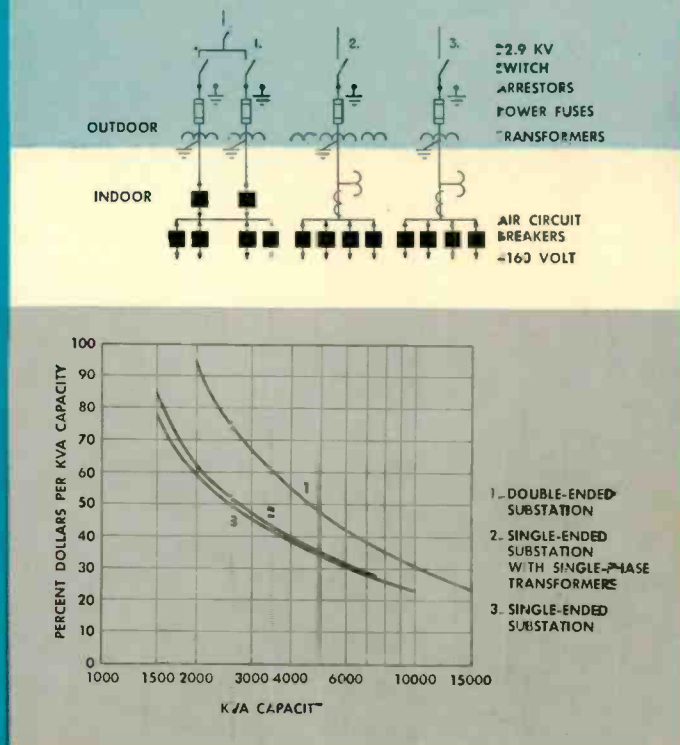

Fig. 2—Relative substation costs.

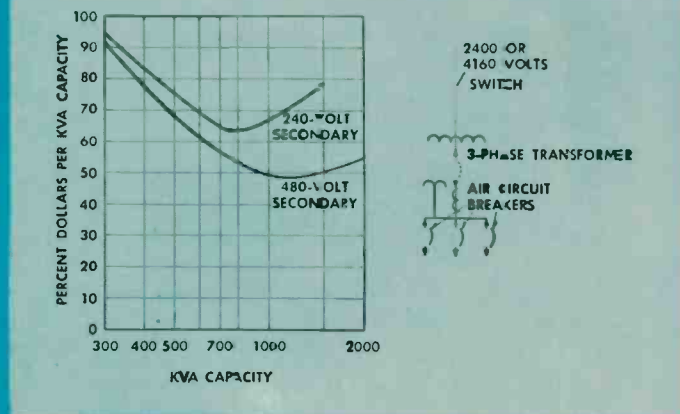
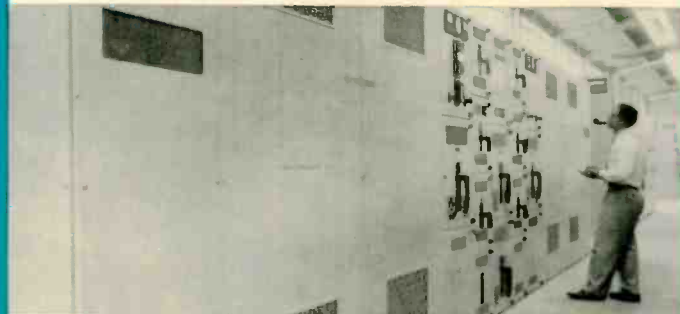
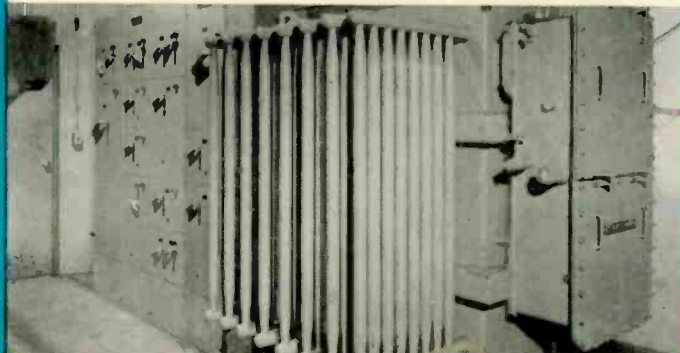

Fig. 3—Relative power center costs.



Indoor dry-type, double-ended 480-volt power center, rated 2000 kva.

Inerteen-filled transformer (750 kva) feeding a control center



Relative costs of power centers versus power-center capacities is shown in Fig. 3. The most economical power centers are between 750 and 1500 kva. Power centers are almost universally supplied with 480-volt secondaries. With the additional cost of cable and equipment and the poorer voltage regulation associated with the 240-volt system, this lower voltage is rarely justified.

Drawout low-voltage air circuit breakers in the power centers usually cable feed control centers where groups of motor controls are concentrated. This facilitates maintenance and promotes continuity by isolating the various individual process functions.

Control Centers

Motor control apparatus grouped in free-standing cubicles is preferred over individually-mounted control units. The grouped control facilitates interlocking and wiring for sequence-controlled, continuous-flow lines used in the modern cement plant. Combination starters, with circuit breakers to quickly and safely isolate faults without the possibility of single phasing, are preferred for each motor control. Depending upon the stiffness of the plant distribution system, application of control centers connected to power centers with rating in excess of 500 kva at 240 volts, or 750 kva at 480 volts, requires a close look at control-center protection. Additional impedance or current-limiting fuses may be required to limit fault duty on the standard molded-case air circuit breakers.

The preferred control-center location is a relatively clean pressurized room adjacent to the working area. Dust-protected control desks out in the plant area provide machine operators with control at the driven machinery.

Quarry Distribution

Electrically-powered shovels, draglines, pumps, drills, and other portable machinery are used in the cement-plant quarry. A single, line diagram of a quarry distribution system is shown in Fig. 4.

The widely varying ground impedance that exists necessitates special grounding equipment to maintain personnel safety. Ground faults are limited to a maximum of 25 amperes by a neutral resistor in the quarry substation transformer secondary. Where quarry power is supplied from the plant substation at 4160 volts, an isolation transformer can be employed to enable safety grounding of the quarry distribution system. The grounded side of the neutral resistor (grounded separately from the substation ground to minimize primary surge and fault transients on the safety ground wire) is connected to the ground wires carried in the interstices of the cable fed from the quarry transformer secondary circuit breaker. These ground wires connect to the frames of portable equipment to keep them at the ground potential established by the substation grounding grid.

Low ground-fault currents through both 4160-volt switch-houses and 480-volt power centers are detected by balanced-flux, window-type current transformers used with sensitive relays to quickly isolate faulted feeders. Machine frame-to-ground voltages are limited to approximately the product of the maximum ground-fault current (limited by the neutral resistor) and the ground-wire impedance. This voltage is usually well below 100 volts.

Where delta-connected transformers are in service, the quarry distribution system can be changed to a safety grounded system by adding a zig-zag grounding transformer, a neutral



Portable switchhouse for an electric shovel.

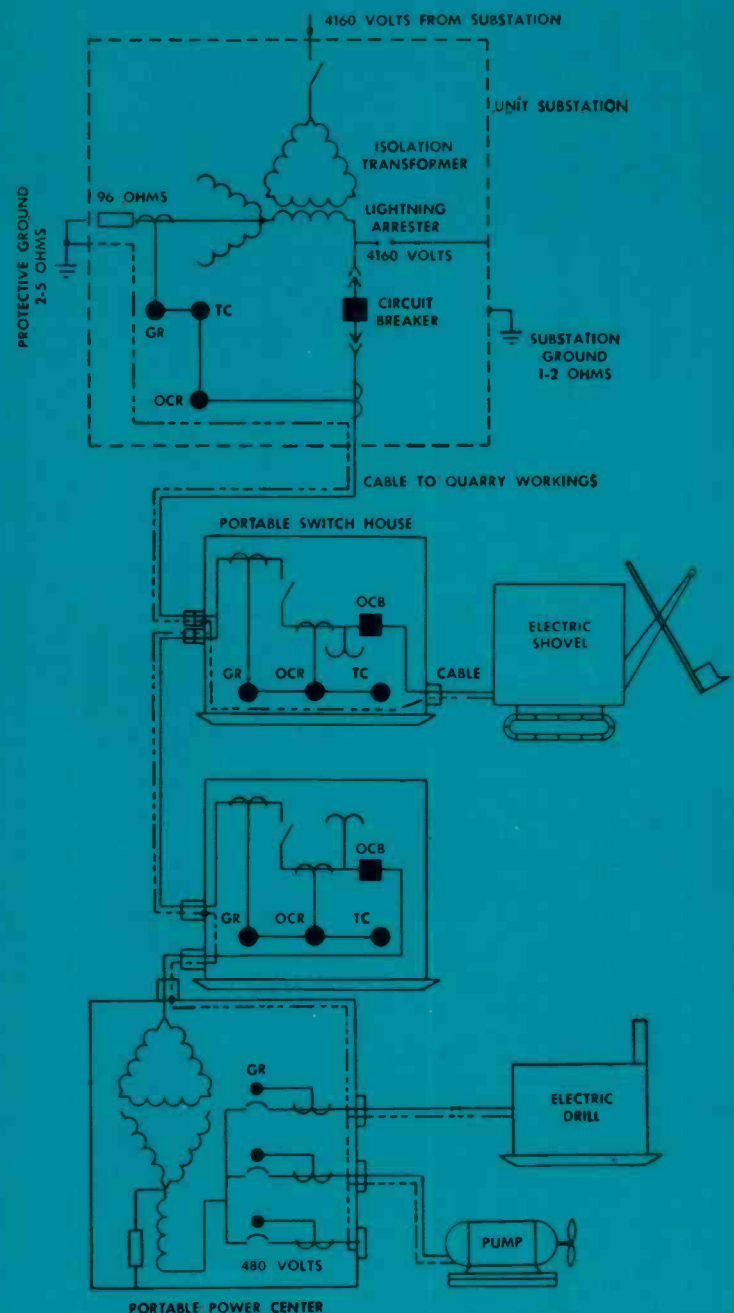
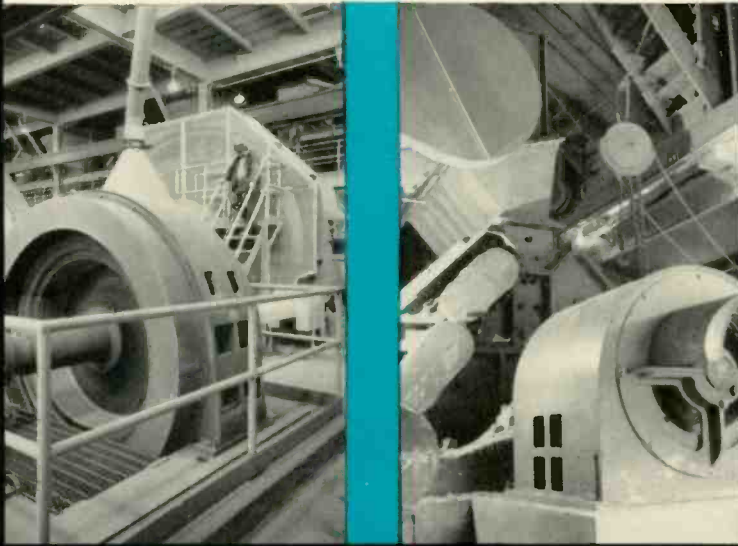

Fig. 4—Quarry distribution circuit.



High-torque, synchronous motor drive (1250 hp) for a ball mill doing finish grinding.

This hammermill secondary crusher is driven by a 600-hp, 900-rpm synchronous motor.

Table 1—Typical Cement Plant Drives

Machine	Horsepower	Motor Type	Control
Gyratory Roll Crusher Jaw	75-400	Wound Rotor	Magnetic secondary
Cane Crusher	50-300	Squirrel Cage NEMA B Spcl.	Full voltage
Hammermill Impactor	150-600	Squirrel Cage Synchronous	Full voltage Full voltage Sometimes reversing
Conveyors	3-60 60-300	Squirrel Cage Wound Rotor	Full voltage Magnetic secondary
Ball Mills	450-2000	Synchronous	Full voltage on low-speed motors, reduced voltage on high-speed motors
Kiln Drive Feeder	75-250 5-15	D-c Stab. Shunt D-c Stab. Shunt	Adjustable-voltage multi-motor drive, sometimes 8:1 speed range
Air Separators	50-200	Squirrel Cage NEMA B or C	Full voltage
Draft Fans	40-600	Squirrel Cage NEMA B Spcl., Synchronous Wound Rotor	Full voltage, sometimes speed control
Coal Crusher	40-200	NEMA B Spcl.	Full voltage
Cement Cooler	40-100	NEMA C	Full voltage
Elevators Screw Conveyors Drag Chain	10-40	NEMA B or C	Full voltage
Bucket Cranes	40-200	Wound Rotor Adjustable voltage D-c hoist drive	Secondary resistance Definite time acceleration, Current limit acceleration, Magamp Rototrol

grounding resistor, and suitable relaying. Wye-wye transformers should be avoided unless a delta tertiary winding is employed to minimize harmonic voltages and to insure sufficient ground current flow when a ground fault exists.

Machine Drives

Motor horsepowers in cement plants range from fractional-horsepower feeder-gate drives up to the 2000-hp large ball-mill drives. Squirrel-cage induction motors, with low first cost and rugged maintenance-free performance, suitably drive most plant machinery. Comparatively little d-c power is used in the modern plant. The kiln and regulated feeder drives often employ adjustable voltage d-c drives to efficiently operate over the speed ranges required; however, these drives amount to less than five percent of the total plant connected horsepower.

Large ball mills are almost universally driven by synchronous motors. These motors have the advantages of high efficiency, low first cost in the range of horsepowers and speeds required, and can aid in power-factor correction.

Present power systems are usually of sufficient capacity to permit application of direct-connected, high-torque synchronous motors, supplying the necessary inrush at low power factor with acceptable voltage regulation. Sufficient torques are designed into the motor to insure that the required shaft torques can be developed at the voltages expected during starting and accelerating.

Accurate positioning of large ball mills is required to facilitate charging and discharging of balls, and to perform other maintenance. Slow-speed rotation (1/360 of synchronous speed) is effected by using a small (20-40 kw) d-c inching generator and applying a slowly varying, stepped approximation of a three-phase sine wave with an inching control.

Limestone is reduced from large pieces of stone as quarried to a one-inch size in two stages. Primary crushing, the first stage in the reduction process is done by jaw, gyratory, or roll crushers. These crushers are high inertia, hard-starting machines with high repeated peak loads. The wound-rotor motor with magnetic secondary control best serves these drives. Secondary crushing is done by hammermills, impactors, or cone crushers. Special squirrel-cage motors with higher than normal starting and breakdown torques and additional rotor

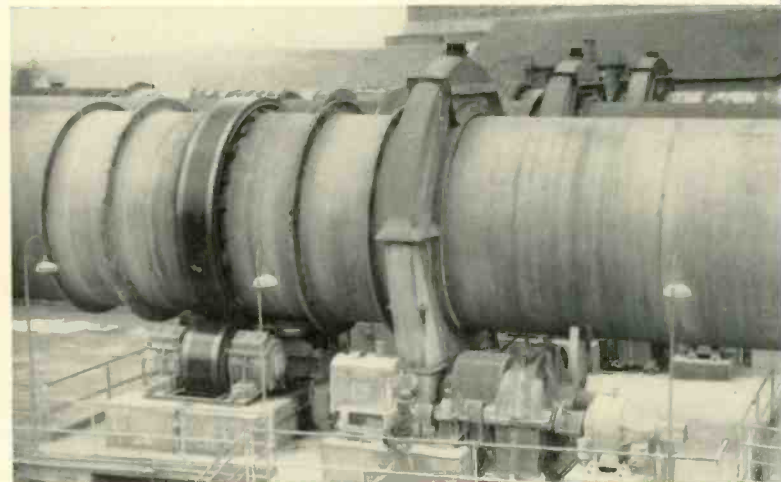

thermal capacity satisfactorily drive these high-inertia loads. Specially constructed synchronous motors are sometimes applied on hammermills and impactors.

Modern kilns are driven by adjustable-voltage d-c drives. A speed range of 4-to-1, continuously rated at constant torque, is the typical operating requirement. Sometimes intermittent operation over an 8-to-1 speed range is desired to facilitate kiln maintenance. Here, the kiln feeder motor (5 to 15 hp) speed is varied in proportion to the kiln drive motor (75 to 250 hp) speed so that the raw material is fed into the kiln at a rate proportional to the kiln rotational velocity. The separately excited kiln and feeder motors are powered from the same adjustable-voltage d-c generator. However, provision is made to allow independent speed adjustment and operation of the feeder motor.

The kiln is usually provided with an auxiliary gasoline-engine drive to provide slow-speed rotation of the kiln during a power outage. Cessation of rotation when the kiln is at operating temperature can cause the kiln to be damaged by warping.

Material is handled in a cement plant by numerous conveyors, elevators, pumps, and overhead traveling bucket cranes. The squirrel-cage induction motor satisfactorily drives the elevators and cement pumps and compressors. Conveyors below 60 horsepower are usually driven by squirrel-cage induction motors. The wound-rotor induction motor is often used on belt conveyors of 60 hp and above to smoothly accelerate loaded conveyors up to rated speed within limiting belt stresses.

The overhead traveling bucket cranes are extremely important to overall plant operation. Failure of the overhead storage cranes would shut down a cement plant in several hours, as these cranes handle practically all of the coal, raw limestone, gypsum, sand, and clinker. The modern trend favors the a-c supplied crane. The bridge and trolley motions of this crane are almost universally wound-rotor induction motor driven with secondary resistance control. The hold- and close-bucket hoist drives are either wound-rotor motor driven with secondary resistance control, or adjustable-voltage d-c drives. When finer speed and torque control and more maintenance-free operation is required, the adjustable-voltage d-c hoist drive is used.

The dripproof enclosed motor is satisfactory for most

cement-plant drives where moderate dust conditions exist. This enclosure minimizes heavy settling of cement dust on windings and commutators, and allows periodic blowing out of the motors with compressed air. In extremely dusty locations, the totally-enclosed, fan-cooled motor with external neoprene rotating bearing seals (flingers) is applied. Special breathers and bearing seals are provided for cement-plant gearmotors. In d-c machine application, machine speeds of 1200-rpm or lower are preferred to minimize brush and commutator maintenance. The large synchronous pedestal-bearing machines are usually of open construction. Special neoprene treatment is given to the Thermalastic insulated windings to protect against abrasive dust particles.

The cost per horsepower at different voltages for motors and associated control is shown in Fig. 6. A choice of motor voltages based on cost alone would dictate that motors of 200 horsepower and above be rated 2300 volts in preference to 440 volts, and 250 horsepower and above be rated 4000 volts, depending upon the distribution voltage available. Other factors also influence the "break points" in motor voltages. For example, it may not be desirable to run a high-voltage line to motors in certain locations or to have a single motor on a higher voltage. Or the higher motor voltage may be preferred where continuity of service requires independence from power centers.

The power factor of a cement plant is unusually high, close to unity in most plants. The leading reactive volt-amperes supplied by large 80 percent power factor synchronous mill motors is sufficient to correct the power factor of the numerous induction motors used throughout the plant. Additional power-factor corrective capacitors are rarely required. Cement plant loads, with the exception of the quarry and crushers, are steady loads; and the load factor is relatively high, usually 80 to 90 percent.

With the continuous flow lines so dependent upon successful operation of electrical equipment for continuity of operation, cement plants have established effective preventative maintenance programs. Regularly scheduled checks of machinery, tabulations of machine operating records, and an adequate supply of spare parts characterize the typical program. From the plant substation to the shipping platform, the electrical supply and drive systems are safeguarded to provide the utmost in flexibility, continuity of service, and safety. ■

Rotary cement kiln drive with a 125-hp d-c drive motor and auxiliary gasoline engine drive.

Fig. 5—Influence of operating voltage on drive cost.

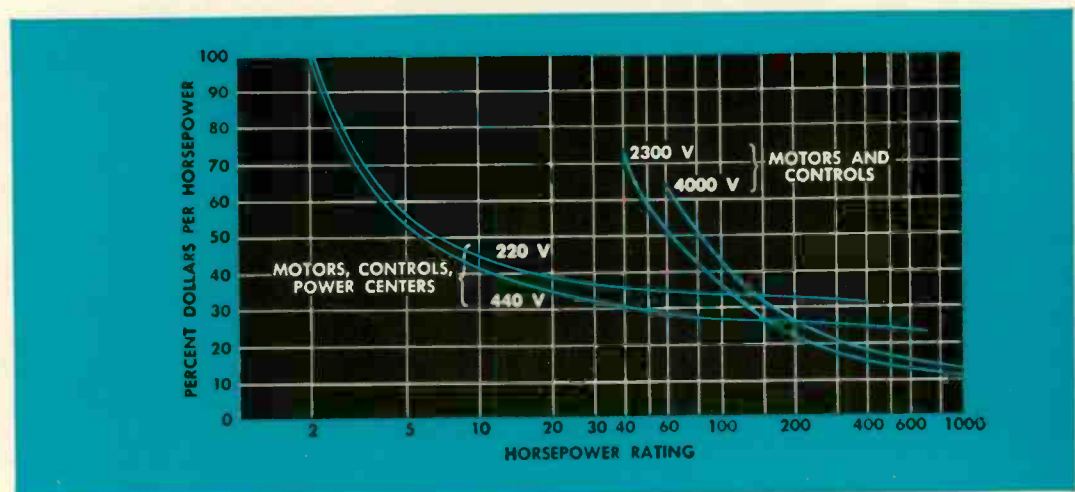

selection of fan types

A. N. ROGERS

Sturtevant Division
Westinghouse Electric Corporation
Hyde Park, Massachusetts

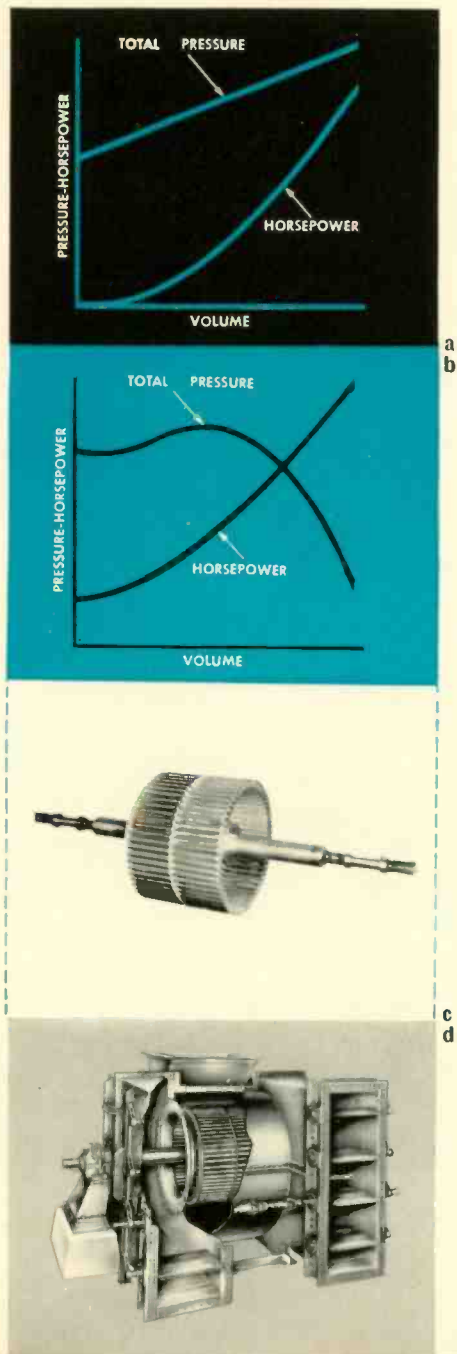

■ The primary problem in fan selection is to evaluate the types of fans commercially available in relation to the application requirements. For any given service, one type of fan will best meet the operating conditions.

The three general types of centrifugal fans are based on wheel blading—forwardly curved, radial, and backwardly inclined. Although performance of individual fan designs by various manufacturers is not identical, the basic characteristics can be predicted and are determined by the wheel blading.

Forwardly-Curved Blading

Basically, forwardly-curved blading is designed to increase the velocity component of the air leaving the tip of the wheel beyond the rotational velocity. Thus, this wheel builds up a large velocity or a high portion of kinetic energy. The diffusion space in the scroll or housing is employed to convert this velocity into pressure or useful potential energy. The transformation of kinetic energy into pressure is at best a difficult and inefficient process.

The theoretical design characteristic of this type of blading is such that the pressure rises continuously as the volume increases. At the individual design point, the area of maximum efficiency, this characteristic is evident (Fig. 1). As the volume increases, however, the blading reaches a stall point where the air is no longer able to follow the blading contour. Beyond the maximum efficiency point the pressure characteristic drops off. Because pressure tends to increase with volume, the horsepower characteristic curves rapidly upward, reaching a high peak at wide-open volume. The characteristic dip in the region of blocked tight is caused by the inefficiency at the lower-volume conditions.

Because of this dip in the pressure curve, fans with forwardly-curved blading have been called characteristically unstable. Assuming proper fan design, however, this type can be perfectly stable in operation even in the region of the dip. In many instances, the system on which the fan operates determines the ultimate stability of operation. If a system follows the fan curve in the portion where it is rising with volume increase, hunting and instability will occur. But such a system is exceptional. Most normal system characteristic curves cross the fan curve at a sharp angle, especially where fan pressure is at a peak.

Stability of operation depends to a large extent upon response characteristics of the system. In theory, the system resistance curve limits the fan to a single point of operation. If the volume increases, the system resistance increases, and conversely if the volume decreases, the system resistance decreases. In practice, however, a system may be made up of long runs of ductwork or a plenum space that has a response lag. This means that a momentary increase in volume can occur before the pressure rises to a compensating point. Following this, the over-compensation of pressure increase tends to reduce the volume, so that surging or pulsation occurs. This condition is not limited to forwardly-curved blading, but is possible with any fan type operating on the blocked-tight side of the pressure peak. However, the dip in the pressure-curve characteristic of forwardly-curved blading often magnifies the problem.

Fig. 1—Forwardly-curved blading
a—Theoretical curve
b—Actual curve
c—Typical wheel
d—Induced draft fan cutaway to show wheel

When quick-response resistance such as filters, coils, or straighteners are located close to the fan and make up a major portion of the total resistance, the tendency toward pulsation is minimized.

The pressure dip of forwardly-curved blading is a serious drawback to parallel operation when fans are operating at peak efficiency. When fans are individually motored, one fan can be carrying more than its share of the load and the other fan much less. However, in unitary equipment with two fans running on a single shaft, this problem is not serious. The overall output will not vary far from design conditions even though the fans are unequally loaded, and the combined horsepower will not normally overload the motor. When air from two fans is carried in individual ducts for a distance before joining, the imposed series resistance helps stabilize operation. Under most conditions, unitary equipment is not operated at the maximum fan efficiency, and where the pressure curve falls off with increased volume, there is no question of successful parallel operation.

Popular misconception of the forwardly-curved blade type is that it is inherently a large volume or high-capacity fan. Examination of the fan characteristics shows that this is not true. A fan of high volumetric capacity has its peak efficiency well out toward the wide-open volume conditions. High efficiency at low pressures is also desirable. With the characteristic increase of pressure with larger volume flow of forwardly-curved blading, this is not possible. The fan has high capacity *pressure-wise*, but as the pressure drops off, inefficiencies build up and design characteristics are low. This fan type can, for a given size, produce a tremendously large volume out toward wide open but at low efficiency. This is due in part to its characteristically low speed.

The scroll of the forwardly-curved bladed fan can be wrapped more tightly around the wheel than other fan types. This is due to the direction of the velocity component leaving the wheel, so the fan can have a comparatively small casing for the size of the wheel. Because pressure builds up rapidly, the rotational speed required for a given duty is low. The wheel design with its multiplicity of small blades set close to the rim permits light-weight construction. This combination of features offers advantages for many applications.

The small casing allows the fan to be used to advantage when space requirements are extremely small. Notable examples are unitary equipment such as air-handling units, packaged air-conditioning units, and furnace fans. The light weight and low rotational speed of the wheel permits a smaller shaft and bearings, and becomes particularly advantageous when two or more fans are operated on a single shaft. Again, low rotational velocity at high pressures makes it well suited for high-pressure applications, such as induced draft, where its small size and low initial cost show up to advantage. (The high velocities across the face of the blades preclude its use when erosive material is present in the air stream.)

Radial Blading

Radial blading was probably the earliest type developed and is exemplified by the early paddle-wheel units. Present-day modifications include radial tip blading. The theoretical characteristic of the pressure curve would show a constant pressure regardless of volume flow. In practice again, the air will not follow the blading as volumes increase and the pressure curve is reduced at the larger volumes (Fig. 2). The horsepower characteristic is close to the theoretical straight-line increase.

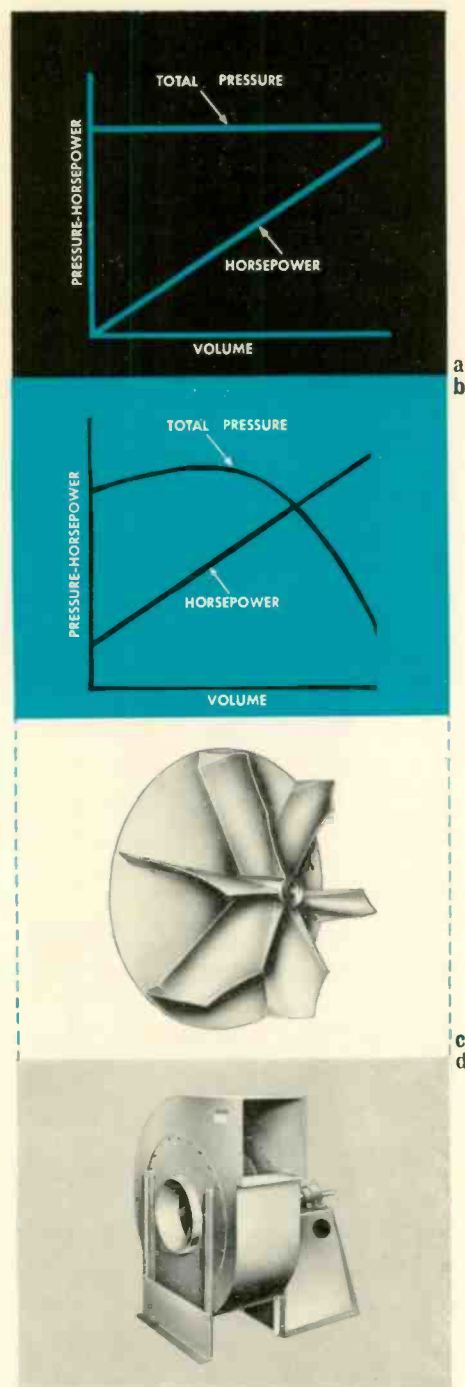

Fig. 2—Radial blading
 a—Theoretical curve
 b—Actual curve
 c—Typical wheel
 d—Industrial fan employs radial blading for material conveying

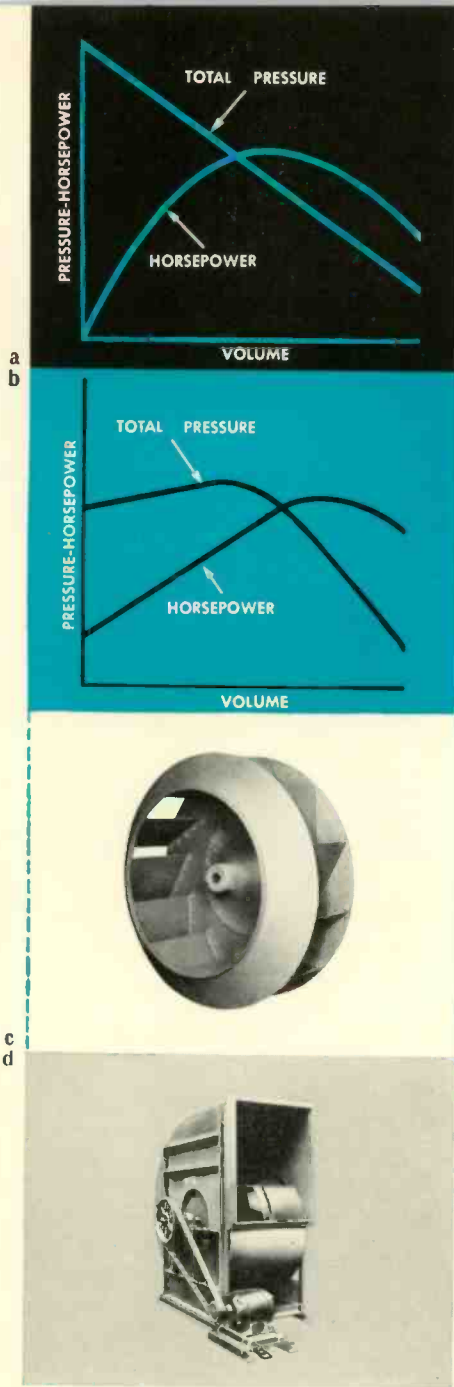

Fig. 3—Backwardly-inclined blading
 a—Theoretical curve
 b—Actual curve
 c—Typical wheel
 d—Heating and ventilating fan

The theoretical design of the casing would be larger than the forwardly-curved blading type, but in practice (due to the casing-width, blade-width ratio) this is not always done. The maximum static efficiency for this type of blading has been about 70 percent and there is no immediate trend towards its increase. One of the major advantages of this type of blading is that the blading stresses are essentially radial, enabling the wheel to be designed for high speeds. This characteristic makes it a popular blading choice for centrifugal compressors. The flat pressure characteristic is also often desirable in centrifugal compressor design, since it enables the machine to handle a range of volumes at practically constant pressure.

The pressure characteristic of radial blading is inherently stable and shows only a minor reduction from the peak pressure at the blocked-tight condition. This type of blading will operate successfully in parallel at the highest efficiency.

The other desirable characteristic of radial-bladed fans is the self-cleaning action of the air sweeping over the blades, thus preventing material build-up. This makes the fan ideal for material handling and other types of dirty-air application.

Backwardly-Inclined Blading

Backwardly-inclined bladed fans, the most recently developed type, have become increasingly popular for general application since the early 1920's. The theoretical pressure curve is maximum at the blocked-tight condition, with pressure decreasing in a straight line as the volume increases. Except for the area close to blocked tight, the actual characteristic closely follows the theoretical (Fig. 3). The horsepower characteristic curves downward as the volume approaches wide open—in both theory and practice. Because this blading type follows more closely the "natural" path of the air through the fan, air tends to follow the blading quite closely even at the higher volume conditions. This enables the design point to be closer to the wide-open volume condition, and efficiency holds up well in the high-volume range. Due to these facts, the backwardly-inclined bladed fan has a higher volumetric capacity than forwardly-curved or radial blading.

The velocities leaving the blade tips are low and most of the pressure increase is brought about in the wheel itself. This apparently is one of the big reasons why, in practice, the efficiency of this type of blading is considerably higher than the other types.

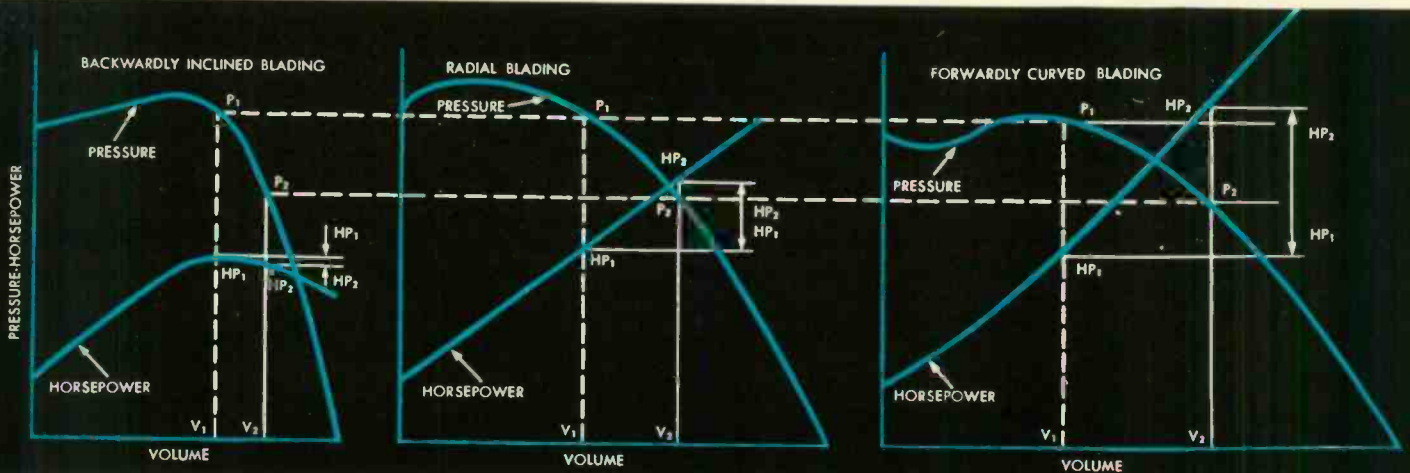

One disadvantage of this type of blading is that the theoretical scroll is very large. However, in commercial designs the size is reduced by widening the casing with respect to the wheel diameter. Thus the casing width of the backwardly-inclined fan is generally much wider with respect to the tip of the fan wheel than the forwardly-curved bladed type.

Another disadvantage of this type of blading is that, because the spin velocity of the air leaving the wheel is low, the rotative speeds must be high. This imposes rather high stresses on the blades themselves, and wheel construction is necessarily heavier.

The pressure characteristic of backwardly-inclined blading is well adapted to parallel operation. Horsepower rises to a peak in the vicinity of maximum efficiency and drops off at larger volumes. In fan selection, this means that if system resistance is less than the design estimate the fan motor will not be overloaded. In contrast, the radial-bladed fan would require a moderate horsepower increase and the forwardly-curved bladed fan would require considerably more power and the motor would be overloaded if the design estimate is not close to the actual condition (Fig. 4).

For heating and ventilating applications, the forwardly-curved bladed fan and the backwardly-inclined bladed fan are generally a standoff as far as price and size are concerned. Size for size in present-day designs, the backwardly-inclined bladed fan is more efficient and thus requires less power to operate. The non-overloading horsepower characteristic of the backwardly-inclined bladed fan is an additional bonus, which compensates for the inaccuracies normally encountered in calculating system resistance.

Much has been said about the relative noise level of forwardly-curved versus backwardly-inclined blading. Considerable testing has been done, and present results indicate that the two types are actually a standoff. Contrary to previous thinking, even the predominant frequency of the noise from both types is in the low-frequency range.

Airfoil blading is a modification of backwardly-inclined blading and is a comparatively recent innovation on a commercial scale. With the streamlining of the blade contours, the air is able to follow the contours of the blading more closely. This results in higher efficiency and quieter operation but the volumetric capacity is reduced to some extent. This type of blading is adapted to high-pressure applications both from a power evaluation standpoint and the strength standpoint. The double surface of airfoil blading is stronger

than a flat blade or a curved single surface. This enables fans to operate at higher peripheral velocities and for the first time permits the high efficiency of the backwardly-inclined bladed wheel to be adapted for centrifugal compressor applications.

Axial-Flow Fans

In recent years, development of axial fans has accelerated at an unprecedented rate. Although the design potentials are too involved to permit detailed explanation here, it is sufficient to say that axial-flow types can be developed to suit most applications. At present the axial-flow design is noisy compared to centrifugal fans, but future developments may eliminate even this drawback. Its potential in the very-high capacity range far outstrips that of any centrifugal type. For this reason, the axial-flow design is well adapted to clean-air industrial applications where noise is a relatively minor consideration. Its compact design and simplicity of mounting and erection make it a good choice whenever conditions will permit its use.

Summary

The forwardly-curved bladed fan is well adapted to high-pressure applications, particularly in mechanical draft work, and can be used when space requirements are limited, as in unitary equipment. The efficiency is not outstanding and its ability to operate in parallel is limited to volumes beyond peak efficiency. The radial-bladed fan is adapted to material conveying and other applications where material must pass through the fan itself. The inherent strength of the radial-blade design is excellent for centrifugal compressors and other types of high-pressure fans, but the efficiency is only medium. The backwardly-inclined bladed fan in commercial form is undoubtedly best for heating, ventilating, air conditioning and general industrial applications. Efficiency is the best, the pressure characteristic is good, parallel operation is no problem, and the non-overloading horsepower characteristic allows leeway in system design. Airfoil blading can be used for high-pressure applications and the efficiency and quietness of operation are even better than the flat-bladed fan. Axial-flow types are excellent for large-volume, low-pressure, clean-air duties where higher noise levels are relatively unimportant. ■

Fig. 4—Effect of pressure change on power consumption. P_1 , P_2 , and V_1 equal for all fan types. HP_1 approximately equal except for efficiency difference

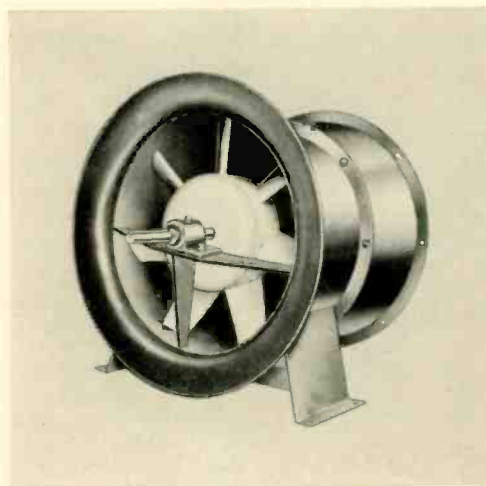

Fig. 5—Typical axial flow fan

super-pressure turbine design

C. C. FRANCK

Consulting Engineer
Westinghouse Electric Corporation
Lester, Pennsylvania

■ When the super-pressure, 5000-psi steam turbine being built for the Philadelphia Electric Company goes into commercial service in 1959, this 325 000-kw machine will be the largest capacity turbine operating with the highest pressure, highest temperature, and on the most efficient cycle ever conceived. Steam will enter the turbine at 1200 degrees F, 5000 psi, and will be reheated twice to 1050 degrees F. The cross-compound machine, shown in Fig. 1, will have the super-pressure element in tandem with a very-high-pressure and high-pressure element, all operating at 3600 rpm; this unit is cross compounded with an intermediate-pressure element in tandem with a double-exhaust, low-pressure condensing element operating at 1800 rpm.

Most of the fundamentally new engineering problems for the turbine are in the super-pressure unit. When the super-pressure turbine design was studied, two basic types of turbines were considered; in one, throttle steam would be expanded completely in a single casing to the first reheat point; the second type split the overall energy drop from the throttle to the first reheat point into two parts: (1) super-pressure, and (2) very-high-pressure, high-pressure turbine units. This second design provided the characteristic construction necessary for 1200 degree F inlet steam, in spite of the fact that available materials are limited to known austenitic compositions.

This selection permits the smallest practical element to be subjected to steam pressures and temperatures beyond the limit of present operating experience. Further, it provides greater latitude in the selection of high-temperature alloys, some of which are not available in large sizes, and permits the use of conventional casing-design principles, and a relatively short and small diameter rotor. The major disadvantage of this selection is the problem of high shaft-end leakages.

Steam Inlet Piping

One of the most important considerations in the design of a large unit for super-pressure operation is the steam inlet piping. A perspective view of the steam inlet piping is shown in Fig. 2. Flexible loops are provided for thermal expansion between the fixed governing valves and the turbine casing. One pair of bolted flanges with a flexitolic gasket is provided in each inlet line; connections to the cover permit dismantling the unit for inspection; those in the base reduce the number of field welds in heavy austenitic piping.

The turbine control system provides means for testing any one pair of stop and governing valves at any time during normal operation. An essential feature for such individual valve "exercising" is shown in Fig. 2. The pair of inlets on each side of the turbine serve nozzle-chamber quadrants diametrically opposite with respect to the axis of turbine rotation. An equalizer pipe connects between the pair of inlet lines leading from the control valves on each side of the turbine. When any one governing valve and/or the companion stop valve is closed, its nozzle chamber will nevertheless receive substantially normal steam flow and pressure through the equalizer. Excessive shaft deflection and blade stress, which would result from a partially admitted first-stage wheel, are thereby avoided. Of course, proper procedure must be followed in closing valves. An automatic trip is provided as a safeguard against maloperation.

Each of the four super-pressure turbine leads from the steam generator is field-welded to a special connector just ahead of the stop valves. Each inlet is provided with a stop valve and a governing valve, close coupled as illustrated in Fig. 3 (a). Each set of stop and governing valves is supported

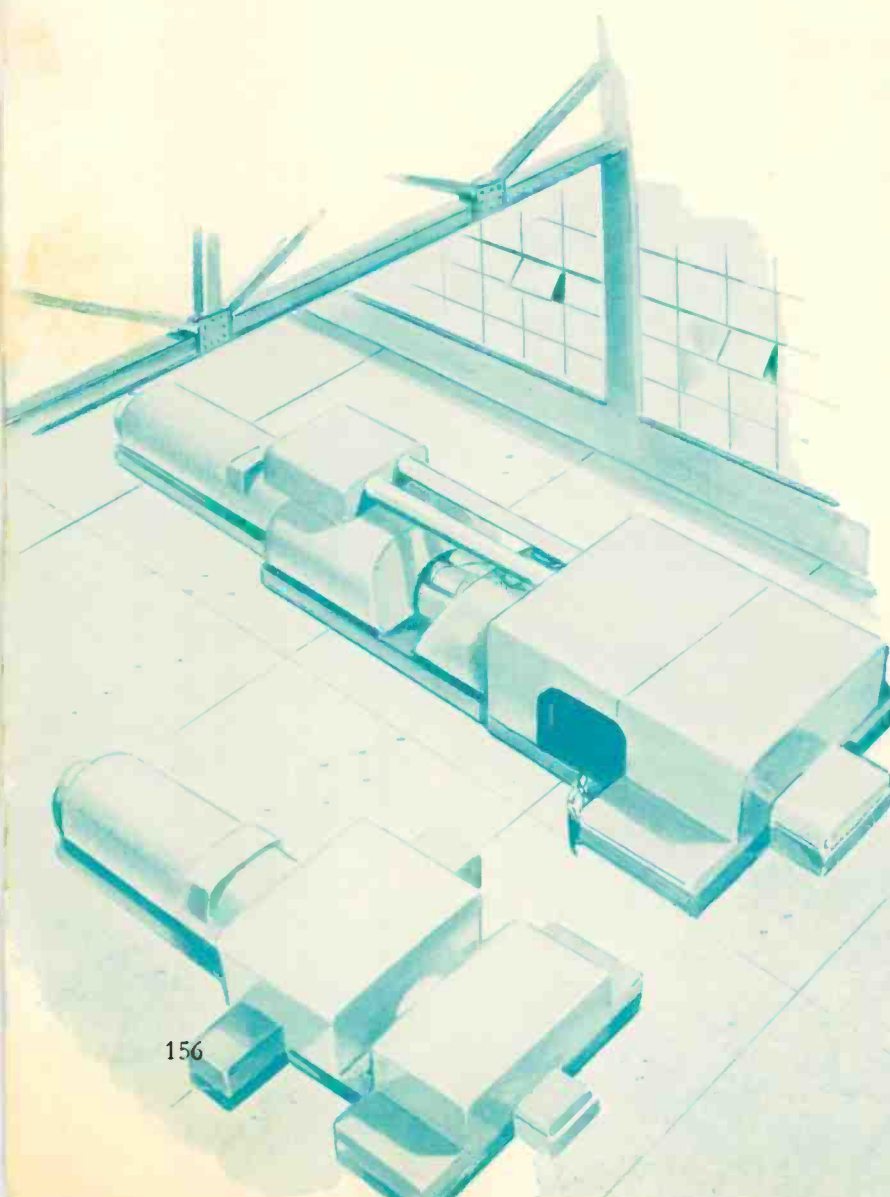

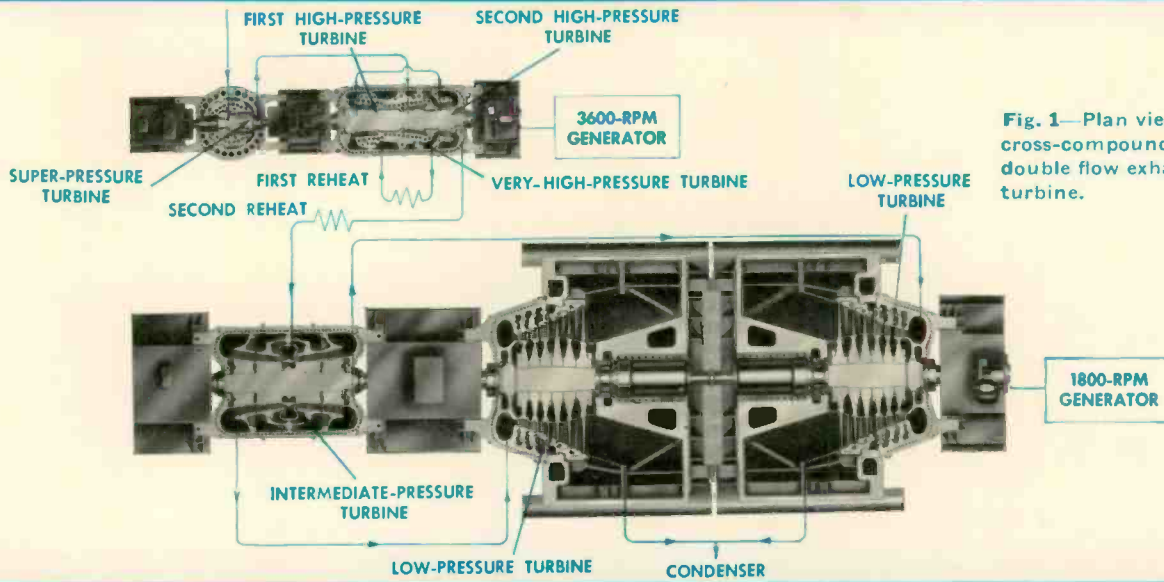

Fig. 1—Plan view of super-pressure cross-compound 3600/1800 rpm double flow exhaust—double reheat turbine.

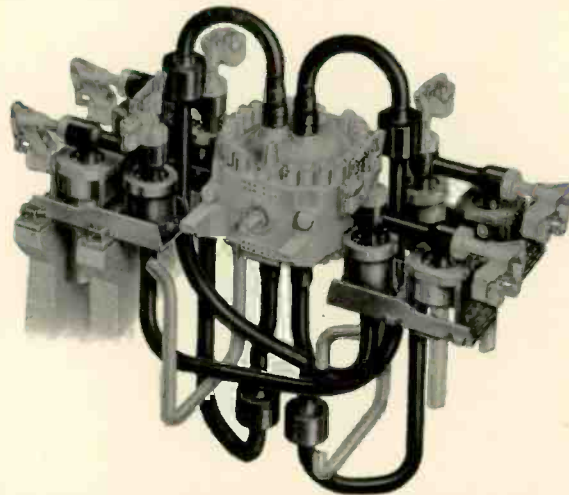

Fig. 2—Inlet piping for the super-pressure turbine element.

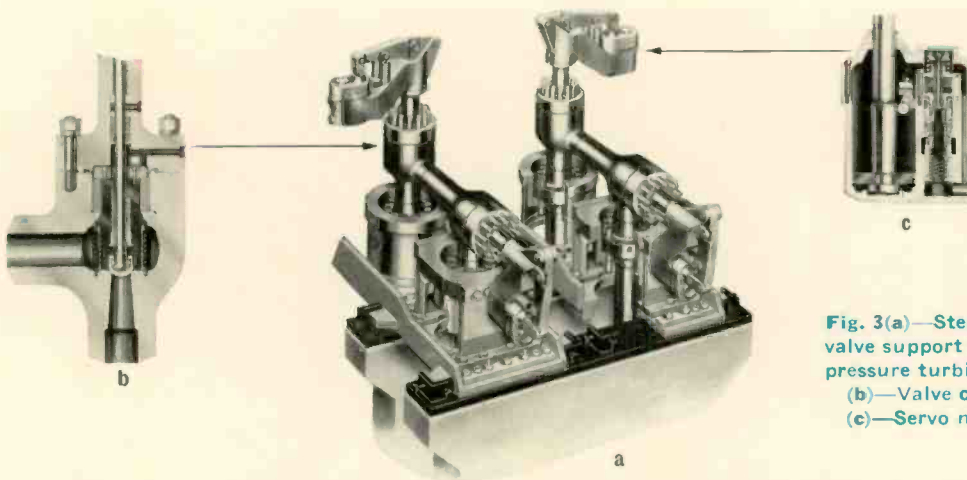

Fig. 3(a)—Steam inlet features and valve support for the super-pressure turbine element.
 (b)—Valve construction
 (c)—Servo motors

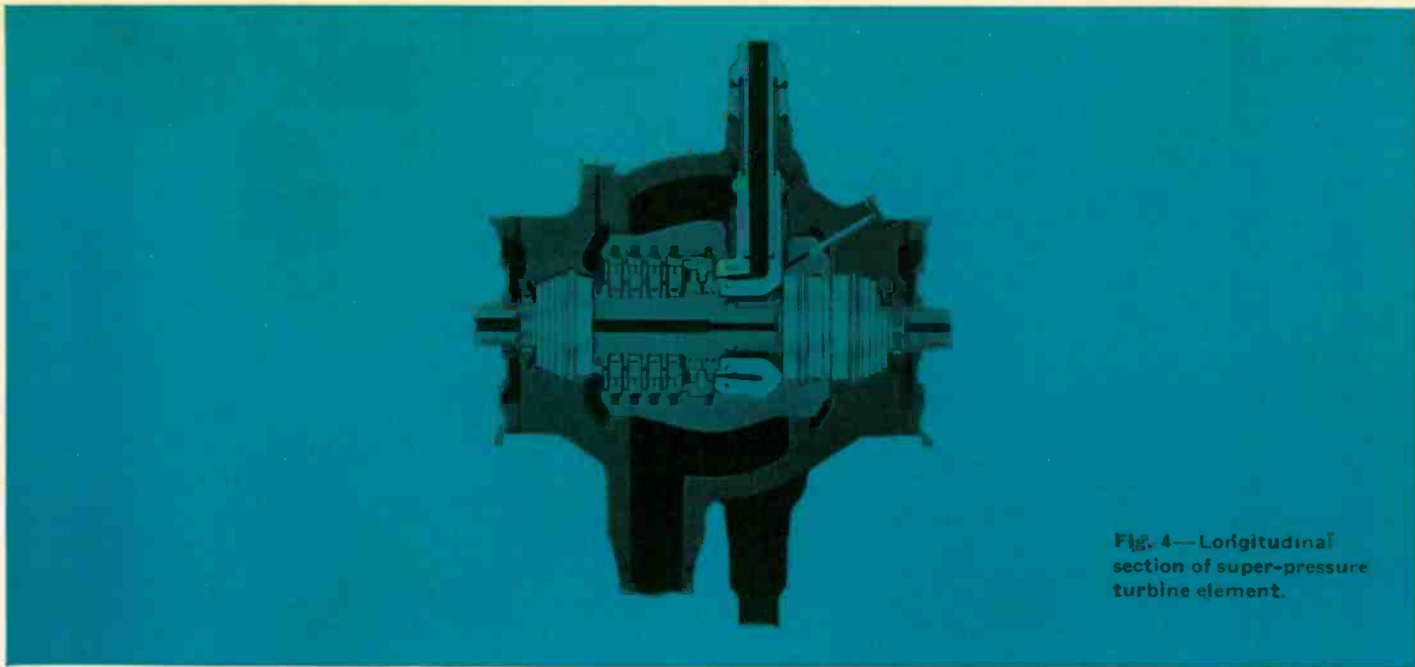

Fig. 4—Longitudinal section of super-pressure turbine element.

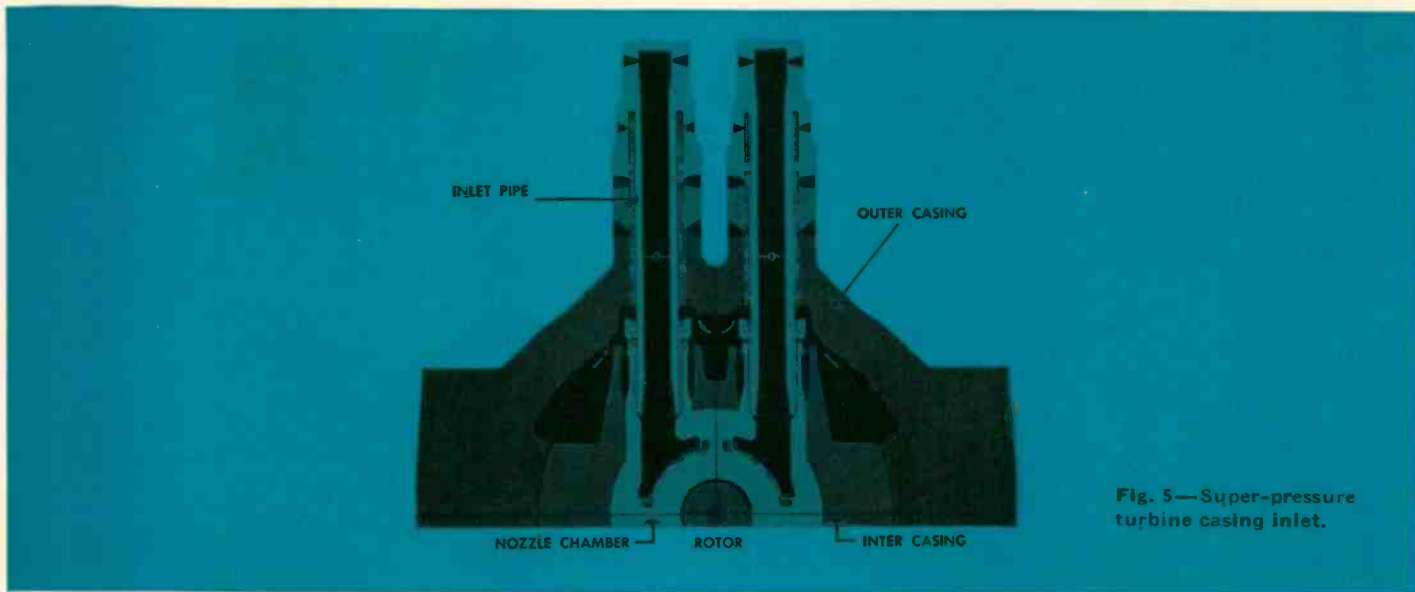

Fig. 5—Super-pressure turbine casing inlet.

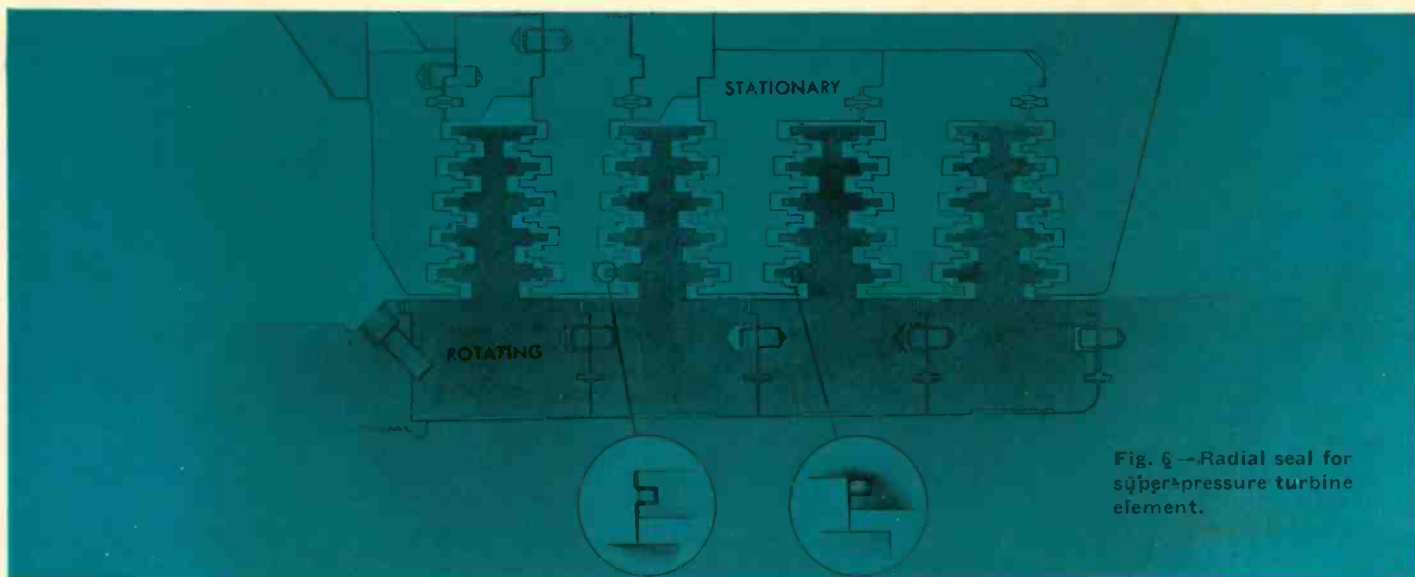

Fig. 6—Radial seal for super-pressure turbine element.

within a steel framework, or "sled," which in turn is fixed rigidly to the turbine foundation. Initial adjustment of sled position is made with spacer blocks to provide for "cold spring," such that at full load, the leads connecting to the turbine are theoretically free of bending stress.

The stop valve is supported by flexplates that fix it vertically, but allow and control the direction of its thermal expansion in a horizontal plane with respect to the governing valve. This anchorage allows the station main steam inlet piping to be designed economically since practically full-code piping stresses can be developed at the user's connections.

Steam inlet valves operating on steam at 5000 psig and 1200 degrees F presented many design problems. Most important is the ability of the valves to be operative when an emergency arises.

Details of valve construction are shown in Fig. 3 (b). Each valve has special anti-vibration and anti-spin features. Valve stems back seat in the full-open position against their inner-guide bushings, thus permitting larger than normal clearance between stem and bushing. The valve body closure is effected by a combination of threaded-plug and pressure-sealing devices, with reduced-pressure steam leakoff. Thus, the flange cover and its bolting is relatively light, the valve is easily accessible, and the body is relieved of a massive flange projection. Each valve body is a closed-die forging, of type-316 alloy.

Servo motors shown in Fig. 3(c) operate both the stop valve and governor valve, and are attached directly to the bonnet of the valve so as to lock in the forces required to move the valve. This eliminates operating bending moments on the joint between the valve body and bonnet, leaving only the direct forces due to internal pressure and servo motor operating loads on the valve stem.

Super-Pressure Turbine Element

The steam from the control valves flows into the super-pressure turbine, shown in Fig. 4. Steam at 5015 psia and 1200 degrees F is supplied through four inlet lines, each having its own stop and governing valve. Each of these inlets is connected to one of the four nozzle chambers, which provide full circumferential admission to the first of a total of five impulse stages. The first stage is velocity compounded, to extract the maximum possible energy, thereby effecting a maximum reduction in steam temperature. In spite of this, the temperature encountered at the exit of the first stage is approximately 1120 degrees F at maximum steam flow. From the final super-pressure turbine stage, steam exhausts at 2500 psia, and 1000 degrees.

The shape of the outer casing of the super-pressure element approaches that of a sphere. The casting is of ferritic steel, horizontally split and flanged, and is center-line supported on adjacent pedestals. The outer casing provides center-line support and key guidance for a cast-austenitic-steel inner casing, which contains the working steam until its pressure has been lowered to 2500 psi. The inner casing is also horizontally split and flanged, and supports the interstage diaphragms and the four 90-degree, cast-austenitic-steel nozzle chambers, the latter through welded connection at their steam inlet necks.

Turbine Case Inlet Features

Two steam inlets are provided in both the inner and outer casing, covers and bases (Fig. 5). These pipes, of austenitic type-316 alloy, are connected to the outer casing through transition pieces and welds. Prolongations of the inlet pipes

extend into the nozzle chambers through slip joints, which are sealed by stacked-type sealing rings. This construction provides rings that are alternately fitted with very small clearance to the turn of the inlet pipe and the bore of the nozzle chamber. Thus, relative motion of the component parts is provided in all directions.

These pipe extensions are for some distance parallel and in close proximity to the outer casing, the transition piece, and its welds. To shield the outer casing from 1200 degree F inlet piping heat radiation, particularly in the zone where dissimilar metals are joined by welding, baffles are placed between the inner pipe and the outer casing snout, as shown in Fig. 5. They consist essentially of spirally surfaced cylinders surrounding the pipes, supplemented by orificed steam leak-offs from the casing end of the transition pieces and terminating at a suitable pressure location in the very-high-pressure turbine. Consequently, super-pressure turbine exhaust steam at 1000 degrees flows outward and then inward along the cylindrical baffle to the very-high-pressure unit, with an insignificant overall loss in thermal availability while still providing adequate cooling. To assure that heat radiation from the inlet portions of the inner casing will not cause excessive heating of stagnant steam and too high a temperature in the ferritic outer casing in this vicinity, an auxiliary exhaust pipe is provided on both the outer casing cover and base at this end of the super-pressure turbine element. These pipes connect back into the main exhaust pipes from the super-pressure turbine element.

The first stage of the super-pressure turbine element is designed for operation with complete admission at all loads. Although this results in a penalty in performance at light loads, various design considerations created by partial-admission operation made complete admission at all loads necessary. For example, if only one quadrant in the arc of admission were wide open, and a second quadrant valve were to start to open, there would be an instantaneous drop of 165 degrees F from the 1200-degree inlet temperature. Conditions under which subsequent valves would operate are much less severe, but still give temperature variations of appreciable magnitude.

Secondly, the loading of the first row of blading is also affected by sectional-valve operation. For example, under normal conditions, the blade loading of the first rotating row is equal to 188 kilowatts per blade; but on the assumption of two quadrants closed and two quadrants open, this load would increase to 270 kilowatts per blade.

Another important consideration resulting from partial-load operation is the resultant force on a spindle, which would cause the shaft to deflect. Under conditions of complete admission, forces are balanced and there is no shaft deflection. However, with two adjacent quadrants closed and two quadrants open, the partial admission force would be approximately 35 000 pounds. This would result in a shaft deflection of 0.06 inch, which would make it impossible to maintain reasonable radial clearance between the rotating and stationary parts.

Turbine Rotor Shaft Seals

The relatively large differential expansion of rotors and casings due to the high operating temperature, along with the necessity of assured control of leakage passages, made individual longitudinal positioning for the super-pressure rotor desirable. The super-pressure rotor is therefore connected through a longitudinally elastic coupling to the remaining 3600-rpm rotors and has its own thrust bearing.

Also, because of the high steam pressure and density involved, the problem of sealing the steam at the casing ends becomes extremely important. If sufficient conventional radial step-type labyrinth seals were applied to keep the leakage within reasonable limits, an extremely long turbine rotor would be required.

These problems are materially reduced with a nested-type radial-seal design, shown in Fig. 6. By this means, a satisfactory number of individual throttlings can be obtained within reasonable axial spacing. This type of construction is used in the seal between the first stage and the outlet of the forward end of the inner casing, and again at both ends of the super-pressure element from the exhaust pressure to the leak-off of the steam seal outer glands. These glands comprise a series of alternately stacked complete ring stationary and rotating members, each of which carries a number of ribbon-type seal strips on its interspaced lands.

Super-Pressure Turbine Rotor

No long-time practical experience is available for high-speed rotors subject to within 140 degrees of the first-stage operating temperature expected at Eddystone. This is perhaps the most important consideration that led to splitting off the super-pressure element into one of small overall dimensions. Although this super-pressure rotor, shown in Fig. 7 (a), will weigh only about 3500 pounds, it will produce 44 000 kw—about one third of the load on the 3600-rpm shaft. As a result, particularly of its small diameter rotor, operating stress levels will be quite conservative for some of the well-known high-temperature alloy forgings. However, although the rotor has been reduced to a small component, the forging required is well beyond prior experience with high-temperature alloys. Consequently, several alternate super-pressure rotor alloys and constructions are being considered.

Discaloy alloy has been used extensively for gas-turbine and jet-engine disc forgings of the diameter required, but without the thickness (or body length) and without integral shaft ends. However, a single-piece Discaloy forging of suit-

able dimensions has been produced and subjected to metallurgical processing, physical examination, and is being machined.

Concurrently, William Jessup and Sons, Ltd., in England have made a single-piece forging of G18B, a well known European gas-turbine alloy.

Either of the foregoing alloys would be expected to provide a normal long-life rotor. However, to assure the availability of an operable rotor, single-piece forgings have been ordered of the following compositions: (a) a modified 12-percent chrome steel forging, and (b) a chrome-molybdenum-vanadium forging, commonly used in steam-turbine rotors. The latter will be vacuum poured. These are being provided purely as insurance against any possible delay resulting from an unexpectedly long period of development for the Discaloy and G18B forgings. Present knowledge indicates these backup rotors would have a reasonable but limited service life.

Furthermore, a shaft and separate-disc rotor of unique detail but assembled in conventional manner has been designed. This rotor, shown in Fig. 7 (b), has six discs, with eccentric hubs, independently shrunk on the shaft. These hubs provide two advantages, one of which is the tendency for the toe to maintain a grip on the shaft despite considerable creep of the disc; and, the other is the available space to permit radial keying to the shaft in a relatively low stressed portion of the disc. The stresses in the disc itself become somewhat larger but since the size of forging is small, it should be possible to assure increased strength of metal. The radial keys have the obvious advantage of maintaining a centered disc even if the bore fit becomes negative, creating a clearance. A loose disc without such a feature becomes an unbalance, the order of which is difficult to predict, but as with any unbalance, a cause for concern.

Such a built-up rotor has little precedent and represents a major undertaking without benefit of background operating experience. However, this construction, if proven satisfactory, could have great possibilities in providing for ultimate reduction in component forging size, thereby permitting use of optimum high-temperature, high-strength alloys. ■

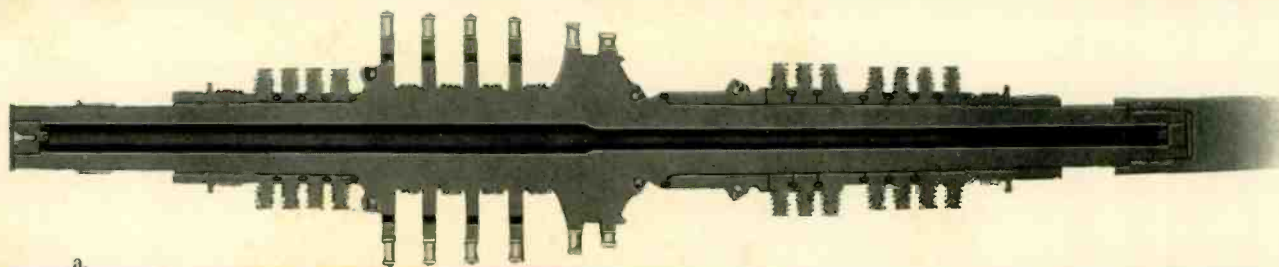

a.

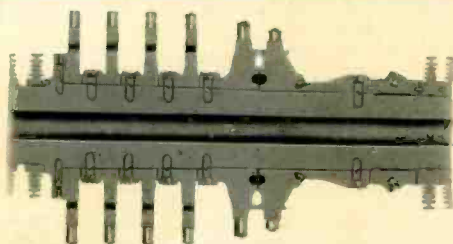

b.

Fig. 7(a)—Solid type super-pressure turbine rotor.
(b)—Disc type super-pressure turbine rotor.

Co-authors **R. L. WITZKE** and **A. R. JONES** are no strangers to either electric utility or nuclear problems. Witzke, a graduate of the State University of Iowa (BS in EE, 1934; MS in 1936) had his first Westinghouse assignment in the Electric Utility Engineering Department. For the next three years he helped in the development of the analog computer at Westinghouse. In 1939, he was assigned responsibility for electric-utility applications on the West Coast and in the New England region—certainly a far flung responsibility. From 1947 to 1952 he was a consulting engineer for the company's Industry Engineering Department, where he helped with the solution of many unusual application problems. In October 1952, Witzke organized and was placed in charge of the Atomic Power Study Group, where he was responsible for the evaluation of reactor types for power production. When this activity expanded in 1954, he was made manager of the plant section, and subsequently manager of the application engineering department.

Jones' course to his present assignment in Witzke's section has followed a different pattern. Originally Andy became a teacher. He attended Western Illinois State Teachers College for three years, and later taught school for a year. In 1942 he began a 40-month tour with the Air Force. After the war Jones decided to try electrical engineering. He enrolled at Clemson College, and one year later earned his bachelor's degree in electrical engineering. (He has since earned his Master's Degree at the University of Pittsburgh in 1953.) He came directly to Westinghouse, and after the usual stint on the Graduate Student Course, spent a great deal of time on the Tidd 500-kv Test Project. In mid-1951 he transferred to the special problem section of Electric Utility Engineering. In November 1952, Jones followed Witzke to the Atomic Power Study Group, and later moved into the application engineering section.

The development of the 10-megawatt magnetron described in this issue was a major engineering and manufacturing effort requiring a team of engineers.

Three of the key tube personnel in the team were **E. C. OKRESS**, **C. H. GLEASON**, and **W. R. HAYTER, JR.** Okress came to Westinghouse in 1940 after obtaining a Master's Degree in physics from the University of Michigan. His early assignment was on theoretical aspects of a high-power klystron development. Subsequently, as project engineer, he was responsible for development of resonators, magnetrons, and microwave devices. He was the principal designer and project engineer of the 10-megawatt magnetron. While assistant manager of advanced development, he fostered a new traveling wave tube development for a Westinghouse radio relay program. Okress is Advisory Engineer for the Elmira engineering department and serves primarily as consultant on microwave tubes and devices.

C. H. Gleason obtained his engineering de-

gree from the University of Kansas in 1940, and two years later his Master's Degree in EE from the University of Missouri. He then came with Westinghouse on the Graduate Student Course, and has since worked with all types of electronic power tubes. In addition to the big magnetron, Gleason has also been working on large hydrogen thyratrons and many types of neutron detector tubes. He was recently made Supervisory Engineer in charge of development activity on ignitrons, thyratrons, transmitting tubes and neutron detector tubes.

W. R. Hayter, Jr., the third co-author, is now a Supervisory Engineer of the microwave tube group responsible for magnetron development. Hayter graduated from the University of Connecticut in 1944, and with spare-time study, obtained his Master's Degree in EE from Stevens Institute in 1950. He came on the Graduate Student Course in 1944, but the Navy had priority on his services for a couple of years shortly thereafter. After returning to Westinghouse, he worked on transmitting tubes for a year and then with magnetrons and microwave devices, primarily on cathodes for magnetrons.

Through formal education and a variety of job experience, **ALBERT KERSTUKOS** has gained a good background in manufacturing methods, processes, equipment, and materials. To this he has also added some design and development experience, to complete the picture. Kerstukos' first job, in 1936, was as a machine apprentice in a transformer plant; then he took a crack at the design of electric coils for motors and transformers. Next he moved more completely into manufacturing engineering, in which job he helped coordinate the efforts of a number of plants. In his next assignment, he went to Mexico to help get initial production started in a new plant he had helped to plan. This job completed, he turned to pilot-plant production of new and special devices for the Armed Forces. In his present job, Kerstukos is an engineer in the New Products Engineering Department. Even while he was busy gaining this experience, Kerstukos found time to further his formal education. While at Westinghouse, he has attended night school at Carnegie Institute of Technology during which time he obtained his BS in 1952 and an MS in 1957.

W. A. PENNOW'S name may be familiar to long-time readers, as the author of a previous article on the problems of landing airplanes in any kind of weather. This time he takes a look at the airport lighting problems that are becoming more intense as jet planes enter the picture. Pennow went to the Milwaukee School of Engineering, from which he gained a BS in electrical engineering in 1923. Then he went on to earn a BA from the University of Wisconsin in 1925, and a Master's Degree from Yale University in 1926.

ANTHONY C. LORDI made his first contacts with Westinghouse through company engineers, with whom he worked while a member of a customer organization. He liked the work they were doing, and in 1954, joined the mining section of the Industry Engineering Department in East Pittsburgh. He works with underground coal mining and the cement industries, hence his article on cement processing in this issue.

Tony spent 1944 to 1946 in the Army Air Force, in the China-Burma-India Theater. Upon leaving the service, he started at Geneva College, but finished up at Penn State University with a BSEE in 1950.

Lordi's hobbies include fishing, golf, and an amateur radio station.

A. N. ROGERS' association with the Sturtevant division started with cooperative work assignments while he was attending Northeastern University, and before the B. F. Sturtevant Company was a part of the Westinghouse family. World War II intervened, and Rogers served three years in the Army, both in Europe and the Philippines. Upon returning to Northeastern, Rogers came back for summer work at Sturtevant—now a Westinghouse manufacturing division.

Rogers joined Sturtevant permanently upon graduation from Northeastern in 1948 with a BSME. He started in the Sales Engineering School, and has since had assignments in several departments—electronic air cleaning, mechanical contractor sales, heat transfer, and general purpose fan products. Rogers is presently a Division Sales Engineer with duties in new product development, market and product data, and fan products application.

C. C. FRANCK came with Westinghouse in 1928 after obtaining a BSME and MSME from Johns Hopkins University. He joined the Steam Division in South Philadelphia, and has worked his way through many phases of steam-turbine design. Various positions have included control engineer, supervisor of the thermodynamics section, section manager of central-station turbine engineering, manager of land turbine engineering, and now, Consulting Engineer for the Lester Division.

Franck is active in a number of technical societies, which include Fellow membership in the ASME, and membership in the International Electrotechnical Commission and the International Steam Tables Committee.

Franck is just as enthusiastic about his hobbies as his work. These include a hi-fi outfit, photography, and boating, his favorite. The owner of a 30-foot twin screw cruiser, he and his family spend their summer leisure in nearby waters. Even the disaster of the *Andrea Doria* did not dim his love for this sport. He was returning from a business-pleasure trip in Europe aboard the ill-fated ship when it was rammed at sea. But upon returning home, Franck was right back out in his own boat the next day.

personality profiles



This is a 45-foot high full-scale mock-up of the pressurized water reactor to be installed at Shippingport, Pa., site of the first full-scale nuclear power plant in the United States for the generation of electricity. The pioneering atomic power station is being built as a joint venture by the Atomic Energy Commission and the Duquesne Light Company of Pittsburgh. Westinghouse Electric Corporation is developing the nuclear components under a contract with the AEC. Duquesne Light Company is financing and building the electric generating portion of the plant and will operate the entire station.

