

WESTINGHOUSE

Engineer



E. Marsh

NOVEMBER 1946

The Ignitron Ignitor—How It Works and Came to Be

Unlike many great discoveries, the ignitor, heart of the ignitron, was no accident. Back about 1930, a group of engineers, headed by Dr. Joseph Slepian, were diligently striving to improve the mercury-arc rectifier. The theory of arc formation clearly dictated the need for the ignitor. But its form, or just how it would work was the large unknown—and presented a problem that required years of research to solve.

Dr. Slepian and his associates, including L. R. Ludwig, D. E. Marshall (who writes on the ignitron in this issue), Adolph Toepfer and others, understood that the greatest weakness of the mercury-arc rectifier was arcbacks. They reasoned that if the presence of an arc could be avoided during the inverse period the major cause of arcbacks would be removed. But this immediately posed the equally difficult problem of how to restart the arc at the beginning of each positive half cycle.

Clearly no mechanical switch could be used to initiate a high-current arc 60 times a second. Among the attempts, a sharpened point of tungsten was touched lightly to the mercury. This performed well from the viewpoint of restarting the arc at the beginning of each half cycle, but was cursed with short life, rapid electrode wear, excessive current, and critical adjustment.

At Slepian's suggestion attempts were made to produce a fuse renewable each half cycle. Actually a sort of mirror arrangement was tried, in which glass or other ceramic was coated with mercury. This mercury would evaporate during the conduction period, but during non-conduction would again condense on it, giving a high-resistance surface necessary for arc formation by the time the potential again became positive.

These futile attempts to obtain a starting electrode with a controlled but fairly high surface resistance led to the notion that the answer lay not in depending on a surface effect—and hence an impermanent quantity—but with a material which itself had the proper resistivity characteristics.

Late one afternoon someone picked a small piece of Carborundum (silicon carbide) from a nearby barrel, and inserted it into the experimental, bulbous glass jar serving as the experimental rectifier. It worked! When the switch was closed, sending a low current through the ignitor, the rectifier fired. As long as current was withheld, no arc ensued. The action was positive, consistent, and rapid, and after repeated operations the ignitor showed no wear. The men were jubilant. The answer seemed so complete, so satisfactory—and appeared so suddenly—that the quitting hour came and went with no one willing to stop “playing” with the new discovery until far into the night when the janitor—clearly annoyed by grown men apparently doing nothing more than closing a switch and “watching a bulb light up”—insisted he had to clean up the place.

This happened in 1932. Clearly in a semi-conducting ignitor electrode lay the basic answer to the worst problem of the mercury-arc rectifier. However, several years of painstaking develop-

ment remained before production of a commercial rectifier known to be reasonably free from mechanical and electrical troubles. The first experimental installation of the ignitron as a rectifier came in 1937, in a coal mine near Pittsburgh.

Curiously, although the whole ignitron research program was aimed to provide a superior rectifier, the first use was for a quite different purpose, one indirectly brought about by the repeal of the 18th amendment. Manufacturers were faced with the problem of rapid production of welded metal beer barrels. Mechanical devices to time the welds automatically gave endless trouble. The newly announced ignitron, being a high-current switch without moving parts, seemed to be the answer. It was. Thus the entrance of the ignitron into the resistance-welding field, in which position it is now pre-eminent.

Experience teaches that, when current-conducting contacts separate the current, and electric-field density at the final point of contact becomes, theoretically, infinite, certainly so high that the last contact point volatilizes in a state of high ionization, an arc develops. The ignitor achieves this without mechanical motion. If an electrode—of any resistivity—enters at a sharp angle any other conducting medium, the conditions are made favorable for arc formation. At the sharp angle formed at the juncture, the current in attempting to “spread out” concentrates with great density at that point, so much so that the voltage drop becomes a million or so per centimeter—over, of course, an extremely small length.

If the electrode were of low resistance the current with practical voltages would be inordinate—millions of amperes, which would promptly fuse any material. But if the electrode has appreciable resistance the high concentration of voltage occurs without excessive current.

Silicon carbide is a material of resistance intermediate between conductors and insulators, i.e., it is a semiconductor. Thus an electrode of silicon carbide projecting into mercury provides the necessary conditions of a high-resistance material making a sharp-angle contact with a good conductor. With practical voltages and currents applied to such an ignitor, the potential gradient at a point less than one hundredth of a millionth of a centimeter from the meniscus edge is at least one million volts per centimeter and the current density at the point is several hundred thousand amperes per square centimeter.

The original ignitors were carborundum. These have been succeeded by boron carbide, which acts the same way but has certain advantages. Boron carbide can be readily formed with a graduated resistance in cross section, the resistance being progressively greater from the center to the outer surface.

The ignitron, for several years a tentative competitor of the synchronous converter, now dominates in the production of direct from alternating current. In the electrochemical field it is supreme, over three million kilowatts of ignitron capacity having been installed in aluminum and magnesium plants during the war. Another 200 000 kw have been installed in railway, mining and other service—not to mention the tens of thousands of small ignitrons in resistance-welding service.



Engineer

VOLUME SIX

NOVEMBER, 1946

NUMBER SIX

On the Side

The Cover—Some of man's machines are inherently appealing in appearance. The artist has captured some of the beauty of the magnetron with its shiny copper cavities.

•••

Westinghouse ENGINEER Indexes are being prepared and will be available on request for those who wish to file or bind their own copies. The indexes are of the cumulative type, embodying in one place all the material appearing in the five previous years of the magazine, as well as the year concluded in this issue.

•••

Bound Volumes—Those who wish to have their 1945 and 1946 issues of the *Westinghouse ENGINEER* bound into a single volume, using our standard binding, may do so by sending their copies to the office of the *Westinghouse ENGINEER*. The cumulative index will be bound as part of the volume. The charge for binding issues supplied by the reader is \$3.50 postpaid. Missing issues can be supplied, as long as the stock lasts, at thirty-five cents per copy.

Please note that this binding is only for the 12 issues appearing in 1945 and 1946. Issues of earlier dates cannot be bound into this volume although it is still possible to bind readers' copies for previous years. Issues for 1941 and 1942 (Volumes 1 and 2) comprise one book, and issues for 1943 and 1944 (Volumes 3 and 4) comprise another book. The cost per book is \$3.50, postpaid. We will supply missing copies for these earlier years, if available, for fifty cents each.

If the reader does not have copies of the *Westinghouse ENGINEER* for the years 1945 and 1946 and wishes to secure a volume, we have a limited number available for \$5.50 each, postpaid.

In This Issue

NUCLEAR REACTIONS.....	166
<i>Dr. W. E. Shoupp and Hugh Odishaw</i>	
THE RESONANT-CAVITY MAGNETRON.....	172
<i>Dr. John W. Coltman</i>	
THE KLYSTRON—RADAR RECEIVER OSCILLATOR.....	176
<i>Dr. Sidney Krasik</i>	
LOST-WAX CASTING.....	180
<i>H. W. Giesecke</i>	
THE PLACE OF THE SEALED-METAL IGNITRON.....	183
<i>J. H. Cox and D. E. Marshall</i>	
WHAT'S NEW!.....	188
Step Toward Industrial Color Harmony	
Inside Job for the Sterilamp	
Time Saving Capsules of Electronics	
Toys at Work	
REVERSE-POWER PROTECTION FOR A-C GENERATORS.....	190
<i>L. L. Fountain</i>	
CHARACTERISTICS OF THE SELENIUM RECTIFIER.....	192
<i>I. R. Smith</i>	

Editor

CHARLES A. SCARLOTT

Editorial Advisors

R. C. BERGVALL

T. FORT

G. EDWARD PENDRAY

The *Westinghouse ENGINEER* is issued six times a year by the Westinghouse Electric Corporation. Dates of publication are January, March, May, July, September, and November. The annual subscription price in the United States and its possessions is \$2.00; in Canada, \$2.50; and in other countries, \$2.25. Price of a single copy is 35c. Address all communications to the *Westinghouse ENGINEER*, 306 Fourth Ave., P.O. Box 1017, Pittsburgh (30), Pennsylvania.

THE WESTINGHOUSE ENGINEER IS PRINTED IN THE UNITED STATES BY THE LAKESIDE PRESS, CHICAGO, ILLINOIS

Nuclear Reactions

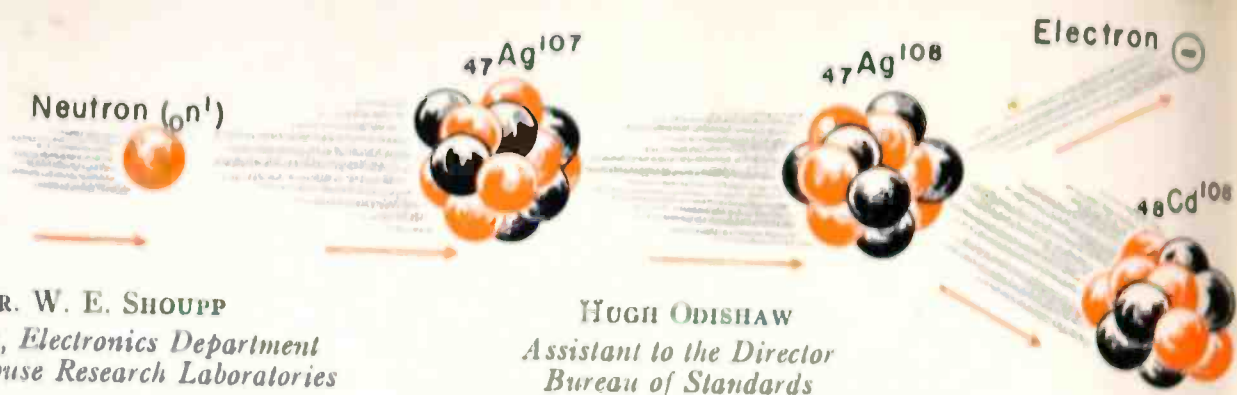

DR. W. E. SHOUPP
 Manager, Electronics Department
 Westinghouse Research Laboratories

HUGH ODISHAW
 Assistant to the Director
 Bureau of Standards

Radium, once most fabulous and most costly substance on earth, is faced with technological unemployment. Materials, made artificially radioactive in atomic-energy piles, bid fair to be superior, more versatile, and even less costly than radium. In this new science, which is both physics and chemistry, hundreds of nuclear reactions have already been performed in the laboratory. Of these, the atomic bomb is but one, albeit at present the most spectacular and notorious.

ARTIFICIAL transmutation of the elements, vainly sought by alchemists for centuries, was discovered less than 30 years ago. In the short time since, nearly a thousand nuclear reactions have been produced in the laboratory. In such reactions chemical elements have been changed into other chemical elements—that is, nuclei have been built up and torn apart in the alchemy of atom smashing.

These reactions, in addition to enabling the production of an enormous family of radioactive substances important in medicine and engineering, provide the only method of investigating nuclear structure and nuclear forces, permitting scientists to postulate upon the basic structure of the universe. It was such reactions that finally led to the realization of atomic explosives, in which fast neutrons are used to smash uranium into two lighter elements characterized by a smaller total mass and a consequent release of a vast quantity of energy. And it is the same body of knowledge that promises peaceful uses of atomic energy—probably, in the case of uranium, through reactions induced by slow neutrons.

Prior to 1932, atom smashing was limited to the use of naturally occurring alpha rays as from radium for the atomic bullets required to penetrate nuclei. Construction of large high-voltage machines—atom smashers—has given the scientist new sources of high-energy particles such as protons, neutrons, deuterons, gamma rays, electrons, and helium nuclei.* With these powerful tools, producing particles having energies as high as 100 million electron volts, a large number of nuclear reactions have been discovered and tabulated.

At the same time, atom smashers are producing radio-

cal reactions, which involve only the electrons in the outer orbits surrounding the nucleus. In fact, they are generally written in the same manner except that chemical compounds are replaced by atomic nuclei. For example, compare the following two reactions, the first is the common chemical reaction of combustion, and the second nuclear:

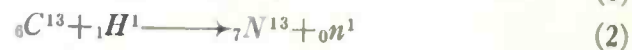

The first reaction states that one atom of carbon unites with two atoms of oxygen to form one molecule of carbon dioxide. The subscripts indicate the relative number of atoms involved in the reaction.

The second reaction states that a carbon nucleus bombarded by a proton (the hydrogen nucleus) forms a nitrogen nucleus and a neutron. Here the subscripts indicate the positive electrical charge of the nucleus. This is the number of protons in the nucleus of that element and is also the position or number of that element in the scale of elements. The superscripts indicate the total number of protons and neutrons in the nucleus (the mass number and is the integer nearest the atomic weight).**

Nuclear reactions are, however, frequently written in another manner, as indicated below where the reaction (2) is rewritten into this shorthand form:

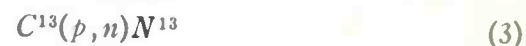

This manner of writing nuclear reactions states the same thing that occurs in eq. (2). However, the incident projectile and the ejected light particle are grouped together in the brackets in the center of the reaction where p denotes the bombarding proton and n the ejected neutron. Thus,

Bombarded Nucleus (Bullet, Fragment)
Resulting Nucleus.

The part in brackets (p, n) is frequently used to describe reactions of this type. This case represents a proton, neutron type of reaction, probably the most frequent of nuclear reactions.

Other symbols used in the brackets to describe nuclear reactions are for other atom-smashing projectiles and other resulting emitted particles or energies. These include: A proton and neutron closely held in one unit, which is one form of hydrogen, ${}_1H^2$, and which is called a deuteron, designated d ; the gamma ray is γ ; two neutrons and two protons, which is the helium nucleus, is called the alpha particle, shown as α ; two neutrons are represented by $2n$,

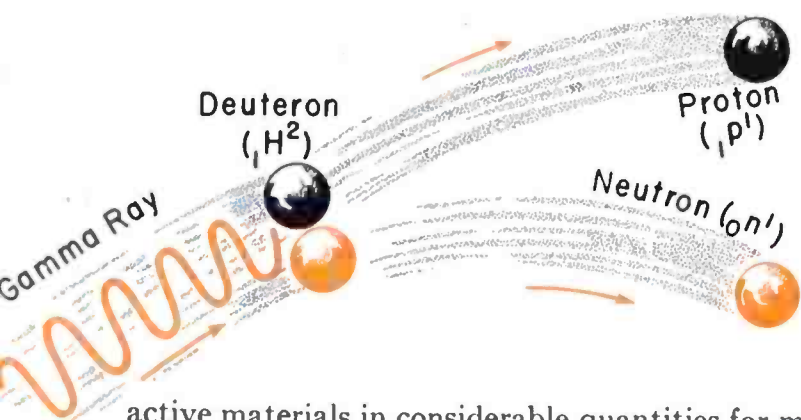

The converse of the preceding reaction—neutron capture with gamma ray emission—also occurs. If gamma rays having 2.20 mev energy are played on deuterons ${}_1H^2$, “photodisintegration” takes place, and the emission of neutrons and protons can be observed. Because the masses of the proton and the deuteron are known, “photodisintegration” offers the most accurate method for the determination of the mass of the neutron (now commonly accepted as 1.008939).

active materials in considerable quantities for medical and research applications. Artificial radioactive substances are made at only a fraction of the cost of natural radium, leading to greater and more prolific use in radiography and medicine.

Nuclear and Chemical Reactions

Nuclear reactions, which deal with changes in the atomic nucleus itself, have many of the same characteristics as chemi-

*The particles of nuclear physics were discussed in “The Structure of the Nucleus,” by Dr. Shoupp, *Westinghouse ENGINEER*, July, 1946, p. 118.

**See “The Relation Between Energy and Mass,” Dr. Frederick Seitz, *Westinghouse ENGINEER* March, 1946, p. 35.

The most common nuclear reaction involving neutrons is one of simple capture. A reaction of this type is the one in which silver $_{47}Ag^{107}$ is bombarded by a neutron, increasing the mass of the resulting nucleus by one and producing the emission of gamma rays. The silver isotope $_{47}Ag^{108}$ is radioactive, however, and unstable; it decays into stable cadmium $_{48}Cd^{108}$ by the emission of a single electron.

(α, p) , (α, n) . Sometimes the incident bombarding projectile is simply captured by the target nucleus; typical reactions of this type in which a neutron or a proton is captured are indicated as follows, (n, γ) and (p, γ) , inasmuch as no particle is emitted, but a gamma ray is formed that carries away the excess energy.

Energy Balance in Nuclear Reactions

In chemistry some reactions require the addition of heat, or energy, to cause the reaction to proceed while in others, such as eq. (1), energy or heat is given off. Precisely the same condition exists in nuclear reactions, and the terms endothermic and exothermic are similarly used to describe whether energy is required or is given off in the process. Like chemical equations, nuclear equations can thus be more accurately represented by including the term Q (energy of reaction or energy balance). Consequently eq. (2) should be written,

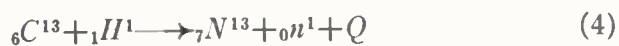

When the "energy balance" or Q -value is positive, energy is emitted and the reaction is exothermic. When the energy balance Q is negative, the reaction is endothermic and energy is absorbed in the process.

The magnitude of the energy balance is easy to compute if the masses of the reaction nuclei or atoms containing these nuclei are known. Consider, for example, the nuclear reaction caused by the bombardment of the metal beryllium (${}_4Be^9$) with deuterium nuclei (${}_1D^2$) accelerated in an atom smasher, producing boron and a neutron. In such a reaction neutrons are emitted and the various nuclei have the following masses, in which μ is mass unit.

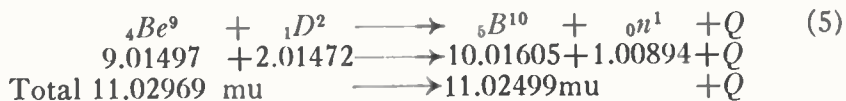

The sum of masses of the nuclei on the left side of the equation is greater than that of the right-hand nuclei by the energy balance $Q=0.00470$ mu. From Einstein's mass and energy equivalence expression, $E=mc^2$, this mass difference amounts to $Q=0.00470 \times 931 \text{ mev} = 4.38 \text{ mev}$, where mev is the abbreviation for a million electron volts, a unit of energy.

When the reaction is examined experimentally, neutrons having energies commensurate with these calculations are observed. Indeed, this reaction is the most commonly used method of securing neutrons. The yield of neutrons exceeds that from any other known reaction utilizing bombarding deuterons with energies of a few million electron volts.

Reactions that are energetically possible can usually be made to take place. The yield, however, is a function of the energy of the bombarding particle. For observable yields from nuclear reactions, the voltage used to accelerate the bombarding projectiles must frequently be millions of volts. One noticeable exception to this is observed in the $H^2(d, n)He^3$ reaction where neutrons are observed for bombarding energies of only 10 000 volts.

Neutron-Induced Reactions (n, γ) and Photodisintegration (γ, n)

When a projectile neutron strikes a nucleus of mass m and charge z , the most common

etc. We have, therefore, reactions of several other types—as well as (p, n) —represented by (n, p) , (n, α) , $(n, 2n)$, (p, α) , (p, d) , (d, p) , (d, n) , (d, α) ,

nuclear reaction is one of simple capture. A reaction of this type, (6), is represented by (n, γ) because a γ -ray is emitted during the process:

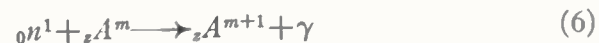

where A represents the nucleus under bombardment. The resulting nucleus is an isotope of the target nucleus and is one unit heavier. Because those nuclei that exist in nature have lasted for thousands of years, they are generally the most stable ones. It follows that the resulting ${}_zA^{m+1}$ isotope is less stable and is frequently radioactive. Hence the product nucleus may emit electrons, positrons, or gamma rays.

A reaction of this type, for example, is produced when neutrons are allowed to fall upon silver:

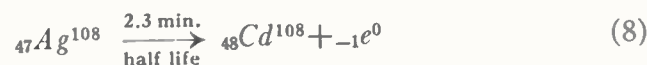
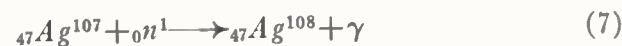

In this reaction ordinary silver is made into a radioactive silver isotope ${}_{47}Ag^{108}$ by the neutron bombardment. The radioactive silver isotope (Ag^{108}) then decays into stable cadmium ${}_{48}Cd^{108}$ by emitting an electron. This reaction is observed frequently—even the silver coin in one's pocket after standing in the vicinity of a neutron source (such as a cyclotron) reveal a definite activity.

Because a neutron is captured in such a reaction, an amount of energy equal to the neutron binding energy must be given off. The binding energy per particle is usually between six and nine mev and gamma rays having roughly this energy are frequently observed when (n, γ) nuclear reactions occur.

Reactions of this type occur only for discrete neutron energies, and generally speaking (n, γ) reactions are said to be "resonance reactions"—that is, the energy of the bombarding particle (the neutrons) must be almost exactly equal to the difference between two energy levels in the "compound" nucleus. If the bombarding neutron is moving much faster or slower the reaction does not follow. A transition then occurs between these two levels in the compound nucleus, and the energy difference is given off in the form of a γ -ray. The frequency of this electromagnetic radiation, ν , is determined by the energy (E) divided by Planck's constant ($\nu = E/h$). Heavy nuclei have a great number of closely spaced energy levels; therefore, neutrons of nearly any energy are captured. However, in the lighter elements, where the number of levels are fewer, (n, γ) reactions occur somewhat less frequently. Roughly, 200 reactions of the (n, γ) type have been observed, and studies of these resonance reactions have been most important in constructing theories of heavy nuclei.

The inverse to the (n, γ) reaction is the photodisintegration reaction (γ, n) . As an example of reactions of these types consider first the formation of a deuteron when a neutron captures a proton. During this process a gamma ray of 2.20 mev

Neutrons can also cause the emission of alpha particles, protons, and even other neutrons. This reaction illustrates the ejection of alpha particles ${}_2He^4$ from oxygen nuclei ${}_8O^{16}$ by neutron bombardment. The oxygen isotope ${}_8O^{17}$ breaks up into carbon ${}_6C^{13}$ and an alpha particle.

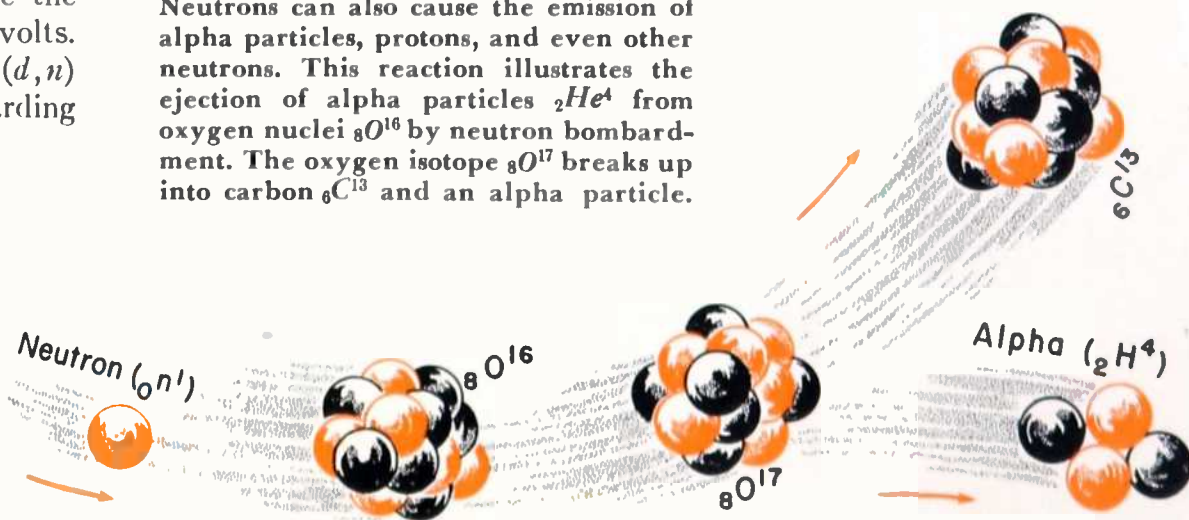

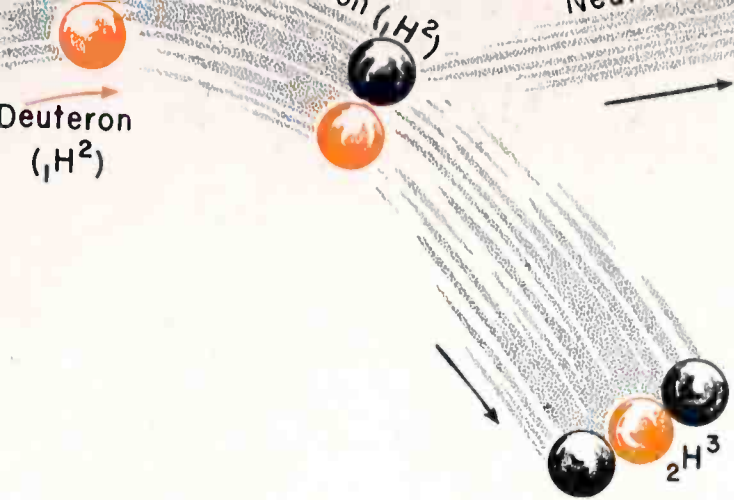

Like neutrons, deuterons are important in creating nuclear reactions, but their charged nature requires that they be accelerated to high velocities before they can cause disintegration. This is done in high-voltage accelerators like the cyclotron. The left reaction shows an accelerated deuteron disintegrating a target deuteron; the products of disintegration are the helium isotope ${}^2\text{He}^3$ and a neutron. This reaction is important because it furnishes a convenient source of neutrons, requiring low-voltage accelerators.

Deuterons can also eject protons. The transformation of silver ${}_{47}\text{Ag}^{107}$ into the radioactive isotope ${}_{47}\text{Ag}^{108}$ by neutron capture (below) can be achieved by deuteron bombardment. In this case, a proton is ejected. As before, the silver isotope decays into a stable form of cadmium by emission of an electron.

Alpha particles ${}^2\text{He}^4$ can also cause nuclear disintegrations. Available from naturally radioactive substances, they were the first particles used for this purpose. In 1919 Lord Rutherford observed the reaction (right) in which nitrogen was converted into an oxygen isotope and a proton by alpha-particles.

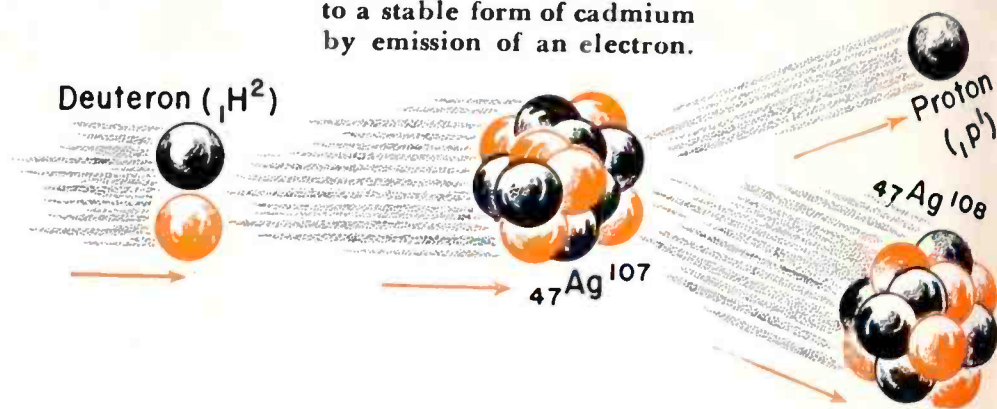

is emitted (Q having a positive value of 2.20 mev,)

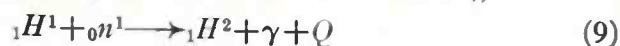

The inverse reaction also occurs. A deuteron can be broken up through photodisintegration by illuminating it with γ -rays of 2.20-mev energy. The emission of a neutron and a proton is then observed as follows:

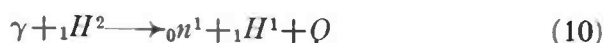

and in this reaction $Q = -2.20$ mev. The importance of this reaction is that it offers the most accurate method for the determination of the mass of the neutron (1.008939), which being electrically neutral is not susceptible to easy analysis.

All other (γ, n) reactions require greater energy than that needed to disintegrate the deuteron. Reactions in beryllium and phosphorus and a few other light elements have been observed. The Q value in (γ, n) reactions is obviously negative while that of (n, γ) reactions is always positive.

Other Reactions Induced by Neutrons

Neutrons can cause the emission of particles as well as gamma radiation from nuclei. In fact, (n, α) , (n, p) and $(n, 2n)$ reactions have all been observed. Reactions of the (n, α) or (n, p) type are easy to observe in a cloud chamber when the target nucleus is available in gaseous form as is possible with targets of carbon, oxygen, fluorine, and neon. In such cases the gas in a chamber is super-saturated by a vapor. Droplet tracks resulting from the ionization produced by charged particles passing through this atmosphere can be observed visually and measured photographically, for example:



Forked tracks are caused by the ${}_6\text{C}^{13}$ product nucleus and the alpha particle (${}_2\text{He}^4$). The neutron being uncharged does not produce ionization and consequently does not cause a track to appear in the cloud chamber. Its presence is immediately obvious, however, because there must be some reason for the forward momentum of the two observed ionizing particles.

Reactions of the (n, α) type have been found for nearly all elements although it is frequently difficult to establish this point definitely for very heavy substances because many competing reactions are also present. A particularly valuable reaction is the $B^{10}(n, \alpha)Li^7$ transmutation. This reaction is prolific and is used to measure the intensity of neutron sources. Because the neutron is not an ionizing particle, it is difficult to detect. However, if the neutrons are allowed to enter a chamber containing a gaseous form of B^{10} , the alpha particles produced by this reaction can be easily detected by amplifying the pulses of ionization they produce when they are emitted in the chamber. The compound, boron tri-fluoride, is used as a source of boron and the ionization is amplified by conventional vacuum-tube pulse rectifiers. By such means ionization produced by single alpha particles can be measured, and so individual neutrons are detected.

Reactions of the (n, p) type form a product nucleus that

has the same mass number (A) as the target nucleus and may consequently retransform into the target element by the emission of an electron. These reactions are energetically probable only for high-energy neutrons and for light target materials. For this reason (n, p) reactions are not prolific, and consequently they are more of academic interest than of practical importance for the formation of radioactive substances.

Reactions of the $(n, 2n)$ type lead to the production of a lower isotope of the bombarded target just as do (γ, n) reactions. Therefore it is frequently difficult to determine which of these two reactions is producing a particular radioactive isotope. The $(n, 2n)$ reaction is observed only for bombarding neutrons of extremely high energy and is identified through the formation of radioactive isotopes of the target nucleus. Over 30 elements spread between beryllium and uranium have been shown to disintegrate in this unusual manner.

Slow and Fast Neutrons

While fast or high-energy neutrons may cause nuclear reactions, slow ones, surprisingly enough, often react more violently. If the reaction, in which a radioactive isotope of silver is formed (eq. 7), is carried out by immersing the neutron source and the silver target within a substance rich in hydrogen (such as water or paraffin), the yield of radioactive silver increases some tenfold. The collisions of the neutrons with the hydrogen nuclei (protons) slow down the neutrons sufficiently so that resonance reactions occur. In fact, neutrons lose (on the average) roughly 70 percent of their energy each time they collide with a hydrogen nucleus. Relatively few collisions are required to reduce high neutron energies to the range that resonance (n, γ) reactions occur (1 to 1000 volts). For example, a 5-mev neutron is reduced by 14 successive collisions to one having an energy of less than 1 electron volt. About 2.5 inches of paraffin is the optimum thickness to reduce neutron energies to the resonance range. If the thickness of the paraffin becomes too great many of the neutrons become absorbed by uniting with protons in the (n, γ) nuclear reaction. Paraffin thinner than 2.5 inches allows large fractions of the projectile neutrons to escape with consequent loss in effectiveness.

Slow neutrons are much more effective in certain nuclear transmutations for another reason. Because they move so slowly they spend more time in the vicinity of the target nuclei, therefore, their probability of capture is much greater than if they passed the target quickly. This results in an effect

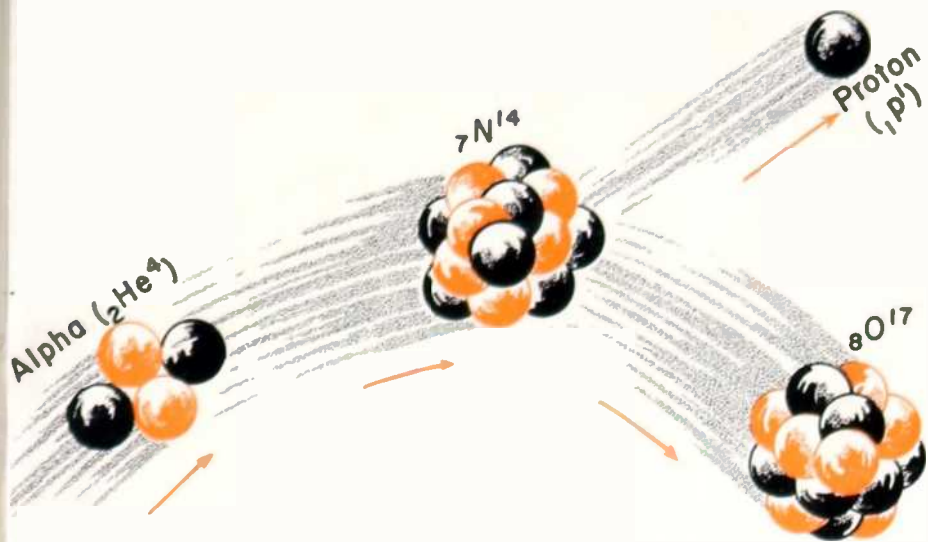

described by stating simply that the probability of a nuclear reaction taking place with a slow neutron (engaged in other than resonance reactions) is inversely proportional to the speed of the neutron.

The above properties of neutrons lead to unusual requirements for the protection of workers in nuclear-physics laboratories or in hospitals where intense beams of neutrons may be present. Tanks of water or blocks of paraffin of considerable thickness are required to slow down the neutrons. Then an absorber for the slow neutrons must be used. For this purpose cadmium metal is very suitable because it strongly absorbs neutrons of 0.03 electron-volt energy. Finally, some neutrons are captured by the reaction (n, γ) , and so the appropriate amount of lead or steel is necessary to stop the gamma rays given by this process. Such complicated arrangements serve to emphasize that operations involving nuclear radiations must be carefully controlled by competent operators and scientists.

Deuteron-Induced Reactions

The deuteron (heavy-hydrogen nucleus ${}_1H^2$) is composed of a proton and a neutron. Because this is a positively charged particle it cannot enter other nuclei and cause transmutations as simply as does the neutron. Deuterons are repelled by other positively charged target nuclei and consequently must be accelerated to high velocities before they can cause a disintegration. Various machines have been designed for this purpose. Cyclotrons able to produce energies of approximately 100 mev are being put into operation.

The electrical coulomb repulsion force between two positive charges (such as a deuteron and a target nucleus) varies inversely as the square of the distance between centers and directly as the product of the two charges. Because the deuteron (${}_1H^2$) is only singly charged, it is generally more effective than doubly charged particles (${}_2He^4$) in producing transmutations. However, compared to neutrons they are some million times less effective.

Reactions of the (d, γ) , (d, n) , and (d, p) type have been observed, and have been studied in great detail. Two of the (d, n) reactions are of particular significance in that they furnish convenient sources of neutrons. The reaction



occurs for energies as low as 10 000 volts and is used as a prolific source of neutrons in small atom smashers operating at low voltage.

The neutrons emitted by this reaction all have the same energy, approximately 2.5 mev. This fact makes the deuteron-neutron reaction valuable for nuclear studies because this is the only strong source of fast neutrons of constant energy. However, for atom smashers operating at voltages above 1 mev, the beryllium-to-boron reaction, $Be(d, n)B$, surpasses this reaction in the quantity of

neutrons produced and is therefore used as the chief source of neutrons for cancer therapy and other applications requiring intense neutron beams.

Reactions of the deuteron-proton (d, p) type, in which a proton is ejected, are important because they result in the formation of radioactive isotopes just as do the neutron absorption (n, γ) reactions. It is more advantageous to use deuterons than neutrons for making quantities of radioactive substances because deuterons (being charged particles) can be accelerated in high-voltage machines. For example, the radioactive silver isotope Ag^{108} , described in eq. (7), can also be produced by deuteron bombardment:



The deuteron-proton reaction occurs with great probability compared to other reactions between charged particles. In this case it is not necessary that the deuteron penetrate all the way through the coulomb potential barrier of the target nucleus to cause the reaction to take place. In fact the deuteron, as it approaches the nucleus, breaks up into a proton and a neutron; the proton is deflected away by the electric field, and the neutron is absorbed forming the reaction as indicated in eq. (6). The proton then acts as a carrier, enabling the neutron to be shot electrically into the proximity of the target nucleus.

Alpha-Particle Induced Reactions

Because alpha particles (${}_2He^4$) are available from natural radioactive substances such as RaC' , they were the first projectiles used to cause atomic disintegrations. Lord Rutherford in 1919 achieved the first successful nuclear disintegrations by bombarding nitrogen gas with RaC' alpha particles. The protons in the corresponding (α, p) reaction were observed by the illumination they produced upon striking a fluorescent screen. The reaction observed was



There was considerable doubt at the time that such a reaction was observable because the size of the alpha particle (${}_2He^4$) as well as the target nucleus (${}_7N^{14}$) were known to be less than 10^{-12} cm in diameter. The probability of scoring a hit on such a small target with a still smaller projectile was slight indeed. Furthermore, the electrical coulomb repulsion between the alpha particles is quite large and it was doubtful that the RaC' alpha particles possessed sufficient energy to approach the nucleus close enough to cause disintegration.

However, the experiment was successful and it launched the study of nuclear reactions that has developed into the complex science of nuclear physics. It is no longer necessary to depend upon natural sources for alpha particles for hom-

Nuclear reactions are not new. It is only that until recently man had no hand in their performance or control. Nature employs them freely. The sun is a "shining" example of reactions in which atomic nuclei take part. Radium was the first example close at hand of a natural nuclear reaction. Radium, aside from its inestimable intrinsic value, has been invaluable to science because it provided clues leading to understanding of atomic structure and proof that elements are alterable. Perhaps—bringing the matter even closer to us as individuals—mysterious changes in the genes that result in mutations in plants, animals, and even man may be the handiwork of cosmic-ray inspired reactions.

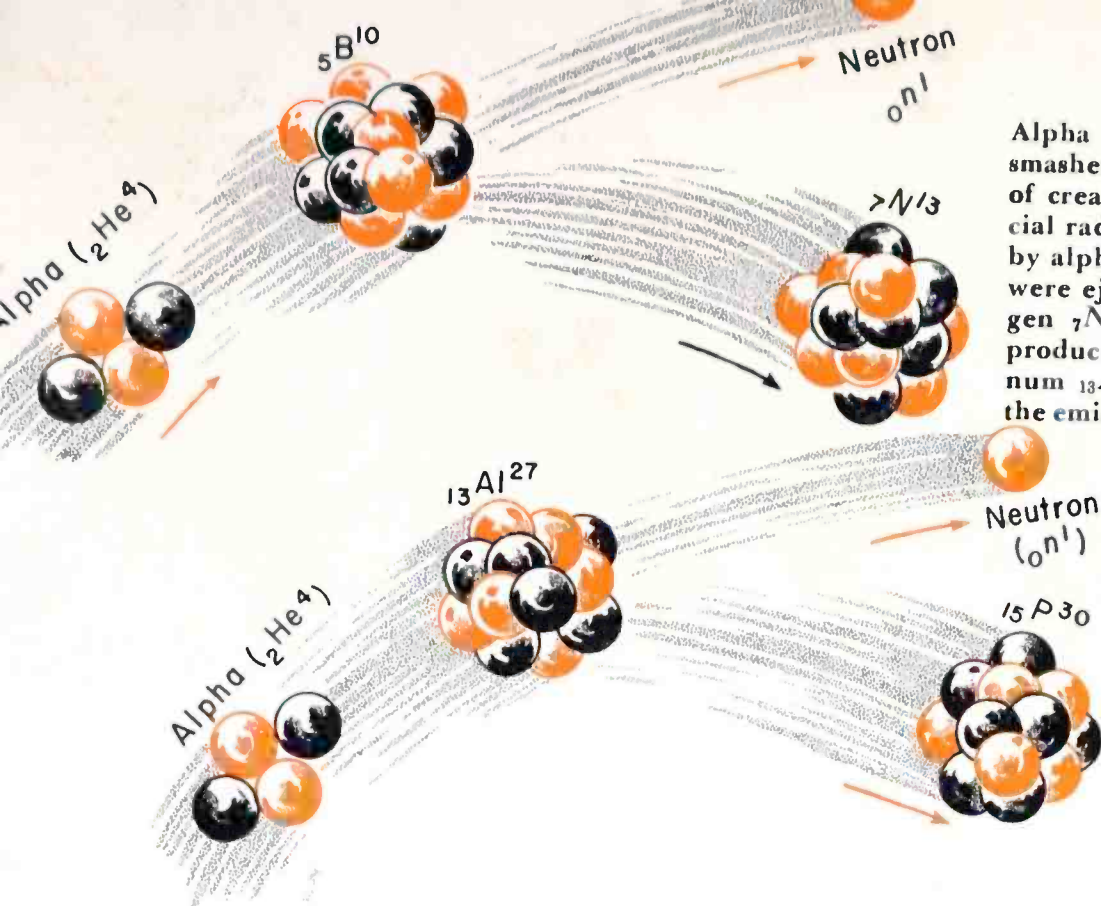

Alpha particles accelerated in atom smashers are now common methods of creating nuclear reactions. Artificial radioactivity was first discovered by alpha reactions in which neutrons were ejected. Thus radioactive nitrogen ${}^7\text{N}^{13}$ and phosphorus ${}^{15}\text{P}^{30}$ are produced from boron ${}^5\text{B}^{10}$ and aluminum ${}^{13}\text{Al}^{27}$, respectively, along with the emission of a quantity of neutrons.

positrons (${}_{+1}e^0$) into the stable carbon (${}^6\text{C}^{13}$). The half-life of the radioactive ${}^7\text{N}^{13}$ nucleus is 10 minutes. Hence prompt use of this material, for chemical tracer and other purposes, is necessary inasmuch as at the end of 24 hours only one radioactive atom in 10^{43} of the

original sample remains. These two reactions, currently being used in tracer studies, are:



Reactions of the (p, n) type are also observed and are particularly valuable for the determination of nuclear masses. When this process occurs, the nucleus simply exchanges one of its neutrons for a proton, resulting in the formation of the next highest element of the same mass number as the bombarded substance. Such a process involves a net loss in mass to the nucleus: the neutron mass (1.00894) is greater than that of the proton (1.00758). Mass or energy (mc^2) must be added to the nucleus to make up for this loss if stability of the same order as the original nucleus is to result. For this reason (p, n) reactions are always endothermic (i.e., Q is negative), meaning that the protons must always have energy greater than a certain amount, called the threshold energy (E_p), before the transmutation occurs. One of the proton-neutron reactions has to do with the bombardment of lithium by protons, thus:

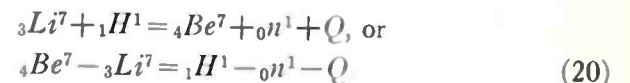

Because both the proton and neutron masses are known, the mass difference between the ${}^4\text{Be}^7$ and the ${}^3\text{Li}^7$ nuclei can be determined provided Q can be measured. Q can be determined from the threshold energy (E_p) of the reaction (p, n) by $Q = (A/A+1)E_p$ where A is the mass number of the bombarded nucleus. If the mass of the bombarded nucleus is known, the mass of the product nucleus can then be determined; or conversely, if the mass of the product nucleus is known the bombarded nucleus is determined. Transmutations of the (p, n) type not only lead to the production of radioactive nuclei but also afford a convenient and highly accurate method of investigating the mass and energy relationships that enter these reactions.

Transmutations of the type in which a proton enters the nucleus and an alpha particle leaves (p, α) are also known. This reaction is usually exothermic because of the high binding of the alpha particle. The probability of occurrence of this reaction is high only when the energy of the bombarding proton is large. Alpha particles are not usually observed because of the experimental difficulty in distinguishing them from protons used in the bombardment. However, the existence of the reaction has been definitely established by examining the radioactive products caused by the (p, α) transmutation. An example of this process is the formation of radioactive fluorine (${}^9\text{F}^{17}$) by the bombardment of neon nuclei:

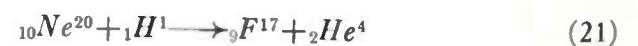

The resulting radioactive fluorine formed in this reaction decays into oxygen by the emission of positrons.

barding purposes. Nuclei of helium can be accelerated in conventional atom smashers and intense beams of alpha particles created. Many nuclear reactions of the (α, p) and (α, n) types have been produced.

Artificial radioactivity was first discovered by the production of radioactive nitrogen and phosphorus from boron and aluminum respectively by reactions of the (α, n) type,

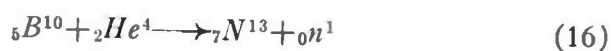

and

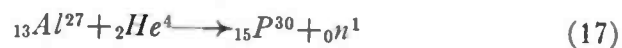

These reactions of the (α, p) type are important because they permitted the investigations of energy levels in compound nuclei, which has been heretofore difficult.

The protons ejected in (α, p) reactions are frequently observed to consist of several discrete energies. Four proton energy groups are observed in the ${}^5\text{B}^{10}(\alpha, p){}^6\text{C}^{13}$ reaction, corresponding to energy balances (Q) of 3.3, 0.5, 0.1, and -0.8 mev, thereby establishing the energy level structure in the stable nitrogen compound nucleus ${}^7\text{N}^{14}$.

Reactions Induced by Protons

Protons accelerated by high-voltage machines were used to produce the first artificially induced nuclear reactions. Since then studies of proton-induced nuclear reactions such as (p, γ) , (p, n) , (p, α) have added greatly to the better understanding of nuclear phenomena.

Generally, the gamma radiation given off by (p, γ) reactions is energetic. Radiation energies as high as 17 mev have been obtained. Nuclear reactions of this type can be used as a source of penetrating gamma radiation to induce still other reactions or for radiographic, medical, or other experimental purposes. Because no material particle is emitted in (p, γ) reactions, the proton energy required to cause the transmutation to take place is a resonance phenomenon and occurs for discrete proton energies. The gamma radiation corresponds to transitions between the energy states of the compound nucleus involved.

Reactions of this type can also result in the formation of a radioactive nucleus as well as the emission of an energetic gamma ray. In fact, when carbon (${}^6\text{C}^{12}$) is bombarded by protons, gamma rays having energies of about 2.5 mev are emitted. The (${}^7\text{N}^{13}$) nitrogen nucleus formed in this reaction is radioactive and decays (eq. 15) by the emission of 1.2-mev

TABLE I—SUMMARY OF NUCLEAR-REACTION TYPES*

Reaction Type	Incident Particle	Ejected Particle	Normal Mass Change	Dependence on Energy of Projectile	Yield	Type of Radioactivity Usually Produced	Sample Reactions
(n,γ)	Neutron	Gamma	Positive	Resonance	Virtually 100%	Electron	Ag ¹⁰⁷ + n → Ag ¹⁰⁸ Br ⁷⁹ + n → Br ⁸⁰
(n,p)	Neutron	Proton	Slightly positive	Smooth	Footnote 3	Electron	N ¹⁴ + n → C ¹⁴ + H ¹ S ³² + n → P ³² + H ¹
(n,α)	Neutron	Alpha	Slightly positive in light elements; negative in heavy	Smooth	Footnote 3	Electron	F ¹⁹ + n → N ¹⁶ + He ⁴ Al ²⁷ + n → Na ²⁴ + He ⁴
(n,2n)	Neutron	2 Neutrons	Very negative	Smooth	Small	Positron	N ¹⁴ + n → N ¹³ + 2n P ³¹ + n → P ³⁰ + 2n
(p,γ)	Proton	Gamma	Positive	Resonance	Large	Positron	C ¹² + H ¹ → N ¹³ F ¹⁹ + H ¹ → Ne ²⁰
(p,n)	Proton	Neutron	Negative	Threshold; smooth increasing with energy	Large	Positron	B ¹¹ + H ¹ → C ¹¹ + n O ¹⁸ + H ¹ → F ¹⁸ + n
(p,α)	Proton	Alpha	Slightly positive in light elements; negative in heavy	Smooth, increasing with proton energy	Large	Generally stable	F ¹⁹ + H ¹ → O ¹⁶ + He ⁴ Al ²⁷ + H ¹ → Mg ²⁴ + He ⁴
(p,d)	Proton	Deuteron	Very negative	Smooth as above	Small	Only one found	Be ⁹ + H ¹ → Be ⁸ + H ²
(α,n)	Alpha	Neutron	Footnote 1	Smooth	Footnote 4	Positron	B ¹⁰ + He ⁴ → N ¹³ + n Al ²⁷ + He ⁴ → P ³⁰ + n
(α,p)	Alpha	Proton	Footnote 2	Smooth	Footnote 4	Generally stable	Al ²⁷ + He ⁴ → Si ³⁰ + H ¹ N ¹⁴ + He ⁴ → O ¹⁷ + H ¹
(d,p)	Deuteron	Proton	Always positive	Smooth	Footnote 4	Electron	Na ²³ + H ² → Na ²⁴ + H ¹ P ³¹ + H ² → P ³² + H ¹
(d,n)	Deuteron	Neutron	Always positive	Smooth	Footnote 4	Positron	C ¹² + H ² → N ¹³ + H ¹ Be ⁹ + H ² → B ¹⁰ + H ¹
(d,α)	Deuteron	Alpha	Always positive	Smooth	Footnote 4	Generally stable	O ¹⁶ + H ² → N ¹⁴ + He ⁴ Al ²⁷ + H ² → Mg ²⁵ + He ⁴
(γ,n)	Gamma	Neutron	Always negative	Sharp threshold	Small	Positron	Be ⁹ + γ → Be ⁸ + n Br ⁸¹ + γ → Br ⁸⁰ + n
(γ,p)	Gamma	Proton	Always negative	Sharp threshold	Small	Only observed for deuteron	H ² + γ → n + H ¹

¹Slightly negative in light elements; positive in heavy.
²Slightly positive except some light elements.

³Large for light elements; escaping barrier to consider.
⁴Large for elements where barrier penetration is easy.

*From "Applied Nuclear Physics," Pollard and Davidson, John Wiley & Sons, 1941.

The investigation of nuclear reactions is obviously complicated. Many reactions may be occurring simultaneously during the bombardment of a target by high-speed particles, for any reaction that is energetically possible has a finite chance of occurrence. It is just this probability feature that specifies the dominant reaction in a given case.

However, the detailed mechanism and nuclear forces that cause one reaction to be preferred to another is not well understood. It is information leading to the eventual explanation of nuclear secrets that is obtained from detailed study of nuclear reactions. It is now possible to tabulate which reactions occur and which do not, but there are many "why's" to be answered.

The study of nuclear physics is still in the early fact-finding stage. It will not be possible for the theorist to formulate an adequate nuclear theory until he is provided with a considerable amount of more accurate scientific data. Compare, for example, the development of the understanding of electrical phenomena with nuclear science. The coulomb inverse square law of force between electrical charges was discovered many years before electricity was put to practical use; in nuclear science we still do not know the law of force that operates between a proton and a neutron—and these are the building blocks from which all nuclei are constructed. The situation is even more complicated in nuclear investigation in that there is no known method of measuring this force.

In electricity it is possible to set up two charged bodies in a mechanical system and to measure the force exerted between them, when they are separated by considerable distances. The action of this force can then be computed for short distances of separation of the charged bodies. In nucleonics analogous experiments are not possible since the force between the neutron and proton falls off so rapidly with increasing particle separation that measurements of its magnitude for reasonable separations are not feasible. Furthermore it is not possible to isolate a quantity of neutrons and attach them to a body for measurement purposes as is done in the determinations of the characteristics of electrical forces. In nucleonics this does not seem possible because no method has yet been discovered to bring the proton and neutron into sufficiently close proximity and at the same time to measure the force of attraction by mechanical means. One can only accelerate a nuclear particle and use it as a projectile to bombard other particles or nuclei and to observe what nuclear reactions or other interactions occur. When studies like these are made with sufficient accuracy, it may be possible to infer what law of force is required to produce such effects. Scattered experiments of this type coupled with nuclear reaction data have indicated that the separation distance between the particles of nuclear physics must be less than 10⁻¹² centimeters before the forces of attraction set in. For separations greater than 10⁻¹² centimeters, no particular effects other than the coulomb electrical forces seem to exist. The greatest value of nuclear reaction studies lies in the fact that detailed examination of the processes that occur enable conclusions to be made concerning the structure of nuclei and the binding forces.

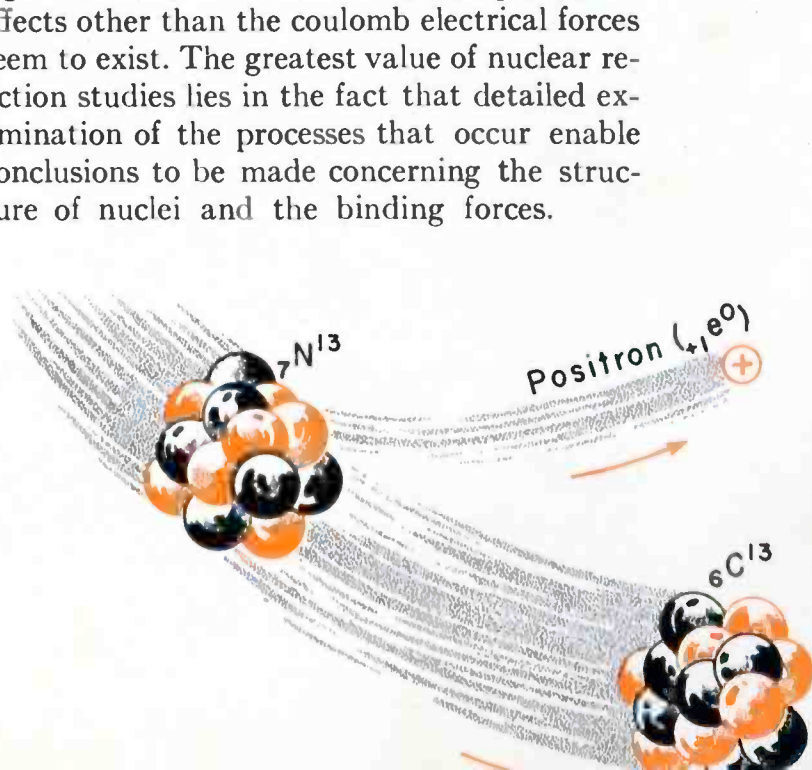
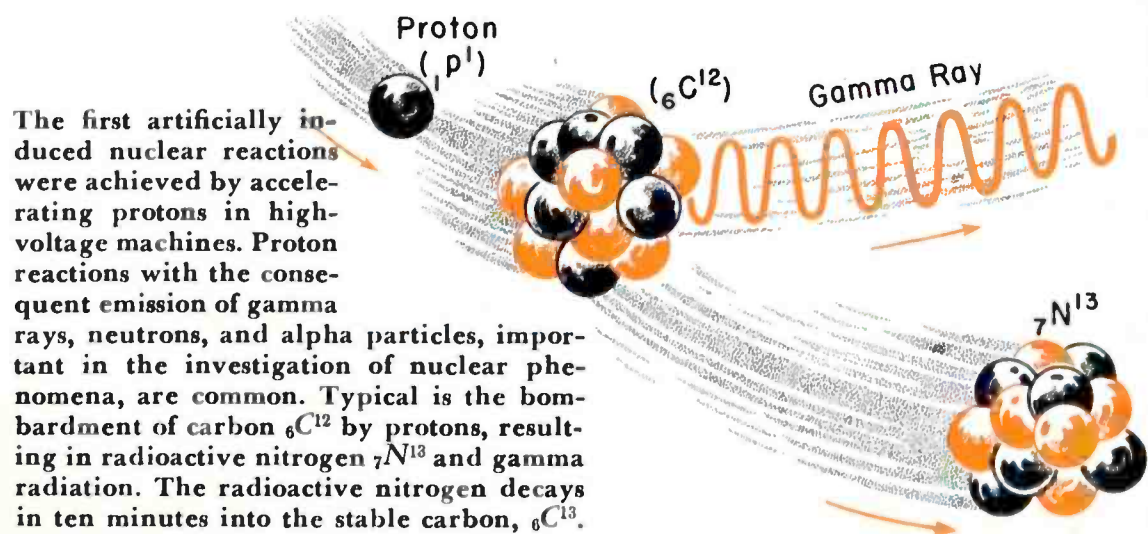

Resonant-Cavity Magnetron

DR. JOHN W. COLTMAN
Westinghouse Research Laboratories

Magnetrons, klystrons, resnatrons, synthetic crystals, TR switches are among the war-produced terms that have intruded into the electrical vocabulary. Furthermore, they are here to stay. They are names of equipment components born of radar, but that will have growing importance as ultra-high frequencies go to work in industry. The power-frequency engineer, sensing a need for forming a speaking acquaintance with these newcomers, is pleased to find that the important principles are simple and can be understood without a schooling in electronics.

UNTIL the development of the high-frequency generator known as the magnetron, microwave radar remained little more than a principle of fascinating possibilities. The resonant-cavity magnetron is the heart of the microwave radar set. The entire radar set is devoted to the formation, transmission, reception and measurement of high-frequency impulses generated by the magnetron. These impulses are short bursts of radio-frequency power, having a duration of about one millionth of a second, repeated about a thousand times a second. For a radar set to have a working range of several miles, tremendous power must be generated during the short transmitting interval. On the other hand, the short wavelengths used require that the generator itself be physically small and, hence, of low capacity.

How successfully these requirements were fulfilled is indicated by the fact that magnetrons to generate three-centimeter radiation have been built that deliver peak powers of more than two hundred kilowatts but are small enough to fit into one's pocket.

Magnetrons of various types have been used for many years as generators of high-frequency radiation. They were, however, inefficient except at the lower frequencies. It was not until the introduction of the resonant-cavity type early in the war by the British that the tube became capable of handling large amounts of power at relatively high efficiency in the microwave region.

Magnetron Operation

A magnetron of the resonant-cavity type is a complete transmitter in itself. Within a single vacuum envelope are contained the resonant tank circuits, the cathode and anode of the generator, and the coupling circuit to deliver the high-frequency power. A pictorial representation of the internal construction is given in Fig. 1. Essential to the operation of the tube is the constant magnetic field, uniform over the anode-cathode region, from which it derives its name. This field is supplied by an external magnet (usually of the permanent type), and is shown in the sketch by means of vectors H parallel to the axis of the tube. A cylindrical cathode C , normally of the indirectly heated, oxide-coated type, is supported coaxially with the cylindrical anode A . In the copper anode block are several resonant cavities, R , symmetrically disposed around the anode. The metal portion, V , between two cavities is known as a segment or vane. A coupling loop, L , in one of the cavities serves to conduct the radio-frequency power to the antenna of the radar set. The input power is applied as a voltage between the cathode and anode, appropriately keyed in the form of pulses whose duration can be of the order of one microsecond. The electrons emitted from the cathode interact under the influence of the magnetic field (H) with the fields produced by the resonant cavities and the applied voltage so as to convert the direct input power to ultra-high-frequency power.

To explain the mechanism by which this transformation takes place it is necessary to examine the configuration of the microwave fields within the magnetron. Each resonant cavity behaves much like the simple resonant circuit shown in Fig. 2. Here a pair of condenser plates are connected by a one-turn coil. At one portion of the cycle the r-f current in the coil creates the magnetic



A 3-cm magnetron cutaway to show internal arrangement. The terminals running up from below are for the cathode heater. Power from the wedge-shaped cavities feeds through the vertical slit into the waveguide at the top. A glass window in the flange forms the vacuum seal. To obtain the desired mode of oscillation, alternate cavities are connected by pairs of circular rings.

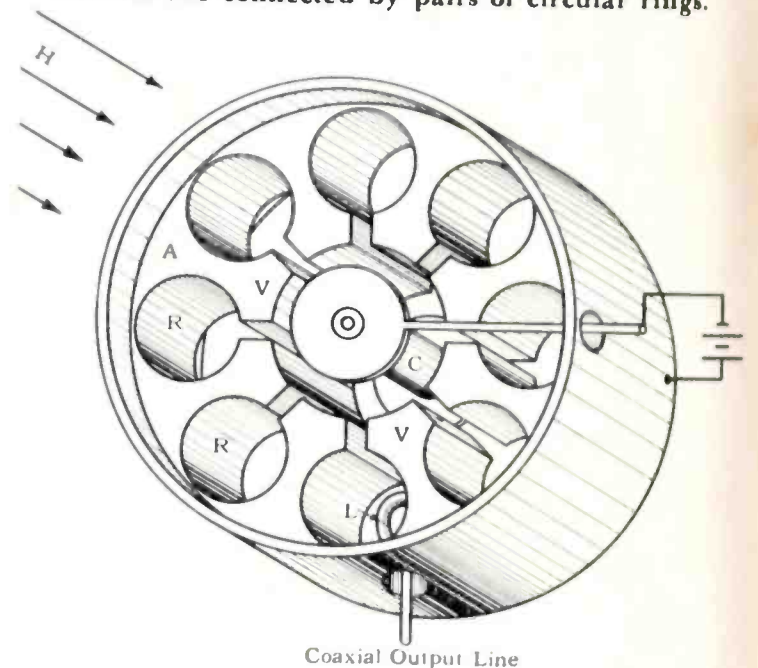
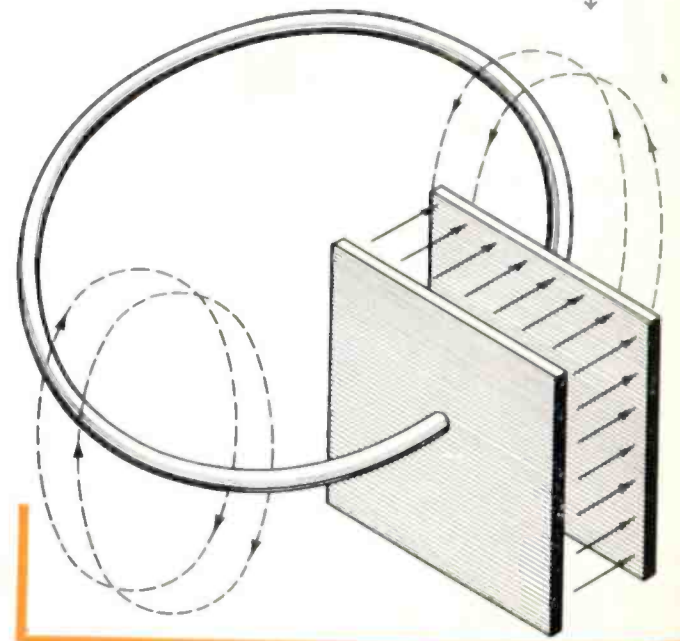
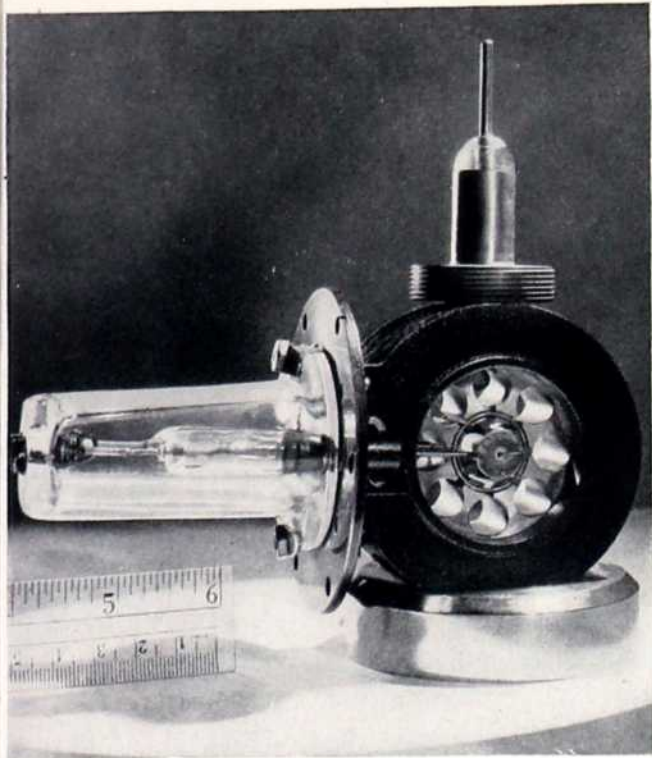

Fig. 2—The magnetron can be considered as employing the action of resonant circuits.





A 10-cm magnetron, capable of 240-kw peak output, is shown here with the sections over the cavities cut away. Cathode connections are enclosed in the glass insulator at the left and the coaxial transmission line is on top, receiving the ultra-high-frequency energy from the coupling loop, a small portion being visible in the top cavity.

Fig. 1—A common form of magnetron is a cylindrical block of copper, *A*, in which are several cavities, *R* surrounding a cathode *C*. A strong constant magnetic field *H* is applied coaxially with the magnetron. In the cavity a loop *L* absorbs the current resulting from the interaction of the fields and delivers the high-frequency output to the coaxial terminal.

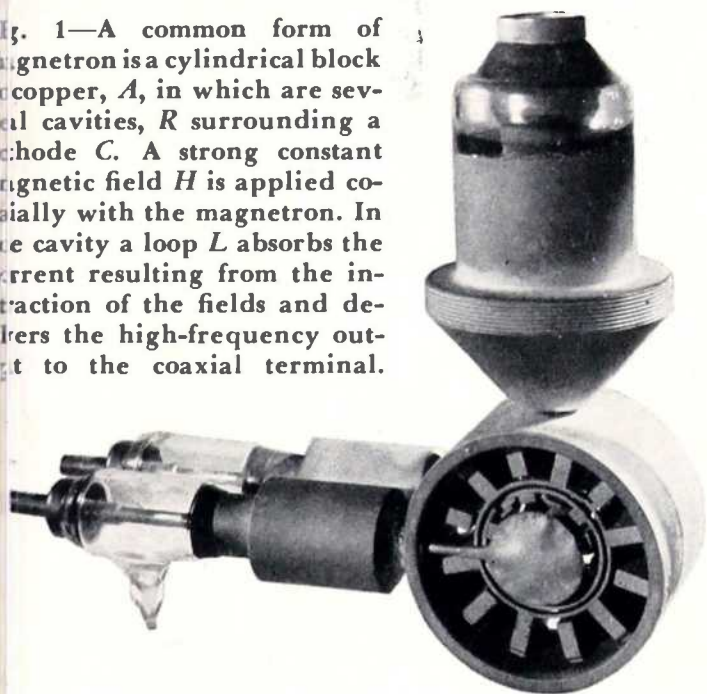

In this 10-cm magnetron the cavities, instead of being holes milled out of a solid block of copper, are formed by brazing vanes into a cylindrical shell. The tube delivers approximately 700-kw peak or pulse power.

Fig. 3—Configurations of electric and magnetic fields.

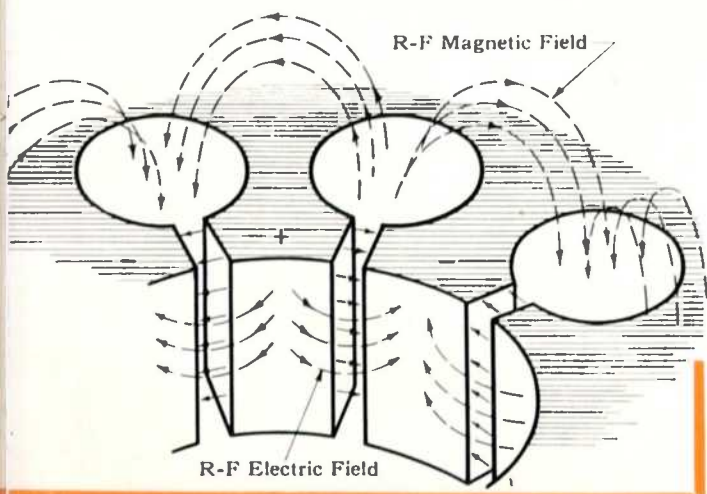

field lines shown (not to be confused with the constant field applied to the magnetron by external means); at the next quarter-cycle the condenser is fully charged and establishes an electric field between the plates. In the magnetron a number of such circuits (typically eight) are arranged in a circle with adjoining plates connected, the magnetic field lines from each circuit returning through the neighboring cavities, as demonstrated in Fig. 3. The fields involved are considerable. For a typical 10-cm magnetron delivering 300-kw peak power, the r-f voltage across the condenser plates is 24 000 volts peak, and the current in a single cavity reaches 330 amperes.

The field configuration shown in Fig. 3 is not the only one that the magnetron is capable of supporting. Each of the cavities is a distinct resonant circuit, and in spite of the close coupling between them, the system can oscillate in as many distinct types of field configurations, or resonant modes, as there are cavities. Each of these modes in general has a different resonant frequency.

As an illustration of the way in which resonant modes of different frequencies can exist in a system of coupled oscillators, the case of the two coupled pendulums shown in Fig. 4(a) is pertinent. One resonant mode of the system is shown in (b) where the two pendulums swing in phase. The spring is not stretched at any time, and it is evident that the frequency of the system is the same as that of the pendulums themselves. In Fig. 4(c), however, the two swing in opposition, stretching and compressing the spring at each swing. The restoring force on the pendulums is thus increased, and the frequency of the system is higher than before.

In an analogous manner, the system of cavities in the magnetron has various modes, characterized by the relative phases of the currents in the individual cavities, and occurring at distinct resonant frequencies. As an example the fields for another possible mode are shown in Fig. 5. Here the cavities oscillate in pairs, the voltage of the even-numbered vanes remaining at zero while the voltage of the odd numbered vanes alternates from plus to minus proceeding around the circle.

The magnetron designer is concerned with the modes from one viewpoint only: to get rid of all but one of them. The mode first described (Fig. 3), commonly known as the π mode because of the phase difference of π (180 degrees) between neighboring cavities, is almost universally employed in magnetron operation. It is common practice to tie alternate vanes together by pairs of rings located at the top and bottom of the anode as the photographs show. This process, known as strapping, does not eliminate the other modes. At these frequencies, the straps have an appreciable inductance, and the vanes are no more forced to oscillate together than the pendulums of Fig. 4 are by the spring. The actual effect is to lower the frequency of the π mode by virtue of the capacity between the straps. The symmetry of the other modes is such that the effect is much less for them than for the π mode, leaving the frequency of the latter well removed from those of the remaining modes.

The principles of the conversion process are most easily understood by reference to a model representing a magnetron that has been developed or "unrolled" so as to form a row of cavities facing the cathode. A plan of this developed magnetron is shown in Fig. 6, the cathode and anode taking the form of parallel planes. The externally applied magnetic field is perpendicular to the paper, and the external voltage is applied between the anode and cathode, giving rise to the electric field shown by the vectors *E*.

When only these two fields are present, an electron emitted from the cathode at *P* starts toward the anode under the force of the field *E*. However, as it acquires velocity it is deflected at right angles to its motion by the magnetic field, causing it to turn to the right. As the electron is turned more and more it eventually is traveling in a direction opposite to the electric field, and is slowed down and comes to rest when it reaches the plane from which it started. The process is then repeated, the electron progressing in a cycloidal path with a general drift at right angles to the electric field. If the magnetic field is strong enough, no electrons can reach the anode, and the magnetron draws no current from the source.

The path of the electrons is somewhat altered by the two fields mentioned, and by the introduction of the alternating electric field resulting from the oscillating cavities. These electric fields drawn in for a particular instant during the cycle are given in Fig. 7. The fringing of the alternating fields outside the condenser portion of the cavities creates field *e* in the interaction space which is

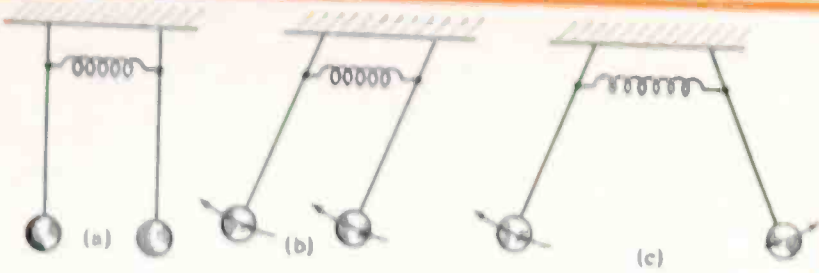

Fig. 4—Two pendulums, spring connected, have two possible modes of oscillation, which is representative of the many modes of oscillation that can exist in a magnetron.

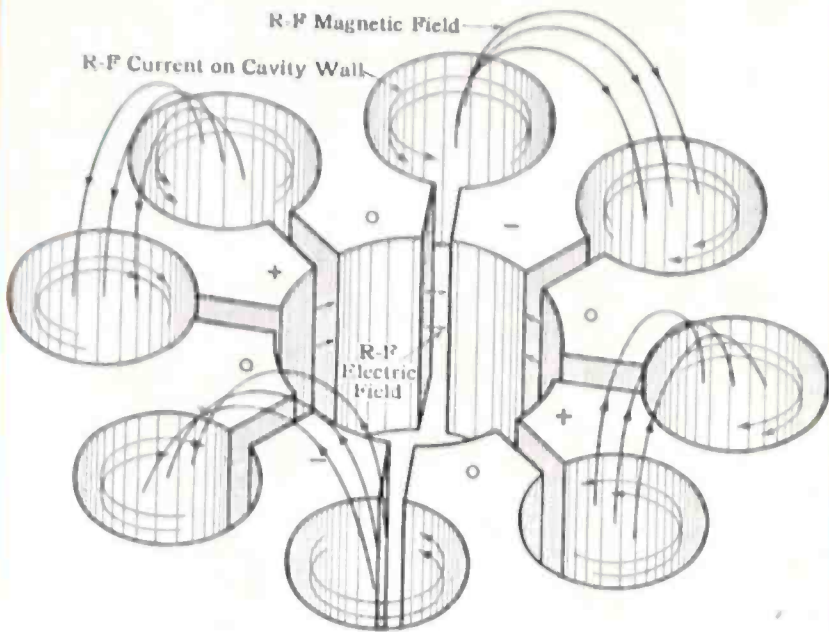

Fig. 5—One possible mode of magnetron oscillation.

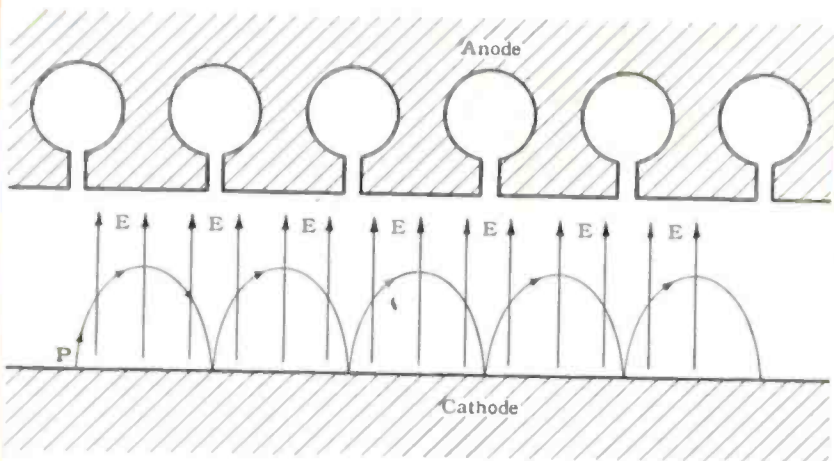

Fig. 6—Electrons in this explanatory diagram follow a cycloidal path when the cavities are not oscillating.

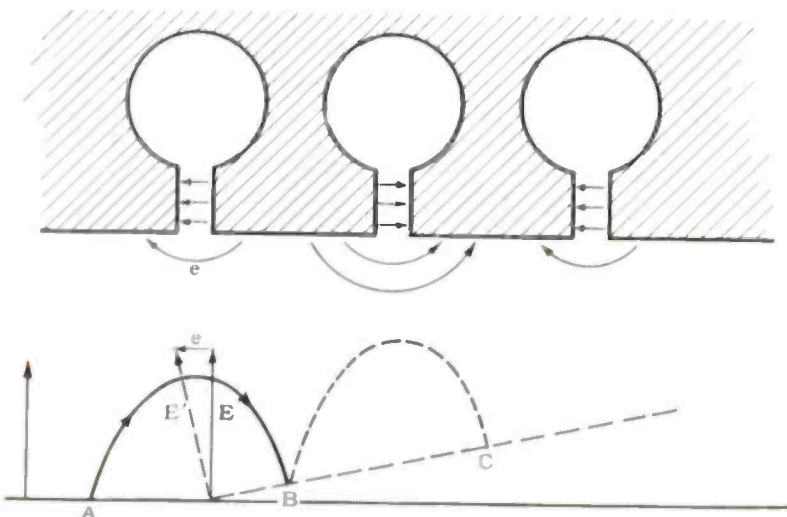

Fig. 7—Under the added influence of the oscillating field, electrons take the path indicated, delivering energy to this field.

at right angles to the d-c field E . Added vectorially, these two produce a total field E' , which is tilted with respect to the cathode plane.

Consider an electron leaving the point A when the field e is just beginning to rise in the direction shown. Assume also that the frequency of oscillation and the strength of the applied electric and magnetic fields have been adjusted so that the time taken for the electron to traverse one loop of the cycloid is just equal to one half cycle of the oscillating frequency. During this half cycle the total electric field E' is tilted to the left, and inasmuch as the drift is at right angles to this field, the electron comes to rest at point B , somewhat above the cathode plane. The electron has moved with the d-c field E for a greater distance than it has moved against it, and this field therefore has given some net energy to the electron. Yet the electron is at rest, and has no kinetic energy of its own. Where has this energy gone? During this half cycle, the electron has been continually moving against the oscillating field e , and has, therefore, given up a portion of its acquired energy to this field. This is the fundamental process by which energy is transferred from the applied d-c field to the alternating field.

The electron has required one half period to go from A to B ; as it starts out from B then, the electric field in the next cavity will have reversed the direction which is given it in Fig. 7, i.e., it will now appear to the electron just as the first cavity did. The electron thus progresses from one cavity to the next, always finding the oscillating field opposing its motion, and thus delivering energy to it until it finally strikes the anode.

Electrons are emitted from the cathode continually, and therefore half of the electrons start at unfavorable times, that is, instants when the oscillating field is in such a direction as to give up energy to the electrons. This would nullify the favorable effect if it were not for the fact that the cycloid for

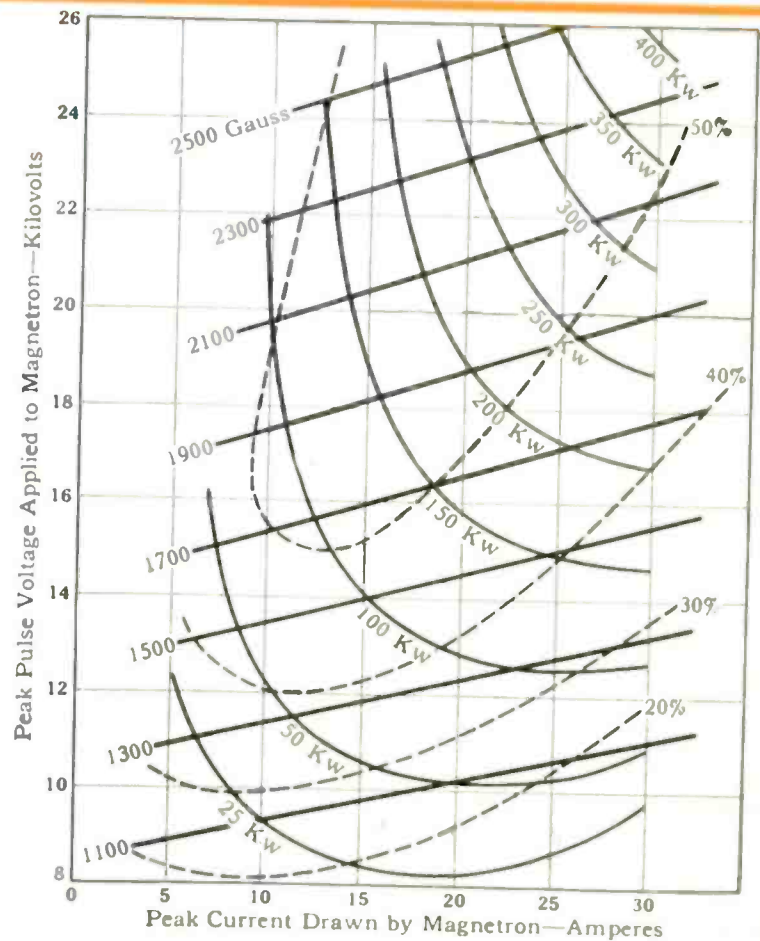

Fig. 8—Performance characteristics of a representative magnetron. A magnetron is operated at constant flux density, i.e., along one of the sloping straight lines. A very large current increase results from a small increase in applied voltage.

the unfavorable case is tilted downward, and the electrons strike the cathode after the first half-cycle and are removed before they have done much harm. Thus, on the whole, more energy is given to the oscillating field than is taken from it, and the magnetron is capable of self-sustained oscillation.

In the actual cylindrical magnetron the paths of the electrons differ considerably from those of the model, the geometrical differences and the effects of space charge making the orbits quite complex. Nevertheless, the underlying principles are the same, the angular velocities of the electrons being synchronized with the frequency of oscillation so as to keep the alternating field continually in opposition to the electron motion, while the electrons starting at unfavorable instants are automatically removed from the interaction space and returned to the cathode.

Sizes of Magnetrons

Resonant-cavity magnetrons have been built in a variety of sizes and power-handling abilities, ranging from tubes whose internal structure resembles that of a lady's wrist watch to those nearly 10 inches in diameter. The peak power output from all these tubes is relatively high, being measured in kilowatts and sometimes megawatts. Inasmuch as the physical size of a tube is dictated almost entirely by the wavelength at which it is to operate, the power-handling ability must be engineered into the tube without greatly changing its size. By using a large number of resonant cavities, the cathode can be made proportionately larger, and thus capable of delivering more current to the system. The number of cavities is limited, however, by the previously mentioned difficulty with undesired modes. The largest number of cavities employed in practice is eighteen.

Typical peak power outputs for 10-cm tubes range from 50 kilowatts for the "low-power" radar sets to over 2 megawatts in experimental sets. However, the average power is only about one thousandth of this, because the magnetron used in radar applications operates for one millionth of a second, and is turned off for one thousandth of a second.

Magnetron Performance and Application

A typical performance chart for a 10-cm magnetron is shown in Fig. 8. Several operating curves are shown, each for a different magnetic field. The slope is small, i.e., at a given magnetic field the operating voltage is nearly constant. This is in accordance with the theory that synchronism between the electron angular velocities and the cavity oscillations is a necessary part of the operation. On the same chart are plotted contours of power output and conversion efficiency.

The radio-frequency power is commonly tapped off by a coupling loop in one of the cavities, as can be seen in the photographs. Currents induced in this loop are fed to a short coaxial line built onto the body of the tube. This line is connected outside the seal either to a coaxial transmission line or to a waveguide by a specially designed transition section.

A method that offers many advantages over this is to use direct waveguide output. The tube on page 172 is provided with this type of output. A slot in the rear of one of the cavities feeds into a quarter-wave section of a constricted waveguide, which serves as a transformer to present low impedance at the back of the cavity, and into standard size guide. A flat glass window is provided in the flange to seal the vacuum envelope. This type of coupling is easier to manufacture to the desired tolerances, is less sensitive to changes in load, and is capable of handling more power without breaking down.

The resonant cavity magnetron is essentially a fixed-

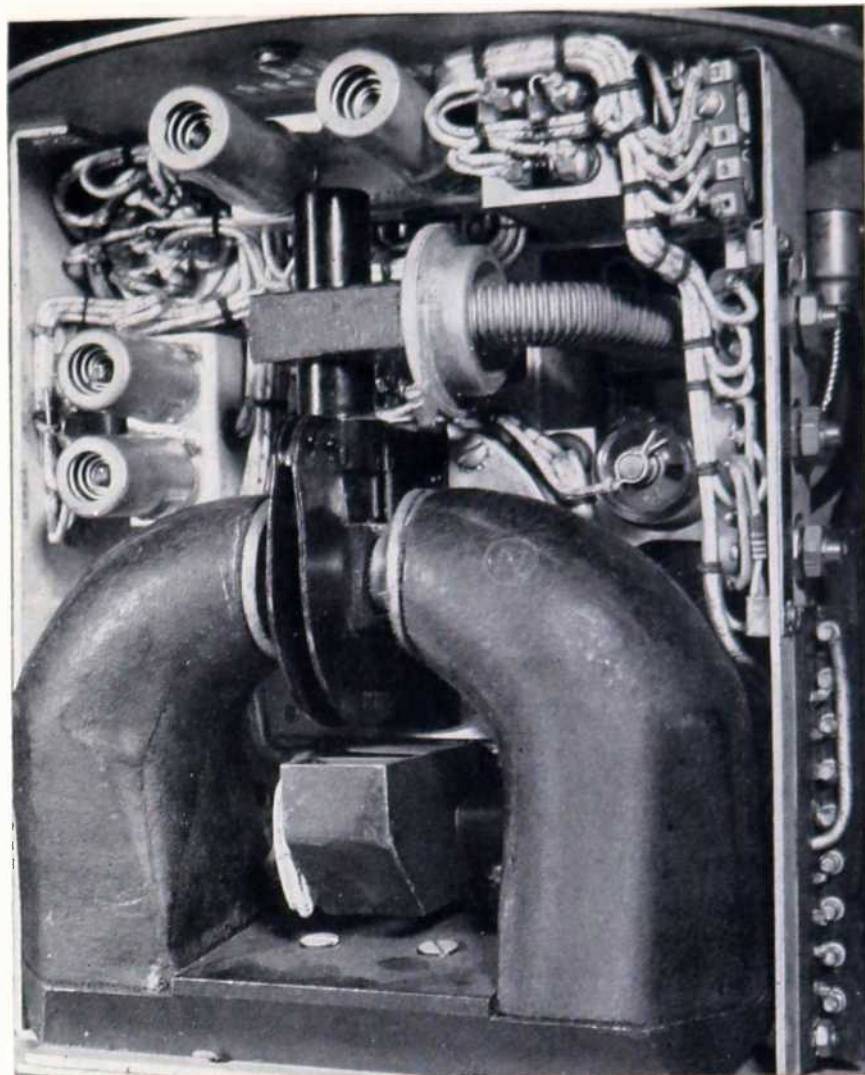

A 3-cm magnetron is mounted between the pole faces of a strong magnet. The flexible waveguide curves away from the upper portion of the tube and disappears into the set.

frequency device, though some tunable tubes are used. The tuning range is less than 10 percent, and the magnetrons might better be called adjustable. The tuning can be accomplished by coupling a single cavity very tightly to an external cavity, variable in size, by providing movable members to project into one or more of the cavities, or by rings in the proximity of the straps.

The magnetic field is usually supplied by a permanent magnet. This magnet can be part of the radar set, so that the magnetrons can be inserted in the gap when being replaced, or each tube can carry its own magnet permanently affixed to the tube. The latter method, though requiring a larger number of magnets, is economical in weight, as the pole faces can be made as lids of the vacuum envelope, shortening the gap and thus reducing the weight of the magnet necessary.

Resonant-cavity magnetrons are preeminently suitable for pulsed operation at high peak powers in the range of wavelengths from 1 to 40 centimeters. For this reason their major field of application is radar, and will probably so remain for some time. Experimental tubes have been built for continuous operation. These can be employed as oscillators for communication, dielectric heating, or any ultra-high frequency applications for which conventional vacuum tube oscillators are now used in the lower frequencies. An interesting application of the pulsed magnetron is its possible use in high-voltage accelerators. A resonant cavity driven from a magnetron can develop voltages of about a million volts. A series of such cavities can be arranged in such a fashion as to accelerate charged particles successively to extremely high velocities. In the future this type of accelerator may well rival the cyclotron and betatron as a research tool in nuclear physics.

The Klystron—Radar-Receiver Oscillator

DR. SIDNEY KRASIK, *Westinghouse Research Laboratories*

The klystron is the running mate to the illustrious magnetron, the two forming a Damon and Pythias combination in the microwave family. The magnetron, a high-frequency generator of great power and high efficiency, provides the rapid but short bursts of radiation required by radar. The klystron, of low power but tunable, is the oscillator of the radar receiver that listens for echoes. It utilizes the resonant-cavity principle and the fact that short but measurable amounts of time are required for the electrons to pass from cathode to anode.

THE KLYSTRON achieved success as a tunable generator of radar frequencies because it makes use of the very effect that hinders ordinary electronic oscillators at those microwave frequencies. The time for electrons to pass from cathode to anode in an electron tube, called transit time, is so short that even at broadcast or short-wave radio frequencies it is not an appreciable part of a half cycle. But at frequencies in the microwave region, say at 3000 megacycles for 10-cm waves or 10 000 megacycles for 3-cm waves, the transit time of an ordinary electron tube may be many cycles in duration. This and the factor of interelectrode capacitance and lead inductance rule out conventional electron tubes for microwave application. Special designs to obviate these difficulties require either microscopic electrode spacings or very high electrode potentials or both, as well as special electrode connections. The klystron on the other hand makes use of the fact that for a brief but finite time the electrons are in flight. During the first part of their flight some electrons (in the klystron) are accelerated while some are decelerated, so that they tend to bunch together as they move toward the anode. Their arrival at the anode in bunches constitutes the desired high-frequency current. The klystron, in short, modulates the

velocity of electrons in the beam rather than the density.

Radar, like radio, depends on the superheterodyne principle for signal detection. The klystron by actually capitalizing on this transit-time effect, provides a satisfactory high-frequency signal for mixing with the received signal. Moreover, the ease with which single-cavity reflex klystrons can be tuned makes them invaluable in radar applications where the output of the frequency converter or mixer must be at a relatively precise frequency but where the frequency of the transmitted magnetron signal tends to vary. Operation at ultra-high frequencies and tunability constitute the two chief advantages of reflex klystrons. Furthermore, klystrons can be used as amplifiers, oscillators, or, with proper resonators, as frequency multipliers.

The klystron is a war-born tube, although it had its beginning several years ago, before the war when the limitations of ordinary electronic tubes at high frequencies set research men thinking about other means of high-frequency generation. Velocity modulation of electron beams was achieved independently by several workers such as Heil in Germany, and Hahn, Metcalf, Varian, and Hansen in this country. This principle is the basis of operation of several microwave generators.

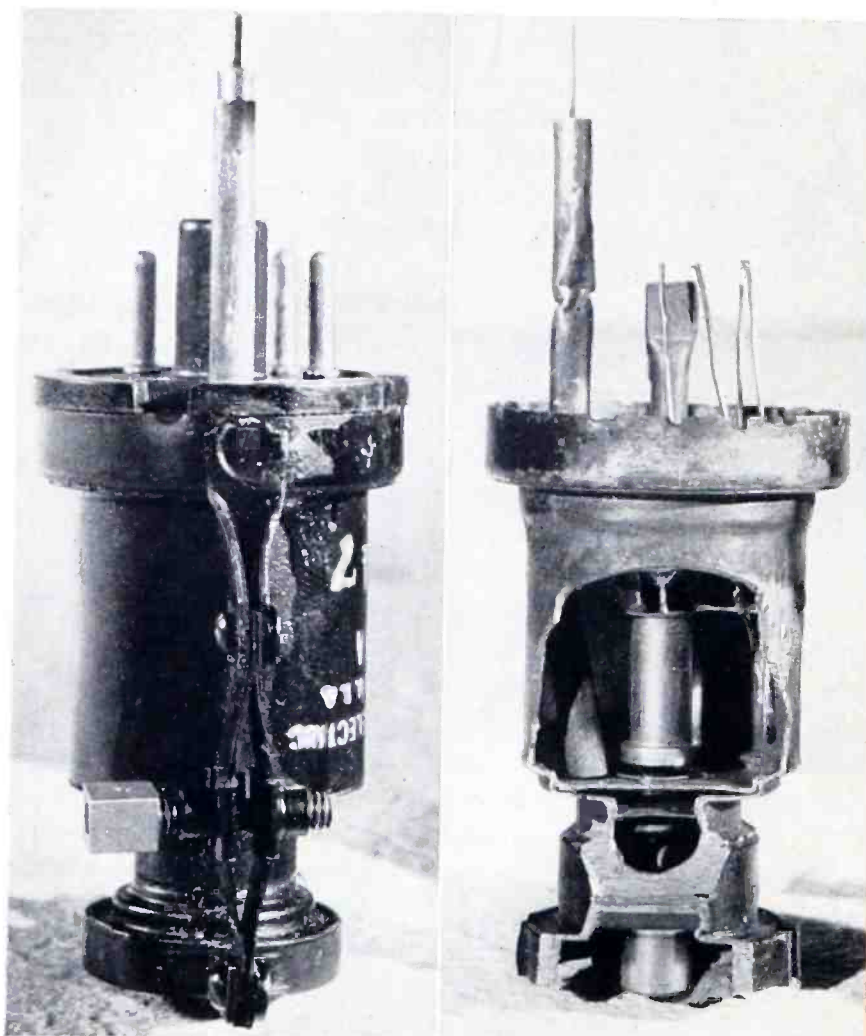

An oscillogram showing a reflector mode of a reflex klystron. The abscissa is reflector voltage. The ordinate is oscillation output. As the reflector voltage is adjusted into the proper range, the tube starts oscillating, and by adjustment of the voltage the oscillations increase in amplitude to a maximum. The range of reflector voltage is about 10 volts. The dots are frequency markers indicative of 10 megacycles between dots.

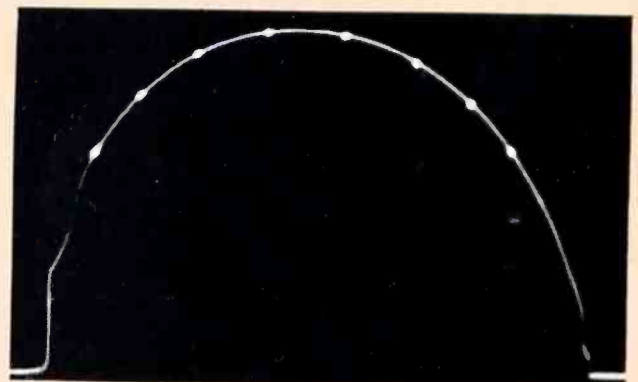

The reflex klystron (left) oscillates at about 10 000 megacycles. The long tube extending out of the base is the coaxial output line. The bowed struts control the gap spacing of the cavity, and thus tune it. The differential tuning screw adjusts the strut length. In the cutaway of a 10 000-megacycle reflex klystron (right) can be seen the electron gun, the cavity, and reflector. The electron gun is the long central tube. The cavity is the gap between the upper and lower parts of the tube. The reflector is the disc connected to the grid cap. The struts, for adjusting the spacing between the upper and lower parts of the tube, thus tuning the cavity, are not visible in the cutaway view of the klystron.

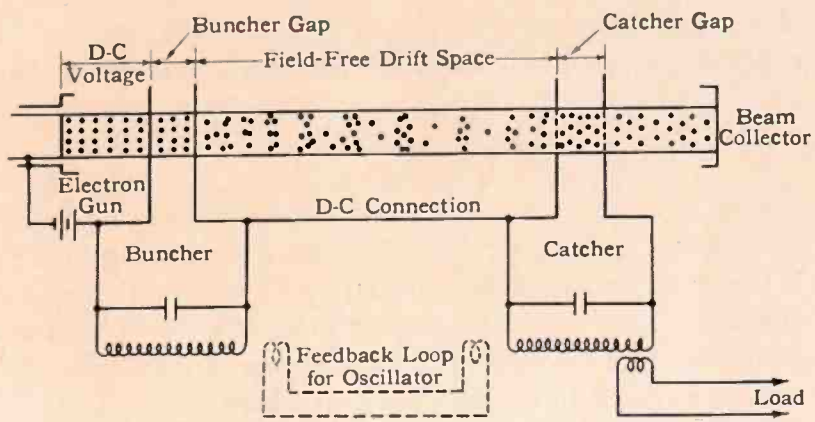

Fig. 1—Diagrammatic sketch of a klystron. It is made up of a cathode and a means for accelerating the emitted electrons into a uniform-density beam. These electrons pass through a high-frequency field created in the buncher where they are accelerated or decelerated depending upon the phase of the buncher field. The electrons then pass through a drift space, which is free of an electric field, into the field of the catcher where the electron beam—now of varying density—delivers high-frequency energy to the load. This drawing of electron bunching in gaps and drift space is purely schematic.

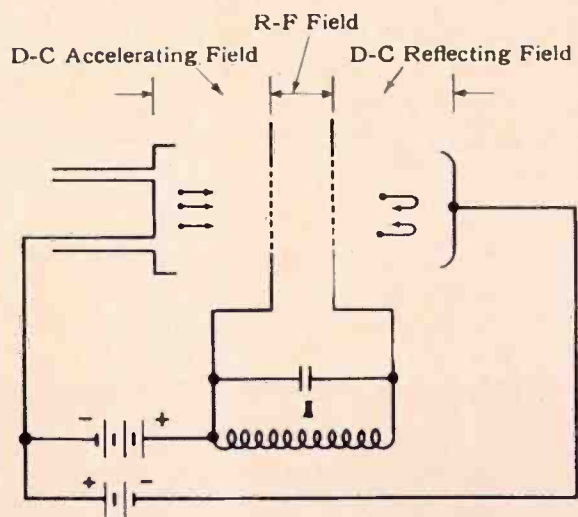

Fig. 2—A schematic drawing of a reflex klystron. As in the regular klystron, the electrons are accelerated from a cathode by a d-c voltage, and leave the buncher gap as a uniform-density beam. On leaving the buncher, the electrons enter a retarding field that permits them to bunch and returns them to the buncher gap. The reflected beam, being of varying density, now delivers high-frequency power to the buncher, which acts as the catcher. Bunching in a reflex takes place because the higher speed electrons spend more time in the reflecting field than the slower ones, just as the time spent by a ball hurled into the air is greater if thrown with more force.

Fig. 4—An Applegate diagram for the reflex klystron.—>

The reflecting field is assumed to be uniform, resulting in a parabolic trajectory on the diagram. As in Fig. 2, the electrons are assumed to cross the bunching field in a negligible fraction of a cycle. The velocity modulation is taken as 25 percent.

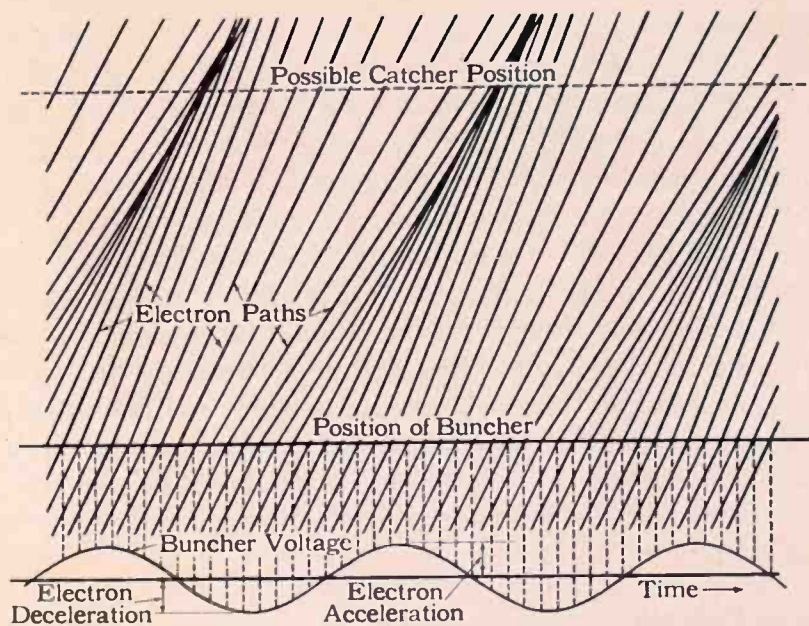

Fig. 3—The bunching process.

The velocity-modulation process can be shown graphically by a diagram of electron position versus time, called an Applegate diagram. The ordinate is electron position—for example, distance from the cathode—while the abscissa is time. The slope of the line showing electron position versus time is thus proportional to the electron velocity; the steeper the line the higher the electron velocity.

The electrons entering the buncher field have been accelerated by the d-c anode potential and enter the buncher as a beam of uniform density. In this diagram an electron is shown, for simplicity, entering the buncher every 20 degrees of electrical phase. The electron velocities are equal so that all the initial trajectories are parallel. The transit time across the buncher gap is assumed to be negligible so that electrons leaving the buncher have their velocities modified by the r-f field when they cross the gap. The sinusoidal wave at the base of the diagram indicates the phase of the buncher field; the diagram is drawn for 25-percent modulation.

Electrons crossing the gap at the voltage node continue into the drift space with their velocities unmodified. All others have their velocities increased or diminished as shown by the slope of the lines above the buncher position. The tendency of the electrons to cluster together into a bunch is evident.

The beam current at the position shown as a possible catcher position is non-uniform in time and has a frequency component equal that of the buncher driving voltage. If a sinusoidally varying field of the same r-f frequency is located at the catcher and if its phase is adjusted to decelerate the bunched group, net power is delivered by the beam to the field.

If the catcher is not used at the indicated position, the electron bunch diverges and at some later time reforms into another bunched pattern. This phenomenon is called overbunching and generally leads to less efficient operation. In any given tube with a fixed drift space, optimum bunching for a given buncher voltage is achieved by adjustment of the anode potential.

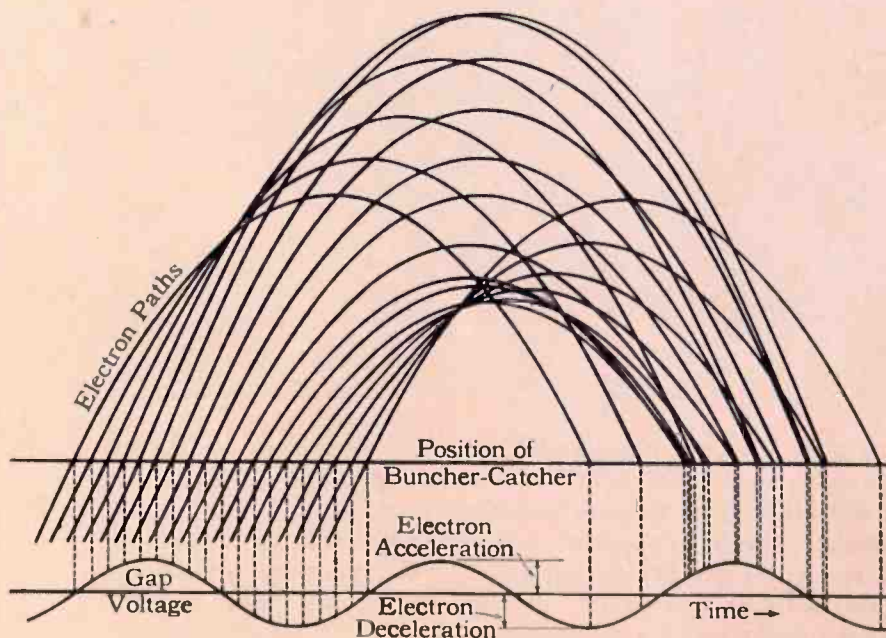

Velocity Modulation

In ordinary electron tubes the control grid regulates the density of electrons leaving the cathode and flowing to the plate. The electron is acted on by the control field from the time it leaves the cathode until it reaches the screen or plate. With appreciable transit time this results in severe loading of the control-grid circuit. In a klystron the electron is acted on by the control field over a limited portion of its path and the action of the control field is to modify the velocity of each electron rather than to control the number of electrons in the beam. The change in velocity of the electrons converts an electron beam of uniform density into one density-modulated, which imparts some of its energy to the output circuit. The process of changing the velocity of the electrons by the control field, which characterizes the action in the klystron, is called *velocity modulation*.

Klystron Operation

The essential parts of a klystron, shown diagrammatically in Fig. 1, are an electron gun, a gap region—usually between two grids—in which the r-f control field acts on the electrons, a field-free drift space in which the velocity-modulated beam is converted to a density-modulated beam, and an output circuit whose field is confined between another pair of grids. An electrode is generally provided to collect the beam after it leaves the output circuit, and, generally, dissipated. The first r-f circuit is commonly called a buncher; the second or output circuit is called a catcher.

In klystrons the electron beam is accelerated by the full d-c anode potential before interacting with the r-f field. This permits reasonable r-f gap dimensions with moderate voltages. To achieve this with ordinary electron tubes would require gap dimensions too small for practical manufacture, of fractions of a thousandth of an inch. In klystrons the gaps are several thousandths of an inch. It is important in klystrons

that the transit time of an electron across the r-f field region be considerably less than a quarter of a period of oscillation, otherwise efficiency is seriously reduced. Thus klystrons are designed with close gap spacings, but the requirements are not nearly so severe as in ordinary tubes.

The r-f buncher and catcher voltages appear across their respective gaps and produce electric fields in the gap in the direction of the electron beam. An electron crossing such a gap is thus accelerated or decelerated by an amount depending on the magnitude of the oscillating field, the time phase of the field when the electron enters the gap, and the time required for the electron to traverse the gap. If the transit time across the gap is negligible, then the electron will gain or lose an amount of energy corresponding to the gap voltage at the time the electron is in the gap.

The electron beam on leaving the buncher gap still is of uniform density but its velocity varies periodically. In the drift space the faster electrons catch up to the slower ones, and the uniform-density beam is converted to a periodic density-modulated beam. The density-modulated beam can deliver energy to a load circuit.

The current at the catcher is non-sinusoidal in time and has a high harmonic content. This can be used to obtain frequency multiplication, and as a frequency multiplier the conversion efficiency of a klystron is quite good even for high harmonic orders. The theoretical electronic conversion efficiency of a klystron, i.e., the fraction of the electron energy converted to oscillating field energy, is almost 60 percent; for the tenth harmonic the conversion is about 30 percent. These are the maximum conversion efficiencies under optimum conditions. The overall actual efficiencies are much less.

The Klystron Oscillator

To convert the klystron amplifier to a self-excited oscillator some catcher power must be fed back to the buncher. This

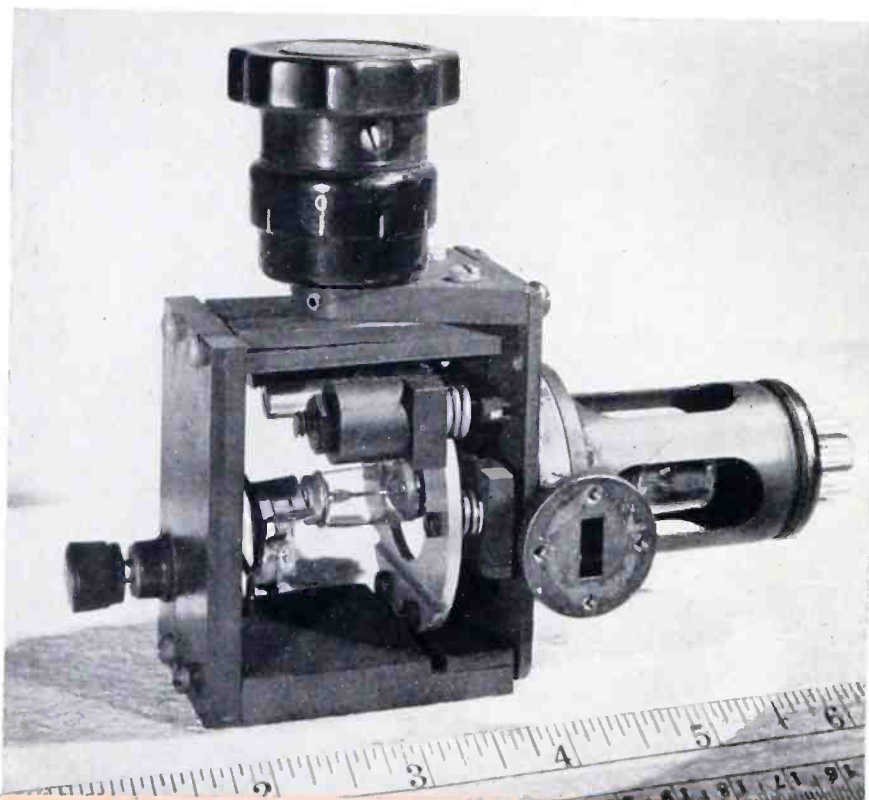

A reflex klystron designed for service as a local oscillator for radar at about 25 000 megacycles per second. The output is available from the waveguide shown in the lower right-hand corner. This particular design of klystron has a portion of the resonant cavity external to the vacuum seal. The knob adjusts the cavity tuning; the springs and screws shown are part of a temperature compensation apparatus.

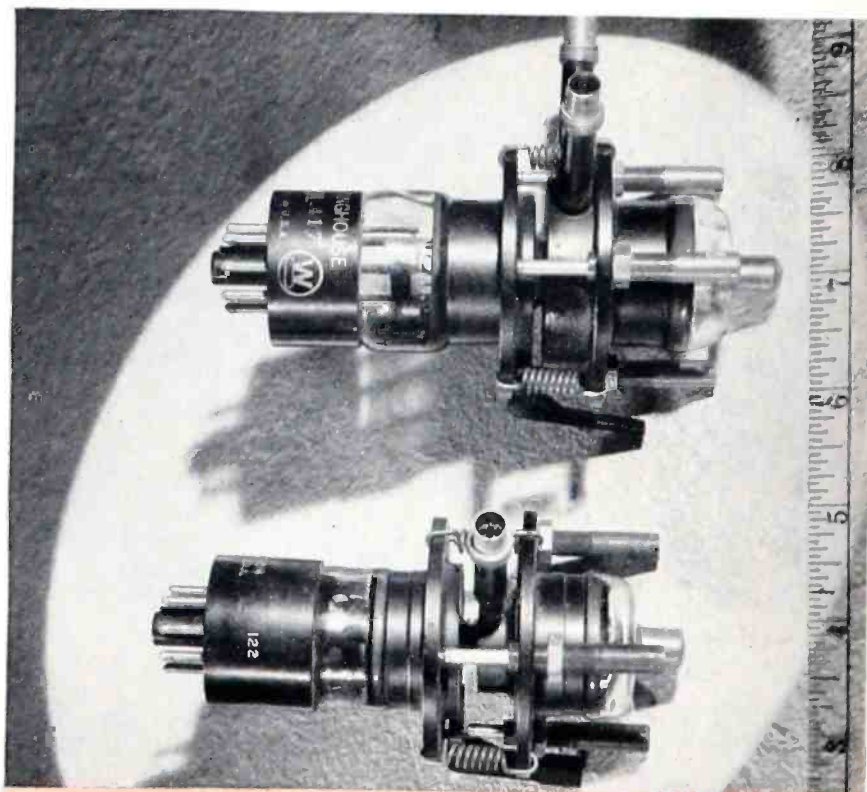

Two similar reflex klystrons designed for 3000 and 10 000 megacycles, respectively. Conspicuous is the difference in the size of the cavities, which is the portion to which the coaxial output lines are connected. The cavities are tuned by adjusting the spacing between the two rings. In service the tube is tuned by a knob mechanism that acts on the lever, seen extending below the left of the spring-held rings.

requires the phase of the buncher and catcher voltages to be appropriately adjusted. With a given feedback loop and drift distance this adjustment can be made by varying the d-c anode potential. This varies the number of r-f cycles spent by the electrons in the drift space. Thus a given oscillator generates power only when the anode voltage is adjusted to certain narrow ranges.

Another pertinent factor is the effective beam current. The amount of power converted varies with the beam current; if the beam current is too small, the power converted is too small and the oscillation amplitude decreases. If the beam current falls below a critical value, called the starting current, oscillations cease completely. As the beam current is raised above the starting current oscillations begin again, and efficiency and output power rise with beam current until optimum bunching is achieved. As overbunching sets in, efficiency drops, although power output continues to rise slowly.

The Reflex Klystron

The two-gap klystron oscillator just described requires correct tuning of the input and output circuits. If a variable-frequency oscillator is required, the tuning arrangement must track the two resonant circuits to a fairly high precision. This is a severe requirement and seriously limits the application of klystrons for certain services. If high efficiency is not essential, an oscillator can be designed in which the bunching and catching functions are combined in a single resonant circuit. Such a tube is a reflex klystron; its advantage is ease of tuning.

In the reflex klystron, shown schematically in Fig. 2, the electrons leave the cathode and enter the bunching field just as in the ordinary klystron. After leaving the buncher, however, the electrons are reversed in direction by a reflector electrode whose potential is negative with respect to the cathode. The reflected electrons pass back through the buncher, which now acts also as a catcher. Velocity modulation can effect a density modulation in this case because the time spent by an electron in the retarding field depends on its initial velocity; a faster electron spends more time in the reflector space than a slow electron because its greater velocity carries it farther into the reflector space before reversal.

The reflex klystron exhibits an extremely important klystron property: a change in oscillation frequency as drift time is varied. For example, if the reflector voltage is raised from the optimum and electrons return to the cavity in advance of their correct phase, the oscillation frequency rises. The amount of frequency change depends on the tube design and loading, but the effect can be thought of qualitatively as a forced oscillation of the cavity caused by electron bunch arriving at the cavity too soon and thus driving it at a somewhat higher frequency. For reflector voltages below optimum the frequency is lowered. This property is extremely important in certain applications, and tubes have been built that cover ranges of tens of megacycles with reflector voltage variations.

Resonant Circuits for Klystrons

Circuits for klystrons are made in the form of resonant cavities. A resonant cavity is a dielectric region enclosed by a metal boundary. Such a cavity has an infinite series of resonant modes, each mode having a specific field pattern and a characteristic frequency.

Klystron Applications

The electron conversion efficiency of a two-cavity klystron is somewhat under 60 percent. Overall efficiency is much lower than this because of grid interception, space-charge debunching, imperfect beam focussing, internal circuit losses, and

other effects. In the higher power designs commercial klystrons have overall efficiencies of around 10 percent. Continuous power of about 50 watts at 3000 megacycles per second is available in commercial tubes. Because of their low efficiency klystrons have not seriously competed with cavity magnetrons for transmitter applications in radar equipment. As a continuous-wave transmitter, however, the klystron is especially useful when employed to amplify crystal-controlled signals. The fact that a klystron can be used as a high-power amplifier gives it quite an advantage over magnetrons for certain communication purposes.

As a low-level amplifier or frequency converter for receiver applications the klystron has been disappointing. This is because the relatively high internal noise results in a poorer signal-to-noise ratio than can be obtained by most other means. Further work may improve the klystron for this application.

Single-cavity reflex klystron oscillators are available commercially with powers of about a watt at frequencies up to 10 000 megacycles per second. The overall efficiency is of the order of one percent. These oscillators are useful for laboratory work and certain communication and signaling purposes.

By far the greatest single application of klystrons—especially during the war—has been as local oscillators in superheterodyne radar receivers. In microwave radar, klystrons are almost exclusively used for this purpose. Reflex klystrons are well adapted to this service because of the relative ease of tuning and the electrical tuning feature that makes simple automatic frequency control of the receiver possible. For this service, efficiency and high output are not required. Frequencies up to 30 000 megacycles per second are available in commercial tubes with output powers somewhat under 0.1 watt and efficiencies of a fraction of one percent.

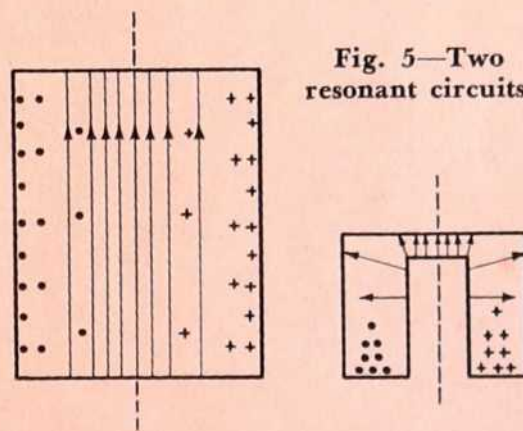

Fig. 5—Two resonant circuits.

Diagram at left is a cross section of a right circular cylinder showing the field pattern of the lowest mode. The electric field is parallel to the axis of the cylinder and is a maximum at the center. The magnetic field—shown as crosses and dots—is a series of concentric circles whose centers are on the cylinder axis. The magnetic field is a maximum near the resonator walls.

For electron-tube applications it is usually necessary to develop the maximum voltage across a relatively short gap. For this purpose a reentrant-type cavity such as shown at right is used. It represents a cross section of a pair of coaxial cylinders joined at the base and with the tops of the cylinders forming the gap. While the total voltage per unit power developed across such a gap is generally less than that between the ends of a hollow cylinder, the short gap length is important.

To a fair accuracy the reentrant cavity shown can be considered a section of coaxial line short circuited at one end and loaded with a lumped capacitance at the gap end. By varying the lumped capacitance the resonant frequency of the cavity can be varied. This is the usual manner of tuning reentrant cavities. The top of the outer cylinder is made of a thin flexible diaphragm that can be mechanically flexed to vary the gap spacing. This procedure is most convenient in tubes in which the entire cavity is part of the vacuum chamber.

Lost-Wax Casting

H. W. GIESECKE
Engineer, New Products Division
Westinghouse Electric Corporation

Lost-wax casting, an art long known in the dental profession and adopted by jewelers, has made its debut in the engineering world. Where involved shapes or fine detail and surface conditions must be reproduced, lost-wax casting offers the solution, and it is particularly valuable in the manufacture of such parts as gas-turbine blades, that use nonforgeable or nonmachineable alloys.

LOST-WAX casting is an ingenious adaptation of a centuries-old method to modern industrial needs. The same process used by medieval artists in producing metal statuary is now employed in the casting of gas-turbine and supercharger blades, switchgear components, dies, tools, and a wide variety of other metal parts. It has two outstanding advantages. Parts characterized by complex shapes or curves can be reproduced with fine detail and excellent surface conditions. More important, highly desirable alloys that are too hard to be machined or forged can be cast with precision.

Essentially, lost-wax casting consists of forming wax replicas of the desired parts. These are surrounded by a compound that hardens under heat to form a refractory mold; the wax is melted out (hence "lost") in the same process, leaving the desired cavity. Molten metal is poured into the cavity, and after solidification the mold is broken away to yield the



The lost-wax casting method is illustrated in this step-by-step formation of gas-turbine blades. It begins with (1) formation of a wax pattern in which a wax compound of high hardness, low shrinkage, and high melting point is injected into the mold and allowed to cool and harden. To make possible simultaneous casting of many pieces, the wax patterns are next (2) placed in a "jig" where they are welded to a crossbar simply by fusing the wax parts with heated tools. A pre-coating of very finely powdered silica and binder is applied (3) and hardens to a thin layer of refractory material with all the surface smoothness of the wax pattern. Next (4) the pre-coated patterns are placed in a metal container called a "flask" and completely covered with a much coarser

The adaptation of lost-wax casting to industrial use step far afield in its search for better and more an orchid is due the dental profession which has used of gold inlays, and which has developed a very also, should go to the Austenal Laboratories, Inc. to include casting of high-melting point alloys, and the numerous other structural elements require



finished casting. Machining is unnecessary except in rare instances. The process is also referred to as "precision casting," but this should not be interpreted too literally. Extraordinary careful process control can produce accuracy as close as plus or minus one mil on fractional-inch parts. However, for most commercial applications precision may be considered of the order of plus or minus two to five mils per inch.

The Lost-Wax Process

Preparation of a master pattern of the desired article is usually the first step. For high accuracy, shrinkage allowances must be considered in preparing this pattern. High-grade master patterns require tool-maker skill in their preparation. Brass can be used as a pattern material although steel is preferred for its more general shop adaptability.

The low-melting alloy molds are formed by a modification

of a technique long used by dentists and jewelry makers. The master pattern (a positive) is partially embedded in a suitable medium such as modeling clay or plaster of paris and the low-melting alloy is cast or sprayed against the exposed portion producing a mold segment which is a negative of the master pattern as well as the final casting. This process is repeated, exposing different areas of the master pattern, using the metal mold segments already cast to support the master pattern during the forming of subsequent sessions. In this manner, a multipart mold that completely surrounds the master pattern is produced. The pattern is removed from the mold, and gates for the entry of wax are cut along the parting lines of the mold segments.

Molds for producing wax patterns can be prepared, however, without the use of a master pattern by machining directly from steel or brass in much the same manner as molds

mixture of silica and binder to form molds, which are (5) placed under a battery of infra-red lamps and dried to a sufficient hardness to hold their shape. Here about 98 percent of the wax pattern is melted out, or "lost." Actual casting takes place in a special electric-arc furnace (6). The mold is placed upside down to the pouring spout of the furnace. The whole assembly is then inverted and air pressure applied to form the metal into all crevices of the cavity. After cooling the flask is removed and the mold crumbled to recover the casting. Finished castings are inspected (7) under a combination spotlight and "black light." The pieces are immersed in fluorescent oil, then used; if cavities or cracks are present, they appear a bright yellow under black light.

... reflects the willingness of heavy industry to adopt efficient manufacturing techniques. In this case, the lost-wax method for many years in the casting of a fund of knowledge in this field. Much credit, New York City which expanded the technique to those used in the manufacture of dentures in modern and highly precise orthopedic surgery.

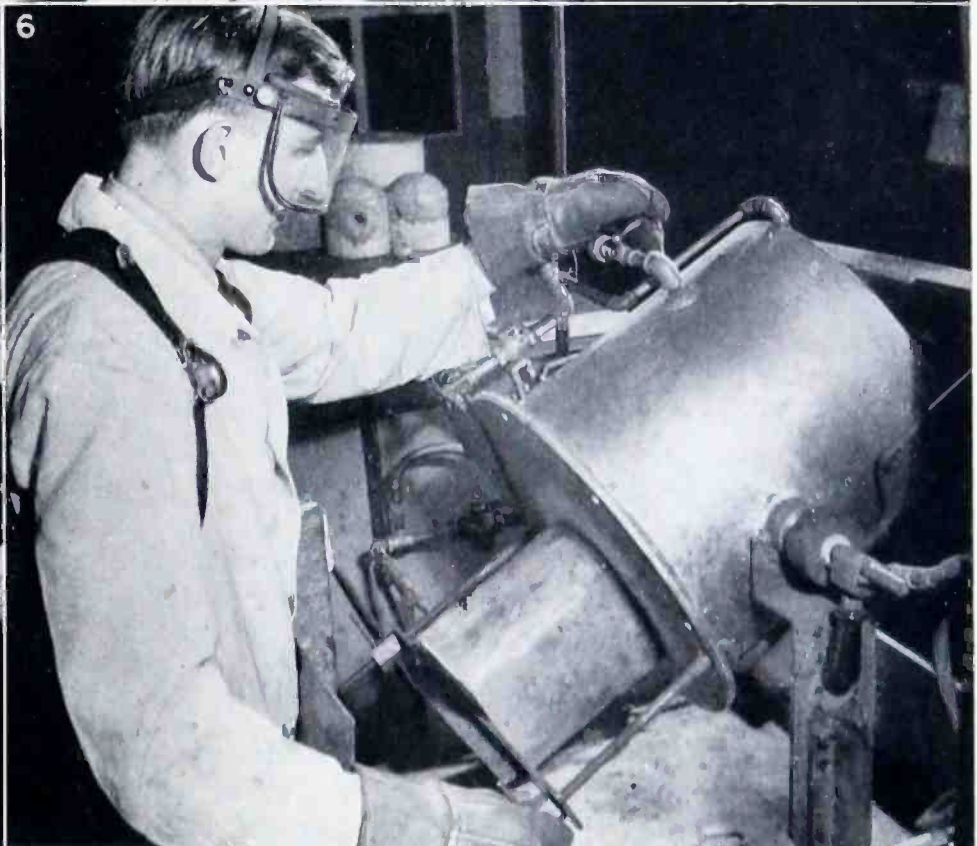
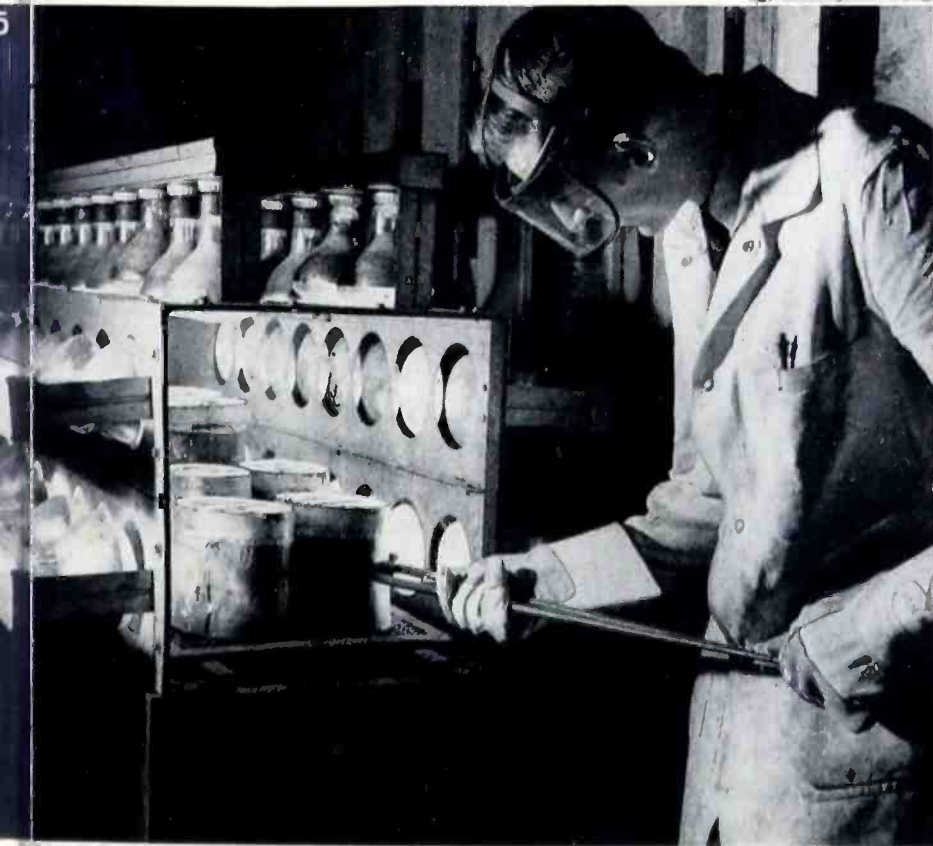
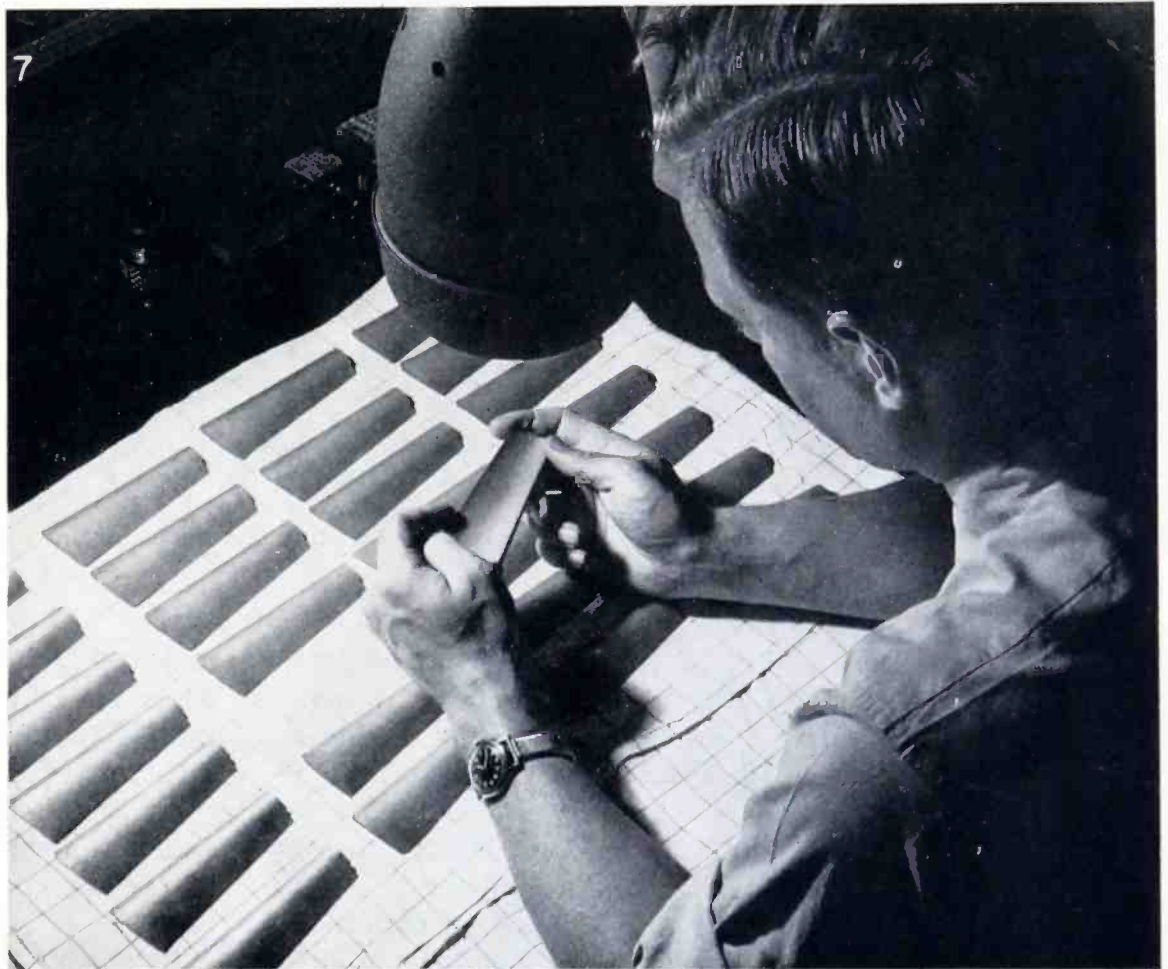

for plastics are made. However, inasmuch as the pressure and temperatures involved in molding wax are considerably lower than those required for plastics, sufficiently strong molds can be made from low-melting alloys such as Wood's metal. The use of these molds reduces tooling time and cost.

A special wax compound selected for hardness, low shrinkage, and melting point is injected into the metal mold. One essential property of the wax is that it must burn without leaving an ash. Increased accuracy can be obtained by lowering the temperature at which the wax is injected and increasing the injection pressure. This reduces the shrinkage of the wax pattern during cooling. Pressure is limited by the strength of the metal mold; molds made of steel instead of bismuth alloy will give longer life at high injection pressure.

A suitable number of wax patterns are assembled with preformed wax gate, sprues, and runners to make an assembled pattern of correct size for the standard refractory mold. This assembly is accomplished very simply by fusing the wax parts together with heated tools. A mass production technique is being developed in which the various wax parts lock together by friction at preformed joints allowing rapid assembly.

The wax assembly is sometimes dipped in a mixture of very finely powdered silica in liquid siliceous binder, which hardens to solid silica on drying. Because the surface of the pre-coat next to the pattern is composed of extremely fine material, a mold is obtained which has essentially the same surface smoothness as the wax pattern.

The pre-coated wax assembly is now placed in a metal flask and the flask is filled with the wet investment mixture. This material is a grade of silica that can be coarser than that used in the pre-coat mixed with a similar liquid binder. The flasks are vibrated to remove air and to settle the investment around the patterns. The investment is air dried to sufficient hardness to hold its shape, then inverted over a steam table to melt out as much of the wax assembly as possible. The air-dried investment is oven baked to a red heat to dry and harden the silica mold thoroughly. Remaining traces of wax are completely burned out during this baking.

The metal charge is melted in a special electric-arc furnace. The mold is placed upside down on top of the furnace and clamped to the furnace with the gate over the pouring spout of the furnace. The assembly is inverted on trunnions and air pressure is applied to force the metal into the mold. This air pressure does not affect the metallurgical properties of the cast metal but does assist in driving the molten metal into all crevices and corners in the mold cavity. The investment is pushed out of the flask after cooling and broken apart to recover the casting. Conventional abrasive tools are used for cut-off and cleaning operations.

A Specialized Production Tool

Like any other engineering technique, lost-wax casting is not a cure-all for production difficulties. It is a specialized

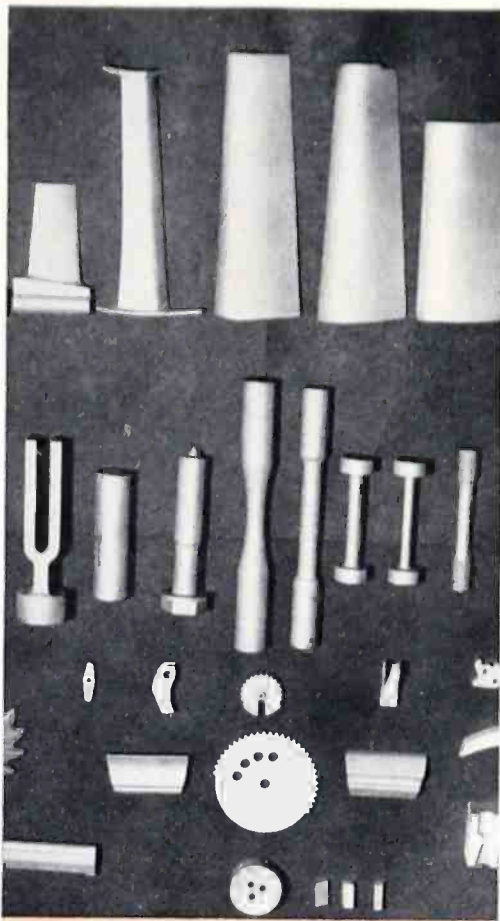

Lost-wax casting has already been applied to a wide variety of machine components. As with any new manufacturing technique, full exploitation of the method is possible only if the part is designed with this type of casting method in mind.

production tool that does several things better than any other available means. Specifically, the process is of greatest value in the following applications:

For casting of parts requiring metallurgical properties obtainable only in alloys that cannot be machined or forged. These include gas-turbine blades of certain alloys, and swaging dies for tungsten rods.

For casting of parts requiring complicated shaping, but not precise dimensional accuracy of a high order. Turbine blades are again a good example.

For casting of tools and parts requiring high metallurgical properties, complicated shapes, and precise dimensions on only one or two easily ground or machined edges or surfaces.

For casting of a limited or sample number of parts in which pattern cost by the lost-wax method would be a small fraction of the cost by other methods. Certain lamp machine parts fall in this class.

For casting of small parts in quantity of an alloy that is expensive to machine, but which can be produced without machining by the lost-wax method; stainless-steel pipe fittings, for example.

Most of the advantages of the lost-wax method are implicit in these applications. It is highly suited to the manufacture of fairly accurate reproductions of many small metal parts, and provides excellent reproduction of curved shapes, fine detail, and good surface conditions. The equipment is not excessively expensive and tooling costs are relatively low; moreover, production time is short compared to other methods. Where great precision is necessary, it is often feasible to cast the parts by this method, which has fair precision, and then use one or two simple grinding or other finishing operations.

Limitations to the Technique

Being a highly specialized tool, lost-wax casting has its limitations and cannot be applied over a broad field of production problems. In general, the process should *not* be used:

Where very high dimensional precision is required. From two to five mils per inch is the precision limit, primarily as the result of shrinkage that enters in at (1) formation of the metal mold, (2) molding the wax pattern, (3) drying and baking the investment, and (4) casting the metal. Shrinkage effects can, of course, be largely predetermined and compensated for.

Where cost reduction is a prime objective. The large number of steps in the process and the amount of manual effort required prevent sufficient cost reduction for many uses. Labor-saving methods, however, will be developed.

Where the part to be cast requires large quantities of metal. Present limit is from 10 to 15 pounds of metal in one mold. Larger molds can be handled, but with difficulty.

In spite of these limitations, which are susceptible to alteration by future improvements, the process is a significant addition to the techniques of industrial casting, especially in the casting of alloys difficult to machine or forge. These alloys include the so-called refractory alloys such as stellite and vitallium, the principal constituents of which are chromium, cobalt, molybdenum, and tungsten.

The Place of the Sealed Metal Ignitron

J. H. Cox*
Rectifier Engineering Manager
Westinghouse Electric Corporation

D. E. MARSHALL
Electronic Engineer

The permanently sealed ignitron has been edging upward in rating. Sealed tubes capable of 400 amperes continuous are in service. The sealed ignitron and its larger brother, the continuously pumped tube, have their own provinces but the overlap in ampere capacity has been creeping upward and will continue to do so.

EVER since the ignitron tube began climbing to its present dominant position as a rectifier and welding control the relative fields of the two basic types—the permanently sealed and the continuously pumped—have undergone a shift. The sealed-off metal ignitron has always been used for the lower capacity installations, whereas the pumped-tubes have had exclusive acceptance where high currents are required. But the region between them has been to some extent an area of overlap, and one that has continually shifted upward. Sealed ignitrons are being built in larger and larger sizes. The present maximum commercial size sealed ignitron is 400 amperes, whereas ten years ago the largest was 50 amperes. This might make it appear that the sealed ignitron will eventually displace the pumped type. There are, however, good reasons why, if this happens at all, it will not happen soon.

*Mr. Cox has since been appointed Manager of Engineering, Emeryville, California plant of Westinghouse.

**The pumped ignitron was discussed in detail in "The Ignitron Mercury-Arc Rectifier," J. H. Cox, *Westinghouse Engineer*, March, 1944, p. 51.

Ignitrons are, in general, used for two fundamentally different purposes—for rectification of alternating to direct current and as a timing and switching device, primarily for resistance welding. Essentially all ignitron tubes used in resistance-welding control are sealed. In the rectifier field the larger capacity units are still being built for continuous pumping **whereas the small capacity installations—up to 500 kw at 250 and 275 volts, and 1000 kw at 600 volts—employ sealed tubes.

Development of the Ignitron

Following the invention of the mercury-arc rectifier about 40 years ago the designer has had two major problems to solve in its application. One of these was the correct design of interior parts to utilize the rectifying properties of the arc. The invention of the ignitron was a major step in the better utilization of the arc-rectification principle.

The other major problem was the construction of an envelope tight enough so that it could be pumped down to and

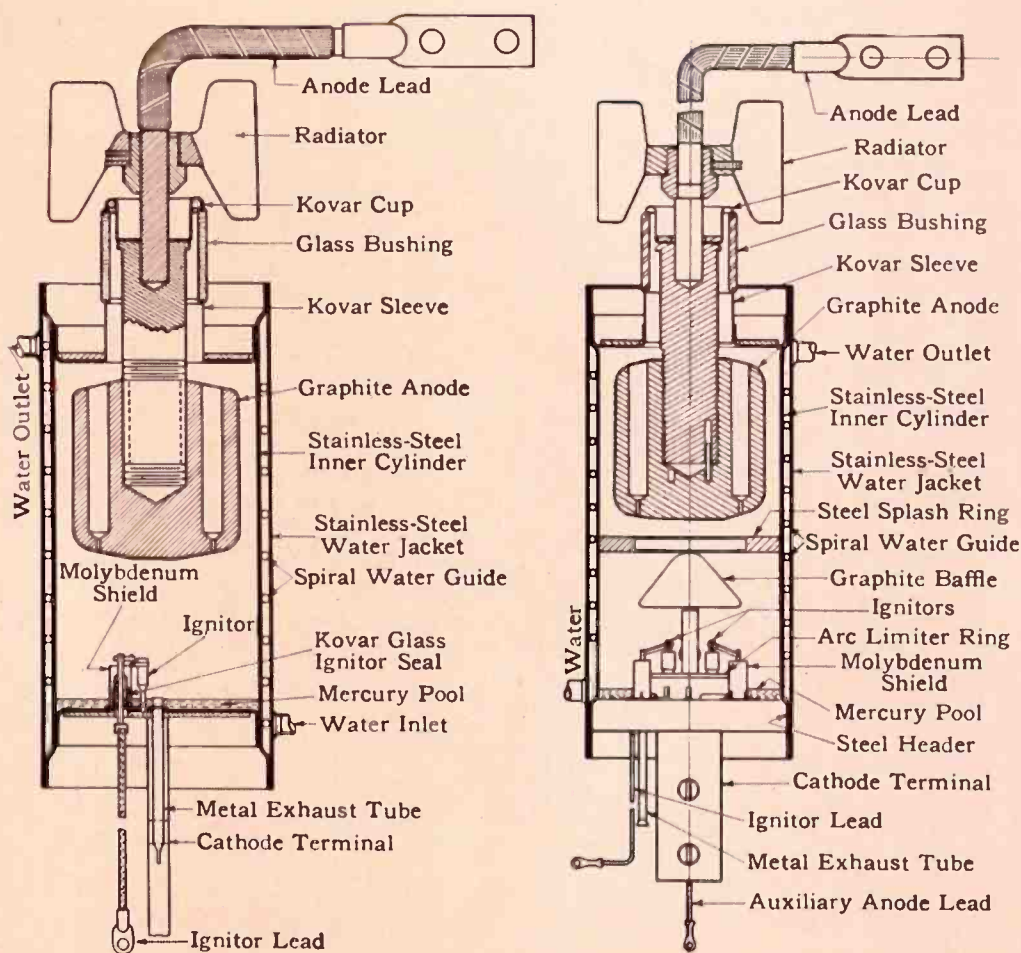

Figs. 1 and 2—The sealed ignitron for resistance-welding service (left above) is somewhat simpler than a rectifier tube (right above). The rectifier, shown in cutaway at the right, has two ignitors and has additional arc shielding.

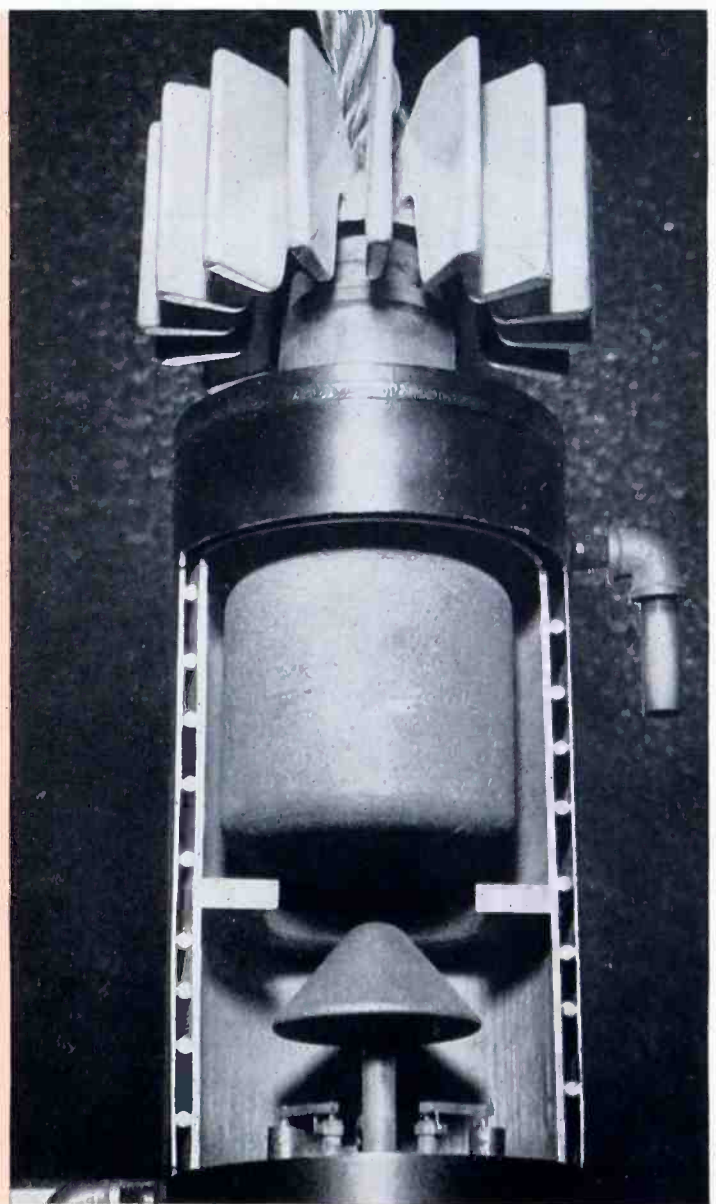



Two sizes of ignitrons for rectifier service. The larger tube is rated at 400 amperes, 300 volts, or 300 amperes, 600 volts. The small one has approximately half the capacity of the large one.

maintained at a low enough pressure for arc rectification, which is about one micron, or 1/760 000 of atmospheric pressure. Gradually improved technique in welding, improved metals, improved seal materials and designs, and steady improvements in vacuum-pump design resulted in a metal envelope that was quite satisfactory in the late 1920's, provided that continuous pumping was used. Before that time it was necessary to build rectifier envelopes of glass. This definitely limited the size of mercury rectifiers, and the fragility of glass constituted an obstacle to their wide-scale application. A still further step was the permanent sealing of the metal envelope. The first sealed ignitrons were built about ten years ago, and have steadily grown in size.

In the simple job of rectifying alternating current to direct current at potentials up to 3000 volts, the most convenient circuit is one in which the cathodes of the rectifier elements are electrically connected. This made it appear logical to the early rectifier engineers to place a group of anodes in a single tank with a single cathode, a single starting and excitation system, and a single pumping equipment. However, because this construction carried with it the objections of lower efficiency, less flexibility, and lower reliability, the idea of single-anode tubes remained attractive. The ignitron is inherently a single-anode tube. It has excitation equipment for each anode, and does not require a cathode insulator. In pumped form the separate tanks are evacuated by a single pumping system connected to a common manifold.

An incentive to the development of sealed tubes was the development of circuits, such as for resistance welding, in which the tubes operate at different potentials. When tubes operating at different potentials use a common pumping system, the insulating sections for the support of high potentials are complicated and expensive because of low breakdown potential between electrodes at intermediate pressures. The alternative of providing a set of pumping equipment for each tube would be prohibitively expensive. The advantages of a sealed tube that can be mounted at any electrical potential

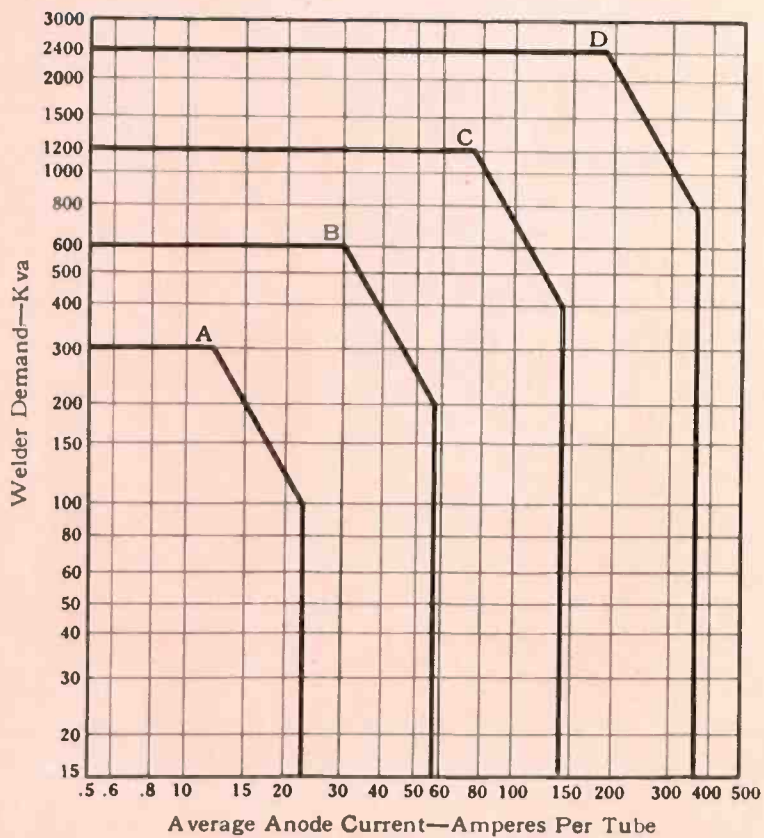

Fig. 3—Current ratings for ignitrons in welding service, 250 to 600 volts. These curves refer to specific tubes as follows: A, WL 681-686; B, WL 652-657; C, WL 651-656; D, WL 655-658.

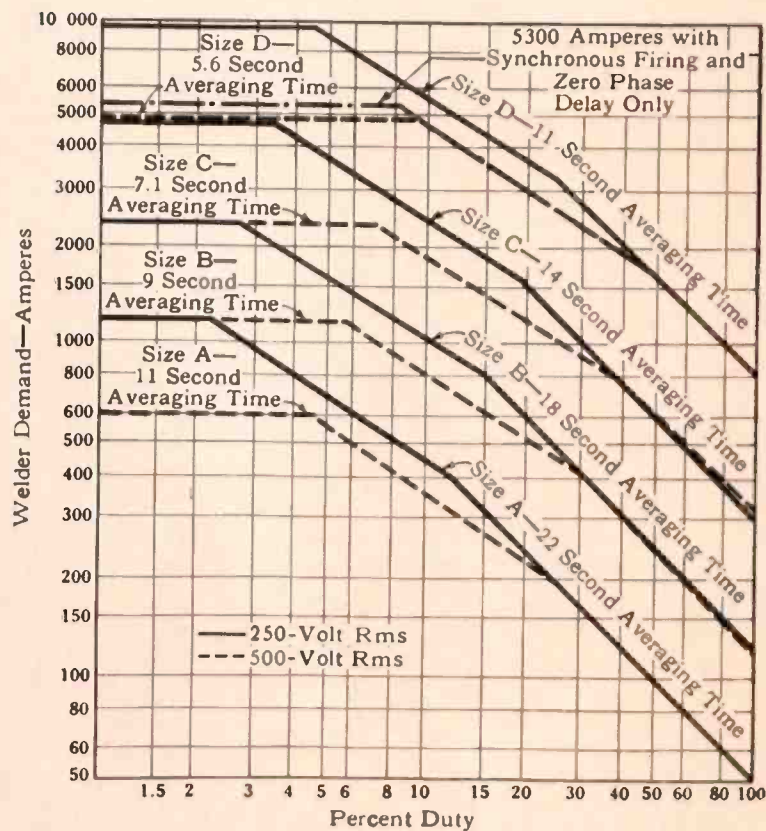

Fig. 4—Ratings for welder ignitrons in 250- and 500-volt service, connected back to back in the standard welding circuit. The current is measured between the tubes and the welder.

and without crossover pumping connections are obvious.

Construction of Sealed Ignitrons

Differences in the two principal functions of sealed ignitrons—rectification and resistance-weld timing—necessitate two types of tubes.

In resistance-welding control, a pair of ignitron tubes are used as an a-c switch. When the excitation control is released so that each tube is fired as required, one tube passes one half of the a-c wave and the other tube passes the other half. When the excitation is blocked the circuit is open. For this service the tube must withstand full back voltage only at the end of each weld, and an arback merely alters the heat of a weld spot. More accurate heat control can be secured by varying the point on each half cycle at which firing takes place. Failure is not a short circuit on the system, but simply misperformance in the tube. The tube has a high probability of recovering on the following cycle. The pickup characteristics must be positive.

In rectifier service an arback results in a short circuit on the system; hence, its arback quality must be high. Although its pickup characteristics must be positive, it need not be of the same order as in welding control. Thus, in general, a tube designed for normal rectification is different from one designed for welding control.

The main difference in design between sealed ignitrons for welding and rectification lies in internal features provided for rectification service, which is the more difficult function. Additional surfaces are placed in the arc path to deionize the gas more quickly, thus increasing its ability to withstand back voltage following a conduction period. The rectifier tube also incorporates an arc-limiter ring of insulating material, which confines the possible location of the cathode spot, and, together with the specific arrangement of the baffling surfaces, acts to shield the anode at all times from a direct view of the cathode spot. Unless this is done, a higher frequency of arback results. The phenomenon is not perfectly understood, but a working hypothesis is that the blast from the cathode spot contaminates the surface of the anode in a way that enhances the occurrence of arback.

The baffle is made of graphite, and is supported by a steel rod welded to the cathode header. The rod is covered by an insulator, thus preventing the arc spot from coming in contact with any metal.

The electrons entering the anode, which constitutes current conduction, liberate thermal energy that must be dissipated. Also, the neutralization of ionization in the arc stream releases energy on all surfaces and raises their temperatures. This energy must be removed either by conduction or radiation. Internal parts not massively connected to the water jacket can best be cooled by radiation. However, the temperatures required to radiate appreciable amounts of energy are high. To withstand these inevitable high temperatures the anode and the baffles are, therefore, made of graphite. Molybdenum shields are provided in all types of tubes to protect vulnerable parts, such as internal glass seals, from the high temperatures that would result from these radiating bodies.

The splash ring is made of a massive section of steel welded solidly to the inner cylinder wall. It, therefore, has sufficient thermal conductivity to the water-cooled wall to cause it to operate well below any dangerous temperatures.

A small auxiliary anode is provided with the rectifier types in the region of the cathode to act as a holding anode. Its function is to provide a small current to the cathode to maintain the cathode spot when needed after its initiation by the



This pair of ignitrons is mounted in a cabinet for resistance-welding control. They each furnish 200 amperes at 440 volts for controlled periods of between two and thirty cycles.

ignitor. The need for this arises from the fact that in many of the most popular rectifier circuits pickup of the main anode does not occur coincident with the excitation impulse under some conditions of load, but follows sometime later. When pulses of short duration are used for ignition, additional means are needed to extend the period of tube excitation. A pulse of holding arc current of sufficient time duration to extend over the variation of anode pickup time is supplied to the auxiliary anode. The tube is thus made serviceable for more than one mode of operation, thereby insuring stability. Tubes for welding do not require this holding anode because the anode is always positive at the instant of ignition, and main anode pickup takes place promptly.

Two ignitors are provided in rectifiers, one being a spare. Failure of an ignitor can result in the loss of an otherwise good tube, and it is therefore considered good practice to provide two ignitors although one is capable of operating the tube throughout its normal life. In welding circuits, "anode firing" is used. This method of ignition, though not suitable for rectifier circuits, is a more positive action and fires an ignitor even when imperfect; hence, two ignitors are not considered justified in welding tubes.

Ignitrons have been built to make use of water cooling almost exclusively. However, air-cooled tubes can be built readily, with some increase in tube size. In certain applications, such as in confined building spaces and under ground, water cooling is much preferred, so water-cooled tubes are

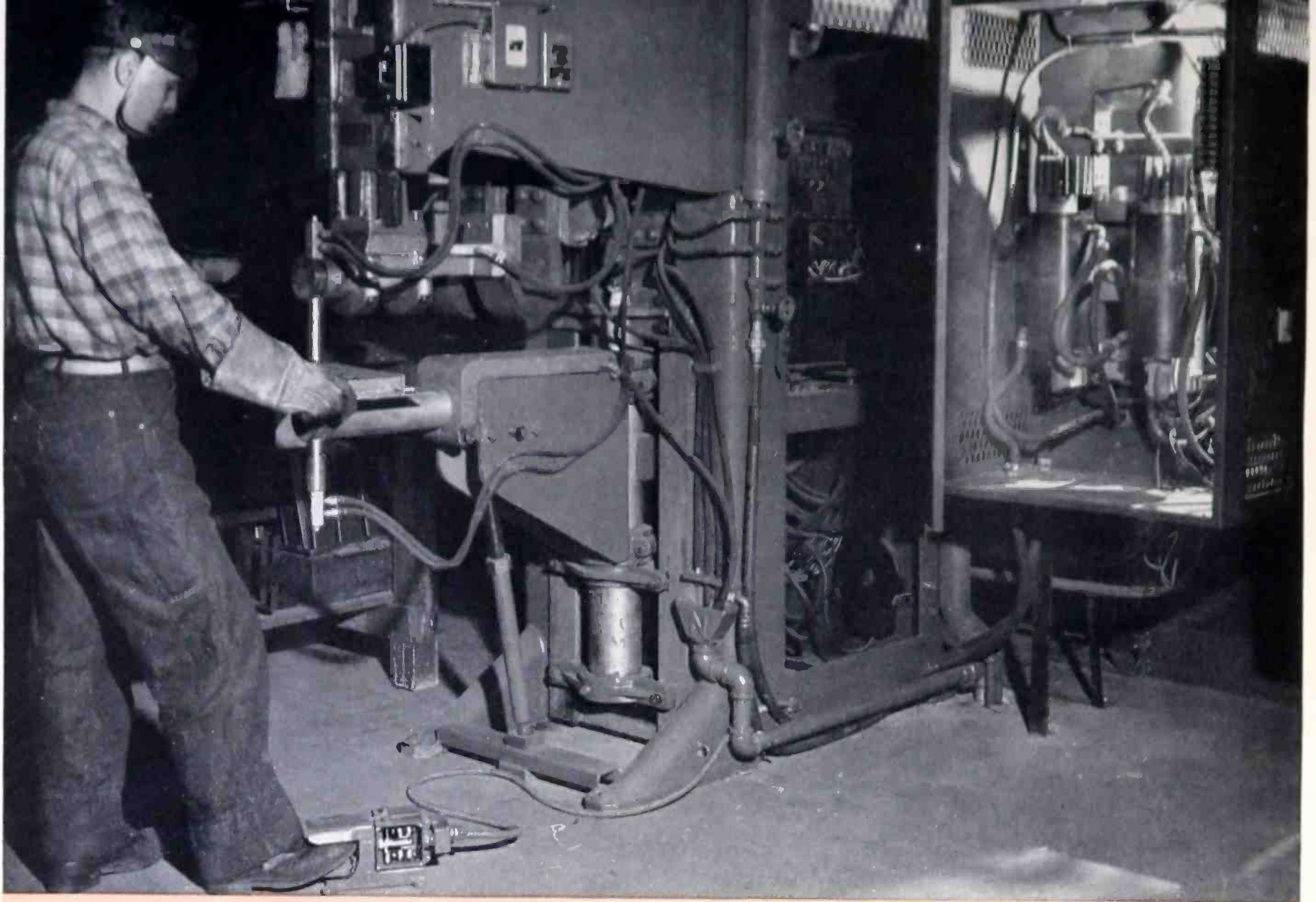

A typical resistance-welding control set-up, with the ignitron cabinet door open and tubes illuminated for purposes of the picture.

demand. In locations without water, such as in mines, air cooling can be accomplished with water-cooled tubes by the addition of a radiator and pump for recirculation of water. In this manner, one design of tube can serve a variety of functions. Both designs can be provided if each is required in sufficient number to justify the development.

In all Westinghouse sealed-metal ignitron tubes the insulation is provided by the use of glass-Kovar seals.* The glass and Kovar closely match each other in thermal expansion throughout the entire working temperature range. This feature of the materials is a necessity, but not altogether sufficient. It is entirely possible that differences of temperature may exist between component parts, thus causing small stresses to exist even with materials having the same thermal expansion. The seal is, therefore, designed to maintain temperatures as nearly constant as possible. The parts are designed to allow for sufficient flexibility so that these stresses can be relieved by slight movements of the component parts to adjust for differences in temperature that exist.

The main metal envelope is of considerable concern. Metal-to-metal joints must be absolutely tight. As mentioned previously, rectifier tubes operate best at pressures of less than one micron, and the pressure must not be allowed to rise to more than several microns throughout the life of the tube. Electrically controlled seam and projection welding performs this function satisfactorily, and does not require skilled operators. Wherever possible, copper brazing is used to back up the welding joints as an added security.

In water-cooled tubes, the water jackets must be constructed so as to cause the water to flow at high velocity to

insure efficient heat transfer from the tube walls to the water. Sealed ignitrons have spiral ribs welded around the circumference of the inner cylinder to guide the water uniformly around the tube, and to reduce the cross section of the flow, thus making the flow velocity high for a given water rate.

The problem of corrosion is serious, not only because of the ensuing deterioration of the walls of the tube, but also because the corrosive action always generates atomic hydrogen, and this passes through ordinarily sound iron and destroys the vacuum in the tube. Therefore, a careful choice of materials is required. All parts of these tubes in contact with water are made of 18-8 stainless steel. This material must be stabilized so as to pass through the welding process as well as the relatively high-temperature cycle to which the assembled tube is subjected during its evacuation, without losing its corrosion-resistance properties. There are various processes by which stainless steel is stabilized in its manufacture. Sealed-tube manufacture is among the most critical applications for stainless steel.

Tubes are exhausted through a metal tube extending through the cathode header and welded there. After the completion of the degassing process, which includes evacuation of not only the gases in the tube spaces, but also the gases absorbed on the surfaces of the materials, the tube is cooled enough to permit insertion of the correct amount of distilled mercury. After filling the tube, it is permanently sealed by welding the metal exhaust tube closed.

Rating of Sealed Ignitrons

Welder tubes are not rated in terms of maximum peak and average currents and inverse voltages as in the usual rectifier rating systems. Instead, the welder tube rating is based on

*See article entitled "Kovar, an Alloy That Seals Metal to Glass," by W. H. Brandt and F. S. Latimer in *Westinghouse ENGINEER*, July, 1945, p. 117.

rms demand currents to the welder through a pair of tubes, and on the line voltage controlled by the tubes. Engineering tests of the capabilities of the tubes have shown that these two ratings bear an inverse relationship to each other. Thus, tubes can be rated on the basis of demand kva in the range of rms line voltages between 200 and 600 volts. It is, however, necessary to reduce the average current rating of the tube as voltage increases.

The curves of welding ignitron currents, Fig. 3, are based on rating tests. They are conventionalized in the interest of standardization. The maximum kva demand rating of each size is twice that of the next smaller size. The maximum average current rating is 2.5 times that of the next smaller size, and is independent of demand current up to a demand current of one third of the maximum. At the maximum-demand rating, the average current is reduced to 54 percent of its maximum rated value. Intermediate points are shown by the straight slant portion of the curve that connects the two points above plotted on logarithmic paper.

The curves of Fig. 3 show the basic ratings. Other, more convenient sets of curves can be derived from these. The voltages are usually 220 and 440 volts. The usual line-voltage variations raise these values to 250 and 500 volts. Two sets of curves for these two voltages are shown in Fig. 4.

The rated "maximum averaging time" is printed on each curve, giving the short-time rating of the tube. This value is used in calculating the percent duty. The duty is the ratio of "on" time to "on plus off" time in a regularly repeated cycle at a constant demand current, assuming that the "on plus off" time is not greater than the maximum averaging time shown on the curve. The maximum length of continuous conduction time at a given current is given from the curve as the product of the maximum averaging time and the percent duty corresponding to that given current.

Sealed rectifier ignitrons are rated in a more orthodox manner. The rating is based on average currents for continuous operation with overload ratings for short periods. The total currents are averaged over short periods of time to prevent intermittent operation at high currents in a manner similar to the welder tubes. Such operation is not normal in rectifier applications, and the limitations of a tube in rectifier service differ from those in welding service. The average current rating is reduced as the voltage is increased.

Comparison of Sealed Tubes and Continuously Pumped Tubes

Continuously pumped tubes offer certain advantages, mainly concerned with the idea that they are permanent equipment and never need replacing. Any evolution of gas, as the result of large overloads or arcbreak, impairs the vacuum. However, this can be overcome by the automatic pumping out of the tube. Any cumulative damage resulting from repeated arcbreaks, or other types of failure, can be corrected by overhauling the tube and cleaning or replacing parts. These advantages are dependent on the ability to service the equipment, the best maintenance being available in large installations where it is economically feasible to maintain a stock of spare parts, and where there is a crew of men who can be trained in the maintenance of this type of equipment.

Sealed tubes are easily replaceable, and by less skilled operators. No specialized knowledge is required to replace a tube. All that is necessary is to remove the connection bolts and water connections, and insert the new tube. This tube is especially valuable on small, isolated installations. Spare tubes must be kept available, either on the user's property or in a

nearby warehouse. However, assuming spares available, length of time of shutdown resulting from tube failure can generally be minimized. In the welding field, the pumped types have largely been superseded by sealed types.

A study of sealed vs. pumped construction necessitates a comparison of the cost and life of sealed tubes with the cost and frequency of maintenance of pumped tubes. The frequency of need for attention must also be considered from a nuisance point of view. Both because of ease of construction and magnitude of risk, the first sealed tubes were of relatively small size. Obviously it is not economical to repair small tubes, so the cost involved at the end of life is the cost of replacement. As larger tubes are built in sealed form the value justifies rebuilding, and the cost at the end of their life is the cost of rebuilding.

Unfortunately, until recently* there has been no satisfactory accelerated test to establish the life of a tube from a vacuum point of view, so it has been necessary to wait for the passage of time to determine this important factor. Several installations have been in service for about five years; many tubes are in operation after 20 000 hours of service, some even after 40 000 hours. The question of accurate determination of average life depends on statistical evaluation of the data being collected. Another complicating factor is that the continuous development applied in the past seven years has profited by past field experiences so that all tubes of which records are available are not of similar design.

General Trend of Development

The development of these tubes is proceeding to higher power ratings both in current rating and voltage rating. Tubes operating at inverse voltages of 15 000 volts at 150 amperes average have been applied.

The experience to date with the five-inch diameter, and smaller tubes, has been such as to justify taking the next step in increased size, approximately eight inches in diameter, which has a continuous average current rating of 400 amperes in the 300-volt class of application. This tube has passed the laboratory stage, and a number of installations are now in satisfactory service.

In the development of the eight-inch tube, the question is raised as to whether this tube should be repaired rather than scrapped at the end of life. The authors believe that its value justifies the expense of returning the tube to the factory for rebuilding. This should further enhance its attractiveness in the larger sizes, and it does not seem unreasonable to predict that someday all tubes will be made sealed.

There seems no insuperable technical barrier to the manufacture of sealed ignitrons in any size desired, and the trend is to the larger sizes as experience has shown. It is entirely possible that eventually all ignitrons will be permanently sealed. However, the larger tubes are always applied in larger power applications where higher maintenance skill is available for other reasons, and this makes maintenance of vacuum-pumping equipment nominal. Modern vacuum pumps have given an excellent account of themselves, and it might be that the permanence of pumped tubes and the opportunity of on-the-spot repairs will prove more attractive than the replacement or exchange of tubes in the larger sizes. However, at the present time the upper limiting rating of sealed ignitrons is still increasing as is the upper rating of pumped tubes. The probable result will be that the border line rating between the two types will increase and each will continue to have its field.

*See "Detecting Vacuum Leaks Electronically," by Thomas, Williams, and Hipple, *Westinghouse ENGI VERR*, July, 1946, p. 108

What's New!

A Step Toward Industrial Color Harmony

COLOR harmony in a factory is universally recognized as desirable to aid visual acuity or speed of seeing, but has been virtually impossible to obtain. Uniformity in hues and values has been simply out of the question. Even a new plant, for which the machinery and equipment are specified to be painted grey, presents an astonishing number of variations—as many as there are suppliers. Furthermore even in a single “color” the number of discordant combinations is discouraging. There are literally hundreds of recognizably different greys, for example, certainly the most neutral of all colors.

An important step to correct this situation has been taken.* The appearance experts of Westinghouse and General Elec-

tric have made a scientific selection of four greys that form the basis of standardization. These four offer variety, yet are harmonious in any combination. Thus a motor paint, for example, could be specified as one of the standard greys—for which exact mixing specifications can be given—with the assurance that when the motor is mounted with machines made by another builder and painted the same or any of the other three greys harmony is assured. These four greys, which are being offered to all industry as a standard, are the outgrowth of the independent efforts of the two companies to meet the request of the Navy for color standardization.

Four greys were selected. The lightest of these, called light grey, has a warmth;

*The full story is told in an article, “Can Industrial Color Finishes be Effectively Standardized,” by D. L. Hadley and C. B. Ryder, in *Industrial Standardization*, July, 1945, p. 151.

enough yellow in it to be properly called a “french” grey. It is close to an average of the majority of light greys now used on indoor apparatus, such as switchgear, and is already almost a standard by common consent for such uses. The darkest grey, called dark grey, is cool, of the typical purple-blue type and dark enough to meet all requirements of formulation for extreme durability in the most severe outdoor application. This also is a standard accepted by many for heavy outdoor apparatus such as transformers. The next to lightest grey has more yellow than blue and is referred to as medium-light grey. This grey is close to the new Machine Tool standard grey.** The last, or medium-dark grey is cool, approaching the blue family. It alone of the four is new to industry, being a little lighter and more blue than the old Machine Tool grey, but its selection was the result of the effort to develop systematic spacing of all, in both hue and value.

The four colors were selected on the basis of the Munsell system, which fortunately lends itself to decimal—and therefore definite—designation.

Sample cards giving the exact values of these four colors are obtainable by addressing Mr. Basil Lee, Appliance Design Department, 3-N-47, Westinghouse Electric Corporation, East Pittsburgh, Pa.

**There is however, a difference, the adjudication of which is being actively discussed.



The principle of the doctor's stethoscope has been adapted to a device for checking performance of high-speed machines. It is a resonance tube devised particularly for steam turbines. By changing the effective length of the telescopic resonance sections, sounds indicative of any malperformance are made clear.

Inside Job for the Sterilamp

THE Sterilamp family has another addition. The newest bacteria-killer is a bulb-shaped, walnut-size lamp specially designed to keep home refrigerators free of odors, enable longer preservation of food in its original stored state, and check the growth of mold and bacteria. In redesigning the lamp, Westinghouse engineers compressed the bacteria-killing power of the eight-inch-long Sterilamp previously used into a three-and-a-half-watt, 12-volt midget that screws into a small niche in the cabinet's interior.

The glass from which the lamp is made is of a new, special sort that passes radiation of both 2537 and 1850 Angstroms wavelength. The 2537-Angstrom radiation is the potent bactericide. The shorter wavelength variety is an effective producer of ozone, which is particularly useful in retarding odor contamination of one food by another. Created for both high-humidity and low-humidity types of mechanical refrigerators, the new Sterilamp should prove of most value to the former type in forestalling spoilage and mold growth that would otherwise occur.

WESTINGHOUSE ENGINEER



In the Westinghouse Laboratories a research engineer (above) measures the effectiveness of one of the new walnut-size Sterilamps made especially for use in refrigerators . . . (upper right). A pocket-size publication, the Electronics Digest, reduces to simple form the best information relating to industrial electronics . . . (right). As an aid to intelligent planning new or revised hospital facilities, scale-models of x-ray machines and associated apparatus are invaluable.

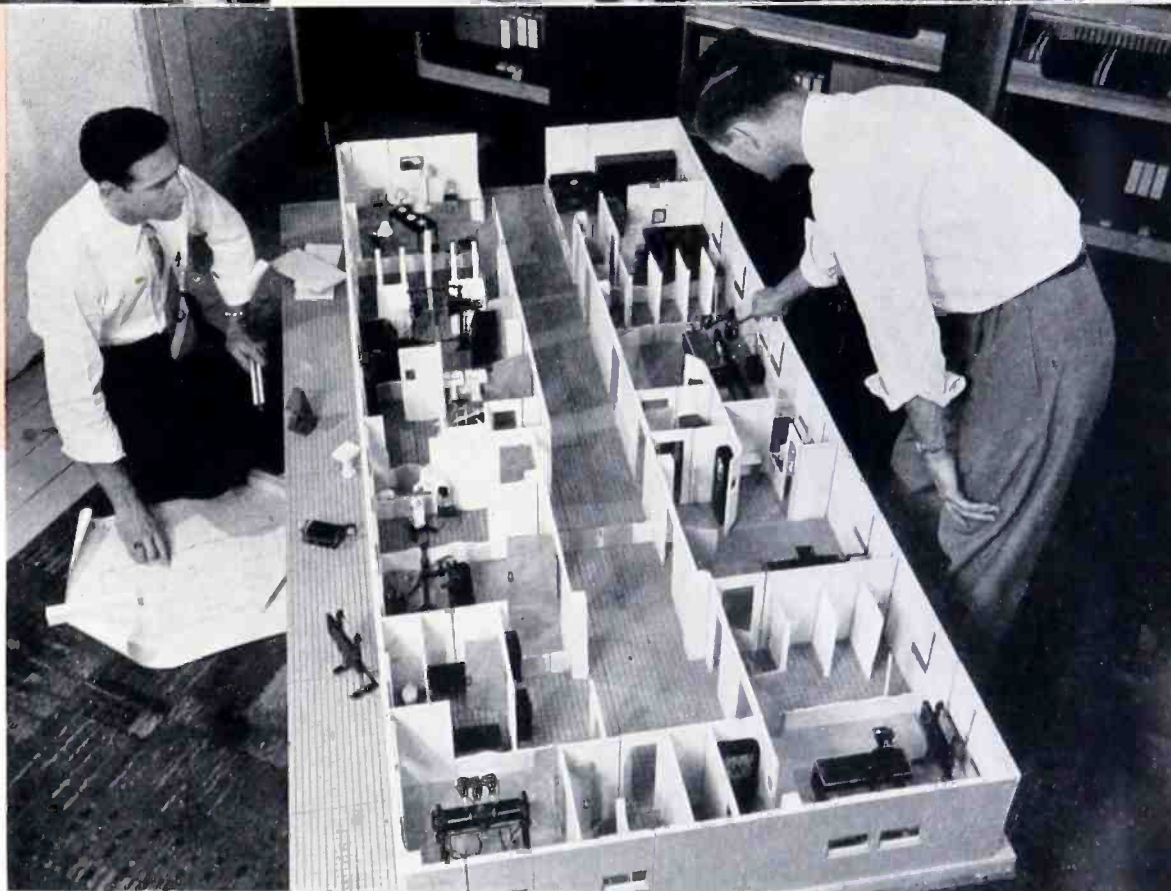

Time-Saving Capsules of Electronics

ONE of the most surprising things about electronics is not its remarkable feats but that it developed its identity as a new and major component of electrical engineering so suddenly. Scores of electrical engineers were a little taken aback to find they had almost overnight become electronics experts. And if they hadn't, they should, or face technical obsolescence.

One large factor in this re-education of "60-cycle" engineers has been the large number of truly excellent publications and training courses developed by intimate participants in the field. One of the most recent worthy members of this important body of literature is the "Electronics Digest," a pocket-size publication by Westinghouse presenting condensations and interpretations of articles on electronics in numerous periodicals.

The publication, appearing at irregular intervals, is distinguished by attractive appearance—by virtue of a multi-color cover, and high-quality format, type, paper, and illustrations. It carries no advertising and is of convenient small size. And,

most important of all, the information is presented in a simple, non-technical manner for the man who has not had opportunity for formal study of electronic principles. It is in short a practical treatment of electronics at work for engineers generally. One desiring to receive "Electronics Digest" as it is issued may do so by addressing a request on his company letterhead to the Westinghouse ENGINEER.

Toys at Work

BOYS never grow too old to play with toys. Witness the electric trains! But with the growing use of scale models, to the fun of toys is added the intensely

practical aspect of the aid they give to engineering planning. Specifically, models are being utilized for the planning of modern x-ray facilities for hospitals.

The new system—to be offered first to the medical profession and under consideration for industrial x-ray users as well—eliminates the flat two-dimensional drawing or blueprint from early planning and substitutes instead tiny scale models of apparatus, partitions, floors, and outer walls. It permits duplication of existing or proposed facilities in miniature and makes possible rearranging until each room and every unit of apparatus is located to the satisfaction of everyone.

Motoring Protection for A-C Generators

L. L. FOUNTAIN, *Switchgear Engineer, Westinghouse Electric Corporation*

WHEN the power input to a prime mover driving an a-c generator is not sufficient to supply all the losses, the deficiency will be supplied through the generator in a motoring action. The generator absorbs power from the system to which it is connected. This absorbed power is in a reverse direction as compared to the generator's normal power flow into the system.

A relay, used to detect this condition and function at the very first increment of reverse power, would have to be infinitely sensitive. For example, suppose the valves of a turbine were closed to slightly less than no-load steam requirements, so that the turbine supplies 99 percent of the losses and the generator, as a motor, 1 percent. If the total losses were 3 percent of the kw rating, then the kw drawn by the generator as a motor from the system would be 1 percent of 3 percent or 0.03 percent of the nameplate rating. To detect such a small amount of power would require a relay with a sensitivity that is impractical to build.

Limits on the sensitivity requirements must be set in keeping with obtainable relays. The reverse power required to motor a generator when the prime mover is being spun at

synchronous speed, without any mechanical power input, has been chosen as this limit. In most cases this is large enough to be easily detected with available relays. Situations that would cause such a condition include complete loss of steam to a turbine, loss of fuel supply to a Diesel engine, or loss of water head on a hydroelectric unit. The amounts of power required to drive prime movers as "motors" are in general about as follows: condensing turbine, 3 percent; non-condensing turbine, 3 percent or slightly more; Diesel engines, 25 percent; and hydraulic turbines, 0.2 percent to 2 plus percent.

A Diesel engine requires about 25 percent of rated kw to drive it at synchronous speed, when no cylinders are firing. When one or more of the cylinders fail to fire at no-load, reverse power will be drawn, dependent in amount on the governor action of the Diesel engine and the effect on the frequency of the system to which the a-c generator is connected. The amount of reverse power resulting from the failure of one or more cylinders to fire, cannot be definitely stated unless the characteristics of both the governor and the system are known. The loss of one cylinder at no-load probably would result in a division of the kw losses normally supplied by that cylinder

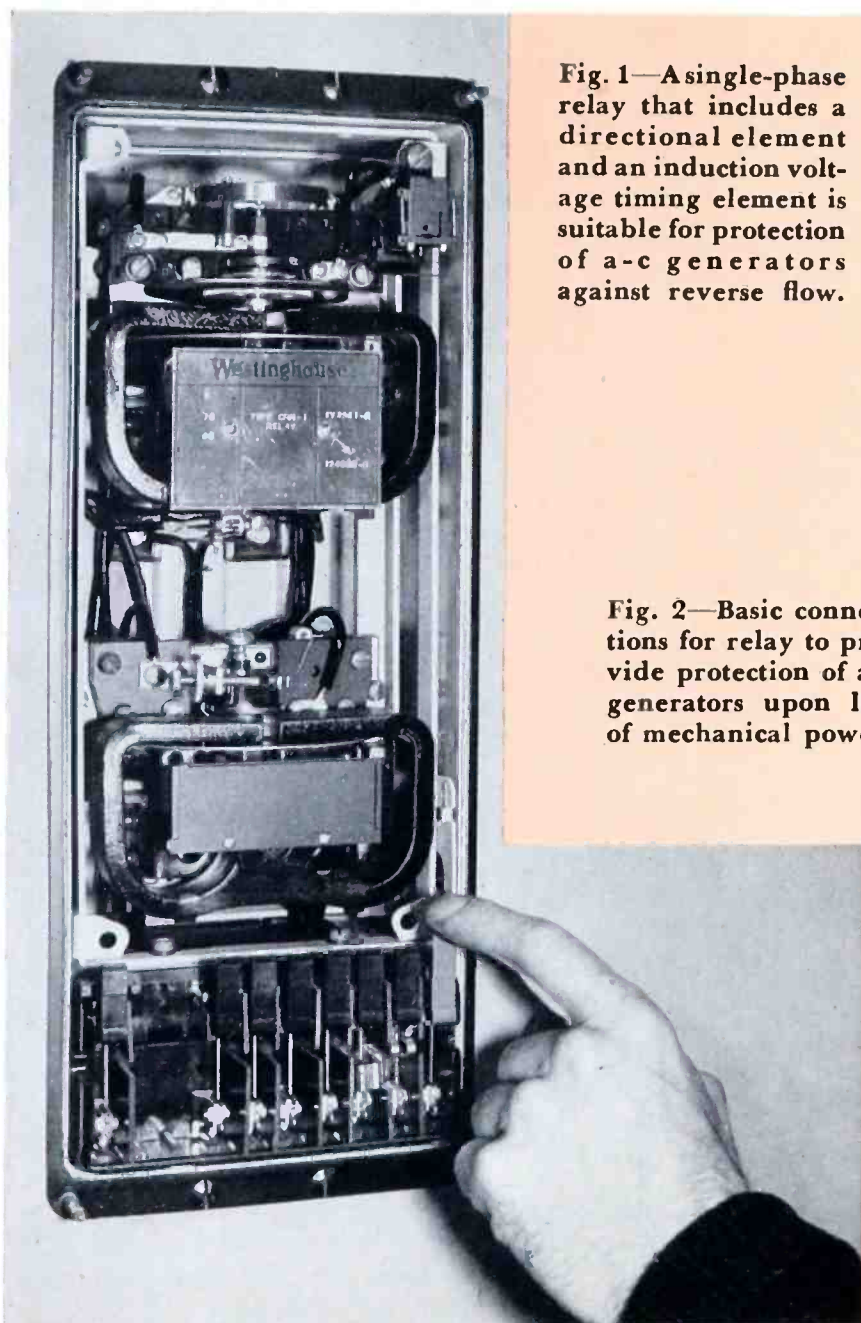
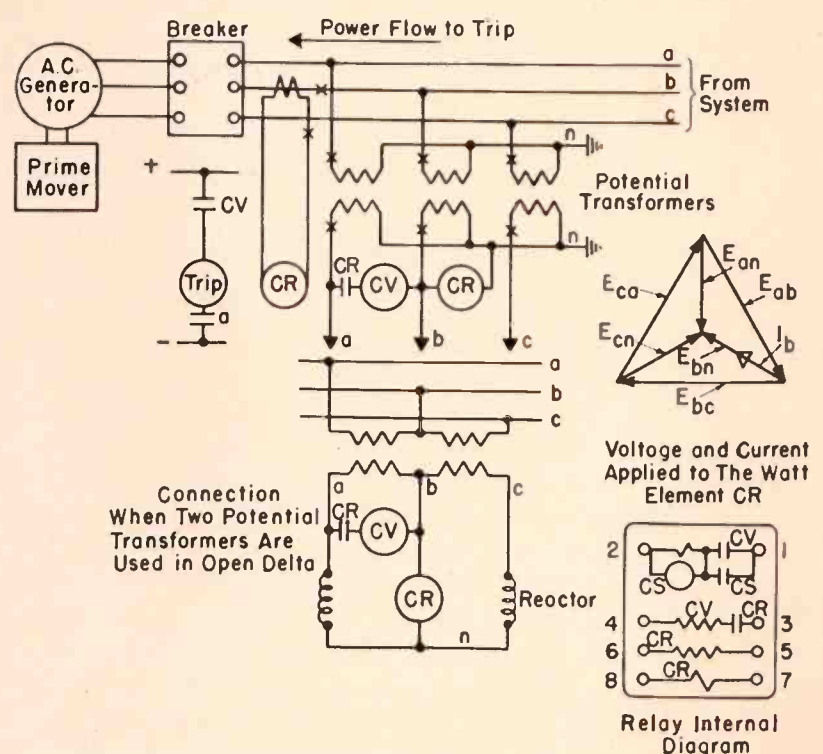

Fig. 1—A single-phase relay that includes a directional element and an induction voltage timing element is suitable for protection of a-c generators against reverse flow.

Fig. 2—Basic connections for relay to provide protection of a-c generators upon loss of mechanical power.

TABLE I—OPERATION DATA FOR REVERSE POWER PROTECTION RELAY (TYPE CRN-1)

Timing Element Potential Coil	Volts—115
	Ohms Impedance— $947+j1328$ Time Setting Range—2 to 23 seconds
Directional Element Potential Coil	Volts—70
	Ohms Impedance— $32+j191$
Directional Element Current Coil	Pick-up Current—0.04 amperes
	Maximum Cont. Current—10 amperes
	Ohms Impedance— $0.083+j0.076$



between the remaining firing cylinders, and the electrical system. The portion imposed on the electrical system would be in the form of motoring kw and might approach in amount the kw losses carried by one cylinder, especially if the response of the Diesel governor is slow.

The variations in waterwheel conditions are numerous, causing a large range in motoring kw. Some of these conditions are as follows:

(a)—When the blades are under tailrace water level, the percent motoring power is high, probably well over the 2 percent value mentioned.

(b)—When the blades are above tailrace water level, from 0.2 percent to 2 percent rated power is required to motor, depending on the design and head.

(c)—When a Kaplan, adjustable-blade, propeller-type unit is used, the flat blade position requires but little power to drive it, probably less than the 0.2 percent listed.

Hence, any waterwheel installation, on which it is desired to have reverse-power or motoring protection, requires special consideration to determine the actual controlling conditions before a relay can be intelligently applied. Under some of the more extreme conditions this type of protection may be impossible.

In numerous waterwheel installations, it is desired to run the generator as a synchronous condenser with all the losses supplied from the electrical system. This situation precludes any reverse-power protection or any need for it.

The Relay to Use

It is desirable to have one relay of such sensitivity that it can be applied for the motoring protection of either turbines, Diesel engines, or where possible, waterwheels. Because motoring or reverse power is a balanced three-phase condition a single-phase relay is adequate. For this purpose the relay known as the CRN-1 relay is suitable.

This relay comprises a directional element as in a CR relay and a CV induction voltage timing element. The contacts of the directional element control the energizing of the CV voltage timing element, which in turn trips the generator circuit breaker or sounds an alarm, after a definite time delay. The time delay is necessary to prevent tripping on syn-

chronizing surges or on reverse power that might occur after improper synchronizing. The number of seconds delay varies with the desires of operators but a time of ten seconds is assumed as practical.

Current Transformers

The sensitivity of the overall motoring protection depends on how near the normal current rating of the current transformer is to the normal current of the generator. The standard current transformer has a secondary current of five amperes at full primary current. The secondary current in the current transformer probably lies between three and five amperes at full load on the generator.

The percent of the generator kw rating that the relay can detect under a motoring condition can be ascertained from the following formula:

$$\text{Percent } Kw_m = \frac{I_r}{I_s} \times 100$$

where percent Kw_m = the minimum percent of normal generator rating that will operate the relay during the reverse current condition.

I_r = Pick-up amperes of relay

I_s = Current transformer secondary current at full kw load on generator, 100 percent power factor.

Assuming that I_s is four amperes and the pick-up current of the relay is 0.04 ampere, the percent of normal kw that can be detected under a motoring condition is

$$\text{Percent } Kw_m = \frac{0.04}{4} \times 100 = 1 \text{ percent}$$

A relay with a pick-up greater than 0.04 ampere would give a proportionately larger value for percent Kw_m . If the ratio of the current transformer is such that there is less or greater than four amperes secondary current at generator full load, there is an inversely proportionate change in percent Kw_m .

In this manner the degree of motor protection obtainable with any relay or current transformer combination can be determined. A relay that is not sensitive enough gives no protection at all.

Telemetry for Project Crossroads

The cataclysmic explosions at Bikini Atoll last July were probably the most thoroughly examined individual phenomena in all of scientific history. Of prime interest to the Navy were the pressures developed by the blast and shock waves, for it is these that are responsible for the primary damage to vessels. To obtain quantitative information as to the magnitude and form of these waves it was necessary to have pressure-measuring instruments within the area of damage.

In the first test a total of 36 complete records of air pressure versus time were simultaneously recorded from as many instruments located at strategic points on two target vessels. In the second test six records of water pressure versus time were similarly obtained. For both the air and underwater tests devices very familiar to electrical engineers were used for recording the variations and pressures. The findings of these devices were broadcast by FM transmitters aboard the test ships to a remote recording point. Such a unit, housed in a single cabinet, is shown at the right.

For the under-water tests the pressure-measuring devices consisted of a piezoelectric tourmaline crystal, about $\frac{1}{4}$ inch in diameter, enclosed in a shield cable, about one foot of which extended through a packing gland from the hull of the ship below the water line. When pressure is applied to the crystal, an electrostatic charge proportional to pressure is developed.

For the measurement of shock waves in air the sensitive element was a strain gauge, a wire of special alloy that changes in electrical resistance when elongated. Four of these wires were connected in a bridge circuit. This system provides means of measuring variations in air pressure of frequencies up to 200 cycles.

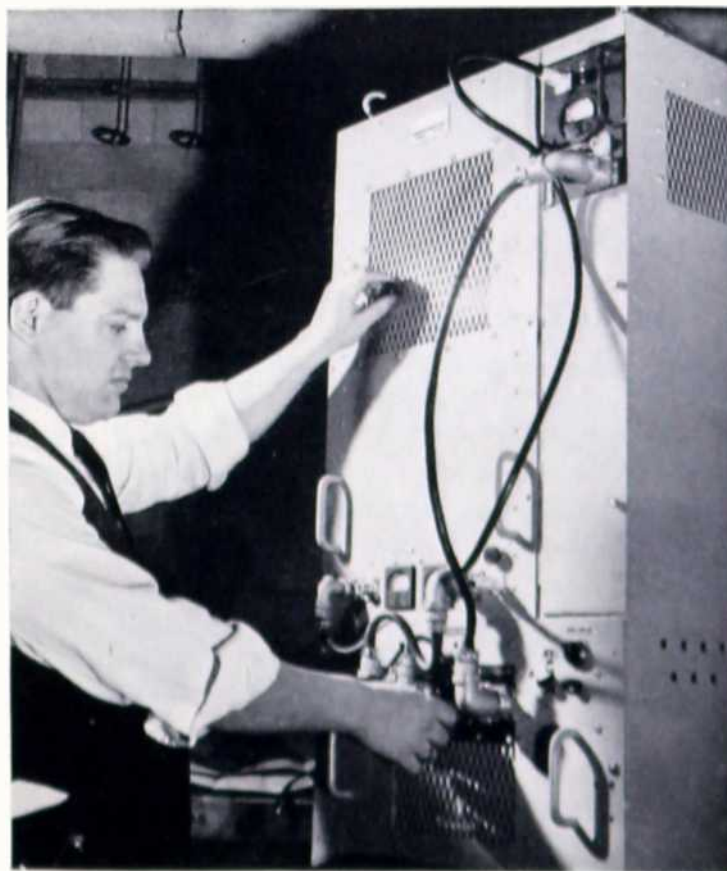
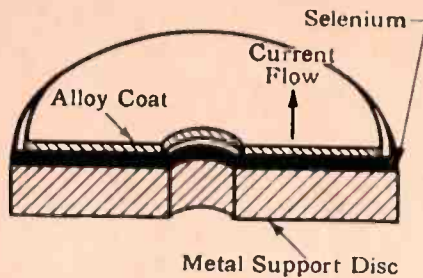

Fig. 1—All commercial metallic rectifiers contain three essential elements—a good conductor, a poor or semi-conductor, and a barrier layer between the two. In the selenium rectifier a thin layer consisting of a compound of selenium itself acts as the semi-conductor. →



Selenium rectifiers are now built up of circular cells varying from one inch to $4\frac{3}{8}$ inches in diameter.

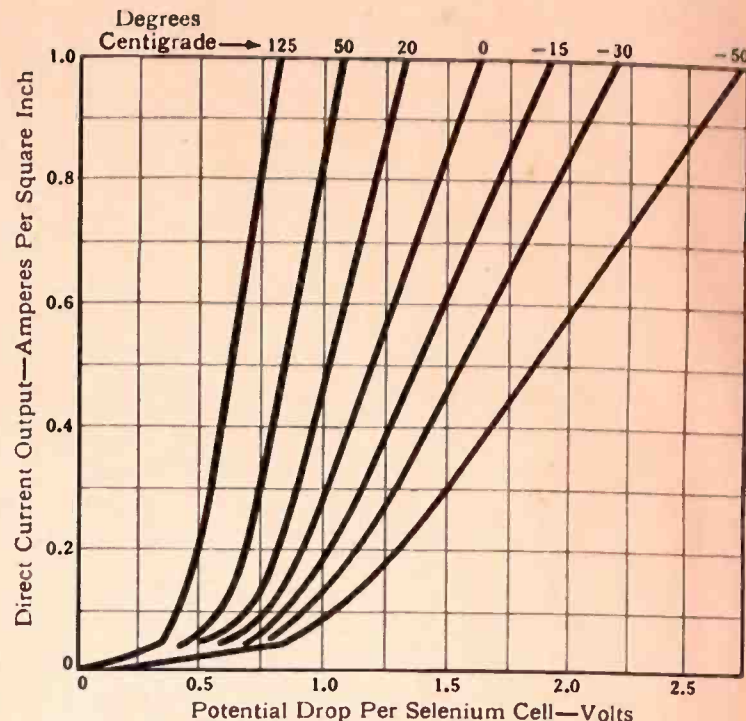
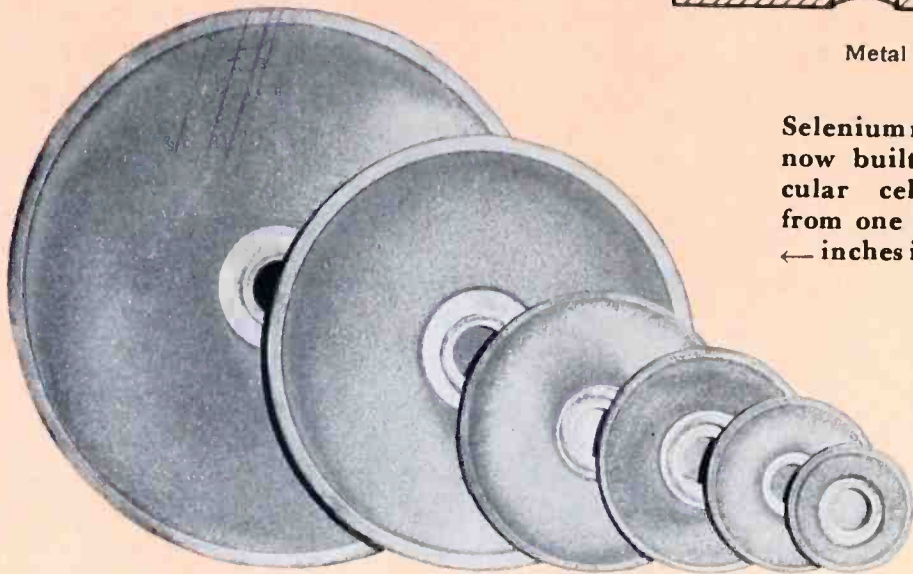

Fig. 2—Variation of selenium-cell current with voltage drop for different ambient temperatures.

Characteristics of the Selenium Rectifier

The selenium rectifier is a relatively new addition to the field of metallic rectification. Comparison with the copper-oxide rectifier, of which literally millions have been built since 1926, shows the attractive features of the selenium rectifier to be appreciably smaller size, less weight, and more favorable temperature characteristics. The copper-oxide type of rectifier, on the other hand, still retains the considerable advantage of thoroughly proved long life.

DEVELOPMENT and expansion of selenium-rectifier manufacture in the past five years has proceeded at a startling rate. Much of the impetus for this came directly from the war effort. This brought forth a large number of rectifier applications for which the selenium rectifier was usually chosen because of its advantages as to size and weight over other types of rectifiers. The fact that little was known about the life of the selenium rectifier was of small moment in military use, where equipment life is often measured in hundreds of hours rather than in years.

Industrial requirements, however, differ from the military in this respect, and long years of operation are reasonably expected from most equipment. The earlier selenium rectifiers were deficient in this respect, at least by comparison with what could be expected from a copper-oxide rectifier. It has always been plain, however, that if this weakness could be eliminated, the other features of the selenium rectifier would make it a very useful unit.

Today, after many years of research, a new type of selenium rectifier is available. A new process has been found for forming the barrier layer, which in conjunction with careful control of the other steps in the manufacture, results in a product that seems to be free from weaknesses previously found.

Particular improvement has been obtained in the matter of stability of characteristics, especially of the forward re-

I. R. SMITH
*Manager, Rectifier Section,
 Westinghouse Electric Corporation*

sistance. In other words, an extremely low rate of forward aging appears to have been achieved. It was necessary to prove that selenium rectifiers have good aging characteristics before commercial applications could be made on a broad scale. This could

be done only by operating large numbers of units continuously at full rating or more. Such tests now have been going on for the past three years, with very successful results.

The only way to prove whether a rectifier will last, say five years, is to operate it for five years. No accelerated tests exist by which this can be predicted. A few months or even a year of operation is not enough, for this is no guarantee that life will not terminate during the second year. This, in fact, was often the case with developmental units.

Even after three years of testing, one can say no more than that three years of life is assured. By careful study of behavior during such tests however, an experienced observer can tell whether an early demise is likely, or whether there is promise of a considerably longer life.

All commercial metallic rectifiers contain three essential elements—a good conductor, a poor or semi-conductor, and a barrier layer between the two. In the selenium rectifier, shown in Fig. 1, the selenium layer itself is the semi-conductor. On the surface of the selenium is sprayed a metal alloy which becomes the good conductor, while the barrier layer is formed at the junction between the two. A supporting plate

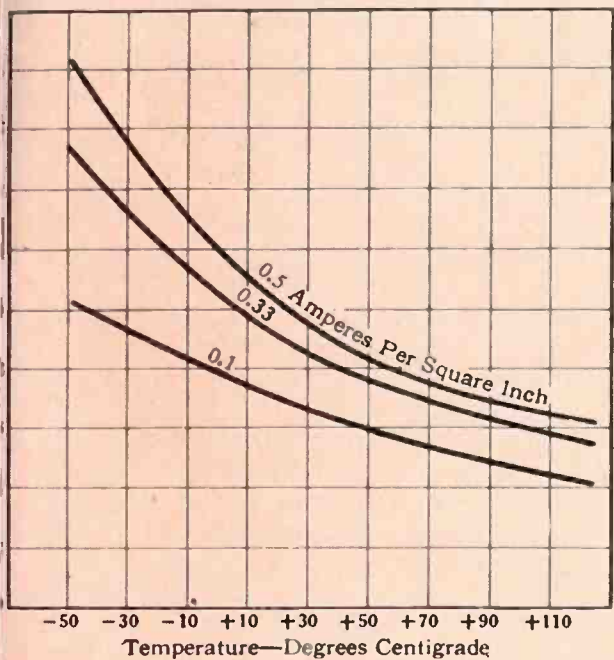
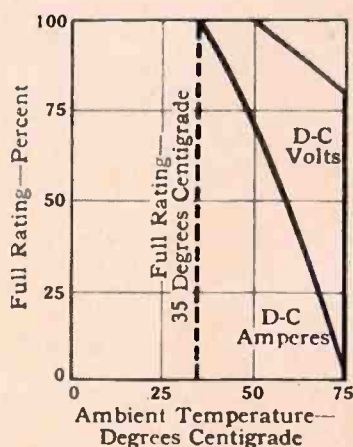
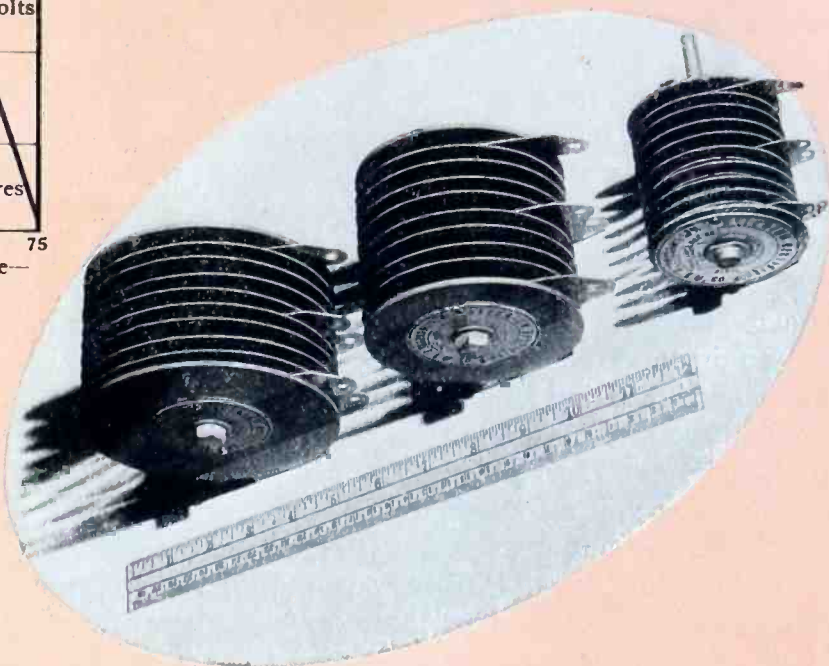

Fig. 3—These curves show the effect of temperature on voltage drop per cell. This repeats in a different form the information given in Fig. 2.



Rectifiers consist of assemblies of the proper number of cells of correct size to provide the desired rating.

Fig. 4—If a selenium rectifier is to be operated above 50 degrees C, the voltage rating must be reduced according to this curve. Above 35 degrees C the rectifier full-load current must also be limited.



is necessary for the selenium layer, and this is usually either aluminum, steel, or nickel. The method of manufacture in general involves applying the layer of selenium on the metal base plate, putting this through a heat-treating cycle, spraying on the alloy surface coat and electrically building up the barrier layer until it is able to withstand the required working voltage stress.

Generally the selenium rectifier is characterized by its small size and weight for a given rating, particularly in the self-cooled stacks. One important factor contributing to the small size and weight of a selenium stack is the much higher voltage that can be tolerated than with copper-oxide cells. Since the losses do not increase as much as the temperature increases, the selenium rectifier has considerable temperature stability. Operation at high temperature—i.e., small, compact units—is permissible.

An important measure of rectifier performance is its volt-ampere characteristic. A family of forward volt-ampere curves for selenium rectifiers covering a wide range of cell temperatures is given in Fig. 2. The essence of these curves is that at rated current density of 0.35 ampere per square inch of active surface the forward voltage drop in a single cell is less than 0.9 volt at 25 degrees C. The effect on forward resistance of varying temperatures, Fig. 3, is obviously not negligible if the rectifier is to be subjected to a wide range of ambient temperature conditions.

A volt-ampere relation also exists in the reverse direction, but it is not so simply disposed of as is the forward, because the matter of barrier-layer formation enters the picture. This is a varying factor that makes d-c static measurements quite different from a-c dynamic values, the end result being that a d-c static volt-ampere curve has little real meaning. For practical purposes it is sufficient to say that the reverse resistance of selenium rectifiers is so high that reverse leakage is negligible and can be disregarded in most applications. The term "static" here refers to readings taken by applying a d-c voltage across a cell and reading the direct current without delay, so that the time element is eliminated. Dynamic readings are those taken while a rectifier is in operation, as might be done with an oscillograph.

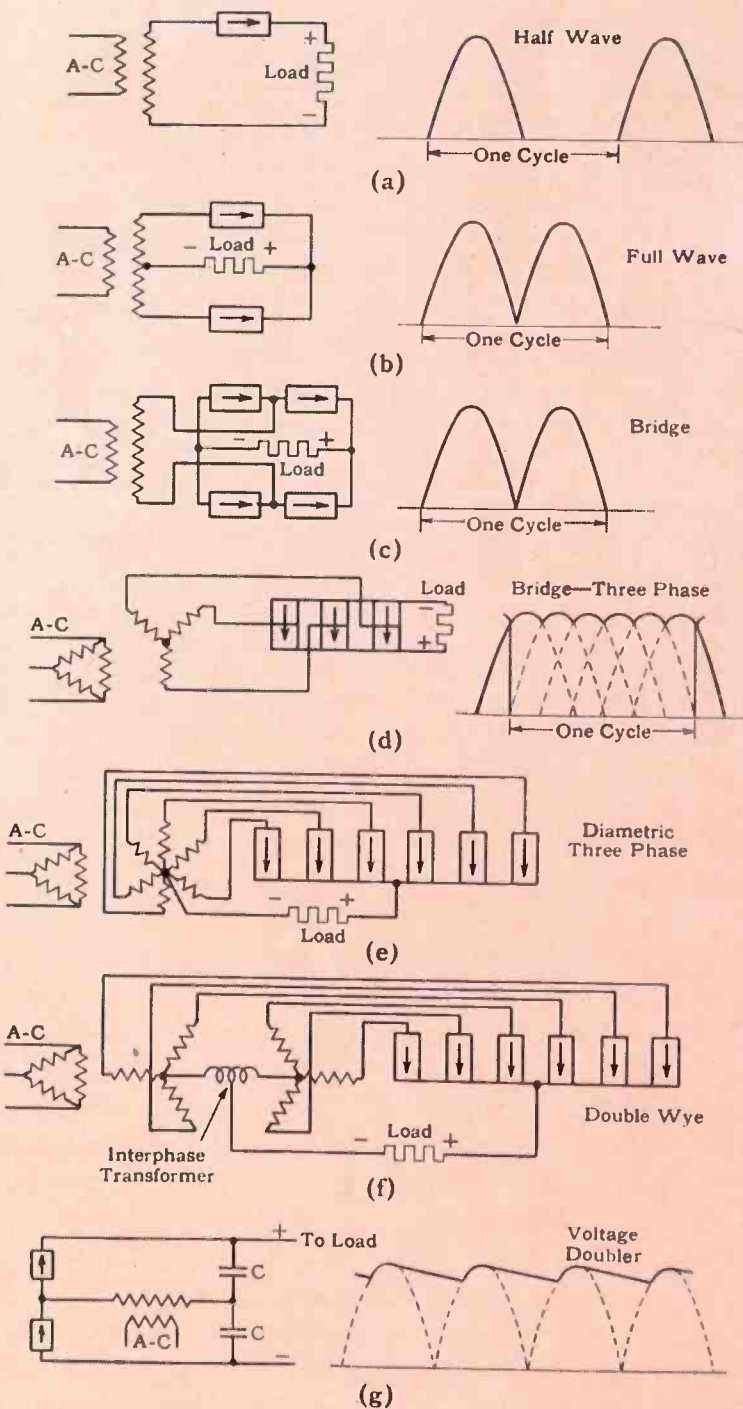

Fig. 5—The more common metal-rectifier circuits.

Effect of Ambient Temperature

Temperature affects the reverse and forward characteristics differently. Generally speaking, the reverse resistance increases as temperature is raised from a low value up to about zero degrees C. Above that point the trend reverses and the resistance decreases, but the rate of change with higher temperatures is quite small so that operation does not tend to become unstable at temperatures normally encountered.

Inasmuch as the reverse resistance does decrease somewhat at the higher temperatures, it is desirable to lower the voltage rating of the rectifier for operation where the ambient exceeds 50 degrees C (122 degrees F). Derating in current is also customary because the higher temperatures accelerate aging. Thus a reduction in current rating has the double effect of reducing aging and reducing the temperature rise of the unit. Recommended derating factors are given in Fig. 4.

Selenium rectifier cells are rated, as are other metallic rectifiers, largely on a thermal basis: ratings must be so chosen that the rectifier unit can dissipate the heat generated by the internal losses without an excessive temperature rise. Ratings must thus be a function of load current, reverse voltage, type of cooling, spacing between cells, and ambient temperature. Ambient temperature for metallic rectifiers has been standardized at 35 degrees C (95 degrees F). Adopted spacings between cells are a compromise between the best theoretical value and considerations of cost and size of stack. Cell sizes are based on the current range to be covered, cell area being directly proportioned to current. The cells are circular. The active area of each cell in square inches, with the standard current ratings of self-cooled units for the six standard cells in any of the common rectifier circuits*, is listed in table I.

Application

A first consideration in making any application is the type of circuit to be used. The number of possible rectifier circuits is large indeed, but, fortunately, most metallic rectifier applications can be adequately served by one of the seven simple circuits shown in Fig. 5. Most rectifier circuits are of the bridge type, either single or three phase.

Center-tap, star, and double-wye connections are used only to get points of maximum efficiency midway between those obtainable from the bridge. For example, the single-phase bridge gives points of best efficiency at 12, 24, 36, etc., volts d-c. The single-phase, center-tap circuit then gives best efficiency at 6, 12, 18, 24, etc., volts d-c. The center-tap circuit also results in a reduction in rectifier material for units designed to be worked at these intermediate values. This advantage of course decreases as output voltage rating increases.

The half-wave circuit is used for special applications, such as vibrators, or where the output current or voltage, or both, is less than half of the normal rating of the available cell.

Ordinary rectifier applications can be made from the following information: (1) forward volt-ampere curves (Fig. 2); (2) temperature de-rating curves (Fig. 4); (3) table of cell sizes, areas, and ratings (table I); and (4) lists of stacks available in each cell size (from manufacturer's catalogue). Rectifier selection is simplified, however, if regulation curves are in hand, such as: (1) single-phase bridge, resistance load; (2) single-phase bridge, battery load; or (3) three-phase bridge, resistance load, which are shown in Fig. 6.

The method of using this information for the solution of a rectifier problem can be outlined briefly by considering a specific problem. Assume that a selenium rectifier is required

to deliver 1.75 amperes at 115 volts d-c to a resistance load from a single-phase, a-c source, at an ambient temperature of 50 degrees C (122 degrees F). The initial step is to select the type of circuit. This is easily done, because single-phase rectifiers are always bridge-connected unless some gain in efficiency can be made by using the center-tap or half-wave circuits, and here there would be none. The temperature de-rating (Fig. 4) at 50 degrees C must then be checked. Full voltage can be used, but only 70 percent of the full current rating. To get 1.75 amperes thus requires a cell with a normal rating of 2.5 amperes. The single-phase bridge current ratings of table I reveal that a no. 5 cell is adequate for 2.5 amperes.

The next step is to find the number of cells in series. According to the table the d-c output voltage per cell is 12 volts. Hence the number of discs in series (per leg) will be $115/12$, or 9.6, so that 10 discs will be needed in each leg. The complete rectifier then is made up of four legs having ten no. 5 cells in series in each leg, a total of 40 cells. This is designated as a 4-10-1 rectifier. However, 40-cell stacks are not built in this size of cell. This requires that two 20-cell stacks must be used.

The required a-c voltage is easily found from the single phase, resistance-load regulation curves of Fig. 6. The load—1.75 amperes—is 70 percent of the normal cell rating as given in table I. D-c voltage per cell is $115/10$, or 11.5 volts. The intersection of these two lines gives a point between the 13 and 15.2 a-c voltage curves; interpolation provides an estimated a-c voltage of 14.5 volts per cell. The total a-c voltage then is 10×14.5 or 145 volts.

Single-phase battery loads are handled in the same way, also using the dotted and dashed curves of Fig. 6. Three-phase rectifiers for any type of load can be estimated from the solid curves of Fig. 6.

Performance Factors

Efficiency values for metallic rectifiers are always given as the ratio, in percent, of average d-c output (d-c volt-amperes) to rms a-c watt input. On this basis, efficiency of a single-phase rectifier is considerably lower than for three phase because of the difference in form factor. In Fig. 7, efficiency curves are given for a single-phase rectifier on resistance load and for the three-phase operation.

Voltage regulation of the selenium rectifier is reasonably good, being less than 10 percent at full rating. The regulation curves of Fig. 6 give values over a wide range of load and output voltage. Like other metallic rectifiers, the selenium rectifier acts as a resistance in series with the load, and thus has very little effect on the power factor of the circuit.

Aging of Rectifiers

Metallic rectifier characteristics change with time and operation. The major effect is an increase in the forward resistance, which may be accompanied by a decrease in the reverse resistance. The extent of these changes varies with different types of rectifiers, and even with different makes of the same type, for it is a function of materials and methods employed in processing.

The extent to which a rectifier ages cannot be predicted nor can it be arrived at by accelerated aging tests. It can be determined only by extended life tests on a fairly large scale. Only after the shape of the aging curve has been fairly well established is one justified in making any predictions as to possible ultimate aging and duration of life.

Life tests have now extended over 3 years of operation at full rated load continuously and at ambient temperatures of 35 degrees C (95 degrees F) or more. Exceptionally good per-

*See "Common Circuits for Metal Rectifiers," I. R. Smith, *Westinghouse ENGINEER*, May, 1944, p. 76.

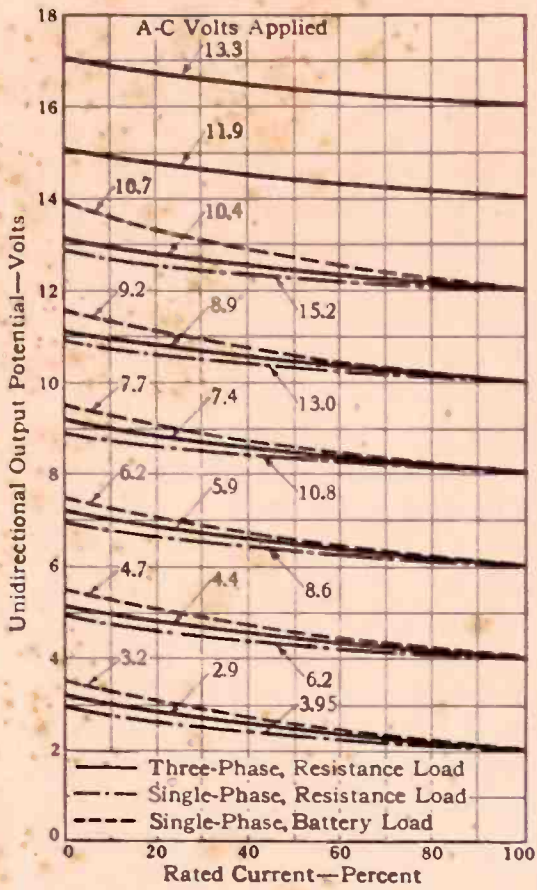
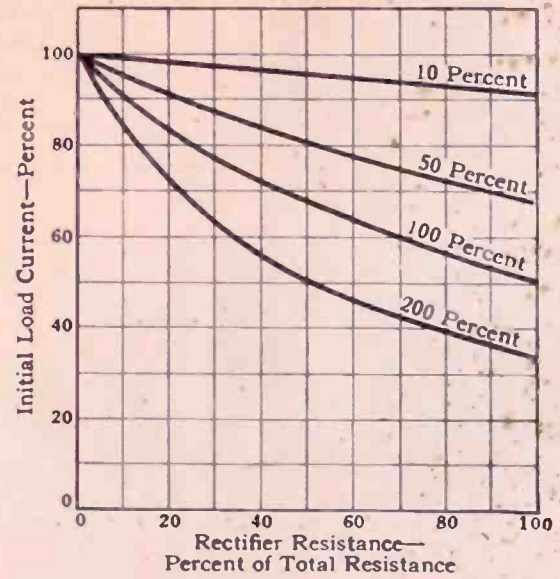
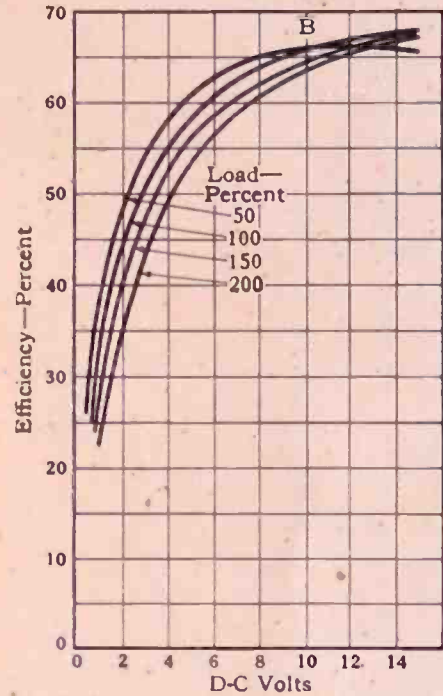
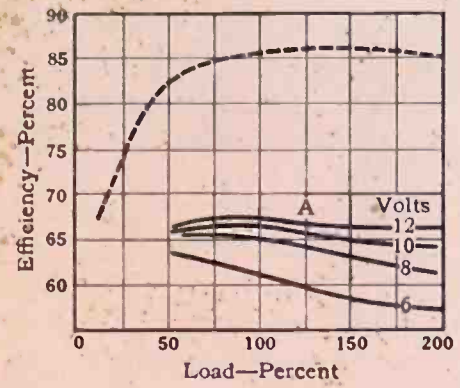
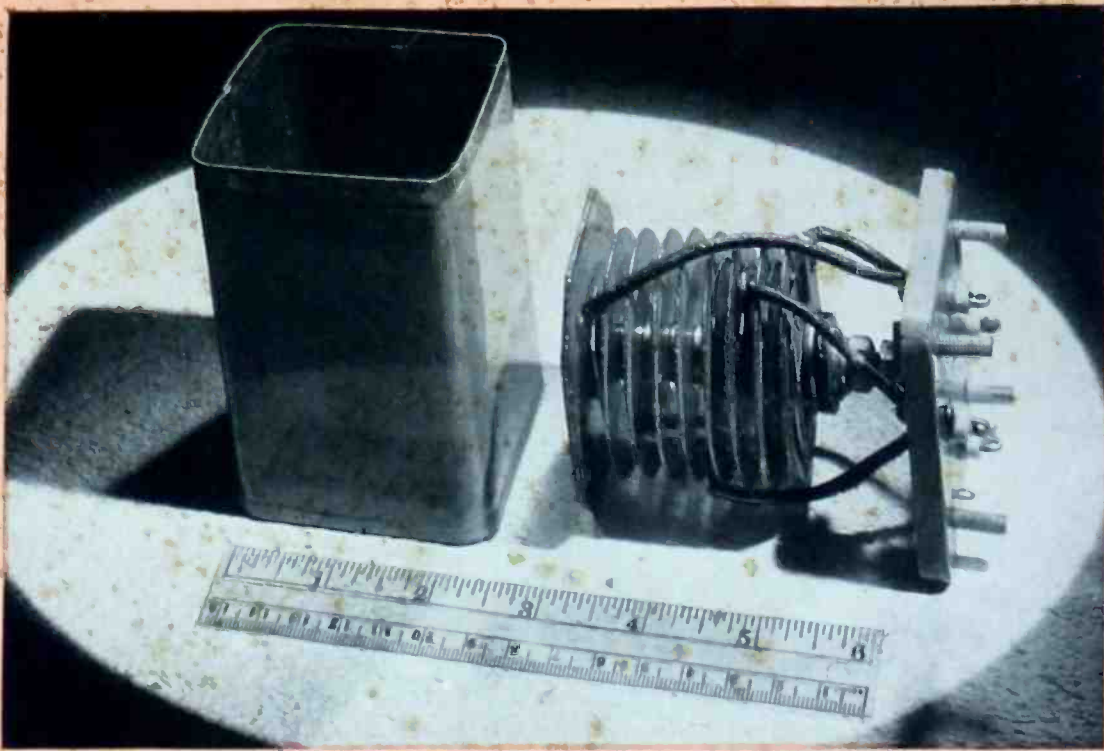

Where the type of service demands it, a selenium rectifier can be immersed in oil and hermetically sealed in a protecting metal case. This gives good protection but increases size, weight, and cost.

Fig. 7—Efficiency of a single-phase selenium rectifier on resistance load with variation in load (A) and voltage (B). The dotted curve in (A) gives the efficiency of a typical three-phase selenium rectifier in which the output is held constant.

Fig. 6—The alternating-current voltages required to achieve various currents and voltages under three common conditions.

Fig. 8—Effect of different percentage increases in rectifier forward resistance on output current of metallic rectifiers.

TABLE I—MAXIMUM RATINGS OF SELENIUM RECTIFIERS SELF COOLED—35 DEG. C AMBIENT—STANDARD SPACINGS MAXIMUM INVERSE VOLTS RMS, 18

Disc Number	1			2			3			4			5			6			
	1			1 3/4			1 3/4			2 1/4			3 3/4			4 3/4			
Disc Diameter—Inches	0.405			1.028			1.82			2.9			7.77			13.61			
Active Area—Sq. Inches	0.405			1.028			1.82			2.9			7.77			13.61			
Connection	D-C Volts	Number of Cells			Number of Cells			Number of Cells			Number of Cells			Number of Cells			Wide Spcg.		
		1-8	9-20	21-40	1-8	9-20	21-40	1-8	9-20	21-40	1-8	9-20	21-40	1-8	9-16	17-36	1-8	9-16	1-36
Current—Amperes																			
Single-Phase Half-Wave	6	0.125	0.100	0.075	0.240	0.190	0.150	0.465	0.37	0.300	0.75	0.6	0.5	1.60	1.35	1.25	2.50	2.25	2.0
Single-Phase Center-Tap	6	0.250	0.200	0.150	0.480	0.380	0.300	0.935	0.74	0.600	1.5	1.2	1.0	3.25	2.75	2.50	5.0	4.5	4.0
Single-Phase Bridge	12	0.250	0.200	0.150	0.480	0.380	0.300	0.935	0.74	0.600	1.5	1.2	1.0	3.25	2.75	2.50	5.0	4.5	4.0
Three-Phase Star	8	0.335	0.265	0.200	0.640	0.510	0.400	1.25	0.99	0.800	2.0	1.6	1.35	4.40	3.70	3.40	6.75	6.0	5.4
Three-Phase Bridge	16	0.375	0.300	0.225	0.720	0.575	0.450	1.40	1.10	0.900	2.25	1.8	1.5	4.85	4.10	3.75	7.50	6.75	6.0
Six-Phase Star	8	0.475	0.375	0.285	0.910	0.730	0.570	1.75	1.40	1.14	2.85	2.3	1.9	6.10	5.20	4.75	9.50	8.5	7.6
Three-Phase Double-Wye	6.8	0.75	0.600	0.45	1.44	1.15	0.900	2.8	2.2	1.8	4.5	3.6	3.0	9.7	8.2	7.5	15.0	13.5	12.0
D-C Valve	15	0.195	0.160	0.12	0.380	0.30	0.235	0.730	0.580	0.470	1.18	0.94	0.785	2.50	2.10	1.95	3.90	3.50	3.15

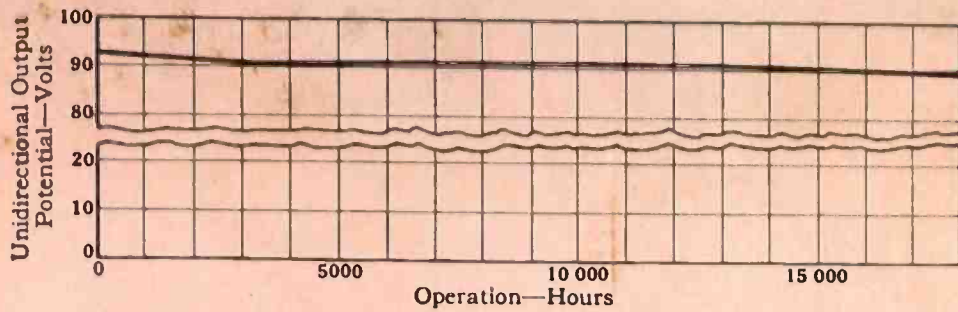

Fig. 9—Variation of selenium-rectifier voltage output with time. A test was made with a watt output 20 percent in excess of full load. A constant a-c potential was applied; ambient temperature, 35 degrees C.

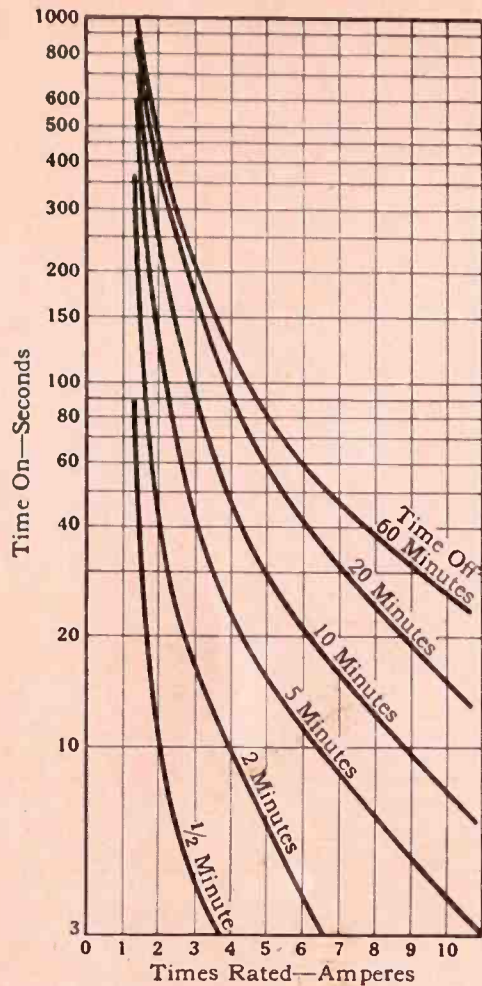
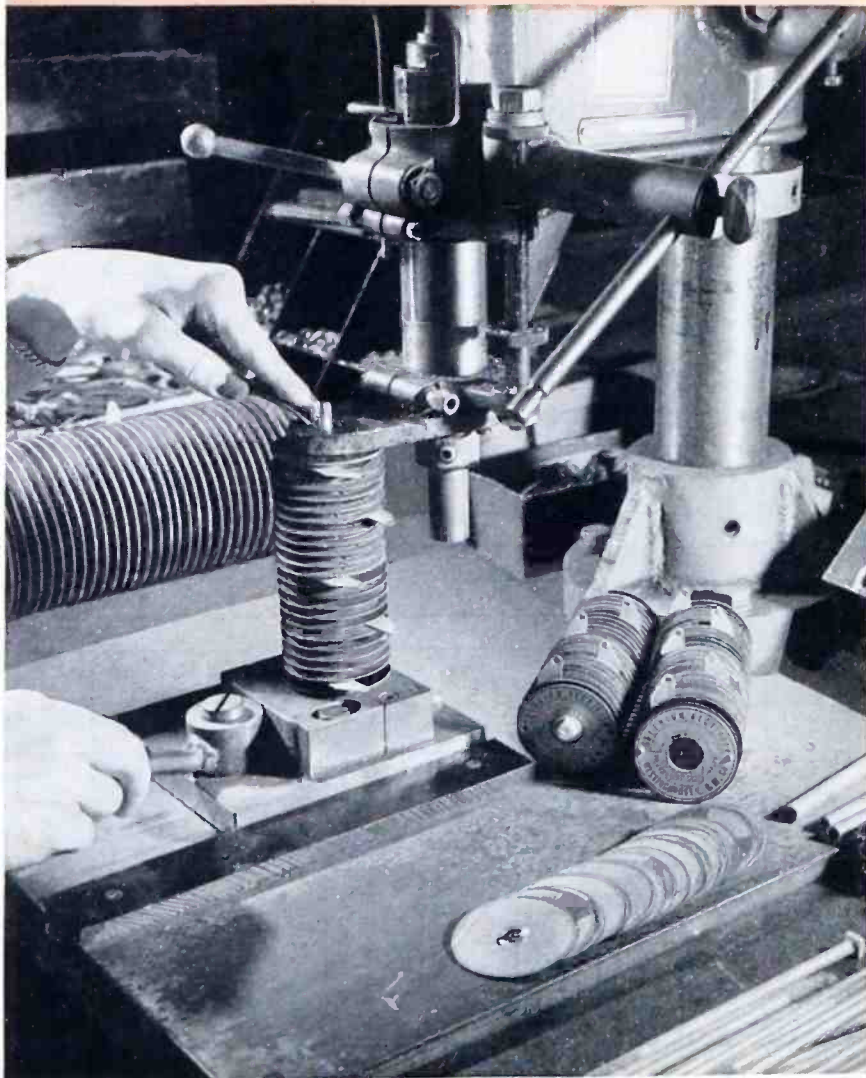

Fig. 10—When a selenium rectifier is used on intermittent duty, the current rating can be increased safely.

Selenium rectifiers, like copper-oxide rectifiers, are made of assemblies of circular discs and insulating washers stacked on a central bolt.



formance has been obtained with an average increase in forward resistance at rated current of less than 10 percent.

An understanding of the effect of increase in forward resistance on output is important. The general relations that exist on resistance load are shown by Fig. 8. As the rectifier resistance in the case we have considered is approximately 14 percent of the total circuit resistance, an increase of 10 percent in forward resistance means a loss in output of about one percent. A change of one percent in 3 years is negligible. Even with an output 20 percent above rating the loss in output voltage in 3 years (Fig. 9) is only about two percent.

One can conclude from the characteristics of the rectifier that operation is quite normal even if rectifier resistance increases 50 percent, which appears to be an ample allowance for rectifier design.

Because rectifier ratings depend mainly on thermal considerations, it follows that for intermittent duty normal ratings can be exceeded. The allowable overload factors for various lengths of time on and for different lengths of cooling periods are presented in Fig. 10. These curves are based on a-c interruption—that is, power is applied to the rectifier only when the load is being supplied.

Overload factors normally apply only to the current ratings, applied voltage being the same as for continuous duty. This of course means a reduction in output voltage because of the inherent regulation of the rectifier, the amount depending on the degree of overload.

Although the de-rating curves of Fig. 4 indicate that the maximum allowable ambient temperature is 75 degrees C, this particular selenium rectifier is distinguished by its ability to operate for extended periods in ambients as high as 130 degrees C. For example, oil-immersed stacks have performed satisfactorily for 5000 hours continuously in ambients outside the case of 80 degrees C (176 degrees F) without any de-rating. This ability to withstand high temperatures is valuable, particularly in military uses where space is frequently limited and ambients are consequently high.

Fields of Application

The range of metallic rectifier application is enormous, and the variety of uses practically endless. Briefly, however, the selenium rectifier today finds its most important application where space and weight are of primary importance, more so than proved long life. Such units then are usually of the self-cooled type, although some cases will be found, as in aircraft power supply, where forced air cooling can be employed to very good advantage.

The selenium rectifier has unique characteristics that make it highly useful in many applications. Improvements in the rate of forward aging have now increased the life expectancy. In addition, raising the previous maximum temperature limitation has added greatly to its versatility. All of these factors, along with the size and weight advantages, presage the growing significance of selenium rectifiers in the rectifier field.

PERSONALITY PROFILES

J. H. Cox presents the natural sequel to his earlier story on the ignitron. The earlier story—March, 1944—dealt with the big fellows, the pumped type, while now he tells, with the help of *D. E. Marshall*, the story of sealed tubes. For ten years before last fall, Cox directed the design and application of pumped ignitrons and certain of the sealed tubes. While preparing the present article, co-author Cox was appointed Manager of Engineering of the Westinghouse plant at Emeryville, Cal., engaged in the production of distribution transformers and similar apparatus. Cox was a Lieutenant-Commander in the Navy of World War I, is an MIT man (electrical, 1923), and after joining Westinghouse in 1923 specialized in lightning studies and lightning-arrester design.

Co-author of the ignitron piece, *D. E. Marshall*, has been around. A native of New Mexico, Marshall studied electrical engineering at the University of Iowa (B.S. in E. E., 1925), came to Westinghouse upon graduation, worked with John F. Peters for a time, and went to California Institute of Technology on a Westinghouse Fellowship during 1931 and 1932. Then back to Pittsburgh, working on mercury-arc rectifiers under the tutelage of Dr. Slepian. Since 1937, Marshall has been in Bloomfield, N. J., mostly nursing sealed ignitrons through their early infancy. To his work in guiding sealed-ignitron development has been added the direction of development of all gas-filled electronic tubes.



This marks the third appearance on these pages of *I. R. Smith*. He has been in on the ground floor of copper-oxide rectifier development ever since its introduction in 1927. A graduate of Worcester Poly-

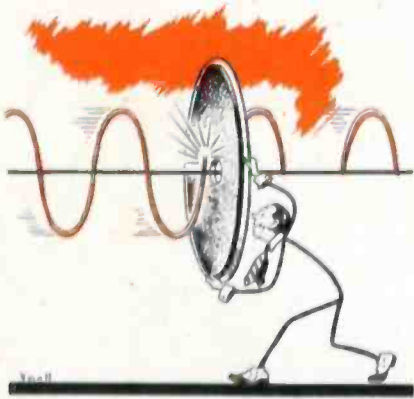

technic Institute in 1921 (B.S. in E.E.), he came to Westinghouse in the same year and shortly thereafter was assigned to help in development work on the newborn Autovalve lightning arrester. He is also largely responsible for the plate-type copper-oxide rectifier and for much of the

work that enables these rectifiers to be built in sizes from one-thousandth ampere to multiple units of 120 000 amperes. In recent years he has been in charge of the development of the selenium member of the barrier-layer rectifier family.



H. W. Giesecke was born in Athens, Ohio, and stayed there long enough to get his B. S. in E. E. from Ohio University. Then he took off for other parts of the United States, and has since bought and sold so much real estate (for living quarters) that he thinks he qualifies as a hobbyist in this field. He has been, among other things, a telephone repairman, a research engineer, a draftsman, and machine-room attendant. During one summer while at college, he even worked as a laborer on a railroad construction gang near Circleville, Ohio.

As a member of the Westinghouse New Products Division, which he joined in 1945, Giesecke might be called a specialist in idea husbandry. His job is to take new products under his wing and to nurture their growth until they reach full commercial bloom. The lost-wax casting method, described by him in this issue, is one such undertaking. Another and newer one is the recently formed Special Products Engineering Department at Westinghouse, which is developing a wide variety of new military equipment for the armed services. Still another is the promotion of aircraft air-conditioning equipment.

Most of Giesecke's experience was gained while working on good solid ground, but as an engineer with the Aero Division of the Minneapolis-Honeywell Regulator Company he took many a trip into the sub-stratosphere in Army Air Force planes. He also lays claim to an M. S. in E. E. from Columbia University in 1936 and a license as a professional engineer in Pennsylvania and Maryland.



The electrical engineering training of *L. L. Fountain* was divided between the Bliss Electrical School and Carnegie Institute of Technology. Between these two periods, however, lay five years of excellent industrial experience, which included three years on the test floor of Westinghouse at East Pittsburgh, and the remainder with Byllesby Engineering & Management Corporation, working on relaying control circuit problems of automatic substations. Since 1930 Mr. Fountain has been with Westinghouse, devoting his energies to the applications of relays and circuit breakers, and making over-all power-system studies.

It was just *J. W. Coltman's* luck to pick for his doctor's thesis at the University of Illinois the subject of "Absorption of Slow Neutrons." Publication of the completed work was deferred for five years when this subject, like all other atomic research projects, went underground in 1941. Another of the Westinghouse Fellows whose articles make up a large part of this issue, Coltman came to the Laboratories in 1941 as a nuclear physicist. But radar then had top priority and he soon found himself heading the group engaged in magnetron research. In almost four years of work on the tube, he and his associates contributed much to tripling its efficiency and raising its power output some fifteen times.

A native of Cleveland, Coltman won a competitive four-year scholarship to Case School of Applied Science, from which he was graduated in 1937 with a B. S. in physics. A teaching fellowship at Illinois netted him both his master's and doctor's degree, in the same field. In the summers, during graduate study, he worked at the Westinghouse Research Laboratories, and likes to recall the day when he accompanied Dr. Condon and Dr. Shoupp to Boston and helped start the new transmitter at Station WBZ with atomic power (utilizing radium).

Coltman now heads the section dealing with x-ray research and development, a three-pronged program aimed at adding to the basic knowledge of x-rays, developing new apparatus, and performing important x-ray tasks at the Laboratories. A while back he took time out to supervise a group of Westinghouse research men who devised the air-pressure and water-pressure instrumentation for the Bikini tests.

He is modest enough to consider himself mostly a gadgeteer, whose interests range from a boyhood project for closing his bedroom window automatically during

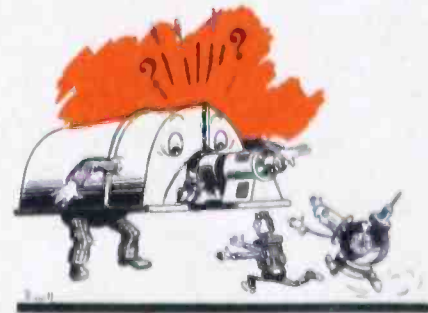

rainstorms, all the way to the highly complicated devices of electronics and x-ray technique. His only "organized hobby," he says, is playing the flute. He is known as an accomplished flutist among his many friends in and outside the Westinghouse symphony orchestra.

Shocking

While an electrical-equipment cabinet undergoes a 5500-pounds-foot impact test, it is photographed by a high-speed movie camera that takes pictures at the rate of 4500 frames per second. From such research comes more rugged apparatus.

