

C  
621.38  
W527

WESTERN  
UNION

# Technical Review

Wire and Cable

•

Tape Creasing Devices

•

Transmission of  
Intelligence

•

Submerged Repeater  
Power Supply

•

Modern Telegraph  
Repeaters



VOL. 7  
APRIL

NO. 2  
1953

# WESTERN UNION

# Technical Review

VOLUME 7  
NUMBER 2

Presenting Developments in Record Communications and Published Primarily for Western Union's Supervisory, Maintenance and Engineering Personnel.

A P R I L  
1 9 5 3

## CONTENTS

	Page
Wire and Cable in the Telegraph Industry, Part I, W. F. MARKLEY . . . . .	41
Perforated Tape Creasing Devices, F. J. HAUPT . . . . .	51
The Transmission of Intelligence in Typescript, Part II, I. S. COGGESHALL . . . . .	56
A Stabilized Power Supply for Use with Submerged Ocean Cable Repeaters, A. ATHERTON . . . . .	63
Modern Telegraph Repeaters, R. V. MORGENSTERN . . . . .	71
Telecommunications Literature . . . . .	79
Patents Recently Issued to Western Union . . . . .	80

*Published Quarterly by*

**THE WESTERN UNION TELEGRAPH COMPANY**

**COMMITTEE ON TECHNICAL PUBLICATION**

F. B. BRAMHALL, Development and Research, *Chairman*

I. S. COGGESHALL . . . . .	Internat'l Communications
H. H. HAGLUND . . . . .	Plant and Engineering
G. HOTCHKISS . . . . .	Development and Research
G. P. OSLIN . . . . .	Public Relations
M. J. REYNOLDS . . . . .	Patents
H. M. SAUNDERS . . . . .	Private Wire Services
C. G. SMITH . . . . .	Operating

NELL ORGAN, *Editorial Secretary*

Address all communications to THE WESTERN UNION TELEGRAPH CO.,  
COMMITTEE ON TECHNICAL PUBLICATION, 60 HUDSON ST., NEW YORK 13, N. Y.

Subscriptions \$1.50 per year

Printed in U.S.A.

(Copyright 1953 by The Western Union Telegraph Company)

# Wire and Cable in the Telegraph Industry

W. F. MARKLEY

## PART I. INSULATION — INSTRUMENT WIRES

THE TECHNOLOGICAL advances in the art of telegraphy starting with the original simple Morse key, sounder and relay, and progressing to the semiautomatic and then the fully automatic selective switching system in a modern telegraph office of today, have justified the modernization of the wire and cable network to insure efficiency of operation and dependability of the complex electronic equipment in continuous operation over a wide range of frequencies and operating conditions. An extremely essential component of this network is the wire plant concentrated in each of the mechanized communication centers where the proper functioning of the automatic equipment is dependent upon the performance of some 3000 miles of high-grade wire conductors and more than 1,000,000 intricate wire connections.

The heart of almost any modern complex apparatus or equipment is the electrical wire or cable required to operate one or more of the component parts. It is customary, frequently, for skilled engineers and craftsmen to spend much time and money in the design and production of equipment that costs many thousands of dollars to manufacture and then select "garden-variety" instrument wire, from some manufacturer's catalog, for use in making the electrical connections. It has been only in recent years that large producers and consumers of expensive equipment began to realize that much of the outage time and maintenance cost of their equipment could be traced to inadequate electrical wiring.

A paper presented before the Winter General Meeting of the American Institute of Electrical Engineers in New York, N. Y., January 1953.

## INSULATION

Almost from the inception of the telegraph over a century ago, rubber compounds, enamel with textile overserves, and dry paper have comprised the insulating materials employed for inside and outside wires and cables. Deep-sea submarine cable has always relied upon gutta-percha as the medium of conductor insulation. Although all these materials have served the industry well, and even today are being employed to a considerable extent in the communication field, they possess certain objectionable characteristics.

Rubber compounds lack heat stability and resistance to deterioration in outdoor exposure, possess high electrical losses in high frequency operation, and adversely affect weights and diameters. The combination of enamel coatings and textile servings does not provide adequate electrical characteristics in the presence of abnormal temperature and humidity and involves high installation and terminating costs. Dry paper for cable conductors always necessitates the use of the traditional lead sheath to exclude moisture and is expensive to terminate and splice. Gutta-percha for deep-sea submarine cable has given an excellent account of itself, except that its uniformity of composition, heat stability prior to final installation, and electrical efficiency have not always been fully adequate.

In recent years, with the development of high-speed transmitting and recording apparatus and all forms of electronic equipment, the old standards of conductor insulation have had to give way to newer

and more efficient materials in order to meet the demands for:

1. Increased sensitivity of the circuits.
2. Reduced transmission losses.
3. Improved electrical efficiency under adverse conditions of temperature and humidity.
4. Greater heat and light stability.
5. Reduced weights and diameters.
6. Decreased labor costs for installation.

These increased demands for more effective primary insulating materials have had a marked influence on the rapidity of development of synthetic resin compounds, which began to appear about 15 years ago. From the very beginning, many of these so-called "plastics" found a ready market because of the many advantages they offered with respect to physical and electrical stability, chemical inertness, heat and light aging, moisture resistance, weight, costs, and so forth.

A "plastic" is defined by the American Society for Testing Materials Specifications D883-51T as "*A material that contains as an essential ingredient an organic substance of large molecular weight, is solid in its finished state, and at some stage in its manufacture or in its processing into finished articles can be shaped by flow.*" Naturally, this definition covers a wide range of compounds and mixtures. However, the number of these materials adopted for wire and cable insulations and jackets in the telegraph industry have been confined to relatively few such formulations. The plastics available for insulating and jacketing applications are primarily thermoplastic in character, that is, capable of being repeatedly softened by increase of temperature and hardened by decrease of temperature.

The plastic compounds employed in the telegraph industry for extruded primary insulation include vinyl compounds, polyethylene compounds, and fluorocarbon resins. The jacketing materials include extruded vinyl compounds, extruded

polyethylene compounds, and extruded and woven nylons.

### Vinyl Compounds

The vinyl insulating and jacketing compounds consist of synthetic base resins, such as polyvinyl chloride or copolymers of polyvinyl chloride and polyvinyl acetate, to which are added plasticizers which serve to convert the rigid resins to flexible, rubberlike materials. These base resins vary in properties depending upon their molecular weight.

Most of the plasticizers employed in these compounds are liquid, such as dioctyl phthalate, tricresyl phosphate, and so forth. Resinous plasticizers are also employed in certain applications where extreme permanence, or very low migration of plasticizer, is essential. Adverse changes in tensile properties and flexibility in plasticized vinyl resin compounds in service, particularly where abnormally high temperature is encountered, are due primarily to the volatilization of the plasticizer.

These plasticized resins are further compounded with small percentages of certain base salts, such as lead salts, which serve as stabilizers to insure heat and light resistance. Other ingredients include lubricants to improve and increase gloss, fillers to provide opacity and decrease cost, and colorants to effect a limitless variety of shades.

These elastomeric compositions are mechanically strong and tough, electrically efficient, nonflammable, resistant to heat and light and unaffected by exposure to water, oils and most chemicals; have an extremely low rate of water vapor transmission; possess a high degree of abrasion resistance; are nonoxidizing; and can be produced in a wide variety of colors.

By means of suitable formulation, it is possible to accent any specific property or group of properties. The wide range over which the physical and electrical characteristics of vinyl elastomers can be varied is evident from the data in Table I.

TABLE I

General Characteristics of Vinyl Insulating and Jacketing Compounds for Wire and Cable.

PHYSICAL PROPERTIES

	RANGE	
Originals		
Tensile Strength (25 C.) psi	1500	3000
Elongation (25 C.) percent	300	200
Aged 60 days at 70 C., percent of original properties retained:		
Tensile Strength	100	100
Elongation	60	90
Hardness, Shore Durometer — Type "A"	70	95
Operating Temperature Range	—50 C.	105 C.
Deformation at 120 C., percent of original wall retained		
500 gram load	50	85
1000 " "	35	70
Resistance to copper corrosion at operating temperature	good	excellent
Underwriters' Laboratories Flame Test	good	excellent
Toxicity	non-toxic	

ELECTRICAL PROPERTIES

D.C. Resistivity—meg.-cm. at 50 C.	$1.0 \times 10^4$	$8.0 \times 10^7$
Insulation Resistance constant (K) at 15.5 C. per 1000 ft. wire	500	10,000
Surface Resistivity	good	excellent
Dielectric Strength (volts/mil in oil)	500	700
Power Factor, at 60 cycles, 15.5 C.	0.070	0.160
at 1000 " , 15.5 C.	0.080	0.120
Dielectric Constant, at 60 cycles, 15.5 C.	5.0	8.0
at 1000 " , 15.5 C.	4.5	7.0

**Polyethylene**

Polyethylene, originally developed in England, is a paraffin-like, pure hydrocarbon resin derived from the polymerization of ethylene gas. The principal advantages in the use of this material over vinyl compounds are its exceptionally low dielectric losses (dielectric constant 2.3 and power factor 0.0004) at all frequencies, its inherent extreme resistance to moisture and its low temperature (minus 45 C.) flexibility. Polyethylene is reasonably tough and flexible, as indicated by its tensile strength of 1400 to 3000 psi and elongation of not less than 400 percent at ordinary room temperature. It is ex-

tremely light in weight (specific gravity 0.92) and contains no plasticizers. Additives in small quantities (less than 2 percent total, except as noted below in reference to ocean cable insulation) comprise anti-oxidants to insure retention of electrical properties under thermal abuse, pigments to produce colored compounds, and carbon black to impart resistance to aging in outdoor exposure. The principal limitations to the use of polyethylene in wire and cable insulations and jackets are thermal in nature, i.e., temperatures above 100 C. appreciably soften the material and, in the presence of an open flame, polyethylene will burn freely.

## Fluorothene

In addition to the vinyl and polyethylene compounds, referred to above, limited use is made of extruded fluorothene synthetic resin as a primary insulation. Chemically, this resin is a polymer of chlorotrifluoroethylene. In its natural state this material is colorless, although it can be blended with solid fillers and coloring agents if desired. Fluorothene was selected as the insulating medium for the conductors used for wiring submarine cable repeaters, primarily because of its extreme toughness and abrasion resistance and its resistance to the oil in which this equipment is immersed as referred to below. It is likely that other fluorocarbon resins, such as teflon, would be equally satisfactory for this application. All these resins are characterized by extreme inertness to chemicals, unusual heat resistance, toughness over a wide range of operating temperatures and good electrical properties. Manufacturing costs of the base resins and processing costs of the wire and cable coverings are relatively high as compared with similar costs for vinyl and polyethylene compounds.

## Nylon

Nylon, because of its abrasion resistance and extreme toughness and thermal stability over a wide temperature range, is employed primarily for jacketing purposes, although it was tried as a primary insulation in the extruded form, as referred to below, in connection with the development of office cable. E. I. du Pont de Nemours & Company describes nylon as a generic name applied to all materials defined scientifically as synthetic fiber-forming polymeric amides having protein-like chemical structure, derivable from coal, air, and water, or other substances. Nylon is supplied in various grades, the electrical grade being the one specified below as the protective covering for insulated wire. It is employed both in the extruded form as a continuous covering and in the form of a braid woven from nylon yarn.

The foregoing brief outline indicates the essential characteristics of the various

plastics used for wire and cable in the telegraph industry. Detailed descriptions are given thereafter showing numerous applications of these different compounds, in specialized telegraph service.

## INSTRUMENT WIRES

### No. 22 A.w.g.

The first major application of plastic insulated wire in the telegraph plant occurred in 1940 when the supply of rubber was critical. At that time Western Union developed a No. 22 A.w.g. solid, plastic insulated instrument wire as an all-purpose wire for general use in wiring equipment and apparatus. Millions of feet of this wire are used annually.

In Figure 1 are shown photographs of the various successive designs of this wire that were developed during the past 12 years during which time plastic compounds have been specified for numerous applications. Prior to 1940 this instrument wire comprised a tinned copper conductor insulated with a 15-mil wall of rubber insulation and an outer treated rayon braid providing an over-all diameter of 90 mils ("A" of Figure 1).

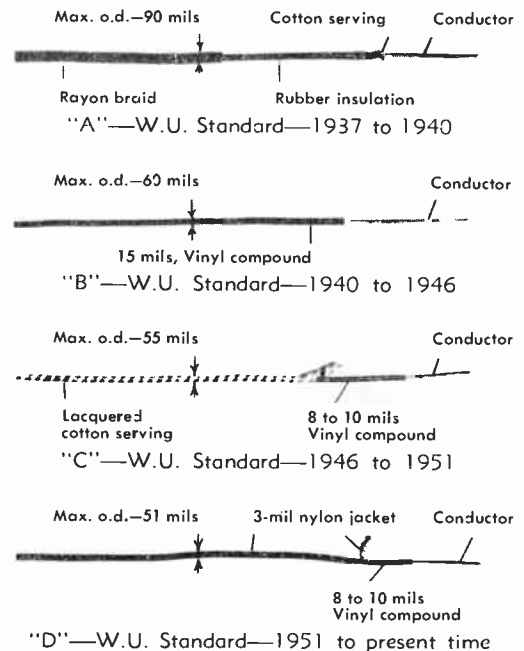

Figure 1. No. 22 A.w.g. instrument wire—successive standards established during the past 12 years

After intensive study, the rubber and rayon covering was replaced with a 15-mil radial thickness of vinyl insulation, without any external jacket of any kind, and suitable for operating temperatures up to 60 C. ("B" of Figure 1). The over-all diameter of this wire was only 60 mils. This reduction of one-third in the diameter of the finished wire was a decided advantage in that it permitted a greater number of wires to be pulled into ducts and effected decreased diameters of hand-made multiple conductor cable forms.

This instrument wire, in the beginning, was found to be lacking in mechanical stability in that the compound became brittle and cracks developed in the insulation within a few weeks after installation. A thorough investigation of this wire in service indicated that the compound was of excellent quality but that the processing during extrusion was inadequate resulting in internal strains in the compound. This defect in the finished insulation was subsequently overcome by incorporating a severe heat shock test, in the specifications for this wire, that would insure relative freedom from this type of physical weakness.

This heat shock test, which is embodied in all Western Union vinyl insulated wire and cable specifications and which is much more severe than that of most national specifications, such as those of Underwriters' Laboratories and American Society for Testing Materials, consists of subjecting a straight specimen of the insulated conductor to a temperature of 100 C. for a period of 72 hours in an oven having inlet and exhaust ports so as to allow for the free circulation of fresh air. After this conditioning period, the specimen is allowed to cool to room temperature and is then wrapped on its own diameter in the form of a closed helix after which it is permitted to stand for at least 8 hours at room temperature in the wrapped form. After this 8-hour period, the specimen is unwrapped and rewrapped in the reverse direction. During these wrapping and unwrapping operations, the insulation must be free from checking or cracking in order to be acceptable for telegraph service.

It has been our experience that the simplified heat shock test of various national specifications, referred to, which merely requires that a specimen of the finished wire, in the form of a closed helix on its own diameter, shall show no cracking of the insulation after baking in a closed oven for 1 hour at 121 C., while adequate for ordinary hook-up and code wire, is not severe enough for plastic insulated conductors employed in the telegraph plant where service interruptions and outages of equipment operating continuously 24 hours a day can be extremely costly.

This vinyl insulated instrument wire in the subsequent few years was found to give considerable maintenance trouble primarily by reason of its inadequate resistance to cold flow, that is, its permanent deformation when subjected to pressure. This weakness is further aggravated during periods of abnormally high room and operating temperature.

Instrument wire must normally withstand considerable abuse in handling and installation. It is bent around steel strips, run up over angles and steel supporting members in cabinets and on frames, and is held in multiple conductor forms by wrappings of twine, tape, and so forth. All these points represent areas of potential weakness in the insulation due to thinning out of the compound frequently resulting in subsequent failure of the circuits either by reason of complete cutting through to the conductor or by excessive current leakage particularly during hot humid weather.

Also, it was found that, frequently, wires pulled tightly across each other in different directions, for instance on the back of relay panels, caused the insulation to cut through and the wires to short out. Similarly, wires looped up against each other caused sufficient pressure to short out and even generate flame as was observed in the case of a failure of an electronic timer (Figure 2).

These wire failures and consequent outages of equipment became so numerous that for a time it looked as though plastic insulated wire could not be depended

upon to give adequate service in high-speed telegraph equipment in continuous operation.

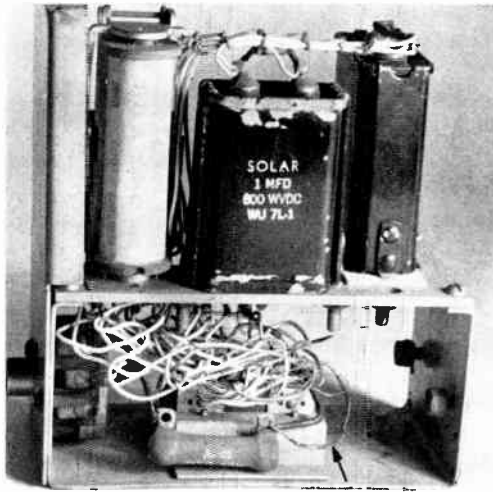

Figure 2. Electronic Timer, with cover removed, showing failure of vinyl insulated wire. (Wire badly disturbed due to examination)

At this point it became obvious that some form of mechanical reinforcement for the insulation must be resorted to if plastic compounds were to be continued for equipment wiring. After considering various methods of mechanical protection for the primary insulation, it was decided in 1946 to specify a lacquered cotton serving as a jacket for this wire using No. 100s single-ply cotton yarn. Laboratory investigation of this type of finished wire indicated that, by reason of the mechanical reinforcement by the cotton serving, the thickness of the vinyl insulation could be safely reduced from the 15 mils specified to a maximum of 10 mils ("C" of Figure 1). This effected a reduction in the minimum over-all diameter from 60 mils for the vinyl insulated conductor without cotton serving to 55 mils for the cotton covered wire.

The production of this wire with its thin wall of vinyl insulation presented a problem to the manufacturer, particularly since full spools of the finished wire were required to meet insulation resistance (1000 megohms per 1000 ft. at 15.5 C.) and

voltage breakdown tests after 6-hour water immersion. It was found that extra care had to be given to the bare conductor to insure a smooth finish and freedom from moisture prior to processing and that the insulation had to be carefully processed to provide the desired quality in the thin extruded wall that was specified. Also, the cotton serving required extreme uniformity to preclude tight convolutions, which adversely affected the electrical properties and free-stripping characteristics. Furthermore, the number of lacquer coats had to be held to a minimum, merely sufficient to prevent fraying of the cotton and to provide adequate flameproofing of the cotton, and a new technique had to be developed for ultrarapid drying of the lacquer since otherwise the volatile solvent of the lacquer penetrated the vinyl compound and severely degraded the insulation resistance. Most of the electrical lacquers that were originally employed for this wire displayed relatively high current leakage over its surface which adversely affected the operating efficiency of the equipment on which the wire was used, particularly during prolonged periods of high temperature and humidity. As a result of this experience, it was found necessary to embody in the specifications a requirement for surface resistivity of the finished wire.

This wire with its lacquered cotton serving was generally satisfactory but still lacked the desired degree of thermal stability and abrasion resistance, showed objectionable wicking action in the presence of moisture, and possessed surface resistivity values, under abnormal conditions of humidity, that varied over a wide range after a period of service, due primarily to the tendency for dirt and foreign matter to collect in the interstices of the lightly lacquered cotton serving.

In order to overcome these weaknesses the lacquered cotton serving was replaced by an extruded electrical grade nylon jacket, in a 3-mil wall, and vinyl insulation heretofore suitable for 60 C. operating temperature was changed to one suitable for 80 C. operation. These revisions were adopted in 1951 and this wire is the present standard ("D" of Figure 1).



The outstanding advantages offered by the nylon jacket include the following:

1. Improved toughness (minimum 7000 psi) and abrasion resistance.
2. Resistance to wetting, thereby effecting vastly improved surface resistivity (usually infinity on a 6-in. specimen of finished wire after 24-hour conditioning at 26.7 C. (80 F.) and 90 percent relative humidity).
3. Freedom from oxidation at temperatures close to 100 C.
4. Greater resistance to fungus.
5. Improved soldering and terminating characteristics.
6. Superior thermal stability — softening temperature well above 150 C.
7. Nonflammability — does not support combustion.
8. Protective effect of the nylon reduces loss of plasticizer from the primary insulation.
9. Improved over-all serviceability over a wide range of temperature and humidity.

This No. 22 A.w.g. solid, vinyl insulated, nylon jacketed wire having an over-all diameter of 51 mils (0.051 in.) provided such outstanding performance as a trouble-free wiring medium that it has now been adopted for general use in making cross-connections on main distributing frames and for making connections on carrier racks and switchboards where heretofore 25-mil vinyl insulated 22-gauge wire without a jacket (over-all diameter 75 mils) was employed, this heavy wall of insulation having been specified originally because of the cold flow characteristics of the vinyl. This change effected a 1/3 reduction in over-all diameter. A companion wire is No. 22 A.w.g. flexible (stranded) instrument wire employed for wiring printers and other apparatus having moving parts, as illustrated in Figure 3. The development of this 22-gauge instrument wire with its extruded thin walls of plastic insulation and jacket, required to meet severe electrical requirements, represents a novel design in the wire and cable industry.

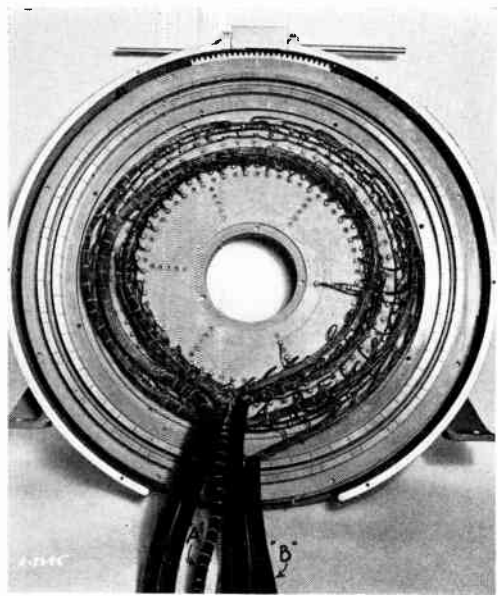

Figure 3. 6-channel face plate, for Multiplex Distributor 226-A, illustrating the intricate wiring, forming and terminating in this unit, requiring some 1,500 ft. of 22-A.w.g. flexible vinyl insulated and nylon jacketed instrument wire. "A" shows one of the hand-made forms before applying the vinyl tubing indicated at "B"

#### No. 24 A.w.g.

Even more spectacular was the development of a No. 24 A.w.g. instrument wire required primarily for wiring rotary switches. Figure 4 shows a multiplicity of these switches assembled on a rotary switch rack. *It is the author's opinion that the design of this wire represents one of the first major advances in the art of ultra-thin wall extruded vinyl insulations having superior electrical properties.*

From the outset, this wire was required to meet unusual conditions with respect to over-all diameter, electrical performance and ease of stripping of the insulation. The compact rotary switches on which this wire is employed are equipped with several hundred soldering lugs mounted in rows in close proximity. In connecting a number of these switches in series, this 24-gauge wire is required to pass between the lugs, a condition which accounts for the limitation on the over-all diameter of the finished wire. In addition, this wire must be capable of being stripped at intermediate points along the wire

when making attachment to corresponding lugs on successive switches. This intermediate stripping is accomplished by specially notched pliers which cut the covering through to the bare conductor and spread it apart for a distance of about 1/4 inch.

After it was definitely determined that No. 24 A.w.g. solid copper wire would be adequate from the standpoint of operating voltage and current, it was decided that the thickness of primary insulation would have to be held to a maximum of 6 mils because of the space limitation. At the time it appeared that, to provide this extremely thin wall of insulation, it would be necessary to resort to pressure sensitive self-sealing insulating plastic tapes which appeared to be the only practical method available.

Lengths of 24-gauge wire were made up with such tapes, comprising vinyl compounds, cellulose acetate butyrate, and so forth, having a thickness of 2 to 3 mils, and applied with a one-half overlap. Extensive laboratory testing indicated that it was practically impossible to obtain a uniform seal between successive convolutions of the tape, that could be depended upon to provide adequate electrical stability under

relatively severe conditions of temperature and humidity.

It was then decided to attempt to extrude a good electrical vinyl compound on the bare conductor in a nominal thickness of 5 mils. This requirement presented a real problem to the manufacturer for the following reasons:

1. Difficulty of obtaining tinned copper wire having extreme smoothness and freedom from surface defects.
2. Low tensile strength of the conductor (about 12 lb.) required delicate handling during the extrusion process to prevent frequent conductor breakage.
3. Difficulty of centering the conductor in the thin wall of insulating compound.
4. The question of insulating and processing technique that would insure a minimum insulation resistance of 200 megohms per 1000 ft. at 15.5 C. for full spools of finished wire after a water immersion period of 6 hours.

Naturally, the first samples of wire that were processed failed to meet all of these requirements by a wide margin. However, with special requirements for smoothness of the tin coating on the bare conductor, adequate conditioning of the bare wire prior to processing, and careful controls during the extrusion operation, a 5-mil vinyl insulated 24-gauge wire was economically produced that conformed to all of the foregoing requirements.

By this time, experience with vinyl compounds indicated the necessity for applying some form of mechanical protection for the primary insulation. To take care of this feature it was decided to adopt a lacquered cotton serving similar to that described above for 22-gauge instrument wire, experience with nylon having been extremely limited at that time. In this instance, the lacquering technique was much more critical than in the case of the 22-gauge wire, by reason of the extremely thin wall of insulation on the conductor. The nominal over-all diameter of this finished 24-gauge wire was only 36 mils (0.036 in.).

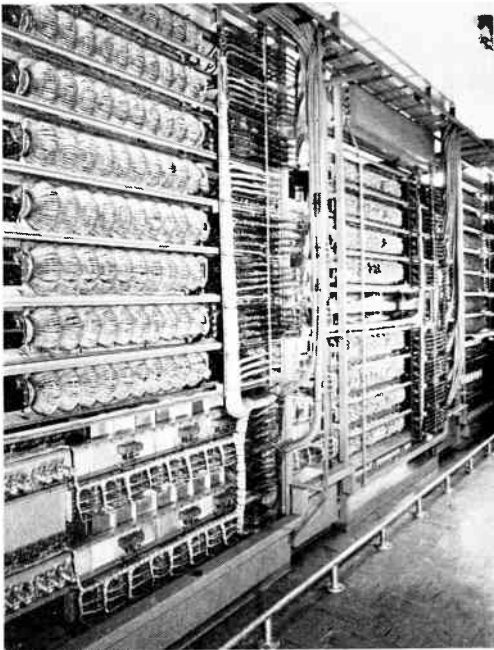

Figure 4. Rotary switch rack

This wire gave an excellent account of itself in service, except that a short time ago complaints were received that the lint or fluff from the cotton serving (Figure 5) was being carried off by air-currents in air-conditioned operating rooms, and lodging in the moving arms of the rotary switches with adverse operating effects.



Figure 5. Illustrating lint and fluff on cotton serving

This trouble could have been overcome by additional coats of lacquer but this procedure was considered undesirable because of the deteriorating effect, electrically, of the lacquer solvent on the thin wall of insulation.

In order to alleviate this trouble, and based on the increased knowledge of nylon subsequently acquired, the lacquered cotton serving on this wire was replaced with an extruded electrical grade nylon jacket having a nominal wall thickness of  $2\frac{1}{2}$  mils. At the same time the thickness of the primary insulation was increased to 7 mils (from 5 mils) to comply with the request of several manufacturers to effect easier processing. With this change the insulation resistance was increased to 500 megohms (instead of 200 megohms) per 1000 ft. when immersed in water at 15.5 C. (60 F.) for 6 hours. The nominal over-all diameter of this finished wire, present Western Union standard, measures about 40 mils (0.040 in.). This design of our 24-gauge instrument wire not only overcame the trouble from the cotton lint, referred to, but also presented several other distinct advantages, such as eliminating the deteriorating effect of the lacquer solvent on the primary insulation, and providing vastly higher surface resistivity, superior

abrasion resistance and improved fungus and flame resistance.

The experience with the development of No. 22 and 24 A.w.g. instrument wires described above served as a thorough background for the design of many other types of plastic insulated wires and cables employed in specialized applications in the telegraph plant.

#### No. 28 A.w.g.

Even though tremendous advances have been made in the development of electronic devices, the relay continues to play an important role in the operation of modern telegraph systems. In fact, the relay can perform many functions better and more economically than the electron tube. In certain polar relays the lead wires for the cores are subjected to abnormal temperatures and severe mechanical abuse in installation and service (Figure 6).

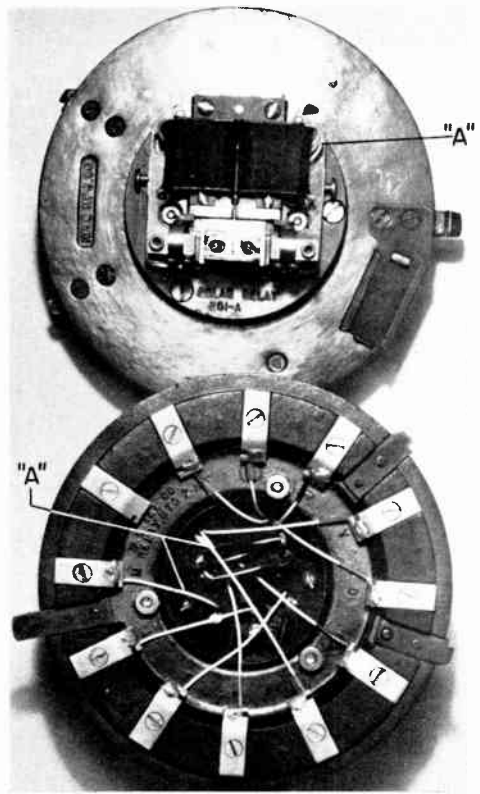

Figure 6. Polar Relay 201-A, top and bottom views  
"A" shows 28 A.w.g. vinyl insulated and nylon jacketed wire leads

For this application, No. 28 A.w.g. flexible copper wire insulated with a 10-mil wall of fluorothene was originally specified in order to provide adequate thermal stability to withstand the high ambient temperature of about 100 C. prevailing during continuous operation, and to insure adequate mechanical stability in view of the bending encountered near terminating points. Subsequently, at a greatly reduced cost for the wire, the fluorothene insulation was replaced with vinyl compound, suitable for 105 C. operation, over which was applied a 3-mil wall of extruded nylon. There would have been some apprehension about the use of the vinyl insulated conductor for this service, but the reinforcement by the nylon jacket from both a thermal and a mechanical standpoint, has provided a finished wire having adequate serviceability. Cable forms, comprising 70 of these wires, have been satisfactorily employed for wiring test tables.

#### Other Types

In addition to the various types of instrument wires referred to above, Western Union employs, in limited quantities, other sizes of solid and stranded conductors insulated with vinyl compounds and an outer jacket of extruded nylon. The nylon jacket is always held to an extremely thin wall because of the toughness of the nylon and its adverse effect on the striping characteristics of the covering.

Our experience has indicated that polyethylene insulation, in the extremely thin walls that we specify for instrument wire, is much more fragile and susceptible to mechanical injury during processing than vinyl compounds. Consequently, polyethylene is used for instrument wire only in exceptional cases where uniformly low capacitance is required over a wide range of frequencies and under extreme variations in temperature and humidity.

All colors for coding purposes consist of solid colors embodied in the primary insulation using light and dark tints of various shades to effect multiplicity of colors desired. All of these colors are sharp and readily distinguishable from one other through the clear nylon jacket. Consideration has been given to employing colored stripes on the primary insulation for coding purposes but experience has indicated that with the various inks used for this purpose there is a serious adverse effect of the ink solvent on the insulation resistance of the primary insulation. One manufacturer has been reasonably successful in applying colored stripes to the nylon jacket but this method of coding has not been satisfactory for the extremely small over-all diameters of the finished instrument wires generally employed in the telegraph plant.

**Parts II and III** of this article will describe Office Wire and Cable, and Outside Wire and Cable, respectively.

---

**W. F. Markley**, Assistant Lines Engineer of the Plant and Engineering Department, joined the Construction Engineer's Division after graduating from Stevens Institute of Technology in 1917. For some years he has been in charge of the development of new standards for insulated wires and cables; he developed the first thermoplastic insulated weatherproof wire to be used for outside service in the communications industry, initiated improvements in the design of equipment and switchboard wire and cable, and directed the development of thermoplastic insulated multipair office cable. He has several U. S. Patents to his credit. Mr. Markley is a member of several Technical Committees of the American Society for Testing Materials and the American Standards Association. He was appointed by the American Society for Metals to serve as an American Conferee to the first World Metallurgical Congress, held in Detroit in October 1951.



# Perforated Tape Creasing Devices

F. J. HAUPT

PERFORATED paper tape is an essential component of Western Union's vast reperforator switching system;<sup>1</sup> its proper performance is as vital to the operation of the telegraph switching centers as is that of the equipment itself. In the 15 area switching centers more than one-half of the incoming messages pass through two reperforators before transmission to the area of destination, where they pass through two more reperforators. Thus the average message originating in one area and destined for delivery in another area appears in the form of perforated paper tape at least four different times.

## Paper Considerations

The Telegraph Company, in common with other large paper-using industries, has been continually engaged in research into a variety of paper problems. In the case of perforated tape, two of the aims, among others, were to achieve stiffness after perforation, and to eliminate accumulation of static under all atmospheric conditions.

Both these factors contribute to cause the tape to buckle and fold, thus impeding its free flow through tape necks and into accumulators, and causing occasional tape jams which render the equipment position temporarily inoperative until the tape is freed manually. The newly developed tape creasing devices described in this paper, two of which are shown in Figures 1 and

2, promise to minimize these effects to the point where they no longer will be nuisance factors.

Paper research<sup>2</sup> encompassed exhaustive tests on various grades of paper before adoption of physical requirements for the paper most suitable for Western Union's needs. The paper had to be of a quality to insure the punching of clean code holes, stiff enough to move freely through reperforators after being punched, and strong enough to feed through the transmitters without the feed holes becoming elongated. A better grade of paper might be used with better results but would be too expensive to be practicable; there is, moreover, no guarantee that such a paper would entirely prevent tape jams.

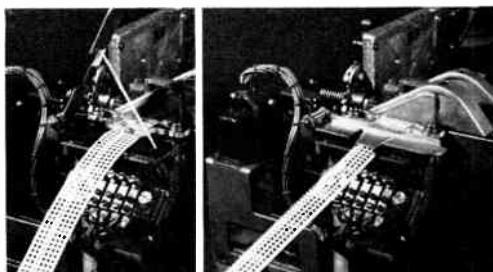

Figure 2. Reperforator 4804-A (with reading attachment) equipped with tape creaser—at left the hinged lid is held open; at right the creaser is in position for crimping

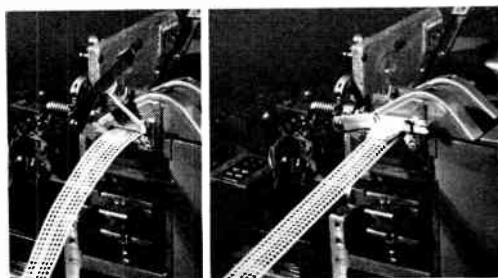

Figure 1. Reperforator 10-B equipped with tape creaser—at left the hinged lid is held open; at right the creaser is in position for crimping

Some accumulators are equipped, however, with exhaust blowers to help draw the tape loop down the neck.

### The Tape Storage Problem

In the normal course of switching operations with cross-office transmission at 125 or 150 wpm and outgoing transmission at 65 wpm, a relatively short loop of the perforated tape forms between the reperforator and its associated tape transmitter. At times, however, there may be periods when retransmission fails to keep pace and the tape loop lengthens. Provision is therefore made for its short-time storage in an accumulator.

A frequently used arrangement for tape storage is shown in Figure 3. Two sending

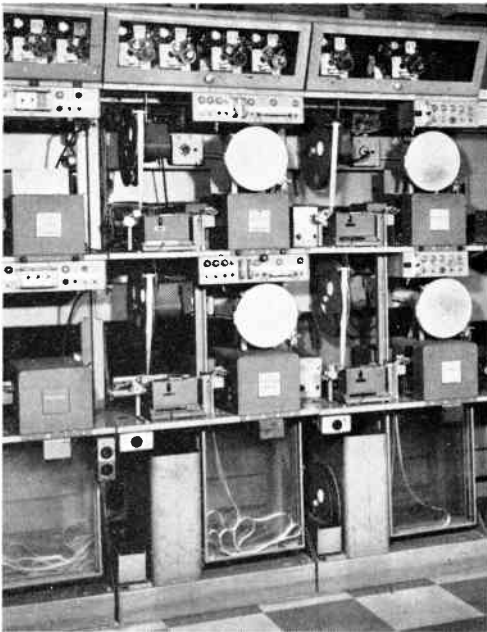

Figure 3. Typical arrangement for tape storage

positions are located on a rack, one above the other. Perforated tape may be seen following a path from the lower reperforator, down the tape neck, and into the accumulator. It has formed a loop in the glass-sided accumulator, and its path carries it back up the tape neck and through the transmitter. The accumulator for the upper position is located immediately behind the one for the lower position. The

tape neck for the upper position, of course, is considerably longer than the neck for the lower one. In an idle circuit condition the length of the tape between the reperforator and the transmitter is minimum. The tape passes above the neck and is under slight tension by the auto-stop arm attached to the top of the tape neck. Resumption of perforation allows the auto-stop arm to fall, tape enters the neck and forms a loop which progresses down the neck and, if retransmission fails to keep pace, into the accumulator.

Freshly punched tape may acquire a static charge which is evidenced by the incoming and outgoing tape in the tape neck clinging together and by the tape adhering to the glass sides of the accumulator instead of falling naturally to the bottom. Thus, forces are established opposing gravity and free movement of the tape. Also, frictional forces are encountered, particularly where the tape loop forces the tape against the confining walls of the neck. Because of the roughened surface it presents, chadless tape introduces a further hazard in that configuration of stored tape in the accumulator may cause the entering tape to touch the tape being drawn out. The outgoing chadless tape tends to engage the entering tape and interfere with its free downward movement. Thus, occasionally tape will buckle and start folding in the neck, causing the tape to build up until it lifts the auto-stop arm, stopping the transmitter and sounding an alarm.

### Safeguards Against Tape Jams

Two steps were taken which minimized the occurrence of tape jams. One involved the redesign of the tape neck to obtain optimum dimensions, and the use of U-shaped guides inside the neck which present a smooth and small area of contact between tape and neck to reduce friction. The other was to remove to a large degree any static charge accumulated by the tape before it entered the tape neck. This was done by placing a block, coated with radium bromide, in a slot provided for that purpose in the top of the tape neck. As the tape passed over it, slight

radiation from the activated block dissipated most of the static charge and offered a considerable measure of relief. However, removal of the static charge from chadless tape did not overcome the frictional problem and accumulators at positions using that tape were therefore equipped with exhaust blowers. The method is effective but expensive.

Tape jams still occurred after equipment changes, except where blowers were used. In some cases more difficulty was experienced in dry winter months, while in others the trouble occurred more frequently during periods of high humidity. Even the air-conditioned offices were not free of difficulty. Study was therefore concentrated on the paper tape itself. While it had been generally recognized that the weakness of the tape was a contributing factor, that fact was amply confirmed by further investigations. The tape jams started when portions of tape having the maximum of five code holes punched in it were preceded by tape having none or only a few perforations. During laboratory tests, it was demonstrated that tape jams could always be caused by feeding blank tape, followed by a length of tape punched with all the code holes. Since the blank tape offered greatest opposition to the progress of the loop down the neck, and the following perforated tape had to furnish the force to push it down, buckling occurred in the weaker perforated tape, resulting in a jam.

At this time a suggestion was made that the tape might be stiffened or made more rigid by introducing a bend or crease in it. A guide, designed to crease the tape at the feed holes, was attached to a reperforator and gave encouraging, but not wholly satisfactory results. It was evident that the tape should be creased in the form of a channel between rows of holes where the paper was solid, and in following up this idea, it developed that two moderate bends between code holes one and two, and four and five, would be as effective as one sharp crease in the center. Trial confirmed this deduction; it was found that tape formed in this manner had sufficient rigidity to overcome the effects of static, friction, and weakness caused by

perforations, and thus could force itself down the tape neck and into the accumulator.

Tape that passed through a creaser tends to flatten out as the loop is formed in the neck. The tape loses most of its stiffness and offers little more opposition than uncreased tape to progress of the loop down the neck. Thus, stiffness is available when required and disappears when it might be a detriment.

### **Design Requirements**

In the design of the tape creaser several requirements had to be satisfied. It was important that no new hazard be introduced, and that the new attachment place no additional burden upon the operating staff. Starting new tape through the reperforator must remain a simple task. Also the perforated code holes must remain visible, or at least provision must be made for viewing them when desired. The feed wheel must furnish the force to propel the tape through the stiffening device, since an auxiliary feed would make the cost prohibitive, and the required force to permit free passage of the tape through the punch block and crimping device must not be excessive. The device must be simple, inexpensive, and readily adaptable to existing reperforators.

### **Design Approval Models**

First models were made for Reperforators 10-B and 4804-A as shown in Figures 1 and 2.

At the left, the hinged lids are propped open and the perforated tape is leaving the reperforator uncreased. The lids are shown held closed under spring tension in the pictures at the right. The crease forming lips in the lid fold the edges of the tape over a shelf supporting it from underneath. Gentle folds, rather than acute bends, are produced; the rigidity of the tape becomes evident when that at the left is compared with the creased tape at the right. Tape thus shaped performs satisfactorily in dry air when the effects of static are pronounced, and also at high humidity when the tape tends to become weak and limp.

As it happened, the task of equipping the first two reperforators with the tape creaser turned out to be the most difficult. The solution found for reperforators of the 16-A type and for Printer-Perforators 36-A and 39-A was simpler. In Reperforators 10-B and 4804-A, the feed wheel pushes the tape through the code punch block and then through the creaser. Accurate alignment of the creaser and the close fitting tape guides of the reperforator is therefore essential to prevent buckling and consequent jamming in the punch block. On the other hand, on Printer-Perforators 36-A and 39-A, the feed wheel pulls the tape through the punch block, thus there is no tendency for the tape to buckle.

It was also found that on Printer-Perforators 36-A and 39-A, the folds in the tape could, with a simple modification, be introduced by the feed wheel itself. The feed wheel normally presents a supporting surface the full width of the tape.

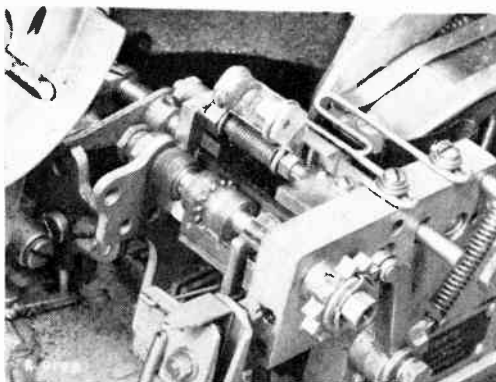
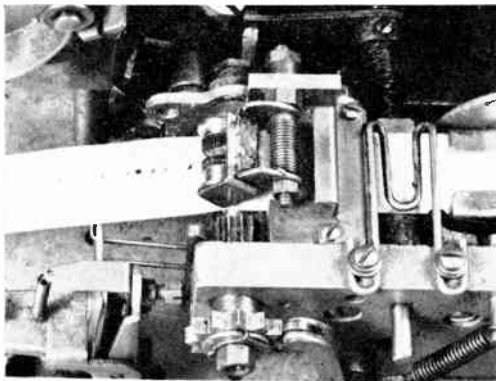

Figure 4. Printer-Perforator 39-A modified to produce folds

This surface was narrowed to allow the flanged ends of the pressure roller to fold the tape over the edges of the feed wheel. The creases thus formed effectively stiffen the tape. Figure 4 shows the tape-feeding mechanism of Printer-Perforator 39-A modified to produce the folds. The same principle was used in developing a model for Start-Stop Reperforator 16-A.

### Greater Storage Permitted

When a Printer-Perforator 39-A used in a patron's switching system was equipped with the tape creaser, an additional and unforeseen advantage was discovered. The patron's system needed storage capacity

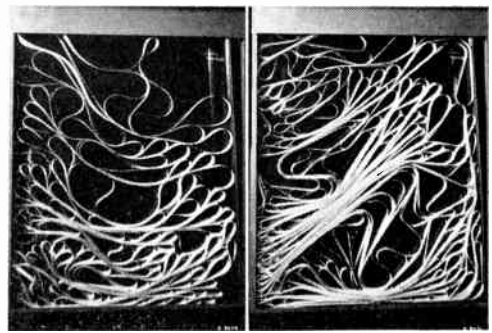

Figure 5. Left—unstiffened perforator tape in accumulator; Right—same accumulator holding almost twice as much stiffened tape

greatly in excess of the standard tape accumulator which accommodates approximately 70 feet of tape. An oversize accumulator which could hold about 150 feet was designed to meet this special requirement. When the stiffened perforated tape was fed into the same accumulator, it was found that it could now hold over 260 feet. (Figure 5.)

### Conclusion

Tape creasers overcome a fundamental and long-standing defect in the prevalent method of temporary tape storage. Their application will obviate the need for static eliminators, and materially reduce the cost of tape necks since elaborate designs will no longer be necessary. On those positions where they are currently used, expensive exhaust blower arrangements will no longer be required. Consideration of the use of special quality tape to pro-



vide the required stiffness may be discontinued. The tape creasers are relatively inexpensive; they are easy to apply by anyone familiar with reperforator equipment, with only minor adjustments of the tape necks.

Thus, what might be considered a small auxiliary item of equipment assumes aspects of importance, especially as there are some 3900 operating positions in the reperforator switching centers which can be equipped with the new devices.

The author wishes to acknowledge the assistance of Mr. W. J. Ramhorst, Plant and Engineering Department, who suggested the crimping device and aided in the development of early models in Western Union's research laboratories.

#### References

1. AUTOMATIC TRUNK SELECTION FOR REPERFORATOR SWITCHING, W. B. BLANTON, *Western Union Technical Review*, Vol. 6, No. 1, January 1952.
2. PAPER RESEARCH AIDS THE TELEGRAPH, W. N. ENGLER, *Western Union Technical Review*, Vol. 4, No. 3, July 1950.

---

**Frank J. Haupt** entered Western Union service in 1910 as an office messenger in the New York main office. In subsequent years, he worked successfully in various clerical positions, as a Morse operator and later as a multiplex technician. In 1926 he joined the Engineering Department, starting as a laboratory assistant. In the ticker group he worked on multiplex channeling of CND services and the design of equipment. He has been associated with the design of most of the units of equipment in the Western Union Reperforator Switching Systems, and assisted in all cutovers of the switching centers comprising the Company's coast-to-coast network. Mr. Haupt's broad experience with equipment and his unusual talent for adjustment resulted in his selection to conduct training schools for equipment maintainers at switching centers. He holds several patents on reperforator equipment, and is now engaged in the design of new equipment for switching systems still in the planning stage.



# The Transmission of Intelligence in Typescript

I. S. COGGESHALL

IN THE INITIAL installment of this article it was shown that Modern Communication Theory (MCT), which is essentially mathematical in concept, considers the transmission of intelligence in typescript, or alternatively, as an extreme case, in the form of television images, merely as two special cases of the common problem of electrically forwarding informational data within available bandwidths in the presence of noise. It was shown that bandwidth requirements might be reduced in fact, at the expense of simplicity of sending and receiving equipment, by incorporating into the terminal apparatus high-speed analytical, memory, and prediction devices which would make it unnecessary to transmit a great deal of the total informational data over the line or through the transmission medium itself.

## PART II — TELEGRAPHIC CODIFICATION

Important to the accomplishment of this objective is the idea of telescoping information by automatically encoding and decoding it. MCT contributes the suggestion, for example, that in transmitting plain language, the code for any given letter be not of fixed length as in Morse and Baudot codes, but vary in length, from place to place in the message, in inverse proportion to the frequency of occurrence, in English, of the digraph or trigraph sequences of which the given letter is the last.

Practical telegraphy, compelled to strike a working balance between shortening codes and designing trouble-free terminal equipment, has contented itself with the simpler mechanisms associated with fixed relationships between typescript characters and their mark-space binary representations.

The urge to conserve bandwidth, by code economies or otherwise, varies widely

with types of circuit. When the long distance telephone is used for 125 words per minute by allocation of a v-f band of 4000 cycles, the spectrum usage is at the rate of 640 pulses per character. Where conductor pairs cost as much for teleprinter speeds of 23 cps as for full voice-frequency bandwidths, as they do within a city, there is no incentive to compress more information into fewer bits; and in such a case it is advantageous to ignore bandwidth, even to the extent of shifting from narrow-band printers to wide-band facsimile for collateral advantages. For the same lack of incentive one would not expect the telephone company to employ Vocoders<sup>29</sup> on local calls.

But when it comes to intercity and international telegraphy, economics bars the general use of wider bandwidths than are essential to convey information, and here the utility of a possible code shorter than 5 impulses per letter becomes of passing interest. MCT says that in an extreme case, the figure can be brought down to approach 2 impulses per letter, using the customary two levels of power<sup>30</sup>.

The term *passing interest* has been used advisedly, because, so lightly are present-day circuits loaded with information in the sense that MCT looks for increased efficiency, that saving 3 out of each 5 impulses by shortening the code is of small moment. Over a period of years, time-division multiplexes, which formerly were common<sup>31</sup>, divided bandwidths as though with a pair of dividers at 5 units per letter. Then start-stop 7½ and 7-unit code printers were adopted on the score of making channels more flexible. Were the industry interested in saving bandwidth at the cost of making its terminal equipment a little more complicated (the situation contemplated by MCT) it could do so by reverting to time-division multiplex. Instead of assigning a telegraph channel, spaced 150 or 170 cycles apart from its neighbors in a v-f band, to a single

A paper presented before the IRE Technical Conference on Communications, Cedar Rapids, Iowa, September 1952.

start-stop teleprinter, a 40-cycle, 3-channel, 60-wpm per channel multiplex could be substituted with a C/W gain of 300 per cent. That would be only the beginning, for there is little doubt that the substitution of new types of electronic for mechanical distributors would make it possible to do away with most of the filtering losses which honeycomb our present wide-band telegraph spectra. Who could gainsay our ability to do it who watches the sweep of the electron beam in TV drop information much more complicated than mark-space into each one of 250,000 allocations on the screen during each interlaced frame? And who could deny the thesis that devotees of MCT should look in that direction for telegraphic progress, rather than in some other, when a present-day 150,000-cycle carrier system, for all its efficiency in stacking channels by translation<sup>32</sup>, will accommodate only 576 one-way start-stop channels the informational content of which, at 5 units per character and 6 characters per channel-second, is only 17280 bits, or 8640 cps? Half this information, in one direction, may be the entire

informational content of a 4-kmc unidirectional radio beam (4,000,000,000 cps) carrier<sup>33</sup>, whose chosen frequency is a function of transmission requirements rather than a tight fit to the informational load to be carried.

In another department of telegraphy, that applying to long ocean cables, informational binaries are more closely packed into the available transmission bandwidths than anywhere else in electrical communication. The combined informational bandwidth of all 18 eastbound channels operated by all the cable companies across the North Atlantic before the advent of submerged repeaters was only 270 cps, and on it was carried 60 per cent of the commercial eastbound traffic load to Europe, Africa, and the Near East, the rest being handled by radiotelegraph. Here existed, indeed, a measure of compulsion to conserve W and to compact C! Every scheme that ever occurred to anybody before MCT seems to have been tried to shorten codes<sup>34</sup>. The principal ones adopted have been Morse, Baudot, and their variants (See Figure 3).

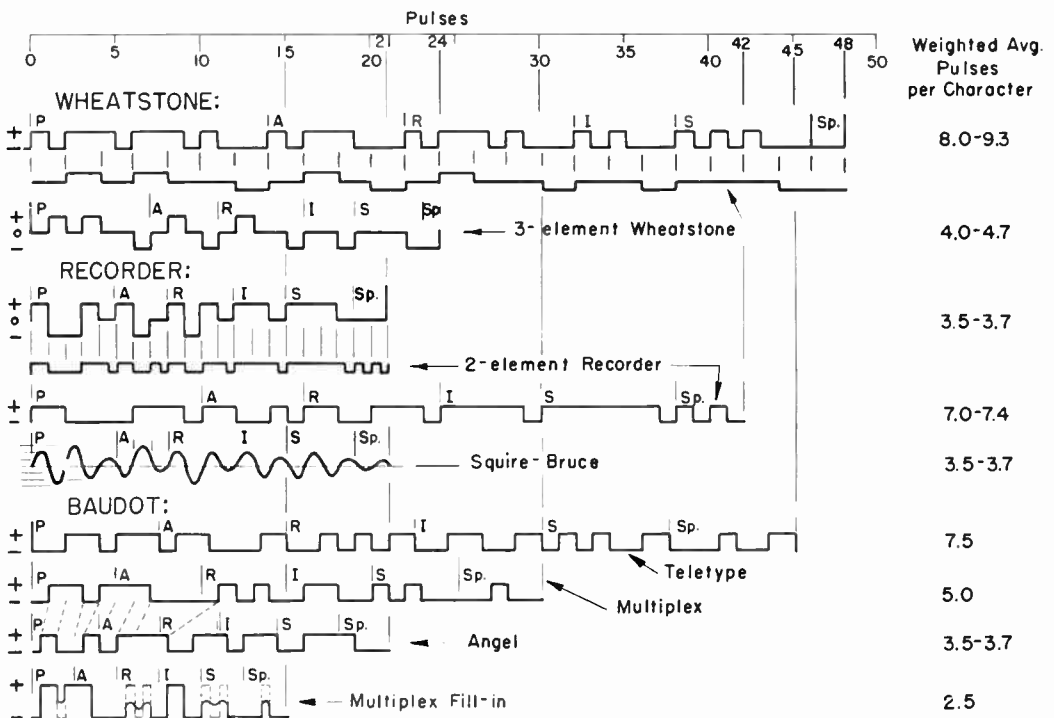

Figure 3.

## Wheatstone Morse

The Continental version of Morse appears in two important forms, Wheatstone and Cable Recorder, both nonuniform in length of characters and both expressed in the same code of dots and dashes but transmitted in a different complex of time intervals and power levels. The length of the various characters in both versions bears a good inverse correlation with frequency of occurrence of letters in English, letters of the frequently employed ETAOIN series containing the fewest dots and dashes per letter; in conformance with MCT in A.D. 1844! When Continental transmission was mechanized by Wheatstone to send open-close, or plus-minus, to line, his transmitter attached to the dot an extra binary to separate it from the dot or dash next following in the same letter, making a dot 2 pulses in length; with a like separation-binary, the dash became 4 pulses long; the extra space separating letters from each other, 2 pulses; and the space separating the final letter of one word from the first of the next, 2 additional pulses. Applied to the word *PARIS* followed by its word-space, the six characters (five of them printed) aggregate 48 pulses, or 8 pulses (4 cycles) per character. This happens to be the average, weighted for frequency of occurrence, of all letters and spaces appearing in English. 100 words per minute Wheatstone = 600 characters per minute = 10 characters per second = 40 cps = 80 bauds. The figure to remember is 8 pulses per character, (sometimes called 8 units, or 8 dots, per letter). The figure rises to 9.3 when figures, cipher, and punctuation occurring in cable traffic are included.

Wheatstone Morse is widely used in radiotelegraphy. Applied to cables its length is intolerable. But a variant has been used by the British on some of their shorter cables based on the observation that, when machine-punched, Wheatstone Morse contains only three combinations of binaries in pairs: mark-mark, space-space, and mark-space (space-mark being absent). This suggested 3-level encoding (positive, zero, negative) at half the Wheatstone length, namely, 4 pulses per letter. This average is better than Baudot's

5 pulses per letter. The conversion of power levels from 2 to 3 and reverse, and the pulses from pairs to singles and reverse, can be accomplished automatically at the points where landlines are repeated into cables and vice-versa, so that operation is regular Wheatstone Morse from landline terminal to terminal, so far as the operators are concerned. The same trick can be turned on radio using two frequencies, both of them on-and-off. The joining of coded impulses in pairs, and the employment of additional quantized power levels when *P/N* conditions permit, are good MCT; so was the original observation that space-mark can be considered absent in Wheatstone tape.

## Cable Recorder

While dating back to the beginnings of cable operation, the cable recorder variant of Continental Morse is extraordinarily short and efficient. Dots and dashes are of the same length, 1 pulse, differing only in electrical polarity as transmitted, there being no time interval between dots, between dashes, or between dots and dashes, of the same letter; a time interval of only 1 pulse (zero potential, cable earthed) for the space between letters; and 2 such pulses, additionally, between words. The word *PARIS* with its accompanying word-space, 21 pulses, averages out at 3.5 pulses per character; the figure rises to 3.7 for run-of-mine cable traffic.

Cable recorder code is used by Cable and Wireless, the British system, throughout the world<sup>35</sup>, it being amenable both to undulator transcription by a typist-operator and to direct printer operation. It is also used by All America on its South American cable system and is printed arrhythmically on standard 5-unit printers by the Woodward-Connery system of conversion<sup>36</sup>. Western Union at New York converts Cable and Wireless' cable recorder signals from Latin America to 5-unit Baudot by a system involving temporary tape storage, (an informational *surge-tank*), and cadenced printing, which is also good MCT.

Three-element, or three-level, cable re-

corder code, handled as such by the operators, can be automatically converted for radio transmission into what is called "Higgitt" code, of double the length (i. e., 7 pulses per character), and twice the frequency by "double current," mark-space, transmission. This is the same in principle as the cable variant of Wheatstone already described, but a shorter code. Higgitt originates and terminates as 3-level code whether it is transmitted as Higgitt over radio or as recorder over cables. It is therefore a versatile code for a cable-radio system.

### 5-Unit Baudot

Five 2-level binaries in time sequence give  $2^5 = 32$  possible combinations of signaled characters, which are allocated in various ways in different applications. By means of shift of case, additional characters and mechanical control functions may be included, some being left common to upper and lower cases, and some doing double, noninterfering, duty. Only in its multiplexed time-division applications does Baudot perform its whole function with five units<sup>37</sup>. In the majority of cases it is raised to a 7-unit (Western Union teleprinter), or a  $7\frac{1}{2}$ -unit (Bell System Teletype) code<sup>38</sup> by the juxtaposition of start and stop (rest) impulses, conveying no intelligence.

Even in its 5-unit multiplex length, this code was too long to be considered for cable use, to replace the 3.7-unit cable recorder. Consideration was given to an old proposal by Cooke for 3-level transmission of a 3-unit code, which would give  $3^3 = 27$  combinations. If any were to be set aside for control functions, this short code would force some alphabetic letters into the upper case, and there was a general indisposition to accept the code's limitations.

A more practicable code was devised by Angel<sup>39</sup> in the form of a shortening of Baudot, and it made possible the first successful transatlantic printer operation of nonloaded cables. The marking pulses of the Baudot code were transmitted full length and at their ordinary frequency, but there was an arbitrary reversal of

polarity between successive marking pulses. The spacing impulses were transmitted at half-length each, any number of them in succession being joined as to polarity with the marking impulse which preceded them. The uniform length of Baudot, of course, disappeared. This is a most interesting code from the viewpoint of MCT. For one thing, the choice of mark rather than space for full-length transmission takes advantage of the statistical feature of Baudot code of punching the fewest holes (mark) in the tape for characters occurring most frequently. For another, it introduces the idea of the half-bit of information and its transmissibility if joined to make the preceding pulse longer. It does not seem to involve cross-over transients the presence of which would introduce doubts as to its theoretical soundness. The receiving margin, of course, has to be such that signals of length 1.5 pulses can be distinguished from those of unit length. The average length of character was 3.5 pulses—the same as cable recorder code. The system worked but was abandoned in favor of the fill-in system next to be described.

### Fill-in Baudot

The code which is used today on Western Union cables starts and ends on terminal landlines as standard Baudot 5-unit multiplex code, transmitted at such a speed (double speed) that single impulses at the receiver do not cross the zero line but merely meet it, and alternations of mark and space are likewise attenuated to about zero level<sup>40</sup>. Such attenuated impulses are overridden, or filled in, by pulses of alternating polarity generated locally at the receiving station through an auxiliary ring on the receiving distributor<sup>41</sup>. Conversely, the full-amplitude double-pulses, triple-pulses, and so forth, are strong enough to take control away from the locally made unit-pulse reversals and to determine the polarity which the first locally generated pulse will have when the cable signal decays.

Since the effect is the doubling of speed without alteration of the 5-unit code as a code, it is somewhat difficult to describe

in terms of MCT although of utmost importance to the cable art. In a sense, it adheres to the dictum of not transmitting anything that the receiver can predict—in this instance that upon the decay of a pulse, or of a succession of pulses of the same sign, the next pulse will be of the opposite polarity whether strong enough to affect the receiver or not. In another sense, the transmission has been changed from two quantized levels to three levels *by proxy*—turning into a virtue the inability of the cable beyond to transmit a steep enough wave front to develop fully the single pulses. A third rationalization is to say that within the transmission band of the cable for signals *which it can pass*, the code has been effectively shortened to a little more than 2.5 units per character, or about 1.25 cycles per character<sup>12</sup>. Whatever the rationale, this system has been working well for more than 25 years.

### Squier-Bruce a-c Code

In discussing signal wave-front shaping, in the first part of this paper, no mention was made of the equal attention which is given to accomplishing a controlled and rapid decay of each pulse, thus robbing a succession of overlapping signals from evidence of their historicity. (This is MCT in reverse, and suggests that under the new theories a way may be found at the sending end to predict and act in opposition to the receiving end effects). Receiving end shaping concerns itself not only with perfecting the slope of the wave front's arrival, but of minimizing the tailings off, whose additive effects may be traced through a number of succeeding pulses. Cable siphon recorder operators used to *read through* this kind of distorted *handwriting*, but relays, which depend upon definite crossings of zero potentials, cannot so well accommodate themselves. As a result the circuits have had to be slowed down when printers were applied, and the signals shaped.

Several expedients are used to help the electrician shape out signal hold-over. One is "curbing", a scheme<sup>13</sup> incorporated in a recorder code transmitter whereby the cable is earthed momentarily between

successive impulses to give the line signals a bias down towards zero. Alternatively, in multiplex working, each channel is split as to marking and spacing polarities<sup>11</sup>, so that when a channel is idle, while 5 spacings will appear in succession, they will be transmitted as 2 plus and 3 minus, for example. Finally, there is the common pulsing method of sending two-element signals by discharge of a condenser, wherein only the changes of polarity are signaled at the instants of change, with an accelerated decay at the transmitting end. Such pulsing might be adaptable to radiotelegraphy.

Squier and Bruce<sup>15</sup> tried out on the Signal Corps' old Alaskan cable a scheme of sending three-level sine-wave signals, representing dot, dash, and space units, there being an arbitrary reversal of polarity between units, so that the signal on the cable looked like amplitude-wobbly a-c. Great hopes were held out for it, and it may very well be possible that it would have paid off in increased speed due to absence of tailings. However, unlike Angel's shortening of Baudot, it seems to contain an MCT *faux pas*. In spite of how innocuous the signal looks, the transmission of its intelligence content depends upon successfully dealing with its a-c transients and side-band components. Faithful transmission of various RMS potential levels over noise is an MCT problem, like duplexing A-M on an F-M modulation. Success in obtaining proper shaping at the receiver cannot be assumed.

### 6-Unit Baudot

While for most types of work the shifting of printer case from letters to figures and back is best handled by assigning a pair of character combinations to accomplish the shifting and unshifting, stock-ticker quotations contain so many transits between upper and lower cases that shifting is best accomplished by lengthening the code to 6 pulses per character. The presence or absence of pulse number 6 determines the case in which the selected type-bar will print.

A 6-unit general purpose printer would afford  $2^6 = 64$  combinations of characters

and controls and has been proposed to increase the usefulness of printers in certain language applications. Among other things, it would make possible tabulators and back-spacers. Another proposal which has been tried in the field is to retain the 5-unit code but shift among 3 cases instead of between two.

### 7-Unit "Error-Detecting" Codes

Noise in radiotelegraphy sometimes reaches levels where  $P/N < 1$ . A radio operator can call upon the remarkable frequency-amplitude discriminations of the hearing function to "read" mutilated signals by a mental process of integration and exercise of judgment, helped greatly by message context (good MCT). Mechanical receivers, however, print wrong letters when  $N > P$ . Two forms of 7-unit printer codes are in successful use to combat the condition, both so devised that marking and spacing will bear a 3-to-4 relationship in each character. Upon receipt, this relationship is checked in a monitor circuit, and if fading has added an extra space or if static has added an extra mark, the balance will be upset and the garbled letter will not be printed.

In one form of reception<sup>16</sup>, the garbled letter is rectified by exchange of service messages (RQ-BQ) between operators. In the other<sup>17</sup> the rejection of the mutilated character by the pulse monitor will result in temporary seizure of the circuit in both directions to accomplish back-stepping of the transmitting tape for a second try at correct reception, certain 7-unit combinations being reserved for this purpose.

### Phillips Code

Before leaving the subject of codes, some of us recall the prevalence of a code used in the days of American Morse on the landlines, known as Phillips, which had to be committed to memory by the operators for the purpose of condensing news dispatches between the "copy" and the key; and re-expanding them upon receipt, between the sounder and the typewriter. Oliver has suggested that anybody can read through omitted vowels:

MST PPL HV LTTL DIFFCLT N  
RDNG THS SNTC.

But the Associated Press used to give its Morse operators a stiffer workout, the symbols:

T CIC F WAD CKX D CHAD YAP  
D 70TH YOHA.  
HE HD FAPIB UFP BF T SCOTUS  
SO TR WS NO ALV UTC.

coming over the wire being required to be typed:

The Commander-in-Chief of the War Department committed suicide in the Chamber of Deputies yesterday afternoon in the 70th year of his age. He had filed a petition in bankruptcy under false pretenses before the Supreme Court of the United States so there was no alternative, under the circumstances.

*In terms of MCT, this is planar prediction folded up like an accordion. By machine, it would take some playing!*

### Codification for Facsimile

Several million telegrams annually, appearing as typescript written on or gummed down to blanks, are scanned, transmitted, and recorded by facsimile<sup>18</sup>, chiefly between main telegraph offices and branch offices or customers in the same city.

Single-spaced elite typewriters space 10 letters to the inch and 6 lines to the inch, so that 60 characters, counting word-spaces, can be crowded into each square inch. Under such conditions—the line/dot structure being 100 x 100, or 10,000 pulses per square inch—pulses per character run  $10000/60 = 167$ . But since an area of 8 inches by 4 inches has to be scanned, the way telegrams are ordinarily typed, and since they average only 40 words, tariffed and gratis, or  $6 \times 40 = 240$  characters per telegram, equivalent to  $240/60 = 4$  square inches if set solid, the spectrum space occupied is  $(32/4) \times 167 = 1336$  pulses or 668 cycles per character.

In applying facsimile to intercity service, these figures are eloquent in showing both the order of handicap under which facsimile machines would compete with printers, and the two principal causes: (1) nearly seven-eighths of the

time being consumed in scanning blank paper; (2) a very high pulse-rate per scanned character. Whether either or both of these inefficiencies can be reduced by MCT remains for the future to disclose. Similarity between facsimile and television is a cause for optimism. The facsimile problem should be the simpler of the two—speeds are slower, and there would be no necessity for tying pick-up speed to reproduction speed. Synchronous drums would no longer be a distinguishing feature of facsimile. Scanning and encoding could take place at electronic speeds; transmission would be leisurely, on a narrower bandwidth than at present. Maybe, as in Angel's variant of Baudot, the white paper could be compressed a hundred to one and tied to the black marks. Perhaps a way might be found to retrieve the information now packed in transmitted but discarded levels of gray above the noise background in black-white facsimile. Several lines of interesting inquiry fan out from where we stand, thanks to MCT.

### Acknowledgment

The author wishes to acknowledge his indebtedness to the engineers in Mr. F. B. Bramhall's division of Western Union's Department of Development and Research for their critical reading of his drafted paper.

### Bibliography

29. ANALYSIS-SYNTHESIS TELEPHONY WITH SPECIAL REFERENCE TO THE VOCODER, R. J. HALSEY and J. SWAFFIELD, *Proc. I.E.E.* (London), Vol. 95, Part 111, 1948, pp. 391-411.

30. RECENT DEVELOPMENTS IN COMMUNICATION THEORY, C. E. SHANNON, *Electronics*, Vol. 23, April 1950, pp. 80-83.

31. PRINTING TELEGRAPH SYSTEMS, J. H. BELL, *AIEE Trans.*, Vol. 39, 1920, pp. 167-230.

32. FREQUENCY TRANSLATION IN WIDE-BAND TRANSMISSION SYSTEMS, F. H. CUSACK, *Western Union Tech. Rev.*, Vol. 2, January 1948, pp. 36-44.

33. A 150 KILOCYCLE CARRIER SYSTEM FOR RADIO RELAY APPLICATIONS, J. E. BOUGHTWOOD, *Western Union Tech. Rev.*, Vol. 2, April 1948, pp. 57-65; also TWO THOUSAND TELEGRAMS PER MINUTE BY MICROWAVE, J. Z. MILLAR, *Western Union Tech. Rev.*, Vol. 1, No. 1, July 1947, pp. 2-8.

34. THE USE OF CODES IN ELECTRICAL COMMUNICATION, J. L. HOGG, *Bell Lab. Rec.*, Vol. 5, 1928, pp. 181-184; also SUBMARINE TELEGRAPHY IN THE POST-WAR DECADE, I. S. COGGESHALL, *AIEE Trans.*, Vol. 49, 1930, pp. 476-485.

35. EMPIRE TELEGRAPH COMMUNICATIONS, K. L. WOOD, *Proc. I.E.E.* (London), Vol. 84, 1939, pp. 638-671; also SOME DEVELOPMENTS IN COMMERCIAL POINT-TO-POINT RADIOTELEGRAPHY, J. A. SMALE, *Proc. I.E.E.* (London), Vol. 94, Part III-A, 1947, p. 345.

36. DIRECT PRINTING OVER LONG NON-LOADED SUBMARINE TELEGRAPH CABLES, M. W. WOODWARD and A. F. CONNERY, *Elec. Eng.*, Vol. 51, 1932, p. 132.

37. THE APPLICATION OF WESTERN UNION MULTIPLEX TO NAVY RADIO, R. HOOVER, *Western Union Tech. Rev.*, Vol. 3, 1948, pp. 29-35.

38. FUNDAMENTALS OF TELETYPEWRITERS USED IN THE BELL SYSTEM, E. F. WATSON, *Bell System Tech. Jour.*, Vol. 17, 1938, pp. 620-639; also EFFECT OF TELEGRAPH DISTORTION ON THE MARGINS OF OPERATION OF START-STOP RECEIVERS, W. T. REA, *Bell System Tech. Jour.*, Vol. 23, 1944, pp. 207-233.

39. PRINTING TELEGRAPHS ON NON-LOADED OCEAN CABLES, H. ANGEL, *AIEE Trans.*, Vol. 46, 1927, pp. 884-896.

40. THYRATRONS IN LOADED CABLE MULTIPLEX, H. H. HAGLUND and A. W. BREYFOGEL, *Western Union Tech. Rev.*, Vol. 3, January 1949, pp. 34-42.

41. AUTOMATIC PRINTING EQUIPMENT FOR LONG LOADED SUBMARINE TELEGRAPH CABLES, A. A. CLOKEY, *Bell System Tech. Jour.*, Vol. 6, 1927, pp. 402-424.

42. HIGH-SPEED OCEAN CABLE TELEGRAPHY, O. E. BUCKLEY, *Bell System Tech. Jour.*, Vol. 7, 1928, pp. 225-267.

43. PRINTING TELEGRAPHS ON NON-LOADED OCEAN CABLES, H. ANGEL, *AIEE Trans.*, Vol. 46, 1927, pp. 884-896.

44. THYRATRONS IN LOADED CABLE MULTIPLEX, H. H. HAGLUND and A. W. BREYFOGEL, *Western Union Tech. Rev.*, Vol. 3, January 1949, pp. 34-42.

45. THE APPLICATION OF RADIO ENGINEERING PRINCIPLES TO SUBMARINE TELEGRAPH CABLES, G. O. SUTTER, *Jour. of the Franklin Inst.*, Vol. 198, 1924, pp. 29-56.

46. INTERNATIONAL RADIOTELEGRAPH COMMUNICATIONS, S. SPARKS, *AIEE Paper* 48-131, Mexico City, June 1948.

47. RCA ELECTRONIC MULTIPLEX AND AUTOMATIC CORRECTION EQUIPMENT, S. SPARKS, *Tel. and Tel. Age*, July 1951, pp. 7-8.

48. AN IMPROVED DESK-FAX TRANSCIVER, G. H. RIDINGS and R. J. WISE, *Western Union Tech. Rev.*, Vol. 6, July 1952, pp. 92-101.

Biography and picture of **Mr. Coggeshall**, who is now Director of Planning, International Communications Department, appeared in **TECHNICAL REVIEW** for January 1951.



# A Stabilized Power Supply for Use with Submerged Ocean Cable Repeaters

A. ATHERTON

IN RECENT months thermionic telegraph repeaters have been connected into each of a number of transatlantic submarine cables at points on the edge of the continental shelves and are submerged there under many fathoms of sea water. All electric current to each repeater is fed over the cable conductor itself, from that end toward which the repeater sends the amplified telegraph signals, and returns by an earth path to the source. The joint use of the cable core for telegraph signals and for power supply offers no great technical difficulty. The geographical location of the cables is such, however, that high differences of potential often occur between remote ground connections. The current path to the repeater is therefore subject to fortuitous disturbances which may either increase or decrease the source potential needed to maintain a given current.

The repeaters themselves require, for faithful operation, an almost perfectly constant current in their circuits. The potential applied to the cable therefore must remain unaffected by any change of voltage of the power available to the station, and at the same time must automatically increase or decrease as earth potentials arise. A special rectifier was found to offer the best solution of the problem. As finally designed, the rectifier and its auxiliary control equipment delivers a current of approximately one-third ampere to the cable with a variation of less than one milliamperere throughout wide swings both of primary source voltage and earth current potentials.

## General Character of Components

A magnetically-controlled diode operates continually to detect the slightest change of current flowing into the cable core, and provides a correcting signal to the rectifier network. The effect of this

signal is amplified to such an extent that full compensation for earth current changes as high as 600 volts is reached with a line current change less than 2 milliamperes.

To prevent ripple and any other transient voltages in the power source from interfering with incoming telegraph signals, the cable termination is made with bridge arms and an artificial line as for duplex telegraph operation with the repeater power entering at the apex of the bridge.

The rectifier itself is a full bridge mercury vapor tube arrangement capable of delivering one ampere of direct current

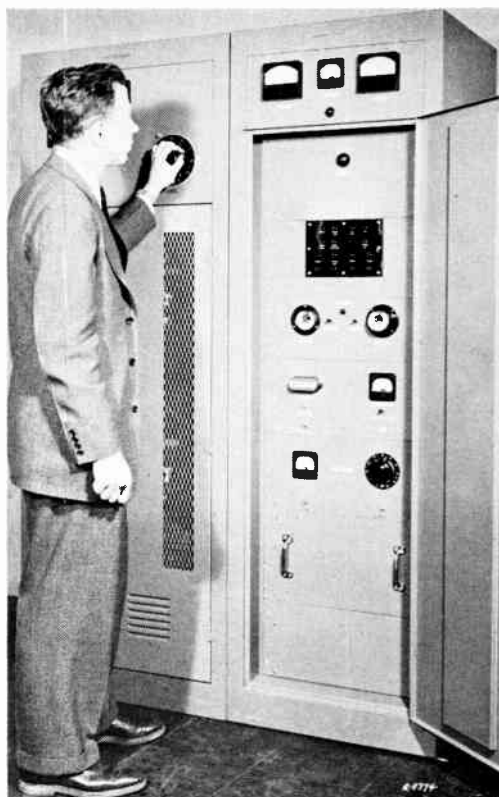

Power supply unit and cable terminating equipment—Manual adjustment of primary voltage. This is necessary only on initiation of service

at 1500 volts. The negative pole connects through a conventional inductor-capacitor filter to the apex of the cable terminating set. Automatic control of apex potential is effected by the action of tandem banks of voltage absorption tubes inserted between the positive pole of the rectifier and the ground. The potential drop across these two banks of tubes is held just sufficient at all times to maintain an apex potential which will produce the correct line current regardless of existing earth potential or power line voltage variation. The interaction of sampling and control equipment and the two banks of absorption tubes is explained in later paragraphs.

Accurate control of a fixed load potential by use of a high-voltage source together with absorption tubes was described in a previous article in *TECHNICAL REVIEW*.<sup>1</sup> One of the two banks of power tubes mentioned above performs as described therein and, within close limits, the potential

across the rectifier minus that across this bank of absorption tubes is not affected by changes of potential to the rectifier.

The potential across the other bank of absorption tubes is regulated at all times by control equipment which responds to minute variations of current entering the cable. In turn, the potential across this bank may be used to regulate that across the first bank. The linkage can be adjusted so that the two banks offer approximately equal drop or other desired ratio of drop when the cable current is at correct strength and the commercial supply potential is at its normal value. In continuing operation, the drop across the first, or voltage control, bank will rise and fall equally with any rise or fall of rectifier potential, and the total drop across the two banks will change as much as required to correct for an earth potential swing.

#### Current Control Amplifier

For the range of compensation necessary in the absorption tube banks to take care of wide differences of earth potential, their control grid biases must swing from a low in the neighborhood of 5 volts to a high of about 65 volts. On the other hand, if the cable current is held to variations of one milliamperere or less from the normal 0.320 ampere current, the available potential change across a low resistance series impedance will not exceed a small fraction of one volt. An amplifier is therefore inserted between a line current sampling device and the grids of the current-controlled bank of absorption tubes.

The amplifier used is a two-stage direct-current type with adaptations to the peculiar problem. The grids to which the amplifier output joins must be held to potentials which are negative to earth, and very accurately maintained to desired levels. To accomplish this, the amplifier derives current from a rigidly stabilized rectifier, the ungrounded pole of which is maintained 250 volts negative to ground. The entire amplifier is thus held in a rigid potential relation to ground while the potential of all parts of the cable network varies with respect to ground when-

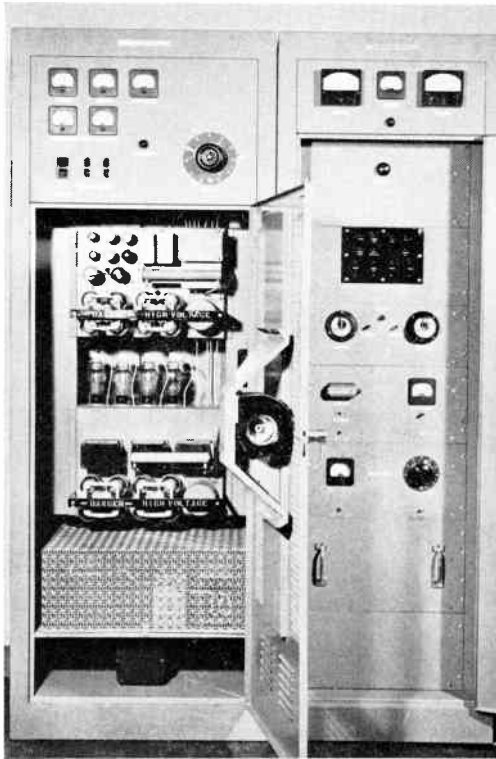

Power supply unit and cable terminating equipment. Left-hand cabinet shows rectifier tubes near middle with absorption banks above and below. Right-hand cabinet contains line terminating equipment and control amplifier

ever earth potentials exist. Conductive coupling of cable network and control amplifier is avoided by use of a magnetically-controlled diode having two magnetizing coils. One of these has relatively few turns and is placed in series with the cable circuit. The other, in series with an adjustable resistor, obtains current from a fixed potential direct-current source. The plate-cathode circuit of the diode provides an input circuit to the amplifier.

Figure 1 shows the linkage of cable terminating equipment and amplifier. At a number of points in this figure (and in Figure 3) the potentials with relation to ground are indicated, those with plus prefixed numbers being positive in relation to ground.

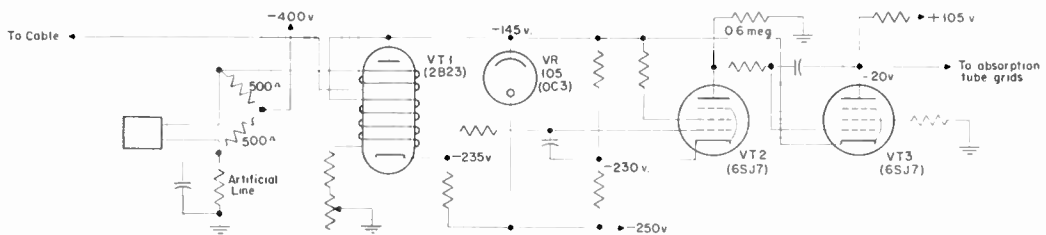

Figure 1. Cable terminating set and current control amplifier

The magnetically-controlled diode VT1 has cathode and anode on a concentric axis and in the absence of a magnetic field behaves like other diodes. However, if the lines of a magnetic field parallel the axis of the tube, electrons are forced from their normal radial paths into a spiral trajectory and, if the magnetic field strength is increased sufficiently, will be turned back on the cathode thus reducing the anode-cathode current flow. There is little change of anode current with increasing magnetic field until a critical magnetization is reached. Beyond this, anode current drops off rapidly with increasing field.

The double-wound magnetizing coil mentioned before is used for control in this application. A constant 145-volt potential is impressed across one coil and a series adjustable resistor. The other coil is placed in series with the cable circuit, and carries the actual cable current. The current is adjusted in the first mentioned

coil until the field derived from both is sufficiently strong to be offering substantial anode current control. The two coils are poled so that an increase of current in either will increase the magnetic effect, and the anode impedance.

The anode-cathode circuit of VT1 and a series resistor carry current from a constant 105-volt source. The junction of resistor and tube cathode connects in turn to the grid of an amplifier tube VT2, and acts as the input to the amplifier. The latter is a conventional cascaded two-stage d-c amplifier, operating between a potential of about 230 volts negative at the cathode of the first stage tube, and 105 volts positive at the plate of the second stage tube. A single voltage regulator tube

stabilizes the potentials on the cathodes of both VT2 and VT3 and the voltage across the plate-cathode circuit of VT1 and its associated resistor.

With 0.320 ampere flowing in the cable, the actual potential at the plate of VT3 needs to be about 20 volts negative to earth. All fixed resistor components are selected so that the actually needed potential can be obtained well within the adjustable limit of steady current in the main magnetizing coil of VT1.

In operation, a change of current in the cable immediately affects the magnet flux in VT1, and its plate-cathode impedance. For example, an increase of cable current will increase the field about the tube, the plate impedance will increase as a result, and the cathode will become more negative approaching 250 volts as the impedance nears infinity. This change will be seen also at the control grid of VT2. The cathode potential of that tube, however,

is fixed and the negative grid bias therefore is increased. The plate-cathode impedance of VT2 is thereby increased and its plate potential becomes less negative as does that of the grid of VT3. The plate-cathode circuit of VT3 now becomes more conductive and its plate potential becomes more negative. In an actual assembly, a variation of 0.1 milliampere in the cable circuit may bring about a swing in the order of 8 volts in this plate potential. The plate potential of VT3 is used also as potential for the control grids of a paralleled group of power tubes which act as voltage "absorbers".

### Absorption Banks

The location of repeaters and character of cable will affect the potential at which the requisite repeater current can be delivered. A typical case will be assumed in which, under stable conditions, the potential at the apex of the terminating set is 400 volts negative to ground and the current flowing through the set is 0.640 ampere. Further it will be assumed that potentials as high as 300 volts poled either way may arise between the terminal set ground and the deep water ground at the repeater. Figure 2 shows the necessary

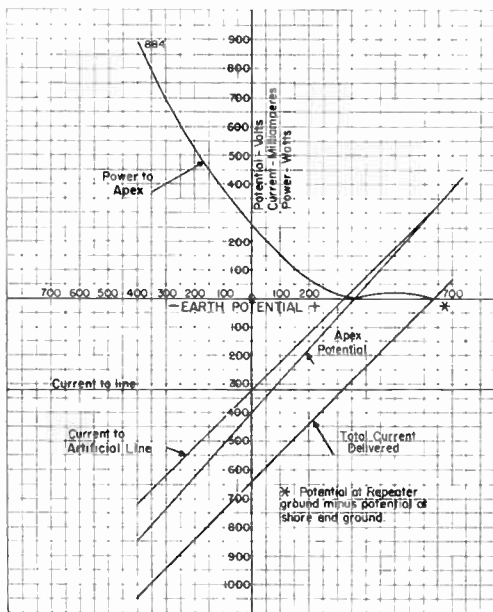

Figure 2. Potential current and power as affected by earth potential

apex potential and current, and the total power delivery to the cable system needed to maintain a line current of 0.320 ampere for a wide range of earth potentials. Only those portions of the curves between earth potential limits of plus or minus 300 volts are of interest.

For this assumed set of conditions, the rectifier voltage would be made approximately 1200 volts, and each of the two absorption tube banks, under normal conditions, would drop this potential by about 400 volts to leave 400 volts available at the apex. Figure 3 shows the connections of all elements of the power source. One tube of each absorption bank appears to the right of the rectifier. However, to carry the current involved with adequate allowance for single tube failures, each bank has eight tubes. Plates and cathodes of each bank are multiplied directly together. Each grid has its own current limiting resistor but the eight grid circuits, in each case, connect to the same voltage source.

Cathodes of the current-controlled tube bank connect to earth, while the plates join the cathodes of the voltage-controlled bank. The plates of the latter are fed from positive pole of the main rectifier. The negative pole of the rectifier connects in turn to the cable terminating set, and the ground connections at the repeater and at the end of the artificial line complete the circuit. The plate potential of the current-controlled bank is being held at 400 volts positive to ground; the plate potential of the voltage-controlled bank is 800 volts above ground, and the apex potential is 400 volts minus to ground; 0.640 ampere is flowing through the apex circuit.

Under the above condition, the current control amplifier maintains a negative grid bias of about 20 volts on the tubes of the current-controlled bank. Should an earth potential appear, this grid potential will become more negative if the line current has increased, and less negative if the line current has decreased. The voltage drop across the plate cathode circuit of the current-controlled tube bank will become greater or less accordingly.

Referring again to Figure 3, an amplifying tube VT4 has its control grid and

cathode connected in networks between the plates of the current-controlled tubes, the negative pole of the main rectifier, and the ground. The control grid, by means of a voltage regulator tube VR2, is maintained at a potential very nearly 150 volts below that of the plates of the current-controlled bank. The cathode network is adjusted so that the cathode potential is somewhat more positive than the grid

in the voltage-controlled bank. The grid potential in this bank of tubes is dependent, then, on the plate impedance of VT4.

By proper selection of all components, the grid bias of the voltage-controlled bank can be maintained very nearly equal to that of the current-controlled bank, so that an increase of drop across the latter resulting from a slightly excess line current will be accompanied by an increase

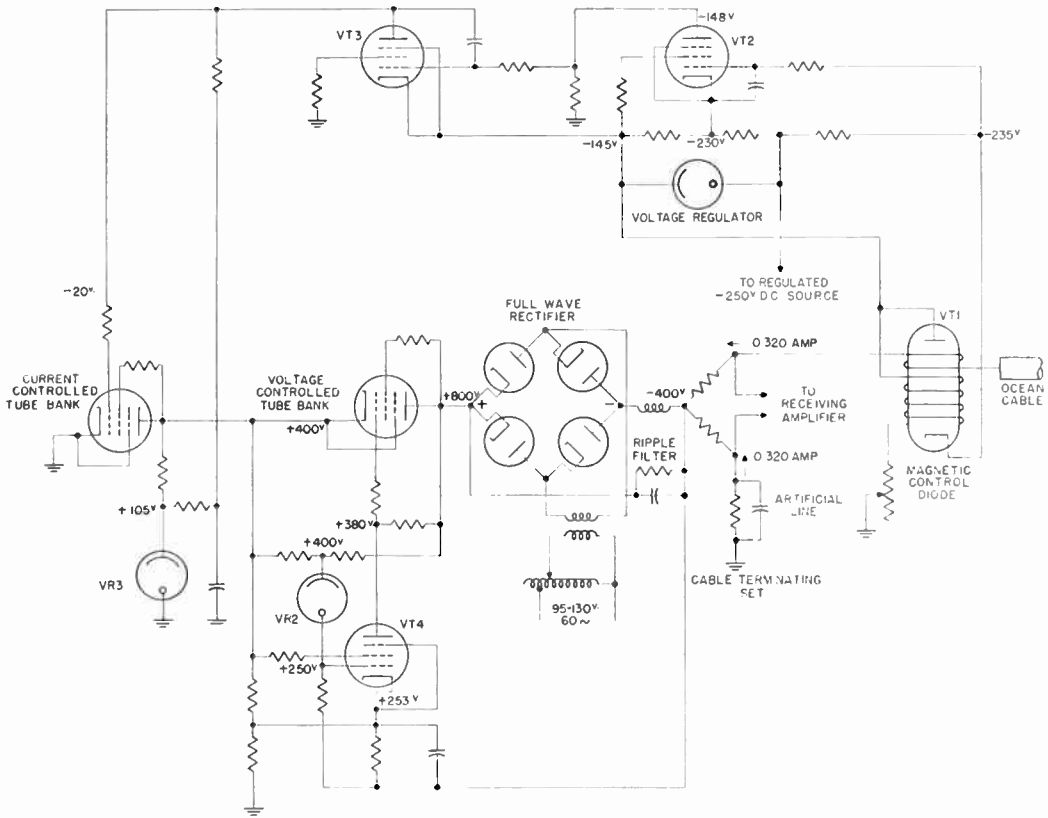

Figure 3. Complete theory of power source

potential. The components are further selected so that the cathode potential of VT4 rises more slowly than the grid potential of that tube as the plate voltage of the current-control bank increases. A change of potential drop across this bank therefore is accompanied by an approximate linear change of grid potential in VT4.

The plate of VT4 connects to the positive pole of the rectifier through a high resistance and also to the grids of all tubes

of drop across the former as well. Thus, if the repeater ground should become 300 volts positive with respect to the terminal ground, the drop in each bank would rise from 400 to 565 volts. Similarly, should the earth present a 300-volt potential tending to reduce the line current, the drop in each bank would fall to approximately 235 volts.

All automatic compensation for variation of potential in the prime a-c feeder to the potential source takes place in the

voltage-controlled bank of tubes. Returning again to Figure 3, the voltage-regulator tube VR2 which sets the grid potential of VT4 connects through a potentiometer both to the plates and the cathodes of the voltage-controlled tubes. Only about two percent of the potentiometer resistance separates the cathodes from VR2 so that the potential at the anode of the latter remains fairly close to that of the cathodes of the voltage-controlled tubes. However, a change of potential at the plates of these tubes is accompanied by a much smaller change of potential to VR2 and a similar change of grid potential to VT4. The plate impedance of VT4 is thereby altered whenever the rectifier voltage changes. Thus increase of rectifier voltage lowers the plate impedance of VT4; the grid potential of the voltage-controlled bank becomes more negative; and the drop across that bank increases to offset the increase in rectifier voltage. Any effect this variation might have on cable current is very small and, at most, transitory as no change of current is necessary to initiate correction.

An interesting side light on the effect of the voltage-controlled absorption bank is its effect on voltage ripple. The inductor-capacitor filter reduces ripple voltage across the main rectifier to about one percent of the d-c potential (10 volts or more). Actual measurement at the cable set apex indicates the residual there is about 50 millivolts. The use of a neutralizing artificial line permits reduction of this until the disturbance to incoming signals is negligible.

### **Operation of the Power Source**

While it is necessary that the power source detect small variations of line current and make automatic voltage compensation, it is equally necessary that incoming cable signals are not distorted. It is important too that the apparatus does not over-compensate and thereby cause a cyclic hunting. A number of shunting capacitors help to make the arrangement less sensitive at signal frequencies but the most effective of these is a fairly large capacitor across plate and control grid of

the second stage amplifier tube VT3. The capacity coupling at that point acts as a transient negative feedback, making the entire amplifier quite deliberate in its response so that the absorption tubes operate sufficiently slowly as to avoid over-throw. The sluggishness in this respect makes it desirable that rectifier voltage be brought up gradually when starting.

The heaters of all vacuum tubes receive current through a voltage-stabilizing transformer. Power for the main rectifier circuit connects through a manually-controlled variable transformer. For starting, the output side of this transformer is set to zero voltage, and power is connected to tube filaments and auxiliary apparatus. After an interval sufficient to allow rectifier tube filaments to reach steady temperature, automatic time delay equipment connects the rectifier and load circuit. The output potential of the variable transformer is now brought up gradually until the cable current reaches the rated level, and the stabilizing controls begin to function. Further adjustment of input potential will have no effect on the cable current. The potential across the plate-cathode circuit of the voltage-controlled absorption bank, however, rises as the applied voltage is increased, and the transformer normally would be left at a setting to give a previously established drop across that bank.

The cable current may be stabilized to the exact level desired by adjustment of the steady bias current in the magnetically-controlled diode. If the line current is low, a decrease of bias current will effect an increase; if it is high an increase of bias current will correct the condition.

It was assumed in discussion that the rectifier output potential would be 1200 volts and that the two absorption tube banks would reduce this to 400 volts at cable set apex. For an actual installation, that line potential likely would not be correct. Earth current potentials to be expected might be appreciably lower, or available commercial power might be more or less stable than assumed. If the actual range of variation is less, some advantages are gained by narrowing the range of compensation. The absorption

banks will not function correctly if plate cathode potentials are reduced much below 170 volts, and the rectifier voltage must be sufficient to provide the maximum need of the cable equipment plus a minimum of 340 volts.

The network components can be selected for any range needed. For example, if earth potentials in excess of 100 volts are not expected, the nominal drop of each of the absorption banks might be reduced to about 300 volts with the voltage-controlled bank automatically compensating for primary voltage changes up to 15 percent and the current-controlled bank providing all compensation for earth potential. The power required would thereby be reduced and the life of the weaker components would be increased.

Considered solely from an efficiency standpoint, the source would be rated very low indeed as approximately 650 watts are dissipated even under normal conditions to provide the approximately 50

watts needed at the submerged repeater. However, the cost of wasted power is a very small forfeit compared with the gains resulting from stable operation of the repeaters.

The units illustrated are those engineered and built by the Plant and Engineering Department, and appear about as they do in actual installations at Hearts Content, Penzance and other cable stations. The left cabinet houses the power and rectifier apparatus, the right one the cable set, bridge arms, artificial line and current control amplifier.

The power supply described is a cooperative development of Messrs. Cannon and Wells of the Transmission Research Division and Mr. Steinmetz of the Equipment Research Division.

#### Reference

1. A PRECISION VOLTAGE STABILIZER FOR DIRECT CURRENT POWER SUPPLY, A. A. STEINMETZ, *Western Union Technical Review*, Vol. 3, No. 4, October 1949.



**A. Atherton**, after graduating from Purdue University in 1917, entered Western Union on the staff of the Apparatus Engineer. A program of substitution of multiplex telegraph printing equipment for the miscellany of Morse duplex and quadruplex apparatus was in action, and Mr. Atherton was drawn into development and engineering of high-speed repeaters and their component apparatus units. During his long service on the staff of the Equipment Engineer, his activities touched on almost every item of inside plant equipment. The various repeaters needed in 1929 and 1930 for teleprinter circuits were developed under his direction. He initiated the Company's facsimile activities in 1934 and was partially responsible for the early engineering of the central office reperforator switching systems. At present, Mr. Atherton, as Assistant to the Equipment Research Engineer, is directing work on power plant development, and on special equipment problems. He is an Associate Member of the Association of American Railroads.

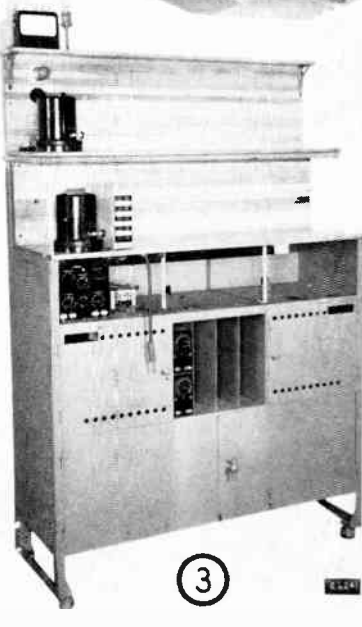
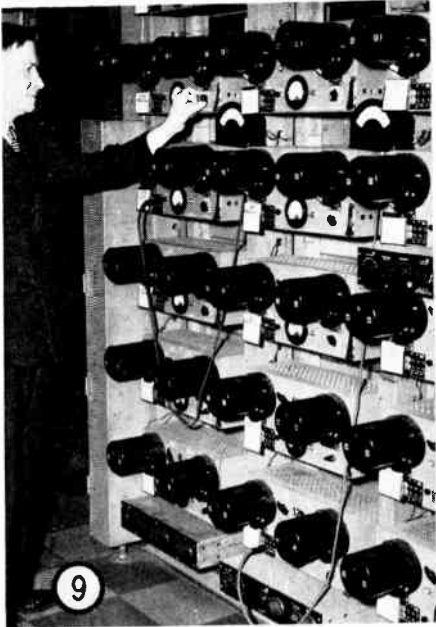
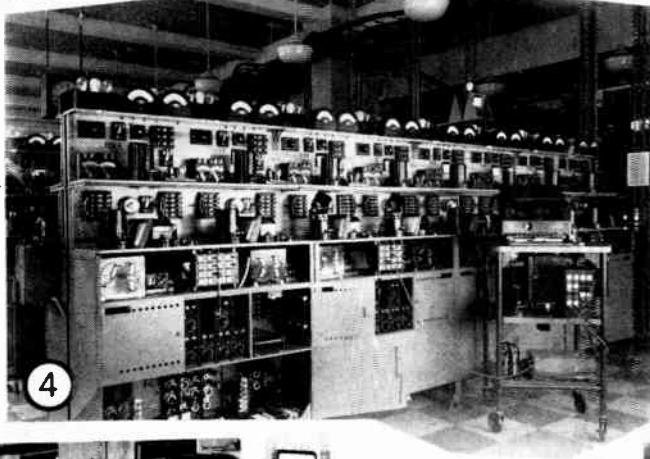
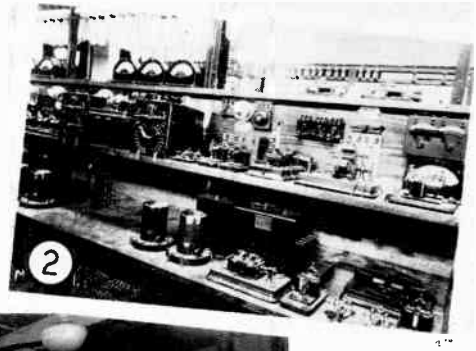

Figure 1. Quad room and line switchboard—Pittsburgh, Pa., 1899. Figure 2. Universal duplex repeater—left. Morse quadruplex—right. Figure 3. Unit set table. Figure 4. Terminal Duplex-Duplex Half Repeaters on unit set tables. Figure 9. Portion of three racks of network repeaters—New York. Figure 10. Duplex Set 8353.



# Modern Telegraph Repeaters

R. V. MORGENSTERN

TELEGRAPH REPEATERS are of many kinds, including carrier and direct-current repeaters as well as those used under the sea to extend the usefulness of ocean cables. It is not desirable to describe in one paper all of the various types of telegraph repeaters which are in service at the present time, or to take into account the many varieties which have existed in the past. Therefore, this paper will deal only with some of the direct-current repeaters which have been developed in comparatively recent years.

The original function of a d-c telegraph repeater was to receive a line signal from a distant transmitting station before it became attenuated to a point where it could no longer operate a telegraph instrument, and pass it on to another section of line in as nearly as possible the same signal strength and wave form as the initial signal. This is still an important function, but since at present most of the long line sections are operated over telegraph carrier equipment, modern d-c repeaters now are more often used to couple carrier channels to physical wires, or to tie together several carrier channels at one point to form a communicating network.

One common legend has it that Thomas A. Edison invented the first d-c telegraph repeater during his career as a telegrapher, so that he could use for other purposes the time he was supposed to employ in manually receiving and retransmitting messages. Like so many legends, this one is not true. Edison did make important contributions to the telegraph art, but he did not originate the telegraph repeater.

As a matter of fact, within four years after Morse demonstrated the first successful telegraph line in 1844, "means were devised," as the patent applications say, for automatically retransmitting telegraph signals from one line section to another, and prior to that time a repeater had been invented which had to be manually re-

versed in direction of signal transmission. From then on, many devices for automatically repeating Morse telegraph signals in either direction over a telegraph wire were invented and placed in service. The advent of duplex telegraphy, in which messages are sent simultaneously in both directions over a wire, brought forth another crop of repeaters and development has continued to the present date.

## Early Repeater Installations

Up until 1910, repeater installations in the Western Union plant appear to have been on a haphazard basis with most of the repeaters concentrated in 57 stations with spacings up to 700 miles. The majority were designed for Morse circuits; there were many varieties but practically no maintenance or operating instructions were available. In many cases the terminal equipment was located directly on the operating tables but sometimes it was concentrated along with the repeaters in "quad rooms", so called because of the presence of quadruplex equipment. Figure 1 shows one such quad room together with the associated line switchboard.

Between 1910 and 1918 there were many changes in all phases of the telegraph industry and repeaters were no exception. Repeater stations were increased to 87 and so located geographically that, in general, the spacing between them was approximately 250 miles, — a distance arrived at after exhaustive studies and field transmission tests. The repeaters themselves were greatly improved, and were designed for the specific purpose and class of service in which they were to be used, duplex repeaters being designed to operate in conjunction with the automatic or printer multiplex circuits which were installed during this same period.

Figure 2 illustrates two of the direct-current repeaters which were put into the telegraph plant at that time. At the left of

the picture is a Universal Duplex Repeater, used largely to repeat multiplex signals simultaneously in both directions between two line sections. A Morse quad-ruplex is shown on the right side of the illustration. Universal duplex repeaters could be used under a variety of main-line conditions or arranged to form two terminal sets. They were mounted on oak tables, supported by angle-iron frameworks, usually 11 or 14 feet in length.

The familiar unit set table, Figure 3, first came into use in 1922 and had the advantage that repeater and terminal sets could be assembled and wired thereon at a central point, then shipped to the place at which they were to be used. The tables are put in place against racks which are permanently installed and which carry the power supply and connections to the switchboards. The potential connections between the unit set table and its associated rack are made by means of cords and plugs, while the telegraph or signal wires are connected to spring clips on terminal blocks.

### Repeaters for Teleprinter Circuits

In the middle 1920's, the teleprinter was being introduced into the telegraph plant in substantial numbers both in new services and to replace Morse circuits. Terminal telegraph sets, or terminal repeaters, which had been used with Morse circuits, could not meet the more exacting transmission requirements of teleprinter signals. This led to the development of a number of telegraph sets especially for use with teleprinter circuits, the most familiar of which are the Terminal Duplex-Duplex Half (TDDH) Repeater which, as its name indicates, could be used with circuits handling signals simultaneously in both directions at a time or on circuits on which signals were sent only in one direction at a time; and the Polar High-Speed Single Line (PHSSL) Repeater. Figure 4 shows a row of TDDH Repeaters on unit set tables.

During the 1920's, Western Union also acquired a large number of circuits leased to newspaper associations which required new repeaters to meet their needs. The

Combination Duplex-Duplex Half (CDDH) Repeater is the most commonly used of this group. It is distinguished for its extreme flexibility and the large number of repeaters which can be interconnected by means of a polar "dummy" circuit to form networks with many branches.

A great many of the last three mentioned repeater sets are still in service.

### Carrier Telegraphy Makes Possible New Repeaters

As can be seen from the preceding, the field of d-c telegraph repeaters has been thoroughly explored for many years. What then is meant by "modern telegraph repeaters" and why are they necessary? All of the repeaters heretofore covered were used in connection with physical line wires, often 250 miles or over in length, and subject to varying weather conditions which made frequent adjustments necessary.

The advent of carrier telegraphy on trunk routes solved many transmission problems and largely changed the field of the d-c repeater from the electrically long sections to relatively short lines and intra-office interconnection of carrier sections. The large and rapid rise in the number of

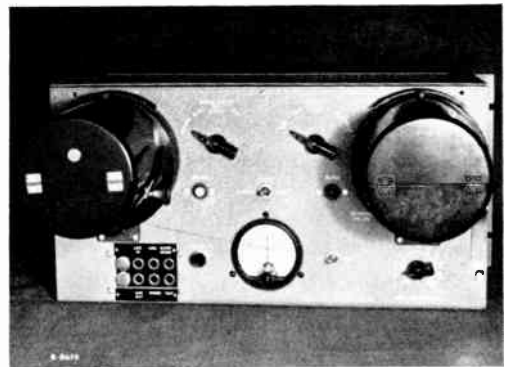

Figure 5. Half-Duplex Network Repeater 4617

leased circuits and networks, together with the introduction into the telegraph plant of the Type 20 Carrier Channel Terminal,<sup>1</sup> created situations calling for new d-c repeaters.

The transfer of the long main-line cir-

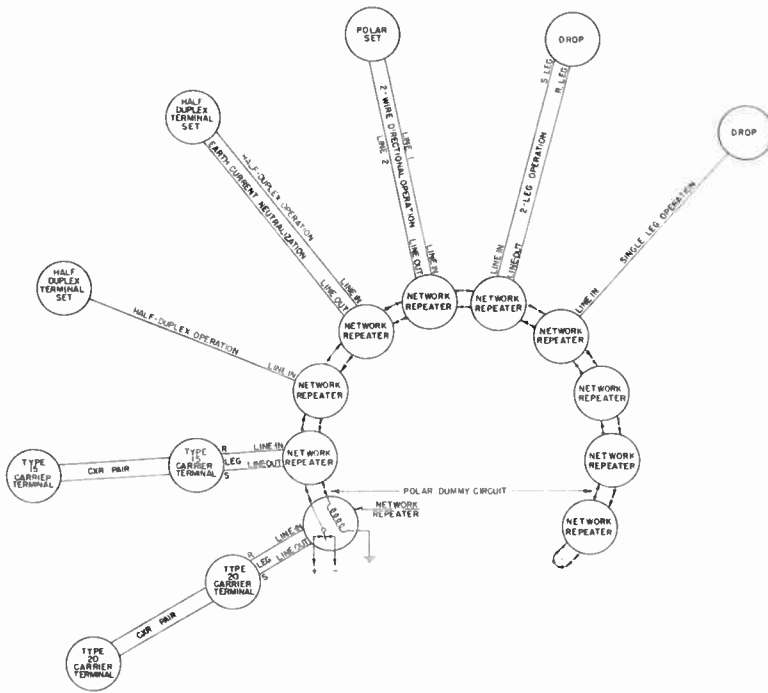

Figure 6. Theory of Application of Half-Duplex Network Repeater 4617

cuits from d-c to carrier operation made it possible to design repeaters with most of the testing and regulating equipment omitted, which in turn permitted rack mounting of d-c equipment, — an important consideration in view of increased demands for floor space in the larger offices. Today the majority of all newly installed repeaters are rack-mounted and have very little testing equipment incorporated as part of the repeater.

Similarly, practice called for compartmentation of the components of d-c telegraph sets. With the equipment spread over an area as large as the unit set table, it was desirable to bring power to a metal compartment and insert protective resistances in the leads before they were carried to other parts of the table. The first rack-mounted telegraph repeaters also followed this arrangement, with a potential compartment serving all of the repeaters on a rack. Present practice is to design a repeater as a complete unit, putting all components into a single cabinet and bringing the power and line connections directly to the unit.

At present, a duplex terminal set, three types of half-duplex network repeaters, a duplex repeater which can also be used as a terminal set, a polar press repeater, a leg-combining set and a multiple control panel, all of which have been standardized, mount on the usual repeater racks. Other modern telegraph sets are being engineered but are not yet ready for service.

### Half-Duplex Network Repeater

The most widely distributed of modern telegraph repeaters is the Half-Duplex Network Repeater 4617, the self-contained unit shown in Figure 5. There are over 2000 in service and the number is continually increasing. The repeater consists essentially of two polar relays, one of which receives signals from a distant point or a customer. This relay sends signals into the circuit, known as a dummy circuit, which interconnects two or more of the network repeaters. The other polar relay receives signals from the dummy circuit and sends them to a distant point or to a customer. The rest of the equip-

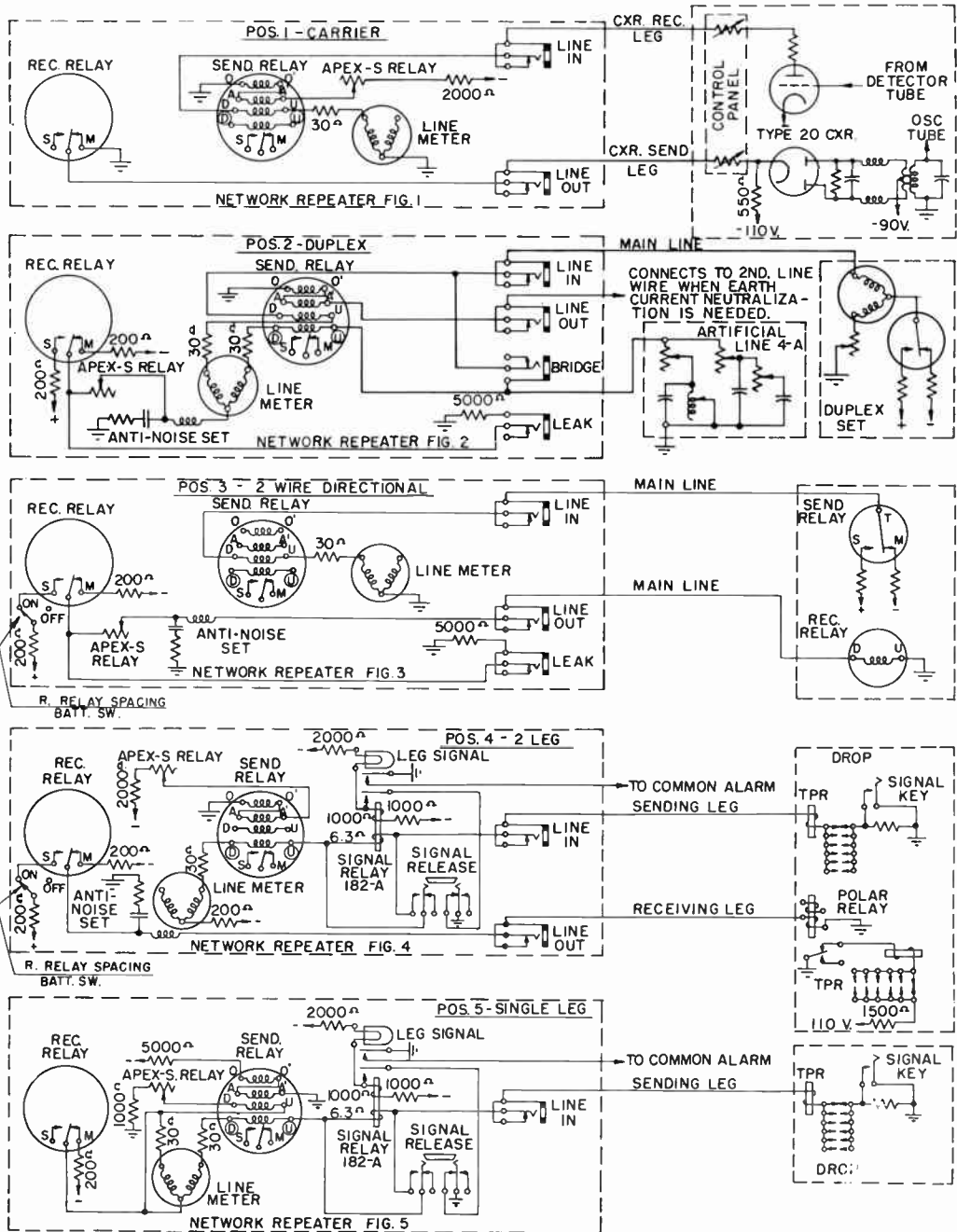

Figure 7. Theory of Line Circuit of Half-Duplex Network Repeater 4617

ment on the repeater is auxiliary to the relays.

A 5-position switch, shown at the upper right in the illustration and labeled "Line Switch", is used to arrange the line circuits of the repeater to meet any of the conditions shown on Figure 6—Theory of Application of Half-Duplex Network

Repeater 4617. It will be noted on the latter figure that there are two leg positions on the switch, enabling the connection to the customer to be made over one wire or two depending upon his requirements. Figures 7 and 8 show the theory of the line and dummy circuits, respectively, of Half-Duplex Network Repeater 4617.

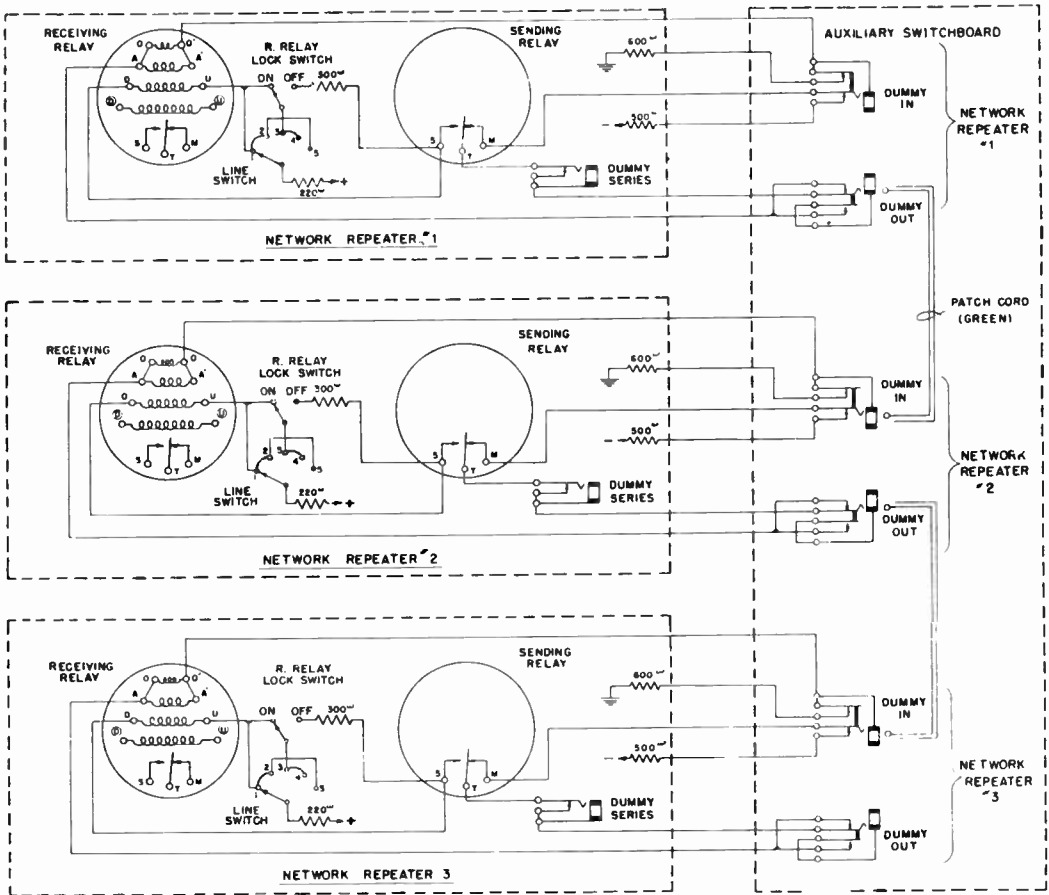

Figure 8. Theory of Dummy Circuit of Half-Duplex Network Repeater 4617

The switch on the left side of the unit, (See Figure 5) called "Dummy Switch", is provided so that in the event of trouble on one of the branches or drops, signals may be transmitted to the branch or drop but not received from it. This prevents false signals from interfering with the entire network. Another position on the same switch arranges the set so that a Wire and Repeater technician can communicate with the branch that is in trouble without disturbing the rest of the network.

Six repeaters mount on one side of a standard repeater rack and take up a total floor space of less than two square feet. The corresponding unit set table repeaters occupy approximately 7½ square feet.

Figure 9 shows a portion of three racks of network repeaters in the New York Testing and Regulating Department. Some network repeaters are used in Western

Union message service to bring way circuits into reperfector offices, but most of them are employed in patrons' leases to interconnect two or more branch circuits coming to a given city with one or more customer's offices in that city. The branch circuits may go to the distant destination over either carrier or physical line facilities. As shown in Figure 6, one repeater is required for each branch circuit or customer's office to be interconnected.

The sending relays connected to each branch or leg circuit receive signals from that branch or leg and send them in to the dummy circuit where the receiving relays pick up the signal and send it to all the other branches and legs. The repeaters are arranged so that signals received from a given point are not normally re-sent to the point from which they originate. However, in case of customers operating on

two legs, signals received from a customer may be sent back to him if so desired.

The interconnection of the various network repeaters in the dummy circuit is accomplished through a switchboard; since the dummy circuit operates on a polar basis, any number of repeaters up to 15 can be interconnected without impairing the transmission or requiring readjustment of the current in the dummy circuit.

Other network repeaters have been designed for special purposes. One of these has been described in the January 1953 issue of *TECHNICAL REVIEW*.<sup>2</sup> Another, in contrast to the Network Repeater 4617, can be used only where it is desired to interconnect three carrier channel terminals, or two carrier channel terminals and a customer's drop. So far its use has been

limiting resistors for all the sets on one side of a standard repeater rack. The first unit above the potential cabinet is an artificial line and the second is a duplex panel which houses the receiving and transmitting relays, test jacks, apex resistors, and so forth.

There is a jack strip 45 inches from the floor which holds two leg jacks, a light, and a switch, for each duplex set on the rack. The switch and light appear only on racks in the reperformer centers and are part of the sending stop system. When a set is taken out of service for regulating, the switch key is turned, preventing the transmitter in the reperformer system assigned to that duplex set from operating. The light serves as a reminder that the sending stop has been applied.

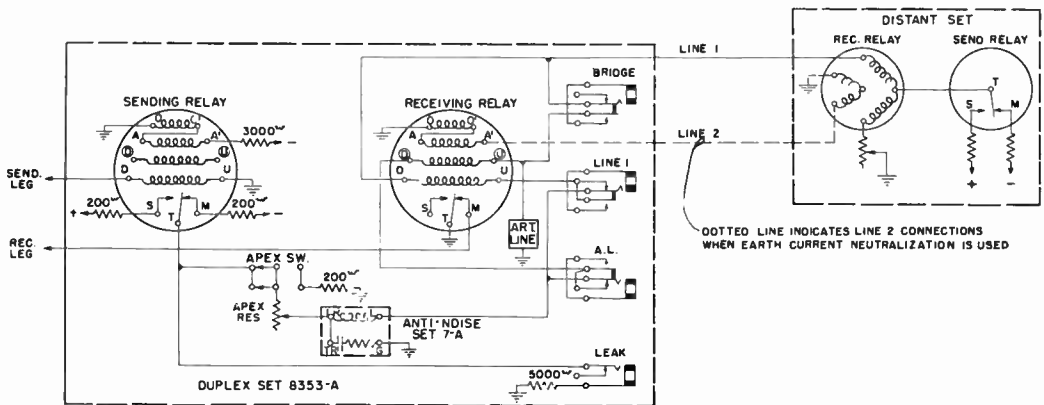

Figure 11. Theory of Duplex Set 8353

restricted to the New York Testing and Regulating Department. Its advantage over Network Repeater 4617 is one of cost, as one unit replaces three of the 4617 repeaters.

### Duplex Set

The next most widely used of the new telegraph repeater sets was designed in 1947. It is Duplex Set 8353, used to bring electrically short physical line sections into reperformer offices, or to extend carrier circuits over physical wires.

The compartment method of arranging the equipment has been followed in the design of these duplex sets, shown in Figure 10. There is a potential cabinet at the bottom of a rack, containing the current-

These duplex sets were designed to meet specific needs with a minimum of cost and floor space. The line circuits are of the conventional polar type. A switch is provided so that they can be operated duplex over one wire, with the aid of an artificial line, or over two conductors, sending polar signals over one and receiving polar signals over the other. It will be noted that most of the repeaters in the figure are operated over two wires and are not therefore equipped with artificial lines. Figure 11 shows the Theory of Duplex Set 8353.

The leg connections are operated make-and-break single current and terminated in a ground connection at the duplex set. Potential must be supplied from the carrier channel terminal or from the reper-

forator section of the office. No bias or leg current adjustments are provided, but the leg circuit jacks allow the leg signals to be observed at the duplex set. Likewise jacks are provided to aid in taking duplex balances and to read the main-line current.

### Duplex Repeater

Duplex Repeater 6370-A (Figure 12) was standardized because of the need for a compact self-contained duplex set which could be installed in small offices and is rapidly becoming one of the "work horses" of the repeater contingent. It is approximately 19 inches long, 9 inches high and 12 inches deep (including the polar relays). It can be mounted on a wall, table, shelf, or a standard repeater rack, and can be provided with a metal handle to make it portable.

When the unit is used as a repeater, the line circuits are again of the conventional polar type and, as with the two repeaters

previously described, the essential elements are two polar relays. However, the screw type terminal blocks (33 terminals) also get considerable use. The operation and maintenance specifications now show 15 different ways the repeater may be strapped to meet circuit requirements and the end is not yet in sight. It might be added that the terminal block is located on the inside of a hinged front panel for easy access.

Power is supplied by two 2-pole variable voltage rectifiers which are part of the repeater. Potentiometers which can be used as resistance artificial lines or bias resistors are also included. Two jacks can be used to take duplex balances or to observe the leg signals depending upon the use to which the repeater is put.

To install the repeater, all that is generally necessary after it is fastened in place is to bring a-c power, line and ground connections to it. However, in those few cases where it is used on a duplex circuit with line facilities of a nature requiring a good balance of the transient portion of the telegraph signals, it is necessary to provide a conventional artificial line which is mounted in close proximity to the repeater.

### Multiple Circuit Control Panel

It will be of interest to discuss one more of the newer telegraph sets because it

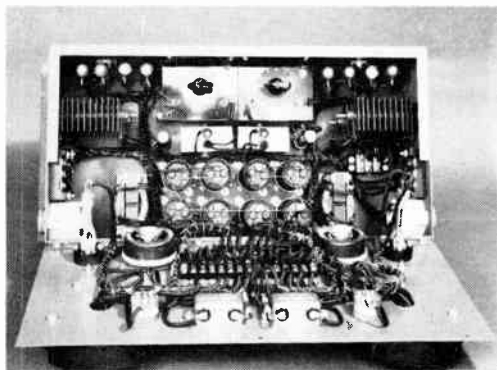
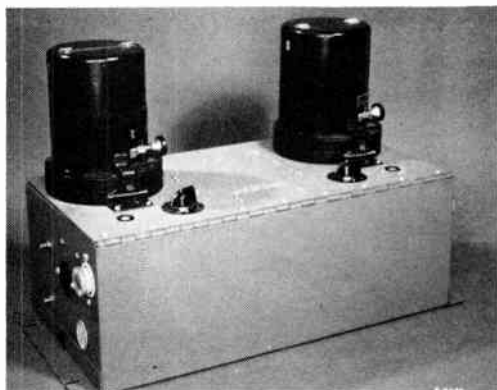

Figure 12. Duplex Repeater 6370-A showing, at bottom, terminal block on inside of hinged panel

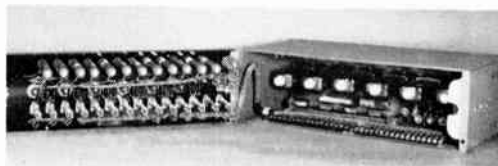
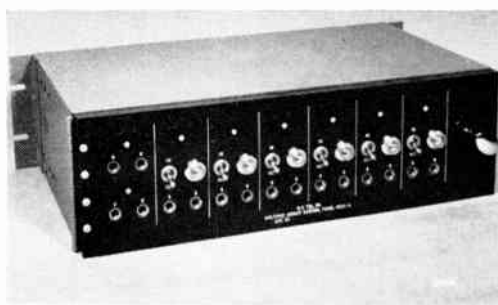

Figure 13. Multiple Control Panel 6504-A showing, at bottom, inside assembly and wiring

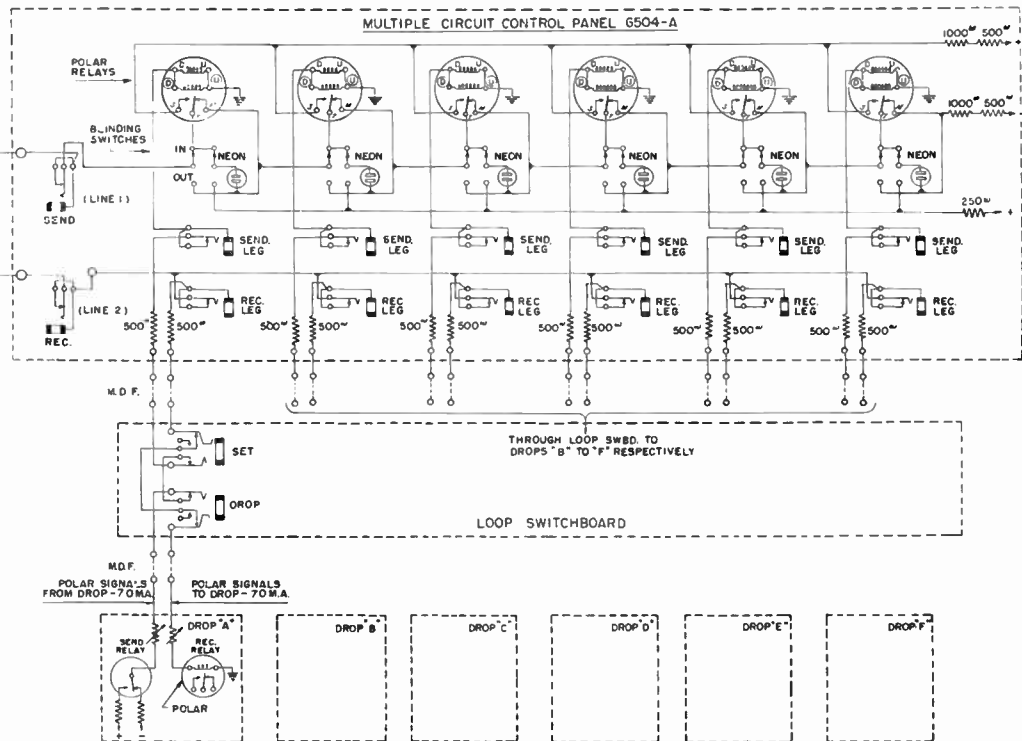

Figure 14. Theory of Multiple Control Panel 6504-A

illustrates how it is occasionally desirable to design repeaters to meet specific conditions which from a technical viewpoint could be handled as well with equipment already standard.

When The Bank Wire leased switching system providing for the interconnection of banks throughout the country was being planned, it was found that there were as many as five customers in one city. Each of these customers could have been brought into the network by means

of Network Repeater 4617. However, since once the arrangement was set up no flexibility was required, it was decided to design a special repeater just for the purpose of interconnecting the drops in a given city in order to save cost and floor space.

This unit was named Multiple Control Panel 6504-A; it is shown in Figure 13. It occupies 5¼ inches of rack space and, in conjunction with one rack mounted duplex set, performs the function of six

**R. V. Morgenstern** graduated from Ohio State University in 1921 with an Electrical Engineering degree. While at Ohio State he was a member of the honor societies of Sigma Xi and Eta Kappa Nu. Coming directly to Western Union upon graduation, he is best known for his work in connection with direct-current telegraph repeaters, teleprinter concentrators and outstation operating tables; he has also had charge of many other projects ranging from experimental light beam transmission to the design of circuits for Partial Reperforation Plan 31. Mr. Morgenstern holds a Professional Engineer's license and is at present Assistant to the Electronics Application Engineer.





Network Repeaters 4617 for this particular application.

Figure 14 shows the theory of Multiple Control Panel 6504-A. There are two conductors from the multiple control panel to each customer, who receives polar signals over one conductor and sends polar signals over the second conductor. The polar signals from the customer operate a polar relay. Provision is made for handling six customers on each multiple control panel. A strapping block is provided so that different numbers of customers can be assigned to the same circuit. As shown on the figure, all six customers operate on the same circuit to The Bank Wire switching center. The contacts of the polar relays which receive signals from the customers are so connected that when any one of the customers sends, signals are transmitted to the switching center,

but if more than one tries to transmit at a time, the signals are broken up.

When a customer transmits, a neon lamp associated with his relay flickers. If any drop becomes disabled a switch associated with the drop is thrown which cuts that drop out of the circuit and the neon lamp glows steadily to indicate that the drop is disabled.

The modern direct-current telegraph repeaters have necessarily been described only briefly in this paper. Full information may be found, however, in more detailed material in which the operation and maintenance of each type of repeater is quite thoroughly covered.

#### References

1. AN FM TELEGRAPH TERMINAL WITHOUT RELAYS, F. H. CUSACK and A. E. MICHON, *Western Union Technical Review*, Vol. 1, No. 2, October 1947.
2. A SWITCHING SYSTEM FOR DISPATCHER TEST WIRES, P. R. EASTERLIN, *Western Union Technical Review*, Vol. 7, No. 1, January 1953.

---

## Telecommunications Literature

There is available for distribution, to those interested in writing for them to the Secretary of the Committee on Technical Publication, a number of mimeographed copies of a paper: FACTORS IN THE TRANSMISSION CHARACTERISTICS OF CABLE CIRCUITS, by LEON T. WILSON. The article contains an excellent treatment of transmission line equations based on:

$$P = \alpha + j\beta = \sqrt{(R + j\omega L)(G + j\omega C)}$$

$$Z = r + jx = \sqrt{\frac{R + j\omega L}{G + j\omega C}}$$

The formulae developed from these fundamental equations bring out the relative importance played by the four parameters, resistance, inductance, conductance and capacitance, in the propagation and impedance characteristics of communication lines.

The author, formerly of the Bell Telephone Laboratories, now of the Wire Communication Branch of the Coles Signal Laboratory, Ft. Monmouth, New Jersey, presented this paper recently at a wire and cable symposium which was attended by several engineers of Western Union upon whom it made such a good impression as an educational vehicle that the Committee on Technical Publication decided to make it available to others.

While basically mathematical in its treatment, the paper takes its illustrative matter from open wire and aerial, underground, and submarine cable lines of the general nature employed by the telegraph and telephone companies in this country.

Serious students of transmission capacity, line loading, skin and proximity effects, properties of dielectrics, and so on, will find this paper of down-to-earth interest. However, no arithmetical examples are included, hence specific applications are left for the student to work out.

# Patents Recently Issued to Western Union

## **Arc Regulator Apparatus**

W. D. BUCKINGHAM

2,622,223—DECEMBER 16, 1952

A regulating mechanism for starting and controlling the spacing of open-air concentrated-arc lamp electrodes. In response to the differential action between the voltage drop across the arc and the arc current flowing, a 2-phase a-c motor, which is the balance detecting unit, advances the electrodes until they touch when the arc is struck by a high voltage starting pulse. When the arc is established the motor draws the electrodes apart to the proper operating distance and then stops. As the electrodes slowly burn away the control motor advances the electrodes to maintain constant their spacing and the relative position of the luminous spots. The two electrode shafts are continuously rotated to maintain the light spots centered in their respective active surface areas.

## **Facsimile Recorder**

R. J. WISE

2,622,957—DECEMBER 23, 1952

A continuous facsimile recorder in which the paper sheet or web moves intermittently past a transfer position where by movement of a printing bail a complete scanning line is impressed on the web from the inked edge of a transfer belt upon which the message signals have been previously recorded. Incoming signals vibrate the armature of a loud speaker type unit to cause contacting

of the belt edge with an ink carrying thread to impress the message upon the transfer belt which at this point moves continuously but is stopped momentarily at the line transfer position. The inking thread operates analogously to a typewriter ribbon.

## **Resiliently Mounted Spool Type Insulator**

W. F. MARKLEY

2,623,094—DECEMBER 23, 1952

In a line insulator of the type having a through opening, a tapered rubber bushing is forced into the tapered through opening to give a tight and snug fit in the opening. An external flange on one outside end of the bushing and an extension of the other end of the bushing beyond the end of the insulator prevents contact between the insulator and the mounting bracket.

## **Inductance Coil**

R. C. TAYLOR

2,628,342—FEBRUARY 10, 1953

A magnetic coil core assembly comprising a pair of cup shaped powdered iron magnetic core elements having a number of features, including engaging edges of spiral shape to permit air gap adjustment, or grooved to hold an adherent thermoplastic spacer, or overlapping to restrict magnetic leakage. The structure may be surrounded by a thick copper shielding tube.

## **I N D E X**

For Index July 1947—October 1949  
see Vol. 3, No. 4, October 1949

For Index January 1950—October 1951  
see Vol. 5, No. 4, October 1951

