

0  
21.38  
1527

**WESTERN  
UNION**

# *Technical Review*

**Suppression of  
Radio Interference**

•

**Location of  
Radio Relay Towers**

•

**Inks for Telegraphy**

•

**Commercial News Center**

•

**Western Union  
Switching Systems**

**R. P. I.  
LIBRARY**

**VOL. 4  
OCTOBER**

**NO. 4  
1950**

# WESTERN UNION

# Technical Review

VOLUME 4  
NUMBER 4

Presenting Developments in Record Com-  
munications and Published Primarily for  
Western Union's Supervisory, Main-  
tenance and Engineering Personnel.

OCTOBER  
1950

## CONTENTS

	PAGE
<b>The Suppression of Radio Interference from Telegraph Equipment . . . . .</b>	<b>137</b>
<i>E. L. Newell, T. F. Cofer and F. H. Cusack</i>	
<b>Factors Affecting Location and Height of Radio Relay Towers . . . . .</b>	<b>143</b>
<i>J. J. Lenehan</i>	
<b>Inks for Record Communications . . . . .</b>	<b>149</b>
<i>B. L. Kline</i>	
<b>The Insidious Decibel . . . . .</b>	<b>158</b>
<i>A. Boggs</i>	
<b>Multi-Send Center for Commercial News Distribution . . . . .</b>	<b>160</b>
<i>F. L. Currie and J. K. Nelson</i>	
<b>The Development of Western Union Switching Systems . . . . .</b>	<b>168</b>
<i>W. B. Blanton and G. G. Light</i>	

*Published Quarterly by*

### THE WESTERN UNION TELEGRAPH COMPANY COMMITTEE ON TECHNICAL PUBLICATION

- F. B. BRAMHALL, Development and Research Dept., *Chairman*
- I. S. COGGESHALL . . . . . Internat'l Communications Dept.
- H. H. HAGLUND . . . . . Plant and Engineering Dept.
- G. HOTCHKISS . . . . . Development and Research Dept.
- G. P. OSLIN . . . . . Public Relations Department
- M. J. REYNOLDS . . . . . Patent Department
- H. M. SAUNDERS . . . . . Operating Department

NELL ORGAN, *Secretary*

Address all communications to THE WESTERN UNION TELEGRAPH Co.,  
COMMITTEE ON TECHNICAL PUBLICATION, 60 HUDSON ST., NEW YORK 13, N. Y.

Subscriptions \$1.50 per year

Printed in U.S.A.

(Copyright 1950 by The Western Union Telegraph Company)

# The Suppression of Radio Interference From Telegraph Equipment

E. L. NEWELL, T. F. COFER and F. H. CUSACK

THE SUPPRESSION of interference from telegraph apparatus to radio receivers has received careful attention in the Western Union system ever since the advent of radio broadcasting in 1921, and even prior to that time in connection with commercial wireless telegraphy. Company policy from the beginning has been to investigate promptly every report of radio interference and to reduce the disturbance to a satisfactory level in any case where telegraph equipment is found to be the cause. In addition, circuit arrangements likely to produce radio noise are avoided.

Initially the elimination of radio interference was necessary as a matter of self-protection in maintaining the secrecy of telegraph traffic. In the early days of wireless telegraphy many Western Union wire line circuits were operated by Morse, which could be copied easily by anyone familiar with the code if signaling circuits were permitted to cause radiation. Today the wide use of automatic telegraph systems with special codes and greatly increased operating speeds has removed the problem of secrecy, but the prevention of radio interference is still accomplished by Western Union as an element of its service in the public interest.

Through the years a considerable amount of engineering time has been devoted to the development of effective methods of suppressing interference when it is encountered in specific telegraph installations. Some 25 different types of radio interference eliminators have been designed and standardized for application to a wide variety of telegraph equipments. These devices have been developed on the basis of extensive tests of typical telegraph circuits, as well as numerous field investigations of telegraph installations in

this country and in foreign cable stations. Figure 1 is a photograph of nine of the units most commonly employed at present. The largest one shown is used to protect motors and generators, while the smallest was designed for mounting on ticker panels. Radio interference eliminators are

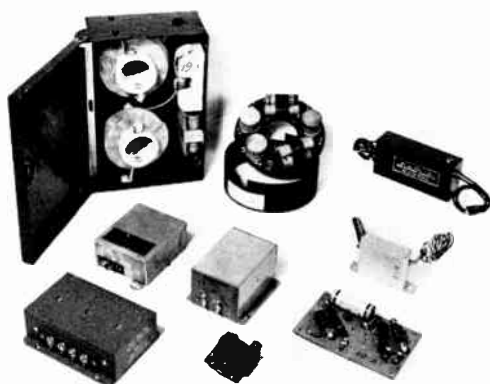

Figure 1. Radio interference eliminators

carried regularly in warehouse stock in sufficient numbers to be obtainable quickly when needed in any part of the system. Our techniques have been made freely available to other users of telegraph circuits, such as the Communication Section of the Association of American Railroads, and as a result all railroads on the North American continent have adopted our methods and designs.

Detailed instructions for the investigation of radio noise are very complete and tell field personnel exactly how to proceed in locating the source of a disturbance and applying the required corrective measures. While it is recognized that the responsibility of the Telegraph Company is discharged whenever such

investigation demonstrates that the interference is not from telegraph apparatus, it is usual policy to cooperate with the complainant in determining the actual cause and possible remedies. As a guide, the specifications list possible sources for sounds variously described as clicking, buzzing, rushing, rattling, whirring, humming, droning, crackling, sputtering, snapping, scraping, and even machine-gunning.

To facilitate the investigation work, field offices have been supplied with radio-frequency noise meters with which field strength can be measured in the range from 150 kilocycles to 18 megacycles. These instruments are equipped with special coupling networks which also permit the measurement of r-f voltages existing from line to line or from line to ground at any point in telegraph or other circuits.

From listening tests which have been made to determine the nuisance value of measured interference superimposed on a measured signal, it appears that a signal-to-noise ratio of at least 30 decibels is required for acceptable reception on an amplitude-modulation broadcast receiver. Since the signal field strength in some localities may be as low as 500 microvolts per meter, it follows that radio interference must be reduced to 15 microvolts per meter or less. In any case it is necessary to reduce the telegraph disturbance below the prevailing noise level. The requirement for satisfactory television reception is probably of the same order as for standard radio broadcast, but frequency-modulation program radio can tolerate somewhat greater noise levels. Disturbances from telegraph circuits into either television or FM radio receivers has not been a problem because the frequencies employed are considerably above those which are readily transmitted by circuit wiring to locations outside of a telegraph office.

Interference from electrical apparatus to radio receivers does not ordinarily result from direct radiation by the primary source, although this method of transference may prevail at very close separations. Usually voltages within the broadcast frequency range are propagated along the associated telegraph or power wires which then act as antennas to radi-

ate the disturbance. In some cases the interference is conducted through the power supply directly to the receiver. Often the telegraph or power circuits radiate radio-frequency energy to other conductors to which they are closely coupled in the interoffice wiring or on the same pole structure. When the interference reaches an open wire line it may carry a considerable distance without much attenuation and thus affect radio reception quite far away from the source.

Fortunately the conditions existing at the Company's larger telegraph offices are not favorable to the broadcasting of radio interference. Adjacent to these installations the telegraph line wires are commonly carried in lead-covered cables for hundreds of feet or even for miles, while power supply feeders are enclosed in grounded conduit. Radio frequencies are usually completely suppressed by the high attenuation and shielding afforded by the entrance cables, and by the shielding of the buildings themselves. This happy circumstance does not always exist at the smaller telegraph offices or at points where telegraph equipment is installed on the customer's premises. In fact, there is substantial justification for a generalized empirical rule to the effect that radiation from telegraph operation is inversely proportional to the size of the telegraph office. Investigation and mitigation of radio interference from the smallest telegraph installations, involving only one or two circuits, has always been the important problem. On the other hand, our large traffic centers, with thousands of potential sources of incidental radiation, have rarely interfered with radio reception outside of the telegraph offices.

Practically all telegraph apparatus is normally equipped with spark-reducing devices for protection of the transmitting contacts, and these networks are so designed as to provide considerable reduction of radio-frequency generation. In addition, telegraph equipment intended for use in a customer's premises is regularly supplied with filter-type radio noise suppressors. Figure 2 is a photograph of the type of teleprinter installed in patrons' offices, with the cover removed to show, at the rear corner of the base, the small

radio interference eliminator which is always furnished. Most central office apparatus is sent to the field without interference suppressors other than conventional spark killers, because only a small percentage of the total amount in service is capable of disturbing radio

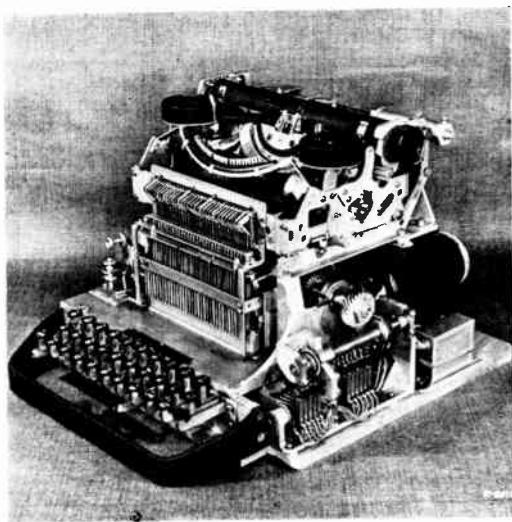

Figure 2. Teleprinter equipped with radio interference eliminator

reception, and even then the resulting instances of actual interference are restricted to special conditions of receiver location and susceptibility.

Whenever the flow of current in an electrical circuit is controlled by the opening and closing of switching contacts, two important effects take place at the gap. One is contact erosion, which is the loss or transference of contact material, resulting in a wearing away of the contacts or the formation of projections and pits on their surfaces. Since the operation of a telegraph system requires that dependability and long life be obtained from millions of such contacts, a great deal of research work has been done to develop better contact materials and also to design effective contact protection. The second effect occurring at the switching contacts, and the one pertaining to the present discussion, is the generation of sporadic high-frequency oscillations spread over a wide band of the spectrum.

While it has long been realized that contact erosion is closely related to the transients generated, it has been only recently that the effects could be studied closely. Even today some of the phenomena involved are only partially understood. As an example of the kind of things that can happen, it will be of interest to examine what might appear to be a very simple circuit, as shown in Figure 3. Here direct current from a grounded battery is flowing to an inductive load, such

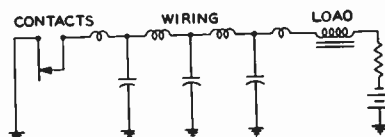

Figure 3. Typical contact circuit

as a relay or printer magnet, through a current-limiting resistance and a pair of switching contacts. Also present is a small amount of wiring inductance and capacitance, which might not be sufficient to affect telegraph signaling but does have a very important effect on the contact phenomena. When the contacts begin to separate to break the circuit, the first thing that happens is that the size of the contacting area decreases rapidly resulting in a corresponding increase in the current density. Just before the circuit is broken, the current density at the last point of contact becomes extremely high and the local heating is so intense that a minute bridge of molten metal is formed. This is drawn out by further separation of the contacts until finally it is exploded. As soon as the contact is opened and the current is suddenly interrupted, the collapsing magnetic field of the inductive load generates a rapid rise in voltage which charges the wiring capacitance. When the voltage becomes high enough, it breaks down the small gap at the contacts and the wiring is then discharged. This quickly drops the voltage so that the gap ceases to conduct, whereupon there is another voltage rise and another spark. A number of these disruptive sparkovers will usually occur during the switching transient. Successive sparkovers are at gradually increasing voltages, as the contact separa-

tion increases, until finally there is no longer sufficient energy left in the magnetic field to break down the widened gap. The voltage and current surges at the contacts are oscillatory at radio frequencies determined by the characteristics of the line wire. Individually the sparkovers are very complicated. The effects at break are different from those on make, and both are influenced by the electrical characteristics of the load and connecting wiring, the physical properties of the contact material, the condition of the surfaces, and many other factors. Peak currents of several amperes are common, and the gap potential usually reaches a peak value in the hundreds of volts.

The most effective means of reducing contact deterioration, and incidentally the generation of r-f oscillation at the contacts, is the familiar spark killer. Consisting of a capacitor in series with a resistor connected to shunt the contacts or the load, this type of spark-reducing network has been used on telegraph equipment for many years. The condenser is intended to absorb a charge wherever a high voltage tends to build up across the opening contacts, and thus prevent sparkover. The resistance is needed to limit the peak current and prevent sparking when the contacts close and the capacitance is discharged. Of course it is essential that the spark killer be properly designed and correctly applied. Otherwise its presence can degrade the telegraph signal impulses and even increase the contact erosion.

Figure 4A shows a contact-shunting spark killer of the type used where the telegraph circuit will tolerate the addition of series resistance. This arrangement has been found very effective in reducing both sparking and r-f oscillations for any kind of load circuit. Figure 4B is a contact-shunting network for use where added resistance is not permissible. This is usually applied when the load is capacitive, while for an inductive circuit the preferred arrangement is the load-shunting spark killer shown in Figure 4C. For the latter two types, the optimum values of resistance and capacitance will depend upon conditions in the particular circuit.

The application of an effective spark-reducing network to the switching con-

tacts often accomplishes the first objective toward radio interference elimination, namely, the prevention or reduction of radio-frequency transients. The next step is to restrain any remaining radio-frequency energy from flowing along the associated signal wiring or power supply leads. This is accomplished by adding

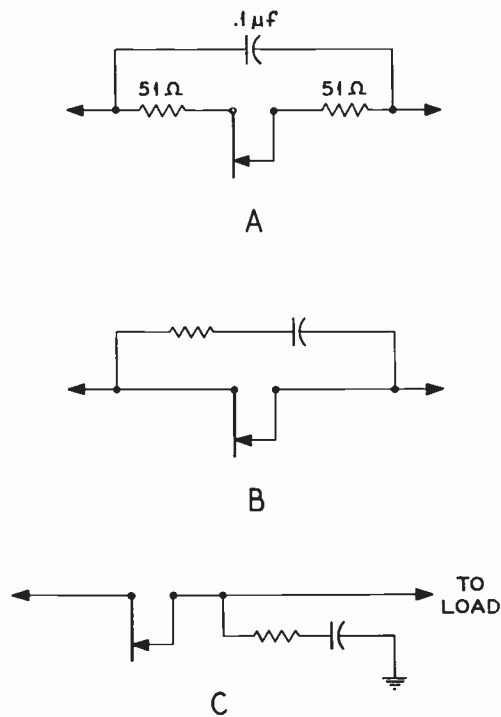

Figure 4. Spark killers

- A. Contact-shunting, with series resistance
- B. Contact-shunting, without series resistance
- C. Load-shunting

condensers or radio-frequency chokes, or both, in a position to suppress any r-f voltage existing from line to line or from line to ground. The complete radio interference suppression network then serves both as spark killer and line filter, the two features being mutually related.

Figure 5A is a schematic diagram of the radio interference eliminator shown in the teleprinter photograph, Figure 2. This type is used to correct radio noise caused by transmitting keys and relays, teleprinter keyboards, and the like. It is

applicable to either polar or single current circuits, but since it adds 100 ohms of series resistance, its scope is limited to situations where this amount is tolerable. Whenever the additional resistance cannot be permitted, or more complete noise

cal dimensions such that they can be fitted into existing equipment without the length of the connecting leads exceeding 10 or 12 inches.

In all cases of radio interference, the object is to use the minimum additional

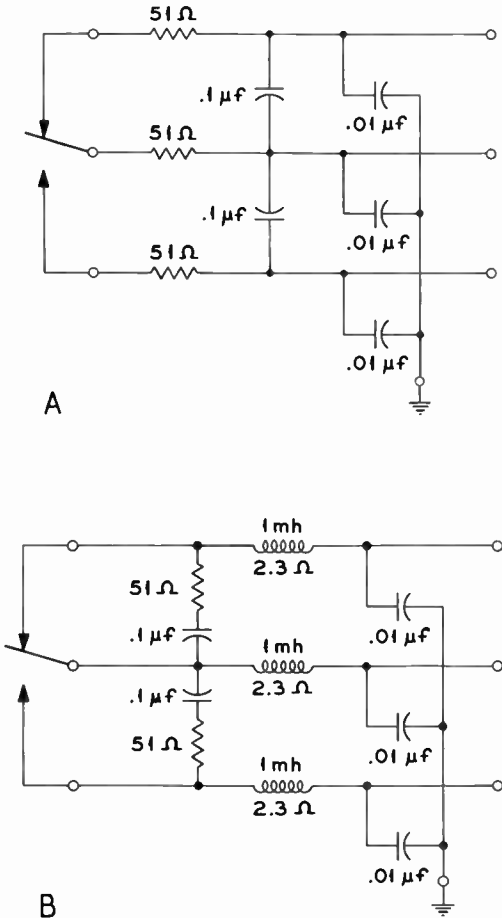

Figure 5. Contact-protecting interference eliminators

- A. Filter with series resistance
- B. Filter without series resistance

suppression is necessary, the alternative shown in Figure 5B is usually employed. A cardinal principle of radio interference elimination is that the suppression network must be located as close to the source as possible. One form of the unit in Figure 5B is made to be mounted directly beneath a relay subbase. Other eliminators are manufactured with physi-

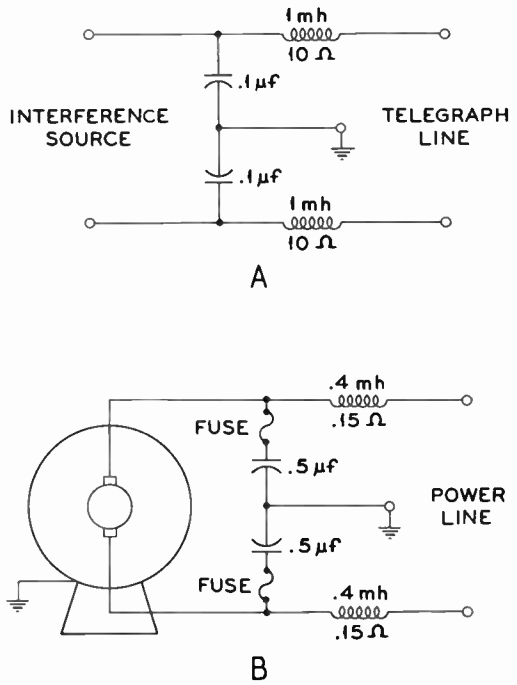

Figure 6. Line interference eliminators

- A. Telegraph line filter
- B. Power line filter

equipment that will reduce the disturbance to a satisfactorily low level. Sometimes where there are many noise sources within one piece of equipment, it is more convenient to prevent the oscillations from traveling along the signal and power leads by inserting filters in these leads, rather than by supplying a separate eliminator for each pair of contacts. Line interference eliminators, like those shown in Figure 6, are available for the purpose. They are often used in conjunction with one or more spark killers or eliminators on the particular contacts which are the most serious offenders. Motors and generators, while not peculiar to telegraph operations, are used in large numbers and must be protected. Figure 6B is a diagram of the

interference eliminator for this purpose which was previously referred to as appearing in the photograph, Figure 1.

It is rather difficult to predict the efficiency of a radio interference eliminator with certainty by using conventional methods of filter design. A realistic evaluation of performance can be obtained only by measuring the noise influence voltage of an offending source, with and without the suppression network. The results of typical measurements of eliminator performance are given in Figure 7. It is seen that the generation of radio frequencies is considerably reduced by a simple spark killer alone, and that very effective suppression of the radio noise is provided by the interference eliminator.

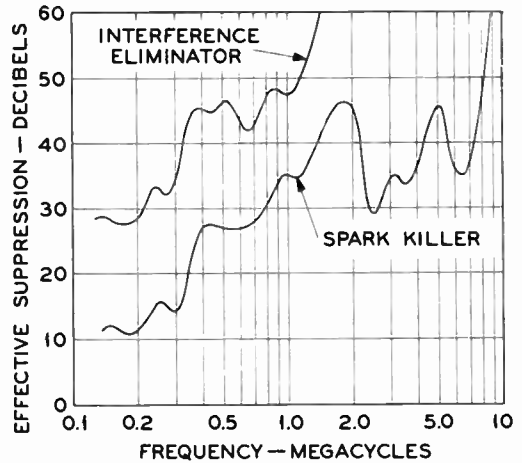

Figure 7. Interference eliminator performance

**THE AUTHORS:** Photograph and biography of E. L. Newell appeared in the April 1950 issue of *TECHNICAL REVIEW*. Mr. Newell is the Telegraph Company representative on the American Standards Association's Committee C-63, an industry body which is taking an active part in cooperation with the Federal Communications Commission in the study of radio interference problems.

F. H. Cusack's photograph and biography appeared in the January 1948 issue of the *REVIEW*.

T. F. Cofer graduated from Virginia Polytechnic Institute in 1923 and shortly thereafter joined the Transmission Research Division of the Telegraph Company. He has been with this division since that time, except for 11 months during which he was Assistant Consulting Engineer. His work has been concerned with inductive coordination, carrier transmission studies, coaxial cables and facsimile, and he designed the open-wire transposition scheme used for 30-kc transmission by Western Union and many railroads. Mr. Cofer has had various assignments on committees of the Communications Section of the AAR. His broad knowledge of telegraph transmission practices led to his choice as alternate representative for Western Union on the ASA committee which deals with the suppression of radio interference. He is a Member of AIEE.





# Factors Affecting Location and Height of Radio Relay Towers

J. J. LENEHAN

THE FLEXIBILITY and wide bandwidth of a microwave radio relay system make it an ideal transmission medium for a modern communication system. However, in order to prove itself, it must meet the exacting standards of performance and reliability of present-day demands and be economically superior to wire and cable facilities.

Throughout the planning of a radio system the combined talents and experience of many engineers are employed to achieve the best possible design commensurate with cost limitations. As in almost any engineering task of comparable size, the individual projects are so closely related that it is difficult to separate the program into independent phases. In radio relay design this is especially true since the radio equipment specifications of transmitter power, receiver design, antenna gain and signal-to-noise ratio must all be known before it becomes possible to establish tower sites and heights.

One of the primary considerations involved is the determination of the maximum possible relay spacing in the system. With wire or cable circuits, it is obvious that the attenuation increases with distance and hence it becomes necessary to insert amplifiers at frequent intervals to overcome these losses. With radio, repeaters are employed to overcome losses of a somewhat different nature. Although the absorption of radio energy is normally negligible, there is a considerable decrease in received signal due to spreading of the wave front with an increase in distance from the transmitter. This is comparable to the decrease in the amount of illumination received from a light when the distance from the source is increased. The geometric distribution of the energy in space which varies with distance determines the normal or undisturbed magnitude of the received signal, and can be found from the following formula:

$$\frac{P_r}{P_t} = \left( \frac{3 \lambda}{8 \pi D} \right)^2 \quad (1)$$

The ratio of received power  $P_r$  to transmitted power  $P_t$ , assumes parallel receiving and transmitting "doublet" antennas of small size compared to  $\frac{1}{2}$  wavelength and located perpendicular to a line connecting their centers. The term  $\lambda$ , which is the wavelength of the propagated radio energy, must be in the same units as the distance  $D$ .

## Antenna Gain

It is possible to reduce the geometric path attenuation described above by the use of directional antennas which concentrate the radio energy into a narrow beam. This is of particular advantage in radio relay systems where the circuits are always fixed point-to-point in nature. The improvement which is designated as antenna gain has been accomplished by various types of horns, parabolas and lenses. Their gain as compared to the theoretical "doublet" is accomplished by their increased effective area when compared to this standard.

The effective area of a parabola is usually considered to be approximately 65 percent of the aperture area. This reduction in efficiency partially results from an attempt to reduce antenna side lobe patterns by non-linear illumination of the parabolic surface. The gain of any antenna is the ratio of its effective antenna area to the effective area of the antenna under comparison. The effective area of a doublet antenna is found from electromagnetic theory to be

$$A = \frac{3 \lambda^2}{8 \pi} \quad (2)$$

where  $\lambda$  is the wavelength of the transmitted energy.

The power gain of a parabola referred to a doublet would then be

$$G = \frac{(A_p) (.65)}{3 \lambda^2} \quad (3)$$

$$\frac{8\pi}{}$$

where  $A_p$  is the parabola aperture area, and  $\lambda$  is wavelength in the same units as  $A_p$ .

In theory there is no limit to the gain obtainable by these methods, but practical considerations of mounting limit the physical size and hence the gain to about 30 to 40 db. With directional receiving and transmitting antennas, the path attenuation is reduced by the sum of the two antenna gains. Figure 1 is a plot of path attenuation versus distance at 4000 megacycles under conditions of normal propagation. The total transmitter and receiver antenna gains were assumed to be 74 db.

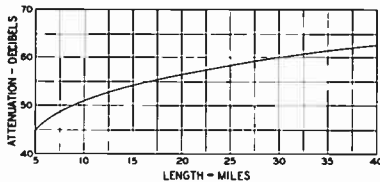

Figure 1. Path attenuation at 4000 megacycles

### Repeater Amplifier Noise

Although the repeater amplifiers increase the received signal to the desired level before retransmission, they also add a quantity of unwanted noise. The amplitude of this noise is of importance in tower planning since the over-all system signal-to-noise is one of the criteria of performance.

The absolute minimum of noise introduced by each repeater is thermal noise. This is the noise generated in the input resistance of the relay receiver by the thermal agitation of electrons. Experiments conducted many years ago indicated that the extent of this noise can be calculated if the receiver bandwidth and operating temperature are known. In the following formula the thermal noise power

$P_n$  is the product of a constant  $K$ , the operating temperature  $T$  in degrees kelvin, and receiver bandwidth  $\Delta f$  in cycles per second.

$$P_n = K T \Delta f \text{ watt} \quad (4)$$

The constant  $K$ , which is known as Boltzmann's constant, is equal to  $1.38 \times 10^{-23}$ .

By careful circuit design, every effort is made to reduce the receiver noise to this absolute minimum. However, the crystal converter, local oscillator and first amplifier increase the aggregate receiver noise power from 10 to 100 times above thermal, and the term "noise figure" is employed to define the ratio of the total noise output power of a receiver to the noise output power attributable to the thermal noise alone. With present-day methods, the noise figure of a wide-band microwave receiver is about 20 times above thermal. This would constitute a "noise figure" of 13 db and would be equivalent to a total noise input of  $16 \times 10^{-13}$  watt for a typical 20-megacycle bandwidth receiver operating at 290 degrees kelvin.

### Transmitter Power

The minimum amount of signal carrier power needed at any receiver for useful reception must be measured in excess of this total receiver noise. The standards of signal-to-noise for a relay system, and the FM noise improvement factor if this type of modulation is being used, determine how far the received signal must be above the total noise.

Since the received power is directly proportional to the transmitted power for any path length and antenna gain under normal propagation conditions, it becomes a major factor in the system layout. There are available several sources of extremely high power at microwave frequencies, but magnetron type oscillators were designed for pulse modulation and do not lend themselves readily to the more desirable frequency modulation. By the use of the Sperry SAC-41 Klystron tube, the transmitted power employed in Western Union's frequency-modulated radio beam

has been increased from one-tenth of a watt to 10 watts since the first installation. Through normal development this figure may be increased if required, but 10 watts is considered typical today.

When the transmitted power is known and the antenna gains have been calculated from formulas (2) and (3), it becomes quite simple to establish the normal received power for any distance. The following formula is simply an expression of the received power in terms of transmitted power  $P_t$ , receiving and transmitting antenna gains  $G_r$  and  $G_t$ , respectively, and the wavelength and path distance in the same units.

$$P_r = \left( \frac{3\lambda}{8\pi D} \right)^2 \cdot G_r \cdot G_t \cdot P_t \quad (5)$$

When the received power has been calculated, the carrier-power to noise-power ratio can then be expressed as a ratio of received power to the product of thermal noise and the numerical "noise figure"  $N$ .

$$\frac{P_r}{(KT\Delta f)(N)} \quad (6)$$

In the construction of Figure 2, which is a plot of formula (6), it was assumed that the transmitter power was 10 watts, the receiving and transmitting antenna gains were 37 db, and the aggregate receiver noise was  $16 \times 10^{-13}$  watt.

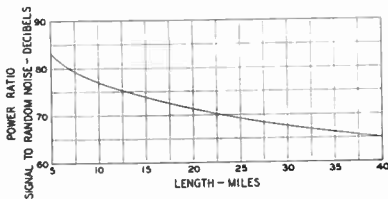

Figure 2. Radio path signal-to-noise ratio

### System Carrier-to-Noise

The receiver at each relay introduces its own portion of the total system noise. Since all receivers in the circuit are usually considered to be identical, the aggregate system noise power is the product of the number of repeaters and the noise power in a single receiver. If it is assumed

that a 60-db carrier-to-noise is required for a 250-mile circuit with equally spaced repeaters, then the radio signal received at each relay would have to be at least 60 db above the aggregate system noise at that point. The following chart indicates the carrier-to-noise to be expected in a 250-mile circuit with various tower spacings. The antenna gain, receiver noise, and transmitter power are the same as employed in Figure 2.

Number of Towers	Tower Spacing	Carrier-to-Noise Power
20	12.5 mi.	63 db
10	25 "	60 "
5	50 "	57 "

The chart indicates that a 60-db ratio would be achieved by employing 10 repeaters spaced 25 miles apart. Reducing the tower spacing improves circuit performance, but at the expense of additional towers and equipment. If the tower spacing is increased sufficiently to reduce the number of repeaters and the total cost, system performance must be sacrificed.

### Fading

The factors already presented in the determination of tower spacing are analogous although not identical to those encountered in wire lines and cables. There is, however, one consideration peculiar to radio transmission. This factor is designated as fading<sup>1</sup> and is the phenomenon of variation in received radio signal due to atmospheric conditions. In microwaves it must not be confused with the better known reflections and bending by the ionosphere usually encountered at lower frequencies. With microwave radio and its optical line-of-sight range, a more likely analogy can be made to the behavior of light as it passes through media of varying density.

The earth's atmosphere has a normal decrease in temperature and water content with elevation. This results in the radio media decreasing in density with elevation, and hence a downward refraction of the radio signal. This is shown

graphically in Figure 3. The radio energy leaving the tower is focused in a narrow beam, with the axis of this cone of energy leaving at right angles to the tower and parallel to the tangent to earth's surface at the tower base. This energy, as a result of the earth's curvature, is always passing through media of decreasing density as it travels away from the tower. This is an increase in velocity with distance, with the result that the ray is curved downward and does not leave the earth's surface as rapidly as it would if the atmosphere were homogeneous. The energy leaving the transmitting tower at angles greater than and less than the horizontal is acted upon in the same way, although it is only the energy in the upper portion of the beam that can arrive at the receiver.

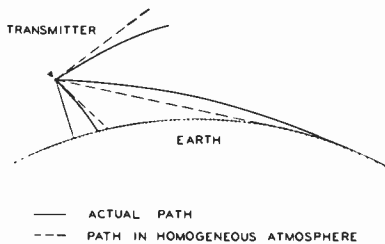

Figure 3. Geometric ray curvature

This bending of the radio beam by the normal atmosphere is unimportant in itself, but the fact that the atmospheric structure frequently changes results in significant signal variations. These variations can, in a general way, be divided into three major groups. The first of these, which occurs when the air is calm or motionless, results in the formation of two or more radio paths through the atmosphere. Since this energy may arrive at the receiver in such a variety of relationships with the direct wave, a wide variation in the carrier amplitude may develop. This type of fading, which is often referred to as multipath, can be partially overcome by the use of diversity receivers. The second condition occurs when the path length difference between the main ray and the reflected or refracted ray traveling near the earth's surface changes sufficiently to produce a field cancellation at the receiving antenna. The extent of the

path length variation depends upon the phase angle and the reflection coefficient of the surface involved. Diversity receivers are helpful during these fades also. The third condition is a rather slow, but severe, fade that covers an extended time interval and is generally attributed to a wide and homogeneous variation in the refractive index from the normal atmosphere over a substantial portion of the radio path. This condition is usually produced by an inversion, i.e., an atmospheric condition in which the density of the medium becomes greater at a distance above the surface of the earth. Thus, reverse bending takes place and the radio energy may fail to reach the receiver because of insufficient clearance at the earth's surface. The diversity receiver and sometimes the main receiver will be subjected to weakened fields simultaneously during this condition of propagation. Obviously, in a properly engineered circuit these changes in the normal refractive index will result in a minimum of outage time, but it can be seen that it is extremely important to establish a relationship between tower spacing and fading ratio. It is known that the numerical fading ratio increases at a more rapid rate than distance, and it is believed that the fading ratio, expressed in db, will increase approximately as the distance ratio.

Although fading is related directly to seasonal variation and other factors, it is random in nature for any small time interval and cross-sectional area. It becomes obvious, therefore, that probability alone would indicate that greater path lengths would result in an increase in the magnitude and frequency of fading. The form of the curve of fading versus distance has not been derived mathematically, nor has one been developed empirically, but as time progresses increased information will be available on this subject.

Also, it would be necessary to establish exactly what is meant by circuit failure. The minimum signal level is set by standards of normal operating performance. The magnitude of fading that can be tolerated before system failure occurs is measured in decibels and is called the system fading factor. This factor is the

difference between the normal carrier-to-noise ratio and the minimum carrier-to-noise ratio required. It is apparent that the larger this initial figure is, the more margin there is against fading. Our experience indicates that with path lengths up to about 25 miles, fades as great as 20 db will occur and a minimum fading factor of this value must be allowed.

An important consideration involved in tower spacing as a function of fading to be expected would depend primarily upon the geographical location of the system involved. It should be quite obvious that the degree of climatic variations would be substantially different in the Rocky Mountain area as compared to the Gulf Coast area. During the last five years of operation of the Western Union microwave system in the Mid-Atlantic states, it has been developed that path lengths should not normally exceed 25 miles to provide the desired degree of service continuity. The use of diversity receivers and additional transmitter power would increase this distance somewhat. There have been in operation path lengths up to 55 miles which have proven satisfactory, but they are located in the mountainous region of central Pennsylvania where a constant state of turbulence provides atmospheric mixing and reduces the possibility of fading. The radio path clearances on these circuits also have been greater than normally encountered and add still greater reliability.

This information indicates that the influence of fading on the location of tower sites is not as simple and general a relationship as is the case in the equipment characteristics discussed previously. The path length of each individual section can be established only after a close analysis of the terrain and possible weather variations.

### Tower Heights

Since the transmission of microwaves requires a line-of-sight path, the construction of towers is necessary to overcome obstructions and the normal curvature of the earth. The height of transmitting and receiving antennas to overcome the earth's

radius can be found from the following formula:

$$D = 1.23 (\sqrt{H_t} + \sqrt{H_r}) \quad (7)$$

where  $D$  is distance in miles,  $H_t$  transmitter height in feet and  $H_r$  receiver height in feet.

With 25-mile spacing a transmitting and receiving height of 104 feet would be required to provide a grazing path over smooth earth.

### Fresnel-Zone Clearance

If the tower elevation was limited to that calculated from formula (7), the received signal would be considerably below the free space value. If the received signal is to be approximately equal to or greater than the free space signal, it is necessary to provide additional tower elevation over and above that required for line-of-sight transmission. When the additional elevation is sufficient to provide first Fresnel-zone clearance, the received signal may assume any value between calculated free space and twice free space. The magnitude and phase of the refracted or reflected wave determine the variation from the calculated free space signal.

The boundary of the first Fresnel-zone is an ellipsoid whose surface is the locus of all points for which the transmitter and receiver path are one-half wave longer than the direct path. In Figure 4, the tower heights are sufficient to provide first Fresnel-zone clearance over all obstructions of this typical profile.

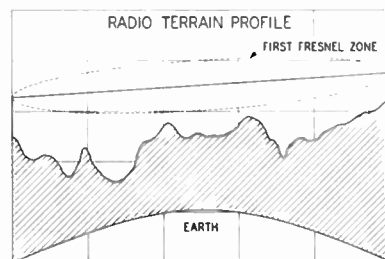

Figure 4. Radio terrain profile

### General Requirements

There are in addition to the factors already mentioned several other considerations in the choice of tower locations.

Every attempt is made to reduce the over-water distances to a minimum. There are two very good reasons for this precaution. The first is the exceptionally good reflection coefficient of a smooth body of water which increases the possibility of signal cancellation due to wave interference. The second is that the sharply defined atmospheric boundaries that often exist above and at the perimeter of large bodies of water are conducive to serious fading. The profiles must also be checked to assure that the path does not traverse marshes or other extended flat areas with relatively high reflection coefficients. The most suitable terrain is one that is rough and contains considerable vegetation since the coefficient of reflection is less when these characteristics are present. These trees and foliage, however, must be outside the first Fresnel-zone to satisfy the clearance requirements.

When the system parameters have been developed and the maximum tower spacing determined, an intensive search of possible repeater locations is made on topographical maps. Although these maps in many areas are accurate, they seldom if ever indicate the heights of trees or other obstructions. These conditions must

then be investigated by field crews and the adjusted path profiles again analyzed for possible obstructions.

The field groups must also decide on practicability of providing commercial power at reasonable cost for the operation of the radio equipment. In addition to this, the repeaters must be readily accessible for routine and emergency maintenance even under adverse weather conditions.

Since there are so many conditions necessary to provide optimum performance, it is not unusual to find that when field surveys uncover one objection to a single path the entire tentative tower arrangement must be discarded. Through perseverance, however, a final route is established and it is possible to conclude the first step in the establishment of a radio relay system.

#### References

1. A MICROWAVE PROPAGATION TEST, J. Z. MILLAR and L. A. BYAM, JR., *Proceedings of IRE*, June 1950

#### Other References

- RADIO RELAY SYSTEMS, C. W. HANSELL, *Proceedings of IRE*, March 1945.  
RADIO WAVE PROPAGATION, National Defense Research Committee.  
REFERENCE DATA FOR RADIO ENGINEERS, Third Edition.

---

**THE AUTHOR:** J. J. Lenahan entered the Engineering Department of the Telegraph Company in February 1942, serving first as office boy and then as draftsman, while he continued his engineering education in the evenings. He served in the U. S. Navy from March 1943 to December 1945, then returned to Western Union and his studies, receiving a Bachelor's Degree in Electrical Engineering from New York University in 1947. Since 1946, Mr. Lenahan has been assigned to the Radio Research Division where he assisted in the preparation of a training program for the engineers and maintenance personnel required by the radio relay system. The author also participated in the early microwave propagation measurements and studies, as well as in the development, installation and testing of the telegraph and television relay circuits now in operation. He is presently engaged in the development of equipment for radio relay systems.



# Inks for Record Communications

B. L. KLINE

THE DESIRE to make fairly permanent records of ideas and events can be traced away back in the history of the human race, and when the early Egyptians developed their papyrus, no doubt a lot of expert stone chisellers encountered unemployment due to "technological displacement". However, as is usually the case, this unemployment was of comparatively short duration due to the establishment of ink and paper factories with shorter hours and more healthful working conditions, free from the silicosis hazard of stone dust. With the advent of paper, great stimulus was given to the development of marking methods, and known coloring agents were adapted for use in making records in addition to use for decorative purposes.

It may be surprising to note that at this early stage both pigments and dyes were known and used, and although their variety was small, they covered a wide range of colors with the natural earth colors and carbon, and the water soluble colors extracted from berries, bark, and similar materials. Indigo, cochineal, and ultramarine also were known and used.

The Chinese and Egyptians laid the original groundwork in the use of inks perhaps as early as 1000 B.C. The earliest inks were suspensions of carbon, in the form of soot, in some sort of vegetable drying oil or an aqueous solution of vegetable gum. In spite of this crude status, the results were comparatively good, for many legible documents still exist that were printed or written with these inks. Clearly the ink business rapidly acquired a permanent status, and its growth pattern to date is obvious. What may not be so obvious, though, is the degree of specialization that has crept into all phases of this industry. This article deals with just the main types to give a general picture into which the inks most used by Western Union may be fitted.

## Three Types Widely Used

The broadest or most general classification would list three ink varieties: (1) viscous paste inks, used in the printing trades; (2) fluid inks, and (3) solid inks, each employing not only different vehicles or solvents for the colors, but in general different classes of colors. All three varieties are employed in the record communications business of the Telegraph Company.

Paste printing inks are used for hundreds of millions of printed telegraph blanks annually as well as for numerous forms and records.

Widely used fluid inks include not only the ordinary writing and drawing materials but also a group of specialty inks of vital importance to record communications which have been developed by continuous chemical research in Western Union laboratories. Some of these special



*Typing mechanism with ink ribbon on Western Union tape teleprinter*

inks are for suitably inking teleprinter and typewriter ribbons, numbering machine and other ink pads, ticker ink rollers, and call circuit register ink rollers, for example.

Solid inks are most familiar as carbon paper coatings but a recent development in this category is the coating for Western Union Desk-Fax sending blanks employed

with conductive scanning. These blanks now are manufactured by the million.

## I. VISCOUS PRINTING INKS

Printing inks are fundamentally a dispersion of finely divided pigment in an oil, but the kind of paper stock on which the printing is to be done, the types of press and printing plates, the number of individual colors required, the degree of light-fastness desired, cost limitations, and a number of other considerations affect the requirements for the ink, and the formulation is adjusted to meet these requirements. This means that a number of different oils are employed, and their characteristics are modified by additions of resins and other materials to get the proper degree of viscosity, tackiness, and flow or spread qualities.

The coloring agents generally used are pigments and carbon dispersed in the varnish vehicle by grinding in such equipment as a three-roll mill which consists of three parallel steel rollers pressing against each other, rotating at different speeds and in opposite direction, so that particles of pigment passing between them are subjected to enormous shearing stresses. After an hour or so of this, the particles have attained such a state of fineness as to be practically indistinguishable, and are mixed uniformly in the ink.

At this stage a chemical "drier" may be added, in a brief mixing operation. Very small percentages of these, which are usually compounds of a metal and an organic material such as lead resinate and cobalt linoleate are used to adjust the drying time of the ink after it has been printed and exposed to the oxygen in the air, just as occurs in the case of paint. The printed headings on message blanks are the most common example of this type of ink in Western Union use.

There have been some interesting variations in printing inks other than the standard letterpress, lithographic, multi-color process, and rotogravure compounds. The idea of making an ink which contains, as part of the vehicle, volatile liquid which can be driven off by application of heat to the moving paper immediately after printing, has resulted in rapid setting or

drying and increased speeds in certain types of printing. Another scheme employed used an ink that is solid at room temperature, but meltable at a moderate point to which the press could be readily heated. Obviously, as soon as the paper cooled off the ink set and was relatively smudge-proof.

It requires little imagination to visualize the many formula changes that such methods necessitate, and how many new materials have found usefulness, if not indispensability, even though method variations of this type account for only a small percentage of the total amount of printing ink made.

## II. FLUID INKS

Fluid inks cover so vast a field that some subdivision must be made, and a good basis for this lies in the fact that some inks like writing fluids used in conventional pens dry rapidly by evaporation whereas others evaporate very slowly, if at all, and "dry" by absorption into the paper or other medium to which they are applied. Writing fluids are, of course, the most common and widely used of the fluid inks and are, as most folks believe, essentially water with a small percentage of coloring matter. but it is not quite as simple as that sounds.

For hundreds of years ink for use with pens was made of an aqueous solution of the old stand-by, iron sulphate and nutgalls (a convenient source of gallo-tannic acid), which in spite of its inconsistencies gave good service at low cost. Its tendency to change color from an original light shade to a deeper shade after a few days and then to a rusty brown after some years stimulated the addition of light-fast dyes, and in recent years improvements in dyes have resulted in their replacing most of the iron tannates. However, although the use of dyes brought many advantages and improved results, a new set of problems was introduced.

For example, depending on the particular dye used, the acidity or alkalinity of the solution is required to be adjusted and fixed. The dye itself must be carefully selected to make either a permanent or washable ink, the affinity of the dye for



cellulose fibers must be reckoned with to get even distribution of color without objectionable spreading, and the surface tension must be rigidly controlled to give proper flow and penetration characteristics. Also, sometimes solvents other than water are used in small amounts to influence evaporation rates, and occasionally such things as gum arabic or a shellac-borax mixture are added which remain as a part of the colored mark after the solvents have evaporated. This latter is especially true of drawing inks which are either water solutions or suspensions and similarly complicated in composition and precisely formulated.

Now the fluid inks which evaporate either very slowly or not at all are used in many more ways than the writing fluids. Stamp pads, numbering machines, and stock market tickers, for example, carry a supply of ink in a pad or roller exposed to the air for long periods and

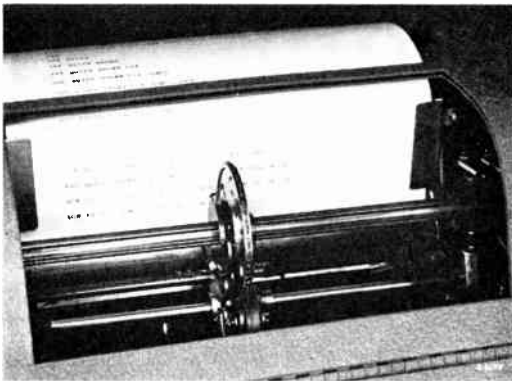

*Ink roller is directly beneath typewheel in this model Western Union teleprinter*

would be thoroughly useless if the ink were subject to loss of solvent or vehicle due to evaporation. Obviously, the ink would get progressively thicker, the apparatus would be gummed, the color intensity would increase, and the printing or flowing qualities would be spoiled.

Ball-point pens, most siphon-type chart recorders, and similar mechanisms have a container reservoir for the ink and, although they feed almost directly to the surface to be marked, there would still be danger of evaporation and clogging the

feeding device if the vehicle were volatile. Although these inks must not dry up when in the equipment, they must quickly attain a non-smudging condition after application to the record surface, and in most cases this occurs simply by absorption of the ink into the paper.

The materials used in these inks are mostly dyes dissolved in such liquids as glycerine or oils, depending on the specific conditions of use. There are scores of dyes that are suitable for this use and they are available in practically any color. If the solvent is a water-soluble liquid, such as glycerine, glycol, or other more complicated related chemical compound, a water-soluble dye like the aniline colors would be used, but with oils or liquids which do not mix with water it is necessary to select a dye from the large class of spirit or oil-soluble colors. Ball-point pen inks, incidentally, can be and are made in both ways.

### **Typewriter Ribbon Inks**

Typewriter ribbon inks are of a consistency similar to that of thick paint, and in most cases are suspensions of pigments or carbon in an oily vehicle plus a little dissolved dye included for toning purposes.

For some special requirements a dye solution in oil can be used very satisfactorily and may give longer life but, in general, carbon black in oil is more popular. It is much easier to erase typed carbon characters because the carbon particles, unlike dye solutions, remain on the surface of the paper, only the oily vehicle penetrating into the sheet. Also, carbon does not stain the skin as dyes do, and is much easier to wash off.

### **Action of Oil Vehicle**

The oil vehicle in an inked typewriter ribbon, due to its fluidity is subject to travel from one part of the fabric to another, and it does this after ink has been removed by typing. The unused areas give some of their oil and, to a much lesser extent, some of their pigment which spread into the areas temporarily depleted

by use, and even up the inking. This explains the well-known recuperation of typewriter ribbons and is one reason why in use they are slowly and repeatedly wound from one spool to the other.

The fact that the oil vehicle spreads so much more readily than the pigment means that a ribbon in the course of use will steadily lose more oil than carbon until the spent ribbon, still very black, no

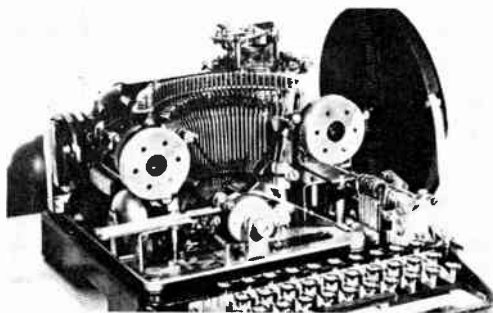

*Recently developed Western Union ribbon rejuvenator attachment to ribbon spool places ink pad in contact with ribbon*

longer gives good copy. A carefully balanced mixture of pigment-free vehicles has been developed for use in rejuvenating old dry ribbon through a simple mechanical device attached to the spools, and this may result in considerable saving.

Western Union ribbons are easy to group. Record or non-copy types are made for use on typewriters, tape and page printers, time and date stamp machines, CND printers, and adding and accounting machines. The inks for these devices all have similar vehicles, that is, a mixture of several oils to get proper body and flow. The black inks use carbon and a toning dye as the coloring agents; the dye, usually dark blue, is added in small quantity to deepen the shade of the carbon which would otherwise appear as pale washed-out grey when light marks are made. In the case of typewriter inks, the proportion of dye is less than for the tape and page printers. This is so that if perchance erasure should be required there will not be too great difficulty. The red and purple record inks usually employ lake colors,\* the purple being selected

\* See supplementary notes for explanation of lake colors.

to match as closely as possible the shade of purple copy ink for the sake of uniformity.

### **Dye Gives Water Copies**

The copying types are the well-known tape and page printer purple copy, and the hectograph ribbons. These, also, have similar oil vehicles, but the coloring agent is methyl or crystal violet, practically all suspended in undissolved form. Just enough is in solution in the ink to give a suitable color to the typed characters.

When used in a wet-press machine or hectographing apparatus the dye particles promptly dissolve in the water and produce a copy on the tissue or other paper. The use of the purple dye is not due to any aesthetic preference on the part of management or stockholders but is based on cold, hard economics. That dye will produce more dark-colored marks per dollar than any other dye available to us. If even the shade of purple should ever have to be materially changed, it would mean use of a different dye and the overall annual cost of copy ribbons might be increased 25 to 50 percent, or even more due to increased unit cost, shorter life, or both.

It is in the fluid inks mainly that Western Union requirements have been so special and exacting that commercially available products have been found inadequate. Ordinary writing fluid has never been much of a problem but such items as Ticker Inks #56 and #71, red non-copy stamp pad and numbering machine ink, call circuit register ink, and several others have been developed specifically for Telegraph Company use.

### **Ticker Ink Research**

For years our ticker ink consisted of methyl violet dye dissolved in a glycerine-alcohol mixture, but there were several serious objections to this which were overcome when the present #56 ink was formulated. This ink is a solution of methyl violet dye in a carefully balanced mixture of glycols and a glycol ether, which has not only the fundamental prop-

erties of low hygroscopicity, non-volatility, and freedom from action on rubber, metal, and other materials, but has the ability to print clear characters on a wide variety of surfaces. When a non-volatile fluid ink is used to print from rubber or metal type onto paper, the essential characteristics that control its printing qualities are viscosity and surface tension. The viscosity is not subject to much variation tolerance because the ink is retained in a felt roller reservoir and must transfer from the felt to an intermediate roller and then to the typewheel in exactly the right amounts, and high viscosity ink would feed too slowly whereas too low viscosity would permit seepage and drip.

Telegraph Company chemists found that when a number of purple inks were formulated, using various solvents but all equivalent with respect to dye content, viscosity, and the like, the printing characteristics varied widely and in proportion to the surface tensions of the individual solvents. A high-surface tension resulted in printed characters which tended to break and mottle, while low-surface tension of course resulted in feathering or spreading of the marks. The problem was further complicated by the fact that in use the ink must print equally well on manila tape, glassine, cellophane, and cellulose acetate tapes, and when these latter transparent tapes were passed through the hot interiors of a projector unit the wet printed characters must not be deformed. The outcome was a compromise in surface tensions, for clearly the interfacial tension in each case was different due to the different materials in contact with the inks, so the proportions of the solvents in the ternary mixture were adjusted to produce a surface tension between 25 and 30 dynes per cm, and it has been there for the past 18 years. Just to give a better picture, the three solvents have individual tensions of 24, 34, and 38 dynes whereas for example water is around 72, soap solution about 12, glycerine 65, and alcohol about 21.

There is a slight degree of hygroscopicity, or susceptibility to atmospheric moisture, in this ink which in most cases is not objectionable, but a newer formulation has been made, called #71, where

the mixture of three solvents has been replaced by just one, which is completely non-hygroscopic and in some respects has better printing qualities.

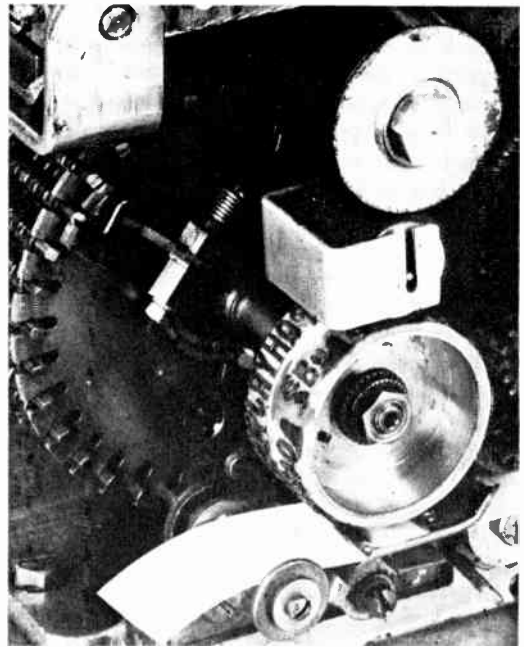

*Ink roller and rubber faced typewheel of a quotation ticker. For projection, printing is on cellophane*

The theory is interesting. Glycols and glycerine are similar to each other and also to alcohol and water in that the east end of the molecule ends in one or more hydroxyl (OH) groups, and it is to this that they owe not only much of their solvent ability for dye, but their hygroscopicity. It is possible and not difficult to unhook one of these juicy hydroxyls, lead it away, and put a greasy one back in its place, thereby changing the characteristics of the vehicle to the extent that its solvent ability for methyl violet is not seriously impaired (in the case of glycols there is one hydroxyl left and with glycerine two hydroxyls are still left), but the hygroscopicity is gone. In fact, a drop of this new compound will float around on water almost like oil, and the material that produced this remedial effect on the molecule was an old familiar standby, castor oil. Naturally, it sounds more scien-

tific when we call the new molecule by its chemical name, diethylene glycol mono ricinoleate.

It is not the intention to imply that these molecular alterations are carried out in the Western Union Laboratories. There are several chemical companies that make and sell these compounds, which are useful for other purposes as well as ink making, and they are bought as such. However, the Telegraph Company does make its own ticker ink by dissolving the dye in the solvents. This ink has a surface tension between 25 and 30 dynes and, therefore, has the desired printing qualities.

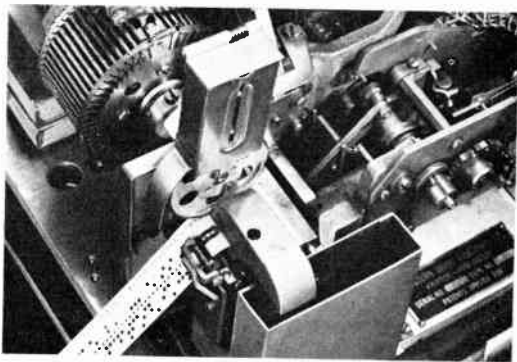

*Here marking fluid is transferred by rubber type from covered ink roller above typewheel to oiled tape*

Two other widely used inks, numbering machine and stamp pad ink, were somewhat similarly improved by research studies in the Company's chemical laboratories. The old numbering machine ink was a suspension of pigment in oil and, when the type had removed the pigment from the felt pad right under the type, re-inking was necessary because the pigment could not travel from other parts of the felt to replenish the color. Also the pigment settled out in the bottles and usually was inadequately stirred before use.

The stamp pad inks were usually mixtures of such things as glycerine sugar, and water, with dye dissolved in them, or in some cases pigment suspended in them. This type of ink not only was subject to drying, but due to its water content and hygroscopicity, caused the fibers in the

cloth pad to soften so that in use they would be flattened and the pad would get hard and caked. Improved inks now are specified.

### III. SOLID INK COATINGS

Solid inks are not as versatile as the printing inks or fluids and need not be given too much space here. Carbon paper coatings, however, and a special wax coating for facsimile telegraph blanks are important record communications items in the non-fluid category, but those rather scarce tablets or pills which must be dissolved in water to make a fluid ink are not included.

The coating of ink on carbon paper appears as a solid. In order to coat the paper tissue, the pigmented wax mixture is melted and, while it is in a quite fluid state, applied by transfer roller to the tissue which is in continuous roll form. A leveling blade makes the coating uniform by scraping off excess; then the coated paper is passed over and partly around a cold steel roller which solidifies the wax mixture, thus permitting the coated paper to be rewound at once, ready for cutting into sheets.

These solid inks are composed of pigments, usually carbon, dispersed in a mixture of waxes and oils, and by varying the ingredients or proportions of ingredients in the wax and oil mixture, they can be adjusted and "tailored" for use on particular machines in any required climate.

One important variation is in the type of "carbon paper" used for multiple copy work on hectograph or spirit duplicator machines. These inks are formulated, manufactured, and used in essentially the same way as the record inks. As in the case of hectograph ribbons, however, instead of an ordinary pigment like carbon, a water or alcohol-soluble dye in powder form is dispersed, undissolved, in the wax and oil. Impressions made from this mixture show comparatively little color until water or alcohol hits them and produces a result that is unmistakable. Anyone who has handled or leaned on one of these sheets has discovered that there is a surprising amount of moisture in human skin

and even in cotton, silk or wool, and that the dyes are selected for their strength and ability to dissolve quickly.

### Facsimile Telegraph Blanks

There is one solid ink that presented a most interesting problem to Western Union research chemists. At the time that low cost facsimile was made practical, transmission by stylus scanning was essential, and therefore it was necessary to have a transmitting blank on which the subject matter had different resistivity from the rest of the blank. A simple

arrangement to marks made with it using any variety of typewriter or handwriting. It must be soft enough to transfer continuous lines on the black paper and then harden itself in less than a minute so that the scanning stylus will not scratch or smear the marks, and it must do these things under all weather conditions. The only known waxy ink that will do this is a four-phase combination of a white pigment, two immiscible crystalline waxes and an oil, applied to the paper hot, and cooled slowly.

This results in a coating in which it appears that large wax crystals form and hold oil and pigment, and when these crystals are shattered by message delineation they transfer to the black paper in much smaller size and offer opportunity for the oil to be absorbed by the black paper, thereby causing hardening of the white characters.



*Sending blanks used with "stylus" Desk-Fax transceiver. White wax solid ink is transferred to black conductive paper from back of white blank*

### Many Special Needs Met

In addition to the inks mentioned that are in general use by Western Union, there are frequent occasions when special ink problems arise in the Company's divisions. Although the usage of any of these special inks is local and in small volume, the chemical research laboratory has produced over twenty such inks for use under unusual conditions where commercially available inks were unsuitable and a formula had to be tailored to exact requirements.

arrangement is to use a sheet of black conductive paper with a sheet of white paper, coated on the reverse side with a dielectric wax coating, placed over the black paper so that when subject matter is typed or written on the white sheet, wax is transferred to the surface of the black sheet. The black sheet with the white subject matter serves as the transmitting blank and the white wax-backed sheet becomes the customer's file copy of the sent telegram.

As changes continue to occur in paper

The requirements that have to be met by this white "ink" are much more stringent than those for ordinary carbon paper coating which needs only to give legible copy. This white waxy ink must be of such grade that it will give not only legibility but adequate electrical resist-

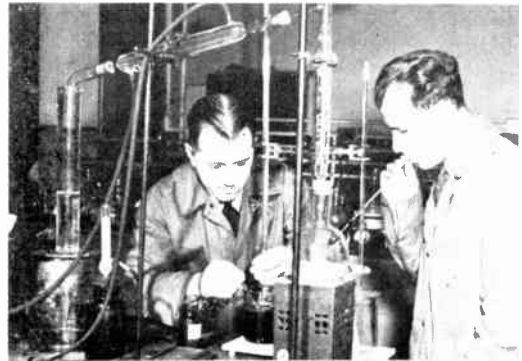

*The author (left) and associate D. Roddin of Western Union chemical research staff*

stocks, sizings, coatings, speeds of operation, and methods in general, compensat-

ing changes will be made in inks for the record communications business.

\* \* \*

## SOME SUPPLEMENTARY NOTES ON COLOR

In connection with an article about inks, a brief discussion of colors may be appropriate, and of interest. There are certain facts about colors that are encountered in everyday work and accepted without much thought about what the effects are, and how they take place, and what must be done about them. It is fundamental that the human eye (normal, of course, not color-blind), is responsive or sensitive to the various wave lengths of light within the visible portion of the energy spectrum and the ability to recognize these wave lengths is our consciousness of color.

When a highly-colored glass is held before the eye and any light source is viewed, only certain wave lengths of transmitted light will come through and cause the eye to respond to their presence. Therefore, essentially no matter what kinds of light are viewed or what colors they appear to be to the naked eye, they will all be the same color when seen through the colored glass, but of greatly different intensity, depending on how much of that particular wave length is present in the light source. Theoretically, if one looks at a pure red object through a pure dark green or blue glass, the red object appears black or may not be seen at all, but since one rarely finds pure colors, that is, a narrow spectral band or monochromatic light, there are generally some small amounts of most of the other wave lengths present and these spoil what would otherwise be the basis for a number of quite startling effects.

Similarly, when light is directed onto a surface certain wave lengths of light-energy are absorbed by the surface material and converted into heat, which is not visible, while other wave lengths are reflected. Since materials in general are consistent in this selective absorption of wave lengths, one can view most objects day after day and have them appear the same color. Identification by color is so commonplace that if this were not the case great confusion would result.

### Materials Appear to Change Color

If, however, a change in chemical composition takes place by evaporation, oxidation, acidity change, or exposure to ultraviolet light, for example; if the size or shape of the particles is changed, or if even only slight contamination occurs, there might be disproportionate changes in the wave lengths absorbed and reflected and the color would be decidedly changed. This, incidentally, is why many materials seem of different color when wet. The index of refraction tends to creep in here, but just a little effort will succeed in keeping it under cover in this discussion.

Also, after considering this explanation, it will be easier to accept the fact that both the purple dye used in many of our copying ribbons, and the dye used in the Telegraph Company's red non-copy stamp-pad and numbering machine ink are harmless-looking green powders in their original state. Furthermore, characters made with purple ink lose the clean purple appearance when viewed with incandescent light such as tungsten filament gives, and appear more red due to the deficiency in the light source of blue component that is not there to be reflected. Under green, which has no red or blue component, the purple will appear black.

### Photocell Sensitivity

It is appropriate to mention at this point that the human eye is but one apparatus capable of discriminating response to different wave lengths of visible energy. There is another, use of which is increasing continually, namely, the photocell. There are a number of types of these and, unlike the eye, all have different degrees of sensitivity to different wave lengths.

For example, a particular photocell may not "see" or respond well to what might be considered a brilliant blue or green, but would be virtually dazzled by a very pale red. In a case of this sort, when it is required that a photocell really observe

something, its relative sensitivity to all of the wave lengths must be studied and then, since it sees white light very well, — and white is a mixture of all wave lengths — a color must be selected that it can see the least and, if use of that one is practical, the maximum result will be obtained from the cell. It is very fine to say merely that since black is absence of color it is the perfect material for this purpose, but sometimes effects are needed that cannot be produced with just black pigments or dyes. Also, the eye is not nearly as discerning with respect to minute differences between blacks as is the photocell, and some of them really reflect appreciable amounts of several wave lengths.

readable and the eye could not distinguish readily any shortcoming in copy quality.

### Tinctorial Strength a Factor

There are materials, different chemically, whose color is substantially identical, but whose capacity for absorbing or reflecting varies enormously. In other words, if a particular color ink is required, there may be two or more ways of producing it; for example, with  $X$  units of one material or with  $3X$  units of another material whose color or tinctorial strength, and probable price, are one third as great. The inks in both cases will be the same color, and with appropriate formula



**THE AUTHOR:** B. L. Kline received his degree of Chemical Engineer from Brooklyn Polytechnic Institute in 1925 and was associated with Charles Hellmuth and Company, printing ink manufacturers, for a year before joining the Western Union Engineering Department in 1926. He is Assistant to the Physical and Chemical Research Engineer and is the Company's head chemist. Besides his work on inks, Mr. Kline has been very active in the development of electrochemically sensitive coatings for facsimile recording papers and has had over 20 patents issued in this field. Researches on lacquer, resins, wood preservation, rust proofing, corrosion, wax compositions and detergents are included in his Western Union activities.

In the early stages of Western Union's photocell Telefax transmission, this was an important consideration, there having been many occasions when various colored marks on a transmitting blank looked to be of adequate intensity to the eye, yet failed to be transmitted properly.

Another interesting thought is that this ability of "colored" individual materials to absorb light energy is dependent on color quantity or density. For example, a highly-colored violet mark will absorb a great amount of white light, reflecting mostly violet, whereas a pale or light violet mark simply has less ability to absorb white and will reflect more than just violet, and so actually give the indication of being of different hue. The photocell would not let one get away with anything here, and many a typewriter ribbon was changed to permit facsimile reproduction by photocell scanning although the copy was quite

adjustments will serve as equivalents, and the cost of the ingredients will be the determining factor.

Our main interest in this difference in strength lies in the fact that colors of such great tinctorial ability can be obtained that our supply reservoir, whether it be a ribbon, felt roller, or hollow container, can be provided with a comparatively small volume of ink that will give good copy for long periods without attention. The violet or purple dye in our copy ribbons and ticker ink is an excellent example of this.

There are colors that are not soluble in the vehicles of inks and these include the pigments and lake colors. Most people are familiar with pigments which include such things as titanium oxide, chrome yellow, vermilion, prussian blue and also carbon blacks.

Lake colors are differently constructed,

in that they are insoluble compounds of dyes with metal salts, some of them being white powders that have had dyes precipitated on the particles, covering each one with a chemically-bound coating of color so that under a microscope no white can be seen at all.

An extremely wide range of very clean colors can be made in this way, some of the more important and well-known of them being madder lake, lithol and para reds, alizarin, and the like. Even methyl violet can be made into a lake color. Those colors that do dissolve in the selected vehicles are the dyes, and there are few

better ways to get lost than in a good book on dyes.

Those who have read or studied on this subject may feel that justice is not being done here to the many varieties of colors that are in wide commercial use. It is in the interest of simplicity that the encyclopedic distinctions between acid and basic dyes, the tungstic, molybdic, aluminum, calcium, and other lakes, the organic, inorganic and metal-organic colors, and others, are being ignored, and instead merely the more practical considerations, from the viewpoint of use by Western Union, have been discussed.

---

## The Insidious Decibel

A. BOGGS

MAN has been long aware of the mysterious and inscrutable ways in which Nature moves, her wonders to perform. The transmission engineer is inclined to substitute exasperating for mysterious on occasion, particularly to designate Nature's predilection to exponential functions. By thinking in terms of decibels, we ignore this exponential type of performance and pretend that simple addition adequately describes the situation. This is convenient but may be misleading. There is a story—doubtless 100-percent fiction, but nevertheless a favorite with writers of mathematical treatises for popular consumption — which, since it illustrates our point, will be repeated here.

The Grand Vizier to the court of some nameless Eastern Potentate had performed some exceptional service for his master who, overcome with gratitude, committed himself to deliver any reward the wise man might wish. The Grand Vizier thought a moment and then replied that since his wants were few, his request would be modest. All he asked was that one grain of wheat be placed on the first square of his checkerboard, two grains on the second, four on the third and so on, doubling the amount with each square

until all 64 squares were accounted for. The unsuspecting Rajah was pleased with this seemingly small request and would have acceded immediately except that the court jester spoke up and warned him to watch his step, remarking that there was a matter of 189 db difference between the amount of wheat on the first and 64th squares. The Rajah replied that but recently he had read in the papers that the Western Union Telegraph Company could transmit 30-kc carrier signals across the continent of North America in 13-gauge paper-lead cable pairs, which by his estimate represented about 3000 db loss, and if this were true 189 db shouldn't bother a man of his standing, and he would grant the Grand Vizier's request.

If you are interested in whether or not he was overly optimistic, calculate the number of grains of wheat on the 64th square. This amount is 2 raised to the 63rd power. The base ten logarithm of 2 is .301 which, when multiplied by 63, equals 18.963 (the jester was in error by .6 db, a common error). The number corresponding to a logarithm of 18.963 is about 9.2 times 10 raised to the 18th power, or 9.2 million, million, million. If, being quite ignorant of what a grain of wheat weighed



in this hypothetical land, we assume the correct weight to be 1 grain, the amount in bushels would be 22 million million bushels. Calculating backward a short way, we see the 63rd square represented 11 million million bushels, the 62nd 5.5 million million and, if the process be continued, finally one single grain on the first square.

We shall not contemplate further the embarrassing predicament in which this potentate became involved from underestimating the power of an exponent, but look and see if we can find what misled him in the scientific article in his local paper.

Of course the Western Union does not have a carrier route consisting of 13-gauge cable throughout from coast to coast, but if it had his estimate of 3000 db loss at 30 kilocycles would be close enough. The attenuation at 30 kc is 1.1 db per mile. Then if we wished to receive at Oakland at a level of one milliwatt a carrier signal sent from New York, the energy input at New York would have to be 3000 db higher. Since a power ratio expressed in decibels is 10 times the base 10 logarithm of the actual ratio, the power supply at New York would be required to deliver  $(10)^{3000}$ , ten raised to the 3000th power, times 1 milliwatt. The number represented by 10 with an exponent 3000 is so large there is no name for it. It is 1, followed by 3000 zeros. The size can be whittled down a bit by using kilowatts in place of milliwatts and making the slight concession of accepting a minus 20 dbm received level at Oakland. The kilowatts required at New York then become 1 followed by 292 zeros. This is still a fairly large number. You might get some concept of its magnitude by saying to yourself "ten thousand", followed by the word "million", repeated 48 times. A further reduction in number size can be made by using voltage instead of power since voltage is proportional to square root of power. When this is done, taking into account cable impedance, the volts become

"35000" followed by "million", repeated 24 times.

Now we all know that cable insulation can't withstand any such voltage as this, yet if the assumptions and the mathematics are accepted this is what we get. Assumptions by their very nature are more to be suspected than mathematical operations, and here the faulty assumption is that a coast-to-coast carrier system would be operated without repeaters. The 3000 db is legitimate and cannot be avoided, and a received level 20 db below 1 milliwatt is reasonable enough. However, if we divide the 3000 db into 100 30-db sections and place a repeating amplifier at each division point, including the sending end, each of these amplifiers would be called upon to supply a power level of plus 10 dbm, since we agreed that a received level of minus 20 dbm was good enough for Oakland, and therefore should be good enough for the repeater points. A power level of plus 10 dbm is 10 milliwatts supplied by each of 100 repeating amplifiers; 100 times 10 equals 1000 milliwatts or 1 watt, the total power supplied to the system. No great hardship results from multiplying the value of the exponential function by 100 if first the exponent has been divided by 100.

If the Grand Vizier's victim had read his paper more carefully, he would not have put himself in the impossible position of trying to place several million bushels of wheat on one square of a checkerboard.

This all may be old stuff and seem rather pointless to those familiar with carrier practices, but it has been retold to protect the interests of those who have to design power amplifiers. System designers have scant hesitancy in adding a little loss now and then to avoid other difficulties; here a db and there a db as a matter of convenience, forgetting for the moment that when these add up to 3 the power required from the amplifier has been doubled. Like the goblins of Little Orphan Annie, the dbs'll get you if you don't watch out.

---

**THE AUTHOR:** Photograph and biography of Mr. A. Boggs appeared in the January 1949 issue of TECHNICAL REVIEW.

# Multi-Send Center for Commercial News Distribution

F. L. CURRIE and J. K. NELSON

THIS ARTICLE is devoted to Western Union's Commercial News Service and describes the new commercial news multi-send centers, termed CND Multi-Send Centers, recently placed in service in some of the new area reperforator offices.

## CND Service

The Commercial News Service is the function of the Commercial News Department which is responsible for the collection of specialized news in the financial, commercial and sports fields, and for the distribution of it to customers on a subscription basis. Its major activity involves reports, commonly called CND's or CND reports, of the transactions of the various Exchanges, Boards of Trade and other markets where stocks, bonds or commodities are traded.

There are several hundred such markets in the United States from which CND reports are distributed. They were organized to promote orderly trading, and to establish fair prices by correlating supply and demand through trading on a bid and ask basis, thus playing an important role in the economy of the country. Their members buy and sell, either for themselves or for their clients, the stocks, the bonds or the commodities which the market was organized to handle. The clients may be the owners of securities, the growers of commodities, independent brokers, or the individual purchasers themselves.

The CND service is provided in two general forms, continuously by ticker or Morse directly to customers over wire networks, and non-continuously, in periodic message form, over the counter, by messenger, by tie-line, or by telephone. This article is restricted to a description of the non-continuous form of the service. The customers who subscribe for such service are generally growers of commodities, local merchants, brokers who buy from

the producers and resell to the large processors or manufacturers, and speculators who buy at one time and sell at another to benefit from quotation fluctuations. All usually are dependent upon up-to-the-minute marketwise news for efficiently conducting their business. For example, a buyer of grain is interested in receiving quotations from the grain exchange so that he can buy grain from growers at current prices and sell it to his best advantage for delivery either immediately or at a specified future date. Likewise, flour mills are interested in CND reports to guide them in the purchase of their future grain supplies at the most favorable prices.

The reports from markets are furnished at various intervals, such as 15 minutes, 20 minutes, half an hour, and so forth, during the trading hours, and also for the opening and closing prices of the trading period. In some cases only three reports are furnished per day, in others only one per day, and in still others only one per week.

Such CND service is classified according to the frequency and the scope of the reports. For example, one class of service may cover three reports daily from the Denver livestock market, while another may cover selected cotton futures at 15-minute intervals. The different classes of service are provided to offer a wide choice to customers, and the charges are made for each class in accordance with the amount of service required.

Because of the highly competitive nature of trading as centered about the different markets, the CND reports emanating from them, to be attractive, must reach all subscribers quickly and as nearly simultaneously as possible. In many offices, where only a few reports are handled daily, they can be handled satisfactorily with the regular message facilities. In other offices, however, the aggregate flow of incoming CND reports becomes so

heavy at times of peak loads that the regular message facilities, if depended upon to handle the load, would be overburdened, and serious delays would result to the CND's. Therefore, it is necessary to furnish additional facilities of a suitable character at those places to handle adequately the CND reports.

### **CND Multi-Send Center**

In the past, where the tributary circuits over which the CND reports were to be sent from a central office were manually operated, various designs of master key sending arrangements were used for simultaneous transmission of those reports to all circuits concerned. The master key arrangement permitted the brief interruption of any transmission then under way over selected groups of circuits, on a pre-empt basis, and the sending of reports, in broadcast fashion, to all circuits from a single sending position. Each office on those circuits which had a subscriber for a particular CND service recorded and delivered to the subscriber the reports constituting the respective class of service for which he subscribed, and ignored all others. A modified form of master key transmission was later devised and used at several Plan 2 reperforator switching offices.

When the new reperforator switching installations of the Plan 21-A type were installed at area offices from which CND market service is distributed in volume to large numbers of tributary points, the previously used master key type of circuits were unsuitable because of the large amount of automatic operation forming a part of the new system. Consequently, the CND multi-send center described in this article was developed for use at those places to meet the new requirements. This center provides for the processing of the CND reports from their initial reception to their ultimate transmission. All such messages flowing to the center either must be received in suitable perforated tape form, or must be manually perforated into suitable tape form, before they can be broadcast by means of the multi-send equipment. A preamble tape announcing

that a CND report follows, as well as a selecting code to call in all stations on way circuits, is transmitted just prior to sending each report.

All circuits that may be connected to the multi-send center must be equipped to operate from teleprinter transmission. Normally they are teleprinter duplex or way station circuits. Those two types of circuits must be treated differently in the Plan 21-A offices, from the standpoint of interrupting their normal traffic flow and seizing control of them for CND transmission. The normal transmission over the duplex sending legs may be interrupted for CND transmission at any time, on a pre-empt basis, but the way station circuits, due to the involved character of their automatic operation, can be taken for CND transmission only between messages. The interruption of the normal transmission over sending legs and other lines for CND transmission is very short, since the average such transmission requires less than a minute.

### **CND Multi-Send Operation**

With suitable preamble and report tapes ready for sending, a multi-send operation is started by selecting the lines to which the report is to be sent. Those lines are selected manually by means of the line selector or of the group of push buttons located in the turret, as illustrated in Figure 1. When a line is selected a selector relay individual to the selected line operates, stores the selection, and causes the respective line signal lamp in the turret to flash. The signal lamps serve as visual indications of lines selected. The selected lines are seized for multi-send transmission by stopping the normal sending to them and by placing them under control of the CND multi-send transmitting relays. The seize and start switch, located in the turret, is used for that purpose.

The indicator of that switch is moved from its first or rest position to its second position for the seizure of the way station lines if any such lines form a part of the selection pattern. Since the way station lines may be seized between messages

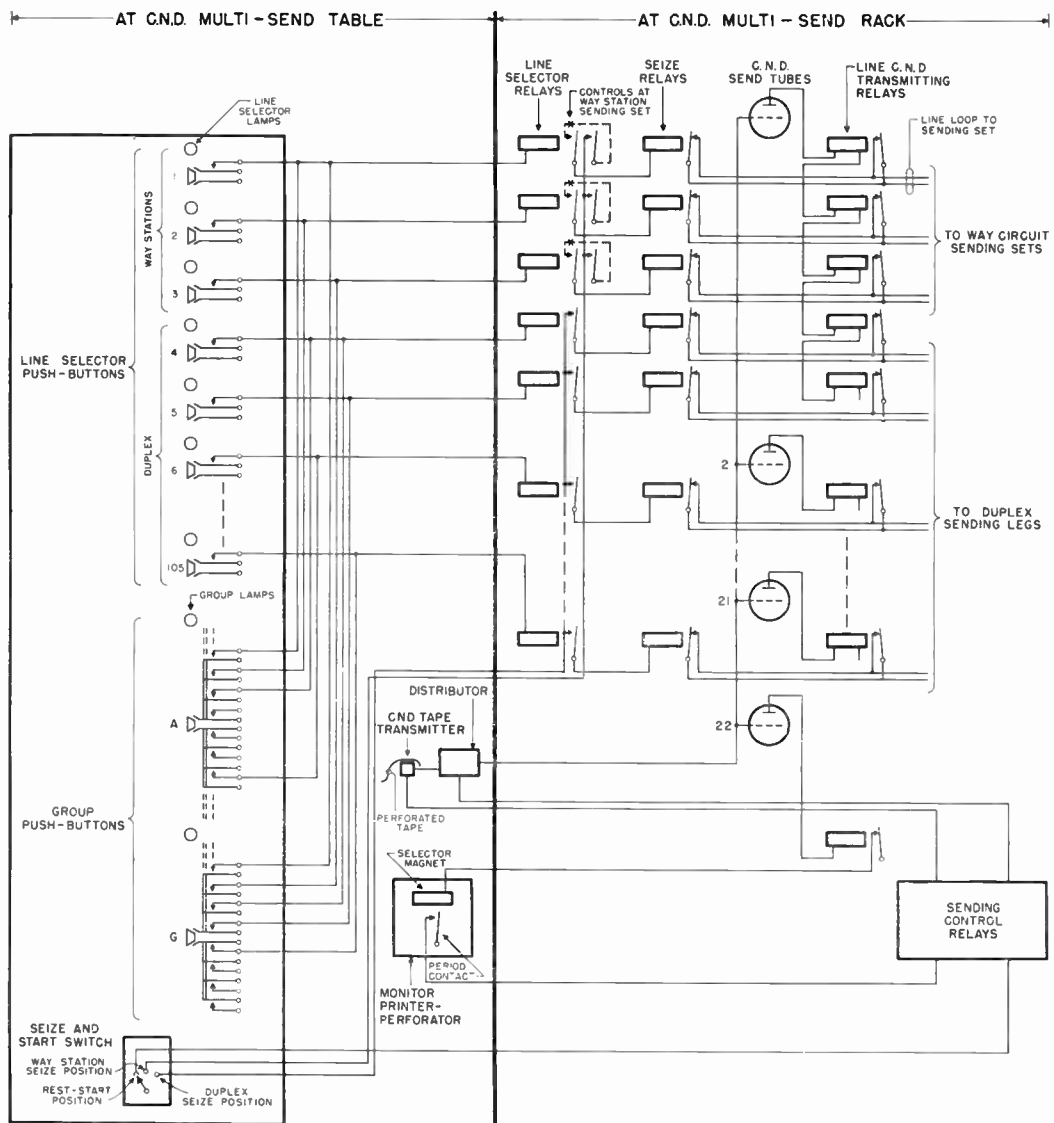

Figure 1. CND multi-send arrangement

only, the indicator usually is left at the second position for several seconds, so as to seize as many lines as reasonable waiting time allows. As each line is seized, its particular line signal lamp in the turret stops flashing and glows steadily. By watching those signal lamps, the CND clerk is advised continuously of the status of the way station line seizures.

When all way station lines are seized, or the allowable waiting time for them has elapsed, the switch indicator is moved to its third position. When the switch in-

dicator is moved off the second position, the seizure of the way station lines ceases, but any way station lines which form a part of the selection pattern and could not be seized due to a busy condition while the switch indicator was on the second position, will be stopped from regular cycling operation at the end of the message and held in an idle condition, in readiness for CND seizure when the switch indicator again is turned to its second position. The movement of the indicator to its third position serves to seize

sending legs of duplex lines, if any form a part of the selection pattern. Their seizure is accomplished immediately on a pre-empt basis. All lamps of selected duplex lines change from a flashing to a steady glow at that time.

The return of the switch indicator to its first position starts the operation of the transmitter and the distributor. The distributor sends into the grids of thermionic tubes which control line relays that repeat the signals into the selected lines and to the monitor printer-perforator. While all line relays follow all the signals sent by the transmitter and distributor, only those line relays actually repeat into their respective lines or sending legs whose associated CND seize relays are operated. When released, a pair of normally closed contacts on those relays short circuit the operate contacts of the line relays.

When the end of the CND report is reached, the double period end-of-message signal is repeated by the period contacts of the monitor printer-perforator to a chain of period counting control relays. Those relays when actuated function to release the seized duplex sending legs immediately and, with the cooperation of an electronic timer, to release the seized way station lines two seconds later. The seized way station lines are held open for two seconds to restore their normal cycling operation.

If any of the selected way station lines were not included in the CND transmission because of busy conditions existing on them at the start of transmission, those lines will remain activated as a selection pattern after the other lines are automatically cleared out. When the message being sent over those way station lines in regular transmission is ended, the lines are automatically held inactive and available for seizure and for receiving a rerun of the report. The aggregate time involved in those operations is small since, as mentioned previously, the average time required for a CND transmission is less than one minute.

### Equipment

A CND multi-send center consists, in general, of a receiving table, a preparation

table, a multi-send table and an equipment rack.

Normally, the receiving table is of the two position type similar to those used for regular message receiving in the respective offices and functions to receive the incoming CND messages, in printer-perforator tape form, from trunk, tributary, and branch office circuits. Actually, for reasons of equipment economy, the two receiving positions of the book message center are used to receive both the incoming book messages and the incoming CND reports in three of the installations made thus far.

The CND preparation table provides space for one or more tickers with tape winders, and also space for writing. The tickers furnish quotations directly from the markets, and the writing space is used for tabulating the quotations from the ticker tape and for preparing CND messages to be distributed to subscribers. The number of tickers required varies with the different installations.

The CND multi-send table, shown in Figure 2, contains primarily a push-button turret, a transmitter, a distributor, an electronic timer, a monitor printer-perforator, and a manual perforator. These facilities permit the selection of a group of tributary or branch office circuits which are to receive a particular report, and the transmission of that report simultaneously to them.

The push-button turret, shown in Figure 3, is a manual control panel for operating the CND multi-send equipment. It, primarily, provides push buttons for selecting the lines to receive each report, signal lamps to identify the lines selected, and a manually operated rotary switch to control the operation of the multi-send equipment.

While at times a CND report may be destined to all lines associated with a multi-send set, usually it is destined to only a portion of those lines. Consequently, push buttons are provided in the turret for conveniently selecting and placing under the control of the multi-send equipment only the lines to which the report is destined. Those push buttons which are located in the upper part of the turret are

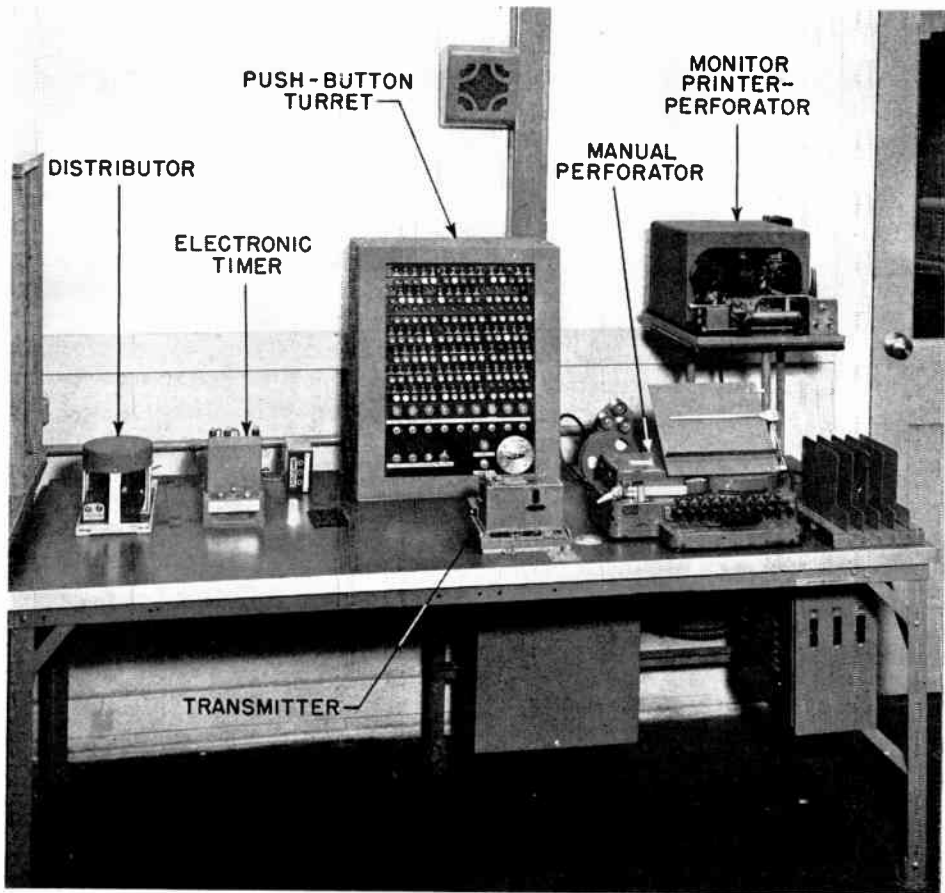

Figure 2. CND multi-send table

termed line selector push buttons and group push buttons.

One line selector push button is furnished for each line and, when pressed, serves to select its respective line to receive the next multi-send transmission. Of course, as many of these push buttons must be pressed to complete the selection pattern as there are lines to which the CND is to be sent. Located directly above each of those push buttons is a line signal lamp which starts flashing when its line is selected and glows steadily after control is taken of the line by the multi-send equipment. Each turret provides 105 line selector push buttons and line signal lamps.

Because of the time and care required to prepare line group setups or selection patterns for each CND report by means of the individual line selector push buttons, group push buttons are included for quickly activating preselected groups of

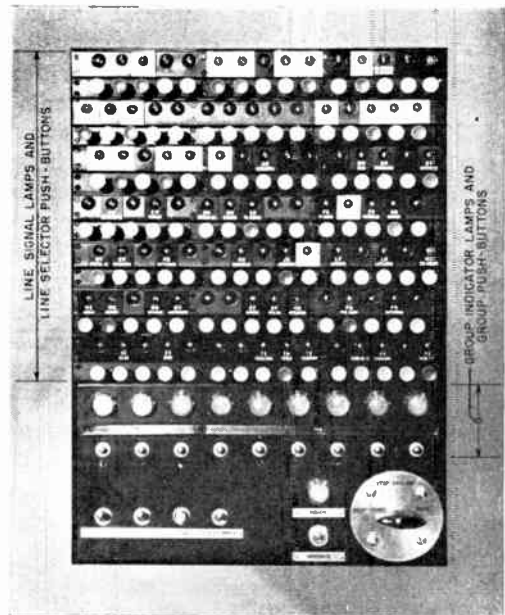

Figure 3. CND multi-send turret

lines in mass at one time. With those push buttons, it is necessary only to press a single push button to establish a complete selection pattern of any number of pre-selected lines. Seven group push buttons, each controlling a different selection pattern, are situated below the line selector push buttons. A group indicator lamp, located directly above each group push button, glows when the respective group selection pattern is activated. In addition, there are two spare group push buttons.

At times, because of new or discontinued CND subscriptions, additions or subtractions must be made to one or more of the prearranged selection patterns controlled by a group push button. The additions may be made by depressing the line selector push buttons of the respective line, and the deletions may be made by depressing, at the same time, both the delete push button and the line selector push buttons of the lines to be deleted. Thus the prearranged selection patterns may be altered until such time as the change can be made in the wiring for the fixed group pattern.

Occasionally, after a selection pattern is prepared, a change to a completely different selection pattern may become desirable for the next CND transmission. The clearout push button was provided for that purpose and when pressed serves to clear out the existing stored line selection pattern so that a new selection pattern may be substituted.

After a selection pattern is prepared, the manual seize and start switch shown in the lower right-hand portion of the turret is used to take control of the selected lines for the multi-send set and to start the actual transmission from that equipment. It is a three-position switch with the first position normally an idle or rest position. The second position stops the normal cycling of the selected way station lines and seizes control of them between messages. The third position seizes all selected duplex lines on a pre-empt basis. When the switch indicator is returned from the third to the first position, the first position then serves to start transmission of the CND report.

The "Disconnect" push button and the "Sdg. Stopped" toggle switch shown at the bottom of the turret are provided for semi-emergency purposes. The pressing of the disconnect push button stops the transmitter, disconnects the multi-send equipment, and restores to their normal message service the lines to which the transmission was sent. That push button is useful when the end-of-message signal is inadvertently omitted in a CND report. The sending stopped toggle switch enables the clerk to stop the transmitter temporarily and quickly when necessary, such as when the tape jams in the transmitter or the tape feed holes are ripped.

The two signal lamps, "Ready" and "Operate", shown at the bottom of the turret, are precautionary signals to indicate when operating failures occur. When the ready lamp glows, the multi-send transmitter and distributor should be operating and the operate lamp should flicker to show that the transmitted signals are being sent to line, except when the sending stopped switch is operated. The transmitter and the distributor function in the usual manner to convert the perforations of the tape into seven-unit teleprinter signals.

The electronic timer serves, at the end of CND transmission, to restore normal traffic operation to all way station circuits to which the report was sent. This is done by causing the line circuit to be opened for a period of two seconds.

The monitor printer-perforator serves, primarily, to actuate the end-of-message control equipment when the double period end-of-message signal is received, and also produces a printed and perforated tape copy of the CND transmission which is available for retransmission purposes when required.

The manual perforator is used to prepare perforated tape for those messages compiled at the preparation table, or received at the multi-send center in written or message form.

The equipment rack, termed CND multi-send rack, is a double-sided rack with the front arranged to swing open in gate fashion to allow ready access for main-

tenance purposes. The front of the rack, shown in Figure 4, contains 106 line transmitting relays, 22 CND send tubes, 15 line selector relays, 15 seize relays, and 6 miscellaneous control relays; the back,

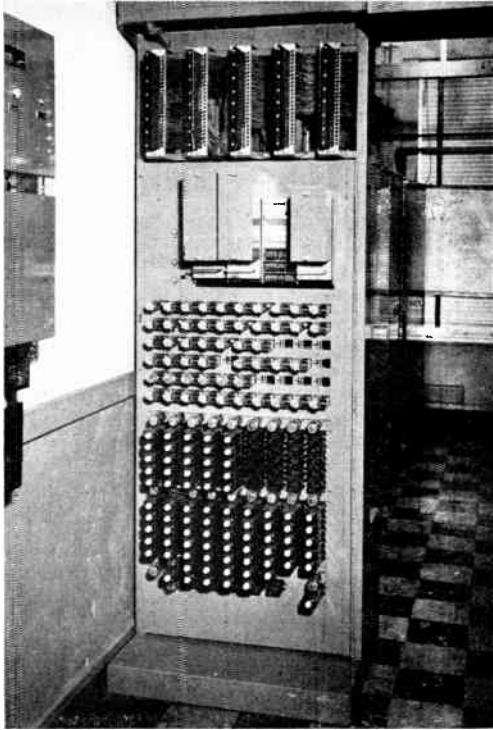

Figure 4. CND multi-send rack—front view

shown in Figure 5, contains 90 line selector and 90 seize relays. The line selector, seize and miscellaneous control relays are mounted on relay banks. Five line selector and 5 seize relays are mounted on one bank, thus constituting 3 such banks for the front and 18 for the back of the rack. The 6 control relays are mounted on a separate relay bank.

The 22 send tubes, which are controlled by the CND tape transmitter and distributor, repeat the transmission signals to the 106 line transmitting relays. Each of the first 21 tubes repeats the signals to a group of 5 relays (1st to 105th), and the 22nd to a single relay (106th). The first 105 of the line transmitting relays repeat the signals to their respective lines or sending legs, provided those lines or sending legs have been selected for CND operation,

and the 106th repeats to the monitor printer-perforator.

The miscellaneous control relays function primarily to start transmission, to temporarily stop it when desired and, in cooperation with the monitor printer-perforator, to stop transmission and disconnect the selection pattern at the end of message.

Also contained on the back of the rack in the compartment at the bottom are most of the fuses, current limiting resistors, and the like, required for the multi-send center.

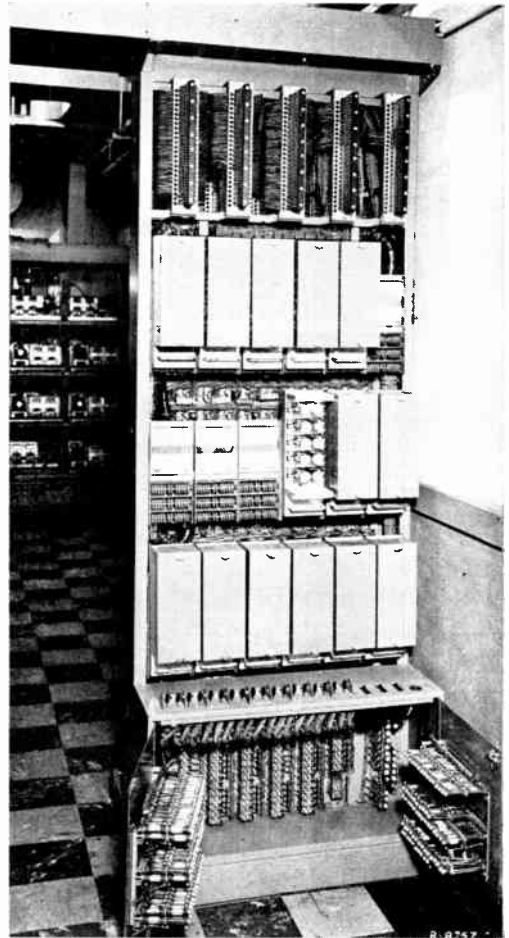

Figure 5. CND multi-send rack—rear view

## Conclusion

At present, three reperforator switching offices of the Plan 21-A type (Kansas City, Minneapolis and New Orleans), and one



of the Plan 20-A type (Cincinnati), serve as primary transmitting points for CND reports. In each of those offices a CND multi-send center has been installed. Experience with these installations indicates

that they satisfactorily meet the operating objectives of the design, and that they have contributed substantial improvement and economy in the handling of periodic CND reports.

---

**THE AUTHOR:** For photograph and biography of Mr. F. L. Currie, see the July 1948 issue of *TECHNICAL REVIEW*.

---

**THE AUTHOR:** J. K. Nelson came to Western Union as an engineering apprentice with the Traffic Department after graduating from Northeastern University in 1930. He was with various field and division offices and the general office of that department until entering the U. S. Army in 1941. There his duties were chiefly concerned with radar development and operations. Leaving the service in 1945 with the rank of Captain in the Signal Corps, Mr. Nelson returned to the Traffic Department. Since 1947 he has been with the Systems Development Division of the Development and Research Department, where his background of traffic experience has enabled him to contribute to the improvement and development of telegraph systems. He is a member of AIEE.



# The Development of Western Union Switching Systems

W. B. BLANTON and G. G. LIGHT

THE PREVIOUS ARTICLES have described the equipment and methods that are employed in the Plan 21-A Reperforator Switching System for the handling of telegrams at both outoffices and area switching centers. In the operation of a switching system that is so largely automatic, it is necessary to provide supplementary equipment arrangements that will permit the operating, supervisory and testing personnel to communicate with each other and to provide human attention when such is necessary to keep the telegrams flowing swiftly and accurately. This concluding article in the series will describe those arrangements.

## Brief Description of An Area Switching Center

Each of the 15 area switching centers that embrace the nation is the hub from which radiate circuits to the tributary offices within the area it serves, to the branch offices within the same city as the switching center, and to various sending and receiving positions located at the switching center. A nation-wide network of trunk circuits connects each area center to the other 14 centers and, where the load justifies, connects an area center to large tributary offices in other areas.

Essentially, the flow of telegrams through an area center is in two directions; telegrams that arrive in the center from points within the area are switched over the outgoing trunks to other areas, while telegrams that arrive in the center over incoming trunks are switched to points within the area. There are exceptions to these generalities. A portion of the telegrams that originate within an area are destined for points in the same area. Also, messages will occasionally be received over incoming trunks that must be switched to outgoing trunks. Such trunk-to-trunk switching is generally

necessitated by the temporary loss of some of the trunk facilities in the nationwide network.

The incoming trunks terminate at push-button switching positions where each message is switched in accordance with its address to the appropriate sending position that feeds a tributary, branch, or local receiving position, or to a sending position that feeds an outgoing trunk.

The incoming circuits from tributaries, branches, and local sending positions, terminate in automatic switching facilities. Each message received in the switching center from these points is prefixed with two selection characters which are acted upon by the automatic facilities to switch the message into the appropriate sending position at the center.

Two types of line termination facilities are employed on incoming tributary and branch office circuits. Heavily loaded tributary and branch circuits terminate in reperforators that record the received messages in perforated tape form. The automatic switching and retransmission of a message to the appropriate sending position is accomplished when the perforated tape flows through an associated transmitter. Lightly loaded tributary and branch circuits terminate in a line finder which connects a calling line into automatic switching equipment. In response to the selection characters that precede each message, the automatic switching equipment connects the calling line to the appropriate sending position and the transmission of the message takes place from the transmitter in the outoffice directly into the reperforator of the selected sending position.

## Supervisory Positions

The trunk receiving positions which employ push-button switching require the attention of a switching clerk on each

message that is switched. Generally, one clerk handles three or more trunk receiving positions depending upon the density of traffic at those positions. On the other hand, the operation of the equipment at both the trunk and intra-area line sending positions, and at the automatic switching positions that terminate the heavily loaded intra-area receiving circuits, is automatic

into two or three supervisory areas. In one of these areas is located a supervisory position as shown in Figure 64 which is designated as the Central Supervisory Position for the whole switching center. This position is provided with a keyboard perforator, a "file" printer and a "supervisory" printer. In each of the other supervisory areas is located a supervisory



*Figure 64. Central supervisory position*

and human attention is required at those positions only occasionally. Therefore, the sending positions and the automatic switching positions are divided into groups, each group forming a supervisory area that is staffed with one or more supervisors who patrol the positions and give them operating attention when necessary. About ten such supervisory areas are established in a switching center.

The trunk sending positions are divided

position, quite similar to the one shown in Figure 65, on which is provided a keyboard perforator and a "supervisory" printer.

When a supervisor wishes to send a note to the distant office of a trunk circuit, she prepares the note in perforated tape form on the perforator at her supervisory position, and then takes the tape to that trunk's sending position. There, she temporarily removes the regular message

tape from the transmitter and inserts the tape containing the note. After the note is transmitted she, of course, replaces the regular message tape.

Supervisory notes from the distant trunk offices are received over the incoming trunks at the push-button switching positions. One push button in each switching turret is designated "Supervisor". The assignment of the receiving trunks to switching turret positions and the intra-office circuit arrangements controlled by the "supervisor" push buttons are such



*Figure 65. Supervisory position*

that each switched supervisory note is retransmitted over the intra-office circuits into the printer at the proper supervisory position.

All of the printers on supervisory positions print on  $\frac{1}{4}$ -inch wide white paper tapes that travel across long viewing-guides when the tapes issue from the printers. This permits the supervisors to make proper pencil endorsements above the received supervisory notes to denote that action was taken on each one.

During the busy part of the day, all of the supervisory positions in the trunk

sending section are "open". However, as the load drops off in the evening, it becomes desirable to close out one or more of the supervisory positions and combine the activities of a closed-out supervisory area with those of one which is still open. The circuit arrangements are such that when a supervisory position is closed, any further notes for that position will be received by a predetermined position that is still open. If a position that is serving two supervisory areas should be closed, any further notes for the two closed-out positions will be received by another predetermined position that is still open. Thus if all the supervisory positions in the trunk sending section are closed except the central supervisory position, all of the supervisory notes for the entire trunk sending section will be received at the central position.

Occasionally bust copies, pilot notes, etc., will be received at the push-button switching positions which require no further handling after passing the push-button switching section. These tapes are switched into the "File" printer at the central supervisory position as a matter of record. The supervisor scrutinizes the file printer tape at regular intervals to guard against misroutes, and checks or endorses each unit, after which the tape is permitted to wind on a tape reel.

The line sending positions for heavily loaded tributary and branch offices are generally located across the aisle from their associated receiving reperforator (automatic switching) positions. These positions are divided into three or four supervisory areas, each area comprising a group of sending positions and their associated receiving positions.

Each supervisory area, designated by one of the letters A, B, C, or D, is provided with a supervisory position equipped with a keyboard perforator and supervisory printer as shown in Figure 65. In order to transmit a supervisory note, an outoffice prefixes it with the selection characters SA, SB, SC, or SD, depending upon which supervisory area at the switching center serves that particular outoffice. These notes are received at the receiving reperforator positions and, in

accordance with the selection characters, are automatically switched to the proper supervisory positions. Supervisory notes are not given a sequence number like regular telegrams, and are transmitted into supervisory printers without call letters and sequence number comparison taking place.

Similarly to the supervisory positions in the sending trunk section, these supervisory positions are arranged so that if one or more positions are closed out, any further notes for a closed-out position will be automatically switched to and received at a predetermined position that is still open.

The line sending positions for lightly loaded tributary and branch offices and their associated receiving circuit sequence number indicators are also divided into three or four supervisory areas, each equipped with a supervisory position (Figure 65). The same procedure of designating these supervisory areas with the letters A, B, C, or D, and using selection characters SA, SB, SC, or SD, to switch notes to the proper supervisory printer is followed. Also, these positions are so arranged that if one or more are closed out, any further notes for the closed-out positions will automatically be received at positions still open.

### Testing and Regulating (T&R) Positions

Notes are received at the switching center from distant trunk offices, and from tributary and branch offices dealing with the testing and regulating of equipment and circuits. These notes are addressed to the T&R personnel. Three T&R positions, each consisting of a tape printer as shown in Figure 66, are generally provided at a switching center: one for the push-button switching section, one for the heavily loaded tributary and branch automatic switching section, and one for the lightly loaded (line finder) tributary and branch automatic switching section.

In the push-button switching turrets, one push button designated "T&R" is provided for switching these notes. In the automatic switching section, these notes are preceded with the selection characters



Figure 66. Testing and regulating (T&R) position

"TR" which cause them to be automatically switched and transmitted into the proper T&R printer. Similarly to supervisory notes, the T&R notes are not given a sequence number, and are transmitted into the T&R printers without call letters and sequence number comparison taking place.

The T&R printers use standard narrow gummed paper tape, thus permitting the T&R personnel to gum the received notes on blanks.

### Loud-Speaker Intercommunicating System

The supervisory and T&R positions provide facilities that permit communication between the personnel at the outside offices and the operating, supervisory, and testing personnel at the switching center. In addition, a loud-speaker intercommunicating system is provided at the switching center that enables the operating, supervisory, and testing personnel at the switching center to communicate with each other.

At each push-button switching turret and at or near each supervisory position, and at other strategic locations throughout the switching center are located a micro-

phone and loud-speaker. At Boston, which is typical of the other switching centers, the loud-speakers in the various sections of the office are arranged on four separate circuits as follows:

1. Push-button switching aisles located on the 12th floor;
2. Line sending and automatic switching receiving position aisles located on the 12th floor;
3. Switching equipment room located on the 11th floor, and test board and repeater room located on the 7th floor;
4. Local sending and receiving position aisles located on the 9th floor.

Convenient to each microphone (see Figure 64 or 65) there is provided a key switching box having two 2-position non-

locking key switches and five lamps. By operation of one of these keys to the appropriate position, the associated microphone may be connected to any one of the four loud-speaker circuits. Four of the lamps are associated with the four loud-speaker circuits, and a lighted lamp indicates that the associated speaker circuit is in use. An amplifier is common to several microphones and the fifth lamp, on top of the box, when lighted indicates the microphone group is busy. Before operating a lever key to connect a microphone, the user of course first observes the appropriate lamps to ascertain whether or not the microphone group and desired speaker circuit are in use.

Figure 67 shows the amplifying equipment, located in the switching equipment room, that is employed in the loud-speaker intercommunicating system.

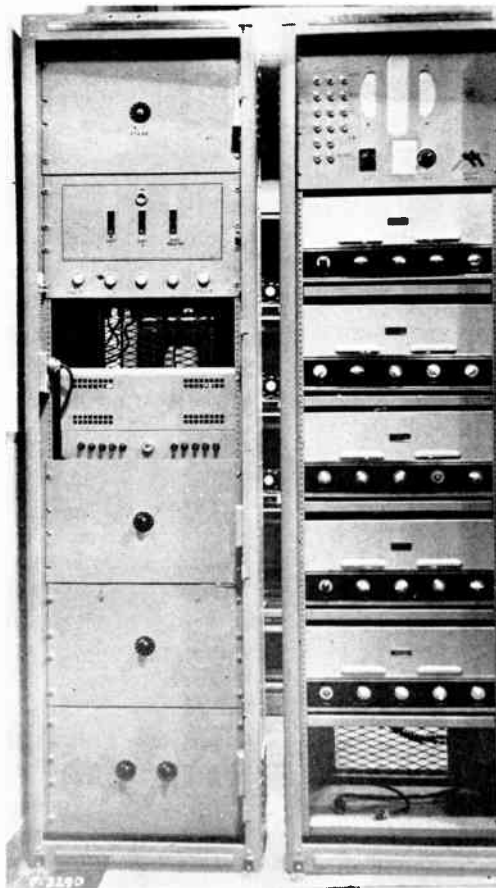

Figure 67. Amplifying equipment for loud-speaker intercom system

#### Low Tape, T&R and Supervisory Pilot Signals

Each position in a switching center that has a reperforator or printer-perforator is provided with a low tape signal lamp that lights when the roll of tape in the reperforator or printer-perforator is nearly exhausted. When two or more of these positions are mounted on a table or rack, a green pilot lamp is provided at the top of the mounting structure which lights when any one of the individual low tape signal lamps on the same structure is lighted.

A custom-engineered signaling system is installed in each operating room of a switching center that enables tape attendants to locate quickly any position that needs tape replenished. A typical arrangement of this signaling system is as follows:

Assume a floor layout where the tables or racks are arranged in rows across the width of the room, while two passage aisles extend down the length of the room, thus dividing all of the positions into three sections. At the aisle end or ends of each row of tables or racks, an overhead green pilot lamp is provided which lights when a low tape signal lamp is lighted at any position in the associated row of tables or racks. Also, in each of the two passage

aisles, there are mounted overhead in a conspicuous location three green pilot lamps, one for each section of the room.

Supplementing these visual low tape signals, an audible signal system consisting of several single-stroke chimes strategically located around the room, is operated once every two seconds whenever one or more low tape signal lamps are lighted in the room.

A red T&R lamp is provided on each rack or table that mounts one or more switching or operating positions. A supervisor, switching clerk or operator may request a T&R attendant by operating a switch that causes this lamp to light. An overhead T&R pilot lamp signaling system is provided similar to the low tape signal system just described except that red lamps are used in the T&R system. The same audible signal system provided for the low tape signals also serves for the T&R signals. In the case of a T&R call, the chimes are actuated twice in quick succession every two seconds, but the T&R signals are timed to sound half way in between the low tape signals. Thus the two types of signals do not conflict.

When describing in the previous articles the line sending positions and the line receiving positions equipped for automatic switching, mention was made of various operating or trouble conditions that might occasionally require the attention of a supervisor at a position. In such cases a lighted signal is operated on the individual position to denote what particular action is required.

At the top of each rack that mounts two receiving or sending positions, there is provided an amber pilot supervisory lamp that lights whenever a signal lamp that requires supervisory action is lighted on either of the individual positions. Instead of providing overhead supervisory pilot lamps at the end of table rows similar to the low tape and T&R pilot lights, an amber pilot lamp is provided on each supervisory position which lights when any position in the associated supervisory area requires attention. In addition to the pilot lamp for its own area, each supervisory position is provided with amber pilot lamps for the other supervisory areas

that it serves when the supervisory positions in those areas are closed out. The pilot lamps for the other supervisory areas are inactive when a supervisory position is serving only its own area, but the appropriate pilot lamp or lamps become active when a supervisory position begins to serve one or more other areas.

### Traffic Routing Board

Occasionally, due to the temporary loss of line circuits to a distant office or for other reasons, it is necessary to route messages at a switching center to outgoing circuits other than those to which the messages would normally be switched.

In the push-button switching section, such emergency routing information is called out to the switching clerks over the loud-speaker system, generally from one of the supervisory positions. The switching clerks make a pencil notation of the routing information and are guided by it until they receive further instructions.

In the automatic switching section, it is impracticable to notify all of the tributary and branch offices of temporary routing changes. Therefore a Traffic Rout-

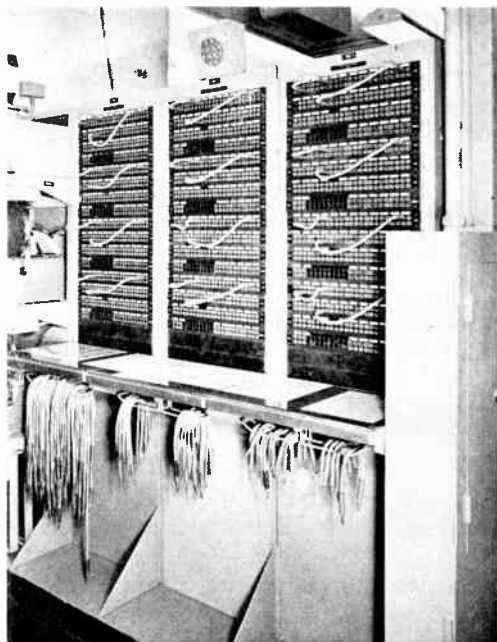

Figure 68. Traffic routing board

ing Board (Figure 68) is provided near the central supervisory position which permits a supervisor, by inserting patching cords, to control the automatic switching units so that messages for any one or more destinations will automatically take the desired new routings.

One jack group is provided in the traffic routing board for each automatic switching unit in the switching center. In Figure 68 there are 12 such jack groups.

It will be remembered that the automatic switching facilities provide for switching to as many as 73 destinations. In each jack group in the traffic routing board, there are provided two jacks for each of these 73 destinations, one termed a "To" jack and the other a "From" jack. When a patch is made between a "From" jack of one destination and a "To" jack of another destination in one of the jack groups, the associated automatic switching unit will switch messages preceded by the selection characters for the "From" destination to the "To" destination. Messages preceded by the selection characters for the "To" destination are unaffected by the patch.

Each of the jack groups also contains six looping jack circuits, each comprising four jacks connected in multiple. These looping jack circuits are provided in order that patches may be made from two or more "From" jacks to the same "To" jack. This is accomplished by placing a patch from one jack in a looping jack circuit to a "To" jack, and then patching each desired "From" jack to one of the other looping jacks in the same circuit.

Separate patches have to be set up in each jack group to accomplish a complete reroute. In Figure 68 it will be noted that two reroutes have been set up in each of the twelve jack groups, and that the reroutes are the same for each jack group. Often, however, it is undesirable to reroute all messages for a destination to the same alternate destination since the line facilities to the alternate destination or leaving the alternate destination may be insufficient to carry the entire rerouted load. Therefore different patches may be set up in some of the jack groups so that the rerouted traffic will go to several

alternate destinations, from where it is switched on to the proper destination.

### Connection Indicator Board

When trouble develops in the circuits or equipment during intra-office transmission to a line sending position it may be necessary, in order to locate and clear the trouble, for the T&R personnel to determine the switching position and other equipments involved in the intra-office connection. Generally, the particular line finder receiving circuit or intra-office transmitter which has a connection to a line sending position can be ascertained by reading the office call letters contained in the preamble of the message that is being received. Infrequently, however, an intra-office connection is established to a line sending position and the received characters are mutilated beyond recognition or no characters at all are received. Under such circumstances, a T&R attendant may go to the Connection Indicator Board (Figure 69) and by depress-



Figure 69. Connection indicator board

ing one, or in some instances two, push buttons and observing which lamp flashes in a lamp panel, immediately determine which receiving circuit or intra-office transmitter is connected to that particular line sending position. Also, the connection indicator board, generally located near the



central supervisory position, can be used to determine the number of intra-office connections actually established to the line sending positions of a particular sending destination, and the number waiting for a connection to that sending destination at any particular moment. Thus it provides a means for analyzing the reasons for excessive waiting times and for determining the line circuit requirements to a sending destination.

In the upper sections of the board are mounted small neon lamps, termed "connected" lamps (associated designation card is black) and "waiting" lamps (associated designation card is white). A connected lamp is provided for each receiving circuit termination in the line finder, while both a connected and a waiting lamp are provided for each line finder receiving distributor, for each intra-office transmitter at push-button switching positions, and for each intra-office transmitter at automatic switching positions.

In the lower sections of the board are provided one push button and "close out" lamp for each sending destination having but one line sending position. The multi-channel sending destinations have one push button and close out lamp labeled for the destination, and to the right of this button there is located an additional push button and close out lamp for each line sending position assigned to that destination.

The close out lamps light when the intra-office circuits are closed out at their associated line sending positions. In the case of a multi-channel sending destination, the close out lamp over the destination push button lights only when all of the sending positions assigned to that destination are closed out.

When the push button for any single channel destination is depressed, the connected lamp for any intra-office transmitter, or for any line finder circuit and receiving distributor that has a connection into the line sending position for that destination will flash. Also, the waiting lamps for any intra-office transmitters and receiving distributors waiting for connections will flash. When the destination push button of a multi-channel destination is depressed, there may be as many con-

nected lamps flashing as there are line sending positions open at that moment. At the same time, the waiting lamps for all intra-office transmitters and receiving distributors waiting for a connection to that particular destination will flash.

If, on a multi-channel destination, it is desired to ascertain what is connected to a particular sending position, the push button for that sending position is depressed at the same time as the destination push button is depressed. Then only the connected lamp for the intra-office transmitter or the line finder circuit and receiving distributor that is connected to that particular position will flash. Also, the waiting lamps of the transmitters or distributors that share the same intra-office path as the connected equipment and are waiting for a connection to that destination will flash.

#### Receiving Leg Patching Board

It is desirable, and at times necessary, to change the termination of receiving legs. Since there are several control con-

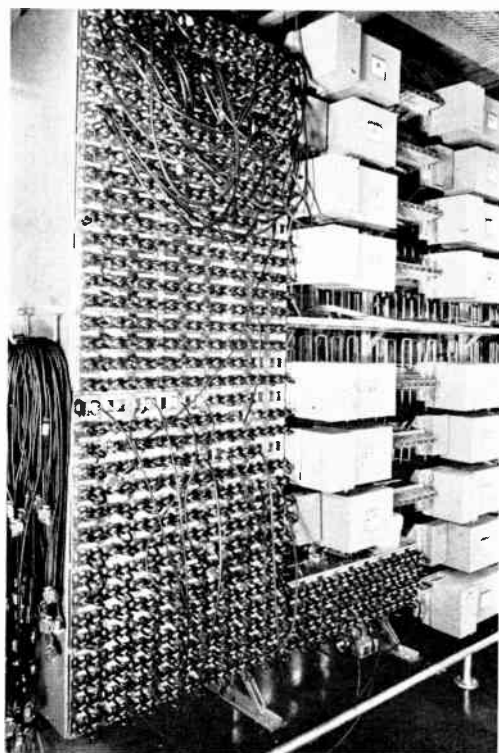

Figure 70. Receiving leg patching board

nections between each receiving termination and the sending position associated with it, these connections must be transferred along with the receiving leg when a change in termination is made. A Receiving Leg Patching Board (Figure 70) that is on a multi-conductor basis is provided for this purpose.

Each receiving leg, as well as the control connections to the sending position normally associated with it, is terminated on an 8-conductor socket. Immediately adjacent to each of these sockets is another 8-conductor socket to which is wired the connections from the receiving termination at which the receiving leg is normally terminated. The connections between the two are completed through a short patching cord equipped at each end with an 8-conductor plug.

Fallback positions and spare line finder terminations are wired to other 8-conductor sockets in the patching board. Thus, by the use of regular patching cords of greater length and, in some instances, specially wired patching cords, receiving legs and the necessary control connections may be readily cross patched to other than their normally assigned terminations.

## Conclusion

When this series of articles was begun in January 1948, reperforator switching was in operation at seven of the 15 important cities designated as area centers. Five were plug and jack centers, two were push-button centers. Now seven additional centers of the Plan 21 type have been placed in operation and one of the original installations, that at Oakland, has been converted to the newer Plan 21 type and doubled in size. Today, after more than a year of service, this nation-wide network of high-speed, mechanized telegraph centers, to which one more at Portland, Oregon, is to be added in November 1950, has fully demonstrated its worth.

The area switching plan, with its trunk circuit grid interconnecting all switching centers, provides both the terminal apparatus and the transmission facilities of a modern, coordinated telegraph plant for fast record communication. With completion of this switching network from border to border and from coast to coast, Western Union assures the nation of public telegraph service at a new high level of efficiency.

---

**THE AUTHORS:** Photograph and biography of Mr. W. B. Blanton appeared in the January 1948 REVIEW; those of Mr. G. G. Light appeared in the April 1949 issue.

