

C 621.38  
WS27

E. P. I.  
LIBRARY

**WESTERN  
UNION**

# *Technical Review*

**RECEIVED**

OCT 28 1948

LIBRARY R. P. I.

**Push-Button Switching  
for Patrons**

•

**Time and Date Transmitter**

•

**Pulse Modulation**

•

**Concentrated-Arc Boresighter**

•

**Filters for Radio Terminals**

•

**The Transistor**

**VOL. 2  
OCTOBER**

**NO. 4  
1948**

# WESTERN UNION TECHNICAL REVIEW

VOLUME 2 • Presenting Developments in Record Communications and Published Primarily for • OCTOBER  
NUMBER 4 Western Union's Supervisory, Maintenance and Engineering Personnel. 1948

## CONTENTS

	PAGE
A MODERN REPERFORATOR SWITCHING SYSTEM FOR PATRON TELEGRAPH SERVICE <i>R. F. Dirkes</i>	138
THE AUTOMATIC TIME AND DATE TRANSMITTER <i>W. S. W. Edgar, Jr.</i>	150
PULSE MODULATION: "THE DOTTED LINE SYSTEM" <i>F. B. Bramhall</i>	155
THE CONCENTRATED-ARC BORESIGHTER FOR FIGHTER PLANES <i>L. G. Pollard</i>	162
FILTERS FOR A 150 KILOCYCLE CARRIER SYSTEM <i>R. C. Taylor</i>	166
THE TRANSISTOR	175

Published Quarterly by

## THE WESTERN UNION TELEGRAPH COMPANY

### COMMITTEE ON TECHNICAL PUBLICATION

P. J. HOWE, Development and Research Dept., *Chairman*  
F. B. BRAMHALL . . . . . Development and Research Dept.  
I. S. COGGESHALL . . . . . Internat'l Communications Dept.  
W. H. FRANCIS . . . . . Plant and Engineering Dept.  
G. P. OSLIN . . . . . Public Relations Dept.  
S. N. PHILLIPS . . . . . Commercial Department  
M. J. REYNOLDS . . . . . Patent Department  
H. M. SAUNDERS . . . . . Traffic Department

NELL ORGAN, *Secretary*

Address all communications to the Committee on Technical Publication,  
THE WESTERN UNION TELEGRAPH Co., 60 Hudson St., New York 13, N. Y.

SUBSCRIPTIONS \$1.50 per year

PRINTED IN U.S.A.

(Copyright 1948 by The Western Union Telegraph Company)

## TO READERS OF THE TECHNICAL REVIEW:

With this issue, TECHNICAL REVIEW completes its first year of publication in its present form. The prime purpose of the REVIEW is to provide a better technical background for the Company's technicians and supervisors and, in fact, all employees so that they may have a fuller appreciation of their part in providing an improved Western Union service. Judged by the circulation increase during the year, as a result of employee requests for the REVIEW, the objective has been attained.

The need for a broader technical knowledge and skill on the part of the Company's operating personnel increases with the development of each new phase of the modernization program which has progressed very rapidly during 1948, and daily involves more employees.

Transmission facilities have been enlarged and improved by the installation of a nationwide network of carriers. Over 1,678,000 miles of carrier telegraph channels will be in operation at the end of 1948, as contrasted with 536,000 miles at the end of 1947. Major reperforator installations providing automatic selective switching on all messages originating in eight area centers will have been largely completed during 1948. A microwave radio relay system interconnecting New York, Washington, Pittsburgh and Philadelphia has been placed in operation. Telefax operations are currently being expanded; varioplex systems have been installed to provide telemeter service to additional cities; several additional patron leased switching systems have been provided to afford improved telegraph service to large users at low cost. In no

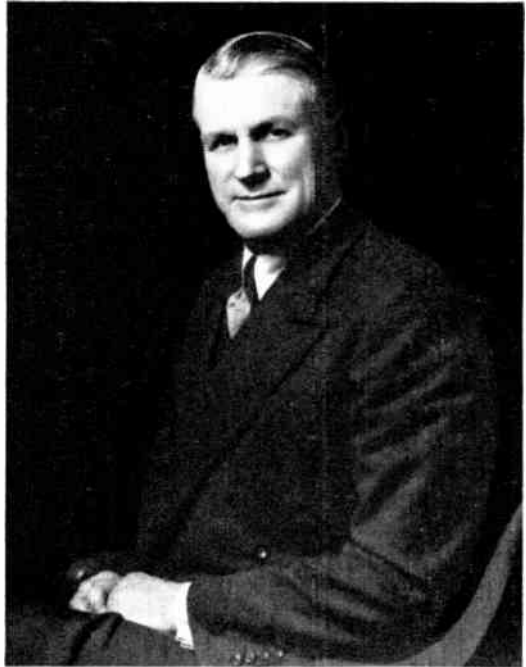

single year has Western Union made broader technical progress to modernize its operations.

Provision of the new systems, methods and apparatus, as reviewed above, will not, by itself, provide better service; to accomplish this objective, knowledge and skill of many employees are also required to operate and maintain the new equipment at peak efficiency.

So that employees may have a fuller comprehension of the technical aspects of this program, TECHNICAL REVIEW will continue to publish articles on all phases of Western Union operations with emphasis on new methods, systems and apparatus.

JOSEPH R. REDMAN

Vice President

Plant & Engineering

OCTOBER 1, 1948.

# A Modern Reperforator Switching System for Patron Telegraph Service

R. F. DIRKES

A paper presented before the Winter General Meeting of the American Institute of Electrical Engineers in Pittsburgh, Pa., January 1948.

## Introduction

The urge for greater economy, accuracy and speed of service in handling telegraph traffic has created a great deal of interest in the use of reperforator switching systems for relaying messages. Western Union is in the process of installing in many large cities reperforator switching arrangements which, in combination with an extensive wire carrier and radio beam telegraph system, will handle practically all of its telegraph traffic. Western Union also has designed and installed a number of successful private wire systems on the premises of its patrons for the handling of their intra-company traffic. The purpose of this paper is to describe the planning and principal features of Western Union's most modern Patron Switching System, which will efficiently handle the telegraph traffic of a typical large business organization.

## Planning

Important in the design and operation of a system is the size and correct location of the switching centers. Center locations may be partly dictated by the geographical structure of the organization to be served. On the other hand, circuit economies and handling savings may well indicate the need for a center in a city where the prospective patron has no office. Obviously, therefore, a most necessary function before deciding on switching center locations and their size, is the conducting of a complete traffic load study. To this end, the load is sampled over a period of three representative working days. A copy is kept of every message sent during this period from every city involved.

These messages are processed, broken down into numbers of words and finally incorporated into a chart called a criss-cross, a section of which is shown in Figure 1. This is a primary step in preparing the data in form for ready reference so that a circuit layout study from the standpoints of both efficient traffic handling and circuit economies can be made. Presuming this to have been done and size and location of switching centers determined, space layouts are next in the order of importance.

Not only should the layout be designed to provide efficient message switching, but also careful consideration should be given to the proper processing of the messages terminating in the switching center. Access to these messages for final delivery should be made as convenient as possible. Delivery to the center of messages to be sent should also be considered. Not to be overlooked are simplification of cable runs as well as equipment maintenance.

A floor plan of the space to be used is, of course, essential. This should include exact location of doors, lighting fixtures, windows, radiators and any other permanent fixtures in the space involved. It is usual practice to prepare an accurate floor plan on a scale of  $\frac{1}{2}$  inch to a foot. This floor plan is cross-hatched with a line every half inch. Models to the exact scale of  $\frac{1}{2}$  inch to the foot of all cabinets, printer consoles, tables, chairs, switchboards, rectifiers, etc., are placed on the floor layout in various combinations and arrangements, giving full consideration to the factors mentioned above.

Figure 2 shows a typical layout of a small switching center. Note that a table for processing messages is situated near the door so that the pick-up and delivery

CRISS-CROSS LOAD STUDY																
	ATLANTA	BALTIMORE	BOSTON	BUFFALO	CHICAGO	CLEVELAND	DALLAS	DENVER	DETROIT	ELKHART	FRESNO	GIBSON	HOUSTON	INDIANAPOLIS	KANSAS CITY	LOS ANGELES
ATLANTA	---	2,000	1,500	---	400	---	---	---	---	---	---	---	---	---	250	---
BALTIMORE	800	---	1,200	---	6,000	2,100	---	---	1,100	---	---	---	---	---	250	---
BOSTON	725	425	---	---	8,000	5,200	---	---	1,250	---	---	---	---	---	---	---
BUFFALO	---	---	840	---	42,000	---	---	---	17,300	9,300	---	2,460	---	2,300	---	---
CHICAGO	800	8,250	7,360	31,700	---	32,120	3,000	7,500	30,500	49,250	2,500	62,150	3,250	52,100	12,100	16,540
CLEVELAND	---	---	2,350	3,570	27,692	---	---	1,540	12,392	4,590	---	3,248	---	4,920	---	2,230
DALLAS	---	---	---	---	2,650	---	---	1,580	3,900	---	2,700	---	3,500	---	7,000	2,100
DENVER	---	---	---	---	7,000	740	1,850	---	---	---	2,200	---	---	---	---	4,200
DETROIT	---	---	1,500	17,000	32,000	15,000	4,000	---	---	21,000	---	18,500	3,100	1,750	4,300	---
ELKHART	---	---	---	13,500	44,000	6,125	---	---	19,500	---	---	23,000	---	2,100	---	---
FRESNO	---	---	---	---	3,250	---	3,200	3,100	---	---	---	---	---	---	---	6,850
GIBSON	---	---	---	4,500	57,690	7,230	---	---	21,360	18,600	---	---	---	---	---	---
HOUSTON	---	---	---	---	4,320	---	3,900	---	2,300	---	---	---	---	---	550	---
INDIANAPOLIS	---	---	---	1,800	46,800	4,500	---	---	7,400	2,300	---	---	---	---	---	---
KANSAS CITY	---	---	---	---	15,640	---	9,210	---	2,900	---	---	---	---	---	---	---
LOS ANGELES	---	---	---	---	18,920	2,100	3,900	5,240	---	---	5,240	---	---	---	---	---

Figure 1. Criss-cross load study

can be made without having messengers enter the operating areas. Local receiving and sending teleprinters are also situated near the delivery area. The maintenance table and control cabinet as well as switchboard and rectifiers are in an area remote from the ordinary operation. Clearances between cabinets and walls

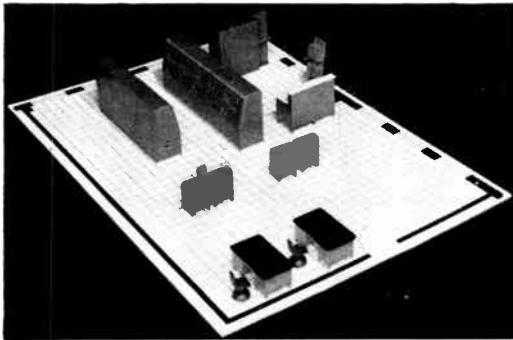

Figure 2. Typical layout of a small switching center

are adequate for the maintenance of equipment. The layout problem can be grasped easily because of the third dimensional character of the display. This method of layout study and display has been found to be especially valuable where discussions are carried on with personnel unfamiliar with the reading of blueprints.

### Operating Routine

In any message switching system, the importance of an efficient operating routine cannot be overstressed. The finest equipment may prove inefficient without strict adherence to a practical and properly designed operating routine. Obviously, operating routines will vary depending upon the type of traffic being handled, so no attempt will be made to describe a complete operating routine. Paramount in operating routines, how-

ever, is the rigid observance of a standard message form. Irrespective of the type of business involved, such a form will, generally speaking, follow a certain line or pattern. Therefore, a suggested form is here illustrated and will be referred to in

At the end of the message, after the proper spacing for tearing off (if such spacing is desired), note the addition of a switching control signal consisting of two carriage returns and two letter combinations. The function of this signal is to

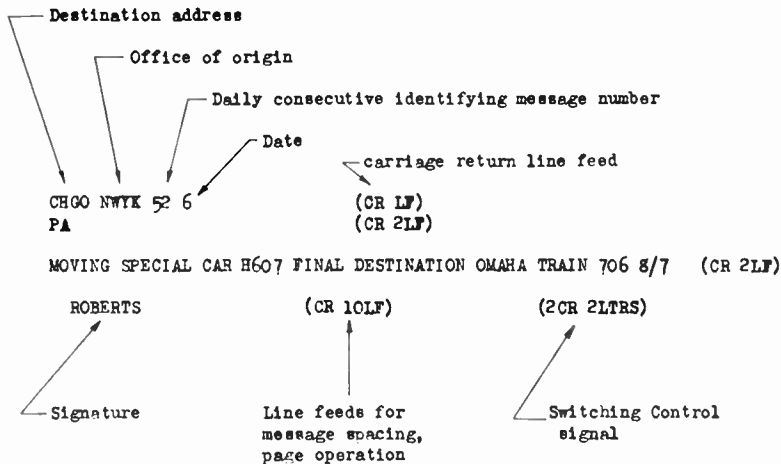

Figure 3. Typical standard form for on line or system message

further explanation of the operation of the switching center to be described. Figure 3 shows a typical form for "on line" or "system" messages. Particular attention is directed to the first line which reads CHGO NWYK 52 6. This indicates that the message is destined to Chicago, and has originated in New York as the 52nd message of the 6th day of the current month. No further information is needed to completely define this message in the event later reference to it is necessary. The second line indicates that the message is directed to the Passenger Agent in Chicago. This information is needed for final delivery but not for routing or switching.

denote the end of the message for automatic stopping features later to be described.

In a switching system messages are received on a printer-perforator. This machine prepares a perforated tape with printed characters on the upper edge of the tape directly above and in register with the perforated combinations. A copy of message NWYK 52 in the printer-perforator tape form is shown in Figure 4. The first intelligence characters appearing in the tape show the destination address. These are followed by characters which show the office of origin, the identifying message number and date. Attention is

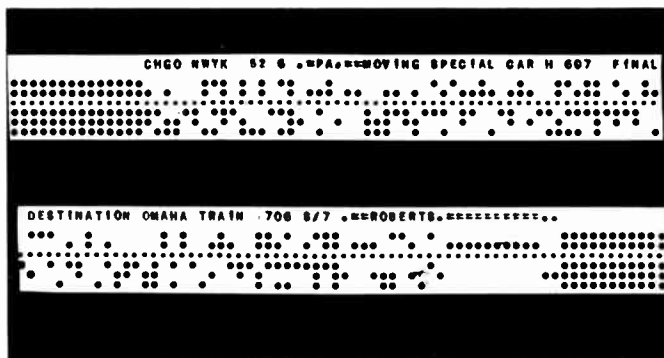

Figure 4. A message on printer-perforator tape

directed to the switching control signal at the end of the message.

Having in mind the general message make-up and its counterpart in the perforated tape, the operation of a switching center may now be studied.

### Plan 51 Center

Obviously, the result of preliminary study may have indicated an installation employing centers of two or three types,

circuit termination is made in a printer-perforator which prepares the tape and is controlled by electrical signals on the line. Each position also has a tape transmitter which can be associated with any of the sending circuits in the center through a push-button panel situated just above the tape transmitter. The tape flow from the printer-perforator through the tape transmitter is continuous. In ordinary operation the tape is not removed from the tape transmitter nor is any tearing of

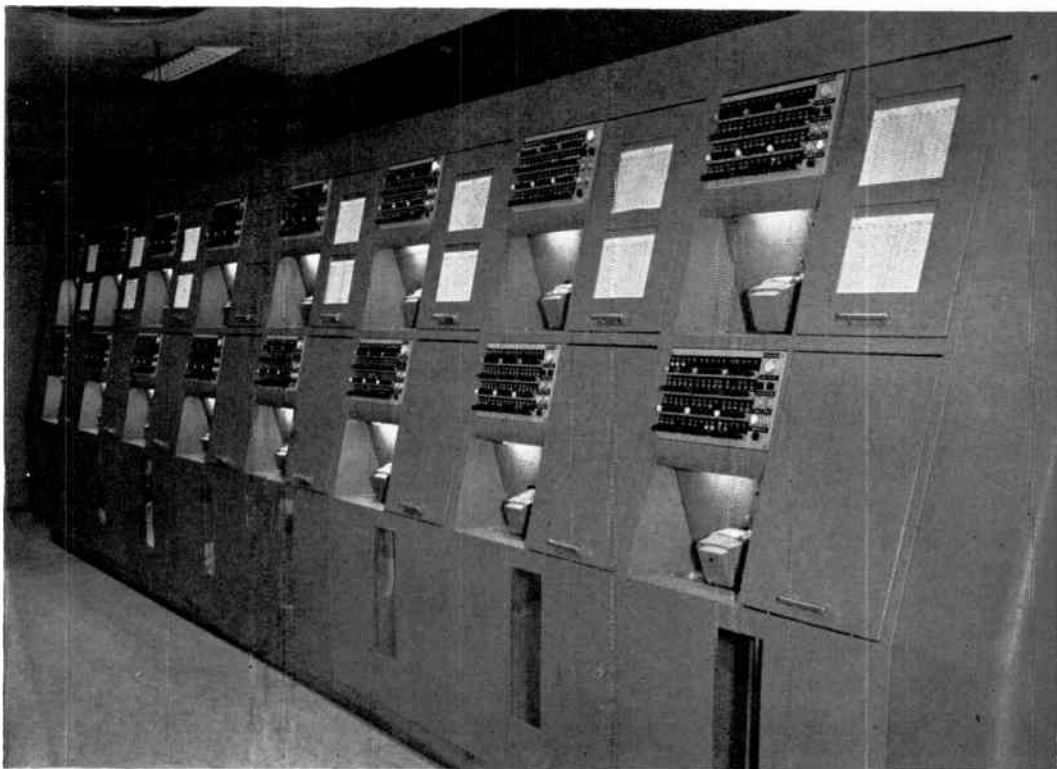

*Figure 5. Assembly of operating cabinets of Plan 51 unit*

operating together. Economies may have dictated even manual handling in some places. However, since a description of centers of all types would be impracticable, the operation of Western Union's most modern Patron Switching System, called Plan 51, has been selected for description in this paper.

Figure 5 shows an assembly of operating cabinets of a Plan 51 unit. Each operating cabinet consists of an upper and a lower position. In other words, two circuits are terminated in each cabinet. Each

the tape involved. Attention is directed to the two message number sheets on the upper door of each cabinet, the purpose of which will be explained later.

Figure 6 is a close-up of one of the operating positions with covers removed, showing the receiving printer-perforator at the right and its associated tape transmitter at the left, with the push-button panel just above the transmitter. To the left of the tape transmitter a chute is provided for the sent tape which flows into a storage bin in the table for ready access

in case of question. The usual tight tape stop equipment is provided, as well as tape accumulators which have been found desirable when lengthy messages are being relayed.

Figure 7 discloses a close-up of the switching panel. It will be noted that each station designation has a small lamp and a push button associated with it, and that a group of lamps and buttons are located

tape finds that the message is destined to Detroit. The button marked "Detroit" is pressed and the lamp is caused to glow above the pressed button. At this time the standby lamp is lighted and the message waiting lamp extinguished.

This indicates that a request for the Detroit circuit has been made. When noting the destination of the message the operator also noted that the message was re-

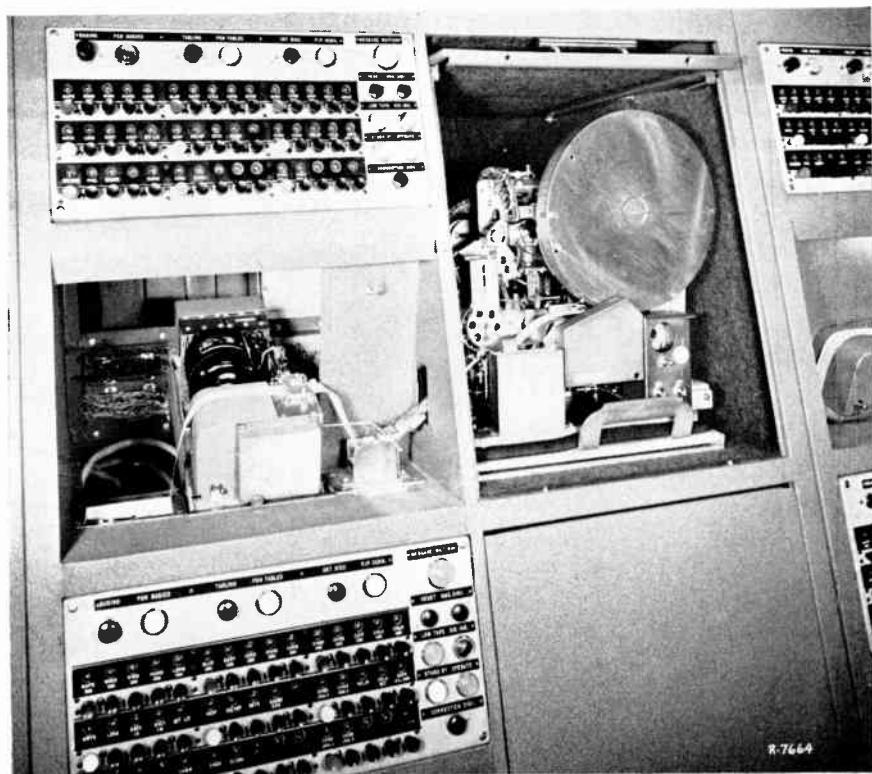

Figure 6. Operating position of Plan 51 unit

in a section to the right of the panel. Particular attention is directed to the lamps marked "Message Waiting", "Standby" and "Operate".

If, for example, this is the Indianapolis receiving position in the Chicago switching center and a message has been received and is in the tape transmitter awaiting switching, the message waiting lamp shown in the upper right-hand corner of the panel will be glowing, thus indicating to the operator the need of a switching operation at this turret. The operator reading the first four characters on the

ceived as, for example, message number 69 from Indianapolis. Each position is provided with a message number sheet with consecutive numbers in blocks of 100 printed thereon. The operator crosses off the number 69 on the associated Indianapolis sheet and in this manner concludes all manual work necessary in the switching of the message. As soon as the Detroit circuit becomes available, the standby lamp on the panel goes out and the operate lamp glows. This indicates that the Detroit circuit has now been seized and the message is being transmitted.



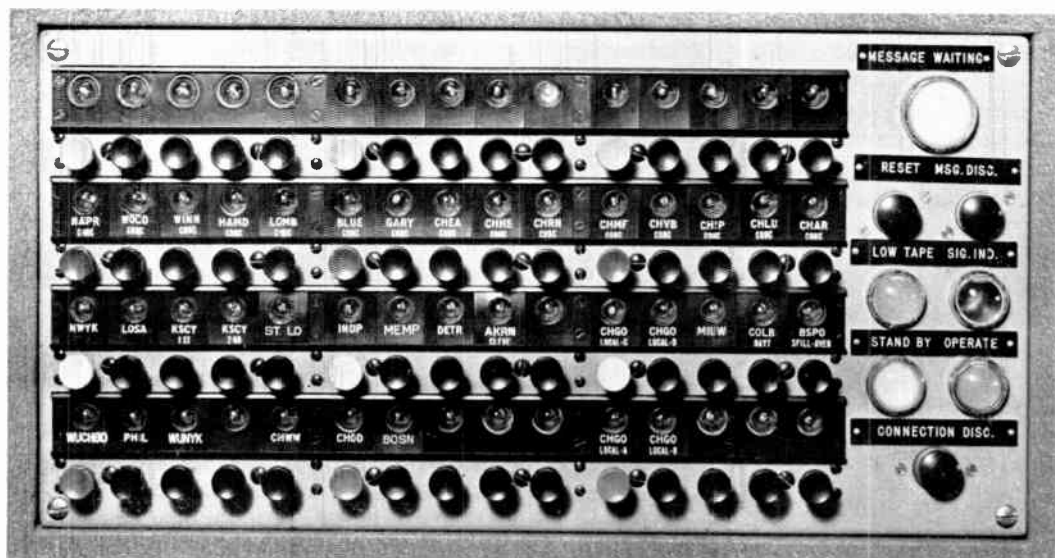

Figure 7. Switching panel

Associated with each circuit is an automatic message numbering machine, the function of which is to transmit to the line a group of letters identifying the center at which the switch is made and the station to which the message is being routed, as well as to apply a consecutive channel number prior to the transmission of such message. Simultaneous with the line seizure, a "diary teleprinter" is connected to the circuit. The function of this teleprinter is to copy the complete top or address line of every message transmitted through the office. Thus, now that

the Detroit circuit is seized, the diary teleprinter is connected to that circuit, and the numbering machine which is associated with the Detroit circuit transmits the switching center code letter, the station code letter, and the next consecutive message identifying number for this channel. As soon as this is done, the message body will be transmitted to Detroit. The diary teleprinter, having copied the transmission from the numbering machine and the first line of the message, which includes the destination, office of origin and origin identifying message

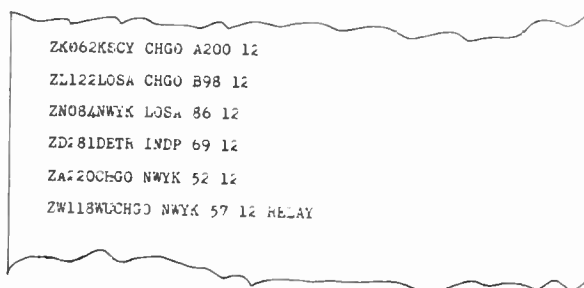

Figure 8. Diary printer record

number and the date, will be cut off and will then be ready for another connection upon receipt of another circuit request. In this manner, the diary teleprinter maintains a complete record of every message flowing through the office so that ready reference may be made thereto and any message quickly located when the necessity for doing so arises.

Figure 8 shows an example of a diary printer record of a group of messages switched from a center with the call letter Z (Chicago). The first line of the record tells that on the 12th day of the current month, a message originating in Chicago at the A position as message number 200 (A200) destined for Kansas City (KSCY) was sent there over the Kansas City circuit (ZK) as message 62 on that circuit (062). The fourth line of Figure 8 tells us that message 69 received from Indianapolis was sent to Detroit on the Detroit circuit (ZD) as message 281 (281).

In discussing the message form, attention was directed to a switching control signal of two carriage returns, two letters, with which every message or unit of work must be terminated in accordance with this routine. As these characters pass through the tape transmitter, the mechanism operates to break the connection to the circuit, thus extinguishing all lamps and restoring the circuit to a normal unoperated condition.

In the event that the operator presses the wrong button, and the operate light indicating actual circuit seizure has not yet glowed, the request for the circuit may be cancelled by pressing the message disconnect button (Figure 7), after which the proper circuit button may be pressed for correct routing. If, however, the operate light is glowing indicating the circuit has been seized, pressure of the message disconnect button will be ineffective and the message should be treated on a misroute basis.

In the event that another message follows the one which has just been switched, the message waiting lamp is again caused to glow as soon as the first letter of the destination address reaches the pins of the tape transmitter. The glowing of the message waiting lamp calls the operator's at-

tention to the fact that another switching operation at this position is called for. Suppose, however, that the message just switched has none immediately following it. It then becomes necessary to provide a loop of tape between the printer-perforator and the tape transmitter so that the entire message may be passed through the tape transmitter without delay. Because no messages follow, a tight tape condition will be experienced during the transmission of the body of the message. However, the message having been completed as far as reception is concerned, the letter combination of the message termination will be resting in the printer-perforator and idle tape will be automatically fed out of the printer-perforator.

This feedout is of measured length and is just long enough to allow the complete message to pass through the tape transmitter. In the event that the automatic feedout is in operation and the recording of another message is started, the automatic feedout becomes instantly inoperative at the reception of the first signal of the new message.

```
MX CGO B 185 16  
NYK BSN ATL LOS STL CGS  
STORE MANAGERS  
ADVISE STOCK OF AUTO TIRES 6.50X16 ALL GRADES.TUBES  
ALL GRADES AND SIZES. SPARK PLUGS STANDARD BRANDS.  
  
SUPT STORES CGJ..
```

Figure 9. Typical multiple address message

In some types of business it is the practice to send identical advices to a number of destinations, which requires the sending of the same message to several addresses. Where this type of traffic is heavy it becomes advisable to incorporate a master sending position in the switching center. Suppose the message shown in Figure 9 is received. The operator, noting this to be a multiple address message by reason of the letters MX on the first line of the address and the multiple station calls on the second line, presses the button connected to the master sending position where the message is received on a printer-perforator. Associated with this position is a special master switching

panel (Figure 10). As soon as the intelligence in the tape engages the pins of the tape transmitter the message waiting lamp is lighted. If switching is not started in twenty seconds the message waiting light flashes, indicating operator laxity. The master send operator, reading the many destinations of the message, sets up the pattern by pressing the buttons involved. At each selection of a button the lamp above the button glows, steadily if the circuit is idle and flashing if the circuit is busy. If a circuit is closed out (not in

of all other circuits has been made, a buzzer sounds to call attention to the offending circuit so that supervisory action can be taken.

A master sending monitor teleprinter is provided and is arranged to record:

- (a) Calls of stations to which the multiple address message is sent.
- (b) Circuit message numbers under which the master message was transmitted.
- (c) The complete message.

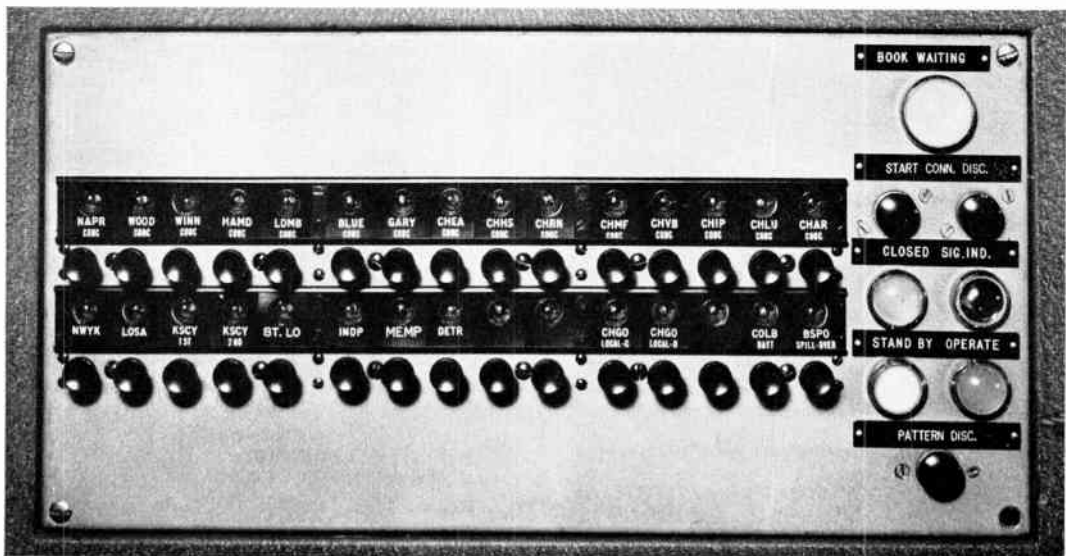

Figure 10. Master switching panel

operation) a buzzer will sound when the associated button is pressed and the lamp will not glow. in which case a "storage position" button is pressed and the message stored for resending to the closed station later.

After the pattern is set up and checked, a start button situated at the right of the panel is pressed, initiating actual collection of and sending to the circuits involved. As a circuit is seized the next message channel number is sent and the circuit held, until all circuits in the pattern have been seized and channel numbers sent, after which the body of the message is transmitted to all stations involved. In the event one circuit is busy for more than twenty seconds after complete selection

Figure 11 is a copy of the master message previously shown as it appears

```
ZAT 061
ZBW 223
ZL 185
ZN 668
ZSL 103
ZCS 337
MX CGO B 185 16
NYK BSN ATL LOS STL CGS
STORE MANAGERS
ADVISE STOCK OF AUTO TIRLS 6.50X16 ALL GRADES. TUBES
ALL GRADES AND SIZES. SPARK PLUGS STANDARD BRANDS.
SUPT STORES CGO..
```

Figure 11. Multiple address message after transmission

on the master sending monitor teleprinter after transmission. Thus a complete check of correct routing can be made by the supervisor.

At the end of the operating aisle is a cabinet quite dissimilar from those just examined. This cabinet, Figure 12, is a supervisory unit and is equipped with a



Figure 12. Supervisory unit

keyboard perforator for sending supervisory notes. Directly above the keyboard perforator are a number of switches and lights. These switches are associated with the circuits operating into and out of the center, each switch and light representing one station. With the switches turned to the normal position, and the circuits operating normally, no lamps will be lighted. Suppose that some of the offices connected to the center are closed while others remain open. In this case, the supervisor or operator must be sure that no messages will be sent to these offices after closing time. This is done by turning the panel switch, associated with the office to be closed, to the right. This causes the associated lamp to glow and also prevents the possibility of connection to that particular circuit from any of the switching panels. Should an operator, under these conditions, have a message for a closed out

office, she presses a button marked "Spill-over" which will connect the transmitter to a printer-perforator in the switching center. The message will be received on this printer-perforator and stored in a tape tank until the time of opening of the office involved. In the event that the operator attempts to switch to a closed office, no connection will be made to the circuit. Upon pressure of the button associated with this office, the standby lamp instead of glowing steadily will flash, indicating abnormal condition.

Messages submitted to the center for transmission over the system are prepared for switching from a standard teleprinter keyboard. This teleprinter is connected to a receiving printer-perforator in the center, the tape from which is switched in exactly the same manner as the tape from any other receiving printer-perforator in the system.

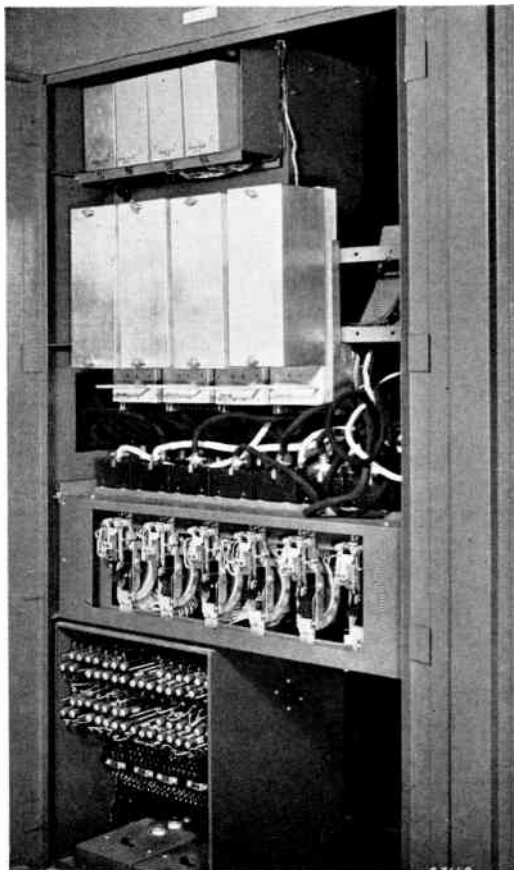

Figure 13. Rear of cabinet

Messages addressed for delivery from the switching center are switched to a local receiving teleprinter in the center, which types the message in exactly the same manner as at any distant station connected to the system.

Messages received for "off line" delivery are switched to the Western Union Telegraph Office in the same manner as any other switch.

The circuit arrangements are such that if a circuit goes open or grounded during

the transmission of a message, the tape transmitter will immediately stop and the operate lamp will flash intermittently, thereby indicating the need for investigation of an abnormal line condition.

Plan 51 apparatus is designed on a clip-connection basis so that all apparatus including switching panels, printer-perforators, tape transmitters, relay banks, etc., can be readily removed and substitutions made.

Ease of addition or removal of oper-

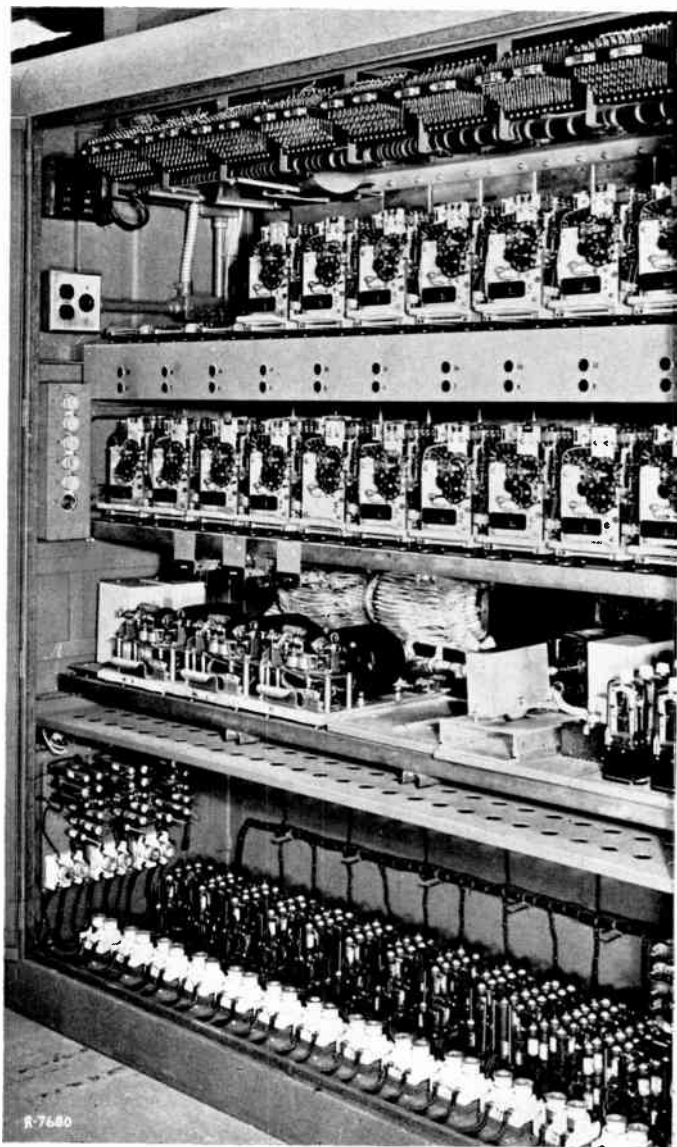
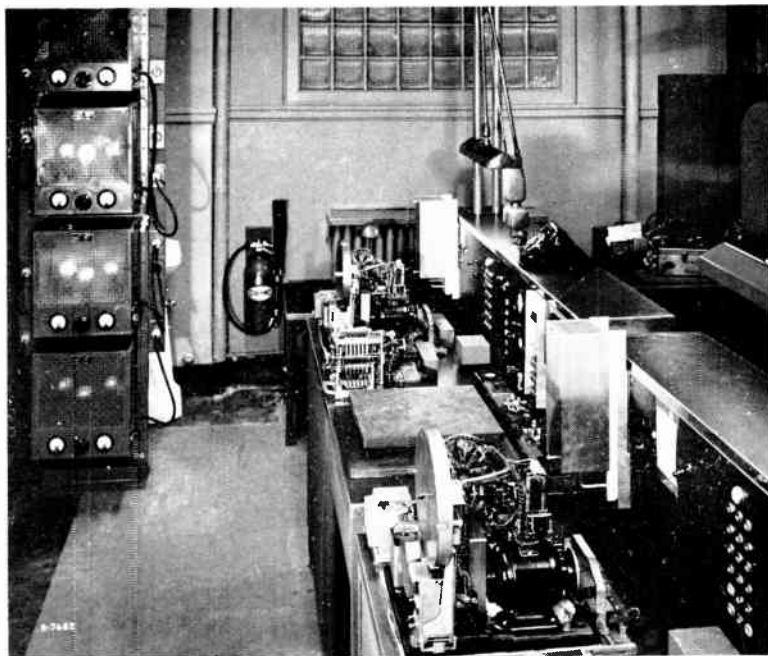

Figure 14. Central control cabinet

ating positions is also an important factor, and to this end the design is carried to the point where, by means of corded plugs, cabinets can be removed or added readily. Figure 13 reveals the rear of one of these cabinets with the cords and plugs in place. It also shows rotary switches and relay banks which are employed in connecting the associated distributor-

Complete testing equipment is provided with each Plan 51 Center and is shown in Figure 15. Facilities for testing relay banks, printer-perforators, distributor-transmitters and numbering machines as well as teleprinters are available. Figure 15 also shows the rectifier equipment provided for furnishing the direct current for the unit.



*Figure 15. Testing equipment provided with each center, and rectifier unit*

transmitters to the selected circuits, and in the control of such functions as stopping the distributor-transmitter at the end of a message and automatic tape feeding of the printer-perforator.

A central control cabinet which is the heart of the installation is shown in Figure 14. Here on the two top shelves are several automatic message numbering machines, one for each station served by the message switching center. Below are distributors, and to the right an allotter switch. These instruments play a part in the pick-up and seizure of the circuits through the push-button panels, as well as the transmission of consecutive numbers and the operation of the diary teleprinter.

#### **Automatic Numbering Machine**

In discussing the operation of the switching centers, reference has been made to an automatic numbering machine which is primarily employed in sending automatic consecutive channel numbers upon seizure of a transmitting circuit. Inasmuch as this unit is rather novel in its operation and construction, it may be of interest to discuss it briefly. Figure 16 is a photograph of a three-digit automatic numbering machine. This machine employs four rotating drums on which contact operating studs are placed. The primary or transmitting drum has ten positions and is so arranged that the signal combinations from this element may be varied by rearrangement of the studs.

The other three drums all have combinations of studs representing the numbers zero to nine. A normal set-up of the studs on the transmitting drum might be letters,

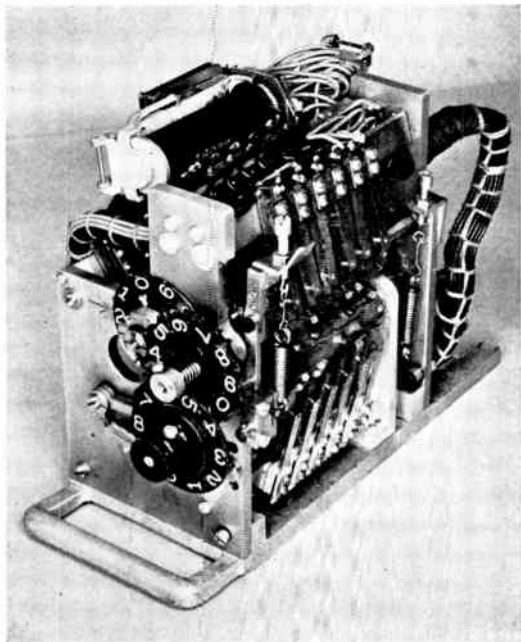

Figure 15. Three-digit automatic numbering machine

letters, letters, Z, B, figures, digit, digit, digit, letters. The Z representing the switching center call letter and the B representing the station to which the message is being sent, and the number (digit, digit, digit) representing the consecutive channel identifying number. In many cases, the numbering machine is employed for automatically selecting stations on way circuits in addition to sending the message numbers. If a way circuit is connected to a switching center and has, let us say, three stations on it, the line will be equipped with three numbering machines, one for each station. As the required numbering machine is activated, it transmits, preceding the station letters (ZB above) and in place of the three letter combinations, the selector signal for the station involved. With this arrangement, the operator need not know that she is switching to a way station, as the operation of the selecting function is entirely automatic.

Other equipment used in this method of switching is more or less standard, or at least follows accepted design, so no further description will be made of the units employed.

**THE AUTHOR:** R. F. Dirkes, who is now Director of Operations reporting to the Vice President in Charge of Plant and Engineering, graduated from the Stevens Institute of Technology in 1920, and joined the staff of the Automatics Engineer shortly thereafter; in 1941 he became Assistant Automatics Engineer. He developed, or directed the development of such now standard pieces of apparatus as the storing transmitter, high-speed ticker, printer-perforator, automatic numbering machine, aircraft printer and silent transmitter. He also supervised or assisted in the installation of reperforator switching systems in both Western Union and patrons' offices. During the war his activities included work on the speeding up of Army Communication circuits, and the application of multiplex to Navy radio circuits, and on the design of an automatic film selector for the Signal Corps. Mr. Dirkes was Patron System Engineer from 1945 to May 1948, and it was under his direct supervision that the modern patron's push-button switching system attained its present efficiency.



# The Automatic Time and Date Transmitter

W. S. W. EDGAR, Jr.

Many of the telegrams handled by Western Union are delivered to the addressee over tie-lines which extend from the local central office to the offices of the larger users of telegraph service. The usual tie-line connects at the patron's office to a teleprinter, and in the manual central office to a concentrator. It has long been the practice for the operator, after she has sent a message to a tie-line, to terminate it with the time and date. The patron thus has a record, on his received copy, of the time of receipt of his message. In the manual offices this is easily done, for the operator, following transmission of the signature, has only to look at a clock and send the few characters that indicate the time and date.

The tie-lines provided from automatic reperforator switching system offices are the same as those from manual offices. However, their operation is not the same as at the manual offices, and in normal handling the operator does not type any part of the message she is sending to the tie-line. At each tie-line switching position, the messages are received on printer-perforators in the form of a tape. The tape has the message both typed on it so it may be read, and punched in it, in the teleprinter code, so it may be re-transmitted. When the two-period end-of-message signal is received at the end of each message, the operator detaches the tape from the printer-perforator. After reading the name of the addressee and editing the message, she inserts the tape into one of several distributor-transmitters available to her. The distributor-transmitters have associated cord circuits terminating in plugs, which may be inserted into any of the jacks in a turret, each jack connecting to a different tie-line. The operator sets up a plug and jack connection between the distributor-transmitter and the proper tie-line, and

transmission of the message then proceeds automatically. The end-of-message signal stops the distributor-transmitter, and she need not give it or the cord circuit further attention, except to pull down the connection after noting that receipt of the message has been acknowledged on a monitor printer associated with the cord circuit.

This routine does not lend itself to the manual transmission of time and date, which would require the operator to watch each transmitter until the end-of-message signal is sent, and then to send time and date promptly, from her keyboard, before the receiving operator removes the message from the tie-line printer. To do this would greatly reduce the number of messages per hour that

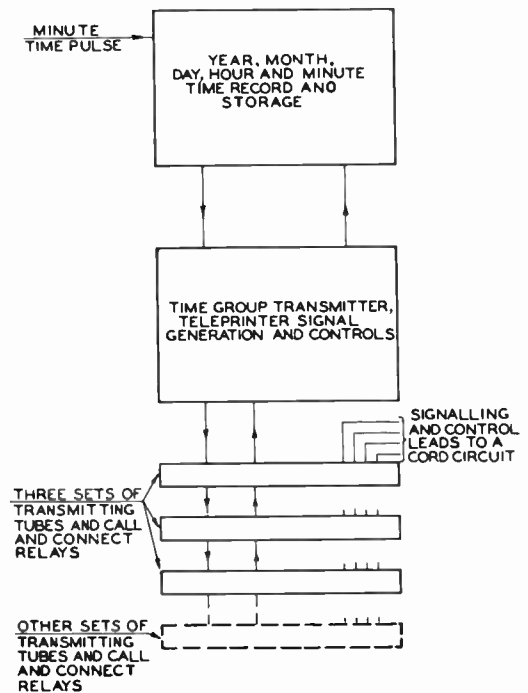

Figure 1. General arrangement of time and date transmitter



could be handled from the tie-line switching position.

In order that the time and date may be readily transmitted with each message, a time and date transmitter has been developed, which performs this function automatically in conjunction with the circuits of the tie-line table. The device is arranged so that it will transmit a time group in the teleprinter code, consisting of twenty-four characters and functions such as ( 1235 PM OCT 15 48 ) = to any cord circuit or other facility calling for it, and will then signal back that it has done so.

Figure 1 is a representation of the general arrangement of the time and date transmitter. The circuits which set up the time and date and generate the teleprinter signals are indicated in Figure 2.

The reception of each minute pulse causes the minutes units switch to advance one step. Having reached the position that sets up the digit 9, this switch provides a stepping connection to the minutes tens switch. The next time pulse then advances both the minutes units switch and the minutes tens switch. The stored record of time is thus changed from 9, 19, 29, etc., minutes past the hour to 10, 20, 30, etc., minutes, respectively, past the hour. Successive minute pulses continue to advance these two switches in a similar manner until the minute time 59 has been set up. The two switches together then provide a stepping connection so that the next minute pulse will advance both of these switches and the hour switch. Thus the time is changed from 59 minutes past the hour the next hour

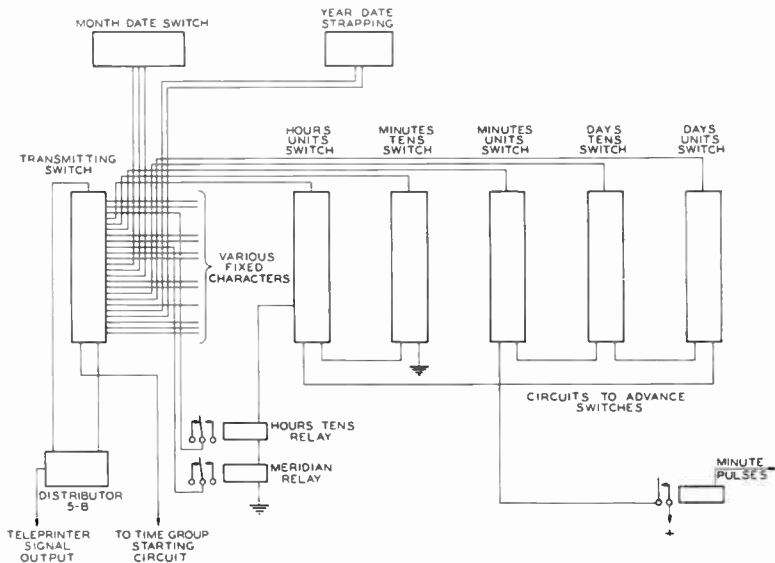

Figure 2. Circuit for setting up time and date

To place the transmitter in operation initially, a manual switch, five rotary switches, and several relays are positioned to set up the correct time and date. Thereafter, the proper rotary switches and relays are caused to move once each minute by a pulse obtained from the Western Union time service. Thus, automatically, the minute and hour time, and the day date, are advanced regularly, so that the current time and date are always set up.

designation, as for example, from 12:59 AM to 1:00 AM. The hour switch and two relays provide the complete hour and meridian storage. Twenty-four stud groups of the switch itself provide a record of the hours units time. One level of the switch either operates or releases relays that control the hours tens time and the meridian indication A or P. The control of the days units date and days tens date switches is handled in the same manner as

that just described for the other three switches.

At midnight on the last day of each month, an alarm is sounded warning that the month and day date must be reset manually, which is done by moving a twelve-position switch to change the month date, and by operating a day-date reset switch. The day date then changes to 1, from any of those dates possible at the end of the month. At the end of the year, the year date is advanced by changing fabricated straps which are marked to indicate the digits they represent.

parenthesis signs, the figure shifts, letter shifts, word spaces, and the equal sign to appear in each time group as it is transmitted. The transmitting switch is caused to step only when a cord circuit or other facility calls for the transmission of a time group. Circuits are provided so that a minute time pulse occurring while this switch is in motion will be held until the transmitting switch returns to its home position. Thus the time indication will not be shifted during the transmission of a time group.

Figure 3 indicates the circuits that

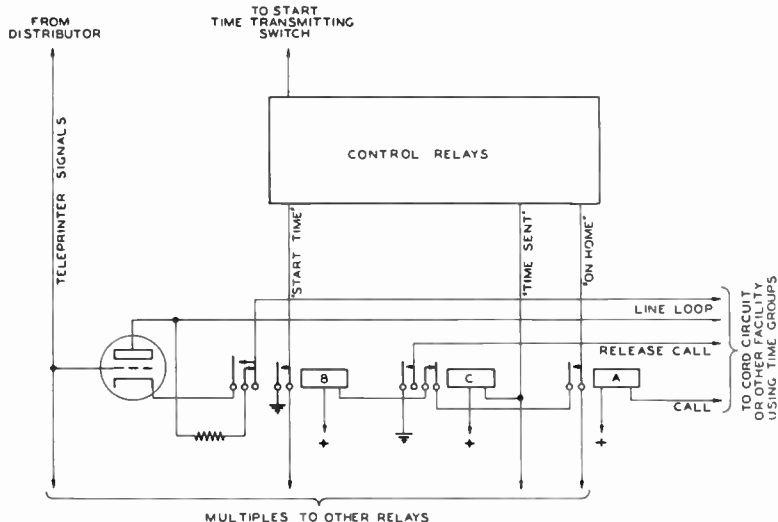

Figure 3. Circuit for sending time and date

A rotary switch is used to transmit the twenty-four characters of the time group referred to above. This rotary switch is stepped over its twenty-five studs by a distributor whenever a time group is sent. The distributor carries the necessary segments to generate teleprinter signals; the particular character to be sent is determined by the position of the transmitting rotary switch and its connections to the various rotary switches and relays on which the time and date are stored. Connections are made from each of the sources of year, month, day, hour and minute time storage to the transmitting switch. In addition, certain stud groups of the transmitting switch are strapped to cause such functions as the

cause the transmitting switch to step and send a time group when the relays that are associated with each cord circuit operate. Each cord circuit or other facility that may call for a time group has a set of three call and connect relays, and a vacuum tube, at the time and date transmitter. These sets of three relays and a vacuum tube are connected by four multiples to several control relays. One of these multiples, when ground appears on it, shows that the transmitting switch is on its home position and that no time group is being sent. The second, when ground is applied to it, will start the transmission of a time group. The appearance of ground on the third indicates that the time group has been transmitted. The

fourth multiple carries the teleprinter signals which compose the time group. Relay A is operated when an associated circuit calls for a time group to be transmitted to it. If the time group transmitting switch is standing at home there will be ground on the "On Home" multiple. Relay B will then be operated and the vacuum tube will be inserted into the signaling loop. The operation of Relay B applies ground to the "Start Time" multiple and the control relays will operate to cause the transmitting switch to step. The distributor then generates teleprinter signals, each character being determined by the position of the transmitting switch. These signals are applied to the grid of the vacuum tube, thus sending the time group to the cord circuit loop. At the conclusion of the time group, Relay C is operated by the "Time Sent" multiple, causing Relay B to release and remove the vacuum tube from the cord circuit loop. The operation of Relay C also supplies ground to the relays associated with the cord circuit as an indication that the time group has been transmitted and prevents further time group transmissions to this particular cord circuit until Relay A has been released and re-operated.

When a time group is called for, by one cord circuit, while transmission of a time group to another cord circuit is in progress, the control relays cause the second call to be held until the first time group transmission is complete. A second transmission will then be made to the waiting circuit. Time groups may be transmitted to any number of circuits at one time. Two calling conditions may bring this about. Several circuits may call for time simultaneously, following which they will all receive the time groups together; or several may call for time while a time group transmission is in progress, which will result in their being held for a second transmission. Approximately four seconds are required to transmit the time group. The maximum delay that may occur before the start of transmission of a time group to any circuit calling for time is then four seconds. The average delay will be less than two seconds by an amount

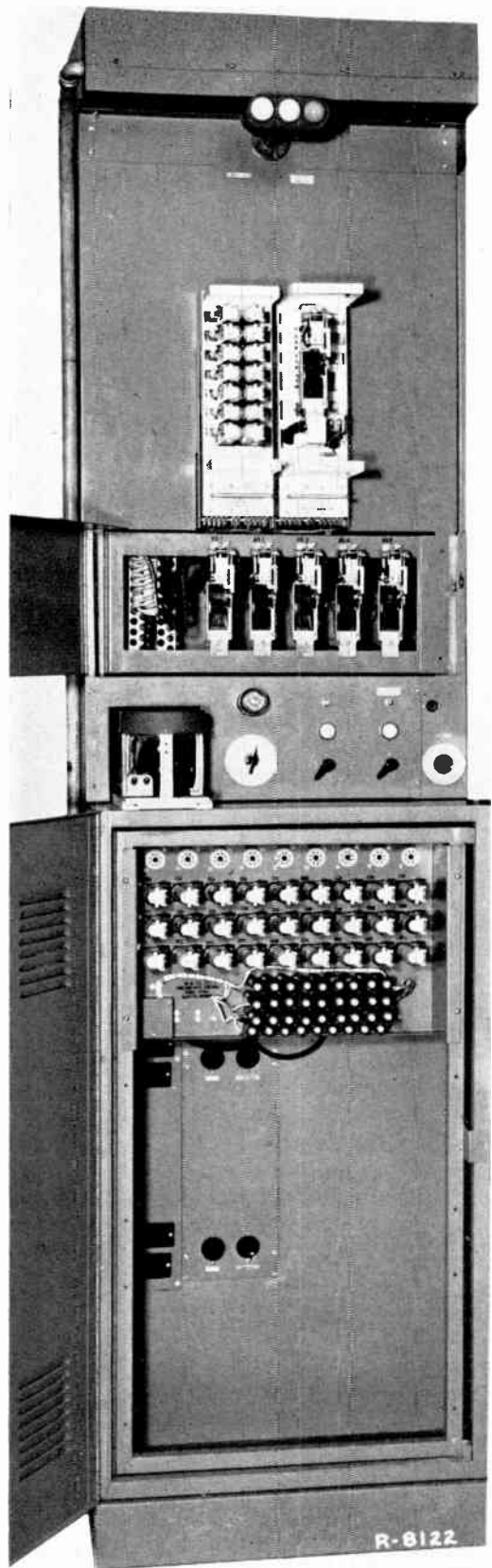

Figure 4. Time and date transmitter

depending upon the frequency and distribution of the calls.

The use of vacuum tube transmission and the arrangement of the circuits make possible the addition of sufficient sets of vacuum tubes and call and connect relays to enable a single time and date transmitter to serve an entire office.

When maintenance work is to be done on the time and date transmitter, or if trouble has occurred, the cord circuits would be tied up by calls for time groups that could not be answered. A disconnect switch is therefore provided which, when operated, causes ground to be applied to the "release call" lead to the cord circuit position as soon as ground appears on the calling lead. The cord circuits thus continue in operation without time groups being transmitted.

A test position is provided at the rack so that the time and date transmission may be checked by plugging a teleprinter to a test jack and pressing a button that causes a time group to be sent.

Figure 4 shows the time and date transmitter. The relay bank on the upper panel contains the controlling relays. The adjacent rotary switch bank is used to transmit the time group in conjunction with the distributor located at the left side of the shelf. Below these banks are the five switches which set up the hour, minute,

meridian and day date. The switch which sets up the month date, and the day-date reset and disconnect switches are located to the right of the distributor. Nine sets of call and connect relays, and the sockets for the vacuum tubes associated with them are mounted in a removable panel in the lower part of the rack. Two more of these panels may be mounted in the front compartment and three in a similar compartment at the back of the rack. The rack has, therefore, sufficient capacity to handle 54 cord circuits. When more facilities are required, auxiliary racks, that mount only panels of call and connect relays, are provided.

The above description centers on the use of the time and date transmitter for tie-line customers. However, the mechanization program has made important use of the apparatus for transmission of time and date information to many branch and tributary offices. In addition, a number of time and date transmitters will be incorporated in one of the important patron's systems that is now being installed. Further expansion in the use of the system will result from arrangements now being made whereby certain tributary offices will receive time and date from the nearest central office, so that the tributary office may in turn supply the information to branches with which it works.



**THE AUTHOR:** W. S. W. Edgar, Jr., of the Automatics Research Division, joined Western Union in 1929 shortly after his graduation from Rensselaer Polytechnic Institute, from which Institute he also received the degree of M.E.E. in 1934. His first assignment with Western Union was in the development of ocean cable terminal equipment; since 1936 he has done development work on varioplex, multiplex, and other automatic printing telegraph equipment. During the war, Mr. Edgar directed the installation, and assisted in the initial operation of various telegraph systems in Alaska, England and Hawaii. He is an associate member of the AIEE and an associate of Sigma XI.

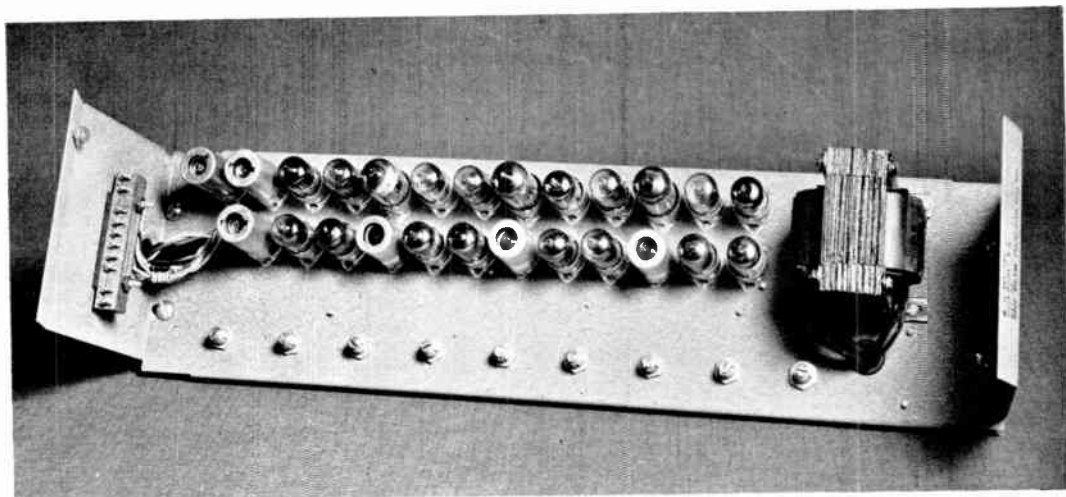

*Western Union pulse modulation equipment is compact*

## Pulse Modulation: "The Dotted Line System"

F. B. BRAMHALL

### The Multiplex Concept

To the telegraph engineer of the old school, the term "Multiplex" conveys a concept of that automatic printing telegraph system wherein letter elements of two or more printer channels are sent over a common transmission circuit in timed sequence. This thought can be expressed in another way by saying that one pair of operators (sending and receiving) use an assigned telegraph circuit to send one letter, then the machinery turns the circuit over to another pair of operators who send one letter of their message, and so on. Two, three, four, or more printer transmissions may share that same circuit. That is not exactly the kind of time division multiplexing I want to discuss here although the analogies will become quite obvious. Rather, I want to draw for you a mental picture of a multiplex system of broader concept, a system capable of sending, not a multiplicity of coded telegraph signals, but a multiplicity of complex, heterogeneous communication currents over a single transmission circuit. Such complex currents may, as we

all know, be conveying speech, voice-frequency telegraph transmissions, printed facsimile copy, pictures, or what not. So many new techniques for multiplying the message capacity of modern-day, wide-band radio channels are being developed, discussed and invented of late that those of us not intimately associated with such work may be at a loss even for simple working definitions of some of the terms now heard.

Take "pulse modulation", for example, —the system of transmission which during the war grew out of the pulsing techniques of radar and television. In an elementary way at least, I shall show that a fundamental concept of pulse modulation can be made childishly simple by comparing it to the multiplex. The more complicated terms such as pulse time modulation, pulse amplitude modulation, pulse code modulation, and all the like can at least be comprehended in the light of the multiplex concept. Because of the possibility that many of us will have to know a lot more about this subject some day, it becomes desirable to base our original ideas on a simple mental picture.

First, let us redefine "Multiplex" as "a method of, or a device for, transmitting multiple communication channels over a single transmission medium". Perhaps that will do. It's in pretty general terms. As a matter of fact, all at once we have brought all manner of carrier systems under the heading of "Multiplex". Now we'll need to differentiate between those multiplex systems which make multiple communications possible by virtue of frequency discrimination, and those which employ time displacement for the separation of channels. So we'll call the carrier systems "Frequency Division Multiplex". This is now fairly well-accepted terminology. The 3-kc bands derived by frequency division multiplex systems (carrier), we all know, are capable of handling complex waves. On them we indiscriminately operate all the commonly-known kinds of communication circuits including facsimile and groups of voice-frequency telegraph channels. We want to evolve a "Time Division Multiplex" capable of handling the same kind of a complex wave. The complexity of the complex wave we're going to worry about is limited only by the requirements, fairly common in communication transmission, that it contain no frequencies in excess of about 3300 cycles, and none below 200 or 300 cycles. This wave could be defined differently by saying that at any particular instant it has no idea of where it's going except that it can't go through one up and down gyration in a shorter time than about  $1/3300$  of a second, and that it can't stay on one side of the zero line for longer than about  $1/500$  of a second. Generally speaking, it's pretty difficult to tell by looking at a complex wave that is carrying some kind of intelligence, whether that intelligence is in the form of speech or a mess of voice-frequency carrier channels which are carrying teleprinter coded pulses either by *AM* or *FM*. Let's draw a couple of typical complex waves. This one is an actual action pho-

tograph of 16 teleprinter messages going by on *FM* carriers, spaced 150 cycles apart to fill a 3-kc voice band. It represents the part that went by in  $1/100$  of a second.

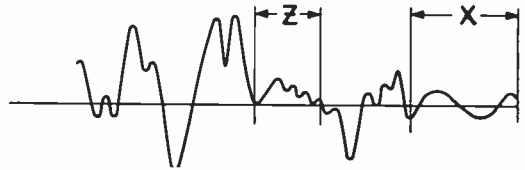

This one represents the voice of a not-so-famous baritone saying the vowel "ahh" as in "bother". This is also a high-speed snapshot of the part that went by in  $1/100$  of a second. Any small increment of the composite carrier telegraph wave can be enlarged with a microscope so that we can see more detail. When it's enlarged, by four to one, the spot marked "X" looks like this:

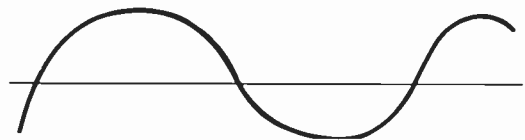

### The Dashed Line System

Now, might we not admit that we don't need to draw that wave as a solid line to convey an entirely adequate idea of its shape? Sure! And, by the same token, it may be needlessly wasteful to send it all over a communication circuit in order to convey all its useful information to the receiving terminal. It will tell us just as good a story if only half of it is drawn or transmitted, and we let anybody's imagination fill in the gaps.



All right, but why? Well, just this. In the time when we are not sending this wave, we could be sending another which represents another piece of information, or maybe another group of telegraph channels. But let's say the second wave we're going to send is the "Y" part of



the first complex wave we drew in the first place, and we'll enlarge that part by four to one.

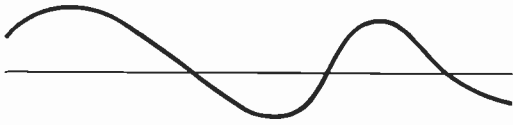

Again, we would be just as happy to have only half of this wave.



So, what do we do? We send them both over the same circuit by a process which is so simple it's beautiful. We just switch back and forth from the *X* wave to the *Y* wave, one-half the time sending a small sample of the former, and the other half sending a small sample of the latter.



The instrumentality for accomplishing this thing isn't too complicated. At the sending end, we need only a high-speed switching device; and vacuum tubes or varistors are known to be excellent high-speed switching devices. At the receiving end, we need such switches too, and suitable means for insuring that the sending-end switches and the receiving-end switches operate simultaneously. Simultaneously isn't quite the rigorous way of saying it, because we know that whatever the transmission medium, a certain propagation time is involved. Perhaps we had better say that the switch operation at the receiving end should lag the operation at the sending end by a time interval which is the time required for the signal to go from one end of the circuit to the other.

Let's consider a moment what we've got on one of the two bands so derived. How's the ear going to like this dashed-

line business, and how many dashes must we give it per unit of speech current? Perhaps the more pertinent question to the telegraph engineer is, How are the *VF* telegraph channels going to operate from the dashed wave? Both questions can be satisfied with the same answer, since in general whatever pleases the ear will keep a group of telegraph channels happy, too. One thing can be certain: the ear will hear very prominently a frequency determined by the rate of the "dashing". Something can be done about that easily, if the "dashing" rate is made just a little higher than the highest frequency which we think it necessary for the ear to hear.

Let's assume some numbers, and consider this "dashing" rate business a moment. The particular part of the complex wave on Channel No. 1 at the instant at which we chose to magnify it may have frequencies ranging from 500 to 1000 cycles. Our dashing, or switching, or sampling, or what do you want to call it, rate seems to be plenty fast enough to let the 500 or even the 1000-cycle signal frequency wave be pretty accurately depicted. The rate has, with some knowledge of previous experience, we'll admit, been chosen to give 8000 samples per second. That means we have eight measurements of the amplitude at each of eight equally-spaced time intervals to let the ear or the telegraph equipment reconstruct every cycle of the 1000-cycle wave.

Now with the 8000-cycle sampling rate tentatively determined, let us look at a piece of the complex intelligence wave we're trying to transmit, where its momentary frequency really hits the ceiling. Remember that the ceiling has been set at the maximum frequency required for reasonably good speech reproduction, which is also the maximum required for a convenient-sized block of *VF* telegraph channels, 3300 cycles. We'll enlarge the "Z" part of the No. 2 complex wave by six to one, and we'll chop this wave at the chosen sampling rate and imagine that we're transmitting only half of it as before. I guess we'll have to admit that the information contained in the chopped one now looks a little bit meagre. Just

the same, we may be able to make something out of it. Let's do what comes naturally, and put a low-pass filter at the



receiving end for the express and sole purpose of removing the 8000-cycle whistle note. Such a note is most certainly going to be prominent because of the sampling switcher. From the filter, we're going to get a by-product effect which is extremely fortunate and desirable. The wave which comes out of such a filter just cannot wander very far away from its original unchopped form. If there's one thing that a filter does well, it is to keep a wave from jumping erratically about and, particularly, to prevent it from jumping up and down at a rate which exceeds its upper rejection frequency. We, therefore, choose a low-pass filter which has a cut-off just above the highest frequency we really need to deliver to the "customer". Now the delivered wave just can't do any shenanigans

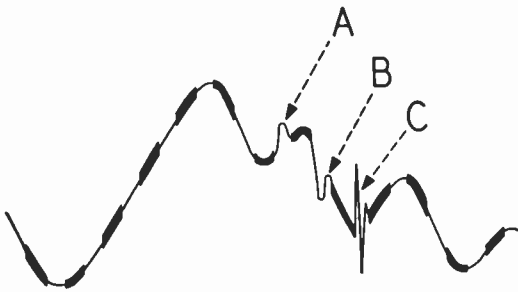

like the "A", "B", or "C" suppositions. Any such crazy gyrations obviously could only represent frequencies above 3300 cycles, because they involve changes in direction faster than the 3300-cycle rate. So what does the filter output wave do? It just leisurely follows the path of least resistance, and fills itself in and smooths itself out to look just as we want it to. All these beautiful ideals are realized with one exception! Being not all there, but only half there, it comes out smaller

than it went in at the other end. That's still all right! A little amplification will make up for the deficiency in amplitude.

Let's see where the word "sample" crept into this conversation. Well, what we've done in reality with this dashed-line system is to send a "sample" of both of the original intelligence waves, alternating the samples between the two waves we're sending. This concept gave us the liberty to call the "chopping" rate the "sampling" rate. Some authors, you will find, like that term. Some others talk about the "pulsing" rate. These latter people like to think they are transmitting pulses, the amplitude of which corresponds to the amplitude of the complex intelligence wave. From such thinking comes the frequently-used and common term "pulse modulation". Between you and me and the lamp post, they're all talking about the same thing, but they all started with slightly different basic concepts.

Why stop at two channels? If we have a 4-position switch instead of a 2-position switch, in fancy at least, we send four separate quantities of intelligence, four separate waves. So far, we can probably still draw a reasonable-looking picture of what goes on. Our separate intelligence currents may be as shown by the finely dashed lines. When the switching is done, we get the solid-but-jumpy line picture.

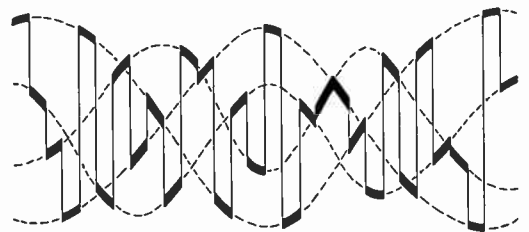

We deliver to each subscriber (voice band jack), dashed indications of what the currents ought to be, which are probably just as satisfying to him. There are just as many samples per cycle of intelligence, but the samples are shorter. The low-pass filter, which still cuts off just above the highest intelligence frequency, restores the wave to its original transmitted form. The fact that the pulses are shorter sim-



ply means a little more amplification is required at each channel receiver.

### The Dotted Line System

It's going to get complicated to draw all the pictures, but if we make a lot of channels, it will be obvious that we're going to get, at any one receiving channel terminal, a dashed line wherein the dashes are really awfully short. Relative to the space between, they are only short dots. Still if they are correctly spaced, and indicate the current amplitude, they'll tell the story about each intelligence wave just as effectively. There are still just as many samples or pulses per cycle of intelligence, and the fidelity of reproduction has to be just as good as it was with the longer dashes.

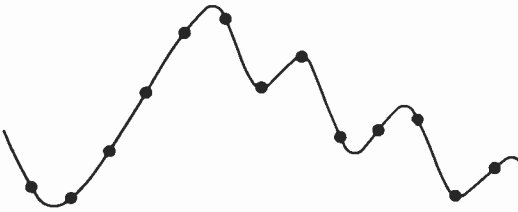

Of course, there are a lot of little matters in the design of a system of this kind that require some very careful thought and engineering. Among these are the details attendant to making the switching devices, the distributors, at the sending and receiving ends run in very exact synchronism. Then if the switching device isn't quite perfect, we're in trouble. Precautions must be taken to insure that any bounce or chatter or travel time or transients that the distributor may generate cannot affect either the position or the amplitude of the dot it lays down as a guide for the reproduction of the original curve. The result of improper switching is cross-talk between the adjacent bands. Besides synchronism, there is a matter of phasing of the distributor. Means must be provided to insure that when the system is started up after an interruption, the samples intended for Channel 7, for instance, don't come out of Channel 11 or some other channel. All of these problems have several possible

solutions, some perhaps more effective than others. The whole business is presently the subject of intensive development work in several laboratories, and one of those is our own.

The requirements of the transmission medium which will handle a time division multiplex of high capacity are in some respects more exacting than for frequency division multiplex. In other respects, they are thought to be less exacting. The band width required per unit of intelligence may not be too much greater than for the carrier system of multiplexing, particularly if the intelligence is carried by pulse amplitude. The amplitude linearity of the medium, and this is a costly quality, may not need to be so good as for frequency division multiplex. The phase shift characteristics, however, would seem to be of extreme importance, because in a multi-channel system, the infinitesimally short pulses must be laid down in a very exact time relationship.

With the "dotted line system" concept, a very elementary yet a very fundamental one, well formed, it is a simple matter to comprehend the other varieties of pulse modulation that have been devised. The basic method we have considered here, we have already said is called "Pulse Amplitude Modulation", frequently abbreviated *PAM*. We have only to conjure up all the possible methods by which one can make pulses differ from one another to form simple concepts of the rest of the commonly-discussed pulse systems. If, instead of adjusting the pulse height to actually draw a dotted line of the desired intelligence wave, we adjust its position while leaving its height uniform, we have "Pulse Position Modulation", *PPM*. In this system, it is necessary to insert a translator which converts amplitude into position.

Here we did a real high-power enlarging job in order to be able to see what goes on. If the average amplitude of the intelligence wave during the sampling interval is  $A$ , then the translator sends a pulse in position 4. If the amplitude is  $A'$ , it sends the pulse in position 7, and so on. Quite obviously, it must make the pulses much shorter than would other-

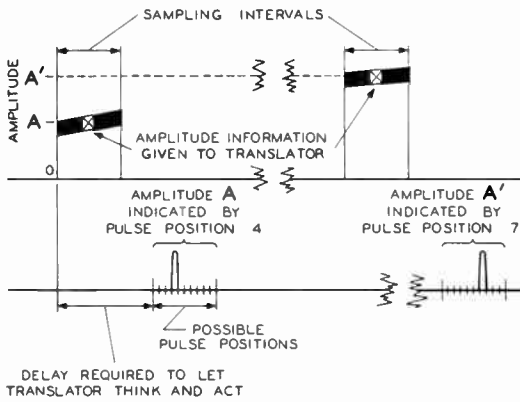

wise be necessary, so that the position of the pulse designated to convey the amplitude of the signaling wave may be shifted between two extreme limits without encroaching on the space assigned to the next channel on either side. With a system of this kind, all pulses can be made of equal height since it is position alone that conveys intelligence. It follows then that steps can be taken at the receiving equipment to insure that they always do come up to a certain standard of height, and so to guarantee that none will be lost or be too small to work the de-translator.

Again, if we choose, we can put in another kind of a translator which can convert the amplitude measurement of the intelligence wave into a series of pulses arranged in accordance with any chosen permutation code. In such a system, for

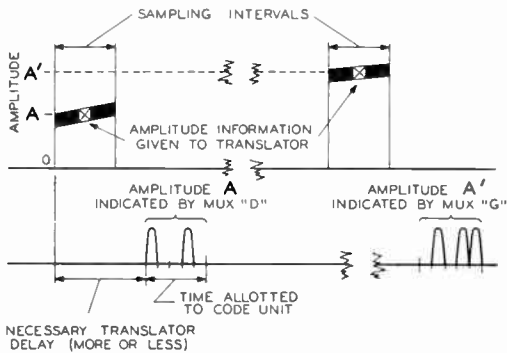

instance, the teleprinter code letter "D" might indicate one amplitude; the letter "G" another, and so on. Here again, the pulses must be very short so that literally room for five or more marks and spaces will be available for each channel of the system. It may seem a paradoxical and strange concept that we should ever get around to the point of actually converting speech into a permutation code, like that used to select letters of a teleprinter in order to multiplex it with a lot of others of its kind. This particular variety of pulse modulation is known as "Pulse Code Modulation", PCM.

The ingenious electronics engineer can think of a lot of ways to make vacuum tubes perform the switching, clipping, gating, translating, and other functions required to make some of these complicated systems work. It is too early to say definitely how the cost of equipment required for time division multiplexing compares with that required for frequency division. For some reason, it looks as if the time division system apparatus ought to be cheaper and more compact. When it has been finally developed to that high state of perfection already attained for frequency division, it may well be that the costs won't be too far apart. One simple difference at once apparent is the fact that low-pass filters can be made to replace band-pass filters. Further, possibly few if any filters will have to be built for high-frequency discrimination. Maybe only voice-frequency filters are required. This factor alone should accord some advantage to time division multiplexing. So far as the pulse frequency sources and the switching devices are concerned, actually these are not too different from the carrier sources and modulators used in frequency division. It is easy to imagine that some of the techniques employed in any pulse modulation resemble those of carrier; some are copied from radar and some from television.



**THE AUTHOR:** F. B. Bramhall, Transmission Research Engineer, graduated from the Pennsylvania State College in 1919, having specialized in communications. Following a short tour as radio operator on shipboard, he joined the Western Union engineering organization in 1920, and telegraph transmission problems engaged his attention from the beginning. He has been closely and responsibly associated with the development of Western Union carrier current systems, from which it followed naturally that the development of "pulse" channelizing techniques should come under his guidance. Because of his opportunity to witness many inspiring advances, Mr. Bramhall has written a number of educational articles, all characterized by an unrestrained style which greatly contributes to an understanding of some of the more obscure principles encountered in transmission work. He is active in the professional societies of his field, IRE and AIEE, holding the rank of Fellow in the latter. He is Secretary of the National Communication Committee of the AIEE, and Junior Past Chairman of Communication in the New York Section.

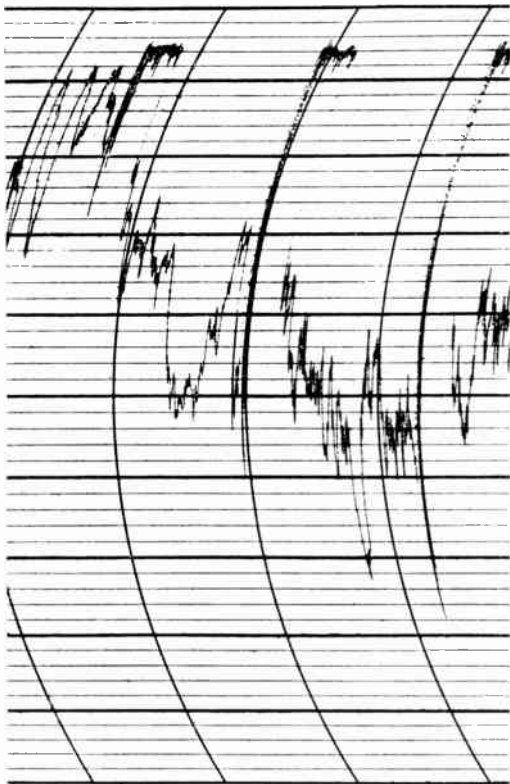

*"Teledeltos"*

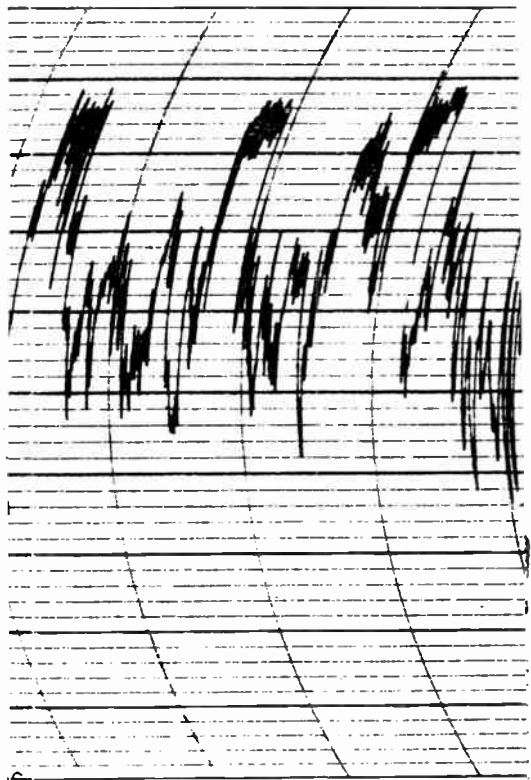

*Pen and Ink*

The development of "Teledeltos" Recording Paper, its properties and some of its many uses will be described in the January REVIEW, in an article by Grove Hotchkiss. The above show comparative instrument recordings on "Teledeltos" and on the standard medium.

# The Concentrated-Arc Boresighter for Fighter Planes

L. G. POLLARD

One of the wartime developments of the Western Union Laboratories was a boresighter utilizing the concentrated-arc lamp. This application of the new light source is only one of the many ways in which it was used during the war, and demonstrates further the numerous by-product possibilities of developments originally intended only for the telegraph service.

A boresighter is an instrument for accurately aiming or harmonizing the machine guns on a fighter plane. Fighter aircraft, such as the P-47's which were used so successfully against the enemy, are equipped with a maximum of eight .50-calibre machine guns, four mounted in the forward edge of each wing. These are called fixed guns, as they are locked in a rigid position in the wings and are all aimed at the same point of convergence, usually about 300 yards ahead of the plane. In shooting down an enemy plane or destroying a ground installation, the pilot must aim his fighter directly at the target and be at a definite distance from it when he fires. This aiming of the plane is accomplished by the use of a cockpit sight through which the pilot continuously watches the target as he maneuvers into position.

The fighter pilot's job is extremely difficult. To track down and destroy an enemy plane, which in all probability is out on a similar mission, requires a great deal of skill. During combat the pilot is flying at 300 miles an hour or more, and in the fraction of a second when the enemy crosses his sight and he fires, he must have full confidence that his guns have done their work. His life is at stake, so he is vitally concerned about his plane and about the care and correct adjustment of his guns.

After every mission the guns are removed from the plane, taken apart and cleaned, then reassembled and installed in exact adjustment. They are accurately set while the plane is on the ground in a stationary position. Tail and wing jacks are used to level the plane in the "attitude" it would assume while traveling at a predetermined speed. A suitable target is set up on the runway 1000 inches in front of the plane and correct points are marked on the target, at which the cockpit sight and each of the eight guns must be aimed to produce convergence of the bullets at a point, for example, 300 yards in front of the plane. Each gun is then adjusted in its wing mount so that it will be aimed accurately at the designated point on the target. This process of aiming the gun is termed "boresighting".

The usual method of boresighting is by the use of an optical device similar to a telescope. The instrument is inserted in the muzzle of the gun and the operator sights on the target by looking through an eyepiece equipped with a prism. In this method there is a certain amount of human error, due to parallax, and two operators will not always agree on the proper adjustment.

Aircorps technicians, trying to improve

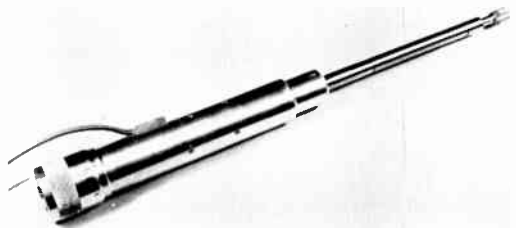

Figure 1. Complete boresighter

the boresighting technique, were experimenting with a light-ray method when they heard about the Western Union concentrated-arc lamp, which was developed for use in telegraph communications. At that time, they were using a small tungsten filament type of lamp masked down with a diaphragm to produce as near a point source of light as possible. The loss of light due to masking was so great that the projected spot was too weak to be usable. The two-watt concentrated-arc lamp proved to be the answer to this problem. With a source diameter of only 0.003 of an inch, a simple lens system could be used to project a beam over a distance of 1000 inches with a resultant image diameter of about one-half inch, which is the same diameter as the bullet shot from the gun.

The Western Union laboratory at Water Mill started work on the design of a light-ray boresighter, and in cooperation with the Air Corps developed both a satisfactory instrument and the technique for its use. This included the development of a collapsible target which could easily be erected on the runway and then stored away in a carrying case for transportation.

Figure 1 shows a complete light-ray boresighter, and Figure 2 is an exploded view of the instrument showing the concentrated-arc lamp and lens mechanism. At one end is an adjustable expanding mandrel which fits into the muzzle of a machine gun. The expansion adjustment is necessary due to the slight increase in diameter of the gun bore with continued firing. This mandrel is very accurately machined and concentrically mounted on the tail piece of the instrument. The boresighter is made in two sections threaded

together about three inches in front of the mandrel. It may be separated at this point for replacing lamps and also for attaching other mandrels for boresighting guns of a larger or smaller calibre.

The main body of the instrument contains the lamp mounting assembly with necessary adjusting screws and the lens focusing mechanism. One essential requirement that must be met is the accurate setting of the point source of light on the optical axis of the instrument. This is accomplished by a ball and socket arrangement supporting the arc lamp, with four adjusting screws accessible from outside of the instrument for tilting the lamp in two planes. When a new lamp is placed in the boresighter a test is made for this alignment which is termed collimation, and each time the instrument is used a further check is made. This simple check insures that the boresighter is always in accurate adjustment. To check collimation, the boresighter is inserted in a gun ready for use, the arc lamp is turned on and the projected spot of light is focused on the surface of the target. The entire instrument is then rotated about its axis while the projected spot of light on the target is observed. If the spot remains in a stationary position, the source of light within the instrument must be on the optical axis, but if the projected spot describes a circle as the instrument is rotated, it is evident that the source is off the optical axis and a correction must be made.

Figure 3 shows the target that was developed by the Laboratory, in conjunction with the Air Corps, for boresighting P-47 fighters. A light metal framework supports two target boards which are covered with "Scotchlite". This is a highly reflecting material now in common use for roadside signs which glows vividly in the dark when the headlights of a car shine on them. On each of these target boards are four red reflection buttons which mark the exact spots at which the machine guns must be aimed for proper adjustment. The projected spot from the boresighter as it is reflected back to the operator is white except when the gun is in proper adjustment, and then it is red.

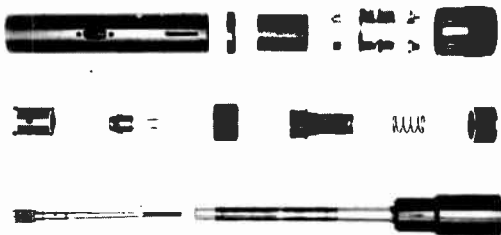

Figure 2. Exploded view of boresighter

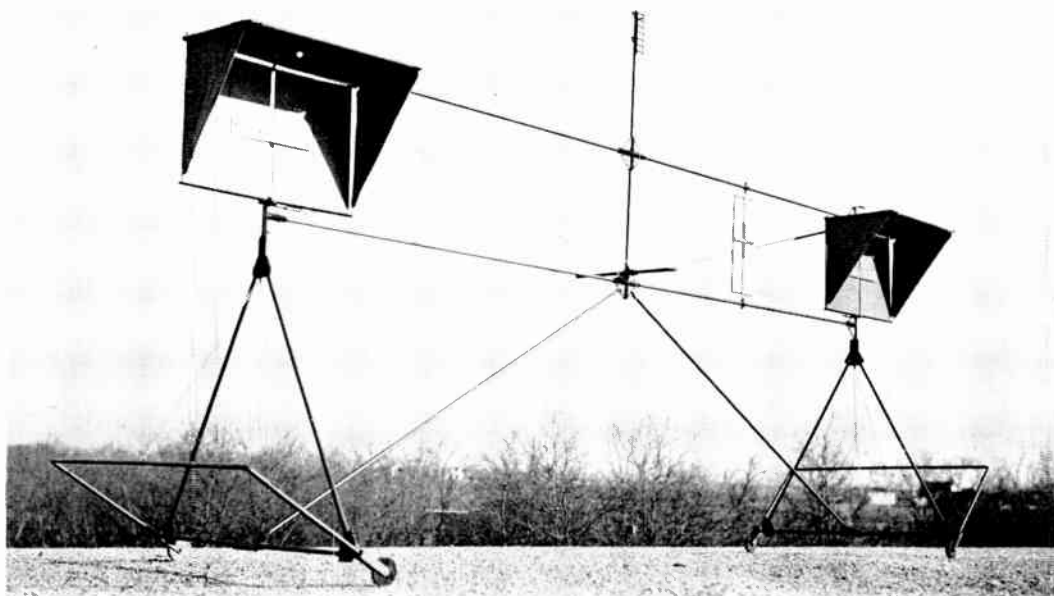

Figure 3. Target for boresighting fighter planes.

Figure 4 shows a P-47 set in position ready for boresighting, and Figure 5 shows the boresighter in use. The instrument is seen inserted in the muzzle of the gun; the operator, lying prone on the wing of the plane, watches the reflected

spot of light on the target as he manipulates the mounting adjustments of the gun located beneath the wing surface. He changes these adjustments until the projected spot falls on the red reflecting button and then locks the gun in place. The



Figure 4. P-47 in position for boresighting

boresighter is then moved to the next gun and the operation repeated. The reflection from the target board is bright enough to permit boresighting by this method in bright sunlight; the method is also very satisfactory for night boresighting.



Figure 5. Boresighter in use

Two other aiming surfaces are mounted on the target, the one at the top of the central support being for the cockpit sight. When the target is set up, it is carefully placed exactly 1000 inches in front of the plane, and oriented until the correct marking on the top target board is visible to the operator looking through the cockpit sight. Maintaining this position, the target assembly is then carefully levelled in the horizontal plane. A second narrow target board mounted just to the right of the central support is used for accurately setting the movie camera which is mounted in the forward edge of the right wing. Fighter planes, especially for training purposes, are equipped with movie cameras which automatically photograph the target, beginning the instant the guns start firing. It is, therefore, essential that the camera also be accurately coordinated with the setting of the guns and the sight.

Figure 6 shows a complete boresighter kit similar to several hundred supplied to the Navy toward the close of the war. The top tray contains the boresight instrument, together with a spare lamp compartment and a second mandrel for boresighting 20-mm guns. The lower part of the case contains the power unit for operating the concentrated-arc lamp. This unit consists of a small dynamotor with the necessary relays and inductances to provide automatic operation. Power to operate this unit is supplied from either a portable storage battery or the 24-volt battery which is standard equipment in fighter planes. A suitable connector is provided to plug into the receptacle on the dash panel of the plane, which is ordinarily used for connecting the pilot's heated flying suit.

Extensive tests with the new type of boresighter showed a definite improve-

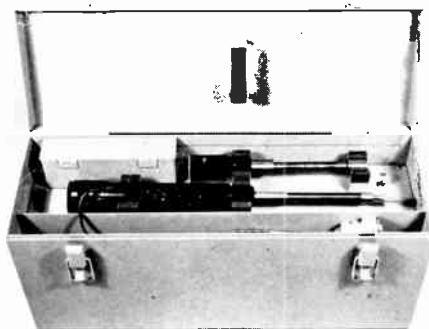

Figure 6. Boresighter kit

ment both in the time required to do the job and in the results. Because of the extreme accuracy of this method, pilots consistently brought in higher scores than they did when using the optical method of boresighting.

---

**THE AUTHOR:** For photograph and biography of Mr. L. G. Pollard, see the July 1948 issue of the *TECHNICAL REVIEW*.

# Filters for a 150 Kilocycle Carrier System

R. C. TAYLOR

A paper presented before the Winter General Meeting of the American Institute of Electrical Engineers in Pittsburgh, Pa., January 1948.

## General

In the wire line carrier systems now widely used in the Telegraph Company's plant, a voice frequency channel having a band width of approximately 3000 cycles constitutes the basic unit. This basic unit may be broken down into a number of narrower channels for teleprinter or multiplex operation, or may be used as a whole for facsimile or telephone transmission. Additional bands required to utilize the available signal-carrying capacities of the various systems are obtained by means of modulators. The translating carrier is suppressed and only one of the sidebands resulting from the modulation process is retained. The

other first order sideband and any interfering higher order sidebands are rejected by suitable filters.

In carrier systems where the total number of voice-frequency bands that must be so derived is small, the design of filters required to select the single desired sideband and reject all the other unwanted frequencies has not presented difficult problems. However, in a system capable of handling 32 bands of signaling frequencies, each 3000 cycles wide and extending up to 150 kilocycles, much more difficult filter design problems are presented. One solution is the crystal filter. Another is described here and in a current paper.<sup>1</sup>

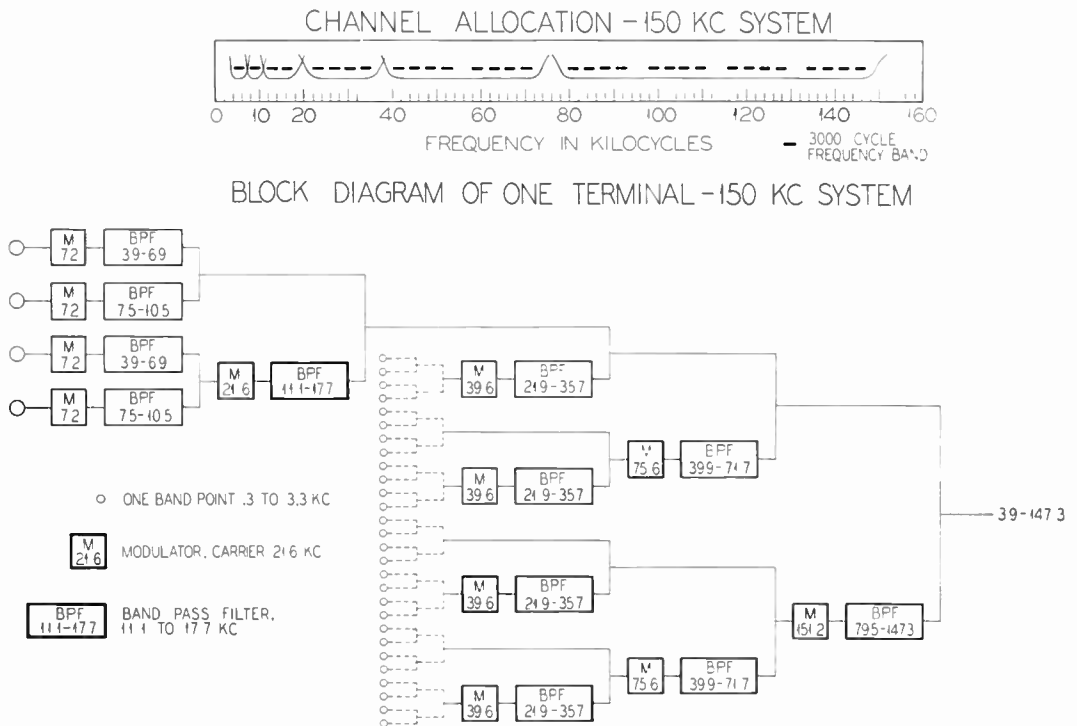

Figure 1. WN system block diagram



In order to simplify the filter design and at the same time to utilize efficiently the 150-kc wide band and retain the 3000-cycle voice-frequency band as the basic unit, a scheme of multiple, or consecutive, modulations was adopted<sup>2</sup>. The resulting system has been designated as Type WN. In this arrangement only two of the side-band selecting filters have 3000-cycle band width, and moreover they occur at the lowest frequency positions in the system. At subsequent modulation points the filters select groups of 2, 4, 8, or 16 bands. A geometric progression in filter band widths is the result, with an approximately constant ratio between band width and location of the band in the 150-kilo-cycle spectrum. Details of this system are shown in Figure 1. As the figure shows, only six different frequency bands in various parallel arrangements are required to yield a total of 32 voice bands.

All the filters have relatively wide pass bands in terms of the ratio of upper cutoff to lower cutoff. This ratio is roughly two in all six bands. For instance, the lowest frequency filter of the series has a lower cutoff of 3600 cycles and an upper cutoff of 7100 cycles, and the highest frequency filter has a lower cutoff of 76,200 cycles and an upper cutoff of 152,000 cycles.

Figure 1 shows the useful signal frequencies as distinguished from the cutoff frequencies, and it may be observed that it is never necessary to filter out frequencies less than 5.5 per cent away from the signal. Since the various 3000-cycle bands must be suitable for facsimile or speech transmission, a signal-to-noise ratio of 50 db or more is desirable and that value is realized throughout the system. It may be accomplished by a combination of two filters or a combination of modulator balance and filter attenuation, but the end result is interference 50 db below the signal.

In the design of the filters, the number of inductive elements was kept at a minimum since coils usually require more space and are more expensive than capacitors. This principle was applied most intensively to the lower frequency bands since they account for the major share

of cost and space in the system. It proved to be possible to develop the required discrimination with five coils and a somewhat greater number of capacitors in each of the three lower frequency bands. The higher frequency filters were permitted more coils, since used in much smaller quantity.

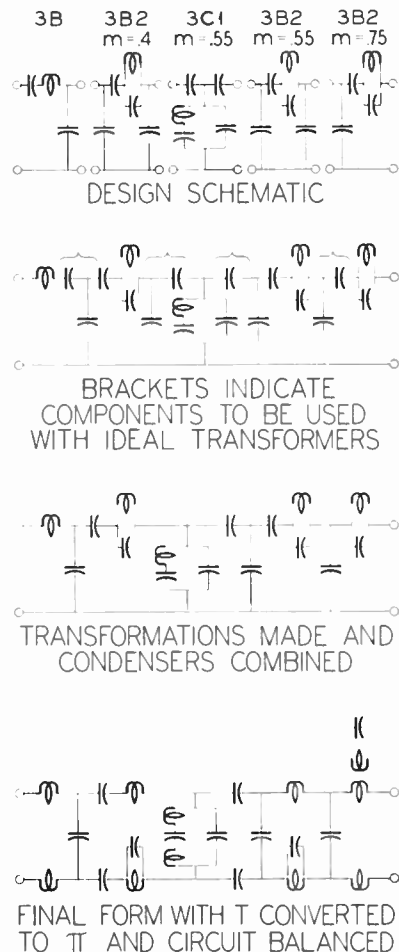

Figure 2. Successive stages in design of typical filter

### Typical Filter

As an example of these filters, consider the filter shown schematically in various stages of development in Figure 2 and indicated by the numbers 3.9-6.9 in Figure 1. It follows a balanced modulator fed with a 7200-cycle square wave carrier frequency and a 300 to 3300-cycle signal band. It must deliver the first order lower

sideband of that modulation (3900 to 6900 cycles), with the upper sideband, signal leak and higher order modulation products suppressed far enough to result in a 50-db signal-to-noise ratio. Since the balance of the modulator may be depended on for 30-db suppression of the signal leak, the filter needs to supply only 20-db attenuation at frequencies less than the useful signal band; however, it must supply the full 50 db unaided at the upper sideband frequencies. Since the carrier is a square wave, the third order products ( $3c \pm s$ ) are only about 10 db below the useful signal level and the filter must supply 40-db attenuation. It is evident that if efficient use of filter elements is to be had, a quite disymmetrical filter characteristic is required and most of the  $m$ -derivation peaks need to be on the high frequency side. The resulting measured attenuation curve is shown together with the straight line curve of requirements in Figure 3.

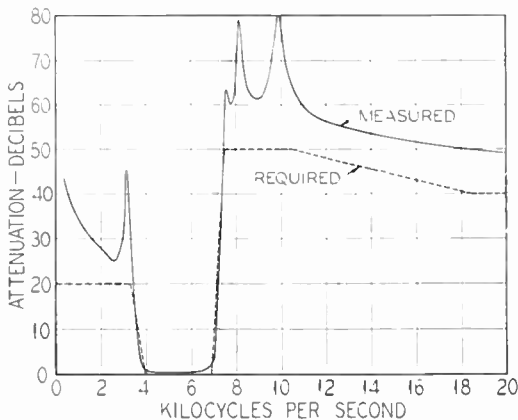

Figure 3. Required (dotted) and measured (solid) attenuation

The various stages of development from the design schematic to the final balanced network are shown in Figure 2. There are a number of steps in the selection of the component filter sections, and in the transformation from the design schematic to the final form which may be of interest, since many filter design sources do not list them. In order to provide a basis for discussion the filter sections considered, together with their  $m$ -derivations and design formulas, are

given in Figure 10 of Appendix I. In the notation of Figure 10, the filter shown in Figure 2 is made up of five half-sections of Type 3B2, two half-sections of Type 3C1, and one half-section of Type 3B with  $m$ -values as shown in the first schematic of Figure 2.

Both the 3B2 and 3C1 half-sections consist of three capacitors and one coil, and provide one peak of attenuation which meets the requirement of minimum inductive elements and permits independent assignment of peak attenuation frequencies. One peak of attenuation can be realized for every coil in a band-pass filter and they may be assigned at will on either side of the pass band. (In this filter, one of the peaks is at infinite frequency.) The selection of  $m$ -values and section types was done by trial and error to fit the required attenuation characteristic with the minimum number of coils, all the section types of Figure 10 being considered.

The section junctions on each side of the 3C1 section may at first sight appear to be mismatched, but according to Figure 10 the mid-shunt surge impedance of Type 3B2 and the mid-series surge impedance of Type 3C1 differ only by the constant factor  $(1 + f_1/f_2)^2$ , and can therefore be perfectly matched by a suitable choice of impedance level in the 3C1 section, or by use of the "ideal transformer" technique as outlined in Appendix II.

In the WN System filter selected for detailed description, several capacitances are larger than is desired for economic application of mica capacitors at a 600-ohm impedance level. To reduce these capacitances, an ideal transformer was applied at four places (shown by the brackets in the second schematic of Figure 2), using the formulas of Appendix II. The result is shown in the third schematic of Figure 2 and was sufficient to reduce the capacitances to satisfactory values while leaving the terminal characteristic impedances unchanged.

The final form is shown in the fourth and last schematic of Figure 2, and is obtained from the third by converting a  $T$  of capacitors into a  $\Pi$  and balancing the circuit against longitudinal disturbances. The three parallel resonant circuits in the

series branches of the design schematic are not treated alike in the final schematic. The method using three windings on a common core as in the  $m = .75$  section is preferable from balance and manufacturing standpoints, but introduces four times the leakage reactance in the series branch. This unwanted leakage inductance tends to reduce the attenuation when series resonant, which effect can be shifted to about twice the frequency by the method used on the  $m = .4$  and  $m = .55$  sections. The effect can be eliminated entirely by applying the tuning capacitor to both halves of the series coil, but that did not prove to be necessary in this case. An alternative procedure would be to increase the amount of interleaving of the windings, but that is always inconvenient for the manufacturer.

The input and output impedances of a filter are always important in determining the flatness of the attenuation-frequency characteristic in the pass band, and in five of the six frequency bands an  $m$ -derived characteristic impedance ( $m = .5$ ) is obtained at the line end by the fractional end branch termination required for satisfactory paralleling, and described in subsequent paragraphs. The sixth filter obtains a similar result illustrated in curve G of Figure 4.

For the higher frequency bands, a conventional six-element symmetrical  $m$ -derived section ( $m = .55$  or  $.65$ ) is used at the set end, but for the lower frequency bands the limitation on coils caused the use of less uniform impedances such as those described by the equation for  $Z_{01}$  of 3B2 in Figure 10. In the case of the filter of Figure 2, the set-end impedance is  $Z_{01}$  of 3B2 with  $m = .75$ , which is similar to the familiar constant  $K$  impedance with which it is identical if  $m = 1$ .

### Modifications for Paralleling

Having secured a satisfactory attenuation characteristic for the individual filters, it remains to make sure that the performance is not degraded when they are paralleled in service. Fortunately, it is possible to make the paralleling filters improve the performance of the one being measured, as has been well described in the literature.<sup>3</sup>

so that only a brief sketch of the method is appropriate here. The basic principle states that a constant (or nearly constant) resistance in series with a reactance of similar or smaller magnitude results in a susceptance-frequency characteristic of negative slope which can be used to resonate or cancel a conventional susceptance, not at a single frequency, but over a band of frequencies. That is, each of a group of parallel connected filters can be made to have a negative slope susceptance in its pass band where its surge impedance is resistive, but will retain a positive slope susceptance outside the pass band. The combination of these positive and negative slope susceptances produces a kind of antiresonance in the pass band of each filter, leaving the real part of the input impedance unshunted by the paralleling filters. Mathematically this inverted susceptance arises from the negative sign on the right-hand half of the following equation whenever  $R$  is large enough to hold the magnitude of the denominator substantially constant.

$$\frac{1}{R + jX} = \frac{R}{(R^2 + X^2)} - j \frac{X}{(R^2 + X^2)} \quad (1)$$

A graphical representation of the admittance of a single filter is shown in Figure 4 for three cases; the added react-

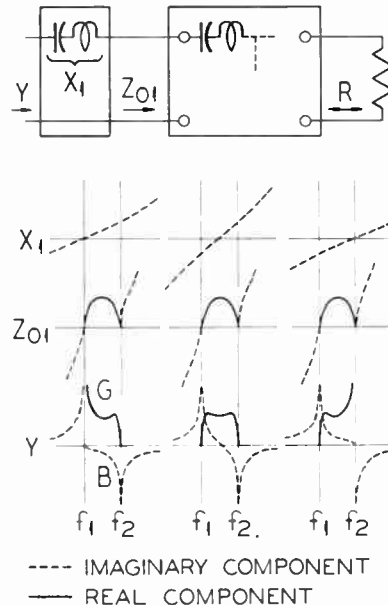

Figure 4. Negative slope susceptance in a filter pass band

ance series resonant at the lower cutoff, mid-band and upper cutoff frequencies, respectively.

This sum of the six susceptances in the signal bands of these filters has been calculated to be less than 50 per cent of the line conductance, and similarly a departure of 25 per cent is calculated for the conductance. It is recognized that smaller tolerances than these can be obtained by more complex susceptance annulling networks, but it is believed that a good economic compromise has been reached. The added series-resonant series branch is included in the schematics of Figure 2, although not mentioned in the discussion of that figure, for the sake of clarity.

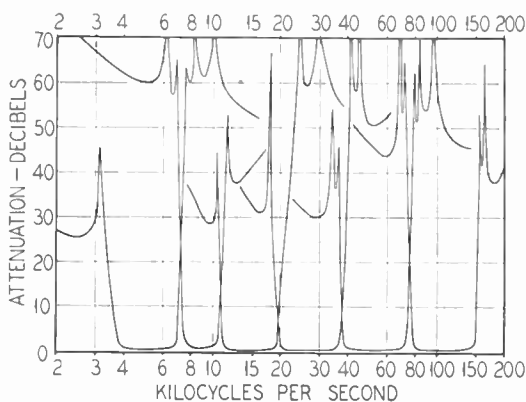

Figure 5. Measured attenuation of six WN System filters

### Measured Attenuation

The most important parts of the measured attenuation curves of the six filters are shown in Figure 5. The combined effects of dissipation and imperfect termination are about one db at the edge of the signal spectrum in all the filters, and any departure from a smooth curve in the central part of the pass band is less than one-tenth db. The result is 32 voice bands in a frequency spectrum of 143.4-kc band width or 4,480 cycles per 3000-cycle band, a spectrum efficiency of 67 per cent. Two filters assembled on a double deck rack panel are shown in Figure 7.

There are a few narrow band filters in the WN System, used to select pilot tones and oscillator harmonics, that are of

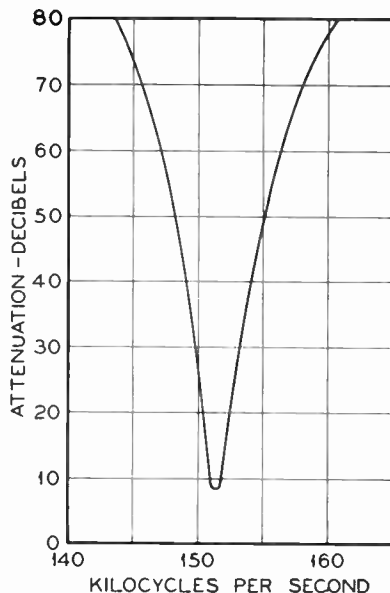

Figure 6. Measured attenuation of 151.2-kc filter

slightly unusual construction. They are made of 3C sections, mid-shunt terminated, and therefore must be connected to a common source or load in series rather than in parallel. This arrangement is used to avoid the high-inductance series branch coils with their troublesome low  $Q$  and humidity coefficients, and at the same time have a convenient inductive impedance transformation to obtain the most reasonable capacitances in the rest of the filter. Figure 6 shows the measured attenuation of such a filter centered on 151.2 kc and with a nominal band width of 1200 cycles.

### Coils and Capacitors

Of the available coils, the ones most suited to this work use a shell-type dust core with a heavy copper shield illustrated by Figure 8. They provide a  $Q$  as shown in the shaded area of Figure 9, the variation at any one frequency depending on nearness to self-resonant frequency, wire diameter and copper space factor. They have adequate stability when subjected to varying temperature and signal levels. The temperature coefficient of inductance is approximately plus fifty parts per million per degree centigrade, and the total

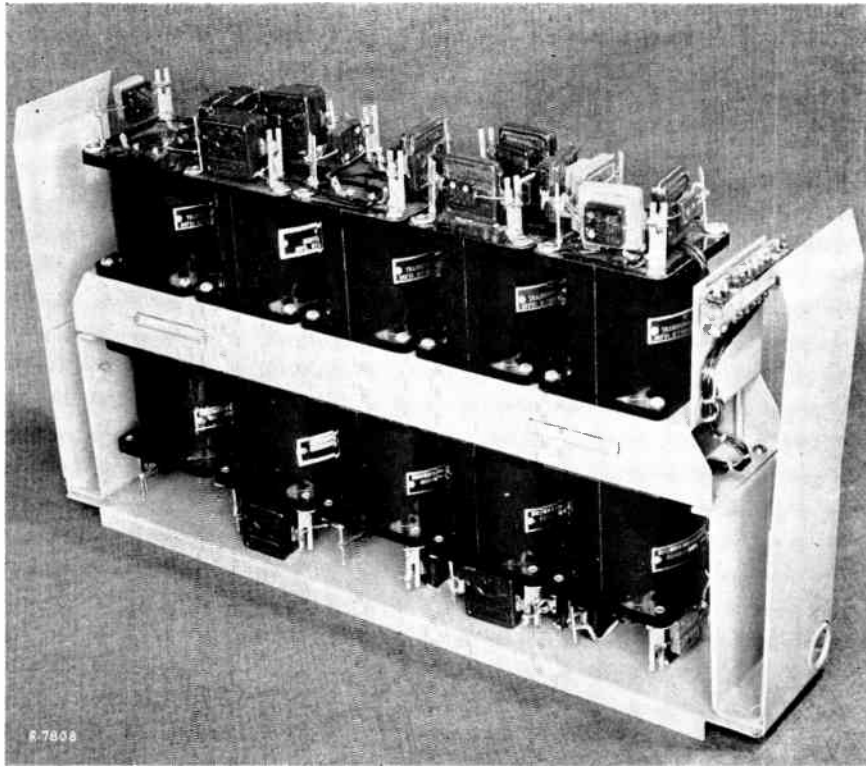

Figure 7. Typical assembly—two filters on double deck rack panel

change of inductance with flux density reaches one part per thousand only at levels well above the operating point. The change of  $Q$  with level is much greater, but of less importance since it is effective only at the "corners" of the propagation characteristic and any changes at normal signal levels are too small to measure.

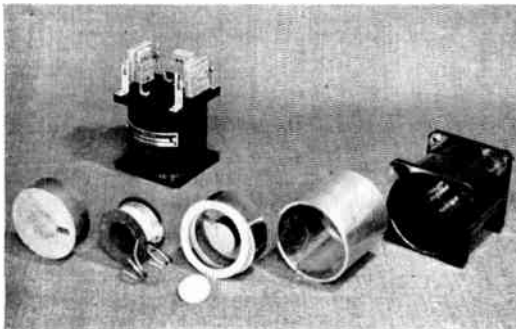

Figure 8. Parts of coil ready for assembly and completed coil with associated capacitors

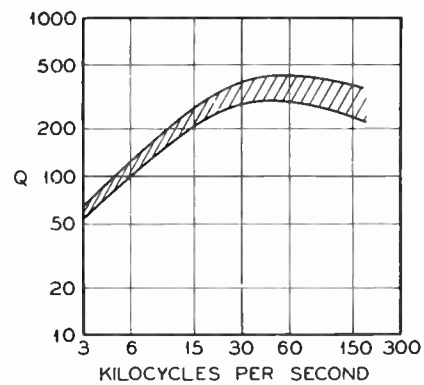

Figure 9. Coil reactance—resistance ratios realized in WN filters

The coils are easily manufactured with an inductance tolerance of plus or minus two per cent. Only a small percentage of rejects is found and those outside inductance limits are easily adjusted to the required value by air gap spacers.

The capacitors used are the usual commercial mica capacitors in sizes from

0.00015 microfarad to 0.07 microfarad with an average of 0.02. They are given an aging treatment by means of temperature cycles and selected in groups of three or less to values accurate to plus or minus one per cent. This requirement is placed on capacitors not associated with a peak of attenuation, and a corresponding requirement of one-half per cent of specified frequency is placed on the frequency of attenuation peaks. (The oscillator used for adjustment is required to be accurate to one-tenth per cent in order not to contribute important errors to the measurements.)

## APPENDIX I

### Three-Element Filter Sections and Their $m$ -Derivations

The four well-known three-element filter sections<sup>3,4</sup> are shown in Figure 10, each grouped with its two  $m$ -derivations and with formulas for element values, dissipationless apparent propagation constant and surge or image impedance. This grouping of the sections is chosen to emphasize the  $m$ -derived relation between sections such as 3B and 3B1, frequently obscure in the literature, and to place on an equal basis the alternative  $m$ -derivation, such as 3B2, usually missing from tables of filter design formulas. This omission probably results from the rapidly varying surge impedance-frequency characteristic which, with a few exceptions, limits their use to the body of the composite filter.

All formulas for element values are given for half sections rather than full sections, since it has been the author's experience that half sections are the building blocks used by the designer. The half-section element equations always contain  $2\pi$  in the denominator while the full-section formulas have either  $\pi$  or  $4\pi$ . (The  $2\pi$  would disappear if angular velocity was used instead of frequency.) The apparent propagation constant,  $\sqrt{ZY}$ , for the half section is identical with the full section parameter  $\sqrt{Z_1/4Z_2}$  of Guillemin<sup>3</sup> and Shea<sup>4</sup>. The square root is shown since the real propagation constant,  $\theta$ , is approxi-

mately equal to  $\sqrt{ZY}$  to the degree that  $\theta$  approximates  $\sinh \theta$ .

The three element branches have been transformed to that canonical form exhibiting the peak forming elements as simple series resonant or parallel resonant elements, for convenience in testing or trouble shooting. Some of the formulas are more complicated when so transformed, but not prohibitively so. Convenient tables<sup>5</sup> are available to aid in evaluating the equations.

The element and surge impedance formulas are given for a one-ohm filter since some economy of design effort may be realized in that way. It is understood that all inductances are to be multiplied by and all capacitances are to be divided by the nominal circuit impedance at the end of the design work. The symbols are largely self-explanatory but for completeness the following list is given.

- $f_1$  — Lower cutoff frequency.
- $f_2$  — Upper cutoff frequency.
- $f_n$  — Frequency of peak attenuation.
- $Z_{01}$  — Mid-series surge impedance.
- $Z_{02}$  — Mid-shunt surge impedance.
- $m$  and  $B$  — Design parameters related to  $f_n$ .

It may be observed from the formulas of Figure 10 that as  $m$  varies from one to zero the  $m$ -derived surge impedance varies between limits defined by the two surge impedances of the prototype. A more nearly constant result can be obtained from such sections as 3A2 and 3B1 than from 3A1 and 3B2.

## APPENDIX II

### Ideal Transformers

The following method for using ideal transformers has been found convenient as it avoids consideration of negative elements and provides a useful tool for changing impedance levels in an otherwise completed filter design. It is similar to the discussion of pages 135-6 of Reference 4.

To avoid having to reverse mentally the direction of a schematic diagram in which a transformation is desired, four ideal transformers as in Figure 11 can be intro-

PROTOTYPE	m - DERIVATIONS		SECTION PARAMETERS
<b>3A</b>  $L_1 = \frac{1}{2\pi(f_1+f_2)}$ $L_2 = \frac{f_2-f_1}{2\pi f_1^2}$ $C_4 = \frac{1}{2\pi(f_2-f_1)}$	<b>3A1</b>  $L_1 = \frac{m}{2\pi(f_1+f_2)}$ $L_2 = \frac{f_2-f_1}{2\pi m B f_1^2}$ $C_4 = \frac{m B^2}{2\pi(f_2-f_1)}$	<b>3A2</b>  $L_1 = \frac{m B}{2\pi(f_1+f_2)}$ $C_1 = \frac{1-m^2}{2\pi m(f_2-f_1)}$ $L_2 = \frac{f_2-f_1}{2\pi m f_1^2}$ $C_4 = \frac{m}{2\pi(f_2-f_1)}$	<b>3A</b> $\sqrt{ZY} = j \frac{f}{f_2} \frac{\sqrt{1-(f_1/f)^2}}{\sqrt{1-(f_1/f_2)^2}} = \frac{\sqrt{1-(f/f_1)^2}}{\sqrt{(f_2/f_1)^2-1}}$ <b>3A1</b> } $\sqrt{ZY} = j \frac{\sqrt{1-(f_0/f_2)^2}}{\sqrt{1-(f_1/f_2)^2}} \frac{\sqrt{1-(f_1/f)^2}}{\sqrt{1-(f_0/f)^2}}$ <b>3A2</b> } <b>3A</b> } $Z_{01} = \frac{1}{1+f_1/f_2} \frac{\sqrt{1-(f/f_2)^2}}{\sqrt{1-(f/f)^2}}$ <b>3A1</b> } $Z_{02} = 1 - \frac{f_1}{f_2} \frac{1}{\sqrt{1-(f_1/f)^2} \sqrt{1-(f/f_2)^2}}$ <b>3A2</b> } $Z_{02} = \frac{1-f_1/f_2}{1-(f_0/f_2)^2} \frac{1-(f_0/f)^2}{\sqrt{1-(f_1/f)^2} \sqrt{1-(f/f_2)^2}}$ <b>3A1</b> } $Z_{02} = \frac{1-(f_1/f_0)^2}{1-(f_0/f_2)^2} \frac{1-(f/f_0)^2}{\sqrt{1-(f_1/f)^2} \sqrt{1-(f/f_2)^2}}$ <b>3A2</b> } $Z_{01} = \frac{1-(f_1/f_0)^2}{1+f_1/f_2} \frac{\sqrt{1-(f/f_2)^2}}{\sqrt{1-(f_1/f)^2} [1-(f/f_0)^2]}$
<b>3B</b>  $C_1 = \frac{f_2-f_1}{2\pi f_1^2}$ $L_3 = \frac{1}{2\pi(f_2-f_1)}$ $C_2 = \frac{1}{2\pi(f_1+f_2)}$	<b>3B1</b>  $C_1 = \frac{f_2-f_1}{2\pi m f_1^2}$ $L_3 = \frac{m}{2\pi m(f_2-f_1)}$ $L_2 = \frac{1-m^2}{2\pi m(f_2-f_1)}$ $C_2 = \frac{m B}{2\pi(f_1+f_2)}$	<b>3B2</b>  $C_1 = \frac{f_2-f_1}{2\pi m B f_1^2}$ $L_3 = \frac{m B^2}{2\pi m(f_2-f_1)}$ $C_3 = \frac{1-m^2}{2\pi m B(f_1+f_2)}$ $C_2 = \frac{m}{2\pi(f_1+f_2)}$	<b>3B</b> $\sqrt{ZY}$ SAME AS FOR SECTION 3A <b>3B1</b> } $\sqrt{ZY}$ SAME AS FOR SECTIONS 3A1 AND 3A2 <b>3B2</b> } <b>3B</b> } $Z_{01}$ RECIPROCAL OF $Z_{02}$ OF SECTION 3A <b>3B1</b> } <b>3B</b> } $Z_{02}$ RECIPROCAL OF $Z_{01}$ OF SECTION 3A <b>3B2</b> } <b>3B1</b> } $Z_{02}$ RECIPROCAL OF $Z_{01}$ OF SECTION 3A2 <b>3B2</b> } $Z_{01}$ RECIPROCAL OF $Z_{02}$ OF SECTION 3A1
<b>3C</b>  $C_1 = \frac{f_1+f_2}{2\pi m f_1 f_2}$ $L_2 = \frac{f_2-f_1}{2\pi m f_1 f_2}$ $C_4 = \frac{f_1}{2\pi m f_2(f_2-f_1)}$	<b>3C1</b>  $C_1 = \frac{f_1+f_2}{2\pi m f_1 f_2}$ $L_2 = \frac{f_2-f_1}{2\pi m B^2 f_1 f_2}$ $C_2 = \frac{m B(f_1+f_2)}{2\pi(1-m^2)f_1 f_2}$ $C_4 = \frac{m B f_1}{2\pi m f_2(f_2-f_1)}$	<b>3C2</b>  $L_1 = \frac{m(f_2-f_1)}{2\pi(1-m^2)f_1 f_2}$ $C_1 = \frac{f_1+f_2}{2\pi m B f_1 f_2}$ $L_2 = \frac{f_2-f_1}{2\pi m f_1 f_2}$ $C_4 = \frac{m f_1}{2\pi m f_2(f_2-f_1)}$	<b>3C</b> $\sqrt{ZY} = j \frac{f_1}{f} \frac{\sqrt{1-(f/f_2)^2}}{\sqrt{1-(f_1/f_2)^2}} = \frac{\sqrt{1-(f_2/f)^2}}{\sqrt{(f_2/f_1)^2-1}}$ <b>3C1</b> } $\sqrt{ZY} = j \frac{\sqrt{1-(f_0/f_1)^2}}{\sqrt{1-(f_2/f_1)^2}} \frac{\sqrt{1-(f_2/f)^2}}{\sqrt{1-(f_0/f)^2}}$ <b>3C2</b> } <b>3C</b> } $Z_{01} = \frac{1}{1+f_1/f_2} \frac{\sqrt{1-(f/f)^2}}{\sqrt{1-(f/f_2)^2}}$ <b>3C1</b> } $Z_{02} =$ SAME AS FOR SECTION 3A <b>3C2</b> } <b>3C1</b> } $Z_{02} = \frac{1-f_1/f_2}{1-(f_0/f_2)^2} \frac{1-(f_0/f)^2}{\sqrt{1-(f_1/f)^2} \sqrt{1-(f/f_2)^2}}$ <b>3C2</b> } $Z_{01} = \frac{1-(f_0/f_2)^2}{1+f_1/f_2} \frac{\sqrt{1-(f_1/f)^2}}{\sqrt{1-(f/f_2)^2} [1-(f_0/f)^2]}$
<b>3D</b>  $C_1 = \frac{f_2-f_1}{2\pi f_1 f_2}$ $L_3 = \frac{f_1}{2\pi f_2(f_2-f_1)}$ $L_2 = \frac{f_1+f_2}{2\pi f_1 f_2}$	<b>3D1</b>  $C_1 = \frac{f_2-f_1}{2\pi m f_1 f_2}$ $L_3 = \frac{m f_1}{2\pi m f_2(f_2-f_1)}$ $L_2 = \frac{f_1+f_2}{2\pi m B f_1 f_2}$ $C_2 = \frac{m(f_2-f_1)}{2\pi(1-m^2)f_1 f_2}$	<b>3D2</b>  $L_1 = \frac{m B(f_1+f_2)}{2\pi(1-m^2)f_1 f_2}$ $C_1 = \frac{f_2-f_1}{2\pi m B^2 f_1 f_2}$ $L_3 = \frac{m B f_1}{2\pi m f_2(f_2-f_1)}$ $L_2 = \frac{f_1+f_2}{2\pi m f_1 f_2}$	<b>3D</b> $\sqrt{ZY}$ SAME AS FOR SECTION 3C <b>3D1</b> } $\sqrt{ZY}$ SAME AS FOR SECTIONS 3C1 AND 3C2 <b>3D2</b> } <b>3D</b> } $Z_{01}$ RECIPROCAL OF $Z_{02}$ OF SECTION 3A <b>3D1</b> } <b>3D</b> } $Z_{02}$ RECIPROCAL OF $Z_{01}$ OF SECTION 3C <b>3D2</b> } <b>3D1</b> } $Z_{02}$ RECIPROCAL OF $Z_{01}$ OF SECTION 3C2 <b>3D2</b> } $Z_{01}$ RECIPROCAL OF $Z_{02}$ OF SECTION 3C1
L, C AND $\sqrt{ZY}$ FORMULAS FOR HALF - SECTION PLUS OR MINUS SIGNS FOR $\sqrt{ZY}$ AND $Z_0$ AS REQUIRED		L, C AND $Z_0$ FORMULAS FOR ONE OHM	$B = \frac{1-(f_1/f_2)^2}{1-(m f_1/f_2)^2}$

Figure 10. Design information for three-element filter sections and their m-derivations

duced, and then in any application only the one needed retained, and the other three caused to vanish by making their turn ratios unity. If the two schematics of Figure 11 are to be equivalent then their impedance matrices<sup>2</sup> must be equal, term for term.

$$\begin{vmatrix} \frac{Z_1 + Z_2}{A^2} & \frac{B}{A} Z_2 \\ \frac{B}{A} Z_2 & B^2 Z_2 \end{vmatrix} = \begin{vmatrix} C^2 Z_1 & C/D Z_4 \\ C/D Z_1 & Z_3 + Z_4/D^2 \end{vmatrix} \quad (2)$$

which leads to the following equations

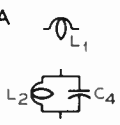
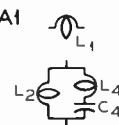
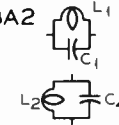
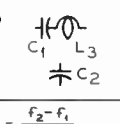
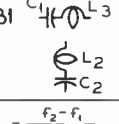
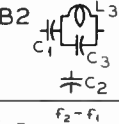
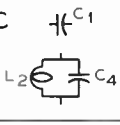
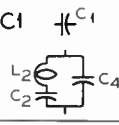
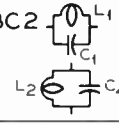
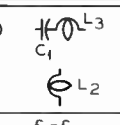
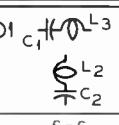
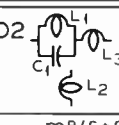
$$Z_1 Z_3 = Z_2/Z_4 = AC/BD \quad (3)$$

$$ABCD = 1 + Z_1/Z_2 = 1 + Z_3/Z_4 \quad (4)$$

As an example, suppose it is desired to introduce an ideal transformer as in Figure 12. The turn ratios A, C and D will be unity. B will equal  $1 + 1.5/0.5$  or 4, and the second schematic is equivalent to the

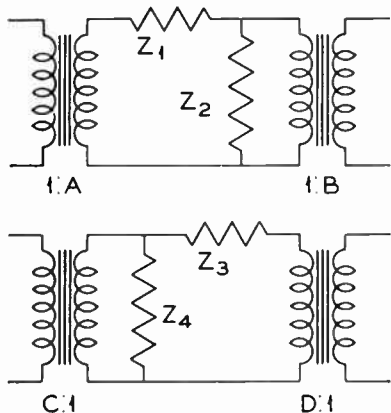

Figure 11. Equivalent L networks using ideal transformers

first. It should be noted that after the transformer is introduced, the series impedance is always on the high impedance side of the circuit, or in other words the configuration of the circuit determines whether the ideal transformer will step up or step down. A, B, C and D are either unity or greater than unity.

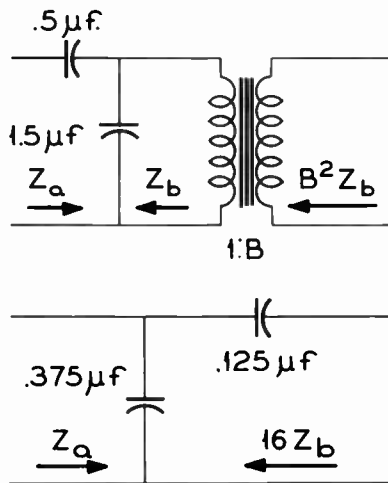

Figure 12. Example of ideal transformer use

### References

1. A 150 KILOCYCLE CARRIER SYSTEM FOR RADIO RELAY APPLICATIONS, J. E. BOUGHTWOOD, *IEEE Transactions*, volume 67, 1948; *Western Union Technical Review*, volume 2, No. 2, April 1948.
2. UNITED STATES PATENT NO. 2374567, R. C. TAYLOR.
3. ELECTRICAL NETWORKS, volume 11, E. A. GUILLEMIN, *John Wiley and Sons, Inc.*, New York, N. Y., 1935.
4. TRANSMISSION NETWORKS AND WAVE FILTERS, T. E. SHEA, *D. Van Nostrand, Inc.*, New York, N. Y., 1929.
5. TABLES OF  $\sqrt{1-x^2}$  AND  $1-x^2$  FOR USE IN PARTIAL CORRELATION AND IN TRIGONOMETRY, JOHN RICE MINER, *The Johns Hopkins Press*, Baltimore, Md.

**THE AUTHOR:** For photograph and biography of Mr. R. C. Taylor, see the April 1948 issue of the TECHNICAL REVIEW.



# The Transistor



The appearance in July of a new amplifying element called "the transistor", was of extreme interest to all communication engineers, many of whom are already engaged in active experimentation with the device. The Bell Laboratories, which originally announced this development, were swamped with inquiries, and quickly arranged demonstrations and lectures which have been attended by members of the Radio Manufacturers Association and by engineers from various branches of the telegraph, telephone, radio and television industries. Interest has been so keen in this revolutionary discovery, perhaps the most important to the art since the introduction of the grid to the vacuum tube, that technical magazines have delayed publication to include the story.

Our Editorial Committee knows that readers of the REVIEW will welcome a brief descriptive statement based on the findings of engineers in our laboratories, who recognize the wide application the transistor may find in the design of new

electronic telegraph equipment. The transistor, like most great discoveries, is a very simple device; one may even be crudely assembled from materials easily obtainable. The basic element is a germanium crystal mounted with two "cat whiskers" about two-thousandths of an inch apart; a very compact arrangement, as shown in the accompanying photograph, Figure 1. This assembly, when

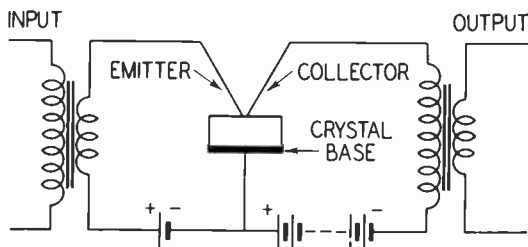

Figure 2. Transistor amplifier circuit

connected into the circuit shown in Figure 2, will provide an amplifier with a gain of about 20 decibels. A power handling capacity of +10 dbm, ten milliwatts, is readily attained. Tandem stages may be used to increase gain and push-pull arrangements to increase available power as with vacuum tubes. But the transistor has no vacuum, hence no glass bulb to break or leak, and no heater, hence no delay in starting due to thermal lag. Both input and output capacitances are low and the device is useful up into the high radio frequencies. It can, of course, also be used as an oscillator over the same range.

Although a satisfying explanation of *why* the transistor works gets one involved in electron physics, an explanation of *how* it works is quite simple. It is well known that in the familiar germanium crystal rectifier, voltage applied to the cat-whisker contact in the "forward direc-



Figure 1. The transistor, shown twice actual size

tion" (plus to the whisker) will cause appreciable current to flow, while voltage similarly applied in the "back direction", even though considerably greater, will cause the flow of only a very small current. The discovery leading to the development of the transistor was that if two cat whiskers are placed very close together, connected respectively to appropriate sources of forward and back voltages, current flow into the crystal in the forward direction will produce an approximately equal current in the back voltage circuit. Using the terminology of Figure 2, the "emitter" current serves to control the "collector" current in a manner somewhat analogous to the grid-plate circuit control in a conventional triode vacuum tube. As opposed to familiar characteristics of the vacuum tube, however, the input circuit of the transistor is of low impedance compared to the output circuit, the ratio being 100 to 1 or more. Amplification takes place, therefore, when these impedances are properly matched to

the external circuits as indicated by the transformers in Figure 2. Experimental transistors have been made in Western Union laboratories with a wide variety of impedances, covering a range of about ten to one. The first commercial product will no doubt be standardized on one or two nominal impedances.

It is now too early to say just where the transistor will fit into our electronics equipment, but there is little doubt that it will find application. The unusual impedance characteristics alone make direct substitution for vacuum tubes impracticable. We can be sure, however, that soon after sufficient quantities of transistors are made available to our electronics and circuit engineers, they will appear in new equipment designs. The absence of the heater battery requirement and the presumed long life (single contact crystal rectifiers remain stable indefinitely), seem to indicate first application in specialized equipment where these advantages have unique value.



FOR "his development of a dry electrosensitive recording blank which can be stored and handled like ordinary paper . . . and which can be permanently marked by simple means", Raleigh J. Wise, Telefax Research Engineer of the Western Union Telegraph Company, has been awarded the Longstreth Medal of the Franklin Institute. This Medal, presentation of which takes place October 20, 1948, was established in 1890 "for the encouragement of invention and in recognition of meritorious work in science and the industrial arts", in memory of Edward Longstreth, a prominent Philadelphia industrialist and a member of the Board of Managers of the Institute.

When informed of the award, Mr. Wise said, "While my work on this highly successful research project has brought me great personal satisfaction, others have contributed vital improvements in formulation and processing that have made 'Teledeltos' recording paper a standard material for science and industry today". He named particularly Curt E. Mobius, Physical and Chemical Research Engineer, and Bernard L. Kline, Chemist, remarking, "research in Western Union is seldom if ever a one-man job".



