

The Scott News

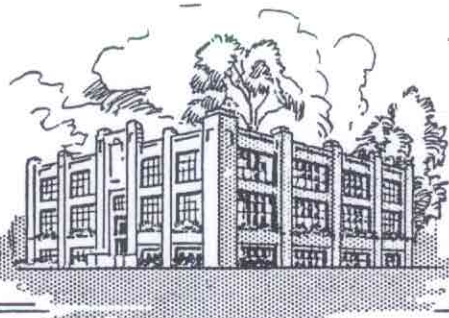

Vol. 8

NOVEMBER, 1935

No. 11

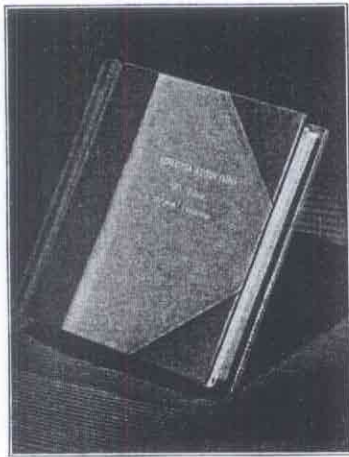

ONE OF THE TWO LEATHER-BOUND VOLUMES OF THE "SINFONIA AUTOCTONA" SYMPHONY



PROFESSOR VICENTE STEA



REPRODUCTION OF GOLD MEDAL AWARDED PROFESSOR STEA AT LIMA CENTENNIAL FOR HIS SYMPHONY

WHILE Scott Receivers have always been noted for the remarkable reception of distant stations they give their owners, it is deeply gratifying to know that they are becoming equally as well known among prominent musicians in all parts of the world, for the perfection of their tonal reproduction.

From Lima, Peru, I have just received, from one of our distinguished owners there, Professor Vicente Stea, a letter and two bound volumes of his Symphony, "The Sinfonia Autoctona." This Symphony has just been awarded the gold medal at the Fourth Centennial of Lima, and I feel deeply honored to know, in a letter just received from Professor Stea, that his appreciation of his Scott Allwave Receiver has inspired him to dedicate this Symphony to me. I

hope in a future issue of the "Scott News" to reproduce some of the music from this Symphony. Professor Stea's letter reads as follows:

My dear Mr. Scott:

"I have always held in highest regard your achievements in the field of musical reproduction. As a musician and composer I believe that I am in a position to really appreciate what this means to music lovers everywhere, who, through your efforts, are now able for the first time to obtain truly life-like reproduction of symphony music in their own homes.

"I have long wanted to express my appreciation to you, and I can think of no more fitting way than to dedicate to you my Autoctone Symphony, which has just won the first prize in the Contest to commemorate the Fourth Centennial of the City of Lima.

"This is the first serious and conscientious work in which is used the famous 'pentaphone' system of five sounds used

by the Inca natives. Up to this time only essays of minor importance have used this pentaphone system, which is the foundation of Peruvian musical art.

"In dedicating my Autoctone Symphony to you, I am expressing my appreciation of your contributions to the field of fine music, in which we both have a common interest.

"For the past several years I have been the proud owner of a Scott Allwave Receiver, for as a musician I am interested in superior tone quality, which I could not find in any set but a Scott.

"A short time ago I was privileged to listen to your new 23 tube Receiver at a private audition in the home of Mr. Henry Gildred in Lima, Peru, along with several prominent musicians and critics. I was literally amazed at the new perfection of tone quality. The other musicians present unanimously agreed that the new Scott Receiver was, without question, the finest they had ever listened to."

Sincerely yours,

VICENTE STEA.



A TRIP THRU OUR MODERN RADIO LABORATORY WHERE SCOTT ALLWAVE RECEIVERS ARE DESIGNED AND BUILT

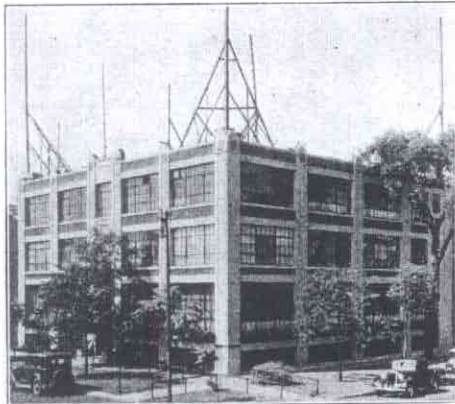

THE MODERN DAYLIGHT LABORATORY IN WHICH SCOTT RECEIVERS ARE DESIGNED AND CUSTOM BUILT.

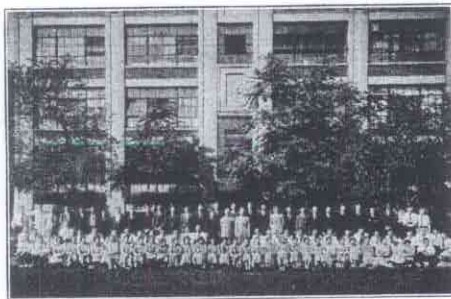

IN THIS GROUP ARE THE HIGHLY SKILLED TECHNICIANS AND STAFF OF THE E. H. SCOTT RADIO LABORATORIES.

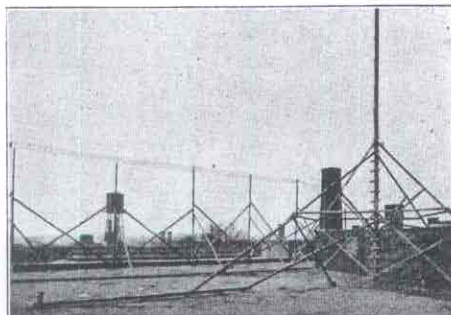

SOME OF THE MANY DIFFERENT TYPES OF ANTENNA.

“WHAT is there about a Scott Custom Built receiver that makes it so much better than other receivers?” This question is asked us time and again, both by callers at the Laboratory and in letters. The shortest answer we know is—“It is an instrument built with the precision of a fine watch, and of such extremely advanced design that it is guaranteed to outperform any other radio receiver in the world.” But suppose we take you thru our Laboratory and show you just what PRECISION BUILDING means in a radio receiver.

THE SCOTT RESEARCH LABORATORY

Let us start our visit by climbing up the stairs to the roof where we have installed a large number of antennas of various types which enable us to duplicate practically any reception condition under which a radio receiver is required to operate.

Next we visit the Experimental and Research Laboratory, one of the best equipped radio laboratories in the world, where we find the very latest measuring and testing equipment, and the instruments used in making the precise measurements required for charting the Sensitivity, Selectivity and Fidelity of curves, and enable us to measure with exactness the efficiency of a receiver. The views on this page will give you some idea of the large amount of precise and delicate measuring and testing equipment used in our Research Laboratory.

Tone distortion is immediately detected by the delicate precise instruments of the Laboratory, which show us if the slightest degree of distortion is present, for these instruments are much more sensitive than the human ear.

The design of the receiver finally completed in the Research Laboratory, a number of models are made up and tested in various locations, and required to perform 100% in places where quite often the average radio set falls down completely. These final reception tests concluded, we start building the receiver for you.

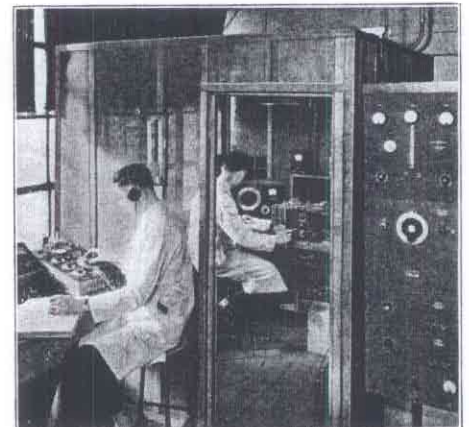

A SECTION OF THE DEVELOPMENT LABORATORY SHOWING THE SPECIAL SIGNAL GENERATOR AND COPPER SCREENED ROOM WHERE SENSITIVITY, SELECTIVITY AND FIDELITY CURVES ARE MADE.



ANOTHER CORNER OF THE DEVELOPMENT AND RESEARCH LABORATORY.

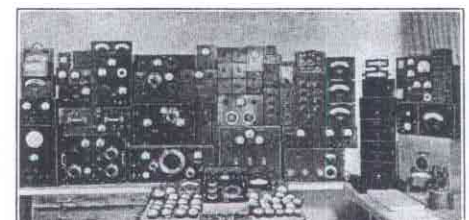

PART OF THE PRECISION EQUIPMENT USED IN THE RESEARCH AND DEVELOPMENT LABORATORIES.

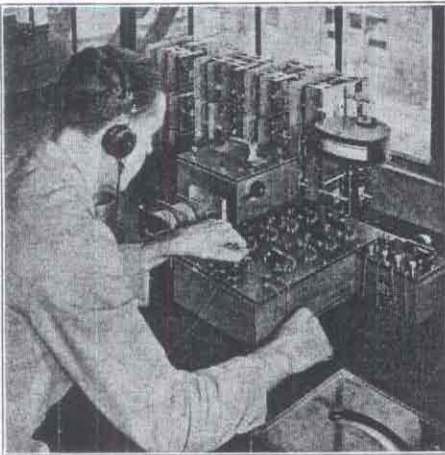

TESTING EQUIPMENT ON WHICH ALL VARIABLE AND FIXED CONDENSERS ARE CHECKED. THIS APPARATUS IS SO SENSITIVE IT WILL MEASURE CONDENSERS WITHIN ONE MILLIONTH OF 1 MFD.



AFTER THE INITIAL TEST AND CALIBRATION, EACH SCOTT RECEIVER IS PLACED IN THESE "AGEING" RACKS AND GIVEN A 24 HOUR CONTINUOUS OPERATION TEST, TO MAKE CERTAIN THAT EVERY PART IN THE CIRCUIT IS PERFECT.

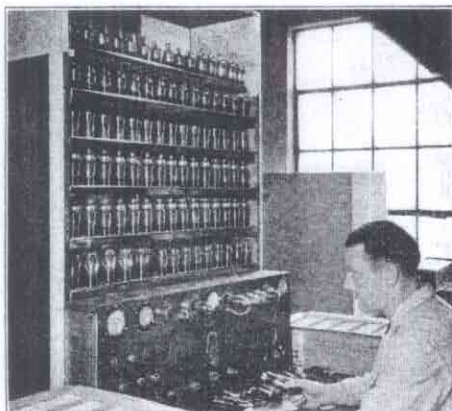

EVERY TUBE USED IN A SCOTT RECEIVER IS FIRST AGED, THEN CAREFULLY CHECKED AND MATCHED.

WHY SCOTT CUSTOM BUILT RECEIVERS GIVE EXCEPTIONAL PERFORMANCE

Scott Receivers are not built to sell at a price, for the most efficient receiver and the finest possible reception cannot be obtained if a set is designed so that it will cost no more than a certain figure. After the completion of the design of a Scott Receiver, the labor and material costs are computed, and the selling price is then set.

ANTENNA AND OSCILLATOR COILS MATCHED TO WITHIN ONE-EIGHTH OF A TURN

A special apparatus designed in our Research Laboratory tests all antenna and oscillator coils, and is, we believe, one of the most efficient pieces of testing equipment ever used to match antenna and oscillator coils. It is so sensitive that if just one turn of wire is removed from a coil containing 80 or 90 turns, it will show a deflection on the meter of 30 points, and our coils are measured accurately to within one-eighth of a turn of wire. This apparatus also indicates the "Q" of the coil, which determines the ultimate sensitivity of the circuit in which it is placed.

ALL CONDENSERS CAREFULLY MATCHED

Each section of every variable condenser is accurately matched to a standard calibration curve at five points of rotation before it is put into a Scott Receiver. The instrument shown makes these calibrations accurately to one millionth of 1 mfd. Every fixed condenser is tested not only for capacity, but for leakage and power factor, and is finally given a test for breakdown at 2½ times its working voltage, to make sure it will never break down under actual operating conditions.

EVERY I.F. TRANSFORMER EXACTLY IDENTICAL

Every I.F. transformer is checked on a very sensitive gain meter which makes certain that every transformer in the I.F. amplifier is exactly identical. This very close matching of the I.F. transformers enables us to secure maximum efficiency in the completed amplifier, so securing maximum Sensitivity and Selectivity.

SPECIAL TREATMENT GIVEN ALL TRANSFORMERS

After test, all transformers are baked in an electric oven, the temperature of which is thermostatically controlled, for 24 hours, to remove every trace of moisture. A special treatment is then given to the transformer which enables it to maintain its characteristics indefinitely. Because of this treatment Scott Receivers will operate satisfactorily for long periods in humid, tropical climates, or on sea coast locations where the salty sea air very quickly renders the ordinary set useless.

To check our methods of impregnation, and to make certain Scott Receivers will operate continuously even in the humid atmosphere of the tropics, we are continually testing parts in the interior of a large refrigerator, to the inside door of which is attached a U. S. Weather Bureau type

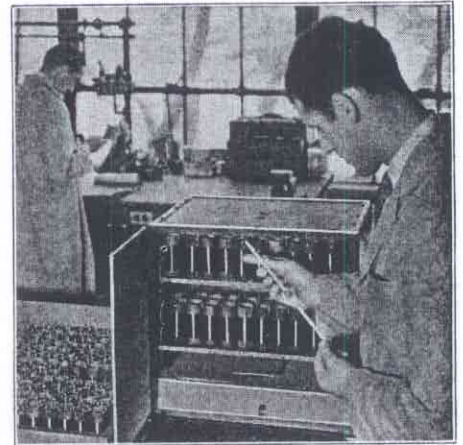

ALL TRANSFORMERS ARE FIRST BAKED IN THIS THERMOSTATICALLY CONTROLLED ELECTRIC OVEN TO REMOVE EVERY TRACE OF MOISTURE, THEN SPECIALLY TREATED TO PREVENT MOISTURE AFTERWARDS AFFECTING THEM.

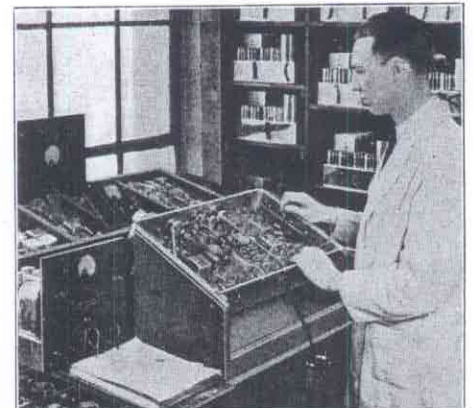

WHEN WIRING OF RECEIVER IS COMPLETED, AN EXPERIENCED ENGINEER CHECKS EVERY CONNECTION AND CIRCUIT.

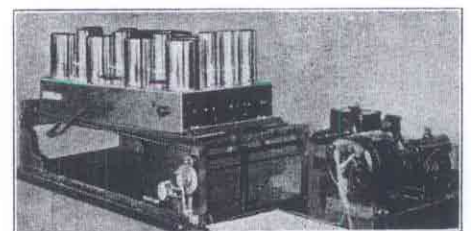

THE "BOUNCER" USED IN LABORATORY FOR VIBRATION TESTS TO CHECK PERMANENCY OF ADJUSTMENTS.

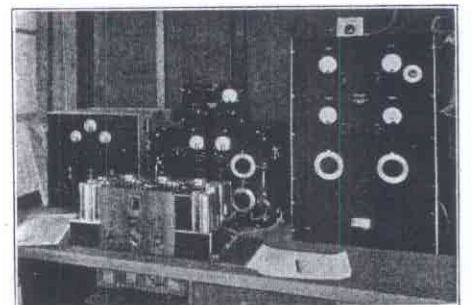

IN THIS COPPER SCREENED ROOM EVERY SCOTT RECEIVER IS TESTED AND ADJUSTED AS CAREFULLY AS A FINE WATCH.

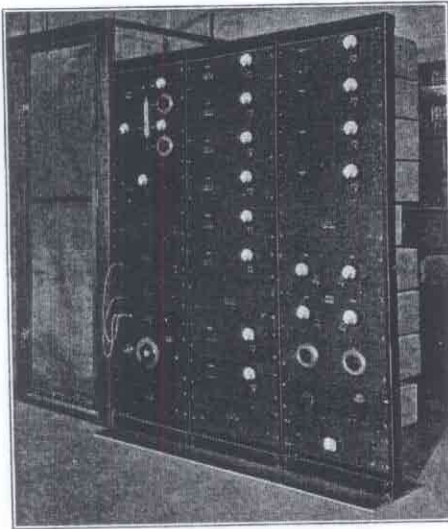

THE SPECIALLY DESIGNED CRYSTAL CONTROLLED MASTER SIGNAL GENERATOR USED TO CHECK AND CALIBRATE ALL SCOTT RECEIVERS. THIS EQUIPMENT IS CHECKED WEEKLY WITH W.W.V., THE FREQUENCY STANDARD TRANSMITTER OF THE BUREAU OF STANDARDS AT WASHINGTON, D. C., AND ITS ACCURACY HAS NEVER VARIED MORE THAN FIVE CYCLES IN ONE MILLION.

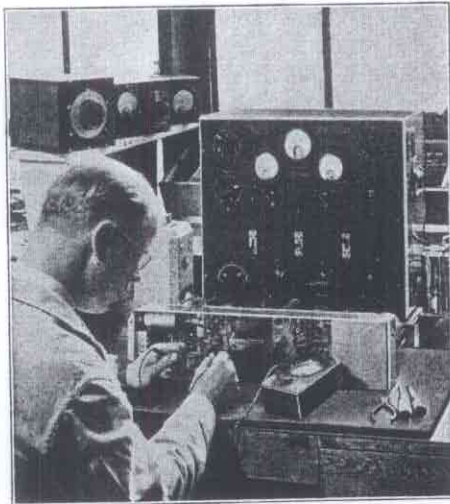

EACH AMPLIFIER, AFTER BEING CONNECTED TO THE CHASSIS FOR 24 HOURS IN THE "AGEING" RACK, IS CAREFULLY TESTED AND CHECKED FOR CORRECT VOLTAGE, POWER OUTPUT, AND TONE QUALITY.

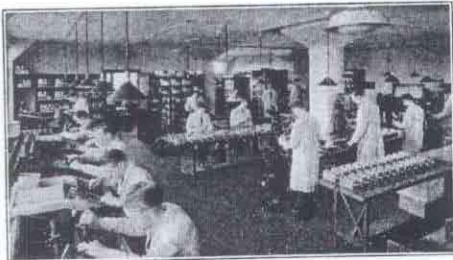

EXPERIENCED TECHNICIANS WORKING UNDER IDEAL CONDITIONS IN THIS DAY-LIGHT ROOM, ASSEMBLE AND WIRE EACH SCOTT RECEIVER. EVERY SET IS BUILT WITH THE SAME CARE AS A FINE WATCH—A STANDARD FOR THE "PRECISION INSTRUMENT OF RADIO."

Hygrometer to show temperature and humidity. At the bottom of the refrigerator is a large pan of water to which salt has been added, with an electric light bulb inserted in it to heat the water. In this refrigerator are placed complete chassis, power amplifiers, speakers and various parts, which are subjected for long periods of time to the extremes of humidity such as would be encountered in very tropical countries. Tests such as these make certain that Scott Receivers can be sent to any part of the world with the certainty that they will give years of satisfactory operation.

ALL TUBES CAREFULLY CHECKED

A section of the Laboratory is devoted to carefully aging and testing every tube used in a Scott Receiver. When the tubes are received from the manufacturer they are given a preliminary test, then placed in the "aging rack" for 24 hours, and later are given a final test. Only those tubes meeting our standards and free from microphonics are used in a Scott Receiver.

MECHANICAL INSPECTION

Every Scott Receiver is assembled and wired by the expert fingers of men who have been trained for many years in our Laboratory, and who know exactly why each wire should go into a certain place or position. Upon completion, the receiver is inspected by the engineer in charge of wiring the receivers. After receiving his OK, it is taken to a shielded test room where the receiver gets its final performance test.

MASTER SIGNAL GENERATOR CHECKS ALL SCOTT RECEIVERS

Our Master Standard Frequency Signal Generator is an extremely precise instrument, the only one of its kind, and specially designed for the Scott Radio Laboratories. Each week the frequency of this Master Generator is checked by the transmissions from station WWV, the Standard Frequency Transmitter of the Bureau of Standards, Washington, D. C. This Generator supplies exact frequencies and calibrations of every band on the receiver.

After the first test, the receiver is placed in an "aging rack" where it is subjected to 24 heating and cooling cycles for 24 hours. After this, it is returned to the screened test room, where it is rechecked, and any receiver which shows the slightest variation from its correct calibration, is rechecked and again placed in the "aging rack." This process of calibration, aging, and checking calibration, results in a receiving instrument that is as precise and dependable as the finest watch.

HOW PERMANENCY OF ADJUSTMENTS ARE CHECKED

The construction of Scott Receivers must be so sturdy that they can be shipped to every corner of the globe and stand the rough handling they undoubtedly get during transit, so that they arrive at their destination with all adjustments unaltered. When the research laboratory completes the design of a receiver it must pass a final test on what we term here in the laboratory



THE OSCILLATOR AND ANTENNA COILS ARE MATCHED PERFECTLY ON THE PRECISE APPARATUS SHOWN, WHICH CAN MATCH COILS TO WITHIN $\frac{1}{8}$ OF A TURN IN A COIL OF 90 TURNS.

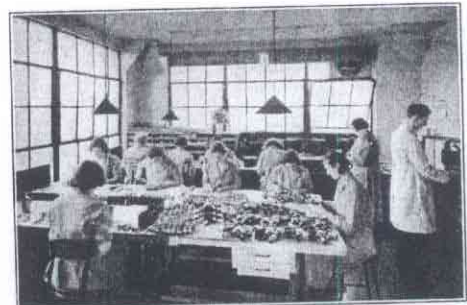

THE EXPERT HANDS OF THE YOUNG WOMEN SHOWN ABOVE, WIND THE SPECIAL PRECISION COILS USED IN SCOTT RECEIVERS.

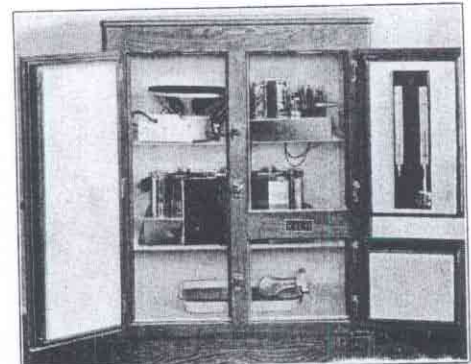

TO MAKE CERTAIN THAT SCOTT RECEIVERS WILL OPERATE INDEFINITELY UNDER ALL CONDITIONS OF TEMPERATURE AND HUMIDITY, PROLONGED TESTS ARE CARRIED OUT IN THIS CABINET IN WHICH WE CAN DUPLICATE PRACTICALLY ALL CONDITIONS UNDER WHICH THEY WILL BE USED.



A VIEW OF OUR GENERAL OFFICE IN WHICH YOU WILL NOTE THE LATEST TYPE OF OFFICE EQUIPMENT SO THAT ALL TRANSACTIONS CAN BE HANDLED QUICKLY AND ACCURATELY.

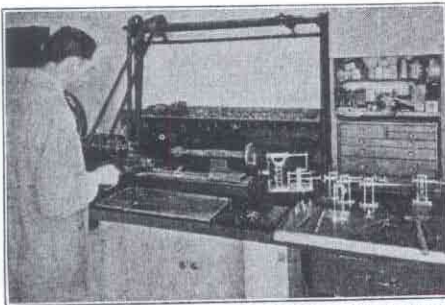

ALL MECHANICAL FEATURES INCORPORATED IN SCOTT RECEIVERS ARE DESIGNED AND BUILT IN OUR OWN LABORATORY.

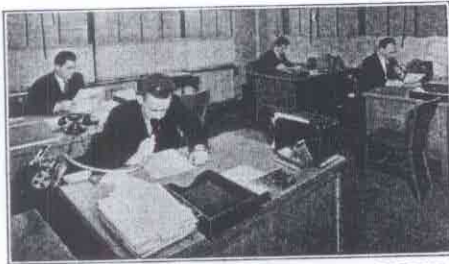

IN THIS BRIGHT, AIRY ROOM ALL CORRESPONDENCE IS HANDLED. LETTERS COME TO US IN MANY LANGUAGES, FROM ALL PARTS OF THE WORLD, BUT ALL ARE ANSWERED IN THEIR OWN LANGUAGE.

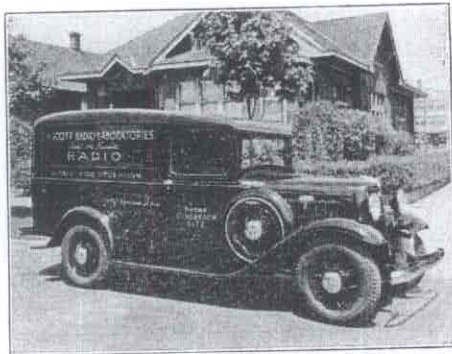

THE DELIVERY AND SERVICE CAR.

the "bouncer." The chassis is placed on the wooden platform, and a cam slowly raises this platform up 1", then Bang—down goes the chassis with a thud that can be heard all over the Research Laboratory. One would think to watch this test no receiver could be built to stand such rough treatment, yet a Scott Receiver will stand this severe jarring for weeks at a time, and still remain in perfect adjustment. The receivers which undergo these special tests are never shipped to customers. These tests are made so that we can deliver a receiver to you which we know will safely arrive at your home in perfect adjustment, and give satisfaction for many years without trouble.

WE VISIT THE STUDIOS

Now that we have completed our trip of the Laboratory proper, I believe you will readily appreciate that the Scott Receiver is the product of a well equipped laboratory, built with precision and watchlike craftsmanship. So let us conclude our tour by going to the second floor, and visit one of the four studios, each one furnished exactly like the living room you have in your own home. Here you will find the final proof of the superiority of a Scott Receiver. You will hear tone so clean cut, clear and perfectly natural, that it requires little effort on your part to imagine the actual artist or orchestra is in the room with you.

While you are listening, you can glance over the many beautiful consoles I have had especially designed for Scott Receivers. Every console is built with selected woods, and is a masterpiece of cabinet maker's art, for they too, like Scott Receivers, are custom built. Their graceful lines will add distinction to a room in any home. All have the same "thoroughbred" look of quality you notice in a custom made suit of clothes—for the really fine things are always hand made.

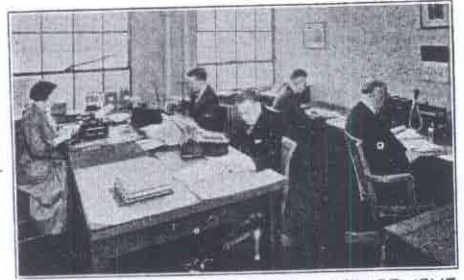

THE AUDITING AND ORDER DEPARTMENT.

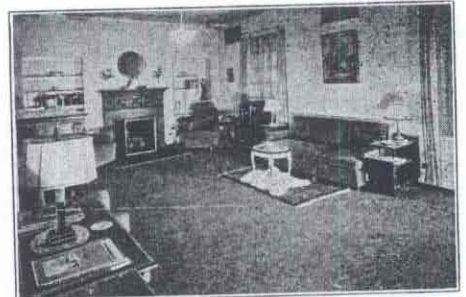

SO THAT VISITORS MAY SEE AND HEAR A SCOTT RECEIVER UNDER THE SAME CONDITIONS THEY WILL LISTEN TO IT IN THEIR OWN HOME, WE HAVE FURNISHED AT THE LABORATORY, FOUR ROOMS OF DIFFERENT TYPES, DUPLICATING IN APPOINTMENT, AND APPEARANCE, THE LIVING ROOMS IN A FINE HOME. TWO OF THESE ROOMS ARE SHOWN IN THE ABOVE PHOTOGRAPHS.

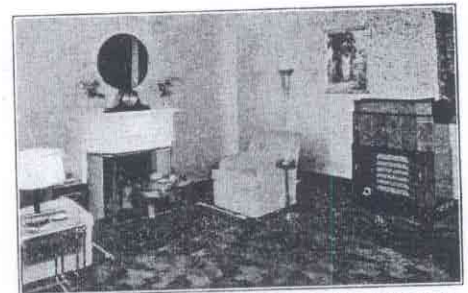

FERENT TYPES, DUPLICATING IN APPOINTMENT, AND APPEARANCE, THE LIVING ROOMS IN A FINE HOME. TWO OF THESE ROOMS ARE SHOWN IN THE ABOVE PHOTOGRAPHS.

World's Verified Long Distance Records Established By Scott Custombuilt Radio Receiver

SCOTT precision workmanship and advanced design is reflected directly in the World's Long Distance Reception Records they have established during the past ten years.

In 1924, the first Scott Receiver, the World's Record Super 8, established no less than Four Verified World's Long Distance Records for the consistent, night after night, reception of stations 6,000 miles or more distant. During a period of 13 weeks, 117 programs were heard, logged, and fully verified, and EVERY ONE of these programs came from a station 6,000 miles or more distant.

In 1931 and 1932, a SCOTT ALL-WAVE RECEIVER established a new World's Reception Record by receiving every single program transmitted from one station over 9,000 miles distant, and receiving every program (except three) transmitted from another station also 9,000 miles distant during a period of 12 consecutive months. This reception has been fully verified in every way, and stands today as the greatest DX record that has ever been established in the history of radio.

Wherever reception conditions are difficult, or reception must be obtained consistently over long distances, there

you will find a Scott Allwave Receiver. Today, they are in use in every country in the civilized world, and letters received by us from owners in these distant lands tell us they are now securing reception such as they had never before been able to accomplish on any other radio receiver.

You can be assured that in the 23 tube SCOTT FULL RANGE HIGH FIDELITY ALLWAVE RECEIVER, you have the last word in radio, with all of the worth while developments in radio science incorporated in its design, and unquestionably the most efficient instrument known to the world of radio.

THE FINEST ALLWAVE HIGH FIDELITY RADIO RECEIVER IN THE WORLD

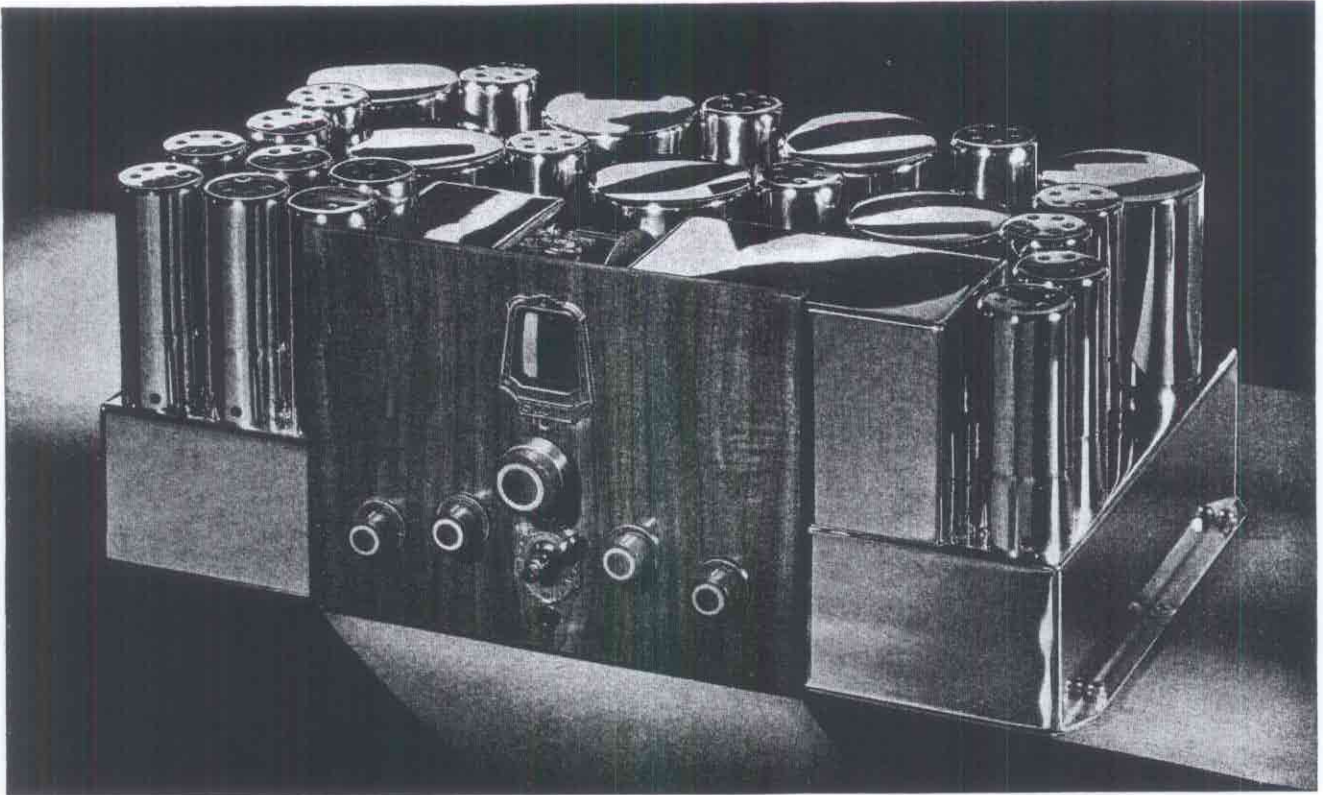

THE 23 TUBE SCOTT FULL RANGE HIGH FIDELITY ALLWAVE CHASSIS

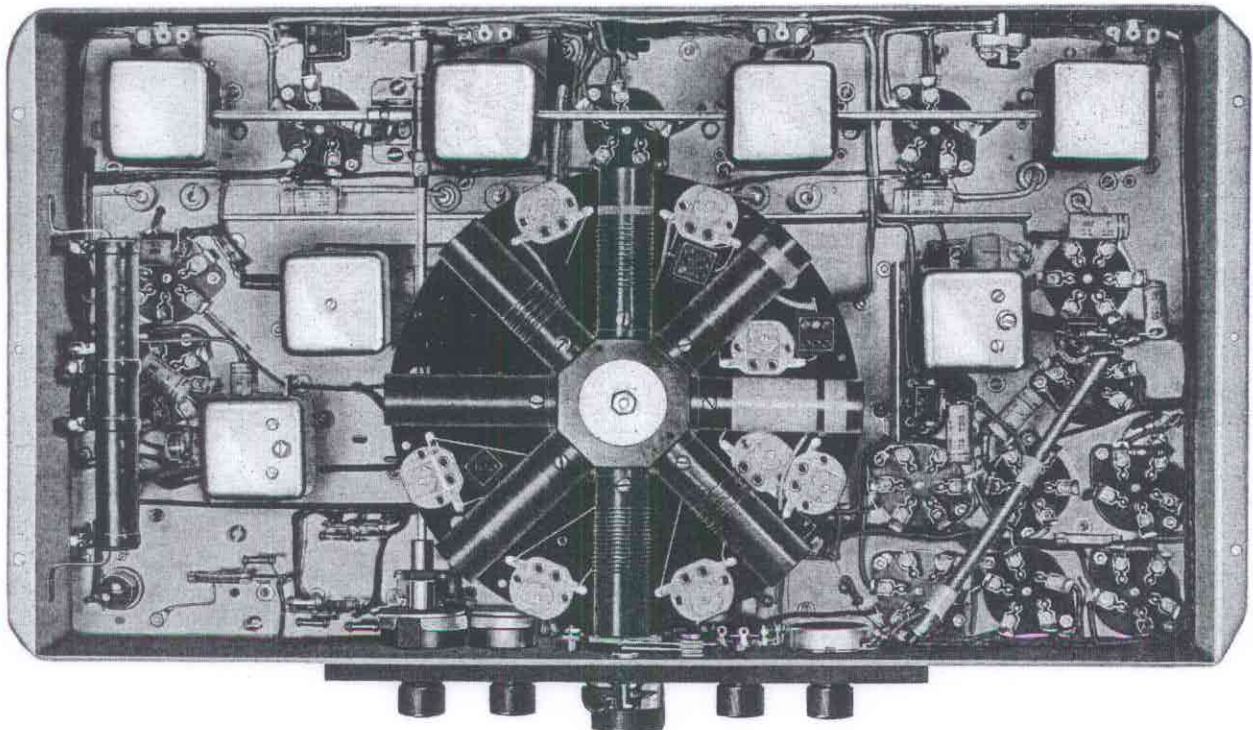

VIEW UNDER CHASSIS SHOWING WAVE CHANGE COILS, SELECTIVITY-FIDELITY CONTROL, ETC.

NO OTHER radio receiver in the world has such high quality parts or is built with the precision of the new 23 tube SCOTT FULL RANGE HIGH FIDELITY ALLWAVE RECEIVER. Most people on seeing the beautifully constructed, chromium plated chassis and amplifier for the first time, are under the impression they are looking at a special set that has been created for show purposes, and are surprised to know that the receiver they are looking at is exactly the same as everyone that leaves the Laboratory.

What is equally important, however, is the fact that the beautiful outside finish is not merely "skin deep," for the parts that are not seen are of exactly the same high quality as those that are seen. An examination of the workmanship under the Scott chassis creates much the same impression as does the examination of the inside of a really fine watch.

WHY SCOTT RECEIVERS ARE FINISHED IN CHROMIUM

However, the beautiful finish of a Scott Receiver is not merely for show. They are shipped to every part of the civilized world, and their finish and construction must be such, that, to stand up and give continuous service for the five years for which they are guaranteed, the finish and construction must be as perfect as it is possible for human hands to make it.

Scott Receivers have been finished in chromium for many years, because it is the only known finish that will retain its gleaming surface indefinitely, in humid tropical climates, and in locations near the sea coast.

AN INTERESTING COMPARISON

All parts that go into the construction of a Scott Receiver are oversize, with safety factors many times that of the ordinary receiver. One very interesting comparison to make between a Scott Receiver, and the regular type of radio, is that of the size of the Power Transformer and the Chokes mounted on the amplifier base, with the Power Transformers and Chokes used in the regular type of receiver. Oversize transformers and chokes mean years of trouble-free service.

Another interesting comparison is the size of the shielding cans of our new receiver with that of any other receiver, for large shield cans mean greater coil efficiency and sensitivity.

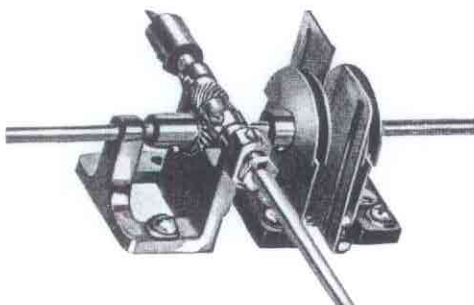

WORM GEAR DRIVE OF SELECTIVITY FIDELITY CONTROL

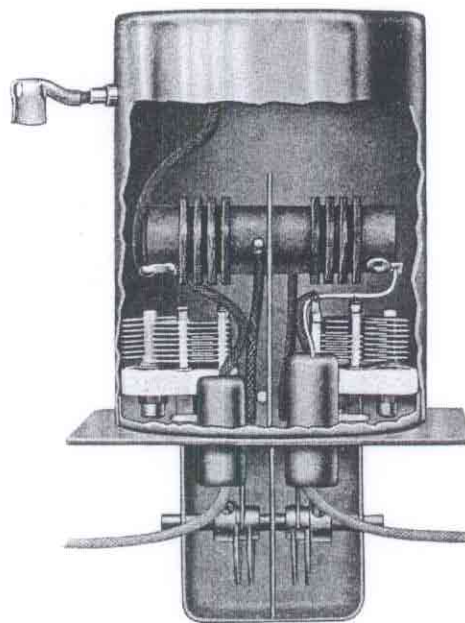

AIR TUNED—4 PI—I.F. TRANSFORMER UNIT

PATENTED WAVE CHANGER INSURES PERFECT CONTACT

Instead of the usual commercial type of coils used to secure reception on the various wave bands, in the Scott Receiver is incorporated a special patented wave change system that is the result of many years of research, and is used exclusively in Scott Receivers. It insures perfect contact between the coils at all times, and the shortest possible connections between the coils and the tubes to secure maximum sensitivity in bringing in distant stations from all parts of the world.

DESIGN YEARS AHEAD OF ORDINARY RADIO RECEIVERS

On the opposite page is a photograph of the top of the chassis, and also a view with the bottom plate of the chassis removed. It is not necessary to be an engineer to realize that here is an instrument of precision.

But the mechanical perfection of the new 23 tube SCOTT FULL RANGE HIGH

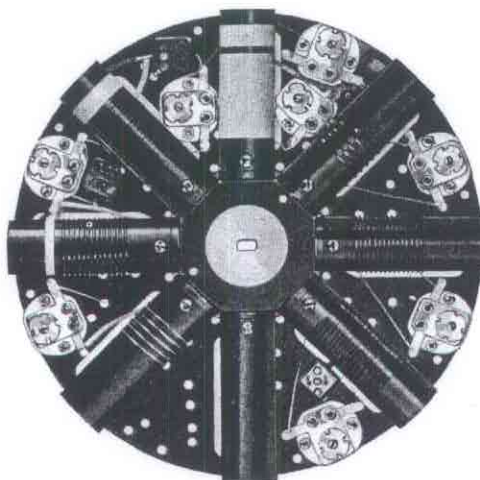

TOP OF WAVE CHANGE COILS

FIDELITY ALLWAVE RECEIVER is only one evidence of its superiority. Incorporated in its design, are features so advanced that it will probably be several years before they are found in the regular commercial type of receiver.

GUARANTEED TO BRING IN LONG DISTANCE STATIONS WITH MORE VOLUME

To bring in stations clearly and with good volume from all parts of the world, a radio receiver must have—first, a high degree of usable sensitivity combined with great selectivity. I believe these two qualities are combined in the new SCOTT FULL RANGE HIGH FIDELITY ALLWAVE RECEIVER to a higher degree than any other receiver in the world today. The high degree of sensitivity secured is largely due to the advanced design and extreme efficiency of the I.F. amplifier, with its 4 stage, air tuned, 4 Pi Litzendrath I.F. transformers.

However, with thousands of stations now on the air in all parts of the world, a high degree of sensitivity is of little use unless the receiver is also capable of providing a high degree of selectivity. The Variable Selectivity system incorporated in our new receiver is the result of many months of intensive work in our research laboratory. It is continuously variable, and provides any degree of Selectivity desired from as sharp as 2 Kc. up to 16 Kc. This extreme usable Sensitivity and high selectivity, enables the 23 tube SCOTT FULL RANGE HIGH FIDELITY ALLWAVE RECEIVER to be guaranteed to bring in more distant stations, with greater volume, than any other receiver.

A PERFECT MUSICAL INSTRUMENT

But tremendous Sensitivity and Selectivity are only two of the features of this remarkable receiver. From all over the world has come an enthusiastic response from musicians and those interested in perfect musical reproduction, who tell us that here at last is an instrument capable of reproducing perfectly every musical sound. The secret of this enthusiasm lies in the ability

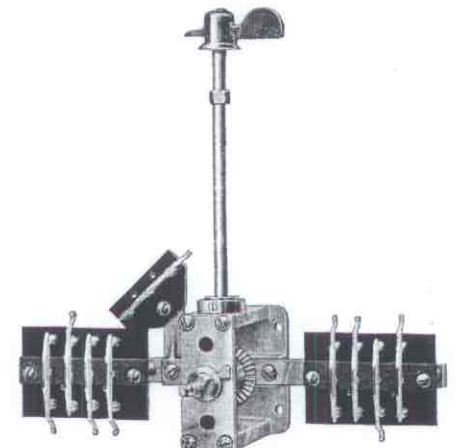

THE CONTACTS AND SWITCH MECHANISM OF WAVE CHANGER

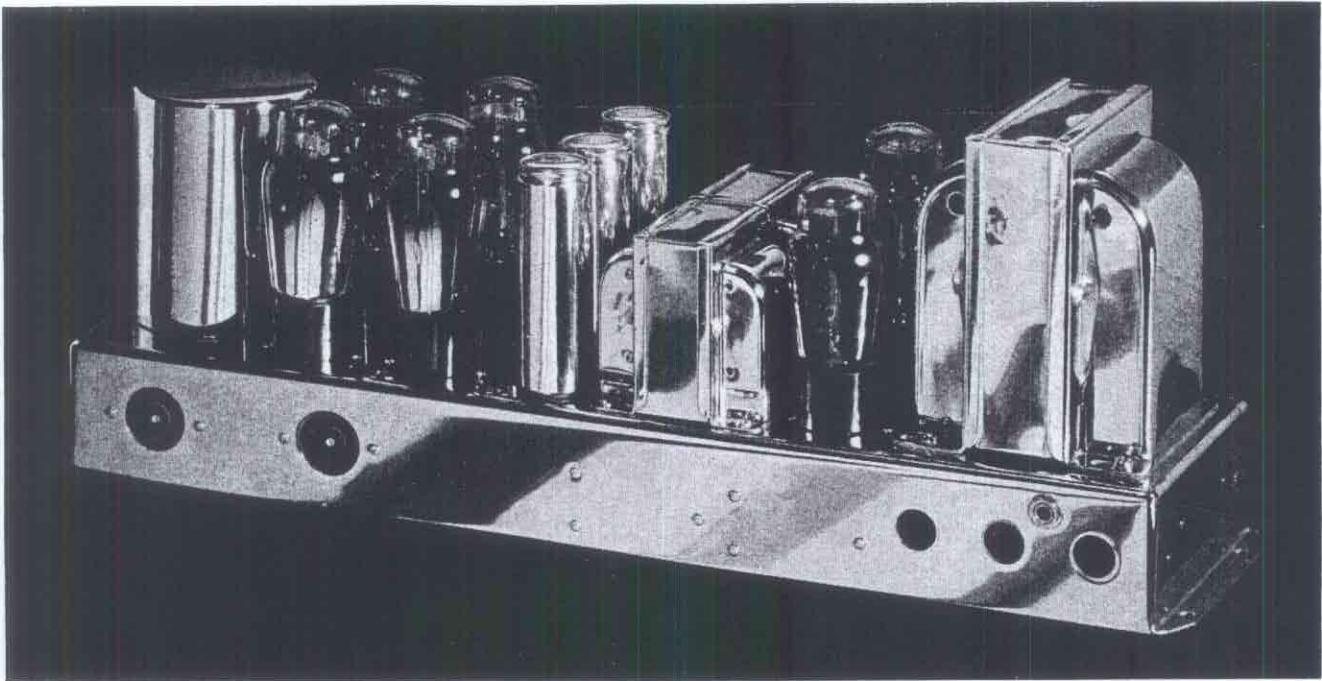

TOP AND BOTTOM VIEWS OF POWER AMPLIFIER FOR THE 23 TUBE SCOTT FULL RANGE HIGH FIDELITY ALLWAVE RECEIVER

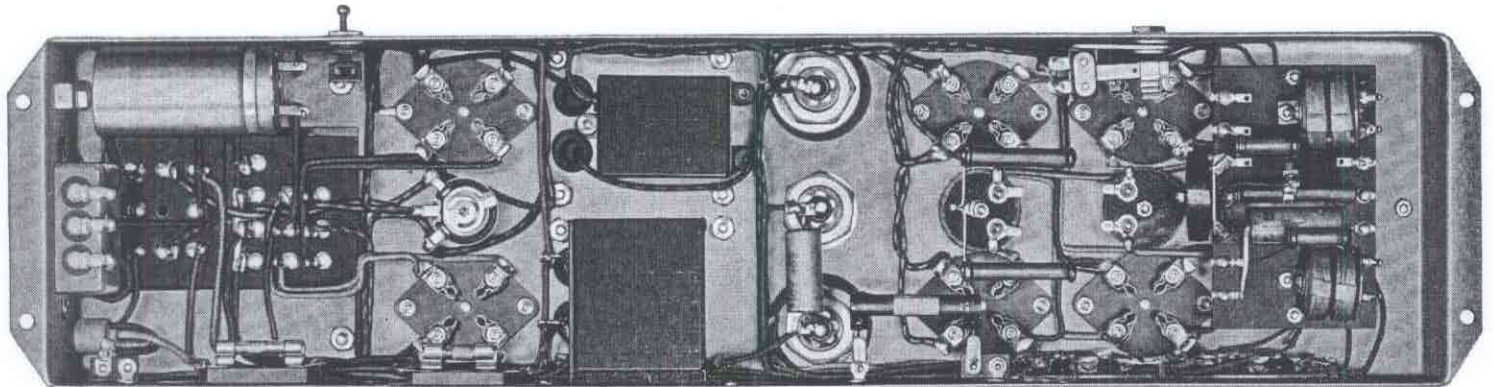

of our new receiver to reproduce faithfully every frequency audible to the human ear, the complete audible range from 25 to 16,000 cycles, more than twice the frequency range of any other radio receiver. This extreme frequency range is a feature that is now being pioneered by the Scott Laboratories, and I confidently predict that the frequency range of the 23 tube SCOTT FULL RANGE HIGH FIDELITY ALL-WAVE RECEIVER, will be the frequency range of the ordinary radio receiver produced two or three years from today.

AND IF YOU BUY A SCOTT RECEIVER

Generally when you buy an automobile or refrigerator or similar type of product, you rarely hear from the manufacturer again until he believes the time has arrived when he can sell you a newer model.

When you become the owner of a Scott Receiver, however, it is just the start of our association with you, for we believe that a Scott owner who is getting the greatest de-

gree of satisfaction, is one of the most valuable assets in our business. For this reason, each month, as long as you own your Scott Allwave, you receive, without charge, the latest advance information on the best foreign short wave stations on the air, with a unique time table showing exactly the time they can be received in each of the four time zones.

A SPECIAL SERVICE TO SCOTT OWNERS

Many hundreds of owners have written us that the first really satisfactory reception they have heard from a radio receiver was when they bought their Scott. Very often this is due to the fact that this owner had some special reception problem in his particular location. Perhaps it was necessary for us to work out some special type of antenna installation, or give him other assistance, which, together with his efficient Scott Receiver, enabled him to secure satisfactory reception for the first time.

Very often owners are interested in using an extra speaker in some other room in the

home, or wish to make a permanent installation of the receiver in a bookcase, etc. In cases like this, you have at your disposal the complete facilities of the Laboratory to help you make the best possible installation.

This personal contact that is continuously maintained with Scott Owners is just one of the reasons why our business has slowly but steadily grown right thru these depression years. When you buy a SCOTT ALL-WAVE RECEIVER you get more than just the finest radio being built today, for with it you receive a service and cooperation that assures you at all times of the greatest possible satisfaction in the operation of your set.

If at any time you visit Chicago, you are extended a most cordial invitation to visit the Laboratories, where it will be a pleasure, not only to let you see and hear the receiver itself perform, but also to conduct you thru each section of the laboratory where you will see the beautiful, expert workmanship, that goes into each set, and exactly how it is tested and checked at every stage of its construction.

What Does It Cost To Operate The New 23 Tube Scott Full Range High Fidelity Allwave

BECAUSE our new receiver uses 23 tubes, many are under the impression the cost of operation must be quite high, and think that a radio tube consumes as much current as an electric light bulb. This is quite a mistaken idea, for the power consumed by the average radio tube is only a very small fraction of the current consumed by the ordinary electric light bulb.

COSTS ABOUT TWO CENTS PER HOUR FOR ELECTRICITY

The power consumed by the 23 tube SCOTT FULL RANGE HIGH FIDELITY ALLWAVE RECEIVER, played at average volume, is approximately 200 watts. Based on 10c per kilowatt hour, which is the average cost of electricity over the country, the 23 tube SCOTT FULL RANGE HIGH FIDELITY ALLWAVE RECEIVER costs approximately 2c per hour to operate, a truly insignificant sum to pay to hear the best on the air, at its best.

COSTS LESS TO OPERATE THAN ELECTRIC IRON OR TOASTER

When the cost of operation of the new SCOTT 23 TUBE FULL RANGE HIGH FIDELITY ALLWAVE is compared with other electrical appliances, its operation cost is extremely low. For example, the ordinary electric iron consumes from 500 to 600 watts, nearly three times more than our 23 tube receiver. An electric toaster consumes from 500 to 800 watts, over three times the power consumed by our receiver. An electric ice box consumes from 250 to 300 watts, much more electric current than a Scott Receiver uses. The average electric light bulb used in a kitchen light fixture consumes over 100 watts, so that two of these use as much electric current as our receiver. The electric bulb used in the average reading lamp uses from 40 to 60 watts, so that four of these cost as much for electricity as our 23 tube receiver.

From the above figures, it will be seen that the operation cost of the SCOTT 23 TUBE FULL RANGE HIGH FIDELITY ALLWAVE is so small, that even when operated continuously on an average of four hours every day in the month, it will add only a few cents over \$2.00 per month to your electric light bill.

Scott Receivers

Can Be Purchased On
The Budget Plan

(In U. S. A. Only)

Write Us For Further Details

The Music Of The Masters In Your Home — Whenever You Wish To Listen To Them

SUPPOSE tonight on switching on your radio you tuned into Yehudi Menuhin playing Beethoven's "Sonata in A Major," (Kreutzer's Sonata), then later Arturo Toscanini directing the New York Philharmonic Orchestra playing Haydn's "Symphony No. 4 in G Major," or Serge Koussevitzky directing the Boston Symphony Orchestra in "Also Sprach Zarathustra," I am sure you would enjoy every second of these programs, and would come to the end of them with regret.

HIGH FIDELITY RECORD REPRODUCTION BEYOND DESCRIPTION

You who have been fortunate enough to have heard, in person, this famous violinist, and these two noted conductors directing their world famous orchestras, must have many times wished that you could enjoy their music more often.

The above are three of the albums of recordings which have recently been added to our library of recorded music here in the Laboratory, and their beauty, when reproduced thru the amplifying system of the new 23 tube SCOTT FULL RANGE HIGH FIDELITY ALLWAVE RECEIVER, is beyond description. They take on a new brilliance and life that is a revelation to those who have been in the habit of listening to phonograph recordings thru the ordinary electric phonograph or radio-phonograph combinations.

SATISFIES EAR OF THE CRITICAL MUSICIAN

When heard thru the ordinary phonograph combination, these recordings sound very much the same as all phonograph records, and it is only when they are reproduced thru an amplifier *that is capable of reproducing the full range of frequencies up to the 9000 cycles, reached*

by the latest High Fidelity recordings, that they begin to satisfy the ear of the critical musician.

When we say that there is as much difference when listening to these recordings thru an ordinary phonograph, then thru the amplifying system of our new 23 tube receiver that reproduces all frequencies up to as high as 16,000 cycles, as there is between a picture of a landscape reproduced in black and white and that same scene reproduced in its natural colors, we are just stating a simple fact.

PHONOGRAPH EQUIPMENT CAN BE ADDED TO ALL SCOTT RECEIVERS

Every 23 tube SCOTT FULL RANGE HIGH FIDELITY ALLWAVE RECEIVER is built so that electric phonograph equipment can be immediately connected to it without alterations either in the circuit or the wiring. Many of the nineteen beautiful Scott Custom Built Consoles have been designed so that either a single record phonograph, or an Automatic 10 Record Changer can be installed in it as well as the receiver. The new Scott Console Brochure illustrates and describes many of the consoles which are adapted for phonograph equipment.

Scott phonograph equipment comes in two styles—a single record type and the Automatic Ten Record Changer. If you like Symphonies, Operas, or wish to play eight or ten records for dancing, etc., without further attention after placing them on the turn table, I suggest the Automatic Ten Record Changer, since you can put all of the records desired on the turn table at once, and they will be played automatically, one after the other, without further attention.

We will be glad to furnish prices on this equipment on request.

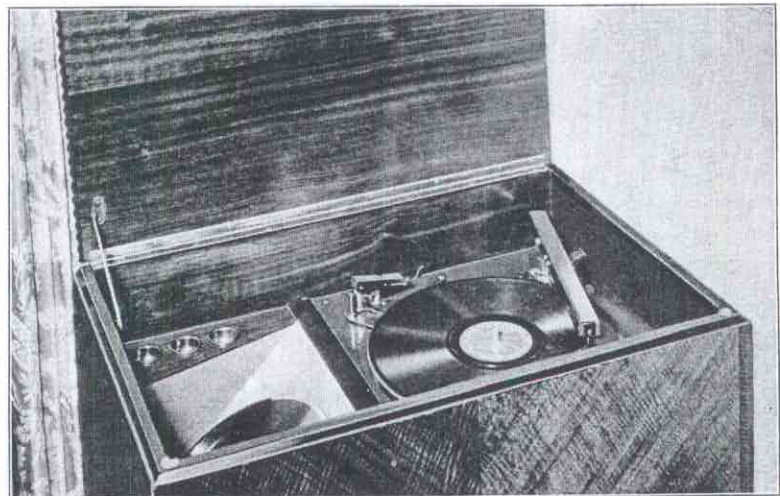

THE SCOTT AUTOMATIC 10 RECORD CHANGER WITH CRYSTAL PICKUP

SCOTT SERVICE NATION WIDE

THE new SCOTT FULL RANGE HIGH FIDELITY ALLWAVE RECEIVER is so ruggedly constructed, so carefully calibrated, tested and checked at the Laboratories, that it is rare indeed that any Scott Receiver ever requires servicing, but when such service is required, the map on the opposite page will show you there is a highly skilled Scott expert always available near you, should you ever need service at any time.

EVERY SCOTT RECEIVER GUARANTEED AGAINST SERVICE DEFECTS FOR FIVE YEARS

The fact that every Scott Allwave Receiver is guaranteed against defects or breakdown (except tubes) for Five Years, gives some idea of the fine quality of parts used, and the highly skilled technicians who build them.

SCOTT REPRESENTATIVE ERECTS ANTENNA AND INSTALLS RECEIVER IN YOUR HOME

When you place your order for a Scott Receiver, our Installation and Service expert located in your territory is notified, and upon receipt of the shipment he will, for a nominal charge, erect the latest type of Scott Super Antenna, install the receiver in your home, and give you complete instructions on tuning and operating, so that you may secure maximum results from your receiver.

EXPERT SCOTT INSTALLATION AND SERVICE REPRESENTATIVES

There are many not familiar with the Scott Radio Laboratory organization, who are under the impression that expert service is available *only* at the Laboratory. To these, it will be a surprise to

know that the purchaser of a Scott Receiver has at his command, in practically every part of the country, the services of possibly the most expert and capable radio technicians in the whole radio industry.

WHO ARE SCOTT SERVICE AND INSTALLATION REPRESENTATIVES?

The great majority of Scott Representatives are men who have been connected with the Scott Laboratory for many years, who started with us in the days when we supplied them, as professional custom set builders with the special laboratory tested parts they used in building their receivers. They are all men who are not only practical, efficient servicemen, but so highly skilled that they can build up a complete receiver from the individual parts if necessary.

When the design of radio receivers became so highly specialized that the building of them required extensive laboratory facilities, the Scott Laboratories discontinued selling parts, and devoted itself exclusively to designing and custom building super-powerful long distance receivers, and these men have continued their association with us as our official Installation and Service Representatives.

Each one of them has been appointed as our Installation and Service Representative only after a very thorough investigation of his experience, ability, character, and responsibility. After their appointment, constant contact is maintained between them and the laboratory, so that they are at all times thoroughly familiar with Scott Receivers. It is only stating a fact that the appointment as an official Scott Representative is an honor eagerly sought after by the highest type of radio technician in the radio

industry, for they know that as a representative of the Scott Laboratories, they are representing the manufacturer of the highest type of radio receiving equipment the world has ever known.

EXPERT ADVICE DIRECT FROM LABORATORY

In charge of our Technical Service Department is Mr. J. O. Barnes, who has been head of this Department for many years. He is a practical radio engineer who has an intimate personal knowledge of every Scott Receiver that has ever been built. Thru Mr. Barnes, every Scott Representative has access to the facilities of every branch of the Laboratories. For those Scott Owners who desire direct contact with the laboratory, a letter to Mr. Barnes or to myself will bring a complete and prompt answer to any question that may arise in connection with the operation of any Scott Receiver.

COMPLETE TEST AND CHECK UP AT LABORATORY FREE OF CHARGE ANY TIME DURING FIVE YEAR GUARANTEE

In addition to the Scott Field Installation and Service Representatives in all parts of the country who are ready to render Scott owners prompt and efficient service should they need it, we of course maintain complete servicing facilities at the Laboratory in Chicago, and after December 1, 1935, will have a direct branch of the Laboratory in New York with similar facilities. Every Scott Owner has the privilege of sending his receiver into the Laboratory either at Chicago or New York for a complete test and check-up, without charge, any time during the Five Year guarantee period.



MR. J. O. BARNES, HEAD OF TECHNICAL SERVICE DEPT.



SERVICE LABORATORY—MR. E. SAYRE, NEW YORK

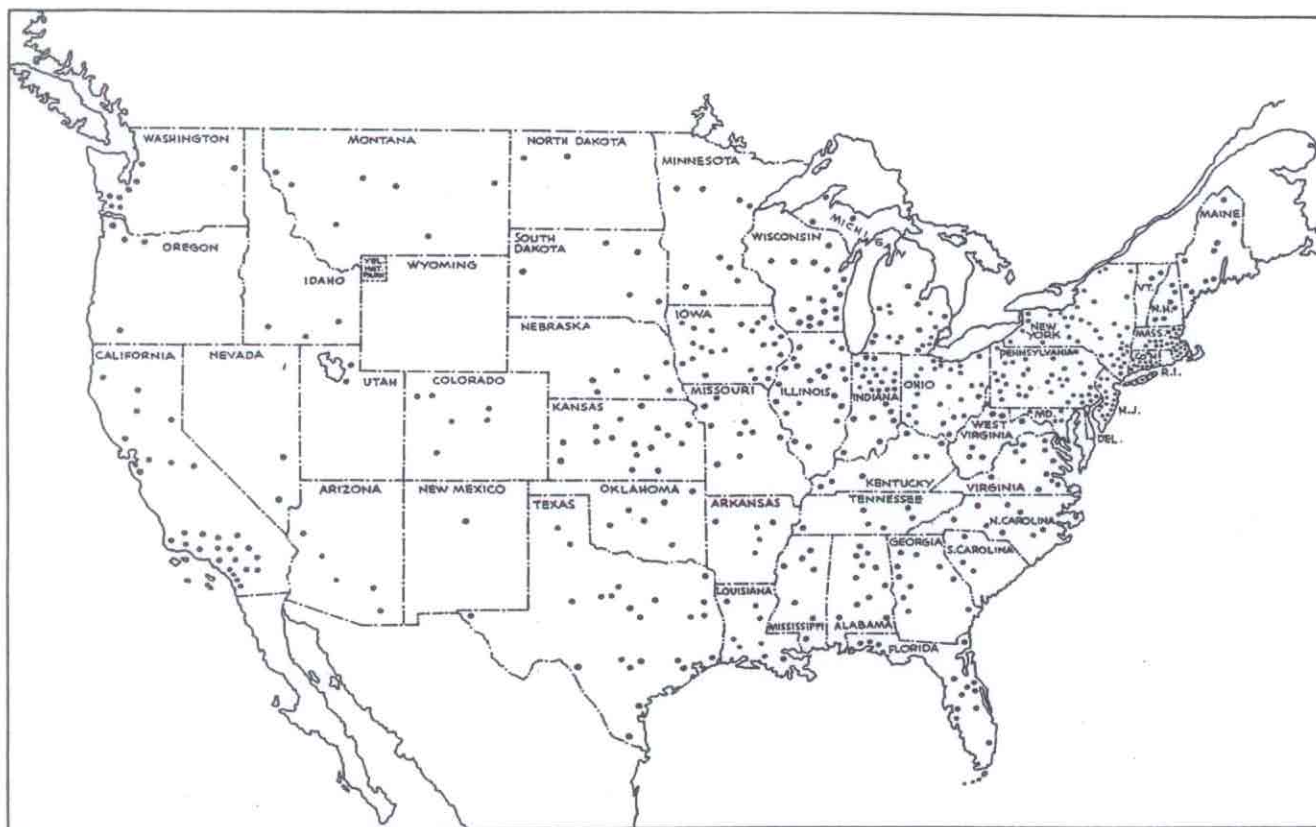

Map Showing Cities Where Scott Installation And Service Representatives Are Located In U. S. A.

ALABAMA—Auburn, Anniston, Bessemer, Birmingham, Collinsville, Cullman, Decatur, Dothan, Mobile, Montgomery, Wetumpka.

ARIZONA—Kingman, Lowell, Phoenix, Tucson.

ARKANSAS—Dewitt, Fort Smith, Piggott, Searcy, Trumann. CALIFORNIA—Alameda, Alhambra, Atascadero, Bakersfield, Delano, Eureka, Glendale, Hawthorne, Hobart Mills, Inglewood, Laguna Beach, Los Angeles, Mill Valley, Oceanside, Palm Springs, Pasadena, Redding, Sacramento, San Diego, San Francisco, San Pedro, Santa Ana, Santa Barbara, Santa Maria, Santa Paula, Sonoma, Stockton, Whittier.

COLORADO—Alamosa, Canon City, Denver, Estes Park, Steamboat Springs, Colorado Springs.

CONNECTICUT—Avon, Danbury, Hartford, Meriden, Milford Devon, New Haven, Springdale, Stafford Springs, Stamford, Old Lyme, Waterbury, West Haven, Wethersfield.

DELAWARE—Marshallton, Wilmington.

DISTRICT OF COLUMBIA—Washington.

FLORIDA—Avon Park, Clermont, Fort Myers, Orlando, Jacksonville, Leesburg, Miami, Pensacola, Quincy, St. Petersburg, Sanford, Tampa, Warrington, Winter Park.

GEORGIA—Atlanta, Augusta, Albany, Bowdon, Canton, Columbus, Dahlonega, Hartwell, Macon, Savannah.

IDAHO—Burley, Filer, Pocatello.

ILLINOIS—Bellefonte, Champaign, Chicago, Danville, Edelstein, Elgin, Granite City, Hamilton, Moline, Kankakee, Peoria, Princeton, Rockford, Rock Island, Paris, Sinclair, Springfield, Spring Valley, Washington, Watseka.

INDIANA—Anderson, Bedford, Bloomington, Cambridge City, Connersville, Elkhart, Evansville, Ft. Wayne, Gary, Indianapolis, Jeffersonville, LaFayette, LaPorte, Logansport, Marion, Michigan City, Nappanee, Richmond, N. Manchester, Terre Haute, South Bend, Warsaw, Wellsboro, Whitestown.

IOWA—Burlington, Carroll, Cedar Rapids, Clarion, Clarksville, Clinton, Council Bluffs, Des Moines, Dumont, Fort Madison, Iowa City, Kent, Luzaene, Marion, Muscatine, Ottumwa, Rippey, Sioux City, Slater, Storm Lake, Volga City, Waterloo.

KANSAS—Arkansas City, Burlington, Edgerton, Ellinwood, Emporia, Fort Riley, Eureka, Jetmore, Leavenworth, Marysville, Sharon Springs, Redwin, Syracuse, Topeka, Tyro, Wichita.

KENTUCKY—Annetta, Ashland, Covington, Kevil, Lexington, Prestonsburg.

LOUISIANA—Baton Rouge, Ferriday, LaFayette, Monroe, Morgan City, New Iberia, New Orleans, Shreveport.

MAINE—Bath, Biddeford, Brownville, Houlton, Portland, Presque Isle, Rumford, Waterville, Waldoboro.

MARYLAND—Baltimore, Cumberland, Pylesville, Westover, Hyattsville.

MASSACHUSETTS—North Adams, Allston, Attleboro, Belmont, Boston, Cambridge, Chelsea, Chicopee Falls, Dedham, Dorchester, Fall River, Farnumville, Framingham Center, Fitchburg, Gloucester, Hudson, Lynn, Malden, New Bedford, Northampton, Peabody, Salem, South Hamilton, Wellesley, Stoughton, Westfield, Whitman, Willamssett, Wollaston, Springfield.

MICHIGAN—Algonac, Allegan, Battle Creek, Benton Harbor, Coopersville, Detroit, East Detroit, East Lansing, Erie, Flint, Grand Rapids, Highland Park, Jackson, Laurium, Litchfield, Marquette, Mt. Clemens, Pontiac, Saginaw, Wyandotte.

MINNESOTA—Amboy, Callaway, Duluth, Minneapolis, Mountain Lake, Proctor, Rochester, St. Paul.

MISSISSIPPI—Burnside, Greenville, Houka, Picayune, Sardis, Schlater, Hattiesburg.

MISSOURI—Boonville, Huntsville, Joplin, Kansas City, Maryville, St. James, St. Joseph, St. Louis, Springfield.

MONTANA—Billings, Butte, Glendive, Great Falls, Lewistown, Libby, St. Ignatius.

NEBRASKA—Humboldt, Lincoln, Loup City, Omaha, Orleans, York.

NEVADA—Calliente, Las Vegas.

NEW HAMPSHIRE—Bartlett, Berlin, Laconia, Pembroke, Milford, Wilton.

NEW JERSEY—Atlantic City, Bogota, Boonton, Caldwell, Haddonfield, Cape May, Cedar Grove, Clifton, Collingswood, Elizabeth, Fair Haven, Maplewood, Ridgewood, Hackensack, Jersey City, Long Branch, Midland Park, Montclair, Moorestown, Morristown, Newark, New Brunswick, Paterson, Passaic, Perth Amboy, Pleasantville, Trenton, Ventnor, Washington, Weehawken, Wood-Ridge.

NEW MEXICO—Albuquerque.

NEW YORK—Albany, Amsterdam, Auburn, Bellerose, Binghamton, Bronx, Brooklyn, Corning, Buffalo, Coxsackie, Endicott, Forest Hill, Geneva, Glen Falls, Glendale, Gloversville, Grant Manors, L. I., Hempstead, L. I., Jamaica, L. I., Jamestown, Ithaca, Little Falls, New City, New Rochelle, New York, Niagara, Old Forge, Oswego, Pawling, Peekskill, Pelham, Penfield, Plattsburgh, Pleasant Valley, Port Jervis, Potsdam, Poughkeepsie, Queen Village, Rensselaer, Richfield Springs, Rochester, Schenectady, Syracuse, Utica, Water Mill, Watertown, W. Winfield, Yonkers.

NORTH CAROLINA—Asheville, Burlington, Charlotte, Durham, Fremont, Mt. Airy, Norwood, Wilson.

NORTH DAKOTA—Minot, Williston.

OHIO—Akron, Albany, Cincinnati, Cleveland, Columbus, Dayton, Hamilton, Jackson, Liberty Center, Lima, Mansfield, Lorain, Marietta, Martins Ferry, Marysville, Painesville, Portsmouth, Russells Point, Salem, Sandusky, Sunbury, Tiffin, Toledo, Toronto, Zanesville.

OKLAHOMA—Guthrie, Hennessey, Kiowa, Miami, Oklahoma City, Tulsa.

OREGON—Ashland, Astoria, Milwaukie, Portland.

PENNSYLVANIA—Aliquippa, Allentown, Bradford, Brookville, Butler, Chambersburg, Chester, Philadelphia, Clymer, Columbia, Coraopolis, Corry, Danville, Donora, Duquesne, Emporium, East Plymouth, Erie, Freeland, Fullerton, Greensburg, Harrisburg, Hellertown, Higspsire, Lemoyne, Longhorne, McKeesport, Meadville, Morton, Mt. Poncono, New Castle, Numidia, Philadelphia, Piteairn, Pittsburgh, Pottstown, Reading, Royersford, Scranton, Shamokin, Sharon, Souderton, Titusville, Upper Darby, Waynesboro, Williamsport.

RHODE ISLAND—East Providence, Newport, Providence, West Warwick, Woonsocket.

SOUTH CAROLINA—Columbia, Greer, Spartansburg.

SOUTH DAKOTA—Aberdeen, Fort Meade, Mitchell, Webster, Sioux Falls.

TENNESSEE—Chattanooga, Cleveland, Sevierville, Knoxville, Memphis, Nashville.

TEXAS—Amarillo, Dallas, Austin, Beaumont, Decatur, Del Rio, El Paso, Fort Bliss, Fort Worth, Henderson, Hico, Houston, Kingsville, Marshall, Matador, Mercedes, Oakwood, Overton, Port Arthur, Randolph Field, San Antonio, Snyder, Texarkana, Waco.

UTAH—Ogden, Salt Lake City.

VERMONT—Newport, Orleans.

VIRGINIA—Bureos Beach, Covington, Dante, Hilton Village, Hampton, Lexington, Gloucester, Madison Run, Norfolk, Newport News, Falls Church, Portsmouth, Saltville, Suffolk.

WASHINGTON—Elma, Chehalis, Centralia, Hoquiam, Olympia, Seattle, Spokane, Tacoma.

WEST VIRGINIA—Alderson, Charleston, Fairmont, Glenalum, Morgantown, Ohley, Wheeling, Wiley Ford.

WISCONSIN—Antigo, Appleton, Beaver Dam, Chippewa Falls, Dorchester, Edgerton, Madison, Evansville, Milwaukee, Monroe, Oshkosh, Pewaukee, Racine, Sheboygan, Two Rivers, Waukesha, Wausau, Wauwatosa.

Some Recent Performance Reports on the New 23 Tube Scott Full Range High Fidelity Allwave Receiver

Naturally, when a manufacturer describes his product he makes the description and results that can be accomplished with it as enthusiastic as possible. Most people, however, prefer a little more unbiased evidence. The letters reproduced below were sent quite voluntarily, and are simply evidence of the enthusiasm the performance of a Scott Receiver generates in those who own one.

If it is not possible for you to visit the laboratory, and you would like to hear a Scott Receiver before you place your order, advise me, and I will be very happy to give you the name and address of the Scott owner nearest to you, together with a note of introduction, which I feel sure will be sufficient to obtain for you a complete demonstration of the performance of his receiver, and will quickly prove to your satisfaction that the new 23 tube Scott Full Range High Fidelity Allwave Receiver truly deserves its title "The World's Finest Radio Receiver."

THE ULTIMATE ACHIEVEMENT IN RADIO RECEPTION

"In this, my first letter since operating the receiver, I will not bother to give you lengthy logs of stations received, but I will say that I am able to hear any station in the world capable of putting an impulse in my antenna. I have heard them from the other side of the earth, need I say more? Occasionally, during our lives we are privileged in seeing or hearing the activities of our fellow men achieve superb heights. At these times, whether they be in the field of athletics, business, science, art, or any combination of them, I am intensely moved. I am so moved as I listen to the Scott. To me, this instrument represents the effort of one whose heart and soul is in the achievement of the ultimate in radio reception."

H. S. Mason, Jr., Azusa, Calif.

PERFORMS PERFECTLY

"I received my SCOTT FULL RANGE HIGH FIDELITY ALLWAVE RECEIVER last week and am writing you to let you know it justifies all your claims as to tone, range, and selectivity. Without a doubt, it is the finest set I have ever heard. The set performs perfectly and is the source of much pleasure and amazement to all of my friends who have heard it."

A. J. McCullough, Chicago, Ill.

HEARS AUSTRALIA ON 15 FT. ANTENNA

"The SCOTT FULL RANGE HIGH FIDELITY ALLWAVE RECEIVER is working as you intended it should. It beats everything, reproduces everything. Recently have been operating it on an inside aerial on account of the electrical storms we are having. Last Sunday morning Sydney, Australia, came in quite clearly while I was using an inside antenna less than 15 feet in length."

C. M. Richardson, Mishawaka, Ind.

RANCHO YUCCA LOMA

VICTORVILLE
CALIFORNIA

E. H. Scott Esq.,
4450 Ravenswood Ave.,
Chicago, Ill.

October 20th, 1935.

Dear Mr. Scott,

Now that the Scott Allwave Receiver has been carefully installed, following your instructions to the letter, I can offer you my whole hearted congratulations and thanks for the existence of this wonderful instrument. It has truly surpassed our expectations in every way. Its range, tone, sensitivity and freedom from noise are a revelation and it is needless to tell you that it is our unanimous choice over a similarly advertised receiver.

You must have become quite used to enthusiastic letters from your customers, but I can see now that they are genuine. I never thought I would be writing a letter like this, but when one hears a great artist give a magnificent performance, one finds oneself out of one seat shouting and applauding without reserve, and that's the way I feel about your radio achievement. I feel that you have made a very great contribution to this age we live in.

And I thank you, sincerely,

DAVID MANNERS

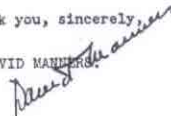

SURPRISED AT REALISTIC TONE

"I had my SCOTT FULL RANGE HIGH FIDELITY ALLWAVE installed in less than three-quarters of an hour. The looks and finish impressed me very much indeed. And as for the tone, I was surprised that a radio could sound so realistic. England, France, Germany, Italy and Rome come in like locals, with the volume on only one-quarter turn. I can see plenty of days of enjoyment with my SCOTT ALLWAVE. I am proud of my SCOTT ALLWAVE, and I want you to know it."

Edgar F. Girard, Holyoke, Mass.

PERFECT SELECTIVITY

"I have never heard another set with such tremendous volume. or with such perfect selectivity. As I told you before I am interested in short wave. I have had some very fine reception from foreign stations. The loudest so far has been Holland on 16 meters. The most consistent reception has been from London. I listen to their news broadcasts regularly at either 7:45 or 9:45 every evening. Japan on 27 and Melbourne have been good most every morning."

G. E. Osha, Minneapolis, Minn

UNLIMITED POWER WITHOUT DISTORTION

"I am not an authority on radios, but even a child can recognize the superior qualities of a Scott. The reproduction is so natural that I have had my two year old child ask me where the man was hiding. I have not spent a great deal of time trying to log foreign stations, but I do get London, and JVH, Japan, quite consistently and with good volume. I derive my greatest enjoyment from listening to local and semi-local stations on the broadcast band. I have had time to fully appreciate the usefulness of the Sensitivity and Selectivity-High Fidelity controls. With these controls, tuning is sharp, easy, efficient, and a pleasure. The unlimited power accompanied with lack of distortion and realistic tone is always a temptation to turn on more volume. When a station is tuned comparatively loud, the reception is still pleasing and does not irritate the nerves and ears. I have been told that I am the only Scott Owner in Salinas; I am proud of that distinction and I hope that the interest and enthusiasm I have aroused will some day prove of benefit to you."

Harry Boucher, Salinas, Calif.

DISTANCE RANGE IS REMARKABLE

"I received the radio receiver in excellent condition. From the standpoint of a radio technician, it may interest you to know that I have always been rather skeptical of all radio receivers, knowing as I do their limitations and the vagaries of radio reception. I have tried out and listened to some of the best commercial sets on the market and among these the —, —, —, —, and will honestly say that I was most agreeably surprised at the performance of your 23 tube SCOTT FULL RANGE HIGH FIDELITY RECEIVER. You have made no claims regarding your set which are not true. The distance range is remarkable and the tone is to say the least, SIMPLY BEAUTIFUL. I never listened to as wonderful a musical instrument as this receiver proves to be."

H. D. Oliver, Missoula, Mont.

**TESTS MANY OTHER RECEIVERS—
BUYS A SCOTT**

"Kindly allow me to thank you for making it possible for anyone, looking over the radio market, to be able to purchase such a fine receiver. Before I purchased your radio I had at least five 'over the counter' radios demonstrated in my home, and they were plenty lacking. The point is, that I cannot see why anyone who wants the best does not go into the matter far enough to discover 'Scott.' These people who want the best, pay more than you ask for 'Scott' and get much less. December 1st, 1934, I decided to buy my Mother a radio for Christmas. We tried many. She was pleased with any of them, but not me. It was May, 1935, when I made a purchase and it was a 'Scott.' Your 'ad' in the Geographic magazine was the start. Business institutions like yours should live forever, because you are really honest with the layman. The firm whose name appears on this paper has been in business over 65 years. My father has been a member of it for 30 years. Somehow, I believe we have the same ideals. Well, anyway, thanks for selling me a 'Scott.' KKH in Honolulu came in last night like a local, between 11:30 and 12:00 midnight, C.S.T."

G. H. Himmelheber, Pekin, Ill.

**"HAS BEEN A PLEASURE TO
DEAL WITH YOU"**

"Your SCOTT FULL RANGE HIGH FIDELITY ALLWAVE RECEIVER is certainly a masterpiece of precision and skill, a beautiful and faithful musical instrument. You should be proud of having created it. I want you also to know that I am very pleased with the way you conduct your business, and I assure you that it has been a pleasure for me to deal with you."

L. Seeley, Endicott, N. Y.

NOTHING LIKE IT IN RADIO BEFORE

"Its tone on any good station and under reasonably good atmospheric conditions, is superb. Everyone who has heard it cannot praise it enough—'nothing in radio like it before.' Frequently members of my family have been startled upon my tuning

in a station where someone is speaking, having the illusion that a stranger had entered the home. Recently I had difficulty in convincing my wife that the birds chirping and singing in the studio on a particular WOR program were actually a part of the broadcast. She was sure she heard the birds in the garden outside the house. I have received numerous short wave stations, practically all that you listed in your short wave schedule, and others beside. Every-morning, with the exception of three, when I did not listen in, I have received Australian stations. I get especially good signal reception on the 20 meter amateur band. For thrills, amusement and an 'ear to the ground' contact with human nature, this 20 meter band is one of the best. Moreover, the distance and clarity of many of these signals with amazingly low power are almost unbelievable. I feel that the attention of Scott owners should be called to the 20 meter band. It may interest you to know that I have tested the calibration of my receiver by means of the CW signals sent out by WWV on 10 and 15 megs. The signals came in 'right on the head.'"

Henry E. Norwood, Bethlehem, Pa.

"HAS NO EQUAL"

"After several months of enjoyment with my SCOTT FULL RANGE HIGH FIDELITY ALLWAVE RECEIVER, I wish to express my pleasure at having been introduced to such a wonderful receiver. Stations which I have reached, so far, South America, Australia, Italy, England, Germany, France, etc., come in as clearly as any local station. I am looking forward to the coming months and anticipate a delightful winter with my set, which I feel, has no equal."

Arthur Simpson, Pawtucket, R. I.

**GETS USABLE RECEPTION FROM
ANY PART OF U. S. A.**

"I wish to thank you for the SCOTT NEWS which I received for August and later for September. Your new Scott Short Wave Radio Guide to foreign stations is a marvel of convenience. I found it of instant help to me although I had been tuning in London daily for the world news. I hope you continue with this guide making it more and more inclusive. It is an enormous pleasure to get usable reception from any part of the U. S. A., to say nothing of bringing in Europe. Never before have I heard such a phonograph reproduction. Instruments are heard which I never heard before coming from my favorite records. My radio is installed together with my smoking set on the right hand side of my desk and my phonograph and records on the left. Some day I expect to send you a photograph of what I call real comfort. A place where I can be at peace with the World and the World at my command to entertain me and my guests."

W. B. Umrston, San Antonio, Texas.

"I NEVER HEARD A RADIO BEFORE"

"About a week ago, two neighbors, collegebred people, stopped me on the street to ask where I got the wonderfully fine

toned radio. A visitor from New York who has often been a guest at broadcasts in Radio City asked if she might come up to my room to hear it. After listening to a symphonic number she said, 'Mrs. Bryden, I never heard a radio before!' I told her it was not a radio, it was a musical instrument. Static is bad tonight so I have cut out the double antenna and I am now listening to Berlin coming in with great volume with an 18-inch bit of wire. Ten minutes ago two more New Yorkers came in, one of them the leader of an orchestra. 'Wonderful! Marvelous! Perfect Tone, every instrument heard!' were some of his exclamations."

W. D. Bryden, Carbondale, Pa.

**CALIBRATION AND SELECTIVITY
PERFECT**

"It is a pleasure to do business with someone that really has the customer's interest at heart and is willing to cooperate to the limit to satisfy this customer. I have been getting acquainted with the new receiver in the last few days, and one of the outstanding features to the writer is the fact that when a station is tuned in it is not five or ten kilocycles off calibration, but right where it should be. The selectivity is perfection itself, on both the broadcast and short wave bands, and the tone is all that could be desired. The following is a list of stations that I have logged in the last few days. I was very much surprised at the stations that I was able to pick up on the 49 meter band, because this band is very noisy at this time of the year and the weather here has been around the 100 mark. I have already logged stations that I have never been able to get in this locality on any other set, and the writer has spent about six years in tuning the short waves on all kinds of receivers. I believe I am more critical than the average radio owner, but in this new receiver, Mr. Scott, you really have something to be proud of, and I, for one, think that you should really say more than you do about it to the prospective purchaser. Following is my log for the first week of tuning my SCOTT FULL RANGE HIGH FIDELITY RECEIVER: Yv6RV, Valencia; VENZ, EAQ, Madrid; GSC, London; DJA, Berlin; HCJB, Ecuador; VK2ME, Australia; PHI, Holland; PCJ, Holland; DJE, Berlin, GSG, London; Pontoise on 15.25; HAS-3, Hungary, VK3ME, Australia; VK3LR, Australia; YV5RMO, Maracaibo; Pontoise, 11.90; GSE, London; 2RO, Rome; DJD, Berlin; COC, Havana; YV2RC, Caracas; COCD, Havana; HJ1ABB, Barranquilla; HV3RC, Caracas; HAT-4, Budapest; PRF5, Rio de Janeiro; COH, Havana; JVM, Japan; HBP, Geneva; HBL, Geneva; HJ4ABC, Pereira; OAX4D, Lima; HAS-3, Budapest; HJ4ABA, Medllin; HIX, Santo Domingo; HJ4ABB, Manizales; CT1AA, Lisbon. I have not included any of the American or Canadian stations but have had practically all of them and most of them several times. I trust that you will pardon this lengthy letter, but felt that you would be interested in knowing just what results I have been able to get from my new receiver."

F. F. Pernal, Columbia, S. C.

Some Distinguished Owners of Scott Allwave Receivers in U. S. A. and Foreign Countries

- Commander A. H. Addoms**
Commandant 5th Naval District
Norfolk, Virginia
- James L. Allen, Judge**
Superior Court
Santa Ana, California
- W. L. Allen, Vice-President**
Standard Accident Ins. Co.
New York City, N. Y.
- Commander E. D. Almy**
U. S. Navy
Director Naval Research
Laboratory
Bellevue Anacostia, D. C.
- Leland C. Altaffer**
American Vice Consul
Madras, India
- Earl C. Anthony, Owner**
Radio Station KFI
Los Angeles, California
- P. D. Armour**
Armour Packing Company
Chicago, Illinois
- John Arnold, Motion Picture
Director**
Metro-Goldwyn-Mayer
Culver City, California
- John Barrymore, Actor**
Beverly Hills, California
- Cardinal Bisleti**
Vatican City, Italy
- Prince Otto von Bismarck**
German Embassy
London, England
- Don C. Bliss**
American Commercial Attaché
The Hague, Holland
- Howard E. Blood, President**
The Norge Corp.
Detroit, Michigan
- Walter F. Boyle**
American Consul
Auckland, New Zealand
- Dr. Tomas C. Le Breton**
Argentine Ambassador
Paris, France
- Prince Michael Cantacuzene**
Sarasota, Florida
- Eddie Cantor, Actor**
New York City, New York
- Dr. Juan Francisco Castillo**
President of State of Merida
Caracas, Venezuela
- Philip S. Cheney**
American Legation
Belgrade, Yugoslavia
- Jack Denny, Orchestra Leader**
New York City, New York
- C. H. Eddins, President**
Plymouth Motor Co.
Detroit, Michigan
- Monsieur Eugene Emanuelli**
Charge d'Affaires de France
Monrovia, Liberia
- H. A. Fisher**
Fisher Body Company
Detroit, Michigan
- Ray Fox**
American Consul
Habana, Cuba
- W. L. Grimm, President**
Peerless Marine Motor Corp.
Buffalo, New York
- President of Guatemala**
Guatemala City, Guatemala
- Wendell Hall**
Radio Star
Chicago, Ill.
- Barton Haselton, Chairman of
Board**
Revere Copper & Brass, Inc.
Rome, New York
- Mark Hellinger, Columnist**
New York City, New York
- W. Hinke**
American Consul
Swatow, China
- R. S. Huestis**
Secretary of American Embassy
Warsaw, Poland
- Ted Husing**
New York City, New York
- Geo. W. Hutchison, Secretary**
National Geographic Society
Washington, D. C.
- Prince of Hyderabad**
Hyderabad, Deccan, India
- W. L. Johnson, President**
W. L. Johnson Company
Endicott, New York
- The Sultan of Johore**
Johore, Federated Malay States
- Al Jolson, Actor**
Bel Air, California
- B. F. Kauffman, President**
Bankers Trust Co.
Des Moines, Iowa
- Hal Kemp, Orchestra Leader**
Chicago, Illinois
- C. F. Kettering, Vice-President**
General Motors
Detroit, Michigan
- Alexander Koryziz, Governor**
National Bank of Greece
Athens, Greece
- Mervyn LeRoy, Motion Picture
Director**
Warner Bros.
Hollywood, California
- Guy Lombardo, Orchestra
Leader**
Royal Canadians
New York City, New York
- Dr. Alfonso Lopez**
President of Colombia
Colombia, South America
- Clarence Macey**
American Consul
Mexico
- John H. Madonne**
American Vice Consul
Beyrouth, Syria
- W. L. McDonald**
British Vice Consul
Antilla, Cuba
- Clement V. McKaig**
Vice-President
Carnegie Steel Company
Pittsburgh, Pa.
- W. L. Mellon, Capitalist**
New York City, New York
- Douglas Miller**
Commercial Attaché
Berlin, Germany
- H. H. Prince Abd El Moneim**
Istanbul, Turkey
- M. K. Moorehead**
American Consul General
Istanbul, Turkey
- Lee C. Morse**
American Commercial Attaché
Riga, Latvia
- R. Henry Norweb**
American Consul
Santiago, Chile
- Monsieur Fazil Ozis, Director**
Bank of Ankara
Ankara, Turkey
- Gennaro Papi, Musical Director**
Chicago Civic Opera Company
Chicago, Illinois
- David Manners, Actor**
Victorville, Calif.
- Stanley Partridge, Director**
Pillsbury Flour Mills Company
Minneapolis, Minnesota
- Daniel Peterkin, President**
Morton Salt Company
Chicago, Illinois
- George Pulford**
British Consul
Tampico, Mexico
- Wm. J. Rague, Director**
American Scantic Line
Copenhagen, Denmark
- Baron R. de Rothschild**
Paris, France
- S. E. Habib Pacha El Saad**
President of the Libanaise
Republic
Beyrouth, Syria
- Maestro Tullio Serafin**
Director Royal Opera
Rome, Italy
- W. A. Shaeffer, President**
Shaeffer Pen Company
Fort Madison, Iowa
- Charles G. Skinner**
American Consul
Moscow, Russia
- K. Sreenivasen**
Indian Institute of Science
Bangalore, India
- Baron de Terschereun**
Brussels, Belgium
- Maestro Arturo Toscanini**
Milan, Italy
- H. H. Prince Said Toussoun**
Alexandria, Egypt
- Baron Guy de La Tournelle**
French Legation, Secretary to
Ambassador
Sofia, Bulgaria
- Baron von Tuereckheim**
Mexico City, Mexico
- Dr. Von Twardowski**
German Embassy
Moscow, Russia
- Rudy Vallee, Orchestra Leader**
Connecticut Yankees
New York City, New York
- Hal Wallis, Motion Picture
Director**
Warner Brothers
Beverly Hills, California
- H. J. White, Architect**
Graham, Anderson, Probst &
White
Chicago, Illinois
- John C. Wiley**
American Consul General
Antwerp, Belgium
- Charles S. Wilson**
American Minister
Belgrade, Jugoslavia
- Walter Winchell, Columnist**
New York City, New York
- Rear Admiral Robert Witthoef**
German Embassy
Washington, D. C.

GUIDE TO FOREIGN SHORT WAVE STATIONS HEARD REGULARLY BY SCOTT ALLWAVE OWNERS

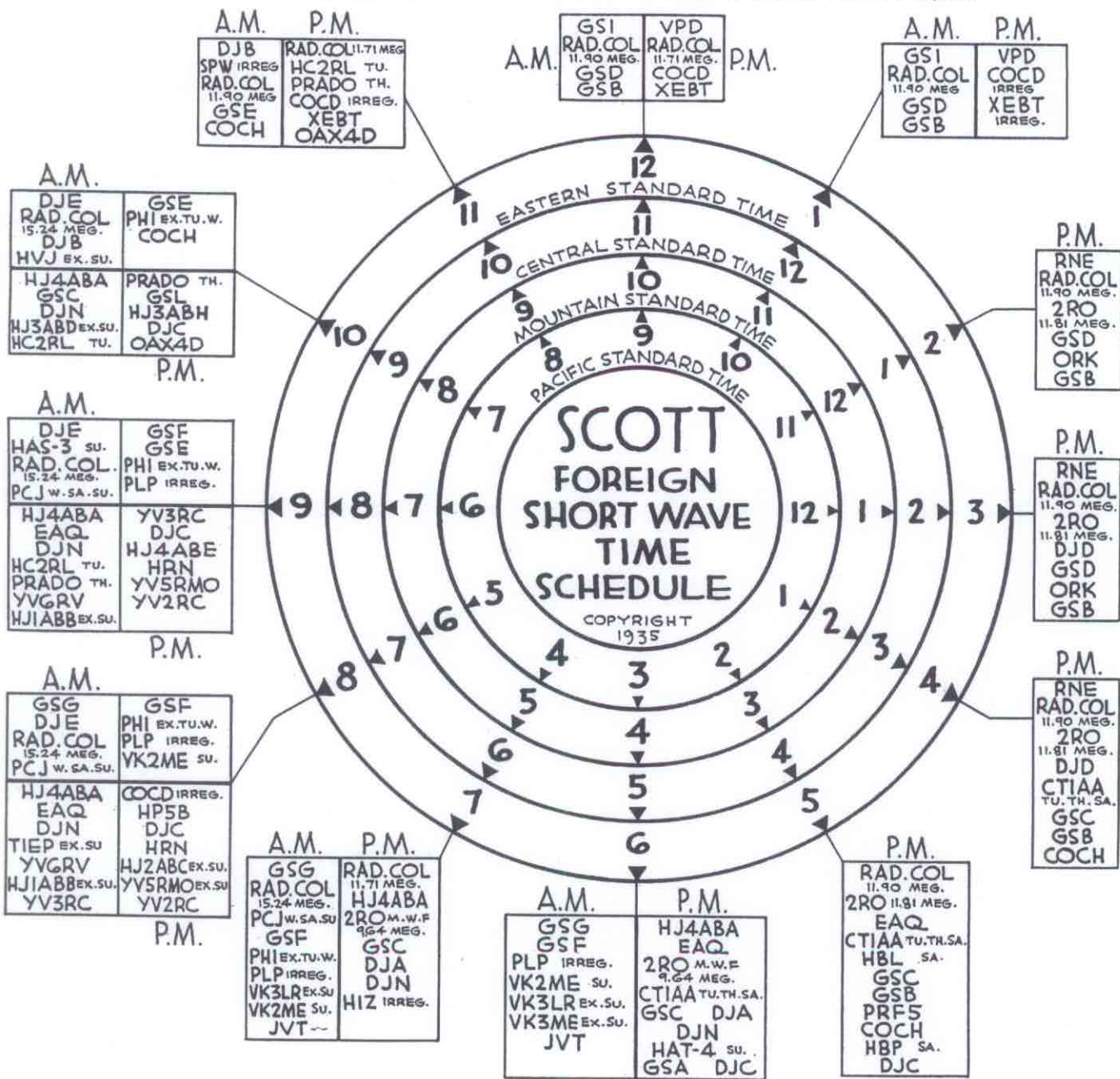

Station	Country	Met.	Meg.
GSG	England	16.86	17.79
DJE	Germany	16.89	17.76
HAS-3	Hungary	19.52	15.37
GSI	England	19.66	15.26
Rad. Col.	France	19.68	15.24
PCJ	Holland	19.71	15.22
DJB	Germany	19.74	15.20
GSE	England	19.82	15.14
HVJ	Vatican City	19.84	15.12
SPW	Poland	22.01	15.63
VPD	Fiji Isles	22.95	13.07
RNE	Russia	25.00	12.00
Rad. Col.	France	25.23	11.90
GSE	England	25.29	11.86
2RO	Italy	25.40	11.81
DJD	Germany	25.49	11.77
GSD	England	25.53	11.75
PHI	Holland	25.57	11.73
Rad. Col.	France	25.61	11.71
HJ4ABA	Colombia	25.63	11.70

Station	Country	Met.	Meg.
PLP	Java	27.26	11.00
ORK	Belgium	29.04	10.33
EAQ	Spain	30.40	9.87
2RO	Italy, M.W.F.	31.13	9.64
CTIAA	Portugal	31.19	9.62
HBL	Australia	31.28	9.59
GSC	Switzerland	31.27	9.59
VK3LR	England	31.30	9.58
DJA	Australia	31.32	9.58
DJN	Germany	31.38	9.56
VK3ME	Germany	31.45	9.54
GSB	Australia	31.55	9.51
PRFS	England	31.55	9.51
COCH	Brazil	31.58	9.50
HAT-4	Cuba	31.80	9.43
HBP	Hungary	32.88	9.12
HJ3ABD	Switzerland	38.47	7.80
JVT	Colombia	40.55	7.40
TIEP	Japan	44.40	6.75
	Costa Rica	44.71	6.71

Station	Country	Met.	Meg.
HC2RL	Ecuador	45.00	6.66
PRADO	Ecuador	45.31	6.62
YV6RV	Venezuela	46.01	6.52
HJ1ABB	Colombia	46.60	6.44
HIZ	Dominican Republic	47.50	6.31
YV3RC	Venezuela	48.78	6.15
COCD	Cuba	48.92	6.13
GSL	England	49.10	6.11
GSA	England	49.59	6.05
HP5B	Panama	49.75	6.03
HJ3ABH	Colombia	49.85	6.02
DJC	Germany	49.83	6.02
XEBT	Mexico	50.00	6.00
HJ4ABE	Colombia	50.60	5.93
HJ2ABC	Colombia	50.85	5.90
HRN	Honduras	51.11	5.87
YV5RMO	Venezuela	51.28	5.85
YV2RC	Venezuela	51.72	5.00
OAX4D	Peru	51.90	5.78

To find what foreign stations are on the air at any hour—simply look opposite the hour of your time zone. For example at 2 P. M. EST station 2RO and RAD COL are on the air. At 11 A. M. EST DJB, GSE, and

COCH can be tuned in. The time schedule above lists only the more important foreign short wave stations whose signals are heard with good volume in most parts of the U. S. A.

THE GUARANTEE AND WHAT IT MEANS!

The manufacturer of a high grade product is generally willing to give a two-fold guarantee. (1) A guarantee that his product or article will operate, perform, and have qualities exactly as represented. (2) That it will *continue* to give satisfactory service over a certain period of time.

On the new 23 tube SCOTT FULL

RANGE HIGH FIDELITY ALLWAVE RECEIVER I have placed what I believe to be the most clear and explicit guarantee that has ever been placed on a radio receiver. Behind this guarantee is a record of 11 years of continuous success in designing and building fine custom built radio receivers, which are now in use in every

part of the civilized world.

Below you will find a copy of the guarantee given with every Scott Receiver which enables you to prove every claim of superiority made for it right in your own home, and assures you of continuous satisfactory service for Five Years after purchase.

PERFORMANCE AND SERVICE GUARANTEE

This guarantee is backed by an organization that has been in business continuously for over 10 years. Your order for a 23 Tube SCOTT FULL RANGE HIGH FIDELITY ALLWAVE RECEIVER, will be accepted with the distinct understanding that you are to be allowed 30 days after delivery in which to make a comparative test against any other Allwave Receiver. If during this period the 23 tube SCOTT FULL RANGE HIGH FIDELITY ALLWAVE does not demonstrate its superiority in your home by bringing in more stations—from greater distances—with more volume—and better tone on both the short waves and the broadcast band, than any other receiver with which it is compared, and **YOU ARE TO BE THE SOLE JUDGE OF THIS SUPERIORITY**, you have the privilege of returning it (you to pay transportation costs) and the money you paid us will be promptly refunded. (Free trial in the U. S. A. only.)

The 23 tube SCOTT FULL RANGE HIGH FIDELITY ALLWAVE is guaranteed against defective parts for Five Years. Any unit of its construction (except tubes, which are guaranteed by the manufacturer) that becomes defective during this period, will, on return to the Laboratory, be replaced free of charge, either for parts, material or labor, provided such defect is not the result of misuse or tampering with the instrument.



NEW ADVANCES IN CONSOLE SOUND CHAMBER DESIGN

The first automobile produced was simply an engine placed on the rear platform of an adapted horse carriage, and was known as the "horseless buggy." However, as the power of the engine increased, buyers demanded more riding comfort, and it was not long before it was discovered that the old buggy was entirely unsuitable as a chassis, so a special design was accordingly developed. While the heart of the automobile, the engine, enables us to travel from one point to another with great speed, *it is the perfected design of the chassis that enables us to travel in such luxurious comfort.*

For many years, radio receivers have been handicapped by cabinet designs which were nothing more nor less than boxes modeled after china cabinets and other pieces of furniture, which made reproduction from even the finest receiver sound "boomy" and mechanical.

NEW SOUND CHAMBER DESIGN CREATED

When the design of the new 23 tube SCOTT FULL RANGE HIGH FIDELITY

ALLWAVE RECEIVER was completed, it was realized more than ever, that the existing type of radio console was quite in-

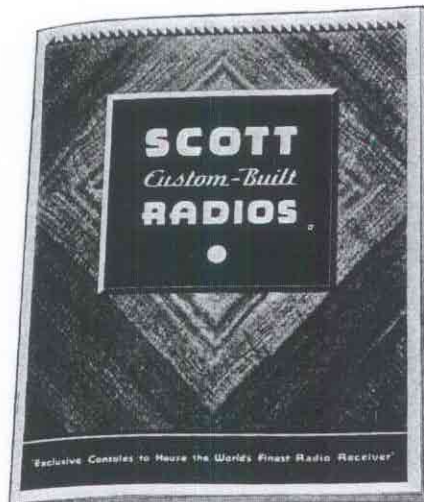

capable of bringing out the best tonal qualities of this perfected instrument. After months of accoustical research, a radically

different type of console sound chamber design was created in our laboratories, which brought out the perfect tonal qualities of our new receiver.

This new development—the "Tone Truth" sound chamber—is now incorporated in all Scott Consoles. This remarkable advance in console design eliminates the impression of mechanical reproduction, and takes the voice of the singer or speaker out of the barrel, making it clear and natural, and brings the instruments of the orchestra out of the box. The new "Tone Truth" sound chamber provides the final touch that makes possible the most natural reproduction of the human voice or musical instrument that has ever been heard from a radio receiver.

GET YOUR COPY OF NEW CONSOLE BROCHURE

Our new console brochure which illustrates and completely describes the nineteen new custom built consoles which have been especially designed for the 23 tube SCOTT FULL RANGE HIGH FIDELITY ALLWAVE RECEIVER, will gladly be sent you on request.

E. H. SCOTT RADIO LABORATORIES, Inc.
4450 RAVENSWOOD AVENUE CHICAGO, ILLINOIS