

# Technical Section

R. A. HUMPHREYS, TECHNICAL EDITOR This information in Sylvania News is furnished without assuming any obligations.

## A LOOK AT UHF

There is now a federal law which requires UHF tuners in all television receivers manufactured for interstate commerce effective after April 1964. This is expected to increase the acceptance and interest in UHF because it removes a potential stumbling block which is the cost of converting a present existing VHF receiver to the UHF stations. Many new sets have UHF capabilities and older sets can easily be converted.

There are a number of differences between UHF and VHF reception, though UHF TV signals differ from standard U. S. VHF TV signals only in the carrier frequencies employed. The bandwidth, channel width, the separation of the video and audio carrier frequencies, the sync pulse arrangements, lines per frame, interlace, and other technical features are all the same except that UHF may have only 10% audio instead of 50%.

If the carrier frequencies of a UHF TV signal can be shifted to coincide with those of a VHF channel, the UHF signal can be received on any VHF receiver. The necessary carrier frequency shift can be accomplished in a relatively simple external converter, or by means of modification of the tuner circuit of the VHF receiver. Such converters or modifications are the accepted method of UHF reception for older VHF sets. New TV sets are almost all UHF-VHF combinations.

In Figure 1, the entire UHF band is shown extending from 470 to 890 mc. This is a tuning range of not quite 2 to 1 while the VHF band, from 54 to 216 mc, has a range of 4 to 1. The tuning range is an indication of the difficulties encountered in the coverage of an entire band with one single tuning device. A tuning range greater than 2 to 1 is usually difficult to achieve unless some means

Channel	Freq.	Video	Audio
14	470-476	471.25	475.75
15	476-482	477.25	481.75
16	482-488	483.25	487.75
17	488-494	489.25	493.75
18	494-500	495.25	499.75
19	500-506	501.25	505.75
20	506-512	507.25	511.75
21	512-518	513.25	517.75
22	518-524	519.25	523.75
23	524-530	525.25	529.75
24	530-536	531.25	535.75
25	536-542	537.25	541.75
26	542-548	543.25	547.75
27	548-554	549.25	553.75
28	554-560	555.25	559.75
29	560-566	561.25	565.75
30	566-572	567.25	571.75
31	572-578	573.25	577.75
32	578-584	579.25	583.75
33	584-590	585.25	589.75
34	590-596	591.25	595.75
35	596-602	597.25	601.75
36	602-608	603.25	607.75
37	608-614	609.25	613.75
38	614-620	615.25	619.75
39	620-626	621.25	625.75
40	626-632	627.25	631.75
41	632-638	633.25	637.75
42	638-644	639.25	643.75
43	644-650	645.25	649.75
44	650-656	651.25	655.75
45	656-662	657.25	661.75
46	662-668	663.25	667.75
47	668-674	669.25	673.75
48	674-680	675.25	679.75
49	680-686	681.25	685.75
50	686-692	687.25	691.75
51	692-698	693.25	697.75
52	698-704	699.25	703.75
53	704-710	705.25	709.75
54	710-716	711.25	715.75
55	716-722	717.25	721.75
56	722-728	723.25	727.75
57	728-734	729.25	733.75
58	734-740	735.25	739.75
59	740-746	741.25	745.75
60	746-752	747.25	751.75
61	752-758	753.25	757.75
62	758-764	759.25	763.75
63	764-770	765.25	769.75
64	770-776	771.25	775.75
65	776-782	777.25	781.75
66	782-788	783.25	787.75
67	788-794	789.25	793.75
68	794-800	795.25	799.75
69	800-806	801.25	805.75
70	806-812	807.25	811.75
71	812-818	813.25	817.75
72	818-824	819.25	823.75
73	824-830	825.25	829.75
74	830-836	831.25	835.75
75	836-842	837.25	841.75
76	842-848	843.25	847.75
77	848-854	849.25	853.75
78	854-860	855.25	859.75
79	860-866	861.25	865.75
80	866-872	867.25	871.75
81	872-878	873.25	877.75
82	878-884	879.25	883.75
83	884-890	885.25	889.75

Figure 1—The UHF Band.

of bandswitching is used.

Virtually all converters in the UHF band use a continuous tuning arrangement since it is difficult to construct an inexpensive 70-position tuner with individual stops. Also, the small tuning ratio of UHF makes this coverage possible in a single range.

### BACKGROUND OF UHF TELEVISION

There are a number of reasons why the American system of television broadcasting may ultimately move from the present VHF channels to the UHF channels. Some of these reasons are technical and some of the reasons are economic.

At the beginning of the rapid expansion of the American television industry following World War II, a limited number of VHF channels were made available on a full commercial basis, but without any realization of the vast potential for growth for modern commercial television. Existing VHF channels created many problems in allocation because there were simply not enough channels to go around to all of the major cities and to provide adequate television coverage without overlap between stations since it is possible for two nearby stations on the same channel to cause interference. This created enormous problems in the allocation of television licenses and in the growth of television stations.

The tremendous economic investment in television broadcasting stations and, in television receivers for the very high frequency band, itself created a problem. The millions of television receivers which are in service must be able to continue to provide service even for the UHF bands. Hence, in order to provide room for enough television stations

to provide for a steady healthy growth of commercial broadcasting in this country, it may become necessary to move the television band to the ultrahigh frequency range. The problem then is one of transition from the existing VHF stations to the new UHF stations.

UHF has been evaluated and tested for many years. The Midwest program for airborne television instruction (MPATI) for example, is a series of UHF telecasts which have been extremely successful. These telecasts have added to the interest in ultrahigh frequencies and have also heightened the interest in educational television (ETV). This program, which involves the transmission of television programs on the UHF bands from an aircraft flying at 20,000 feet, have been extremely important to the development of UHF. This program and others have field-tested receivers and UHF techniques.

A great deal of testing was done by the FCC in the city of New York. For UHF Channel 31 a transmitting antenna (primary) was mounted on the top of the Empire State Building aimed toward the heavily populated area of Manhattan. To fill in the shadow areas a translator (secondary) was installed on the George Washington bridge in an area high enough so that it could provide a strong signal into the shadow areas created by the straight-line UHF signal paths. This translator received the signal on Channel 31 and it re-transmitted it on Channel 77. Only a 100-watt transmitter was necessary because its only job was to fill in the shadow areas or holes. This technique is shown in Figure 2.

It is possible to use a translator (which receives on one channel and transmits on another) to fill in the UHF shadows and it is also possible to use this to extend the UHF range. Suppose that there is a UHF transmitter located in a major city and some twenty-five or thirty miles away there is a mountain range which prevents the signal from being received on the other side of the mountain. It is a simple matter to provide a translator on the mountaintop so that the signal from the main transmitter can be picked up and beamed toward the other side of the mountain while the transmitter is mounted on the mountaintop itself so that reception can be received on both sides of the mountain with no problem.

Television translators are automatic and, under FCC laws each has its own television call letters or

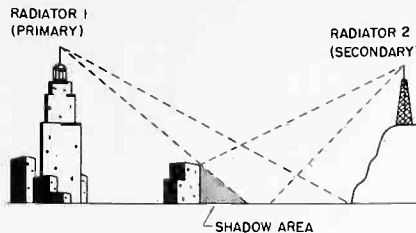

Figure 2—Use of a Translator to "Fill-In" Shadow Areas.



Figure 3—UHF Converter. (Courtesy Blonder-Tongue)

station identification although these are not seen by the person who views the program. If an original signal is transmitted on Channel A and the translator operates on Channel B (where both are UHF channels) a viewer tuning his station to either Channel A or B sees identical programs and cannot tell them apart.

Under the FCC rules UHF channels 70 to 83 are suggested for this use. The cost of a single channel translator is as little as \$20,000.00 and such a unit can serve a modest-sized locality with complete television service. The FCC limitation on power output is 100 watts of transmitted power. This is not the ERP or effective radiated power but the actual power from the transmitter.

Sylvania has been active for many years in obtaining data on UHF

coverage from small translator type TV stations, and operates three experimental stations at its Electronic Tube Division plant in Emporium, Pennsylvania.

## CONVERSION OF UHF SIGNALS

In general, there are two types of UHF receiver methods used for television. One is the converter which changes a VHF television set into a UHF television set, and the other is a built-in UHF tuner which, together with a VHF tuner, allows the television receiver to work on either or both of the two bands.

A converter (Figure 3) is, in effect, an incomplete superheterodyne receiver. When used with a television receiver it makes a double-conversion superheterodyne; its output is usually two television channels wide and set for Channels 5 and 6 although it can be set for any VHF channel. The converter consists of a preselector or a group of r-f tuned circuits, a local oscillator and a mixer. The preselector is necessary to provide UHF selectivity and prevent pick up of image, IF, or VHF channel signals and to reduce radiation by the local oscillator which could interfere with other receivers.

The law requires that all future TV receivers be equipped to receive all UHF channels. This is usually accomplished by equipping the set with two tuners; a 13-position VHF tuner, and a continuous coverage UHF tuner. Reception on UHF is accomplished by switching the VHF tuner to the "UHF" position and tuning the desired signal on the UHF tuner. The output of the UHF tuner

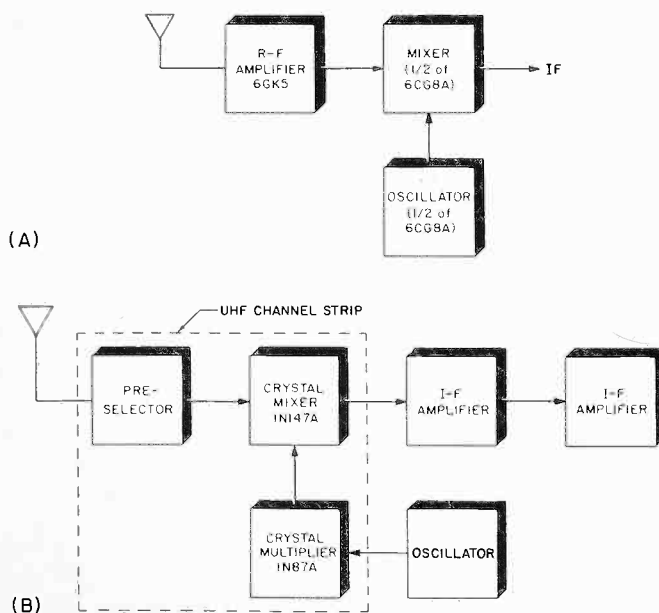

Figure 4—Methods of Producing the Receiver IF.

# Dealer Section

EDITOR: DICK DE SALVO

## FULL SCALE PRODUCTION OF SYLVANIA COLOR PICTURE TUBES UNDER WAY

During the past ten years Sylvania has been one of the leaders in the development of picture tubes for color television. Original color picture tube production was started at Sylvania's Seneca Falls picture tube plant in the early Fifties. Production of tubes for the replacement tube market has continued since that time.

Now with the growing demand for color television sets, Sylvania has vastly expanded its color picture tube capacity. Sylvania's strong desire to maintain its leading position in the Electronic Components field has been reinforced by the enthusiastic demand of major television manufacturers for high quality picture tubes.

Although Sylvania's been manufacturing replacement types 21AXP22, 21AXP22A, and 21CYP22A for these several years, production of types 21FBP22, 21FJP22, and 21FKP22 has gradually built up to full scale during 1963.

These types are capable of producing either a full-color or a black and white picture measuring 19 1/4" x 15 1/2" with rounded sides, and a projected area of 261 square inches.

Each tube utilizes three electrostatic focus guns spaced 120° apart with axes tilted toward the tube axis

to facilitate: (1) convergence of the three beams at the shadow mask; (2) individual convergence control of each beam radially by internal magnetic poles; (3) supplemental control of the three beams horizontally by internal magnetic poles; and (4) an assembly consisting of a spherical metal graded-hole shadow mask and a tri-color, phosphor dot screen on the inner surface of the spherical Filterglass faceplate.

The tri-color-phosphor dot screen is composed of an orderly array of small closely-spaced, phosphor dots arranged in triangular groups. To produce the color picture that you view, each triangular group consists of a green-emitting dot, a red-emitting dot, and a blue-emitting dot, and is aligned with a corresponding hole in the shadow mask.

Since it is impossible for everyone of you to visit Sylvania's facilities, this photographic essay serves to illustrate the various steps, processes and inspections that each tube must undergo. It's Sylvania's "built-in" quality story for color picture tubes.

And by all means, if you're ever in the area of Seneca Falls, New York . . . stop by and see it for yourself *in person*.

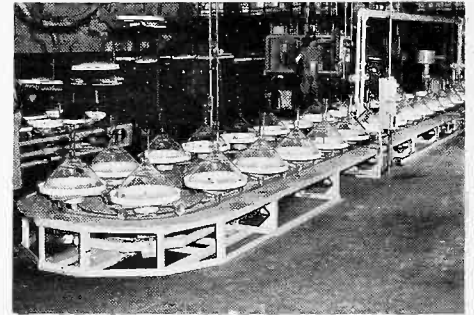

Photo 5—Glass bulbs go through preparation stages prior to internal coat operation.

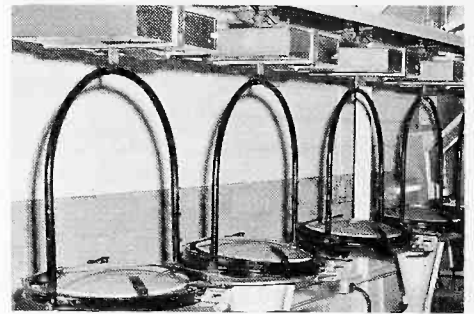

Photo 6—Screens are dried after phosphor deposition.



Photo 7—After mask is inserted in CRT face panel and photosensitive screen is deposited, face panel is exposed on exposure table.

(Cont'd on Page 2)

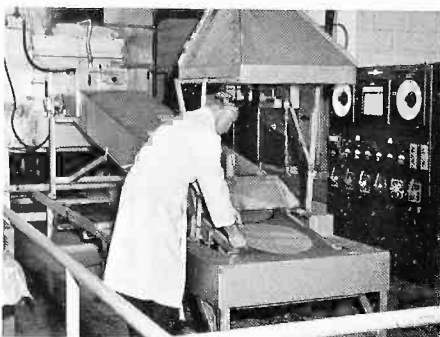

Photo 1—Aperture masks are being removed from this conveyor after being annealed in the lehr visible in background.

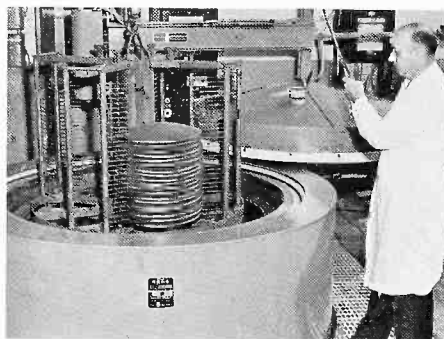

Photo 2—Aperture masks are being lowered into a steam tank for blackening. This process increases thermal radiation properties.

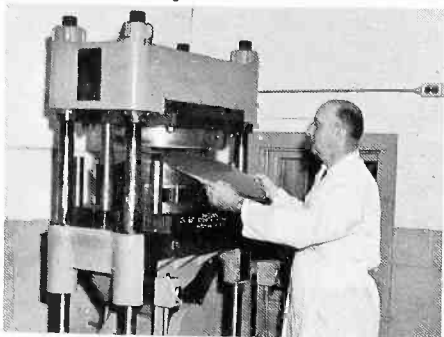

Photo 3—Masks are then shaped properly ("domed") on this press.

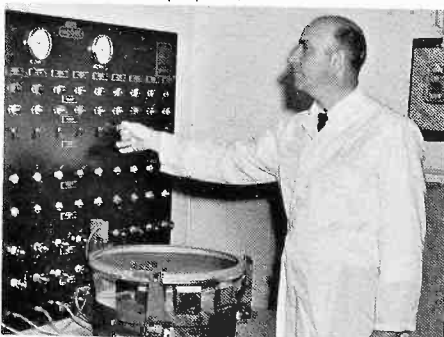
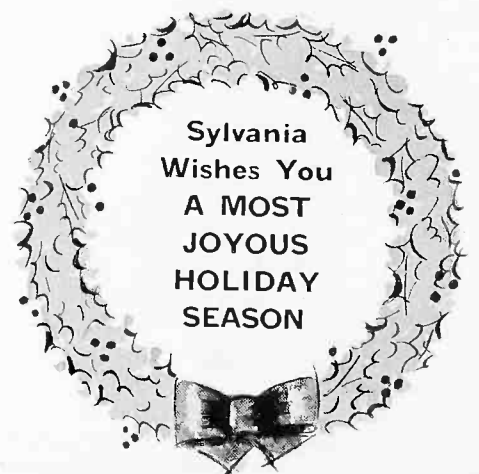

Photo 4—Control panel monitors tests to determine if mask contours are properly formed.



Sylvania  
Wishes You  
A MOST  
JOYOUS  
HOLIDAY  
SEASON

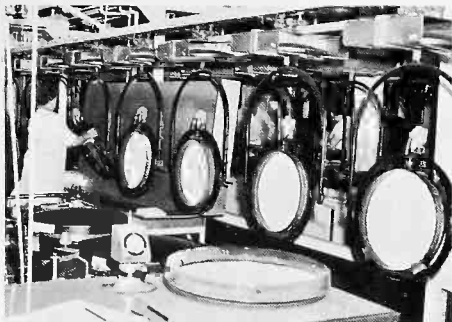

Photo 8—Exposed screens are developed leaving phosphor dots.

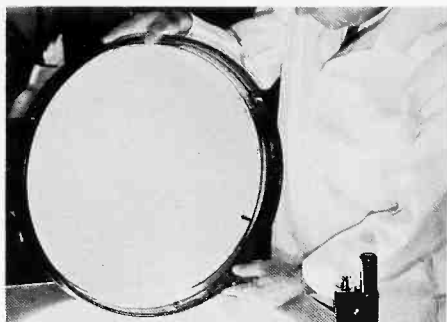

Photo 9—When dots are on faceplate panel, screen is inspected for dot size, structure and density. Inspection is made with the aid of a powerful microscope.

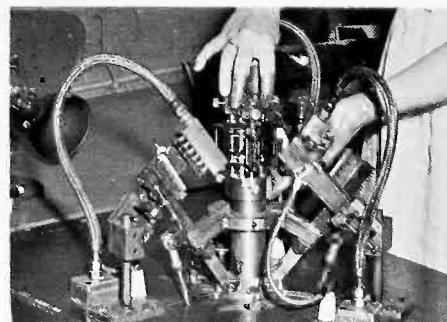

Photo 10—Beading machine is used to produce electron guns—three for each color tube. Bead temperature is carefully controlled to produce sturdy construction . . . assuring needle-sharp focus, and pin-point convergence.



Photo 11—Color tubes' last mile of production is conveyed to exhaust machine.

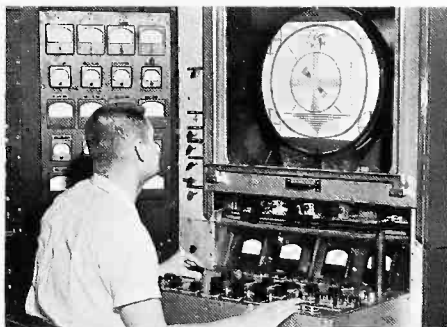

Photo 12—Final testing for all electrical and screen characteristics. Electrical tests include such items as emission, grid cutoff, and heater current of each gun. Screen characteristics checked range from light output to uniformity of white raster.

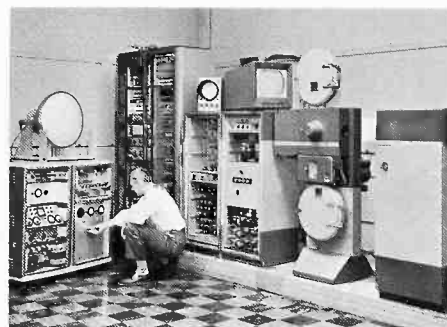

Photo 13—Application Engineer adjusts test equipment to evaluate color CRTs.

# IT PAYS TO LOOK PROFESSIONAL

ET-6204



ET-6201

For the cold months ahead, deck yourself out in a handsome, forest green uniform by Sylvania. Made of dacron to give exceptionally long service with a minimum of care, these heavier-weight uniforms protect you from the winter weather, at the same time give you a smart professional look that spells success.

Featuring a Sylvania insignia, the uniforms come in all popular sizes, and can be monogrammed at a nominal charge to individualize your outfit!

Order through your Sylvania Distributor!

**ET-6201—GREEN DACRON JACKET**

Size: 34-50 Price: \$8.75

**ET-6202—COTTON FLANNEL LINING**

Price: \$3.50 (not shown)

**ET-6203—GREEN DACRON PANTS**

Size: Waist 28-50; Length 29-35 Price: \$7.98

**ET-6204—GREEN DACRON VISOR CAP**

Size: 6½-7¾ Price: \$4.85

**ET-6224—GREEN WASH 'N WEAR SHIRT**

LONG SLEEVES . . . Neck 14-18; Sleeve 32-35  
Price: \$4.25

The nominal charges for embroidery are:

**SPECIAL CHAIN LETTERING ON BACK**

\$1.25 for 15 letters or less  
\$.09 for each additional letter

**SCRIPT NAME OVER LEFT POCKET**

8 letters or less—10¢,  
plus 2¢ for each additional letter

ET-6224



ET-6203

# SYLVANIA SETS EVEN HIGHER STANDARDS FOR SILVER SCREEN 85

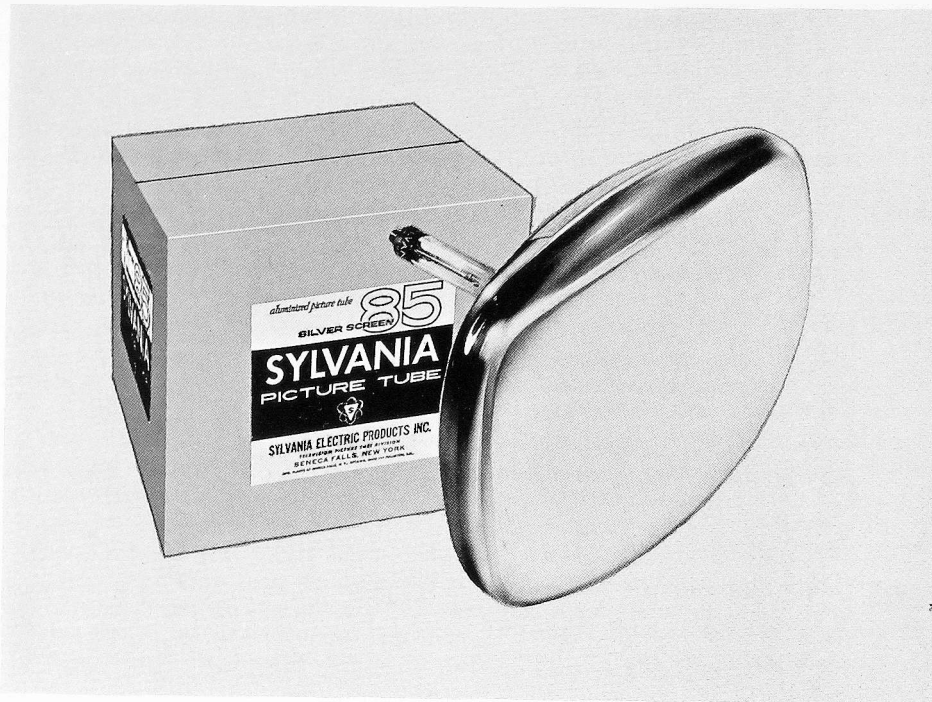

Dealers everywhere have long recognized Sylvania's Silver Screen 85 as the quality picture tube of the industry.

Time and time again tests have proved that the Silver Screen 85 gives the sharpest, clearest, brightest reception, *and* the longest tube life performance. So it's a natural conclusion, that dealers insist on installing the Silver Screen 85 when a customer wants his set to work like new again—maybe better than new!

Knowing that 7 out of 10 *major* manufacturers, or 16 out of 24 of all manufacturers, buy Sylvania picture tubes for their new sets, tells you immediately the quality reputation that Sylvania picture tubes enjoy. Add to these impressive credentials the fact that every Silver Screen 85 picture tube and its component parts must pass 781 quality control checks and inspections. Unsatisfactory performance at any one single check point is grounds for rejection. Not even 780 out of 781—99.87%—is good enough.

When you're in the enviable position of making the best, there may be a tendency to relax on your laurels, thereby letting competition catch up with you. Not Sylvania.

In an effort to make the best—PERFECT, Sylvania has intensified

its picture tube reliability program. Here's a continuing program that promises to improve the new-equipment tube types, and bring quality benefits to the renewal line. Results: significant, overall improvements in picture tube quality that mean competitive selling advantages for you.

New or improved manufacturing techniques now employed by Sylvania in the production of Silver Screen 85 picture tubes include:

**IMPROVED ALUMINIZING DISTRIBUTION AND THICKNESS**—To reduce center-to-edge gradations in aluminum thickness, an ideal combination of the aluminizing coil, coil shield, and support has been adopted. At the same time this has permitted Sylvania to increase the aluminum thickness by approximately 25%, thus providing maximum resistance to electrical burning.

**"BETTER INTELLIGENCE" ON FOCUS SPACING**—Process control information and feedback of data to the Production Department has been increased to assure uniformity of focus G3-G5 spacing, tube to tube!

**BETTER EXTERNAL CONDUCTIVE COATING**—An improved water-base external conductive coating, which exhibits greater resistance to peeling under high humidity, has been adopted. To obtain higher conduc-

tivity, improved spray techniques and equipment are now being used in production.

**ADVANCES IN PRODUCTION OF HIGH VACUUM**—Extremely tight standards and procedures have been established to measure the effectiveness of each exhaust cart's vacuum system. In addition, a new method of determining minute leaks in the vacuum system is in effect, and any questionable exhaust carts are removed from production.

**EXHAUST EMISSION TESTING TO HIGHER MINIMUM LIMITS**—Each tube is checked to significantly higher minimum emission limits off the exhaust machine. This control measures the effectiveness of our processing, exhaust machine, mount parameters and operator techniques.

**MORE SEVERE LIFE TEST CONDITIONS**—Tubes are being run at higher average and higher peak current conditions to provide information on the ability of the tube to give satisfactory performance under these conditions, thus provide additional safety factor in the field. In addition, tubes are being run on life beyond normal life hours to add to our information and provide extended life expectancy statistics.

In stepping up the Silver Screen 85 reliability program, Sylvania has not left a stone unturned. The following innovations concern Sylvania's precision electron gun mounts:

**CONTROL OF CATHODE SPRAY DENSITY**—To provide greater uniformity of cathodes and assure improved density coating control, Sylvania's quality sampling program was intensified! *Each lot* of cathodes is carefully checked on a sample basis, replacing the inspection program previously in effect.

**NEW PLASTIC AND METAL CONTAINERS FOR MOUNT PARTS**—Plastic and metal containers are now in use for parts transfers in the Mounting Department.

**"FRESHER" MOUNTS**—Tighter scheduling of mount production/inventory results in using "fresher" mounts in each tube. Also, heated mount transfer carts and plio-film bags are employed to reduce exposure to plant atmosphere.

All these improvements add up to mean that you install America's finest picture tube—the Sylvania Silver Screen 85—with even more confidence. And your customers view the sharpest, clearest, brightest picture possible.

# THE LATEST WORD IN SYLVANIA RECEIVING TUBES

To better service your customers and to realize bigger profits, keep in mind these 27 new additions to Sylvania's Receiving Tube line.

TYPE	DESCRIPTION	TYPE	DESCRIPTION	TYPE	DESCRIPTION
1AD2	T9 Compactron filamentary diode. For high voltage rectifier applications. Used in GE TV receivers.	6BF11	Dissimilar double pentode in T9 Compactron construction. For audio detector and audio output applications. Used in GE TV receivers.	6LB8	Medium mu triode and strap frame sharp cutoff pentode in Sylvania 9T9 construction. For voltage amplifier and video amplifier service. Used in Philco TV receivers.
2DV4	Medium mu Nuvistor triodes, 450 ma and 135 ma heater versions respectively. For UHF oscillator service in TV receivers. Used in RCA, Zenith and Silvertone TV equipment.	6DV4	Medium Mu Nuvistor triodes, 450 ma and 135 ma heater versions respectively. For UHF oscillator service in TV receivers.	12BE3	T-9 Compactron—half wave rectifier diode. Used as a damper in TV receivers. Used in GE and Admiral TV receivers.
3AT2	T-9 Compactron diode half wave rectifier. Used for damper. Used in Motorola and Zenith TV receivers.	6FY7	Dissimilar double triodes in T9 Compactron construction. For vertical deflection oscillator and amplifier applications. Used in GE TV receivers.	12BS3	600 ma half wave (diode) rectifier in T9 Novar construction. Used as damping in horizontal deflection circuits. Used in Emerson TV receivers.
4JC6	Sharp cutoff pentodes in 9 pin miniature and featuring strap frame grid construction. Used as IF amplifier. Currently used in RCA TV receivers.	6G11	T-9 Compactron dissimilar double pentode (sharp cutoff, dual control and power pentodes). FM detector and AF output amplifier. Used in GE TV receivers.	12FX5	T5½ power pentode. Audio output tube in TV receivers. Used in RCA and Westinghouse TV receivers.
4JD6	Semi-remote cutoff pentode in 9 pin miniature featuring strap frame grid construction. For IF amplifier applications in TV receivers. Currently used in RCA TV receivers.	6HA5	7 pin miniature gain controlled triode featuring strap frame grid construction and 600 ma heater for RF amplifier use in VHF tuners. Used in Motorola and GE TV receivers.	16AQ3	9 pin miniature diode featuring double ended construction. For use as damping diode in 600 mil TV receivers. Used in Emerson TV (series string model)
6AF11	Dissimilar double triode and pentode in T9 Compactron construction. For AGC Keyer, sync separator and video amplifier applications.	6HF5	Beam power pentode in T-12 Compactron. For horizontal deflection use in color TV receivers. Used by Zenith in their color models.	17GT5	Single ended beampower tube (triode-pentode). Used in horizontal deflection circuits. Used in RCA and Zenith TV receivers.
6AN5	T4½ beam power pentode. Video amplifier service. Used in IT&T equipment.	6JC6	Sharp cutoff pentodes in 9 pin miniature and featuring strap frame grid construction. Used as IF amplifier. Used in RCA TV receivers.	17LD8	450 ma triode pentode in T9 Novar construction. For vertical deflection oscillator and amplifier application. Used in Silvertone TV receivers.
6BD11	Dissimilar double triode and pentode in T9 Compactron construction. For video output sync separator and sound IF applications. Used in GE TV receivers.	6JD6	Semi-remote cutoff pentode in 9 pin miniature featuring strap frame grid construction. For IF amplifier applications in TV receivers. Currently used in RCA TV receivers.	19HS6	Miniature sharp cut-off pentode. Used in If amplifier and limiter stages. Used in Zenith and RCA FM receivers.
6BE3	T9 Compactron halfwave rectifier diode. For use as damper in TV receivers. Used in GE receivers.	6JN8	9 pin miniature sharp cutoff pentode and medium mu triode. For video IF and AGC keyer application. Used in GE TV models.	22JG6	Beam power pentode in Novar T12 outline. Used as the horizontal deflection amplifier in low B+ TV receivers. Used in Silvertone low B+ models.

## SYLVANIA TV SET PROVES TOUGH TARGET

Ready on the right. Ready on the left. Ready on the firing line. But not in the living room!

Just a short time ago the quietude that characterizes the house at 3670 Washington Boulevard in Cleveland, Ohio came to an abrupt halt. It all happened at the home of Dr. L.

Bakker, a Senior Research assistant for Sohio. It seems his son Bert, an acknowledged rifle expert, was—you guessed it—cleaning his rifle. Bert has a theme song now that goes something like "I didn't know the gun was loaded . . . and I'll never, never do it again."

Loaded it was, all right. And before you could say "Ready, Aim, . . ."—the rifle misfired right into the middle of the Bakker's TV set. (Proving Bert's marksmanship.)

Nothing short of a miracle and the tough construction of the safety glass shield on the Sylvania set saved the whole family from serious injury.

In the words of the Doctor—

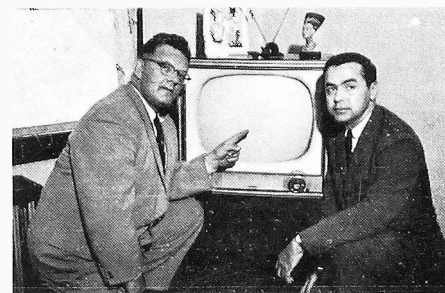

Dr. Bakker points to the "dead center" bullet hole in this Sylvania television screen. The marksman? The Doctor's son Bert Bakker, on the right.

"Scientifically speaking I can offer no explanation why the television did not explode. However, I'll play it safe from now on and buy only Sylvania Televisions." Amen.

is the i-f frequency of the receiver and the VHF tuner is made to serve as an additional i-f stage when switched to the UHF position.

### THE UHF CHANNEL STRIP

Using a 12-position VHF tuner, the channel strip is inserted on a vacant local channel and converts UHF signals as in Figure 4. In normal use the tuner has three stages; an r-f amplifier, a mixer, and an oscillator. The new channel strip changes the function of the r-f amplifier and the mixer so that they are converted to i-f amplifiers for UHF reception. It contains two crystal diodes in addition to the circuits needed to change the r-f and mixer stages. One of these is used as a frequency multiplier which takes the local oscillator signal and multiplies its frequency. The second crystal diode, acting as a mixer, uses the signal from the local oscillator, after it is multiplied, to beat against the UHF signal which has passed through a tuned r-f stage. This difference, frequency is the second-stage i-f of the receiver. There are now two stages of i-f amplification (the first—the former r-f and mixer stages) after which the signal is applied to the i-f strip of the receiver. Fine tuning with the receiver control changes the oscillator

frequency and allows reception over a portion of the UHF band. Since only one lead-in is used, a filter is needed to separate the UHF and VHF stations when separate antennas are used.

There is another approach to the use of the channel strips on a 13-position VHF receiver. The two crystals on the strip can be used to make the receiver into a double superheterodyne, with the original tubes retaining their original function. Here again, a harmonic of the local oscillator signal is used through a crystal harmonic generator. This is beat against the UHF signal in a crystal detector in the channel strip. The resultant signal, in the VHF band, is then passed through the receiver in the normal manner; amplified in the r-f stage and mixed for the second time in the VHF mixer stage. From there it is applied to the i-f strip in the receiver. The strips convert the UHF signals to 45.75 mc i-f signals as in Figure 5.

### THE ALL-CANNEL TUNER

This is the UHF-VHF tuner which has been used in some sets. Instead of the usual 12 switch positions, there are perhaps 15 positions. For VHF reception the tuner works in the normal fashion. In the UHF posi-

tions of the channel selector, the usual practice is to use a separate UHF local oscillator. A tuned input passes the UHF signal to a mixer, usually a crystal. This combines the UHF signal and the local oscillator to produce the intermediate frequency of the receiver. The VHF r-f amplifier and the VHF local oscillator are not in use in this position of the selector switch. In advanced designs of the All-Channel Tuner the same tubes are used as r-f amplifiers and local oscillators for both bands.

A modified system can be used where the UHF tuner output is Channel 5 or 6 which passes through the receiver in the normal manner.

### UHF INSTALLATIONS

Experience will always be the best guide to the installation problems of UHF, but there are some important points that will help the technician to get started. First, obviously, is the choice of the type of conversion system to use. In some cases this will be dictated by the type of receiver design.

In situations where more than two UHF stations are going to be or already are within range, a full range VHF-UHF receiver is desirable. If there is any question as to the number of stations that will be in receiving

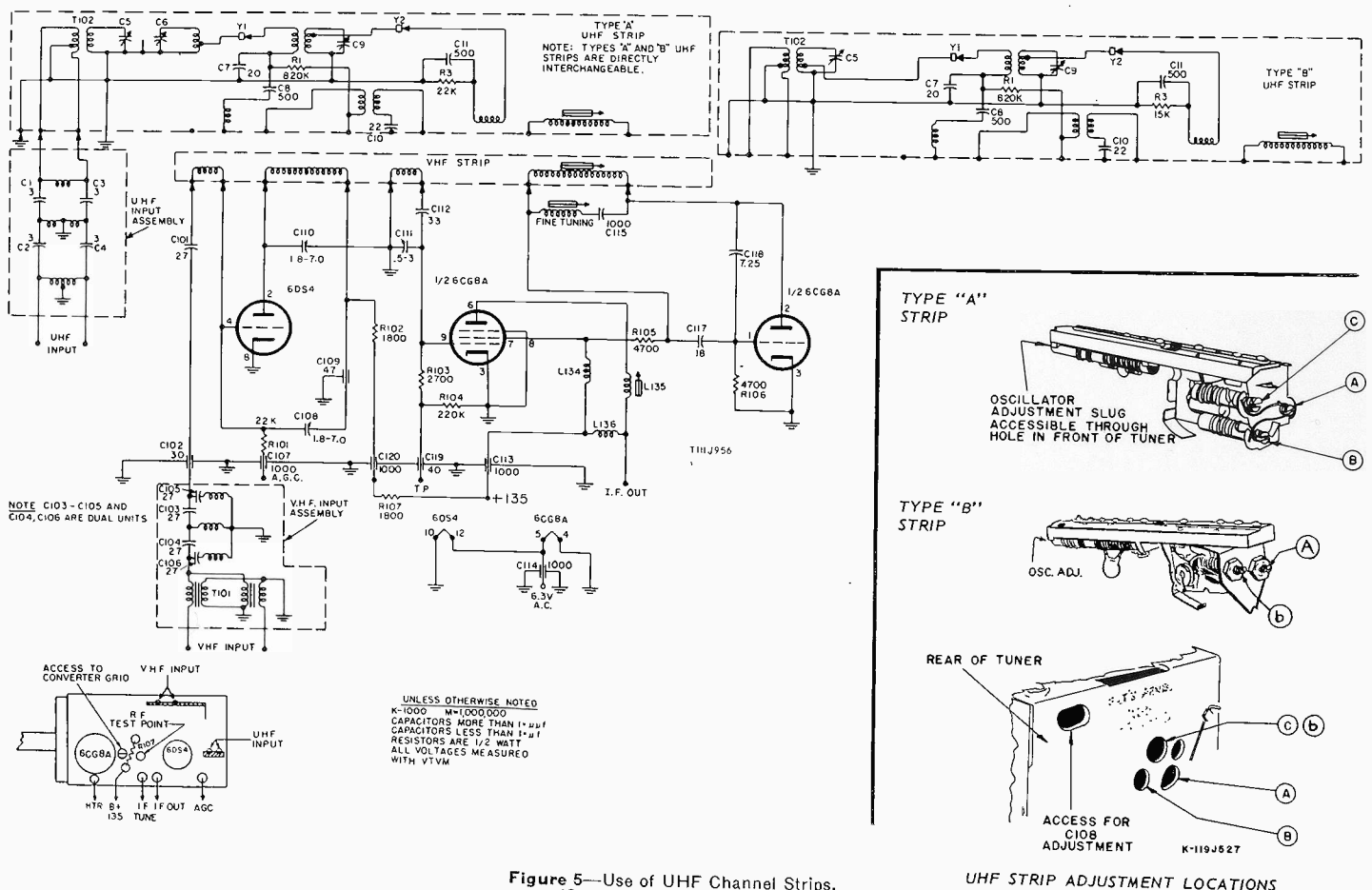

Figure 5—Use of UHF Channel Strips. (Courtesy General Electric)

UHF STRIP ADJUSTMENT LOCATIONS

range, the full range units are the only answer. The installation must be able to receive all the stations that come into the given area with sufficient signal strength. Only in this way will the user be completely satisfied with the job.

After the choice of the type of converter, the next logical step in the problem is that of the antenna and the lead-in. Unless the transmission line is new (within the last six months), experience shows that best results cannot always be obtained. This line should be one of the better grades of 300-ohm line. However, it is possible that installation of tubular 300-ohm line will result in better pictures in all kinds of weather. Amphenol 214-105, RCA 933014, or Belden 8325 or 8275 are designed for UHF use. The results of many actual field tests show that the serious effect of rain, ice and snow on reception on the standard 300-ohm line in the UHF band must be considered. In severe cases of lead-in trouble due to great line length, some type of open-wire line is recommended. This has less loss than any other type of line and improves the picture in different areas. In all cases the lead-in path should be chosen with care, so that it will be as short as possible and will

pass a minima of nearby conductors such as rainspouts and gutters.

It is important that UHF antennas be installed with care using the shortest possible lead-in of high quality and, if necessary, that a pre-amplifier be used in order to give complete customer satisfaction.

Usually only one transmission line is needed. Almost all conversion systems make provision for a separate UHF antenna input when needed. In some cases the same antenna can be used for both bands. This is the simplest solution. However, it can be used only where the VHF antenna system has sufficient UHF gain. In addition, stations in both bands must be in the same general direction so that there is no serious orientation problem. If a separate UHF antenna is needed, and if two transmission lines are needed, the UHF transmission line is tied directly to the converter and the VHF line goes to the receiver through the converter selector switch.

Choice of the type of UHF antenna depends on several factors. First, there is the problem of gain. For strong local UHF stations it is possible that the existing VHF antenna will work. If not, a simple but separate antenna, such as the

single bow tie, may suffice. Figure 6 shows a bow-tie and reflector, for greater gain a stacked bow-tie (Fig. 7) can be used; both will improve a poor UHF signal.

In fringe areas, need for a higher gain dictates the use of a Yagi (for stations that are close in frequency), or a rhombic or a parabolic reflector (for complete coverage of the entire band). Figure 8 shows a parabolic antenna with from 14.5 to 19.1 db of gain over the UHF band.

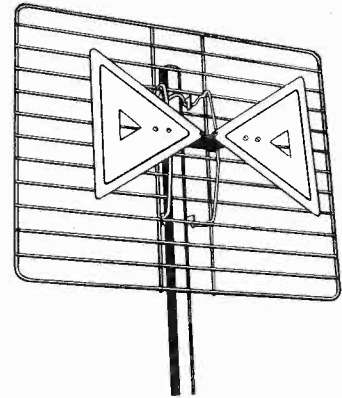

Figure 6—Bow-Tie with Reflector.  
(Courtesy Channel-Master)

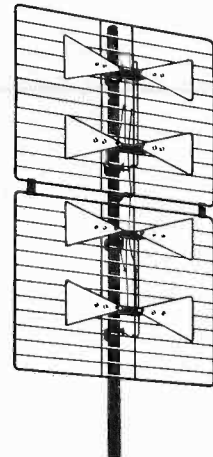

Figure 7—Multi-Bow-Tie.  
(Courtesy Channel-Master)

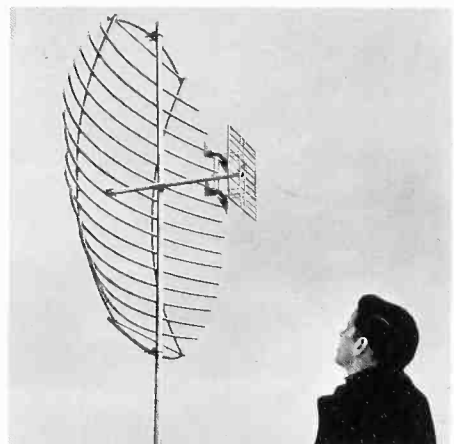

Figure 8—Parabolic Reflector.  
(Courtesy Channel-Master)

\*\*\*\*\*  
U.S. POSTAGE  
02 1/2  
PA. PB 314629  
METER  
READING  
ADL 1/8¢ PD  
BLK RT

Sylvania News  
Winter 1963

~~SYLVANIA ELECTRONIC PRODUCTS CO. INC.  
PITTSBURGH, PA.~~

BARBEY'S  
READING  
LANCASTER  
POTTSTOWN  
LEBANON

Printed in U.S.A.

19230-27-1

JOHN L. GIGL  
437 NEVIN ST.  
LANCASTER, PA. 17603



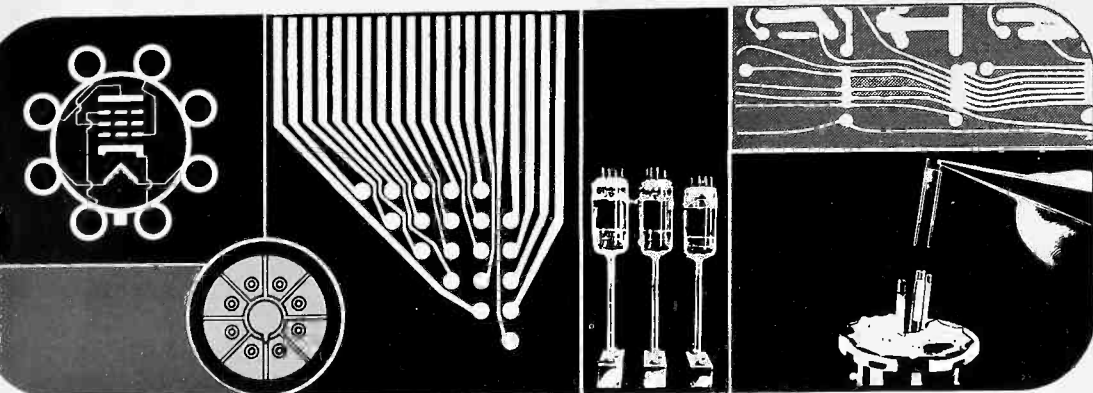

R. A. HUMPHREYS, TECHNICAL EDITOR This information in Sylvania News is furnished without assuming any obligations.

## TV TUNER REPAIR AND ALIGNMENT PART II

### ALIGNMENT PROCEDURE

In the preceding issue several tuner circuits were considered, the mechanical and electrical defects apt to be encountered enumerated, and their repair discussed. The equipment required for tuner alignment was also listed. This article concludes the actual alignment procedure.

### EQUIPMENT SETUP

The connections for tuner alignment are shown in Figure 6. The signal generator time base is applied to the horizontal input of the oscilloscope. The sweep signal is applied to the tuner through the termination pad while the sound or picture carrier marker is capacitively coupled to the 300 ohm line leading to the tuner. Individual tuners usually have a

built-in test point for connection of the oscilloscope. If the specific tuner does not have an indicated test point, the vertical input of the oscilloscope is connected to the grid network of the mixer stage. It is desirable to use a 10-K resistor in series with the scope lead, connected at the tuner. For accurate results keep the tuner shields in place in their normal position. An attenuator

pad may also be required to reduce the generator's output to a usable level.

Before beginning alignment, it is necessary to disable the first IF stage. If the filaments of the set are in series, the first IF grid can be grounded through a 0.005 mfd capacitor since removing the IF tube would prevent the operation of the receiver. Where the filaments are

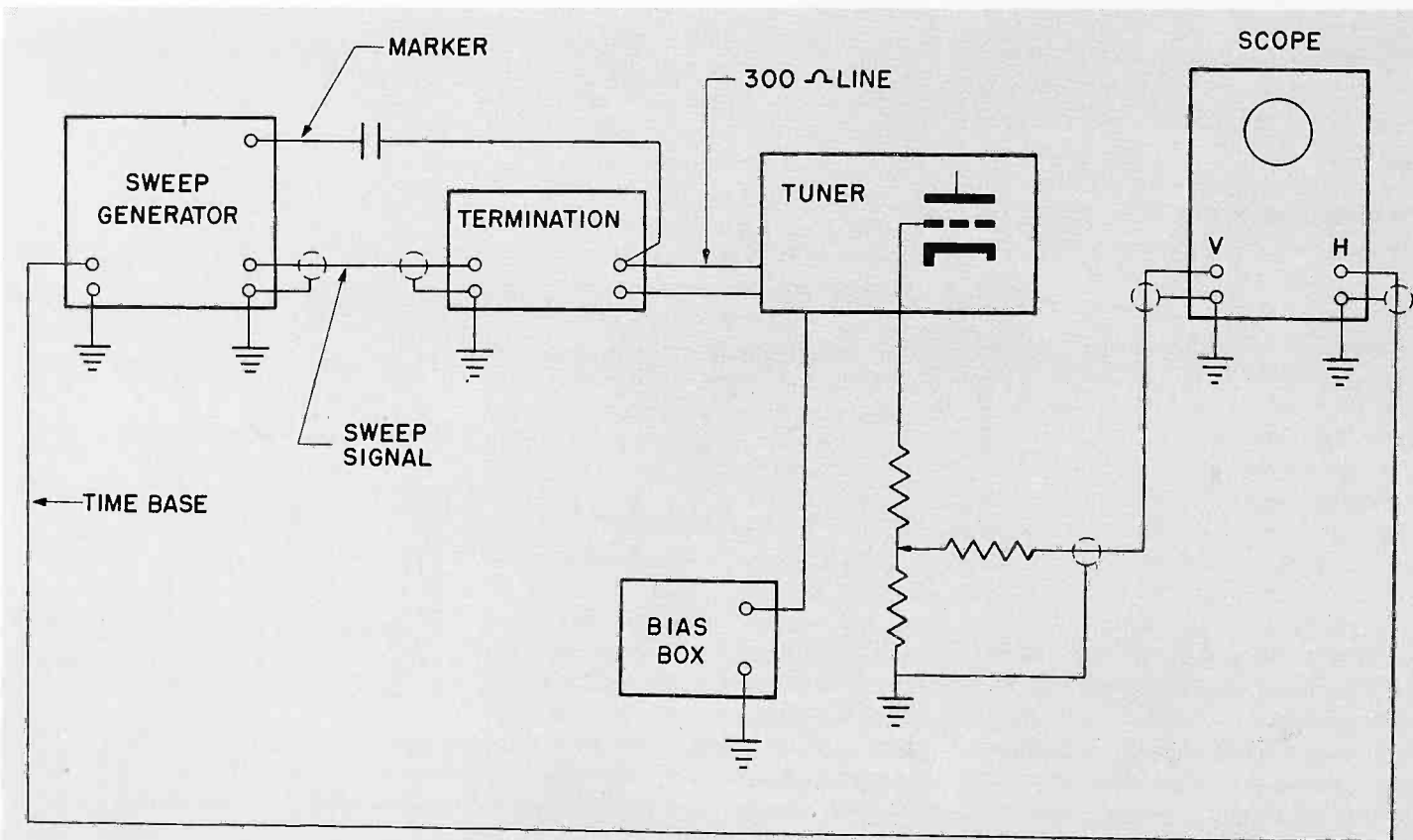

Figure 6—Connections for tuner alignment.

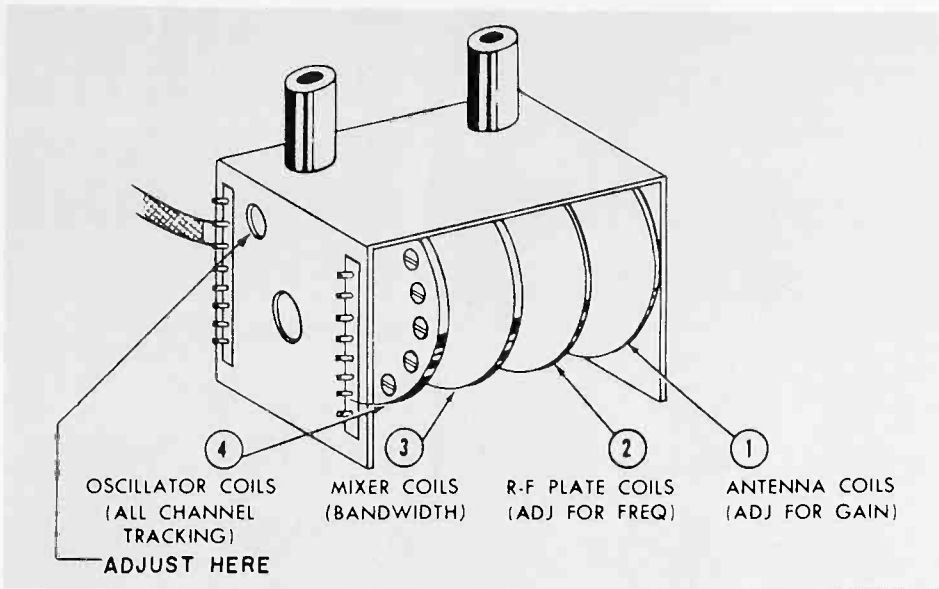

Figure 7—Relative positions of various coils in typical wafer tuner and order of adjustment.

in parallel, the first IF tube can be removed and its grid resistor shunted with a low value of resistance (100 ohms) to ground. The primary of the mixer output should be de-tuned to prevent any distortion of the waveform as seen on the oscilloscope. A smallest possible signal which will give the necessary response curve should be used again to prevent distortion.

#### ADJUSTMENTS AND THEIR SIGNIFICANCE

Consider the alignment of a wafer type of tuner with the signal generator tuned to the high frequency end. Adjustments are made in this order, (Figure 7); the antenna coil, the RF plate coil, the mixer coil and the oscillator coil.

The antenna coils are adjusted for maximum gain, the RF plate coils are adjusted for frequency while the mixer coils are adjusted for bandwidth. Tilt refers to the equal level of peaks. Tracking is obtained by the adjustment of the oscillator coils. Figure 8 shows the significance of these adjustments on the curve as seen on the scope.

Where there is no movable coil slug or core, the adjustments are made by physically moving the coil itself. The coil can be spread apart or bent together or moved closer to or further away from the wafer. Rather than using hit or miss, a tuning wand is a valuable tool. This plastic rod has a ferrite section on one end and a brass slug mounted on the other end.

Suppose that you place the ferrite end of the tuning wand near a coil. If this increases the response curves, this means that you should press the turns of the coil together because more inductance is needed. If this decreases response curve, you should spread the turns of the coil apart slightly. The opposite effect will occur using the brass end of the tuning wand. If both ends of the wand have the same effect, this coil does not need adjustment for it is properly connected.

#### RESPONSE CURVES

A basic response curve is shown in Figure 9 where the peaks, valley, slopes, and skirts are shown. In some cases the curve is flopped over and appears upside down.

Some typical alignment curves are shown in Figure 10. Usually the alignment is for as high and narrow a symmetrical curve as possible, but keeping the markers for the sound and picture carriers on the flat portion of the curve if possible. In some cases the manufacturer provides detailed response curves which should, of course be followed.

#### OSCILLATOR ALIGNMENT

Adjustments to the oscillator frequency are made from the front of the receiver and these can usually be made without removing the receiver from the cabinet. There are access holes on the front of the tuner so that each individual oscillator coil can be adjusted as in Figure 11.

Before making any adjustments to

the oscillator frequency, set the fine tuning control in the middle of its range.

There are three ways of adjusting the oscillator to the correct frequency:

1. If an accurately calibrated grid dip meter is available, it can be used as a diode wave meter to measure the oscillator frequency. Remember that the oscillator frequency is equal to the signal

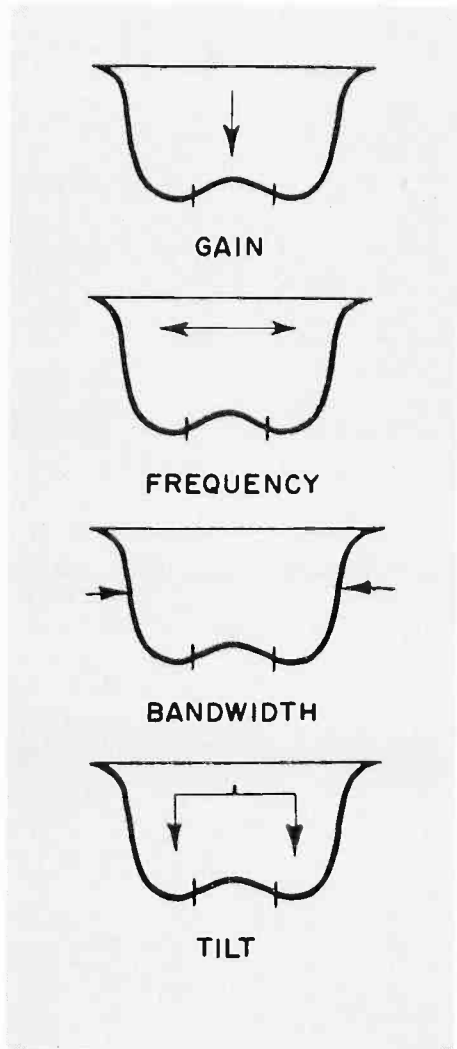

Figure 8—Significance of adjustments made in aligning tuner.

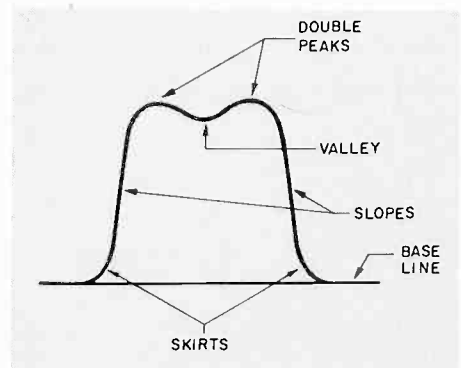

Figure 9—Basic response curve.

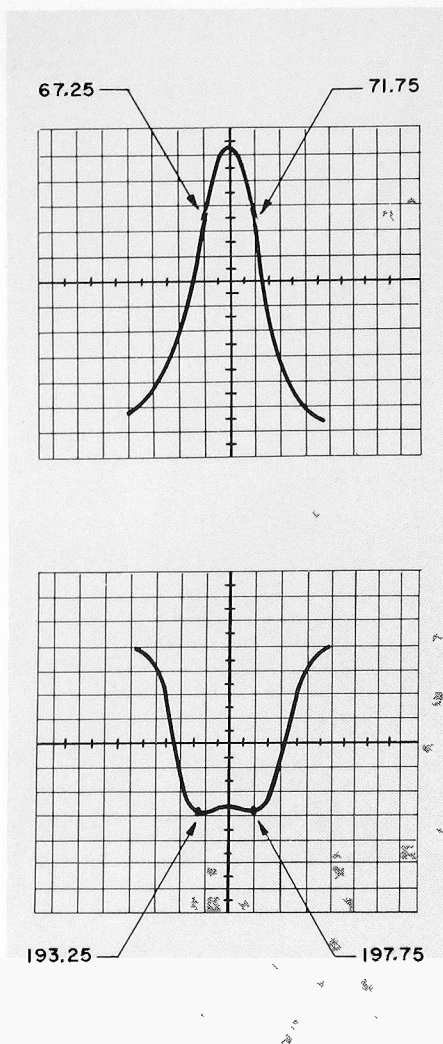

Figure 10—Typical response curves: Top—narrow band curve; Bottom—wide band curve.

frequency plus the IF frequency. For example, the sound IF frequency on modern receivers is 41.25 mc, and the sound RF carrier frequency is .25 mc less

than the top of the TV channel, or 71.75 mc for channel 4. The oscillator frequency should then be  $41.25 + 71.75 = 113$  mc for channel 4.

2. If a TV broadcast station is available, the oscillator frequency may be adjusted to produce the best picture and adequate sound for that particular channel.
3. The last method uses the alignment set-up shown in Figure 6 with a sweep generator and an accurate sound carrier marker for each channel and an IF sound marker at 41.25 mc loosely coupled to the mixer. The local oscillator in the tuner beats with the RF marker to produce a marker within the pass band of the RF response displayed on the oscilloscope. By tuning the local

oscillator, this marker can be made to move along the response curve until it coincides with the RF sound carrier marker. When the two are exactly the same frequency, an audio beat note will be visible on the oscilloscope indicating correct oscillator frequency.

TV tuner servicing and alignment is no more difficult than servicing or aligning, say the IF strip. More care is required to be sure, and the techniques need to be mastered, but the results in improved set performance are worth the effort.

A good RF sweep generator and an adequate marker generator are required to supply the needed signals for alignment. If such equipment is not available, alignment should not be attempted.

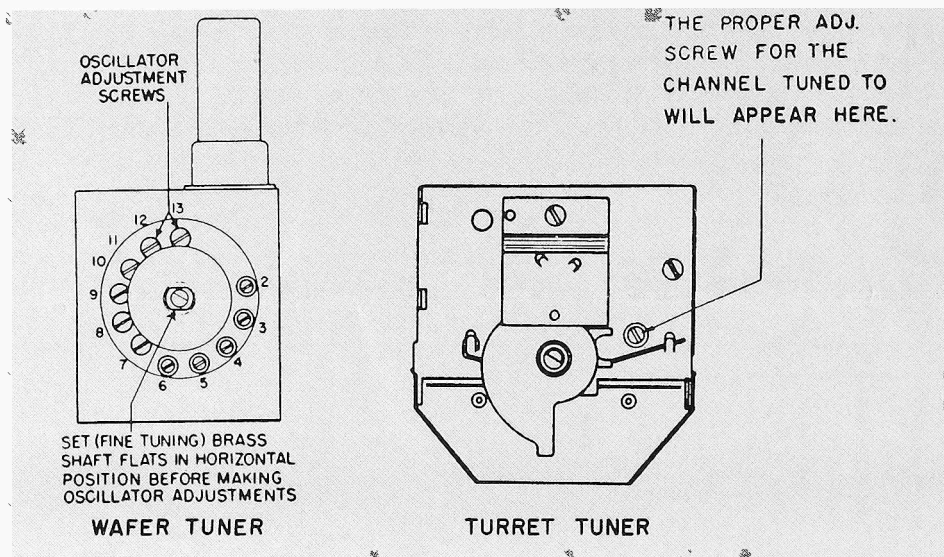

Figure 11—Adjustment of oscillator frequency is made via access hole in tuner. It is not usually necessary to remove tuner from cabinet. Left—wafer tuner; Right—turret tuner.

# NEWEST EDITION OF SYLVANIA TECHNICAL MANUAL IS VALUABLE DEALER REFERENCE

Make room on your shelf for the newest edition of the professional service dealer's "bible," the Sylvania Technical Manual. All of the very latest, most up-to-date technical tube data is compiled into this just-printed 12th Edition, now available from your Sylvania Distributor or directly through Sylvania.

The 12th Edition is the newest number in the Sylvania Tech Manual Series, which dates back to 1929. If you've used any of the previous editions, you know that it's probably the single most useful reference in your technical library.

The all new 12th Edition has been expanded to include the most recent tube releases and information (including the entire series of 240 supplement sheets to the 11th Edition), revised to eliminate any obsolete data, and re-organized so that it's actually easier than ever for you to find the information you want.

The price of the Sylvania Technical Manual is only \$3.00, and it's easily worth more. Look at some of the features in this new 12th Edition:

- Complete characteristic on over 2,000 tube types
- Data on Receiving Tubes, Cathode Ray Tubes, Semiconductor Diodes and Rectifiers; Special Purpose Tubes
- Picture Tube Interchangeability Guide
- European-American Substitution Guide
- Semiconductor Diode Interchangeability Chart
- Brand new Master Indexing system for quick reference

**Free supplementary data** — To insure that your copy of the 12th Edition is always up-to-date, you'll receive periodic mailings of supplementary data sheets, incorporating all the newest tube releases. There is no extra charge for these additional sheets. Simply fill out and mail in the post card included in every Technical Manual. (You must send in this post card to receive the supplementary mailings.) In the past, supplement sheets have been sent out every three or four months, averaging 30 new sheets each mailing.

See your Sylvania Distributor soon to get your copy of the new 12th Edition of the Sylvania Technical

Manual. Or, send \$3.00 in check or money order to Sylvania Electric Products, 1100 Main St., Buffalo 9, New York.

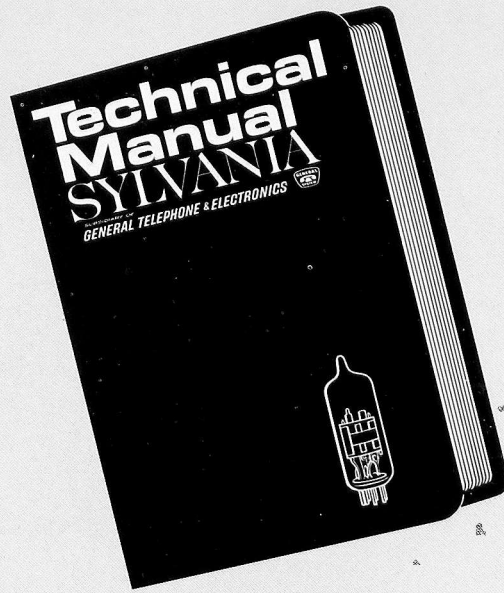

Newest edition of the Sylvania Technical Manual has 632 pages, lists data on over 2,000 tube types, and is fully indexed and tabbed for quick reference.

BULK RATE  
U.S. POSTAGE  
PAID  
Permit No. 3402  
Buffalo, N.Y.

AS

Henry Zimmerman  
2635 S. Home Ave.  
Berwyn, Ill.



**SYLVANIA  
ELECTRIC**  
PRODUCTS INC.  
1100 MAIN ST.  
BUFFALO, N.Y.  
**SYLVANIA NEWS**  
MARCH-APRIL 1963

Printed in U.S.A.

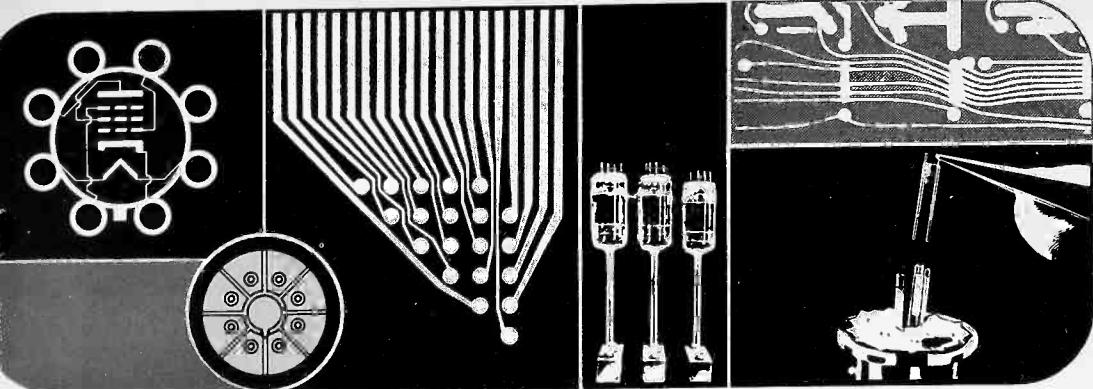

R. A. HUMPHREYS, TECHNICAL EDITOR This information in Sylvania News is furnished without assuming any obligations.

## TV TUNER REPAIR AND ALIGNMENT PART II

### ALIGNMENT PROCEDURE

In the preceding issue several tuner circuits were considered, the mechanical and electrical defects apt to be encountered enumerated, and their repair discussed. The equipment required for tuner alignment was also listed. This article concludes the actual alignment procedure.

### EQUIPMENT SETUP

The connections for tuner alignment are shown in Figure 6. The signal generator time base is applied to the horizontal input of the oscilloscope. The sweep signal is applied to the tuner through the termination pad while the sound or picture carrier marker is capacitively coupled to the 300 ohm line leading to the tuner. Individual tuners usually have a

built-in test point for connection of the oscilloscope. If the specific tuner does not have an indicated test point, the vertical input of the oscilloscope is connected to the grid network of the mixer stage. It is desirable to use a 10-K resistor in series with the scope lead, connected at the tuner. For accurate results keep the tuner shields in place in their normal position. An attenuator

pad may also be required to reduce the generator's output to a usable level.

Before beginning alignment, it is necessary to disable the first IF stage. If the filaments of the set are in series, the first IF grid can be grounded through a 0.005 mfd capacitor since removing the IF tube would prevent the operation of the receiver. Where the filaments are

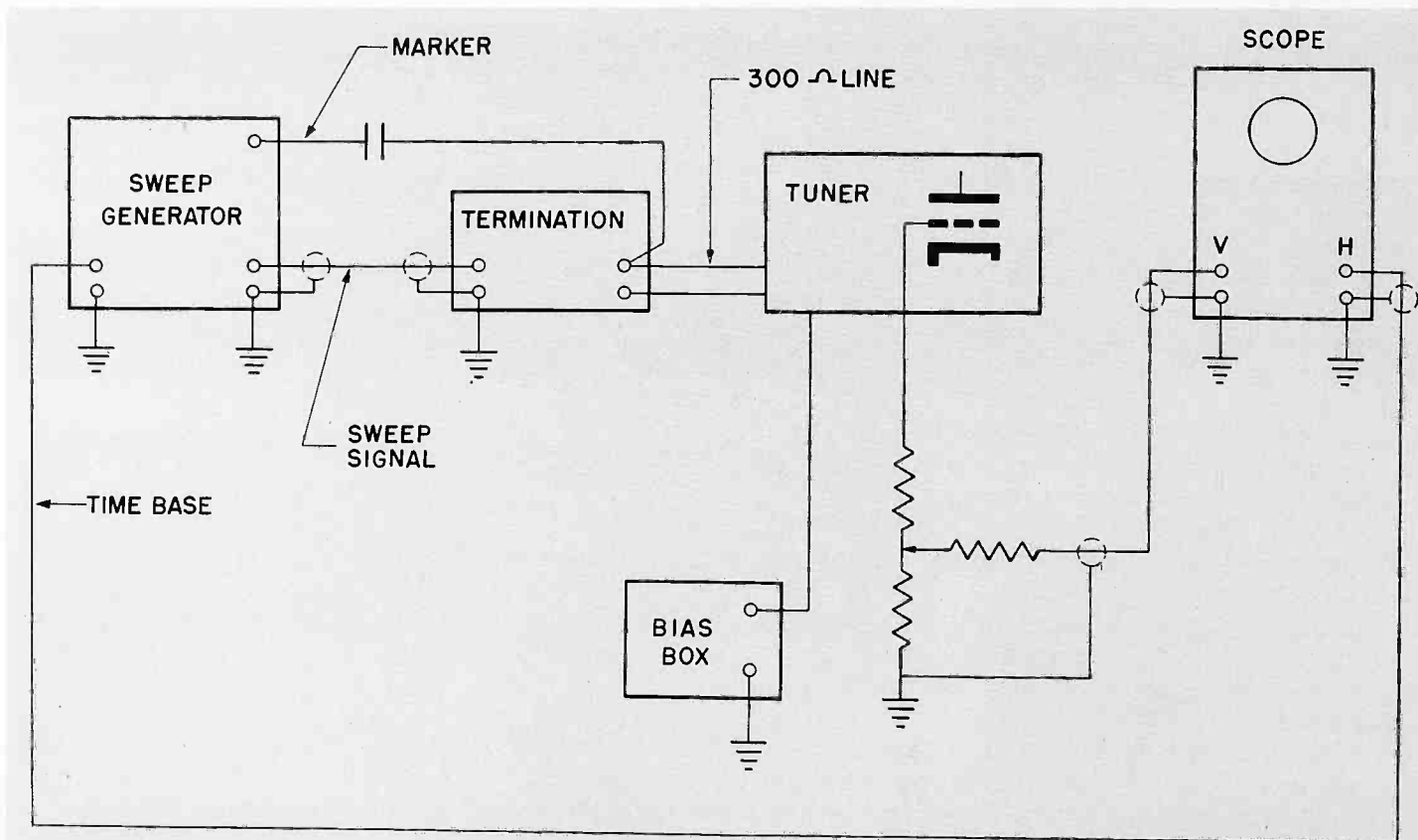

Figure 6—Connections for tuner alignment.

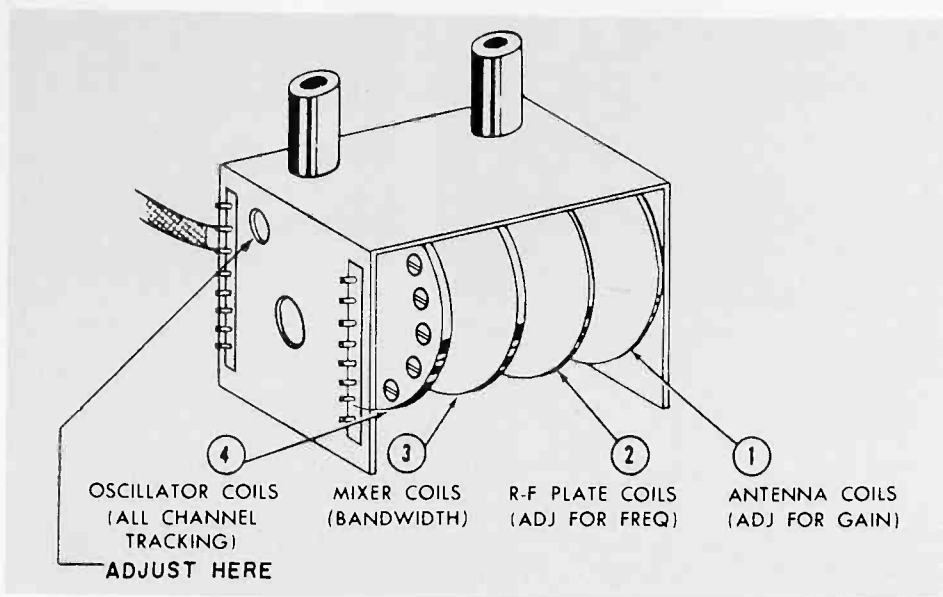

Figure 7—Relative positions of various coils in typical wafer tuner and order of adjustment.

in parallel, the first IF tube can be removed and its grid resistor shunted with a low value of resistance (100 ohms) to ground. The primary of the mixer output should be de-tuned to prevent any distortion of the waveform as seen on the oscilloscope. A smallest possible signal which will give the necessary response curve should be used again to prevent distortion.

#### ADJUSTMENTS AND THEIR SIGNIFICANCE

Consider the alignment of a wafer type of tuner with the signal generator tuned to the high frequency end. Adjustments are made in this order, (Figure 7); the antenna coil, the RF plate coil, the mixer coil and the oscillator coil.

The antenna coils are adjusted for maximum gain, the RF plate coils are adjusted for frequency while the mixer coils are adjusted for bandwidth. Tilt refers to the equal level of peaks. Tracking is obtained by the adjustment of the oscillator coils. Figure 8 shows the significance of these adjustments on the curve as seen on the scope.

Where there is no movable coil slug or core, the adjustments are made by physically moving the coil itself. The coil can be spread apart or bent together or moved closer to or further away from the wafer. Rather than using hit or miss, a tuning wand is a valuable tool. This plastic rod has a ferrite section on one end and a brass slug mounted on the other end.

Suppose that you place the ferrite end of the tuning wand near a coil. If this increases the response curves, this means that you should press the turns of the coil together because more inductance is needed. If this decreases response curve, you should spread the turns of the coil apart slightly. The opposite effect will occur using the brass end of the tuning wand. If both ends of the wand have the same effect, this coil does not need adjustment for it is properly connected.

#### RESPONSE CURVES

A basic response curve is shown in Figure 9 where the peaks, valley, slopes, and skirts are shown. In some cases the curve is flopped over and appears upside down.

Some typical alignment curves are shown in Figure 10. Usually the alignment is for as high and narrow a symmetrical curve as possible, but keeping the markers for the sound and picture carriers on the flat portion of the curve if possible. In some cases the manufacturer provides detailed response curves which should, of course be followed.

#### OSCILLATOR ALIGNMENT

Adjustments to the oscillator frequency are made from the front of the receiver and these can usually be made without removing the receiver from the cabinet. There are access holes on the front of the tuner so that each individual oscillator coil can be adjusted as in Figure 11.

Before making any adjustments to

the oscillator frequency, set the fine tuning control in the middle of its range.

There are three ways of adjusting the oscillator to the correct frequency:

1. If an accurately calibrated grid dip meter is available, it can be used as a diode wave meter to measure the oscillator frequency. Remember that the oscillator frequency is equal to the signal

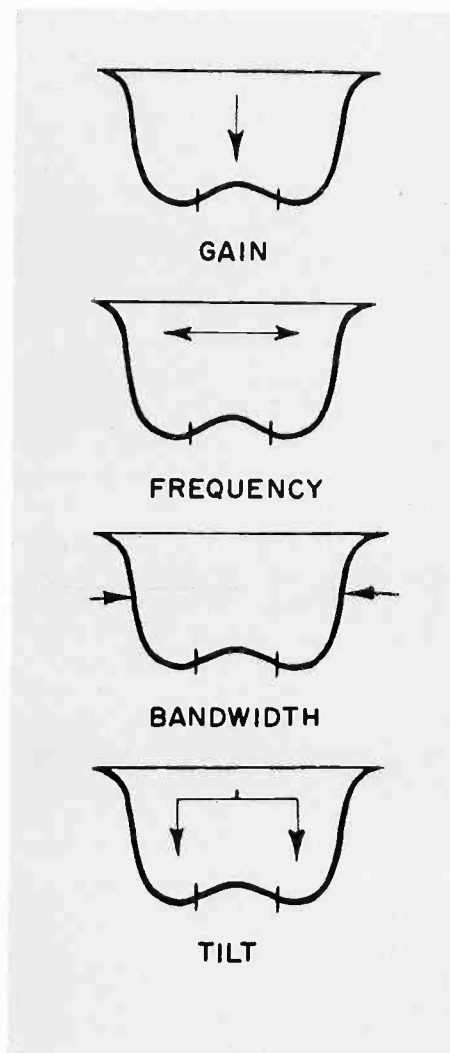

Figure 8—Significance of adjustments made in aligning tuner.

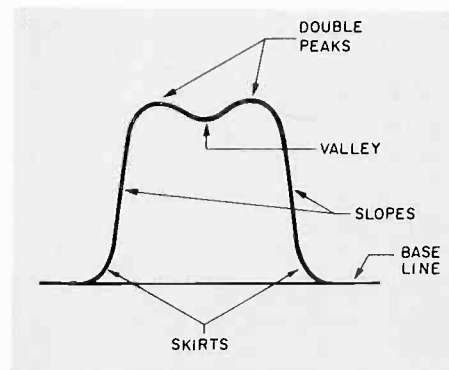

Figure 9—Basic response curve.

# Dealer Section

MARCH-APRIL 1963 □ VOL. 30, NO. 1

## SYLVANIA SPRING SAVATHON

# SAVE



ON AMERICA'S  
MOST RELIABLE  
**SERVICING**  
COMBINATION!



**SPECIAL LIMITED TIME OFFER**

# BONUS

**SYLVANIA QUALITY  
RECEIVING TUBES**

WHEN YOU BUY

**SILVER SCREEN 85  
PICTURE TUBES**

**(GET FULL DETAILS HERE)**

**SEE  
YOUR  
PARTICIPATING  
SYLVANIA  
DISTRIBUTOR  
FOR THE  
NEW  
SYLVANIA  
SILVER  
SCREEN 85\*  
BONUS  
PICTURE  
TUBE  
PROMOTION.  
HE'S GOT  
ALL THE  
DETAILS!**

LOOK FOR THIS POSTER AT YOUR SYLVANIA DISTRIBUTOR STORE: It means he's giving bonus Sylvania Receiving Tubes with every purchase of a Silver Screen 85 during the Sylvania Spring Savathon, from March 11 through May 3, 1963.

*\*\*The Silver Screen 85 is engineered from all new parts and materials with the exception of the glass envelope which prior to reuse is tested to the same standards as a new one.\*\**

# SYLVANIA SELF-EDUCATION PROGRAM IS KEY TO NEW PROFITS FOR MANY DEALERS!

*Four Self-Study Courses Available Through Sylvania Help You Improve Servicing Techniques*

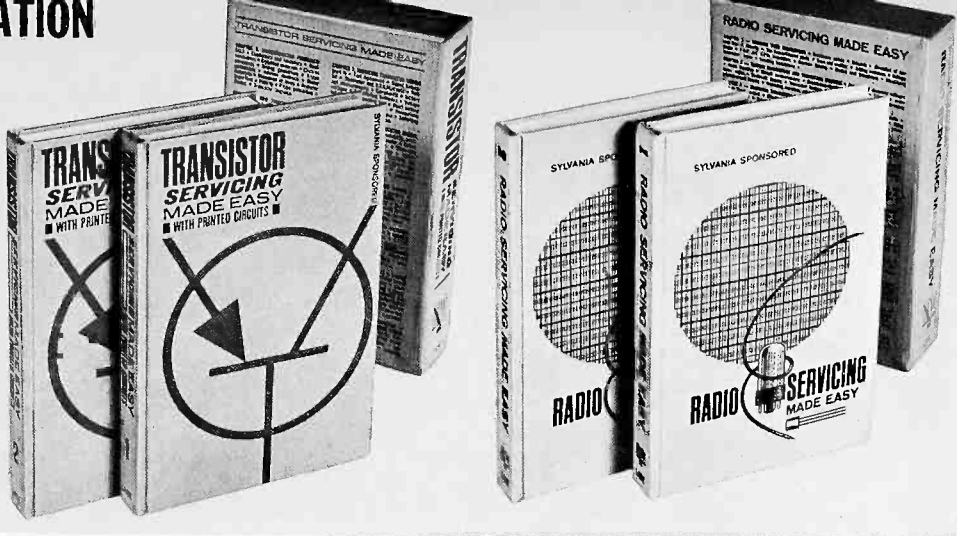

If you're anxious to expand your knowledge of servicing techniques in the four big servicing fields—black and white TV, color TV, radio and transistorized equipment—and increase your earning power at the same time, the Sylvania Self-Education Program is designed for you!

Through its Distributors and the facilities of the Radio-Television Training Association, Sylvania offers up-to-date self-study courses in each of these profitable areas. The courses represent a thorough compilation of the latest information, equipment and servicing techniques in each field. They can help you cut down servicing time, handle more jobs, take on *new* jobs. Each course is a valuable, profitable reference book for the professional service dealer. They should be part of your library!

#### **New Shortcuts to TV Servicing**

Dozens of Time-saving servicing shortcuts are featured in this 12-lesson course. Recently revised, this course describes the very latest servicing techniques and procedures for black and white TV. New material has been added on portable and transistorized TV; hundreds of photographs and illustrations are included.

The material is covered in two hardcover volumes. A sampling of chapter subjects will show how this course can help you cut down on servicing time: Front End Troubles, Troubleshooting the I.F., Video Amplifier Defects, Sync Troubles, Picture Tube and Picture Tube Circuit Troubles, High Voltage Troubles, Deflection Troubles. Each chapter presents a thoroughly detailed analysis of trouble symptoms, likely causes and shortcuts to their cure.

The complete two-volume course is only \$6.75. See your Sylvania Distributor.

#### **Color TV Technician Course**

The future of color TV is steadily getting brighter and brighter. This Sylvania Color TV Technician Course can provide you with the fundamental knowledge to enter this profitable field yourself.

Fourteen easy-to-understand lessons introduce you to the theory and practice of color TV receivers and their servicing. Special attention is paid to color picture tubes, color TV circuitry and color TV test equipment.

Individual chapter titles include "An Introduction to Color," "Formation of the Color Signals," "General Operation of the Color Receiver," "Adjusting the Color Receiver," "Troubleshooting the Color Receiver," and "Servicing Procedures."

The price for the two volumes of this detailed course is \$25.00. They can be ordered through your Sylvania Distributor.

#### **Radio Servicing Made Easy**

Dealers anxious to cash in on radio's resurgence in popularity would do well to study the techniques presented in this Sylvania course. Just considering the variety of types of radios available today will indicate the different servicing techniques necessary. For example, there are clock radios, small transistor portables, FM receivers, console receivers, short wave sets, marine radio receivers, police and airplane receivers and automobile radios (both AM and FM).

These are some of the lesson subjects covered in this two-volume, hardcover-bound course: Working with Transistors, Servicing Transistor Radios, Repairing Auto Radios, Servicing AM and FM Receivers and Tuners, Servicing Communications Receivers, Mobile and Marine Radio Equipment.

This course is only \$6.75 from your Sylvania Distributor.

#### **Transistor Servicing Made Easy**

The semiconductor has opened a whole new servicing field to the TV service dealer, not only in the pocket radio area but in two-way communications, and in business and industry, too. This course is designed to give the service technician a better-than-average working knowledge of transistors, their components and associated circuitry. It should enable you to increase your business by cutting down your transistor servicing time and helping you to service new kinds of transistorized equipment.

The course material is compiled into two hardcover volumes, and includes such topics as Semiconductor Fundamentals, How Transistors Work, R.F. and I.F. Stages, Audio Amplifiers, Servicing Transistor Radios, Transistor Auto Radios, Printed Circuits, and Transistors in Industry.

This course can also be ordered through your Sylvania Distributor. The cost is only \$6.75.

*NOTE: The prices shown here are for the books only. Should you wish to study any of these subjects as correspondence courses through RTTA you may do so. See your Sylvania Distributor for details.*



---

# USE YOUR SHOP WINDOW TO SELL YOUR SERVICE . . . SHOW THIS NOVEL SYLVANIA DEALER DISPLAY KIT!

---

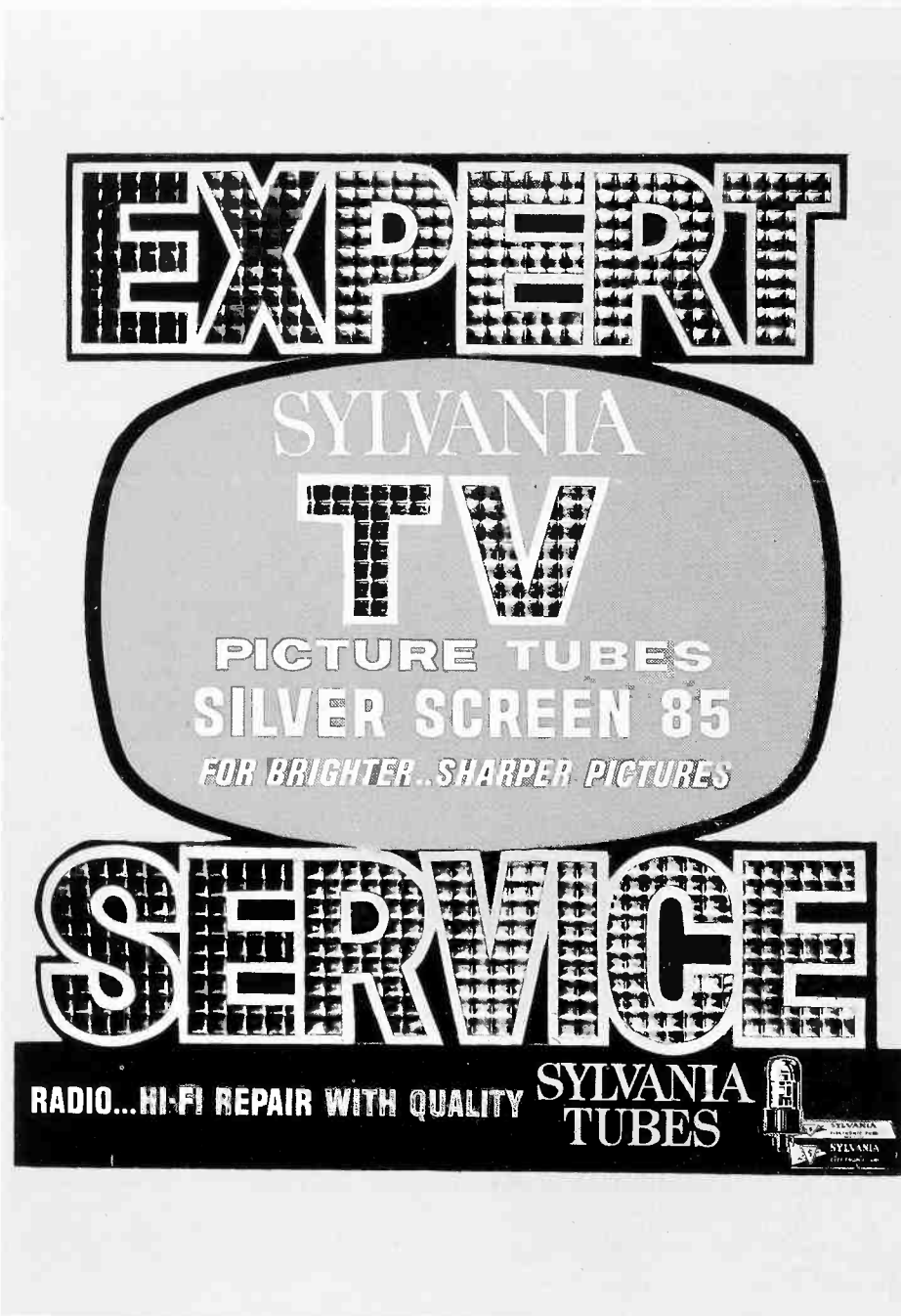

Your shop window can be a powerful advertising medium to sell your services to people passing by . . . if it invites those passers-by to stop and take a second look.

First thing to do is make sure your window (and the shop that's seen through it) is clean and neat. People are not likely to associate expert electronic service with an unkept store front.

A second excellent idea is to dress up your window with the attractive Sylvania Dealer Display Kit shown here. This novel kit includes seven three-dimensional display pieces that stand by themselves, plus one window streamer. The entire eight-piece kit is only \$1.35, which also makes your shop window one of the most economical advertising media at your disposal.

The three-dimensional displays come folded flat—just tuck in the flaps and they pop to life, selling your service and the Sylvania tubes you install. You can make your own arrangements, displaying them to fit your particular window layout. Show them inside on your counter top if you prefer—they make an eye-catching display wherever you spot them.

You can order this unique display kit from your Sylvania Distributor or directly from Sylvania. If ordering from Sylvania, include the \$1.35 remittance (no COD's). Send your order to Sylvania Electric Products, 1100 Main Street, Buffalo 9, New York. Shipping is prepaid and prompt.

Colorful three-dimensional Sylvania Dealer Display Kit will have people stopping and looking in **your** shop! Entire kit only \$1.35. When ordering, request display number ET-1151.

# NEW ADDITIONS TO KEEP YOUR PICTURE TUBE COMPARISON CHART UP-TO-DATE

New picture tube types are constantly being developed at a rate to bewilder most busy service dealers. In order to keep you abreast of the many picture tube types and their characteristics, Sylvania recently published a Picture Tube Comparison

Chart, the industry's most up-to-date such reference.

The chart below lists new tube types, registered since the publication of the Comparison Chart. To keep your information current, clip out this chart and keep it with your

Sylvania Picture Tube Comparison Chart. If you don't already have the original chart, or its companion pocket guide, you can get one from your Sylvania distributor, or by sending 10¢ to Sylvania Electric Products, 1100 Main Street, Buffalo 9, New York, for each chart or pocket guide ordered. For the wall chart, request No. ET-1050; for the pocket guide, request No. ET-1051.

## LATEST ADDITIONS TO PICTURE TUBE WALL CHART & POCKET GUIDE

Type	Ef Volt	If Amp.	Face AR,C, A,T	Bulb M or G	Ext. Cond. Coating (pf)	Focus	Def. Ang.	Anode Voltage Ab. Max.	Basing	Ion Trap Mag.	Nominal Length (Inches)
8NP4	6.3/.60		TA	G	None	LoEs	90°	19.8	12M	N	9¾
8QP4	6.3/.60		TA	G,B	None	LoEs	90°	19.8	12M	N	9¾
16ANP4	6.3/.60		TA	G,B	800-1200	LoEs	114°	19.8	8HR	N	10½
16AQP4	6.3/.60		TA,AR	G,B	800-1200	LoEs	114°	19.8	8HR	N	10½
16ASP4	6.3/.60		TA	G,B	1000-1500	LoEs	114°	22.0	8HR	N	10½ <sub>32</sub>
16ATP4	6.3/.45		TA	G,P	1000-1500	LoEs	114°	18.0	8HR	N	10½
16AUP4	6.3/.60		TA	G	800-1500	LoEs	114°	15.4	8HR	N	10½
16AVP4	6.3/.45		TA	G,B	900-1400	LoEs**	114°	17.6	7FA	N	10½
16AWP4	6.3/.30I		TA	G,P	1000-1500	LoEs	114°	19.8	8HR	N	10½
19BEP4	6.3/.30		TA	G	1000-1500	LoEs	110°	20.0	8HR	N	11½ <sub>16</sub>
19BNP4	6.3/.60		TA	G,B	1000-1500	LoEs**	114°	20.0	8HR	N	12½
19BQP4	6.3/.60		TA,AR	G,B	1000-1500	LoEs**	114°	20.0	8HR	N	12½
19CDP4	6.3/.60		TA	G	1400-1900	LoEs**	114°	19.8	7FA	N	11½
19CFP4	6.3/.60		TA	G	1000-1500	LoEs**	114°	17.5	8HR	N	11½
19CGP4	6.3/.60		TA,AR	G,B	1400-1700	LoEs	92°	20.0	12L	N	15½
19CHP4	6.3/.60		TA	G	1000-1500	LoEs**	114°	20.0	8HR	N	11½
19CKP4	6.3/.60		TA	G	1000-1500	LoEs**	114°	22.0	8HR	N	11¾
19CLP4	6.3/.60		TA	G	1500-2000	LoEs**	92°	19.8	12L	N	15½
19CMP4	6.3/.45		TA	G	1000-1500	LoEs**	114°	20.0	8HR	N	11¾
21FMP4	6.3/.60		TA	G	2000-2500	LoEs**	110°	22.0	8HR	N	14¾
23AUP4	6.3/.60		TA	G	1700-2500	LoEs	92°	25.0	12L	N	18
23AXP4	6.3/.30		TA	G	2000-2500	LoEs	110°	20.0	8HR	N	14
23BEP4A	6.3/.30I		TA	G,B	2000-2500	LoEs	110°	22.0	8HR	N	15¾
23BNP4	6.3/.60		TA	G,B	2000-2500	LoEs	110°	22.0	8HR	N	15¾
23CWP4	6.3/.60		TA	G	2000-2500	LoEsTPF	110°	22.0	8JR	N	13¾
23CXP4	6.3/.30I		TA	G	2000-2500	LoEsTPF	110°	22.0	8JR	N	13¾
23CZP4	6.3/.60		TA	G	2000-2500	LoEs	92°	25.0	12L	N	18½
23DAP4	6.3/.60		TA	G	1700-2500	LoEs**	94°	23.5	8HR	N	16½ <sub>4</sub>
23DBP4	6.3/.60		TA	G	2000-2500	LoEs**	110°	22.0	8HR	N	14¾
23DHP4	6.3/.30		TA	G,B	2000-2500	LoEs	110°	22.0	8HR	N	14¾
23DJP4	6.3/.30		TA,AR	G,B	2000-2500	LoEs	110°	22.0	8HR	N	14¾
23DKP4	6.3/.60		TA	G,R	1700-2500	LoEs	92°	22.0	12L	N	18
23DLP4	6.3/.60		TA	G,R	1700-2500	LoEs**	92°	22.0	12L	N	18
27YP4	6.3/.60		TA	G,B	2000-2500	LoEs	90°	25.0	12L	N	21¾
27ZP4	6.3/.60		TA	G	2000-2500	LoEs	110°	22.0	8HR	N	17¾
27ABP4	6.3/.60		TA	G,B	2000-2500	LoEs	110°	22.0	8HR	N	17¾
27ACP4	6.3/.60		TA	G,B	2000-2500	LoEs	90°	25.0	12L	N	21½ <sub>16</sub>
27ADP4	6.3/.60		TA	G,B	2000-2500	LoEs	110°	22.0	8HR	N	17¾
27AEP4	6.3/.30		TA	G	2000-2500	LoEs	110°	22.0	8HR	N	17¾
27AFP4	6.3/.30		TA	G,B	2000-2500	LoEs	110°	22.0	8HR	N	17¾

## COLOR TV PICTURE TUBES

Type	Ef Volts	If Amps	Anti-Ref. Alum Tinted	Round or Rect.	Metal or Glass	External Coating Capacitance pf	Horizontal Angle (Degrees)	Focus	Convergence	Anode Volts KV Max.	Basing	Nominal Length (Inches)
14BCP22	6.3/1.8		TA	Rect.	G	500-1500	70°	HiEs	Mag.	22.0	14AU	19½

SS—Silver Screen 85 • Mag.—Magnetic • Es.—Electrostatic • Auto—Automatic Electrostatic • LoEs—Low Voltage Electrostatic • HiEs—High Voltage Electrostatic • LWG—Lightweight Glass • \*\*—Low Grid No. 2 Voltage • N—No Magnet • S—Single Magnet • D—Double Magnet • I—Internal Magnet • C—Rectangular with Cylindrical Faceplate • I—Bulb varies in dimensions from normal • B—Bonded Shield Safety Glass • I—18 Second Heater Warm-up Time • P—Integral Plastic Laminate Cover • R—Rim Band Tube.

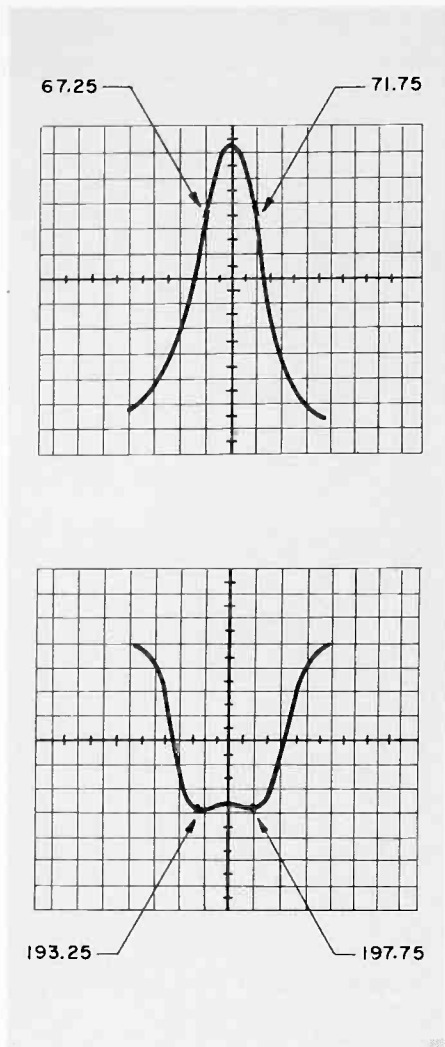

Figure 10—Typical response curves: Top—narrow band curve; Bottom—wide band curve.

frequency plus the IF frequency. For example, the sound IF frequency on modern receivers is 41.25 mc, and the sound RF carrier frequency is .25 mc less

than the top of the TV channel, or 71.75 mc for channel 4. The oscillator frequency should then be  $41.25 + 71.75 = 113$  mc for channel 4.

2. If a TV broadcast station is available, the oscillator frequency may be adjusted to produce the best picture and adequate sound for that particular channel.
3. The last method uses the alignment set-up shown in Figure 6 with a sweep generator and an accurate sound carrier marker for each channel and an IF sound marker at 41.25 mc loosely coupled to the mixer. The local oscillator in the tuner beats with the RF marker to produce a marker within the pass band of the RF response displayed on the oscilloscope. By tuning the local

oscillator, this marker can be made to move along the response curve until it coincides with the RF sound carrier marker. When the two are exactly the same frequency, an audio beat note will be visible on the oscilloscope indicating correct oscillator frequency.

TV tuner servicing and alignment is no more difficult than servicing or aligning, say the IF strip. More care is required to be sure, and the techniques need to be mastered, but the results in improved set performance are worth the effort.

A good RF sweep generator and an adequate marker generator are required to supply the needed signals for alignment. If such equipment is not available, alignment should not be attempted.

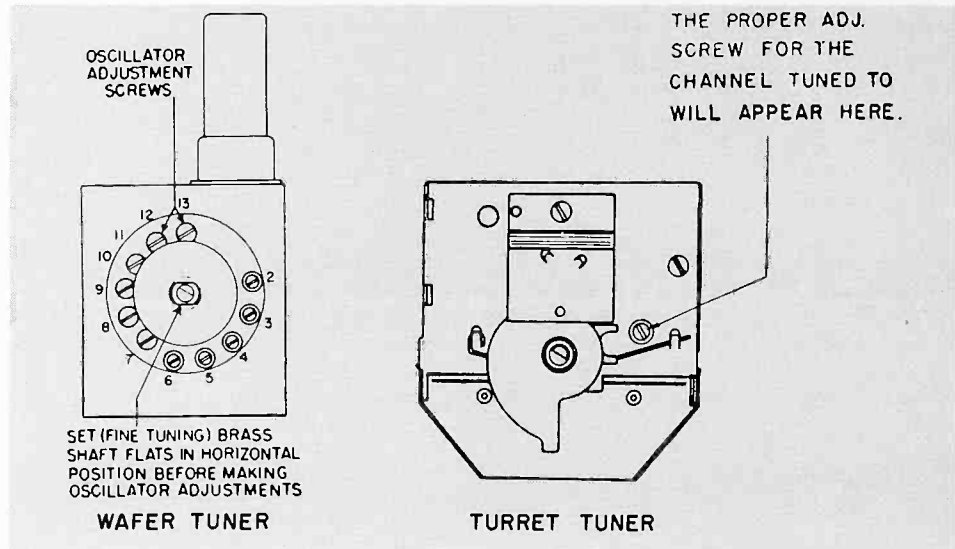

Figure 11—Adjustment of oscillator frequency is made via access hole in tuner. It is not usually necessary to remove tuner from cabinet. Left—wafer tuner; Right—turret tuner.

# NEWEST EDITION OF SYLVANIA TECHNICAL MANUAL IS VALUABLE DEALER REFERENCE

Make room on your shelf for the newest edition of the professional service dealer's "bible," the Sylvania Technical Manual. All of the very latest, most up-to-date technical tube data is compiled into this just-printed 12th Edition, now available from your Sylvania Distributor or directly through Sylvania.

The 12th Edition is the newest number in the Sylvania Tech Manual Series, which dates back to 1929. If you've used any of the previous editions, you know that it's probably the single most useful reference in your technical library.

The all new 12th Edition has been expanded to include the most recent tube releases and information (including the entire series of 240 supplement sheets to the 11th Edition), revised to eliminate any obsolete data, and re-organized so that it's actually easier than ever for you to find the information you want.

The price of the Sylvania Technical Manual is only \$3.00, and it's easily worth more. Look at some of the features in this new 12th Edition:

- Complete characteristic on over 2,000 tube types
- Data on Receiving Tubes, Cathode Ray Tubes, Semiconductor Diodes and Rectifiers; Special Purpose Tubes
- Picture Tube Interchangeability Guide
- European-American Substitution Guide
- Semiconductor Diode Interchangeability Chart
- Brand new Master Indexing system for quick reference

**Free supplementary data** — To insure that your copy of the 12th Edition is always up-to-date, you'll receive periodic mailings of supplementary data sheets, incorporating all the newest tube releases. There is no extra charge for these additional sheets. Simply fill out and mail in the post card included in every Technical Manual. (You must send in this post card to receive the supplementary mailings.) In the past, supplement sheets have been sent out every three or four months, averaging 30 new sheets each mailing.

See your Sylvania Distributor soon to get your copy of the new 12th Edition of the Sylvania Technical

Manual. Or, send \$3.00 in check or money order to Sylvania Electric Products, 1100 Main St., Buffalo 9, New York.

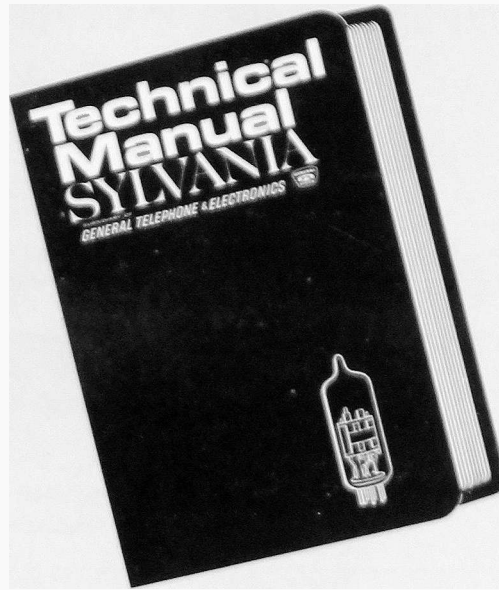

Newest edition of the Sylvania Technical Manual has 632 pages, lists data on over 2,000 tube types, and is fully indexed and tabbed for quick reference.

GEORGE D. BARBEY CO. INC.  
333 N. 4TH ST. - P O BOX 2  
READING, PA.

IF IT'S ELECTRONICS  
CALL BARBEY'S FIRST



JOHN L. GIGL  
437 NEVIN ST.  
LANCASTER, PA.

19230-07-1

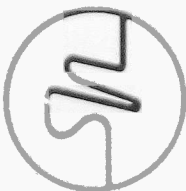

SYLVANIA  
ELECTRIC  
PRODUCTS INC.  
1100 MAIN ST.  
BUFFALO, N.Y.  
SYLVANIA NEWS  
MARCH-APRIL 1963

Printed in U.S.A.

R. A. HUMPHREYS, TECHNICAL EDITOR This information in Sylvania News is furnished without assuming any obligations.

## ADVANCES IN TELEVISION PICTURE TUBES

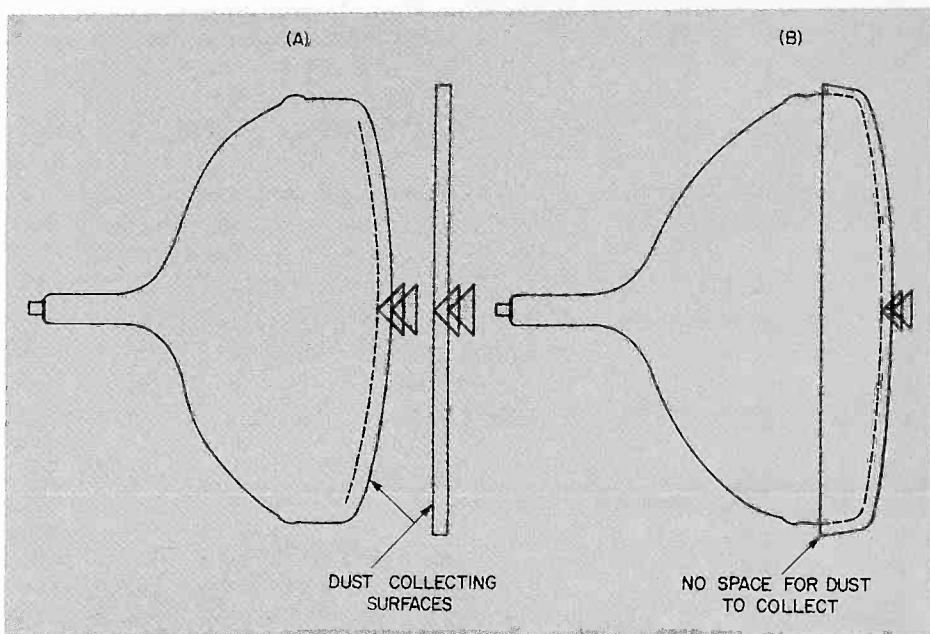

Figure 1

Several new and improved types of television picture tubes have been in production for some time. Additional new types of tubes are under development and will be appearing in new television receivers. This article is written to explain something about these tubes which are being used in new receivers and which will appear on the replacement market.

These tubes are designed to: allow easier cleaning of the tube face; reduce glare and reflection to improve contrast; have a flatter and more rectangular screen.

The regular type of television picture tube uses a separate glass plate as a safety feature; this type of construction has been used since television first came on the American market, and is quite familiar. The glass protective safety plate used in front of the picture tube, however, has a number of disadvantages. Dirt

and dust particles collect on the inside of the safety glass and on the front of the picture tube. This reduces the picture contrast and gradually reduces the picture quality. While cleaning is a very simple thing, it does require that either the chassis and picture tube or separate safety glass assembly be removed from the cabinet so that the front of the picture tube and the inside of the safety glass can be cleaned.

This protective safety glass usually appears as in Figure 1. There are a total of four reflecting surfaces, so that in addition to dirt and dust on the surfaces, the picture contrast is often reduced to unacceptable levels by reflected light. The newer types of picture tubes, with a special construction for the safety glass features, have at most only two reflecting surfaces. These tubes represent significant advances in television receivers. There are four types of new tubes.

### Bonded Shield Tube

The first is a Bonded Shield (contoured cap) picture tube as in Figure 2. Sylvania pioneered the techniques that made possible the quantity production of Bonded Shield tubes. Bonded Shield tubes use a permanently bonded-on wrap-around glass panel which is permanently fixed to the picture tube at the time the tube is manufactured. When a tube of this type is placed in this receiver, no additional safety glass is required. The construction of the Bonded Shield tube may be seen in Figure 3. The shield or contoured glass is manufactured separately with an inside contour equal to the contour of the face of the picture tube, and this shield is bonded to the face of the picture tube by a special resin, so that it is an integral part of the tube.

The epoxy resin which is used to bond the glass cap to the picture tube has the same index of refraction as the picture tube and glass cap itself for an optical match. With this type of construction, the only surface which can collect dust or dirt is the front of the wrap-around panel. Since this is exposed and is actually the viewing surface itself, it is a very simple matter for the television set owner to keep this clean and to keep the picture contrast at normal levels.

### The Bonded-Shield tube has these important features:

1. Removing of the dust and dirt from the picture tube face is no longer a problem for the set owner.
2. There is less light reflection and glare because there are only two surfaces that can reflect light.
3. The screen is shaped more nearly as a rectangle and there is a larger viewing angle.

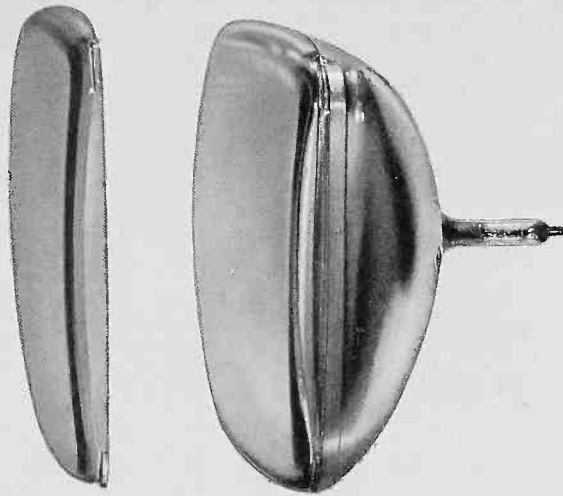

Figure 2

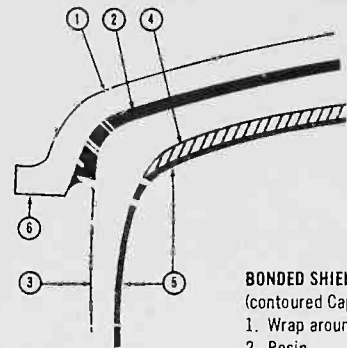

Figure 3

- BONDED SHIELD**  
(contoured Cap)
1. Wrap around safety panel
  2. Resin
  3. Faceplate
  4. Fluorescent screen
  5. Aluminum film
  6. Corner mounting ear

4. The screen is flatter for improved viewing.

5. There is improved picture contrast. When the rounder screen of a standard picture tube is fully scanned horizontally and vertically, the corners are being over-scanned. The amount of overscan is shown in Figure 4-A by the shaded areas. The electrons represented by these shaded areas strike the walls of the bulb where they are reflected to the screen. The effect is reduced picture contrast, particularly in the corners of the screen. The straighter sides and squarer corners of the Bonded Shield design appreciably reduce the amount of corner overscan (B), and measurably improve picture contrast.

This Bonded Shield is available in 19" and 23" sizes only.

#### Bonded-On Glass Panel

The second type of Bonded Shield is very similar to the type discussed above except that it does not have a wrap-around cover panel. As shown in Figure 5, a glass panel fits over the front surface and is bonded to the tube. A plastic tape or other means is used to form a cavity between the faceplate of the tube and cover panel. This cavity is filled with the laminating resin.

These tubes are currently available in 16", 19", 21", 23" and 27" sizes, but can be made in any size.

#### Laminated Fiber-Glass Tube

A third type of new cathode ray uses laminated fiberglass. The fiberglass is bonded to the tube on the funnel

surface, but it does not cover the front or the viewing surface of the picture tube. This is a specially designed, heavy-weight cathode ray tube. As shown in Figure 6, a rim band is secured to the tube at the edge of the fiber glass. A tension band surrounds the picture tube over the rim band so that the face plate is under the desired tension.

Transmission characteristics of this tube are about the same as Bonded Shield; because of the construction of this tube, no separate glass plate is required. Both 19" and 23" tubes of the square-corner type are available. Other sizes are in the planning stages.

#### Plastic Laminate Face Plate Tube

A fourth type of design uses a plastic laminate; this is similar to the original Bonded Shield type except that a plastic is used for the shield or cover panel rather than glass. This laminated plastic sheet is vacuum formed so that it covers the face of the picture tube and wraps around the

edges as in Figure 7. A binding tape is used around the tube at the edge of the wrap-around sheet.

The plastic face-plate can be cleaned easily and small scratches may be polished and removed. These tubes (16" rectangular) are used in portable receivers where weight-saving is important.

#### Replacing Picture Tubes

While replacements are not difficult, there are certain considerations which must be kept in mind.

There are basically three ways in which a cathode ray tube is mounted in a television receiver, as shown in Figure 8. In A, for a horizontal chassis, a metal strap is clamped around the picture tube. This metal strap is connected directly to the chassis so that after the picture tube neck is placed through the yoke and the strap is tightened, the picture tube and chassis form an integral unit which is then placed in the cabinet.

In B, the second type of common

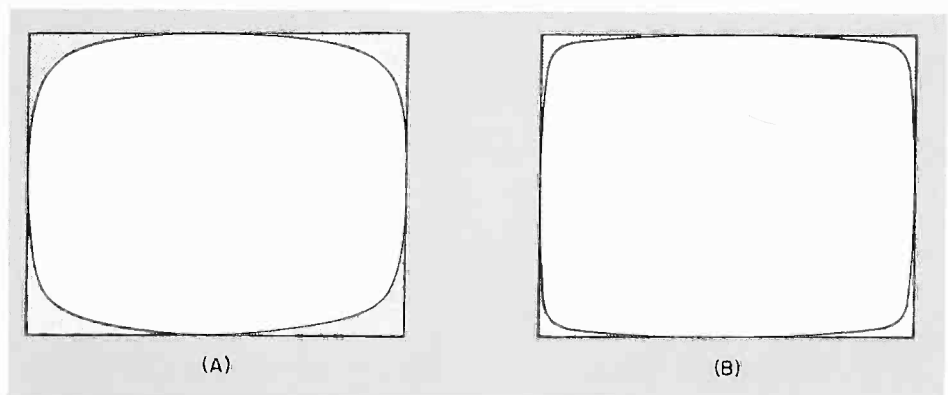

Figure 4

# Dealer Section

MAY 1963 □ VOL. 30, NO. 2

## DEALER AIDS FOR MORE PROFESSIONAL SERVICE

### *Sylvania Tube Merchandisers*

For finger-tip control over your fast-moving items, mount tube merchandisers on your shop wall. Or place them on your counter. They have a handsome yellow-baked enamel finish and are ruggedly constructed for long use. The shelves are sloped and an ample number of dividers are included.

Dimensions: 32 $\frac{5}{8}$ " high, 36" wide, 12" deep

A—ET-5998

Without drawers—\$17.95

B—ET-5997

With drawers—\$24.95

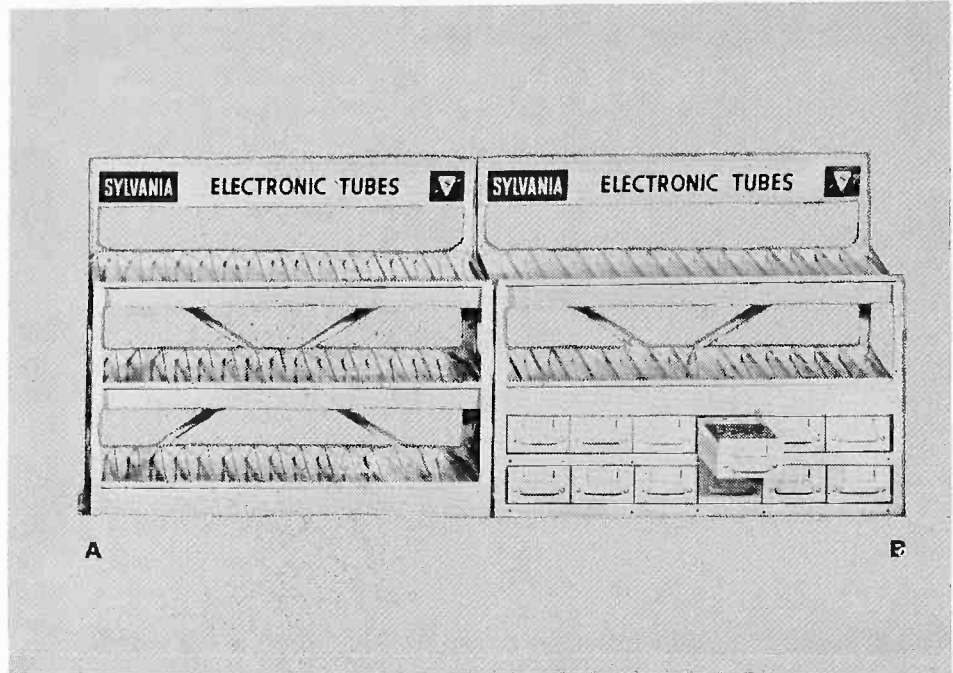

### *Tubes Tested Free*

Dealers! Attract the "do-it-yourself" customers with this specially designed sign. It's produced in 3 brilliant, fade-resistant colors and comes in rolled steel for durability. A baked glass white finish gives maximum reflection of the 20-watt fluorescent lamp. 24" long ET-1122—\$6.45.

### *Dealer Drop Cloth*

Win the good will of your customers by laying down this drop cloth before beginning work. Protects carpets from dirt or damage—even fallen hot solder. It's so serviceable—besides being smart, and professional looking. 3 feet by 3 feet. ET-8999—\$1.00 (minimum order of 5).



---

# SYLVANIA TRAINS DISTRIBUTOR SALESMEN TO SERVE DEALERS BETTER

---

A little more than a year ago, Sylvania undertook the preparation of a training program for distributor salesmen that would result in direct benefits to dealers. In keeping with this motto: "The greatest service we can perform for ourselves is to help our customers buy wisely", the program was initiated.

After extensive field work and behind-the-counter experience the questions and problems encountered were many. But it was hoped when this program—"Selling to Dealers"—was started that solutions could be found. Or at least some of the many problems could be alleviated. Exactly what improvements were needed and what considerations were necessary for distributors to give their dealers top-notch service, were part of the problems.

The answers weren't *that* clear—for giving better service doesn't just entail putting more stock on dealer shelves, *but* means helping the dealer move the tubes off his shelves and plugged into his customers' sets. After 6 months of hard work the program was formulated and ready for baptism in the field.

It started with prolonged training of Sylvania's Renewal Sales Force. These men in turn approached their distributors to arrange meetings and dates when their sales staffs could convene to learn the latest techniques of improving dealer service.

The program as of now, consists of 3 three-hour sessions, each entirely separate but each equally important. There are three more advanced lessons being prepared.

With six months of operation now history, some 82 meetings have been held with over a total of 900 distributor salesmen attending. Not only has the attendance been outstanding, but the meetings have met with highly favorable reactions. Many participants have called it "the most worthwhile training I have ever received."

The first meeting is entitled "Take Another Look at Your Job." As the opener of the program, it asks the salesman—whether counterman or outside man—to re-examine his job in relation to dealers. How can he give the dealer the best order, and point out *all* the benefits he gets for his money, come under discussion during this session.

Topic No. 2, "Build a Good Order," includes servicing dealers' individual shop needs. For example, knowing what products move fastest by scientific inventory control so that he can give better and faster service—no more delays due to out-of-stock items.

Finally, the third meeting of the series is "Sell from the Dealer's Viewpoint." This lesson deals with anticipating dealer needs and problems—the needs and problems of business and profits. Through the discussion and understanding of these problems, the distributor salesmen with you can work out solutions that mean better business.

Here's an approximate rundown on how the sessions are conducted. Each one starts with a ten minute tape of a true-to-life salesman's situation—the problems and objections all salesmen have encountered. This is followed up with a discussion of an opinion sheet each man has filled out, and then the meeting is wrapped up by listening to a tape of a hypothetical panel discussion that crystallizes good selling techniques.

Sylvania's "Selling to Dealers" Program was instrumented principally for distributor salesmen. Through it they will attain a higher degree of professionalism in serving you—the dealer. With such an enthusiastic initial reception, it has been planned for even stronger efforts in the immediate future—efforts that will mean more sales for the salesman, and quicker Sylvania turnover and higher profits for you.

---

## *Rhenium Tungsten Heaters* *Benefit Over 225 Receiving Types*

Now, over 225 Sylvania receiving tube types specify Rhenium Tungsten Heaters. Of these, at least 45 types are using this more costly material in 100% of their manufacture. Types with any heater burnout problem are getting first priority in utilizing this material. Basically, Rhenium Tungsten Alloy provides better reliability through its physical properties, i.e.

**Less Brittle**—Eliminates breakage during life due to ON/OFF cycling. Jostling of equipment, etc.

**Higher Resistance**—More reliable operation at high line conditions, surge current damage reduced, more stable emission on life.

**Improved Ductility**—Heater insulation less apt to crack causing heater cathode shorts. Better life.

The typical tube types using Rhenium Tungsten are: 6BQ7A, 6BZ7, 6BC8, 6BS8, 12AU6, 12AC6, 12BA6, 12BD6, 12CX6, 12AF6, 12BL6, 50C5, 50B5 and 50EH5.



# SYLVANIA STRAP FRAME GRID IMPROVES TUBE PERFORMANCE

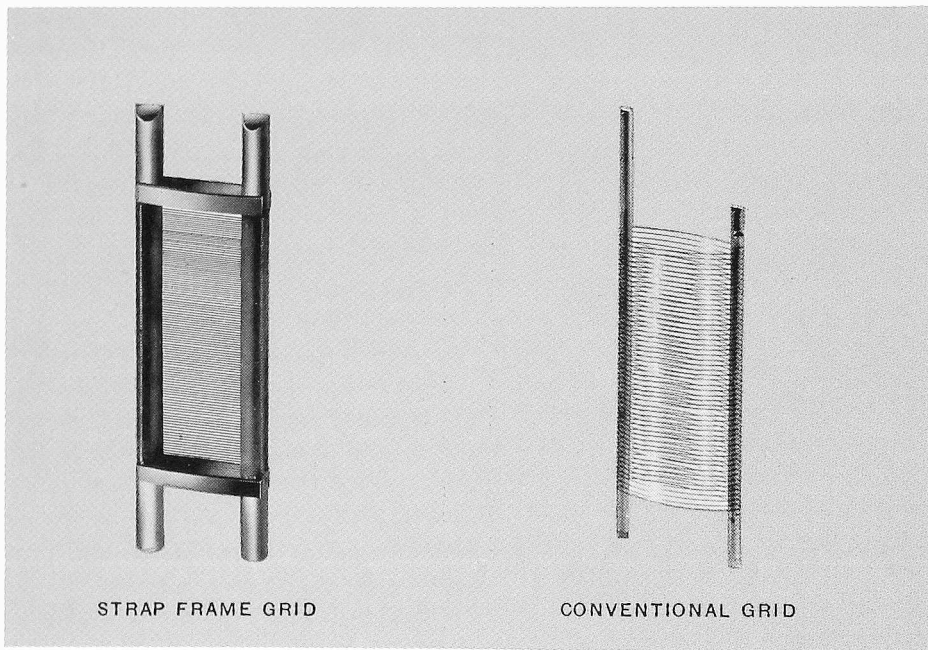

The Strap Frame Grid is another example of how Sylvania advances electronics by introducing—ahead of the field—better-performing, more reliable components.

It was several years before other U. S. tube manufacturers followed Sylvania's lead of putting Strap Frame Grids in subminiature tubes. And industrial and commercial versions in miniature size had been star performers for Sylvania even longer.

The Strap Frame Grid is formed by putting metal braces across the grid side supports. Therefore, the grid is rigid even without winding. The conventional grid must depend on its winding for rigidity. Because of this there is automatically imposed a minimum size limit on the wire. Since the Strap Frame Grid is self-supporting, the wire can be smaller (allowing more turns per inch) and placed a short precise distance from the cathode—permanently.

The size reduction reduces the grid

cathode spacing, increasing Gm. The greater rigidity of the Strap Frame Grid also contributes to the reduction in grid-cathode spacing which further improves Gm. It is Sylvania's pioneering leadership that has perfected the automatic grid-winding technique which insures this optimum uniformity.

Add to this the other singular advantages of the rugged Strap Frame Grid—very fine grid wire which improves transconductance, extreme accuracy of grid pitch—and the result is a near ideal combination for high db gain, unusually low noise and exceptional ratio of GM per mA of plate current. Plus, the physical stability translates into electrical stability, even with jarring vibrations, shock or environmental changes. Rough treatment of the sort encountered in missile and planes can easily change conventional grid spacing between the winding and the cathode it surrounds.

## *Improved High-Voltage Rectifiers —1J3, 3A3*

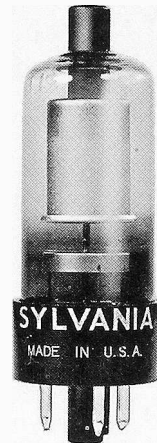

Progress marches on as Sylvania produces more reliable types 1J3 and 3A3. A silver deposition on the inside surface of the bulb has shown a marked improvement in life performance and maintenance.

This improvement is most noticeable on late model TV receivers where higher voltages, high circuit efficiency and component placement has made more pronounced the phenomena of "diodehausen." This is nothing more than a dark or light band (depending on signal at the time) showing up on the TV picture tube. Cause: Radiation from the high voltage rectifier being picked up by nearby circuitry, amplified and appearing in the TV picture. The Sylvania improvement shields the "escape point" of this radiation in the high voltage tube. Customer satisfaction is guaranteed due to the new improved life resulting from extremely good tolerance to high arc-over voltages and reduced glass damage caused by ring glow. Ring glow, which caused this tube to get very hot (due to concentration of radiation), does not occur during normal operation of the tube. Ring glow only occurs at unusually high voltages and is the exception rather than the rule.

# REALIZE NEW PROFITS THROUGH NEW PRODUCTS

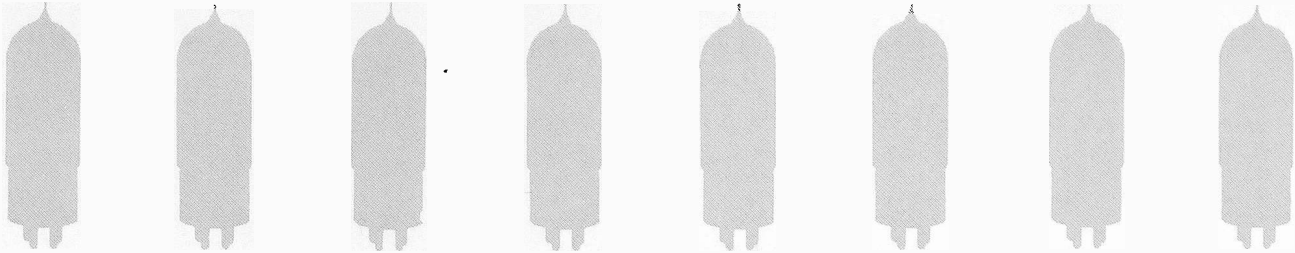

Available *now* are these latest additions to Sylvania Receiving Tube line:

TYPE	DESCRIPTION	TYPE	DESCRIPTION
<b>2/3/4 &amp; 6HK5</b>	Sylvania developed 7 pin miniature gain controlled strap frame triodes. For RF amplifier use in VHF tuners. Used in Sylvania, Silvertone, RCA and other TV receivers.	<b>12AX3</b>	Damping diode in T-9 compactron; 600 heater version of 6AX3. Used for horizontal deflection circuits of TV receivers. Used in Admiral TV receivers.
<b>3EH7</b>	9 pin miniature high Gm remote cutoff pentode. For VHF IF amplifier applications. Used in Emerson series string TV receivers.	<b>12GE5</b>	Beam power pentode in the T12 compactron outline. For horizontal deflection amplifier application. Used in Admiral TV receivers.
<b>3GW5</b>	7 pin miniature gain controlled strap frame grid triode for RF amplifier use in VHF tuners employing grounded grid circuitry. For use in some Sylvania TV receivers.	<b>12GN7</b>	Video pentode in 9 pin miniature featuring strap frame grid construction. Used as video amplifier. Used in Zenith color TV receivers.
<b>4HS8</b>	Twin pentode in 9 pin miniature. Used for syn and AGC function. Used in Silvertone low B/ TV and Zenith models.	<b>13FM7</b>	Double triode in 12 pin T9 Compactron outline; 450 ma heater version of type 6FM7. Used for vertical deflection and amplifier application. Used in Zenith TV receivers.
<b>5GH8</b>	9 pin miniature sharp cutoff pentode and medium Mu triode. For use as horizontal deflection oscillator and general purpose triode. Used in Emerson series string TV receivers:	<b>15EW6</b>	T5½ 7-pin miniature pentode for IF amplifier application. Used in GE radios.
<b>5KD8</b>	Medium Mu triode and sharp cutoff pentode in 9 pin miniature and features a 450 ma heater. Used as combined VHF oscillator and mixer. Used in Sylvania TV receivers.	<b>15FM7</b>	Dissimilar double triodes—identical to 13FM7 except for Ef (see remarks). For vertical deflection oscillator and amplifier application in TV. Used in Zenith TV receivers (alternately with 13FM7).
<b>6GD7</b>	Medium Mu triode and sharp cutoff in 9 pin miniature pentode featuring high Gm's of 10,000 and 12,000 respectively. Designed for VHF oscillator mixer applications. Used in Sylvania closed circuit TV.	<b>16GK6</b>	Power pentode in 9 pin miniature, 300 ma heater version of type 6GK6 and controller for series string operation. Used as video and audio output stage. Used in Motorola TV.
<b>6GF7</b>	Dual dissimilar triode in T9 Novar construction. Used as vertical deflection oscillator and amplifier. Used in RCA TV models.	<b>17BS3</b>	Half wave rectifier (diode) in Novar T9 construction. Used as damping diode in horizontal deflection circuit. Used in Silvertone TV low B/ receivers.
<b>6GJ5</b>	Beam power pentode in T12 Novar outline. Used as horizontal deflection amplifier. Used in Sylvania TV receivers.	<b>17GJ5</b>	Beam power pentode in T12 Novar construction. 450 ma heater version of type 6GJ5. Used as horizontal deflection amplifier. For use in Sylvania TV receivers.
<b>6JB6</b>	Beam power pentode in T12 Novar design. Used as horizontal deflection amplifier. Used in Zenith, Emerson and RCA TV receivers.	<b>17JZ8</b>	Triode pentode. Vertical deflection oscillator and amplifier. Used by Philco and Westinghouse.
<b>6KT8</b>	Triode pentode; oscillator mixer. Used in Zenith TV receivers.	<b>21GY5</b>	Beam power pentode. Horizontal deflection amplifier. Used by Philco and Westinghouse.
<b>10KU8</b>	Strap frame pentode and double diode in Sylvania 9T9 construction. Used as video output and AFC horizontal phase detection. Used in Sylvania TV receivers.	<b>34GD5A</b>	T5 ½ 7-pin miniature beam power pentode used for audio output application in radio receivers. Used in RCA and Silvertone radios.

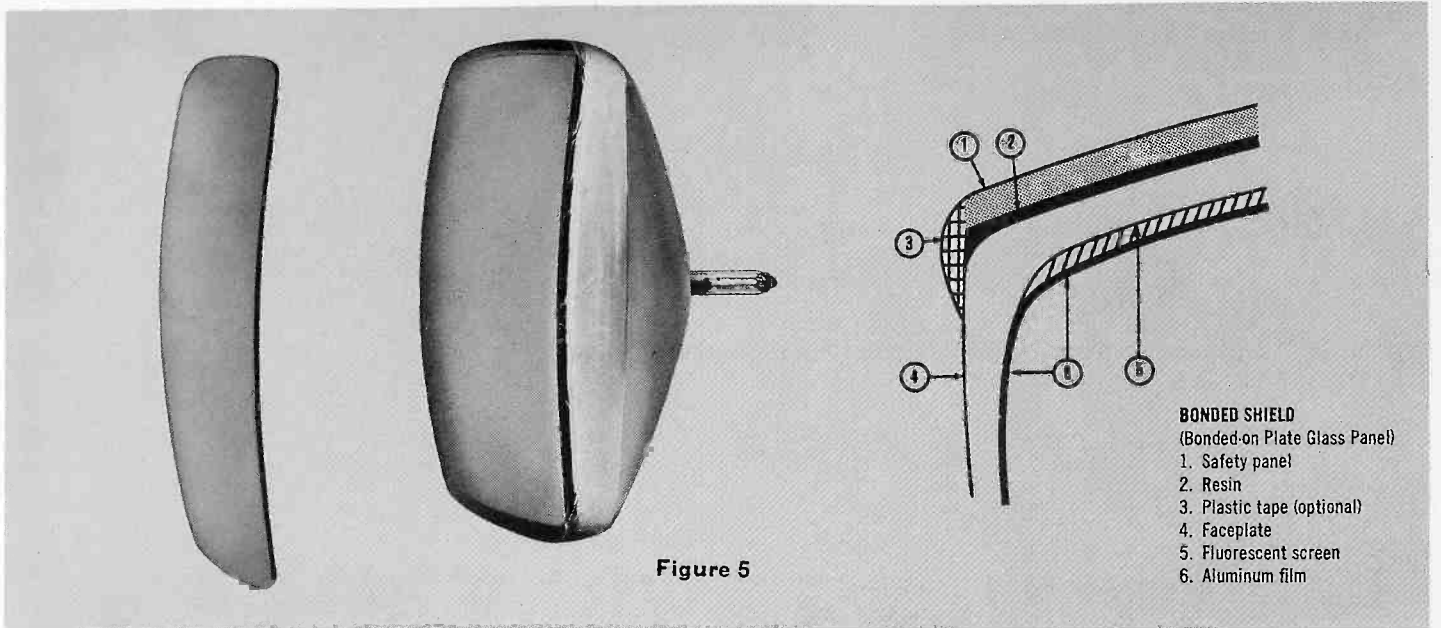

Figure 5

mounting is shown where again the tube is mounted in a metal clamp or ring. There are brackets on this ring so that the cathode ray tube can be mounted into the cabinet by screws or bolts. In this type of mounting, the cathode ray tube is separate from the chassis.

A third type of mounting can use a wire ring as shown in C. This ring is around the bulb of the picture tube, between the face and the neck of the tube. Clamps are used to hold the ring securely in place as a technique for mounting the picture tube to the cabinet.

All of these methods are in wide use. For these special picture tubes, however, there are some modifications in mounting.

Replacing a picture tube in a television receiver where one of these special types of tubes are used is not difficult, but certain precautions must be taken. Because there are several different types of mounting available, it is important to examine carefully the mounting which is used so that the tube may be re-inserted without any difficulty.

For example, the original Bonded Shield picture tube has four lugs or ears, one at each corner of the glass face-plate. In mounting, these ears fit into sockets and a clamp is used over each ear. The mounting ears are so designed to accommodate the weight of the tube (figure 9).

In replacing a picture tube of this type, it is necessary to see that each

of these lugs is properly seated before the mounting bars are tightened. This will prevent any possibility of improper mounting which could break one of the glass mounting lugs.

Figure 8 shows three types of mounting commonly used by TV set manufacturers. In some cases, type "A" mounting is also used for Bonded Shield picture tubes.

All of the four types of picture tubes discussed above are advances in television receiver design. While it is possible in theory to use one of these tubes to replace a conventional tube, used with a separate safety glass, this will seldom be done, because of the extra trouble involved in the mounting and because of the differences in tube face sizes.

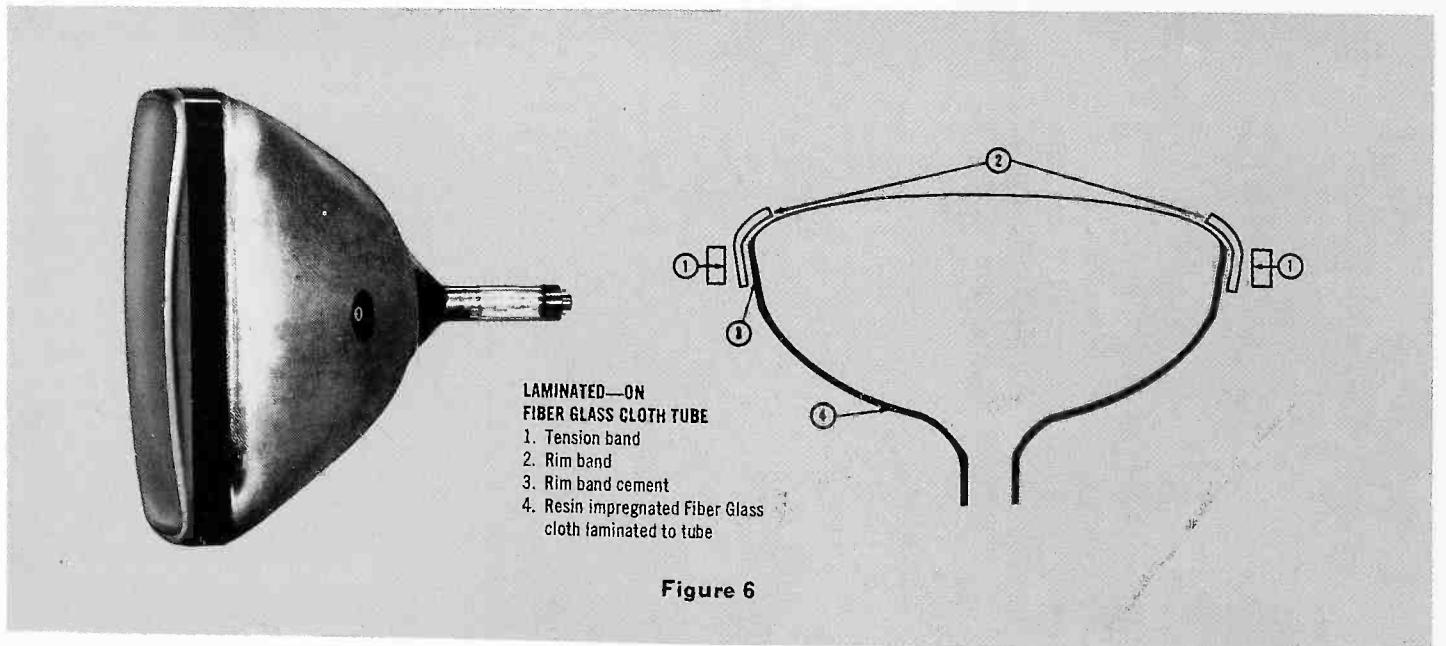

Figure 6

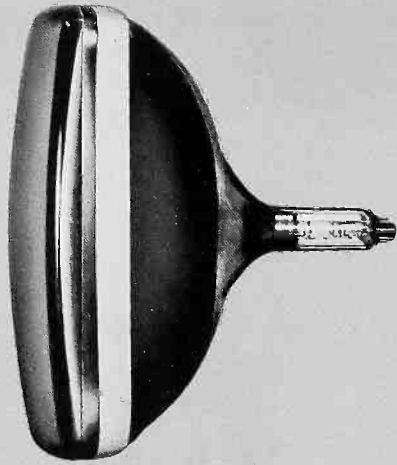
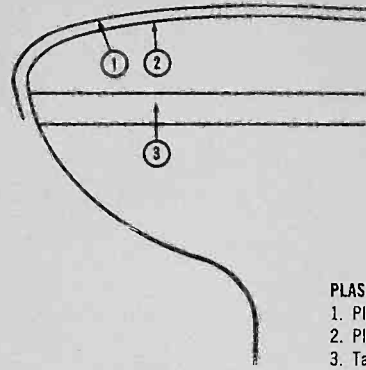

Figure 7



PLASTIC LAMINATE TUBE  
 1. Plastic sheet (laminated)  
 2. Plasticizer  
 3. Tape

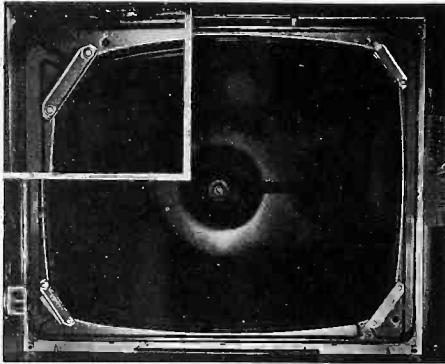
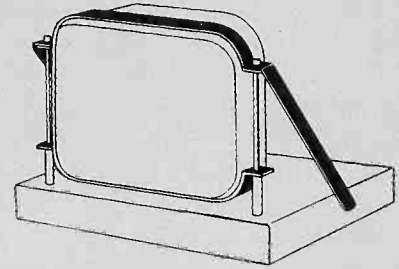

Figure 9

IT IS EXTREMELY IMPORTANT THAT UNDER NO CIRCUMSTANCE SHOULD ONE OF THESE NEW SPECIAL PICTURE TUBES BE REPLACED WITH AN ORDINARY OR CONVENTIONAL PICTURE TUBE. THIS WOULD CREATE A POTENTIAL HAZARD IN THE HOME AND SHOULD NEVER BE DONE.

*Ordinary tubes require safety glass and should never be used without this protection.*



A

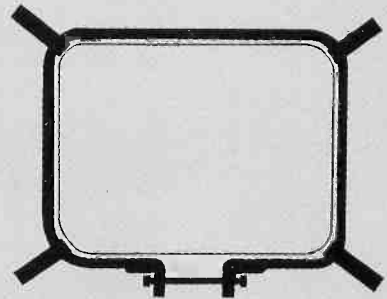

B

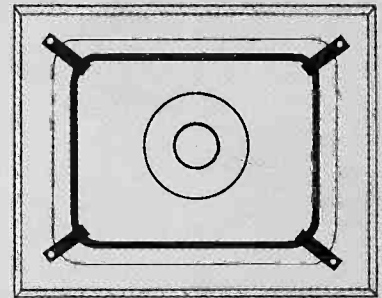

C

Figure 8

BULK RATE  
 U.S. POSTAGE  
 PAID  
 Permit No. 3402  
 Buffalo, N.Y.

Richard J. Kerr  
 Central Services  
 428-430 W. Colvin St.  
 Syracuse 5, N. Y.

TMS 2

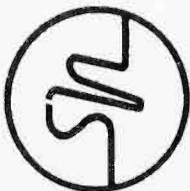

**SYLVANIA  
 ELECTRIC**  
 PRODUCTS INC.  
 1100 MAIN ST.  
 BUFFALO, N.Y.  
 SYLVANIA NEWS  
 MAY 1963

Form 3547 Requested  
 Printed in U.S.A.

R. A. HUMPHREYS, TECHNICAL EDITOR This information in Sylvania News is furnished without assuming any obligations.

# PHOTOCONDUCTOR PROPERTIES AND CIRCUITS

PART 1

By E. T. Zmuda and R. A. Humphreys  
Sylvania Electric Products Inc.

The photoconductor was first presented in SYLVANIA NEWS to readers in an article describing their operation in automatic brightness controls in television receivers (Spring, 1962 issue). This use is but one of a long list of applications for this light sensitive device that continues to grow in leaps and bounds. Responsible for this growth is the fact that the photoconductor will operate a relay or relatively insensitive meter without the usual intermediate amplifier normally required with photoemissive and photovoltaic cells to boost the output to a useable level. Typical among the list of applications is the automatic utility light control, furnace flame sensor, lightmeter or photometer and tachometer, mentioning but a few. Another application, more closely akin to the automatic brightness control, is the remotely operated volume control.

This article is presented to enlarge the serviceman's knowledge of the properties of photoconductors and provide a working knowledge of principal circuits, in the interest of opening the door to new business.

## CELL CONSTRUCTION AND PROPERTIES

Photoconductors come in a variety of sizes and shapes and are generally encased in glass or plastic. Pictured in Figure 1 are several Sylvania photoconductors. These are known as T-4 size cells and measure approximately 1/2 inch in length and diameter. The construction of the cell is clearly shown in Figure 2. The envelope is all glass and provides a true hermetic seal to fully protect the light sensitive wafer of cadmium



Figure 1—Sylvania T-4 photoconductor. Hermetically sealed all glass envelope protects sensitive wafer against moisture.

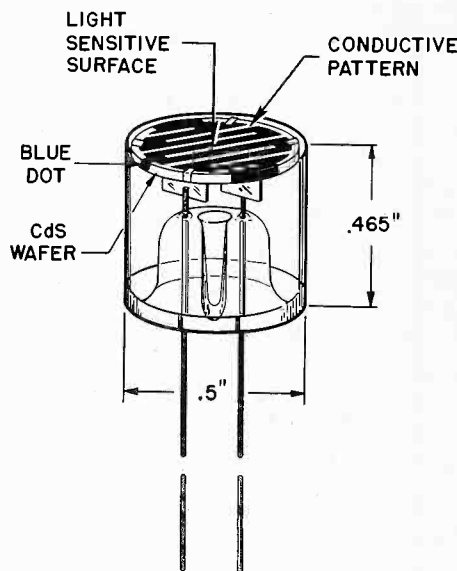

Figure 2—Line rendition of photoconductor clearly shows construction details.

sulfide from moisture or other contamination that would render the cell inoperative or produce a significant change in characteristics. Moisture is a principal failure mechanism of all photoconductors. As a further safeguard against moisture, a spot of

“blue dot compound” is applied to the edge of the wafer of Sylvania cells. Should the envelope become damaged and moisture enter, its color will change from blue to pink. The compound is extremely sensitive and will commence changing color in the presence of only .02% moisture.

Positioned on the wafer is an interleaved pattern of conductive material, that forms the two electrodes for the cell, and determines to a degree its characteristics. Connection to the electrodes is made by means of two leads which protrude from the base of the cell for connection to the circuit by soldering.

## SENSITIVITY

The photoconductor is essentially a resistor whose ohmic value depends upon the intensity of the light striking its sensitive surface. In total darkness, the resistance will be as high as 2 megohms and under stimulated conditions, as low as 10 ohms. The exact values depend on cell design. Typical resistance versus light in-

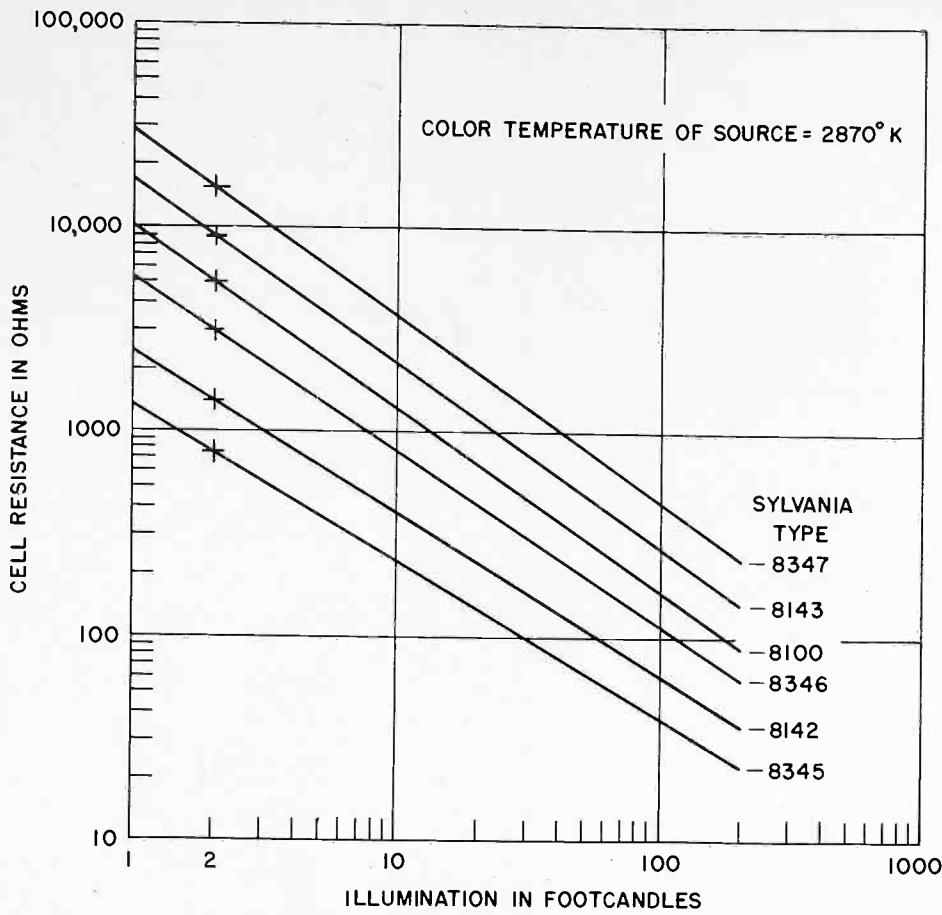

Figure 3—Curves showing how resistance changes with changing illumination for 6 different photoconductors.

tensity curves are shown in Figure 3 for six Sylvania T-4 photoconductors.

Like photoemissive light sensors, the photoconductor requires an external power source. The photoconductor should not be confused with photovoltaic cells which actually produce a small voltage when stimulated by light.

Sensitivity of photoconductors is usually expressed in terms of the current through a cell at a given voltage and at a given light level. The change in current (or resistance) for a change in illumination is also an important characteristic. A high ratio of current change is generally preferred. Since this characteristic is different for different types of photoconductors, sensitivity is usually specified for two light levels, a dark value and a light value.

Figure 4 shows the relationship between cell voltage and cell current as illumination is varied, for a Sylvania Type 8100 photoconductor. The high sensitivity is readily seen from this illustration by observing the cell current at 50 FC and 0.1 FC for a cell voltage of 10 volts. The respective currents are 30 Ma and 100 microamperes approximately. In complete darkness, the cell current

would be only a few microamperes.

The photoconductor is approximately 1000 times more sensitive than the photovoltaic class and up to

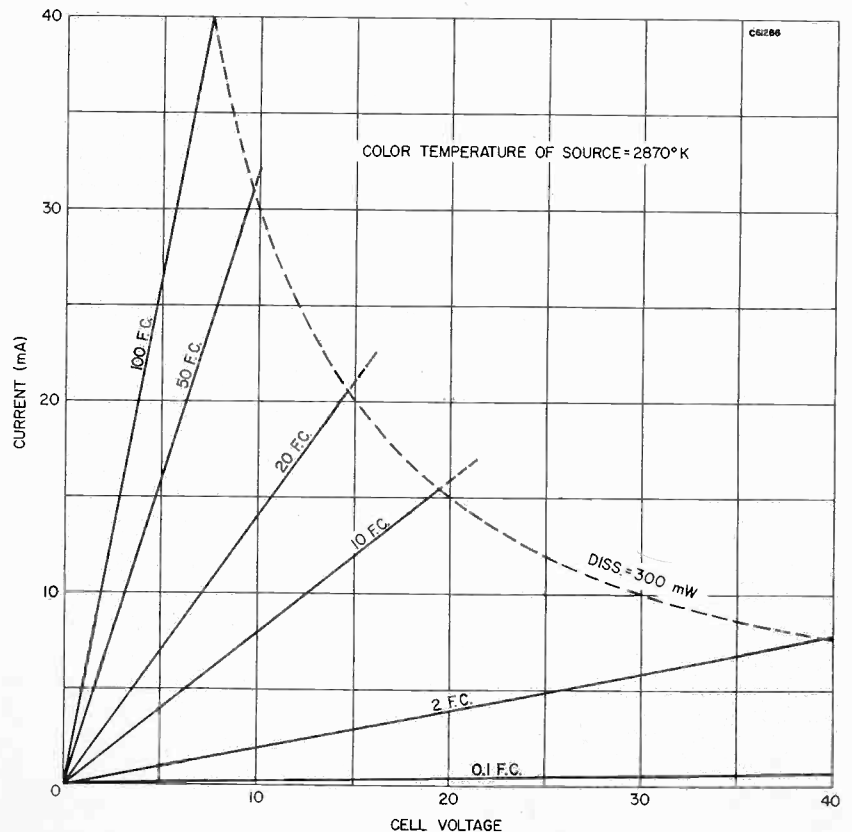

Figure 4—Voltage-current characteristics of Type 8100 photoconductor with changing illumination.

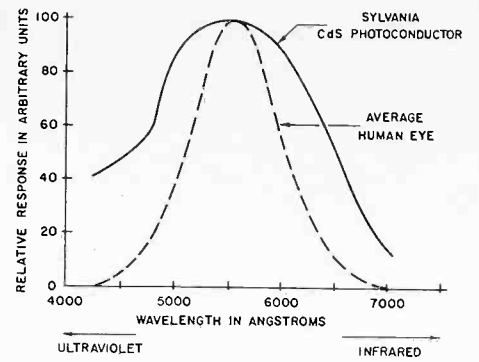

Figure 5—Spectral response of typical CdS photoconductor and human eye.

1,000,000 times more sensitive than ordinary photoemissive types.

### SPECTRAL RESPONSE

The spectral response of a photoconductor depends, among other things, upon the composition of the sensitive material. Figure 5 compares the sensitivity of a typical Sylvania cadmium sulfide cell with the human eye. Like the eye, CdS cells are more sensitive to white light, with the response tapering off toward ultraviolet and infrared.

### SPEED OF RESPONSE

Because of the intrinsic properties of cadmium sulfide, photoconductors made of this material are comparatively slow in responding to rapid changes in illumination levels (about 1 Kc maximum). With this limita-

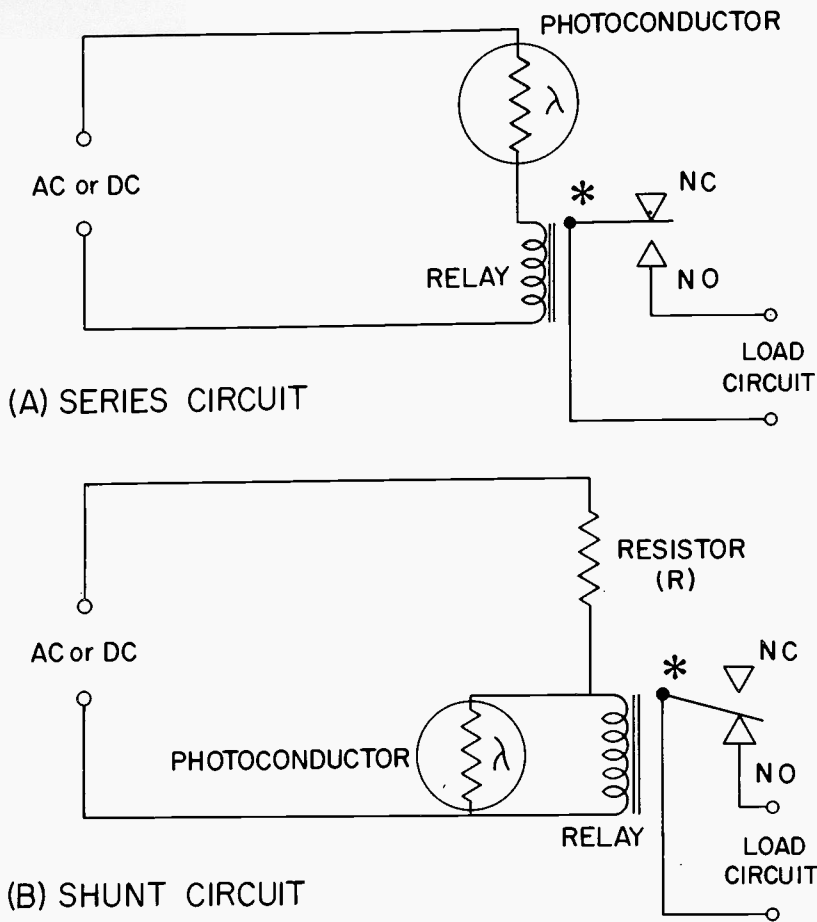

\* POSITION OF ARMATURE WITH PHOTOCONDUCTOR DARK

Figure 6—Basic series and shunt relay circuits. Circuits will operate from AC or DC with proper choice of components.

tion, the photoconductor cannot be used in applications where the cell must respond to light intensities which vary at voice or music rates (such as movie film sound track pick up). For these applications, it is necessary to use photoemissive types since their capabilities extend well into the kilocycle range.

#### POWER HANDLING CAPABILITY

The primary advantage of the photoconductor in comparison with other types of light sensors is its higher power dissipation capability. This feature, in conjunction with its comparatively low resistance when stimulated by light, enables the photoconductor to actuate a relay directly. T-4 cells made by Sylvania are rated to safely dissipate 300 milliwatts. The significance of this rating is illustrated in Figure 4 by the wide current operating range that is permitted. The Type 8100, for example, can safely handle a current of 40 Ma at a light level of 100 FC, which is several times the current required to actuate a medium duty relay. The comparatively low resistance of the

photoconductor when stimulated enables it to be used with a power source of only a few volts in many applications.

#### BASIC CIRCUITS

There are two basic methods of connecting the photoconductor for direct relay control. Both arrangements are shown in Figure 6.

In the series circuit, Figure 6A, the photoconductor is connected in series with a relay and power supply. Operation is a corollary to a simple switch controlled circuit. Under low light levels, the photoconductor has high resistance simulating an open switch. To energize the relay thereby closing the load circuit, the cell is stimulated with a high light level. As long as the cell is stimulated, the circuit remains closed.

In the second type connection, Figure 6B, the cell shunts a relay which is connected in series with resistor R and a power source. The operation of this circuit is opposite that of a series circuit. That is, with no light striking the photoconductor, the resistance is high and, therefore,

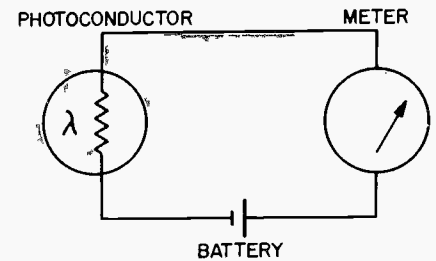

Figure 7—A photoconductor, battery and meter in a simple series circuit form a photometer.

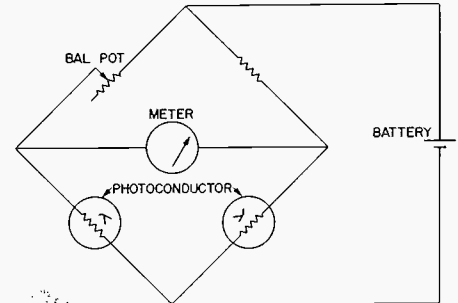

Figure 8—This simple bridge circuit is useful to match direct or reflected light from two sources.

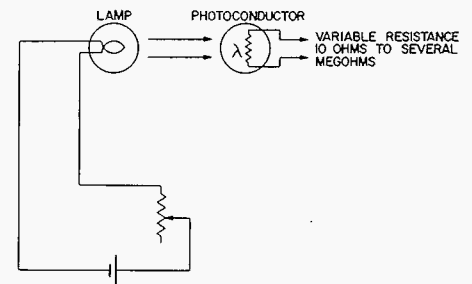

Figure 9—Basic circuit for remote (scratchless) volume control.

all current flowing in resistor R will pass through the relay coil and the controlled circuit will be closed. In order to open the circuit, the cell must be stimulated so that its resistance will drop to a low value. As long as the stimulus is supplied, the circuit will remain open.

While both circuits employ only a few parts, they are completely practical for a wide variety of "on-off" applications. With the proper choice of components, a wide range in operating voltage can be accommodated, and it may be either AC or DC.

More complex light-controlled relay circuits represent extensions or refinements of the two basic circuits (either singly or in combination) to meet the different or more precise requirements of certain applications.

The photoconductor is also particularly well suited to measurement type circuits where a meter is employed as a readout device. Connecting a photoconductor in series with a battery and a meter as shown in Figure 7 produces a photometer.

(Continued on following page)

# IMPROVED PICTURE TUBE REPLACES TYPE 24AVP4

Type 24BEP4, a picture tube featuring longer life through improved heater design characteristics, is now being recommended as the replacement for the 24AVP4 in Philco Chassis 9L60, 9L60U, 10L60 and 10L60U.

To take advantage of this improved design, and thus reduce call-backs and in-warranty replacements, minor circuit modifications must be made. The 24AVP4 has a 2.35-volt heater and the 24BEP4 has a 6.3-volt heater. Both types operate at 600 ma. The conversion is very simple since these chassis employ parallel heater circuitry and use 6.3-volt tubes with exception of the 24AVP4 picture tube. To obtain 6.3 volts for the 24BEP4, all that is required is to jumper the original 7-ohm dropping resistor, WR4 or WR5. The location of this resistor is shown in Figure 1.

The last step in making the replace-

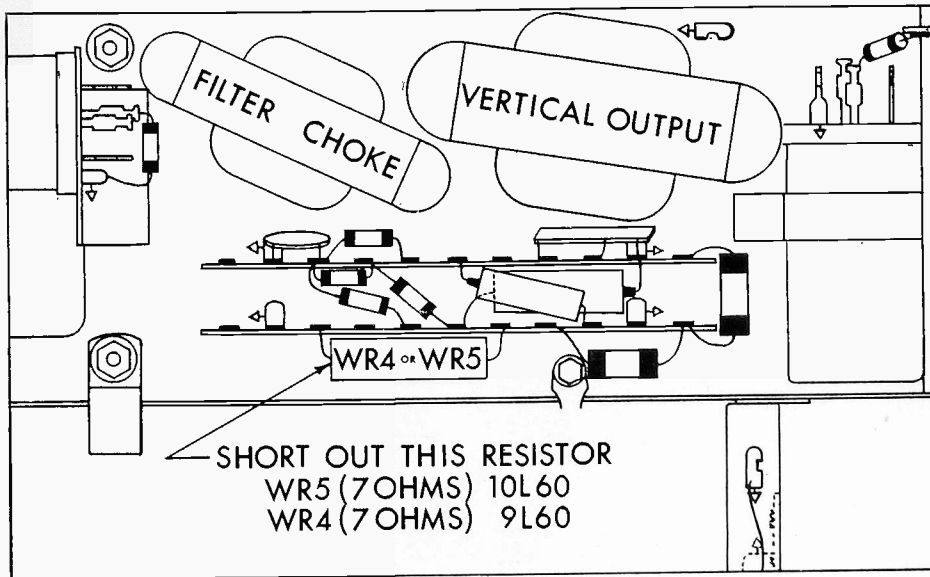

Figure 1

ment is to affix the warning label supplied with the Sylvania Type 24BEP4 to the set near the serial number and tube layout diagram.

This label notifies future servicemen that "This TV receiver has been modified for use with a Type 24BEP4 cathode-ray tube."

BULK RATE  
U.S. POSTAGE  
PAID  
Permit No. 3402  
Buffalo, N.Y.

A

David E. Zarin  
11905 Ivahar Street  
Wheaton, Md.

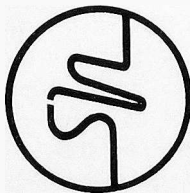

**SYLVANIA  
ELECTRIC**  
PRODUCTS INC.  
1100 MAIN ST.  
BUFFALO, N.Y.  
**SYLVANIA NEWS**  
JUNE-JULY 1963

Printed in U.S.A.

## Photoconductor Properties And Circuits

(Continued from preceding page)

Expanding this into the bridge circuit shown in Figure 8, produces an instrument which can be used to match the light output of two light sources.

Still a third application is to use the photoconductor in an indirect method. This may be in a lamp-photoconductor combination as shown in Figure 9. In this arrangement, the photoconductor is stimulated by a lamp which is optically but not electrically connected to the cell. Applications for this combination could be a remote and/or scratchless volume control, light chopper, remote antennae tuner, etc.

The foregoing basic circuits are intended to show the versatility of the modern photoconductor and a more comprehensive discussion of the circuits will be given in Part 2 of this article which will appear in the next issue of SYLVANIA NEWS.



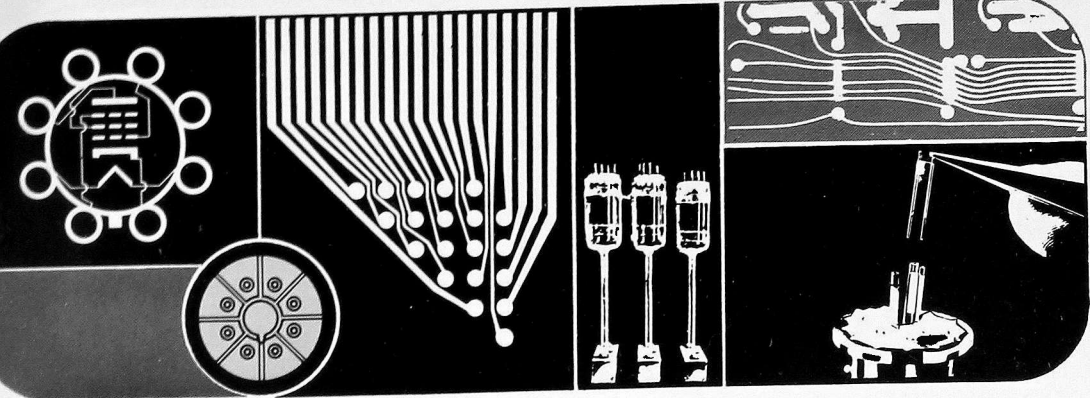

R. A. HUMPHREYS, TECHNICAL EDITOR This information in Sylvania News is furnished without assuming any obligations.

# PHOTOCONDUCTOR PROPERTIES AND CIRCUITS

By R. A. Humphreys and E. T. Zmuda  
Sylvania Electric Products Inc.

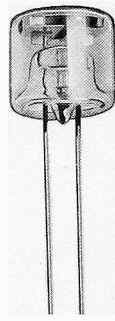

PART 2

## INTRODUCTION

Part I of this article (June/July 1963 issue) described the construction and electrical properties of photoconductors and compared them with photoemissive and photovoltaic light sensing devices. The basic ways of connecting a photoconductor to actuate a relay (series and shunt) directly and to operate a meter were also described.

Part II deals with specific applications. Circuits are presented for a variety of end uses ranging from an automatic lighting control to a basic remote volume control. The operation of each circuit is described.

While not intended as a construction article, sufficient information is presented to enable the reader who would like to assemble any of the circuits, either to serve a useful purpose about the shop or home—or simply as a means of becoming better acquainted with the operation of photoconductors, to do so.

## RELAY CIRCUITS

### AUTOMATIC LIGHTING CONTROL

One of the principal applications served by the photoconductor is the automatic street lighting control which responds to the cyclic variation of natural light (both daily and seasonal) as well as irregular variations produced by the weather. While lighting controls of this type are not new, usage was limited before the development of the modern photoconductor because of circuit complexity and the corresponding high cost of control units. The simplicity afforded by the photoconductor has not only expanded use by public utility companies but has put the automatic lighting control in the home and small businesses to control yard, sign, window display and night safety lights.

The circuit of a basic automatic lighting control designed to operate from 110 vac is presented in Figure 1. With the components specified the load circuit will close at an ambient light level of approximately 2 foot-candles (FC) and open at 5 FC. The

circuit will be readily recognized as the series configuration with additional resistors which are necessary

to establish the operating points and for clean switching when the relay opens and closes. Without these

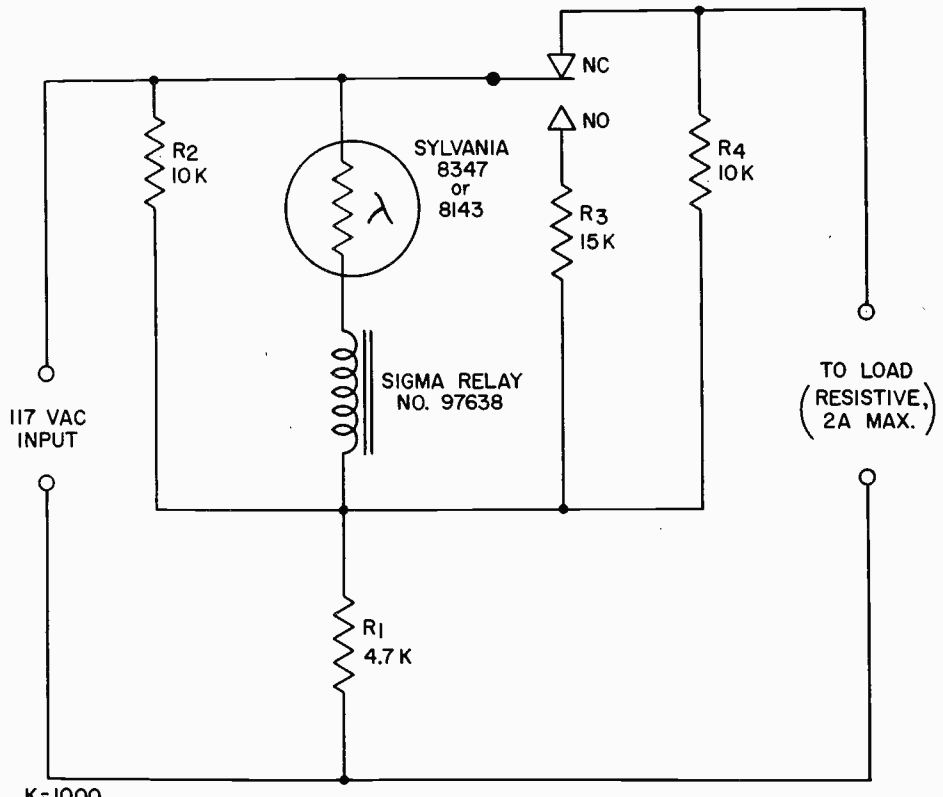

Figure 1—Automatic Lighting Control.

K=1000

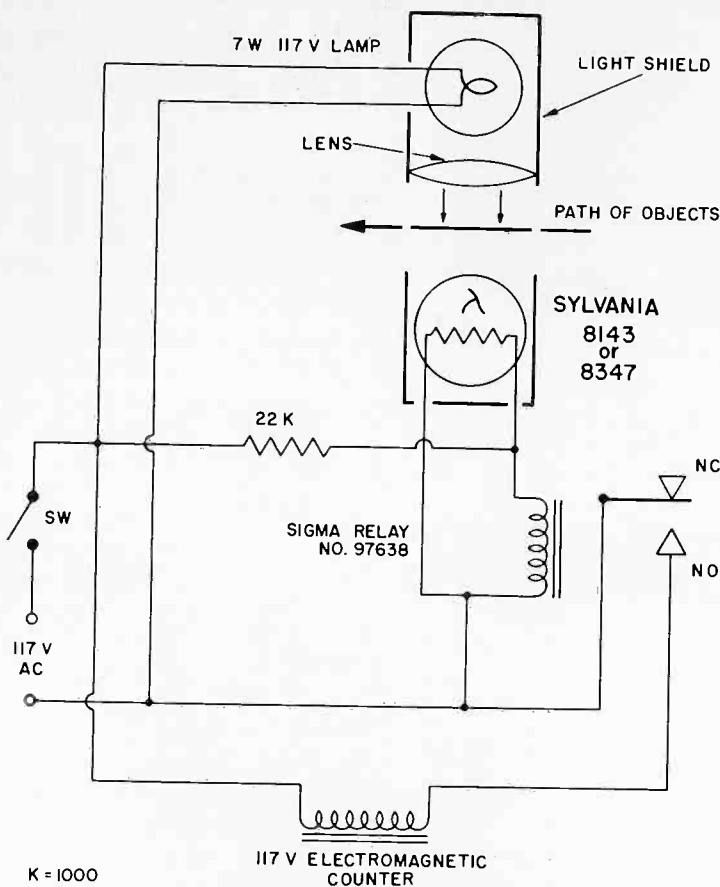

Figure 2—Circuit of Simple Industrial Counter.

additional components the slow transition would cause severe chatter when the relay is near its operating point.

In order to describe how the circuit operates, let us assume that the light level is less than 2 FC. Because of the high resistance of the photoconductor under this condition, the voltage across the relay coil is below the operating level. The normally closed contacts are therefore closed and power is applied to the load. When the light level reaches 5 FC, the relay voltage reaches the operating level, the armature pulls in and the load is disconnected. However, as a result of the closing, the coil voltage increases because of the higher impedance assumed by the coil when the armature is close to the coil pole piece. To offset this increase and establish the drop out point at the desired 2 FC light level, R3 is

shunted across the photoconductor-relay combination.

The photoconductor is mounted so that it will be exposed to ambient light but not to direct illumination from the lamp being controlled and extraneous illumination from passing autos, etc. It should be noted that the relay will chatter with gradual changes in light if the load is not connected.

#### FURNACE SAFETY CONTROL

Another application of the series circuit which is gaining general acceptance in the home or industrial heating industry is the furnace safety control. In oil fired furnaces, the flame is "seen" by the cell. If after a predetermined time after the oil inlet is opened the oil does not ignite, the monitor circuit automatically cuts off the oil supply and could sound an alarm. If the flame should go out

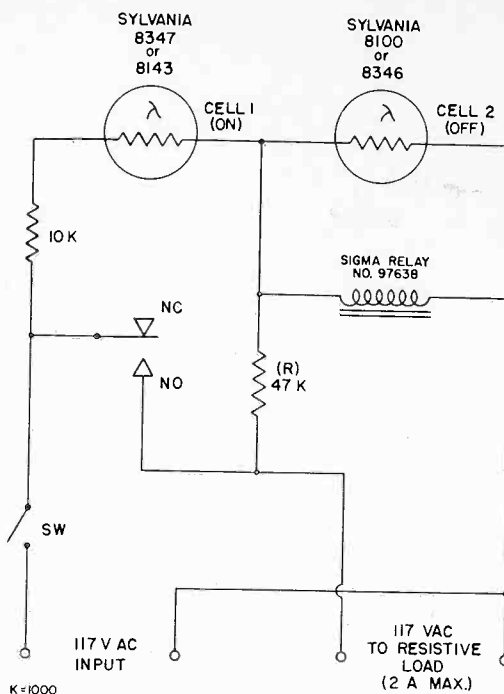

Figure 3—Circuit of Bi-Stable, Light Actuated Switch.

after ignition, the oil supply is again shut off.

The primary advantage of the photoconductor safety control over conventional thermal protectors is faster action. Bi-metal thermal switches can require up to many seconds to close the fuel supply should the burner flame be extinguished unintentionally. Photoconductor type protectors can be made to respond immediately, thereby preventing possible "flooding" and any attendant explosion hazard.

#### INDUSTRIAL COUNTER

Shown in Figure 2 is a simple counter circuit for industrial uses such as the counting of various items as they pass along a conveyor belt.

The circuit is the straightforward shunt arrangement with the stimulus for the photoconductor provided by an incandescent lamp. The counter or totalizer is of the electromagnetic impulse type and is connected to the normally open contact of the relay.

As long as the lightbeam is not uninterrupted, the photoconductor appears as a low resistance in shunt with the relay coil and the normally open contact stays open. When the lightbeam is broken, the resistance of the photoconductor rises sharply. No longer shunted by a relatively low resistance, the current through the relay coil increases and the armature pulls in and closes the counter circuit.

#### FOOTNOTES

- (1) The recommended relay is a Sigma Model 97638 (the Sigma Model 41FZ-5000 ACG-BSL may be used as an alternate). This is an AC/DC relay having two fixed contacts, one which is closed (normally closed contact) when the relay is not energized, and one which is open (normally open contact) when the relay is not energized. The DC coil current required to close the normally open contact is 3.5 Ma approximately; it opens at approximately 0.5 Ma. On AC, it will close at approximately 60 volts and open at 56 volts. The DC coil resistance is 5000 ohms. Contact current should not exceed 2 amperes (Resistive load).
- (2) Fixed resistors: 1-Watt; Carbon;  $\pm 10\%$  Tolerance—Unless otherwise specified.

# Dealer Section

AUGUST 1963 □ VOL. 30, NO. 4

PUBLISHED FOR THE PROFESSIONAL RADIO-TV SERVICE DEALER

## THE SYLVANIA PHOTOCONDUCTOR KIT (PCK-10)

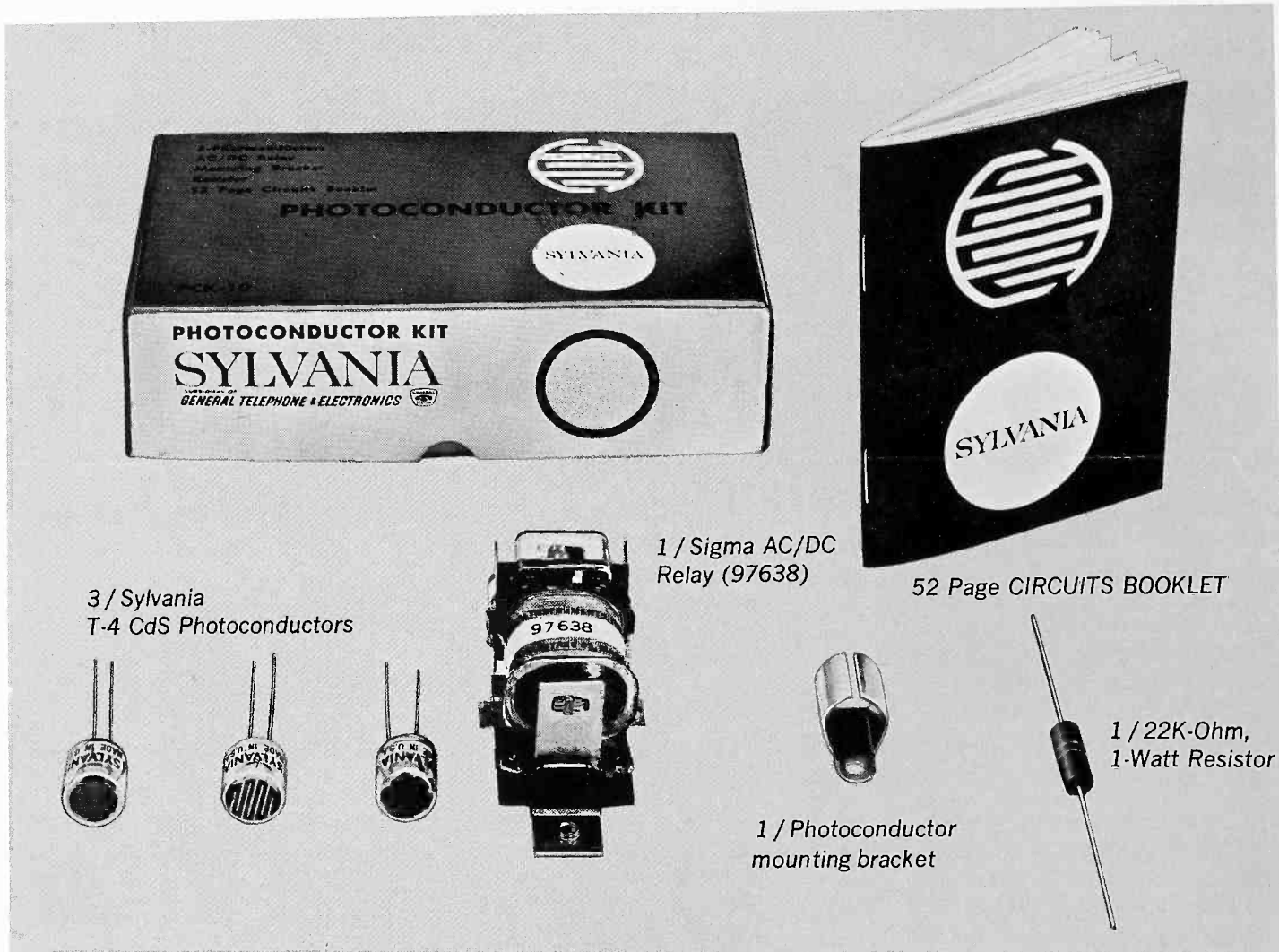

3 / Sylvania  
T-4 CdS Photoconductors

1 / Sigma AC/DC  
Relay (97638)

52 Page CIRCUITS BOOKLET

1 / 22K-Ohm,  
1-Watt Resistor

1 / Photoconductor  
mounting bracket

... NEW! ... DIFFERENT! ... EXCITING!

Be the proud possessor of Sylvania's new Photoconductor Kit! Glow with satisfaction when you construct Photoconductor circuits that work like magic!

Here's a handy do-it-yourself kit that lets you experiment in your spare time with one of the electronic industry's most fascinating developments. (Sylvania News Technical Sections, this issue and the June-July

issue, boast feature articles on the Photoconductor.)

With just this kit and a few parts every serviceman has on hand, you are able to mount circuits for game room target shoots, model railroad crossing guards, photoflash slaves, and *many, many* more. The 52-page Circuits Booklet included with the kit explains in detail, yet clearly, how you can construct simply and easily 19 different applications.

But use your imagination. There are countless photoconductor applications you can design that will not only be of practical use, but give you hours of experimenting enjoyment.

And the PRICE IS RIGHT! \$9.95. That means you pay less for the entire kit than you would normally pay for the component parts. Order your Photoconductor Kit (PCK-10) from your Sylvania Distributor . . . today!

## SYLVANIA PACKS 'EM IN

**IMPORTANT FACTS TO HELP YOUR TV LIVE LONGER**

You'll enjoy brighter, clearer TV pictures with the Sylvania Silver Screen 85 picture tube that's just been installed in your set. See inside for helpful hints to always keep your set operating at peak performance.

Mr. Service Dealer: Stamp or print your name on the reverse side of this sticker. Then tear off and attach it on the back of your customer's TV set. Pass this important booklet along to your customer.

## NEW SILVER SCREEN 85 CARTON INSERT

Here is the carton insert that Sylvania is now packing with every Silver Screen 85 picture tube.

For you it's an extremely im-

portant merchandising aid on several accounts.

The second page, headlined "You've Already Given Your Set A

New Lease On Life," tells your customer about the superior quality this Silver Screen 85 boasts, and the engineering standards it meets to give him lasting satisfaction. Not only does this page sell the SS 85, but it also promotes the industry-wide acceptance Sylvania receiving tubes enjoy.

Page 3, "Remember These Tips for the Best in TV Viewing," imparts five basic rules that if followed result in longer TV-set life and top television viewing for your customer.

The back cover, "Why You Save When You Call an Expert," features an imprint space that attaches to the back of your customer's set for his future reference. And to sell him on your expert TV repair service . . . the whole back panel's copy is devoted to this purpose.

For all concerned — you, your customer, your distributor and Sylvania—this carton insert serves a most useful purpose. Make sure you employ it to its full advantage. Hand them out to your Silver Screen 85 customers, and attach your imprint sticker to the back of their sets.



## SYLVANIA SERVICE 'N SAVE PLAN BOASTS NEW S & H CATALOG

An immediate success ever since it was inaugurated in July 1962, the popular Sylvania S&H Service 'n Save Plan continues to win dealer approval.

And with reason. The S&H bonus you earn with Sylvania Receiving Tube purchases pays you dividends

of fabulous gifts the whole family will enjoy.

And now Sylvania has prepared a new S&H catalog that is bigger and better than ever. You choose from pages and pages of more exciting, more wonderful premiums. Everything from the latest in home furnish-

ings to the latest fur styles can be yours when you save famous S&H Green Stamps given with famous quality Sylvania Receiving Tube purchases.

When you save S&H you save with America's largest trading stamp firm . . . for over 90,000 retail establishments coast to coast are on the S&H bandwagon. And for the more than half of all American families that save S&H, there are over 800 nation-wide centers where their books can be redeemed.

Add the S&H stamps received from your Sylvania Receiving Tube orders with those you earn from other purchases and you'll find S&H Green Stamps add up *faster* . . . exchange for the *Distinguished Awards* in the new catalog *sooner*.

Make sure you have a copy of Sylvania's new S&H catalog at your finger tips. Stop at your Sylvania Distributor who displays the S&H signs and posters and pick one up. They're FREE! Continuing to service with America's most reliable receiving tubes, and saving America's most valuable stamps are two of the *smartest moves you'll ever make!*

# Sylvania Wall Charts Win Friends And Influence People !!!

Build good will by displaying these educational wall charts in your store

... or donate them to your local high school. The charts are extensively

illustrated and incorporate pertinent, up-to-date information regarding the construction, operation and important features of cathode ray tubes, receiving tubes, and industrial tubes. The complete set of six . . . \$5.00; single charts . . . \$1.00 through your Sylvania distributor.

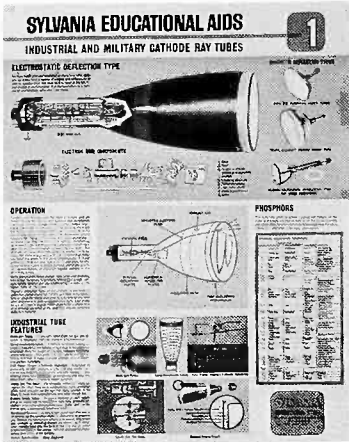

**CHART NO. 1**—Industrial and Military Cathode Ray Tubes illustrates an electrostatic deflection industrial CRT, its gun construction, operation, modern features, and a phosphor chart.

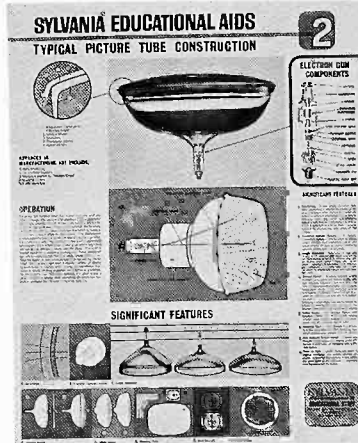

**CHART NO. 2**—Typical TV Picture Tube Construction illustrates a modern picture tube, its gun construction, operation, and features.

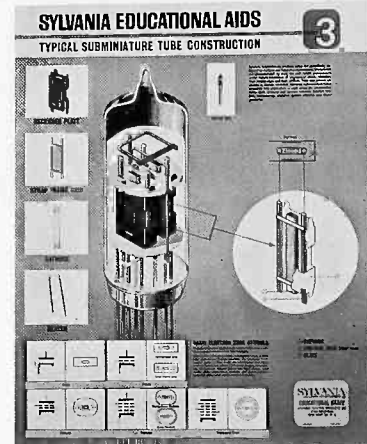

**CHART NO. 3**—Typical Subminiature Tube Construction illustrates a subminiature tube and the basic schematic symbols for electron tubes.

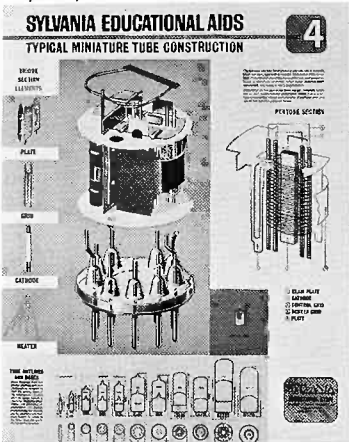

**CHART NO. 4**—Typical Miniature Tube Construction illustrates a miniature tube and the popular bulb outlines.

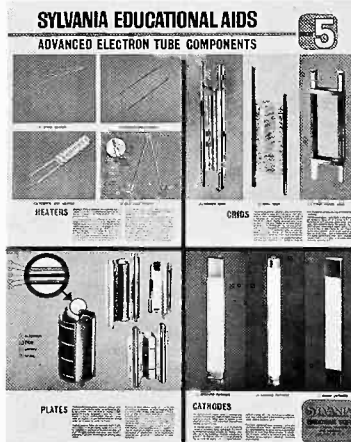

**CHART NO. 5**—Advanced Electron Tube Components illustrates and explains different types of modern heaters, cathodes, grids, and plates used in electron tubes.

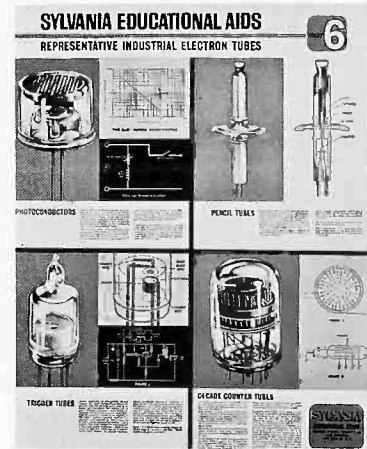

**CHART NO. 6**—Representative Industrial Electron Tubes illustrates photoconductors, pencil tubes, decade counter tubes, and trigger tubes.

## Sylvania Tourists

When it comes to open-door policies, Sylvania's plants are always ready to roll out the red carpet. Recently two Sylvania plants were on display for distributors and their dealers. Reactions overwhelmingly indicated that the familiarization with Sylvania facilities was time very well spent.

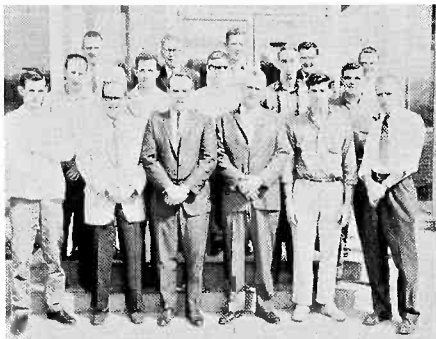

Barron Radio of Butler, Pennsylvania sponsored a tour of the Altoona Receiving Tube Plant. Sylvania's plant manager, Bill Bowes, conducted the day's tour that included approximately 15 dealers, servicemen, and industrial customers.



T&W Electronics personnel and area service dealers arrive by bus from Grand Rapids, Michigan to tour the Ottawa, Ohio Picture Tube Plant. After what was termed a "very worthwhile" tour, a sales advertising meeting was held for members of the T&W organization and its dealers.

# SYLVANIA ADDS **22** to the RECEIVING TUBE LINE

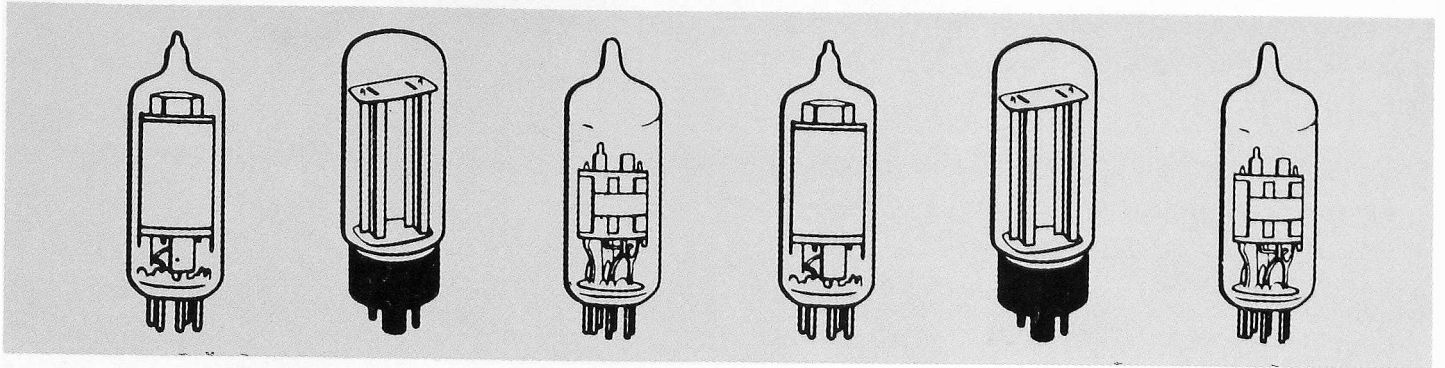

Sylvania . . . so that you can better serve your customers with an up-to-date inventory, and keep an eye focused for new and bigger profits . . . produces the latest word in Receiving Tubes.

TYPE	DESCRIPTION	TYPE	DESCRIPTION	TYPE	DESCRIPTION
<b>2AS2</b>	T9 Compactron diode for high voltage rectifier applications. Used in Zenith TV receivers.	<b>6GU5</b>	Shadow grid beam pentode. RF amplifier in UHF TV. Used in GE TV receivers.	<b>9EA8</b>	Triode-pentode 9-pin miniature. For oscillator-mixer use in TV tuners and FM stereo circuits. Currently used in Zenith FM stereo radios.
<b>2CW4</b>	5-pin Nuvistor triode used as the RF amplifier in television tuners. Used in RCA television receivers.	<b>6GU7</b>	Medium mu twin triode. For matrixing circuits of color TV receivers. Used in RCA color receivers.	<b>10JA8</b>	Triode-tetrode in 9-pin miniature construction. For video output and sync sep., sync clipper and phase inverter service. Currently used in Westinghouse TV receivers.
<b>2GU5</b>	Shadow grid beam pentode 600 ma version. RF amplifier in VHF TV receivers. Used in Sears TV receivers.	<b>6HB5</b>	Beam power pentode in T9 Compactron. For horizontal deflection amplifier application. Used in GE TV receivers.	<b>13GB5</b>	9-pin beam power pentode in the all-glass "Magnoval" base construction. Used for horizontal deflection output stage of TV receivers. Used in Emerson series string models.
<b>2HA5</b>	7-pin miniature gain controlled triode featuring strap frame grid construction and 600 ma heater. For RF amplifier use in VHF tuners. Used in Motorola and GE TV receivers.	<b>6HE5</b>	Beam power pentode in 12-pin Compactron design. Used as vertical deflection amplifier in TV. Used in Zenith TV receivers.	<b>13GF7</b>	Dual dissimilar triodes in T9 Novar construction. 450 ma heater version of type 6GF7. Used as the vertical deflection oscillator and amplifier. Used in Silver-tone and RCA TV receivers.
<b>3HA5</b>	7-pin miniature gain controlled triode featuring strap frame grid construction. For RF amplifier use in VHF tuners. Used in Motorola and GE TV receivers.	<b>6JE6</b>	T-12 Novar beam power pentode (Novar version of 6DQ6). For horizontal deflection amplifier applications. Used in RCA color receivers.	<b>13J10</b>	Beam pentode and gated-beam discriminator. For audio power output and FM or TV limited applications. Used in Zenith TV receivers.
<b>6BA11</b>	Triode and twin pentode in Compactron construction. For vertical deflection oscillator, syn and AGC applications. Used in Zenith TV receivers.	<b>6JH6</b>	Semi-remote cutoff pentode. For gain controlled picture IF amplifier application. Used in RCA TV receivers.	<b>7868</b>	Power pentode in T9 Novar construction. For audio output applications in hi-fi amplifiers and radio receivers. Used in Sylvania Hi Fidelity phonographs.
<b>6FW5</b>	T-9 octal beam power pentode used as the horizontal output tube in TV receivers. Used in GE TV receivers.	<b>6JU8</b>	Quadruple diode in 9-pin miniature. For phase detector and color killer circuits in color TV receivers. Currently used in Zenith color receivers.		
<b>6GT5</b>	Single ended beam power pentode in Novar construction. For horizontal deflection amplifier application. (6V) Used in Magnovox TV receivers.	<b>8CW5</b>	9-pin miniature pentode. Used for audio output stage. Used in Emerson series string TV receivers.		

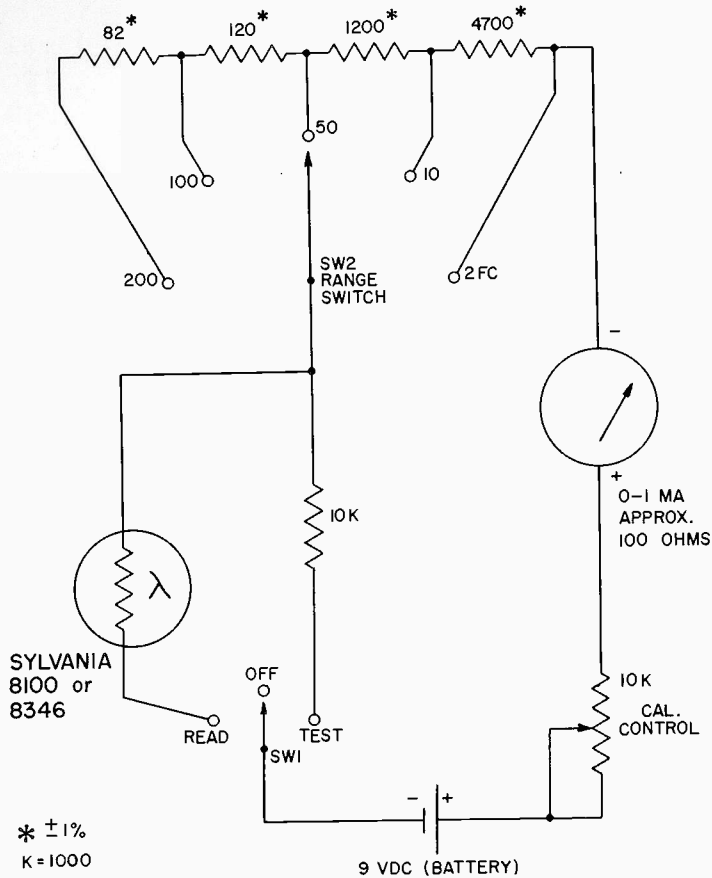

Figure 4—Sensitive Photometer.

The photoconductor must be shielded from ambient light for the circuit to operate. A simple lens system is used to obtain a narrow beam from the exciter. The objects to be counted must completely mask the sensitive face of the photoconductor.

The photoconductor and exciter lamp are positioned on opposite sides of the conveyor belt or as positioned on the same side with a mirror opposite to reflect light back to the photoconductor. As an alternate, reflected light from the objects themselves can be used to trigger the counter.

#### BI-STABLE SWITCH

In the circuit of Figure 3, the series and shunt arrangements are used in combination with two photoconductors to provide a bi-stable switch that is actuated by light pulses. Momentary illumination of Cell No. 1 closes the load circuit. The circuit remains closed until Cell No. 2 is illuminated briefly.

The unique feature of the circuit is its bi-stable characteristic which is achieved by switching a fixed resistor

(R) in parallel with Cell No. 1 the instant the relay pulls in. The resistor maintains the current flow through the relay coil at a value sufficient to keep the relay pulled in when Cell No. 1 returns to a high value of resistance upon removal of excitation.

The 10 K-ohm resistor connected in series with both photoconductors provides protection against excessive dissipation and resultant damage to the photoconductors should they be illuminated simultaneously.

The photoconductors must be shielded from ambient light for the circuit to operate. If the load is a lamp, it must be positioned so that it will not be seen by the cells, or unstable operation will result.

#### NON-RELAY CIRCUITS

The circuits described thus far use the photoconductor in conjunction with a relay. As pointed out earlier, the photoconductor is also particularly well suited to measurement circuits where the photoconductor operates a meter or acts directly upon a signal.

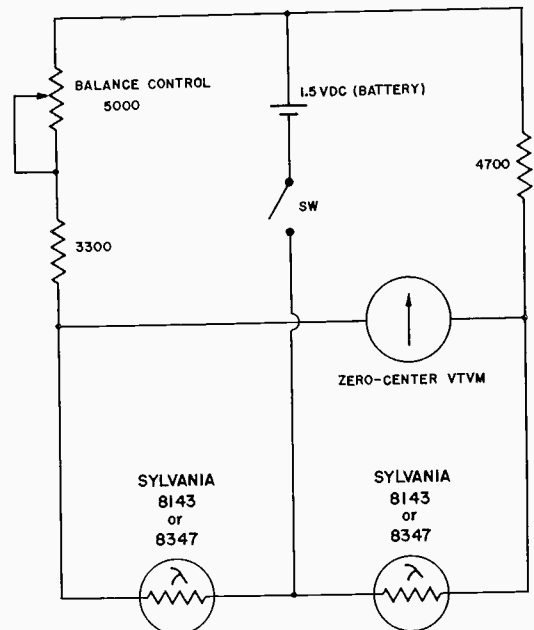

Figure 5—Simple Light Level Comparator.

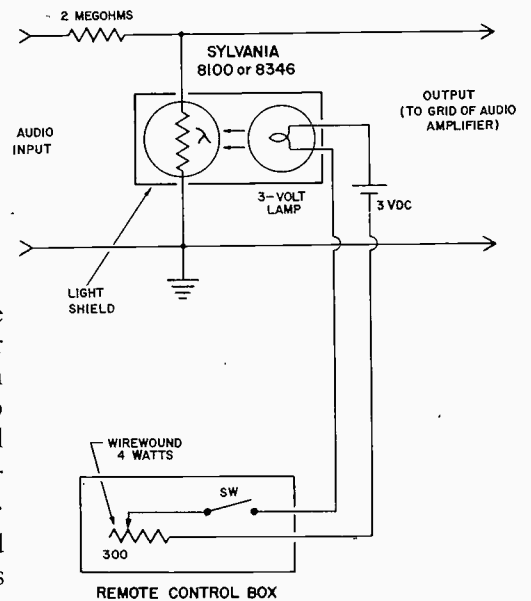

Figure 6—Remote Volume Control.

#### PHOTOMETER

The photographers photometer or light meter, shown in Figure 4, is an excellent example of this type of application. The design affords high sensitivity for the indoor photographer who uses extremely fast film with existing light.

The basic circuit consists of a 0-1 Ma meter connected in series with a photoconductor and a battery. The amount of current flowing through the circuit and indicated by the meter is proportional to the amount of light striking the photoconductor.

For the reader interested in assembling this circuit, calibration can be accomplished with the aid of a com-

mercial lightmeter and a variable light source. Both meters are placed the same distance from the light source. The illumination is then adjusted so that the commercial meter reads 100 FC. With the range switch of the unit to be calibrated set to the 100 FC position, its meter is made to read full scale by adjusting the calibration control. Intermediate values are next established by adjusting the light source to different values still using the commercial unit as a standard. It is only necessary to calibrate one range.

Switch SW1 is provided to assure accurate readings as the battery voltage decreases with life. Upon completing calibration as described in the preceding paragraph, set SW1 to the test position and the range switch to the 2 FC position. Note the exact reading of the meter. As the battery voltage decreases, the meter is brought up to this reference by adjustment of the calibration control. (If the regular meter scale is replaced

by one calibrated in FC, this value should be marked in red.)

#### LIGHT LEVEL COMPARATOR

The basic circuit of the photometer can be modified to provide a light level comparator as shown in Figure 5. This device is useful to compare or match direct illumination from different sources or it can be used with a common light source to compare the reflective properties of different surfaces.

The circuit is a bridge with a photoconductor in each leg. The balance indicator is a VTVM of the type that can be adjusted to read zero at center scale. The balance is accomplished by placing a light source equidistant from the two photoconductors and adjusting the balance control for a zero meter reading.

Since maximum bridge sensitivity is realized when the fixed resistors

are equal to cell resistance, the bridge as shown in Figure 5 has its greatest sensitivity at approximately 10 foot-candles. If a light level other than this is used the resistors should be changed correspondingly.

#### REMOTE VOLUME CONTROL

Figure 6 shows a unique yet simple way to provide a remote volume control for a radio, TV, Hi-Fi or other audio device.

The potentiometer adjusts the voltage to the lamp, which in turn sets the resistance of the photoconductor. The resistance of the photoconductor determines the amount of the signal that appears at the output terminals of the network. Greatest attenuation is obtained when the lamp is at its brightest, since the photoconductor exhibits a low resistance under this condition.

Advantages of this arrangement are: (1) elimination of mechanical noise caused by the slider of a conventionally-wired audio control, and (2) immunity to hum pick-up via the remote lead wires.

To prevent modulation of the signal being controlled, a DC power source is required for the exciter lamp.

#### CONCLUSION

The preceding are but a few of the many applications of modern cadmium sulfide photoconductors. The circuits presented can be considered as basic building blocks adaptable to a variety of end uses. More complex circuits, for the most part, represent extensions or refinements of the circuits discussed to meet the different or more precise needs of certain applications.

*Editor's Note—A photoconductor kit (PCK-10) is now being marketed by Sylvania. The kit contains: three T-4 photoconductors; the relay specified in this article; a photoconductor mounting clip; a 22 K-ohm resistor; and a 52-page booklet of practical photoconductor circuits. For full information, see the DEALER SECTION of this issue of the NEWS.*

BULK RATE  
U.S. POSTAGE  
PAID  
Permit No. 3402  
Buffalo, N.Y.

Richard J. Kerr  
Central Services  
428-430 W. Colvin St.  
Syracuse 5, N. Y.

TMS 2

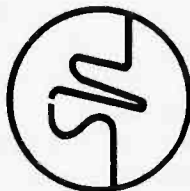

**SYLVANIA  
ELECTRIC**  
PRODUCTS INC.  
1100 MAIN ST.  
BUFFALO, N.Y.  
**SYLVANIA NEWS**  
AUGUST 1963

Form 3547 Requested  
Printed in U.S.A.