

# RADIOTRONICS

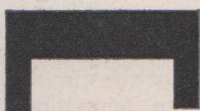

A  
N

P  
U  
B  
L  
I  
C  
A  
T  
I  
O  
N

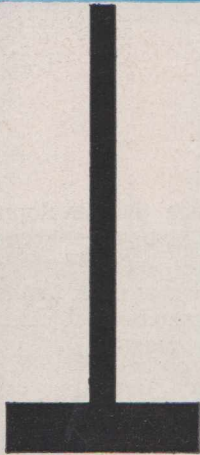

Vol. 29, No. 12

December, 1964

## IN THIS ISSUE

OPERATION FLIP-FLOP ..... 250

An interesting story which concerns an exhibition, a competition, and the result. A sub-title could be "Electronics in High Schools".

PHOTOTUBES AND PHOTOCELLS. 7: INTERPRETATION OF DATA ..... 258

This is the concluding article in the series we have been running on photosensitive devices.

300-WATT, 432-MC AMPLIFIER ..... 262

Describing how K2BTM uses the 8122 as a class-C amplifier in a transmitter operating in the frequency range 400 to 500 Mc.

# 12

## OPERATION "FLIP-FLOP"

An important event took place in Melbourne during the period August 7 to August 15, an event which has made a contribution to science in Australia, and which, with other similar events, will allow Australia and her people to take their place in the technological age which is upon us. The event was the "Science in the Development of Australia Exhibition," combined with the "1964 Science Talent Search," organised by the Science Teachers' Association of Victoria, and held in the Exhibition Buildings in Melbourne.

Whilst the Science Talent Search was the thirteenth of the series, having begun in 1951, the Exhibition was certainly the first of its kind attempted in Australia. The splendid organisation by the S.T.A.V., and the assistance given by industry, made the exhibition an outstanding success. Amalgamated Wireless Australasia Ltd. and Amalgamated Wireless Valve Co. Pty. Ltd. are proud to have been associated with the exhibition in the provision of a splendid exhibit, which was almost overwhelmed by interested and eager young citizens of tomorrow.

At the same time, it was a welcome opportunity for our companies to put into practice our avowed policy of encouraging technical education and advancement of all kinds. Industrial sponsors, by offering such encouragement and assistance, are helping both Australia and themselves to find the scientists and engineers that are going to be needed so urgently by this country in the years of development ahead.

### Science Talent Search

The Science Talent Search, begun in Victoria in 1951, has been organised and conducted each year by the S.T.A.V. It was based on the Talent Quest held in the U.S.A., but in Victoria much more emphasis is placed on actual experimental work done by the student, rather than on essays and collections alone. The aims in Victoria, as explained in a brochure sent to all schools, is (a) to encourage science students to undertake independent research along lines of their own

interests, and to encourage the development of experimental techniques, and (b) to encourage students to explain clearly and effectively, both in writing and orally, their purposes, methods and results—both at the layman's level, and at the level of the professional scientist.

The Search has achieved, over the years since its inception, a very high standard and reputation. The subsequent careers of past entrants have shown high attainments and qualifications.

The 1964 entries to the Search reached the record number of 200, involving about 300 students from all types of school, both metropolitan and country, in Victoria. A study of the list of bursaries awarded, over 150 in number, and the diverse subjects chosen by the students, is a most illuminating example of the growth of scientific work in schools, and a warming reflection on the quality of tomorrow's citizens.

### Operation Flip-Flop

In addition to the magnificent exhibit provided by our companies, AWV sponsored a competition called "Operation Flip-Flop," as a specialised transistor project for students. We developed a symmetrical multivibrator or flip-flop circuit, using two transistors and operating from a small dry battery. The two transistors were used to switch low-current lamps on and off at a comparatively slow rate. We then gave copies of the circuit, and two suitable transistors, to students who visited our stand, and invited them to make up the flip-flop and enter the competition.

The terms of the competition are reproduced here, together with a copy of the circuit diagram. The competition closed on September 1, and entries were judged by officers of the S.T.A.V. and Amalgamated Wireless Valve Co. Pty. Ltd. The prize awarded to the winner of the competition is a return air trip to Sydney for the student and his science teacher, including a visit to the transistor and valve factory of AWV at Rydalmere.



Some views of the AWA/AWV stand at the exhibition.

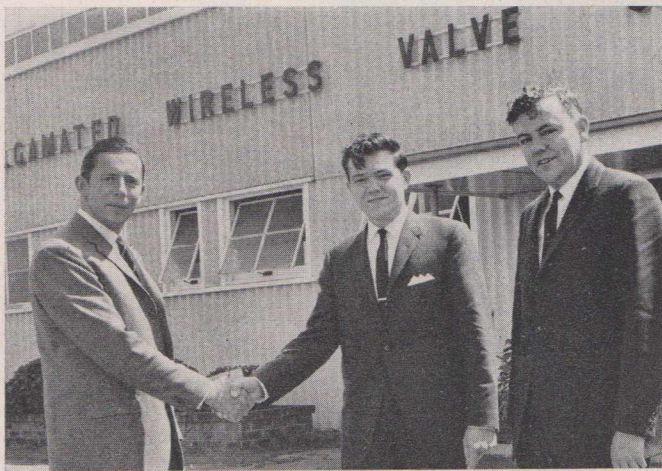

Photographs taken during the visit of Mr. Stevenson and Master Francis to the AWV works, with Mr. D. Cunliffe-Jones.

It is interesting to note that in order to make the project as reliable as possible for the students, no less than 25 models of the multivibrator were assembled in our laboratories before the circuit was issued, and the transistors given to students were specially rated and branded with a special type number. The interest in our stand and the project is reflected in the fact that we gave away over 15,000 transistors in the week the exhibition was open.

All entries were of a very high standard. Several of the models made up by the students were of a quality which we would find very acceptable in our own laboratories. The written portions of the entries were also of high quality. There were cases where particular students excelled especially in one phase of the entry, either in the practical side or in the written entry. Judging was a very difficult task, to say the least. The high quality of the entries has persuaded us to add many consolation prizes for those whose efforts fell short of winning by a very small margin.

### The Winner

The winner of the competition was Master Roy Francis, of the Springvale High School. Roy has already been congratulated by us on his win, and the honour he has brought to Springvale High. A close-up photograph of Roy's entry is reproduced here, and we feel we cannot do less than to reproduce also Roy's written entry.

Roy's model was extremely well constructed on a section of matrix board, into which he had inserted eyelets at the appropriate points to carry the various connections required. The layout on both the front and the back of the assembly was meticulous. All soldered joints were well made, and as an added touch, the name "Operation Flip-Flop" had been lettered onto the front of the board.

Roy's prize, as the winner of the competition, was an air-trip to Sydney with his science teacher, Mr. Stevenson, on Monday, October 12. The day dawned fine and clear in Sydney, and the two visitors were met at the airport by Mr. D. Cunliffe-Jones, representing AWV. The morning was spent in an inspection of the Company's plant at Rydalmere, N.S.W., followed by a scenic drive and lunch at Whale Beach, one of the magnificent ocean beaches of which Sydney is so proud.

More sight-seeing followed after lunch, culminating in a trip on Sydney Harbour on one of the famous Manly ferries, always a highlight of any visit to Sydney. The afternoon drew to a close as the party reached the roof garden of the AMP Building, the highest in Australia, from which a magnificent view of the central city area of Sydney can be obtained. And then to the airport on the way back home.

The occasion was a double first for Roy: his first visit to Sydney, and his first flight. AWV was pleased and honoured to have Roy and Mr. Stevenson as guests, and wish Roy well in his future career.

### Other Awards

In addition to the winner, two entries were classified "Highly Commended" by the judges, and four "Credit." To all six of these entrants we have awarded special consolation prizes of a copy of "Radiotron Designers' Handbook," edited by F. Langford-Smith, and a two-year subscription to our monthly magazine, "Radiotronics."

The highly commended entries were submitted by Master M. Kishkurno, of Rosanna High School, and Master N. McLaren, of Wesley College. Credits were awarded to Master Trevor Lamb, of Melbourne Grammar School; Master R. Edwards,

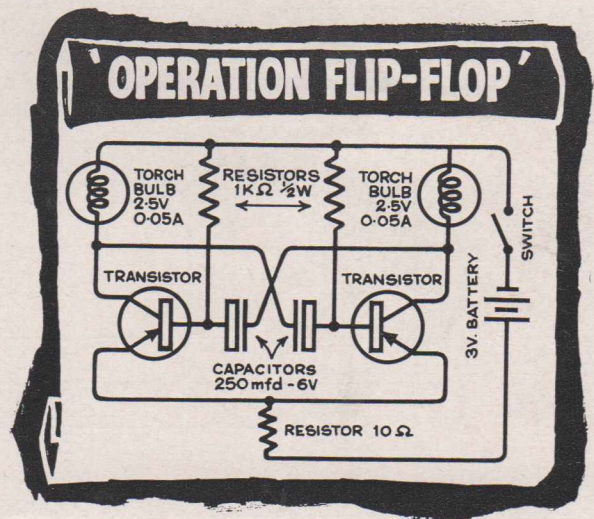

## CONDITIONS

- (1) Construct the unit (consideration will be given to neatness and layout).
- (2) Answer these questions:—
  - (a) What can be done to speedup or slow down the rate at which the lamps flash?
  - (b) What can be done to make one lamp stay on longer than the other?
  - (c) Are the lengths of the wires important?
  - (d) Should care be taken to avoid reversing battery polarity. If so, why?
- (3) Suggest a useful purpose for this particular unit (e.g., as a front door "bell" for people who are hard of hearing).
- (4) Write 200 words on the subject "The Place of Transistors in Electronics Today".

Submit your completed project, the answers to the questions and your essay clearly marked with your name and School to —

The competition circuit and terms of the competition.

# OPERATION "FLIP-FLOP"

ROY FRANCIS

SPRINGVALE HIGH SCHOOL

2. (a) In order to speed up or slow down the rate at which the lamps flash, it is necessary to change both values of the two 1 k.ohm resistors or both 250 m.f.d. electrolytic capacitors, which form the base circuits of the transistors. The values of these components determine the rate of charge and discharge of the capacitors. This is because the resistors determine how much current will be supplied to the capacitors, while the capacitors themselves determine how much charge may be stored until discharge into the circuit occurs. Therefore, an increase in value of these components causes the globes to flash slower, while a decrease in either value results in faster flashing. The effect on the globes by changing the resistor values may be shown graphically.

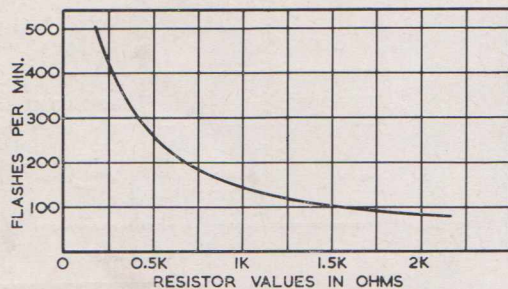

2. (b) To make one lamp stay on longer than the other, only one of the two resistance-capacitance combinations mentioned previously should be altered. That is, if the resistor or capacitor in the base circuit of the left-hand transistor is increased in value, the right-hand lamp will stay on longer, and vice-versa. In effect, doubling one capacitor value increases the length of flash more than doubling a resistor value. The same effect may be produced in a globe, though not so noticeably, by reducing the value of the base resistor or capacitor of the same transistor to which that globe is connected.

2. (c) The lengths of the wires are not important. Small effects of inductance or capacitance due to long leads are of no significance in circuits of this kind, since there are no "critical" frequencies or coupling effects to worry about. Similarly, the resistance inherent in long wire is negligible, since to produce a resistance of only one ohm anywhere in the circuit using quite thin hook-up wire, a length of about forty feet would be required. (A limit of about one hundred and fifty feet of this wire could be used before the globes began to decrease in brightness, say, where the unit is to be operated from some distance.)

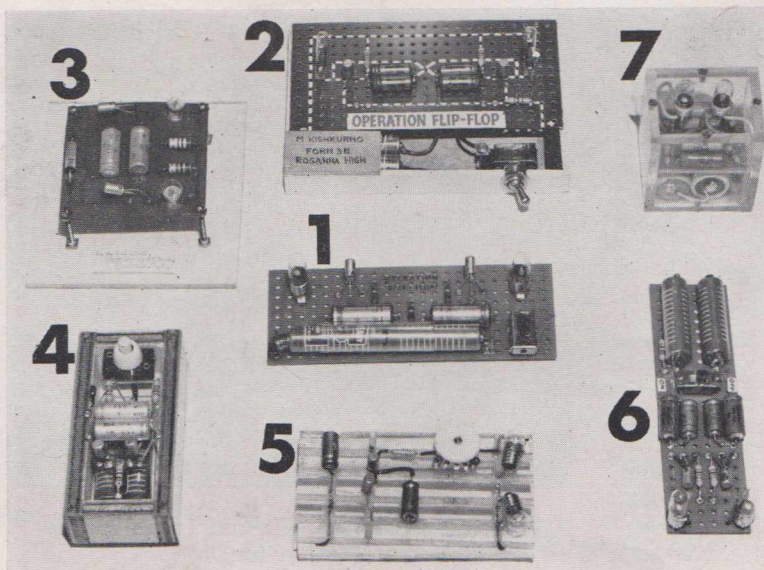

The winning entry, surrounded by two models awarded "highly commended" and four models awarded "credit." See text for key.

2. (d) Care must be taken to avoid reversing battery polarity, since possible permanent damage to the transistors may result. The reason for this is that if a positive potential is "inadvertently" applied to the collector of a p-n-p transistor, as is the AS28 transistor, the delicate junctions of NP material in it may break down if sufficient current is forced through them. A high leakage current, detrimental to future performance of the transistor, often results.

Also, if reverse battery polarity is maintained for some time, the electrolytic capacitors, which are polarity sensitive, may be damaged due to the transistor conducting in the wrong direction.

3. A useful purpose for this particular unit could be as a portable warning device to motorists, to be carried by pedestrians at night. All too many pedestrians are needlessly injured or killed on dark nights especially on country roads, simply through motorists not being able to see people crossing or walking along a road. Alternately flashing lights could not help but be conspicuous to oncoming motorists, and are therefore better than a single torch beam. The actual light thrown out by the globes does not appear to be much in themselves, but when used at night in conjunction with their "flickering" effect, they may be seen from a considerable distance. The unit may easily be carried in the hand with an attached strap, or with a little physical modification, could be carried in the pocket.

## The Place of Transistors in Electronics Today

Doubtless is the fact that transistors marked a new point of departure in electronic development. Since the interesting, while hardly spectacular discovery of the "crystal amplifier" by J. Bardeen and W. Brattain in 1948, the transistor has become a household word.

The transistor is versatile. It may now be used in apparatus where once bulk, weight, power consumption and reliability were serious limiting factors. For instance, repeater relays incorporated in submarine telephone cables and the now famous pace-makers used to stimulate weak or abnormal hearts, are both dependant on the extreme reliability of transistors, since there is no room for failure in either case. Revolutionary changes in computer techniques through the reduction in size and power consumption and the increase in speed of such machines as business calculators and the industrial computers which lead this age of automation, have been due to the introduction of transistors. Combining all these assets including light weight and extreme ruggedness, the transistor forms an invaluable device in artificial satellites and missile technology in general.

As electronics has become an integral part of industry, the transistor has become an indispensable part of electronics. Thus transistors do not merely occupy a place, but the place in electronics today.

### The winning entry, submitted by Master Roy Francis, of Springvale High School.

of Glenroy Technical School; Master G. Powell, of Carey Baptist Grammar School; and Master I. Goding, of Scotch College. Incidentally, we note also that Ian Goding also won a bursary in the Science Talent Search, for a project on a power supply for an electronic flash unit, and a bursary was also won by a Master James Goding, also of Scotch College, and presumably a brother of Ian's, for a project on a 144-Mc receiver. If these two young men are brothers, there is obviously no shortage of talent in that family.

The highly commended and credit entries are shown in one of the accompanying photographs. The highly commended entries by Master M. Kishkurno and Master N. McLaren are indicated in the photograph by numbers 2 and 3 respectively. The method of construction adopted by Master Kishkurno was similar to that employed by the winner (number 1), whilst Master McLaren

employed a printed circuit. Master Kishkurno submitted what must have been one of the most unusual uses for the device, an intrusion alarm on his pigeon cage.

The four entries which received credits are identified in the photograph by numbers 4, Master G. Powell; 5, Master I. Goding; 6, Master T. Lamb; and 7, Master R. Edwards. Of this group, Master Powell constructed in a stained wooden box with transparent plastic top. Master Goding had an interesting approach by constructing on a section of transparent plastic with holes drilled from edge to edge through the plastic to carry the connecting wires. Master Lamb used matrix board in putting together a very neat and efficient model. The entry submitted by Master Edwards was built into a transparent cube made up from sheet plastic, with a pressure-sensitive switch on the underside: a very fine entry.

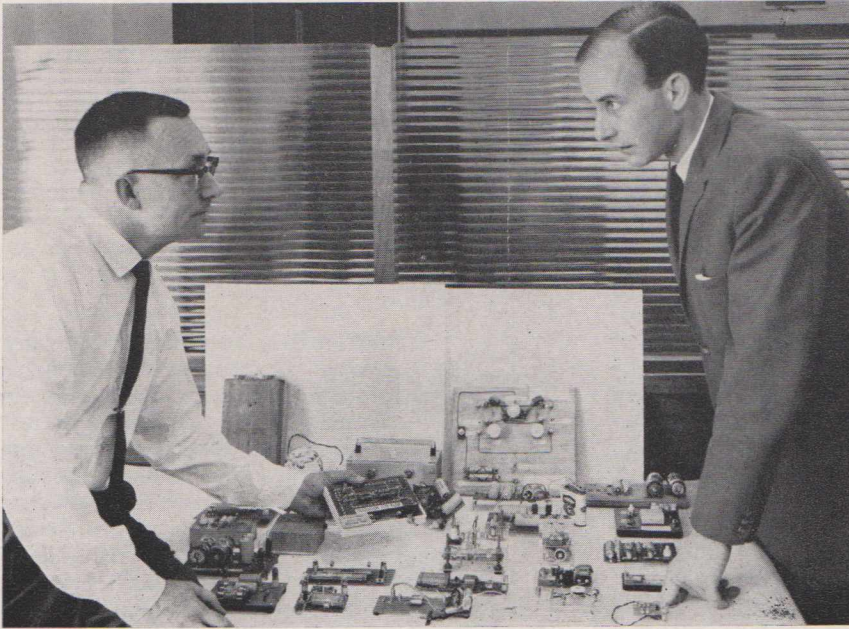

Models being examined in Sydney by Mr. E. Pietor (right) and Mr. B. Simpson, of Amalgamated Wireless Valve Co. Pty. Ltd.

### Other Notable Entries

Out of all entries received, 26 were considered of sufficiently high standard to get into the final judging, with the results detailed above. All these 26 entries were sent to our laboratories at Rydalmere, N.S.W., where they were examined by AWV officers and engineers. In addition, a complete survey of all of the final 26 entries was made by the editor of this magazine. Whilst this

involved a great deal of work, including detailed examination of each entry and the careful reading of the written sections, it was very rewarding and thrilling.

The editor picked out five entries from the remainder who did not receive awards, five entries where originality and/or skill were demonstrated in the construction of the model, with good sup-

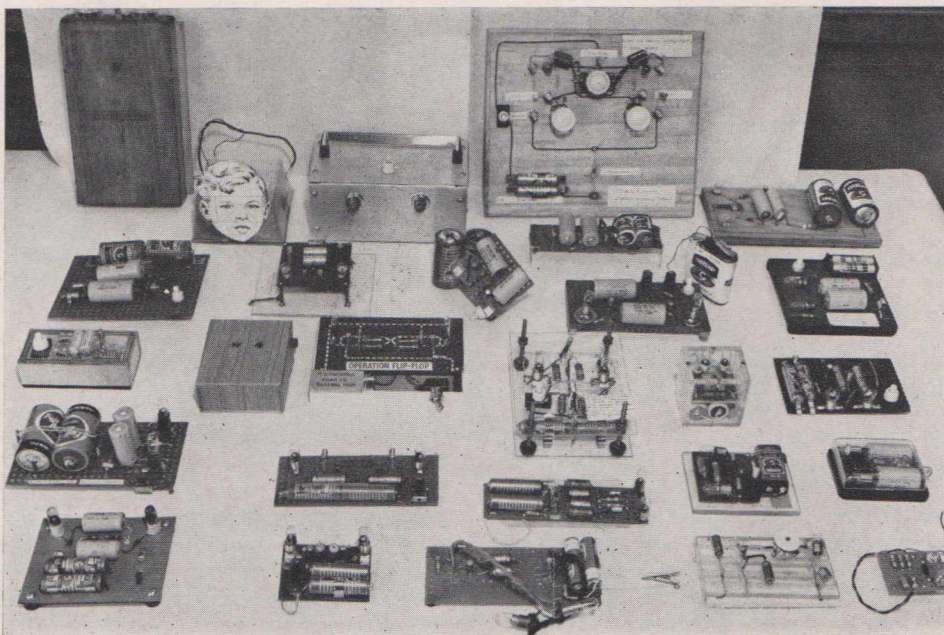



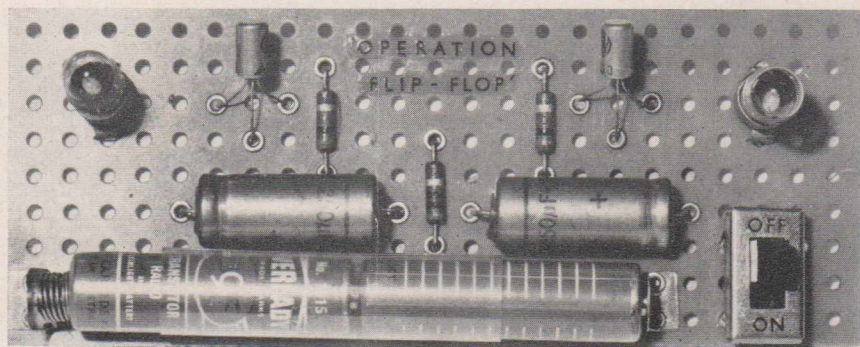

Close-up of the winning entry.

port given in the written section of the entry. These five have been awarded a special consolation prize of a two-year subscription to "Radio-tronics." These five entries which have received special consideration are shown in the accompanying photograph, and are identified by numbers 1, Master D. Phipps, of Oakleigh Technical School; 2, Master L. Roberts, of Balwyn High School; 3, Master A. Morgan, of Blackburn High School; 4,

Master P. Sheen, of Brighton Technical School; and 5, Master N. Rischbieth, of Essendon Grammar School.

Master Phipps went to a great deal of trouble to build a unit in which both the resistors and capacitors in the timing sections of the circuit could be varied: a good entry. Master Roberts made a neat model with red and blue lights, and also used some very fine prose in his written section. The model submitted by Master Morgan was also of a high standard, as was his essay on the place of transistors in electronics. Both Master Sheen and Master Rischbieth used a printed circuit to construct efficient and compact models, and their written entries were also of a high standard. Special mention must be made of the written entry of Master Sheen, which was beautifully laid out and decorated on a large sheet of drawing paper. Special congratulations, Peter, on a fine effort.

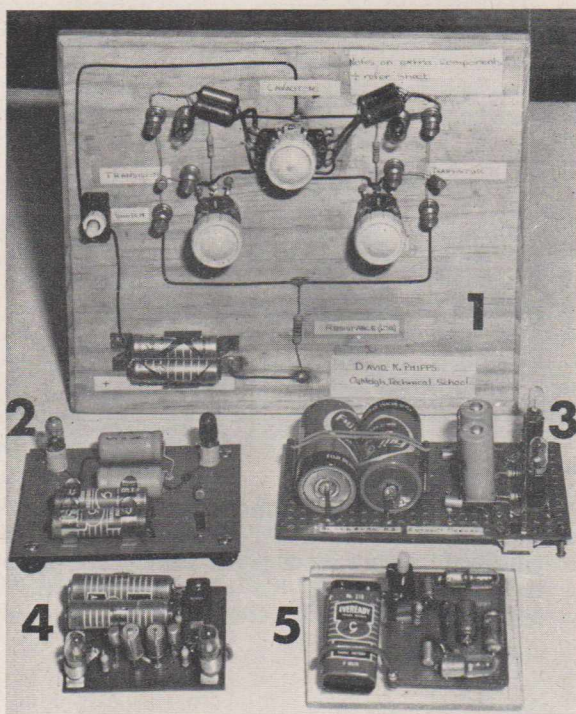

Five other entries which showed great merit. See text for key.

## Summary

This is the first competition of its kind that has ever been staged by AWV. The response was gratifying and the general quality of the entries, most of which appear to have come from third to fifth year students, was excellent. It is a fact that we would have liked to have rewarded each of the fine entries in the final list with a trip to Sydney, but this could not be. The competition was full of "photo-finishes," and the task of the judges was an exacting one.

Our thanks are due to all who submitted an entry, to the Science Teachers' Association of Victoria for their assistance, and to the many individuals who assisted in making this project such a success.

## Phototubes and Photocells

# 7: Interpretation of Data

The data published by manufacturers of phototubes and photocells include ratings, characteristics, minimum circuit values, and characteristic curves for vacuum and gas photodiodes, multiplier phototubes, photoconductive cells and photo-junction cells. This section discusses the parameters given in the data and indicates briefly the method of measurement used for the more important parameters.

### Maximum Ratings

**Ratings** are established on phototube and photocell types to help equipment designers utilize the performance and service capability of each device to best advantage. These ratings are based on careful study and extensive testing by the tube manufacturer, and indicate limits within which the operating conditions must be maintained to ensure satisfactory performance. The maximum ratings given for photosensitive devices are usually based on the **Absolute Maximum System**. This system has been defined by the Joint Electron Device Engineering Council (JEDEC) and standardized by the National Electrical Manufacturers Association (NEMA) and the Electronic Industries Association (EIA).

**Absolute-maximum** ratings are limiting values of operating and environmental conditions which should not be exceeded by any device of a specified type under any condition of operation. Effective use of these ratings requires close control of supply-voltage variations, component variations, equipment-control adjustment, load variations and environmental conditions.

For the most part, electrode voltage and current ratings for phototubes are self-explanatory and require little discussion. However, it should

be noted that the maximum average cathode current (for gas and vacuum phototubes) and the maximum average anode current (for multiplier phototubes) are averaged over an interval no longer than 30 seconds.

### Characteristics

The characteristics given by makers are typical values which indicate the performance of the device under certain operating conditions. Characteristic curves represent the characteristics of an average tube; however, individual tubes (like any manufactured product) may have characteristics that range above or below the values given in the characteristic curves. The more important of these characteristics for phototubes are discussed below.

The **spectral-sensitivity characteristic** represents a response curve which is typical of the spectral response obtained with a given phototube. Such a curve also indicates the range of maximum response. The short-wavelength cutoff of the

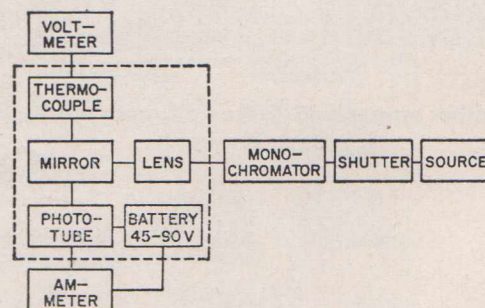

Fig. 93—Typical system for determining spectral-sensitivity characteristics of phototubes.

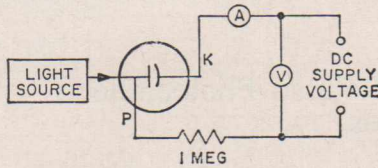

Fig. 94—Typical circuit for measuring of photodiodes.

spectral response is fairly well fixed by the ultraviolet absorption properties of the tube envelope. The long-wavelength cutoff is determined by such factors as the thickness of the photo-cathode layer and the particular activation of the photo-surface.

In some critical applications, an exact knowledge of the spectral response of a phototube may be required. A simplified system for the measurement of spectral response as a function of wavelength is shown in Fig. 93. For this measurement, one or more monochromators are used to select narrow bands of radiation from a given source of radiant energy. The output radiant flux in the narrow bands is then directed to a calibrated radiation thermocouple and measured in watts. This same output flux is also directed to the photocathode and measured in amperes by a current-reading device.

**Luminous sensitivity** is defined as the output current divided by the incident luminous flux at constant electrode voltages. This parameter is expressed in terms of amperes per lumen (a/lm). Fig. 94 shows a typical circuit for the measurement of luminous sensitivity of photodiodes; Fig. 95 shows a similar circuit used for multiplier phototubes. For these measurements, the phototube is placed in a light-tight shielded enclosure to prevent extraneous radiation from affecting test results. The light source normally used is an aged 50-candlepower tungsten-filament lamp operated at a color temperature of 2870°K and having a lime-glass envelope. The lamp is calibrated for color temperature and candlepower against a secondary standard lamp supplied by the U.S. National Bureau of Standards.

For the measurement of luminous sensitivity of vacuum phototubes, a voltage in the order of 250 volts is generally applied; for gas photodiodes, 90 volts is used. As shown in Fig. 94, a microammeter is inserted in series with the photodiode. A one-megohm resistor is also used in series with the phototube because it represents a typical load and, in addition, provides a measure of safety for the meter in case of a short circuit. With multiplier phototubes, the tube is connected across a voltage divider, as shown in Fig. 95, which provides voltages as specified for the individual type. The current passing through the divider should have a value at least ten times that of the maximum anode current to be mea-

sured. A luminous flux in the range of  $10^{-8}$  to  $10^{-5}$  lumen (0.01 to 10 microlumens) is directed to the photocathode.

(As shown in the data for some multiplier phototubes, the luminous sensitivity can also be given with the last dynode stage used as the output electrode. With this arrangement, an output current of opposite polarity to that obtained at the anode is provided. Under this condition, the load is connected in the last dynode circuit and the anode serves only as the collector.)

**Cathode luminous sensitivity** is the photocurrent emitted per lumen of incident light flux at constant electrode voltage and is expressed in terms of microamperes ( $\mu\text{a}$  or  $10^{-6}$  ampere) per lumen. For photodiodes, this characteristic is measured by means of the circuit shown in Fig. 94 with a light flux of approximately 0.1 lumen applied. From a practical standpoint, there is no distinction made between the measurement of anode and cathode luminous sensitivity for photodiodes. In the case of multiplier phototubes, a measuring circuit similar to that shown in Fig. 95 is used with a dc voltage of 100 to 250 volts (specific value given in data for individual type) applied between the cathode and all other electrodes connected as anode. Light-limiting apertures are used and a light flux in the order of 0.01 lumen is generally applied. The measured photocurrent (minus the dark current) is then divided by the specified light level to determine cathode luminous sensitivity.

**Radiant sensitivity** is the output current divided by the incident radiant power of a given wavelength at constant electrode voltages. **Cathode radiant sensitivity** is the amount of current leaving the photocathode divided by the incident radiant power of a given wavelength. These parameters are generally expressed in terms of amperes per watt (a/w). Although these characteristics can be measured by use of the circuits described above with the addition of a calibrated radiation thermocouple, they can be more readily

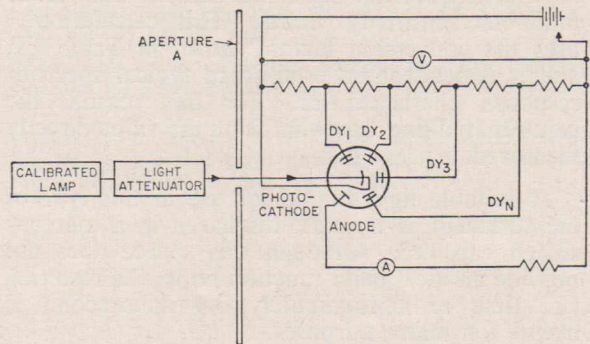

Fig. 95—Typical circuit for measuring sensitivity of multiplier phototubes.

TABLE IX  
Spectral Responses for Devices with Related Photocathode  
Characteristic Values

Device S-Number	Conversion Factor (k) (lm/w)	Typical Luminous Sensitivity		$\lambda_{\max}$ (angstroms)	Typical Radiant Sensitivity ( $\sigma_{\text{rvn}}$ ) (ma/w)	Typical Quantum Efficiency <sup>2</sup> (per cent)	Typical Photocathode Dark Emission <sup>2</sup> at 25°C (amperes/cm <sup>2</sup> x 10 <sup>-15</sup> )
		( $S_{\text{rvn}}$ ) (2780°K) ( $\mu\text{a/lumen}$ )	Max Luminous Sensitivity <sup>1</sup> ( $\mu\text{a/lumen}$ ) $S_{\max}$				
S-1	93.9	25	60	8000	2.35	0.36	900
S-3	286	6.5	20	4200	1.86	0.55	
S-4	977	40	110	4000	39.1	12	0.2
S-5†	1252	40	80	3400	50.1†	18†	0.3
S-8	755	3	20	3650	2.26	0.77	0.13
S-9	683	30	110	4800	20.5	5.3	
S-10	508	40	100	4500	20.3	5.6	70
S-11	804	60	110	4400	48.2	14	3
S-13	795	60	80	4400	47.7	13	4
S-17	664	125	160	4900	83	21	1.2
S-19	—*	40	70	—*	22*	11*	0.3
S-20	428	150	250	4200	64.2	18	0.3
S-21	779	30	60	4400	23.4	6.6	—

<sup>1</sup> Care must be used in converting  $s_{\max}$  to a  $\sigma_{\max}$  figure. Photocathodes having maximum lumen sensitivity frequently have more red sensitivity than normal, and the formula cannot be applied without re-evaluation of the spectral response for the particular maximum sensitivity device.

<sup>2</sup> 100 per cent quantum efficiency implies one photoelectron per incident quantum, or  $e/h\nu = \lambda/12,395$ , where  $\lambda$  is expressed in angstrom units. Quantum efficiency at  $\lambda_{\max}$  is computed by comparing the radiant sensitivity at  $\lambda_{\max}$  with the 100 per cent quantum efficiency expression above.

<sup>3</sup> Most of these data are obtained from multiplier phototube characteristics. For tubes capable of operating at very high gain factors, the dark emission at the photocathode is taken as the output dark current divided by the gain (or the equivalent minimum anode dark current input multiplied by cathode sensitivity). On tubes where other dc dark-current sources are predominant, the dark noise figure may be used. In this case, if all the noise originates from the photocathode emission, it may be shown that the photocathode dark emission in amperes is approximately  $0.4 \times 10^{18} \times$  (equivalent noise input in lumens times cathode sensitivity in amperes per lumen)<sup>2</sup>. The data shown are all given per unit area of the photocathode.

\* No value for k or  $\lambda_{\max}$  is given because the spectral response data are in question. The values quoted for  $\sigma$  and typical quantum efficiency are only typical of measurements made at the specific wavelength 2537 angstroms and not at the wavelength of peak sensitivity as for the other data.

† The S-5 spectral response is suspected to be in error. The data tabulated conform to the published curve, which is maximum at 3400 angstroms. Present indications are that the peak value should agree with that of the S-4 curve (4000 angstroms). Typical radiant sensitivity and quantum efficiency would then agree with those for S-4 response.

computed from the measured cathode and anode luminous sensitivity values. This calculation<sup>1,2</sup> uses the conversion factors shown in Table IX, and is dependent on established typical spectral-response characteristics. For this reason, the result may differ somewhat from the value directly measured.

A suitable light source for use in this type of measurement is a spark discharge in a mercury switch capsule<sup>3</sup>. Although this source does not provide an ideal delta-function pulse, the resulting rise time of approximately 0.4 nanosecond is useful for many purposes.

**Current amplification** for multiplier phototubes is the ratio of the anode luminous sensitivity to the photocathode luminous sensitivity at constant

electrode voltages, and is a computed parameter. (This characteristic can also be given as a ratio of radiant sensitivity.) Because of its magnitude, the amplification factor for multiplier phototubes is generally expressed in terms of millions, and is plotted logarithmically.

For a gas photodiode, the **amplification factor** is a ratio of photocurrents at two different anode voltages: the operating voltage (usually 90 volts) and 25 volts.

**Equivalent anode-dark-current input** is the anode dark current of a phototube divided by the radiant or luminous sensitivity. This parameter serves as a useful figure of merit for the comparison of dark current in multiplier phototubes, and can be expressed in picowatts (pw

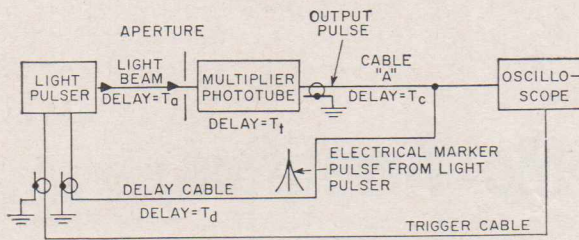

Fig. 96—Typical circuit for determining time response of phototubes.

or  $10^{-12}$  watt) or nanolumens (nlm or  $10^{-9}$  lumen). The measurement method for this characteristic is similar to that for luminous sensitivity except that the applied voltage is adjusted until a specified anode luminous sensitivity is obtained. The light flux is then removed and the anode dark current is measured. If the measurement is made in terms of radiant flux, the wavelength of radiant energy is also specified and the applied voltage is adjusted to a specified anode current.

**Equivalent noise input** is that value of incident luminous flux which, when modulated in a stated manner, produces an rms output current equal to the rms noise current within a specified bandwidth. This characteristic can be expressed in terms of picolumens (plm or  $10^{-12}$  lumens). The test conditions for this measurement are similar to those used for luminous sensitivity measurements except that the incident radiation is modulated by a mechanical "light-chopper" which produces a square-wave signal at the phototube anode.

**Transit time** of multiplier phototubes is defined as the time interval between the arrival of a delta-function light pulse (a pulse having finite integrated light flux and infinitesimal width) at the entrance window of the tube and the time at which the output pulse at the anode terminal reaches peak amplitude. Fig. 96 shows a typical circuit for the measurement of transit time. As shown, a small pulsed light spot of specified diameter is directed on a central area of the photocathode. Because transit time is dependent upon the magnitude of the applied voltage, the voltages are specified for each type.

For this measurement, the length of the delay cable is adjusted until the time difference ( $T_0$ ) between the phototube output pulses and the marker pulses from the light source can be observed on a sampling oscilloscope. Transit

time ( $T_t$ ) is then equal to

$$T_t = T_0 + T_d - T_a - T_c$$

where  $T_d$  is the electrical transit time of the delay cable;  $T_a$  is equal to the time it takes the light pulse to travel the distance between the mercury-switch light-pulse generator and the photocathode;  $T_c$  is equal to the electrical transit time of cable "A".

**Anode-pulse rise time** indicates the time required for the instantaneous amplitude of the output pulse at the anode terminal to go from 10 per cent to 90 per cent of the peak value. This parameter is normally expressed in nanoseconds (nsec or  $10^{-9}$  second). The circuit shown in Fig. 96 can also be used to measure rise time. For this measurement, the incident light usually illuminates the entire photocathode. The rise times of the light source and the oscilloscope (or other display devices used), however, must be considered.

**Transit-time spread** is the time interval between the half-amplitude points of the output pulse at the anode terminal, which results from a delta function of light incident on the entrance window of the tube. This parameter is seldom measured directly because it is difficult to differentiate between the decay of the light source and the decay of the phototube. Transit-time variations between anode pulses as a function of light-spot position on the photocathode serve as a satisfactory indication of transit-time spread. This parameter is usually expressed as greatest delay between anode pulses. For measurement of this parameter, a small-diameter light spot is initially centered on the photocathode; the transit time of the phototube is then determined and used as a reference point. The same light spot is then directed to another specified point on the cathode and this transit time is determined. The difference between these transit times indicates the transit-time spread.

## References

- Engstrom, R. W., "Calculation of Radiant Photoelectric Sensitivity from Luminous Sensitivity," *RCA Review*, **16**, No. 1, March 1955.
- Engstrom, R. W., "Absolute Spectral Response Characteristics of Photosensitive Devices," *RCA Review*, **21**, No. 2, June 1960.
- Kerns, Q. A., Kirsten, F. A., and Cox, G. C., "Generator of Nanosecond Light Pulse for Phototube Testing," *Rev. Sci. Instr.*, **30**, pp. 31-36, Jan. 1959.

# 300-Watt, 432-Mc Amplifier

By John M. Filipczak, K2BTM

RCA Electronic Components and Devices

The author considers the 8122 an ideal choice for use as a class C amplifier in transmitters operating in the frequency range from 400 to 500 megacycles.

One of the most versatile and reliable beam-power valves ever offered to promote high-efficiency operation on amateur uhf, this ceramic-metal type offers the ham outstanding performance characteristics at an attractive price.

Ceramic-metal construction, combined with RCA's exclusive grid-making technique for pre-

cision grid alignment, afford this valve exceptional structural and electrical stability.

Featuring a 13.5-volt heater and rated for CW and linear rf service, the 8122 is intended for either mobile or fixed-station operation. High-perveance design helps achieve uhf power output at relatively low plate voltages. At an operating frequency of 470 megacycles, a plate voltage of 2,000 volts, and a current of 0.3 ampere, useful CW power output is 300 watts.

## Design Features

Figure 1 shows the package layout and Figure 2 the schematic for an 8122 in a class C amplifier designed to operate at 432 megacycles. At this frequency, the output circuit is effectively isolated from the input circuit by the low-inductance ring terminal attached to grid No. 2. Input admittance at the high frequencies is reduced by three separate cathode leads which provide a low-inductance rf path to ground. One of the cathode leads—preferably the one from the No. 4 pin—can be series-tuned to ground with a small trimmer capacitor. This provides an additional means for broadband neutralization in the upper frequency range of the valve.

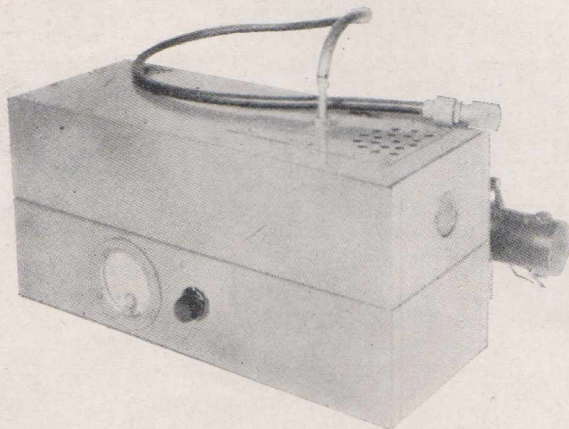

General view of the low-cost, 300-watt, 432-Mc amplifier.

The amplifier was designed to be driven by a 6939 twin pentode exciter driver,\* but can use any other driving source which operates at the fundamental-amplifier frequency. It is vital, however, that the driving source selected maintain 5 watts of output under the required load.

The 8122 uses a coaxial type of electrode arrangement. When operated as a class C amplifier, the valve is capable of supplying 300 watts of rf power output (at frequencies up to 470 megacycles) for an input driving power of only 5 watts. It is designed to operate with plate voltages from 700 volts (for 100-watt power output) to 2,000 volts (for 300-watt power output). The high power outputs achieved from relatively low plate voltages and driving power are made possible by the valve's high power sensitivity and perveance.

The 8122 requires forced-air cooling during operation. The combined effect of this cooling, plus the heat dissipation capability from its highly efficient radiator, permits the valve to be operated at a maximum plate dissipation of 400 watts without any sacrifice in reliability. At this plate dissipation, the radiator-core temperature is rated at 250°C. for the valves specified air flow of 6½ cubic feet per minute. The radiator-core temperature at maximum plate dissipation can be substantially reduced, however, if the rate of cooling

\* The 6939 was described by the author in an earlier paper, "Five Watts at 432 Megacycles with the 6939 Dual Pentode," published in "QST" for March, 1962.

is increased. The blower for the 8122 may be any one of the smaller, commercially available types.

### Circuit Details

The control grid (grid No. 1) of the amplifier valve is connected to a half-wavelength strip line which is tuned at its open end by a glass-type piston-adjusted capacitor. This grid line is made from a piece of flat copper  $\frac{1}{8}$ -inch thick which reduces rf losses and helps maintain the grid temperature at a safe level.

A combination of fixed (10.5-volt battery) and grid-leak bias is used in the circuit. The fixed bias makes certain that the valve will be operated within a safe range of dissipation should the driving power fail. The input-coupling link ( $L_1$ ) is series-tuned to reduce reactance and provide optimum coupling between the driver and grid No. 1 of the 8122.

Cathode pins 1 and 9 are grounded to the chassis. The remaining cathode pin (No. 4) is then series-tuned to ground with a small trimmer capacitor to provide the required neutralization adjustment at 432 megacycles.

The screen grid (grid No. 2) is bypassed to ground at the operating frequency by a screening capacitor. Additional neutralization of the amplifier circuit may be obtained by eliminating one or more of the screen-ring contact fingers. This effect is most easily accomplished by separating the contact finger from the screen-ring terminal on the valve with 0.01-inch-thick Teflon strips. The number of fingers that must be insulated is determined by the compensation necessary to obtain complete neutralization. Requirements for neutralization vary among different amplifiers. In some cases, none of the contact fingers need be insulated. In any event, since

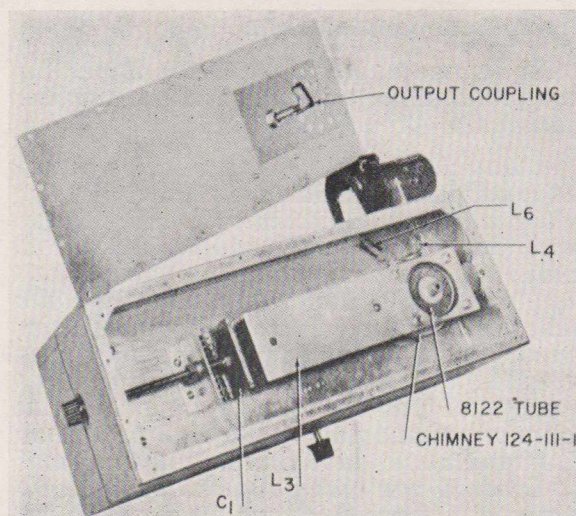

Top view of the amplifier, showing the plate-line assembly.

insulation can be easily added after the package has been completely assembled, it should be avoided unless shown absolutely necessary by a neutralization check.

The plate line is the most critical part of the amplifier circuit, and must maintain low-loss contact with the plate to insure satisfactory performance at the desired operating frequency. The plate line is a half-wavelength strip line tuned at its open end by a specially constructed tuning capacitor. This capacitor,  $C_1$ , is shown in Figure 1, and the details of its construction are outlined in the section that follows.

Power may be transferred from the plate line to the load through either a link coupling or capacitive-probe coupling. The latter is preferable because it provides greater flexibility of adjustment.

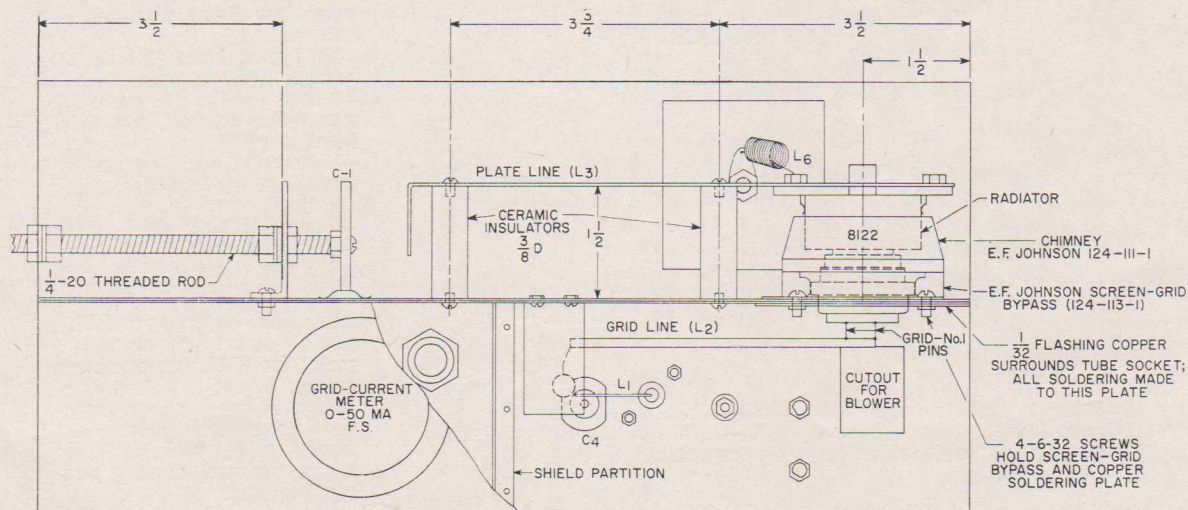

Fig. 1—Cutaway view of plate-line and grid-line assembly, with dimensions in inches.

## Mechanical Construction

The illustrations accompanying this article offer data you need for construction of the amplifier "package."

As shown in Figure 1, the amplifier is mounted in two standard aluminium chassis, each of which is 13 inches long, 5 inches wide, and 3 inches deep. The chassis are fastened back-to-back to provide separate compartments for the grid and plate lines. Thus attached, all mounting holes with the exception of the valve-socket holes (whose diameters for the two chassis differ) may be drilled to size. A  $\frac{1}{8}$ -inch pilot hole is drilled through both chassis to correctly centre the socket holes for accurate punching to final size. After all mounting holes have been drilled, the chassis are detached from each other, and holes for the valve socket punched in each chassis. This can be done in the sizes required with socket punches. The outline of the plate chassis (Figure 3) indicates the sizes and locations of the socket holes for both chassis. The ventilation holes surrounding the socket holes should be punched through both chassis while they are fastened together. Locations and sizes of all other chassis holes are shown in Figures 1 and 4.

All electrical ground connections are soldered to a piece of flashing copper which surrounds the base of the valve socket. This piece of copper is

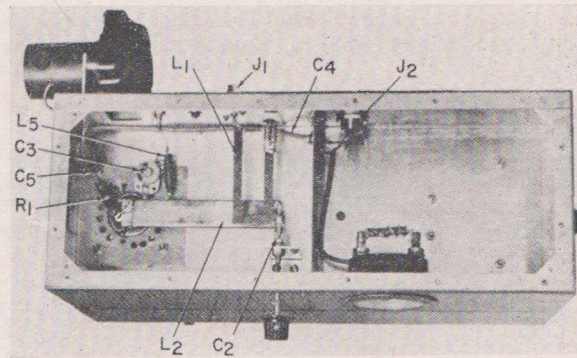

Bottom view of the amplifier, showing grid No. 1 assembly.

held to the base of the grid-line compartment by the four No. 6-32 screws that also hold the screen bypass ring, which is located in the plate-line compartment.

The grid-No. 1 line is held in place by soldering one end to the tab of the piston capacitor,  $C_2$ . The remaining end is soldered to the three grid-No. 1 socket pins, as shown in Figures 1 and 4. An aluminum bracket,  $\frac{1}{16}$ -inch thick, holds the grid-tuning capacitor,  $C_2$ , in position. The centre of  $C_2$  and the bushing holding the tuning shaft must line up if smooth tuning is to be obtained. A shield (see Figure 1) is placed in the grid

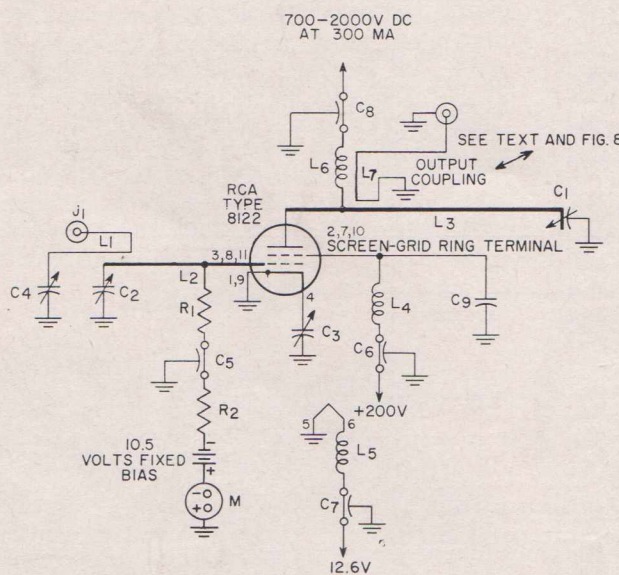

$C_1$ —Refer to text material and Figures 1 and 7.  
 $C_2$ —0.5-3.0 pf, glass-piston capacitor.  
 $C_3$ —7-45 pf, trimmer.

$C_4$ —1.8-9.0 pf, variable.  
 $C_5$ —1,000 pf, button-type mica capacitor.

$C_6, C_7$ —1,000 pf, feed-through capacitor.  
 $C_8$ —High-voltage bypass (see Figure 9).  
 $C_9$ —Screen-grid bypass.  
 $J_1$ —Coaxial cable connector (UG 290 A/U or equiv.).  
 $J_2$ —2-wire connector.  
 $L_1$ —See Figure 4.  
 $L_2$ —Flat piece of copper 4-5/16-inches long,  $\frac{3}{8}$ -inch wide, and  $\frac{1}{8}$ -inch thick.  
 $L_3$ —See Figures 1 and 6.  
 $L_4$ —Ohmite Z-460 or equiv.  
 $L_5$ —8 turns of No. 18 enamelled wire,  $\frac{1}{4}$ -inch diameter, spaced to 1-inch length.  
 $L_6$ —11 turns of No. 18 enamelled wire, 5/16-inch diameter close-wound.  
 $M$ —Meter, 0-50 ma.  
 $R_1$ —82 ohm, 2 watt.  
 $R_2$ —680 ohm, 1 watt.

Miscellaneous—High voltage "THRU" panel insulator, 0-50 ma meter; socket for 8122, two aluminium chassis, 13-by-5-by-3 inches,  $\frac{1}{8}$ -inch shaft-lock bushings, beryllium finger stock; blower (air-flow-rating 6 $\frac{1}{2}$  cubic feet per minute minimum); chimney, ceramic insulators.

Fig. 2—Schematic diagram and parts list for the 300-watt amplifier.



compartment to isolate the grid-current meter from the rf field. The shield also reduces the size of the grid section, thereby increasing the efficiency of "pressurized" cooling.

Before the valve socket is assembled, all screen-contact tabs should be removed from the socket—that is, from pins 2, 7, and 10. The dc connection to the screen grid is made in the plate compartment. Figure 5 shows the method used for the dc connection to the screen grid.

Details for the construction of the plate line are shown in Figures 1 and 6. The bracket assembly that guides the No. 4-20 threaded plate-capacitor tuning shaft should be constructed close to the dimensions shown in Figure 7. An improperly constructed bracket will result in an erratic ground for the plate-tuning assembly. The distance of the plate line from the ground reference should be the required  $1\frac{1}{2}$  inches. This distance provides the correct surge impedance and resonant frequency of the strip line with the top cover in place.

The B+ choke is connected to the plate line by one of the screws which hold the plate assembly together. The B+ choke is connected at the low-voltage, high-current point of the plate line. The output-coupling probe shown in Figure 8(a) is located in this area. The specially constructed high-voltage bypass capacitor consists of a 1/32-inch brass plate insulated from the chassis by a 0.006-inch-thick piece of mica insulation (see Figure 9). The value of the bypass capacitance is sufficiently great to make it essentially a short circuit at the operating frequency.

The 1/4-inch shaft-lock bushings are also used for guiding the shaft for the plate-tuning capacitor. These bushings are ideal for this application because they can be adjusted to provide the

amount of "drag" or tension required to sustain a good contact.

The soldering of the finger stock to the plate assembly can be simplified by use of a tapered wooden plug as shown in Figure 10. The plug will hold the finger stock in place and prevent excessive heat absorption during the soldering operation.

## Operation and Tuning

Adherence to the following procedures and instructions is recommended to assure safe and satisfactory operation of the amplifier circuit:

1. All plate-supply voltages in the range specified for the operation of the 8122 are high enough to represent a potential danger to human life. Therefore, as a safety precaution, all supply voltages should be interlocked.

2. In the proposed application, the heater power for the 8122 should be 12.5 volts, ac or dc, at 1.3 amperes. After the heater power is applied, the valve should be allowed to warm up for at least one minute before the plate voltage is applied. This procedure will help assure substantially longer life.

3. All tests for neutralization and tuning should be made with both grid- and plate-compartment covers in place.

The general procedure for preparing the amplifier for operation is as follows:

After a sufficient heater-warmup period has been allowed, the driving power is applied to the amplifier circuit without plate or screen-grid voltage supplied to the valve. The grid-No. 1 current meter should indicate approximately 30 to 35 milliamperes of current for 5 watts of drive power. If the grid current is insufficient, the

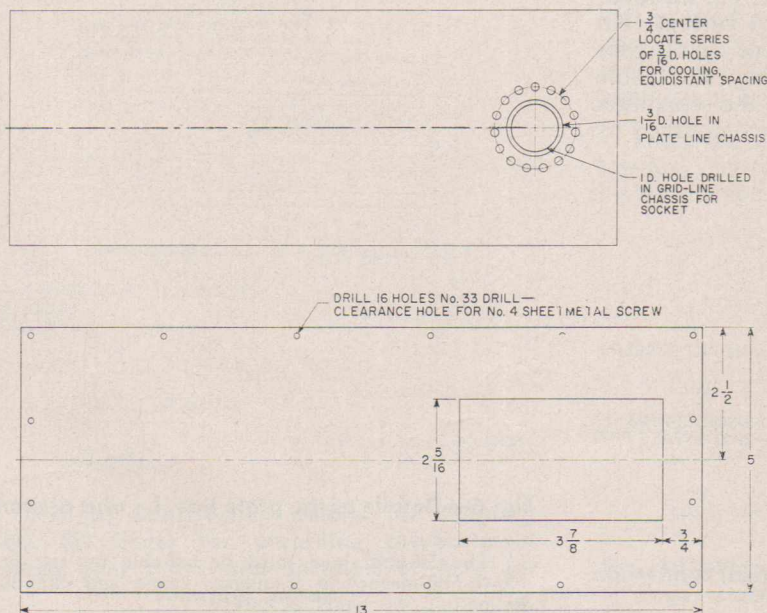

Fig. 3—(a) Details of vent and socket holes; (b) Details of top cover for plate-line chassis.

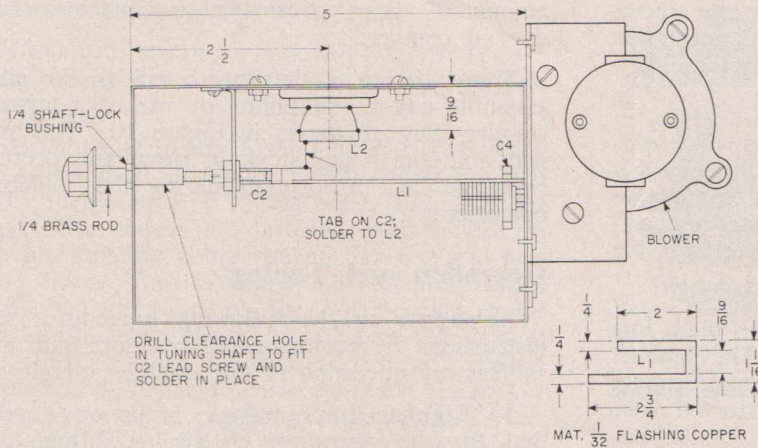

Fig. 4—Side view of grid No. 1 compartment, including construction details of inductor  $L_1$ .

following adjustments should be made:

1. The cathode neutralizing capacitor,  $C_3$ , should be adjusted for maximum grid current. Approximately one-half the total capacitance should be sufficient to provide the required indication, although further adjustments of  $C_3$  may be necessary upon application of plate and screen-grid voltages.

2. Position the input-coupling link,  $L_1$ , for maximum grid current and a minimum input standing-wave ratio. The grid-line tuning capacitor,  $C_2$ , and the input-line capacitor,  $C_4$ , must be adjusted simultaneously with the positioning of  $L_1$  with respect to the grid line. A standing-wave-ratio bridge inserted between the driver and  $L_1$  will make the preceding adjustments much simpler.

After the input coupling has been properly adjusted, a preliminary check of the amplifier neutralization should be made as follows:

Adjust the plate-tuning capacitor,  $C_1$ , throughout its range and observe grid-No. 1 current. No change in grid current should occur as  $C_1$  goes through resonance. If there is any noticeable change, readjust  $C_3$  slightly. If the condition persists, further neutralization is accomplished by

insulating one or more fingers of the bypass ring from the screen-ring terminal of the valve. Small pieces of 0.010-inch-thick Teflon can be used for this purpose. Generally, no more than two fingers should have to be insulated to obtain complete neutralization. The insulation of more than two fingers can result in self-oscillation, which is indicated by excessive grid-No. 1 current.

In the next stage of the amplifier-circuit preparation, terminate the output-coupling probe with a 50-ohm load,<sup>†</sup> and apply dc voltages to the plate and screen grid of the valve from a variable supply. Begin with 700 volts on the plate and something less than 200 volts on the screen. The plate capacitor is then tuned to resonance and the probe coupling adjusted, simultaneously, for maximum power output. Maximum power output does not necessarily occur at minimum plate current; therefore, some form of output-power measuring device is required.

At resonance with 700 volts on the plate and 200 volts on the screen grid, the power output

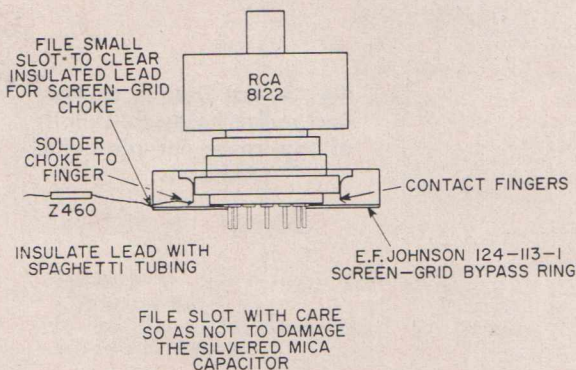

Fig. 5—Procedure for making electrical connection to grid No. 2.

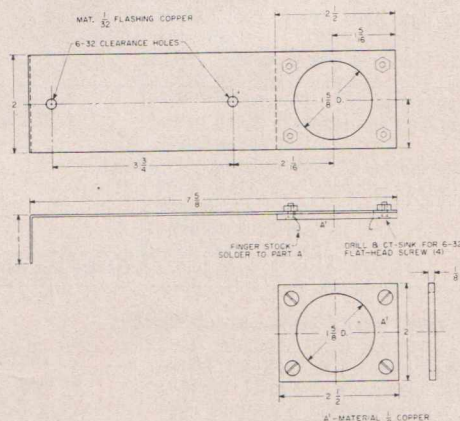
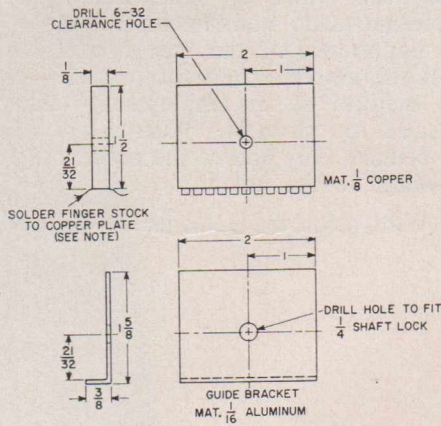

Fig. 6—Details of the plate line,  $L_3$ , and assembly.

<sup>†</sup> The 50-ohm load must be suitable for use in the 400-to-500-megacycle frequency range and capable of dissipating 300 watts of power.



Note: beryllium finger stock (Instrument Specialties Co., Inc., 97-115 or equivalent).

Fig. 7—Details of C<sub>1</sub> construction.

should be approximately 100 watts. The plate current should be in the range from 260 to 300 milliamperes. Grid-No. 1 current should be between 25 to 30 milliamperes. If grid-No. 1 current is found to be higher than 35 milliamperes at this point, recheck for neutralization. When the plate potential is increased to 1,500 volts,

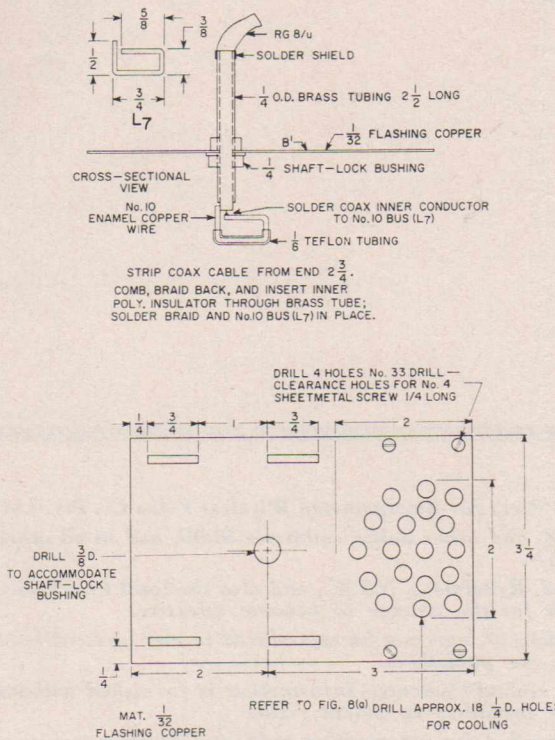

Fig. 8—(a) Construction details for coupling probe; (b) Cover for plate-line compartment showing vent holes and location of hole for coupling probe.

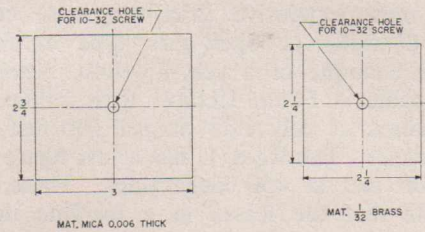

Fig. 9—Details of high-voltage capacitor.

the power output will be approximately 235 watts. For a plate potential of 2,000 volts, the power output will be 300 watts for 600-watt input.

### Antenna and Feedline System

The antenna and feedline used with the amplifier unit must be judiciously selected if the desired output is to be obtained without the cost of the system becoming exorbitant. A recommended arrangement that is relatively inexpensive and provides a low-loss antenna feed is described as follows:

In this arrangement, an antenna that presents a 300-ohm load impedance should be used. The main portion of the feedline, which will extend from the antenna into the "shack," can then be a low-loss, 300-ohm, open-wire line or one of the better-quality, television-transmission lines. This 300-ohm line must be connected to the amplifier through a 4-to-1 balun, which may be constructed from Rg-11/U coaxial. (For instruction on balun construction, refer to ARRL Handbook.) This balun is needed to provide the impedance transformation of 300 to 50 ohms required to match the antenna system to the power amplifier. The advantage of this arrangement is that the length of coaxial cable used in the feed system need not be longer than 5 or 6 feet. The use of Rg-8/U cable in lengths greater than 6 feet is not recommended because of the high attenuation factor of this cable at 450 megacycles.

There are several commercially available very-low-loss, 50-ohm coaxial cables that would be highly suitable for use as antenna feedlines for

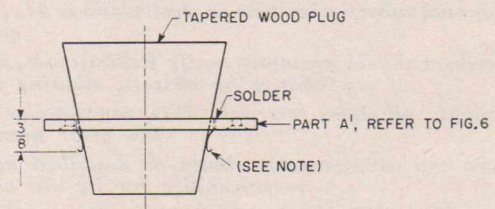

Note: 3/8-wide beryllium finger stock (Instrument Specialties Co., Inc., 97-136 or equivalent).

Fig. 10—Recommended procedure for soldering finger stock to A<sup>1</sup> of plate-line assembly.

the power amplifier; however, they are substantially more expensive than the more common Rg-8/U cable or open-wire type of line. A typical example of a very-low-loss, 50-ohm coaxial cable is Foam Heliac. This cable has an attenuation of only 1.25 db per 100 feet at 450 megacycles. The Rg-8/U has a loss figure of 5db per 100 feet at 450 megacycles. These figures indicate that the losses in a feedline made of

Rg-8/U cable would be more than twice those in a feedline made from Foam Heliac.

The importance of the type of feedline used between the amplifier and the antenna—as well as the method of its employment—cannot be emphasized too strongly. With a loss of 3 db in the feedline, only half of the power output will be delivered to the antenna.

(With acknowledgements to RCA.)



Editor ..... **Bernard J. Simpson**

*Radiotronics is published twelve times a year by the Wireless Press for Amalgamated Wireless Valve Co. Pty. Ltd. The annual subscription rate in Australasia is £1, in the U.S.A. and other dollar countries \$3.00, and in all other countries 25/-.*

*Subscribers should promptly notify Radiotronics, P.O. Box 63, Rydalmere, N.S.W., and also the local Post Office of any change of address, allowing one month for the change to become effective.*

*Copyright. All rights reserved. This magazine, or any part thereof, may not be reproduced in any form without the prior permission of the publishers.*

*Devices and arrangements shown or described herein may embody patents. Information is furnished without responsibility for its use and without prejudice to patent rights.*

*Information published herein concerning new releases is intended for information only, and present or future Australian availability is not implied.*

CLOISTER PRESS (W. SHORT), 45 George Street, Redfern